

OWNERS REPORT ON THE PLYMOUTH

# POPULAR MECHANICS

## MAGAZINE

WRITTEN SO YOU CAN UNDERSTAND

REG. TRADE MARK, GREAT BRITAIN, NO. 80422

MAY OFF

MAY 1956  
35 CENTS



*Read what happens when*  
**THE ATOM STRIKES A VALLEY**

**Outboards Jam the Water**

*For the Craftsman*

**Build Your Own Greenhouse**

**CAMPING IN A STATION WAGON**



**French Revolution  
in the Air—page 112**



# For fishermen who love their families



## America's Most Beautiful Outboard Motors

JAVELIN® . . . . .	30 hp . . .	\$582.00
SEA-HORSE 30® . . . . .	30 hp . . .	552.00
SEA-HORSE 30 . . . . .	30 hp . . .	462.00
SEA-HORSE 15® . . . . .	15 hp . . .	452.00
SEA-HORSE 15 . . . . .	15 hp . . .	362.00
SEA-HORSE 10 . . . . .	10 hp . . .	321.00
SEA-HORSE 7½ . . . . .	7½ hp . . .	241.00
SEA-HORSE 5½ . . . . .	5½ hp . . .	216.00
SEA-HORSE 3 . . . . .	3 hp . . .	146.00

\*Electric Starting . . . Prices f. o. b. factory, subject to change . . . Mile Master Fuel System included with all models except the "3" . . . OBC certified brake hp at 4000 rpm (30's at 4500).

**Johnson**  
**SEA-HORSES**  
**FOR DEPENDABILITY**



**ASK COMMERCIAL USERS . . . SEA-HORSES WORK FOR THEM!**

More than one smart fisherman has got the family on *his* side by sharing blue skies and open waters with them. The outboard cruiser does it! And leads the way to a new world of fishin' too! Here is golden family fun at little cost, thanks to Johnson's development of high-power outboard motors that carry a load — fast and far.

Talk to your Johnson Dealer. He *knows* the way to new adventure—to boatloads of family fun!

**FREE!** Write for your copy of the new Sea-Horse Booklet describing all models of the 1956 Johnson line. Complete, factual, helpful.

**JOHNSON MOTORS, 400 Pershing Road, Waukegan, Ill.**  
A DIVISION OF OUTBOARD MARINE AND MANUFACTURING COMPANY  
In Canada: Manufactured by Johnson Motors, Peterborough

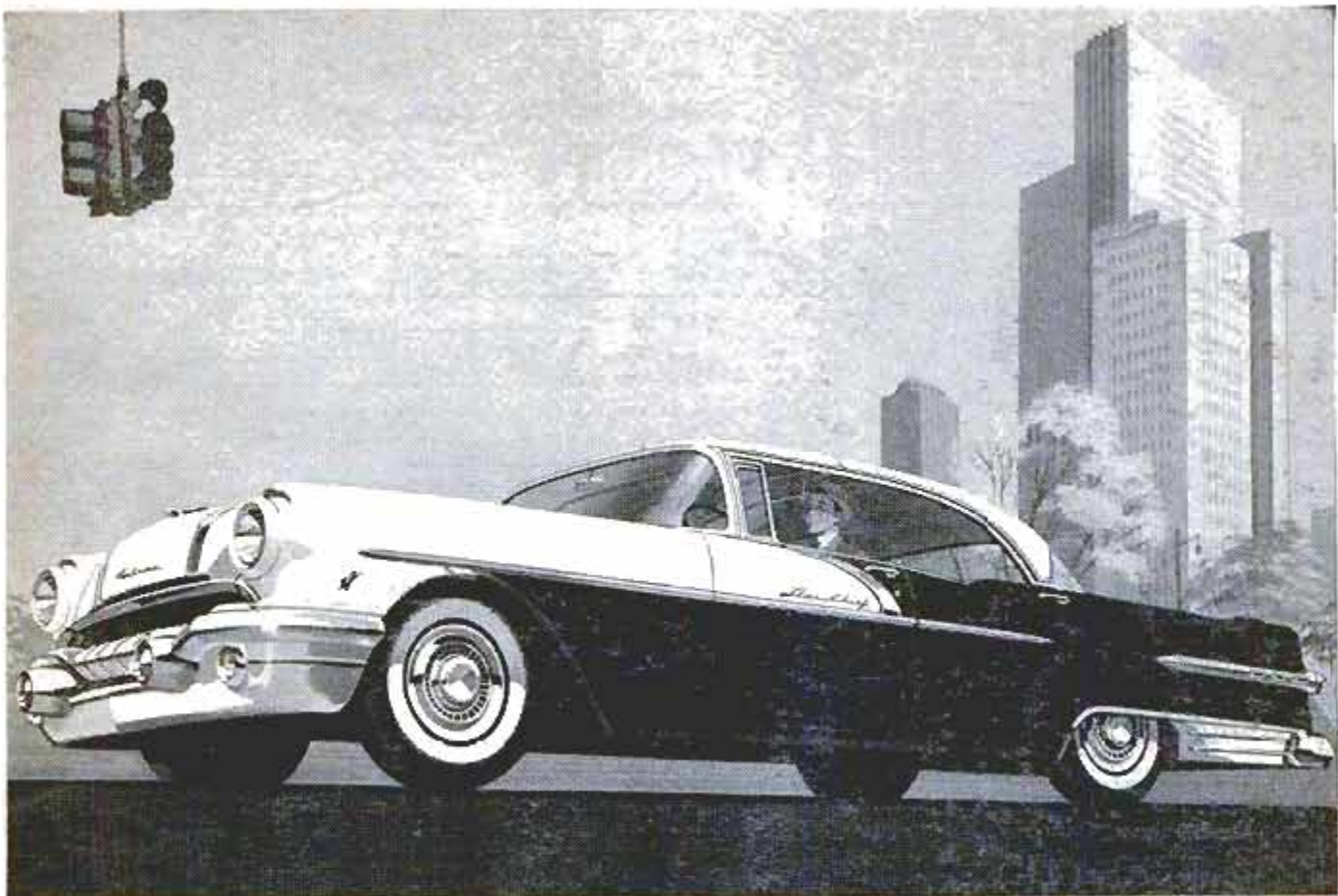

STAR CHIEF 4-DOOR CATALINA

The car says **GO** and the price won't stop you!

## Easy Does It—This One's Loaded!

Here's all the go you'll ever want for normal driving . . . with lots more where that came from whenever you need it!

Take it easy . . . in seconds you'll be sailing serenely along at the legal limit or leaving the steepest grade behind unnoticed . . . and always with that big "something extra" for safety!

You're piloting *America's most modern V-8!* It's the mightiest, highest-compression, highest-torque V-8 in Pontiac history . . . available in 205 h.p., 227 h.p. (you can add another 12 horsepower with low extra-cost dual exhausts)

And its teammate, the new *Strato-Flight Hydra-Matic\** is just as advanced! This revolutionary automatic transmission gives you gears for crisp, positive action—sparkling response at any speed. And with those gears there's an amazing new liquid-link coupling to make that flow of power oil smooth!

It's loaded all right, with more glamour and go than you ever dreamed possible at a price so low.

Come on in and see. Whether you're talking performance or price, *easy does it* with this fabulous '56 Pontiac!

This One



Z6DF-3YK-542L

# PONTIAC



Over 40 models of the low-priced three cost more than a big, glamorous Pontiac 860.

PONTIAC MOTOR DIVISION OF GENERAL MOTORS CORPORATION

# Popular Mechanics Magazine

Registered in U. S. Patent Office and Canada

H. H. WINDSOR, Founder

H. H. WINDSOR, JR., Editor and Publisher



## Next Month

LIGHTNING PLAYS TRICKS that rival those of another much-publicized demon of nature—the tornado. One day a boy was sitting in a cart beneath a tree when lightning suddenly struck the tree. Three sides of the cart were sliced off but the boy was unharmed. In White Plains, N. Y., the entire side of a house was shorn off by a stroke of lightning and once a farmer's well went dry when lightning struck nearby. Lightning concerns almost everybody because each square mile of the United States receives an average of 10 strokes a year. Scientists have studied lightning for years and although they have made some progress in penetrating its mysteries they agree that the only predictable thing about it is that it's unpredictable. A June article, "Lightning Plays Queer Pranks," includes excerpts from a long-lost diary of the first weatherman stationed on Pikes Peak.

Information not listed on articles in the index, starting on page 74, frequently is listed in the WHERE-TO-FIND-IT LIST, which is available to readers without charge. A copy may be obtained by writing to the Bureau of Information, Popular Mechanics, 200 E. Ontario, Chicago 11, Ill.

Published monthly by Popular Mechanics Company, 200 E. Ontario St., Chicago 11, Ill. H. H. Windsor, Jr., president; Wm. Harrison Fetridge, exec. vice-pres.; Franklin S. Forsberg, operations vice-pres.; D. F. Windsor, vice-president and secretary-treasurer; H. H. Windsor III, vice-president; W. T. Windsor, vice-president; Joseph R. Buell, Jr., advertising manager; Alan M. Deyoe, circulation manager. Single copy in the United States and Canada, 45 cents; subscription rates in the United States and possessions, Canada, Philippines and countries of the Pan-American Postal Union, 1 year \$1.50; 2 years, \$6.00; 3 years, \$8.00. To all other countries add \$1.00 a year over United States prices for overseas postage. If you plan to move, notify us at least 30 days in advance so you will not miss an issue. Give both your old and new addresses. Entered as Second Class Matter, September 15, 1903, at the Post Office at Chicago, Illinois, under Act of March 3, 1879. Entered as Second Class Matter at Post Office Dept., Canada. Registered as Second Class Matter at the Post Office at Mexico, D. F., Mexico, June 20, 1950. Copyright 1956 by Popular Mechanics Company. Copyright under International Copyright Union. Copyright in France. All rights reserved under Pan-American Copyright Union. Printed in the United States of America.

Volume 105

MAY 1956

Number 5

Address all communications to: 200 E. Ontario St., Chicago 11, Ill.

Managing Editor.....	Roderick M. Grant
Assistant Managing Editor.....	Wayne Whittaker
Shop Notes and Crafts Editor.....	James R. Ward
Radio-Television, Electronics Editor.....	Lothar Stern
Associate Editor.....	Clifford B. Hicks
Associate Editor, Automotive.....	Arthur R. Railton
Associate Editor, Shop Notes and Crafts.....	Wayne C. Leckey
Associate Editor, Shop Notes.....	W. Clyde Lammy
Assistant Editor, Crafts.....	Jay W. Hedden
Assistant Editor, Makeup.....	John C. Dalen
Automotive Correspondent.....	Leo Donovan
Art Director.....	Frank Beatty
Assistant Editors—Leonard F. Hiltz, Elliott H. McCleary, Emily Mullaney, Earl F. Wabeck	
Eastern Editor.....	Richard F. Dempewolff
Empire State Bldg., Room 2906, New York City 1	
Western Editor.....	Thomas E. Stimson, Jr.
Suite 1010, 3460 Wilshire Blvd., Los Angeles 5, Calif.	
London Manager.....	Douglas W. Wedderspoon
Eagle House, Jermyn St., London S. W. 1, England	
Director, Bureau of Information.....	Allan Carpenter
200 E. Ontario St., Chicago 11	

### Advertising Offices

Chicago: 200 E. Ontario St., Whitehall 4-0100; New York: Empire State Bldg., 350 Fifth Ave., Longacre 5-7580; Detroit: General Motors Bldg., TRinity 5-8711; Cleveland: Hanna Bldg., 1422 Euclid Ave., PProspect 1-0456; Los Angeles: Tishman Bldg., 3460 Wilshire, DUnkirk 2-8458; San Francisco: Russ Bldg., 235 Montgomery St., YUkon 2-0823.

## In This Issue...

Look What Happens When the Atom Strikes a Valley	81
The Owners Report on the '56 Plymouth	92
Seabees Build a Town Under Antarctic Ice—Part II	98
Traffic Jam at the Water's Edge	104
Detroit Listening Post	110
The New French Revolution—in the Air	112
What's New for Your Home	122
TV That Looks Two Ways	126
Shooting Salmon From the Sky	130
Eyes Over the Ocean	136
Citroen Springs Some Surprises	142
Electric Farm Hands	150
Keeping Up With the Atom	159
Radio, TV and Electronics	161

## For the Craftsman...

Build Your Own Greenhouse	165
Fix Your Wagon for Roughing It	174
Solving Home Problems	178
What to Do About Roof Leaks	181
Photo Sketching	186
Put Your Garden Hose Underground	192
Time to Build a Clockcase—Part II	197
Know Your Shop Motors—Part II	202
Multipurpose Power Tools	207
Shopping for Tools	218
On the Market for the Do-It-Yourselfer	220
Clinic for Homemakers	222

See pages 74, 76 and 78

for other items and manufacturers of available products

# Texaco Tips On Car Care

## ★ How to check your shock absorbers

Because shock absorbers are so vital to driving comfort — as well as control of your car — it's a good idea to check them regularly. Step on your car's bumpers and press down hard — as far down as they go. When you let go, the car should come up smoothly and rather slowly. If it bounces up sharply or vibrates up and down, your "shocks" should be either repaired or replaced.



## ★ How to increase engine life, driving economy

Use *Havoline Special 10W-30*, the all-temperature oil. When you start 'er up, it's *light* — for flash lubrication, fast getaways. Yet when your engine heats up, it has *body* — for protection against sizzling engine heat. Yes, *Havoline Special 10W-30* thinks for itself... saves you thinking about seasonal grades of oil. So change today, change regularly. Get *Havoline Special 10W-30* from your Texaco Dealer, the best friend your car has ever had!

THINKS  
- FOR  
ITSELF!



THE  
TEXAS  
COMPANY

**TEXACO DEALERS IN ALL 48 STATES**

*Texaco Products are also distributed in Canada and in Latin America*

TUNE IN: TEXACO STAR THEATER starring JIMMY DURANTE, on TV Saturday nights, NBC.

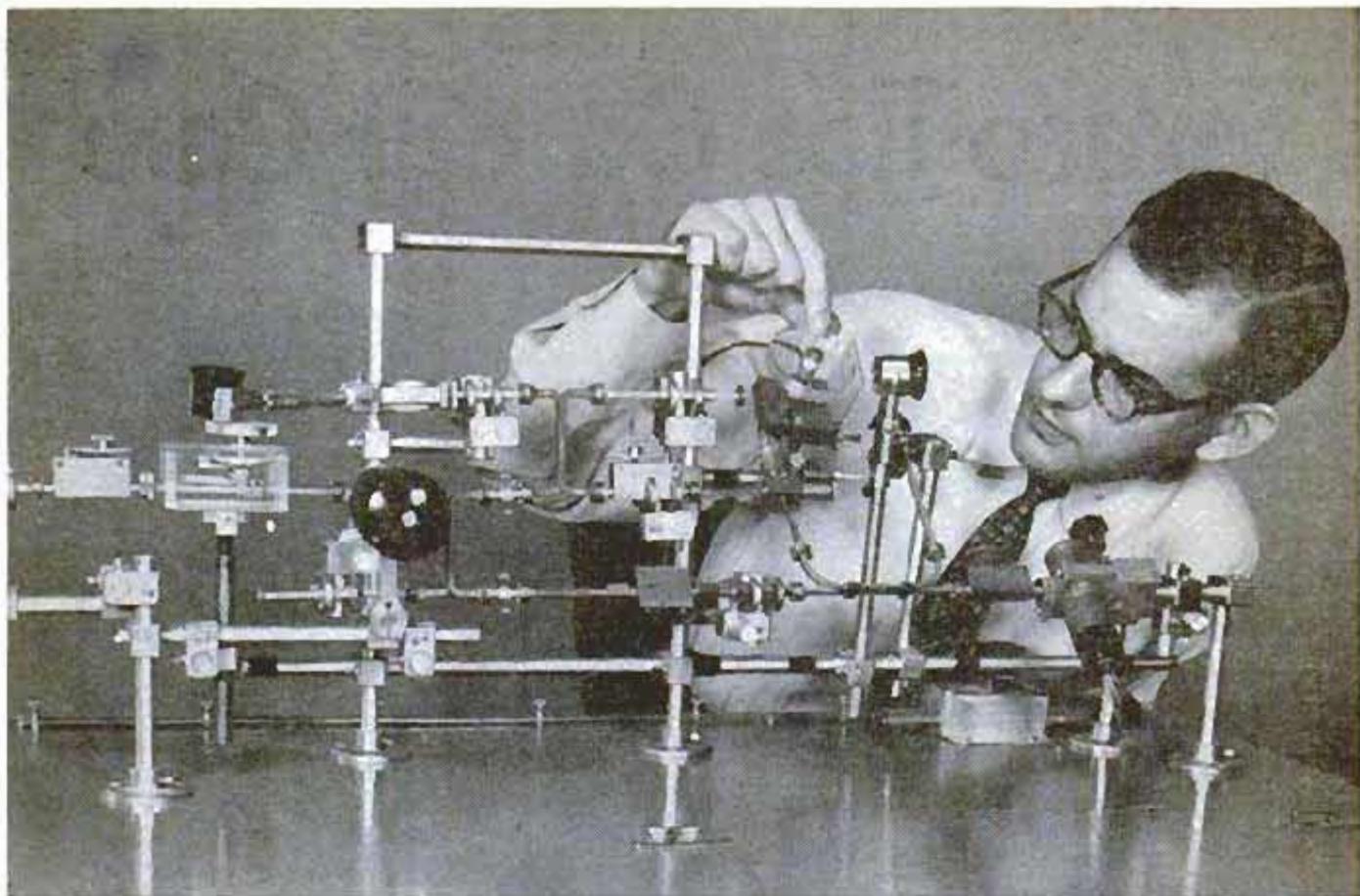

Physicist G. K. Farney checks the frequency of Bell's new klystron, which is located at far right. Tube's output is about 20 milliwatts.

## Sixty billion vibrations per second

A great new giant of communications—a waveguide system for carrying hundreds of thousands of voices at once, as well as television programs—is being investigated at Bell Telephone Laboratories.

Such a revolutionary system calls for frequencies much higher than any now used in communications. These are provided by a new reflex klystron tube that oscillates at 60,000 megacycles, and produces waves only 5 mm. long.

The resonant cavity that determines the frequency is smaller than a pinhead. The grid through which the energizing

electron beam is projected is only seven times as wide as a human hair, and the grid "wires" are of tungsten ribbon  $3/10,000$  inch in width.

G. K. Farney, University of Kentucky Ph.D. in nuclear physics, is one of the men who

successfully executed the development of the klystron. Dr. Farney is a member of a team of Bell scientists whose goal is to harness the immense bandwidth available with millimeter waves . . . and to keep your telephone system the world's best.

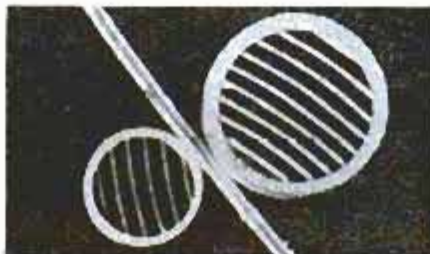

Grids in new tube, enlarged 30 times, with human hair for comparison. Electronic beam passes through smaller, then larger, grid.



Wavelengths produced by the klystron tube are only .2 inch long— $1/15$  that of the transcontinental radio relay system.

**BELL TELEPHONE LABORATORIES**  
WORLD CENTER OF COMMUNICATIONS RESEARCH



Look for



the man who makes the difference

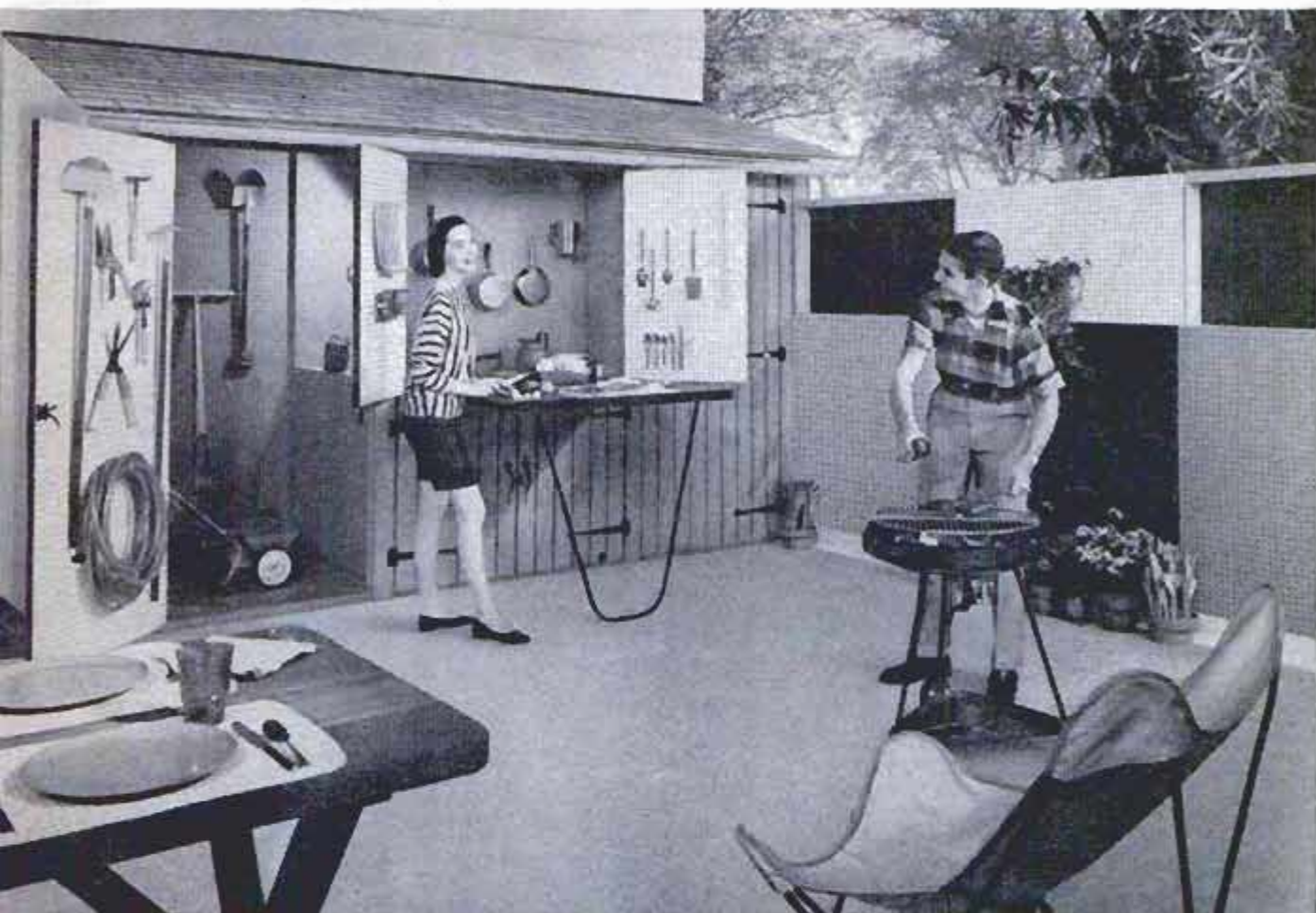

## Build your own outdoor living room! Free plan from Masonite shows how!

You'll double the fun when you build this outdoor living center yourself. It's fun when you use Masonite Presdwood®—sturdy, weather-defying panels that are easy to saw, bevel, plane and sand. They go up quickly and take beautiful, long-lasting finishes.

You'll want Masonite Peg-Board\* panels

to keep cooking utensils neat and handy... to store garden tools without crowding... to build your "hanging garden" fence. You'll find the 4-foot width of Masonite Panel-groove quickly builds an attractive shed wall. See your lumber dealer for all Masonite hardboards. Send the coupon for a free, illustrated plan folder.

©Masonite Corporation

\*"Peg-Board" T.M. Reg. U.S. Pat. Off. B. B. Butler Mfg. Co., Inc.

### FREE PLANS!



Fix it up with Presdwood inside and out



Masonite® Corporation  
Dept. PM-5, Box 777, Chicago 90, Ill.  
In Canada: Masonite Corporation, Gatineau, Quebec  
Please send me a free plan for the open-air living room and more information about Presdwood.

Name.....  
Address.....  
Town..... Zone.....  
County..... State.....

# NEW! PROTO'S "Rotahead" Free Wheeling Socket Hinge Handle



Every Tool User  
Will Want One!



Revolutionary in design, the patented "Rotahead" socket handle takes the place of a  $\frac{1}{2}$ " drive reversible ratchet and conventional hinge handle. Just press the head downward and the handle rotates freely. Release pressure and the head engages the drive plug. The strong free-wheeling mechanism permits a new bite every 12 degrees. The compact head gets into tight places. And the 16" length provides high leverage. Buy this sensational time saver at your PROTO dealer's. Send 10¢ for catalog of entire line to **PROTO TOOLS** 2207 Santa Fe Ave., Los Angeles 54, Calif.

## ALSO NEW



Patented Spark Plug Holding Sockets with  $\frac{3}{16}$ " Openings. Cutaway view. Rubber insert holds plug securely, speeds work, prevents burning of fingers. No. 5026HP— $\frac{3}{8}$ " drive. No. 5326HP— $\frac{1}{2}$ " drive.



Whitworth  $\frac{3}{16}$ - $\frac{3}{8}$ " Opening Sockets. For repair of foreign cars and motorcycles. Nos. 5206W-5212W— $\frac{3}{8}$ " drive.



Double Hex Sockets. For elastic stop nuts. Nos. 4708T-4714T ( $\frac{1}{4}$ "- $\frac{3}{16}$ " openings)— $\frac{1}{4}$ " drive. Nos. 5210-5228- $\frac{3}{8}$ " drive ( $\frac{5}{16}$ "- $\frac{7}{8}$ " openings)— $\frac{3}{8}$ " drive.

5683



Eastern Factory, Jamestown, N.Y. • Canadian Factory, London, Ont.

## ACROSS THE DESK



### Throw-Away Houses Coming?

How would you like a disposable house—one you could throw away after 20 years of use? Are houses too well built nowadays? Should they be built, instead, of materials that would depreciate completely and be ready for the junk pile in two decades? These questions were recently tossed around at a meeting of architects and builders at the Illinois Institute of Technology in Chicago. One architect suggested that houses should be junked like cars when they become outmoded and replaced with new models. All deplored the fact that houses of today are built like monuments to last generations. The big stumbling block is to find an inexpensive material that will wear out in 10 or 15 or 20 years. When they do—look out. The only hope for people living in a 1915 or 1930 model is that it may be a classic like some of the old cars.



Why people want to fly over rivers and count the salmon swimming upstream is of no concern to this youngster. If he knew what they were about he would regard



their mission as a bit silly. But he does have a deep personal interest in the biologists, really; they give him bubble gum. Read the story of the piscatorial census takers—"Shooting Salmon From the Sky"—on page 130.

### To the Editor:

Your article "Ships That Buck the Polar Seas" was very interesting. However, the

(Continued to page 8)



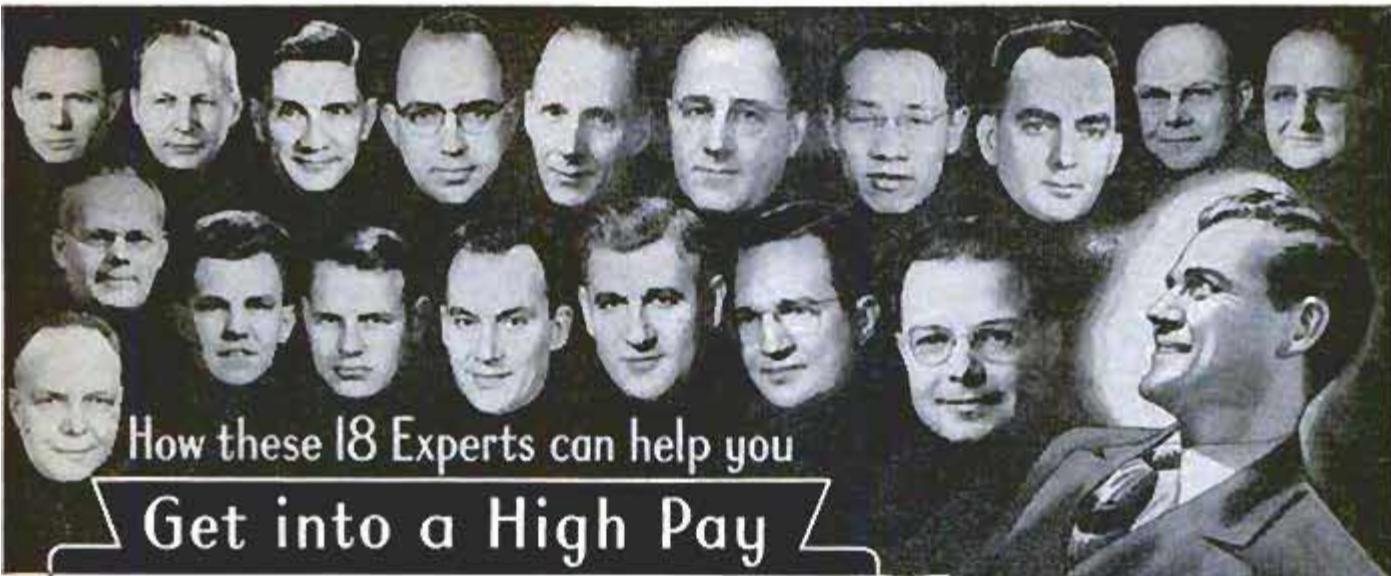

How these 18 Experts can help you

Get into a High Pay

# ACCOUNTING CAREER

LaSalle's famous staff of Accounting authorities are helping thousands prepare for fast promotions and bigger pay. They can do the same for you!

**SAMPLE LESSON SENT FREE  
MAIL COUPON BELOW**

You don't have to wonder what LaSalle's Accounting plan is like. You will be sent a free sample lesson, which does not obligate you in any way. Study it—keep it—see for yourself how simple, clear, and easy it is to master. This is an actual lesson right out of the regular training—to show you exactly how LaSalle's Problem Method has trained more than 1,350,000 men and women from all walks of life.

Also . . . the latest book, "Accountancy, the Profession That Pays," gives all the latest facts about the new and growing opportunities in several different fields of profitable employment.

This can be an important day in your life. A coupon like the one below has started hundreds of thousands of men and women toward a bigger job, a larger income. It can do the same for you.

Member, National Home Study Council

If your heart is set on a larger income and all that it means . . . better home—fine car—larger bank account—more of the good things of life. . . .

If that's your ambition and you are really serious about it, then you owe it to yourself to get the REAL FACTS about LaSalle Accounting, and the many good-pay opportunities that can be YOURS through LaSalle's famous Problem Method plan.

It matters not whether you've had a single day of experience in this field—or whether you have already started but want to climb higher. LaSalle's expert training is designed to take you from where you are . . . to where you want to be . . . in higher positions and a lifetime career of security and good income.

**WHY YOU CAN'T FAIL TO GAIN**

You see on this page a panel of experts who know Accounting from A to Z . . . all the way from Basic Accounting, on up through Accounting Systems, Cost Accounting, Auditing, Income Tax, and training for the C.P.A. certificate. These are only part of our instruction staff. But what is most important to you . . .

. . . These C.P.A.'s and Expert Accountants know how to impart their knowledge to others . . . how to help you prepare quickly yet thoroughly for success in this lucrative field.

The proof? What stronger proof could there

be than that more than 4,200 Certified Public Accountants (one out of every 13 of the U.S. total) has trained with LaSalle?

Or the hundreds of thousands of men and women whom LaSalle has helped qualify rapidly for more money, a brighter future, in a high-pay-lifetime career? These thousands came to us with different backgrounds of experience and varying degrees of ambition. Many have reported raises and promotions after only a few weeks of training. Thousands of them have written to say they are now earning 50% more—even double their former incomes—often in less than a year. These letters are published in book form for your inspection. They were written by real people, with real income, problems and ambitions—people who might be your next-door neighbor.

Yes, if you are really sincere in wanting to better your position—start your income climbing—enjoy a lifetime career of high standing and high reward—this friendly staff of experts can help you.

*Mail the Coupon Today!*

FREE BOOK

**LA SALLE  
EXTENSION UNIVERSITY**

A Correspondence Institution

417 S. Dearborn St., Dept. 564H, Chicago 5, Ill.

Send free Sample Lesson in Accounting—also, latest free book, "Accountancy, the Profession That Pays" . . . all without cost or obligation.

Name.....Age.....

Address.....

City & Zone.....State.....

FREE SAMPLE  
LESSON



**FOR YOUR  
TECHNICAL EDUCATION  
COME TO THE  
COLLEGE OF TECHNOLOGY  
UNIVERSITY OF HOUSTON**

(Located in Houston, Texas)

*Select* from these fields

- Air Conditioning and Refrigeration Technology
- Air Conditioning, Refrigeration and Stationary Engineering Technology
- Diesel Technology
- Diesel Electric Technology
- Drafting Technology
- Electrical Technology
- Electronic Technology

**PREPARE FOR YOUR FUTURE NOW . . .**

With the very latest methods and equipment, at modern College of Technology, University of Houston. Open to high school graduates or equivalent. Accredited curricula.

Beautiful campus—275 wooded acres in Houston, Texas. All residence halls air conditioned. University T.V. and radio stations. Full college activities, intercollegiate sports, social life. Co-educational. Extensive personal guidance and counseling for all students. Continuing job placement assistance while attending school and at graduation. Earn part of tuition and expenses with part-time job while you learn. G.I. approved—V.A. office on campus.

Opportunity for graduates of the above programs to continue education and earn a Bachelor of Applied Science degree. Sept., Feb., and June semesters. Mail coupon now for FREE brochure. No obligation. Do it today.



**COLLEGE OF TECHNOLOGY, University of Houston**  
DEPT. 156, 3801 Cullen Blvd., Houston, Texas

Without cost or obligation, please send me brochure and full particulars. I am interested in subject marked X above.

Name \_\_\_\_\_ Age \_\_\_\_\_

Address \_\_\_\_\_

City \_\_\_\_\_ State \_\_\_\_\_

(Continued from page 6)

author made a slight error: the Coast Guard does not have an icebreaker smaller than the Wind class named the *Mackinac*. The *Mackinac* is a 311-foot AVP stationed at St. George, Staten Island. The Coast Guard does have a larger icebreaker on the Great Lakes named the *Mackinaw*, 290 feet long and of such a beam that she cannot leave the lakes.

Cadet George F. Viveiros, Jr.,  
U.S. Coast Guard Academy,  
New London, Conn.

*Cadet Viveiros is right. Editor Richard F. Dempewolf, who radioed his story in the March issue from Antarctica, confused the two ships of similar but not identical names.*

**Correction**

In the automobile-specifications chart of our February issue, the price of a Chevrolet Bel Air V8 four-door sedan with automatic transmission was incorrectly given as \$2223. The correct price of this car is \$2322, which includes federal excise tax and dealer-handling charges, but does not include transportation to your city and state or local taxes.

**To the Editor:**

The enclosed picture is of the car my son and I recently completed. Being an ardent reader of your magazine, we have



seen pictures of little cars in it; ours turned out very successfully, with some of the ideas coming from your magazine. The car is powered by a 2½-horsepower Briggs and Stratton air-cooled engine with a centrifugal clutch and dual-belt drive to rear wheels. It seats two, has a wheelbase of 52 inches and a tread of 33 inches. Steering is similar to large automobiles with kingpins. The front axle is pivoted in the center and has coil springing, giving semiknee

(Continued to page 10)



# This man is a "security risk"!

Age, 29. Married. Two children. High school education. Active in local lodge, church, veterans' organization. Employed by large manufacturing concern. Earns \$82 a week.

SOUNDS like an Average Joe. And he is. Too average! He's got a job. It pays fairly well. He's satisfied.

But here's the catch. With the right kind of training, this young

man could be stepping into better jobs. He could be making \$7-8000 a year. He could be cashing in on those spare-time hours he now wastes.

As it stands now, he's stuck in his job. Can't seem to make any headway. He's reluctant to try. So he just hangs on.

This man is a "Security Risk" to his wife and children.

His family probably will never enjoy the comforts, the prestige, the good living that could be theirs. If hard times come, they are almost sure to be hurt. For an Average Joe can't expect to compete with trained men when the chips are down.

A man like this would do well to start a planned program of self-improvement. In his spare time. In a field related to his interests and abilities. Right NOW!

One good way to start—a way proved by hundreds of thousands of once-Average Joes who are making good today—is to enroll for special training with a recognized correspondence school. One like I. C. S., the oldest and largest in the world.

Don't you be a "Security Risk." Mail the coupon for full, free details while there is still time.

CUT OR TEAR HERE

## INTERNATIONAL CORRESPONDENCE SCHOOLS, SCRANTON 9, PENNA.

Please rush me copies of the three books listed here—without cost or obligation.

1. Big opportunity handbook in field checked below.

2. Famous 36-page career guide, "How to Succeed."

3. Sample lesson in Math demonstrating I.C.S. method.



93624X

### ARCHITECTURE and BUILDING CONSTRUCTION

- Air Conditioning—Refrig.
- Architecture
- Architectural Interiors
- Building Contractor
- Building Estimator
- Building Maintenance
- Carpentry and Mill Work
- Heating
- Painting Contractor
- Plumbing
- Reading Arch. Blueprints

### ART

- Cartooning
- Commercial Art
- Fashion Illustrating
- Magazine Illustrating
- Show Card and Sign Lettering
- Sketching and Painting

### AUTOMOTIVE

- Auto Body Rebuilding
- Auto Elec. Technician
- Auto-Engine Tune Up
- Automobile Mechanic

### AVIATION

- Aeronautical Engineering Jr.
- Aircraft & Engine Mechanic

### BUSINESS

- Advertising
- Bookkeeping and Accounting
- Business Administration
- Business Correspondence
- Public Accounting
- Creative Salesmanship
- Federal Tax
- Letter-writing Improvement
- Office Management
- Professional Secretary
- Retail Business Management
- Sales Management
- Stenographic-Secretarial
- Traffic Management

### CHEMISTRY

- Analytical Chemistry
- Chemical Engineering
- Chem. Lab. Technician
- General Chemistry
- Natural Gas Prod. & Trans.
- Petroleum Engineering
- Plastics
- Pulp and Paper Making

### CIVIL, STRUCTURAL ENGINEERING

- Civil Engineering
- Construction Engineering
- Highway Engineering
- Reading Struct. Blueprints
- Sanitary Engineering
- Structural Engineering
- Surveying and Mapping

### DRAFTING

- Aircraft Drafting
- Architectural Drafting
- Electrical Drafting
- Mechanical Drafting
- Mine Surveying and Mapping
- Plumbing Drawing and Estimating
- Structural Drafting

### ELECTRICAL

- Electrical Engineering
- Electrical Maintenance
- Electrician  Contracting
- Lineman

### HIGH SCHOOL

- Commercial  Good English
- High School Subjects
- Mathematics

### LEADERSHIP

- Foremanship
- Industrial Supervision
- Leadership and Organization
- Personnel-Labor Relations

### MECHANICAL AND SHOP

- Gas—Electric Welding
- Heat Treatment  Metallurgy
- Industrial Engineering
- Industrial Instrumentation
- Industrial Supervision
- Internal Combustion Engines
- Machine Design-Drafting
- Machine Shop Inspection
- Machine Shop Practice
- Mechanical Engineering
- Quality Control
- Reading Shop Blueprints
- Refrigeration
- Sheet Metal Worker
- Tool Design  Toolmaking

### RADIO, TELEVISION

- Industrial Electronics
- Practical Radio TV Eng'ng
- Radio and TV Servicing
- Radio Operating

### TELEVISION TECHNICIAN

- RAILROAD
- Air Brake Equipment
- Car Inspector
- Diesel Engineer & Fireman
- Section Foreman

### STEAM AND DIESEL POWER

- Combustion Engineering
- Diesel—Elec.  Diesel Eng's
- Electric Light and Power
- Stationary Fireman
- Stationary Steam Engineering

### TEXTILE

- Carding and Spinning
- Cotton, Rayon, Woolen Mfg.
- Finishing and Dyeing
- Loom Fix'g  Textile Des'g
- Textile Eng'g  Throwing
- Warping and Weaving

### MISCELLANEOUS

- Domestic Refrigeration
- Marine Engineering
- Ocean Navigation
- Professional Engineering
- Short Story Writing
- Telephony

Name \_\_\_\_\_ Age \_\_\_\_\_ Home Address \_\_\_\_\_

City \_\_\_\_\_ Zone \_\_\_\_\_ State \_\_\_\_\_ Working Hours \_\_\_\_\_ A.M. to P.M. \_\_\_\_\_

Occupation \_\_\_\_\_

Canadian residents send coupon to International Correspondence Schools, Canadian, Ltd., Montreal, Canada. . . . Special tuition rates to members of the U. S. Armed Forces.

action. Hood is covered with galvanized tin plate, the rear of sections from automobile fenders. Top speed is approximately seven miles per hour. Gearing can be changed, when present driver becomes more proficient, to give a higher top speed.

E. G. Apple,  
Burlington, N. C.

### Ye Old Horseless Carriage Race

Chicago's Museum of Science and Industry has shown us a letter received recently from John L. Ovendon of Newcastle, New South Wales, Australia, inquiring the outcome of the famous "Race of the Horseless Carriages" sponsored by *Popular Mechanics* back in 1951. In that colorful event two Museum staff men who rebuild old cars staged a race from Chicago to New York, pitting a 1913 Stanley Steamer against a 1911 Stoddard-Dayton. The victory of the ancient steam car over its four-cylinder rival gas buggy was recorded in our November 1951 issue.

### To the Editor:

It is most gratifying to see coverage of our recently installed induction-heating unit (the largest in the world) on page 130 of your March issue. You have presented the facts in a concise manner, sufficiently

technical, yet clear and direct. To you this would be a routine assignment. To us it is a further demonstration of the standard of coverage and reporting maintained by your magazine.

Charles D. Heap,  
Public Relations Officer,  
Western Canada Steel, Ltd.,  
Vancouver, B.C.

### To the Editor:

There's at least one man around Santa Fe, N. Mex., whom people have no trouble finding. They are apt to be directed by something like, "Look for the place with the screwy mailbox." It is literally screwy. The support is part of a feed screw out of a ready-mix concrete machine, scrounged from a junk yard.



James Wing,  
Santa Fe, N. Mex.

## "My Army job training was made to order!"

"Yours can be, too—  
if you choose it before enlistment!"

*"I picked just the training I wanted—an automotive ordnance course—and all before I enlisted in the Army. You see, I reserved the technical schooling I wanted. And until I saw my recruiter I never knew so many different subjects were taught—practically everything. I found just the right course for me—so can you! And it's really excellent training. The Army taught me more in my ten-week course than I'd learn in a year at a commercial school. Now I'm working right in my field—piling up valuable experience. This technical training program is sure a good idea for high school graduates. I think you ought to look into it!"*

PVT. JAMES D. STEWART, Page, Nebraska  
Graduate, Page High School



**Over 100 courses available!** You'll find the right career training for you, too, at one of the fine Army technical schools. There are over 100 courses to choose from—aviation, photography, medicine, finance, communications—almost anything you want. And the course you *pick* is the course you *get!* You receive a written guarantee that a place in class is reserved for you—all before *enlistment!* It's the *right* way to enter the Army because it's *your* way!

**How you can qualify.** If you have a high school diploma or its equivalent, or if you are a high school senior, you can reserve your Army schooling right *now!* See if this isn't just the deal you've been looking for. For full details, clip this coupon and *mail* it today!

**Get CHOICE, not chance, in the ARMY!**

**FILL OUT COUPON AND MAIL IT TODAY!**

THE ADJUTANT GENERAL PMS6-5  
Department of the Army, Washington 25, D. C.  
Attn: AGSN

Please send me the Army booklet describing special opportunities for high school graduates.

Mr. ....

Address. ....

City. .... State. .... Date of Grad. ....

# Radio-Television Can Give You a Job with a Future

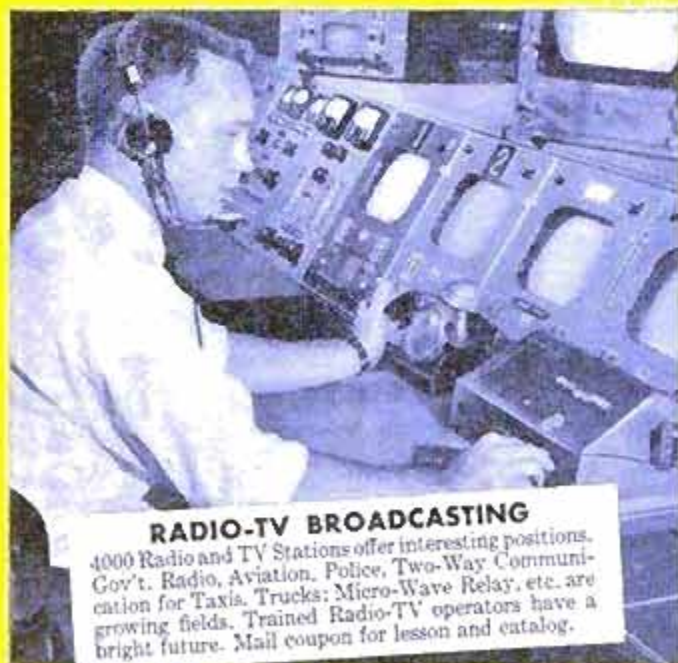

## RADIO-TV BROADCASTING

4000 Radio and TV Stations offer interesting positions. Gov't. Radio, Aviation, Police, Two-Way Communication for Taxis, Trucks; Micro-Wave Relay, etc. are growing fields. Trained Radio-TV operators have a bright future. Mail coupon for lesson and catalog.



## RADIO-TV SERVICING

125 million home Radios, 30 million auto Radios PLUS 40 million Television sets; millions more sold each year. COLOR TV and Hi-Fi are making new demands for trained technicians. Good opportunities for spare time earnings, or a business of your own.

### Read What N.R.I. Graduates Say About RESULTS of Training

#### Good Spare Time Earnings

"Before enrolling I was a laborer in a factory. Now I have good Radio-TV service job PLUS profitable spare time business."

E. M. DUDEK, Chicago, Ill.

#### Started His Own Business

"Decided to quit my job and do Television work full time. Doing all right financially. Not punching a time clock."

W. F. KLINE, Cincinnati, Ohio

#### Now TV Studio Supervisor

"I have progressed very rapidly. My present position is Studio Supervisor with KEDD Television, Wichita." — ELMER FREWALDT, Wichita, Kansas

## N.R.I. Trains You at Home in Spare Time

### Fast Growing Industry Offers You Better Pay and Bright Future



J. E. Smith  
founder

Training PLUS opportunity is the ideal combination for success. You know the rich opportunities in Radio-TV. And NRI can supply the training to prepare you quickly. Keep your job while training. Learn at home in spare time.

many students earn \$10, \$15 a week extra in spare time fixing sets. Vacuum Tube Voltmeter you build helps locate and correct set troubles. Easy to understand lessons supply the basic principles. And you LEARN-BY-DOING with kits of equipment which "bring to life" what you read in NRI lessons.

"There is no future for me here. What can I do without specialized training? What chance have I got, I can't go away to school?" If thoughts like these worry you—if you question your chances for advancement and security—find out what NRI offers you. For over 40 years NRI has been helping ambitious men train for and cash in on the opportunities and security to men who know Radio-Television.

### Oldest and Largest Home Study Radio-TV School

NRI has grown with Radio-TV. Skilled instructors, specialists, technicians, etc. devote full time to providing effective, easy-to-understand courses. You are backed by the record and reputation of the OLDEST and LARGEST home study Radio-TV school. NRI training is low cost, Easy terms. Many students pay for training with spare time earnings. Some make enough to start their own business when they get the NRI Diploma. Find out more. Mail coupon. NRI, Dept. 6EA, Washington 9, D. C.

### Added Income Soon — \$10, \$15 a Week in Spare Time

As proof that NRI training is result-getting, practical—soon after enrolling.

## FREE LESSON AND CATALOG

Mail Coupon. Paste on post-card or mail in envelope. NRI will send SAMPLE LESSON and 64 Page Catalog. Shows job opportunities, what graduates are doing, how you learn, equipment you get.

## VETERANS

Available Under G.I. Bills

## MAIL COUPON NOW

### National Radio Institute

Dept. 6EA, Washington 9, D. C.

Mail me Sample Lesson and 64-Page Catalog FREE. (No salesman will call. Please write plainly.)

Name \_\_\_\_\_ Age \_\_\_\_\_

Address \_\_\_\_\_

City \_\_\_\_\_ Zone \_\_\_\_\_ State \_\_\_\_\_

Approved Member National Home Study Council

## You Learn by Practicing with Kits N.R.I. Sends



Nothing takes the place of practical experience. That's why a feature of NRI training is LEARNING-BY-DOING. You build this low-power Radio-Transmitter, other equipment, as part of Communications Course. You build Vacuum Tube Voltmeter, other equipment, as part of Servicing Course.

REGULAR

4.98



No  
Splash!

(Copyright  
1954—  
M-M Co.)

~~HI-SPEED~~

# HOME & CAR washer

with  
**2**  
washing heads **1.98**

**FREE** MAGIC DETERGENT PELLETS  
Wash your car 10 times FREE! Place magic detergent pellet in hydraulic sudser. Bursts into foamy suds as water flows thru. Road dirt dissolves and slides off. No streaks! No marring! 10 Pellet Package free with your washer.

**Wash away Dirt . . . Quick! Easy!**



now . . . in one single operation  
you can scrub . . . suds . . . rinse!

Simply attach to hose . . . wash cars, barns, chicken coops, troughs, windows, porches, screens, outside walls of your home in **HALF** time! No splash! No mess! New, improved model now has 2 washing heads instead of one! Change over in seconds. An automatic **HYDRAULIC SUDSER** is built in. Now—suds, wash, scrub and wipe off in one easy operation!



**SAVE LABOR . . . SAVE TIME!**

Wash away accumulated soot from outside your home—save an expensive paint job! Wash your car in just minutes with no back or arm strain—without splashing or getting messy. Cleans screens, porches, tiles, awnings, storm windows, boats, floors. New 3 section handle! Make it long, make it short to suit yourself! Extends from **ONE** to **THREE** feet! Complete kit—a \$4.98 value—including Pellets, 2 Heads, 3 Section Handle—all yours for **1.98** complete. Order yours **NOW**—on full week's home trial. Satisfaction guaranteed or money back!

No. 44 . . . . . complete kit . . . 1.98  
(EXTRA DETERGENT PELLETS: Available in packages of 24 pieces, at \$1. Car washes only cost you 4 cents each! Check No. 44B in coupon)

**THORESEN'S, Dept. 6-E, 352 Fourth Avenue, New York 10, N.Y.**

RUSH items checked below on 7-Day home trial . . . money-back guarantee. If not delighted with the merchandise, I will return it within 7 days for full refund.

Payment enclosed. Send postpaid.

Send C.O.D. I'll pay charges.

No. 44—Hi-Speed Car Washer (1.98)  
 No. 44B—Pkg. of 24 Pellets, extra (1.00)

No. 90—Spectoscopes (99c)  
 No. 88—Swiss Officer's Knife (2.98)  
 No. 84—Helen of Troy Knife (1.98)

Name \_\_\_\_\_

Address \_\_\_\_\_

City \_\_\_\_\_

Zone \_\_\_\_\_ State \_\_\_\_\_

(CANADIANS: Order direct from Thoresen Ltd., Dept. 6-E, 45 St. James St. West, Montreal 1, P.Q. Same price. Same guarantee.)

★ ★ ★ ★  
**4 Star Specials**

Save on these 4 Star Specials! These are the biggest values we've ever offered. Order now on 7 day Home Trial. Check item number in coupon and mail now!



**99c**  
**BINOCULARS**  
**YOU WEAR LIKE GLASSES**

These binocular-spectacles are now being sold at a price that only we, as exclusive importers can offer. Use 'em for close-up or distant viewing. Get clear, magnified images. Ideal for watching all sports, TV, plays, opera, public events, etc. Made in West Germany. Precision optical lenses. In ebony finish. Light—only 1 oz. Formerly sold for \$2.98.

No. 90 . . . . . now only 99c



**2.98**  
**Swiss Officer's**  
**10-in-1 Knife**

Never before! Truly an amazing value! This handsome pocket knife is really 10 tools in one: saw, scissors, jackknife, can opener, screwdriver, awl, icepick, penknife, corkscrew, and bottle opener. Precision made in Solingen, Germany. No. 88 . . . . . cut price 2.98

**Helen of Troy**  
**HUNT KNIFE** **1.98**

REG. 3.95



The most unique knife of the year — made by the renowned craftsman of Solingen, Germany. Blends utility and art with a master's touch. Artistically cast and finished in a rich golden hue. To see it is to want it . . . Six inch blade of heavy-duty Solingen steel, 10" over-all. Tough — rugged — sharp! A collector's item: one that graces rec or den wall as well as a superb hunting knife. Metal-tipped leather sheath included at no extra cost.  
No. 84 . . . only 1.98

# INVENTORS

Learn how to protect your invention. The U. S. Patent Laws provide that any new and useful art, machine, article of manufacture, or composition of matter, or any new and useful improvement thereof, may be patented if the act of invention is involved. Therefore, every inventor with a valuable invention should take advantage of the Patent Laws and proceed for patent protection in order to safeguard his rights.

A patent gives the inventor the exclusive right to prevent others from making, using, or selling the invention claimed in the patent for a period of seventeen years.

The Patent Laws were enacted for the benefit of the inventor to give him protection for the features of his invention which are patentable. These features must be properly and concisely set forth and claimed in a formal application for patent, in order to comply with the requirements of the Patent Laws. For that reason, unless the inventor is familiar with patent matters, he should engage a competent registered patent attorney or agent to represent him. We are registered to practice before the U. S. Patent Office and are prepared to serve you in the handling of your patent matters.

A specially prepared booklet entitled "Patent Guide for the Inventor", containing detailed information with respect to patent protection and procedure, together with a "Record of Invention" form will be promptly forwarded to you without obligation upon request.

---

**CLARENCE A. O'BRIEN & HARVEY JACOBSON**

*Registered Patent Attorneys*

**61-E DISTRICT NATIONAL BUILDING**

**WASHINGTON 5, D. C.**

## FREE COLOR BOOKLET

Reveals Remarkable Plan

*Own, enjoy and use now  
the New Edition of*

# ENCYCLOPAEDIA BRITANNICA

**GET ALL  
24 VOLUMES  
NOW**



### PAY LATER ON EASY Book a Month Payment Plan

To spread the cultural benefits of Encyclopaedia Britannica ownership to new thousands—the publishers offer a remarkably simplified ownership plan.

You can receive the entire set immediately, all 24 volumes.

You can stretch out the small payments, paying on the easy Book a Month Payment Plan.

To obtain this full story, plus the beautifully illustrated colorful Preview Booklet of the new edition, send the coupon at once.

The new edition of the world-famed Encyclopaedia Britannica almost "televises" the information for you. It attempts to convey with pictures, facts that would take thousands of words. Actually 23,225 pictures, plus charts, maps and drawings are used in this way. It is called the Picture-Fact Presentation that makes an encyclopaedia fascinating to look through, thrilling to consult.

But this new edition does not merely show "attractive" pictures. It is the work of 5,258 of the world's best minds. The final authority on factual knowledge; a constant inspiration that will enrich the lives of yourself and your family.

Accept while they last one of these valuable Booklets! Mail the coupon now, while this deluxe booklet is still available!

Mail the coupon now, you will be glad you did!

**ACCEPT  
PREVIEW  
BOOKLET  
OF NEWEST  
EDITION**

**MAIL COUPON  
TODAY!**

**HURRY! While Supply  
of Beautiful FREE  
Booklets Lasts!**



ENCYCLOPAEDIA BRITANNICA INC., Dept. 27-D  
425 N. Michigan Avenue, Chicago 11, Ill.

Please let me have the FREE PREVIEW BOOKLET, and complete details about the Book a Month Payment Plan.

NAME.....

ADDRESS.....

CITY.....ZONE.....STATE.....

In Canada, E. B. Ltd., Terminal Bldg., Toronto, Ont.

start a big profit business  
with a small investment  
**EARN UP TO  
\$200 a DAY**

Manufacturing Exciting New

## RAINBOW ROCK

Concrete Slump Brick  
in your back yard

Earn big building boom profits with Rainbow Rock, the colorful new building brick that's taking the country by storm. Sell all you can make to contractors, builders, building supply houses. RAINBOW ROCK CUTS LABOR COSTS BY 1/3! Amazing low cost machine makes modern slump brick 24" long (3 times the length of ordinary brick) in a variety of widths and pastel colors . . . up to 1500 bricks a day! NEEDS NO SPECIAL SKILL. Operates indoors or out. Full instructions and valuable mixing formulae supplied. YOU CAN START EARNING BIG MONEY NOW. PAY AS YOU PROFIT! A limited number of machines available on easy payment terms. NOW is the time to start. Write today for free literature and full information.

**GENERAL ENGINES CO., INC.**  
Dept. MR-56—Route 130,  
Thorofare, N. J. - Tilden 5-5401



**STEEL PIER SENSATION**  
Luxurious RAINBOW ROCK fireplace wall in living room of the "Home of the Century" in Atlantic City, N. J.'s Steel Pier . . . acclaimed by over 500,000 Summer, 1953 visitors as the most beautiful they'd ever seen! Endorsed by the Pier's famous architect, William F. B. Koelle.



Makes beautiful, decorative fences, garden walls, garages, outside walls, room separators, etc.



### The "SCOUT" COMPASS In New ASSEMBLY KIT

Now you can assemble this handsome, precision pocket compass yourself. Kit contains all parts and instructions. 1 1/2" forest green anodized case, white and black dial, jeweled bearing and hardened steel pivot will give years of accurate service.

Kit only . . . . . **\$1.50**

Money Back Guarantee . . . . . P.P.D.

**SHERMAN-OSBORNE CO.**

DEPT. M56 PEMBROKE, MASS.

*Write Like This*

YOUR penmanship can be improved in 3 hours or corrected to your satisfaction in 10 hours' practice with my **DEFINITE HAND CONTROLS**. New way!

**WRITE OZMENT** BOX 665  
34-P, ST. LOUIS, MISSOURI

**Complete  
OUTLINE  
FREE!**



## I Made \$14,839 in 1 Year SERVICING RADIATORS!

Rex Ryan (Iowa) and hundreds of others earn \$8,000-\$20,000 a year servicing auto-truck-tractor radiators the inland way. Inland, largest radiator servicing equipment mfg., offers the complete package — equipment, merchandising, "Pays-for-itself" financing, and Free training school for customers.

WRITE for FREE Radiator Servicing Folder.

**INLAND MFG. COMPANY** Dept. PM-5  
1108 Jackson St., Omaha 8, Nebr.

**Say You Saw It in Popular Mechanics**



### Home Craftsmen And Do-It-Yourself Fans—

You're dressed for the job — and neatly, too — when you wear N&W work and leisure clothes. Full line for men and women.



Sold by  
25,000 stores

**N&W INDUSTRIES, Inc.** Lynchburg, Virginia  
Jackson, Mississippi



# THESE MEN ARE GETTING PRACTICAL TRAINING IN **ELECTRICITY**

—ELECTRONICS

*On Real:*

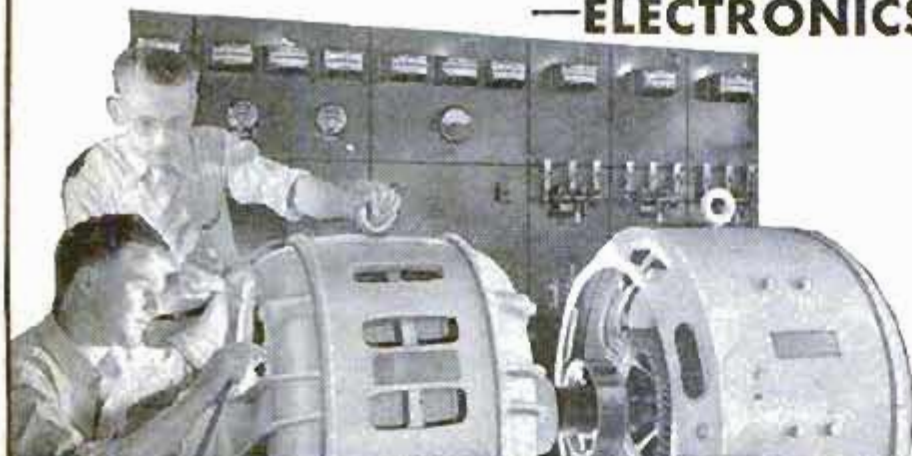

**A.C. and D.C. MOTORS  
GENERATORS  
SWITCHBOARDS  
CONTROLLERS  
WIRING JOBS  
APPLIANCES  
ELECTRONIC UNITS**

*(Shown at left—Instructor explaining operation and testing of a large Motor Generator in our A.C. Department.)*

# AND **TELEVISION-RADIO**

*On Real:*

**TELEVISION  
RECEIVING SETS  
Including Color TV  
AM and FM RADIO  
RECEIVERS including  
AUTO RADIOS  
TELEVISION TEST  
EQUIPMENT**

*(Right — Instructor helping students check the wiring and trace circuits of television receivers.)*



## Train in the great SHOPS of COYNE

**Largest, Oldest, Best Equipped School Of Its Kind In The U. S.**

Whether 17 or up to 45 years of age, prepare for your future now. Don't be satisfied with a "No Future" job. Train the Coyne way for a better job in a field that offers a world of opportunities in the years ahead.

**FINANCE PLAN** Enroll now, pay most of tuition later. Part-time employment help for students. **WE TRAIN YOU IN CHICAGO** on real equipment. Trained instructors show you how, then you do practical jobs yourself. No previous experience or advanced education needed.

**CLIP COUPON NOW** for big new illustrated Coyne book "Guide to Careers in ELECTRICITY and TELEVISION-RADIO". No obligation; no salesman will call. Get vital facts now! *Training in Refrigeration and Electric Appliances can be Included.*



*Mail Coupon for  
Big Free Book*

Training Offered  
to **VETERANS**  
and  
**NON-VETERANS**  
Alike

**B. W. COOKE, President  
COYNE ELECTRICAL SCHOOL**

500 S. Paulina St., Chicago 12, Ill. Dept. 56-72H

Send **FREE** book and details of all the training you offer. This does not obligate me and no salesman will call. I am especially interested in:

- ELECTRICITY-ELECTRONICS**  
 **TELEVISION-RADIO**

NAME.....

ADDRESS.....

CITY.....STATE.....

B. W. COOKE, Pres. **COYNE** FOUNDED 1899  
**ELECTRICAL SCHOOL**

**A TECHNICAL TRADE INSTITUTE OPERATED NOT FOR PROFIT**  
500 S. PAULINA STREET, CHICAGO, Dept. 56-72H  
**ELECTRICITY ★ RADIO ★ TELEVISION ★ REFRIGERATION ★ ELECTRONICS**

# WHAT ALL AUTO MECHANICS WANT TO KNOW

1664 PAGES

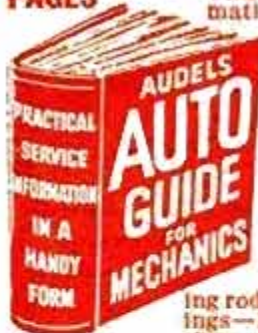

This Big Practical Book gives full information with working diagrams covering the principles, construction, ignition, service and repair of modern cars, trucks and buses.

## Diesel Engines, Hydramatic & Fluid Drives Fully Explained.

A complete Guide of 1664 pages, with over 1500 illustrations showing inside views of working parts, with instructions for service jobs.

### IT PAYS TO KNOW

How to fit pistons—How to locate engine knocks, How to fit connecting rod bearings—How to service main bearings—How to recondition valves—How to time valves—How to adjust fan belts—How to adjust carburetors and chokes, How to rebuild a clutch—How to service automatic transmissions—How to service brakes—How to adjust steering gear—How to cope with ignition troubles—How to service distributors—How to time ignition—How to "tune up" an engine.



**\$4 COMPLETE • PAY \$1 A MO.**  
TO GET THIS ASSISTANCE FOR YOURSELF SIMPLY FILL IN AND MAIL COUPON TODAY.

Step up your own skill with the facts and figures of your trade. Audel Mechanics Guides contain Practical Inside Trade Information in a Handy Form, Fully Illustrated and Easy to Understand, Highly Endorsed. Check the book you want for 7 DAYS FREE EXAMINATION. Send No Money. Nothing to pay postman.

## MAIL ORDER



**Check NOW!**

You Can Look Over Any Guide In Your Own Home — Start the Easy Payments If Satisfied

**MAIL THIS TODAY**



AUDEL, Publishers, 49 W. 23 St., NEW YORK 10, N. Y.

Please send me (for FREE EXAMINATION books marked x) below, if I decide to keep them I agree to mail \$1 in 7 days on each book or set ordered and further mail \$1 monthly on each book or set until I have paid price, otherwise I will return them.

- AUTOMOBILE MECHANICS GUIDE, 1664 Pages. \$4
- TRUCK & TRACTOR GUIDE, 1299 Pages. \$4
- DIESEL ENGINE MANUAL, 575 Pages. 2
- MACHINISTS HANDY BOOK, 1650 Pages. 4
- WELDERS GUIDE, 400 Pages. 1
- BLUE PRINT READING, 416 Pages. 2
- MATHEMATICS & CALCULATIONS, 700 Pages. 2
- SHEET METAL PATTERN LAYOUTS, 1100 Pages. 4
- SHEET METAL WORKERS HANDY BOOK, 388 Pgs. 1
- MECHANICAL DRAWING GUIDE, 160 Pages. 1
- MECHANICAL DRAWING & DESIGN, 480 Pages. 2
- AIRCRAFT WORKER, 240 Pages. 1
- TELEVISION SERVICE MANUAL, 434 Pages. 2
- RADIOMANS GUIDE, 1040 Pages. 4
- ELECTRONIC DEVICES, 216 Pages. 2
- ELECTRIC MOTOR GUIDE, 1000 Pages. 4
- WIRING DIAGRAMS (Light & Power), 272 Pgs. 1
- ELECTRICIANS EXAMINATIONS, 250 Pages. 1
- ELECTRIC POWER CALCULATIONS, 425 Pages. 2
- HANDY BOOK OF ELECTRICITY, 1440 Pages. 4
- ELECTRIC DICTIONARY, 9000 Terms. 2
- ELECTRIC LIBRARY, 7000 Pages (12 Book Set) 18
- SHIPFITTERS HANDY BOOK, 250 Pages. 1
- REFRIGERATION & Air Conditioning, 1280 Pgs. 4
- MILLWRIGHTS & MECHANICS GUIDE, 1200 Pgs. 4
- POWER PLANT ENGINEERS GUIDE, 1500 Pages. 4
- ENGINEERS & FIREMANS EXAMS, 525 Pages. 1
- PUMPS, Hydraulics & Air Compressors, 1658 Pgs. 4
- OPERATING ENGINEERS LIBRARY (3 Books). 9
- MECHANICAL DICTIONARY, 950 Pages. 4
- GARDENERS & GROWERS GUIDES (4 Book Set) 6
- CARPENTERS & BUILDERS GUIDES (4 Book Set) 6
- PLUMBERS & Steamfitters Guides (4 Book Set) 6
- MASONS AND BUILDERS GUIDES (4 Book Set) 6
- PAINTERS & DECORATORS MANUAL, 450 Pgs. 2
- HOUSE HEATING GUIDE, 1000 Pages. 4
- OIL BURNER GUIDE, 384 Pages. 1
- HOME APPLIANCE SERVICE GUIDE, 800 Pages. 4

Name \_\_\_\_\_  
Address \_\_\_\_\_  
Occupation \_\_\_\_\_  
Employed by \_\_\_\_\_ PS

## If Ruptured

For lasting relief your rupture must BE HELD BACK DAY and NIGHT.

Consult Your Doctor.

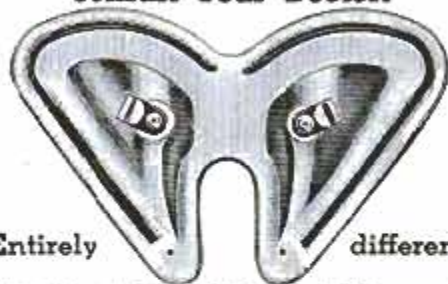

Entirely different

SOFT, FLEXIBLE, and fits neat as a glove. The famous Miller saves you TIME, MONEY, DISAPPOINTMENT.

Write for my FREE booklet today.

**FRED B. MILLER** Manufacturer  
Dept. PM56, Hagerstown, Maryland



## WORLD'S LOWEST PRICED ADDING MACHINE

Counts up to 999,999,999. IDEAL FOR BUSINESS AND PERSONAL USE—GUARANTEED ACCURATE. Not a toy. Operates with only a finger flick. Adds, subtracts, multiplies, divides. Counts up to one billion. Pays for itself over and over. Ideal Gift—for Business, Income Tax and School use. **MONEY BACK GUARANTEE.** Send name and address. Pay postman only \$2.95 plus postage. Beautiful rich-looking Leatherette Case included at no extra cost. Money back in 10 days if not delighted. AGENTS WANTED.

Vest Pocket Size  
FREE TRIAL  
**\$2.95**  
only  
TOTAL COST SEND NO MONEY

CALCULATOR MACHINE CO., (Mfgs.)  
Box 84 Dept. MY-56 Glenview, Illinois



## DRAINS cellars, cisterns, wash tubs; IRRIGATES - CIRCULATES - SPRAYS \$7.95

Type P Pump has 1,001 uses. Up to 3000 GPH; 450 GPH 80' high; or 1800 GPH from 25' well. Use 1/8 to 3/4 HP motor. Coupling included free. 1" inlet; 3/4" outlet. Stainless shaft. Won't rust or clog! Postpaid (1 cash with order. Rush your order today.)

**MONEY BACK GUARANTEE**  
Centrifugal and Gear Pumps in All Sizes  
LABAWCO PUMPS, Belle Meade 7, N. J.

SAY YOU SAW IT IN POPULAR MECHANICS



## TRAIN WRECK STAMPS!

Cuba's famous stamps of 1946, showing actual train wreck scene! Complete set of 3, a dramatic display for your collection, only 10¢. Handsome, exciting stamps to look over, too, without charge or obligation.  
WINTHROP STAMP CO., Dept. P-5, GROTON, CONN.

## Subscribe to...Trailer Topics Magazine

6-Month Trial Subscription \$1



Discover how you can enjoy every modern convenience in your own home for just pennies a day. Read the true-life stories of those who live in mobilehomes and love it.

Only \$3.00 for 2 years.

..... TRAILER TOPICS MAGAZINE  
Room 1571 28 East Jackson Blvd. Chicago 4, Illinois

# INVENTORS

If you believe that you have an invention, you should find out how to protect it. The first step is to have a search made of the prior pertinent U. S. patents. If a report on this search indicates that the invention appears patentable you can apply for a patent, and the specifications and claims should be prepared.

The firm of McMorrow, Berman & Davidson, with offices in Washington, D. C., is qualified to take the necessary steps for you. We can make a preliminary search on your invention, advise you whether we think it can be patented, and prepare your application for patent.

Unless you are fully familiar with the U. S. Patent Laws, we recommend that you engage the services of a Registered Patent Attorney to protect your interests. The patent laws are *your* laws. A patent gives you the right to prevent others from making, using or selling the invention claimed in your patent for a period of 17 years.

Use these patent laws for your protection. Investigate whether your invention can be patented. If you have what you believe to be an invention, we suggest that you have this firm make a search for you.

*Send for a copy of our Patent Booklet entitled "How To Protect Your Invention," containing information about patent protection and patent procedure. Along with this we will also send you an "Invention Record" form, for your use in writing down and sketching details of your invention. We will mail them promptly. No obligation. They are yours for the asking.*

**McMORROW, BERMAN & DAVIDSON**

*Registered Patent Attorneys*

**PATENTS • COPYRIGHTS • PATENTS**

**135-W VICTOR BUILDING, WASHINGTON 1, D. C.**

# (Check the Kind of Body YOU Want!)

**RIGHT IN THE COUPON BELOW**

...and I'll Prove How EASILY You Can Have It!

*Charles Atlas*

Twice winner and holder of the title "The World's Most Perfectly Developed Man."



JUST tell me where you want it—and I'll add **SOLID INCHES** of powerful muscle **SO FAST** your friends will grow bug-eyed with wonder. I'll **PROVE** you can be a new man in just 15 minutes a day—in your own home—or it won't cost you a penny!

I myself used to be a 97-lb. weakling. Men called me "Skinny." Girls made fun of me. THEN I discovered my great new muscle-building system—"Dynamic Tension." It turned me into such a specimen of **MANHOOD** that today I hold the title "**THE WORLD'S MOST PERFECTLY DEVELOPED MAN.**"

"Dynamic Tension" is the easy, **NATURAL** method you can practice in your own room—**JUST 15 MINUTES A DAY**—while your chest and shoulder muscles begin to swell . . . those arms and legs of yours bulge . . . and your whole body starts to feel "alive," full of zip and go!

## FREE My 32-Page Illustrated Book Just Mail the Coupon

Send **NOW** for my famous book "Everlasting Health and Strength." 32 pages, packed with photographs, valuable advice, answers many vital questions. This book is a real prize for any fellow. Yet I'll send you a copy absolutely **FREE**. Just glancing through it may change your life! Rush coupon to me personally: **CHARLES ATLAS, DEPT. 85, 115 East 23rd St., New York 10, N. Y.**



**CHARLES ATLAS, Dept. 85,  
115 East 23rd St., New York 10, N. Y.**

Dear Charles Atlas: Here's the Kind of Body I want:  
(Check as many as you like)

- |  |  |
|--|--|
| <input type="checkbox"/> More Weight—Solid—to The Right Places | <input type="checkbox"/> Powerful Arms and Grip    |
| <input type="checkbox"/> Broader Chest and Shoulders           | <input type="checkbox"/> Slimmer Waist and Hips    |
|  | <input type="checkbox"/> Powerful Leg Muscles      |
|  | <input type="checkbox"/> Better Sleep, More Energy |

Send me absolutely **FREE** a copy of your famous book "Everlasting Health and Strength"—32 pages, crammed with photographs, answers to vital health questions, and valuable advice. I understand this book is mine to keep and sending for it does not obligate me in any way.

NAME \_\_\_\_\_ AGE \_\_\_\_\_  
(please print or write plainly)

ADDRESS \_\_\_\_\_

CITY \_\_\_\_\_ STATE \_\_\_\_\_

**INSURED TIRE SERVICE**  
**POPULAR BRANDS**

**FREE** INSURANCE POLICY given with each used tire sold. We guarantee the amount of service you pay for.

NOWHERE CAN SUCH QUALITY BE FOUND AT SUCH LOW PRICE!

**SPECIAL!**  
Deduct 10% on orders for two or more used tires

**YOU CAN'T LOSE!!**

Super Quality — Rugged Performance — 6 Months Insured Service	
600x16 \$3.65	670x15 \$3.95
650x15 3.85	670x16 4.05
650x16 4.25	700x15 3.95
700x16 4.45	760x16 4.45
760x16 4.95	820x15 4.95
820x15 4.65	850x17 4.65

Supreme Quality — Nothing Finer — 12 Months Insured Service	
600x16 \$5.25	475x19 \$5.45
600x16 (6) 6.75	640x15 4.95
650x16 5.75	670x15 5.35
650x16 (6) 7.25	710x15 5.45
700x16 6.35	760x15 5.95
750x16 (6) 8.45	800x15 6.35
550x18 4.95	820x15 6.35
550x17 4.75	550x18 5.35
650x15 5.25	670x16 5.15
700x15 5.35	700x16 (6) 10.25
	32x6 (10) 12.75

Whitewalls \$1.00 extra.

**MIDLAND TIRE SALES**  
3701 S. Normal, Dept. PM-46, Chicago 9, Ill.

## YOU BUILD 'EM — WE SELL 'EM EARN UP TO \$50.00 A DAY AT HOME

Here is a new business for people who would like to make extra money full time or spare time. Our program enables you to work in your home and participate in national sales secured through our firm. You assemble luggage and special cases for photographic equipment—musical instruments—salesmen's samples and all types of portables. We supply complete instructions—materials—tools—everything. No previous experience is necessary. Write for free details. **Abarsi Casecraft, Dept. AF, 807 W. Sunset Blvd., Los Angeles 12, Calif.**

**SAY YOU SAW IT IN POPULAR MECHANICS**

## MONEY in DONUTS

Make new greaseless donuts. Start in kitchen. No smoke. Sell stores. **HALF PROFIT.** Cash daily. **Free recipes.** No obligation. Write! **MARTIN RAY CO., 3905 SO. 15th AVENUE, MINNEAPOLIS 7, MINN.**

## TELEPHONES



**Desk Stand Style**  
Slightly used but in excellent condition

Many Valuable Uses  
Inter-House Phones    House to Barn, etc.  
Loud Speakers        Microphones  
Educational Purposes, Toys, etc.

Come complete, ready to use with wiring diagrams included. **\$2.75** Postpaid in U.S.A.  
Two complete for only **\$5.00**

**TELEPHONE LAMP KIT**—with illustrated instructions for making Desk Telephone Lamp including all parts (lamp, nipples, push switch, cord, plug, etc.) . . . \$6.50 Ppd. (Shade is not included)

**MICROPHONE, Dept. X-3802, 1760 W. Lunt Ave., Chicago 26, Ill.**

## we're sorry...

that we have not had the production to supply all the demand for Life-Time 50,000 Mile Spark Plugs. New equipment and greatly accelerated production enable us now to make immediate delivery. If you have ordered and your check has been returned, please place your order again. **Life-Time Spark Plug Sets** may be ordered from this advertisement. We will postpay at regular retail price. Specify make, model and year of car. Set of 6, \$7.14; set of 8, \$9.52.

**DISTRIBUTORSHIPS**  
Some additional distributorships are now available. If you have already written us regarding your area, please contact us again. If you have not written before, please send us an outline of your previous business experience and qualifications.

**CONTINENTAL MANUFACTURING CORP.**  
Washington Blvd. at Motor Ave.      Culver City 139, California



**NO  
PREVIOUS  
TECHNICAL  
EXPERIENCE  
OR ADVANCED  
EDUCATION  
REQUIRED**

**MEN  
17 to 55  
YEARS OLD  
PREFERRED**

**DEVRY TECH PUTS 25 YEARS OF SUCCESSFUL  
KNOW-HOW BEHIND YOU AS YOU**



Prepare for a Profitable Future in  
**TELEVISION  
AUTOMATION**  
ELECTRONICS

**2 Exclusive DTI Features**

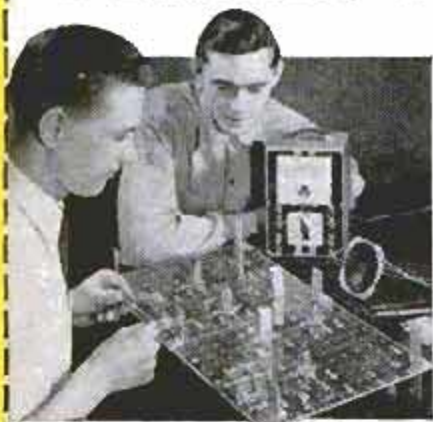

**THE DTI ELECTRO-LAB\***

The men above are learning principles of Television-Radio-Electronics at home the practical DTI way, using the styrene Electro-Lab, Vacuum Tube Voltmeter and speaker—furnished by DTI. It is fun to learn when using this equipment!

\*Trademark



**HOME MOVIES**

It is much easier to understand an electronic principle by movies at home, than by reading about it. Using a special movie projector and instructive films, you "see" what happens in tubes, etc. Yes, the DTI movie way of home training is fun! Let us tell you about it.

**RADIO • ELECTRONICS**

What a wonderful future ahead in Television-Radio-Automation Electronics! Television is booming! Communications is also offering fine opportunities. And now that Electronics is being used more to speed production, Automation Electronics is calling for skilled men.

What's also important: Today's opportunities for starting your own profitable part time or full time servicing business are great.

See how YOU may prepare to fit into this vast field by sending the coupon below. Find out how DeVry's 25 years of experience may start you toward a REAL FUTURE. Prepare at home in spare time, or come to Chicago and get the KNOW-HOW you need in our well equipped training center. Details are yours for the asking.

**EMPLOYMENT SERVICE**

When you complete the training, you get the benefit of effective starting help toward a good job or your own business from DeVry's Employment Service. This is one of the most valuable . . . most effective . . . parts of DeVry's program.

**MILITARY SERVICE**

If you are subject to military service, we have some very valuable information for you.

**YOU BUILD YOUR OWN EQUIPMENT**

Yes, you learn by doing! With 16 shipments of parts furnished by DTI, you work over 300 projects which include building your own test equipment. You build a 5-inch Oscilloscope and a multi-range Vacuum Tube Voltmeter, yours to work with during training—to keep and continue to use after graduation.



**89 WAYS TO  
EARN MONEY  
IN TELEVISION  
RADIO  
ELECTRONICS**

**REGARDLESS OF YOUR  
PRESENT JOB, FILL  
IN COUPON BELOW!**

**Get this interesting publication FREE!**

**DEVRY TECHNICAL INSTITUTE**

4141 Belmont Ave., Chicago 41, Ill., Dept. PM-5-M

I would like late facts about the many opportunities in Television-Radio-Electronics, and how DTI can prepare me for my start in this billion dollar field.

Name \_\_\_\_\_ Age \_\_\_\_\_  
(PLEASE PRINT)

Street \_\_\_\_\_ Apt. \_\_\_\_\_

City \_\_\_\_\_ Zone \_\_\_\_\_ State \_\_\_\_\_

1028 DTI's training is available in Canada

**DEVRY TECHNICAL INSTITUTE**

CHICAGO 41, ILLINOIS

FORMERLY

DEFOREST'S TRAINING, INC.

Member of National Home Study Council

These great minds were Rosicrucians . . .



Francis Bacon Benjamin Franklin Isaac Newton

## WHAT SECRET POWER DID THEY POSSESS?

### Why were these men great?

How does anyone—man or woman—achieve greatness? Is it not by mastery of the powers within ourselves?

Know the mysterious world within you! Attune yourself to the wisdom of the ages! Grasp the inner power of your mind! Learn the secrets of a full and peaceful life!

Benjamin Franklin, statesman and inventor . . . Isaac Newton, discoverer of the Law of Gravitation . . . Francis Bacon, philosopher and scientist . . . like many other learned and great men and women . . . were Rosicrucians. The Rosicrucians (NOT a religious organization) have been in existence for centuries. Today, headquarters of the Rosicrucians send over seven million pieces of mail annually to all parts of the world. Address: Scribe S.Q.X.

THIS BOOK FREE



## The ROSICRUCIANS

San Jose (AMORC) California, U.S.A.

SEND THIS COUPON

Scribe S.Q.X.  
The ROSICRUCIANS  
(AMORC)  
San Jose, California, U.S.A.

Please send me the free book, *The Mastery of Life*, which explains how I may learn to use my faculties and powers of mind.

Name \_\_\_\_\_  
Address \_\_\_\_\_  
City \_\_\_\_\_  
State \_\_\_\_\_

## Learn CARBURETOR and IGNITION



### Start Training at Home For This Clean, High-Class Type of Position

Get in line for a raise—or for more profits in your own shop. Learn testing and adjusting with latest-type scientific motor tune-up equipment. This enables you to locate the trouble exactly, and fix it fast—handling and getting paid for more jobs per day. There's money in this, and it's clean, high-class work which gets the respect and confidence of your customers.

### Send for FREE SAMPLE LESSON

Carburetor and Ignition Specialization offers very superior opportunities for better pay and bigger profits because relatively few mechanics know anything about this time-saving, money-making new test equipment. Now our spare-time home-study method teaches you the principles and shortens your shop training. Ambitious men (age 18-55): Send for full FACTS and FREE SAMPLE LESSON at once. Write today to

UTILITIES ENGINEERING INSTITUTE  
2525 Sheffield Ave., Dept. OC-3, Chicago 14

## I'll Send You This Handsome SAMPLE CASE—FREE



### and Show You How to Make Up to \$30.00 in a Day

WRITE for this FREE Tailoring Sample Case packed with 150 beautiful, big-value suit and overcoat fabrics. Take orders from friends, fellow-workers, others, for fine quality, made-to-measure clothes. Pocket big cash profits in advance.

Because wearing our suits and overcoats brings more orders, we make it easy for you to get your own clothes without the cost. No experience is needed. SATISFACTION GUARANTEED. SEND NO MONEY. Rush your name, address, and age—today!  
PROGRESS TAILORING COMPANY, Dept. S-216,  
500 SOUTH THROOP STREET CHICAGO 7, ILLINOIS

## REAL ESTATE BE A BROKER

PAYS BIG! SEND FOR FREE, BIG, ILLUSTRATED CATALOG NOW! Graduates report making substantial incomes. Start and run your own business quickly. Men, women of all ages, learn easily. Course covers: Sales, Property Management, Appraising, Loans, Mortgages, and related subjects. STUDY AT HOME or in classrooms in leading cities. Diploma awarded. Write TODAY for free book! No obligation.

Approved for World War II and Korean Veterans  
WEAVER SCHOOL OF REAL ESTATE (Est. 1936)  
2020 Grand Avenue Kansas City, Mo.

FREE BOOK TELLS NOW

## MAKE TREMENDOUS PROFITS

Have fun! Earn Big Money! Cast plaster figurines, bookends, plaques, novelties at home in your spare time with X.L. rubber molds! NO EXPERIENCE NEEDED! Models and rubber for 3 molds, only \$1.50 ppd. Send 25¢ (refunded with order) for 40 page catalog now!  
PLASTIC ARTS STUDIO 3403 SO. MADISON, DEPT. PM2  
MUNCIE, INDIANA

## Do FALSE TEETH Rock, Slide or Slip?

FASTEETH, an improved powder to be sprinkled on upper and lower plates, holds false teeth more firmly in place. Do not slide, slip or rock. No gummy, gooey, pasty taste or feeling. FASTEETH is alkaline (non-acid). Does not sour. Checks "plate odor" (denture breath). Get FASTEETH at any drug counter.

## See the Greatest Show on Earth with this GIANT ASTRONOMICAL TELESCOPE

\$15.00 FULL PRICE



Delivered ready for use. Has 45X, 75X and 100 power individually mounted eyepieces with brass focusing tube plus sun projector lens for observing sun spots and solar storms. Steel telescope tube 50 in. long. Rigid 6 ft. tripod adjustable to any height. Steel forked mounting with closely machined aluminum tripod head assembly assures extra fine adjustments. This professional type instrument provides full power with clear vision at all times. See the moons of Jupiter, our own moon, planets, milky way, double stars, star clusters, etc. All for only \$15.00 FOB Mattituck. Sent express. COD orders require \$5.00 deposit. Satisfaction guaranteed. 200X and 400X eyepieces available at \$2.00 ea.

SUFFOLK SCIENCE SERVICE  
Dept. TD-5 MATTITUCK, N. Y.

# Up to 15 More Horsepower 6 Miles More per Gallon Or It Doesn't Cost You a Cent!

**IT'S TRUE!** Now you can get the breath-taking acceleration... jack-rabbit starts... blazing new power that you've dreamed about for years—*simply by harnessing the raw, unburnt gasoline that your engine is wasting today!*

You can get performance from your present car that will make your friends gasp with astonishment—and you can save \$25, \$50, even \$75 a year on gas bills alone doing it!

Yes! You, yourself, can fit this amazing GASOLINE ATOMIZER onto your car in as little as 20 easy minutes! And it is guaranteed to pay you back your full purchase price, in gas savings alone, in the first 3 to 4 short months that you use it.

By RICHARD JOHNS

Mr. Car Owner! How would you like to have the driving thrill of your life next weekend?

Picture this yourself! Next weekend go down to your car—the same tired car you've been driving for years. You've made one simple change to that car, so easy your 16-year-old son could do it! But now, when you turn on the ignition, a modern miracle of engineering science comes to life under your hood.

From the very first moment, you'll see and feel the difference in that engine. That engine will rumble with new, throbbing power. When you release the emergency brake, your car will glide out of its parking space... roll down the street with your foot hardly touching the pedal. Every 30 or 40 seconds, give that car an extra shot of gas... feel it spurt ahead... test the new power that's singing under your foot!

We ask you to pull up to another car at the stop light, of approximately the same year and make as your own! Wait until the light changes to green. Let the other car start first. Wait till the other car gets half way across the street. And then slam your foot down on the gas pedal!

Before that other car has even crossed the street, you will have caught up with him. For one brief second, you and that other car will race fender to fender. Then you will flash away from him... you will leave him a full block behind... you will look in your rear view mirror and see the startled look of amazement in the other driver's eyes!

## EXTRA! FREE BONUS!

**AMAZING NEW DIAL-O-MAGIC TROUBLE SPOTTER!  
SAVES YOU UP TO \$250 ON REPAIRS THIS YEAR ALONE!**

Think of it! With a 20-second flick of your finger, you can actually save up to 50% of the money you're throwing away on repair bills right now! You can save up to \$250 this year alone—without special tools, even if you never picked up a screwdriver before!

Here is a complete CAR-REPAIR-MANUAL-AT-A-GLANCE, that tells you instantly what to do when your engine won't start, or heats up, or sputters and stalls. What to do when it leaks water, chugs on the hills, burns oil. What to do when your battery won't charge, your oil pressure drops, your clutch slips, when you're bothered by squeaks, groans or rattles.

Here are professional, 20-second secrets that show you how to prevent rust from ruining your radiator; get quicker starts in winter; keep your engine from overheating even in the hottest weather. How to keep your upholstery spotless; your

**WE GUARANTEE YOUR GAS SAVINGS!**  
Save this guarantee section. It authorizes you to try this amazing new MINI-SUPERCHARGER for a full four months ENTIRELY AT OUR RISK! This device must save you — on gas alone — EVERY SINGLE CENT OF THE MONEY THAT YOU PAID FOR IT — OR YOUR FULL MONEY WILL BE REFUNDED! This offer is good for a full four months! It is probably the most amazing offer in car history! You have nothing to lose! ACT TODAY!

Eugene Stevens, Inc.

### TEST THIS NEW POWER A HUNDRED DIFFERENT WAYS!

But this is just the beginning! Test this equipment for one full month—entirely at our risk! Use it to flash away from other cars... spurt up the steepest hills... actually pass other cars in 2, 4, 6 and even 8 seconds LESS than you could have done formerly!

See the enormous gas savings it gives you at high speeds! Prove to yourself that at 50... 60... even 70 miles an hour, your foot is still half-way up on the pedal—you still have all the reserve power you need to get out of any emergency on the highway!

Yes, and test it in stop-and-go city driving! Prove to yourself that it gives you the instant acceleration you need to get out in front of the crowd... with far less gas than you're using today! Prove to yourself that it can actually save you \$25 to \$50 to \$75 on your gas bills each year... that it actually pays back its full cost, in gas savings alone, during the first three or four months — or your full money back!

### HOW DOES THIS PRODUCT GIVE YOU SUCH TREMENDOUS NEW POWER?

And you get all this performance—and more—from a small, polished machine of bronze and aluminum that you can hold in your hand! Here's why:

Gasoline in its liquid form is



YES! This amazing "MINI-SUPERCHARGER" gives you as much as 15 more horsepower from your engine! Gives you the gas economy you've dreamed about for years! This Power Booster is patented after superchargers selling for as high as \$600. Its whirlwind propeller (A) breaks up the raw, unburnt gas that your engine is wasting today... gives you blazing new power from every drop! Its emergency breather valve (B) draws fresh clean air into your engine... forces that engine to breathe deeper... push harder... pile up more mileage from every gal-

lon you buy! No wonder dozens of leading car magazines call this the "money saving discovery of the year." Test this amazing gas-saver yourself — without risking a penny! The thrilling facts are on this page!

not explosive. If you accidentally drop a lighted match into a bucket full of gasoline, the chances are 10 to 1 that that gasoline will actually put out that match. But simply mix that same bucket full of gas with the proper amount of air, and you will have enough explosive power to drive a ten ton truck!

This machine SUPER-MIXES... SUPPLIES VAPORIZES... SUPER-ATOMIZES your gas in exactly that way! Squeezes the hidden power out of that gas! Mixes that gas with much greater volumes of air! Makes that gas more explosive in your engine!

Men have paid up to \$600 for Superchargers! This is a MINI-SUPERCHARGER — easier to install — less expensive! But still the only power product you can buy with all these tremendous advantages:

1. Install it yourself, in just 20 minutes, even if you never picked up a tool before in your life!
2. Never needs further adjustments, for the life of your car!
3. Takes up no room in your car, makes no "souped-up" noise!

### MAIL NO-RISK COUPON TODAY!

EUGENE STEVENS, INC.  
132 WEST 21 STREET DEPT. GS-12  
NEW YORK 11, N. Y.

IMPORTANT: For fast service, be sure coupon is completely filled in. PLEASE PRINT.

Yes, I want to try your amazing MINI-SUPERCHARGER entirely at your risk! I will pay postman only amount checked below plus low C.O.D. charges:  
 \$11.95 (My car does not have a four-barrel carburetor.)  
 \$14.95 (My car is equipped with a special four-barrel carburetor.)  
 I understand that it must do everything you say or my full money back! Also send me as your Extra Gift Premium, the Free Dial-O-Magic Trouble-Spotter Chart. This is mine to keep even if I return the MINI-SUPERCHARGER.

MAKE OF CAR \_\_\_\_\_ YEAR \_\_\_\_\_  
 MODEL \_\_\_\_\_ 4 DOOR OR 2 DOOR \_\_\_\_\_  
 6 CYLINDERS \_\_\_\_\_ STRAIGHT 8 \_\_\_\_\_ V-8 \_\_\_\_\_  
 STANDARD TRANSMISSION \_\_\_\_\_ AUTOMATIC \_\_\_\_\_  
 NAME \_\_\_\_\_  
 ADDRESS \_\_\_\_\_  
 CITY \_\_\_\_\_ ZONE \_\_\_\_\_ STATE \_\_\_\_\_  
 CHECK HERE TO SAVE MORE! Enclose check or money order, and we pay all postage and handling charges! You save as much as \$1.06. Same money-back guarantee, of course!

© Entire Contents Copyrighted By Eugene Stevens, Inc. 1956

# HOW TO FIX ANY CAR

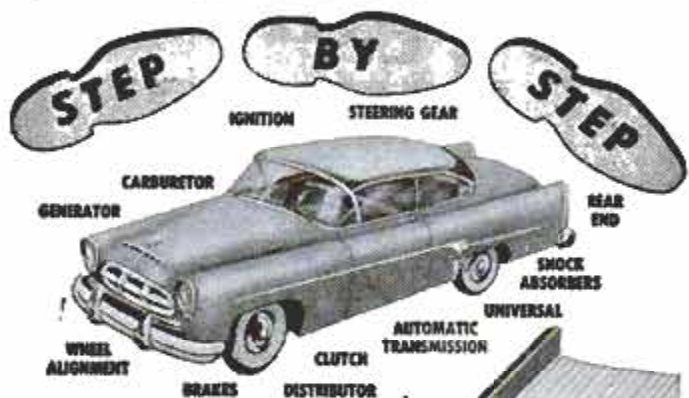

**STEP BY STEP**

**FREE 7-DAY TRIAL**

ANY tune-up, service or repair job on ANY car can be as easy as A-B-C when factory experts show you how-to-do-it one step at a time. That's why no job's too tough to handle when you've got MOTOR'S brand-new AUTO REPAIR MANUAL at your elbow!

Book "starts from scratch" — tells you WHERE to start, what TOOLS to use. Whether you're a beginner or an expert mechanic—you can "breeze through" ANY repair on ANY make or model car built from 1946 through 1956!

Everything You Need to Know in 1000 Big ILLUSTRATED Pages!

NEW, REVISED, 1000-Page Edition contains the "meat" from over 160 OFFICIAL shop manuals—simplified for YOU. 23,436 essential repair specifications on over 650 chassis models. More than 2,900 "this-is-how" pictures. 225,000 service and repair facts. Leads beginners every step of the way. Time-saving factory repair procedures for experts. Instructions and pictures so clear you CAN'T go wrong. Used by U. S. Army and Navy. 2,000,000 COPIES SOLD!

**Try Book FREE 7 Days**  
SEND NO MONEY! Pay postman nothing. Make Manual PROVE to you what it's got. Unless you agree this is the greatest time and work saver you've ever seen—return book in 7 days and pay nothing. Mail coupon today for MOTOR Book Dept., Desk 1E, 250 W. 55 St., N. Y. 19



- Covers 650 Models — 1946 thru 1956
- Buick Imperial
  - Cadillac Kaiser
  - Chevrolet Lincoln
  - Chrysler Mercury
  - Clipper Nash
  - Continental Oldsmobile
  - Crosley Packard
  - De Soto Plymouth
  - Dodge Pontiac
  - Ford Rambler
  - Frazer Studebaker
  - Henry J Thunderbird
  - Hudson Willys

**Same FREE Offer On MOTOR'S New Truck Repair Manual**

Brand new! covers EVERY job on EVERY popular make gasoline and Diesel truck, made from 1948 thru 1955. FREE 7-Day Trial. Check proper box in coupon.



**MAIL COUPON NOW FOR 7-DAY FREE TRIAL**

**MOTOR BOOK DEPT.**  
Desk 1E, 250 W. 55th St., New York 19, N. Y.

Rush to me at once (check box opposite book you want):

MOTOR'S New AUTO REPAIR MANUAL. If O.K. I will remit \$2 in 7 days, \$2 monthly for 2 months and a final payment of 90c (plus 35c delivery charges) one month after that. Otherwise I will return the book postpaid in 7 days. (Foreign price, remit \$9 cash with order.)

MOTOR'S New TRUCK REPAIR MANUAL. If O.K. I will remit \$2 in 7 days and \$2 monthly for 2 months, plus 35c delivery charges with final payment. Otherwise I will return book postpaid in 7 days. (Foreign price, remit \$10 cash with order.)

Print Name..... Age.....

Address .....

City..... State.....

Check box and save 35c delivery charge by enclosing WITH coupon entire payment of \$6.95 for Auto Repair Manual (or \$8 for Truck Repair Manual.) Same return-refund privilege.



**22 YEARS AT THIS ADDRESS**  
AN ESTABLISHED POLICY OF CAREFUL SELECTION ASSURES YOU MANY HAPPY MILES. BE WISE—TRY ONE—YOU'LL BUY MORE! WE WELCOME COMPETITION. NO ONE CAN TOUCH OUR QUALITY & PRICE! White Walls \$1.00 Ex. 50 Years of Combined family experience in High Quality tires. "FREE TUBE" PARTIALLY USED TIRES. FREE FACTORY-TESTED TUBE

**DEDUCT \$1.00** from every Passenger Tire you buy—Does not include W.W., or Truck Tires.

**12 MOS. WRITTEN GUARANTEE**  
WE SPECIALIZE IN TRUCK TIRES  
Matched Tires Shipped all over USA and Foreign Countries. IMMEDIATE SHIPMENTS Same Day. Depend on STANDARD for SERVICE.

Selected for Toughest Jobs — Prices Shaved to the Bone

600-16	\$5.42	475-19	\$4.72	700-15-6	\$7.72	700-20	\$8.72
600-16(6)	5.62	640-15	5.62	750-16(8)	8.92	750-20(10)	13.72
650-16	5.62	670-15	5.52	700-17	7.72	750-20(8)	10.72
650-16(6)	6.42	710-15	5.62	750-17	9.72	825-20	16.52
700-16	6.02	750-15	5.62	825x15	12.92	900-20	16.52
750-16(6)	7.52	800-15	5.92	600-20	9.52	1000-20	17.02
550-18	5.22	820-15	5.82	650-20	10.92	1100-20	17.02
550-17	5.22	670-16	5.32	32x6.8	12.02	1100-22	21.72
650-15	5.42	780-16	7.72	32x6(10)	13.92	1000-22	19.22
700-15	4.92	700-16(11)	7.72	750-15	10.92	1100-24	23.72

"EXTRA SPECIAL" Fully guarantee all size 4-ply pass. FREE TIRE with 2 or more of these. W.W. \$1.00 Extra. Factory Tested Tube given. **GIANT TIRE SALE \$6.92 EA.**

Thousands of tires shipped all over the U.S.A. All tires shipped F.O.B. Phila. Send Check or M.O. with this ad. Dept. 2. No C.O.D. **STANDARD 834 N. Broad St., Philadelphia 30, Pa.**

**LEARN MEAT CUTTING**

Train quickly in 8 short weeks at Toledo for a bright future with security in the vital meat business. Big pay, full-time jobs—HAVE A PROFITABLE MARKET OF YOUR OWN! Pay after graduation. Diploma given. Job help. Thousands of successful graduates. Our 33rd year! Send NOW for FREE catalog. No obligation. GI approved. NATIONAL SCHOOL OF MEAT CUTTING, Dept. 50-E, Toledo 4, Ohio

Send for **FREE** 112 page Illustrated Catalog of Farm, Home, and Workshop Bargains.

Write to **WELLWORTH TRADING COMPANY**  
Dept. F-5  
1832 S. WABASH AVE. CHICAGO 16, ILL

**MONEY in WORMS**

Big money made raising fishworms and crickets. Billions used yearly—unlimited market—sell by mail—we teach you how to raise and where to sell. Start in backyard or basement. Send \$2.95 for complete guaranteed instructions or write for free literature. CARTER WORM RANCH, PLAINS, GEORGIA

**FREE — Amazing Book on RHEUMATISM, ARTHRITIS**

If you suffer the aches, pains and discomforts of Rheumatism, as manifested in ARTHRITIS, NEURITIS, SCIATICA or LUMBAGO, send today for the FREE Book. It reveals important facts about why drugs and medicine give only temporary relief without removing cause. Explains fully a proven, specialized system of treatment that may save you years of distress. No obligation. Write for this FREE Book today!

**BALL CLINIC, Dept. 756, Excelsior Springs, Mo.**

**PUMP WATER FAST!**

Drains Wash Tubs, Cellars, Cisterns. Famous #7 pumps 2800 gph. 420 gph. at 75' high or 1600 gph. from 25' well. Sturdy rustproof alloy metal. Six blade impeller. 3/4" inlet, 1/2" outlet. Standard pipe threaded. Uses any 1/2 to 1/4 H.P. Motor. Will not leak or clog. Ironclad guarantee. Send check, M.O., or sent C.O.D. **\$695 IN U.S.**

Irrigate, Fill Tanks, Draw Well Water. Heavy duty #8 pumps 7000 gph. —1000 gph. 75' high 3000 gph. from 25' well. Rustproof alloy metal. 8 blade impeller. 1" inlet, 1" outlet. Standard pipe threaded. Will not leak or clog. Iron clad guarantee. Send check, M.O., or sent C.O.D. **\$1195 IN U.S.**

Free Catalogue—Gear Pumps, Large Centrifugal Pumps, Deep and Shallow Well Pumps, Sump Pumps.

**MOORE MANUFACTURING CO.**  
SWEDSBORO 1, NEW JERSEY



# Shrinks Hemorrhoids New Way Without Surgery

Science Finds Healing Substance That Relieves Pain—Shrinks Hemorrhoids

For the first time science has found a new healing substance with the astonishing ability to shrink hemorrhoids and to relieve pain — without surgery.

In case after case, while gently relieving pain, actual reduction (shrinkage) took place.

Most amazing of all — results were so thorough that sufferers made astonishing statements like "Piles have ceased to be a problem!"

The secret is a new healing substance (Bio-Dyne\*) — discovery of a world-famous research institute.

This substance is now available in suppository or ointment form under the name Preparation H.\* Ask for it at all drug counters — money back guarantee. \*Reg. U. S. Pat. Off.

## GIANT BALLOONS



They're really BIG—surplus U.S. Govt. (new overage) Neoprene weather, target balloons. GREAT FUN in the backyard: at parties, picnics, dances, fairs. TERRIFIC for high school and college PROMS. They attract BIG CROWDS to business openings, civic events, conventions, exhibitions, trade shows. ORDER TODAY! Great for gift. Approx. inflated sizes:

18 in. dia., 3 for 70c  
3 ft. dia., 49c—5 ft. dia., 99c  
10 ft. dia., \$1.59—13 ft. dia., \$1.95

Postage paid on prepaid orders.  
Calif. residents please add sales tax.

VOLUME SALES CO., War Assets Division  
Dept. PM-556 3930 Sunset Blvd. Los Angeles 29, Calif.

## LEARN DIESEL AT HOME

Train to specialize! Run and repair these remarkable precision machines. Opportunities world-wide. Learn tricks of trade at home; finish quickly in our big Chicago training shops. Send name now for FREE BOOK.

UTILITIES ENGINEERING INSTITUTE, Est. 1927  
2521 SHEFFIELD AVE., DEPT. DC-56, CHICAGO 14, ILLINOIS

## TV or RADIO NOISY?

NEW NOISE-FILTER PLUG ENDS INTERFERENCE PROBLEMS

Put a stop to annoying static, whistling, humming and other noises with this easy-to-install filter plug. Just plug into electric outlet and enjoy trouble-free reception. Money back guarantee. Send cash, check or M.O. Postage Free. Try 10 days.

\$1.00  
PPD.

2 for \$1.75

TELECLEAR CO., 25-M Willett St., N. Y. 2, N. Y.

## SAY YOU SAW IT IN POPULAR MECHANICS

## "How to Go into Business for YOURSELF"

If you know a trade or occupation—why not go into business for yourself? Why not make the profits others are now making?

IT'S EASY TO START A NEW BUSINESS. It's easier than you think—once you learn the 9 easy steps of building a new business of your own. National Business Consultants has shown over 5000 others how to be successful —let us show YOU too. We guide you every step of the way with sound, proved simple business practices. EXPAND YOUR OWN BUSINESS. Learn our tested, profit-making methods for business success. If you already own a business, let N.B.C. guide you too. You'll be amazed. SEND FOR FREE BOOKLET TODAY! "How to Start a Business" is jam-packed with revealing information. In easy-to-understand language it explains how to start and make any kind of business profitable. Free for the asking! Sent to you in confidential plain envelope. Just write: NATIONAL BUSINESS CONSULTANTS, Office P-5

**BOTH FREE!**  
Rush Name on Postcard Today!

Los Angeles 61, Calif.

Send in your  
best cartoon  
for  
Free evaluation!

— says

**AL CAPP**

creator of "Li'l Abner"



Here's your chance to find out whether you have the kind of talent that could mean a well-paying career in cartooning. Draw *your own* cartoon, caricature or sketch — on a sheet of paper that can be folded to fit an ordinary envelope. Print the caption (if any) and send your drawing, with the coupon, to the Famous Artists Schools.

### America's Most Famous Cartoonists

Al Capp  
Milton Caniff  
Harry Haenigsen  
Rube Goldberg  
Willard Mullin  
Gurney Williams  
Virgil (Vip) Parth  
Barney Tobey  
Whitney Darrow, Jr.  
Dick Cavalli

Your drawing will be returned to you with a frank evaluation. There is no charge for this service. If your work shows promise, you will be afforded the opportunity of learning from America's most famous cartoonists.

They have created the Famous Artists Cartoon Course—the newest, most modern and practical way to learn this fascinating profession. Now they are looking for men and women who have talent worth developing for a full time or part time career in cartooning. You may be one of them. Send your cartoon today.

## FAMOUS ARTISTS **CARTOON** COURSE

Studio 6-EC, Westport, Connecticut

Here's my sample cartoon. Please return it to me with your professional evaluation. If, in your opinion, I have talent worth developing, send me full information on the new Famous Artists Cartoon Course.

Name.....Age.....

Address.....

City..... Zone... State.....

# DRAFTSMEN



**CASH BIG  
PAY CHECKS!**

**Train Now for  
more success,  
greater security**

**LEARN AT HOME IN SPARE TIME  
(or at college in Chicago)**

Check the want ads in any newspaper—SEE the big-pay opportunities open to you as a draftsman. What's more, you can learn this well-paid, prestige profession at home—quickly, easily! No special talent needed. Get complete, step-by-step Chicago Tech lessons in the mail, spend a few pleasant hours studying each week. In a short time you'll be a well-trained draftsman, ready to take your pick of many good jobs. Act now!



**Free Information—Mail Coupon Today!**

Get FREE TRIAL LESSON plus information about C.T.C. practical training. Learn what successful Chicago Tech graduates say about high pay and opportunities in drafting. No charge, or obligation.

## CHICAGO TECHNICAL COLLEGE

E-254 Tech Bldg., 2000 So. Michigan Ave.  
Chicago 16, Illinois

Mail me FREE lesson with facts about big opportunities in DRAFTING.

Name \_\_\_\_\_ Age \_\_\_\_\_  
Address \_\_\_\_\_  
City \_\_\_\_\_ Zone \_\_\_\_\_ State \_\_\_\_\_

## LEARN WATCH REPAIRING

**AT HOME** Modern, original instruction. Prepare for a position or start in business after completing our course. Write Today!  
WISCONSIN SCHOOL OF WATCH REPAIRING  
2908 N. 44th St. Dept. M Milwaukee 10, Wis.

# MAGIC MAIL PLAN

**that comes with this Little Machine  
CAN MAKE YOU \$5.00 AN HOUR**

The machine is turning out a job that will bring operator \$2.58, by mail. Material cost, only 11c!



Write today for free facts about the newest and most fascinating of all new home operated businesses. For the first time, a simplified machine brings the fabulous profits of Plastic Sealing and Plastic Laminating within reach of the small operator. Anyone can learn to operate it with a few minutes practice. Then—with our MAGIC MAIL PLAN—can get mail orders pouring in daily with cash in every envelope.

### No Canvassing or Selling

Fill orders at home in spare time to start. Then expand to full time business. We even supply circulars to bring back cash and orders. Rush name for all the facts you need to start. A postcard will do. No charge.

**WARNER ELECTRIC CO., Dept. L-105  
1512 Jarvis, Chicago 26, Illinois**

# YOU MAY THINK YOU'RE TALL ENOUGH... BUT

It's easy to be taller! Change to "ELEVATORS", the amazing height-increasing shoes that make you almost 2 inches taller instantly... confidentially. Only you know "ELEVATORS" secret, but everyone notices the difference. So, don't just think you're tall enough; BE SURE! Wear "ELEVATORS"!

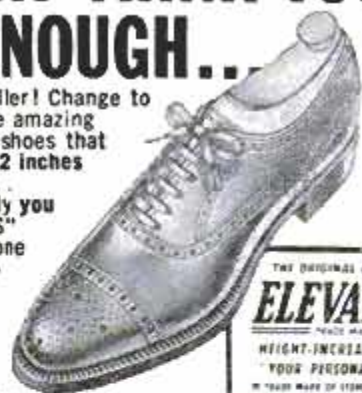

WHAT DO OTHERS THINK?

THE ORIGINAL AND GENUINE  
**ELEVATORS**  
"MADE MADE"  
HEIGHT-INCREASING SHOES  
"YOUR PERSONAL PODIATRY"  
"MADE MADE OF STEEL ARCHES TO 100"

Write for free booklet

**STONE-TARLOW CO., INC., DEPT. PMS-56, BROCKTON 68, MASS.**

# Learn to MOUNT BIRDS

**Tan SKINS, make up FURS**

Be a Taxidermist. Double your hunting fun. We teach you at Home. Mount Birds, Animals, Fish, Heads, common specimens. Fun and profits. Decorate home and don't MAKE MONEY. Mount game, tan for others. Big profits in spare time. WRITE TODAY. 100 game pictures in FREE BOOK. Hunters, get your copy. It's Now Free. Send post card. State your AGE. NORTHWESTERN SCHOOL OF TAXIDERMISTRY, Dept. 2505, Omaha, Nebraska

FREE BOOK

# A "GOOD HAND" HELPS YOU SUCCEED! LEARN TO WRITE WELL

Handwriting quickly improves with our easy-to-understand picture lessons! Put your spare time to good use; send today for FREE BOOKLET OF PENMANSHIP COURSES AND SUPPLIES or check volumes wanted below at \$1 each:  
 Business Writing  Artistic Writing  
 Card Writing  Bird & Design Flourishing  
 Engraving Alphabets, COMPLETE SET \$4.50. Act now!

**TAMBLYN SCHOOL OF PENMANSHIP**  
S.A. Ziller, Pres., 442 Ridge Bldg., Kansas City, Mo., USA

# SAY YOU SAW IT IN POPULAR MECHANICS

## CABINET MAKING

**LOW COST HOME TRAINING COURSE FOR BEGINNERS & ADVANCED CRAFTSMEN**

Make money. Learn skills and secrets of fine woodworking and tool use. Professionally prepared shop method training tells and shows how. Covers everything. Easy to master.

**INTERSTATE TRAINING SERVICE**  
DEPT. F3, PORTLAND 13, OREGON

# SKIN DIVING!

THE WORLD'S MOST THRILLING SPORT FOR ALL AGES  
**AQUA LUNGS**

The world's largest stock deep sea commercial and sport diving equipment. Large illustrated catalogue describes complete selection of lungs, tanks, guns, spears, goggles, etc.

SEND FOR NEW 1956 CATALOGUE 20¢

**M & E MARINE SUPPLY CO.**  
P.O. BOX 601, CAMDEN 1, N.J.

# NATIONAL SCHOOLS

*proudly presents*

FOR MEN  
WHO WANT  
TO EARN  
MORE MONEY

## TELERAMA • ALL 8 BRANCHES OF TELEVISION • ELECTRONICS • RADIO IN ONE DYNAMIC, MODERN SHOP METHOD, HOME TRAINING COURSE

\*Registration applied for

Another great advance in **HOME STUDY TRAINING**. Let National Schools, of Los Angeles, a practical Technical Resident Trade School for over 50 years, train you at home by Shop-Method, for today's unlimited opportunities in **ALL 8 BRANCHES** of the Television, Electronics, Radio Industry.

Check all you receive in *One Master Course* at One Low Tuition

1. Television — Including Color TV
2. Radio — FM and AM
3. Industrial Electronics
4. Sound Recording and Hi-Fidelity
5. Preparation for FCC License
6. Automation
7. Radar and Sonar
8. Communications

ALL OF THIS MODERN, NEWEST, PRACTICAL EQUIPMENT IS YOURS TO KEEP!

- Parts to Build a modern TV set, including large screen Picture Tube.
- Parts to build a powerful Superhet Receiver, standard broadcast and short wave.
- Parts to conduct many experiments and build Continuity Checker, RF Oscillator, TV Circuits, Audio Oscillator, TRF Receiver, Signal Generator.
- Professional Multitester
- These are a MUST for all technicians.

### YOU DO MANY PRACTICAL JOBS.

You do servicing, circuit analysis and many other down-to-earth experiments. You build a modern TV set from the ground up... with equipment kits we give you, including a new large screen picture tube and professional Multitester, at no additional charge.

**EARN AS YOU LEARN!** Many of our students earn their entire tuition and more in Spare Time jobs we show them how to do while learning. **YOU GET GRADUATE ADVISORY SERVICE, TOO.**

ALL YOURS  
TO KEEP

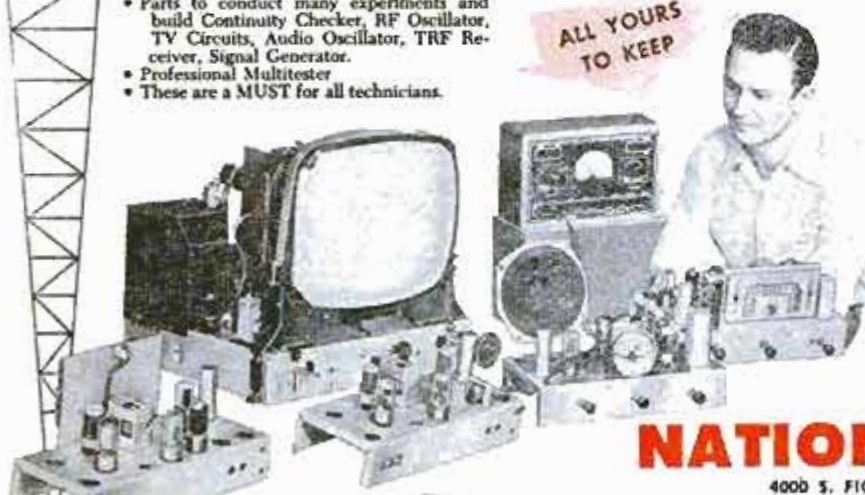

### L. J. ROSENKRANZ

President of NATIONAL SCHOOLS



This Master-Shop-Method course is completely up-to-date. Here in Los Angeles, the TV and Electronics center of the world, we are able to keep in constant touch with the industries' latest developments. As a student, you will quickly master all phases at home... in your spare time. Your earning power will grow with every lesson. Just as thousands of National Schools graduates do every day, you can handle servicing, manufacturing, repairing, hundreds of other jobs, or make good money in your own business. **SECURE YOUR FUTURE-NOW. SEND COUPON BELOW.**



IN THESE MODERN TV STUDIOS, SHOPS AND LABORATORIES, your Shop Method Home Study Course was developed by experienced instructors and engineers. What an advantage that is to you at home — each lesson is tested, proved, easy to understand. You can master the most up-to-date projects, such as color TV set repair, printed circuits — even prepare for F.C.C. License and industrial electronics without taking a special course. **TAKE YOUR FIRST STEP NOW TO A TOP-PAY JOB IN TV, ELECTRONICS, RADIO. SEND COUPON BELOW TODAY.**



APPROVED FOR  
VETERANS  
AND  
NON-VETERANS

## NATIONAL SCHOOLS

4000 S. FIGUEROA ST., LOS ANGELES 37, CALIF  
187 N. LA SALLE ST., CHICAGO 1, ILL.

IN CANADA: 811 W. Hastings St., Vancouver, B. C.

### NATIONAL SCHOOLS

TECHNICAL TRADE TRAINING SINCE 1905  
Los Angeles, California

GET FAST SERVICE — MAIL NOW TO OFFICE NEAREST YOU!

NATIONAL SCHOOLS, DEPT. RB 56  
4000 S. FIGUEROA ST. OR 187 N. LA SALLE ST.  
LOS ANGELES 37, CALIF. OR CHICAGO 1, ILL.  
Rush free TV-Radio "Opportunity" Book and sample lesson. No salesman will call.

NAME \_\_\_\_\_ BIRTHDAY \_\_\_\_\_ 19\_\_

ADDRESS \_\_\_\_\_

CITY \_\_\_\_\_ ZONE \_\_\_\_\_ STATE \_\_\_\_\_

VETERANS: Give Date of Discharge \_\_\_\_\_



### FREE!

Fully illustrated "CAREER" BOOK in TV, Radio, Electronics. AND actual Sample Lesson — yours at no cost, no obligation **SEND COUPON NOW — TODAY!**





YOU  
can  
acquire

## LAW NIGHTS AT HOME! LL. B. DEGREE

LaSalle's famous Law Library—used as reference in many Law libraries and Law offices—has enabled thousands to master Law surprisingly fast, in spare hours at home, for business and professional advancement.

These 14 remarkable volumes, compiled by leading professors and lawyers, cover the whole basic field of Law in condensed, orderly, simplified manner.

You advance rapidly with this great library, plus special lectures furnished. We guide you step-by-step with personalized Problem Method of instruction . . . you learn by doing—handling legal problems—not by memorizing rules.

Send for two FREE booklets, "Law Training for Leadership," and "Evidence," answering questions about Law and its value to you, and telling how LaSalle Law graduates are winning rapid advancement in business and public life. Mail coupon below. No obligation.

### LA SALLE EXTENSION UNIVERSITY

A Correspondence Institution

417 S. Dearborn St. Dept. 564L Chicago 5, Ill.

Send me your two FREE booklets described above, without obligation.

Name.....Age.....

Street.....

City, Zone & State.....

## RUPTURE



**RELIEF...OR YOUR MONEY BACK**  
Write now for free booklet and pictures of rupture care. You can be helped...work steady, with low cost, easy to wear Web Truss, thousands satisfied.

WEB TRUSS CO. Dept. M-5. Hagerstown, Maryland

## Would YOU Like to Make \$1 000 A MONTH?



That's What Stanley Hyman  
Made Selling PRESTO  
**AMAZING MIDGET  
FIRE EXTINGUISHER**

Sensational! Presto does job of bulky extinguishers costing 4 times as much. Ends fires fast as 2 seconds; fits palm of hand. Never corrodes; guaranteed 20 years! Sells for only \$4.95. Show it to owners of homes, cars, boats, farms, etc., and to stores for re-sale—make good income. Write for FREE Sales Kit. No obligation.



Stanley Hyman

MERLITE INDUSTRIES, Presto Div., 114 East 32nd St., Dept. P-15F, New York 16, N. Y. In Canada: Mopa Co., Ltd., 371 Dowd St., Montreal 1, P. Q. If you want a regular Presto to use as a demonstrator, send \$3.00. Money back if you wish.

New  
Midget  
Miracle—  
"Presto"



### AMERICA'S NEWEST OPPORTUNITY

New fur-bearing animal now being bred in U. S. Offers huge profits to breeders. This fur is next to Mink NOW in price and will soon surpass it. 15 to 20 young per year. Most easily and economically raised animal known. 1 1/2¢ per day to feed. ANY CLIMATE, disease resistant. Build yourself a sound future with this fine, registered stock. WRITE TODAY FOR FREE BOOKLET.

**CABANA NUTRIA, INC.**  
636-M West Lemon Ave., Arcadio, Calif.

**BUY IT WHOLESALE!**

GET  
UP TO  
40%  
OFF

★ Agents-Start Buying Service at Home. Get big-name merchandise for clients up to 40% off. Sales easy as you can give sizable discounts, still make fat commissions. Postcard brings FREE COPY "The Wholesale Plan."

FREE!  
"THE  
WHOLESALE  
PLAN"

**American Buyers Service**

HERTEL STATION, DEPT. R, BUFFALO 16, N. Y.

**IMMEDIATE DELIVERY**



### MARCOT KEY MACHINE

Marcot No. 8 Key Machine, 1950 Model	\$123.00
Auto Code Book and Depth Keys	13.75
Yale Padlock Code Book and Depth Keys	6.25
45 Doz. Asst. Cylinder Key Blanks	35.46
Set-Locksmithing Tools, Pins & Springs	10.50
5 Locksmithing Manuals and Instruction Books	10.25
	<b>\$199.21</b>

**SEND FOR CATALOG**

**A. J. MARCOTTE CO.** 1200 N. KEDZIE AVE.  
DEPT. PM-5, CHICAGO 51, ILL.

### Secrets of VENTRILOQUISM Now Revealed!



Easy to learn in 60 to 90 days with our Home Study Course. RESULTS GUARANTEED. Make Money! Be Popular! Have Fun! Big Opportunity! Radio, Television, Stage Appearances! For FREE Information regarding price and terms WRITE. You must state your age. JIMMY CARROLL 236.  
**FRED MAHER SCHOOL OF VENTRILOQUISM**  
Box 36, Studio PM-5 Kensington Station  
Detroit 24, Michigan

### Learn ACCOUNTING

**Business Administration**

Bookkeeping, secretarial and allied subjects at home in your spare time or attend nationally approved resident school. Write for FREE Success Book giving complete details on courses, plans, rates and employment opportunities. G.I. approved. Write Dept. A.



**Hills BUSINESS UNIVERSITY AND  
EXTENSION SCHOOL**  
619 W. MAIN ST. OKLAHOMA CITY 2, OKLAHOMA



### Stammering?

**BREAK THAT HABIT NOW!**  
SUCCESSFUL EMERY CORRESPONDENCE COURSE FEATURED IN NEWSWEEK & MEDICAL RECORD. WRITE TODAY FOR FREE INFORMATION.

**EMERY INSTITUTE**  
P.O. Box 867-PMS Winter Park, Florida

### Learn BAKING At Home

Baking is one of America's high industries in wages. Nearly DEPRESSION-PROOF. Thorough basic home course lays sound foundation. If you have aptitude, write for FREE Booklet, "Opportunities in Commercial Baking."

**NATIONAL BAKING SCHOOL**  
835 Diversey Pkwy. Dept. 1355 Chicago 14, Ill.



# MAKE BIG MONEY

# Plasticasting!



## MAKE JEWELRY, NOVELTIES, STATUES, ETC.

Unlimited opportunities making beautiful and useful things out of LIQUID PLASTIC, LIQUID MARBLE, LIQUID IVORY, LIQUID GLASS, LIQUID GEMSTONE, LIQUID PORCELAIN, CERAMICS, ETC., without tools or machinery! Anyone can do it! . . . . . PLASTICASTING costs you but pennies, the items you make sell for dollars! . . . . . It is as easy as pouring water out of a glass! Thousands now prospering because of Liquid Plastics.

Make novelties, jewelry, gifts, artware, toys, tools, dies, gadgets, ceramics, etc. A million useful things!

We supply everything you need—MATERIALS AND INSTRUCTIONS. Send only 25c for big 98 page catalog of casting materials, molds and accessories and we will include free of extra cost a remarkable book . . . . . "THE WONDERS OF LIQUID PLASTICS" . . . . . that will open your eyes to marvels you never even dreamed of! Send 25c today . . . . . this may be the lucky coin that will start you on the most fascinating and profitable phase of your entire life!

### PLASTICAST COMPANY

6612 N. CLARK ST., DEPT. PC-602  
CHICAGO 26, ILL.

A PROFITABLE  
HOBBY THAT LEADS  
TO A FULL-TIME  
*Big Money*  
BUSINESS!

PLASTICAST CO., Dept. PC-602  
6612 N. Clark St., Chicago 26, Ill.

I am enclosing 25c for PLASTICASTING Catalog 19 and include free of extra cost "THE WONDERS OF LIQUID PLASTICS."

Name \_\_\_\_\_

Address \_\_\_\_\_

City \_\_\_\_\_ Zone \_\_\_\_\_ State \_\_\_\_\_

## IT'S EASY . . .

## MAKE MONEY IN PHOTOGRAPHY

If you are over 17—good pay and fascinating work await you in photography! Start making money quickly in sparetime—step into your own studio or exciting career job. LEARN-BY-DOING method trains you at home! Write TODAY for FREE catalog. Also Resident Training. 46th Year. Approved for Vets.

NEW YORK INSTITUTE OF PHOTOGRAPHY  
Dept. 49, 10 West 33 Street, New York 1, New York  
46th YEAR

## SHORTHAND IN

Famous SPEEDWRITING shorthand, 120 words per minute. No symbols; no machines; uses ABC's. Easiest to learn, write and transcribe. Low cost. 300,000 taught by mail. For business and Civil Service. Typing available. 33rd Year. Schools in over 400 cities. Write for FREE booklet to:

**Speedwriting**  
1505-G  
55 W. 42 St., N.Y. 36, N.Y.

**6**  
WEEKS

## FREE! Fabulous Collection from SOUTH of the BORDER



Start TODAY to enjoy an exciting new hobby! Rush Coupon for big, valuable collection of genuine, all-different postage stamps from the exciting land of the mysterious Amazon . . . scarce airmails, gorgeous commemoratives, giant-sized stamps picturing wild horses, covered wagons, action-packed fights, native war heroes; PLUS sensational train stamp, beautiful "Christ of the Andes"; many others. EXTRA! Bargain Catalog, "Collector's Manual" plus other exciting offers for your inspection. Enclose 10c for mailing expenses. . . ACT NOW!

JAMESTOWN STAMP CO. DEPT. NSPM, JAMESTOWN, N. Y.

## Auto Service Men . . .

# STEP UP YOUR PAY!



New Sun School  
Makes it  
Easy!

### Be an EXPERT in Scientific Engine Tune-Up and Service!

Sun-trained experts in the use of electronic engine test equipment are in demand now! They MAKE MORE MONEY because they know how to use the "tools" which can quickly and profitably keep today's complex engines tuned up to their full power and economy levels!

You Can Provide This Service and Increase Your Earnings—*it's easy the Sun way!*

Sun Electric Corporation, Chicago—world's largest

Costs are LOW . . . plan NOW to increase your skill and position in the industry! Send for complete information . . . FREE Brochure!

manufacture of automotive test equipment—Now offers a completely new service training program. Train with specialists in the fully-equipped Sun Technical Training School, at Sun's Chicago headquarters. Learn the latest on any or all of these subjects:

- Test Equipment Operation . . . on Modern engines! You use every piece of Sun equipment!
  - Automotive Electricity . . . full coverage with accent on generators and regulators!
  - Modern Tune-Up Procedures . . . Carburetion—how to do it fast, accurately, prevent comebacks!
  - Service Merchandising . . . how to sell all work needed by customer!
- G. I. Bill Approved!

Sun Electric Corp., Dept. PM-5  
Harlem & Avondale Ave., Chicago 31, Ill.

NAME \_\_\_\_\_  
COMPANY \_\_\_\_\_  
ADDRESS \_\_\_\_\_  
CITY \_\_\_\_\_ ZONE \_\_\_\_\_ STATE \_\_\_\_\_

# Inventors

Take these necessary preliminary steps promptly to protect your invention by applying for a United States patent—

Sketch and describe your invention. Sign, date and have this disclosure witnessed by two people who understand your invention. Have us make a preliminary search among U. S. patents already granted for similar types of invention. We then report to you on the probable patentability of your invention and recommend your further course of action.

Write for our instructive booklet, "Patent Protection for Inventors" and our convenient "Evidence of Invention" disclosure form. No obligation.

**VICTOR J. EVANS & Co.** *Merlin M. Evans*  
REGISTERED PATENT ATTORNEY

230-E MERLIN BUILDING, WASHINGTON 6, D. C.

## LEARN UPHOLSTERY

in your spare time  
run your own  
business  
AT HOME



**FREE BOOK**  
with sample lessons  
with course  
YOU MAKE  
SLIPPER CHAIR  
CLUB CHAIR  
OTTOMAN

FREE TOOLS WITH COURSE!

### BE YOUR OWN BOSS

Earn more from the start! Set up your own profitable business, in your own home, enjoy steady income, independence for life—in the booming field of Custom Furniture Upholstery. Right off you start learning with tools, complete frames, fabrics and materials, included FREE with your UTS course. You learn skilled professional custom upholstery, reupholstery, furniture finishing, repairs, how to make beautiful slip covers, window cornices, cushions and draperies. EARN WHILE YOU LEARN, in your spare time . . . the UTS easy way.

FREE illustrated book, with sample lessons. Get ready for well-paid job and big profits, from steady work, as your own boss, running your own business. Mail coupon NOW! Training in N. Y. School also available.

### APPROVED FOR VETERAN TRAINING

UPHOLSTERY TRADES SCHOOL  
Dept. EE-310, 721 B'way, N. Y. 3, N. Y.

Send me FREE book "Your New Way to a Successful Career," and FREE sample lesson. No obligation—no salesman will call.  
 Home Study  N. Y. School Training

Name \_\_\_\_\_  
Please Print Plainly

Address \_\_\_\_\_

City \_\_\_\_\_ Zone \_\_\_\_\_ State \_\_\_\_\_

Check if Korean Veteran

PLUS  
SLIP COVERS  
Yours to Keep  
or Sell

## NEW INVENTION ELECTROPLATES METALS CHROME SILVER GOLD!

**BRUSHES NEW PLATING ON EASILY!** Builds-up a thick, new Plating with each application

Appli-Coter, an amazing new invention of modern science actually plates metals as you brush. It uses the mild, safe current of 2 flashlight batteries in the handle. Replates metal to a new sparkle—and the plating you apply becomes an **INDESTRUCTIBLE** part of the metal itself! Miracle solution Met-L-Cote for worn Auto Chrome, nickel, etc. All you do is dip & brush plating on!



COMPLETE KIT & full instructions only \$3.95. Money-Back Guarantee. Silver Plating Kit—\$4.95, Gold—\$6.95, Copper—\$3.95. Order the kit you want today!

EMPIRE MERCHANDISING CO., Dept. J-5A  
28 E. First St. Mt. Vernon, N. Y.

## BECOME AN EXPERT IN

### TRAFFIC and TRANSPORTATION

Traffic men earn \$4,000 to \$10,000 and up. Thousands of firms need experts on rates, tariffs, regulations. We train you thoroughly in spare time at home for executive traffic jobs. Personal training under traffic authorities. Write for free book "Traffic and Transportation."

LASALLE Extension University, 417 So. Dearborn St.  
A Correspondence Institution Dept. 564T Chicago 5, Ill.



### ... Swiss or American

Unique Sweazy System starts you making repairs right away. Develops your skill step-by-step. Teaches modern methods... professional short cuts. Learn by personal attendance or spare time home study. Approved for veterans. Free Sample Lesson. No obligation. Write today!

### CHICAGO SCHOOL OF WATCHMAKING

2330 Milwaukee, Dept. 156, Chicago 47, Ill.

### WHOLESALE Electric Guitars - Parts - Factory to You

Solid-body Spanish, amplifiers, double-necks, single-necks, triple-necks, 3-necks, solid-body mandolin, electric violin, pickup mikes, non-electric instruments, etc. 1956 Models wholesale. FREE CATALOG. Free home study course with instruments. Parts & plans available to build your own.

CARVIN CO., Box 287, PM-5, Covina, Calif.



### DEVELOP A HE-MAN VOICE!

Write for FREE book "How to Strengthen Your Voice for Greater Success" by Eugene Fenchinger. No obligation. Book will be mailed at once in plain wrapper, postpaid. Just send your name and address. State age. PERFECT VOICE INSTITUTE, 210 S. Clinton St., Studio EU-2, Chicago 6, Ill.

## STUDY INDUSTRIAL DESIGN

You can train at Art Center School in California with practicing-professionals for upper-level jobs in INDUSTRIAL DESIGN. Recent graduates have been added to the staff at General Motors, Chrysler, Raymond Loewy, Henry Dreyfus, etc. Majors in transportation, general product design, structures, community development, furniture design, packaging, display, 4-year degree courses. Learn to combine imaginative design with technical proficiency, coordinate utility and beauty. Stimulating environment. Field trips. Advantages of mild Southern California climate and nearby holiday spots. Accredited. Coed. Placement service. Established 25 years. New terms Feb., June, Sept. Catalog.

ART CENTER SCHOOL, Edward M. Adams, Director  
5353 WEST THIRD STREET, LOS ANGELES 5, CALIFORNIA

## HIGH BLOOD PRESSURE?



New simplified gauge tests blood pressure at home! This instrument detects internal changes which lead to unexpected strokes, heart and kidney damage, insomnia, headaches, etc. No experience or assistance needed to test pressure accurately. Operating instructions also include information on what to do to prevent or reduce the damaging effects of high blood pressure. These useful instruments are fully guaranteed and actually pay for themselves within a week. Order now for immediate shipment.

THE STANDARD UNIT . . . . . \$6.50 postpaid  
Or C.O.D. plus postage. Contains everything that is needed, including functional stethoscope.

THE DELUXE UNIT . . . . . \$9.75 postpaid  
Or C.O.D. plus postage. Same outfit as standard unit, but includes genuine professional stethoscope.

JOY SPECIALTY COMPANY, Scientific Instrument Div.  
2320-A W. HUBBARD STREET CHICAGO 12, ILL.

# AMMUNITION



Reload a whole carton for the cost of a few rounds of factory ammunition. Shotgun shells, rifle and pistol cartridges can be reloaded safely and easily with an inexpensive set of famous IDEAL Reloading Tools. 164 page IDEAL Reloaders Handbook ... \$1.00, post-paid. Free folder on request.

**THE LYMAN GUN SIGHT CORP.**  
MIDDLEFIELD, CONN.

# BECOME AN Electrical Engineer



- Major in Electronics or Power
- Earn B. S. Degree in 36 Months

Over 50% of the nation's industrial leaders began their careers with engineering training. Prepare now for a rewarding future as an Electrical Engineer or Engineering Technician. Enroll at the Milwaukee School of Engineering.

## TERMITES IN YOUR HOUSE?

GET RID OF THEM YOURSELF!

DON'T PAY \$300.00 AND UP TO ERADICATE TERMITES FROM YOUR HOME OR PREVENT INFESTATION. DO IT YOURSELF IN ONE AFTER-NOON, EASILY! QUICKLY! INEXPENSIVELY WITH "TERM-OUT"! SEND STAMP FOR HANDBOOK.



### COMPASS RESEARCH

90-A CLAIRTON BLVD., PITTSBURGH 36, PA.

## 250 POWER . . . .



Complete Telescope Lens Kit

only \$3.49 postpaid

Conquer Space, Explore the Universe, Planets, Moon Craters, New Stars, etc. Complete Lens Kit consists of 80 inch focal length ground and polished objective lens, eyepiece lenses for 50 POWER, 100 POWER, 150 POWER, 200 POWER, 250 POWER, and all necessary lens fittings. Easy to make from simple step by step instructions. (Tripod and mount not included.) Money back guarantee.

BUSSE SALES CO., Hartford 1, Conn., Dept. PM 45

## PORTABLE CAR COVER Heavy Vinyl Plastic (formerly \$8.95)

Protect Against RAIN • SUN • DUST. \$6.95

Long-lasting plastic, folds compactly, off and on in a jiffy, sturdy elastic binding gives extra security. State make, model and year—buy direct from mfr. Send \$6.95 plus 35¢ postage or sent C.O.D.

MARDO SALES CORP., Dept. G-71 480 LEXINGTON AVE. New York 17



SAY YOU SAW IT IN POPULAR MECHANICS

Better Than Your Own

## SHOE STORE AT HOME

No investment, no experience needed. Just show magic cushion comfort to friends, neighbors, co-workers. Advance commissions to \$4.00 a pair, plus Cash Bonus, Paid Vacation, \$25.00 Reward Offer. Outstanding values for men, women, children. Money back guarantee. Shoe samples supplied without cost. Write TODAY for FREE new 84 page catalog and full details.

TANNERS SHOE CO., 774 BROCKTON, MASS.



Two-Eyelet Hit With Cushioned Comfort

## Plan Your Career—Eight Courses Give You Wide Range of Study

### ENGINEERING COURSES

Electrical Engineering-Bachelor of Science Degree  
Save a valuable year through optional year 'round study.  
Electronics major ..... 36 months  
Power major ..... 36 months

### TECHNICIAN COURSES

Electro Technician ..... 12 months  
Electronic Technician ..... 12 months  
Radio Technician ..... 12 months  
Radio and Television Technician ..... 18 months

### SERVICE COURSES

Electrical Service ..... 6 months  
Radio and Television Service ..... 12 months

### MECHANICAL TECHNOLOGY COURSES

— Also available, Service and Technician courses 6 to 18 months — Heating, Refrigeration, Welding, Air Conditioning and Mechanical — B.S. Degree in Mechanical Engineering with a major in Design, Metal Fabrication, or Plant Engineering. Also, general 3-month preparatory course.

Terms open July, September, January, April  
Prior Military, Practical or Academic training evaluated for advanced credit. Faculty of specialists. 50,000 former students. Annual enrollment from 48 states and 23 overseas countries. 52nd year. Non-profit.

Residence courses only. Send handy coupon today. MS-11A



## MILWAUKEE SCHOOL OF ENGINEERING

### MILWAUKEE SCHOOL OF ENGINEERING

Dept. PM-556, 1025 Milwaukee St., Milwaukee, Wis.

Send free illustrated career booklets  Electrical Technology  Mechanical Technology  Radio-Television.

I am interested in \_\_\_\_\_ (name of course)

Name \_\_\_\_\_ Age \_\_\_\_\_

Address \_\_\_\_\_

City \_\_\_\_\_ Zone \_\_\_\_\_ State \_\_\_\_\_

If veteran, indicate date of discharge \_\_\_\_\_

# U-MAK-IT BOAT KITS

**TWICE THE FUN—  
HALF THE COST!**

**MOST COMPLETE LINE OF  
BOAT KITS 8 TO 23'—  
PRAMS, ROWBOATS, OUT-  
BOARDS, CABIN CRUISERS**

**Finest hobby with unequaled  
rewards for you, your family  
and friends.**

**Start building! Stop wishing!  
Be shipshape for the  
first break of the season.**

**Ask for your copy  
of our completely  
ILLUSTRATED CATALOG  
showing all models, accessories,  
all you need to build your own.  
Send 25¢ (coin) for postage and handling**

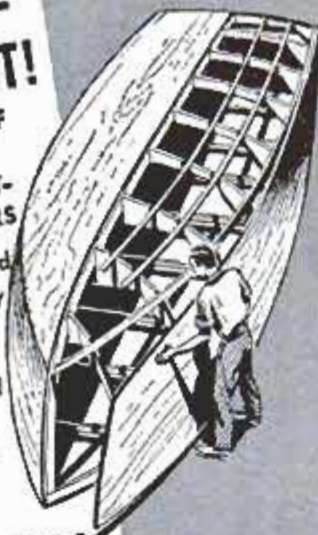

**U-MAK-IT products**

703P WHITTIER ST., BRONX 59,

NEW YORK

## Multi-Million Dollar Business Now Being Split Up Among Home Operators in Small Communities

**Inexpensive Table Top  
Machine Pays Profits  
UP TO \$9.20 AN HOUR**

The multi-million dollar Rubber Stamp Business is now being taken over by small home operators throughout the U.S. Men and Women who operate this inexpensive machine can turn out large numbers of Rubber Stamps with special wording of all kinds. Material costing only 27¢ makes a stamp that sells for \$1.80. The machine is easy for anyone to operate. It molds as many as six Rubber Stamps at a time, each with different wording such as names, addresses, notices, stock numbers, prices and other 'copy' needed by offices, factories and individuals. At full capacity, it can earn as much as \$9.20 an hour for the operator! You don't need experience to get into this big profit business at home. We supply everything, including complete instructions and eight ways to get orders for stamps coming in fast. Start making up to \$9.20 in one hour right away. We'll mail full particulars FREE and no salesman will call. Be first in your locality. Rush coupon. RUBBER STAMP DIV., 1512 Jarvis Ave., Dept. R-25, Chicago 26, Ill.



**RUBBER STAMP DIV., Dept. R-25  
1512 Jarvis Ave., Chicago 26, Ill. FREE!**

Please mail all facts showing how I can get started in the profitable Rubber Stamp business at home in spare time. Everything you mail me is FREE and no salesman will call.

NAME \_\_\_\_\_  
ADDRESS \_\_\_\_\_  
CITY \_\_\_\_\_ Zone \_\_\_\_\_ STATE \_\_\_\_\_



**GET MAXIMUM USE  
OF 4-WHEEL DRIVES!**

**MAKE 2 VEHICLES OUT OF 1!**

**New  
LOCK-O-MATIC!**

- Automatic five-wheeling 2 w. d.
- Automatic 4 w. d. forward & reverse
- Locking control for "anti-idle" 4 w. d.

Your 4 w. d. is a 4 w. d. work horse or 2 w. d. "pick-up" as you need it—as you shift! No drag, gear whine, shimmy in 2 w. d.; big savings in gas, tires, repairs. For all 4 w. ds. to 1½ tons at dealers or writes:



**WARN HUBS**

WARN MANUFACTURING CO.  
Riverton Box 6064-A5 Seattle 88, Wash.

## JEEP OWNERS

STA. WAGONS • JEEPSTERS • PICK-UPS!

RE-POWER with Ford 6 or V-8 engines. Our F-J ADAPTOR-CONVERSION KITS fit ALL Willys Jeeps including 1956. Kit No. 4-K for 1949-56 Ford engines in 1954-56 Pickups & Sta-Wagons priced at \$82.85 incl. Fed. tax. Kits for 1932-56 Ford engines in ALL other Willys Jeeps. \$43.25 Tax incl. Write today for free details or send check or M.O. for prepaid shipment. Tell us year engine you will use and whether 2 or 4 Whi-Dr. ORDER NOW FOR EARLY SHIPMENT.

HOOSIER MACHINE PRODUCTS CO.  
312 S.E. 6th St. Pendleton, Oregon



**STAMP COLLECTORS  
314 STAMPS 25¢**

Big imported collection of 314 all different foreign stamps including Monaco, Jules Verne Science-Fiction Set showing balloon & elephant, steamer & Atlantic Platform, giant tank, Argentina Flying Horse, Bolivian Revolution set, National Anthem, Italy AMG set PLUS hundreds of fascinating stamps of the world. This collection, cataloging over \$7.00, is yours for only 25¢ to introduce our bargain approach. BONUS: 48 Page Stamp Dictionary included free.

STAMP EX CO., Dept. HM, P.O. Box 47, White Plains, N.Y.

## ACCORDIONS

**Save  
1/2**

Finest Italian makes! Buy direct at Amazing Savings! 6 DAY TRIAL. Low down payment, easy terms. FREE color catalog, lowest wholesale prices. Write today to Accordion Manufacturers & Wholesalers Outlet 2003 West Chicago Avenue, Dept. R-56, Chicago 22, Illinois



## MECHANICAL DENTISTRY

A profession offering unlimited opportunities. Most modern and complete course embracing every branch from Plate to Porcelain Work, which prepares you to work for Dentists or start your own business. Individual instruction—practical training in day or night school. No books—no classes. Catalog upon request. MCCARRIE SCHOOL OF MECHANICAL DENTISTRY 207 N. Broad Street Dept. 53 Philadelphia 7, Penna.



**700% PROFIT  
taking & FINISHING PHOTOS  
in 2 MINUTES with  
CHAMPION PHOTOMASTER**

Simple instructions. Easy to learn. Make nice photos of children, group-ups, at 25¢, costs 2¢. For FREE information write PDQ CAMERA CO., 1546 W. Cortez, Dept. PM Chicago 22, Illinois

## LEARN AT HOME

**Key to Success**  
**LOCKSMITHING**  
Learn this profitable business from experts in your spare time. Locksmiths have no "slow" seasons or layoffs; they are always in demand. Age or minor physical handicap can't stop you. America's only recognized locksmithing school can teach you easily and quickly. Simple, illustrated lessons plus materials and tools supplied. Make money while learning. Get into this uncrowded field now!

INSTITUTE OF LOCKSMITHING  
Dept. R-78, 15 Park Avenue, Rutherford, N. J.  
Lic. by N. J. State Board of Education  
Approved for Veterans  
**FREE BOOKLET**



If You Can Light a Match... You Can  
**MAKE UP TO \$1,000<sup>00</sup> AND MORE IN A MONTH**

Amazing... New... Super Sensitive  
**MERLITE FIRE ALARM**  
**HOWLS 1/5 MILE WARNING**  
When You Hold a Lighted Match Near It



Make sensational 3-second "Lighted Match" Demonstration, pocket biggest earnings of your life, full time or spare time! Simple test proves new Merlite Fire Alarm so sensitive to fire, a lighted match "triggers" the unmistakable irritating "howl," audible 1/5 mile away! No installation, no connection to house current (which can fall in fire); self-contained. Hang on wall like a picture, always on guard. Only \$4.95, less batteries. Homes, farms, stores, offices, factories buy 4 to 12 at a time when you show how Merlite "smells" any fire before danger point. Make up to \$2.70 on each one; up to \$1,000 and more profit in a month!

**FREE!** Rush name, address for exciting money-making facts, complete Illustrated Sales Kit **FREE**—everything you need to make money first day. If you wish Merlite Fire Alarm Demonstrator, complete with batteries (\$3.50), send no money, we send C.O.D. Or enclose \$3.50 and we pay shipping charges. Money-back guarantee. Many localities now open—write **TODAY!**

**MERLITE INDUSTRIES (Fire Alarm Div.)**  
114 E. 32nd ST. DEPT. F-15F NEW YORK 16, N. Y.  
In Canada: Mopa Co., Ltd., 371 Dowd St., Montreal 1, P.Q.

**LOOK!** **A MILLION THRILLS!**  
High Power  
**BINOCULARS**  
33 Models: \$9.95 to \$135  
Free! Catalog & Book  
"How to Select Binoculars"  
**BUSHNELL Binoculars**  
Dept. M25 43 E. Green  
Pasadena, Calif.

**FREE TRIAL PLAN**

**'How to MAKE MONEY with Simple CARTOONS'**  
A book everyone who likes to draw should have. It is free; no obligation. Simply address **FREE BOOK**  
**CARTOONISTS' EXCHANGE**  
Dept. 95D Pleasant Hill, Ohio

**LAW FREE BOOK THE LAW TRAINED MAN**  
Write today for a **FREE** copy of illustrated law book, "THE LAW-TRAINED MAN," which shows how to earn the professional Bachelor of Laws (LL.B.) degree through home study of the famous Blackstone Law Course. All necessary books and lessons provided. Moderate cost; convenient monthly terms. Write for **FREE** law training book today.  
**Blackstone School of Law, 225 N. Michigan Ave.**  
Founded 1890 Dept. 55 Chicago 1, Ill.

**STOP BURNING OIL**  
SAVE \$75 ON OVERHAUL, DO IT YOURSELF IN 15 MINUTES  
MORE POWER MILEAGE SPEED  
GUARANTEED TOP END PERFORMANCE FOR AT LEAST 15000 MILES WITH EACH TREATMENT  
INCREASE COMPRESSION PICK UP

Just put our **AUTO LIFE** into your engine. It instantly goes to work to put a metal film around the rings and cylinder walls. With just 15 minutes of your time you have the equivalent of an expensive overhaul, for the fraction of the cost. It's so easy, anyone can do it. Nothing else to buy. **SEND NO MONEY.** We will send you **AUTO LIFE C.O.D.** plus postage. Or send \$3.95 **NOW** and receive it postpaid. If after trying **AUTO LIFE** for 30 days, your car doesn't **STOP OIL BURNING, GET MORE PEP, BETTER GAS MILEAGE** and are not completely satisfied, we will immediately refund your money.  
**AUTO CHEMICAL LIFE IND., Dept. F-2, 230 Division St., N. Y. 2, N. Y.**

**YOU'RE HIRED**  
WHEN PROPERLY TRAINED  
AS AN  
**ALL-AROUND MECHANIC**

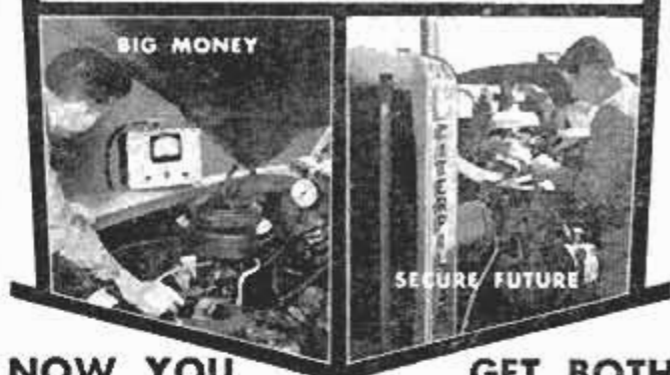

**NOW YOU GET BOTH**  
**AUTO MECHANICS**  
(AT HOME,  
**AND DIESEL IN SPARE TIME**)  
**IN ONE LOW TUITION COURSE**

Train right. Don't be a "one engine mechanic" Learn all engines, including diesel. The *qualified, all-around mechanic* can pick and choose, specialize anywhere, repair anything, from foreign cars to diesel jobs — he's always in demand where pay is tops

- COURSE COVERS:**
- all engines
  - fuel injection
  - automatic transmissions
  - overhauling
  - rebuilding
  - customizing
  - servicing, maintenance

**National Schools of Los Angeles**, a leader since 1905, brings its famous training shops to your home — to give you everything you need to make good in today's opportunity-filled Auto Mechanics & Diesel industry

Earn as you learn. We show you how. Free technical consultation service with qualified staff. Job Placement Service.



**THIS SET OF LIFETIME TOOLS AND ALL-METAL TOOL BOX ARE YOURS TO KEEP, AS PART OF YOUR COURSE.**

Send for **FREE FACT-BOOK** and **SAMPLE LESSON** NOW! To serve you faster, Mail coupon today to address nearest you.

**SAMPLE LESSON**  
YOUR FUTURE IN AUTO MECHANICS

**NATIONAL SCHOOLS**

4000 S. FIGUEROA ST., LOS ANGELES 37, CALIF.  
187 N. LA SALLE ST., CHICAGO 1, ILL.  
IN CANADA: 811 W. Hastings St., Vancouver, B. C.

**NATIONAL SCHOOLS**  
TECHNICAL TRADE TRAINING SINCE 1905  
Los Angeles, California

**GET FAST SERVICE — MAIL NOW TO OFFICE NEAREST YOU!**

**NATIONAL SCHOOLS, DEPT. DB-56**  
4000 S. FIGUEROA ST. OR 187 N. LA SALLE ST.  
LOS ANGELES 37, CALIF. CHICAGO 1, ILL.

Send **FREE** Auto-Mechanics Book and Sample Lesson  
No obligation, no salesman will call.

NAME \_\_\_\_\_ BIRTHDAY \_\_\_\_\_ 19 \_\_\_\_\_

ADDRESS \_\_\_\_\_

CITY \_\_\_\_\_ ZONE \_\_\_\_\_ STATE \_\_\_\_\_

VETERANS: Give Date of Discharge \_\_\_\_\_

YOU CAN MAKE

**\$100**

ON YOUR FIRST JOB!

START YOUR OWN BUSINESS... AS

WATER-PROOFING Contractor

Yes, you can earn \$100 profit on your first job, as a Water-proofing Contractor. We will furnish all necessary equipment and materials for the average job... for just \$50. Complete instructions FREE. Be your own boss in a very profitable business... full or part-time.

For details, write to:

LASTING PRODUCTS CO.

DEPT. MR 200 S. Franklinton Rd. - Balto. 23, Md.

NEVER AT THIS LOW PRICE!

GENUINE 120-POWER ACHROMATIC TELESCOPE

with Coated Lens and 3-POWER FINDER attached

ONLY \$18.95 PREPAID

EXTRA BONUS GIFTS:

- 108 page book, "Discover The Stars"
- Magic Star Finder Dial
- 220X & 400X Eyepiece lenses



BRING THE MOON, PLANETS, STARS, PEOPLE 120 TIMES CLOSER, CLEARER, SHARPER.

Never before has an ACHROMATIC 120X telescope with range finder and tripod sold for anywhere near this amazing low price! Now you can not only explore the heavens and bring the moon, planets, stars, etc. 120 times closer, but you can also observe all distant objects, people, ships, etc. too, because all pictures are erect, and not upside down as in all astronomical telescopes. The kind of needle-sharp color-free viewing only a genuine achromatic lens can bring you. Ready for immediate use. Its 5 precision lenses bring you viewing at 40X—80X—120X, the tubes extend to 43", made of jet bakelite, finished in camera bellows black (for sharper, clearer images). Trimmed with gleaming brass. The 3 power finder scope mounted on main tube is a feature usually found on more expensive telescopes—brings difficult objects on target before observing with main scope. For extra stability 5 ft. hardwood folding tripod is equipped with heavy cast iron head fitted with Criterion's famous 360 degree all aluminum mount that locks instantly in any position. Obtainable only from Criterion, shipped prepaid. 4-Bonus gifts—108 page book "Discover The Stars," magic star finder dial that aids in locating stars ANYWHERE at ANY TIME of the year, and 220X and 400X eyepiece lenses included free of any cost for experiments. You must be completely satisfied with this super offer or your money back in full. Shipped to you complete, nothing else to buy, at the amazing low price of \$18.95. Without tripod \$14.95.

Send cash, check, or money order today to:

Dept. PMA3, Criterion Co., 331 Church St., Hartford, Conn.

PENN YAN BOATS...



New Striptites!

All Wood—No Soaking, Work-Free!

Outboards incl. Cartops®, Trailboats, Racing Runabouts; also canoes—all beautifully finished, masterfully built. Types for fishing, hunting, cruising. Choose from over 100 models of fine, small watercraft.

Free CATALOG: 44 pages, color illustrations. Write TODAY! Penn Yan Boats, Inc., 34th St., Penn Yan, N. Y.



LEARN METALCRAFT and JEWELRY MAKING

Low Cost Home Training Now Available

Make money. Learn profitable skills and arts of decorative metal and jewelry crafts. Course is complete. Professionally prepared. Easy to master. Special tools and materials furnished.

Write for Free Booklet

INTERSTATE TRAINING SERVICE DEPT. K-3 PORTLAND 13, OREGON



FREE! CALIFORNIA GARDEN BOOK

Pictorial round-up of latest, smartest ideas in garden arrangement and structures, by famous California landscape architects. Dramatic new planters, terraces, fences, arbors, shelters.

Write for Garden Book, California Redwood Assn., 576 Sacramento St., San Francisco 11.

2 TELEPHONES \$22.75



Inter-communication handsets, two wire system. Included Two 3 volt batteries. 50 ft. of wire and simple wiring instructions. Additional wire 1 cent per ft. or \$25.00 per mile. Complete list of telephone parts, handsets, magneto—common battery — and dial telephones, switchboards, etc. "All shipments F.O.B. Simpson, Penna."

TELEPHONE ENGINEERING CO., Dept. 5B6, Simpson, Pa.

Say You Saw It in Popular Mechanics

POW!!! hunting slingshot

- accurate — powerful — silent
- kills small game, pests
- hits like a rifle

\$1.50 postpaid (no cod's)



Used by expert marksmen! 7" hardwood stock, 45 lb. pull. Best rubber. FREE!!! — extra rubber and big supply heaviest steel balls used by experts, illustrated catalog.

order today from — J. J. STONE DEPT. B-81616 Oak St. Santa Monica, Calif.

RUPTURED

BE FREE FROM TRUSS SLAVERY

NOW there is a new modern Non-Surgical treatment that permanently corrects rupture. These Non-Surgical treatments are so certain, that a Lifetime Certificate of Assurance is given. Write today for our New FREE Book that gives facts that may save you painful and expensive surgery, and tells how non-surgically you may again work, live, play and love and enjoy life in the manner you desire. There is no obligation. Excelsior Hernia Clinic Dept. 8305 Excelsior Springs, Mo.

**RCA** offers you the  
 finest training  
 at home in  
 Radio-TV  
 electronics,  
 TV servicing,  
 Color TV

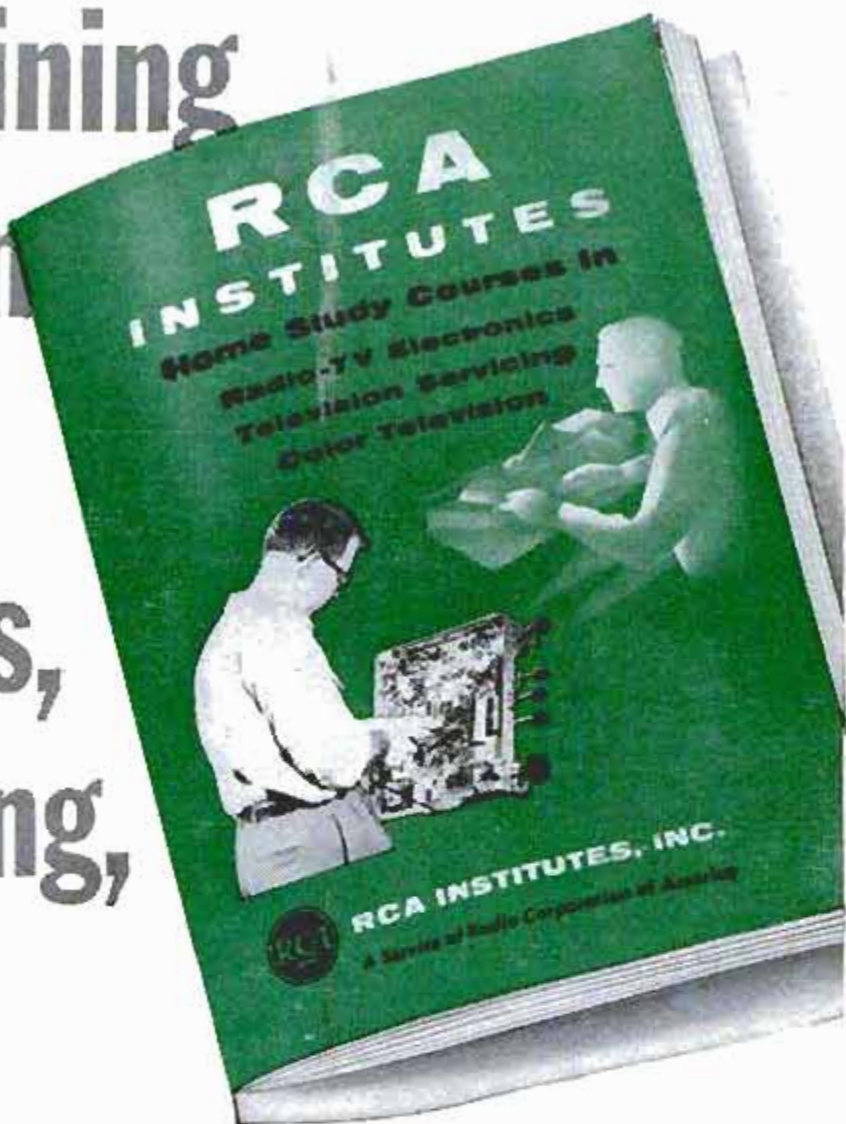

**SEND FOR THIS FREE  
 BOOK NOW!**

The instruction you receive and equipment you get (and keep) will start you on your way. Pay-as-you-learn. You pay for only one study group at a time. This 52 page book contains complete information on Home Study Courses for the beginner and the advanced student.



**RCA INSTITUTES, INC.**  
 A SERVICE OF RADIO CORPORATION of AMERICA  
 350 WEST FOURTH STREET, NEW YORK 14, N.Y.

RCA Institutes, Inc., Home Study MP65,  
 350 West Fourth Street New York 14, N. Y.  
 Without obligation, send me FREE CATALOG  
 on Home Study Courses in Radio, Television  
 and Color TV. No salesman will call.

Name ..... Please Print  
 Address .....  
 City ..... Zone ..... State .....

**IMPORTANT**  
 Be sure to write  
 for RCA Institutes  
 catalog before  
 signing up for any  
 Radio-TV course



LEARN  
AT HOME

## A BETTER JOB or YOUR OWN SHOP

Make \$3 to \$5 an hour as  
you train for big money!

A PRACTICAL NEW WAY TO LEARN

# AIR CONDITIONING & REFRIGERATION

Thousands of trained men are needed right now to service the 150 million air conditioning and refrigeration units in use—and the millions more being sold. You train at home in spare time for a good pay job or a business of your own. Mail coupon today for two FREE BOOKS which show how to break into this big, uncrowded field!

### 23 KITS—Build A Freezer Or Air Conditioner

You get practical training because CTI sends 23 kits. You get motor, compressor, testing gauges, controls, refrigeration hi-side, tools. You build and keep a freezer, refrigerator, air conditioner or milk cooler as you learn. Get the facts about America's fast-growing industry. Mail coupon today.

### MAIL TODAY FOR 2 FREE BOOKS

COMMERCIAL TRADES INSTITUTE Dept. R-277  
1400 Greenleaf Ave., Chicago 26, Ill.

Send me your big FREE books which tell me how I can train at home to make top money in Air Conditioning & Refrigeration.

Name \_\_\_\_\_ Age \_\_\_\_\_

Address \_\_\_\_\_

City \_\_\_\_\_ Zone \_\_\_\_\_ State \_\_\_\_\_

Member: National Home Study Council



## ... TURN CONCRETE INTO GOLD!



### MAKE UP TO \$75 A DAY IN YOUR OWN BUSINESS

If you want to have your own business — to start a business on your own — here's your big opportunity! New high speed, low cost General block machine produces up to 1,000 concrete blocks a day. Sell all you make to builders, supply houses, and others for homes, factories, buildings, garages. Cash in on the building boom! You can make profits of 100% to 150% — up to \$75 a day! General block machine equipped with 1/2 h.p. electric motor — or can be supplied with gasoline engine — works anywhere, in little space, indoors or out. Operates on ordinary house light socket. Simple, foolproof 3 step operation — so easy a child can do it. Makes superior 3 core blocks any size from 4" to 12". Also makes chimney, sash, corner and other types. Blocks meet any building code anywhere in the country. Materials — sand, water, cement, available anywhere. Simple illustrated operating instructions and mixing formulae for cement and cinder blocks supplied with each machine. Write for FREE folder with full information.

MOTOR  
DRIVEN

R.L.T. of  
New York City re-  
ports: "MY GENERAL  
BLOCK MACHINE  
PAID FOR ITSELF  
IN FIRST 2 WEEKS!"  
Hundreds now in  
use the world over!  
Write for FREE details today!

EXTRA

Book gives floor plans for 6 sensational concrete block bungalows. Tells how to lay blocks, lay out building lines, mix concrete, build steps, porch and concrete floors all at great savings. Written by experts. Can save many times the cost of the machine! Get it now! No strings attached. Send \$1.

BOOK SENT FREE IF YOU BUY MACHINE.  
\$1 REFUNDED IF YOU BUY LATER.

## GENERAL ENGINES CO.

DEPT. M-56, ROUTE 130, THOROFARE, N. J.



## BE A CLAIM INVESTIGATOR



INVESTIGATE ACCIDENTS! Many earning \$750 to \$1000 a month. Thousands of insurance companies, airlines, steamship lines and Government Offices need Claim Investigators. Also big opportunities for your own spare time business. We train you at home. National Placement Service FREE of extra charge. Bill King writes: "Your course has paid off for me with large earnings. You can quote me—your Adjuster Training Course is worth many times the cost." Write TODAY for FREE book.

### UNIVERSAL SCHOOLS

University Park, Dept. PM-5, Box 8202, Dallas 5, Texas

BIG TOP  
MUSCLE DAN

Save 60% on FAMOUS "TV — BIG TOP"



BUY  
DIRECT  
SAVE 5

### DAN LURIE BARBELLS

FREE— 60 MUSCLE BUILDING COURSES—  
68 HOW TO DO IT PHOTOS

SEND FOR FREE CATALOG

50 lb. set, \$ 8.48 • 150 lb. set, \$20.48  
100 lb. set, \$13.98 • 200 lb. set, \$25.98  
Order by mail—50% with order. Balance  
C.O.D. Extra wts. 13c lb. FOB Plant.

DAN LURIE BARBELL CO.

Dept. 659E, 52M5 Bristol St.,  
Brooklyn 12, N. Y.

LET MUSCLE DAN MAKE YOU A MAN.  
Results guaranteed or money back

SAY YOU SAW IT IN POPULAR MECHANICS

### ROLLER RULE "PENCIL WITH A BRAIN"

Precision made, accurate, handy. Roll it over any surface. Measures curves and straight lines, any shape, any distance. Excellent pencil too.



\$1.49

POST  
PAID

A must for architects, engineers, carpenters, plumbers, painters, students, pilots, navigators, etc. Available in inch or nautical measurements. Specify choice. "Your name imprinted in gold—15c extra."

ROLLER RULE MFG. CO.  
1319 Gaviota Ave. Long Beach 13, Calif.

## YES! SEND



directly  
to my door  
every month

I am enclosing

- \$3.50 for 1 year  
 \$8.00 for 3 years

name \_\_\_\_\_

address \_\_\_\_\_

city \_\_\_\_\_

zone \_\_\_\_\_

state \_\_\_\_\_

A-56

Hand this order to your newsdealer or send it to

POPULAR MECHANICS  
200 East Ontario St. Chicago 11, Ill.

**WAR SURPLUS BARGAINS**

**WAR SURPLUS BARGAINS**

\$500,000.00 INVENTORY for QUICK LIQUIDATION

Surplus items—hundreds of them for home, shop, factory, farm and outdoor use. New items, used items, reconditioned items—all at tremendous savings—all priced for quick sale.

Page After Page of Values

This big catalog shows page after page of amazing money saving values. Write for your copy today. Send 10c to cover postage, mailing, etc. Write today! SEND TODAY FOR YOUR COPY

**10c**

**STARK'S** 212 W. Madison St.  
Dept. PM-565  
CHICAGO 6, ILL.

**SPARE TIME PROFITS EARN MONEY AT HOME**

Cash in on this pleasant and profitable business. Re-string Rackets full or spare time. No experience or skill required. Easy to learn. Full line of finest quality, guaranteed Stringing Tools, Frames, Gut and Nylon Strings.



FREE CATALOG INSTRUCTIONS WRITE TODAY

W. A. BICKEL & CO., 803 South Blvd., Dept. PM-5, Oak Park, Ill.

**Finish HIGH SCHOOL AT HOME**

Complete 4 Yrs. in 12 Months

Learn More! Earn More! Enter professional or technical schools. Advance Socially. Live a Happier, Fuller Life. Individual Courses or complete schedule. WRITE FOR SCHOOL BULLETIN.

**ACADEMY FOR ADULTS**

30 W. Washington, Dept. PM-56, Chicago (Ill.)

**LOCKSMITHING**

Practical Up-to-Date Course — ONLY \$4.95

53 illustrated self-instruction lessons. Easy to learn. Full price only \$4.95 postpaid—or COD plus postage. Satisfaction guaranteed or full refund! Mail your order today. NELSON HALL CO., 210 S. Clinton St., Dept. EU-2, Chicago 6, Ill.

**SCIENTIFIC CRIME DETECTION**



**IT'S EASY TO LEARN**

Let us teach you in your own home. Learn Finger Printing, Firearms Identification, Police Photography, Criminal Investigation Methods thoroughly, quickly, at small cost. Over 800 Bureaus of Identification in the U. S. employ I. A. S. students or graduates. Write today, stating age.

INSTITUTE OF APPLIED SCIENCE, 1920 Sunnyside Ave., Dept. 1355  
(A Correspondence School Since 1916) Chicago 40, Ill.

**MOTORIZE YOUR BARBECUE!**

Easily rigged up by anyone. Handles whole ham or 4 small chickens. Commercial-quality thrust—2 r.p.m. gear-head motor (110V-AC)—spring-tension bronze bearing permits spit removal—

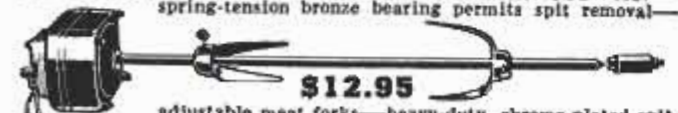

**\$12.95**

adjustable meat forks—heavy-duty, chrome-plated spit. Limited time, introductory offer. Postpaid. (\$13.95 Denver and West).

B & R SALES CO. — Dept. PM456 — Muncie, Indiana

**TERMITES**

Kill Termites Yourself with ARAB U-DO-IT TERMITE CONTROL

Costs \$20.00 to protect 5-room house for 5 years. Harmless to flowers and shrubs. FREE FOLDER and prices at Bldg. Supply Dealers or write FEDERAL CHEMICAL CO., INC., 2701 Winthrop Ave., Indianapolis, Dept. PM 556.

**94.6% OF BAILEY GRADUATES ARE EMPLOYED AT TOP PAY IN THE FIELDS WHICH THEY WERE TRAINED!**



**DIESEL-AUTO MECHANICS DESPERATELY NEEDED!**

We have a far greater demand for our students than we can fill!

We can show you an actual waiting list of leading companies throughout the world who have tried Bailey graduates — found them outstanding, and are coming back for more!

Bailey Graduates are Successful . . . RECEIVE BIG PAY — HAVE SECURE FUTURE!

The Famous Bailey Course prepares you for BOTH Diesel and Gasoline Mechanics.

This is a must—due to the advent of using Diesel principles, such as 'Fuel Injection' on passenger cars . . . use of gasoline engines for starting Diesel engines, etc. You learn all this at Bailey in the amount of time ordinarily required to learn just one of these subjects, ALL FOR THE PRICE OF ONE.

Don't be satisfied with a 'futureless', one-type job — learn how you can make big money now! Write today for Free Booklet that takes you on a step-by-step camera tour through our spacious, modern shops — See Bailey students in action as they Learn-by-doing with the Famous Bailey Method of training!

We provide you with housing and part time jobs while in school, plus nation-wide placement service for graduates.

**BAILEY Technical SCHOOLS**

1634 S. GRAND ST. LOUIS 4, MO.

**MAIL TODAY!**

Please mail immediately this free booklet without obligation.

FREE BOOKLET



Name.....

Address.....

City..... State.....

APPROVED FOR VETERAN... NON-VETERAN

# Learn at Home to Fix Electric Appliances

## Better Pay—More Opportunities

Get into a field where there is important work, good pay, a good future for the trained man. Today's automatic electric appliances need expert service. Up to 10 million are sold each year. Owners pay well to have them fixed properly.

## A Way To Extra Money

This is your opportunity for a better job, extra earnings or a business of your own. Soon after starting you can earn many extra dollars fixing toasters, clocks, fans, vacuum cleaners, etc., for your neighbors, friends. Keep your job while learning. The record, reputation and 40 years' experience of NRI back up this course. It's the training you need to learn Appliance Servicing at home in your spare time.

## Tester Furnished

With this NRI course you get parts to build professional type Appliance Tester. It takes guess work out of servicing at home. Get started toward this profitable career now. Mail coupon for Sample Lesson and Book FREE. Address: Electric Appliance Training, NRI, Dept. AE6, Washington 9, D.C.



## MAIL—Lesson and Book—FREE

### NATIONAL RADIO INSTITUTE

Dept. AE6, Washington 9, D. C.  
Send me Lesson and Book Free. No Salesman will call.

Name.....Age.....

Address.....

City.....Zone.....State.....

APPROVED MEMBER, NATIONAL HOME STUDY COUNCIL

SAY YOU SAW IT IN POPULAR MECHANICS

## PEE WEE BATTERYLESS TUBELESS "LIFETIME" RADIO



**REALLY WORKS—FOR LIFE!**  
Works WITHOUT TUBES, BATTERIES OR ELECTRICAL PLUG-INS. Will never run down or burn out! World's smallest, SMALLER THAN A PACK OF CIGARETTES! GUARANTEED TO RECEIVE LOCAL RADIO STATIONS ANYTIME—ANYWHERE YOU GO! Sensational new Ferrite Selective Tuner—Perma-Crystal diode, Super SPEAKERPHONE, durable black and gold plastic case.

SEND ONLY \$2.00 plus ck. inc. and pay postman \$4.00 COD postage on arrival or send \$6.99 for postpaid delivery. SENT COMPLETE READY TO LISTEN WITH LIFETIME GUARANTEE. Nothing extra to buy—ever. Available only from: MIDWAY COMPANY Dept. WPM-5 KEARNEY, NEBRASKA

## Paint STRIPES with New "PAINT PEN"!

### Straight, Curved or Parallel Lines

Use like a fountain pen with any color paint to stripe furniture, bikes, autos, model planes, toys, linoleum, wall board. Beautiful clean, crisp results every time. Can't clog or smear. Also use with glue, tempera, textile paint or ceramic under glaze. Paints on wood, glass, plastic, metals, fabrics and paper. Tool complete with tip for 1/16" stripe only \$1.25 postpaid. Other complete tools with following tips, 1/64", 1/32", 3/64", 5/64", 3/32", 1/4"—\$1.75 each. Extra tips 90c each. Entire kit with tool and 7 tips—\$5. A 1/4" tip only \$1.20 each. C.O.D.'s postage collect.

### New! "DOUBLE-STRIP" 5 Way Combination Model only \$3.25

Double Stripes—one wide and one narrow or two wide or two narrow at the same time.

FREE Send postcard for complete information—or ORDER TODAY.



**DEALERS:** Master Paint Stripping Tool in display cartons of 1 doz. FAST, PROFITABLE SALES. Write for new discounts.  
**HOME CRAFTSMEN!** New Paint Stripping Tool gives "professional" results every time, simple, easy to use. Send \$1.25 now.  
**MANUFACTURERS:** Write today for information about industrial models and production stripping tools.

WENDELL MFG. CO., Dept. 317  
4234 Lincoln Ave., Chicago 18, Ill.

# INVENTORS

PROTECT YOUR INVENTION BY A U. S. PATENT. SEND FOR FREE "INVENTION RECORD" FORM AND "PATENT INFORMATION EVERY INVENTOR SHOULD HAVE".

**CARL MILLER**  
REGISTERED PATENT ATTORNEY  
WOOLWORTH BLDG., 35th FLOOR, 56A  
NEW YORK CITY

# INVENTORS

Whether an invention is patentable can be substantially determined by a search of the U. S. Patent records. Without obligation, write for information explaining the steps you should take to secure a patent.

**JOHN N. RANDOLPH**  
Registered Patent Attorney  
201 Columbian Building, Washington 1, D. C.

## PATENTS

### C.A. SNOW & CO.

REGISTERED PATENT ATTORNEYS  
WRITE FOR INFORMATION TO  
428 SNOW BUILDING, WASHINGTON 1, D. C.

# INVENTORS

Send for PATENT INFORMATION Book and INVENTOR'S RECORD without obligation

REGISTERED PATENT ATTORNEY  
ASSOCIATE EXAMINER  
U.S. PAT. OFF. 1922-1929  
**GUSTAVE MILLER**  
Patent Attorney & Advisor  
U. S. NAVY DEPT. 1930-1947  
PATENT LAWYER

56-PM WARNER BUILDING  
WASHINGTON 4, D.C.

### CASH IN ON YOUR IDEAS

EXPERT, PROFESSIONAL ASSISTANCE FOR INVENTORS AND IDEA MEN WHO NEED HELP IN GETTING IDEAS INTO PRODUCTION. LOW FEES, FREE DETAILS.

*National Institute of Design and Invention*  
P.O. BOX 127-D SAN MATEO, CALIFORNIA

# INVENTIONS WANTED

If you want to market, or sell, your invention for cash or royalties, Write for our Free Booklet. Send no drawings. We also welcome hearing from firms, or private capital, wishing to review inventions in any field. We will be glad to send notice of our clients' inventions.

**GLOBAL MARKETING SERVICE**  
2420 77th Ave. Dept. PD Oakland 5, Calif.

## INVENTORS

I shall be pleased to furnish you, upon request, with full information relative to patent procedure—without any obligation on your part.

**PATRICK D. BEAVERS**  
Registered Patent Attorney  
934 Columbian Building Washington 1, D. C.

**Build it Yourself!** Furniture • Furnishings • Work Benches • Children's Toys • Shelves • Boat • Cupola • Weathervane • With

**Popular Mechanics NEW**

# FULL SIZE PATTERNS

**Authentic Designs by Professional Designer**  
Trace Patterns on Wood and Follow Simple Guides  
Every Step Made Easy for Building at Home

Now, save money and turn out professional-looking jobs in your own home. Everything you need to know for building handsome furniture, a 12-foot outboard, toys for the children and many other items is contained in these patterns. Trace the patterns on the lumber, saw, smooth the edges and assemble—it's as easy as that. Every nail, screw, dowel and bolt is clearly located for you on the pattern. You can't make a mistake.



**Modern Step Table**

**No. 104.** Designed to be a companion piece for No. 103, described in the listing below, this table is 28 x 18 inches, upper step 24 inches high. Complete in one pattern. **50 cents**

## 11 OTHER PATTERNS AVAILABLE

In addition to the 4 full-size patterns illustrated, there are 11 others in stock. If you've been looking for some good projects for your shop, you'll want more than one of them. These patterns have become so popular that the supply may soon be exhausted. It is not surprising that Popular Mechanics readers have responded enthusiastically to the original announcement of these patterns—just think of it, you can't go wrong! Every pattern has been proven for design and correct fit of parts—is guaranteed to please you! So act now, while all patterns are still available.

**No. 103. Modern Cocktail Table.** Matches No. 104 above. 40 x 19 inches, 15½ inches high. Plank top and metal grill inserts in sides. One pattern. . . . **50 cents**  
**No. 105. Toys for the Children.** "Giraffe Drawing Board" and "Bucking Bronco" riding toy. Pattern includes painting suggestions. One pattern. . . . **50 cents**  
**No. 106. Juvenile Chest Robe.** Has hanging storage space, two drawers and shelf, 30 inches wide, 16 inches deep, 39 inches high. Two patterns in set. . . . **\$1.00**  
**No. 107. Cupola and Weathervane.** 24 x 24 inches, 34 inches high, plus height of vane, which is made of metal or tempered hardboard. One pattern. . . . **50 cents**  
**No. 109. Valances and Trims.** Twelve designs included. Merely trace patterns on the wood, saw and assemble. Finishing suggestions given. One pattern. . . . **50 cents**  
**No. 115. Corner Table.** A new pattern to be used with the cocktail and step tables (Nos. 103 and 104) or alone. 29½ x 29½ inches, 18 inches high, plus an 8 inch diagonal step. One pattern. . . . **50 cents**

**No. 110. Decorative Wall Shelves.** Modern shelf with metal trim is 28 x 16 x 8 inches. Traditional shelf is 29½ x 16 x 8 inches. One pattern. . . . **50 cents**  
**No. 111. TV Chair.** Seat 22 inches deep, 24 inches wide. Overall, 27½ x 32½ inches, 26½ inches high. Sagless springs and foam rubber. Two patterns in set. **\$1.00**  
**No. 112. Modern Tub Chair.** Seat 22 inches deep, 24 inches wide. Overall, 28 x 27 x 27 inches. Sagless type springs and foam rubber. Two patterns in set. . . . **\$1.00**  
**No. 113. Sofa Bed.** 78¾ x 29¾ inches, 33 inches high, with removable bolster. Uses 4½ inch standard foam rubber or other mattress. Two patterns in set. **\$1.00**  
**No. 114. Love Seat.** Uses sagless type springs with foam rubber padding. 48 inches between arms, 21 inches deep. Overall, 35½ x 29 inches. Two patterns in set. . . . **\$1.00**



**Personal Work Bench**

**No. 108.** This compact, sturdy work bench has sliding doors and a drawer. Top is 44 x 20 inches, 35 inches high. Lots of work space in small area. Two patterns in set. . . . **\$1.00**



**CRUSETTE 12 Foot Utility Outboard**

**No. 101.** Build this runabout at amazing savings with ordinary hand tools. Length 12 feet, beam 4½ feet. Complete material list and instructions included. Four patterns. . . . **\$2.00**



**Trundle Beds**

**No. 102.** These space-saving beds are safer for young people. 90 x 45½ inches. Top bed 10 inches, lower bed 23 inches high. Three patterns in set. . . . **\$1.50**

## Order Blank for Popular Mechanics Patterns

**Popular Mechanics Press • 200 E. Ontario St. • Chicago 11**

Send postpaid Popular Mechanics Full Size Patterns as indicated below. Remittance for \$\_\_\_\_\_ enclosed. I understand that any pattern which does not please me may be returned within 7 days for full refund.

Gentlemen: Please send me Full Size Patterns numbers:  
101 102 103 104 105 106 107 108 109 110 111 112 113 114 115  
(circle numbers desired)

Name \_\_\_\_\_

Address \_\_\_\_\_

City \_\_\_\_\_ State \_\_\_\_\_

## SAVE MONEY DO IT YOURSELF



"Can't-Go-Wrong" method assures expert results very first time you cut your child's hair—IT'S EXCLUSIVE WITH



### Supreme SUPER HOME HAIRCUTTING KIT

Here's everything you need. Shock-proof plastic case designed to fit your hand. Electromagnetic motor with surgical type Swedish steel blades. Crew cut attachment for that popular butch cut, Barber shears, comb and clipper oil.



\$12.95

Other complete kits  
\$14.95 \$16.95 \$19.95



First 8 haircuts pay for kit! Figure savings on haircuts and tips when you cut family's hair.

### SUPREME PRODUCTS, INC.

Makers of Versamatic and other precision tool products.  
2222 South Calumet • Chicago 16, Illinois

## GET UP AND GO WITH A TRIUMPH

**FUN! INDEPENDENCE! ECONOMY!** Go where you want to go; do what you want to do. Be independent. Have more fun! Enjoy the thrill of motorcycling at its BEST with a gleaming, precision-made Triumph! Easy to ride . . . exciting to own . . . real economy, too—60 to 90 miles and up per gallon. Triumph's two-level cushion seat means real comfort for two! Priced surprisingly low, with easy terms available. See your nearest Triumph dealer for a free demonstration. He will teach you to ride.



RUSH THIS COUPON to nearest address below. Dept. P  
THE TRIUMPH CORP. JOHNSON MOTORS, INC.  
Towson, Baltimore 4, Maryland 267 W. Colorado St.  
Pasadena 1, Calif.

Send me absolutely FREE the 1956 Triumph Motorcycle catalogue in full color. If under 16 years of age, check square for special pictures.

NAME \_\_\_\_\_

ADDRESS \_\_\_\_\_

PHONE \_\_\_\_\_

## AMAZING NEW PERSONAL POCKET RADIO

LISTEN WHILE YOU  
WALK DOWN THE STREET!



Fits in any pocket—wt. only 7 ozs. Size 2 3/4" x 4 3/4" x 1 1/4". Beautiful Black Gold Plastic Case. NO HOOKUPS—NO WIRES—NO PLUG-INS! Self-contained, 100-hour life flashlight batteries and BUILT-IN ANTENNA. POSITIVELY NO AERIAL HOOKUPS EVER! GUARANTEED RECEPTION OF RADIO STATIONS TO 60 MILES up to 1500 miles for powerful stations! New patented Super-regenerative Diode tube and transformer audio stage for sharp selectivity and sensitivity! Easy to use top tuner (while walking). Tiny, plastic personal ear plug.

LET'S YOU ALONE LISTEN WHILE YOU WALK, VISIT, WORK, RIDE OR SLEEP ANYTIME—ANYWHERE. MONEY-BACK GUARANTEE AND ONE YEAR SERVICE GUARANTEE.

SEND ONLY \$5.00

(ck. mo) and pay postman \$14.95 plus postage on delivery or send \$19.95 for postpaid delivery. GET YOUR TINYTONE REAL POCKET RADIO now and be ready to listen to Civil Defense Alarms, news, music, sports, etc. on a moment's notice without bothering those around you. NOT AN UNWORKABLE, INCOMPLETE KIT OR PLAYTHING. BUT A REAL POCKET RADIO! Shipped complete with batteries—ready to listen! Available only from: WESTERN RADIO, Dept. APM-S, Kearney, Nebr.



### KIDS! "BIG" RACKET

Make your Bike sound and feel like a real Motorcycle. Adjustable amplifier for normal or loud noise. Simply attached with screw driver, only

\$150

BIG RACKET MFG. CO.

Box 2121 Colorado Springs 2, Colo.

## GIANT STAMP ZOO FREE!

Snakes, Leopards, Rhinoceros, Zabu, Koalabear and other fierce jungle beasts, Approvals. Send 10c for handling. FREE STAMP MAGAZINE.

LINCOLN STAMP COMPANY,  
St. Catharines 57, Ont., Canada



PLEASE  
SEND ME



for the  
time checked.  
I am enclosing . . .

1 year \$3.50

2 years \$6.00

name \_\_\_\_\_

address \_\_\_\_\_

city \_\_\_\_\_

zone \_\_\_\_\_

state \_\_\_\_\_

C-56

Hand this order to your newsdealer or send it to

POPULAR MECHANICS  
200 East Ontario St. Chicago 11, Ill.



## FILMS DEVELOPED ½ PRICE

ONLY 40¢ A ROLL FOR 8 EXPOSURES, 12 EXPOSURES . . . 55¢. STOCK UP WITH 3 ROLLS NAME BRAND FILM.....99¢. COLOR AT EQUALLY LOW PRICES. FILM DEVELOPED AND RETURNED SAME DAY RECEIVED. MONEY-BACK GUARANTEE + NEW ROLL OF FILM IF NOT SATISFIED.

Please find \$\_\_\_\_\_ for:

developing \_\_\_\_\_ rolls of film

Please send \_\_\_\_\_ rolls of name brand film

127  620  120  116  616

Please send free mailing envelope & price list

PHOTO WHIZ • Hillside Manor 10, New York



### Easy to make your own BOWS—ARROWS—EQUIPMENT

Illustrated Hand-Book 84 pgs. \$1, tells you how! Large Colored Catalog So—Send for It!

Ask your dealer for "Stemmler's Archery" (Oldest Mfr. in U.S.A.)

**L. E. STEMMLER CO.**

Manorville (Box 1) L. I., N. Y.

ONLY \$495  
Free folder  
FREE FOLDER

18 FT CRUISER

**BOAT KITS**

12 Models as low as \$39.95 (freight included). Fiberglass boat covering kits, marine supplies, etc. Free folders.

**TAFT MARINE WOODCRAFT**  
DEPT. PM-5 636-39th Ave. N.E., Minneapolis 21, Minn.

### MAKE USEFUL, ATTRACTIVE ARTICLES OF ALUMINUM

Book gives 125 plans, plus directions for working with aluminum. Make screens, tables, toys, garden items, etc. Send no money. Read book 10 days FREE, then send low price of \$3.95. Order now—DO IT YOURSELF WITH ALUMINUM. Address Dept. PM-5, McGRAW-HILL BOOK CO., 330 W. 42nd St. New York City 36

**RADIO** Engineering. All phases radio & electronics theory & practice; television; FM; broadcasting; servicing; aviation, marine & police radio. Prepare for good pay; 18-month course. Graduates in demand by major companies. Enter Jan., March, June, Sept. Regular campus life. Write for catalog. VALPARAISO TECHNICAL INSTITUTE, Dept. D, Valparaiso, Ind.

## Say You Saw It in POPULAR MECHANICS

**LAW** Men and women STUDY AT HOME for Business Success and LARGER PERSONAL EARNINGS, 44 years expert instruction—over 114,000 students enrolled. LL.B. Degree awarded. All text material furnished. Easy payment plan. Send for FREE BOOK—"Law and Executive Guidance"—NOW!

**AMERICAN EXTENSION SCHOOL OF LAW**  
Dept. H-11, 201 N. Wells St., Chicago 6, Illinois

### 60 POWER TELESCOPE \$3.98

VARIABLE EYEPIECE 20X-40X-60X — BRASS BOUND

**NEW!** Three telescopes in one, 3 different magnifications. 20 power for ultra-bright images with 40 and 60 power for extra long range. Guaranteed to bring distant objects, people, sports events, ships, moon, stars, etc. 60 times as close.

Most powerful for any where near the moon. Contains 4 ground and polished lenses. Also used as a powerful compound microscope. Directions included. Mass production enables us to offer this instrument at amazing price of \$3.98 complete. Money back guarantee. We pay postage. Get yours now. CRITERION CO., 331 Church St., Hartford, Conn., Dept. PMB 34

# DIESEL MECHANICS IN DEMAND

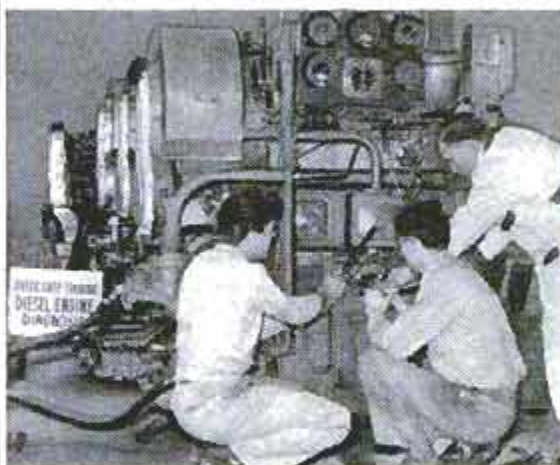

Learn to earn big pay in DIESEL in our large, modern equipped Chicago school and shop. No previous experience or training necessary. We help you find living quarters and part time job while in school. Complete, practical courses taught in the following trades, under the supervision of experienced, expert technicians.

APPROVED FOR CIVILIANS  OR GI'S

### — CHOOSE YOUR TRADE —

CHECK HERE	WEEKS
<input type="checkbox"/> DIESEL MECHANICS	20
<input type="checkbox"/> AUTO MECHANICS	20
<input type="checkbox"/> BODY & FENDER	16½
<input type="checkbox"/> GAS-ARC WELDING	4-12
<input type="checkbox"/> REFRIGERATION	13½
<input type="checkbox"/> AIR CONDITIONING	8½
<input type="checkbox"/> MACHINIST TRADE	30
<input type="checkbox"/> ADVANCED MACHINIST (includes tool & die)	32½
<input type="checkbox"/> PIANO TUNING & REPAIR	36

### CHOOSE YOUR ENGINEERING COURSE

These courses are intended as terminal education for men who wish to enter the Diesel-Automotive and Refrigeration-Air Conditioning fields as technicians. These courses are designed to prepare men for supervisory positions. Students with a high school education, or equivalent, will be accepted.

<input type="checkbox"/> DIESEL AUTOMOTIVE ENGINEERING	2 years
<input type="checkbox"/> REFRIGERATION & AIR COND. ENGINEERING	18 months

### FREE EMPLOYMENT HELP

Start your career with Greer by checking your interest above and mail coupon for complete information at no obligation.

NAME \_\_\_\_\_ AGE \_\_\_\_\_  
STREET \_\_\_\_\_  
TOWN \_\_\_\_\_ ZONE \_\_\_\_\_ STATE \_\_\_\_\_

Established 1902 — Over 50,000 Graduates.

54 years of continuous trade school experience to guide your training.

## GREER SHOP TRAINING

Box E, 2236 S. Michigan Ave.  
Chicago 16, Illinois

## "Building Beautifiers" Can Earn High Incomes

Colorcrete, a cementitious plastic, gives lifetime beauty and protection to drab, dirty masonry — concrete, stucco, etc. — on all kinds of buildings. Tough, renacious, enduring. Easily cleaned. Helps to daylight dark interiors. Choice of gleaming white or 30 colors. Applied under pneumatic pressure to form an inseparable bond.



More Colorcretors are needed to supply the ever-increasing demand. Low investment appeals to men of limited capital. Work is easy, fascinating, highly profitable. Broad opportunity to develop a lifetime business. No special ability or experience needed because we supply full instructions and sales co-operation. Colorcrete machine is simple to operate, easy to move around. Write today for Opportunity Book.

Colorcrete Industries, Inc. **COLORCRETE** Co.  
570 Ottawa Av., Holland, Mich.  
IN CANADA: DUNN MASONRY MACHINERY LIMITED  
1020 Dundas Highway, Cooksville, Ont.

## Learn All About Cars!

AUTO MECHANICS — AUTOMATIC TRANSMISSIONS  
ACETYLENE AND ARC WELDING  
BODY AND FENDER REPAIR

Day-Night School 30 Years in the Same Location  
**WOLVERINE SCHOOL OF TRADES**

Approved Under the G.I. Bill of Rights by the State Board of Education

WOLVERINE SCHOOL OF TRADES, Dept. PM  
1400 West Fort St., Detroit 16, Mich.

Name \_\_\_\_\_

Address \_\_\_\_\_

City \_\_\_\_\_ State \_\_\_\_\_

## ENGINEERING DEGREE IN 27 MONTHS

### Big Demand for Graduates

Aeronautical, Chemical, Civil, Electrical, Mechanical  
and Electronic Engineering (inc. Radio and TV)

Hundreds of young men are earning B. S. ENGINEERING DEGREES annually in this recognized institution — year around operation. New terms start quarterly. Many students earn a major part of their college expenses in this large industrial center.

Low tuition. Competent instruction. Thorough, intense practical program. Modern, well-equipped laboratories including new physics laboratory and modern wind tunnel. Individualized instruction emphasized.

Government approved for G.I.'s. Engineering preparatory courses. Students from 48 states and 21 foreign countries. Enter June, September, December and March. Send coupon for free catalog and full information. Enroll now.

## INDIANA TECHNICAL COLLEGE

556 E. Washington Boulevard, Fort Wayne 2, Indiana

Please send me free information on B.S. Engineering Degree in 27 months as checked.

Aeronautical,  Chemical,  Civil,  Electrical,  
 Mechanical,  Electronics

Name \_\_\_\_\_

Address \_\_\_\_\_

## Now You Can Upholster Any Piece of Furniture!

### Upholster—Restyle Any Piece of Furniture Yourself

John Bergen, custom furniture designer, tells and shows you how to transform old out-of-date furniture into brand new smart-looking comfortable furniture in his new book **ALL ABOUT UPHOLSTERING**.

### No Experience Needed

Bergen tells you every step to follow in amazingly clear easy-to-understand step-by-step instructions and then shows you how in hundreds of big, clear drawings and photos. You read and see how to strip the old frame, install new webbing and springs, apply burlap, install stuffing and padding, fit the muslin cover and the final fabric and install trim.

### Use New Materials—Methods

Now you can have furniture upholstered with foam rubber, sagless springs and other new materials that add so much to comfort and durability and are so costly when included in new furniture.

### Save 50% of Usual Cost

Don't pay a small fortune for new furniture when you can make your old furniture better than new! Why pay high prices to have someone else upholster and restyle your old furniture when you can do it yourself for cost of materials alone? It's easy and it's fun.

### Special Chapter on Slipcovers

Learn how to make custom-made slipcovers with professional look and fit. Find out how you can realize tremendous savings by investing a few spare-time hours and the cost of a few yards of fabrics.

### 7-Day Money Back Guarantee

Send for your copy of **ALL ABOUT UPHOLSTERING** today. Read and use it for 7 days. If it isn't entirely satisfactory return it for a full refund.

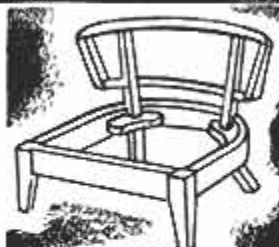

## USE THIS HANDY ORDER COUPON

POPULAR MECHANICS PRESS, Dept. AAU  
200 E. Ontario St., Chicago 11, Illinois

Gentlemen:

Please send my copy of **ALL ABOUT UPHOLSTERING**. Enclosed is my remittance of \$3.50. If I am not completely satisfied with the book I will return it for a full refund after 7 days.

Name \_\_\_\_\_

Address \_\_\_\_\_

City \_\_\_\_\_ Zone \_\_\_\_\_ State \_\_\_\_\_

# SEWS LEATHER AND TOUGH TEXTILES LIKE A MACHINE

With **SPEEDY STITCHER** Automatic Sewing Awl, anyone can quickly and skillfully sew or repair anything made of **LEATHER, CANYAS, NYLON, PLASTIC**, or other heavy materials. Sews firm, even lock-stitches like a machine. Gets into hard-to-reach places. Specially made for heavy duty sewing on **LUGGAGE, FOOTWEAR, RUGS, AWNINGS, SAILS, SADDLERY, UPHOLSTERY, OVERALLS, AUTO-TOPS, SPORTS GEAR**, and other tough sewing jobs. Here's the handiest tool you'll ever own. Will save you many times its small cost. Comes ready for instant use . . . complete with bobbin of waxed thread and 3 different types of diamond-pointed needles. Easy-to-follow directions will make you an expert in minutes. Extra needles and waxed-thread always available. Save money, send \$1.98 for postpaid delivery. If C.O.D., \$1.98 plus postage. **MONEY BACK GUARANTEE.**



**SPORTSMAN'S POST**  
366 Madison Ave., Dept. A-345, New York 17

ONLY **1.98**

## ELECTROPLATE IT YOURSELF!

**NOW using NEW plating kit.** It's easy to electroplate any object with the same **LUSTER and DURABILITY** as done by the most expensive equip. Complete kit and instructions on plating metal and non-metal objects, with Nickel, Chrome, Copper, Gold, etc. **ONLY \$5.95. SEND NO MONEY**—everything sent C.O.D. plus postage. **OR send \$5.95 now and receive it postpaid.** Money back in 7 days if not satisfied.

**M. Z. SALES CO., Dept. G-7, 113 W. 42nd St., New York 36, N. Y.**

## GIANT FREE CATALOG of OPTICAL BARGAINS

**ASTRONOMICAL TELESCOPE HEADQUARTERS**  
Complete Line of Astronomical Telescope Parts and Assembled Telescopes. Also huge selection of lenses, prisms, war surplus optical instruments, parts and accessories. Telescopes, microscopes, binoculars, etc. Fresnel Lenses for making Solar Furnace. **SEND ONLY \$1.00** for beginner's 10-lens kit and big instruction booklet Stock 2-H. Ask for **FREE** catalog H. **EDMUND SCIENTIFIC CORP., Barrington, N. J., U.S.A.**

## REFRIGERATION MADE CHILDISHLY SIMPLE

An unusual, easy basic theory method, non-technical, no mathematics. Repair used refrigerators at home for profit while learning. Designed to aid mechanically inclined men to start in the trade, earning as much as \$6.00 an hour. This book of over 100 pages is a personal edition, by a self-made refrigeration man. Write for additional information or mail \$4.95 for prompt delivery. No C.O.D. **R. G. ADCOX, 2210 N. 48th St., Dept. 2c, East St. Louis, Ill.**

## HELPFUL BOOKS

Send post card asking for **FREE** catalog  
Popular Mechanics Press, 200 E. Ontario, Dept. 601, Chicago 11

## GROW WITHOUT SOIL

You can grow vegetables, flowers or rare plants without soil (**HYDROPONICS**) every day of the year. Start this fast, clean **EASY** way to grow any plant for fun or **PROFIT** now. Big returns from small space. Send postcard today for **FREE** picture book showing how others from every state are succeeding in this new wide open field.

**GILBERT CO., BOX 54, 525 SPRUCE STREET SAN DIEGO 3, CALIFORNIA**



**NOW—32 PAGE BOOK** filled with photos, drawings, specifications, records, wholesale price, and Rider Agents plan if no dealer near you. Send 25c for book, or send \$1 (refunded first order) for it plus actual operating book and service manual.  
**MIDGET MOTORS MFG. CO., ATHENS 1, OHIO**



# 1956 ALLIED

## ELECTRONIC SUPPLY CATALOG

**324 value-packed pages**

Save on Everything in TV and Radio Parts & Equipment



Everything for Experimenters, Builders, Amateurs, Servicemen, Engineers & Hi-Fi Specialists

Send for **ALLIED's** big 324-page value-packed guide to *everything* in TV, Radio and Electronics! Select from the world's largest stocks of High Fidelity systems and components; recorders and phono equipment; TV tubes, antennas and accessories; Amateur station equipment and supplies; P.A. systems; test instruments; latest build-your-own kits; industrial electronic supplies—plus *everything* in electronic parts, tubes, transistors, tools and books. Save on everything in Electronics—send today for your **FREE 1956 ALLIED Catalog.**

Everything in Electronics From One Reliable Source

send for it **FREE CATALOG**

## ALLIED RADIO

**ALLIED RADIO CORP., Dept. 5-E-6**  
100 N. Western Ave., Chicago 80, Ill.  
 Rush **FREE** 1956 **ALLIED** 324-Page Catalog

Name \_\_\_\_\_  
Address \_\_\_\_\_  
City \_\_\_\_\_ Zone \_\_\_\_\_ State \_\_\_\_\_

# FREE

8mm. or 16mm. SILENT OR SOUND

# FILM

Yours to keep — free — an actual projection-length film for your

## HOME MOVIE SHOWS

This is a real thriller—full of action. We'll mail it free (for only 25c shipping costs) to show you what exciting films we offer at bargain prices. Special Illus. List of films—all types—at Discount Prices also sent free with your free film. Enclose 25c for shipping and specify if you want 8mm.—16mm. Silent or 16mm. Sound—to GUY'S "UNIQUE FILMS," Dept. 107, 2424 Entrance Drive, Hollywood 27, California.

SIMPLIFY PREVENTIVE MAINTENANCE WITH  
**MACHINE TOOL RECONDITIONING**  
 & THE ART OF HAND SCRAPING (2nd printing)  
 SEND FOR FOLDER DESCRIBING ILLUSTRATED BOOK  
 MACHINE TOOL PUBLICATIONS, 382 Holly Ave., St. Paul 2, Minn.

## 4-WAY COMBINATION KNIFE, FORK, SPOON SET WITH BOTTLE OPENER

This handy little set is made of non-corrosive stainless steel with beautifully colored, easy to clean plastic handles. Knife and fork slide snugly into each other's handles, spoon slips into pocket on knife handle, making a neat little package that's safe to carry. Fits easily into pocket, purse or glove compartment of car.

Wonderful for barbecues, picnics, or the home. Ideal for campers, hunters, fishermen

Please Specify Color. Order Today from  
**LEON RUMMEL** 328 E. Washington Blvd.  
 Los Angeles 15, Calif.



Available in red, yellow, green and ivory.  
**\$1.25 PER SET** PPD.  
 4 sets only \$5.00 Ppd.  
 Knife and fork set, without spoon, \$1.00 Ppd.

Say You Saw It in Popular Mechanics

MAKE YOUR OWN  
**FOLDING TABLES**  
 IN MINUTES...  
 AND SAVE MONEY!

WITH TABLECRAFTERS'  
 TUBULAR STEEL  
**FOLDING TABLE LEGS**

You simply screw leg assemblies to your table top. They're sturdy and rustproof. Won't collapse... yet fold easily for storage. For banquet, buffet, hobby, work and game tables.

COMPLETE KIT **\$8.95**  
 FOR ONE TABLE \$9.95 W. of Miss.  
 Send check or money order and we'll pay postage. Write Dept. P-1

**TABLECRAFTERS** 6731 CASTOR AVE.,  
 PHILADELPHIA, PA.

**ATTENTION!**  
 SHOW THIS AD TO THE  
 COMMITTEE OF YOUR  
 CHURCH, LODGE OR  
 OTHER ORGANIZATIONS.  
 THEY'RE ENTITLED TO  
 SPECIAL DISCOUNTS.

# OUTDOOR KITCHEN



Written Step-by-Step For You!

Now you can have a beautiful outdoor kitchen to enjoy all summer long. Tom Riley, well-known building authority, tells and shows you how you can build your own outdoor fireplace, Chinese oven, barbecue pit or grill. There are complete building instructions included.

### A Standard Piece of Equipment

Once the almost exclusive luxury of Western ranches, the outdoor barbecue now is a coast-to-coast American institution. Every year more families take to this pleasant and gracious way of outdoor dining and entertaining. Now with this book, you can join in with a minimum of expense and the utmost in results. Mr. Riley, an old hand around the barbecue ovens of Oregon, has prepared this complete book, in order that you may find the ideal outdoor fireplace for your particular back yard. He not only gives you many fireplaces from which to choose, but he also gives you money-saving short cuts in construction, hints on firing up and cooking and for extra good measure a collection of fire-tested recipes ranging from tasty frankfurters to filet of sole al fresco.

### No Experience or Special Tools Needed

Complete step-by-step building instructions with diagrams, photos and drawings make construction a cinch. There are designs for brick, field country stone, cement, concrete block and poured concrete, and many examples of each. With the know-how gained from this book, yours can be the most popular back yard in town and, besides you'll have lots of fun.

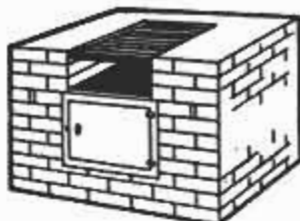

### Special Section of 40 Tested Recipes!

Here are some secrets of successful barbecuing—the best fuels to use, ways to maintain proper draft, and hints on firing up and cooking that will enable you to capture the authentic barbecue flavor in the foods you serve to family and friends. So that your fare won't be confined to wieners and hamburgers, Tom Riley also tells you how to prepare and serve such barbecued delicacies as ribs, roasts, fowl, fish, special sauces, and various vegetables.

### Partial Contents

Which Barbecue for you? Barbecue Fireplaces, Portable Grill, Masonry Grill, Barbecue Pits, Chinese Ovens, Infra Red Roasters, Combination Barbecues. Construction plans, Basic Fireplace Foundation, Barbecue Fireplace of poured concrete, stone construction, Firing Up! Types of Charcoal, Hardwood, Softwood, Compressed Sawdust, Cooking Temperature, Flame Tested Recipes, Charcoal Broiled Steaks, Barbecued Spareribs, special section of cooking methods employing various vegetables not usually associated with outdoor cooking, and much more.

### 7-Day Money Back Guarantee

Send for your copy of OUTDOOR KITCHEN, today. Read and use it for 7 days. If it isn't entirely satisfactory, return it for a full refund. We know once you have looked your copy over, and found the fireplace for your backyard, you won't part with this book under any conditions.



Use This Handy Order Coupon

**POPULAR MECHANICS PRESS**  
 200 E. Ontario St., Chicago 11, Illinois

Gentlemen:  
 Please send my copy of HOW TO BUILD AND USE YOUR OWN OUTDOOR KITCHEN, now. Enclosed is my remittance of \$2.00. If I am not completely satisfied with the book I will return it for a full refund after 7 days.

Name \_\_\_\_\_

Address \_\_\_\_\_

City \_\_\_\_\_ Zone \_\_\_\_\_ State \_\_\_\_\_

Send C.O.D. I will pay postman

POPULAR MECHANICS

# TENSE NERVOUS HEADACHES

call for

## STRONGER Yet SAFER

# ANACIN

Won't Upset The Stomach

Anacin® not only gives stronger, faster relief from pain of headache, but is also safer. Won't upset the stomach and has no bad effects. You see, Anacin is like a doctor's prescription. That is, Anacin contains not just one but a combination of medically proven, active ingredients. Scientific research has proved no single drug can give such strong yet such safe relief as Anacin. Buy Anacin Tablets today!

## POWER MOWER KITS FREE PLANS

3 or 4 Wheel Model



Have one of the finest mowers money can buy. Write for FREE PLANS and PARTS LIST showing you how to SAVE MONEY by assembling Triangle's POWER MOWERS.

### SPECIAL FACTORY PRICES

Kits, Parts, Engines, Wheel, etc. 18" and 20" sizes; 3 or 4-wheel models; belt or direct drive. Latest improvements, sturdy construction, money-back guarantee, fully told in

FREE color folder. Also complete TRIANGLE MOWERS ready to mow at low Factory Prices. Write today.

▲ TRIANGLE MFG. CO., Dept. MA-56, Ft. Scott, Kan.



## DOLLARS for 18¢?

Yes, buy U. S. \$1.00 values for 18¢ abroad. Get new, big profit mail order plan proved by 100,000 cash orders shipped from overseas. You carry no stock. Full or part time—even from home. Export and travel abroad opportunities too. Details with bargain import examples FREE. Write MELLINGER CO. Dept. F255 1717 Westwood, Los Angeles 24, Calif.

## BUILD YOUR OWN MIDGET ROADSTER \$25 BUILDS BODY & FRAME



Build a PONY ROADSTER or PICK-UP in few spare hours. Uses 2 hp engine, 450 lb. loads, 70 m.p.gal. Great for kids, sturdy utility car. Designed for VERY LOW COST assembly from PARTS BOUGHT IN YOUR NEIGHBORHOOD. Use home tools. No welding needed on body or frame. COMPLETE step-by-step plans, 17 large size pages, 10 "show-how" photos, parts list, and hood insignia. ORDER NOW. ONLY \$1.95 post-paid. Satisfied or money back.

PONY PLANS, DEPT. 45, 7641 TEXHOMA AVE., NORTH'DGE, CALIF.

## FREE AMAZING NEW BOOK "HOW TO ANSWER ADS"



Never before have you seen anything like this. Tells you in simple language the correct way to answer ads. Gets you quicker replies—better results, and greater satisfaction. Will save you time and money and it's ABSOLUTELY FREE. No obligation whatever. Every reader of advertising should have this booklet. Send a postcard for your copy NOW. F. W. JOHNSON, Popular Mechanics Magazine, Room 600-A, 204 East Ontario Street, Chicago 11, Ill.

Say You Saw It in Popular Mechanics

## LEARN PLASTICS



COMPLETE LOW COST SHOP METHOD HOME TRAINING NOW AVAILABLE

Get in on Big Money opportunities in Plastic molding, casting, forming, carving, etc. Earn as you learn with Interstate's professionally prepared course. All plastic materials furnished.

WRITE FOR FREE BOOKLET

INTERSTATE TRAINING SERVICE

DEPT. C-3, PORTLAND 13, OREGON

# Over \$3,000<sup>00</sup> Monthly

## -NET PROFIT-

(\$40,000.00 A YEAR PROFIT)

### My Income Tax Records PROVE This a Fact

My unique different method can be applied by almost anyone almost anywhere to any sensible mail order speculation. An exciting opportunity. Your easy-to-follow Instruction Manuscript, "How I Made Over \$3,000 a Month" (every month in the year) selling BY MAIL from my home, will be sent for ONLY \$1.00.

California customer writes:

"Through your efforts I am clearing better than \$25.00 a day. Everything you have said worked. This past week I have taken in \$238.50. Altogether it has taken about one hour of my time. No money at all. The business is getting better every day."

(Unsolicited letters like above, from customers in many States will be sent with your \$1.00 instruction as undisputed proof of my method.)

Do you want to help fill fantastic demand? One dollar (\$1) credited to you, brings complete story and instructions. No time to waste with curiosity seekers... answering with post cards or letters.

This Ad MUST Be Returned with Your \$1.00 Remittance

## I. A. SERVICE

P. O. BOX 248, ROWLEY, MASS.

No need to write, slip THIS AD in an envelope with \$1 in any convenient form. Allow 2 to 4 weeks for your shipment to reach; your THIRD CLASS, or send 9c service fee for FIRST CLASS or 18c for AIR MAIL delivery.

FREE in appreciation of your promptness, if you send your \$1.00 today, we will include the famous "The ONE Right Way to 40-PAGE BOOK Sell By Mail."

## PREPARE FOR BETTER JOB, BIGGER PAY IN SPARE TIME AT HOME

Today, choose the job you want—and prepare for it in time you might otherwise waste. Or if you are already in the work you like best, start training now for quicker promotion and increased pay. During more than 50 years AMERICAN SCHOOL has helped ambitious people to reach higher goals. Check subject that interests you and mail coupon for full information.

AMERICAN SCHOOL, Dept. G545, Drexel at 58th, Chicago 37, Ill. Without obligation, please send FREE and postpaid, full particulars about the subject checked below.

- |  |   |  |
|--|---|--|
| <input type="checkbox"/> Accounting              | <input type="checkbox"/> Diesel Technician      | <input type="checkbox"/> Mechanical Technology |
| <input type="checkbox"/> Apprenticeship Courses  | <input type="checkbox"/> Drafting—Building      | <input type="checkbox"/> Metalworking Courses  |
| <input type="checkbox"/> Architecture & Building | <input type="checkbox"/> Drafting—Machines      | <input type="checkbox"/> Plumbing—Practical    |
| <input type="checkbox"/> Automotive Technician   | <input type="checkbox"/> Electrical Engineering | <input type="checkbox"/> Private Secretary     |
| <input type="checkbox"/> Better Foremanship      | <input type="checkbox"/> Electricity—Practical  | <input type="checkbox"/> Retail Merchandising  |
| <input type="checkbox"/> Bookkeeping             | <input type="checkbox"/> Electronics—Industrial | <input type="checkbox"/> Salesmanship—Outside  |
| <input type="checkbox"/> Business Management     | <input type="checkbox"/> HIGH SCHOOL COURSES    | <input type="checkbox"/> Sheet Metal Work      |
| <input type="checkbox"/> Civil Engineering       | <input type="checkbox"/> Mechanical Engineering | <input type="checkbox"/> Tool Making           |
| <input type="checkbox"/> Contracting             |   |  |

NAME \_\_\_\_\_ OCCUPATION \_\_\_\_\_ AGE \_\_\_\_\_  
 HOME ADDRESS \_\_\_\_\_ STATE \_\_\_\_\_  
 CITY \_\_\_\_\_

Canadians: Write American School, Dept. G545, 1610 Sherbrooke St. W, Montreal

MAIL COUPON NOW



# PREPARE FOR THE BEST JOBS

IN INDUSTRY

**TRAIN at HOME**  
IN YOUR SPARE TIME  
or at  
**ALLIED INSTITUTE**  
in Chicago

- MECH. ENGINEER
- DRAFTSMAN
- TOOL DESIGNER
- TOOL ENGINEER
- TOOL & DIE MAKER
- MASTER MACHINIST

## NO RECESSION FOR ALLIED TRAINED MEN

**MORE JOBS THAN GRADUATES** Shortages of Draftsmen, Designers, Tool Engineers, Machinists, Tool & Die Makers are so widespread that you can pick a highly paid key job and look forward to Achievement and Security.

You can begin your training in Short Courses and continue progressively to a Bachelor Degree in 26 months.

Allied is approved by Industry, Dept. of Education, Office of Public Instruction, State of Illinois, U. S. Veterans Admin., U. S. Dept. of Justice. Accredited: C. S. A.

SEND FOR  
**FREE**  
BOOKS

**ALLIED SCHOOL of MECHANICAL TRADES**  
1338-42 South Michigan Ave. Dept. PM-5 Chicago 5, Illinois

SEND ME WITHOUT OBLIGATION INFO. ON YOUR COURSES:

HOME STUDY  RESIDENT  VETERAN  NON VETERAN

NAME \_\_\_\_\_

ADDRESS \_\_\_\_\_ AGE \_\_\_\_\_

CITY \_\_\_\_\_ COUNTY \_\_\_\_\_ STATE \_\_\_\_\_

## At last! A FOLDING SKILLET GRILL

**FOR CAMPING • HUNTING  
FISHING • PICNICS**

This combination skillet and grill is a full 12" x 12". Large enough to cook for one or many. Handle folds back flat saving valuable space. Nickel plated. Ideal for all outdoor purposes. An excellent gift item for Father's Day and any day. Made by the manufacturers of the famous Shepherd Camp Stove.

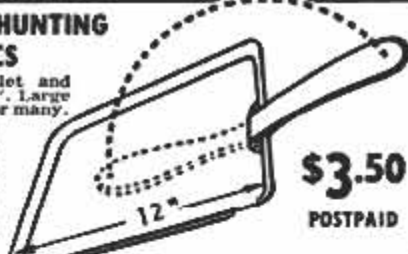

**\$3.50**  
POSTPAID

**RAINIER MFG. CO.,** 6629 8TH AVENUE  
LOS ANGELES 43, CALIF.

## SAY YOU SAW IT IN POPULAR MECHANICS

THE ORIGINAL  
**PACKAGED  
BOAT KITS**

Made ONLY by *Custom-Craft*

Top Performance,  
Design, Styling!  
Over 70 Models  
8 to 21 ft

World's largest line! Over 200 Boats: Kits, Formed-Hulls, Semi & Custom-finished! All types: Prows - Cruisers! Easy to build! Flying stern, Tredonic bottom, Bulkhead construction!

**Send 25¢ for KIT CATALOG**

52 pages! Includes Victory Series, hardware, point accessories, Fiberglass! Send \$1.00 for Catalog Plus "Boating Handbook". DEALERS-AGENTS INQUIRE

**BOAT PLANS  
& PATTERNS  
Frame-Pac Kits**

World's largest selection; over 200 plans, full-size patterns, frame-pac kits! Designed strictly for amateurs! All types: prows, kayaks, racers, runabouts, catamarans, houseboats, cruisers - Inboard-outboard 6-40' wood-plywood-steel!

**Send 25¢ for PLAN CATALOG**  
Catalog PLUS "Boatbuilding Handbook" \$1.00

DEPT. A

CUSTOM-CRAFT - BUFFALO 7, N. Y.

**FULL 7" PAINT BRUSH**

**\$1.25**  
POST-PAID



As advertised in the Saturday Evening Post for \$3.69  
Manufactured by the Pittsburgh Plate Glass Co.

**COVERS WALLS FASTER—EASIER—BETTER!** Made of NEOCETA, the bristle specifically designed for painting. Revolutionary locked-in construction holds bristles permanently. Easy to clean! Lasts longer! At \$1.25 this 7" brush is the best buy we have ever offered.

**TWIST DRILLS** for steel or wood, hand or electric. Assorted sizes 1/16" to 3/4". With 5 plastic drill cases—ppd. 45 for \$2.00.

**MONEY BACK GUARANTEE ON ANY PURCHASE**

**DAVID-FAY CO., DEPT. PM-1**  
403 EAST 45th ST. BROOKLYN 3, N. Y.

## Catalog of 3100 Novelties 10c

Send 10c for amazing catalog of novelties, live animals, scientific supplies, hobbies, funmakers, planes & boats, looms, magic tricks, joke articles, unusual seeds, gadget time-savers, cameras, optical goods, projectors, movies, lucky jewelry, religious novelties, disguises, musical instruments, stamps, coins, puzzles, fortune tellers, radios, auto & bike accessories, telescopes, magnifiers, compasses, banks, smokers' gadgets, artists' supplies, printing sets, engines, motors, shockers, knives, billfolds, guns, rifles, sports, books, games, plants, etc. Send 10c (3 for 25c—get for friends!).  
**JOHNSON SMITH & CO.** Dept. 201 Detroit 7, Michigan

**GROW**

**ORCHIDS AT HOME**

**BIG PROFITS  
SPARE OR  
FULL TIME**

World's most thrilling hobby - profitable home business. Single Orchid plant may multiply into many - each as valuable as the first. Successful home grower shows you how! Raise gorgeous Cattleyas, Cymbidiums, Epidendrums, on living-room table. Big-profit orders come from friends, neighbors, florists, etc. - also Mail Orders. Illustrated secrets of the experts in simple "show-how" language AND blooming-size Orchid plants sent at NO RISK. Everything you need to start - for pleasure or profit. FREE - full details - SEND NO MONEY. Write today. **TROPICAL FLOWERLAND, Dept. 315, 4622 Wilshire, Los Angeles 5, Calif.**

## SEND ME



every month so I am sure to see each new issue. Here's

- \$3.50 for 1 year  
 \$8.00 for 3 years

name \_\_\_\_\_

address \_\_\_\_\_

city \_\_\_\_\_ zone \_\_\_\_\_ state \_\_\_\_\_

Hand this order to your newsdealer or send it to

**POPULAR MECHANICS**  
200 East Ontario St. Chicago 11, Ill.

# CENSORED

Truth is censored in Soviet Satellite Europe. The Communists fear it . . . do everything to prevent it. But the truth is spreading—with the powerful aid of Radio Free Europe and Free Europe Press. Now they need your help. Send your Truth Dollars for their support to:

## CRUSADE FOR FREEDOM

c/o Your Local Postmaster

Published as a public service in cooperation with The Advertising Council

### TASOPE PHOTO-ENGRAVING PLANTS



Material Cost Of This Cut 3/4c Selling Price \$1.00 And Up

Establish your own profitable PHOTO-ENGRAVING business. Make cuts for newspapers, printers, and advertisers. Make etched name plates, plaques etc. Instructions furnished, no experience necessary. Sold direct from factory since 1931. First five hundred cuts sold locally or by mail will pay for plant and pay you well for your time. Write for FREE catalog.

TASOPE, DEPT. PM-5, AURORA, MO.

Also Eshelman Adult 2 Pass. **SPORT & GOLF Cars** 1/5 the Price of most other Cars. 70 Miles Per Gal. Free Catalog.

**ESHELMAN TRACTORS** LOW AS \$99

MAKES - FLOWS - DELIVERIES - SAYS  
DOES - HARROWS - SNOW - PLOW - HOLLS  
SPORTS - HORLS - MOWS - CUTS - TRAIL

Eshelman Tractors, Tillers, Riding Rotary Mowers for Better Lawns and Gardens. Advertised in GOOD HOUSEKEEPING. Thousands of Satisfied Users. Write for Free Literature. **ESHELMAN CO., Dept. R-55, 109 Light St., Balto. 2, Md.** 2 to 8 HP

Shipping Points: BALTIMORE - CHICAGO - RENO

**ENGINEERING DEGREE IN 27 MONTHS**

## INDIANA TECHNICAL COLLEGE

**SPARE-TIME MONEYMAKING OPPORTUNITIES**

**READ OUR CLASSIFIED ADS**

HUNDREDS OF BARGAINS

AMAZING OFFERS

### JITTERBUG • CATCHES MORE FISH

Noisy surface bait. World's best hooker — day or night. Gurgling, paddling action of the double-lobed lip makes fish strike hard. 5/8 oz. or 3/8 oz. or 1/4 oz. spinning size \$1.25. Musky size \$2.00.



FRED ARBOGAST CO. INC., 2245 W. North St., Akron 3, Ohio

**FREE** WRITE TODAY FOR YOUR BIG FREE ARBOGAST COLOR CATALOG — FULL OF PICTURES OF CATCHES

## FIXIT TIPS WITH "SCOTCH" COLORED PLASTIC TAPE



**MEND BROKEN TOYS** with bright strips of this tough, all-plastic tape. Stretches to fit curved surfaces, sticks smooth and tight as skin.



**IDENTIFY OVERSHOES**, rubbers, other look-alike items with a small strip of "SCOTCH" Brand Plastic Tape. Seven colors, two widths to choose from. Only 25¢ or 50¢ at stores everywhere. **MINNESOTA MINING & MFG. CO., ST. PAUL 6, MINN.**



## SALE

**15 X 65** Regularly \$59.50 Save \$10.00

Tremendous power. Brings objects 15 times closer! Wide field (65mm objective lens . . . almost 3" across!) Easy to hold—focus. 8 1/4" x 9". Exclusive with UNITED. Regularly \$59.50. **SALE PRICE \$49.50** FOR THIS SALE ONLY . . . including case, straps! Made in Japan. **USE 30 DAYS**, if not satisfied return for refund.

**UNITED BINOCULAR CO.**  
9043 S. Western, Dept. ARS-208, Chicago 20. DEALERS WANTED.



Reg. U. S. Pat. Off.



## BUILD 16 RADIO

CIRCUITS AT HOME WITH THE NEW DELUXE 1956 PROGRESSIVE RADIO "EDU-KIT"

A PRACTICAL HOME RADIO **\$19.95** COMPLETE COURSE. Only . . .

Learn practical electronics theory, construction, trouble-shooting. Build 16 Receiver, Transmitter, Signal Tracer, Code Oscillator, Signal Injector Circuits at home. Excellent background for TV. No knowledge of radio necessary. "Edu-Kit" includes all radio parts, punched metal chassis, Printed Circuit materials, instruction manuals, electric soldering iron, Tester, Tools, High Fidelity Guide, TV Book, Quizzes, Tester Instruction Manual, Consultation Service. 30 Day Money-Back Guarantee.

PROGRESSIVE "EDU-KITS" INC.  
497 UNION AVE., ROOM 545-B, BROOKLYN 11, N.Y.

MAIL COUPON OR POSTCARD

Rush me Free Descriptive Literature concerning "EDU-KIT." Also send me Free Radio-TV Servicing Literature. No obligation.

NAME \_\_\_\_\_  
ADDRESS \_\_\_\_\_  
CITY \_\_\_\_\_ ZONE \_\_\_\_\_ STATE \_\_\_\_\_

## FIX ANY AIR COOLED ENGINE!

### Repair Your Own Garden Tractor, Power Mower or Chain Saw

First and only do-it-yourself manual ever published covering air cooled engines. Enables you to make expert repairs, tune-up, overhaul or troubleshoot on 200 makes and models. Edited by engineers and professional mechanics.

Eliminates guesswork on any job on 2 or 4-cycle popular makes and models. Includes 1, 2 and 4 cylinder models in light weight and heavy duty types—1 to 35 H.P.

Contains 25,000 maintenance and repair procedures with easy-to-follow instructions plus time-saving short cuts used by top mechanics. Covers 200 models and 6,000 detailed specifications. Over 300 drawings and illustrations to guide you. Complete parts information on 1,700 items.

This book is daily used in thousands of garages, fix-it shops, garden and farm equipment stores. Now offered to you at low, introductory price of \$3.45. Send check or M.O. with order. If not satisfied, your money refunded. For quick delivery order today.

### SMALL ENGINES SERVICE MANUAL

600 Graphic Arts Bldg.

Kansas City 5, Mo.

# CHEMISTRY

### BIG LABORATORY GIVEN FREE!

Be a CHEMIST! One of the really GREAT professions! We teach you at home. Simplified (but thorough) course; no previous training required. Earn while you learn. This is a GOLDEN AGE for those with special knowledge! Diploma awarded! Send 25c for first lesson and KIT or \$1.00 for first 5 lessons and supplies including

URANIUM TESTER, CHEMICAL PUZZLE (worth \$2.50) and HOW TO MAKE 100 NEW CHEMICALS!

**FREE!**

### NATIONAL SCHOOL OF CHEMISTRY

P.O. BOX 606-A

REDWOOD CITY, CALIF.

**YOUR OWN BUSINESS with BIG EARNINGS in..**

**ELECTRIC APPLIANCE REPAIRING**

50,000,000 Families Are Your Prospects! Repair electrical appliances for friends and neighbors. Service electrical equipment in stores, etc. Earn up to \$5.00-\$8.00 an hour or more! New shop method home study training. Electronic Kit makes it now possible. Rush name for FREE Book, and Special PAY LATER form. **CHRISTY TRADES SCHOOL, 4804 N. Kedzie Ave., Dept. D-5403, Chicago 25.**

**SEND FOR FREE BOOK!**



**Instead of a job . . . train for a Career**



Industrial growth . . . automation . . . technical advances create career opportunities for engineers, accountants, management experts. Share rewards awaiting college-trained men. Important firms visit campus regularly to employ Tri-State College graduates. Start any quarter in this world-famed college. *Approved for veterans.*

### Bach. of Science degree in 27 months

In Mechanical, Civil, Electrical, Chemical, Aeronautical, Radio (TV-Electronics) Engineering. In 26 Months a B.S. in Business Administration (General Business, Accounting, Motor Transport Management majors). Capable students may accelerate. 36-weeks course in Drafting. *Intensive program: technical fundamentals stressed; comprehensive courses with more professional class hours. Small classes; personalized instruction. For earnest, mature students whose time and budget requires accelerated courses and modest costs. Preparatory courses. Beautiful campus in friendly college town. Well-equipped, new and modernized buildings and laboratories. Enter June, Sept., Jan., March. Write Jean McCarthy, Director of Admissions, for "Your Career in Engineering and Commerce."*



## TRI-STATE COLLEGE

456 College Avenue

Angola, Indiana

# OWN A... FORD?

## FIX IT YOURSELF!

Popular Mechanics Magazine has published an Owners Manual covering all 1941 to 1952 models of Ford cars . . . So accurate mechanics use it . . . so simple a woman can understand it.



Save money on your Ford car repairs. Prevent trouble. Enjoy care-free driving. Increase trade-in value. Avoid major repairs by fixing minor troubles before they get serious. Get sparkling performance at all times. Has 272 pages, more than 350 photos, diagrams, tables, charts, breakdown drawings, plus clear, non-technical directions that make all repairs simple as A B C. Written by Ed Packer with the assistance of the Ford Motor Company. Shows you how to diagnose all Ford troubles by feel, sound, sight, smell and performance. Simple trouble shooting. Permanent repairs. Emergency repairs. Plus, "How to get value from garages."

## MONEY BACK IF IT DOESN'T SAVE MORE THAN IT COSTS!

One minor repair will save the cost ten times over. Read it. Then you decide. If you don't see that you'll save more than the cost, send it back for refund. SEND NO MONEY. Send postcard. Ask for the Ford Manual. Postman will deliver C. O. D. for \$3.50 plus postage. Or, save postage by sending \$3.50 with order. Send today. Save its cost on your next repair.

### POPULAR MECHANICS PRESS

200 E. Ontario, Dept. 90, Chicago 11, Illinois

MAKE A "Stradivarius" VIOLIN

—For Pleasure  
—For Profit  
—For Your Own Use

BOOK AND PLANS ALL YOU NEED

You Can Do It at Little Cost!  
It's Easy! It's Fun!

Here is the "top" of all home crafts projects. Make a violin—a replica of a famous "Strad"—the original of which sold for \$80,000.00. Joe Reid who has made hundreds of fine violins makes the job so easy—so inexpensive—in his new book "You Can Make a 'Stradivarius' Violin." You don't need any tools. Reid shows you how to make all the tools you need from old table knives, worn out files, sheet metal, etc. Eight full-size plans, 16x23 inches, folded into the book give you every detail in actual size.

### Violins Bring High Prices

Make a violin and you probably will never want to sell it. But good tone modern violins bring terrific prices. Yet the materials cost comparatively little. With Reid's plans and step-by-step instructions you can make such a violin for yourself. 15 chapters guide you in selection of wood, fashioning the belly, back, sides, mold, lining, neck, scroll, purfling. Other chapters cover varnishing, finishing, stringing. Others show how to make tools and clamps at little or no cost.

### Order Book Today. Money Back if Not Satisfied.

Make your own violin for pleasure or profit. Get book and plans now. Clip this ad and mail with check, money order or cash for only \$2.50 or we will ship C.O.D. Money back in 7 days if not satisfied.

**FULL SCALE PLANS INCLUDED**  
Working plans, drawn to full scale, are included in a special pocket inside the book where they may be withdrawn for quick and easy reference.



Complete Instructions  
8 Actual Size Plans  
How to Make the Tools You Need  
Where to Get the Materials

You trace or work direct from actual size plans. No measurements to translate or confuse you. You see the entire violin in the plans. You read the how-to-do-it instructions in the book.

\$3.50 Cloth Bound

### POPULAR MECHANICS PRESS

Dept. 30  
200 E. Ontario St., Chicago



# Log Cabins,

Homes, Clubs, Lodges, Shops,  
Restaurants, Motels, etc.

85% pre-cut and/or pre-fab, your plans—or ours—light, summer, vertical—or heavy, year 'round, log-on-log and vertical (patented) easily, quickly erected—low cost—extremely low maintenance. NO studs, rafters, plaster, paint, wallpaper, insulation or bearing partitions required. Log walls of genuine Michigan White Cedar, lightest and most unique wood in N. America . . . "rough, rugged and rustic"—or "streamlined," with beveled, paneled plank partitions. Definitely different, durable and distinctive!

Individual and Dealer inquiries invited.  
Phone - WASHINGTON 7473

"The Log Cabin Man"

120 PM Delaware Ave. Buffalo 2, N. Y.

## NEW BENJAMIN SUPER CO<sub>2</sub> GAS CARBINE - \$16.50

HI-LO (2 Stage) Jet Power  
Cal. .177 or .22

RIFLED  
Shoots  
Pellets  
& Darts



New Benjamin .177 or  
.22 CO<sub>2</sub> ROCKET Gas  
Pistol with HI-LO JET  
POWER..... \$15.00

IDEAL FOR  
TARGET & SMALL GAME  
SAFE - ECONOMICAL - ACCURATE  
CONVENIENT - PRACTICAL - NON TOXIC  
EASY TO OPERATE - NO PUMPING - NO FLINCHING.  
Get 40 SHOTS from each 10¢ STANDARD SIZE CO<sub>2</sub>  
(Soda) CARTRIDGE. Up to 3/4" penetration.  
Ask your DEALER for DEMONSTRATION.  
BENJAMIN AIR RIFLE CO.  
896 MARION ST., ST. LOUIS 4, MO., U.S.A.

FREE  
Folder

## OWN a Business

If employed, start part time. Alert dealers can gross \$5 hourly profit on own service plus \$3 on EACH serviceman. Clean, revive, moth-proof rugs & upholstery on location. No shop needed. Services nationally advertised. Repeat customers. Easy to learn. We locally train and assist you. Quickly established. Easy terms. Send today for FREE booklet. No obligation.

**DURACLEAN CO., 6-185 Duraclean Bldg., Deerfield, Ill.**

## Make your own Gems 29<sup>50</sup> F.O.B.

The Gem Maker comes complete with all necessary equipment, including a super-charged diamond blade for sawing, and all wheels for grinding, shaping and polishing; also complete instructions. The complete equipment as shown, less motor and belt, for only \$29.50, f.o.b., Burlington, Wisconsin. Write today for information and literature.

**B & I MANUFACTURING CO.**  
Dept. S Burlington, Wis.

## What Every Farmer Should Know About Taking Care of Farm Animals

The Most Popular Veterinary Guide Ever Printed

This practical and helpful VETERINARY GUIDE FOR FARMERS prepares the farmer to perform many routine veterinary tasks—provides quick information that can often save the life of an animal—prevents disease in herds—saves money on the farm in a hundred different ways.

Written in plain understandable language. It covers symptoms, causes of disease and prevention, and treatment of cattle, swine, sheep, horses and poultry and warns when to call in the professional veterinarian. Names, terms and phrases made clear in a separate section. Over 100,000 copies of this book are in use on American farms. 275 pages. Fully illustrated. Only \$3.95. Order today under money-back guarantee.

**POPULAR MECHANICS PRESS, Dept. PM13**  
200 E. Ontario St. Chicago 11, Ill.

## FOR EVERY BOAT OWNER

**FREE SAMPLE**  
OF UNBELIEVABLE  
*Brolite*  
**Z-SPAR**  
World's finest Marine Enamel

QUALITIES OF LIQUID PORCELAIN  
DRIES GLASS-SMOOTH  
WON'T CHECK OR CHALK

Test Z-Spar Enamel on your own boat. Apply this sample where you can watch it. There is no enamel as fine, as durable, as Z-Spar. After you've tried it, buy it from any marine paint dealer. Brolite Z-Spar is the Salt Water Sailor's favorite enamel. 21 colors, black & white.



### FREE SAMPLE MAIL COUPON

ANDREW BROWN COMPANY, 5431P So. District Blvd., Los Angeles, Calif.

I am a boat-owner.  I am a marine dealer.  
Send me a FREE sample of Brolite Z-Spar Gloss White Enamel. Also send one to my marine dealer.

Name \_\_\_\_\_

Address \_\_\_\_\_

City \_\_\_\_\_ State \_\_\_\_\_

Type of boat \_\_\_\_\_

My Marine Paint Dealer is: \_\_\_\_\_

(No street address necessary)

## RADIO CONTROL YOUR MODEL

"CUSTOM MIDGET" RADIO \$9.98 LICENSE FREE BAND OPERATES SAME AS \$50.00 SETS. INCLUDES LONG RANGE TRANSMITTER RADIO, RECEIVER RADIO AND CONTROL ACTUATOR ALL 3 EASY ASSEMBLY WITH OUR PARTS AND PLANS \$9.95. PLANS ALONE \$1.	PLANE BOATS CARS DETAILED INFORMATION & RADIO CATALOGUE 25c SPECIAL "SUPPLY SOURCE DIRECTORY" & \$7.00 SUPPLY COUPON... \$1.00 BOOK "RADIO CONTROL OF MODEL AIRCRAFT" CONTAINS 14 PLANS \$3.98 RADIO CONTROL GARAGE DOOR DETAILS..... \$1.00
--	--

RADIOMODELS BOX 36 DEPT. PM BALTIMORE 6, MARYLAND

## NEW and BETTER DOCK BRACKET

Here is the ideal means of mounting and unmounting wooden dock sections in any desired style of dock—I, H, L, or T. Employs V-block principle which provides more rigid fastening than ordinary set screw and allows use of any pipe at hand, varying in size from 1 1/4" to 2", as legs. Easily and permanently fastened to dock sections and adjusted for height. Cast of corrosion resistant aluminum alloy—very strong. Furnished complete in sets of 2 with lag and U-bolts. Only \$5.10 per pair. See your Michigan dealer or order direct—C.O.D. if you wish. MICHIGAN WHEEL COMPANY, Dept. P5B, Grand Rapids 3, Mich.

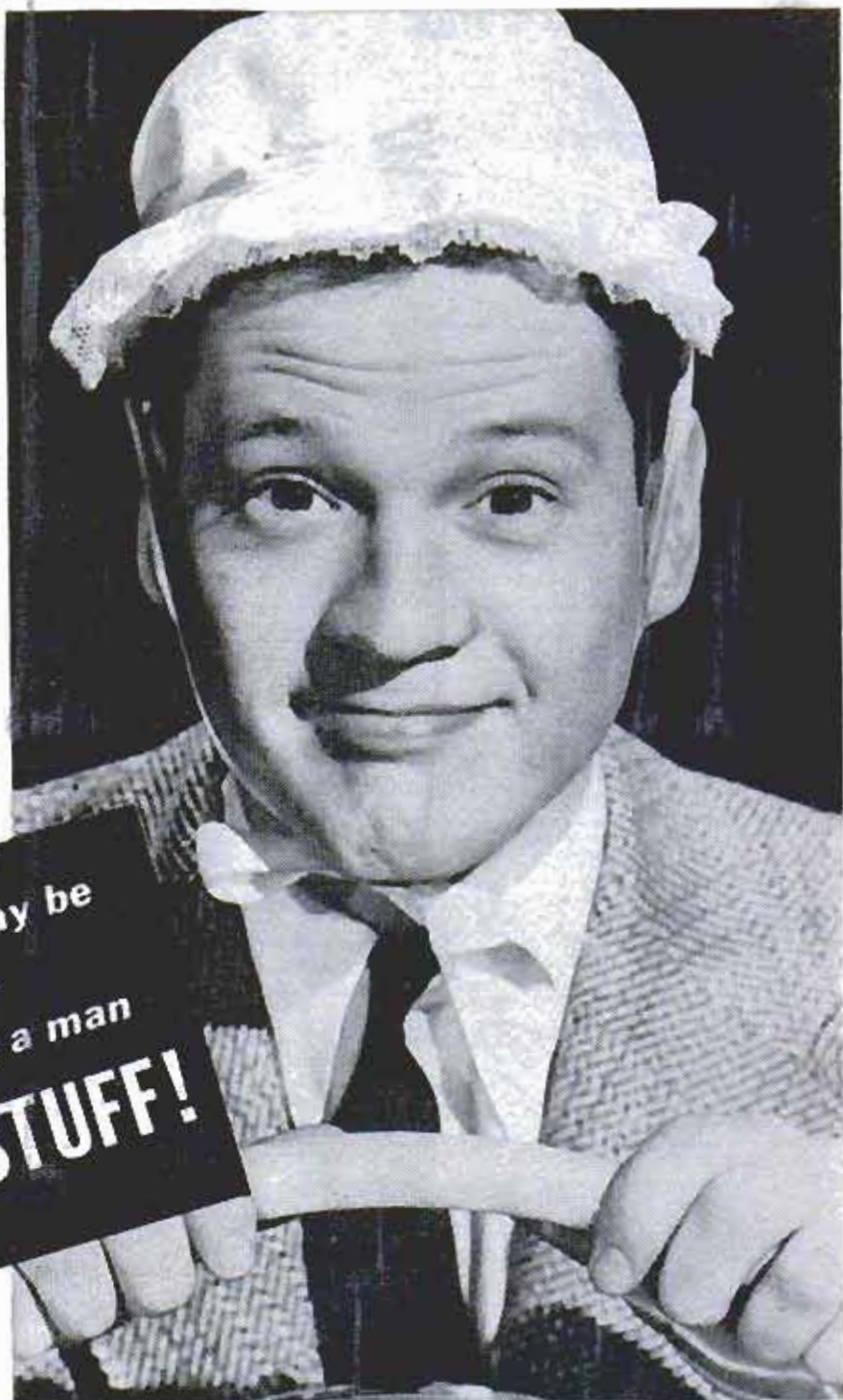

Taking chances may be  
part of growing up—  
But when you're a man  
**IT'S KID STUFF!**

This fellow takes chances. He's a crazy driver.

Why? For attention! So—people will know he's around. He thinks it makes him stand out. Same as when he was a kid.

If he only knew!

His friends have him pegged—"strictly juvenile." They have an expression—"Careless driving is kid stuff." That's him.

If he only knew. He'd wise up and drive right.



An official public service message prepared by  
The Advertising Council in cooperation with the  
National Safety Council



# SAVE 1/2!

## AUTOMATIC HEADLIGHT DIMMER

A well rated electronic manufacturer is offering a limited quantity of NEW automatic headlight dimmer at a special introductory price of \$27.95, postpaid.

**HIGHWAY DEPARTMENT APPROVED, FULLY GUARANTEED.**

Complete operating and easy installation instructions furnished. State make, year and model of car; 6 or 12-volt. Rush check or money order for \$27.95 today to:

21 N. 3rd St., Minneapolis 1, Minn.

**DYNAMU MAGNETRONICS CORPORATION**

## THE EASY WAY TO MARK METAL

Just lift the cap on Magic Marker

to mark, color! Make patterns, decorate models, mark metalwork, identify tools. Amazing color brilliant, clear solid lines, any width. On paper, wood, glass, metal, plastic, leather, painted surfaces.

At Stationary, Hardware and Art stores  
**SPEEDRY PRODUCTS, Inc.**  
Dept. A-5, Richmond Hill 18, N.Y.

**69¢ 3 for \$2**  
Slightly Higher West Coast



MARCO 14  
\$189.50 Delivered

WRITE FOR FREE FOLDER

or send \$4 for complete catalog.  
ACCESSORIES • FIBERGLAS  
**Marine ASSOCIATES**  
BOX 8188W LONG BEACH 11, CALIF.

**Marine KIT BOATS • DO IT YOURSELF • SAVE 50%**

- Factory To You, No Dealers
- Mahogany Decks and Framework
- All Brass Fastenings
- Deluxe 14' Boats, \$159.50 Freight Incl.

## MEN WANTED

Earn \$100 Per Week and up  
**AUTO DIESEL MECHANICS**

Master a trade with a future—learn Auto-Diesel mechanics in our shops. You learn with tools on real equipment. Earn while you learn. Many of our graduates earn \$100 per week and up. No previous experience necessary. Day and night courses. Approved for veterans. Write for free bulletin.

**NASHVILLE AUTO-DIESEL COLLEGE**

226 7th Ave., N., Dept. 75

Nashville 3, Tenn.

**SAY YOU SAW IT IN POPULAR MECHANICS**

**CLEAR \$700 AND MORE AN HOUR**

Finish famous Karle-Kraft Metalware in spare time, using revolutionary spinning machine designed for home use. We supply pre-formed food mixers, giftwares, planters, many more fast-selling items of distinctive design—you give them a fine custom look. Protective franchise helps you get quick return of original investment—steady profits thereafter. Learn about Karle-Kraft's unusual Profit Plan now! Write today for free particulars to Dept. B

**KARLE-KRAFT HOME SHOPS CO.**  
1 Cedar Blvd., Pittsburgh 28, Pa.

## Superior's New Streamlined Model TC-55 TUBE TESTER



QUICKLY AND EFFICIENTLY TESTS RADIO AND TV TUBES INCLUDING: SEVEN PIN MINIATURES; EIGHT PIN SUBMINARS, OCTALS AND LOCTALS; NINE PIN NOVALS

**YOU CAN'T INSERT A TUBE IN THE WRONG SOCKET.**

It is impossible to insert the tube in the wrong socket when using the new Model TC-55. Separate sockets are used, one for each type of tube base. If the tube fits in the socket it can be tested.

**"FREE-POINT" ELEMENT SWITCHING SYSTEM.**

The Model TC-55 incorporates a newly designed element selector switch system which reduces the possibility of obsolescence to an

absolute minimum. Any pin may be used as a filament pin and the voltage applied between that pin and any other pin, or even the "top-cap."

**CHECKS FOR SHORTS AND LEAKAGES BETWEEN ALL ELEMENTS.** The Model TC-55 provides a super sensitive method of checking for shorts and leakages up to 5 Megohms between any and all of the terminals.

**ELEMENTAL SWITCHES ARE NUMBERED IN STRICT ACCORDANCE WITH R.M.A. SPECIFICATION.**

One of the most important improvements, we believe, is the fact that the 4 position fast-action snap switches are all numbered in exact accordance with the standard R.M.A. numbering system.

Thus, if the element terminating in pin No. 7 of a tube is under test, button No. 7 is used for that test.

The Model TC-55 comes complete with operating instructions and charts. Use it on the bench—use it for field calls. A streamlined carrying case, included at no extra charge, accommodates the tester and book of instructions.

**26<sup>95</sup>**

**SHIPPED ON APPROVAL NO MONEY WITH ORDER — NO C.O.D.**

© M. STEIR

Try it for 10 days before you buy. If completely satisfied then send \$6.95 and pay balance at rate of \$5.00 per month—for 6 months—No Interest or Finance Charges Added. If not completely satisfied, return to us, no explanation necessary.

**MOSS ELECTRONIC DIST. CO., INC.**  
Dept. D-233, 3849 Tenth Ave., N.Y. 34, N.Y.

Please rush 1 Model TC-55. I agree to pay \$6.95 within 10 days after receipt and \$5.00 per month thereafter.

Name .....  
Address .....  
City ..... State .....

## Say You Saw It in Popular Mechanics

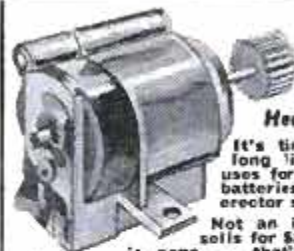

**Attention Hobbyists**  
World's Great TINY MOTOR Value  
New **MIGHTY MOTOR**  
Heavy Duty

It's tiny—but powerful. Weighs 2 oz. This long life MIGHTY MOTOR has hundreds of uses for hobbyists. Runs on 1 or 2 flashlight batteries. Fine for toy motor boats, airplanes, Erector sets, Bar-B-Q Spitters, Elect. items, etc.

Not an import. American made. Motor alone sells for \$2.50 everywhere. When limited supply is gone... that's all. Motor, plus gear, reduction gear with shaft, battery holders and reversible switch. A \$3.65 value, sent postpaid for only... **\$1.00**

(6 COMPLETE SETS FOR ONLY \$5.00)

SEND CASH, CHK. OR M.O. ... NO C.O.D.'S Satisfaction Guaranteed  
**GENERAL TOOL CO.** DEPT. M, 1439 GRAND AVE.  
KANSAS CITY 6, MO.



**START AS HIGH AS \$4,525.00 YEAR**

Prepare NOW for next exams

**MEN—WOMEN** FRANKLIN INSTITUTE, Dept. R-93, Rochester 4, N.Y.  
Many appointments being made. 36-page book with partial list of U.S. Government Jobs made. 36-page book FREE. (2) Tell me how to qualify for tests.  
Name.....  
Mail Coupon Today. SURE. Address.....

**MAKE UP TO \$1,500<sup>00</sup> AND MORE IN A MONTH!**

**WITH NEW SENSATIONAL MOTOR OVERHAUL**

*Needed by 60,000,000 Cars and Trucks, Just*

*add to the oil... Drive at once... and it can*

**INCREASE COMPRESSION UP TO 58%\***

**INCREASE GAS MILEAGE UP TO 54%\***

**INCREASE OIL-SAVING EFFICIENCY UP TO 900%\***

**EXTEND ANY ENGINE'S LIFE FOR YEARS!\***



**\*CERTIFIED BY INDEPENDENT TESTING LABORATORY!**

**TESTED AND CERTIFIED**  
AMERICAN SCHOOL  
AND TESTING LAB  
CHICAGO

I'll prove you can make up to \$1,500.00 in a month with fabulous new Motor Overhaul. Motorists, truck fleet operators, taxi companies, police and fire depts., big-quantity buyers "snap them up"—8 to 12 dozen cans

at a time for \$2.98 each—when you show them sensational Independent Laboratory Test Report which certifies increase of 58.26% in motor compression, 54.12% in gas mileage, 900% in oil-saving efficiency—more pep, more power, extends engine life for years, even oldest motors! You make up to 148% profit on every can—big earnings, full time or spare time, and TREMENDOUS REPEAT BUSINESS, because Motor Overhaul is added at every oil change!

**FREE! BIG-PROFIT ILLUSTRATED SALES KIT and AMAZING CERTIFIED LABORATORY REPORT**

Rush name, address TODAY for complete money-making Illustrated Sales Kit, customer Circulars, big-profit plans and actual copy of Independent Laboratory Report—sent FREE, no obligation! If you wish a full-size \$2.98 sample can of Motor Overhaul to try in your own car, enclose check or money order for only \$2.00. We ship postpaid. Money back guarantee. Write NOW!

**POPE CHEMICAL CO. 224 W. HURON ST., DEPT. E-3, CHICAGO 10, ILL.**

**AGENTS!**

**AMAZING POCKET DEVICE CAN DOUBLE YOUR PROFITS**

*...with no EXTRA calls!*

Here is a proven seller you can carry in your pocket and demonstrate on your regular calls... increase your volume and profits! Needed by stores, banks, homes, auto owners everywhere. Your investment is less than \$5.00. Learn more about this proven selling success. You'll find unbelievable profits in our complete line. 38 years of product leadership... Write for details today!



HAGEN SUPPLY CORP., Dept. PMS, St. Paul 4, Minn.

**Say You Saw It in Popular Mechanics**

**High School at Home**

**MANY FINISH IN 2 YEARS**

No classes. No time wasted going to and from school. Progress as fast as your time and abilities permit. Standard H. S. texts supplied. Thousands enroll each year in this 59-year-old school. Send for FREE descriptive booklet.

**AMERICAN SCHOOL, Dept. H545  
Drexel at 58th St., Chicago 37, Ill.**

Without obligation, please send FREE descriptive booklet.

Name.....

Address.....

Complete Canadian Courses available. Write American School, Dept. H545, 1610 Sherbrooke St. W., Montreal



**Shampoo Bowl**

Soap in your eye doesn't have to be part of a shampoo, according to an enterprising French woman. She's invented a soft-rubber headgear designed to end such unpleasantness. The snug-fitting device keeps water and suds from seeping down over your face. An overflow pipe carries away waste and rinse water.

**Synchroflash Tester**

Amateurs can now test camera-shutter synchronization, flash circuits, flash lamps and batteries with a simple, compact unit. Usually such work must be done in a camera shop. Simplified instructions are given on the front plate attached permanently to the tester, which measures only two by three by four inches.



## SHEET METAL BRAKES

Forms angles, locks, pans, etc. New eccentric clamps. All steel construction. Size 15" — 16 gauge steel, \$23.50; 36" — 22 ga. \$35.50; 48" — 24 ga. \$52.00. Stand \$8.00.

16 ga. Metal Bender 40" size, \$42.00  
1/4" x 12" Angle Former \$15.50  
14 ga. 6" Compound lever shear \$29.00

SEND FOR FREE CATALOG

VYKE MFG. CO., 4158-P Jason St., Denver 11, Colo.



HOME CRAFTSMEN! HOBBYISTS! INVENTORS!



SAVE \$100 ORDER DIRECT

Easily converts from

- 1—LATHE into
- 2—Drill Press
- 3—Hand Drill
- 4—Polishing or Grinding
- 5—Tool Grinding

UNIMAT 10 in 1 COMPLETE HOME POWER WORKSHOP

Save by eliminating all middleman profit! Send for FREE illustrated literature and reduced price list. These terrific savings are offered for a limited time only—Act now! Write for complete information to Dept. PM-5, American Edelmetal (Amsterdam) Inc., 350 Broadway, New York City 13, N.Y.

## WHEELS WHEELS WHEELS

7" Disc Wheel 3/4" Tire 3/4" sleeve	45c ea.
8" Disc Wheel 1 1/4" Tire 1 1/4" sleeve	70c ea.
7" Disc Wheel 1" Tire 1/2" ball bearing	80c ea.
8" Disc Wheel 1 1/4" Tire 1/2" ball bearing	\$1.00 ea.
6" Disc Wheel 1.50 semi-pneum. Tire 1/2" B.B.	\$1.35 ea.
8" Disc Wheel 2" semi-pneum. T. 1/2" B.B.	\$1.50 ea.
10" Disc Wheel 1.75 semi-pneum. T. 1/2" B.B.	\$1.50 ea.
10" Disc Wheel 2.75 semi-pneum. Tire 5/8" B.B.	\$3.50 ea.
12" Disc Wheel 1.75 semi-pneum. T. 1/2" B.B.	\$1.85 ea.

Above wheel prices includes hub cap. Plus Postage. C.O.D.'s accepted. AXLES—Sizes 5/16 in., 3/8 in., 1/2 in.—Cut to size—End holes drilled.

UNITED WHEEL STAMPING CO.

12131 S. PEORIA STREET PM-5 CHICAGO 43, ILLINOIS



## ELECTRIFY YOUR SEWING MACHINE!

Buy direct and save! Kit comes fully wired, installed in a jiffy. Fits all machines. ALL-NEW PARTS!  
• AC-DC Motor & bracket • Multi-speed foot control • Cord set & block • 115 v 60 c • Full instructions • Steel pulley & belt  
BONUS: 10 day free trial. Reg. \$2.95 Sewlite given FREE with kit. Reg. \$7.95 pinking shears only \$1 with order. Send no money. Kit sent C.O.D. Or send money order and we'll pay postage. State whether wheel on your machine turns towards or away from you. Shipping wt. 6 lbs.

SENIOR SEWING MACHINE CO., Box 142, Dept. PM07, Bklyn 6, N. Y.



## Make Your Own TV REPAIRS!

This Book Can Save You \$50 - \$100 Per Year

Amazing New T.V. GUIDE with "Magic Memory" will positively repair your set 95% of the time. Patented method automatically tells you tube or part causing trouble. Tells how to fix in a jiffy! Works like magic. Revolutionary New "Attic-Master" Antenna included FREE. Outperforms all other antennas—gives you unbelievable MOVIE-SHARP reception. Install in minutes! Guaranteed money-back if not worth 10 times the price. Both only \$2.95 postpaid. SUPPLY LIMITED. Write T.Y. ENGINEERING CO., Dept. PMS 1036 S. La Brea, Los Angeles 19, Calif.

## GET THE HABIT OF READING OUR CLASSIFIED ADS.

Wonderful Opportunities Amazing Bargains

## Build Your Own Professional Instruments — Save 50%



World's largest manufacturer of Kits & Instruments  
Vacuum Tube Voltmeter  
KIT \$25.95 Easy Instructions  
Factory Wired \$39.95 46 models to choose from  
Write for FREE new 1956 Catalog PM-5  
Electronic Instrument Co., Inc. 84 Withers St., B'klyn 11, N. Y.

## HIGH WAGES!

Are being paid to Operators of Bulldozers, Draglines, Back Hoes, Earthmovers and Motor Graders. Contractors want our graduates. Learn these skills NOW

National School of Heavy Equipment Operation  
P.O. Box 8243-D-7, Charlotte, N. C.  
Please send me your School Catalog FREE  
Name \_\_\_\_\_  
Street Address \_\_\_\_\_  
City \_\_\_\_\_ State \_\_\_\_\_

## AMERICA'S FAVORITE Preferred at famous Fishing Spots AUTOMATIC REEL



## New improved model HICO-MATIC

No. 9 \$8.50

A new model in H-I's world-famous line of automatic fly reels—especially designed and balanced for glass fly rods. Light weight—rigid aluminum construction... free-stripping... silent wind... right or left hand operation... striking anodized finish... all parts chromium plated. The finest "auto" reel you can buy. Also Utica Automatic No. 7 (upright) \$8.00 and No. 5 (standard) \$7.00.

Look for H-I

on the tackle you buy  
Rods, Reels, Lines, Lures,  
for every fisherman and  
every kind of fishing



Valuable Fishing Guide. Send 25¢ to  
HORROCKS-IBBOTSON CO. Dept. PM-526, UTICA, N. Y.  
Manufacturer of the largest line of fishing tackle in the world

## Popular Mechanics Book for Pleasure or Profit 23 BOATS You Can Build

Build the boat you have always wanted. Build it for fun or to sell at a profit. Get Popular Mechanics 23 BOATS YOU CAN BUILD — row boats, canoes, sail boats, power boats and other craft including a 25 foot cabin cruiser. Book includes more than 500 photos, plans, diagrams and working drawings, plus step by step instruction that anyone can follow. Only simple tools needed. Material list of lumber, hardware, fittings, etc., included. Order today under money-back guarantee. Only \$2.00 postpaid.  
POPULAR MECHANICS PRESS, Dept. PM3, 200 E. Ontario St., Chicago 11



## THE ORIGINAL CARVER LAMINATING PRESS

Now, do your own plastic laminating: identification and membership cards; badges; photos; clippings; documents; nameplates; charts; diagrams; religious pieces, etc. Moisture-proof, tamper-proof, long-wearing protection. Exclusive, patented 2-opening design for fast, simultaneous heating and cooling; accurate, adjustable, time, temperature and pressure controls. Uses regular electric outlet. NOT A TOY — but easily operated, commercially proven — same as used by U.S. Army, Navy, Air Force, Coast Guard, Dept. of Justice, State Dept., industrial firms and institutions. Laminates over 1200 wallet size pieces a day! 2 sizes up to 9" x 12". Send for facts.

FRED S. CARVER INC.  
HYDRAULIC EQUIPMENT  
SUMMIT, NEW JERSEY

**Finest you can buy!**

# WISS

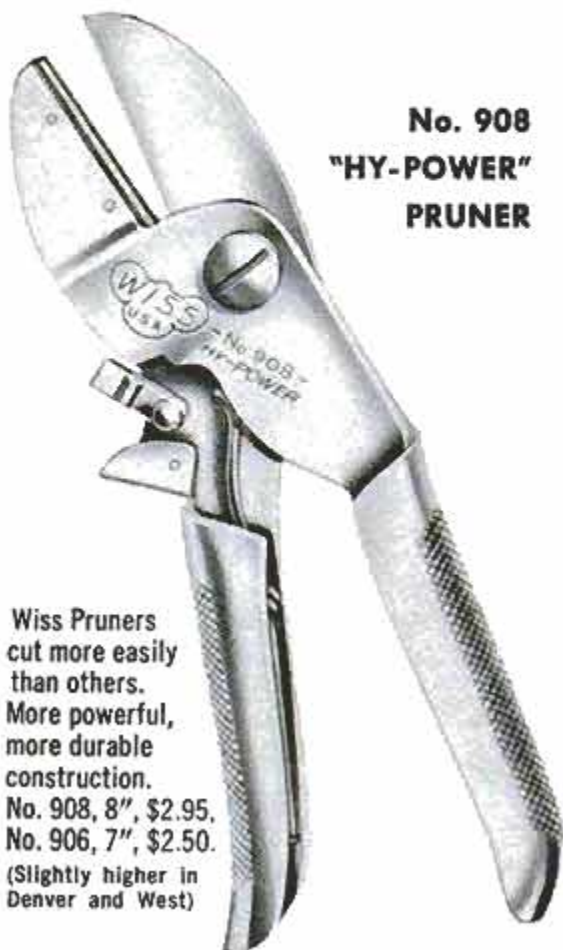

**No. 908  
"HY-POWER"  
PRUNER**

Wiss Pruners cut more easily than others. More powerful, more durable construction. No. 908, 8", \$2.95. No. 906, 7", \$2.50. (Slightly higher in Denver and West)

**J. WISS & SONS CO.,  
Newark 7, N. J.**

**\$200 WEEKLY and MORE from  
YOUR OWN BUSINESS!**

**BE YOUR OWN BOSS!  
● OPERATE AN AUTHORIZED  
STRIPWASH  
SERVICE STATION**

America's newest development in Paint Chemistry. You remove all kinds of paint from cars, trucks, small and heavy equipment, etc.—with a water hose, right in your own shop or garage. **NO SCRAPING. NO SANDING—Just wash the old paint off with water.** A gold mine for those getting in on the ground floor. Easy to learn. Profits year after year. No slack seasons. Start full or part time.

**FREE** If you are under 45, reliable, tired of your job and want to increase your income **QUICKLY—WRITE OR WIRE for our FREE packet of valuable information.** Explains everything. No obligation whatsoever.

Small initial investment covers all materials, supplies, training, and operational aids. **TERRITORIES AVAILABLE.**

**STRIPWASH CORPORATION  
FEDERAL TRUST BLDG., DEPT. A, NEWARK 2, N. J.**

FIRST INQUIRIES WILL BE GIVEN PREFERENCE!



### Small-Parts Painter

Small parts are painted 10 times faster with an experimental rig. As the parts are tumbled inside a rotating can, paint and air are introduced at six-second intervals through a small hole in the side of the can. Air permits the paint to dry sufficiently to prevent surface damage. The unit consists of a 10-gallon paint can, baffle and detachable screen. The tumbling unit is mounted on a horizontal fixture to rotate at 100 revolutions per minute. Including the loading and unloading, it takes only two minutes to paint a canful of small parts—a saving of 18 minutes over previous methods requiring laborious laying out of the parts.

### Refrigerant Gas Used as Lubricant in Lab Tests

Tests are now being carried on to find out whether or not Freons, the gases used in refrigerators, might not be used as lubricants in machinery running at temperatures too high to tolerate normal lubricating oils. The tests, conducted at the Lewis Flight Laboratory of the National Advisory Committee for Aeronautics in Cleveland, indicate that when Freon comes in contact with certain metals, a slippery film is formed. Tool steels have given good performance when used with the gaseous lubricants, while stainless steel and parts plated with silver were damaged by the lubricant.

☐ A new type of dry-process enlarging printer, capable of reproducing 15 standard-size engineering drawings a minute from microfilm originals, has been developed by the Radio Corporation of America.

## SLIGHTLY BLEMISHED CASES

MESSAGE TO POPULAR MECHANIC'S READERS. For a long time we have been one of the country's largest importers of quality optical goods. You may have seen our research and school microscopes advertisements in many of the other men's magazines over the past several years. We have always carried a complete line of binoculars as well. Our last inventory revealed quite a quantity of binoculars whose cases have a slight blemish, flaw, or discoloration which prevents them from being sold at regular retail prices. The cases are genuine pigskin (2 pigskin carrying straps included as usual). We guarantee that all binoculars are NEW, PERFECT in every re-

spect, optically, mechanically and in every detail. RINGULARS are wide field, full size, calibrated for individual focus and interpupillary adjustment. They are made in Japan. Both objective and ocular lenses are fully coated. Prisms are top quality color corrected.

**TO ORDER:** Send check, cash or m.o. For C.O.D. send \$5 for each pair. Binoculars shipped complete with cases and straps. Well packed and insured. RETURN WITHIN 10 DAYS FOR FULL REFUND IF NOT COMPLETELY SATISFIED. Calif. resid. add 3% state tax.

## SIX MODELS ON SPECIAL

6 x 30

The standard 6 Power (67 on hand). Reg. retail price—\$30.00. SPECIAL PRICE—\$15.99 Plus 10% Fed. Tax.

8 x 30

A favorite plains glass, 8 Power. (32 on hand.) Reg. retail price—\$35.00. SPECIAL PRICE—\$16.84 Plus 10% Fed. Tax.

12 x 50

12 Power. The most powerful in standard length (30 on hand). Reg. retail price—\$60.00. SPECIAL PRICE—\$23.48 Plus 10% Fed. Tax.

8 x 40

A special wider angle model, Bausch & Lomb style. Reg. retail price—\$69.50. SPECIAL PRICE—\$26.90 Plus 10% Fed. Tax.

7 x 35

7 Power Bausch & Lomb style. The special wide field design always scarce (34 on hand). Reg. retail price—\$49.95. SPECIAL PRICE—\$22.46 Plus 10% Fed. Tax.



7 x 50 \$19.72

7 Power large objective. The most popular American binocular (87 on hand). Reg. retail price—\$40.00. SPECIAL PRICE—\$19.72 Plus 10% Fed. Tax.



## 151 POWER SPACE SCOPE \$89.50 ppd. Complete with hardwood case

SO POWERFUL . . . YOU MUST SWEEP IT ACROSS THE MOON TO SEE ALL ITS MOUNTAINS, CRATERS AND DESERTS. The greatest value in astronomical telescopes ever. Will show you the moons of Jupiter, the rings of Saturn, with brilliance and pinpoint clarity. It is massive, stable and big, about 7 ft. high when fully extended. Has both universal micro and free-swinging adjustments. May be locked at any exact position. 6X searching scope with crosshairs, both straight through viewing and prismatic attachment. Achromatic lenses included: 151X, 73X, 35X, 28X, integral sun filter. Objective lens: 60MM. Shipped carefully packed, padded, insured in hardwood cabinet. If made in this country this instrument would have to be sold for about \$500. The Space Scope is a product of the very fine optical industry which has developed in Japan as a result of German assistance during WW II. We are the designers and direct importers, offering the Space Scope direct from factory to you.

**TO ORDER:** Send check or money order. \$20 deposit on C.O.D. As usual, our 10-day money-back guarantee applies. Calif. resid. add 3% state tax.

WHEN IN LOS ANGELES VISIT THE TWO UNUSUAL AKRON DEPT. STORES THE AKRON, 4413 Sunset Blvd., Los Angeles 27, Calif.

## BOAT PLANS-PATTERNS INBOARDS and OUTBOARDS especially for the amateur builder

SEND 40c FOR Our New Complete CATALOG



marine GLEN designs Box 568T Compton, Calif.

## SUPREME Versamatic REVERSIBLE SCREW DRIVER AND SPEED REDUCER



fits all power drills

## First time ever! It REVERSES!



Drive and remove screws with Supreme Versamatic. Versamatic reduces speed 7 to 1, increases power 7-fold. Reverses with one twist. Handles even the largest screws with ease. Also for nut running (adapter furnished); tapping; and all heavy duty drilling where speed reduction is needed. Fingertip control means safe, fast work. Complete set \$14.95.

(1/2" chuck extra). At better hardware stores.

SUPREME PRODUCTS, Inc., 2222 S. Calumet, Chicago 16

## TELEVISION NEEDS TRAINED MEN

Train AT HOME for a top-pay job or your own business. No experience needed. "Learn by doing" with 15 big radio-TV kits, including TV receiver. Licensed by N.Y. State; Approved for Veterans. Write for FREE BOOK & SAMPLE LESSON. RADIO-TELEVISION TRAINING ASSOCIATION, Dept. M5C, 52 E. 19th St., N. Y. 3, N. Y.

## Need Water? Get it for less

WITH A General Motors DELCO Wellmaster Jr. Water Pump

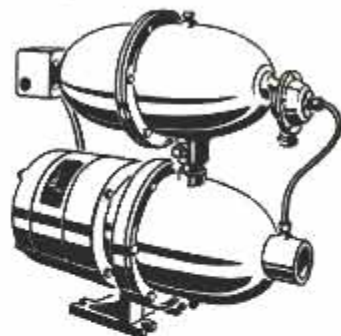

ONLY \$89.95 I.s.b. Rochester, N.Y.

Suggested List Price Model S33T2 as illustrated

Only one moving part in this new Delco Wellmaster Jr. permits simple, compact design, new durability! Self-adjusting capacity, 2-gallon galvanized tank. Unmatched for quality and low price in the 1/3 H.P. class! Other models from 1/4 to 1 H.P. available for shallow- and deep-well operation where water conditions vary. Built and backed by General Motors . . . your assurance of years of trouble-free service.

**FREE!** Water Systems Demonstration and Survey of Your Problem

Write Today! DELCO APPLIANCE DIVISION  
GENERAL MOTORS CORPORATION  
Dept. PM, Rochester 1, N. Y.

## TRAIN AT HOME FOR BIG PAY IN AUTO MECHANICS

You can make up to \$125 a week and more—or open your own shop—as an auto mechanic. 50,000 more trained men needed at once to service 50 million vehicles. You learn at home in spare time thru easy CTI Shop-Method plan. You get extra training in Diesel or Body-Fender Repair if desired. Mail coupon for 2 FREE books on job facts!



**MAKE TO \$5 AN HOUR AS YOU TRAIN** Earn up to \$5 an hour while learning. Many pay for course this way.



### TUNE-UP KIT & TOOLS SENT

Only CTI sends you a valuable Tune-Up Kit. You also get professional tools. These help you start earning soon after you enroll. Mail coupon today!



### MAIL TODAY - 2 FREE BOOKS

COMMERCIAL TRADES INSTITUTE Dept. A-301  
1400 Greenleaf Ave., Chicago 26, Ill.  
Send me your new, FREE BOOKS which show me how I can train at home to make big money in the auto field.

Name \_\_\_\_\_ Age \_\_\_\_\_  
Address \_\_\_\_\_  
City \_\_\_\_\_ Zone \_\_\_\_\_ State \_\_\_\_\_  
Member: National Home Study Council



## Make her happy — INSTALL BEAUTIFUL JALOUSIES

Add an extra room with jalousie windows installed in porch or breezeway. Win-Dor jalousies fit any opening, are easily screwed in place. Requires no special tools. Any homeowner can do it. Win-Dor jalousie hardware package includes complete instructions for making your own jalousie windows and doors, all hardware needed including screws. Satisfaction guaranteed.

Please send me information on how to order Win-Dor jalousie hardware by mail.

NAME \_\_\_\_\_  
ADDRESS \_\_\_\_\_  
CITY \_\_\_\_\_ ZONE \_\_\_\_\_ STATE \_\_\_\_\_

**CASEMENT HARDWARE COMPANY**  
612 N. Michigan Ave. • Chicago 11, Ill.



## Foolish To Pay More—Dangerous To Pay Less!

Entire stock of our family-safe Top Grade, 40,000 mile Passenger Tires, (worn very slightly) at PRICES LISTED BELOW! It's cheaper than offers of \$1 off or "Free Tire Offers" on ordinary used tires. "The Blatt Name" famous in tires for 40 Years—I don't just repair it, I offer a free fast REPLACEMENT guarantee on ANY defective tire within 12 months. Prt. Excl. CHOOSE YOUR FAVORITE BRAND. Not Recaps or Retreads.

### GOOD YEAR Firestone

U.S. Goodrich, General, Atlas, Lee & others. **FREE** This pictured tire ash tray given with 2 or more tires!

12 MONTH TIRE GUAR. & FREE FACTORY-TESTED TUBE			
500-16	\$5.22	670-15	\$5.12
550-16	5.62	710-15	5.32
700-16	5.72	760-15	5.32
840-15	4.82	800-15	5.62
700-15	4.92	820-15	5.62
475-19	5.32	550-17	5.32
WHITEWALLS \$1.00 EXTRA		DEPENDABLE TRUCK TIRE	
700-20	\$8.92	600-16(6)	\$5.62
750-20	9.52	650-16(6)	6.42
825-20	16.52	700-16(6)	7.02
900-20	15.52	700-15(8)	7.82
1000-20	17.22	650-20	8.92
1100-20	17.22	750-16	7.52

MARVIN BLATT 6th & Spring Garden Sts. Philadelphia, Pa. MILITARY MUD-GRIP TIRES  
AA Guar. 6 Mos. AA 12 Months  
900-16 \$9.52 900-16 \$13.92  
750-20 10.52 750-20 17.92

Send Check or M.O. & this ad for fast shipment. FOB Phila. I personally select your tires—as if my future depended on it. Read that top line again.

## FREE New FAN—Shutter—Motor—Catalogue



Packed with the Largest Selection of Fan equipment BUY FROM MFR. and SAVE MONEY FANTEX AND TORRINGTON BLADE KITS

Attic Fans • Exhaust Fans • Pedestal Fans • Window Fans  
• Shutters • Motors • Tub Enclosures • Sewing Machines  
• Awnings • Home and Industry Supplies

VISIT US OR SEND FOR FREE COPY TODAY

16" Attic or Window Fan Kit. Includes Steel Blade—2 Pulleys—2 Bearings—2 Collars—Shaft—Instructions—Easy assembly. Enclose Postage with order. (Wt. 7 lbs.) **\$7.95** REG. PR. \$15.90 SALE PRICE

ALBIN MACHINE Dept. M, N.Y. 423 Broome St., N.Y. 13  
DETROIT, 14030 W. 6 Mi. Mich. 35  
LOUISVILLE, 710 W. Market, KY.

## OIL BURNER SERVICING

Learn at home in your spare time.  
Earn big money

MASS TRADES 161A HIGH ST., BOSTON 10, MASS.

WRITE FOR  
FREE  
SAMPLE  
LESSON!

## STOP "JERKY" STARTS! with an AUTOMATIC CLUTCH

1956 Models have increased H.P. capacity. Improved design adds new belt grip under load and decreases creep at idling speed. Prevent stalling engine, cut belt wear, gain no-load idling. Quickly installed on 1/2, 3/4, 1 and 1 1/2" shafts. See your small engine dr. \$595 and up



**V-PLEX CLUTCH** • Hagerstown, Indiana **NEW LOW PRICE**

## Say You Saw It in Popular Mechanics

### FIBERGLAS STOPS BOAT LEAKS FOREVER!

NO SANDING  
DO IT YOURSELF

At last! The perfected Fiberglass process—permanent armor protection for decks, cabin tops, bottoms... any size boat. Now apply without expensive, laborious sanding. EVERSHIELD Paint Peeler removes old paint in one easy operation—no gooey mess, no oil or wax. Leaves wood ready for Fiberglass. Cuts cost, work! EVERSHIELD increases speed up to 25%, stops leaking seams, rotted planks, boat worms. Ends yearly hauling, scraping, painting & caulking. Can't waterlog, crack, peel or stretch. Choice of 9 colors or clear. Light, yet gives 5 times tensile strength of steel. Used for Navy boats, bulletproof vests, etc. Can't deteriorate or rot, even in salt water. Adds years of life to old or weak hulls. Makes boats drier than new.



• Cuts Work & Costs  
• Pays For Itself

**FREE!**  
Complete instructions & brochure.

### NEW! EVERSHIELD "BRIT-WORK"

Glossy clear wood finish... cures by own heat... equal to 5 coats varnish, guaranteed 5 years.

DEALERS: Territories open for exclusive No-sanding Fiberglass process and guaranteed Brit-Work. Write "Denier Division" today on your letterhead.  
EVERSHIELD INC., Dept. P-5, 918 St. Paul St., Baltimore 2, Md.



WORLD'S  
BEST  
WANT-AD  
MEDIUM

# CLASSIFIED ADVERTISEMENTS



Advertisements in this section \$1.25 per word, each insertion, minimum 10 words, payable in advance.

To be inserted under proper classification, copy must be in our office the

20th of the second month preceding date of issue

F. W. Johnson, Manager, Classified Advertising

Popular Mechanics Magazine, 200 East Ontario Street, Chicago 11, Illinois

## YOU'LL PROFIT

By reading and answering the classified ads in this section. Hundreds of opportunities for you to make and save money

### AUTOMOBILES, MIDGET CARS

**MICRO** Midget auto, 2 h.p. engine, 5 to 30 m.p.h. Runs on walk, lawn, street. Ideal for boys 10 to 16. \$100. Guaranteed. Micro Midget, 940 North 23rd St., Omaha, Nebr. Free literature.

**MAGAZINE** About antique automobiles. Send for free sample copy. Franson's Motor News, Box 254, Eugene, Oregon.

**ANTIQUE** Automobile color slides, 2x2. Illustrated catalog free. Universal, Box 779A, Beverly Hills, Calif.

**BUY** Surplus trucks, jeeps. Direct from government. List \$1.00. Box 1842AH, Hartford 1, Connecticut.

**POWERFUL** Alcohol injection—Costs pennies installed. Plans, how-to, sources 50¢. Demitz, Box 241, Arlington 10, Va.

**MIDGET** Auto plans \$1.25. Buy our parts. Gillmore, Box 26, Bowling Green, Ohio.

**FREE** Motor magazines; automobile literature; old, new and foreign; glossy photos, dealer books; shop manuals—offered with non-profit organization. Write today; get on free mailing list. Auto Maniacs, Stockbridge, Mich.

**BOYS'** Power-driven auto. Build your own. Plans 25 cents. Sypher Co., Sta. F., Toledo, Ohio.

### AUTO SUPPLIES AND EQUIPMENT

**KAR-GLEEM.** Long-lasting, silicone-treated wonder cloth. Cleans and polishes your car in 6 minutes. Gently wipe. That's all! Guaranteed. Only \$1.00. Keefe, Box 214, Latrobe, Penna.

**GM71-110** Discarded injector parts wanted. Bonus on HV. Bares, 7120 Carnegie, Cleveland 3, Ohio.

**CRANKSHAFT** Grinder, hand operated. Makes bearings fit without taking engine apart, \$3.75. Literature. L. D. McGee, 719 Cascade St., Wenatchee, Wash.

**PUNCTURE** Seal tires. Costs less than repairing any puncture. Agents wanted. Write for folder. Selo, North Muskegon, Michigan.

**UP TO \$50.00** each for new or used GM-110 diesel fuel injectors. Parts also purchased. Bruce W. Mayer, 3090 East 19th Street, Cleveland 15, Ohio.

**NEVER** Change oil. 12½¢ refill filter. Tissu-Pak, B1115, Sacramento 5, Calif.

**BATTERYLESS** Flashlight, miniature dynamo provides emergency light for car or home. \$2.95 p.p. Sterling, 2017-A Walnut, Philadelphia, Penna.

**SPARK** Booster gadget. Power, acceleration, mileage. \$2.98. Literature? Automobler, 722 W. North Avenue, Baltimore 17, Maryland.

**MECHANICS**—Time saving starter-ignition switch for tuning and motor work. Send \$4.75 or \$1.00, balance c.o.d. Satisfaction guaranteed. Car Thief, Box 226, Pacoima, California.

**CHAMMOIS,** Mammoth size, crust cod oil tan. \$4.50 postpaid check or money order. Satisfaction or money back. Baumhofer-Importer, Pecatonica, Ill.

**JEEP** Owners—V8 power. Read Jeep owners ad, page 30.

**AUTO** Accessory and parts catalog. 1956 edition—all new! 180 pages. Save up to 50%. Over 75,000 items, including Hollywood accessories, hi-speed equipment, rebuilt engines, all parts and accessories for all cars and trucks! Hard-to-get parts! Send 25¢ (refundable). J. C. Whitney, 1919-PM Archer, Chicago 16, Ill.

**AUTOMOBILE** Burglar alarm "Mercury-O-Matic." Amazing and dependable. Electrically controlled. Price complete \$10.00. To order or for complete information write Chicago Alarm Company, 2252 W. 111th Place, Chicago 43, Illinois. Distributors and agents inquiries invited.

**CHILDREN'S** Safety belts. Heavy rayon webbing. Permits child to stand or sit. Money-back guarantee. Send \$2.00. M. Kent, 1796 University Ave., New York City 53.

**RADIATOR** Like-new using guaranteed Ion-20 cleaner! \$3.00. Prompt order-premium. Wong Laboratories, 3259 Madison, Cincinnati 9, Ohio.

**ST. Christopher,** highway madonna emblems, statuettes for autos, bicycles, boats. Wholesale prices. Heleden, Box 143, Ridgefield, N.J.

**BUY** Wholesale nationally advertised auto supply, thousands other products at big discount. Free "Wholesale Plan." American Buyers, Hertel Station, Buffalo 16-O, N. Y.

**SAFETY** Belts. Free literature, samples. Sabelco, Box 1142, Poughkeepsie, N. Y.

**WHY** Burn gasoline? Burn wonder fuel, more power, r.p.m., torque. Engine life extended three times. 60,000 miles to oil change. Send \$2.00 to: Richard Voigt, 290 Highland, Kenmore 23, New York, for full details.

**"DANDY"** Back rest for automobile \$3.95 post paid-U.S. Frank Veale Mfg. Co., Inc., Columbus, Indiana.

**FORD** T parts? Try best source old car parts anywhere. Wisneski, Milwaukee 7, Wis.

**NEW** And used parts at savings. Complete guaranteed parts service for all models cars and trucks, 1924 and later. Largest in the West. Army parts specialists. No catalog, write for quotations. Fast mail order service. Pioneer Auto and Truck Parts Co., 734 W. 13th Avenue, Denver, Colorado.

**LATEST** Custom accessories. Items not in stores. New low prices. Continental tire kits, push-button doors, trunks, etc. New illustrated catalog, biggest ever, 25¢. Eastern Auto, 3319-A South Grand, Los Angeles 7, California.

**BRAND** New first quality tires. Tractor, truck, aircraft, passenger. Wholesale prices. Also all size army surplus used tires, at tremendous savings. Duddy's, 152 No. Beacon Street, Boston, Mass.

**FREE,** Illustrated, descriptive information "The Truth About Water Injection." Injector. Box 526, Burbank, California.

**FREE** Discount catalog—Speed, power, custom equipment. Almqvist Engineering, Milford T.P. Pennsylvania.

**ELECTROPLATE** Auto parts, novelties, mirrors. Easy, inexpensive home processes. Free booklet. Tyco Metals, Box 13231-BG, Houston 19, Texas.

### AUTO TRAILERS

**TRAILER** Manual blueprints \$2.00. Booklet 20¢. Kamcraft, Box 1153, Milwaukee 1, Wis.

**EXCEPTIONAL** Expanding eight foot trailer. Accommodates family of five. Build yourself. Literature 10¢. Framar Company, Wilmington, Mass.

**TRAILER** Parts catalog. Largest in mid-west. Send 25¢. Refundable. Hanna Trailer Supply, 615 West Layton, Milwaukee, Wis., Dept. M.P.

**"SHORT-Short"** camping trailer. Sleeps four. Plans \$1.75. Welch Workshop, 645 Rochdale Circle, Lombard, Illinois.

### MOTORCYCLES, BICYCLES, MOTORSCOOTERS AND SUPPLIES

**RECONDITIONED** Motorcycles and motors. Chromium accessories. Complete stock Indian parts. Expert rebuilding. Fast service. Indian Motorcycle Sales, Kansas City 27, Missouri.

**PARTS,** Pistons, new, used. Harley, Indian, Henderson, list 10¢. Ballak, 811 N. 9th, St. Louis 1, Missouri.

**MOTOR** Scooter parts—Send 25¢ for list. Give make and model of scooter. Motor Scooter Parts Co., Dept. P5, Box 7211, Indianapolis 1, Indiana.

**HARLEY-Davidsons**—Used bargains, shipped prepaid. New, used parts, accessories for current and obsolete models. Bulletin, catalog 25¢. Knuth's (factory dealer), 2491 Fond du Lac, Milwaukee, Wis.

**DOODLEBUG** Motorscooter \$15; Whizzer \$14; Servicycle \$20; Salisbury \$40; Crosley convertible \$25; outboard motorboat engine \$5. (Mailorder only.) Send 25¢, (35¢ for first class mailing) for directory-catalogue number 71 listing these and hundreds of other bargains in Homebuilders parts, plans, etc. Midget Motors Directory, Athens, Ohio.

**SERVICYCLE** \$20.00; Whizzer motorbike \$25.00; Cushman motorscooter \$25.00; midget auto \$25.00. Rush 25¢ (35¢ first class mail) for new catalog #958 listing many other amazing bargains in motors, midget cars, motorscooters, motorbikes, construction plans. Associated, Box 534, Toledo, Ohio.

**1000** BANKRUPT Motorcycle bargains. Catalog 25¢. Bunico, 146, Covington, Va.



**SCOUTS & Campers.** Free new catalog with over 5000 outdoor items at lowest prices. Included are tents, sleeping bags, air-mattresses, cook kits, stoves, lanterns, also many G.I. surplus camping goods. Discounts to scouts and church organizations. Free, write today: Goldberg's, 218 Market St., Philadelphia 6, Penna. Phone WA2-6968.

**OLD Guns.** Current prices. Free catalog. Pioneer Books, Harriman, Tennessee.

**180 PROFUSELY** illustrated pages antique pistols, swords, daggers, armor, etc. 50c. Robert Abels, M866 Lexington Ave., New York 21.

**MOLDS—**For making fishermen's sinkers. Free illustrated booklet. Reading Instrument Co., Box 78, Reading, Penna.

**5000 BARGAINS.** Firearms, binoculars, war relics. Catalog 50c. Smith Firearms, Runnecede, N. J.

**JAP Rifle** altering to 30-06, \$6.00. Jap-shells, \$3.75. Catalog 5c. T. P. Shop, West Branch 11, Mich.

**DIVING** Equipment for skin divers and professional divers. Send 25c for catalog and decompression chart. Desco, 212 N. Broadway, Milwaukee 2, Wisconsin.

**"SHOCKING"** Expose! Catfish caught with telephone apparatus! Complete details. \$1.00. Pop. Box 6122, Houston 6, Texas.

**LEARN** Gun repairing at home. Profitable business. Details 10c. Modern Gun Repair School, Box 430-P, Marshfield, Wis.

**SAMPLE:** 25c Copy of "The Archers Magazine." Send 10c. 1200 Walnut Street, Philadelphia 7, Pennsylvania.

**MOLDS** For fisherman's sinkers, jigs, squids, casting and spinning lures. Free catalog. Sweet's Molds, Tonawanda 1, New York.

**FISHERMEN** Catch your limit every time. Our free 1956 catalog tells you how. Hergert Company, Box 741, Coral Gables.

**FREE** Below wholesale fishing catalog. Fishing Tackle Mart, Dept. 55, Box 6737, Chicago, Ill.

**CATCH** Fish with smell. Old timer's secret recipes, formulas, processes. 10c. Johnson's, 312-F Lake Avenue, Ithaca, New York.

**CAMPING** Equipment, tents. Direct from manufacturer. World's largest selection. Send 15c for 100-page 1956 tent and camping equipment catalogue-handbook. Morsan Tents, 10-21, 50th Ave., Long Island City 1, New York.

**FISHERMEN.** Sensational new style hooks. Sample 25c. Dahle, Box 7PM, Omaha 10, Nebraska.

**1,000,000 ITEMS—**Every gun accessory! New, used, antique. Kentuckies, Lugers, Mausers, P38's, Colts, double rifles, swords, armor. Agramonte's, Yonkers, 2G, N. Y.

**FREE—**Giant 1956 wholesale sporting goods catalog. Lowest wholesale prices. Complete line of cameras, sporting goods, appliances, outdoor items. Write today. Santa Fe Distributing Co., 1321 Main St., Dept. PM, Kansas City, Missouri.

**JEEP Owners—**V8 power. Read Jeep owners ad, page 30.

**CAMPERS.** Outdoorism, scouts! Send 15c for our "Campdown, U.S.A." giant catalog. Thousands of bargains. I. Goldberg & Co., 429 Market St., Philadelphia 6, Penna.

### BINOCULARS, TELESCOPES, MICROSCOPES, MAGNIFIERS

**SAVE.** Buy United. America's largest selection. 103 models. \$3.95 to \$250.00. Use on 30 day no risk offer! Free 56 page binocular, telescope, riflescope catalog. United, 9043 S. Western, A-108, Chicago 20. Dealers wanted.

**400 POWER** Telescope easily made. Kit includes focusing tube, erector, five finished lenses and instructions—\$3.75. Giant astronomical telescope complete with tripod \$15.00. Free information. Suffolk Science, Mattituck 3, N. Y.

**REFLECTOR** Telescope kits \$8.25 (3") to \$175. (12"). Mirrors, cells, focusing mounts, tripods, eye-systems. Anything, everything in telescopes. Free illustrated catalog. Also ready to use telescopes from \$26 to \$176. Inquiries to Esco Products, Dept. PM, Oakridge, N. J.; Sales showroom 166 Church St., New York City.

**6 THUMBS** On each hand? Even you can assemble our telescope kits from our easy instructions. Enjoy the heavens with a high precision telescope assembled in less than an hour. You'll like our complete line of telescopes, microscopes and accessories, biological stains, etc. Send for free Catalog T of finest quality and newest design astronomical kits or free Catalog M of microscopes. Optical Engineering Co., 184-19 Northern Boulevard, Dept. PM, Flushing, New York.

**AMAZING** Prices binoculars, guns, scopes. Free trial. Folder "Binocular Selecting," catalog free. Prentiss Importers, Mercury Bldg., West Los Angeles 25, Calif.

**DYNASCOPE—**Sensational new reflector telescope. Send for details. Criterion Co., Dept. DP 20, Hartford, Conn.

**REFLECTING** Telescopes, mirrors, kits. Lowest prices anywhere. Free catalogue. Aurora Telescope Company, 266 Avenue C, Bayonne, N.J.

**BINOCULARS,** Telescopes, microscopes, terrific values \$3.98 up. Request free money saving catalog. Criterion, Dept. P41, Hartford, Conn.

**REFLECTING** Telescope, 60X, completely assembled \$29.75. Guaranteed observatory clearness. Free information. Skyscope, 475 Fifth Avenue, New York City 17.

**BUILD** Your own reflector telescope. Complete kit: Mirrors, eyepieces, tripod, all other accessories. Request free illustrated literature. Criterion Manufacturing, Dept. KPM 17, Hartford, Conn.

**REFLECTOR** Telescope mirrors, refiguring. Henderson, 833 W. Alhuras, Tucson, Arizona.

**JOE'S** Binoculars, 4827 Second, Detroit 1, Michigan. Lowest prices, all sizes, binoculars, microscopes, telescopes catalog.

**WAR** Surplus bargains: Millions of lenses, instruments, telescopes, binoculars, components and complete line of astronomical telescope items. World's greatest optical market place! Send only \$1.00 for beginner's 10-lens kit and big instruction booklet stock 2-CH. Write for catalog CH, free! Edmund Scientific Corp., Barrington, New Jersey.

**MICROSCOPES,** Telescopes, binoculars, surveying, everything optical, photographic. Importers' prices. 25c catalog. Magnification Instrument Co., 2 East 45, New York City.

### PETS—DOGS, BIRDS, RABBITS, HAMSTERS, ETC.

**MAKE** Big money! Raise Chinchilla rabbits. Cash markets supplied. Write today! Rockhill Ranch, Sellersville 15, Penna.

**MONTHLY** Bird magazine (budgies, canaries, finches, etc.). One year \$3.00. American Cage-Bird Magazine, 3449 N. Western Avenue, Dept. P.M., Chicago 18, Illinois.

**\$5,199.90 WAS** Paid to John Betts, in few weeks. Grow mushrooms. Cellar, shed. Spare, full time year round. We pay \$3.50 lb. Free book. Mushrooms, Dept. 171, 2954 Admiral Way, Seattle, Wash.

**RAISE** Money-making Angora, New Zealand rabbits. Particulars free. White's Rabbitry, Jackson, Mich.

**MAKE** Money raising chinchillas, mink, pigeons, rabbits, cavies for us. Free catalog. Keeney Brothers, New Freedom 2, Penna.

**CHINCHILLAS—**Now you can afford them. Registered, graded stock. Wholesale, \$50.00 a pair, one or a hundred. Price list on request. Fernando Chinchillas, 4963 Densmore, Encino, California.

**HAMSTERS,** Pair \$2.95. Free booklet. Jer-Fre's Hamstery, 2425 Hoyt, Muskegon Heights 13, Mich.

**BEEKEEPERS—**\$1,000,000 French industry. Read "Miracle of Royal Jelly," \$2.50. L. Smith & Co., Box 2003, Hartford, Conn.

**CHINCHILLAS—**High graded Blend-Traxt. Willard George. Wholesale prices. Chinchillas, 21219 Figueroa, Torrance, Calif.

**PEAFOWL** Pheasants, guineas, bantams, waterfowl, thirty varieties pigeons. John Hass. Bettendorf, Iowa.

**CHINCHILLAS—**Wholesale \$75.00 pair. Slater Chinchillas, 2721—182nd, Torrance, Calif.

**MINK** Raising information free. Complete. Lake Superior Mink Farm, Superior, E.EI, Wisconsin.

**RAISE** Rabbits successfully by knowing facts. 48 page illustrated book describing 25 breeds. Housing, feeding, breeding, marketing, etc. Plus bulletin. 25 cents. American Rabbit Association, 38 Arba Building, Pittsburgh, Penna.

**EXTRA** Money raising Angora, New Zealand rabbits. Write Martin's Rabbitry, Morganfield, Ky.

**BABY** Skunks, raccoons. Catalog, 25c. Shady Fur Farm, Springfield, Minnesota.

**STANDARD** Rabbit Journal, Milton 3, Penna. Year \$1.00. Sample dime. Beginners manual 25c.

**\$1,000 MONTHLY** Possible raising red-worms; large African nightcrawler! Backyard, garage, basement. Illustrated booklet explains raising, packing, marketing. 25c postpaid! Ozark Worm Farm-J, Willow Springs, Missouri.

**CHINCHILLAS.** Registered. Unbelievable prices. Far-West Chinchilla, 1446A Jones, San Francisco 9, California.

**CHINCHILLAS.** Profit plus pleasure. Registered. Graded. Delivered personally. Stewart Chinchilla Ranch, Washingtonville, N. Y.

**RAISE** Cavies for laboratories. Pair \$3.50. Information 25c. Jimmy Cash, Rutherfordton, N. C.

### PLANTS, SEEDS, BULBS, NURSERY AND GARDEN SUPPLIES

**SOIL** Conditioner. Turkey manure, dried. Wholesale prices. Only place available in U.S. Wonderful for all plant life. Mishek, Waseca, Minn.

**CUSTOM** Built lawn rollers. Patent forward-reverse drive. Eaton Roller & Manufacturing Co., 300 N. Meridian, Eaton, Indiana.

**WORLD'S** Greatest cash crop. Free information. Write Ginseng Gardens, Asheville, N. C.

**GINSENG.** Goldenseal. Roots bring up to \$12 pound. Full information. F. M. Collins, Viola, Iowa.

**RAISE** Your shrubs, trees from seed. Free planting guide, price list. Woodlot Seed Co., Norway 9, Michigan.

**GARDEN—**Fresh looking flowers. Guaranteed results. Course \$2.00. Miken, Box 193, Lemoine, Penna.

### FARMS, FARM LANDS, REAL ESTATE

**\$5.00 MONTHLY** Buys 40 acres productive land; near town; good fishing; price \$250.00; free list. Box 425-P, Carthage, Mo.

**OZARKS!** \$7 Acre. Diversified listings free. Write: Armstrongs, Shook, Missouri.

**FLORIDA—**Beautiful retirement homesites near gulf coast. Excellent hunting, fishing in 9 fresh and salt water rivers. 11 bays and gulf. \$250 at \$10 monthly. Free literature. V. M. Mathews, Box 1406, Asheville, N. C.

**CANADIAN** Tax sale lands for three dollars an acre and up. Small monthly payments. Farms, timber, hunting and fishing camps, minerals. Limited number of properties. Write at once for free catalogue. Tax Sale Service, Room 105, 120 Bloor St., West, Toronto 5, Canada.

**HOMESITES** \$15 Monthly—California's finest garden section. Morro Bay's scenic shores. Wonderful fishing, boating. Fertile soil, softest water, temperate climate, congenial community. Free literature. Richard Otto, Department M, San Luis Obispo, California.

**CALIFORNIA** Farm and ranch lands. \$15 to \$35 per acre. 10 to 640 acre parcels. Easy terms. Free catalog. Pacific Tax Sales, 1621-A Cahuenga, Hollywood 28, California.

**FLORIDA** Wooded homesites in beautiful Green Hills. Near famous Panama City pleasure resort. World's finest beaches. Many lakes. Best fishing, hunting. 5 and 10 acre garden farms and 20 acre tung grove tracts. Lowest prices—Easy terms. Booklet free. Wendell Wood, Fountain, Florida.

**STROUT Catalog**—Mailed free! Farms, homes, businesses, 34 states, coast-to-coast, 3,046 bargains described. World's largest; 56 years service. Strout Realty, 7-MP So. Dearborn St., Chicago 3, Ill.

**RICHLAND Garden Farms** near Atlantic City, N.J. (world's playground), fine poultry-garden wooded acre homesteads for retirement. Excellent fishing-hunting nearby. \$10.00 monthly, \$50.00 down. Price \$495.00. Box 581, Philadelphia 5, Penna.

#### POULTRY. FARM SUPPLIES

**EMBDEN**, Toulouse, African goslings; descriptive literature. Seminole Ranch, Goulds 45, Florida.

**CAPONIZE** Cockerels chemically. 100 pellets, implanter included, \$2.00. Success guaranteed. Circular free. Majors Produce, Manhattan 5, Kansas.

#### PROFITABLE OCCUPATIONS

\$5,199.90 WAS Paid to John Betts, in few weeks. Grow mushrooms. Cellar, shed. Spare, full time, year round. We pay \$3.50 lb. Free book. Mushrooms, Dept. 99, 2954 Admiral Way, Seattle, Wash.

**RAISE** Everbearing strawberries. Unlimited demand everywhere. Make thousands dollars from acre. Write. Samouce, 1688 Forsyth, Macon, Ga.

**YOUR Own** wholesale business with no investment. Free catalog. Jay Norris Co., 487X Broadway, New York City.

**FOREIGN Jobs**—Latin America, Alaska, Canada, up to \$1500 monthly. Up-to-date 1956 foreign service directory gives complete information; hot list of firms hiring for military and civilian construction, aircraft, oil, exporters-importers, mining, \$1.00. How-when-where to apply. 9th successful year! Global Reports, Box 883-S, Hollywood 28, Calif.

**FREE Folio** "\$5,000-\$45,000; Unlimited Vacations." No merchandise, equipment. Unknown! Work home, sparetime! Haylinds, Carlsbad, Calif.

**MUSHROOM** Spawn seed plus directions manureless, various, growing, marketing \$1.00. Free information, gladly. Luxur, 641 South 19th, Newark 3, New Jersey.

**RAISE Pheasants** on \$100 week plan. Little capital and space can make you independent. Free details. Great Central System, Columbus 1, Kansas.

**MAKE New** greaseless doughnuts in kitchen. Sell stores. Free recipes. Michael Ray, 3605 South 15th Ave., Minneapolis 7, Minnesota.

**BE The Popular Mechanics** representative in your neighborhood and earn big profits in your spare time. Write Popular Mechanics Magazine, Room 408M, 200 E. Ontario St., Chicago, Ill.

**FORTUNE Possible** raising fishworms and crickets. Free literature. Carter Wormery, Plains, Georgia.

**WHOLESALE Catalog!** 30-80% discounts! Appliances, musical instruments, typewriters, phonographs, watches, jewelry, recorders, housewares, etc. Consolidated Distributors, 21-14 Lafayette, Paterson 15, New Jersey.

**AUCTIONEERING**—Home study course. Diploma granted. Auction School, Ft. Smith, Ark.

**MAKE Flexible** molds. Cast figurines, plaques. Free sample. Tooker, 630-M Chestnut, Hamilton, Ohio.

**FREE Book** "505 Odd, Successful Businesses." Work home. Pacific, Oceanside, Calif.

**FOREIGN Employment** construction work. If interested in foreign projects with high pay write Foreign Service Bureau, Dept. PM, Metuchen, N. J.

**FOREIGN, Alaskan, U.S.A., jobs!** Earn to \$1500.00 monthly. Million Americans employed overseas. Opportunities galore. Latest copyrighted reports. Who to contact for highest paying jobs. Laborers, trades, truck drivers, equipment operators, helpers, clerks, engineers, many others. Over 52 countries—St. Lawrence project, Spain, Latin America, northern projects, Europe, Pacific, etc. Year registration-advisory service. Application forms. Unconditional money-back guarantee. Act today! Only \$2.00. Airmailed \$2.25. (C.O.D.'s accepted). International Reporter, St. Louis 1-PE, Missouri.

**\$150 WEEK—Easy!** Start home Venetian blind laundry. Revealing book free. A.T. Co., 101 S. 44th, Philadelphia 4, Penna.

**WELDING Pays big money.** Learn easily at best equipped school in country. Non-profit school with low cost training. G. I. approved. Write Hobart Trade School, Box M562, Troy, Ohio.

**MAGAZINE Subscriptions**—Largest commissions, bonus. Qualified Agency, 451EA Kingston, Brooklyn 25, N. Y.

**BUY Wholesale** thousands nationally advertised products at big discount. Free "Wholesale Plan." American Buyers', Hertel Station, Buffalo 16-B, N. Y.

**\$10,800 PROFITS!** Your own mailorder business! No risk! Success plan free! Treasury, 709 Webster, New Rochelle L-35, N. Y.

**TERRIFIC Profits possible.** "Money Getters Bulletin." 25c. Kingsley, Chepachet, Rhode Island.

**JOB Information**—High pay. South America, the Islands, USA, foreign countries. All trades. Clerical, labor, engineers, drivers, others. Women also. Companies pay overseas fare if hired. Write Section 92F, National Employment Information, 1020 Broad, Newark, N. J.

**MUSHROOMS** Grown boxes. Manureless process. Spawn \$1.00. Gordons, 553 William, Winnipeg, Manitoba.

**JOBS on ships!** Experience unnecessary. For information, employment instructions. Write, Transoceanic, Box 494-P, Baltimore 3, Maryland.

**SELL Frankfurters** and refreshments from stainless steel mobile units and carts; good steady income. Write Admar, 16 Catherine St., New York City 38.

**HOME Mailorder sources, methods, opportunities.** Literature free. Carnahan Bros., 9610-D Acacia, Fontana, Calif.

**APPRENTICE Training,** best nationwide opportunities, all trades. Get paid to \$375 monthly to learn. Details free. Surveys, Box 181, Glastonbury, Conn.

**NEW Orleans**—Work in the Crescent City of Mardi-Gras. Get job-packed New Orleans classified \$1. Housing 25c extra. Hopkins, 611 Wohl, 2111 St. Charles, New Orleans, Louisiana.

**EARN At home.** Write National, P.O. Box 185, Orangeburg, S.C.

**DETROIT Classifieds** airmailed. Thousands of jobs. Highest wages in America. Send \$1.00. Young, 14924 West Chicago, Detroit 28, Michigan.

**CONFIDENTIAL Reports** on best paying jobs with travel, adventure, promotions. Construction, aviation, shipping, laborers, clerical, trades, supervisory, factory, unusual opportunities, all types of work. Skilled and unskilled. Foreign and state-side openings for men and women. Only \$2.00 (\$2.25 airmail), including year registration-advisory service. Satisfaction guaranteed. Included absolutely free: Special reports on Alaska, Spanish airbase construction, South American opportunities, and husband-wife foreign jobs. Research Services, Suite 207-FMD, Brown Building, St. Louis 5, Missouri.

**LEARN Real estate** by listening to records. Lee Institute, Brookline 47, Mass.

**BAXTER'S Foreign** and construction jobs. Worldwide. South American section. \$1 airmailed. Baxter, P.O. Box 4032, San Francisco 1, Calif.

**JOB Counseling** by experts. Approved methods. Plan for successful future. Request free questionnaire. National Guidance Service, Bainbridge Road, Elizabethtown, Pennsylvania.

#### BOOKS, PERIODICALS, PICTURES, POSTCARDS

**BOOKS.** Free 1956 catalog, 100 pages. Text, vocational, educational, instructional subjects. Millions of volumes, new and used. Bargain prices. Books bought. Est. 1903. Long's College Book Co., Dept. PM, Columbus 1, Ohio.

**RARE Magazines!** Send 10c for prices. Nationwide Magazine Exchange, Box 1375-P, San Antonio 6, Texas.

**BOOKS Found!** Any author, old or new. Rush titles wanted; no obligation. International Bookfinders, Box 3003-PM, Beverly Hills, California

**BOOKFINDERS!** All subjects. Send wants! Jaher Book Service, 183 Hazelwood Drive, Westbury, N. Y.

**"SCIENCE Milestones."** Records march of science starting 400 years before Christ, right up to date. Amazing facts revealed. 312 pages packed with startling information that will thrill you. A real history of science. \$5.00. Literature free. Popular Mechanics Press, 200-SM East Ontario St., Chicago 11, Ill.

**NATIONAL Geographic Magazines,** 1888-1956. Periodical Service, Box 465-PM, Wilmington, Delaware.

**FREE Howard W. Sams & Co.** book list describing latest Sams books on every phase of TV-radio, audio, electronics and electricity. Invaluable, instructive books for experimenter, hobbyist, service technician, engineer and student. Send for free list today! Howard W. Sams & Co., Inc., 2201 E. 46th St., Dept. 24-E6, Indianapolis 5, Ind.

**SAVE Up to 50%** on the magazines you buy! Right now, tremendous savings are available to you on a wide list of America's finest magazines. You'll find your own favorites in the list—at special prices far below regular rates. Don't miss this opportunity to save on the very magazines you want. Send today for complete list. No cost. No obligation. But hurry—This is a limited time offer. Mail post card with your name and address to: Publishers Clearing House, Dept. 555, 273 Main Street, Port Washington, New York.

**EVERYONE Can afford** an eight volume encyclopedia set at \$7.50 prepaid. Free illustrated literature. Macleans, Houma, La.

**BRITISH Books**—All subjects. Catalog 10c. Wants solicited. Box 22-PMA, Brooklyn 26, N. Y.

**OLD, New, rare, books located.** Write to Old South Book Service, 24 St. Botolph Street, Boston 16, Mass.

**BOOKHUNTERS!** All subjects. Send wants! College Book Service, 52 W. Kingsbridge Rd., New York 68, N. Y.

**BOOK Catalog,** 1000 interesting titles. Send 10c. Books Publishing Co., Amityville 3, N. Y.

**DON'T Be nervous.** Dr. Walter C. Alvarez, Mayo Clinic consultant who himself faced failure because of nerves, has the formula that works. "How To Live With Your Nerves," \$1.00 ppd. The Stewart Co., Box 1418, Dept. A, Chicago 90, Ill.

#### GAMES, TOYS, NOVELTIES

**X-O.** Exciting new game for all, \$1.00. Lejac, 135 Aspinwall, Westbury, N. Y.

#### MAGIC TRICKS, PUZZLES, JOKER NOVELTIES

**GIGANTIC** illustrated magic catalog plus book of over 100 tricks with cards, coins, puzzles, mind reading. Each trick fully illustrated. 25c. New Jersey Magic Supply, Dept. M, Sea Bright, N. J.

**LEARN Ventriloquism,** easiest method. Details free. Smith, 801 Bigelow, Peoria, Ill.

**PROFESSIONAL.** My greatest card discovery! 25c. Yevrah, 6 Midwood, Levittown, Penna.

**"102 MAGIC Tricks"** plus 500 trick catalog 50c. Stowell, Woodstock, New York.

**BE A magician!** Large professional catalog of latest tricks, 35c. Ireland, C-109 North Dearborn, Chicago 2, Illinois.

**FIVE Joke novelties** one dollar. Free list. Bender Sales, Box 45, South Houston, Texas.

**500 TRICKS,** Douglas famous 120-page catalog, only 10c. Fastest service to magicians for 30 years. Send 10c today. Douglas Magicland, Dept. 1, Dallas, Texas.

**GO Ventriloquist,** all secrets told. Make money, surprise friends. Send 35c for information. Free \$1.00 catalogue of dummies, dialogues, etc. Limited supply. Gough, R. 3, Hartford City, Ind.

**SMOKEBOMBS** 25c. 7 For \$1.00. Terrific! 4463-PM Greene, Philadelphia 44.

**BEST Magic Joker's novelties.** Lower prices. Catalog 10c. Top Hat, Evanston 12, Ill.



WOW! 135 All different Germany 10¢. Zeppelins, semi-postals, airmails, high values. Big bargain lists and approvals included. Jamestown Stamp, Dept. A5PMC, Jamestown, N. Y.

ROOSEVELT, Flower triangles, 26 others. 3¢ Approvals. Marylandco, Arlington, Baltimore 15, Maryland.

THOUSANDS OF stamps for your collection at 1¢ and 2¢. See our big books of attractive approvals. Everything catalogued. Large discounts. Modern Stamp Co., Dept. A-2, Ferrysburg, Mich.

WORLDWIDE Better grade assortment 25¢. Including commemoratives, pictorials. Higher values (off paper). Gerhardt Stamp, 405 E. 6th St., Austin 1, Texas.

ANTIGUA, Bermuda, Cayman Islands, Ceylon, Dominica, Egypt, Fiji, Grenada, Hong Kong, Indonesia, Jamaica, Malaya, Singapore, Suriname, are in our bargain packet. Bi-colors, topicals, high values. Every continent represented. 333 different beauties. 25¢ with attractive approvals. Roseland Stamps, Dept. A-37, Spring Lake, Mich.

CANADA — Newfoundland collection including early issues, commemoratives, pictorials and high values. Plus set of fascinating triangle stamps. Plus set of unused British Colonies. Plus large stamp book. All four offers free. Send 10¢ to cover postage. Empire Stamp Corp., Dept. PM, Toronto, Canada.

QUEER Country collection from Baden, Camerouns, Indo-China, Indonesia, Hong Kong, Madagascar, Malaya, Monaco, Rheinland-Pfalz, Saar, Saint Pierre, Togo. High values, low values. Bi-colors, topicals. A collection in itself. Only 10¢ with beautiful inexpensive approvals. Clark Stamps, Dept. A-47, Muskegon Heights, Mich.

U. S. Stamps at discount prices. Giant illustrated catalog. Only 10¢. Raymax, 37VZ Maiden Lane, New York City 38.

3 SOUVENIR Sheets. (regular 50¢ value). only 10¢. with approvals. Variety Stamps, 57-S Circuit, Newton Highlands 61, Mass.

500 DIFFERENT Germany \$1.00. Merkel Stamps, 45 Cherry, Holyoke, Mass.

TOPS! Free book. "How to Collect Stamps." Send for your copy today! Approvals. Littleton Stamp Co., Littleton, E. I. N. H.

FREE! Giant catalog offering thousands of bargains. Sent with beautiful approvals. Jamestown Stamp Co., Dept. E5PMC, Jamestown, N. Y.

APPROVAL Booklets by country for serious collectors. British, French Colonies my specialty. Connelly, Box 106, Shelby, Ohio.

AMERICAN Stamps! Coins! Extensively! Sullivan, 127-F East 4th, St. Paul 1, Minn.

MINT U.S. lot 10¢. Approvals. Silver Dollar Stamps, 6 Cypress Street, Carteret, N. J.

FREE Valuable stamps given with our good value, selected approvals. Cranmoor Stamp Shop, Pine Beach, New Jersey.

TOP Quality penny approvals. Parkes, 2024 South Cotner, Lincoln 6, Nebraska.

FREE! Flower triangles, others. Approvals. Delton Page, Box 201X, East Paterson, New Jersey.

FIRST U.N. set. Among world's prettiest. Only 10¢. Approvals. Welles, Box 1246-R, New York City 8.

111 TRIANGLES, Diamonds, rectangles, nudes, warthog, death stamp. Bargain approvals. Catalogs. 25¢. Imperial, 2545PM Fourth, San Diego 3, Calif.

DEALERS—Wholesale list. Postage 3¢. Frank, 5031 Queensberry, Baltimore 15, Maryland.

100 DIFFERENT Spain 25¢. Penny approvals included. Reed, Box 980, Chicago 90, Ill.

AUSTRALIA — Fifty different exciting commemoratives, animals, kings, queens. This valuable Australian collection only 10¢ with approvals. Viking, Great Neck 8, N. Y.

"STAMP Dealer's Weekly." Send for sample copy on business letterhead. Lyben, 5560 Buckingham, Detroit 24, Michigan.

LATIN Americans, 99 different, 10¢ with colorful approvals. Fred Pittsley, South Montgomery, Napa, Calif.

FREE: Ten different ancient and modern locomotives. Attractive approvals included. H & H Stamp Center, Box 76, Brooklyn 26, New York.

BEAUTIFUL Sets 10¢, packets 10¢, attractive singles 1¢. Send 10¢ for sample set, packet and list. Hallmark Stamps, Dept. M-2, Box 539, Wellston Station, St. Louis 12, Missouri.

100 BRITISH Colonies 10¢. Approvals. Neal, 5950 Tower, Riverside, Calif.

1000 DIFF. World-wide only \$1.00. Wilbur Craig, 302 State St., Camden 2, N.J.

MONACO'S Grace Kelly wedding set 25¢. Approvals. Royal Stamp Company, Tamaqua, Penna.

500 WORLDWIDE Mixture. Big variety. 25¢. Monjar, Fairmount, Cincinnati 14, Ohio.

U. S. Revenues on approval. El Jay Stamps, Box 286, New York 36, New York.

70,000 FOREIGN Stamp grab bags. 35¢ each. Eagleys, 4520 Frances, Burnaby 2, B. C., Canada.

25 PHILIPPINES 10¢. Worldwide approvals. Moffat's, 740-A Milton, Rock Hill, South Carolina.

30 DIFFERENT Commemoratives 1893 up, 10¢. U. S. approvals. 10 mint sets, 15¢. Foreign approvals. K & B, Box 5, Brooklyn 14, N. Y.

500 FINE Mixed U.S. 15¢. Wright, 201 Mealey, Hagerstown, Maryland.

ALBANIA Roosevelts set free. Approvals. W B Stamp Inc., Wilkes-Barre, Penna.

FREE! \$1 Mint set with each \$2 purchase. Approvals. Farmer, 6919 Camrose, Los Angeles 28.

FREE! Seven short sets! Approvals. Gernert, 4235-X Alton, Louisville 7, Ky.

FREE U.S. plate block list. Simstaco, Box 63, Mattapan 26, Mass.

LOTUS Stamp Exchange Club. 800 members. \$1.00 year. Four exchange plans. Rev. Guy Hawley, Kalamazoo, Mich.

THREE Exciting sets, send dime. Request approvals. Frank's, 19366 Danbury, Detroit 3, Michigan.

MONACO'S Kelly-Rainier III nuptial 10¢. Approvals. Gatewood, Box 346, Winston Salem, N. C.

50 BRITISH Colonials free approval applicants. Handling 10¢. Gene's, 1707 N. Congress, Austin, Texas.

SERIOUS Collectors trade stamps between them. List names 25¢. Philate World, 1900 Plessisville, Canada.

START Your own stamp business. Send for free circular. Donald Shepard, Box 1147, Chicago 90.

WANTED—Stamp collections, accumulations. Murray Gold. 62-95p Saunders, Rego Park 74, N. Y.

25 UNUSED China, 10¢ with approvals. Kenny, Box 2142, Pittsburgh 30, Penna.

125 DIFFERENT United States \$1.00. Approvals. Utechts, 1143D North Keeler, Chicago 51, Illinois.

UNITED States or Canada collection on approval. Enclose 10¢. Peterson, Box 31, St. Paul 2, Minn.

FIRST Day cover approvals! Valuable airmail cover free with first selection. Myers, Coopersburg, Penna.

## ANTIQUES, RELICS, INDIAN GOODS, CURIOS

SCALPING Knife, spearhead, thunderbird, drill, \$4.00. List free. Arrowhead, Box 1249, Hot Springs, Arkansas.

2 SELECTED Arrowheads \$1.00. List 5¢. H. Talburt, Calico Rock, Ark.

SELLING 50,000 Indian relics, etc. List free. Lear's, Glenwood, Arkansas.

TAHITI Hula skirts and curios. Yves Jarsillion, Box 467, Papeete.

8 ARROWHEADS \$1.00. Guaranteed perfect. Navajo Shop, 687 So. Patton Court, Westwood, Colo.

## PRECIOUS STONES, MINERALS

SAPPHIRE, Topaz, tourmaline, garnet, peridot. Five uncut gem specimens, \$1.00. Ten polished gems, baroque shaped, \$1.00. Free big bargain list jewelry, gems, profitable, easy "do it yourself" projects. O'Brien's, 1116M Wilcox, Hollywood 38, Calif.

GEMCUTTING — Silvercraft illustrated magazine. Tells how to cut gems, make jewelry. 150 ads illustrating equipment, gems for collectors, cutters. Free literature. Lapidary Journal, Del Mar 2, Calif.

## HOBBIES AND COLLECTIONS

MATCHBOOKS For collectors. Catalog 25c. Charles Edelman, 1311-C East 84, Cleveland 3, Ohio.

COLLECTORS And hobbyists. Beads, imported and domestic, wide selection, sizes, shapes, colors, designs, pound contains thousands; 5 pounds \$5.00. Sample pound \$1.50. Lhogo, 19-P East 16th Street, New York 3, N. Y.

NAZI Medals listings, 10¢. Kingstons, 920 Third B338, Seattle 4, Washington.

GENUINE Nazi medal \$1.00; 37 different American emblems \$1.00. Catalog 10¢. Insignia Club, 550-B Fifth Avenue, New York.

INVENTING Can be an interesting and profitable hobby. Write for complete particulars. Institute of American Inventors, Dept. 40-E 631-E St., N.W. Washington 4, D. C.

NAZI Insignia, 12 different, \$1.00. Medals, armbands, flags, daggers. Illustrated lists. Medcrafts, 1923 34th St. S.W., Calgary 2, Canada.

FREE Three months' subscription Leathercraft News, write Tandy Leather Co., Box 791-F21, Fort Worth, Texas.

EXCITING New book. "How to Collect Stamps, Coins, Paper Money." Packed with amazing facts; information worth dollars. Fully illustrated. 160 pages. 75¢. Popular Mechanics Press, 200-ST E. Ontario St., Chicago 11, Ill.

GROW Giant crystals! Send dime for booklet explaining hobby. Crystocraft Company, College Station, Texas.

65 ASSORTED Army patches, insignias, ribbons (irregulars) \$1.00. Surprise included. Lhogo, 19-X East 16th St., New York City 3, N. Y.

RETURNING Boomerangs. Make your own. Complete course \$1.00. Danacrafts, Duntroon Avenue, Epping, N.S.W. Australia.

## CAMERAS, PHOTO SUPPLIES

SOMETHING Different. Soil resistant, loose leaf albums. Trial offer. 8 exposures 30¢; 12, 45¢. Jim Dandy, Dept. 8, Newberry, South Carolina.

BASS Says: Quality cameras since 1910. When in Chicago visit the camera cross roads of the world, or write us for your favorite equipment, new or used. Satisfaction guaranteed. Bass Camera Co., Dept. AG, 179 W. Madison St., Chicago 2, Ill.

20 TO 50% Discount everything photographic, giftware. Free catalogue. Dart, 3812E Atlantic Avenue, Brooklyn 24, N. Y.

SAVE Money. Give your camera proper care. Send one dollar for brochure "Camera Care." Projector Camera Service, P.O. Box 5612, Tucson, Ariz.

REAL Wholesale sources. Thousands nationally advertised products. Details free. Martex, 132-A Nassau St., New York 7, N. Y.

ATTENTION Camera owners. Can you use several hundred dollars? See Polytip ad in "Money-making Opportunities."

PROFESSIONAL Camera buyer sells wholesale plus very nominal service fee. Five year guarantee. Minimum \$100. References: First National Bank Colchester, Dun & Bradstreet, Bonded. State your need exactly, in duplicate, enclosing return envelope. Justin Hartley, 10 years at 13 Main Street, Colchester 10, Connecticut.

BUY Wholesale nationally advertised cameras, photo supplies, thousands other products at big discount. Free "Wholesale Plan." American Buyers, Hertel Station, Buffalo 16-E, N. Y.

PHOTOGRAPHY For pleasure or profit. Learn at home. Practical basic training. Long established school. Free booklet. American School of Photography, 835 Di-versey Parkway, Dept. 3441, Chicago 14.

1956 ARGUS Automatic projector \$44.50. Terrific savings, photo equipment, appliances. Free catalog. Mallers Mart, Box 135-A9, New Rochelle, New York.

WOBBLY Movies, blurred stills? Try "Pocket-Pod" \$1.00. Haines Mfg., Box 371, Troy, Ohio.



**OPERATE Profitable mailorder business.** Splendid opportunity. For details write, Thomas L. Bond, 1637 W. Vernon, Phoenix, Ariz.

**WANTED!** Home workers to assemble luggage and cases for ready market. Instructions, materials, tools, everything supplied. Free details. Abarsl, 807-BF Sunset, Los Angeles 12.

**DOLLARS**—In baby record books. Baby Gay shoe kits. Agents or mail order. Liebig Industries, Beaver Dam 5, Wis.

**YOU'LL Be amazed** at the tremendous profit possibilities in selling the world's finest family and educational reference Bibles! Many make \$30,000 yearly as full or part time distributors! Get my free proven Bible sales course plus magnificent seven color, 52 page catalog of 50 Morocco grain, genuine leather covered Bibles, and Bible story books. For the whole story write: Joseph W. Cain, Wholesaler, Box 5065, AT San Antonio 1, Texas.

**WHOLESALE Catalogue!** Appliances, cameras, watches! Cam Company, 6806PM 20th Ave., Brooklyn 4, N. Y.

**COLOR Concrete** with chemicals. Marble-glaze cement benches, pottery. Home-shop. Hundred beautiful designs, made without molds. Birdbaths to waterfalls. Your chance for fame, fortune. 10c brings sample, pictures. Hollywood Cementcraft, 8527-R Wonderland, Hollywood 40, Calif.

**MINIATURE Trees.** Why pay \$2.00-10.00 for growing secrets? Free details. Tiny Trees, Box 3084-P, Chicago 54.

**MAKE Flexible molds.** Cast figurines, plaques. Free sample. Tooker, 630-R Chestnut, Hamilton, Ohio.

**HOW And where to obtain capital.** Particulars free. Star Service, Wapakoneta, Ohio.

**EARN \$10,000** Yearly raising Angora rabbit wool for us. Information 25c coin. American Angora Company, Malta 12, Montana.

**"MAILORDER Laws and Regulations."** Discusses federal, state, local licenses, necessary taxes, legal requirements governing mailorder businesses, \$1.00. "Mail-order Rules for Beginners." Additional helpful information, \$1.00. Play safe. Order both. Tasker, 105 East Custis, Alexandria, Virginia.

**HAVE Home business!** Get \$10.00 merchandise orders by mail. Keep \$8.00. Everything furnished. National, Box 88W, Dorchester 22, Massachusetts.

**IMPORT-Export opportunity,** profitable, world-wide, mail-order business from home, without capital; or travel abroad. Established world trader ships instructions for no-risk examination. Experience unnecessary. Free details. Mellinger F701, Los Angeles 24.

**REBUILD Batteries; repair dolls; make rubber stamps; "60 Ideas" free.** Universal, Box 1076-A, Peoria, Ill.

**MONEY In saw and lawnmower sharpening sparetime at home.** Free book. Virgil Foley Company, Columbia Heights, Minnesota.

**POPCORN And potato chip equipment.** Eakins, Box 933-A6, Springfield, Ohio.

**FREE Folio "\$5,000-\$45,000, Unlimited Vacations."** No merchandise, equipment. Unknown! Work home, sparetime! Haylings, Carlsbad, Calif.

**\$250 WEEK Cleaning venetian blinds.** Patented machinery. Free literature. Robinson, 7213B, Indianapolis 1, Indiana.

**NATURAL Molding rubber, extra thick.** Free sample. W. Wooley, 115-A Donald, Peoria, Illinois.

**TO \$100.00 Weekly.** Sparetime, home operated mailorder business. Successful beginner's plan. Everything supplied. Lynn, 10420-M National, Los Angeles 34.

**MAKE-Sell polishes, cleaners, anything.** Formula catalog free. Kemixer, Park Ridge, Ill.

**EARN Money at home!** Homemaker Magazine tells how. Sample 25c. Sizemore, 20-H East Delaware, Chicago 11.

**BOOKKEEPERS,** Keep books, small firms spare time. Manual latest technique by C.P.A., \$3.00. Modern Business, Box 406, Youngstown 1, Ohio.

**PLASTERCRAFT** Molds, liquid rubber, plasters, flocks, candle supplies. Catalog and manual free. Blue Rapids Supply, Blue Rapids, Kansas.

**WHAT'S New in mailorder?** Let "Mail-order World," published monthly, keep you informed. Sample, 35c. Wayte, 1233 Elden, Los Angeles 6, Calif.

**ELECTROPLATE** Auto parts, novelties, mirrors, baby shoes. Easy, inexpensive home processes. Free booklet. Tyco Metals, Box 13231-MM, Houston 19, Texas.

**BREED** Rare tropical fish at home. Earn big money! Learn secrets! Help fill huge demand. Amazing opportunity! Free plan. Tropical Fish Breeders, Los Angeles 61, Calif.

**BE Appointed state notary public now.** Write, Stationers, Helotes, Texas.

**COPUBLISH Mail Sale Advertiser,** leading mail order paper. Details, latest copy, dime. Vanroy Shirk, Lebanon, Penna.

**MINK Raising information free.** Complete. Lake Superior Mink Farm, Superior, EE1, Wisconsin.

**FREE Book "505 Odd, Successful Businesses."** Work home. Expect something odd! Pacific, Oceanside, Calif.

**BRONZE** Baby shoes. Instructions, equipment and mountings for genuine electroplated process. Free catalog. Hollywood Bronze Supply, Dept. B-3, 1824 East First Street, Los Angeles 33, Calif.

**YOUR Own name brand business.** No investment; no inventory. Part time or full time. Sell famous brands of appliances, housewares, silverware, radios, vacuum cleaners, lamps, tools, clocks, watches, jewelry, etc., etc., over 1000 items. Join thousands of successful independent dealers. Send for free catalog and dealer price list. H. B. Davis Corp., Dept. W, 145 W. 15 St., New York City.

**BIG Profits raising fishworms and crickets.** Free literature. Carter Farms, Plains, Georgia.

**GROW Orchids at home**—Profitable, fascinating. Year 'round, Maine to California. No greenhouse. Gorgeous cactileyas, cymbidiums, etc. Successful home grower shows you how. Full details free. Flowerland, 4622 Wilshire, Los Angeles 5.

**We Love our mailman—He leaves over \$1000.00 monthly** in our rural mailbox. My college professor husband drafted a scientific home mailorder method. We bought a Texas ranch, live as we always wanted. Now we sell the Ranch Mailorder Method. Operates anywhere. Inquire: Eveningshade Ranch, Helotes, Texas.

**PIX Typewriters.** Inexpensive home course teaches factory secrets. Free booklet. Write, Typewriter, Tarentum 1, Penna.

**NEWEST Spare, full-time home business.** \$5 to \$10 hour possible. Paint with sudee. The finish with touch and eye-appeal. Beautiful auto dashboards, signs, radios, toys, figurines, lamps—1001 others. Complete, step-by-step instructions sent for no-risk examination. Free details. Coast, Los Angeles 61.

**IMPORT-Export mailorder opportunities!** Details. Warner, Box 6, Fort Scott, Kansas.

**MAKE New greaseless doughnuts** in kitchen. Sell stores. Half profit. Free recipes. M. Ray, 3605 South 15th, Minneapolis 7.

**\$46 FROM Square foot plywood; jigsaw necessary.** Details free. Woodart, Bridgewater, Mass.

**\$70 WEEKLY—Home, spare time.** Simplified mail bookkeeping. Immediate income—easy! Auditax, 34757A, Los Angeles 34.

**\$150 WEEK—Easy!** Start home Venetian blind laundry. Revealing book free. A. T. Co., 101 S. 44th, Philadelphia 4, Penna.

**SELL Real merchandise by mail.** Four ways. Everything supplied. Orders filled. Big profits. Charles, Box 32-P, New York 63, N. Y.

**COLORGLAZED Concrete** pottery made without molds. Patented method. Cemetery products, novelties, tiles. Basement leak-sealing. Money-making projects. Booklet, details free. Men only. National Potteries Company, Grand Rapids, Minnesota.

**\$5,199.90 WAS Paid** to John Betts, in few weeks. Grow mushrooms. Cellar, shed. Spare, full time year round. We pay \$3.50 lb. Free book. Mushrooms, Dept. 172, 2954 Admiral Way, Seattle, Wash.

**VENDING Machines—Every description.** New or used. Lowest prices—Start a route or sell outright. Mack Postel, 2952 Milwaukee, Chicago 18.

**WANT To make big money at home?** \$5 profit in an hour possible with invisible reweaving. Make tears, holes disappear from clothing, fabrics. Steady year-round demand from cleaners, laundries, homes. Details free. Fabricon, 8334 Prairie, Chicago 19, Illinois.

**WORK At home.** Make money. Amazing opportunities. Free details. Coleman, Box 821-A, Newark 1, N. J.

**\$30.00 A Day** profits raising earthworms. Illustrated booklet, 25c postpaid. North St. Paul Worm Farm-D, North St. Paul 9, Minn.

**YOUR Own business.** No investment. No inventory. Sell name brand nationally advertised items. Free catalog. Confidential wholesale price list. Normandy Dist. Co., Dept. PM, 133 Fifth Ave., New York 1, N. Y.

**INTERESTED Mail order?** Copies leading mail order magazines. All different, 25c. Palm, Box 1221, Baton Rouge, La.

**BRUSH** Plating outfits for plating articles in the home and shop. No tanks necessary. Good income spare or full time. Free particulars. Gunmetal Co., Ave. H, Decatur, Illinois.

**\$1,000 MONTHLY** Possible in collection agency business. Free details. Write Cole Associates, Syracuse 2, N. Y.

**HIGHEST Commissions** all magazines. Free catalogue, supplies, prizes, exclusive extras. Subscription Service Co., Box 2070, Birmingham, Alabama.

**PROFITS Stamping** social security plates. Catalog free. General Products, 188-PM State, Albany 10, N. Y.

**HOME Business,** spinning Angora wool. Steady cash market for wool. Angora House, PM, Springfield, Illinois.

**MONEY Learning** sewing machines. Beginners lesson 20c. Purdy's, 207M, Weatherford, Texas.

**OPERATE Mailorder** folio business! Bailard's, 425 East Catherine, Louisville 3, Ky.

**I Made \$10,000.00** typing at home. Guaranteed proof. Free details. Lenore Feigen, Box 1125-PM, Oak Park, Ill.

**RECEIVE Advance** notice of new products and inventions. Wealth of ideas. Send 50c to New Products, Box 592, Austin 63, Texas.

**REAL Wholesale** sources, thousands nationally advertised products. Details free. Martex, 132-B Nassau St., New York 7, N. Y.

**DOLLARS: Baby record books, Kitty Kat shoes, My Baby's Album,** eleven thousand new prospects daily, sold by mail, use our literature. No-Co-Ro, Capitola, Calif.

**OWN A collection agency.** Pays big. Franklin Credit, Roanoke 7, Virginia.

**FREE! Complete mailorder business!** Terrific profits! No investment! Sample 30-day supply \$1.50 refundable. VitaMins, 2908PM Beverly, Los Angeles 57.

**IMPORT Your own products** in small lots. Also, start profitable mail-order business using International drop shipment method. Capital unnecessary. Free details. Ga. Overseas Trading Co., Dept. W, 715 Persons Bldg., Macon, Ga.

**PRINT** Without a printing press! Amazing new method! Print colorful signs, banners, cards, posters, glasswear; anything at home. Big profits. Money-making opportunity! We supply everything. Beautiful sample, home-business plan free! Write Screen-Print Company, PM-5, Los Angeles 61, California.

**FIGURINES! Easy to make!** New illustrated course shows how! Includes mold-making, casting, painting! Quick methods! Perfect results! Complete course only 25c! Castcraft Studios, 508-PM Marion St., Brooklyn 33, N. Y.

**SPECIALIZED Magazines** give you new ideas. Examine current copies, one or all those covering your field. 5,186 different publications—All businesses, trades, vocations, professions, sports, hobbies, etc. Free list. Write today. Commercial Engraving Publishing Company, 34C North Ritter, Indianapolis 19, Indiana.

**MAKE Extra buck.** Sell nationally advertised merchandise. Free wholesale catalog. Harry Cohon & Sons, Inc., 1069-PM5 Utica Ave., Brooklyn 3, N. Y.



**CAPITAL** Raising methods. Copyrighted—“How and Where to Raise Capital.” Counselor folio. Establish your own business. Expand! Free particulars. A. P. Service, Box 1377-BE, Miami 8, Florida.

**AMBITIOUS** But lazy? Big money at home while others do most of work! Post-card OK. Maxson, Falls Church 17, Va.

**LEARN** Reweaving! Free details. Harris Reweavers, Box 7112, New Orleans 19, La.

**SAVE** Gasoline! Proof trial. Agents: Fantastic earnings! Cross Company, Eutawville, S.C.

**LEARN** Sewing machine big money repair, sales, service. Machines, “everything” wholesale. Taylor Service, Box 2126, San Bernardino, Calif.

**INTERNATIONAL** Mailorder business. Complete setup service—Not just instructions. Hermes, 152 West 42, New York City 36.

**CASH** From sawdust, seventy methods. Tin-cans, thirty methods. Newspapers, eighteen methods. Instructions 50¢ each. All three \$1.00. Charles Company, 12-DXV, Norwood, Ohio.

**AMAZING** Home business. Terrific profits. Make, sell sensational cleaner for woodwork, tile. 12¢ makes gallon. Sells \$2.00. Formula \$1.00. Details free. Money-back guarantee. Sayco, Box 158-PM, Eden, Ala.

**FRANCHISE** Opportunities nationwide! Profitable distributorships, dealerships, agencies. Request interesting information immediately. National Franchise Reports, 333 North Michigan, Chicago 1.

**HOME** Operated business. New discovery. No competition. We show you how to make beautiful practical high profit product, full or part time. Steady demand through stores every locality. Details free. Wells System, 14040 Euclid Avenue, Cleveland 12, Ohio.

**BUY** Wholesale! Resell at big profits. Brand name merchandise—Appliances, cookware, housewares, watches, jewelry, dry goods, clothing, sporting goods, toys, gifts, etc. Free 124 page illustrated color catalog with confidential cost sheet. Merit Home Products, Dept. PM-5, 107 Manhattan Ave., Brooklyn 6, N. Y.

**ADVERTISING** Book matches—Cash in on big demand! Sell union label matches. Cuts for all businesses and political parties. Free powerhouse selling kit, low prices, protection guaranteed on repeat orders. Cash commissions. Superior Match Co., Dept. MX556, 7530 Greenwood, Chicago.

**EARN** Up to \$2000.00 monthly with spare or full time route of infra-red sandwich machines, not vending machines, in your community. We assist you in getting started. \$1290.00 cash starts you. Write W & K Mfg. Co., 2319 Hampton Ave., St. Louis 10, Mo.

**WHOLESALE** Buyers' service! Buy nationally advertised merchandise wholesale. Sell way below retail. Fabulous profits. Write Wholesale Buyers, Box 22-PD, St. Louis 3, Missouri.

**AMBITIOUS?** We establish you in your own business, supply catalogues, circulars, etc., ship orders under your name, paid or c.o.d., show you exactly what to do. Household items needed in every home. Sell direct, by mail or through agents. Catalogue, plans, details, absolutely free. Write Topval Corp., Lindenhurst 518, N. Y.

**BEST** Moneymakers in ladies' and men's wear specialties at rock-bottom manufacturer's prices! Risk free, easy way to your own year-round business on a shoestring! Sensational success plan with newest display catalogs cost free! Write: Progress Textilecraft, Dept. PM, 230 Fifth Avenue, New York 1, N. Y.

**DISCOUNT** Catalogue! Appliances, housewares, jewelry, watches. Nationally famous brands, beautifully illustrated. International Consolidated Merchandising Corporation, Box 6480-PM, Los Angeles 55, California.

**YOU** Can make money at home in spare time taking magazine renewal subscriptions. No capital or experience necessary. All supplies furnished. Write today! McGregor Magazine Agency, Dept. 500B, Mount Morris, Illinois.

**FROG** Raising! Season just starting! Get this year's eggs. New book tells how. Folder 10¢. Broel-A, Box 506, New Orleans 1, Louisiana.

**MANUFACTURE** Successfully! Fortunes made daily. Write: Alltools, Box 268-BX, New York City 5.

**BACK** Seat eating tray. Fits all autos. Lease on royalty basis. Contact M. L. Kimrey, 317 Richardson Street, High Point, N. C.

**97** SCHEMES To make a million. You might! Information free. L. Womack, 156 Ponce de Leon Crt., Decatur, Ga.

**\$26,500** SALES In two weeks! Amazing radio-mail order method. Free details Broadcast Service, 1412-BA Great Northern Building, Chicago 4, Illinois.

**FLORIDA** Jobs, business opportunities, housing, retirement. 135 page book \$2.00. Four Sunday newspapers \$1.00. Reliable representative. Florida Information, P.O. Box 908, Miami 6, Florida.

**OPERATE** Restaurant or diner. Free booklet reveals plan. Write Restaurant Arts, BU-15, Fremont, Ohio.

**FREE** Advertising. Amazing opportunity. Rush request to Oakwood Press, Philadelphia 26.

**100** JOBS At home. Free details. Business, 60, Des Ormes, Quebec 3, P. Q., Can.

**NEW**, Exciting business. Hustlers can make tremendous profits. No special training or experience needed. Startling manual tells all. Free details. Robert Albers, So. 2 Airport Road, St. Johns, Mich.

**WONDERFUL** Homework opportunity. Recording for profit. Write: Baron's, Lynden, Wash.

**ILLUSTRATED** Book “Photo-Offset Printing—Career or Sideline” \$1.00, refunded with first easy-to-get orders from schools, churches, clubs, merchants, manufacturers. Everybody needs this economical service. Photolith Printing, Dept. PM, 715 Broadway, New York City 3.

### MONEYMAKING OPPORTUNITIES

**FREE** Literature 500 easy moneymaking plans. Barnes, 8401N Miami Ave., Miami 38, Fla.

**EARN** Money evenings copying and duplicating comic cartoons for advertisers. Adservice, Argyle 1, Wisconsin.

**\$20.00** RETURNS \$400.00. Lifetime repeats. Sample \$1.00. Refundable. Ezeq, Bayport 7, Mich.

**TO** \$100.00 Weekly. Sparetime, home operated mailorder business. Successful beginner's plan. Everything supplied. Lynn, 10420-M National, Los Angeles 34.

**MAKE** Spare time money preparing and mailing sales literature. Adams Surveys, 3513-AT Sunset Blvd., Los Angeles 26, Calif.

**EARN** \$50.00 Daily making mats, shoes and mud guards from old tires. S and S Patents Inc., 1307 North Clark St., Chicago 10, Ill.

**GENERAL** Contest Bulletin. Issued monthly. Sample, 25c. 1609 1/2 East 5th, Duluth, Minn.

**FREE** Book “505 Odd, Successful Businesses.” Work home. Expect something odd! Pacific, Oceanside, Calif.

**READ** Progressive Mailtrade, the magazine that tells how to make money by mail. Dime brings sample and special offer. Progressive Mailtrade, Box 357, Sheboygan, Wisconsin.

**SELL** Titania gems; far more brilliant than diamonds. Catalog free. Diamonite, 2420-M 77th, Oakland 5, California.

**PLASTIC** Laminating. Pleasure and profit. Self-sealing. No machines. Complete home kit, \$1.00. Mountainside 1, Springwater, New York.

**PRIZE** Contests provide fabulous and confidential home income opportunities! Here's how and where to win your share! Send stamp! National Contest Bulletin, Box 2685-P, Miami 16, Florida.

**\$150** WEEK—Easy! Start home Venetian blind laundry. Revealing book free. A. T. Co., 101 S. 44th, Philadelphia 4, Penna.

**\$5,199.90** WAS Paid to John Betts, in few weeks. Grow mushrooms. Cellar, shed. Spare, full time year round. We pay \$3.50 lb. Free book. Mushrooms, Dept. 173, 2954 Admiral Way, Seattle, Wash.

**LEARN** Technical metaphysics and insure your future. Easy, inexpensive correspondence course. Simplest method known. Diploma. Write: Premier College of Technical Metaphysics, 2532 McKenzie St., Vancouver 8, B. C., Canada.

**MAKE** Money at home. Spare time. Free literature tells how. Maletto, 1312 So. Clinton, Berwyn, Illinois.

**INCREASE** Your income. Free details. Bercher, Box 500, Shreveport, Louisiana.

**EXTRA** Cash cleaning windows. Uncrowded opportunity. Kent Window Cleaning, Box 6807, Philadelphia 32, Penna.

**ADULTS.** Genuine additional income opportunities; interesting offers. Stamp appreciated. Geo. Gent, Box 484, Tremonton, Utah.

**FREE** Folio “\$5,000-\$45,000, Unlimited Vacations.” No merchandise, equipment. Unknown! Work home, sparetime! Haylings, Carlsbad, Calif.

**PLEASANT** Profits—Let us show you how to start your own complete scissors and tool sharpening business. Free details. Serr-Edge Inc., 9729 Lorain, Cleveland 2, Ohio.

**FORTUNE** Possible raising, fishworms and crickets. Free literature. Carter Hatchery, Plains, Georgia.

**SELLING** Merchandise by mail to women can mean big profits for you. Details free. John Hall, Room 1002, 509 Fifth Ave., New York 17, N. Y.

**NEW** 1956 Lamp parts catalog showing everything you need to make and repair most types of lamps. Everything at lowest wholesale prices. Send only 25¢ today for both catalog and wholesale price list. Gearon Co., Dept. 503-B5, 27 S. Desplaines, Chicago 6, Ill.

**START** A buying service, buy wholesale thousands nationally advertised products. Make big profits selling at sizable discounts. Postcard brings details. American Buyers, Hertel Station, Buffalo 16-D, New York.

**PRINTING**, Office supplies wholesale. Save 50%. Royal, Box 368-A, Cleveland 27, Ohio.

**IMPORTED** Oriental pearl necklaces. (\$1.95 sellers) \$4.00 dozen. Sample 50¢. Matlack Enterprises, Box 28, Sharon Hill, Penna.

**OIL** Reclaiming plan. \$50 week profitable business. \$1.00. Sackett, Box 326, Greenfield, Iowa.

**LET** Others do the work. You receive profit. Send only \$1.00 for sample and complete instructions. Caudle, P.O. Box 5903, Birmingham 9, Ala.

**CONVERT** Cheap foods into money making mink. Complete free information. Voigt Farms, Lomira 2, Wisconsin; or Atlanta 2, Texas.

**CHAIN** Reaction mail order method. Huge profits possible. Sample, details, 25¢. Smith's Sales, Box 288A, Wenatchee, Wash.

**MAKE** Money writing short paragraphs! No tedious study. I tell you what to write, where and how to sell; and supply list of editors buying from beginners. Many small checks add up quickly. Write to sell, right away. Send for free facts. Benson Barrett, 1751 Morse, Dept. C-27-S, Chicago 26.

**ATTENTION:** Typewriter owners. Make handsome profits. Write today. Groves Company, 682, Hastings 8, Nebraska.

**WATCH** And diamond line. Profitable opportunity. Dealer catalogs 25¢. Cook Sales, 602 Locust, Fall River, Mass.

**YOUR** Own business at home. \$20 investment. Western Investment Co., 1020 West Fiat Street, Torrance, California.

**EARTHWORMS:** Small investment opportunity. \$5.00 brings 1000 bed-run earthworms, raising and marketing manual. 25¢ brings literature only with “senior kit” information. Multiple Enterprises, P.M.-72, Kalkaska, Michigan.

**DOLLARS** Every day! Start your own mail-order business. Work home! Complete details free. Dave Martin, 3575 Sacramento, San Francisco 18, California.

**BIG** Profits selling ties (\$2.00 value) \$6.50 dozen. Free catalog. Empire Cravats, 611-PM Broadway, New York 12.

**NEW** General, religious, comedy 7"x11" signs—cost 7¢, sell 50¢. Sample free! Lowy, 812 Broadway, Dept. 925, New York City 3.

**HUSBAND** And wife operate profitable steady home business repairing brassieres and girdles. Sewing machine and ten dollars materials starts you. Chic, 5315 Thirteenth Ave., Brooklyn.

**SELL** Sparetime from free wholesale catalog. Nationally advertised watches, jewelry, appliances. Save on personal needs. Big discounts, huge profits. No investment. Louis Perloff, Dept. PM, 733 Walnut St., Philadelphia, Penna.

**SELL** Aluminum awnings. Baked enamel colors. All sizes. Write Jack Groff, Box 10254, Tampa, Florida.

**UNIQUE** Businesses of America! Benefit yourself. Secure exclusive, rewarding franchise. Investigate! National Franchise Reports, D-528, 333 North Michigan, Chicago 1.

**EARN** \$50.00 A month without stepping out your front door. Make money with your telephone. Free details. National Telephone Survey Bureau, 837-A West 59th Terrace, Kansas City 13, Missouri.

**SPECIAL Offer**, 8 perfect arrowheads \$1.00, U. S. only, Arrowhead Sales, 4588 South Acoma, Englewood, Colorado.

**MAMMOTH** Mail—Offers, opportunities, specials, extras. 50¢. Mid-State, 402½ C Arthur, Syracuse 4, N. Y.

**CASH** In on contests now! Get facts that help. Write Sanders & Co., 1762 Euclid, Lincoln, Neb.

**VITAMINS**—All formulas. Private labels available. Big profits. Repeat orders guaranteed. Chemo, P.O. Box 4435, Philadelphia 40, Penna.

**MAKE** Money with your camera. Amazing new low cost color enlargements can bring you hundreds of dollars in spare time. Nothing else like it! Send 10¢ for samples and eye-opening facts. Dept. PM-5A, Polypix Co., 723 S. Wells, Chicago 7, Illinois.

**GET** The latest—Best low cost starting mail offers. Everything furnished. Orders filled. Rush name. Modern Industries, 405 E. Chestnut St., Wauseon, Ohio.

**WANT** To go in business for yourself without capital? We show you how. Start part time your own home. Postcard brings details absolutely free. Topval Corp., Lindenhurst 420, N. Y.

**\$50.00 TO \$100.00** Per week. No skill necessary. Send 25¢ for sample and details. Arrowhead Sales, 4588 So. Acoma, Englewood, Colo.

**500 WAYS** To earn money at home. Literature 10¢. A. Welch, Lake and Central Ave., Delaware, Ohio.

**THERE'S** Money in earthworms. (Breeder's supplied.) New book 35¢ postpaid. Colonie Bait Farms, 1273 Central, Albany 5, N. Y.

**WONDERFUL** Home business. Pays excellent profits. Work sparetime. Brand new manual explains all. Be your own boss. Amazing information free. Lowell Service, Box 468, Wellsboro, Penna.

#### FORMULAS, PLANS, ETC.

**FREE** Formula catalog. Anything analyzed \$35.00. Western Chemical, Salem, Oregon.

**MAKE** More money with formulas. Free information. Formuco, 4015 So. Lincoln, Englewood, Colorado.

**MILLER'S** Modern manufacturing formulas make fastest-selling products that get the business and pay. Fifty years supplying the best. Valuable literature free. Miller, Chemist, 1517-F, Tampa, Florida.

**PRACTICAL** Formulas. Lists free. Cummings, Chemist, Gordon Ave., Syracuse 4, N. Y.

**FORMULAS:** All kinds, latest, best. Literature free. Kemixal, Park Ridge, Ill.

**PRODUCT** Analysis, manufacturing formulas, processes developed. Moderate fees. Plastics, Box 1574, Boston 4, Mass.

#### PLASTICS

**PLEXIGLAS,** Fiberglass, polyester, acetate. Unique wholesale-retail catalog—15¢. Gem-O-Lite, Box 886M, North Hollywood, California.

**WE** Seal in plastic: Soc. security, wallet-size cards, and photos 25¢. Ray Putt, 1640 Dyre Street, Philadelphia 24, Penna.

**PLASTIC.** Sheet, rod, tubing. Catalog 10¢. Coleman Sales, 5926 Cornell, Dearborn, Michigan.

**NEW** Liquid casting plastic, clear, colors. Embed real flowers, insects, photos, coins. Saw, drill, carve. Send 25¢ for handbook, "How to Cast with Liquid Plastic," and proved success plan showing how to make money at home. Castolite. Dept. E-101, Woodstock, Ill.

**PLASTICS** Home-craft course for men and women. Tells and shows how to make hundreds of fast selling plastics products. All plastics and materials for 23 projects included in course. No special tools needed. Course pays for itself. Write for free booklet. Interstate Training Service, Dept. D-3, Portland 13, Oregon.

**LAMINATING** Supplies. Free price list. Solomson, 46 Cornhill, Boston 8, Mass.

**PLEXIGLAS.** Cut to size. Clear. Any thickness. Colors. Rods. Tubing. McClarin Plastics, P.O. Box 166H, Hanover, Penna.

#### CHEMISTRY

**SPECTROSCOPE** For quick chemical analysis \$3.00. Kutting Sons, Los Altos, Calif.

**HOME** Laboratory and apparatus kits, laboratory supplies. Catalog 25¢. John H. Winn, 124A West 23rd St., New York, N. Y. Established 1931.

**AMAZING** New book of science. Experiments, formulas and catalogue of laboratory supplies. Only 25¢. National Scientific Co., Dept. PM-5, 2204 W. North Ave., Chicago 47, Illinois.

**CHEMICALS,** Supplies. Catalog 25¢, refundable. Laboratory Sales, Box 161-E, Brighton, Mass.

**ILLUSTRATED** Catalog: Chemistry, mineralogy, biology 20¢. Tracey Laboratories, Evanston, Illinois.

**CHEMICALS** And apparatus for industrial, analytical, and private laboratories. Catalog 25¢. Dept. M-50, Biological Supply Co., 1176 Mt. Hope Ave., Rochester 20, N. Y.

**BOOKLETS:** 60 pages each! "Beginners Chemistry," "Chemistry," "Einstein's Relativity," "Physics," "Atomic Theory," "Electron Theory," "Scientific Oddities," "Light," "Sound," "Heat," "Electricity," "Radio," "Astronomy," "Useful Tables," "Geometry," "Mathematical Oddities," "Scientific Terms." Order by titles. 10¢ each. Franks, 3121 South Racine, Chicago 8.

#### AGENTS WANTED

**PROFIT** With fun: Sell our nationally advertised greeting cards and gifts. Make money, make friends and help the paralyzed veterans. Write for free full color catalog and confidential profit list. Paralyzed Veterans, 432 Fourth Avenue, New York City 16.

**MEN-Women** agents: Sensational new money-makers — Beautifully hand-painted, plastic personalized photo enlargements, compacts, rings, bracelets, lockets, etc. Simply take orders, pocket 40% commission. We deliver and collect. Sales outfit free. Novelco, 3343 North Avenue, Chicago 47.

**MEN, Women,** make money spare time plus new car as bonus for encouragement. Amazing hosiery guaranteed to wear without holes, snags, and runs, or replaced free. For example, lovely 60 gauge nylon guaranteed for as long as 1½ years, or replaced free. Write Wilkmit, 1765 Wash., Greenfield, Ohio.

**CHANGEABLE** Letter electric sign 18x24. Sells for \$12.50. Make \$5.00 each sale. Kenray Industries, 47 Franklin Street, Jersey City 7, N. J.

**BUY** Wholesale thousands nationally advertised products at big discount. Free "Wholesale Plan." American Buyers, Hotel Station, Buffalo 16-A, N. Y.

**FREE!** Beautiful feather pictures. 200% profit! Apartado 9036, Mexico 1, D. F.

**80% PROFIT** On cosmetics—Famous nationally advertised Hollywood cosmetics pay 60%! Make \$25 day up! Hire others. For free samples, details, write Studio Girl, Glendale, Calif., Dept. 1265G.

**SHAVING** Revolution. No electricity. blades, soap required. 140% profit. Inter-cost, 2325 Bon Air, Montreal, Canada.

**AGENTS** And demonstrators tested and proven fast seller. Does the work of 20 necessary kitchen utensils. Costs 9¢, retails 49¢. Send 25¢ for sample and sales plan. New Method Co., Box PMM-5 Numethod Bldg., Bradford, Penna.

**HEATING** And air conditioning service men, salesmen and engineers. Profitable, dignified accepted item. \$10.00 profit per \$28.95 sale. Exclusive territories available. Write Comfort, Box 455, Highland Park, Ill.

**GOLDMINE** Of 600 money makers. Copy free. Specialty Salesman Magazine, Desk 5-B, 307 N. Michigan, Chicago 1.

**HOME** Motorized massage. Big money! Mary Mac, 1012 Powhattan, Dallas 2, Tex.

**YOUR** Own business—Used suits \$1.50, overcoats 65¢, mackinaws 35¢, shoes 12½¢, ladies coats 30¢, dresses 15¢. Enormous profits. Catalog free. Nathan Portnoy Associates, 605-AA West 12th Place, Chicago 7.

**GOLD** Or silver letters, numbers. Windows, doors, trucks. 1" to 6". 500% profits. Free samples. Atlas-T, 544 West 79th, Chicago 20.

**PRINTING.** Advertising salesmen—Excellent moneymaking sideline selling decalcomania name plates, small quantities. Automobile initials, sign letters. Free samples. Raico, XL, Boston 19, Mass.

**\$1.00 PROFIT** Selling \$2.95 photo enlargement deal. Allen Studio, Riegler Bldg., Little Rock, Ark.

**AGENTS** — 300% Profit selling genuine gold window letters; stores and offices. Free samples. Metallic Sign Letter Co., 431-D North Clark, Chicago.

**CALIFORNIA** Sweet smelling beads. Sensational sellers. Particulars free. Mission, 2328 FR, W. Pico, Los Angeles 6, Calif.

**USED** And new watches \$2 up. Free list. Southern Watches, Gray, Georgia.

**YOUR** Ad in this space will get some good agents for you. Yes, I'll prove it. Write for Folder "A" right now. F. W. Johnson, Classified Advertising Manager, Popular Mechanics Magazine, 200 E. Ontario St., Chicago 11, Ill.

**EASY** Handwork makes fast-selling articles. Sample free. Sunmade Company, Brockton 64, Massachusetts.

**WANT** More business? Here's an amazing opportunity to increase your sales. Talk to thousands of interested readers of "Mechanica Popular." Our Spanish Edition covers the Latin American countries like a blanket. They're real mailorder buyers. Classified rate 75¢ per word. Try an ad in our next issue. Classified Advertising Department, Popular Mechanics Magazine, 200 East Ontario Street, Chicago 11, Ill.

**WHOLESALE.** Famous make scatter rugs. Free details. Dorsey, 210 Fifth Ave., New York City.

**SELF** Starting cigar lighter, no flint or friction. New principle of ignition. Chrome plated, cost \$6.00 a dozen. Retail \$1.50. Sample and can of fluid 75¢. New Method Company, Box PM-5 Numethod Bldg., Bradford, Penna.

**AGENTS** — Fast selling specialty from Italy. Box 277, Lewiston, Idaho.

**NEW** Official baseball pitching machines \$195. Box 20730, Los Angeles 6, Calif. Agents.

**NEW** Magic metallic ironing board cover. Women buy on sight! Send for free demonstration sample. Take orders immediately. Quality Products, Box 748, Passaic, N. J.

**A** Dress shop in your home. No investment. Good commissions selling better dresses. Write Modern Manner Clothes, Hanover YS, Penna.

**TREMENDOUS** Market, new product. Alumicone, cleans, polishes, protects outdoor aluminum, doors, windows, trailers, etc., contains General Electric silicones. Details free. Mark "A" Products, P.O. Box 24, Dept. A, New York 69, N. Y.

**I** Put photos on stamps. People see it but don't believe it. Agents wanted. 300% profit for you. Free sample. National Photostamp Co., Dept. 4, 309 New York Ave., Brooklyn, N. Y.

**SENSATIONAL** Moneymakers! Catalogue, gift, free. Braver Co., 1478-39 St., Brooklyn 18, New York.

## BUY IT WHOLESALE

61 PIECE Socket wrench set. Agents cost \$19.95—3 sets or more. Garage price \$29.95. Retail \$49.95. Robe, 1923 East 79th, Chicago 49.

BUY Wholesale. Famous brands. Catalog 25¢. Golden Feather Service, 1061-A Atlantic, Long Beach, Calif.

WHOLESALE Brand named products catalog \$1.00. D. Kabel, 870 Lafayette, Buffalo, N. Y.

WHOLESALE Catalog! Appliances, cameras, watches. Postcard. Selbyco, Decatur 256, Illinois.

FREE Wholesale catalog. Appliances, cameras, watches, tools, sporting goods, summer needs. Housewares, 7502-D Cottage Grove, Chicago 19.

BIG Discount on consumer purchases. Catalog \$1. Refundable. Discount House, 1023 Gregory Street, Greensboro, N. C.

BUY Wholesale Nationally advertised appliances, radios, watches, etc. Catalog \$1.00 (refundable). D'Auria, Box 355-PM, Jackson, Michigan.

1956 "PORTABLE Showroom" (catalog). Rush 50c to Edward Clemens, 318 W. Bridge St., Morrisville, Penna.

WHOLESALE Catalog! 30-80% discounts! Appliances, musical instruments, typewriters, phonographs, watches, jewelry, recorders, housewares, etc. Consolidated Distributors, 21-20 Lafayette, Paterson, New Jersey.

WHOLESALE Name brands. Illustrated catalog 50c. Refundable. Distributors, Box 106A, Hudson, New York.

FREE Lists. 640,000 items wholesale. P. Cottage Industries, Omaha 12, Nebr.

WHOLESALE Coverage, complete! Amazing details. Mailtrader, Box 643, Ann Arbor, Michigan.

BUY Wholesale! Television, radios, refrigerators, freezers, water heaters, air conditioners, sewing machines, power tools, housewares, etc. Catalog 10¢. Marpat, Box 1485, D-PPM, Milwaukee, Wis.

ELECTRIC Guitars, amplifiers, accordions, wholesale. Free catalog. Carvin, PM287, Covina, Calif.

REAL Wholesale sources thousands nationally advertised products. Details free. Martex, 132-C Nassau St., New York 7, N. Y.

USED And new watches \$2 up. Free list. Southern Watches, Gray, Georgia.

VITAMINS, Wholesale prices, highest quality and potency. Details free. Hudson's, Box 4015, Fresno 4, California.

LEARN Wholesale buying secrets. Details free. Wholesalers, 25 West Lane, Columbus, Ohio.

YOUR Cost as little as 25c on dollar! Household items needed in every home. Sell direct, by mail or to agents. Catalogue, confidential distributors' wholesale prices and money-making plans absolutely free. Rush postcard to Topval Corp., Lindenhurst 224, N. Y.

VITAMINS—Save 40%. Free catalogue lists all brands. Vitamins, 3600-06 North 15th Street, Philadelphia 40, Penna.

## SALESMEN—DISTRIBUTORS

NEW Jobs open in selling! Send name, address for five free issues of Opportunity Magazine's money-making guide, listing hundreds of companies who'll pay you well, full or part-time. No experience needed. Opportunity, 850 N. Dearborn, Dept. 17, Chicago 40, Ill.

CASH In on 1956 elections! Big advance commission selling low priced union label political posters, cards, labels, book matches to candidates. Complete printing line for all businesses. Free kit. National Press, North Chicago 2, Ill.

BUILD Sales by recruiting productive distributors selling direct or to retail outlets. Secure most concentrated circulation through classified columns of Salesman's Opportunity. Write for facts. Gilbert, Salesman's Opportunity, Room 1700, 850 N. Dearborn, Chicago 10.

PRINTING, Calendar, novelty salesmen; America's best deal. New, hot best selling samples free. Write. South's largest. Nationwide, Arlington, Texas.

8150 WEEK Extra. New wireless intercom. Plug into outlet for dramatic demonstration. Guaranteed Sales plan. Claude Products, 8607 S. Bennett, Chicago.

EXCLUSIVE Distributorships available for world-famous Micro Bronze Permanent All-Metal Oil Filter. Tremendous demand created by ads in national magazines. Make big profits for full or part time business. No charge for 5 year written franchise. Wire or write Dept. W, Micro Bronze Filter Corp., 140 Kansas St., El Segundo, Calif.

SALESMEN: Sell merchants. Repeat business assures steady income. Details free. Box 1663, Fargo, N. Dak.

\$60 WILL Earn \$10,000. Long needed invention. Proved sales plan. Send no money. Details free. Write Cyclo, Dept. 120, 3816 Dahlia, Denver, Colo.

SELL Calendars. You make big money daily. Giant line. Every business buys. Also business printing, book matches, advertising specialties. Big sales outfit free. Write, Arrow Press, 515-E Fourth Ave. So., Minneapolis, Minn.

GET New shirt outfit free. Make \$90.00 weekly on 5 average orders a day. Famous quality made-to-measure dress and sport shirts at \$3.95 up sell fast to all men. No experience needed. Full or part time. Write: Packard Shirt Co., Dept. 266, Terre Haute, Ind.

SIX! \$1.00 Mailorder items. Proven successful money-makers everywhere. Evans Manufacturing, 5930 Comey, Los Angeles 34, California.

AD Matches! Sell amazing designs—10, 20, 30, 40 and 240-light book matches. Bigger spot cash commissions; every business a prospect. Low prices for high quality. Repeats. Start without experience; men, women; full, part time. Buy nothing! Sales kit furnished. Match Corp., Dept. PM-77, Chicago 32, Illinois.

BIG Money-making opportunity. Exclusive line work uniforms. Jackets, pants, shirts, coveralls. Advertising embroidered. Every business prospect. Outfit free. Master Div., 688 Water, Ligonier, Ind.

BUY Wholesale thousands nationally advertised products at big discount. Free "Wholesale Plan." American Buyers, Hertz Station, Buffalo 16-J, N. Y.

CALENDARS. Advertising novelties, matches. All styles, including religious, varnished, 12 sheet, girls. Hundreds of advertising novelties, book matches, etc. Fleming Calendar Co., Sales Division, 6539 Cottage Grove, Chicago 37, Ill.

DISTRIBUTORSHIP Available, easily worth \$10,000 and up, to sales-minded person. Investment of \$900 or more needed for stock. Write: President, Box 66, Youngstown, Ohio.

CREDIT Deal. Power mowers. Wholesale. Agents, dealers. Gemco, PM, Excelsior Springs, Missouri.

EARN Big money giving samples away. Ohio, North Madison 3, Ohio.

ADVERTISING Book matches—Cash in on big demand; sell union label matches. Cuts for all businesses and political parties. Free powerhouse selling kit, low prices, protection guaranteed on repeat orders. Cash commissions. Superior Match Co., Dept. M-556, 7530 Greenwood, Chicago.

EXCLUSIVE Territory. Fast selling product. Great demand. Repeat sales. Profits unlimited. Forrest Products Co., Box 244, Piqua, Ohio.

SENSATIONALLY New, easy selling. Taverns, restaurants, gas stations, other businesses, buy immediately. Substantial earnings. Details, samples free. Fritch-Hayden, 610 South Coronado, Los Angeles 57.

## EDUCATIONAL AND INSTRUCTION

FREE Trial—Complete language course for home study by Linguaphone, the world's standard conversational method. At home, easily, quickly learn to speak French, Spanish, German, Japanese, Modern Greek—Your choice of 34 languages. It's like living in another country. Send for free book and details of free trial. No obligation. Try, don't buy! Linguaphone Institute, T-83-056 Rock Plaza, New York City 20.

BLUEPRINT Reading — Train at home. Learn to read blueprints with confidence in 10 easy lessons. Write today Belton School, 1059-N North Lawndale, Chicago 51.

WELDING Training pays at Hobart Welding School, Box M-561, Troy, Ohio. VA contract. Best equipment. Catalog free.

FREE Listings used correspondence courses and books. Bought and sold. Photographers Market Guide \$1. Money-making Guide \$1. Gem Publications, Linwood, N. J.

EARN Degree. Free bulletin. Home-study only. Midwestern Bible School, 517 Merchants Bank Bldg., Indianapolis.

COMPLETE Your high school at home in spare time with 59-year-old school. Texts furnished. No classes. Diploma. Information booklet free. American School, Dept. X545, Drexel at 58th, Chicago 37, Ill.

BECOME A doctor of psychology or metaphysics. Learn secret of contentment, happiness. Win degree of Ps.D. or Ms.D. Correspondence only. Free book. College of Universal Truth, 23-C East Jackson Blvd., Chicago 4, Ill.

HANDWRITING Character analysis self-taught. Quickly learn six basic principles. Instantly recognize introvert, extrovert; emotion, mind-ruled; logical, intuitive types. Free brochure. DeWitt Lucas, 2419 Sunset Boulevard, Los Angeles 26, Calif.

APPLY For jobs by letter. Folio \$1. Telesis Company, Room 706, 507 Fifth Avenue, New York 17.

STUDY For Doctor's degree of psychology, metaphysics and divinity. Correspondence courses only. College of Divine Metaphysics, Dept. P-M, 2811 North Illinois, Indianapolis 8, Indiana.

LEARN Mineralogy at home. Diploma course. Fortunes now being made in uranium and other minerals. Free catalog. Mineral Science Institute, Desk 2, 159 East Ontario, Chicago 11.

HIGH School diploma at home. Licensed teachers—Approved materials. Southern States Academy, Box 144-MX, Station E, Atlanta, Georgia.

PIANO Tuning pays. Big money in spare time. Learn at home in 30 days. No musical knowledge necessary. Phonograph, records, tools and instructions furnished. Free catalog. Capital Tuning School, 18 Southwest Second, Fort Lauderdale, Fla.

I Want to send you proof of the wonderful pulling power of Popular Mechanics classified pages. What's your proposition? Write me today. Include literature if possible. F. W. Johnson, Manager Classified Advertising, Popular Mechanics Magazine, 200 E. Ontario St., Chicago 11, Ill.

\$5,199.90 WAS Paid to John Betts, in few weeks. Grow mushrooms. Cellar, shed. Spare, full time, year round. We pay \$3.50 lb. Free book. Mushrooms, Dept. 174, 2954 Admiral Way, Seattle, Wash.

BE A real estate broker. Study at home. Write for free book today. GI approved. Weaver School of Real Estate, 2018P Grand, Kansas City, Missouri.

INVESTIGATOR Training. Phillips Secret Service System, 1917-B North Kenneth, Chicago 39.

SECRET Investigation. Experience unnecessary. Investigators particulars free. George Wagner, M125 West 86th, New York 24.

EARN While you learn. Auto and diesel mechanics master this top paying trade. Many graduates earn \$100 a week and up. Approved for Korean veterans. For free information write Dept. No. 256, Nashville Auto-Diesel College, Nashville 3, Tenn.

BOOKKEEPERS! Increase your earnings! Operate your own simplified "Dollar-A-Week" bookkeeping and tax service. Full or spare time. Details free. No obligation. Ellis, Box 200, Cedar Grove, North Carolina.

USED Correspondence courses and books sold and rented. Money back guarantee. Catalog free. (Courses bought.) Lee Mountain, Pisgah, Alabama.

WANT A diesel job? New opportunities to increase income. Higher pay. More money. We can help you qualify. Tools. Shop method home training. Write today! Diesel, Tractor, Heavy Equipment Division, Interstate Training Service, Dept. B-3, Portland 13, Oregon.

PHYSICAL Therapy and massage. We train you at home. Earn big profits from your own private practice or work with hospitals and doctors. Free catalogue. National Institute, Desk 4, 159 E. Ontario, Chicago, Ill.

SPEAK. Sing with power, personality. Home self-training method on records. Amazing details free. Canfield, 2018-A 5th Ave. South, Minneapolis 4, Minn.

**PIANO** Tuning pays. Learn this profitable profession at home easily with patented Tunometer and mechanical aids. No knowledge music necessary. Diploma granted. Write for booklet. Niles Bryant School, 3731 Stockton Blvd., Dept. P, Sacramento 20, California.

**FINGERPRINTING** Course, \$12.00. Details free. Alabama School of Fingerprinting, Box 185-A, Fairfield, Alabama.

USED Correspondence courses and educational books bought, sold, rented. Free catalog. Educational Exchange, Menlo, Georgia.

200,000 **TURBO-Jet** specialists needed now. Qualify for jet industry's biggest opportunities. Enroll in first all-jet aircraft home study course. Complete information. United Jet Institute, 288 Seventh Street, San Francisco 3, California.

**STUDY** Law; correspondence course; standard books; personal instruction by mail by practicing attorneys. Franklin School, Box 1344, Roanoke, Virginia.

**LEARN** To speak, sing and sell with power. New amazing subconscious method. Works wonders. Easy, pleasant, guaranteed. Details. Golden Plains, Inc., Box 765, Chicago 90, Illinois.

**WRITE** For money. Established author offers help. Free details. Hatch, Box 185, Bangor, Maine.

**TRANSFORM** Yourself via subconscious. Free brochure. Box 847 (H-5), Ocean Park, Calif.

**SENSATIONAL!** Home-study yearbook. \$2.80. Aurea, 156 West 73rd Street, New York City.

**WANT** Strong, masculine voice? Send for free booklet. Perfect Voice Institute, 210 South Clinton, Studio 2EU-2, Chicago 6.

**U.S. Civil Service tests!** Training until appointed. Men—women, 18-55. Start high as \$377.00 month. Many jobs open. Qualify now! Get free 36-page illustrated book showing salaries, requirements, sample tests. Write: Franklin Institute, Dept. S-24, Rochester, N. Y.

**LEARN** Free how to become glamour photographer. Make big profits photographing beautiful models. Opportunities nation-wide. No previous experience or expensive equipment needed. Write for free illustrated Success Plan. Harrison's, 1031-C Magnolia Park Station, Burbank 10, Calif.

### PLAYS, STORIES, MANUSCRIPTS

**WANT** Your book published? Learn how we publish, advertise, promote, distribute. Many successes. Free booklet PM, Vantage, 120 West 31, New York City.

**WANTED:** Book manuscripts, all subjects considered. Greenwich Book Pub., Attn. Mr. Zealand, 489 Fifth Ave., New York City.

### SPECIAL SERVICES

**INFORMATION** On anything. Ferguson Research Specialists, 116-14 141 St., South Ozone Park 36, N. Y.

**WE'LL** Buy every Swedish necklace you make for \$4.25. Guaranteed. Earn \$46.75 weekly, minimum. Instructions: \$1.00. Inquiries welcomed. Alix, 611 15th N.W., Albuquerque, New Mexico.

**INFORMATION!** Any subject! Certified research! Griffith, 613 Latham, Wynnewood, Pennsylvania.

2000 **CASH** Remitters from recent orders—\$5.00. Poulson, 428 West Century Boulevard, Los Angeles 3, California.

**VETERANS**—Papers scattered? Free folder! Records Holder Co., Charles Town, W. Va.

### ARTISTS' SUPPLIES

**IF** Interested in artist frames, canvas, canvas boards, Red Sable brushes, etc., be sure to get our money saving price lists before buying. International Sales Co., 414-APM E. Baltimore St., Baltimore 2, Md.

### CARTOONING, COMMERCIAL ART, SHOWCARD & SIGN PAINTING, TATTOOING

**DRAW** Your way to fame. Free information. Cartoons-of-the-Month, Roslyn, N. Y.

**LEARN** Sign painting at home. Free talent test. Ben Kerns, Box 812-PM, Greenville, S. C.

**LEARN** Cartooning from famous cartoonists. Details. Cartoonists, 2776 California Court, Lincoln 10, Nebraska.

**"HOW** To Make Money With Simple Cartoons"—A book everyone who likes to draw should have. It is free; no obligation. Simply address Cartoonists' Exchange, Dept. 95C, Pleasant Hill, Ohio.

**COMPLETE** Course in cartooning \$1.98. Interesting details free. Murphy's, Woodstock, New York.

**MAKE** Money with art. Straley, 410 S. Western, Springfield, Ohio.

**YOU** Can entertain with chalk talks. Catalog 10c. Balda The Cartoonist, Oshkosh, Wis.

**9 ALPHABET.** 3 Numeral pattern sets and raised wood letter catalog. \$1.00. Sign Letter Distributors, P.O. Box 101, Mineola, N. Y.

**TATTOOING** Supplies, licensed course, illustrated brochures 25c. Zeiss, 728 Lesley, Rockford, Illinois.

### ADVERTISING AGENCIES, LETTER WRITERS, FOR ADVERTISERS

**ADS** Placed in out of town newspapers and magazines. Low rates. Catalogue free. Ideas that pay. Baker Advertising Agency, Successors Ankrum Agency, 189 W. Madison, Chicago 2.

**ADVERTISE:** 24 Words, 100 Canadian newspapers \$5.50. Lists free. Advertising Bureau, 10511-C Springfield, Chicago 43.

80,000 **UNINVADED** Mailorder prospects, 98% accurate. \$3.00 per thousand. Parkwoods Company, Manhasset, N. Y.

**ADVERTISING** Ratebook leading newspapers, magazines, free. Chicago Advertising Agency, Chicago 4.

**MAILING** Lists most any classification \$5.00 1000. Your circulars mailed with ours \$4.00 1000. Write for our literature. Dixie Mailers, King, N. C.

### RUBBER STAMPS AND OFFICE SUPPLIES

**QUALITY** Rubber stamps, 60¢ up. Catalog. Creative, Box 5005, St. Louis 15, Mo.

**3 LINE** Stamp 75¢. Pocket stamp \$1.00. Stamps, P.O. Box 65, Vallejo, California.

**THREE** Lines \$1.00. Free stamp pad. Barber, 596 Girard, Marion, Ohio.

**NEW** Low price. Pocket stamp 3 lines and automatic inker, 90¢. Geo. Gent, Box 484, Tremonton, Utah.

**RUBBER** Stamps by professional craftsmen. 3 lines \$1.00. Price list. South Coast Press, P.O. Box 2074, San Bernardino, Calif.

**3 LINES.** \$1.00. Fast service. Catalogue. Johnson, 443 MacDonough, Brooklyn 33, N. Y.

### TYPEWRITERS, DUPLICATORS, OFFICE DEVICES

**RECONDITIONED** Typewriters, duplicating, printing devices, \$25.00 up. Supplies. Appliances. DixieGraph, King, N. C.

**CASH** For typewriters, adding machines, any make, condition, portable, standard. Lengene's, 1271 Broadway, Buffalo 12, New York.

**PORTABLE** Mimeograph! Uses no stencil, no ink. The newest, cleanest, smallest, lightest and cheapest. Weight 15 pounds. DuPont Distributors, Dept. A, P.O. Box 695, New York 1, N. Y.

### PRINTING, MULTIGRAPHING, MIMEOGRAPHING, GUMMED LABELS

**QUALITY** Printing at wholesale prices. Catalog, samples, free. Kingsley, 1538 N.E. 17 Way, Ft. Lauderdale 5, Florida.

100 **8 1/2 x 11** HAMMERMILL Letterheads and 100 envelopes postpaid \$1.98. H. Hudson, Centredale, R.I.

\$2.99. 1000 **EMBOSSSED** Business cards. Libbey's, 3741 Morrison, Portland 15, Ore.

**DISTINCTIVE** Embossed cards, stationery. Lowest prices. Edward Cass, Melbourne, Iowa.

**OFFSET** Printing \$6.00—1000, 8 1/2 x 11, 16 lb. Lore, East Dedham, Mass.

**QUICK** Service printing. Letterheads, envelopes, etc. Free details. Harold Kroll, Seymour, Wisconsin.

**LITHOGRAPHED** Circulars with sales impact our specialty. Samples free. Bandy Color Press, Gainesville, Texas.

**MIMEOGRAPHING**—Letters, pricelists, formulas, instructions. Lowest prices. Lem's Letter Shop, 5710 Stanton, Detroit 8.

**ADS** Running under this heading sell printing. Ask me for proof. I'll gladly send you amazing facts. Ask for Folder "P." F. W. Johnson, 200 E. Ontario St., Chicago 11, Ill.

1,000 **RAISED** Letters business cards only \$2.95 postpaid. Samples free. Pioneer, 195 Quebec, Island Park, N. Y.

200 **LETTERHEADS,** Envelopes \$4.95. 1000 cards \$2.99. Samples. Ridgecrafters, Glencoe, Mo.

**MIMEOGRAPH** Stencils cut electronically! Free samples. Bert's, 3603 W. North, Chicago 47, Ill.

**OFFSET** Printing \$6.50—1000, 8 1/2 x 11, 16 lb. National Letter, 251 W. 42 St., New York City 36.

1000 **EMBOSSSED** Business cards, \$2.95 up. Samples. Decco Service, St. Louis 21.

125 **LETTERHEADS** 8 1/2 x 11, \$1.00 Postpaid. Envelopes same. Econoprint, Box 625, Whittier, California.

**BETTER** Printing at reasonable prices. Send for price list. Acme, Box 1831, Sioux City 2, Iowa.

**FINEST** Quality printing. Lowest prices. Free samples. Hampton Printing, 601 1/2 N. Main, Wichita, Kans.

**PHOTO** Offset. Lowest prepaid prices. D'Yarmett, 420 Columbian, Columbus 23, Ohio.

**ORDER** Blanks, letterheads, etc., \$1.90 thousand. Our high speed rotary presses save you money. National Depoforms, Box 624, Binghamton, N. Y.

**RUSH** Service 100 8 1/2 letterheads \$2.00 postpaid. Bass Press, Knox, Indiana.

**QUALITY** Mimeographing, printing. Free samples. Currier, PM, New Lebanon Center, N. Y.

500 **PRINTED** Gummed name and address labels, \$1.00. No c.o.d.s. Print clearly. Addison, 1840-G Addison, Chicago 13.

**FREE** Cut, 1000 embossed cards \$4.00 postpaid. Farrell, Box 452, Buffalo 5, N. Y.

**REASONABLE** Printing. Write Yates Printing, 120 Liberty Street, New York 6, N. Y.

**MIMEOGRAPHING.** Offset, printing. Complete lettershop services. Samples. Pennway, 439 Adams, Scranton, Penna.

1000 **EMBOSSSED** Business cards, one color \$3.95, two color \$4.50. Samples free. L. Watson, Box 162, St. Charles, Illinois.

**FREE** Catalog, business, personal printing. D. M. Press, Sebastopol, California.

1000 **EMBOSSSED** Business cards \$3.00, prepaid, postpaid. Samples. Pantone Company, Box 432, Milwaukee 1, Wis.

**"HOW** To Buy and Use Printing"—Free booklet tells how to cut costs, choose paper, type, etc. Samples and prices included. R-K Press, 825 Powder Mill Lane, Philadelphia 31, Penna.

**BUSINESS** Printing. Reasonable. Catalog free. Howprint, 723-G Eunice, Webster Groves 19, Missouri.

**MIMEOGRAPHING!** Free illustrations! Inexpensive. Fast! Edwards, 1567 Park Place, Brooklyn 13, New York.

**RAISED** Printing. Free samples, prices. Rich, 24 Burlington, Springfield, Mass.

**POSTCARDS,** 100, \$1.00. Personalized \$2.00. 200, \$3.00. 1000, \$11.00 delivered. McKeown, 107P South Capitol Avenue, Indianapolis, Ind.

### PRINTING OUTFITS AND SUPPLIES

**OFFSET** Plates \$2.50 your copy. Campbell, 14258 Maiden, Detroit 13, Michigan.

**MAKE** Your own rubber stamps and printing plates. Box 4308-M, Mobile, Ala.

**PRESSES.** Type cabinets, supplies. List for stamp. Lincoln Press Company, 220-E Hartwell, Fall River, Mass.

**MAKE** Your own self-molding rubber stamps and printing cuts. Plexirubber, Argyle 1, Wisconsin.

RUBBER Stamp making presses, supplies. Custom, Box 211-M, Springfield, Missouri.

DO Your own printing. Save money. Simple rules. We supply everything. Print for others; good profit. Raised printing like engraving too. Have home shop. Details free. Kelsey Presses, V-11, Meriden, Connecticut.

### PATENT ATTORNEYS

**INVENTORS**—Take these preliminary steps toward patent protection. Sketch and describe your invention. Sign, date and have this disclosure witnessed by two people who understand your invention. Have us make a preliminary search among U.S. patents already granted for similar types of invention. We report on the probable patentability of your invention and recommend your further course of action. Write for our instructive booklet, "Patent Protection for Inventors" and convenient "Evidence of Invention" disclosure form. Victor J. Evans & Co., 231-E Merlin Building, Washington 6, D. C.

**INVENTORS**—If you believe you have an invention, you should find out how to protect it. The firm of McMorrow, Berman & Davidson with offices in Washington, D.C., is qualified to take the necessary steps for you. Send for copy of our patent booklet "How to Protect Your Invention." We will also send you an "Invention Record" form. No obligation. They are yours for the asking. McMorrow, Berman & Davidson, Registered Patent Attorneys, 1341 Victor Building, Washington 1, D. C.

**CANADA**—Ramsay Company Registered. 273 Bank Street, Ottawa, Canada.

**PATENTS**—Irving L. McCathran, 315 McLachlen Bldg., Washington 1, D. C. Registered Patent Attorney.

**INVENTION Record form free and "Patent Information Every Inventor Should Have."** Carl Miller, Registered Patent Attorney, Woolworth Building, New York.

**REGISTERED Patent attorney offers services.** Sanders, 6430 Evans, Chicago 37, Illinois.

**C. A. Snow & Co.—M427, Snow Building, Washington 1, D. C. Registered Patent Attorneys. Write for information.**

**INVENTORS:** When you are satisfied that you have invented something of value write me, without obligation, for information as to what steps you should take to secure a patent. Write Patrick D. Beavers, Registered Patent Atty., 935 Columbian Bldg., Washington 1, D. C.

**PATENTS. "Proof of Invention" free.** E. E. Vrooman, Registered Patent Attorney, 507 McKim Building, Washington 5, D. C.

**INVENTORS:** Without obligation, write for information explaining the steps you should take to secure a patent. John Randolph, Registered Patent Attorney, 203 Columbian Bldg., Washington 1, D. C.

**"INVENTOR'S Guide," "Record of Invention," sent free.** Frank P. Ledermann, 154 Nassau Street, New York 38, N. Y.

**INVENTORS:** Learn how to protect your invention. Unless the inventor is familiar with patent matters, he should engage a competent registered patent attorney or agent to represent him. We are registered to practice before the U. S. Patent Office and prepared to serve you in handling your patent matters. "Patent Guide for the Inventor" containing detailed information concerning patent protection and procedure with "Record of Invention" form will be forwarded to you upon request, without obligation. Clarence A. O'Brien & Harvey Jacobson, Registered Patent Attorneys, 61B-D District National Building, Washington, D. C.

### FOR INVENTORS

**CREATE Successful inventions!** Positive, proven method. Write Waldman, Box 121, Brownsville Sta., Brooklyn 12, N. Y.

**INVENTORS:** Learn how you can protect your invention. A specially prepared booklet "Patent Guide for the Inventor" containing detailed information concerning patent protection and procedure together with "Record of Invention" form will be promptly forwarded to you upon request—without obligation. We are registered to practice before the United States Patent Office and are prepared to serve you in the handling of your patent matters. Clarence A. O'Brien & Harvey Jacobson, Registered Patent Attorneys, 61A-D District National Building, Washington, D. C.

**PATENT Searches \$5.00. 48-hour airmail service.** Invention protection forms free. Write Patent Engineering Service, 711 14th Street N. W., Washington 5, D. C.

**INVENTORS**—Send for free patent information book and inventor's record. Registered Patent Attorney, Associate Examiner, Patent Office 1922-29, Patent Attorney & Advisor, Navy Department 1930-47. Gustave Miller, 56A Warner Building, Washington 4, D. C.

**AMATEURS!** Professionals! We develop and finance good ideas and worthwhile inventions. Free particulars, John Paul Enterprises, Inc., 150 Broadway, New York 38, New York.

**FREE Patent book.** Write Blasius, 15 Park Row, New York 38, N. Y.

**JOIN Inventors Club \$1.00.** Free list inventions wanted, literature. Write McIntyre, Swiftcurrent, Saskatchewan.

**INVENTORS Profit in booming Canada.** Patent application on pending U. S. patent will be promptly filed in Canada before U. S. patent issues for \$100.00. Joseph O'Brien, former manager Canadian patent firm; foreign patents filed. 132 Nassau Street, New York, N. Y. 30 years in business.

**INVENTORS:** If you have an invention for sale, patented or unpatented, write Institute of American Inventors, Dept. 40A, 631-E St. N.W., Washington 4, D. C.

**PATENT Searches, including copies of nearest patents, \$6.00.** Reports airmailed within 48 hours. More than 100 registered patent attorneys use my service. For free invention protection forms, write Miss Ann Hastings, P.O. Box 176, Washington 4, D. C.

**INVENTION Record form free and "Patent Information Every Inventor Should Have."** Carl Miller, Registered Patent Attorney, Woolworth Building, New York.

**SEARCHES**—Put your patent searches in the hands of a registered patent attorney or agent, as he qualifies to give a worthwhile patentability report. Record of invention form upon request and information on patent protection. Patrick D. Beavers, Registered Patent Attorney, 935 Columbian Bldg., Washington 1, D. C.

**INVENTORS:** Information on patent procedure furnished on request, without obligation. John Randolph, Registered Patent Attorney, 202 Columbian Building, Washington 1, D. C.

**PATENT Searches \$5.00. 48-hour service.** Free invention protection forms. Write Raymond L. Smith, Patent Searcher, 620 Sheraton Building, Washington 5, D. C.

**PROBLEM?** Licensed, graduate M.E. will assist you to perfect your invention. \$5.00 deposit required. Prompt reply. R. M. Vincent, Consulting Engineer, 2727 Stevens, Parsons, Kansas.

**"INVENTOR'S Guide" sent free.** Frank P. Ledermann, 154 Nassau Street, New York 38, N. Y.

**INVENTORS**—If you believe you have an invention, you should find out how to protect it. The firm of McMorrow, Berman & Davidson with offices in Washington, D.C., is qualified to take the necessary steps for you. Send for copy of our patent booklet "How to Protect Your Invention." We will also send you an "Invention Record" form. No obligation. They are yours for the asking. McMorrow, Berman & Davidson, Registered Patent Attorneys, 134-Z Victor Building, Washington 1, D. C.

**INVENTORS**—This firm is registered to practice before the United States Patent Office and available to assist you in the preparation and prosecution of your patent application. "Patent Protection for Inventors" booklet containing detailed information and steps to take toward patent protection sent promptly upon request. No obligation. Victor J. Evans & Co., 232-E Merlin Building, Washington 6, D. C.

### INVENTIONS WANTED

**INVENTIONS Promoted.** Write for free booklet "Your Invention." Kessler Corporation, 551W, Fremont, Ohio.

**AMERICAN Congress of Inventors**—Quick response, free "Edison Formula for Success." Inventors, Box 1481, Milwaukee 1, Wis.

**SUPERIOR Promotions.** Patented; unpatented inventions. New, informative booklet on request, Superior, 338-344 North Rodeo, Beverly Hills, Calif.

**INVENTORS:** Hundreds of manufacturers have requested our assistance in locating marketable new products. Complete information free. Institute of American Inventors, Dept. 40-D, 631-E St. N.W., Washington 4, D. C.

**INVENTORS.** Don't sell your invention patented or unpatented until you receive our offer. Write Cowgill, Box 298, Marion, Ohio.

**INVENTIONS And patents promoted.** A-1 service for inventors for many years. Write Adam Fisher Co., 5418 Idaho, St. Louis, Mo.

**INVENTIONS Wanted.** Patented or patent pending. 25 years experience promoting inventions. National Service Bureau, 3120 Meramec, St. Louis 18, Mo.

**INVENTIONS Wanted.** Patented; unpatented. Tremendous manufacturers lists. Global Marketing Service, 2420 77th, Oakland 5, California.

**INVENTIONS Wanted now by my manufacturer-clients.** Patented, unpatented. Write Adams, Patent Broker, 80-5 Wall Street, Financial District, New York City.

**NO Prepayments.** Inventions marketed, 20% of profits. Gerry Peters, Box 9238, Reslyn Station, Arlington 9, Virginia.

### PATENTS FOR SALE

**INVENTORS:** Test the commercial value of your patented or unpatented inventions, quickly and inexpensively. Write for free information. Institute of American Inventors, Dept. 40-B, 631-E St., N.W., Washington 4, D. C.

**NOVEL Inventions wanted.** We pay all manufacturing, distribution expenses. Mail \$1. Examination fee. Weyman Co., MC253, San Antonio 9, Texas.

### MANUFACTURING

**MODELS**—Small lot manufacturing. Metals, plastics, etc. Milburn, Burlington, Kentucky.

### MODELS, MODEL SUPPLIES

**BALSA Wood and model aircraft.** 40-page catalog 10c. Sig Co., Montezuma, Iowa.

**SHIP And yacht model fittings; blueprints.** Send 35c for illustrated catalog listing hundreds of items. A. J. Fisher, 1002-1 Etowah Ave., Royal Oak, Mich.

**1956 CAR Models, 1/25 scale, all metal, chrome trim.** Send for catalog! Cars and Hobbies, Dept. PM-14, 2333 Haddon, Chicago.

**SHIP Model kits and fittings including clippers, trawler, fishermen, frigates, privateer, radio control tug, etc.** Send 25¢ for 1956 catalog. Model Shipways, Box 85, Bogota, N. J.

**SHIP Models.** Most complete line in New England. Kits, fittings, plans, books, tools, engines, motors. Illustrated catalog 30¢. James Bliss & Co., Inc., Dept. SM, 342 Atlantic Ave., Boston 10, Mass.

### HOME CRAFTSMEN

**RUBBER Molds, liquid rubber, leathercraft, unpainted figurines, paints and supplies.** Catalog 10c. Steece Bros., Box 177-S, Sioux Falls, S. D.

**FREE Handicraft supply and project catalog.** American Handicrafts, Box 1479-PM, Fort Worth, Texas.

**GRANDFATHER Clocks.** Build a tubular chime at factory prices. Send 50c. Wills Bros., 237 S. Ellwood Ave., Baltimore 24, Maryland.

**FREE Catalog.** 1560 patterns and designs. Craftplans, 1321-A South Michigan, Chicago 5.

**129 NEW Full-size jigsaw patterns.** Artist-drawn. \$1. Craftplans, 1321-A South Michigan, Chicago 5.

**WOODWORKING Course for home craftsmen.** Twenty-two manuals. Over 1600 pages. 75 training projects. Only complete home training program available today. Carefully written, profusely illustrated. Covers everything from wood selection to final finishing. Complete instruction in care and use of all hand and power tools. Prepared by expert manual training instructors. Write for free booklet, Interstate Training Service, Dept. D-4, Portland 13, Oregon.

**KNOCKDOWN** Cedar chests. Lumber and veneers. Free price list. Giles & Kendall Company, Huntsville, Ala.

**STYLECRAFT** Sure fire hits. "Pre-traced" leather kits. Handbags, billfolds, filigree belts, over fifty other projects. Patterns on leather. Why trace? Just carve, assemble and lace. Large assortment "precarved" kits also available. Send 25c for catalog, free folder. Refunded first order. Apache Leather Company, 2804 E. Washington St., Phoenix, Arizona.

**KNOCKDOWN** Cedar chests and lumber. Free price list. Bedford Lumber Company, Shelbyville, Tennessee.

**18 FULL-Size patterns.** Save money with easy-to-use, professionally designed full-size patterns. Make money selling beautiful, useful furniture. Make modern step and cocktail tables; metal lamps; cupola; 12-foot outdoor. All patterns test-built; sold with money-back guarantee. Get your free list of these convenient, economical patterns today. Popular Mechanics Press, 200-HH E. Ontario Street, Chicago 11, Illinois.

**LEATHERCRAFT.** Send 10c for new 60-page catalog of tools, supplies, kits, including metalcrafts, enameling, ceramics, all other crafts. Complete stock. Reasonable. Since 1910. Sax Bros., Dept. PM1, 1111 N. 3rd, Milwaukee, Wis.

**ALL Crafts supplies.** Large free catalog. National Handicraft, 199 William Street, New York City 38.

**PLASTICS** Home-craft course for men and women. Tells and shows how to make hundreds of fast selling plastics products. All plastics and materials for 23 projects included in course. No special tools needed. Course pays for itself. Write for free booklet. Interstate Training Service, Dept. D-4, Portland 13, Oregon.

**FREE, 40** Sea shell jewelry designs and instructions with illustrated supply catalog, 25c. Modern Shellcraft, Dept. B, P.O. Box 22, Station A, St. Petersburg 2, Fla.

**LEATHERCRAFT.** Metal enameling, beadcraft, shellcraft, metal tooling, textile painting, many other crafts. Free big illustrated catalog. Kit Kraft, Dept. 235, Studio City 1, California.

**AROMATIC** Red cedar lumber. Small lots shipped anywhere. 3 1/2", 2 1/2", 2 1/4", 2 1/8"; 3' to 7' long. R. E. Johnson, Robertsville, Mo.

**LEATHERCRAFT** Quality supplies at lowest prices. Send 10c (refundable) for most complete catalog containing 16 other crafts. Russo Handicrafts, Box 29-P-5, Los Angeles 12, California.

**BUY Wholesale** nationally advertised power, hand tools, thousands other products at big discounts. Free "Wholesale Plan." American Buyers, Hertel Station, Buffalo 16-P, N.Y.

**LAMP** Size cypress knee with nipple installed, \$2.00. Cy Products, Dept. 2-T, Lafayette, La.

**101 FULL** Size patterns. Smart, new, gifts, novelties. Lawn figures, shelves, action windmills, alphabets. Plus "Make Money Jig Sawing." Only \$1.00. Mastercraft 55M, 7041 Olcott, Chicago 31, Illinois.

**CERAMIC** Tile for bath wall, floors and tables. Applied with adhesive. Instructions furnished. Artistic Tile Co., 2562 First Ave. No., St. Petersburg, Fla.

**OVER 900** Woodworking projects. Books and patterns. Free catalog. Craftsman, 115-C Worth Street, New York City 13.

### DO IT YOURSELF

**ROTARY** Lawn mower—Make powerful, low cost, battery operated mower from old auto parts. Plans \$1.00. Jack Hart, 2031 20th Ave. N., St. Petersburg, Fla.

**"HOW To Make Basements Dry.** Beautiful and Livable." 28 page illustrated booklet. Instructions, plans, color schemes. Send 25 cents to: Medusa Masonry Paints, Court Square Building, Baltimore 2, Md.

**INEXPENSIVE** Device cuts long sheet metal easily, quickly. Instructions, diagrams, \$1.00. Henry Woolston, Route 3, Albion, N.Y.

**ELECTRICALLY** Operated garage door opener. Complete detail and assembly drawings any home owner can follow. Send \$2. Electric Garage Door Co., Box 301 D, Park Ridge, Ill.

**CLOCK** Movements—Gorgeous dials. Plans, kits. See ad page 261.

**GEIGER** Counter and metal detector kits. Inexpensive, educational. Free literature. Electronic Applications, 5024 Lee Highway, Arlington 7, Va.

**CARPORTS.** Patio roofs. Partitions. build them yourself with beautiful Fiberglass planks. Details free. Concourse, 4003 Dyre, New York 66, N. Y.

**"DO It Yourself Encyclopedia."** 12 giant volumes (3,000 pages) packed with thousands of ideas, plans, gadgets and projects you can do yourself. How to weld, paint, repair most anything. How to make boats, deepfreeze, draperies, jigsaw projects and just scores of other items. How to do electric wiring, plumbing, room building. How to modernize kitchens, bathrooms. Greatest, most complete fix-it library ever offered. Written so you can understand it. You'll be thrilled when you see what these 12 big volumes contain. It's simply sensational. You must really see them to fully appreciate this exciting fix-it library. You'll fall in love with them just as soon as you open the first volume. I'll send you a descriptive circular that will open your eyes to the greatest, most complete and beautifully illustrated "Fix-it" library you ever laid your eyes on. Send a postal right now. Popular Mechanics Press, 200-DY East Ontario St., Chicago 11, Illinois.

**TREAT** Nylon hose for longer life free of runs. Send \$1.00 for complete formula, instructions. Research, R 1, Box 194, Bainbridge, Ga.

**WILL** Correspond with anyone wanting to build own garden tractor, whirlcut or other 3 to 5 h.p. implements. Eaton Roller & Manufacturing Co., 300 N. Meridian, Eaton, Indiana.

**MAKE** Your own garden tractor from hand lawnmower or power lawnmower. Plans \$1.00. George's Hobby Shop, Chilli-wack, B. C.

**LAWN** Mower conversion kit, \$8.00. Make your present mower electric. Free literature: Motron, 5212-A Foothill, Oakland 1, Calif.

**BOOKS:** Hundreds of subjects. Big catalog free. Popular Mechanics Press, 200-BC East Ontario St., Chicago 11.

### WATCHES, OLD GOLD, JEWELRY

**WATCH** And clock repairing books. Free information. North American, Dept. 16D, 2320 N. Milwaukee, Chicago 47, Illinois.

**WATCHMAKERS'—Jewelers'** supplies, instructions. Catalog 20c. Bengale Company, Culver City, California.

**COSTUME** Jewelry supplies. Catalog and samples. 35c. Largest line in America. Milady-Fair Co., G.P.O. Box 1328, New York City 1.

**USED** And new watches \$2 up. Free list. Southern Watches, Gray, Georgia.

**HIGHEST** Cash for old gold, broken jewelry, gold teeth, watches, diamonds, silverware, spectacles, platinum, mercury. Free information. Satisfaction guaranteed. Rose Refiners, Heyworth Bldg., Chicago 2.

**10 SWISS** Watches \$18.00. Catalog 10c. Berkowitz, 1150 Castlehill, New York City 62.

**MAKE** Rhinestone jewelry. Complete introductory kit and illustrated catalog \$1.00. Catalog alone 10c. J & M Novelities, Dept. CE-3, Griffith, Indiana.

**WATCHMAKERS' Tools,** materials, supplies, watches. Catalog. Gales, Box 1000, Chicago 90, Illinois.

**MEN'S** Wrist watches. Written guarantee. \$10.95. Billera, 38 Circle Drive, Hicksville, New York.

**HELBROS** Watches. Jewelry 70% discount. Catalog 25c. Dorinda, Huntington Station 7, N. Y.

**RHINESTONES** Send \$2.98 for six gross, value \$7.00, free bargain list, catalog. Ebert, Box P183, East Orange, New Jersey.

**DIAMOND** Rings. Free catalog. Factory prices. Hedges, Amityville 187, N. Y.

### TOBACCO, SMOKERS' SUPPLIES

**BRIER** Blocks, stems, semi-finished pipes, for carvers. Pipe-making tools. Instructions. Walter Miller, Germantown, Ohio.

**FOLDING** Pipe. Imported briar. Fits vestpocket. Dry, pleasant smoking. Free literature. Lane Pipe Co., Box 496, Freeport, Penna.

### RAZORS, BLADES, SHARPENING

**BLADES—100** For \$1.00. Microsharp-ened. Guaranteed smooth shaves. Double-edge. Bardin's, Box 821, Chicago 90, Ill.

**NEW** Improved styptic paper dispensing package for razor nicks. Will stop bleeding in seconds. Will not stick. Will not sting. Patent pending. 25¢ postpaid. Ash & Rhein, 140 No. 10th St., Reading, Penna.

### FOR THE HOME

**HENCKELS** Forged carbon steel knives. Dollar brings sample (not stainless) and big catalog. Kirkhams, Glens Falls, New York.

**FREE** Foam rubber catalog: Cushions, pillows, etc. 50% discount. Barry-Foam, 20F Ardsley Ct., Newark 2, N. J.

**FOAM** Rubber furniture cushions. Factory seconds. 50% discount. Free catalog. Perma-Foam, 429C Central Ave., East Orange, New Jersey.

**YOUR** Name beautifully engraved on sign for front door. Only \$1.00. Engravers, P.O. Box 113, Malden-on-Hudson, N. Y.

### OF INTEREST TO WOMEN

**GOOD** Money in weaving. Weave rugs at home for neighbors on \$69.50 Union Loom. Thousands doing it. Booklet free. Union Looms, 153 Post St., Boonville, N. Y.

**\$5,199.90** WAS Paid to John Betts, in few weeks. Grow mushrooms. Cellar, shed. Spare, full time, year round. We pay \$3.50 lb. Free book. Mushroom, Dept. 176, 2954 Admiral Way, Seattle, Wash.

**SELL** Fine fabrics. Get yours wholesale. Box 863, Norwalk, Conn.

**WANT** To make big money at home? \$5 profit in an hour possible with invisible reweaving. Make tears, holes disappear from clothing, fabrics. Steady year-round demand from cleaners, laundries, homes. Details free. Fabricon, 8332 Prairie, Chicago 19, Illinois.

**MOTHERS!** Three 8x10 enlargements your baby \$1.00. Send negatives, no prints. Star Photo P.M., Box 16, Andover, Mass.

**NEW** And different modernistic sectional what-not-shelf. \$2.00 cash. Money-back guarantee. Chester Products, B-513, Lansing 3, Mich.

**PROFITABLE** Woodfibre flowers. Kit \$1.00. Catalog 25c. Artificial Flowers, 203 Worthington, Springfield, Mass.

**PARENTS!** Double your child's reading power and pleasure in 60 days using \$4.95 reading kit! Ages 8-12. Free details, Box 664, Hawthorne, California.

**WEDDING** Invitations \$5.50. Samples 10¢. Bell, 1401 1/2 North 16th, Birmingham 4, Alabama.

### WANTED—MISCELLANEOUS

**SCRAP** Mercury (quicksilver) containers supplied—Tantalum, bismuth, tungsten. Metallurgical Products Company, Established 1909, 35th and Moore Sts., Philadelphia 45, Penna.

**QUICKSILVER.** Sterling, silver solders, precious metals. Wholesale Terminal, Norwood, Massachusetts.

**BOOKS:** Hundreds of subjects. Big catalog free. Popular Mechanics Press, 200-BC East Ontario St., Chicago 11.

### PERSONAL

**THE Courier!** Sample of this fast growing mailorder publication for stamp! Courier, 910 Marion, Pharr 23, Texas.

**"HOW Can I find out?"** You can! Information confidentially developed. Any matter, person, problem. Worldwide. Officially licensed. Established 1922. William Herman, 170 Broadway, New York City.

**REMAILING.** Forwarding 25c each. Ace Service, Box 186, Tampa 1, Fla.

**BUY** Vitamins direct. Amazing savings. Catalog free. Matoska, White Bear, Minn.

**BOOKS:** Hundreds of subjects. Big catalog free. Popular Mechanics Press, 200-BC East Ontario St., Chicago 11.

**EXCITING** New book, "How to Collect Stamps, Coins, Paper Money." Packed with amazing facts; information worth dollars. Fully illustrated. 160 pages. 75¢. Popular Mechanics Press, 200-ST E. Ontario St., Chicago 11, Ill.

**BORROW** By mail from Postal Finance Co. Employed men and women can easily obtain \$50 to \$600 fast, entirely by mail. Repay in small monthly payments. Friends, relatives, employer, tradespeople will not know you are applying for loan. Advise occupation, amount wanted. Postal Finance Co., 200 Keeline Bldg., Dept. 73, Omaha, Nebraska.

**BORROWING** By mail. Loans \$100 to \$600 to employed men and women. Easy, quick. Completely confidential. No endorsers. Repay in convenient monthly payments. Details free in plain envelope. Give occupation. State Finance Co., 323 Securities Bldg., Dept. U-227, Omaha 2, Nebraska.

**CHICAGO** — Mail forwarding address. Business, personal. Low rates. Continental, 20-M West Jackson, Chicago 4.

**HOLLYWOOD!** Letter remainings 25¢! Postmarked anywhere within U.S.A. \$1.00! Box 2751, Hollywood.

**WESTERN** Remaining 25¢. Sunday Oregonian \$1.00. Confidential address \$3.00 monthly. Lucille Taylor, 3039 East Burnside, Portland 15, Oregon.

**HELP Yourself!** Solve personal problems by self-mastery. Free information. The Leavitt Science, Clinton, Illinois.

**ORANGES,** Grapefruit. Tree-ripened. Reasonable. Free literature. Krajna, Opa Locka, Florida.

**WHAT Is your I.Q.?** Take reliable intelligence test. Approved, scientific. Confidential report by mail. Free information. University Test Bureau, Desk M-6, Box 401, Palo Alto, California.

**LAST Will** and testament forms. Complete easy instructions. \$1.00 each. Wills, 4838 North 9th, Tacoma, Washington.

#### REMAILING SERVICE

**MAIL** Received-forwarded. \$3 month. Hedgpath, Box 830, Alhambra 23, Calif.

**LETTER** Remaining-receiving address for rent. Details free. William McLaughlin, 800 Stewart, Columbus 6, Ohio.

**REMAINS** From seaway port 25¢. Bylon, 17167 Bentler, Detroit 19, Michigan.

**LETTERS** Remailed from Canada 35¢. I affix Canadian stamp. Ross, 83 Belhaven Rd., Toronto 8, Ontario.

**HONOLULU** Remailing 25¢. Receiving-forwarding available! Write: Fobel, 3132-C George Street, Honolulu.

**NIAGARA Falls** or Buffalo remail 25¢. Sunday classified \$1.00. Farrell, Box 452, Buffalo 5, N. Y.

**NEW York City**—Remails 25¢. S. H. Brown, 178-39 Leslie Rd., St. Albans, L. I., 34, N. Y.

**PHOENIX, Arizona,** opportunities, classified \$1.00, remails 25¢. Unique, Box 83.

**REMAINS** 25¢. Sunday classifieds. \$1.00. Torrey, P.O. Box 136, Phoenix, Arizona.

#### TREASURE FINDERS

**NEW!** Uranium detector kit, \$8.49. Free catalog. CMG, Box 611-PM, Laramie, Wyoming.

**URANIUM** Prospector's information — Map portfolio. Uranium, Box 788R, Washington, D. C.

**GEIGER** Counter kit \$15.95. Send \$5. balance c.o.d. Amerlabs, 471 Clifton Ave., Newark 4, New Jersey.

**JEEP Owners** — V8 power. Read Jeep owners ad, page 30.

**GOLD,** Silver, metal detectors. Geiger counters for uranium. Vio-Lites. Sensational new fully guaranteed models. None finer. Information free. Detetron Corp., 5528 Vineland Ave., North Hollywood, California.

**FOR** Treasure locators, geiger, scintillation counters, mineralights, M-Scope. Fisher Research Laboratory. See advertisement page 261.

**FIND** Buried treasure, gold and silver, with Goldak's sensational 3½ lb. "find-it" locator, only \$49.50. Write for free literature on complete line of mineral, metal locators; Geiger and scintillation counters. Goldak, 1541 W. Glenoaks Blvd., Glendale, Calif.

**URANIUM,** Gold, silver treasure. New, power-packed, highly sensitive metal detectors, Geiger counters and mineralights, kits and assembled models from \$12.50. Lightest weight, guaranteed, free literature. Electronic Applications, 5024 Lee Highway, Arlington 7, Va.

**URANIUM** Finding made easy! Completely transistorized Geiger counters. Extra sensitive. Lightweight. Scientifically engineered. Unconditionally guaranteed. Also complete line prospecting instruments from \$19.95. Write for free information, techniques. Universal Atomics Corp., Dept. PM4, 19 East 48th Street, New York City.

#### FOR SALE—MISCELLANEOUS

**HEARING** Aid batteries, wholesale. Free list. Habs, Box 51, York, Penna.

#### MISCELLANEOUS

**CESSPOOL** Trouble? Use Sursolvent, the miracle cesspool and septic tank cleaner. No pumping necessary. Restores systems to a condition approaching newness. Electric Sewer Cleaning Co., Boston 34, Mass.

**RECEIVE** Magazine samples, mails, offers by hundreds. Get listed 25¢. Rorick, Cincinnati 26, Ohio.

**LIKE** Full mail boxes? Interesting offers galore 25¢. Traylor's Enterprises, La Feria, Texas.

**STUPENDOUS** Mental power. Adults. (Details 10c.) Delmar Wisdom, 846 Sunnyside, Chicago 40.

**YOUR** Name wanted. We'll send 1000 publishers, mailers, wholesalers your name, on our list one year 25¢. Dixie Mailers, King, N. C.

**WHOLESALE** Catalog! 30-80% discounts! Appliances, musical instruments, typewriters, phonographs, watches, jewelry, recorders, housewares, etc. Consolidated Distributors, 21-13 Lafayette, Paterson 15, New Jersey.

**BE** Your own plumber. You can. Few inexpensive tools and our instructive book, "Home Plumbing Guide," shows and tells you how. Hundreds of photographs and diagrams. Easy to follow. 160 pages. \$3.50. Catalog free. Popular Mechanics Press, 200PG East Ontario St., Chicago 11, Ill.

**\$5,199.90 WAS** Paid to John Betts in few weeks. Grow mushrooms. Cellar, shed. Spare, full time, year round. We pay \$3.50 lb. Free book. Mushrooms, Dept. 175, 2954 Admiral Way, Seattle, Wash.

**REFRIGERATION** Surplus. New Freon hermetic unit, with freezing coil. List \$98.00. \$42.50 f.o.b. New cold controls list \$11.00, \$4.25. Sterling, 3916 W. Montrose, Chicago 18.

**SEND** 5 Used ties; 4 different, cleaned, in return. Equal value. No bows. Pay postman \$1.00. Necktie Exchange, Rt. 1, Box 60, Gresham, Ore.

**FREE** Wholesale catalogs! Sporting equipment, cameras, homewares, everything. Econ-O-Mart, Whippany 2, New Jersey.

**BIG** Mails, 25¢ listing with us will fill your mailbox with mail. C. M., Box 1211-P, Chattanooga, Tennessee.

**PANNING** Gold lesson—Free mail-order catalog, mining supplies, mineral books. Old Prospector, Box 729D1, Lodi, Calif.

**BUY** Wholesale thousands nationally advertised products at big discount. Free "Wholesale Plan." American Buyers, Hertel Station, Buffalo 16-K, N. Y.

**CHRIST'S,** Gal. 5, Whitcomb, 308 Sycamore, Newport News, Va.

**REMODEL** Your own home. Save hundreds of dollars. New, amazing book shows you how. Written so you can understand it. Step by step instructions make it easy. Fully illustrated, 400 photographs, hundreds of diagrams. 160 pages. \$2.95. Literature free. Popular Mechanics Press, 200-RH East Ontario St., Chicago 11, Ill.

**DELIGHTFUL** Delicious pecan pralines. A supreme southern candy chunk full of pecan halves. Large 24-ounce box postpaid \$2.75. Praline Company, Cedar Valley, Texas.

**AT** Last! Neoprene sheeting. Send postcard for free sample and learn how to identify this wonder rubber. It can save you money. T. Davis & Associates, New Braunfels, Texas.

**AUTOMATIC** Washer timers repaired, exchanged \$4.00. Mallory, Ingraham, Soren, 48 hour service. Thomas Morris, Rt. 2, Box 282A-2, Edwardsburg, Michigan.

**INSECT** Trap guaranteed to catch flying insects, boll weevil and bean beetle king. \$10 plus postage. J. C. Smith and Son, R. 2, West Blocton, Ala.

**BIG** Mails, four months listing. 25c. Wright Publications, 2270 Hubbard, Memphis 8, Tenn.

**FREE:** Exciting catalog packed with books covering most everything. Think of it—From cover to cover you will find described and illustrated hundreds of books telling how to fix and how to build almost anything. How to remodel your home; do your own decorating, plumbing, electrical work. Simplified books covering concrete work, carpentry, painting, furniture making and refinishing. How to build your own boat, home workshop tools. Best books on photography, welding, hobbies, homecraft. How to make a home freezer. Send for your free copy now. Popular Mechanics Press, 200-BO East Ontario St., Chicago 11, Ill.

**ADVERTISING** Offer! E-Z hang window shade bracket. Easy to use. Self adjusting. Adjusts automatically. Fits any window, any shade. Introductory advertising special 3 pairs only \$1.00, post paid. Send cash, check, m.o. Coleman Company, 3801 Belle Avenue, Baltimore 15, Maryland.

**AWNINGS,** Door canopies. Plasticized, serviceable, distinctive two-tone colors, easily affixed with our do-it-yourself kit. \$19.95. Also double-wall garage kits. Write Pyramid Builders, 418 West Bancroft, Toledo, Ohio. Dealers invited.

**NEED** Money? We'll mail you \$100 to \$600 in complete privacy. No fees, no signers, no deductions. Easy monthly payments. Nobody knows you're borrowing. Write for free complete loan papers. Postal Finance, Dept. 623-H, 200 Keeline Bldg., Omaha 2, Nebraska.

**ALL** Makes. Fountain pens, ball pens. Bargains. Engraved free. Even one. Eve Export, 1046 East 15th Street, Brooklyn 30, N. Y.

**DO** It yourself. What? Repair TV, build furniture, make barbecue, plumbing repairs, build boats, do house wiring, remodel home, lay tile, modernize kitchen, repair home, and scores of other things you can do yourself. Books covering each subject, only 25¢. Send for descriptive list. It's free. Popular Mechanics Press, 200-LB East Ontario St., Chicago 11, Ill.

**CHINESE,** Japanese art designs. Giant 17"x22" charts. Beautiful for painting, tracing on fabric, ceramics, wood, metal, leather. 30 to 70 unusual drawings. Flowers \$1.00; birds \$1.00; butterflies \$1.00; fish \$1.00; horses \$1.00; secrets oriental brush technique \$1.50. Free catalog oriental books, art supplies. Art, Inc., House Shoe, North Carolina.

**FISHWORMS** Urgently needed! We shipped \$3,175.75 worth, first year, spare-time, backyard! Why can't you? Raising, marketing instructions, 10¢. Oakhaven-M, Cedar Hill, Texas.

**"HOME** Improvement Guide." New, amazing 192 page volume. Packed with ideas, plans for remodeling, decorating, landscaping, built-in projects. \$2.50 pre-paid. Popular Mechanics Press, 200-HG East Ontario St., Chicago 11.

**OLD** English nameplate, 2x10 hardboard. Send name, \$1.00. Howie's Sign, Box 41, Nixon, N. J.

**BEAUTIFUL** Foreign magazines, single copies. Illustrated brochure 25¢. Contacts, Box 4563-PM, Sarasota, Florida.

**ORNAMENTAL** Iron designs. Book of 1500 beautiful, practical designs for railings, columns, etc. Free literature. Cunningham, 3881 South 3200 West, Salt Lake City, Utah.

**LUCKY** Bible, world's smallest, 50¢, three \$1.00. Research, Box 115, Midwood Station, Brooklyn, N. Y.

**SAVE** On auto expenses, repairs. Household bargains. Free information. Specialty Sales Company, Box 254, Clinton, Iowa.

**CARPENTER'S** Rafter framing instrument. Gives rafter lengths, cuts for all runs, rises. Most revolutionary invention for roof framing since steel square. Mastered in few minutes. Easterly Enterprises, 1310 Lincoln, Watonsville, Calif.

**BARGAIN.** Exciting Little Library booklets, 25¢ each. Tool making, painting, welding, home improvement, games, models, plastics, lamp making, glass blowing, boats, photographs. Free catalog. Popular Mechanics Press, 200-LB East Ontario St., Chicago 11.

## NOW—EASY, EFFICIENT PAINT REMOVERS THAT PEEL OLD FINISHES IN MINUTES



**DOW METHYLENE CHLORIDE** makes your paint-removing jobs much more effective, faster . . . and safe

New type paint removers, based on this high-power Dow solvent, give you "brush on—wait just ten minutes—peel off" results. Old finishes actually *lift*, require no hard scraping or rough sanding. And these removers are *nonflammable*, too. Be sure to ask your local paint or hardware dealer for a paint remover clearly marked "nonflammable or contains methylene chloride."

For further information, write to THE DOW CHEMICAL COMPANY, Dept. S944E1, Midland, Mich.

you can depend on **DOW CHEMICALS** 

FREE

NEW  
PRECISION  
TOOLS  
FOR 1956



LUFKIN

NEW TOOL  
DATA

Get the latest information on new and improved precision tools. Send coupon for your **FREE** illustrated catalog and examine these new tools in detail. Before you buy, see LUFKIN'S complete selection.

**BUY LUFKIN PRECISION TOOLS**  
At Your Hardware Or Tool Supply Store  
SEND COUPON FOR FREE ILLUSTRATED CATALOG  
**MAIL TODAY** 424

THE LUFKIN RULE COMPANY, DEPT. PM, SAGINAW, MICH.  
Please send your free "New Tools" catalog to:

NAME \_\_\_\_\_

STREET \_\_\_\_\_

CITY \_\_\_\_\_ STATE \_\_\_\_\_



### Exposure Meter

Photographers can obtain the convenience of a built-in incident and reflected-light exposure meter with a meter that slips into an accessory clip on the camera. The tiny unit can be used for both direct and "off the camera" readings. It has a high-sensitivity photoelectric cell, an ASA film-speed scale from 10 to 800, speeds from 4 seconds to  $\frac{1}{1000}$ , f-stops from f:1 to f:32, direct readings at  $\frac{1}{50}$  with Plus X,  $\frac{1}{100}$  with Super XX.

### Miniature Car

Sleek is the word for a midget car built by two brothers in the machine shop of their farm near Bogota, Colombia. A Lauson four-horsepower engine propels it at a top speed of 28 miles per hour. Hector Macias, a mechanical engineer, designed and built the chassis, while his brother Alvaro designed and fabricated the body, using information garnered from sheet-metal-working articles in *Popular Mechanics*. The car, painted red and gray, was one of the star attractions on exhibition at the recent International Industries Fair in Bogota.





# SPECIALS \$1.50 POSTPAID

## 2 SAW BLADES

Genuine Simonds  
COMBINATION  
BLADES

List \$7.00  
**\$1.50**

6" diam. 1/2" arbor



## Aluminum SANDING PLATE

Value \$2.80  
**\$1.50**

Fits 5/8" & 1/2" arb.  
6" disc, Distic 50¢  
6 Sanding Discs 25¢



## 3 WIRE BRUSHES

List \$3.95  
**\$1.50**

6" diam. Fit 1/2" arbor.  
Top quality.



## 2 SHAPER CUTTERS

**\$1.50**

For planing and shaping. 1" face;  
5/8" radius, 1/2" arbor. Total Value  
\$3.90. Ideal for lathes, etc.



**ELECTRIC MOTOR**  
**\$1.50**

110 Volt  
AC

**FREE**

100 PAGE CATALOG

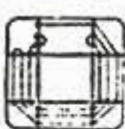

## HEATING ELEMENT

1320 W. - 110 V. 10"  
x 9 1/2" - make your  
own heater for Bath  
or Poultry House.

\$10 Value **\$1.50**

**PENNA.** WHOLESALE DISTRIBUTORS  
104 N. 6th ST. PHILA., PA.

## SPARE-TIME MONEYMAKING OPPORTUNITIES READ OUR CLASSIFIED ADS

HUNDREDS OF BARGAINS AMAZING OFFERS

## SOLD DIRECT, FACTORY-TO-YOU 8" TILT ARBOR POWER SAW

NOW **\$19.95**  
ONLY

Save big money. Buy this fine 8 inch Tilt Arbor Power Saw direct from manufacturer. All cast iron and steel construction. Will last a lifetime; shipping weight 30 lbs. Crosscuts, rips, bevels, mitres, dados, cuts compound angles. Massive cast mitre gauge. Heavy steel base fastens to any workbench. Uses any standard 1/4 to 1/3 H.P. motor. INCLUDED at no extra charge: 8" Simonds Combination Blade that sells for \$4.95. Buy direct and save. Send check, M.O., or sent C.O.D.



## FAMOUS AMERICAN IRONCLAD GUARANTEE...

Try any Plano Centric power tool for 10 days. If you are dissatisfied, return for full and complete refund - no questions asked. Guarantee offered on more than 3 1/2 million power tools, and never violated.

## LOOK AT ALL THESE SPECIAL FEATURES

• Heavy, long lasting cast iron and steel construction • Precision ground cast iron table • Famous patented tilt arbor construction. Blade tilts 0° to 50°; table is always level • Automatic depth of cut control from 0" to 2-3/16"; blade locks in any setting • Single hand wheel control. Tilts blade and locks at chosen angle • Saw insert quickly removable for dadoing • Motor rides on patented ball bearing roller drive • Self-aligning patented cam action rip fence is always straight. Locks rigidly against table surface.

FREE CATALOG—Write for big bargains in home power tools.

All power tools sent express collect

**AMERICAN MACHINE & TOOL CO.**  
ROYERSFORD 13, PA.



Easy as A-B-C



# Be Your Own MUSIC Teacher

## PLAY ANY INSTRUMENT

### LEARN AT HOME THIS QUICK MONEY-SAVING WAY

Simple as A-B-C. Your lessons consist of real selections, instead of tiresome exercises. You read real notes—no "numbers" or trick music. Some of our 900,000 students are band LEADERS. Everything is in print and pictures. First you are told what to do. Then a picture shows you how. Then you play it yourself and hear how it sounds. Soon you are playing your favorite music.

### STOP CHEATING YOURSELF OF THESE JOYS!

Popularity! New friends. Gay parties. Good times. Career. Extra Money. Understand, appreciate and converse about music. Learn lives and compositions of modern and great masters... Relax! Banish worries and frustrations. Satisfy self-expression, creative urge. Gain self-confidence.

Mail coupon for Free 36-page illustrated book. Mention your favorite instrument. U. S. SCHOOL OF MUSIC, Studio 305, Port Washington, New York.

FREE BOOKLET

U. S. SCHOOL OF MUSIC, Studio 305, Port Washington, N. Y.

Please send me your FREE 36-page illustrated book. I would like to play (Name Instrument).

Instrument \_\_\_\_\_ Have you Instrument? \_\_\_\_\_

Name \_\_\_\_\_ (Please Print)

Address \_\_\_\_\_

## PERFECT LETTERING Quick-Easy-Inexpensive with STENSO Lettering Guides

### FOR EVERY SIGN-MAKING NEED



Easy as writing your name, with STENSO Lettering Guides of sturdy treated stencil board. Use over and over for perfect lettering.



**GOTHIC** No. 210... 1/2-3/4-1-1 1/4- and 1 3/4 inch letters and numbers... **\$1.50**

**ROMAN** No. 211... 1/2-3/4-1-1 1/4- and 2 inch letters and numbers... **\$1.50**

**Old English** No. 212... 1-1 1/4 and 2 1/4 inch letters and numbers... **\$1.50**

At stores selling school supplies, stationery, art materials, hobbies, or order below from...

**STENSO LETTERING CO.** Dept. 25  
1101 E. 25th St., Baltimore 18, Md.

Please send me:

Set #210-\$1.50 Set #211-\$1.50 Set #212-\$1.50

**LARGE SIZE STENSO LETTERING GUIDES**

#93-3 inch letters, numbers, \$1.00 #95-5 inch letters, numbers, \$2.50

#94-4 inch letters, numbers, \$1.75 #96-6 inch letters, numbers, \$4.00

NO C. O. D.'S PLEASE!

Name \_\_\_\_\_

Address \_\_\_\_\_

City \_\_\_\_\_ Zone \_\_\_\_\_ State \_\_\_\_\_



it's easy to  
connect  
Tubing with

## IMPERIAL TOOLS

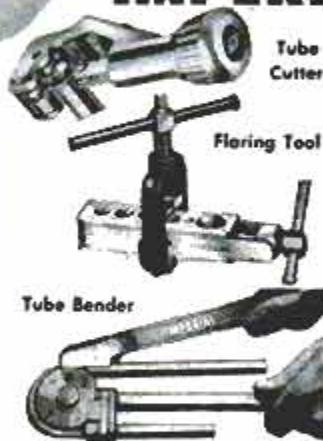

Tube  
Cutter

Flaring  
Tool

Tube  
Bender

Use the quality tools preferred by skilled mechanics everywhere — tube cutters, flaring tools and tube benders that get jobs done faster, better, easier. Simple instructions in the Imperial Tube Working Handbook show you the short cuts. Ideal for connecting tubing for cars, trucks, tractors, oil burners, gas appliances, LP-Gas, plumbing, hydraulics, etc. Get these Imperial Tools for your work or hobby now. Economically priced.

See your dealer or write today!

Send 10¢ for VALUABLE HANDBOOK & CATALOG

THE IMPERIAL BRASS MFG. CO.  
1212 W. Harrison St., Chicago 7, Ill.  
Send me 36-page Imperial Tube Working Handbook  
and Catalog Today — also name of nearest dealer.

Name \_\_\_\_\_  
Occupation \_\_\_\_\_  
Street \_\_\_\_\_  
City \_\_\_\_\_ Zone \_\_\_\_\_ State \_\_\_\_\_



Have you this  
INSIDE  
BATHROOM  
PROBLEM?

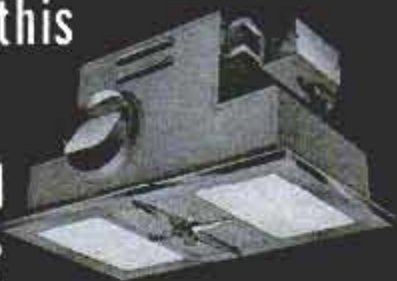

### New TRADE-WIND Unit Gives Both LIGHT AND VENTILATION

This easily installed combination light and fresh air ventilator keeps your bathroom always fresh and free from steamed up mirrors and damp walls. F.H.A. and UL approved for inside or outside baths in existing or new homes. Beautifully designed in bright chrome with alba-lite glass. Mounts flush in ceiling. Complete instructions tell you how to install between ceiling joists with connection to nearest electric circuit.

Mail Coupon for Complete Information

Trade-Wind Motorfans, Inc.  
7755 Paramount Blvd., Dept. PM, Rivera, California  
Please send complete information on bathroom  
Light/Ventilator.

Name \_\_\_\_\_  
Address \_\_\_\_\_



## Dutch Ice Cycle

With a motor scooter on runners, C. P. de Jonge of Haarlem, Netherlands, glides over the ice at 50 miles per hour. De Jonge built the scooter himself, equipping it with a headlight and steering wheel, and wheels which fold down for easy transport on land. A cleated wheel in the rear pushes it along. De Jonge has little opportunity to open it up on Holland's crowded canals, but hopes others will build similar scooters with which he can race.



## DO EVERY FASTENING JOB 10 TIMES FASTER!



Amazing one-hand operation, 10 times faster than hammer & nails. Can't jam.

### ARROW DO-IT-YOURSELF TACKER, No. T-50

for ceiling tile, insulation, wire fence & every home job.

At your local hardware dealer or lumber yard

Arrow Fastener Co., Inc., 1 Junius St., Brooklyn, N. Y.

You can make your own conversion



### AIRCRAFT STARTERS

Makes an excellent winch for loading hay, wagon unloaders, pulling stumps, stretching fence or moving heavy objects—1001 uses at home, farm or factory. Operates on 6 to 32 volts or manually. Has built-in reduction gear (150:1) and clutch. High torque, low speed. Made by Bendix at many times this price.

**\$15.89**

KARL ORT, Dept. PM555, York, Pa.

Shipping Weight 42 lbs.

## WHY TAKE LESS THAN THE BEST?

**INSIST ON EAGLE FOLDING RULES**  
**COIL SPRING JOINTS**  
GUARANTEED AGAINST JOINT FAILURE FOREVER  
EAGLE RULE MFG. CORP. N.Y. 59, N.Y.

The **ONE** Tool You Can Use on **EVERY** Job!

### SPRAYS:

- PAINT
- ENAMEL
- LACQUER
- AUTO PAINT
- VARNISH
- WAXES
- WHITENING
- PLASTICS
- REMOVES WALLPAPER
- INFLATES TIRES, TOYS
- OPERATES CAULKING GUNS
- BLOW GUNS
- BARN FOGGERS
- SPRAYS INSECTICIDES
- LIQUID FERTILIZERS
- WEED KILLERS

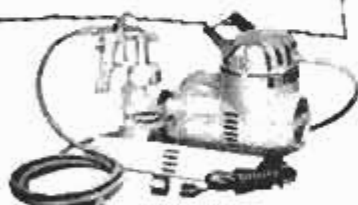

### SPRAYIT

Paint Sprayer and Compressor

- Lightweight, portable
- 1/2 h.p. built-in motor
- All-purpose spray gun
- 2.2 cu. ft. air per min.
- Up to 35 lbs. pressure
- 1-year warranty

Designed for the do-it-yourself fan or home-owner. Priced exceptionally low.

SPRAYIT COMPRESSORS PRICED FROM

Prices slightly higher in the 11 Western States **\$34<sup>50</sup>**

If your dealer does not handle SPRAYIT, write to:  
**THOMAS INDUSTRIES INC.**

Electric Sprayit Division  
Dept. PM5, Sheboygan, Wis.

## NOW DRIVE UP TO 20,000 MILES and MORE . . . WITHOUT AN OIL CHANGE

- IMPROVES ENGINE PERFORMANCE
- RETARDS OXIDATION
- HYDRAULIC VALVE LIFTS KEPT AT PEAK EFFICIENCY

EASY TO INSTALL  
SIMPLY REPLACE  
YOUR OIL DRAIN  
PLUG



**\$3.50**  
POST PAID

POS-MET OIL DRAIN PLUG IS UNCONDITIONALLY GUARANTEED TRUCKS OR MONEY REFUNDED \$4.00

MANUFACTURED UNDER DIRECT LICENSE FROM THE NATIONAL RESEARCH COUNCIL OF THE CANADIAN GOVERNMENT

### INTERNATIONALLY ACCLAIMED!

POS-MET—recently acclaimed in all leading Canadian and American Newspapers and Magazines is NOW available to American Car and Truck owners.

POS-MET—developed by scientists of the National Research Council of the Canadian Government—is capable of giving you a minimum of 20,000 miles without an oil change. It is a new calcium alloy that prevents rather than reduces acid content. Oxidation is retarded and the performance of the entire engine is improved. Maintenance costs are reduced.

### DO NOT CONFUSE WITH MAGNESIUM

Only a highly positive metal such as Calcium can do what we claim. Magnesium reduces after the acid exists. POS-MET calcium alloy prevents acidity—retards oxidation.

Foreign particles are kept in suspension—close tolerance parts are free to function at maximum efficiency—Hydraulic Valve Lifts are kept completely free of sludge and foreign matter, which assures you that the lifter will not collapse.

TO: **POS-MET PRODUCTS INC.**  
1764 E. 7 Mile Rd., Detroit, Michigan  
IN CANADA WRITE: **POSITIVE METALS & ALLOYS**  
Toronto 15, Ontario

Enclosed is \$3.50 for Passenger Car Unit • Enclosed is \$4.00 for Truck Unit • FLEET DISCOUNTS ON REQUEST

FROM: \_\_\_\_\_

CHECK MONEY ORDER CASH

MAKE OF CAR MODEL YEAR

# SAVE ON GAS! GET FAST STARTS!

**FUL-SPARK POWER PLUGS,  
AMAZING NEW DESIGN,  
GIVE ANY CAR  
BIG GAS MILEAGE**

You will save up to \$100 a year on gas—get lightning fast starts in bitter cold weather with new FUL-SPARK POWER PLUGS. Two revolutionary new engineering advances offer this outstanding performance. FUL-SPARK POWER PLUGS BURN GAS MORE COMPLETELY—there is less wasted fuel than with ordinary plugs; and the Spark NEVER jumps or flashes over. The FUL-SPARK is ALWAYS delivered right at the electrode. FUL-SPARK POWER PLUGS can actually operate filled with oil or filled with water—and never fail! This new insulator design offers you faster starting, prolonged spark plug life, and reduced misfiring. FUL-SPARK sizes are available for all cars, tractors, trucks, and outboard motors. Each one is fully guaranteed—you must be delighted—or your money will be refunded with no questions asked. Start right now to save big money on your gasoline bills. Send coupon below.



## HERE'S WHY!

**1** Exciting new design of insulator prevents flash-over and misfiring. The spark cannot jump or flash-over down the side of a FUL-SPARK POWER PLUG, therefore, the full power of the spark is delivered through the electrode. You never lose a combustion chamber full of gas-air mixture. The FUL-SPARK fires every time. You get faster starting, much longer spark plug life, and misfiring is eliminated.

**2** The FUL-SPARK POWER PLUG is the ONLY plug that ACTUALLY provides a full 360° for spark. The big high-tension electrode, by its design, retards carbon and oil entering the gap area, which prevents fouling and shorting. The FUL-SPARK POWER PLUG never needs to be cleaned or reset. It eliminates pre-ignition firing. Greatly increases performance and efficiency of any engine. Gives you faster start—Quicker and smoother acceleration—Greatly increases gasoline mileage. By sheer size of the high-tension electrode, you can see that its life is many times longer than an ordinary plug. We promise you'll see these improvements on your car—or your money back. See for yourself.

### MUST-WORK GUARANTEE

Each FUL-SPARK POWER PLUG must greatly improve engine performance—give much better gas mileage—in first 10 days operation, or return to factory for full money-back refund IMMEDIATELY.

### DEALERS!

Get in on the ground floor. Write today for full distributor and dealer territory information and sales plan.

**ORDER TODAY  
SEND COUPON**

FUL-POWER CORPORATION, Dept. PM-56  
Indiana Theatre Bldg., Indiana, Penna.

Please send postpaid \_\_\_\_\_ sets of FUL-SPARK POWER PLUGS. I understand that I must be delighted with my car's increased mileage, horsepower, and efficiency, or I can return in 10 days for full refund. (Set of 6, \$8.95; set of 8, \$11.95, or send \$2.00 each set, pay balance C.O.D.)

Your Name .....

Street .....

City ..... Zone ..... State .....

Year of Car ..... Model of Car .....

Make of Car ..... No. of Cylinders .....

Enclosed find  Check  Cash  Money Order  
(or Send \$2 Each Set, Pay Balance C.O.D.)

## WHERE-TO-BUY-IT INDEX

Source of supply appears after items commercially available

### AUTOMOTIVE

Miniature car.....	70
What will it take to win at Indianapolis?.....	88
Four-wheel cycle mounts "trunk".....	90
Renault's new Dauphine introduced in Switzerland.....	97
Czech Tatra V8 is newly styled.....	103
Detroit Listening Post.....	110
They build Fords in England, too, and here are the new models .....	111
Italian station wagon.....	124
Traffic kindergarten teaches safe driving.....	147
East German front-wheel-drive car has plastic body.....	149
Truck trailer has sliding roof for overhead loading (Strick Co., Whitaker Ave. at Godfrey, Philadelphia 24, Pa.).....	158

### AVIATION

Interceptors seek, find and kill enemy electronically.....	87
Fast-acting jet starter lows plane to take-off spot.....	91
Inflatable airplane .....	111
Pokker "Friendship" is latest short-haul turboliner.....	129
Lift-measuring instrument for military planes.....	141
New phonetic alphabet for air-ground communications.....	250

### CONSTRUCTION

24-mile causeway uses prefabrication.....	121
Liquid rubber and powder combined to make pliable concrete.....	141
Telephone cable to Hawaii.....	158

### FARMS AND FARMING

Pipe carrier loads or unloads as it travels down the row.....	91
Pasture in the barn produces winter feed (Niamco, Inc., 3905 Elm St., Dallas, Tex.).....	135
Mobile sprinkler system for irrigated farms (Pomona Irrigation Equip. Co., Pomona, Calif.).....	140
All-in-one farm machine.....	160

### HOUSE AND HOME

What's New for Your Home—	
Utility rack that holds kitchen implements.....	122
Roast holder of novel design.....	122
Sprayer attachment for lawn mower.....	122
Antispatter cover for food mixers.....	123
Milk dispenser for homes.....	123
Air conditioners for casement windows.....	123
Triple-threat kitchen appliance.....	123
Snap-on wall panels utilize aluminum channels (Erdle Perforating Co., 175 York St., Rochester 11, N. Y.).....	125

### MISCELLANEOUS

Shampoo bowl.....	50
Refrigerant gas used as lubricant in lab tests.....	52
Small-parts painter.....	52
Exposure meter (Photographic Importing & Distributing Corp., 135 Broadway, New York City 6).....	70
Synchroflash tester (Ansco Photographic Co., Binghamton, N. Y.) .....	72
Dutch ice cycle.....	72
Lock inside refrigerator prevents accidents (Admiral Corp., 3800 Cortland, Chicago 47).....	87
Doctor's medical kit carried in pocket (Lomist Corp., 39 S. LaSalle St., Chicago).....	90
Candy-cane antenna .....	97
Icebox smoker .....	103
Giant retriever for landing craft.....	120
Cycling soccer .....	121
Helicopter serves to lower painter to roof of building.....	124
Electric log stacker lifts 20-ton load (R. G. LeTourneau, Inc., 2399 S. MacArthur, Longview, Tex.).....	129
Check writer for personal use can be carried in pocket (Lansdale Products Corp., Box 568, Lansdale, Pa.).....	135
Drawings made with etching ink "cut" stencil for mimeographing (Gestetner Duplicator Corp., 50 McLean Ave., Yonkers 5, N. Y.).....	140
Dispenser for fish worms.....	141
Manhattan in miniature to take world tour.....	147
Aluminum framework for tent does away with ropes and poles (Bemis Bros. Bag Co., 408 Pine St., St. Louis 2, Mo.).....	148

(Continued to page 76)

**BUILD IT**

**FIX IT**

with

**AMBROID**



- Ready-to-use
- Fast drying
- Extra strong
- Flexible
- Waterproof

**IT STAYS STUCK**

Excellent for model building, home crafts, projects, furniture making, jewelry, toys, etc. Bonds many materials ordinary adhesives fail to hold.

MENDS wood, leather, canvas, upholstery, china, glass, pottery, etc.



Try Ambroid in your Business, too. Unsurpassed for Radio, TV and Electronics. Makes ideal protective coating on wiring, coils, etc. Suited for quick assembling.

SPORTSMEN! Take Ambroid on your trips—first aid for sports equipment. Perfect for Archery, too.

If your hardware or hobby dealer cannot supply you, send 30c for large tube, postpaid. Money back guarantee.

**AMBROID** WEYMOUTH 88, MASS.

You MIGHT get along without a RADIO...



but your family deserves the

**finest water system**

See your Goulds Dealer — he'll be glad to help you plan a perfect water system for your family. In his big Goulds Pump line, you'll find the exact pump you'll need—including Balanced-Flow, the amazing water system that *needs no tank!* See him soon — or mail coupon...



Be sure you get a **GOULDS** water system

**GOULDS PUMPS, Inc., Dept. PM-556, Seneca Falls, N.Y.**

Please send 20-page Pump Booklet and Distributor's name. Name ..... Address ..... Easy Credit Terms Available .....

**Mammoth 1956 Wholesale Tool Catalog**

**TOOL CATALOG**



YOUR NAME



The opportunity now awaits you to own and operate your own business on a part time or full time basis in the lucrative field of **HARDWARE, HAND TOOLS, FANS, POWER TOOLS, MOTORS, PAINTS, etc.** or **BUY TOOLS FOR YOUR INDUSTRIAL OR INSTITUTIONAL USES.**



Buy Nationally Advertised Tools for Resale or Industrial or Institutional Use **NO INVESTMENT REQUIRED. BUY AS YOU NEED IT. A MILLION DOLLAR INVENTORY AT YOUR FINGER TIPS.**

**Discount UP TO 50%**

\$1.00 refund on first purchase or refund if you are not 100% satisfied.



Every one needs tools. Meet the demands of the growing "Do-it Yourself" markets. Sell direct from the jumbo buying guide—your cost is known only to you.

**JUST FILL OUT COUPON**

ENCLOSE \$1.00 FOR DEALER'S 1956 MAMMOTH TOOL CATALOG.

**SILVO HARDWARE COMPANY**  
Dept. PM-5, 108 Market St., Philadelphia 6, Pa.

I am enclosing \$1.00. Rush me your dealer's mammoth Catalog Today. If I am not completely satisfied with your plan, I understand that I can return the Dealer's Catalog for refund, and if I decide to order, my \$1.00 will be deductible from my first order.

NAME ..... ADDRESS ..... CITY ..... ZONE ..... STATE .....

For summer sunning—build it with

## ELMER'S® Waterproof Glue



Here's a chair with deep, slope-back comfort. Build it with Elmer's Waterproof Glue to assure completely waterproof joints stronger than the wood itself. Elmer's also resists acids, alkalis, fungus, rot.



Luxury Lawn Chair. EASI-BILD® Pattern #32. Just trace, saw, assemble. Send 35¢ in cash or money order to Elmer's Pattern Dept. 56, P.O. Box 215, 350 Madison Avenue, New York 17, N. Y.

\*U. S. Pat. Reg.  
EASI-BILD Pattern Co., Inc.

Repairing?  
Indoors?  
Building? Outdoors?  
**Glue it Best**  
WITH  
**ELMER'S**

Repair or build household furniture with

**ELMER'S®  
GLUE-ALL**

Make old favorites sturdy as new with Elmer's GLUE-ALL. Handy squeeze bottle.

Fast drying.  
Won't stain.  
Ideal for wood,  
paper, cloth.



Install kitchen counter tops with

## ELMER'S® CONTACT CEMENT

You're a "pro" with Elmer's! Bonds plastic laminates to plywood without clamps, nails, or presses.

Highly resistant to heat, water. Also good for other hard-to-glue jobs.



At hardware, lumber, paint, marine supply dealers.  
The Borden Company, Chemical Division

IF IT'S **Borden's** IT'S GOT TO BE GOOD

(Continued from page 74)

Freight-car scale signals retarder.....	148
Unit serves five ways.....	148
Mountain-top television room.....	149
Missouri River towboat destroys sand bars.....	154
Piggyback truck.....	155
Splices for cables come in kits.....	155
Torpedo transistor.....	155
Portable lifesaver (Z & W Machine Co., Wickliffe, Ohio).....	242
Improved light bulb is more efficient.....	250

### SCIENCE

Scientists measure twinkle of stars.....	78
Natural-gas substitute made in laboratory.....	124
Medics build own X-ray to fight tuberculosis.....	125
Infrared telescope.....	128
Scientists make synthetic virus.....	158
Frozen blood stored indefinitely.....	232
Oxygen inhaler (Research Laboratories, Inc., Erie, Pa.).....	238

### PHOTOGRAPHY

Camera photographs in the dark with heat rays from subject (Baird Associates, Inc., University Rd., Cambridge 38, Mass.).....	90
Attachment enables camera to shoot pictures from three sides (Davis & Sanford Co., New Rochelle, N. Y.).....	160

### Radio-Television, Electronics

Build your own hi-fi speaker enclosure.....	161
Humidity controlled electronic switch.....	163

### Craftsman and Shop Notes Index

#### AUTOMOTIVE

Projecting-load warning flag.....	170
Embossed auto-lamp lenses cleaned with toothbrush.....	172
Preparing scratches on automobile body for repainting.....	180

#### HOUSE AND HOME

Cabinet combines incinerator and garbage-can holder.....	170
Bright light helps in repainting and applying of clear finishes.....	177
One-legged breakfast-nook table bolted to wall studs.....	177
Solving Home Problems—	
Wire coat hanger serves as cord holder for electric iron.....	178
Handy twine dispenser.....	178
Nail or tack driven into lock-plate mortise.....	178
Soap rubbed on bathroom mirror will prevent fogging of surface.....	178
Hairpin bent and taped to easel.....	178
Bar of soap inserted in slot cut in sponge dispenses soap-suds.....	178
Reminders to call clipped to phone cord.....	179
Rubber hose cut into 4 or 6-in. lengths hold slip covers.....	179
Salt solution will remove grease stains from fabric.....	179
Abrasive soap cleans fireplace.....	180
Winter protection for vents under picture windows.....	180
Salvaged fireplace and mantel lend atmosphere to home.....	189
Rock lining protects garbage can.....	190
Plant stand.....	191

#### MISCELLANEOUS

Rough-water outboard refueling easy with motor oil can.....	169
Spinning black-and-white disk makes visible colored rings.....	170
Reusable metal standards support plants.....	172
Sand and gravel for concrete checked for silt content.....	177

(Continued to page 78)

**IMPORTANT NOTICE**—It is the intention of this magazine to provide its readers with information regarding the latest developments in the mechanical arts. We take no responsibility as to whether the disclosures contained in our articles are covered by patents and advise readers to investigate this subject before making, using, or selling any of the products, machines, or processes described in order to avoid possible liability for patent infringements.

## FOR BETTER WATER SKIING



Fit your outboard motor with the **MICHIGAN PROPELLER** designed to give you greater thrust, quicker pull-ups, more skiing buoyancy. Write for your **FREE** copy of our new 1956 **OUTBOARD CATALOG**, NOW! It contains propeller recommendations carefully engineered to provide better performance for every specific motor-boat-load combination — whether for skiing, speed, cruising or all around operation.

**MICHIGAN WHEEL COMPANY** • Dept. P-5  
Grand Rapids 3 Michigan

695



**FREE WIN A TRACTOR FREE**  
WRITE FOR ENTRY BLANK  
NOTHING TO BUY  
**HEAVY OIL-PH-BALL BEARINGS**  
**PUMPS MILLIONS OF GALS.**

IRRIGATE, SPRAY, DRAIN OR FILL ANYTHING—ANYWHERE! Will not Rust—Clog—or Leak. Patented Seal. Pumps 2800 gph, 420 gph at 75' high or 1600 gph from 25' well, 5/8" blade impeller. Threaded for pipe, 3/4" inlet, 1/2" outlet. Use 1/2 to 3/4 hp motor. . . . 7500 gph 9.95  
Heavier 2800 gph 8.95 Heavier 11.95  
Check, MO or C.O.D.—Money Back Guarantee

**FREE Literature—Comparison Charts**  
**U. A. T. ENG. & MFG. CO.** NICKSVILLE 273,  
NEW YORK

## MAKE BIG CASH PROFITS ASSEMBLE YOUR OWN LAWN TRACTOR



**NEW!** You can now send fertilizer, pull chains, grass, "bowl", cut knives, wheels, etc.

When your neighbors see the fun you have mowing your lawn with **RIDE-TRAC**, they'll want one too. Make Big Cash Profits in your own neighborhood with our Rider Agent Plan. Complete **RIDE-TRAC** kit goes together quickly with wrench and screw-driver. **RIDE-TRAC** makes fun out of all your lawn work. Write today for details of Rider Agent plan. **BELSAW RIDE-TRAC DIVISION**, 556 Field Bldg., 315 Westport Rd., Kansas City 11, Mo.

## BRONZE FOUNDRY

Schools and Home Workshops

Make your own castings of aluminum, copper, bronze, silver. Foundry sets are available in three sizes including 2400 Deg. F. blast furnaces. \$22.50; \$29.50; and \$42.00. f.o.b. Marysville, Kans. Free Circular.

**KANSAS CITY SPECIALTIES CO.** P. O. Box 6022, Dept. P-5  
MARYSVILLE, KANS.

14' Model Pictured

**42 TOP PERFORMING  
MODELS, 8' thru 18'**  
... from \$39.25 incl. frt.

**FREE!**  
**BOAT  
KIT  
CATALOG**

Runabouts, Cruisers, Convertibles, Fishing, etc. for every purpose with modern styling, advanced design. No experience necessary, amateurs can easily assemble. Save 1/3 to 1/2 "factory-built" prices!

**FIBERGLAS, TRAILERS, ACCESSORIES**

**UGER INDUSTRIES, INC.** DEPT. 3404 Lyndale S.  
B-5 Minneapolis 8, Minn.

## NOW! Test Your Own TV AND RADIO TUBES

with new **Omni-Tester**. Save the cost of one TV service call and **Omni-Tester** pays for itself. Easy to operate—no technical knowledge required. Absolutely safe. Use 110 volts AC or DC. Complete with test cords and instructions.

Guaranteed. No C.O.D. Please. **ONLY \$3.98**  
**OMNI-ELECTRONICS CORP.** 911 W. 53rd St., Dept. 11,  
CHICAGO 9, ILL.

## MONEY MEN ALL FREE

THE **PLASTEX** Industry needs manufacturers on small scale and for big production of Lamp and Clock Stands, Art Goods and Novelties in **Plastex** and **Marlin** imitation. Experience unnecessary. Use material makes regular 10¢ store sellers. Rubber moulds furnished for speed production. Small investment brings good returns. We are now placing big Chain Store Orders with manufacturers. Ambitious men have chance for real prosperity. Our Free booklet will interest and benefit you.

**PLASTEX INDUSTRIES, Dept. A**  
3400 Third Ave. New York 56, N. Y.

# ALL AMERICAN!

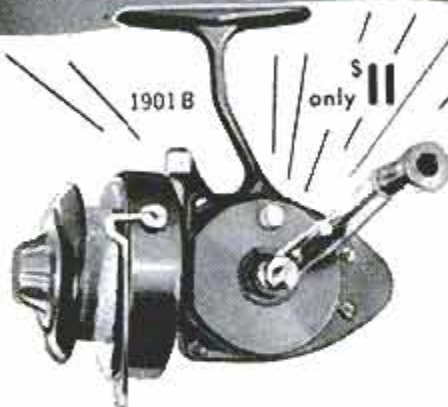

Finest Lightweight

Spinning Reels made in America

All American in name, performance and manufacture! **H-I Spin Reels** set new standards for quality, value and long, trouble-free service. Light weight—only 6 oz. . . . right- or left-hand operation, without interior adjustment . . . noiseless nylon gears, oil-less bearings . . . adjustable spool drag . . . anti-reverse button . . . handsome, long-lasting finish, with all fittings hard chrome plated.

Also a de luxe model 1903 (\$15.00) especially balanced for super performance on glass rods.

Look for 

on the tackle you buy  
Rods, Reels, Lines, Lures,  
for every fisherman and  
every kind of fishing



Valuable Fishing Guide. Send 25¢ to  
**MORROCKS-IBBOTSON CO.** Dept. PM-516, UTICA, N. Y.  
Manufacturer of the largest line of fishing tackle in the world

## HELPFUL BOOKS

Send post card asking for **FREE** catalog

Popular Mechanics Press, 200 E. Ontario, Dept. 601, Chicago 11



Convert Lawn Mowers into Power Units with this

**Briggs & Stratton**  
**2-H.P., 4-Cycle GAS ENGINE**

**AIR COOLED FULLY GUARANTEED**

Reg. Price \$68.00

**SAVE! SPECIAL OFFER \$37.50**

while they last... **\$37.50** fob

**Powers Farm, Home & Industrial Tools**

• Garden Equipment • Pumps • Compressors

**GOV'T SURPLUS** Briggs & Stratton leads the world in dependable, trouble-free performance. A precision-built 2-

horsepower, 4-cycle engine with advance styling and economical operation. Easy rope start—sure fire ignition in all weather. Positive, automatic splash-lubrication system. 2 Qt. gas tank. Float feed carburetor with adjustable idle speed and automatic governor. Oil bath air cleaner. Complete with muffler, 3 Piston rings for added compression. 2000-3600 RPM adjustable speed range.

**SUPPLY LIMITED! IMMEDIATE DELIVERY! ORDER FROM AD FREE CATALOG of Compressors, Generating Plants, Motors**  
**Roberts Electric Co., Dept. PM-450, 849 W. Grand, Chicago 22, Ill.**

# NOW AUTOMATIC POWER LUBRICATION FOR YOUR CAR



WITH THE NEW

## Multi-Luber

If you own a late model Ford or Chevrolet, this is for you. With a mere press of a button on your dash, all chassis points are high pressure lubricated in seconds . . . guarantees that smooth "Just Lubricated" ride every day . . . provides wonderful, time-saving convenience . . . adds years of economical car operation. The Multi-Luber has been exhaustively tested and is available on current models of one of the largest car manufacturers.

Buy it installed from your car dealer, garage, or service station—or install it yourself. Kit includes complete instructions for quick and easy installation.

IN KITS  
AS LOW AS  
**\$46<sup>95</sup>**  
PLUS  
INSTALLATION



LINCOLN ENGINEERING  
COMPANY, St. Louis 20, Mo.

Please send me your illustrated leaflet describing MULTI-LUBER, and the name and address of my nearest Multi-Luber Dealer.

NAME.....

STREET.....

CITY..... STATE.....

(Please print or typewrite)

(Continued from page 76)

Foam rubber on wooden hanger provides nonslip surface.....	177
Aluminum-foil "scarecrows" protect plantings.....	185
Finding correct height for setting plate bolts into concrete...	190
Battery holder used in electrical and radio experiments.....	190
Simple rubber-band gun.....	191
Removing fruit-juice stains.....	196
Insulation board backstop safe for air-rifle target practice...	196
Snap-hook shortens anchor chain on fishing boat.....	196
Tent anchor ropes kept taut with heavy rubber bands.....	196
Water-tank planting boxes mounted on chain standard.....	196
Can on trailer wall provides running water in isolated area...	206
Aluminum rack stores milking-machine inflation tubes.....	212
Masking tape on wood chisels protects sharp cutting edges...	212
Altered drill chuck allows work to pass through headstock...	216
On the Market—	
Adhesive for plastic and metal wall tile.....	220
Low-cost flooring.....	220
Repairing broken pot handles and other metal objects.....	220
Thermostatic water control.....	220
Blond finish for furniture.....	220

### SHOPPING FOR TOOLS

Combination tool.....	218
Woodworking unit utilizes a portable power saw.....	218
Masonry drill is adjustable for drilling.....	218
Pipe wrench is fitted with a Z-shaped pin.....	218
Wobble-saw attachment for portable electric drill.....	219
Rotary planer head.....	219
Universal motor mount.....	219
Portable welder works on 115-v., 60-cycle, a.c.....	219
Quick-adjusting C-clamp.....	219

### WORKSHOP HINTS

Clamps hold thin wooden members while edge-sanding them...	180
Detergent cleans asbestos siding.....	180
Notched cork stores razor blade.....	185
Punch made from drill shank.....	185
Sheet-metal jig locates nails along edge of workpiece.....	185
Hole cutter "turns" plugs.....	189
Wheels for toys cut from wringer roll.....	189
Floor flange holds lathe center.....	212
Sliding jig supports plane iron for accurate honing.....	212
Spotting fence-post holes for tractor-driven auger.....	212
Shop chair.....	213
Shop Hints—	
Boring out a cored hole.....	214
Hand plane serves as ideal sanding block.....	214
India ink can be used for layout work.....	214
Prevent a small-diameter drill bit from drifting off center...	214
Drilling and tapping a hole.....	214
Time saved when using wood lathe.....	215
Dowel inserted in copper tubing.....	215
Auxiliary pivoting jaw cut from steel plate.....	215
Combination-square set.....	215
Threaded cleaning tool.....	215
Gasket cement forms insulators around wires in car body...	216
Pulley-flange repair.....	216
Toolholder cut from glove.....	216

## Scientists Measure Twinkle of Stars

Twinkling in stars is caused when pockets of air of various densities pass between the star and the viewer. And now astronomers at the University of Pennsylvania are going to measure the twinkle with electronic meters, and compare their findings with weathermen's reports of upper-air direction and velocity. If they can find a relationship and reduce it to a formula, it may be possible to gauge upper-air winds in the future by measuring starlight.



AMAZING ELECTRIC SPRAY GUN ELIMINATES EXPENSIVE AIR COMPRESSORS AND MOTORS

# MAKE MONEY! SAVE MONEY! With Amazing SUPER JET Spray Kit!

**No Experience Needed To Operate Easy-To-Use All Purpose Spray Gun.**

Now anyone can own a professional, all-purpose spray gun. Homeowners! Hobbyists! Handymen! Paint the fast, easy way with the amazing new Super Jet Spray Gun. Save money spray painting shelves, closets, cabinets, furniture, bookcases, doors and other things around the house. Make money in your spare time spraying fine finishes on automobiles, fences, metalwork and hundreds of other projects for your friends, neighbors or customers. Super Jet can pay for itself on the very first job. It costs just \$1.00 a week — no money down!

This lightweight, self-contained spray gun makes painting the easiest thing in the world because there are no tanks, no compressors, no complicated equipment to cause trouble or confusion. Simply plug Super Jet into any 110 Volt A.C. electrical outlet, fill the non-breakable aluminum container with paint and pull the trigger to start spraying. Spray paint, enamel, lacquer, varnish, shellac, insecticide, deodorants, liquid fertilizer, oil and water as easily as pointing your finger! Just about any liquid that pours easily, sprays easily when you use Super Jet!

**SELF-CLEANING!**

Simply spray solvent through the gun after painting and Super Jet cleans itself in seconds... automatically!

**ONE CONTROL KNOB!**

A simple turn to the right or left instantly adjusts Super Jet to atomize the material you are spraying!

**JEWEL NOZZLE**

U.I. and C.S.A. approved

**ALL METAL**

No Breakable Glass Or Plastic Polished Aluminum Jar

**AUTOMATIC PAINT STRAINER**

Super Jet's ingenious fine-screen metal filter automatically strains paint and spray materials. Dirt, pigments, etc. are automatically filtered out and prevented from clogging gun!



110 VOLT A.C.

**FREE TRIAL IS BEST PROOF! SEND NO MONEY!**

**A COMPLETE SPRAY KIT!**  
Only \$29.95-\$1. a week!

- NEW SUPER JET SPRAY GUN
  - POLISHED ALUMINUM JAR
  - AUTOMATIC PAINT STRAINER
  - 15 FT. DISTANCE TUBING
  - 23 FT. NEOPRENE CORD SET
  - GEM NOZZLE DISC
  - WALL CHART & INSTRUCTIONS
  - STEEL CARRYING CASE
- PLUS Your Name In 23 KARAT GOLD

**FREE!**

Mail Coupon Today with order and get FREE 5-piece Screw Driver Set.



**EXTRA BONUS!** Send \$29.95 in full payment of your SUPER JET SPRAY KIT and receive as extra bonus tool kit pictured! Tempered steel 6 inch wrench, 7 inch pliers, screw driver blades and chuck, complete with carrying case. Not a toy!



**MAIL COUPON TODAY FOR 10 DAY FREE TRIAL**

POWER PRODUCTS, Super Jet Division 5-A  
175 East 87th Street, New York 28, N. Y.

Please send amazing new SUPER JET SPRAY KIT. I must be completely satisfied or I may return within 10 days for full purchase price refund. I am using payment plan checked below.

- PAYMENT IN FULL. Enclosed is \$29.95 (check or money order) in full payment. Be sure to send my FREE GIFT plus EXTRA BONUS.
- SIMPLIFIED BUDGET PLAN. (No Money Down) I will pay \$29.95 at \$1.00 per week plus postage and small credit service charge. (No credit charge if paid within 60 days.) Be sure to send my FREE GIFT!

YOUR NAME will be written in 23 Karat Gold on your kit. Please Print

NAME \_\_\_\_\_  
 ADDRESS \_\_\_\_\_  
 CITY \_\_\_\_\_ ZONE \_\_\_\_\_ STATE \_\_\_\_\_  
 EMPLOYED BY \_\_\_\_\_ POSITION \_\_\_\_\_  
 ADDRESS \_\_\_\_\_

**FULLY GUARANTEED! 10 Day Free Trial plus 90 Day Guarantee Against Mechanical Defects.**

POWER PRODUCTS, 175 EAST 87th STREET, NEW YORK CITY

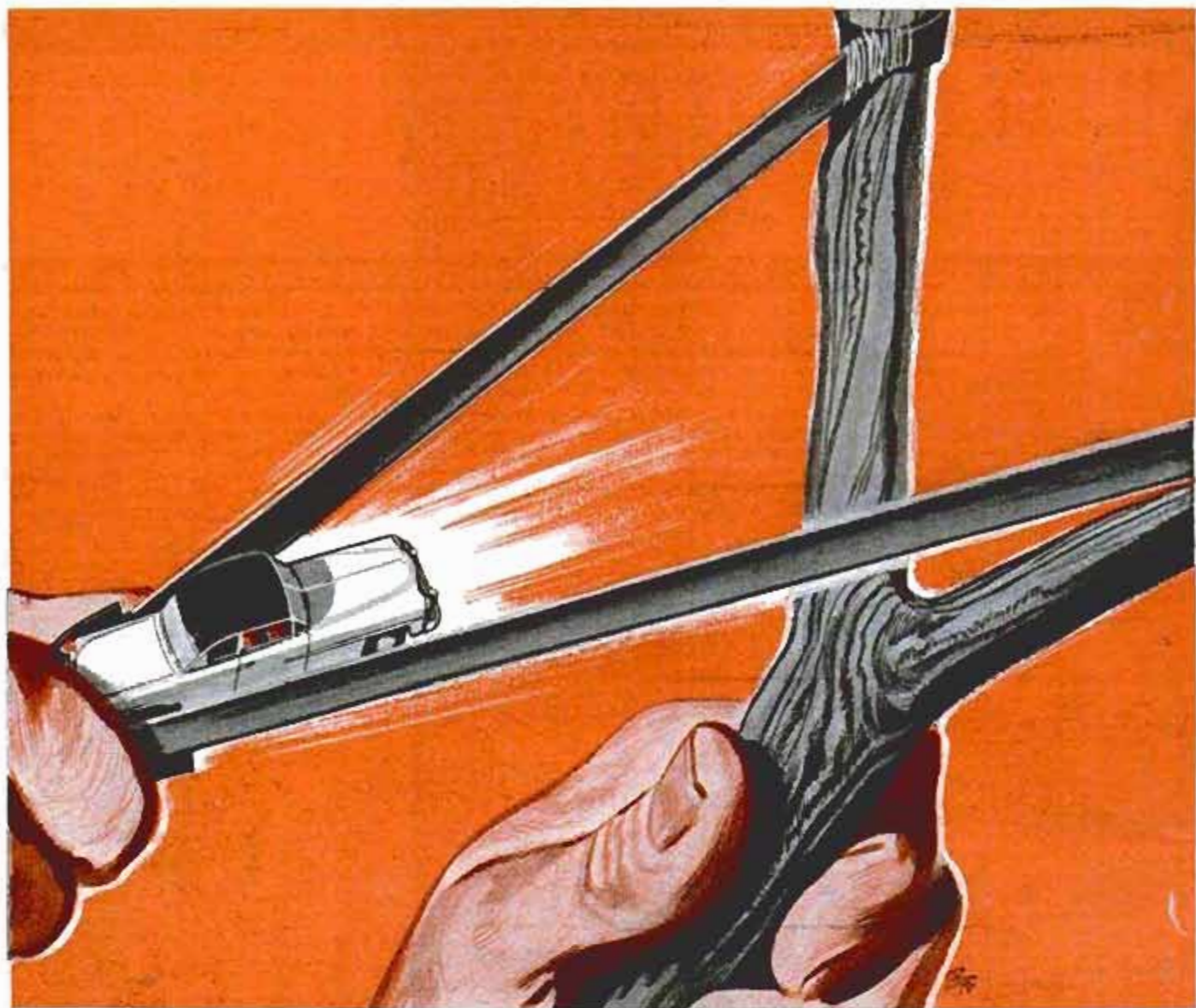

## For Instant Acceleration and Sustained Power...

see your Doctor of Motors!

If the engine in your car is sluggish and tired, the installation of new Perfect Circle 2-in-1 Chrome piston rings could make a world of difference. Restore the alert, responsive power the engine was designed to deliver!

In Perfect Circle's 2-in-1 Chrome set, the top compression ring was specially designed to perform where pressures are greatest, heat is highest and lubrication is poorest. The new Type "98" oil ring with self-expanding spacer assures a uni-

form pressure against the cylinder wall plus a side sealing action on the ring groove. And both rings are plated with thick, solid chrome that resists wear, more than doubles the life of cylinders, pistons and rings.

For thousands of extra miles of sustained power with positive oil control—and performance that makes you proud of your car—ask your Doctor of Motors—your skilled mechanic—to install Perfect Circle's in your engine.



Better Mechanics everywhere install  
**PERFECT CIRCLE**

2-in-1 chrome piston rings  
THE STANDARD OF COMPARISON

Perfect Circle Corporation, Hagerstown, Indiana; The Perfect Circle Co., Ltd., Toronto, Ontario.



**A**T 11:00 O'CLOCK on the morning of August 12, 1952, the Atomic Energy Commission announced in Washington, D. C., that it was investing \$1,000,000,000 of the taxpayers' money in a vast new gaseous-diffusion plant. This atomic factory would be built into the Scioto River Valley of southern Ohio.

A few minutes later a congressman picked up his phone and placed a call to the old industrial town of Portsmouth, Ohio. The call brought the news to Portsmouth. For a decade the town had been slowly fading. Jobs were scarce, school kids disappeared upon graduation, and the population had been dropping steadily since the depression.

By midnight it was apparent to the people of Portsmouth that some sort of atomic bomb had been dropped on their town. The hotels suddenly were jammed, long-distance lines were tied in knots and speculators were swarming into the area.

The next morning trailer-camp operators started dickering for choice tracts along Highway 23 which runs north out of Portsmouth to the area selected for the atomic plant some 22 miles away. Scouts for restaurant chains hustled into town, and speculators were picking up options on corn-fields for future drive-in theaters.

The atom had come to the

# POPULAR MAY 1956 MECHANICS

WRITTEN SO YOU CAN UNDERSTAND IT  
VOL. 105 NO. 5



Security force stands eternally vigilant over huge atomic plant. Cloud of vapor rises night and day

## Look What Happens When **THE ATOM STRIKES A VALLEY**

By  
**Clifford B. Hicks**

Post-construction sale brought thousands who bid on items from houses to tools

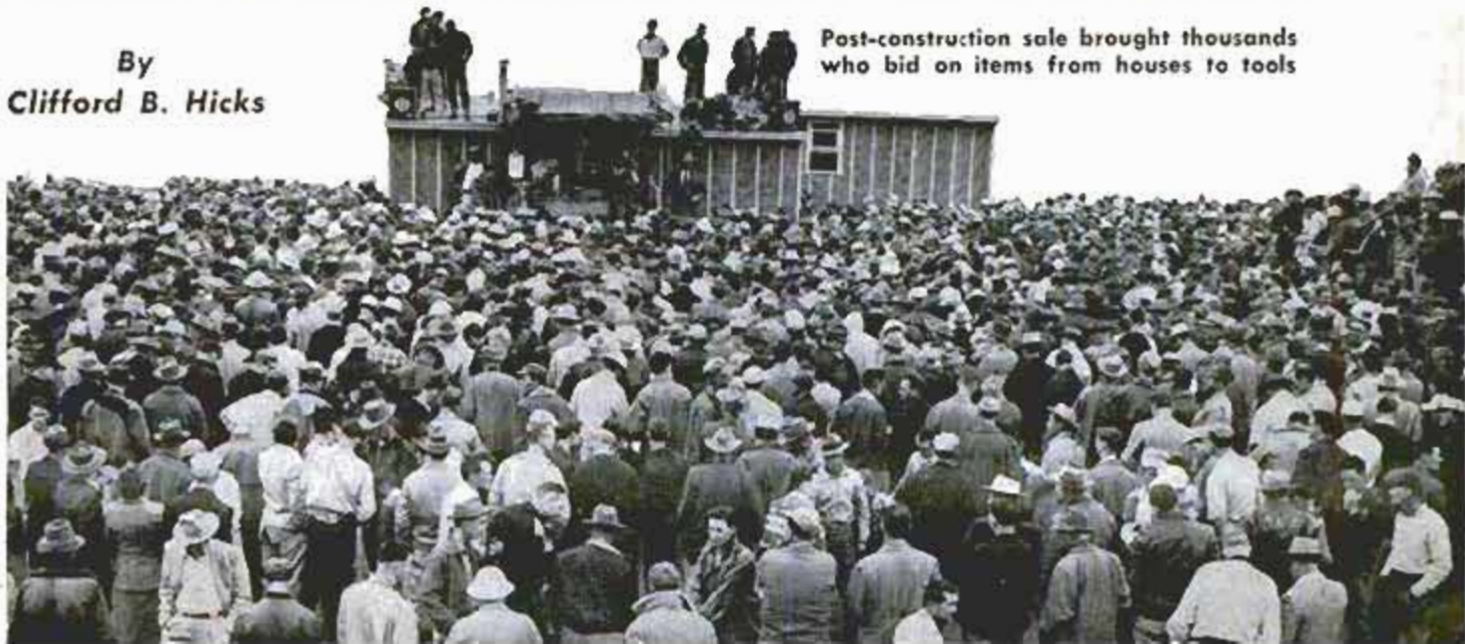



Old farm buildings in foreground stand in sharp contrast to atomic plant that sprawls across 3700 acres

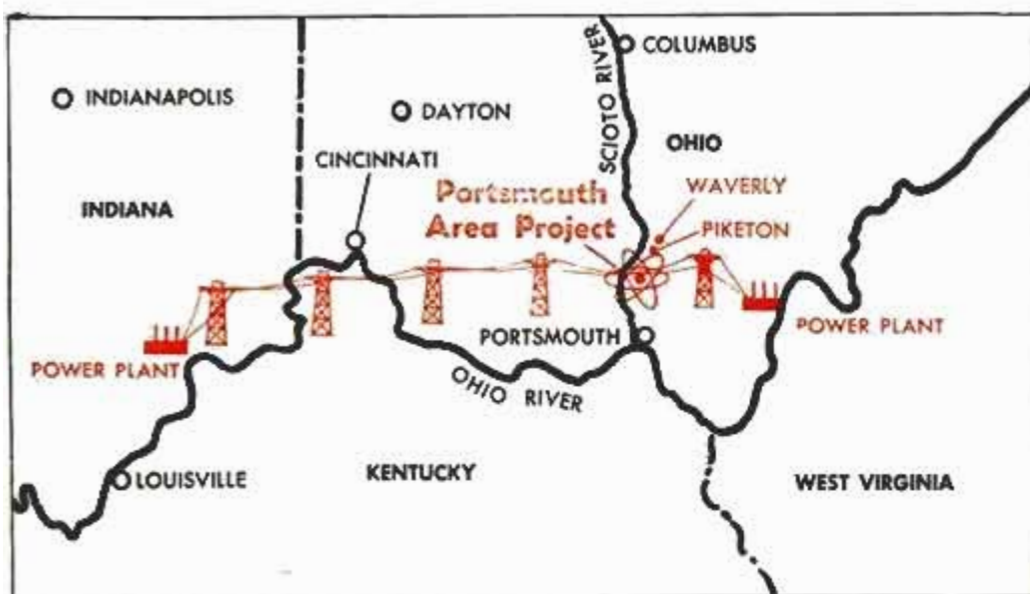

Map shows location of project, the power plant and towns of Waverly and Piketon, most affected by boom. Below, atomic workers attend class



Scioto River Valley, and was threatening it with a human flood. Today the local citizens are still feeling the backwash, and things will never be quite the same in the placid valley again.

### Industrial Explosion

The story of the atom and the Scioto Valley is the story of a small area that suddenly finds itself in the middle of an industrial explosion. It's a story that may be repeated elsewhere as the atom becomes a big peacetime business, or as other big industries suddenly expand into rural areas.

It's the story, too, of one of the biggest industrial projects ever undertaken in the United States. The existence of the Portsmouth Area Project is no secret, but relatively few Americans have ever heard of it. They should. They can point to it with pride.

Back in the summer of 1952, the residents didn't quite know what was up as the speculators swarmed into the area. A few suddenly found themselves offered fantastic prices for their land. One old-time farmer snapped up \$25,000 for five acres of mediocre soil. Another grabbed off \$75,000 for a 1500-foot strip



During construction period, mysterious windowless buildings seemed to spring up on the site overnight

fronting the highway. In the little town of Waverly, right next door to the plant, an old store brought \$35,000 to its owner; he couldn't have sold it for \$5000 a week before.

Such high prices were mere tokens of what was to come before the gaseous-diffusion plant was completed. Now it has gone into full production and it's a sight to see, though of course you can't get inside the chain-link and barbed-wire fence that stretches more than four miles around the perimeter. But you can see vast windowless buildings that give you a vague notion of the size of your investment as a taxpayer.

There are about 220 acres of floor space in this incredible atomic factory—enough to accommodate 166 football games going on simultaneously! If you assembled all the engineering drawings for this intricate

plant they would cover  $2\frac{1}{2}$  acres of land. A whopping 9,000,000 cubic yards of dirt were excavated for the buildings, which soaked up 525,000 cubic yards of concrete, 30,000 tons of reinforcing steel, 1600 miles of pipe and tubing, 2,500,000 sacks of cement and some 4600 miles of electrical wiring.

About 120,000,000 man-hours of work, sweat and worry went into the project, enough to keep one man busy on a 40-hour week for 57,692 years. It's essentially an automated factory operated by about 87,000 instruments. Each day some 350,000,000 gallons of water surge through the plant.

#### Plant Sifts Atoms

These incredible figures seem even more incongruous when the purpose of this new

Schematic diagram shows how U-235 atoms penetrate barriers faster than U-238 to produce enriched gas

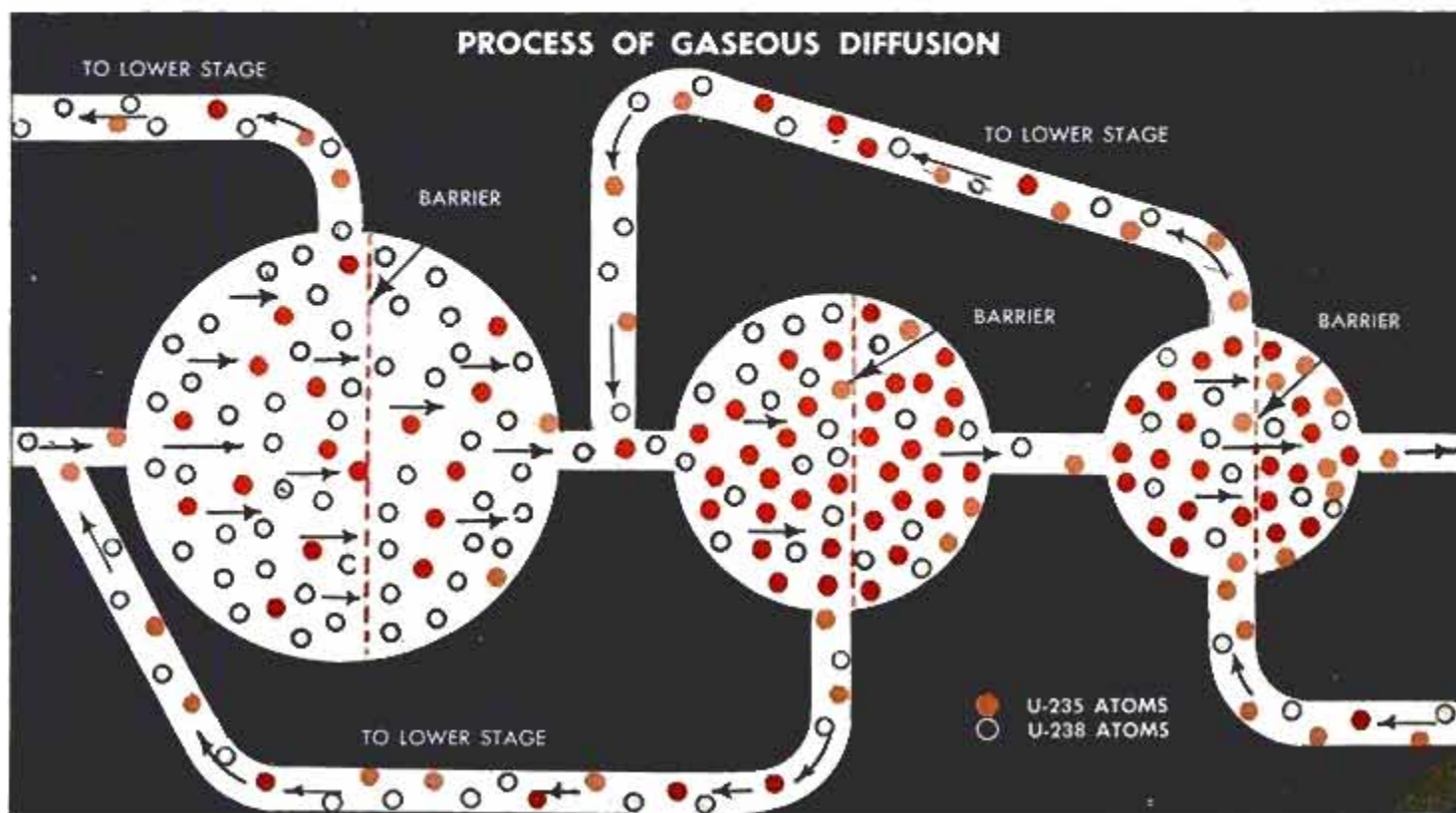

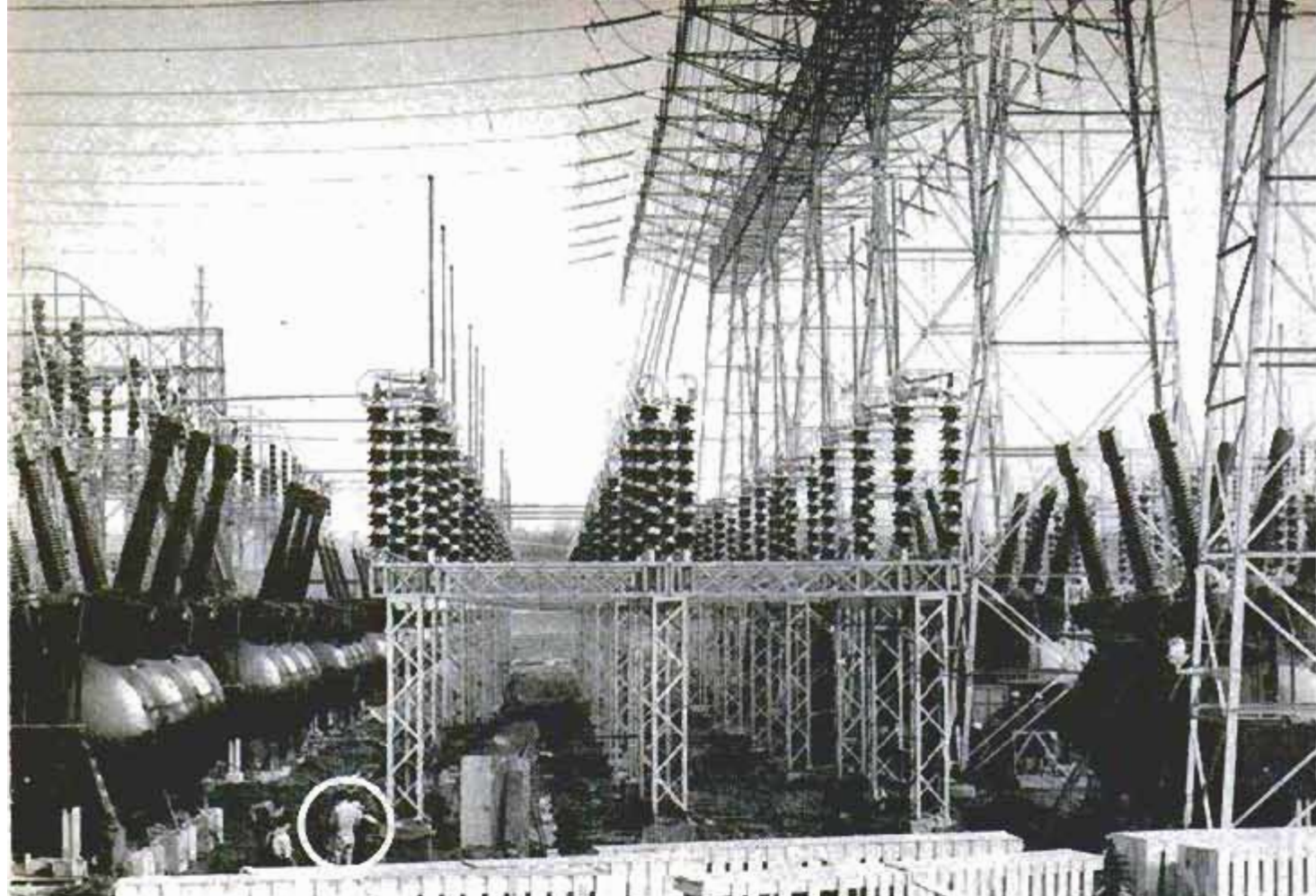

Project requires a tremendous supply of electricity, brought in to this terminal area. Note size of man

factory is considered. Night and day it sifts invisible atoms into two stacks.

U-235 atoms are what make the atomic program go 'round. They keep the *Nautilus* under way, explode atomic bombs and are the fuel of peacetime reactors. Uranium, as found in nature, contains only one U-235 atom for every 140 atoms of U-238. The two isotopes are identical except for an incredibly slight difference in weight. The mysterious plant simply sorts out these two types of atoms.

#### Uranium Becomes Gas

Uranium as it is used in the plant is combined with fluorine to make a gas, which then is pumped through countless miles of piping. At intervals it must pass through

barriers which contain literally billions of holes, each less than  $\frac{3}{1,000,000}$  inch in diameter. All atoms can easily pass through these holes, but the U-235 atoms, being slightly lighter, move just a bit faster, and therefore tend to pass through the holes first. As the gas pours through thousands of these barriers it becomes more and more enriched in U-235 atoms until it is highly concentrated and becomes the basic stuff of atomic science.

Back in the summer of 1952 there was no hint that this process of sifting the invisible would be done in Pike County. Then the AEC made its announcement and immediately arranged to buy 3700 acres of farm fields, wooded hills and yellow clay. On this large tract of land were about 40 farm

Hundreds of temporary "flattops" housed workers. In backwash of boom, some sold for \$350 including utilities





Some 20,000 new workers—plus their families—invaded the area. Here one shift files through time-clock gates

families, one church and two cemeteries.

Everything seemed to happen at once. The AEC entered into a contract with Goodyear Tire & Rubber Company to operate the nonexistent plant. Goodyear formed the Goodyear Atomic Corporation (GAT), pulled in a cadre of key men from all over the world and sent them to Oak Ridge to learn how to sift atoms. Eventually these men arrived at the Portsmouth site and started recruiting workers. The recruits then went through a school taught by men who, a few weeks before, had been attending school themselves.

#### Well-Planned Project

Meanwhile AEC, the construction company and GAT studied the history of the Oak Ridge and Paducah atomic installations to find out what they could expect from an industrial boom, and to make their plans accordingly. It's a fact that, despite the pinches and crises that cut tempers short, this was the best-planned project of its scope ever undertaken.

The contract to build the plant was awarded to Peter Kiewit Sons' Company, one of the largest construction firms in the country. The first real pinch came when Kiewit sent out the call for workers. Cars and house trailers started rolling in from virtually every state in the Union.

More than 20,000 workers had to be hired and roofs put over their heads. The govern-

ment agreed to arrange for 1000 permanent homes, and to move in 250 temporary homes and 750 trailers. During the next several months a total of 3700 privately owned trailers somehow were bedded down in the area.

But this housing didn't pop up overnight. Meanwhile empty rooms in private homes suddenly became valuable, rooms once

Plant has a complete building for decontamination of equipment. Spray booth washes away radioactivity

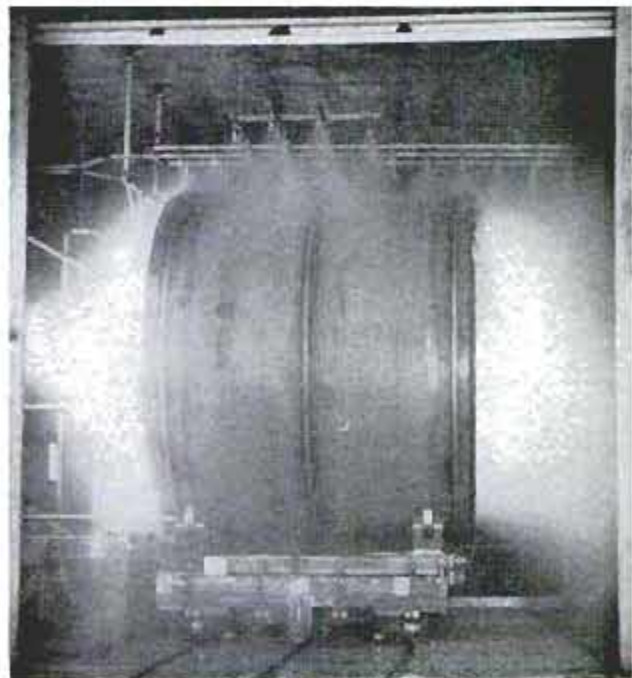



Project required 1600 miles of pipe and tubing, 4600 miles of wiring

occupied by youngsters who had been forced elsewhere to find work. There was a short period when homeowners had three or four men living in one spare bedroom, each paying \$8 to \$10 per week. Motels sprang up everywhere and were promptly inundated. In a few cases chicken coops and sheds were cleaned up and rented for \$50 to \$60 a month until something else was available. Contractors found themselves building big housing projects they wouldn't have considered a few months before. In Portsmouth alone, the value of building permits leaped from about \$1,000,000 in 1951 to almost \$5,000,000 in 1953.

Two small towns adjacent to the site had convulsive growing pains. At the time of

ing in the plant alone. And these were just workers. A good many of them moved their families to the area."

What about those families? A wave of kids poured into the school system. In the village of Beaver, five miles from the plant, youngsters attended classes in the city hall and jail. Kids left home in shifts like their fathers until the frantic residents, with the help of the U. S. Office of Education, could build some permanent schools.

Churches were jammed to the doorways. Ministers addressed congregations in trailers, houses, tents and barns. An enterprising doctor rolled a trailer into the middle of the area and started treating an overflow of patients in this "office." A dentist soon followed suit.

Stan Spalding, now editor of the *Waverly News*, worked for the construction company during those exciting, exasperating days. "When that many people suddenly move into an area," says Spalding, "it's not just a matter of finding a roof to put over their heads. Seems like everything strains until it's ready to snap. Highway 23 was one big traffic jam around the clock. It took an hour and a half for a worker to drive the 22 miles from Portsmouth to the plant. This stretch of highway was widened to four lanes as fast as possible, and a huge cloverleaf and access

(Continued to page 244)

New houses sprang up by hundreds in nearby towns. Now many are vacant





## Lock Inside Refrigerator Prevents Accidents

Concerned over the rising number of fatalities resulting from children crawling into abandoned refrigerators and being locked in, the Admiral Corporation is building a lock-release inside of its new line of refrigerators. The release glows in the dark, and all a child has to do to open the door is to touch the glowing button. Since an estimated two to three million refrigerators go out of service each year, the potential danger to children is great. In 1955, 18 youngsters suffocated inside abandoned refrigerators—18 lives which might have been saved by lock releases.



## Interceptors Seek, Find and Kill Enemy Electronically

Every interceptor plane, both American and Canadian, now guarding the North American continent is equipped with a "seek, find and kill" radar system operated by an electronic brain. Dispatched by ground radar, the pilot flies to within 15 miles of approaching enemy bombers. Then he turns on his automatic gear. The plane's

radar seeks out the enemy and the brain flies the plane into firing position. It computes aim for rockets, fires them at the right moment and then pulls the interceptor up and away from target debris. The system has as many parts as 200 television sets, can operate effectively day and night and in all kinds of weather.

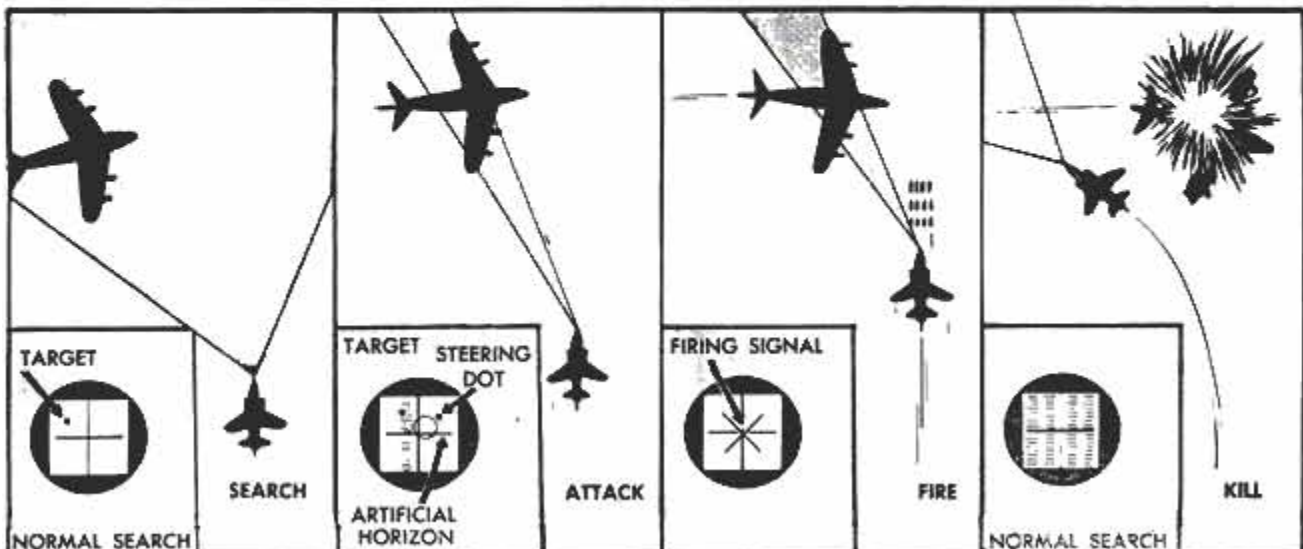
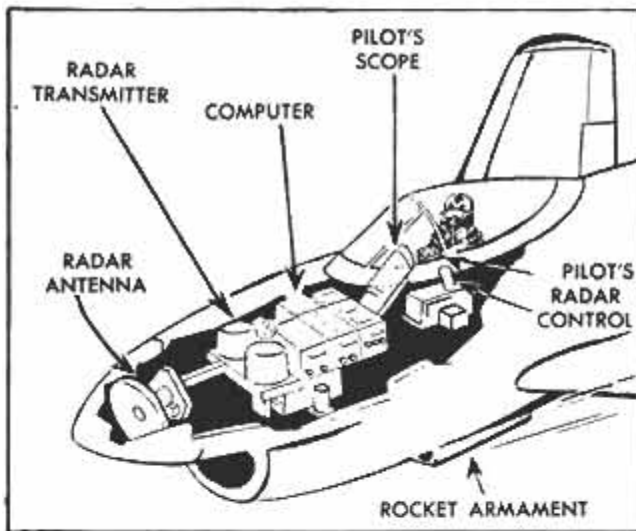



## ***What Will it Take to Win At Indianapolis?***

**WHICH CAR** will win the "500" this year? It's a good bet it will be a Kurtis "500" roadster powered by a four-cylinder Meyer-Drake engine that has a 13:1 (or higher) compression and burns straight alcohol.

That's a good bet if you are a form player and like the favorite.

Experts agree the winner is likely to be a roadster designed for the 500 (not a dual-purpose car that races dirt tracks, too); it should weigh about 1800 pounds; it should

**New this year is the 405-hp. Hopkins V8 which is built up from a Studebaker block and uses Cadillac rods**

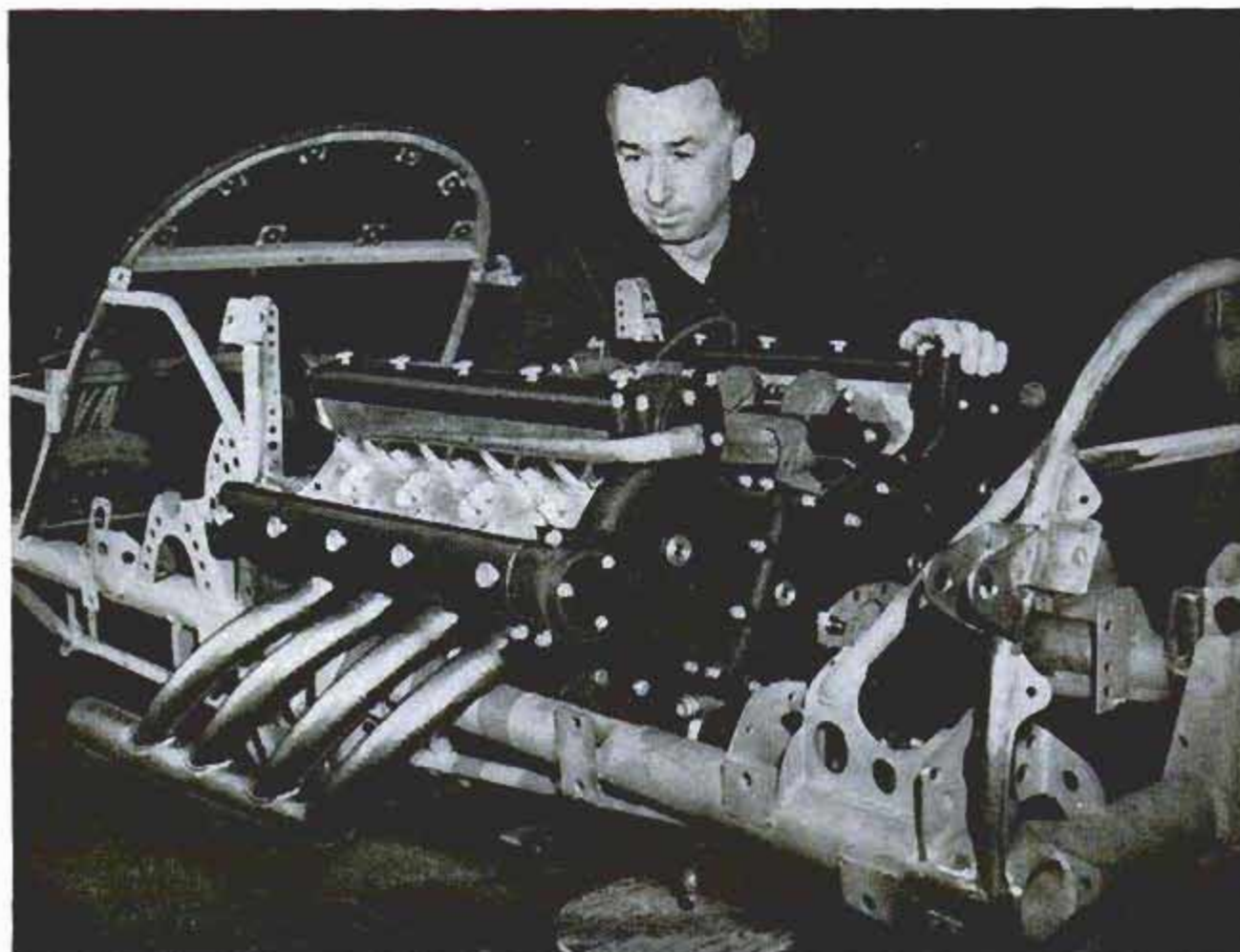

have a dependable, powerful engine offset four to seven inches to the left (putting more weight inside the counterclockwise corners); it should have fuel injection and it should have more power rather than more streamlining.

But not everybody plays according to form. One persistent nonform player is Lou Welch, owner of the high-powered, low-lucked Novi V8s, which have set qualifying records but have never won.

After 10 winless years with front-wheel drive, Welch has switched to rear drive and has installed his supercharged Novi V8s in two Kurtis-built roadsters. The reworked engines develop well over 600 horsepower (compared to 330 of the Meyer-Drake engines).

Another nonform player is Lindsey Hopkins who plans to enter a 405-horsepower fuel-injection V8 built up from a Studebaker block.

Expected again this year (it didn't make it in 1955) is a 400-horsepower Ferrari six-cylinder engine in a Kurtis chassis.

More than half the track has been resurfaced to eliminate ripples on the turns. Qualifying speeds are expected to be about 1.5 miles per hour faster than in 1955. Race speeds should set a record, barring rain, accident or any of the unpredictable occurrences that make predictions by anyone (expert or otherwise) unreliable. ★ ★ ★

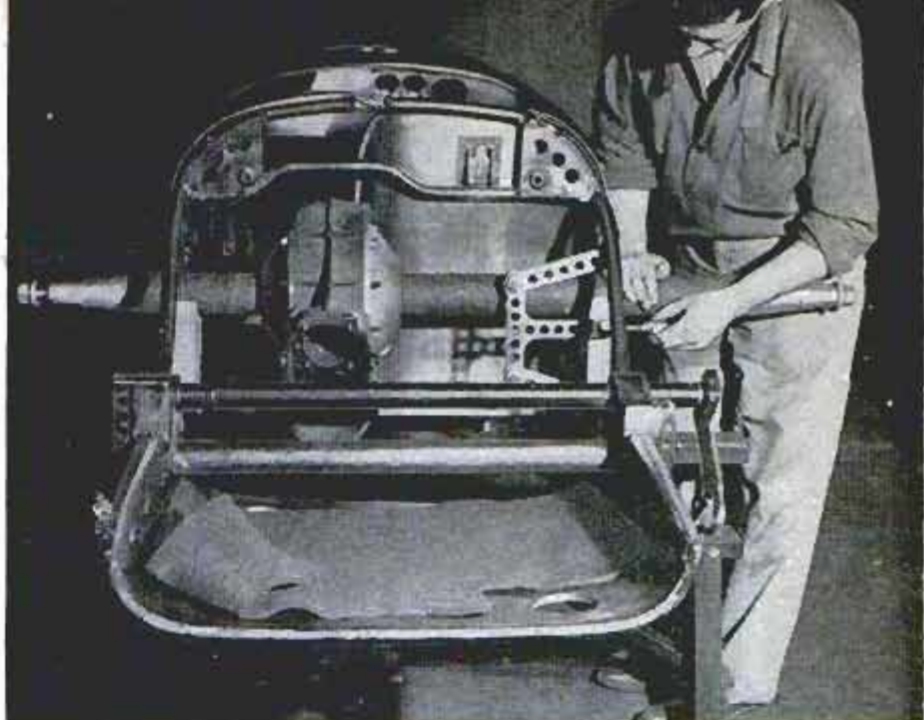

Rear view of new Novi which is rear-wheel drive this year. Ring-gear housing is offset to the left to line up with engine

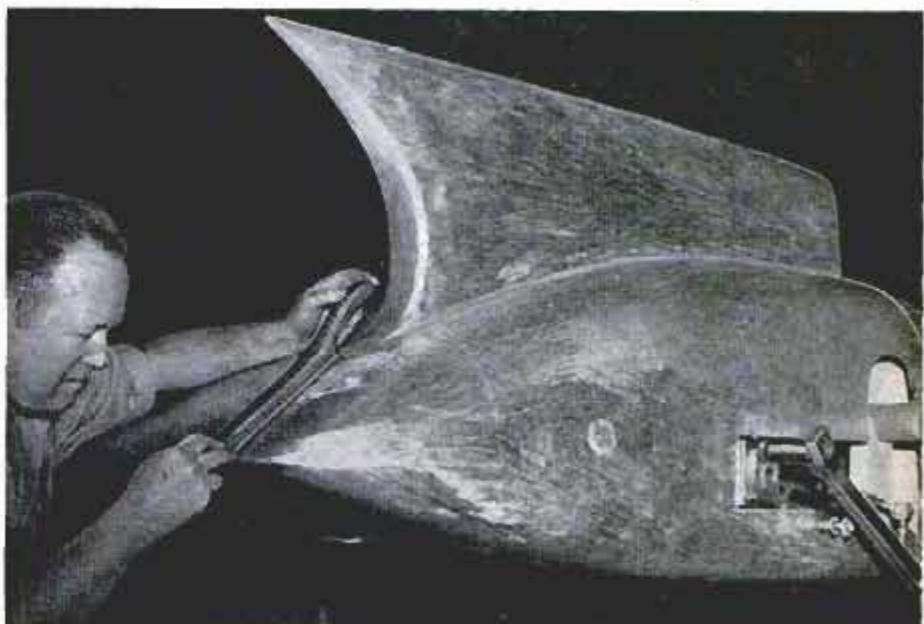

Tail fin on the Novi is offset to the right behind the driver's head. It's a styling trick for looks only

Right side of the cockpit on the Novi (under construction here) is cut low for driver's exit should car overturn

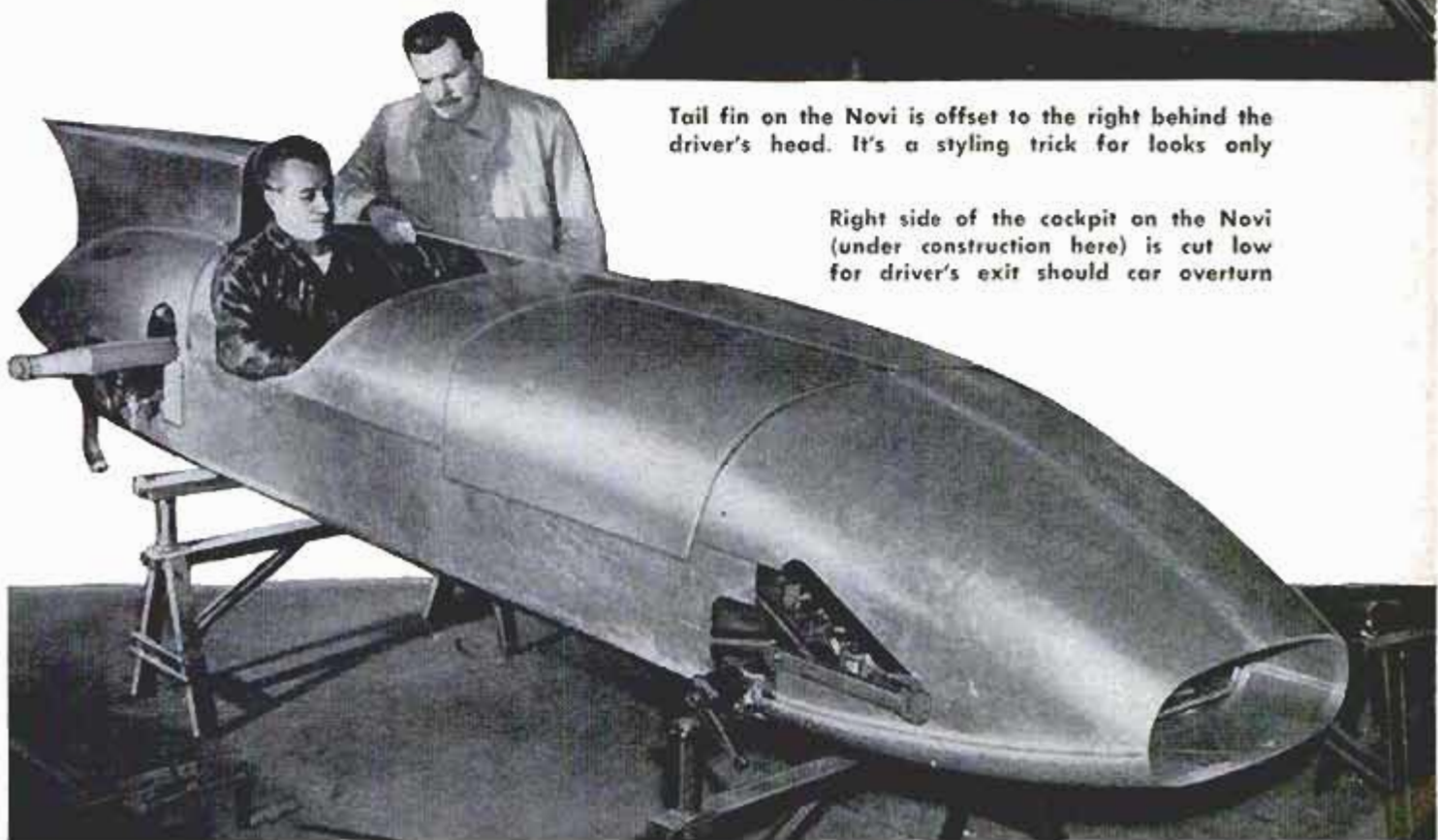

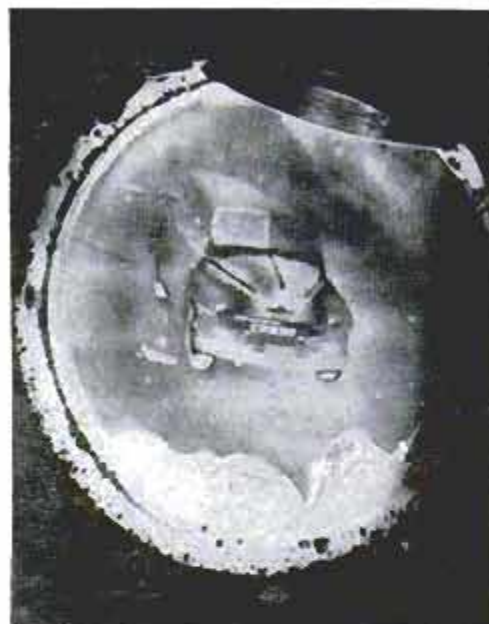

Rear view of the instrument. Evapograph picture of parked auto accents warm tires and hot area around engine

## Camera Photographs in the Dark With Heat Rays From Subject

Pictures are taken in complete darkness by a camera that employs the infrared rays emitted by a faintly warm object. The heat rays are focused on the photographic plate by a concave mirror like a telescope's. The plate itself is a narrow plastic membrane coated with a thin film of oil. As the oil evaporates under influence of radiation, an image emerges, with different colors in the

oil denoting minute differences in the heat emitted. The camera may see use in charting hot spots in electronic apparatus, spotting flaws in hot metal parts and may even be able to spot tumors in the human body that cause a temperature rise in certain parts of the skin. The camera, known as the Evapograph, can "see" objects as far as a mile away.

## Doctor's Medical Kit Carried in Pocket

Having been caught more than once in an emergency without his black bag, a Chicago physician has invented a lightweight medical kit that can be carried like a bill-fold in the hip pocket. The kit contains essential diagnostic instruments, therapeutic equipment and medications. The secret of its compact size is the facility for combining two instruments to make a third.



## Four-Wheel Cycle Mounts "Trunk"

By combining bicycle and tricycle parts, C. A. Cole of Graham, Ala., has made a four-wheel vehicle with plenty of cargo space in the "trunk." An extra-wide handle bar makes turning easy. The vehicle is pedaled like a regular bicycle and stopped with a coaster brake.





## Fast-Acting Jet Starter Tows Plane to Take-Off Spot

Jet planes are started in 14 seconds instead of 50 seconds with a unit that takes its power directly from a gasoline engine through a hydraulic torque converter. The low-slung wheeled unit, which looks like an Indianapolis racer, can drive directly under a jet to start it, then tow the plane to take-off position. It is designed to replace the much slower and more expensive air-turbine-type starters which require electrical outlets and produce a high-pitched whine. The new starter has a four-wheel drive, four-wheel steering and provides 28-volt direct current and 400-cycle alternating current for the plane. It is



powered by a standard automobile engine and uses many stock automotive parts. The 3500-pound unit has a chassis of tubular steel with torsion-bar suspension, a 160-inch turning radius, and is only 30 inches high, 144 inches long and 65 inches wide.

## Pipe Carrier Loads or Unloads as It Travels Down the Row

Irrigation pipe can be picked up or laid down in a field of tall corn with a self-propelled carrier built by Clarence Koselke

of Wanatah, Ind. It straddles two rows of corn, loading or unloading as it goes. It is shown here in a soybean field.

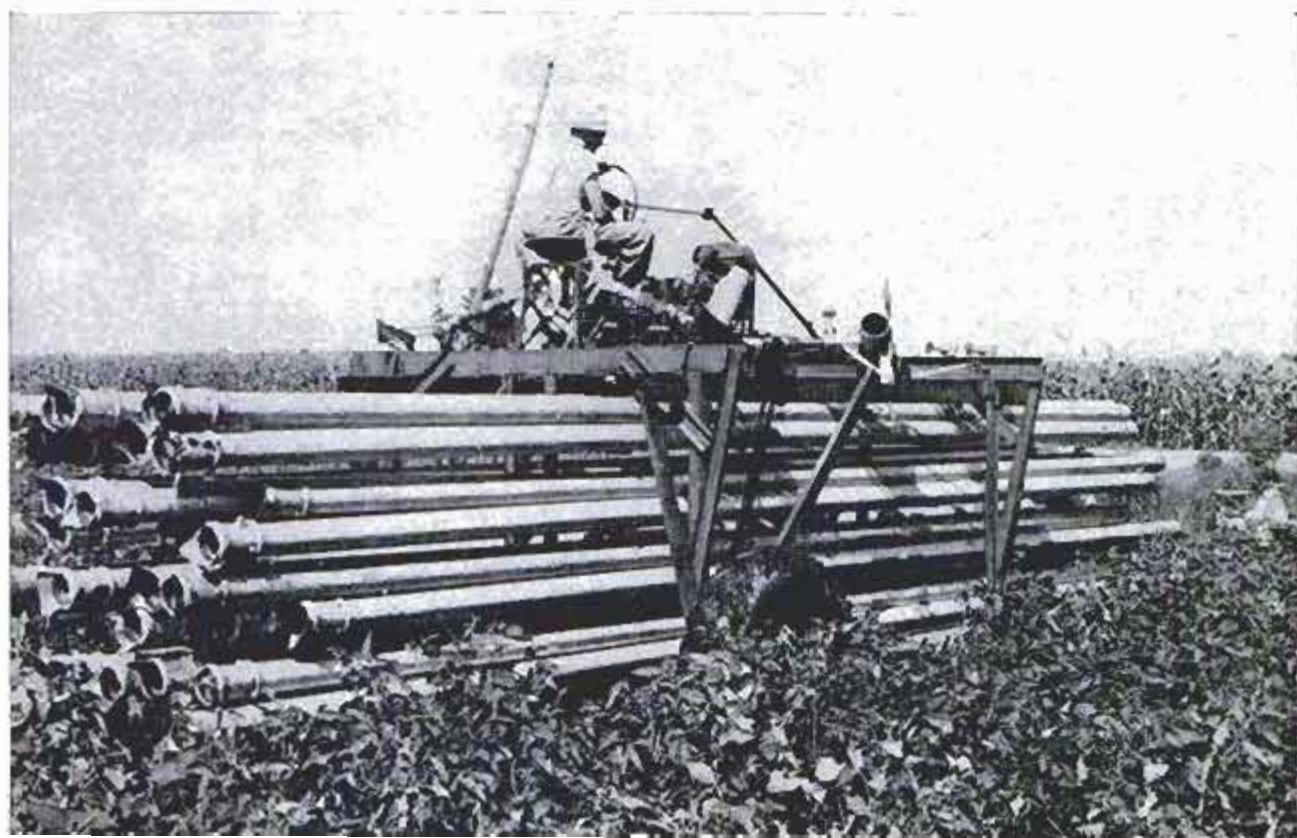

## Best-Liked Features

### Handling

"I like the way it handles on long trips. Easy to park. I can see both rear fenders."

VIRGINIA MEAT CUTTER

49.0% V8 Owners  
40.9% Six Owners

### Performance, Power

"Outperforms any car I have ever driven. Fast pickup. On trip to Oregon with two adults, three children and baggage, it held 80 m.p.h. easily."

CALIFORNIA HOUSEWIFE

38.1% V8 Owners  
19.3% Six Owners

### Push-Button Shift

"I like the push-button shift. It is much easier. Don't have to worry about the children touching it."

NEW JERSEY TRUCK DRIVER

31.6% V8 Owners  
34.8% Six Owners

### Riding Comfort

"Driving is easy, pleasant, comfortable. Easy to get in and out. Tasteful interior is roomy, quiet."

NEW YORK HOUSEWIFE

33.2% V8 Owners  
31.3% Six Owners



## Most-Frequent Complaints

### Poor Gas Mileage

"Gas mileage poor. I average only 13 miles per gallon. This is poor considering size of car."

INDIANA INSURANCE ADJUSTER

17.8% V8 Owners  
5.5% Six Owners

### Dashboard Design

"Don't like lights for oil and amperes. Lighter, ash tray and heater controls too far from driver."

CONNECTICUT TECHNICIAN

14.4% V8 Owners  
8.6% Six Owners

### Battery Troubles

"Batteries in new Plymouths are no good. I have had a dead battery three times in two months."

PENNSYLVANIA SECRETARY

4.5% V8 Owners  
5.2% Six Owners

### Rattles, Squeaks

"Body could be tighter. Seems to have a number of small rattles."

WISCONSIN SALESMAN

13.4% V8 Owners  
7.0% Six Owners

# OWNERS REPORT:



**THE WORLD'S LONGEST ROAD TEST: 2,265,758 MILES!**  
*Equal to 90 trips around the earth. That's how many owner-driven miles are behind this frank account of*

## What Owners Think of the Plymouth

*As Told By the Owners Themselves*

**M**ILLIONS OF MILES—that's how long this owners' road test of the 1956 Plymouth is, making it the longest road test we have ever printed!

Total mileage on the Plymouths in the Report is 2,265,758 miles. In that much driving just about everything about a car, good and bad, will come to light.

"Its beauty and lines get many admiring glances."—Florida therapist.

"Different in styling from any other car."  
—Pennsylvania mill worker.

First, let's look at some of the good points. Owners of the 1956 Plymouth really like its styling, especially the tail fins.

"Jet-age styling makes it look like 'GO'."  
—Florida inspector.

"Tail fins give it a new-car look. Other new cars appear to be '55 models with some chrome added."—California bookkeeper.

But there are some who have reservations about the new "jet era" styling.

"Fins look good, but I'm always bumping

(Continued to page 95)



## CLYMER TESTS THE 1956 PLYMOUTH

*By Floyd Clymer*

**P**LYMOUTH'S new push-button shift is a fascinating gadget, although a little time is required to get accustomed to it. I like it. What happens if you push the wrong button? An interlock device throws the car into neutral automatically if you push the reverse button at speeds above 10 miles per hour. You must push the button all the way in to engage it properly. Alternate operation of Low and Reverse is possible and you can do this very fast—a

good feature for rocking the car in mud or snow.

After a short time I was shifting by touch and not by sight. Shifting is faster by this method. The buttons have dim lighting for night use and are clearly marked. There is no parking-lock position.

My 965-mile test of the Belvedere V8 two-door hardtop was from Los Angeles to San Francisco and return via Reno, Nev.,

(Continued to page 272)

# An Engineer Analyzes the Plymouth V8 With Power Pack

By Dale Kelly, SAE

Model tested: Belvedere four-door sedan with PowerFlite automatic transmission, power brakes and steering, and an extra-cost power pack consisting of a four-barrel carburetor and dual ex-

hausts. Weight: 3675 pounds with gas tank half full (56 percent on front wheels, 44 percent on rear). Rear-axle ratio: 3.54 to 1 (measured). Wheelbase (measured): 114.5 inches left, 115.0 inches right.

## ACCELERATION



TIME IN SECONDS	0-20	0-40	0-60	0-80	¼ mile
Ignition timed for regular gasoline	2.8	7.4	13.3	28	19.8
Ignition timed for premium gasoline	2.8	7.1	13.3	28	19.8

(The watch was started at the instant the accelerator was floored. The engine was not run up against the brakes before the start. All tests were in Drive range.)

## FUEL ECONOMY



MILES PER GALLON	Steady 30 m.p.h.	Steady 50 m.p.h.	Steady 70 m.p.h.	Traffic Route
Ignition timed for regular gasoline	20.7	16.0	13.7	9.5
Ignition timed for premium gasoline	20.8	15.9	13.7	9.0

(On traffic route, car makes 10 full stops per mile and is driven at speeds fast enough to average 15 miles per hour over-all.)

ESTIMATED ANNUAL GASOLINE BILL: \$182 for 10,000 miles. Based on 2000 miles at 30 m.p.h., 5000 miles at 50 m.p.h., 1500 miles at 70 m.p.h. and 1500 miles in traffic, and on the exclusive use of regular gasoline at 27 cents a gallon.

## SPEEDOMETER ERROR



MILES PER HOUR	30.0	40.0	50.0	60.0	70.0	80.0
Indicated speed	30.0	40.0	50.0	60.0	70.0	80.0
True speed	30.0	38.5	47.0	56.0	65.0	73.0

### ODOMETER ERROR:

The odometer indicated 3.5 percent more than the actual distance traveled or 103.5 miles for an actual 100.

## DRIVER'S VISION



Some portion of the road could be seen 13 feet in front of the car (A in sketch) by an average driver (5 feet 9 inches tall); full width of the road could be seen 19 feet in front of the car (B in sketch).

## GROUND CLEARANCE



With no passenger load, the ground clearance was 6¾ inches at the oil pan and 6¼ inches at the steering linkage. The car consequently dragged when driven in ruts that do not bother most other cars.

The low corner of the rear overhang would drag if the car were driven up an incline whose profile had a radius of curvature of less than 27 feet (solid line in sketch). The center of the car would clear a circular hump with a radius of 18 feet or more (dotted line). Doors will open over an 11-inch curb.

## MISCELLANEOUS

**Octane requirement:** Ignition timing had to be retarded to three degrees after top dead center for knock-free operation on an 85-percent octane blend of octane and heptane, equivalent to typical regular gasoline (octane 82 Motor, 88 Research). Acceleration and gasoline-mileage data listed above for regular gasoline were obtained at this setting.

The best acceleration from standstill to 45 miles per hour was obtained with the ignition advanced to two degrees before dead center. The acceleration and gasoline-mileage data listed above for premium gasoline were obtained at this setting.

Ignition could be advanced another degree (to three degrees before dead center) before there was any knocking on a 90-percent octane blend of octane and heptane, equivalent to a typical premium gasoline (octane 85 Motor, 95 Research).

The test results show that this car, with a 4000-mile accumulation of carbon, was able to deliver peak performance on typical regular gasoline. Another car of the same model may, however, have an octane requirement several points higher or lower.

**Steering:** From straight ahead, the steering wheel had to be turned 0.7 revolution to make the outside of the outer front wheel travel in a circle with a radius of 50 feet. The steering wheel made 3.75 turns, lock to lock. Turning-circle diameter, curb to curb, was 41.0 feet; from wall to wall, 43.6 feet. Steering-wheel diameter: 17.5 inches.

**Trunk capacity:** In addition to spare tire and tools, the trunk could accommodate 14 cardboard cartons of the size used for 48 tall cans of evaporated milk. Since this car was not air-conditioned, there was no evaporator to use up trunk space.

**Gasoline fill rate:** Fuel tank could be filled at better than 14 gallons per minute when almost empty. No filling-station pump used in the test could pump faster than the inlet pipe could take it.

**Interior sound level:** Sound level inside the car was 93 decibels at 40 m.p.h. and 94 decibels at 60 on a smooth road with all windows closed.

**Water resistance:** Car was washed in an automatic high-pressure car wash and driven through a standard splash pan. In the wash test a few drops of water got past the door seals and a few ounces got into the trunk. In the splash pan no water entered the car. In neither test were brakes or ignition affected.

**Center of gravity:** Center of gravity of the unloaded car was 23.5 inches above the ground.

**Brakes:** Hand brake and foot brakes worked well. The hand brake held the car on a 14-percent grade. It works on the drive shaft and is therefore ineffective when either rear wheel is off the ground (as when a rear tire is being changed). The pressure required by the foot-brake pedal was very light with engine vacuum assist and moderate with the engine not running. There was a vacuum-reserve tank with enough capacity for one or two brake applications with the engine not running.

**Observations:** Water-temperature gauge was inaccurate. It still registered in the normal band when the engine was hot enough to open the radiator pressure cap.

On the car tested there was a light leak from the transmission push-button panel. At night this shone directly into the eyes of one test driver.

The taillights in the rear fenders project back to within an inch of a line extending vertically upward from the rear bumpers. If the car were maneuvered close to a wall on uneven ground the taillights could strike the wall before the rear bumper.



Total mileage on Plymouths in survey is an amazing 2,265,758 miles! Owners live in 21 states (color)



## The Owners Analyze The 1956 Plymouth V8

### OVER-ALL RATING OF THE V8

Excellent .....	73.3%
Average .....	22.7%
Poor .....	4.0%

#### Had trouble with engine?

No trouble.....	80.2%
Some trouble.....	14.9%
Considerable trouble.....	4.9%

#### What was engine trouble?

Carburetion, fuel system....	5.9%
Noisy engine.....	5.0%
Battery trouble.....	3.0%
Ignition trouble.....	2.5%
Oil, water leaks.....	2.5%
Frequent stalling.....	2.0%

#### Is push-button shift convenient?

Yes.....	97.9%
No.....	2.1%

(Asked only of PowerFlite owners)

#### Did styling influence your choice?

Yes, styling important.....	60.9%
No, styling not important.....	34.7%
Undecided.....	4.4%

#### Do you like tail fins?

Yes, like them.....	91.1%
No, don't like them.....	5.4%
Undecided.....	3.5%

#### Would buy a Plymouth next time?

Yes, would.....	57.4%
Might.....	35.2%
No, would not.....	7.4%

#### Best-Liked Features

Handling ease.....	49.0%
Performance, power.....	38.1%
Comfort of ride.....	33.2%
Push-button shift.....	31.6%
Exterior styling.....	30.2%
Economy of operation.....	7.9%
Interior styling.....	7.9%
Vision.....	4.9%

#### Most-Frequent Complaints

No complaints at all.....	32.7%
Poor gas mileage.....	17.8%
Dash design, arrangement....	14.4%
Rattles, squeaks.....	13.4%
Engine rough.....	7.9%
Poorly assembled.....	7.4%
Water leaks.....	5.4%
Battery trouble.....	4.5%

#### Why Did They Buy Plymouth?

Exterior styling.....	23.3%
Previous experience.....	14.9%
Push-button shift.....	10.4%
Price.....	5.0%
Comfort of ride.....	4.5%
Handling ease.....	4.5%

## The Owners Rate Plymouth Dealers

#### How is dealer service?

Excellent.....	50.7%
Average.....	33.3%
Poor.....	16.0%

#### Would buy from him again?

Yes, would again.....	71.5%
No, would not.....	19.5%
Undecided.....	9.0%

#### What make car was traded?

Plymouth traded.....	40.8%
Other Chrysler product.....	8.9%
Non-Chrysler product.....	32.6%
No trade, no answer.....	17.7%

#### Trade-in allowance on Plymouths

Above average.....	38.9%
Average.....	57.3%
Below average.....	3.8%

#### Trade-in allowance other makes

Above average.....	39.1%
Average.....	53.5%
Below average.....	7.4%

## The Owners Analyze The 1956 Plymouth Six

### OVER-ALL RATING OF THE SIX

Excellent .....	64.3%
Average .....	31.5%
Poor .....	4.2%

#### Had trouble with engine?

No trouble.....	80.1%
Some trouble.....	16.7%
Considerable trouble.....	3.2%

#### What was engine trouble?

Hard to start.....	4.4%
Frequent stalling.....	3.4%
Skips, bucks.....	2.3%
Carburetor trouble.....	2.1%
Automatic choke.....	1.3%

#### Is push-button shift convenient?

Yes.....	98.7%
No.....	1.3%

(Asked only of PowerFlite owners)

#### Did styling influence your choice?

Yes, styling important.....	54.4%
No, styling not important.....	40.9%
Undecided.....	4.7%

#### Do you like tail fins?

Yes, like them.....	86.2%
No, don't like them.....	10.2%
Undecided.....	3.6%

#### Would buy a Plymouth next time?

Yes, would.....	57.8%
Might.....	35.7%
No, would not.....	6.5%

#### Best-Liked Features

Handling ease.....	40.9%
Push-button shift.....	34.8%
Comfortable ride.....	31.3%
Exterior styling.....	29.7%

Economy of operation.....	22.7%
Power, performance.....	14.3%
Vision.....	9.1%
Dependability.....	7.3%

#### Most-Frequent Complaints

No complaints at all.....	33.9%
Dash design, arrangement....	8.6%
Rattles, squeaks.....	7.0%
Poor gas mileage.....	5.5%
Battery trouble.....	5.2%
Transmission.....	4.9%
Body leaks.....	4.9%
Poor assembly.....	4.9%
Noisy engine.....	4.2%

#### Why Did They Buy Plymouth?

Exterior styling.....	23.4%
Previous experience.....	21.4%
Economy of operation.....	8.3%
Push-button shift.....	8.1%
Best deal.....	4.9%
Price.....	4.9%

myself on them when walking around rear of car."—Wisconsin civil servant.

"Tail fins too obtrusive. Out of harmony with rest of design."—California manager.

"Purpose of a car is transportation and the tail fins add nothing to this."—Maryland lawyer.

### Approve Push Buttons

Another innovation this year on Plym-

outh is push-button control of the automatic transmission. Rarely, if ever, has such a new departure been accepted with so much enthusiasm. When you realize that the control panel is on the left of the dash and requires left-hand operation, a complete departure from the standard of years, it is unbelievable that acceptance could be so complete. Almost 100 percent of the owners who have it like the push-button



Like many cars, Plymouth has a long overhang that may damage tail pipe on steep incline like garage ramp, above. Photo below shows how little clearance there is as car descends the ramp

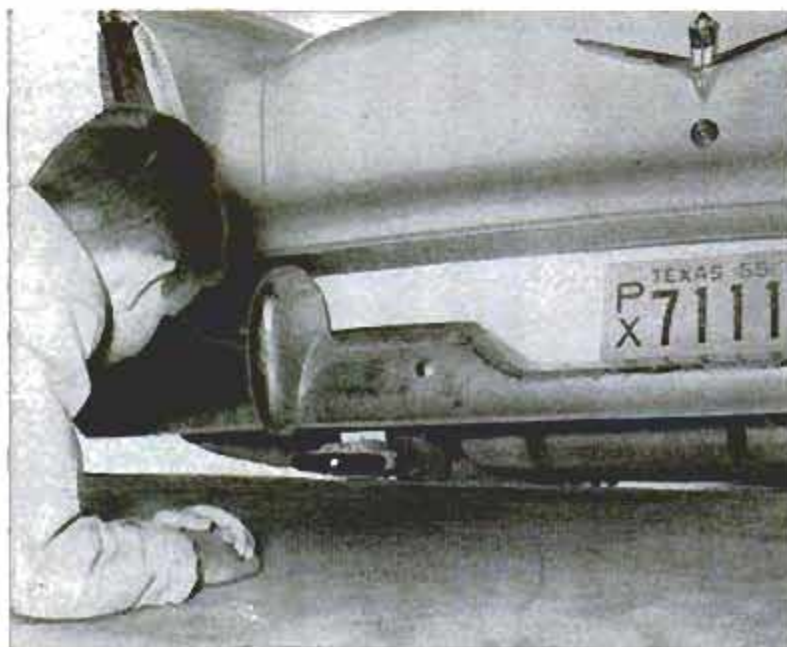

Owners rave about push buttons (left), but don't like indicator lights (center) or distant location of heater controls (right)



control (the actual percentage was 98.2 percent).

"Push-button drive is much easier to operate. I don't have to worry about children handling it."—New Jersey truck driver.

"Push buttons are away from my two small boys who play on the right side."—Maryland salesman.

"Transmission on the left is great on a date or in a crowded car."—Maryland high-school student.

"Push-button drive is very good for rocking the car in deep snow."—Washington engineer.

There are a few owners with reservations.

"It is possible to push a button in and have it come out again so you can't tell what range you are in."—Maryland machine operator.

"I have to reach too far to shift with push buttons."—Illinois assembler.

#### What Should Be Changed?

Although about 40 percent of the Plymouth owners state that nothing needs to be changed on their cars, the other 60 percent don't agree. The most frequently mentioned change involves the dashboard and location of controls and conveniences.

"Should mount heater controls on the driver's side and add an ash tray for the driver."—California mechanic.

The heater controls are mounted far to the right of the dashboard, requiring a long reach by the driver to adjust.

"Occasional use of the glove compartment does not warrant its being in such a prominent position in middle of dash. It should be moved over and the heat controls put in its place."—New York sheet-metal mechanic.

"I would rather have a real oil gauge and ammeter instead of indicator lights."—Washington technician.

#### Handling Is Best Liked

Again this year, handling is a best-liked feature among Plymouth owners. Both V8 owners and six-cylinder owners rate the car's ease of handling as its best feature.

(Continued to page 266)



## Renault's New Dauphine Introduced in Switzerland

Introduced at the Geneva, Switzerland, Auto Show, the all-new Renault Dauphine is a complete departure from previous Renault styling. Still retained and identifying it as a Renault are the vertical grilles just ahead of the rear wheels through which air is taken in to cool the rear en-

gine. No specifications are available at this time, although it is known that the Dauphine has slightly more horsepower than the Renault 4CV, the model now on sale. Production plans for the new model are unannounced and they are not expected in this country until later this year.

## Candy-Cane Antenna

On a desert in California stands a weird antenna sprouting seven long tubes, each of them striped like a candy cane. The special antenna is designed to pick up radio signals from aircraft, rockets and missiles which telemeter information during flight or free fall. The tubes, made of glass fiber, are 7 feet long and 18 inches in diameter. Each tube has a ribbon of copper wound spirally around it to form one element of the antenna. Signals come through the new equipment at significantly greater strength than through former telemetering antennas. The instrument is installed on a modified anti-aircraft-gun mount. An automatic-tracking system keeps the array pointed at the signal source at all times.

There now are 6921 civil airports in the United States, with 1216 of them lighted and 1373 paved.

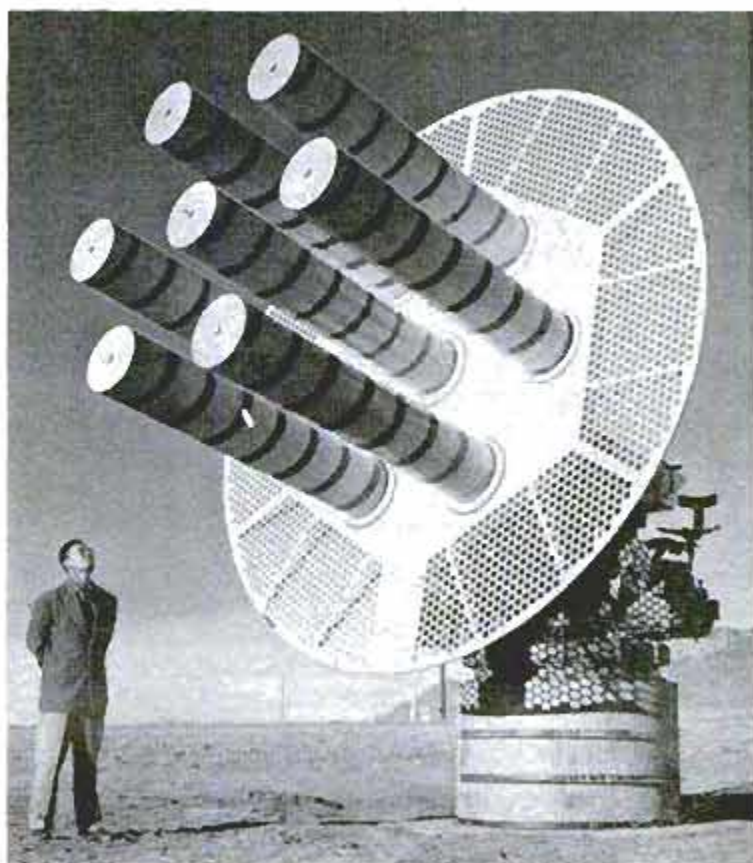



Expedition plane is grounded by white-out—a weather condition during which white sky matches the snow

## UNDER ANTARCTIC ICE

# *The Seabees Build a Town*

By Richard F. Dempewolff

PM's Staff Editor With Operation Deepfreeze

### PART II

**I**F ANTARCTICA'S THICK CRUST of glacial ice, with its mighty pressure ridges and chasms, gave trouble to the Seabee base-builders on Operation Deepfreeze, the white continent's bay ice was even

worse. Awesome ice-bound inlets, stretching like floating aprons between mountain-ringed shores and white barrier cliffs, look great for travel. They're flat and hard, with a blanket of wind-packed snow on top for traction.

But all of us soon learned that sea ice is fraught with booby traps. Great tidal cracks, or "hinge lines," fracture the surface where it joins land or barrier. Sea currents torture and score it with jagged

Food buried in snow since 1902 was found at camp of Robert Scott, a British explorer. It was still good





Airbase camp on McMurdo Sound occupies rare patch of bare ground which is swept clear of snow by wind

breaks until, from the air, it resembles a gigantic jigsaw puzzle. Then along come polar winds that drift snow over the openings, where it cements itself across the top, sealing the breaks with fragile bridges. Penguins waddle across such bridges with no strain, waving flippers as they go. But people do not—unless they wear skis—and neither do heavy vehicles. We'd barely arrived at McMurdo Sound when a group of Herb Whitney's Seabees took off across the ice on a penguin hunt. During the six-mile trek, half a dozen trail breakers tromped on solid-looking snow and plunged through to the frigid sea beneath. Friends scrambled around five feet above their heads, trying to haul them out. They came home dripping icicles.

Building a town in Antarctica is more than carpentry, masonry and glazing. Transportation of building materials from ship to site is one of the biggest problems.

The trail across McMurdo Sound to Hut Point had just been flagged last December when Herb Whitney, Vic Young and two Seabee enlisted men

started out from base camp in a Weasel, bound for the ships tied at ice edge nearly 40 miles north. Halfway, a howling wind roared down on them, drifting snow 15 feet off the ice and obscuring everything in a stinging white blanket. Within minutes, the Weasel had wandered off the trail, plunged sideways with a sudden lurch and wedged

Bobsled-trailer hauls gasoline from antarctic supply ship to airbase

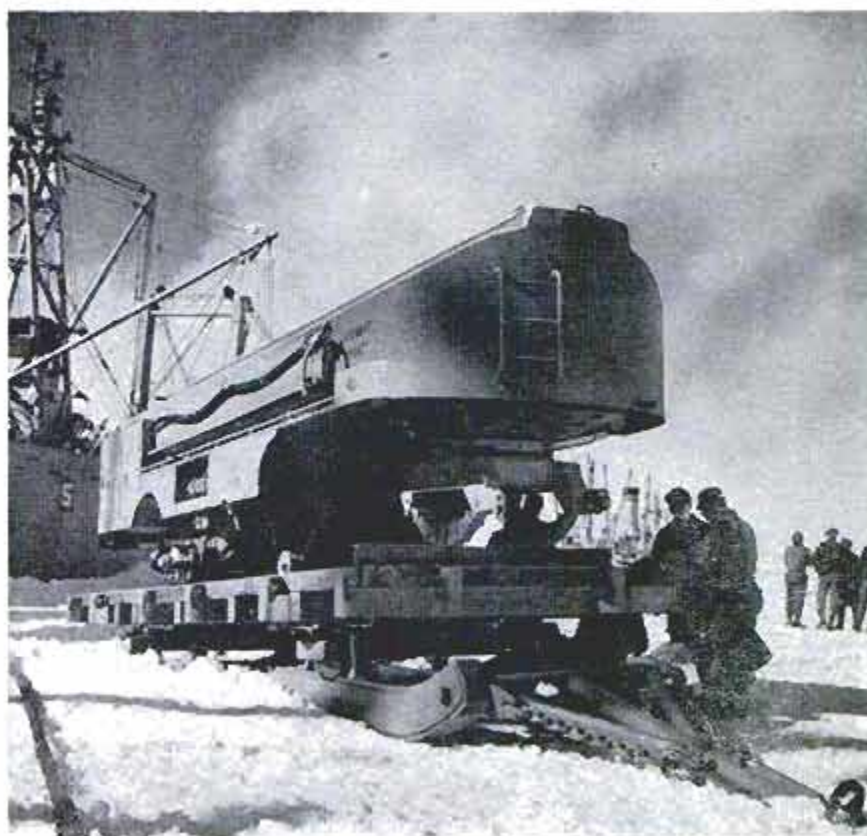



Seabees test thickness of bay ice with a 20-foot motor-driven auger to make sure ice will hold heavy vehicles. Below, icebreaking USS *Glacier* cuts 30-mile channel through 15-foot bay ice so ships can get closer to camp for unloading. Bow of ship is driven up onto ice to break it



nose down in a wide crack. As sea water crept in the front, the men scrambled out an escape hatch, salvaging what few items they could—a stove, an abandoned nylon parachute and a handful of survival rations. For two miserable days, the survivors bucked zero temperatures and blizzard in a jerry-rigged parachute tent, until a helicopter could get to them. "We'd just about given up hope." Vic recalls grimly. "We huddled for warmth. Didn't dare sleep for fear of freezing." Before it could be salvaged, the Weasel slipped under the ice and disappeared.

Testing thickness of bay ice to make sure it would support big Deepfreeze vehicles, Dr. Willis Tressler, of the U.S. Hydrographic Office, tried a new tool this year—a giant motor-driven auger 20 feet long. Hauling it by sledge, Tressler and his crew worked along the trails gouging deep holes at intervals. Ice ran from 5 to 25 feet thick when offloading began. But bay ice has a nasty habit of melting—from the bottom up. Tiny marine organisms called diatoms coat the underside of all sea ice with brownish layers that absorb the sun's rays and cause warming below. From the surface it's impossible to tell that the deck under you is disappearing. Such thinning ice at McMurdo brought new disaster to the Seabees. They had just installed a Bailey bridge





Crevasse detector out front, Weasel with sled train is prepared for 400-mile trip to Marie Byrd Land

over a new crack. The first vehicle across was a lumbering 35-ton tractor piloted by Harold Williams, Seabee construction driver. Williams clanked across the span cautiously, but as his giant "Cat" thudded off the opposite side, the jar broke off a huge chunk of ice under him. It tilted crazily under the weight, as Williams and his tractor slid slowly backward into 100 fathoms of icy water. The unfortunate Seabee was last seen struggling to escape through an open door as the sea closed around him.

The long trail on endless bay ice at McMurdo plagued the entire expedition. Racing against frigid polar night, which begins to settle as the sun skids around the rim of the horizon in late February, tractors broke down, sleds bogged in drifts, perpetual storms slowed everything to a grinding halt. But it also sparked Yankee ingenuity. All kinds of vehicles were pressed into service. Even a grounded de Havilland Otter ski plane was loaded with supplies and sent taxiing at a great



Trail to Little America weaves across barrier ice filled with snow-bridged chasms. Seabees called this "Crevasse Valley"

Snocat pulls sled train loaded with tanks and lumber over the ice. Polar blizzards and white-outs were a hazard to the crews who had to keep on alert to avoid crevasses near trail



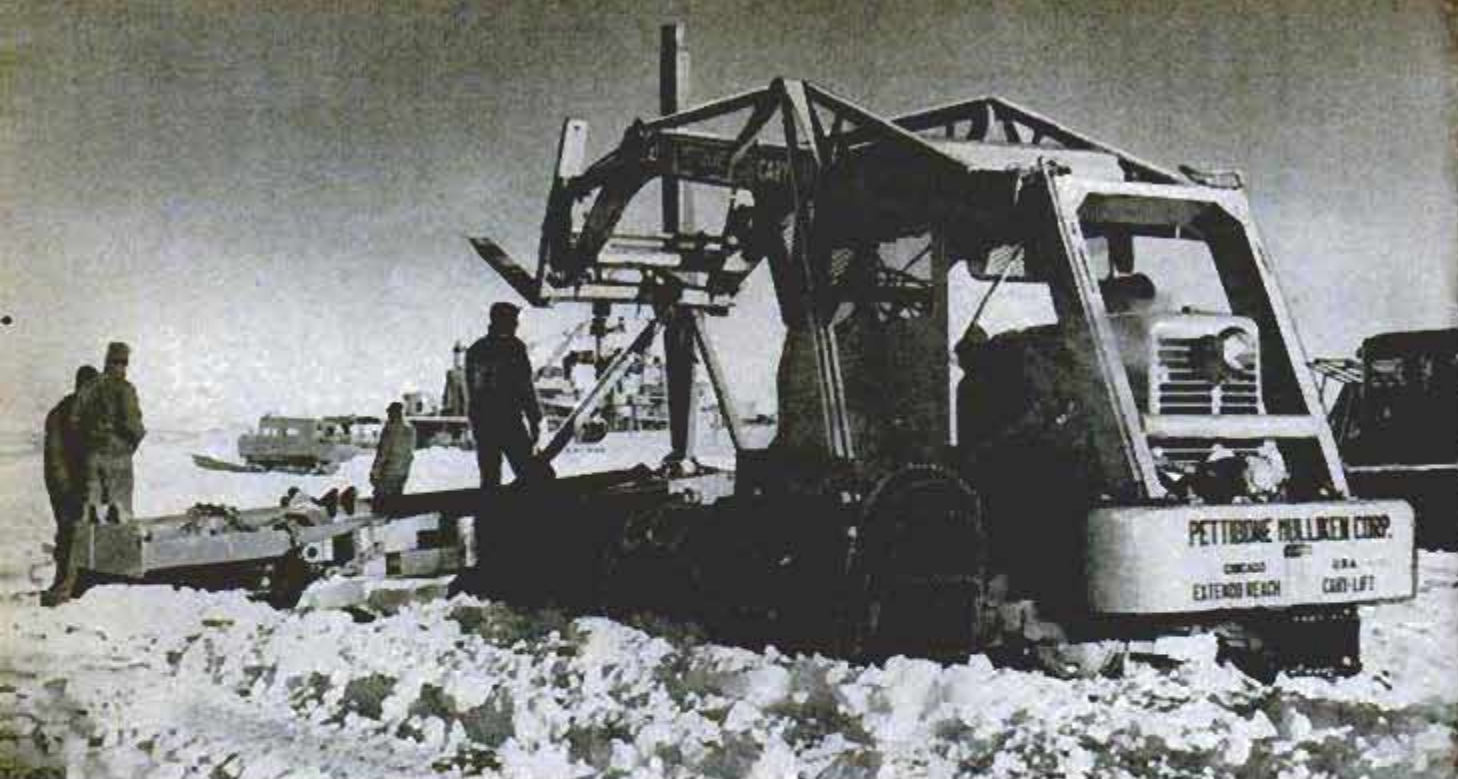

Huge "carry lifts" bogged down in snow but worked fine in areas where the snow was cleared from bay ice



Oil-burning stoves warmed tents used by Seabees at Little America. Forty degrees was considered warm. Below, laying six-mile fuel line to a "tank farm"

wobble across windswept snowdrifts on shuttle runs.

Then someone had a brainstorm. The icebreaker *Glacier* was used to forge a 30-mile channel through the 15-foot-thick bay ice to within six miles of Hut Point base. Supplies were then swung from freighters to the expedition's three icebreakers. Acting as lighters, the breakers whammed up through the broken ice and unloaded to sled trains within sight of the growing polar town, saving days of overland hauling.

There's another way bay ice can wreck things. It disappears. In one wild day of wind and snow, more than half the entire ice mass on McMurdo Sound—an area twice the size of Los Angeles—broke up and went to sea. The same day the identical thing happened in Kainan Bay. Ships that had been moored at ice edge three miles off the barrier, suddenly were looking for a place to tie up at the formidable ice cliffs themselves. All ships dodged heaving floes. At McMurdo, the tanker *Nespelen* was caught in a squeeze that crunched her hull and spilled thousands of gallons of precious fuel across the water. A fast-working crew

(Continued to page 256)





## Czech Tatra V8 Is Newly Styled

One of the world's most famous (and oldest) cars, the Tatra, has introduced a more streamlined body. The low-slung, six-passenger car is powered by an air-cooled V8 engine mounted in the rear. Top speed is over 100 miles per hour. The Tatra is made in Czechoslovakia, where it has been in production for about 60 years. The rear engine leaves the hood space free for luggage. Headlights are recessed in the grille.



Above, the Tatra, built behind the Iron Curtain in Czechoslovakia, has three headlights in its front grille. Two girls sit in the front "trunk" space to demonstrate its large capacity



Left, newly streamlined, the Tatra T603 has a rear-mounted air-cooled V8 engine. Absence of transmission hump or tunnel for drive shaft makes it roomy enough for six. It has a four-wheel independent suspension

## Icebox Smoker

Two Oconomowoc, Wis., men have turned an old icebox into a "hot box" for the smoking of carp. The chunks of carp are placed in the top compartment. In the bottom goes a pan of wood chips on an electric hotplate. This provides the smoke and enough heat to cook the fish. The result is "tasty," say William Buckeridge and M. J. Bartelme, who are responding to an appeal made by the state conservation department to smoke and eat more carp. At present there are too many of the big fish in Wisconsin lakes and streams.

☞ Two kinds of radio "signals" have been received by radio astronomers from Jupiter, the only planet in our system from which such signals have been detected. One is a sharp crackling sound like static, the other a rumble.

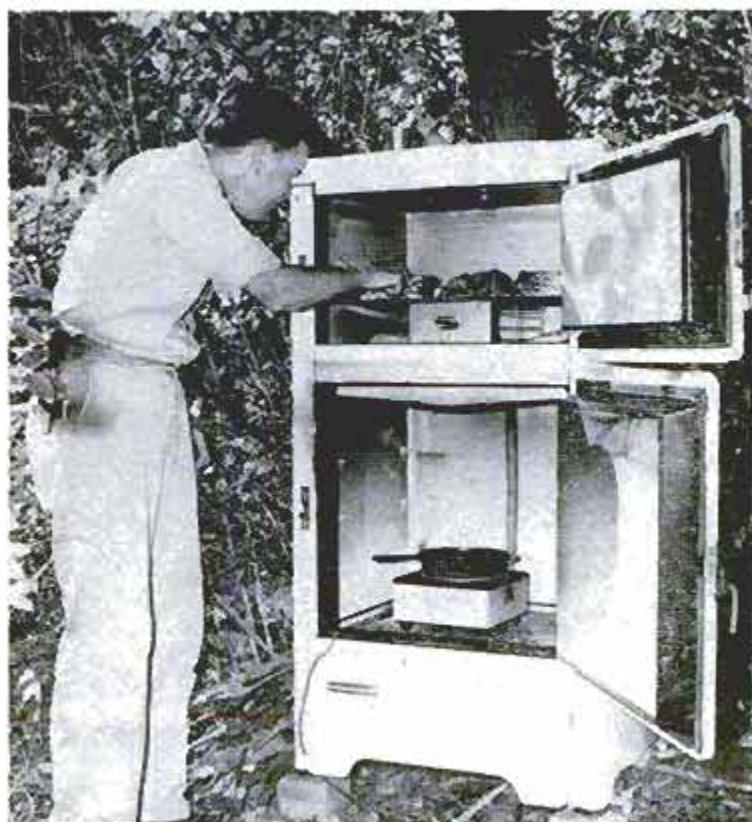



At San Diego, the city built a clubhouse and broad launching ramp when club members agreed to supervise them

## **How to Beat the— TRAFFIC JAM at the WATER'S EDGE**

*By Stephen Porter*

**A** NAUTICAL traffic jam that has been building up for several years will reach a new peak of confusion and frustration during the coming boating season. But there is relief in sight—partly because the nation's 16,000,000 users of small boats of the outboard-powered variety, who created the snarl, are helping untangle it.

The bottleneck is at the water's edge. Our waterways still represent one of our last uncrowded recreational resources. But the development of means for getting boats into and out of the water has not kept pace with a growing inclination on the part of Americans to be sailors.

In warmer parts of the country the congestion is already manifesting itself. There nautical-minded citizens, with their craft, line up for blocks waiting to use their communities' meager launching facilities. This water's-edge traffic snarl soon will range northward and will be at its worst around Labor Day.

Some of the reasons can be seen in studies conducted by the Outboard Boating

Club of America, national association of boating enthusiasts and manufacturers and sellers of boating equipment.

The association's surveys show that today there are some 4,170,000 outboard motors in use, most of them by families, as compared with only 761,000, most of them by fishermen, in 1941. Not everyone who owns a motor owns a boat (some, who use their motors only on vacations, rent boats at resorts) but there are at least 2,500,000 boats in use designed for outboard power.

### **Half-Million Trailers**

And then there is the mass-produced, factory-built boat trailer. There was no such thing prior to 1939, when the first company in the business turned out 1000 units. By 1947 fewer than 4000 had been produced. Now several dozen manufacturers are selling an estimated total of 150,000 annually, and by the height of the 1956 boating season there should be about half a million of them on the road. In addition, there are many home-built jobs.

The boat-motor-trailer package has brought into being an amphibious breed of boater, composed largely of persons who 10 years ago would have considered boating a rich man's sport and who would have thought of the outboard as strictly a fishing instrument, not suited for such family activities as cruising and week-end picnicking. The new yachtsmen usually "dock" their trailer-borne craft at home in back yards and garages. The traffic jam that results when they try to put their boats in the water stands to get worse before it gets better.

Members of a new kind of "yacht club," composed of owners of outboard craft, are beginning, however, to make some progress towards alleviating the crowding by working with their community governments and local marine dealers, or assuming the responsibility themselves.

#### City Foots the Bill

In California, the San Diego Outboard Boating Club this season will be using clubhouse facilities valued at \$16,000 and a \$3000 concrete launching ramp. The city's Harbor Department, which constructed the installation and footed the bill, is convinced it has made a money-saving deal.

The arrangement was that the city would undertake the initial costs if club members would take over the operation, including policing the area, maintaining control of the ramp to enforce safety

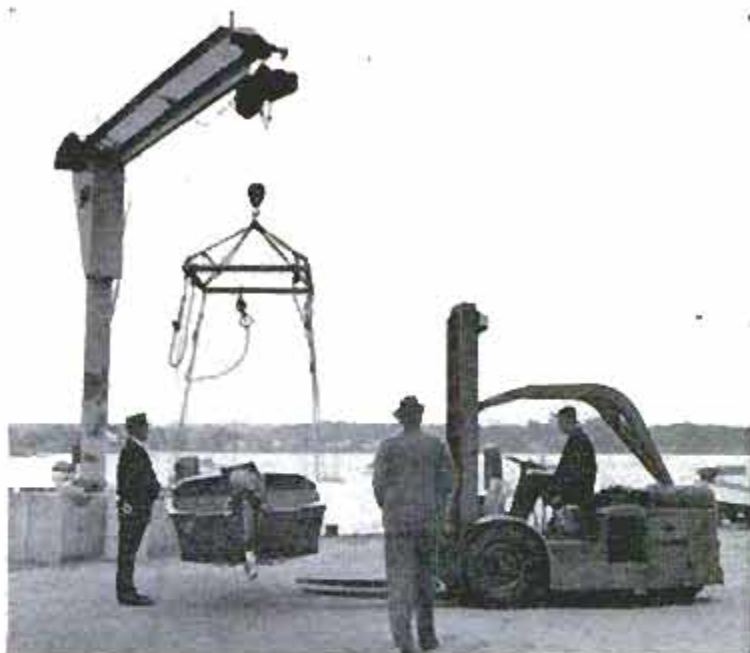

At one marina, a derrick hoists each boat out of water and eases it onto a lift truck. The truck then totes it over to one of several racks, below, and slips it into proper tier

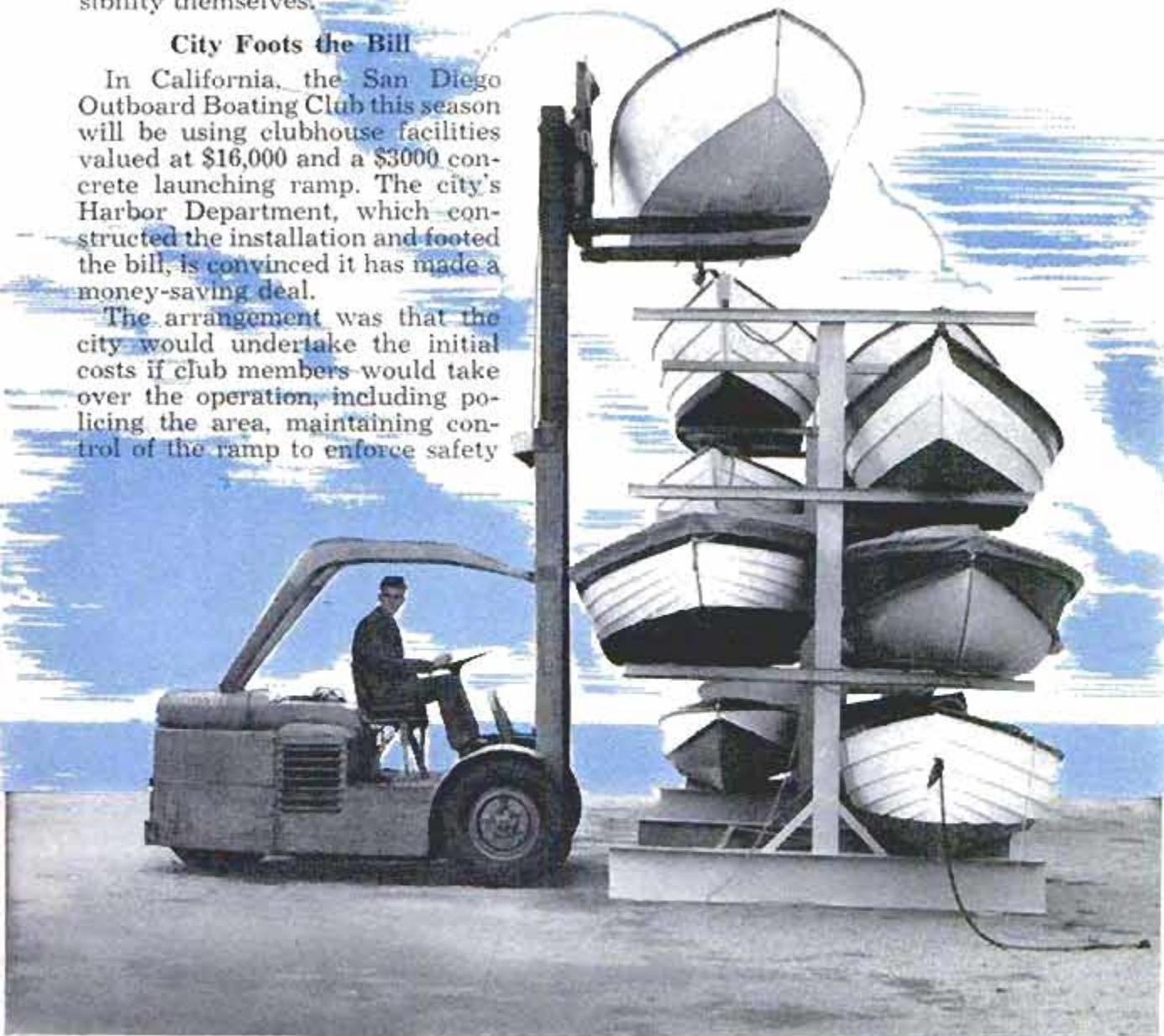



Hoist lifts boats to the second floor of this boat-house, where there are repair and storage facilities

procedures and providing help for boaters.

A city official commented recently that "to hire the necessary personnel trained to render the services performed gratis by members of the club, the Harbor Department would have to spend perhaps \$10,000 annually in wages and other costs." In short, the city made a long-term investment of around \$19,000, but the outlay is being paid back, in public service, at the rate of \$10,000 a year.

Elaborate yacht clubs have built complete facilities for the outboard boaters as well as cruiser owners



The Greater Little Rock (Ark.) Boat Club has created a home for itself on a lake near the city, largely as the result of the work of women members. The female sailors staged pie suppers, raffles and chicken dinners to build up a club-facilities fund. Land was leased and then the women pitched in with the men to clear the site and build a concrete launching ramp, floating docks, a judges' stand for competitive events and a playground for small fry.

Members of the Walla Walla (Wash.) Boat Club call themselves "sagebrush sailors" because their center of boating activity is 30 miles from home in an area marked until late in 1953 by the barren sand and rock walls of the Columbia River gorge. They exemplify how the boating population is being increased in areas where arid or semiarid conditions prevailed until a few years ago—and the ingenuity displayed by today's yachtsmen.

### Floating Clubhouse

What put this club in business was the building of McNary Dam, which formed a 70-mile-long lake over parts of the Columbia and lower Snake. The Walla Walla organization had its troubles in establishing an operational headquarters. The solution was found in acquiring the use of what had been a two-decker floating dormitory for the survey crew engaged in building the dam. Now the club has a base for family cruises on the lake as well as fishing expeditions on a stretch of water below the dam, where steelhead trout abound. To reach the fishing grounds from their clubhouse, club members descend 92 feet through a navigation-lock chamber that is 86 feet wide and 675 feet long.

The Ten Thousand Lakes Family Boating Club of Minneapolis-St. Paul encountered a lack of enthusiasm on the part of city fathers when it proposed a ramp that would give access to the Mississippi River. But when the Civil Defense possibilities were pointed out, the club got its facility. Boats can now be launched opposite St. Paul's business district by means of a ramp that consists of a hard-surfaced roadway to the river's high-water mark, with steel mat extending down to the low-water level.

The Jacksonville (Fla.) Outboard Boating Club worked with marine dealers of the area to conduct a survey to back up a contention that the municipal government should improve launching facilities.

The survey showed that an estimated 19,000 persons made use of two existing municipal ramps, which had cost the city \$8250, while only 4780 persons used the city golf and tennis installations which represented a municipal investment of \$409,000. A study of the 14 major Jacksonville retail outlets for equipment for these three



At a Wisconsin marina, boat is lifted in a sling and carried by monorail to the water or storage area

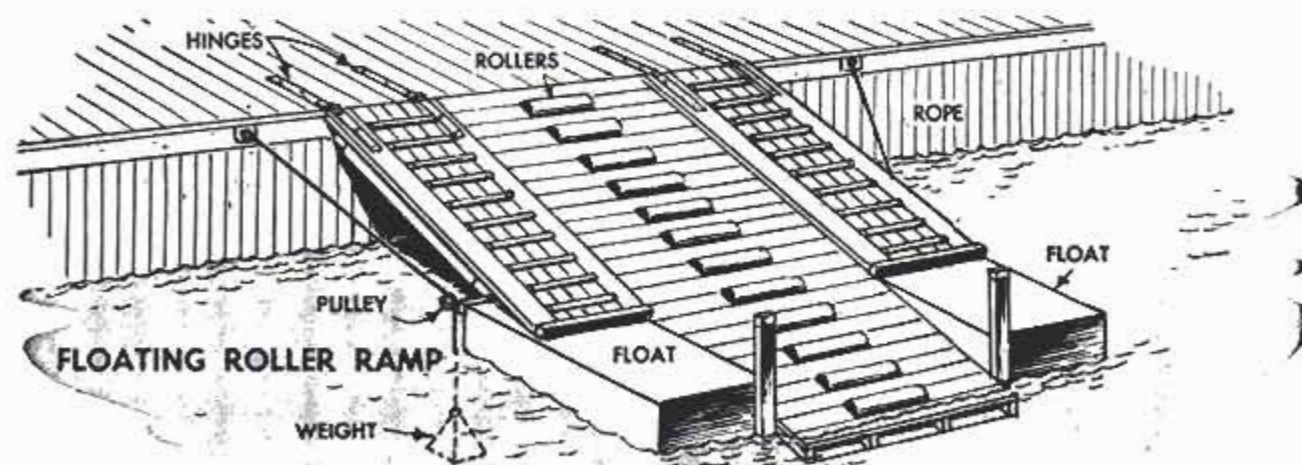

Drawing shows construction of a typical floating ramp. Below, rollers solve problem of moving a heavy boat



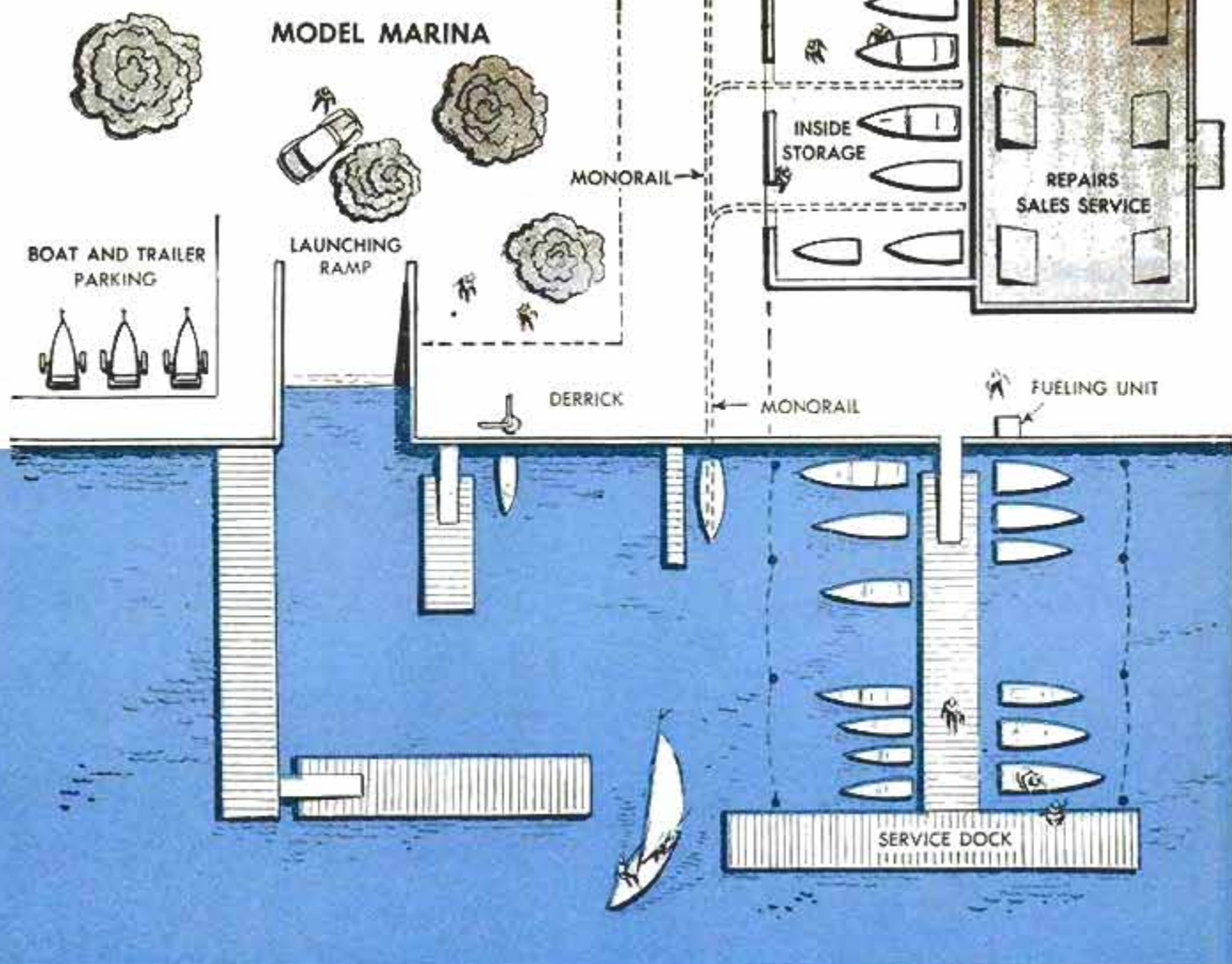

recreational sports showed a total of \$2,328,860 spent for outboard boats, motors and supplies, while the golf and tennis-equipment total reached only \$117,000. Analyzing these figures, the city government saw that its investment in boat-launching facilities was only two percent of that invested in golf and tennis, yet the sales by local retailers of boating equipment was approximately 2000 percent of those made in golf and tennis stores.

Jacksonville's boating facilities are being improved.

Chicago's several outboard-boating clubs worked with city officials in designing ramps at three Park District harbors which give access to Lake Michigan. A new parking lot for trailers and automobiles will be ready for use during the 1956 season.

#### Commercial Mariners

Chicago's Temulac Boat Club is working with a member family to set up what will become a commercial establishment for boats and boaters. The family is developing a five-acre tract on the Little Calumet River into a facility that will provide such services as mooring, launching, fuel and provisions and a clubhouse. While it will be a commercial venture, club members will have use of the facility by virtue of dues paid to their club treasury.

In Florida, the Leesburg Boat Club leased land on Lake Griffin from the city and then raised money to build two clubhouses, docks and other facilities.

Most of these new yacht clubs, outboard variety, have been organized in the last 10 years. Just how many of them there are is anybody's guess.

The Outboard Boating Club of America (which calls itself OBC for short) fills thousands of requests annually for a free booklet on how to form a club. The booklet is complete with instructions for getting

**Homemade dock is the simplest of facilities to build**



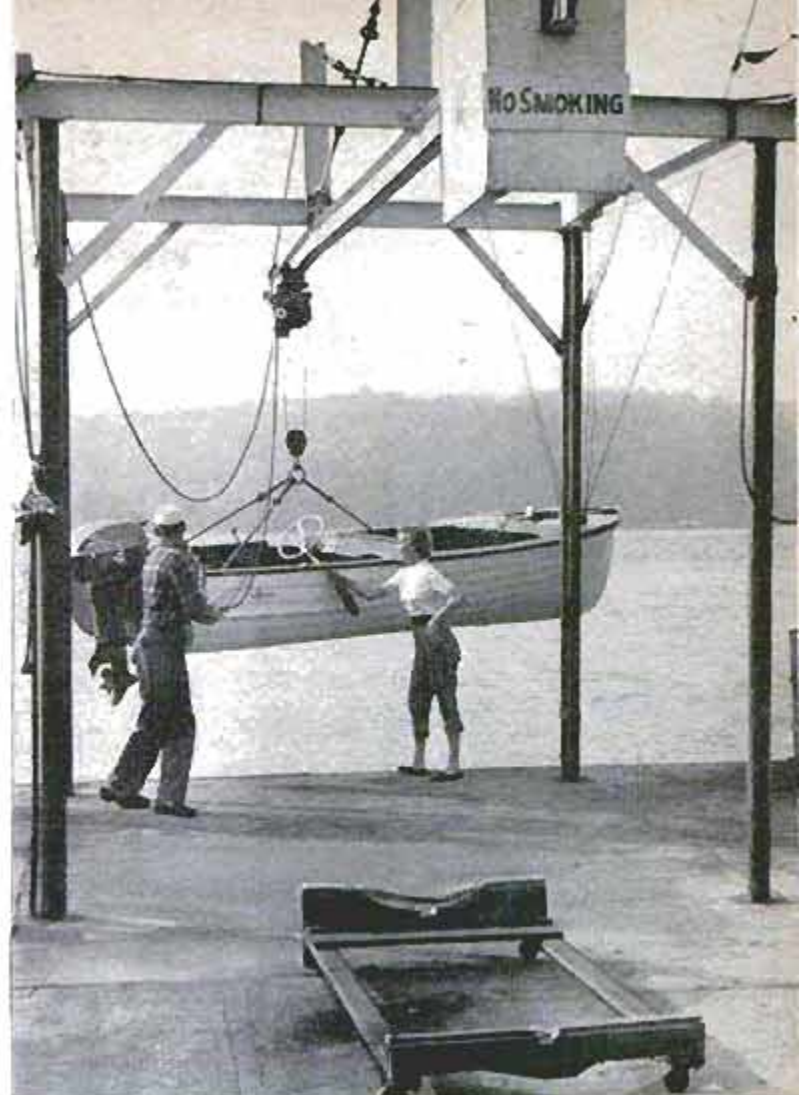
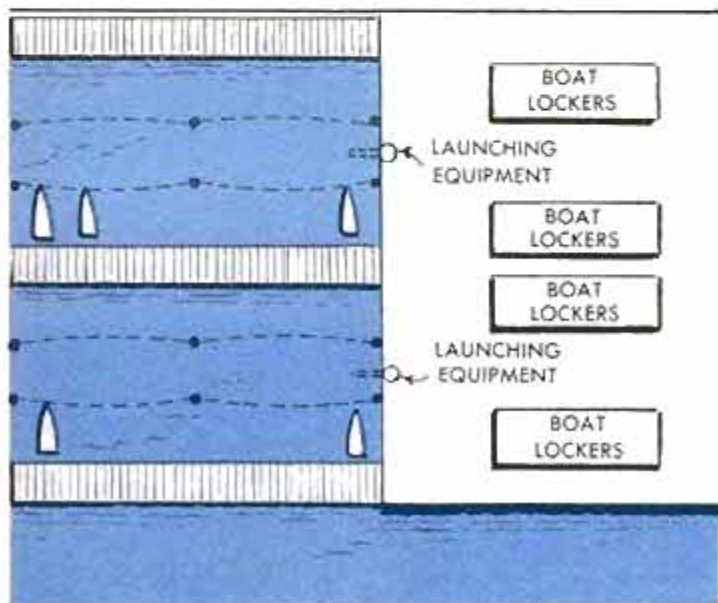

Drawing shows facilities of a typical marina. Right, overhead monorail lifts out boat, places it on a dolly

started, sample bylaws—and even sample membership-building letters and releases for the press.

The clubs have much in common with the yacht clubs of the traditional type. They create boating facilities for the use of club members. They hold social functions. Members go cruising, stage regattas and turn out with pennants flying for special occasions.

The outboard version of the yacht club of old is different, however, in one regard.

Outboard clubs cut across all occupation and economic lines in their memberships. The commodore of one Chicago club is an executive of a metal-fabricating firm; other officers include a truck driver, a school principal and a politician. A Wisconsin club, headed by a barbershop proprietor, has a school athletic coach for its vice-commodore; its members include bankers, manufacturers and business executives.

All clubs are organized primarily to have

(Continued to page 240)

Small-boat owners have a big choice of strong prefabricated docks which arrive at the site in kit form

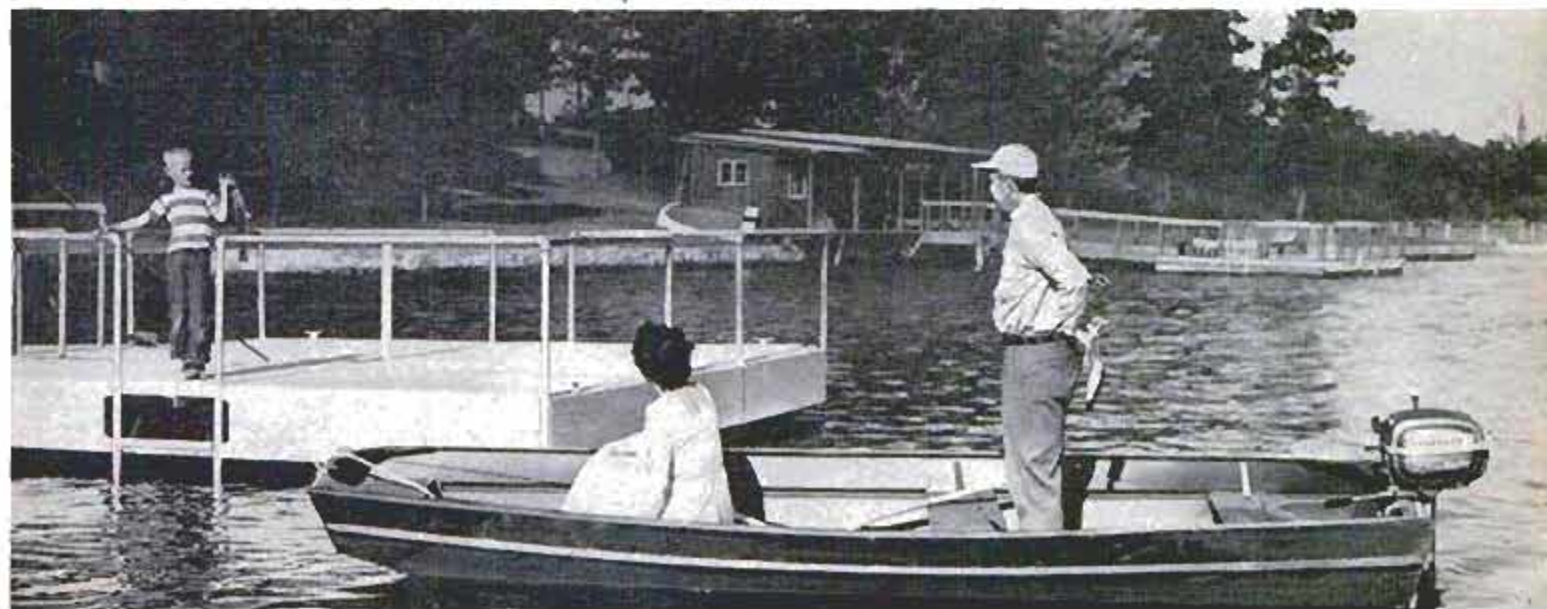

# Detroit Listening Post



By Leo Donovan

**I**F YOU'RE PLANNING a garage for your '57 car, better build it a couple of feet longer, just to be safe. Insiders (who claim they know) say the lengthened frames for next year's Ford indicate a lower car, several inches longer.

Henry Ford II, president of the Ford Motor Company, disclosed during testimony in Washington some weeks ago that push-button shifting may appear on some of his 1957 cars.

Although safety-belt sales admittedly have been disappointing, particularly in the big-city markets, Ford's second annual national safety forum is expected to introduce more safety features this summer.

General Motors has said that its 1957 cars will be introduced at about the same time as last year—in October or November. Ed Ragsdale, new general manager at Buick, stated that the 1957 Buicks will come out in November. It is definite that the 1957 Buick will be all-new, as will the Olds and Cadillac. And there will be more than sheet-metal changes at Buick. The chassis will be different. However, it is doubtful if Buick or anybody else will have the much-talked-about "air ride" for 1957. For 1958, maybe.

Whether Pontiac and Chevrolet will be all-new is still speculative. Both share the same body shell, so they do or don't together. But with Chevrolet sales up sharply (the only GM division that is, by the way), there is some talk that it would be dollar-foolish to get on a two-year-cycle treadmill when the three-year-cycle cars are still selling. Of course the unknown is whether a 1957 Chevrolet facelift could sell against an all-new Ford and Plymouth.

Contributing to Chevrolet's sales record is, no doubt, the increased availability of its V8 engine which was in short supply last year, especially during the early months. In the battle for first place, Chevrolet seems to have proved that power outsells safety. Chevie has been stressing its record-setting performance as "the hot one." Ford's original advertising this year

stressed safety, playing down performance.

What happened? Chevrolet moved far in front of Ford in sales during the early part of 1956. In the same period last year, Ford was ahead of Chevrolet.

Then Ford switched its pitch and introduced a new model with additional power. With it, Ford is winning races and telling the nation about it. What this will result in is anybody's guess.

Chevrolet's big lead provokes speculation that Ford may introduce its 1957 models earlier than planned (September seems likely) and with greater changes.

## More Rainbows?

Aluminum is continuing to replace certain steel and chrome-plated zinc parts. The Electric Auto-Lite Co., announces new facilities for stamping aluminum grilles and trim as well as new anodizing equipment for coloring the metal. This is expected to mean that some, if not all, Chrysler Corporation cars will feature colored aluminum brightwork in '57.

Ford has announced a contract with Reynolds Aluminum that may indicate an even greater use of aluminum than just trim parts. It may be that we'll see aluminum radiators.

Ed Cole, chief engineer for Chevrolet, forecasts the beginning of a light-metal era in car design which will result in as much as 100 pounds of aluminum per car by 1970.

Kaiser Aluminum is reported developing a one-piece wheel, drum and hub made of die-cast aluminum.

## Solid, Not Spectacular

The new car that Ford plans to bring out for 1958 (which will not be called the Edsel, although no other name seems to be bandied about) will not be revolutionary. It will be a good, solid performer in all speed ranges. Don't expect any engineering spectaculars like four-wheel independent suspension or fuel injection or turbine power! It will embody good, sound engineering concepts and will be in no way experimental. To make any economic sense at all, it will probably share the Lincoln body shell so you can guess at its dimensions. As you know by now, it will fit between Lincoln and Mercury in price.

What are engineers at Continental Division doing these days? Although the division is aloof to annual style changes, they are working on the Mark III. However, its introduction date is still in the dim distance. When the change does come, the current two-door model will be replaced by a four-door hardtop. This will require some readjustment of proportions. For one thing, the hood will have to be shortened to make room for more "greenhouse."





## Inflatable Airplane

Like blowing up your water wings before swimming, you can now inflate your airplane before flying. At least, that's what the Goodyear Aircraft Corporation had in mind when they developed this inflatable rubber plane that can be deflated and packed into the trunk of the family car. Wing, tail assemblies and pilot's seat are made of Airmat material, a rubber-coated nylon fabric. Less air pressure than that required to inflate passenger-car tires is needed to pump up the plane. It is powered by a two-cycle, 40-horsepower motor mounted on a tubular support above the fuselage and behind the wing.

Only metal on rubber plane is motor support and wheel assembly. Below, deflated and folded, plane makes compact package



## They Build Fords in England, Too, and Here Are the New Models

Big enough to seat six, British Fords come in three models. The two top lines, Zodiac and Zephyr, have a 107-inch wheelbase and are 178 inches long over all. Their six-cylinder engines develop 86 horsepow-

er. The smaller Consul (right in photo below) has a 59-horsepower four-cylinder engine. All are built with unit or integral body construction. The engines feature Ford's German Taunus hollow crankshaft.

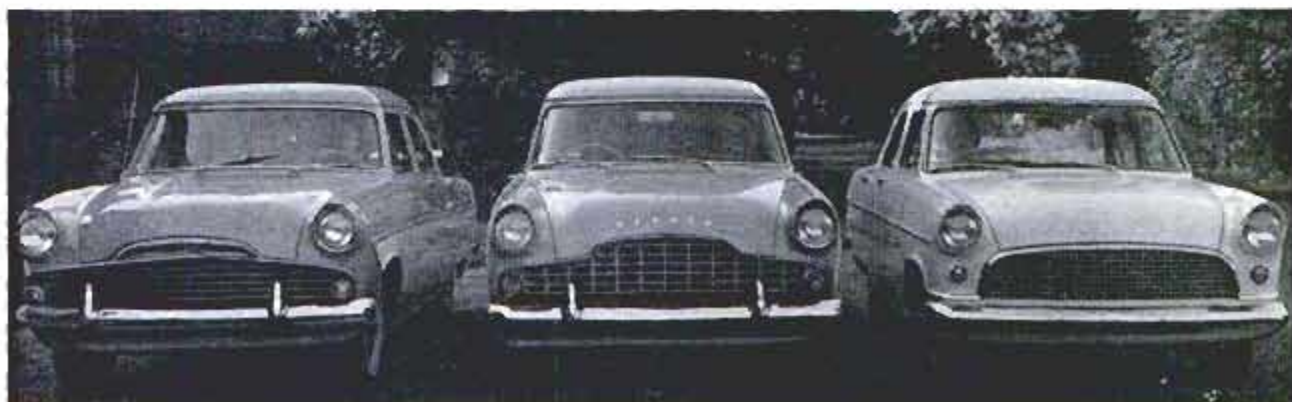

# The New French Revolution—in the Air

Text and Paintings by G. H. Davis

EARLY AVIATION HISTORY is filled with the names of French aeronautical designers and builders—Voisin, the Farman brothers, Bleriot, Breguet, Nieuport and many others. From the first investigations of powered flight up through World War I, French planes were among the world leaders.

But between the two world wars, the United States, Great Britain and Germany raced ahead in aircraft development, while in France the industry seemed overcome with lethargy. At the air shows there were always ultramodern models displayed by French engineers—but these seldom got out of the model stage. France had an advanced air fleet on the drawing boards and, unfortunately, an obsolete one in the air.

This was the condition at the outbreak of World War II, when German Stuka dive bombers roared

through the sky. The French had nothing that could cope with them, even though the Stuka later proved to be vulnerable when opposed by the modern fighters of the United States and Great Britain.

Following World War II, French aeronautical designers continued to produce plans for aircraft of an advanced and even revolutionary nature. But few were built.

In the last few years, however, there have been unmistakable signs of a change in France—perhaps the ground swell of an aeronautical revolution. French inventiveness and ingenuity have continued at a high level, and more and more new French types are getting beyond the blueprint and model stages, as prototypes are built and experimentally flown.

On these pages we show a few of the excellent designs that have been flown in France recently. ★★

Mr. Davis, internationally known British artist, journeyed to France to make these on-the-spot paintings for *Popular Mechanics Magazine*

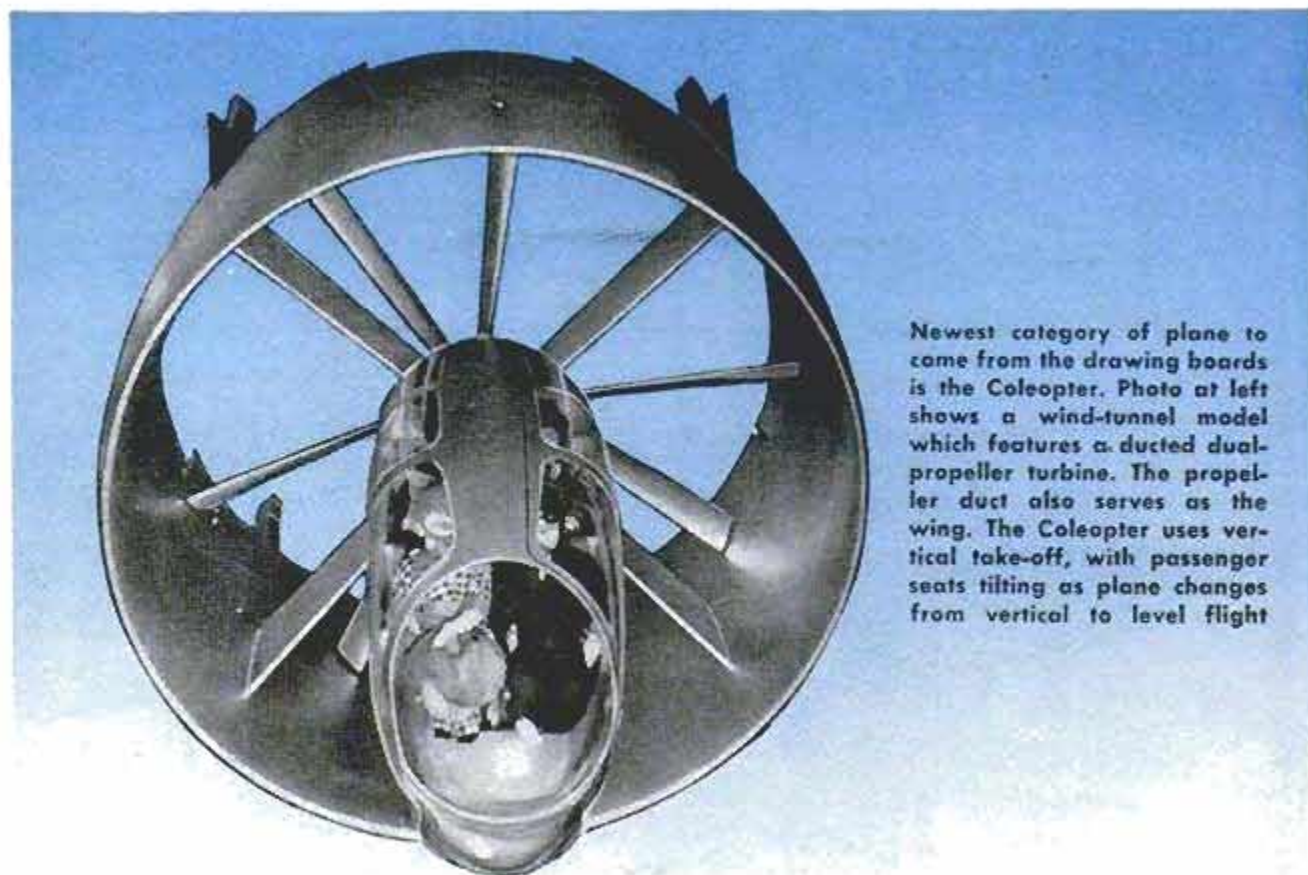

Newest category of plane to come from the drawing boards is the Coleopter. Photo at left shows a wind-tunnel model which features a ducted dual-propeller turbine. The propeller duct also serves as the wing. The Coleopter uses vertical take-off, with passenger seats tilting as plane changes from vertical to level flight

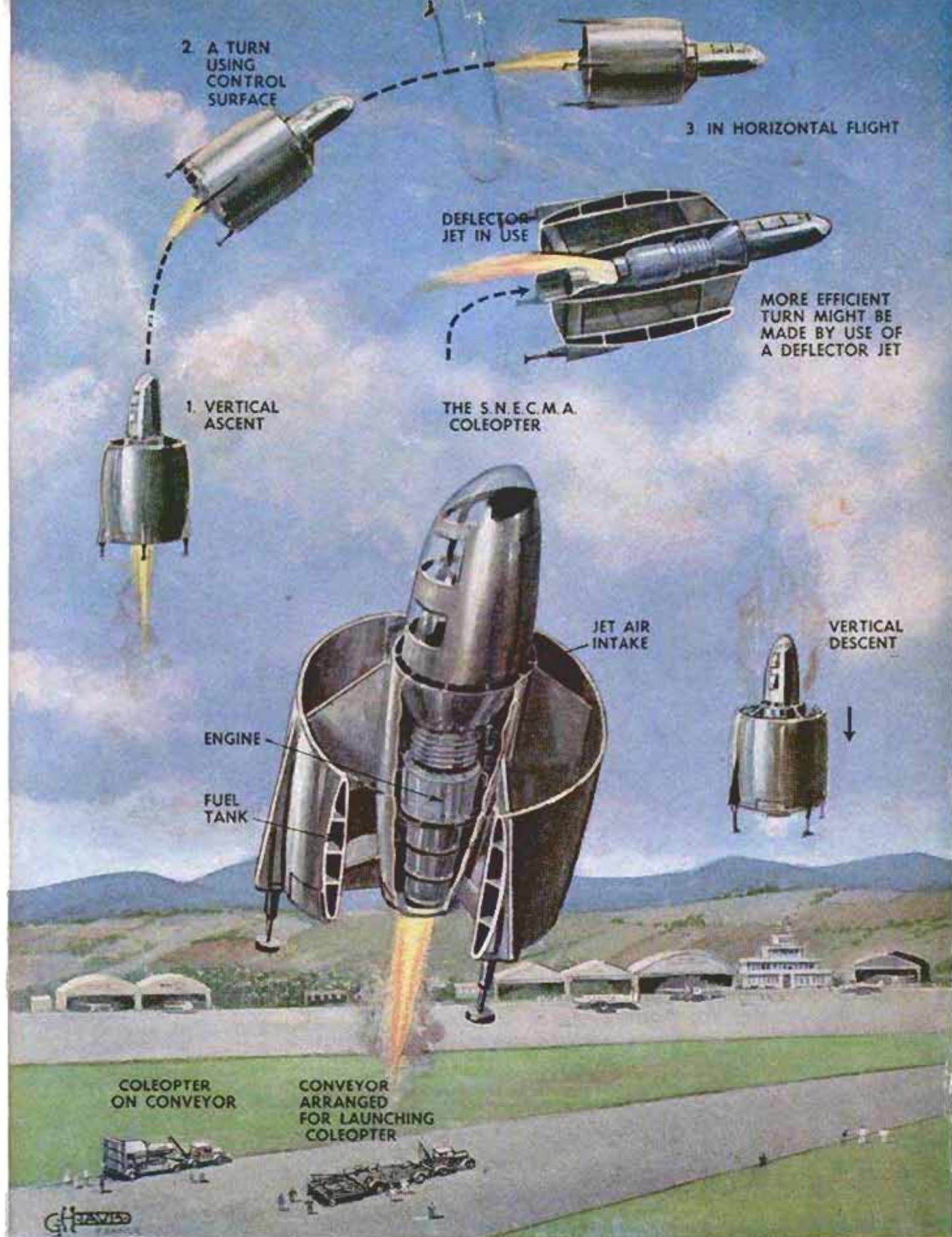

Military version of the Coleopter, shown above, is powered by an Atar 101-E jet engine. Wind-tunnel studies indicate that it would climb to 49,200 feet in two minutes, and have a speed exceeding Mach 2 in level flight. Designed and patented by Helmut von Zborowski, builder of the plant that produced the first rocket aircraft, the Messerschmitt 163, the Coleopter is being tested and refined by S.N.

E.C.M.A., French manufacturer of aircraft engines. The annular wing, which serves simultaneously as a lifting surface and a power-plant housing, is light in weight and easy to produce. Since the Coleopter is launched from a special truck-trailer, it requires no airport as a base of operations. One objection to the design: In the event that the engine failed, the crew would have no choice but to bail out

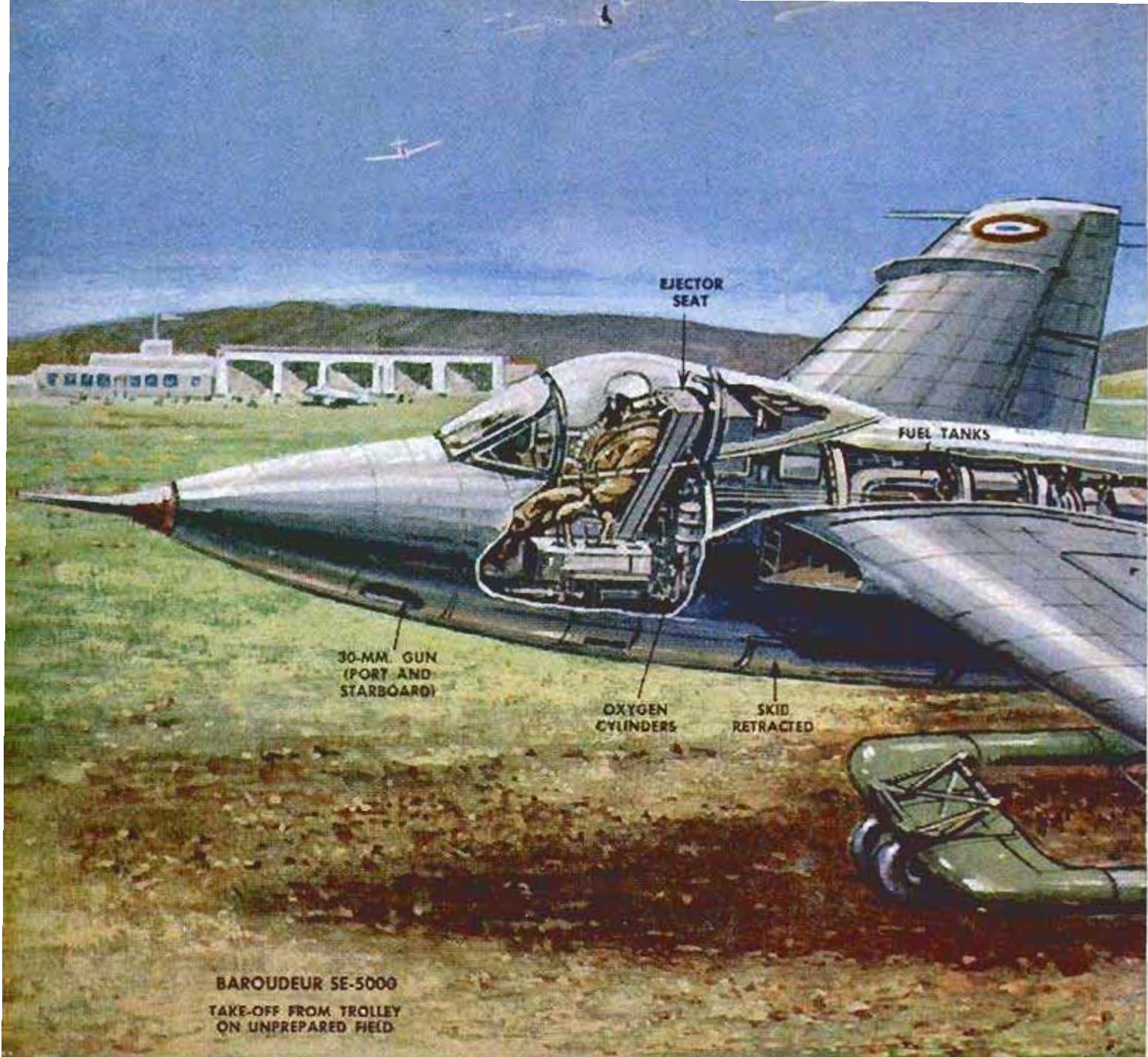

JEEP WITH SPECIAL GEAR  
LOADING AIRCRAFT ON TROLLEY

JEEP HAS TURNED AROUND  
AND IS TOWING  
AIRCRAFT AND TROLLEY TO  
TAKE-OFF POSITION

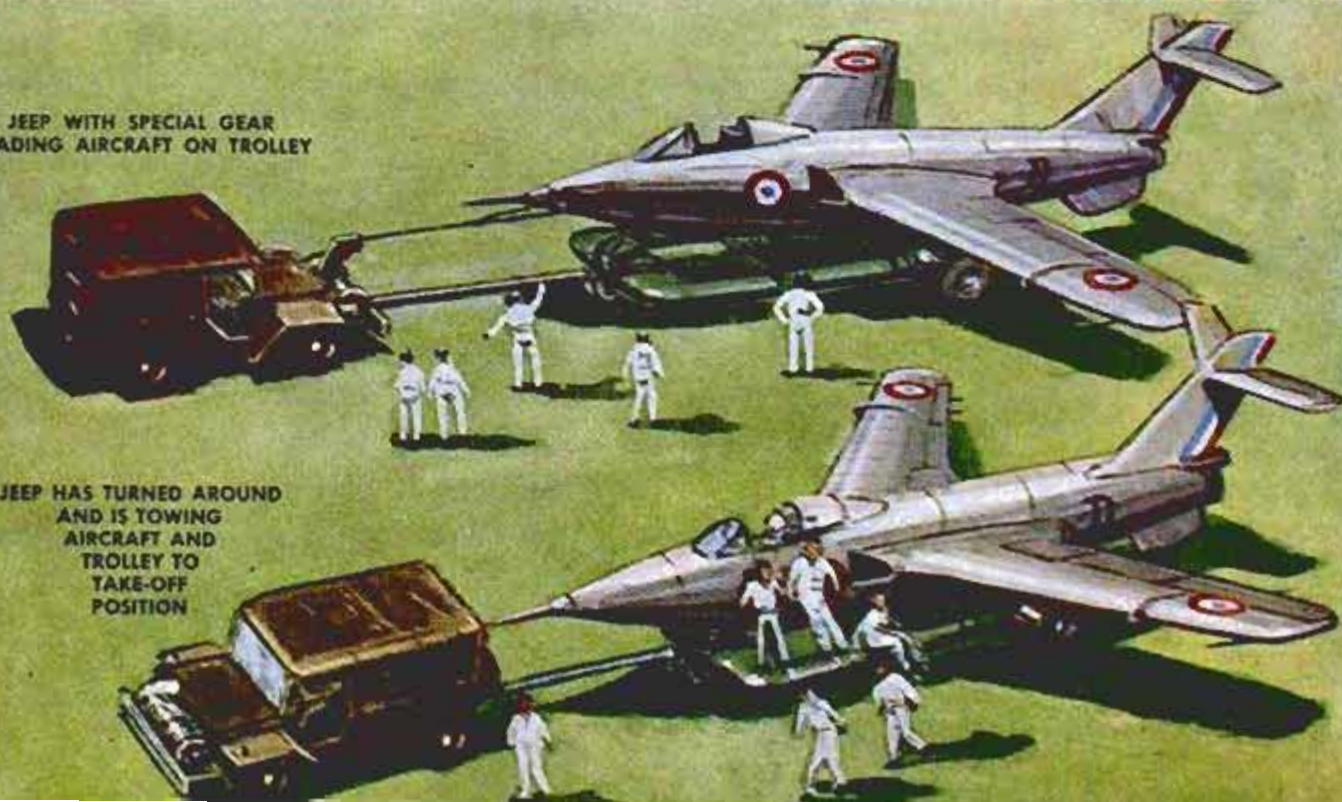

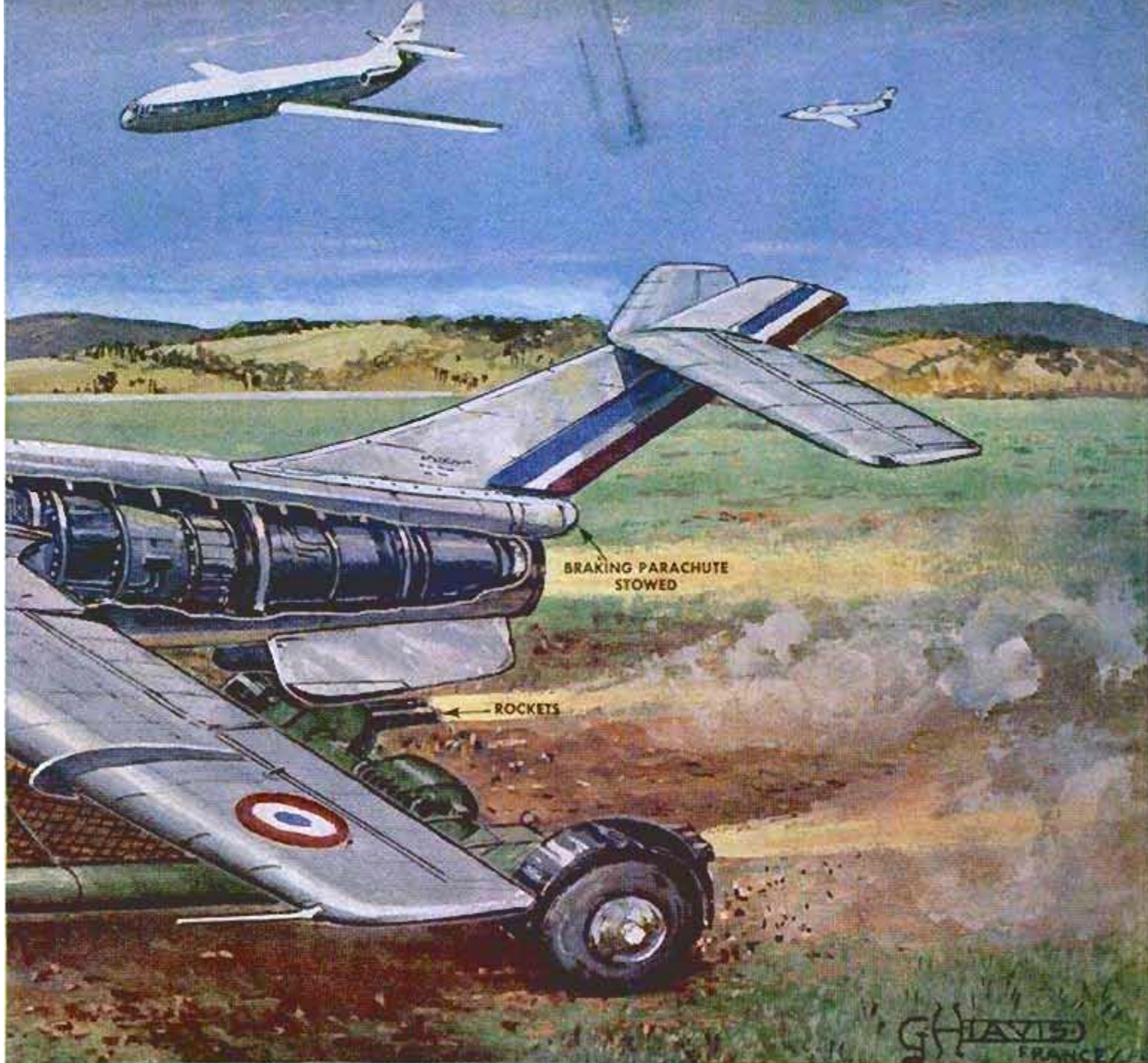

AIRCRAFT LANDING ON ITS SKIDS  
WITH BRAKING PARACHUTE IN USE

France has done a considerable amount of experimental work with aircraft suitable for NATO requirements, one of which is that the plane should be able to take off and land on unprepared grass fields. One of the most interesting types evolved is the Baroudeur SE-5000, a light fighter that is launched from a trolley and lands on skids. The trolley is provided with four rockets to give it sufficient speed to launch the plane. At take-off speed, the pilot cuts the trolley loose and climbs. The trolley is braked automatically. Tests have shown that the Baroudeur will fly with the trolley still attached. The take-off run is less than 770 yards. The transport above the Baroudeur in the picture is the new Caravelle, designed for 70 passengers. Powered by two Rolls-Royce Avon turbojet engines, it has a range of 1500 miles



AFTER LAUNCHING  
THE LEDUC-021  
THE LANGUEDOC  
TURNS AWAY



LANGUEDOC  
WITH LEDUC 021  
READY FOR LAUNCHING

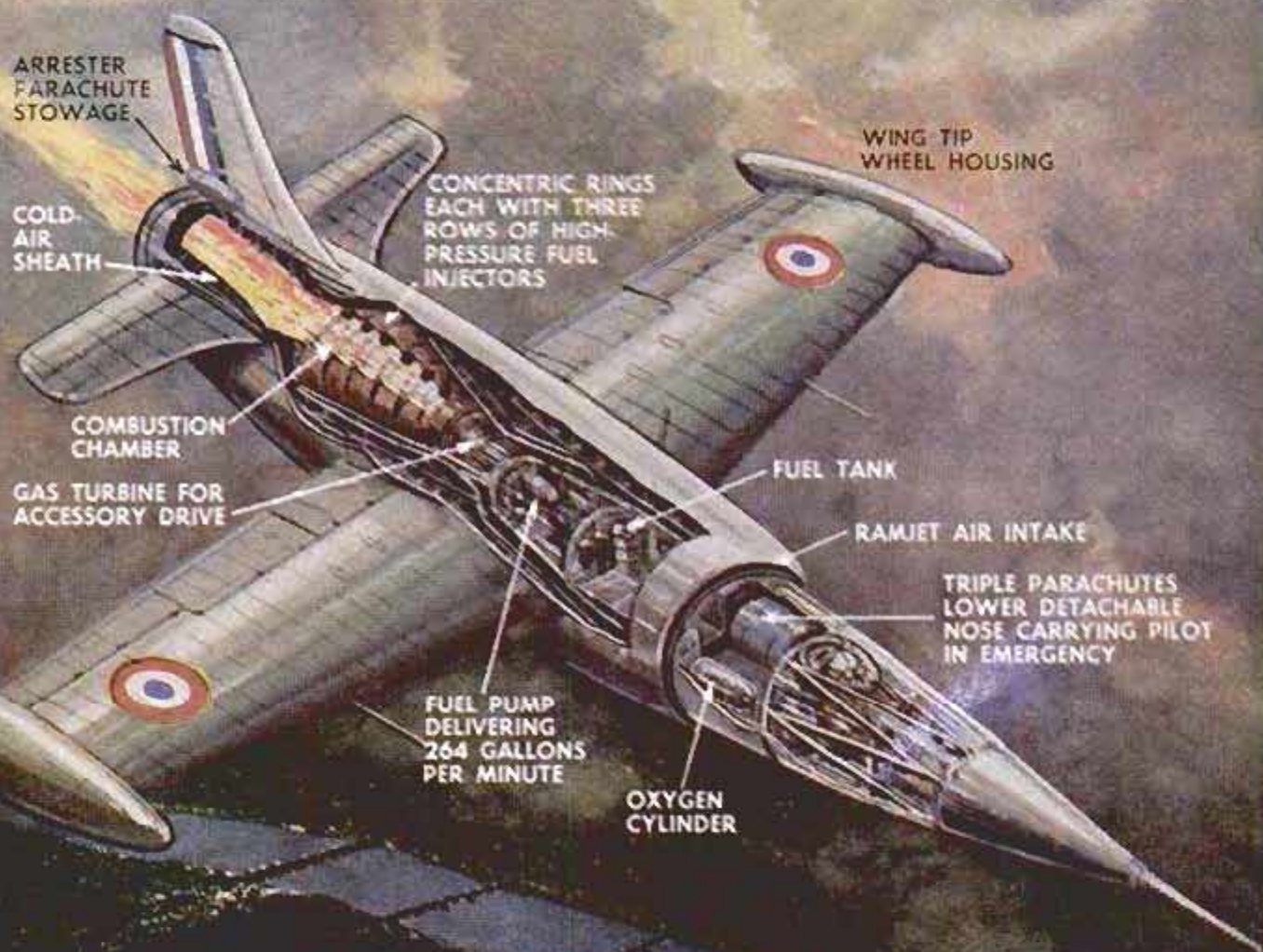

ARRESTER  
PARACHUTE  
STOWAGE

COLD-  
AIR  
SHEATH

COMBUSTION  
CHAMBER

GAS TURBINE FOR  
ACCESSORY DRIVE

CONCENTRIC RINGS  
EACH WITH THREE  
ROWS OF HIGH-  
PRESSURE FUEL  
INJECTORS

FUEL PUMP  
DELIVERING  
264 GALLONS  
PER MINUTE

OXYGEN  
CYLINDER

WING TIP  
WHEEL HOUSING

FUEL TANK

RAMJET AIR INTAKE

TRIPLE PARACHUTES  
LOWER DETACHABLE  
NOSE CARRYING PILOT  
IN EMERGENCY

WEIGHT, EMPTY, 8380 POUNDS  
SPEED, 0.87 MACH  
CLIMB, 16,400 FEET PER MINUTE

LENGTH 41 FEET  
SPAN 38 FEET

Leduc-021 is carried aloft on top of a Languedoc airliner, and when its ramjet engine starts building up power it is released. It has a ceiling of 65,000 feet and an endurance of 15 to 25 minutes after release. The central body is used to form a diffuser, with a duct to give maximum ram increase. The combustion chamber is formed by a number of concentric rings, each of which carries a triple ring of

high-power injectors or burner-nozzles. A turbine in the assembly is used for an accessory drive and also provides the flame for ignition. The shroud narrows at the rear to give the burning gases added velocity as they escape. In the event of an emergency, the entire nose section is detached from the plane with the pilot still in place and three parachutes lower it to the ground. Designer is Dr. Rene Leduc

SPLIT RUDDER  
ACTS AS  
AIR BRAKE

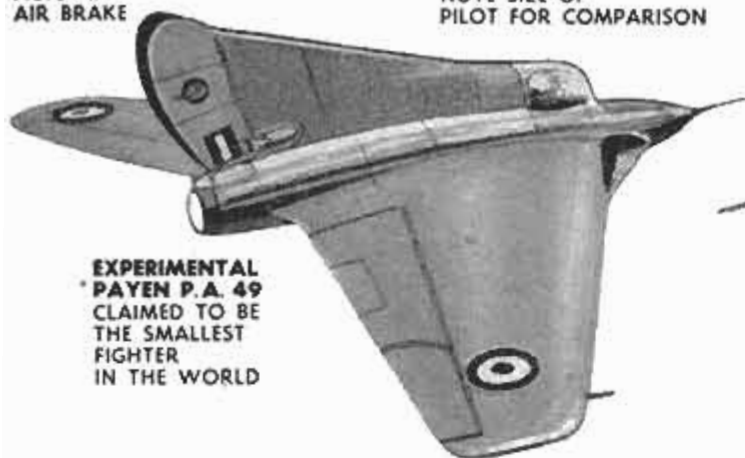

EXPERIMENTAL  
PAYEN P.A. 49  
CLAIMED TO BE  
THE SMALLEST  
FIGHTER  
IN THE WORLD

NOTE SIZE OF  
PILOT FOR COMPARISON

NOTE  
CURVED  
LEADING EDGE

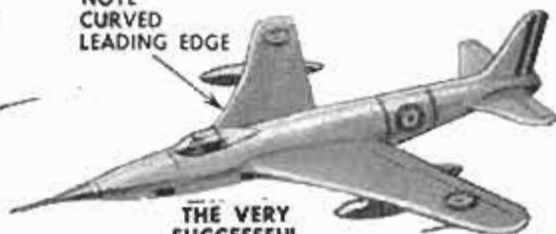

THE VERY  
SUCCESSFUL  
"TAON"



AT LEAST TWO OF  
THE LARGE AIRCRAFT  
FIRMS HAVE UNDER  
DEVELOPMENT VERY  
FAST DELTA-WING  
LIGHT FIGHTERS

THE SECRET  
"MYSTERE XXII-B"

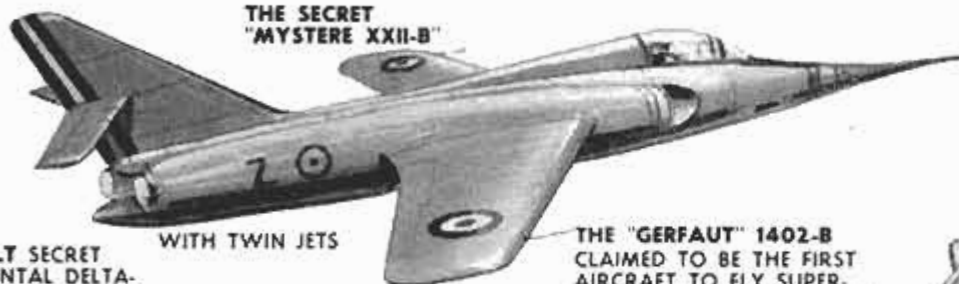

WITH TWIN JETS

DASSAULT SECRET  
EXPERIMENTAL DELTA-  
JET WITH A SPAN OF  
UNDER 14 FEET



THE "GERFAUT" 1402-B  
CLAIMED TO BE THE FIRST  
AIRCRAFT TO FLY SUPER-  
SONICALLY IN LEVEL FLIGHT  
WITH UNAUGMENTED POWER

TWO ROWS  
OF VORTEX  
GENERATORS

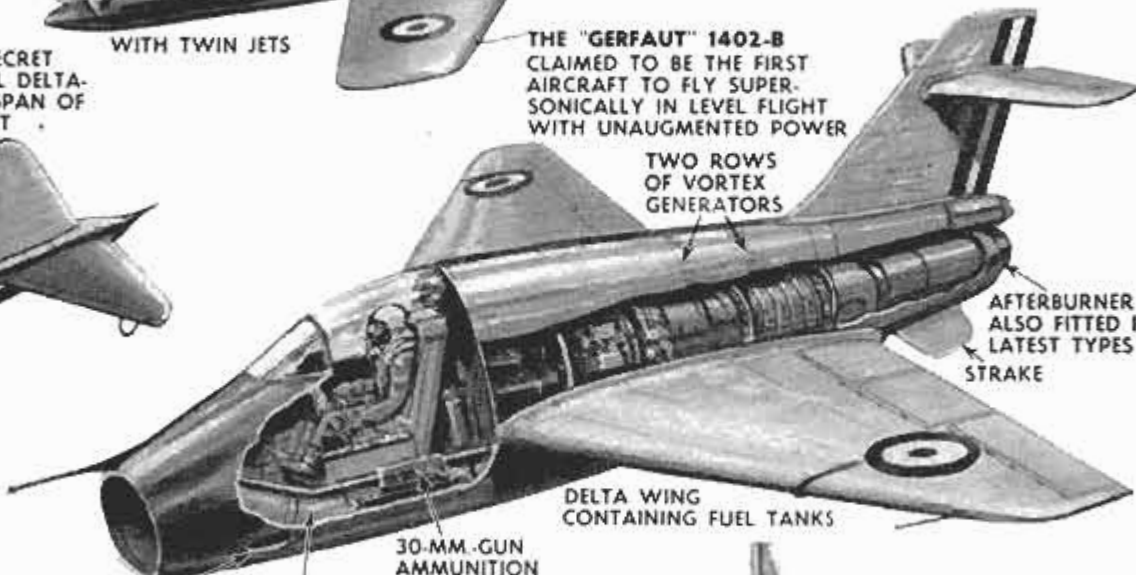

AFTERBURNER  
ALSO FITTED IN  
LATEST TYPES  
STRAKE

DELTA WING  
CONTAINING FUEL TANKS

ARRESTER  
PARACHUTE  
STOWED

GUN PORT

30-MM. GUN  
AMMUNITION  
PACK

AIR INTAKE  
PASSING UNDER  
COCKPIT FLOOR



MYSTERE  
IV-B

ANHEDRAL  
TAIL PLANES

FUEL TANK

WING TIP  
"VIPER" TURBOJET

CHEMICAL  
ROCKET MOTOR  
FOR FIGHTING-SPEED  
BURSTS AND TAKE-OFF

THE REVOLUTIONARY  
"TRIDENT"

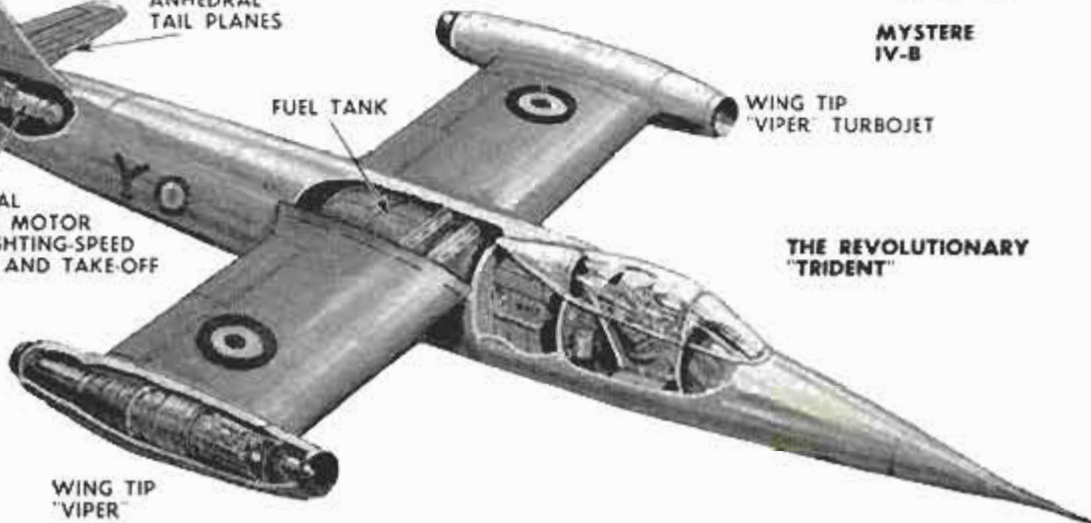

WING TIP  
"VIPER"  
TURBOJET  
1648-POUND THRUST



An electric drill burrows into a mountainside made of uncooked rhyolite. Heat turns rock into a rainbow

## ***They Cook the Rainbow Into Rock***

By Leland Elam and Leo Rosenhouse

**VOLCANIC ROCK** from California's Sierra Nevada Mountains is being cooked like baked potatoes to produce a rainbow-colored material that is proving a boon to the building industry.

The material is rhyolite and it is distributed commercially under the name of Placerite. Rhyolite, which until recently has been scarce, is well-known to geologists. This material is a light-colored rock, similar to granite except for a fine-grained texture. It can be worked much in the same fashion as hardwood. The rock can be cut, sawed, chopped, grooved, and it rarely cracks or crumbles as it ages. In pebble form it serves as roofing material or insulation. When used in the form of slabs or bricks, this rock becomes building blocks, patio stones, facings on houses and buildings, barbecues, walks, ornaments, curio pieces and is of practically unlimited

use. It's even used for costume jewelry.

This versatile product is composed chiefly of silicas and metallic oxides. It is the latter ingredient which carries the secret of the rainbow within the rock. Properly baked (2000 degrees F. for 14 hours) rhyolite turns into a flood of color with red, orange and bright yellow predominating. An entire mountainside of it has been found in the Mother Lode, not far from Old Hangtown (renamed Placerville). R. C. Young, an amateur geologist, discovered the rhyolite when he was looking for pumice. One of his tests was to bake it in a kiln with startling results. He found that bright sunshine, acid treatment, heavy sprays of water and natural erosion had no effect on the colors baked into the rock.

Rhyolite is obtained by surface mining which includes drilling, blasting and prying. Small segments are crushed for use as



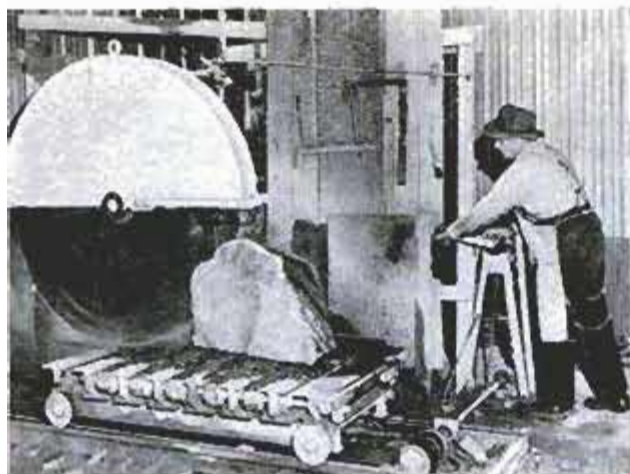

Top, from left to right, a chunk of rhyolite moves into teeth of saw; slabs are fed into a "breaker" machine that looks like guillotine. Above, huge slabs are cut by a small-toothed saw into squares, strips and blocks. Above right, slabs are being placed in kiln for cooking. They cook 14 hours and cool 1½ days. The finished product is shown (right) used as a colorful building facing and flower box

roofing granules. A ton of it can be spread out to cover completely a roof area of 90 square feet.

Large chunks of the rock are cut by a water-cooled circular saw into slabs and small blocks. A 30-inch portion of rock can be sliced by a saw in less than two minutes. Cooking the rhyolite not only adds to its beauty, but increases its crushing strength from 4690 pounds per square inch to 7014 pounds.

Promoters of the rock believe that it will eventually come into use as kitchen tile and table tops. There's enough rhyolite for built-in rainbows for all. ★ ★ ★

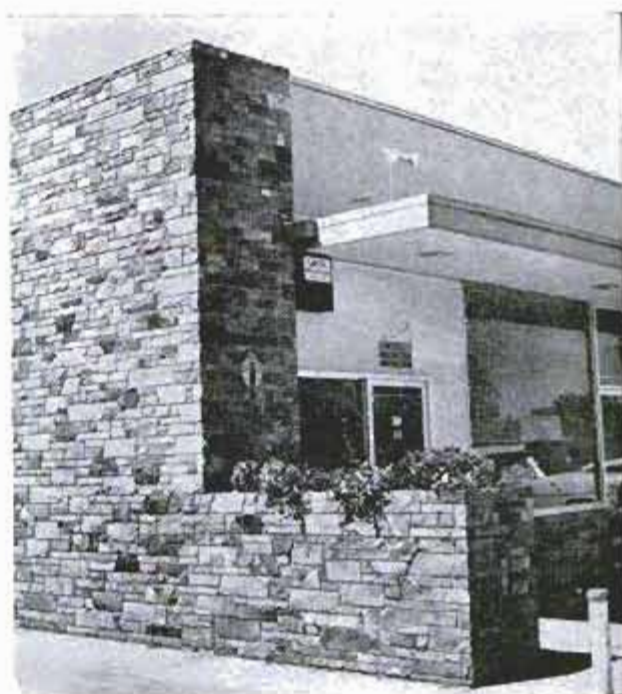



Heavy landing craft is dropped on the beach by the LeTourneau retriever at completion of salvage operation

## *Giant Retriever for Landing Craft*

LOOMING like a huge sea crab in the surf, a retriever to salvage disabled landing craft is now undergoing tests at Fort Eustis, Va. The retriever, built by R. G. LeTourneau, Inc., of Longview, Tex., waddles into the surf and straddles any sunken landing craft, up to and including the 67-ton LCM-8. Then it either floats the boat or carries it to the beach. The secret behind the retriever's mobility is an electric motor and gear-reduction unit built into the center of

each wheel, where it operates in a water-proof housing cooled by air pumped in under pressure. Each wheel is equipped with the world's largest tire, 10 feet high and 4 feet wide, for traction in soft terrain. Eight floodlights are spotted on the vehicle for night operations. The retriever was developed after a study showed that only 10 percent of landing-craft losses were from enemy action. The rest resulted from mishaps during beaching.

Self-propelled retriever is operated by one man. Crew assists by attaching hoist cables to disabled craft

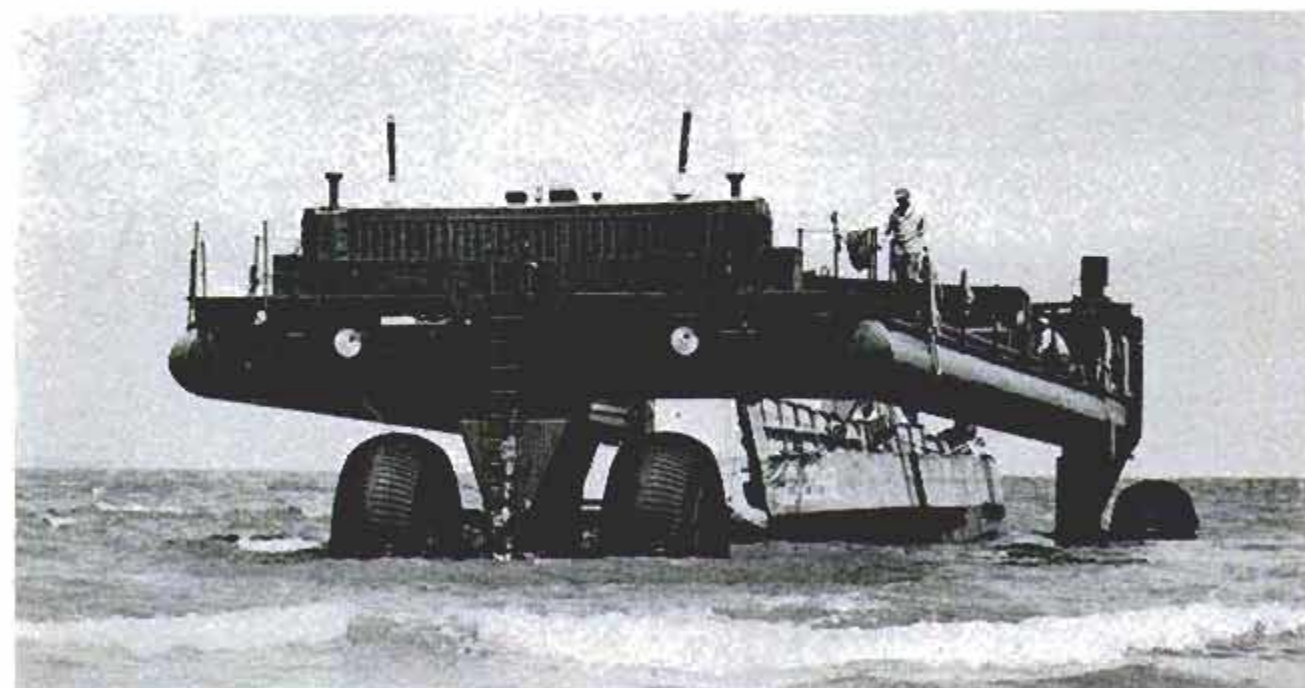



## Cycling Soccer

Four soccer players, two to a team, mounted bicycles to play their favorite sport at Milan, Italy. The ball could only be "kicked" with a bike's wheels or hit with the hand to knock it into the opponent's goal. All of the men used special bicycles for the match

## 24-Mile Causeway Uses Prefabricication

Stretching across Lake Pontchartrain, La., to connect New Orleans and Mandeville, a 24.1-mile causeway is expected to be completed by December 1956. Contrary to most construction operations, all pilings, concrete caps and slabs of roadway are made in sections in a sprawling plant set up at Mandeville, and taken by barge out to the lake site to be put in place. The piles are driven into the lake bottom by huge pile drivers, and the road slabs, 56 feet long, are lifted by cranes to the top of the pilings. Some 750,000 tons of concrete will be used in the construction.

Prefabricated slabs of two-lane roadway, each 56 feet long, are placed on concrete pilings by crane

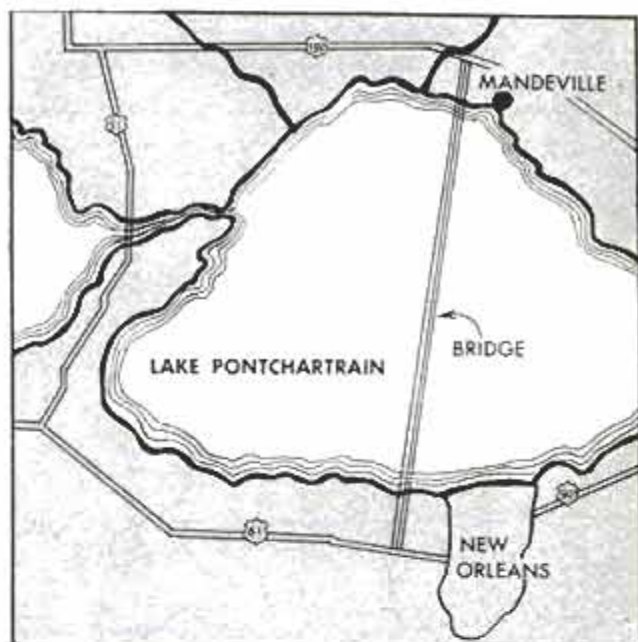

# WHAT'S NEW FOR Your Home

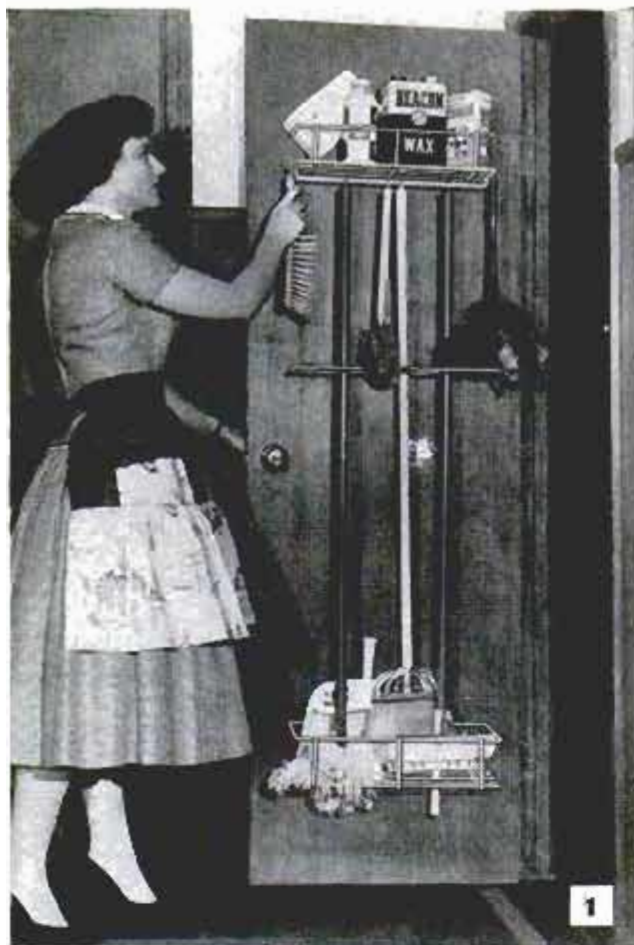

**1. UTILITY RACK** that holds most of the implements used around the kitchen can be attached to the inside of a closet door. The rack is in three separate units, the top and bottom units being handy shelves. Dust mops, brooms and other long-handled tools are hung from hooks on the top shelf. The rack has a chromelike finish. Exposed ends are rubber tipped

Dennis Mitchell Ind., 4424 Paul St., Philadelphia, Pa.

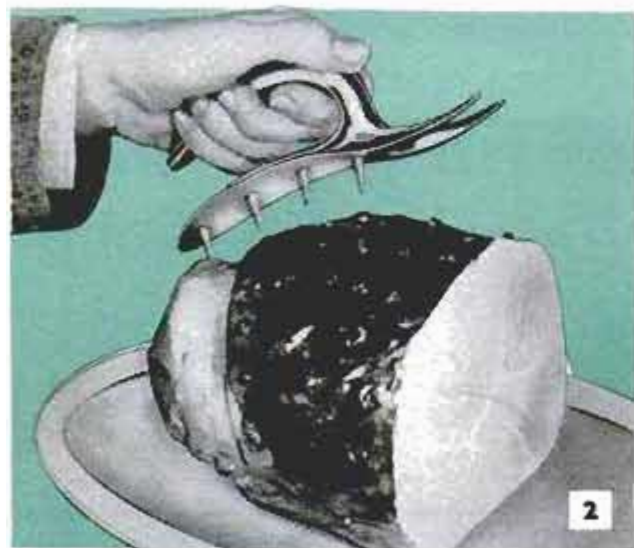

**2. ROAST HOLDER** of a novel design has four sharp prongs to keep roasts, turkeys, chickens, hams and other meats from slipping during the carving. When the carving is finished, a two-tined fork on the front is used to serve the meat. The double-purpose tool, called "Carv-n-Fork," is made of aluminum and plated with a chromium finish that is rustproof

Mrs. Dorothy Damar, 748 Damar Bldg., Newark 5, N.J.



**3 and 4. SPRAYER ATTACHMENT** will convert almost any rotary lawn mower into a lawn sprayer. The mower then can be used to spray insecticides, weed killers and liquid fertilizers. The attachment is a distributor disk which replaces the mower blade. A tank is mounted on top of the mower and feeds the liquid through an adjustable valve to the disk

Rocklin Mfg. Co., 110 S. Jennings St., Sioux City 2, Iowa

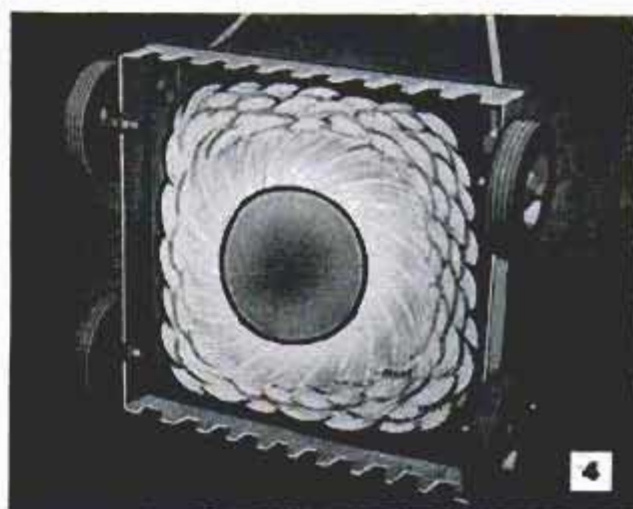



**5. ANTISPLATTER COVER** for use with electric or hand mixers will help the housewife keep her kitchen neat and clean. The cover is of stretchable plastic that slips over the edge of the mixing bowl, with a hole in the center for the mixing blades to enter

Frankl Plastic Products, 1209 Elizabeth St., Denver, Colo.



**6. MILK DISPENSERS** such as used in restaurants are now going to be available for homes. Dispenser keeps two 12-quart containers at 35-degree temperature. On delivery day, milkman replaces empty containers, eliminating the handling of bottles and cartons

Norris Dispensers, Inc., 2720 Lyndale Avenue S., Minneapolis, Minn.

**7. AIR CONDITIONERS** designed to fit into any casement window are attached to the window in the same manner as the screen. No window alterations are necessary to fit the conditioner in place. The entire unit is within the room, allowing window to be closed

Airtemp Div., Chrysler Corporation, 1600 Webster St., Dayton 1, Ohio

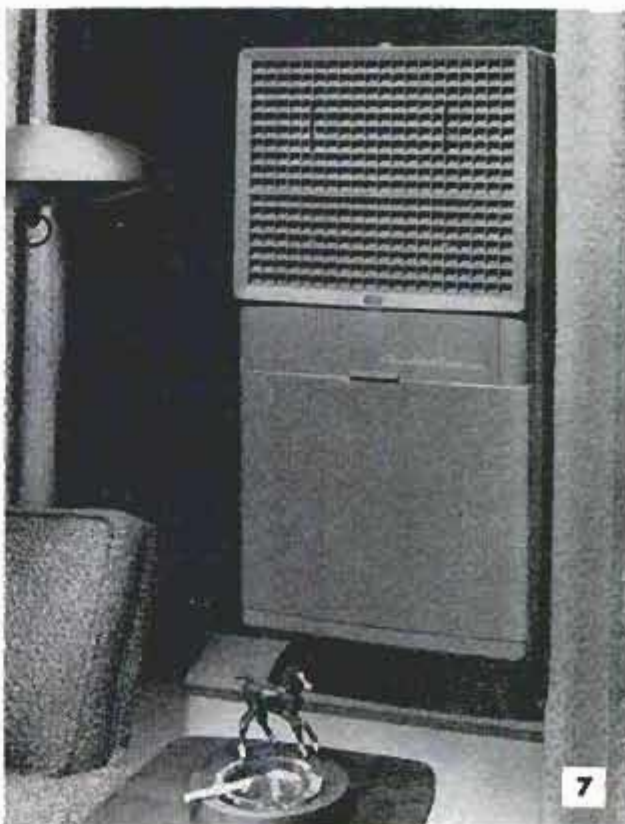

**8. TRIPLE-THREAT KITCHEN** appliance is a combination mixer, blender and electric knife sharpener. One compact 300-watt motor with six speeds drives all three. Fruit-juicer attachment is also available. Various combinations of the three units are offered

NuTone Inc., 200 Fifth Ave., New York City

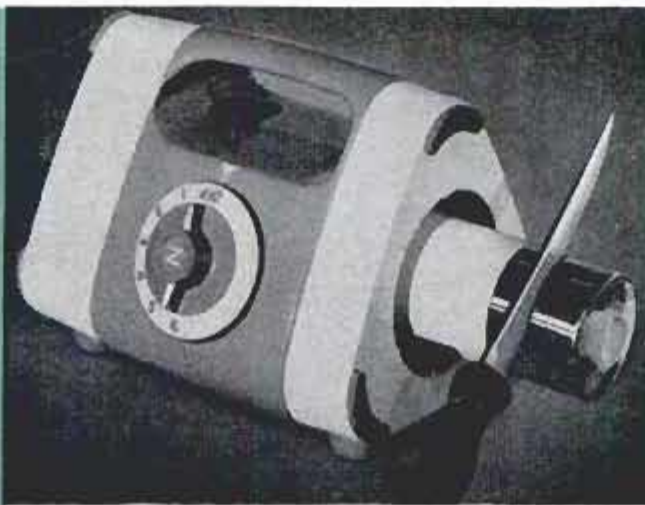
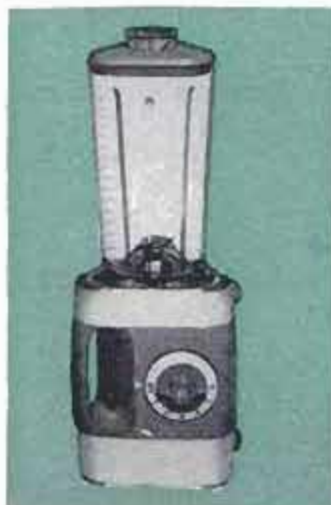



Above, Italy's tiny station wagon is rear-engined. Right, top two sketches show two seat variations. Rear seats in both versions fold as in lower sketch

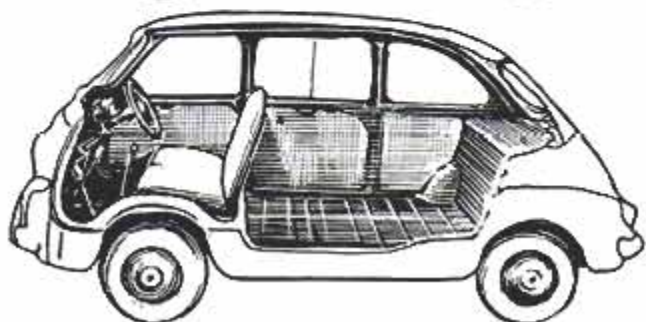
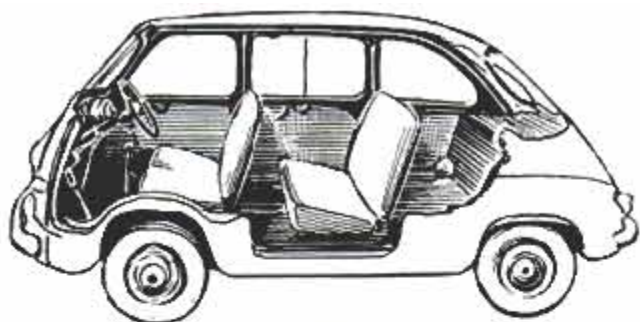

## Italian Station Wagon

Called a utility car, the new Fiat Multiple 600 is a station-wagon version of the recently introduced Fiat 600, Italy's answer to the Volkswagen. It will seat six persons, although it is only 11½ feet long and 4 feet wide. The rear engine develops 22 horsepower. Its rear seats fold down into the floor, allowing the vehicle to be used as a small truck. Spare tire is carried vertically below the windshield.

## Helicopter Serves to Lower Painter to Roof of Building



Lowering a painter from a helicopter proved necessary when a pumpkin-shaped radome at Thule, Greenland, was painted. The fabric-covered building, maintained by Bendix Aviation technicians, houses radar equipment. The painter and a rope ladder were lowered to the crown of the building. With the flexible ladder hanging from the center, the painter had no trouble in doing his job.

## Natural-Gas Substitutes Made in Laboratory

Homeowners awaiting permission to install natural gas in their homes but thwarted by the lack of supply can take hope from the fact that research performed at the Institute of Gas Technology promises a laboratory-made natural-gas substitute. The biggest problem in achieving the substitute—the manufacture of a gas composed primarily of methane—has been solved on a laboratory basis. Commercial use will depend on tests now being conducted at the pilot-plant level.



Homemade unit at left photographs fluoroscopic X-ray image of chest. Commercial X-ray source is at right

## Medics Build Own X-Ray To Fight Tuberculosis

Lacking a budget large enough to purchase chest X-ray equipment to examine Japanese civilians at Ashiya Air Force Base, Japan, two Air Force doctors built their own. To purchase the completed equipment would have cost almost \$3500, but by buying parts locally and assembling their own, the doctors built a unit for \$292. Used on 4339 patients, the machine has detected 62 active cases of tuberculosis. The cost per examination is 3½ cents, as compared with 40 cents on standard equipment.

After exposure the chest films are evaluated in this illuminated viewer. Cost is 3½ cents per examination

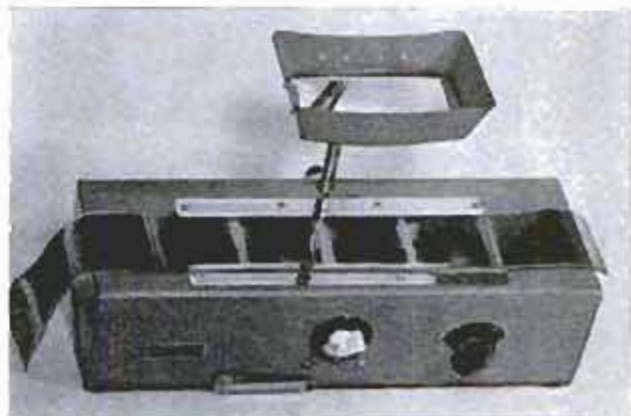

## Snap-On Wall Panels Utilize Aluminum Channels

Perforated acoustic wall panels that fit onto aluminum channels can be installed on the walls and ceiling of a room in a few hours. Five different extruded channels form the basis for the snap-on, snap-off wall. Included in the extrusions are inside and outside corners, edging, furring and snap-on members. The channels are attached to the old walls or studs with nails, screws or adhesives. Sound-absorbing material is placed between panel and wall. The wall can be snapped off just as easily to be replaced, painted or cleaned.

☐ One electric motor built for the Armed Forces is smaller in diameter than a half dollar and shorter than a cigarette, yet contains ⅓ of a mile of ultrafine copper wire.

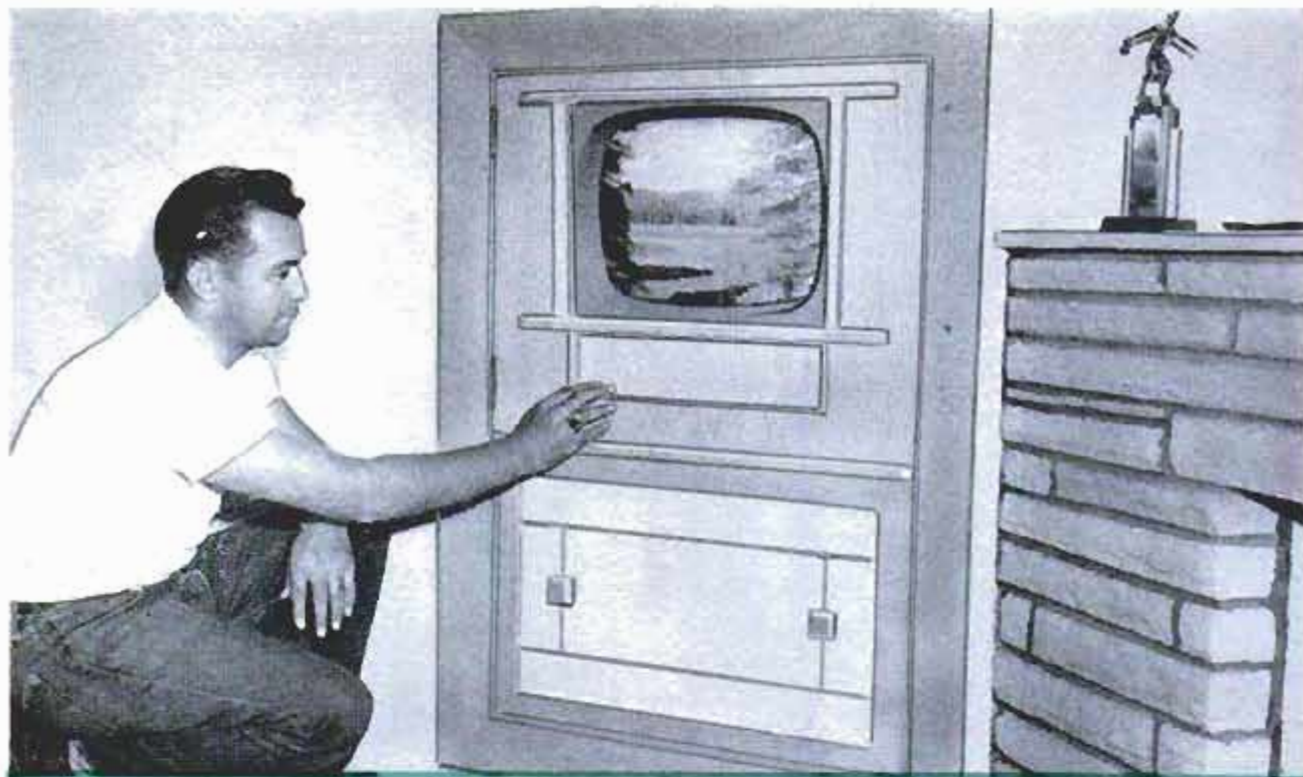

On the den side the TV set is flush with wall. Removable panel covers instrument-panel opening

*In a home full of homemade conveniences  
a Phoenix electrical engineer has installed a*

## **TV That Looks Two Ways**

Carbiener inspects speaker of television set. Electric motor drives pulleys to revolve the set

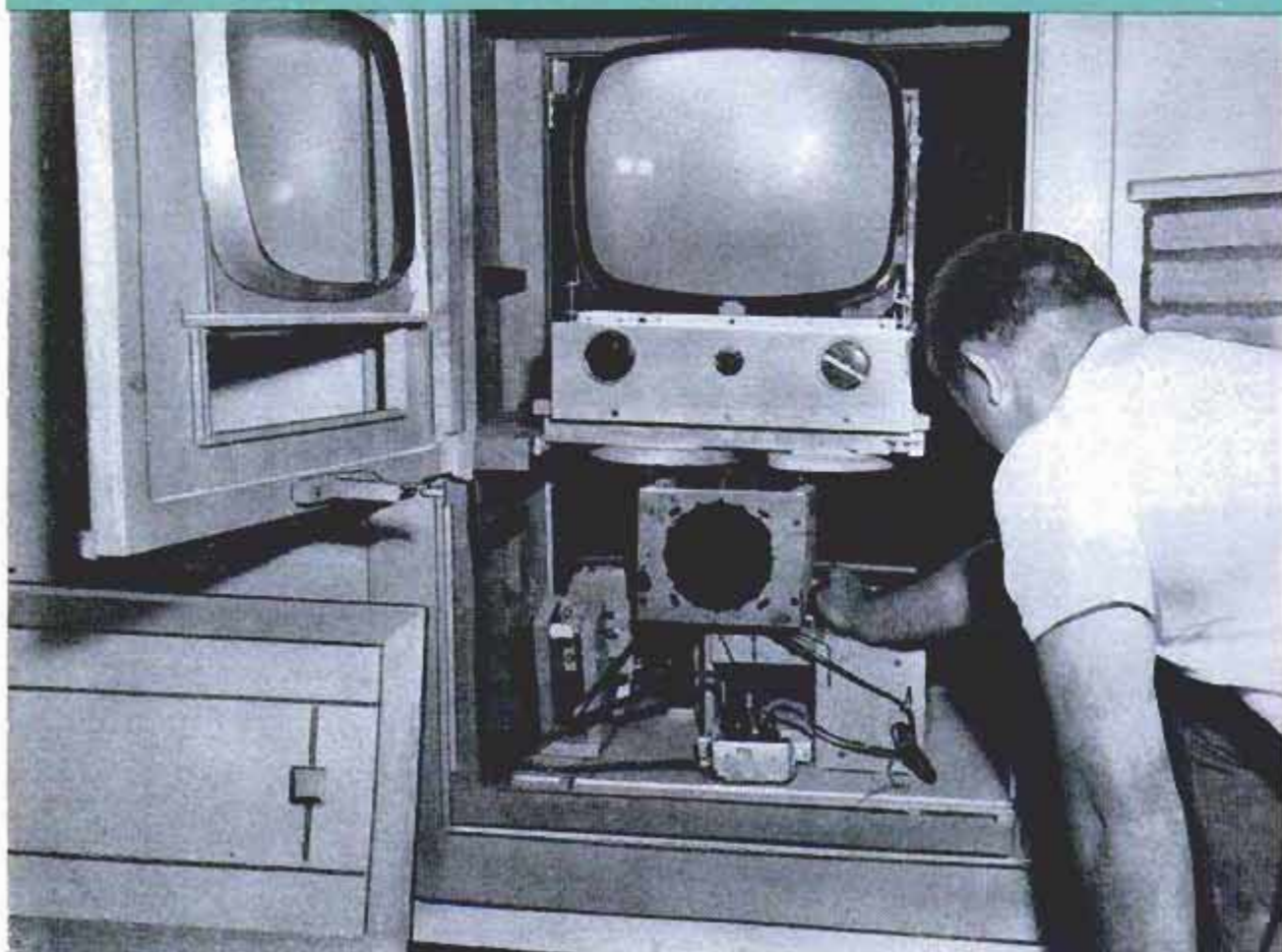



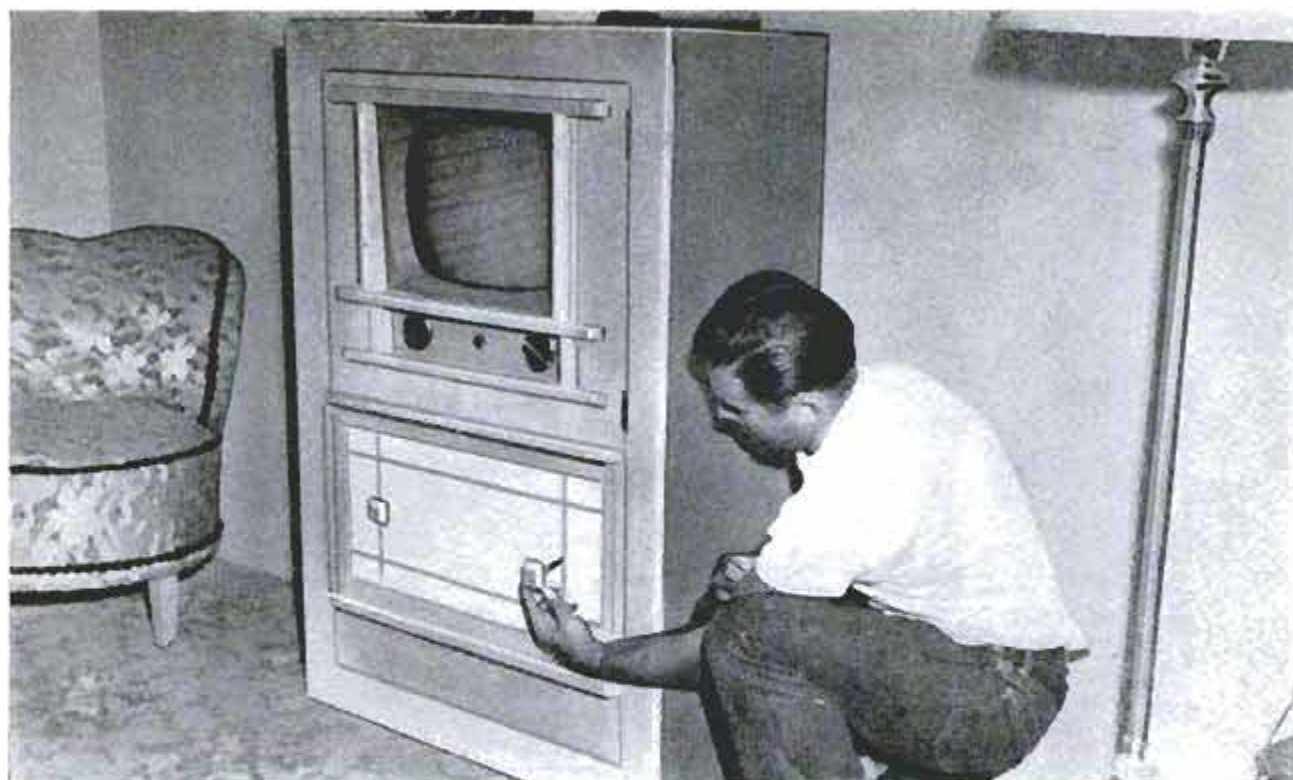

Here is the way set looks from the living-room side. Carbiener pulls out knob to start set revolving

*By Henry F. Unger*

**W**HEN AN ELECTRICAL ENGINEER turns his efforts toward improving his home, interesting results are inevitable.

That, in a nutshell, is the story of Homer Carbiener of Phoenix, Ariz., and his revolving TV set. It also explains the work-saving features built into his home, and even the decorations on the walls.

The two-way TV set cost about \$25 for materials. It enables viewers to watch from either the den or the living room.

Housed inside a much larger cabinet, the TV set extends into the living room from a hole cut in the wall of the den. At the pull of a knob, an electric motor in the base of the cabinet goes to work and turns the set around so that it faces the den. A scenic view replaces the screen, and the knob opening is covered by a panel.

A cloth screen covers the speaker opening. Along the sides of the set are 20 slots for cooling purposes.

The set inside the cabinet rests on a turntable of  $\frac{3}{4}$ -inch plywood. Beneath the turntable is a framework attached to a pipe standard which revolves. Nylon rollers support the sides of the set as it turns.

The motor shaft connects to a worm gear that has a 100-to-1 ratio. A V-belt drives two pulleys to give a half revolution in nine seconds.

In the kitchen, Carbiener has installed a roll-out shelf which keeps electrical appliances always ready for use. Around the Formica surface he has built a  $1\frac{3}{4}$ -inch

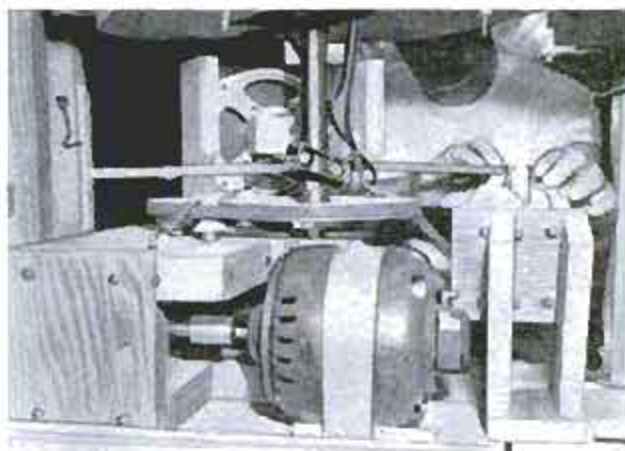

Electric motor drives shaft that turns worm gear to revolve pulleys. Set, with speaker hanging from it, turns on pipe standard. Below, picture takes place of TV screen when it is turned to the other side





Appliances are always within easy reach when they are stored on roll-out shelf built into kitchen cabinet



Lazy Susan shelves in small kitchen cabinet turn to bring any needed pot or pan into convenient reach

Decorative fish and panel on wall were made by Carbiener of metal lath edged with coat-hanger wire

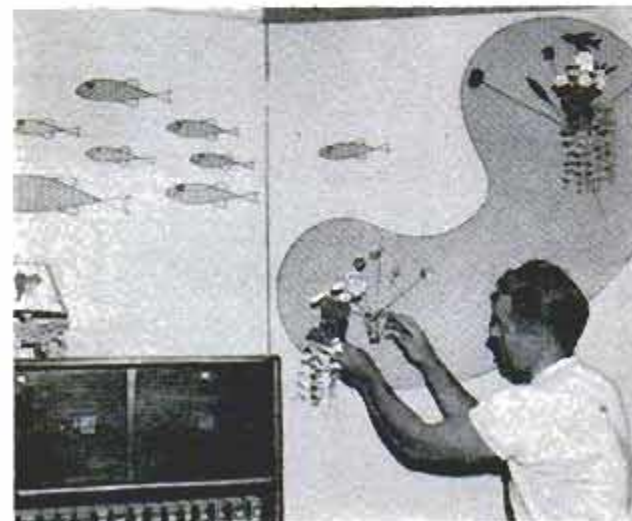

wooden piece for decorative purposes. On the outside and between the two doors, he has placed a false piece of 1¼-inch wood to blend with the remainder of the setup.

Adjoining the roll-out shelf is a three-tiered revolving shelf housed in a cabinet. Four one-inch supports bolster the center and a half-inch pipe through the center fits into the pipe flanges. Eight nylon rollers beneath support the weight of the shelves as the unit turns to bring needed utensils into easy reach.

Carbiener has also built a novel primping mirror into the wall beside the front doorway. Recessed between the studs, it takes up no space and can't be knocked down.

Coat hangers furnish the material for many decorative and useful items around the Carbiener household. Holders for salt-and-pepper shakers, mail and earrings were fashioned by Carbiener out of hangers. On one wall is a school of fish with bodies made of wire-edged metal lath. Next to it is a decorative panel made of the same material. ★ ★ ★

### Infrared Telescope

Speeding trucks are identified at night with an infrared instrument designed for Navy use. A spotlight bathes a section of the highway in invisible infrared light. A special telescope enables an observer to identify passing trucks while radarscopes check their speeds. The instrument is used by the Pennsylvania Motor Truck Association to police truck drivers.



Fokker F-27 flies at 280 miles per hour, but lands at 75. It can carry up to 28 passengers comfortably

## Fokker "Friendship" Is Latest Short-Haul Turboliner

High wing of "Friendship" makes ground loading of plane easier, gives passengers better view and provides increased stability



Aircraft designers the world over are still working to find a modern replacement for that old workhorse, the DC-3. The newest entry into this race is the Fokker F-27, named the "Friendship," now being constructed in The Netherlands. The Friendship is a 28-passenger turboprop liner, powered by two Rolls-Royce Dart engines. The maximum cruising speed at its optimum flight altitude of 20,000 feet is 280 miles per hour. Revised versions of the plane could carry up to 36 passengers. The chief distinguishing feature is the high wing design.

## Electric Log Stacker Lifts 20-Ton Load

In one massive "bite," a new electric log stacker lifts a 20-ton truckload of ironwood logs and deposits them on a pile. Ordinarily, the logs are dumped on the ground and then stacked one by one. The machine, which can take a 25-ton bite, inserts two 10-foot prongs underneath the load, then clamps two huge tusks over the top. After freeing the truck of the load, it turns and scoots off to a storage and processing area where the operation is repeated in reverse. The new stacker promises to save aching backs, time and money in lumber mills.



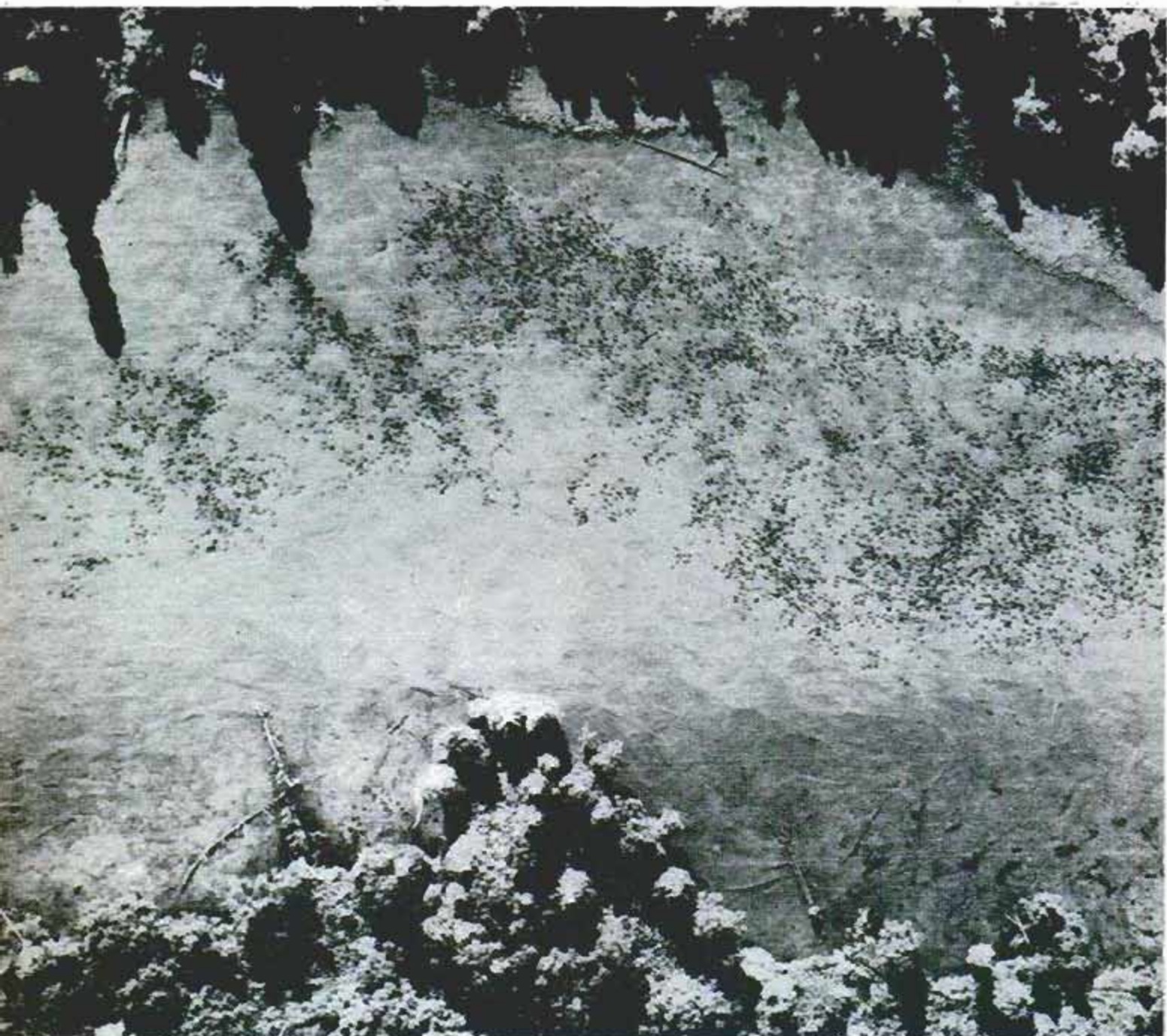

U.S. Fish and Wildlife Service photos

Salmon by the thousands show up in aerial photograph. Plastic grid laid over photo aids in accurate count

## "SHOOTING" SALMON From

By Rafe Gibbs

**T**HEY ARE COUNTING FISH in Alaska from the air—visually and photographically.

Even some old sourdoughs, who today are more used to airplanes than automobiles, are inclined to put this scientific development of the U.S. Fish and Wildlife Service in the "tall tale" class. Commented a stubble-faced, Irish prospector in the Bristol Bay area to a biologist:

"So you be countin' and snap-shootin' them fish—underwater, you say—from up

there in the sky? Interestin', interestin'. Reminds me of years ago in Dawson when some of the boys showed a bunch of goggle-eyed tourists a handful of ice worms. Ice worms? Oh, they're interestin', too. Spaghetti with ink dots for the eyes."

But the aerial fish counting—vital to checking on Alaska's multimillion-dollar salmon industry—is no tall tale of ice-worm altitude, unless you figure it starts about 600 feet up. It is not stretching this fish story, either, to say that an observer may



see in one day's flight as many as 300,000 salmon on their death trek to spawning waters. From the land, he would spend weeks trying to spot that many fish.

Alaska is big and rugged—586,400 square miles of mountains, brush and tundra. Consequently, in Alaska you use an airplane whenever and wherever you can. As the Nome postmaster, who had just begun using airplanes for remote mail deliveries, commented in 1928:

"The day of the dog is done."

But the first fish counting by air in 1930—prelude to today's improved and highly systemized methods—started by accident. Actually, because the fish counter arrived too late to do enough counting by land to make it worthwhile. The counter, C. M. Hatton, a resourceful employee of the U.S. Bureau of Fisheries, hired a bush pilot to fly him over the spawning beds.

Today's use of the airplane, however, is no expedient. The plane is being used because it provides a cheaper method of counting—a saving of about 90 percent—and a better method in certain areas, on broad streams, on lake beaches and in the mouths of streams. Accuracy of this method is astonishingly high.

"With surface methods in such places, you get only vague impressions of numbers," explained George J. Eicher, Jr., who is heading the aerial work out of the service's Seattle office. "You are bothered by reflections, the salmon are inclined to scoot off when they see you, and your angle of view doesn't let you look very far below the surface of the water. In a plane, you can overcome these problems—but an aerial-survey trip is no joy ride."

Added Charles Hunter, another member of the U.S. Fish and Wildlife Service:

"It's particularly not so good for the stomach."

He may have flown with the pilot who claimed that he "not only twists the plane at the bends in the stream, but joggles it up and down for the waterfalls."

The survey plane with pilot and observer moves over the stream or beach in visual counting at a constant speed and altitude—about 75 miles per hour and 600 feet up

Men of U.S. Fish and Wild Life Service interrupt flights to catch sample specimens in nets. This way they check on size and age of fish

## the Sky





Salmon population in 1955 was one of largest since 1913, thanks to conservation program. This assures big catches like above for years to come



get the best results. The usual impulse of a new pilot is to fly too low. Result: The observer sees too many fish too fast, and gets all tangled up in his arithmetic.

If the fish are few and far between, the observer uses a hand tally. When the fish get thick, however—and they sometimes literally clog streams—he has to rely on mental notes.

Where the salmon run heavy, the observer first counts 10 individual fish, then he mentally connects 10 such groups into a block of 100 fish. After that he starts multiplying by 100, and often gets up to 10,000 in a hurry.

Meanwhile, the pilot is just as busy. He must not only maintain speed and altitude, and follow the water course, but must keep the plane in the correct relationship between sun angle and fish to avoid glare. Where there is glare,

Salmon in this unusual photograph taken over Kejik Lake, Alaska, seem to be moving in military formation—point, main body and rear guards

there are no fish—to be counted.

Then there are the distractions.

Flying along a river, the observer is intensely counting fish when he sees two huge brown bears beside the water. They are fighting over a fish, charging, slashing. Now one bear clamps teeth on the neck of the other . . . but the observer must turn his eyes again to the fish, relentlessly weaving upstream.

"But the main problem," said Eicher, "is fatigue of pilot and observer. As the men become weary and get in more of a sheep-counting than fish-counting mood their efficiency drops sharply. It has been found that by breaking up the period—landing and relaxing a bit—it is possible to extend a day's survey to six hours, not counting the return to base."

Those stopping periods can be diverting, especially when they come at native camps. The old bucks are usually interested in reports on how the salmon are running, for the fish have been a major source of food for many centuries. But the youngsters more often than not want to know if the biologists have any bubble gum.

Men of the Fish and Wildlife Service have chanced upon such native activities as a reindeer rodeo, complete with "bulldogging." When a young buck was asked where he learned the cowboy art, he replied:

"Movum pitchurs . . . Roy Rogers."

Taking photographs of salmon for later counting is more intricate than counting on the spot. The methods now used have been worked out by joint pioneering of Eicher and George B. Kelez of the Fish and Wildlife Service.

The plane flies at about 75 miles per hour at altitudes varying from 500 to 1000 feet, depending on stream width. And that stream must be followed just as closely as in visual counting, if not closer. Planes used have been various—usually whatever was available.

The camera is an F-56, military-type aerial outfit with an 8½-inch lens, set in the bottom of the plane. The high light demand of underwater photography is alleviated by using fast panchromatic film with an index speed of 200 increased to 1000 through use of a special developer.

"Infrared film was recommended to us on the theory that it would produce white-appearing fish in dark water," said Eicher. "We tried it, and what we got was jet-black water with nothing visible below the



Seals are among forms of wildlife seen from the air by the flying biologists. These are gathering on the Bering Sea coast

surface. Might just as well have been photographing a black bear eating blackberries in a cave."

Then there was the matter of filters. It was found that no single filter could be used for all situations. Now, for gravel and sand bottoms, a yellow filter is attached. On bottoms covered with vegetation or algae, a green filter is substituted. Then, in really deep water—to reduce reflections—it was found necessary to use a Polaroid filter.

Results have been some highly spectacular—and practical—photographs, which have played their part in conservation practices that have brought the salmon runs back as of old. In 1951, the runs were the largest since 1913. Runs in 1955 came close to this high.

In interpreting the pictures, a sheet of clear plastic, gridded into squares is laid over a photograph and the fish are counted.

"We haven't the time or money, of course, to photograph every mile of a stream," said Eicher, "but we are able to make a lot of spot checks. And the aerial photographs provide a permanent index. Photographs taken during different periods and different years give a good idea of changes in the fish runs."

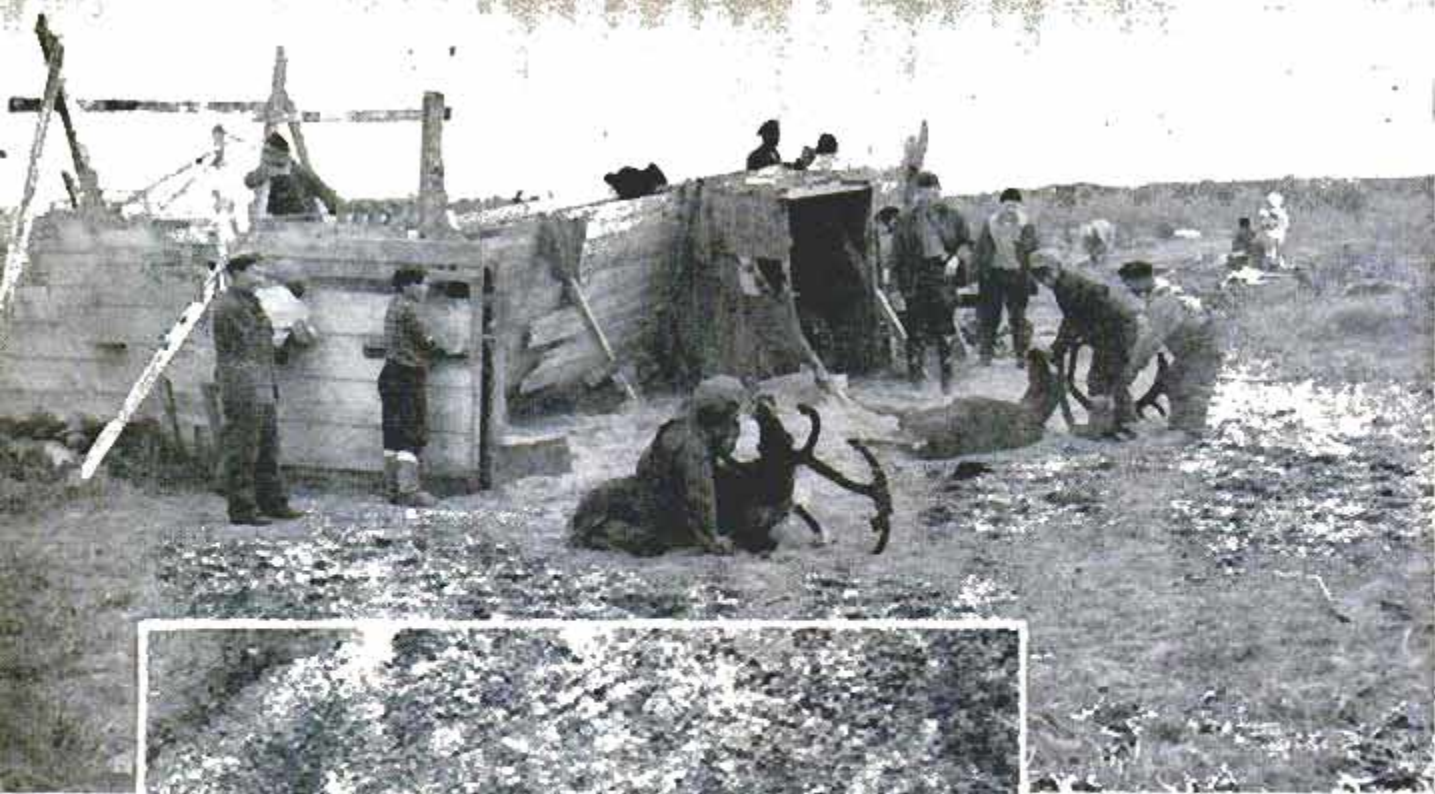

Visiting biologists see a free reindeer rodeo as Eskimos, who learned lesson from Western movies, show "reindeer dogging"



Reindeer get their pictures snapped from the air, too. This stampeding herd was photographed near Nunivak, Alaska

Eicher spends most of his time in the Seattle headquarters and laboratories of the Fish and Wildlife Service but, when the salmon start spawning in Alaska, he heads north fast. The season is short—about May 15 to September 1—and the days are long, with the sun taking an unreasonable time to set. Both eight-hour day and five-day week are forgotten during spawning.

A pilot himself, Eicher loves the aerial work, even when he has to paddle his plane home. He did that once when his craft "conked out" on a take-off over Nystrom Lake. Bringing it down on the lake, he paddled to the shore, made the necessary repairs to the plane and promptly started skyward once again for another day of fish-surveying. ★ ★ ★

## Life of Flashlight Dry Cells Quadrupled by Recharging



Increasing their life by 400 percent, dry cells used in flashlights are now being recharged at Northrop Aircraft, Inc. A compact bench-size charger holding 184 batteries at one time recharges the cells in two hours. Efficiency of the cells is as good as when new up to the third recharging, and four charges are the limit of the cell's usefulness. Before installing the charger, Northrop used and discarded 13,000 dry cells per month.



## Pasture in the Barn Produces Winter Feed

Farmers can grow green grass for their cattle during the winter with a "pasture" housed in the barn. In six days, seeds placed in a tier of trays produce succulent shoots seven to nine inches high. When the grass-filled trays are placed before them, the cattle eat even the roots, for no soil is used in the growing process. The plants are nourished by enriched water that flows through the perforated bottoms of the trays. Minerals necessary to the growing process are mixed with the water in a tank on the top of the electrically heated, glass-enclosed structure. Automatic regulators feed the water to the plants in controlled amounts. The system, brought to America by Karl and Petti Wagner, now of Dallas, Tex., is designed for feeding swine, horses, sheep and poultry, as well as cattle. The green forage in mid-

Plants are ready for harvesting six days after seeds are placed in trays. Water enters tray through bottom



Easily removed trays with plants in various stages of growth are contained in the well-heated, glass-enclosed "incubator"

winter promotes the health and productivity of livestock and results in important savings of other feeds. Dairy cattle are said to produce 10 to 20 percent more milk with 10 to 20 percent more butterfat when they get their winter greens.

Cattle eat roots and all of the juicy forage. No dirt is used in process. Enriched water feeds plants



## Check Writer for Personal Use Can Be Carried in Pocket

You can carry a new check writer in your pocket. The seven by three-inch device prevents a check from being altered, for the numbers it prints are permanently embedded in the paper fibers. By pressing its keys, you can imprint the dollar sign, digits and a star. Openings beside each key enable you to align and space figures.

One digit at a time is printed by pressing keys. Check can be seen through open slots

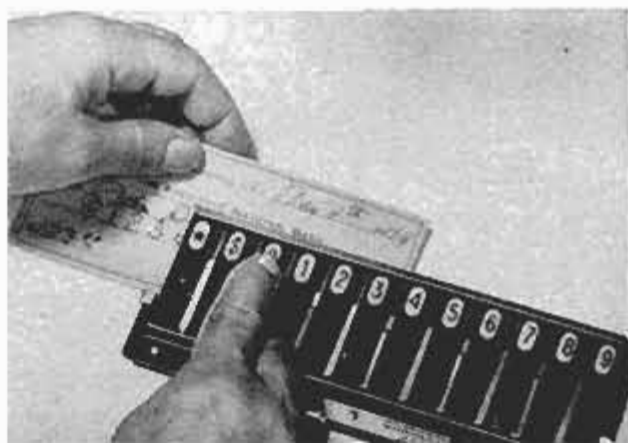



# Eyes Over the Ocean

By Elliott H. McCleary

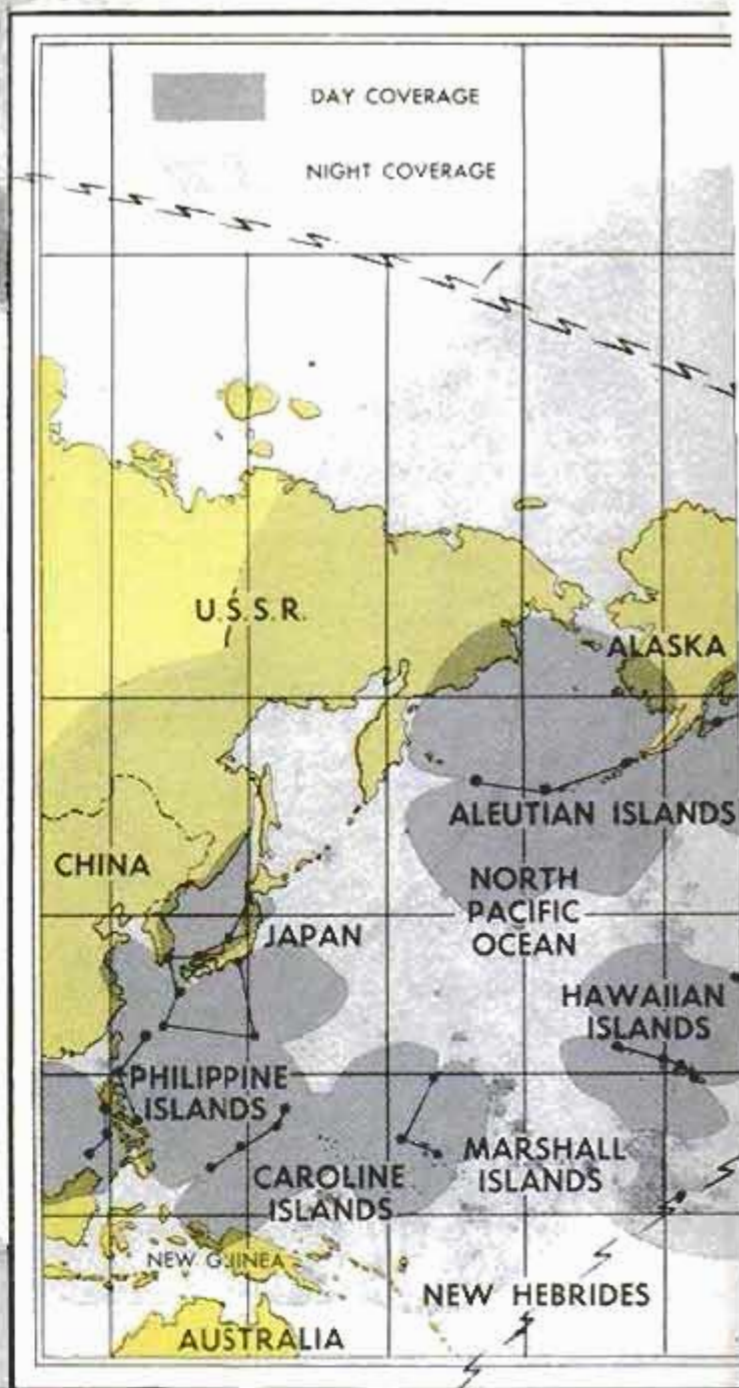

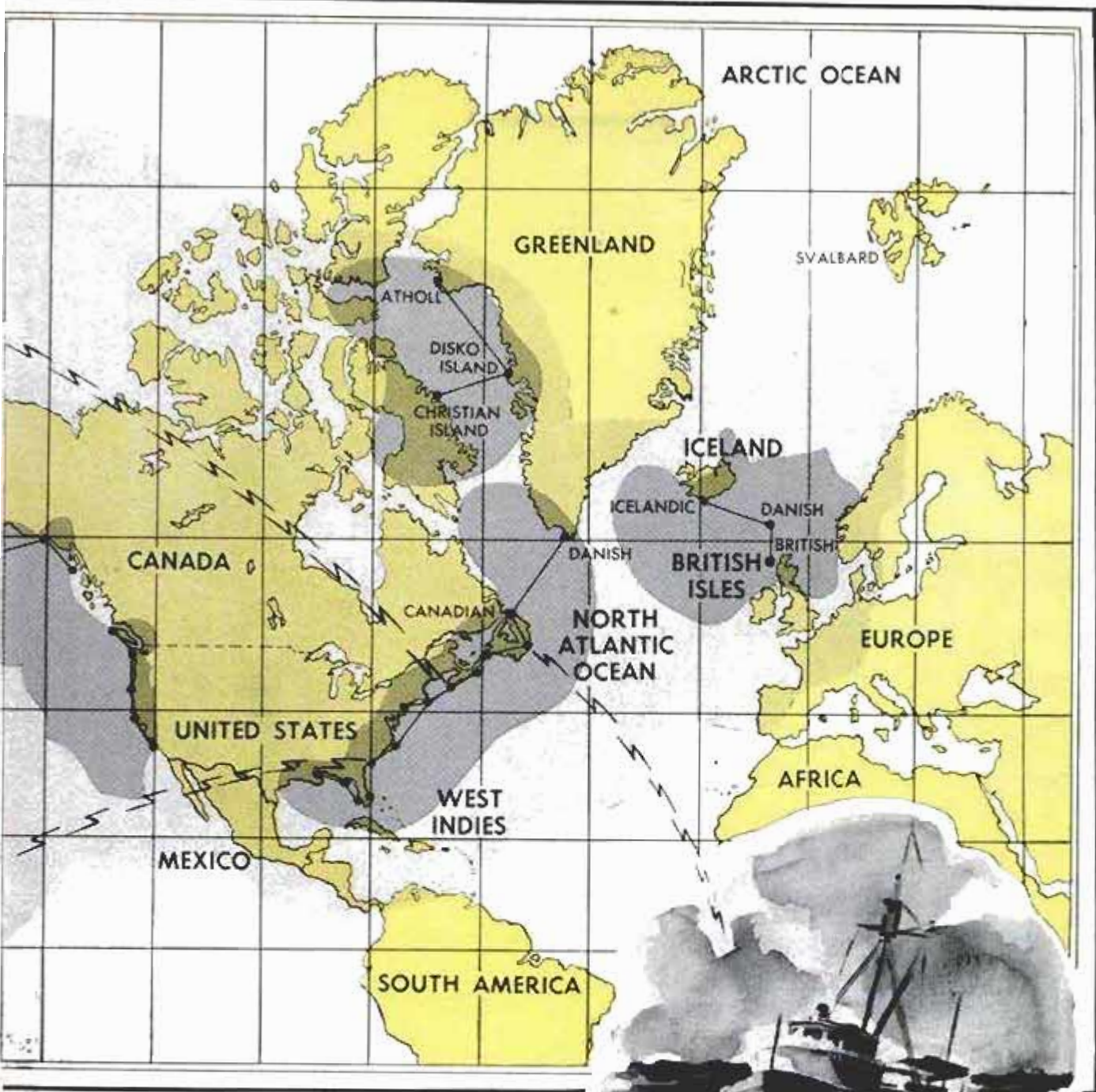

Map shows location of all 54 loran stations in world. All are above equator and all but 11 are operated by America. Gray areas show day and night coverage



SOMEWHERE on the North Atlantic a fishing boat is lost under lowering skies . . . a tanker, heavy-laden with Texas oil, is threading the Gulf Stream northward . . . a passenger plane drones through the clouds toward Paris.

A score of years ago they would have been adventurers alone, navigating as navigators of the seas have done for hundreds of years. Today they have "eyes" in common—the eyes of the war-born miracle, loran.

Coastguardsmen keeping vigil at some of the loneliest spots on the earth perpetually watch and tune their instruments so that fishing boat, freighter, destroyer and the

continuous stream of air traffic over the oceans can always pinpoint their positions, regardless of weather.

Loran, the LONG-RANGE navigation system, was born of the wartime need for a sure method of guiding fighting ships and planes to port and to meetings on the high seas. Today it has settled down to the routine business of guiding peacetime air and ocean traffic; any traveler who cares to buy a loran receiving set can avail himself of the international loran services, and hundreds of ships and planes are using it every day.



**Queen Mary officer operates shipboard loran set. Time difference in arrival of two signals is shown on scope and indicated numerically on dial at lower left. Below, skipper uses set's remote-control dial**



Thus far loran guards only the North Atlantic and the Pacific; there are 54 stations at work, none in the South Atlantic. Most of them are operated by United States coastguardsmen. Canada operates six stations, Denmark three, Great Britain and Iceland one each. From such desolate spots as Pusan, Korea; Cape Sarichef, Alaska; Cape Atholl in arctic Greenland and from Tarumpitao Point in the Philippines, near the jungle home of fierce Moro tribesmen, American Coast Guard operators on round-the-clock watches keep the loran signals on the beam.

A typical station, located on a high cliff, a tiny island or a point of land jutting into the ocean, consists of a few buildings grouped around a pair of tall antenna poles. In one of the buildings, technicians watch scopes to see that the equipment is operating properly. Another building houses generators to supply electric power to the transmitter.

Loran stations operate in pairs; both are manned by small crews of scope watchers, but one station is called the master station and the other the slave station. They are 200 to 300 miles apart. The master station repeatedly sends out a time beat. After a measured interval of millionths of a second, the slave station sends out another beat.

The loran operator on ship or plane tunes in a pair of stations, which register on his picture tube as two "blips" of light. The distance between the two blips represents the difference in arrival time of the two signals.

By reading this time interval on the loran set, and using a special loran map, the



operator can tell that he is on a certain line extending through a point between the two stations.

He doesn't know just where on the line he is located. So he tunes in another pair of stations and finds a line leading from them.

Where the two lines cross on the loran map is his position.

The key of the whole system is the time interval. It varies because the signals from the two stations have different distances to travel. This "travel time" changes the length of the original time interval.

Finding a position with loran takes less than five minutes. It is accurate within one percent (one mile possible error at a distance from the stations of 100 miles).

A "fix" obtained by sighting the sun or the stars takes 30 minutes. If clouds or fog prevents celestial observation on the high seas, the navigator may have no choice but "dead reckoning," which means that he must plot the speed and direction of the ship for days on end in foul weather and hope that he is within 10 miles of where he thinks he is.

The speed with which loran "fixes" can be made is especially valuable to pilots, for a plane travels at least 150 miles in the time it takes to make one celestial "fix."

The experienced navigator

(Continued to page 226)

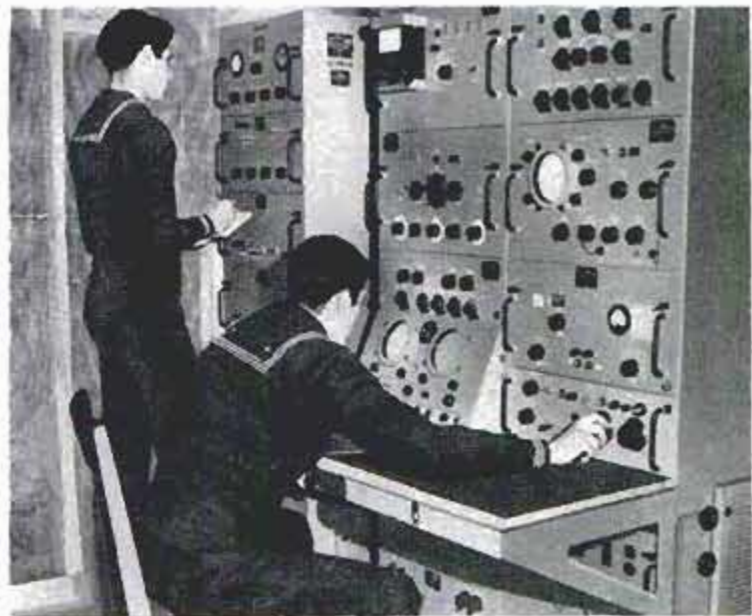

Top, loran station at Adak, Alaska. Tall poles support the transmitting antenna. Above, monitor crew in loran station checks scopes. Below, loran lines of position cross at ship's position. Loran-set readings are matched with lines on loran map

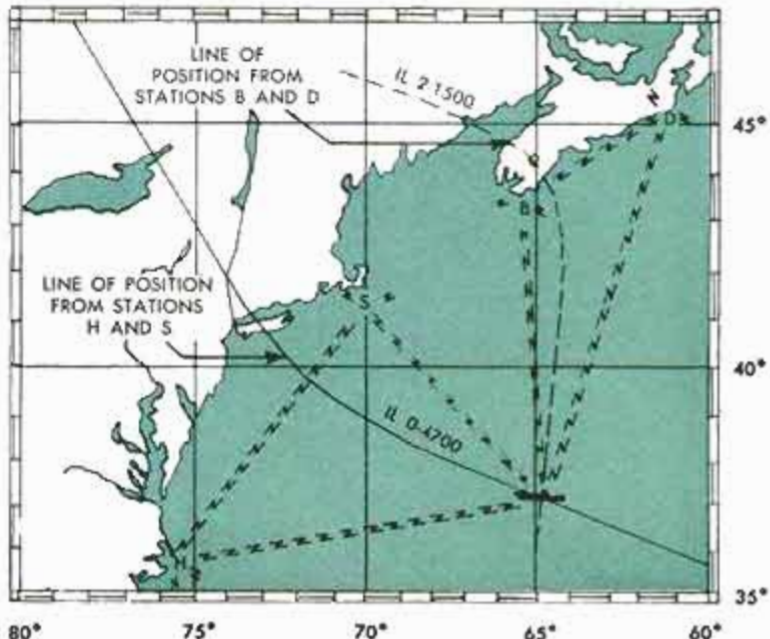



One man can move 400 feet of system, which is designed for turf crops such as clover, without strain

Flexible Neoprene sleeve joint between pipes is reinforced with glass fibers to take 300-pound pressure

## Mobile Sprinkler System For Irrigated Farms

Mobile sprinklers for irrigation systems are not new, but many older types have disadvantages which are eliminated in a system just developed. It is so portable that one man can pull 400 feet of the pipe with little effort. Lengths of pipe are connected by a glass-fiber-reinforced, flexible Neoprene sleeve which will withstand 300 pounds of pressure. At the connection point, the pipes are mounted on a wheeled carriage which permits the entire pipe to be turned in a 30-foot arc. To avoid any torque or other excessive stress that could damage the pipe, all angular movement at this point is provided for in a universal joint. Thus, when the pipe is bent or pulled, the universal joint—and not the Neoprene sleeve—takes the stress. The system is designed so that the sprinkler heads and standpipes are always vertical. Since the sprinkler never touches the ground, a minimum of foreign material gets into it.



## Drawings Made With Etching Ink "Cut" Stencil for Mimeographing

Greater versatility in reproducing artwork and lettering is possible on a duplicator stencil "cut" with a brush. A special etching ink, applied with an ordinary artist's brush, prepares the stencil for duplicating. After the ink is blotted, the stencil can be used immediately on the mimeograph.





## Liquid Rubber and Powder Combined to Make Pliable Concrete

After a new concrete hardens, a thin slab can be rolled by hand into a tube without breaking. Mixed like regular concrete, the substance consists of powder and liquid rubber. After mixing, it can be troweled or buffed and can be used on standard concrete, metal, brick, tile or glass. It is intended primarily as a finish coat or for repair work on floors with heavy loads or

heavy traffic; it also may be used to dampen the shock and noise of heavy machinery. Laid in  $\frac{1}{4}$ -inch layers, the concrete withstands compressive loads up to 2500 pounds per square inch. It resists alkalis and mild acids and is waterproof and slipproof. It hardens in a few hours and is completely cured in two or three days. It also resists cracking over a wide temperature range.



## Dispenser for Fish Worms

Fishermen around Helena, Mont., can drop 50 cents into a converted soft-drink dispenser and receive three dozen worms in return. Bernard M. Chaffin and Ross Allen, Jr., developed the "Worm-o-Mat" to provide anglers with bait day or night. The machine is an ordinary soft-drink dispenser in which the coins unlock one end. Instead of bottles, milk cartons are used. The machine holds 450 cartons of worms at a cool temperature.

## Lift-Measuring Instrument for Military Planes

For the first time, military aircraft are being equipped with an instrument which tells the pilot the best speeds to use for landing, take-off and other low-speed flight conditions. The Fairchild C-123B assault transport is equipped with a lift-measuring instrument. On take-off, the instrument tells the pilot the exact speed at which the plane should become airborne, and the best initial climb under the existing weight and power conditions. A fingernail-sized vane on the lower edge of the wing senses changes in wing lift, and this information is passed along to the instrument on the panel.

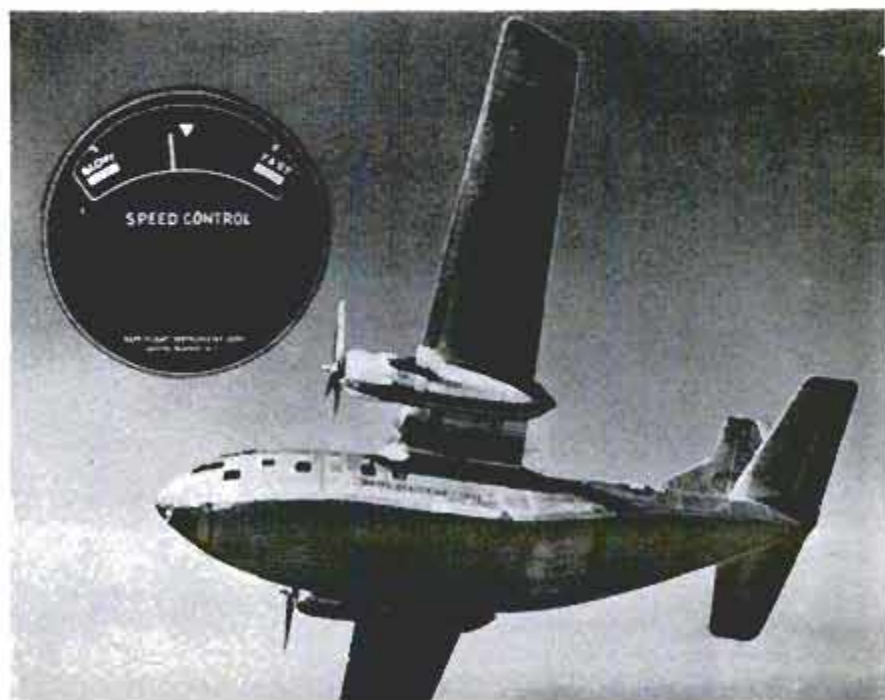



## CITROËN SPRINGS SOME SURPRISES *with the first model change in 21 years*

By Arthur R. Railton

**CITROËN** is different! It's as individualistic as the average Frenchman who, incidentally, loves the car with a devotion that approaches fanaticism.

Looking at the pictures on these four

pages will convince you that the Citroën DS 19 is different. It is even different in its basic philosophy—this is the first time in 21 years it has changed body styling. Even more unbelievable is the fact that,

Lift the hood and get the first of a succession of surprises: The spare tire is in front of the radiator

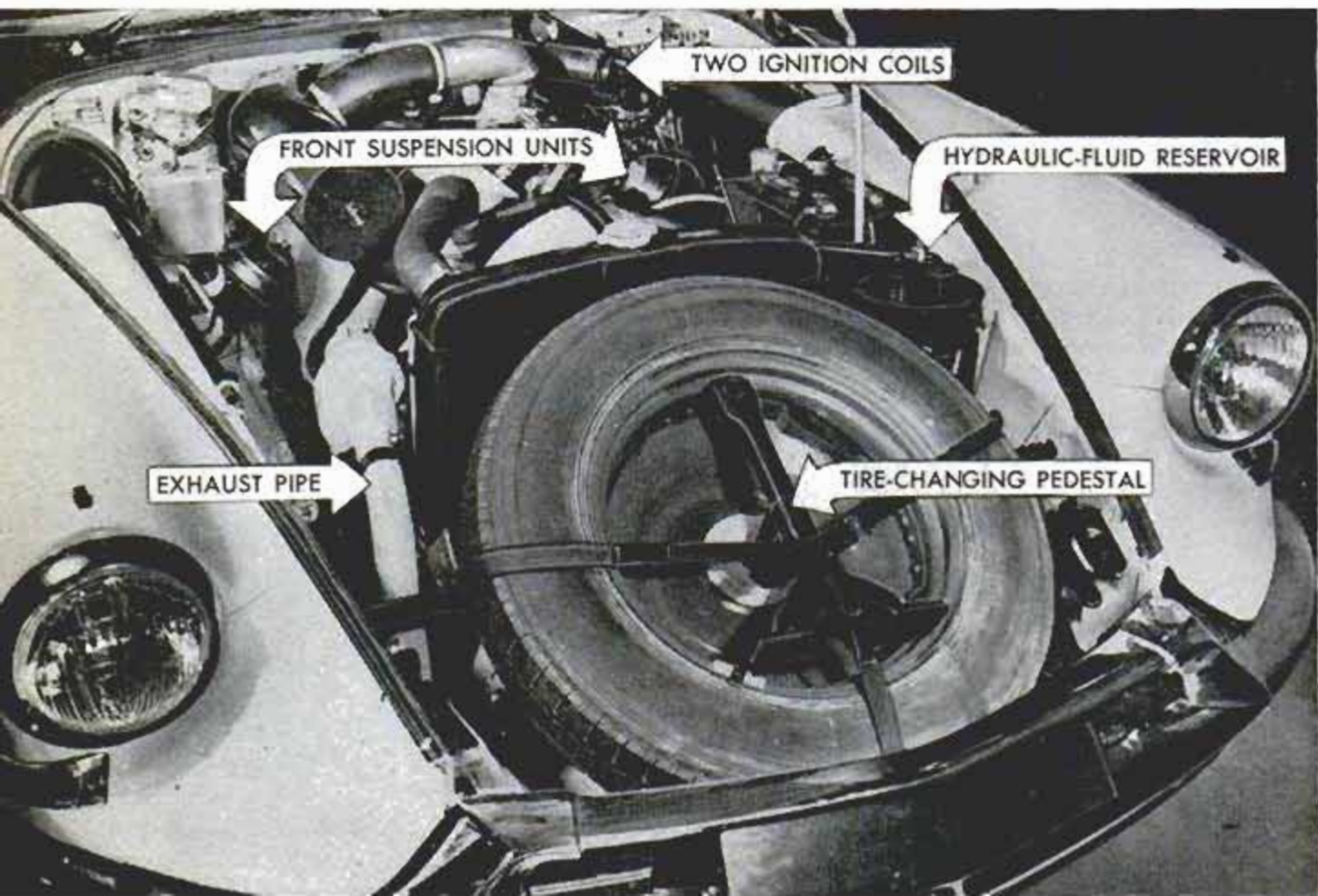



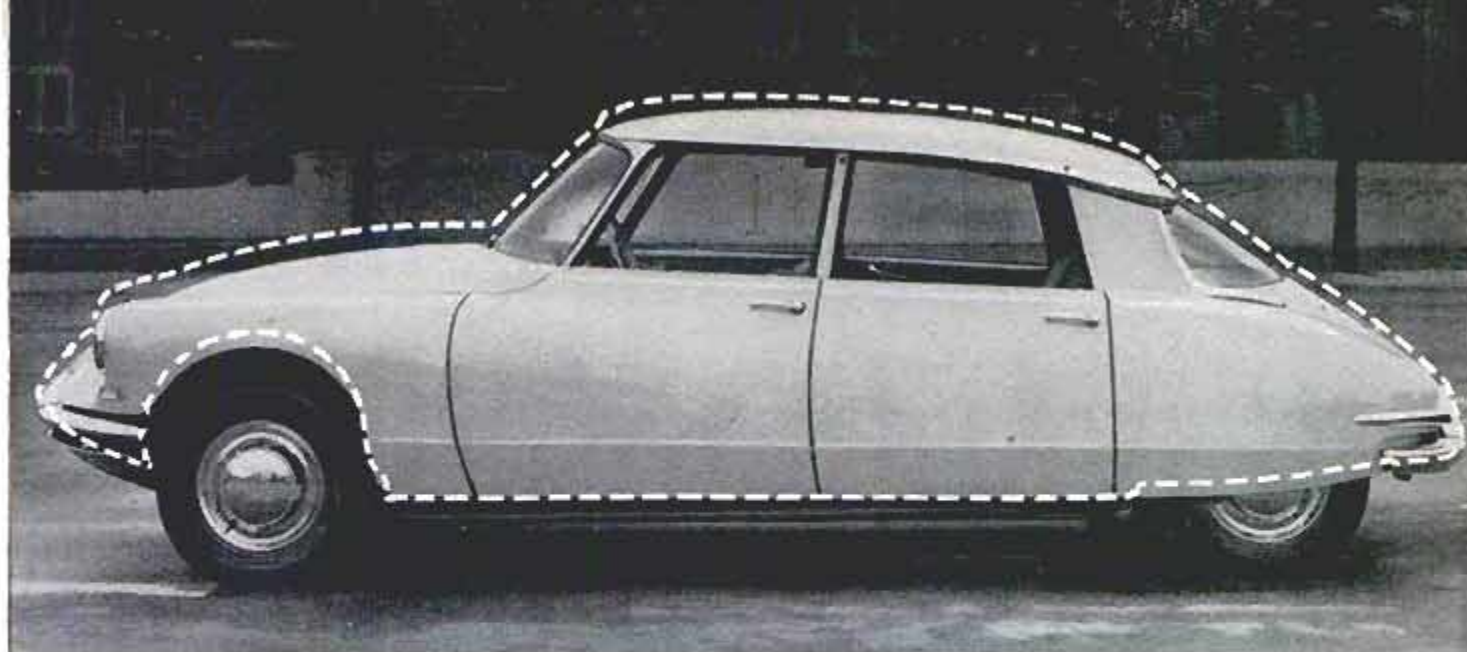

Suspension is at low point here; dotted outline shows its high point. Driver can select any height he wants

despite the arrival of the new DS 19, the factory continues to build and sell the 21-year-old body style, too!

But there are greater differences that you can't see—engineeringwise.

Consider suspension. It has an air-oil system by which the passengers literally ride on air. There are no metal springs between the wheels and the body. The body actually floats on compressed air, giving it a softness that smooths out the roughest roads and yet, by some miracle, hangs on like a sports car in a fast corner.

The body remains at a constant level regardless of load and this level is adjustable

**CITROEN'S CENTRAL HYDRAULIC SYSTEM**



For a detailed explanation of the world's first central hydraulic system, as featured in the new Citroën DS 19, see page 192 of the February 1956 issue of *Popular Mechanics*. The full-page diagram explains the system and shows the layout of the 115 feet of tubing by which a single pump powers brakes, suspension, transmission and steering

Handle (arrow) operates windshield wipers should motor fail. Top of dash lifts up to uncover big glovebox

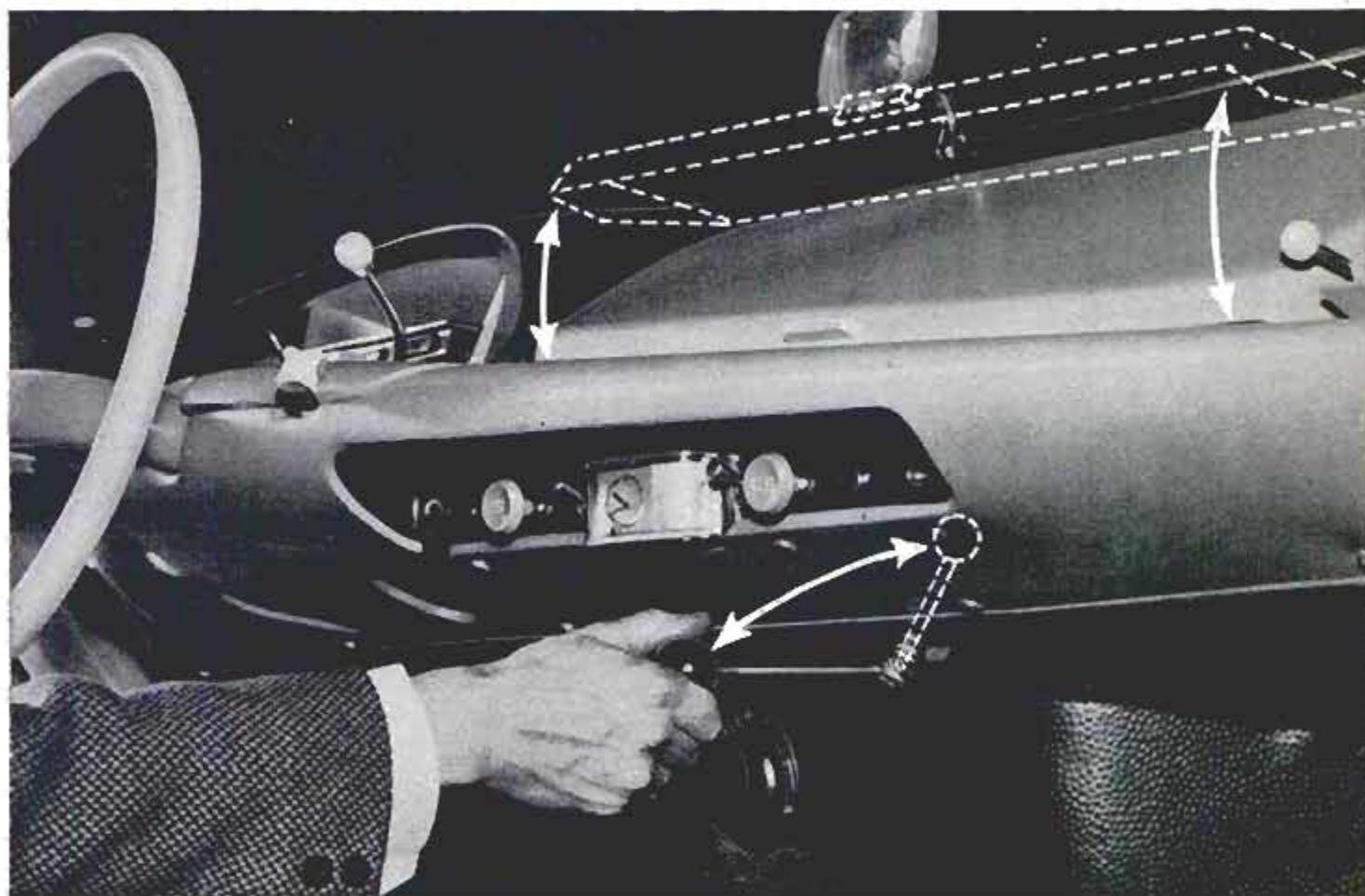

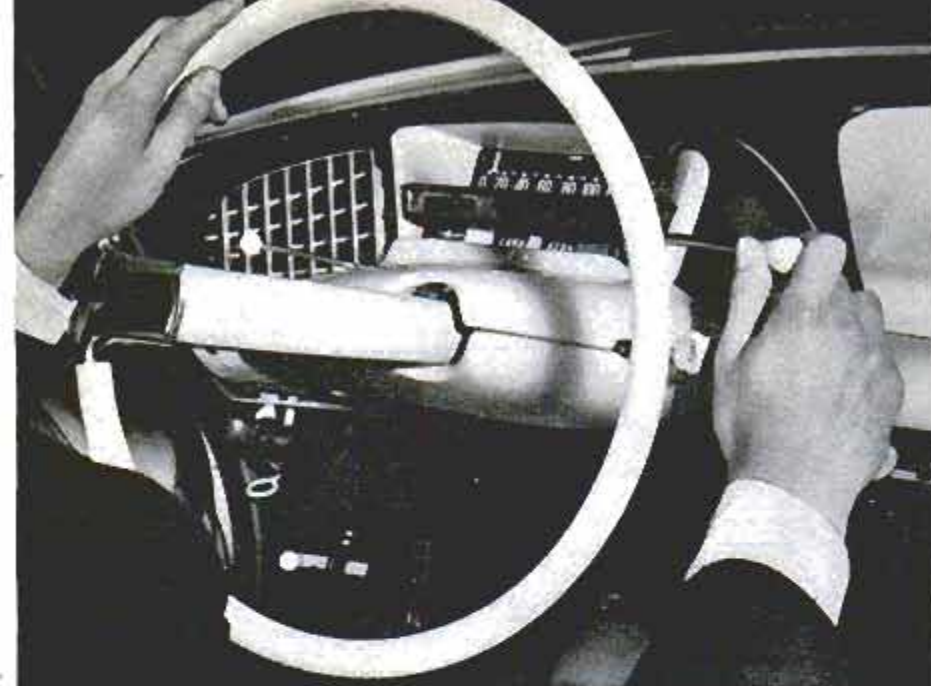

Steering wheel has no spokes! Actually it is attached to an extension of the column. Grille visible is fresh-air inlet



To use the ash tray, you pull out the clock. Below, some of the controls. Suspension control adjusts height of the body

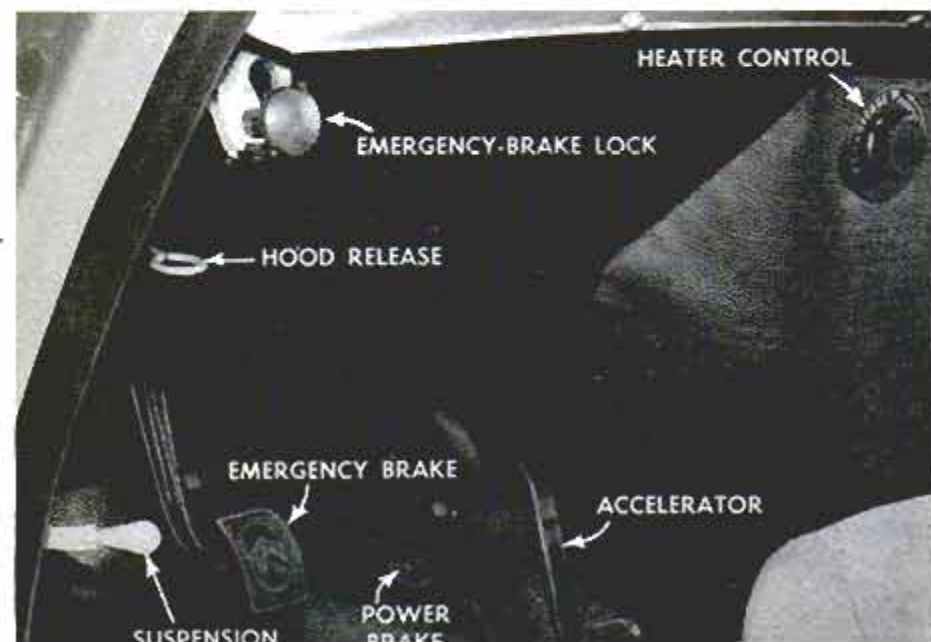

so that in deep snow or on a rutted road the driver can raise the body several inches to keep from "bellying." As if that isn't enough, the same air-oil suspension lets you "jack up" the car without a jack!

Key to the air-oil suspension system is the Citroen's new central hydraulic system—the world's first, by the way.

What's that, you ask? It means that all power accessories (power brakes, steering, clutch, gear-shifting and suspension) are powered from one pump—a small cylinder about half the size of the generator on your car. The pump maintains hydraulic pressure in the system. From it radiate 115 feet of tubing to carry pressurized fluid to all parts of the car. Such a system is predicted for the cars of the future, but the Citroen has it today!

The ignition system is different, too. It doesn't even have a distributor. There are two coils for the engine's four cylinders instead of the usual one. The only timer required is a make-and-break device that never needs adjustment and which, by the way, is completely waterproof and will operate underwater.

Of course, Citroen has been famous since 1934 for its front-wheel drive. The advantages: An unbelievable cornering ability that has made Citroen the favorite quick-getaway car; and (more important to the passenger's comfort) a completely flat and underslung floor that requires no bothersome hump or tunnel to cover a long driveshaft.

Citroen with its new DS 19 has solved one problem that has plagued front-wheel-drive cars for years: too large a turn circle caused by limitations of the universal joints. The DS 19 will turn inside a 35-foot circle, considerably more maneuverable than any American car of its size.

The pedal for the power brakes is about as big as the dimmer switch on your floorboard. But the differences don't end here. The Citroen braking system has a sensing valve that maintains the correct amount of braking front and rear regardless of weight distribution. As the car is loaded, the valve adjusts the relative braking to allow for the change in load.



With no tire or differential in the way, the trunk is amazingly deep. Note the unusual shape of trunk lid

The front brakes are disk, mounted in-board to reduce unsprung weight to a minimum. Citroën claims to be the first company to mass produce a car with disk brakes that are self-adjusting for wear. Rear brakes are conventional (a word not often used in describing the DS 19).

As a safety measure, the parking brake is applied with the left foot on a large pedal. This pedal is connected mechanically to the front disk brakes and provides an excellent brake should the hydraulic system fail.

The spare tire is carried ahead of the

(Continued to page 230)

To remove a rear fender, you loosen one bolt (arrow). Two pins hold forward end in place

To change tire, you fit pedestal in slot (right), flip the suspension lever and wheel goes up. One nut secures wheel

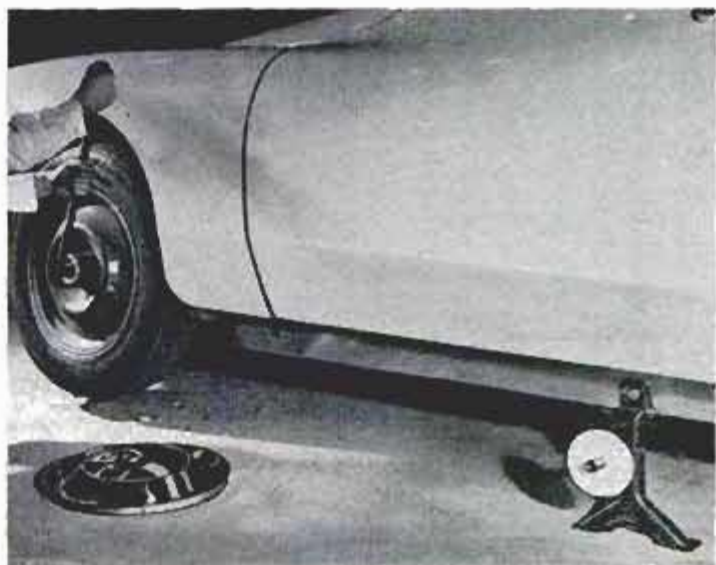
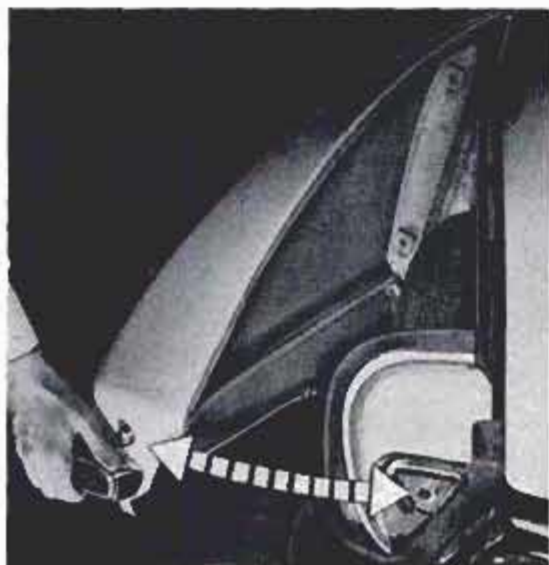

# What to Pack for Winter

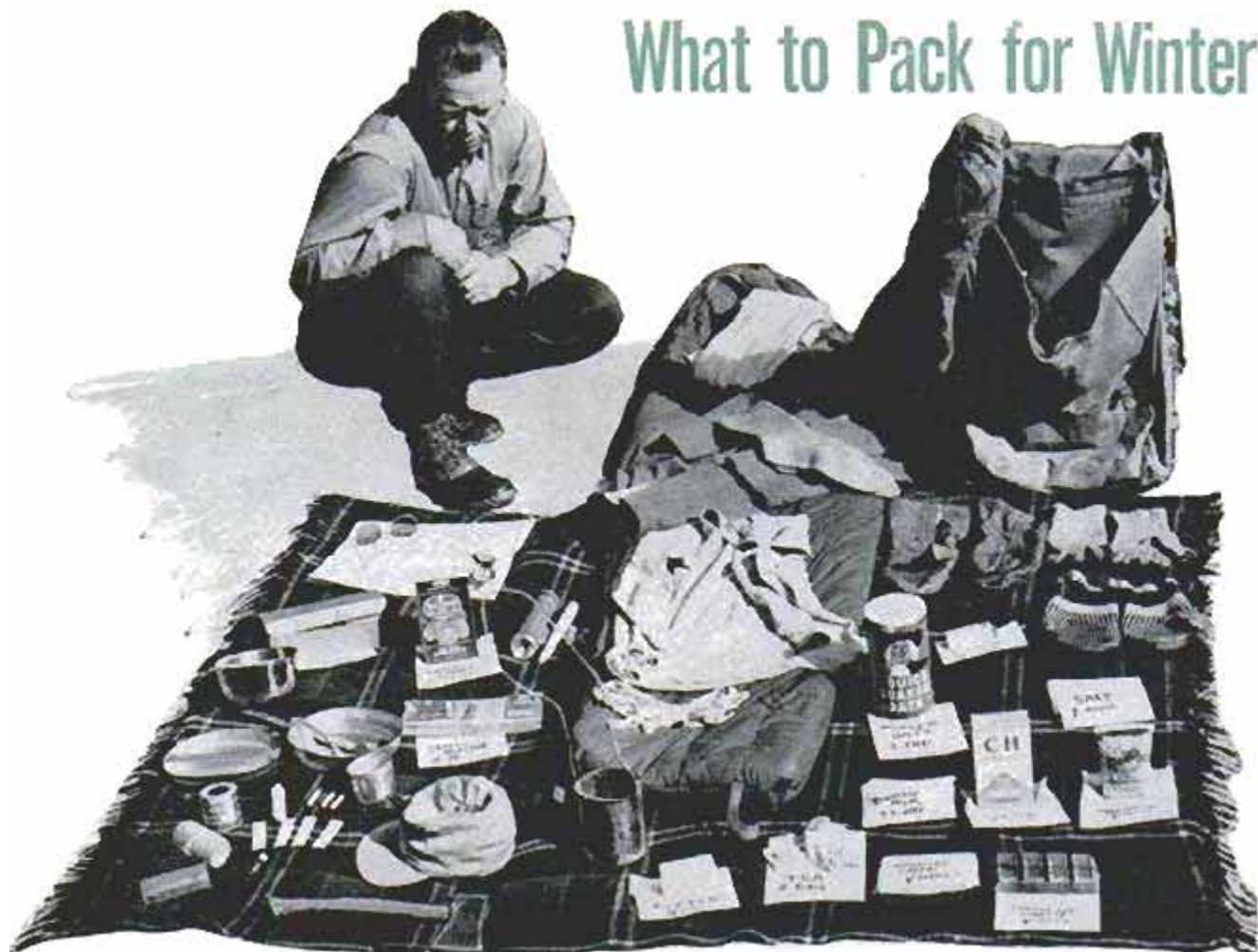

WHAT EQUIPMENT will you need for a winter day's camp in the wilderness? Readers have asked us to give a detailed list of the equipment in this ranger's kit, shown in the photograph which appeared originally in the January article, "Stay Alive in the Great Outdoors," by James Joseph. Here are the specifications for the ranger's full winter field kit. Food portions are for one day; for longer trips multiply by the number of days, and vary the menu.

## Ranger is wearing:

- Medium-weight khaki shirt
- Woolen trousers
- 2 pairs woolen socks
- 8-inch snowshoe pacs
- 2-piece woolen underwear

## He carries:

- 2 pairs woolen inner-liners for gloves
- 1 pair of leather mittens
- 2 pairs of woolen socks
- Change of two-piece woolen underwear
- Nylon poncho
- Long-billed cap (Perhaps also a woolen cap)
- Water-repellent parka which should fit over pockets and hips
- Trapper Nelson or traditional rucksack
- Light down sleeping bag

## Miscellaneous:

- Pocket compass
- Pair of dark glasses
- Map of country he's camping
- Hand ax
- Flashlight and extra batteries
- Candle
- Waterproofed matches (dipped in paraffin)
- Waterproof matchbox
- "Billy" can with wire handle (from quart can)
- Pocketknife
- Pitchwood for fire starting
- 30-foot nylon cord for erecting shelter, binding windbreaks

## Medical:

(No first-aid kit. Individual items easier to pack)

- 2-inch adhesive tape (for sprains, blisters)
- 2 or 2½-inch elastic restrictive bandage
- Triangular bandage (for arm slings)
- 2-inch roll of gauze
- 4 capsules of Merthiolate
- Stick of lip medication
- 4-6 small prepared bandages
- Toilet paper

## Utensils:

- 1 frying pan with collapsible handle
- Standard Boy Scout or Army mess gear, with knife, fork and spoon
- 1 set of nesting cups
- Quart pot (optional)

## Food:

(Portions shown are for one day of camping. Multiply by the number of days out and vary the menu)

- ½ pound sliced bacon
- ½ pound dried fruit
- 4 ounces salted crackers
- 4 ounces butter (optional)
- 6 tea bags
- 4 ounces American cheese
- 4 ounces sweet chocolate
- 3 ounces powdered milk
- 4 ounces sugar
- 1 cup rolled oats
- 1 ounce salt
- 2-6 bouillon cubes



## Manhattan in Miniature To Take World Tour

In nine years, Miller has built 185 miniatures of major downtown-Manhattan structures. Four more years are needed to complete his project



Guy Cleveland Miller wants to take Manhattan Island and all of its 58,503 buildings on a world tour. Since the real thing isn't portable, he's building a scale model. Working from sketches, photographs and memory, he has completed 185 of the more difficult downtown structures in nine years of steady effort. He estimates it will take another four years to complete the other island buildings. Materials used in construction include old boxes, real glass, water colors and balsa wood. This is Miller's second city-building project. He made his first when he was only 12 years old.



## Traffic Kindergarten Teaches Safe Driving

Impressed by the rising automobile accident rate, authorities in the French sector of Berlin have established a permanent traffic kindergarten as a regular part of the school curriculum. Toy automobiles and bicycles are driven through a miniature street layout, and pedestrians as well as drivers receive instruction from regular West Berlin traffic policemen. Traffic lanes, sidewalks, main and side streets simulate actual conditions. One corner of the 4000-square-yard area is equipped with chairs, desks and blackboards so that lectures may be given by the policemen.

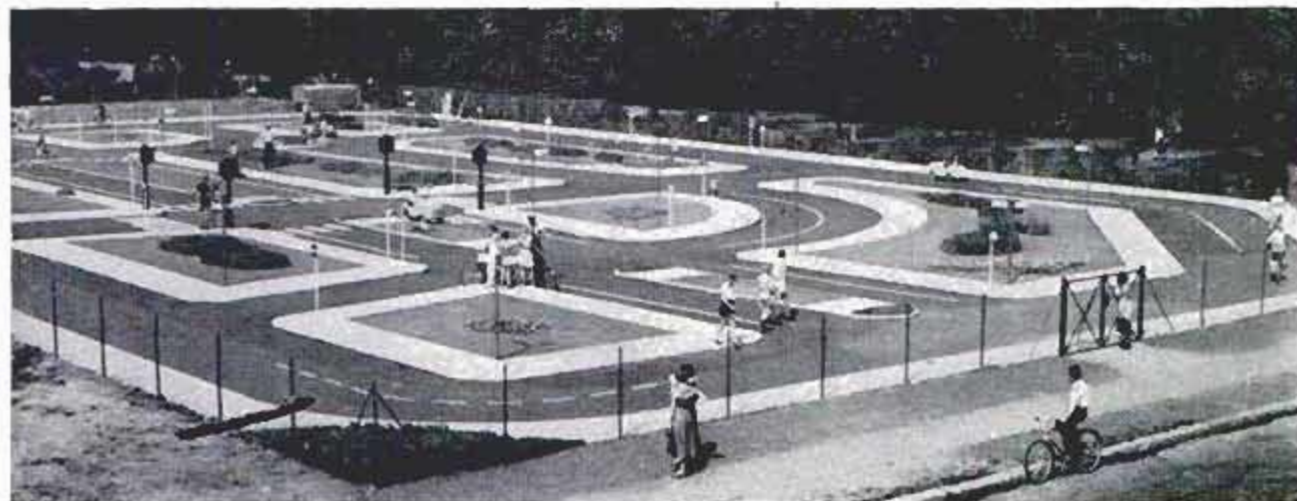

## Unit Serves Five Ways

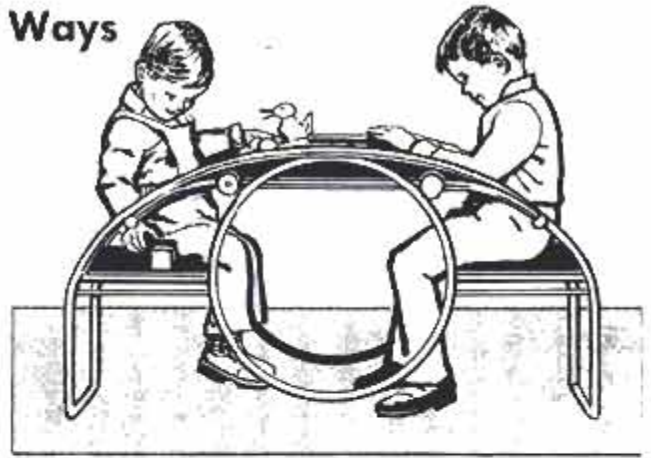
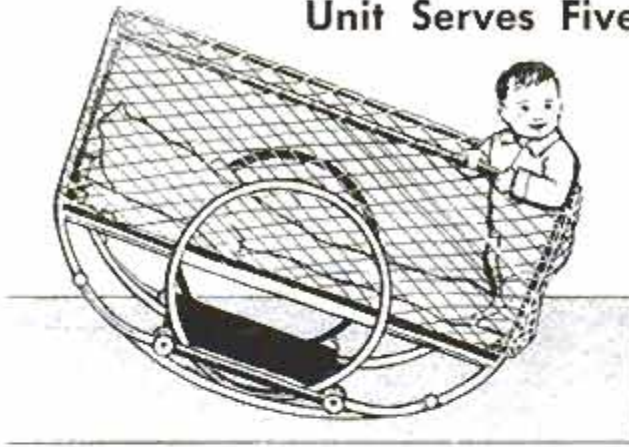

Five different functions are performed by a piece of furniture which "grows with the child." Its curved tubular-steel framework makes it ideal as a cradle. Retractable legs are turned down to make it into a

bed. Later, simple adjustments make it into a rocking toy with seats for two. Turned upside down, the toy is a chair and a table for two. When the child is grown, the table becomes a flower and knickknack stand.

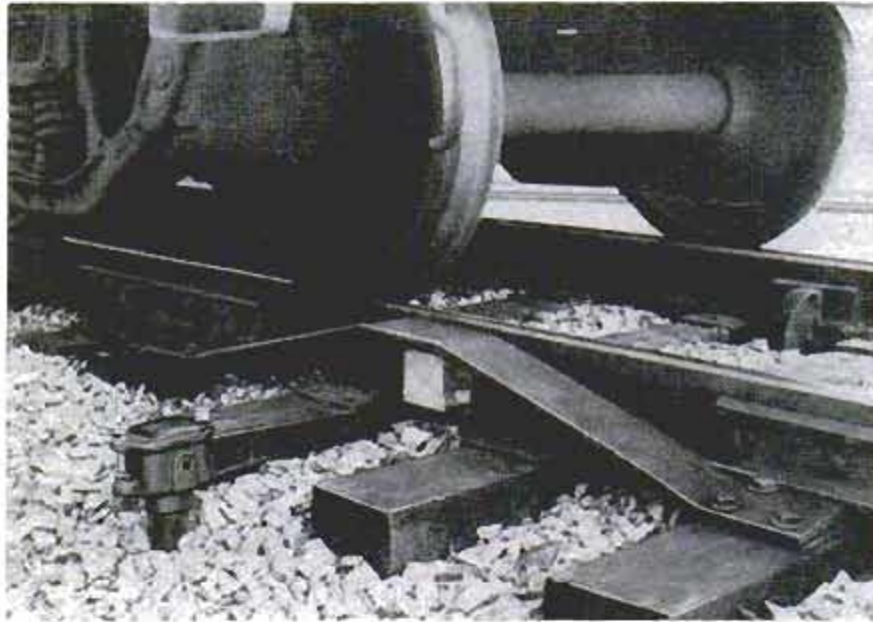

## Freight-Car Scale Signals Retarder

Freight cars coasting toward the master retarder in a classification yard are weighed by a small device attached to a rail section. It sends signals to the retarder which slows the car to the proper speed. Three settings—under 35 tons, 35 to 55 tons, and above 55 tons—determine how much pressure is needed to slow the car. The system frees the yard operator from any necessity of controlling the retarder.

## Aluminum Framework for Tent Does Away With Ropes and Poles

You need no ropes or poles to support a tent that has a lightweight aluminum framework. The framework is slipped together in minutes without the use of tools. Since there are no center poles, there is

more living space within the tent. Once erected, it can be moved by two men to a new site without dismantling. The folded tent and disassembled framework easily fit into a duffel bag.

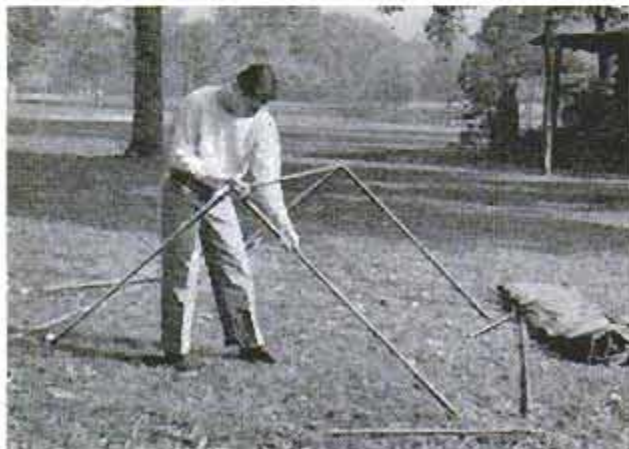

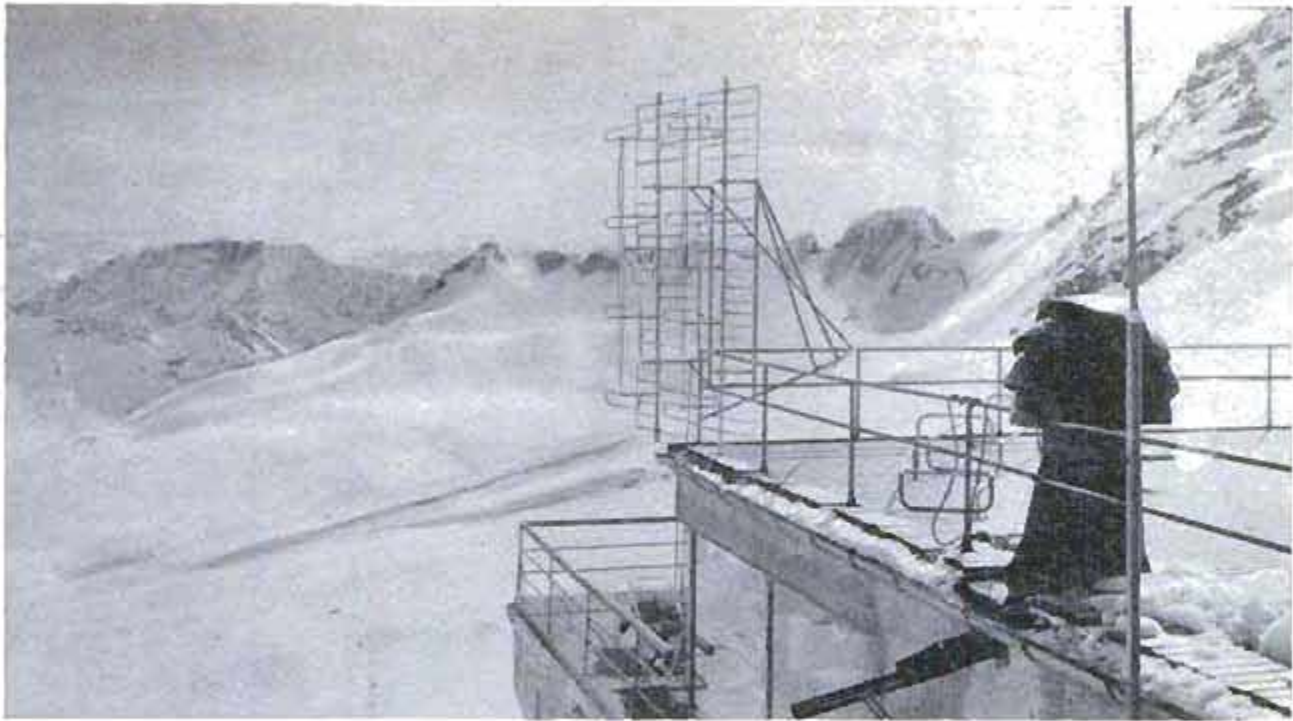

Located atop Germany's highest mountain, this TV antenna picks up clear pictures from transmitter 68 mi. away

## Mountain-Top Television Room

Sportsmen visiting the "Schneefernerhaus" atop Germany's highest mountain, the Zugspitze, can now enjoy television in the evening after skiing for the day is finished, thanks to a new antenna installation designed for the spot. Despite the mountainous terrain clear pictures are received from a transmitter 68 miles away. To achieve this, the receiving antenna had to be aligned perfectly with the transmitting antenna.

Weary skiers relax and watch television in the lounge of the "Schneefernerhaus" after day of strenuous activity in the Alps



## East German Front-Wheel-Drive Car Has Plastic Body

With its engine mounted ahead of the radiator, a small East German car, the P70, has an all plastic body. The two-cylinder

engine is mounted crosswise directly behind the front bumper. It drives the front wheels. Top speed is 56 miles per hour.

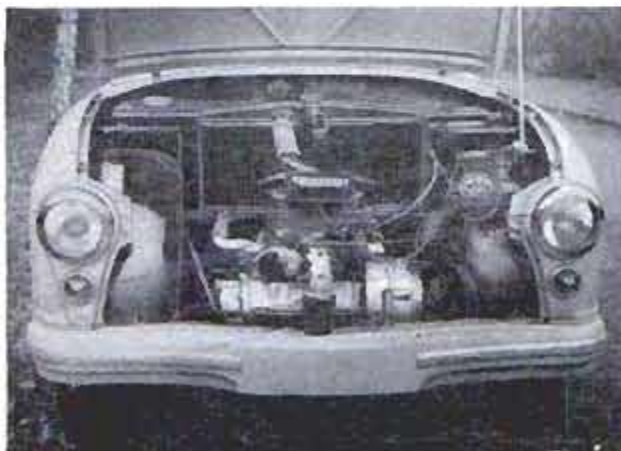

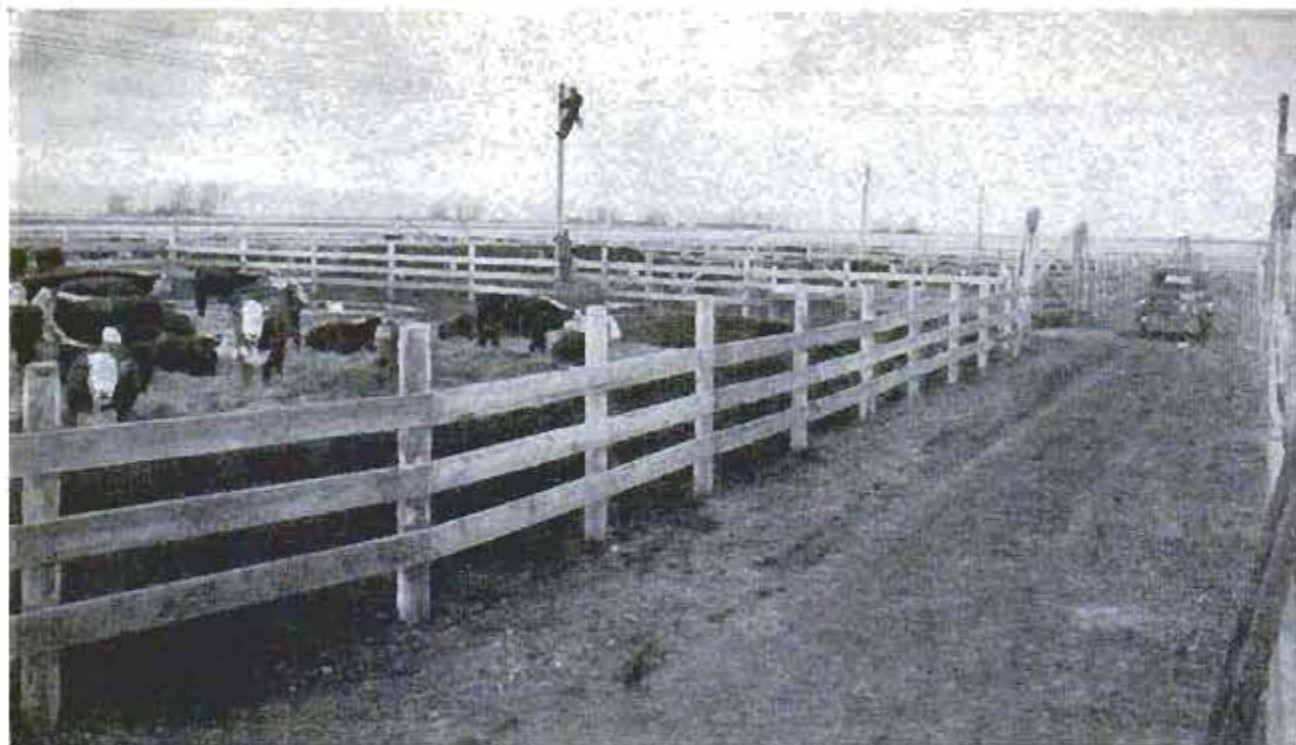

Man on a power pole symbolizes this electrified farm in Idaho, where 20 motors streamline the chores

## Electric Farm Hands Take Over the Chores On a 400-Acre Farm

Clogging is avoided in the feed mixer by an electric heating system that keeps the molasses flowing

By Rafe Gibbs



**T**WO SHOVELS leaning against a barn of the Meyers brothers' place near Sugar City, Idaho, stand like symbols. The brothers, Marvin, 49, and Wayne, 48, have one of the most electrified farms and stock-feeding enterprises in the West, and they don't have much use for shovels any more.

To see the Meyers place is to see the *new* West . . . a West that has tamed its bucking rivers with dams, and now rides their bridled horsepower. On the Meyers' 400 acres of intensified production are more than 20 different electrical motors—none for frills, all for better farming. There are also two electrical heating systems; one for warming the water in stock drinking troughs, the other for heating molasses before mixing it in feed.

We talked with another farmer in the county.

"Yes," he said, "Marv and Wayne run an efficient place. I'm glad, though, I don't get their electric bills."

Although the farm at the time had a con-





Wayne and Marvin Meyers stand at nerve center of their electrified farm, where 260 horsepower is harnessed

nected load of 260 horsepower, those bills — even in the peak months — totaled no more than \$100 to \$145. And the man-hours, the money saved. . . .

The Meyers brothers annually fatten some 25,000 head of sheep, 2000 head of cattle. That means a lot of water is needed and, as portable sheep pens are constantly being moved, all water to the sheep is hauled by truck. The brothers started out with a 1½-horsepower motor pumping from an old well, but it took 45 minutes to fill a 900-gallon tank on a truck. Two men and two vehicles were needed to haul water. This was too slow and too expensive.

The brother-partners — a slim, sandy-haired, high-voltage unit in themselves — dug a new well, and installed a 1000-gallon pressure tank and a pump with a 10-horsepower motor. Now only one man and one truck are needed to haul water. We held a watch as the truck driver filled his 900-gallon tank. Three minutes flat. Cost of electricity for filling that tank was about 1½ cents.

The farm has water pressure (60 pounds per square inch) equal to that of many small towns. It has a cart with 350 feet of hose connected to a ¾-inch nozzle that shoots water 100 feet in the air. In 30

Three minutes is all it takes to fill a 900-gallon stock-watering tank when water is electrically pumped from pressure tank



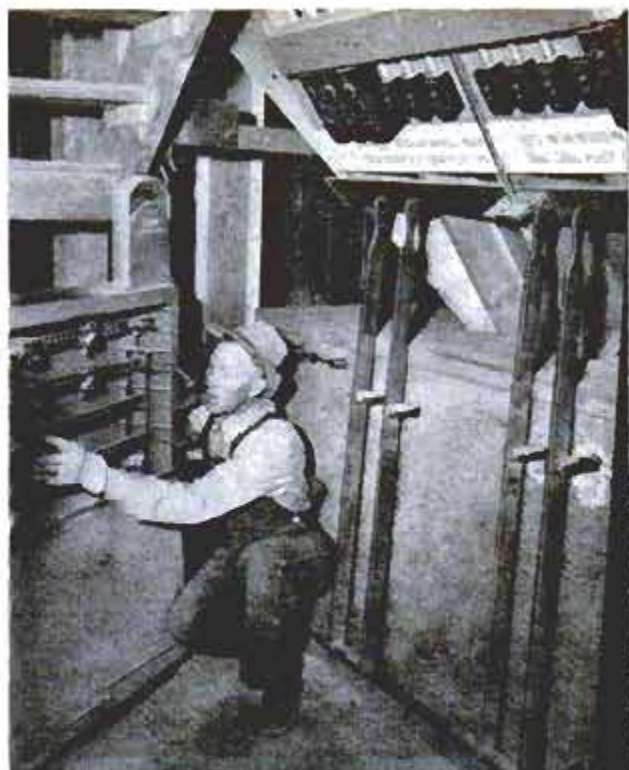

At the left, a portable worm takes the place of shovels in handling grain. Above, automatic scale weighs grain for mixing. Push of button does the rest

seconds, a stream of water could be poured on a fire any place in the barnyard.

Insurance companies figure 90 percent of major-loss farm fires could have been put out with minor damage if city-hydrant water pressure had only been available. It is on the Meyers farm.

Studies conducted by the University of Idaho college of agriculture showed that stock gains on chopped alfalfa averaged 12.1 percent greater than on long alfalfa. Playing the percentages on the 2000 tons of hay they feed annually, the Meyers brothers decided in 1946 to install a big-scale chopping system.

Soon purring on the farm were a three-horsepower motor for dragging baled hay into a breaker, a 15-horsepower motor for breaking the bales, a 100-horsepower motor for chopping the hay, a 30-horsepower motor for blowing the hay into a shed, and a 7½-horsepower motor for operating a "worm" to draw the hay into a scale hopper.

Inspired by the success of the hay chopping, the brothers determined the next year to eliminate entirely hand-mixing of feed. They were tired of shoveling in the granaries — breathing and eating dust — guessing wrong on feed proportions and watching sheep die as a result of that guessing. Death losses were running about three percent.

More motors came to the Meyers place, and it now has the nearest thing to push-button farming. One man flicks switches and pulls levers, and the mixing is done.



**No job is too small to be done by electricity, as long as Meyers brothers can see it will save manpower**

It's as easy as that. The ingredients, from grain to sugar-beet pulp, are automatically weighed, and the proportions are right. Death losses, as a result, were cut to 1½ percent.

A huge magnet pulls out any metal particles that may have gotten into the feed. A blower shoots the feed into second-story bins. Top-hinged doors on the side of the barn swing open to let the feed pour into

a truck for transporting to the livestock.

Blending of sugar-beet molasses in the mix in January was literally a sticker until the Meyers installed an electric heater. Now the molasses flows freely with the temperature outside below zero.

With all the various switches to operate in the mixing shed, one would think that sometimes the wrong switch would be

(Continued to page 234)

**Some secondhand pipe, a ½-horsepower motor and a little ingenuity provided farm with gasoline pump**



**Automatic waterers for cattle are heated in winter to prevent ice. Cattle feeding is year-round business**





*Lachlan MacLeay*, 162 feet long and 45 feet wide, has a draft of 5½ feet, plies between St. Louis and Omaha

## Missouri River Towboat Destroys Sand Bars

WHEN A SAND BAR blocks her way, the newest and most powerful towboat on the Missouri River digs her own channel. Normally the *Lachlan MacLeay* pushes her barges. But she can move up front to wash a sand bar away with her four propellers, each driven by a 900-horsepower engine.

Huge rudders under her stern increase her maneuverability. Four main steering rudders, each 5 feet high and 10 feet long, aft of the propellers, are used when the boat is moving forward. Six flanking rudders

forward of the propellers are used in backing.

The boat has a draft of 5½ feet, one foot less than the shallowest parts of the channel between Omaha and Kansas City.

The boat, 162 feet long and 45 feet wide, is part of the Federal Barge Lines fleet. She can handle tows as long as 1000 feet and as wide as 105 feet, weighing 10,000 tons. A unique feature of the *MacLeay* is the arrangement of her four stacks, placed side by side behind the pilothouse.

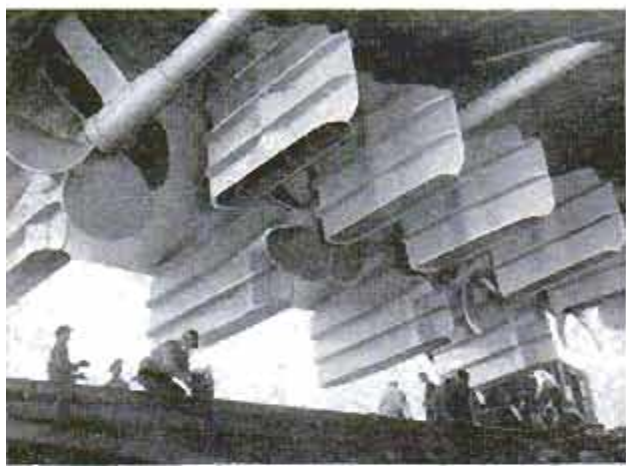

Four main steering rudders, left, aft of propellers, are each about 5 by 10 feet. Six forward rudders are used when boat is backing. Below, boat can handle line of barges 1000 feet long, 105 feet wide. Four stacks side by side behind pilothouse vent engines

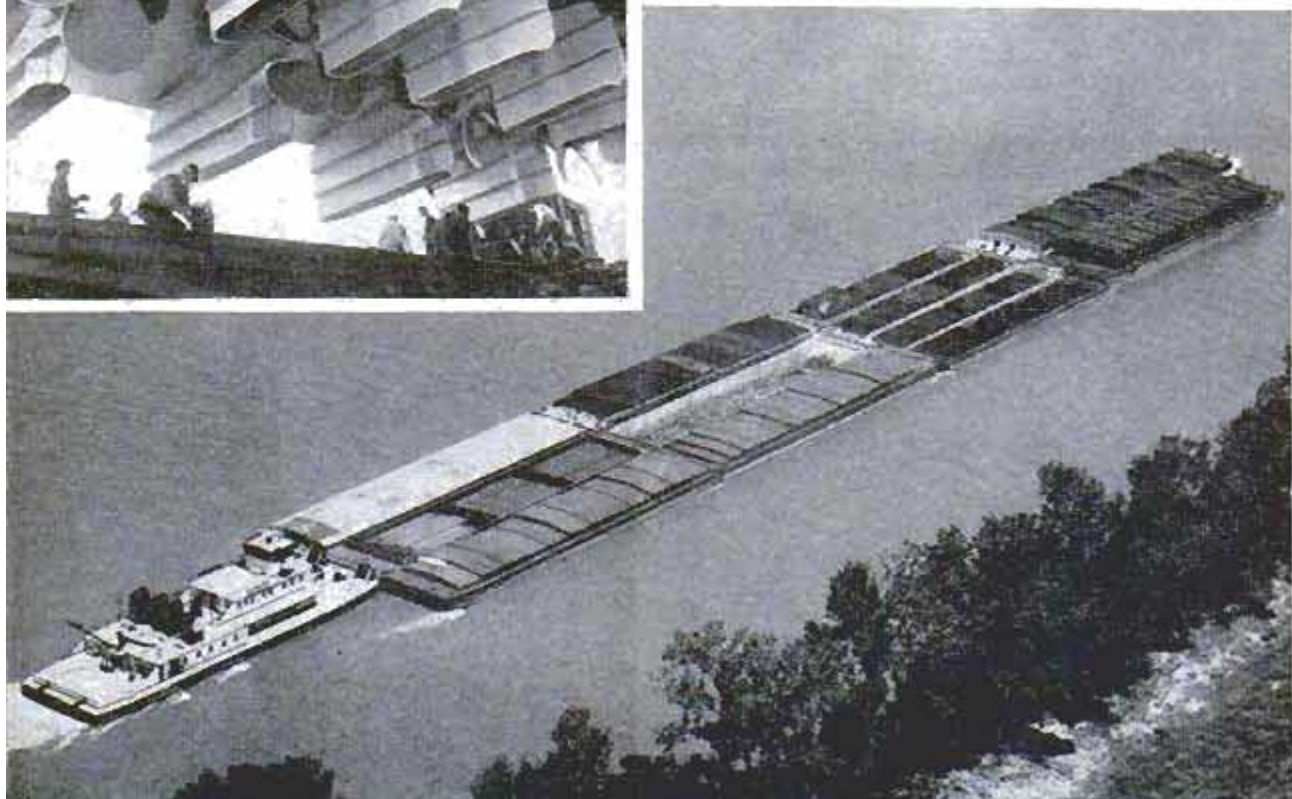

## Piggyback Truck

Low bridges over the right of way don't bar the rail transport of a German truck trailer designed for piggyback hauling. It doffs its wheels once it has been driven onto a flatcar. Hydraulic legs fitted to the box of the trailer lower it to within a few inches of the car floor. The undercarriage is nested together at the rear of the trailer.

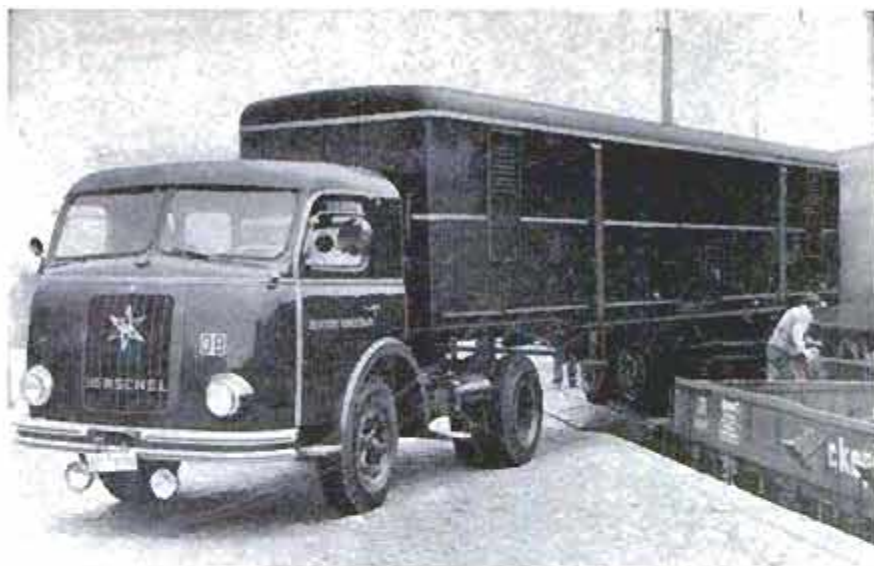

## Torpedo Transistor

Transistors replace vacuum tubes in an ultrasonic control system that "homes" a torpedo in on its target. The compact, rugged transistors, unlike tubes, do not require a separate source of high-voltage power but operate directly on the low voltage of the torpedo battery. Their power requirement is  $\frac{1}{10}$  that of tubes. The transistorized control dispenses with the usual 30-second warm-up period.

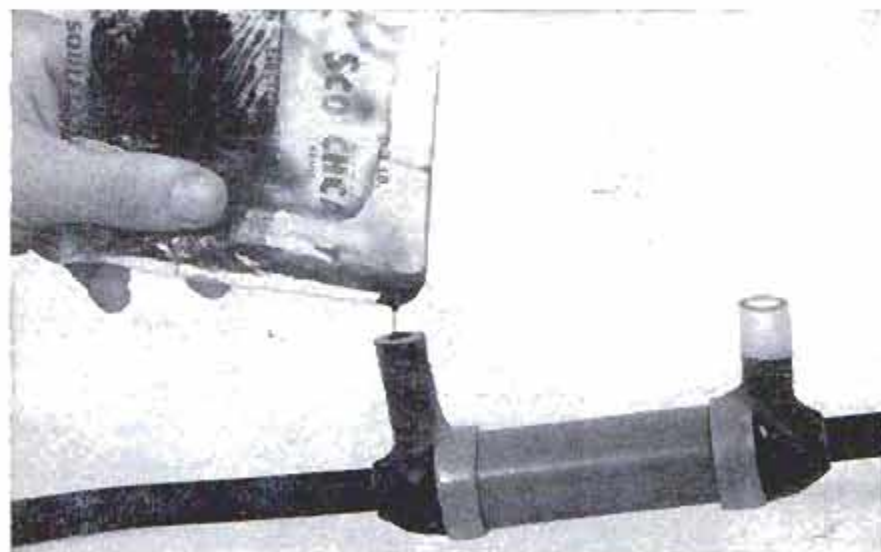
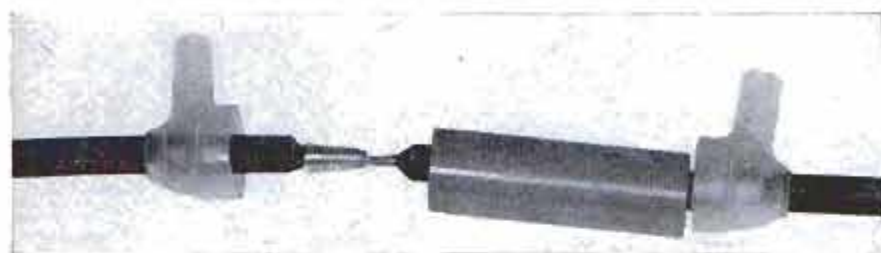

## Splices for Cables Come in Kits

Factory-perfect cable splices, hermetically sealed in epoxy resin, can be made in the field with a splicing kit produced by the Minnesota Mining and Manufacturing Co. The kit contains spring electrical contacts to make the actual splice, a three-piece plastic mold and a plastic bag containing the resin and a hardener. To make the splice the wires are connected by the contacts, the mold is placed around them, and the resin, mixed with its hardener in its own bag, is poured into the mold. The resin hardens in 5 to 15 minutes. The splice is said to be completely weatherproof.

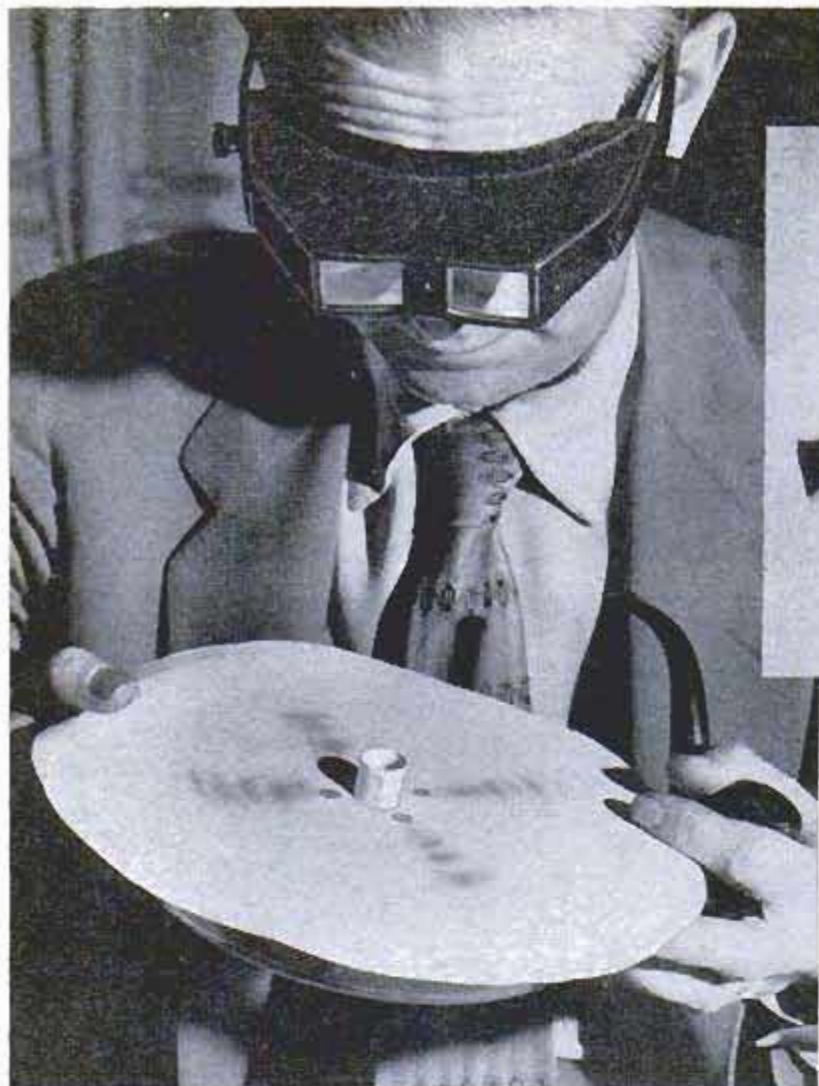

Paper-chromatography sheet shows various patterns made by different inks as they spread out from center

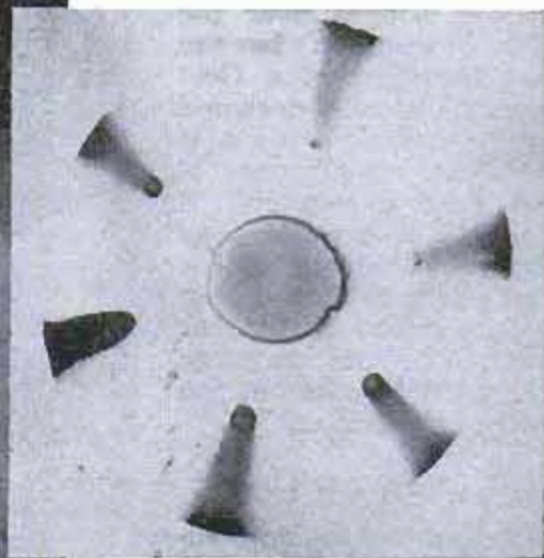

## Crime Detectives *Solve* Chemical "Fingerprints"

By Thomas E. Stimson, Jr.

Here is how chromatography sheets are made. Solvent drawn up from reservoir by cylindrical wick spreads across ink spots to separate each into bands. Below, Kirk and his ink and ball-point-pen samples



**N**EW TOOLS for catching criminals are being perfected at the University of California.

Two techniques now allow quick and easy identification of various substances, and can be used even by small police departments not equipped with crime labs.

They have the cumbersome names of "paper chromatography" and "paper electrophoresis." Used principally by biochemists, they are being adapted to the field of crime detection by Dr. Paul L. Kirk, professor of criminalistics at U.C.

By means of paper chromatography a criminologist can scrape a tiny sample of ink from a document, then quickly compare its "fingerprint" with another sample to learn if the two are identical. The method takes advantage of the fact that an ink spreads out into colored bands or lines when mixed with a solvent and placed on filter paper.

One black ink may separate into characteristic red, blue and yellow bands, for instance, while another ink that appears identical may produce entirely different gradations of color, depending upon its ingredients. Of two dyes in an ink, one is more solvent than the other, hence is transported a greater distance on the filter paper. Butyl alcohol is a common solvent. Water, phenol, acetone and ammonia also are used as solvents.

Paper electrophoresis is similar except that the solvent is allowed to creep downward on a sheet of filter paper at the same time that an electric current flows across the paper. The current makes a sidewise distribution of the materials carried by the solvent, forming a characteristic pattern of bands or spots. Distribution is based on the tendency of particles to migrate in directions depending on their electrical charge. Doctor Kirk uses the method to compare samples of such substances as dried blood, paints, metals and various poisons, even in tiny amounts.

Studies of inks include ball-point inks, mimeograph inks, typewriter ribbons and even printing inks. There is a hint that the comparative ages of inked writing can be determined even though made with the same ink.

Another field that Doctor Kirk is investigating is the possibility of identifying a person from a sample of his blood, even though dried. The pattern of disease and infection on the blood antibodies appears to be different in each person. It is already possible to show the difference between two persons by means of blood samples and Doctor Kirk expects that ultimately a person's blood will serve to identify him just as precisely as do his fingerprints. ★ ★ ★



Electric current flows across filter paper in the electrophoresis method, separating the ingredients

Ink pattern produced when solvent was allowed to flow across ink samples consists of various colors

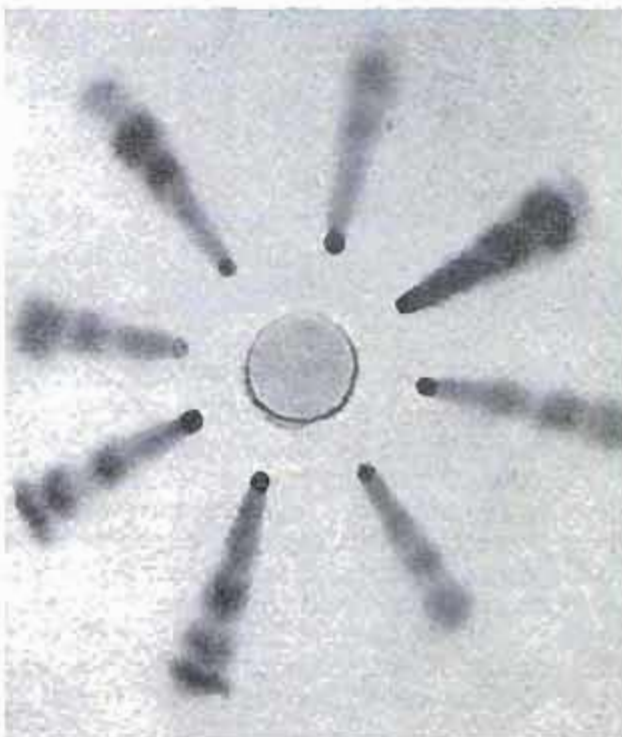

## Truck Trailer Has Sliding Roof For Overhead Loading

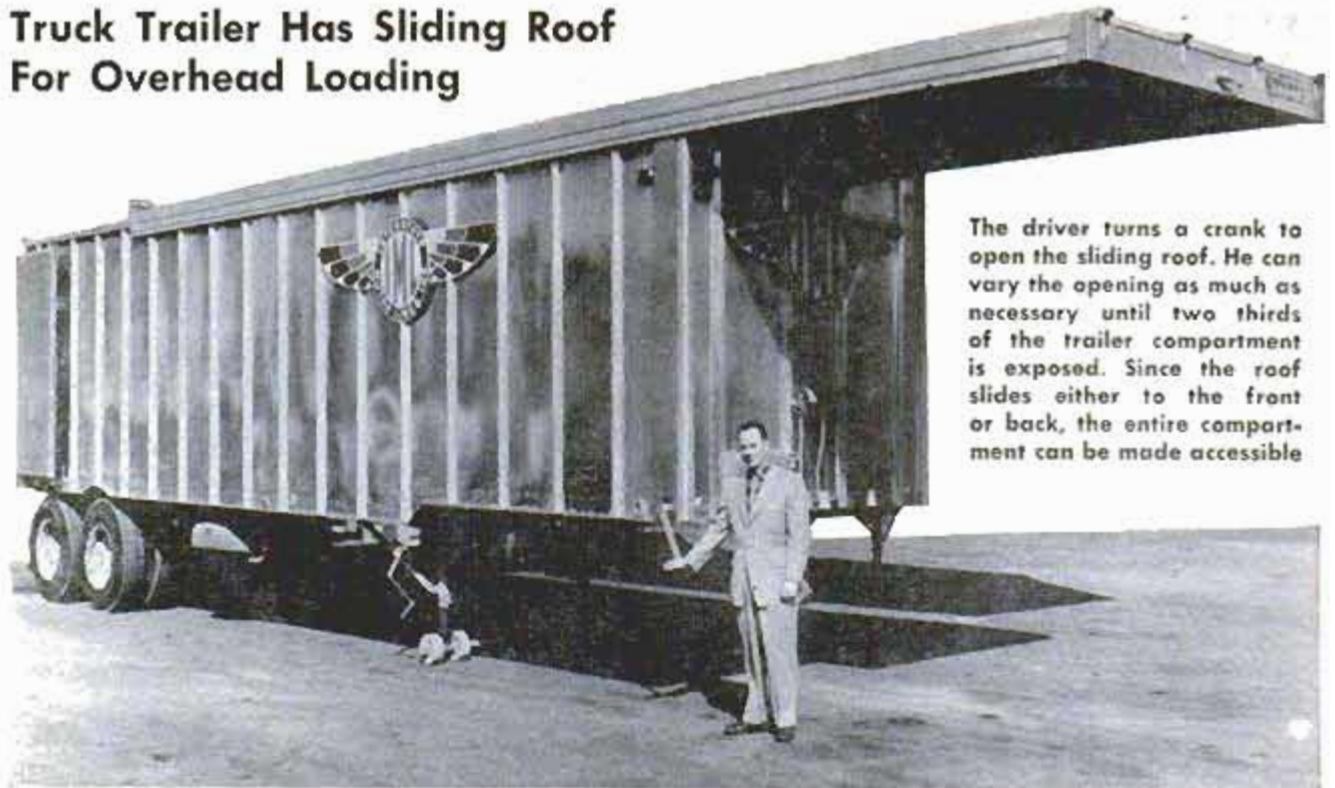

The driver turns a crank to open the sliding roof. He can vary the opening as much as necessary until two thirds of the trailer compartment is exposed. Since the roof slides either to the front or back, the entire compartment can be made accessible

With the top of the trailer cranked open, a crane can be used for large, heavy cargoes

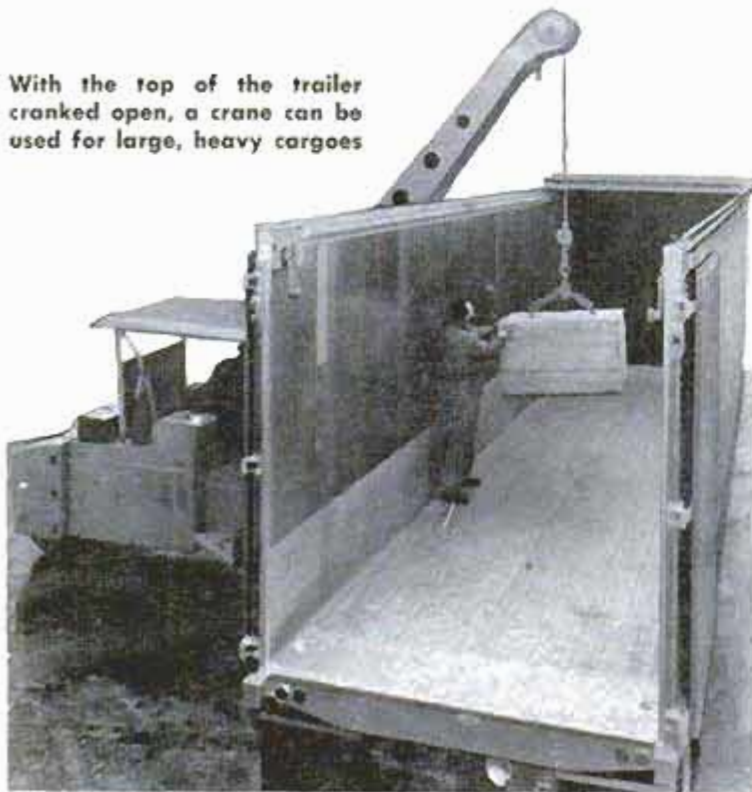

Like the top of a crayon box, the entire roof of a new kind of truck trailer can be slid forward to permit easy loading from above. With the top open, a crane can be used to swing machinery, large crates and other bulky objects into the trailer. To operate the sliding roof, the driver turns a crank at the front of the trailer. He can stop the roof at any point and can extend it until as much as two thirds of the trailer compartment is exposed. The roof also can slide toward the back, opening the front of the compartment. The trailer is weatherproof when the roof is closed because the roof overlaps the slide runners, making a weathertight seal. Loading heavy cargoes by crane, as compared with loading through a side door, is expected to reduce trucking costs by cutting down on time spent in loading and unloading trucks.

## Telephone Cable to Hawaii

California and Hawaii will be connected for the first time by telephone cable when a \$35,000,000 project is completed in 1958. The twin cable, the world's longest, will have three times the capacity of the present radiophone circuits. It will allow 36 simultaneous conversations. Amplifiers built into the cable at 40-mile intervals will boost the signals. A start is being made this year on a similar cable between Port Angeles, Wash., and Ketchikan, Alaska.

## Scientists Make Synthetic Virus

University of California scientists recently announced that they have achieved the first partial synthesis of a virus, which may be a major milestone in the fight against virus diseases. Taking inert fragments of viruses, they put them together to form active viruses capable of causing rampant disease. Using this method, it may be possible to "tailor make" viruses which are capable of imparting immunity and yet incapable of causing disease.



# KEEPING UP WITH THE ATOM

**S**CIENTISTS at the University of California at Los Angeles have established a "clearing house" to sift information on the atomic nucleus from laboratories all over the world. Human and electronic brains process the information. The studies indicate that the nucleus does not have a sharp edge. Dr. David Saxon, who directs the group of physicists, compares the nucleus to a ball of yarn with a very fuzzy edge, or to a cloud whose trailing edges gradually disappear into the blue. He describes the assault on the atom with cyclotrons and other instruments as "like trying to determine the shape of a house in the dark by bouncing tennis balls off it. Neutrons and protons fired by these atom smashers are like luminous tennis balls. By noting the way the balls bounce we are beginning to get an idea of the shape of the atom's core."

This basic research will provide a foundation for applied engineering in the future. For example, the Army is looking for a way to power huge overland trucks with atomic energy. Most likely use for the trucks would be to haul a string of trailers in a "land train" to supply bases in isolated areas. One engineer estimates the atomic engine for such a truck would have to be 10 feet wide and weigh about 100 tons. Shielding to protect the crew would account for much of this size and weight.

Protection of personnel got a boost on another front with the development of a rubber head (above) by General Electric

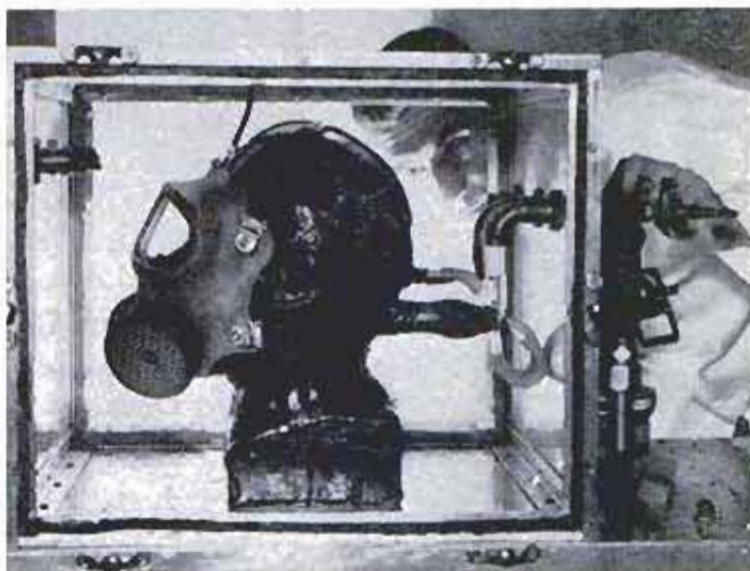

scientists to test face masks which protect atomic workers from radioactivity. Pumps fitted to the head "breathe" through the mask. A filter inside the rubber windpipe collects any radioactive particles that manage to get through the mask. In this way the mask's efficiency can be tested.

Further protection for workers is provided by what is probably the world's "hottest" safe (below, left). Built at the Hanford, Wash., plant, the safe is a 15-ton cylinder. The floor vault is used to store "hot" samples of uranium which have been subjected to chain reaction in a plutonium-producing reactor. The samples are stored on cylindrical shelves under a steel lid 10 inches thick. When a worker wants a sample, he turns a wheel which rotates one of the shelves below him. This brings the

desired sample in line with an access hole. A one-ton lead cask then is placed over the hole, and a claw mechanism seizes the sample and lifts it into the cask.

Radioactive materials—in tracer amounts—are now being used to tag insecticides. Some stubborn insects have resisted all the new insecticides. By using the tracers, scientists can follow the course of an insecticide through the insect's body. This research yields clues as to how an insect can convert a poisonous substance into a harmless one. Scientists then may be able to develop poisons that the insect can't resist.

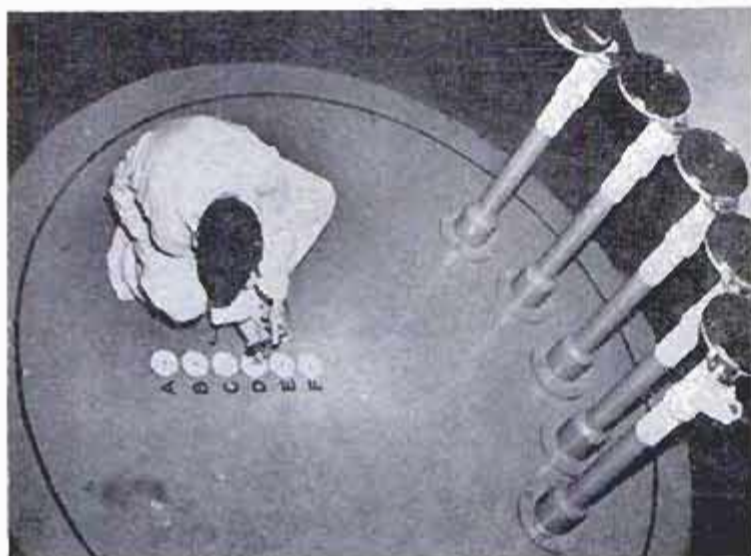

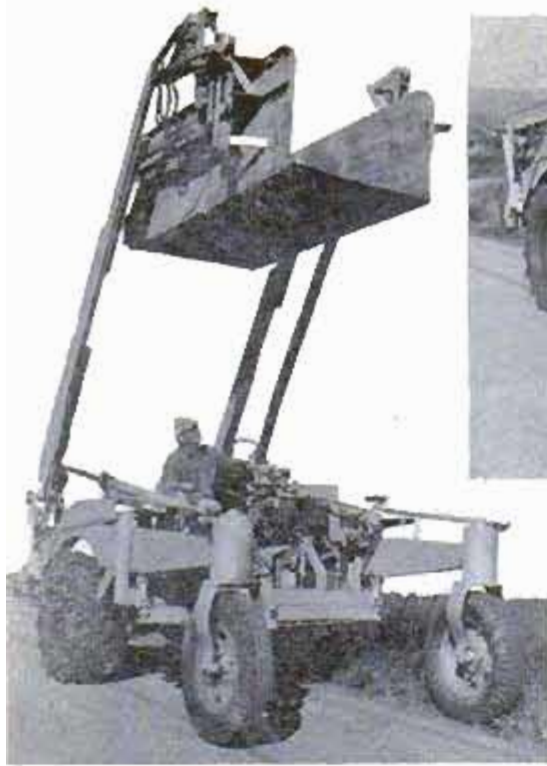

With a dump body attached, the machine can lift 2¼ tons and load it to any height up to 14 feet. The 80-inch tread of the versatile machine is designed to fit between rows of particular crops the inventor cultivates

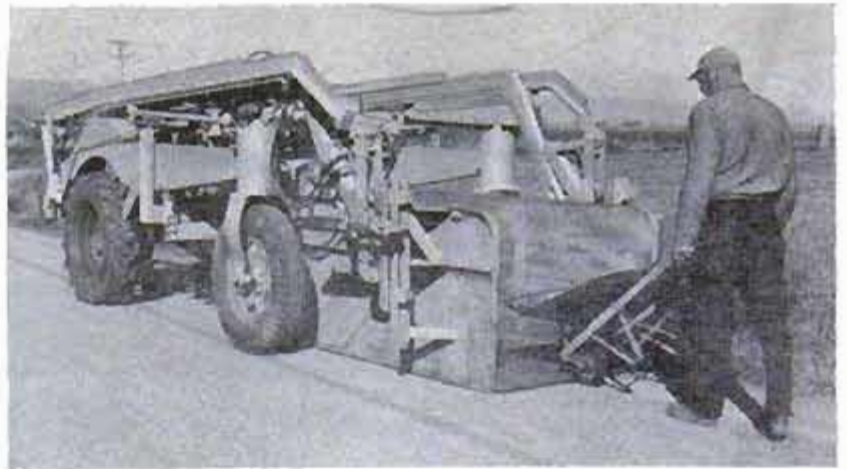

## All-in-One Farm Machine

Almost any job around his farm is easier for Donald E. George of Greenfield, Calif., now that he has built a versatile, all-purpose machine. The machine combines the functions of a tractor, dump truck, lumber carrier, spray rig, cultivator and harvester. It also may be used as a fork lift or fitted with a bulldozer blade. A rear-mounted 1937 Plymouth engine powers the machine. Two transmissions and a two-speed rear end provide 38 forward speeds and 10 speeds in reverse. The machine operates at 1/3 to 20 miles per hour.

## Attachment Enables Camera to Shoot Pictures From Three Sides

You can make intentional double or triple exposures with an attachment that fits on the lens of a still or movie camera. The objects to be combined are placed at either side and at the front of the unit. In-

side are two one-way mirrors, so placed that rays of light from all three sides pass through them and are reflected into the camera lens. A view finder on top shows when to shoot.

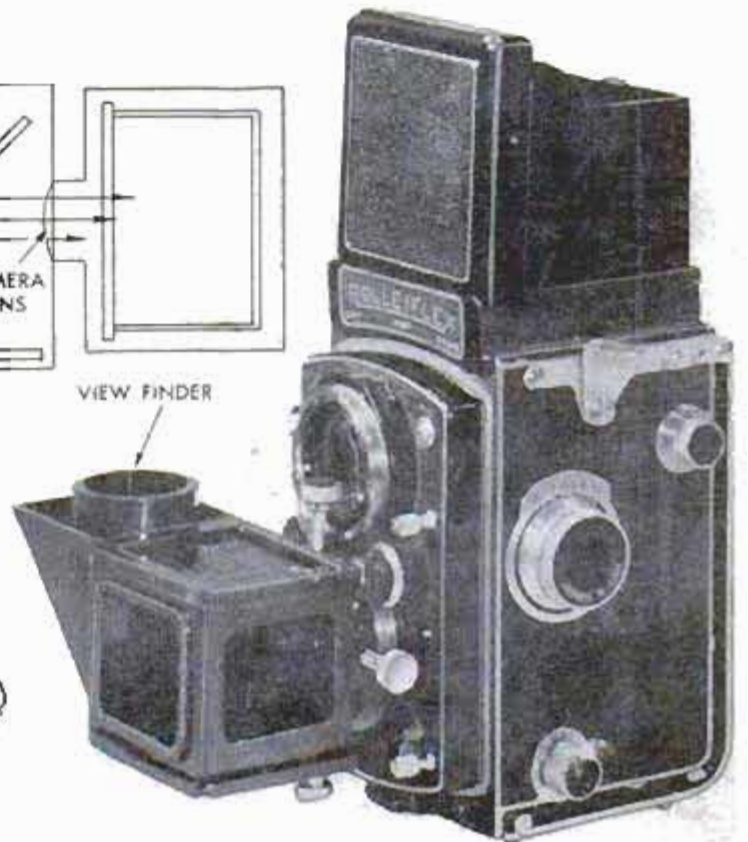
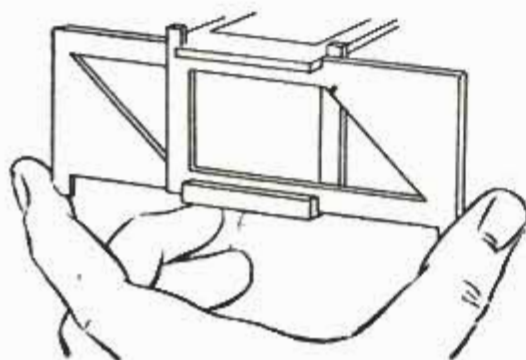
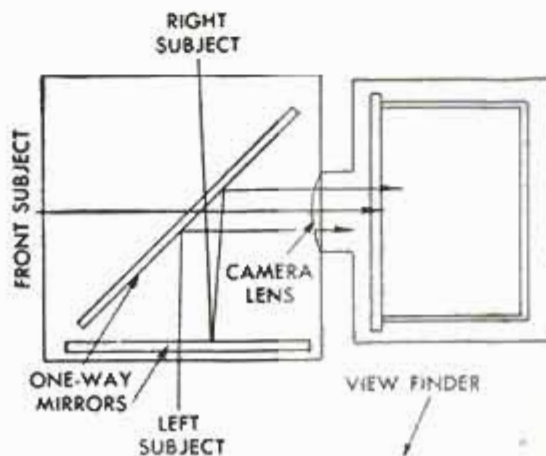

# RADIO *Television* ELECTRONICS

## Build Your Own Hi-Fi Speaker Enclosure

By Lothar Stern



WHILE THE PHONO cartridge, the amplifier and the loud-speaker represent the "meat" of any high-fidelity music system, the speaker enclosure certainly adds the "flavor." Like a well-balanced meal, which would taste flat without salt and other seasonings, even the finest hi-fi system sounds lifeless and unnatural unless the speaker is properly housed and baffled.

The enclosure is more than just a housing for the loud-speaker. It actually provides the means for transferring the vibrations of the speaker cone to the surrounding air, so that the resultant sound waves are produced with maximum efficiency.

Particularly effective at the low audio frequencies, a properly designed enclosure makes it possible to hear bass tones which would otherwise be highly distorted, if not altogether lost. Thus, the enclosure becomes a vital part of the hi-fi system, one which must be engineered with the same precision as any other component.

Available in kit form, Electro-Voice line of enclosures includes a wide variety of styles to match any single or multiple-speaker combination



THE PATRICIAN



THE BARONET



THE EMPIRE



THE GEORGIAN

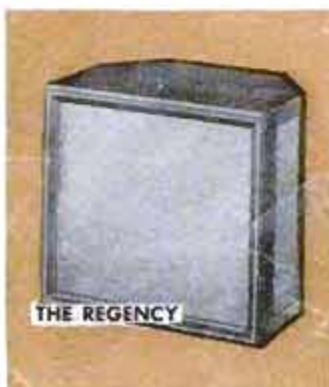

THE REGENCY



THE CENTURION

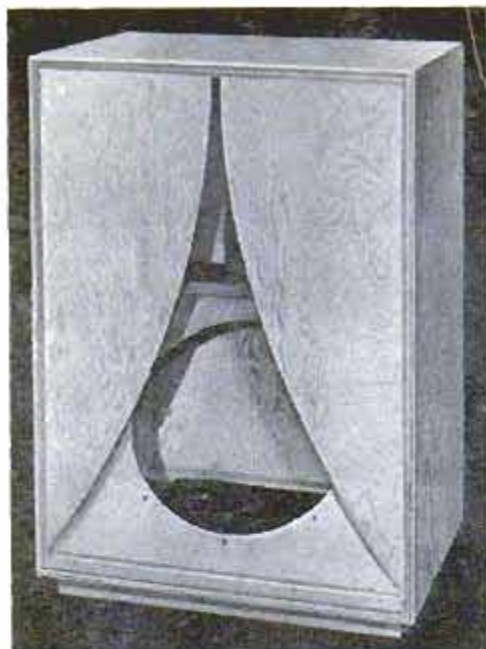

**"Karlson" enclosure shown in rough and finished form combines unusual styling with outstanding performance. Available for 8, 12 or 15-in. single or multiconed loudspeakers**



Like all other items of custom-built furniture, commercially assembled hi-fi enclosures are relatively expensive. In fact, the purchase of a good enclosure may make a sizable dent in the budget of the average music lover. Realizing this, many manufacturers have gone into partnership with the do-it-yourself fans by making their enclosures available in kit form at a tremendous saving. The manufacturer furnishes the design, materials and complete assembly instructions, while the purchaser supplies the few hours of time required for assembly of the cabinet. The kits, when properly constructed, are capable of performance comparable in all respects to their commercial counterparts.

One manufacturer of high-fidelity-speaker

(Continued to page 248)

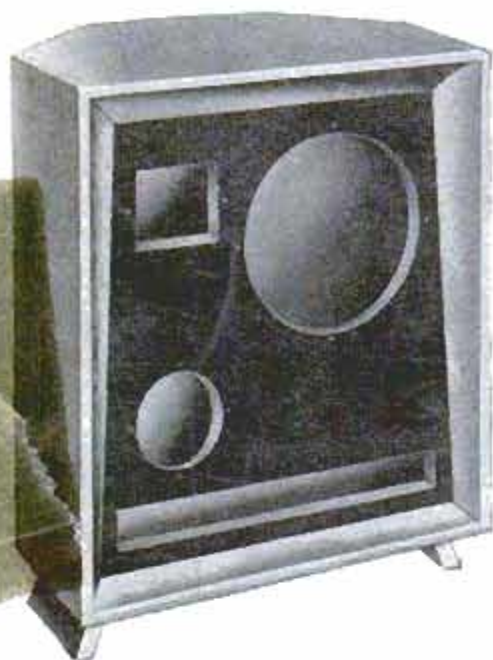

**Above: Latest enclosure kit by University Loudspeakers, Inc., White Plains, N. Y.**

**Below: Disassembled Cabinart "Rebel" enclosure, long-time favorite with high-fidelity enthusiasts**

**Below: Original Klipsch-designed "Shorthorn" corner enclosure is now available as a do-it-yourself kit**

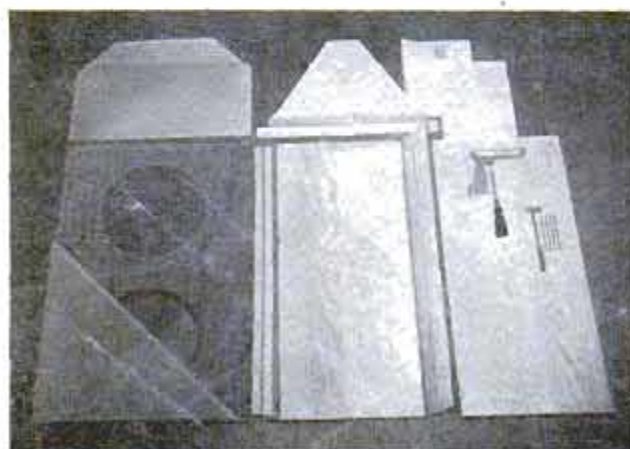

**WITH THIS** automatic on-off control you can completely forget about the operation of your humidifier or dehumidifier. In fact, the electronic switch will take over the function of turning the device on and off for any change in humidity far more efficiently than you can do yourself.

Simple to build and foolproof in operation, this inexpensive control uses a unique sensing element for the detection of humidity changes. It is well-known that ordinary table salt can readily extract moisture from, and return it to, the atmosphere. In doing this, the electrical resistance of the salt varies over a wide range. This change in resistance is utilized to control the firing of a thyatron which, in turn, closes or opens a set of relay contacts to control the external unit.

The operation of the electronic switch is explained with the aid of the schematic diagram shown on page 164. The resistor, R1, in series with sensitivity control, R2, forms a voltage divider across the a.c. line. During the positive half cycle of the applied line voltage, the cathode of V1 is more positive than the grid, which is connected to the variable arm of

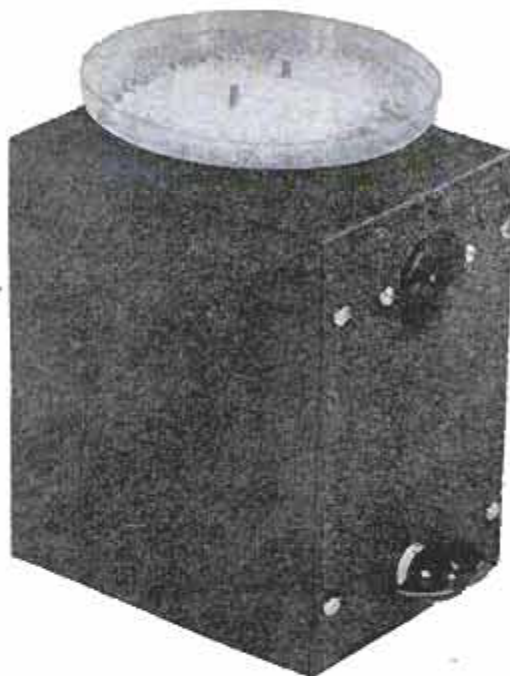

## Humidity-Controlled ELECTRONIC SWITCH

By  
James A. McRoberts

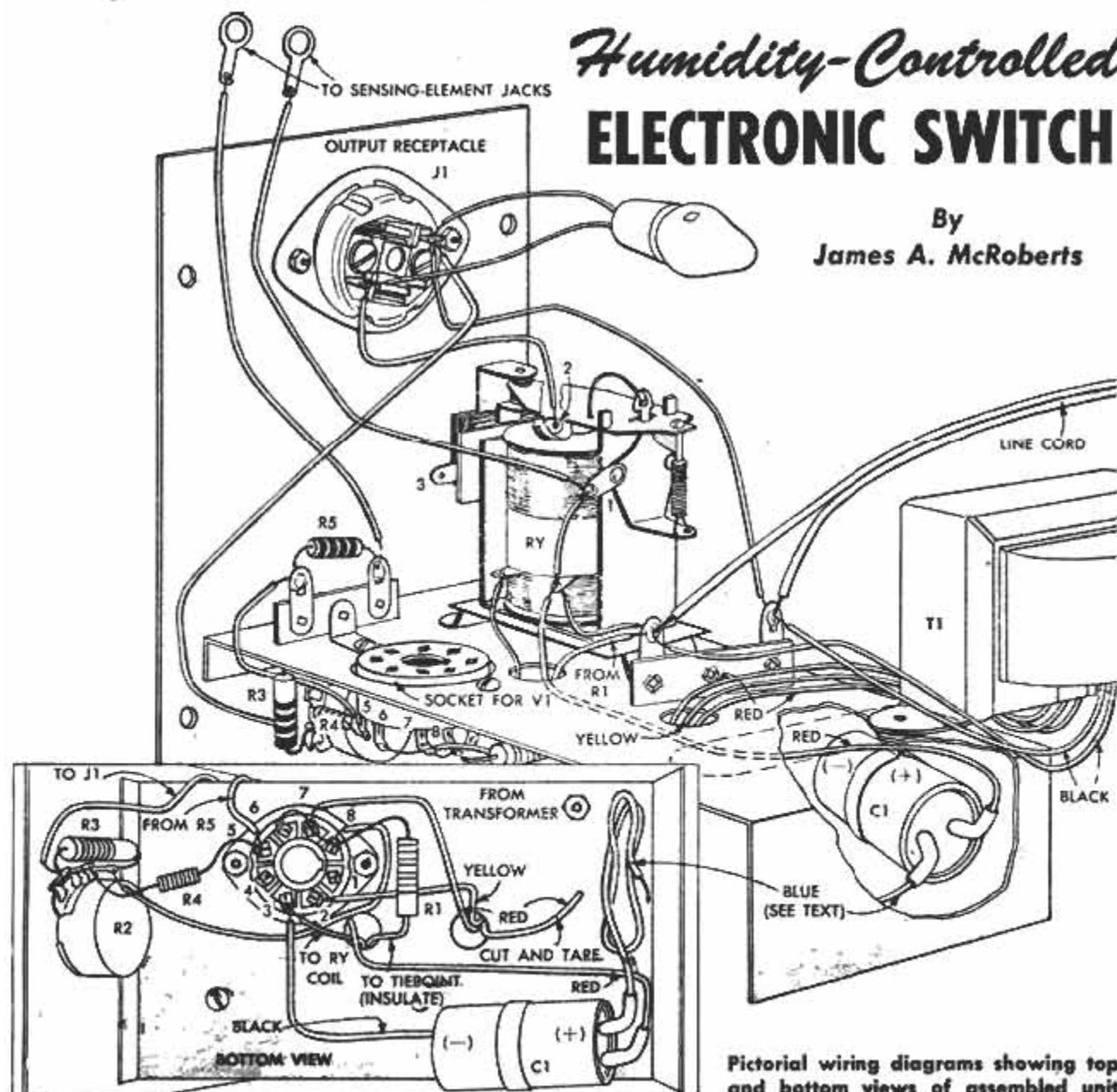

Pictorial wiring diagrams showing top and bottom views of assembled unit

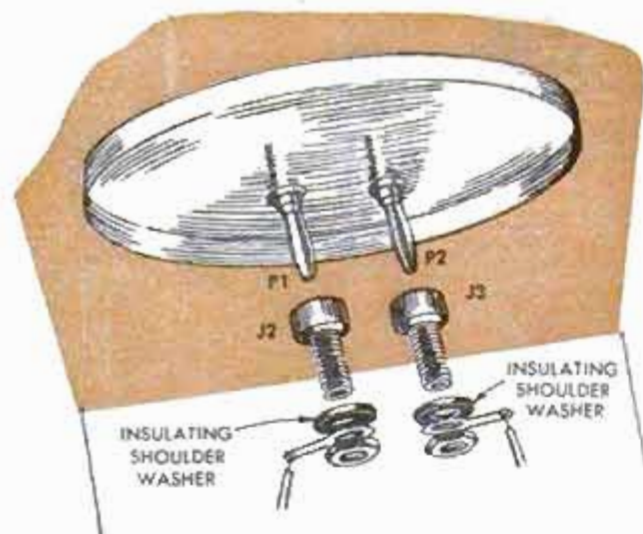

Assembly detail of sensing-element leads and jacks

the control. By rotating the control, it is possible to bias the tube to cutoff, thereby preventing all plate-current flow through the relay coil. Under this condition, the relay contacts will be in the position shown in the diagram.

A second path across the a.c. line consists of the lower part of R2, R4, R5 and Rx (sensing element). The current flowing through R4 applies a voltage to the grid of the tube to counteract the original bias. When the resistance of Rx is high, the current through R4 is small and the applied grid voltage is insufficient to bring the tube out of cutoff. However, when the resistance of Rx is reduced, as the salt in the sensing element collects moisture, the voltage drop across R4 will increase. This increased voltage drives the tube into con-

duction and causes plate current to flow through the relay coil. This closes contacts 1 and 2 and applies the line voltage to the a.c. receptacle, J1.

When the humidity is reduced, the moisture in the salt evaporates, and its resistance will increase. The tube will again cut off and the relay contacts will open.

Resistor, R3, is connected in parallel with the sensitivity control in order to make the setting of this control somewhat less critical. The electrolytic capacitor, C1, across the relay contacts, prevents relay chatter during the negative half of the line-voltage cycle.

Since salt absorbs moisture somewhat more readily than it returns it to the atmosphere, a bulb is used to apply a small amount of heat underneath the sensing element to compensate for the normal time lag. The bulb is lit only during the "on" cycle of the relay.

### Construction

The construction details are illustrated on page 163. The assembly is built into a commercially available metal case with a built-in chassis. Assembly should begin by mounting the larger parts to the chassis and front panel. When mounting the sensitivity control and a.c. receptacle, be sure to leave enough clearance at the top and bottom so that these will not interfere when the chassis is inserted in the case.

All wiring is shown in the wiring diagram. If the diagram is carefully followed, no difficulty should be encountered in

(Continued to page 252)

Schematic diagram of the humidity-controlled electronic switch. The sensing element is described in text

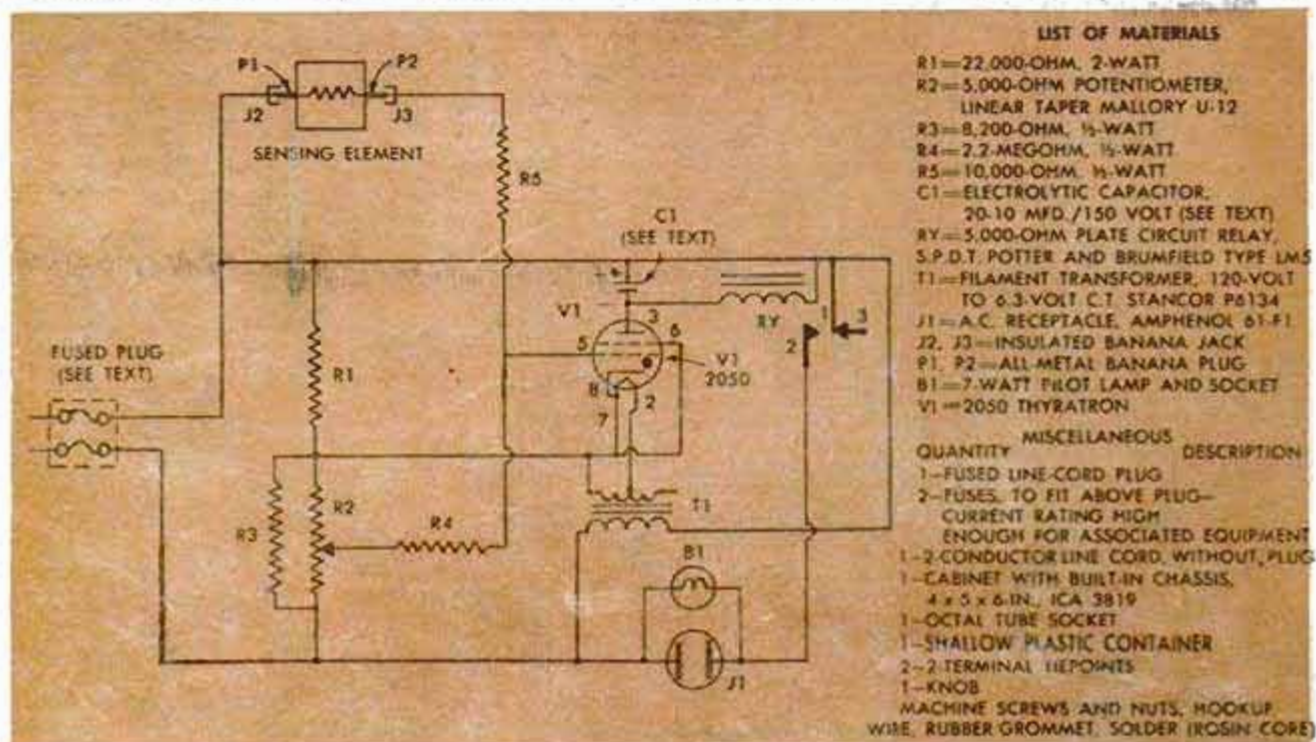

#### LIST OF MATERIALS

- R1—22,000-OHM, 2-WATT
- R2—5,000-OHM POTENTIOMETER, LINEAR TAPER MALLORY U-12
- R3—8,200-OHM, 1/2-WATT
- R4—2.2-MEGOHM, 1/2-WATT
- R5—10,000-OHM, 1/2-WATT
- C1—ELECTROLYTIC CAPACITOR, 20-10 MFD./150 VOLT (SEE TEXT)
- RY—5,000-OHM PLATE CIRCUIT RELAY, S.P.D.T. POTTER AND BRUMFIELD TYPE LMS
- T1—FILAMENT TRANSFORMER, 120-VOLT TO 6.3-VOLT C.T. STANCOR P6134
- J1—A.C. RECEPTACLE, AMPHENOL 61-F1
- J2, J3—INSULATED BANANA JACK
- P1, P2—ALL-METAL BANANA PLUG
- B1—7-WATT PILOT LAMP AND SOCKET
- V1—2050 THYRATRON

- | QUANTITY | MISCELLANEOUS  | DESCRIPTION |
|----------|--|-------------|
| 1        | FUSED LINE-CORD PLUG   |             |
| 2        | FUSES, TO FIT ABOVE PLUG—CURRENT RATING HIGH ENOUGH FOR ASSOCIATED EQUIPMENT |             |
| 1-2      | CONDUCTOR LINE CORD, WITHOUT PLUG  |             |
| 1        | CABINET WITH BUILT-IN CHASSIS, 4 x 5 x 6 IN., ICA 3819                       |             |
| 1        | OCTAL TUBE SOCKET  |             |
| 1        | SHALLOW PLASTIC CONTAINER  |             |
| 2-2      | TERMINAL BLOCKS  |             |
| 1        | KNOB   |             |
|          | MACHINE SCREWS AND NUTS, HOOKUP WIRE, RUBBER GROMMET, SOLDER (ROSIN CORE)    |             |

the

POPULAR  
MECHANICS

## CRAFTSMAN

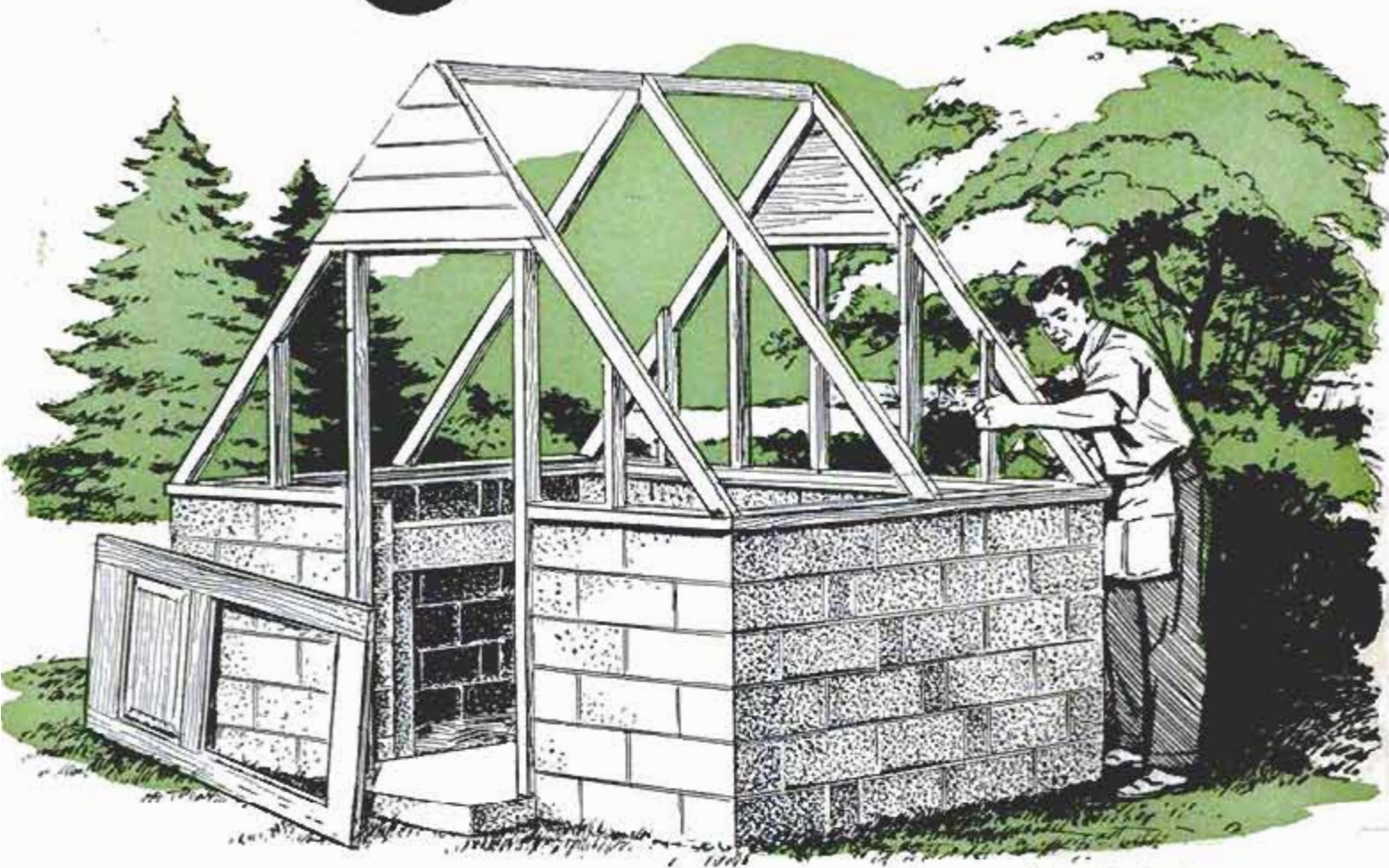

Designed by John Bergon

## BUILD YOUR OWN GREENHOUSE

**F**OR THE PROPAGATION and healthy growth of plants and the production of seedlings for spring planting, there's nothing quite as effective and satisfying as a greenhouse. A separate structure, or true greenhouse, is preferable as it more nearly serves the twofold purpose of propagation and display of plants. However, a lean-to built against the house or garage, or over a basement window, offers safe growing conditions for many common seedlings, cuttings and also for the display of plants not hardened to sudden temperature changes. The one disadvantage of the lean-to type is that it is not always possible to locate it to take full advantage of light and heat from the sun.

### True Greenhouse

A separate structure like that pictured above is the choice of experienced gardeners. It offers a much better opportunity for proper management of the house during the

growth period of most plants and a better utilization of available sunlight during the season. Note from the following pages that ordinary storm sashes form the glass roof and that both ends of the structure are glazed. The sashes are shown hinged at the top. If desired they also can be hinged at the lower ends. If this is done, each sash should be fitted with a storm-sash bracket so that it can be locked in the open position. The size of the structure detailed permits use of two 3'-0" x 6'-0" storm sashes on each side of the gable. When selecting these be sure there are no pronounced ripples in the glass panes. Ripples in the glass may tend to concentrate the sun's rays and damage plants.

In the sectional detail of the house, page 167, the foundations are shown without footings. In stable soils this construction is permissible. But in loose loam and in sandy or gravelly soils the foundation should be on a footing about 6 x 12 in. in sectional



Above, separate structure, or true greenhouse, is most suitable for all-around use of experienced gardener. Center, lean-to greenhouse includes a potting shed

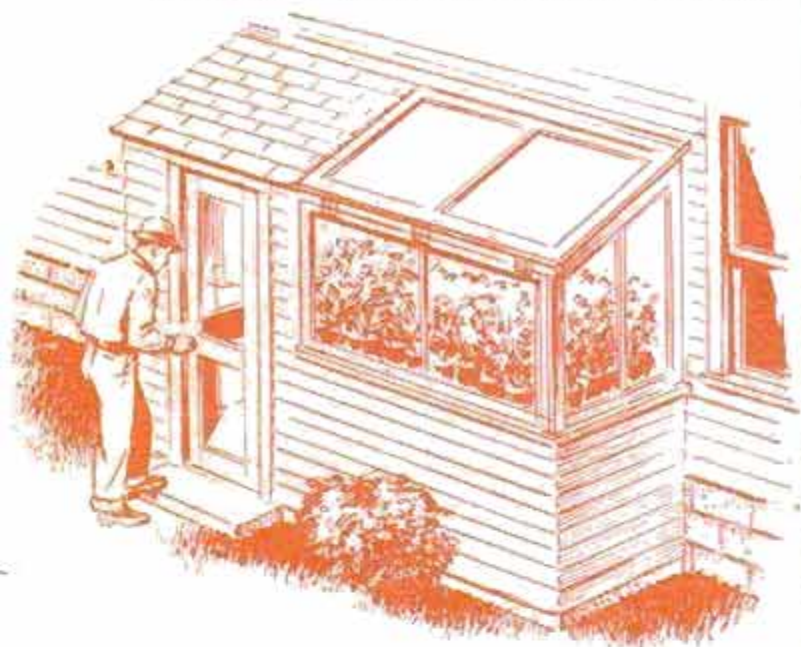

Window greenhouse serves as starter for transplants

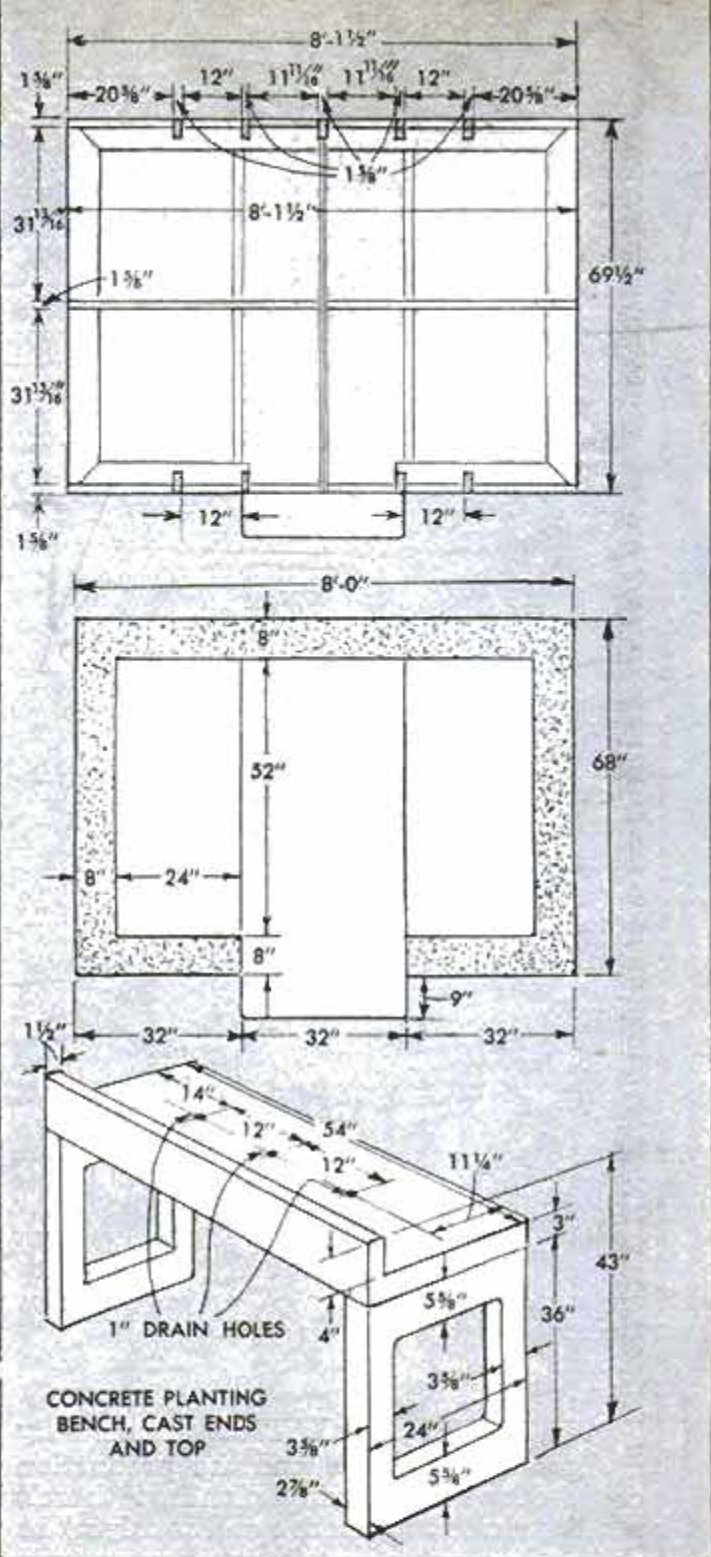
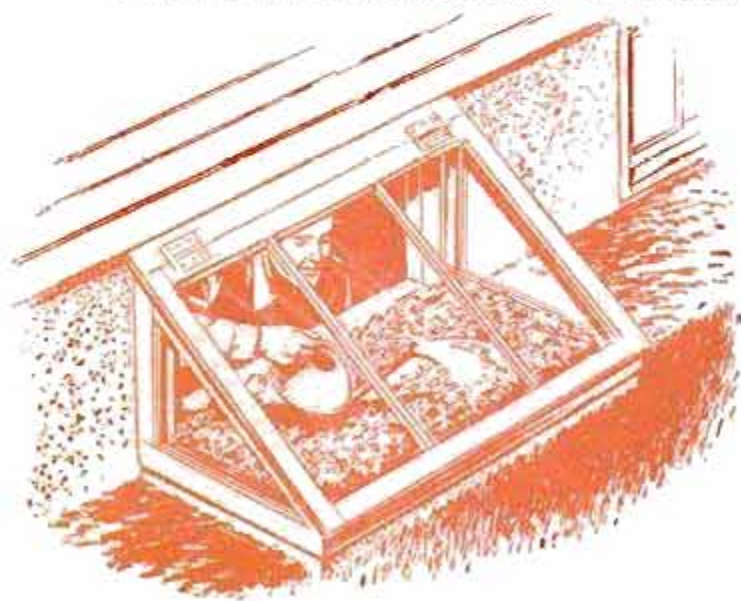

size. The cast-concrete planting benches detailed above and on the opposite page can be omitted and planting benches constructed of cypress substituted. These can be constructed inexpensively and in considerably less time. If you do cast the benches of concrete be sure to reinforce the top either with reinforcing rods or wire mesh.

The walls can be laid up of cinder block, concrete block, or natural stone. Fill the voids in the top course of blocks with cement mortar and rubble (small stones or coarse gravel) and insert anchor bolts before the mixture hardens. The bolts provide a means of attaching the 2 x 6 plates securely to the wall. When laying the blocks be sure to bed each one in sufficient mortar



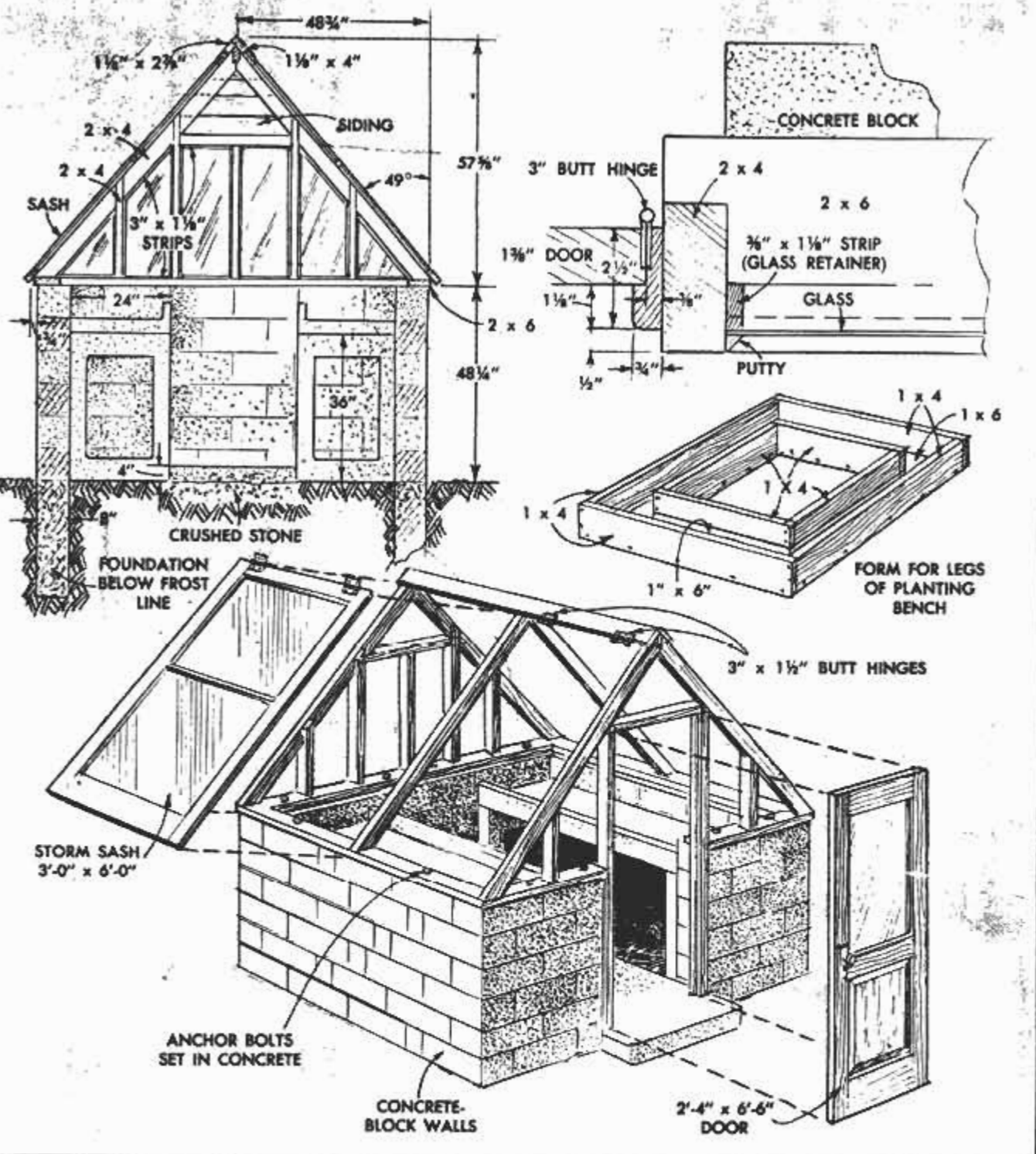

to assure watertight joints of maximum strength. Keep each course of blocks level and the corners plumb.

Cut all wooden parts of the structure to finished size, trial-fit each one, then prime with a suitable primer, making sure that the priming coat covers all surfaces, especially the end grain. Give the priming coat time to dry thoroughly, then bed the 2 x 6 plates in mortar, allow the mortar to set partially and tighten the nuts on the anchor bolts. Note that the plates are notched to take the 2 x 4 uprights that form the side jambs of the doorframe. The top jamb is end-lapped onto the upright side jambs. The sectional detail through the doorjamb shows the door hinged to swing in. This assembly can, of course, be re-

versed and the door hinged to swing out, if desired. To avoid cutting triangular pieces of glass to fit over the header in the rear gable and over the top jamb above the door, these areas are covered with siding as indicated.

#### Lean-to Greenhouse and Potting Shed

This unit is designed to be built against the house or garage where space is available for a southern exposure. It should not be built under a wide cornice. Sills of the structure are bolted to a concrete foundation poured to a depth well below the normal frost line. Studs, plates and rafters complete the framing ready for siding and roof boards. The concrete floor, poured over a tamped gravel fill, is an optional

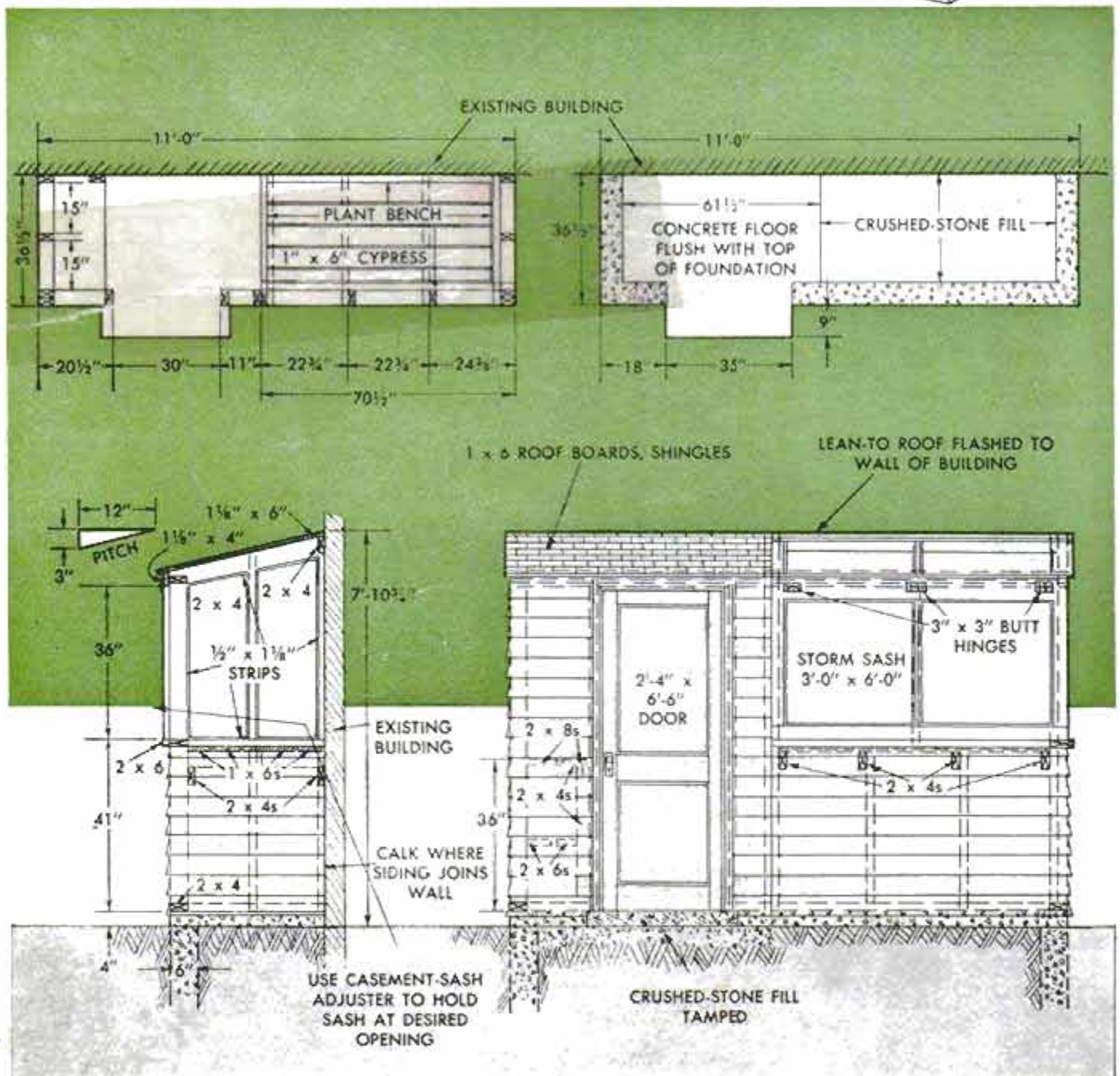
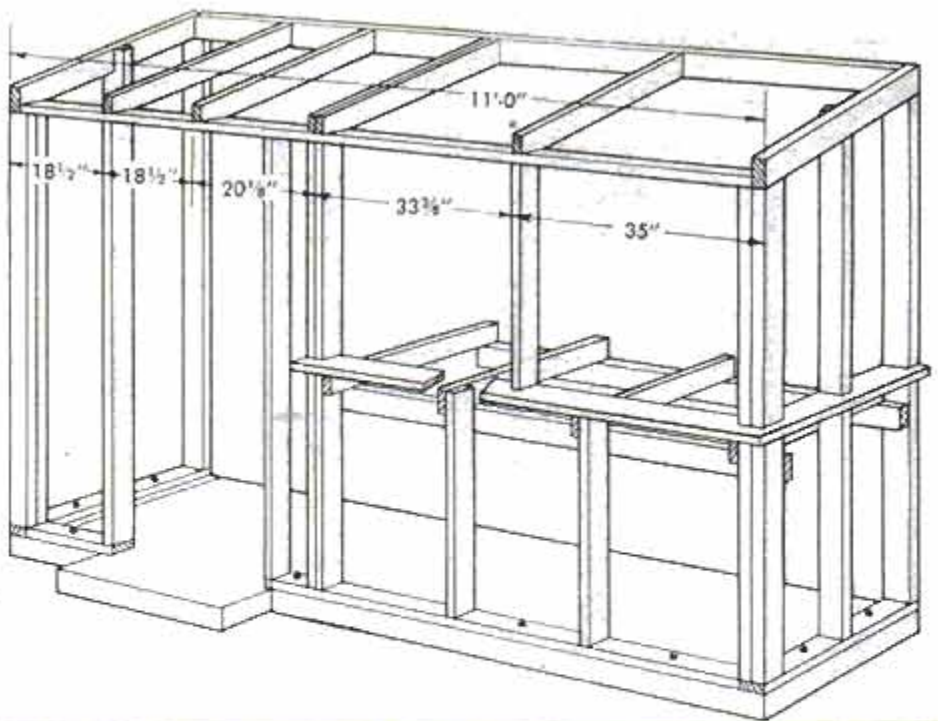
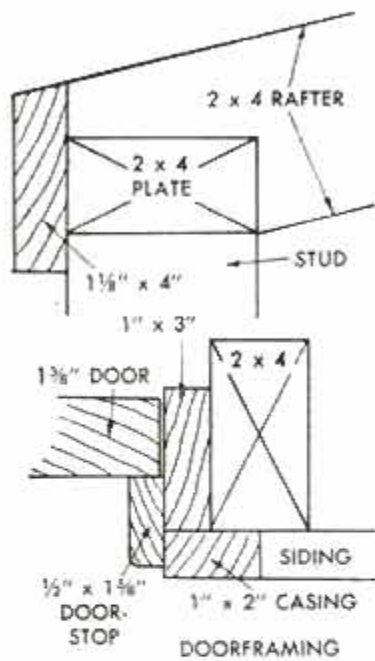

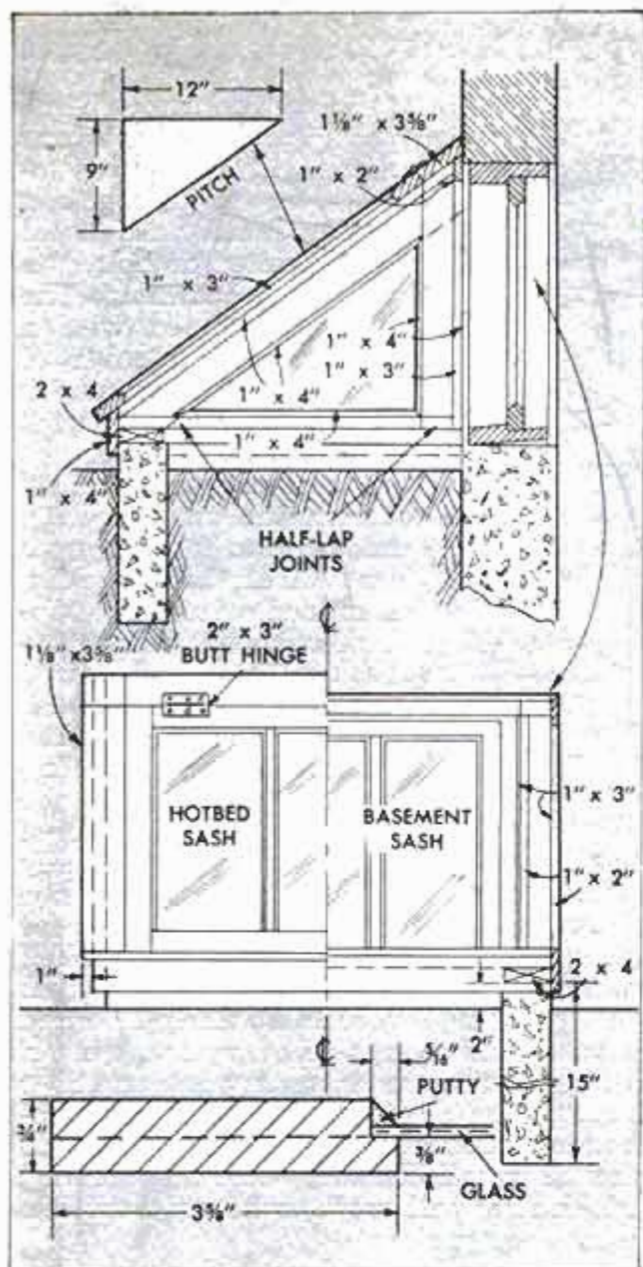

feature. The greenhouse half of the structure is housed with two standard storm sashes and the end is glazed as detailed. The potting bench and plant bench can be made in any way that best suits the pur-



pose. Cypress wood is the most durable because of its ability to resist rot.

### Window Greenhouse

For starting seedlings in flats and for advancing the growth of certain house plants which are to be reset out of doors later in the season, a window greenhouse is ideal. The details giving the construction of this unit are not fully dimensioned as certain changes may have to be made when fitting it to the basement window. Note in the construction details that the ends are shown glazed to admit the maximum amount of light. The unit should be located on the south side of the house.

### Heating

Unless used during the four seasons, the lean-to and window greenhouses will not ordinarily require heat. In an emergency a small electric heater will serve for the lean-to in the early spring and late fall months. To utilize the separate greenhouse to the fullest a reliable source of heat is necessary. In all except the more severe climates a small greenhouse usually can be adequately heated by means of lead-covered electric heating elements. ★ ★ ★

## Rough-Water Outboard Refueling Easy With Motor Oil Can

A quart-size outboard-motor oil can filled with an emergency supply of gasoline is easy to pour into a sputtering engine in a rough sea at a time when it is impossible to stand up and pour from the standard 2 1/2-gal. can. With the can painted red, marked with an "O" to identify it and filled with outboard fuel mix, all that is necessary in an emergency situation is to unscrew the lid and tip the open spout into the filler hole of the motor's fuel tank. When under way again the quart can is easily refilled from the large fuel can, and is ready to use once more if necessary.

Ivan Grosvenor, Indian Rocks, Fla.

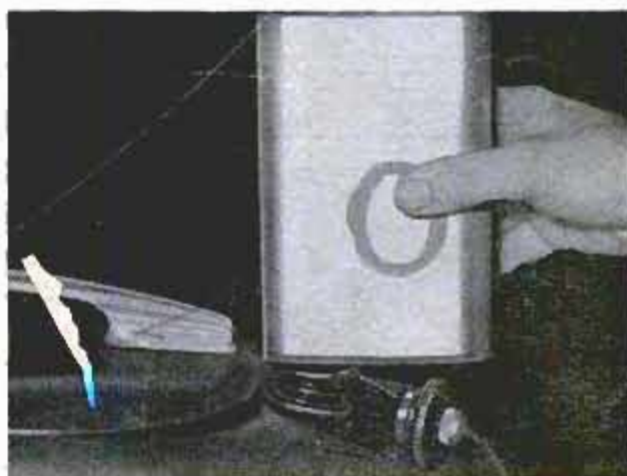

# Cabinet Combines Incinerator and Refuse Can



Solve the rubbish-disposal problem at your house with this sturdy incinerator and garbage-can holder faced with sheet steel riveted or bolted to angle-iron corners. The top is equipped with a hinged screen cover of welded flat iron which prevents fiery material from flying. Two lengths of steel pipe are welded across the incinerator chamber to form a grate on which is placed a standard wire-type rubbish burner. Beneath the basket is a galvanized clean-out pan that also acts as a draft intake. The handle shown in the illustration just above the clean-out pan is one of

four installed so the cabinet can be easily carried by two people. On the other side of the steel center partition is a space for the garbage can which rests on a shelf attached to the door. Door is made from wood paneling covered with thin galvanized sheeting and swings on heavy butt hinges. A finger latch prevents stray cats and dogs from prying open the door, and as a protection against rodents, a steel floor should also be installed. Sturdy and long lasting, this cabinet will prove to be a worthwhile home-shop project.

George R. Harrison, Valparaiso, Ind.

## Spinning Black-and-White Disk Makes Visible Colored Rings

Spin this black-and-white disk and it will appear to have several colored rings painted on it. To try it for yourself, first cut out the design and glue it to a piece of cardboard. Then drive a nail through the exact center of the disk to provide a shaft on which it can spin. Convinced, you can make an enlarged design with drafting ink on a piece of cardboard, keeping the spacing proportional in size. Rotating the disk in an opposite direction will reverse the color scheme.



## Projecting Load Warning Flag

When loads of pipe, lumber, or other materials project beyond the truck bed you can warn other motorists with this easily attached flag placed at the rear end of the load. One edge of a piece of red cloth is sewn to a wooden dowel rod to keep it spread out, and a heavy rubber band, cut from an inner tube, is looped around the center of the rod through a hole cut in the cloth. The rubber band stretches easily over the end of a pipe or piece of lumber thus eliminating the need for tacking or tying.

Hugh Lineback, Stillwater, Okla.

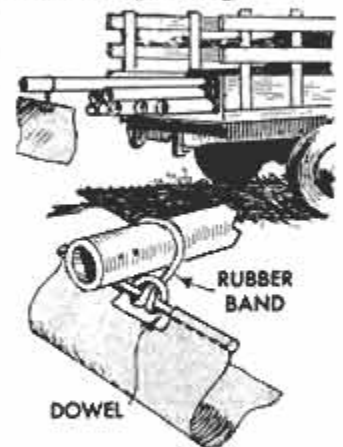



## MINIATURE DESK *is cigarette holder*

FOR AN ATTRACTIVE novelty that can be used in your living room or office, make this miniature desk. It has a practical use as well. A hinged lid covers a shelf of cigarettes, and two small drawers that slide open as in a full-size desk provide a handy place to keep rubber bands, paper clips, stamps and other small objects. Cut all parts for the desk from hardwood according to the dimensions given below. After the desk is glued together, stain the surfaces to bring out the grain and apply a coat of varnish. For the drawer handles bend short lengths of brass wire into staples with square corners.

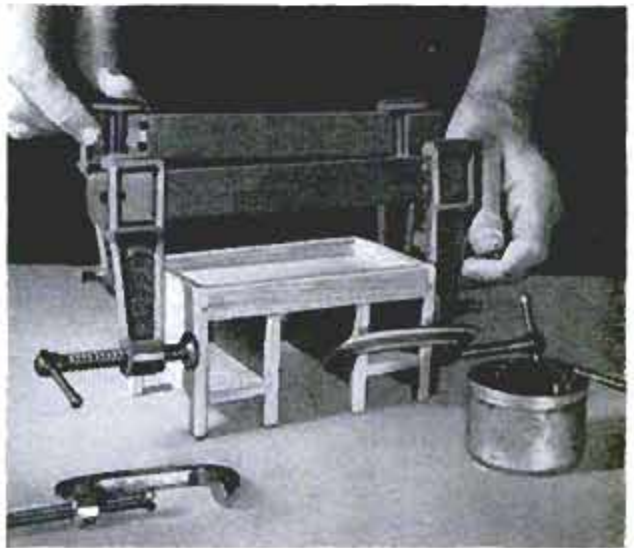

After glue is applied to joints of all fixed parts of desk, fasten clamps in the positions shown above

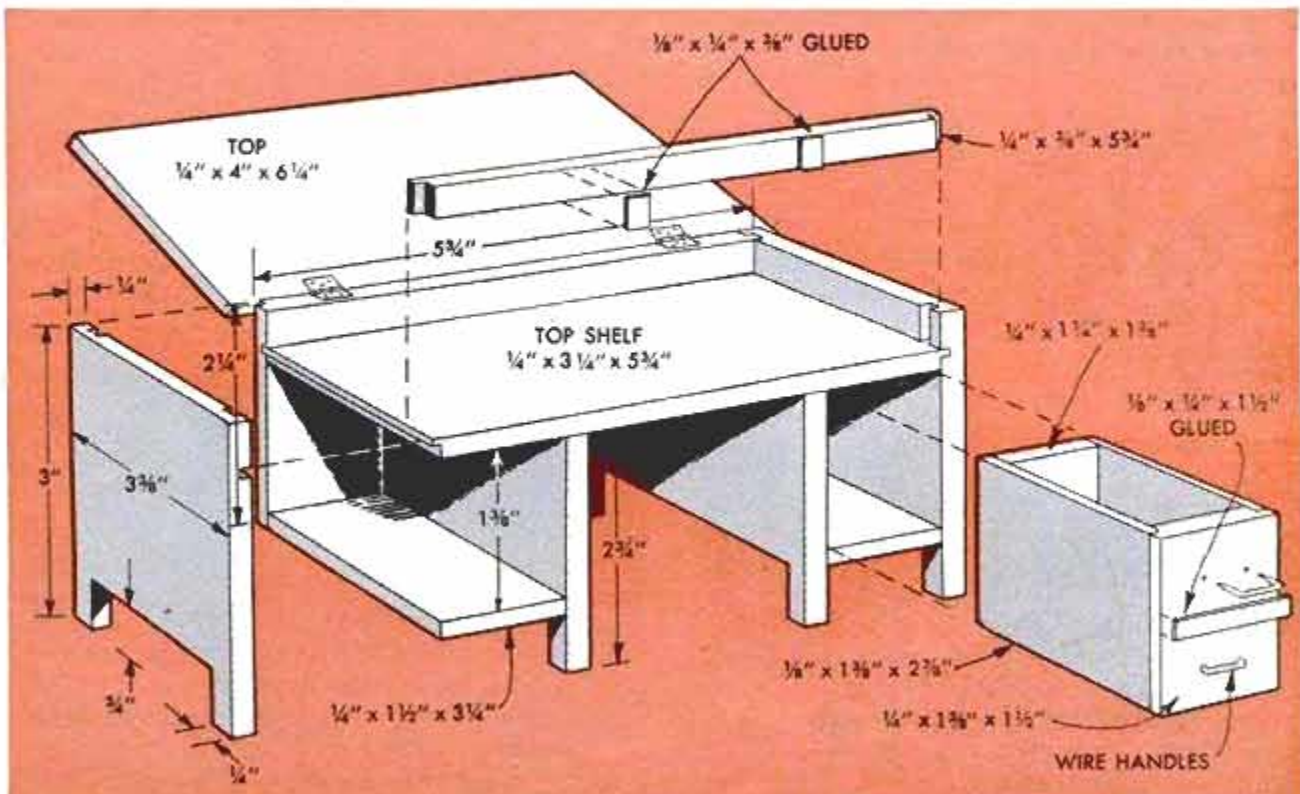



### Embossed Auto-Lamp Lenses Cleaned With Toothbrush

The deeply embossed lenses of automobile backup lights and taillights can be cleaned easily by scrubbing them with a discarded toothbrush dipped into a mild soap-and-ammonia solution. The mixture is made by dissolving a teaspoonful of soap flakes in a half pint of water and then adding a teaspoonful of household ammonia. After all dirt has been scrubbed loose, the lens and surrounding areas should be thoroughly rinsed with clear water, wiped dry and polished with auto wax for added luster and easier cleaning next time.

Walter E. Burton, Akron, Ohio.

### Reusable Metal Standards Support Plants

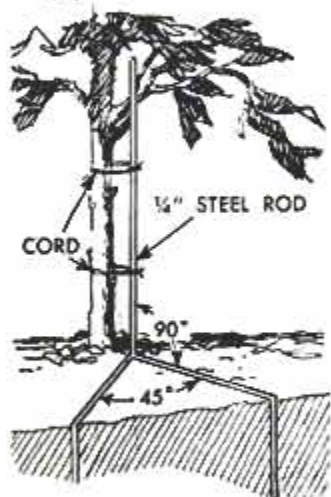

Instead of wooden stakes or poles, which require frequent replacement, one gardener uses metal standards to support young trees, shrubs and plants. Each standard consists of an upright fitted with two horizontal spreaders. One spreader and the upright are bent from a single piece

of rod, the other spreader is welded to the bottom of the upright. The ends of the spreaders are bent down so they may be forced into the earth as shown.—Henry F. Kangieser, Palo Alto, Calif.

# "Stowaway"

By Bertram Brownold

**E**ASILY DISASSEMBLED for compact storage, this attractive inlaid chess table is ideal for a small apartment, or wherever living space must be utilized fully. The legs pull out of sockets on the underside of the table top, then themselves are pulled apart, resulting in eight short sections that fit into a rack on the underside of the top. The sides of the rack are formed by two compartments which have sliding lids and provide storage for the chessmen.

Start construction by cutting a 15 x 15-in. square of  $\frac{3}{8}$ -in. plywood. Next, four hardwood blocks  $\frac{1}{2}$  x 3 x 3 in., in which 1-in. holes are drilled, are glued and screwed to the underside of the top at the corners,  $\frac{5}{8}$  in. in from each edge. Cut out the parts of the boxes, assemble them and glue and screw into position. Use flatheaded wood screws and countersink them so they do not interfere with the wood squares of the playing board which are glued over them.

Before installing the squares, B, fit the table top with a mitered frame. The frame

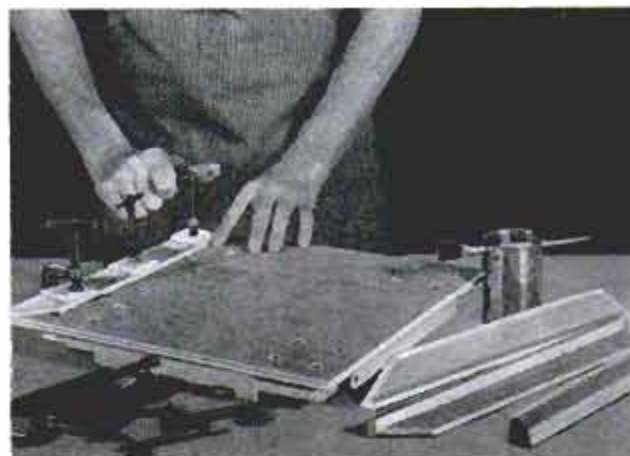

Above, mitered frame of table is glued and held in place with clamps until glue has set. Below, since frame and squares of playing board cover screwheads, leg blocks are screwed to underside of table top first

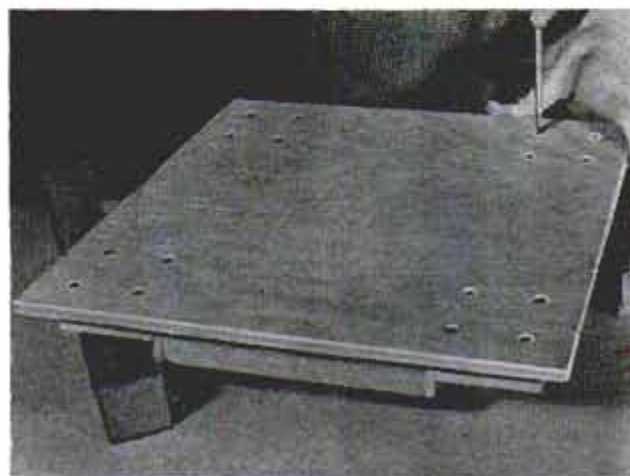

# Chess Table

stock is glued up from two pieces as indicated in the lower left-hand detail. Light-colored wood is used for 32 of the 64 squares and dark-colored wood for the other 32. Light-colored wood can be used for all, by staining half of them dark. Each table leg consists of two 12-in. lengths of 1-in. dowel joined by a 3-in. ferrule, A, made from 1-in. brass tubing. Pin or screw the ferrule to one leg section. The two crosspieces of the leg rack, C, are cut from  $\frac{3}{8}$ -in. plywood and measure  $\frac{3}{4} \times 8\frac{3}{4}$  in. Locking strip, D, measures  $\frac{1}{2} \times \frac{7}{8} \times 10\frac{1}{2}$  in., as does the fixed strip at the opposite end. When the table is completed, sand it smooth and give it several coats of varnish. For easy cleaning, apply wax. ★ ★ ★

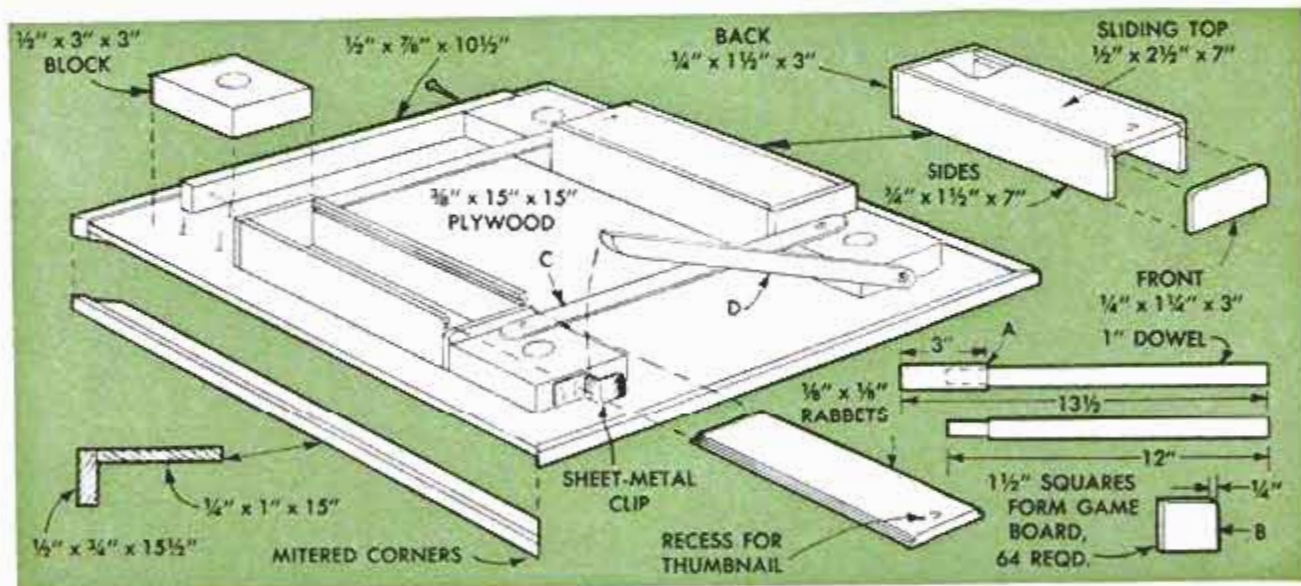

Below, after frame has been glued in place, squares for playing board are brushed with glue and carefully fitted in place, resulting in attractive inlay

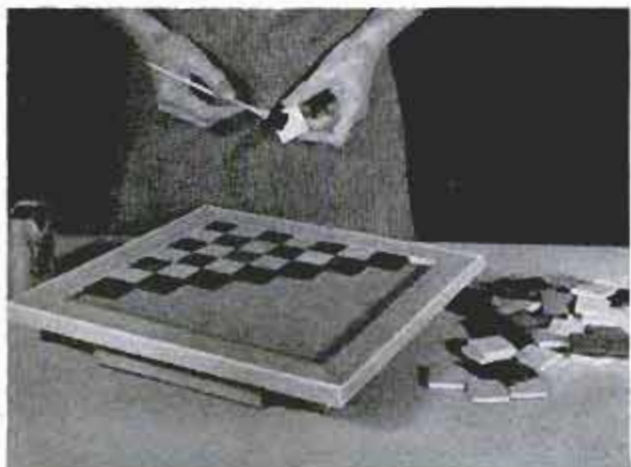

Below, two-piece legs fit neatly in rack on underside of table top. Two boxes which form sides of leg rack also provide neat storage for the chessmen

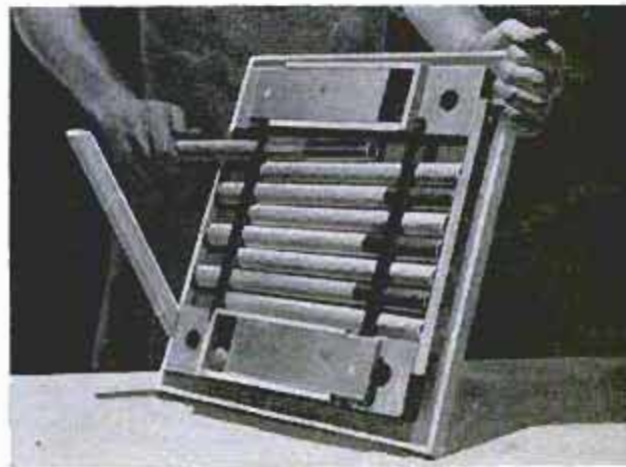

# Fix your Wagon for Roughing it

By William B. Barry



Any station wagon can be equipped with two comfortable bunks without sacrifice of inside storage space

**S**TRETCH those vacation dollars and stop where and when you please by living aboard a station wagon that has bunk beds for two, cooking facilities and all camping gear neatly stowed inside. After many years of camping I believe this method to be the most economical and care-free. A station wagon arranged in this manner permits one to walk through the car and out the tail gate without the usual obstructions. The bunks may also double as seats for carrying several extra passengers. Meals are cooked and eaten on the lowered tail gate, at which time two folding chairs serve as seats. During bad weather one bunk becomes a table and the other makes a very nice bench. Any station wagon may be rigged in the same way with slight variations in procedure, depending upon the seating arrangement.

## Interior Rearranged

The first step in the conversion is to remove the spare tire and rear seats. The

Meals are cooked and eaten on lowered tail gate, at which time two folding chairs serve as seats. During foul weather cooking is done inside, one bunk becomes a table and the other serves as a bench

wide driver's seat is taken out and the small folding rear seat is then converted to a narrow driver's seat by removing the two pipe seat supports and welding flat steel supports in their place to provide proper elevation and tilt, Figs. 7 and 8. Now the car is ready for installation of the storage boxes and bunk beds.

Two plywood storage boxes are made to fill the spaces behind the seats, Fig. 9. The boxes should be shaped to fit the slant of the seat backs and extend from the seats to the rear fender wells. The box behind the driver's seat is made smaller to permit long-legged drivers to push the seat back. The storage boxes must be set out from the wall a short distance to allow the lids to clear the slanting body line.

## Making the Bunks

To obtain a pattern for each bunk deck, stretch one string across the rear end of the car at the desired level for the bunk tops and another between the front doors immediately in back of the front seats. Connect these two strings with a third and fourth string in positions that will indicate the upper, inside edge of each bunk for the length and height. Measure from the third and fourth strings to the wall at close intervals to determine the curve of the car body on each side.

The bunk decks are then cut from 1/2-in.







All camping gear and other duffel are neatly stowed under bunk beds



plywood and fitted with hinged supports, Fig. 10. Each deck is attached to the storage box ahead of it with two small metal brackets. Use of continuous-type hinges makes it possible for the supports at the ends of the decks to be swung outward to facilitate removal of large pieces of luggage with the tail gate down, Fig. 10. Sash locks are used for securing the end supports to the hardwood runners on the car floor. The entire unit is assembled in the car for fitting and making minor adjustments and then disassembled so that it can be removed and the finish applied.

#### Insulating Storage Boxes

Next, install locks on the storage boxes and pad the walls with two layers of

Spare tires are mounted on auto-top carrier located toward rear of car for easy removal and servicing

corrugated paper to provide protection for camera equipment and other instruments. Because of its load-bearing requirement the bottom of each box is covered with a layer of cotton padding and an overlay of 1/2-in. plywood. This completes the interior alteration of the wagon. Ordinary lounge pads from outdoor furniture can be used for mattresses on the bunks.

#### Curtains and Screens for Windows

To assure privacy while dressing, draw curtains can be attached to the interior beading along the tops of the windows. At least two of the windows should be equipped with screens to permit ventilation yet keep out insects. The slip-on type screens currently available for some makes

The first step in the conversion is to remove the rear seats, spare tire and removable floor fittings





8  
One of narrow back seats is converted to driver's seat to permit unobstructed movement inside car for convenience when en route or when wet outside

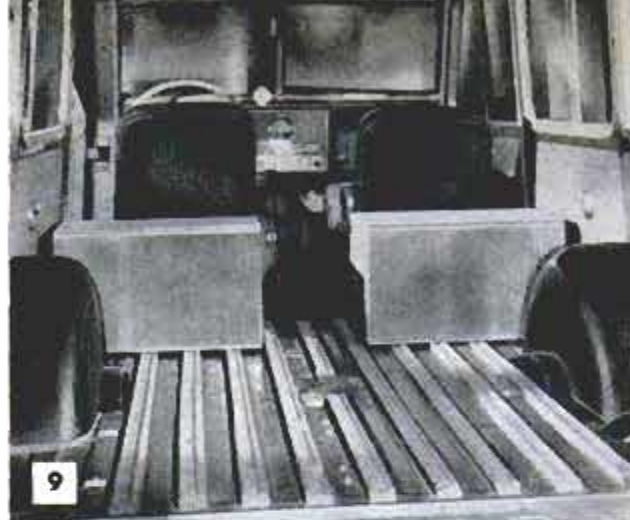

9  
Two plywood storage boxes, shaped to fit slant of seat backs, extend from seats to rear-fender wells

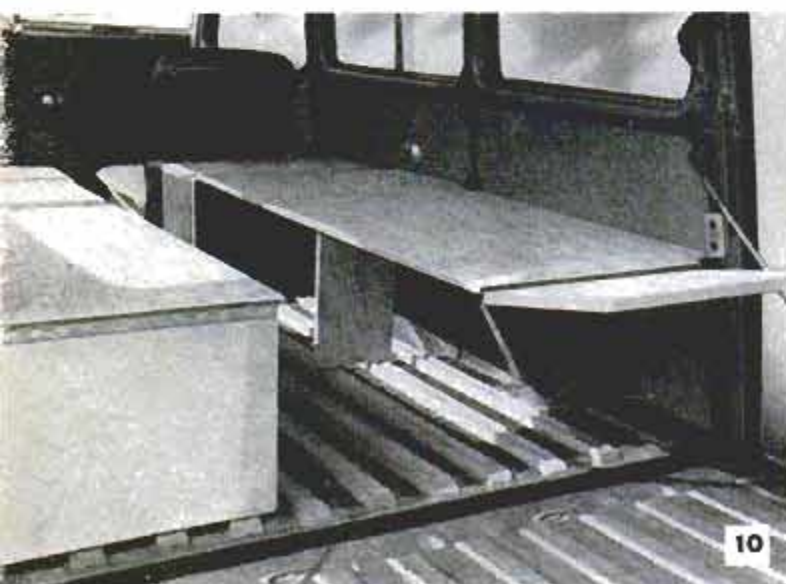

10  
Continuous-type hinges on supports at ends of decks permit easy removal of luggage stowed under bunks toward rear end of station wagon as shown above



11  
Above, bunk deck is attached by metal brackets to storage box forward and is supported by a member at rear fender well and a hinged end support. A sash lock secures end support to wooden runner on car floor. Right, lounge pads from outdoor furniture make comfortable, lightweight mattresses

of cars can be used. Or, remove the garnish molding around a window, stretch mosquito netting over it and replace the molding for an alternate method of providing screens. Operation of the window will not be impaired by either type of screen.

A carrier on top provides ample room for two tires and is located toward the rear so that spares can be removed by standing on the lowered tail gate, Fig. 6. Valves should be turned out and down to permit easy checking of air pressure from the ground. Fabric straps for fastening the carrier to the car top should be replaced with steel straps and bolted clamps to discourage tire theft.

Upon completion of the conversion, a shakedown run was made across some of the most rugged desert terrain in southern California and into the Kofa Mountain region of Arizona. It was possible to move about inside the car and photograph from all sides. Meals were taken completely in the open and usually with the tail gate used as a table. The bunk arrangement is unbeatable with an over-all length of 7 ft., which is longer than most standard beds. Everything for an extended trip is carried inside the station wagon where it is much less of a temptation to thieves and is protected from wind and weather. Our bed and board are on wheels and home is wherever we stop. ★ ★ ★



12  
POPULAR MECHANICS

## One-Legged Breakfast-Nook Table Bolted to Wall Studs

With its simple modern appearance, this breakfast-nook table can be made and permanently attached to the wall in a very short time. It is screwed to cleats along the side and one end which are in turn fastened to the wall studs with  $\frac{1}{4}$  x  $2\frac{1}{2}$ -in. lag screws. Before attaching the table to the cleats install the leg made from a length of chrome-plated tubing 1-in. dia. or larger. The upper end should fit snugly in the round hole drilled partially through the cross-brace cleat that is screwed to the underside of the table surface. A rubber crutch tip is fitted to the lower end of the leg to protect the floor covering.

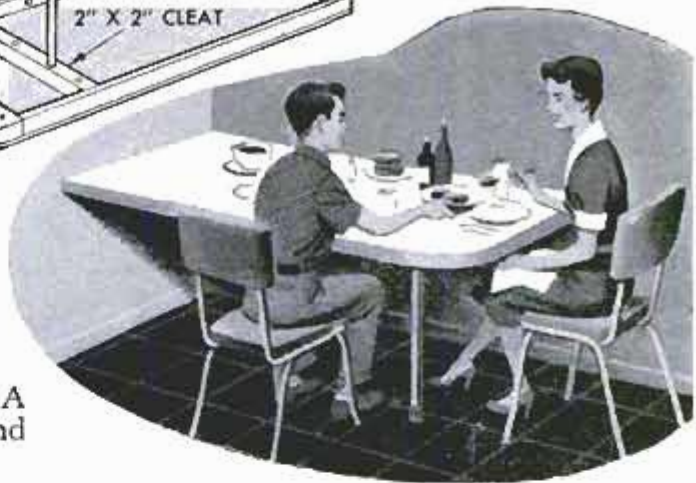
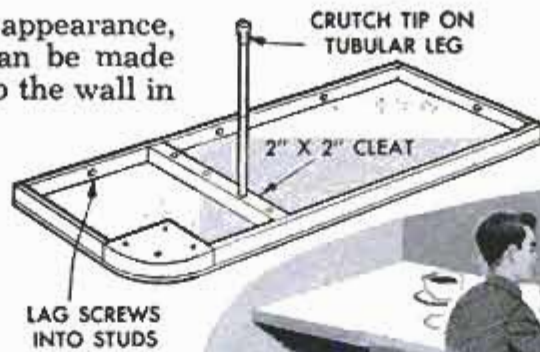

## Sand and Gravel for Concrete Checked for Silt Content

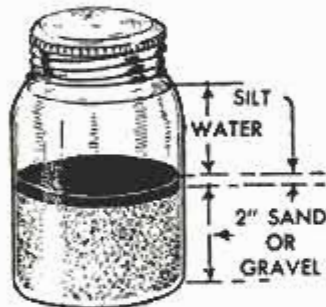

For best results, ordinary bank-run sand and gravel should be checked for silt content to determine their suitability for use in making concrete. Too much silt will prevent the cement from

bonding properly to the sand and gravel, resulting in weak and porous concrete. To check for silt content, place a sample amount of sand or gravel in a pint fruit jar to a depth of 2 in., add clear water to almost fill the jar. Shake vigorously and allow to stand until the water clears. If there is a layer of silt on top of the sand or stones of more than  $\frac{1}{8}$  in. in depth, the material will require washing before using in concrete.

## Bright Light Helps in Repainting And Applying of Clear Finishes

Excessive overlapping and "holidays" (poorly covered areas) frequently occur when indirect lighting is used to illuminate a surface being covered with a paint of similar color or a transparent finish. A source of strong, glaring light to accent the wet surface will help to avoid this difficulty and also eliminate unnecessary eyestrain. When working on floors or walls, simply remove the shade from a table lamp and place the lamp just outside the line of vision. One or two strategically placed floor lamps will aid in repainting ceilings and the tops of high walls.

Henry M. Gerome, Hopwood, Pa.

## Foam Rubber on Wooden Hanger Provides Nonslip Surface

Foam-rubber strips glued or tacked to the supporting surfaces of wooden clothes hangers permit a better grip by light articles of clothing such as shirts or blouses. The rubber used may be of the type mounted on cloth backing and sold by the yard for use inside skirt waistbands

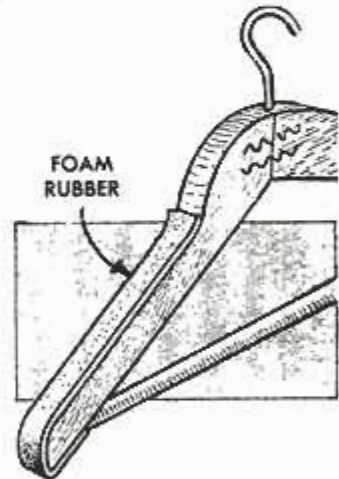

to anchor blouse "tails." The tape backing should be removed from the material before applying it to the hanger with rubber cement. A good substitute is foam-rubber weather stripping with adhesive backing.



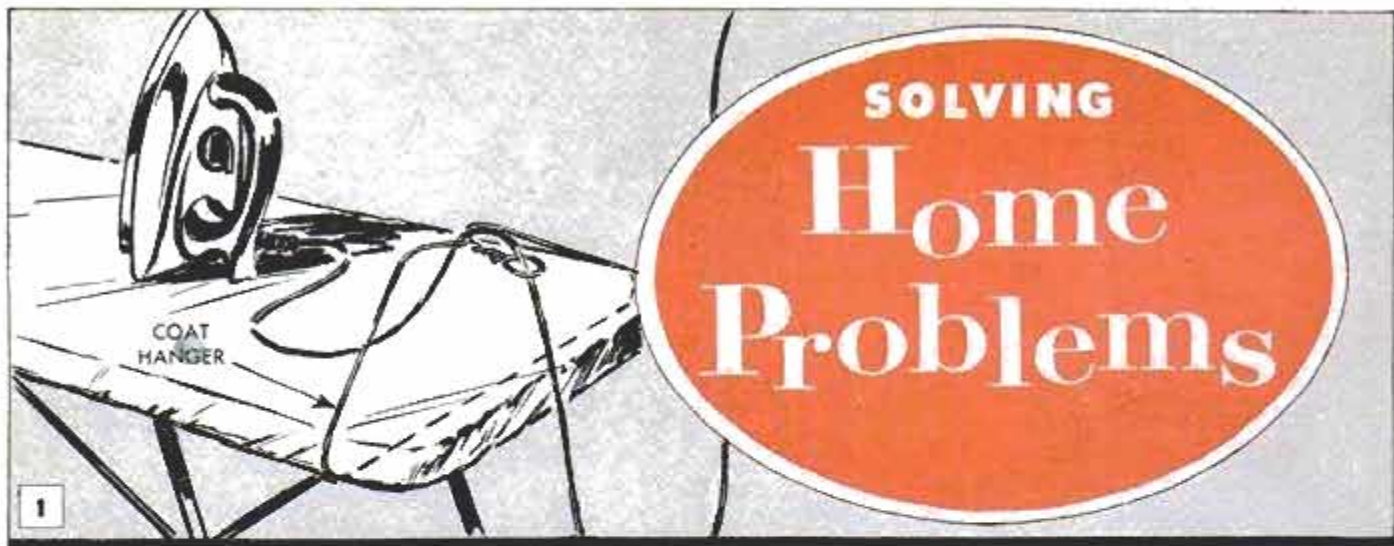

**1. WIRE COAT HANGER** with hook bent to form an eye serves as a cord holder for electric iron. It supports cord at the right height and prevents kinking. Hanger is wedged over end of ironing board to make it stand upright and eye is bent downward as shown

**2. HANDY TWINE DISPENSER** is made from the half of a coconut shell containing the "eyes." Drill hole through one eye, pass twine through it. Invert on shelf. Weight of coconut is sufficient to permit twine to be pulled through hole without upsetting the shell

**3. NAIL OR TACK** driven into lock-plate mortise will prevent youngsters from locking themselves in playroom or bathroom. Nailhead must be flush with plate. Screw may be used instead of a nail, if you wish, which will allow it to be turned in the right amount

**4. SOAP** rubbed on bathroom mirror and immediately wiped off with a soft cloth will prevent fogging of surface. Coat surface with uniform film before wiping. When coated in this manner, steam from shower or wash bowl will not cloud the glass in usual manner

**5. HAIRPIN** bent and taped to an easel support provides necessary tension to hold easel securely upright. Degree of bend determines angle at which easel stands. It may be found necessary to add two pins to provide adequate support in the case of a large frame

**6. BAR OF SOAP** inserted in slot cut in artificial sponge dispenses soapsuds in just the right amount for cleansing washable wallpaper or delicate fabrics. Form a pocket in the end of the sponge by carefully cutting through the center with a sharp paring knife

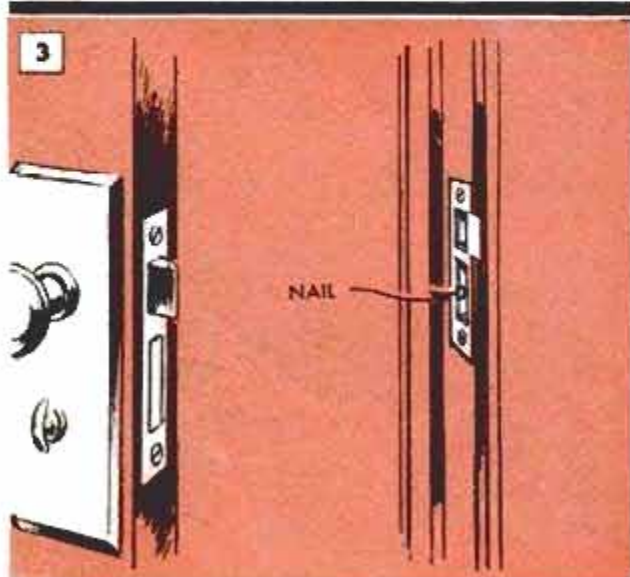
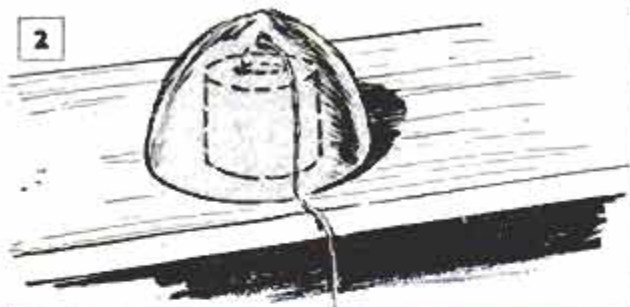

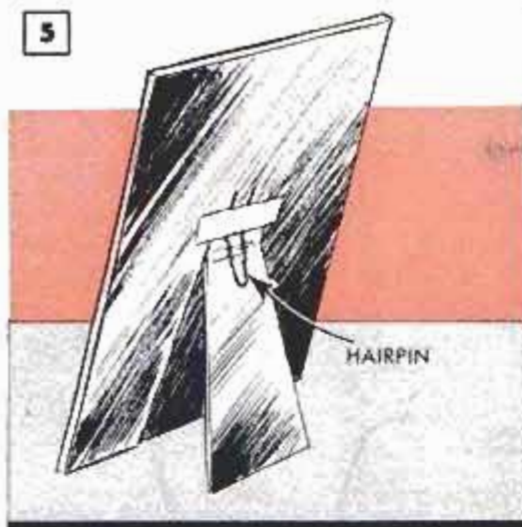

**7. REMINDERS TO CALL** are sure to be noticed promptly if the notation is clipped to the phone cord with a spring clothespin rather than written on a pad where it may be overlooked or misplaced. Works equally well with wall phone or desk phone for messages that are important. Plastic clothespin is best



**8. RUBBER HOSE** cut into 4 or 6-in. lengths makes just the right kind of wedge for holding plastic slip covers in place. Forced down between cushions and arms of upholstered chairs and sofas as in the detail, wedges hold covers taut, preventing wrinkling and tearing and also greatly improving their appearance

**9. SALT SOLUTION** of mild to medium strength generally will remove grease stains from fabrics without leaving a trace. Just spread fabric on a flat surface and sponge solution liberally onto the stained area. Then rub lightly with a soft, dry cloth. Repeat the procedure if any traces of grease remain

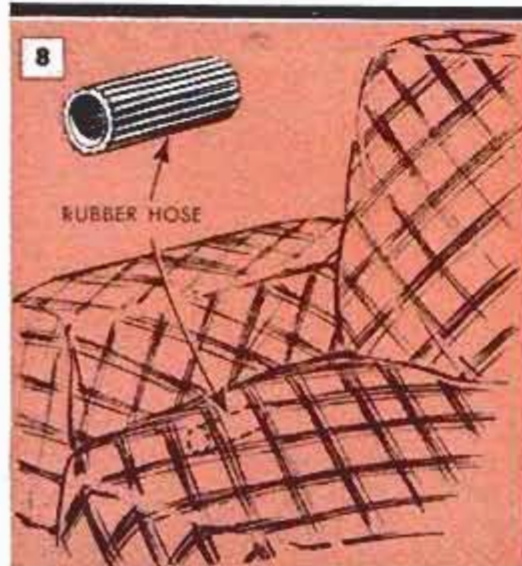



## Clamps Hold Thin Wooden Members While Edge-Sanding Them

When edge-sanding thin wooden members that are difficult to hold, you can do a better job if the work is held against a block with a C-clamp (left). For extra-thin or long members, fasten a clamp on two ends and both hands will be free.

## Winter Protection for Vents Under Picture Windows

In localities where cold winters are experienced, a louvered vent under a stationary picture window must be provided with adequate insulation to keep out cold, and a vapor barrier to prevent condensation on the cover fitted over the inside of the vent. During cold weather a panel of exterior-type plywood should be placed on the outside over the vent and the insect screen on the inside should be replaced with a panel of rigid insulation board. A vapor barrier should be applied to the room side of the insulation board. The inside panel is hinged at the top and fitted with a storm-sash adjuster at the bottom to permit opening it for ventilation on mild days.

## Detergent Cleans Asbestos Siding

Asbestos-siding shingles look as good as new after cleaning with a good detergent powder. Soak them with clear water and then scrub with a strong, hot solution, using a half cupful of detergent in each bucket of water. Be sure to work up from the bottom and rinse thoroughly to avoid streaking. Stubborn spots remaining may be removed with scouring powder.

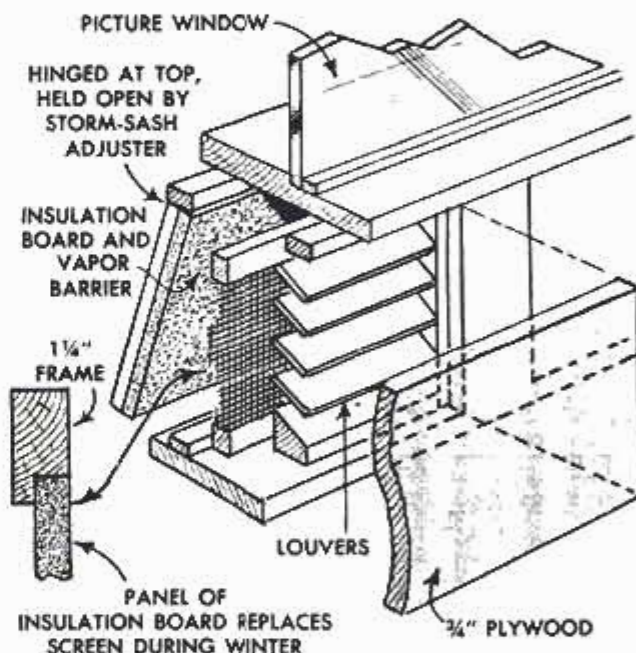

## Preparing Scratches on Automobile Body for Repainting



When scratched and chipped spots on an automobile finish must be cleaned of rust before repainting, use a small wire wheel chucked in a hand grinder. The wire wheel will remove rust and paint quickly and can reach areas difficult to clean with sandpaper. After wire-brushing, wash the area with gasoline or solvent, then apply a coat of primer.

Harrison Neustadt, New York City.

## Abrasive Soap Cleans Fireplace

An abrasive soap in paste form such as mechanic's hand soap will shorten the time it takes to clean a brick fireplace. Used with hot water and applied with a stiff-bristle brush it will remove grime and smoke deposits. Rinse with clear water.

Blanche Campbell, Los Angeles, Calif.

4570



## What to do about ROOF LEAKS

*Simple and effective ways to stop leaks before they can cause extensive damage and costly repairs.*

By E. R. Haan

**N**O PART OF A HOUSE takes a more severe beating from wind and rain than the roof, since it is exposed to all kinds of weather. Because it must protect structure, furnishings and occupants from direct contact with the elements, a roof deserves the best of care. When you notice water stains on walls and ceilings, check for roof leaks. The latter may be the cause if the stained spots become damp during or immediately after a rainstorm, or when snow is melting. Repeated leakage may rot wood, cause paint to peel and ruin plaster.

### Pinpointing Roof Leaks

Some roof leaks are easy to find. Others take a long, devious route that is concealed for the most part. On a sunny day you may be able to detect small holes in the roof from inside a dark attic. When a hole is located from the inside, stick a fine wire through it so the wire can be seen from the outside.

The sources of many leaks are the flashed

Above, "metal shingles" are pushed under wooden shingles to stop leakage through valley flashing. Below, leak in metal deck temporarily repaired by squeezing calking compound under loosened solder



Tuck-point chimney brickwork when necessary so that rain cannot seep through mortar. Be sure counter-flashing has a watertight seal in mortar joints

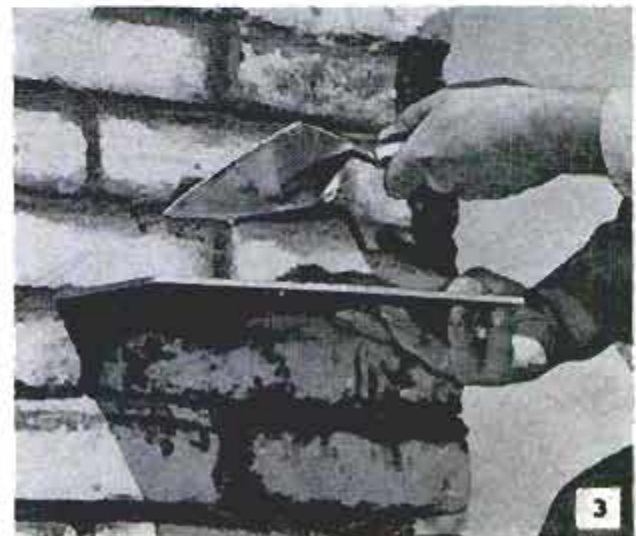



joints of a roof valley as in Fig. 1, chimneys, vent pipes, or where a roof joins a wall. Mortar joints on a chimney require periodic tuckpointing, Fig. 3. Gutter hangers should be nailed under shingles directly to the roof sheathing as shown in Fig. 4. If a leak is detected during the winter months fill holes or cracks with calking compound or roofing cement for a temporary repair, then make permanent repairs in warm weather.

### Safety on a Roof

Don't court an accident by taking chances on a wet, high or steep roof. Repairs can be made on a steep roof with relative safety from a ladder provided with a ridge hook, Fig. 5. A roof scaffold can be arranged similarly as in Fig. 6. For additional safety anchor the ladder with a length of strong rope tied to a crosspiece placed inside a window, Fig. 7.

### Flashing Repair

When it is necessary to repair leaky flashing, first cover the affected area with flashing compound. If this does not stop the leak, replace bad sections with copper or aluminum flashing. When only the lower part of a valley flashing is replaced some shingles must be removed temporarily, the defective portion cut off and a longer piece of equal width installed as in Fig. 8. Sheet-metal flashing for valleys should be 18 in. wide or more for a closed valley, 24 in. or more for an open valley, depending to some extent on the roof pitch. When installing flashing, bend it longitudinally to conform to the pitch of the roof. Nail the flashing at the side edges only.

If roll roofing is used for flashing it

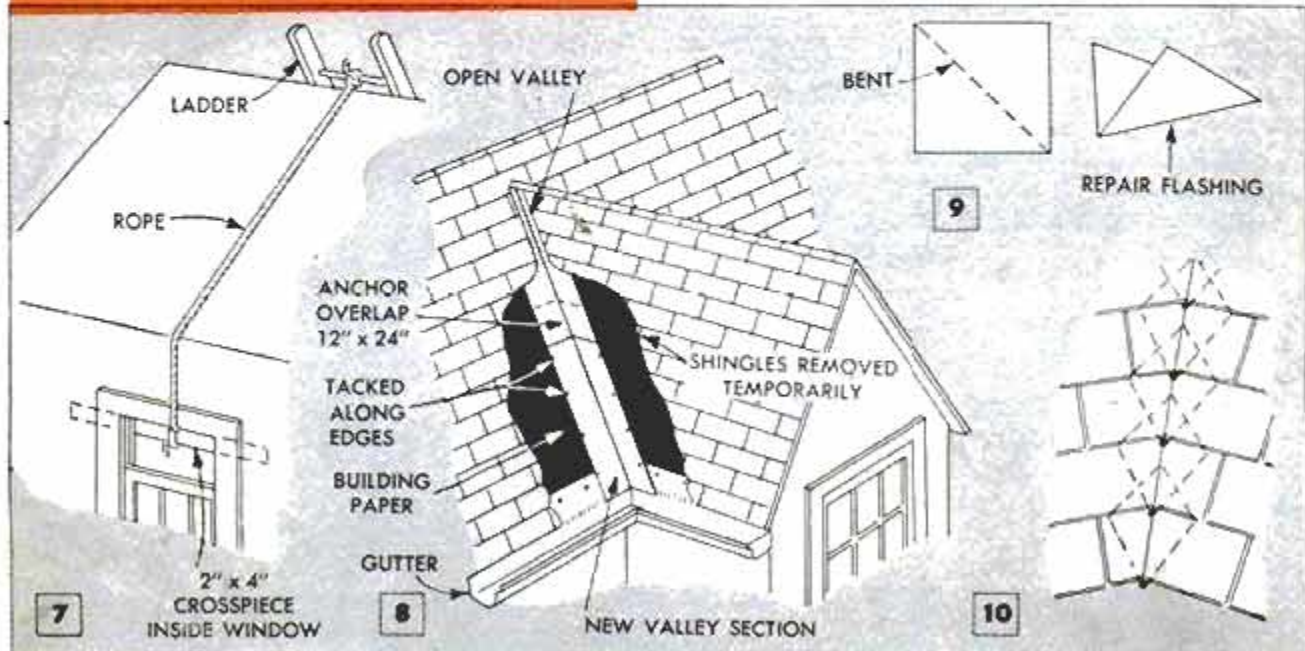
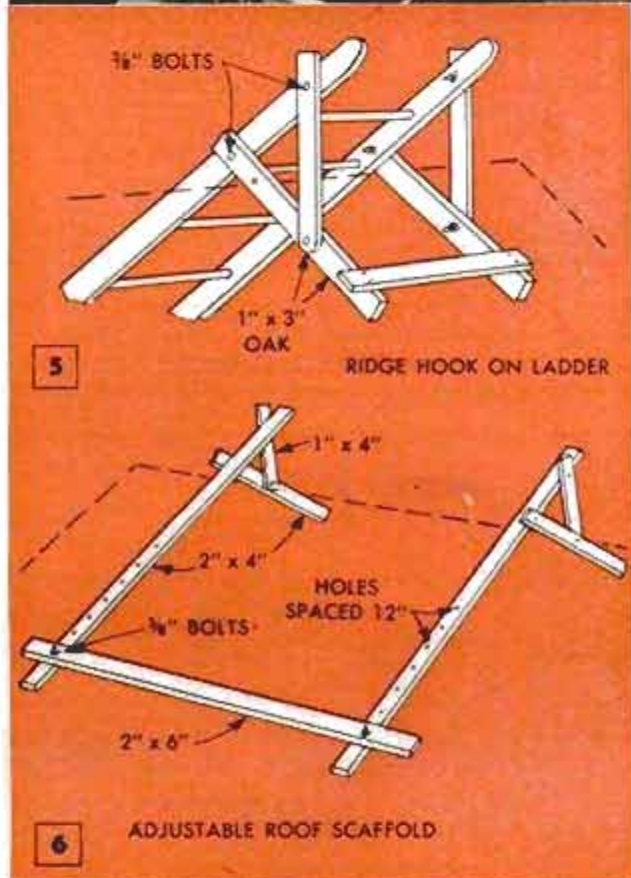



should consist of two layers. Unsurfaced asphalt felt not less than 18 in. wide is cemented to the sheathing for the inner layer and a mineral-coated asphalt-felt strip 36 in. wide is cemented to the first layer for the outer one.

When a leak develops in flashing under wooden shingles a temporary repair can be made by pushing sheet-metal squares, bent diagonally, under the shingles, Fig. 9. Begin at the bottom and work upward. Each piece should extend about 3 in. above the butts of the next higher course of shingles.

### Chimney and Other Flashing

Chimney flashing, which consists of two layers of sheet metal—the base flashing and the counter flashing, Fig. 12—often is the source of leaks. Counterflashing is embedded in mortar joints of the brickwork. The latter is kept in good condition by tuck-pointing when needed. Single lengths of flashing are used to span the chimney width when the joint between chimney and roof is horizontal. Small “metal shingles” are used where the roof slopes along the chimney. A saddle, Fig. 13, helps to shed water from melting snow.

A horizontal joint between a roof and wall covered with siding, shingles or stucco is flashed with sheet metal installed under the wall covering about 4 in., and over the adjoining roof about the same distance. When a roof joins a brick wall, follow the same method of flashing as is used on a chimney.

### Asphalt Shingles

The most common roof-covering material is asphalt shingles in strip form. Sometimes shingles are damaged by wind, which raises and breaks them off, causing leaks. It is best to replace shingles damaged in this way with new ones. When prying up the nails, a strip of wood or metal is used as a fulcrum under the prying tool, Fig. 11. Install the new shingles at the bottom of the damaged area first, using rust-resistant nails, Fig. 13.

When a leak in an asphalt-shingle roof is caused by water driven under the shingles, the trouble can be corrected by applying roofing cement under the lower parts of the shingles.

### Wooden Shingles

Leaks can occur in a roof covered with wooden shingles when the shingles dry out, curl and crack. Curling can be prevented by applying shingle oil or paint periodically. When a wooden shingle is cracked in line with the joining edges of shingles just above and below it, a leak is likely to result. If the shingle is not loose, a piece of

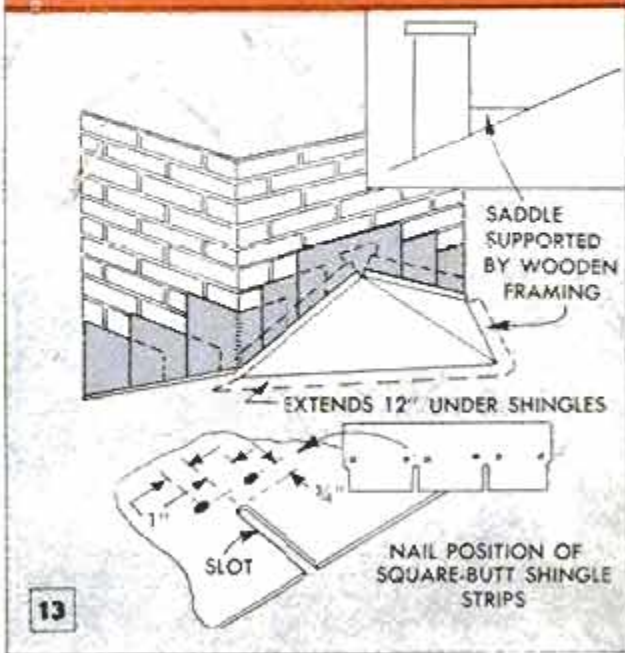
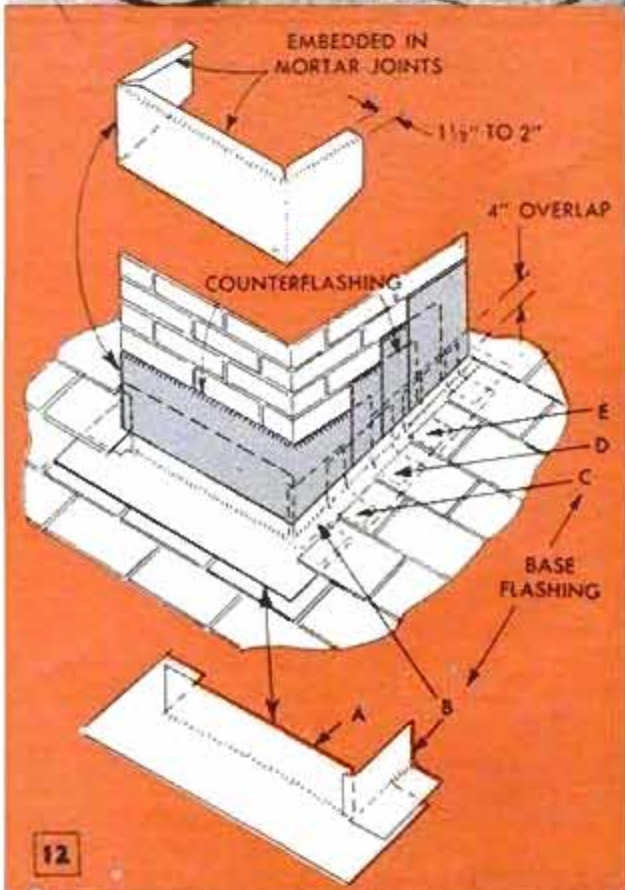

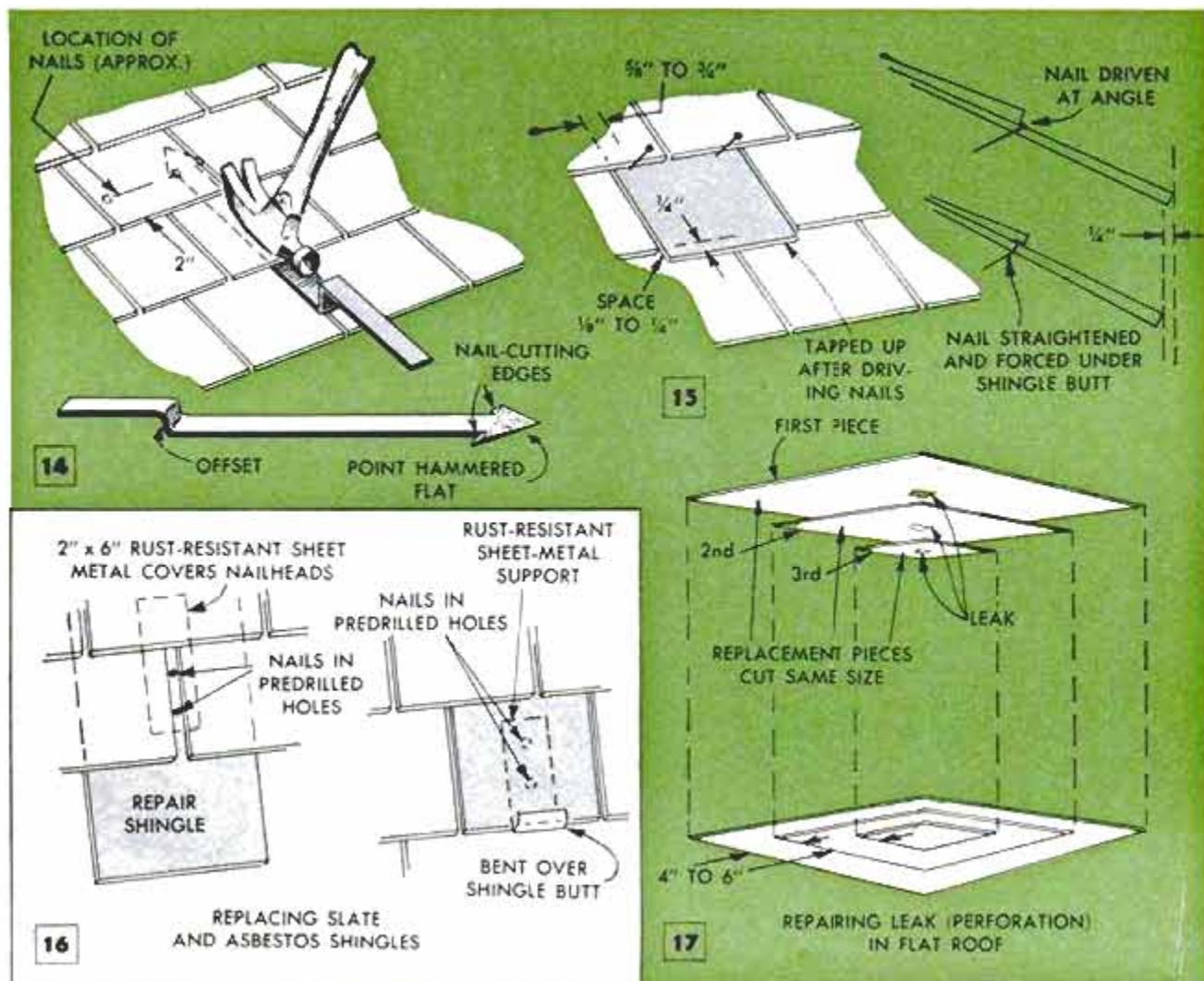

sheet metal can be pushed under the crack to stop the leak.

When a defective shingle must be replaced, the nails holding it should be severed first with a nail cutter as shown in Fig. 14. After the replacement shingle has been driven so that its butt end is  $\frac{1}{4}$  in. below adjacent shingles of the same course, drive two shingle nails at an angle just under the butt end of the overlying shingles, Fig. 15. Tap the shingle up in place to bring the nailheads under the overlying shingles.

### Slate, Asbestos, Tile Shingles

This group of shingles will last a lifetime under normal conditions but is susceptible to mechanical breakage. Broken shingles can be replaced in two ways, Fig. 16. The detail at the left shows how nails are driven through holes drilled after the shingle has been pushed into position. A piece of sheet metal is then pushed over the nailheads. The detail at the right, Fig. 16, shows a strip of metal fastened under the replacement shingle and bent up against the butt end of the shingle to anchor it.

When asbestos or slate roofs fail because the nails have rusted, the entire roof cov-

ering should be removed and replaced. All unbroken shingles can be reused. A roof tile that is broken should be replaced with a new tile set in roofing cement.

### Built-up Asphalt and Gravel Roofing

Although very durable, initial failures of built-up asphalt and gravel roofing occur at flashings. A leak can be repaired by removing and replacing only two or three layers of the roofing, one at a time in progressively smaller squares as in Fig. 17. Each of the new pieces is cemented with hot tar, followed with a layer of gravel and a coat of topping cement.

### Metal Roofs

Galvanized-iron roofs require periodic painting to prevent excessive rusting. Leaks usually develop at rust spots, loosened seams, or where the metal is pierced by nails or screws. When galvanized iron is too rusty for soldering, it can be repaired by coating the affected area with roofing cement. Then press a piece of muslin on the cement and brush more cement over it. Another similar method of patching which is more permanent is to use glass-fiber cloth saturated with a special resin, such as used for auto-body repairs. ★ ★ ★

# Aluminum-Foil "Scarecrows" Protect Plantings

Strips of aluminum foil, creased in the middle and suspended from a cord, will discourage birds from pulling up young plants. The cord is run through screw eyes on posts at the ends of the rows, and weighted to keep it taut. On long seedbeds, the end posts should be slanted out away from each other to give added support to the cord.

Tender plants which are susceptible to hot sun or cold air can be protected with a cover of translucent-plastic laminated screening, which also is effective in warding off attacks by birds, insects and small animals. Triangular-shaped wooden ends are held erect and apart by joining similar corners of the triangles with lengths of stiff, heavy wire. The plastic screening then is wrapped over the top wire, stapled to the bottom

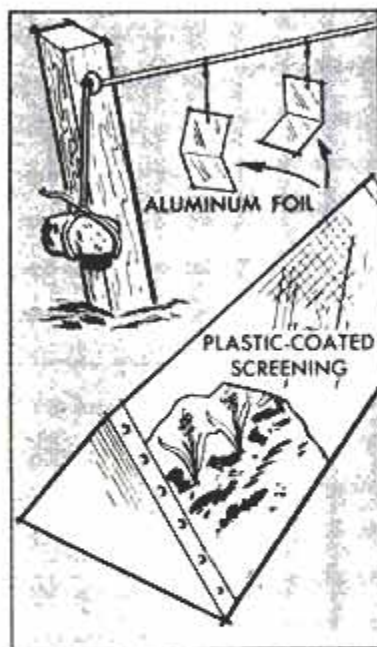

two and tacked to the end supports. A stick driven into the ground and nailed against one end will aid in keeping the assembly steady. In windy areas it may be necessary to locate stakes along the lower wire to keep it in place.

## Punch Made From Drill Shank

A punch for use on light sheet metal can be made from the shank of a discarded or broken drill of the diameter needed for a particular job. After cutting off the shank, grind a V-slot in the severed end of the shank as indicated. A sharp blow with a hammer on the blunt end of the punch will cut a clean, neat hole in the sheet metal.

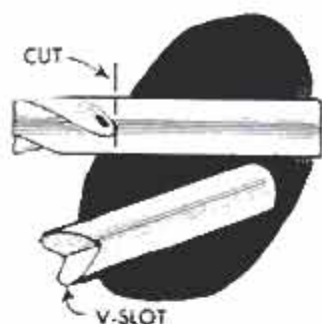

Henry Josephs, Gardenville, Pa.

## Notched Cork Stores Razor Blade

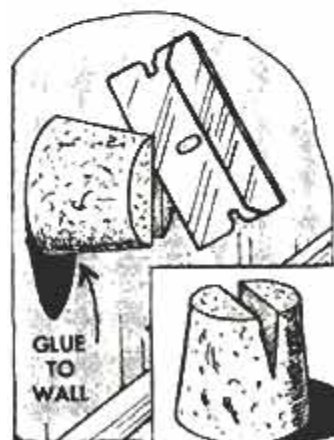

To keep a single-edge razor blade in a safe place in your workshop, cut a deep V-notch in a large cork and glue it to a wall or other appropriate surface near the workbench. The blade is always at hand to cut patterns, trim photos and for other jobs.

## Sheet-Metal Jig Locates Nails Along Edge of Workpiece

This simple jig will enable you to do an accurate job of locating nails along the edge of a piece of work. The jig is simply a strip of tin-can metal bent at right angles and with a V-notch cut in one leg to position the nail the right distance from the edge. In use, the jig is held against the edge of the work and the nail is started in the bottom of the V-notch.

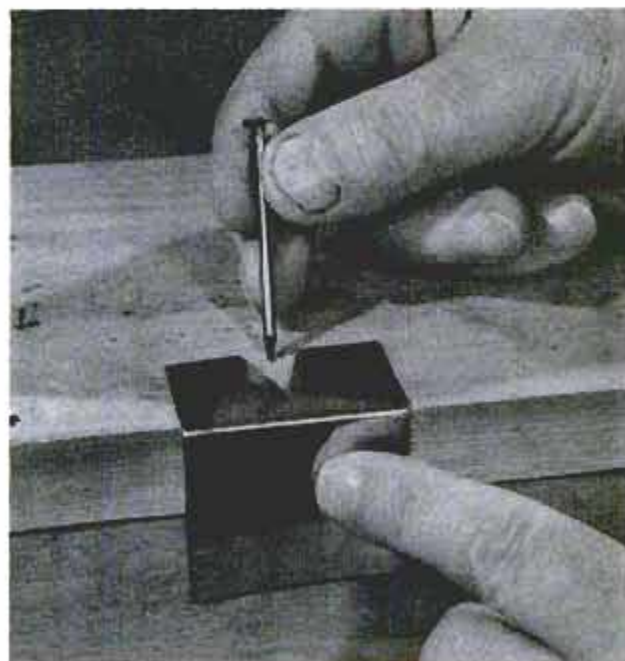

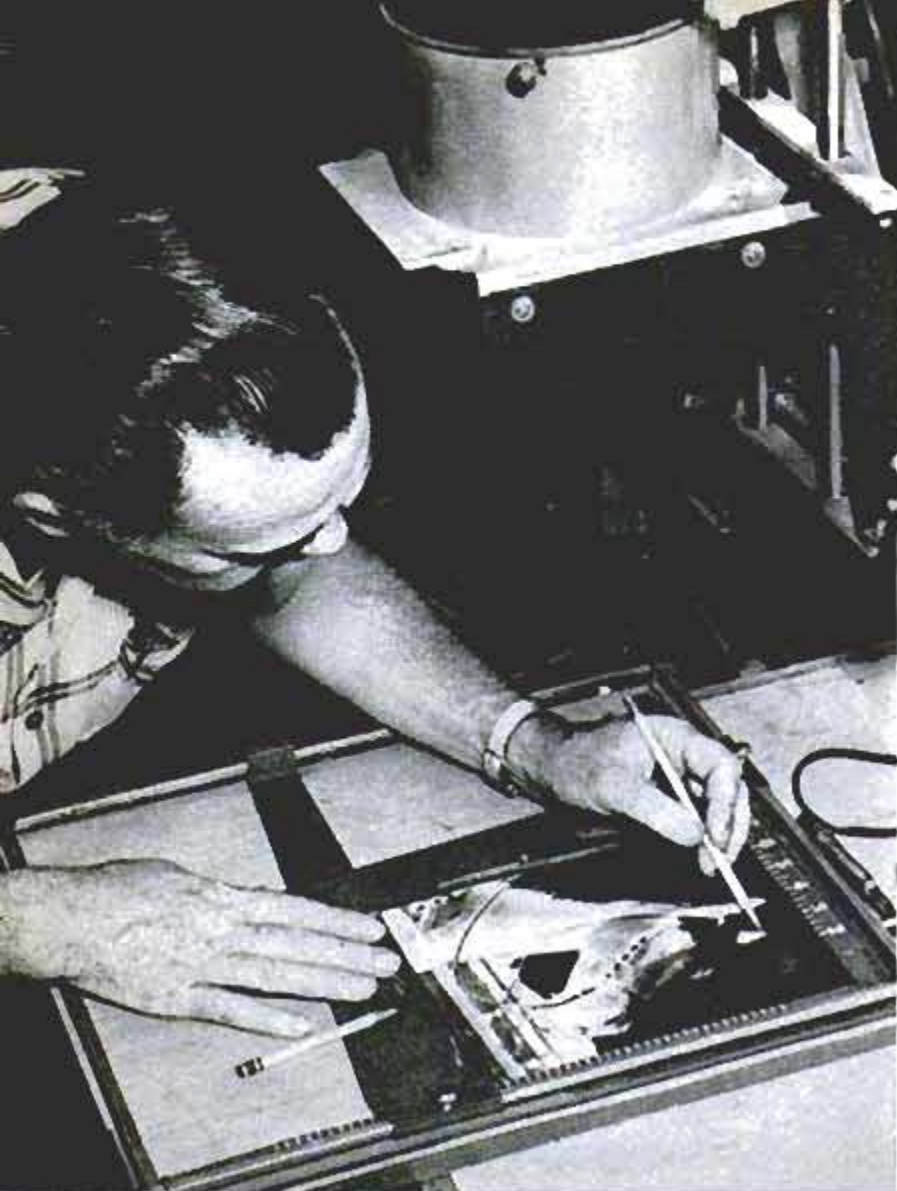

Note how drawing of horse above is simplified as compared to the photo below



Start at the top of the print and work downward, shading in all the light areas with a pencil. Do not draw in the background

Photo of the head of a horse is excellent subject; has simple lines and shading

WTM 58  
or  
PHOTO SKETCHING 58

## PHOTO SKETCHING

By Shep Shepherd



**H**AVE YOU EVER WISHED to sketch a figure, object or scene, but lacked artistic ability? If you have a camera and an enlarger, you can make sketches or paintings of anything that can be photographed. Photo sketching permits substituting time and patience for natural ability.

You will need these items: 3 pencils (soft, medium and hard), an ordinary pencil eraser, drawing paper and a photo negative. The reverse side of photo-enlarging paper can be used for drawing paper. Because you will later need a photoprint for checking the sketch, first make an enlargement from the negative in the usual manner. Make it the same size that you intend to make the sketch. Leave the negative in the enlarger, place a sheet of drawing

If pencil shading goes beyond lines of figure or into white areas, make corrections with an eraser



First step in making painting by using photo-sketching technique is to sketch photo as above. Include only outlines of prominent objects and indicate shading

Select photo that can be sketched with simple lines. In photo below, mountains, hills and stream are single curves, while rocks in stream are irregular spheres



Using original photo as guide, artist first makes rough sketch, as above, then applies oil paints to produce picture below



paper on the easel and open the enlarger lens to its fullest aperture to obtain a brilliant image on the paper. If the enlarger does not have heat-resistant glass condensers, open the head to prevent overheating.

At this point you have a negative image projected on the drawing paper. This means that all the areas that are black in the finished positive print will be white in the negative image, and those that will be white on the finished print will be black. Start at the top and work downward, shading all the light areas until they are as dark as the darkest part of the image. On those areas that are completely white, use a soft pencil. Use a medium soft on the light-gray areas and hard pencil on the dark-gray areas. Do not sketch over areas that are black. Continue until the entire picture is one shade of black or dark gray. Occasionally turn on the room lights and inspect the work as you progress.

Draw a pencil line around the outer edges of the image to outline it, since the background will not be copied. Also, draw lines in any important areas within the image itself, such as eyes, hairlines, collars, etc. It is advisable to outline the image before any sketching is done, then if the

easel accidentally is moved, the outline will permit quickly realigning the sketch with the image. Although the work can be done completely under the enlarger, it is best to sketch in only the important areas, plus the outline and important inner lines. Then the partially finished sketch is placed beside the print of the original on a desk or table, where the work can be done more comfortably under a bright light. Study the photograph and sketch in shaded areas in the drawing where they are needed. You also can insert new lines or omit lines that are in the original picture, if by doing so the appearance of the drawing is improved or simplified. Note that in the sketch of the palomino horse several changes were made in the reins and bridle to omit tedious detail. Omission of the detail does not change the over-all appearance of the sketch, and actually adds to its "freehand" look.

When shading areas near the edge of a figure, do not worry about running over the outline. The sharp edge of an eraser can be used to correct this situation. In fact, it sometimes is better to let the pencil sweep over the edge of the outline so that a sharp edge does not result from the pencil being lifted abruptly or turned along the

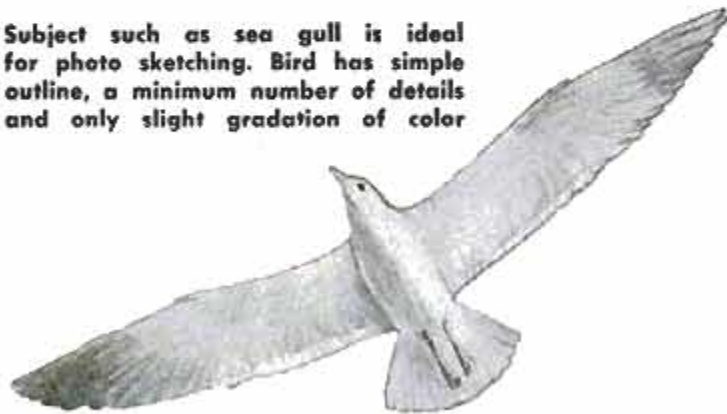

Photo sketch of beribboned puppy demonstrates again how the drawing should be simplified as compared to photo. For purposes of illustration, pencil mark around outline of figure is exaggerated

edge of the outline. For the same reason, if the pencil lines run into areas that will be white in the finished sketch, erase them after the drawing is removed from the enlarger easel.

Subjects with simple lines and areas of smooth gradation are best for photo sketching. For example, a lion would make a better subject than a tiger, since the latter's stripes would entail too much critical work. Although the finished sketch may not have a professional appearance, it will have a unique quality that is not produced by any other method. One useful application of the photo-sketching technique is to make an outline or rough sketch of a picture that is to be painted in oils or water colors. The paint will, of course, cover the faint pencil lines of the sketch made from the photo.

Subject such as sea gull is ideal for photo sketching. Bird has simple outline, a minimum number of details and only slight gradation of color



A practical use for the technique is in determining the appearance of a building when changes are to be made that will change its exterior size and shape. Make a sketch of the building and draw in the suggested changes. The appearance can be judged at a glance.

However, the greatest value of photo sketching comes from its sheer entertainment value in creating unusual pencil drawings of pets, children, friends and other familiar subjects and later displaying them. After doing a number of drawings with the photo-sketching technique you will gain skill and can start improvising. An example is shown in the treatment of a landscape photograph on page 187. In the original photo, a fisherman was standing beside a small, meandering stream. The finished painting, which was done with oils, omitted the man, enlarged the stream and changed the character of the mountains in the background. There is little resemblance in the finished painting to the original photo. ★ ★ ★



## Wheels for Toys Cut From Wringer Roll

Next time you make a mobile toy why not equip it with rubber-tired wheels cut from a discarded clothes-wringer roller? First drill a hole in the center of the roller shaft to facilitate mounting. Then slice off the wheels in any desired width using a metal-cutting saw blade. The edges on the circumference of the wheels can be removed with coarse-grit sandpaper to give them a contour similar to auto tires. If a tread pattern is desired, "brand" it on with the cutting edge of a hot hacksaw blade. Attach the wheels to the toys with wood screws.

Earl R. Phelan, San Jose, Calif.

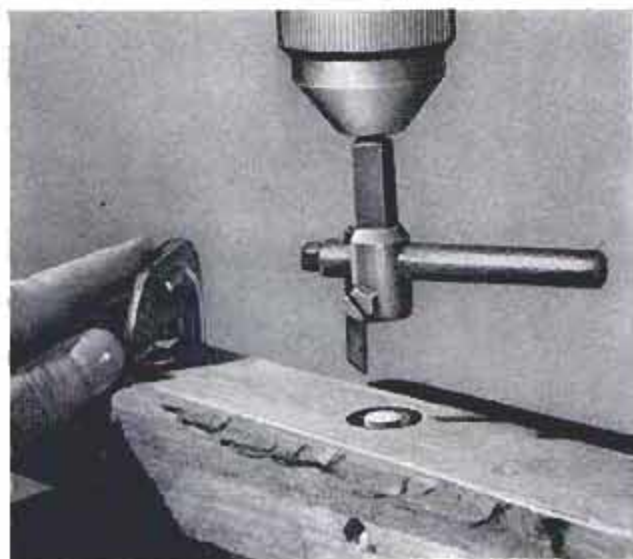
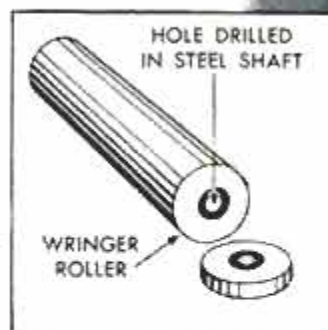

## Hole Cutter "Turns" Plugs

When you need round wooden plugs to fit screw holes, or other openings, make them with an adjustable hole-cutting tool. Remove the pilot bit, and reverse the blade so that it makes a perpendicular cut on the inside. Use scrap stock matching the piece to be plugged and clamp it firmly to the drill-press table. The blade on the hole-cutting tool should have a sharp edge to prevent chipping or gouging the top of a plug, especially when soft or coarse-grained wood is used for this purpose. After a plug is cut it can be removed by prying with a narrow chisel or similar blade-type tool, then cut to the required length.

Ken Murray, Colon, Mich.

## Salvaged Fireplace and Mantel Lend Atmosphere to Home

Installing a false fireplace front and mantel in your home adds an atmosphere of warmth, whether you live in a house or apartment. The basic unit might be salvaged from an abandoned farmhouse, or procured from a homeowner who is remodeling his house. Start by laying the hearth floor, using a panel of hardboard which has been scored into 4-in. squares. If the adjacent floor is exposed, a molding of 1/4-in. quarter-round is nailed on around the edge of the panel. Setting up the unit, it may extend from the wall, as shown in the illustration, or be cut shallow to give the appearance of being recessed. A panel of hardboard is then fastened inside the fireplace to conceal the wallpaper behind it. If the mantel top is warped or cracked, cover it with a narrow piece of hardboard. Floor panel is given one coat of tile-red deck paint to create a mottled effect and the panel inside the fireplace is painted black.

Masonite Corporation, Chicago.

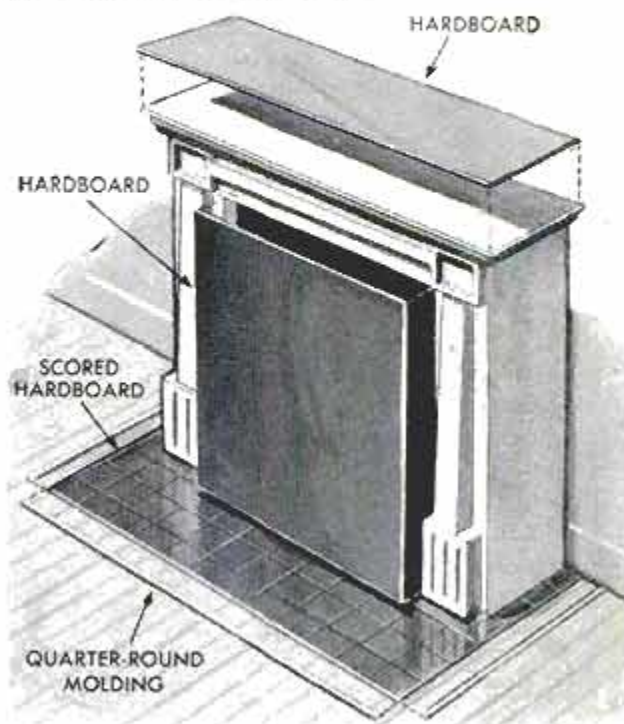

## Finding Correct Height for Setting Plate Bolts Into Concrete

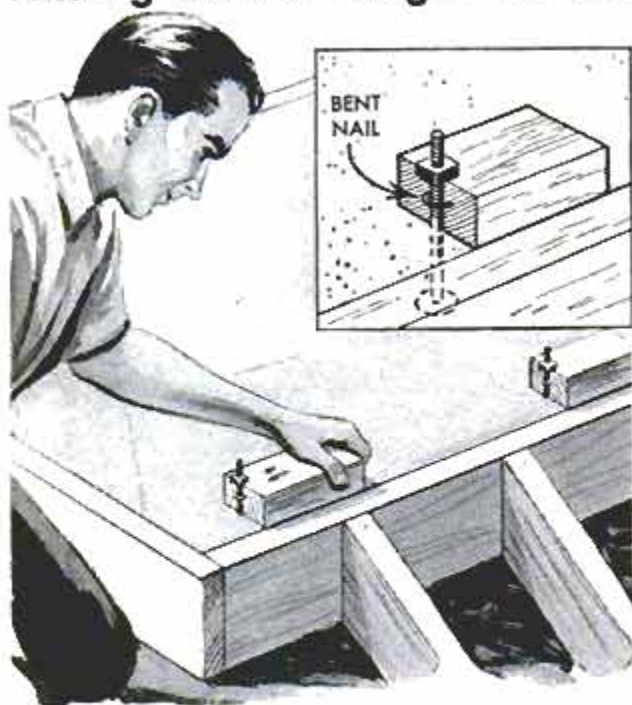

Bolts for attaching the bottom plate of a frame wall to a concrete foundation or floor can be set to the correct height by first nailing the bolts to the ends of scrap pieces of 2 x 4-in. lumber. The nails are driven slightly off-center and then bent around the bolt, as shown in the detail. While the concrete is still wet, place the blocks flush with the form edge, forcing the bolts down head first into the concrete so that the attached nut rests on top of the block. After the concrete has set, the nuts are unscrewed and the blocks removed. Then the bottom plate is placed alongside the bolts and marked for drilling. After matching holes have been drilled, the plate is slipped over the bolts and fastened down. Not only will use of the blocks keep the bolts at the proper height, but they will also keep them vertical and at the same distance in from the edge of the concrete, which simplifies laying out and drilling holes in the plate.

Herbert E. Fey, New Braunfels, Tex.

## Rock Lining Protects Garbage Can

To provide drainage around his underground garbage can and prevent rusting, one homeowner encased the can in gravel and rock. The bottom of an oversize pit was covered with flat pieces of broken concrete sidewalk and a steel liner lowered into the hole. With a corrugated cardboard form, 4 in. greater in diameter, placed around the liner, gravel is poured between the latter and the cardboard. To prevent the cardboard from buckling, the gravel should be poured at the same rate the dirt fill is added outside of it. A gravel cap on the surface completes the installation. The can is lifted out by means of a wire bail.—Larry W. Smith, Portland, Ore.



## Battery Holder Used in Electrical and Radio Experiments

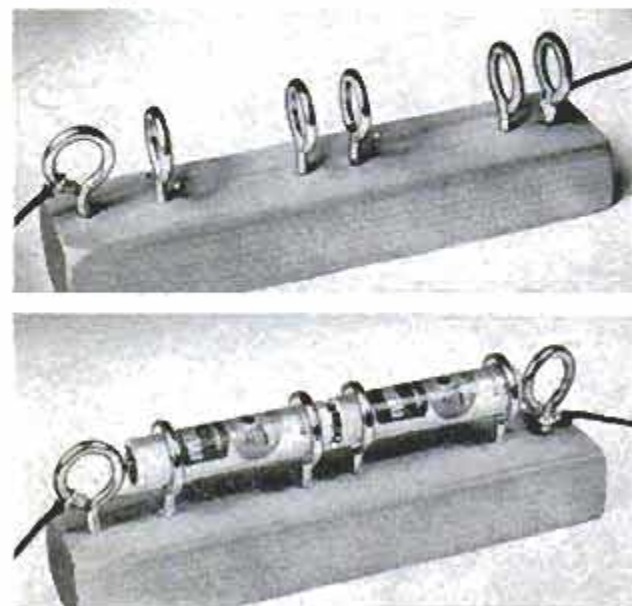

Hold penlight batteries for electrical and radio experiments in this simple block-and-screw-eye assembly. A pencil line was drawn down the center top of a  $4\frac{3}{4} \times 1 \times \frac{1}{2}$ -in. strip of soft wood, and six  $\frac{1}{2}$ -in.-dia. screw eyes were twisted an equal distance into the wood in line. The two end eyes should be exactly 4 in. apart, but the other four eyes need only to be placed approximately as shown. Slip the batteries in through the right-hand eye so the positive terminal of the first battery contacts the left-hand eye, which is at right angles. Then turn the right-hand eye until it contacts negative end of the second battery and presses it snug. Leads are connected to the end screw eyes with alligator clips, or by soldering.

Arthur Trauffer, Council Bluffs, Iowa.



# Plant Stand

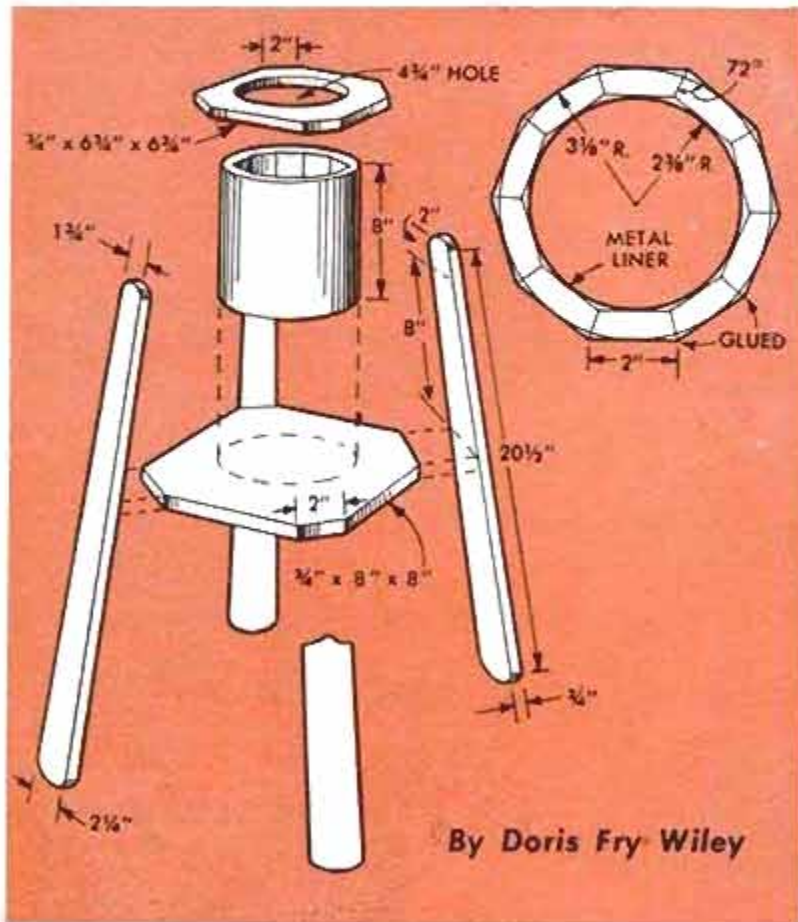

Overcoming the disadvantages of most containers for large plants, which are unattractive and easily upset, this plant stand is modern in design with wide-spaced legs that prevent its being tipped accidentally. Start construction of the stand by cutting 10 strips of 3/4-in. plywood or solid stock 2 x 8 in. Saw the long edges at 72-deg. angles and glue the strips together to form a cylinder as detailed. Cut two disks from 3/4-in. stock 6 1/2 in. in diameter and screw them temporarily to the ends of the cylinder thus formed. After the glue between the strips has dried thoroughly—about 12 hr.—center the cylinder in a lathe and

turn it to a diameter of 6 1/4 in. Then remove the disks.

Cut four tapered legs to the dimensions given in the detail, rounding the ends as shown. Mark the shelf locations on the insides of the legs, then cut the two shelves from 3/4-in. stock. The upper shelf, in which a 4 3/4-in. hole is cut, is screwed and glued to the top of the cylinder and to the legs after a metal container is fitted inside the cylinder. The container can be a large food tin or, lacking this, can be cut and soldered from sheet brass. Brass should be used, since it will not rust as will steel. Food tins have a rust-resistant coating.

## Simple Rubber-Band Gun

This toy gun utilizes a rubber band to shoot arrows that consist of small suction cups fitted to lengths of 3/16-in. dowels. The paddle-shaped gun is cut from a piece of plywood or tempered hardboard. The arrows are inserted through a 1/4-in. hole drilled centrally and a rubber band is slipped through two saw cuts in the edges of the gun on the center line of the hole. A thumbtack on the front side keeps the band from obstructing the hole.

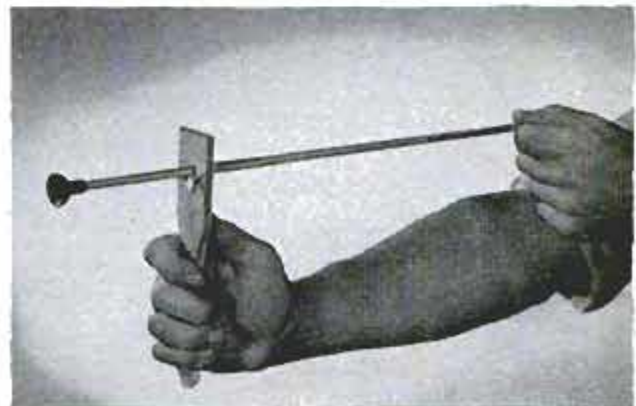

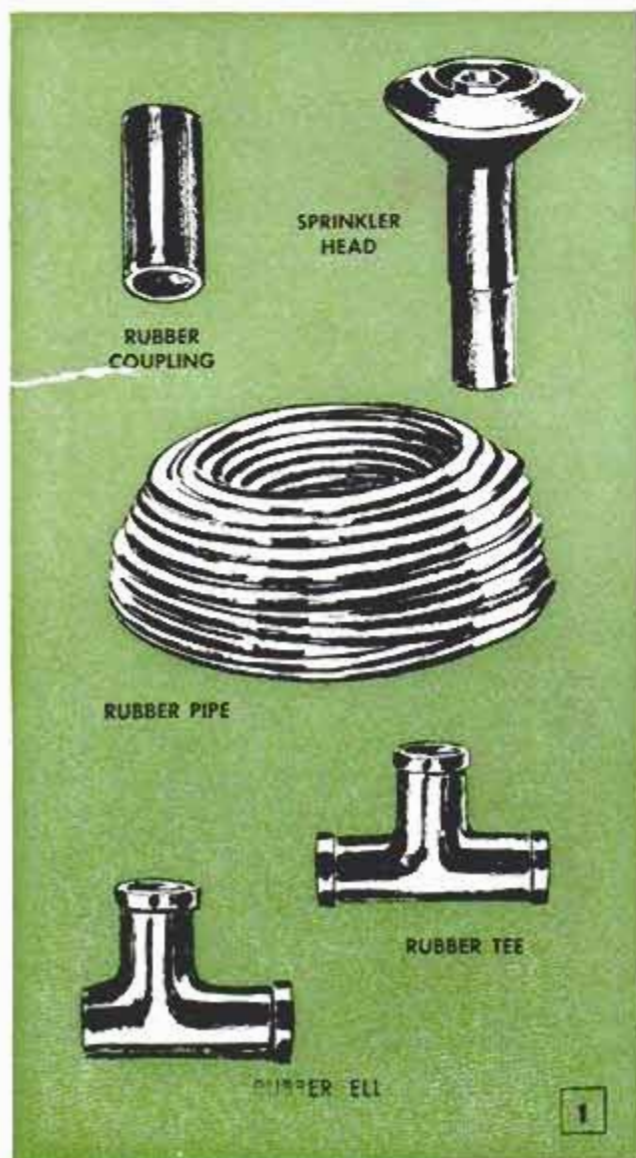
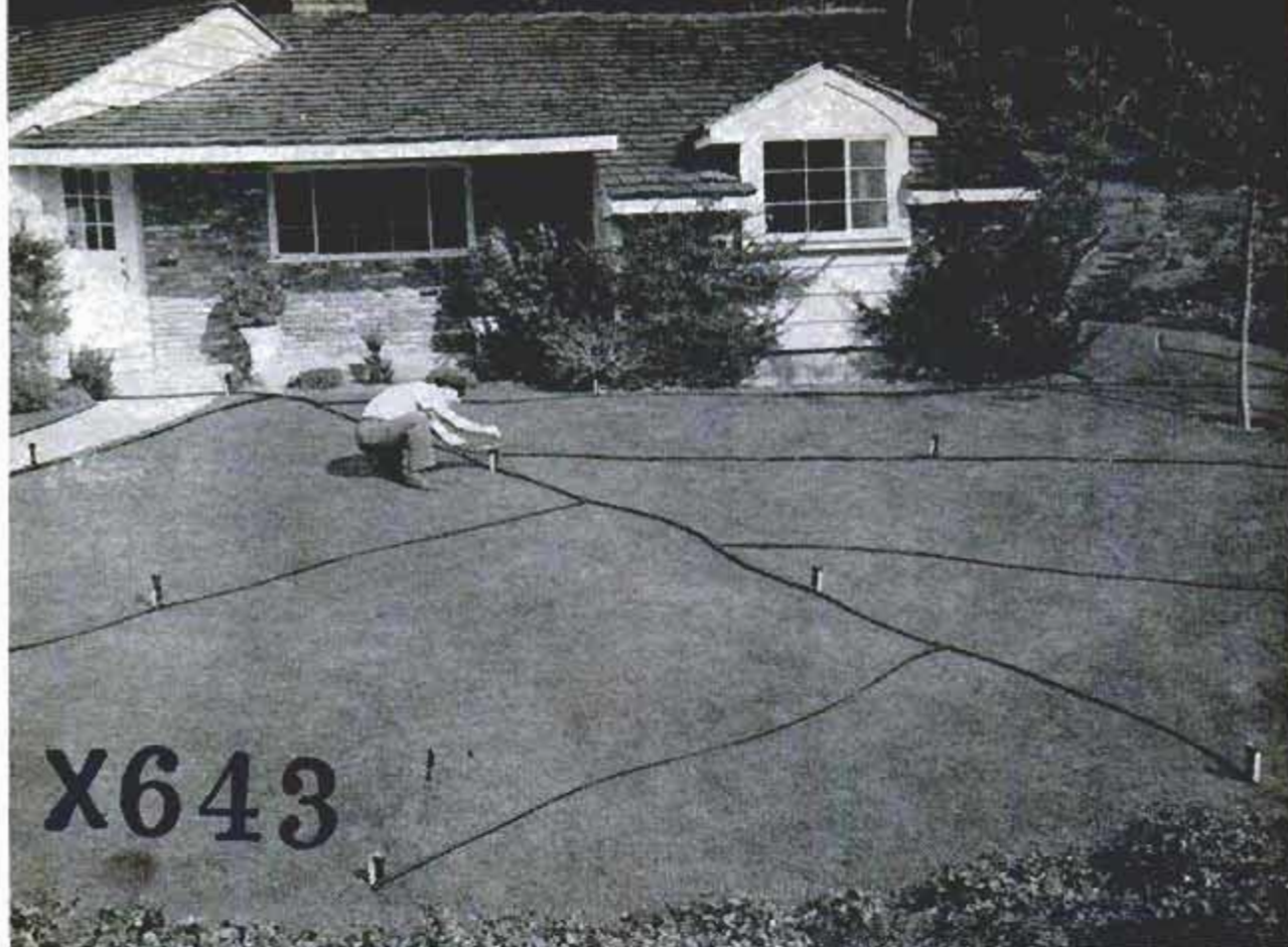

## Put Your

**W**HAT SOUNDS like a homeowner's dream is a practical, inexpensive underground sprinkling system that can be installed by the homeowner himself over a week end. The system is not damaged by alternate freezing and thawing, and consists of flexible rubber pipe, fittings and rubber sprinkler heads that have brass nozzles. Four types of nozzles are available, Fig. 2, providing spray patterns from a quarter to a full circle.

The first step in installing the system is to make a scale drawing of your property and lay out the system as in Fig. 3. Sprinkler heads spray water in a 7-ft. rad., but should be located only 10 ft. apart to assure an overlap in the spray pattern. A typical plan is shown in Fig. 3. After the plan has been drawn, make a table like Form 1 to determine the volume of water required for your particular system. Normally the volume of water available is insufficient to operate all the sprinkler heads together so the system must be divided into circuits which are controlled by separate valves, Fig. 7.

A quick method of determining the volume of water available at your water meter is to open four or more faucets in the house and count the number of times the cu.-ft. dial on the water meter rotates in 1 min.

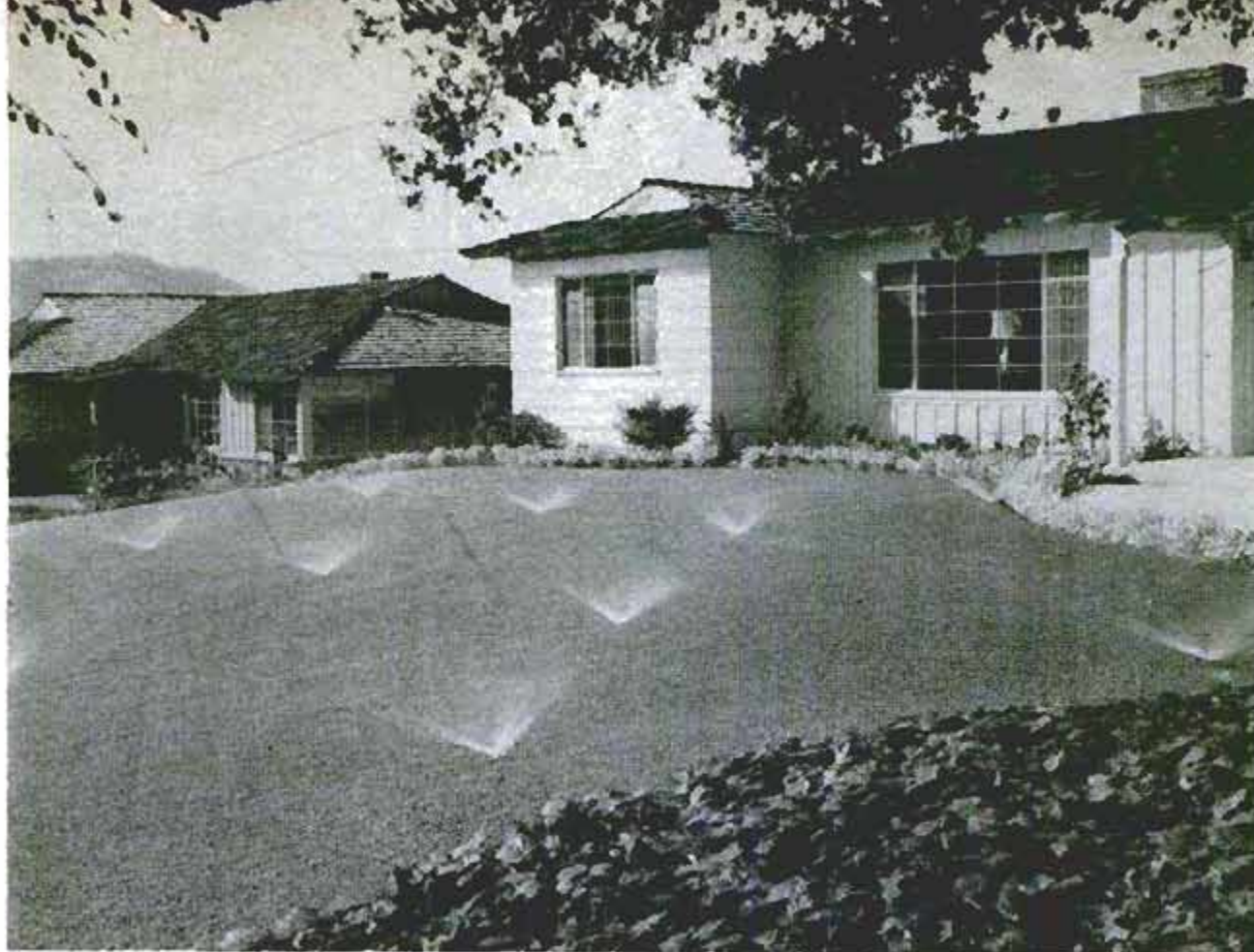

## Garden Hose Underground

Multiply the number by 7.5 to determine the g.p.m. In some instances, a water meter will read directly in g.p.m. If you do not have a water meter, an alternate method of determining the volume of water available is to use a pressure gauge. Borrow one from your plumber or hardware dealer, fit it into the water line and use the table in Form 2 for converting water pressure into the number of control valves needed for your particular system.

If a  $\frac{3}{4}$ -in., or larger, dia. pipe leads to an outside faucet, it may be possible to connect control valves directly to this line. However, if the pipe is small or is rusted inside, it is best to install a separate supply line of  $\frac{3}{4}$  or 1-in. pipe directly to the valves from the meter. The number of control valves required is figured by dividing the volume of water your system requires by the volume of water available. Draw these control valves on your plan, making sure they are in a location convenient for connecting to the supply line and accessible for operation, as well as clear of sprinklers that would wet anyone operating the valves.

If your particular plan results in a circuit that has a line pressure of more than 60 p.s.i., it will be necessary to install a pressure regulator between the meter and

the control valves or, when no meter is present, on the pressure side of the control valves. An excess amount of water pressure causes the sprinkler heads to discharge water in a fine spray instead of small droplets. The spray is difficult to control and evaporation is much greater. It is possible, in some instances, to control the pressure to the spray heads by partially closing the control valves. However, this may result in rapid wear of the valve seat and face.

Draw lines on your plan from each control valve so that it connects the correct number of sprinkler heads. After the pipelines have been laid out, recheck the water-volume requirements to make sure that each control valve has to deliver about the same amount of water.

With the system now laid out to scale, you can figure the number of feet of pipe, the number of sprinklers and other fittings needed. To begin the actual installation, set up the control valves as in Fig. 7, using galvanized-steel pipe and fittings. Note that the connections between the steel and rubber pipes must be underground. Also, some provision must be made for draining the valve system during freezing weather. In Fig. 7, a petcock has been installed at the low point of the system. The



full-circle head ●    ¾-circle head ◐    ½-circle head ◑    ¼-circle head ◒    control valve ⊕

**FORM 1 — TO DETERMINE VOLUME OF WATER REQUIRED**

Type of Heads	Number of Heads Needed	Gallons Per Minute Required by Each Type of Head	Total Gallons Per Minute Needed
¼ circle		approx. ½	
½ circle		approx. 1	
¾ circle		approx. 2	
full circle		approx. 2	
Gallons per minute required by system			

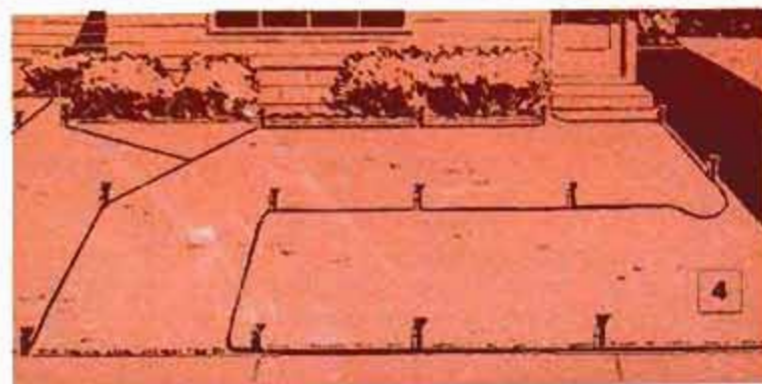
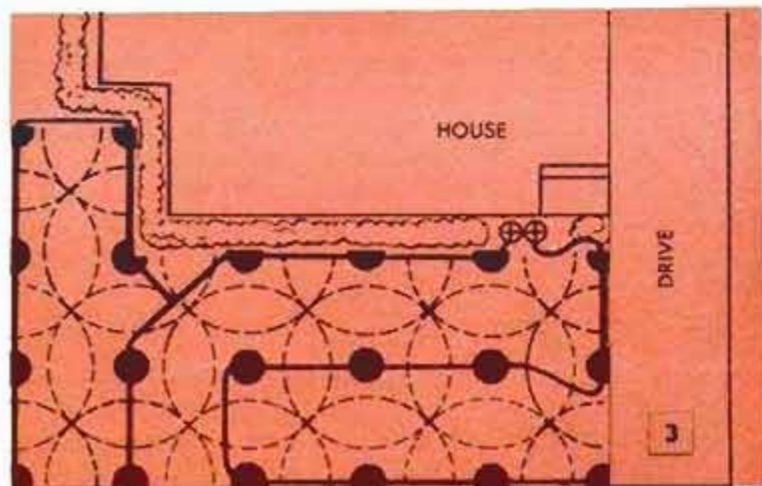

control valves should be the anti-siphon type which in many communities are required by law.

The next step in the installation is to stake out the locations of all the sprinkler heads, Fig. 2, according to your plan. Wire a sprinkler head to each stake, as in the detail in Fig. 2. Now, use a rubber coupling to connect the rubber pipe to the steel pipe at the control-valve connection. Clean the end of the steel pipe back about 2½ in. with steel wool or sandpaper, apply a ring of adhesive around the end and slip on the rubber coupling, forcing it over the pipe for the full 2½ in.

It may be necessary to warm the coupling in hot water for about 15 min. so that it will slip over the steel pipe more readily. Next, rough up the end of the rubber pipe, apply a ring of adhesive and force the pipe into the coupling until it contacts the end of the steel pipe. Unroll the rubber pipe to the first sprinkler head, cut off the pipe and connect it to the first tee as indicated in details A, B and C in Fig. 5. Repeat this operation on the opposite side of the tee and fit the sprinkler-head-and-riser combination into the tee, making sure the nozzle in the head is facing in the proper direction. Do not cement the sprinklers to the tees as yet. In some instances it may be desirable to run a single line of smaller-dia. pipe to locate a sprinkler some distance from the main group. To effect a size

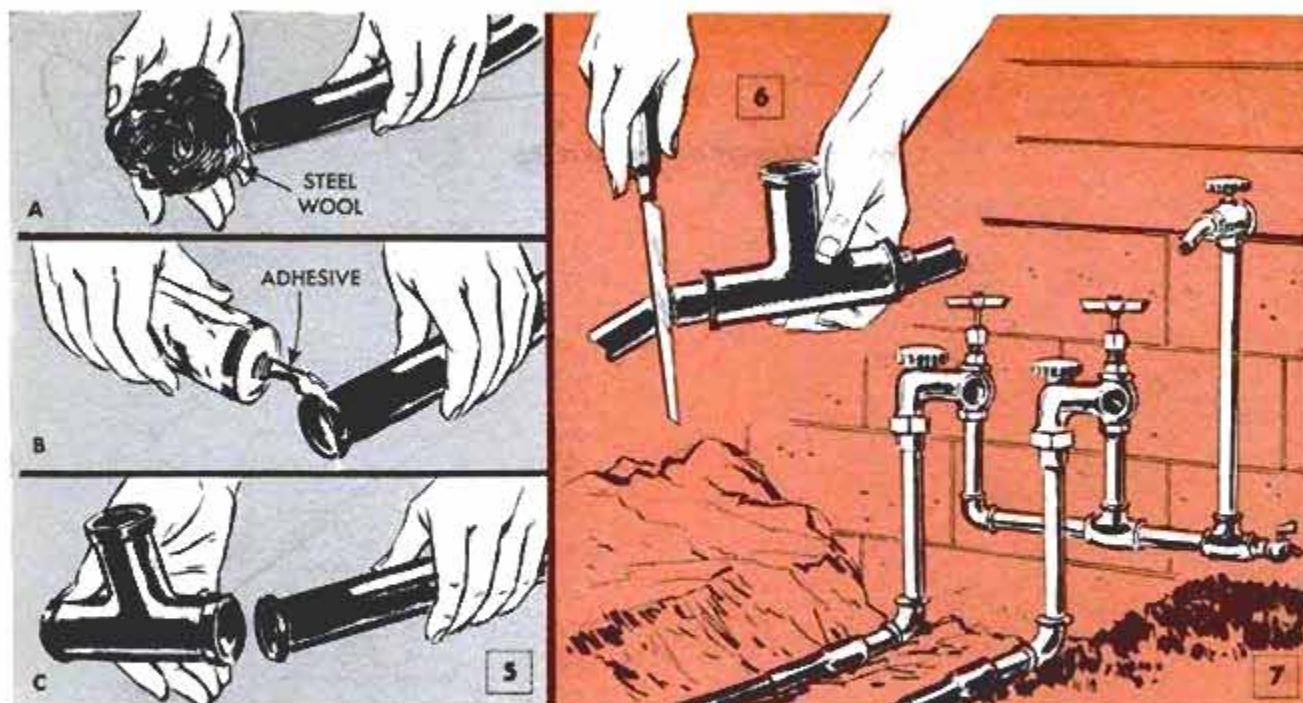

reduction in rubber pipe, for example from  $\frac{3}{4}$  to  $\frac{1}{2}$  in., cement a length of  $\frac{3}{4}$ -in. pipe in the  $\frac{3}{4}$ -in. fitting and cut it off so that about  $\frac{1}{4}$  in. projects. Then insert the  $\frac{1}{2}$ -in. pipe inside the projecting  $\frac{3}{4}$ -in. pipe. Reduction from 1 in. to  $\frac{3}{4}$  in. is done in the same manner.

Continue unrolling the pipe and connecting the sprinklers until the job is complete, Fig. 4. Now, test the system by opening a control valve until the spray from each head is about 15 in. in diameter. Adjust the screw in the middle of each nozzle so all heads have an equal spray radius. Finally, open the control valve all the way and check for complete coverage. Repeat the procedure for each circuit in the system.

To bury the system, turn on the water in the circuit you wish to work on first and let it soak the ground for about 45 min. or until a spade can be inserted in the ground easily to a depth of 4 to 6 in. Start at the control valve and cut the sod on a line extending a couple of feet past the first sprinkler head. Next, push the spade into the ground at a slight angle for about an inch and pry back, Fig. 8. Repeat this until the slit is 5 or 6 in. deep. At the location of the sprinkler head the slit should be vertical. Cut out a circle of sod for the sprinkler head. Start at the control valve again and insert the rubber pipe, using the rounded end of a length of 1 x 8, Fig. 8. At the sprinkler head make sure the head fits flush with the ground. If it cannot be set deeper, cut off a portion of the riser. Now, remove the riser from the tee,

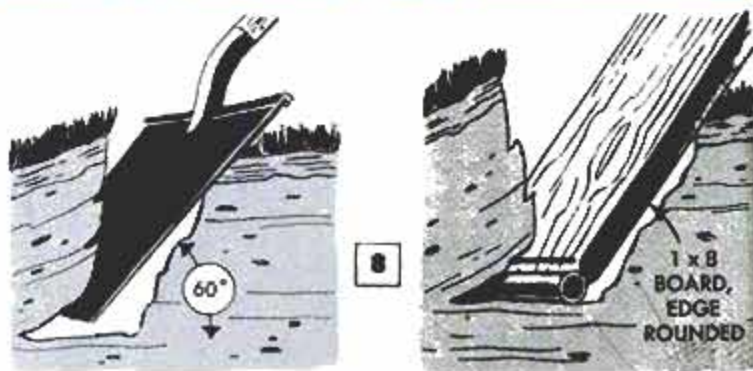

**FORM 2 — NUMBER OF CONTROL VALVES NEEDED AT VARIOUS PRESSURES**

Line Pressure	1 Control Valve Serves: No. full-circle heads (spacing—approx. 10')			Line Pressure	1 Control Valve Serves: No. half-circle heads (spacing—approx. 10')		
	$\frac{1}{2}$ " pipe	$\frac{3}{4}$ " pipe	1" pipe		$\frac{1}{2}$ " pipe	$\frac{3}{4}$ " pipe	1" pipe
30-lb.	4	6	14	30-lb.	7	10	25
40-lb.	5	8	17	40-lb.	9	15	32
50-lb.	6	10	20	50-lb.	11	18	36
60-lb.	7	12	23	60-lb.	13	23	42

wipe dry, rough with sandpaper, apply cement and reinsert in the fitting. Do not cement the last head in the circuit until all the fittings and pipe have been buried. Then remove the last head, turn on the water and allow it to flush all foreign matter out of the system.

Finally, start at the control valve and tamp the sod into place. Repeat the above operations with the other circuits. The directions of the spray head of fractional heads are given a final adjustment by turning the brass nozzles with a wrench. When separate circuits are installed to cover flower beds, make sure they are located so they will not be disturbed when the flowers are cultivated. ★ ★ ★

## Snap-Hook Shortens Anchor Chain On Fishing Boat



Limit drifting of a fishing boat by adjusting length of anchor chain to correspond with the depth of the water, retaining the balance with a snap hook attached to a screw eye driven into the gunwale

## Insulation-Board Backstop Safe For Air-Rifle Target Practice

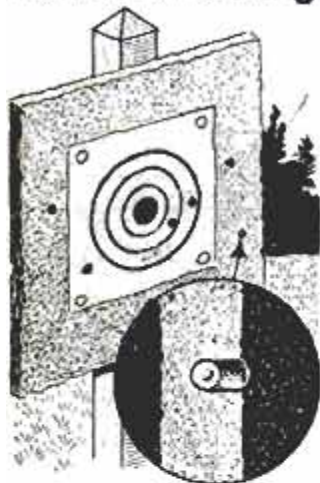

A target backboard constructed of soft insulation board will prevent pellets or shot fired from an air rifle from ricocheting and causing possible damage. The material is firm enough to provide a suitable surface on which to attach paper targets, yet soft enough to retain the missiles that come in contact with it. For maximum effectiveness and safety, the backboard should be at least 2 ft. square and attached to a sturdy post.

## Air Conditioners on Parade

The day is coming when you'll be air conditioning your home—it could be this very summer. A 6-page feature "Year-Round Climate Control" in the June issue brings you up-to-date on what's new in air-conditioning equipment and shows what strides the industry is making in this business of keeping you cool and comfortable 365 days a year

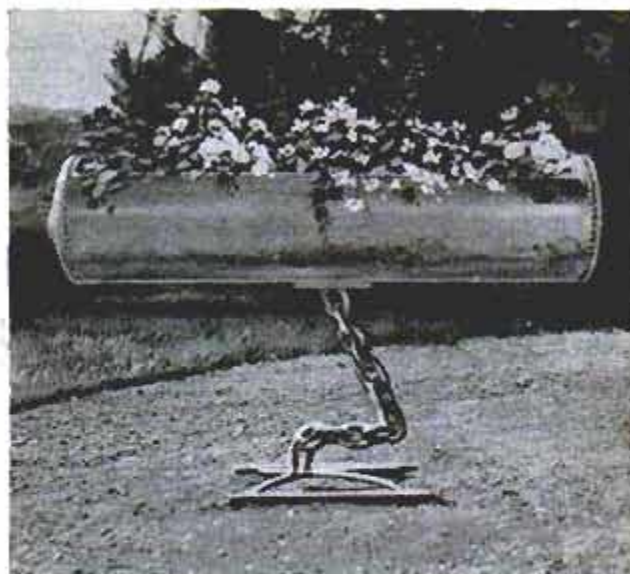

## Water-Tank Planting Boxes Mounted on Chain Standard

Unique "planting boxes" on one Montana farm consist of hot-water tanks cut open on one side. Each tank is mounted horizontally on a standard made by welding together the links of a heavy chain. The lower end of the chain is welded to a base made from steel rod. Because the planting boxes are stored away in the winter, the bases are not anchored in the ground.

E. V. Reynor, Townsend, Mont.

## Removing Fruit-Juice Stains

To remove acid stains, such as result from spilled fruit juices, on leather upholstery, wipe the spot with a cloth dipped in a solution consisting of 1 teaspoonful of baking soda in a glass of water. Then rinse with a soap-and-water solution.

## Tent Anchor Ropes Kept Taut With Heavy Rubber Bands

Rubber bands cut from an auto inner tube maintain adequate tension on tent anchor ropes when they are installed as shown. After the tent is erected and initial adjustment made, no further attention is required. When rain or heavy dew causes the canvas to stretch, the band permits automatic adjustment. It also absorbs shocks caused by campers stumbling against the ropes.

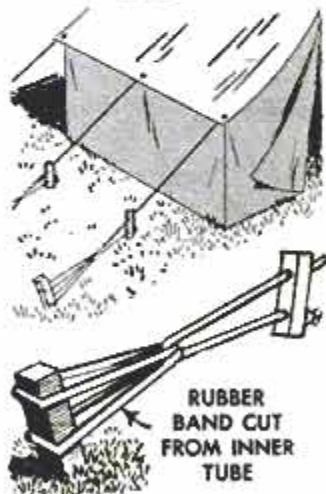

Gordon Boose, Windsor, Ont.



# TIME

## TO BUILD A CLOCKCASE

### PART II

**I**F THE grandfather clockcase presented last month was too massive for your particular home, you may find this smaller grandmother version more suitable. It stands about 6 ft. tall and is considerably less difficult to build than the grandfather clockcase since the hood is greatly simplified. The case is designed to accommodate a standard clock movement which you can buy as a kit and install yourself.

The case consists of three separate sections which are assembled individually and then joined together as a single unit. Either mahogany or walnut may be used, selecting the wood for beauty of grain and uniformity of color.

#### Start With the Sub-Base

Construction details are given on the following page. You'll notice that the base actually has a sub-base. Make this part first. The top requires a piece of  $\frac{3}{4}$ -in. plywood,  $12\frac{7}{16}$  in. wide and  $17\frac{3}{4}$  in. long. This allows stock for making  $\frac{1}{4}$  x  $\frac{1}{4}$ -in. rabbet-tenons around three sides to fit grooves in the scrolled base members. A  $\frac{1}{8}$ -in. groove is formed in the sub-base for the front plywood panel by making a second rabbet cut across the front top corner. Thus when the front scroll member is in place, the rabbet becomes a groove. The scrolled side members extend  $\frac{1}{4}$  in. at the back, and a  $\frac{3}{4}$  x  $2\frac{3}{4}$ -in. brace is fitted between them across

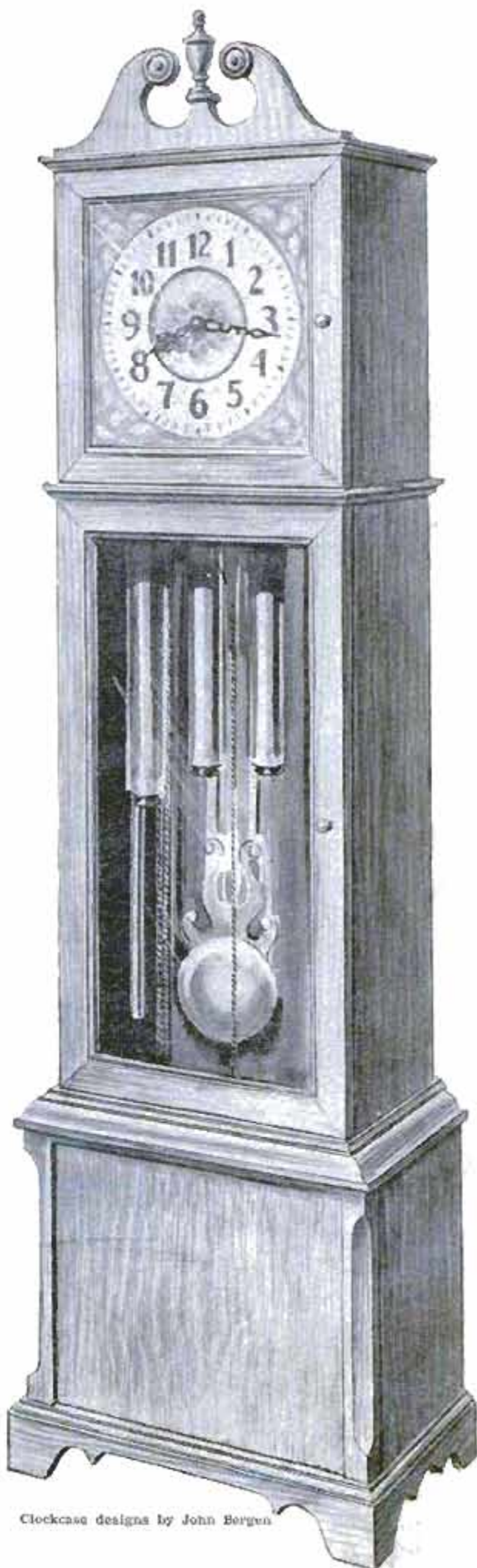

Clockcase designs by John Bergren

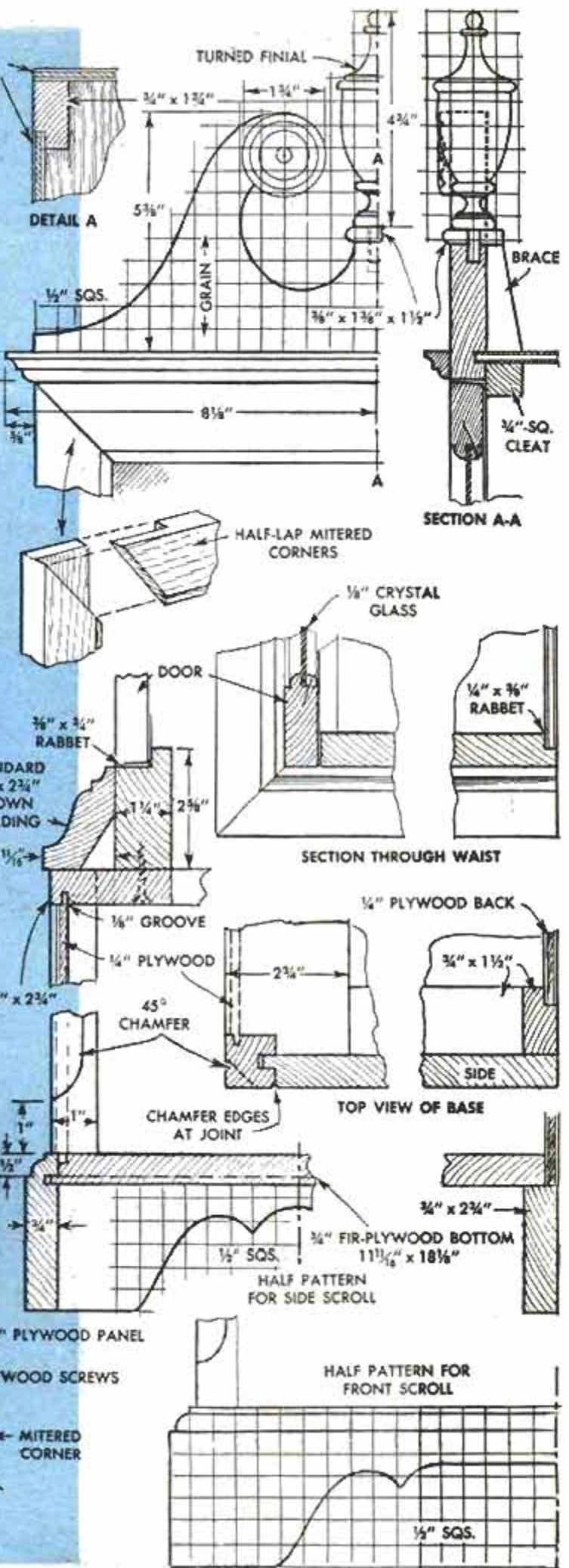
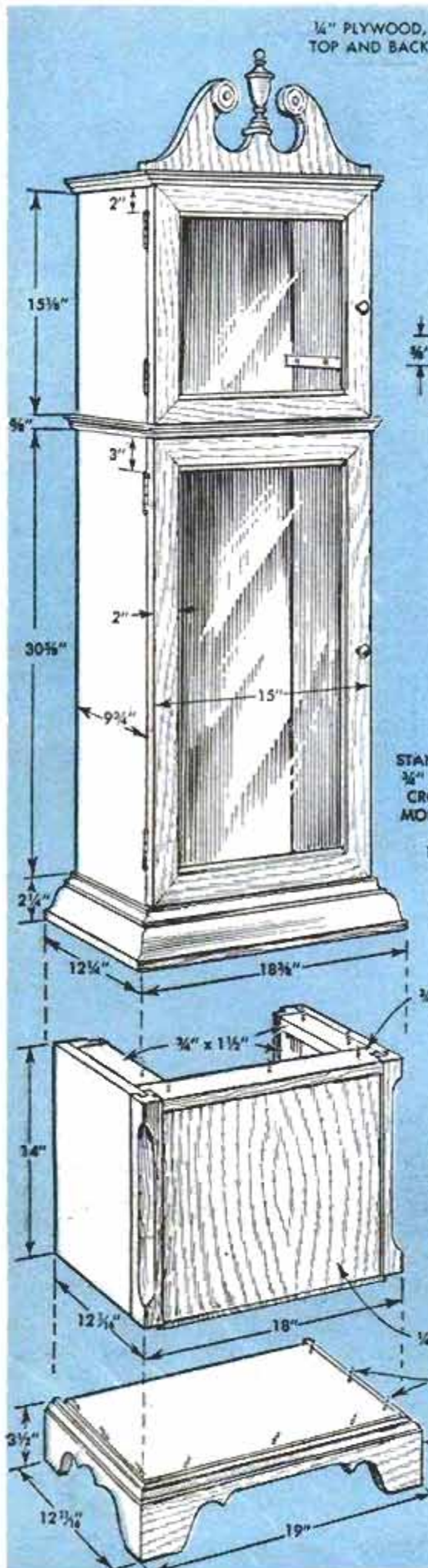



the back. The top edges of the scrolled pieces are shaped, which can be done on the saw with a molding head or on a regular shaper. The front corners of the members are mitered before they are scroll-cut, after which the parts are assembled with glue and finishing nails.

The sides for the upper part of the base measure  $\frac{3}{4} \times 11\frac{1}{8} \times 14$  in. Tenons are formed along the inside front edges by rabbeting as shown in the top-view sectional detail. These edges are fitted with 1-in.-sq. posts, 14 in. long, which are grooved for the  $\frac{1}{4}$ -in. tenons and the  $\frac{1}{8}$ -in. rabbeted edges of the plywood front. Notice in the top-view drawing of the base that abutting edges of the posts and sides are chamfered slightly to form a V-joint. The outside corners of the posts also are chamfered 45 deg. to within 1 in. of each end. The plywood front panel is cut  $13\frac{3}{4} \times 16\frac{1}{2}$  in. and a  $\frac{1}{8} \times \frac{1}{4}$ -in. rabbet is run around the four edges. The rabbet at the top of the panel fits in a groove cut in the underside of a  $\frac{3}{4} \times 2\frac{3}{4}$ -in. cleat which is notched at the ends to fit around the posts. Similar cleats,  $\frac{3}{4} \times 1\frac{1}{2}$  in., are added at the top of the sides on the inside and these, as well as the cleat across the front, serve as screw cleats for attaching the waist section to the base section. Rabbeted cleats also are fitted at the rear edges of the sides to provide a screwing surface for the plywood back.

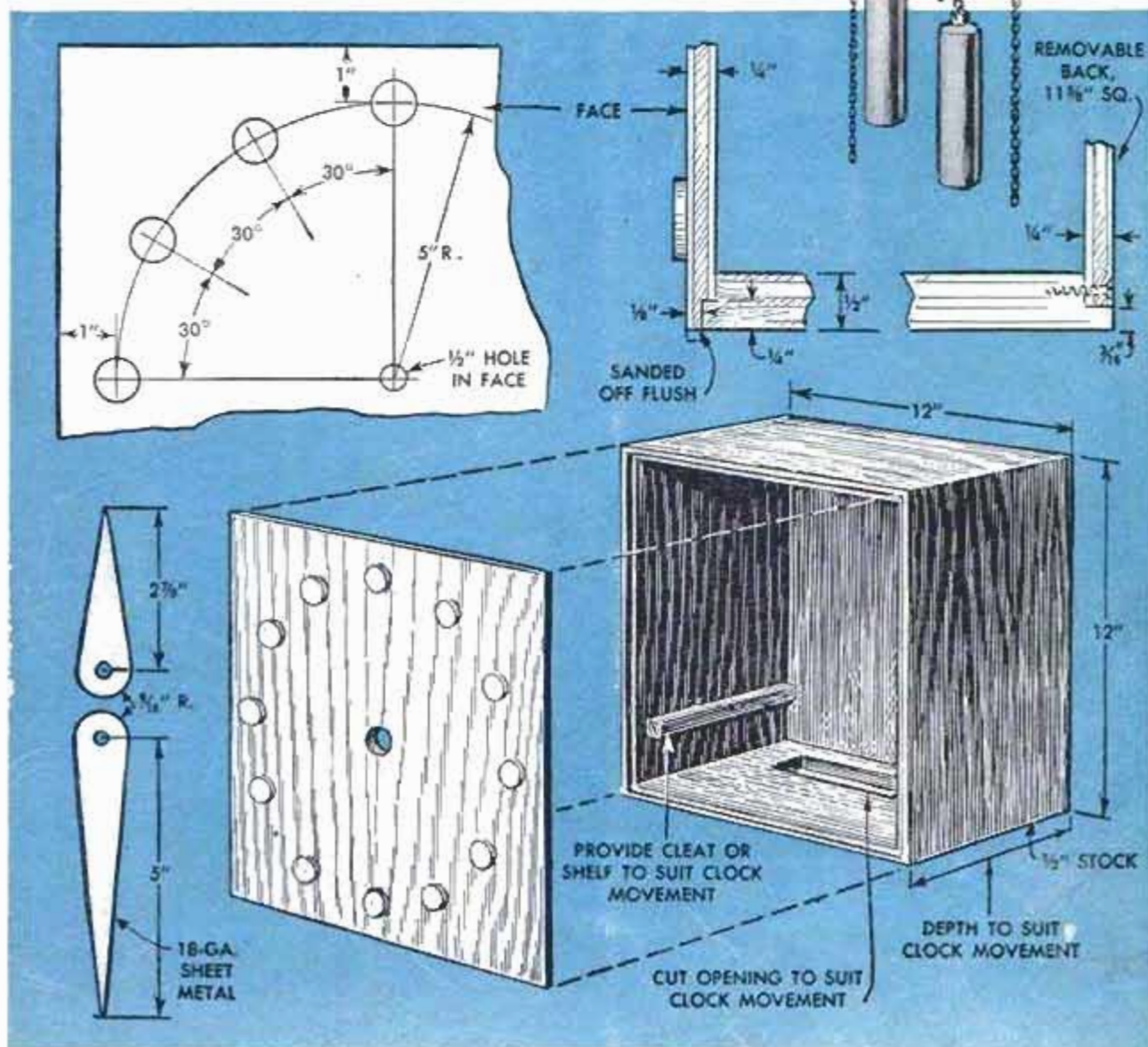
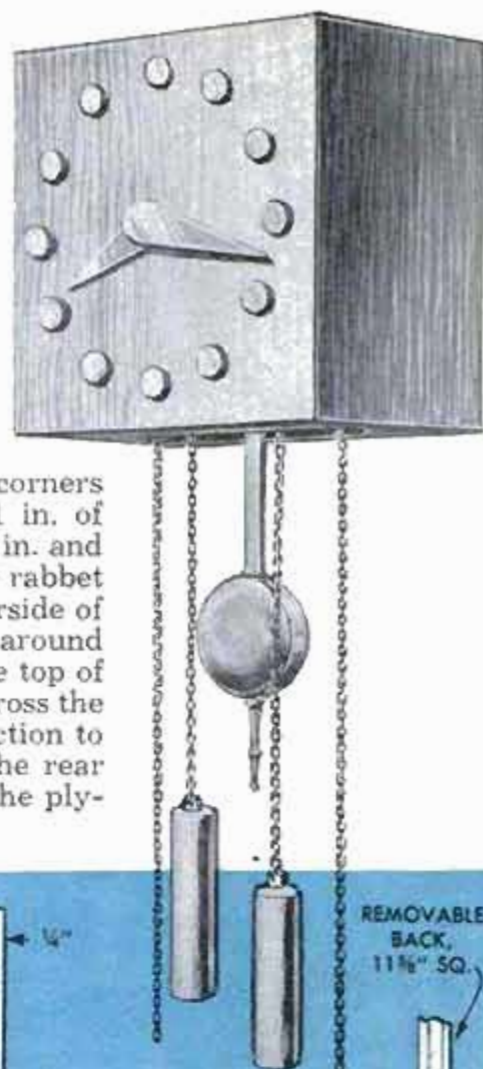

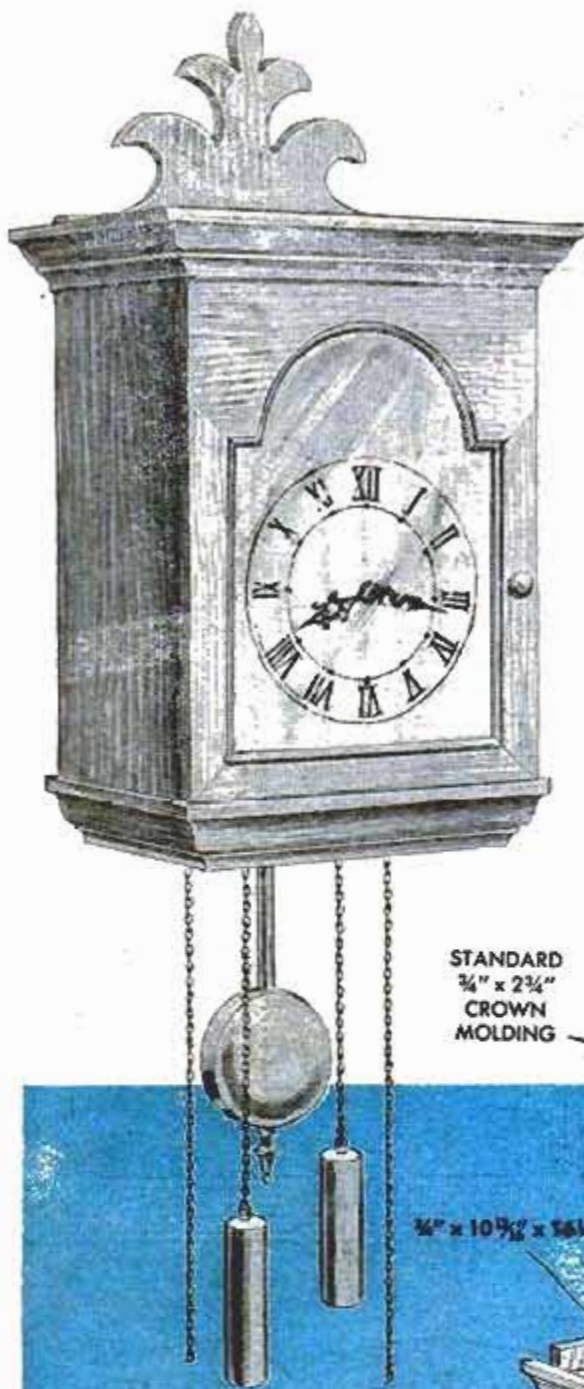

### Make the Waist Next

Two pieces,  $\frac{3}{4} \times 9\frac{3}{4} \times 48\frac{5}{8}$  in., are needed for the sides of the waist. These pieces also form the sides of the hood since the waist and hood actually are of one piece. The rear edge of each sidepiece is rabbeted,  $\frac{1}{4} \times \frac{3}{8}$  in., to receive the plywood back and then the pieces are glued and screwed to the base section. Place them  $1\frac{1}{2}$  in. in from edges so the waist will be 15 in. wide and drive the screws up into the end grain through the cleats provided. Temporarily brace the assembly at this stage.

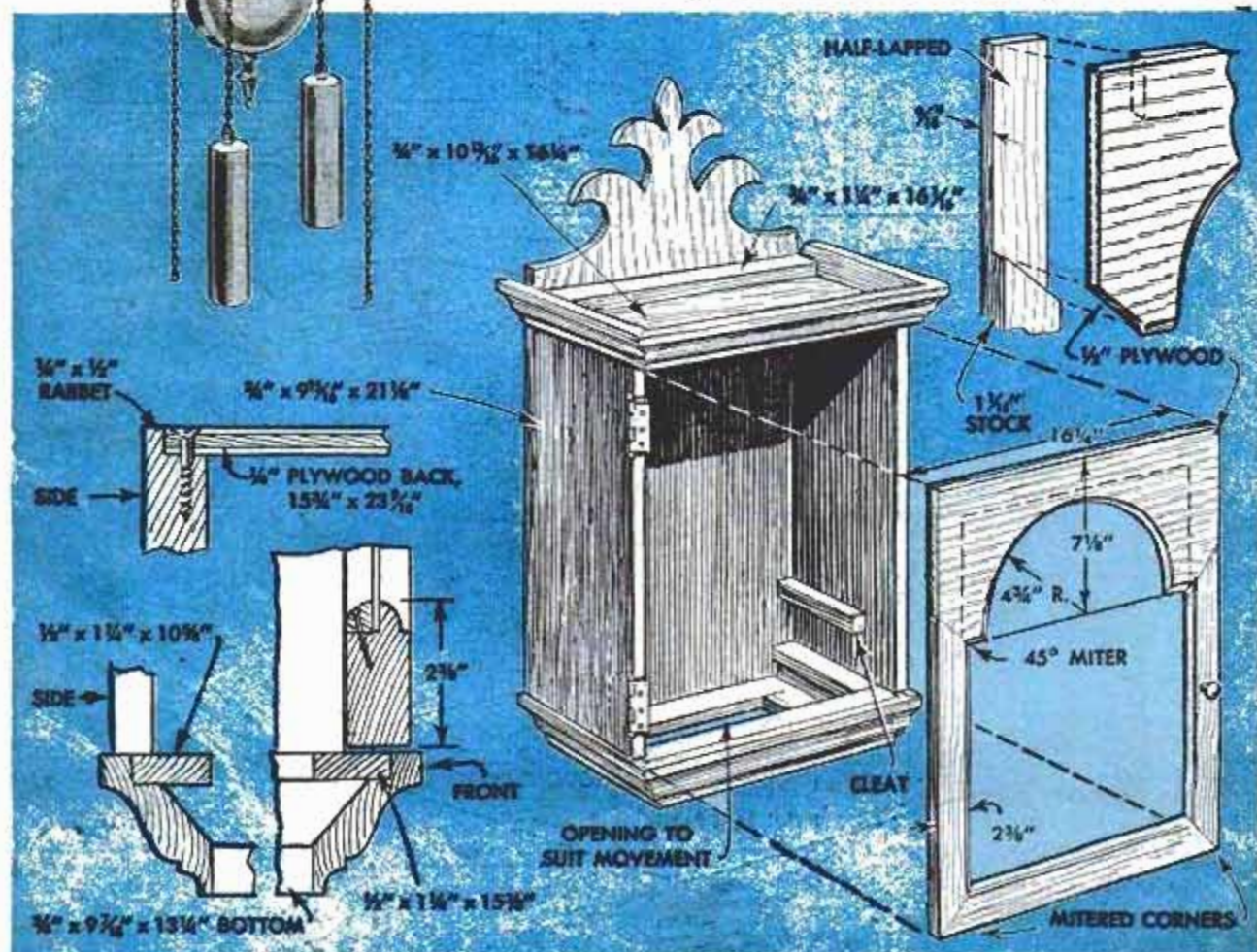
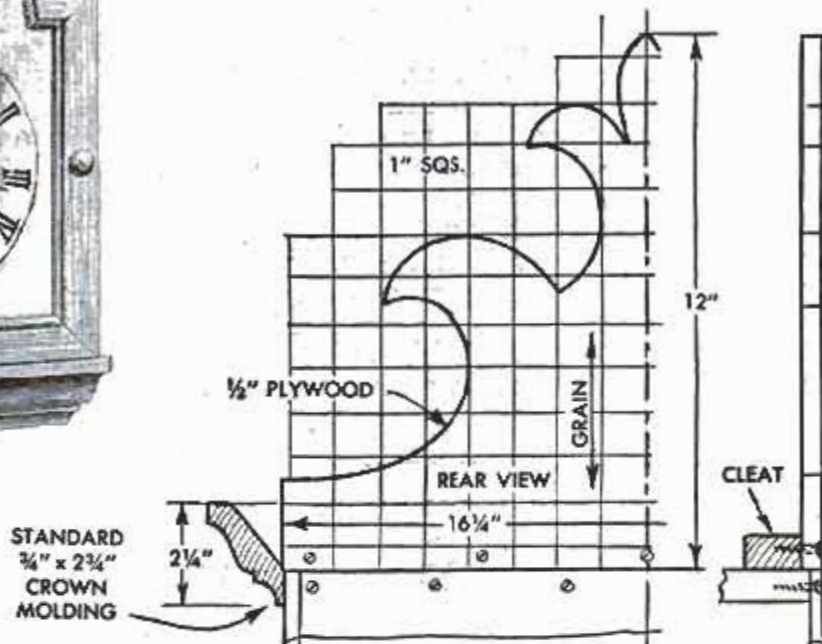

Next, cut a piece  $1\frac{1}{4} \times 2\frac{5}{8} \times 13\frac{1}{2}$  in. to fit between the sides at the front. This piece is rabbeted along the top edge to provide a ledge for the waist door, after which it is glued and screwed directly to the base section, keeping it even with the front edges of the side members. Drive the screws up through the  $2\frac{3}{4}$ -in. cleat. Standard crown molding is used to finish off the base at the top. This is allowed to overhang the base about  $\frac{1}{8}$  in. at the sides and front and is mitered at the front corners and then glued and nailed to both the base and waist. Notice that the top of the molding is kept even with the door rabbet.

Standard  $\frac{5}{8}$ -in. glass-bead molding applied to the waist at a point  $30\frac{5}{8}$  in. up from the crown molding makes the hood appear as a separate section. Although not shown, a rabbeted T-shape cleat is fitted between the sides at the front to provide stops for the doors and a backing strip for the front molding. This cleat is cut from a  $1\frac{1}{4} \times 1\frac{1}{4} \times 13\frac{1}{2}$ -in. piece and a rabbet,  $\frac{1}{4} \times 1\frac{3}{16}$  in., is formed along the top and bottom front edges. Glue and finishing nails are used to fasten the cleat to the sides before the molding is applied.

### Finally the Pediment

Notice in the broken pediment at the top of the hood that the grain runs vertically. This means you will have to edge-glue two or more pieces to make up the 15-in. width required. You'll need a piece 6 in. long. A  $\frac{1}{4} \times \frac{1}{4}$ -in. groove is made along the lower edge on the back of this piece to receive a  $\frac{1}{4}$ -in.-plywood top piece. The latter is cut  $10 \times 10\frac{1}{2}$  in. so it will lap the edges of the sides. Notice in section A-A that a  $\frac{3}{4}$ -in.-sq. cleat is added to the underside of the top to form a stop for the hood door. Turned rosettes,  $\frac{1}{4}$  in. thick, are applied to the face of the pediment after it is jigsawed, and a turned finial is mounted at the center. Finally, molding is added around the top of the hood, letting it cover the plywood edges of the top piece at the sides. A rabbeted cleat,  $\frac{3}{4} \times 1\frac{3}{4}$  in., is fitted across the back at the top, as in detail, to support the removable back.

The doors are assembled from  $\frac{3}{4} \times 2$ -in. rabbeted stock and are half-lapped and mitered at the corners. The glass is held in place with quarter-round molding fastened with brads.

### Modern Wall Case

This case, page 199, is of boxlike construction, the depth of which is made to suit the particular movement the case is to house. Either a true weighted or an electrical or mechanical movement may be installed. If the latter, dummy weights, chains and pendulum can be attached to the bottom of the

### Finishing Your Clockcase

The first step and, perhaps, the most important step in applying the finish to your completed clockcase, is the sanding. This should be done carefully and thoroughly, starting out with 2/0 paper and then using progressively finer grades.

The second step is dusting. Use a clean, dry paintbrush for this and a tack rag to pick up surface dust. The latter can be purchased at most paint stores or you can make one by pouring a little varnish on turpentine-saturated cloth and wringing dry.

The third step is to apply a non-grain-raising (NGR) stain. This can be applied with either brush or spray and is left to dry for about 30 min.

The fourth step is to apply a wash coat of white shellac or clear lacquer over the stain. This should be water-thin. If shellac, mix alcohol, 4 parts, shellac, 1 part.

The fifth step is to fill the pores of the wood, assuming you are finishing mahogany or other open-grain wood. Use a dark paste filler and brush it on with the grain. Then after it flattens, wipe filler off across grain with coarse cloth and finish wiping with grain.

The sixth step is to seal the surface with a coat of sealer. This can be shellac thinned 2 to 1.

The seventh step is to smooth the sealer with 6/0 garnet paper and dust off, using a tack rag.

The eighth step is to apply mahogany pigment stain. Brush this on and then wipe stain with a coarse cloth, shading it lightly and leaving more stain at the edges.

The ninth step is to apply a top coat of lacquer or varnish, using either brush or spray.

The tenth step is to rub down the top coat with rubbing compound, using a felt or burlap pad. Rub with the grain.

case for effect. Veneer-faced plywood,  $\frac{1}{2}$  in. thick, is used for the four sides of the case and the front and back edges are rabbeted as detailed to receive a  $\frac{1}{4}$ -in. plywood clockface and a  $\frac{1}{4}$ -in. plywood removable back. The corner joints of the case employ rabbeted joints also. Here the rabbets are made to overhang the edges a bit so they may be sanded off flush after assembly. Numerals on the clockface are  $\frac{1}{8}$ -in.-thick disks sliced from  $\frac{3}{4}$ -in.-dia. brass, copper or aluminum rod and polished. Cut the hands from 12-ga. sheet brass, copper, aluminum or stainless steel.

### Traditional Wall Case

This case, detailed in the drawings on the facing page, is somewhat more involved. Start by cutting the sides to size from  $\frac{3}{4}$ -in. material. A  $\frac{1}{4} \times \frac{1}{2}$ -in. rabbet is cut in the rear edge of each sidepiece for a  $\frac{1}{4}$ -in. back panel. The sides are glued and nailed to a  $\frac{3}{4}$ -in. top piece which fits between them, and then standard crown molding is applied to three sides, mitering it at the front corners. The same type molding is used around the bottom of the case, rabbeting the upper edge of the molding to fit a three-sided frame on which the sides rest. The scrolled ornament is cut from  $\frac{1}{2}$ -in. veneer-faced plywood, the grain running vertically. This is glued and screwed to a cleat attached to the top of the case. A bottom board, having an opening cut in the center, is fitted in the bottom of the case and the back panel is screwed to the rear edge of it. The door is made as detailed. ★ ★ ★

# KNOW YOUR SHOP MOTORS

By J. R. Williams

## PART II

WHEN YOU PURCHASE an electric motor, especially a used one, for use in your workshop, the first step is to check the name plate, which gives the current characteristics, speed of the motor, type, frame number and, on motors designed for operation on 110-220-v. current, will include wiring diagrams showing how to interchange the motor leads for operation on either voltage. The name plate also will indicate whether the motor is for operation on single-phase or polyphase current, 60 cycles or less, a.c. or d.c. It's important to make this check before you test-run a used motor. Motors designed to operate on single-phase current will not operate on polyphase (2 or 3-phase) current. Motors wired for operation on 110-v. current only will be damaged if connected to a 220-v. circuit. Only universal-type motors will operate on either a.c. or d.c.

After checking the name plate, test-run fractional-hp. motors by plugging into the proper power source. If the motor hums but will not start, spin the shaft by hand. If the motor starts and runs at full-rated speed, then it is likely that the starting switch is at fault. Note the starting and running positions of a typical centrifugal switch, Figs. 27 and 28. As a rule this defect is easily corrected by a thorough cleaning of the parts, using carbon tetrachloride.

The outward appearance of a used motor



cannot always be relied on as an indication of its condition. Press the shaft in and out several times. Excessive end play indicates worn spacer washers, Fig. 26, also part No. 8 in Fig. 27. Turn the shaft slowly by hand. If it binds at any point in one complete revolution, three possible defects are indicated. The bearings, either ball or sleeve type, may be badly worn, may even permit the armature to strike the stator bars as it rotates. The armature shaft may be bent. In a repulsion-start motor the commutator may be grooved due to wear, or the brush-mounting ring may be damaged. Worn bearings, especially sleeve bearings, are

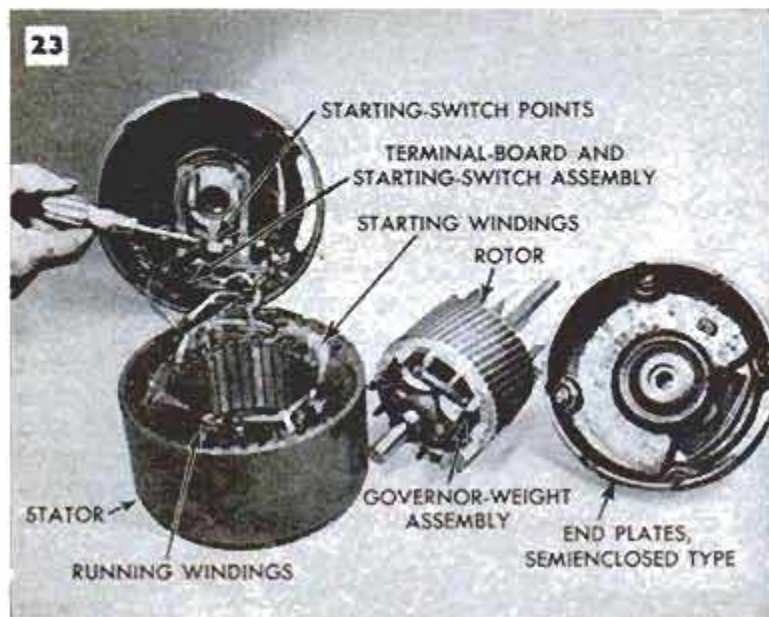

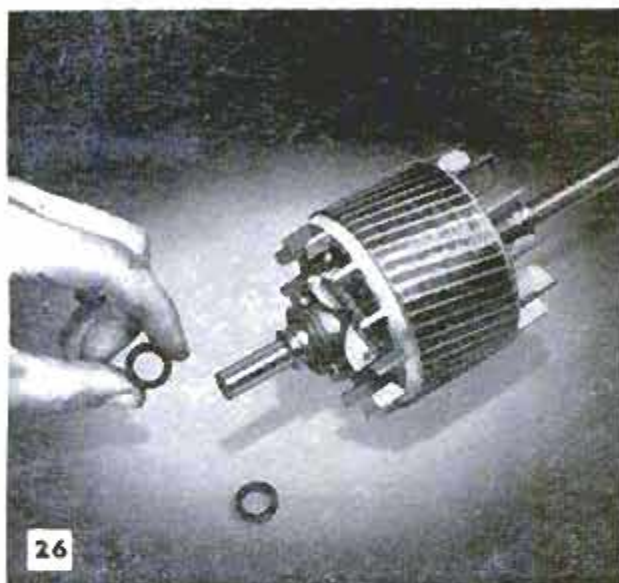
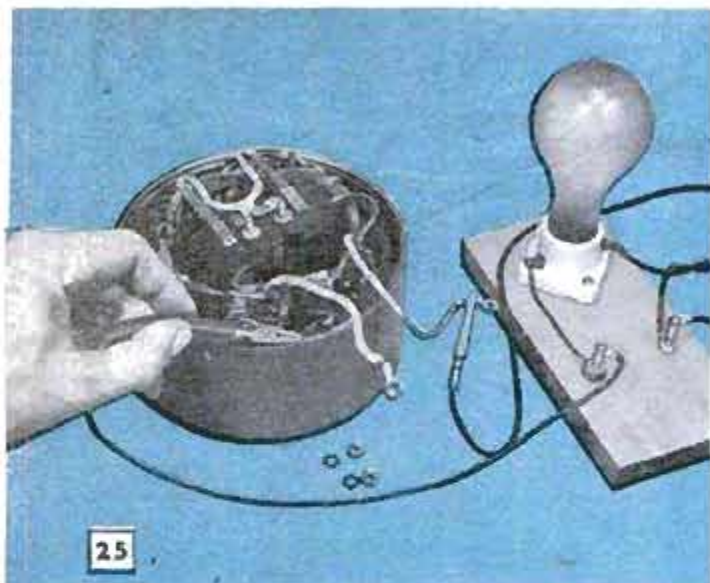

easily replaced, but if the motor has a bent armature shaft or is otherwise damaged it is seldom worth the necessary repairs.

In order to replace sleeve bearings it usually is necessary to disassemble the motor to the stage shown in Fig. 23, which pictures a motor of the capacitor type. Sleeve bearings are removed from the end shields with a shouldered rod, Fig. 29, and are replaced as in Fig. 22, using the drill press as an arbor press.

While you have the motor disassembled clean all parts thoroughly, being especially careful to see that the air passages in the stator frame are free from dust and other foreign matter that may interfere with air circulation. If the motor is of the repulsion-start type, the brushes may need replacing and it is possible that the commutator will require undercutting and truing up. The commutator job should be taken to a shop equipped for this special work.

When testing salvage motors in order to select one which is serviceable, it will help

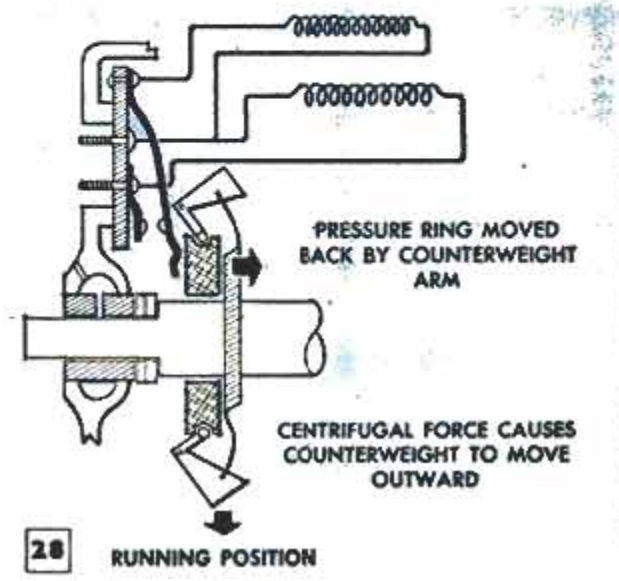
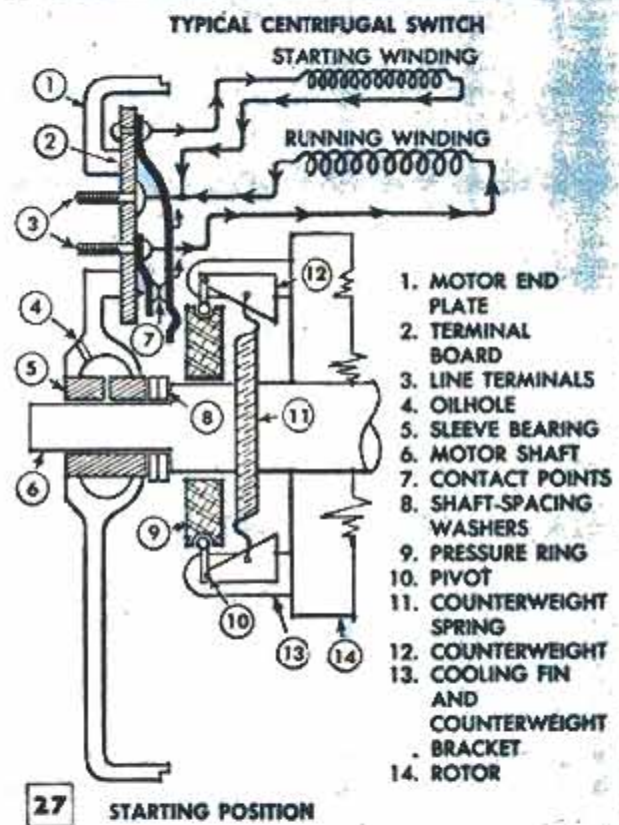
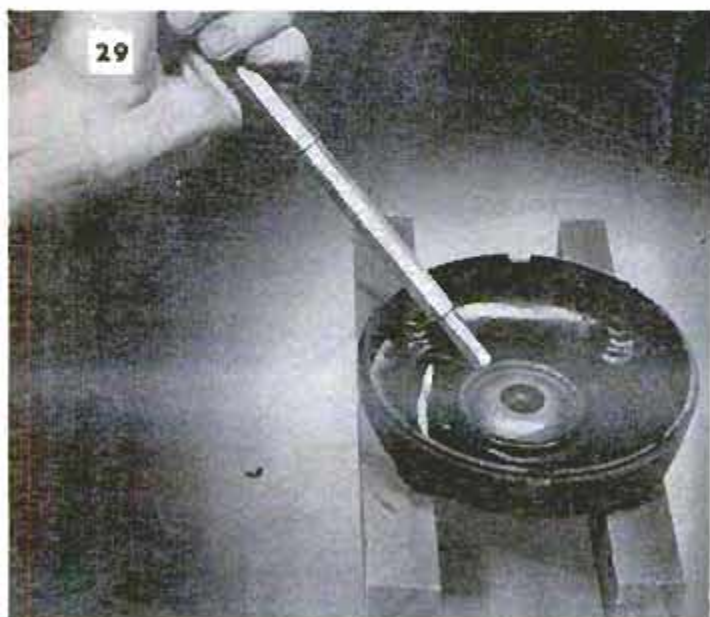

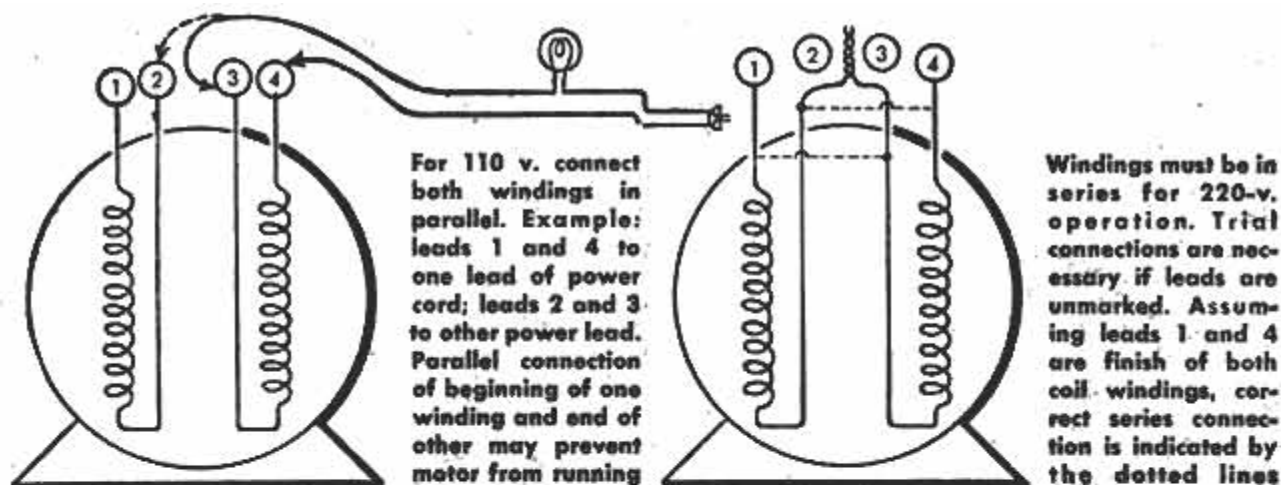

30

### TWO-VOLTAGE REPULSION-INDUCTION WIRING

to improvise the test unit pictured in Figs. 25 and 31. This unit provides a fuse in the cord from the current source, Fig. 31, which can be used to check the motor for actual operation. By substituting a lamp bulb for the fuse in the test block the unit provides a continuity light for testing motor circuits, Fig. 25. To test the starting and running windings separately, mark the winding leads with pieces of colored or marked tape and remove one pair of leads from the terminal plate. Clip the test leads across the removed leads and plug the line cord into a 110-v. source. The test lamp will light if the motor wiring circuit is complete. Failure of the lamp to light indicates an open circuit. If the circuit under test shows continuity (lamp burns), remove one test lead and touch it to the motor frame. If the lamp burns, it indicates a short circuit which must be corrected or the motor discarded.

Next, the free test lead is touched to one of the winding leads remaining on the terminal block. If the test lamp lights, it indicates a short circuit between the two sets of windings. Again it will be necessary to locate the short and correct it before the motor can be considered serviceable. The second set of windings is tested for open circuits in the same manner, removing the circuit leads for this set of windings from the terminal plate, or closing the starting-switch contacts to obtain a continuity indication on the test block.

If the initial running test showed the motor to be somewhat slow in starting, the capacitor may be at fault. If there is reason to suspect a faulty capacitor, either discard the motor or, if the capacitor is of the removable type (mounted on the outside of the motor frame), remove and have it tested at a shop having suitable testing equipment. If this test shows it to be faulty, it should of course, be replaced. Field windings of repulsion-start motors, Fig. 30, can be

checked in the manner just described, but the armatures are wire-wound and must be checked on an armature growler.

When reassembling a motor that has been disassembled for any reason, be sure that the end shields are seated correctly and that the through bolts are tightened to a uniform tension. Be sure also that all wire leads inside the motor are so located that they cannot come in contact with any rotating part. On brush-type motors be especially careful to see that the brushes are correctly located in the holders. If the original brushes were found to be in serviceable condition when removed, place them in order on the bench where they will not be disturbed. In this way they can be replaced in the holders in the same order and in the same position as they were before they were removed from the motor.

When the motor has been assembled, turn the shaft slowly by hand. On capacitor-type motors the shaft should turn freely without the slightest tendency to bind at any point. On repulsion-start motors having axial-type commutators with the brushes always in contact, there will be a slight drag due to contact of the brushes. It is important that this be uniform throughout the entire revolution. On brush-lifting motors the shaft will turn freely, of course. If the motor passes this check, test-run it before putting in service.

On repulsion-start motors some provision is always made for changing the direction of rotation. This usually is done by shifting the brushes. Fig. 24 pictures an older-type motor with two index marks and a pointer on the end shield. Loosening the screw and moving the pointer to the opposite index mark will shift the brushes and reverse the motor.

The chart outlines the common methods of motor trouble shooting. It is not, of course, all-inclusive, but does cover the common procedures. ★ ★ ★

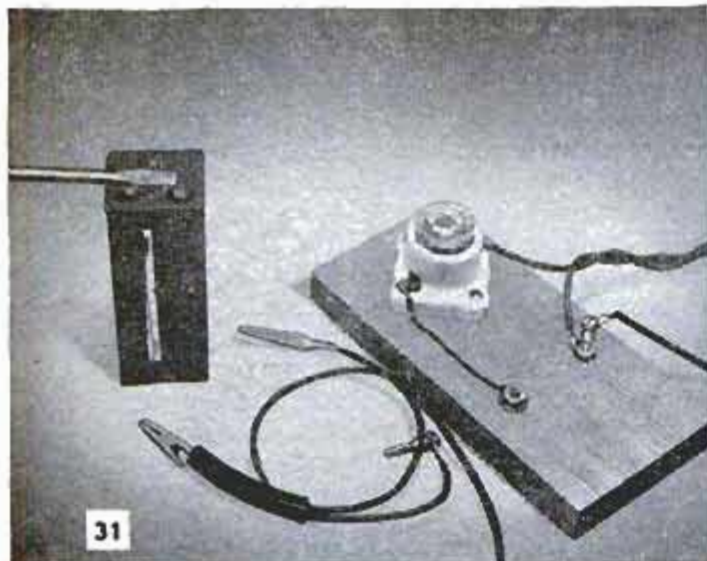

31

## MOTOR TROUBLE-SHOOTING CHART

### Split-Phase and Capacitor-Start Motors

Symptoms	Possible Cause	Remedy	
Motor hums, but fails to start	Excessive overload	Remove load from motor	
	Worn or tight bearings	Check bearings; replace if worn, ream if tight	
	End plates improperly tightened, causing shaft to bind	Tighten all bolts to insure proper seating	
	Open running winding	Check continuity; if open, check for break in coil connections and leads	
	Open starting winding	Same procedure as above	
	Centrifugal-switch contact points dirty	Check for continuity through contact points, clean as required	
	Centrifugal-switch contact points not closed	Add fiber washers at opposite end of the shaft	
	Grounded windings	Check starting and running windings for ground; if ground exists, correct condition as required	
	Overload device open-circuited	Check continuity. Replace if defective	
	Motor fails to attain normal running speed	Short circuit in running winding (internal short)	With hand, check main poles of motor to determine if one or more is heating excessively. Usually an internal short requires replacement of the winding
		Starting winding remains in circuit	Contact points may be stuck together (centrifugal switch). Centrifugal throwout device may be defective. Check entire assembly, repair as required
		Incorrect polarity of stator poles	Would result only if individual windings had been disconnected. Check polarity with compass; reverse connections on individual winding leads if necessary to change polarity
	Rotor dragging on stator	Replace worn bearings	
Loose rotor bars	Check rotor on growler. Replace or repair as required		

### Split-Phase and Capacitor Motors

Symptoms	Possible Cause	Remedy
Motor runs hot	Motor overloaded	Allow motor to run without load to determine if overload is cause
	Running or starting winding internally shorted	Replacement of the winding is usually required
	Windings grounded at several points	Check for grounds with continuity light. Correct as required
	Short circuit between running and starting windings	Check with continuity light. Correct as required
Motor noisy	Motor dirty	Dirt and lint possibly hindering air circulation. Blow out dirt with high-pressure air
	Shorted winding, improperly connected poles, loose rotor bars	These conditions produce a magnetic hum; the remedy has been discussed under symptoms above
	Worn bearings, worn centrifugal-switch parts, foreign material in motor	Mechanical defects causing noise, correct by replacing defective parts

### Capacitor Motors Only

Motor fails to start	In addition to causes listed under split-phase types. Open circuit in starting capacitor	If motor will start after shaft is first turned manually, and the centrifugal switch and starting circuit are in order, check capacitor. Replace if defective
----------------------	--	---

### Repulsion Motors

Motor fails to start, or does not start properly	Brushes stuck in holder	Check brushes for free movement
	Worn brushes	Determine if brushes are contacting commutator
	Open circuit in stator	Check windings for continuity
	Open circuit in armature	Check armature in growler
Motor heats excessively	Dirty commutator	Clean with sandpaper
	Armature-shorting device sticking in running position	Check centrifugal throwout device; clean
	Shorted armature. Brush holder in wrong position	Check in growler. Try shifting brush holder to different positions
	Operation on the wrong voltage	Check connection of field leads to determine whether they are wired correctly for operating voltage
	Shorts and grounds in field windings or armature	Inspect and correct as given under split-phase types. Check armature on growler
Motor sparks internally	One or more open armature coils	Check continuity from one commutator segment to another, or check armature on growler
	Sticking brushes	Check brushes for free movement. Clean brushes and brush holder
	High mica on commutator, causing brushes to jump	Chuck armature in lathe, turn down commutator section

## Can on Trailer Wall Provides Running Water in Isolated Area

Tap water can be supplied to an isolated house trailer by means of a hose attached to a 5-gal. reservoir constructed from a

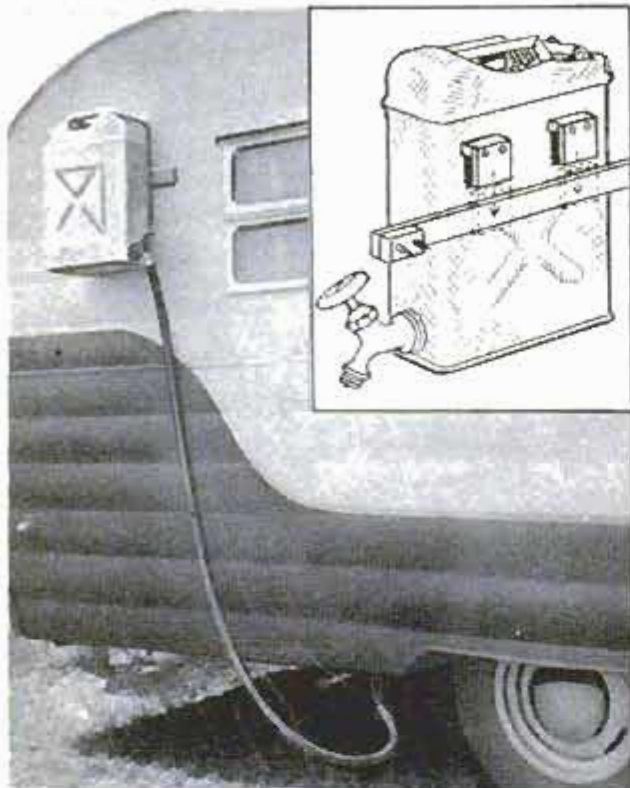

war-surplus water can mounted on the outside wall of the trailer. Use a can with an enameled inside surface and originally intended for water. From a length of aluminum channel cut two L-shaped brackets about 2 in. long and bolt them to the can as shown in the detail, using fabric washers on the inside as a seal. Cut the mounting bar from flat aluminum stock long enough to reach across two studs of the trailer wall, and of a thickness that will fit snugly in the can brackets. Use spacers between it and the wall, and install it as high as possible, taking into consideration the weight of the can and the convenience of the location. The can must be hung above the height of the sink tap inside the trailer for the water to flow. Next, drill a hole in the edge of the can as close to the bottom as possible, leaving room for the flange of a faucet to clear the beading at the bottom of the can. Use a 1/2-in. brass or bronze faucet and place a rubber gasket, flat washer and a nut on the inside. Braze or solder the flange to the outside of the can. Run a hose from the can to the trailer fresh-water intake and your mobile home is equipped with running water.

Jesse D. Cope, San Diego, Calif.

## Do-It-Yourself MATERIALS GUIDE for the Homeowner and Handyman

### Cross Indexed for Easy Use

If you've ever walked into a hardware store without knowing exactly what you need (and walked out without being sure of what you'd bought), you'll want a copy of this new guide that lists *all* the specifications for *all* Do-It-Yourself materials. With this book, you'll know exactly what to look for, and how to save money when you buy.

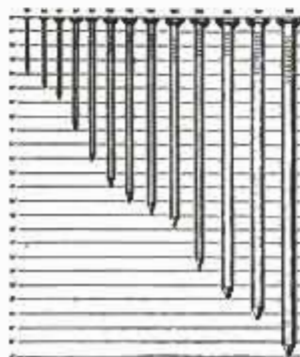

Need to know how long a 50d (penny) nail is? In the Do-It-Yourself Materials Guide, charts like the one at the left (4½ times larger in the book) will show you it's 5¾ inches.

The chart at the right, of common wood-screw sizes and gauges, is typical of the dozens of illustrations (all much larger) in the book. Now you'll know how to choose and where to use building and hobby materials.

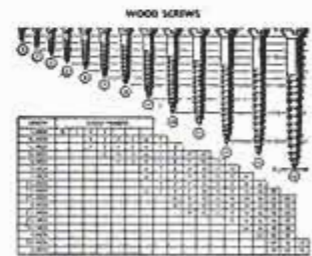

### A Key to Buying and Using:

Adhesives	Fuses	Plumbing
Bolts	Glass	Plywood
Bricks	Hinges	Roofing
Conduit	Locks	Siding
Doors	Millwork	Tile
Glass fiber	Paint	Wiring

... Plus 31 other basic products. For only \$3.50 you can get this 160-page guide that will *save you time and money every time you buy supplies*. So send your order today to:

**POPULAR MECHANICS PRESS, 200 East Ontario Street, Chicago 11, Illinois**



# SHOP NOTES

## MULTIPURPOSE POWER TOOLS

WHERE SPACE is the main problem in equipping your home shop, a multi-purpose power tool can be the answer. These units reduce floor-space requirements to the point where you can usually set up shop in the end of the garage or in a corner of the utility room and still have space left over in which to work. Multi-purpose tools are one-motor units, a feature which reduces not only the space requirement but also the initial cost. Which one to select is more a question of personal preference than of quality or utility.

Many craftsmen will prefer the radial saw, upper photo at the right, which is not only a power saw but can be converted into a groover, shaper, sander, drill and wood lathe with accessories which are available at a reasonable cost. All radial machines pictured in the accompanying photos share a common advantage, that is, you can buy

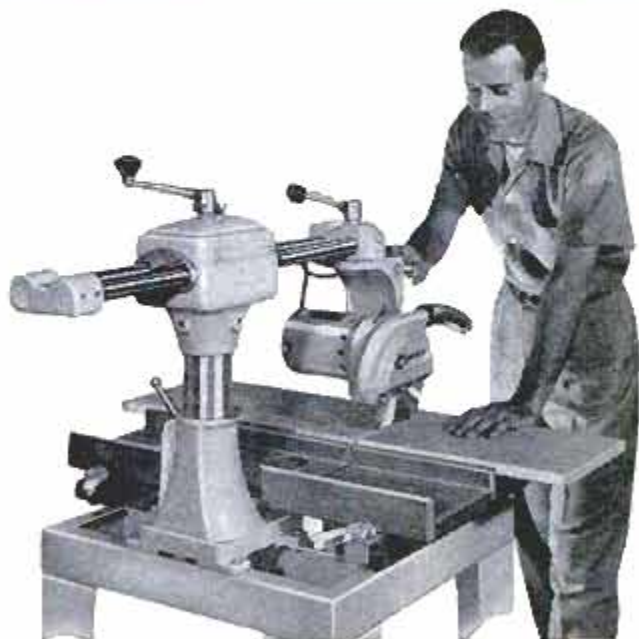

Comet

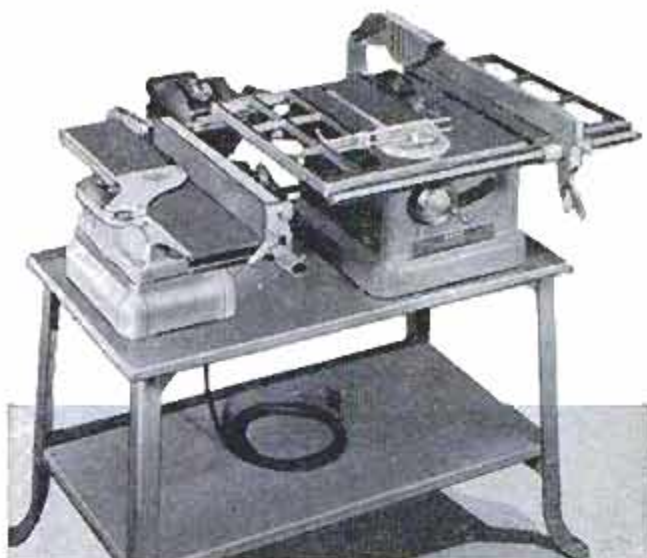

Duro

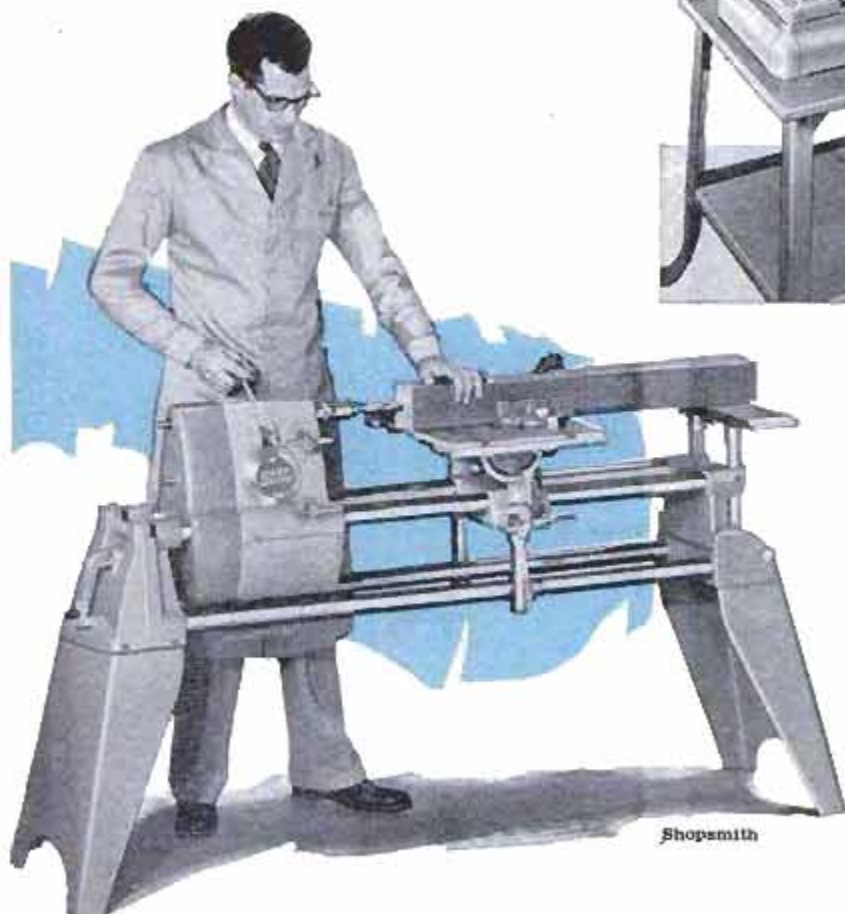

Shopsmith

In many home shops a radial saw will prove the best choice in a multi-purpose power tool. It not only will perform all sawing operations as in the top photo, but with accessories will cut dados, moldings, make turnings and do other cabinet-making jobs. Center, saw-jointer combination also is good choice

Left, multipurpose machine for the craftsman who wants a compact unit combining several machines in one requiring the minimum shop space. All cabinetmaking operations can be done on this machine, including full-length table-leg turnings. As pictured, the machine is set up as a horizontal drill

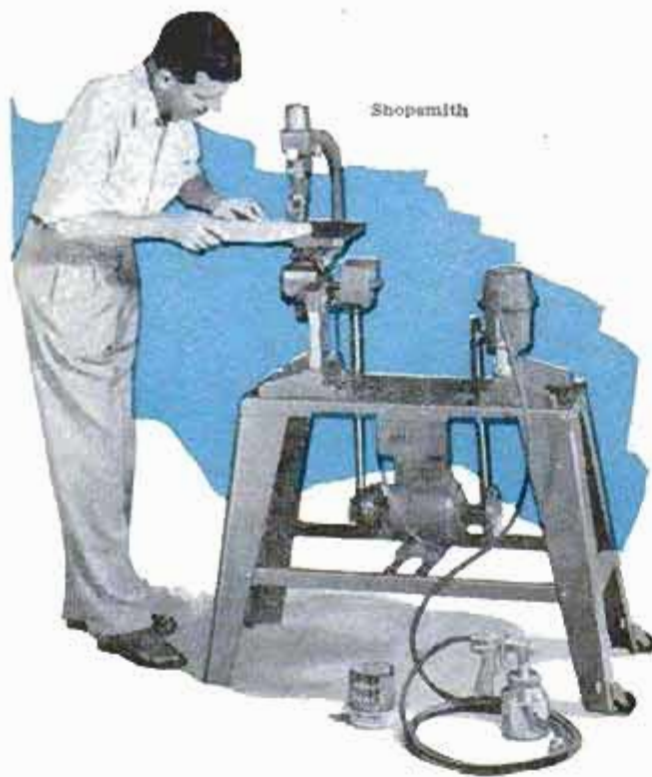

Shopsmith

**Jigsaw and paint sprayer mounted on a stand and driven by one motor. Tool mounts on stand also take bandsaw, jointer and sander in handy combinations**

the basic radial saw and add whatever accessories are suited to your needs.

Craftsmen who like to build modern home furnishings and have no present need for a lathe can settle for the saw-jointer combinations, several of which are pictured. Other than turnings, these two-ma-

**Here's a radial saw cutting dados (grooves) at an angle across width of stock. Saw blade has been replaced by a dado head to cut groove in one pass**

DeWalt

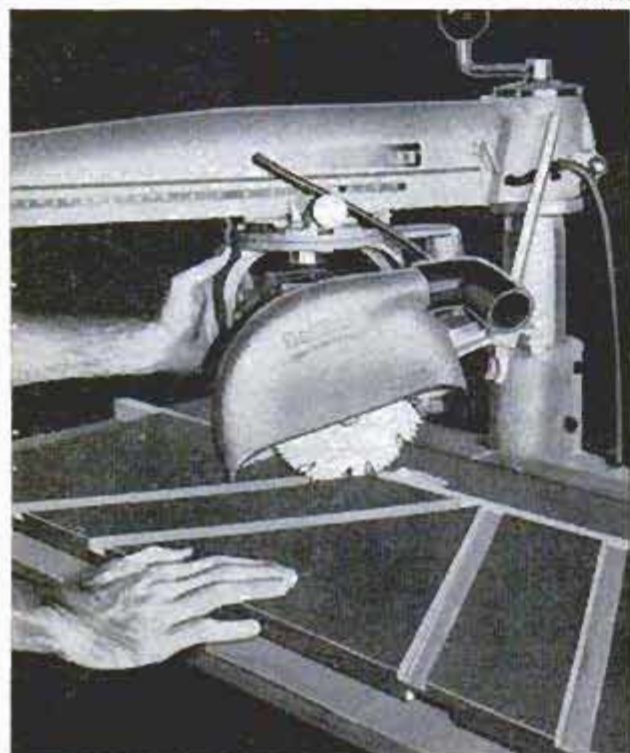

chine units provide all that is necessary for cabinet joinery of professional quality and workmanship. You can take a piece of stock quickly through all necessary operations of ripping to width, cutting to length, planing to thickness, grooving, rabbeting, jointing and molding—whatever is necessary to ready it for use in a project—all without shifting machines, belts, or motor. One manufacturer of saw-jointer combinations includes a folding drill press, making a three-machine unit as in the lower right-hand photo, page 211. Both the radial saws and the saw-jointer combinations are fitted with tilting saw arbors, making it possible to cut off stock at any angle, including compound miters. Another saw-jointer unit includes a disk sander as regular equipment as in the lower right-hand photo, page 209.

A third type of combination, or multipurpose, machine is a good choice for the craftsman who wants the nearest approach to a complete power shop in a one-motor tool. You see it pictured in the lower photo on page 207. With this unit a number of machines can be set up simply by shifting component parts of the basic machine. Accessory machine units such as a jointer, jigsaw, bandsaw, belt sander and paint sprayer are mounted individually on the frame of the basic machine and driven by power take-off shafts. In several of the accompanying photos you see it set up as a vertical and horizontal drill press, shaper, disk sander, router and wood lathe. A similar machine of much the same versatility,

**Multipurpose tool set up as a shaper. Variable-speed drive gives necessary high speed for shaper work. Starting pins in table used for shaping curved work**

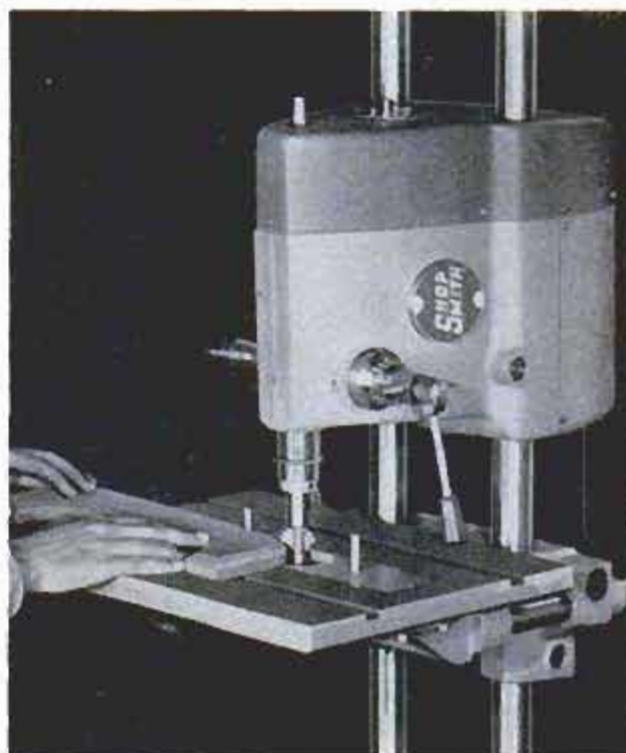

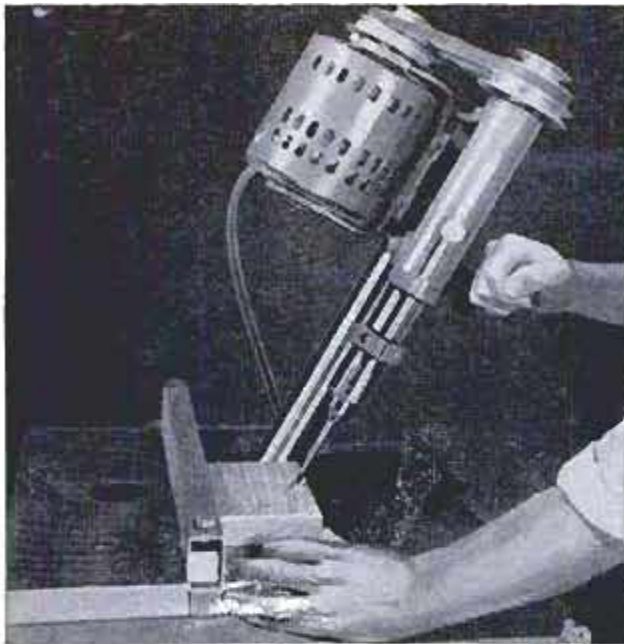

Paramount

Multipurpose tool set up for angle drilling. Saw table is used as drill table. Ripping fence serves as stop. Head can be set to drill horizontally

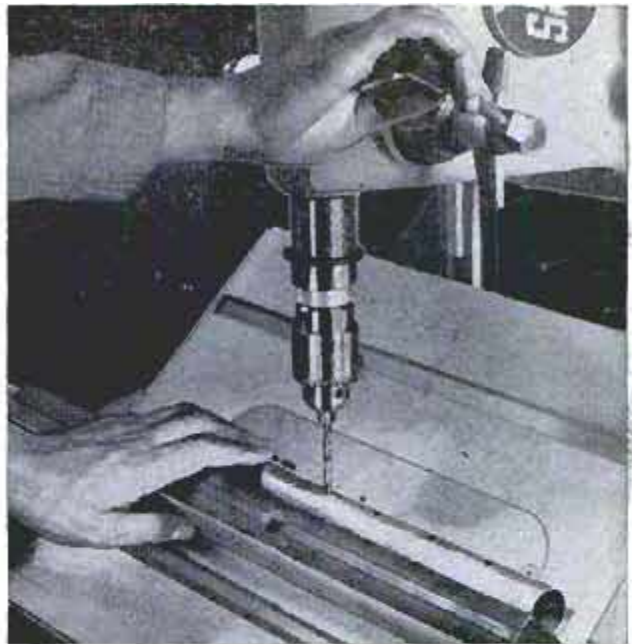

Here ripping fence and saw table form V-block for drilling spaced holes in one wall of metal tubing. Speed of spindle can be varied to suit drilling job

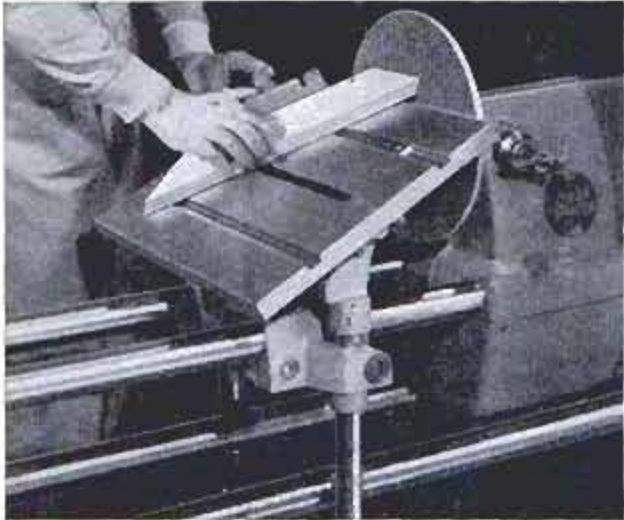

Above, disk-sanding a compound angle to smooth surface for perfect fit of hopper joint. Below, multi-purpose tool set up for grinding hand tools such as plane irons, knives, chisels and wood-turning tools

Power Tools Super-shop

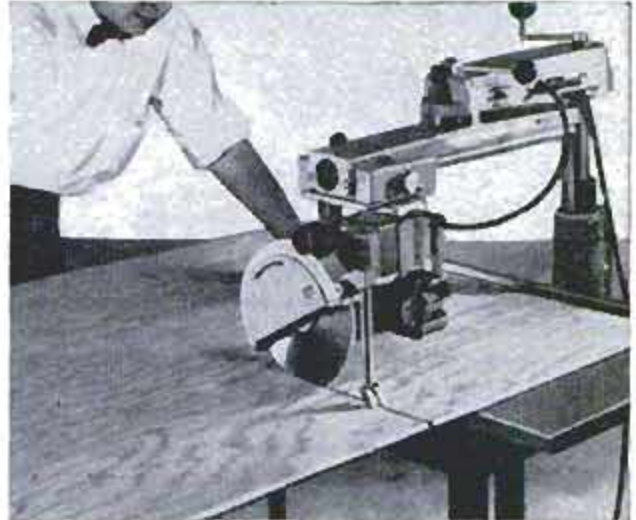

Delta

Above, radial saw set up to crosscut a large plywood panel. Job being done is a good measure of the capacity of these machines. Below, saw-jointer-disk-sander combination has all three units in easy reach

Yates-American

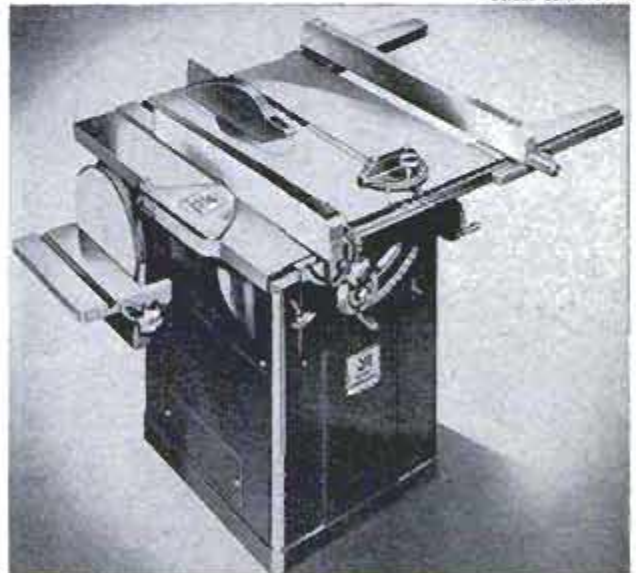
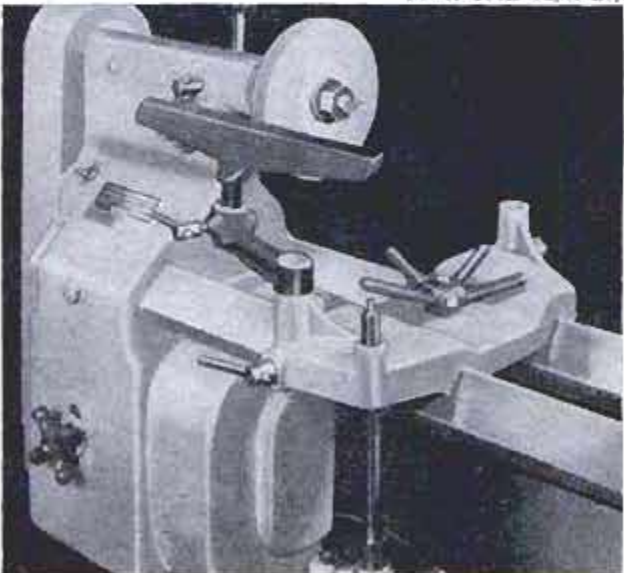

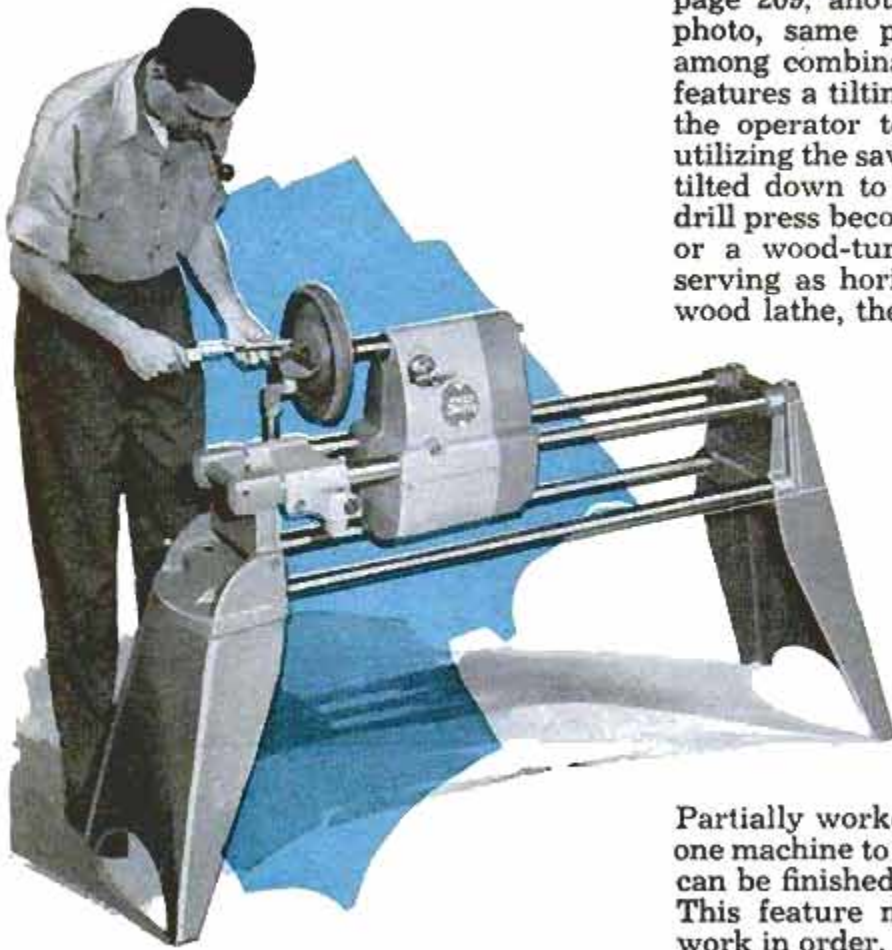

It takes less than a minute to set up this tool as a faceplate lathe. Just remove saw table, substitute faceplate for saw arbor, insert tool rest and there you are. Simple turn of the dial varies spindle speeds

Wide grooves can be cut with saw blade simply by shifting blade after each pass of stock a distance equal to width of saw kerf, the table height being set beforehand to give a groove of required depth

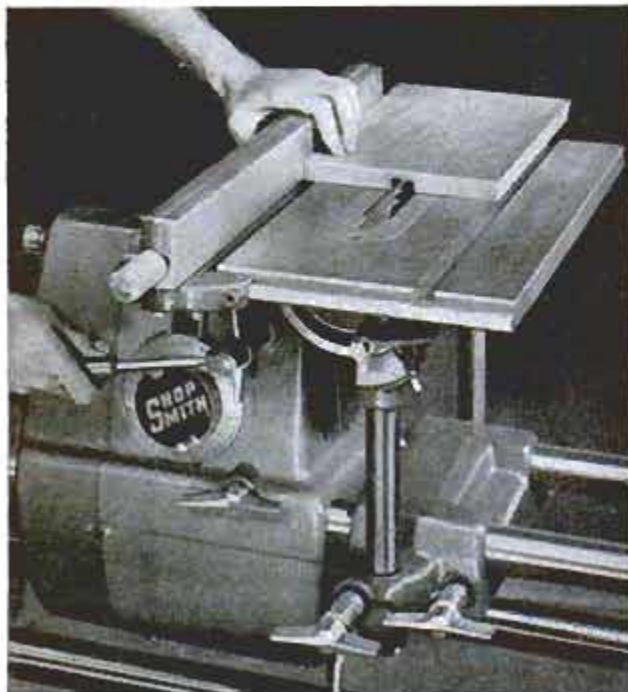

is pictured in the lower left-hand photo, page 209, another in the upper left-hand photo, same page. The latter is unique among combination power tools in that it features a tilting drill-press head, enabling the operator to drill holes at any angle, utilizing the saw table as a drill table. When tilted down to the horizontal position the drill press becomes either a horizontal drill or a wood-turning lathe. In addition to serving as horizontal and vertical drill or wood lathe, the machine becomes a power saw and sander with only minor accessory changes. Like the other combination units this machine is mounted on a compact floor stand.

For the user the multi-purpose machines not only economize on space and reduce first cost. They also save time and effort by correlating the various operations necessary in the construction of even the simplest projects.

Partially worked stock is not carried from one machine to another; often all operations can be finished from one working position. This feature makes it easier to keep all work in order, thus lessening the chance of error in measuring and cutting stock. On all the types of machines pictured, change-over time has been reduced to the minimum. Many units are fitted with casters and can be rolled to the job. ★ ★ ★

Craftsmen who regularly work with small parts of wood and have no need of a large saw table or a jointer larger than 4-in. cutting width will like this saw-jointer combination with simple one-motor drive

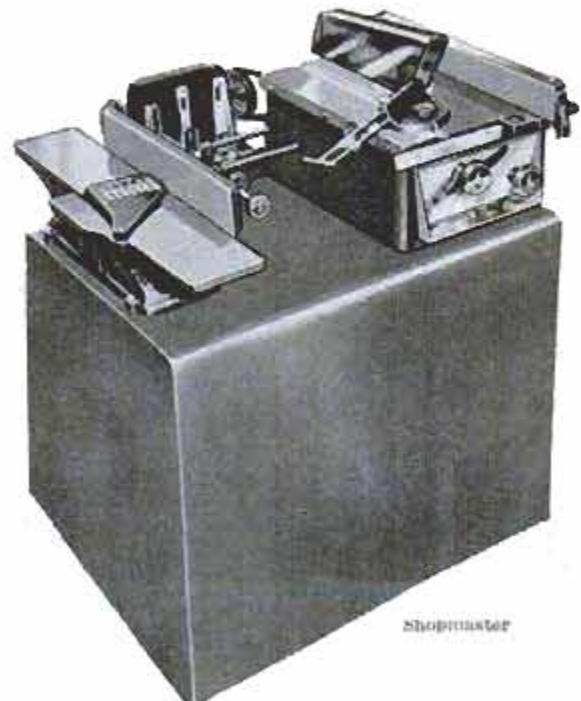

SHOPMASTER

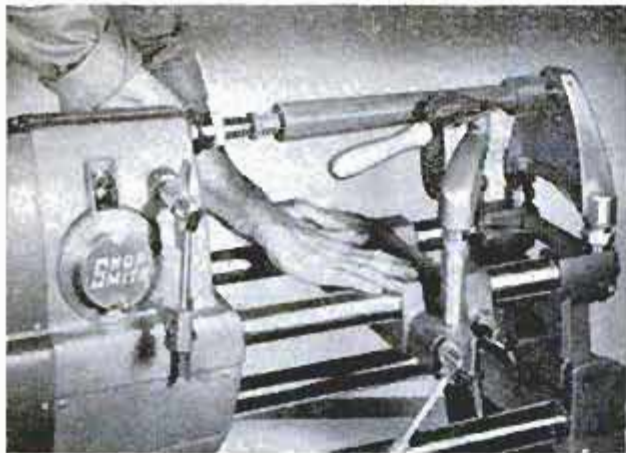

By combining offset tailstock with which the machine comes equipped with a turning tool clamped to tool rest, operator can run tapered turnings on a production basis. Tailstock has offset settings which enable operator to obtain desired variations in taper

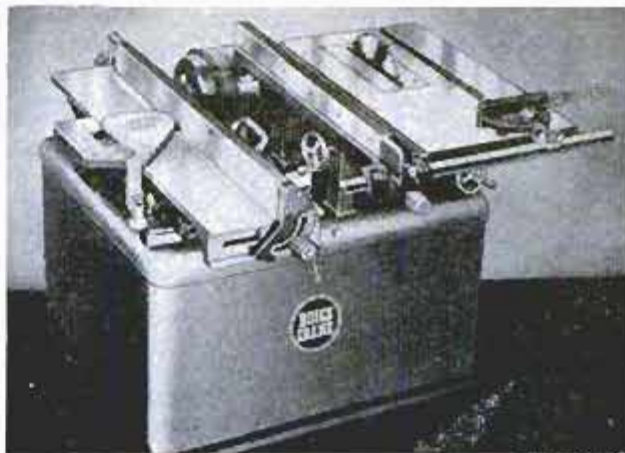

Boice-Crane

Saw-jointer combination is of a heavier type suitable for cabinet shops and builders, also do-it-yourselfers who require a machine of greater capacity. Saw takes 10-in. blades and jointer surfaces stock up to 6 in. wide. One motor powers both machines



Sanding a perfectly round disk is easy with the setup pictured. Here wooden disk is drilled to take a pin attached to crosscut-guide bar. Table is moved in or out to give work the correct radius

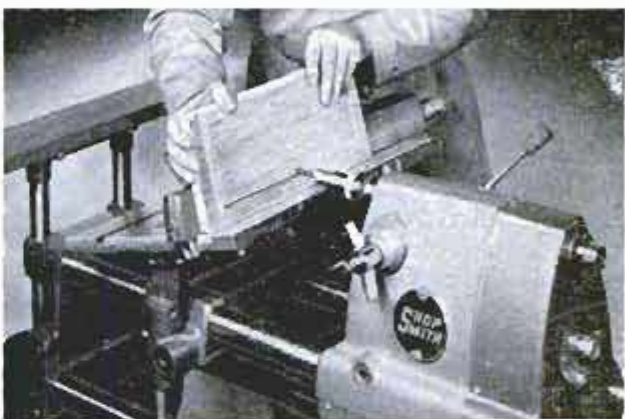

Routing at an angle with surface of work stops most individual machines, but here you see it done on a multipurpose tool, using the saw table and ripping fence to give the job the required accuracy

Another setup with a multipurpose tool—mortising a storm-door stile for lock. Note how saw table is used as a combined stop and guide to hold the work in alignment

Hinged drill press driven off saw arbor is the novel feature of this basic saw-jointer combination tool. When saw table is to be used, V-belt is removed from arbor and drill press is swung down, leaving the saw table clear for other operations

Delta

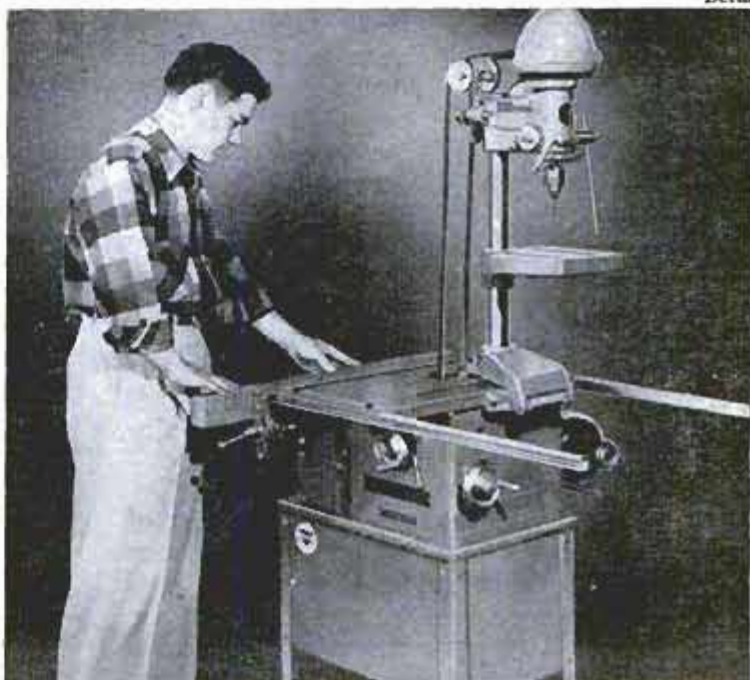
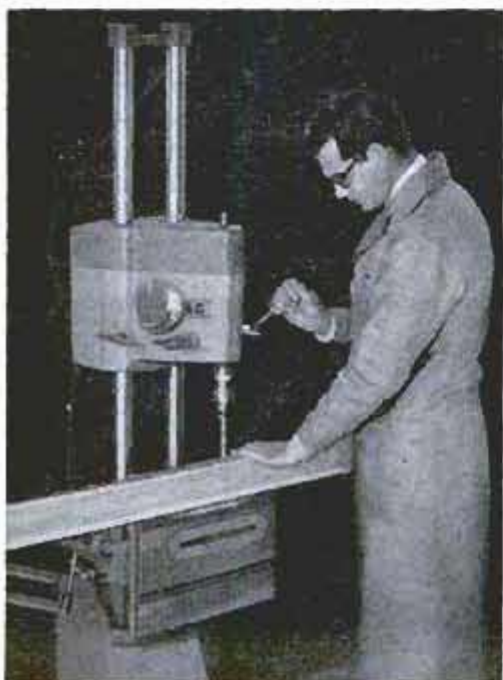

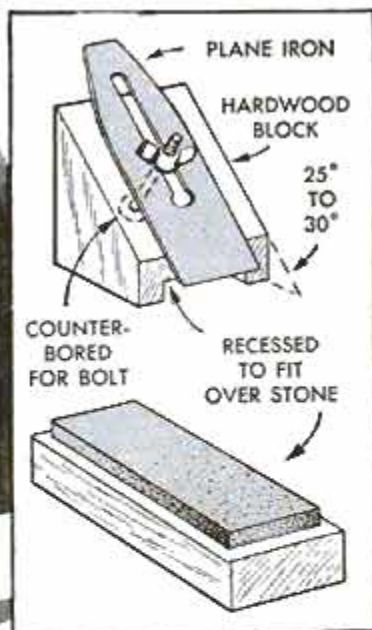

### Sliding Jig Supports Plane Iron For Accurate Honing

To maintain the correct bevel when honing a plane iron, mount it on a jig made from a hardwood block. The block is recessed to clear the stone yet ride on the edge of the case that holds the stone. Bevel the block at a 25 to 30-deg. angle and bore a hole for a carriage bolt perpendicular to this surface. When fitted with a wing nut and washer, the bolt will hold the plane iron securely. Wood chisels can be sharpened with the same device simply by bolting a sheet-metal clamp across the chisel.

### Floor Flange Holds Lathe Center

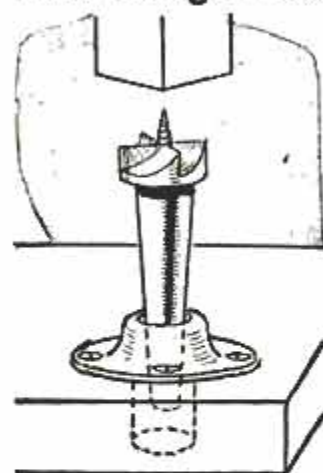

Holding a lathe turning square steady while driving a spur center into it is no problem when the center is held upright in a floor flange mounted on your workbench top. First, a hole is drilled in the bench top and the floor flange is screwed down over it. To use the

"vise," the lathe center is dropped into it and the turning square held vertically while being tapped onto the center.

When it is necessary to cut off part of the threaded end of a bolt, first turn a nut down to the end of the threads. Then, saw off the end where desired and unscrew the nut. This will remove the burrs so that a nut can be started easily.

### Spotting Fence-Post Holes For Tractor-Driven Auger

When drilling fence-post holes with a tractor-driven auger, here is an easy way of spotting the exact location for each hole. As the alignment and distance for each hole are measured, carry along a bucket of dry lime and a small scoop. Then, as the exact spot for each hole is located, cover it with a dash of lime. The tractor operator can readily see the exact spot on which to set the point of the auger for drilling each fence-post hole.

George A. Smith, Quarryville, Pa.

### Masking Tape on Wood Chisels Protects Sharp Cutting Edges

Keen-edged wood chisels will retain their sharpness longer when carried with other tools in a toolbox, if the cutting edges are protected with strips of masking tape. Fit the tape over the ends of the chisels as indicated, so the folded portion of the tape projects and provides a "cushion" for the cutting edge. Friction or rubber tape also may be used to protect the edge.



### Aluminum Rack Stores Milking-Machine Inflation Tubes

A sanitary, nonrusting and easily cleaned rack for holding the inflation tubes used on electric milking machines is made completely from "do it yourself" aluminum. Two  $\frac{3}{8}$ -in. rods provide the horizontal supports, which are held by two brackets shaped from  $\frac{1}{4}$  x 1-in. aluminum flat bar. The splashboard is cut from either plain or embossed sheet aluminum. Aluminum screws are used to assemble the unit.

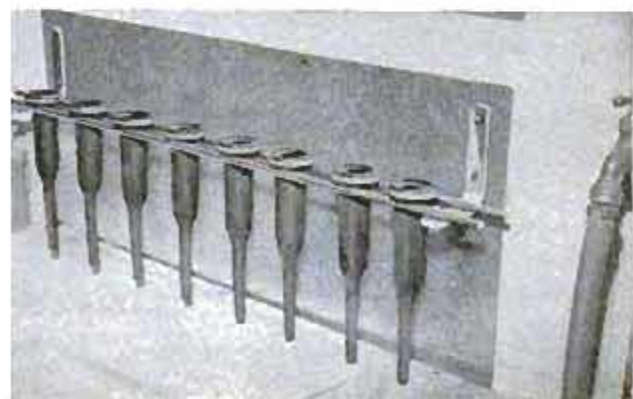

# SHOP CHAIR

By Hi Sibley

ADJUSTABLE IN HEIGHT so that it can be used at bench, lathe, or drill press, this shop chair permits you to be seated comfortably for many bench and machine operations. The base of the chair is a spider salvaged from an office chair into which an 18-in. length of 1-in. pipe is fitted. The chair seat is supported on a floor flange screwed to an 18-in. length of  $\frac{3}{4}$ -in. pipe which slips inside the 1-in. pipe. The clamp for locking the column can be machined from solid stock or bent from bar stock and slipped over the  $\frac{3}{4}$ -in. pipe. This arrangement permits the chair to swivel. An alternate method of making height adjustments is to drill  $\frac{3}{8}$ -in. holes through the pipes, spaced 1 in. apart. Alternate holes are at right angles. A  $\frac{3}{8}$ -in. bolt then supports the chair column at the desired height.

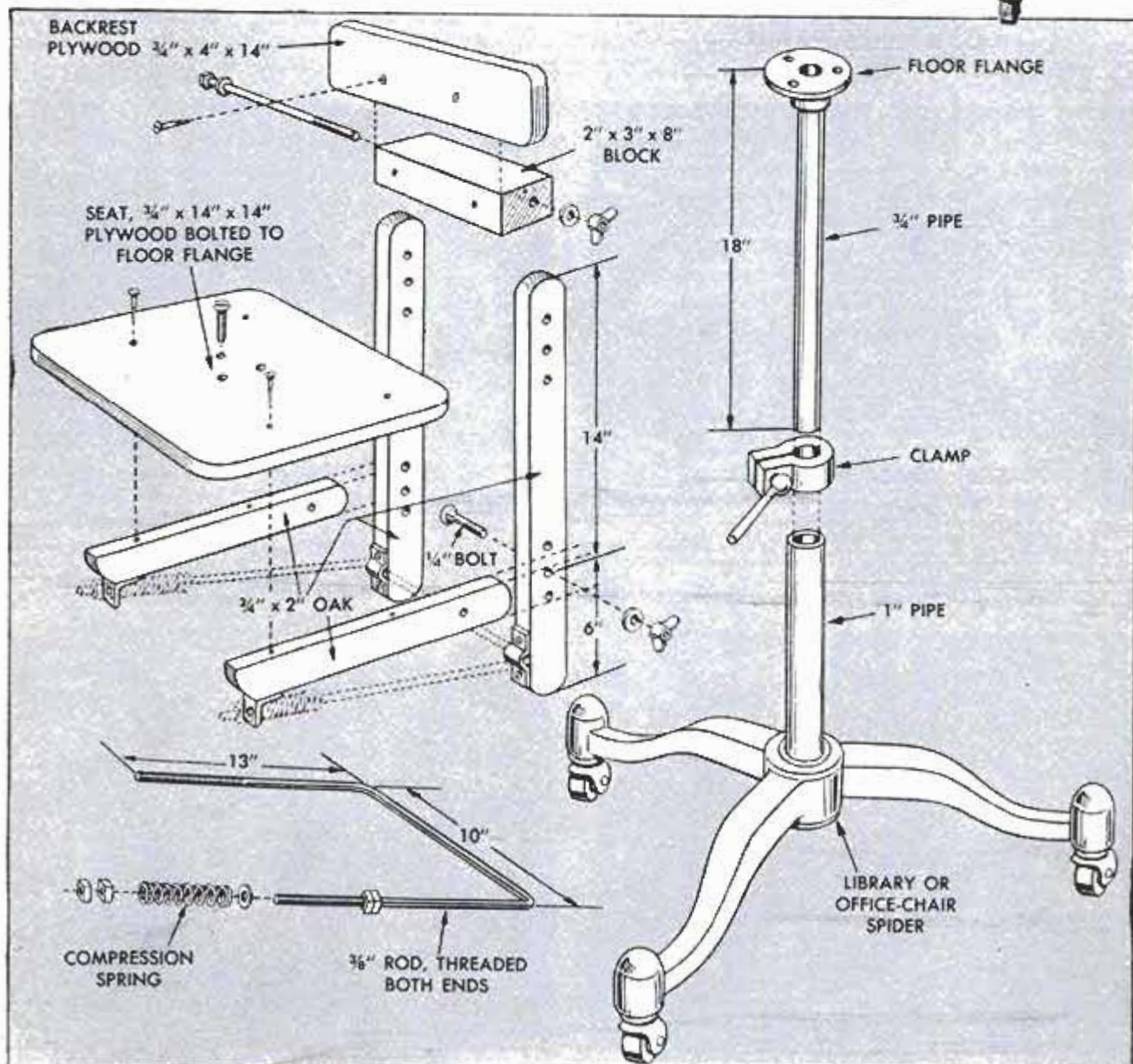

# SHOP

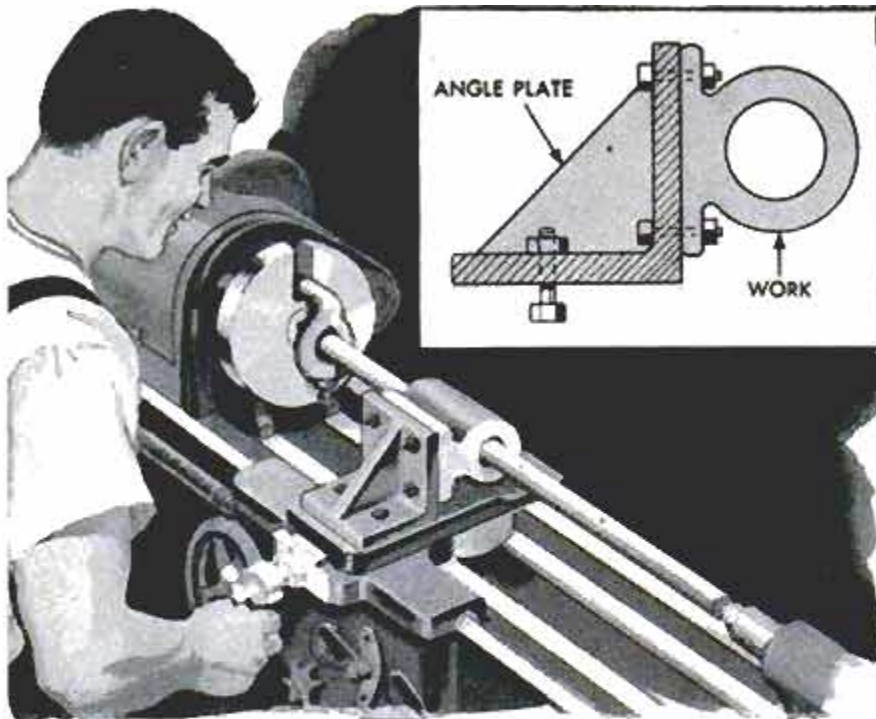

**BORING OUT A CORED HOLE** in a casting set up in a lathe is less of a problem when the workpiece is bolted solidly to an angle plate which is bolted to the cross slide as shown in the detail. A boring bar then is mounted between centers and is driven by a dog. With the bar turning and the work held stationary, the bored hole will be true throughout its length. A boring bar can be improvised from a length of round steel bar, with both ends center-drilled

**HAND PLANE SERVES AS IDEAL SANDING BLOCK**, below, when the blade is retracted, a pad of felt or thin sponge rubber placed on the bottom of the plane and a sheet of sandpaper folded over the sides of the plane. The sandpaper can be held in place with the fingers or with spring-type clips

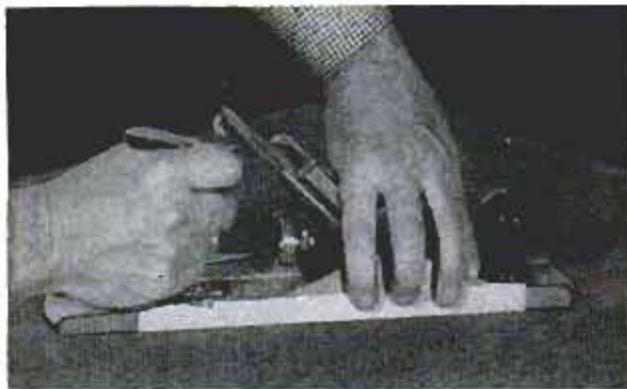

**TO PREVENT A SMALL-DIAMETER DRILL BIT** from drifting off center when drilling round stock, use a piece of square stock of the same size for a drill guide as shown. The square is placed above the round stock, center-punched and drilled. The drilled hole acts as a guide to keep the bit from drifting

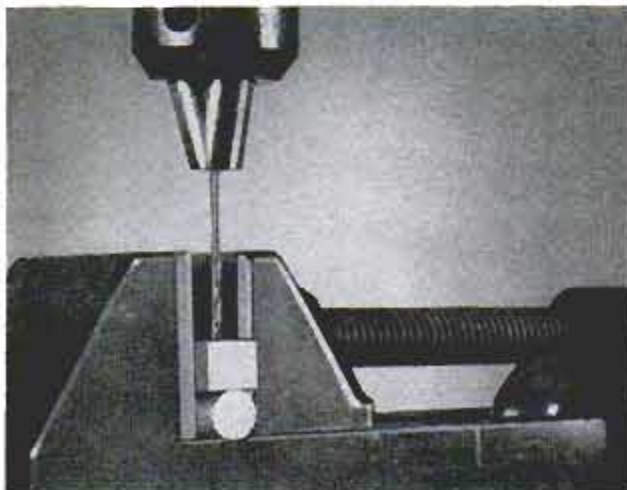

**INDIA INK CAN BE USED FOR LAYOUT WORK**, below, when there is only occasional need for layout blue. For scribing work obtain an inexpensive compass and replace the pencil with a length of dowel fitted with a nail sharpened on one end. Use a piece of adhesive tape on the work to anchor one leg of the compass

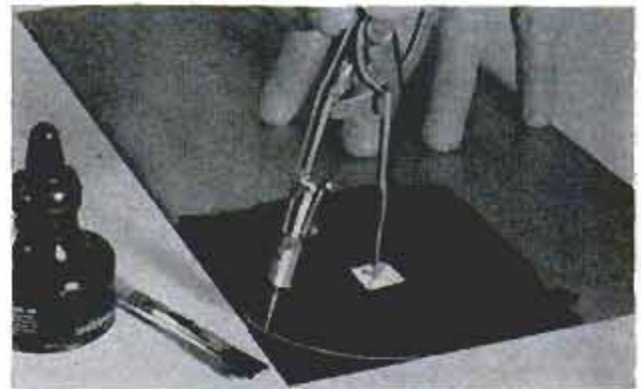

**DRILLING AND TAPPING A HOLE** in the arbor at the end of a flexible shaft, below, makes it possible to eliminate the weight and bulk of a conventional chuck. The hole must be centered accurately. To use various tools on the shaft, simply thread their arbors to match the tapped hole in the arbor shaft





# HINTS

**IF EXTREME ACCURACY** is not necessary, time can be saved when turning a duplicate part on a wood lathe by holding a pattern close to the turning blank. A holder for the pattern consists of a length of  $\frac{1}{4}$ -in. drill rod, threaded on one end and fastened to a flat-steel arm that pivots on a second arm which is mounted on the headstock casting. Two adjustable brass rods with a phonograph needle fitted near the end of each hold the pattern in position

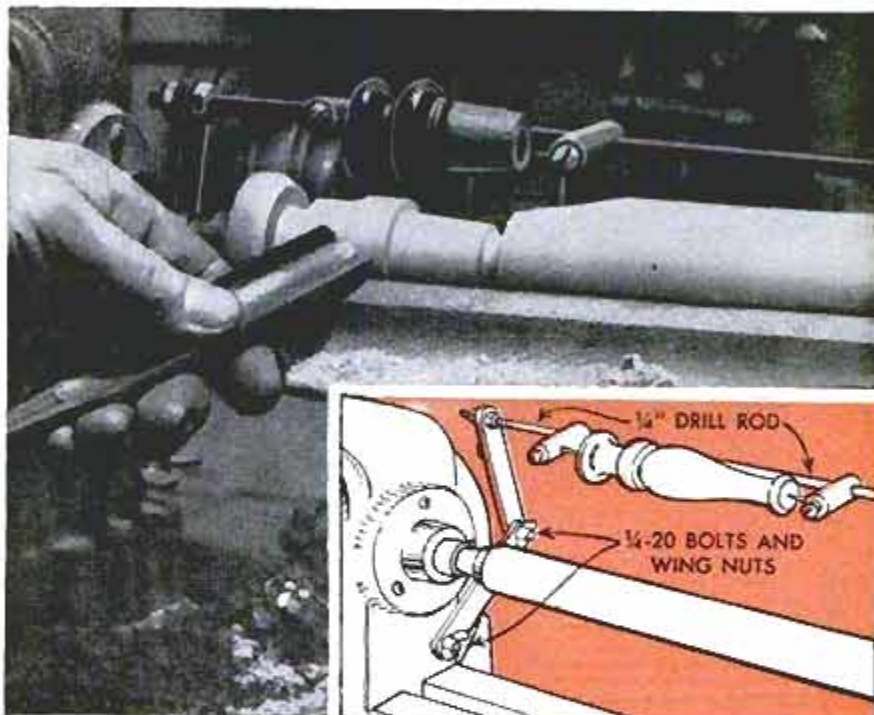

**A DOWEL INSERTED IN COPPER TUBING** will prevent it from becoming crushed out of round if cut in pieces less than 1 in. long with a pipe cutter. If a tight-fitting dowel is forced into a tube, it is possible to cut washers as little as  $\frac{1}{8}$  in. thick

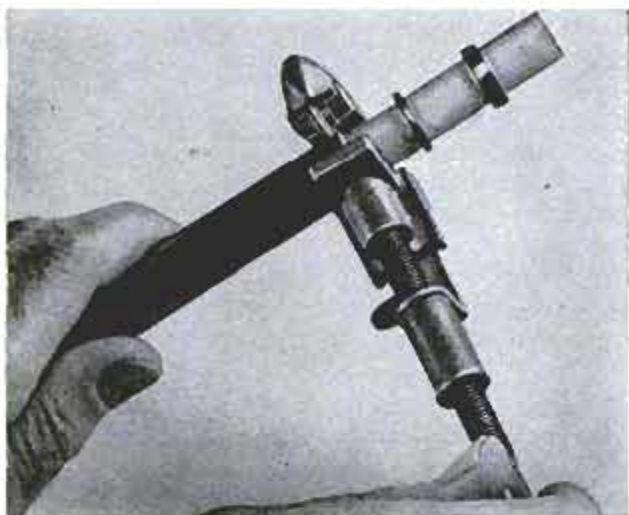

**COMBINATION-SQUARE SET** that includes a protractor head may be used to determine the diameter of cylindrical objects. Set protractor at 90 deg. and slide it along the scale as shown below. The diameter of an object then can be read directly from the scale

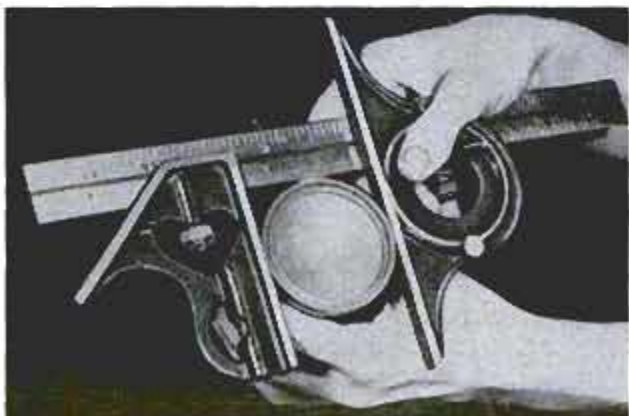

**AN AUXILIARY PIVOTING JAW** cut from steel plate permits holding tapered pieces of work in the jaws of a regular bench vise. The auxiliary jaw consists of two triangular pieces which pivot on a flanged pin fastened to the clamped piece by two dowel pins

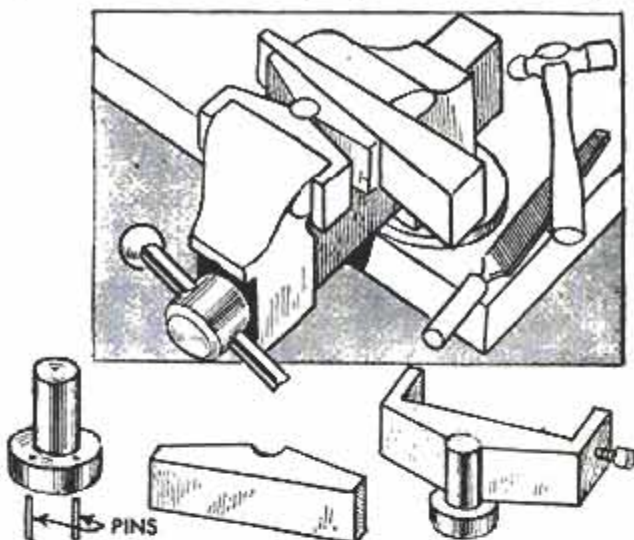

**THREADED CLEANING TOOL**, below, can be used to remove tightly embedded metal chips from threads on a lathe chuck. The tool is made by threading a piece of steel tubing or pipe and providing a shear on the leading edge of each of three segments as shown



## Altered Drill Chuck Allows Work to Pass Through Headstock

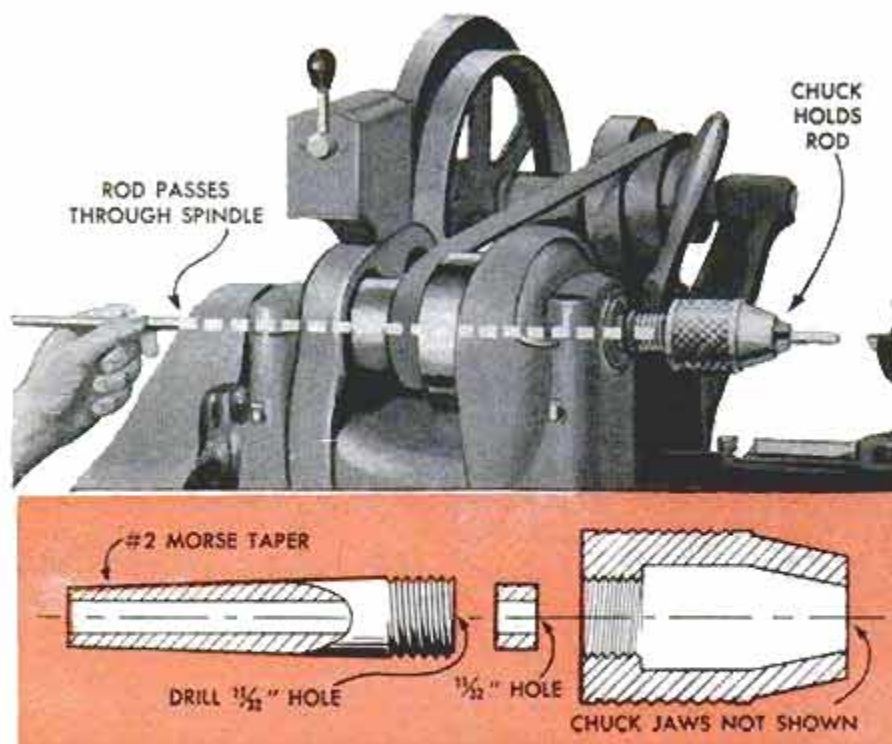

As a substitute for a collet chuck one machinist drilled an  $\frac{1}{32}$ -in. hole through the tapered drill-chuck adapter of his lathe to permit long rods to be passed through the lathe spindle for machining. This allows the rod to be gripped at any point along its entire length as indicated in the detail. A lathe drill chuck altered in this manner and mounted on a tapered adapter will take stock ranging in size from  $\frac{1}{8}$  to  $\frac{5}{16}$ -in. dia. The chuck adapter is especially useful in facing and cutting-off operations of small diameter round stock.—Harvey H. Adams, St. Louis, Mo.

## Pulley-Flange Repair

Large metal washers bolted to a V-belt pulley were used by one mechanic as an emergency repair to replace a broken section of the pulley flange. First, the broken edge of the flange was filed round and smooth. Then, holes were drilled in the pulley, located so that when the washers were bolted to the pulley the edge of the washers projected the same distance as the edge of the original flange. The additional weight of the washers was counterbalanced by other washers bolted to the opposite side of the pulley. As a further safety precaution, the power tool on which the pulley was used was run only at slow speed.

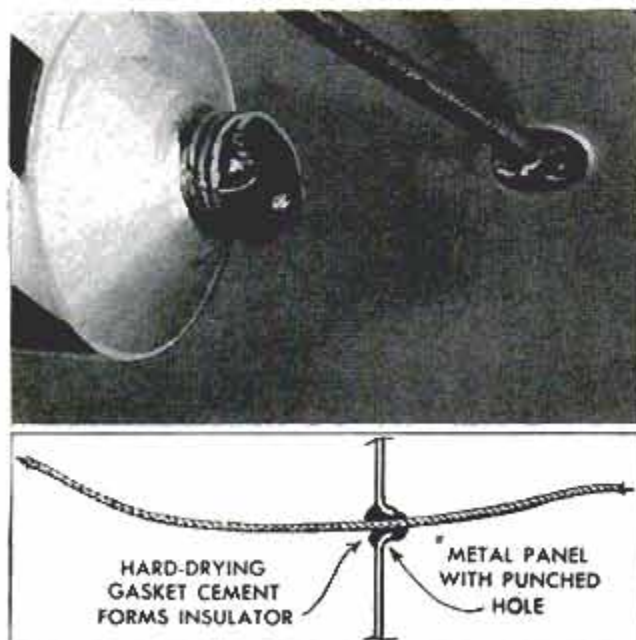

## Toolholder Cut From Glove

A belt toolholder that will accommodate small tools, such as a screwdriver, file, nail set, pliers and punch, is cut from an old leather glove as shown. After the front half of the cuff is removed, the back is folded and stitched so that the holder can be slipped on a belt. The thumb can be left on the glove for short tools, or removed, as desired.

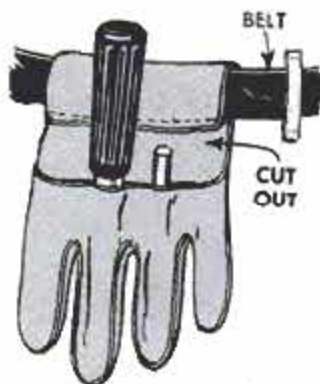

Frank Shore, New York City.

## Gasket Cement Forms Insulators Around Wires in Car Body

Hard-setting gasket cement can be used to make insulators for wires that pass through sheet metal in automobile bodies. Holes are made with a center punch instead of a drill. Center-punching forms a hole with a smooth "collar" through which the wire is pulled. Gasket cement is applied to the wire at the point where it will pass through the hole. The wire is worked back and forth until cement forms an insulator.

Ⓞ Rusted chrome plating on auto parts and accessories can be polished to a like-new shine by wiping with a damp cloth, then buffing briskly with aluminum foil.

SN 57

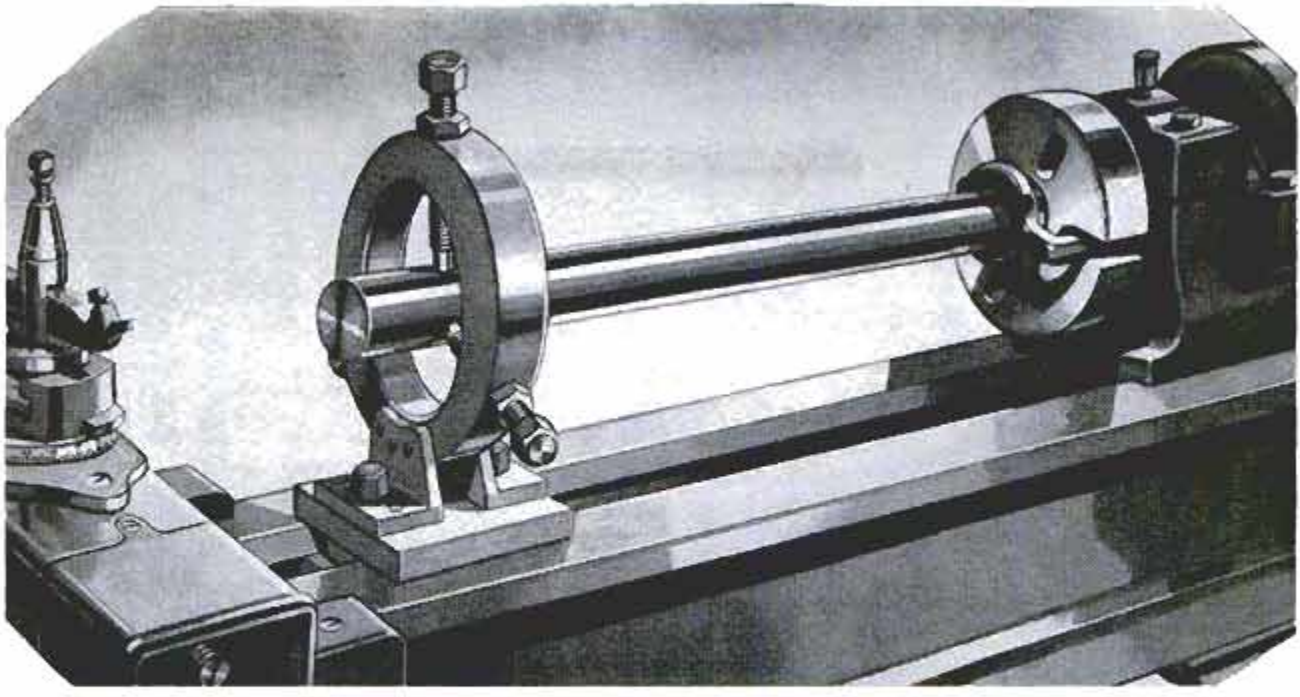

## Steady Rest for Metal-Cutting Lathe

HOME CRAFTSMEN who own a small lathe will find this steady rest, made from cold-rolled steel scrap, a useful accessory for supporting long work during turning, boring or threading operations. The large ring can be made from heavy-walled tubing or bored and turned from 3/4-in. steel plate. Tap 3 holes 5/16-18, spaced 120 deg. apart, in the finished ring for bronze capscrews which serve as adjustable jaws. With the capscrews in the ring the latter is mounted and accurately centered on a mandrel held between centers on the lathe. This will support the ring with its center at lathe-center height so that its lower outline can be scribed on angle-iron brackets set up temporarily on the base. This must be done to locate the vertical position of the brackets to support the ring center at exactly lathe-center height. When the brackets are filed flush with the inside surface of the ring they can be clamped together with the ring and cross-drilled for three rivets as shown. The assembly then is clamped to the base member and guide and drilled for rivets to hold these parts together. To complete the project, a hole is drilled through the bracket, base, guide and clamp on each side of the ring for clamp screws.

In the illustration, the setup is shown for machining unfinished stock, the left end of which must be held against the live center either with a rawhide lacing or by means of a special dog. The lacing has been omitted from the illustration for purposes of clarity. Finished stock can be mounted in a three-jaw chuck with the outer end supported in the steady rest.

C. W. Woodson, Chicago.

All parts of lathe steady rest detailed below are machined from cold-rolled steel, except capscrews

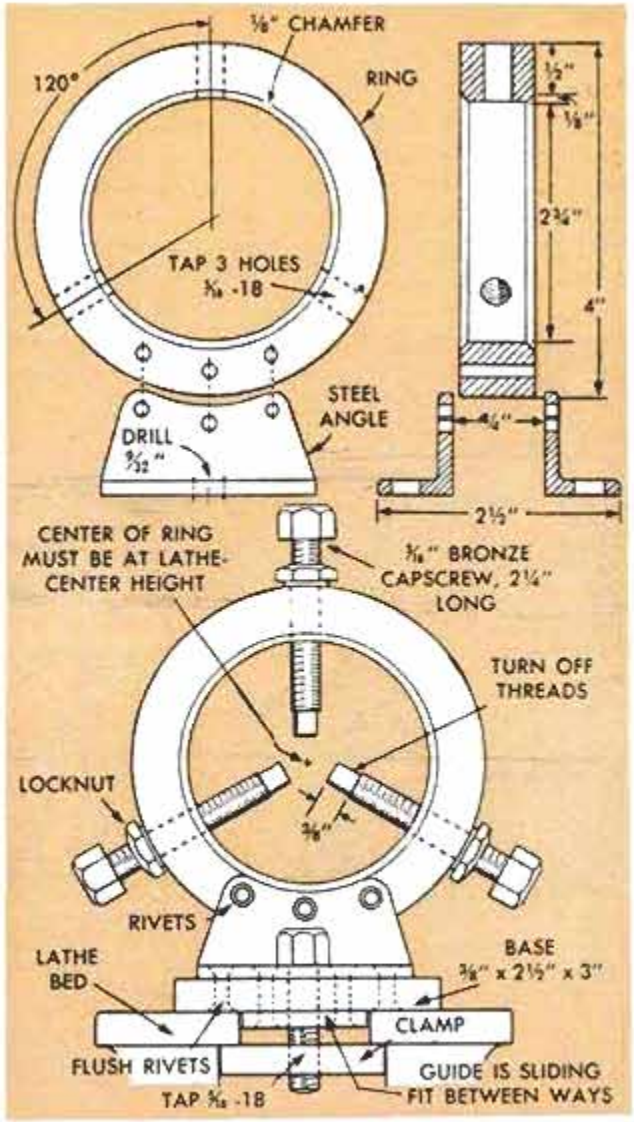

# SHOPPING FOR TOOLS

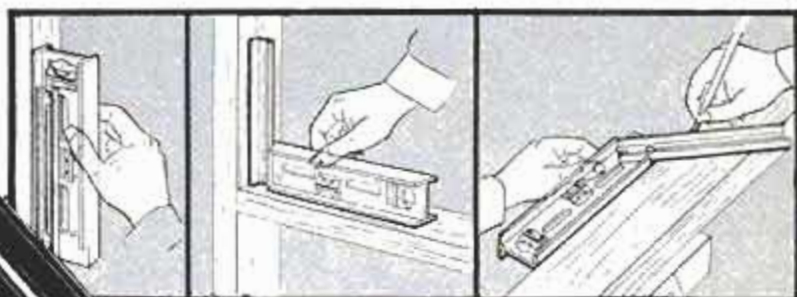

**COMBINATION TOOL** consists of a level, T-bevel and square combined in one handy unit. Change is made from one tool to another by the simple adjustment of a wing nut. Adjustable arm, or blade, which slides in or out can be set at an angle as in the sketch at right. Comes with both level and plumb vials

Macklaunburg-Duncan Co., Box 1197, Oklahoma City, Okla.

**WOODWORKING UNIT** utilizes a portable power saw for stationary operations such as crosscutting, ripping, beveling and mitering. Attachments for shaping, jointing, turning, drilling, sanding and mortising also are available. Table is 36 in. wide. Power unit is quickly detached for use as portable saw

Reamstown Products Co., Reamstown, Pa.

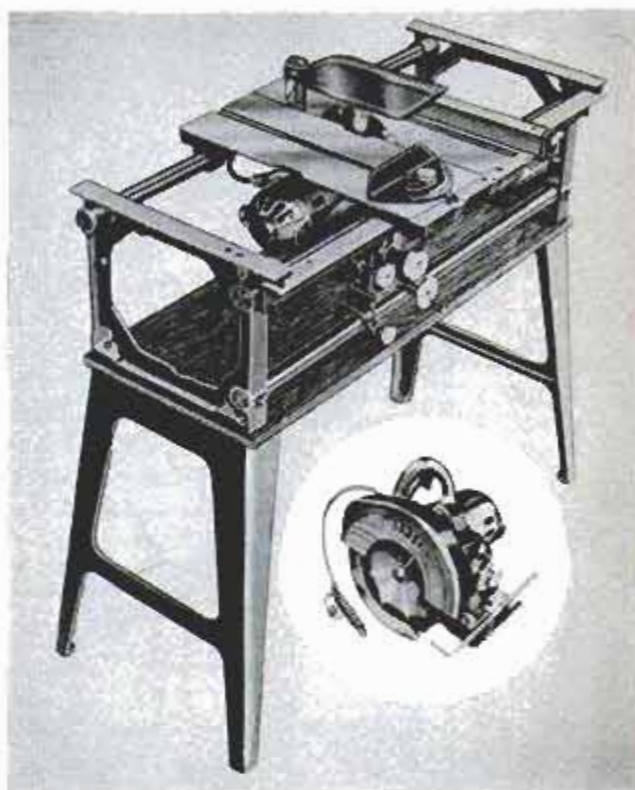

**MASONRY DRILL** is adjustable for drilling neat, round holes up to 5¼-in. dia. in building block, tile and plasterboard. Cutters are carbide-tipped for long life without resharpening. Comes with a small carbide-tipped drill bit for drilling the pilot hole. A ½-in. electric drill powers the unit to full capacity

Hendles & Reynolds Machine Co., Alpena, Mich.

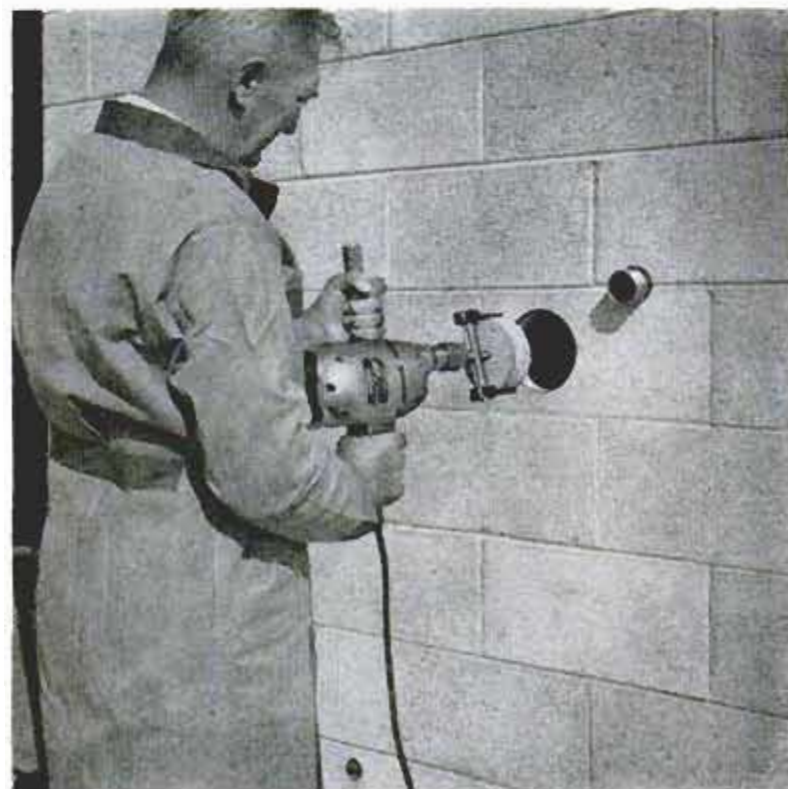

**PIPE WRENCH** is fitted with a Z-shaped spring bent to fit under a pin running transversely through wrench housing. Pin acts as a pivot, giving a more positive bite and release of the pipe jaws. Upper photo shows position of movable jaw when there is no pressure on handle. Lower photo shows jaw position when pressure is applied. When pressure is released, jaw assumes original position

Erie Tool Works, Erie, Pa.



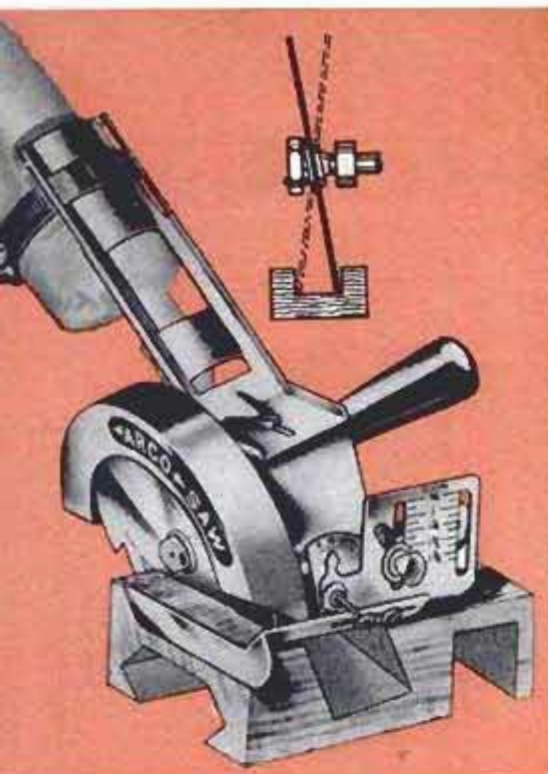

**WOBBLE-SAW ATTACHMENT** for portable electric drill cuts grooves up to  $\frac{1}{2}$  in. wide by 1 in. deep in one pass over the stock. Can also be used as a straight cutoff and rip saw by removing the wobble-saw arbor. Unit comes fitted with an adjustable ripping fence for cutting strips of stock to a uniform width  
Arrow Metal Products Co., 140 W. Broadway, New York City 13

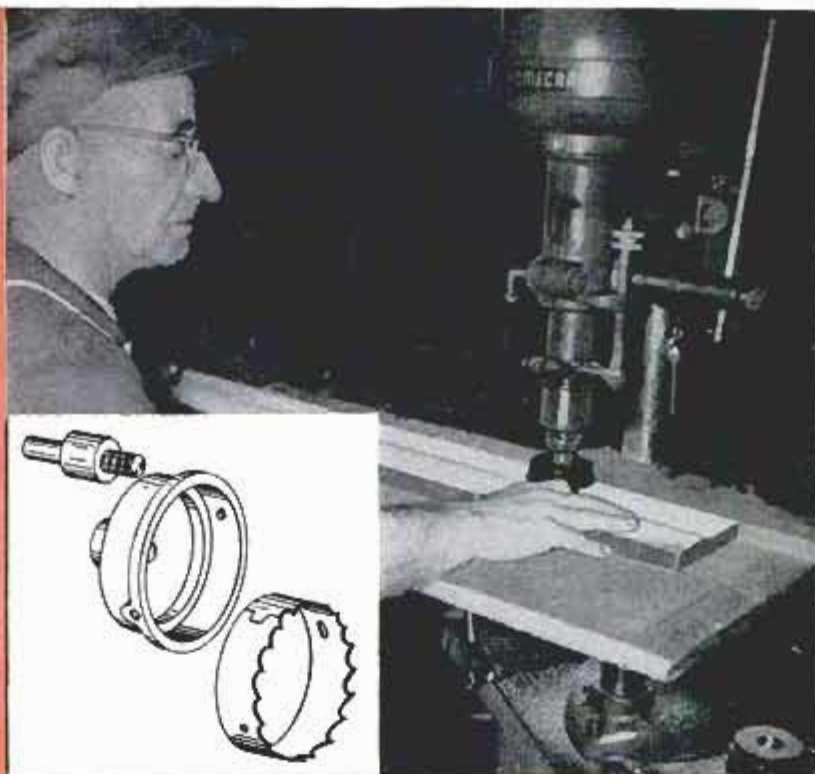

**ROTARY PLANER HEAD** for use with a drill press planes a smooth, true surface on either hard or soft wood without chatter marks when driven at speeds as low as 1800 r.p.m. This is possible due to special shape of the cutting teeth. Removes up to  $\frac{1}{16}$  in. in one pass. Will also make light cuts on plastic  
Winkelman & Spott, Inc., P.O. Box 58, Lincoln Park, N. J.

**PORTABLE WELDER** works on 115-v., 60-cycle, a.c. For continuous welding of light sheet metals it provides about 50 amps. The holder is angled for handy manipulation in partially fabricated units and is provided with a cool handle. Using  $\frac{1}{16}$  and  $\frac{1}{8}$ -in. rods it has a capacity to weld 16-ga. sheet metal

Cauhorn Distributing Co.,  
9999 Broadstreet, Detroit 4, Mich.

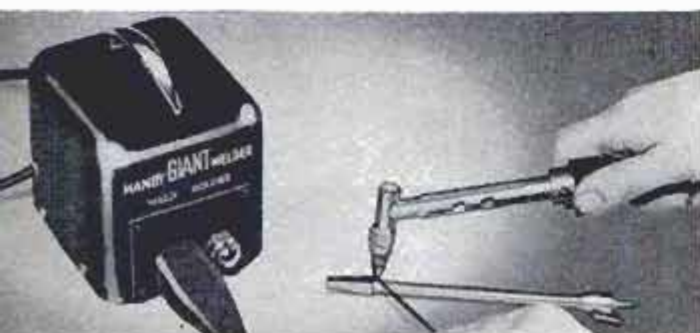

**UNIVERSAL MOTOR MOUNT**, lower left-hand photo, is especially designed for fractional-hp. motors and small gas engines. Adjustments provide for pulley alignment and adjusting for belt tension. Motor-driven appliances also can be bolted directly to the motor-mounting unit and pulleys properly aligned  
Arco Mfg. Co., P.O. Box 817, Grand Forks, N. D.

**QUICK-ADJUSTING C-CLAMP** is fitted with an elliptical nut which automatically releases, permitting threaded spindle to be rapidly adjusted to thickness of stock. A turn of handle clockwise engages nut. Once engaged, clamp can be tightened at any point along the length of spindle. Comes in 6 sizes

Wilton Tool Mfg. Co., Inc.,  
925 Irving Park Rd., Schiller Park, Ill.

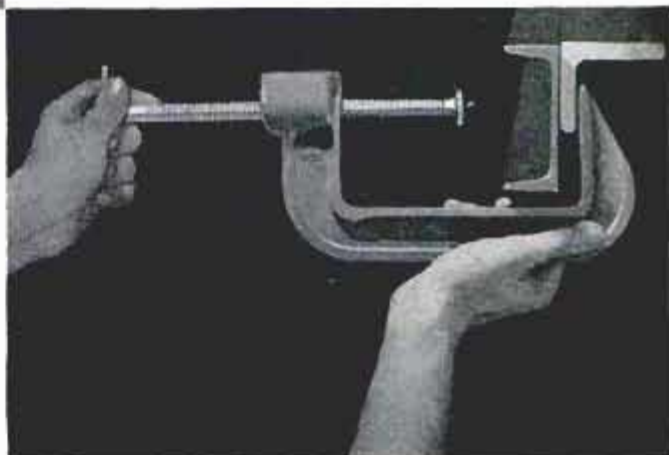
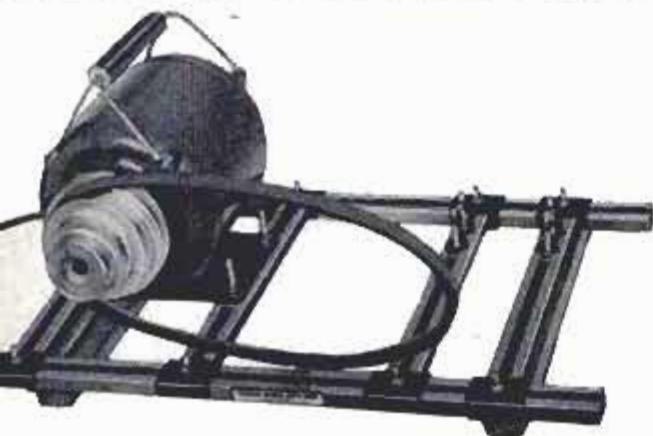

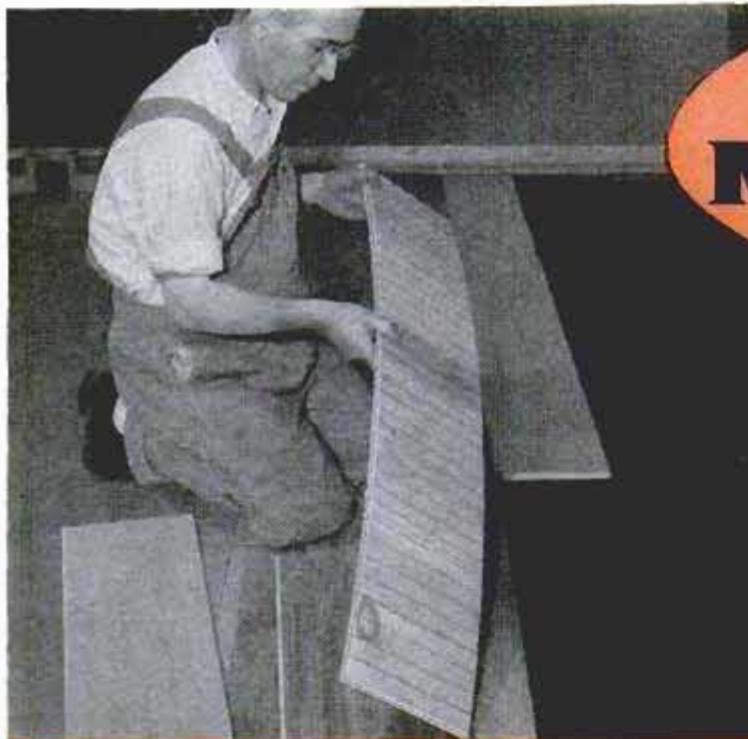

# On the MARKET

FOR THE DO-IT-YOURSELFER



**ADHESIVE FOR PLASTIC and metal wall tile, (above) can be worked four hours after application, remains plastic to absorb expansion and contraction of tiles**  
 Midcontinent Adhesive Company, Grove City, Ohio



**LOW-COST FLOORING** (above) consists of  $\frac{1}{8}$ -in. hardwood veneer glued to  $\frac{5}{8}$ -in. softwood backing, which is grooved so it is flexible enough to follow slight irregularities when nailed to wood subfloor or set in mastic on concrete

U.S. Forest Products Laboratory, Madison, Wis.

**BROKEN POT HANDLES** and other metal objects around the home can be repaired without heat by using a plastic paste containing epoxy resin (right). Paste adheres firmly to metal and when dry can be drilled and worked like metal

Taylor and Art, Inc., 1710 E. 12th St., Oakland 6, Calif.



**THERMOSTATIC WATER CONTROL** adjusted by one dial (below) has safety limit to keep water below 110 deg. F. If cold-water supply fails, control shuts off water completely, assuring safety of children in shower or bathtub

The Powers Regulator Company, 3400 Oakton St., Skokie, Ill.

**BLOND FINISH FOR FURNITURE** originally stained dark is applied in paste form in two coats. After second coat is applied, special tool with flexible blades marks in wood "grain"

Frost Paint and Oil Corp.,  
 1209 Northeast Tyler, Minneapolis 13, Minn.

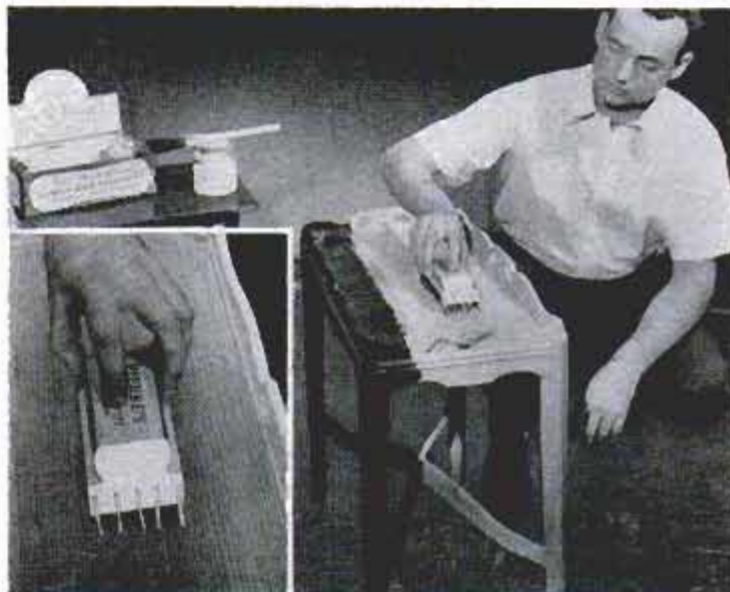
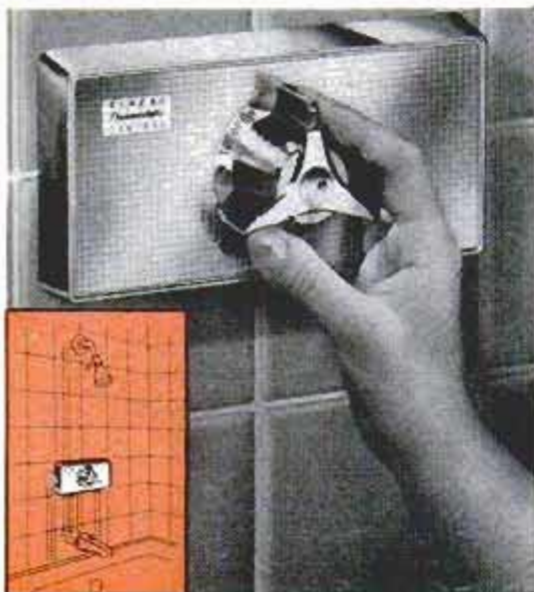

BRAND NEW FROM KODAK:

# Handiest filter kits ever designed!

Imagine the convenience of having all your basic filters visible, instantly available—yet *individually protected* in a rugged case small enough to tuck in your pocket or gadget bag!

That's what you get in a smart new Kodak Filter Kit. Each kit comes *complete* with the basic filters you'll be using the year around, plus an adapter ring (if your camera requires one). For color shots you have a Kodak Skylight Filter to cut down haze in distant scenes and a Kodak

Daylight Filter that lets you shoot indoor color film outdoors.

In addition, a Kodak Pictorial Filter is included in the still-camera kits to accent clouds in your black-and-white pictures, or a Kodak Portra Lens can be added for dramatic close-ups.

Ready-to-use Kodak Filter Kits for most still and movie cameras are priced from \$6—the *regular price* of the filters and lens attachments. *There's no extra charge for the case!*

For still or movie cameras—

## KODAK FILTER KITS

- Complete with basic filters, ready to use
- Handy "swing out" compartments, snap closures
- Room to spare for extra filters, attachments
- Each filter visible, protected in its own compartment
- Convenient size for pocket or gadget bag
- Filter Kits are also available without adapter rings so that kits can be custom-made by your dealer to fit your particular camera.

*Prices are list, include Federal Tax, and are subject to change without notice.*

**Eastman Kodak Company**  
Rochester 4, N. Y.



**Kodak**  
TRADE-MARK

# Care and Feeding of Engines



BY  
S. P. CORP

## VALVE TAPPET ROTATION

Valve tappets should rotate on the cam lobes. This rotation is caused by a small degree of rake on the surface of the cam lobe of the camshaft, coming in contact with a convex surface on the tappet foot and moving it part of a turn each time the tappet is lifted. This insures long life for tappets.

This rotation should be verified whenever valves are inspected. Failure to rotate means tappet may be dry in the guide, or a flat spot may be worn in the foot of the tappet. Check rotation when installing a new tappet or a new camshaft. If either tappet or cam lobe is worn, tappet may not rotate, causing wear and noise.

In L-head engines, tappet rotation promotes valve rotation, insuring a tight seal. In OHV engines it is important that valves rotate each time they open or close, to keep valve seat clean and minimize wear. If valves are not turning, look for a sticking condition in valve guides and check for correct valve adjustment. Lubricate valves around guides with penetrating oil.

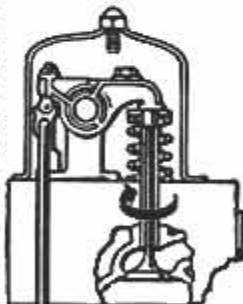

## TORQUE AND HORSEPOWER

Torque is twisting effort. If a man applied 53 pounds of torque on a 10-foot lever, moving over a 62.8-foot circumference in one minute, he would perform one-tenth of a horsepower of work. If he increased his speed to make two revolutions a minute, he would exert twice as much horsepower, but the 53 pounds of torque would remain the same. When an engine has 218 foot-pounds of torque at 2000 R.P.M., that is simply a statement of pull at the end of shaft (or lever).

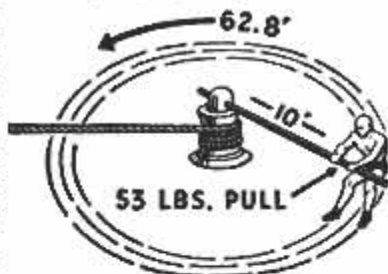

## WRITE FOR FREE MANUAL

Your name and address on a postal card will bring you this valuable illustrated manual of car care. It's full of detailed instructions, indexed by subject. When you re-ring, use **SEALED POWER KromeX Ring Sets** for longest ring life, easiest starting, and maximum oil control. KromeX Ring Sets break in fast! Your dealer has them or can get them for you. Sealed Power, Dept. G-5, Muskegon, Mich.



# Sealed Power

## PISTON RINGS

# Clinic for Homemakers



As a service to our readers in solving the hundreds of problems pertaining to a home—inside or out—the editors of *Popular Mechanics* invite you to present your problems to The Clinic Editor for help and advice. Address your questions to The Clinic Editor, *Popular Mechanics Magazine*, 200 East Ontario Street, Chicago 11, Ill.

## Rose Feeding

Q—I'm a rose fancier, have grown several varieties for some years, but I'm still not satisfied with the quality of blooms I'm able to produce. I've always used plant-food mixtures containing natural organic materials, never the chemical fertilizers which I'm told have a higher rate of availability of plant nutrients. Can I change to chemical fertilizers without damaging the established plants?

—R. T., Ark.

A—In general, yes. But it should be remembered that production of top-ranking blooms is not due merely to the kind of fertilizer used. Cultural methods, soils, the growing season and many other factors that influence growth play a part in determining the results. One of the main problems in the use of supplemental fertilizers in rose culture has been to obtain a combination of organic materials that would release nitrogen slowly and at a continuing rate sufficient to support a vigorous growth during the season. In a general way this has been achieved by the use of organic materials such as cottonseed meal, bone meal and tankage which maintain a fairly uniform plant-food release rate. However, on well-drained soils the complete chemical fertilizers seem to produce equally good results, assuming that other conditions are favorable. A new complete chemical fertilizer especially compounded for rose culture is soon to be available. It is said to contain nitrogen in four different forms of varying rates of availability, also two sources of potash and phosphorus.

## Natural Finish

Q—The siding on my new home is finished in the natural color. At first it was a very beautiful blending of reds and browns, but within six months it began to darken and now what was once brown is almost black. The lower edges of some of the boards are beginning to turn gray. What causes this change and how can I restore the color?—O. G., Ore.



(Continued to page 224)



MEN WITH MECHANICAL SKILLS:



# CAN YOU MEET THIS CHALLENGE?



## Mechanics Creed

Upon my honor I swear that I shall hold in sacred trust the rights and privileges conferred upon me as a certified mechanic. Knowing full well that the safety and lives of others are dependent upon my skill and judgment, I shall never knowingly subject others to risks which I would not be willing to assume for myself, or for those dear to me.

In discharging this trust, I pledge myself never to undertake work or approve work which I believe to be beyond the limits of my knowledge; nor shall I allow any superior to persuade me to approve aircraft or equipment as airworthy against my better judgment; nor shall I permit my judgment to be influenced by money or other personal gain; nor shall I pass as airworthy aircraft or equipment about which I am in doubt, either as a result of direct inspection or uncertainty regarding the ability of others who have worked on it to accomplish their work satisfactorily.

I realize the grave responsibility which is mine as a certified mechanic to exercise my judgment on the airworthiness of aircraft and equipment. I, therefore, pledge unyielding adherence to these precepts for the advancement of aviation and for the dignity of my vocation.

If you are a man who takes real pride in a job well done, the Air Force offers you a challenging and rewarding career. The safety of our country, and the lives of its defenders, depend on your accuracy and devotion to duty. Act today and put your skills to work tomorrow—in the U. S. Air Force.

GO PLACES FASTER ON  
THE ALL VOLUNTEER  
TEAM

**THE U. S. AIR FORCE**

### PASTE COUPON ON POSTCARD

*And Mail To*

M-40-PM2

Airman Recruiting Information Branch  
Box 2202  
Wright-Patterson AFB, Ohio

Please send more information on my opportunities for enlisting in the U. S. Air Force. I am between the ages of 17-34 and reside in U.S.A. or possessions.

Name \_\_\_\_\_

Address \_\_\_\_\_ Age \_\_\_\_\_

City \_\_\_\_\_ Zone \_\_\_\_\_ State \_\_\_\_\_

Seal  
packages  
for safe  
arrival  
with...



## Behr-cat® STRAP TAPE

Your packages won't break apart when you wrap them with rugged Behr-cat Strap Tape. It's glass-fibre reinforced for super-strength, and sticks at a touch, assuring quick, neat packaging everytime. Behr-cat Strap Tape is also useful for countless other taping jobs throughout the home and shop where strength is a "must." Try it today.



Look for  
this display!

at Hardware and  
Housewares Stores  
everywhere.

C-6  
**BEHR-MANNING**  
TROY, N. Y.  
division of NORTON Company

Pressure-sensitive masking, strapping, freezer and many other tapes. Sandpaper, abrasive cloth and sharpening stones for home and industry.

(Continued from page 222)

A—You cannot restore the original color of the wood without scraping the surface sufficiently to expose new wood. Neither can you "hold" the original new-wood color with any ordinary transparent finish. Even the application of the finish itself will immediately darken the wood somewhat due to the change in reflective properties at the surface. The most commonly used siding woods are cypress, redwood, western red cedar and white pine. The reds and browns in these woods tend to intensify, that is, darken on exposure to rain, wind and sun. After a time the wood turns a grayish color, especially where the exposure is greatest as on the east, west and south sides of the structure. There are several clear finishes now available which are especially compounded for use on siding. These are said to be quite effective. However, the protective coating must be renewed at least once a year, and sometimes more often on those areas where exposure is greatest. Some of these finishes contain a small amount of pigment for greater protection against weathering. However, this is not sufficient to hide the grain of the wood. Judging from your description of the condition of the siding on your own home, the best procedure would be to sand the surface lightly and then apply one or two coats of a new finish containing pigment. This will not lighten the wood, but it should help to preserve whatever there is remaining of the original new-wood color. We hesitate to suggest that you scrape the surface simply because of the amount of labor and time involved. However, if you wish, you might try using a portable power sander of the belt type.



### Power Sander

Q—I have a home workshop equipped with a few power tools and now I'd like to purchase a power sander. I want a tool suitable for all-around work, one with which I can turn out a professional job of sanding ready for finishing on cabinets and home built-ins, also hardwood floors on occasion. I want a small, inexpensive portable type. What machine will fill my requirements?—M. H., Tex.

A—Except for sanding floors, a portable belt sander probably would be the best selection. We could not recommend a belt sander of the portable type for floor sanding due to the time required to cover an appreciable area effectively. It is better to rent a floor sander from your local hardware or paint dealer for this purpose. For rough-sanding and finish-sanding on cabinets, or any flat surface of limited area, a portable belt sander will come the nearest to filling your requirement for an all-around machine. By using belts of various grit sizes ranging from coarse to fine you can do a professional job on either hard or soft wood. Portable belt sanders with coarse-grit belts cut very fast on unfinished wood. For this reason use care when sanding plywoods as you may cut through the face veneer. When sanding veneered stock it's best to use a medium or fine-grit belt. Machines taking belts 3 in. wide are perhaps best for general use.

### Removing Stains From Linoleum

Q—My kitchen-cabinet tops are red linoleum. There are several stains in the form of rings on one cabinet top. I don't know what has caused them. Is there any way to remove the stains?—T. E., Calif.

A—You might try going over the area lightly with fine steel wool, then wash thoroughly with mild soap and water and allow to dry. Stains that have not penetrated too deeply usually can be removed entirely in this manner or at least so greatly reduced that they are no longer noticeable. Sometimes it will help to apply raw linseed oil to the areas after washing. Allow plenty of time for drying, then rub in the oil with a soft cloth.

Glidden Announces . . .

# New GLID-TONE products specially made for do-it-yourself wood finishing

Now Glidden takes the "mystery" out of wood finishing, staining. The new array of Glid-Tone products have "built-in" features for amateur use; give *professional results*. Look for the Glid-Tone label at your paint store.

**New, easy-to-use stains in color!** Use *Glid-Tone Stains* either inside or out. Seals, does not raise grain. Extremely easy to use—just wipe or brush on, wipe off!

**For high gloss** and highest resistance to alcohol, acid, heat and abrasion, use all-purpose *Glid-Tone Gloss Varnish . . .* for floors, furniture, table tops, bars, cabinets!

**For exterior trim, paneling, boats and marine uses—***Glid-Tone Spar Varnish* is extremely tough, withstands effects of water, salt spray, heat, sun, cold.

**For modern, hand-rubbed effects** without laborious rubbing, use *Glid-Tone Satin Sheen Varnish*. Self-priming. No thinners or other extras required.

**Glid-Strip**—a safe, effective paint and varnish remover. Lets you work larger areas because it stays wet longer. Non-flammable. Cleans up with water!

**Glid-Tone Natural Wood Filler**—for filling open-grained woods . . . oak, chestnut, walnut, mahogany, pine, fir, redwood.

**Glid-Tone Crystalacq**—an all-purpose, crystal-clear brushing lacquer coat for beautifully grained light woods. Dries in only 20 minutes, provides lasting protection. Non-yellowing.

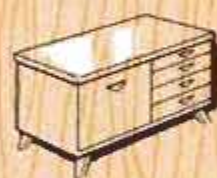

Unfinished Furniture

Furniture Refinishing



Interior and Exterior Paneling

Floors



Pleasure Boats

Wood Hobby Products



Antiques



Picnic Tables, Benches, Lawn Furniture

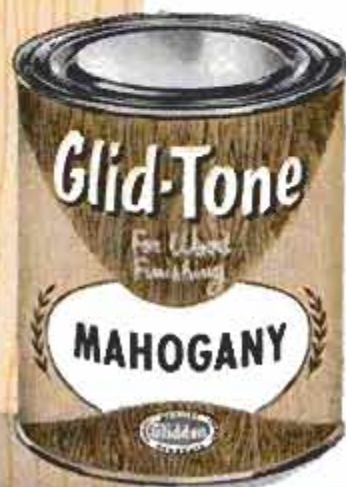

## Glidden

*Pacemaker in Paints*

THE GLIDDEN COMPANY • Cleveland 2, Ohio  
In Canada: The Glidden Company, Limited, Toronto

**FREE!**

Write for Glidden Service Sheet PM-5 . . . complete wood finishing directions!

# FUN AND IT'S EASY! PLAYHOUSE-PLAYSTORE and PACKAWAY DOLL HOUSE

## Send for plans



Your girl will love this 2-bedroom Cape Cod doll house. It's 23" x 17" with slotted construction so it can be packed away in its own base-storage chest. Roof swings up, front removable for access to all rooms. Full size pattern. Easi-Bild plans just 50c.

Build this colorful, 4' x 5½' PlayHouse-PlayStore, too. Even a beginner can do the job with Easi-Bild pattern directions and plans. Sturdy PlayHouse-PlayStore has shelves, room for furniture, door and window, plus clever cut-out trim. Plans—60c.



Both projects made with rugged 3/16" Upson fiber board, the easy-to-work board that makes any home project a cinch to build. 3/16" Upson saws easily, is light in weight, yet is strong and durable. Edges sand smooth. Paints and finishes beautifully.

All Upson fiber board sizes and types are available at your nearby lumber dealer's. Use 3/16" indoors, 3/8" All Weather outdoors.

Send today for your Easi-Bild Patterns. Included: complete directions, step-by-step pictures and material list. Enclose 50c for Doll House, 60c for PlayHouse-PlayStore. *Mail coupon today!*

# UPSON

## LAMINATED FIBER BOARD

94% wood fiber laminated for great strength

PROVEN QUALITY YOU CAN TRUST

THE UPSON COMPANY  
445 Upson Point, Lockport, N. Y.

Please check Easi-Bild Pattern desired. Enclose cash with order.  
 No. 148 PlayHouse-PlayStore 60c  No. 596 Doll House 50c

Send free details on \_\_\_\_\_ (TYPE OF BOARD)

Name \_\_\_\_\_

Address \_\_\_\_\_

City \_\_\_\_\_ State \_\_\_\_\_



## Eyes Over the Ocean

(Continued from page 139)

continues to use celestial observations, radar ranges or bearings and radio-direction-finder bearings when he can obtain them. But loran signals, according to the Coast Guard, are correct 99.7 percent of the time. When the scope watchers in a loran station find an error in synchronization, they switch to a blinking signal that warns loran users to disregard the signals. In a moment a stand-by transmitter takes over.

At Sandy Hook, near the entrance to New York Harbor, technicians have installed an "automatic" station that needs no scope-monitoring teams. If this type of system proves effective, the Coast Guard will have found a way to reduce drastically the personnel assigned to the monotonous work of the lonely loran outposts.

### Loran Rescue

Loran has more than once saved a life. One stormy January night the fishing boat *Student Prince II* lay foundering at a point 200 miles north-northeast of Bermuda. Her seams ripped open, her lifeboat smashed in a futile attempt to abandon ship, she was sinking rapidly with 10 men aboard. The outbound *Queen of Bermuda*, 150 miles away, heard her distress call. Time was precious. Fortunately, the *Student Prince* was equipped with loran, as was the *Queen*. She radioed her loran readings to the *Queen*, which was able to speed in a direct line to the ailing vessel, to reach her in seven hours. Two hours after the crew was removed the ship sank.

The precise location-finding help that enables a ship or tug to speed to the rescue of a stricken ship aids a fisherman in getting bigger catches. Almost all of the Gloucester fishing fleet is equipped with loran sets, many of them sold for surplus after the war. A trawler captain reports that loran saves 10 hours on each trip. He finds that he can get on top of a favorite fishing spot and start dragging right away. If a storm comes up, and he has to head for port, he can resume operations immediately after the storm subsides.

Sometimes the fishing boats heading home can get on a loran line that intersects their home port. It's then a simple matter to speed home on the "loran highway."

In the Bering Sea, where fog and stormy weather make fishing hard work, the trawler *Deep Sea*, fishing for king crabs, "prospects" along loran lines of position. Once, the *Deep Sea* marked a favorite fishing spot with a buoy. When the ship returned to the area later, the buoy had sunk. The skipper

(Continued to page 228)

The only heavy-duty jig saw on the market able to cut bevels up to 45° angle . . . on either side!

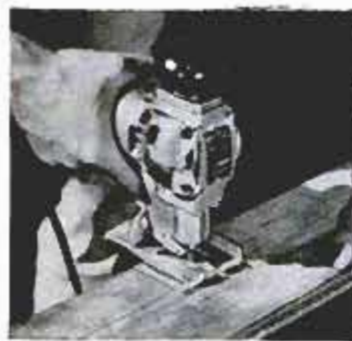

**BUILDERS**



**ELECTRICIANS**



**PLUMBERS**

# New *Black & Decker*® Heavy-Duty Jig Saw lets you:

- ★ Cut bevels to 45° . . . either side!
- ★ Cut patterns in heavy stock—even 2 x 4's!
- ★ Cut practically any building material!
- ★ Cut sheet steel, curve or straight!

This versatile new B&D Heavy-Duty Jig Saw does *more* than you've ever seen a jig saw do! Runs cooler, even sawing 2 x 4's—powered by a custom-built B&D motor! Notice that *bevel-cutting* feature—think how that will help you

on your job! Makes pocket cuts, too. Full 1-inch stroke for greater speed. See your B&D dealer *today*, or write to: THE **ONLY** BLACK & DECKER MFG. Co., **\$120<sup>00</sup>** Dept. M-56, Towson 4, Md.



## HOMEOWNER'S JIG SAW!

This U-10 is designed for lighter jobs and priced still lower! Ideal for average home and light maintenance jobs . . . this wonderful B&D Jig Saw is perfect for cutting intricate patterns! Saves hours of hard work on projects, opens new workshop horizons. Make shelves, tables, outdoor furniture! **ONLY \$54<sup>50</sup>**

LOOK IN THE YELLOW PAGES UNDER "TOOLS-ELECTRIC"



**Black & Decker**®  
PORTABLE ELECTRIC TOOLS

*We don't buy motors—we build them!*

# Graphic® 35

**WITH EXCLUSIVE  
PUSH-BUTTON FOCUSING**



## f/2.8 Lens for Available Light Photography

With the fine, extra fast f/2.8 Graflar lens on the Graphic 35 you can make excellent pictures with fast black and white films. Available light pictures offer infinite variety to the amateur photographer and are considerably less expensive than black and white flash photos. A few years ago only the most expensive 35mm cameras gave you the fast lenses needed to take indoor shots without the aid of flash or flood lights. Now, the Graphic 35 gives a fast f/2.8 lens plus exclusive Push-Button Focusing and other outstanding features.

### EASY TO USE SETTINGS INDOORS OR OUT

Indoor color flash photography is easy with the Graphic 35 because it also features exclusive Spectramatic Flash Settings that take the arithmetic out of lens and aperture settings. A Visi-Ready footage scale gives instant depth of field reading plus correct flash code. Fully synchronized for all flash lamps including electronic flash. All-metal body offers quality—durability. Write for free folder: Dept. PM-56, Graflex, Inc., Rochester 8, N.Y.

Graphic 35 with f/3.5 lens..... \$77.50  
Graphic 35 with f/2.8 lens..... 87.50  
Leather carrying case..... 7.50  
Clip-on flash unit..... 6.50

ONLY  
**\$775**  
DOWN

**GRAFLEX®** *Price-Winning  
Camera*

Prices include federal tax where applicable and are subject to change without notice. Prices are slightly higher in Canada.

estimated the position with loran. Later, when the nets were hauled up, the sunken buoy and its anchor were found in the net.

"In eight months we doubled our take of king crab with loran," says Lowell Wakefield, captain of the *Deep Sea*.

Loran is even more profitable for Western Union Telegraph's cable ship, the *Cyrus Field*. In certain areas where much repair work is necessary, fog formerly prevented celestial "fixes" and kept the ship in port for as long as 10 days at a time. The ship costs \$2000 a day to operate. With loran, such \$20,000 delays are eliminated.

Skippers traveling along the Atlantic coast have long tried to take advantage of the Gulf Stream. Going north, they can gain extra speed by riding the current. Going south, they try to avoid it. But it has always been difficult to follow the course of the meandering stream. Now, many oil companies have equipped their entire fleets with loran. The SS *Bulkfuel* reports that it saves four hours per voyage by using loran. Other ships report greater savings.

Almost all the big passenger liners and transoceanic aircraft are now equipped with loran, as are all U.S. Navy combat ships, planes and auxiliary vessels. Merchant ships and even pleasure yachts are using the electronic navigational system.

### Other Position Finders

Loran supplements and does not directly compete with the many other forms of navigational aids. Loran has a range of 700 to 900 miles by day and up to 1400 miles by night, when sky waves from the station bounce off the ionosphere and are reflected the greater distance. Decca, a British position-finding device, is limited to 600 miles by day and 300 by night. Shoran is a short-range United States system. Tacan, likewise, is short range. Consol, a long-range beam system in common use because any radio picks up the signals, is not as accurate as loran.

Loran is not affected by other electronic equipment on board, and is not put out of order by magnetic storms.

The loran receiver, which is basically a superheterodyne radio receiver on which signals are seen rather than heard, is connected to a 25 to 30-foot whip antenna by coaxial cable.

Tested and proved, the loran receiver has reached a state of perfection which makes it a standard instrument on ship or plane. A model now in experimental use gives a continuous reading as the craft carrying it moves across the earth.

When jet airliners streak from New York to Paris in six hours, the set will prove a vital tool in keeping them on course. ★★

**1956 CHEVROLET**

# The safety story behind horsepower that ranges up to 225!

by ED COLE, *Chevrolet Chief Engineer*

Lately, it seems, all my friends are asking me about higher horsepower ratings. "Two hundred and twenty-five horsepower means just that much more speed, doesn't it?" many of them ask. I tell them that top speed isn't the point at all—that higher horsepower in the '56 Chevrolet means better acceleration, response and maneuverability. It means the car is *safer to drive!*

For instance, Chevrolet's new horsepower, ranging up to 225, gives you a split-second punch of acceleration that can whisk you out of a potential accident situation in a jiffy. That same burst of acceleration from a stop can put you in motion in the blink of an eye when you want to get away fast. Chevy's higher horsepower means safer passing, too. You can get around a car more quickly and back into your own lane. It means more power for safer hill climbing and more power in reserve at all times.

That big-bore V8 of ours *does* have more power. Up to 45 more horsepower than last year! The compression ratio's been boosted as high as 9.25 to 1 for an even greater high-compression power punch. But that power is put there for your pleasure and safety and I'd like to suggest this: See your Chevrolet dealer and road test one of our new Chevrolets. See if you don't agree that it gives you a new margin of safety on the road! . . . Chevrolet Division of General Motors, Detroit 2, Michigan.



help yourself  
to the  
handiest  
plier  
ever  
designed

CHAN NEL LOCK

No. 420

GRIPS LIKE  
A PIPE  
WRENCH

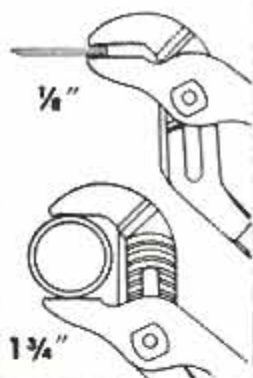

No other plier does so many jobs so well as a Channellock No. 420. Grips anything from a small cotter pin to a 1 1/4" hex nut. And what a grip! Just like a pipe wrench. What's more, Channellocks are streamlined . . . easy to use in hard-to-get-at places. Ask your hardware man for a Channellock plier. You'll soon agree with thousands of other craftsmen . . . Channellock is the handiest plier of them all.

BE SURE IT'S A GENUINE CHANNELLOCK



CHAMPION DEPARTMENT TOOL CO. MEADVILLE, PA.

## Citroen Springs Some Surprises

(Continued from page 145)

radiator, making the trunk almost as deep and roomy as the hold in a ship. The gasoline tank is located under the rear-seat cushion so the 17-cubic-foot trunk looks bottomless.

Frenchmen (and other Europeans) are not anxious for automatic transmissions—gasoline costs are too high. They want miles per gallon, especially in city driving. Citroen has the next best thing to an automatic transmission, an effortless four-speed shift. There is no clutch pedal. Clutch operation is automatic. When you move the shift lever, the clutch automatically operates. Gear shifting is power assisted so that all the driver does is move a valve and the hydraulic pressure slides the gears. This eliminates linkage problems and cuts time lag to zero. But that's not all: A modulator controlled by the accelerator varies the speed of the engagement so it engages fast when you want a "jump" start or slowly when you want to ease away without a jerk. The clutch automatically disengages when the car comes to a stop.

While the DS 19 is all new (the only part of the old car retained is the cylinder block), it still has the Citroen characteristic of putting the wheels on the corners which makes it one of the world's most roadable cars. But that means no rear overhang—as one viewer said "It has no tail!" Many devotees of the current "emphatic tail" school of styling criticize this, but the short overhang does make it amazingly maneuverable and, perhaps more important in France where the bigger the car the more it costs to park, the short overhang puts it in a lower parking-rate bracket!

The roof of the DS 19 is plastic and for those who like to look up as they drive, it is available transparent. Directional signals are mounted high along the roof line at the rear so there is no excuse for the following driver not to see them.

What about the engine? It is a small, economical four-cylinder with hemispherical combustion chambers. Its cylinder head is aluminum. Valves are overhead, being mounted at a 60-degree angle. Horsepower is 75 at 4500 revolutions per minute. Displacement is 1911 cubic centimeters (hence the 19 in DS 19) or 116.57 cubic inches, making it about half as big as a Ford six-cylinder engine.

Top speed is 90 miles per hour, by factory guarantee. It cruises at about 72 miles per hour. It will average more than 20 miles to the gallon over-all. The car weighs 2947 pounds.

(Continued to page 232)



# new saws that DO MORE and COST LESS

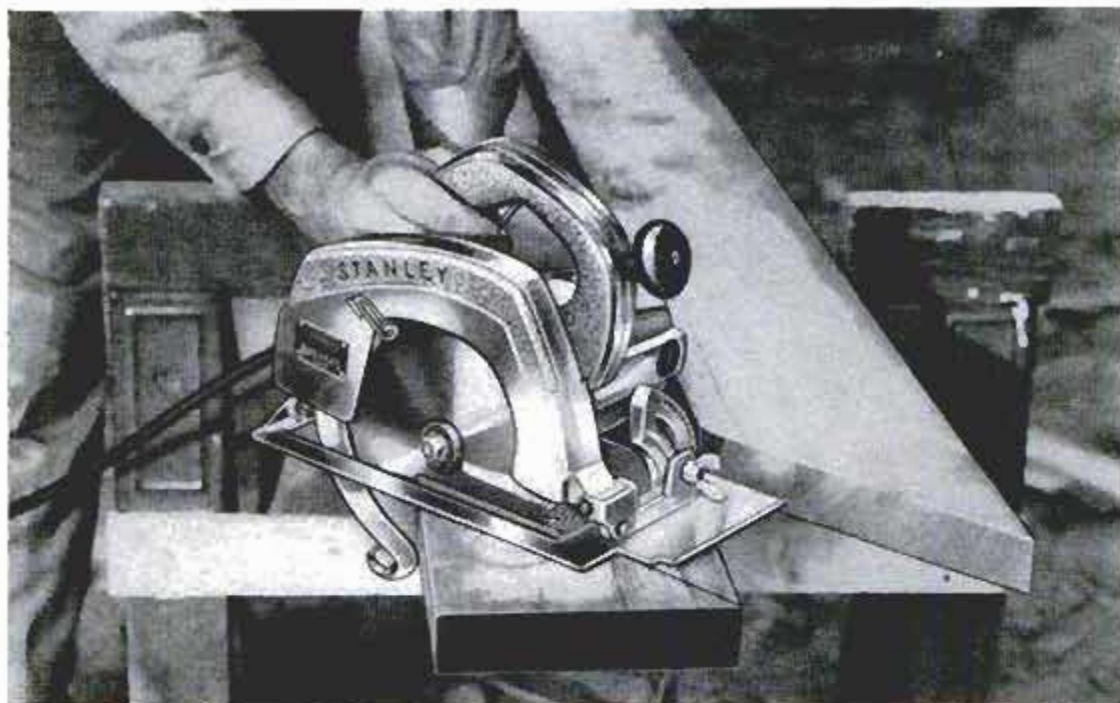

Whether you prefer a 6", 7" or 8" saw, Stanley makes them all . . . and all for heavy duty. Now at reduced prices.

6" H65 cuts 2" at 90° — 1½" at 45° and retails at \$59.95.

7" H70 at \$69.95 cuts 2¾" at 90° — 1¾" at 45°.

8" H85 at \$79.95 cuts 2¾" at 90° — 2½" at 45°.

## STANLEY BUILDERS SAWS . . . the finest you can buy



**The "Motor Saver"**  
*Power plus protection!*

**Exclusive** Stanley drive protects saw motor against impact shock when blade hits nails, etc., and ensures full cutting power at all other times.

Featuring . . .



**The "Free-Start" Guard**  
*Ease of operation!*

**Exclusive** Stanley blade guard makes starting cuts accurate and easy. Guard never sticks regardless of angle of cut . . . no "hang-up" or "drift" in starting.

Look for these fine saws. Your dealer can supply you or obtain them promptly for you. For free power tool catalog No. 400, write Stanley Electric Tools, 625 Myrtle St., New Britain, Conn.



# STANLEY



# Shakespeare SPIN-WONDEREEL



SO EASY  
SO SIMPLE  
YOU CAN OPERATE IT  
**BLINDFOLDED**



No. 1755L



"Made Me a Better  
Fisherman"

SAY VETERAN  
SPIN-FISHERMEN

"I switched because, with  
cone design, it's trouble-  
free at night and in the  
wind," says John Cook,  
of Minneapolis.

When experts switch, the reasons are important! With Shakespeare's SPIN-WONDEREEL, the line is always at your fingertip; you simply pick up the line, back up the crank, and cast. So easy . . . so simple, you can operate it blindfolded. Even beginners can make long, effortless casts right from the start. No groping for a bail or knob; nothing exposed to foul the line. Smooth, adjustable drag. No. 1755 L (above) latest non-reverse

crank model, factory-filled with 150 yards new, extra-limp 6-lb. test Tynex monofilament line . . . . . **\$17<sup>95</sup>**

(Other models from \$13.50 to \$28.50.)

LOOK FOR THIS DISPLAY AT YOUR DEALERS

See how easy and simple it is to operate a Spin-Wondereel or the Wonder-Spin . . . easiest-to-use of all open-face reels.



**Free!** NEW 1956 "TIPS and TACKLE"

BOOK-PAK WITH POCKET FISHING CALENDAR

Catch more fish! These 4 new books show ways to fish, where to find 'em, tackle for:

SPINNING • BAIT CASTING  
FLY FISHING • SALT WATER

SHAKESPEARE COMPANY  
Dept. PM-5, Kalamazoo, Michigan.

Please send, FREE, new 1956 "TIPS and TACKLE" booklets and Joe Godfrey pocket fishing calendar.

Name \_\_\_\_\_

Address \_\_\_\_\_

City \_\_\_\_\_ Zone \_\_\_\_\_ State \_\_\_\_\_

Here are some additional items of interest about the DS 19:

- It has a flexible nylon engine fan that consists of eight very short blades.

- It has a control on the dashboard that lets you disengage the automatic clutch so the car can be left in gear on an incline. Incidentally, the DS 19, despite its modern design, still provides a hand crank.

- The steering wheel is spokeless. The steering column is bent and flattened to support the rim and sticks out of the dashboard like the tongue on a cow. This design gives excellent instrument vision and has a safe cushioning effect in a crash.

- Rear fenders are removed by loosening one bolt. Front fenders come off when three bolts are removed.

- Seats recline to form a bed.

- There are no pivoted vent windows in the front doors. Instead, air enters through a grille at each end of the dashboard, eliminating the wind noise inevitable with usual no-draft systems. Deflectors on the grille let you direct the incoming air in any direction.

- Tire changing involves removing only one central nut instead of the usual five lugs.

- Every power-assist feature is backed up by a mechanical system for safety. Should the whole hydraulic system go out, the car can be driven safely to the garage. Even windshield wipers can be hand operated if the electric motor fails (this, by the way, is required by French law).

- The braking system is double—a separate master cylinder and tubing for the front brakes and another independent circuit and master cylinder for the rear brakes. Thus if one system fails, the other still operates.

- In typical French fashion, the DS 19 comes with a ladies' hand mirror tucked in a pocket inside the glove compartment!

Is it selling? Well, the factory is 28 months behind on its orders for French delivery. Americans are luckier. They can get one delivered here in only a few months. The price? It sells for \$3285 in New York City, complete with all accessories. ★ ★ ★

## Frozen Blood Stored Indefinitely

Research now indicates that frozen blood can be stored indefinitely in liquid nitrogen. The freezing, done fast enough to prevent ice crystals from forming, is accomplished by spraying the blood through a fine plastic tube onto the surface of the liquid nitrogen. When needed, the liquid blood is reconstituted by sprinkling the frozen droplets into a warm salt solution or plasma.

ALL  
"FUELS"  
SAY...

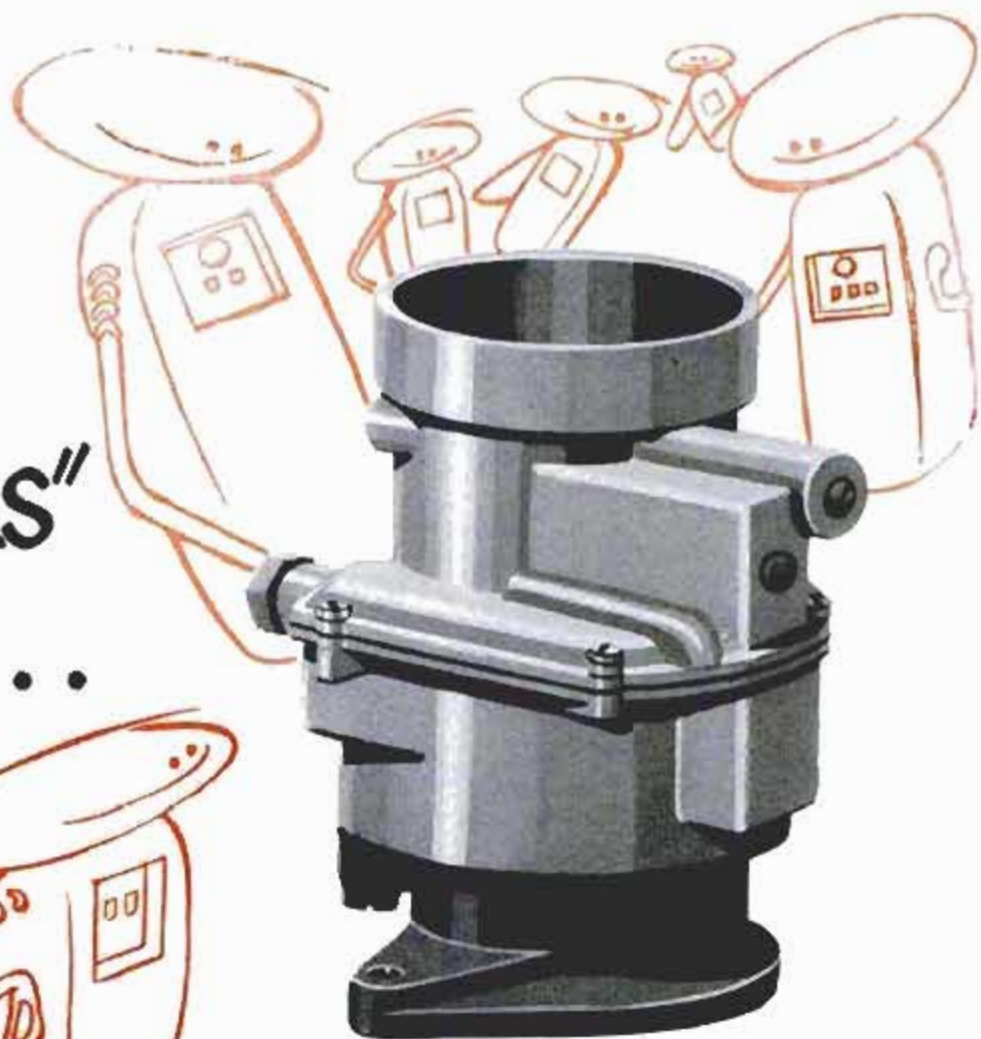

## "Rochester Carburetors Treat Us Right!"

Any "fuel" knows it . . . you can't beat a Rochester Carburetor for feeding fuel to a modern engine. Every gallon's a long gallon—every gallon's a "go" gallon—when Rochester is the go-between. So stretch out your mileage between station stops—specify a gas-saving, money-saving Rochester Carburetor every time. Original equipment for Cadillac, Buick, Oldsmobile, Pontiac and Chevrolet cars.

**CARBURETORS BY ROCHESTER**  
**PRODUCTS**

ROCHESTER  
PRODUCTS  
DIVISION OF  
GENERAL MOTORS  
CORPORATION  
ROCHESTER N.Y.





*A fastener that grips fixtures to walls quickly, securely...*



## ★STAR WALLGRIPS



makes any fixture-hanging job a simple task. Fixtures can be quickly removed or replaced when redecorating without disturbing the WALLGRIP. Send for new booklet "The Hang of Things", showing how to fasten all kinds of fixtures to any type of wall.

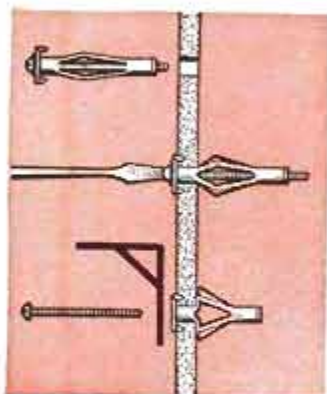

### How WALLGRIPS work in hollow walls:

1. Insert in Hole. Wings spread as bolt is tightened.
2. Positive Stop tells WALLGRIP is set.
3. Remove bolt and replace through fixture and tighten.

### ★STAR EXPANSION

Fasteners for Home and Industry  
Dept. PM-5 142 Liberty Street  
New York 6, N. Y.

Please send me a FREE copy of the book "The Hang of Things".

Name \_\_\_\_\_  
Address \_\_\_\_\_  
City \_\_\_\_\_ Zone \_\_\_\_\_ State \_\_\_\_\_

## Electric Farm Hands

(Continued from page 153)

pulled and there would be consternation and confusion. Well, that hasn't exactly happened, but when the molasses blower was first installed, too much pressure was applied and molasses shot over floors, walls and men. It was like a scene out of an old Mack Sennett comedy film. But the brothers figure they quickly paid for the cost of new overalls and jackets with their mixing equipment.

While we were on the Meyers place, 1000 head of lambs were put on the scales prior to shipping. Fifty days earlier those lambs had weighed in at an average of 84 pounds. We watched the scales balance again—this time to show an average weight of 112 pounds. That meant a gain of more than a half pound a day.

Sight of a shovel always gets the Meyers brothers to thinking. A man using a shovel represents only  $\frac{1}{10}$  horsepower. In 10 hours, the man can do only one horsepower of work. At Idaho rates, electricity will do one horsepower of work for about one cent. Thus, for a cent a day electricity provides the farmer with the equivalent of a shovel-wielding hired man.

### Shovel Gives Way to Electricity

The Meyers figured they could profitably substitute electrical power for the hand-shoveling of whole grain into the barn for storage. This is the result of that figuring:

Bulk grain is hauled to the barn entranceway in a truck. The load is emptied into a specially constructed bin that tapers down in the center to a pipe. A  $7\frac{1}{2}$ -horsepower motor then blows the grain through the pipe that is shifted from place to place in the barn by the tug of a rope.

To get the grain out of the barn, an electrically operated worm is used. It functions on the same principle as a furnace coal stoker. Mounted on wheels, it can be moved to any part of the barn to pick up grain and pour it back into a dump truck.

Still without a shovel being used, the truck backs up to a basement bin in a mixing shed, and empties its load. The electrical mixing equipment carries on from there.

No hand operation on the place is too minor, either, for the Meyers brothers to consider rigging up a motor to do the job better. Deciding that hand-pumping of gasoline for their vehicles was too slow, they attached a  $\frac{1}{2}$ -horsepower motor to a couple of dollars' worth of pipe on their gasoline tank, and now they have a service station in miniature.

(Continued to page 236)

**FOR YOUR LAWN...buy**  
***Roto Clipper***

Light weight...easy handling...greater cutting power...extra strong steel housing...replaceable Econo-Blade cutting tips...choice of engines...ultra-modern styling.



**Rotary and Reel Mowers**

**Falls Products, Inc.**  
**Genoa, Illinois**

**NEW, IMPROVED CALCULATOR FOR WOODWORKERS only 25c**

Instantly gives information on lumber, nails, concrete mixes, painting materials, etc. Convenient, simple to read. Just set dial for nail specifications, to convert linear to board feet, find bit sizes for screws, compare characteristics of woods. 6" diameter heavily varnished cardboard. Send 25c, no stamps, please to Greenlee Tool Co., 2105 Columbia Avenue, Rockford, Illinois.



*NEW Catalog*



**x-acto KNIVES • TOOLS • KITS**  
**for every hobby, art & handicraft**

Designed by craftsmen and precision-made to the highest quality standards.

Write today for our 28-page, fully illustrated catalog—only 25c.



**x-acto, Inc.**

48-45 Van Dam Street, L.I.C. 1, New York

**ROAD TO RICHES**

You can be the next uranium millionaire! Government guarantees huge bonus! PRI instruments from \$29.95. See your local dealer today! **FREE CATALOG!** Write PRI, 4223 PM W. Jefferson Los Angeles 16, California



**CUT-TO-FIT HOMES CUT BUILDING COSTS**

CHOICE OF 57 DESIGNS

**ORDER NOW**

**SAVE UP TO 1/3**



Build your own home and save the builders' profit—plus savings in lumber and labor with Sterling Ready-Cut-Homes. Anyone can assemble with simple, easy to follow plans furnished. Every house complete with all lumber, roofing, nails, glass, hardware, paint, doors and windows marked ready to erect. Freight paid. Complete building plans ready for filing at low cost. Sold separately if desired. Write today!

**PRICED FROM \$2150 up**

Five Easy Payment Plans

Send 25c for **NEW COLOR CATALOG**

**INTERNATIONAL MILL AND TIMBER CO.**  
 DEPT. PM 56 BAY CITY, MICHIGAN

## AT LAST! Make Floors, Patios, Driveways and Walks Look Different — use ROX

TESTED  
FOR  
YEARS

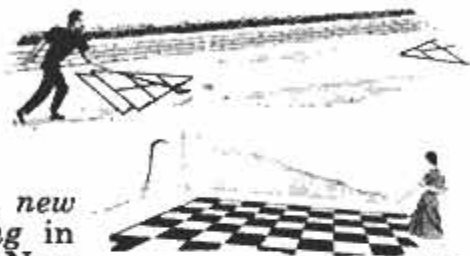

Something new and exciting in decorating! Now

Rox shows you how to design a shuffleboard, a hopscotch block and many other interesting or decorative patterns for porches, basement floors, driveways and patios. Or, if you are tiling your floor, seal out moisture with Rox first. And remember . . . Rox is guaranteed not to blister or peel!

### Beautiful, Durable Exteriors with ROX

Masonry walls absorb tons of water—this water, if not kept out, can deteriorate masonry. Rox becomes part of the masonry surface itself as it seals this surface and protects against water even in gale driven rains. Rox adds distinctive exterior beauty.



### Guaranteed Protection Against Water Leakage!

Rox guarantees to protect your basement against water leakage. Convert

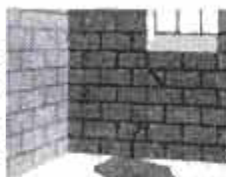

it to a usable recreation room or workshop where tools are safe from moisture with Rox.

#### Helpful Booklet

Illustrated in color to help you apply that professional decorator touch as you protect and beautify your basement and masonry surfaces. Diagrams and explanations to make shuffleboard and other games or decorative designs on floors, patios, driveways, walks, etc., and give new interest to masonry walls. Send 15c for handling. Available in 5 colors and white at authorized Rox dealers in U. S. and Canada or write Rox Products Co., Dept. M5, Detroit 27, Michigan.

© ROX PRODUCTS CO.



Then there are six automatic cattle waterers. With each unit containing two 300-watt heaters, the water is warmed enough during the winter to prevent freezing.

The brothers are continually thinking about adding more electrical equipment—if they are convinced it will do the job more efficiently. Matter of fact, they are interested in electrical ideas still unborn.

Marvin serves on the University of Idaho's Farm Electrification Research Committee. This is a committee composed of farmers and power representatives who are advisors to the university's researchers on farm-electrification needs. This program has helped bring electricity to more than 95 percent of the state's farms.

"But the Meyers farm, with its many and varied electric timesavers, is in a class by itself," commented Prof. J. W. Martin, head of agricultural engineering at the University of Idaho. "The Meyers brothers also started right by installing adequate wiring, and they got experts to do it. This isn't true on many farms. The Meyers have followed the principle that you need large wires to carry heavy electrical loads just as you need large and adequate pipes to carry a lot of water."

#### Farm Was Run-Down

When the brothers bought the farm in 1944, it was about the most run-down place in the county. The land had been milked almost dry . . . it was rolling and hard to irrigate . . . weedy . . . 100 of the 400 acres were absolute waste . . . sloughs with willows and cattails. . . .

"Good for ducks," snorted Wayne Meyers. "But we bought it."

Why? Well, Marvin and Wayne, along with three other brothers and two sisters, had been raised on 100 acres just across the road—land to which their father, Charles, had come in 1911, and leveled and nourished and irrigated the hard way. It is good land now, and Marvin and Wayne figured there was fundamentally no difference in the land just across the road. But the land had to be put in profit-producing shape fast.

Using a 12-yard scraper and a 40-foot leveler, pulled by big "Cats," the brothers tore into the 400 acres. Not only did they make the land almost as level as a bowling alley, but they carved out new and bigger fields.

"Too often old fence rows are followed by one generation after another," said Marvin. "Fields were originally cut out for operation with smaller and more primitive equipment. We figure the best economy is to make the fields big enough so they can be worked with big equipment."

(Continued to page 238)

**WEIGHTED HEAD GIVES**  
**"FEEDING MINNOW"**  
**ACTION**



**JOHNSON'S**  
**LUJON**

**FORGED BRASS LURE**

The new drop-forged LUJON has amazing action for *all* kinds of fishing. Four sizes, 1/10 oz to 2½ oz, with nickel or brass "mirror" finishes. Write for catalog.

**LOUIS JOHNSON COMPANY**

1549-W Deerfield Rd., Highland Park, Ill.

**Makers of Johnson's Silver Minnow**

**BOAT KITS** 28 MODELS—8 to 19 ft.  
**\$39 up—FREE FREIGHT**

SAVE 2/3!  
 Easy-to-build  
**MAHOGANY**  
 DECKS & FRAMES  
 SEND 10¢ for CATALOG

Includes Hardware—Trailers—Fiberglass



**Boat Plans—Patterns—Frame Kits**

Build over 50 modern boats from large scale plans, available with FULL-SIZE patterns, new PRE-FAB frame kits! All types: prams to cruisers, 6 to 25 ft. Best buy for Amateurs! SEND 10¢ for CATALOG.

**Craig Craft**  
 Tonawanda, N. Y.

**KADET** 4-WHEEL TRACTOR  
 LOW IN COST—HIGH IN QUALITY



Tillers, Mowers,  
 Tractors  
 low as  
**79<sup>50</sup>**

This tractor is ideal for Farms, Estates, Schools, Nurseries, Parks, etc. 12 quick-hitch attachments available, including Snow Plow, Sickle Mower, Trailer, Turning Plow, etc.  
 FREE catalog write Dept. '21'

**NATIONAL FARM EQUIPMENT CO., INC.**  
 142 GREENE STREET • NEW YORK 12, N. Y.

Protect your home against  
 power interruptions  
 with an...

**ONAN Emergency**  
**ELECTRIC PLANT**

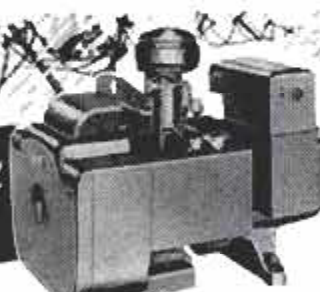

Provides dependable stand-by electricity for heating system, pumps, freezer, lights, appliances. Keeps home safe, livable. Automatic start and stop. Find out how little it costs!

Write for Folder!

**D. W. ONAN & SONS, INC.**  
 3638 University Ave. S. E. • Minneapolis 14, Minnesota

**A SIZE FOR EVERY NEED**  
 500 to 50,000 watts.  
 Compact, quiet-running.  
 Gasoline-powered.  
 Priced from \$255.00

**Coleman** "OUTING  
 PALS"

Add Hours of Fun  
 to Every Outing!

You'll have more fun, enjoy new comfort outdoors with Coleman Outing Pals. See them at your dealers.

**New Coleman Portable Cooler**

Keeps foods, beverages freezer fresh. Low "K-factor" (heat-transfer) holds the cold longer. Lid catch lifts easily, locks automatically. Inside corners rounded, stay clean, odor-free.



**Coleman Folding Camp Stove**



Lights instantly. Hot, homelike meals anywhere... in a jiffy! Burns low-cost Coleman Fuel or unleaded gasoline. Folds up, carries like small suitcase.

**Coleman Carrying Case—Camp Table**

Roomy, all-steel carrying case holds 4 folding stools, cooking utensils, food, hunting and fishing gear. Unfolds into strong, rigid picnic table, 28-in. square. Keeps food away from damp ground, insects, litter!



**Coleman Floodlight Lantern**



Brilliantly floodlights 100-ft. area. Safe, stormproof. Lights instantly. Gives 8 to 10 hours service on single filling. Burns inexpensive Coleman Fuel or unleaded gasoline. Coleman REFLECTOR converts it to a powerful spotlight.

Try new Coleman FUEL. Specially blended, clean burning. Has rust inhibitor. Won't gum up.

**FREE** New Outdoor Book. Many useful tips for your hunting, fishing and vacation trips.



**FILL OUT COUPON!**

**THE COLEMAN COMPANY, INC.**  
 Dept. 11-PM2, Wichita 1, Kansas

Please send me free copy of the new Coleman Book "More Fun on Every Outing."

Name.....

Address.....

City..... State.....



Smooth Engine Power  
calls for Quality Bearings . . .

## FEDERAL-MOGUL QUALITY!

Federal-Mogul engine bearings are first choice for replacement in commercial vehicles and industrial engines. They are preferred by men who know their business . . . and their bearings! In your car engine, too, Federal-Mogul bearings restore smooth power, lively pick-up and economical operation. They are *engineered* for dependable performance!

### FEDERAL-MOGUL SERVICE

Federal-Mogul-Bower Bearings, Inc.

Ask your Mechanic!

RESEARCH • DESIGN • METALLURGY  
PRECISION MANUFACTURING • SERVICE



But once the brothers had leveled the land for efficient subirrigation, the topsoil was gone. Now, the Meyers had been watching Californians come into southern Idaho and buy stock and feed, ship both to California, and fatten the stock at a profit. Why couldn't they do the same, and leave the fertilizer on their 400 acres?

"Natural droppings, we figure, are worth twice as much to the land as those hauled out in a manure spreader," said Wayne. "We felt that if we would only break even on a stock-feeding business we would profit through the land with our hay, grain, sugar beets and potatoes."

But the profit has been there from both stock and land. There is no question about that when you know how the Meyers operate. As a general rule, the brothers buy no new equipment until they have earned the money. They have a lot of equipment.

But the Meyers say they could never have accomplished so much so soon with the tools available a half century ago. They needed their modern, scientific equipment, particularly that connected with a canyon dam.

With all their equipment now, the Meyers simply do not have any labor problem.

"Taking a few of the backaches out of farming has eliminated a big labor turnover," said Wayne. "The men get the same thrill out of working with good and efficient equipment as we do. When an electric blower starts acting up, they tell us right away or fix it themselves, but they wouldn't do the same thing for a creaking wagon wheel."

Irving Spillman, a hired man, used to punch cows over Camas way.

"Looks good in the movies," he said, "but I'd a darned sight rather ride herd on a lot of electrical equipment." ★ ★ ★

### Oxygen Inhaler



People who occasionally require respiratory stimulation can get it from a tiny oxygen inhaler about the size of a fat fountain pen. Scheduled for early production, it has a plastic tip that fits the nostrils, a small reducing valve, a drawn-aluminum

case and a replaceable cartridge that holds oxygen at about 5000 pounds' pressure. It dispenses the oxygen when a small valve is pressed.



# New Bronson Spin-King

... the only reel that  
**CAN'T TWIST LINE!**

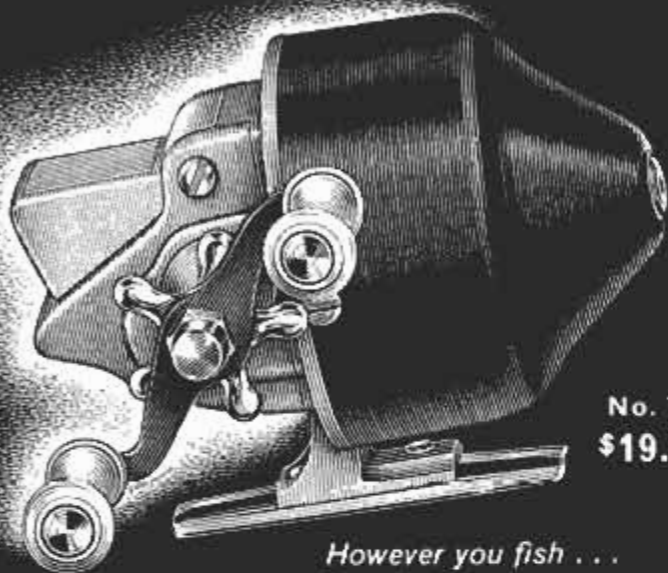

Designed for both fresh water  
and salt water fishing

It's fool-proof . . . the first push-button spinning reel with star drag! Placement of star drag means the "Spin-King" spool never turns, so line can't twist. Finger-tip drag adjustment, too! Special thumb-lever control assures perfect line feathering—no mid-air snapping. Reel fits on bait or spin rod—comes with line-filled spool. Write for free "Bronson Spinning Guide"—Bronson Reel Co., Bronson, Mich.

No. 700  
**\$19.95**



However you fish . . .  
spin, fly or bait cast . . .  
a Bronson Reel makes it more fun!

Div. of Higbie Mfg. Co.

## FIND HIDDEN RICHES!

NOW—find buried treasure, gold, silver, and metal objects, with sensational 3 1/2-lb. locator—GOLDAK'S "FIND-IT" . . . only \$49.50 complete with earphones, batteries, instructions.



Manufacturers of metal detection devices since 1933

Write for FREE literature: full line metal, mineral locators, gauges and scintillation counters.

**GOLDAK CO.** 1542 W. Glenoaks Blvd., Glendale, Calif.

## Print Your Own

Cards, stationery, circulars, tags, labels, photo and movie titles, advertising, etc. Save money. **Print for Others, Good Profit!** Easy rules sent. Raised Printing like Engraving, too. Sold direct from factory only. Write for free catalog of outfits and all details. **KELSEY PRESSES, M-37, Meriden, Conn.**

you don't baby a *Cadillac*



Cadillac all-aluminum boats are light, fast and virtually indestructible . . . require no upkeep! Pound it in rough water, beach it on gravel or stones—there's no wood to gouge, rot or splinter. Cadillac outperformed 12 leading makes 6 ways in independent tests—gives you more go per h.p. Car-top models take up to 16 h.p. motors . . . do-it-yourself accessories available.

WRITE FOR FREE literature.  
**CADILLAC MARINE & BOAT CO.**  
178 Seventh St., Cadillac, Michigan



**DEPENDABLE!**

## ELECTRIC TACHOMETERS by Stewart-Warner

**Full line!** Fills every need. Models for cars, trucks, buses, boats, stationary engines.

**Accurate!** Positive electric drive assures accurate speed indications.

**Reliable!** Vibration-proof . . . no flexible

shafts, no oscillators.

**Easy to read!** Large 3" diameter, illuminated dial face. Pointer has full 270° travel.

**Exclusive!** The only electric tachometer with an odometer. Records total engine revolutions.

See your dealer or write:

**STEWART-WARNER**

Instrument Division

Dept. N-56, 1840 Diversey Parkway, Chicago 14, Illinois

# TRUE TEMPER® Hammer News



## HOME OWNER'S SIZE

Here's a 13-oz. ROCKET hammer made specially for the 1001 handyman jobs around your home. It's smaller than the 16-oz. carpenter's-size ROCKET, and it's the sweetest-swinging hammer you ever laid your hands on.

That chrome-plated hollow steel handle won't bend or break. Polished head is locked on forever. Cushion grip soaks up shocks and won't slip even if your hands are wet or if you have gloves on.

One word of caution: Men—hide this hammer from the lady of the house, or buy her one of her own! At your hardware or building supply store. See all the other ROCKET tools and our fine hickory-handled hammers, too. True Temper Corp., Cleveland 15, Ohio.



Finest quality in Hammers, hatchets, axes • Garden, lawn and farm tools • Shovels • Shears • Fishing tackle • Golf-club shafts

## Traffic Jam at the Water's Edge

(Continued from page 109)

fun afloat. But a special preoccupation nowadays is the breaking of the water's-edge traffic jam.

Until not so long ago, these efforts were pretty much on an every-man-his-own-naval-architect basis. Within recent months help has come from national boating organizations in the form of basic planning material and from manufacturers in the form of prefabricated facilities and components.

The simplest launching ramp, OBC points out, is a ready-made one—a beach that extends underwater at a gradual slope to allow a trailer-borne boat to be backed up until it begins to float.

Next in order of simplicity is a slope formed by cutting down a bank with a road grader—or pick and shovel. Since trailers are not designed to operate in deep mud, a desired improvement is the surfacing of the slope with gravel.

A hard-surfacing technique that has found favor with city park officials employs precast concrete blocks.

### Floating Ramps

Where there is a considerable and periodic variation in the water level, as in tidewater areas, the fluctuation must be compensated for in the design of the ramp. A ramp hinged at the shoreside and having floats at the waterside is the answer.

At locations that are bulkheaded and where space is limited, launching can often be handled best by means of a derrick or a monorail, which lifts the boat from the dock or pier and lowers it into the water.

Some clubs build wooden docks or piers. But steel and wood-and-steel combinations offered by manufacturers in ready-to-install form have taken practically all the work out of putting in facilities of this kind. In one version, the supports are driven into the harbor bottom with a sledge hammer; in another, the support ends are fitted with auger devices which screw into the bottom.

The ultimate in accommodations for the owner of a small boat is a "marina."

Marina will not be found in many dictionaries. It's a coined word and, so far as facilities for the boater are concerned, it can mean just about what the operator of the marina wants it to mean. In OBC's booklet on the subject, a "model marina" is described as consisting of these essential elements: Docks, boat slips, fueling units, a launching ramp, derrick and monorail launching devices, boat and trailer parking areas, sales and service accommodations, boat lockers and a restaurant and snack

(Continued to page 242)

## Space-saving bunks are easy to build— economical, too!

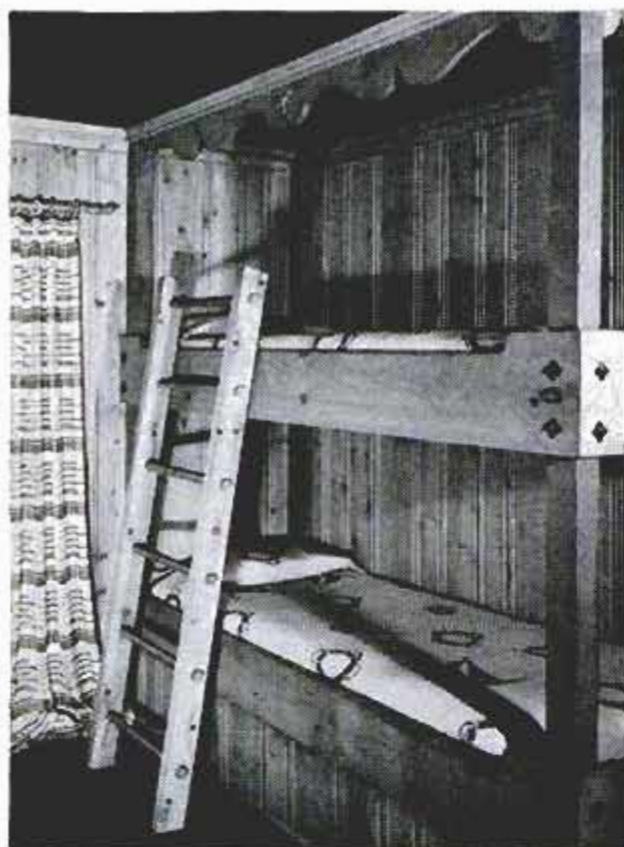

You'll enjoy making these sturdy bunk beds of clean-cutting, even-grained Western Pine® woods. They'll take years of hard wear and keep their good looks indefinitely, thanks to the handsome natural texture and grain of these mellow woods.

Easy workability and amazingly low cost are *plus* values you get when you use carefully selected, well-seasoned Western Pines. See them at your local lumber dealer's and get an estimate.

**FREE** "INSTALLING AND COLORING YOUR WALLS OF WESTERN PINES." Also, "FRIENDLY HOME IDEAS IN WESTERN PINE," new 88-photo booklet of building and remodeling ideas. Write for both to Western Pine Association, Dept. 500-N, Yeon Building, Portland 4, Oregon.



the Western Pines

- \* IDAHO WHITE PINE
- \* PONDEROSA PINE
- \* SUGAR PINE

## LOOK-

A great value! Sturdy metal case. Rich two-tone green finish. Gold-color bright plated lens ring. Famous G. E. Sealed Beam unit. See your dealer...Get one!

**DELTA ELECTRIC CO.**  
Marion, Indiana

A SEALED BEAM  
ELECTRIC LANTERN  
for only \$5.69  
less 6V  
battery



**Delta-RAY** SEALED BEAM  
Electric Lantern

## REMOVE ANY FINISH QUICKLY EASILY



Make floors, furniture, wood trim, etc. like new! Strip off old paint, varnish, shellac, enamel with Wonder-Paste. Comes off easily in one scraping. Adheres to upright surfaces. At paint and hardware stores.

• Write for helpful Wonder-Paste leaflet and advice on your removing problem.  
Wilson-Imperial Co., 119 Chestnut St., Newark 5, N.J.

**WONDER-PASTE** 5 MILLION  
CANS SOLD

## Cushman PACEMAKER

ACE of ACES in  
LOW-COST  
transportation



- The original all-use light vehicle
- Powered by Cushman Husky 4-cycle engine
- Up to 75 miles per gallon
- ... 3/4c per mile total operating cost.

Ask your dealer for a **FREE** demonstration or write for illustrated literature. Dealer inquiries invited.

936 No. 21st  
Lincoln, Nebraska

**CUSHMAN MOTOR  
WORKS, Incorporated**

money-saving idea for  
Popular Mechanics readers:

## "Do It Yourself" Vacation in MISSOURI!

History, scenery, sports on 8-day,  
1,000-mile vacation for about \$41\* per person!



See big league baseball and outdoor opera in Kansas City or St. Louis. Visit famous Forest Park or Swope Park zoos. See magnificent bridges across Mississippi and Missouri rivers.

You can take a "do-it-yourself" vacation in Missouri, spend as little as \$41 per person each (in a family of four), and see and do more for the money than in any comparable vacationland in the U. S. Your \$41 a person will include gas and oil, plus tickets to big-league baseball, outdoor opera, boat trips, modern accommodations, reasonable recreation and incidentals. \*You can cook anywhere for no more than at home or eat at good restaurants for about \$3.50 per day.

What will you see and do in Missouri? You'll visit more than 60 places, travel a thousand miles and 200 years into history. Start at Mark Twain's Hannibal; visit pre-Civil War homes in the Daniel Boone and Old Trails regions; explore the Capitol and museum at Jefferson City; see the New Orleans Opera House at Cape Girardeau; stop in the restful White River country. See the gorgeous Ozarks; ride Missouri saddle horses; visit the home where Jesse James was killed in St. Joseph. Everywhere in Missouri, you'll find dozens of interesting and different things to do for less. Get the whole story. Write for free literature now!

Plenty of fish in Missouri: bass, crappie, walleye, channel and flat-head catfish, rainbow trout, and many others. All in Missouri's clear, spring-fed streams and lakes.



**FREE!**

"Pictorial Missouri", full-color folder of places to go and things to do in Missouri. Send name and address to:

**MISSOURI DIVISION OF RESOURCES & DEVELOPMENT**  
Dept. E667  
Jefferson City, Missouri

bar. In short, a marina is an establishment where a boater can fill nearly his every need—buying boating equipment, launching and hauling out or storing his boat, servicing and fueling his rig, provisioning himself and his crew.

Most marinas are established as commercial enterprises, although some are run by clubs or in cooperation with clubs.

All these efforts by today's new yachtsmen, their "yacht clubs" and the boating trade will result in improvements in the lot of the boater and an easing of the nautical traffic jam eventually. But it will take considerable doing just to catch up and keep caught up—especially if, as seems likely, outboarding continues its recent expansion rate, which has been a five-fold one in 15 years. ★★★

### Portable Lifesaver

Seventeen ounces is the weight of a portable unit that can be used anywhere as a resuscitator or to give anesthesia. It can be used in mines, at swimming resorts and on the battlefield to revive persons overcome by near-drowning or smoke. In hospitals, it can be employed to give preliminary anesthesia to children who might be frightened by large operating-room machines, or to prepare patients for minor operations.



# DISSTON

D-23 Lightweight, Straight-back

## HAND SAW

CHKP

CUTS CLEANLY!

CUTS SMOOTHLY!

ONLY  
**\$895**

CUTS FOR A  
LIFETIME!

Whether you're a professional or home craftsman, here's the saw that can help you improve and speed up your work . . . save spoiled materials . . . and save your strength, too.

The light, narrow blade of the Disston D-23 is designed for easy sawing . . . for clean, straight cutting and smooth edges. The D-23 runs true and stays sharp.

Hold the D-23—and you'll *feel* the difference in its fine balance. Sight down its edge—and you'll *see* the difference in its accurately set and bevel-filed teeth. Bend it—and you'll hear the difference in the "twong"

of the double-taper ground blade of perfectly-tempered steel. Then use the D-23—and enjoy the extra satisfaction that comes with using a fine tool.

Available in cross-cut and rip types in all popular lengths and points. Full carved handle secured with five nickel-plated screws, one a medallion. The complete Disston line includes saws in all price ranges. See them at your hardware or tool store.

### CARLSON STEEL TAPE RULES AND TAPES



WHITE CHIEF  
(6 ft.) \$1.80

BIG CHIEF  
(12 ft.) \$3.50

STAR CHIEF  
(25 ft.) \$4.00

Finest quality long tapes and pocket-size rules for every purpose. From 6 feet to 100 feet. Accurate, easy-to-read. Double graduations, feet and inches. Stiff, rigid, easily-changed blades. Easy-action swing tips.

FREE ILLUSTRATED BOOKLET! 63-page Disston Saw, Tool & File Manual. Tells how to choose and use tools; how to care for them. Helpful hints on wood working, metal working and selection of materials. Write today for your free copy.

### DISSTON DE LUXE CIRCULAR SAWS AND DADOS

from \$2.25 to \$22.80



Make cutting easy and accurate. Made of famous Disston steel. High finish; keen teeth; accurate fitting. Special styles to fit all makes of bench and portable electric hand saws.

ASK YOUR HARDWAREMAN  
TO SHOW YOU THESE FINE DISSTON TOOLS

# DISSTON

Henry DISSTON DIVISION • H. K. PORTER COMPANY, INC.  
511 Tacony, Philadelphia 35, Pa.



## The Atom Strikes a Valley

(Continued from page 86)

roads were built into the plant. Altogether the roads alone cost almost \$25,000,000."

Other facilities threatened to break down. Waverly's sewerage system definitely was not geared to the atomic age. The town got a federal grant of \$598,300 for a new sewerage system and voted a bond issue of \$600,000 to enlarge the city's water system. Piketon had similar crises. Chain stores, bowling alleys and drive-in theaters sprang up in cow pastures. Yet the merry-go-round never seemed to slow down or stop. Every new housing development, every mile of highway, every improvement to a sewerage or water system meant more construction work, bringing more workers into the area and burdening the existing facilities even further.

### Big Payroll

Few long-time residents of the area were complaining, though. In the record months of 1954 an extra \$10,000,000 flowed into the economy of the area *each month*. Fifty and hundred-dollar bills were a common sight. Many a merchant who had been struggling along with his back to the wall suddenly found himself expanding that wall.

No sooner did the pinch appear in the Portsmouth area than it was compounded on both sides by two other vast construction projects. The process of gaseous diffusion requires enormous amounts of electricity. The government contracted with 15 private utility companies to do the job. They banded together, forming two new companies to build and operate generating plants at Cheshire, Ohio, and Madison, Ind. These are the two largest steam power plants ever built. The one at Madison alone cost \$185,000,000, three times the cost of the Empire State Building. Together they provide an incredible 1,800,000 kilowatts 'round the clock, a total of 15,000,000,000 kilowatt-hours annually, or more energy than is consumed by the states of Indiana and Kentucky combined. This tremendous surge of power is three percent of the nation's total supply!

There was a critical race to deliver this power by the time it was needed at the gaseous-diffusion plant. Thousands of workers were needed at these two construction sites. Land speculators who had lost out in the Portsmouth shuffle raced for the two generating plants. Workers broke ground in December 1952, and just within the past few weeks both plants have been virtually completed. They are incredible. Three of the stacks are the tallest ever built, towering 682 feet above the ground. Together

the two plants burn coal at a rate of 7,500,000 tons per year, enough to fill a train of hopper cars stretching all the way from New York City to Miami. Electricity is carried away on the tall shoulders of 1558 steel towers averaging 158 feet high, spaced four to a mile.

### Workers Move Away

By the middle of 1955 this wave of construction had smashed against southern Ohio and now was receding almost as fast as it came. Workers were laid off by the hundreds each week. Long lines of trailers which had rolled into the area some 30 months before now were moving out, many of them tracking the yellow clay of Pike County north toward the St. Lawrence Seaway project.

GAT's 2750 permanent workers by this time had settled into the routine of their jobs. Visitors with business at the plant could drive around the perimeter, marveling at the tremendous plume of vapor that hangs over it constantly, reflecting the lights at night to cast an eerie glow across the sky. But not even the rashest of visitors would try to get by the big security force that is on duty to keep the secrets secret.

Townfolk, some of them bitter, some of them glad, tried to go back to their former way of life. But the area isn't the same. In Waverly, brand-new homes stand vacant on street after street, permanent and attractive homes in eight new housing developments, homes that would be snapped up in other parts of the country. The government has auctioned off the demountable "flattops" in Waverly. Some of these temporary homes were sold for \$350 including plumbing, heater, water heater and kitchen range. Last winter rows of government

(Continued to page 246)

Town of Waverly, with homes standing empty, now is trying to attract new residents and industries

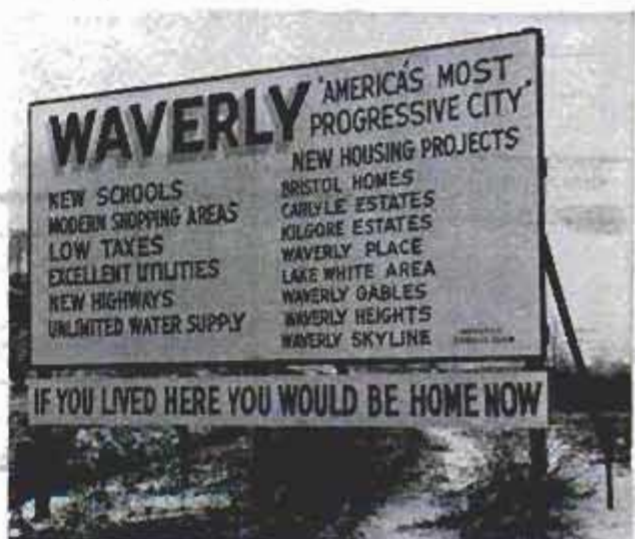

**Just what paste wax needed - a built-in cleaner!**



**Johnson's J-Wax  
new Paste Wax Discovery  
does the cleaning work for you!**

LONG-LASTING WAX  
KEEPS FRESH AND EASY  
TO APPLY IN THIS  
NEW  
KEY-OPENING  
CAN



**Start right in waxing! No extra  
cleaner needed—nothing else to buy!**

Here's what you've been waiting for—a paste wax with a cleaner built right in! Johnson's new J-Wax saves you hours of pre-cleaning. J-Wax takes the dirt off for you—replaces grime with a crystal-clear coating of wax. Even the dirt you can't wash off loosens instantly and disappears as you rub on this new self-cleaning paste wax.

Then watch the high brilliant luster that comes as you buff. J-Wax sets smooth and hard—bonds itself into a long-lasting wax-tight seal. Gives your car tough wax protection it needs for any weather. And look!! The colors are far brighter, truer—even the chrome glistens.

Get your car ready now for the months ahead—with J-Wax. It's the easiest, fastest way to genuine wax protection—*paste wax protection!*

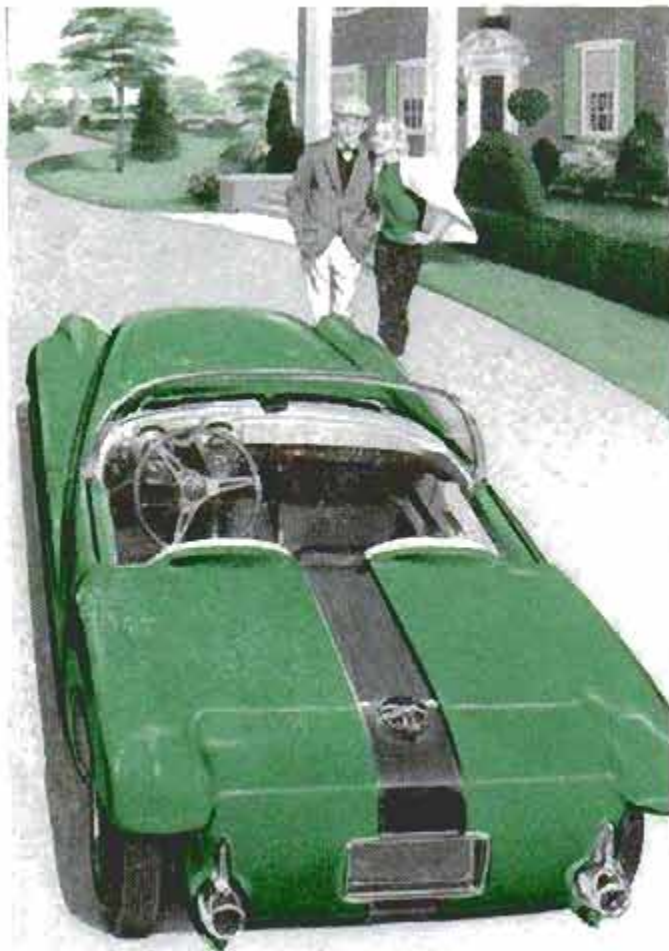

Proved in years-ahead motors...  
**Quaker State gives**  
 smoothest performance today!



Super-refined from Pure Pennsylvania Grade Crude  
 Oil, world's finest. Famous for performance,  
 protection, economy! Try it!

**QUAKER STATE OIL REFINING CORP., OIL CITY, PA.**  
 Member Pennsylvania Grade Crude Oil Association

trailers were standing deserted in the empty streets.

Piketon has formed a Chamber of Commerce to try to attract new industry which will take up the slack. Waverly's mayor, A. S. Keechle, a former Linotype operator, has appointed a committee of prominent citizens for the same purpose.

"When this thing started," says Mayor Keechle, "this town owed only \$20,000. Now, because of our new water system, we owe \$600,000. We have a population of 6313, but we're equipped to handle 20,000 people. We're determined to get them. We can offer any industry good homes, standing ready for its workers. We have an unlimited supply of water, schools with plenty of classroom space, and all the low-cost electricity any industry could need."

New industries are taking up the slack somewhat. Near Portsmouth there's been a \$64,000,000 expansion of the Detroit Steel Corporation's steel mill. The Olin Mathieson Chemical Corporation is building a \$90,000,000 plant at Clarrington, Ohio, which will help. In the town of Waverly alone, since the atom came, there are 20 to 25 new businesses.

#### Pinch on Older Folks

How did the area come out of the boom? Probably only a few people suffered in terms of dollars. Clarence L. Adams, who has been a barber in Portsmouth for 35 years, says, "The pinch was hardest on older folks who had retired. Their taxes went up so high a few of them had to sell out and move away. On the other hand, others who had wanted to sell for a long time and couldn't find a buyer now are living in Florida."

GAT's employees, thanks to Paul Bliss' well-planned community-relations program, are thoroughly integrated into the community. "We aren't outsiders anymore," says Bliss. "The average age of GAT workers is 30, and a good many of the men have married local girls. The older ones now are serving on church boards, city councils and school boards."

Today if you visit the area you can buy uraniumburgers and stop overnight at the Atomic Trailer Court. You can watch the races at the Atomic Speedway and pick up your victuals at the Atomic Grocery—Get Your Energy Here.

The atom that touched off the explosion over the Scioto Valley is there to stay. One of America's biggest industrial plants, hidden in the hills of Pike County, goes on sifting invisible and elusive little particles under a plume of vapor that billows upward day and night. ★★★



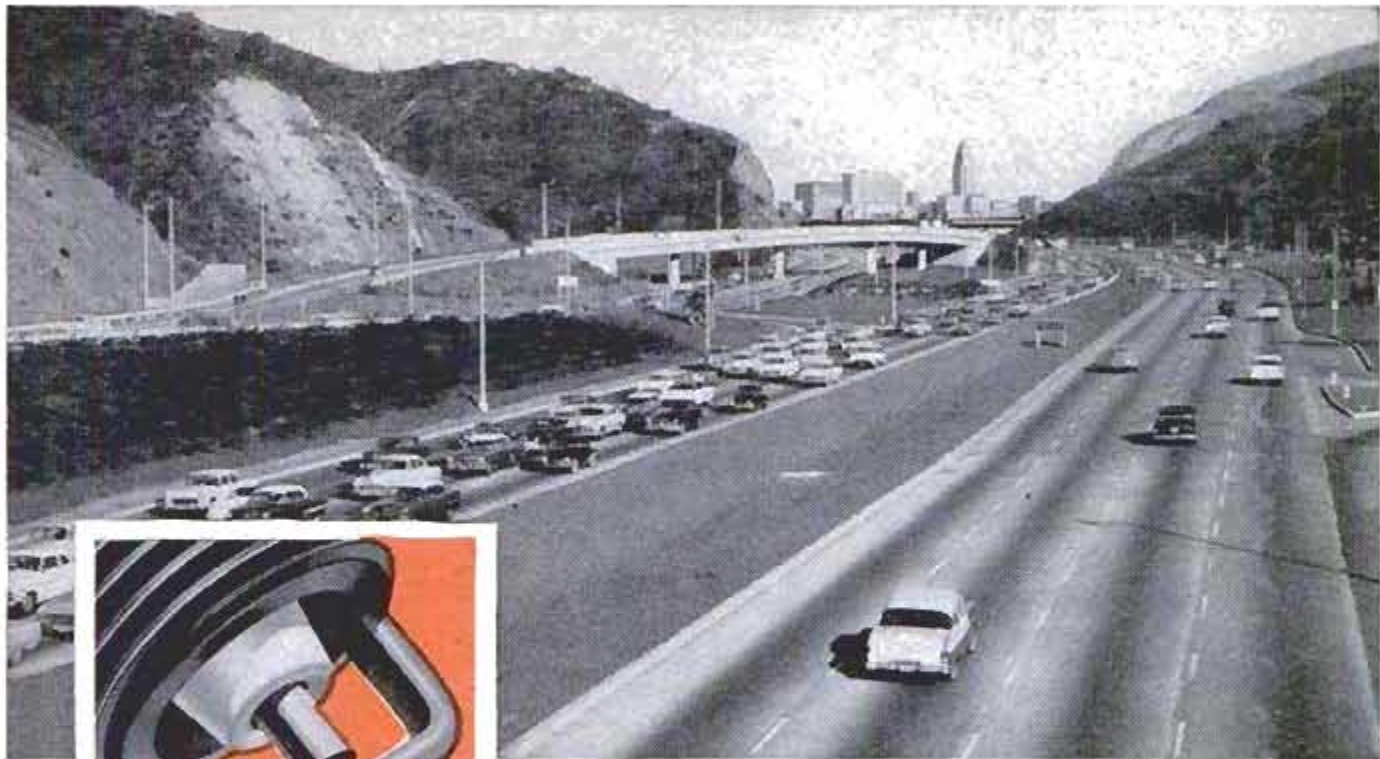

Some spark plugs are designed for low speeds  
 Some spark plugs are designed for high speeds, but . . .

## Only new **POWER TIP** "fires up" your engine at all speeds!

**Auto-Lite Resistor Spark Plug with Power Tip is the first and only spark plug ignition-engineered for today's engines and today's driving.**

Up until now you just couldn't get a spark plug that would continue to operate at top efficiency at all speeds! Either you got "hot" plugs that were satisfactory for city driving only . . . or "cold" plugs that were fine at higher speeds but easily fouled at lower speeds, causing engine misfire, wasting fuel and power.

Now at last there's a spark plug that's hot enough at low speeds to resist fouling and cold enough at highway speeds to check destructive pre-ignition. It's the revolutionary new Auto-Lite

Resistor Spark Plug with Power Tip! It's the only spark plug that "fires up" your engine for peak performance and economy at all speeds.

**The protruding Power Tip makes the difference.** It gets hotter than the conventional plug at low speeds because the Power Tip extends into the combustion chamber. It resists fouling because fuel deposits burn away clean. Yet at high speeds Power Tip gets the full benefit of the cooling intake gases. It "keeps cool" to check destructive pre-ignition.

Fits all these cars with overhead-valve V-8 engines using 14 mm. spark plugs . . . Buick, Cadillac, Chevrolet, Chrysler, DeSoto, Dodge, Ford, Hudson, Imperial, Lincoln, Mercury, Nash, Oldsmobile, Packard, Plymouth, Pontiac, and Studebaker. See your nearest Auto-Lite Spark Plug Dealer.

ENGINEERING CHART SHOWS HOW ONLY POWER TIP DELIVERS TOP PERFORMANCE AND ECONOMY AT ALL SPEEDS.



AUTO-LITE RESISTOR SPARK PLUG WITH POWER TIP . . . for all speeds.

# AUTO-LITE **POWER TIP** RESISTOR SPARK PLUG WITH



Auto-Lite manufactures over 400 products, including Spark Plugs, Batteries, Wire and Cable and Automotive Electrical Systems . . . sold throughout the United States and Canada.

Which *finishing* **Weldwood<sup>®</sup> Wizard** can help you today?



It's a good idea to keep them all handy. You never know what finishing problem may develop in working with wood. As products of the world's largest plywood organization, these "wizards" are designed to give you expert results in many finishing tasks.

For protecting and bringing out the natural beauty of any wood—use **SATINLAC<sup>®</sup>**

Makes the most practical, beautiful and durable natural finish for hard or soft wood! So quick-drying you can apply 3 coats a day. SATINLAC is so easy to maintain!



For blond woodsy effects without a "painty" look—use

**WHITE FIRZITE<sup>®</sup>**

Versatile! A two-fold boon: (1) As an undercoater for soft wood or plywood paint jobs, seals pores to help prevent grain raise and checking. (2) As a finish, produces a blond woodsy finish with no "painty" look. Great for pickled and wiped effects too!



For making fir plywood look like costlier woods—use **CLEAR FIRZITE<sup>®</sup>**

Magic action for plywood stain jobs! Tame wild grain with a starting coat of Clear Firzite—add colors in oil to achieve the rich look of oak, walnut, mahogany. Clear Firzite also helps prevent grain raise and face checking.



Ask your hardware, paint, or lumber dealer about these Weldwood Finishing Wizards... or mail coupon for FREE leaflets.

**UNITED STATES PLYWOOD CORPORATION**  
Box 525 - New York 46, N. Y. PM 5-65

Send me leaflets on:

Satinlac  White Firzite  Clear Firzite

NAME \_\_\_\_\_

ADDRESS \_\_\_\_\_

CITY \_\_\_\_\_ ZONE \_\_\_\_\_ STATE \_\_\_\_\_

**Build Your Own Hi-Fi Speaker Enclosure**

(Continued from page 162)

systems (Electro-Voice Corp., Buchanan, Mich.) has made his entire line of enclosures available in kit form. What's more, the plans and instructions for building any of these are available at a very low cost so that the more hardy individualist can build his enclosure by cutting the lumber himself.

Electro-Voice enclosure kits can be bought in a variety of sizes ranging from the diminutive 23-in.-high Baronet to the impressive 57½-in. Patrician 1V. They are suitable for use with most coaxial or triaxial speakers, and separate 2 and 3-way speaker systems.

Also available in kit form is the patented and widely copied "Klipschorn" (Klipsch and Associates, Hope, Ark.). Especially designed as a corner enclosure, it will provide best results with separate woofer-tweeter speaker combinations. By utilizing the corner walls of the room as part of the sound-radiation system, the Klipsch enclosure has long been recognized for its excellent bass response and wide sound dispersion.

**Versatility Plus Style**

One of the latest and most widely discussed enclosures, the Karlson (Karlson Associates, Inc., Brooklyn 29, N. Y.), has achieved wide acclaim. It offers the utmost in versatility, outstanding bass response and unusual styling. The Karlson is primarily designed for coaxial or triaxial speakers, or single-cone units. It is claimed to improve the performance of even the least expensive of the hi-fi speakers by a remarkable degree.

Not limited to corner installations, the Karlson can provide some very unusual effects. When laid on its side against a wall, it gives the illusion that the music is radiating from the entire wall, "as though the wall were a sound-transparent curtain in front of a stage" (according to an independent research organization). This effect is highly pleasing to some listeners.

High-fidelity speaker-enclosure kits are also available in a wide variety of designs and styles from Cabinart (G. & H. Wood Products Co., Brooklyn, N. Y.); River Edge Sales Corp., Port Washington, N. Y., and other manufacturers. Among these are units whose appearance will please even the most discriminating interior decorator, and whose performance will enhance the quality of all loudspeakers.

While a well-designed enclosure is a

(Continued to page 250)

# Which Weldwood® Wizard can help you today?



What are you making or mending? Do you know about Weldwood's new developments in adhesives? Do you know that you need special glues for special jobs? Do you keep on hand all 4 of these Weldwood Wizards, developed to make your jobs easier, quicker?

## For wood-to-wood joints that never come loose—use **WELDWOOD Plastic Resin GLUE**

Imagine—joints glued with this Wizard are stronger than the wood itself! And they grow even stronger with age! That's why it's America's most popular wood glue. Highly water-resistant, stain- and rot-proof. Easy-to-mix powder. 15c, 35c, 65c and larger sizes.



## For weatherproof boat repairs—use **WELDWOOD WATERPROOF RESORCINOL GLUE**

100% Waterproof! A "must" for any wood gluing exposed to climate, boiling or salt water, cold weather, mold, fungus, mild acids, alkalies, etc. Terrific for sporting goods, woodwork in damp basements, lawn furniture. ¼ pints, pints, quarts, gallons.



## For in-a-hurry gluing of wood, paper, cloth, fabric—use **WELDWOOD PRESTO-SET® GLUE**

Ready to use. Sets fast! Glues like magic! Presto-Set is the Weldwood-perfected white glue that bonds wood to wood, wood to cloth, cloth to paper, upholstery fabrics to wood, leather to leather, etc. Clean to work with—no sticky hands. 25c, 45c tubes; pint and quart jars.



## For putting up plywood panels without nails—use **WELDWOOD CONTACT CEMENT**

Revolutionary! Speedier, easier, new way to install plywood panels. No nails, no holes to fill and finish. Bonds instantly, permanently on contact. No clamps and presses—ideal for applying plastic laminates like Micarta to table tops, kitchen counters, etc. 1001 other uses for home, hobby, garage. 25c, 35c, 60c and larger sizes.



*There's a special Weldwood  
Wizard for every gluing job.  
Ask your lumber, paint or  
hardware dealer... or mail  
coupon for FREE leaflets.*

### UNITED STATES PLYWOOD CORPORATION

Box 525 - New York 46, N. Y.

PM 5-66

Send me leaflets on:

- Weldwood Plastic Resin Glue  
 Weldwood Waterproof Resorcinol Glue  
 Weldwood Presto-Set Glue  
 Weldwood Contact Cement

NAME \_\_\_\_\_

ADDRESS \_\_\_\_\_

CITY \_\_\_\_\_ ZONE \_\_\_\_\_ STATE \_\_\_\_\_

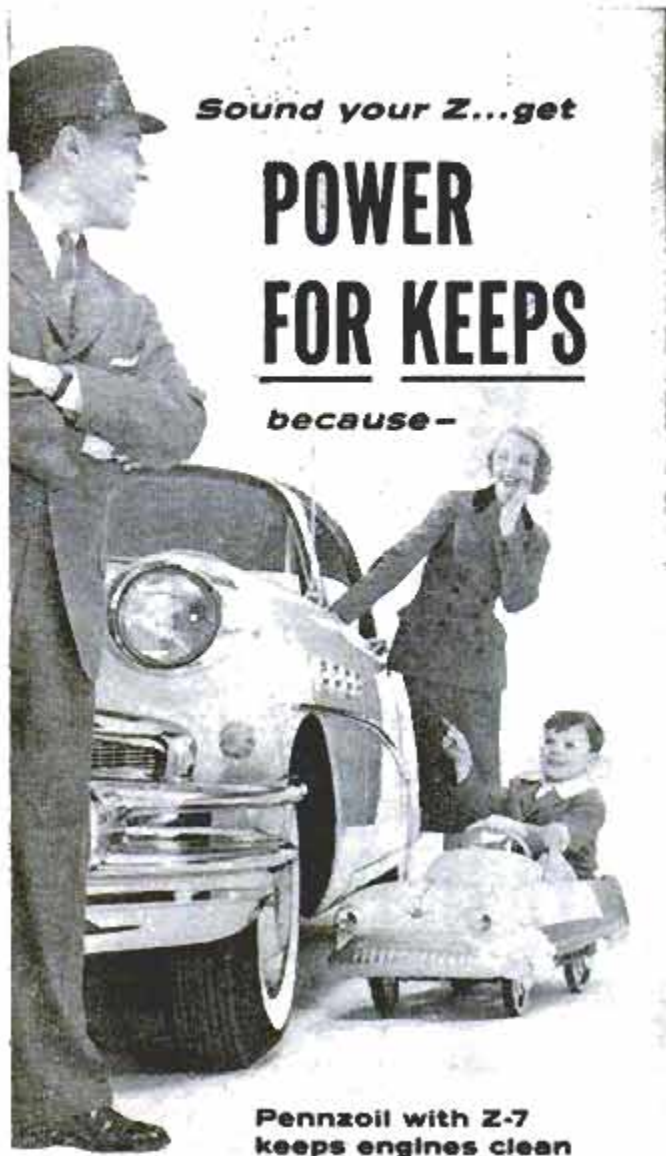

Sound your Z...get

# POWER FOR KEEPS

because—

**Pennzoil with Z-7  
keeps engines clean**

Pennzoil with Z-7 is The Tough-Film® oil with an all-oil lubricating body. It stays tough under engine heat and pressures, prevents build-up of power-stealing deposits. By keeping engines clean, this different Pennsylvania motor oil controls carbon completely. There's no knock, no ping. Horsepower stays unlocked—not for just a few miles after an oil change, but for keeps. To enjoy all the smooth power you bought, get Pennzoil with Z-7 now in the exact seasonal grade for your car!



IN EVERY STATE,  
AT DEALERS WHO  
**Care** FOR YOUR CAR



MEMBER PENN. GRADE CRUDE OIL ASSN., PERMIT NO. 2, OIL CITY, PA.

must for all high-fidelity systems, it will also improve the performance of loud-speakers presently housed in open-backed radio or television console cabinets. The installation of such speakers in a separate hi-fi enclosure usually results in a marked increase of fundamental bass reproduction.

Although all speakers will sound better in a good enclosure, some of them will provide optimum performance only with a specific type of cabinet design. Speaker manufacturers can usually supply information on cabinets which will result in best possible performance with their particular units. On the other hand, the makers of enclosures can often recommend speakers which will provide best performance in their particular cabinets. Such recommendations, as well as additional descriptive literature and illustrations, can be obtained directly from the manufacturer, or from the radio-parts distributors handling their products. \*\*\*

## Improved Light Bulb Is More Efficient

Light bulbs give more light with the same amount of electricity because of an improved design. The tungsten filament is positioned lengthwise in the bulb, permitting it to burn at a higher, more efficient temperature. Bulb blackening is concentrated in a smaller area, permitting more light to escape. The increased efficiency amounts to 6 percent in household bulbs and 15 percent in the larger industrial sizes. Double-coil filaments, formerly restricted to small-wattage bulbs, account for the greater increase of efficiency in the over-300-watt bulbs. The new bulbs are made by General Electric.

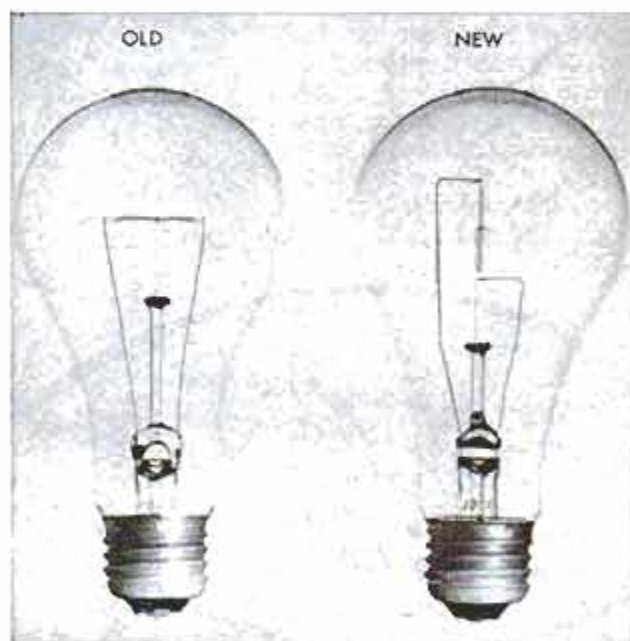



Biggest value ever!

## Sensational new heavy-duty saw

—only **\$69<sup>50</sup>**

At last—true heavy-duty design and precision engineering in a *professional quality* 6½" saw!

Porter-Cable's revolutionary new Model 146 has the *capacity* you need—makes every cut it takes to build a house! It slices through 2" dressed lumber—even at a 45° angle—with speed and power to spare. It does everything that bigger saws can do—does it *easier*—does it all day long without a whimper.

Model 146 is light and handy—just 11 lbs. of perfect "feel" and balance. And just check its features! Full ball-bearing construction, telescoping guard, exclusive new calibrated depth gauge, famous Porter-Cable Kick-Proof Clutch, husky 9-ampere Universal motor (1.3 equivalent h.p.) and many, many more.

See the new Model 146 at your dealer's *now*—or mail the coupon below. At only \$69.50, it's the saw "buy" of the century!

SEE YOUR DEALER — OR MAIL COUPON TODAY!

PORTER-CABLE MACHINE CO.  
6145 N. Salina St., Syracuse 8, N. Y.

Yes, send me a complete catalog sheet on the Model 146 Heavy-Duty Saw, and the name of my nearest dealer.

Name \_\_\_\_\_

Address \_\_\_\_\_

City \_\_\_\_\_ Zone \_\_\_\_\_ State \_\_\_\_\_

**Porter-Cable**

*Quality Electric Tools*

First with the finest for 50 years

# KLEINS

mean a better job

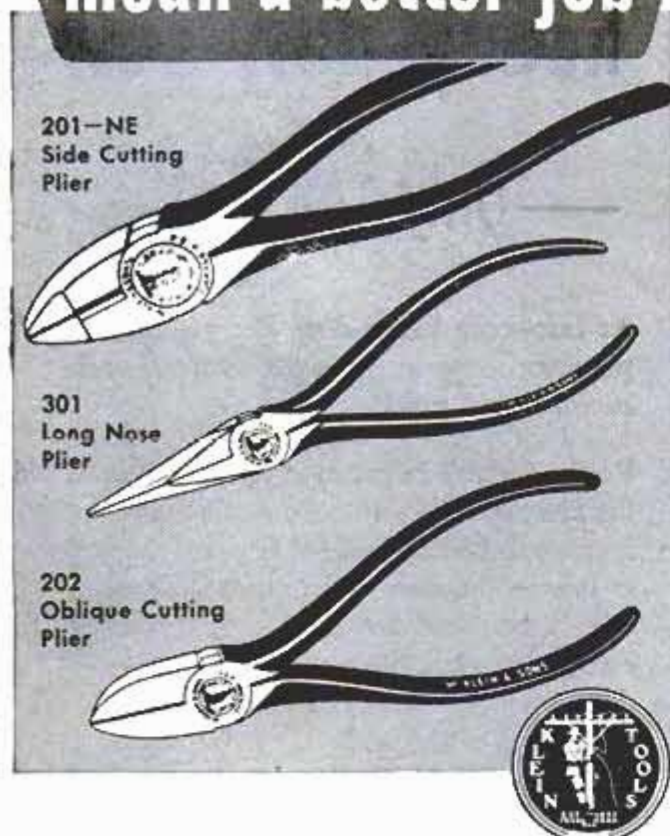

Here are three pliers that will help you do a better job—three tools that should be in every workman's kit.

Klein pliers are recognized by electricians, linemen and good workmen everywhere as the standard of comparison by which other pliers are judged.

The work you do is only as good as the tools you use. Be sure the tools on your bench or in your kit include genuine Kleins, famous for quality "since 1857."



Your hardware store has Kleins in stock or can get them for you quickly. Look for this new display board. It shows the most popular items in the Klein line.

Mathias **KLEIN** & Sons  
Established 1857 Chicago, Ill., U.S.A.  
7200 McCORMICK ROAD • CHICAGO 45, ILLINOIS

## Humidity-Controlled Electronic Switch

(Continued from page 164)

obtaining satisfactory operation. The only necessary precaution is to keep the wire leading to the grid pin of the tube socket and the lead from the tie point to the sensing element well separated from any leads carrying alternating current. Failure to observe this may result in the induction of hum into the grid circuit which might cause unstable operation.

The line-cord leads are soldered to the terminal strip after passing through a hole in the case. A rubber grommet inserted in the hole protects the cord against damage. A knot in the cord, just inside the case, will act as a strain relief.

The sensing element is made of a plastic container, such as the shallow lid of a cheese carton, and two all-metal banana plugs, which serve as electrodes. These plugs are fastened to the plastic lid through two holes spaced approximately 1 in. apart. The exact spacing of the plugs is not critical, but the holes in the lid must line up perfectly with two corresponding jack holes in the top of the metal case. The lid itself must be shallow to permit the free access of air.

The jacks must be well insulated from the case by means of the insulating shoulder washers supplied with the jacks.

After the final wiring has been completed the unit may be tested before it is installed in the case. To do this, fasten the sensing-element leads to the jacks mounted on the case and insert the fuses in the line-cord plug. These fuses must have a high enough current rating to handle the surge current drawn by the dehumidifier. Pour a small amount of salt of the free-pouring variety into the sensing element and insert the line-cord plug in a wall outlet. (Use just enough salt to make good contact with both sensing electrodes. A random sprinkling of salt, as shown in the photo, page 163, can be used.)

When the unit is plugged in, the bulb will light if the sensitivity control is turned fully counterclockwise. Rotate this control until the bulb is extinguished. Then breathe into the salt as you would on a pair of glasses in order to clean them. After one or two long breaths, the bulb will light and remain lit for a short time, until the moisture has evaporated. Then it will go out. This indicates that the unit is operating properly.

The value of capacitor C1, across the relay coil, is somewhat critical. Too small a

(Continued to page 254)



*At Bonneville Salt Flats . . .*

## Records Prove Top Performance of Auto-Lite Original Service Parts

31,224 miles of continuous driving averaging 92.86 mph.! 306 official A.A.A. records, including 27 World's Unlimited Records, shattered! That's the record set by an Auto-Lite equipped 1956 Dodge at the famous Bonneville Salt Flats, Utah. And in those 14 blistering days and nights of continuous driving, not a single electrical failure occurred.

This amazing performance by the complete Auto-Lite electrical system . . . standard factory equipment on the Dodge . . . is important to every car and truck owner. When new electrical units are needed on your Auto-Lite equipped car, make sure you get Auto-Lite Original Service Parts. It's your guarantee of full power performance.

Engineers of many leading makes of America's finest cars specify Auto-Lite complete electrical systems as original equipment. That's sound support for your decision to insist on Auto-Lite Original Service Parts.



Whether it's a contact set, coil, condenser, distributor or voltage regulator, you can be certain of top performance if it's backed by world-famous Auto-Lite ignition engineering. Get these same race-tested electrical parts for your Auto-Lite equipped car.

Get full power performance with . . .

# AUTO-LITE

Original  
Service Parts



Auto-Lite manufactures over 400 products, including Spark Plugs, Batteries, Wire and Cable, and Automotive Electrical Systems . . . sold throughout the United States and Canada.



**"Our New CHILDERS CARPORT Saved Us \$95 and we installed it in Just One Afternoon"**



Install the beautiful Childers Do-It-Yourself Carport in one afternoon, save \$95 over the price of a job-built carport. Beautifully designed to blend with any type architecture, it increases the value of your property. Your Childers Carport can be used in many ways — as protection for your car, a patio cover, a play area for children. Precision-made from zinc plated steel, it will last as long as your home.

Erect in one afternoon. Full size, 20'x10'. Nothing Down, only \$2.48 a week. Free standing or attached.

**EASY 1-2-3 INSTALLATION**



1. Assemble frame on ground.



2. Attach legs and raise carport.



3. Put roof sheets into place.

**CHILDERS ALUMINUM AWNINGS GUARANTEED TO SAVE YOU 30%**



Berkley



Windsor

Your cost will be at least 30% less than your neighbor paid last year for his old fashioned, job-built awnings because:

1. You get factory prices from direct factory outlet.
2. You install Childers Awnings yourself with screwdriver and pliers. Saves installation charges.
3. Mass production in world's largest aluminum awning factory saves costly hand assembly.



Casement Awning



Door Canopy

**FREE IDEA FOLDER**

Childers Manufacturing Co., Dept. P-3  
3620 W. 11th St., Houston 8, Texas

Send me free literature on the Childers guaranteed products checked below; also name of my local Childers factory outlet.

Childers Carport  Childers Aluminum Awnings   
Childers Patio Cover

Name \_\_\_\_\_

Address \_\_\_\_\_

City \_\_\_\_\_ Zone \_\_\_\_\_ State \_\_\_\_\_

**WORLD'S LARGEST ALUMINUM AWNING FACTORY**



value will cause relay chatter, while too much capacity may cause the relay to flicker just before turning off. For this reason, a dual unit is specified in the parts list. If the 20-mfd. unit originally used causes relay flicker, it should be replaced with the 10-mfd. section. The unused lead should be taped and tucked away underneath the chassis. If relay chatter is encountered, the 10-mfd. section should be connected in parallel with the 20-mfd. section.

When installing the unit in the case, the bulb should be taped to the top of the case beneath the sensing element. If a pilot bulb socket is used, it can be fastened to the case with a screw and nut.

The filaments of the tube are powered by only half of the transformer filament winding. This reduced filament voltage effectively increases the life of the tube, and reduces the power consumption of the unit.

In actual operation, the sensitivity control is adjusted by the breath-blowing technique described earlier. It should be set so that the relay is activated by two long breaths, although actual experimentation may dictate the use of a more or less sensitive setting.

When wired as shown the unit can be used with a dehumidifier. If a humidifier control is desired, the wire from the a.c. receptacle should be connected to contact 3 of the relay instead of contact 2.

Finally, the case of the unit should be grounded during operation to prevent the build-up of a static charge. This can be done by running a wire inserted under one of the cabinet screws to some grounded metal object. ★ ★ ★

**New Phonetic Alphabet For Air-Ground Communications**

Coca, Metro, Nectar, Union and Extra have been thrown into the wastebasket, and have been replaced by Charlie, Mike, November, Uniform and X Ray. That's the word from the Civil Aeronautics Authority. And if this all sounds like voodoo Mumbo Jumbo, it isn't. It simply means that five letters in the phonetic alphabet, used in air-ground communications, have been replaced by five others which will cause less confusion. The change was made after tests in the United States, Canada and the United Kingdom. The revised international phonetic alphabet now reads:

- |           |                  |           |
|-----------|------------------|-----------|
| A Alpha   | J Juliett        | R Romeo   |
| B Bravo   | K Kilo (Kee'loe) | S Sierra  |
| C Charlie | L Lima           | T Tango   |
| D Delta   | (Lee'mah)        | U Uniform |
| E Echo    | M Mike           | V Victor  |
| F Foxtrot | N November       | W Whiskey |
| G Golf    | O Oscar          | X X Ray   |
| H Hotel   | P Papa (Pop'a)   | Y Yankee  |
| I India   | Q Quebec         | Z Zulu    |



# Why grope your way like this in fog?

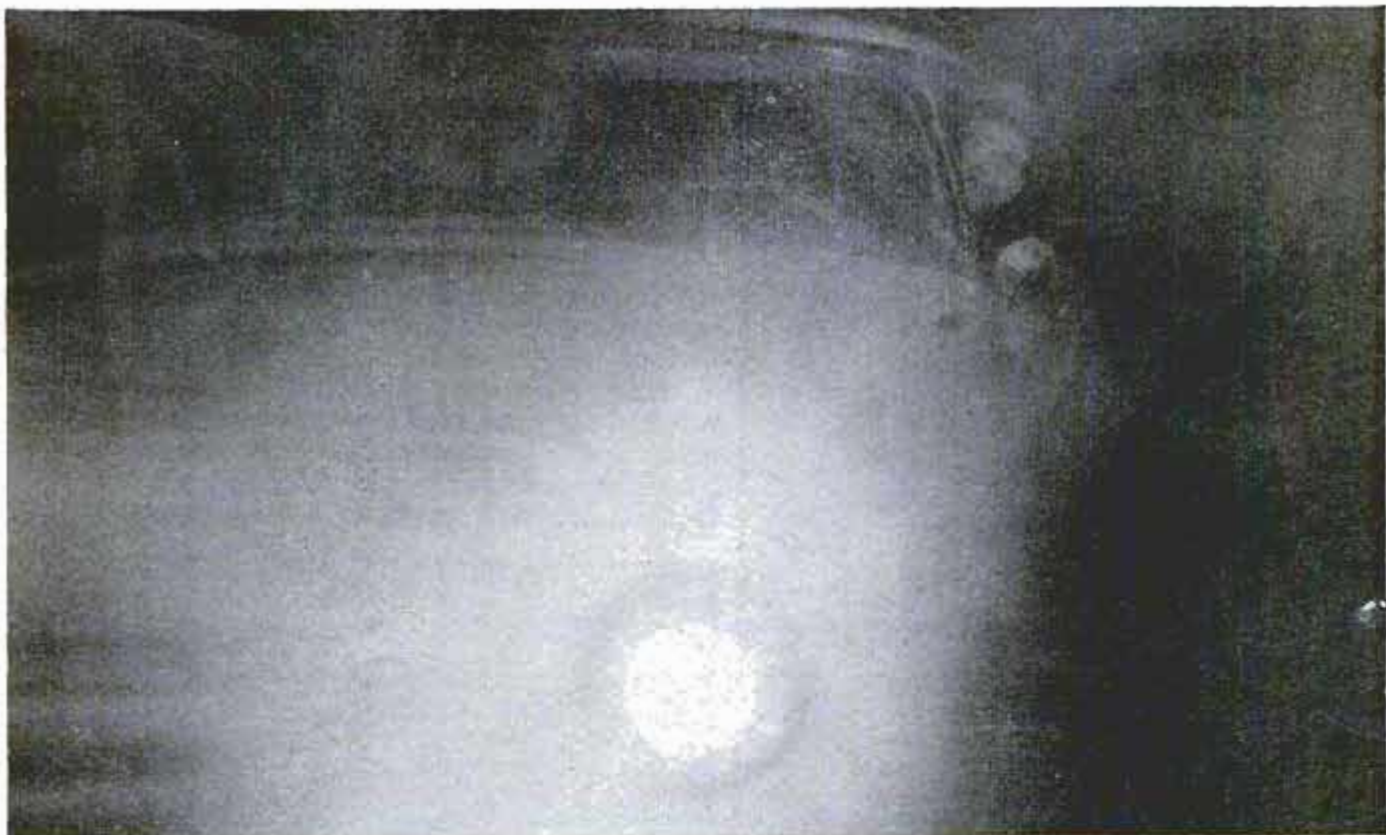

## Get a pair of G-E *All-Weather* Headlamps... see better in any weather

**N**EW General Electric *All-Weather* Headlamps are so revolutionary they make all ordinary headlamps obsolete.

With ordinary headlamps, upward light is uncontrolled. This light is reflected back into your eyes by millions of tiny moisture particles—that is why seeing at night in fog, rain, or snow, is so difficult. New G-E *All-Weather* Headlamps have a special shield over the lower beam filament that blocks out uncontrolled upward

light. Kick-back glare is reduced to a minimum . . . you can see the road ahead more clearly.

On clear nights, the upper beam filament which is purposely not shielded, puts light farther down the road. You can see curves, dips and obstacles in time to slow down.

With a pair of G-E *All-Weather* Headlamps you get 25% more light. Passing oncoming cars is easier, too, because the light is concentrated where you need it—on the right-hand side of the road.

Replace your present headlamps with a pair of new G-E *All-Weather* headlamps. They can be quickly installed and accurately aimed for a surprisingly modest cost. Ask for them by name: G-E *All-Weather* Headlamps.

Miniature Lamp Dept., General Electric Co.,  
Nela Park, Cleveland 12, Ohio

*Progress Is Our Most Important Product*

**GENERAL  ELECTRIC**



ORDINARY  
HEADLAMPS

Ordinary Headlamps: Uncontrolled upward light bounces off moisture particles, causes kick-back glare, blinds driver.



G-E *All-Weather*  
HEADLAMPS

G-E *All-Weather* Headlamps: G-E filament shield controls upward light, reduces kick-back glare, makes seeing easier.

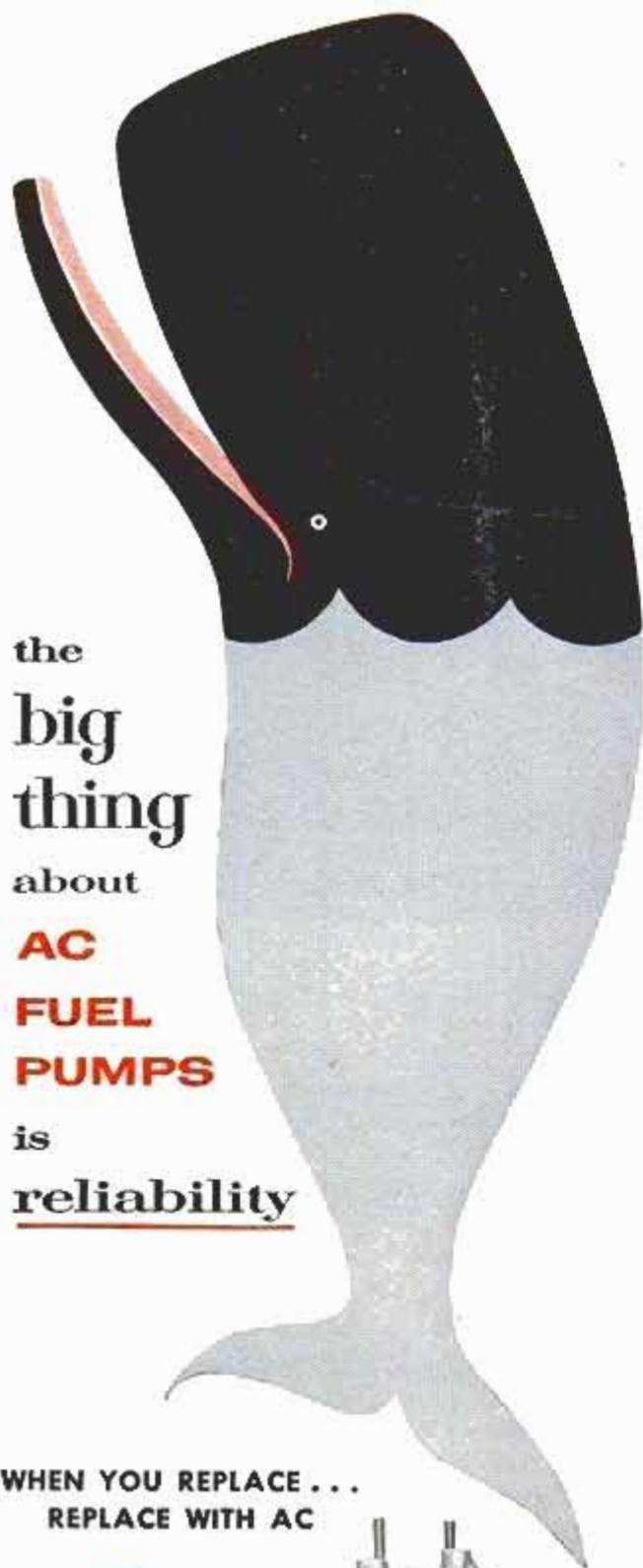

the  
big  
thing  
about  
**AC**  
**FUEL**  
**PUMPS**  
is  
reliability

WHEN YOU REPLACE . . .  
REPLACE WITH AC



AC SPARK PLUG   
THE ELECTRONICS DIVISION OF GENERAL MOTORS

## Seabees Build Town Under Ice

(Continued from page 102)

plugged the gash, but for days there was no smoking on McMurdo Sound.

The cataclysmic disappearance of bay ice was not without its bright side. One of the problems facing Dave Canham and his men was transfer of loose fuel from the tanker to the 400,000-gallon tank farm they had assembled from pieces of prefabricated steel at Hut Point. With ice gone, and ships within four miles of camp, Seabee Weasels hauled strings of one-ton sleds loaded with 50-foot lengths of four-inch flexible hose. Working through whirling snowstorms most of the time, sled crews hitched length after length by means of jiffy-clip couplers. The Weasel driver would pull the train out from under each length as it was connected



Hot water was obtained by placing immersion heater in can and shoveling in snow—25-gallon capacity

to already laid hose. In four days, Antarctica's first "Big Inch" snaked across remaining bay ice to offloading point, and fuel flowed through it from ships to the continent's first big tank farm.

With all this completed, Whitney and his men still have plenty to do. Their polar villages are complete enough so they'll have comfortable living this winter. But before the sun sets for good this month, an airstrip must be finished and GCA (ground control approach) equipment set up at McMurdo Sound. Big Air Force planes coming in next December need a place to sit down. Flying boxcars will be needed to make 100 round trips to the South Pole, where they'll airdrop 20 men plus 350 tons of material (including a 12-ton tractor) to construct South Pole Base. Another satellite town—Byrd Base—must be constructed next October, 600 miles out on the unexplored barrier east of Little America

(Continued to page 258)

DO IT BETTER . . .  
**DO IT WITH DP**



**GLAZE  
CAULK  
SEAL  
PATCH**

Broken window panes? Glaze and seal 'em for keeps with D-P Glazing Compound. Works perfectly on wood, steel, aluminum . . . gives a permanent, elastic seal between glass and sash. Easy to use, looks better, lasts longer, no annual retouching. Just one of the many fine D-P products . . . at all good stores!

Ask your dealer for D-P Products.

**THE DICKS PONTIUS CO.**  
5301 Huberville Ave., Dayton 3, Ohio  
INSIST ON D-P BEST SINCE 1867

**"We made our home  
15° cooler in summertime**



**with Gold Bond  
TWINSULATION®**

"'Twinsulating' our attic gave us our first comfortable summer. And the job took just a few hours. We simply tucked the blankets between the rafters, from the floor up to and between the crossbeams, stapling as we went.

"TWINSULATION not only keeps our home cool in summer; it cuts winter fuel bills up to 25%. It's called TWINSULATION for its twin-insulating action. It *blocks* heat with fireproof rock wool, *reflects* heat with a covering of silvery aluminum all around."

"Twinsulate" your attic—before summer. See your Gold Bond dealer. He'll show you samples and supply a stapler for application.

**GENUINE ALNICO  
MAGNETS**

AMAZING, PERMANENT, NON-ELECTRIC, HIGHLY PRACTICAL. Conduct interesting experiments. Hundreds of uses. Retrieve valuable steel items such as guns, tackle from fresh or salt water; tools from tanks & drains. **GUARANTEED.** Try any magnet one week. Money back if you are not well-pleased.

Send M.O. or check. We pay postage. Sorry no C.O.D.'s.

MIAMI MAGNET COMPANY, 3240 N.W. 27th Ave., Miami 42, Fla.

Say You Saw It in Popular Mechanics

**NOW—SHOPSMITH®**  
for as little as **\$3 per week**

Start enjoying SHOPSMITH now for only \$29 down, \$3 weekly. Start saving now! Savings on projects and home repairs can more than equal weekly payments. See your hardware dealer or Montgomery Ward store. Write for 2 big, free, illustrated books. SHOPSMITH, Dept. 321-B, Menlo Park, Cal., or Box 2808, Ft. Wayne, Ind.

**NEW CONVENIENCE AND BEAUTY  
NEW HULL AUTO COMPASS**

Enjoy greater-than-ever-convenience with the NEW Hull Auto Compass . . . easier installation, easier compensation, easier reading. Its sparkling, new beauty of styling is easy to admire, too. At better dealers everywhere. Write for literature.

NEW COMBINATION MOUNT STANDS ON DASH, OR HANGS FROM WINDSHIELD MOULDING OR GLASS

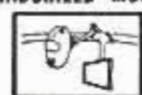

**Beaconlite®** \$6.50  
illuminated

**Streamline** \$4.95  
non-illuminated

HULL MFG. CO. P. O. Box 246 D-5 WARREN, OHIO

**NATIONAL GYPSUM COMPANY**  
Buffalo 2, N. Y.



Send for booklet that tells all about Gold Bond TWINSULATION . . . what it does for your home, how it cuts fuel bills.



NATIONAL GYPSUM COMPANY  
Dept. PM 56, Buffalo 2, N. Y.

I enclose 10¢ for "Home Insulation" booklet.

Name \_\_\_\_\_

Address \_\_\_\_\_

City \_\_\_\_\_ County \_\_\_\_\_ State \_\_\_\_\_

*"My 6 big reasons for buying this Fiberglas<sup>®</sup> Boat-Covering Kit!"*



- It'll make my boat leak-proof and dry!
- I'll be saying 'so long' to scraping, sanding, caulking—and be first in the water every spring.
- My boat'll be stronger and more rigid—more resistant to hull damage!
- It'll get a longer lease on life!
- I get resin, activator, color pigment and Fiberglas fabric all together. No shopping around!
- I'll spend less time on maintenance, more time on the water.

Over 400,000 boat owners have improved their boats this way! How about you? For covering materials, see your local marine dealer. Or, for step-by-step instructions, write me for my free boat-covering booklet and a list of kit suppliers. Charlie M., Dept. 178-E, Essex, Conn.



OWENS-CORNING  
**FIBERGLAS**

®T.M. (Reg. U.S. Pat. Off.) Owens-Corning Fiberglas Corporation

—a high, inland snow prairie vaguely encompassing a 10,000-square-mile expanse known as Marie Byrd Land.

As you read this, Vic Young is preparing the huge tractor train that will follow a flag-marked trail some 400 miles into Marie Byrd Land. He'll carry 550 tons of gear to build Byrd Base next fall. That train will be the most awesome caravan Antarctica has ever seen. Painted bright orange for quick identification from air or ground, the half-mile-long string composed of 22 monster sleds drawn by ten 35-ton "snowshoe" tractors will set out early in October when the weather begins to "warm up." Vic will command a group of 30 Seabees. Each will serve a hitch at the controls of a tractor.



Narrow runners on this bobsled trailer could not support a 3000-gallon fuel tank on sugarlike snow

Once he gets rolling, Vic expects to keep engines roaring and massive tracks spinning 24 hours a day, stopping only for refueling at caches he laid down every 50 miles during a lighter run last month. When off duty, men will eat in a messing wanigan on one of the big steel bobsleds, and nap in a bunkhouse on another.

The plan doesn't account for polar blizzards that will drive blankets of snow through the air until a "cat skinner" can't see the tail sled of the train ahead. That's when the caravan will have to halt. Runners will freeze fast. To start, drivers will ram back into the load, yank forward, ram back again—repeating the process until everyone is jerking spasmodically and something gives. "If it's the hitch," says Vic, "we'll have a welding torch along to fix it up. If it's the driver's neck, Doc Erlich will fix that when we get back." Like most men in MCB (Marine Construction Battalion) Special, Vic talks about his colossal assignment with breezy abandon, but no one treats Antarctica's treachery lightly.

The trail Vic will follow is a hard-won circuitous route. Marked by red flags, four to the mile, it winds eastward between

(Continued to page 260)

Save

**SURPLUS & NEW MANUFACTURE EQUIPMENT**

at GROBAN'S

All Items Unconditionally Guaranteed

**BRAND NEW 1 H.P. 12 Volt Electric Motor**



For electric wheel chairs (Pop. Mech. design—Mar., 1953)  
For electric golf carts  
For self-propelled scooters, children's mid-gate cars.

ITEM #308  
Rated 1 H.P.—100 amps., 2600 R.P.M., 12 volts, D.C.—This double shaft motor of ball-bearing construction may be run on 6 volts for lower horsepower requirements—Standard 3/4" shafts, flange mountings—Dimensions: 9"x4 1/2"x4 1/2" Ship. wt. 19 lbs. A. .... **12.50** F.O.B. Chicago

**GROBAN HYDRAULIC SPEED REDUCER with FINGERTIP CONTROL**

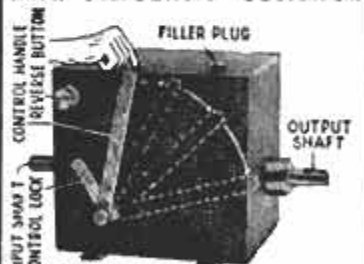

ITEM #115  
FOR: Reamer Drives • Midget Cars • Feed Mills • Canning Machines • Conveyors • Lathes • Milling Machines • Motor Boats • Cream Separators • Garden Tractors • Pumps.  
Variable output speeds from 0 to input speed available by moving control handle. Locking handle maintains setting. Use input power of 1/4 to 1 1/2 H.P. Shafts 3/4" diam. Input rotation counter-clockwise facing shaft. Input speed 750 R.P.M. 7 1/2" x 7 1/2" x 11 1/2". Output rotation reversible. Ship. wt. 31 lbs. Complete with 2 qts. of oil and full instructions. F.O.B. Chicago ..... **54.50**

**GROBAN FOUR-WAY OPEN CENTER HYDRAULIC CONTROL VALVE**

ITEM #126 — Four-way open center control valve, with built-in adjustable relief valve factory set at 1000 P.S.I. Spring loaded neutral position. For use with one double acting cylinder. In neutral position cylinder is locked and pump unloaded. Can be used as single unit or mounted in series. Has 3/4" pipe thread inlet and outlet. 1/2" pipe thread cylinder ports. Finger grip handle. Ship. wt. 10 1/2 lbs. AN OUTSTANDING BUY! F.O.B. Chicago **21.50**

**FACTORY-TO-YOU-VALUE PORTABLE ELECTRIC LIGHT PLANTS**

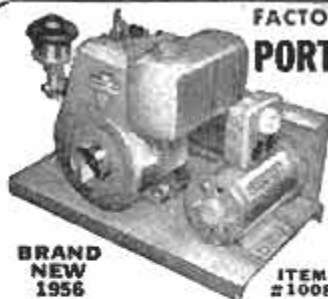

BRAND NEW 1956

ITEM #1008

COMPACT — FITS IN THE TRUNK OF YOUR CAR  
**1000 WATTS OUTPUT.** continuous duty. 115 Volts A.C. 60 cycles, 9 amps. Powered by husky, easy starting Clinton engine. Engine and generator operate at 3600 R.P.M. for maximum efficiency at minimum weight. Both units are mounted on steel base, with heavy sheet metal belt guard. Generator is self regulating, and is equipped with outlet box containing fuse and 2 A.C. convenience receptacles. Cost only 5c an hour to operate. Dimensions: Length 20 1/2". Width 12". Height 16". Shipping wt. 100 lbs. F.O.B. Chicago ..... **149.50**  
**700 WATT-GENERATOR SET**—same as above, slightly smaller—with Briggs-Stratton Engine—Model 708—F.O.B. Chicago ..... **129.50**  
**ITEM #2008—2000 WATTS**—115 V. A. C. generator set, powered by husky, fast starting Briggs-Stratton engine. Mounted on portable steel carrying base for easy handling. — Just right for small cottage and cabins needing inexpensive 2000 Watts of electricity. Ship. Wt. 190 lbs. F.O.B. Chicago ..... **295.00**

POWER TO OPERATE:  
Electric Saw, Electric Drills, Pipe Bender.  
Refrigerator, Deep Freezer, Incubator.  
Water Pump, Radio, Lights, Air-conditioner.

**BELT DRIVEN A. C. GENERATORS**

ITEM #700  
Ideal for powering electric tools, oil burner, refrigerator, lights, or other appliances requiring up to 700 watts of power. **700 WATTS.** 115 Volts. 60 cycles A.C. 3600 R.P.M. Compact, self-regulating generator with V belt pulley and double outlet receptacle. Rotation counterclockwise. May be driven by tractor or auxiliary gasoline engine. Requires 2 HP minimum. Dimensions: 10" long x 8" high x 6" wide. Shipping wt. 27 lbs. F.O.B. Chicago ..... **59.50**  
Model 1010 — **1000 WATTS** (Same as above) F.O.B. Chicago ..... **79.50**



**MULTI PURPOSE HYDRAULIC PUMP OR MOTOR**

ITEM #55 Silent, high efficiency Helical Gear Type Ball Bearings. Hydraulic Pump or Motor. Rated 8 Gal. Per Min. At 1500 R.P.M.—Delivers 1000 P. S. I.—Largest 6 H.P.—Reversible Rotation—3/4" Pipe Thread Inlet and Outlet Ports—1/4" Drain Port—3/4" shall with keyway and flat for either direct or pulley drive. Dimensions—5 3/4" high, 7 1/2" long, 5 1/4" wide. Shipping weight 18 lbs. F.O.B. Chicago ..... **45.50**

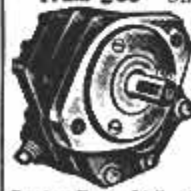

**MASTER & SLAVE HYDRAULIC REMOTE CONTROL SET**

ITEM #415—Designed for remote operation of controls on engines, boats, special machinery, etc. Eliminates complicated mechanical linkages, cables, pulleys, etc. The master unit connects to the slave unit with a single 1/4" tube. When master control lever is moved, slave lever follows exactly. Light, compact, aluminum alloy construction. Dim. of both units: 5 1/4" W. 9" H. 1 3/4" D. (exclusive of handle) Ship. Wt. 8 lbs. F.O.B. Chicago ..... **27.50** per pair (Note — tubing not supplied)



**U. S. NAVY ALL BRONZE CENTRIFUGAL PUMP**

These all bronze Centrifugal Pumps are ideal for use as marine bilge pumps, circulating pumps, fire protection or irrigation, car-washing, dewatering, basement sump pumping, lawn sprinkling. Will pump water, oil, brine, gasoline, DDT and sulphur compounds. Equipped with 6" adjustable "V" pulley, 2" dia. inlet and outlet, 180 GPM capacity. Inlet and outlet take hose with 2 1/4" inside diameter. Dimensions 11"x8"x11".  
Total head-feet Speed H.P. GPM  
25 3600 RPM 3 180  
35 3000 RPM 1 1/4 90  
20 2400 RPM 1/2 75  
Back plate may be rotated for most convenient inlet position. Shipping weight 31 lbs. Govt. cost \$66.00. F.O.B. Chicago ..... **29.50**



ORDER DIRECT FROM AD SATISFACTION GUARANTEED  
Send Payment Or Purchase Order Today  
All Phones—WEster 9-3793  
**FREE! — NEW CATALOG**  
1956 EDITION, 56 PAGES, chock-full of unmanufactured War Surplus and newly manufactured Equipment Bargains for farm, home, factory, workshop. Write letter today.

**GROBAN SUPPLY CO.** Dept. PM-5  
1139 S. WABASH AVE., CHICAGO 5, ILL.

**DOUBLE ACTION HYDRAULIC CYLINDERS**

ITEM #31C—3 1/2" bore, 11" stroke. Alloy steel cylinder wall. Micro-Honed and all steel 1 1/2" diameter piston rod. 19 1/2" overall length closed. Clevis mounting at base and shaft. Will lift 9625 lbs. with 1000 PSI Pump Pressure. Uses 3/4" tubing fittings. (Fittings to pipe thread: two 3/4" MPT @ 35c. A \$102.00 value. Shipping weight 11 lbs. FOB Chicago ... **25.00**

ITEM #16C—1 1/2" bore, 20" stroke. Will lift 1760 lbs. with 1000 lbs. pump pressure. Great for hay loaders, etc. 1" stainless steel piston rod. Postpaid ... **16.95**

**HYDRAULIC LIFT CYLINDERS**

For Fork Lift Trucks • For Presses • Loading Ramps • Lifts 12500 lbs. Heavy duty hydraulic cylinders, at big savings.  
ITEM #502—4" Bore—36" Stroke—1 3/4" Piston Rod. Wt. 95 lbs. F.O.B. Chicago ..... **72.00**  
ITEM #503—4" Bore—54" Stroke—1 3/4" Piston Rod. Wt. 135 lbs. F.O.B. Chicago ..... **96.00**



**SET OF 3 PAINT BRUSHES \$1.29**

**SURPLUS BIG BARGAIN OFFER**  
Here's the all-purpose set of Genuine Bristle Quality Brushes for the Do-It-Yourself painting of Furniture, Walls, Woodwork . . . for any paint job inside or outside your home. This matched set consists of a 1", 2" and 3". Finest quality brushes vulcanized-in-rubber. Made by one of the Top Brush Co.'s in U. S. All three brushes actually cost less than you could pay for any one of these brushes elsewhere! Get all three at our low price of \$1.29 plus 25c PP. (Only three sets to a customer.)  
**Money Back Guarantee, If Not Delighted**  
**MATTHEW DAY CO., INC., Dept. PM-5, Dumont, N. J.**



**Stiff lock?**

The key to a stiff lock is 3-IN-ONE Oil. Quickly penetrates, lubricates and prevents rust—without leaving gummy deposits as other oils do.  
**"3-IN-ONE" OIL**



# Make BIG MONEY

with this combination

## a.c. welder - a.c. power



Welds or runs tools, lights, motors, etc.

A REAL PROFIT MAKER

for emergency repair jobs

TWO machines in ONE



200 Amp. AC Welder-AC Power Combination, four cylinder air-cooled engine. Furnishes 200 amperes of welding current and 5,000 watts of AC power alternately. Easily mounted on your truck or trailer for quickly getting to where it's needed on a moment's notice.

"Husky Boy"

"Husky Boy" 200 amp. welder driven by a 2 cylinder air-cooled engine. Perfect for outside or around the shop welding. Handles the big pay jobs.



AC Power or AC Welder. An excellent dual purpose combination available in 200 and 300 amp. welding sizes. Can be belted or coupled direct to your own gas engine.

AC Power-AC Welding

Transformer Type AC Welder 250 amp. A real welder for production and repair work in shops that have only single phase power available.



"Bantam Champ" 250 amp. electric motor driven welder for general shop use. Ideal where compactness and low investment are prime considerations.

Investigate these BIG MONEY MAKERS today

AC Transformer



"Bantam Champ"

**Hobart School of Arc Welding**  
Learn arc welding quickly by actual on the job experience at the non-profit Hobart Trade School. Complete or partial courses.

Modern Arc Welding Lessons 200 pages, Fully illustrated. Learn practical arc welding in your spare time. . . . . Only \$1.00.



**HOBART BROTHERS CO., BOX M-56, Troy, Ohio, Phone 21223**

"One of the world's largest builders of arc welding equipment."

Clip this COUPON and mail today

**HOBART BROTHERS CO., BOX M-56, TROY, OHIO**

Please send additional data on items checked:

- "Husky Boy"  AC Power-AC Welding  
 AC Transformer  "Bantam Champ"  
 Hobart Welding School  Welding Lessons,  Welder's Vest Pocket Guide

free!

NAME \_\_\_\_\_

ADDRESS \_\_\_\_\_

CITY \_\_\_\_\_

STATE \_\_\_\_\_

peaks of the Rockefeller Mountains that jut through the polar plateau like some lunar landscape. Lt. Comdr. Jack Bursey (USCG), who took a dog team 1200 miles into these same wastes in 1940, marked the trail for Vic last January. This time, as advisor to MCB trail parties, he first flew reconnaissance over his route in a ski-equipped Neptune. Then he rode overland with a "pathfinder" crew of six Seabees in a colorful train of sleds loaded with drums of fuel to cache en route for the return trip, rations and 2500 trail flags. The caravan was hauled by two Snocats and led by the crevasse-detector Weasel—all fitted with built-in bunks, cookstoves and heaters. Fuel for the outbound trip was in five-gallon tins on smaller dog sledges in the train.

"We'll live in the vehicles," Jack explained the day he took off. He demonstrated the removable plywood decks inside the Snocats, where kitchen utensils, duffel and food were stored. The benches on each side were converted to bunks that accommodated sleeping bags. The Weasel had a built-in bunk that folded up out of the way when not in use, and a generator on the rear deck to supply power for the "Angry Nine" radio transmitter. His Seabee crew—George Moss, chief surveyor; Alvah Edwards and Roland "Dick" Levesque, construction drivers; Charlie Wedemeyer, mechanic; Ray Dube, radioman, and Chester Stevens, photographer—were loading the last of the gear and gassing the vehicles. "We're taking 60 days of trail rations," Bursey revealed. "This includes pemmican, tea, oatmeal, chocolate and canned stuff." Pemmican, a highly nutritive concoction invented by Arctic Eskimos who use blubber as a base, comes in hard blocks like frozen butter. It's largely fat, with ground-up dried meat, berries, vegetable oils and a few dozen other ingredients. It can be cooked like cereal, or eaten cold in chunks. It sticks to the roof of your mouth and tastes like a mixture of lard and peanut butter—not recommended for steady diet, but great if you're starving on a polar waste. Bursey, who says he likes it, promptly was dubbed "Pemmican Jack" by the Seabees, who admit they don't.

The tiny expedition roared out of Little America on a brilliant antarctic morning and disappeared over the horizon in a thin veil of drift. Each quarter mile, a bamboo pole topped by a fluttering red pennant was speared into the snow to mark safe trail for Vic Young's sled train. Every 50 miles the caravan stopped. Seabees trundled two 50-gallon drums of fuel from the sleds and planted them in the snow, marking the cache with a 20-foot-high flag so it

(Continued to page 262)



# Hard to beat Easy to keep

**ALUMACraft**



It's hard to beat an Aluma Craft... no matter how you look at it. Fast, smooth, stable, Erich Swenson designs assure top performance. Pre-formed parts, strong aluminum extrusions, careful forethought in the small important details... no boat is better built.

And easy to keep... they are practically no work at all. No caulking, painting or annual overhaul. Always dry. Always ready. Always fast. Always steady. Easy to own on easy terms.



To select the right boat for your needs, see your dealer or write for beautiful 1956 free catalog today.

## ALUMA CRAFT BOAT COMPANY

2625 27th Avenue South ★ Minneapolis, Minnesota

ENJOY TRAVELING WITH AMERICA'S FINEST  
AUTO COMPASSES



TRAVELITE \$5.95  
ILLUMINATED

GUIDEWAY \$4.95  
NON-ILLUMINATED

ONLY COMPASS  
APPROVED BY  
AUTO MAKERS

**DINSMORE...**

Shows you the right way — the short cuts. Always accurate and dependable anywhere. Fits all cars. Send for free folder — "Pants, Knives and Compasses" and name of nearest dealer.

DINSMORE INSTRUMENT CO., 1802-29 Kelso Street, Flint 1, Mich.

**BUILD FINE GRANDFATHER CLOCK NOW**



The simple sensible Red-i-Kut way as thousands have — SAVE HALF. SHOP TESTED PLANS "SPIRIT OF THE CENTURY" Narrow waist 89" tall or stately straight side "SPIRIT OF AMERICA." EASY-TO-FOLLOW photomicro PLANS tell all—plus BROCHURE of heavy brass weight Westminster, tube chime, movements, gorgeous dials, 3/4" solid mahogany case kits. Send \$1.00 today—Both plans \$1.50 NOW.

KUEMPEL CHIME CLOCK CO., 27 Kuempel Bldg., Minneapolis 16, Minn.



The *Flatfish*

THE LURE THAT  
NEVER GOOFS

With its lifelike motion, its exclusive offset hooking and its quick-penetrating hooks, the Flatfish is always geared for action. It brings in the fish—and that's for sure! World's largest selling plug. Over 17,000,000 sold. Get it at your tackle dealer's. Write for 48-page book with fishing secrets of famous anglers.

Free  
CATALOG

HELIN TACKLE CO.  
4099 Beaufait Detroit 7, Mich.



## A Nose for Action

...Yes, there's real action in UTICA's® Long Chain Nose Cutting Pliers.

No. 654-6  
\$3.00 LIST

They're specially designed for year in, year out service on those hard-to-get-at jobs. And they stay sharp!

They'll cut tempered steel wire in a snap—will even cut paper like a pair of scissors.

See your hardware dealer today. Just ask for UTICA® No. 654 Pliers—they'll make your work easier!

**UTICA**®  
Tools

UTICA DROP FORGE & TOOL CORP., UTICA 4, N. Y.



**South Bend**

# Lazy Day POLES

with Rigid "Taper Fit" Joints



**EXCLUSIVE Super-Strong Alloy Metal Sleeve at Each Joint Prevents Splitting and Distortion**

Here's a still fishing pole that goes anywhere you go! Telescopes to fit trunk of car...yet a flick of the wrist extends it to fishing length. Strong, yet light — each section tapered throughout to provide a binding joint, easily engaged or disengaged. Equipped with tip-top and rubber butt cap. Dark green finish.

**Telescopic • Hollow Glass  
Light • Easy to Carry**

**5 LENGTHS  
To Choose From**

12'—14'—16'

18'—20'

\$9.95 to \$17.95

See them at  
your dealer's.

*(Prices slightly higher  
west of Rockies  
and in Canada.)*



South Bend Tackle Company, Inc.  
891 High Street, South Bend 23, Indiana  
In Canada: Campbell Mfg. Co., Ltd., Toronto (licensee)

# South Bend

THE BEST IN RODS • REELS • LINES • LURES

would be readily found on the return trip.

Battered by blizzards and balked by white-outs, the trail blazers snaked nearly 400 miles up to the 6000-foot-high polar plateau. They circumvented mountains and rugged crevassed areas. Some of those cracks are 100 feet wide, so deep the bottoms fade into midnight blue, and they stretch away as far as you can see. "You don't ride across them like you do with dogs," Bursey pointed out. On his 1200-mile dog-team trek in 1940, Jack crossed the Hal Flood Range (where one peak was later named after him). He and three other men, all roped together, managed to cross snow bridges over huge crevasses with only a few minor incidents. "Several times the dogs broke through," he recalls. "But in each case the lead dogs were across and pulled the rest to safety. The men went over all of them safely on skis. "We made about 15 miles a day, instead of the 30 we're doing on this trip," he recalls.

The caravan was serviced on good days by a ski-wheel de Havilland Otter from the Little America snow airstrip. Across the featureless plateau, they steered by gyro-compass and celestial navigation. When blizzards hit, they holed in and camped in the vehicles and a polar tent.

Blazing trail across unexplored icecap with a light reconnaissance sled train, such as this one, takes considerable know-how. The man who briefed Bursey's Seabee crew on techniques for guiding their Snocat-and-Weasel safari was Silas B. Bowling, Army warrant officer with years of icecap experience in Greenland.

"Navigating is the big bugaboo," he explains. "Especially in white-out, when everything is one solid mass of nothing—shadows evaporate, snow mountains melt into the sky, ruts and holes disappear in a single white background that obliterated the horizon. Suddenly you are traversing the side of a hill—you keep working the side-slipping track on the downhill side, to straighten out your vehicle. In 10 minutes you may be hundreds of yards off course." It happened to a train of five sleds and two big tractors moving across Greenland. "Even though the navigator kept correcting course," says Si, "he wound up in a heavily crevassed area half a mile off trail, where he was found holed in—a few days later."

"Backsighting" is the trick George Moss and Jack Bursey used on their trail-blazing journey to stay on course in white-out. "If you know the direction you want to go, it works," Bowling explains. "We hit a white-out nine miles out of camp one day. I knew the heading we had to make, so took the lead vehicle and 20 flags. I laid out three

(Continued to page 264)



# IDEAS FROM WELDWOOD

## The Weldwood Question Box

**Q.** The doors in our house seem to transmit a lot of noise. How can this be corrected?

**A.** If wide cracks around the door are responsible for your problem, seal them with felt or rubber weatherstripping tacked to the door frame. But if the noise is coming *through* the doors, your best bet is to replace them with Weldwood Stay-Strate® Doors. The mineral core cuts noise transmission and, because Stay-Strate Doors won't warp or shrink, you'll effectively reduce sound *around* the doors.

**Q.** Must I use sheathing behind exterior plywood walls?

**A.** Yes—with three exceptions. Weldwood Texture 111, Exterior Weldtex® and Duraply® are approved by federal housing authorities in many areas for use without sheathing—a real saving of time and money. Check your local building laws first, though.

**Q.** How can I give birch plywood a natural finish?

**A.** It's easy. Go over plywood with No. 4/0 sandpaper—apply two coats of Satinlac®—let dry—then steel-wool and wax. For a "pickled" finish, first apply a coat of white Firzite®. Let stand a few minutes—wipe off with a clean cloth—follow with two coats of Satinlac, as above, then wax.

### GOT A QUESTION?

Send it to "The Weldwood Question Box," 55 West 44th St., New York 36, N.Y.

## THIS MONTH'S PROJECT—THE "SINBAD" AQUA-SLED



Here's a project for family fun— assembling the "Sinbad" Aqua-Sled. "Sinbad" is more than just a new class of sailboat, it's an aqua-plane and surfboard, too. (To get "Sinbad" kit, see coupon.)

"Sinbad's" makers—like many fine boatbuilders—use new Duraply for sound construction. Duraply, you know, is a *new type* of plywood: waterproof plywood with a special overlay permanently bonded to its surface. This super-smooth surface needs less paint than ordinary wood; paint lasts longer, too. And there's no sanding, no primer, no sealer coat. The tough overlay stands up to banging and pounding—helps "Sinbad" look better longer.

## This month's hints

**1. Make an inexpensive dining room table . . .** quick to build, for your summer cottage, handsome enough for your own dining room. Buy one Weldwood hollow core flush door—they start from about \$15—screw wooden or metal legs to the solid part of the door (around the edges), and you're

done! Weldwood flush doors come in a variety of beautiful hardwoods. You'll have no trouble matching wood you have in your room.

**2. Finishing exposed plywood edges** of tables or furniture is easy now. Get out your Presto-Set Glue and apply Weldwood Flexible Wood-Trim®. Comes in easy-to-use rolls 1" wide, 8' long. It can bend around corners . . . and matches wood perfectly because it's *real wood* itself.

### \$10 For your Ideas

for "This Month's Hints." (Hints must apply to some Weldwood product.) Send them to "Weldwood Hint Editor," 55 West 44th St., New York 36, N. Y.

# Weldwood®

A product of

UNITED STATES PLYWOOD CORPORATION

Weldwood—The Best Known Name in Plywood

United States Plywood Corporation  
55 West 44th St., New York 36, N. Y.

RUSH ME all the information and descriptive literature about "Sinbad" Aqua-Sled kits and Weldwood Duraply. **PM5-56**

Name.....

Address.....

City.....State.....



Why  
wash  
those  
walls?

It's so easy to  
give them fresh new  
beauty with

**LATEX PAINT\***



IT'S 6 WAYS BETTER:

1. no brush or lap marks
2. no painty odor
3. fast drying
4. rinses right out of brush or roller
5. tough and scrubable on the walls
6. wonderful color choice

\*Dow does not manufacture paint but is the leading producer of latex for paint manufacturers.

THE DOW CHEMICAL COMPANY  
MIDLAND, MICHIGAN



flags, about 40 feet apart, aimed in the right direction. By sighting back across them, we crept ahead another 40 feet and planted another flag. We sighted back over that, and the ones behind it. By continuing the process, we made it right on the nose."

Even backsighting doesn't always work. On one 1200-mile tractor-train trip, Bowling suddenly found himself completely turned around in white-out, headed back toward where he'd come from. "We finally put two men on compasses and made a 180-degree turn," he recalls. "We couldn't even tell we were turning and wondered if the instruments were lying. They weren't."

The huge crevasses on the Marie Byrd Land plateau were hazard enough for the Bursey trail party, but white-outs and blizzards made them even worse. "In clear weather you spot the cracks. Sometimes they're just concave or humped patterns in the snow," Bowling explains. "In tension areas, where the huge ice mass is being pulled apart underneath by a rise in the sub-terrain, there will be jagged ice hills or 'haycocks.' In compression areas, where the ice is squeezed by fantastic forces, cracks are ridged, iced over, and you can't tell whether the chasms will be parallel or at right angles. They may be every way—all hidden by snow bridges. You generally find them after you've crashed into them."

Winding across limitless wastes can be hypnotizing and, for that reason, Moss and the other Seabee drivers shifted frequently. "Trailing vehicles can almost guide themselves in the tracks of the leaders," says Si, "and it's easy to fall asleep. I remember one long train where the fifth driver, hauling a wanigan, stopped to get something. The sixth Weasel kept coming. The driver was snoozing and letting the vehicle steer itself. He came to in the nick of time, swerved aside and took a door off No. 5.

"We used to spot lots of sleeping drivers behind us, in big trains. They'd drift off the trail every now and then, and we'd let them go out across the open spaces for a way, then send someone after them to wake them up. It was always an awful shock for a driver to wake up and find himself headed into nowhere."

None of Bursey's three trains wandered away. And nobody went through any cracks—though there were many lengthy detours to get around abysses. And there were other troubles to plague them. The tired engines broke down time after time. Tracks, made brittle by cold, shattered. Finally, the caravan ground to a halt on the plateau—still 200 miles from its goal.

*Editor Dempewolf's reports on Operation Deepfreeze will continue in forthcoming issues.*

*For your Ford — always specify the brake linings with the*

# IRON GRIP

**"Genuine Ford Brake Linings** prove they can keep their iron grip in 3,250 torture tests," says Al Esper, Ford's Chief Test Driver. "In tests like these, inferior brake linings fade. But Ford linings beat the heat and go on to pass repeated 80 m.p.h. emergency stop tests without a falter!"

## *Like these brake linings, all Genuine Ford Parts must pass severe torture tests*

When a replacement will add to your Ford's performance—such as water pumps, shock absorbers, distributor points—make sure it's a Genuine Ford Part.

It will help your car run "like new" because it's built to the specifications set when your car was brand new. You can count on long, dependable service, too, for all Genuine Ford Parts must pass grueling endurance tests before they are accepted for manufacture.

That's why you should always specify Genuine Ford Parts. They're *made right to fit right to last longer in your Ford.*

May is National Safety Month—be sure you can see, steer, stop safely!

**Keep your Ford all Ford**



# choose your ride



This is the only genuine adjustable shock absorber. A twist of the wrist gives the ride you want—for your make of car, your kind of driving. Only Gabriel has it... Adjustomatic!

# Gabriel

AJUSTOMATIC

**SHOCK ABSORBERS**

The Gabriel Company • Cleveland, O.

## What Owners Think of the 1956 Plymouth

(Continued from page 96)

"Mine is a taxi and the best thing is the way it handles."—Maryland cab driver.

"I like the way it handles on long trips. I never get tired."—Virginia meat cutter.

"Easiest handling car I have ever had and without power steering."—Illinois foreman.

Second on the list of features best-liked by owners of the six-cylinder Plymouth is the push-button shift. Second on the list of V8 owners is power and performance.

"Wonderful get-up-and-go, especially for passing and climbing hills."—Maryland nurse.

"On parking lots they call it the hottest on the lot."—California retired merchant.

"Plymouth has an engine I thought it would never have. It would be a good one to soup up for drag races."—Washington milkman.

Comfortable ride was third on the list of best-liked features among both V8 owners and six-cylinder owners.

"Plymouth rides perfect. Hundreds of miles in a day and not a bit tired."—California railroad worker.

"Rides comfortably. Has the 'heavy car' feel."—California examiner.

"Luxury feel. It has the sensation of a heavy car, but the price of a lightweight."—North Carolina foreman.

"Fits as comfortably as an old shoe."—Florida electrician.

"Seats are high enough for comfort."—Maryland inspector.

### There Are Complaints

About one third of the Plymouth owners make no complaints at all about their cars. On the whole, V8 owners complain more than those with six-cylinder engines. The most-frequent complaint of V8 owners is poor gasoline economy (17.8 percent); the most-frequent complaint of the six-cylinder owners is the dash design and arrangement (only 8.6 percent).

"Poor gas mileage. I only average 13 miles per gallon. This is poor considering size of the car."—Indiana V8 owner.

"Had a few body squeaks, but they seem to have disappeared."—California chaplain.

Next on the complaint list of V8 owners are body rattles, dashboard design and poor body assembly. Among six-cylinder owners complaints include battery troubles, poor gas mileage and transmission trouble. Here are some V8 complaints:

"I have a four-door hardtop. The doors rattle."—Pennsylvania salesman.

"Don't like the dashboard setup in gen-

(Continued to page 268)

# WARNING!



Today's high-powered engines need frequent spark plug checks to prevent dilution of oil

## Don't change to summer oil without a spark plug check!

*If you haven't checked your plugs in the last 5000 miles, they may be misfiring—and will dilute your new oil with gasoline!*

It's a fact that every time a spark plug misses, raw gasoline remains in the cylinder and drains into your crankcase!

Naturally, this thins the oil so it can't properly protect costly engine parts . . . and may lead to a big repair bill.

So replace winter-worn plugs with new 5-rib Champions before you change to summer-grade oil! No matter what make or model car you drive, new full-firing Champions will protect your oil from dilution. What's more—they'll give you quicker starts, greater horsepower—and more miles per gallon of gasoline.

Ask your serviceman to check your spark plugs today. If you need new ones, insist on 5-rib Champions—the finest money



5-RIB

**CHAMPION**

SPARK PLUGS

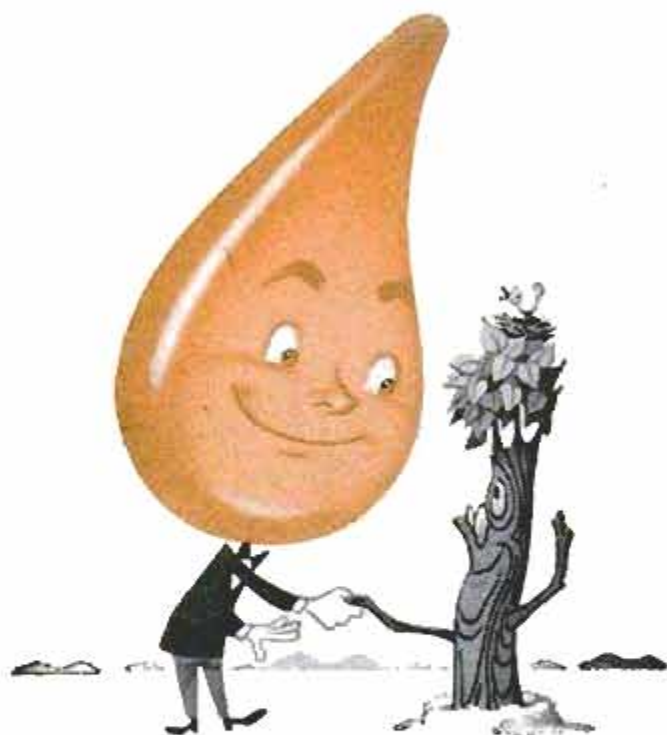

Pete Penn says:  
**"Mother Nature...**

stored her finest crude oil beneath the hills of the Pennsylvania Grade oil regions, where I come from."

That's why today's best motor oils are brands of Pennsylvania. No other motor oils are so *naturally* suited to the high-speed, high-temperature service of today's engines.

Take a tip from Pete Penn. At your *next* oil change, ask for a brand of Pennsylvania motor oil. Sold by good dealers everywhere.

**Today's BEST Oils**

**Start with Nature's Best Crude  
 ...and that means Pennsylvania!**



INSIST ON A BRAND OF



© 1956  
 PENNSYLVANIA GRADE CRUDE OIL ASSOCIATION, Oil City, Penna.

eral, particularly the placing of the radio speaker. If you have a passenger, the volume will drive him out if you are to hear."  
 —Texas Navy man.

"Can't see the gas gauge because of the horn ring."—Maryland repairman.

"Engineering is unquestionably the best, but more than half the screws were not fully tightened. Some were barely started. Sun visors do not move easily. Trouble with trunk lock. Radio knobs rattle."—New York electrician.

Here are some quotations from six-cylinder owners:

"Battery trouble from the beginning. Now on the third battery."—New York bookkeeper.

"I get very poor gas mileage. The salesman told me there is nothing wrong with 11 miles per gallon around town. I don't have automatic transmission."—Pennsylvania repairman.

"PowerFlite transmission has too much jerk when changes from high to low."—Florida widow.

**More Best-Liked Features**

The following quotations describe other best-liked features and are listed in order of frequency of mention. For a detailed tabulation of percentages see page 95.

"Not too expensive to keep up."—Connecticut six-cylinder owner.

"Spacious and beautiful interior with matching washable upholstery."—Washington, D.C., mechanic.

"Engine is quite powerful for a small car. The six-cylinder engine and standard transmission use less gasoline."—Illinois clerk.

"You can see everything from the driver's seat. Backing is easy."—Massachusetts cook.

"I drive nearly 40,000 miles a year. I get economy and dependability with no breakdowns."—Maryland superintendent.

"I have operated taxi fleets since 1933 and find Plymouths best for troublefree operation."—Washington, D.C., cab operator.

"Sure starting in cold weather."—Maine truck driver.

"Lots of room inside. Three can sit in one seat very comfortably."—California truck driver.

"Brakes are excellent. Even when wet they always work."—California farmer.

"I service my Plymouth Six myself and find adjusting brakes and other maintenance simpler on Plymouth."—Virginia clerk.

"Hugs the curves at high speed."—New Hampshire caretaker.

"Best heater I ever had."—North Carolina farmer.

(Continued to page 270)

# NEW!

## CRESCENT SOCKETS, ATTACHMENTS AND SETS



Complete Set No. CSB18-  
1/2" Square Drive. Twelve 12 point  
sockets 7/16" to 1-1/4", three handles  
and two extensions in a heavy gauge,  
piano-hinged steel case.

"Midget" Set No. CMB16. 1/4" Square Drive. Eight  
6 point and three 8 point sockets 3/16" to 7/16".  
two handles and cross bar and two extensions in a  
sturdy metal case with piano-hinged cover.

Now you can get world-famous Crescent quality in a new, moderately priced line of Socket Wrenches. All popular sizes. Six set combinations: 1/4" and 1/2" square drives; 6, 8 and 12 point sockets; standard and deep types; and a variety of handles, drives and attachments. Precision machined from alloy steel, permitting thinner than average side walls with no sacrifice of strength. Chrome-plated — loaded with utility features. Ask your hardware dealer.

CRESCENT and CRESTOLOY TOOLS are sold by hardware dealers and industrial distributors everywhere. Look for the bright yellow Crescent Display panels and select from one of the world's greatest assortments of quality hand tools.

**CRESCENT TOOLS**

*Give Wings to Work*

*Sign of the Artisan  
Symbol of Excellence*

Crescent is our trade-mark, registered in the United States and abroad, for wrenches and other tools. Sold by leading distributors and retailers everywhere and made only by **CRESCENT TOOL COMPANY, JAMESTOWN, NEW YORK**

# AMAZING TUBELESS AND TUBE-TYPE TIRE REPAIR SYSTEM ANNOUNCED!

REPAIR YOUR OWN TUBE  
OR TUBELESS-TYPE TIRES  
IN 5 MIN. *Without Removing  
WHEEL OR TIRE!*

Tyron's pure latex compound when inserted in puncture forms a sealant and lubricant for —



Tyron's exclusive 2-stop rubber plug. When plug is inserted in puncture hole according to directions form-fits, insuring a lifetime repair.

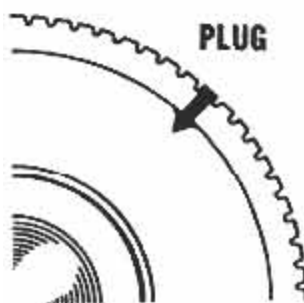

## TUBE-TYPE TIRE REPAIR

The use of Tyron's pure latex rubber compound alone will repair tube-type tires without removing the tube. Shown at left; lifetime patch made with Tyron pure latex compound.

PLUS...

Truck Tire Repair  
Bicycle Tire Repair  
Motorcycle Tire Repair  
Tractor and Farm Implements

Automotive Kit TMK-2 . . . \$1.98

**TYRON CORPORATION, Goodland, Kansas**

Dear Sirs: Please send me additional information about this amazing tire repair system.

For Tubeless Tires  For Conventional Tires

NAME \_\_\_\_\_

ADDRESS \_\_\_\_\_

CITY \_\_\_\_\_ STATE \_\_\_\_\_

"Tail fins make parking very simple. Just sight along them and park."—New York teacher.

"Conveniently arranged under hood for servicing."—Connecticut physician.

"Defroster is wonderful."—Washington, D.C., cab operator.

### And More Complaints

For a list of the most-frequently mentioned complaints, turn to the table on page 95. The following quotations describe the complaints and are arranged in order of frequency:

"V8-engine idle not set properly. Sometimes too slow, then too fast. Stalls frequently during warm-up especially in rainy weather."—Maryland scientist.

"Engine does not idle smoothly. Roars like a jet when you are starting out."—Wisconsin cemetery superintendent.

"Windshield leaks. Also doors."—Massachusetts setup man.

"Roof over windshield leaked considerably."—New York assistant manager.

"Glove compartment and ash tray give it a look of cheapness."—Maryland mechanic.

"Interior decoration too inexpensive."—Pennsylvania librarian.

"My complaint is with the dealer. I am actually leery of taking the car to them for service for fear they would foul it up some way."—New Jersey worker.

"Dealer service is fine, but the Plymouth factory doesn't send replacement parts on time. I waited two months for a dash-light switch and sun visor to replace those that were defective."—Connecticut mechanic.

"Transmission slippage excessive. Howls with grinding noise up to 35 miles per hour."—California maintenance man.

"Door doesn't fit right."—New Jersey housewife.

"Dome light goes on only with operation of right front door."—Wisconsin minister.

"Door handle broke. Window handles keep falling off. When gas tank is below half full, gas gauge jumps continually and it is impossible to tell gas level."—New Jersey project engineer.

"Gas indicator has continuous wide quiver that dealer says is normal."—New York clerk.

"Insufficient take-off with six-cylinder engine."—California accountant.

"Hard to start in cold or rainy weather."—New Jersey six-cylinder owner.

The following complaints, while not mentioned by very many owners, are interesting and valid enough to merit quotation:

"Trunk lid closes too hard. Have to bang lid so hard it sways car up and down. Road dirt covers apron in rear under back-up

(Continued to page 272)



# BIGGEST SAW VALUE

in power tool history!

Completely **NEW**  
**DURO MASTER**  
8" Tilting Arbor Saw

Here is everything you ever wanted in a power saw. Design, quality, precision, ruggedness and low cost. The *all new* DURO MASTER 8" Tilting Arbor Saw includes all important features and operating advantages including: "floating" motor shift, precision ball bearings, rugged "quick lock" rip fence, handy blade raising and lowering knob, one piece steel frame, convenient blade tilting mechanism with graduated scale and modern safety guard. And only DURO MASTER offers built-in conversion and adaptation features for tomorrow's needs, too!



Write for **FREE Brochure and Catalog** giving full details and specifications on this remarkable new saw plus other Duro models from \$59.95 to \$320.00.

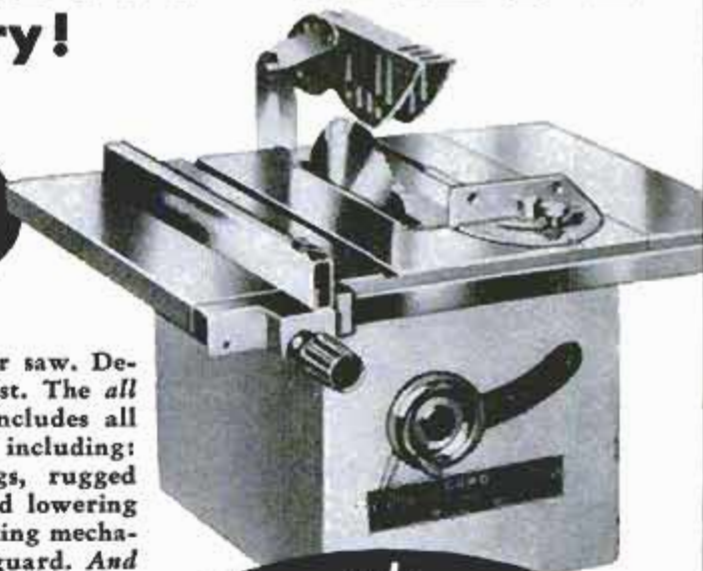

only  
**\$48.45**

Less extensions, splitter and guard  
\$53.45 as illustrated

**DURO METAL PRODUCTS CO.** 2683 N. KILDARE AVE.  
CHICAGO 39, ILLINOIS

World's Largest Manufacturers of Power and Hand Tools (Duro Chrome)

... now with the **NEW**



**Airguide**  
**Outboard**  
SPEEDOMETER

it's so easy  
to know  
how fast  
you can go

ONLY  
**\$15**

COMPLETE

AND WHAT A  
GIFT FOR A  
SPORTSMAN!

The only complete portable speedometer—No tubes to connect—No holes to bore

- Designed especially for outboards. Mounted on transom near motor. Head, bracket, stabilizer and pitot all in one compact portable unit. Instantly attached and detached, easy to carry (only 1½ lbs).
- Exclusive Airguide CONTRALOG® movement permits nearly uniform graduations from top speeds down to zero for easier reading.
- Sturdily made of finest materials. Fits transoms from 12" to 20" high and up to 1½" thick. Dial diam. 3". Choice of speed ranges 0-15, 0-30, 0-45 MPH. Other models available for permanent installation.

Made and guaranteed by  
**AIRGUIDE INSTRUMENT CO.**  
Chicago 47, Ill.

SEE THEM AT YOUR DEALER'S

Make **\$500 an Hour**  
**CASH PROFIT**  
THE DAY YOU START!



**START YOUR OWN BUSINESS AT HOME... SHARPEN HOUSEHOLD, GARDEN AND SHOP TOOLS IN SPARE TIME**

Now you can turn spare time into Big Cash Profits with new Belsaw Sharp-All. Sharpen knives, scissors, shears, snips, ice skates, mower blades, hedge trimmers, grass whips, axes, chisels, screw drivers, scrapers and saws... just about any household, garden and shop tool. Your own CASH business with no inventory. No calls to make. No experience needed.

Learn how easily you can start your own spare time business. Amazing low cost easy-payment plan. Send postcard for FREE BOOK.

**BELSAW SHARP-ALL CO**

716 Field Bldg.

Kansas City 11, Missouri

**FREE BOOK**

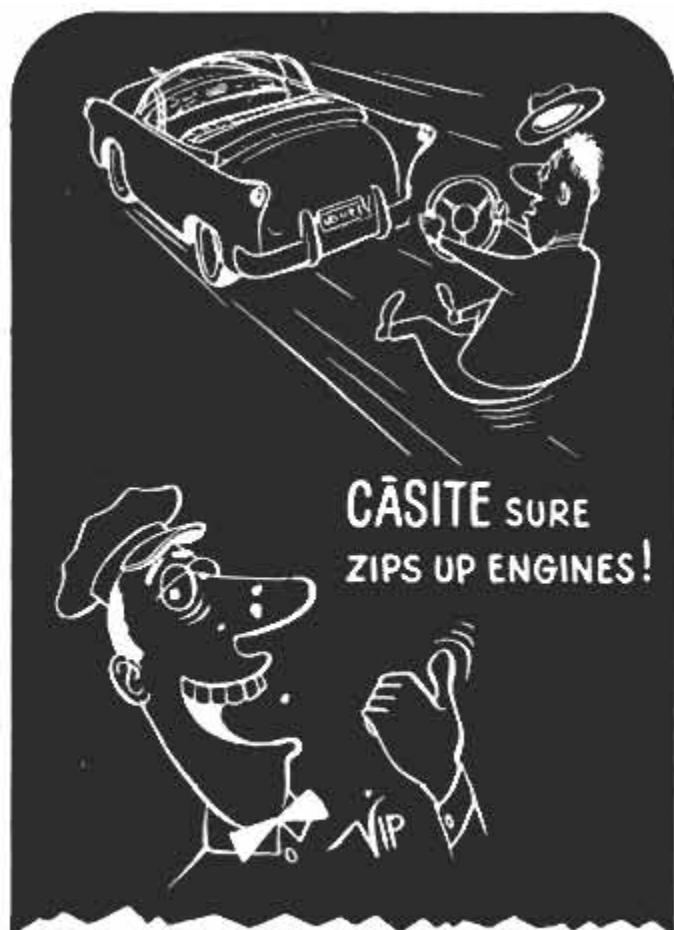

# TUNE-UP when you GAS-UP

A pint in the crankcase . . . a pint through the air intake . . . restores pep and performance—frees sticky valves and rings—keeps your engine clean or *Double-Your-Money-Back!*

# CASITE



HASTINGS MANUFACTURING CO., HASTINGS, MICH.  
Casite, Wear Reducer, Piston Rings,  
Oil Filters, Spark Plugs

lights."—New York hospital attendant.

"Both sun visors were too tight. Could not be used."—Indiana inspector.

"The emergency brake handle is L-shaped and gives a child enough leverage to release it by pulling on one side. It happened to us once. We have had handle cut down. There should be a park position in the transmission for additional protection."—Connecticut toolmaker.

"Heater instructions are very poor. They confuse our family."—California oilman.

"I don't like the unreliability of prices from dealers. Prices are inflated to compensate for high trade-in allowances. No two dealers carry same price list."—Connecticut store owner.

"Front license plate should not mount on bumper where it gets battered."—Washington, D.C., lawyer.

"Don't like oil filter. You have to throw the whole unit away at 5000 miles. It costs over \$6 instead of merely \$1.69 for a new replacement element."—Illinois owner.

"Center piece of grille seems to stick out too far and is easily dented by another car backing into it."—Illinois businessman.

And that is the story on the 1956 Plymouth. It is the good and the bad, as told to our survey. These hundreds of owners who drove millions of miles provided the most comprehensive test ever published by *Popular Mechanics*. ★ ★ ★

Turn back to page 93 for Floyd Clymer's impressions of the Plymouth and to page 94 for Dale Kelly's engineering data.

## Clymer Tests the 1956 Plymouth

(Continued from page 93)

the Mojave Desert and the Angelus Crest mountain highway.

I ran into snow with a sandstorm that caused the California Highway Patrol to close the Ridge Route for four hours, due to snowdrifts and winds of gale proportions. I cut across and drove the coast route to San Francisco. No dust entered the tight body, but the windstorm did a good job of sandblasting the windshield glass.

The big performance surprise was the increased wallop the V8 engine develops. Except for the increased acceleration and top speed, the 1956 model handled about the same as the last Plymouth tested. However, there is no complaint on this score, because Plymouth has always been one of the finest road cars in the low or medium-price field. It is not only comfortable and easy-riding, but roadability is tops, regardless of whether one is cornering, hitting bumps at high speed, or traveling over rough dirt roads. The car seems to loaf at

(Continued to page 274)

Get **MORE SPEED,**  
**SKILL, POWER**  
for **LESS MONEY!**

## Dormeyer POWER TOOLS

Only Dormeyer offers you more exclusive features, high quality at lowest prices!

**Dormeyer 1/4" Drill Kit**  
Drill has famous geared chuck. Exclusive saw attachment.  
Model 5-3320  
\$49.95

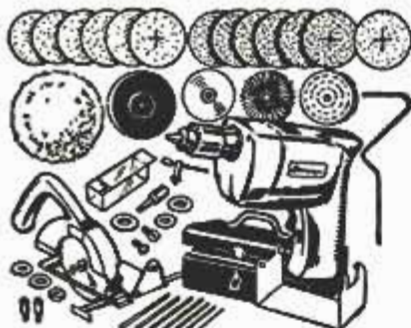

**Dormeyer Portable 6 1/2" Power Saw**  
Exclusive eye shield. Fingertip adjustments. Cutting line always visible.  
Model 5-7020  
\$69.95

**Dormeyer** Dormeyer Corporation  
Power Tool Div., Chicago 10

## NEW! Giant AUTOMOTIVE CATALOG

1956 Edition! Everything for car, truck, custom-styled car, hot rod . . . at **LOWEST PRICES!**

**SAVE UP TO 50%** on all parts, accessories! Only complete automotive buying guide . . . 75,000 items . . . 150 pages! Thousands of hard-to-find parts; equipment, parts for 1920 to 1956 models; Hollywood accessories never before offered; hi-speed parts. Send your name and address and 25c (refundable with first \$5.00 order) to:  
J. C. Whitney & Co. 1917 Archer, Dept. P-5, Chicago 16, Ill.



**YOU SHOULD EQUIP  
YOUR  
TRAILER  
WITH**

**why...**



## BULL DOG

- AXLE ASSEMBLIES
- JACKS • COUPLERS

**BULL DOG** straight or drop axles in single or tandem—capacities up to 10,000 lbs. steel axles—any width—and the famous safety-engineered "Torq-Less" axles for all types of trailers.

**JACKS**—Bull Dog Jacks make hitching and parking a one-man job . . . easy to install.

**COUPLERS**—Bull Dog Couplers hitch or unhitch mobile homes in a moment.

Write today for **FREE** descriptive folder 13-D.

**HAMMER BLOW  
TOOL COMPANY**  
WAUSAU • WISCONSIN



MAY 1956

Made  
**\$900**  
IN SPARE TIME

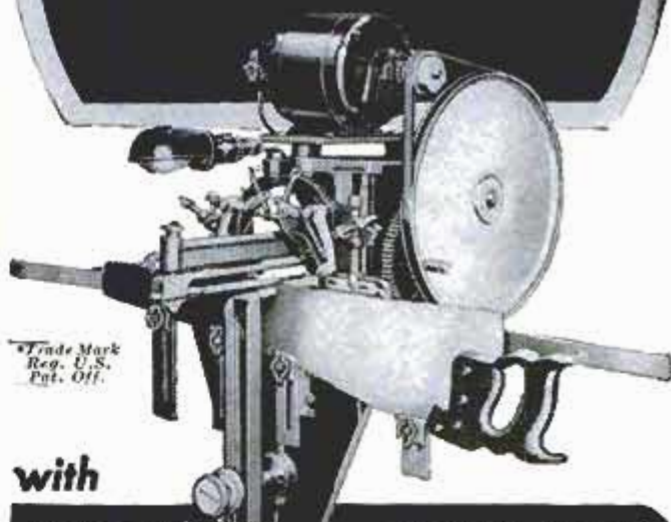

Trade Mark  
Reg. U.S.  
Pat. Off.

with

## FOLEY\* automatic SAW FILER

"I did very well last year with my Foley equipment, sharpening about 950 saws in my spare time. About \$900 for me."

Leo H. Mix

"I have done 4 or 5 thousand saws in my spare time in the 4 1/2 years since I got the outfit, and they are all coming back with repeat orders."

Len Crego

## Make up to \$3 or \$5 an hour in Spare Time

With the high prices of food, clothing and everything else, just think what you could do with extra money every week! With a Foley Automatic Saw Filer you can file hand, band and circular saws better than the most expert hand filer. "The first saw I sharpened with my Foley Filer came out 100%" — writes Clarence E. Parsons. Cash business, no canvassing. No eyestrain — no experience needed.

## FREE BOOK Shows How to Start

"**MONEY MAKING FACTS**" tells just what to do to start your own spare time business in your basement or garage. Just think — with a small investment, no overhead, no stock of goods to carry, you can get right into a cash business. Send coupon today — no salesman will call.



Send for **FREE BOOK**

**FOLEY MFG. CO.,**  
516-6 Foley Bldg., Minneapolis 18, Minn.  
Send **FREE BOOK** — "Money Making Facts"

Name \_\_\_\_\_

Address \_\_\_\_\_

273

now! assemble your own

## ALUMINUM SCREENS



save up to  
**50%**

LIFETIME PROTECTION—

YET IT'S ONLY MINUTES FROM PARTS TO FINISH WITH

## HOMESHIELD easy-to-make SCREEN KITS

Make your work shop pay off! Assemble these maintenance-free aluminum window screens for your home, cabin, or shop and save money. make 'em for neighbors, apartment houses or businesses, and make money! It's a simple assembly job that requires no special tools.

No more repairing or repainting! Replace heavy, old-type screens or screen your new home with sparkling Homeshield screens that'll dress up your home for life. Eliminates rust and stained walls. Lightweight—install or remove in a jiffy. No ladders needed.

Kits are complete with sturdy aluminum frames, easy-to-handle Fiberglas® screening, corner locks, installation hardware — even a miter box. Sizes for full screens and sliding half screens (and storm sash, too!)

Ask your department store, hardware or lumber yard dealer, or mail coupon for folder and name of nearest Homeshield distributor.



AMERICAN SCREEN PRODUCTS CO.  
Dept. PMK-5, 807 N.W. 20th Street, Miami, Florida

Name .....

Street .....

City ..... State .....

## HOLD-F-ZEE®

the Original AUTOMATIC GRIP  
SCREWDRIVERS

FINEST  
MATERIALS  
AND  
WORKMANSHIP



LOK-BLOK® makes blade twist and impact proof.  
GRIPPER recedes deep into handle, giving full blade use.  
SPECIAL BIT fits both types cross-point screws.

—YET COST NO MORE THAN  
ORDINARY SCREWDRIVERS!

At Leading Dealers Everywhere

UPSON BROS., INC., ROCHESTER 14, N. Y.

90 to 95 miles per hour. Indicated top speed by speedometer was 110 miles per hour. The speedometer was found to be about 7 percent fast.

The Plymouth suspension system, as in the past, is tops. A combination of Plymouth's direct-action shock absorbers and a linkless stabilizer has much to do with Plymouth's excellent roadability. Front springing is rather soft, yet when cornering, control of the car is good, although there is above-average body roll. I like Plymouth's full-time power steering.

The test car was equipped with power-operated brakes, having 158 square inches of effective area and bonded (not riveted) brake linings are used. Brake shoes are individually anchored. There are two cylinders in each front wheel. Plymouth has one of the best sets of brakes I have ever used. Only slight fade was noticeable in stops from top speeds and on some steep, winding descents when brakes were used a lot.

Plymouth's PowerFlite automatic transmission is a torque converter with gears. With proper use of the throttle it shifts quite smoothly, but if handled carelessly shifting can be rough. The only objection I have is that above 55 miles per hour no kickdown gear is available. Below 55, if the throttle is floored, the car leaps forward with a surge as the lower gear comes into use. If the throttle is held down, the upshift takes place at about 63 miles per hour.

There is a minimum of engine vibration at any speed. There is some hood flutter at speed on rough or wavy roads. Wind noise and body rumble seem to be less than in previous Plymouths.

Plymouth's gas mileage has suffered as a result of larger displacement, more horsepower, automatic transmission and more weight. It can't match the old dependable L-head Six for economy, but the buyer of a 1956 car is apparently more interested in performance than in economy. The buyer must decide which he wants, as high performance and economy do not go together. I found regular gas to be satisfactory.

Interior appointments are of high quality, although the painted lower portion of the dash is not in keeping with the rest of the instrument panel. Instrument vision is good, but the full-circle horn ring is annoying because the top portion is directly in line of speedometer vision. The gasoline and temperature gauges are directly in front of the driver (also with vision obstructed by the horn ring). I have always liked Plymouth's electric windshield wipers. All lights are controlled by a left-hand-operated switch, as is the push-button-transmission control, which is located out

(Continued to page 276)



## LOWEST COST PER MILE

Here is the electric fuel pump that will give you greater power and faster acceleration. The Bendix\* Electric Fuel Pump has better performance with less operating cost per mile. Sold by independent garages and service stations.

\*REG. U. S. PAT. OFF.



**FREE:** A complete descriptive folder is yours for the asking. Write us today.

**Bendix**

## ELECTRIC FUEL PUMP

Grand Prix Winner

ECLIPSE MACHINE DIVISION, BENDIX AVIATION CORP.  
ELMIRA, N. Y.

## MAGNETS

5 Assorted Size Magnets \$1.00. Powerful Pocket Magnet W/ case \$1.00. Hot Pad Magnets—large size \$/ \$1.00. Bulletin Board Magnets \$/ \$1.00. Slender Magnets—pencil type 2/ \$1.00. Car Compass—accurate, useful \$1.50. Retrieving Magnets—extra power, heavy duty—30 lb. pull \$4.00, also 50-75-100 lb. pull.

Explore, learn Electricity, Magnetism, Electro magnets, complete kit and instructions with 22 experiments and models.....\$3.98 Also — Rods, discs, bars, horseshoes. Send stamp for catalog — Specify your requirements — 100% SATISFACTION GUARANTEED. PARK MAGNETS, 265, 1557 GREENBAY RD., HIGHLAND PARK, ILL.

## MORE \$\$\$ PER HOUR WITH MODERN IMPROVED LAWNMOWER SHARPENER



Write for free booklet 10A

Grinds All Reel Type Mowers Hollow Grinds or Flat Grinds Bed Knives

Engine, oil, or gasoline are not removed from power mowers. Wheels, handle and roller remain in place. Moderns precision grinding assures repeat business. 100% Steel Construction

Compare Before You Buy

Faster—Easier to operate

NO CHANGE IN PRICE FOR OVER 10 YRS.

**\$263.00** Complete with 1/2 H.P. Motor f.o.b. Pasadena, Calif

**MODERN MFG. CO.**

160 N. FAIR OAKS, PASADENA, CALIF.

## How to choose a paintbrush that does faster, streak-free work



Here's why it pays you to use a brush with Du Pont TYNEX nylon bristles



**1. No break-in!** You don't have to soak or flex a new brush . . . if it has "Tynex" nylon bristles.



**2. Full paint pickup!** Specially tipped and flagged "Tynex" bristles hold a full load of paint.



**3. Smooth, even flow!** Anyone can do streak-free work, because each tapered "Tynex" bristle provides better, more even flow.



**4. Easier to clean!** They're the easiest-to-clean bristles there are! Paint loosens quickly in any commercial cleaner, rinses out thoroughly.

**FREE!** 8-page booklet full of helpful painting tips. Write Du Pont Company, Polychemicals Dept. PM-5, Wilmington 98, Del.



"Tynex" is the registered trade-mark for Du Pont nylon bristles.

BETTER THINGS FOR BETTER LIVING... THROUGH CHEMISTRY



**Chuck Stevenson**, ace driver of NASCAR (National Association for Stock Car Auto Racing) says:

## "Here's the oil filter we 'pro' drivers use!"

**—Purolator is best for every make of car!"**

Protect your car like the "pro's" do! Driving cars just like yours, 9 out of 10 NASCAR drivers choose Purolator oil filters . . . find they trap up to 3 pounds of grit in every race!

Purolator Micronic filters stop dirt fine as 39 millionths of an inch . . . have up to 10 times greater capacity than many oil filters.

Ask your serviceman to put in a Purolator refill every 4000 miles—when he changes your oil. Takes only minutes. From \$1.60.

©1956, Purolator Products, Inc., Rahway, N. J.; Toronto, Canada.

"Purolator" and "Micronic," Reg. U. S. Pat. Off.

**Proved best for every make of car**

# PurOlator

**OIL FILTERS**

of reach of children. Plymouth now uses warning lights for generator and oil pressure. I prefer the needle indicators.

Directly in the center of the dash is the radio and it is a good one. Heater controls have been moved far to the right, directly in front of the passenger. The location is fine for the passenger, but requires considerable reaching for driver operation. The heater is effective.

There is a lot of leg and interior room. The driving position is most comfortable. The cushions and seat backs are well upholstered, with good springing. The brake pedal is wide and well located. The parking brake operates on the propeller shaft, independently of the wheel brakes. Applying and releasing is smooth as the operating rod slides through a pivoted bracket, which eliminates binding action.

Doors now open with a pull of the handle instead of by push button or a twisting movement. Closing of the doors is a little on the hard side. The doors have a solid feel and there was no evidence of dust leakage even after three hours of one of the worst sandstorms I ever drove through. Three turns of the crank lower or raise a window and cranking seems harder than on previous models.

Plymouth bumpers have no bulletlike projections front or rear, although the center of the bumper (where the license plate is mounted) is the first part of the bumper to touch another car. It is a poor location because it offers no protection for the license plate, which as a rule soon becomes battered from contact in parking. The counter-balanced rear-compartment lid is easily opened and closed. It is not self-locking and requires a key to lock it. ★ ★ ★

*For engineering data on the Plymouth V8 turn back to Dale Kelly's report on page 94.*

## Artificial Respiration For Young Children

Children under two years old are given artificial respiration with a new method explained in the American Medical Journal. The child is held on the outstretched forearm of the operator, with the head face-down in the operator's hand and the legs straddling the elbow joint. The tongue is depressed with a finger. The operator lowers and raises forearm and baby eight to twelve times per minute in a 90-degree arc bisected by the parallel. The baby's abdominal organs push and tug on the diaphragm, forcing air in and out of the lungs. The easily learned method prevents injuries possible with other systems.

# NEW Easy-to-Use SOLDER



**Solders in ONE  
operation... just apply  
Swift and heat**

SWIF is a real 50/50 tin-lead solder in paste form with flux combined. Just apply Swift and heat. All extra preparatory steps are eliminated by its one-step cleaning, tinning and soldering action. It makes perfect soldered connections with the heat of a match, torch, or soldering iron. Tube holds enough Swift for hundreds of jobs. Swift has been used by professional plumbers for years. At hardware, hobby, plumbing and auto stores. 59¢ per tube.

Send For Free Literature

**HERCULES CHEMICAL CO., Inc.**  
416 B'way., New York 13, N. Y.



## BUILD D.C. WELDER!

BUILD 150-400 amp. DC WELDER without re-winding! Buy welder kits, aircraft generators, etc; DIRECT FROM MANUFACTURER. Easy illustrated plans & welding booklet 50c. Includes WHOLESALE CATALOG & questions on welding answered. Send 50c TODAY. Money back guarantee.



LEJAY MFG CO., 1247 Le Jay Bldg., Minneapolis 8, Minn.

Say You Saw It in Popular Mechanics

## KEEP ALL SAWS SHARP



SO EASY: With this new filing jig and jointer anyone can now sharpen any handsaw like new! When file hits hardened steel rollers teeth are finished and EXACTLY SAME HEIGHT. All teeth cut and saw runs true and smooth. Jig and instructions \$2.95 postpaid. Free literature.

SAVE TIME AND \$\$\$

### JOINT & SHARPEN CIRCULAR SAWS

Sensational new Super Filer No. 11 joints and sharpens both hand and circular saws 6" to 10" with all teeth the correct height, depth, pitch and bevel. Easy to use—when file hits hardened steel roller, teeth are finished. Saw runs true and smooth with no side pull. Complete with special 8" file \$9.95 p.p.d. "TRU-CIRCLE" saw set automatically sets teeth at 10° or more \$2.95.

### SUPER SAW FILER NO. 6

Automatic controls  
DEPTH ANGLE PITCH  
Automatic DEPTH CONTROL  
Rollers

**SUPER DRILL GRINDER**  
Sharpens round shank drills from 3/32" to 1/2" in diameter, up to 6" long. Grinds old drills like new in 4 different point angles, using hand or power grinding wheels... \$2.95

A. D. MCBURNEY, 5908 Hollywood Blvd., Hollywood 28, Cal., Dept. A-56

## FREE! SPRAY-GUN PAINT STRAINER

LIMITED TIME OFFER  
Mail this coupon today! Get your FREE strainer.

**JOHNSON SERVICE COMPANY**  
Compressor Division, PM-5, Milwaukee 1, Wisconsin  
Please send me price list and free literature describing the Johnson Compressor line. Also send me my free spray-gun paint strainer. No obligation.

NAME \_\_\_\_\_  
STREET \_\_\_\_\_  
CITY & STATE \_\_\_\_\_

## JOHNSON Portable & Piston Model AIR COMPRESSORS

Professional Quality at Popular Prices!  
for SHOP, HOME or FARM USE

MAIL TODAY!

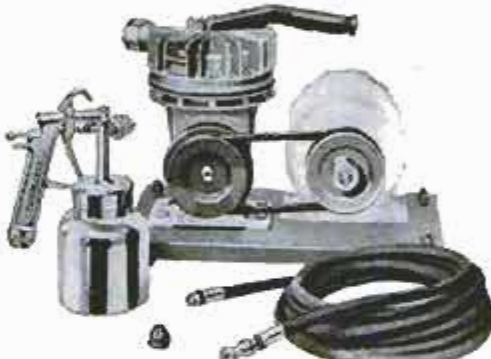

These are the same top quality compressors that deep sea divers, Army and Marine field forces depend upon! 17 different models... a popular priced unit for every use. All guaranteed to deliver 100 lbs. pressure.

For Painting, Spraying, Inflating, Lubricating, Cleaning... Model 1520 (illustrated) delivers more air than many models three times its size! Sealed ball bearings. No piston rings... no oil needed. Helps you do dozens of "everyday" jobs easier, faster, better, cheaper! Cuts down on repair bills for home, car, machinery.

Powered by Electricity, Gas Engine, 6 or 12 Volt Storage Battery. Regardless of the job, wherever you want to work, there's a Johnson Compressor to fit your exact needs!

Complete Line of Matched Accessories for Every Job. Free catalog illustrates 17 different compressors and all kinds of accessories... hose, spray guns, tire chucks, grease guns, mounting brackets, air gauges, blow guns, etc. For farm buildings, famous Insectospray attachment kills insects with push-button ease!



**JOHNSON SERVICE COMPANY**  
507 E. Michigan St., Milwaukee 1, Wisc.

# REPLACE YOUR

## OLD WOOD CELLAR DOOR



WITH A  
MODERN  
ALL-STEEL  
BILCO  
DOOR

# DO IT YOURSELF

IN JUST 3 TO 4 HOURS

Think of it! Only a few hours of pleasant work to replace your unsightly, troublesome wood hatchway with a lifetime, weathertight BILCO . . . the door installed on tens of thousands of new homes.

**PAYS FOR ITSELF!** Cost so little, yet never needs repair or replacement. Operates at a touch. Smooth, trim appearance adds amazing new beauty to your home.

Rush coupon TODAY for free folder and "Do It Yourself" pamphlet showing step by step replacement of wood hatchway.

# Bilco®

AMERICA'S FINEST  
BASEMENT DOOR

THE BILCO CO.  
DEPT. 330C  
NEW HAVEN, CONN.

Gentlemen: Please send me "Do It Yourself Pamphlet" along with other literature showing sizes.

Name \_\_\_\_\_

Street \_\_\_\_\_

City \_\_\_\_\_ State \_\_\_\_\_

## BUILD YOUR OWN POWER TOOLS-

With

GIL-BILT PARTS-PLAN  
KITS

PLANS  
only  
\$1.00  
EACH  
POSTPAID

### 10" TILT/ARBOR SAW

Sturdy wood, steel, and aluminum construction. NEW DEPARTURE ball bearings. Capacity and performance of floor saws selling for \$150.00 and up. Plans, all metal parts in kit with 10" comb. blade \$25.90, less blade \$22.95, F.O.B. St. Louis. Detail PLANS—PATTERNS only \$1.00 postpaid.

### 12-IN. BAND SAW

Ball bearing drive, rigid cast aluminum wheels, rubber tires. Handles stock up to 6 inches thick. Cuts to center of 24" circle. 18 x 18 inch tilt table. Capacity and performance of band saws selling for \$80 and up. Plans and all metal parts in kit with 1/4" blade \$23.95. Detail PLANS—PATTERNS only \$1.00 postpaid.

For shipments up to 600 miles, add 3%; over 600 add 10%. Amount in excess of actual postage will be refunded.

Also Build-it-yourself 18" Band Saw, 6" Belt Sander, Shaper, 8" Tilt-Table Saw. Simplified plans, build easily with hand tools only. Advertised and sold for 8 years, over 30,000 units in use. Money back Guarantee. FREE CATALOG.

GILLIOM POWER TOOLS DEPT. 80-E, LAMBERT FIELD  
ST. LOUIS 21, MISSOURI

## SUPER-LIGHT LEVEL HAS MAGNIFIED VIALS!



EMPIRE  
ACRA-LITE  
No. 1521

A craftsman's dream! Acra-Lite Magnesium Level is ONE THIRD Lighter — for easier, faster handling. Easier to read, too. Super-accurate vials have "Full-View" magnifying cover plates. Get YOURS today — at your dealer, or order direct.

New Empire Acra-Lite Magnesium Level No. 1521,  
24" Only 28" 48"  
\$6.70 \$7.60 \$13.50

EMPIRE LEVEL MFG. CO.  
10930 W. POTTER RD., DEPT. PM, MILWAUKEE 13, WIS.

... Your assurance of a job well done!

## KATO A.C. GENERATORS

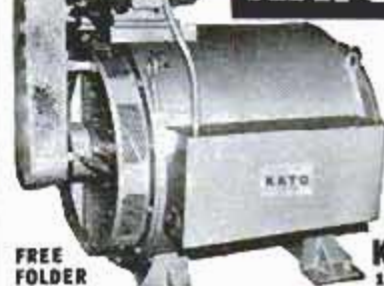

A WIDE VARIETY FOR ANY  
ELECTRICAL APPLICATION!

Adaptable to all well-known makes of engines. 350 Watts through 500 KVA and larger. To 600V. Odd frequencies from 25 to 400 cycles. Also, Rotary Converters, High Frequency Changers, Motor Generator Sets.

FREE  
FOLDER

KATO Engineering Company  
1402 First Ave., Mankato, Minn.

## SAY YOU SAW IT IN POPULAR MECHANICS

Need an extra \$1,000, \$2,000, or more? Make it with an

## IDEAL LAWNMOWER SHARPENER



There are thousands of lawnmowers in your locality; Average \$1,000 profit per 250 mowers with customer satisfaction and repeat business assured. Provide this essential service with an Ideal® Lawnmower Sharpener, the only machine that grinds the reel to "fit" the bed knife. Compare by any standard. The Ideal, backed by 53 years of experience, costs no more. Write today for complete, free catalog.

THE FATE-ROOT-HEATH COMPANY  
Dept. PM-5 Plymouth, Ohio



**U. S. DEPT. OF AGRICULTURE PERFECTS NEW GRASS THAT SMOTHERS CRABGRASS & STAYS GREEN DESPITE DROUGHT!**



Grows so thick, 2 men can't pull it apart.



**AMAZOY**  
MEYER Z-52  
ZOYSIA GRASS

**MEYER Z-52 ZOYSIA GRASS GIVES RICH VELVETY TURF**

- Now Is The Time To Plant
- Grows Well In Any Soil
- Needs 1/3 Less Mowing
- Never Needs Re-Seeding

FEATURED in LOOK and Other Mags. Also by Godfrey on TV

**NOT ENOUGH FOR DEMAND!**

There is not enough Meyer Z-52 Zoysia Grass in the ground to supply the fast growing demand. Order now for prompt delivery.

**AMAZOY GRASS Won't Burn Brown! Thrives Under Scorching Sun!**

At last, a care-free lawn that stays lush, green! AMAZOY MEYER Z-52 ZOYSIA GRASS thrives in hottest weather. Its deep root system (2 ft. or more) holds deep water. Goes weeks without rain or watering. Eliminates ugly brown or bare spots due to drought.

**U. S. GOVERNMENT APPROVED**

Credit for amazing Meyer Z-52 Zoysia Grass belongs to U. S. Dept. of Agriculture and the U. S. Golf Assn., Greens Section. After years of research their specialists perfected this amazing grass that "weeds" itself, grows in any soil, sand, gravel, subsoil or clay. Now thousands of delighted lawn owners all over the country have proven that an AMAZOY lawn improves year after year.

**CHOKES OUT CRABGRASS, WEEDS, NEEDS 1/3 LESS MOWING**

AMAZOY Zoysia Grass spreads from root runners to form a dense velvety turf! Grows so thick that crabgrass, weeds, disease, insects cannot live in it. Grows wonderfully even at ocean beaches . . . perfect on hills and slopes to prevent costly erosion. Never requires reseeding. Goes off color after heavy frosts . . . survives sub-zero temperatures . . . reverts to deep rich green each spring. A true winter-hardy perennial! Resists "playground" punishment.



**EASY TO PLANT NOT GROWN FROM SEEDS!**

AMAZOY comes to you in vigorous plugs of Zoysia grass ready to plant as recommended by the U. S. Dept. of Agric. No loss as with seeds, by washout or hungry birds. Once established, AMAZOY's flourishing plugs spread to form a thick velvety turf . . . and you can take 50 transplants from each square foot of your AMAZOY LAWN, YEARLY.

**YOUR LAWN can be a GOLD MINE**

Once established your perennial Zoysia Lawn can offer you a CONTINUOUS SOURCE OF INCOME. Sell Zoysia Transplants to neighbors. Endless supply year after year.

**AMAZOY GUARANTEED TO GROW!**

AMAZOY is the finest pure strain of Meyer Z-52 Zoysia Grass. Guaranteed free of weeds. Shipped fresh from the ground, Processed, packaged and guaranteed to reach you at peak vitality! We guarantee any AMAZOY plugs which fail to grow will be replaced absolutely free of cost. Order with full confidence direct from nation's leading Zoysia Grass Farm! No middleman.

**ORDER AMAZING ZOYSIA GRASS BY MAIL!**

**50 PLUGS \$4.98**

Plants 50 sq. ft. One Plug per sq. ft.

**FREE! REG. \$4.95 Exclusive 2-WAY PLUGGER**

With 100 or more plugs, we enclose our new patented step-on plugger . . . plugs lawn and destroys harmful competing grass at same time, giving you far faster, healthier growth. NO ONE ELSE CAN GIVE YOU THIS work-saving, growth-producing 2-way PLUGGER with your Zoysia Plugs.

- 100 plugs & plugger . . . \$11.98
- 300 plugs & plugger . . . 24.98
- 650 plugs & plugger . . . 49.98

Enclose check or Money Order. Sorry No C.O.D. Shipped Postpaid E. of Miss. Riv. West of Miss. add 75c per 50 plugs for shipping. WRITE FOR PRICES ON LARGER QUANTITIES



**ORDER ZOYSIA FARM NURSERIES, Dept. 11E-1 BY MAIL** 333 N. Michigan Ave., Chicago 1, Ill. -602 N. Howard St., Baltimore 1, Md.

**NOW! It's EASY To REMOVE STUMPS With "MAGIC" STUMP REMOVER**

All you do is pour "Magic" Stump Remover—a new, quick-acting chemical compound—into hole drilled in center of stump. Wood fibres soon decompose all way to root tips, making removal easy . . . even for women and youngsters! SPECIAL TRIAL OFFER: 8-oz. Can (enough for one stump)—\$1.50; 16-oz. — \$2.50; 3 lbs. \$5.00. Send no money! Pay postman, plus postage. (Or send full amount with order for postpaid delivery.) Satisfaction Guaranteed or Money Refunded!



No Digging! No Chopping! No Blasting!

EASY TO USE! Saves Time, Money!

FREE! Generous sample of "GRO-GREEN," new liquid lawn fertilizer, with each Stump Remover order. H. D. CAMPBELL CO. Rochelle 42, Ill.

**BUILD YOUR OWN ELECTRO-FOAM ARC WELDER**

\$1.00 worth of material or so builds indestructible arc welder that can weld up to 1/4" rod intermittently. Can be plugged into 110 volt outlet for light work. Order complete assembly plan for only \$1.98 to ELECTRO-FOAM ARC R.F.D. Box 437A Westbrook, Conn.

**PAGE TILLERS**

New 1956 "Page-Boy"

Makes tough jobs easy! 3 Models—1 1/2-2-3 1/2 HP. Tiller, mower, snow blow attachments easily shifted. Safe and easy to operate. Rugged steel frame, adjustable rubber tired wheels. So handy around the home or farm!

- ★ FULLY GUARANTEED
- ★ LOW PRICED
- ★ EASY TERMS



FREE CATALOG—Complete tractor line with all attachments. PAGE 1904 South 81st Street Milwaukee, Wisconsin

**Greatest SANDER VALUE in Power Tool HISTORY**

NOW Only \$19.95

MODEL 2000



Now you can buy the most popular sander in the home workshop field at the new, low price of only \$19.95. Dremel's Model 2000 is the ideal all-purpose sander for all your home sanding and polishing tasks, spring clean-up work, boat refinishing, etc. Why sand by hand or bother to rent a machine—when you can get a high quality sander at this sensational low price.

DREMEL STRAIGHT-LINE ACTION SANDERS sand with-the-grain of the wood. Any other action sands across-the-grain leaving orbital scratches and swirl marks, spoiling the finished appearance of your wood.

- Model 2000 Sander with 6 abrasive sheets, 1 polishing pad. . . . \$19.95
- Model 2000 Sander Deluxe Kit with steel case, 24 abrasive sheets, 1 polishing pad. . . . \$24.50

SEE YOUR DEALER. If he cannot supply, order direct on a 5-day trial, money-back guarantee. Remit in full for postpaid shipment; or send \$2.00, pay postman balance plus postage and C.O.D. fee.

Write For FREE Catalog Dremel Manufacturing Co. DEPT. 116-E RACINE, WIS.

# DS19... the new CITROËN is here!

The most advanced expression of automotive design... economically European... automatically American... so unmistakably CITROËN.

We cordially invite you to see the new DS 19, the safest car in the world, in the CITROËN showroom today... where a complete demonstration awaits you!



For more information and Dealer nearest you write:

## CITROËN CARS CORPORATION

300 PARK AVENUE, NEW YORK 22, N.Y. EL 5-2872 • 8423 WILSHIRE BLVD., BEVERLY HILLS, CALIF. OL 3-4745



### 1/6 H.P. HIGH SPEED MOTOR

A Whirlwind of Power — BRAND NEW WESTINGHOUSE 10,000 R.P.M. . . . Series Type

Heavy, continuous duty — Full 1/6 H.P. Operating on AC or DC. Life-Standard base mtg. 5/16" dia. shaft, 1 1/4" long. Use as a variable speed unit with rheostat. Ideal for tool post grinders, dental & jewelry lathes, laboratory equipment, blowers; and for building countless special devices. Compact powerhouse — 3 1/2" h. x 3 1/2" l. A Bargain!

Regularly \$28.00

Only \$16<sup>50</sup>

Prepaid

ROBERTS ELECTRIC CO., Dept. PM-452, 849 W. Grand, Chicago 22, Ill.

Say You Saw It in Popular Mechanics

## WAR SURPLUS AND OTHER BARGAINS SAVE UP TO 90%



### ARC WELDER KIT \$24.95—build your own

Complete make-up package consisting of 1 Aircraft DC Generator, Electric Auto-Lite, 200-250 Amps, 24 Volt, RPM from 2800 up, 1 Rheostat, 1 Giant Toggle Switch, 1 Ammeter, 1 Shunt, 0 to 240 Amps, 1 Voltmeter, 0 to 30 Volts, 1 Electrode Holder, Wiring diagram chart showing conversion of Aircraft Generator to Arc Welder, Shpg. Wt. under 100 lbs. Approx. GOVT. COST \$475. Buy of a lifetime. Like new, perfect. \$24.95.

D.C. Generator—same as above, if purchased separately: \$12.50.



### BUILD YOUR OWN ARC WELDER, LIGHT PLANT OR BATTERY CHARGER

Complete Kit \$39.95

Kit consists of: 1 Famous Navy NEA-5 Generator, New! Combination AC-DC Type, AC voltage—115 V, DC voltage—24 V, 200-300 Amps, 2 complete generators in 1... 2 separate fields & 2 separate armatures on same shaft yet no larger than reg. aircraft generator. Ideal for home, farm & shop lighting plants by hooking wires to AC side which will give 1200 watts, DC side can be used for charging batteries, welding & operating war surplus low voltage hobby motors & equipment. Also in kit: 1 Voltage Regulator DC, 1 Voltage Regulator AC, 1 Reverse Current Relay, 1 Ammeter, 1 Shunt, 0 to 240 Amps, 1 Voltmeter, 0 to 30 Volts, 1 Rheostat, 1 Electrode Holder, 1 Giant Toggle Switch, Wiring diagram for hookup as welder, Wt. under 100 lbs. Approx. GOVT. COST \$600. Kit, only \$39.95.

Navy NEA-5 Generator—same as above, if purchased separately: New—\$27.50.



### HIGH SPEED HAND TAPS

10 assorted, precision-ground thread. Popular sizes, National Mfr. Like NEW. Approx. GOVT. COST \$25. Now \$2.50.



### "HELIOS" ORIGINAL TOOLMAKERS VERNIER CALIPERS

ULTRAPRECISION—Imported. Used by machinists at Lockheed, Douglas, Bendix, GM, RCA, GE. Model 51/2E. Genuine Helios. Hardened lapped precision surfaces. 1/1000" and 1/128" graduations. Handy slide roll and thumb lock. Quick, accurate depth. A \$35 value. Satin finish. ALL NEW. Just \$6.99. Leather carrying case, \$1 extra.



MICROMETERS Chrome plated, precision engineered, carefully tooling to give long life. All new 0-1" cap. \$2.25 ea., 1-2" cap. \$3.50.

### NEW! 1956 CATALOG

Largest ever... just out... new low prices. Send 25c for your copy today. Prices F.O.B. Culver City unless otherwise stated. Check, cash or money order. 25% deposit for C.O.D.

AIRBORNE SALES CO., INC. DEPT. PM556  
8501 Stellar Drive, Culver City, Calif.

Also Eshelman Adult 2 Pass. SPORT & GOLF Cars

1/5 the Price of most other Cars. 70 Miles Per Gal. Free Catalog.

**ESHELMAN TRACTORS** LOW AS \$99

For Better Lawns and Gardens Investigate Eshelman Riding Rotary Mowers, Tillers, Tractors. Advertised in GOOD HOUSEKEEPING. Thousands of Satisfied Users. Free Literature Write:

**ESHELMAN**  
Dept. M-55, 109 Light St., Balto 2, Md.

Shipping Points: BALTIMORE - CHICAGO - BENO



## Get New 128 Page Catalog of WOOD AND WOODWORKING MATERIALS

WORLD'S LARGEST SELECTION—Lowest Prices Your buying guide for finest kiln dried domestic and rare imported woods, inlays, bendings, matched plywood, mouldings, ornaments, etc. Biggest selection of tools and hard-to-find hardware. Filled with scroll saw patterns, projects, wood facts and money making ideas. Enclose 25c (refunded on first order) to help pay mailing and handling costs. Write today to **CRAFTSMAN WOOD SERVICE CO.** 2729 S. Mary St., Dept. A-5, Chicago 8, Ill.

## ELECTRIC SELF STARTER

for small aircooled engines up to 12 horsepower.—All kits designed for easy installation on lawn-mowers, garden-tractors, etc.

Write for details regarding Dealerships and Distributorships **CHIEF INDUSTRIES, Dept. P.M., Dowagiac, Michigan**

## "SPEEDY" DRILL GRINDING GUIDE

MAKE OLD DRILLS LIKE NEW...

For repointing dull and broken twist drills up to 1/2" in diameter. One piece cast Aluminum. Simple. Anyone can use it. Order your to-day. \$1.00 post-paid.



**BRASS CASTING CO.** \$1.00  
P. O. Box 3034 Memphis 9, Tenn.

DO IT YOURSELF  
It's Easy With...



Soldering's really a "cinch" . . . when you use time-tested, reliable KESTER . . . available everywhere.

FREE! "Soldering Simplified" . . . 16-page how-to-solder booklet. At your dealer or write direct.

**KESTER SOLDER COMPANY**  
4251 Wrightwood Avenue Chicago 39, Illinois

most amazing blade you ever saw!

# Tyler SPYRAL BLADE

SAWS METAL, WOOD, PLASTIC, ETC.  
up or down, right or left, even in circles!



Does what no other Blade can Do. Fits Standard Coping Saw or Hacksaw Frames. NO special adapters needed! World's safest saw blade.

You'll find hundreds of uses for Tyler Spyral Blades. There's nothing like them! The first important improvement in blades since the invention of the saw. Fun to use... cuts so fast and easy; no chipping or tearing—leaves clean smooth edge.

AT YOUR HARDWARE DEALER, OR SEND \$1.00 FOR...  
12 Spyral Coping Saw blades—OR—3 Spyral Hacksaw blades

TYLER MANUFACTURING CO. 1005 W. Arbor Vitae Ave., Inglewood, Calif.



## The Modern PLASTIC for lasting Home Repairs

PERMANENTLY mends cracks or holes in wood, tile, stone or plaster. Sticks and stays put—Does not chip, shrink or fall out. Easy to use. Economical. Mold it, chisel it, polish or paint it. The big 4-lb. can is obtainable from your lumber, paint or hardware dealer at \$1.25; or will be shipped direct postpaid (in U. S.) for \$1.50. Complete satisfaction guaranteed or your money refunded.

DONALD DURHAM CO.  
Box 804-T Des Moines, Iowa

## Find HIDDEN TREASURES

GOLD, SILVER, PRECIOUS METALS with the Famous Model 27 Metal Detector. Lightweight, ultra-sensitive, low cost. None finer. Also GEIGER COUNTERS for uranium and the VIOLITE for tungsten. INFORMATION FREE

THE *Detector* CORP.  
5528 Vineland Ave., No. Hollywood, Calif.



## SAY YOU SAW IT IN POPULAR MECHANICS

## BETTER WORKMANSHIP IS EASY

- with NICHOLLS TOOLS
- It's easier to do a better job with Nicholls quality TROWELS, FLOATS, CEMENT TOOLS, DARBIES and HAWKS.

NICHOLLS  
CARPENTER SQUARE  
... the leader since 1896!



ASK YOUR  
DEALER FOR

NICHOLLS  
TOOLS

You Can't Buy a Better Tool

NICHOLLS MANUFACTURING CO. OTTUMWA IOWA

# SO EASY TO USE...

# SO POWERFUL.. SO DURABLE!

and



MODEL 900

Heavy duty. Out-sands, outlasts others. Exclusive "No Jumping." Multi-Motion sanding action ..... \$39.95

MODEL 504

Light. Powerful. Easiest for vertical use. America's greatest finish sander.. \$19.95



## SYNCRO SANDERS Feature the MODERN SYNCRO RECIPROCATING MOTOR

... today's greatest achievement of all electro-mechanical research! Powerful! Smooth! No cams, belts or gears. No rotating parts to wear out. No brushes to burn out. See sanders at stores. Write Syncro for Free catalog and sanding handbook.



## MULTI-MOTION SYNCRO SANDERS

SYNCRO CORPORATION  
DEPT. 1-56  
OXFORD, MICHIGAN, U.S.A.

# WORLD'S LARGEST MANUFACTURER OF RECIPROCATING MOTORS

## COMPLETELY AUTOMATIC "SEA-HORSE" DIVING LUNGS

\$169 VALUE

2-TANK UNIT

# 99<sup>50</sup>

COMPLETE  
Approx. 2 Hours  
Underwater Time



New Improved

SINGLE TANK  
Outfit Complete  
\$110 Value  
Approx. 1 Hour  
Underwater Time **\$69**

The 2-stage demand REGULATOR automatically releases air as needed; effortless breathing in any position, includes both emergency and warning device; L.C.C. approved tanks . . . 84 cu. ft. cap. at 2000 psi; non-return mouthpiece keeps water out of hose; adjustable harness. Weight 55 lbs.

SIGNED GUARANTEE of SATISFACTION

**FREE** Valuable Booklet on SAFETY in Skin Diving with each Diving Lung. Full instructions included.

Send Check or Money Order, if C.O.D., 25% with order. Layaway Plan, 10% Deposit, balance monthly payments

WE PAY FREIGHT CHARGES ANYWHERE IN U. S. A.

Write for Literature TODAY . . . Club Inquiries Invited

DIVING INDUSTRIES  
813 LIBERTY AVE. DEPT. PM-5  
Division of HONUS WAGNER CO. PITTSBURGH 22, PA.

*Soldering is Easy*

with  
INSTANT STARTING



**Lenk**  
LIQUEFIED **LP** PETROLEUM  
**Torch**



only **\$3.49**

THE ONLY THROW-AWAY FUEL CONTAINER WITH SELF-SEALING SAFETY VALVE.

Here's what you can do:

- regular soldering.
- sweat fittings.
- silver soldering, refinish furniture.
- remove paint and putty.

Available at Hardware Counters Everywhere

Write for FREE Soldering Instructions

THE **Lenk** MFG CO.  
BOSTON 15, MASS



\$1.95 complete—at leading hardware, electric and department stores.

## Ever See A Light Switch Like This?

New decorator light switch easiest yet to install! Honeywell Tap-Lite is a new kind of wall switch. Transparent plate snaps off for decorating; just add your own wallpaper, drapery material, or one of the colored inserts provided. It's simple to replace old switches; Tap-Lite has screwless terminals. Quiet and easy to operate. Tap—it's on! Tap—it's off!

Tap-Lite by

MINNEAPOLIS  
**Honeywell**



THE PAYSWELL ALL-PURPOSE

**Sprayer**  
by  
**SELLCO**

Compressor, Motor, Gun  
... All in ONE Unit  
Sprays At 50 Lbs. Pressure



**\$49.95**

- ★ paints
- ★ lacquers
- ★ liquid plastics
- ★ liquid waxes
- ★ deodorants
- ★ disinfectants
- ★ fireproofing
- ★ rust inhibitors
- ★ wood preservatives

For Further Information Write

SELLCO CORPORATION, 224 W. 7th, St. Paul, Minn.



**G E A R S**

In Stock - Immediate Delivery  
Gears, speed reducers, sprockets, thrust bearings, flexible couplings, pulleys, etc. A complete line is carried in our Chicago stock. Can also quote on special gears of any kind. Send in your blueprints and inquiries.

Send for Complete Catalog No. 10

**CHICAGO GEAR WORKS**  
440-50 N. Oakley Blvd., CHICAGO 12, ILL.

**DO MORE PLANING JOBS WITH LOW COST BELSAW**



Exclusive MONEY-MAKING Features: Full 12 1/4" x 6" capacity • Power feeds at 14" to 34" a minute • Provides for Grinding Knives in the Cutter-head • Attachments for Jointing, Rabbing, Tongue, Matching, Groove. Convert low cost rough lumber into high priced stock. Easy to make flooring and popular patterns. Send Today for FREE Literature and Prices.

Belsaw Machinery Co., 2056 Field Bldg., K.C. 11, Mo.

LOW DOWN  
PAYMENT  
EASY TERMS

**DITCH-WITCH TRENCHER**



Portable DITCH-WITCH digs 4 1/2" or 6" clean, even ditches to 36" depth in all types of soil. Four rugged models. Complete unit — self-propelled. **OUTDIGS 8 MEN**  
Write for Illustrated Literature

The CHARLES MACHINE WORKS  
620 B Street Perry, Okla.

**What to Make with CONCRETE**

Even little concrete jobs cost big money — mostly for labor. Get Popular Mechanics **WHAT TO MAKE WITH CONCRETE** and save all the labor cost while making your home or farm ship-shape. Book shows all—tells all — how to make the right mixture, plan, apply and gives 50 professional short cuts. Hundreds of pictures. Only \$2.00 postpaid. Order today. Money back if not pleased.

POPULAR MECHANICS PRESS, Dept. PM9, 200 E. Ontario St., Chicago 11



Build Your Own Fireplace, Driveways, Walks, Etc.

**GOVERNMENT SURPLUS**

**MILLERS FALLS BREAST DRILL**



Orig. Govt. Cost  
Approx. \$12.00

Cap: 1/8" to 1/2" Round Bit and No. 1 Morse Taper Shanks

Two-jaw motor chuck—2 speeds; gear ratios even and 3 to 1. Ball bearing spindle and ball thrust bearing with take up nut to provide for wear. Level anchored. Length 17 1/2"—Weight 6 1/2 pounds.

40% OFF ON NEW DART STEEL TAPES

Black on White Markings. Blade stays put—no cropping. Case is of Chrome. Only 2" long and has 90 degree corner for close work.

Length	Price	10% Discount in Dozen Lots.
6 Ft.	.25	
8 Ft.	.35	
10 Ft.	.45	

OUR LOW PRICE \$4.50

SINGLE END GRINDER

Totally enclosed Ball Bearing Motor—Single Phase—Explosion Proof—3500 RPM—with Capacitor. Ideal for Polishing, grinding and other operations.

ORIGINAL GOVT. COST \$84.00

OUR LOW PRICE \$9.50



**ASH AND COMPANY** 5100 GRAND RIVER AVENUE  
DETROIT 8, MICHIGAN

## BUILD WELDER OR LIGHT PLANT

Instruc. incl. TYPES AMPS VOLTS PRICE  
 Westinghouse F1 200 24 \$15.50  
 J & Helms RI 300 24 \$25.50  
 G-1, 160-250 amps, 30V, new \$19.50 used \$12.95  
 U.E. #511, AC-DC, 200 Amps, 30V, D.C.  
 1250 Watts, 800 cy, 115V, A.C. NEW \$27.50  
 used \$17.50.

Flexible Coupling to fit G-1, P-1 or R-1, \$4.95  
 Rheostat #227, or Carbon Pilot Volt.  
 Reg. Instructions incl. \$6.95 ea.

SPRAYER, 4 gallon size with 3 ft. hose  
 & nozzle, wt. 15 lbs., 2 for \$5.00  
 (add postage). BRASS EXTINGUISHER,  
 Quart size \$3.95.

(5) SENSATIONAL SELSYNE. For con-  
 trolling distance operations, etc. \$6.95  
 per pair. (6) Solenoid VALVES, Bendix  
 #51560 for hydraulics, distance oper-  
 ation, etc. Up to 1500 P.S.I. \$7.50  
 per pair. (7) BEAM ROTATOR MOTOR  
 #101 for TV, HAM, FM, reversible, 2  
 R.P.M. for D.C. or 110V. A.C. Gov't  
 cost \$150. \$9.95. Instructions incl.

174 C.M.P. BLOWER & 1/2 H.P. MO-  
 TOR. Runs on 6-12 or 24 V. D.C.  
 12"x7"x6". O.C. \$50.00. New \$12.95.

(9) CUNO OIL FILTER for autos, fil-  
 ters without cartridge replacements, 3/4"  
 ports \$4.95. PURULATOR #255 for  
 trucks & tractors, 1" ports \$4.95 postpaid.

## General SALE

MAKES IDEAL WINCH HOIST 1/2 H.P. motor with  
 gear unit, 14:1 ratio,  
 runs on 6, 12 or 24VDC, reversible, belt or  
 direct drive, \$7.95.

BLACK & DECKER, D.C. MOTOR & Pump, 2  
 G.P.H., 1200 R.P.M., 1/2" ports, \$8.95.

(2) CHANDLER EVANS LARGE WATER  
 PUMP, oil, insecticide, etc. 400  
 G.P.H. Adj. relief, 1" ports \$8.95.

THOMPSON PUMP & D.C. MOTOR,  
 for fuel, hot water, etc. 300 G.P.H.  
 Instructions for DC-AC incl. \$7.50.

ROYAL GEAR PUMP #101 for hy-  
 draulic, water, or vacuum, 180 G.  
 P.H., 200 P.S.I., 29" Vacuum \$7.95

(5) VOLTMETER D.C. 30 Volts, 0-300  
 Ohms. \$8.95. TACHOMETER INDI-  
 CATOR, 0-10,000 R.P.M. New \$8.95.

HYDRAULIC PRESSURE GAUGE, 0-  
 2000 P.S.I. 1/4" ports, \$4.95.

AMMETER 0-380 Amps, \$4.95.

WATER PUMP & PESCO MOTOR, 1/2  
 H.P., 200 G.P.H., runs on 6, 12, or  
 24 v. D.C. Adj. press. 1" ports \$12.95.

(7) NEW ELECTRIC LINEAR ACTUA-  
 TOR gives 5 1/4" stroke, 800 lbs. thrust & 1750  
 lbs. static load. Motor is 24 VDC, 1/2 H.P., 9  
 Amps. 7500 RPM & appl. for 115V. A.C.  
 Instructions incl., \$8.95.

## NEW HYDRAULIC CYLINDERS

Air or Oil Bore Stroke Shaft Double Action				
#11	1 1/2"	6"	1/2"	\$7.95
#11	3/2"	2 1/2"	1/2"	\$29.75
#127	4 1/4"	10 1/2"	1-5/16"	used \$25.50 New \$32.50

(2) HYDRAULIC PUMP BARGAINS 1500 P.S.I.  
 MFG. TYPE R.P.M. G.P.H. PRICE  
 Pesco (Gear) 1500 198 \$12.95  
 Pesco (Gear) 4300 360 \$17.50  
 7 Stratopower 3750 (4.50 cu. in.) \$22.50  
 Vickers .507 cu. in. 3750 used \$17.50 New \$25.50

NEW FOUR WAY OPEN CENTER CONTROL  
 VALVE has built in adj. relief for 1 to 4 D.A.  
 cylinders. 3/8" ports. #10060 \$14.50. #4W11  
 four way with 1 handle for 1 D.A. cyl. \$8.95.

(7) FOUR WAY SOLENOID VALVES.  
 Instruction for 24V D.C. & appl. for  
 110V. A.C. off in neutral. 3/4" #1213,  
 \$12.50. #324 with 1/4" ports, \$9.95. #322  
 one way normally closed 1/4" ports, \$2.35.

PESCO EQUALIZER #397-D balances the  
 flow & pressure to 2 cylinders or sep-  
 arate systems rated 360 G.P.H., 1500  
 P.S.I. used \$9.95 NEW \$19.50.

PORTABLE WINCH HOIST lifts 1500 lbs.,  
 40" arm extension drum has 12 ft. 3/16"  
 steel cable, handle with ratchet brake \$19.50

GENERAL SALVAGE CO. CHECK OR M.O.  
 2922 E. 27 St., Dept. 75, Kansas City, Mo.

## NEW PICKETT DIAL CALIBRATED LEVELS READ IN DEGREES

READS ALL ANGLES. VERTICALS INSTANTLY  
 HORIZONTALS INSTANTLY  
 NOW AVAILABLE in new Pickett all-magnesium span bar model with two dial  
 calibrated units as shown above. Absolute precision, accurate to a hairline. 18" model (shown), \$6.75 each  
 postpaid. 24" model, \$7.25 postpaid. For all home and professional uses. Dealer inquiries invited.

TO ORDER: Send check or M.O. Calif. resid. add 3% state tax. 10-day money-back guarantee.  
**R. C. ENGINEERING SALES CO.,** 10 Tech Bldg., 1545 Mendocino Drive, Altadena, California

**39" SHEARS**

- Mfrd. by PEKTO
- Hand or Bench Plate Shears
- 1/2" Capacity
- 9" Shear Blade
- Shipping Weight—25 lbs.
- Regularly Wholesale Priced at \$60.00

**\$16.50** Send check or M.O. 30% Dep. with C.O.D. Write for free cat-  
 F.O.B. Montebello alog listing additional items F.O.B. Montebello

**HEAVY DUTY SHEAR**

- Mfrd. by BARTH
- 1/2" Capacity—(Mild Steel)
- 5" Shear Blade
- Complete with Handle
- Shipping Weight—240 lbs.
- Regularly Wholesale Priced at \$140.00

**\$69.50**

**ROSEN'S ELECTRICAL EQUIPMENT CO., INC.**  
 P.O. Box 189 Dept. W Montebello, Calif.

## GET THE HABIT OF READING OUR CLASSIFIED ADS.

Wonderful Opportunities Amazing Bargains

### AMAZING NEW "ARCO-SAW" CUTS ANY GROOVE!



WHIZZES THRU 2x4's!

Not even a \$100 Portable Saw has a dado cutter! "Arco-Saw" (guaranteed to fit any 3/4" electric drill) with sensational new "Dado-Arbor" adjusts easily to cut any size groove up to 1/2" wide x 1" deep in ONE CUT! Graduated Depth-Bevel-Rip Gages adjust for depth of cut up to 1 3/4", angle cuts to 45°. Amazing swivel action of "Dado-Arbor" (see sketch at right) cuts large grooves cleanly and accurately with little power. "Dado-Arbor" is easily removed to use the saw for straight ripping, crosscutting or angle cuts. Right angle steel gear drive and safety-yoke permit ONE HAND operation. Includes quick-cutting 5" Safcut Blade. . . . . **\$12.95**

BLADES—5" Rip, Crosscut or Combination . . . . . \$1.75  
 SOLD AT BETTER HOME STORES EVERYWHERE. If not available, order direct and try this amazing tool on our UNCONDITIONAL 10-DAY MONEY BACK GUARANTEE. Send check or M.O. (ppd.) C.O.D.'s—plus post.

**ARROW METAL PRODUCTS CO.**  
 Dept. PM-5, 140 WEST BROADWAY, NEW YORK 13, N. Y.

SAY YOU SAW IT IN POPULAR MECHANICS

Better than Your Own

## SHOE STORE AT HOME!



EVERY LATEST STYLE!

• Your Own Business!  
 • Your Own Hours!...

No experience, no investment! Make up to \$64 a week in EXTRA CASH! Show nationally advertised Kushiontred shoes. A post card NOW brings you 84 page catalog, shows 118 styles. Sport, dress, work shoes, for men, women, children. BIG SAVINGS on shoes for your own family too! Work full or spare time. We train, we explain and supply everything you need—FREE! Work where and when you please. Advance commissions to \$4.00 a pair. National Ads back you up. WRITE TODAY for FREE CATALOG!

SEND FOR FREE CATALOG NOW!

**TANNERS SHOE COMPANY**  
 775 Brockton, Mass.

# IT'S A SNAP!

MANUFACTURING



Ornamental Concrete

## BIG PROFITS

Imagine - A Business Of Your Own - so interesting and so much fun that it's like getting paid to play. That's what the Ornamental Concrete Business can mean for you. Products made in CMC Molds practically sell themselves on sight - truly an excellent Money-Making Opportunity - AND, starting costs are astoundingly low! OVER 200 DIFFERENT MOLDS TO CHOOSE FROM.

### IT'S A SIMPLE "DO-IT YOURSELF" PROJECT WHEN YOU USE DURABLE C M C ALUMINUM MOLDS

Perhaps you have wondered how the products are made. With CMC's new book as a guide, it's a SNAP! After a few minor preparations, you simply fill the mold with concrete, let it set, remove the mold, and there's your product. Could anything be easier?



#### THIS BRAND-NEW BOOK TELLS YOU "HOW TO TURN CONCRETE INTO GOLD"

CMC, The World's Largest Manufacturer of Specialty Molds for Making Ornamental Concrete Products, has left nothing undone to make this Big, 80-Page (8 1/2" x 11") Book an "Indispensable MANUAL" for the Ornamental Concrete Industry. It describes the more than 200 different CMC Molds and presents large, clear photographs of the products you can make, AND... it gives complete "From Start To Finish Instructions" (Priceless Trade Secrets)! IT'S A MUST! GET THE FULL STORY TODAY.



SEND ONLY \$2.00 For YOUR COPY Rushed To You By First Class Mail

(All Foreign except Canada, Mexico, and Cuba-\$5.00)

CONCRETE MACHINERY COMPANY, INC.  
Dept. PM Hickory, North Carolina

A perfect paint job with half the trouble. Get your money's worth. Paint shaken on a Red Devil Paint Conditioner is ready to use right out of the can. Paint is perfectly mixed factory-fresh - needs no stirring. Ask your dealer to mix your paint on a

## Red Devil PAINT CONDITIONER



FREE

How to Prepare Surfaces for Finishing. Illustrated instructions on preparing masonry, wood and metal surfaces for painting.

Red Devil Tools, Dept. 144  
2400 Vauxhall Rd., Union, N. J.

Please send FREE copy of "HOW TO PREPARE SURFACES FOR FINISHING."

NAME \_\_\_\_\_

ADDRESS \_\_\_\_\_

CITY \_\_\_\_\_ ZONE \_\_\_\_\_ STATE \_\_\_\_\_

1662

**NEW!** **RECLAIMO**  
ELECTRICALLY HEATED  
Oil RE-REFINING Filter

**Super-Efficient Filtration**

for TODAY'S Car-Truck-Tractor Engines  
INCOMPARABLE PERFORMANCE! RECLAIMO—REMOVES Solids—PREVENTS Excess Water Accumulation, Acid and Sludge Formation—CHECKS Fuel Dilution—MAINTAINS Stable Viscosity! Keeps engines "young and frisky" with crankcase oil in peak lubricating quality at all times. FULLY GUARANTEED.

**ENDS NEEDLESS OIL CHANGING!**

**NEW FEATURES:** Electric Heat from generator, thermostat controlled—Dual Flow by-pass—Steel non-corrosive body—Hinged mounting bracket—Easy to install or transfer to other equipment.

**JUDGE FOR YOURSELF!** Each Reclaimo is sold with an unconditional 6 months' no-risk return privilege.

Write for folder with full details.  
**RECLAIMO MFG. CO., Dept. M-56,**  
6251 TOUHY AVE., CHICAGO 30, ILL.  
*Manifold-heated Reclaimos NOW ORSO-LITE, accepted (new or used) for trade-in.*



**Wm. Schwalge,**  
Author,  
Inventor,  
Pioneer in  
oil reclaiming  
since 1910.

**NEW!** **ALL-IGATOR ADJUSTABLE SOCKET**  
"READY TO ROTATE"

ALWAYS THE PROPER SIZE TIME VALUABLE? HERE'S YOUR TOOL!

- STRENGTH
- POWER
- FAST ASSEMBLY



Fits EVERYTHING from 3/8" to 3/4" — 3/4" drive. GRIPS, STARTS difficult, DISTANT nuts, bolts. HI-TORQUE: 1/2" bolts shear first. VARIABLE diameter needs little or NO clearance. EASY, FINE adjustment. PARALLEL jaws slip ON-OFF. Hot forged, machined, treated, tested.

FREE FOLDERS — Dealers Welcome

SEND NO MONEY — Send C.O.D. at low introductory price of only \$4.95 or mail check or money order and we pay postage. Full satisfaction or absolute refund.

**ALLIANCE TOOL CO., 845 KENNETH AVE., ST. PAUL, MINN.**

**Wholesale!** **TOOLS! GUNS! CAMERAS!**

AGENTS — BUY TOOLS, PHOTO EQUIP., SPORTING GOODS, JEWELRY AND THOUSANDS OTHER NATIONALLY ADVERTISED PRODUCTS AT BIG DISCOUNTS. BIG PROFITS SELLING TO OTHERS.

POSTCARD BRINGS FREE COPY "THE WHOLESALE PLAN"

**AMERICAN BUYERS SERVICE**

HERTEL STATION, DEPT. 15, BUFFALO 16, NEW YORK

Get up to  
**40% off**

**EXPLORE FOR TREASURE!**

Find gold, silver, coins, jewelry, battle relics! Treasure-Metal-Mineral Detectors. M-SCOPE. Used worldwide for Treasure Hunting. Mineralights, Geiger, Scintillation Counters. Prices from \$14.75. Fully GUARANTEED. Time Payment Plan. FREE Treasure and Uranium booklets. New outfitting catalog. FISHER RESEARCH LAB., INC., Dept. PM-1, Palo Alto, Calif.



Say You Saw It in Popular Mechanics

6-ft. only  
**\$149**

Insist on  
**Evans**  
**TAPES "KING-SIZE"**

At your hardware store  
**STANDS UP STRAIGHT**  
EXCLUSIVE! Belt clip for handy carrying.

Also available in 8, 10, 12-ft. lengths with free plastic utility case.

**EVANS RULE CO., Elizabeth, N. J.**



**CHROME VANADIUM 60 Pc. Set WIRE GAUGE  
29 Pc. DRILL SET CHROME VANADIUM DRILLS**

Specialty made for speed drilling. In sturdy plastic tool roll. Finest alloy steel drills hardened and precision ground to the sharpest, longest lasting cutting edge obtainable; will easily and cleanly bite through hardwoods, plastics, aluminum, iron and the toughest steels. Unconditionally guaranteed for thousands of drillings. Full jobber length. Sizes by 64th from 1/16" to 1/2". NOW... **\$6.49** ppd.

Also available with Turned Down Shanks to fit all 1/4" drills. In individual pocket roll... **\$8.95** ppd.

Top quality high test Chrome Vanadium Drills designed for speed drilling through toughest steels, woods, plastic, iron and aluminum. Precision ground, long-lasting cutting edges. Guaranteed to give years of satisfaction. A full 60 pc. set nos. 1 through 60. A \$14.95 value—**\$5.40** NOW ONLY... **PLUS 35c PP. & HDLG.**

Same set above available with Huet Metal Index container. Only... **\$6.65** PLUS 35c PP. & HDLG.

Send Check or M.O. C.O.D. fee extra. **MONEY BACK GUARANTEE**  
**SCOTT-MITCHELL HOUSE, INC.** DEPT. M-187, 611 BROADWAY NEW YORK 12, N. Y.

**AUTOMATIC RETOOTHING**

MAKES NEW PROFITS

for HAND SAWS

Cuts new teeth in 50 seconds—only 1/2¢ to 1¢ to 1¢ per tooth. Old teeth fall off as chips. Easy to operate. A perfect job.



**BURR MFG. CO.**  
8933-Y VENICE BLVD. LOS ANGELES 34, CALIFORNIA

RETAIL PRICE \$125.00  
FACTORY TO YOU \$79.95

**SUPERSHOP** includes precision-built 8" tilting table saw, vertical and horizontal drill press, 30" lathe, sander, grinder. 100% BALL BEARING. Write for FREE catalog, full details, trial plan. Easy Pay Plan.



**POWER TOOLS, INC.** 183 YATES AVENUE BELOIT, WIS.



**ELECTRIC WELDER** AC or DC 110 Volts  
The "Little Marvel" all-metal welder. 5-year written guarantee. Welds 1/8" metal or money back. Repairs tanks, tools, fenders, machine parts, etc. Complete with everything—rods, unit, eye shield, directions. \$6.95 plus 50c postage. Flame torch accessory for soldering, cutting, brazing \$3.95 complete with carbons, brass rods, flux. \$2.00 Deposit on C.O.D. 75 ampere 1/2 inch Transformer Welder \$21.95 F.O.B.

**\$6.95** Complete

**ESSAY MFG. CO.,** Dept. 51, Quiney 69, Mass.

Say You Saw It in Popular Mechanics

**WORN ENGINE BURNING OIL!**

Reduces oil bills!  
Restores compression!  
Increases miles per gallon!  
Forms self-lubricating seal at piston top. Inserted through spark plug holes. Used by millions of motorists. Tested and approved by motoring experts.

**\$4.95**  
Tube for most cars

**PISTON SEAL**

See Your Neighborhood Auto Accessory and Parts Replacement Store

**TREGLOWN CO. INC., FANWOOD 75, N.J.**  
\* TRADE MARK REGD. CANADA: 1366 GREENE AVE, MONTREAL 8 (PRICES HIGHER)

Write for Full DETAILS

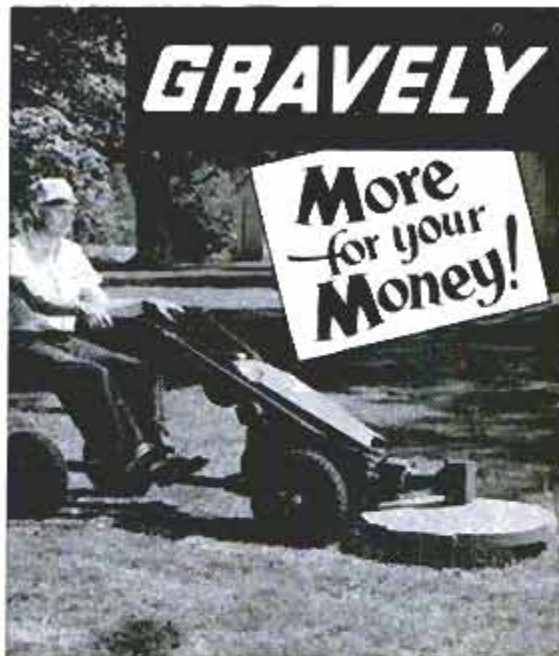

**More Power for TOUGH JOBS!**

Gravely Rotary Mower attachment makes the toughest mowing jobs easy. Lawn or weeds, cut 30-inch swath fast and clean with suction-tip, file sharpened knives.

Gravely does jobs other tractors won't... because the 5-HP Gravely has the extra power that makes tough jobs easy.

Let us show you the advantages of the Gravely's extra power... all-gear drive... power reverse... your choice of 23 tools. Push-button Starter optional.

**EASY PAYMENT PLAN**



Write for FREE Booklet "Power vs Drudgery"

**GRAVELY TRACTORS, INC.**  
BOX 563 DUNBAR, W. VA.

**SUPERIOR PERFORMANCE**



You can rely on Gerstner Chests to provide proper care for your precision tools. Free Catalog.

**GERSTNER TOOL CHESTS**  
456 Columbia St., Dayton 7, Ohio

**Holt's HAVE THE ANSWER!**

**REPAIR MUFFLER AND EXHAUST LEAKS in 10 min.**

The plastic gas-tight seal sets hard, withstands heat and vibration. Prevents carbon monoxide gas poisoning.



**\$1.69** per can

SETS LIKE A WELD—NO TOOLS NEEDED

**Holt's GUN-GUM MUFFLER SEAL**

**TITAN**  
GIVES YOU ALL THREE

**POWER  
PERFORMANCE  
PORTABILITY**



Model 30, direct drive, 27 pounds, bars, 14" to 22"

There's a noticeable difference in a Titan Chain Saw. It's rugged, powerful, well-balanced. Titan is precision engineered—with the service guarantee of America's pioneer chain saw manufacturer behind it. There's a brand new 1956 model for every timber cutting job.

**LET A TITAN  
CHAIN SAW  
WORK FOR YOU!**

See your authorized dealer or send coupon for information on Titan Saws.

038

**TITAN CHAIN SAWS, INC.**  
2700 Fourth Avenue South, Seattle 4, Wash.

Name .....

Address .....

City .....

*Say You Saw It in*  
**POPULAR MECHANICS**

send for  
**FREE**  
tool catalog

**SNAP-ON TOOLS CORPORATION**  
8062-E 28th Avenue, Kenosha, Wis.

Send me free catalog.

OCCUPATION .....

NAME .....

ADDRESS .....

CITY ..... ZONE ..... STATE .....



A big, fact-packed catalog full of pictures and tool information . . . yours for the asking.

- Snap-on tools help you handle repair jobs faster, easier, better.
- Snap-on tools LAST . . . pay for themselves over and over.
- Used and endorsed by America's top-earning mechanics in all fields.
- Start building your Snap-on set with basic units . . . add other tools any time.

**Snap-on Tools**  
THE CHOICE OF BETTER MECHANICS

**Loose Castor?**

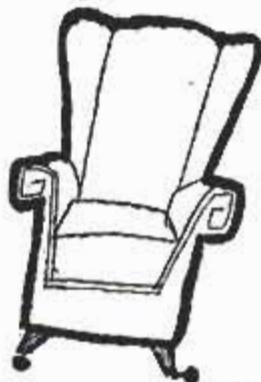

Anchor it with *New Plastic Wood*. Makes a permanent fix that won't crack, chip or peel. And *New Improved Plastic Wood* has a finer grain—minimum shrinkage! Takes stain, lacquer and varnish with excellent results.

**NEW "PLASTIC WOOD"**



Handles like putty—hardens into wood.

**VARIABLE SPEED** HYDRAULIC POWER TRANSMISSION



It has Infinite Speeds 0 to 550. Reverse. Automatic Overload Protection. Adjustable Torque up to 180 inch pounds. 5/8" Input and Output Shafts. It will handle 1/4 to 1 1/2 H.P. Motor. Case measures 7 1/2" long, 7" high, 6 1/2" wide. **VALUE OVER \$300.** Shipping Wt. **\$54.50** 25¢. On C.O.D. Orders we require a 10% only Fob. Chicago Deposit.

DIRZIUS MACHINE SHOP "B" 1423-25 So. 52nd Ave., Cicero 50, Ill.

• automatic •



**POWER TILL**

- Tills Automatically
- Works ALL SOILS!
- Width: 24" to 7"

SEE YOUR  
DEALER  
OR WRITE

**UNIVATOR**

UNIVATOR, INC., 2030-52 Center St., Berkeley, California

**Fabulous Little ALCOHOL STOVE**



**FOR INDOORS AND OUTDOORS**

Here's a genuine sturdy reinforced-steel alcohol stove for all kinds of cooking. Long life, no-weld aluminum top burner for frying, stewing, boiling. Compact and easy-to-take-anywhere. Weighs but 8 oz. Ideal for travel, picnics, camping, gifts, for hot snacks at home, office, school or factory lunches. Makes an excellent replacement unit on Chafing Dishes—a great help in emergencies. Instant heat, gas type flame regulator adjusts to powerful or low flame. There's no wick to replace. 5 cents worth of alcohol burns for 3 hours. Large opening for easy refill. Only \$1.98 plus 25¢ for PP and Handling.

Money Back Guarantee  
**MATTHEW DAY CO., INC., Dept. PMX, Dumont, New Jersey**



# Speedy Sprayer

## mobile paint sprayer



**FREE!**

Write for  
"How to Spray"  
Booklet and  
Literature.

Choice of craftsmen for 35 years! Saves time, paint and money. Quickly gives flawless finish to walls, furniture, screens, fences and handiwork. Sprays all materials; 1/4 H.P. motor. Diaphragm principle assures clean, oil-free air. Never needs lubrication. With gun, less motor. **No. 890 Speedy Sprayer . . . \$3850**

Add wheels with Wheel Kit No. 909. Includes 6" wheels, handle, fittings. **\$6.95**



At dealers everywhere

**W. R. BROWN CORPORATION**  
2635 N. NORMANDY AVE., CHICAGO 35, ILLINOIS

## SAVE MONEY on SURPLUS PARTS for MILITARY TYPE TRUCKS & JEEPS

4 & 6 wheel drive. FREE catalog to Jeep owners. State make truck or Jeep. (New Jeep Tops, steel or canvas all models). **AMERICAN AUTO PARTS CO., Inc., 1830 Locust, Kansas City, Mo.**

**WELD** **BRAZE**  
**SOLDER** **CUT**



**4WAY**  
**ONLY \$14.75**  
f.o.b. factory

**WELDER**

Complete with  
Twin Carbon Arc  
Torch and ac-  
cessories . . . to  
handle all metal-  
craft work.

Acclaimed by thousands of Homeowners, Mechanics and Hobbyists as the welder of 1001 uses. Easily operated from properly wired 110 volt AC or DC line. The ideal gift with a life-long use. . . . Order today on 10 day money back guarantee.

**FOUR-WAY WELDER CO., Dept. F2-E**  
1810 S. Federal St. • Chicago 16, Ill.

## BIG PROFIT IN YOUR OWN BUSINESS

### GRINDRITE LAWMOWER SHARPENER

Fastest, easiest to use sharpening machine available. GRINDRITE will sharpen any hand or power mower in 10 to 20 minutes. Set-up time less than 30 seconds. Make \$2.50 to \$6.00 a job in your basement or garage. Full or part time, work your own schedule. Lawnmowers everywhere need repeated sharpening. Investment returns in a few days. Write today for Money Making Plan.



**\$28500**

Complete with  
110v. motor.  
Freight paid,  
U. S. A.

**GRINDRITE, Dept. P-3, 9841 Alpaca, El Monte, Calif.**

# BIG Money-Saver

## Atlas 6" JOINTER-PLANER



### For Furniture, Remodeling, Construction

Whatever you want to do—"finish out" a house or a room, remodel, make kitchen cabinets or furniture—this Atlas 6" jointer-



Rear table is wide to support big boards.



New type fence mount assures fast set up—greater rigidity and accuracy.



Cutter head removes for sharpening blades without disturbing their setting.

planer is the tool to own. You can plane mirror-smooth surfaces in seconds with the Atlas—rabbet, chamfer, taper, edge.

Table and fence are both big for big board work . . . precision-ground for smoothness and accuracy. Fence is rigid—triple supported, easily positioned, has width-of-rabbet scale.

Atlas has no equal in value for the home shop, contractor, or commercial shop. See it at your dealer's, or send post card or coupon for catalog.



### NEW MODERN FURNITURE PROJECT BOOK

16 complete, easy-to-follow plans for beautiful modern furniture . . . chairs, lamps, tables, etc. Build your own! Have fun! Save! — Only \$.50 postpaid, \$.65 outside U.S.A.

**ATLAS PRESS CO.**  
524 N. Pitcher St., Kalamazoo, Mich.

Please send catalog showing jointer-planer. Inclosed is \_\_\_\_\_ for \_\_\_\_\_ plan book.

Name \_\_\_\_\_  
Address \_\_\_\_\_  
City, State \_\_\_\_\_

**GIGANTIC MAIL SALE** WAR SURPLUS EXCESS INVENTORY BANKRUPT STOCK

**WEED SPRAY OUTFIT**

Leading make. Latest design. 5-row (17) P.T.O. tractor drive finest pump. T-jet nozzles, precision controls, gauges, hose. Complete. List \$175.00. Postpaid in U.S.A. **\$97.65**  
FREE big weed spray catalog.



**HYDRAULIC BARGAINS**

Savings to 80%. Build loaders, diggers, presses, etc. Marvellous values.

- Control Valve, 1 or 2 way.....\$18.00
- Pump, 1000 lbs. 12 gpm.....\$45.50
- Pressure Gauge, 1500 lbs.....\$3.49
- Cylinder, 2"x10", 3141 lbs. lift \$17.50

Many other types, sizes and items. All brand new. Free catalog.

**AIR COMPRESSORS**

- 1-Cylinder Air Compressor, 150 lbs. \$19.95
- 2-Cylinder Air Compressor, 150 lbs. \$49.95
- Auto Pressure Switch for motor...\$4.95
- Air Kit, Compr., Tank, Gun, etc. \$39.95

Many other items available—  
Save to 10%. FREE CATALOG.

**ARMY POWER PLANTS**

Marvelous buys in new condition Govt. surplus plants and generators. We pay freight!

- 1000-w, 115-v, 60-c, \$149.50
- 2000-w, 115-v, 60-c, \$269.95
- 3000-w, 115-v, 60-c, \$299.50
- 7500-w, 115-v, 60-c, \$595.00
- 3000-w, DC generator \$58.75

Many others. Send for Free Catalog.

**IRRIGATION PUMPS**

2 1/2" size, 16,500 gph

- Brand new Navy bronze ball bearing hi-capacity centrifugal. Wonderful farm and truck irrigation, many industrial uses.
- Capacity to 280 gpm. Pressure to 65'. Speed 2100-2700. Clock-wise rotation. Complete with 6" pulley. Wt. 40 lbs. Size 10"x11"x9". Inlet 2 1/2", outlet 2".
- 2 units driven by single engine deliver almost 600 gpm or 33,000 gph. Nat'l Adv. list \$98 each. SALE Prepaid.....\$44.37
- 1 1/2" size—8,400 gph—70 ft. head

Same general specifications as above pump except smaller size.  
Govt. cost \$62.00. Ppd.....\$24.61

Many other pumps and accessories. Send for FREE Catalog.

**SPECIAL OF THE MONTH! GEAR-HEAD MOTOR**

Brand new. Govt. Surplus. Many uses. Will operate air-conditioner dampers, valves, remote boat steering, open window and door locks, garage doors, many industrial applications.

- 9000 rpm all ball-bearing motor driving a worm gear, rotary double shaft. Very powerful due to high (1000 to 1) reduction ratio. Output speed is 6-10 rpm. Will operate on 6 to 24 volts DC or 8 to 12 volts AC.
- Has limit switches to control travel limit. Splined drive, shaft 3/8" dia. Overall dimensions 9"x5"x4". Marvellous equipment buy. Govt. cost over \$100. Special.....**\$8.72 PPD.**



**SPECIALS FROM PREVIOUS ADS**

- AC-DC Power Rectifiers (F.O.B.)...\$15.81
- Campers Power Plant 28-V (\$425)...\$69.50
- Robot Control Cylinder.....\$3.89
- Govt. Steel Tower, 30' F.O.B. Ky...\$31.95
- Automatic Remote Control Switch...\$13.71
- Air Power Tree Trimmer.....\$19.37
- Surveyors Level and Tripod.....\$42.95
- Navy Bomb Moist (150 lbs.).....\$29.95
- Boat Winch, 150 lbs.....\$8.95
- Tractor Nitrogen Spray Pump \$54.50
- Farm Wall Phone.....\$9.95

ORDER FROM AD or write us for big **FREE CATALOG** 1000s of items! Motors, sporting goods, hand and electric tools, watches, tarps, etc. We pay freight except where stated "F.O.B."  
**BURDEN SALES COMPANY**  
807 "O" St., LINCOLN, NEBR.



Heavy Duty, All Steel **TOOL CHEST**  
**\$24<sup>75</sup>** F.O.B. ST PAUL

**WHERE ELSE** can you get 4 drawers with built-in-locking system, sliding on compound glides—at this price! Baked blue-gray enamel. 26" x 12 1/2" x 12 1/4". Your money back if not satisfied! Write for bulletin, describing this and 12 other models.  
**NUOT MANUFACTURING CO.**  
555 No. Wheeler St., St. Paul 4, Minn.



Loosens Rusted Bolts nuts, screws, "frozen" parts!  
**LIQUID WRENCH**

AT HARDWARE STORES, GARAGES SERVICE STATIONS EVERYWHERE  
For information write manufacturer Radiator Specialty Co., Charlotte, N. C.

**SEND ONLY \$1** for next 6 issues of famous DELTA-GRAM, best home woodworking magazine you ever saw. Packed with shop-tested ideas—12 to 15 in each issue. Send \$1 (no stamps) to Delta Power Tool Division, Rockwell Mfg. Co., 502E N. Lexington Ave., Pittsburgh 8, Pa.

**24" ATTIC FAN KIT**

Easy to assemble. Belt-driven. Blade, shaft, 2 self-aligning bearings, 2 pulleys, 2 collars, and V-belt. Everything you need, except frame and 1/4-hp motor, to make your own house cooler. Send for complete list of fan parts. **SAVE \$46.00**  
**ONLY \$9.95**  
**PENNA. WHOLESALE DISTRIBUTORS**  
104 N. 6th St., Phila. 6, Pa.



**SAY YOU SAW IT IN POPULAR MECHANICS**

**Metal Turning Lathe for Model Makers**

Ball bearing headstock spindle. Bed length, 12"; swing, 4 1/2"; between centers, 7"; adjustable tailstock; mounting bolts. Complete with face plate & driving dog. Ship. wt. 27 lbs. Guaranteed. F.O.B. Lansing. **\$29.95**  
Send for Free Descriptive Folder  
**ROSEMOOR MFG. CO., 2501 Bernice Rd., Lansing, Illinois**



**\$50<sup>00</sup> PER DAY AND MORE**

**SAW-KEEN** PORTABLE, ELECTRIC, EASY - TO - OPERATE

Be your own boss, work anywhere, full or part time. Every restaurant, hotel, drive-in, etc., repeat customers. Serrated (saw-edged) table and steak knives in great demand. \$98.50 investment returns first week. Guaranteed. Write today for proven daily profit plan.

**CUTTER-CRAFT** 58-G SOUTH RAYMOND PASADENA 1, CALIF.

**SERRATING AND SHARPENING TABLE KNIVES**



**WELD IT YOURSELF IN A JIFFY!**

Weld, Cut, Brize, Solder: Iron, Steel, Brass, Bronze, Aluminum and other metals safely and easily. Make your wrought iron furniture, porch railings, fences, knick-knacks and other metal specialties. With this fine equipment anyone can do professional-like work with little practice. Tool and equipment breakdowns are annoying and costly. Don't let them bother you. The Dynamic will pay for itself quickly in both time and money and is designed to operate from any properly wired 110 volt AC line.

Order your Dynamic Industrial type transformer Arc Welder for Workshop or Industrial use today. Order from this ad.  
Literature on larger equipment available on request.  
**DYNAMIC WELDER COMPANY, 1808 S. Federal Street, Dept. D2-E, Chicago 16, Illinois**

**EASY PAY PLAN**  
Low down-payment. Pay as you weld. Money back guarantee. Send for details. Complete outfit. **Only \$38.50**  
F.O.B. Factory

# RIDE and MOW with the

## SHAW DU-ALL



Model RM 24 (24" cut)

or

Model RM 32 (32" cut)

**Biggest little mower on the market!**

**LOW PRICE**, too. Great for estates, farm and suburban homes, parks, cemeteries, etc. Trims smartest lawn; or tallest grass, turning radius only 45 inches. Sturdy 2½ to 3 H.P. air-cooled engine. 110 volt starting motor plugs into house current (optional). RM 32 is 6 H.P.

**WRITE TODAY** for free folder, prices, and full details. Also walking and riding tractors, 1½ to 12 H.P.

**SHAW MFG. CO.** 4505 Front St., Galesburg Kansas  
668-G N. 4th St., Columbus, Ohio

# LUBRIPLATE

THE MODERN LUBRICANT



### FOR UNDERWATER GEAR CASES

LUBRIPLATE C-105 (GREASE)

For non-gear shift types

LUBRIPLATE C-90 (HYPOID)

For gear shift types

### FOR ENGINE LUBRICATION

LUBRIPLATE

2-C OUTBOARD MOTOR OIL

To get the longest life and best performance out of your outboard, use the lubricants that outboard racing drivers use. LUBRIPLATE Lubricants are different. LUBRIPLATE gear greases are white and clean, will not leak out or wash off. They're waterproof. LUBRIPLATE 2C Outboard Motor Oil keeps spark plugs clean. Ask your Dealer about them.



### USE LUBRIPLATE LUBRICATION FOR YOUR CAR

LUBRIPLATE car greases and LUBRIPLATE H.D.S. Motor Oil make cars run better... last longer—protect your car investment. If you want the very best for your car, ask your car dealer or garageman about LUBRIPLATE Lubricants today.



### LUBRIPLATE IN TUBES

For cars, for sports equipment, for everything around the house. In handy tubes at sporting goods and hardware stores.

## Accurate Easy LEVELING

for FOOTINGS ..... FLOORS etc.

Accuracy and dependability of expensive instruments—simple, fast, durable. A professional builders' level.



**WRITE FOR FREE** DETAILS ON MODERN LIQUID LEVELING

HYDROLEVEL Suite 915, 407 S. Dearborn, Chicago 5

## Exclusive Double-Bearing HEAVY-DUTY PUMPS

IRRIGATE • DRAIN • CIRCULATE • SPRAY

Up to 7,500 GPH, 3,000 GPH from 20' well. Use ¼ to 1 HP motor. 1¼" inlet; 1" outlet. Stainless shaft.

TYPE X—2 oilless bronze bearings. \$10.95

Won't rust. . . . .

TYPE XB—Ball bearing model. . . . . \$12.95

Postpaid if cash with order. Rush your order today

**MONEY BACK GUARANTEE**

Centrifugal and Gear Pumps in All Sizes

LABAWCO PUMPS, Belle Mead 2, N. J.



## KAKEST MORTAR PLANE

"Amazing New Mason's Tool"

Makes it easy for amateurs to build masonry block walls. Lays smooth ribbon of mortar. Saves time and money. No waste of mortar. Send for FREE Folder.

**KAKEST COMPANY** Dept. PM  
Carwensville, Penna.

\$12.95  
Money Back  
Guarantee



Insist on *Evans* TAPES  
POCKET SIZE  
At Your Hardware Store

6, 8, 10, 12-ft.  
lengths

from **98¢**

with FREE  
plastic utility  
case.



Self-adjusting sliding  
hook starts you at  
zero for accurate measuring  
inside or outside measuring.

EVANS RULE CO., Elizabeth, N. J. 3067



Best for  
Cars

Best for  
Reels and Guns

Best for  
Bicycles

LUBRIPLATE DIVISION, Fiske Brothers Refining  
Company, Newark 5, N. J., Toledo 5, Ohio

# IN YOUR CAR RADIATOR... GUARANTEED TO STOP RUST!

**WATER STAYS  
CRYSTAL CLEAR  
FOR OVER  
ONE YEAR**

Just one can of  
MAC'S NO. 13 re-  
moves rust and scale  
... prevents costly  
repairs. Get MAC'S  
NO. 13 today.



**AT SERVICE  
STATIONS EVERYWHERE**

**MAC'S SUPER GLOSS CO., INC.**  
Los Angeles 42, California

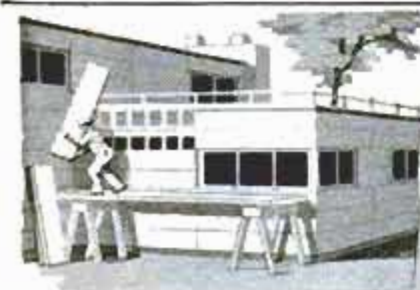

## For basic economy in SHEATHING

Eliminate a dozen costly details in sheathing—with better end results—this is Homasote economy. Homasote insulates, sheathes and weatherproofs your house—all with only one material. Homasote is different.

The famous Homasote One-Man Sheathing is easy-to-handle, clean-to-handle— asphalt-free and in sturdy, V-grooved 2'x8' panels. As pictured above, one man sheathes a building with Homasote quickly and easily—and with assurance that the job is done right, because the Homasote

Handbook gives the know-how.

The Homasote Handbook describes another sheathing value—Big Sheets in sizes up to 8' x 14'. Big Sheets need no corner bracing and save on nailing. Sheathing is only one of many subjects in this new 64-page Handbook—backed by 46 years' experience in the making of quality products. Use the coupon to secure your copy—plus three fully-illustrated folders suggesting 18 interesting and practical make-it-at-home projects, including furniture.

### MAKE IT AT HOME—WITH HOMASOTE

HOMASOTE COMPANY  
Department E-1, Trenton 3, N. J.

- I enclose 10¢ for Homasote Handbook.  
 I enclose 10¢ for 3 Make-It-At-Home Folders.

Name.....  
Address.....  
City..... Zone..... State.....

## SAVE 50% ON THIS NEW 16" ROTARY MOWER

**WITH 1/2 HP ELECT. MOTOR**

Has heavy duty 1/2 HP electric motor with On-Off switch on handle and overload relay to prevent burn-out. Operates forward or backward. Has non-breakable, heavy gauge chassis. Oilite Bronze Bearings. Semi Pneumatic Tires. One of the most versatile grass and weed mowers ever made. The easiest handling power mower of them all. Cuts a full 16 INCH strip in either forward or reverse direction. Makes trimming around plants and shrubs a cinch. So safe and so light in weight even a child can operate it. Cutting height is adjustable from 1" to 2-1/8". A smooth, efficient performance is insured by the sharp cutting blades revolving at high speed (3400-3600 RPM). Blades are easily removed for re-sharpening.

**EASY TO  
USE  
LIGHTWEIGHT  
BLADES  
ROTATE AT  
3400 RPM  
FACTORY  
GUARANTEED**

**PACKED  
FOR SAFE  
SHIPMENT**



**ONLY  
39.95**

**OVER 1000 AUTHORIZED SERVICE CENTERS**



**3400 RPM 1/2 HP POWER SAW**

COMPARES TO SAWS  
SELLING UP TO \$49.50  
WITH A 3 1/2" BLADE **ONLY 19.98**

**RIPS - CROSSCUTS**

**CUTS A FINISHED 2x4 LIKE A  
KNIFE THROUGH BUTTER**

A rugged, professional type, adjustable saw. Will cut any angle from 0 to 45°. Has an adjustable 10 to 6" rip fence. Safety-trigger switch on handle. Full 1/2 HP Universal AC DC, 110-120 Volt, 60 cycle motor. Weighs only 6 1/2 lbs.

**SAVE  
50%**

**PHILIPPINE MAHOGANY  
LUAN PLYWOOD  
AT LESS THAN WHOLESALE**

For Paneling Dens, Offices, etc. Use in Cabinets, Furniture, etc. Rotary cut. Both sides sanded.

Bonded with finest resin adhesive. Face side unjointed. Shipped at lowest rates.

**3MM (1/8") x  
3 FT. x 6 FT.  
\$500 VALUE  
MINIMUM ORDER 8 SHEETS**

**179  
PER SHEET  
FREE  
SAMPLE  
ON  
REQUEST**

**1/4" x 4 FT. x 8 FT.  
950 VAL.  
MIN. ORDER  
4 SHEETS  
449  
PER SHEET**



**SAVE 50% ON TRANSLUCENT  
FIBERGLAS PANELS**

Use for patio covers, interior decor, walls, partitions and many other uses. Ideal for the home, office, shop, indoor or outdoor installations. Finest quality. Available in many widths and lengths. Excellent color selection. Write for a FREE Sample and Booklet.

**Only  
49¢  
SQ. FT.**

**IMPORTED FROM  
HOLLAND**

**SAVE \$30.00 ON 26" SPORT BIKE**

The 'Jaguar' of Sports Bicycles. Designed and built with all the 'know-how' of the finest European craftsmen. Beautifully finished in two-tone Grey & Cream baked enamel plus other de-luxe features such as:

- 1- 3-SPEED GEAR SHIFT with handlebar control to select gear ratio.
- 2- TWO-WHEEL CALIPER HAND BRAKES.
- 3- De-Luxe Saddle Bag, 4-Pump & Tools.
- 5- Kickstand and Sport Tires.



**Only 39.50 IN SPECIAL PROTECTIVE PACKING**



**BICYCLE HEADLIGHT AND  
TAILLIGHT GENERATOR KIT**

DEVELOPS 3 WATTS OF POWER at 6 volts, 0.5 amp. Easy to install on any bike. Kit includes generator, head and tail lights, all parts. Beautiful chrome.

**595**

**SAVE UP TO 85% AT PALLEY'S SEE THE OPPOSITE PAGE**

## GIVE THE KIDS A THRILL



### CRYSTAL RADIO

**3.95**  
**NEW**

Picks up standard broadcast stations without using batteries or electricity. Just plug in headset, antenna and ground wires and tune in your favorite program. You'll be amazed at the STRONG, CLEAR SIGNAL. Has a 100KC tuning range. Comes complete with Receiver, Antenna and Ground wires PLUS a 2000 ohm Headset. A GENUINE CRYSTAL RADIO SET.

### SOUND POWER PHONES

Originally used by the Navy for gun control. Ideal for emergency communication because each set is "sound powered". Will operate up to 1/2 mile distance. Set includes 2 phones on chest plate, 2 headsets, approx. 35 feet of wire.

**9.95**  
**PER SET**

### RS38A MICROPHONE

Carbon type with push-to-talk button. Ideal for use where background noise is high. Can be operated with 110V dry cell. Comes 6 ft., 3 conductor, shielded cable & plug.

**2.49**

### HS-30U Signal Corps HEADSET - Low Impedance. Two earphones & bond...

**3.45**

### SAVE ON U-LINE MODELS

#### NAVY F4U CORSAIR

Has 20" wingspan - 16-1/4" length. For .099 Gas powered engines. Complete with pre-cut parts.

**2.99**

#### Famous P-51 MUSTANG - Class A

23" wing. Complete kit...

**3.95**

### FREE FOLDER ON MODELS

Complete with prices and descriptions of our complete line of U-Control planes, Electric Boats, Model Gas Engines, etc. SEE our flying model of the famous F-86 SABREJET powered with a real Jet engine. Send for your copy Today.

### SURPLUS HOISTS

#### 5 TON HOIST

A real heavy duty Hoist. Mfg. by the Seattle Chain & Mfg. Co. Crank operated. Has two speeds one for rapid lift - other for heavy duty. Drum size 8-3/8" x 5" diameter. Complete with hand brake and handle.

**510.00 VALUE**  
**69.95**

3 TON WINCH HOIST - With crank type handle and ratchet brake. In excellent condition. Ideal for truck or jeep mounting...

**39.95**

#### 800.00 VALUE

#### HOIST

Lifts 2500 lbs. with 24 to 1 gear ratio. Bronze worm gear drive. Has 18 ft. of 3/16" steel cable.

**ONLY 32.50**

#### PORTABLE WINCH HOIST

A "swing around" type hoist. Will lift up to 1500 lbs. with 21 to 1 gear ratio. Has 12 ft. of 3/16" steel cable. 40" arm with 3" pulley.

**22.50**

## NOW! A PROVEN FACT - SAFETY BELTS SAVE LIVES

### NYLON AUTO SAFETY BELTS

MADE TO WITHSTAND A CRASH PRESSURE OF 3000 POUNDS

Meets Civil Aeronautics Standards. Approved by Police, Safety Councils, Highway Patrol, Fleet Operators, etc. Made of finest NYLON webbing and fitted with Aircraft type buckle. Easily installed in any car. Special sizes for Sports Cars. Available in the following colors: Blue, Green, Gray and Maroon.



9.95 VAL. ONLY **4.89** EACH

### STATION WAGON AIR MATTRESS

Convert your wagon to a snug, comfortable FULL SIZE Double BED with this lightweight, durable air mattress. Made of heavy duty, laminated vinyl plastic with double welded seams. Excellent for camping, sunbathing, etc. The safest way for the kiddies to ride. Easily operated, non-abrasive valves.

5 SECONDS TO FASTEN - 1 SECOND TO UNFASTEN

### NEW OUTDOOR BUBBLER

Convert any outdoor faucet to a drinking fountain. Now you can have a convenient drinking fountain in your yard or patio. Attaches directly to your regular faucet and you enjoy a cool, refreshing drink by pressing a button. DOES NOT INTERFERE with the use of your garden hose. Made of polished nickel-plated bronze and brass with a durable Styrene Plastic Bowl.

ONLY **3.95**

### NEW 60-450X MICROSCOPE

FEATURING 60, 120, 150, 180, 300 AND 450 POWER MAGNIFICATION. NEWLY DEVELOPED - Self-Contained SUB-STAGE LIGHT ELIMINATES NEED FOR EXTERNAL LIGHT SOURCE.

Take advantage of our tremendous low-price purchase. Ideal for use by Amateur Scientist, Student, in Home Laboratory for study of insects, plant life, etc.

#### CHECK THESE FEATURES

- 1- Triple, revolving turret with 10X, 20X, 30X precision ground & polished lenses.
- 2- Two interchangeable eyepieces, 6X and 15X with precision ground and polished lenses.
- 3- SIX MAGNIFICATIONS for all purposes - 60X, 120X, 150X, 180X, 300X and 450X.
- 4- NEW! Sub-stage with SELF-CONTAINED LIGHT. No external light source needed.
- 5- Large sub-stage mirror for use with external light sources.
- 6- All Metal Body - inclines through 90 degrees.
- 7- Special Hardwood Case and 3-glass slides.

FREE! with MICROSCOPE - 8 Pc. DISSECTING SET with hardwood case.

**12.95**

### Special 12 Pc. SPORTSMAN'S KNIFE

4 5/8" BONE HANDLE

Eliminates 12 Items from Pack or Tool Kit

**ONLY 9.95**

Contains a regular knife, a fork, a spoon, scissors, draw knife, bone saw and fish scaler, can & bottle opener, cork screw, awl punch, screwdriver, and metal file. Mounted in a rugged bone handle.

COMPLETE WITH LEATHER BELT CASE

Order From This Ad. Pay by M.O. or check. P.O.'s accepted from D&B firms. 1% deposit with C.O.D.'s. All Prices FOB Los Angeles.

## FAMOUS PALLEY MIXES

**GADGET MIX** - Consists of 5 pounds of Rivets, Spacers, Bolts, Screws, Gears, Wheel Bearings, Springs, Clamps, and many more, ALL for ONLY... **1.19**

**BEARING MIX** - Approximately 20 needle and Ball and Roller bearings. New and Used. Sizes: 1/2" to 4". Some of these cost the Gov't \$10 apiece. Never such a value. 5 lbs. ONLY... **1.59**

**FILE MIX** - Ten assorted Files, 4" to 12", includes 3 Vixens, half rounds, rounds, mills, etc., in second hand used but in good condition. 1 Vixen alone worth our price for entire mix. **1.09**

**PULLEY MIX, No. PM-1** - You'll want this one around. 10 pulleys & metal pulleys ranging from 1" to 3" with ball and one piece bearings. These are aircraft pulleys, the best made with 100% of steel. A WONDERFUL BUY!!! **2.95**

**300 FT COPPER ANTENNA WIRE** - Can be trimmed to 80 Meter. 50 Band with up to 75 feet lead-in. Standed copper with 149 eyelet end. A BUY AT **1.49**

**SIGNAL CORPS WHIP ANTENNA** - Ideal for use with auto or portable radios. Can be used with FM receivers. Telescoping type, from 12" to 7 feet. **1.99**

**REFLECTOR ANTENNA** - Originally used in Radar. Can be adapted to TV or FM use. Webbing is zinc mesh metal wire. Overall span 48 inches... **1.49**

**180° OFFSET DRIVE** - For use where tremendous power at low take-off RPM is desired. 6 gears make an all-steel, cast-iron roller bearing. 85 to 1 gear ratio. Shafts are 1/4" & 3/8" dia. USED **5.95** NEW in excellent condition... **8.95**

### UNIVERSAL JOINTS

#### 90 to 180° UNIVERSAL

Has a heavy duty, solid cast Bronze body. Rotates from 90° to 180° as desired. Has 29/32" dia. steel shafts. Ball and socket joint. **5.95**

UNIVERSAL JOINT - Same as above with cast iron body. **5.25**

In excellent condition and in many sizes and types. Listed below are a few examples.

#### TUBULAR SHAFT TYPE

- 1- 1/2" OD x 3/8" ID x 2-3/8" long **75c**
- 2- 1/2" OD x 1/2" ID x 2-3/16" long **75c**
- 3- 1" OD x 3/16" ID x 3-3/8" long **1.10**
- 4- 3/4" OD x 5/8" ID x 3-1/4" long **1.25**
- 5- 1/2" OD x 3/8" ID x 2-5/16" long **.75c**

#### HEAVY DUTY TUBULAR TYPE

- 6- 1" OD x 13/16" ID x 4-3/16" long **1.65**
- 7- 1-1/4" OD x 1-1/8" ID x 3-11/16" long with gimbal ring in center. **1.65**

#### HEAVY DUTY SOLID SHAFT

- 8- 1-1/4" diameter x 3-3/4" long **1.95**
- 9- 1/2" dia. (one side) x 3/8" dia. (other side) x 2-1/4" long... **1.35**

ORDER BY ABOVE NUMBERS - Send for FREE BOOKLET on our Full line of flex drives, universal joints, etc.

## SAVE 50% ON PALLEY 10 HYDRAULICS

For our Special HYDRAULIC CATALOG SUPPLEMENT - Shows the entire line of our New Hydraulic Equipment designed especially to fill the needs of industry. Also shows our regular line of War Surplus hydraulics such as pumps, valves, cylinders, fittings, etc. at SAVINGS UP TO 85%. Write today. It's FREE!

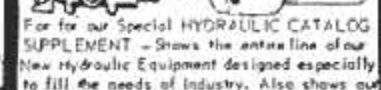

Order From This Ad. Pay by M.O. or check. P.O.'s accepted from D&B firms. 1% deposit with C.O.D.'s. All Prices FOB Los Angeles.

**Palley's**

2263 E. VERNON AVE., DEPT. PM-5  
LOS ANGELES 58, CALIF.

# THIS FAMOUS COUPON BRINGS YOU THREE VALUABLE BOOKS!

(See advertisement on page 9 )

1. "How to Succeed"—36-page job manual and career handbook.
2. Opportunity outlook catalog in field that interests you.
3. Sample lesson (math.) to demonstrate unique I.C.S. method.

CUT OR TEAR HERE



INTERNATIONAL CORRESPONDENCE SCHOOLS, SCRANTON 9, PENNA.

Please rush me copies of the three books listed here—without cost or obligation.

1. Big opportunity handbook in field checked below.
2. Famous 36-page career guide, "How to Succeed."
3. Sample lesson in Math demonstrating I.C.S. method.

## ARCHITECTURE and BUILDING CONSTRUCTION

- Air Conditioning—Refrig.
- Architecture
- Architectural Interiors
- Building Contractor
- Building Estimator
- Building Maintenance
- Carpentry and Mill Work
- Heating
- Painting Contractor
- Plumbing
- Reading Arch. Blueprints

## ART

- Cartooning
- Commercial Art
- Fashion Illustrating
- Magazine Illustrating
- Show Card and Sign Lettering
- Sketching and Painting

## AUTOMOTIVE

- Auto Body Rebuilding
- Auto Elec. Technician
- Auto-Engine Tune Up
- Automobile Mechanic

## AVIATION

- Aeronautical Engineering Jr.
- Aircraft & Engine Mechanic

## BUSINESS

- Advertising
- Bookkeeping and Accounting
- Business Administration
- Business Correspondence
- Public Accounting
- Creative Salesmanship
- Federal Tax
- Letter-writing Improvement
- Office Management
- Professional Secretary
- Retail Business Management
- Sales Management
- Stenographic-Secretarial
- Traffic Management

## CHEMISTRY

- Analytical Chemistry
- Chemical Engineering
- Chem. Lab. Technician
- General Chemistry
- Natural Gas Prod. & Trans.
- Petroleum Engineering
- Plastics
- Pulp and Paper Making

## CIVIL, STRUCTURAL ENGINEERING

- Civil Engineering
- Construction Engineering
- Highway Engineering
- Reading Struct. Blueprints
- Sanitary Engineering
- Structural Engineering
- Surveying and Mapping

## DRAFTING

- Aircraft Drafting
- Architectural Drafting
- Electrical Drafting
- Mechanical Drafting
- Mine Surveying and Mapping
- Plumbing Drawing and Estimating
- Structural Drafting

## ELECTRICAL

- Electrical Engineering
- Electrical Maintenance
- Electrician  Contracting
- Lineman

## HIGH SCHOOL

- Commercial  Good English
- High School Subjects
- Mathematics

## LEADERSHIP

- Foremanship
- Industrial Supervision
- Leadership and Organization
- Personnel-Labor Relations

## MECHANICAL AND SHOP

- Gas—Electric Welding
- Heat Treatment  Metallurgy
- Industrial Engineering
- Industrial Instrumentation
- Industrial Supervision
- Internal Combustion Engines
- Machine Design-Drafting
- Machine Shop Inspection
- Machine Shop Practice
- Mechanical Engineering
- Quality Control
- Reading Shop Blueprints
- Refrigeration
- Sheet Metal Worker
- Tool Design  Toolmaking

## RADIO, TELEVISION

- Industrial Electronics
- Practical Radio TV Eng'ng
- Radio and TV Servicing
- Radio Operating

## TELEVISION TECHNICIAN

- RAILROAD
- Air Brake Equipment
- Car Inspector
- Diesel Engineer & Fireman
- Section Foreman

## STEAM AND DIESEL POWER

- Combustion Engineering
- Diesel—Elec.  Diesel Eng's
- Electric Light and Power
- Stationary Fireman
- Stationary Steam Engineering

## TEXTILE

- Carding and Spinning
- Cotton, Rayon, Woolen Mfg.
- Finishing and Dyeing
- Loom Fix'g  Textile Des'ing
- Textile Eng'g  Throwing
- Warping and Weaving

## MISCELLANEOUS

- Domestic Refrigeration
- Marine Engineering
- Ocean Navigation
- Professional Engineering
- Short Story Writing
- Telephony

Name \_\_\_\_\_ Age \_\_\_\_\_ Home Address \_\_\_\_\_

City \_\_\_\_\_ Zone \_\_\_\_\_ State \_\_\_\_\_ Working Hours \_\_\_\_\_ A.M. to P.M. \_\_\_\_\_

Occupation \_\_\_\_\_

Canadian residents send coupon to International Correspondence Schools, Canadian, Ltd., Montreal, Canada. . . . Special tuition rates to members of the U. S. Armed Forces.

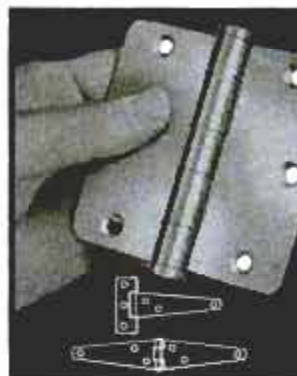

best hardware . .  
for hard wear  
**® GRIFFIN**  
**HINGES**

at your hardware or  
building supply store

GRIFFIN MFG. CO., ERIE, PA.

## Say You Saw It in POPULAR MECHANICS

### ONE-BAG MIXER THAT TRANSPORTS



Universal Transmix® transports, mixes and dumps cement, silage, dirt, etc. P. T. O. driven—no gears or chains. Can be installed or removed in 15 minutes. Fits Ford, Ferguson, AC-WD, IHC Super C, H&M, Case VAC, J. D., 40, Oliver 55, and other 2- and 3-plow tractors. Unconditionally guaranteed. See your dealer or write, giving tractor model, to

UNIVERSAL PULLEYS COMPANY  
330 NORTH MOSLEY • WICHITA, KANSAS

## EARN GOOD MONEY—Spare or Full Time IN A BUSINESS OF YOUR OWN...

### SMALL INVESTMENT — NO EXPERIENCE NEEDED

Thousands of men are making big money in their own business. You too, can have a fine income with an assured future in spare or full time with the Universal lawn mower grinder. Investigate our success plan now, it includes everything you need plus facts on how others have earned over \$3,600 in one season, working part time. Act now! Mail coupon today!

**ROGERS**  
MANUFACTURING CO.  
Lindsey, Ohio

ROGERS MFG. CO., Dept. M-56, Lindsey, Ohio  
Gentlemen: Rush me FREE details on easy inexpensive way to get into my own business.

Name \_\_\_\_\_  
Address \_\_\_\_\_  
City \_\_\_\_\_ State \_\_\_\_\_

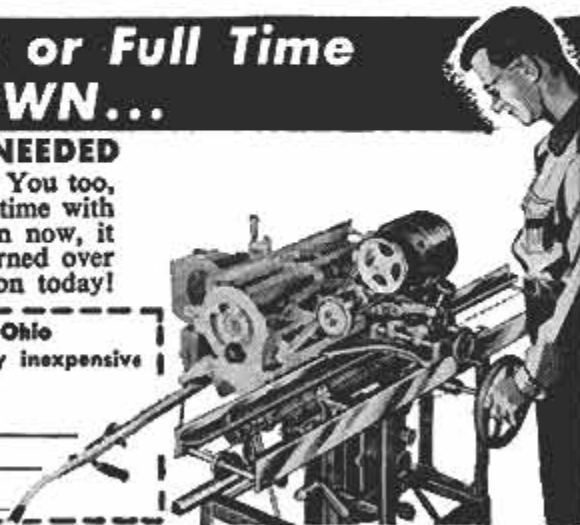

## PORTABLE LIGHT PLANTS

### GIANT 2000-2500 WATT PLANT

110-120 v. 60 cyc. AC. Absolutely the best made — exclusive dynamically balanced armature; heavy windings develop up to 500% watt overload for motor starting. Skid mounted — portable. Powered by an easy starting Briggs or Wisconsin 6 HP engine—complete with all accessories; engine easily disconnected for other uses. Big outlet box, voltmeter, no wiring necessary. Ample current for all purposes. Factory warranty. (Item 31) Wt. 210 lbs. Reg. price \$585. Special at..... **\$299.50**  
Same plant with electric self starter (Item 31a)..... **\$359.50**  
Generator only and control box..... **\$169.50**  
**DUAL VOLTAGE 110-220** available on any of above models for \$28.00 additional.

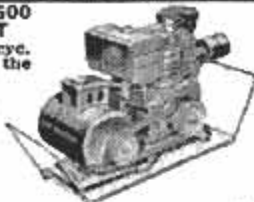

### Variable-Speed Selector

Heavy duty, made by B. F. GOODRICH for industrial use. Provides instant speed changes for any drive. For machine tools, dryers, printing, conveyors, production lines, hoists—any operation requiring variable speed. Employs reliable "trouble free" planetary system. No hydraulic power losses. Infinite range, smooth operation, easy installation. 3 sizes: 1/2-1 hp. 36 lbs.; 1-2 hp. Wt. 55 lbs.; 2-3 hp. Wt. 105 lbs.; Reg. list \$228, \$252 and \$352. Our prices **\$79.50, \$89.50 and \$114.50**



### HEATING & VENTILATING FAN

(Item 10) Easily installed in furnace pipes. Forces even heat to all rooms. Over range removes kitchen smoke and odors. Powerful, continuous duty motor, 110-120v. AC. Mount in wall or ceiling to ventilate any area. Quiet, super-efficient fan moves huge volume of air. (400 to 600 CFM).  
8" Pipe, wt. 5 lb. .... **\$6.85**  
9" Pipe, wt. 6 lb. .... **\$7.85**  
10" Pipe, wt. 7 lb. .... **\$8.85**  
12" Pipe, wt. 8 lb. .... **\$9.85**  
**HEAVY DUTY FAN.** Semi-enclosed motor, suitable for spray booths, restaurant exhausts, poultry houses, etc. 10" Fan, wt. 8 lbs. (Item 10E)..... **\$11.95**  
12" Fan, wt. 10 lbs. (Item 10D)..... **\$12.95**



### FUEL OIL FILTER

Stop 90% of all oil burner & heater troubles with this big capacity fuel filter made by American Bosch. Removes every last trace of rust, dirt, tank scale and water! Easily installed—inlet and outlet have standard 1/4" pipe thread opening (tubing adapters included if requested). Easily cleaned by opening drain plug and flushing through—lasts for years. Saves service calls. Ideal for filtering fuel on Diesel engines too. (Item 793). Wt. 3 lbs., Regularly \$9.95 **\$4.95**  
A Master Mechanic Special.

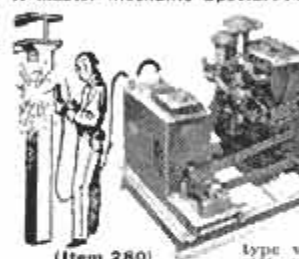

### MASTER DC ARC WELDERS

Now! a portable rugged, industrial type welder with terrific performance, yet built with a price hundreds of dollars less than you'd expect. Senior model made for years of trouble-free, continuous service. High capacity DC welding unit enables you to tackle any job with confidence—easily welds anything up to 2" plate using from 1/16" to 1/4" rods. Built-in stabilizer and cooling system makes arc easy to strike and hold. Dual control rheostat provides low heat soldering, brazing and welding from 30 to 300 amps. Complete with instructions, guarantee and triple V-belt or flat pulley. Easy to hook up and easy to operate. **WELDER ONLY — DUAL CONTROL MODEL.** Same as above, but drive with your tractor, jeep or gas engine of 14 HP or more. (Item 22a). Wt. 110 lbs. \$450 value..... **\$119.50**  
**WELDER ONLY—STANDARD MODEL.** Same as above but with single rheostat for heavy metal welding only. (Item 38). Wt. 110 lbs. \$400 value. Special..... **\$99.75**  
**COMPLETE POWER MASTER** (Illustrated above) powered by a 14.6 hp., air cooled Wisconsin engine. Wt. 480 lbs. (Item 280). Compare with welder costing \$1200. Factory Special..... **\$449.50**  
**WELDING KIT** Two 10 ft. leads, welding helmet, electrode holder, ground clamp. Sold only with welder at..... **\$10.50**

# SAVE

middleman profits...  
get **MASTER MECHANICS**  
bedrock factory prices



(Item 24)  
**600-700 WATT PLANT**  
**PUSH BUTTON START**  
115 v. 60 cyc. AC Powered by a rugged 2 HP, easy starting Briggs engine. No wiring necessary; just plug in and operate. Plenty of current for any oil burner, freezer, brooder, emergency lights, etc. which require up to 700 watts. Ideal for television and radios. Complete with voltmeter and built-in winding to charge 6 v. auto batteries. (Item 24) Wt. 75 lbs. Easily fits in car trunk. Be prepared if storm knocks out power lines. **\$143.50**  
Regular \$275.00 value.....  
**1000-1200 Watt Plant (Item 45)** same as Item 24 but larger generator and engine **\$199.50** with 50% greater output.....

### RUBBER HOSE

Genuine Neoprene Hose—outlasts ordinary rubber 3 to 1. Reinforced with super tough cotton cord plies—yet completely flexible. Equipped with standard thread male and female fittings. Pump water for irrigation, stock tanks, home, barn, fire fighting, etc.—or pump gas and fuel oil. Volume factory prices—save more than 60%!  
Inside Dia. Length Price  
10 ft. 9.95  
10 ft. 10.95  
25 ft. 13.95  
50 ft. 24.75  
100 ft. 49.95  
10 ft. 10.95  
10 ft. 10.95  
25 ft. 14.75  
10 ft. 16.50  
10 ft. 19.50  
14 ft. 21.50  
10 ft. 21.75  
10 ft. 25.50  
2" (no cord plys) 10 ft. 16.50  
2" (suction) 14 ft. 21.50  
2 1/2" (discharge) 10 ft. 21.75  
3" 10 ft. 25.50  
**1 1/2" I.D. HIGH PRESSURE STEAM HOSE** per ft. **\$1.00**  
**AIR HOSE** Heavy duty, 1/4" I.D., 2 braided (150 lb. pressure) with standard couplings, 20 ft. lengths, ea. .... **\$2.95**  
**PAINT SPRAY MATERIAL HOSE** 3/4" I.D. Synthetic Thickwall innertube and neoprene cover—finest model 25 ft. lengths with standard couplings. (Item 62) each... **\$7.50**



### EXTENSION CORD

Heavy duty and very flexible. Neoprene 1-4-2 cable, 20 year quality Wt. 19 lbs. (Item 185) 100 ft. Complete with rubber plug and outlet. A terrific buy at only **\$8.95**  
**No. 10-2 POWER CABLE.** Heavy duty, very flexible, rubber covered, 50 ft. with male and female fittings. Wt. 9 lbs. (Item 592a) **\$10.45**  
**No. 12-2 POWER CABLE.** Very flexible rubber covered, special outside shield for grounding power tools, etc. 50 ft. (Item 199) wt. 8 lbs. **\$6.95**, 100 ft. (Item 200)..... **\$12.95**



### MASTER AIR COMPRESSOR

**COMPARE!** This is the only compressor built with a **NO RUST** stainless steel tank. Safe up to 500 lbs. (Item 209) High pressure type (4 c.f.m.) Large volume of air for heavy duty service. For painting, inflating truck & auto tires, greasing, sand blasting, etc. Piston type 2" bore compressor with built-in air filter, Master built with high strength alloys and precision bearings. Tank, 12"x21", 2100 cu. in. cap. Equipped with automatic switch that starts and stops motor to maintain desired pressure (up to 150 lbs.) and check valve, safety valve, gauge, shut-off valve, 20 ft. air hose and tire chuck. Beautifully balanced on ball bearing wheels and rubber tires. Don't take chances with used or surplus equipment. Our compressors are factory new and are guaranteed **SAFE**. Low factory prices. 1 1/2 HP Model (cap. 85 lbs.) **\$99.50**  
Reg. \$175. (Item 209).....  
1 1/2 HP heavy duty model, Rep. Ind. (Item 209a) **\$129.50** motor & unloader switch



## LESS THAN WHOLESALE

### 1300-1500 WATT PLANT

115v. 60 cyc. AC Push Button Start. Powered by a 3 1/2 HP, Clinton engine. Combined, big output with easy portability. Provides emergency power for operating any oil burner, sump pump, freezer, television, lights, communications systems, etc. which require up to 1500 watts. (Item 22). Wt. 110 lbs. Reg. \$475 value. Factory price... **\$239.50**



### 1750 Watt Plant Powered by 4.5 Briggs engine.

Electric starting & battery charging built-in! Factory price... **\$279.50**  
**MASTER-LITE 2500 Watt Plant** 110/120 v. 60 cyc. AC. A powerful plant, ruggedly constructed and yet designed for easy portability. Can be started by rope or built-in 12 v. electric push button starter. Built-in winding to charge battery. Powered by a big 7.10 HP Briggs engine, complete with all accessories. Includes control box, voltmeter, and handy plug-in power receptacle. An ideal plant for permanent or stand-by service. Wt. 225 lb. Reg. price \$645.00 **\$329.50** (Item 21) Factory Price.....



### 3500 Watt Plant Push Button Start (Item 23)

115 v. 60 cyc. AC. Similar to above, but larger and 33% more capacity. Wt. 270 lbs. Reg. \$700. Factory Price..... **\$379.50**  
**DUAL VOLTAGE 110/220** for any of above plants—\$30 additional.

### 2-Speed Aluminum Alloy WINCH

Sturdy high-speed, ball bearing winch—super tough aluminum alloy construction (weighs only 60 lbs.) rugged yet portable! Two speeds, first three gears for easy handling of heavy loads, (second) direct drive for fast take up. Built-in drum brake with ratchet hand lever, enables operator to ease loads down gently and lock at any point desired. Large crank handle gives extra leverage—has non-slip, two handed revolving grip. Rated at 3000 lbs. lifting capacity. Drum handles 400 ft. of 3/8" cable or 600 ft. of 1/4" cable. Ideal for contractors, farmers, boat operators—mounting on trucks, tractors, farm implement trailers etc. Easily converted for power operation. (Item 794) **\$49.50** \$200 value—only.....

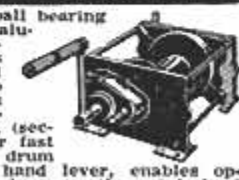

### CONDITIONAIRE VENTILATING FANS

Save big money installing your own exhaust fan. Efficient propeller type blade moves huge volume of air quietly and effortlessly. Heavy welded frame—pre-drilled for easy installation. Just cut opening and bolt in place. Continuous duty motors. Ideal for attics, restaurants, garages, barns, chicken houses, etc. Control manually or with thermostat. **Blade Opening CFM Wt. Item**  
16" 1814 19 lb. 365a **\$27.95**  
18" 1974 27 lb. 365b **\$31.95**  
20" 2114 41 lb. 365c **\$39.95**



### THERMOSTATS: BARN type (range 40°-60°), Wt. 2 lbs. \$6.95.

### HI-FLO Centrifugal PUMP

Completely self-priming! No foot valve required. Tremendous capacity—100 gal. per min. . . . Special impeller enables pump to handle muddy or sandy water. Simple to operate—simply start engine and watch the water go. Powered by a rugged, easy-starting 2 HP Briggs engine. Pre-lubricated sealed bearings for years of heavy low-cost service. **Big 1 1/2" Model.** Item 502. Wt. 70 lbs. **\$134.50** Factory price.....  
**2" Model** (150 gal. per min.) with 1 1/2 HP engine. Item 502a. 90 lbs. Fact. Spec. **\$154.50**



### 9 TON HYDRAULIC PRESS

A tremendously powerful hydraulic press, capable of exerting 18,000 lbs. pressure. Pays for itself many times over—straightening bent connecting rods, king pins, crankshafts, axes, link pins and bars—or pushing out frozen bearings and bushings. Developed pressure under precise control and visible at all times on accurate gauge. Complete with both large and small anvils and flgs to straighten any kind of curve or bend. (Item 464) Wt. 11 lb. Actual list price **\$365**. Our special close-out price... **\$69.50**



Send check or M.O. Prices f.o.b. Factory. 10 day Money back guarantee. SEND 10c for **BIG 1956 Catalog**  
**MASTER MECHANIC MFG. CO., DEPT. 54-M Burlington, Wis.**



**KEEP CLOSE-TOLERANCE MACHINING EFFICIENT!**

# South Bend PRECISION TURRET LATHES

South Bend 2-H Precision Turret Lathe—1" collet capacity, 16 1/4" swing, 96 power turret feeds, 48 cross slide feeds, 48 carriage feeds, 48 thread cutting feeds.

Base Price \$3350

South Bend Precision Turret Lathes keep efficient the machining of small duplicate parts. Their remarkable accuracy and positive controls simplify the holding of close tolerances with only normal machine handling care. Finishes are commonly produced that otherwise would require additional operations. Simplicity of tooling makes job changes quick and economical. Wide ranges of power feeds and thread cutting feeds assure maximum efficiency on every job. They are particularly suited for second operations. Sizes available include: 1" collet—16" swing; 1" collet—13" swing; 1" collet—10" swing. Priced from \$1601. Time payment terms can be arranged. Only 3 1/4% annual interest on original unpaid balance.



## TURRET ATTACHMENTS

South Bend Turret Attachments are available for tooling 9", 10", 13" and 16" swing South Bend Lathes for repetitive operations. Precision built for precision work, their rigidity and accuracy permit maximum feeds and speeds. Prices of hexagon bed turrets range from \$273.00 to \$698.00. Square Turret Tool Blocks are priced from \$41.50 to \$91.00. Write for Attachment Catalog giving full information on South Bend Turrets and the complete line of South Bend Attachments and Accessories.



PLEASE SEND INFORMATION CHECKED:

- |   |   |   |  |   |   |   |
|---|---|---|--|---|---|---|
|  |  |  |  |  |  |  |
| <input type="checkbox"/> 9" and 10" BENCH LATHES                                    | <input type="checkbox"/> 10" to 16-24" FLOOR LATHES                                 | <input type="checkbox"/> DRILL PRESSES  | <input type="checkbox"/> 1/2" & 1" Collet TURRET LATHES                              | <input type="checkbox"/> TOOL GRINDERS  | <input type="checkbox"/> 7" BENCH SHAPERS   | <input type="checkbox"/> MILLING MACHINES   |

Name \_\_\_\_\_ Street \_\_\_\_\_  
City \_\_\_\_\_ State \_\_\_\_\_

Building Better Tools Since 1906 • SOUTH BEND LATHE • South Bend 22, Indiana



newest one for *fishing fun*



*- quietest too !...*  
the "Fisherman"

Behold the Fisherman! . . . never was a motor more patly named! 5½ horsepower, 51 pounds of everything a fishing motor ought to be. *So wonderfully quiet!* Quietest of Whispering Power Evinrudes . . . and that means *quietest of outboard motors.* And so easy to start! With new Eas-A-Matic starting you simply "make a pass" with the Simplex Starter knob—and it starts—that's all! So s-m-o-o-t-h! Breezing home at open throttle—ticking along at slowest troll—*no vibration*—none! There's fuel for all-day fishing in the Cruis-a-Day tank. And Gearshift with neutral, forward, reverse. Roto-Matic speed control, Co-Pilot, Transom Trigger—*everything!* See your Evinrude Dealer—look for his name under "Outboard Motors" in your phone book. **CATALOG FREE!** Write today for full-color catalog of the complete Evinrude line for 1956—nine models, 3 to 30 horsepower. **EVINRUDE MOTORS, 4273 North 27th Street, Milwaukee 16, Wisconsin.**



*A Division of Outboard, Marine & Mfg. Company*  
In Canada: Mfd. by Evinrude Motors, Peterborough



**Evinrude**

*quiet Outboard Motors*

IT'S A PSYCHOLOGICAL FACT: PLEASURE HELPS YOUR DISPOSITION



*How's your disposition today?*

**FEEL BADGERED SOMETIMES** if things don't add up? That's natural when little annoyances bother you. But it's a psychological fact: pleasure *helps* your disposition. So everyday pleasures are *important*. If you're a smoker, choose your cigarette for utmost pleasure. *Choose Camels* — America's most popular cigarette!

H. J. Reynolds Tobacco Co., Winston-Salem, N. C.



**BRIAN KEITH**, Star of TV's "Crusader": "I've tried them all. It's Camels for me for good, rich taste, genuine mildness!"

**RISE STEVENS**, Metropolitan Opera Star: "I choose Camels because they give me so much more pure pleasure out of smoking!"



**MARGUERITE HIGGINS**, Pulitzer Prize-Winning Correspondent: "No other cigarette gives me the rich taste and real mildness of Camel."

**CLAIRE L. CHENNAULT**, Major General (Ret.) USAF: "I've smoked Camels over 40 years. They taste so rich, yet smoke so mild!"

**No other cigarette tastes so rich, yet smokes so mild!**