

APRIL 1958 35 CENTS

# POPULAR MECHANICS

## MAGAZINE

WRITTEN SO YOU CAN UNDERSTAND IT

REG. TRADE MARK, GREAT BRITAIN, NO. 810422

*Alpine Cableway*  
—Page 81

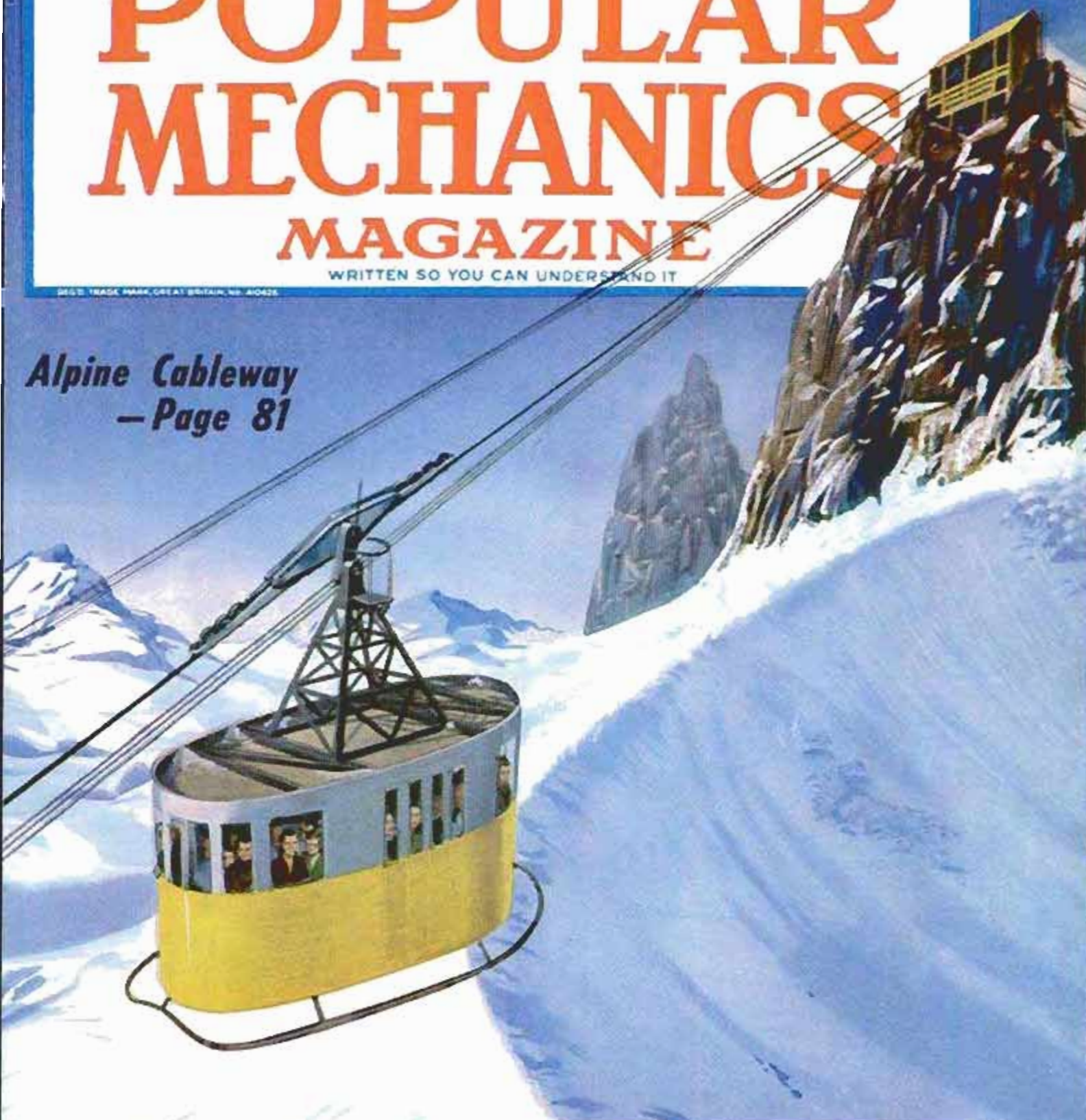

**22 Pages on**  
**OUTDOOR LIVING**  
PATIOS, GRILLS, GAMES, LIGHTING  
*For the Craftsman*  
**How to Build a Screen House**



# Speed, Spray and Dependability!



**America's  
Most Beautiful Outboard Motors**

JAVELIN*	.....	30 hp.	..\$582.00
SEA-HORSE 30*	...	30 hp.	..552.00
SEA-HORSE 30	...	30 hp.	..462.00
SEA-HORSE 15*	...	15 hp.	..452.00
SEA-HORSE 15	...	15 hp.	..362.00
SEA-HORSE 10	...	10 hp.	..321.00
SEA-HORSE 7½	...	7½ hp.	..241.00
SEA-HORSE 5½	...	5½ hp.	..216.00
SEA-HORSE 3	.....	3 hp.	..146.00

\*Electric Starting... Prices f.o.b. factory, subject to change... All models except the "3" have separate Mile-Master Fuel System... OBC certified brake hp at 4000 rpm (30's at 4500).

Sea-Horses are terrific for water skiing — so responsive, so maneuverable, so **DEPENDABLE!** And Johnson gives you a choice of three 30's—electric starting, manual starting and the magnificent, high-fashion Javelin with concealed controls and wrap-around chrome cowling. All fitted for remote control. All equipped with separate Mile-Master Fuel System. All *quiet!* See your Johnson Dealer. Look for his name under "Outboard Motors" in your classified telephone directory.

**FREE!** Write for your illustrated copy of the new Sea-Horse Catalog. Complete, factual, helpful.

**JOHNSON MOTORS, 400 Pershing Rd., Waukegan, Ill.**  
A DIVISION OF OUTBOARD, MARINE & MANUFACTURING COMPANY  
In Canada: Manufactured by Johnson Motors, Peterborough

## **Johnson** SEA-HORSES

FOR **DEPENDABILITY**

**ASK COMMERCIAL USERS... SEA-HORSES WORK FOR THEM!**

Some spark plugs are designed for low speeds, some spark plugs are designed for high speeds, but . . .

# Only new **POWER TIP** "fires up" your engine at all speeds!

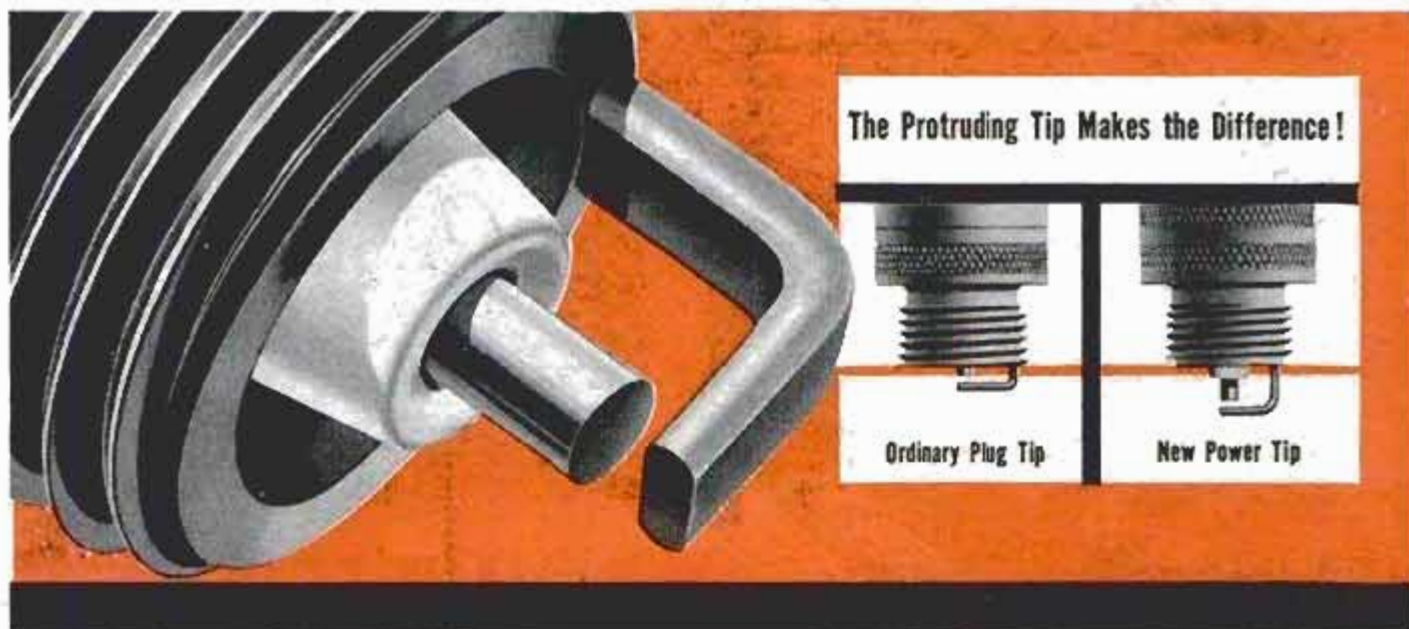

Up until now, if you really wanted top performance at all speeds you'd have to carry two sets of spark plugs. A set of "hot" plugs for slow city driving—to fight fouling. A set of "cold" plugs for fast highway driving—to fight pre-ignition.

### POWER TIP TOPS AT ALL SPEEDS

But now Auto-Lite introduces a spark plug that "fires up" modern overhead-valve engines to deliver top performance and economy at all speeds: The amazing new Auto-Lite Resistor Spark Plug with Power Tip! It's the first and only spark plug

"ignition-engineered" for today's engines and today's complex driving.

### THE PROTRUDING TIP MAKES THE DIFFERENCE

The difference is the protruding spark plug tip . . . the Power Tip . . . that extends the spark gap inward toward the center of the combustion chamber. It's hot at low speeds because it's "in the thick" of combustion. Fouling is checked because deposits burn away clean. Yet the Power Tip is cool at high speeds to check pre-ignition because it gets the full benefit of cooling intake gases.

### TESTED AND PROVED BEST

IS YOUR CAR LISTED HERE? If so, you need the Auto-Lite Resistor Spark Plug with Power Tip, as proved by actual road tests at all speeds. It fits all these cars with overhead-valve engines using 14 mm. plugs. So see your nearest Auto-Lite Spark Plug Dealer for Auto-Lite Resistor Spark Plugs with Power Tip for these fine cars . . . Buick, Cadillac, Chevrolet, Chrysler, DeSoto, Dodge, Ford, Hudson, Imperial, Lincoln, Mercury, Nash, Oldsmobile, Packard, Plymouth, Pontiac and Studebaker.

ENGINEERING CHART SHOWS HOW ONLY POWER TIP DELIVERS TOP PERFORMANCE AND ECONOMY AT ALL SPEEDS.



AUTO-LITE RESISTOR SPARK PLUG WITH POWER TIP . . . for all speeds



# AUTO-LITE **POWER** RESISTOR SPARK PL

This One



P2NY-TE0-Y7JP

Auto-Lite manufactures over 400 products, including Spark Plugs, Batteries, Wire and Cable and Automotive Electrical Systems . . . sold throughout the United States and Canada.



**MECHANICAL  
SKILLS  
CAN GET  
YOU  
AHEAD  
IN THE  
U. S.  
AIR FORCE**

**Here's why —**

If you're interested in mechanics, join the U. S. Air Force. As an Airman you may develop your technical ability and learn a skill that will pay well...and win you extra stripes. Such interesting career fields as Aircraft and Engine Maintenance, Rocket Propulsion and Intricate Equipment Maintenance are open to you, if you qualify. Don't delay — see your local Air Force Recruiter or mail the coupon.



**YOU GO  
PLACES  
FASTER  
IN THE  
U. S. AIR FORCE**

**PASTE COUPON ON POSTCARD** M-19-PM3  
and mail to

AIRMAN RECRUITING INFORMATION BRANCH  
BOX 2202, WRIGHT-PATTERSON AFB, OHIO

Please send more information on my opportunities for enlisting in the U. S. Air Force. I am between the ages of 17-34 and reside in U. S. A. or possessions.

NAME \_\_\_\_\_

ADDRESS \_\_\_\_\_ AGE \_\_\_\_\_

CITY \_\_\_\_\_ ZONE \_\_\_\_\_ STATE \_\_\_\_\_

# Popular Mechanics Magazine

Registered in U. S. Patent Office and Canada

H. H. WINDSOR, Founder

H. H. WINDSOR, JR., Editor and Publisher



## Next Month

THIS PRETTY LASS owns just one of the 2,500,000 small boats in this country. She's a lucky lass because she has access to a derrick to launch and retrieve her craft. Not so lucky are most week-end sailors. Outboard boating has hit with such a bang that suddenly there is a genuine traffic jam at the water's edge. Boaters have neither the facilities nor the room to get their craft in and out of the water. This has led to the development of thousands of yacht clubs of a new type. Members are truck drivers, schoolteachers and the man next door. Some of their ingenious boat-handling methods are shown next month

Information not listed on articles in the index, starting on page 74, frequently is listed in the WHERE-TO-FIND-IT LIST, which is available to readers without charge. A copy may be obtained by writing to the Bureau of Information, Popular Mechanics, 200 E. Ontario, Chicago 11, Ill.

Published monthly by Popular Mechanics Company, 200 E. Ontario St., Chicago 11, Ill. H. H. Windsor, Jr., president; Wm. Harrison Fetzridge, vice-president; Franklin S. Forsberg, operations vice-pres.; D. F. Windsor, vice-president and secretary-treasurer; H. H. Windsor III, vice-president; W. T. Windsor, vice-president; Clover L. Perkins, advertising manager; Alan M. Deyoe, circulation manager. Single copy in the United States and Canada, 35 cents; subscription rates in the United States and possessions, Canada, Philippines and countries of the Pan-American Postal Union, 1 year \$3.50; 2 years, \$6.00; 3 years, \$8.00. To all other countries add \$1.00 a year over United States prices for overseas postage. If you plan to move, notify us at least 30 days in advance so you will not miss an issue. Give both your old and new addresses. Entered as Second Class Matter, September 15, 1903, at the Post Office at Chicago, Illinois, under Act of March 3, 1879. Entered as Second Class Matter at Post Office Dept., Canada. Registered as Second Class Matter at the Post Office at Mexico, D. F., Mexico, June 20, 1950. Copyright 1956 by Popular Mechanics Company. Copyright under International Copyright Union. Copyright in France. All rights reserved under Pan-American Copyright Union. Printed in the United States of America.

Volume 105

APRIL 1956

Number 4

Address all communications to: 200 E. Ontario St., Chicago 11, Ill.

Managing Editor.....	Roderick M. Grant
Assistant Managing Editor.....	Wayne Whittaker
Shop Notes and Crafts Editor.....	James R. Ward
Radio-Television, Electronics Editor.....	Lothar Stern
Associate Editor.....	Clifford B. Hicks
Associate Editor, Automotive.....	Arthur R. Railton
Associate Editor, Shop Notes and Crafts.....	Wayne C. Lecky
Associate Editor, Shop Notes.....	W. Clyde Lamme
Assistant Editor, Crafts.....	Jay W. Hedden
Assistant Editor, Makeup.....	John C. Dalen
Automotive Correspondent.....	Leo Donovan
Art Director.....	Frank Beatty
Assistant Editors—Leonard F. Hilts, Elliott H. McCleary, Emily Mullaney, Earl F. Wobeck	
Eastern Editor.....	Richard F. Dempewolff
Empire State Bldg., Room 2906, New York City 1	
Western Editor.....	Thomas E. Stimson, Jr.
Suite 1010, 3460 Wilshire Blvd., Los Angeles 5, Calif.	
London Manager.....	Douglas W. Wedderspoon
Eagle House, Jermyn St., London S. W. 1, England	
Director, Bureau of Information.....	Allan Carpenter
200 E. Ontario St., Chicago 11	

### Advertising Offices

Chicago: 200 E. Ontario St., Whitehall 4-0100; New York: Empire State Bldg., 350 Fifth Ave., Longacre 5-7580; Detroit: General Motors Bldg., TRinity 5-8711; Cleveland: Hanna Bldg., 1422 Euclid Ave., Prospect 1-0456; Los Angeles: Tishman Bldg., 3460 Wilshire, DUnkirk 2-8458; San Francisco: Russ Bldg., 235 Montgomery St., YUkon 2-0823.

## In This Issue...

Cableway to the Top of the Alps - - - - -	81
Seabees Build a Town Under Antarctic Ice - - - - -	89
Disaster Clinic - - - - -	96
Owners Report on the '56 Cadillac - - - - -	104
Target: Satellite Europe - - - - -	110
Now You're Cooking With the Sun - - - - -	114
What's New for Your Home - - - - -	122
Here's Fun From My Bag of Camera Tricks - - - - -	126
Radio, TV and Electronics - - - - -	161

## Outdoor-Living Section—

Get Ready for Outdoor Living - - - - -	145
Eight Patios You Can Build Yourself - - - - -	146
Light Up the Outdoors - - - - -	149
Keep Cool in a Screen House - - - - -	145
Do You Have a Landscape Problem? - - - - -	170

(plus many other ideas for your outdoor comfort)

## For the Craftsman...

Time to Build a Clockcase—Part I - - - - -	173
Modernize Your Home With Practical Built-Ins - - - - -	186
Use Engine for Your Power Mower for Other Jobs - - - - -	194
Keep Your Outboard Humming - - - - -	201
Build Your Own Belt Sander - - - - -	205
Know Your Shop Motors—Part I - - - - -	209
Shopping for Tools - - - - -	218
Clinic for Homemakers - - - - -	224

See pages 74, 76 and 78

for other items and manufacturers of available products



Special during Hardware Week—April 12-21

# this NEW Black & Decker 1/4" Drill... makes your home repair jobs easy!



**NEW Orbital Sanding Attachment**  
for B&D 1/4" Drills . . . gives professional finishes!  
**Only \$16.95**

Use this new orbital sanding attachment . . . with, across or against the grain! Get a satin-smooth finish like never before. Big bottom plate extends beyond housing—sands right up to obstructions. No swirl marks; no chance to ruin the job! Amateurs do perfect work with this wonderful new sanding attachment. And any B&D 1/4" Utility Drill has plenty of power to get your sanding done faster!

Over 2,500,000 homeowners now do *their own* repair and building jobs with Black & Decker 1/4" Drills—world's most famous do-it-yourself tool! This new, powerful, lower priced drill handles like a charm—with attachments to drill, saw, sand, drive screws, mix paint—any home application you can think of. Make your own lawn chairs, end tables, children's furniture! Polish tables easily, quickly—sharpen garden tools—clean rust off metal railings!

For help with your home jobs write for "Handy Tips" booklet. Send 25 cents to: Bob Davis, Home Director, THE BLACK & DECKER MFG. CO., Dept. M-46, Towson 4, Maryland.

LOOK IN THE YELLOW PAGES UNDER "TOOLS-ELECTRIC"

 **Black & Decker®**  
WORLD'S LARGEST MAKER OF  
PORTABLE ELECTRIC TOOLS

# Give your car **NEW LIFE!**



## Get the **FULL** energy of your battery

with

# **BOWES** Tension-Lock



## **TERMINAL** **BATTERY CABLES**



### Note these **BIG Advantages**

- 1 No trouble making nuts or bolts.
- 2 Guaranteed corrodless.
- 3 Can't slip or work loose.
- 4 Longer battery life.
- 5 Road tested in hundreds of cars over many thousands of miles for more than two years with perfect performance record.

### Fully 50% of Cables now in use are faulty

Have your Bowes Dealer check your cables now. If faulty he will assure you greatly improved performance with the full energy providing, trouble free Bowes Tension Lock Terminal Battery Cables.

Old style nut and bolt type battery cable terminals are trouble makers. They will develop energy stealing corrosion, and, in many cases, work loose and rob you of the full energy of your battery.

With the new Bowes Tension-Lock Terminal Battery Cable there are no bolts or nuts. Instead, a heavy duty tempered spring steel clip is die cast into the noncorrosive terminal which is quickly and easily removed or applied with specially designed reverse pliers.

You are thus assured not only of no corrosion... but also constant perfect contact enabling your battery to deliver its full energy.

**Guaranteed for the life of your car and guaranteed to provide full capacity of your battery at all times**

BOWES "SEAL FAST" CORP., INDIANAPOLIS 7, INDIANA • HAMILTON, ONTARIO, CANADA • LONDON, ENGLAND  
BOWES PACIFIC CORPORATION, RIVERSIDE, CALIFORNIA



IF YOU "EAT, SLEEP  
AND LIVE" CARS...  
**TURN YOUR HOBBY  
INTO A CAREER!**

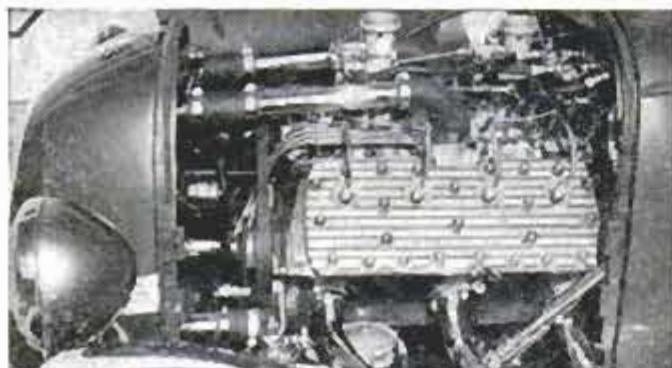

Get America's Big-time, Big-future

## **AUTO MECHANICS & DIESEL COURSE** at home in your spare time!

Los Angeles' National Schools, America's automotive Technical Trade School since 1905, now brings its famous resident Shops and Faculty direct to you at home—to prepare you to earn more money, with job security, in today's fast-moving, opportunity-filled Auto Mechanics Industry! Get your home training from the "Car Capital of The World"—America's most auto-minded city, center of Hot Rod and Sports Car activity! Mail coupon right now!

### "SHOP-METHOD" HOME TRAINING!

**YOU MASTER ALL PHASES, INCLUDING DIESEL!** All lessons fully illustrated. Latest equipment covered.



**THIS SET OF LIFETIME TOOLS IS YOURS!** Also all-metal tool box. Part of your course, yours to keep. **EARN WHILE YOU LEARN!** We show you how to start Spare Time Earnings soon after enrollment.

**ATTENTION MEN OF DRAFT AGE.** Learn how you can achieve higher rating and pay. Mail coupon at once! **APPROVED FOR G. I. TRAINING.** Both Home Study & Resident Courses. Free help with technical and personal problems—Job Placement Service.



**Send for FREE FACT-BOOK  
AND SAMPLE LESSON!**

**NOW! 2 offices to serve you faster!  
Mail coupon today to one nearest you!**

## **NATIONAL SCHOOLS**

Technical Trade Training Since 1905

LOS ANGELES 37, CALIFORNIA

IN CANADA: 811 West Hastings Street, Vancouver, B. C.

### **MAIL NOW TO OFFICE NEAREST YOU!**

(mail in envelope or paste on postal card)

**NATIONAL SCHOOLS, Dept. DB-46**

4000 S. FIGUEROA STREET OR 187 N. LASALLE STREET  
LOS ANGELES 37, CALIF. CHICAGO 1, ILLINOIS

Send **FREE** Auto-Mechanics Book and Sample Lesson.  
No obligation, no salesman will call.

NAME \_\_\_\_\_ BIRTHDAY \_\_\_\_\_ 19 \_\_\_\_\_

ADDRESS \_\_\_\_\_

CITY \_\_\_\_\_ ZONE \_\_\_\_\_ STATE \_\_\_\_\_

Check if interested **ONLY** in Resident School Training at Los Angeles.  
VETERANS: Give Date of Discharge \_\_\_\_\_

## **ACROSS THE DESK**



### To the Editor:

In your February issue ("Seattle Police Patrol an Underwater Beat") you made a statement that "Patrolman Theodore Yerbek, equipped with oxygen tank and rubber suit, prepares to go below." Oxygen when used under pressure will become a deadly poison as the pressure increases, such as when it is used in the aqualung or other self-contained breathing equipment . . . Tanks are filled with compressed air only.

Joe Vogel,  
2618 N. College Ave.,  
Indianapolis, Ind.

We stand corrected.

### Sports Cars on Display

At the same moment that you were receiving your February issues with the eight pages of beautiful paintings of famous sports cars, the originals of those paintings by Paul Hamlin went on display before 700 members of the Sports Car Club of America, in convention at Detroit. Naturally we



were gratified at the enthusiastic reception they received. Many extra sets of the printed color section were ordered by the sports-car fans, and a few are still available to those interested. Readers will receive prints of the paintings suitable for framing if they send 25 cents for the set of eight to our Bureau of Information, 200 E. Ontario St., Chicago 11.

### Prize PM Authors

Our Book Department is bursting with pride. Two authors of PM books have won prize awards from the Thomas Alva Edison Foundation. In December 1955, one of the

(Continued to page 8)



# 5 reasons why ACCOUNTING



**offers you MORE MONEY... and SUCCESS!**

**REASON #1.** If you were an expert accountant right now, chances are you would find yourself among the highest-paid of all professional men and women. Even back in "depression years," accountants earned more than many men in other major professions.

**REASON #2.** The demand for accountants is great—everywhere. All businesses must have trained accountants to cope with ever-growing requirements. It's a profession offering wide opportunity—always—to the man who knows.

**REASON #3.** You can fit into any business, anywhere in the country—because accounting principles are universal. Think what this means in terms of security and independence!

**REASON #4.** Accounting is open to all. Any man or woman of good intelligence, who enjoys figure work and is willing to follow LaSalle's systematic "problem method" plan, can rapidly qualify for a highly profitable, enjoyable lifetime career... and he doesn't have to finish his training before beginning to "cash in."

**REASON #5.** Without losing a day from your present work, you can prepare in spare hours at home, at low cost, under LaSalle's step-by-step "Problem Method" of "learning by doing." This famous plan accounts for LaSalle's remarkable record of having trained one out of every 13 of all Certified Public Accountants in the U. S. . . . and of having put many thousands of others into high-paying careers.

Send today for Free Sample Lesson and "Accountancy, the Profession That Pays." Learn about the several great fields of opportunity . . . and LaSalle's time-tested plan for helping men and women to rapid advancement, higher income, greater prestige and professional standing. The coupon below will bring this information to you—without cost or obligation.

**MAIL THE COUPON—NOW**

*Member, National Home Study Council*

**GET FREE SAMPLE LESSON**

**LaSalle Extension University**

**A Correspondence Institution**

**Dept. 464H 417 S. Dearborn St., Chicago 5, Ill.**

Please send me, free of all cost or obligation, a sample lesson in Accounting . . . also, your latest illustrated book, "Accountancy, the Profession That Pays."

Name.....Age.....

Address.....

City, Zone, State.....



**LASALLE**  
417 S. Dearborn St.,  
CHICAGO 5, ILL.  
APRIL 1956

(Continued from page 6)

awards went to Don Herbert as producer of the best children's science-TV program and author of *Mr. Wizard's Science Secrets*, published by Popular Mechanics Press.

In February 1956, John Lewellen's book *The Boy Scientist*, also published by *PM*, brought him a beautiful scroll and check for \$250 as the best children's science book published in 1955. The Foundation's awards were presented by the Honorable Charles Edison, son of Thomas A. Edison.

### Teachers Wanted

In a land of plenty there are still critical shortages. Notably there is a shortage of engineers and, along with that shortage, there is a growing need for teachers—the teachers who help produce the engineers.

Dr. Jess H. Davis, president of Stevens Institute of Technology at Hoboken, N. J., reported recently that Soviet Russia last year graduated 53,000 engineers—the United States only 22,500. If America is to keep its leadership, he pointed out, engineering colleges will have to concentrate on teaching engineering science—improving the undergraduate's understanding of the theoretical concepts of that science—leaving it to industry to handle the "how to do it" technical instruction in particular fields.

The shortage of science teachers is exemplified in a letter received by *PM* recently from Monroe M. Freedman, administrative assistant at Samuel Gompers Vocational and Technical High School, New York City. He reported the New York schools "in urgent need of radio, communications and television instructors" and, as a licensed amateur-radio operator, appealed to fellow amateurs and technical men to become electronics teachers. Qualifications for such teaching opportunities are high-school graduation and five to seven years of trade experience, with maximum age of 60 years; the salary range is from \$3900 to \$7600.

### To the Editor:

As a member of the sports-car cult, as you call it, I was especially glad to see your sports-car section in the February issue of *PM*. The portraits of 10 leading sports cars were masterfully done by Artist Hamlin, although there are two errors, one by the caption writer, concerning the portraits.

First of all, the Jaguar shown was not an XK140 model, but the earlier Jaguar model, the XK120. The other error concerns the Ferrari 70 Monza portrait. Ferrari factory literature lists the Monza as being

(Continued to page 10)

## New greaseless way to keep your hair neat all day



Prevents dry, unruly  
"North-woods hair"

New Vitalis keeps hair in place and prevents dryness with V-7, the *greaseless* grooming discovery.

You never have an overslick, plastered-down look. Try it. You'll like it.



ANOTHER FINE PRODUCT  
OF BRISTOL-MYERS

## New VITALIS® Hair Tonic with V-7.



# What's your boss saying about you?

The door is usually open. Today it's closed. They're talking about you . . . about your future. You don't have to hear to know what they're saying. Because there's nobody who knows more about you and your present job than you. O.K. . . . So you have "experience." Five years on the same job.

Have you *mastered* the job . . . learned everything there is to know about it? If your answer is "yes," success is right around the corner. But if the answer is "no," then your experience doesn't amount to much. And chances are these things are true about you: you just "coast" along with things . . . you do nothing and go

home all tired out. **BEWARE!** Those are danger signals. Unless you take a fresh look at things, you'll be doing the same job at the same salary for the next five years. And the *next* five.

### What you can do about your future

If you want to succeed . . . make more money, earn the respect of your family and community . . . you have to take the bull by the horns. Success doesn't just come along. You have to meet it halfway. So act **NOW** and make your experience mean something. Add I. C. S. *training* to your record and start going places. Do it at home, in your spare time, for a few cents a day.

*Does it work?* These *facts* answer that. A recent survey shows that in a single 120-day period, 1973 I. C. S. students were promoted to better jobs. If you had acted a year ago, one of them could have been you. So mail the coupon below *today*.

### Pick your favorite subject

256 I. C. S. courses to choose from. 203 expert I. C. S. instructors to give you personal help. No time or expense going to and from classes. No interference with business and social life.

### Your first step

Sit down *right now* and fill out the coupon below. Check your favorite subject. I. C. S. will send you **FREE** and without obligation of any sort, three books. One, "How to Succeed," tells you how to start climbing to the top. Second book outlines the opportunities in the field of your choice. Also, a free sample lesson in basic mathematics.



**For Real Job Security—Get an I. C. S. Diploma! I. C. S., Scranton 9, Penna. Member, National Home Study Council**

## INTERNATIONAL CORRESPONDENCE SCHOOLS

ICS

BOX 45626D, SCRANTON 9, PENNA.

(Partial list of 256 courses)

Without cost or obligation, send me "HOW TO SUCCEED" and the opportunity booklet about the field BEFORE which I have marked X (plus sample lesson):

- |  |   |   |   |  |
|--|---|---|---|--|
| <p><b>ARCHITECTURE and BUILDING CONSTRUCTION</b></p> <ul style="list-style-type: none"> <li><input type="checkbox"/> Air Conditioning—Refrig.</li> <li><input type="checkbox"/> Architecture</li> <li><input type="checkbox"/> Architectural Interiors</li> <li><input type="checkbox"/> Building Contractor</li> <li><input type="checkbox"/> Building Estimator</li> <li><input type="checkbox"/> Building Maintenance</li> <li><input type="checkbox"/> Carpentry and Mill Work</li> <li><input type="checkbox"/> Heating</li> <li><input type="checkbox"/> Painting Contractor</li> <li><input type="checkbox"/> Plumbing</li> <li><input type="checkbox"/> Reading Arch. Blueprints</li> </ul> <p><b>ART</b></p> <ul style="list-style-type: none"> <li><input type="checkbox"/> Cartooning</li> <li><input type="checkbox"/> Commercial Art</li> <li><input type="checkbox"/> Fashion Illustrating</li> <li><input type="checkbox"/> Magazine Illustrating</li> <li><input type="checkbox"/> Show Card and Sign Lettering</li> <li><input type="checkbox"/> Sketching and Painting</li> </ul> <p><b>AUTOMOTIVE</b></p> <ul style="list-style-type: none"> <li><input type="checkbox"/> Auto Body Rebuilding</li> <li><input type="checkbox"/> Auto-Elec. Technician</li> <li><input type="checkbox"/> Auto-Engine Tune Up</li> <li><input type="checkbox"/> Automobile Mechanic</li> </ul> | <p><b>AVIATION</b></p> <ul style="list-style-type: none"> <li><input type="checkbox"/> Aeronautical Engineering Jr.</li> <li><input type="checkbox"/> Aircraft &amp; Engine Mechanic</li> </ul> <p><b>BUSINESS</b></p> <ul style="list-style-type: none"> <li><input type="checkbox"/> Advertising</li> <li><input type="checkbox"/> Bookkeeping and Accounting</li> <li><input type="checkbox"/> Business Administration</li> <li><input type="checkbox"/> Business Correspondence</li> <li><input type="checkbox"/> Public Accounting</li> <li><input type="checkbox"/> Creative Salesmanship</li> <li><input type="checkbox"/> Federal Tax</li> <li><input type="checkbox"/> Letter-writing Improvement</li> <li><input type="checkbox"/> Office Management</li> <li><input type="checkbox"/> Professional Secretary</li> <li><input type="checkbox"/> Retail Business Management</li> <li><input type="checkbox"/> Sales Management</li> <li><input type="checkbox"/> Stenographic-Secretarial</li> <li><input type="checkbox"/> Traffic Management</li> </ul> <p><b>CHEMISTRY</b></p> <ul style="list-style-type: none"> <li><input type="checkbox"/> Analytical Chemistry</li> <li><input type="checkbox"/> Chemical Engineering</li> <li><input type="checkbox"/> Chem. Lab. Technician</li> <li><input type="checkbox"/> General Chemistry</li> <li><input type="checkbox"/> Natural Gas Prod. &amp; Trans.</li> <li><input type="checkbox"/> Petroleum Engineering</li> <li><input type="checkbox"/> Plastics</li> <li><input type="checkbox"/> Pulp and Paper Making</li> </ul> | <p><b>CIVIL, STRUCTURAL ENGINEERING</b></p> <ul style="list-style-type: none"> <li><input type="checkbox"/> Civil Engineering</li> <li><input type="checkbox"/> Construction Engineering</li> <li><input type="checkbox"/> Highway Engineering</li> <li><input type="checkbox"/> Reading Strud. Blueprints</li> <li><input type="checkbox"/> Sanitary Engineering</li> <li><input type="checkbox"/> Structural Engineering</li> <li><input type="checkbox"/> Surveying and Mapping</li> </ul> <p><b>DRAFTING</b></p> <ul style="list-style-type: none"> <li><input type="checkbox"/> Aircraft Drafting</li> <li><input type="checkbox"/> Architectural Drafting</li> <li><input type="checkbox"/> Electrical Drafting</li> <li><input type="checkbox"/> Mechanical Drafting</li> <li><input type="checkbox"/> Mine Surveying and Mapping</li> <li><input type="checkbox"/> Plumbing Drawing and Estimating</li> <li><input type="checkbox"/> Structural Drafting</li> </ul> <p><b>ELECTRICAL</b></p> <ul style="list-style-type: none"> <li><input type="checkbox"/> Electrical Engineering</li> <li><input type="checkbox"/> Electrical Maintenance</li> <li><input type="checkbox"/> Electrician <input type="checkbox"/> Contracting</li> <li><input type="checkbox"/> Lineman</li> </ul> <p><b>HIGH SCHOOL</b></p> <ul style="list-style-type: none"> <li><input type="checkbox"/> Commercial <input type="checkbox"/> Good English</li> <li><input type="checkbox"/> High School Subjects</li> <li><input type="checkbox"/> Mathematics</li> </ul> | <p><b>LEADERSHIP</b></p> <ul style="list-style-type: none"> <li><input type="checkbox"/> Foremanship</li> <li><input type="checkbox"/> Industrial Supervision</li> <li><input type="checkbox"/> Leadership and Organization</li> <li><input type="checkbox"/> Personnel-Labor Relations</li> </ul> <p><b>MECHANICAL AND SHOP</b></p> <ul style="list-style-type: none"> <li><input type="checkbox"/> Gas—Electric Welding</li> <li><input type="checkbox"/> Heat Treatment <input type="checkbox"/> Metallurgy</li> <li><input type="checkbox"/> Industrial Engineering</li> <li><input type="checkbox"/> Industrial Instrumentation</li> <li><input type="checkbox"/> Industrial Supervision</li> <li><input type="checkbox"/> Internal Combustion Engines</li> <li><input type="checkbox"/> Machine Design-Drafting</li> <li><input type="checkbox"/> Machine Shop Inspection</li> <li><input type="checkbox"/> Machine Shop Practice</li> <li><input type="checkbox"/> Mechanical Engineering</li> <li><input type="checkbox"/> Quality Control</li> <li><input type="checkbox"/> Reading Shop Blueprints</li> <li><input type="checkbox"/> Refrigeration</li> <li><input type="checkbox"/> Sheet Metal Worker</li> <li><input type="checkbox"/> Tool Design <input type="checkbox"/> Toolmaking</li> </ul> <p><b>RADIO, TELEVISION</b></p> <ul style="list-style-type: none"> <li><input type="checkbox"/> Industrial Electronics</li> <li><input type="checkbox"/> Practical Radio TV Eng'ng</li> <li><input type="checkbox"/> Radio and TV Servicing</li> <li><input type="checkbox"/> Radio Operating</li> </ul> | <ul style="list-style-type: none"> <li><input type="checkbox"/> Television Technician</li> </ul> <p><b>RAILROAD</b></p> <ul style="list-style-type: none"> <li><input type="checkbox"/> Air Brake Equipment <input type="checkbox"/> or</li> <li><input type="checkbox"/> Car Inspector</li> <li><input type="checkbox"/> Diesel Engineer &amp; Fireman</li> <li><input type="checkbox"/> Section Foreman</li> </ul> <p><b>STEAM AND DIESEL POWER</b></p> <ul style="list-style-type: none"> <li><input type="checkbox"/> Combustion Engineering</li> <li><input type="checkbox"/> Diesel—Elec. <input type="checkbox"/> Diesel Eng's</li> <li><input type="checkbox"/> Electric Light and Power</li> <li><input type="checkbox"/> Stationary Fireman</li> <li><input type="checkbox"/> Stationary Steam Engineering</li> </ul> <p><b>TEXTILE</b></p> <ul style="list-style-type: none"> <li><input type="checkbox"/> Carding and Spinning</li> <li><input type="checkbox"/> Cotton, Rayon, Woolen Mfg.</li> <li><input type="checkbox"/> Finishing and Dyeing</li> <li><input type="checkbox"/> Loom Fix'g <input type="checkbox"/> Textile Des'g</li> <li><input type="checkbox"/> Textile Eng'g <input type="checkbox"/> Throwing</li> <li><input type="checkbox"/> Warping and Weaving</li> </ul> <p><b>MISCELLANEOUS</b></p> <ul style="list-style-type: none"> <li><input type="checkbox"/> Domestic Refrigeration</li> <li><input type="checkbox"/> Marine Engineering</li> <li><input type="checkbox"/> Ocean Navigation</li> <li><input type="checkbox"/> Professional Engineering</li> <li><input type="checkbox"/> Short Story Writing</li> <li><input type="checkbox"/> Telephony</li> </ul> |
|--|---|---|---|--|

Name \_\_\_\_\_ Age \_\_\_\_\_ Home Address \_\_\_\_\_  
 City \_\_\_\_\_ Zone \_\_\_\_\_ State \_\_\_\_\_ Working Hours \_\_\_\_\_ A.M. to P.M. \_\_\_\_\_  
 Occupation \_\_\_\_\_

Canadian residents send coupon to International Correspondence Schools, Canadian, Ltd., Montreal, Canada. . . . Special tuition rates to members of the U. S. Armed Forces.

## HOW TO REPAIR

# Electric Appliances

ASK TO SEE IT!



This HANDY, Practical "How to Do It" book for Electric & Gas Home Appliance Servicemen, Mechanics & Users covers Principles, Servicing & Repairs, Tells How to Locate Troubles, How to take Appliances Apart, How to Make Repairs, How to Assemble and Connect. Gives up to date testing methods, wiring diagrams and complete data on each appliance.

**SAVE TIME, TROUBLE, MONEY WITH AUDEL'S BIG 800 PAGE HOME APPLIANCE SERVICE GUIDE**

Toasters—Pressing Irons—Waffle Bakers—Casseroles—Roasters—Broilers—Coffers

Mixers—Space Heaters—Water Heaters—Ranges—Home Wiring—Shop Work—Appliance Testing—Fundamental Electricity—Fractional H.P. Motors—Food Mixers—Fans & Blowers—Vacuum Cleaners—Washing Machines—Clothes Dryers—Ironers—Dishwashers—Garbage Disposers—Refrigeration—Window Air Conditioners—Oil Burners—Drainage Pumps—Gas Ranges, Furnaces & Water Heaters—Bottled Gas Appliances.

A SHOP COMPANION THAT ANSWERS YOUR QUESTIONS. Easy to read and understand—over 800 pages fully illustrated—with 500 photos and diagrams—1001 Facts. A ready reference.

**\$4 COMPLETE • PAY \$1 A MONTH TO GET THIS SERVICE INFORMATION FOR YOURSELF—FILL IN AND MAIL 7 DAY TRIAL COUPON TODAY.**



Step up your own skill with the facts and figures of your trade. Audel's Mechanics Guides contain Practical Inside Trade Information in a handy form. Fully illustrated and Easy to Understand. Highly Endorsed. Check the book you want for 7 DAYS FREE EXAMINATION. Send No Money, Nothing to pay Postman.

## MAIL ORDER



**Check NOW!**

You Can Look Over Any Guide In Your Own Home — Start the Easy Payments If Satisfied

**MAIL THIS TODAY**



AUDEL, Publishers, 49 W. 23 St., NEW YORK 10, N. Y.

Please send me for FREE EXAMINATION books marked (x) below. If I decide to keep them I agree to mail \$1 in 7 Days on each book of set ordered and further mail \$1 monthly on each book or set until I have paid price, otherwise I will return them.

- HOME APPLIANCE SERVICE GUIDE, 800 Pages \$4
- AUTOMOBILE MECHANICS GUIDE, 1664 Pages 4
- TRUCK & TRACTOR GUIDE, 1299 Pages 4
- DIESEL ENGINE MANUAL, 575 Pages 2
- MACHINISTS HANDY BOOK, 1650 Pages 4
- WELDERS GUIDE, 400 Pages 1
- BLUE PRINT READING, 416 Pages 2
- MATHEMATICS & CALCULATIONS, 700 Pages 2
- SHEET METAL PATTERN LAYOUTS, 1100 Pages 4
- SHEET METAL WORKERS HANDY BOOK, 388 Pgs. 1
- MECHANICAL DRAWING GUIDE, 160 Pages 1
- MECHANICAL DRAWING & DESIGN, 480 Pages 2
- AIRCRAFT WORKER, 240 Pages 1
- TELEVISION SERVICE MANUAL, 434 Pages 2
- RADIOMANS GUIDE, 1040 Pages 4
- ELECTRONIC DEVICES, 216 Pages 2
- ELECTRIC MOTOR GUIDE, 1000 Pages 4
- WIRING DIAGRAMS (Light & Power), 272 Pgs. 1
- ELECTRICIANS EXAMINATIONS, 250 Pages 1
- ELECTRIC POWER CALCULATIONS, 425 Pages 2
- HANDY BOOK OF ELECTRICITY, 1440 Pages 4
- ELECTRIC DICTIONARY, 9000 Terms 2
- ELECTRIC LIBRARY, 7000 Pages (12 Book Set) 18
- SHIPFITTERS HANDY BOOK, 250 Pages 1
- REFRIGERATION & Air Conditioning, 1280 Pgs. 4
- MILLWRIGHTS & MECHANICS GUIDE, 1200 Pgs. 4
- POWER PLANT ENGINEERS GUIDE, 1500 Pages 4
- ENGINEERS & FIREMANS EXAMS, 525 Pages 1
- PUMPS, Hydraulics & Air Compressors, 1658 Pgs. 4
- OPERATING ENGINEERS LIBRARY (3 Books) 9
- MECHANICAL DICTIONARY, 950 Pages 4
- GARDENERS & GROWERS GUIDES (4 Book Set) 6
- CARPENTERS & BUILDERS GUIDES (4 Book Set) 6
- PLUMBERS & Steamfitters Guides (4 Book Set) 6
- MASONS AND BUILDERS GUIDES (4 Book Set) 6
- PAINTERS & DECORATORS MANUAL, 450 Pgs. 2
- HOUSE HEATING GUIDE, 1000 Pages 4
- OIL BURNER GUIDE, 384 Pages 1

Name \_\_\_\_\_  
 Address \_\_\_\_\_  
 Occupation \_\_\_\_\_  
 Employed by \_\_\_\_\_

P4

(Continued from page 8)

available only with right-hand drive, not left-hand drive as the artist pictured.

These errors are very small, but I thought that you might interested in correcting them. As I said before, the portraits are very good and the errors don't detract from their excellence.

Your auto section was exceptionally good this year. Keep up the good work in bringing reports on automobiles up-to-date!

An Enthusiast,  
 Tim Ennor,  
 434 Washington St.,  
 Reno, Nevada

Mr. Ennor is correct, and we regret the errors.

☆☆☆

Other comments on the February automobile section:

I enjoyed your articles on sports cars. I own one of these magnificent "animals," and I can say that truer words were never spoken.

Dick Cook,  
 Lakewood, Ohio

☆☆☆

Enclosed please find 25c to cover cost of mailing these (sports car) pictures. I'm a schoolteacher and would like to use them for classroom display.

Robert Finch,  
 San Diego, Calif.

☆☆☆

I found the survey "Why Do People Buy the Cars They Do" very interesting and I think it ought to provide conversation around the industry for some time to come.

Harry A. Williams,  
 Public Relations Director,  
 Automobile Manufacturers Association,  
 Detroit, Mich.

☆☆☆

Would like to give you my definition of a sports car: "Like my own right arm."

Donne Alves,  
 Santa Cruz, Calif.

☆☆☆

It is good to see that a magazine other than a regular sports-car magazine gives these cars the recognition they deserve.

Edmond F. Gormel, Jr.,  
 Nunda, N. Y.

☆☆☆

Would like to have the paintings of the 10 sports cars. We will be moving into our new house shortly so I would like to frame the paintings for my room. None of the other magazines ever show the specifications of the new cars and the wallet-sized

(Continued to page 14)



# I WILL TRAIN YOU AT HOME FOR GOOD PAY JOBS IN RADIO-TELEVISION

J. E. SMITH has trained more men for Radio-Television than any other man. OUR 40th YEAR.

## America's Fast Growing Industry Offers You Good Pay—Bright Future—Security

### I TRAINED THESE MEN

 "Started to repair sets six months after enrolling. Earned \$12 to \$15 a week in spare time."—Adam Kramlik, Jr., Sunnyside, Pennsylvania.

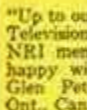
 "Up to our necks in Radio-Television work. Four other NRI men work here. Am happy with my work."—Glen Peterson, Bradford, Ont., Canada.

 "Am doing Radio and Television Servicing full time. Now have my own shop. I owe my success to N.R.I."—Curtis Scath, Ft. Madison, Iowa.

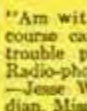
 "Am with WCOC. NRI course can't be beat. No trouble passing 1st class Radio-phone license exam."—Jesse W. Parker, Meridian, Mississippi.

 "By the time I graduated I had paid for my course, a car and testing equipment. Can service toughest jobs."—E. J. Streitenberger, New Boston, Ohio.

AVAILABLE TO  
**VETERANS**  
UNDER G. I. BILLS

## You Learn by Practicing with Parts I Send

Nothing takes the place of PRACTICAL EXPERIENCE. That's why NRI training is based on LEARNING BY DOING. You use parts I furnish to build many circuits common to Radio and Television. As part of my Communications Course, you build many circuits, including low power transmitter shown at left. You put it "on the air," perform procedures required of broadcast operators. With my Servicing Course you build modern Radio, etc.; use Multitester you build to make money fixing sets in spare time while training. You can stay at home, keep your job, learn Radio-TV in spare time at low cost. Mail coupon for book showing other equipment you build and keep.

**The Tested Way To Better Pay!**

Training plus opportunity is the PERFECT COMBINATION for job security, good pay, advancement. In good times, the trained man makes the BETTER PAY, GETS PROMOTED. When jobs are scarce, the trained man enjoys GREATER SECURITY. NRI training can help assure you more of the better things of life.

### Start Soon to Make \$10, \$15 a Week Extra Fixing Sets

Keep your job while training. I start sending you special booklets the day you enroll, that show you how to fix sets. Multitester built with parts I send helps you make \$10, \$15 a week extra fixing sets while training. Many start their own Radio-Television business with spare time earnings.

### My Training Is Up-To-Date

You benefit by my 40 years' experience training men at home. Well illustrated lessons give you basic principles you need. Skillfully developed kits of parts I send (see below) "bring to life" things you learn from lessons.

2 FREE BOOKS SHOW HOW MAIL COUPON



**Television Making Good Jobs, Prosperity**—Even without Television, Radio is bigger than ever. 115 million home and auto Radios are big market for servicing. 3000 broadcasting stations use operators, technicians. Government, Aviation, Police, Ship, Micro-wave Relay, Two-way Radio Communications for buses, taxis, trucks, R. R. are growing fields. Television is moving ahead fast.



About 200 Television stations are now on the air. Hundreds of others being built. Good TV jobs opening up for Technicians, Operators, etc.

25 million homes now have Television sets. Thousands more are being sold every week. Get a job or have your own business selling, installing, servicing.

### Radio-TV Needs Men of Action—Mail Coupon

Without obligating you in any way, I'll send an actual lesson to prove that my training is practical, thorough; 64-page book to show good job opportunities for you in Radio-TV. Terms for NRI training are as low as \$5 a month. Many graduates make more in two weeks than total cost of training. Mail coupon now. J. E. SMITH, President, National Radio Institute, Dept. 6DA, Washington 9, D. C. OUR 40TH YEAR.

### Good for Both—FREE

MR. J. E. SMITH, President, Dept. 6DA  
National Radio Institute, Washington 9, D. C.  
Mail me Sample Lesson and 64-page Book, FREE.  
(No salesman will call. Please write plainly.)

Name ..... Age .....  
Address .....  
City ..... Zone ..... State .....

**VETS** write in date of discharge .....

The ABCs of SERVICING

How to Be a Success in RADIO-TELEVISION

# NEW, EXCITING SEX HORMONES MAKE FISH BITE LIKE CRAZY!

**Quick—Easy—Convenient To Use!  
Just Dab On Your Favorite Bait,  
Drop In Water And Fish As Usual!**

Are you down on your fishing luck? Have you been coming home recently with an empty creel? Have you invested hard earned cash on the latest fishing tackle, fancy lures and bait—only to be frustrated time after time? No matter how unlucky you've been, this new discovery may change all that—quickly! Now, at last, you too can use a secret that professionals have tried with astounding results—a secret that even a schoolboy can use to catch more fish, no matter what the weather, bait or tackle. Yes, you can even get big ones out of what the misinformed call "fished-out" waters. And you can do it with your present fishing methods and equipment! No need for special bait . . . whether you fish in a river, lake, pond or the open sea . . . whether you cast, spin, troll or do still-fishing . . . this new discovery will give you the thrill of your life!

## SCIENTISTS DISCOVER STRANGE HABITS OF SEA LIFE

Man has been fishing since the dawn of time. Yet during countless centuries he's never really known much about sea life. Then leading scientists from all over the world got on the job, including the U. S. Dept. of Fisheries. Ichthyologists, chemists, zoologists and sportsmen joined in the quest. Millions of dollars were spent on gigantic glass aquariums, sub-marine cameras, recording devices and lab equipment. In less than a generation man learned more about the mysteries of sea life than in the previous 10,000 years!

## EXPERIMENTS PROVE FISH ARE ALMOST BLIND

Here is the most startling discovery that the scientists unearthed: most fish—of ALL species—have very poor eyesight compared to birds and mammals. Some are almost blind! No wonder, then, that you can use the most attractive dry lures—yet go home after a day's fishing excursion with little to show for it but a sunburn!

It doesn't make much difference how good the bait is you use nor how hungry a fish may be—if he doesn't SEE it, if he isn't DRAWN to it, you won't get a nibble! And test after test proved that unless you get the lure right under the fish's nose, you simply cannot attract him to your hook!

## NEW SEX-HUNGER FISH LURE DEVELOPED BY GERMAN CHEMIST

The new Lurene formula was developed by a German chemist, a graduate of the University of Tubingen in Wurtemberg, Germany. An acknowledged leader in his profession, he knew that certain lures and bait failed simply because many fish were nearly blind. But he learned that Mother Nature in her bounty provided fish with extra powerful sense-instincts that led them irresistibly to their food supply.

## FAMOUS SPORTS EDITOR PRAISES LURENE FORMULA

Millions of readers follow Walter S. Miller's sports column, "Rod, Gun & LENS," which appears in over 15 metropolitan newspapers. He tests new products thoroughly, warning readers against shoddy, defective articles but also giving praise where praise is due. This is what this great sports authority says about LURENE:



"Recently a product called 'Lurene,' a prepared bait oil came into my possession with instructions to test it and pass on my opinion to you. Accordingly here are the results on several such tests.

"Using an artificial lure of the spoon type in salt water the number of casts per fish was 27. With 'Lurene' the number of casts per fish was 9. Accordingly this product is active enough to salt water fishermen since tests prove it will triple your catch regardless of type of fish. "Again using an artificial lure of the spinner type in fresh water the number of casts per fish was 50. Using 'Lurene' the number of casts per fish was reduced to the phenomenal low of 10 casts per fish. The results proved beyond doubt that in fresh water 'Lurene' quintupled the catch. I heartily endorse this product."

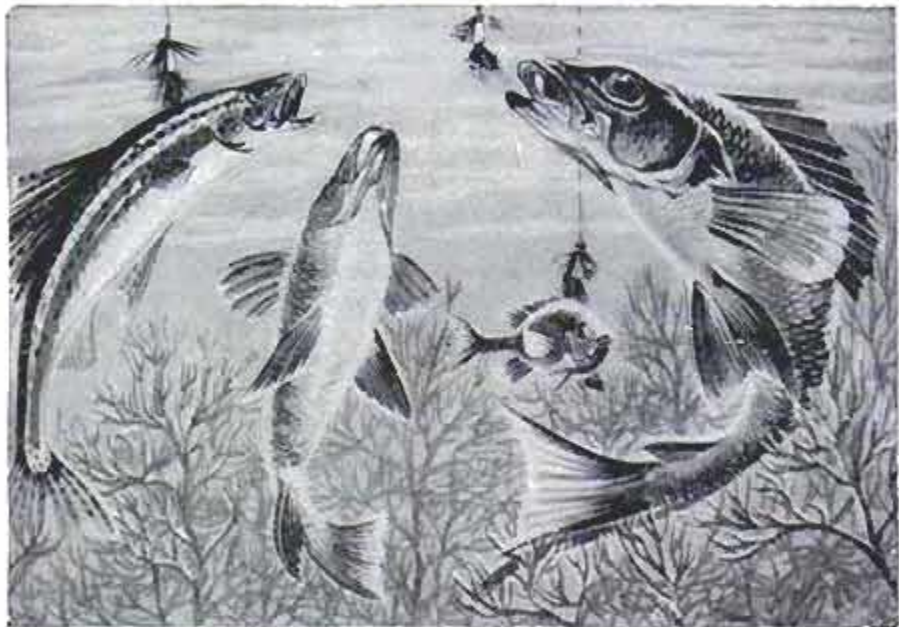

## TEST IT YOURSELF THIS EASY WAY!

No elaborate equipment required! An ordinary glass aquarium tank and ANY species of fish will prove this new method really works! Drop in 2 or 3 lines with your favorite bait. Treat only ONE with the new LURENE "triple-instinct" preparation. It's the same bait . . . the same lures . . . yet right there before your eyes you'll be witnessing a fascinating spectacle! You'll hardly believe your eyes! The fish, as if compelled by some unknown power are drawn to the Lurene-treated line. This article explains how this "triple-instinct" in fish can increase your fishing luck.

you greater penetration, longer range and far more attraction power.

## RESULTS GUARANTEED OR IT DOESN'T COST YOU 1c

Now you can try Lurene at our risk! It must help you catch more fish—faster! Lurene must prove to be the best scent lure you've ever used—or your money back! You're invited to try it without obligation. We want you to see for yourself how Lurene releases its deep, penetrating "call" into the surrounding waters. See how the mysterious instincts of the sea world help attract fish to your hook. And—of this you can be sure: Lurene really works—it positively helps draw 'em in! So we say: try it and judge for yourself. See if you don't get the big ones—even in "fished-out" waters! Use it to pull in your favorites . . . trout, pickerel, catfish, blues, weaks, pike, perch, bass, snappers, porgies. You need send no money now. Simply deposit 1.98 plus postage with your mailman when the Lurene arrives—or mail 1.98 now for immediate prepaid shipment. But please remember: you're trying—not buying! Unless you're satisfied in every way with this new, different product. It won't cost you a penny. rush the coupon now while supplies are available to:

**LURENE CO., Dept. 6-D-10**  
352 Fourth Ave., New York 10, N. Y.

Change Your Fishing Luck—Mail Coupon Today!

**LURENE CO., Dept. 6-D-10**  
352 Fourth Ave., New York 10, N. Y.

Rush—1.98 packages of Lurene on 5-day Free Trial. It is guaranteed—the formula must help me catch more fish. I must give me thrilling results. Otherwise, you will refund my 1.98—no questions asked.

- \$1.98 enclosed—rush prepaid.  
 Send C.O.D. plus postage.

Name.....

Address.....

City..... State.....

SPECIAL OFFER: Save \$1.00 by ordering 2 packages for only \$2.98. Send check, cash or m.o. on this offer as we cannot ship C.O.D. at this low price.



# INVENTORS

**L**earn how to protect your invention. The U. S. Patent Laws provide that any new and useful art, machine, article of manufacture, or composition of matter, or any new and useful improvement thereof, may be patented if the act of invention is involved. Therefore, every inventor with a valuable invention should take advantage of the Patent Laws and proceed for patent protection in order to safeguard his rights.

A patent gives the inventor the exclusive right to prevent others from making, using, or selling the invention claimed in the patent for a period of seventeen years.

The Patent Laws were enacted for the benefit of the inventor to give him protection for the features of his invention which are patentable. These features must be properly and concisely set forth and claimed in a formal application for patent, in order to comply with the requirements of the Patent Laws. For that reason, unless the inventor is familiar with patent matters, he should engage a competent registered patent attorney or agent to represent him. We are registered to practice before the U. S. Patent Office and are prepared to serve you in the handling of your patent matters.

A specially prepared booklet entitled "Patent Guide for the Inventor", containing detailed information with respect to patent protection and procedure, together with a "Record of Invention" form will be promptly forwarded to you without obligation upon request.

**CLARENCE A. O'BRIEN & HARVEY JACOBSON**

*Registered Patent Attorneys*

**61-D DISTRICT NATIONAL BUILDING**

**WASHINGTON 5, D. C.**

# Learn at Home

*in your spare time*

## to Fix Electric Appliances



### Better Pay—More Opportunities

Get into a field where there is important work and opportunity for the trained man. Millions of electric appliances are sold every year. Every wired home now has an average of 8. Many of them need service and repair. Owners pay well to have them fixed quickly, properly. This is your opportunity for a better job, your own part time or full time business. NRI can give you the training you need, at home, in your spare time.

### A Way to Extra Money

Soon after starting you will be able to earn extra cash fixing toasters, clocks, fans, vacuum cleaners, etc., for neighbors and friends. Keep your job while learning and earning. Put spare time to work for you. Work in your basement, garage, spare room. You'll be amazed how easily, quickly you, too, can start earning many extra dollars. NRI shows you how. Even before you finish training your spare time earnings may pay for the course and equipment.

### NRI Sends Tester to Learn and Earn

You need proper equipment to service today's automatic appliances. With *this* course you get parts to build professional type, multi-use Appliance Tester. You learn to use it. Takes guess work out of servicing. Mail coupon for FREE book and Sample Lesson. See how easy it is to learn. Find out about NRI—a school that for more than 40 years has been training men, through home study, for success, good pay jobs. Our reputation, record, experience back up this course. Write now to: Electric Appliance Training, NRI, Dept. AD6, Washington 9, D. C.



**FREE Lesson and Book**  
Mail this NOW!

**NATIONAL RADIO INSTITUTE**  
Dept. AD6, Washington 9, D. C.  
Send me Lesson and Book Free. No Salesman will call.

Name.....Age.....

Address.....

City.....Zone.....State.....

APPROVED MEMBER NATIONAL HOME STUDY COUNCIL

(Continued from page 10)

insert of the specifications in your February issue is just the thing for proving an argument.

Paul DeVelder,  
Canton, Ohio

☆☆☆

I always look forward to your "auto issue" with much eagerness, and this year I think you have outdone your own standards; this one is the greatest yet. Keep up the good work.

Truman W. Abbott,  
Lakeland, Fla.

☆☆☆

As an avid sports-car fan, I think the current article is one of the best I have seen for a long time.

Barry E. Noice,  
Woodstock, Ontario, Can.

☆☆☆

I greatly enjoyed your auto section in February . . . looking forward to next year's review.

Richard Walsh,  
Englewood, N. J.

☆☆☆

. . . exquisite article, "Sports Cars of the World," in the February issue.

Rob Muir,  
Maryville, Tenn.

### To the Editor:

Currently much is being written about safety features in the 1956 cars. While safety is important to all of us, the following is equally important: The matter of designing and building cars for more economical maintenance. Just about every car owner has had the aggravating experience of repeated expense in having many little factory-built defects repaired, mainly because the car makers did not see fit to build a little more quality into their cars.

Right now, certain car makers are so wild to outproduce one another that car quality as we know it is getting less and less in some cases. How many readers of *Popular Mechanics* will agree that shoddy workmanship, sloppy assembly methods and lack of adequate assembly inspection are on the increase?

Now is the time for all car owners to put their expensive experience to work by notifying the car makers with repeated reminders that they have a responsibility to us; that in return for the increasing cost of cars we want at least our money's worth in more car quality, noticeably better workmanship and a change from the attitude so

(Continued to page 16)



# I saw my job failure in my family's eyes



... but how they smiled when I.C.S. pulled me through

Take it from me. That's the hard way to discover a mistake.

I thought I was in solid down at the plant with my years of experience. They'd never lay me off.

But they did. And I was in solid—as long as business was good. But when things started getting tight...

"In times like these," the boss told me, "everybody has to pull his own weight and a little more. Experience is more than just adding up years. You have to learn something, too."

I was sore, sure. But when I calmed down I realized he was right. I decided then to start learning. I signed up for an I. C. S. Course, studied at home in my spare time.

Then I went back to the plant. The boss was so impressed with my I. C. S. diploma, he gave me another try... and soon after I even got a raise!

## TRAINED men are in demand

It's a fact. Right now there are plenty of job opportunities for trained men. How do you get training and hold down a job at the same time? Simple. Study with I. C. S. at home, in your spare time, at a cost of only pennies a day.

I. C. S. is the oldest and largest correspondence school. 277 courses. Business, industrial, engineering, academic, high school. One for you. Direct, job-related. Bedrock facts and theory plus practical application. Complete lesson and answer service. Diploma to graduates.

## 3 FREE BOOKS

1. "How to Succeed," a gold mine of job tips that will open your eyes to your own mistakes. 2. An outline of job opportunities in the field of your choice. 3. A sample I.C.S. lesson text. Send for them today.



For Real Job Security—Get an I. C. S. Diploma! I. C. S., Scranton 9, Penna. Member, National Home Study Council

## INTERNATIONAL CORRESPONDENCE SCHOOLS

BOX 22626D, SCRANTON 9, PENNA.

(Partial list of 256 courses)

Without cost or obligation, send me "HOW TO SUCCEED" and the opportunity booklet about the field BEFORE which I have marked X (plus sample lesson):

### ARCHITECTURE and BUILDING CONSTRUCTION

- Air Conditioning—Refrig.
- Architecture
- Architectural Interiors
- Building Contractor
- Building Estimator
- Building Maintenance
- Carpentry and Mill Work
- Heating
- Painting Contractor
- Plumbing
- Reading Arch. Blueprints

### ART

- Cartooning
- Commercial Art
- Fashion Illustrating
- Magazine Illustrating
- Show Card and Sign Lettering
- Sketching and Painting

### AUTOMOTIVE

- Auto Body Rebuilding
- Auto Elec. Technician
- Auto-Engine Tune Up
- Automobile Mechanic

### AVIATION

- Aeronautical Engineering Jr.
- Aircraft & Engine Mechanic

### BUSINESS

- Advertising
- Bookkeeping and Accounting
- Business Administration
- Business Correspondence
- Public Accounting
- Creative Salesmanship
- Federal Tax
- Letter-writing Improvement
- Office Management
- Professional Secretary
- Retail Business Management
- Sales Management
- Stenographic-Secretarial
- Traffic Management

### CHEMISTRY

- Analytical Chemistry
- Chemical Engineering
- Chem. Lab. Technician
- General Chemistry
- Natural Gas Prod. & Trans.
- Petroleum Engineering
- Plastics
- Pulp and Paper Making

### CIVIL, STRUCTURAL ENGINEERING

- Civil Engineering
- Construction Engineering
- Highway Engineering
- Reading Struct. Blueprints
- Sanitary Engineering
- Structural Engineering
- Surveying and Mapping

### DRAFTING

- Aircraft Drafting
- Architectural Drafting
- Electrical Drafting
- Mechanical Drafting
- Mine Surveying and Mapping
- Plumbing Drawing and Estimating
- Structural Drafting

### ELECTRICAL

- Electrical Engineering
- Electrical Maintenance
- Electrician  Contracting
- Lineman

### HIGH SCHOOL

- Commercial  Good English
- High School Subjects
- Mathematics

### LEADERSHIP

- Foremanship
- Industrial Supervision
- Leadership and Organization
- Personnel-Labor Relations

### MECHANICAL AND SHOP

- Gas—Electric Welding
- Heat Treatment  Metallurgy
- Industrial Engineering
- Industrial Instrumentation
- Industrial Supervision
- Internal Combustion Engines
- Machine Design-Drafting
- Machine Shop Inspection
- Machine Shop Practice
- Mechanical Engineering
- Quality Control
- Reading Shop Blueprints
- Refrigeration
- Sheet Metal Worker
- Tool Design  Toolmaking

### RADIO, TELEVISION

- Industrial Electronics
- Practical Radio TV Eng'ng
- Radio and TV Servicing
- Radio Operating

### TELEVISION TECHNICIAN

- RAILROAD
- Air Brake Equipment
- Car Inspector
- Diesel Engineer & Fireman
- Section Foreman

### STEAM AND DIESEL POWER

- Combustion Engineering
- Diesel—Elec.  Diesel Eng's
- Electric Light and Power
- Stationary Fireman
- Stationary Steam Engineering

### TEXTILE

- Carding and Spinning
- Cotton, Rayon, Woolen Mfg.
- Finishing and Dyeing
- Loom Fixt'g  Textile Des'ng
- Textile Eng'g  Throwing
- Warping and Weaving

### MISCELLANEOUS

- Domestic Refrigeration
- Marine Engineering
- Ocean Navigation
- Professional Engineering
- Short Story Writing
- Telephony

Name \_\_\_\_\_ Age \_\_\_\_\_ Home Address \_\_\_\_\_  
 City \_\_\_\_\_ Zone \_\_\_\_\_ State \_\_\_\_\_ Working Hours \_\_\_\_\_ A.M. to P.M. \_\_\_\_\_  
 Occupation \_\_\_\_\_

Canadian residents send coupon to International Correspondence Schools, Canadian, Ltd., Montreal, Canada. . . . Special tuition rates to members of the U. S. Armed Forces.

# DIESEL MECHANICS IN DEMAND



Learn to earn big pay in DIESEL in our large, modern equipped Chicago school and shop. No previous experience or training necessary. We help you find living quarters and part time job while in school. Complete, practical courses taught in the following trades, under the supervision of experienced, expert technicians.

APPROVED FOR CIVILIANS  OR GI'S

## — CHOOSE YOUR TRADE —

CHECK HERE	WEEKS
<input type="checkbox"/> DIESEL MECHANICS	20
<input type="checkbox"/> AUTO MECHANICS	20
<input type="checkbox"/> BODY & FENDER	16 2/3
<input type="checkbox"/> GAS-ARC WELDING	4 - 12
<input type="checkbox"/> REFRIGERATION	13 1/2
<input type="checkbox"/> AIR CONDITIONING	8 1/3
<input type="checkbox"/> MACHINIST TRADE	30
<input type="checkbox"/> ADVANCED MACHINIST (includes tool & die)	32 1/2
<input type="checkbox"/> PIANO TUNING & REPAIR	36

## CHOOSE YOUR ENGINEERING COURSE

These courses are intended as terminal education for men who wish to enter the Diesel-Automotive and Refrigeration-Air Conditioning fields as technicians. These courses are designed to prepare men for supervisory positions. Students with a high school education, or equivalent, will be accepted.

- DIESEL AUTOMOTIVE ENGINEERING ..... 2 years
- REFRIGERATION & AIR COND. ENGINEERING ..... 18 months

### FREE EMPLOYMENT HELP

Start your career with Greer by checking your interest above and mail coupon for complete information at no obligation.

NAME \_\_\_\_\_ AGE \_\_\_\_\_

STREET \_\_\_\_\_

TOWN \_\_\_\_\_ ZONE \_\_\_\_\_ STATE \_\_\_\_\_

Established 1902 — Over 50,000 Graduates.  
54 years of continuous trade school experience  
to guide your training.

## GREER SHOP TRAINING

Box D, 2236 S. Michigan Ave.  
Chicago 16, Illinois

(Continued from page 14)

common among the top management of certain car makers of "what are a few dissatisfied customers lost here and there."

R. Blagden,  
Box 42, R.R. 3,  
East Hampton, Conn.

### Memo to Ben Franklin:

In our January issue we dedicated an article to you, "Ben Franklin—Trail Blazer for Inventors." The occasion, of course, was your 250th birthday. We described one of your inventions, the armonica, a musical



instrument consisting of rotating glass bowls played with moistened fingers.

Now the Corning Glass Works is reproducing the bowls to your exact specifications for the American Academy of Arts and Sciences. They will be assembled into a reproduction of your armonica, and the instrument will be played at a special concert at Cambridge, Mass. Recordings probably will be made so anyone can enjoy the tones which you described as "incomparably sweet."

Just thought you'd want to know about this during your big birthday year.

### To the Editor:

Am writing you to let you know that I have an original *Popular Mechanics* which will be 50 years old in July.

Still am a *Popular Mechanics* reader today. Comparing the old with the late editions is amazing.

Newt Stairs,  
Greensburg, Pa.

# INVENTORS

If you believe that you have an invention, you should find out how to protect it. The first step is to have a search made of the prior pertinent U. S. patents. If a report on this search indicates that the invention appears patentable you can apply for a patent, and the specifications and claims should be prepared.

The firm of McMorrow, Berman & Davidson, with offices in Washington, D. C., is qualified to take the necessary steps for you. We can make a preliminary search on your invention, advise you whether we think it can be patented, and prepare your application for patent.

Unless you are fully familiar with the U. S. Patent Laws, we recommend that you engage the services of a Registered Patent Attorney to protect your interests. The patent laws are *your* laws. A patent gives you the right to prevent others from making, using or selling the invention claimed in your patent for a period of 17 years.

Use these patent laws for your protection. Investigate whether your invention can be patented. If you have what you believe to be an invention, we suggest that you have this firm make a search for you.

*Send for a copy of our Patent Booklet entitled "How To Protect Your Invention," containing information about patent protection and patent procedure. Along with this we will also send you an "Invention Record" form, for your use in writing down and sketching details of your invention. We will mail them promptly. No obligation. They are yours for the asking.*

## McMORROW, BERMAN & DAVIDSON

*Registered Patent Attorneys*

PATENTS • COPYRIGHTS • PATENTS

135-V VICTOR BUILDING, WASHINGTON 1, D. C.

free!

1956  
ALLIED

ELECTRONIC  
SUPPLY  
CATALOG

324  
value-packed  
pages

Save on Everything  
in TV and Radio  
Parts & Equipment

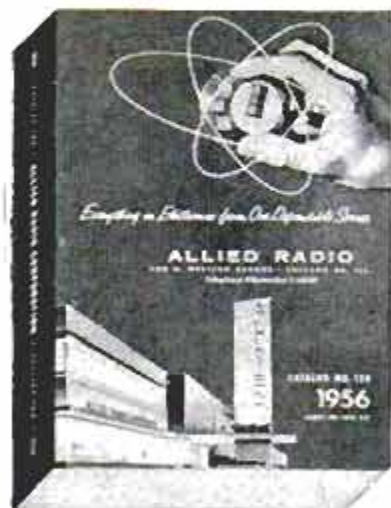

Everything for Experimenters,  
Builders, Amateurs, Servicemen,  
Engineers & Hi-Fi Specialists

Send for ALLIED's big 324-page value-packed guide to everything in TV, Radio and Electronics! Select from the world's largest stocks of High Fidelity systems and components; recorders and phono equipment; TV tubes, antennas and accessories; Amateur station equipment and supplies; P.A. systems; test instruments; latest build-your-own kits; industrial electronic supplies—plus everything in electronic parts, tubes, transistors, tools and books. Save on everything in Electronics—send today for your FREE 1956 ALLIED Catalog.

Everything in Electronics  
From One Reliable Source

send for it

FREE  
CATALOG

ALLIED RADIO

ALLIED RADIO CORP., Dept. 5-D-6  
100 N. Western Ave., Chicago 80, Ill.

Rush FREE 1956 ALLIED 324-Page Catalog

Name \_\_\_\_\_

Address \_\_\_\_\_

City \_\_\_\_\_ Zone \_\_\_\_\_ State \_\_\_\_\_



Use my TESTED SALES  
PLAN to make an extra  
\$50.00 every week!

Just a few hours each week — evenings, Saturdays — can add \$50 to \$100 to your regular income. Be a factory representative for Charles Chester patented Air-Cushion shoes — bring new comfort to friends, neighbors, co-workers — dress, work, leisure shoes for all the family sold only direct from factory to wearer. No investment is required — you make no deliveries, no collections. Just collect deposit from your customers; we do the rest!

STEADY AUTOMATIC REPEAT BUSINESS

Satisfied customers reorder constantly! CHARLES CHESTER representatives offer more than 140 styles, in a tremendous size range, 1-18, AAA to EEE. No Experience Needed — our tested, proven Sales Plan shows you how! Write today for details and FREE SALES KIT!



AIR-CUSHION SHOES



FREE SALES KIT!

CHARLES CHESTER SHOE COMPANY  
8 Foundry St., Brockton, Mass.

TELEPHONES



Desk Stand Style

Slightly used but in excellent condition

Many Valuable Uses

Inter-House Phones House to Barn, etc.  
Loud Speakers Microphones  
Educational Purposes, Toys, etc.

Come complete, ready to use with wiring diagrams included. Two complete for only \$5.00 \$2.75 Postpaid in U.S.A.

TELEPHONE LAMP KIT — with illustrated instructions for making Desk Telephone Lamp including all parts (harp, nipples, push switch, cord, plug, etc.) . . . \$6.50 Ppd. (Shade is not included).

MICROPHONE, Dept. X-3702, 1760 W. Lunt Ave., Chicago 26, Ill.



Print Your Own

Cards, Stationery, Advertising, labels, circulars, photo and movie titles, church work, tags, etc. Save money. Sold direct from factory only. Raised printing like engraving, too. Print for Others, Good Profit. Have a home print shop. Easy rules supplied. Pays for itself in a short time. Write for free catalog of outfits and all details.

KELSEY PRESSES, N-37 MERIDEN, CONN.

How to Make Money with Simple Cartoons  
A book everyone who likes to draw should have. It is free; no obligation. Simply address  
FREE BOOK  
CARTOONISTS' EXCHANGE  
Dept. 94D Pleasant Hill, Ohio



LEFAX  
TECHNICAL DATA BOOKS  
POCKET SIZE • LOOSE LEAF

- Printed on loose leaf, 6 hole, 6 3/4" x 3 3/4" bond paper, each book contains about 140 pages of technical data, condensed, accurate, essential, for engineer, technical worker, student, business man
- |                    |                  |                        |                     |
|--------------------|------------------|------------------------|---------------------|
| Architecture       | Surveying        | Mech'l Drawing         | Metallurgy          |
| Home Heating       | Surveying Tables | Machine Design         | Hydraulics          |
| Illumination       | Highway Eng'g.   | Machinist's Data       | Radio               |
| Electrician's Data | General Math     | Mech. of Materials     | Television & FM     |
| Builder's Data     | Math Tables      | Pwr. Trans. Mach.      | Electricity, AC     |
| Lumber Data        | Physics          | Thermo. Tbls. & Charts | Electricity, DC     |
| Air Conditioning   | Trig-Log Tables  | Phys. & Thermo.        | AC Motors & Gen'rs. |
| Building Constr.   | Gen'l Chemistry  | Data                   | Transformers.       |
| Reinf. Concrete    | Chemical Tables  | Metals                 | Relays & Meters     |
| Piping Data        | Analytic Chem.   |                        |                     |

Write for FREE catalogs (2000 listings). See how helpful LEFAX can be to you. Send \$1.25 book, or \$6 for any five books to

LEFAX PUBLISHERS, Dept. PM-2, PHILADELPHIA 7, PA.

POPULAR MECHANICS

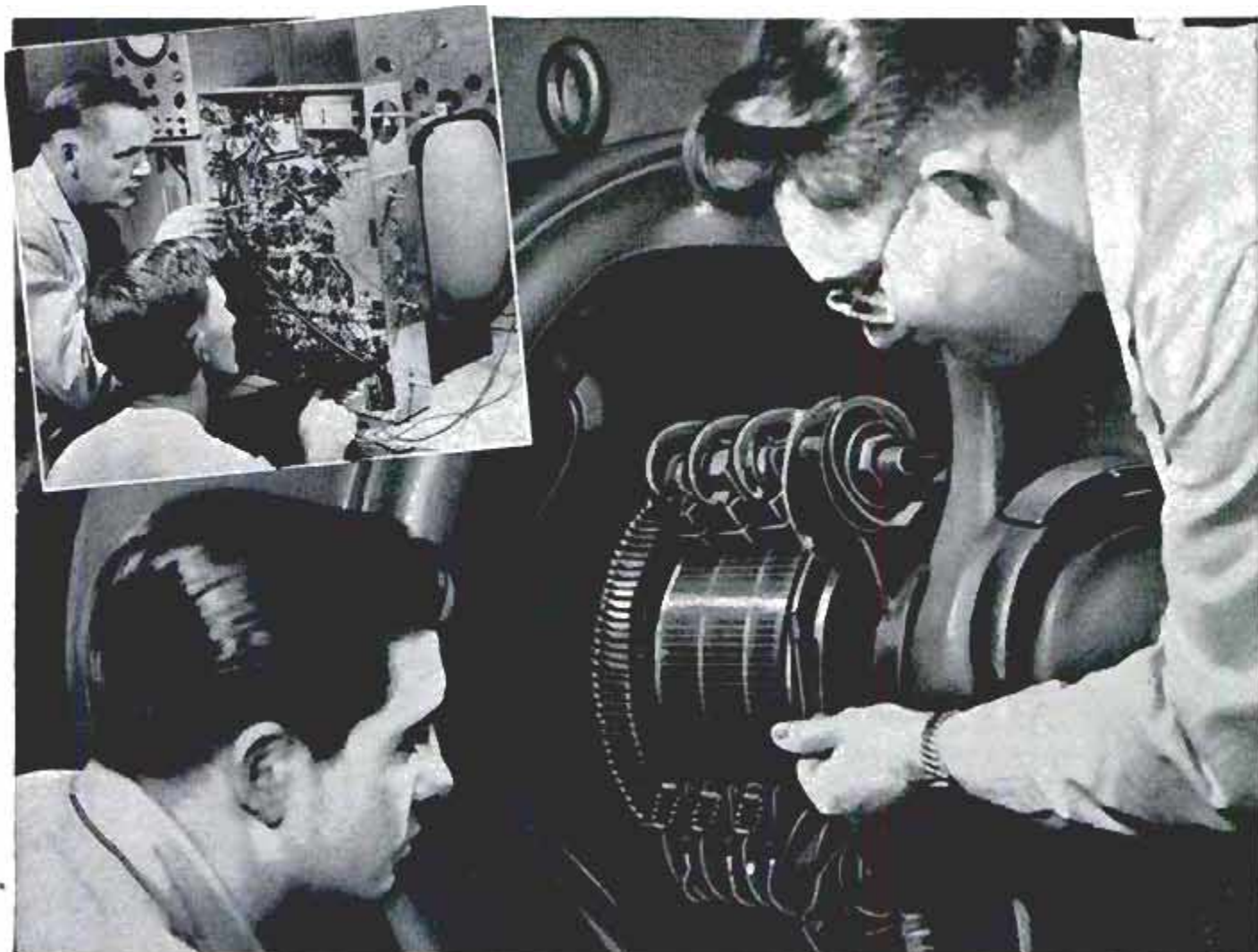

# TRAIN FOR A FUTURE IN Electricity or Television-Radio

**IN GREAT SHOPS OF COYNE—  
Largest, Oldest, Best Equipped  
School Of Its Kind In The U. S.**

Prepare quickly at Coyne for a career with a future! Whether 17 or up to 45 years of age, prepare for your future now. Don't be satisfied with a "No Future" job. Train the Coyne way for a better job in a field that offers a world of opportunities in the years ahead.

### WE TRAIN YOU IN CHICAGO

Learn the easier, practical way at Coyne, on real, full size equipment. No advanced education or previous experience needed. You learn *better* the Coyne way.

**Train in the shops of Coyne**—where thousands of successful men have trained for over 56 years—*Coyne is the largest, oldest, best equipped school of its kind*—established in Chicago in 1899.

**FINANCE PLAN** Enroll now. You may pay most of tuition later. We have a *special plan for men of draft age*.

**CLIP COUPON NOW** for big new illustrated Coyne book. No obligation; *no salesman will call*. Get vital facts now!

**APPROVED  
FOR  
VETERANS**

Mail Coupon  
Today for  
**BIG FREE  
BOOK**

"Guide to Careers  
in **ELECTRICITY** and  
**TELEVISION-RADIO**"



B. W. COOKE, President  
COYNE ELECTRICAL SCHOOL  
500 S. Paulina St., Chicago 12, Ill., Dept. 46-72H

Send **BIG FREE** book and details of your training offer. This does not obligate me and no salesman will call. I am interested in:

**ELECTRICITY**     **TELEVISION-RADIO**

Name.....

Address.....

City..... State.....

B. W. COOKE, Pres. **COYNE** FOUNDED 1899

**ELECTRICAL SCHOOL**

A TECHNICAL TRADE INSTITUTE OPERATED NOT FOR PROFIT  
500 S. PAULINA ST., CHICAGO, Dept. 46-72H  
**ELECTRICITY ★ RADIO ★ TELEVISION ★ REFRIGERATION ★ ELECTRONICS**

Anvil Brand



**Anvilwear**  
means  
**comfort**  
wear

There's extra relish in home chores, shop work and other tasks when you ease into such action clothes as Anvil work wear, Tom Long sportswear and J'nettes for misses. Durable, smart, easy to care for, and so economical in price.



**ANVIL BRAND** factories  
SINCE 1900 HIGH POINT / NORTH CAROLINA

## MANUFACTURE THIS BEAUTIFUL CONCRETE OUTDOOR FIREPLACE

Right In Your Own Backyard

**\$4.00 Worth of Sand & Cement produces this Attractive Fireplace.**



**Sells on Sight from \$60. to \$80. Easy to start your own Profitable Business.**

The General Fireplace Molds and Process are the most amazing and foolproof ever invented. Simple to operate. Two men can produce five fireplaces a day.

### BIG DEMAND!!

Sell all you produce to Department Stores, Homeowners, Parks, Nurseries and Pleno Groves. Fireplaces sell on sight. No experience necessary. We supply full operating instructions and equipment plus the know-how that spells **BIG PROFITS**. This is an outstanding opportunity for men of vision and small capital to get into a busy rich paying field. Don't delay, be the only exclusive manufacturer in your own home town. Mail coupon at once for full details as to how you can reserve your territory. Molds sold only on exclusive franchise.

**GENERAL ENGINES CO., Inc., Dept. MF-46**  
ROUTE 130, THOROFARE, N. J.

Mr. Tor of Philadelphia writes: Sold 250 in first 4 months. Selling to Sears Roebuck, John Wanamaker, and Gimbel Bros. in Philadelphia area.

Name .....  
Address .....  
City ..... Zone .....  
State .....

**GENUINE GUM GRIPPER**

# False Dental Plate!

ONE DAY AIRMAIL SERVICE...

Now Only  
**\$15.95**



**MONEY BACK GUARANTEE**  
Our 10th Year Serving You!

Lowest price in history... only our tremendous volume makes it possible. Let our wonderful new scientific method transform your old, discolored, damaged plate into a beautiful lustrous Gum Gripper Plate... of fine stainless Dupont Beauty-Pink Plastic. One day service!  
**SEND NO MONEY**—Rush name, address for full details sent **FREE**. Mention if your present plate is **LOOSE**, so we can show you how to make it comfortable before duplication. Write West Dental Laboratory, Dept. M-128, 127 N. Dearborn St., Chicago 2, Ill.

**FREE!**  
Now You Get  
**FULL YEAR**  
GUARANTEE  
against breakage



**WORLD'S LOWEST PRICED**  
**ADDING MACHINE**

**IDEAL FOR BUSINESS AND PERSONAL USE—GUARANTEED ACCURATE.** Not a toy. Operates with only a finger flick. Adds, subtracts, multiplies, divides. Counts up to one billion. Pays for itself over and over. Ideal Gift—for Business, Income Tax and School use. **MONEY BACK GUARANTEE.** Send name and address. Pay postman only \$2.95 plus postage. (Send full cash if outside U.S.) Beautiful rich-looking leatherette case included at no extra cost. Money back in 10 days if not delighted. **AGENTS WANTED.**

**CALCULATOR MACHINE CO., (Mfrs.)**  
Box 84 Dept. A-56 Glenview, Illinois

**\$2.95 OR 2 FOR \$5.00!**



Genuine Telephone Company Upright Telephones, tested and guaranteed with 50 ft. of wire, like new factory and inter-communication instructions. Complete line of telephones, dial, magnets, extension, etc. Write for free list. All shipments FOB Simpson, Pa. C.O.D. orders, 50% deposit. **TELEPHONE ENGINEERING CO., Dept. 486, Simpson, Pa.**



## TRAIN WRECK STAMPS!

Cuba's famous stamps of 1946, showing actual train wreck scene! Complete set of 3, a dramatic display for your collection, only 10c. Handsome, exciting stamps to look over, too, without charge or obligation. **WINTHROP STAMP CO., Dept. P-4, GROTON, CONN.**

## JEEP OWNERS

STA. WAGONS • JEEPSTERS • PICK-UPS!

**RE-POWER** with Ford 6 or V-8 engines. Our F-J ADAPTOR-CONVERSION KITS fit ALL—Willys Jeeps including 1956. Kit No. 4-K for 1949-56 Ford engines in 1954-56 Pickups & Sta-Wagons priced at \$52.95 Incl. Fed. tax. Kits for 1932-56 Ford engines in ALL other Willys Jeeps... \$43.25 Tax incl. Write today for free details or send check or M.O. for prepaid shipment. Tell us year engine you will use and whether 2 or 4 Whl-Dr. **ORDER NOW FOR EARLY SHIPMENT.**

**HOOSIER MACHINE PRODUCTS CO.**  
312 S.E. 6th St. Pendleton, Oregon



**GET MAXIMUM USE OF 4-WHEEL DRIVES!**

**MAKE 2 VEHICLES OUT OF 1!**

New **LOCK-O-MATIC!**

- Automatic free-wheeling 2 w. d.
- Automatic 2 and 4 w. d. reverse
- Locking control for "solid" 4 w. d.



Your 4 w. d. is a 4 w. d. work horse or 2 w. d. "pick-up" as you need it—as you shift! No drag, gear whine, shimmy in 2 w. d.; big savings in gas, tires, repairs. For all 4 w. ds. to 1½ tons at dealers or write:

**WARN HUBS**

WARN MANUFACTURING CO.  
Riverton Box 6064-A-4 Seattle 88, Wash.

POPULAR MECHANICS

**NOW...from D.T.I.'s MILLION DOLLAR TRAINING CENTER**



# Learn to master TELEVISION AUTOMATION

**RADIO - ELECTRONICS**  
by getting **EVERYTHING YOU NEED!**

**NOW—  
get training  
to suit your NEEDS**

**TAKE YOUR  
CHOICE**

Come to  
D.T.I.'s  
great **CHICAGO  
LABORATORIES**  
...one of the Nation's **FINEST!**

Now, in the heart of the nation's TV Center, you can get all of your preparation in D.T.I.'s big, modern, wonderfully equipped training laboratories. Loads of commercial equipment and ample, well qualified instructors help you get a thorough, practical preparation in the **SHORTEST POSSIBLE TIME**. Part time student Employment assistance can help you pay your way while in training.

### EMPLOYMENT SERVICE

As soon as you complete either the Chicago Laboratory or Home Training, you'll find D.T.I.'s grand Employment Service ready to help you start earning real money. Get full facts. Mail coupon today.

**MILITARY SERVICE:** If subject to military service, the training information we have for you should prove very helpful. Mail coupon today.

**89 WAYS  
TO  
EARN  
MONEY  
IN TELEVISION  
RADIO ELECTRONICS**

**ACT NOW! MAIL COUPON TODAY**  
**Get this publication FREE!**

**DeVRY TECHNICAL INSTITUTE** MEMBER OF NATIONAL HOME STUDY COUNCIL  
4141 BELMONT AVE., CHICAGO 41, ILL. DEPT. PM-4-M

I would like your Opportunity News Bulletin showing "89 Ways to Earn Money in Television-Radio-Electronics"; also, complete facts about the training opportunity made possible by your organization.

Name \_\_\_\_\_ Age \_\_\_\_\_  
(PLEASE PRINT) \_\_\_\_\_  
Address \_\_\_\_\_ Apt. \_\_\_\_\_  
City \_\_\_\_\_ Zone \_\_\_\_\_ State \_\_\_\_\_

D.T.I.'s Training is available in Canada

America's amazing multi-billion dollar Television field offers a chance of a lifetime to get started toward a good job or your own business. With over 400 TV stations in operation and more than 30 million receivers in use, Television is one of today's most promising fields. Mail coupon today. See how you may prepare to cash in on this grand opportunity.

Get **ALL** of your training  
**AT HOME!**...including setting  
up your own **HOME LABORATORY**



**ABOVE:** You build and keep this big 5 INCH commercial-type oscilloscope — one of the most useful test units used in TV today.



Build and keep this **BIG DTI** Engineered TV set—easily converted to U.H.F. (DTI offers another home training, but without the TV set.)

**Use 16 mm. MOVIES** Only D.T.I. provides you with the loan of visual training movies at home to help you master important basic points faster... easier... better!



"One of America's Foremost Electronics Training Centers"



**DeVRY TECHNICAL INSTITUTE**  
CHICAGO 41, ILLINOIS  
FORMERLY  
**DeFOREST'S TRAINING, INC.**

Some make more, some less. T. THORN reports:

**\$690** gross in single  
**MONTH**  
IN MY OWN BUSINESS!

**Start  
YOUR OWN  
Business!**



● Here's YOUR chance to start a money-making, year-'round business of your own and make the success you've dreamed about. R. O. Donnelly took in \$40 in seven hours. O. W. Ware landed a \$750 hotel job. R. Traynor grossed over \$450.00 in five days. Homes, hotels, offices, clubs, offer you big profit possibilities. Auto upholstery also.

**NO SHOP OR OFFICE NECESSARY.** You clean furniture on customers' premises. No hauling. No high rents. Supplies inexpensive; operate from your home. What you take in is mostly profit.

● If you want to be your own boss—free from layoffs, strikes and bosses, we will help you to start and succeed. Don't delay... read the facts, then decide for yourself.

**MAIL COUPON TODAY FOR FREE BOOK**

**VON SCHRADER MFG. CO.**  
410 "D" Pl., Racine, Wisconsin

Without obligation rush your **FREE** booklet about how I can start my own permanent, profitable electric Upholstery Cleaning business.

Name \_\_\_\_\_

Address \_\_\_\_\_

City \_\_\_\_\_ Zone \_\_\_\_\_ State \_\_\_\_\_

*The finest of Gifts...*

**ENCYCLOPAEDIA BRITANNICA**

**Valve Lifters Click? Get PYROIL**

CLEANS, LUBRICATES, RESTORES LOST POWER



**Now... Quiet 'em**

Pyroil "B" added to engine oil clings to metal. Lifters won't stick and click. Pyroil fights heat, acid, corrosion. Increases mileage. Saves gas and repairs. Get Pyroil "B" today. Save more... buy in pints, quarts, gallons.

Write for trial offer. Dept. PM-46,

**PYROIL COMPANY**

LaCrosse, Wis., U.S.A.,

Toronto, Canada

IN CANADA  
1700

**PYROIL**

SUPER LUBRICANTS • WORLD FAMOUS SINCE 1929

**If Ruptured**

For lasting relief your rupture must  
**BE HELD BACK DAY and NIGHT.**

Consult Your Doctor.

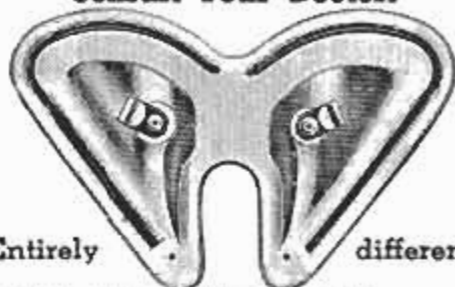

Entirely different

**SOFT, FLEXIBLE,** and fits neat as a glove. The famous Miller saves you **TIME, MONEY, DISAPPOINTMENT.**

Write for my **FREE** booklet today.

**FRED B. MILLER** Manufacturer  
Dept. PM46, Hagerstown, Maryland



**I Made \$14,839 in 1 Year  
SERVICING RADIATORS!**

Re: Ryan (Iowa) and hundreds of others earn \$6,000-\$20,000 a year servicing auto-truck-tractor radiators the Inland way. Inland, largest radiator servicing equipment mfr., offers the complete package — equipment, merchandising, "Pays-for-itself" financing, and Free training school for customers.

WRITE for **FREE** Radiator Servicing Folder.

**INLAND MFG. COMPANY** Dept. PM-4  
1108 Jackson St., Omaha 8, Nebr.

**Secrets of VENTRILOQUISM  
Now Revealed!**



Easy to learn in 60 to 90 days with our Home Study Course. **RESULTS GUARANTEED.** Make Money! Be Popular! Have Fun! Big Opportunity! Radio, Television, Stage Appearances! For **FREE** information regarding price and terms **WRITE.** You must state your age. Dummy Catalog 25c.

**FRED MAHER SCHOOL OF VENTRILOQUISM**  
Box 36, Studio PM-4 Kensington Station  
Detroit 24, Michigan

**MONEY in WORMS**

Big money made raising fishworms and crickets. Billions used yearly—unlimited market—sell by mail—We teach you how to raise and where to sell. Start in backyard or basement. Send \$2.95 for complete guaranteed instructions or write for free literature. **CARTER WORM RANCH, PLAINS, GEORGIA**

**GEIGER COUNTERS  
BUY DIRECT FROM FACTORY**

Write for time payment plan

**NUCLEONIC COMPANY OF AMERICA**

Dept. P.M. 46, 196 Degraw St., Brooklyn 31, N. Y.

**LEARN AT HOME**

**Key to Success**

**LOCKSMITHING**

Learn this profitable business from experts in your spare time. Locksmiths have no "slow" seasons or layoffs; they are always in demand. Age or minor physical handicap can't stop you. America's only recognized locksmithing school can teach you easily and quickly. Simple, illustrated lessons plus materials and tools supplied. Make money while learning. Get into this uncrowded field now!

Send for **FREE BOOKLET**

**INSTITUTE OF LOCKSMITHING**  
Dept. P-77, 15 Park Avenue, Rutherford, N. J.  
Lic. by N. J. State Board of Education  
Approved for Veterans



# PUT YOURSELF IN THE Top-Paying TELEVISION PICTURE...



L. C. Lane, B.S., M.A.  
President, Radio-Television  
Training Association,  
Executive Director, Pierce  
School of Radio & Television.

Today, when demand for trained men is higher than ever before, pay is higher than ever before, you can train AT HOME in your SPARE TIME to become a Television Technician.



**NO EXPERIENCE NEEDED...** Many of my successful graduates had no more than a grammar school education.

## VETERANS!

My school fully approved to train Veterans under new Korean G.I. Bill. Don't lose your school benefits by waiting too long. Write discharge date on coupon.

### GOOD SPARE TIME EARNINGS

Almost from the very start you can earn extra money while learning by repairing radio-TV sets for friends and neighbors. Many of my students earn up to \$25 a week... pay for their entire training from spare time earnings... start their own profitable service business.

### OPTIONAL: 2 WEEKS TRAINING IN NEW YORK CITY AT NO EXTRA COST

You get two weeks, 50 hours, of intensive laboratory work on modern electronic equipment at our associate school in New York City — Pierce School of Radio and Television. And I give you this AT NO EXTRA COST whatsoever, after you finish your home study training in the Radio-FM-TV Technician Course or FM-TV Technician Course. However, your home study course is complete even without this two-week laboratory session. It is only one of the many Extras available to you from RTTA if you want it.

### CHOOSE FROM THREE COMPLETE COURSES covering all phases of Radio, FM and TV

1. Radio, FM and Television Technician Course — no previous experience needed.
2. FM-TV Technician Course — previous training or experience in radio required.
3. TV Cameraman and Studio Technician Course — advanced training for men with Radio or TV training or experience.

## Radio Television Training Association

52 EAST 19th STREET • NEW YORK 3, N. Y.

Licensed by the State of New York • Approved for Veteran Training



C-W Telephone Transmitter



Combination Voltmeter-Ammeter-Ohmmeter



Public Address System



AF-RF Signal Generator



Super-Het Radio Receiver



## ENOUGH EQUIPMENT TO SET UP YOUR OWN HOME LABORATORY

As part of your training I give you the equipment you need to set up your own home laboratory and prepare for a BETTER-PAY TV JOB. You build and keep an Electromagnetic TV RECEIVER designed and engineered to take any size picture tube up to 21-inch, (10-inch tube furnished. Slight extra cost for larger sizes.)... also a Super-Het Radio Receiver, AF-RF Signal Generator, Combination Voltmeter-Ammeter-Ohmmeter, C-W Telephone Transmitter, Public Address System, AC-DC Power supply. Everything supplied, including all tubes.

## FCC COACHING COURSE

Qualifies you for Higher Pay! Given to all my students AT NO EXTRA COST after TV Theory and Practice is completed. Helps you qualify for the TOP JOBS in Radio-TV that demand an FCC License! Full training and preparation at home for your FCC License.

## MY FREE AIDS SHOW YOU HOW AND WHERE TO GET A BETTER PAY JOB IN TELEVISION

See for yourself how my simple, practical methods can make success as easy for you as they have for my hundreds of graduates.

## MAIL THIS COUPON TODAY

Mr. Leonard C. Lane, President  
RADIO-TELEVISION TRAINING ASSOCIATION  
Dept. M-4C, 52 East 19th Street, New York 3, N.Y.

Dear Mr. Lane: Send me your NEW FREE BOOK, FREE SAMPLE LESSON, and FREE aids that will show me how I can make TOP MONEY IN TELEVISION. I understand I am under no obligation.

(PLEASE PRINT PLAINLY)

Name \_\_\_\_\_ Age \_\_\_\_\_

Address \_\_\_\_\_

City \_\_\_\_\_ Zone \_\_\_\_\_ State \_\_\_\_\_

I AM INTERESTED IN:

- Radio-FM-TV Technician Course  
 FM-TV Technician Course  
 TV Cameraman & Studio Technician Course

**VETERANS!**  
Write discharge date

**NO OBLIGATION**

# DRAFTSMEN



**CASH BIG  
PAY CHECKS!**

**Train Now for  
more success,  
greater security**

**LEARN AT HOME IN SPARE TIME  
(or at college in Chicago)**

Check the want ads in any newspaper—SEE the big-pay opportunities open to you as a draftsman. What's more, you can learn this well-paid, prestige profession at home—quickly, easily! No special talent needed. Get complete, step-by-step Chicago Tech lessons in the mail, spend a few pleasant hours studying each week. In a short time you'll be a well-trained draftsman, ready to take your pick of many good jobs. Act now!



**Free Information—Mail Coupon Today!**

Get FREE TRIAL LESSON plus information about C.T.C. practical training. Learn what successful Chicago Tech graduates say about high pay and opportunities in drafting. No charge, or obligation.

## CHICAGO TECHNICAL COLLEGE

D-254 Tech Bldg., 2000 So. Michigan Ave.  
Chicago 16, Illinois

Mail me FREE lesson with facts about big opportunities in DRAFTING.

Name \_\_\_\_\_ Age \_\_\_\_\_

Address \_\_\_\_\_

City \_\_\_\_\_ Zone \_\_\_\_\_ State \_\_\_\_\_

**SAY YOU SAW IT IN  
POPULAR MECHANICS**

# CHEMISTRY



**BIG LABORATORY GIVEN FREE!**

Be a CHEMIST! One of the really GREAT professions! We teach you at home. Simplified (but thorough) course; no previous training required. Earn while you learn. This is a GOLDEN AGE for those with special knowledge! Diploma awarded! Send 25c for first lesson and KIT or \$1.00 for first 5 lessons and supplies including

**FREE!**

**URANIUM TESTER, CHEMICAL  
PUZZLE (worth \$2.50) and  
HOW TO MAKE 100 NEW  
CHEMICALS!**

**NATIONAL SCHOOL OF CHEMISTRY**

P.O. BOX 606-A

REDWOOD CITY, CALIF.



**INSURED TIRE SERVICE  
POPULAR BRANDS**

**FREE** INSURANCE POLICY given with each used tire sold. We guarantee the amount of service you pay for.  
NOWHERE CAN SUCH QUALITY BE FOUND AT SUCH LOW PRICE!

**SPECIAL!**  
Deduct  
10% on  
orders for  
two or  
more used  
tires

**YOU CAN'T  
LOSE!**

Super Quality — Rugged Performance — 6 Months Insured Service	
600x16 \$3.65	670x15 \$3.95
650x15 3.85	670x16 4.05
650x16 4.25	700x15 3.95
	760x16 \$4.45
	820x15 4.35
	850x17 4.45
	850x17 4.65

Supreme Quality — Nothing Finer — 12 Months Insured Service	
600x16 \$5.25	475x19 \$6.45
600x16 (6) 6.75	640x15 4.95
650x16 5.75	670x15 5.35
650x16 (6) 7.25	710x15 5.45
700x16 6.35	760x15 5.95
750x16 (6) 8.45	800x15 6.35
550x18 4.95	820x15 6.35
550x17 4.75	550x15 8.35
650x15 5.25	670x16 5.15
700x15 5.35	700x16 (6) 10.25
	32x6 (8) 11.95
	1100x22 12.75
	1100x24 22.95
	1100x20 15.50
	1500x20 17.50
	1500x20 (11) 21.50
	1900x20 19.95
	1000x20 20.45
	1100x20 21.25
	1000x22 21.95
	1100x22 22.75
	1100x24 25.95

Whitewalls \$1.00 extra.

**MIDLAND  
TIRE SALES**

Speedy shipments on Mail Orders. F.O.B. Chicago. Insurance policy sent with each order. Deduct 10% on orders for 2 or more used tires. Send CHECK or MONEY ORDER.—No COD's.  
3701 S. Normal, Dept. PM-45, Chicago 9, Ill.

**A "GOOD HAND" HELPS YOU SUCCEED!**  
**LEARN TO WRITE WELL**

Handwriting quickly improves with our easy-to-understand picture lessons! Put your spare time to good use; send today for **FREE BOOKLET OF PENMANSHIP COURSES AND SUPPLIES** or check volumes wanted below at \$1 each:

- Business Writing
- Artistic Writing
- Card Writing
- Bird & Design Flourishing
- Engrossing Alphabets. COMPLETE SET \$4.50. Act now!

**TAMBLYN SCHOOL OF PENMANSHIP**  
S.A. Ziller, Pres., 442 Ridge Bldg., Kansas City, Mo., USA

## ACCORDIONS

Piano and Chromatic—Vienna & Italian System. Heligons—Irish—Club Models—Hohner & All button type. Also Concertinas & Bandoneons. Buy direct from Factory Representative at Lowest Wholesale Prices and Save Money. We take any instrument in trade.

**Expert repairing—Write for Free Catalog**

**ITALIAN ACCORDION MFG. CO.**  
7600 Cottage Grove Ave., Dept. PM-4, Chicago 19, Illinois

**Make BIG MONEY!**  
**RAISE CHINCHILLA RABBITS!**

Cash Markets Supplied for Your Production  
**FREE - Illustrated Booklet - WRITE TODAY!**  
ROCK HILL RANCH, SELLERSVILLE 36, PA.

World's Largest Breeder of Chinchilla Rabbits

## ARTHRITIS—RHEUMATISM VITAL FACTS EXPLAINED

**FREE DESCRIPTIVE BOOK**

How crippling deformities may be avoided. This amazing FREE BOOK explains why ordinary methods give only temporary relief—if that. Describes a drugless method of treatment successfully applied in thousands of cases. Write for this 44-page FREE BOOK today. No obligation.

**BALL CLINIC, DEPT. 756, EXCELSIOR SPRINGS, MO.**

See the Greatest Show on Earth with this  
**GIANT ASTRONOMICAL TELESCOPE**

**\$1500 FULL PRICE**

Delivered ready for use. Has 45X, 75X and 100 power individually mounted eyepieces with brass focusing tube plus sun projector lens for observing sun spots and solar storms. Steel telescope tube 50 in. long. Rigid 6 ft. tripod adjustable to any height. Steel forked mounting with closely machined aluminum tripod head. Assembly assures extra fine adjustments. This professional type instrument provides full power with clear vision at all times. See the moons of Jupiter, our own moon, planets, milky way, double stars, star clusters, etc. All for only \$15.00 FOB Mattituck. Sent express. COD orders require \$5.00 deposit. Satisfaction guaranteed. 200X and 400X eyepieces available at \$2.00 ea.

**SUFFOLK SCIENCE SERVICE**  
Dept. TD-4 MATTITUCK, N. Y.

# HOW TO FIX

Brakes, Clutches, Transmissions, Rear Ends, Carburetors — Yes, •

# ANY PART OF ANY CAR

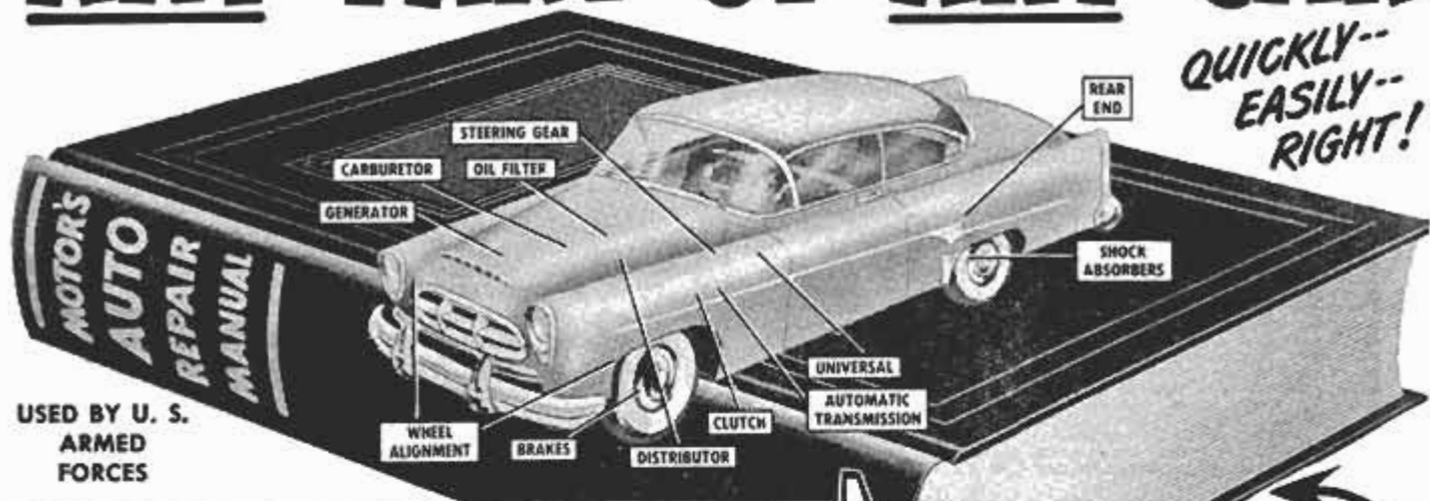

USED BY U. S. ARMED FORCES

**NOW—Whether You're a Beginner or an Expert Mechanic—You Can "Breeze Through" ANY AUTO REPAIR JOB! MOTOR'S BIG BRAND-NEW AUTO REPAIR MANUAL Shows You HOW—With 2900 PICTURES AND SIMPLE STEP-BY-STEP INSTRUCTIONS.**

**Free 7-DAY TRIAL**  
Return and Pay Nothing if Not Satisfied

## COVERS EVERY JOB ON EVERY CAR BUILT FROM 1946 THRU 1956

**YES**, it's easy as A-B-C to do any "fix-it" job on any car whether it's a simple carburetor adjustment or a complete overhaul. Just look up the job in the index of **MOTOR'S New AUTO REPAIR MANUAL**. Turn to pages covering job. Follow the clear, illustrated step-by-step instructions. Presto—the job is done!

No guesswork! **MOTOR'S Manual** takes nothing for granted. Tells you where to start. What tools to use. Then it leads you easily and quickly through the entire operation!

### Same FREE Offer On MOTOR'S New Truck Repair Manual

Covers EVERY job on EVERY popular make gasoline and Diesel truck made from 1946 thru 1955. FREE 7-Day Trial. Check proper box in coupon.

cuts that will amaze you. No wonder this guide is used by the U. S. Army and Navy! No wonder hundreds of thousands of men call it the "Auto Repair Man's Bible"!

### Meat of Over 160 Official Shop Manuals

Engineers from every automobile plant in America worked out these time-saving procedures for their own motor car line. Now the editors of **MOTOR** have gathered together this wealth of "Know-How" from over 160 Official Shop Manuals, "boiled it down" into crystal-clear terms in one handy indexed book!

### Covers 650 Models—All These Makes

- |             |          |            |             |
|-------------|----------|------------|-------------|
| Buick       | De Soto  | Kaiser     | Pontiac     |
| Cadillac    | Dodge    | Lincoln    | Rambler     |
| Chevrolet   | Ford     | Mercury    | Studebaker  |
| Chrysler    | Frazer   | Nash       | Thunderbird |
| Clipper     | Henry J  | Oldsmobile | Willlys     |
| Continental | Hudson   | Packard    |             |
| Crosley     | Imperial | Plymouth   |             |



Many Letters of Praise from Users "MOTOR'S Manual paid for itself on the first 2 jobs, and saved me valuable time by eliminating guesswork."  
—W. SCHROP, Ohio

He Does Job in 30 Min.—Fixed motor another mechanic had worked on half a day. With your Manual I did it in 30 minutes."  
—C. AUBERRY, Tenn.



Over 2,900 Pictures! So Complete, So Simple, You CAN'T Go Wrong!

**BIG BRAND-NEW REVISED Edition.** Covers everything you need to know to repair over 650 chassis models—including ALL 1956 CARS. OVER ONE THOUSAND giant pages, 2,900 "This-Is-How" pictures, 291 "Quick-Check" charts—23,436 essential repair specifications. Over 225,000 service and repair facts. Instructions and pictures are so clear you can't go wrong!

Even a green beginner mechanic can do a good job. And if you're a topnotch mechanic, you'll find short-

Try Book FREE 7 Days SEND NO MONEY!

Just mail coupon! When the postman brings book, pay him nothing. First, make it show you what it's got! Unless you agree this is the greatest time-saver and work-saver you've ever seen—return book in 7 days and pay nothing. Mail coupon today! Address: **MOTOR Book Dept. Desk 1D, 250 West 55th St., New York 19, N. Y.**

## MAIL COUPON NOW FOR 7-DAY FREE TRIAL

**MOTOR BOOK DEPT.**  
Desk 1D, 250 W. 55th St., New York 19, N. Y.

Rush to me at once (check box opposite book you want):

- MOTOR'S New AUTO REPAIR MANUAL.** If O.K., I will remit \$2 in 7 days, \$2 monthly for 2 months and a final payment of 96c (plus 35c delivery charges) one month after that. Otherwise I will return the book postpaid in 7 days. (Foreign price, remit \$9 cash with order.)
- MOTOR'S New TRUCK REPAIR MANUAL.** If O.K., I will remit \$2 in 7 days, and \$2 monthly for 3 months, plus 35c delivery charges with final payment. Otherwise I will return book postpaid in 7 days. (Foreign price, remit \$10 cash with order.)

Print Name.....Age.....

Address .....

City..... State.....

- Check box and save 35c shipping charge by enclosing WITH coupon entire payment of \$6.95 for Auto Repair Manual (or \$8 for Truck Repair Manual). Same 7-day return-refund privilege applies.

## Amazing 100-Year-Old Gypsy Bait Oil MAKES FISH BITE Every day OR NO COST!



PICTURES PROVE IT REALLY WORKS! Look at 1295 lbs. fish landed by Roy Martin party, Destin, Fla. Gypsy Fish Bait Oil used on every bait! Hundreds of pictures on file!

### Mystery Scent Makes Fish Go Crazy

Fishing scientists are just learning what wandering Gypsies knew 100 years ago... hungry or not any fish strikes any bait scented with Gypsy Fish Bait Oil! Gypsies invented this amazing scented oil formula that excites all kinds of fish thru thousands of small organs that cover their bodies. When one strikes madly for your bait they all fight over it and usually the largest fish wins. It makes no difference what bait you use... plug, minnow, worm, fly or even a piece of cloth... we don't care if you fish lakes, rivers, creeks, ponds or ocean... still fish with pole and bobber, cast, troll or spin... no matter what kind of fish you're after... all you have to do is dab a little ready to use Gypsy Fish Bait Oil on the bait and you'll catch more and larger fish than anyone else in your party. IT WORKS ANY DAY, ANY TIME OF DAY. The fish don't live that won't strike bait dabbed with Gypsy Fish Bait Oil. In season, that is. So say we're crazy. Be skeptical as you like. But let us send you scented Gypsy Fish Bait Oil to try... at our risk.

### SEND NO MONEY... Fish ON APPROVAL

Write asking for one double size bottle Gypsy Fish Bait Oil for \$1.98 or 3 for \$4.98. On arrival deposit your money plus C.O.D. postage thru postman. Cash orders sent postage paid. Dab Gypsy on bait the next time you fish and if you don't catch so many fish (large ones too) you're absolutely amazed, simply return what's left for money back. FREE! Handy water-resistant large fisherman's pouch for matches, lunch, tobacco, etc. included free to keep even if you return oil. Accept this friendly challenge! Write today to

FISHERMAN'S PRODUCTS CO.

Dept. 49-D, 2832 Niazuma Ave., Birmingham 5, Ala.

## Say You Saw It in POPULAR MECHANICS

T-4



### BIG PROFIT making Concrete Drain Tile

Millions of dollars' worth of drain tile are used every year for farm drainage, building construction, reclamation projects, highways, and other purposes. And the big swing is to concrete tile because it's better and costs less. Sales potentials are BIG.

Concrete drain tile is locally manufactured of local materials, for direct selling to local users or contractors. Useless costs—freight, distribution, breakage—are eliminated. While worth more than clay tile, concrete tile can sell for less and still earn a handsome profit.

Tile made on the Champion Machine are strong and uniform. Truly round. All sizes up to 12" diameter. Easy to make because the Champion is simple to operate.

### Get The Champion Facts

Write for the Champion book. Tells about concrete drain tile as an outstanding manufacturing opportunity. Describes the machine and outlines liberal payment terms.

W. E. DUNN MFG. CO.  
522 W. 24th Street, Holland, Mich.

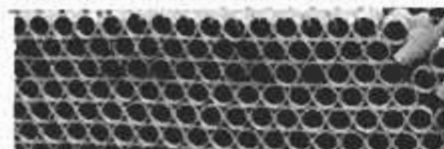

IN CANADA: DUNN MASONRY MACHINERY LIMITED  
970 Dundas Highway, Cooksville, Ont.

## SEND FOR Free Record

### START SPEAKING FRENCH OR SPANISH ALMOST OVERNIGHT!

HERE'S the easiest way to learn FRENCH, SPANISH, Russian, German, Italian, Japanese or Brazilian. Listen to FREE 2-sided non-breakable record. Let your eyes follow words in FREE sample lesson. Almost at once you'll be chatting in a new language with a perfect accent! That's all you hear! No dull, tedious work. Just listen—imitate! It's that easy! Offer may end soon. Rush 25c to help cover cost of special packaging, shipping. State language you want. We'll also send free information on full Cortina course. CORTINA ACADEMY, Dept. 644, 136 W. 52nd St., New York 19.

### YOU BUILD 'EM — WE SELL 'EM EARN UP TO \$50.00 A DAY AT HOME

Here is a new business for people who would like to make extra money full time or spare time. Our program enables you to work in your home and participate in national sales secured through our firm. You assemble luggage and special cases for photographic equipment—musical instruments—salesmen's samples and all types of portables. We supply complete instructions—materials—tools—everything. No previous experience is necessary. Write for free details. Abarsi Casecraft, Dept. AD, 807 W. Sunset Blvd., Los Angeles 12, Calif.

## LAW

Men and women STUDY AT HOME for Business Success and LARGER PERSONAL EARNINGS, 44 years expert instruction—over 114,000 students enrolled. LL.B. Degree awarded. All text material furnished. Easy payment plan. Send for FREE BOOK —"Law and Executive Guidance"—NOW!

### AMERICAN EXTENSION SCHOOL OF LAW

Dept. H-10, 201 N. Wells St., Chicago 6, Illinois

## MONEY in DONUTS

Make new greaseless donuts. Start in kitchen. No smoke. Sell stores. HALF PROFIT. Cash daily. Free recipes. No obligation. Write! MARTIN RAY CO., 3605 SO. 15th AVENUE, MINNEAPOLIS 7, MINN.

### \$1300 BUILDS INCOME DUPLEX

#### FINANCIAL SECURITY!



Build your own 24'x36' concrete block duplex, complete for \$1300. Slab floor, steel windows, rock wool insulated, no block cutting necessary. Each side contains 11'x17' Living Room and Kitchenette, 10'x11' bedroom, 6'x9' bath and four closets. Genuine blueprint, scale 1/4"=1', step by step instructions, and material cost list. \$1.00 ppd. Money back guarantee. \$1150 BLOCK GARAGE APARTMENT, 22'x24' Liv. Room, Kit., bath and two bedrooms. Double garage below. Plan \$1.00. MEMBER ARKANSAS HOME BUILDERS ASSOC.

BAILEY BUILDERS, 915 Pyramid Bldg., Little Rock, Ark.

### TASOPE PHOTO-ENGRAVING PLANTS



Material Cost Of This Cut 1/4c Selling Price \$1.00 And Up

Establish your own profitable PHOTO-ENGRAVING business. Make cuts for newspapers, printers, and advertisers. Make etched name plates, plaques etc. Instructions furnished, no experience necessary. Sold direct from factory since 1931. First five hundred cuts sold locally or by mail will pay for plant and pay you well for your time. Write for FREE catalog.

TASOPE, DEPT. PM-4, AURORA, MO.

### Learn BAKING At Home

Baking is one of America's high industries in wages. Nearly DEPRESSION-PROOF. Thorough basic home course lays sound foundation. If you have aptitude, write for FREE Booklet, "Opportunities in Commercial Baking."

NATIONAL BAKING SCHOOL  
835 Diversey Pkwy. Dept. 1354 Chicago 14, Ill.





## ... but the Egyptians knew it ages ago!

POWERS to overcome sickness! Means to escape poverty! Knowledge to bring happiness and peace of mind! Skill and genius to create a civilization which we still copy today! These are only some of the accomplishments of the ancient Egyptians.

Above and beyond these physical achievements was the secret wisdom possessed by the Egyptian mystery schools. In these centers of learning men and women were taught the laws of life and how to master them. With this mastery they were able to shape their destinies as they wished them to be. It takes no greater mental effort to *achieve results* when you know how. Successful living is the oldest art in the world. It consists of developing *initiative, foresight* and the ability to combine experiences into new and workable ideas.

These laws operate as unfailingly as the laws which govern the sun, moon and planets. They were discovered centuries ago by certain wise men of Egypt, and preserved down through the ages by the Rosicrucians.

Time has since crumbled Egypt's walls, but it couldn't destroy this formula for the

control of life. In your hands, this knowledge could alter the entire course of your affairs.

The Rosicrucians offer to you—if you have the courage to break away from limited forms of thinking—these same simply expressed truths of life which have led thousands to a joyous method of better living.

### Let This FREE Book Help You

Learn how you may share the private instructions of The Rosicrucians, a non-profit fraternity of men and women whose influence extends into every land. Let this be the turning point in *your* life! For your copy of "*The Mastery of Life*" use the coupon below or write to Scribe S.Y.F.

### **The Rosicrucians**

[ A M O R C ]

SAN JOSE, CALIFORNIA, U. S. A.

Scribe S.Y.F.  
The Rosicrucians (AMORC)  
San Jose, California, U.S.A.

Please send me, without obligation, my copy of "*The Mastery of Life*" which explains how I may receive and use your intelligent and age-old method for attaining mastership of life.

Name.....

Address.....

# Inventors

Take these necessary preliminary steps promptly to protect your invention by applying for a United States patent—

Sketch and describe your invention. Sign, date and have this disclosure witnessed by two people who understand your invention. Have us make a preliminary search among U. S. patents already granted for similar types of invention. We then report to you on the probable patentability of your invention and recommend your further course of action.

Write for our instructive booklet, "Patent Protection for Inventors" and our convenient "Evidence of Invention" disclosure form. No obligation.

**VICTOR J. EVANS & Co.** *Merlin M. Evans*  
REGISTERED PATENT ATTORNEY

230-D MERLIN BUILDING, WASHINGTON 6, D. C.

## 105 POWER SUPER TELESCOPE



Everything for the Astronomer, Hobbyist, Student, & Scout in this complete astronomical super value telescope combination. Comes ready for immediate use, consists of brilliant 33x-65x-105x telescope, 5 foot hardwood Tripod, carrying case for scope, Star Explorer map, 108 page book "Discover the Stars." 3 foot telescope (closes to 16 inches) is brass bound, has 4 precision lenses that will bring distant objects, people, moon, stars, ships, etc., 105 times closer. 11,025 area magnification. All images erect. Sturdily built tripod is equipped with universal mount that has 360 degree horizontal range & 180 degree vertical range. Locks in any position with one simple adjustment. The Star Explorer map enables you to find any star automatically. This marvelous all purpose instrument is proclaimed by Scientists as a most unusual development. Everyone that has used it is amazed at its performance and value. It will fascinate the entire family. Shipped to you complete, nothing else to buy, at the amazing low price of.....

**\$1195**  
POST PAID

Satisfaction guaranteed or money refunded. We pay all delivery charges. Send check or money order to DEPT. PMS15

CRITERION CO. 331 CHURCH ST., HARTFORD 1, CONN.

## Shrinks Hemorrhoids New Way Without Surgery

Science Finds Healing Substance That Relieves Pain—Shrinks Hemorrhoids

For the first time science has found a new healing substance with the astonishing ability to shrink hemorrhoids and to relieve pain — without surgery.

In case after case, while gently relieving pain, actual reduction (shrinkage) took place.

Most amazing of all — results were so thorough that sufferers made astonishing statements like "Piles have ceased to be a problem!"

The secret is a new healing substance (Bio-Dyne\*)—discovery of a world-famous research institute.

This substance is now available in suppository or ointment form under the name Preparation H.\* Ask for it at all drug counters—money back guarantee. \*Reg. U. S. Pat. Off.

## Learn LEATHERCRAFT

- Sell for big Profits. Markets Everywhere.
- Up to 500% Profit. Make Leather Goods, Billfolds, Bags, Belts, & 200 other items.
- EASY TO MAKE WITH THE NEW TANDY PROCESS.
- We supply complete instructions & materials.

WRITE FOR FREE DETAILS, FREE CATALOG

81 TANDY STORES COAST-TO-COAST

**TANDY LEATHER CO.** EST. 1919  
P.O. BOX 791-TJ FORT WORTH, TEXAS

**FREE**  
Catalog  
U-DO-IT  
KITS

## LAW FREE BOOK

THE LAW  
TRAINED  
MAN

Write today for a FREE copy of illustrated law book, "THE LAW-TRAINED MAN," which shows how to earn the professional Bachelor of Laws (LL.B.) degree through home study of the famous Blackstone Law Course. All necessary books and lessons provided. Moderate cost; convenient monthly terms. Write for FREE law training book today.

**Blackstone School of Law, 225 N. Michigan Ave.**  
Founded 1890 Dept. 54 Chicago 1, Ill.

Send for **FREE** 112 page  
Illustrated Catalog of Farm, Home,  
and Workshop Bargains.

Write to **WELLWORTH TRADING COMPANY**  
Dept. F-4

1832 S. WABASH AVE.

CHICAGO 16, ILL.

Say You Saw It in Popular Mechanics

**MEN! TRAIN NOW FOR A BIG PAY FUTURE IN**



**GO PLACES WITH DIESEL!** Farms, factories and power plants, trains, ships, trucks, busses all use DIESEL POWER . . . all need DIESEL-trained men! You can start your DIESEL training at home, in spare time, with tested, proved U E I training. Course includes practical work on Diesel engines under skilled instructors. You learn the operation, maintenance, servicing of all types of Diesel engines, PLUS Scientific Motor Tune-up.

- Diesel Construction
- Diesel Engine Repairman
- Diesel Operator

**ACT NOW!** If you have mechanical ability, YOU'LL LIKE DIESEL! High School diploma not necessary. Write now for FREE book, "EARNING POWER IN DIESEL."

UTILITIES ENGINEERING INSTITUTE, Dept. DC-55  
2521 SHEFFIELD AVENUE, CHICAGO 14, ILL.



# Fix any AUTO part

ENGINES • FUEL, LUBRICATING, COOLING SYSTEMS • CHASSIS  
TRANSMISSIONS • POWER TRAINS • ELECTRICAL EQUIPMENT

# FASTER

**FREE**

10 day trial

**MEETS AUTO  
INDUSTRY  
STANDARDS!**

Follows Standards for Automotive Service Instruction released January, 1956, by the Automotive Industry-Vocational Education Conference.

**Repair all models—old or new!**

**Helps you fix, for example:**

V-8 engines  
power steering  
12-volt electrical systems  
autronic eye  
automatic transmissions  
4-barrel carburetors  
electric window adjusters  
dual exhaust systems,  
etc., etc.

**Get COMPLETE help from this giant Library!**

Over 2500 pages, almost 2000 "show-how" pictures, scores of troubleshooting charts show you exactly what to do step by step

Now you can be "Mr. Auto Fix-It." Handle any auto repair job that comes your way with greater speed and ease. With this storehouse you get for the first time ALL the know-how the auto industry requires of the best paid mechanics and servicemen. Developed because no single volume could ever meet modern needs, McGraw-Hill's new COMPLETE AUTO REPAIR AND SERVICING LIBRARY . . .

**GIVES YOU QUICK MASTERY OVER AUTO PROBLEMS**  
from the smallest job to the biggest

*Everything is here. Step-by-step testing and repair procedures for the entire car! More clearly than ever before you see how to tune-up engines . . . handle valve jobs . . . overhaul Ford, Plymouth, Chevvie, and all other carburetors . . . service and repair Long, Borg and Beck, and Auburn clutches . . . diagnose rear axle and differential troubles . . . troubleshoot and fix Gyro-Matic, Hydra-Matic, Powerglide, Dynaflo, Fordomatic, and Powerflite automatic transmissions . . . service car air conditioners . . . use specialized tools and test instruments. For any car, the COMPLETE Library helps you do hundreds of different repair jobs.*

**Much more than a reference manual**

The Library shows you a great deal more besides *how* to make each repair and adjustment. It shows you *when* to do it, *what* steps to follow, *which* tools to use, *how* to check and test your work—as *thoroughly and helpfully as only a five-volume Library can*. You get complete training covering everything the Automotive Industry-Vocational Education Conference says a **QUALIFIED** auto mechanic needs — training that gives you an expert's knack for fixing even those rare breakdowns that won't respond to normal methods.

The McGraw-Hill

## COMPLETE AUTO REPAIR and SERVICING LIBRARY

By **WILLIAM H. CROUSE**, formerly with a Div. of General Motors, noted author of practical auto repair books.

- **Engines**—Gives clear, non-technical picture of fundamentals plus the causes of engine troubles and their cures.
- **Fuel, Lubricating, and Cooling Systems**—Why they're designed certain ways, how they operate, how to test, service, and repair them.
- **Chassis & Body**—All parts, including springs, shock absorbers, steering, brakes, tires, etc.
- **Transmissions**—Operation and repair, including clutches, drive lines, and differentials.
- **Electrical Equipment**—Everything that uses electricity.

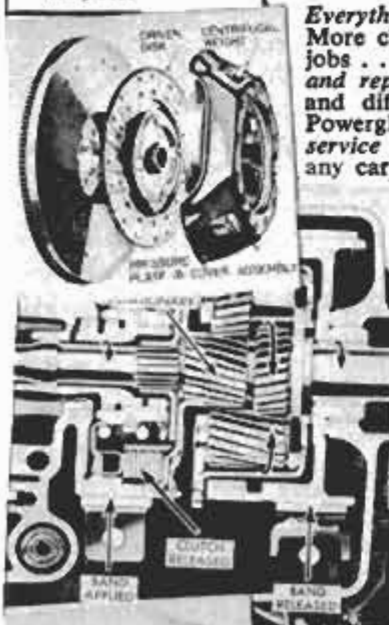

**Almost 2000 show-how pictures take guesswork out of car repairs**

Mail coupon or write McGraw-Hill, Dept. PM-4, 327 W 41 st., N.Y.C. 36

McGraw-Hill, Dept. PM-4  
327 W 41 St., N.Y. 36, N.Y.

Send me for 10-day free trial the Complete Auto Repair and Servicing Library. In 10 days I will remit \$3.75, and \$5.00 a month, until \$28.75 is paid—a savings of \$5.00 on the regular list price of \$33.75. Otherwise, I will return books postpaid. **SAVE EXTRA \$1!** If you remit in full for Library, price is only \$27.75. (Same return privilege.)

(Check below to examine free for 10 days individual books by Crouse)

- |  |  |
|--|--|
| <input type="checkbox"/> Engines \$6.50                              | <input type="checkbox"/> Chassis & Body \$7.50 |
| <input type="checkbox"/> Fuel, Lubricating, & Cooling Systems \$6.50 | <input type="checkbox"/> Transmissions \$7.50  |
| <input type="checkbox"/> Electrical Equipment \$6.50                 |  |

**\$5.75**  
For any book I keep I'll send \$3.00 plus delivery cost in 10 days. Balance of regular price one month later. (PRINT)

Name .....

Address .....

City & Zone.....State.....

Company .....

Position .....

For price and terms outside U.S. write McGraw-Hill Int'l., N.Y.C. PM-4

**SAVE  
\$5.00**

**FREE  
TRIAL**

Easy terms  
1/2 year to pay

# GET UP AND GO WITH A TRIUMPH

**FUN! INDEPENDENCE! ECONOMY!** Go where you want to go; do what you want to do. Be independent. Have more fun! Enjoy the thrill of motorcycling at its BEST with a gleaming, precision-made Triumph! Easy to ride... exciting to own... real economy, too—60 to 90 miles and up per gallon. Triumph's two-level cushion seat means real comfort for two! Priced surprisingly low, with easy terms available. See your nearest Triumph dealer for a free demonstration. He will teach you to ride.



RUSH THIS COUPON to nearest address below. Dept. P  
**THE TRIUMPH CORP.** Johnson Motors, Inc.  
 Towson, Baltimore 4, Maryland 267 W. Colorado St.  
 Pasadena 1, Calif.

Send me absolutely FREE the 1956 Triumph Motorcycle catalogue in full color. If under 16 years of age, check square for special pictures.

NAME \_\_\_\_\_  
 ADDRESS \_\_\_\_\_ PHONE \_\_\_\_\_

## ...TURN CONCRETE INTO GOLD!



**MAKE UP TO \$75 A DAY IN YOUR OWN BUSINESS**

If you want to have your own business — to start a business on your own — here's your big opportunity! New high speed, low cost General block machine produces up to 1,000 concrete blocks a day. Sell all you make to builders, supply houses, and others for homes, factories, buildings, garages. Cash in on the building boom! You can make profits of 100% to 150% — up to \$75 a day! General block machine equipped with 1/2 h.p. electric motor — or can be supplied with gasoline engine — works anywhere, in little space, indoors or out. Operates from ordinary house light socket. Simple, foolproof 3 step operation — so easy a child can do it. Makes superior 3 core blocks any size from 4" to 12". Also makes chimney, sash, corner and other types. Blocks meet any building code anywhere in the country. Materials — sand, water, cement, available anywhere. Simple illustrated operating instructions and mixing formulae for cement and cinder blocks supplied with each machine. Write for FREE folder with full information.

R.L.T. of New York City reports: "MY GENERAL BLOCK MACHINE PAID FOR ITSELF IN FIRST 2 WEEKS!" Hundreds now in use the world over! Write for FREE details today!

**EXTRA**

book gives floor plans for 6 sensational concrete block bungalows. Tells how to lay blocks, lay out building lines, mix concrete, build steps, porch and concrete floors all at great savings. Written by experts. Can save many times the cost of the machine! Get it now! No strings attached. Send \$1.

BOOK SENT FREE IF YOU BUY MACHINE.  
 \$1 REFUNDED IF YOU BUY LATER.

**GENERAL ENGINES CO.**

DEPT. M-46, ROUTE 130, THOROFARE, N. J.



## PAINTING IS EASY! WITH THE FAMOUS BURGESS electric SPRAYER

Just plug in and Spray



**SPRAYS:**

PAINT • VARNISH • ENAMEL • SHELLAC • MOTHPROOFERS • GARDEN SPRAYS • WATER • INSECTICIDES

**1,000 USES IN EVERY HOME!**

For the fastest, smoothest painting or spraying job you ever saw, try the Burgess Sprayer. Completely self-contained... just plug into regular household outlet, pull the trigger, and paint furniture, floors, walls, screens, cabinets, fences. Fine for mothproofing and garden spraying, too. New sapphire nozzle, handy spray-adjuster. 25-oz. graduated jar. Easier to clean than a brush. Get your Burgess Sprayer today!

only **\$12.95** AT YOUR FAVORITE DEALER

If not available locally, send \$12.95 for post-paid delivery. Money-back guarantee.

SEND FOR FREE BOOKLET "HOW TO PAINT THE EASY WAY" BURGESS VIBROCRRAFTERS, INC.

DEPT. A-14 • GRAYSLAKE, ILLINOIS

## GIANT BALLOONS



They're really BIG—surplus U.S. Govt. (new overage) Neoprene weather, target balloons. GREAT FUN in the backyard: at parties, picnics, dances, fairs. TERRIFIC for high school and college PROMS. They attract BIG CROWDS to business openings, civic events, conventions, exhibitions, trade shows. ORDER TODAY! Great for gift. Approx. inflated sizes:

18 in. dia., 3 for 70c  
 3 ft. dia., 49c—5 ft. dia., 99c  
 10 ft. dia., \$1.59—13 ft. dia., \$1.95

Postage paid on prepaid orders. Calif. residents please add sales tax.

VOLUME SALES CO., War Assets Division  
 Dept. PM-456 3930 Sunset Blvd. Los Angeles 29, Calif.

## LEARN WATCH REPAIRING

AT HOME Modern, original instruction. Prepare for a position or start in business after completing our course. Write Today! WISCONSIN SCHOOL OF WATCH REPAIRING  
 2908 N. 44th St. Dept. M Milwaukee 10, Wis.

## CABINET MAKING



LOW COST HOME TRAINING COURSE FOR BEGINNERS & ADVANCED CRAFTSMEN Make money. Learn skills and secrets of fine woodworking and tool use. Professionally prepared shop method training tells and shows how. Covers everything. Easy to master.

Write for Free Booklet INTERSTATE TRAINING SERVICE  
 DEPT. F3, PORTLAND 13, OREGON

## Would You Like to Make \$1,000 A MONTH?

That's what Stanley Hyman made selling the amazing new PRESTO Fire Extinguisher!



Science's New Widgeo Miracle— "PRESTO"

AMAZING new kind of fire extinguisher does job of bulky extinguishers that cost 4 times as much. Ends fires fast as 2 seconds. Fits in palm of hand. Never corrodes. Guaranteed for 20 years! Sells for only \$3.98! Show it to owners of homes, cars, boats, farms, etc. and to stores for resale—make good income. Write for FREE Sales Kit. No obligation. (If you want a regular Presto to use as a demonstrator, send \$2.50. Money back if you wish.) MERLITE INDUSTRIES, Dept. P-15E, 114 East 32nd St., New York 16, N. Y. In Canada: Mops Co., Ltd., 371 Doid St., Montreal 1, P. Q.



Stanley Hyman



# LAW TRAINING *for* BUSINESS

*[in spare time at home]*

## Earn LL.B. Degree



Thousands of men and women who never intend to practice are studying Law in spare time at home—not for a legal career but as an aid to business advancement.

Law today is involved in almost every major business decision. In many lines of work it is almost indispensable—credits and collections, accounting, traffic and transportation, employee relations, real estate, insurance, finance, taxation, etc. For all types of work, Law training develops keen, clear, quick, correct, and decisive thinking.

You can study LaSalle's American Law and Procedure right in the privacy of your own home—progressing as rapidly as your time and ability permit. LaSalle has, for nearly 50 years, helped more than 1,350,000 ambitious people get ahead in the business world. Thousands of letters in our files from grateful students and businessmen who have achieved greater success speak of—better jobs, more money and the satisfaction it brings, prestige and leadership.

### A MOST UNUSUAL LAW LIBRARY

This training includes the fourteen-volume LaSalle Law library—AMERICAN LAW AND PROCEDURE, which is the basis of all the instruction service. This library has been compiled by leaders in the field of Law. It covers the whole basic field of Law in an orderly and simple manner that is easy to learn and understand. Collateral reading and printed lectures on legal problems which are furnished at regular intervals throughout the training, supplement the text. Law instructors personally supervise your program from the first assignment to the LL.B. degree or diploma. Under the LaSalle method you deal with legal problems—you learn by

doing—actually solving legal problems—not just memorizing rules.

### WRITE TODAY FOR TWO FREE BOOKS

You are determined to get ahead—to prepare for greater future possibilities—and to earn more money. Send the coupon below and find out how to qualify yourself for the many openings available to the Law-trained man. In our FREE books, "Law Training for Leadership" and "Evidence," you will find answers to all your questions about the study of Law and the LaSalle method.

No investment is likely to pay higher returns than an investment in yourself, by enrolling in the American Law and Procedure training. Send coupon today for full information—no obligation, of course.

### LaSalle Extension University A Correspondence Institution

Dept. 464 L, 417 S. Dearborn St., Chicago 5, Ill.

Gentlemen: Please send me your two free booklets, "Law Training for Leadership" and "Evidence," which tell how I may study Law at home and qualify for the LL. B. degree.



Name.....Age.....

Street.....

City.....Zone.....State.....

# REAL OPERATING SUBMARINE



## SUBMERGES... SURFACES... UNDER ITS OWN POWER

Of course you recognize it! It's the famed U.S.S. NAUTILUS... an accurately detailed, authentic scale model (fully half-a-yard long) of the world's first atomic submarine. This exciting sub model actually speeds along the water surface... submerges to periscope depth... then automatically resurfaces. Easy to assemble kit includes power unit and all prefabricated parts. A cinch to assemble! Only some lead ballast needed (available at any hardware store)

ONLY  
**\$198**

### Guaranteed to Work or Your Money Back

At Dealers or Order-By-Mail. Send \$2.00 and we pay postage  
SCIENTIFIC, Dept. PM3, 115 Monroe St., Newark 5, N. J.

# BE A CLAIM INVESTIGATOR



**INVESTIGATE ACCIDENTS!** Many earning \$750 to \$1000 a month. Thousands of insurance companies, airlines, steamship lines and Government Offices need Claim Investigators. Also big opportunities for your own spare time business. We train you at home. National Placement Service FREE of extra charge. Bill King writes: "Your course has paid off for me with large earnings. You can quote me—your Adjuster Training Course is worth many times the cost." Write TODAY for FREE book.

### UNIVERSAL SCHOOLS

University Park, Dept. PM-4, Box 8202, Dallas 5, Texas

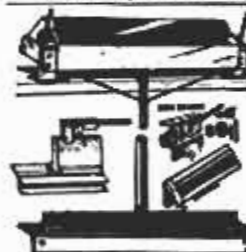

## SHEET METAL BRAKES

Form angles, locks, pans, etc. Quick eccentric clamp. All steel construction.

15" - 16 gauge steel	\$23.50
30" - 22 gauge steel	35.50
48" - 24 gauge steel	52.00
49" - 16 gauge Bender	32.00
12" - 12 gauge Bender	16.00
3/4" - 1/2" Pipe Bender	16.00
1/4 x 3 Adjustable Bender	11.50
14 gauge Bench Shear	29.00
30" - 20 gauge Curve Former	9.50

ORDER DIRECT OR SEND FOR FREE CATALOG

YVKE MFG. CO., 4158-P Jason St., Denver 11, Colo.

# ENGINEERING DEGREE IN 27 MONTHS

## Big Demand for Graduates

**Aeronautical, Chemical, Civil, Electrical, Mechanical and Electronic Engineering (inc. Radio and TV)**

Hundreds of young men are earning B. S. ENGINEERING DEGREES annually in this recognized institution — year around operation. New terms start quarterly. Many students earn a major part of their college expenses in this large industrial center.

Low tuition. Competent instruction. Thorough, intense practical program. Modern, well-equipped laboratories including new physics laboratory and modern wind tunnel. Individualized instruction emphasized.

Government approved for G.I.'s. Engineering preparatory courses. Students from 48 states and 21 foreign countries. Enter June, September, December and March. Send coupon for free catalog and full information. Enroll now.

## INDIANA TECHNICAL COLLEGE

546 E. Washington Boulevard, Fort Wayne 2, Indiana

Please send me free information on B.S. Engineering Degree in 27 months as checked.

- Aeronautical,  Chemical,  Civil,  Electrical,  
 Mechanical,  Electronics

Name \_\_\_\_\_

Address \_\_\_\_\_

Better Than  
Your Own

# SHOE STORE AT HOME



Two-Eyelet  
Hit With  
Cushioned  
Comfort

No investment, no experience needed. Just show magic cushion comfort to friends, neighbors, co-workers. Advance commissions to \$4.00 a pair, plus Cash Bonus, Paid Vacation, \$25.00 Reward Offer. Outstanding values for men, women, children. Money back guarantee. Shoe samples supplied without cost. Write TODAY for FREE new 84 page catalog and full details.

TANNERS SHOE CO., 794 Brockton, Mass.



## 700% PROFIT

### taking & FINISHING PHOTOS in 2 MINUTES with CHAMPION PHOTOMASTER

Simple instructions. Easy to learn. Make nice photos of children, groupings, at 25c, costs 2c. For FREE information write

PDQ CAMERA CO., 1546 W. Cortez, Dept. PM Chicago 22, Illinois

## 250 POWER.....



Complete

only \$3.49 postpaid

### Telescope Lens Kit

Conquer Space. Explore the Universe, Planets, Moon Craters, New Stars, etc. Complete Lens Kit consists of 80 inch focal length ground and polished objective lens, eyepiece lenses for 50 POWER, 100 POWER, 150 POWER, 200 POWER, 250 POWER, and all necessary lens fittings. Easy to make from simple step by step instructions. (Tripod and mount not included.) Money back guarantee.

BUSSE SALES CO., Hartford 1, Conn., Dept. PM 44



## MECHANICAL DENTISTRY

To make Crowns, Plates, Bridgework, etc., for Dentists. Easy practical way to learn mechanical dentistry at home in spare time. FULL EQUIPMENT OF TOOLS AND MATERIALS INCLUDED WITH COURSE. Low tuition. Easy terms. Write for FREE BOOK about this money making profession that is not affected by machine age.

McCARRIE SCHOOL OF MECHANICAL DENTISTRY  
207 N. Broad St., Dept. 52, Philadelphia 7, Pa.

## TERMITES IN YOUR HOUSE?

GET RID OF THEM YOURSELF!

DON'T PAY \$300.00 AND UP TO ERADICATE TERMITES FROM YOUR HOME OR PREVENT INFESTATION. DO IT YOURSELF IN ONE AFTERNOON. EASILY! QUICKLY! INEXPENSIVELY WITH "TERM-OUT"! SEND STAMP FOR HANDBOOK.



### COMPASS RESEARCH

90-A CLAIRTON BLVD., PITTSBURGH 36, PA.



## GIANT FREE CATALOG of OPTICAL BARGAINS

### ASTRONOMICAL TELESCOPE HEADQUARTERS

Complete Line of Astronomical Telescope Parts and Assembled Telescopes. Also huge selection of lenses, prisms, war surplus optical instruments, parts and accessories. Telescopes, microscopes, binoculars, etc. America's No. 1 source of supply for Telescope Makers. SEND ONLY \$1.00 for beginner's 10-lens kit and big instruction booklet Stock 2-H. Ask for FREE catalog H.

EDMUND SCIENTIFIC CORP., Barrington, N.J., U.S.A.

# RUPTURED

## BE FREE FROM TRUSS SLAVERY

NOW there is a new modern Non-Surgical treatment that permanently corrects rupture. These Non-Surgical treatments are so certain, that a Lifetime Certificate of Assurance is given. Write today for our New FREE Book that gives facts that may save you painful and expensive surgery, and tells how non-surgically you may again work, live, play and love and enjoy life in the manner you desire. There is no obligation. Excelsior Herasia Clinic Dept. 8305 Excelsior Springs, Mo.

**RCA** offers you the  
 finest training  
 at home in  
**Radio-TV**  
 electronics,  
**TV servicing,**  
**Color TV**

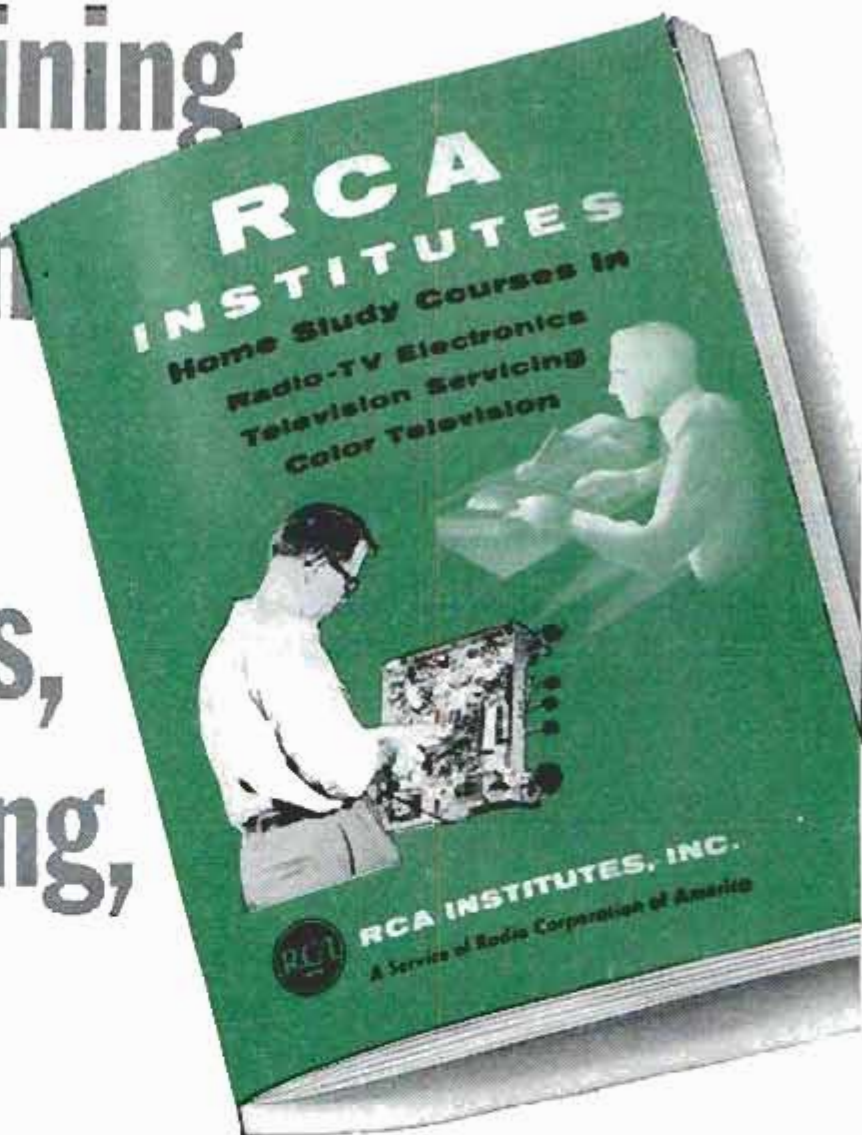

**SEND FOR THIS FREE  
 BOOK NOW!**

The instruction you receive and equipment you get (and keep) will start you on your way. Pay-as-you-learn. You pay for only one study group at a time. This 52 page book contains complete information on Home Study Courses for the beginner and the advanced student.



**RCA INSTITUTES, INC.**  
 A SERVICE OF RADIO CORPORATION OF AMERICA  
 350 WEST FOURTH STREET, NEW YORK 14, N.Y.

RCA Institutes, Inc., Home Study MP64,  
 350 West Fourth Street New York 14, N. Y.  
 Without obligation, send me FREE CATALOG  
 on Home Study Courses in Radio, Television  
 and Color TV. No salesman will call.

Name .....  
 Please Print  
 Address .....  
 City ..... Zone ..... State .....

**IMPORTANT**  
 Be sure to write  
 for RCA Institutes  
 catalog before  
 signing up for any  
 Radio-TV course

## FLYING WEATHER IS HERE NEW FLYING SENSATION

### THE HELI-FLYER



YOU control Heli-Flyer as it soars to any height by the rotation of an 8 blade rotor 3 ft. in Dia. The Heli-Flyer

**ONLY  
\$1.98**

was designed and developed by a former AIR FORCE PILOT. Two years were spent testing and redesigning to give YOU a new THRILL in flying both practical and economical. ROTARY FLYING is NEW and EXCITING. YOU'LL enjoy it.

Scientifically Engineered by  
**MARSHALL MFG. CO.**  
BOX 144  
MERCHANTVILLE, N. J.

- Flies like a Helicopter
- Variable Pitch Rotors
- All Parts Replaceable
- Gyroscopic Stability

Please send \_\_\_\_\_ HELI-FLYERS @ \$1.98 each  
NAME \_\_\_\_\_  
ADDRESS \_\_\_\_\_  
CITY \_\_\_\_\_ STATE \_\_\_\_\_  
SEND CHECK OR MONEY ORDER. NO COD'S. SATISFACTION GUARANTEED

## High School at Home

### MANY FINISH IN 2 YEARS

No classes. No time wasted going to and from school. Progress as fast as your time and abilities permit. Standard H. S. texts supplied. Thousands enroll each year in this 59-year-old school. Send for FREE descriptive booklet.

**AMERICAN SCHOOL, Dept. H445**  
Drexel at 58th St., Chicago 37, ILL.

Without obligation, please send FREE descriptive booklet.

Name \_\_\_\_\_

Address \_\_\_\_\_

Complete Canadian Courses available. Write American School, Dept. H445, 1610 Sherbrooke St. W., Montreal

### Say You Saw It in Popular Mechanics

**Let Me Show You  
How I Made  
\$20,000 a Year  
Buying Junk Jewelry**

### Learn at home in one evening



No selling. Pay friends and neighbors good prices for old rings, watches, chains and bridges. U. S. Gov't pays you \$35 an ounce for the gold this junk contains.

**T**HERE'S gold to be picked up on any street in any town any day of the year if you know my secrets. I teach you how to find it, how to buy it, what to pay for it, how to test and how to ship to Uncle Sam for cash. I supply you with testing outfit and weighing scale. Takes only one evening to learn at home. Next day you are ready to fill your pockets with gold at junk prices. I'll teach you the secrets by which I made \$20,000 a year. No charge for facts. Send name on postcard—no money. **Leslie Patton, 335 W. Madison Street, Dept. 94, Chicago 6, Illinois.**

## REPAIR ANY WATCH



### ... Swiss or American

No previous experience needed to learn modern watch repair. An enjoyable hobby or profitable career. Unique Sweazey System starts you making repairs right away. Develops your skill step by step. Teaches you modern shop methods... professional short cuts... mistakes to avoid. Learn by personal attendance or spare time home study. Individual training. Start any time. Free sample lesson. No obligation. Write today!

### CHICAGO SCHOOL OF WATCHMAKING

2330 N. Milwaukee, Dept. 146, Chicago 47, Illinois  
Founded 1908 • Approved for veterans



## UPHOLSTERY BE YOUR OWN BOSS

Practical, low-cost, LEARN-BY-DOING UTS Course, complete with tools, materials, frames, trains you quickly AT HOME in spare time. Start making money in Upholstery almost at once! Big FREE illustrated book and FREE sample lesson shows you how—gives full facts about business, job opportunities for men and women. Write TODAY! Also Resident Training. VET Approved.  
**UPHOLSTERY TRADES SCHOOL**  
Dept. ED-309 721 Broadway, New York 3.

## "YOU ARE UNDER ARREST!"



### Help Bring Crooks to Justice Through Scientific CRIME DETECTION!

We have taught thousands this exciting, profitable, pleasant profession. Let us teach you in your own home. Learn Fingerprinting, Firearms Identification, Police Photography, Secret Service Methods thoroughly, quickly, at small cost. Over 800 of all American Bureaus of Identification employ I.A.S. students or graduates. Write stating age, for "Blue Book of Crime."

I.A. Correspondence School Since 1916

**INSTITUTE OF APPLIED SCIENCE, 1920 Sunnyside Ave., Dept. 1354, Chicago 40, Ill.**



### DEVELOP A HE-MAN VOICE!

Write for FREE book "How to Strengthen Your Voice for Greater Success" by Eugene Feuchtinger. No obligation. Book will be mailed at once in plain wrapper, postpaid. Just send your name and address. State age.  
**PREFECT VOICE INSTITUTE, 210 S. Clinton St., Studio DU-2, Chicago 6, Ill.**

## IMPORTED KNIVES

Daggers, Stilettoes, Bowies, Throwing, Hunting, Pocket Knives, Fencing Equipment, Etc. The finest from 10 countries. Send for your FREE CATALOG Today.

**J. D. CLINTON**

**Mt. Clemens 2, Mich.**

### SPARE-TIME MONEYMAKING OPPORTUNITIES

#### READ OUR CLASSIFIED ADS

HUNDREDS OF BARGAINS

AMAZING OFFERS

## It's Quick, Easy, Fun To Learn A LANGUAGE by LINGUAPHONE

AT HOME, quickly, easily, correctly master FRENCH, SPANISH, GERMAN, JAPANESE, RUSSIAN, MODERN GREEK—any of 34 languages, by Linguaphone, The World's Standard Conversational Method. Go places—add to business, school, cultural, travel, armed services' opportunities. Save time, work, money. Over a million home study students of all ages. Write for FREE book TODAY. Linguaphone Institute, 143-046 Rock. Plaza, N. Y. 20.

## POW!!! hunting slingshot

- accurate—powerful—silent
- kills small game, pests
- hits like a rifle

**\$1.50**  
postpaid  
(no cod's)



Used by expert marksmen! 7" hardwood stock, 45 lb. pull. Best rubber. FREE!!—extra rubber and big supply heaviest steel balls used by experts, illustrated catalog.

Order today from— **I. J. STONE DEPT. B-41616 Oak St. Santa Monica, Calif.**

# BARGAINS

IS THE ONLY BIG TABLOID PUBLICATION in  
Existence That Tells You WHERE & HOW  
—EVERY MONTH—



- To Buy Bankrupt, Closeout, Surplus Bargains!
- To Buy Items at Wholesale! ● At Below Wholesale!
- To Buy Many New & Unusual Items!
- To Obtain Information on Rare Money Making Offers!

**TOYS, BOOKS, JEWELRY, GREETING CARDS,  
COSMETICS, HOUSEHOLD MERCHANDISE,  
APPLIANCES, INDUSTRIAL MATERIALS,  
MACHINERY, TOOLS, ETC.**

**Often as Low as 10c-25c on the Retail Dollar!!**

ONE issue of this Sensational NEW publication can save you MORE MONEY than the cost of the entire subscription! You can BUY BETTER, CHEAPER, NEWER THINGS EVERY MONTH OF THE YEAR! Today, when your dollar buys so little, you absolutely need every single issue of BARGAINS in order to get the MOST FROM EVERY PENNY YOU SPEND. Each issue carries HUNDREDS of bargain offers . . . many times SO EXTRAORDINARY that it's hard to believe that they're GENUINE! Buying at WHOLESALE, BANKRUPT, SURPLUS, CLOSEOUT PRICES can save you from 40c to 80c or more on every dollar you spend! THIS MAY BE HARD TO BELIEVE, BUT IT IS THE TRUTH!

**YOU Can make FANTASTIC PROFITS Buying Up Bargain  
Merchandise CHEAP and Selling It CHEAP**

Thousands of Agents, Salesmen, Dealers are subscribers to "BARGAINS." They want to know where to buy BEST in order to sell at low prices for BIG PROFITS. NO REASON why you CAN'T DO THE SAME! Special articles in BARGAINS give you valuable tips on HOW to sell these bargains for BIG PROFITS. And you know, EVERYBODY is looking for bargains these days . . . in fact, this is the only kind of merchandise that is being sold in tremendous volume. Ask any big businessman!

**Unique "Subscribers Shopping Service"  
Enables You to Buy Big Name Merchandise  
at TREMENDOUS SAVINGS**

You won't find this feature in ANY OTHER MAGAZINE. ONLY "BARGAINS" has it. For subscribers ONLY, each month it negotiates bargain offers in famous merchandise at LOW WHOLESALE PRICES and then offers them to subscribers AT NO PROFIT! Enables you to buy in small lots—singly or in quantity at the same prices (sometimes even lower) than dealers are paying! This SINGLE FEATURE OF BARGAINS IS WORTH THE LOW SUBSCRIPTION PRICE A DOZEN TIMES OVER. Yet, it's only ONE feature among many to be found! Yes. Just one!

**"Bargains" is the ONLY Publication of Its  
Kind in Existence!**

Search your newsstand high and low. You won't find another publication like it! BARGAINS is available by subscription ONLY. Read the glowing letters by subscribers who received their first copies and WERE AMAZED by this sensational publication! You will be, too!

**SAVE Up to \$1,000 — EARN Up to \$3,000**

We honestly believe that it's possible to SAVE up to \$1,000—and EARN up to \$3,000 within a year by reading "BARGAINS" EVERY MONTH! WHY NOT PROVE THIS FOR YOURSELF! Your subscription will automatically include the BIG 1956 CHRISTMAS SPECIAL ISSUE . . . jam full of terrific, eye opening holiday BARGAINS! JUST \$2.00—17c per month gives you 12 great money saving issues of BARGAINS!

**\$2.00 Per Year — 12 Big Issues**

(Regular price, \$3.00 per Year)

Special Limited Time Offer  
to Get 10,000 New Subscribers!

**Your Money Back IN FULL  
if the First Issue Doesn't Please You!**

LET'S FACE IT . . . Claims, promises are easily made on paper. You may or may not believe all we say here. BUT can you go wrong in subscribing to "Bargains" on this iron-clad MONEY BACK GUARANTEE . . . Your money back IN FULL if the first issue that you receive doesn't please you! Can any offer be more POSITIVE, more FAIR than this POWERFUL guarantee?

**TOWER PRESS, INC., P.O. Box 591-ZH, Lynn, Mass.**

**Here's a FEW Samples of the  
Bargains Usually Found in  
"BARGAINS"!**

- PENCILS, 57 1/2c per Gross!
  - 25c Rudolph the Reindeer Brooches, 2c each!
  - Plastic Toy GUNS, 2c each!
  - \$1 Mufflers, Scarfs, 12 1/2c each!
  - Double edge razor blades, \$1.50 per 1000!
  - LADIES APRONS, 6 1/4c each!
  - \$2.50 WALLETS, 30c each!
  - \$1 val. BILLFOLDS, 15c each!
  - \$1 Kiddies handbags, 3c each!
  - CIGARETTE HOLDERS, 1c each!
  - BUTTONS, 144 for 25c!
  - NEW Phono records, 78 & 45 r.p.m. 7c each!
  - 69c Insect Repellent, 5c each!
  - New 20" T.V. Pic. tubes, \$21.95 each!
  - Famous brand \$18.75 perfume, \$1 each!
  - 49c Xmas window decorations, 10c per set!
  - \$1-\$3 Hard cover books, 20c each!
  - \$200.00 Surplus typewriters, \$23.00 each!
  - 50c Everyday greeting cards, 7c per box!
  - \$1.95 Men's Silk Ties, 12 1/2c each!
  - \$1 val. personal cloth name tapes, 40c for 72!
  - 39c Under arm deodorant, 2c jar!
  - \$1 Automatic card shufflers, 9c each!
  - NEW HAIRNETS, 1/2c each!
  - \$15.00 Electric Percolators, \$5.00 each!
  - \$1.75 Rudolph Reindeer kiddies toiletry sets, 35c each!
  - \$5.50 Lucite Hairbrushes, 65c each!
  - New Bobby Pins, 70c per 700 pins!
  - \$10 Men's Toiletry Sets, 60c each!
  - Calendar Wrist Watches, \$5 each!
  - Christmas Seals, 25c per 1000!
  - \$2.98 Horserace game records, 30c each!
- **PLUS HUNDREDS OF OTHER SENSATIONAL BUYS!**

(Above list merely illustrates type of bargains usually found in this paper. Lists naturally change from month to month.) Pro rate prices based on quantity buys.

Every One OF THESE LETTERS ARE IN OUR FILES & WERE NOT SOLICITED IN ANY WAY OR MANNER!

—Tear out Coupon. Mail NOW—at once!—

Tower Press, Inc., P.O. Box 591-ZH, Lynn, Mass.  
O.K. Here's my \$2.00 for 1 year subscription. Rush me 1st copy!

Name \_\_\_\_\_

Address \_\_\_\_\_

City \_\_\_\_\_ State \_\_\_\_\_

Remember! Your Money Back IN FULL if the 1st issue you receive doesn't please you!

# CAVITEX

Superfine  
Masonry



X-5

## Manufacturing Rights Now Available in 427 Territories

CaviteX offers building owners the ultimate in masonry at sensationally low costs. Designed in line with today's architecture. Long and low. Large color range. Modular in all dimensions. Strong—safe—enduring. Suited to all types of wall construction—8' solid, cavity, partition, veneer.

As a local manufacturing opportunity, CaviteX has tremendous potentials. Local materials are processed by local labor for local consumption. Vast economies effected. That's why CaviteX has price-appeal to buyers and profit-appeal to producers. Hundreds of territories are open.

CaviteX manufacturers operate in franchise-protected territories and with exclusive privileges. Extensive sponsor cooperation. Basic machinery available on lease. Write or wire for book "Opportunity, Unlimited" and tentative reservation of territory.

W. E. DUNN MFG. CO.

409 W. 24th St., Holland, Mich.

In Canada

Dunn Masonry Machinery, Ltd.

844 Dundas Highway

Cooksville, Ontario



## Learn All About Cars!

AUTO MECHANICS — AUTOMATIC TRANSMISSIONS  
ACETYLENE AND ARC WELDING  
BODY AND FENDER REPAIR

Day-Night School 30 Years in the Same Location

### WOLVERINE SCHOOL OF TRADES

Approved Under the G.I. Bill of Rights by the State Board of Education

WOLVERINE SCHOOL OF TRADES, Dept. PM  
1400 West Fort St., Detroit 16, Mich.

Name \_\_\_\_\_

Address \_\_\_\_\_

City \_\_\_\_\_

State \_\_\_\_\_

## WORLD'S BIGGEST BUYS IN MINIATURE ELECTRIC MOTORS—

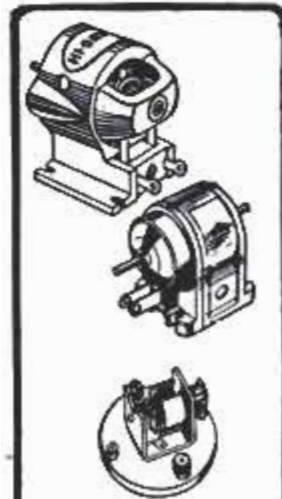

Your choice of five tiny battery-operated motors—one for every use—from 1½ to 6 volts—and today's biggest values in the hobby motor field. These motors, with accessories in kits listed below, provide all types of drives for hobby items, toys, research and industrial devices.

- \*No. 7-100 Hi-Drive Motor, 1½-3V ..... \$2.00
- \*No. 8-100 Same for 3-6V ..... \$2.50
- \*No. 9-100 Same for 12V ..... \$3.00
- \*No. 3-100 Tiny Atom Motor, 1½-3V ..... \$2.00
- For higher voltages, ..... \$2.50
- \*No. 96 Steel frame motor with gear, pinions, pulley, worm \$4.00
- No. 3113-N Tiny Atom motor assembly kit with many acc. \$3.50
- No. 1300 Small accessories kit \$1.00
- No. 3700 Large accessories kit \$3.00
- No. 4000 Deluxe accessories kit with motor, ..... \$5.00
- No. 700 Super-Power kit with motor, speed reducer, all accessories ..... \$10.00
- No. 88 Kit of 8 pulleys—2 belts \$2.00
- No. 3000 Vari-speed gear unit \$4.00

\*Items illustrated. Write for FREE catalog.

All Wilson's motors have Permanent Alnico Magnets.

Remit with order and we pay postage in U.S.A. No C.O.D. Add 3% Sales Tax for delivery in Ohio. Write Dept. PM

For quick delivery see your local dealer — or order direct



WILSON'S OF CLEVELAND

425 Lakeside Ave., N.W. • Cleveland 13, Ohio

# INVENTORS

PROTECT YOUR INVENTION BY A U. S. PATENT. SEND FOR FREE "INVENTION RECORD" FORM AND "PATENT INFORMATION EVERY INVENTOR SHOULD HAVE".

CARL MILLER

REGISTERED PATENT ATTORNEY

WOOLWORTH BLDG., 35th FLOOR, 46A  
NEW YORK CITY

# INVENTORS

I shall be pleased to furnish you, upon request, with full information relative to patent procedure—without any obligation on your part.

PATRICK D. BEAVERS

Registered Patent Attorney

934 Columbian Building Washington 1, D. C.



# PATENTS

## C. A. SNOW & CO.

REGISTERED PATENT ATTORNEYS

WRITE FOR INFORMATION TO  
428 SNOW BUILDING, WASHINGTON 1, D. C.



# INVENTORS

Send for PATENT INFORMATION Book and INVENTOR'S RECORD without obligation

GUSTAVE MILLER

46-PM WARNER BUILDING  
WASHINGTON 4, D. C.

REGISTERED PATENT ATTORNEY

ASSOCIATE EXAMINER  
U.S. PAT. OFF. 1922-1929

Patent Attorney & Advisor  
U. S. NAVY DEPT. 1930-1947  
PATENT LAWYER

# INVENTORS

Whether an invention is patentable can be substantially determined by a search of the U. S. Patent records. Without obligation, write for information explaining the steps you should take to secure a patent.

JOHN N. RANDOLPH

Registered Patent Attorney

201 Columbian Building, Washington 1, D. C.

Say You Saw It in Popular Mechanics

COMPLETE NEW



FALSE IN  
24  
PLATE HOURS

FROM YOUR OLD \$15.95  
NOW LOW AS . . . \$1.95

New process transforms old, broken or loose plates into new lightweight plastic plates. NO IMPRESSION NEEDED. Let us help you enjoy life again. You will marvel at this revolutionary new method. Using your own old plates, we will remake them completely in only 24 hours. Missing teeth are carefully matched and replaced. Work is done on an absolute MONEY BACK GUARANTEE. SEND NO MONEY — just rush your name and address for full FREE DETAILS. If your teeth are loose, we'll tell you how to tighten them before duplication. Act now.

Tru-Grip Dental Labs., 7th Fl., 127 N. Dearborn, Dept. R, Chicago 2, Ill.

# NEW INVENTION **REPLATES** by **ELECTROPLATING** RESTORES HOME, AUTO METALS **CHROME-SILVER-GOLD!**

NEW BRILLIANCE WITH SAME PROCESS AS PROFESSIONAL PLATERS  
**SILVER-CHROME-GOLD, ETC.**



**REPLATED. Quickly, Easily** Now—with an amazing new invention, **APPL-I-COTER**, you plate hundreds of items, using the mild, safe current of 2 flashlight batteries in its handle. **ALL YOU DO** is simply hold disk on Applicator to metal, dip brush into solution—and plate as you brush. It's Easy, Quick, Genuine plating. **RESTORES METALS LIKE NEW** Replates Silver, Chrome, Nickel, Steel, Gold and Brass—all worn Spots, Stains, "Blisters," Silverware, Trays, Teapots, Rims of Holloware and other items can look like new again with this exclusive Electroplating process. Restore all your valuable Gold jewelry with amazing **APPL-I-COTER**. The plating you apply becomes an indestructible part of the metal itself!

**QUICKLY BUILDS-UP A THICK NEW PLATING WITH EACH APPLICATION.**



**COMPLETE PLATING KITS:**  
**MET-L-COTE:** For Chrome & other white metals... **\$3.95**  
**SILV-R-COTE:** For Silver-plating with pure Silver... **\$4.95**  
**GOLD-COTE:** Gold Plate with 24 K. Gold... **\$6.95**  
Copper **\$3.95**; Rhodium **\$8.95**  
**ALL 5 METALS... \$19.95**  
(You Save \$8.80)



**BRILLIANT AUTO TRIM** — You'll be mighty proud of the Dazzling new finish on your car's bumpers and trim after replating with **MET-L-COTE**... and remember, each time you electroplate worn areas you build up a lasting layer of coating that tremendously lengthens the life of original trim.

**MET-L-COTE** is constantly used in leading hospitals, and in doctors and dentists offices to Replate surgical instruments—Also in hotels and restaurants to **RESTORE** cutlery.

**EMPIRE MERCHANDISING CO.**  
Dept. J-456  
28 E. First St., Mt. Vernon, N.Y.

**MONEY-BACK GUARANTEE**

Please rush the Complete Plating Kits including Solution, New Pocket Applicator & full simple instructions I have checked below. I enclose full price, sent postpaid, or send C.O.D. plus postage.

- MET-L-COTE**—\$3.95
- GOLD-COTE**—\$6.95
- RHODIUM**—\$8.95
- SILV-R-COTE**—\$4.95
- COPPER-COTE**—\$3.95
- ALL 5 METALS**—\$19.95 (Save \$8.80)

NAME \_\_\_\_\_  
ADDRESS \_\_\_\_\_  
CITY \_\_\_\_\_ STATE \_\_\_\_\_

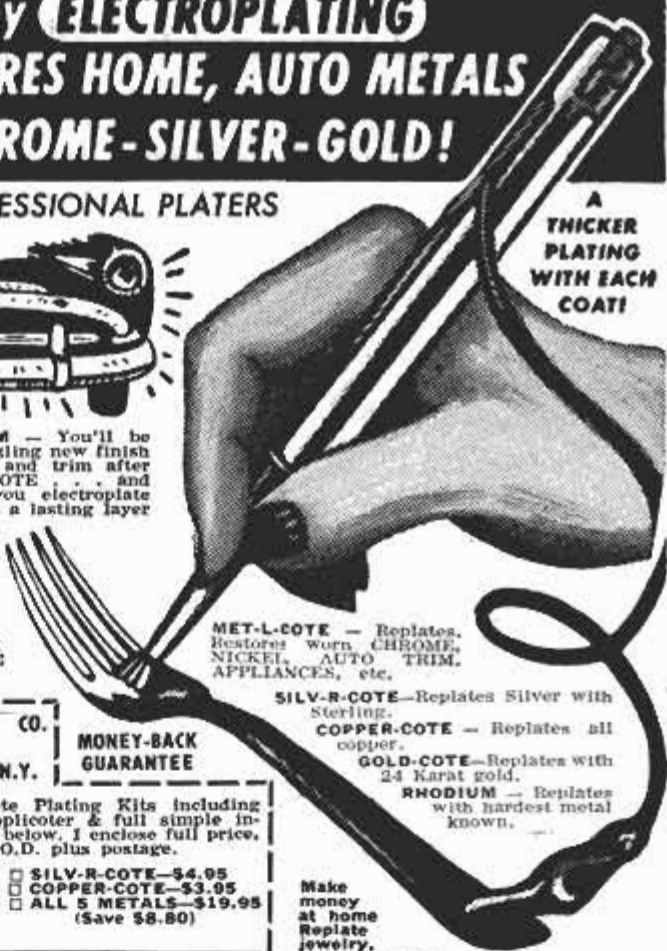

**A THICKER PLATING WITH EACH COAT!**

**MET-L-COTE** — Replates, Restores worn **CHROME, NICKEL, AUTO TRIM, APPLIANCES, etc.**

**SILV-R-COTE**—Replates Silver with Sterling.

**COPPER-COTE** — Replates all copper.

**GOLD-COTE**—Replates with 24 Karat gold.

**RHODIUM** — Replates with hardest metal known.

Make money at home Replate jewelry, silver, chrome. Earn up to \$10 per hour.

**RESTORE YOUR TREASURES... MAKE THEM VALUABLE AGAIN**

Empire Mds. Co., 28 E. First St., Mt. Vernon, N.Y.

## IT'S EASY... MAKE MONEY IN PHOTOGRAPHY

If you are over 17—good pay and fascinating work await you in photography! Start making money quickly in sparetime—step into your own studio or exciting career job. **LEARN-BY-DOING** method trains you at home! Write **TODAY** for **FREE** catalog. Also Resident Training. 46th Year. Approved for Vets.

**NEW YORK INSTITUTE OF PHOTOGRAPHY**  
Dept. 49, 10 West 33 Street, New York 1, New York  
**46th YEAR**

## NEW BENJAMIN SUPER CO<sub>2</sub> GAS CARBINE — \$16.50

**HI-LO (2 Stage) Jet Power**  
Cal. .177 or .22

**RIFLED**  
**Shoots**  
**Pellets**  
**& Darts**



**IDEAL FOR TARGET & SMALL GAME**

**SAFE — ECONOMICAL — ACCURATE**  
**CONVENIENT — PRACTICAL — NON TOXIC**

**EASY TO OPERATE—NO PUMPING—NO FLINCHING.**  
Get 40 SHOTS from each 10¢ STANDARD SIZE CO<sub>2</sub> (Soda) CARTRIDGE Up to ¾" penetration. Ask your DEALER for DEMONSTRATION.

New Benjamin .177 or .22 CO<sub>2</sub> ROCKET Gas Pistol with HI-LO JET POWER... \$15.00

**BENJAMIN AIR RIFLE CO.**  
896 MARION ST., ST. LOUIS 4, MO., U.S.A.

**FREE Folder**

## Finish HIGH SCHOOL AT HOME

**Complete 4 Yrs. in 12 Months**

Learn More! Earn More! Enter professional or technical schools. Advance Socially. Live a Happier, Fuller Life. Individual Courses or complete schedule. **WRITE FOR SCHOOL BULLETIN.**

**ACADEMY FOR ADULTS**  
30 W. Washington, Dept. PM-46, Chicago Ill.

## PUMP WATER FAST!

Drains Wash Tubs, Cellars, Cisterns. Famous #7 pumps 2800 gph. 420 gph. at 75' high or 1600 gph. from 25' well. Sturdy rustproof alloy metal. Six blade impeller. ¾" inlet, ½" outlet. Standard pipe threaded. Uses any ¼ to ½ H.P. Motor. Will not leak or clog. Ironclad guarantee. Send check, M.O., or sent C.O.D. **IN U.S. \$695**

Irrigate, Fill Tanks, Draw Well Water. Heavy duty #8 pumps 7000 gph. —1000 gph. 75' high 3000 gph. from 25' well. Rustproof alloy metal. 8 blade impeller. 1" inlet, 1" outlet. Standard pipe threaded. Will not leak or clog. Iron clad guarantee. Send check, M.O., or sent C.O.D. **\$1195**

Free Catalogue—Gear Pumps, Large Centrifugal **IN U.S.** Pumps, Deep and Shallow Well Pumps, Sump Pumps.

**MOORE MANUFACTURING CO.**  
SWEDSBORO 1, NEW JERSEY

## NOW—Own and Play an Italian ACCORDION



**Save UP TO 50%**

Choose from famous quality makes at **LOWEST WHOLESALE PRICES**

Get the facts about owning and playing the accordion... it's easy and loads of fun! You order on **no risk plan**... **5 DAYS FREE TRIAL!** Save up to 50% off regular price.

**5-DAY FREE TRIAL**  
**Easy Terms**

Easy, convenient terms. You choose from the finest and most famous Italian accordion makes for which we are authorized direct factory distributors. **FREE** home study course included. Find out about the fun and profit in store for the accordion player. Rush coupon for big Color Catalog and low Wholesale Prices—yours free. No obligation.

**Accordion Manufacturers & Wholesalers Outlet**  
2003 W. Chicago, Dept. R-46, Chicago 22, Ill.

**MAIL COUPON**  
Accordion Manufacturers & Wholesalers Outlet  
2003 W. Chicago Ave., Dept. R-46, Chicago 22, Ill.  
Send big **FREE** Color Catalog, best terms and lowest wholesale prices.

NAME \_\_\_\_\_  
ADDRESS \_\_\_\_\_  
CITY \_\_\_\_\_ ZONE \_\_\_\_\_ STATE \_\_\_\_\_

# U-MAK-IT BOAT KITS

**TWICE THE FUN—  
HALF THE COST!**

**MOST COMPLETE LINE OF  
BOAT KITS 8 TO 23'—  
PRAMS, ROWBOATS, OUT-  
BOARDS, CABIN CRUISERS**

**Finest hobby with unequalled  
rewards for you, your family  
and friends.**

**Start building! Stop wishing!  
Be shipshape for the  
first break of the season.**

**Ask for your copy  
of our completely  
ILLUSTRATED CATALOG  
showing all models, accessories,  
all you need to build your own.**

**Send 25¢ (coin) for postage and handling**



**U-MAK-IT products**

**703P WHITTIER ST., BRONX 59,**

**NEW YORK**

## SAVE 1/2 on WATER SKIS

**\$18.00**



Simply assemble and finish our new water ski kit and you have a pair of skis worth twice the price of the kit. Skis are 7 ply moulded plywood, 67½" long, 7" wide, ¾" thick. Sturdy rubber foot pieces. All parts plus instructions included—\$18.00. Order from your Michigan dealer or MICHIGAN WHEEL CO., Dept. P-4, Grand Rapids, Mich. C.O.D. orders accepted.

## Paint STRIPES with New "PAINT PEN"!

### Straight, Curved or Parallel Lines

Use like a fountain pen with any color paint to stripe furniture, bikes, autos, model planes, toys, linoleum, wall board. Beautiful clean, crisp results every time. Can't clog or smear. Also use with glue, tempera, textile paint or ceramic under glaze. Paints on wood, glass, plastic, metals, fabrics and paper. Tool complete with tip for 1/16" stripe only \$1.25 postpaid. Other complete tools with following tips, 1/64", 1/32", 3/64", 5/64", 3/32", 1/4"—\$1.75 each. Extra tips 90¢ each. Entire kit with tool and 7 tips—\$5. A ¼" tip only \$1.20 each. C.O.D.'s postage collect.

### New! "DOUBLE-STRIP" 5 Way Combination Model only \$3.25

Double Stripes— one wide and one narrow or two wide or two narrow at the same time.

**FREE** Send postcard for complete information—or ORDER TODAY.



**\$1.25**

**DEALERS:** Master Paint Striping Tool in display cartons of 1 doz. **FAST, PROFITABLE SALES.** Write for new discounts.

**HOME CRAFTSMEN!** New Paint Striping Tool gives "professional" results every time, simple, easy to use. Send \$1.25 now.

**MANUFACTURERS:** Write today for information about industrial models and production striping tools.

**WENDELL MFG. CO., Dept. 316  
4234 Lincoln Ave., Chicago 18, Ill.**

**WAR SURPLUS BARGAINS**

# WAR SURPLUS BARGAINS

**\$500,000.00 INVENTORY for QUICK LIQUIDATION**

Surplus items—hundreds of them for home, shop, factory, farm and outdoor use. New items, used items, reconditioned items—all at tremendous savings—all priced for quick sale.

**Page After Page of Values**

This big catalog shows page after page of amazing money saving values. Write for your copy today. Send 10¢ to cover postage, mailing etc. Write today! **SEND TODAY FOR YOUR COPY**

## 10c

**STARK'S** 212 W. Madison St.  
Dept. PM-564  
CHICAGO 6, ILL.

## MOTORIZE YOUR BARBECUE!

Easily rigged up by anyone. Handles whole ham or 4 small chickens. Commercial-quality thruout—2 r.p.m. gear-head motor (110V-AC)—spring-tension bronze bearing permits spit removal—

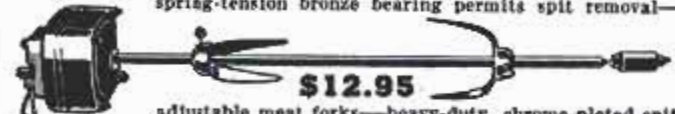

**\$12.95**

adjustable meat forks—heavy-duty, chrome-plated spit. Limited time, introductory offer. Postpaid. (\$13.95 Denver and West).

**B & R SALES CO. — Dept. PM356 — Muncie, Indiana**



## NEW JENSEN MANUAL TELLS HOW TO BUILD YOUR OWN HI-FI SPEAKER SYSTEMS

Save money . . . have fun building your own Jensen 2-way or 3-way hi-fi speaker system. New 36-page manual tells how to make enclosures and assemble 18 different systems with 8 new Jensen speaker kits. Send 50¢ today for Jensen Manual 1060.

**JENSEN MFG. CO. Dept. G 6601 S. Laramie, Chicago 38**

## YES! SEND



**directly  
to my door  
every month**

**I am enclosing**

- \$3.50 for 1 year  
 \$8.00 for 3 years

name \_\_\_\_\_

address \_\_\_\_\_

city \_\_\_\_\_

zone \_\_\_\_\_

state \_\_\_\_\_

A-46

Hand this order to your newsdealer or send it to

**POPULAR MECHANICS**  
200 East Ontario St. Chicago 11, Ill.





## FULLY GUARANTEED TIRES COST LESS!

Nationally famous FIRESTONE, GOODRICH, U. S. ROYAL, GOODYEAR, and other makes. Every tire selected and inspected for your safety.

BUY WITH CONFIDENCE FROM PYRAMID TIRE

WHITE WALL TIRES \$1 EXTRA

### HIGH GRADE TIRES GUARANTEED 12 MONTHS

600x16	4.14	700x16	5.14	32x6(8)	8.84	825x20	14.24
650x16	4.54	670x15	4.74	32x6(10)	10.84	900x20	13.34
650x15	4.34	650x20	7.84	750x20(8)	8.54	1000x20	14.14
700x15	4.64	700x20(8)	8.94	750x20(10)	9.94	1100x20	16.14

### AAA PREMIUM GRADE GUARANTEED 12 MONTHS

550x15	5.48	700x15	5.98	760x15	5.58	750x20(10)	14.98
600x16	5.28	700x16	6.78	550x17	5.48	825x20	18.68
600x16(6)	6.58	700x16(6)	7.98	600x20	9.78	900x20	18.98
640x15	5.68	750x16(6)	8.98	650x20	10.88	1000x20	19.98
650x16	5.78	800x15	8.88	700x20	12.88	1000x22	21.98
650x16(6)	6.98	820x15	7.48	32x6(8)	10.48	1100x20	20.98
650x15	5.98	710x15	6.09	32x6(10)	12.48	1100x22	21.98
670x15	6.18	550x18	5.98	750x20(8)	12.98	1100x24	23.98

### MILITARY SPECIAL AA Guaranteed 12 Months—

900x16	10.69	1000x20	19.98
750x20	10.98	1100x20	21.98

### AAA GUARANTEED 12 MONTHS

900x16	14.98	750x20	16.48
--------	-------	--------	-------

Largest stock of used tires in the East. Thousands of satisfied customers. Write for Free Catalogue. MONEY ORDER OR CHECK WITH ORDER. NO C.O.D.'s

**PYRAMID TIRE CO.**  
1333-35 North 5th St.  
Dept. M., Phila. 22, Pa.

**"WE'RE LOOKING FOR PEOPLE WHO LIKE TO DRAW" ... says Norman Rockwell, one of America's 12 Most Famous Artists. If you like to draw, you may have talent to become a successful artist, spare or full time. Find out for sure with our scientific, 8-page Free Art Talent Test. Thousands paid \$1 to take it. Get it FREE. No obligation. Send your name, address, age to: Famous Artists Schools, Dept. 6-D, Westport, Conn.**



## Learn ACCOUNTING Business Administration

Bookkeeping, secretarial and allied subjects at home in your spare time or attend nationally approved resident school. Write for FREE Success Book giving complete details on courses, plans, rates and employment opportunities. G.I. approved. Write Dept. A.

**Hills BUSINESS UNIVERSITY AND EXTENSION SCHOOL**  
619 W. MAIN ST. OKLAHOMA CITY 2, OKLAHOMA

## SHORTHAND IN 6 WEEKS

Famous SPEEDWRITING shorthand. 120 words per minute. No symbols; no machines; uses ABC's. Easiest to learn, write and transcribe. Low cost. 300,000 taught by mail. For business and Civil Service. Typing available. 33rd Year. Schools in over 400 cities. Write for FREE booklet to:

**Speedwriting**  
Dept. 1504-G  
55 W. 42 St., N.Y. 36, N.Y.

## GROW WITHOUT SOIL

You can grow vegetables, flowers or rare plants without soil (HYDROPONICS) every day of the year. Start this fast, clean EASY way to grow any plant for fun or PROFIT now. Big returns from small space. Send postcard today for FREE picture book showing how others from every state are succeeding in this new wide open field.

**GILBERT CO.** BOX 52, 525 SPRUCE STREET  
SAN DIEGO 3, CALIFORNIA

## Learn PHOTOGRAPHY at Home

Splendid opportunities. Prepare in spare time. Practical basic training. Long-established school. Send for free book, "Opportunities in Photography." No obligation.

American School of Photography, 835 Diversy Parkway, Dept. 1354, Chicago 14, Ill.

## 94.6% OF BAILEY GRADUATES ARE EMPLOYED AT TOP PAY IN THE FIELDS WHICH THEY WERE TRAINED!



### DIESEL-AUTO MECHANICS DESPERATELY NEEDED!

We have a far greater demand for our students than we can fill! We can show you an actual waiting list of leading companies throughout the world who have tried Bailey graduates — found them outstanding, and are coming back for more!

**Bailey Graduates are Successful . . . RECEIVE BIG PAY — HAVE SECURE FUTURE!**

The Famous Bailey Course prepares you for BOTH Diesel and Gasoline Mechanics.

This is a must—due to the advent of using Diesel principles, such as 'Fuel Injection' on passenger cars . . . use of gasoline engines for starting Diesel engines, etc. You learn all this at Bailey in the amount of time ordinarily required to learn just one of these subjects, **ALL FOR THE PRICE OF ONE.**

Don't be satisfied with a 'futureless', one-type job — learn how you can make **big money** now! Write today for Free Booklet that takes you on a step-by-step camera tour through our spacious, modern shops — See Bailey students in action as they Learn-by-doing with the Famous Bailey Method of training!

We provide you with housing and part time jobs while in school, plus nation-wide placement service for graduates.

## BAILEY Technical SCHOOLS

1634 S. GRAND ST. LOUIS 4, MO.

### MAIL TODAY!

Please mail immediately this free booklet without obligation.

FREE BOOKLET



Name.....  
Address.....  
City..... State.....  
APPROVED FOR VETERAN . . . NON-VETERAN

## TRAIN AT HOME FOR BIG PAY IN AUTO MECHANICS

You can make up to \$125 a week and more—or open your own shop—as an auto mechanic. 50,000 more trained men needed at once to service 50 million vehicles. You learn at home in spare time thru easy CTI Shop-Method plan. You get extra training in Diesel or Body-Fender Repair if desired. Mail coupon for 2 FREE books on job facts!



**MAKE TO \$5 AN HOUR**

**AS YOU TRAIN** Earn up to \$5 an hour while learning. Many pay for course this way.



### TUNE-UP KIT & TOOLS SENT

Only CTI sends you a valuable Tune-Up Kit. You also get professional tools. These help you start earning soon after you enroll. Mail coupon today!



## MAIL TODAY • 2 FREE BOOKS

COMMERCIAL TRADES INSTITUTE Dept. A-293  
1400 Greenleaf Ave., Chicago 26, Ill.  
Send me your new, FREE BOOKS which show me how I can train at home to make big money in the auto field.

Name \_\_\_\_\_ Age \_\_\_\_\_  
Address \_\_\_\_\_  
City \_\_\_\_\_ Zone \_\_\_\_\_ State \_\_\_\_\_

Member, National Home Study Council

## OWN Your Own Business

**\$5 per hour**

Clean and mothproof rugs and upholstery "in the home", office, institution. If now employed, you can operate in spare time and build a permanent full-time business.

Alert dealers can gross \$5 hourly profit on service they render plus \$3 on EACH serviceman. We locally train and assist you. Easy to learn quickly established.

**DURACLEAN** cleans by absorption! No scrubbing, soaking or shrinkage. Dirt and grease vanish... matted pile rises... colors revive. Furnishings used again same day.

**DURAPROOF** resists moths and carpet beetles. Your service backed by an International Money Back 6 Year Warranty.

We furnish enough material to return your total investment. Send TODAY for FREE booklet explaining details and EASY TERMS.

**DURACLEAN CO.**, 6-164 DURACLEAN BLDG. DEERFIELD, ILL.



PATENTED PORTABLE EQUIPMENT

## SALE! CHRONOGRAPHS!

Waterproof

\$64.95

FEED-TAK-INC.



\$34.95

FEED-TAK-INC.



Immediate Delivery — Money Back Guarantee

- 17 jewel • anti-magnetic
- stop watch, 6 hands
- sweep hand, time out feature
- 30 min. — 12 hr. dials
- waterproof steel case
- incabloc, shock resistant
- 17 jewel • steel case
- 45 or 30 min. recorder
- radium dial and hands
- sweep second hand
- anti-magnetic
- tachimeter scale

Send 10c for illustrated catalog

**WHITE PLAINS WATCH CO., INC.**  
15 West 47th St., New York 36, JUDSON 6-1751

## we're sorry...

that we have not had the production to supply all the demand for Life-Time 50,000 Mile Spark Plugs. New equipment and greatly accelerated production enable us now to make immediate delivery. If you have ordered and your check has been returned, please place your order again. Life-Time Spark Plug Sets may be ordered from this advertisement. We will postpay at regular retail price. Specify make, model and year of car. Set of 6, \$7.14; set of 8, \$9.52.

### DISTRIBUTORSHIPS

Some additional distributorships are now available. If you have already written us regarding your area, please contact us again. If you have not written before, please send us an outline of your previous business experience and qualifications.

**CONTINENTAL MANUFACTURING CORP.**  
Washington Blvd. at Motor Ave. Culver City 131, California



**ONLY \$9.95**  
\*POSTPAID  
Money-Back Guarantee

Compares with \$25 to \$100 Air Horns

**Blast off with DUAL vacuum AIR HORNS!**

The voice of authority and commanding warning for safer highway driving. One BLAST and those "Road Hogs" really move over. Installed under the hood or on the front fender. Beautiful lacquer finish. Operates from intake manifold. No tank needed. Only \$9.95 complete with cylinder head bracket, steering column lever, hose, fittings, etc. Send check or money order today. We pay postage. \$1.00 deposit required on all C.O.D. orders.

**THE PROTECTUROD CO.**  
Dept. 804, 2750 N.E. 19th Street, Fort Lauderdale, Fla.

## REAL ESTATE BE A BROKER

**PAYS BIG! SEND FOR FREE, BIG, ILLUSTRATED CATALOG NOW!** Graduates report making substantial incomes. Start and run your own business quickly. Men, women of all ages, learn easily. Course covers Sales, Property Management, Appraising, Loans, Mortgages, and related subjects. **STUDY AT HOME** or in classrooms in leading cities. Diploma awarded. Write TODAY for free book! No obligation.

Approved for World War II and Korean Veterans  
**WEAVER SCHOOL OF REAL ESTATE (Est. 1936)**  
2020 Grand Avenue Kansas City, Mo.

**FREE BOOK TELLS NOW**

## EASY SHOP MATH

SEND FOR FREE LITERATURE!

TRIG-EASY, DEPT. 3, BOX 587, CULVER CITY, CAL.

## SAY YOU SAW IT IN POPULAR MECHANICS



## LOCKSMITHING

Practical Up-to-Date Course — ONLY \$4.95

53 illustrated self-instruction lessons. Easy to learn. Full price only \$4.95 postpaid—or COD plus postage. Satisfaction guaranteed or full refund! Mail your order today. **NELSON HALL CO.**, 210 S. Clinton St., Dept. DU-2, Chicago 6, Ill.

## STUDY INDUSTRIAL DESIGN

You can train at Art Center School in California with practicing-professionals for upper-level jobs in INDUSTRIAL DESIGN. Recent graduates have been added to the staff at General Motors, Chrysler, Raymond Loewy, Henry Dreyfuss, etc. Majors in transportation, general product design, structures, community development, furniture design, packaging, display, 4-year degree courses. Learn to combine imaginative design with technical proficiency, coordinate utility and beauty. Stimulating environment. Field trips. Advantages of mild Southern California climate and nearby holiday spots. Coed. Placement service. Established 25 years. New terms Feb., June, Sept. Write for catalog.

**ART CENTER SCHOOL**, Edward M. Adams, Director  
5353 WEST THIRD STREET, LOS ANGELES 5, CALIFORNIA

## AUTOMOBILE RACING—Sixth Edition

Full description with over 100 illustrations of new fast racing creations. Working drawings with step by step building instructions for successful Ford 60 Midget—Model A Roadster—Offenhauser Dirt Track Racer—Miller 158.5 m.p.h. Racer. Details on axles, frames, engines, bodies, etc., etc. Entrance Blank with rules and regulations. A book full of interest for every Auto Racing Fan, Driver, Mechanic and Owner. Money back if not satisfied.

ORDER NOW! \$1.00 POSTPAID!  
Sorry, No C.O.D.'s

**POPULAR MECHANICS PRESS**, 202 E. Ontario St., Chicago 11, Ill.





**22 YEARS AT THIS ADDRESS**  
AN ESTABLISHED POLICY OF CAREFUL SELECTION ASSURES YOU MANY HAPPY MILES. BE WISE—TRY ONE—YOU'LL BUY MORE! WE WELCOME COMPETITION. NO ONE CAN TOUCH OUR QUALITY & PRICE! White Walls \$1.00 Ex. 50 Years of Combined family experience in High Quality tires. "FREE TUBE." PARTIALLY USED TIRES. FREE FACTORY-TESTED TUBE

**DEDUCT \$1.00** from every Passenger Tire you buy—Does not include W.W., or Truck Tires.

**12 MOS. WRITTEN GUARANTEE**  
WE SPECIALIZE IN TRUCK TIRES  
Matched Tires Shipped all over  
USA and Foreign Countries. IMMEDIATE SHIPMENTS Same Day. Depend on STANDARD for SERVICE.



Selected for Toughest Jobs—		SAVE 5 5 5	
600-16	\$5.42	475-19	\$4.72
600-16(6)	5.62	640-15	5.62
650-16	5.62	670-15	5.62
650-16(6)	6.42	710-15	5.62
700-16	6.02	760-15	5.62
750-16(6)	7.52	800-15	5.92
550-18	5.22	820-15	5.82
550-17	5.22	670-16	5.32
650-15	5.42	760-16	7.72
700-15	4.92	700-16(6)	7.72
		700-15(6)	\$7.72
		750-16(8)	8.92
		700-17	7.72
		750-17	9.72
		825-15	12.92
		600-20	9.52
		650-20	10.92
		32x6(8)	12.02
		32x6(10)	13.92
		750-15	10.92
		700-20	\$8.72
		750-20(10)	13.72
		750-20(8)	10.72
		825-20	16.92
		900-20	16.52
		1000-20	17.02
		1100-20	17.02
		1100-22	21.72
		1000-22	19.22
		1100-24	23.72

"EXTRA SPECIAL" Fully guarantee all size 4-ply pass. FREE TIRE with 2 or more of these. W.W. \$1.00 Extra. **\$6.42** EA. Factory Tested Tube given. **GIANT TIRE SALE**

MILITARY TIRES	900-16	\$9.32	900-16	\$13.62
MUD-GRIP TIRES	750-20	12.72	750-20	17.02

Thousands of tires shipped all over the U.S.A. All tires shipped F.O.B. Phila. Send Check or M.O. with this ad. Dept. 2. No C.O.D.  
**STANDARD 834 N. Broad St., Philadelphia 30, Pa.**

**GEIGER COUNTERS**  
*Rent by Mail*  
**ONLY 50¢ A DAY**

RENT OR BUY ANY MODEL DIRECT FROM FACTORY  
NUCLEONIC CO. OF AMERICA  
Dept. F.M. 44 194 DEGRAW ST. BROOKLYN 31, N.Y.

**PORTABLE CAR COVER** Heavy Vinyl Plastic (formerly \$8.95)  
Protect Against RAIN • SUN • DUST. **\$6.95**  
Long-lasting plastic, folds compactly, off and on in a jiffy, sturdy elastic binding gives extra security. State make, model and year—buy direct from mfr. Send **\$6.95** plus 35¢ postage or sent C.O.D.  
MARRO SALES CORP., Dept. 6-68 480 LEXINGTON AVE. New York 17



**Stammering?**  
BREAK THAT HABIT NOW!  
SUCCESSFUL EMERY CORRESPONDENCE COURSE FEATURED IN NEWSWEEK & MEDICAL RECORD. WRITE TODAY FOR FREE INFORMATION.  
**EMERY INSTITUTE**  
P.O. Box 867-PM4 Winter Park, Florida  
SAY YOU SAW IT IN POPULAR MECHANICS

**you may think you're TALL enough..but what do others think?**



If you're always overlooked when the boss looks for a "take-charge-man", DO SOMETHING ABOUT IT! Step into "ELEVATORS", step up and be noticed! These amazing height-increasing shoes make you almost 2 inches taller, instantly...confidentially. Only you know the secret, but everyone notices the difference in your looks. So, don't just think you're tall enough—BE SURE! For free booklet write  
**STONE-TARLOW CO., INC., DEPT. PM4-56, BROCKTON 68, MASS.**

**NATIONAL SCHOOLS**  
*proudly presents*  
**TELERAMA • ALL 8 BRANCHES OF TELEVISION • ELECTRONICS • RADIO •**  
**IN ONE DYNAMIC, MODERN SHOP METHOD, HOME TRAINING COURSE**

You get and keep ALL this modern, newest, practical equipment!

\* Registration applied for



YOU COVER ALL 8 BRANCHES IN ONE MASTER COURSE, ONE LOW TUITION

1. Television—including color TV
2. Radio — FM & AM
3. Industrial electronics
4. Sound recording and Hi-Fidelity
5. Preparation for FCC license
6. Automation
7. Radar & Sonar
8. Communications

- Parts to build a modern TV set, including large screen Picture Tube.
- Parts to build a powerful Superhet Receiver, standard broadcast and short wave.
- Parts to conduct many experiments and build — • Continuity Checker • RF Oscillator • TV Circuits • Audio Oscillator • TRF Receiver • Signal Generator
- Professional Multitester
- A MUST for all technicians

**FOR MEN WHO WANT TO EARN MORE MONEY!**  
Another great advance in Home Study Training. Let National Schools, of Los Angeles, a practical Technical Resident

Trade School for over 50 years, train you at home by Shop-Method, for today's unlimited opportunities in ALL 8 BRANCHES of the Television, Electronics Radio industry.

**YOU DO MANY PRACTICAL JOBS** — including servicing, circuit analysis. Build a modern TV set from ground up, with equipment kits we send you, including a new large-screen picture tube and professional Multitester, at no additional charge. You receive an experiment lesson with each kit.

**EARN AS YOU LEARN.** Many of our students earn their entire tuition and more in Spare Time jobs we show them how to do while learning. **YOU GET GRADUATE ADVISORY SERVICE, TOO.**



**SEND FOR FREE FACT-BOOK AND FREE SAMPLE LESSON!**  
Mail coupon now to office nearest you.

**NATIONAL SCHOOLS**  
4000 S. FIGUEROA ST., LOS ANGELES 27, CALIF.  
187 N. LA SALLE ST., CHICAGO 1, ILL.  
IN CANADA: 811 W. Hastings St., Vancouver, B. C.

**NATIONAL SCHOOLS**  
TECHNICAL TRADE TRAINING SINCE 1905  
Los Angeles, California

**GET FAST SERVICE — MAIL NOW TO OFFICE NEAREST YOU!**

NATIONAL SCHOOLS, DEPT. RB-46  
4000 S. FIGUEROA ST. LOS ANGELES 27, CALIF. OR 187 N. LA SALLE ST. CHICAGO 1, ILL.

Rush free TV-Radio "Opportunity" Book and sample lesson. No salesman will call.

NAME \_\_\_\_\_ BIRTHDAY \_\_\_\_\_ 19 \_\_\_\_\_

ADDRESS \_\_\_\_\_

CITY \_\_\_\_\_ ZONE \_\_\_\_\_ STATE \_\_\_\_\_

VETERANS: Give Date of Discharge \_\_\_\_\_

World-famous Victoreen "Vic-Tic"

# GEIGER COUNTERS

Up to now nationally advertised at \$125



Entire unit bears factory warranty for 90 days.

**HALF PRICE**

**62.50**  
post paid in U.S.A. Ohioans add 3% sales tax

**THE GOVERNMENT PAYS \$30,000 REWARD FOR ANY WORKABLE URANIUM STRIKE!**

Find uranium in your own backyard! Get in on this once-in-a-blue-moon opportunity! The internationally known Victoreen "Vic-Tic" Geiger counter (now in current production) . . . **HALF PRICE!** Now any family can prospect for fabulous uranium in spare time! Hunters, fishermen, campers can prospect on "location". Farmers, vacationers, hikers, picnickers, scouts . . . **YOU . . .** might hit the \$30,000.00 jackpot leading to security for life! **WHAT ARE THESE GEIGER COUNTERS?** They're the original "Vic-Tic" model in use all over the world! Made by the Victoreen Instrument Co., pioneers in radiation-detection instruments since 1928; suppliers of 75% of ALL Geiger tubes used in ANY Geiger counter; developers of special detection instruments for the AEC; now selling and servicing thousands of instruments for the U. S. government. They're brand new current production! Individually factory-checked and factory-packed with fresh batteries. Transistor-amplified loud speaker. Four sensitivity ranges (0-200; 0-1000; 0-100,000; 0-100,000). Speaker pitch control. Clear, easily read meter. Weighs only 3 lbs. Batteries good for 100 hours, 4 hours per day. Complete with radio-active sample, detailed instruction manual and convenient shoulder strap. Rush order NOW. No C.O.D.'s, please.

**DO-IT-YOURSELFERS . . . SCHOOLS . . . ELECTRONICS TINKERERS**

Vic-Tic Geiger counter assembly kit—Save more! Same instrument as above, but in semi-assembled form. Major components and sub-assemblies completed, tubes mounted on circuit board, power supply assembled. Simple instructions included. All you need is a screw driver and soldering iron. **ONLY 12 SOLDERING OPERATIONS NEEDED!** Knowledge of electronics

not necessary. Complete outfit, less batteries only **\$4.50**

Your counter will be **12 to 20 times more sensitive** with the addition of the Bismuth Six-Pack. Unit will attach to any Vic-Tic counter. Reg. 115.00 **\$7.50**

Canvas carrying case for Vic-Tic or Vic-Tic with Bis-Pak, Reg. 4.50 **2.25**

Hand probe for exploring crevices, etc., regularly 19.50 . . . . . **9.75**

**JOSEPH SALES CO., 1740 East 12th St., Suite 507, Cleveland 14, Ohio**

Joseph Sales Co., 1740 E. 12th St. Suite 507, Cleveland 14, Ohio.

Please rush me . . . . .

Check or money order enclosed, No C.O.D.'s, please.

Name . . . . .

Address . . . . .

City . . . . .

**POWER MOWER KITS FREE PLANS**

3 or 4 Wheel Model

Have one of the finest mowers money can buy. Write for **FREE PLANS** and **PARTS LIST** showing you how to **SAVE MONEY** by assembling Triangle's **POWER MOWERS**.

**SPECIAL FACTORY PRICES**

Kits, Parts, Engines, Wheel, etc. 18" and 20" sizes; 3 or 4-wheel models; belt or direct drive. Latest improvements, sturdy construction, money-back guarantee fully told in **FREE color folder**. Also complete **TRIANGLE MOWERS** ready to mow at low **Factory Prices**. Write today.

**▲ TRIANGLE MFG. CO., Dept. MA-4, Ft. Scott, Kan.**

**FINE WORK CLOTHES**

AT LESS THAN

**1/3 COST!**

STERILIZED, CLEAN-AS-NEW

Surplus Stock. Terrific Values!



**PANTS** Worth \$3.95 new! You get 4 used pairs for less than the price of 1 new pair! Navy or green. Send waist and inside leg measurements.

**99c**  
4 for \$3.75

**SHIRTS to Match.** (Made to sell for \$2.99). 4 for the price of 1! Sturdy fabrics for long tough wear. Send neck size.

**79c**  
4 for \$2.99

**COVERALLS.** Made to sell for \$5.95. Yours for less than 1/3! Send chest measurement.

**\$1.95**  
3 for \$5.45

**MONEY BACK GUARANTEE** If you're not convinced these are terrific bargains, return 'em within 10 days for full refund. Order today. C.O.D., or send money and we'll pay postage.

\$1.00 Deposit Required on C.O.D. Orders.

**TRU VALU SALES CO., Dept. PM-28 1294 E. 9th St. Cleveland 14, Ohio**



MARCO 14 \$189.50 Delivered

WRITE FOR FREE FOLDER

Marine ASSOCIATES  
BOX 5188M LONG BEACH 11, CALIF.

**Marine KIT BOATS-DO IT YOURSELF-SAVE 50%**

- Factory To You, No Dealers
- Mahogany Decks and Framework
- All Brass Fastenings
- Deluxe 14' Boats, \$159.50 Freight Incl.

LOOK!



**A MILLION THRILLS!**

High Power **BINOCULARS**

33 Models: \$9.95 to \$135

Free! Catalog & Book "How to Select Binoculars"

FREE TRIAL PLAN

**BUSHNELL Binoculars**  
Dept. M24 43 E. Green Pasadena, Calif.

Do a Real Professional-Like Job Yourself and **SAVE**

**HOW to PAINT**  
With Brush and Spray

Covers All Painting Methods and Materials

You can do professional-like painting and finishing jobs yourself and save about two-thirds of the cost. Sam Brown, noted craft authority, makes it so easy for you in his book, **HOW TO PAINT WITH BRUSH AND SPRAY**. Order your copy now and enjoy this tremendous saving. It covers exterior painting, wall and interior decorating, furniture finishing, concrete painting — every type of painting with brush, spray gun, roller and other methods. Tells what finish is best; what materials to use, etc. No previous experience needed. Fully illustrated. Order by mail. Only \$2.50. Money back if not pleased.



**POPULAR MECHANICS PRESS, Dept. PM18 200 E. ONTARIO ST., CHICAGO 11, ILL.**

**POPULAR MECHANICS**

# Make SURE, SAFE INSULATED ELECTRICAL CONNECTIONS

## The New SUPER *Champ* Hand Tool

The ONE Tool for ALL Wire Sizes used in Home Wiring, Appliances, Automobiles.

### DOES ALL THESE THINGS BESIDES

**CRIMPS** Solderless Terminals and Connectors without solder or tape for safe connections.

**STRIPS** Wire sizes #22-#10. Gauges assure proper length for sure, safe crimp.

**CUTS** Wire, making clean, sharp cut through insulation and conductor.

**SHEARS** Bolts and screws without damaging threads — no filing or hack sawing.



comes with  
**PRE-INSULATED**



**FREE with Each TOOL**

### ORDER DIRECT—USE COUPON

Satisfaction guaranteed or money back. Send check or money order for \$3.95. (Ohio residents add 12c sales tax.)

T. W. Berger, Inc.  
National Distributor Consumers and Dealers  
**AIRCRAFT-MARINE PRODUCTS, Inc.**  
210 A Mairemont Center Bldg., Cincinnati 27, Ohio

Only  
**\$3.95**

Post Paid

T. W. Berger, Inc.  
National Distributor Champ Tool  
210 A Mairemont Center Bldg., Cincinnati 27, Ohio  
Send me post paid the new super Champ Hand Tool. I am enclosing \$3.95. (Ohio residents add 12c sales tax.)

check  money order

NAME \_\_\_\_\_

ADDRESS \_\_\_\_\_

CITY \_\_\_\_\_ ZONE \_\_\_\_\_ STATE \_\_\_\_\_

## HULA DANCER • GETS BIG FISH

Small but mighty, this deadly open-water hooker is heavy enough to make long casts easier. Sinks and runs medium depth. Special "lip" gives special action—fools the wise ones. 5/8 oz. or 1/4 oz. AT YOUR DEALER, \$1.25 each.  
FRED ARBOGAST CO., Inc., 2274 W. North St., Akron 3, Ohio



**FREE** WRITE TODAY FOR YOUR BIG FREE ARBOGAST COLOR CATALOG—FULL OF PICTURES OF CATCHES

## LEARN METALCRAFT and JEWELRY MAKING

Low Cost Home Training Now Available.

Make money. Learn profitable skills and arts of decorative metal and jewelry crafts. Course is complete. Professionally prepared. Easy to master. Special tools and materials furnished.

Write for **INTERSTATE TRAINING SERVICE**  
Free Booklet DEPT. K-3 PORTLAND 13, OREGON

## SAVE GAS! I'LL SEND YOU THIS FREE!

**10 DAY FREE TRIAL! SEND NO MONEY! PAY POSTMAN NOTHING!**  
Users Report 4, 5, 6 Extra Miles per Gallon with New Miracle Gane Air-flow Needle. (\$1.50 Value)  
Up to 25% MORE MILEAGE, FASTER PICK-UP, QUICKER STARTING reported. Phenomenal money-saving results coming from 1/2 MILLION USERS. Carburetor Engineering Co. reports SAVING OF 73¢ PER DAY. YELLOW CAB CO., FLEET OWNERS, POLICE, EMERGENCY vehicle users. Outstanding performance "approved". FITS ALL CARS AND TRUCKS. INSTALL YOURSELF IN 2 MINUTES with simple twist-of-the-wrist. (Replaces present idle adjustment screw in your carburetor.) **AMAZINGLY EASY TO DO!**

**also FREE!** Receive valuable revealing booklet if you WRITE TODAY without delay.  
**HOW TO OBTAIN OVER 47 MILES PER GALLON**

NEWHOUSE AUTOMOTIVE INDUSTRIES  
5805 E. Beverly Blvd. Los Angeles 22, Calif.

## PREPARE FOR BETTER JOB, BIGGER PAY IN SPARE TIME AT HOME

Today, choose the job you want—and prepare for it in time you might otherwise waste. Or if you are already in the work you like best, start training now for quicker promotion and increased pay. During more than 50 years AMERICAN SCHOOL has helped ambitious people to reach higher goals. Check subject that interests you and mail coupon for full information.

AMERICAN SCHOOL, Dept. G445, Drexel at 58th, Chicago 37, Ill.

Without obligation, please send FREE and postpaid, full particulars about the subject checked below.

- |  |   |  |
|--|---|--|
| <input type="checkbox"/> Accounting              | <input type="checkbox"/> Diesel Technician        | <input type="checkbox"/> Mechanical Technology |
| <input type="checkbox"/> Apprenticeship Courses  | <input type="checkbox"/> Drafting—Building Trades | <input type="checkbox"/> Metalworking Courses  |
| <input type="checkbox"/> Architecture & Building | <input type="checkbox"/> Drafting—Machine Trades  | <input type="checkbox"/> Plumbing—Practical    |
| <input type="checkbox"/> Automotive Technician   | <input type="checkbox"/> Electrical Engineering   | <input type="checkbox"/> Private Secretary     |
| <input type="checkbox"/> Better Foremanship      | <input type="checkbox"/> Electricity—Practical    | <input type="checkbox"/> Retail Merchandising  |
| <input type="checkbox"/> Bookkeeping             | <input type="checkbox"/> Electronics—Industrial   | <input type="checkbox"/> Salesmanship—Outside  |
| <input type="checkbox"/> Business Management     | <input type="checkbox"/> HIGH SCHOOL COURSES      | <input type="checkbox"/> Sheet Metal Work      |
| <input type="checkbox"/> Civil Engineering       | <input type="checkbox"/> Mechanical Engineering   | <input type="checkbox"/> Tool Making           |
| <input type="checkbox"/> Contracting             |   |  |

NAME \_\_\_\_\_ OCCUPATION \_\_\_\_\_ AGE \_\_\_\_\_

HOME ADDRESS \_\_\_\_\_

CITY \_\_\_\_\_ STATE \_\_\_\_\_

Canadians: Write American School, Dept. G445, 1610 Sherbrooke St. W, Montreal

MAIL COUPON NOW



## Free! SCARCE "TRIANGLE" COLLECTION



Start TODAY to enjoy an exciting new hobby! Get this big, valuable collection of gorgeous, multi-colored triangle shaped postage stamps . . . brought to you from strange and mysterious lands in the wilds of Africa, enchanting Europe, exotic Latin America, etc. All genuine, all-different—picturing man-eating reptiles, jungle birds, action-packed sports, ancient clipper ships; PLUS scarce airmails, fabulous commemoratives, giant and midget-sized stamps. EXTRA! Bargain Catalog, "Collector's Manual" plus other exciting offers for your inspection. Enclose 10c for mailing costs Supplies limited. ACT NOW!

JAMESTOWN STAMP CO. Dept. M4PM JAMESTOWN, N. Y.

RUSH my Free "Triangle" Collection and other offers. I enclose 10c for mailing costs.

Name.....  
Street.....  
City..... State.....



## ELECTROPLATE IT YOURSELF!

NOW using NEW plating kit. It's easy to electroplate any object with the same LUSTER and DURABILITY as done by the most expensive equip. Complete kit and instructions on plating metal and non-metal objects, with Nickel, Chrome, Copper, Gold, etc. ONLY \$5.95. SEND NO MONEY—everything sent C.O.D., plus postage—\$3.95 now and receive it postpaid. Money back in 7 days if not satisfied.

M. Z. SALES CO., Dept. G-6, 113 W. 42nd St., New York 36, N. Y.



## Instead of a job . . . train for a Career

Industrial growth . . . automation . . . technical advances create career opportunities for engineers, accountants, management experts. Share rewards awaiting college-trained men. Important firms visit campus regularly to employ Tri-State College graduates. Start any quarter in this world-famed college. Approved for veterans.

### Bach. of Science degree in 27 months

In Mechanical, Civil, Electrical Chemical, Aeronautical, Radio (TV-Electronics) Engineering. In 36 Months a B.S. in Business Administration (General Business, Accounting, Motor Transport Management majors). Capable students may accelerate. 36-weeks course in Drafting. Intensive program: technical fundamentals stressed; comprehensive courses with more professional class hours. Small classes: personalized instruction. For earnest, mature students whose time and budget requires accelerated courses and modest costs. Preparatory courses. Beautiful campus in friendly college town. Well-equipped, new and modernized buildings and laboratories. Enter June, Sept., Jan., March. Write Jean McCarthy, Director of Admissions, for "Your Career in Engineering and Commerce."



## TRI-STATE COLLEGE

446 College Avenue Angola, Indiana

### FIBERGLAS STOPS BOAT LEAKS FOREVER!

Now EVERSCHILD Process

- Cuts work & costs
- Pays for itself
- Do it yourself!

At last! The perfected Fiberglass process you've wanted—permanent armor protection for decks, cabin tops, bottoms . . . any size boat. Now apply without expensive, laborious sanding. EVERSCHILD Paint Peeler removes old paint in one easy operation—no gooey mess, no oil or wax to neutralize. Leaves wood ready for Fiberglas. Cuts cost, work! EVERSCHILD increases speed up to 25%; stops leaking seams, rotted planks, boat worms. Ends yearly hauling, scraping, painting & caulking. Can't waterlog, crack, peel or stretch. Choice of 9 colors or clear. Light, yet gives 5 times tensile strength of steel. Used for Navy boats, bulletproof vests, etc. Can't deteriorate or rot, even in salt water. Adds years of life to old or weak hulls. Makes boats drier than now. Only EVERSCHILD 2-resin process with Paint Peeler offers all these advantages!

DEALERS: Territories open for exclusive No-sanding Fiberglass process and guaranteed BriteWork. Write "Dealer Division" today on your letterhead. EVERSCHILD INC., Dept. P-4, 918 St. Paul St., Baltimore 2, Md.

**NO SANDING!**

**FREE!**  
Complete instructions & brochure.

**NEW! EVERSCHILD "BRITE-WORK"**

Glossy clear wood finish . . . cures by own heat . . . equal to 5 coats varnish, guaranteed 5 years.



### The "SCOUT" COMPASS In New ASSEMBLY KIT

Now you can assemble this handsome, precision pocket compass yourself. Kit contains all parts and instructions. 1 3/4" forest green anodized case, white and black dial, jeweled bearing and hardened steel pivot will give years of accurate service. **\$1.50** Kit only. Money Back Guarantee PPD.

**SHERMAN-OSBORNE CO.**  
DEPT. M46 PEMBROKE, MASS.



## MEN WANTED

Earn \$100 Per Week and up  
AUTO DIESEL MECHANICS

Master a trade with a future—learn Auto-Diesel mechanics in our shops. You learn with tools on real equipment. Earn while you learn. Many of our graduates earn \$100 per week and up. No previous experience necessary. Day and night courses. Approved for veterans. Write for free bulletin.

**NASHVILLE AUTO-DIESEL COLLEGE**  
226 7th Ave., N., Dept. 75 Nashville 3, Tenn.

### FAMOUS MAKE TV TRADE-IN SETS

10" — \$16.95 • 12"-17" — \$19.95 up  
Complete Listing! **ELECTRONIC WORLD**  
237 SUNRISE H'WAY, ROCKVILLE CENTER, N.Y., Dept. PM1



## BECOME AN EXPERT IN TRAFFIC and TRANSPORTATION

Traffic men earn \$4,000 to \$10,000 and up. Thousands of firms need experts on rates, tariffs, regulations. We train you thoroughly in spare time at home for executive traffic jobs. Personal training under traffic authorities. Write for free book "Traffic and Transportation."

**LASALLE Extension University, 417 So. Dearborn St.**  
A Correspondence Institution Dept. 464T Chicago 5, Ill.

### MINIATURE EAR PHONE \$2

\$7.95 value, low impedance personal phone with 4 ft. cord. Ready for connection to any radio or TV. No C.O.D.'s, send \$2.00 postpaid to:

**TURNER RADIO** 1217 Nicollet Ave. Minneapolis, Minn.



### 60 POWER TELESCOPE \$3.98

VARIABLE EYEPIECE 20X-40X-60X — BRASS BOUND NEW! Three telescopes in one. 3 different magnifications. 20 power for ultra-bright images with 40 and 60 power for extra long range. Guaranteed to bring distant objects, people, sports events, ships, moon, stars, etc. 60 times as close. Most powerful for any ey. 5 sections where near the moon. Closes to 1 ft. long. Contains 4 ground and polished lenses. Also used as a powerful compound microscope. Directions included. Mass production enables us to offer this instrument at amazing price of \$3.98 complete. Money back guarantee. We pay postage. Get yours now. All Bakelite Telescope — Coated Achromatic Lens \$7.98

**CRITERION CO., 331 Church St., Hartford, Conn., Dept. PMB 33**



# STUDY IN CALIFORNIA ABSOLUTELY FREE!!

MAIL COUPON FOR A...

**FREE BOOK & LESSON** SHOWING HOW YOU CAN BUILD AND KEEP A POWERFUL GIANT SCREEN TV SET!

STUDY IN CALIFORNIA ABSOLUTELY FREE!! (Two weeks free training in our Los Angeles Laboratory)



GREATEST OFFER IN OUR 23 YEARS!

LOOK AT THESE ADVANTAGES FROM C.E.T.I.!! TRAIN AT HOME in your spare time and get into the high-paying Radio & Television field. "LEARN BY DOING" by building your own radio and TV SET and performing 100's of experiments in your own home. All kits are yours TO KEEP. COLOR TELEVISION is included in your training course. FCC COACHING COURSE qualifies you for higher pay!! LOS ANGELES TRAINING is yours at no additional expense (two weeks in our laboratory). MAKE MONEY while you are still training. ACT TODAY!! Send for our free book explaining in detail the many advantages you receive ONLY FROM C.E.T.I. YOU OWE IT TO YOURSELF TO SEE HOW YOU CAN STEP INTO HIGH-PAYING RADIO & TELEVISION JOBS WHILE YOU STUDY AT HOME IN YOUR SPARE TIME!!

CALIFORNIA ELECTRONICS & TELEVISION INSTITUTE Dept. 11  
1121 W. PICO BLVD., LOS ANGELES 15, CALIF.  
Send, without obligation, your Big Book containing hundreds of TV-RADIO Facts and Ideas plus Free Lesson. (No salesman will call.)

Name \_\_\_\_\_  
Address \_\_\_\_\_  
City \_\_\_\_\_ Zone \_\_\_\_\_ State \_\_\_\_\_



STUDY IN SPARE TIME AT HOME



MAIL COUPON TODAY! GET FREE TV FACTS-TV IDEAS

BONUS 12 BIG KITS OF RADIO PARTS



CALIFORNIA ELECTRONICS & TELEVISION INSTITUTE  
1121 W. PICO BLVD., LOS ANGELES 15, CALIF.

**MARCOT KEY MACHINE**

IMMEDIATE DELIVERY

Marcot No. 8 Key Machine, 1956 Model	\$123.00
Auto Code Book and Depth Keys	13.75
Yale Padlock Code Book and Depth Keys	6.25
45 Doz. Anst. Cylinder Key Blanks	35.46
Set-Locksmithing Tools, Pins & Springs	10.50
5 Locksmithing Manuals and Instruction Books	10.25
	<b>\$199.21</b>

SEND FOR CATALOG

A. J. MARCOTTE CO. 1200 N. KEDZIE AVE. DEPT. PM-4, CHICAGO 51, ILL.

Learn To **MOUNT BIRDS**

Here's Best Hobby for Fun & Profit

TAN SKINS, MAKE UP FURS

Be a Taxidermist. We teach you at Home. Mount Birds, Animals, Pets, common specimens. Save your hunting trophies, decorate home and den. Make genuine KROMB LEATHER, tan and make up furs for sparetime profit. INVESTIGATE TODAY

FREE BOOK 48 pages-tells all about it. Hunters, get your copy. It's Now Free. Send post card. State your AGE.

N. W. SCHOOL OF TAXIDERM, DEPT. 2504, Omaha, Nebr.

**Wholesale!** TOOLS! GUNS! CAMERAS!

AGENTS - BUY TOOLS, PHOTO EQUIP., SPORTING GOODS, JEWELRY AND THOUSANDS OTHER NATIONALLY ADVERTISED PRODUCTS AT BIG DISCOUNTS. BIG PROFITS SELLING TO OTHERS.

POSTCARD BONUS FREE COPY "THE WHOLESALE PLAN"

**AMERICAN BUYERS SERVICE**

HERTEL STATION, DEPT. 15, BUFFALO 16, NEW YORK

Get up to 40% off

Write Like This

YOUR penmanship can be improved in 3 hours or corrected to your satisfaction in 10 hours practice with my DEFINITE HAND CONTROLS. New way!

WRITE OZMENT BOX 665 34-P, ST. LOUIS, MISSOURI

Complete OUTLINE FREE!

**WHEELS WHEELS WHEELS**

7" Disc Wheel 3/4" Tire 3/4" sleeve	45c ea.
8" Disc Wheel 1 1/4" Tire 1 1/4" sleeve	70c ea.
7" Disc Wheel 1" Tire 1 1/2" ball bearing	80c ea.
8" Disc Wheel 1 1/4" Tire 1 1/2" ball bearing	\$1.00 ea.
6" Disc Wheel 1.50 semi-pneum. Tire 1 1/2" S.B.	\$1.35 ea.
8" Disc Wheel 2" semi-pneum. T. 1 1/2" S.B.	\$1.50 ea.
10" Disc Wheel 1.75 semi-pneum. T. 1 1/2" S.B.	\$1.50 ea.
10" Disc Wheel 2.75 semi-pneum. Tire 3/4" S.B.	\$3.50 ea.
12" Disc Wheel 1.75 semi-pneum. T. 1 1/2" S.B.	\$1.85 ea.

Above wheel prices includes hub cap. Plus Postage. C.O.D.'s accepted.

AXLES—Sizes 5/16 in., 3/8 in., 1/2 in.—Cut to size—End holes drilled.

**UNITED WHEEL STAMPING CO.**  
12131 S. PEORIA STREET PM-4 CHICAGO 43, ILLINOIS

Reg. U.S. Pat. Off. Pend.

**BUILD 16 RADIO CIRCUITS AT HOME WITH THE NEW DELUXE 1956 PROGRESSIVE RADIO "EDU-KIT"**

ONLY \$19.95 COMPLETE

All parts, instructions, punched metal chassis, printed circuit materials, electric Soldering Iron, Tester included. 30 Day Money-Back Guarantee.

**PROGRESSIVE "EDU-KITS" INC.**  
Room 544-B, Progressive Building, 497 Union Ave., Brooklyn 11, N. Y.

Please Rush me Free Descriptive Literature concerning "EDU-KIT." Also send me Free Radio-TV Servicing Literature. No obligation.

NAME \_\_\_\_\_  
ADDRESS \_\_\_\_\_  
CITY \_\_\_\_\_ ZONE \_\_\_\_\_ STATE \_\_\_\_\_

Say You Saw It in Popular Mechanics

# Get into.. PLASTIC LAMINATING AT HOME!



THIS MAN... is taking out of the machine a Plastic Sealing Job - ordered by mail - only 1lb in material cost brings back \$2.50 in cash by mail. Capacity of machine: \$25.00 profit per hour of operation.

Get ORDERS and CASH from your mailman—do work in SPARE TIME at home—or expand into FULL TIME business. Send coupon for Free facts about the newest and most fascinating of all home operated businesses. For the first time a simplified machine brings the fabulous profits of Plastic Sealing and Plastic Laminating within the reach of the small operator. Anyone can learn to operate the machine with a few minutes practice—then with our Magic Mail Plan can get mail orders pouring in daily with cash in every envelope. No canvassing—no selling. We even

Make \$20 to \$30 a Day by.. **MAGIC MAIL PLAN!**

**Make Thousands of Beautiful Art Creations**

COSTUME JEWELRY • CIGARETTE BOXES TRAYS • CANDLESTICKS • COASTERS LAMP BASES • BOOK ENDS...ALL IN SPARKLING COLORED PLASTIC



supply the circulars you mail to bring back cash and orders. Don't waste a minute. Rush your name. We'll send you FREE and postpaid, pictures, prices, details, and all the facts you need to start. Mail coupon or send name on postcard. No charge.

**Warner Electric Co., 1512 Jarvis Av., Dept. L-104, Chicago 26, Ill.**

**WARNER ELECTRIC CO., 1512 Jarvis Av. Dept. L-104, Chicago 26, Ill.**

At no cost to me, please rush complete details postage prepaid. I am under no obligation.

Name \_\_\_\_\_  
Address \_\_\_\_\_  
City \_\_\_\_\_ Zone \_\_\_\_\_ State \_\_\_\_\_

# FREE IMPORT



## by Return Mail

To demonstrate your big money-making opportunities in my proved, successful mail-order import plan, I'll send you FREE an imported, hand-tied Coachman casting fly, made in the Orient to sell there for less than 2¢. A retail price of 30¢ in the U. S. gives 1500% mark-up. There are 19 Million U. S. fishermen who are prospects for casting flies, a heavy spending market. Other, even larger markets await hundreds of foreign products we find for you and show you how to import—cameras, watches, toys, perfumes, fashions, art objects, etc.

### GET CASH-IN-ADVANCE MAIL ORDERS

Pocket big profits in advance. Pay traders abroad with the balance, to ship direct to your customers by parcel post. No stocks to carry. No face-to-face selling. Or if you like personal contacts then import for stores or wholesalers. Your own full or part time business from home or a small office. Export and travel abroad opportunities too, for men and women under my simple direct methods.

**ALL THREE FREE! HURRY!**

Write today for your copy of my booklet, "Success Stories in World Trade," showing how others have done, full details and imported Coachman Fishing Fly—ALL FREE. No obligation. (Only one fly to a person. This ad must be sent with your request.) Airmail reaches me overnight.

B. L. Mellinger, The Mellinger Co., Dept. F254  
1717 Westwood Blvd., Los Angeles 24, Calif.

## SEWS LEATHER

AND TOUGH TEXTILES LIKE A MACHINE

With SPEEDY STITCHER Automatic Sewing Awl, anyone can quickly and skillfully sew or repair anything made of LEATHER, CANVAS, NYLON, PLASTIC, or other heavy materials. Sewers firm, even lock-stitches like a machine. Gets into hard-to-reach places. Specially made for heavy duty sewing on LUGGAGE, FOOTWEAR, RUGS, AWNINGS, SAILS, SADDLERY, UPHOLSTERY, OYEBALLS, AUTO-TOPS, SPORTS GEAR, and other tough sewing jobs. Here's the handiest tool you'll ever own. Will save you many times its small cost. Comes ready for instant use... complete with bobbin of waxed thread and 3 different types of diamond-pointed needles. Easy-to-follow directions will make you an expert in minutes. Extra needles and waxed-thread always available. Save money, send \$1.98 for post-paid delivery. If C.O.D., \$1.98 plus postage. MONEY BACK GUARANTEE.



SPORTSMAN'S POST  
366 Madison Ave., Dept. A-344, New York 17

ONLY **1.98**

Say You Saw It in Popular Mechanics

## WORK FOR THE



## GOVERNMENT

START AS HIGH AS \$3,880.00 YEAR  
Many Appointments To Be Made. Prepare now for next Exams. Experience Often Not Required. MEN—WOMEN.

FRANKLIN INSTITUTE, Dept. P-93, Rochester 4, N. Y.  
(Not Government Controlled) Sir: Rush FREE: (1) 36-page book with partial list of U.S. Gov't Jobs. (2) Tell me how to prepare for these tests.  
Name \_\_\_\_\_ Age \_\_\_\_\_  
Address \_\_\_\_\_

## MAKE UP TO \$20 A DAY WITH

## EASISHARP



MONEY MAKING SALES PLAN FREE

Big profits in your spare time sharpening scissors. We show you how to start making money immediately. This is your chance now to have your own business and a steady income. Sharpen a pair of scissors in less than two minutes. A child can operate it. Weighs only 10 lbs. Every home, barber, tailor, dressmaker—everybody uses scissors and all need sharpening two to four times a year. Don't let some one else beat you to this opportunity. Write immediately to

SERR-EDGE MACHINE CO., 9731 Lorain Ave., Cleveland, Ohio

## WHAM-O SPORTSMAN

\$1.50

35-LB. PULL!

HITS LIKE A RIFIE—KILLS RABBITS, SQUIRRELS.

Powerful, silent, accurate.

For hunting, target,

and raving pests.

Sportsman's choice sold world over!

HUNTING SLINGSHOT

Heavy duty 7" ash stock.

40 steel balls, extra rubber target.

GUARANTEED. Professional model

of Nat'l Slingshot Assn. At dealers or write

WAMO MFG. CO. Box G-82, San Gabriel, Calif.

## \$950 BUILDS GARAGE APT.



### EXTRA INCOME

Build your own 22'x24' concrete block garage apartment complete for \$950. Pays for itself in two years. Slab floor, steel windows, wall furnace, rock wool insulated, overhead garage door, no block cutting necessary. Contains blueprint, scale 1/4"=1', step by step instructions, and material cost list \$1.00 post. Money back guarantee.

MEMBER ARKANSAS HOME BUILDERS ASSOC.  
BAILEY BUILDERS, Pyramid Life Bldg., Little Rock, Ark.

## WHOLESALE Electric Guitars - Parts - Factory to You

Solid-body Spanish, amplifiers, double-necks, single-necks, triple-necks, 4-necks, solid-body mandolin, electric violin, pickup mikes, non-electric instruments, etc. 1950 Models wholesale. FREE CATALOG. Free home study course with instruments. Parts & plans available to build your own.



CARVIN CO., Box 287, PM-4, Covina, Calif.

## Catalog of 3100 Novelties 10c

Send 10c for amazing catalog of novelties, live animals, scientific supplies, hobbies, funmakers, planes & boats, looms, magic tricks, joke articles, unusual seeds, gadget timesavers, cameras, optical goods, projectors, movies, lucky jewelry, religious novelties, disguises, musical instruments, stamps, coins, puzzles, fortune tellers, radios, auto & bike accessories, telescopes, magnifiers, compasses, banks, smokers' gadgets, artists' supplies, printing sets, engines, motors, snickers, knives, billfolds, guns, rifles, sports, books, games, plants, etc. Send 10c (3 for 25c—get for friends!).

JOHNSON SMITH & CO. Dept. 200 Detroit 7, Michigan

ENGINEERING DEGREE IN 27 MONTHS

B. S. DEGREE, Aeronautical; Chemical; Civil; Electrical; Mechanical and Electronic Engineering (inc. Radio and TV); Drafting, One-year, G.I. Government approved. Low rate. Earn board. Large industrial center. Students from 48 states, 21 countries. Demand for graduates. Enter June, September, December, March. Write today for catalog. 1646 E. Washington Boulevard, Fort Wayne 2, Indiana.

## INDIANA TECHNICAL COLLEGE

## LEARN PLASTICS



COMPLETE LOW COST SHOP METHOD HOME TRAINING NOW AVAILABLE

Get in on Big Money opportunities in Plastic molding, casting, forming, carving, etc. Earn as you learn with Interstate's professionally prepared course. All plastic materials furnished.

WRITE FOR FREE BOOKLET

INTERSTATE TRAINING SERVICE  
DEPT. C-3, PORTLAND 13, OREGON



# LEARN MEAT CUTTING AT NATIONAL

Pay After Graduation



The steady dependable trade of Meat Cutting taught easily in 8 short weeks. YOU LEARN BY DOING under actual meat market conditions in big modern school at Toledo.

For beginners or men with experience. Get a profitable store of your own. Remember, PEOPLE MUST EAT! Big pay jobs. Free employment help. Thousands of successful graduates.

Buying, cutting, percentage, pricing, advertising, selling, etc. A complete retail meat education. National School established 33 years. Get National training NOW. Pay your tuition in easy weekly payments

after you graduate. Send coupon for FREE 52 page school catalog — TODAY. G.I. approved.

## National School of Meat Cutting, Inc., Dept. 50-C, Toledo 4, Ohio

Send me your FREE school catalog on National Training at Toledo in Meat Cutting, Meat Merchandising and Self Service Meats. No obligation. No salesman will call.

Name \_\_\_\_\_ Age \_\_\_\_\_  
 Address \_\_\_\_\_  
 City \_\_\_\_\_ State \_\_\_\_\_  
 Approved for training Korean Veterans

## SPARE-TIME MONEymAKING OPPORTUNITIES

### READ OUR CLASSIFIED ADS

HUNDREDS OF BARGAINS AMAZING OFFERS

## SPARE TIME PROFITS EARN MONEY AT HOME

Cash in on this pleasant and profitable business. Re-string Rackets full or spare time. No experience or skill required. Easy to learn. Full line of finest quality, guaranteed Stringing Tools, Frames, Gut and Nylon Strings.

W. A. BICKEL & CO., 803 South Blvd., Dept. PM-4, Oak Park, Ill.



FREE CATALOG INSTRUCTIONS WRITE TODAY

only \$95 freight incl. Write For FREE FOLDER

## 12 ft. SPORTBOAT KIT



Includes ready-cut parts and hardware. Models low as \$39.00 freight incl.

### TAFT MARINE WOODCRAFT

Dept. PM-4, 636 39th Ave. N.E., Minneapolis 21, Minn.

## RADIO CONTROL YOUR MODEL

PLANES BOATS CARS

"CUSTOM MIDGET" RADIO \$9.98

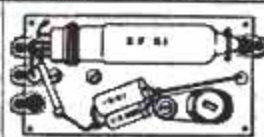

DETAILED INFORMATION & RADIO CATALOGUE 25c

SPECIAL "SUPPLY SOURCE DIRECTORY" & \$7.00 SUPPLY COUPON... \$1.00

BOOK "RADIO CONTROL OF MODEL AIRCRAFT" CONTAINS 14 PLANS \$3.98

RADIO CONTROL GARAGE DOOR DETAILS... \$1.00

OPERATES SAME AS \$50.00 SETS. INCLUDES LONG RANGE TRANSMITTER RADIO, RECEIVER RADIO AND CONTROL ACTUATOR ALL 3 EASY ASSEMBLY WITH OUR PARTS AND PLANS \$9.98. PLANS ALONE \$1. RADIOMODELS BOX 36 DEPT. PM BALTIMORE 6, MARYLAND

## BIG MONEY... LEARN ELECTRICAL APPLIANCE REPAIRING!



### Start Your Own Business

New short-cut, shop-method, home training system gives you electrical know-how that used to take years to learn. Learn at home by building valuable testing kits, repairing your own and neighbors' appliances.

### FREE ILLUSTRATED BOOK

EARN \$5.00 to \$6.00 & MORE PER HOUR Shows you every phase of electrical appliance repairing and electrical equipment servicing. Rush name for your copy and SPECIAL form for paying from earnings while learning.

### CHRISTY TRADES SCHOOL

Dept. D-5303, 4804 N. Kedzie, Chicago 25



Charles Atlas

# I Build Prize-Winning HE-MAN Bodies!

Here's What I Did for Hector Romero, My Newest Atlas Champion — Let Me Show What I Can Do for YOU!

Hector Romero is just one of thousands who have become men of might and muscle—with my quick "Dynamic Tension" method. All it takes is just 15 minutes a day—right in the privacy of your own room. And there's NO COST if I fail! Mail coupon and I'll send you FREE my new 32-page book. Reveals how "Dynamic Tension" changed me from a 97-lb. weakling to "The

World's Most Perfectly Developed Man." Shows how I can add inches to your shoulders and chest, arms and legs—give you a handsome HE-MAN body! Let me PROVE I can make you the MAN nature intended you to be. Mail coupon NOW to: Charles Atlas, Dept. 84, 115 East 23 St., N. Y. 10, N. Y.



CHARLES ATLAS, Dept. 84, 115 East 23 Street, New York 10, N. Y.  
 Send me your Free Book which proves how "Dynamic Tension" can make me a NEW MAN.  
 Name \_\_\_\_\_ Age \_\_\_\_\_  
 Address \_\_\_\_\_  
 City \_\_\_\_\_ State \_\_\_\_\_



SEND POSTCARD FOR LITERATURE DEPT. P

# THE BACKYARD PLAYBOY

AMERICA'S NEWEST FUN FOR JUNIOR. HIS FIRST PERSONALLY-OWNED MOTOR VEHICLE. INSTRUCTIVE, SAFE, ECONOMICAL AND LOADS OF FUN!

**\$119.95**  
FOB  
**OAKLAND**

- LIGHT
- SIMPLE
- SAFE

Weights less than an overseas bag. Only 42 pounds ready to run. Rugged welded frame strong enough for a 200-pounder. 15 miles per hour. Turns short as a sidewalk bike. Quiet enough for the backyard. Simple controls. A 7-year old can learn in minutes.

A rugged dependable, 200-miles-per-gallon motor scooter with famed Pranafa .7 Hp, 2-cycle engine. Ideal for personal aircraft and yachtsmen.

**HAP ALZINA 3074 Broadway Oakland 11, Calif.**

## THE MASONIC CASUALTY COMPANY



OFFERS  
**ACCIDENT—HEALTH—HOSPITALIZATION INSURANCE AT COST**

- Non Cancellable
  - Benefits Not Prorated
  - No Medical Examination
  - No Paid Agents
  - Coverage On or Off the Job
- FIRST 3 MONTHS PROTECTION FOR MEMBERSHIP FEE \$2.00 FOR MASONS ONLY under 56 yrs. of age**

**WRITE AT ONCE**  
**THE MASONIC CASUALTY COMPANY**  
80 BOYLSTON STREET, Dept. P-4, BOSTON 16, MASS.  
NO AGENT WILL CALL

## Watch Repairing Pays Big Money Learn at home



Watch repairers in great demand. Train step-by-step in 10 easy lessons. We furnish all tools and 15 jewel watch and practice movement. Turn spare time into cash. A licensed school. Low cost. Send for FREE book today.

**ILLINOIS SCHOOL OF WATCH REPAIRING**  
2870 Elston Ave., Dept. PM46, Chicago 18, Ill.

### ORIGINAL ARRO-PING

VEST POCKET ARCHERY

Guide-barrel improves accuracy—live-rubber propulsion gives lightning-power for target and small game! Fun in rumpus room or patio, on picnics, hikes, in camp. Quiet, safe, cannot be discharged accidentally. Economical, use arrows over and over. New! Leather arrow-grip!



NEW LOW PRICE  
**\$1.00**

with 3 metal-tip arrows or 3 shafts and 6 interchangeable safety rubber tips. Extra arrows 12 for \$1 ppd. (C.O.D. if desired, you pay fees and postage)

ARRO-PING CO.  
P.O. Box 779-H  
Colorado Springs 4, Colo.

## These brand new SPERRY Gun Sights

Cost the Air Force nearly \$200

Can you use one at this pennies-on-the-dollar price?



**\$588**  
TAX AND POSTPAID

7.45 west of Mississippi  
**EXPERIMENTERS INVENTORS TINKERERS LABORATORIES**

Here's a partial list of what's inside!

- Silver Surface Optical Mirrors
- Electrical Fittings, Switches
- Big, 1½-inch F:1.9 Optical Lens
- Scores of fine Gears... Cams
- 3 Miniature Differentials
- A 24-volt Rheostat and Lamp

Frankly we don't know what you'll do with these remarkable instruments! But we do know they're about the most amazing and intricate things we've seen. They're the original, super-secret (now declassified) Sperry gun sights that made our gunners the most deadly in the war. They're chock full of marvelously made gears, cams, wheels and electrical equipment, and put together with the precision and accuracy of a fine watch! Many individual parts are worth more than the price you pay now for the entire unit! Dimensions, about 8x6x6 inches; weigh 8 lbs. Brand new in original government cartons. Send for yours today.

RUSH YOUR ORDER TO:

**JOSEPH SALES Co.** Rm. 507-1740 E. 12th St. CLEVELAND 14, OHIO

## Save on all PLUMBING JOBS

When You Build - When Making Improvements - Repairs - Maintenance

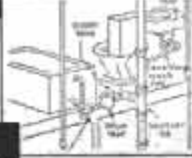

Get POPULAR MECHANICS Home Plumbing Guide



How to plan plumbing installations, select materials and fixtures.

### 15 Ways to Save Money

- All about modern home plumbing
- How to use plumbing tools
- Getting acquainted with pipe
- Planning home plumbing systems
- Installing and maintaining home drainage systems
- Private sewage disposal systems
- Causes and cures of drainage troubles
- Installing home water lines
- Private water supply systems
- Water Heaters
- Water Conditioning
- Water system troubles and cures
- Installing and caring for fixtures
- What to do with valves and faucets

How to save money on all plumbing jobs using approved methods.

Easy to Do Professional-Like Jobs and Save Over One-Half

Get the Popular Mechanics HOME PLUMBING GUIDE. It shows how you can do every kind of plumbing job yourself and save from a few to hundreds of dollars. Covers plans, layouts, installation, maintenance and repair. Shows what materials to get and use, where to get them and how to do a proper job with approved methods. Few, other than the simplest tools are required and some of these can be rented. Don't pay high prices for work you can do yourself. Get the HOME PLUMBING GUIDE for only \$3.50. You will be amazed how jobs you thought difficult are simplified.



Clip This Ad and Mail. Money Back if Not Pleased. Invest only \$3.50. Use the book for 7 days. Then if you are not satisfied return it for full refund of your money. Sent C.O.D. (U.S.A. only) if you prefer.

Over 500 How-to-do-it Pictures Guide You

POPULAR MECHANICS PRESS, Dept. HPG-10, 200 E. Ontario St., Chicago 11

## IF YOU LIKE TO DRAW, SKETCH OR PAINT...



You may have talent that could earn you \$75 to \$500 a week. Find out now!

See if your talent is worth training.

Take this simple Art Talent Test at home, in spare time.

Test was developed by professional artists to uncover new talent.

Trained artists are needed today for advertising and illustrating.

Thousands got started by taking this talent test. Mail coupon today for free copy. No obligation.

**ART INSTRUCTION, INC.,** Studio 4138  
500 South 4th Street, Minneapolis 15, Minnesota

Please send me your Talent Test, without cost or obligation. (PLEASE PRINT)

Name \_\_\_\_\_ AGE \_\_\_\_\_

Address \_\_\_\_\_ Phone \_\_\_\_\_

City \_\_\_\_\_ Zone \_\_\_\_\_ County \_\_\_\_\_

State \_\_\_\_\_ Occupation \_\_\_\_\_

### Say You Saw It in Popular Mechanics

#### Pocket Size ADDING MACHINE

Adds • Subtracts • Multiplies  
Calculates 999,999

Accurate  
Quick  
Easy

Operates with a flick of the finger. As accurate as a machine costing many times this amazing low price. A practical machine—NOT A TOY. Sturdily constructed, fully guaranteed. Saves money and time in avoiding calculating errors. Ideal for offices, clerks, farmers, schools and other personal uses such as keeping scores.

**SEND NO MONEY**—just mail order. Pay postman only \$1.49 plus postage and C.O.D. fee on delivery. Or send \$1.00 with order and we pay postage. Use 10 days. If not delighted, return for money back. Immediate delivery. **ORDER NOW!**

**RAY CALCULATOR CO.,** 259 Strader Ave., Dept. A-15, Cincinnati 26, Ohio



only \$149

### TOOLS & HARDWARE WHOLESALE!

#### HUGE PROFITS!

#### MORE MONEY!

#### Start Your Own Business

Sell nationally advertised tools to your friends, neighbors for industrial & institutional use. New giant 1956 illustrated wholesale catalog has only your name on it. You get all the orders and re-orders. A MILLION DOLLAR INVENTORY AT YOUR FINGERTIPS. NO STOCK TO CARRY. ORDER AS YOU NEED IT!!! You sell merchandise that is pre-sold for you through national advertising by the country's leading tool manufacturers.

**WHOLESALE DISCOUNTS UP TO 50% OFF**... Send \$1 deposit for dealer's card and get the new 1956 giant illustrated wholesale catalog at no extra charge. Your \$1 is credited to your first purchase or refunded if not 100% satisfied. Write NOW!

Get up to  
**50%**  
off

#### TOOL DISCOUNT HOUSE

DEPT. 44 318 MARKET ST. NEWARK, NEW JERSEY

# HOW TO START YOUR OWN HOME BUSINESS

and make up to **\$8<sup>80</sup>** an hour—It's Easy

With What I Call **"MY LITTLE MONEY MAKER"**



Set it up anywhere—kitchen, basement, attic or garage. Turn out a product that sells for \$6.00. Materials cost you only 54c so you make \$5.46 profit on every job.

#### NO EXPERIENCE NEEDED No Canvassing or Selling

Both men and women can easily operate these little Electroplating Machines and make extra money whenever they want it. Here's why. While working or while sleeping—your "Little Money Maker" is busy bronzing baby shoes—coating them with copper to preserve the shoes forever. There is a tremendous

demand for Bronzed Baby Shoes and there are seven ways to get orders without making any house-to-house calls. Lots of orders come to you by mail with the money in the envelopes. Let me send you all the facts about this fascinating home business. I'll show you how you can make up to \$8.80 an hour from the very beginning. Send your name on a postcard. I'll answer by return mail and the information I send you will not cost you a penny. No salesman will call. Get in touch with me at once so I can help you get started making lots of money. **Harry A. Mason, 1512 Jarvis Ave., Chicago 26, Illinois.**

Pay Only **54¢** for Material  
**SELL FOR \$6.00**

5 Engineering Technicians  
needed for each engineer



Become an  
**ENGINEERING  
TECHNICIAN**  
at **MSOE**  
in Milwaukee

Industries need five technicians for every engineer—and there is a critical shortage of both. Top jobs are waiting for well-trained men. Join the engineering team!

MSOE's unique educational program of technical institute and collegiate engineering courses offers you step-by-step advancement. You can become a qualified engineering technician in 12 to 18 months, ready to begin your career in industry. Or you may continue your studies, without loss of time or credit, to earn a Bachelor of Science degree in engineering in 36 to 42 months. Prepare yourself for the opportunities ahead in one of these MSOE courses:

#### ENGINEERING TECHNICIAN COURSES

**MECHANICAL:** Air Conditioning — Industrial Technology

**ELECTRICAL:** Radio — Television — Electronics — Electrical Power Technology

#### BACHELOR OF SCIENCE DEGREE COURSES

**MECHANICAL ENGINEERING:** Refrigeration, Air Conditioning and Plant Engineering option, or Metals Fabrication and Industrial option

**ELECTRICAL ENGINEERING:** Electronics major or Power major

MSOE's complete, modern facilities include specialized technical laboratories and equipment, visual aid theater, and reference library. Fully accredited technical institute courses approved for veterans; 50,000 former students; excellent placement record for graduates.



4 TERM OPENINGS YEARLY  
JULY, SEPTEMBER, JANUARY, APRIL

Clip and Mail Today!

## MILWAUKEE SCHOOL OF ENGINEERING

Dept. PM456, 1025 N. Milwaukee St. MS-41  
Milwaukee 1, Wisconsin

Please send me free career booklets on:

- Mechanical Engineering and Technology  
 Electrical Engineering and Technology  
 Radio-Television

I am interested in ..... (name of course)

Name..... (Age).....

Address.....

City and State.....

If veteran, give discharge date.....



Foolish To Pay More—Dangerous To Pay Less!

Entire stock of our family-safe Top Grade, 40,000 mile Passenger Tires, (worn very slightly) at PRICES LISTED BELOW! IT'S CHEAPER THAN OFFERS OF \$1. OFF OF JUST ORDINARY TIRES. "The Blatt Name famous in tires for 40 Years—I don't just repair it, I offer a free fast REPLACEMENT guarantee on ANY defective tire within 12 months." Frt. Excl. CHOOSE YOUR FAVORITE BRAND. Not Recaps.

**GOOD YEAR Firestone**

U.S. Goodrich,  
General, Atlas,  
Lee & others.

**FREE** This pictured tire ash tray given with 2 or more tires!

12 MONTH TIRE GUAR. & FREE FACTORY-TESTED TUBE  
Many of our customers say **36 MONTHS SERVICE.**  
our tires give as much as

600-16		650-16		700-16		750-16		800-16		850-16		900-16		950-16	
\$5.27	5.67	\$5.17	5.37	\$5.37	5.67	\$5.67	5.97	\$5.97	6.27	\$6.27	6.57	\$6.57	6.87	\$6.87	7.17
700-16	750-16	800-16	850-16	900-16	950-16	1000-16	1100-16	1200-16	1300-16	1400-16	1500-16	1600-16	1700-16	1800-16	1900-16
5.77	6.07	6.37	6.67	6.97	7.27	7.57	7.87	8.17	8.47	8.77	9.07	9.37	9.67	9.97	10.27

**SPECIAL TIRES** RELEASED BY CO. ADJUSTERS! If a tire fails in 12 months, I charge you nothing. Just slightly used. Any car size. World's top tire value. (Whitewalls \$1 extra) Free tube with each tire. **\$7.53**

MARVIN & Spring Garden Sts. Philadelphia, Pa. **BLATT** 6th  
MILITARY MUD-GRIP TIRES  
AA Guar. 6 Mos. AAA 12 Months  
900-16 \$9.97 900-16 \$13.97  
750-20 12.97 750-20 17.97

Send Check or M.O. & this ad for fast shipment. FOB Phila. I personally select your tires—as if my future depended on it. Read that top line again.

## TERMITES

### Kill Termites Yourself with ARAB U-DO-IT TERMITE CONTROL

Costs \$20.00 to protect 5-room house for 5 years. Harmless to flowers and shrubs. FREE FOLDER and prices at Bldg. Supply Dealers or write **FEDERAL CHEMICAL CO., INC., 2701 Winthrop Ave., Indianapolis, Dept. PM 456.**

### ELECTRIFY YOUR SEWING MACHINE!

Buy direct and save! Kit comes fully wired, installed in a jiffy. Fits all machines. ALL-NEW PARTS! Multi-speed foot control • Cord set & block • 115 v 60 c • Full instructions • Steel pulley & belt BONUS: 10 day free trial. Reg. \$2.95 Sewite given FREE with kit. Reg. \$7.95inking shears only \$1 with order. Send no money. Kit sent C.O.D. Or send money order and we'll pay postage. State whether wheel on your machine turns towards or away from you. Shipping wt. 6 lbs. SENIOR SEWING MACHINE CO., Box 142, Dept. PM166, Bklyn 6, N. Y.

NEW LOW PRICE! **\$9.95** 90 DAY GUARANTEE

## MONEY in SHOES

"I'll set you up in a profitable spare time "shoe store business" at my expense. Run it from home, 2 orders a day will pay you \$168 a month. Send postcard for FREE Selling Outfit. **MASON, Dept. 209, CHIPPEWA FALLS, WISCONSIN**

### NOW MARK ANY SURFACE!

Use **MAGIC MARKER** to mark, color! Make patterns, decorate models, mark metalwork, identify tools. Amazing color brilliance, clear solid lines, any width. On paper, wood, glass, metal, plastic, leather, painted surfaces.

**69¢ 3 for \$2** Slightly higher wear coat

**SPEEDY PRODUCTS, Inc.** Dept. A, Richmond Hill 18, N. Y.

INSTANT DRY WATERPROOF PERMANENT 9 COLORS

## HIGH BLOOD PRESSURE?

New simplified gauge tests blood pressure at home! This instrument detects internal changes which lead to unexpected strokes, heart and kidney damage, insomnia, headaches, etc. No experience or assistance needed to test pressure accurately. Operating instructions also include information on what to do to prevent or reduce the damaging effects of high blood pressure. These useful instruments are fully guaranteed and actually pay for themselves within a week. Order now for immediate shipment.

**THE STANDARD UNIT.....\$6.50** postpaid Or C.O.D. plus postage. Contains everything that is needed, including functional stethoscope.

**THE DELUXE UNIT.....\$9.75** postpaid Or C.O.D. plus postage. Same outfit as standard unit, but includes genuine professional stethoscope.

**JOY SPECIALTY COMPANY, Scientific Instrument Div.**  
2320-A W. HUBBARD STREET CHICAGO 12, ILL.

# New Spark Plug Invention!

## SELF-CLEANING, 21 POINT

# Nickel-Cadmium SPARK PLUG

**TESTS PROVE: ★ 10 HORSEPOWER GAIN  
★ 9 MPH GREATER SPEED  
★ 15% FUEL SAVING**

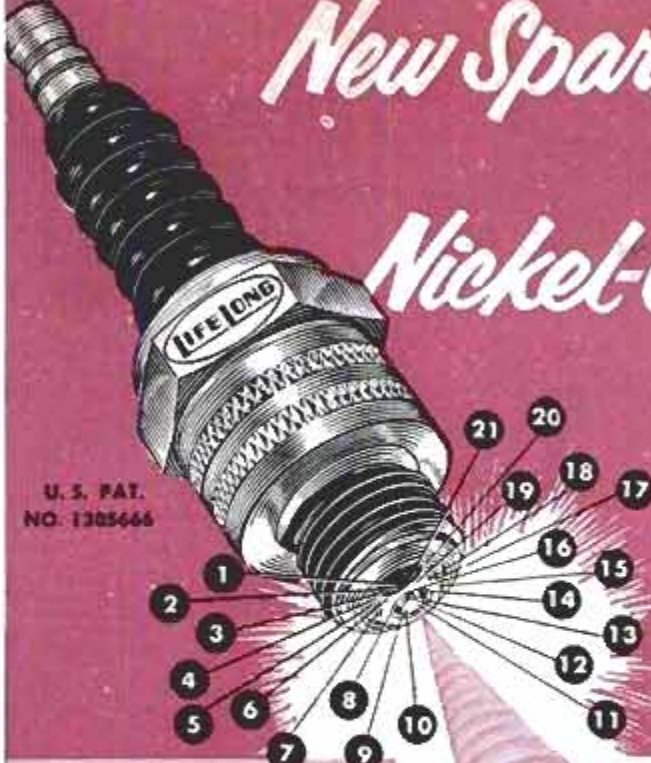

U. S. PAT.  
NO. 1305666

Spark arcs  
from 21 or  
more points

### OIL INDUSTRY RESEARCH DISCOVERS AMAZING ELECTRODE SECRET

Research engineers of leading oil companies recently revealed that nickel-cadmium is the most perfect material yet developed for the electrodes of spark plugs designed for modern high-compression, internal combustion automobile engines. The nickel-cadmium solid electrode of the Life-Long Plug has ideal characteristics of extremely high conductivity and durability, being able to withstand temperatures of 3500° indefinitely.

### BUILT-IN CADALLOY CATALYST

These same research engineers also discovered that a new alloy (which we call Cadalloy) introduced into the combustion chamber of a plug, acts as a catalyst to produce the most efficient fuel combustion. Life-Long Plugs are the first to use this important discovery!

### ATTENTION, OWNERS OF 12-VOLT AUTOS.

Conventional plugs, designed for 6-volt electrical systems, do not function well in modern 12-volt systems. Life-Long Plugs are designed to handle twice the voltage capacity of 6-volt systems. If your car has a 12-volt system, don't be misled—only Life-Long gives you full plug efficiency!

### LIFE-LONG PLUGS ACTUALLY COST LESS!

A set of Life-Long Nickel-Cadmium Plugs will outlast six or more sets of ordinary plugs. You end replacement costs completely. Yet the set of 6 Life-Long Plugs costs only \$8.95 each. Set of 8 only \$11.95.

### ORDER REGISTERED SET FOR YOUR CAR NOW.

Life-Long Nickel-Cadmium Spark Plugs come to you in a tamper-proof, laminated plastic container. Sealed at the factory, your Life-Long Plugs are not touched until you break the seal.



LIFE-LONG SPARK PLUG CORP., Dept. PM-46  
140 Kansas Street, El Segundo, California

Please mail postpaid \_\_\_\_\_ registered sets of Life-Long Nickel-Cadmium Spark Plugs guaranteed to increase my car's mileage, speed and horsepower (Set of 6, \$8.95, set of 8, \$11.95.)

Name \_\_\_\_\_

Street \_\_\_\_\_

City \_\_\_\_\_ Zone \_\_\_\_\_ State \_\_\_\_\_

Year of Car \_\_\_\_\_ Model of Car \_\_\_\_\_

Make of Car \_\_\_\_\_ No. of Cylinders \_\_\_\_\_

Enclose \_\_\_\_\_ check \_\_\_\_\_ cash \_\_\_\_\_ money order \_\_\_\_\_

### LIFE-LONG NICKEL-CADMIUM PLUGS ARE GUARANTEED TO:

- |                                  |                        |
|----------------------------------|------------------------|
| 1—End plug replacement costs     | 4—Improve acceleration |
| 2—Step up engine horsepower      | 5—Give smoother idling |
| 3—Increase your gasoline mileage | 6—End engine knock     |
|                                  | 7—Never need regapping |

With the introduction of sensational new-type Life-Long Nickel-Cadmium Plugs, the spark plug is no longer the "most troublesome, most often-replaced" part of your automobile. In fact, you will never have to replace the plugs in your car once you install a set of Life-Long Plugs!

### LIFE-LONG—WORLD'S ONLY PLUG WITH FULL-CIRCLE FIRING

Life-Long's revolutionary "ring of fire" principle is the first major improvement in plugs in 25 years. Instead of small "spot" spark arcing between the same two points, the Life-Long Plug makes a hot spark 400% to 500% greater in volume, spread around the entire circumference of the solid electrode. The piston stroke of today's high-compression engines is so powerful that it can actually "blow out" the spark produced by old type plugs. Blowing out is impossible with Life-Long's full-circle spark.

Heat is spread around the full perimeter, resulting in cooler electrode temperature. The causes of wear, burning and insulator failure are eliminated.

**SELF-CLEANING.** Because the Life-Long Plug fires simultaneously inside and outside the shell, fuel mixture is ignited at the same time a powerful turbo wiping action, created by the piston stroke, burns and blows out the carbon. Power loss is prevented and you get greatly increased horsepower and gasoline mileage. In a series of road tests, some cars have shown 10 horsepower gain, mileage increase 15% and more.

**PLEASE NOTE:** The Life-Long spark plug is different in every way—not just an "improved" plug, but an entirely new engineering development!

# LIFE-LONG

SPARK PLUG CORPORATION  
140 Kansas Street, El Segundo, California

**THE INSULATOR...** High-voltage patented Ebanite® insulator, developed and used only by Life-Long, has a hardness in the same range as precious jewels. You can identify Life-Long Plugs by the black insulators. This costly new material has 20 times higher thermal conductivity than ordinary insulators.

**THE BUSINESS END**  
... New type solid electrodes have no points to burn off. The "business" end of Life-Long Plug utilizes unique nickel-cadmium electrodes to produce fuller, hotter spark arcing from 21 or more points and spreading around the full 160° circle. Life-Long Plugs have approximately 40 times more firing surface than conventional one-electrode plugs, giving more efficient, even combustion.

**THE SHELL...** Made of a new alloy developed specifically for Life-Long by modern metallurgy. Unlike old style 2-piece shells, the Life-Long shell is one precision-machined piece fused to the Ebanite insulator under tremendous hydraulic pressure and induction to make a positive seal. This prevents "blow-by," major cause of failure in plugs with 2-part shells.

**Bonded Guaranteer**  
"I certify that the set of self-cleaning, 21 pt. Life-Long Nickel-Cadmium Spark Plugs you will receive are identical to those used in my own car for over 100,000 miles. I guarantee that Life-Long Plugs will give you an immediate horsepower and mileage gain and will continue to fire clean, hot and steady without cleaning or regapping."

*J. M. Watt*  
J. M. WATT, President  
LIFE-LONG SPARK PLUG CORP.

Only spark plug guarantee backed by a cash bond held by an independent financial institution (details on request).

### OPPORTUNITY FOR DISTRIBUTORS

Many choice territories are still available. All territories are awarded on an exclusive basis, protected by a written franchise. No charge for franchise. Write, wire or phone today. Cable: Sparkplug, Los Angeles



**A BETTER JOB  
or YOUR OWN SHOP**  
Make \$3 to \$5 an hour as  
you train for big money!

A PRACTICAL NEW WAY TO LEARN

## AIR CONDITIONING & REFRIGERATION

Thousands of trained men are needed right now to service the 150 million air conditioning and refrigeration units in use—and the millions more being sold. You train at home in spare time for a good pay job or a business of your own. Mail coupon today for two FREE BOOKS which show how to break into this big, uncrowded field!

**23 KITS—Build A Freezer Or Air Conditioner**  
You get practical training because CTI sends 23 kits. You get motor, compressor, testing gauges, controls, refrigeration hi-side, tools. You build and keep a freezer, refrigerator, air conditioner or milk cooler as you learn. Get the facts about America's fast-growing industry. Mail coupon today.

### MAIL TODAY FOR 2 FREE BOOKS

COMMERCIAL TRADES INSTITUTE Dept. R-274  
1400 Greenleaf Ave., Chicago 26, Ill.  
Send me your big FREE books which tell me how I can train at home to make top money in Air Conditioning & Refrigeration.

Name \_\_\_\_\_ Age \_\_\_\_\_

Address \_\_\_\_\_

City \_\_\_\_\_ Zone \_\_\_\_\_ State \_\_\_\_\_

Member: National Home Study Council

EARN AS  
YOU LEARN  
AT HOME!

## SCREEN-PRINT ADVERTISING



Make REALLY BIG MONEY supplying never-ending need of business, theatres, stores, clubs, gas stations for Signs, Banners, Posters, Labels, other Printed Specialties—all produced WITHOUT A PRINTING PRESS at low cost by amazing new method!

JOIN OTHERS EARNING TOP MONEY IN THIS BOOMING BUSINESS—**WHY NOT YOU?**

The word's getting around! Everywhere business men are learning how much cheaper, more colorful, faster modern Screen Printing is than ordinary printing. This new process saves merchants as much as 50% on advertising costs—yet you can make up to 300% profit filling orders for Signs, Banners, Posters, other printed Advertising. For the truly ambitious man this ready-made opportunity offers unlimited reward—with earnings as high as \$21,000 a year!

**START SMALL—GROW QUICKLY—**  
You don't have to study for months or years to make money with Screen Printing. Demand is so great you can start to earn as soon as you learn! Work full or part time. Soon as people discover you're a Screen Printer, orders pour in! So new is this remarkable process that many sell successfully entirely by mail.  
**WORK ANYWHERE!** No special space or expensive equipment is required. Start in corner of kitchen, basement, garage, anywhere. We supply everything you need to start

—full instructions, materials, equipment, paper, ink, business development service, personal guidance... everything to learn and earn immediately.

**PRINT WITHOUT PRINTING PRESS—**  
Revolutionary Screen Printing is new, non-technical, easy-to-learn. It is based on an amazingly simple scientific principle that produces beautiful, professional-quality results at once... without any previous experience. For FREE Facts, Actual Samples, Proven Money-Making Plan, mail coupon now!



MAIL COUPON TODAY—EARN MORE SOON

Screen Print Co., Dept. 24  
15127 S. Broadway, L.A. 61, Calif.

Please send me samples and Opportunity Plan for making Big Money in Screen Print Advertising, FREE and without obligation.

Name \_\_\_\_\_

Address \_\_\_\_\_

City \_\_\_\_\_ Zone \_\_\_\_\_ State \_\_\_\_\_

JIM NORMAN  
and  
Millions  
did it!  
So can  
YOU!



LAST  
CHANCE  
Photo Book of  
STRONG MEN also  
FREE for quick action

Come on, Pal  
STOP Being **SKINNY** Like I  
Was!  
In 10 MINUTES of FUN A DAY  
Quickly **GAIN 25 LBS.** of  
**HANDSOME, POWER-PACKED  
MUSCLES** all over! like I did.

Send for these 5 Picture Courses  
ALL 5 **FREE** Before \$1 price goes back.

1. How to GAIN MIGHTY ARMS
2. How to GAIN A BIG CHEST
3. How to GAIN A MIGHTY BACK
4. How to GAIN POWERFUL LEGS
5. How to GAIN A GRIP OF STEEL

Send a dime for postage NOW for all 6 AMAZING  
HE-MEN ITEMS to **JOWETT INSTITUTE**  
Dept. PM-64, 220 Fifth Ave., New York 1, N. Y.

CLEAR  
\$700  
AND MORE  
AN  
HOUR

Finish famous Karle-Kraft Metalware in spare time, using revolutionary spinning machine designed for home use. We supply pre-formed food mixers, giftwares, planters, many more fast-selling items of distinctive design—you give them a fine custom look. Protective franchise helps you get quick return of original investment—steady profits thereafter. Learn about Karle-Kraft's unusual Profit Plan now! Write today for free particulars to Dept. A

**KARLE-KRAFT HOME SHOPS CO.**  
1 Cedar Blvd., Pittsburgh 28, Pa.

## Become a Doctor of PSYCHOLOGY

Win the degree of Ps.D. Learn the secret of contentment, happiness. Solve mental worries. Experience the revelation of truth. Correspondence only. Individual help. Write for FREE book. **COLLEGE OF UNIVERSAL TRUTH, 23B E. Jackson Blvd., Chicago.**

## RADIO

Engineering. All phases radio & electronics theory & practice; television; FM; broadcasting; servicing; aviation, marine & police radio. Prepare for good pay; 18-month course. Graduates in demand by major companies. Enter Jan., March, June, Sept. Regular campus life. Write for catalog. **VALPARAISO TECHNICAL INSTITUTE, Dept. D, Valparaiso, Ind.**



**DRAINS** cellars, cisterns, wash tubs; **\$7.95**  
**IRRIGATES - CIRCULATES - SPRAYS**

Type P Pump has 1,001 uses. Up to 3000 GPH; 450 GPH 80' high; or 1800 GPH from 25' well. Use 1/6 to 3/4 HP motor. Coupling included free. 1" inlet; 3/4" outlet. Stainless shaft. Won't rust or clog! Postpaid if cash with order. Rush your order today.

**MONEY BACK GUARANTEE**  
Centrifugal and Gear Pumps in All Sizes  
**LABAWCO PUMPS, Belle Meade 7, N. J.**

## SAY YOU SAW IT IN POPULAR MECHANICS

Build Your Own Walks,  
Driveway, Outdoor  
Fireplace, Steps, Etc.

What to Make With  
**CONCRETE**



The terrific high costs of even little concrete jobs are mostly for labor. Get Popular Mechanics **WHAT TO MAKE WITH CONCRETE** and save all the labor costs while making your home or farm ship-shape. You can lay foundations, sidewalks and driveways; build steps, outdoor fireplaces, sandboxes, tennis courts, garden and swimming pools and other installations at very little cost. Book shows all—tells all—how to make the right mixture, plan, apply and gives 50 professional short cuts. Hundreds of pictures. Only \$2.00 postpaid. Order today. Money back if not pleased.

**POPULAR MECHANICS  
PRESS**

Dept. PM17, 200 E. Ontario  
Chicago 11, Ill.

**POPULAR MECHANICS**



**WORLD'S  
BEST  
WANT-AD  
MEDIUM**

# CLASSIFIED ADVERTISEMENTS



Advertisements in this section \$1.25 per word, each insertion, minimum 10 words, payable in advance.  
To be inserted under proper classification, copy must be in our office the  
20th of the second month preceding date of issue  
F. W. Johnson, Manager, Classified Advertising  
Popular Mechanics Magazine, 200 East Ontario Street, Chicago 11, Illinois

## YOU'LL PROFIT

By reading and answering the classified ads in this section. Hundreds of opportunities for you to make and save money

### AUTOMOBILES, MIDGET CARS

**AUTOMOBILE** 60" Long, gasoline powered, excellent styling, details. Box 182, Shelton, Conn.

**FREE** Motor magazines, automobile literature; old, new and foreign; glossy photos, dealer books; shop manuals—offered with non-profit organization. Write today; get on free mailing list. Auto Maniacs, Stockbridge, Mich.

**1956 PONTIACS** By mail. Buy 1 or 20. Save 26%! Write for factory net prices. Pontiac Fleet Sales, Box 45144M, Airport Station, Los Angeles.

**ANTIQUA** Automobile color slides. 2x2. Illustrated catalog free. Universal, Box 779A, Beverly Hills, Calif.

**BOYS' Power-driven auto.** Build your own. Plans 25 cents. Sypher Co., Sta. F., Toledo, Ohio.

### AUTO SUPPLIES AND EQUIPMENT

**CAR** Burning oil? Losing compression? Try Clifford's Compression Seal. Tube, \$2 postpaid. Clifford's Engineering, 452 Claim, Aurora, Illinois.

**BUY Wholesale** nationally advertised auto supply, thousands other products at big discount. Free "Wholesale Plan." American Buyers, Hertel Station, Buffalo 16-G1, N. Y.

**TEACH** Driving safely—Our dual brake fits all cars. Attached or detached in 2 minutes, postpaid \$86.95. Reliable Mfg., Box 234, Elizabeth, N. J., Dept. A-C.

**PARTS**—Any make, any year. Antique, classic, foreign, trucks, modern. Otto's Box 294, No. Hollywood, Calif.

**NEVER** Change oil (12½¢ refill) filter. Tissu-Pak, P.O.B. 1115, Sacramento 5, California.

**AUTO-Top** carriers, heavy-duty 44 inch 16-gauge cross-bars. \$8.50 value, \$4.95. Weight 10 pounds. Less cross-bars, \$5.00 value, \$3.50. Weight 4 pounds. Add parcel-post. No c.o.d. 7 day money-back guarantee. Miracle Squeegie Co., 2849 West Madison Street, Chicago 12, Illinois.

**MOTORIST** Save gasoline vacuumating overrich mixtures. For free particulars, how you install on your car for introducing, write Vacuumat, Dept. 855, Wauwatosa, Wis. Salesmen wanted.

**RADIATOR** Like-new using guaranteed Ion-20 cleaner! \$3.00. Free literature. Wong Laboratories, 3259 Madison, Cincinnati 9, Ohio.

**AIR** Condition your car for \$25.00. One plan \$1.25, two \$2.00. Write Aircon, 1718 W. 9th, Sedalia, Missouri.

**SPARK** Booster (patented). Tremendous acceleration, power, mileage. \$2.98. Free folder. Automobiler, 722 W. North Avenue, Baltimore 17, Maryland.

**NATIONALLY** Advertised timing light, compression tester, vacuum gauge. Guaranteed. \$4.45 ea. Save postage enclose money-order. Free literature. Asco Distributing, P.O. Box 189, Coral Gables, Fla.

**GM71-110** Discarded injector parts wanted. Bonus on HV. Bares, 7120 Carnegie, Cleveland 3, Ohio.

**JEEP Owners**—V8 power. Read Jeep Owners ad, page 20.

**SENSATIONAL** (Patented) 100,000 mile motor treatment. Lachapelle's. Renews compression, power. Saves gas, oil, repairs. \$3.00 delivered. Money-back guarantee. You can't lose. Free circular. Write Joe Dillon, Authorized Warehouse, Agents Distributor, Box 32319, Bridgeport, Ohio. Exclusive agencies.

**FORD T** parts? Try best source old car parts anywhere. Wisneski, Milwaukee 7, Wis.

**NEW** And used parts at savings. Complete guaranteed parts service for all models cars and trucks, 1924 and later. Largest in the West. Army parts specialists. No catalog, write for quotations. Fast mail order service. Pioneer Auto and Truck Parts Co., 734 W. 13th Avenue, Denver, Colorado.

**LATEST** Custom accessories. Items not in stores. New low prices. Continental tire kits, push-button doors, trunks, etc. New illustrated catalog, biggest ever. 25c. Eastern Auto, 3319-A South Grand, Los Angeles 7, California.

**AUTO** Accessory and parts catalog. 1956 edition—All new! 164 pages. Save up to 50%—Over 50,000 items. Including Hollywood accessories, hi-speed equipment, rebuilt engines, all parts and accessories for all cars and trucks; Hard-to-get parts! Send 25c (refundable). J. C. Whitney, 1919-PM Archer, Chicago 16, Illinois.

**BRAND** New first quality tires. Tractor, truck, aircraft, passenger. Wholesale prices. Also all size army surplus used tires, at tremendous savings. Duddy's, 152 No. Beacon Street, Boston, Mass.

**FREE** Illustrated, descriptive information "The Truth About Water Injection." Injector, Box 526, Burbank, California.

**FREE** Discount catalog—Speed, power, custom equipment. Almquist Engineering, Milford 7P, Pennsylvania.

**ELECTROPLATE** Auto parts, novelties, mirrors. Easy, inexpensive home processes. Free booklet. Tyco Metals, Box 13231-BG, Houston 19, Texas.

**RACE** Fans! Learn speed of your favorite car and driver on ¼ or ½ mile tracks. Copyrighted time and speed conversion tables. Converts elapsed time for one lap directly to speed in miles per hour. \$1.00. Mark Davis, 212 20th, Toledo 2, Ohio.

### AUTO TRAILERS

**TRAILER** Axles with brakes, truck wheels, springs, \$88.00. Broadway Trailers, No. Branch, N. J.

**"SHORT-Short"** camping trailer. Sleeps four. Plants \$1.75. Welch Workshop, 645 Rochdale Circle, Lombard, Illinois.

**TRAILER** Manual blueprints \$2.00. Booklet 30c. Kamcraft, Box 1153, Milwaukee 1, Wis.

**MOBILE** Home supplies, free list, plan-ettes, 15c. Sharratt, Chili, Wis.

**PICKUP** Canopies, Coach kits, Trailer supplies, Blueprints, Literature 10c. Comstock Trailers, Parsons, Kansas

**BUILD** Your own trailer! Plans for all kinds. Illustrated catalog 10c. Jim Dandy, 125-M, Wausau, Wisconsin.

**EXCEPTIONAL** Expanding eight foot trailer. Accommodates family of five. Build yourself. Literature 10c. Framar Company, Wilmington, Mass.

### MOTORCYCLES, BICYCLES, MOTORSCOOTERS AND SUPPLIES

**MOTORCYCLE** Repair manuals, English, American. Also used and new spares for C-2. Lists free. F. D. Hirsch & Co., Peace Dale, R. I.

**HARLEY-Davidson**—Used bargains, shipped prepaid. New, used parts, accessories for current and obsolete models Bulletin, catalog 25c. Knuth's (factory dealer), 1753 Muskego, Milwaukee, Wis.

**WHIZZER** Motors \$20.00; midget race car reasonable; motorscooter \$6.00; Cushman two-speed \$20.00. Send 25c (35c first class mail) for catalog #30 jammed with sensational bargains in wheels, motors, motorscooters, midget cars, motorbikes, construction plans, etc. Gail, 1313 Jefferson, Toledo, Ohio.

**MOTOR** Scooter parts—Send 25c for list. Give make and model of scooter. Motor Scooter Parts Co., Dept. P4, Box 7211, Indianapolis 1, Indiana.

**"WHAT To Make."** Greatest books ever written. 3,364 projects. 12 volumes. Catalog free. Popular Mechanics Press, 200-WTM East Ontario St., Chicago 11.

**RACING** And stock parts, all makes, all models, new and used, accessories too. Tell us your needs. Cycle Co., 813 Ohio, Wichita Falls, Texas. Our 31st year.

**WHIZZER** Motorbike engine \$5; midget car \$25; Micromidget racer \$65; Briggs Wagonmobile \$19; Doodlebug motorscooter \$15; (mailorder only). Send 25c (35c for first class mailing) for directory-catalogue Number 69, listing these and hundreds of other bargains. Midget Motors Directory, Athens, Ohio.

**RECONDITIONED** Motorcycles and motors, Chromium accessories. Complete stock Indian parts. Expert rebuilding. Fast service. Indian Motorcycle Sales, Kansas City 27, Missouri.

**PARTS, Pistons**, new, used. Harley, Indian, Henderson, list 10c. Ballak, 811 N. 9th, St. Louis 1, Missouri.

**1000** BANKRUPT Motorcycle bargains. Catalog 25c. Bunico, 146, Covington 1, Virginia.

**NSU** And BMW motorcycles, 2 to 35 h.p., singles and twins, chaindrive and shaft-drive. Butler & Smith, P.O.B. 45, New York 24, N. Y.

## AVIATION

**AIRLINE Steward-purser.** Fly 85 hours monthly. Starting salary \$235 up. G.I. approved. Free catalog. Air-Purser School, Room H, 1030 Nicollet Ave., Minneapolis, Minnesota.

**LIGHTPLANE Manual blueprints, etc.** Booklet 30c. Kamcraft, Box 1153, Milwaukee 1, Wis.

**CONSTRUCT Jet helicopter.** Drawings, 50c. Complete plans, \$6.50. Amalgamated Helicopter, P.O. Box 384, Windsor, Ont., Canada.

**BUILD Jet helicopter.** Detailed blueprints \$8.00. Apache Aircraft, St. David, Arizona.

**PROPELLERS.** Plans, supplies—World's oldest and largest manufacturer of special design airboat, snow sleigh propellers. Prompt delivery. Satisfaction guaranteed. 48 page catalog 25c. Banks-Maxwell, Box 3301E, Ft. Worth 5, Texas.

**PROPELLERS.** Plans, supplies for air boats, snow sleighs. Catalog 10c. Gano Propellers, Box 3284-A, Ft. Worth, Texas.

**AVIATION Surplus bargain catalogue.** One dime. Box 22-S2, Thomasville, Penna.

**HELICOPTERS—1 And 3 men.** Aviation marvels. Construct own. Plans \$3.50, \$6.00 respectively. Mayberry Aircraft Manufacturing, P.O. Box 343, St. Clair Shores, Michigan.

## BATTERIES, GENERATORS

**EDISON Nickel storage batteries.** Any voltage, any amperage. Unconditionally guaranteed. Power plants, generators, motors. Literature. Hawley Smith Co., Croton Falls 1, N. Y.

## ELECTRICAL SUPPLIES

**NEW 1956 Lamp parts catalog** showing everything you need to make and repair most types of lamps. Everything at lowest wholesale prices. Send only 25c today for both catalog and wholesale price list. Gearon Co., Dept. 503-B4, 27 S. Desplains, Chicago 8, Ill.

**LAMP And electrical parts—Wholesale.** Thousands of items for building, repairing, and converting lamps. Illustrated catalog 25c. Brown Lamp Co., Box 501, Wellston Sta., St. Louis 12, Mo.

**ELECTRIC Pencil:** Engraves all metals \$1.50. Beyer Mfg., 10511-H Springfield, Chicago 43.

**NEON Stripping,** straight tubing (straight electrodes), 89c per ft. (minimum order 40 ft.) transformer, tube supports, insulators and simple instructions on how to install included. Colors: white, green, blue, red and rose. Give measurements of building and colors desired. Hulme Neon Sign Co., 125 W. Earle St., Anderson, S.C.

**LAMPS,** Parts catalog containing wiring instructions 25c. Gyro Lamps, 5402P Clark, Chicago 40.

**ELECTRICITY, Magnetism set.** 22 instructive experiments. Induction coil, telegraph, motor. \$3.98 postpaid. Free details. Technifun, 8420 Cedarbreak, Houston 24, Texas.

## WELDING, SOLDERING, PLATING

**A.C. Welders.** 4 sizes. Lowest prices. Free literature. Holgeron's Serv., Canton, Kan.

**WELDERS,** 110/220, \$39.50. Morris, 1070 Inner Drive, Schenectady 3, New York.

**ACETYLENE Welding outfits,** new \$49.00; used \$29.00; arcwelders \$56.50. Eagle Welding, Dept. PM, 5085 Broadway, Chicago 40, Ill.

**ELECTROPLATING Equipment,** anodes and solutions for all types of plating. Instructions. Assemble your own plater and save. Free catalog. Ramyr, Dept. E-4, 1624 East First Street, Los Angeles 33, California.

**BUILD 300-Ampere welder** using aircraft generator. Plans 10c including big catalog welder-kits, generators, winches, motors, hydraulics. Dunbar Mfg., 6600 Sylvan, Houston 23, Texas.

**WELDERS Complete guide,** prepaid \$1.00. Harry Noll, R. 3, Lewisburg, Penna.

**NEW And different oxy-acetylene out-**fit welds, cuts, heats, brazes, with interchangeable tips. No attachments needed. Light, portable. Complete outfit, full instructions, only \$78.50. Special money-saving plan for oxygen and acetylene supply. Write for free literature today: Dept. M, Linde Air Products Company, 30 East 42nd Street, New York 17, N. Y.

**"BUILD-UR-OWN" a.c. welder** and a.c. power plant with a good used engine and low cost Hobart generator. Welds anywhere and supplies 5k.w. stand-by power for any emergency. Write Hobartweld, Box M-463, Troy, Ohio.

## MACHINERY, TOOLS, SUPPLIES

**SHEET Metal punches;** sizes  $\frac{1}{2}$ " to  $1\frac{1}{2}$ " for metal shops and neon signs. Abdon Neiss Tools & Dies, 1831 S.E. 49th Avenue, Portland 15, Oregon.

**AT Discount prices—Hardware,** hand and power tools, motors, machinists tools, etc. Send \$1.00 for big illustrated catalog. Alfred A. Supina, Dept. M-4, 35 Evergreen Ave., Hartford 5, Connecticut.

**HARDWARE.** Power tools, taps, dies, brass, steel, drill rod. Stamp for catalog. Terek, 6304 Patterson, Chicago 34.

**SUN Combustion efficiency tester** \$75.00. Vacuum compression gauge \$2.00. Tire theft hose \$2.00. Battery gravity temperature hydrometer \$2.00. New Mall  $6\frac{1}{2}$ " electric saws \$29.95. New  $\frac{1}{4}$ " electric drills \$9.95. Jacobs  $\frac{1}{4}$ " hex key chucks \$2.00. All items prepaid. Ace Surplus Sales, 5159 S. Christiana Ave., Chicago 32, Illinois.

**YOU Can cut threads** on any lathe, drill press on hand. Write Box 63, Maywood, Ill.

**FREE Literature!** Seventeen operations with electric drills. Multi-Tool, Box 13153, New Orleans, La.

**LAWNMOWER Grinder:** New, fast, different. Heavy duty. Only complete mower shop. Includes grinder, lapper, "Lightning" bed knife grinder, built-in bench. Write Turner-Cline, 430 Yellowstone, Pocatello, Idaho.

## SURVEYING INSTRUMENTS

**GUARANTEED Factory rebuilt transits** and levels, sale or rent, with purchase option. We will repair, trade or buy old instruments. Write for list M-64, Warren-Knight Co. (Manufacturers of Surveying Instruments), 136 N. 12th St., Philadelphia 7, Penna.

## ENGINES, MOTORS, DYNAMOS

$\frac{1}{2}$  HORSEPOWER Motors, used, good, \$5.00 each, f.o.b. Plant Machinery Corp., Richmond & Norris Sts., Philadelphia 25, Penna.

**A.C. Generators** 750 watt \$42.50, 1500 watt \$67.50. Motors  $\frac{1}{2}$  horse \$15.00, 1 horse \$35.00, 2 horse \$65.00. Butler, 1885 Milwaukee, Chicago.

**REWINDER'S Supplies,** instructions, equipment plans. Modern, Box 8715, Kansas City 14, Mo.

**REWIND Motors yourself.** Complete instructions \$1.00. Lewis Mfg., Howell, Michigan.

**WINDING Data.** 275 motors, single and three phase, \$1.10. Data Company, Box 7631, Kansas City 28, Mo.

## BOATS, OUTBOARD MOTORS

**STOP Boat leaks forever.** No-sanding Fiberglass process. Evershield, 918 (B) St. Paul, Baltimore 2, Maryland.

**"SPEED-GLAS" Your boat!** Leakproof, wormproof, strengthens and increases speed. Ends annual painting. Easy to do. Our fiberglass kits contains necessary tools and top grade materials. Write for information or include 25c for "Speed-glas Manual." Medina Products, Inc., Box 423, Hondo, Texas.

**BUY Wholesale** nationally advertised outboards, thousands other products at big discount. Free "Wholesale Plan." American Buyers', Hertel Station, Buffalo 16-H1, N. Y.

**FIBERGLASS Top marine grade.** Yard or kit. Ontario Fiberglass Co., Box M, Ontario, N. Y.

**FIBERGLAS.** Complete stocks. Send 30c for two fully illustrated handbooks on coating and molding. Allied Resin Products, 216 Milk St., Boston 9, Mass.

**OUTBOARD Motor parts—New,** used for all makes. Send list of parts needed. Enclose stamp. We save you money. Outboard Motor Mart, Inc., 229M State Street, Boston, Mass.

**FULL Size, cut-to-shape boat patterns,** blueprints, 7 $\frac{1}{2}$ -38 feet. New 1956 illustrated "Build a Boat" catalog of 50 naval architect-designed cruisers, runabouts, sloops, skiffs, outboard boats, sailing, racing, houseboats, 50c. Small boat hardware catalog, \$1.50. Bigger, better 1956 "How to Build Boats" book, \$2.50. Cleveland Boat Blueprint Co., Dept. A-66, Box 1651, Cleveland 4, Ohio.

**FREE Instructions.** Boat docks. Built, installed out of water. Dock Products Company, 3422 26th Avenue South, Minneapolis, Minnesota.

**FREE Catalog!** Boat kits, trailers, fiberglass, marine hardware. Luger Industries, Dept. M, 4452 Nicollet, Minneapolis, Minn.

**MARINE Conversion,** Willys to Cadillac, engines, kits and parts. Catalogue and conversion hints free. Barr Marine, 2706 Castor Avenue, Philadelphia 34, Penna.

**JOHNSON Outboard specialists.** Used parts for all models at substantial savings. Prompt quotations. Specify model serial. Crandall-Hicks, 910 Commonwealth, Boston, Mass.

**NEW, Used, rebuilt marine motors.** Marine conversions, fittings. Free catalog. Stokes Marine Supply, Dept. 24, Coldwater, Michigan.

**MARINE Conversions** for Ford and Jeep engines. Catalog 25c. Lehman Manufacturing Company, 972D Broad Street, Newark 2, New Jersey.

**BOAT Plans.** Welded steel, wood, plywood. Inboards, cruisers, sail. Free literature. Please specify size-type. John B. Clark, N.A., Box 51, Bay Village, Ohio.

**FORDS And Jeeps 100% marine engines** with famous Convo-Kits. Deluxe catalogue 25c coin. Osmotors, 3627B Lawrence, Philadelphia 40, Penna.

**"GLASBOTE" Plastic and glass cloth** for boat covering. Complete information and material price list free. Buchanan Plastics, 1728 Hamilton Road, Okemos, Michigan.

**BOAT Plans, patterns, frame kits.** Modern inboard and outboards 11'-22' for amateur builders. State requirements or send 40c for complete catalog. Glen Designs, Box 568, Compton, Calif.

**WATER Skis,** \$21.95; kits, \$9.95 up. Literature. Enterprise Products, 28400 Gilchrist, Willoughby, Ohio.

**FIBERGLAS Boat coating.** Plexiglas boat windshields—clear, blue, green tints. Wholesale-retail. Complete information catalog—15c. Gem-O-Lite, Box 686M, North Hollywood, California.

**KIT Boats, free folder.** Marine Associates, Box 6188-MM, Long Beach 11, Calif.

**WHOLESALE! Sea Legs boat kits,** factory prices from \$31.98. Savings to 25%. Pre-assembled frames, pre-cut parts, illustrated instructions. Penny Woodcraft Industries, Dept. C-64, Defiance, Ohio.

**FIBERGLAS Permanent boat water-**proofing. Special 25% spring discount. Complete kits, \$9.45 up. Guaranteed materials. Easy application. Full instructions. Free literature. Ajax Plastics, Dept. PM, P.O. Box 1323, Fort Worth, Texas.

## ATHLETIC EQUIPMENT, BODY BUILDING COURSES

**MEN'S Athletic supporters.** Knitted form-fitting pouch. S-M-L. \$1.00. Gordon's, Dept. PM, Box 3203, Ft. Worth 5, Texas.

**FREE Catalogue,** 1000 items. 10c for postage appreciated. Dr. Thompson, 919 Fourth, Manhattan 30, Kansas.

**100 TRICK Knockouts** for self-defense \$1.—1c each. Priest, Box 251, Evanston 1, Illinois.

**BARBELLS.** Exercise equipment. Courses. Free booklet. Good Barbell Co., Reading, Penna.

**4 MUSCLE Courses** 25c. Fully guaranteed. Sid's System, Southgate, California.

**"HOW To Box" book** 99c. Pictures, information by Joe Louis. Refund guarantee. Krajna, Opa Locka 1, Florida.

**BARBELLS, Dumbbells.** Build them yourself! Inexpensive! Complete plans, \$1.00. Perfect Physique, 334 Sutter Street, San Francisco.



## SPORTING GOODS, GUNS, FISHING TACKLE, ARCHERY, TRAPPING

**FISHERMEN** Get your limit fast with SureBite Golden "Jumbo" Grubs. Millions now being shipped. Live delivery guaranteed. Keeps months. 200 extra large \$1.00. Introductory offer. Dealers, distributors wanted. SureBite, Box 1033, Culver City, California.

**SCOUTS & Campers.** Free new catalog with over 5000 outdoor items at lowest prices. Included are tents, sleeping bags, air-mattresses, cook kits, stoves, lanterns, also many G.I. surplus camping goods. Discounts to scouts and church organizations. Free, write today: Goldberg's, 218 Market St., Philadelphia 6, Penna. Phone WA2-8968.

**DISCOUNT** Athletic equipment. Guns, fishing, skin diving. Ryans, Newport, R. I.

**FISHING Tackle**—30% to 50% off! Also guns and camping equipment. Cash or credit. Free bargain catalog. Write to: Klein's, Dept. C-M4, 227 W. Washington St., Chicago 6, Ill.

**FREE Fishing catalog**—132 pages. Over 3000 hard to find fishing specialties. Netcraft Company, Dept. PM4, Toledo 13, Ohio.

**BUY Wholesale** nationally advertised sporting goods, thousands other products at big discount. Free "Wholesale Plan." American Buyers', Hertel Station, Buffalo 16-II, N. Y.

**NYLON Rope, lines, cords.** Every description for all household and sportsmen's uses. Finest made. Free catalog and samples. Beebe Cordage Co., Cranford 8, N. J.

**OLD Guns.** Current prices. Free catalog. Pioneer Books, Harriman, Tennessee.

**180 PROFUSELY** illustrated pages antique pistols, swords, daggers, armor, etc. 50c. Robert Abels, M860 Lexington Ave., New York 21.

**MOLDS**—For making fishermen's sinkers. Free illustrated booklet. Reading Instrument Co., Box 78, Reading, Penna.

**5000 BARGAINS.** Firearms, binoculars, war relics. Catalog 50c. Smith Firearms, Runnemeade, N. J.

**JAP Rifle** altering to 30-06, \$6.00. Japshells, \$3.75. Catalog 5c. T. P. Shop, West Branch 11, Mich.

**WHY Chase fish?** Three drops of our lure on bait draws 'em. Guaranteed. Send \$1.00 to Ficta Sales, Box 944, Kansas City, Kansas.

**DIVING** Equipment for skin divers and professional divers. Send 25c for catalog and decompression chart. Desco, 212 N. Broadway, Milwaukee 2, Wisconsin.

**"SHOCKING"** Expose! Catfish caught with telephone apparatus! Complete details, \$1.00. Pop, Box 6122, Houston 6, Texas.

**LEARN** Gun repairing at home. Profitable business. Details 10c. Modern Gun Repair School, Box 430-P, Marshfield, Wis.

**SAMPLE:** 25c Copy of "The Archers' Magazine." Send 10c. 300 Walnut Street, Philadelphia 7, Pennsylvania.

**SKIN Diver's** catalog. Free. Shows everything from aqua-penell to submarine! Skis, Trunks, Books, Premiums, Aquafun P-M, Davenport, Iowa.

**MANY** Modern, antique guns. List 10c coin. Ed Howe, 52 Main, Coopers Mills, Maine.

**TENTS** (Direct from manufacturer), camping equipment. World's largest selection. Send 15c for 120 page 1956 tent and camping equipment catalogue-handbook. Morsan Tents, 10-21R 50th Avenue, Long Island City 1, New York.

**1,000,000 ITEMS**—Every gun accessory! New, used, antique. Kentuckies, Lugers, Mausers, F38's, Colts, double rifles, swords, armor. Agramonte's, Yonkers 2G, N. Y.

**MOLDS** For fisherman's sinkers, jigs, squids, casting and spinning lures. Free catalog. Sweet's Molds, Tonawanda 1, New York.

**SIX** Inch automatic buoy marker easily made. Automatic stopper part and instructions 25c postpaid. Satisfaction guaranteed. Keller Laboratories, Oneida 2, N. Y.

**FISHERMEN** Catch your limit every time. Our free 1956 catalog tells you how. Hergert Company, Box 741, Coral Gables, Fla.

**JEOP** Owners — V8 power. Read Jeep Owners ad, page 20.

GUNS Magazine, brings you whole wide wonderful world of hunting, shooting. Send 25c in coin for sample copy. Guns Magazine, Dept. PM 8150 N. Central Park Blvd., Skokie, Illinois.

## BINOCULARS, TELESCOPES, MICROSCOPES, MAGNIFIERS

**BUILD** Your own reflector telescope. Complete kit: mirrors, eyepieces, tripod, all other accessories. Request free illustrated literature. Criterion Manufacturing, Dept. KPM16, Hartford, Conn.

**SAVE.** Buy United. America's largest selection. 103 models. \$3.95 to \$250.00. Use on 30 day no risk offer! Free 56 page binocular, telescope, rifle scope catalog. United, 9043 S. Western, A-108, Chicago 20. Dealers wanted.

**DYNASCOPE**—Sensational new reflector telescope. Send for details. Criterion Co., Dept. DP19, Hartford, Conn.

**AMAZING** Prices binoculars, guns, scopes. Free trial. Folder "Binocular Selecting," catalog free. Prentiss Importers, Mercury Bldg., West Los Angeles 25, Calif.

**400 POWER** Telescope easily made. Kit includes focusing tube, erector, five finished lenses and instructions—\$3.75. Giant astronomical telescope complete with tripod \$15.00. Free information. Suffolk Science, Mattituck 3, N. Y.

**6 THUMBS** On each hand? Even you can assemble our telescope kits from our easy instructions. Enjoy the heavens with a high precision telescope assembled in less than an hour. You'll like our complete line of telescopes, microscopes and accessories, biological stains, etc. Send for free Catalog T of finest quality and newest design astronomical kits or free Catalog M of microscopes. Optical Engineering Co., 164-19 Northern Boulevard, Dept. PM, Flushing, New York.

**REFLECTOR** Telescope kits \$6.25 (3") to \$175. (12"). Mirrors, cells, focusing mounts, tripods, eye-systems. Anything, everything in telescopes. Free illustrated catalog. Also ready to use telescopes from \$26 to \$176. Inquiries to Esco Products, Dept. PM, Oakridge, N. J.; Sales showroom 166 Church St., New York City.

**WAR** Surplus bargains! Millions of lenses, instruments, telescopes, binoculars, components and complete line of astronomical telescope items. World's greatest optical market place! Send only \$1.00 for beginner's 10-lens kit and big instruction booklet stock 2-OH. Write for catalog CH, free! Edmund Scientific Corp., Barrington, New Jersey.

**BINOCULARS,** Telescopes, microscopes, terrific values \$3.98 up. Request free money saving catalog. Criterion, Dept. P40, Hartford, Conn.

## PETS—DOGS, BIRDS, RABBITS, HAMSTERS, ETC.

**CHINCHILLAS**—Now you can afford them. Registered, graded stock. Wholesale, \$50.00 a pair, one or a hundred. Price list on request. Fernando Chinchillas, 4963 Densmore, Encino, California.

**PEDIGREED** Police puppies. White or cream. \$30 to \$60. Ansonia Kennels, Mose, N. Dak.

**CALIFORNIAN** Chipmunks lovable pets. \$3.95. Baby alligators, \$3.50. Baby turtles, \$1.00. Nature at Home, 4001 W. Pico, Los Angeles 19, California.

**HAMSTERS,** Pair \$2.95. Free booklet. Jer-Fre's Hamstery, 2425 Hoyt, Muskegon Heights 13, Mich.

**MINK**—\$25.00 each. Bred females for April delivery. Book "Domestic Mink," \$1.00. Harry Saxton's Mink Ranch, Bemus Point, N. Y.

**BEEKEEPERS**—\$1,000,000 French industry. Read "Miracle of Royal Jelly," \$2.50. L. Smith & Co., Box 2003, Hartford, Conn.

**HAMSTERS**—Golden: young, \$3.00 pair; fully developed, \$4.00 pair. Adirondack Hamstery, Prospect 148, New York.

**CHINCHILLAS**—High graded Blend-Trast, Willard George. Wholesale prices. Chinchillas, 21219 Figueroa, Torrance, Calif.

**RAISE** Birds for pleasure or profit. "Encyclopedia of Cage Birds" (parakeets, canaries, all cage birds; questions and answers; illustrations) \$3.95. Audubon Publishing, 3449 N. Western, Dept. P.M., Chicago 18, Ill.

**PEAFOWL.** Pheasants, guineas, bantams, waterfowl, thirty varieties pigeons. John Hass, Bettendorf, Iowa.

**\$1,000 MONTHLY** Possible raising red-worms; large African nightcrawlers! Backyard garage, basement. Illustrated booklet explains raising, packing, marketing. 25c postpaid! Ozark Worm Farm-J, Willow Springs, Missouri.

**CHINCHILLAS**—Whole ale \$75.00 pair. Slater Chinchillas, 2721—132nd, Torrance, Calif.

**RAISE** Rabbits successfully by knowing facts. 48 page illustrated book describing 25 breeds. Housing, feeding, breeding, marketing, etc. Plus bulletin. 25 cents. American Rabbit Association, 38 Arba Building, Pittsburgh, Penna.

**1000 BRED** Mink—Booklet plans 20c. Wetlaufer, Gravel Road, Webster, N. Y.

**EXTRA** Money raising Angora, New Zealand rabbits. Write Martin's Rabbitry, Morganfield, Ky.

**STANDARD** Rabbit Journal, Milton 3, Penna. Year \$1.00. Sample dime. Beginners manual 25c.

**MINK** Raising information free. Complete. Lake Superior Mink Farm, Superior, EEL, Wisconsin.

**CHINCHILLAS.** Registered. Unbelievable prices. Far-West Chinchilla, 1446A Jones, San Francisco 9, California.

**MAKE** Big money! Raise Chinchilla rabbits. Cash markets supplied. Write today! Rockhill Ranch, Sellersville 15, Penna.

**MONTHLY** Bird magazine (budgies, canaries, finches, etc.). One year \$3.00. American Cage-Bird Magazine, 3449 N. Western Avenue, Dept. P.M., Chicago 18, Illinois.

**\$5,199.90** WAS Paid to John Betts, in few weeks. Grow mushrooms. Cellar, shed. Spare, full time year round. We pay \$3.50 lb. Free book. Mushrooms, Dept. 171, 2954 Admiral Way, Seattle, Wash.

**RAISE** Moneymaking Angora, New Zealand rabbits. Particulars free. White's Rabbitry, Jackson, Mich.

**MAKE** Money raising chinchillas, mink, pigeons, rabbits, cavies for us. Free catalog. Keeney Brothers, New Freedom 2, Penna.

## PLANTS, SEEDS, BULBS, NURSERY AND GARDEN SUPPLIES

**CUSTOM** Built lawn rollers. Patent forward-reverse drive. Eaton Roller & Manufacturing Co., 300 N. Meridian, Eaton, Indiana.

**TREES** And shrubs. Raise your own from seed for shade, windbreak, snow fence, ornament, erosion control, etc. For free planting guide, pricelist, write Woodlot Seed Co., Norway 2, Michigan.

**WORLD'S** Greatest cash crop. Free information. Write Ginseng Gardens, Asheville, N. C.

**GINSENG.** Goldenseal. Roots bring up to \$12 pound. Full information. F. M. Collins, Viola, Iowa.

## FARMS, FARM LANDS, REAL ESTATE

**FLORIDA** Lot—\$5 down. Full price only \$99. Located on fabulous east coast near Daytona Beach. Streets, electricity, phones, churches, schools, shopping. Near ocean and St. Johns river. World's best fishing! Write for free photos. H. C. Leff, Box 826, Orange City, Florida.

**NEW** Strout catalog. Just out! Mailed free! Farms, homes, businesses, coast-to-coast. 34 states. 3,046 bargains described. World's largest: 56 years service. Strout Realty, 7-MP 4th Ave., New York 10, N. Y.

**\$5.00** MONTHLY Buys 40 acres productive land; near town; good fishing; price \$250.00; free list. Box 425-P, Carthage, Mo.

**OZARKS!** \$7 Acre. Diversified listings free. Write: Armstrongs, Shook, Missouri.

**FLORIDA**—Beautiful retirement homesites near gulf coast. Excellent hunting, fishing in 9 fresh and salt water rivers. 11 bays and gulf. \$250 at \$10 monthly. Free literature. V. M. Mathews, Box 1406, Asheville, N. C.

**FLORIDA.** Nice homesites, \$245 at \$10 monthly. Folder free. Howard Vernor, DeLand, Florida.

**CANADIAN** Tax sale lands for three dollars an acre and up. Small monthly payments. Farms, timber, hunting and fishing camps, minerals. Limited number of properties. Write at once for free catalogue. Tax Sale Service, Room 105, 120 Bloor St., West, Toronto 5, Canada.

**FLORIDA** Lakefront homesites near Ocala forest. Excellent fishing-hunting. \$10.00 monthly without interest. Complete price \$195-\$995. Literature. Grace Parker, Paisley, Florida.

**HOMESITES** \$15 Monthly—California's finest garden section. Morro Bay's scenic shores. Wonderful fishing, boating. Fertile soil, softest water, temperate climate, congenial community. Free literature. Richard Otto, Department M, San Luis Obispo, California.

**FLORIDA** Waterfront homesites on famous Saint John's river. \$50.00 front foot. Also inland lakefront five miles from river \$195.00-\$995.00. Specify which literature. Easy monthly payments. Pine Lakes, Eustis, Florida.

**FLORIDA** Winter Garden farms, money-making tung groves, and wooded homesites in beautiful Green Hills. Near famous Panama City pleasure resort. World's finest beaches. Many lakes. Best fishing, hunting. 10 and 20 acre farms. Bearing tung groves. Lowest prices, easy terms. Booklet free. Wendell Wood, Fountain, Florida.

**FLORIDA** Retirement in Gulf Highlands offers finest life anywhere for sportsmen, hobbyists. Established community adjoins heavily developed beach area in Florida's fastest growing county. All sports nearby. Lots low as \$345. Complete homesite (two lots) just \$14.37 down, \$14.37 monthly. No interest. Title insured. Color brochure free. Write today! Sam B. Hearn, Developer, Box V-177, Panama City Beach, Fla.

**FLORIDA** Bargain homes. Low taxes. Cummins Realty Agency, Box 848, Eustis, Florida.

**EXCITING** New book, "How to Collect Stamps, Coins, Paper Money." Packed with amazing facts; information worth dollars. Fully illustrated, 160 pages. 75c. Popular Mechanics Press, 200-ST E. Ontario St., Chicago 11, Ill.

**CENTRAL-American** homesteads open, file-develop while living U.S.A., mining-construction, import-export business. Foreign and U.S. Islands. Information \$1.00. Inter-American Development, P.O. Box 264D, Avalon, Calif.

**RICHLAND** Garden Farms near Atlantic City, N. J. (world's playground), fine poultry-garden wooded acre homesites for retirement. Excellent fishing-hunting nearby. \$10.00 monthly, \$50.00 down. Price \$495.00. DeMay Realty, P. O. Box 581, Philadelphia 5, Penna.

**FLORIDA**—Several 5 acre tracts, grand climate and location near Gulf Mexico. For fishing, boating and bathing. Priced at only \$985.00, \$30.00 down, \$20.00 month. For information write G. B. Potterfield, Dept. X, Union Bldg., Charleston, W. Va.

**CALIFORNIA** Farm and ranch lands. \$15 to \$35 per acre. 10 to 640 acre parcels. Easy terms. Free catalog. Pacific Tax Sales, 1621-A Cahuenga, Hollywood 28, California.

#### FARM MACHINERY AND SUPPLIES

**GOPHER** Or mole troubles. Famous Cinch trap is the answer. \$1.25 postpaid. Morton Specialties, 404 Prospect Avenue, Manhattan Beach, Calif.

#### POULTRY, FARM SUPPLIES

**RAISE** Turkeys the new way. Information explaining how to make up to \$3,000.00 in your own backyard. Literature 10c. Address—National Turkey Institute, Dept. 3, Columbus, Kansas.

#### PROFITABLE OCCUPATIONS

**BEST** Paying jobs are in foreign lands; Alaska, Hawaii, South Seas, Asia, Africa, South & Central America. Transportation, hospitalization and bonus. We guarantee to list every current job for every type of work. Send \$2.00 for airmail list: World Wide Employment, P.O. Box 5391-A, Metro, Sta., Los Angeles, Calif.

**MANUFACTURE** Cutting tools and gages. Send for catalog on hardened high speed steel drill blanks. Warwick Twist Drill Co., 16167 Warwick Rd., Detroit 19, Michigan.

**JOBS** On ships. Experience unnecessary. Write Box 494-P, Baltimore 3, Maryland.

**BUY** Wholesale thousands nationally advertised products at big discount. Free "Wholesale Plan." American Buyers' Hertz Station, Buffalo 16-B1, N. Y.

**MUSHROOMS** Grown boxes. Manureless process. Spawn \$1.00. Gordons, 553 William, Winnipeg, Manitoba.

**WELDING** Pays big money. Learn easily at best equipped school in country. Non-profit school with low cost training. G.I. approved. Write Hobart Trade School, Box M-462, Troy, Ohio.

**\$5,199.90** WAS Paid to John Betts. In few weeks. Grow mushrooms. Cellar, shed. Spare, full time, year round. We pay \$3.50 lb. Free book. Mushrooms, Dept. 99, 2954 Admiral Way, Seattle, Wash.

**RAISE** Everbearing strawberries. Unlimited demand everywhere. Make thousands dollars from acre. Write. Samouce, 1668 Forsyth, Macon, Ga.

**YOUR** Own wholesale business with no investment. Free catalog. Jay Norris Co., 487X Broadway, New York City.

**FOREIGN** Jobs—Latin America, Alaska, Canada, up to \$1500 monthly. Up-to-date 1956 foreign service directory gives complete information; hot list of firms hiring for military and civilian construction, aircraft, oil, exporters-importers, mining, \$1.00. How-when-where to apply. 9th successful year! Global Reports, Box 883-S, Hollywood 28, Calif.

**FREE** Folio "\$5,000-\$45,000; Unlimited Vacations." No merchandise, equipment. Unknown! Work home, sparetime! Haylings, Carlsbad, Calif.

**MAKE** Good money, weather-proof doors and windows, do other home services, new easy methods. Box 274, Ogallala, Nebr.

**CONFIDENTIAL** Reports on best paying jobs with travel, adventure, promotions. Construction, aviation, shipping, laborers, clerical, trades, supervisory, factory, unusual opportunities, all types of work. Skilled and unskilled. Foreign and state-side openings for men and women. Only \$2.00, including year registration-advisory service. Reports airmailed same day order received. Guaranteed best service available or double your money back. Research Services, Suite 207-PMC, Brown Building, St. Louis 5, Missouri.

**MAGAZINE** Subscriptions. Largest commissions, bonus. Qualified Agency, 451DA Kingston, Brooklyn 25, N. Y.

**MUSHROOM** Spawn seed plus directions manureless, various, growing, marketing \$1.00. Free information, gladly. Luxur, 641 South 19th, Newark 3, New Jersey.

**JOBS**—High pay. South America, the Islands, U.S.A., foreign countries. All trades. Clerical, labor, engineers, drivers, others. Women also. Fare paid. Application forms. For information write Section 92F, National Employment Information, 1020 Broad, Newark, N. J.

**FREE** Book "505 Odd, Successful Businesses." Work home. Pacific, Oceanside, Calif.

**RAISE** Pheasants on \$100 week plan. Little capital and space can make you independent. Free details. Great Central System, Columbus 1, Kansas.

**MAKE** New greaseless doughnuts in kitchen. Sell stores. Free recipes. Michael Ray, 3605 South 15th Ave., Minneapolis 7, Minnesota.

**BE** The Popular Mechanics representative in your neighborhood and earn big profits in your spare time. Write Popular Mechanics Magazine, Room 408M, 200 E. Ontario St., Chicago, Ill.

**FORTUNE** Possible raising fishworms and crickets. Free literature. Carter Wormery, Plains, Georgia.

**WHOLESALE** Catalog! 30-80% discounts! Appliances, musical instruments, typewriters, phonographs, watches, jewelry, recorders, housewares, etc. Consolidated Distributors, 21-14 Lafayette, Paterson 15, New Jersey.

**AUCTIONEERING**—Home study course. Diploma granted. Auction School, Ft. Smith, Ark.

**MAKE** Flexible molds. Cast figurines, plaques. Free sample. Tooker, 630-M Chestnut, Hamilton, Ohio.

**FREE!** "301 Profitable Small Businesses!" Amazing shoestring plans! Work home! Start sparetime! Deumant Surveys, Kenmore 23-PM, N. Y.

**FOREIGN** Employment construction work. If interested in foreign projects with high pay write Foreign Service Bureau, Dept. PM, Metuchen, N. J.

**VENDING** Machines earn big money! Request 32 page free catalogue. Parkway Machine Corporation, Dept. 25, 715 Ensor St., Baltimore 2, Maryland.

**\$150 WEEK**—Easy! Start home Venetian blind laundry. Revealing book free. A.T. Co., 101 S. 44th, Philadelphia 4, Penna.

**ROOT** Cuttings for profit or pleasure. \$1.00 illustrated booklet explains how. Orchard Nursery, Route 3, Mobile, Ala.

**PHILADELPHIA**, Sunday classified airmailed \$1.00. The Ronoco Co., 178 W. Raymond, Philadelphia 40, Pa.

**JOBS** Paying to \$350 weekly now available on overseas and American projects. Men and women. All trades. Transportation paid. Free information. Write Transworld, Dept. M1, 200 W. 34th St., New York, N. Y.

**EVERYBODY** Likes candy. Learn to make professionally home. Our 45th year. Ragsdale Candies, D6, East Orange, New Jersey.

**BUY** Wholesale 750,000 products. Details free. Carter, Box 6011-D, Chicago 80.

**GOOD** Jobs now available in Southern California. Send \$1.00 for latest guaranteed list. California Jobs, 601-B South Vermont, Los Angeles 5, California.

**FOREIGN**, Alaskan, U.S.A., jobs! Earn to \$1500.00 monthly. Million Americans employed overseas. Opportunities galore. Latest copyrighted reports. Who to contact for highest paying jobs. Laborers, trades, truck drivers, equipment operators, helpers, clerks, engineers, many others. Over 52 countries—St. Lawrence project, Spain, Latin America, northern projects, Europe, Pacific, etc. Year registration-advisory service. Application forms. Unconditional money-back guarantee. Act today! Only \$2.00. Airmailed \$2.25. (C.O.D.'s accepted). International Reporter, St. Louis 1-PE, Missouri.

**LOS** Angeles is booming, classified help wanted ads airmailed \$1.00, remails 25c, unlimited monthly \$3.00, folio on Southern California. Free details. Yoder Service, Box 95, Upland, California.

#### BOOKS, PERIODICALS, PICTURES, POSTCARDS

**MEDICAL** Books, all subjects. Special offer to laymen. Reduced prices. Write for free list. Milbon Medical Book Co., 6643 Newgard, Chicago 26, Ill.

**SEND** 10c For copy of "Rockets." Box 271, Pittman, Nevada.

**TAINTER'S** Book Shop, Temple, N. H. Books on everything. Try our search service.

**WARTIME** Cook book. Collectors item. Younger generation should see. \$1.00 ppd. Books, 6643 Newgard, Chicago 26, Ill.

**BOOKS**. Free 1956 catalog, 100 pages. Text, vocational, educational, instructional subjects. Millions of volumes, new and used. Bargain prices. Books bought. Est. 1902. Long's College Book Co., Dept. PM, Columbus 1, Ohio.

**RARE** Magazines! Send 10c for prices. Nationwide Magazine Exchange, Box 1375-P, San Antonio 6, Texas.

**BOOKS** Found! Any author, old or new. Rush titles wanted; no obligation. International Bookfinders, Box 3003-PM, Beverly Hills, California.

**BOOKFINDERS!** All subjects. Send wants! Jaher Book Service, 183 Hazelwood Drive, Westbury, N. Y.

**"SCIENCE** Milestones." Records march of science starting 400 years before Christ, right up to date. Amazing facts revealed. 312 pages packed with startling information that will thrill you. A real history of science. \$5.00. Literature free. Popular Mechanics Press, 200-SM East Ontario St., Chicago 11, Ill.

**NATIONAL** Geographic Magazines, 1888-1856. Periodical Service, Box 465-PM, Wilmington, Delaware.

BOOK Catalog, 1000 interesting titles. Send 10c. Books Publishing Co., Amityville 3, N. Y.

WIN Success quickly. Send dime. (Refundable). Pop Vallon, 63 Perry, New York 14, N. Y.

### GAMES, TOYS, NOVELTIES

PAINT Them yourself kit. Five soldiers. \$1.00. Jones, 504 Lunt, Desplaines, Ill.

### MAGIC TRICKS, PUZZLES, JOKER NOVELTIES

LARGE Professional magic catalog \$1.00, including free dollar mystery cigarette case. H. Seltzer, 1639 Fulton Avenue, Bronx 57, New York.

VENTRILOQUIAL Course \$1.00. Figure catalog 35c. Magic catalog 50c. Finis, 624 West 3rd, Waterloo, Iowa.

FOUR Deluxe baffling puzzles \$1.00. Lejac, 135 Aspinwall, Westbury, N. Y.

500 TRICKS, Douglas famous 120-page catalog, only 10c. Fastest service to magicians for 30 years. Send 10c today. Douglas Magicland, Dept. 1, Dallas, Texas.

FUN With mechanics. Watch them try to use lead nails, screws, drill bits. Ten for dollar. Ditto Casting Co., 152 Riverdale Ave., Yonkers 2, N. Y.

THRILLING 224 Page catalog. Magician's tricks, Houdini escapes, handcuffs, amusement goods and "Mystery Review Book." All \$1.00 prepaid. Magician Heaney Co., Oshkosh, Wis.

GO Ventriloquist, all secrets told. Make money, surprise friends. Send 35c for information. Free \$1.00 catalogue of dummies, dialogues, etc. Limited supply. Gough, R. 3, Hartford City, Ind.

COMPLETELY Illustrated 500 trick magic catalog 25c. Stowell, Woodstock, New York.

3100 NOVELTIES, Jokes, tricks, gadgets, funmakers, hobbies. Big catalog 10c. Johnson-Smith, D-252, Detroit 7.

SMOKEBOMBS 25c. 7 For \$1.00. Terrific! 4463-PM Greene, Philadelphia 44.

BEST Magic, Joker's novelties. Lower prices. Catalog 10c. Top Hat, Evanston 12, Ill.

DOLLAR Magic set free with catalog 25c. 4462-PM Germantown, Philadelphia.

FREE Trick and professional catalog of 800 tricks, \$1.00. Terry's Magic Studio, 1921-66th Street, Brooklyn 4, New York.

SENSATIONAL Magician's wand 25c. Vanishes handkerchief! Catalog included. Box 1352-PM, Philadelphia 5.

500 TRICKS, Douglas famous catalog, 10c. Fastest magic service for 30 years. Douglas Magicland, Dept. 1, Dallas, Texas.

PROFESSIONAL Catalog, 175 pages, 25c. Williams, 900 Plymouth, Ellwood City, Penna.

WOODEN Nickels, Magic catalog, free trick, 10c. Fun'n Magic, Box 1375, San Antonio, Texas.

SVENGALI Trick deck free with catalog 50c. 1746-PM Market, Philadelphia 3.

VENTRILLO, Professional voice-throwing instrument and catalog 25c. Box 971-PM, Philadelphia 5.

5 SUPER And 38 assorted paper tricks, big surprise included, \$1.00. Lhgco, 19-H East 16th Street, New York 3, N. Y.

IT'S Hot off the press! Send 10c (to cover postage and handling) for new catalog of magic tricks. Entertain and amaze friends. Send dime today to: Chicago Magic Center, America's Largest Magic Suppliers, 19 W. Randolph St., Chicago 1, Ill.

### COINS, TOKENS, CURRENCY

CANADIAN Coin catalogues complete with prices and mint reports, \$1.25. Chuck's Coin Shop, 682 Main St., Winnipeg, Canada.

TWO Different uncirculated Morgan dollars \$3.00. Bargain lists free. Sayers, 1000 East Unaka, Johnson City, Tennessee.

OLD Money wanted. Will pay fifty dollars for nickel of 1913 with Liberty head (no buffalo). We pay cash premiums for all rare coins. Send 4c for large coin folder. May mean much profit to you. Numismatic Co., Dept. 20, Fort Worth, Texas.

\$3,000.00 FOR 1913 Liberty head nickel. Dimes 1894-S, 1895-O, 1916-D. Quarters 1827, 1896-S, 1901-S, 1913-S, 1923-S, we pay \$5.00 to \$1,500.00. Certain dates—Lincoln cents, \$60.00. Indianheads, \$60.00. Large cents \$500.00. Eagle cents, \$200.00. 2c pieces, \$45.00. 3c pieces, \$60.00. Half-dimes, \$500.00. Shield nickels, \$100.00. Old dimes, \$300.00. 1875 Canadian quarter, \$50.00. Hundreds of others worth \$5.00-\$500.00. Wanted—Half dollars, dollars, gold coins, paper money, etc. Know their true value. Our large illustrated guarantee buying-selling catalogue, giving complete all coin information—Send \$1.00. Purchase catalogue before sending coins. Catalogue money refundable. Worthycoin Corporation, Leaders Numismatic Quotations, K-140-C, Boston 8, Massachusetts.

FIVE Foreign coins from Switzerland, Belgian East Africa, etc., plus foreign banknote, only 10c with coin approvals. Littleton Coin Company, Littleton R1, New Hampshire.

AMERICAN Coins! Stamps! Extensively! Sullivan, 127-FF East Fourth, St. Paul 1, Minnesota.

GET Profit and pleasure in collecting old coins. Send 10c for 56-page illustrated coin catalog. You'll be delighted with it. Send for it now. B. Max Mehl, 370 Mehl Building, Fort Worth, Texas. Largest rare coin establishment in U.S. Established 56 years.

6-IN-1 Special: Magnifying glass; check list; 25 coin envelopes; giant 60 page bargain catalog; ten different Indian pennies; Mexican ten-peso: All six, \$1.00 postpaid. Ben's Coin Shop, 31 North Clark, Chicago 2, Illinois.

FREE! Foreign coin, banknote and coin collectors illustrated catalog to approval service applicants. Send 3c postage. Tatham Coinco, Springfield 30, Mass.

MORGAN Dollars; 1878, 1887, 1890, 1891, 1897 S mint unc. \$2.00 ea. Illustrated catalogue, 25c. Shultz, Salt Lake 10, Utah.

SAN Francisco mint closed! Made only cents and dimes in 1955. In short supply and great demand. One each, brilliant uncirculated, for 25c. Free coin lists with order. Bryson Stamp & Coin Company, 612 White, Toledo 5, Ohio.

FIVE Page bargain list. Five Indian-head cents, 25c. Economy Sales, Box 227, Mansfield, Mass.

LARGEST Coin magazine (160 pages) 35c. Scrapbook, 7320-J Milwaukee, Chicago 31.

40 DIFFERENT Selected coins, \$1.00. Oddehon, Box 482, St. Louis, Mo.

COIN Collector's greatest magazine, huge illustrations, 10c. Lawrences, Anamosa, Iowa.

1955 SAN Francisco coins are advancing in price. Per roll: Cents, \$1.90; dimes, \$7.25. 1955 Denver dimes, \$6.75 per roll. Smallest Denver issue since 1938. Proof Maria Theresa thaler 1780, \$2.50. Oliver James, Box 299, San Francisco 1, Calif.

BRILLIANT Uncirculated complete sets—Jefferson nickels \$19.75; Roosevelt dimes \$14.95; Franklin \$12.24.75. Giant bargain catalogue 50c. Bebee's, 4514 North 30th, Omaha 11, Nebraska.

SENSATIONAL Illustrated U.S. 16 page coin list 10c. Stoney, 192 Washington, Boston 8, Mass.

MINT Set 1953 pds uncirculated \$5.75. Bargain list U.S. coins free. L. C. Dillon, 513 Cliffside Drive, Columbus 2, Ohio.

UNCIRCULATED Sets and singles—Coin supplies. Dealers write for wholesale prices. Louis Bell, Masonic Bldg., Decatur, Alabama.

\$12,500 FOR One silver dollar! What are other U.S. coins worth? Fell's U.S. Coin Book gives value of all U.S. coins from Colonial times to present. Also, how to collect them, what makes them valuable, how to sell coins, and everything else. Profusely illustrated, hard-cover book. \$2.00 postpaid from: Fell, Publishers, 386B-15 Fourth Ave., New York City 16.

ROLLS Uncirculated 1955S, 1955D dimes \$7.00, 1955S cents \$1.75. Jack Turner, Prescott, Arizona.

FULLY Illustrated catalog U.S. currency, gives values. \$1.00 postpaid. Large \$10.00 note \$14.00. Quaker Currency Co., Box 3654, Washington 7, D. C.

20 DIFFERENT Indian head cents \$1.00. Lists free. Chelsea, 26 West 18 St., New York City 11.

### STAMP COLLECTING

MINT U.S. flag set, \$1.00 with approvals. Naco, 682 Pearl, Benton Harbor, Mich.

COLORFUL Brilliant Japanese pictorials (mostly mint, bi-colors) including complete sets, 22 different. Catalog value over \$2. Only 25c with approvals. Elliott Norton, Box 926, San Antonio 6, Texas.

FREE Stamps! 2 for 1c approvals! Dahlsten, Box 75, Warrensburg 22, Mo.

COMPLETE Washington bicentennial set, 12 stamps only 20c, with United States approvals. Stamp Shop, 719 Pierce St., Sioux City, Iowa.

FIRST U.N. set. Among world's prettiest. Only 10c. Approvals, Welles, Box 1246-R, New York City 8.

U.S. Stamps. Top philatelic investment. At discount prices. Giant illustrated catalogue. Only 10c. Raymax, 37-VZ Maiden Lane, New York City 38.

PAYING High prices for approvals? Try ours at 1c and 2c in books of 1,000. Special offers and U.S. available. Clark Stamps, Dept. A-45, Muskegon Heights, Mich.

PICTORIAL Packet from Antigua, Barbados, British Guiana, British Honduras, Burma, Curacao, Leewards, Rhodesia, Trinidad, Tobago, and many other hard to get countries. Bicolors, topicals. Tremendous value. Each stamp a beauty. 10c with inexpensive, attractive approvals. Wolverine Stamps, Dept. A-27, Fruitport, Michigan.

SPACEPHOBIA? Fill your pages from our 1c-2c books of 1000. BKJ, Astor Sta., Boston 23, Mass.

40,000 VARIETIES Available on approvals, 1/4c upwards. Keigwin, Box 933B, Daytona, Florida.

MINT U.S. lot 10c. Approvals. Wilson, 6 Cypress St., Carteret, N. J.

TWO \$5.00 U.S. stamps plus 20 different, 10c with U.S. approvals. Irwin, Box 1105, Brooklyn 30, N. Y.

30 DIFFERENT Commemoratives, 1893 up, 10c. U.S. approvals. K & B, Box 5, Brooklyn 14, N. Y.

FULL Mint sheet foreign stamps. A real curiosity for your collection. 10c. No approvals. Lakewood Postal Exchange, 2226 Lincoln, Lakewood 7, Ohio.

UNHINGED U.S. mint approvals, singles, blocks, plate blocks. References please. Illustrated catalog 10c. Dale Dronso, 3647A Plankinton, Cudahy, Wis.

SAMOA, Borneo, Fiji and many other South Sea islands stamps, all for 10c. Approvals. Hallmark Stamps, Dept. M-1, Box 539, Wellston Station, St. Louis 12, Mo.

FREE Sample stamp newspaper, information on collecting, special lists. Approvals. Littleton Stamp Co., Littleton A1, New Hampshire.

FREE! Giant catalog offering thousands of bargains. Sent with beautiful approvals. Jamestown Stamp Co., Dept. EAPMC, Jamestown, N. Y.

UNITED States or Canada collection on approval. Enclose 10c. Peterson, Box 31, St. Paul 2, Minn.

TRAVEL Through fifty countries! A virtual world cruise! Each stamp from different country, Abyssinia to Zanzibar. Bargain unsurpassed! To new approval applicants, 5c. Avalon Stamp Co., Dept. M, Springfield, Mass.

25 PHILIPPINES 10c. Worldwide approvals. Moffat's, 740-A Milton, Rock Hill, South Carolina.

AMAZING Savings! Picture stamps by the thousands; choose choice ones for pennies. Approvals postpaid both ways. Costs nothing to try us. The Elders, El Venado Dr., Puente, Calif.

U.S. \$5 Coolidge 25c. Approvals. Gatewood, Box 346, Winston-Salem, N. C.

FREE Monthly stamp newspaper, Stories, contests, cartoons, etc., and an exciting stamp error. Send 25c for handling. TV Stamp News, 109L West 43 St., New York City 36.

CORONATIONS, Triangles, sports, animals, free with approvals. Exotic, Box 482-M, Coral Gables 34, Florida.

45 DIFFERENT United States 10c, approvals. Standard, 10840 Woodview, Parma Hts. 30, Ohio.

**KOREA** Flowers, Formosa Chiang Kai-shek birthday issue, Hungary pic.orials, Ceylon (elephant) Royal Visit, South Africa Cape of Good Hope triangle centennial, Italian Colony flowers. Nine bi-color maps, African wild animal set. Many more beauties. All for 25¢ with interesting approvals. Every continent represented in this collection. Modern Stamp Co., Dept. A-3, Ferrysburg, Mich.

**FREE!** 107 British Colony stamps. All different, from Britain's farflung colonial empire. Catalog value \$2.50. Free stamp magazine. Approvals. Send 10¢ for handling. Act now! Niagara Stamp Co., St. Catharine's 71, Ontario.

**GIGANTIC** Collection free. Includes triangles, early United States, animals, commemoratives, British Colonies, high value pictorials, etc. Complete collection plus big illustrated magazine all free. Send 5¢ for postage. Gray Stamp Company, Dept. PM, Toronto, Canada.

**WOW!** 135 All different Germany 10¢. Zeppelins, semi-postals, airmails, high values. Big bargain lists and approvals included. Jamestown Stamp, Dept. A4PMC, Jamestown, N.Y.

**FREE:** Mint British Colonies from Brunel, Papua, New Guinea, Caymans, Gilbert Ellice, Seychelles, Sarawak, Grenada. Free with approvals. Viking, Great Neck 8, N.Y.

**BULGARIA** Pictorials: 50 diff. 15 cents. approvals. Boger, Box 152, North Wales, Pennsylvania.

**RUSSIA.** 25 Exciting gems 5¢ with approvals. Belmont Stamp, Washington 15, D. C.

**300 DIFFERENT** Given free with approvals. Particulars. Windsor Stamps, 8834 Cornell Ave., Chicago 17.

**U.S. Approvals.** Five 19th free. Teddie, B782, Crystal Beach, Florida.

**100 DIFFERENT** Worldwide 10¢; 500, 75¢; 1000, \$1.75; 5000, \$13.75. Price list free. Philatelic House, Rockville Centre, N. Y.

**ECONOMICAL** 1/2c, 1c, 2c. Approvals, 22,000 varieties available. Dresel, Box 270-N, New York City 25.

**100 YEAR** Old United States stamps are sent on approval together with all commemoratives, airmails, etc. Also all foreign, Roosevelts, etc. Send 10¢ for 50 different U. S. and approvals. Globus Stamp Co., 268-4th Ave., New York 10, N. Y. Dept. 213.

**50 DIFFERENT** Bulgaria 10¢! Approvals. Ensign Stamp Company, Dept. M, Berdan Avenue, Paterson 2, New Jersey.

**FREE!** World's 10 ugliest! Weird colors, valuable cut design. Send 3¢ postage today! Norrisco, Milwaukee 7, Wis.

**FREE** U.S. stamps, 1943 occupied nations flag, airmails, commemoratives included, collection of 25 different U.S., plus \$5.00 stamp. Everything for 10¢ mailing charge. Approvals. Willett Stamps, 141-A, E. Main St., Mount Kisco, N. Y.

**OLYMPIC** Set, 1000 hinges only 10¢. Approvals. Buckley, 208 Ludlow Bldg., Dayton 2, Ohio.

**STAMP** Collecting outfit. Includes packet worldwide stamps, package hinges, watermark detector, millimeter gauge. Everything, 10¢ with approvals. Lorain Brown, Marion 1, Michigan.

**100 CHINA** 10¢. Approvals, gifts. Coast, P.O. 2187H, Santa Ana, California.

**SELL** Your surplus good grade stamps. Write, describing fully what you have. Vanroy Shirk, Lebanon, Pennsylvania.

**FREE!** Surprise packet with approvals. Pioneer, Box 414M, Pasadena, California.

**GIANT** Approvals, thousands different, 1c and 2c each. Wahl's Stamp Exchange, 7008P Farragut, Chicago 31, Ill.

**FREE!** Catalog! About stamps. Illustrated. Free! The Stampmart, Hartford 1, Connecticut.

**WONDERFUL** Offer, 7 complete mint sets only 10¢ with approvals. Reich (M26), 1033 Lawrence, Chicago 40.

**1000 DIFFERENT** 95¢. John Hourigan, 1500 Archer Road, New York 62, New York.

**FREE** United States price list. Mark Hanna, 335 Fifth Ave., Pittsburgh 22, Penna.

**50 DIFFERENT** Argentine 10¢. Approvals. Reuter, 611 W. 40th Pl., Los Angeles 37.

**OLD** Scarce U.S. seconds on approvals. Slight imperfections, lowest prices. Hornfield, Clintonhill Sta., Newark 8, N. J.

**THOUSANDS** Of exciting stamps, all different, yours for 1c, 2c each. Fill your album for pennies! Big collection sent for free examination. Cole, 43-A Rinewalt, Buffalo 21, N. Y.

**50 DIFFERENT** United States 5c with bargain approvals, lists. Bookman, Box 8245-M, Madeira Beach, Fla.

**U. S. Classics.** Over 50 yrs. old. 15 selected old-timers. Missing in biggest collections. All 15 at less than 1c each. 10¢ with approvals. Jaro, Box 246-T, New York City 8.

**AMAZING** Offer! 200 United States stamps—including commemoratives, airmails, high denominations to \$1.00. Only 10¢ to approval applicants! Illustrated bargain lists free. Mystic Stamp Co., Dept. 80, Camden, New York.

**FREE** Sample! Interesting, illustrated, informative! National Stamp News, Anderson, South Carolina.

**300 DIFF.** World wide 25c, plus surprise packet. Packet list free. Econopackets, Box 168, Riverside 9, Calif.

**WORLD'S** Largest stamp (7 1/2 x 14 inches). A real curiosity! Retail for 50¢, only 3¢ to approval applicants. Tatham Stamp Co., Springfield 30, Mass.

**WEIRD** Diamond shape coffee stamp! Lovely flower triangle! First American big commemorative, Greenland, idol dancer, etc. Free with approvals. Capital Stamp Co., Little Rock 2, Ark.

**100 OLD** United States between 1861 and 1935, \$1.00. Roush Stamps, 51 Chestnut, Mansfield, Ohio.

**225 STAMPS** For only 10¢! This mammoth value includes airmails, pictorials; stamps from strange countries cataloging up to 25¢ each! Also approvals. Mystic Stamp Company, Camden 80, New York.

**FAMOUS** Men, jungle scenes, zoo, United States commemoratives, 100 others. Ten cents with request for thrifty approvals. Casner Stamps, 247-A Riverside, El Paso, Texas.

**14,000 DIFFERENT**—Yours on our streamlined systematic club plan for only 50¢ weekly. Big shipment every two weeks. Details free. Sjoquist, Box 217, Valley Stream 75, New York.

**MINT** Commemoratives at face! Send 25¢ for surprise packet of all different, mint U.S. commemoratives. Mint U.S. approvals too. Western, Box 1689P, Salinas, California.

**UNITED** States approvals. Select copies, used—mint. Kingsbury, Fairfax, Vermont.

**TRINIDAD.** 12 Different. 10¢ with approvals. Seminole Stamps, Box 1138-P, Coral Gables 34, Florida.

**PACKETS!** 10¢ each. Free lists. Karr Ross, 2614 Elmwood, Alexandria, Virginia.

**315 DIFFERENT** 25¢. Approvals. Hathaway, P.O. Box 145, Garden City, N. Y.

**SUPERIOR** Worldwide mission mixture. Amazing variety! Half pound only \$1.50. Baye Nielsen, 4545B Harvard, Montreal 28, Canada.

**200 DIFFERENT.** Including Macau, Rhodesia, Caymans. 10¢ to approval applicants. Evden, Box 128, Valley Stream 50, New York.

**100 DIFFERENT** Austria 10¢. Aronson, 91 Marion, Brookline 48, Mass.

**U. S. Revenues** on approval. El Jay Stamps, Box 286, New York 36, New York.

**CATALOG** Disregarded: Giant approvals. Easy to fill sets, spaces. No stamp over 2c. Ask for Big Fellow. Frazer, 1093 "D" Street, Springfield, Oregon.

**FREE**—Your choice of \$2.00 to \$10.00 from our sensational approvals every time you buy an equal amount. Bargain Stamp Service, Redlands, California.

**ROMANTIC** Spain! 100 different 10¢ including airmails, pictorials. Attractive approvals. Darling's, Ridgway 3, Penna.

**SURPRISE** Bundle! Stamp album, gifts, money-making offers, 10¢, to serious approval applicants. Adventure, Buckland, Connecticut.

**BARGAIN** Approvals—Mounted. Free gift, discounts. Cranmoor Stamp Shop, Pine Beach, New Jersey.

**100 DIFFERENT** U.S.—50¢ approvals. Utechs, 1143J North Keeler, Chicago 51.

**FREE!** 25¢ Worth from wholesale priced approvals. Your choice. Buy wholesale. Cactus Stampco, Box 729, Redlands 1, California.

**AUSTRALIAN** Office mixture, large variety. 2 lbs. \$4.00, 11 lbs. \$20.00 postpaid. Arnold, Wheeler Company, 495 Collins Street, Melbourne, Australia.

**FREE** Commemorative stamped cover. Creative Products, Box 5005, St. Louis 15, Mo.

**ICELAND** 10 Different beautiful stamps for only 10 cents to applicants for our good old fashioned approvals. Old Colony Stamp Co., Dept. A, Milford, Connecticut.

**SAVE** Money! Buy country collections at lowest prices. 50 Korea \$2.00; 100 Liberia \$6.00; 500 Scandinavia \$2.50; 1000 Latin America \$7.50. All different. Price list free. No approvals. David Mark, 13205 Aetna, Van Nuys, Calif.

**ITALY**—100 Different, 10¢ with approvals. DeRespinis, G.P.O. Box 771A, New York 1, N. Y.

**50 DIFFERENT** U. S. commemoratives 25¢; 135 for \$1.00. Approvals. Harold Holub, 18 East 198th Street, New York 68, N. Y.

**100 JAPAN** 10¢. With approvals. Goulds Stamps, Box 631, San Francisco.

**MANY** Premiums given when buying our approvals half catalogue. Tru-Value, P.O. Box 2098, Santa Ana 2, Calif.

**25 AIRMAIL** 10¢. Approvals. Warden Co., 139 Bonita, Sierra Madre, Calif.

**SIX** Monaco triangles, 10¢, and receive my illustrated price lists. Lees, Box 9520, Philadelphia 24, Penna.

**PHILIPPINES:** Japanese occupation. 30 diff. \$1.00; 40 diff. \$2.00. Price list 10¢. J. Woolslair, 645 30th, Hermosa Beach, Calif.

**UNITED** States commemorative collection containing 33 different. 10¢ approvals. White, 516-A Avenue L, Brooklyn 30, New York.

**DIFFERENT.** 500, 50¢; 1000, \$1.25; 2000, \$3.00; 5000, \$12.00 with approvals, wholesale. K. S. Holmes, London, Canada.

**FREE!** 25 Different mint China. Approvals. Wright, 6435 Edloe, Houston 5, Texas.

**U.S. 35** Different commemoratives, 19th century, high values \$1.00 and \$5.00, etc., only 10¢. U. S. approvals accompany. Esco, Port Jervis, N. Y.

**WINTER** Olympics. San Marino skier, skaters, bobsleds—Free! Approvals. William Deems, Ravenswood, West Virginia.

**FREE** United States illustrated catalog. Bailey, 44 Bromfield, Boston, Mass.

**FOUR** United States commemorative sets 25¢. No approvals, free list. Rose, 217 Union, Kingsport, Tenn.

**SEND** 10¢ Now for 210 different stamps worth \$4.25. Mint colonials, Asia, world. Outstanding bargain penny approvals. Lybens, 5560 Buckingham, Detroit 24, Mich.

**QUEEN** Elizabeth mint sets, Barbados, Caymans, Dominica, Tristan, Gibraltar, Leewards. 21 bicolors, 25¢. Approvals. Gannon Stamps, Box 931, Canton 1, Ohio.

**SENSATIONAL** Illustrated U.S. 72 page catalogue free. Stone, 192 Washington, Boston 8, Mass.

**SPECIAL!** U.S. mint flag set complete, #909-21, \$1.00. Free price list. Brooks, 2352B East 23rd Street, Brooklyn 29, New York.

**25 UNITED** States commemoratives 15¢. Worldwide approvals. Loring's, Framingham, Mass.

**CIPEX** Souvenir sheet plus 25 different U.S., 10¢. Approvals (used U.S.) accompany. Village Stamps, 90-39P 214 St., Queens Village 28, N. Y.

**FREE:** Weekly new issue list. Kozorog, 1160 Addison, Cleveland 3, Ohio.

**500 DIFFERENT** Worldwide, 35¢ with attractive approvals. Rainy Day Stamps, Wellsville, N. Y.

**FREE!** 1956 Bargain set catalog. Gernert, 4235-X Alton, Louisville 7, Kentucky.

**99 DIFFERENT** Latin Americans, just 10¢. Approvals included. Fred Pittaley, South Montgomery, Napa, Calif.

**1000 DIFFERENT.** 50¢. Approvals. Ouellette, Box 66M, Flint, Fall River, Mass.

**PHILATELIC** Color chart, identifies 100 different colors, 10¢ to approval applicants. J. E. Gage, Box 23H, Sta. B, Toledo 6, Ohio.

**UNITED** States large commemoratives, 100 different \$1.00; 150 different \$2.00. Acevedo, 206 West 92 St., New York City 25.

VATICAN Beautiful 24 mint stamps, \$1.00, plus scarce 19th century U.S. postal card. Gerhardt, 405 E. 6th St., Austin 1, Texas.

1500 MIXED Foreign stamps \$1.00. No approvals. Aaron, 789 Valencia, San Francisco 10.

### ANTIQUES, RELICS, INDIAN GOODS, CURIOS

WANTED—Nazi daggers, relics. Peter Laboranti, 4528P 50th St., Woodside 77, New York.

WANTED—Bird points, gem, select arrowheads any quantities. Bill Lamme, Laclede, Missouri.

SCALPING Knife, spearhead, thunderbird, drill, \$4.00. List free. Arrowhead, Box 1249, Hot Springs, Arkansas.

SPECIAL Offer, 8 perfect arrowheads, \$1.00 U.S. only. Arrowhead Sales, 4588 So. Acoma, Englewood, Colo.

4 SELECTED Perfect arrowheads \$1.00. Smith, 841 N. Tacoma, Indianapolis, Ind.

4 SELECTED Arrowheads \$1.00. List 5c. H. Talburt, Calico Rock, Ark.

SELLING 50,000 Indian relics. List free. Lear's, Glenwood, Arkansas.

### PRECIOUS STONES, MINERALS

TEN New Mexico minerals \$1.50, six fluorescent \$1.00, five crystallized minerals \$1.00, fool's gold 25c. Free literature. Minerals, Winston, New Mexico.

FIND Uranium, tungsten, mercury, hundreds of other minerals with Mineralight. Free information kit on fun and profit in fluorescent minerals; hobby set. Write Dept. PM8, Ultra-Violet Products, San Gabriel, California.

GEMSTONES, Mineral specimens. Every variety. Lowest prices. Free booklet. Flummer's, 4720 Point Loma Ave., San Diego 7, Calif.

SAPPHIRE, Topaz, tourmaline, garnet, peridot. Five uncut gem specimens, \$1.00. Ten polished gems, baroque shaped, \$1.00. Free big bargain list jewelry, gems, profitable, easy "do it yourself" projects. O'Brien's, 1116M Wilcox, Hollywood 38, Calif.

GEMCUTTING—Silvercraft illustrated magazine. Tells how to cut gems, make jewelry. 150 ads illustrating equipment, gems for collectors, cutters. Free literature. Lapidary Journal, Del Mar 2, Calif.

EARTH Science, the Rockhounds' national magazine. Subscription \$2.00, sample 25c. Box 1357, Chicago 90.

### HOBBIES AND COLLECTIONS

WANTED—Cigarette, tobacco cards. Write Charles Bray, East Bangor, Penna.

NAZI Medals listings, 10c. Kingstons, 920 Third B338, Seattle 4, Washington.

20 HOTEL Baggage labels \$1.00. H. Copleston, 1555 Odell, New York 62, N.Y.

HOBBIES, Craft sets and model kits. Daters, 821 Divisadero Street, San Francisco 17, California.

GENUINE Nazi medal \$1.00; 37 different American emblems \$1.00. Catalog 10c. Insignia Club, 550-B Fifth Avenue, New York.

65 ASSORTED Army patches, insignias, ribbons \$1. Surprise included. Lhgco, 19 East 16th St., New York City 3.

INVENTING Can be an interesting and profitable hobby. Write for complete particulars. Institute of American Inventors, Dept. 40-E 631-E St., N.W. Washington 4, D.C.

NAZI Insignia, 12 different, \$1.00. Medals, armbands, flags, daggers. Illustrated lists. Medcrafts, 1923 34th St. S.W., Calgary 2, Canada.

UNUSUAL Hobby: Authentic army patches, insignias, ribbons, enameled crests, navy rates. 50 assorted for \$1.00. Rex Military, Dept. B, 1261 Broadway, New York City.

FREE Three months' subscription Leathercraft News, write Tandy Leather Co., Box 791-F21, Fort Worth, Texas.

FREE! Leather-reedcraft catalogs. Do it yourself. Tandy Leather, Box 397AH, Tulsa, Okla.

EXCITING New book, "How to Collect Stamps, Coins, Paper Money." Packed with amazing facts; information worth dollars. Fully illustrated, 160 pages, 75c. Popular Mechanics Press, 200-ST E. Ontario St., Chicago 11, Ill.

MATCHBOOKS For collectors. Catalog 25c. Charles Edelman, 1311-C East 84, Cleveland 3, Ohio.

DECLARATION Of Independence \$1.00. Howard Sawyer, 5813 Benton Hgts., Baltimore 6, Md.

GROW Giant crystals! Send dime for booklet explaining hobby. Crystcraft Co., College Station, Texas.

COLLECTORS And hobbyists. Beads, imported and domestic, wide selection, sizes, shapes, colors, designs, pound contains thousands; 5 pounds \$5.00. Sample pound \$1.50. Lhgco, 19-P East 16th Street, New York 3, N.Y.

### CAMERAS, PHOTO SUPPLIES

EXCLUSIVE Colorful production. Projection Kodachrome, sampler 16mm; \$2.00, 8mm; \$1.00. Illustrated listings 10c. Film Wizard, Box 38441-M, Hollywood 38, Calif.

PHOTOGRAPHY For pleasure or profit. Learn at home. Practical basic training. Long established school. Free booklet. American School of Photography, 835 Diversey Parkway, Dept. 3441, Chicago 14.

SOMETHING Different. Soil resistant, loose leaf albums. Trial offer, 8 exposures 30c; 12, 45c. Jim Dandy, Dept. 8, Newberry, South Carolina.

BUY Wholesale nationally advertised cameras, photo supplies, thousands other products at big discount. Free "Wholesale Plan." American Buyers, Hertel Station, Buffalo 16-E1, N.Y.

BASS Says: Quality cameras since 1910. When in Chicago visit the camera cross roads of the world, or write us for your favorite equipment, new or used. Satisfaction guaranteed. Bass Camera Co., Dept. AG, 179 W. Madison St., Chicago 2, Ill.

20 TO 50% Discount everything photographic, giftware. Free catalogue. Dart, 3812E Atlantic Avenue, Brooklyn 24, N.Y.

BUY Your new camera at European price. \$1. shows you how. Justin Hartley, Authorized Agent, Colchester 18, Conn.

FREE Flash cameras. Given away in Delco's get-acquainted campaign. Delco Film Lab, Box 362T, Upper Darby, Penna.

CAMERA Repairmen greatly needed! You can learn manufacturers' service methods at home, in your spare time! Free, big illustrated book tells how: Write today. National Camera Repair School, Dept. PM-4, Englewood, Colorado.

SAVE Money. Give your camera proper care. Send one dollar for brochure "Camera Care." Projector Camera Service, P.O. Box 5612, Tucson, Ariz.

FREE Catalog of everything in film and paper. Save 60% and more when you buy from the world's largest suppliers at reduced prices. Supreme Photo, 11 Broadway, New York City 7.

REAL Wholesale sources. Thousands nationally advertised products. Details free. Martex, 132-A Nassau St., New York 7, N.Y.

ATTENTION Camera owners. Can you use several hundred dollars? See Polypix ad in "Money-making Opportunities."

### PHOTO FINISHING

ENLARGEMENTS. Heavyweight eight 5x7's or five 8x10's, \$1.00. Jack Koons, Huntington Mills, Luzerne County, Penna.

QUALITY Kodak finishing. 8 exposure roll 35c; 12 exposure 50c; 16 exposure 60c. Reprints 4c. Fast service. Guaranteed quality. 40 years continuous operation. Be a satisfied customer. We do color. Send for mailers. Mail Order Photo Service, Box 297, Watertown, Wisconsin.

SPECIAL Introductory offer. 8 jumbos 25c, 12—35c. Western Photo, PM46, Box 298, San Francisco 1, Calif.

TOP Quality. Fast service. 8 jumbos 35c, 16 contacts 40c. Reprints—Jumbos 4c; contacts 3c. Satisfaction guaranteed. Free mailers, circulars. Fast-X-Foto, Box A, Jersey City, New Jersey.

8-HOUR Service on deluxe jumbo prints, 8-exposure roll developed and 8 jumbo prints 40c, 12 exposure 55c, 16 exposure 70c; 35mm, 20 exposure 75c, 36 exposure \$1.25. Jumbo deckledge reprints 4c each. Contact prints made if specified. Bay Photo Service, P.O. Box 210, Oakland, California.

FREE Superpak album with 8 jumbos only 35c, 12—50c. Prompt superior service. Quality guaranteed. Mailers and circulars free. Grand Fotos, GPOB 1410, New York City 1.

6 OR 8 Picture roll 35c, 12 or 16 picture roll 55c. Each roll developed and printed in handy pocket wallet. Send coin with roll. No c.o.d.'s. Mailing containers sent free. DeLuxe Film Service, Box 1268-A, Shreveport, Louisiana.

FROM Rolls or negatives. Jumbos 4c. Regulars 3c. This ad and \$1.00 for 30 jumbos or 8—5x7. Guaranteed. Square Deal Photos, Hutchinson, Kansas.

ENLARGEMENTS! Eight 5x7's or five 8x10's, \$1.00. Wilart Enlargers, Box 967, Little Rock, Ark.

8-12 EXPOSURE Rolls 39c, jumbo prints, Free 5x7 enlargement with each roll developed. Guaranteed work, one day service. Lincoln Studios, Dept. K, Box 13, Lincoln, Nebraska.

SURPRISE Gift with first roll developed. 8 jumbo superpak album prints or 16 contact prints 40c, 12 exposure roll 50c. Certificate for 3 5x7 enlargements. Dept. B-21, Owl Photo Co., Weatherford, Okla.

DELCO For better pictures, fast first-class return free. April special: Free plastic camera cover, eliminates dust, dampness, with oversize album prints. 8-exposure roll 49c, 12—59c, 20—\$1. Delco Film Lab, Box 362Y, Upper Darby, Penna.

HIGH Quality finishing—Rapid service. 8 exp., 35c; 12, 50c; 16, 75c; 20, \$1.00. Camera, Box 280, West Chester, Penna.

ONE Day service. Microdol developing. Jumbo prints 20 exposure 35mm, \$1.00; 36 exposure \$1.49; 8 exposure rolls 35c; 12 exposure 50c. Reprints 4c. Foto Craft, Box 3146, Washington, D.C.

TRIAL Offer. Any size roll 35c, blow-ups, in albums. Pak Pix, Iroquois Station, Louisville 14, Kentucky.

BETTER Pictures faster. 8 oversize in album 35c, 12—50c. Red Robin, Box 573C, Clifton Heights, Penna.

FREE! 5"x7" Sepia tone enlargement, double weight silk paper, with each roll. 8 exposures 60c, 12 exposures 80c, 16 exposures \$1.00. Jumbo prints sepia toned at no extra cost. Complete color service, also. Satisfaction guaranteed. Have printed over 150,000,000 perfect pictures. One of world's largest, finest labs. Target Photo Finishers, Dept. G, Box 3581, Jackson, Mississippi.

COLOR, 24-Hour service. Ektachrome, Anscochrome, 20 mounted \$1.25. Free Kodacolor price list. Delco Film Lab, Box 362W, Upper Darby, Penna.

### MOTION PICTURES AND SOUND EQUIPMENT

16MM. Sound features. Herby's Films, 922 Ninth Northeast, Canton, Ohio.

MOVIES Bought, sold, exchanged, rented. Catalogue dime. Reed, 1797 Seaman Neck, Seaford, N.Y.

MOVIE Camera film: 8mm, roll \$1.50, 16mm, 100' \$3.00. Free processing. Better Films, 742 New Lots, Brooklyn, N.Y.

SAVE 50%! Guaranteed-fresh color, b.&w. movie film! 8mm., 16mm. Free catalog! Eso-R, 47th Holly, Kansas City 12, Missouri.

8-16MM. Free catalogue (with sample film 10c). Garden, 690 Howard Ave., Brooklyn, N.Y.

TAPE Recorders, tapes; wholesale prices. Carstan, 215 E. 88, New York City 28.

16 MM. Sound-used projectors and films. Rental, sale, exchange, bargain prices. Free lists. National Cinema, 71 Dey Street, New York City.

5,000 8-16MM. Movie films. Free catalogues. International, Greenvale, N.Y.

ALL Kinds 16mm sound films. Rent, sale. Roshor, 335 Fifth, Pittsburgh 22, Penna.

FREE! Blackhawk's big sale catalog new and used 16mm., 8mm. films; 2"x2" color slides; used 16mm. sound projectors. Biggest stock in U.S.A. Blackhawk Films, 1200 Eastin, Davenport, Iowa.

EARN Money daily with your movie projector! Write: Metcalf, 10806 Glenroy, Chicago 43.

POCKET Tape recorder. New. Factory guarantee. \$190. Box 6111, Cleveland.

TAPE Recorders, tape. Unusual values. Free catalog. Dressner, 69-02M 174 St., Flushing 65, N.Y.

FREE Superpak album with 8 jumbos only 35c, 12—50c. Prompt superior service. Quality guaranteed. Mailers and circulars free. Grand Fotos, GPOB 1410, New York City 1.

FREE! Blackhawk's big sale catalog new and used 16mm., 8mm. films; 2"x2" color slides; used 16mm. sound projectors. Biggest stock in U.S.A. Blackhawk Films, 1200 Eastin, Davenport, Iowa.

EARN Money daily with your movie projector! Write: Metcalf, 10806 Glenroy, Chicago 43.

POCKET Tape recorder. New. Factory guarantee. \$190. Box 6111, Cleveland.

TAPE Recorders, tape. Unusual values. Free catalog. Dressner, 69-02M 174 St., Flushing 65, N.Y.

FREE Superpak album with 8 jumbos only 35c, 12—50c. Prompt superior service. Quality guaranteed. Mailers and circulars free. Grand Fotos, GPOB 1410, New York City 1.

FREE! Blackhawk's big sale catalog new and used 16mm., 8mm. films; 2"x2" color slides; used 16mm. sound projectors. Biggest stock in U.S.A. Blackhawk Films, 1200 Eastin, Davenport, Iowa.

EARN Money daily with your movie projector! Write: Metcalf, 10806 Glenroy, Chicago 43.

POCKET Tape recorder. New. Factory guarantee. \$190. Box 6111, Cleveland.

TAPE Recorders, tape. Unusual values. Free catalog. Dressner, 69-02M 174 St., Flushing 65, N.Y.

## MUSIC AND MUSICAL INSTRUMENTS

**POEMS, Songs wanted!** Free examination. Bengal, 93 Jefferson, Chelsea 50, Massachusetts.

**ELECTRIFY** Reed organs. Instructions \$1.50. Galloway, Box 211, Beaufort, S. C.

**ACCORDIONS** — Direct from importer. Save 50% and more! Free trial. Lifetime guarantee. Trades accepted. Free catalog. Write Accordion Manufacturers, Dept. 46R, 2003 Chicago, Chicago 22, Illinois.

**POPULAR Songs.** How to write and sell them. Write for free booklet Successful Songwriting. Gateway Songs, Box 2470, Hollywood 28, Calif.

**PLAY Piano** the first day! Copyrighted secret. Details free. Miracle Method, Box 5203P, Phoenix, Arizona.

**SONGWRITERS!** Send poems, songs. Music Service, 243 West 72nd St., PM, New York City 23.

**FREE Records** of your song. Your words, my melody. Free information. Johnny Mack's Melody Mart, 1094 West 39th Street, Dept. A, Los Angeles 37.

**ACCORDIONS.** Wholesale to everyone. Save up to 60%. All national known brands. Free catalogue. Del Principe, 29 South Cicero, Chicago 44.

**POEMS** Wanted for new songs. Send poems. Immediate consideration. Crown Music Company, 1476 Broadway, New York City 36.

**WANTED!** Poems for musical settings. Write Songwriters' Service, Clifton, N. J.

**WRITE Songs.** Big money and reputation. Write for information. J. Gordon Pub. Co., 4700 South California Avenue, Chicago.

**VIOLINMAKERS.** Repairers. Fine tone wood, and all violin supplies. Send for free wholesale price list. International Sales, 414-MPM E. Baltimore St., Baltimore 2, Maryland.

**SONGPOEMS** And lyrics wanted. Mail to: TinPan Alley, Inc., 1650 Broadway, New York 19, N. Y.

**SONGS** — Poems wanted. Good opportunity. Tunsmiths, 1609 Vista Del Mar, Dept. U, Hollywood, Calif.

**POEMS** Wanted for musical setting. Send poems. Free examination. Five Star Music Masters, 630 Beacon Bldg., Boston, Mass.

**1956 ACCORDIONS** — Wholesale. Free catalog. American Accordion Center, PM-3, 5329 Belmont, Chicago.

**POEMS** Needed for new songs. Send poems for free examination, details. Immediate consideration. Songcrafters, 2724 Arcade Station, Nashville, Tenn.

**POEMS** Wanted to be set to music. Free examination. Send poems. McNeil, Master of Music, 510-PM S. Alexandria, Los Angeles, California.

**SWISS Musical movements.** \$1.90. Helax, 218 West 72nd Street, New York 23.

**SONGWRITERS:** Recording company wants new songs. Royalty basis. National sales, promotion if selected. Send material. Music Makers, Dept. E-20, Box 2507, Hollywood, Calif.

**100 ADVERTISED Music publishers' addresses,** California, New York, Chicago: \$2.95. Publishers Reporter, 2420-M 77th, Oakland 5, California.

## RADIO, TELEVISION AND ELECTRONICS

**MAKE Simple,** tubeless, batteryless, distance-getting radio. Genuine Melomite crystal, detector, illustrated instructions. 50c postpaid. Allen, 427-PM5, Clinton, Missouri.

**CRYSTAL Radio builders.** Free information. Hulet, 305 Hope, Lakewood, N. J.

**RECORDERS.** Tapes. Sensational discounts! Free catalog. Towers, Box 155, Philadelphia 5.

**SPEAKER** Reconciling. McDonald's, 506 Ward, Benton, Illinois. Prices upon request.

**AMAZING** Crystal diode pocket radio kit, complete with earphone, \$5.95. Rotac Company, Salmon Falls, New Hampshire.

**FREE.** New 1956 bargain filled bulletin. Includes 40 \$1.00 kits, meters, tubes, timers, microscopes, gadgets. Lektron Specialties, 131A Everett Avenue, Chelsea, Mass.

**REMOVE TV commercials electronically.** State color. \$3.95. Karl's, Box 333, Lodi, N. J.

**NEW TV catalog** free. Loaded with bargains. Finest new TV antennas, converters, motors, boosters, parts, instruments, hundreds of quality accessories. Get your catalog now. National Electronics, Dept. P-4, 6608 Euclid, Cleveland 3, Ohio.

**CRYSTAL Radio apparatus.** Free catalog. Robert Mickelson, 1342A W. Cornelia, Chicago 13, Illinois.

**EASY Build** radios, hi-fi phono-amplifiers. Plans \$1.00 each. Wolins, Amazon Rd., Peekskill, N. Y.

**WALKIE-Talkie.** Build wireless two-way portable radiophone for less than \$10.00. Plans 50c. Springfield Enterprises, Box 54-B4, Springfield Gardens 13, New York.

**TV Trade-in sets.** Philco, Emerson, G.E., Admiral, Motorola, Tele-King, others. List available. 10", \$12; 12" to 17", \$15 up. Washtek Service Co., 956 Southern Blvd., Bronx, N. Y.

**20 DX Crystal set plans,** catalog and "Radiobuilder" magazine 25c. Laboratories, 328-C Fuller, Redwood City, Calif.

**ILLUSTRATED** Transistor radio plans, 50c. Cook, 4003-M Roosevelt, Midland, Texas.

**FREE!** Newark's new 1956 catalog. A postcard will bring you 260 pages full of the latest releases and largest selections of the world's finest radio, TV, amateur, electronics and high fidelity equipment. Write today to: Newark Electric Company, 223 W. Madison St., Dept. PM-4, Chicago 6, Ill.

**PLANNING** To take up TV servicing? Let practical advice increase your income! Send today for special booklet prepared by successful technician. Only \$1 full price. Elkar Enterprises, Box 70, Des Moines, Iowa.

**PLANS** For 100, different, homemade, television antennas. \$2. Brule, 12954 Bess, Baldwin Park, Calif.

## BUSINESS OPPORTUNITIES

**IMPORT** Without capital. Details free. Georgia Overseas Trading Co., Dept. W, 714 Persons Bldg., Macon, Ga.

**WHOLESALE Catalogue!** Appliances, cameras, watches! Cam Company, 6806PM 20th Ave., Brooklyn 4, N. Y.

**COLOR Concrete** with chemicals. Marble-glaze cement benches, pottery. Home-shop. Hundred beautiful designs, made without molds. Birdbaths to waterfalls. Your chance for fame, fortune. 10c brings sample, pictures. Hollywood Cementcraft, 8527-R Wonderland, Hollywood 46, Calif.

**MINIATURE Trees.** Why pay \$2.00-\$10.00 for growing secrets? Free details. Tiny Trees, Box 3084-P, Chicago 54.

**MAKE Flexible molds.** Cast figurines, plaques. Free sample. Tooker, 630-R Chestnut, Hamilton, Ohio.

**HOW** And where to obtain capital. Particulars free. Star Service, Wapakoneta, Ohio.

**EARN \$10,000** Yearly raising Angora rabbit wool for us. Information 25c coin. American Angora Company, Malta 12, Montana.

**"MAILORDER** Laws and Regulations." Discusses federal, state, local licenses, necessary taxes, legal requirements governing mailorder businesses, \$1.00. "Mailorder Rules for Beginners." Additional helpful information, \$1.00. Play safe. Order both. Tasker, 105 East Custis, Alexandria, Virginia.

**FREE!** "301 Profitable Small Businesses!" Amazing shoeing plans! Work home! Start sparetime! Deumant Surveys, Kenmore 23-PM, N. Y.

**BUY Wholesale!** 100,000 name brand products! Save 66%! Big profits selling others spare time! Free catalogs! National Buyers Service, Box 426EE, Oakland, Calif.

**HAVE Home business!** Get \$10.00 merchandise orders by mail. Keep \$8.00. Everything furnished. National, Box 88W, Dorchester 22, Massachusetts.

**IMPORT-Export opportunity,** profitable, world-wide, mail-order business from home, without capital; or travel abroad. Established world trader ships instructions for no-risk examination. Experience unnecessary. Free details. Mellinger F701, Los Angeles 24.

**REBUILD Batteries;** repair dolls; make rubber stamps; "60 Ideas" free. Universal, Box 1076-A, Peoria, Ill.

**NATURAL Molding** rubber, extra thick. Free sample. W. Wooley, 115-A Donald, Peoria, Illinois.

**MAIL Sale Advertiser Magazine.** Mail order plans and "how to" enterprises. Copy 10c. Year \$1.00. Ernest L. Gentry, 2623 Pollard Lane, Mobile 5, Alabama.

**MONEY** In saw and lawnmower sharpening sparetime at home. Free book. Virgil Foley Company, Columbia Heights, Minnesota.

**POPCORN** And potato chip equipment. Eakins, Box 933-A6, Springfield, Ohio.

**FREE Folio** "\$5,000-\$45,000, Unlimited Vacations." No merchandise, equipment. Unknown! Work home, sparetime! Haylings, Carlsbad, Calif.

**\$250 WEEK** Cleaning venetian blinds. Patented machinery. Free literature. Robinson, 7213B, Indianapolis 1, Indiana.

**LEARN Sewing** machine "big money" repair. Machines, supplies wholesale. Write Taylor Service, Box 2126, San Bernardino, Calif.

**TO \$100.00** Weekly. Sparetime, home operated mailorder business. Successful beginner's plan. Everything supplied. Lynn, 10420-M National, Los Angeles 34.

**"HOW To Profitably Operate a Mail Order Business."** Free literature. Lawrence J. Archer, Rt. #1, Navarre, Ohio.

**MAKE-Sell** polishes, cleaners, anything. Formula catalog free. Kemixer, Park Ridge, Ill.

**EARN Money** at home! Homemaker Magazine tells how. Sample 25c. Sizemore, 20-H East Delaware, Chicago 11.

**BOOKKEEPERS.** Keep books, small firms spare time. Manual latest technique by C.F.A., \$3.00. Modern Business, Box 406, Youngstown 1, Ohio.

**PLASTERCRAFT** Molds, liquid rubber, plasters, flocks, candle supplies. Catalog and manual free. Blue Rapids Supply, Blue Rapids, Kansas.

**WHAT'S New** in mailorder? Let "Mail-order World," published monthly, keep you informed. Sample, 25c. Wayte, 1233 Eiden, Los Angeles 6, Calif.

**ELECTROPLATE** Auto parts, novelties, mirrors, baby shoes. Easy, inexpensive home processes. Free booklet. Tyco Metals, Box 13231-MM, Houston 19, Texas.

**BREED** Rare tropical fish at home. Earn big money! Learn secrets! Help fill huge demand. Amazing opportunity! Free plan. Tropical Fish Breeders, Los Angeles 61, Calif.

**BE Appointed** state notary public now. Write, Stationers, Helotes, Texas.

**WE Love** our mailman—He leaves over \$1000.00 monthly in our rural mailbox. My college professor husband drafted a scientific home mailorder method. We bought a Texas ranch, live as we always wanted. Now we sell the Ranch Mailorder Method. Operates anywhere. Inquire: Eveningshade Ranch, Helotes, Texas.

**COPUBLISH** Mail Sale Advertiser, leading mail order paper. Details, latest copy, dime. Vanroy Shirk, Lebanon, Penna.

**MINK** Raising information free. Complete. Lake Superior Mink Farm. Superior, EE1, Wisconsin.

**FREE Book** "505 Odd, Successful Businesses." Work home. Expect something odd! Pacific, Oceanside, Calif.

**BRONZE** Baby shoes, instructions, equipment and mountings for genuine electroplated process. Free catalog. Hollywood Bronze Supply, Dept. B-3, 1634 East First Street, Los Angeles 33, Calif.

**YOUR Own** name brand business. No investment; no inventory. Part time or full time. Sell famous brands of appliances, housewares, silverware, radios, vacuum cleaners, lamps, tools, clocks, watches, jewelry, etc., etc., over 1000 items. Join thousands of successful independent dealers. Send for free catalog and dealer price list. H. B. Davis Corp., Dept. W, 145 W. 15 St., New York City.

**BIG Profits** raising fishworms and crickets. Free literature. Carter Farms, Plains, Georgia.

**GROW Orchids** at home — Profitable, fascinating. Year 'round, Maine to California. No greenhouse. Gorgeous cattleyas, cymbidiums, etc. Successful home grower shows you how. Full details free. Flowerland, 4622 Wilshire, Los Angeles 5.

**FLX Typewriters.** Inexpensive home course teaches factory secrets. Free booklet. Write, Typewriter, Tarentum 1, Penna.

**NEWEST Spare, full-time home business.** \$5 to \$10 hour possible. Paint with suede—The finish with touch and eye-appeal. Beautifully auto dashboards, signs, radios, toys, figurines, lamps—1001 others. Complete, step-by-step instructions sent for no-risk examination. Free details, Coast, Los Angeles 61.

**IMPORT-Export mailorder opportunities!** Details, Warner, Box 6, Fort Scott, Kansas.

**MAKE New greasless doughnuts in kitchen.** Sell stores. Half profit. Free recipes. M. Ray, 3606 South 15th, Minneapolis 7.

**"23 WAYS To build a home mail business."** Free details. Penn General Distributors, Monessen, Penna.

**A Monthly repeat business which you can operate in your own community.** For free details write Grasak, Dept. A-101, P.O. Box 494, McKeesport, Penna.

**\$46 FROM Square foot plywood; hgsaw necessary.** Details free. Woodart, Bridgewater, Mass.

**VENDING Machines earn big money!** Request 32 page free catalogue. Parkway Machine Corporation, Dept. 26, 715 Ensor St., Baltimore 2, Maryland.

**\$70 WEEKLY—Home, spare time.** Simplified mail bookkeeping. Immediate income—easy! Auditax, 34757A, Los Angeles 34.

**\$150 WEEK—Easy! Start home Venetian blind laundry.** Revealing book free. A. T. Co., 101 S. 44th, Philadelphia 4, Penna.

**TRAIN Yourself for TV!** Free information for each inexpensive complete course. How To Be Successful in Show Business, Practical Musicianship and Songwriting, Master Ventriloquism. Omnibus, 30C Inghram, Newark 8, N. J.

**SELL Real merchandise by mail.** Four ways. Everything supplied. Orders filled. Big profits. Charles, Box 32-P, New York 63, N. Y.

**"FROG Raising!"** Season just starting! Get this year's eggs. New book tells how. Folder 10c. Broel-A, Box 506, New Orleans 1, Louisiana.

**INTERNATIONAL Mailorder business.** Complete setup service—not instructions only. Hermes, 152 West 42, New York City 36.

**COLORGLAZED Concrete pottery** made without molds. Patented method. Cemetery products, novelties, tiles. Basement leak-sealing. Money-making projects. Booklet, details free. Men only. National Potteries Company, Grand Rapids, Minnesota.

**YOU Are cordially invited to learn the secrets of operating a successful saw shop.** Send for free literature. Max Manufacturing Company, Dept. A, 138 Stockton Avenue, San Jose 26, California.

**\$5,199.90 WAS Paid to John Betts.** in few weeks. Grow mushrooms. Cellar, shed. Spare, full time year round. We pay \$3.50 lb. Free book. Mushrooms, Dept. 172, 2954 Admiral Way, Seattle, Wash.

**3 SUGGESTIONS For sales-at-a-profit** by mail, plus free counsel offer, 25c. Rawson Wood, 30 East Delaware, Chicago 11, Illinois.

**VENDING Machines—Every description.** New or used. Lowest prices—Start a route or sell outright. Mack Postel, 2952 Milwaukee, Chicago 18.

**EARN Up to \$2000.00 monthly** with spare or full time route of automatic 3 in 1 hot drink merchandisers using Maxwell House coffee, Bakers chocolate, Tenderleaf tea, in your community. We train you. \$1190.00 starts you. Write Superior, 4555-BH East Warren, Denver, Colorado.

**AMAZING Home business.** Build tubular glass fishing rods. Everything furnished. Wonderful profit. Free details. Rodman, Box 41, Wauwatosa, Wis.

**LIQUID Rubber.** Make flexible molds. Free sample. Chaney, 1130 E. 16th St., Jacksonville 6, Fla.

**WANT To make big money at home?** \$5 profit in an hour possible with invisible reweaving. Make tears, holes disappear from clothing, fabrics. Steady year-round demand from cleaners, laundries, homes. Details free. Fabricon, 8334 Prairie, Chicago 19, Illinois.

**BUY Wholesale thousands nationally advertised products** at big discounts. Over 3,000 suppliers. Free wholesale plan. Associated Wholesalers, 1016-D3 Starr, Burlington, Iowa.

**WORK At home. Make money.** Amazing opportunities. Free details. Coleman, Box 821-A, Newark 1, N. J.

**\$30.00 A Day profits raising earthworms.** Illustrated booklet, 25¢ postpaid. North St. Paul Worm Farm-D, North St. Paul 9, Minn.

**YOUR Own business. No investment.** No inventory. Sell name brand nationally advertised items. Free catalog. Confidential wholesale price list. Normandy Dist. Co., Dept. PM, 133 Fifth Ave., New York 1, N. Y.

**INTERESTED Mail order?** Copies leading mail order magazines. All different, 25¢. Palm, Box 1221, Baton Rouge, La.

**PRINTING, Office supplies wholesale.** Save 50%. Royal, Box 368-A, Cleveland 27, Ohio.

**MONEY Raising methods.** Copyrighted "How and Where to Raise Capital." Revealing! Establish your own business. Expand! Free details. A.P. Service, Box 1377-BD, Miami 8, Florida.

**OPERATE Profitable mail order business.** Write Walter Service, 4159A East 112th, Cleveland 5, Ohio.

**RENEW Lawns! Profit opportunity!** Eliminate crab grass, weeds, disease, pests. Vigorous green all season. Send for free facts. Pleasantcraft, Buckhout Rd., White Plains, N. Y.

**AMBITIOUS? We establish you in your own business,** supply catalogues, circulars, etc., ship orders under your name, paid or c.o.d., show you exactly what to do. Household items needed in every home. Sell direct, by mail or through agents. Catalogue, plans, details absolutely free. Write Topval Corp., Lindenhurst 418, N. Y.

**BRUSH Plating outfits for plating articles** in the home and shop. No tanks necessary. Good income spare or full time. Free particulars. Gunmetal Co., Ave. H, Decatur, Illinois.

**ADVERTISING Book matches—Cash in on big demand;** sell union label matches. Cuts for all businesses and political parties. Free powerhouse selling kit, low prices, protection guaranteed on repeat orders. Cash commissions. Superior Match Co., Dept. MX456, 7530 Greenwood, Chicago.

**WANTED! Home workers to assemble luggage** and cases for ready market. Instructions, materials, tools, everything supplied. Free details. Abaris, 807-BD Sunset, Los Angeles 12.

**START A buying service,** buy wholesale thousands nationally advertised products. Make big profits selling at sizable discounts. Postcard brings details. American Buyers, Hertel Station, Buffalo 16-C1, New York.

**WORK From home in spare time.** Start profitable magazine renewal service. We show you how; furnish everything free. No experience needed. Write McGregor Magazine Agency, Dept. 500-B, Mt. Morris, Illinois.

**BUY Wholesale! Resell at big profits.** Sell nationally advertised brand name merchandise. Appliances, cookware, housewares, watches, jewelry, dry goods, clothing, sporting goods, toys, gifts, etc. Build a profitable repeat business. Send for free 124 page illustrated color catalog with separate confidential cost sheet. Merit Home Products, Dept. PM-4, 107 Manhattan Ave., Brooklyn 6, N. Y.

**MAKE Perfumes, other products.** Sell mailorder. International, 6347 Parnell PM-4, Chicago 21, Illinois.

**WHY Beginners lose money.** How to avoid such mistakes. \$1.00. Beach, Box 2965-S, Baltimore 29, Md.

**\$1,000 MONTHLY Possible in collection agency business.** Free details. Write Cole Associates, Syracuse 2, N. Y.

**EARN \$70.00 Weekly sparetime!** Everything supplied. Free details, no obligation. Plastico, Box 674, Pottstown 2, Penna.

**HOT Dogs electrically cooked inside bun** in bag. Details free. Conrad, 3821 Locust Lane, Harrisburg, Penna.

**HIGHEST Commissions all magazines.** Free catalogue, supplies, prizes, exclusive extras. Subscription Service Co., Box 2070, Birmingham, Alabama.

**PROFITS Stamping social security plates.** Catalog free. General Products, 188-PM State, Albany 10, N. Y.

**HOME Business,** spinning Angora wool. Steady cash market for wool. Angora House, PM, Springfield, Illinois.

**FIGURINES! Novelties! Easily made!** Illustrated course teaches rubber mold-making! Plaster casting! Figurine painting! Quick methods! Perfect results! Only 25¢! Castcraft Studios, 508-P Marion Street, Brooklyn 33, N. Y.

**EXTRAORDINARY Business opportunities** provided via inexpensive, self-teaching capsule course "Air Conditioning Simplified." Free impressive particulars. Kowalski, Box 409, New Britain, Conn.

**YOU Can earn extra cash** selling our rubber stamps. Easy. Average \$1.00 profit per stamp. Free details. Green Bay Mail Order, 613 Phoebe Street, Green Bay, Wisconsin.

**MONEY Learning sewing machines.** Beginners lesson 20¢. Purdy's, 207M, Weatherford, Texas.

**START Home mailorder business.** Small investment brings wonderful profits. Postcard brings free details. I. W. Service, P.O. Box 1083, Tacoma, Wash.

**FRANCHISE Opportunities nationwide!** Profitable distributorships, dealerships, agencies. Request interesting information immediately. National Franchise Reports, 333 North Michigan, Chicago 1.

**SPECIALIZED Magazines give you new ideas.** Examine current copies, one or all those covering your field. 5,166 different publications—All businesses, trades, vocations, professions, etc. Write today for free current list. Commercial Engraving Publishing Company, 34C North Ritter, Indianapolis 19, Indiana.

**OPERATE Mailorder folio business!** Ballard's, 425 East Catherine, Louisville 3, Ky.

**\$40.00 DAILY Teaching driving** with your car. Driver Education Service, Box 8507, Chicago 80, Illinois.

**AMBITIOUS But lazy? Big money** at home while others do most of work! Postcard OK. Maxson, Falls Church 17, Va.

**BECOME Manufacturer or management executive!** Fortunes made daily. Alltools, 268-BK, New York City 5.

**REWEAVING Taught by professionals!** Harris Reweavers, Box 7112, New Orleans 19, Louisiana.

**WANTED: Home producers, to be subcontractors.** Cast plastic products for manufacturers in our clearing house service. Thousands of easily-made items required. Cash in at home, without previous experience. Plastic Service Associates, Dept. 4-PM, East Boston 28, Massachusetts.

**CASH From sawdust, seventy methods.** Tin-cans, thirty methods. Newspapers, eighteen methods. Instructions 50¢ each. All three \$1.00. Charles Company, 12-DXV, Norwood, Ohio.

**SAN Francisco, S.J., classifieds, opportunities,** plus questions answered, airmailed, \$1. Baker, 13100 Potts, San Jose 12, Calif.

**AMAZING Waterless hand cleaner.** Sell or manufacture. Sample \$1.00 includes instructions. Easy Life Manufacturing Company, 12906 Estelle Rd., Silver Spring, Md.

**MAKE Up to \$50 weekly sparetime** writing orders for stainless steel tableware, guaranteed 50 years. Details free. Block, 35-A Hoeltzer, Rochester, New York.

**BUY Wholesale thousands products.** Free literature. Triple J Industries, 132 Berkshire, Bridgeport 8, Conn.

**YOU'LL Be amazed at the tremendous profit possibilities** in selling the finest quality Bibles available anywhere! Many men make \$30,000 yearly and more. Get my free proven Bible sales course plus catalog of many Morocco grain genuine leather covered Bibles and related items. Joseph W. Cain, Wholesaler, Box 5065 FM, San Antonio 1, Texas.

**MAKE Rubber stamps.** Tremendous profits. New home shop method. Free details. Box 4308, Mobile, Alabama.

**I Made \$10,000.00 typing at home.** Guaranteed proof. Free details. Lenore Felgen, Box 1125-PM, Oak Park, Ill.

**DOLLARS Every day!** New magic mail plan. Setup free. Miller, Box 588P, Oshkosh, Wis.

"ONE Hundred Jobs at Home" shows you how to earn money in spare time. Request free booklet. Business, 60-T Des Ormes, Quebec 3, P.Q., Canada.

PRINT Without a printing press! Amazing new method! Print colorful signs, banners, cards, posters, glassware; anything at home. Big profits. Money-making opportunity! We supply everything. Beautiful sample, home-business plan free! Write Screen-Print Company, PM-4, Los Angeles 61, California.

\$26,500 SALES In two weeks! Amazing radio-mail order method. Free details. Broadcast Service, 1412-AP Great Northern Building, Chicago 4, Illinois.

WHOLESALE Buyers' service! Buy nationally advertised merchandise wholesale. Sell way below retail. Fabulous profits. Write Wholesale Buyers, 1720 Market, St. Louis 3-PC, Missouri.

HOW To make money in rubber stamp business. Nothing to sell. Complete truth. Details \$1.00. Johnson, 391 Highland, San Bernardino, Calif.

MAKE Fast buck. Sell nationally advertised merchandise. Free wholesale catalog. Harry Cohen & Sons, Inc., 1069-PM Utica Avenue, Brooklyn 3, N. Y.

RECEIVE Advance notice of new products and inventions. Wealth of ideas. Send 50¢ to New Products, Box 582, Austin 63, Texas.

REAL Wholesale sources, thousands nationally advertised products. Details free. Martex, 132-B Nassau St., New York 7, N. Y.

SELL Merchandise by mail. We supply products, literature, lists, everything. Fill your orders. Write: Associated, Box 174, Garland, Utah.

97 SCHEMES To make a million. You might! Information free. R. & S. Distributors, 19 Emory St., Jersey City 4, N. J.

BECOME Tax consultant. Our students earn to \$3,000 in 3-month season, part-time. We train you—help you start. State approved. Union Institute, 68 Hudson, Hoboken 2J, New Jersey.

#### MONEYMAKING OPPORTUNITIES

SELL Aluminum awnings. Baked enamel colors, all sizes. Write Jack Groff, Box 10254, Tampa, Florida.

\$2.00 RETURNS \$10.00. Lifetime repeats. Black Diamond perfume. Free sample. Exclusive Import, 1139-PM So. Wabash, Chicago 5, Ill.

GOLDEN Opportunity. Twin system home mail-order. Fabulous earnings possible. Details free. Prinz, 402-P, Pico, California.

WANT To go in business for yourself without capital? We show you how. Start part time your own home. Postcard brings details absolutely free. Topval Corp., Lindenhurst 320, N. Y.

START A buying service, buy wholesale thousands nationally advertised products. Make big profits selling at sizable discounts. Postcard brings details. American Buyers, Hertel Station, Buffalo 16-D1, New York.

FREE Literature 500 easy moneymaking plans. Barnes, 8401N Miami Ave., Miami 38, Fla.

WHOLESALE, Brand named products catalog \$1.00. D. Kabel, 870 Lafayette, Buffalo, N. Y.

MAKE Money writing short paragraphs! No tedious study. I tell you what to write, where and how to sell; and supply list of editors buying from beginners. Many small checks add up quickly. Write to sell, right away. Send for free facts. Benson Barrett, 1751 Morse, Dept. C-27-R, Chicago 26.

POSTCARD Collecting is profitable and interesting. Free information. Inter-American Features, Jenkintown 1, Penna.

EARN Money evenings copying and duplicating comic cartoons for advertisers. Adservice, Argyle 1, Wisconsin.

\$20.00 RETURNS \$400.00. Lifetime repeats. Sample \$1.00. Refundable. Ezee, Bayport 7, Mich.

FREE! "301 Profitable Small Businesses!" Amazing shoestring plans! Work home! Start sparetime. Deumant Surveys, Kenmore 23-PM, N. Y.

"MONEY Getter's Bulletin," sample 25¢. Donovan, 791 Greenbelt, Levittown, N. Y.

TO \$100.00 Weekly. Sparetime, home operated mailorder business. Successful beginner's plan. Everything supplied. Lynn, 10420-M National, Los Angeles 34.

MAKE Spare time money preparing and mailing sales literature. Adams Surveys, 3513-AT Sunset Blvd., Los Angeles 26, Calif.

EARN \$50.00 Daily making mats, shoes and mud guards from old tires. S and S Patents Inc., 1307 North Clark St., Chicago 10, Ill.

GENERAL Contest Bulletin. Issued monthly. Sample, 25¢. 1609½ East 5th, Duluth, Minn.

FREE Book "505 Odd, Successful Businesses." Work home. Expect something odd! Pacific, Oceanside, Calif.

READ Progressive Mailtrade, the magazine that tells how to make money by mail. Dime brings sample and special offer. Progressive Mailtrade, Box 357, Sheboygan, Wisconsin.

ATTENTION: Typewriter owners. Make handsome profits. Write today. Groves Company, 682, Hastings 8, Nebraska.

SELL Titania gems; far more brilliant than diamonds. Catalog free. Diamonite, 2420-M 77th, Oakland 5, California.

PLASTIC Laminating. Pleasure and profit. Self-sealing. No machines. Complete home kit, \$1.00. Mountainside 1, Springwater, New York.

PRIZE Contests provide fabulous and confidential home income opportunities! Here's how and where to win your share! Send stamp! National Contest Bulletin, Box 3685-P, Miami 16, Florida.

VENDING Machines earn big money! Request 32 page free catalogue. Parkway Machine Corporation, Dept. 27, 715 Ensor St., Baltimore 2, Maryland.

\$150 WEEK—Easy! Start home Venetian blind laundry. Revealing book free. A. T. Co., 101 S. 44th, Philadelphia 4, Penna.

\$5,199.90 WAS Paid to John Betts, in few weeks. Grow mushrooms. Cellar, shed. Spare, full time year round. We pay \$3.50 lb. Free book. Mushrooms, Dept. 173, 2954 Admiral Way, Seattle, Wash.

BUY Wholesale! Save 66%! Appliances, furniture, jewelry, toys, sporting goods, tools. Free catalog. National Buyers Service, Box 426EB, Oakland, Calif.

LEARN Technical metaphysics and insure your future. Easy, inexpensive correspondence course. Simplest method known. Diploma. Write: Premier College of Technical Metaphysics, 2532 McKenzie St., Vancouver 8, B. C., Canada.

500 WAYS To earn money at home. Details 10¢. A. Welch, Lake and Central Ave., Delaware, Ohio.

BUILD Grandfather clocks. Information booklet 25¢. Mason-Sullivan, Noroton, Connecticut.

SEND Me your name and I'll show you how I made \$24.00 in one hour. You can, too, with my amazing new patented scissors sharpener that sells on sight. Be first in your locality. Write Ken Kessler, Kessler Enterprises, Dept. S34-E, Fremont, Ohio.

MAKE Money at home. Spare time. Free literature tells how. Maletto, 1312 So. Clinton, Berwyn, Illinois.

INCREASE Your income. Free details. Bercher, Box 500, Shreveport, Louisiana.

EXTRA Cash cleaning windows. Uncrowded opportunity. Kent Window Cleaning, Box 6807, Philadelphia 32, Penna.

EARTHWORMS. Sensationally profitable. Prized English hybrid. Balt! Soil! Breeders, 1000—\$10.00. Best buy, gallon (culture, worms, eggs) \$5.00. Instructions \$1.00 postpaid. Horton's Hatchery, 9492 South Linden Road, Swartz Creek, Mich.

ADULTS. Genuine additional income opportunities; interesting offers. Stamp appreciated. Geo. Gent, Box 484, Tremonton, Utah.

COAT Hangers bring cash. Instructions \$1.00. Talley, 1054 Juneau, Akron 20, Ohio.

EARTHWORMS: Small investment opportunity. \$5.00 brings 1000 bed-run earthworms, raising and marketing manual. 25¢ brings literature only with "Senior Kit" information. Multiple Enterprises, PM-72, Kalkaska, Michigan.

FREE Folio "\$5,000-\$45,000. Unlimited Vacations." No merchandise, equipment. Unknown! Work home, sparetime! Haylings, Carlsbad, Calif.

PLEASANT Profits—Let us show you how to start your own complete scissors and tool sharpening business. Free details. Serr-Edge Inc., 9729 Lorain, Cleveland 2, Ohio.

WILL Send 2 wholesale catalogs and another money-making plan. \$2.00. Latonia Pilgrim Hour, Box 31, Latonia, Ky.

SENSATIONAL New mailorder consumers' item. 60 million daily users, sold through costfree relay advertising. This amazing no-investment plan, samples, year's supply for own use, 400% profit proposition, all \$1.00 exclusively from manufacturers Aurolabs, 1305-7 Oaklane, Philadelphia 26.

FORTUNE Possible raising, fishworms and crickets. Free literature. Carter Hatchery, Plains, Georgia.

HELP Us! Help yourself! Get \$2.00 orders by mail. 100% profit. Details, 50¢. Co-Operative, Box 278-P, Manchester, New Hampshire.

MAKE Money with your camera. Amazing new low cost color enlargements can bring you hundreds of dollars in spare time. Nothing else like it! Send 10¢ for samples and eye-opening facts. Dept. PM-4A, Polypix Co., 723 S. Wells, Chicago 7, Illinois.

#### FORMULAS, PLANS, ETC.

PRACTICAL Formulas. Lists free. Cummings, Chemist, Gordon Ave., Syracuse 4, N. Y.

FORMULAS: All kinds, latest, best. Literature free. Kemixal, Park Ridge, Ill.

PRODUCT Analysis, manufacturing formulas, processes developed. Moderate fees. Plastics, Box 1574, Boston 4, Mass.

AUTHENTIC Formulas. Thousands, listings free. Brockway, 1145 High, Topeka, Kansas.

MILLER'S Modern manufacturing formulas make fastest-selling products that get the business and pay. Fifty years supplying the best. Valuable literature free. Miller, Chemist, 1517-F, Tampa, Florida.

#### PLASTICS

NEW Liquid casting plastic, clear, colors. Embed real flowers, insects, photos, coins. Saw, drill, carve. Send 25¢ for handbook. "How to Cast with Liquid Plastic," and proved success plan showing how to make money at home. Castolite, Dept. D-101, Woodstock, Ill.

PLASTICS Home-craft course for men and women. Tells and shows how to make hundreds of fast selling plastics products. All plastics and materials for 23 projects included in course. No special tools needed. Course pays for itself. Write for free booklet. Interstate Training Service, Dept. D-3, Portland 13, Oregon.

LAMINATING Supplies. Free price list. Solomson, 46 Cornhill, Boston 8, Mass.

PLEXIGLAS, Cut to size. Clear. Any thickness. Colors. Rods. Tubing. McClarin Plastics, P.O. Box 168H, Hanover, Penna.

PLEXIGLAS, Lucite. Square foot cost, 1/16", \$1.15; 1/8", \$1.52; 3/16", \$1.86; 1/4", \$2.21; 3/8", \$3.23; 1/2", \$4.38. Colors add 10%. Send 15¢ for postage. Aristocrat Plastics, 23-25 Sussex Avenue, Newark, N. J.

PLEXIGLAS, Fiberglass, polyester, acetate. Unique wholesale-retail catalog—15¢. Gem-O-Lite, Box 686M, North Hollywood, California.

#### CHEMISTRY

CHEMICALS, Supplies. Catalog 25¢, refundable. Laboratory Sales, Box 161-E, Brighton, Mass.

ILLUSTRATED Catalog: Chemistry, mineralogy, biology 20¢. Tracey Laboratories, Evanston, Illinois.

CHEMICALS And apparatus for industrial, analytical, and private laboratories. Catalog 25¢. Dept. M-50, Biological Supply Co., 1176 Mt. Hope Ave., Rochester 30, N. Y.

BOOKLETS: 60 pages each! "Beginners Chemistry," "Chemistry," "Einstein's Relativity," "Physics," "Atomic Theory," "Electron Theory," "Scientific Oddities," "Light," "Sound," "Heat," "Electricity," "Radio," "Astronomy," "Useful Tables," "Geometry," "Mathematical Oddities," "Scientific Terms." Order by titles. 10¢ each. Franks, 3121 South Racine, Chicago 8.



HOME Laboratory and apparatus kits, laboratory supplies. Catalog 25c. John H. Winn, 124A West 23rd St., New York, N. Y. Established 1931.

AMAZING New Book of Science. Experiments, formulas and catalogue of laboratory supplies. Only 25c. National Scientific Co., Dept. PM-4, 2204 W. North Ave., Chicago 47, Illinois.

### AGENTS WANTED

RUN A spare-time greeting card and gift shop at home. Show friends samples of our new 1956 all-occasion greeting cards and gifts. Take their orders and earn up to 100% profit. No experience necessary. Costs nothing to try. Write today for samples on approval. Regal Greetings, Dept. 59, Ferndale, Michigan.

GOLDMINE Of 600 money makers. Copy free. Specialty Salesman Magazine, Desk 5-B, 307 N. Michigan, Chicago 1.

HOME Motorized message. Big money! Mary Mac, 1012 Powhattan, Dallas 2, Tex.

YOUR Own business—Used suits \$1.50, overcoats 65c, mackinaws 35c, shoes 12½c, ladies coats 30c, dresses 15c. Enormous profits. Catalog free. Nathan Portnoy Associates, 605-AA West 12th Place, Chicago 7.

MAKE \$100 Up weekly—Demonstrate, take orders. Sensational new product. Prospects everywhere, part-full time. Campbell Company, Rochelle 53, Illinois.

GOLD Or silver letters, numbers, windows, doors, trucks. 1" to 6", 500% profits. Free samples. Atlas-T, 544 West 79th, Chicago 20.

PRINTING. Advertising salesmen—Excellent moneymaking sideline selling decalcomania name plates, small quantities. Automobile initials, sign letters. Free samples. Balco, XL, Boston 19, Mass.

\$1.00 PROFIT Selling \$2.95 photo enlargement deal. Allen Studio, Riegler Bldg., Little Rock, Ark.

AGENTS—300% Profit selling genuine gold window letters; stores and offices. Free samples. Metallic Sign Letter Co., 431-D North Clark, Chicago.

CALIFORNIA Sweet smelling beads. Sensational sellers. Particulars free. Mission, 2328 FR, W. Pico, Los Angeles 6, Calif.

USED And new watches \$2 up. Free list. Southern Watches, Gray, Georgia.

YOUR Ad in this space will get some good agents for you. Yes, I'll prove it. Write for Folder "A" right now. F. W. Johnson, Classified Advertising Manager, Popular Mechanics Magazine, 200 E. Ontario St., Chicago 11, Ill.

EASY Handwork makes fast-selling articles. Sample free. Sunmade Company, Brockton 64, Massachusetts.

SELL Sick call crucifixes. Big commission. The James Company, North Attleboro, Mass.

VITAMINS. Buy direct—Wholesale. Highest potency, lowest prices. Build very profitable repeat business. Complete sales program free. Write now! Daily Vitamins, 1001A Glendale Blvd., Los Angeles 26, Calif.

\$200-\$1000 WEEKLY: "Spark-O-Matic" lifetime spark plug. Exclusive territories. Almqvist, Milford P16, Penna.

WANT More business? Here's an amazing opportunity to increase your sales. Talk to thousands of interested readers of "Mechanics Popular." Our Spanish Edition covers the Latin American countries like a blanket. They're real mailorder buyers. Classified rate 75c per word. Try an ad in our next issue. Classified Advertising Department, Popular Mechanics Magazine, 200 East Ontario Street, Chicago 11, Ill.

MEN, Women, make money spare time plus new car as bonus for encouragement. Amazing hosiery guaranteed to wear without holes, snags, and runs, or replaced free. For example, lovely 60 gauge nylons guaranteed for as long as 1½ years, or replaced free. Write Wilknit, 1764 Wash., Greenfield, Ohio.

START Your own business on credit. Your own boss. 1598 dealers sold \$5,000 to \$32,000 in 1955. We supply stocks, equipment on credit. 200 home necessities. Sales experience unnecessary. Pleasant profitable business backed by world-wide industry. Write Rawleigh's, Dept. D-U-PPM, Freeport, Ill.

60% PROFIT On cosmetics. Famous nationally advertised Hollywood Cosmetics pay 60%. Make \$25 day up! Hire others. For free samples, details, write Studio Girl, Glendale, Calif., Dept. 1264G.

AGENTS-Salesmen: Sell beautiful hand-colored plastic enlargements and sensational new personalized photo compacts, rings, bracelets, lockets, etc. Experience unnecessary. 40% advance commissions. We deliver, collect. Wonderful sideline. Better full time. Free sample outfit. Novel Portrait Co., 3343 North Ave., Chicago, Ill.

FREE Money-making guide shows new easy ways to make extra money. Sell friends new type greeting card assortments, wrappings, novelties. Profits to 100%. Bonus. Write today for feature boxes on approval, 29 free samples personal stationery, free illustrated catalog. New England Art Publishers, North Abington 433-Y, Mass.

BE First. Sell safety. America's newest, hottest \$1.00 car accessory. Record profits. Part, full time. Write manufacturer. Minier, Box 1416, Dept. M-P, McAllen, Texas.

SELL Carbon paper. Wonderful sideline. Sample sheet free. Tasker's, 105 East Custis, Alexandria, Virginia.

WHOLESALE Merchandise. Terrific savings. American Wholesalers, 12503 Superior, Cleveland 6, Ohio.

EVERYTHING For food! Unlimited demand for cookware, dinnerware and tableware. Make 75c profit on dollar! No stock to carry. We ship orders for you. Choice of ten money-making plans! Catalogue, plans free. Topval Corp., Lindenhurst 71, N. Y.

BUY Wholesale thousands nationally advertised products at big discount. Free "Wholesale Plan." American Buyers, Hertel Station, Buffalo 16-A1, N. Y.

FREE! Beautiful feather pictures 200% profit! Apartado 9036, Mexico 1, D. F.

EARN 50%, 75%. Write: Eisenberg's, 104-15 116th St., Richmond Hill 19, N.Y.

SUBSCRIPTION Agents wanted. Make money in your spare time. Free kit available to put you in business. No money needed to get started in this very profitable sideline. ATSA, 2020 M St., N.W., Washington 6, D.C.

YOU! Can make extra money. Distribute our discount catalogs and receive commission on sales. Write Consumers Discount Service, Box 1646, Hebron, N. Dak., Dept. PMD.

EXCLUSIVE Territories open. Top quality imported chamois. Babrok Tannery, 4M, Hudson Falls, N.Y.

WHOLESALE. Famous make scatter rugs. Free details. Dorsey, 210 Fifth Ave., New York City.

BEAUTIFUL Featherbird pictures. Details, sample 10c. Thomas, 54B Central, North Tonawanda, New York.

NYLONS—Lowest prices! Essential Products Co., 210 Fifth Ave., New York 10, N. Y.

GENEROUS Commission selling personalized cast aluminum estate and mail box signs. Write Doucette Foundry, Worthington, Mass.

NYLONS \$6.25 Dozen. Free displays. Stretch socks. Arenel Mills, 1209 W. Chicago Ave., Chicago 22, Illinois.

\$125 WEEKLY. New, doctor approved products for home use. Prospects galore. Free details. DeAns, 259 So. Robertson, Beverly Hills 50, California.

### BUY IT WHOLESALE

BUY Wholesale Nationally advertised appliances, radios, watches, etc. Catalog \$1.00 (refundable). D'Auria, Box 355-PM, Jackson, Michigan.

WHOLESALE Catalog! Appliances, cameras, watches. Postcard: Selbyco, Decatur 255, Illinois.

YOUR Cost as little as 25c on dollar! Household items needed in every home. Sell direct, by mail or to agents. Catalogue, confidential distributors' wholesale prices and money-making plans absolutely free. Rush postcard to Topval Corp., Lindenhurst 124, N. Y.

THOUSANDS Nationally advertised brand name products, including new 1956 automobiles—Discounts to 80%. Meder, 550-PM Fifth Avenue, New York City 36.

1956 "PORTABLE Showroom" (catalog). Rush 50c to Edward Clemens, 318 W. Bridge St., Morrisville, Penna.

WHOLESALE Catalog! 30-80% discounts! Appliances, musical instruments, typewriters, phonographs, watches, jewelry, recorders, housewares, etc. Consolidated Distributors, 21-20 Lafayette, Paterson, New Jersey.

WHOLESALE Name brands. Illustrated catalog 50c. Refundable. Distributors, Box 106A, Hudson, New York.

FREE Lists. 640,000 items wholesale. P. Cottage Industries, Omaha 12, Nebr.

WHOLESALE Coverage, complete! Amazing details. Mailtrader, Box 643, Ann Arbor, Michigan.

1956 WESTINGHOUSE Washers, dryers, refrigerators, freezers, TV, etc. G.E., Sunbeam, Universal, and many other accepted brands. All merchandise positively guaranteed. 25c brings wholesale price lists. Refundable. Western Sales Co., Inc., Box 607, Lubbock, Texas.

VITAMINS Wholesale fresh from California. Sell others for good profit. Particulars free. Hudson's, Box 4015, Fresno 4, California.

LEATHER Work gloves wholesale. Briggs Co., Gorham Building, Minneapolis 3, Minnesota.

BUY Wholesale! Television, radios, refrigerators, freezers, water heaters, air conditioners, sewing machines, power tools, housewares, etc. Catalog 10c. Marpat, Box 1485, D-FPM, Milwaukee, Wis.

ELECTRIC Guitars, amplifiers, accordions, wholesale. Free catalog. Carvin, PM287, Covina, Calif.

61 PIECE Socket wrench set. Agents cost \$19.95—3 sets or more. Garage price \$29.95. Retail \$49.95. Robe, 1923 East 79th, Chicago 49.

REAL Wholesale sources thousands nationally advertised products. Details free. Martex, 132-C Nassau St., New York 7, N. Y.

### SALESMEN—DISTRIBUTORS

FREE—1 Dozen beautiful pins with every 3 dozen gorgeous assorted earrings. Send \$6.00 complete deal. Bargain Jewelry Company, Box 215, Brookline, Massachusetts.

\$800 PROFIT On a single sale! One salesman did it selling work uniforms that advertise! Prospects everywhere, garages, factories, institutions, businesses. Show all colors, styles, fabrics including miracle Orion, Acrilan, Dynel. Outfit free. Write Topps, Rochester 614, Indiana.

AD Matches! Sell amazing designs—10, 20, 30, 40 and 240-light book matches. Bigger spot cash commissions; every business a prospect. Low prices for high quality. Repeats. Start without experience; men, women; full, part time. Buy nothing! Sales kit furnished. Match Corp., Dept. PM-76, Chicago 32, Illinois.

WILL You wear new suits and topcoats without one penny cost and agree to show them to friends? You can make up to \$30.00 in a day even in spare time, without canvassing. Stone-Field, 532 South Throop Street, Dept. S-926, Chicago 7, Illinois.

BIG Money. Be manufacturer's distributor. Evans, 5930 Comey, Los Angeles 34, California.

ADVERTISING Book matches—Cash in on big demand; sell union label matches. Cuts for all businesses and political parties. Free powerhouse selling kit, low prices, protection guaranteed on repeat orders. Cash commissions. Superior Match Co., Dept. M-456, 7530 Greenwood, Chicago.

EVERYTHING For food! "Waterless" cookware to cook; unbreakable Melmac dinnerware to serve; stainless steel tableware to eat the food. Up to 75c profit on dollar! Write orders deposit-c.o.d.; sell time payments; have others sell for you; sell wholesale to agents; use mails; establish own business. There is a custom-made plan to suit you! Postcard brings everything needed to make money absolutely free. Topval Corp., Lindenhurst 525, N. Y.

EXCLUSIVE Territory. Fast selling product. Great demand. Repeat sales. Literature furnished. Forrest Products Co., Box 244, Piqua, Ohio.

GET New shirt outfit free. Make \$90.00 weekly on 5 average orders a day. Famous quality made-to-measure dress and sport shirts at \$3.95 up sell fast to all men. No experience needed. Full or part time. Write: Packard Shirt Co., Dept. 265, Terre Haute, Ind.

BUY Wholesale thousands nationally advertised products at big discount. Free "Wholesale Plan." American Buyers, Hertel Station, Buffalo 16-J1, N. Y.

**BUSINESS Kit free!** Postcard puts you in business! Complete line, 160 shoe styles. Also jackets. New discoveries pay big commissions. No investment. Send for free kit. Mason Shoe, C4, Chippewa Falls, Wis.

**SELL Calendars.** You make big money daily. Giant line. Every business buys. Also business printing, book matches, advertising specialties. Big sales outfit free. Write, Arrow Press, 515-D Fourth Ave. So., Minneapolis, Minn.

**ANYONE** Can sell famous Hoover uniforms for beauty shops, waitresses, nurses, doctors, others. All popular miracle fabrics, Nylon, dacron, orlon. Exclusive styles, top quality. Big cash income now, real future. Equipment free. Hoover, Dept. D-100, New York 11, N. Y.

**BIG Money-making opportunity.** Exclusive line work uniforms. Jackets, pants, shirts, coveralls. Advertising embroidered. Every business prospect. Outfit free. Master Div., 687 Water, Ligonier, Ind.

**NEW Jobs open in selling!** Send name, address for five free issues of Opportunity Magazine's money-making guide, listing hundreds of companies who'll pay you well, full or part-time. No experience needed. Opportunity, 850 N. Dearborn, Dept. 17, Chicago 40, Ill.

**BIG Money!** Buy wholesale, sell retail. Dresses, children's wear, family apparel. Lowest factory prices. No stock to carry. No samples to buy. Big sales kit with actual fabrics free. C. E. Israel, Dept. R-5703, Cincinnati 25, Ohio.

**HERE'S** The perfect sales item! Talk sixty seconds to any woman. If eight out of ten don't buy, give up selling because it isn't for you. Perfect for mail order. 100% profit. Overseas Imports, Bridgeton 33, New Jersey.

**FREE Kit.** Power mowers. Wholesale. Sell dealers. Farm Products-51, Excelsior Springs, Missouri.

**NEW Product** for tubeless tires in urgent demand by garages, service stations, tire shops. Outstanding opportunity. Write The Esquire Company, Box 2586-A, Phoenix, Arizona.

**EUREKA Vapor lamp** kills insects outside anywhere. Coddling fly, tobacco fly. World wide market. Retail \$6.95. Send \$5.00 for demonstrator and literature. Eureka Vapors, Inc., Lynchburg, Va.

**CASH** in on 1956 elections! Big advance commission selling low priced union label political posters, cards, labels, book matches to candidates. Complete printing line for all businesses. Free kit. National Press, North Chicago 2, Ill.

**BUILD Sales** by recruiting productive distributors selling direct or to retail outlets. Secure most concentrated circulation through classified columns of Salesman's Opportunity. Write for facts. Gilbert, Salesman's Opportunity, Room 1700, 850 N. Dearborn, Chicago 10.

**MAKE \$50 A day,** sell modern fire extinguisher featured in Look Magazine. Aerosol bomb Kill-Flame retails \$1.98. Safe, no toxic chemicals, panic-proof, sells easily in homes, factories, garages, boats. Also in aerosol bomb, new do-it-yourself paint remover Sprays-Off. Eliminates scraping, sanding, hard work. Send \$1 each for demonstrator model to Allichem Mfg. Co., 15 West 39 Street, Dept. F56, New York.

**PRINTING,** Calendar, novelty salesmen: America's best deal. New, hot best selling samples free. Write, South's largest. Nationwide, Arlington, Texas.

#### EDUCATIONAL AND INSTRUCTION

**SIMPLIFIED** Analytics teach algebra clearly, \$1; guaranteed. Ziemba, H-6123 Orchard, Dearborn, Mich.

**BIBLE** And religious studies available by mail, \$6.50 up. Information free. Baptist Seminary Extension Department, P.O. Box 530, Jackson, Mississippi.

**APPLY** For jobs by letter. Folio \$1. Telesis Company, Room 706, 507 Fifth Avenue, New York 17.

**COMPLETE** Your high school at home in spare time with 59-year-old school. Texts furnished. No classes. Diploma. Information booklet free. American School, Dept. X445, Drexel at 58th, Chicago 37, Illinois.

**LANGUAGES?** Learn Esperanto, used globally. Free details. Esperanto, Hillsboro, Oregon.

**FREE!** Send for amazing illustrative lesson. Rapid mental multiplication. Math Institute, Box 204, Mobile 1, Ala.

**OFFICE Automation:** prepare for the future with the only home study course instructing application of electronic computers to business clerical operations. Free information. Business Electronics, Computer Department, Box 3330 Rincon Annex, San Francisco 19, California.

**HIGH School—No classes.** Study at home. Spare time. Diploma awarded. Write for free catalog HF-63. Wayne School, 2527 Sheffield, Chicago 14, Ill.

**WELDING** Training pays at Hobart Welding School, Box M-461, Troy, Ohio. VA contract. Best equipment. Catalog free.

**BLUEPRINT Reading—Train at home.** Learn to read blueprints with confidence in 10 easy lessons. Write today Belton School, 1059-L North Lawndale, Chicago 51.

**COLLEGE Degrees—Independent study.** Keep employed. Brentwood College, Box 19-721, Los Angeles 19.

**STUDY** For Doctor's degree of psychology, metaphysics and divinity. Correspondence courses only. College of Divine Metaphysics, Dept. P-M, 2811 North Illinois, Indianapolis 8, Indiana.

**LEARN** Mineralogy at home. Diploma course. Fortunes now being made in uranium and other minerals. Free catalog. Mineral Science Institute, Desk 2, 159 East Ontario, Chicago 11.

**HIGH School diploma** at home. Licensed teachers—Approved materials. Southern States Academy, Box 144-MX, Station E, Atlanta, Georgia.

**PIANO Tuning** pays. Big money in spare time. Learn at home in 30 days. No musical knowledge necessary. Phonograph, records, tools and instructions furnished. Free catalog. Capital Tuning School, 16 Southwest Second, Fort Lauderdale, Fla.

**I Want to send you proof** of the wonderful pulling power of Popular Mechanics classified pages. What's your proposition? Write me today. Include literature if possible. F. W. Johnson, Manager Classified Advertising, Popular Mechanics Magazine, 200 E. Ontario St., Chicago 11, Ill.

**\$5,199.90 WAS Paid** to John Betts, in few weeks. Grow mushrooms. Cellar, shed. Spare, full time, year round. We pay \$3.50 lb. Free book. Mushrooms, Dept. 174, 2954 Admiral Way, Seattle, Wash.

**BE A real estate broker.** Study at home. Write for free book today. GI approved. Weaver School of Real Estate, 2018F Grand, Kansas City, Missouri.

**INVESTIGATOR Training.** Phillips Secret Service System, 1917-B North Kenneth, Chicago 39.

**SECRET Investigation.** Experience unnecessary. Investigators particulars free. George Wagner, M125 West 86th, New York 24.

**EARN** While you learn. Auto and diesel mechanics master this top paying trade. Many graduates earn \$100 a week and up. Approved for Korean veterans. For free information write Dept. No. 356, Nashville Auto-Diesel College, Nashville 3, Tenn.

**BOOKKEEPERS!** Increase your earnings! Operate your own simplified "Dollar-A-Week" bookkeeping and tax service. Full or spare time. Details free. No obligation. Ellis, Box 206, Cedar Grove, North Carolina.

**USED** Correspondence courses and books sold and rented. Money back guarantee. Catalog free. (Courses bought.) Lee Mountain, Pisgah, Alabama.

**WANT A diesel job?** New opportunities to increase income. Higher pay. More money. We can help you qualify. Tools. Shop method home training. Write today! Diesel, Tractor, Heavy Equipment Division, Interstate Training Service, Dept. B-3, Portland 13, Oregon.

**PHYSICAL Therapy** and massage. We train you at home. Earn big profits from your own private practice or work with hospitals and doctors. Free catalogue. National Institute, Desk 4, 159 E. Ontario, Chicago, Ill.

**SPEAK.** Sing with power, personality. Home self-training method on records. Amazing details free. Canfield, 2018-A 5th Ave. South, Minneapolis 4, Minn.

**PIANO Tuning** pays. Learn this profitable profession at home easily with patented Tomometer and mechanical aids. No knowledge music necessary. Diploma granted. Write for booklet. Niles Bryant School, 3731 Stockton Blvd., Dept. P. Sacramento 20, California.

**FINGERPRINTING** Course, \$12.00. Details free. Alabama School of Fingerprinting, Box 185-A, Fairfield, Alabama.

**USED** Correspondence courses and educational books bought, sold, rented. Free catalog. Educational Exchange, Menlo, Georgia.

**HELP Yourself!** Solve personal problems by self-mastery. Free information. The Leavitt Science, Clinton 5, Illinois.

**CORRESPONDENCE** Courses, books bought, sold. Free catalog. Bayles, 211 Essex, Hackensack, New Jersey.

**GAG-Writing** pays \$200.00-\$400.00 monthly. Amazing. Simple. Easily understood folio tells how. Satisfaction guaranteed. \$1.00. Fields, 409-A Boundary, Portsmouth, Ohio.

**TRANSFORM Yourself** via subconscious. Free brochure. Box 847 (H-4), Ocean Park, California.

**JOB Counseling** by experts. Approved methods. Plan for successful future. Request free questionnaire. National Guidance Service, Bainbridge Road, Elizabethtown, Penna.

**U.S. Civil service tests!** Training until appointed. Men-women, 18-55. Start high as \$377.00 month. Many jobs open. Qualify now! Get free 38-page illustrated book showing salaries, requirements, sample tests. Write: Franklin Institute, Dept. R24, Rochester, N. Y.

**GET Into politics.** Brand new course tells how. Get into the big money class. Details free. Realfact Publishers, Post-office Box 137-A, New York 51, New York.

**LEARN Advertising—High pay profession!** Individual tutoring by mail by advertising agency president and staff. Textbooks, trade magazines included in cost of course. Easy payments if desired. Facts free. Write to Robert Eastman, President, Robert Eastman, Inc., Box 365-A, Ithaca, New York.

**LEARN To speak, sing and sell** with power. New, amazing system. Works wonders. Easy. Pleasant. Guaranteed. Free details. Golden Plains, Inc., Box 765, Chicago 90, Ill.

**\$4 TO \$10 Hour** spare time in billion-dollar adjustment field. Free book, now! Universal Schools, 6801 Hillcrest, M104, Dallas 5, Texas.

**\$500 MONTHLY!** Operate collection agency—Home, sparetime! Financial, B-740-P4, Chicago 90.

**UNIVERSITY Degrees** by residence, correspondence. Golden State University, Box 2883, Hollywood, Calif.

**WANT Strong, masculine voice?** Send for free booklet. Perfect Voice Institute, 210 South Clinton, Studio 2DU-2, Chicago 6.

#### PLAYS, STORIES, MANUSCRIPTS

**WANT Your book published?** Learn how we publish, advertise, promote, distribute. Many successes. Free booklet PM. Vantage, 120 West 31, New York City.

**WANTED:** Book manuscripts, all subjects considered. Greenwich Book Pub., Atten. Mr. Zealand, 489 Fifth Ave., New York City.

#### SPECIAL SERVICES

**VETERANS—Papers scattered?** Free folder! Records Holder Co., Charles Town, W. Va.

**INFORMATION** Any manufacturer, \$1.00, product and address. Agentservice, Box 1039, New Haven 11, Conn.

**INFORMATION,** Any subject, \$1. Certified research! Griffith, 613 Latham, Wynnewood, Pennsylvania.

**INFORMATION** On anything. Ferguson Research Specialists, 116-14 141 St., South Ozone Park 36, N. Y.

**WE'LL Buy every Swedish necklace** you make for \$4.25. Guaranteed. Earn \$46.75 weekly, minimum. Instructions: \$1.00. Inquiries welcomed. Altx, 611 15th N.W., Albuquerque, New Mexico.

## CARTOONING, COMMERCIAL ART, SHOWCARD & SIGN PAINTING, TATTOOING

ART Self employment, 27 plans. Free literature. Hal Barebo, O'Fallon, Mo.

MAKE Money with art. Straley, 410 S. Western, Springfield, Ohio.

LEARN Cartooning from famous cartoonists. Details. Cartoonists, 2776 California Ct., Lincoln 10, Nebraska.

"HOW To Make Money With Simple Cartoons"—A book everyone who likes to draw should have. It is free; no obligation. Simply address Cartoonists' Exchange, Dept. 94C, Pleasant Hill, Ohio.

YOU Can entertain with chalk talks. Catalog 10c. Balda The Cartoonist, Oshkosh, Wis.

9 ALPHABET, 3 Numeral pattern sets and raised wood letter catalog, \$1.00. Sign Letter Distributors, P.O. Box 101, Mineola, N. Y.

TATTOOING Supplies, licensed course, illustrated brochures 25c. Zeiss, 728 Lesley, Rockford, Illinois.

LEARN Sign painting at home. Particulars free. Bolger, 148 Concord, River Edge, New Jersey.

PAINT With fire. Glowing black light colors. Different as day from night because you literally paint with light! Water colors, oils, chalks, crayons—Blak-Ray lamps. Free—write today for idea packet. Black Light Corporation of America, San Gabriel M. Calif.

PAINT Signs—Master die cut, outline letter patterns. Complete assortment 1 1/2" to 12" high, prepaid \$2.00. Eyerly, 583, Newton, Iowa.

## ADVERTISING AGENCIES, LETTER WRITERS, FOR ADVERTISERS

BEFORE Advertising—Get instructive Ad-Guide and newspaper-magazine rate-book, 10c. Chicago Advertising Agency, Chicago 4.

SUBSCRIBE 300 New opportunity seekers names typed on gummed labels four weeks (1,200 names) \$9.00. Ken-West Distributors, 7K South Harlem, Worcester 4, Mass.

ADS Placed in out of town newspapers and magazines. Low rates. Catalogue free. Ideas that pay. Baker Advertising Agency, Successors Ankrum Agency, 189 W. Madison, Chicago 2.

MAILING Lists, most any classification. 1000 names \$5.00, 1000 your circulars mailed with ours \$4.00, 5000 your circulars printed and mailed \$12.95. Write Dixie Mailers, King, North Carolina.

ADVERTISE: 24 Words, 100 Canadian newspapers \$5.50. Lists free. Advertising Bureau, 10511-C Springfield, Chicago 43.

## RUBBER STAMPS AND OFFICE SUPPLIES

NEW Low price. Pocket stamp 3 lines and automatic inker, 90¢. Geo. Gent, Box 484, Tremonton, Utah.

RUBBER Stamps by professional craftsmen. 3 lines \$1.00. Price list. South Coast Press, P.O. Box 2074, San Bernardino, Calif.

3 LINES, \$1.00. Fast service. Catalogue. Johnson, 443 MacDonough, Brooklyn 33, N. Y.

## TYPEWRITERS, DUPLICATORS, OFFICE DEVICES

PORTABLE Mimeograph! Uses no stencil, no ink. The newest, cleanest, smallest, lightest and cheapest. Weight 15 pounds. DuPont Distributors, Dept. A, P.O. Box 695, New York 1, N. Y.

RECONDITIONED Typewriters, duplicating, printing devices. \$25.00 up. Supplies. Appliances. DixieGraph, King, N. C.

## PRINTING, MULTIGRAPHING, MIMEOGRAPHING, GUMMED LABELS

OFFSET Printing \$6.00—1000, 8 1/2 x 11, 16 lb. Lore, East Dedham, Mass.

FREE Catalog. Business, personal, printing. D. M. Press, Sebastopol, Calif.

AIRMAILED Free—Samples quality printing. Southwestern Stationery, 1901 North Tenth, Tucson, Arizona.

100 LETTERHEADS (8 1/2 x 11) Printed carefully, \$1.00, postpaid. Envelopes same. Race Printers, Hudson, New York.

POSTPAID, Quality business printing, rubber stamps. Pricelist. Haines, Petersham, Massachusetts.

DISTINCTIVE Embossed cards, stationery reasonable. Samples. Edward Cass, Melbourne, Iowa.

GENUINE Engraved stationery. Lowest prices. Service, 624 Humboldt, Richmond 9, California.

LITHO Printing. Estimates-samples free. Studio Press, 754 North Arthur, Pocatello, Idaho.

MIMEOGRAPHING. Offset - printing. Complete lettershop service. Samples. Pennway, 439 Adams, Scranton, Penna.

500 PRINTED Gummed name and address labels, \$1.00. No c.o.d.s. Print clearly. Addison, 1840-F Addison, Chicago 13.

LITHOGRAPHED Circulars with sales impact our specialty. Samples free. Bandy Color Press, Gainesville, Texas.

100 LETTERHEADS (8 1/2 x 11) Printed neatly \$1.00 postpaid. Envelopes same. Blue or black ink. Stark Press, Capitola, Calif.

MIMEOGRAPHING—Letters, pricelists, formulas, instructions. Lowest prices. Lem's Letter Shop, 5710 Stanton, Detroit 8.

ADS Running under this heading sell printing. Ask me for proof. I'll gladly send you amazing facts. Ask for Folder "P." F. W. Johnson, 200 E. Ontario St., Chicago 11, Ill.

1,000 RAISED Letters business cards only \$2.95 postpaid. Samples free. Pioneer, 195 Quebec, Island Park, N. Y.

PRINTING, Diecutting. Rough ideas developed free. Lisk, Central Lake, Mich.

MIMEOGRAPHING—Reasonable. Any copy. Mailers Service, Box 606-B, Chicago 90, Ill.

200 LETTERHEADS, Envelopes \$4.95. 1000 cards \$2.99. Samples. Ridgecrafters, Glencoe, Mo.

MIMEOGRAPH Stencils cut electronically! Free samples. Bert's, 3603 W. North, Chicago 47, Ill.

OFFSET Printing \$6.50—1000, 8 1/2 x 11, 16 lb. National Letter, 251 W. 42 St., New York City 36.

100 BOOK Matches printed to order, \$1.50. Printer, Box 93, Honor, Mich.

AMERICA'S Finest economical printing. Letterheads, envelopes, business cards, illustrated catalog. Steinbergen Press, GPO 291Z, New York City.

100 SHEETS 5 1/2 x 8 1/2, 50 Envelopes, three lines, black, \$1.00. Bunker, 88 Abbott Road, Dedham, Mass.

1000 EMBOSSED Business cards, \$2.95 up. Samples. Decco Service, St. Louis 21.

INEXPENSIVE Mimeographing: Illustrated. Looks like printing! Fast! Samples free. Edwards, 1567-B Park Place, Brooklyn 13, New York.

"HOW To Buy and Use Printing." Free booklet, samples and prices. R-K Press, 825 Powder Mill Lane, Philadelphia 31, Penna.

250 RED OR blue 8 1/2 x 11 letterheads \$3.00. Ken-West Distributors, 7-K South Harlem, Worcester 4, Mass.

FREE Quotations. Trisize. Economize. Postcard. Describe needs. Redoprint, Ojai, Calif.

SENSIBLY Priced business printing. Special! 250 8 1/2 x 11 bond letterheads, 250 #10 heavyweight envelopes, \$6.95. Postpaid, guaranteed. Free samples, quotations. Sparks Company, Box 4096, Austin, Texas.

500 PRINTED Gummed name and address labels. Only 50¢. Free—Ball point pen with every order. Names, P.O. Box 8893, Kansas City 15, Mo.

## PRINTING OUTFITS AND SUPPLIES

RUBBER Stamp making presses, supplies. Custom, Box 211-M, Springfield, Missouri.

DO Your own printing. Save money. Simple rules. We supply everything. Print for others; good profit. Raised printing like engraving too. Have home shop. Details free. Kelsey Presses, V-11, Meriden, Connecticut.

MAKE Your own self-molding rubber stamps and printing cuts. Plexirubber, Argyle 1, Wisconsin.

PRESSES, Type cabinets, supplies. List for stamp. Lincoln Press Company, 220-D Hartwell, Fall River, Mass.

## PATENT ATTORNEYS

HERMAN Lewis Gordon, registered patent attorney. Patent investigations and opinions. Warner Building, Washington 4, D. C.

PATENTS—Irving L. McCathran, 315 McLachlen Bldg., Washington 1, D. C. Registered Patent Attorney.

INVENTION Record form free and "Patent Information Every Inventor Should Have." Carl Miller, Registered Patent Attorney, Woolworth Building, New York.

REGISTERED Patent attorney offers services. Sanders, 6430 Evans, Chicago 37, Illinois.

C. A. Snow & Co.—M427, Snow Building Washington 1, D. C. Registered Patent Attorneys. Write for information.

INVENTORS: When you are satisfied that you have invented something of value write me, without obligation, for information as to what steps you should take to secure a patent. Write Patrick D. Beavers, Registered Patent Atty., 935 Columbian Bldg., Washington 1, D. C.

PATENTS, "Proof of Invention" free. E. E. Vrooman, Registered Patent Attorney, 507 McKim Building, Washington 5, D. C.

INVENTORS: Without obligation, write for information explaining the steps you should take to secure a patent. John Randolph, Registered Patent Attorney, 203 Columbian Bldg., Washington 1, D. C.

"INVENTOR'S Guide," "Record of Invention," sent free. Frank P. Ledermann, 154 Nassau Street, New York 38, N. Y.

INVENTORS—If you believe you have an invention, you should find out how to protect it. The firm of McMorro, Berman & Davidson with offices in Washington, D. C., is qualified to take the necessary steps for you. Send for copy of our patent booklet "How to Protect Your Invention." We will also send you an "Invention Record" form. No obligation. They are yours for the asking. McMorro, Berman & Davidson, Registered Patent Attorneys, 134-Y Victor Building, Washington 1, D. C.

INVENTORS—Take these preliminary steps toward patent protection. Sketch and describe your invention. Sign, date and have this disclosure witnessed by two people who understand your invention. Have us make a preliminary search among U.S. patents already granted for similar types of invention. We report on the probable patentability of your invention and recommend your further course of action. Write for our instructive booklet, "Patent Protection for Inventors" and convenient "Evidence of Invention" disclosure form. Victor J. Evans & Co., 231-D Merlin Building, Washington 6, D. C.

INVENTORS: Learn how to protect your invention. Unless the inventor is familiar with patent matters, he should engage a competent registered patent attorney or agent to represent him. We are registered to practice before the U. S. Patent Office and prepared to serve you in handling your patent matters. "Patent Guide for the Inventor" containing detailed information concerning patent protection and procedure with "Record of Invention" form will be forwarded to you upon request, without obligation. Clarence A. O'Brien & Harvey Jacobson, Registered Patent Attorneys, 61B-D District National Building, Washington, D. C.

## FOR INVENTORS

INVENTORS Profit in booming Canada. Patent application on pending U. S. patent will be promptly filed in Canada before U. S. patent issues for \$100.00. Joseph O'Brien, former manager Canadian patent firm; foreign patents filed. 132 Nassau Street, New York, N. Y. 30 years in business.

INVENTORS: If you have an invention for sale, patented or unpatented, write Institute of American Inventors, Dept. 40A, 631-E St. N.W., Washington 4, D. C.

**PATENT Searches**, including copies of nearest patents, \$6.00. Reports airmailed within 48 hours. More than 100 registered patent attorneys use my service. For free invention protection forms, write Miss Ann Hastings, P.O. Box 176, Washington 4, D. C.

**INVENTION Record form free** and "Patent Information Every Inventor Should Have." Carl Miller, Registered Patent Attorney, Woolworth Building, New York.

**SEARCHES**—Put your patent searches in the hands of a registered patent attorney or agent, as he qualifies to give a worthwhile patentability report. Record of invention form upon request and information on patent protection. Patrick D. Beavers, Registered Patent Attorney, 936 Columbian Bldg., Washington 1, D. C.

**INVENTORS:** Information on patent procedure furnished on request, without obligation. John Randolph, Registered Patent Attorney, 202 Columbian Building, Washington 1, D. C.

**PATENT Searches \$5.00.** 48-hour service. Free invention protection forms. Write Raymond L. Smith, Patent Searcher, 620 Sheraton Building, Washington 5, D. C.

**PATENT Searches \$5.00.** 48-hour airmail service. Invention protection forms free. Write Patent Engineering Service, 711 16th Street N. W., Washington 5, D. C.

**PROBLEM?** Licensed, graduate M.E. will assist you to perfect your invention. \$5.00 deposit required. Prompt reply. R. M. Vincent, Consulting Engineer, 2727 Stevens, Parsons, Kansas.

**PATENT Searches, \$5.00.** Free protection forms. Prompt airmail service. Complete reports. Patent Service Institute, 725-A Albee Building, Washington 5, D. C.

"**INVENTOR'S Guide**" sent free. Frank P. Ledermann, 154 Nassau Street, New York 38, N. Y.

**INVENTORS:** Learn how to protect your invention. Unless the inventor is familiar with patent matters, he should engage a competent registered patent attorney or agent to represent him. We are registered to practice before the U. S. Patent Office and prepared to serve you in handling your patent matters. "Patent Guide for the Inventor" containing detailed information concerning patent protection and procedure with "Record of Invention" form will be forwarded to you upon request, without obligation. Clarence A. O'Brien & Harvey Jacobson, Registered Patent Attorneys, 61A-D District National Building, Washington, D. C.

**INVENTIONS** Consisting of wood patented or unpatented for manufacturing and marketing. Snell Woodworking Co., 101 Linwood Ave., Albion, N. Y.

**INVENTORS!** Have you good patentable idea? Write Mr. Metzler, 11 West 42nd, New York City.

**INVENTORS**—If you believe you have an invention, you should find out how to protect it. The firm of McMorrow, Berman & Davidson with offices in Washington, D. C., is qualified to take the necessary steps for you. Send for copy of our patent booklet "How to Protect Your Invention." We will also send you an "Invention Record" form. No obligation. They are yours for the asking. McMorrow, Berman & Davidson, Registered Patent Attorneys, 134-X Victor Building, Washington 1, D. C.

**FREE Patent booklet.** Write Blasius, 15-A Park Row, New York City.

**INVENTORS**—Send for free patent information book and inventor's record. Registered Patent Attorney, Associate Examiner, Patent Office 1922-29. Patent Attorney & Advisor, Navy Department 1930-47. Gustave Miller, 46A Warner Building, Washington 4, D. C.

**INVENTORS**—This firm is registered to practice before the United States Patent Office and available to assist you in the preparation and prosecution of your patent application. "Patent Protection for Inventors" booklet containing detailed information and steps to take toward patent protection sent promptly upon request. No obligation. Victor J. Evans & Co., 232D Merlin Building, Washington 6, D. C.

#### INVENTIONS WANTED

**SUPERIOR Promotions.** Patented; unpatented inventions. New, informative booklet on request. Superior, 338-344 North Rodeo, Beverly Hills, Calif.

**YOUR Idea** may be worth a fortune. For full and complete information write: Inventors, Box 1481, Milwaukee 1, Wisconsin.

**INVENTORS:** If your invention is adaptable to promoting we will contract on cash or royalty. If not, we will attempt selling it for you. Special booklet free. Kessler Corporation, 541W, Fremont, Ohio.

**NO Prepayments.** Inventions marketed, 20% of profits. Gerry Peters, Box 9238, Roslyn Station, Arlington 9, Virginia.

**FREE Record of Invention form.** Keep idea secret until recorded. Patent office search, including copies of closest patents, plus sales suggestions, \$5. We contact hundreds of manufacturers seeking inventions. Inventors Sales and Engineering Service, Box 4973, Washington, D. C.

**INVENTIONS Wanted** now by my manufacturer-clients. Patented, unpatented. Details free. Adams, Patent Broker, 80-S Wall Street, Financial District, New York City.

**HIGHEST Cash, royalties** for unpatented inventions, patents. We have investors, manufacturers lists. Write Inventors Creative Service, 354-M South Spring, Los Angeles 13, Calif.

**INVENTIONS Examined, promoted.** Free appraisal—competent engineering staff. Invention Development Council, Box 2194, Edgewood 5, R. I.

**INVENTORS:** Hundreds of manufacturers have requested our assistance in locating marketable new products. Complete information free. Institute of American Inventors, Dept. 40-D, 631-E St. N.W., Washington 4, D. C.

**INVENTORS, Don't sell your invention** patented or unpatented until you receive our offer. Write Cowgill, Box 298, Marion, Ohio.

**INVENTIONS And patents promoted.** A-1 service for inventors for many years. Write Adam Fisher Co., 5418 Idaho, St. Louis, Mo.

**INVENTIONS Wanted, Patented or patent pending.** 25 years experience promoting inventions. National Service Bureau, 3120 Meramec, St. Louis 18, Mo.

**INVENTIONS Wanted, Patented; unpatented.** Tremendous manufacturers lists. Global Marketing Service, 3420 77th, Oakland 5, California.

#### PATENTS FOR SALE

**FOR Sale.** Automatic golf cart patent. Nothing on market like it. Free details. R. E. Moreland, Box 1441, Houston 1, Tex.

**INVENTORS:** Test the commercial value of your patented or unpatented inventions, quickly and inexpensively. Write for free information. Institute of American Inventors, Dept. 40-B, 631-E St., N.W., Washington 4, D. C.

#### MANUFACTURING

**MODELS**—Small lot manufacturing. Metals, plastics, etc. Milburn, Burlington, Kentucky.

#### MODELS, MODEL SUPPLIES

1956 **CAR Models**, 1/25 scale, all metal, chrome trim. Send for catalog! Cars and Hobbies, Dept. PM-13, 2333 Haddon, Chicago.

**RAILROADERS** Get 1956 catalog-reference manual. O gauge scale, tinplate 50c. HO 50c. Terminal Hobby, 247 Erie, Milwaukee 2, Wis.

**SHIP Models.** Most complete line in New England. Kits, fittings, plans, books, tools, engines, motors. Illustrated catalog 25c. James Bliss & Co., Inc., Dept. SM, 342 Atlantic Ave., Boston 10, Mass.

**BALSA Wood** and model aircraft. 40-page catalog 10c. Sig Co., Montezuma, Iowa.

**SHIP And yacht model fittings; blueprints.** Send 35c for illustrated catalog listing hundreds of items. A. J. Fisher, 1002-1 Etowah Ave., Royal Oak, Mich.

#### HOME CRAFTSMEN

101 **FULL Size patterns.** Smart, new, gifts, novelties, lawn figures, shelves, action windmills, alphabets. Plus "Make Money Jig Sawing." Only \$1.00. Mastercraft 45M, 7041 Olcott, Chicago 31, Illinois.

**LEATHERCRAFT** Quality supplies at lowest prices. Send 10c (refundable) for most complete catalog containing 16 other crafts. Russo Handicrafts, Box 29-P-4, Los Angeles 12, California.

**PLASTICS Home-craft course** for men and women. Tells and shows how to make hundreds of fast selling plastics products. All plastics and materials for 23 projects included in course. No special tools needed. Course pays for itself. Write for free booklet. Interstate Training Service, Dept. D-4, Portland 13, Oregon.

**SELL Your handicraft profitably.** Sell all you can make. "How and Where to Sell Handicraft," is the answer to your markets problem. Contains large list of gift shops who sell on commission and pay cash also. Price \$1.00 ppd. Money back if dissatisfied. Oliver Bell, 204 W. 5 St., Cle Elum, Wash.

**LAMP Size cypress knee** with nipple installed \$2.00. Cy Products, Dept. 2-S, Lafayette, La.

**LEATHERCRAFT, Metal enameling, beadcraft, shellcraft, metal tooling, textile painting, many other crafts.** Free big illustrated catalog. Kit Kraft, Dept. 234, Studio City 1, California.

**OLD Cape Cod finishers' formula** gives professional results staining new wood, refinishing old with warm, mellow look. In antique pine, Guilford pine, Salem maple, driftwood, colonial cherry, natural. \$1.50 pint; \$2.00 quart postpaid. Color card, brochure on request. Cape Cod Finishes, Dept. 4B, 145 Main Street, Cambridge 42, Mass.

**BUY Wholesale** nationally advertised power, hand tools, thousands other products at big discounts. Free "Wholesale Plan." American Buyers, Hertel Station, Buffalo 16-F1, N.Y.

**RUBBER Molds, liquid rubber, leathercraft, unpainted figurines, paints and supplies.** Catalog 10c. Steece Bros., Box 177-S, Sioux Falls, S. D.

**FREE Handicraft supply and project catalog.** American Handicrafts, Box 1479-PM, Fort Worth, Texas.

**OVER 900 Woodworking projects.** Books and patterns. Free catalog. Craftsman, 115 Worth Street, New York City 13.

"**PRACTICAL Violin Making**" with patterns \$1.00. Supplies. Chelsea Fraser MV, 2025 Stark, Saginaw, Mich.

**GRANDFATHER Clocks.** Build a tubular chime at factory prices. Send 50c. Wills Bros., 237 S. Ellwood Ave., Baltimore 24, Maryland.

**FREE Catalog.** 1560 patterns and designs. Craftplans, 1321-A South Michigan, Chicago 5.

129 **NEW Full-size jigsaw patterns.** Artist-drawn. \$1. Craftplans, 1321-A South Michigan, Chicago 5.

**WOODWORKING Course** for home craftsmen. Twenty-two manuals. Over 1000 pages, 75 training projects. Only complete home training program available today. Carefully written, profusely illustrated. Covers everything from wood selection to final finishing. Complete instruction in care and use of all hand and power tools. Prepared by expert manual training instructors. Write for free booklet. Interstate Training Service, Dept. D-4, Portland 13, Oregon.

**JIGSAW, Bandsaw owners,** let your machine bring extra profits, fun. Free details. Nu-Art, Box 2235, Boston, Mass.

**KNOCKDOWN Cedar chests.** Lumber and veneers. Free price list. Giles & Kendall Company, Huntsville, Ala.

**STYLECRAFT** Sure fire hits. "Pre-traced" leather kits. Handbags, billfolds, fillgree belts, over fifty other projects. Patterns on leather. Why trace? Just carve, assemble and lace. Large assortment "precarved" kits also available. Send 25c for catalog, free folder. Refunded first order. Apache Leather Company, 2804 E. Washington St., Phoenix, Arizona.

**KNOCKDOWN Cedar chests and lumber.** Free price list. Bedford Lumber Company, Shelbyville, Tennessee.

18 **FULL-Size patterns.** Save money with easy-to-use, professionally designed full-size patterns. Make money selling beautiful, useful furniture. Make modern step and cocktail tables; metal lamps; cupola; 12-foot outboard. All patterns test-built; sold with money-back guarantee. Get your free list of these convenient, economical patterns today. Popular Mechanics Press, 200-HH E. Ontario Street, Chicago 11, Illinois.

**LEATHERCRAFT.** Send 10c for new 60-page catalog of tools, supplies, kits, including metalcrafts, enameling, ceramics, all other crafts. Complete stock. Reasonable. Since 1910. Sax Bros., Dept. PM1, 1111 N. 3rd, Milwaukee, Wis.

ALL Crafts, supplies. Large free catalog. National Handicraft, 199 William Street, New York City 38.

MASTER Designer volume available for art craftsmen, illustrating 470 actual size ornamental tracing designs for leather, metals, wood, \$5.00. F. O. Baird, Box 1367, Manitou Springs, Colorado. Satisfaction guaranteed. Free folder.

### DO IT YOURSELF

TREAT Nylon hose for longer life free of runs. Send \$1.00 for complete formula, instructions. Research, R 1, Box 194, Bainbridge, Ga.

ATTENTION: Hard of hearing. Make your own hearing device, with articles you have at home. Hear radio, television, without your noisy hearing aid. Amazing reception guaranteed. Instructions 25 cents and stamped addressed envelope. Also \$2.00 personal aids for telephone. Bedard, Base Dept., 39 Lynnway, Lynn, Mass.

WILL Correspond with anyone wanting to build own garden tractor, whirlicut or other 3 to 5 h.p. implements. Eaton Roller & Manufacturing Co., 300 N. Meridian, Eaton, Indiana.

BUILD Inexpensive concrete blockmaker. Motor. Hand. Then make blocks for 5 room house for \$95. Write. C. Lee, Mountain View, Oklahoma.

FIRE Alarm system—Protects life, property; battery, electric or combination; inexpensive to install. Plans \$1.00. Davis, Box 23, Shadyside, Maryland.

"HOME Fix-It Guide" 230 pages. Do own home repairs. Refund guarantee \$1.98. Krajna, Opa Locka 1, Florida.

SNOWFLAKES! 53 Designs for tracing on scarfs, blouses, trays, \$1.00. Alice Wentworth, 5251 - 12th N.E., Seattle, Wash.

MAKE Your own garden tractor from hand lawnmower or power lawnmower. Plans \$1.00. George's Hobby Shop, Chilliwack, B. C.

LAWN Mower conversion kit, \$8.00. Make your present mower electric. Free literature; Motron, 5212-A Foothill, Oakland 1, Calif.

INTERCOMMUNICATION Kit. Sensational value complete metal cases, parts, instructions. \$31.50 ppd. Sierra Scientific, Dept. 7, 5415 York, Los Angeles 42, California.

"AUTOMATIC Garage Door Control." 48 page fully illustrated simplified book gives complete instructions. All parts obtainable at hardware store. Guaranteed. \$1.50. R-L Books, 13339 Debby, Van Nuys, California.

CLOCK Movements—Gorgeous dials, plans, kits. See ad page 235.

GEIGER Counter and metal detector kits. Inexpensive, educational. Free literature. Electronic Applications, 5024 Lee Highway, Arlington 7, Va.

CARPETS. Patio roofs. Partitions, build them yourself with beautiful Fiberglass planks. Details free. Concourse, 4003 Dyre, New York 66, N. Y.

"DO It Yourself Encyclopedia." 12 giant volumes (3,000 pages) packed with thousands of ideas, plans, gadgets and projects you can do yourself. How to weld, paint, repair most anything. How to make boats, deepfreeze, draperies, jigsaw projects and just scores of other items. How to do electric wiring, plumbing, room building. How to modernize kitchens, bathrooms. Greatest, most complete fix-it library ever offered. Written so you can understand it. You'll be thrilled when you see what these 12 big volumes contain. It's simply sensational. You must really see them to fully appreciate this exciting fix-it library. You'll fall in love with them just as soon as you open the first volume. I'll send you a descriptive circular that will open your eyes to the greatest, most complete and beautifully illustrated "Fix-it" library you ever laid your eyes on. Send a postal right now. Popular Mechanics Press, 200-DY East Ontario St., Chicago 11, Illinois.

### WATCHES, OLD GOLD, JEWELRY

CASH For used watches, diamonds, etc. Star Watch Repair, 323 Jackson, Toledo 4, Ohio.

MAKE Rhinestone jewelry. Complete introductory kit and illustrated catalog \$1.00. Catalog alone 10c. J & M Novelties, Dept. CD-3, Griffith, Indiana.

GOLD, Silver, platinum, diamonds wanted. Cash immediately, highest prices, appraisals made. Wilmot's, 2547 102nd St., Toledo 11, Ohio.

WATCHES Repaired, \$4.50. Guaranteed! Star Watch Repair, 323 Jackson, Toledo 4, Ohio.

WHOLESALE To you. Bulova movement, 17 jewel watch, latest style, \$18.75, money-back guarantee. Photo, details, sent free. Reliable Wholesale Co., Box 2022, Arlington 4, Va.

RHINESTONES. Send \$2.25 for five gross, value \$5.00, free catalog, bargain list. Ebert, Box P183, East Orange, New Jersey.

WATCH And clock repairing books. Free information. North American, Dept. 16D, 2320 N. Milwaukee, Chicago 47, Illinois.

WATCHMAKERS'—Jewelers' supplies, instructions. Catalog 20c. Bengale Company, Culver City, California.

COSTUME Jewelry supplies. Catalog and samples. 35c. Largest line in America. Milady-Fair Co., G.P.O. Box 1328, New York City 1.

USED And new watches \$2 up. Free list. Southern Watches, Gray, Georgia.

HIGHEST Cash for old gold, broken jewelry, gold teeth, watches, diamonds, silverware, spectacles, platinum, mercury. Free information. Satisfaction guaranteed. Rose Refiners, Heyworth Bldg., Chicago 2.

10 SWISS Watches \$18.00. Catalog 10c. Berkowitz, 1150 Castlehill, New York City 62.

### TOBACCO, SMOKERS' SUPPLIES

SMOKE Habana cigars! Imported from Cuba. Deliveries by mail to all states. Minimum five, 25c each. Special wholesale price. E. Rivas, 724 Amsterdam Ave., 2D, New York City.

BRIER Blocks, stems, semi-finished pipes, for carvers. Pipe-making tools. Instructions. Walter Miller, Germantown, Ohio.

### RAZORS, BLADES, SHARPENING

BLADES—100 For \$1.00. Microsharp-ened. Guaranteed smooth shaves. Double-edge. Bardin's, Box 821, Chicago 90, Ill.

### FOR THE HOME

FOAM Rubber furniture cushions. Factory seconds. 50% discount. Free catalog. Perma-Foam, 429C Central Ave., East Orange, New Jersey.

SEPTIC Tanks, etc. How they function and how to keep them working. Free literature. Chemical Cleaning Co., Boston, Zone 34, Mass.

NEW Hoover Constellation canister vacuum \$64.90 (regularly \$97.50). Terrific savings, appliances, photo equipment. Free catalog. Mailers Mart, Box 135-A8, New Rochelle, New York.

YOUR Name beautifully engraved on sign for front door. Only \$1.00. Engravers, P.O. Box 113, Malden-on-Hudson, N. Y.

DECORATING Idea guide. "How to Decorate Your Own Home" plus "Color Schemes." Both \$1.00. Color Monitor, 297-A Rybe Avenue, Rye, N. Y.

### OF INTEREST TO WOMEN

\$5.00 DAILY. Making scented orchids. Easy. No canvassing. Free sample. Boycan Industries, Sharon 33, Penna.

"8 MISTAKES Parents Make." Every parent should have this new book about child training. It is free; no obligation. Simply address Parents Association, Dept. 674, Pleasant Hill, Ohio.

BEAUTIFUL Simulated pearl necklace, yours, sell 2 bottles Sen La Fra perfume at 50c a bottle. Order today. We trust you. Frey Products, Apollo, Penna.

PROFITABLE Home business. Make fast-seller chenille monkey trees, dolls, flowers. Terrific holiday demand. Information free. Velva, Bohemia 16, N. Y.

DRESSES 24c; Shoes 39c; men's suits \$4.95; trousers \$1.20. Better used clothing. Free catalog. Transworld, 164-S Christopher, Brooklyn 12, N. Y.

GOOD Money in weaving. Weave rugs at home for neighbors on \$69.50 Union Loom. Thousands doing it. Booklet free. Union Looms, 153 Post St., Boonville, N. Y.

\$5,199.90 WAS Paid to John Betts, in few weeks. Grow mushrooms. Cellar, shed. Spare, full time, year round. We pay \$3.50 lb. Free book. Mushrooms, Dept. 176, 2934 Admiral Way, Seattle, Wash.

SELL Fine fabrics. Get yours wholesale. Box 863, Norwalk, Conn.

WANT To make big money at home? \$5 profit in an hour possible with invisible reweaving. Make tears, holes disappear from clothing, fabrics. Steady year-round demand from cleaners, laundries, homes. Details free. Fabricon, 8332 Prairie, Chicago 19, Illinois.

### WANTED—MISCELLANEOUS

SCRAP Mercury (quicksilver) containers supplied—Tantalum, bismuth, tungsten. Metallurgical Products Company, Established 1909, 35th and Moore Sts., Philadelphia 45, Penna.

QUICKSILVER, Sterling, silver solders, precious metals. Wholesale Terminal, Norwood, Massachusetts.

### PERSONAL

RESURRECTION On earth—Not heaven! Free! Write: Harvest, Jefferson City 5, Mo.

MEN & Women wanted. Make big money taking monument orders. Genuine granites. No substitutes. Full or part time work. Earn \$200 week and more part time. One of country's oldest manufacturers. Write Winterset Monument Company, Winterset, Iowa.

TEN Most vital and inexpensive foods. Simplest, complete nutritional knowledge, 50c. Wright's, 82 Soundview, East Northport, L.I., N.Y.

THE Courier! Sample of this fast growing mailorder publication for stamp! Courier, 910 Marion, Pharr 22, Texas.

LETTERS Remailed, 25c! Classifieds, 50c! Senders, 13031 Ventura, North Hollywood 80, California.

BORROW By mail from Postal Finance Co. Employed men and women can easily obtain \$50 to \$600 fast, entirely by mail. Repay in small monthly payments. Friends, relatives, employer, tradespeople will not know you are applying for loan. Advise occupation, amount wanted. Postal Finance Co., 200 Keeline Bldg., Dept. 7H, Omaha, Nebraska.

FAR Away Guam Island—Reairmails \$1.00. Foreign gift items, jade, ivory, linens, brocades, painted dishes, pictures, etc. Harold Haynes, Station #1, Box 287, Agaña, Guam.

SURPRISE Your friends! Honolulu re-mails 10c. Confidential receiving address available! Fobel, 3132 George Street, Honolulu.

"HOW Can I find out?" You can! Information confidentially developed. Any matter, person, problem. Worldwide. Officially licensed. Established 1922. William Herman, 170 Broadway, New York City.

LETTERS Remailed 25c. Personal forwarding address. Monthly rates. Hicks Service, Box 1547, Washington 13, D. C.

GLOBAL Viewcard selection, worldwide remailing. Travelpost, Box 198, Nogales, Arizona.

REMAILING. Forwarding 25c each. Ace Service, Box 186, Tampa 1, Fla.

BORROWING By mail. Loans \$100 to \$600 to employed men and women. Easy, quick. Completely confidential. No endorsers. Repay in convenient monthly payments. Details free in plain envelope. Give occupation. State Finance Co., 323 Securities Bldg., Dept. T-227, Omaha 2, Nebraska.

BUY Vitamins direct. Amazing savings. Catalog free. Matoska, White Bear, Minn.

MEXICAN Law. General Practice Attorney. Apartado 79, Juárez, Chih., México.

"MAKE Up Your Mind," copyrighted method book. How to make your best decisions. \$2.00. Oliver Publications, Box 766, Alice, Texas.

NORWAY Remail \$1.00. Henry Gravdal, Langesgate 5-2nd, Oslo, Norway.

PACIFIC Coast jobs, opportunities, galore. San Francisco Sunday classified airmailed \$1.00. Brown, Box 5072, Oakland 5, California.

TRAVELING? Terrific values. \$1.00. Meridian Sales, 1053 West Avenue, Buffalo 13, New York.

CONFIDENTIAL Address \$5.00 yearly. Letters remailed from anywhere within U.S.A. \$1.00. Specify postmark desired. Box 2751, Hollywood, California.

TREE-Ripened oranges, grapefruit, tropical jellies. Reasonable. Krajna, Ops Locka 1, Florida.

BOOKS: Hundreds of subjects. Big catalog free. Popular Mechanics Press, 200-BC East Ontario St., Chicago 11.

EXCITING New book, "How to Collect Stamps, Coins, Paper Money." Packed with amazing facts; information worth dollars. Fully illustrated, 160 pages, 75¢. Popular Mechanics Press, 200-ST E. Ontario St., Chicago 11, Ill.

#### REMAILING SERVICE

PORK Center of world. Remails 25¢. Box 245, Stanwood, Iowa.

LETTERS Remailled 25¢. Received, forwarded, monthly rates. Box 195, Ft. Lauderdale, Fla.

LETTERS Remailled from Corpus Christi or San Antonio, Texas. 25¢. Box 923, Corpus Christi, Texas.

MAIL Received-forwarded. \$3 month. Hedgpeh, Box 830, Alhambra 23, Calif.

DERBY-Town address. Letters received, forwarded \$5 month, remailed 25¢. Souvenirs mailed \$2.00. Business Service, 212 Republic Building, Louisville 2, Kentucky.

REMAILING From "Cowtown" — 25¢. Cowboy, Box 11065, Fort Worth, Texas.

STEEL City of America. Remail 25¢. Box 294, Gary, Ind.

SCENIC Utah remails 25¢. Private receiving address \$2.00 month. National Mailers, 361P East 2nd, South Logan, Utah.

LETTERS Remailled 25¢. Confidential receiving-forwarding address. \$2.00 monthly. Details free. International Courier Service, Box 6480-PM, Los Angeles 55, California.

LETTER Remailing, receiving-forwarding address for rent. McLaughlin, 800 Stewart, Columbus 6, Ohio.

FAMOUS Daytona Beach, Florida, cards mailed and letters remailed 25¢. Carle, 263-15th St., Holly Hill, Fla.

REMAILS 25¢. Sunday classifieds. \$1.00. Jordan, 1120 Chenevert, Houston, Texas.

#### TREASURE FINDERS

URANIUM Finding made easy! Completely transistorized Geiger counters. Extra sensitive. Lightweight. Scientifically engineered. Unconditionally guaranteed. Also complete line prospecting instruments from \$19.95. Write for free information, techniques. Universal Atomics Corp., Dept. PM4, 19 East 48th Street, New York City.

URANIUM Prospector's guidebook; uranium handbooks; all \$2. Uranium, Box 788R, Washington, D.C.

INDICATOR: Locates uranium, buried money, minerals. Price \$25.00. Dirt samples tested free for oil. Horton's Surface Oil Survey, Belle River, Illinois.

NEW! Uranium detector kit, \$8.49. Free catalog. CMG, Box 611-PM, Laramie, Wyo.

FOR Treasure locators, geiger, scintillation counters, mineralights, M-Scope. Fisher Research Laboratory. See advertisement page 261.

JEEP Owners — V8 power. Read Jeep Owners ad, page 20.

LITHIUM — The wonder metal. Free booklet describes prospecting information, uses, etc. Nu-Age, Box 142, North Battleford, Sask, Canada.

FIND Buried treasure, gold and silver, with Goldak's sensational 3 1/2 lb. "find-it" locator, only \$49.50. Write for free literature on complete line of mineral, metal locators; Geiger and scintillation counters. Goldak, 1541 W. Glenoaks Blvd., Glendale, Calif.

URANIUM. Gold, silver treasure. New, power-packed, highly sensitive metal detectors, Geiger counters and mineralights, kits and assembled models from \$12.50. Lightest weight, guaranteed, free literature. Electronic Applications, 5024 Lee Highway, Arlington 7, Va.

GOLD, Silver, metal detectors. Geiger counters for uranium. Mineralights. Sensational new fully guaranteed models. None finer. Information free. Detectron Corp., 5528 Vineland Ave., North Hollywood, California.

#### FOR SALE—MISCELLANEOUS

COMET Refills for Papermate pens, blue, green, red, black, 25¢ (5 for \$1.00), postpaid. Frank Shelley, Box 8, Hawthorne, California.

HEARING Aid batteries, wholesale. Free list. Habs, Box 51, York, Penna.

WAR Surplus bargains! New government releases arrive constantly. Save up to 80%. Blankets, boots, cots, tents, wearing apparel. Send for free war surplus catalog. Sioux Falls Surplus Store, Sioux Falls, South Dakota.

#### MISCELLANEOUS

NEW Rafter framing instrument. Easy to operate. Gives rafter lengths and cuts for all runs and rises. Requires no books or mathematics. Master it in a few minutes. Easterly Enterprises, 1310 Lincoln, Watsonville, Calif.

SPECIALY Formulated anti-fog, anti-haze, anti-static cloth. Ideal for windshields, eye glasses, TV plastic masks, etc. Attractive individual packages. \$1.98. Jones, 4412 N. Albina, Portland 11, Oregon.

STUDY Deut. 22; 1 Cor. 6. Whitcomb, 308 Sycamore, Newport News, Va.

FLORIDA'S Money town—Ft. Lauderdale! Population doubled last 5 years. Business and job opportunities unlimited. Full details, \$1. Kemp, 823 NE 7th Ave., Ft. Lauderdale, Fla.

CHROME Plated solid brass liquor dispenser. Ideal for home bars or individual bottle. Opens and closes automatically. Stops evaporation. A quality product. Each \$1.00, six \$4.50. McDonald, 3611 Brookview, Rockford, Ill.

BIG Mails, 25¢ listing with us will fill your mailbox with mail. C. M., Box 1211-PM, Chattanooga, Tennessee.

CESSPOOL Trouble? Use Sursolvent, the miracle cesspool and septic tank cleaner. No pumping necessary. Restores systems to a condition approaching newness. Electric Sewer Cleaning Co., Boston 34, Mass.

BEAUTIFUL Foreign magazines. Single copies, illustrated brochure 25¢. Contacts, Box 4563-PM, Sarasota, Florida.

RECEIVE Magazine samples, mails, offers by hundreds. Get listed 25¢. Rorick, Cincinnati 26, Ohio.

BUY Wholesale thousands nationally advertised products at big discount. Free "Wholesale Plan." American Buyers, Hertel Station, Buffalo 16-K1, N.Y.

70 BIBLE Lessons, 25¢. Bulletin, Box 87, Cathedral Station, New York 25.

URANIUM Identification. Easy, positive spot method. Complete instructions and basic materials, \$5.00. H. Goudey, Research 12, Gabbs, Nevada.

LIKE Full mail boxes? Interesting offers galore 25¢. Traylore's Enterprises, La Feria, Texas.

WHOLESALE Sporting equipment, cameras, homewares, everything. Free catalogs! Econ-O-Mart, Whippany 2, New Jersey.

STUPENDOUS Mental power. Adults. (Details 10¢.) Delmar Wisdom, 846 Sunny-side, Chicago 40.

YOUR Name wanted. We'll send 1000 publishers, mailers, wholesalers your name, on our list one year 25¢. Dixie Mailers, King, N. C.

WHOLESALE Catalog! 30-80% discounts! Appliances, musical instruments, typewriters, phonographs, watches, jewelry, recorders, housewares, etc. Consolidated Distributors, 21-13 Lafayette, Paterson 15, New Jersey.

BE Your own plumber. You can. Few inexpensive tools and our instructive book, "Home Plumbing Guide," shows and tells you how. Hundreds of photographs and diagrams. Easy to follow. 160 pages. \$3.50. Catalog free. Popular Mechanics Press, 200PG East Ontario St., Chicago 11, Ill.

\$5,199.90 WAS Paid to John Betts in few weeks. Grow mushrooms. Cellar, shed. Spare, full time, year round. We pay \$3.50 lb. Free book. Mushrooms, Dept. 175, 2954 Admiral Way, Seattle, Wash.

CIGARETTES—Roll 20 for 9¢, guaranteed to please. Facts free. Pete Moberly, Box 797, Owensboro, Kentucky.

SNAFU Doomed! Attention, vacationers, campers, tourists! Don't shoot your spouse for packing your stuff where you can't find it! Use my Houseboy and save arguments! Use in car, cabin, tent, outdoors. Saves expensive luggage! Make-it-yourself. Mail only \$1.00 for easy plans to William Gillette, Sweeney, Texas.

ORNAMENTAL Iron designs. 1500 beautiful, practical designs for railings, columns, etc. Free literature. Cunningham, 3881 South 3200 West, Salt Lake City, Utah.

REMODEL Your own home. Save hundreds of dollars. New, amazing book shows you how. Written so you can understand it. Step by step instructions make it easy. Fully illustrated, 400 photographs, hundreds of diagrams. 160 pages. \$2.95. Literature free. Popular Mechanics Press, 200-RH East Ontario St., Chicago 11, Ill.

SIX Bow-ties, beautiful clip-ons for every occasion. Only \$2.00 postpaid. Belthor Trading, 416 Broadway, New York City.

BIG Mails, four months listing, 25¢. Wright Publications, 2270 Hubbard, Memphis 8, Tenn.

FREE: Exciting catalog packed with books covering most everything. Think of it—From cover to cover you will find described and illustrated hundreds of books telling how to fix and how to build almost anything. How to remodel your home; do your own decorating, plumbing, electrical work. Simplified books covering concrete work, carpentry, painting, furniture making and refinishing. How to build your own boat, home workshop tools. Best books on photography, welding, hobbies, homecraft. How to make a home freezer. Send for your free copy now. Popular Mechanics Press, 200-BC East Ontario St., Chicago 11, Ill.

JAPAN: Buy gifts direct from Japan. Kimono, pearls, children's reversible silk jackets, model jet engines, colored slides, novelties, hand paintings, others. Business information fee \$1.00. Send money orders. Clarence Yamagata, Room 202, Naka 7 Bldg., Marunouchi, Tokyo, Japan.

ADVERTISING Offer! E-Z hang window shade bracket. Easy to use. Self adjusting. Adjusts automatically. Fits any window, any shade. Introductory advertising special 3 pairs only \$1.00, post paid. Send cash, check, m.o. Coleman Company, 3801 Belle Avenue, Baltimore 15, Maryland.

"THE Atom Bomb in Bible Prophecy." Remarkable publication 50¢. Scripture, Box 1242, Santa Rosa, California.

ALASKA: All questions answered \$1.00. Homesteads, jobs, tourist information, anything. Alaska Research, Box 37, Haines, Alaska.

"HOME Improvement Guide." New, amazing 176 page volume. Packed with ideas, plans for remodeling, decorating, landscaping, built-in projects. \$2.50 pre-paid. Popular Mechanics Press, 200-HG East Ontario St., Chicago 11.

FLORIDA Facts—Interested in Florida? You need this 60-page illustrated catalog telling where to get information about fishing, hunting, boat trips, guides, maps, camp lists, etc. Complete descriptions. No other like it. Send 25¢ coin to The Great Outdoors Association, 730 Second St. S., St. Petersburg, Florida.

METAL Marking set. Numbers 1 to 10, letters A to Z. 1/8 inch; wooden box; only \$4.65 pre-paid. Send check or M.O. Free catalogue. Nationwide Supplies, 1353 N. W. 29th Street, Miami, Fla.

AFRICAN Curios. Fascinating, unusual articles. Large assortment. Literature free. Osher, Box 11429, Johannesburg, South Africa.

PAINT Brushes, new fully 7" wide (manufactured by Pittsburgh Plate Glass Co., retailed \$3.69). Postpaid \$1.25 each. David-Fay Co., Dept. M-1, 403 East 45th Street, Brooklyn 3, N. Y.

SANI-Straw-Miser saves 50% of soda straw expenses. Write: Alfred Schupp, Rt. 10, Box 20, San Antonio 12, Texas.

BARGAIN. Exciting Little Library booklets, 25¢ each. Tool making, painting, welding, home improvement, games, models, plastics, lamp making, glass blowing, boats, photographs. Free catalog. Popular Mechanics Press, 200-LB East Ontario St., Chicago 11.

# BEST JOBS ARE FILLED BY ALLIED TRAINED MEN

Yes, you can train now for the best paying jobs, and become one of the Builders of Industry! Due to the great present day industrial expansion programs throughout our country, Industry has been clamoring for Allied-trained men to fill important jobs. Shortages of Draftsmen, Designers, Tool Engineers, Machinists, Tool and Die Makers are so wide spread that you can pick one of these highly paid key jobs and then look forward to a life of security and success. Get started now—take advantage of these opportunities to earn good money—to build for your security and success.

*Foundation of Industry is Built by the:*

**DRAFTSMAN  
MASTER MACHINIST  
TOOL-DIE MAKER  
TOOL-DIE DESIGNER  
TOOL ENGINEER  
MACHINE DESIGNER  
MECH. ENGINEER**

Allied is the outstanding school of its kind—the foremost school in its field. Allied is approved by Industry, Department of Registration and Education, Department of Public Instruction, State of Illinois, Department of Justice for Foreign Students, and the Veterans Administration. Accredited by Central Schools Association.

**Train at Home in Your Spare Time  
or at The Allied Institute in Chicago**



Free employment service and housing assistance all through your training period and after your graduation. Our industrial contacts cover the U.S.A.

Allied's training program permits you to study right at home in your spare time or at the Allied Institute's fully equipped shops and laboratories. You can begin your training in short courses and continue progressively to a Bachelor Degree in 26 months.

## ALLIED SCHOOL of MECHANICAL TRADES

*Allied Institute of Technology*  
1338-42 South Michigan Ave., Dept. PM-4, Chicago 5, Illinois

Gentlemen:

Mail me FREE BOOKS explaining ALLIED'S courses of instruction, and FREE SAMPLE lesson.

I am interested in resident training  home study

VETS write in date of discharge \_\_\_\_\_

Name \_\_\_\_\_ Age \_\_\_\_\_

Address \_\_\_\_\_

City \_\_\_\_\_ County \_\_\_\_\_ State \_\_\_\_\_

SEND FOR **FREE BOOKS**

**ALLIED SCHOOL  
of Mechanical Trades**  
1338-42 South Michigan Ave  
Chicago 5, Illinois

# I'll Send You This Famous TRAVIS BIKE MOTOR AT TREMENDOUS 30% SAVING



IF YOU'LL AGREE TO DEMONSTRATE TO YOUR BIKE-RIDING FRIENDS

AMAZING NEW RIDER-DEMONSTRATOR PLAN CAN PAY FOR YOUR MOTOR... AND BRING YOU EXTRA CASH, TOO!



If you'll agree to demonstrate to friends, we'll sell you a rugged, powerful 1 1/2 H.P. world-famous Travis Motor for your own bike at amazing low Demonstrator Price of 30% off! Just ride around town and see how everyone wants a Bike Motor like yours. Only 3 orders and your own Travis is paid for—costs you nothing. Then you keep on making wonderful profits in your spare time!

## World's Lowest-Priced Bike Motor . . . Unequaled Features!

**SAFE** . . . mounts on front fork away from rider, always under control of bike brakes. **POWERFUL** . . . climbs hills, carries heavy loads. **SMOOTH-RIDING** . . . 3-cycle airplane-type multi-finned air cooled engine, ball bearing construction, direct drive to front wheel (no belts or pulleys to break). **LIGHT-WEIGHT** . . . only 17 lbs., perfectly balanced. **MOUNT IN LESS THAN 30 MINUTES** . . . anybody can do it with just pliers and screwdriver. **FITS ALL BIKES** . . . boys' or girls', balloon or lightweight. Motorcycle-type control. Unconditionally guaranteed . . . carries unique LIFE-TIME Factory Rebuilding Policy.

**FREE!** Rush name, address NOW for complete details of amazing Rider-Demonstrator Plan that saves you 30% and shows you how Travis pays for itself, makes EXTRA MONEY for you. Everything FREE. No obligation. Write:



TRAVIS PRODUCTS CO. 224 W. HURON, DEPT. D-3, CHICAGO 10, ILL.



Save 60% on FAMOUS "TV - BIG TOP"

## DAN LURIE BARBELLS

FREE—60 MUSCLE BUILDING COURSES—60 PHOTOS WITH YOUR ORDER  
50 lb. set, \$ 8.48 • 150 lb. set, \$20.48  
100 lb. set, \$13.98 • 200 lb. set, \$25.98

SEND FOR FREE CATALOG

Order by mail—50% with order. Balance C.O.D. Extra wts. 13c lb. FOB Plant.

DAN LURIE BARBELL CO.  
52M4 Bristol St., Dept. 659D,  
Brooklyn 12, N. Y.

SEE DAN ON TV "BIG TOP" SHOW  
LET STRONGMAN DAN MAKE YOU A MAN  
Results guaranteed or money back

## SAY YOU SAW IT IN POPULAR MECHANICS

## MEN! NEED MONEY?

Check here how much you need EXTRA per week to balance your budget!

\$10  \$20  \$50  MORE



High living cost getting you down? Need extra money to pay off the mortgage? Want a new car and can't seem to quite make the down payment—or maybe you're having trouble making payments on the new 2-tone job you just bought? Then there's the fellow whose family is growing. The pay check just won't stretch to take care of everything the newcomer needs. Or maybe you're single and waiting till your income is bigger before getting married. Whatever your reason for needing extra income, you owe it to yourself to investigate my proven plan for adding to your regular pay check with just a few hours a week of pleasant occupation at home. My plan has helped men all over the country. Why not let it help you too. NO door-to-door selling. No overhead or big investment in materials or equipment. No artistic skill required. It helps though, if you qualify as a handyman around the house. This plan works around a new needed service and a new product. We need ambitious men throughout the country to help us fill a tremendous, growing demand. No room here to outline everything in detail but I would like to send you complete printed literature that can put you on the road to a part-time big profit business that may be operated successfully without affecting your regular job. I want to help you put extra dollars in the bank to meet the increasing needs of today's high living costs. Everything I send you now is postpaid and FREE of charge. Don't send any money—just name and address on a postcard. I'll rush you free facts about my amazing money-making plan that caused N.J.M. to write and say, " . . . To start a business of my own has always been a foremost ambition. I've at last done just that . . . and no previous experience whatever . . . Thanks . . ." Why don't you write to me today for a better tomorrow.

NELS IRWIN, Coast Industries, Dept. 24, Los Angeles 61, Calif.

# OUTDOOR KITCHEN



## Written Step-by-Step For You!

Now you can have a beautiful outdoor kitchen to enjoy all summer long. Tom Riley, well-known building authority, tells and shows you how you can build your own outdoor fireplace, Chinese oven, barbecue pit or grill. There are complete building instructions included.

## A Standard Piece of Equipment

Once the almost exclusive luxury of Western ranches, the outdoor barbecue now is a coast-to-coast American institution. Every year more families take to this pleasant and gracious way of outdoor dining and entertaining. Now with this book, you can join in with a minimum of expense and the utmost in results. Mr. Riley, an old hand around the barbecue ovens of Oregon, has prepared this complete book, in order that you may find the ideal outdoor fireplace for your particular back yard. He not only gives you many fireplaces from which to choose, but he also gives you money-saving short cuts in construction, hints on firing up and cooking and for extra good measure a collection of fire-tested recipes ranging from tasty frankfurters to filet of sole a la sauce.

## No Experience or Special Tools Needed

Complete step-by-step building instructions with diagrams, photos and drawings make construction a cinch. There are designs for brick, field country stone, cement, concrete block and poured concrete, and many examples of each. With the know-how gained from this book, yours can be the most popular back yard in town and, besides you'll have lots of fun.

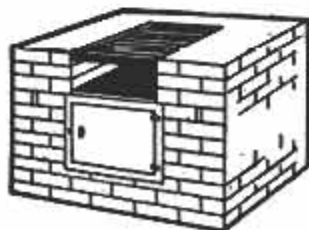

## Special Section of 40 Tested Recipes!

Here are some secrets of successful barbecuing—the best fuels to use, ways to maintain proper draft, and hints on firing up and cooking that will enable you to capture the authentic barbecue flavor in the foods you serve to family and friends. So that your fare won't be confined to wieners and hamburgers, Tom Riley also tells you how to prepare and serve such barbecued delicacies as ribs, roasts, fowl, fish, special sauces, and various vegetables.

## Partial Contents

Which Barbecue for you? Barbecue Fireplaces, Portable Grill, Masonry Grill, Barbecue Pits, Chinese Ovens, Infra Red Roasters, Combination Barbecues, Construction plans, Basic Fireplace Foundation, Barbecue Fireplace of poured concrete, stone construction, Firing Up! Types of Charcoal, Hardwood, Softwood, Compressed Sawdust, Cooking Temperature, Flame Tested Recipes, Charcoal Broiled Steaks, Barbecued Spareribs, special section of cooking methods employing various vegetables not usually associated with outdoor cooking, and much more.

## 7-Day Money Back Guarantee

Send for your copy of OUTDOOR KITCHEN, today. Read and use it for 7 days. If it isn't entirely satisfactory, return it for a full refund. We know once you have looked your copy over, and found the fireplace for your backyard, you won't part with this book under any conditions.



## Use This Handy Order Coupon

POPULAR MECHANICS PRESS  
200 E. Ontario St., Chicago 11, Illinois

Gentlemen:

Please send my copy of HOW TO BUILD AND USE YOUR OWN OUTDOOR KITCHEN, now. Enclosed is my remittance of \$2.00. If I am not completely satisfied with the book I will return it for a full refund after 7 days.

Name \_\_\_\_\_

Address \_\_\_\_\_

City \_\_\_\_\_ Zone \_\_\_\_\_ State \_\_\_\_\_

Send C.O.D. I will pay postman

POPULAR MECHANICS



# NEW RUBBER STAMP BUSINESS PAYS BEGINNERS UP TO \$9.20 AN HR.

**START AT HOME  
IN SPARE TIME**  
with Table Top Machine!

The multi-million dollar Rubber Stamp business—once controlled by a few big companies—is now being taken over by small operators—one in each community throughout the United States. Men and Women who have this inexpensive machine can turn out huge quantities of Rubber Stamps with special wording that buyers once were forced to buy from big cities. Material costing only 27c makes a stamp that sells for \$1.80. The machine that does the work is simple and easy to operate and it turns out as many as six Rubber Stamps at a time, each with different wording such as names, addresses, notices, stock numbers, prices and other "copy" needed by offices, factories and individuals. Working full capacity, it can earn as much as \$9.20 an hour for the operator! Now you can get into the big-pay business yourself, with your own home as headquarters. You don't need experience. We supply everything, including complete instructions and eight ways to get business coming in fast. Start making up to \$9.20 an hour from the very beginning. Cash in on the profitable Rubber Stamp business in your community, right away. We'll mail full particulars FREE and no salesman will call. Be first in your locality. Rush coupon today or send your name on postcard to

**RUBBER STAMP DIV., Dept. R-24**  
1512 JARVIS AVENUE • CHICAGO 26, ILLINOIS

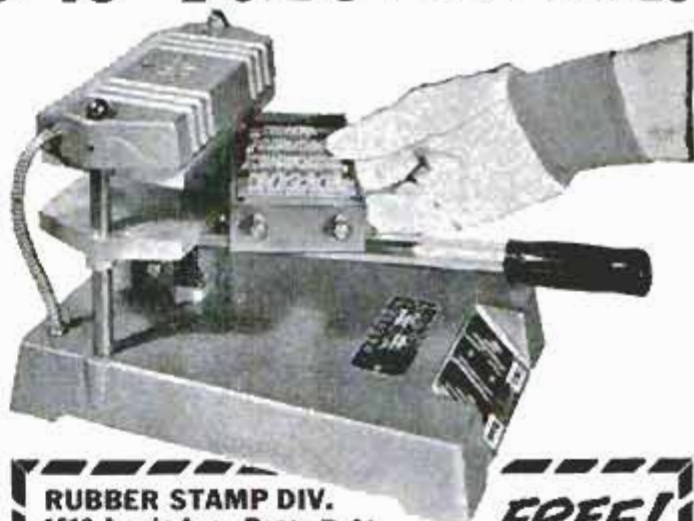

**RUBBER STAMP DIV.**  
1512 Jarvis Ave., Dept. R-24  
Chicago 26, Illinois

**FREE!**

Please rush full particulars about the little machine that can get me started in the profitable Rubber Stamp business at home in spare time. Everything you send me is FREE and no salesman will call.

NAME .....

ADDRESS .....

CITY ..... ZONE ..... STATE .....

## FREE AMAZING NEW BOOK "HOW TO ANSWER ADS"



Never before have you seen anything like this. Tells you in simple language the correct way to answer ads. Gets you quicker replies—better results, and greater satisfaction. Will save you time and money and it's ABSOLUTELY FREE. No obligation whatever. Every reader of advertising should have this booklet. Send a postcard for your copy NOW. F. W. Johnson, Popular Mechanics Magazine, Room 600-A, 204 East Ontario Street, Chicago 11, Illinois.

## HELPFUL BOOKS

Send post card asking for FREE catalog

Popular Mechanics Press, 200 E. Ontario, Dept. 601, Chicago 11

## OIL BURNER SERVICING

Learn at home in your spare time.  
Earn big money

**MASS TRADES** 161A HIGH ST.,  
BOSTON 10, MASS.

WRITE  
FOR  
FREE  
SAMPLE  
LESSON!

## Make Your Own TV REPAIRS!

This Book Can Save You \$50 - \$100 Per Year

Amazing New T.V. GUIDE with "Magic Memory" will positively repair your set 95% of the time. Patented method automatically tells you tube or part causing trouble. Tells How to fix in a jiffy! Works like magic. Revolutionary New "Attic-Master" Antenna included FREE. Outperforms all other antennas—gives you unbelievable MOVIE-SHARP reception. Install in minutes! Guaranteed money-back if not worth 10 times the price. Both only \$2.95 postpaid. SUPPLY LIMITED. Write: T.V. ENGINEERING CO., Dept. P.M.-4 1036 E. La Brea, Los Angeles 19, Calif.



# Something Wonderful Happens to people who learn MUSIC!

... here's how YOU can learn ANY instrument,  
even if you don't know a single note now!

A WHOLE NEW WORLD opens up when you learn to play. You are invited everywhere. Gain poise, self-confidence. Relax in leisure time. Enrich your life.

Even if you've never played a note, we can show you how to sit down at the piano—or any instrument—and start playing simple pieces right away. NO special "talent" needed. NO tedious exercises. NO teacher. Learn to play by playing real music BY NOTES—popular music, classical, hymns, musical comedy, etc. Pennies per lesson. (58th year.)

### SEND FOR FREE BOOK

about our famous words-and-pictures lessons used by 900,000 people. No obligation. No salesmen. Just send name and address to:

U. S. SCHOOL OF MUSIC  
Studio 304, Port Washington, N. Y.

Name .....

Address .....



## FROM ALL OVER THE WORLD...

news you want to hear with a



### hallicrafters Model S-38D—Only \$49.95

It's a fascinating, exciting hobby to listen in on the whole wide world by short wave with Hallicrafters S-38D radio. With this exceptional receiver you enjoy not only standard broadcasts . . . but can choose from the 3 international short wave bands. You, too, will praise the performance of Hallicrafters S-38D radio . . . the choice of countless governments as well as radio experts the world over. Hear the S-38D at your nearest Electronic Parts Distributor today—\$49.95 . . . or write

## hallicrafters

CHICAGO 24, ILLINOIS

## HANDY TIPS YOU CAN USE!



To remove squeaks, prevent sticking and binding, do as the experts do. Use **DOOR-EASE** Stainless Stick Lubricant like a crayon, along doors, drawers and windows. Try some on screens and storm windows—they'll slip in and out with the greatest of ease. Clean and easy to use. **DOOR-EASE** universal 15¢. - large size, 39¢.

For "hard-to-get-at" places where ordinary oils fail, use **AMERICAN Dripless Oil**. No messy oil stains caused by "afterdrip", because "DRIPLESS" "runs in — won't run out"! Use it to lubricate, rust-proof, and protect fine sports equipment, mechanisms, appliances, tools and toys. 4-oz. 29¢.



Locksmiths use and recommend **LOCK-EASE** Graphited Lock-Fluid for locks that are apt to stick, rust or freeze. A few drops seal out dust and moisture. Especially recommended for car locks to protect against winter ice and summer dust. Only 39¢ 4-oz.

**SPECIAL "COMPLETE KIT" OFFER**  
Sold at leading stores everywhere. If not available, send \$1.00 for complete "Popular Mechanics" home lubricant kit, including large size of each product. No COD's please. Dept M-4 AGS Co. Muskegon, Mich.



An Introduction to Wonderful Worlds for Young Americans!

One pound Uranium Equal to 2,600,000 pounds of coal

## the Boy Scientist



A Space Platform May Look Something Like This

### New Popular Mechanics Book Packed With Thrilling Facts and Fascinating Information

Get this thrilling Popular Mechanics book for every boy you know. In it, your own boy scientist can pore over the world-shaking discoveries in astronomy, physics, chemistry, sound, electricity, atomic theory and relativity. In the same thrilling pages, he can meet the greats of the world of science such as Galileo, Newton, Franklin, Faraday, Einstein and many others. With its help, he can participate in monumental discoveries by performing the many experiments which are suggested in the book and explained in word and picture.

### The Spark That Opens Up a New World

Written by John Lewellen, noted writer of a dozen books on science and natural history, Preface by Dr. Wilbur Beauchamp, Professor of Education, University of Chicago, who says "the Boy Scientist may well be the spark that starts some boy on the way to becoming a scientist and the Nation's need for scientists is very great."

### Finest Gift for Boys Use "Money Back" Coupon

Is there a boy in your family? Then get him the Boy Scientist. It could be one of the most important books he ever reads. Want to send the supreme gift to some boy you know?

Then give him the Boy Scientist too. There is no finer gift for any occasion. Sent postpaid to any address for only \$3.95. Order on Money Back coupon now. If not immensely pleased with the book return in 5 days and the entire purchase price will be refunded.



### Meet These Greats . . . Know Their Achievements

- Galileo . . . the first modern scientist
- Newton . . . the law of gravity and famous three laws of motion
- Boyle . . . and how gases behave
- Archimedes } . . . and liquids
- Pascal } . . . and liquids
- Bernoulli } . . . and liquids
- Huygens . . . and light
- Benjamin Franklin . . . and electricity
- Becquerel . . . radioactive fog
- Einstein . . . theory of relativity
- Rumford . . . heat
- Mersenne . . . the laws of sound
- Tomorrow . . . will bring new discoveries



Prepared in the famous Popular Mechanics easy-to-read and easy-to-understand style. Adults too, will find this a fascinating book.

Library Cloth Binding  
6 3/4 x 10 in.  
264 Pages  
277 Illustrations

## Use This "On Approval" Coupon

POPULAR MECHANICS PRESS

Dept. 256, 200 E. Ontario Street, Chicago 11

Send at once \_\_\_\_\_ copies The Boy Scientist, \$3.95 each, I understand I may return books in 5 days and you will refund full purchase price.

- Remittance for \$\_\_\_\_\_ enclosed. Send postpaid.
- Send COD. I will pay postman.

Name \_\_\_\_\_  
Address \_\_\_\_\_  
City \_\_\_\_\_ Zone \_\_\_\_\_ State \_\_\_\_\_

POPULAR MECHANICS

# GIVE



Each dollar you contribute to Crusade for Freedom sponsors a Minute of Truth over Radio Free Europe. Truth builds hope and continued resistance among Europe's captive people. Help keep Radio Free Europe on the air. Send your Truth Dollars to:

## CRUSADE FOR FREEDOM

c/o Your Local Postmaster

*Published as a public service in cooperation with The Advertising Council*

## PLEASE SEND ME



for the time checked.  
I am enclosing . . .

- 1 year \$3.50  
 2 years \$6.00

name \_\_\_\_\_

address \_\_\_\_\_

city \_\_\_\_\_ zone \_\_\_\_\_ state \_\_\_\_\_ C-46

Hand this order to your newsdealer or send it to

**POPULAR MECHANICS**  
200 East Ontario St. Chicago 11, Ill.



### Installs in less than ONE DAY!

This full-size prefabricated fireplace can be quickly installed in your home because it requires no costly masonry, no foundation, no facing or mantel. It comes complete with its own chimney, damper and flexible firescreen.

Installation of the new Uni-bilt Fireplace is so easy that it can be done even by the average home mechanic. It can be mounted directly against any wall, floor, ceiling or roof material . . . in either new or existing homes. And the price is surprisingly low.

**Adds Charm to Any Room!** Its dramatic design harmonizes with any style of architecture and it can be painted to blend with any color scheme.

**Write today for FREE details**

Vega Industries, Inc. Uni-bilt Division  
774 Glen Avenue Syracuse 5, N. Y.



## NOW! SAW STEEL • 2x4's PLYWOOD • PLASTICS • ON ONE SAW!

ONLY  
**\$34<sup>95</sup>**  
with Motor  
and  
Blade



**FAMOUS BURGESS electric TOTE-SAW** with built-in motor

**MAKES STRAIGHT OR CURVED CUTS**  
Handiest tool ever! Sturdy, compact Tote-Saw weighs only 15 lbs. . . . carry right to job anywhere.

Built of cast aluminum and steel. Blower-cooled motor is built right in. Cuts to center of pieces 24" wide . . . any length!

**SAWS AN INCH A MINUTE THROUGH 1/2" STEEL!**



**BURGESS BELT SANDER**  
ONLY **\$24<sup>95</sup>** complete

Saws 20 inches a minute through 3/4" plywood, 4 inches a minute through 1/4" brass, 12 inches a minute through 1/16" steel! Use Tote-Saw also for cutting plastics, wall tile, aluminum, cast or wrought iron. 2-speed adjustment for cutting various materials. Variety of special-purpose blades available.



PORTABLE!

See these fine Burgess tools at your favorite dealer  
**WRITE DEPT. A-19 FOR COMPLETE CATALOG**

**BURGESS VIBRO-CRAFTERS, INC.**  
GRAYSLAKE, ILLINOIS

# Is your radiator ready for Summer driving?

**SUMMER**—with hot weather, more driving, heavier traffic—puts a two-way strain on your car's cooling system. The cooling load is much heavier and heat multiplies the speed of rust and corrosion.

**A clean system** • To get good heat transfer the cooling system must be clean. Often the inside surfaces are coated with dirt, grease, rust or mineral scale. Sometimes there's enough sediment and rust to clog up some passages and part of the radiator section. A dirty system can cause engine overheating even if fan and pump are working right.

**Take out anti-freeze** • Anti-freeze, too, increases overheating. In hot weather, it is important to remember that water can transfer more heat than anti-freeze solution does. Result? A combination of anti-freeze and a dirty system will\* cause enough overheating to cost you as much as 4½ points in gasoline octane rating. Put another way, that means the equivalent loss of 1½ gallons of premium gasoline in every tankful.

**Stop corrosion damage** • Water alone will cause rust and corrosion. In Summer heat, water plus carbon dioxide, exhaust gases and other likely impurities can cause serious corrosion damage. The inhibitors in anti-freeze will protect you for the Winter, but they may become exhausted and you can't depend upon them for Summer driving.

**Expert advice** • The Society of Automotive Engineers recommends, "Where anti-freeze has been used, drain the solution in the Spring; flush the system thoroughly and clean if necessary; then install a fresh filling of Summer rust inhibitor and water."

*A service message from . . .*

## OLIN MATHIESON CHEMICAL CORPORATION

Automotive Products Department  
Baltimore 3, Maryland

## WHERE-TO-BUY-IT INDEX

Source of supply appears after items commercially available

### AUTOMOTIVE

Oil cup for batteries stops corrosion (Jano Sales Co., 2946 Los Feliz Blvd., Los Angeles 39, Calif.)	118
Reclining seat fits any car (Coachcraft, Ltd., 9017 Santa Monica, Hollywood, Calif.)	118
Tire "pumped down" with fast deflator (Akro-Mils, Inc., P. O. Box 989, Akron 9A, Ohio)	118
Auto-top sleeping bunk folds into compact package (Gibbons Supply Co., Birmingham, Mich.)	120
Shovel hits 'em . . . and hits 'em (Clark Equip. Co., Constr. Mach. Div., Benton Harbor, Mich.)	135
Plastic cutout alerts drivers	137
Wheels, wheels and more wheels add up to French trailer	141

### AVIATION

Aerocycle lifts soldier	88
Synchrophasing of propellers quiets plane-cabin noise (United Aircraft Corp., Windsor Locks, Conn.)	117
Chemical deodorizes air in Swiss transport planes	119
Seat-belt safety release (Pan Avion Co., P. O. Box 213, Miami 48, Fla.)	124
TV camera cuts testing time	134
Swiss P-16 jet for short runways	136

### CONSTRUCTION AND INDUSTRY

Sewer-sealing machine patches cracks underground	86
16-story mobile shovel takes 90-ton bites of earth (Marion Power Shovel Co., Marion, Ohio)	95
Giant jungle destroyer clears forested land (R. G. Le Tourneau, Inc., 2399 S. MacArthur, Longview, Tex.)	124
Watery coal mine	132

### HOUSE AND HOME

What's New for Your Home—	
Air cleaner uses electronic filter	122
Dolly fastened to the bottom of garbage can	122
Window lock permits leaving windows open	122
Sliding panels on each side of picture window	123
Wheeled reel for garden hose rolls easily	123
Nutcracker fastens to any table	123
Bath hammock holds baby	123
Outdoor Living—	
Get ready for outdoor living	145
Light up the outdoors	148
Better tables for your patio	150
More than a fence	151
Portable grills for every pocketbook	152
Have fun in your back yard	154
Rolling cupboard for the barbecue	158
Workshop moves outdoors	159

### MISCELLANEOUS

Roll-on roll-off ship (Searoad Transport Co., 110 Ocean St., Hyannis, Mass.)	87
Level's floating pointer measures tilt in degrees (Laramie Chemical Corp., 16 Putnam Park, Greenwich, Conn.)	95
Look, Ma—no wires! (Telechron Clock and Timer Dept., General Electric Co., Ashland, Mass.)	102
Meat-cutting guide protects user's fingers	102
Two-power telescopic sight for BB gun (Daisy Mfg. Co., Plymouth, Mich.)	102
Kit permits amateur to bind books and magazines at home (Hewitt Prod., Liberty, N. Y.)	119
"Mechanical stomach" for elevators (Westinghouse Electric Corp., Merchandise Mart, Chicago 54)	120
Antiwind wall protects ships	121
Motor scooters replace horses in Berlin trotting races	121
Pasteurizing eggs	124
TV guards gate	126
Sahara sailboat	134
Farmer's jack-of-all-trades pushes or pulls upward	134

(Continued to page 75)

## KEEP ALL SAWS SHARP

### SUPER SAW FILER NO. 6

**IT'S NEW!** with Automatic DEPTH CONTROL ROLLERS

Automatically controls **DEPTH—ANGLE—PITCH**

Perfect bevel and angle maintained, and fool-proof depth control for all Rip, Cross-cut, and Handsaws. Precision made and calibrated for instant setting at desired angle. Can be used in any vise or clamp. Complete with file, only... **\$6.50 ppd.**

**SAVE TIME AND \$\$\$**



### JOINT & SHARPEN CIRCULAR SAWS

Sensational new Super Filer No. 11 joints and sharpens both hand and circular saws 6" to 10" with all teeth the correct height, depth, pitch and bevel. Easy to use—when file hits hardened steel roller, teeth are finished. Saw runs true and smooth with no side pull. Complete with special 8" file **\$9.95 ppd.** "TRU-CIRCLE" saw set automatically sets teeth at 10° or more **\$2.95.**

**SHARP SAWS CUT TRUER**

**SEND FOR FREE CATALOG**

Guaranteed  
A. D. McBURNEY, 5908 Hollywood Blvd., Hollywood 28, Cal., Dept. A-46



## Free! FROM THE WORLD'S HOT SPOT



Sensational Get-Acquainted Offer! Yours FREE... big valuable collection of all-different, all-genuine postage stamps from the fabulous Middle East—the world's powder keg. Exciting history-making stamps from war-threatened Israel, Arab Jordan, Palestine, Iraq, Pakistan, Bahrain, Syria, Aden, Lebanon, Afghanistan, many others. Spectacular issues picturing men of war, flashing bayonets, ancient

fortresses, strategic maps, admirals, generals, kings, sultans PLUS scarce Korea set. Guaranteed worth over \$2.00 at Standard Catalog prices! EXTRA: other exciting offers. 64-page Collectors Guide; complete U.S. catalog. Supply limited... send 10c for mailing costs. ACT NOW! HARRIS, 2701 TRANSIT BLDG., BOSTON 17, MASS.

You MIGHT get along without TV...

but your family deserves the



finest water system

Health... comfort... convenience—demand dependable running water. See your Goulds Dealer—in his big Goulds Pump line you'll find the exact pump you'll need—including Goulds famous low-cost Deep Well Jet for wells to 150 ft. See him soon—or mail coupon today...



Be sure you get a **GOULDS** water system

**GOULDS PUMPS, INC.,** Dept. PM-456, Seneca Falls, N.Y.

Please send 20-page pump booklet telling how to select the correct water system. Include distributor's name.

Name.....

Address.....

Easy Credit Terms Available

Build this Colonial Cobbler's Bench with

## ELMER'S® GLUE-ALL

Brings compliments galore. 4 handy drawers. Use ELMER'S fast-drying plastic glue to make joints strong as wood itself. Won't stain. Handy squeeze bottle speeds job. Ideal glue for pottery, paper, cloth, too.

Colonial Cobbler's Bench. Easi-Bild® Pattern #586 Just trace, saw, assemble. Send 50¢ in cash or money order to Elmer's Pattern Dept. 46, P. O. Box 215, 350 Madison Avenue, New York 17, N. Y. \*T.M. Reg. Eas-Bild Pattern Co., Inc.



glue it Best WITH ELMER'S

Building?  
Repairing?  
Indoors?  
Outdoors?

Build or repair outdoor furniture, boats with

## ELMER'S® Waterproof Glue

Makes joints super-strong even when wood is oily or resin impregnated.

Resistant to acid, alkali, solvent, fungus, rot.

It's the glue that boat-building experts use.



Bond plastic laminates to plywood with

## ELMER'S® CONTACT CEMENT

Does professional job quickly

without clamps, nails, presses. Highly resistant to heat, water. Outperforms other contact cements in stress tests.



At hardware, lumber, paint, marine supply dealers. The Borden Company, Chemical Division

OT.&C.

IF IT'S *Borden's* IT'S GOT TO BE GOOD

# CLEAN YOUR CARBURETOR

Feel the difference!



- ✓ Easier starting
- ✓ More power
- ✓ Less gas consumption



## GUMOUT

- Cleans carburetors quickly and easily.
- Saves time and money.
- Nothing to take apart. Anyone can use it.
- Add it to your gas tank regularly . . . or have your serviceman run it through your carburetor.
- Available at service stations, garages, auto supply stores, and hardware stores.

SEND FOR **FREE**

36-page  
"CARBURETOR HANDBOOK"

**GUMOUT DIVISION**  
Pennsylvania Refining Co.  
2671 Lisbon Road  
Cleveland 4, Ohio



(Continued from page 74)

Wooden works for grandfather's clock assembled from kit (Corry Clock Co., Corry, Pa.)	135
Over-the-carpet dance floor converts parlor into ballroom (Mueller Dance Floor Co., 530 Sunset Blvd., Los Angeles 27, Calif.)	136
Model railroad wreck	137
Portable paint drier uses infrared coils	141
Magnifier permits focusing on silver grains of negative (Bausch & Lomb Optical Co., Rochester, N. Y.)	141
Electric oil gauge measures well level	144
Watertight zipper	236
Sun shield for air conditioner increases efficiency	244
Sinking town	244
Dictionary stand (L. C. Products Co., Box 188, Elsie, Mich.)	244
Case of mistaken identity in 44-year-old explosion	248

### SCIENCE

Ammoniated cigarettes next?	78
Ultraviolet water sterilizer	86
Kitchen of future has glass-dome oven and automatic food mixer	88
Can you cry for science?	102
Hormone makes pale apples blush	118
Atomic-cannon barrel takes 48-foot ramrod	132
Keeping up with the atom	133

### Radio-Television, Electronics

TV for trailers	161
Car radio doubles as PA system	162
Electronics and hobbyists	164

### Craftsman and Shop Notes Index

#### FARM AND FARMING

Weather vane indicates wind direction on vertical dial	184
Large portable feedbin built on spreader frame	213
Feed bunk "roofed" on one end to protect mineral and salt	214
Haymow doors counterweighted for easier operation	214

#### HOUSE AND HOME

Lightweight bathtub sea: doubles as "vanity"	179
Air conditioner in living room cools upstairs bedroom	180
Dan the doorstop man	181
"Bookworm" bookends offer novel book display	184
Panels in door replaced with glass to light dark entryway	197

#### HOUSEHOLD HINTS

Soiled book edges cleaned with fine sandpaper	169
Stop brass tarnish	169
Tape makes waterproof seal between sink and cabinet	172
Tank-type vacuum cleaner defrosts home freezer	172
Wax marproofs furniture casters	181
Yarn sample attached to box identifies contents	192
Paint renews worn linoleum	192
Loose slide fastener repaired	216
Solving Home Problems—	
Ordinary soap applied to bottom of pans eases cleaning	198
Small jars or tumblers won't tip	198
Sandpaper taped to thimble speeds plucking basting threads	198
Coat hanger will support stepladder	198
Clothesline prop won't slide or fall	198
Strips of luminous tape attached to door	199
Buttons that have been sorted kept in order	199
Salt solution will soften hard residue in bottom of pan	199

(Continued to page 78)

**IMPORTANT NOTICE**—It is the intention of this magazine to provide its readers with information regarding the latest developments in the mechanical arts. We take no responsibility as to whether the disclosures contained in our articles are covered by patents and advise readers to investigate this subject before making, using, or selling any of the products, machines, or processes described in order to avoid possible liability for patent infringements.

strike  
back  
at  
**CANCER**

man's  
cruellest  
enemy

**GIVE**  
AMERICAN  
CANCER  
SOCIETY

*Finest you can buy!*

**WISS**

No. 908  
"HY-POWER"  
PRUNER

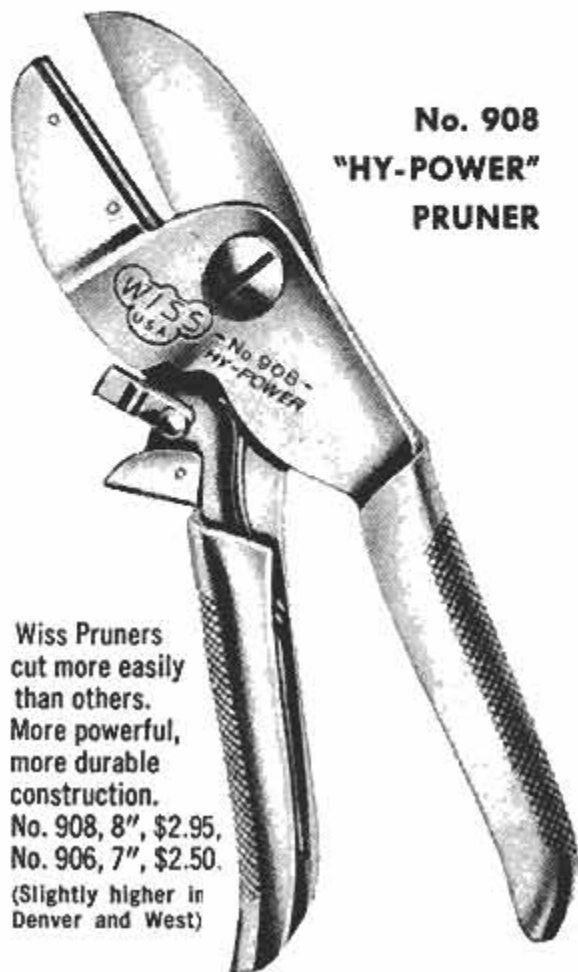

Wiss Pruners  
cut more easily  
than others.  
More powerful,  
more durable  
construction.  
No. 908, 8", \$2.95,  
No. 906, 7", \$2.50.  
(Slightly higher in  
Denver and West)

**J. WISS & SONS CO.,**  
Newark 7, N. J.

**KADET** 4-WHEEL TRACTOR  
LOW IN COST - HIGH IN QUALITY



Tillers, Mowers, Tractors - low as **79<sup>50</sup>**  
This tractor is ideal for Farms, Estates, Schools, Nurseries, Parks, etc. 12 quick-hitch attachments available, including Snow Plow, Sickle Mower, Trailer, Turning Plow, etc.  
FREE catalog write Dept. '22'

NATIONAL FARM EQUIPMENT CO., INC.  
142 GREENE STREET • NEW YORK 12, N. Y.



**YOU CAN BUILD A VIOLIN FOR PLEASURE OR PROFIT**

Now you can build a rich toned mellow violin modeled after a famous "Strad." YOU CAN MAKE A STRADIVARIUS VIOLIN contains 8 full scale plans plus complete instructions. You work directly from the plans with no confusing scale of dimensions to translate. Detailed instructions for each step including varnishing and stringing—even shows how to build your own tools. Cloth bound. Order today from

POPULAR MECHANICS PRESS . . . \$3.50  
200 EAST ONTARIO STREET, CHICAGO 11, ILLINOIS

Build Your Own Professional Instruments — Save 50%



**EICO**  
World's largest manufacturer of Kits & Instruments

Vacuum Tube Voltmeter  
**KIT \$25.95** Easy Instructions  
Factory Wired \$39.95 46 models to choose from!

Write for FREE new 1956 Catalog PM-4

Electronic Instrument Co., Inc. 84 Withers St., B'klyn 11, N. Y.

**ALL-PURPOSE FAN MOTOR**



6-32v. AC-DC up to 7000  
R.P.M. \$2.49 each; 3 @ \$7.

**PRECISION MINIATURE MOTOR Shown 2/3 ACTUAL SIZE!**

100-160 R.P.M.  
Geared Hi-Torque B. B. Motor for Bar-B-Q. Model Trains. Models.



6-24v. DC — \$6.95 each; 3 @ \$20. Original Cost \$22.00!

FREE CATALOG

**THERMO-SWITCH**



Regulates temperature — adjustable 100  
600°F. 1" 0-110v. @ 10 Amps; 23v. @  
5 Amps AC-DC — \$1.95 each; 3 @ \$5.

**PRACTICAL ENGINEERING**

707 N. Sheridan Rd. — Tulsa, Okla.

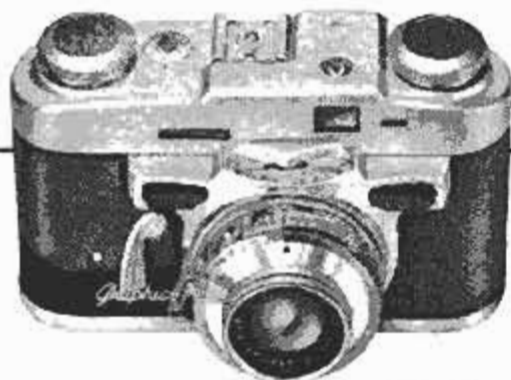

## Graphic® 35

### ONLY CAMERA WITH PUSH-BUTTON FOCUSING

With the Graphic 35 you simply squeeze the focusing buttons and, as you look through the rangefinder window, you can see your subject come into perfect focus, whether it's three feet away or at infinity. An accurately calibrated footage scale operates simultaneously as you move the push buttons, giving you direct reading of distance and depth of field.

#### IMPROVED SPECTRAMATIC FLASH SETTINGS

Both focusing distances and lens settings on the Graphic 35 are color coded so that by matching colors, the camera is perfectly adjusted for each flash picture. Takes the arithmetic out of flash photography!

#### POPULAR FEATURES

The Graphic 35 has a precision, all-metal camera body, a built-in self-timer to enable you to get into the picture, and red dot markings that give you correct settings for outdoor color pictures under average light conditions. Your choice of two needle-sharp lenses— $f/3.5$  or  $f/2.8$ , each color-corrected and coated, in shutter synchronized for flash lamps or electronic flash at all speeds from 1 to  $1/300$  second. Built-in double exposure prevention. Handy clip-on flash shoe permits easy, quick attachment of flash unit. Automatic exposure counter.

#### PROXIMETERS

These auxiliary close-up lenses permit viewfinding and rangefinder focusing at distances as close as 12". \$22.95 each, in leather carrying case.

Camera with  $f/2.8$  lens.....\$87.50  
 Camera with  $f/3.5$  lens.....\$77.50  
 Leather carrying case.....\$ 7.50  
 Clip-on flash unit.....\$ 6.50

AS LITTLE AS

**\$775**  
DOWN

Prices include federal tax where applicable and are subject to change without notice. Prices are slightly higher in Canada.

# GRAFLEX®

*Price-Winning Camera*

For Free Graphic 35 Folder, write:  
 DEPT. PM-46, GRAFLEX, INC., ROCHESTER 8, N. Y.

(Continued from page 76)

#### MISCELLANEOUS

Foil shields corsage pin.....	169
Painting ship's water line.....	169
Simple table for sickroom slides on bedrails.....	169
Block of insulation board holds fishhooks safely.....	172
Stove clock fitted in box used as darkroom timer.....	172
Small holes punched in paper bags foil noisemaking urge.....	179
Date stamp cleaned in solution of dilute ammonia water.....	181
Positive steering "gear" for coaster wagon.....	181
Paper cups and tape support sales cards.....	184
Vacuum fitting cleans camera.....	185
Mirror "stitched" on tent wall is convenient for shaving.....	192
Rough gems embedded in plaster easily held while cutting.....	192
Coat-hanger "clamps" hold cover on car seat.....	197
Turn buttons on tent pole hold fishline for quick drying.....	200
Upturned brush is soap dish.....	213
Reflective tape on headlights eliminates "one eyed" hazard.....	216

#### TOOLS

Bolt turned in threaded tubing prevents drill-bit breakage.....	208
Wrench for socket-head screws improvised from file tang.....	208
Proportional dividers.....	217
Shopping for Tools—	
Masonry drill for cooling diamond drill bit.....	218
Hacksaw with special frame.....	218
Bench-leg bracket holds angle-steel legs.....	218
File guide is aid in sharpening circular-saw blades.....	219
Self-ejecting chuck key.....	219
Center-point locator eliminates guesswork.....	219
Soft hammer comes equipped with interchangeable heads.....	219
Sawhorse made from steel tubing.....	219
Tap-chaser holder.....	220
Variable-speed driver for wood screws.....	220
Dry lubricant comes in a squeeze-type dispenser.....	220

#### WORKSHOP HINTS

"Self supporting" paintbrush keeps paint off surface.....	172
Rubber grips table-saw blade when touching-up with file.....	179
Tools kept within easy reach on improvised stringer.....	179
Determining approximate speed of slowly rotating object.....	180
Legs for modern furniture.....	180
Bevel on butted trim boards assures tight-fitting joints.....	184
Knockdown shelves.....	185
Rigid workbench joints.....	185
Burrs removed from new keys to protect pockets.....	192
Straightedge is "skidproofed" to minimize glass breakage.....	193
Lawn-mower roller lubricated by saturated felt disks.....	197
Match holder to light gas pilot made from alligator clip.....	200
Paint can has job-data label.....	200
Paraffin lubricates screws.....	200
Wooden plaster trowel.....	200
Pedal-driven miniature tractor has V-belt "transmission".....	204
Screen strip used as compass.....	204
Air cleaner on electric motor.....	208
Cellulose tape holds gasket when assembling engine.....	208
Aluminum tea infuser used as small-parts washer.....	208
"Backstop" on drill-press table prevents work from turning.....	213
Soapy water softens stiff rope.....	213
Case mounted on shop wall stores safety glasses.....	217

### Ammoniated Cigarettes Next?

Ammoniated cigarettes may be the next thing tried by smokers who want to go on smoking without fear of getting lung cancer. Chemists have discovered that benzpyrene found in the tars from burning cigarette papers causes cancer in laboratory animals. And now they have also discovered that when the paper is treated with chemicals which give off ammonia when heated the benzpyrene found in the tar is reduced by 95 percent.



## SAVE HUNDREDS OF DOLLARS with HOME-A-MINUTE "KIT"

This is not something to fool around with.



### A Hard Hitting System of Saving Big Money

Design and build your New Home, Attic Flat, Extra Bedrooms or Remodeling—**IN MINUTES**—with dozens of fiber partitions. Doors, Windows, Kitchen Cabinets, made to 1/4 inch scale same as blueprint. **THEN, BE-**

**IEVE IT OR NOT, YOU, THE LAYMAN**, who knows nothing about building, can estimate your own costs—**IN MINUTES**—after you adjust charts to local prices.

Don't build anything until you get this "KIT" if you want to save money. Handbook tells you how. This information should not pass you by. Complete "KIT" \$3.95 ppd., if COD plus postage and \$1 deposit required. Handbook without "KIT" \$1.95 or free literature. Money back guarantee. Return in 10 days.

**SPECIAL NOTICE!**—As a builder, controlling over 3 million dollars worth of home construction, we will ATTEMPT, but not promise, to obtain a special discount to you for your building materials on your new project, thru your favorite, local, Lumber Dealer. Details with "KIT."

**R. J. HALL & CO.** 3824 W. ROOSEVELT DR. MILWAUKEE 16, WIS.

## BUILD YOUR OWN MIDGET ROADSTER \$25 BUILDS BODY & FRAME



Build a **PONY ROADSTER** or **PICK-UP** in few spare hours. Uses 2 hp engine, 450 lb. load, 7.9 m.p.gal. Great for kids, sturdy utility car. Designed for **VERY LOW COST** assembly from **PARTS BOUGHT IN YOUR NEIGHBORHOOD**. Use home tools. No welding needed on body or frame. **COMPLETE** step-by-step plans, 17 large size pages, 30 "show-how" photos, parts list, and hood insignia. **ORDER NOW, ONLY \$1.95** postpaid. Satisfied or money back.

**PONY PLANS, DEPT. 44, 7641 TEXHOMA AVE., NORTHRIDGE, CALIF.**

## FIX TV TUBES • FOR FUN OR PROFIT • WITHOUT EQUIPMENT

Save money! Fix your own picture tubes. Earn extra money fixing tubes for others. Gives months of extra service to weak or shorted tubes. Big profits soon repairing expensive color tubes. Learn this easy, tried and tested method now and cash in. For complete instruction folder send \$1. Order now.

**TELEPARTS CO., 172 Narragansett St., Cranston 5, R.I.**

**GROW ORCHIDS AT HOME**

**BIG PROFITS SPARE OR FULL TIME**

World's most thrilling hobby—profitable home business. Single Orchid plant may multiply into many—each as valuable as the first. Successful home grower shows you how! Raise gorgeous Cattleyas, Cymbidiums, Epidendrum, on living-room table. Big-profit orders come from friends, neighbors, florists, etc.—also Mail Orders. Illustrated secrets of the experts in simple "show-how" language AND blooming-size Orchid plants sent at **NO RISK**. Everything you need to start—for pleasure or profit. **FREE**—full details—**SEND NO MONEY**. Write today. **TROPICAL FLOWERLAND, Dept. 314, 4622 Wilshire, Los Angeles 5, Calif.**

**YEAR ROUND ANY CLIMATE NO EQUIPMENT**

Say You Saw It in Popular Mechanics

## AMAZING NEW PERSONAL POCKET RADIO



### LISTEN WHILE YOU WALK DOWN THE STREET!

Slips in any pocket—wt. only 7 ozs. Size 2 3/4" x 4 3/4" x 1 1/4". Beautiful Black Gold Plastic Case. **NO HOOKUPS—NO WIRES—NO PLUG-INS!** Self-contained, 150-hour life flashlight batteries and **BUILT-IN ANTENNA**. **POSITIVELY NO AERIAL HOOKUPS EVER!** GUARANTEED RECEPTION OF RADIO STATIONS TO 50 MILES up to 1500 miles for powerful stations! New patented Super-regenerative Diotride tube and transformer audio stage for sharp selectivity and sensitivity! Easy to use top tuner (while walking). Tiny, plastic personal ear plug

**LETS YOU ALONE LISTEN WHILE YOU WALK, VISIT, WORK, RIDE OR SLEEP ANYTIME—ANYWHERE. MONEY-BACK GUARANTEE AND ONE YEAR SERVICE GUARANTEE.**

**SEND ONLY \$5.00** (ck. mo) and pay postman \$14.95 plus postage on delivery or send \$19.95 for postpaid delivery. **GET YOUR TINYTONE REAL POCKET RADIO** now and be ready to listen to Civil Defense Alarms, news, music, sports, etc. on a moment's notice without bothering those around you. **NOT AN UNWORKABLE, INCOMPLETE KIT OR PLAYTHING, BUT A REAL POCKET RADIO!** Shipped complete with batteries—Ready to listen! Available only from: **WESTERN RADIO, Dept. APM-4, Kearney, Nebr.**

# Non-Sticking Truscon Double-Hung Steel Windows Are Easy to Install... *Yourself!*



You can buy these Truscon® Series 138 Steel Windows from your dealer *ready to install*. And because they're steel, they can't rot, warp, swell, or shrink—*will never stick or rattle*.

All bronze hardware is factory-attached. Stainless Steel weather stripping is built in. There are types and sizes for every home style—with storms and screens available, too.

## Free Booklet Shows How...



to install Truscon Steel Windows in frame, brick veneer, masonry and concrete block construction. Clear pictures and complete step-by-step explanation are easy to follow—with helpful tips on professional methods. Send coupon below.

**TRUSCON STEEL DIVISION  
REPUBLIC STEEL  
YOUNGSTOWN 1, OHIO**



**TRUSCON STEEL DIVISION  
REPUBLIC STEEL**

1126 Albert Street • Youngstown 1, Ohio  
Please rush free book showing how to install Truscon® Double-Hung Steel Windows, Series 138.

Name \_\_\_\_\_

Address \_\_\_\_\_

City \_\_\_\_\_ Zone \_\_\_\_\_ State \_\_\_\_\_

C-1096

# Increase the value of your home

install a new

## MATICO TILE FLOOR

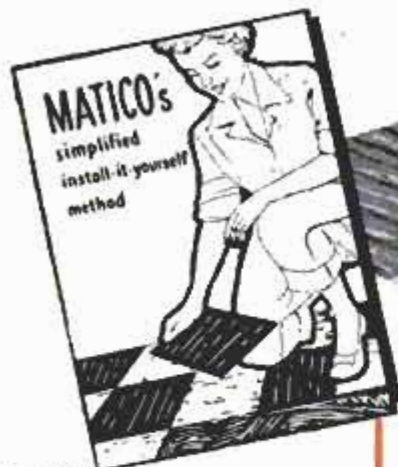

### FREE INSTRUCTION BOOK SHOWS YOU HOW!

Installation is made easy by following the step-by-step instructions. Contains fully illustrated details on installing MATICO from start to finish. Mail coupon for your copy!

### SMART, DURABLE, LOW-COST . . .

### IT'S THE MODERN FLOOR FOR MODERN HOMES

Your home is your most valuable investment! Protect it and increase its value . . . install beautiful, durable MATICO TILE floors in every room. Do it yourself and SAVE! MATICO TILE floors cost so little, and you can finish an entire room in a few hours. You'll be proud of the smart, exclusive patterns you create from the full line of colors. And you'll be amazed at MATICO's rugged, long-lasting wear. MATICO looks like new for years . . . resists scratches, scuff marks, stains . . . is easy to clean. The colors can't wear off because they go right through the tile.

Yes, for all-around utility, nothing compares with MATICO TILE.

QUALITY CONTROLLED

**MATICO**  
PRODUCTS



REPLACEMENT OF REFUND OF MONEY  
Guaranteed by  
Good Housekeeping  
IS NOT AN ADVERTISED FEATURE

See your local  
MATICO dealer  
as soon as possible.  
He's listed  
in your classified  
telephone directory.

### MASTIC TILE CORPORATION OF AMERICA

Houston, Tex. • Joliet, Ill. • Long Beach, Calif. • Newburgh, N. Y.

Aristoflex • Confetti • Parquetry • Maticork • Asphalt Tile  
Rubber Tile • Vinyl Tile • Cork Tile • Plastic Wall Tile

Mastic Tile Corp. of America  
Dept. M2-4, P. O. Box 986, Newburgh, N. Y.

Please send me FREE install-it-yourself instruction  
book and color charts on Matico Tile Flooring.

Name \_\_\_\_\_

Address \_\_\_\_\_

City \_\_\_\_\_ Zone \_\_\_\_\_ State \_\_\_\_\_

# POPULAR APRIL 1956 MECHANICS

WRITTEN SO YOU CAN UNDERSTAND IT  
VOL. 105 NO. 4

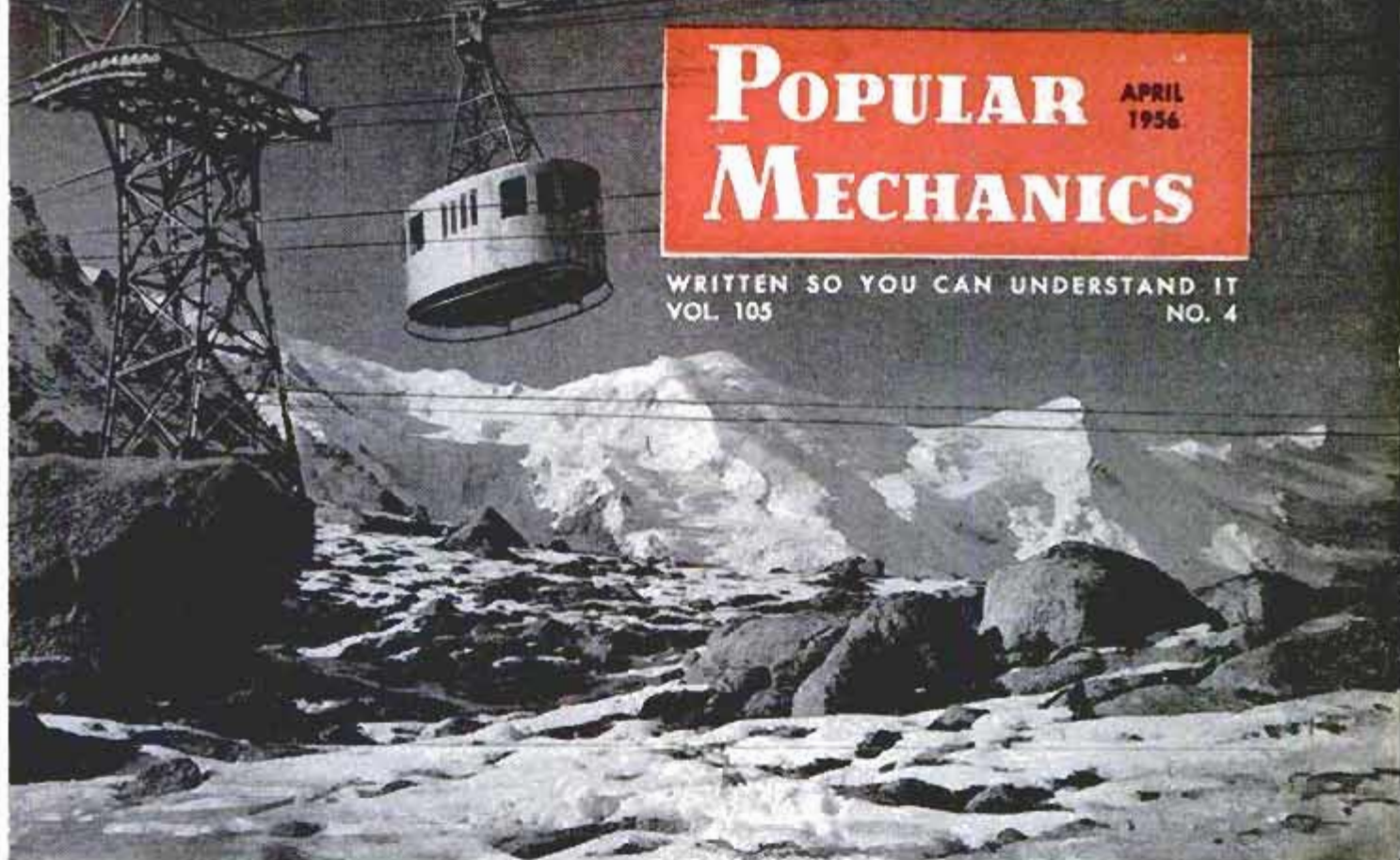

In test run, cabin car nears midway station with two miles more to go to summit of 12,600-foot Alpine peak

**V**ISITORS TO THE ALPS can now ride a cable car above the clouds on a breath-taking climb to within 3600 feet of the highest summit in Europe. More than 100 men worked for five summers to build the cableway into this region of eternal ice and snow where winds can rage at 75 miles per hour, crumpling scaffoldings like matchsticks. The cost was 10 lives and \$1,000,000.

The funicular cableway starts in the village of Chamonix and extends to 12,600-foot-high Aiguille de Midi (Needle of Noon) with a midway station at 6900-foot Plan des Aiguilles. There are two jagged peaks at the summit of Aiguille de Midi: North Point and a slightly higher South Point. A mountain station and hotel were built on North Point. The cableway passes through a shaft dynamited through the rock of North Point, across a steel bridge over a precipice to South Point and through another tunnel to the far side of this peak. There, spread before the visitors, is the snowy panorama of Vallee Blanche (White Valley) where skiing can be enjoyed 12 months of the year.

The men who built the cableway, mostly Italians from the

## *Cableway to the Top of the Alps*

Car approaches North Point of Aiguille de Midi (with hotel). Cableway goes through shaft to steel bridge to South Point



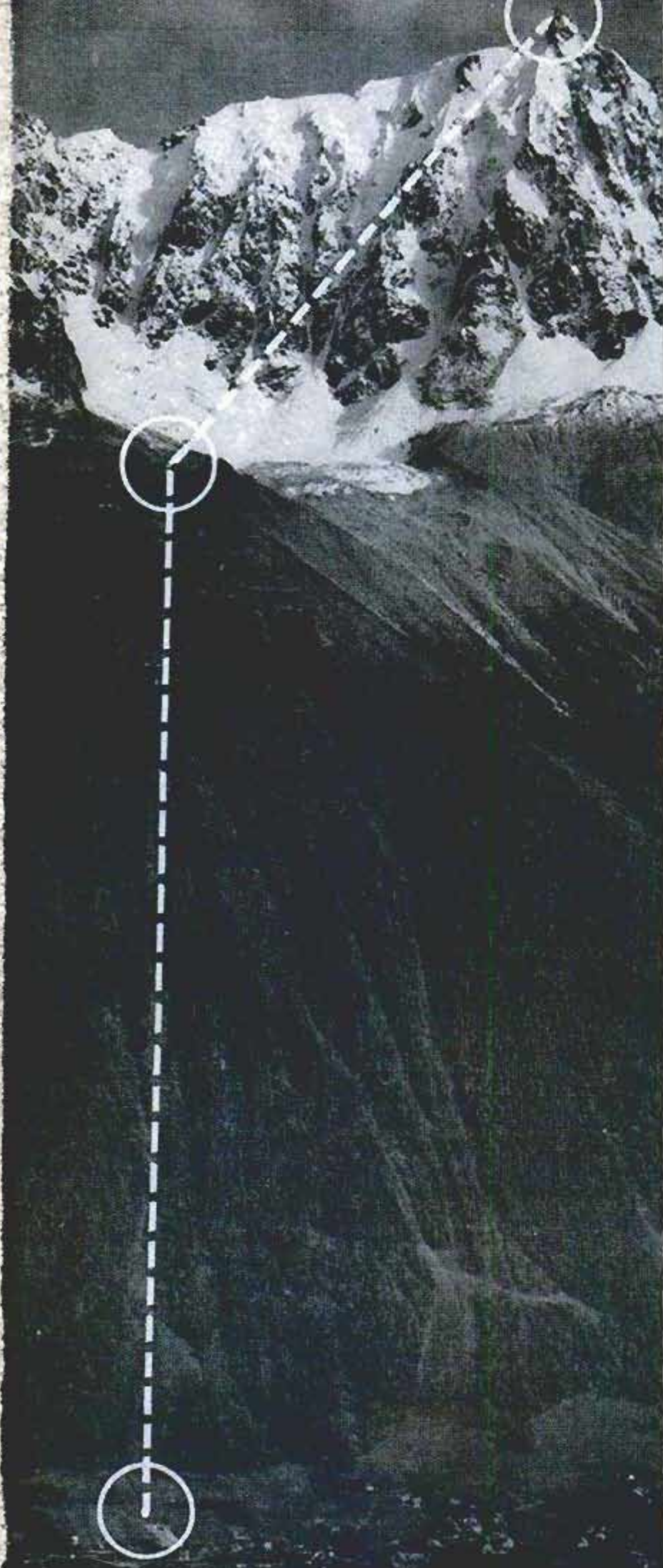

Plain of Aosta, are said to be the only workmen in the world who can work at heights of 12,500 feet without becoming giddy. During most of the construction period they slept in sheds at the summit and traveled to various working points by lifts and by steep ladders. Every piece of steel, cement, nail and cogwheel had to be transported by hoists and sleds. Snow or ice had to be melted to obtain water for making concrete during the entire working season from May through the end of October. Sudden and treacherous winds were the greatest hazards encountered by the workmen as they clung to crags overlooking ice chasms. The workers called themselves "spiders of the sky."

The citizens of Chamonix had talked about building a funicular cableway to Aiguille de Midi for more than 50 years. Plans were made to start building as far back as 1905. It was not until August of 1944 that three mountain climbers, Camille Tournier, Jean Morin and Alexis Caux, succeeded in making the first ascent. Aiguille de Midi is part of 15,800-foot Mont Blanc and is situated in the heart of some of the world's most beautiful mountain scenery. When the climbers returned with glowing reports of unsurpassed winter beauty, the funicular project was revived and a private company was formed to finance the project.

The first leg of the project to the intermediate station at Plan des Aiguilles was completed in 1954. The summit, Aiguille de Midi, is two miles from this point and 5000 feet higher. The two-inch-thick double line of steel cable that now links these points and extends to Chamonix weighs 174 tons. Electric motors for operating the cable cars are located at the intermediate station.

The two cars, each carrying 40 persons, travel from Chamonix to the intermediate station in about eight minutes and from there to the summit in sixteen minutes—about 23 minutes for a one-way trip. The cars travel a little over 16 miles per hour from the village to the intermediate station and

**Route of world's highest cableway starts at Chamonix, climbs to intermediate station and then to summit above timberline**



**"Spiders of the Sky" traveled to work points on lifts over icy chasms. Ten men lost their lives on project**

about 7 miles per hour from there to the summit. Passengers have a choice of making a quick trip up and back, spending a day at the top, or staying over night in the well-equipped hotel on North Point.

Visitors to Aiguille de Midi, including

ski enthusiasts from all over the world, predict that Vallee Blanche will become the world's most famous summer skiing resort. In winter, there are skiing tracks all the way down to Chamonix. One of these, from Col du Midi (altitude 11,500 feet), is

**This picture was taken during midsummer while workmen were building mountain station on Aiguille de Midi**

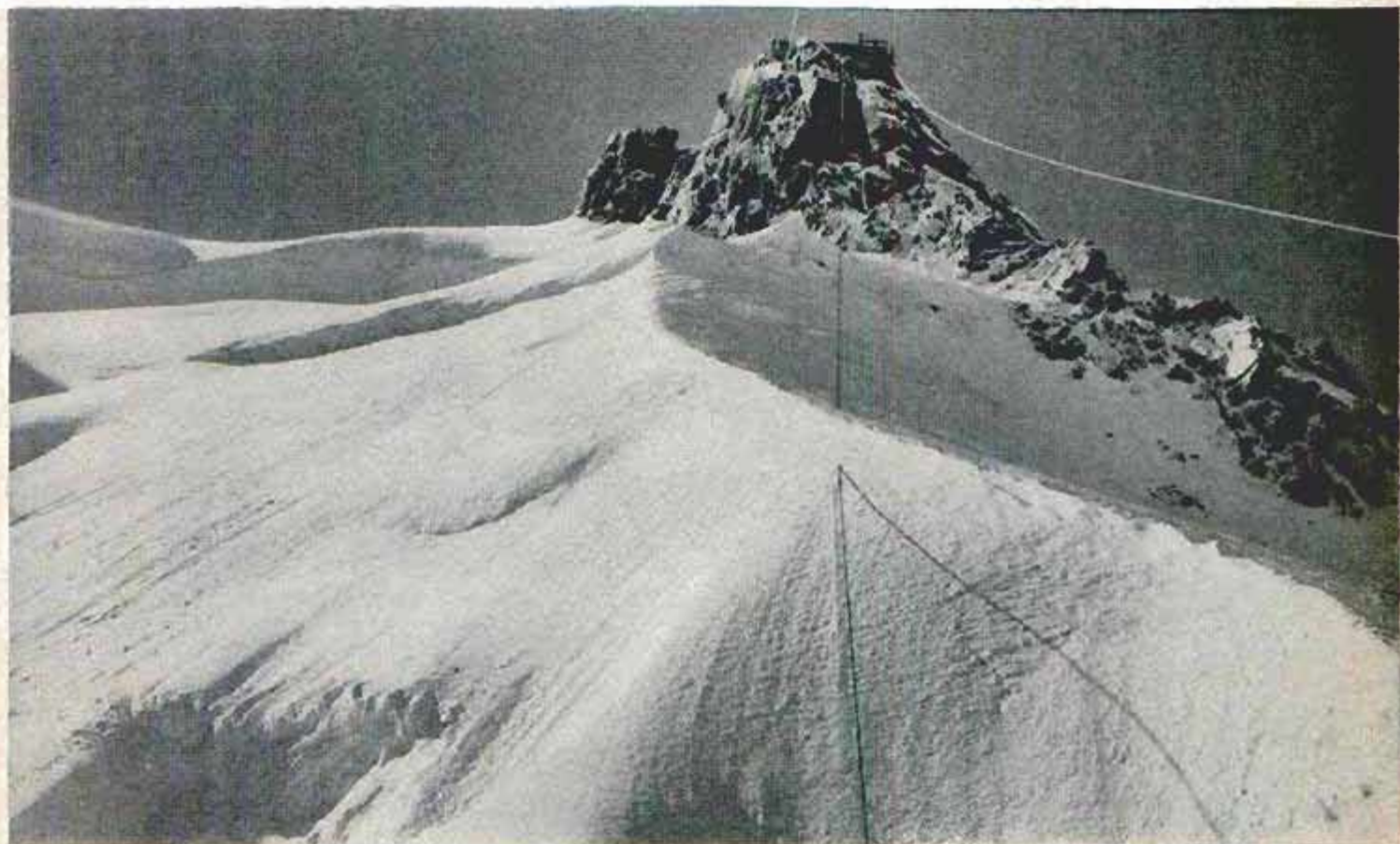



Men worked on edge of precipice to blast tunnel through peak so tourists can view valley on other side

Crude ladders and trolley tracks were used by the workmen to move materials. They slept in the shed



11 miles long. Another track leads over the Mer de Glace which has been called the most beautiful glacier in Europe.

Plans are already being made to build another cableway from the South Point of Aiguille de Midi to the Vallee Blanche so skiers can travel quickly and comfortably to this year-round ski paradise.

Chamonix, long a favorite winter and summer resort and the scene of Olympic winter games in the past, has renewed its claim to fame with the new cableway which is the highest in the world. The view from the cable route can be duplicated only from a plane.

As thousands of visitors ride the comfortable cabin cars and look down on magnificent mountain landscape, they will also see (unless they are buried in snow) 10 wooden crosses. They were erected by the sturdy workmen from the Plain of Aosta as a memorial to their friends who gave their lives that others may enjoy the beauty of the peaks and glaciers, the snow fields and icy crags they conquered. ★ ★ ★

**D**ETROIT HAS A billion-dollar secret that it's not anxious to discuss! It's the billion dollars' worth of new tooling for the 1957 cars—the most expensive re-tooling in automobile history.

Tool-and-die shops are working overtime (and have been for months) to provide the tools required for 1957's all-new bodies.

It's not considered cricket to discuss next year's models in April—the middle of the spring selling season. For an obvious reason: The job at hand is to sell 1956 cars—and sales are not exactly booming!

The industry has put itself in a trap. With a two-year styling cycle, it is having trouble convincing customers to buy at the tail end of the run. The customer asks himself: Why not wait?

Reports that the 1957 cars will be out earlier is another topic not freely discussed. This, too, might encourage buyers to hesitate and hesitancy is not a desirable trait when inventories are high (they are highest in history at this moment—over three times last March's figure).

Yet it is likely that 1957 cars will be out by December 1. That date explains the frantic activity in tool-and-die shops. Moving up a month or two in a two-year cycle is ulcer-causing.

Gossip is that Chrysler plans some sort of a big shindig around November 30—perhaps something to compete with General Motors' Motorama. All Chrysler cars must be out by then. When you consider that there are five divisions (all with new bodies) you can imagine what's involved.

### Good Buy in Spring

It's a fact, though, that there are valid economic reasons for buying in the spring, not even taking into account the irresistible urge to drive through fresh green countryside in a shiny new car. Customers generally find dealers more discount-minded when inventories bulk heavily and the slow selling days of summer loom ahead.

This year many companies agreed to pay more of the cost of preparing cars for delivery. That should mean you'll get your new car in better shape than you did when dealers footed the bill.

Manufacturers are now giving dealers the equivalent of a price cut in more liberal rebates and awards for volume sales. An interesting sidelight is that manufacturers pay an extra bonus if the customer trades in a competitive car—dealers get richer selling to the "switcher"!

While it may not be cricket, here are some guesses about the 1957 cars. They will be lower in height if not in price. By now you know that 14-inch tires will be standard. But the lower roof line won't be due entirely to the smaller wheels (outside

# Detroit Listening Post



By Leo Donovan

tire diameters will be only slightly less). Interior space will have to shrink, especially headroom. If you're having trouble wearing a hat in your present car, wait 'til next year!

Hood lines and trunk lids will be lower, fenders will be higher. On a few cars you may see doors extending into the roof and "receding hairline" windshields that curve upward into the roof. (This could revive the postwar sunshade craze!)

### Four Headlights

Cars are expected to wear four headlights. Only two of them will burn at a time. One pair will provide the high beam, the other pair the low beam. The industry can design more and better controlled light into lamps when it doesn't have to compromise by putting high and low filaments in one bulb.

Rumors of new suspensions are current, possibly the air-oil type pioneered by the French Citroen. Nonslip differentials (introduced by Packard) may appear on other cars. At least one car is rumored to have a rear-axle-mounted transmission. Fuel injection? A possibility, but no more than that. It's even more expensive than four-barrel carburetors and companies are not anxious for higher costs.

In April, American Motors will deliver cars with its new V8 engine. It will be the smallest V8 in the industry, making it around 250 cubic inches. Horsepower is 190 with a two-barrel carburetor.

### DAYTONA SPEED RUNS

Fastest speeds at Daytona Beach over the two-way flying mile by makes:

(Figures are miles per hour)

Corvette 145.543	Buick 119.403
Chrysler 300B 139.373	Ford 118.130
Thunderbird 134.404	Pontiac 116.618
Dodge D-500 130.577	Cadillac 113.636
Mercury 124.503	Chrysler N. Y. 113.475
Stude. G. Hawk 122.407	Chrysler Wind. 113.386
Chevrolet 121.335	Buick Cent. 111.645

Several Chevrolets were disqualified earlier for running without fan belts after hitting well over 130 m.p.h.

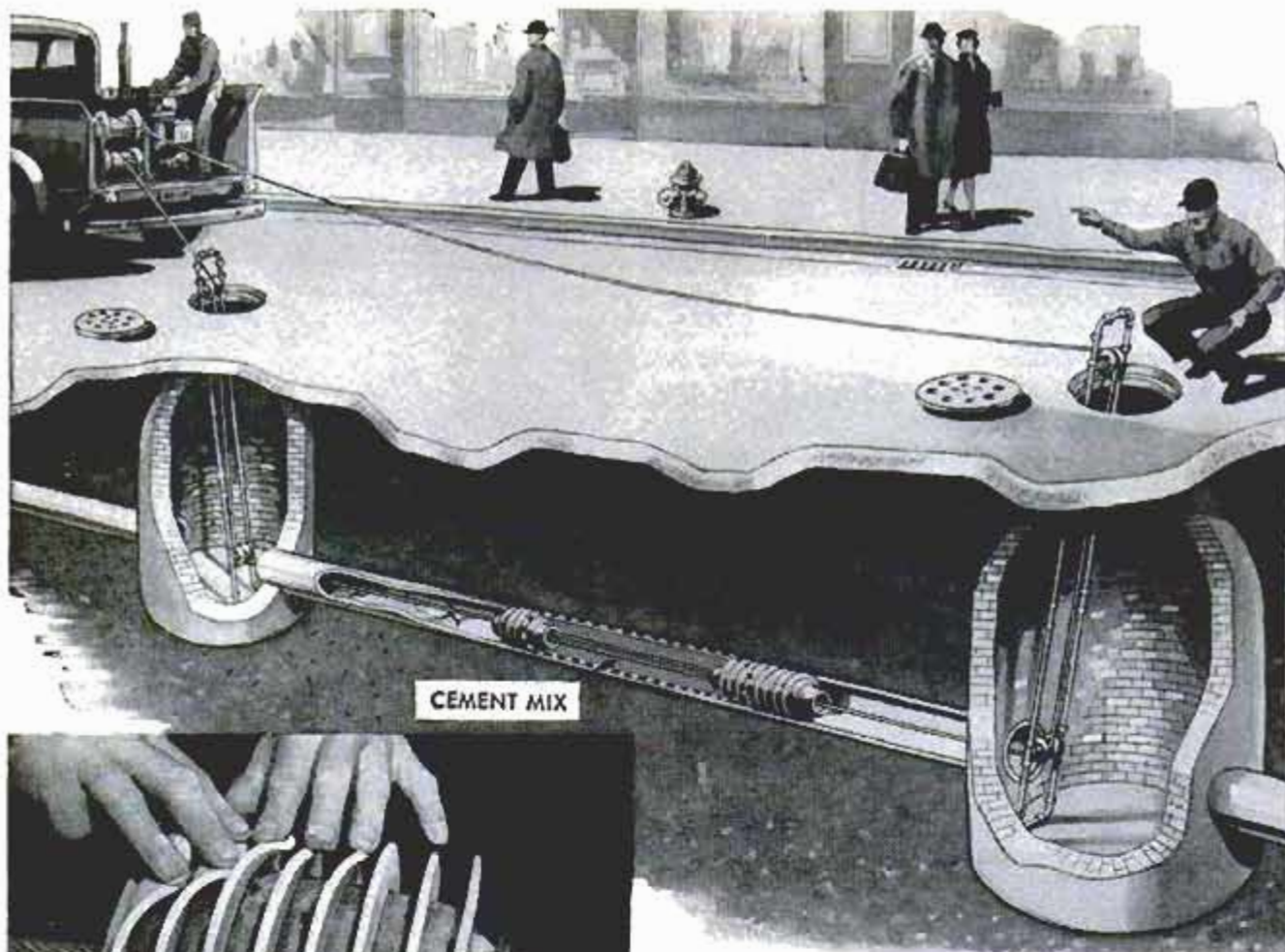

Two Oregon men who had never before so much as looked into a manhole have invented a machine to apply a special cement mixture to seal leaky sewers without the necessity of digging them up. As the sealing machine is drawn through the sewer line by heavy steel cables, a new cement-mix lining is applied to the pipe. Plastic

sewer sealer uses about 300 pounds of cement to repair 400 feet of eight-inch sewer. Inventors say it can be used on pipe up to 24 inches in dia. Rings on sealer are made of special long-wearing plastic

### Sewer-Sealing Machine Patches Cracks Underground

disks on the machine force the cement under heavy pressure into all cracks, joints and other faults. Until now, no cement would stick to the inside of an old sewer, but this has been overcome by the addition of a special chemical. A device also has been designed to seal off laterals connecting to the sewer during repairs.



### Ultraviolet Water Sterilizer Does Not Affect Taste

Water for drinking or laboratory use is sterilized by ultraviolet rays in a German-made unit. When water enters the sterilization unit, an ultraviolet lamp switches on automatically. After about two minutes, the irradiated water drains off through a spill pipe. The apparatus has a capacity of 33 gallons per hour. An advantage of this type of sterilization is that it does not add a foreign taste or smell to the water.

☐ In 1955, more than 80,000,000 tons of goods were hauled on the Mississippi River.





Stubby, clumsy-looking craft is designed from keel up to carry freight trucks. Skipper pilots her from "penthouse"

## Roll-On Roll-Off Ship

PIGGYBACK FREIGHT, in which loaded semi-trailers are carried aboard railroad flatcars, now has gone to sea in a new version. The *Searoad* is believed to be the first vessel ever designed specifically to haul loaded freight trucks. She plies the water between Nantucket Island and Hyannis, Mass. At Hyannis she backs up to the dock, her tail gate is lowered and loaded trailers roll aboard. Her basic load is three 30-foot road trailers, one carried forward and two side by side at the stern. At the other end of the sea route, tractor units hitch onto the trailers and haul them away.



Above right, *Searoad* fights her way through ice as thick as 12 inches. Her bow is specially built to crush ice. Below, tail gate is winched down and loaded truck rolls aboard. Craft can carry three loaded semitrailers



## Aerocycle Lifts Soldier



U.S. Army photo

Infantrymen may someday fly into combat on one-man helicopters called Aerocycles. The Army is planning tactical tests of the little flying machines. The pilot stands on a platform over the rotor blades and guides by leaning in the direction he wants to go. Tests show that inexperienced men can become proficient operators after only 20 minutes of instruction. The 200-pound Aerocycle has an estimated maximum speed of 65 miles per hour.

## Kitchen of Future Has Glass-Dome Oven and Automatic Food Mixer

Like the dream cars of the motor manufacturers, a dream kitchen unveiled by Frigidaire has a host of startling features—and you won't be able to buy it for a long time. The oven is housed in a big glass dome to let you see what's cooking. Surface cooking is done on a marble counter top with induction heating units below that speedily cook food but don't warm the marble. A punched recipe card fed into an IBM unit controls the measuring and dispensing of the right ingredients. Dishes are washed in three minutes by ultrasonic waves. The self-rinsing sink features a warm-air hand drier, power-driven pot scrubber and a control that measures out a given amount of water heated to a desired temperature. A cylindrical refrigerator with rotating shelves can be loaded from inside or outside the house. An upper section stores dry foods. A hands-free, distant-talking

TV telephone features a device that automatically dials any of 50 most frequently called numbers when a button is pressed. It can be set so that, by dialing home, you can start the oven, open or close windows, or perform other operations. A TV tube would show the faces of telephone callers, views of the nursery or front door, or regular TV programs. A motorized serving cart can be moved by remote control.



Glass-dome oven, range that cooks by induction heating without warming its marble top and a refrigerator with revolving shelves are features of kitchen. Uncooled top section of refrigerator stores dry foods. Recipe maker is in center at rear. TV is also feature



Ships moor to "deadmen" frozen in holes at the edge of Antarctica's bay ice, and supplies move off on sleds

## UNDER ANTARCTIC ICE

# *The Seabees Build a Town*

By Richard F. Dempewolff

PM's Staff Editor With Operation Deepfreeze

### PART I

ANTARCTICA'S first housing boom—one of the toughest construction jobs in history—is under way. For three months I lived with a group of rugged Navy Seabees in what probably are the world's coldest, most unique villages. They are base camps for the United States antarctic participation in the International Geophysical Year, and were built by these men under staggering odds.

I've watched 700 square miles of bay ice, over which their red-flagged supply trails snaked from ships to base sites, break out in vast chunks and drift to sea in 12 howling hours—leaving ships without moorings and crushing the hull of a stout tanker.



"Summer" features of McMurdo Sound air facility are publicized by Seabees on trailside billboard

Refrigerator-walled village at Little America will insulate residents when snow covers it next month



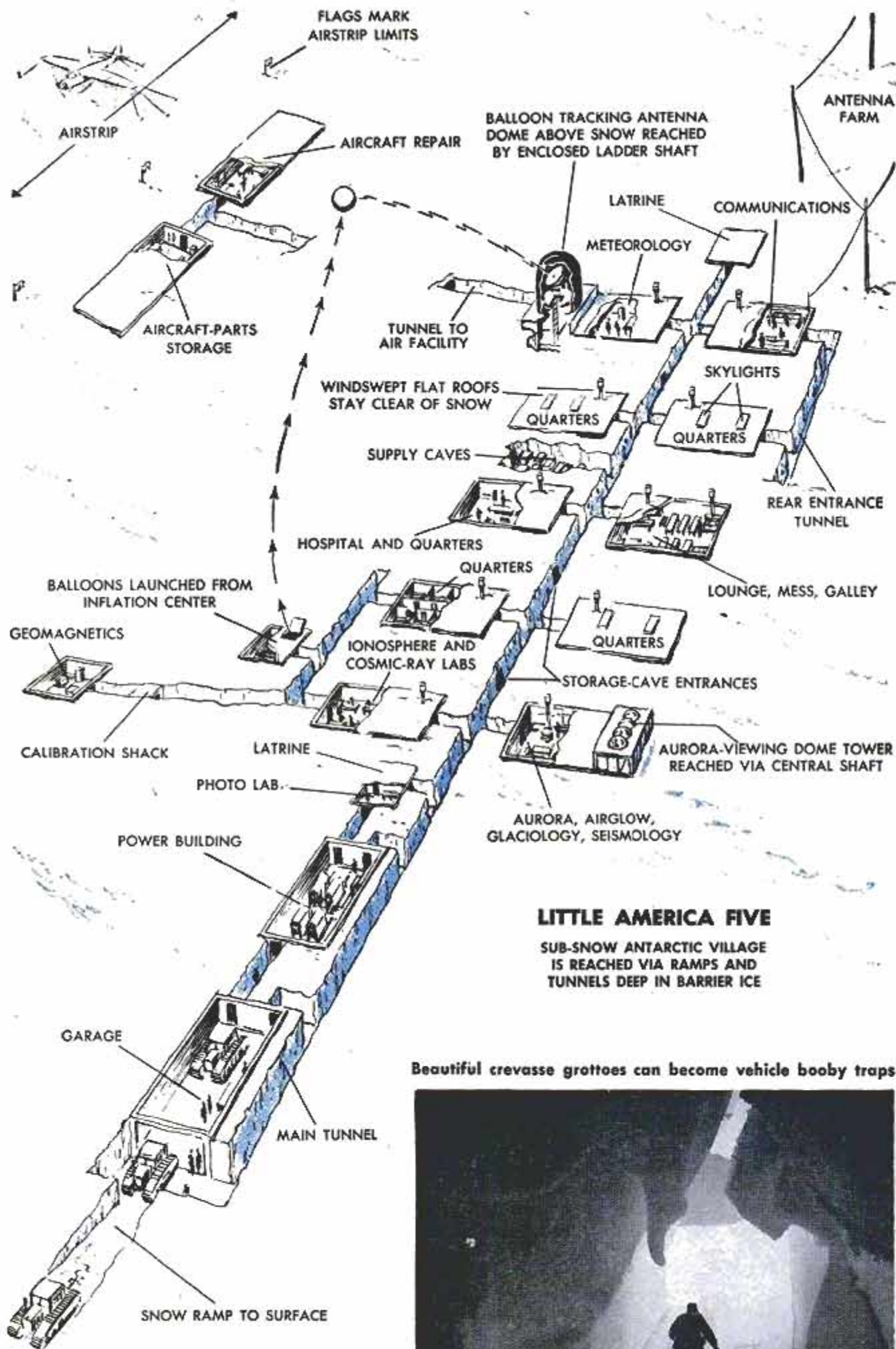

### LITTLE AMERICA FIVE

SUB-SNOW ANTARCTIC VILLAGE  
 IS REACHED VIA RAMPS AND  
 TUNNELS DEEP IN BARRIER ICE

Beautiful crevasse grottoes can become vehicle booby traps





Pressure ridges in ice near Little America made it tough for icebreaker *Glacier* to carve ship parking space

Along with the rest, during antarctic blizzards, I've been isolated out on the snow prairies for days in a wildly flapping tent, where a single Primus stove warmed my scalp to 38 degrees while my boots froze to the snow floor and canned rations turned to bulging tins of solid ice. Twice in that time, rescue parties hit out across the desolation to save victims of downed aircraft. In two "summer" months of hazardous trail breaking, snow roofs of deep crevasses broke through to trap one monstrous tractor and completely swallow two others.

In spite of it all the towns are built. Today, Little America V, main base for the 1956-57 scientific foray, squats on an endless expanse of snow atop 150-foot ice cliffs on the eastern rim of the Ross Barrier. It consists of 18 featureless cubicle buildings inhabited by a population of 76 men. The bright-orange structures line up along "Main Street" (dubbed "Whitney Lane" for boss Seabee Comdr. Herbert F. Whitney) like a double row of huge reefer boxes. Each has refrigerator doors and two skylights for windows.

There's a reason for their boxlike shape.



Even tractors wear snowshoes in Antarctica. This 35-ton prime mover has five-foot-wide steel tracks

Deepfreeze sled trains are biggest ever used in Antarctica, but extra large runners kept them afloat

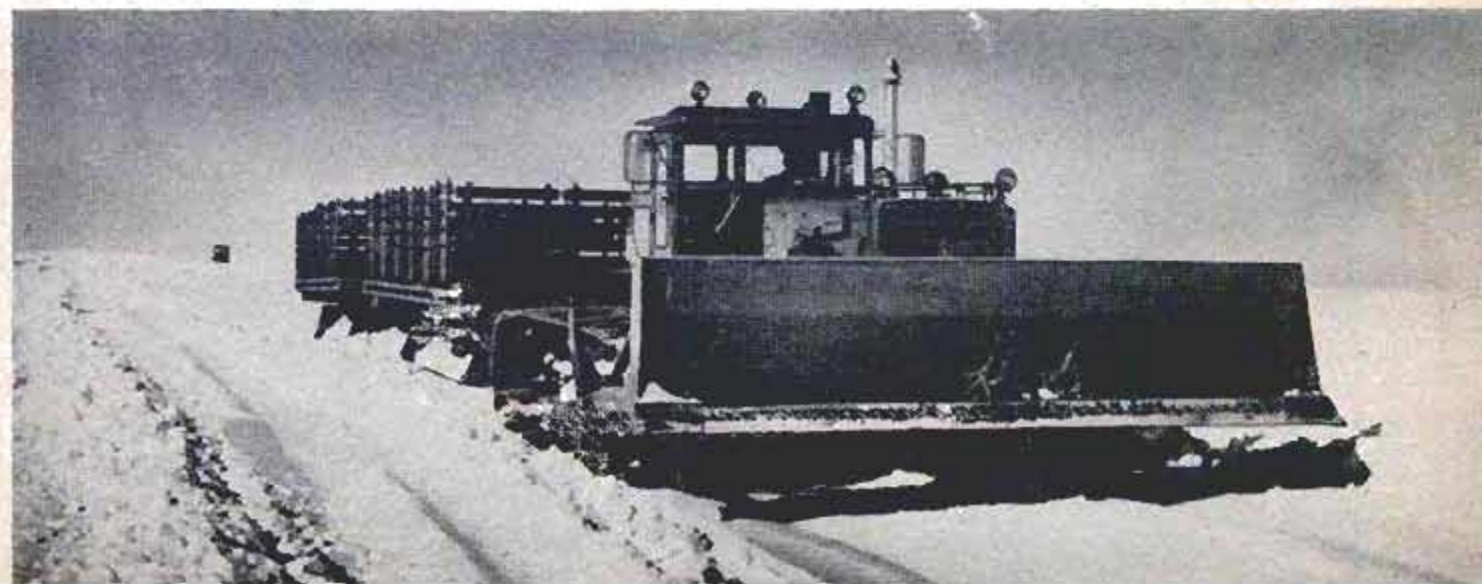



Snow melter, above left, produces 1000 gallons of drinking water per hour from four scoops of clean snow



Snow-roofed crevasse near McMurdo base trapped 35-ton tractor that had to be winched out carefully

Replacing traditional flags, wire-mesh trail markers guide radar-equipped Weasels across snowy waste

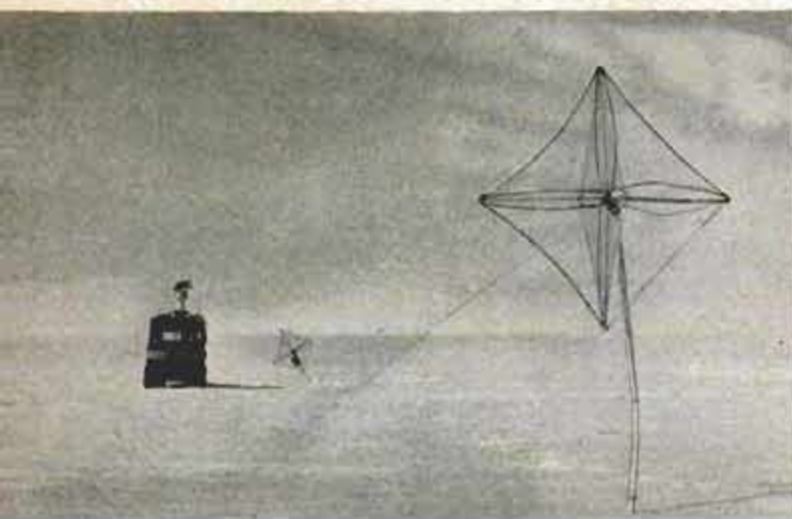

In just another month, frightful storms whirling through the polar night from Antarctica's two-mile-high central plateau will have buried the entire town to the level of its flat roofs. Outside, 100-mile-per-hour winds will howl and temperatures will skid to minus 70° in a land where metal freezes to exposed flesh on contact, kerosene flows like heavy oil and steel becomes brittle as glass. Snug in their warrens, men will move from building to building through a network of shored snow tunnels with wire-mesh ceilings to support the drift.

Everything necessary to life, as well as a wide program of research scheduled for IGY scientists, will be contained in the subsurface metropolis. Main entrance is via ramp, where tracked snow vehicles rumble down to a heated garage for maintenance and repair. Beside it, inhabitants walk down a main access tunnel stretching off into blue gloom past the chain of interconnected buildings. Big diesel generators in the powerhouse turn out enough electricity to service a village of 250 homes, running a nightmarish array of electronic gear and a radio center capable of voice contact with New York, 12,000 miles away. Towering latrines have built-in overhead snow melters to produce continuous hot

Target markers are picked up on the Weasel's scope, permitting driver to follow trail in any weather

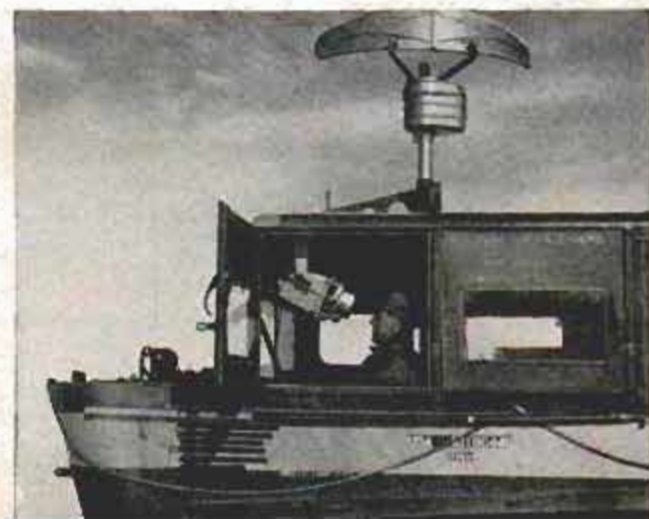

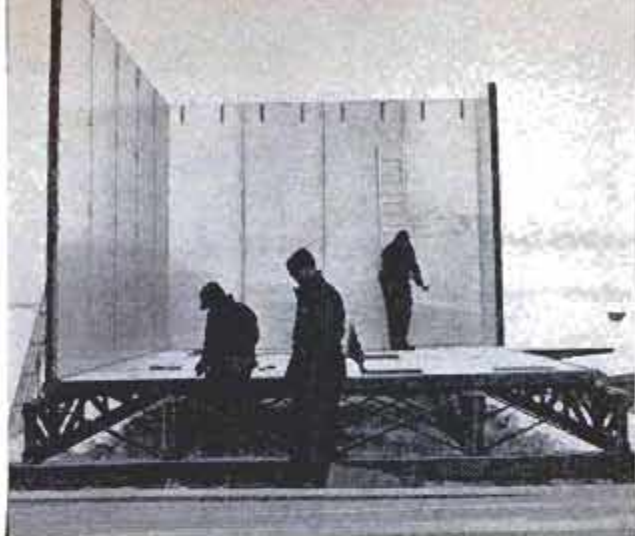

Little America's buildings of prefab panels are erected on snowshoe footings and aluminum beams . . .



Ceiling beams fit into slots in side walls of huts and help to make the entire structure rigid . . .



By slipping and clipping pieces together Seabees erected one 24 by 48-foot building per day . . .



Then moved sleeping bags from frigid tents to insulated floors. Buildings will soon be under snowdrifts

water for showers and laundry. Tunnels branch out to partitioned living quarters, a complete hospital and scientific labs, some resembling Hollywood's idea of something from another world.

Aurora and air-glow scientists won't leave the insulated warmth to observe shifting, colored curtains of the aurora australis during the frigid polar night. From their lab they ascend a ladder through a shaft to a Buck-Rogerish tower above snow level. It sits on stilts, so drifting snow blows under it instead of piling up. Sitting in a heated trunk, men can watch ionospheric lights through a row of plastic viewing domes. Two are for visual work. In the third, an all-sky camera hangs over a convex mirror from which it photographs the entire reflected dome of the night sky. A fourth dome is metal, with sliding hatch through which instrumental readings can be made. Tunnels lead off to rows of labs where cosmic-ray experts, meteorologists,

seismologists, glaciologists and geomagneticians pore over precision instruments measuring the forces that make the world tick. A black, dome-shaped tower jutting up through the snow encloses a big telemetering antenna for tracking weather balloons. Balloons are released through a special hatch from the subsnow inflation center where helium is stored. Through a quarter-mile-long tunnel, inhabitants reach two buried aircraft-repair buildings beside the snow-compacted airstrip.

Living in Little America V will be luxurious by antarctic standards. Every man has 100 square feet of private space, sharing a partitioned cubicle with one roommate. Throw rugs, lamps, easy chairs and inner-spring mattresses make it more like a modern motel than a forward polar base. Bored men can wander to the linoleum-tiled lounge in the separate mess building, listen to music piped by PA system, watch movies or join in recreation programs.



Probing electronic boom on crevasse-detector Weasel locates hidden cracks that booby trap snow vehicles

Once located, crevasses are dynamited and bottom is tested so the chasm can be either filled or bridged



Between buildings men duck through yawning holes along the tunnel to enter storage caves where food, fuel and spare equipment are cached. Supplies are enough to last all inhabitants three years.

"Main Base" is one of five such snow-bound towns being built in Antarctica this year and next by Rear Adm. George Dufek's Task Force 43, logistic spearhead for Operation Deepfreeze under Rear Adm. Richard E. Byrd. Some 375 miles westward, on the other rim of the Ross Sea, tractor-drawn sled trains piloted by bearded men in fur-hooded parkas weave across the bay ice of McMurdo Sound and up black volcanic slopes of Hut Point. Here, on barren ground, 34 curious structures, including a

400,000-gallon fuel farm and ice runway for IGY air operations, are mushrooming above the weathered cabin built by Robert Scott on his first expedition in 1902. Three other subsnow satellite bases—one on the South Pole itself, another 400 miles out in Marie Byrd Land and a third on the unexplored Knox Coast barrier—have been reconnoitered for completion next fall.

#### Building Town Is Big Job

The job of erecting these insulated polar towns adds up to the most monumental building program ever attempted on the silent continent. The men doing it are a group of specially "winterized" Seabees. Known as MCB (Marine Construction Battalion) Special, the 200-man crew, under Herb Whitney, was hand-picked from 11,000 volunteers. Dressed in insulated thermosuits, they whirled over the snowy barrier in helicopters, scouting building sites. They jounced across wind-drifted snow ridges in Weasels and Snocats, piloted rumbling giant sled trains along flagged trails. Spanning a 20-foot crevasse with a newly designed Bailey Bridge was an evening's work for five of them. The long, beam-shaped sections hook together like pieces of a toy log-cabin kit, and will span up to 100 feet. Tricky buildings shot up at a rate of one a day. At McMurdo air base, Lt. Comdr. Dave Canham, air-operations officer, lived on one to two hours' sleep in 24 as he bounced around volcanic ridges in Jeep or Weasel, doling out jobs to his lieutenants: Jim Bergstrom, GCA officer;

(Continued to page 266)



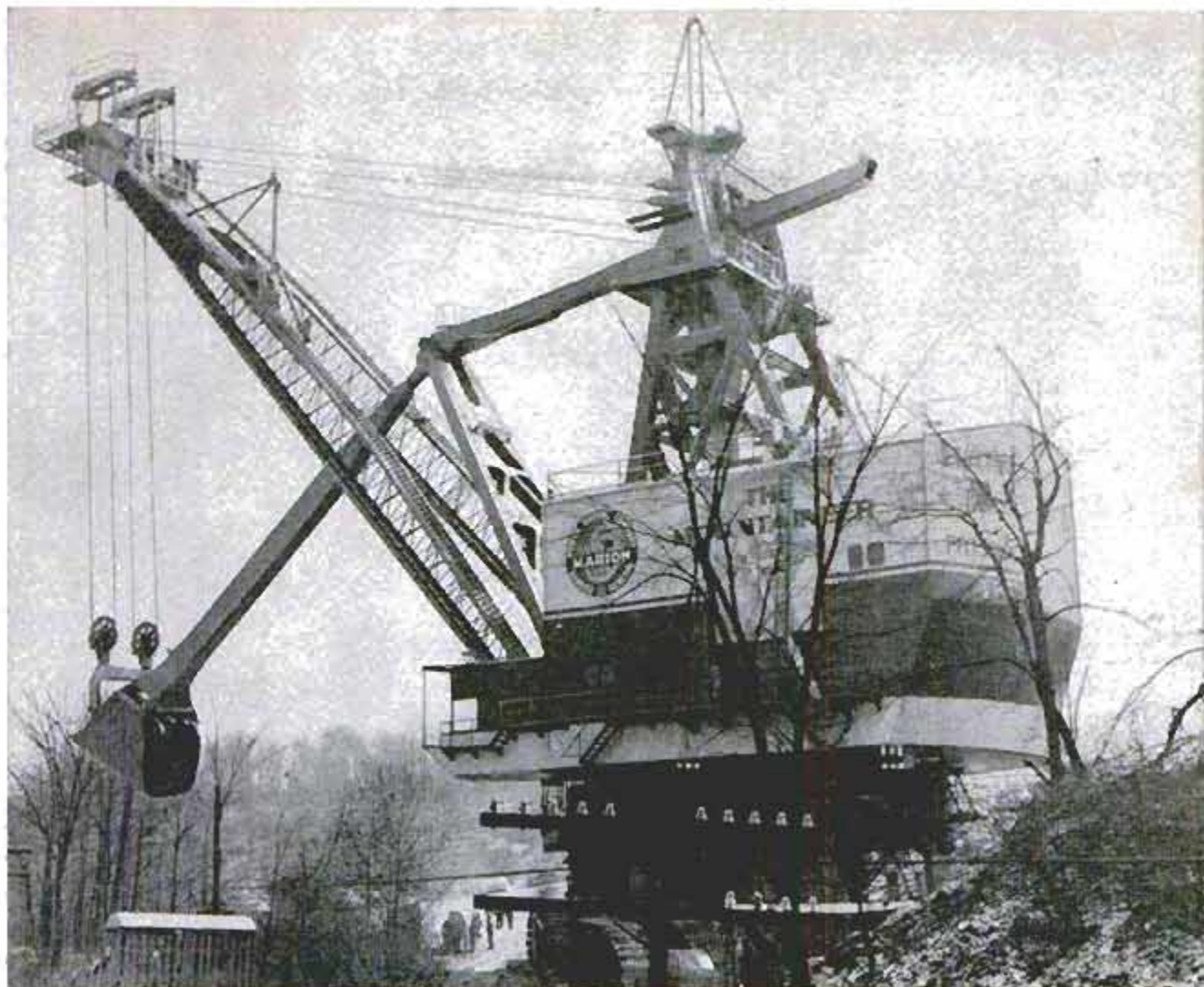

## 16-Story Mobile Shovel Takes 90-Ton Bites of Earth

Called "The Mountaineer," the largest shovel ever built here is at work removing 90-ton bites of earth from coal seams in eastern Ohio. Towering 16 stories in the air and weighing 5,500,000 pounds, The Mountaineer is said to be the largest unit of mobile land machinery ever built in

this country. To demonstrate its tremendous lifting power, its builders say the shovel has enough power to lift a platform of 166 automobiles 100 feet in the air, swing them the length of a football field and set them on top of a 10-story building and then swing back—all in 45 seconds.

## Level's Floating Pointer Measures Tilt in Degrees

You can measure degrees of tilt with a new level that has the size and appearance of a big ice cube. An air-filled pointer immersed in oil instantly flicks to vertical when the level is tilted. Read from the side, it has two faces, one for degrees and another for feet. Suitable for leveling pictures and furniture, for terracing, roofing and for registering roll and pitch of boat.

¶ In a new campaign to eradicate malaria in Mexico, the United Nations Children's Fund in cooperation with the Mexican government is sending 550 crews throughout the country, to spray houses to eliminate the anopheline mosquito.

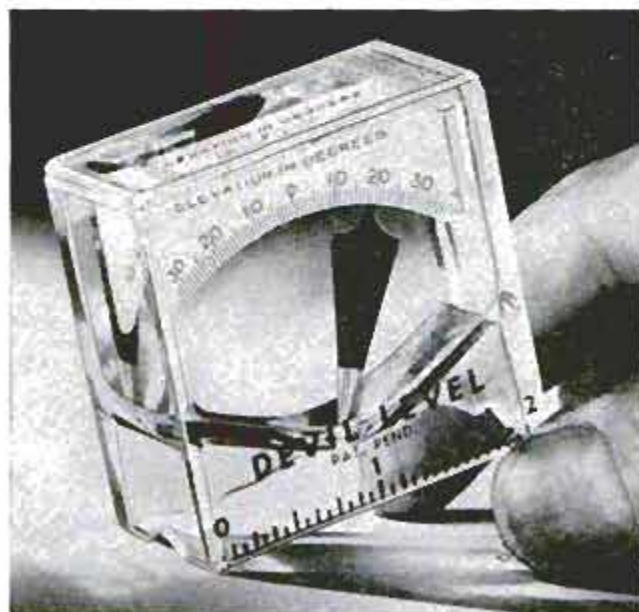



Investigators work on still-burning engine. Lifelines are used because full gas tank is buried near engine

# DISASTER CLINIC

*After every air crash the experts of the Civil Aeronautics Board move in, sift every telltale bit of evidence to find the reason why . . . to make sure it will not happen again*

**By Leonard F. Hiltz**

Carrying sacks and forming a skirmish line across the wreckage area, helpers pick up even smallest parts



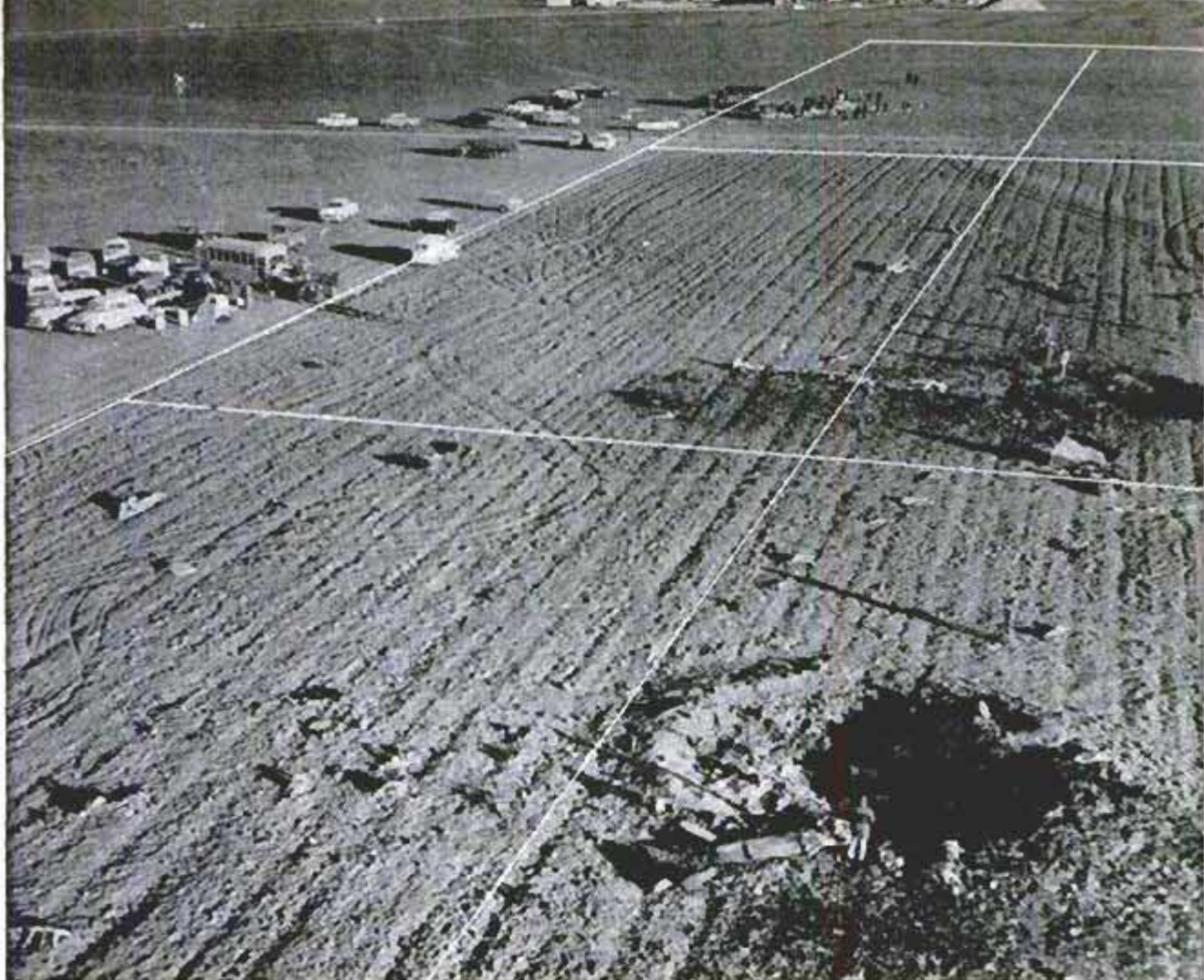

Surveying company divided wreckage area into 1000 foot areas so a wreckage pattern could be established

**A**S SHE WASHED the dinner dishes on the evening of Nov. 1, 1955, a farm housewife absently listened to the drone of a plane overhead. Her home was located under a busy airway, and the sound was a familiar, comfortable one. Then suddenly the steady drone was cut off by a thunderous, window-rattling explosion. The woman and her husband rushed out of the house, afraid even to guess what had happened.

There in the deepening shadows of early evening, before their eyes and not half a mile away, a giant airliner plunged into a sugar-beet field. A second explosion split the air and the ground shook under their feet. And above the shattered liner, a brilliant flare floated slowly to earth, its eerie white light making the landscape stark and unreal.

Breaking from the grip of horror, the woman rushed into the house. Her call to the Colorado State Troopers was the first notice that the nation had suffered another major air tragedy—this one more ghastly and bizarre than any before it. The trooper dispatched all available men to the scene, then located a telephone number that state police in all 48 states keep posted in plain sight—the emergency number of the Bureau of Safety Investigation of the Civil

Aeronautics Board in Washington, D. C.

The CAB's safety investigators—18 men spotted at field offices around the country and 27 on constant alert in Washington—are one of the world's most unusual and efficient detective forces. They are the Scotland Yard of American aviation. The techniques they have developed for uncovering the causes of plane crashes have been so effective that of the 70 fatal air accidents in scheduled passenger operations during the past 10 years, only six remain unsolved—and three of these could not be investigated because the planes were swallowed up by the sea.

These men have a twofold job: To find out why an accident occurred, and to see that the cause is eliminated so that others like it can't happen. According to the records, there never has been a repeat accident once the CAB sleuths have found the cause of a fatal crash involving mechanical failure. Because of their findings, aircraft designs have been changed, pilot procedures revised, overhaul and maintenance techniques revamped. Airlines and aircraft manufacturers work closely with the CAB because air-carrier safety is the lifeblood of their business.

The trooper's call from Colorado was



Resting nearly two miles from cabin wreckage, tail section gave first major clue as to accident's cause

switched to the home of William K. Andrews, director of the bureau, who took swift notes and went into action. As he established phone contact with his investigators, more specific details on the accident came in. The plane, a United Air Lines' DC-6B, left Denver and headed north over the flat plateau just east of the Rockies. Near Longmont, Colo., 35 miles north of Denver, it had exploded in mid-air. All 44 of the crew and passengers were dead.

Andrews made one call after another and, after each, another investigator was

**Helper notes position of switches on control panel. No evidence of any emergency procedures was found**



on the move to the scene. By morning the man designated "Investigator in Charge" had set up CAB headquarters. The other investigators reported to him on arrival and immediately were assigned to investigating teams.

At every crash scene four teams are set up, to study structures, engines and propellers, flight operations and to interview witnesses. These teams work independently of each other and make separate reports. But at coordinating meetings each day they exchange information, and in these conferences the reason for the accident usually becomes apparent. Later a fact-finding panel is convened, at which all reports are reviewed and testimony taken. Testimony and reports are condensed and sent on to the five-man Civil Aeronautics Board, headed by Ross Rizley. The board then issues an official report on the cause of the accident.

When the investigators went to work at Longmont, the press was already speculating on the cause. But even under pressure from the press, the CAB teams work methodically. The interviewing team began a house-to-house survey, talking to everyone along the flight path of the plane. All passengers on the plane at any time in its flight from New York to Denver were queried to learn if they had noticed anything irregular. All witnesses to the accident were interviewed.

Stories often differed in detail, but gradually a pattern emerged. The flight from New York had been uneventful, and the take-off at Denver normal. Observers



Like a giant puzzle, pieces of liner are put back together to confirm investigators' theories. This is section of fuselage containing No. 4 baggage hold

agreed the engines sounded normal in flight. But suddenly there had been a bright flash, followed by an explosion. Then another flash as the emergency flares were set off. The airliner, its engines still roaring, tumbled from the sky. The wings hit in one section of farm land, the tail in another, and the main portion of the fuselage in yet another.

Investigators studied the pattern of the strewn wreckage for clues. A surveying company was called and, using the line of flight as a base, divided the wreckage area—2500 by 10,252 feet—into 1000-foot areas. Close to the main wreckage, the squares were 500 feet. Marked off with rope, the squares were also drawn on a large map. As each piece of debris was identified, it was tagged as to its location in a square, providing an accurate wreckage-distribution chart for study. Army photo planes took aerial pictures of the area.

In the wreckage pattern, CAB men noted wreckage strewn to the left side of the flight path contained parts of the right engine and wing. Wreckage to the right had parts from the left side. The tail section, almost intact, was at the back of the wreckage area, almost two miles from the fuselage. The fact that it had separated from the plane as a whole piece and was so far from the cabin was significant.

Engine specialists determined by examining the engines and propellers that the plane was in a normal, steady climb at the

Interviewer takes a statement from one of first witnesses to reach crash scene. CAB men may talk to witnesses as far as 35 miles from scene for leads





**Engine-and-propeller team work in pit containing two engines. Bulldozer was used to help uncover wreckage**

time of the explosion. There was no evidence that the pilot had any difficulty or had taken emergency procedures.

CAB investigators learn to read wreckage as the average person reads a book. When trying to determine whether an en-

gine was developing power at the time of impact, for example, they look at the propeller. They judge the blade damage in general, the location of breakage and direction of blade bending, the condition of the blade-angle actuating mechanism, and

**Reconstructed heater compartment of DC-6 that crashed at Bryce Canyon in 1947, shows fire damage**



**Cylinder from Convair 240 developed metal-fatigue crack to cause crash at Fort Leonard Wood, Mo.**



the type of terrain or objects struck by the propeller. A general rule of thumb is that blades bent or broken in a forward direction indicate the engine was under power and high r.p.m. Blades broken or bent in the direction of the tail indicate the power was off when the engine hit.

Torn and twisted metal tells a story, too. A fatigue failure in metal leaves a clamshell pattern on the broken end, while a piece breaking under tension is narrowed at the point of break, with a cup-cone formation and a velvety appearance. A shear failure produces a surface that looks like cake sliced with a dull knife.

Investigators are wary of instrument readings, because these may change on impact. The settings of cockpit switches are more reliable, and the parts of the hydraulic system are good indicators of conditions aboard.

Even when a plane has burned, investigators can see whether a fire in flight caused the accident or whether the fire followed impact. And usually they can spot the source of an in-flight fire. Fire leaves smoke streaks. If all streaks are vertical, the fire occurred after impact. Nonvertical streaks indicate an in-flight fire. By following the streaks to their point of origin, an investigator can locate the source of the fire.

At Longmont, structures men found the remains of each wing with its two engines buried in 10-foot holes. The outer portion of each had broken off in descent. The puzzling thing was that the break had been in a *downward* direction, which could have happened only if the plane were inverted.

Operations men learned that the plane left Denver at 6:52 p.m., 11 minutes prior to the explosion, bound for Seattle, Wash., on a flight plan calling for a cruising altitude of 22,000 feet. The explosion had occurred at 11,000 feet above sea level, about 6000 feet over the ground. Weather had not been a factor. There had been no radio contact with the pilot.

Postal inspectors collected the remains of the plane's mail, and reported that it had scattered over an eight-mile area—unusual even in high wind. They recovered 95 percent of it undamaged. The remaining five percent was ripped to bits, another unusual circumstance.

Early witnesses reported smelling gunpowder around the wreckage, and investigators localized the smell around the aft section of the fuselage. Pieces of the aft section just forward of the tail were gathered up and examined critically. The manner in which they had ripped apart indicated an explosion had taken place inside the Number Four baggage hold.

(Continued to page 238)



Above, switches on copilot's panel are checked. Below, CAB propeller expert examines damaged blades



Every large piece of wreckage is tagged to identify it and to indicate where in the wreckage pattern it was found. Pattern often yields valuable information





## Two-Power Telescopic Sight for BB Gun

Just like a high-powered hunting rifle, a new BB gun has a telescopic sight (left). The two-power scope has a four-lens optical system. The scope also is available alone and can be fitted to most existing air rifles.

## Meat-Cutting Guide Protects User's Fingers

Meat and bread can be cut precisely with a cutting guide (right) made in West Germany. A metal standard keeps the knife in place as pressure is applied. A groove in the cutting board helps to guide it. The folding metal standard also protects the fingers of the person using it.

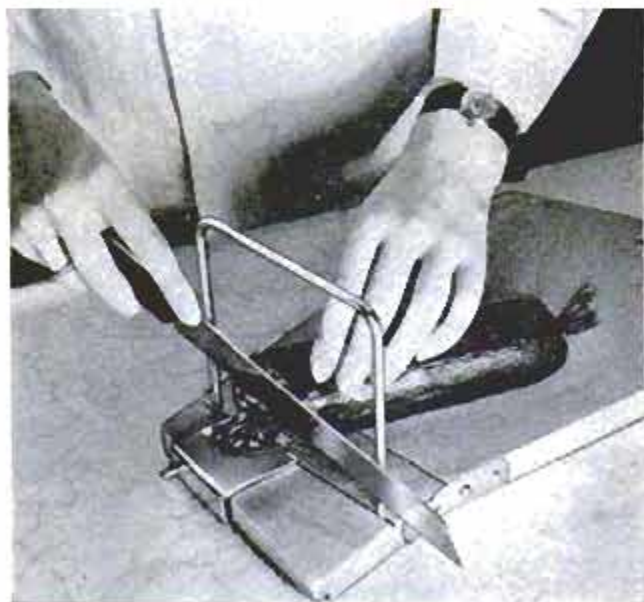

## Look, Ma—No Wires!

Electronic impulses picked up from the air synchronize a battery-powered clock. The impulses come from the 60-cycle alternating current of nearby wiring in the building, and are already present in any wired room. A small transmitting pylon may be plugged into a wall outlet to amplify the synchronizing waves. The cordless clock keeps running during a utility power failure, although an extended power failure may temporarily affect its timekeeping quality. The batteries last from one to two years.

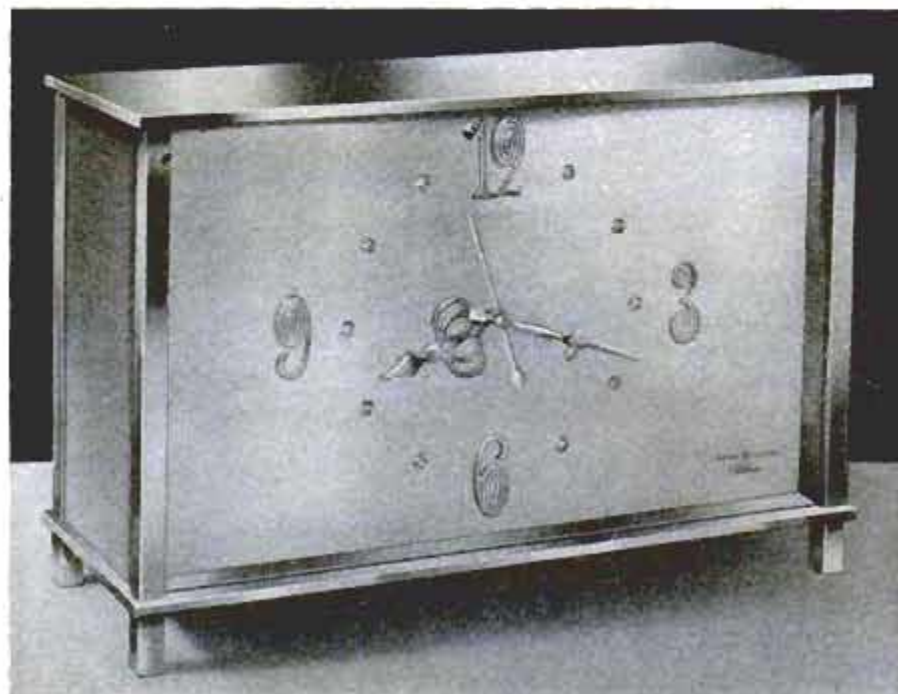

## Can You Cry For Science?

There's a crying need for tears at the Medical Center of the University of California at Los Angeles. Dr. Robert Brunish is studying the chemical composition of tears in an effort to find the elusive eye irritant in smog. Tears, according to Doctor Brunish, are not just drops of salt water, but a complex solution with a high protein content. Tears shed in pain, sorrow or anger differ from those touched off by peeling an onion or by smog. Doctor Brunish has been able to obtain plenty of small-fry tears from the children's ward of a hospital, but grown-up tears are more difficult to find.

☐ The world air-transport fleet — aircraft operating in scheduled service — totals approximately 2800 planes.



Cushman will travel up to 36 holes without recharging, carries two passengers and has carrier space for as many as four golf bags. It climbs steep hills, has forward speeds of three and seven miles per hour, one rear speed. Four automotive batteries power unit

Cushman Motor Works,  
Lincoln, Neb.

## Golfers Mobilize

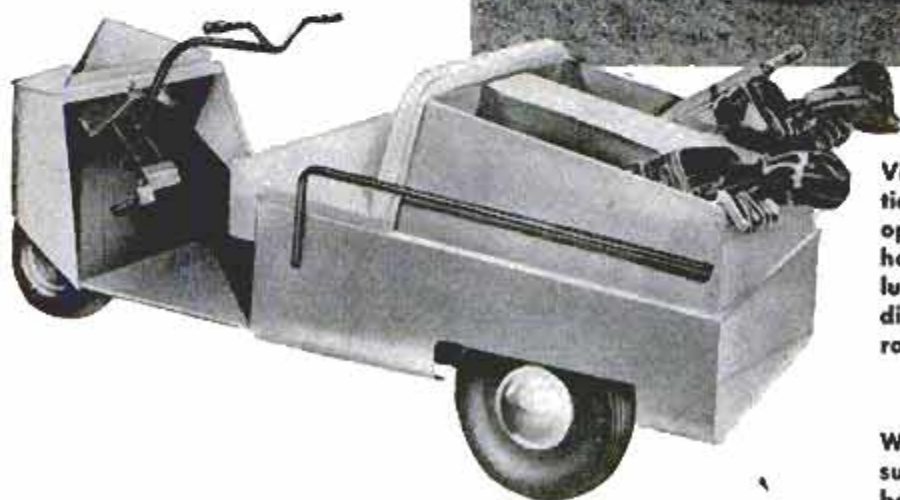

Victor also has two-wheel differential drive and forward or reverse operation. Batteries power the 1½ horsepower, 24-volt d.c. lifetime-lubricated motor. It has disk brakes, direct drive, adjustable steel brake rod directly connected to the pedal

Victor Adding Machine Co.,  
3900 N. Rockwell St., Chicago 18

WALKING from one green to another used to be as much a part of the game of golf as the clubs themselves. But now, more and more people are cruising around the fairways in electric or gasoline-driven cars. Apart from the golfers who just dislike exercise, the mobilized ranks include many who, because of age or doctor's orders, would have to give up their favorite sport because of the strenuous hikes and climbs that the golfers' cars eliminate. Battery-driven cars are the most popular on the nation's courses. Shown on this page are some of them.

Westcoaster has all-point coil-spring suspension, heavy-duty batteries, V-belt drive, moistureproof built-in charger, safety gearshift. A radio and a cigarette lighter are among the optional features. The car has forward and rear speeds, climbs hills well

Mennen Industries Inc.,  
1121 E. Artesia Blvd.,  
Long Beach, Calif.



Low slung Lectracar has dentproof and corrosionproof plastic body and weighs only 600 pounds. A foot pedal controls both forward and reverse speeds and braking. It has a maximum speed of 10 miles per hour and can run 20 miles without a recharge

Nears Hoebuck and Co.

# OWNERS REPORT:

Who knows most about a car? Its owner? The engineer? Or a veteran road tester? *Popular Mechanics* lets you hear from all three in this report on the '56 Cadillac

## Why Did They Buy a Cadillac?

24.0% said

**Previous Experience**

"Previous satisfactory experience."

RHODE ISLAND PHYSICIAN

13.0% said

**Prestige, Pride, the Name**

"Prestige of the car."

OHIO DISTRICT MANAGER

"Some snob appeal."

KANSAS FARM OWNER

12.3% said

**Low Depreciation**

"Can sell my car each year and get a new one with very little loss."

WASHINGTON THEATER OWNER

## What Do They Like Best About Cadillac?

35.0% said

**Riding Quality**

"I like its riding quality and comfort. I put 50,000 miles a year on my car."

TENNESSEE TRAVELING SALESMAN

32.7% said

**Power, Performance**

"Plenty of power to pass trucks and cars. Speed with ease."

OKLAHOMA OIL MAN

## What Are Their Complaints?

23.7% said

**Poor Assembly**

"For its price, it should be better assembled. Too many little things not properly taken care of. Continuous return to dealer takes up too much of one's time."

ILLINOIS EXECUTIVE

22.7% said

**Transmission Trouble**

"New transmission is slow to take hold when cold."

IOWA INVESTOR

"Dislike new transmission very much. This is second transmission within 6000 miles."

TEXAS SALESMAN



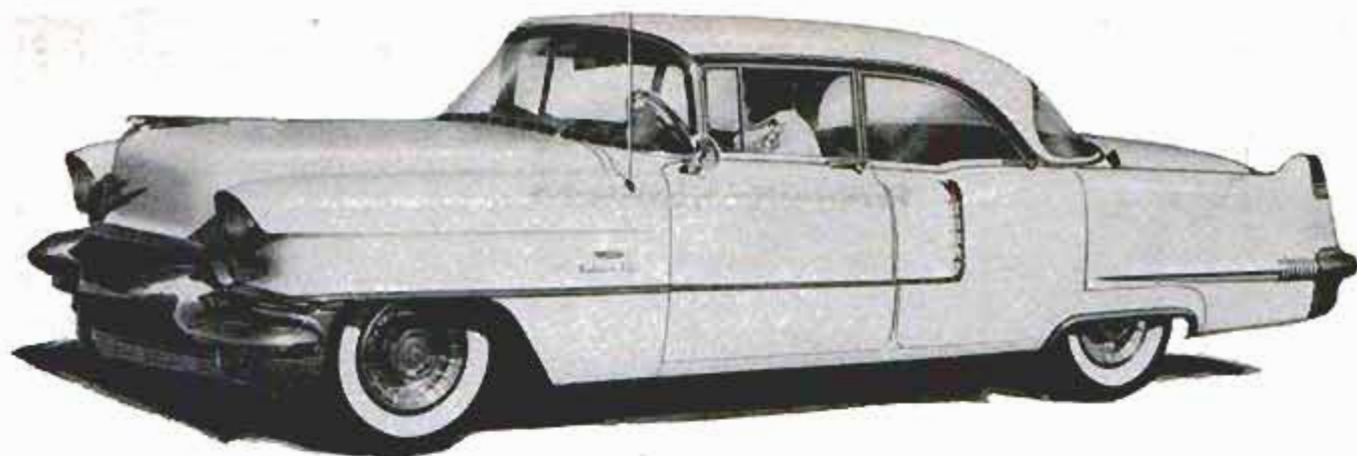

## Owners Praise Cadillac's Performance But Complain of Transmission Troubles

As Told by Owners of 1956 Cadillacs

**CADILLAC** CONTINUES to impress people. Our Owners Report proves it and so did our survey on why people buy the cars they do (February 1956). Regardless of income group, more people would like to own Cadillac than any other car—and by a wide margin.

What is there about Cadillac that makes it a symbol? What do owners like most about the Cadillac? Why did they buy a Cadillac? We asked 1000 owners of 1956 Cadillacs. This article is their report.

The most frequently mentioned reason for buying a Cadillac is "previous experience." Cadillac owners usually buy Cadillacs again. As a Virginia optometrist writes:

"I bought this Cadillac because I didn't want to step down in class."

Second reason is prestige or pride of ownership. Third is the car's resale value.

When asked what they like most about their cars, 35 percent of the Cadillac owners say its riding qualities.

"Rides smoothly. Drove 460 miles yesterday and felt not a bit tired."—New Jersey realtor.

"I like best its riding qualities and comfort on long trips. I put 35,000 to 50,000 miles a year on it."—Tennessee salesman.

"I like the ease of getting in and out of it plus the comfort it gives on long trips as

(Continued to page 107)



## CLYMER ROAD TESTS THE 1956 CADILLAC

By Floyd Clymer

**THE TEST CAR** was the 1956 Series 62 Special four-door sedan. The route was to Las Vegas, Nev., returning via Death Valley, Lone Pine, across the Mojave Desert and over the Angeles Crest mountain highway to Los Angeles for a distance of 729 miles, which included some testing over desert and mountain back roads.

The new 365-cubic-inch engine (upped from 325 last year) now has 9.75:1 compression ratio (9.0:1 last year). Horsepower is up from the 250 in last year's

car to 285 at 4600 revolutions per minute.

The Cadillac engine is perfection personified—it is smooth, flexible, powerful, responsive and has less engine vibration than any car I have ever tested. American cars, by public demand, have soft springing. As a result, there is considerable "roll" when cornering at speed and Cadillac is no exception. But stability is good and this is due somewhat to the fact that rear-wheel tread is wider by 3.16 inches than the front

(Continued to page 258)

# An Engineer Analyzes the 1956 Cadillac

By Dale Kelly, SAE

## ACCELERATION



Model tested: Series 62 four-door sedan with automatic transmission, power brakes, power steering, power seats and windows, air conditioning. Rear-axle ratio: 3.36 to 1 (measured). Curb weight: 4920 pounds with gas tank half full (53 percent on front wheels, 47 percent on rear wheels). Measured wheelbase: 129.5 inches left, 128.5 inches right.

TIME IN SECONDS	0 to 20	0 to 40	0 to 60	0 to 80	¼ mile
Ignition timed for regular gasoline	3.0	6.8	12.7	21.1	19.4
Ignition timed for premium gasoline	3.1	6.5	12.0	19.8	19.15

(Watches started instant accelerator floored. Engine was not run up against brakes before start. Drive 4 range was used. No improvement could be obtained with transmission in Low.)

## FUEL ECONOMY



MILES PER GALLON	Steady 30 m.p.h.	Steady 50 m.p.h.	Steady 70 m.p.h.	Traffic Route
Ignition timed for regular gasoline	20.2	17.1	13.9	7.9
Ignition timed for premium gasoline	20.8	16.9	13.4	8.3

(On traffic route, car makes 10 full stops per mile and is driven at an over-all average of 15 miles per hour.)

### ESTIMATED ANNUAL GASOLINE BILL: \$196 FOR 10,000 MILES

Figured at 2000 miles at 20 m.p.h., 5000 miles at 50 m.p.h., 1500 miles at 70 m.p.h. and 1500 miles in traffic and on the assumption that 25 percent will be able to get satisfactory performance on regular (27 cents a gallon), the rest requiring premium (29 cents a gallon).

## SPEEDOMETER ERROR



MILES PER HOUR	20.0	30.0	40.0	50.0	60.0	70.0	80.0
Indicated speed	20.0	30.0	40.0	50.0	60.0	70.0	80.0
True speed	20.0	30.0	41.0	50.0	60.0	70.0	80.0

(This is an unusually and commendably honest speedometer.)

**ODOMETER ERROR:** The odometer indicated 1½ percent less than the actual distance traveled (98.5 miles for an actual 100).

(This is unusual. The error is on the low side.)

## DRIVER'S VISIBILITY



Some portion of the road could be seen 13 feet in front of the car (A in sketch) by an average driver (5 feet 9 inches tall); full width of the road could be seen 23 feet in front of the car (B in sketch).

## GROUND CLEARANCE



The bottom corner of the rear overhang would touch the ground if the car were driven up an incline whose profile had a radius of curvature of less than 25 feet (see sketch). Bottom of the differential was 8¼ inches from the ground and should not give trouble except in deep ruts which are almost extinct.

## MISCELLANEOUS

**Octane requirement:** Acceleration and fuel-economy tests with regular gasoline were taken with ignition timing set at top dead center (slightly retarded from manufacturer's recommendations). The fuel used was an 85-percent octane blend of octane and heptane, the equivalent of a typical regular fuel of 88 octane Research. For premium-gasoline tests ignition timing recommended by manufacturer (5 degrees before top center) was used. At this setting, engine did not knock on a 90-percent blend of octane and heptane, the equivalent of a typical premium fuel of 95 octane Research. Timing could, in fact, have been still farther advanced without knock, if desired.

**Steering:** From straight ahead, the steering wheel had to be turned 0.8 of a revolution to complete a circle with an outside radius of 50 feet. Lock to lock, the wheel required 4.25 turns. Turn-circle diameter, curb-to-curb, was 43.4 feet; from wall-to-wall 46.2 feet. Steering-wheel diameter: 18 inches.

**Trunk capacity:** In addition to spare tire and tools, the trunk accommodated 11 cardboard cartons of the size used for 48 tall cans of evaporated milk. The car tested was a four-door sedan, a coupe would have a roomier trunk.

**Interior sound level:** Inside the car the noise level with all windows closed was 91 decibels at 40 m.p.h., 95 decibels at 60 m.p.h., on a smooth road.

**Water resistance:** Car was washed in an automatic high-pressure car wash and driven through a standard splash pan. No water entered the trunk or passenger space. Ignition and brakes were not affected.

**Center of gravity:** Center of gravity of unloaded car was 21.5 inches above the ground.

**Gasoline fill rate:** Fuel tank could be filled at the rate of more than 13 gallons per minute. This is faster than the standard pump can deliver it.

**Brakes:** Both hand brake and foot brakes worked well. Hand brake held the car on a 14-percent grade. Reserve vacuum tank had enough capacity for three or four brake applications with the engine not running.

**Air conditioner:** Use of air conditioner reduces gasoline mileage by approximately 0.5 of a mile per gallon in highway driving. The air conditioner is relatively ineffective at 30 miles per hour or less unless engine speed is increased by the use of Drive 3 range. In this range, mileage is 13.4 miles per gallon at 30 miles per hour with air conditioner operating.

Cadillac trunk holds 11 canned-milk cartons, used by Kelly as a yardstick to measure trunk capacity. The air conditioner occupies some of the trunk space





Cadillac owners in 43 states (in color) took part in the poll. Their opinions are summarized below

## THE OWNERS ANALYZE THE 1956 CADILLAC

### OVER-ALL RATING

Excellent .....	69.0%
Average .....	25.9%
Poor .....	5.1%

#### Over-all performance is

Outstanding .....	66.4%
Average .....	29.3%
Below average.....	4.3%

#### Over-all handling is

Outstanding .....	76.8%
Average .....	21.5%
Below average.....	1.7%

#### Exterior styling is

Outstanding .....	66.9%
Average .....	31.4%
Below average.....	1.7%

#### Styling influenced choice of car?

Styling was important.....	33.8%
Styling not important.....	57.1%
Did not answer.....	9.1%

#### Had trouble with engine?

No trouble.....	79.3%
Some trouble.....	17.0%
Considerable trouble.....	3.7%

#### What was engine trouble?

Carburetor .....	5.4%
Valves .....	4.7%
Pings .....	3.7%
Oil leaks.....	1.7%

#### Had trouble with Hydra-Matic?

Yes, had trouble.....	24.7%
No, had no trouble.....	75.3%

#### Owned Cadillac before?

Yes, have owned before.....	84.5%
No, have not.....	15.5%

#### Is new Hydra-Matic better?

Yes, it's better.....	71.0%
No, it's not as good.....	17.7%
It's about the same.....	11.3%

#### What make of car was traded?

Cadillac .....	72.1%
Other General Motors car..	11.0%
Ford Motor Company make..	2.2%
Chrysler Corporation make..	1.3%
Other make.....	1.0%
No trade or no answer.....	12.4%

#### Trade-in allowance on Cadillacs

Excellent .....	36.3%
Average .....	45.8%
Poor .....	14.6%
No answer.....	3.3%

#### Trade-in allowance other makes

Excellent .....	19.1%
Average .....	51.1%
Poor .....	25.5%
No answer.....	4.3%

#### What year Cadillac was traded?

1956 Cadillac.....	0.4%
1955 Cadillac.....	29.3%
1954 Cadillac.....	29.7%
1953 Cadillac.....	19.4%
1952 Cadillac.....	10.4%
1951 Cadillac.....	5.8%
Earlier models.....	5.0%

#### Would buy a Cadillac next time?

Yes .....	65.2%
Might .....	28.3%
Would not.....	6.5%

#### Dealer service is

Excellent .....	50.2%
Average .....	38.9%
Poor .....	10.9%

#### Who are Cadillac owners?

Businessmen .....	48.3%
Retired owners.....	10.7%
Doctors, dentists.....	9.0%
Farmers, ranchers.....	6.7%
Salesmen .....	6.7%
Lowyers .....	2.0%
Others .....	16.6%

#### Best-Liked Features

Riding qualities.....	35.0%
Power, performance.....	32.7%
Handling ease.....	28.3%
Styling .....	21.0%
Transmission .....	8.3%
Low depreciation.....	7.0%
Power brakes.....	7.0%
Prestige .....	6.7%

#### Most-Frequent Complaints

No complaints at all.....	33.4%
Poor assembly.....	23.7%
New transmission.....	22.7%
Body rattles.....	12.0%
Uses too much gas.....	10.7%
Engine troubles.....	10.3%
Poor dealer service.....	7.0%
Door fits.....	6.0%

#### Why Did They Buy Cadillac?

Previous ownership.....	24.0%
Prestige, the name.....	13.0%
Resale value.....	12.3%
Styling .....	10.0%
Quality .....	7.3%
Riding comfort.....	6.0%

well as in town."—North Carolina widow.

Almost as popular with owners as the excellent ride is the power and performance of Cadillac's 285-horsepower engine. This feature is mentioned by 32.7 percent.

"Plenty of power to pass big trucks and cars. Plenty of speed with ease."—Oklahoma oilman.

"Smooth power. Living in hilly country this means a lot when you come to a steep grade."—Washington theater owner.

"Adequate horsepower in emergencies."—New York engineer.

"I never drove a car with better performance."—Iowa farmer.

Third most frequently mentioned of the best-liked features is handling ease with 28.3 percent mentioning it.

"It drives so easily."—Nebraska rancher's wife.

"Very easy to park in a small space."—California owner.

#### But Even Cadillac Is Not Perfect

Although 33.4 percent of the Cadillac owners don't make a single complaint, the car does have faults, say 66.6 percent.

And the most frequently mentioned of the faults is the same as the one most frequently mentioned by owners of many low-price cars: poor assembly. Nearly one quarter of all the Cadillac owners complain of slipshod workmanship (23.7 percent to be exact), and many of them complain vehemently.

"I think it is sad that the standards are such that a fine car at such a high price has the same evidence of sloppy, fast-production defects found in all cars at any price."—California Eldorado owner.



Owners report they like the rear-view-mirror control. Handle inside door (arrow) lets driver move mirror with window closed

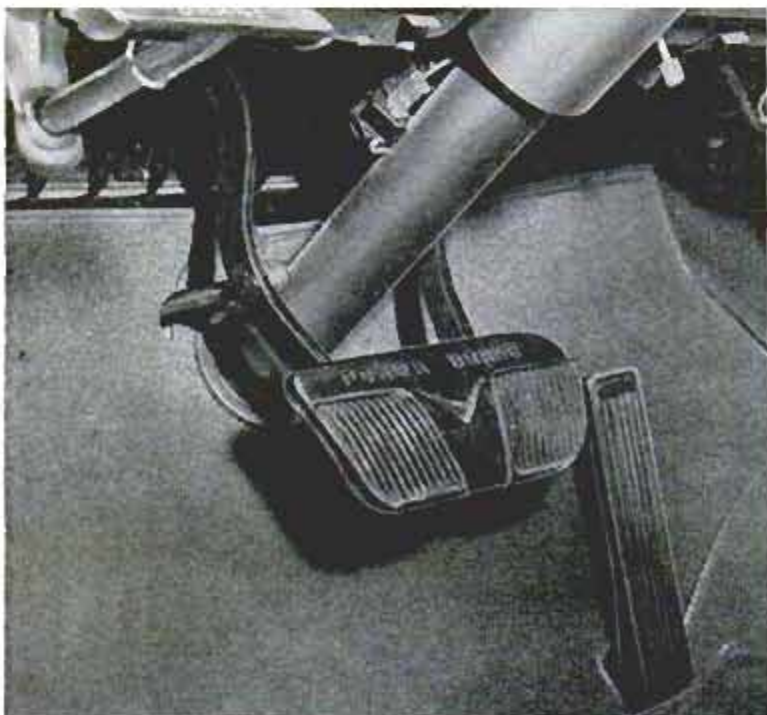

Above, new this year is the center-mounted brake pedal. It straddles the steering column and is easily operated by either foot. Below, some owners complain about the extra-big horn ring. It is too close to the steering-wheel rim for comfort



"Mechanically the poorest of the four Cadillacs I have owned. For this amount of money one should not expect a slam-bang careless assembly nor accept any adjustment they cram down your throat."—Oklahoma oilman.

"Factory inspection poor. Radio not wired up. Map light same. Faulty backup lights. One door lock inoperative. Gas tank delivered with huge dent in bottom. Trip mileage not working. Headlights out of focus. Door-top snap closures stay open. No effort by factory to rush replacements for defective parts."—Montana police officer.

"It was minus half of the screws in the interior. Upholstering wasn't put on right. Gas gauge broken. Aerial doesn't work. Brakes squeak. Air comes in around windows. Rattles and squeaks in all doors."—Texas housewife.

Cadillac has the new Hydra-Matic transmission in its 1956 models. This new version of the four-speed automatic transmission has a second fluid coupling to eliminate the jerkiness characteristic of the previous unit. Many of the owners are not impressed with the new transmission and 22.7 percent list it as one of their complaints, making it the second highest on the gripe list.

"Transmission is not as good as old one. In cold weather it does not take hold at once."—Michigan machinist.

"Hydra-Matic went bad at 1500 miles. Clutches burned out."—Illinois executive.

"Transmission has no pickup. Uses too much gas. Had to put a new one in at 6000 miles."—Texas salesman.

"Downshift does not always work on flooring accelerator."—New York lawyer.

"Hydra-Matic went out at 325 miles. Car was laid up 16 days."—Idaho motel owner.

Third on the list of complaints is another familiar one: body rattles. Apparently luxury cars are no different from other cars in this respect.

"Windows and doors rattle."—Idaho government worker.

"Body rattles more than any other Cadillac I have ever owned."—California broker.

(Continued to page 250)



Newest transport by Douglas for the Air Force, the C-133A, carries a radar scanner in its big, black nose

## Latest Flying Freighter Can Carry 200 Troops

IF YOU PARKED America's newest military transport on a football field with its nose at the goal line, its tail would be two feet beyond the 50-yard line. Its wings would spread 10 feet past each sideline.

Including its radome nose, the aerial monster is 152 feet 7 inches long. Wingspan is 179 feet 8 inches. Even though the fuselage squats close to the ground for easy handling of cargo the top of the tail is more than 48 feet tall, about the height of a four-story building. The fuselage is 16 feet in diameter.

The Douglas-built C-133A can carry twice the payload of the Douglas C-124 Globemaster, and nearly any military vehicle can be driven up a low ramp under the tail and into the cargo hold. A load might include two big prime movers weighing 20 tons each, 16 loaded Jeeps and 20 jet engines. The plane can be modified to carry more than 200 troops, or can serve as a hospital plane. Its cargo hold is heated and pressurized for high flights.

Now undergoing flight tests, the C-133A is powered with four Pratt & Whitney T34-P-3 turboprop engines each rated at 6000 horsepower. Each engine drives a three-bladed turboelectric propeller 18 feet in diameter. A battery starts auxiliary gas-turbine engines which supply compressed air for starting the main power plants. A crew of four flies the plane.

Plane is designed as a cargo or troop transport. The fuselage is 16 feet in diameter, with clean interior

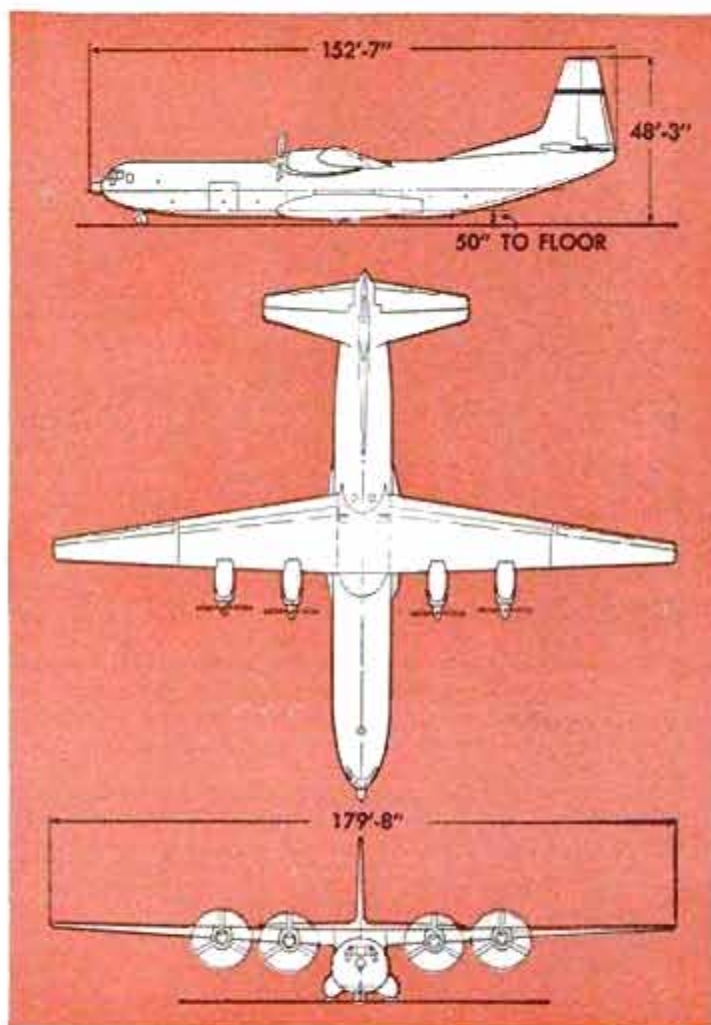

# TARGET: Satellite Europe

By Clifford B. Hicks

**A** FEW MONTHS ago officials of Free Europe Press learned of a sports event to be held in Prague. About 100,000 people were expected to jam the stadium.

This seemed an ideal target. Free Europe Press and Radio Free Europe are twin projects of a group of American citizens banded together into the Crusade for Freedom. The purpose of the Crusade is to penetrate the iron curtain by radio broadcasts and, more recently, by balloons which shower down leaflets by the millions.

To officials of the organization, the Prague sports event was too alluring a target to pass up. For three weeks in advance they sent up practice balloons which were carried by westerly winds into Czechoslovakia.

At last came the morning of the event. The leaflets were fastened to the balloons, which were released at the proper moment and disappeared high in the sky.

Some 4½ hours and 150 miles later, the leaflets suddenly spilled down on 100,000 spectators jammed into the arena. Thanks to amazingly accurate forecasts and a bit of windblown luck, Free Europe Press hit its target smack on the button.

The Prague incident is an example of the bull's-eye accuracy with which the organization is lobbing the truth across the iron curtain. During the past two years Crusade for Freedom has launched more than 400,000 balloons carrying more than 250,000,000 leaflets into the satellite countries.

For the most part the leaflets are illustrated biweekly newspapers which carry items of interest to citizens of the target country. A typical issue may contain stories about prominent citizens who are living in the West, book reviews,



Girls pack miniature newspapers into open cartons which will be dumped by balloons. Two different systems are used. Following pages show another type of balloon which holds leaflets in bundle without carton. Below, dry ice is weighed to the gram





sewing patterns and craft projects.

These newspapers reach their targets on inexpensive polyethylene balloons measuring 13 feet high and carrying a payload of less than 10 pounds. Filled with hydrogen, the balloons rise to predetermined levels from 24,000 to 40,000 feet—high above airline traffic—where the winds carry them along at speeds up to 37 miles per hour. They may travel 200 miles before the release mechanism dumps the leaflets.

Considering its accuracy, the mechanism is surprisingly simple. It is a cross made of linked sections of wire. On one arm is a small counterweight. On the opposite arm is hung a package of dry ice, weighed to the gram. The leaflets are hung by a cord or suspended in an open-top box from the bottom of the cross.

As the balloon moves along its invisible airway, the dry ice vaporizes. Over a distance of 150 to 200 miles the counterweight gradually presses down the arm. Then

Leaflets carry news items of particular interest to target country. Drawing shows complete assembly of balloon and release

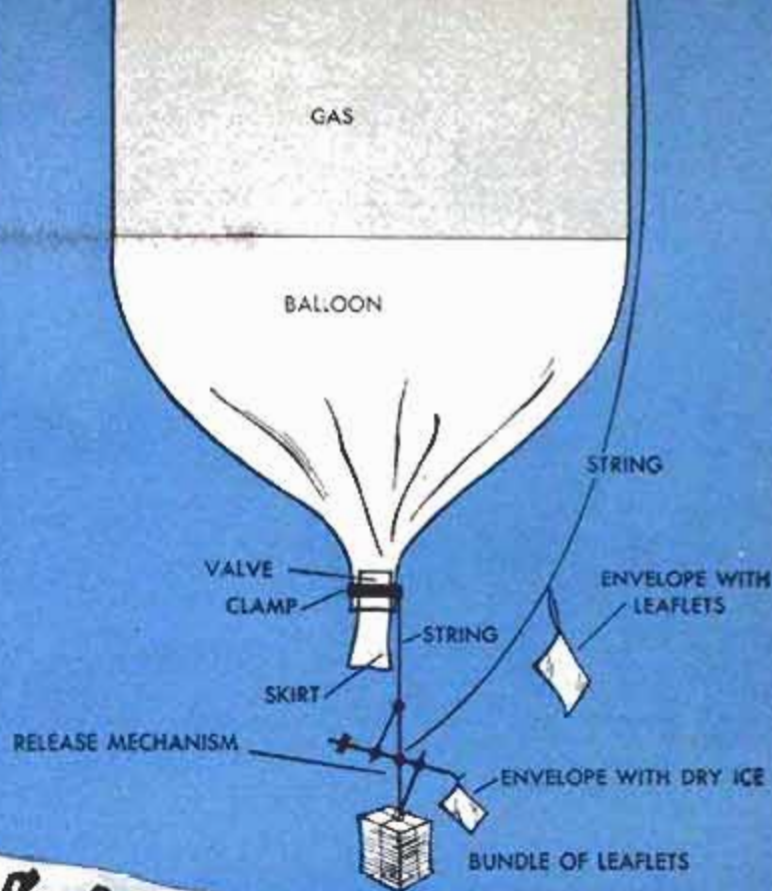

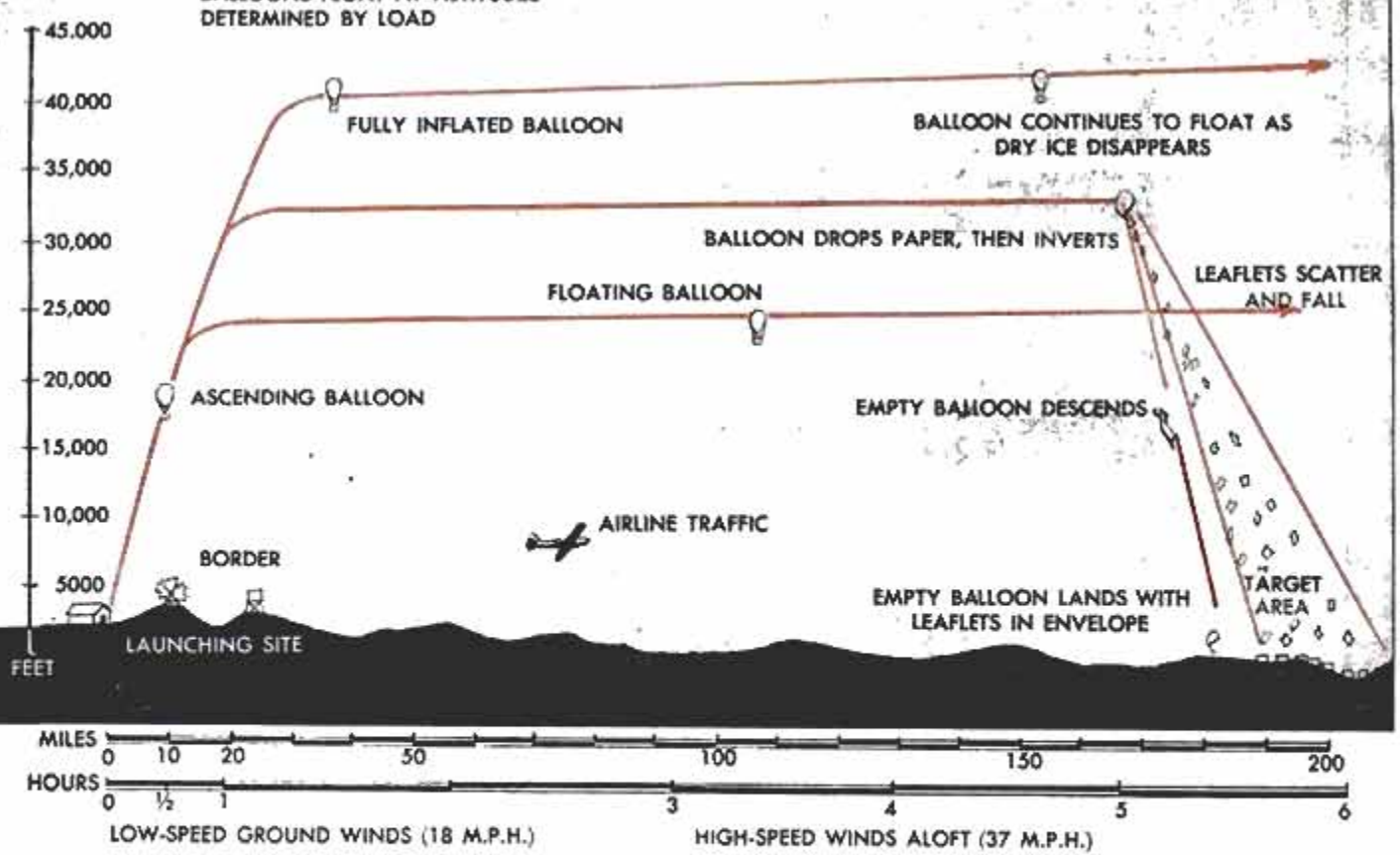

Balloons go much higher than airline traffic. Blown at speeds up to 37 miles per hour, they may travel 200 miles

at a predetermined moment the crossarm droops low enough to release a wire which is threaded through an eye. A string then slides free, releasing the leaflets.

Meanwhile, something else happens to the balloon. Another wire slips out of an eye, releasing the bottom of the balloon. Held now only by a string to the top, the balloon swings upside down and all the gas

escapes through the open neck. The balloon then falls to the ground, harmless but carrying an envelope holding more leaflets.

So effective is the leaflet barrage that the Communists attempt to shoot down the balloons with planes and anti-aircraft guns. But anything that goes up must come down, and the leaflets still reach the hands of the people below. ★ ★ ★

As dry ice evaporates it becomes lighter, and counterweight triggers release. Gas escapes when balloon inverts

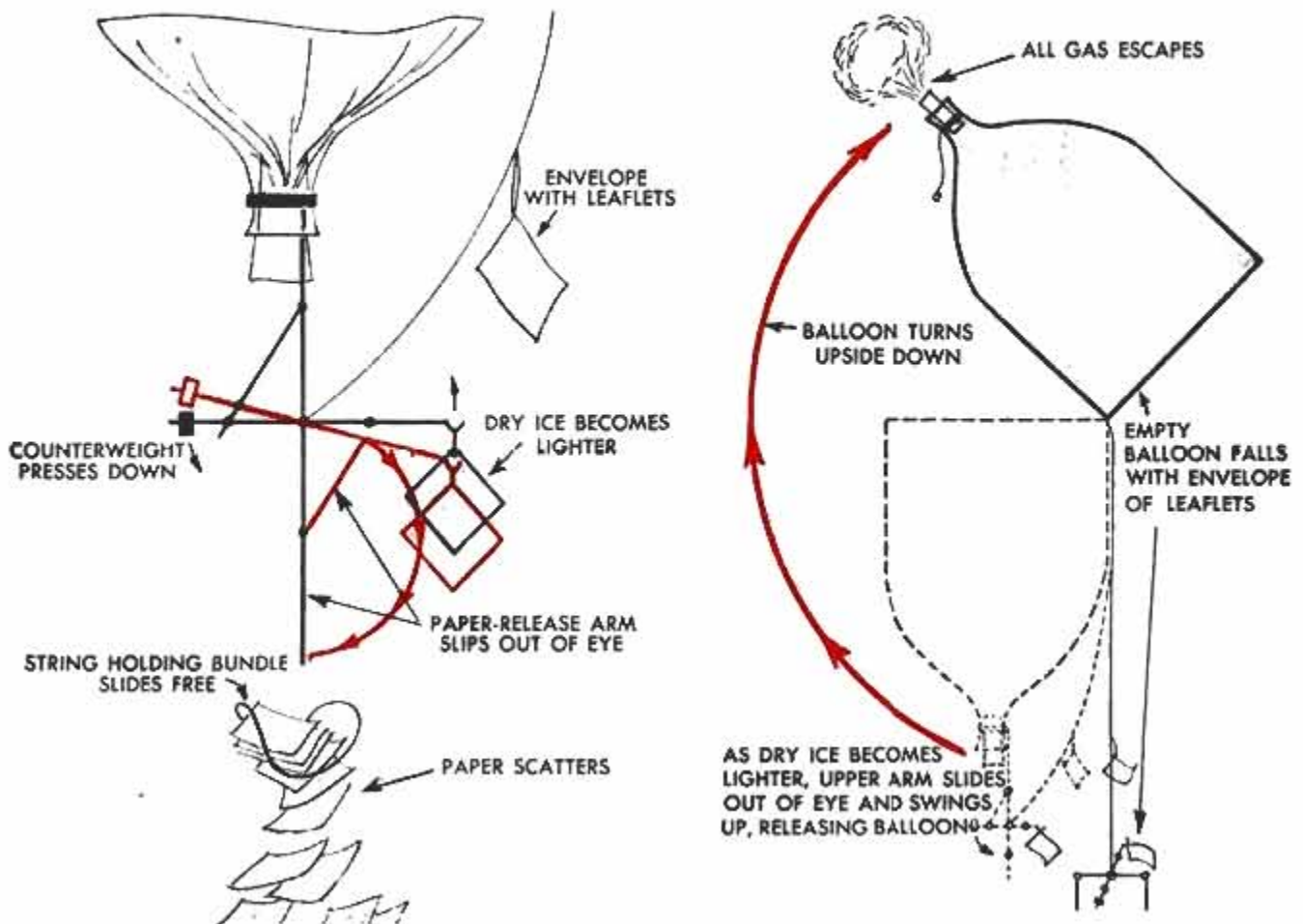



Back propeller linked through pulley to lower engine is spinning. Front propeller operates from top engine

## ***Twin-Engine Safety for Light Plane***

LOOKING FOR AN EXTRA MARGIN of safety in light airplanes, Joseph L. Halsmer, Lafayette, Ind., has equipped a four-place Piper Tri-Pacer with two engines instead of one. Mounted over-and-under and driving two propellers in line with each other, the engines each develop 95 horsepower and replace the plane's original 150-horsepower plant. Separate instruments and throttles are provided for each

engine, and one can idle while the other is revving up. Thus, if one fails, the other serves as a spare. With power on both engines, cruising speed is 130 miles per hour, compared to 120 on the original engine, while gas consumption only rises from 10 gallons per hour to 11. Halsmer estimates that the two-engine installation increases the plane's cost by \$800 or \$900, and has applied for a patent on the arrangement.

Top engine is installed upside down. Eight V-belts in separate grooves link back prop to lower engine

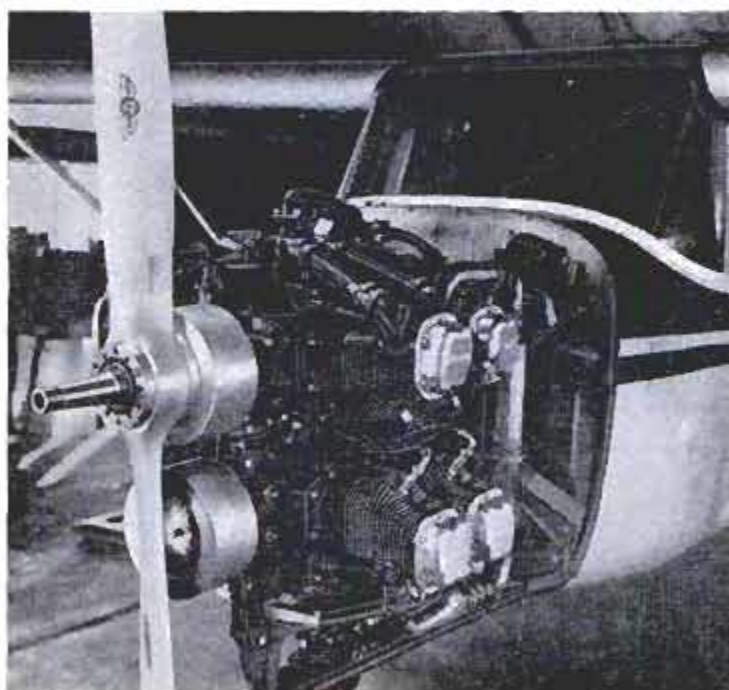

June 26 4, Mayor - Heard Bldg.,  
Phoenix,  
Ariz.

# Now You're Cooking With

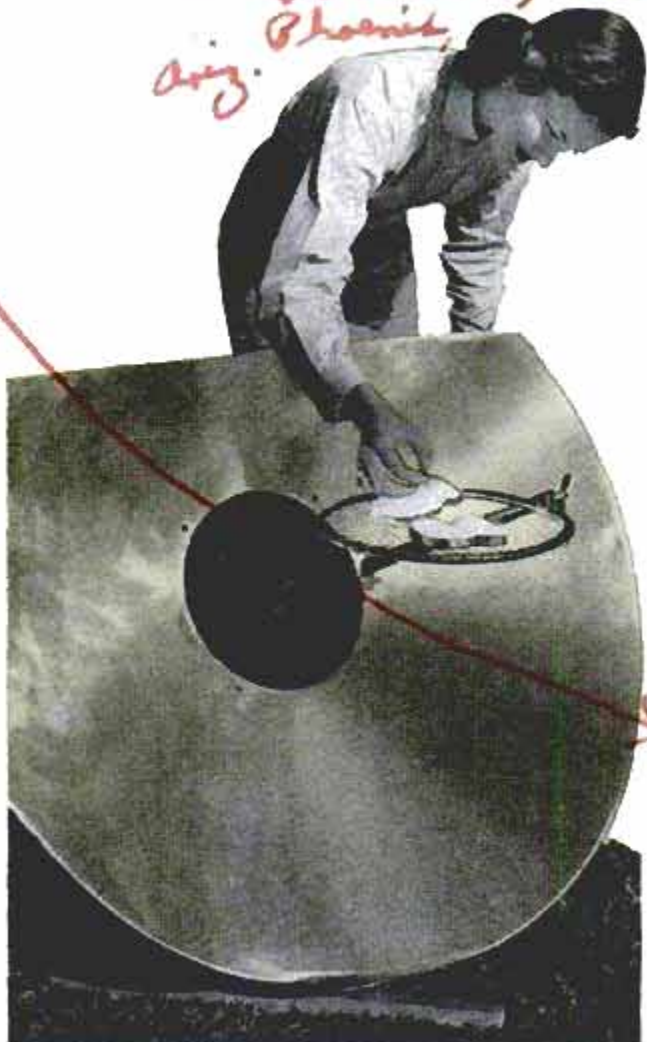

**Toast a la Sol** coming up! Toaster is simple form of solar cooker. Aluminum reflector concentrates heat. Amateur radio station is powered by this solar engine which turns a turbine to develop electricity

**O**LD SOL has put on a chef's cap and picked up a spatula. And not only is he going to take up cooking, but he's also going to work in other ways. He'll be busy changing ocean water into fresh water, heating homes during winter months and cooling them in the summertime, and even supplying electric power in areas where fuel and water power are scarce.

All of these facts came out at the World Symposium on Applied Solar Energy held a short time ago at Phoenix, Ariz., where inventions from all over the world for converting the sun's heat into useful work were put on exhibition.

Most fossil fuels, especially oil and gas, are diminishing in supply rapidly. Water power is limited in expansion by the number of suitable rivers—and the fact that not all areas have water resources. The two sources of energy, then, that will provide the world with its power in the future are nuclear fission and the sun.

One conclusion reached at the symposi-

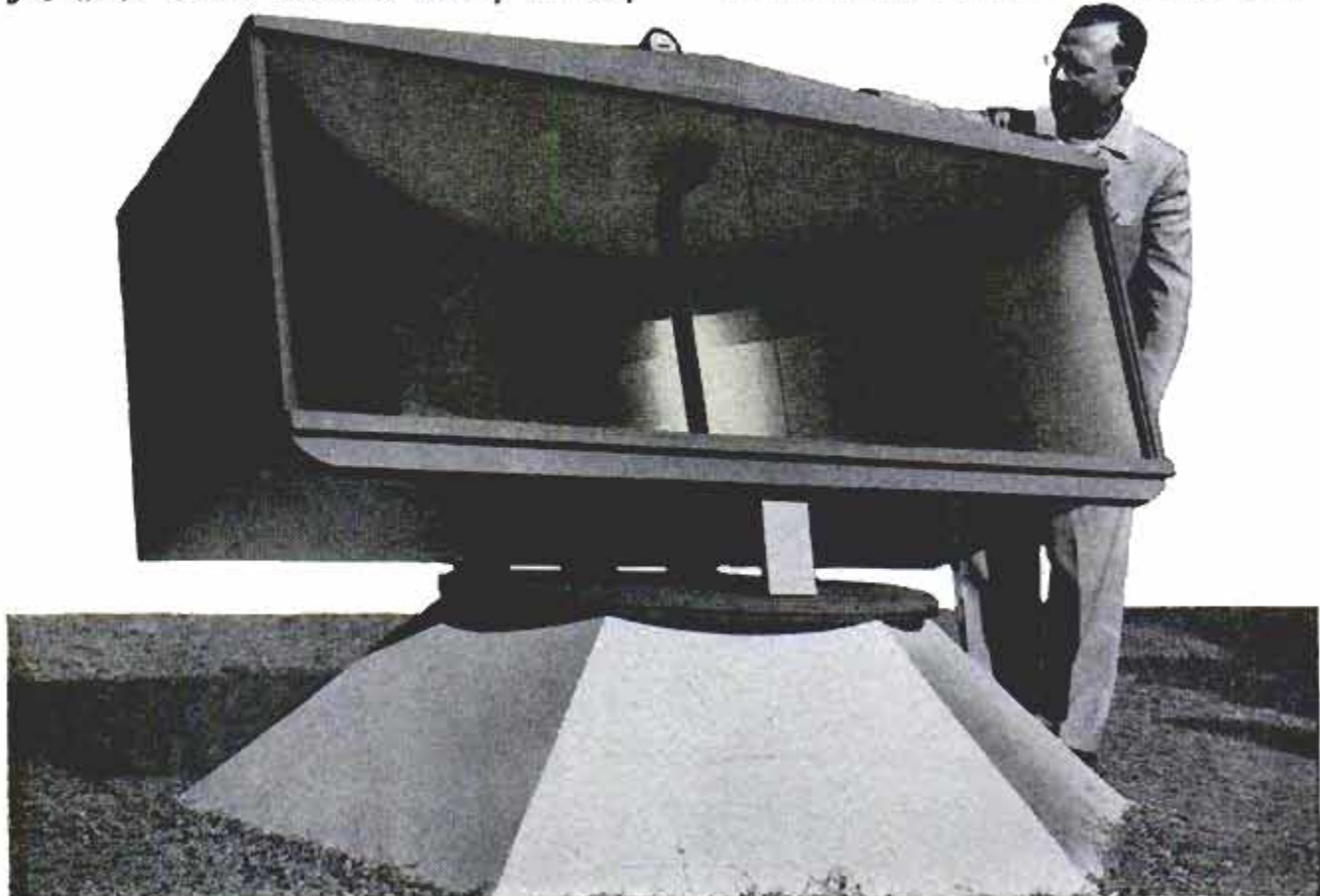

# the Sun

um was that solar heat seems well adapted for doing such jobs as cooking meals, heating water, heating or cooling a home and for pumping water, but it is improbable that the sun's energy will be harnessed for producing large amounts of central-station power in the foreseeable future.

Solar energy is so diffuse that very large tracts of land would be required for the equipment to do such a job. Nuclear energy has much more promise than solar energy for delivering large amounts of power.

But solar energy will be important and, in fact, is already used in areas of the world where fuels are scarce — India, Arabia and Lebanon. In these areas, solar cookers are already being manufactured commercially.

The solar energy hitting the United States every year, scientists say, is equal to 2000 times the present total heat and power requirements of the country. The chief problems in putting this energy to work have been how to collect the heat, concentrate it and contain it. Thus far, these problems are only partially solved, and most inventions using solar energy can claim only about a five-percent efficiency. Experimenters say that improved designs could raise this to about 10 percent.

Efficient or not, the sun machines on display at Phoenix seemed to be doing the jobs for which they were designed.

The solar stoves really



Above, aluminum solar oven on display at Disneyland. Sun's rays are reflected into oven where they build up enough heat to cook roast

Below, for use on picnics, a portable solar cooker that folds up like an umbrella. Aluminized fabric reflects sun's rays to cooking grill



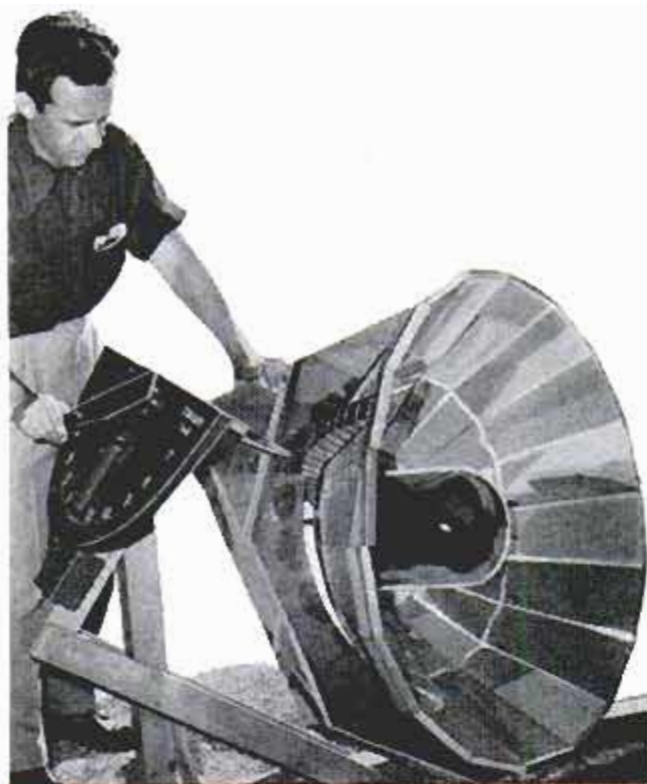

Developed in Japan, solar rice cooker has a latitude scale to aid in tilting toward sun

This collapsible cooker folds into space less than a small suitcase, cooks food rapidly



Solar stove with one glass wall which can be pointed toward sun. Aluminum side panels concentrate heat

cook the food placed in them. Most of these consist essentially of reflective devices which pick up the sun's rays and direct them toward an oven or grille. Some have concave circular reflectors that focus all the rays on one spot; others are of the "hot box" type—an insulated oven with reflector wings that direct the heat of the sun inside.

Members of an Arizona fine-arts club displayed a solar kiln for glazing pottery. Using a relatively flat plastic lens mounted on an equatorial framework, they focus the sun's rays on the object that has been coated with glazing material. Temperatures in excess of 1000 degrees are created and the heat rapidly melts the glaze allowing it to flow over the object.

Another attention getter was a solar "engine" invented by Jack Hedger, of Lakeside, Calif., to operate his 100-watt amateur radio station. The engine consists of a curved aluminum reflector that focuses the sun's heat on a black central copper tube in which a lightweight (SAE 10) engine oil is circulated. Heated to 400 degrees, the oil is used to boil water and produce steam. The steam in turn drives a homemade turbine connected to an electrical generator.

When Hedger is not using the sun for direct radio transmission in the daytime, he switches the power to a battery charger and charges a bank of storage batteries. Thus he can operate his radio station on solar power even after dark.

Short, rapid strokes of mechanical power



Solar engine called the Novoid produces pulsations through cycle of boiling water and condensing steam

are produced by a new solar engine called the Novoid. The apparatus uses a curved reflector to focus the sun's heat on one end of a pipe filled with water, and the heated water alternately explodes into high-pressure steam and then condenses again. Strong pulses of hydraulic thrust are thus produced at the other end of the pipe.

Dr. Maria Telkes of New York University, a leader in solar-power research, exhibited a solar still for converting sea water to fresh water. This and other stills shown would be able to accomplish this at an average cost of 86 cents per 1000 gallons—a cost that is not too high, considering that the need for fresh water is one of modern civilization's most pressing demands.



Pottery glazing with solar heat of over 1000 degrees is new twist to ancient art. Flat lens focuses rays

The stills all work on the same basic principle. Ocean water is run very slowly through a shallow trough covered by a transparent roof. The sun shining through the roof heats the water, causing some of it to evaporate and collect on the roof. This condensate is pure water which trickles into gathering troughs near the edge of the roof and then runs into storage containers below.

The symposium indicated that research into how to use the sun's energy has just reached the threshold of practical application. Advances should be rapid from this point forward. It won't be long until you'll be cooking with the sun—on the outside burner. ★★★

## Synchrophasing of Propellers Quiets Plane-Cabin Noise

Sound engineers have discovered that sound waves emanating from the propellers of multi-engine aircraft beat together to create additional sound and vibration in the plane's cabin. To combat this, an electronic synchrophaser, that varies the pitch of each propeller slightly to keep its sound waves in phase, has been developed. Weighing only 35 pounds, the equipment is as effective in decreasing the noise in the cabin as 800 additional pounds of insulation.

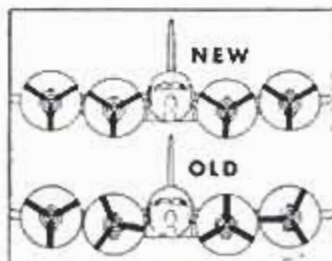
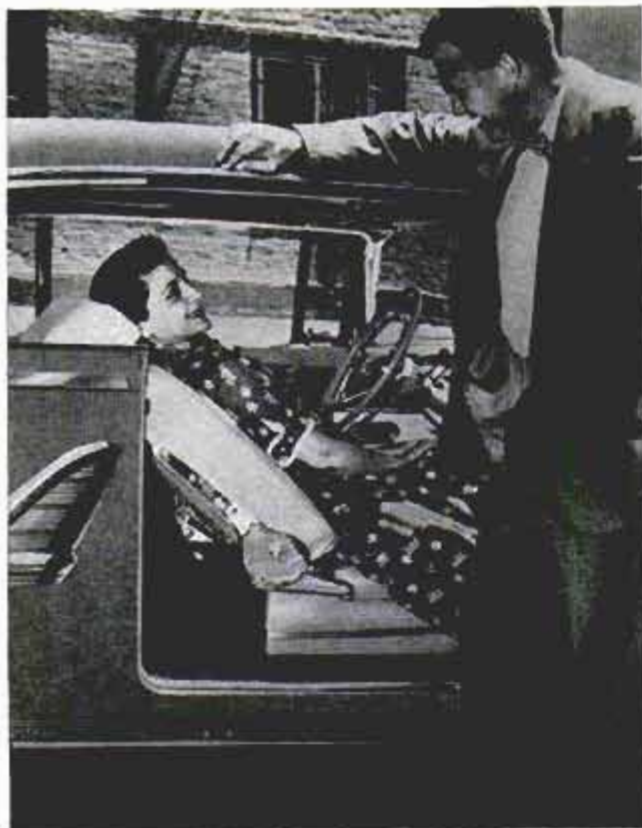

Diagram shows how synchrophaser adjusts propellers to quiet them



## Reclining Seat Fits Any Car

Now you can install a reclining front seat in any car (left). A finger-touch adjustment control tilts the seat forward or backward and locks safely in place. A companion piece to the reclining seat is a soft headrest that protects against "whip lash," caused when the head bounces back and forth after bumper-to-bumper accidents. The unit is made here from patents developed in Germany.

## Tire "Pumped Down" With Fast Deflator

Tire changing is speeded by a deflating tool (below) that uses the air hose to "pump down" the tire. So fast is air exhausted from the casings that the beads on tubeless tires break away from the rims. The device works by a siphoning action. Air from the hose rushes past the valve stem and drags the air from the tire. It is especially useful in deflating large tires.



## Hormone Makes Pale Apples Blush

Science is teaching pale apples to blush a brilliant red. A new chemical is sprayed on trees 14 days before the fruit is picked. It causes the apples on the lower boughs, usually much paler than those on top, to turn red. The chemical also keeps the top apples from falling too soon. Made from a plant hormone which nature uses to ripen apples, the spray was developed by Treesdale Farm, Mars, Pa., working with Pennsylvania State University.

## Oil Cup for Batteries Stops Corrosion

Car and truck batteries remain corrosion-free when the terminals are fitted with plastic oil cups. The heavy-grade oil in each cup surrounds the terminal to prevent the build-up of oxidized material that interferes with electrical contact. A screw-on knob fastens the battery cable to a thimble that grips a clamp mounted on the battery post. Because there is no corrosion formation, there is no variation in line resistance. The correct setting of the voltage regulator is maintained, giving protection from overload to the entire electrical system of the vehicle.







Kit includes all materials needed to do the job



Adhesive to join cover sections is squeezed from tube

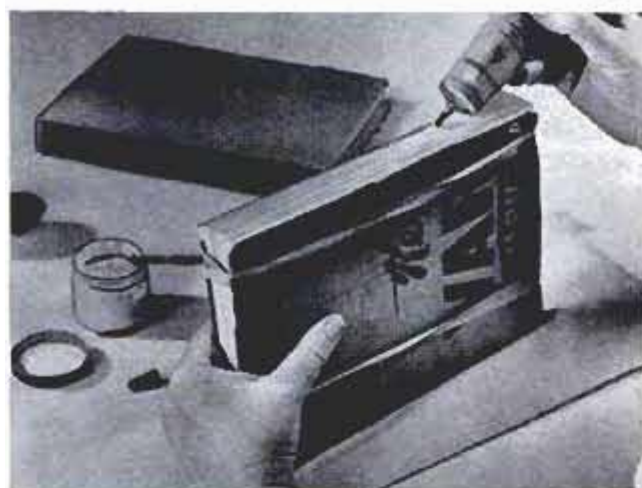

More adhesive is used to cement sections together



The book cover is painted with waterproof coating

## Kit Permits Amateur to Bind Books and Magazines at Home

You can rebind old books, or bind notes, pocket-size books and magazines into hard-covered books with a new kit. A strong adhesive is used to cement the ends of the pages together without sewing. The kit includes tubes of a waterproof coating for

the covers, adhesive, a bottle of solvent, water colors, ruler, compass, brushes, hinge stick, rounding block, book papers and other necessary items. Heavy cardboard is used in making the covers. Binding a book with the kit takes about an hour.

## Chemical Deodorizes Air In Swiss Transport Planes

Cigar-smoking will be permitted on Swissair airliners, now that a new device which eliminates cooking and smoking odors from the air has been installed in the cabins. Called P-6, the chemical which does the work is a hydrocarbon compound. Small containers, filled with glass fiber that has been treated with P-6, are placed throughout the cabin. Tests indicate that P-6 will keep the air clean and fresh for long periods and, as an additional advantage, is helpful in preventing airsickness.

**Tiny containers of P-6 located throughout cabin eliminate cooking and smoking odors**

☐ Russia has 700,000 TV sets, America 31,000,000 and Britain nearly 4,000,000, according to the United Nations.





## Auto-Top Sleeping Bunk Folds Into Compact Package

Motorists can now carry a ready-to-use sleeping bunk on top of their cars. At night the unit is expanded from a compact 150-pound package and a screened tent encloses the sleepers. A two-piece telescoping tubular-steel ladder is part of the equip-

ment. The innerspring mattress measures four by six feet and holds two comfortably. A rear boot designed for some types of station wagons screens the interior of the car so it can be used for sleeping as many as four adults and three children.



## "Mechanical Stomach" For Elevators

Elevator engineers have devised a "mechanical stomach" that measures the sudden changes of speed which make human stomachs queasy. The little instrument rides up and down in the elevator to record its findings on a moving graph. With the graph, engineers can adjust the elevator for a smooth, comfortable ride. The instrument, built by Westinghouse, contains a spring-suspended weight which "weighs" more or less as the elevator moves up or down. An arm attached to the weight tips to close one of two electrical circuits. One of the circuits energizes a magnet to bring the weight back down, the other acts to bring it back up. The current flow powers the drawing of the graph to record acceleration and deceleration.

☞ Claiming a sharper, truer picture, the owner of a drive-in theater near Melbourne, Australia, has installed a projection screen, measuring 45 by 98 feet, of a specially treated aluminum.



## Motor Scooters Replace Horses in Berlin Trotting Races

In Berlin, Germany, the horse lost another battle in his fight against extinction as motor scooters took over the pulling job in trotting races. The scooters, boasting five horsepower each, towed their sul-

kies around the track at a Berlin sports show. Members of a German cycle club manned the scooters, while lady jockeys held the reins in the sulkies. Fans found the race noisy and exciting.

## Antiwind Wall Protects Ships

Ships moored at a dock in Marseilles, France, are protected from high winds by a slatted shield (arrow) on a low building beside the dock. The shield cuts a 77-mile-per-hour gale down to a speed of 17 miles per hour, facilitating unmooring and the final phase of mooring. It permits cranes to operate more easily and passengers to embark and disembark without inconvenience. The top of the antiwind wall is 74 feet above water level, so that most of the exposed areas of a large ship are protected. The wall is 394 feet long, and will be extended another 82 feet when an extension of the building on which it is mounted is completed.



## WHAT'S NEW FOR



**1. AIR CLEANER** consists of a fan mounting an electronic filter that traps dust, pollen, even smoke. Filter pads remove coarse particles. Fine particles are charged, attracted to an electrostatic collection plate and held there by adhesive coating

Radex Corp., 2076 Elston Ave., Chicago 14



**2. DOLLY** can be fastened to the bottom of any garbage can so that it can be pushed rather than carried. The ball-bearing casters roll easily on any hardtop driveway or sidewalk. The elevated position of the can prevents rusting away of bottom

Sphere Engineering & Mfg. Co., 648 S. Illinois Ave., Villa Park, Ill.

**3. WINDOW LOCK** permits you to go away and leave windows open, yet securely locked. Bolt of clamp on lower sash is screwed into one of three holes in plate on upper sash. Either sash can be opened. Burglars can't get in and children can't crawl out

Pilgrim Products Co., 10 Clarence St., Worcester 5, Mass.

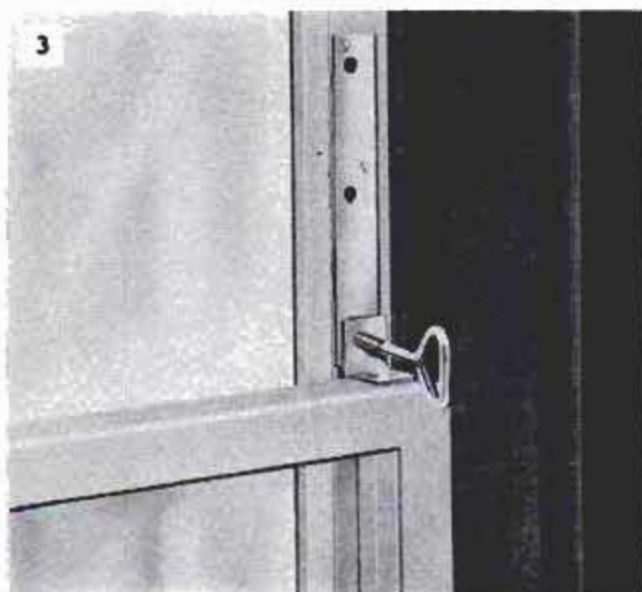
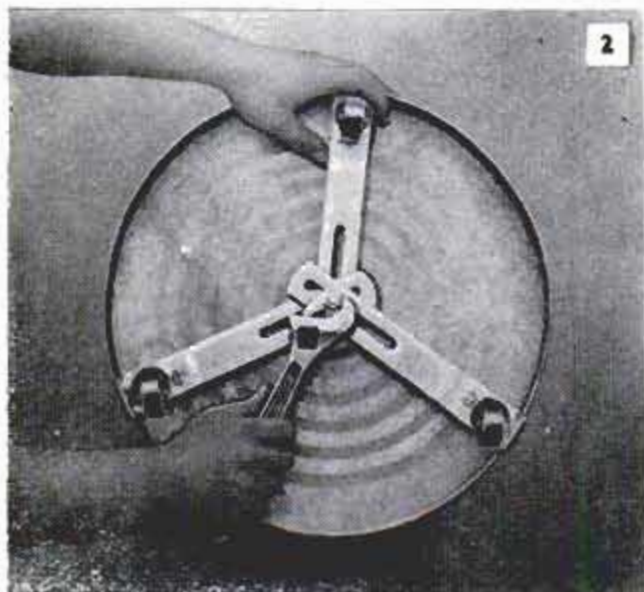

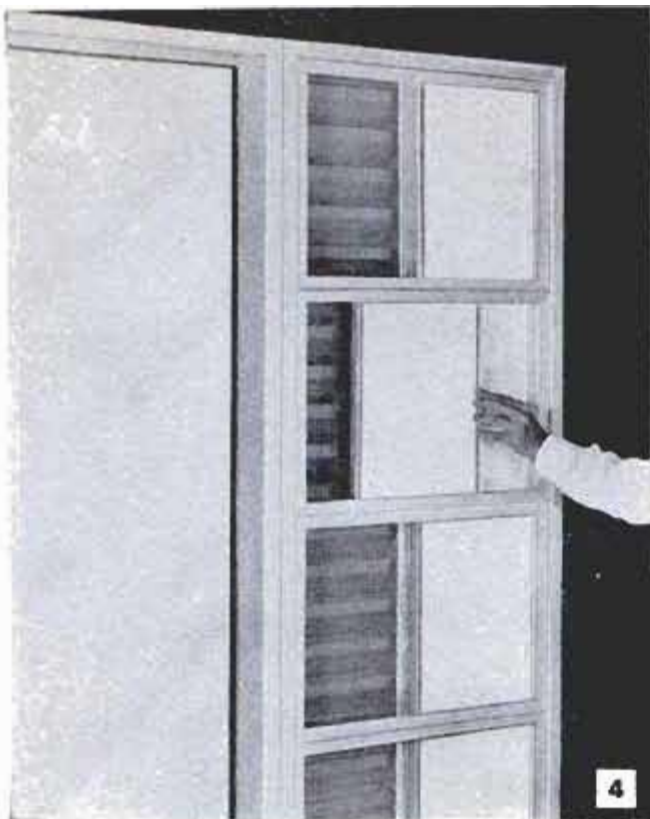

**4. SLIDING PANELS** on each side of an aluminum-frame picture window provide ventilation. Panels are behind louvers on the side or bottom of the window. Window screen or filters go into space between  
Maco Corp., Huntington, Ind.



**5. WHEELED REEL** for garden hose rolls easily about the yard on rubber tires. It holds 200 feet of plastic or 100 feet of rubber hose. One model can be connected to faucet and unreeled as water runs  
Specialty Mfg. Co., 2356 University Ave., St. Paul, Minn.

**6. NUTCRACKER** that fastens to any table, shelf or counter cracks shells without breaking the kernels. Unyielding pressure is applied with a long hand lever against nut held lengthwise in jaws of aluminum unit  
Woldert Co., Inc., Tyler, Tex.



**7. BATH HAMMOCK** holds baby while he is washed in kitchen sink, leaving mother's arms free. Suction cups anchor metal frame. Holding straps are adjustable. Unit also serves for changing, feeding, dressing  
New York Art Iron Works, 47-18 37th St., Long Island City, N.Y.

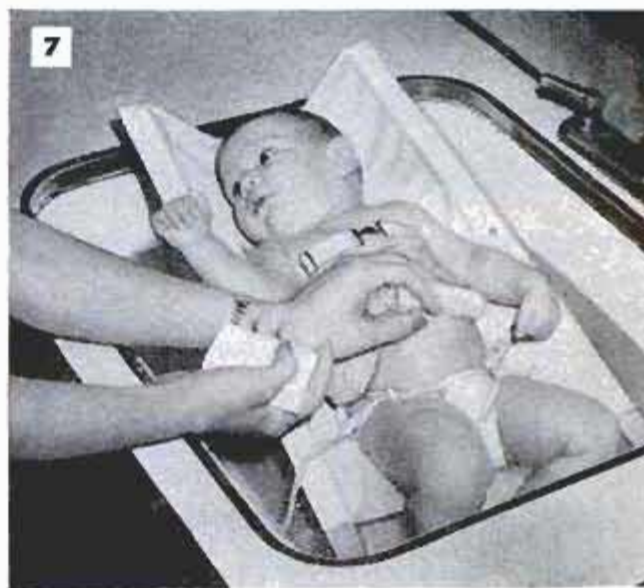



## Giant Jungle Destroyer Clears Forested Land

Packing three times the wallop of an M-24 tank, a mechanized monster called "The Tree Crasher" has begun land-clearing work in the Florida-Georgia coastal area. It was designed to uproot heavy trees and is controlled by an operator sitting in a tiny cab high over the front wheels. With the blade raised about 10 feet in the air, he maneuvers into larger trees, pushing them over, roots and all. For smaller trees and

underbrush, he moves in with the blade lowered. Weighing 120,000 pounds, the machine rolls on six huge tires, each 10 feet tall and four feet wide. Instead of receiving power from one central drive, each of the mammoth wheels has its own electric motor and gear reduction. These motors are driven by generators which, in turn, are driven by two giant diesel engines near the center of the unit.



Top, belt before crash. Middle, during crash. Bottom, after crash. Pressure is released, belt falls apart

## Seat-Belt Safety Release

Lifesaving seat belts in autos and planes are released automatically after a crash by a new device. Dazed victims can't be trapped in the wreckage by a seat belt that refuses to open. The safety release is built into the under-the-seat section of a standard seat belt and remains undisturbed under ordinary usage. But when extreme pressure is applied, one section slides to a hook of the other, still holding the belt until all pressure is removed. Then it simply falls apart, the two halves of the belt divide, and the passenger is free.

## Pasteurized Eggs

Pasteurizing eggs by dipping them into warm water for two to three minutes before storing cuts spoilage losses almost to the zero point, according to a team of Australian scientists. In experiments, they found 60 percent losses after just a simple washing, and as low as one percent losses after pasteurization. The brief hot bath, in water at 145 degrees Fahrenheit, does not affect the physical condition of the eggs, while it does destroy most of the harmful bacteria that cause rotting.



## TV Guards Gate

TV TAKES the place of a gateman at the Nine Mile Point generating station of Louisiana Power and Light Company, across the Mississippi River from New Orleans.

A TV camera pointed at the gate permits an office employee to do the gateman's work. Using a direct telephone, she can talk to as well as see visitors. Four push buttons give her control over the opening of the gate. Most of those who try to enter are employees or visitors known to plant officials. When strangers arrive unheralded, an official walks the few feet to the gate to conduct a personal interview before admitting them.

Secretary talks by direct phone to visitor at gate while she observes him on TV screen. She presses buttons to open gate

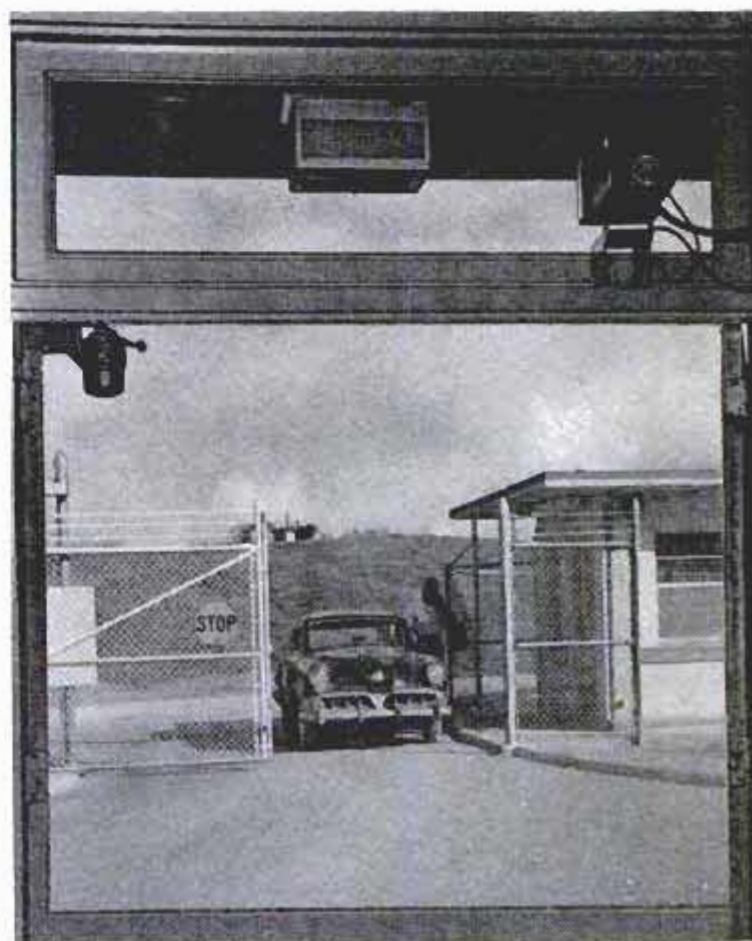

Everything that goes on at the gate is observed by camera at door of office building. Here a visitor is communicating by phone with the office. Coming or going, each visitor has to be identified. At left, driver remains in car while phoning

# Here's Fun From My Bag Of Camera Tricks

BY  
WEEGEE

Posing as ice-cream vendor in darkened movie theater, Weegee got candid shots of viewers (above). Infrared flash gave invisible light

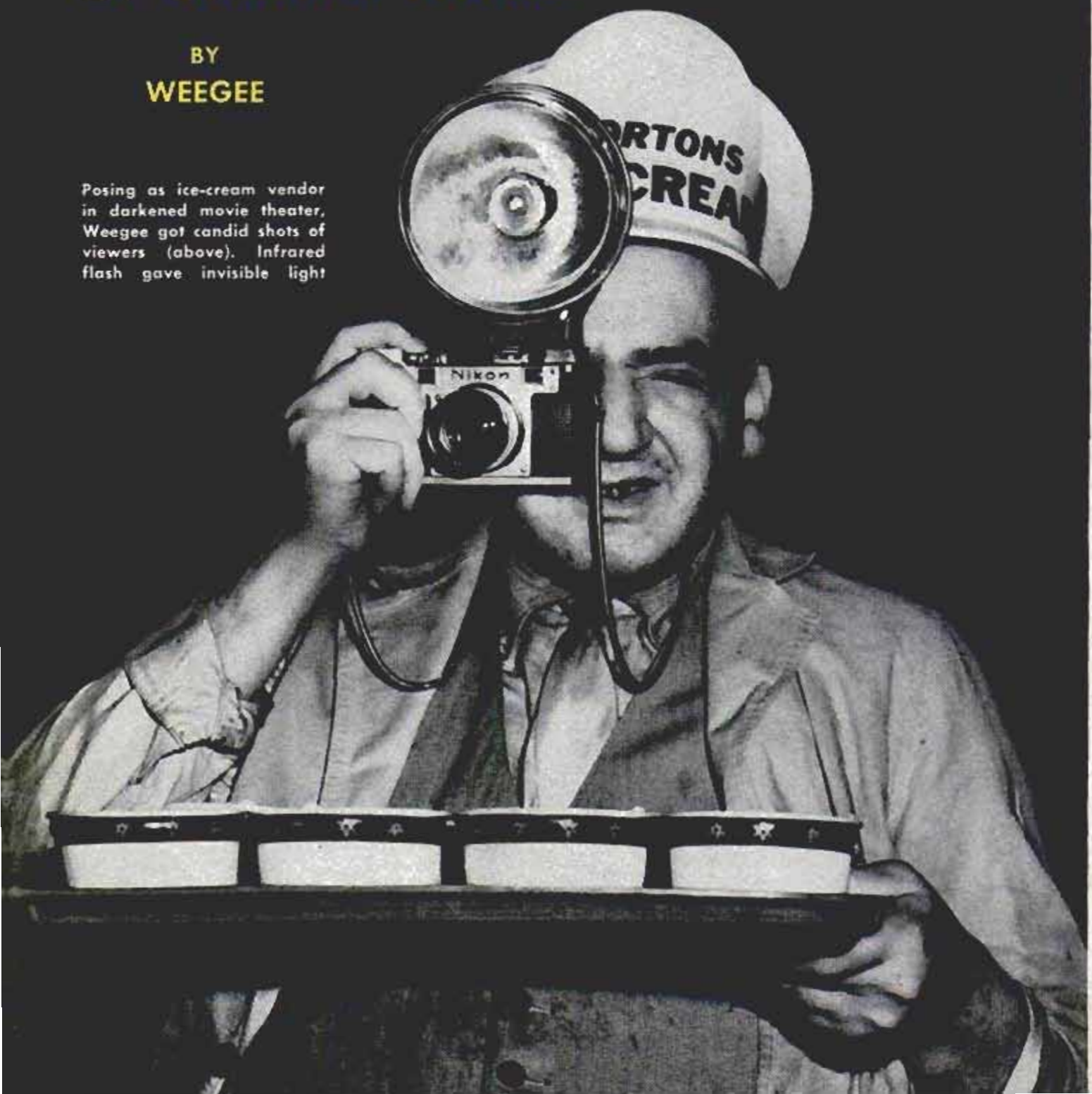



**M**ANY AMATEUR PHOTOGRAPHERS spend a lifetime taking pictures of baby's first teeth or Aunt Minnie at the beach. This is a shame, because photography offers more exciting things than that! The photographer who keeps trying new stunts and techniques is the one who achieves the most fun and satisfaction from his hobby.

Over the years, I seem to have gained a degree of fame—or infamy—from my irreverence for the "classic" shot, which looks like a duplicate print of 10,000,000 others. That doesn't mean I haven't aimed my camera at such weary scenes and portraits. I have. But with the help of a mirror sliver, a few darkroom gadgets or techniques, and other simple devices, I've managed to turn these dull pictures into hilarious caricatures and artistic studies.

I've put an elephant on the Capitol dome. I once wiped the famous smile off the Mona Lisa's face and made her sneer instead. I have a shot of the Sphinx howling. I've photographed two-headed Weegees, Marilyn Monroe with 10-foot legs, people in bottles, corkscrewed Empire State Buildings, and Times Square under 10 feet of floodwater on a sunny afternoon.

Until now, my methods for achieving many of these startling results were my own secrets, tucked in my personal bag of tricks. When *Popular Mechanics* asked me to unveil them for its readers I agreed, and you'll find them all on these pages. There isn't one that even the most amateur shutterbug can't achieve himself with a little extra work at his camera or in his darkroom. All are simple and satisfying.

Suppose, for instance, you have a static scene in your negative file—not good, not bad, but lacking

Printing easel sawed in half and hinged can stretch or squash a scene when film is projected on enlarging paper clipped to the bent easel. Capitol photograph at right was made this way. Easel was bent the other way to produce picture below

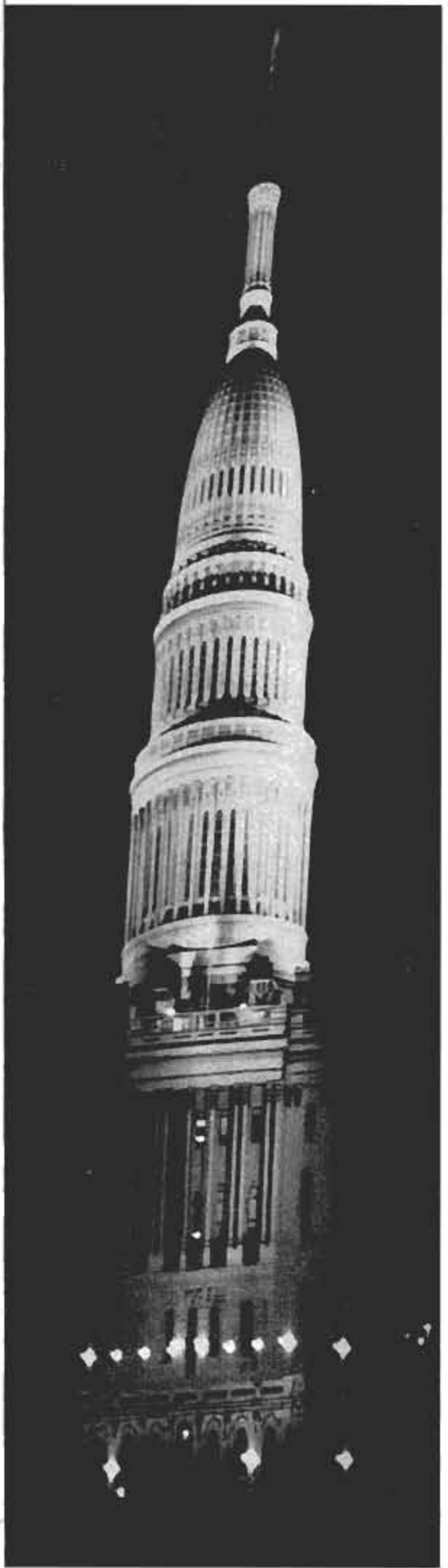
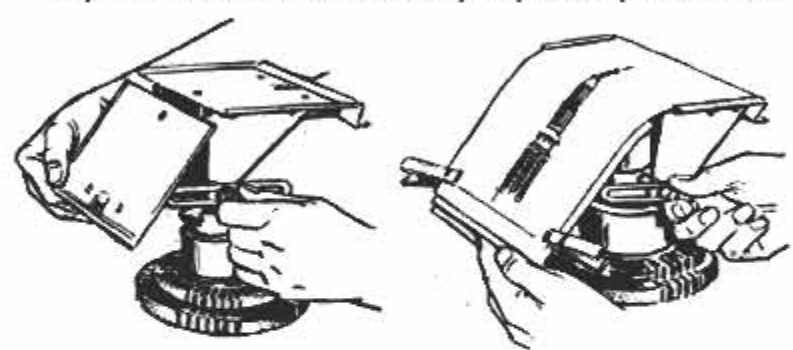

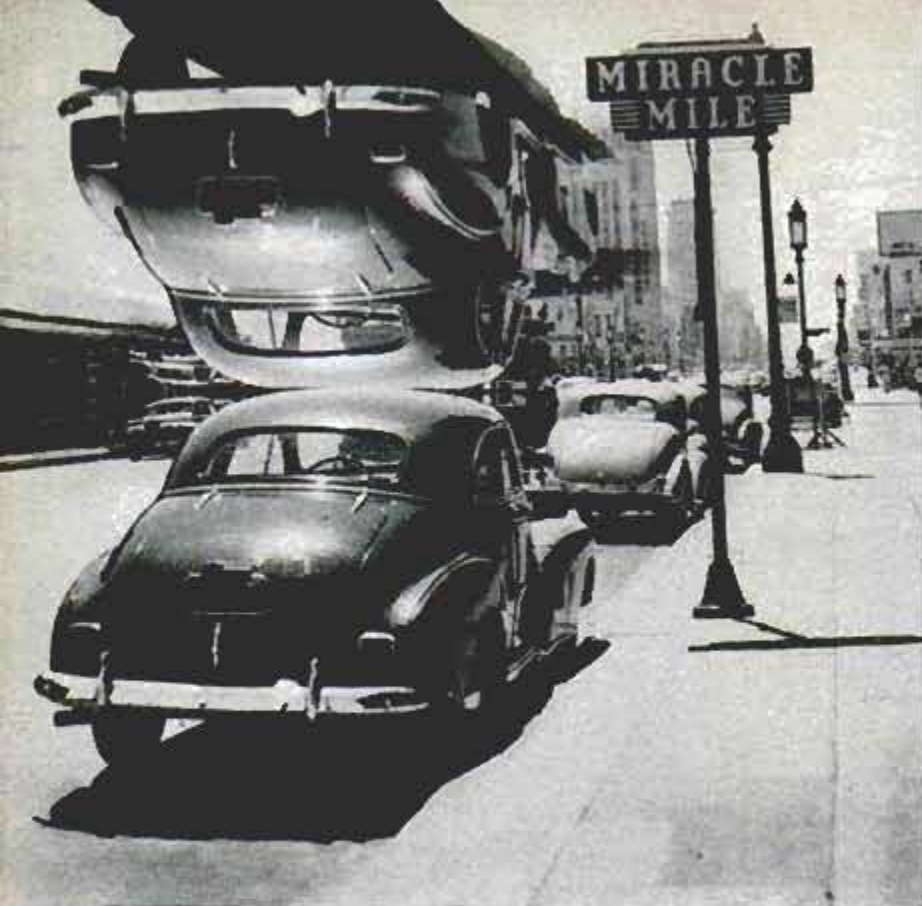

interest. It might be a gallery shot if only you could make it a little "different"—softly textured like a painting or etching. Can you fix it? You bet. This, one of my most successful tricks, is done with textured glass in the enlarger. The glass can be striated, pebble-grained, fluted, "bathroom" pattern, or other. Be sure it's colorless, or you're likely to find you've built a safelight right into your enlarger! The neighborhood glazier has leftover scraps he'll sell cheaply, and for a few extra pennies he'll cut them to fit your enlarger. Clean the glass with ammonia solution and polish it with a clean, soft flannel. Look out for fingerprints!

The glass slides into the enlarger above the bellows. Then lay the negative you've chosen (in its holder) directly on top of the glass. Check the effect on the easel. If you're not satisfied, rotate the negative holder until you get the effect you do want. Rotating the negative is particularly effective when you're using ribbed or fluted glass—every degree of rotation will change the image in a different and original way.

Naturally every negative will yield different effects—some pleasing, some caricaturing, some satirical. And the more different types of glass, the more effects you'll get. I've made as many as 50 different



Weegee managed to set one parked car on top of itself by holding a tiny sliver of surface-coated mirror over one side of the lens until he got just what he wanted. The drawing at left shows how it's done. The mirror was held vertically and moved back and forth until the right position was achieved to get double-dachshund photo at the bottom



distortions from a single negative.

In the hands of an artist, a photo technique like the one I've described can open magnificent creative horizons. Its forms of light and shadow remind me of the oddly attractive French and Spanish primitive painters, for no longer is the camera merely a recorder of unvarnished fact. It has become a tool in the field of abstraction.

The beautifully textured shot of Times Square on page 130 was achieved with a piece of bathroom-window glass. I found the possibilities endless. I could make fantastic caricatures of famous faces, twist the Eiffel Tower and make a corkscrew of the Empire State Building. It was while fooling with textured-glass distortions that I stumbled on another trick—performed with the aid of a hinged easel. The easel does the trick—but the effect is as though your camera had a rubber lens!

The easel is simple to make, and can be used for straight printing as well as for trick effects. I cut a standard 8 by 10 easel in half and joined the two pieces with a hinge. The back of a picture frame serves as base for the easel. Both sit atop a ball-and-socket tripod head, which is attached to a brass pipe (for height) mounted on an old camera window-display stand.

Half of the easel remains flat while the other half can be bent up or down. Thus half of the face or scene you're printing is normal, while the other half stretches . . . and stretches . . . and stretches! Of course you'll have to stop your enlarging lens 'way down to keep the whole print sharp. And when you stop so far down, you'll need an extra amount of light to keep your exposures from running into many minutes. You can get that extra light by using a No. 1 photo-flood bulb in place of your regular enlarging lamp. Be careful not to leave it on too long while focusing. It gets hot and can damage your negatives.

To print, put a sheet of white typewriter paper in the hinged easel, using film clips on all four corners of the paper to keep it in place. Focus on the part of the image that's bent, with your lens wide open. Then shut off the enlarger, stop the lens all the way down, and replace the focusing

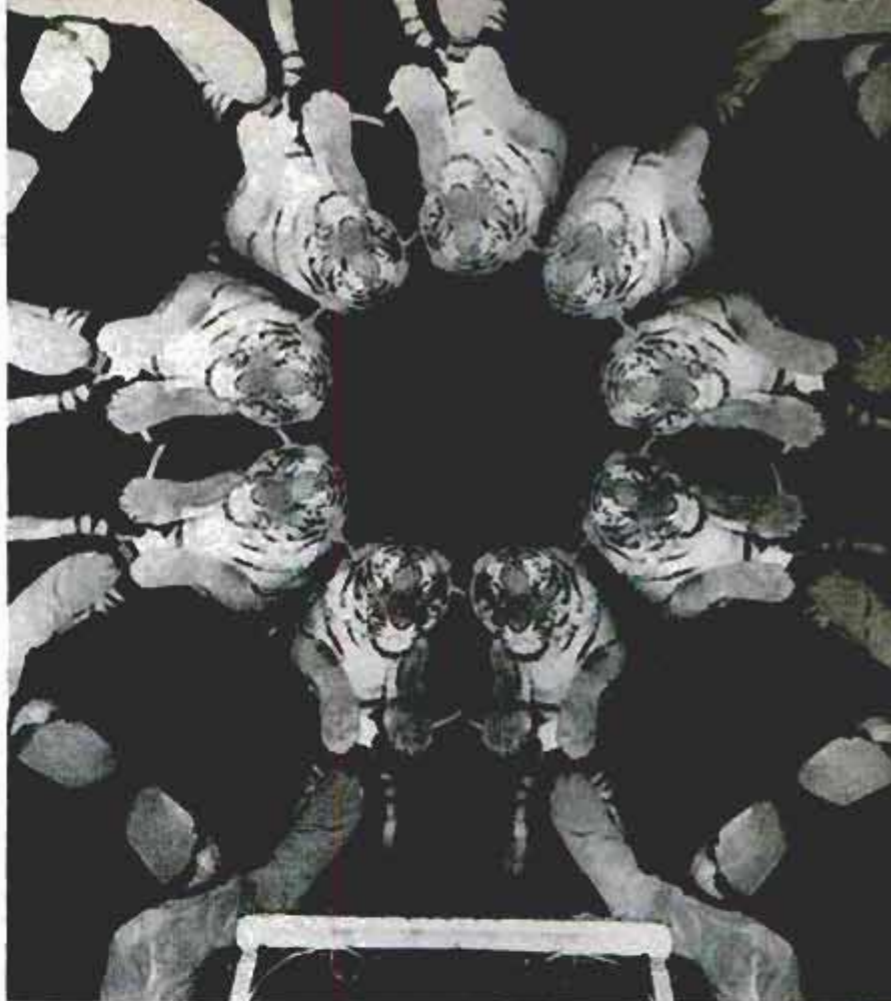

Circus offers great opportunities for kaleidoscope. Leaping tiger becomes pattern of nine by action of V-shaped mirrors

Kaleidoscope is made by taping two long mirrors at V-angle into tube. Weegee demonstrates device's image-dividing effect





Stock negative of Times Square on a wet night was projected through pebble-grained glass to get this effect

Textured glass in enlarger gave Empire State Building "new look"

Easy way to produce distorted pictures is to slip clear textured glass into enlarger—right in the slot where the negative holder slips in

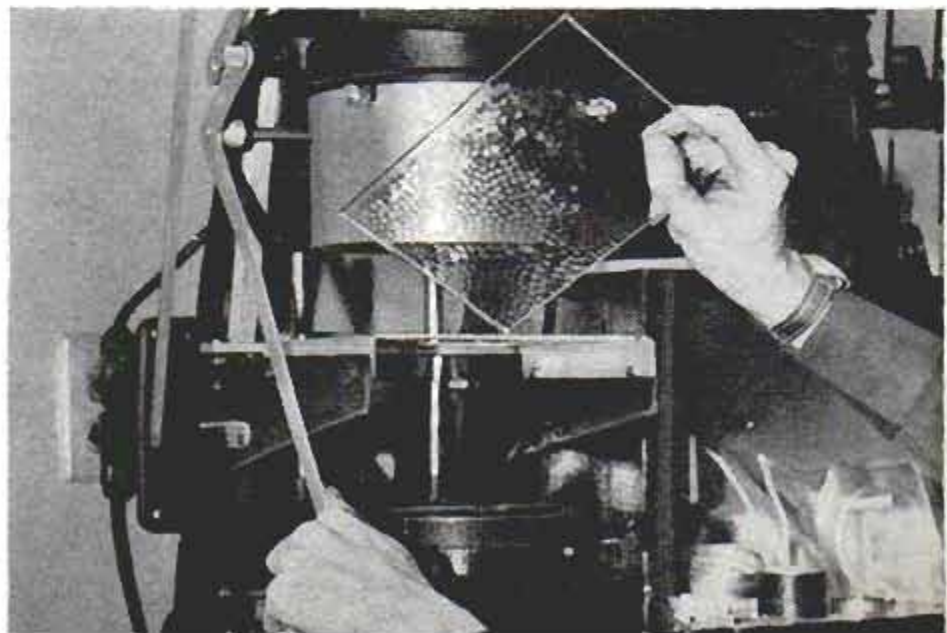

sheet with photo paper. Now make your exposure, and you've got a hair-raising print.

Distortion is great fun, as well as being startling and artistically satisfying. But other techniques provide equally impressive results.

I'm a curious person, and will satisfy my curiosity even if it kills me. A few years ago I saw a child's kaleidoscope in a five-and-ten-cent store. The silly gadget fascinated me. What would happen, I asked myself, if my camera looked through one of these mirror-and-prism contraptions—at people and places instead of the colored stones at the end of the cylinder? I took the thing apart to see how it worked and built a duplicate that would fasten on the lens frame of my camera. The results were startling! Multiple images from a single exposure, incredible patterns of people and architecture, a whole new world of photographic and artistic exploration!

Anyone can do it, and here's how: You'll need a tube of cardboard or metal, two inches in diameter and eight inches long. Then you'll need a pair of long, thin mirrors that will fit into the tube in a V shape. The mirrors should be *front-surface* (ordinary mirrors are coated on the back and give off undesirable ghost images).

Take the two mirrors and hinge them with a piece of cellophane tape on their longer edges to form a vee. The front surfaces of the mirrors should be on the *inside* of the vee. Since front-surface mirrors appear to reflect from both sides, you can determine the reflecting surface by touching a pencil to the glass. If the pencil is touching the *front* surface, its reflection will touch the tip of the pencil. On the *back* surface, there'll be a separation between pencil point and reflection. Now fit the hinged mirrors into the tube as shown in the photo on page 129. Then fasten your new kaleidoscope in front of your camera lens with tape and start snapping. Your pictures will be decorative cartwheels of repeated designs from the scene you take.

You can also use your kaleidoscope in an enlarger by placing it *inside* the enlarger on top of the enlarging lens. Focus the usual way . . . rotate the negative carrier to get the effect you want. This way you can add new life and interest to negatives already in your files. Be sure to tape both ends of the tube so as not to scratch either negative or lens . . . and use a glass carrier if you can to prevent negatives from buckling if touched by the tube.

Mirrors can do remarkable things to a photo even *without* building a kaleidoscope. By placing a single mirror between a negative and lens while you're enlarging, you can stack automobiles on top of each other, grow two heads on otherwise normal people, produce rainy reflections on sunny days and a host of other weird effects.

Here again, mirrors should be either metal or *front-surface*. Your mirror should be about as long as the focal length of your enlarging lens (2 inches for 35-millimeter enlargers, 3 inches for 2¼ inches by 2¼ inches, etc.). Mount the mirror inside the enlarger bellows by slipping it into the outer rim of an adhesive-tape can, using some of the tape

(Continued to page 228)

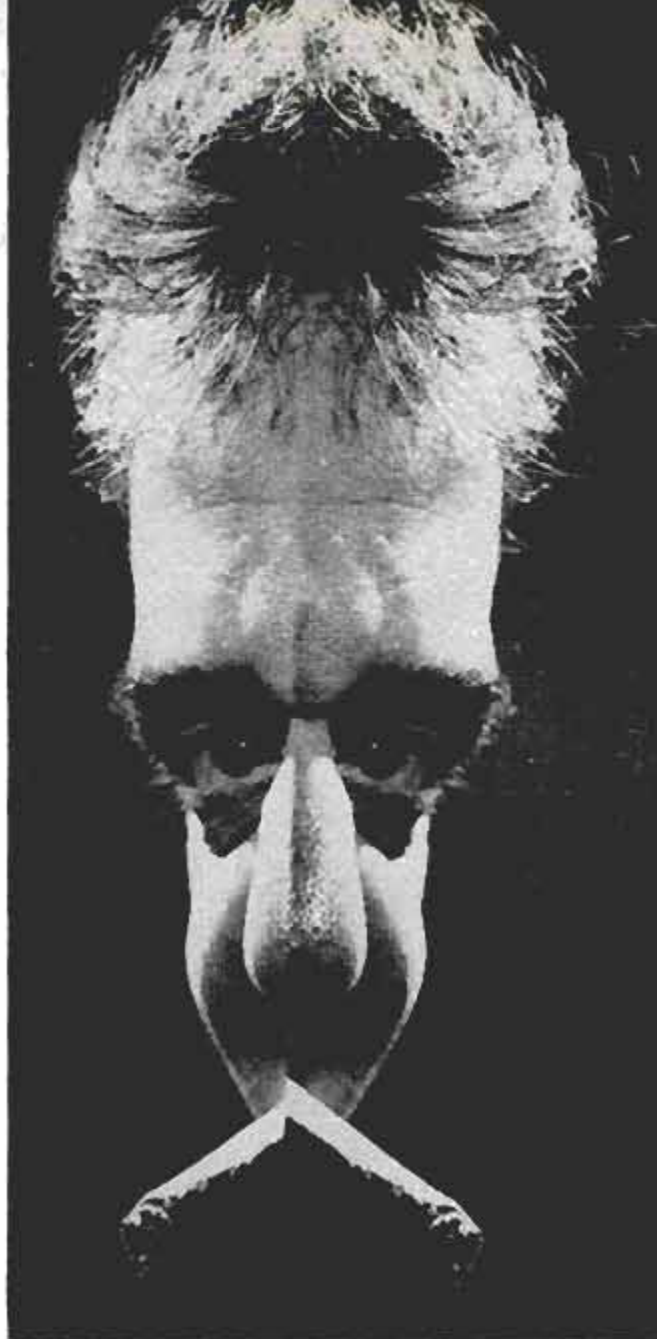

"Weegee self-portrait" was made when upright mirror was taped into metal circle and placed behind the lens of enlarger

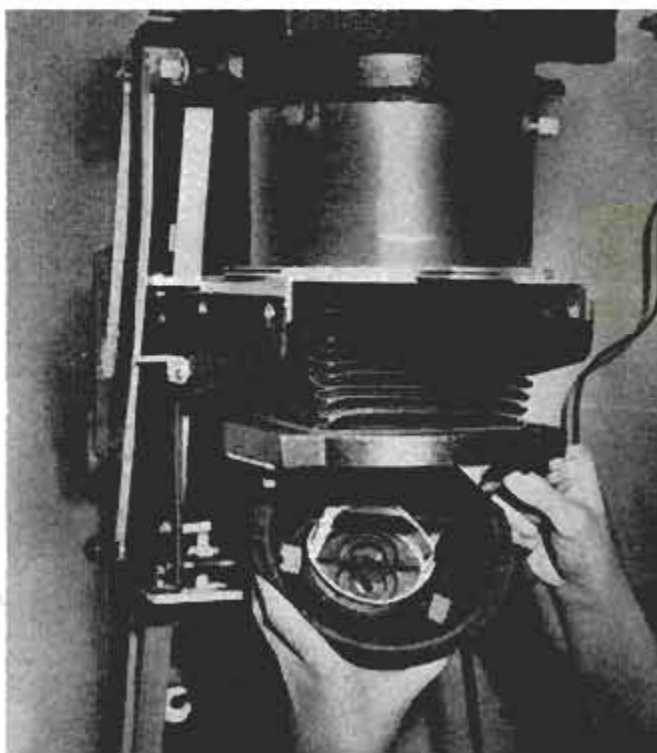

## Watery Coal Mine

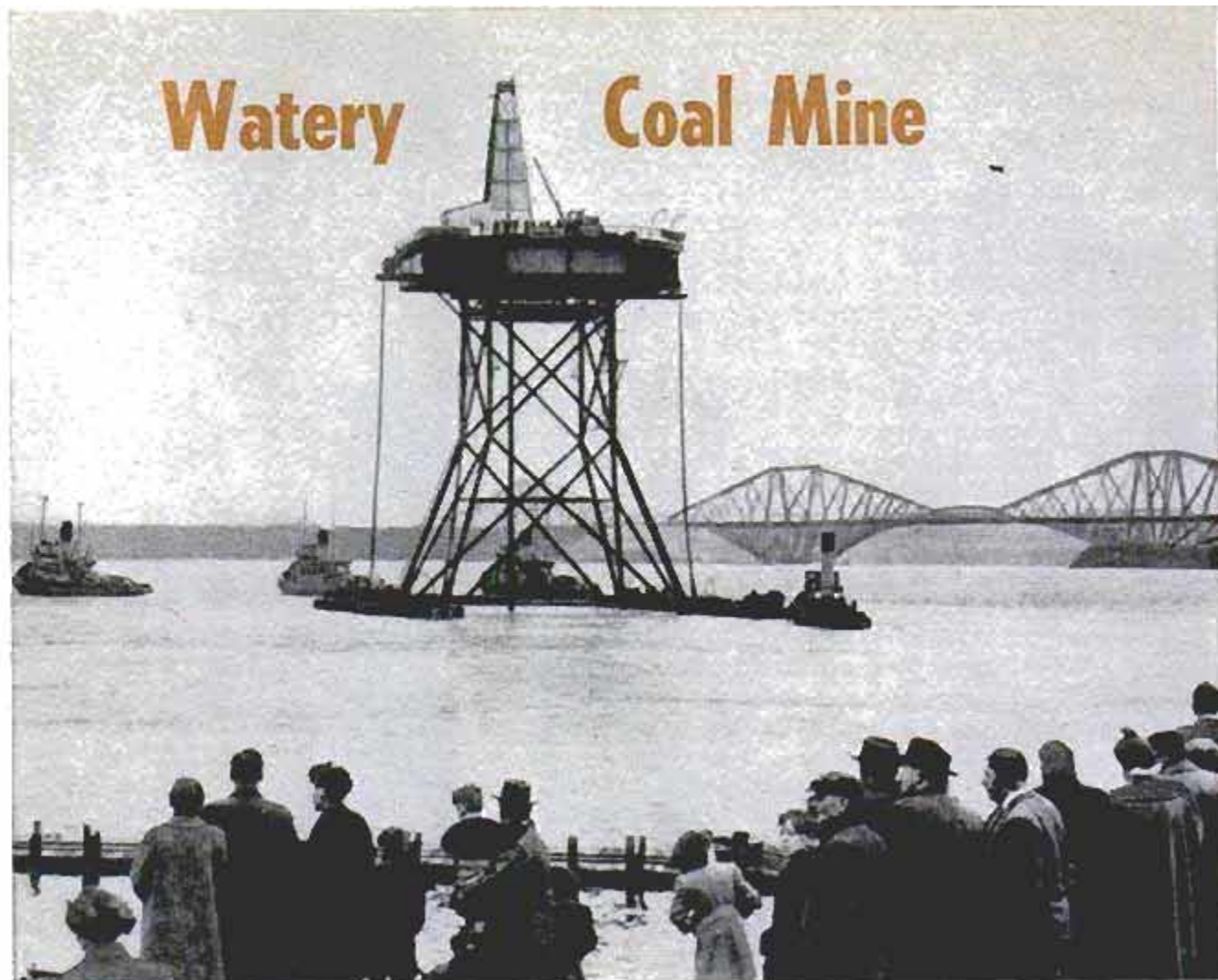

Coal is being drilled from the sea bottom off Scotland by a 185-foot tower rig that rests in 70 feet of water. The 5000-ton tower was recently floated into position a mile offshore in the Firth of Forth. There its steel legs were fixed to a base on the sea floor. Its drills will probe to a depth of 2000 feet for a tremendously rich coal field that is believed to underlie the inlet. British experts suspect the reserve is as

great as 6,000,000,000 tons, 15 times as much as is mined in the United States per year. A second bore hole is being drilled three miles offshore. If much coal is found, shafts from mines on shore will be extended toward the richest veins, or the coal will be mined from the water's surface. The tower has a working platform 50 feet above sea level and can withstand 80-mile-per-hour gales and 30-foot waves.



### Atomic-Cannon Barrel Takes 48-Foot Ramrod

Five men and a 48-foot ramrod are needed to clean the bore of the Army's 280-millimeter cannon, now a vital tool in Western defense. The gun is designed to fire either atomic missiles or conventional shells. It is in use at the 265th Field Artillery Battalion station at Baumholder, Germany.

□ A British motorcycle-sidecar combination is being equipped with an intercommunication set so that rider and passenger can talk through a headphone in the rider's helmet and loudspeaker in the sidecar.

# KEEPING UP WITH THE ATOM

**C**LEAN-UP MEN at the Hanford Atomic Products Operation can put in more time on the job, thanks to an improved atomic-ray detector (see photo below). The men use caustic steam to remove radioactive material from the plant's equipment. The time they can spend on the job is limited by the amount of radioactivity. Former monitoring instruments gave an accurate reading only of the rays coming directly at the instrument. A safety factor had to be computed for rays coming in at an angle. The new monitor reacts to rays coming from various directions. This eliminates the need for an artificial safety factor, permitting the men to work longer in a given area and thus expediting production at Hanford.

☆☆☆

Countless sightseers have stood close to a large body of uranium-rich ore without knowing it. One of the largest pitchblende discoveries to be made in this country is located 1300 feet down the slope from the south rim of the Grand Canyon. It is within the only privately owned land in Grand Canyon National Park. The deposit is estimated to contain between 100,000 and 300,000 tons of rich ore.

☆☆☆

Want to buy some thorium? The government will sell it to you now, under certain conditions. Thorium is a so-called "fertile" material that can be transmuted into uranium-233, which then can be used to power nuclear reactors or to make weapons. The government now is offering to sell thorium to private industry for "peacetime applications." The price is about \$19.50 a pound.

☆☆☆

Tests of big nuclear weapons are not causing hazardous radioactive fallout, according to Dr. Willard F. Libby, Commissioner of the Atomic Energy Commission. The greatest long-term danger in fallout is strontium-90, an isotope that seeks bones and can cause bone tumors. However, the total released to date is very far below the amount calculated as the maximum permissible concentration.

Doctor Libby also made a "low" estimate of \$210,000,000 as the potential savings to American agriculture each year through the use of atomic radiation. Tracer elements are showing farmers how to make better use of fertilizers. Radiation is also being used to cause hereditary changes in crops, resulting in disease-resistant strains.

☆☆☆

Rubber has been vulcanized without heat and without the addition of sulphur by irradiating it with short gamma rays of cobalt-60. The process was discovered at Wright-Patterson Air Force Base.

☆☆☆

Ultrasafe vaccines, including those for protection against polio, may be possible by "killing" viruses with high-intensity gamma rays. This has been suggested by Dr. Russell T. Jordan of the City of Hope Medical Research Institute, Duarte, Calif. Heat, chemicals and ultraviolet light now are used to inactivate viruses. Gamma-irradiated viruses have resulted in experimental vaccines more stable and of higher potency than those "killed" by chemicals.





## Sahara Sailboat

To sail across the Sahara Desert is the aim of writer-photographer J. Mortimer Sheppard, who has obtained a wheeled sloop for the venture. His route, from southern French Morocco to Dakar in French Senegal, is 1710 miles long. Conventional sand yachts, used for racing on tideland beaches and salt flats, have widely spaced front wheels. Because of road towing problems, Sheppard's craft is narrow. To add stability on the desert run, an "outrigger" wheel on an extension bar was added.

## TV Camera Cuts Testing Time

De-icing tests on the Bristol Proteus turboprop engine, the power unit for Britain's airliner, required only 20 hours in place of the usual 200, thanks to a small television camera mounted inside the engine. Engineers, watching a 14-inch screen in the cockpit, were able to observe the icing characteristics of the engine in flight. This eliminated many test flights interspaced with ground checks.

## Farmer's Jack-of-All-Trades Pushes or Pulls Upward

With 8000 pounds of direct lift, a new hydraulic jack can be used to perform heavy jobs on the farm. The jack has interchangeable heads—a hook and a pulley—so it can be used either to push upward for overhead support or to pull upward, as in

dumping a grain wagon. The jack stands on two legs and weighs only 59 pounds. The lifting range is 50 inches. It can be used to lift tractors, remove fence posts, raise small buildings, support overhead beams and lift farm implements.

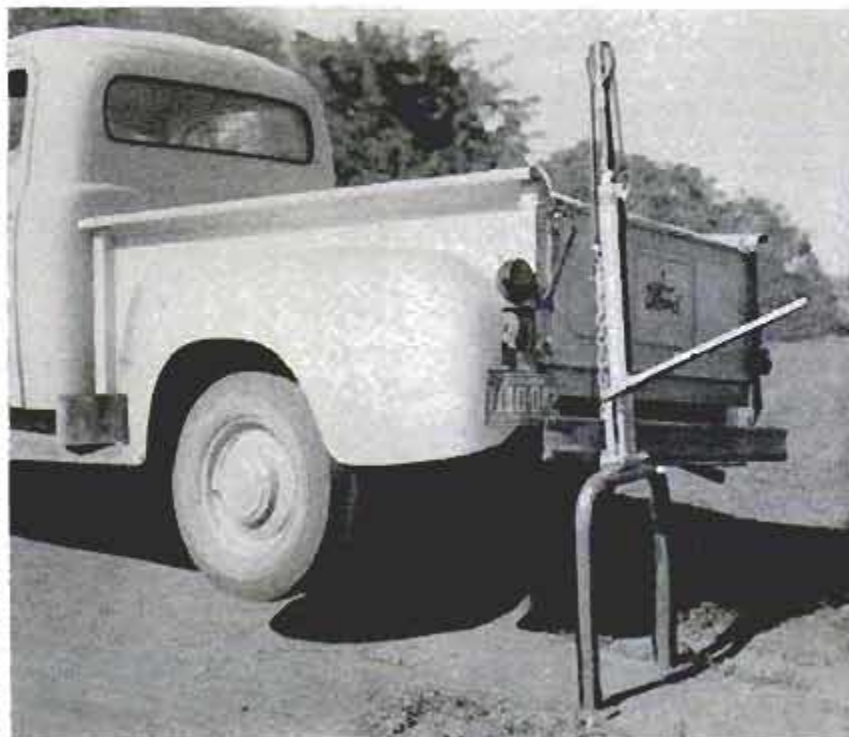



Dispatching ancient autos is the job of a big tractor shovel at an East Rochester, N. Y., scrap yard. In one blow, the huge shovel squashes the car into a more compact hunk of twisted metal. The machine then picks up the remains and deposits them in a truck bound for a salvage depot.



## Shovel Hits 'Em



## ... and Hits 'Em

Shovel slams down on roof of car from which motor and other mechanical parts have been taken

Veteran of many traffic battles is really battered now as it nears consignment to scrap heap

## Wooden Works for Grandfather's Clock Assembled From Kit

You can build your own clock with a kit that includes all parts and instructions. An unusual feature of the clock is the fact that all parts except the weight, its chain and a pendulum bob are made of wood, mostly maple. Even the smallest, precision-cut gears are wooden. The hands can be carved to suit individual taste, and the 12-inch wooden face can be painted or varnished to fit a particular color scheme. The clock is wound for a 36-hour period by pulling a weight attached to a ratchet gear. The 19-inch-high clock may be hung from the wall or built into a cabinet.



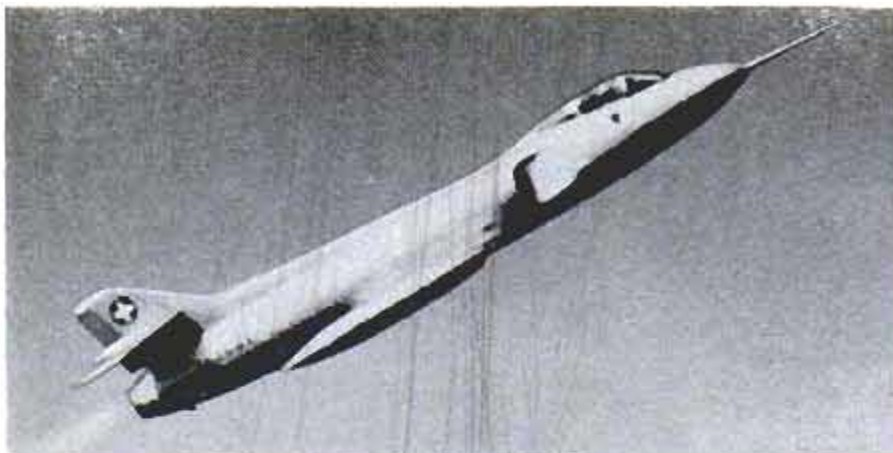

## Swiss P-16 Jet For Short Runways

When it came to procuring jet aircraft, the Swiss air force faced a serious problem, since none of the jet fighters being produced in the world could land on the tiny airports nestled in the Alps. Finally, they had the Swiss P-16 designed with a very thin wing for high-speed performance and an unusual leading-edge flap which changes the profile of the wing when extended. The larger wing area provided by the flap permits low-speed landings, enabling the P-16 to land and take off on a 2600-foot runway. The craft is intended for use both as a high-speed interceptor and as a ground-attack plane. The prototype models are now undergoing flight tests.

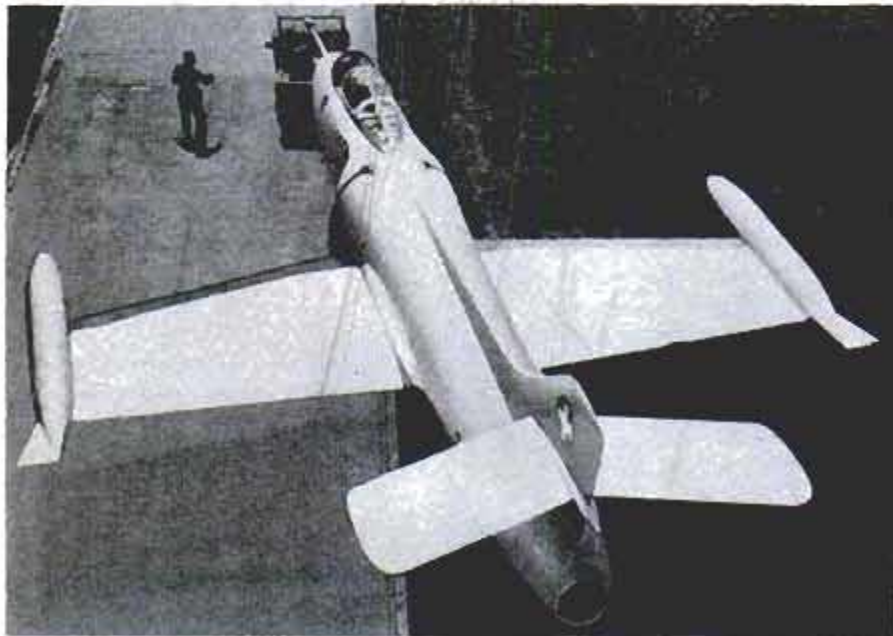

Flap on leading edge of wing extends to increase area for slow landings

## Over-the-Carpet Dance Floor Converts Parlor Into Ballroom

You can transform your parlor into a ballroom with a prefabricated dance floor that is quickly placed over the carpeting. The dance floor is made up of squares of pressed wood bordered by metal tongues

and grooves. A special tool locks the sections together. The squares, which come in 4-square-foot and 16-square-foot sections, are black on one side and brown on the other for various designs in the floor.



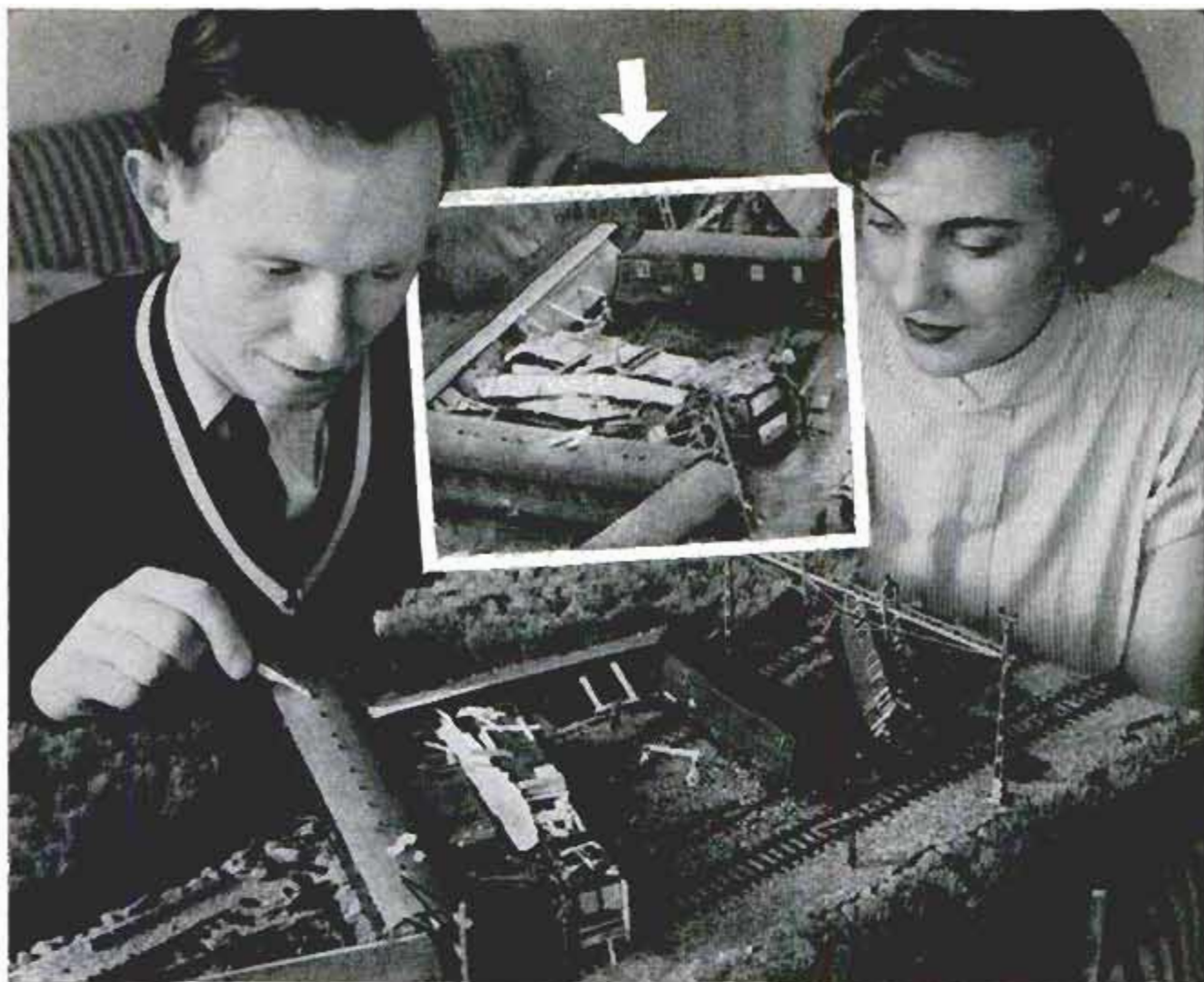

Instead of building model trains, Swedish journalist Sonny Hultberg builds scale-model railroad accidents. His first project, which took 500 hours to complete, shows a spectacular passenger-train wreck that actually occurred a year before. Hultberg, with the aid of newspaper photographs, was

### **Model Railroad Wreck**

able to duplicate every feature of the wreck scene. A hole in a roof that rescue workers cut to enter a car is visible, as is a broken rail that had pierced the side of the car. The small windows of the cars are partially broken. Road bed, rails and even reeds are all faithfully duplicated.

### **Plastic Cutout Alerts Drivers**

Drivers are warned of school zones by a giant plastic figure cut out of plastic and cemented to the pavement. The figure, a silhouette of a running boy, is about 10 feet tall. The white plastic sheeting used for the cutout is impregnated with glass beads for longer wear and reflective qualities. An additional visual warning is provided by a yellow ball, cut out of plastic sheeting, and placed alongside the figure.





The Dalles Dam, as it will appear when completed. Ship lock is left of main spillway, powerhouse at right

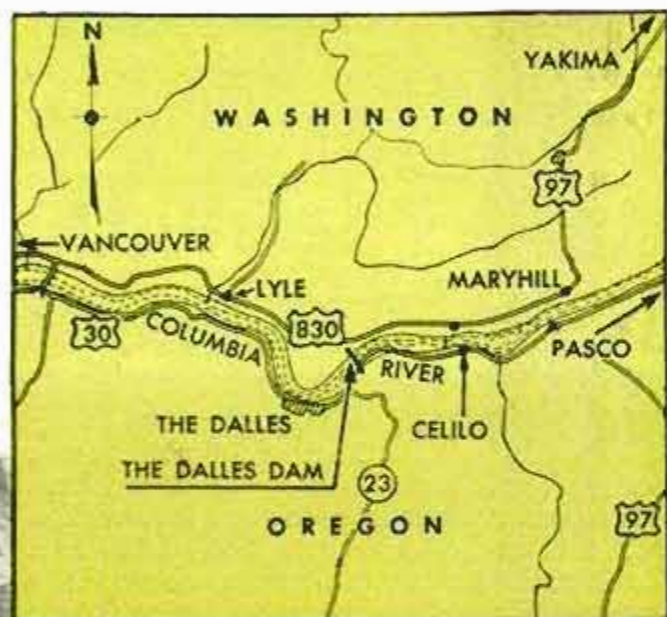

## THE DALLES DAM TO SUBMERGE

Upstream view of single-lift navigation lock, 86 feet wide by 675 feet long, cut through on the Washington shore of the Columbia River. It will provide a minimum 15-foot depth of water over the sills at the maximum drawdown of the reservoir pools

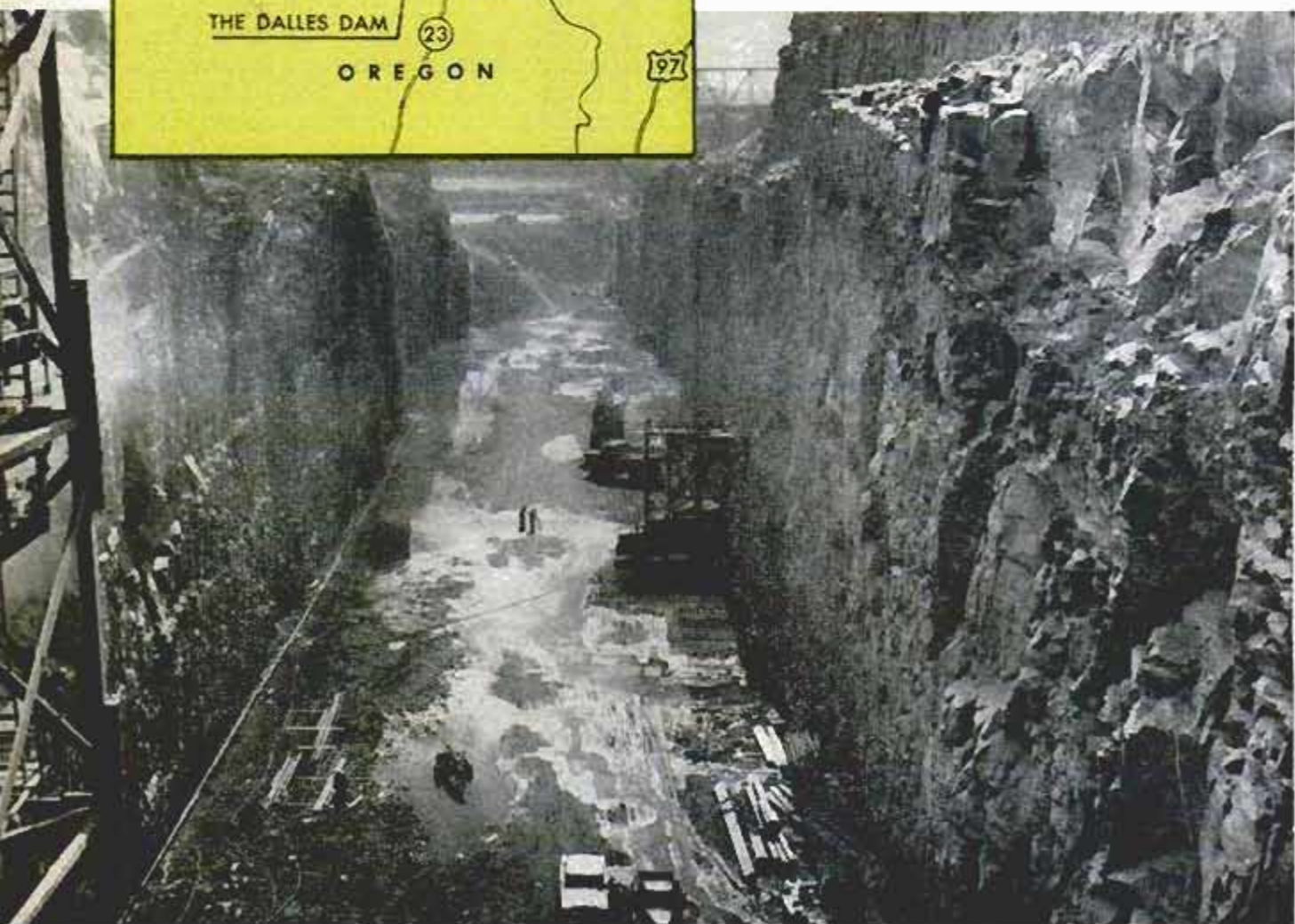



Spillway of The Dalles Dam nears completion. Reservoir will back up 25 miles, cover 11,000 acres with water

## FAMOUS INDIAN FISHING SPOT

By Thomas E. Stimson, Jr.

**H**YDROELECTRIC POWER equal to 2,500,000 tons of coal or 9,000,000 barrels of oil will be produced annually at The Dalles Dam now under construction on the Columbia River. Fourteen generators having a capacity of 1,092,000 kilowatts are to be installed in a powerhouse almost half a mile long, as tall as a 12-story building and with an area equal to that of 15 football fields.

The new dam is upstream from Bonneville Dam and is the sixth of 12 dams that ultimately will convert the Columbia into a series of giant steps leading all the way to the Canadian border. The Dalles Dam is to be 8500 feet long and 125 feet high at the spillway. Its reservoir will cover 11,000 acres, creating slack water all the way upstream to the site of the proposed John Day Dam, 25 miles away.

Spectacular Celilo Falls where Indians have speared salmon for

Famous Indian salmon-fishing spot at Celilo Falls, Ore., will disappear after The Dalles Dam goes into operation





Most of the salmon caught by the Indians was sold to a cannery, which erected this cableway to take the Indians to their fishing site free of charge. Cableway was dismantled during high water each year

Below, the face of the dam is a study in modern design. The Dalles is one of 12 dams being built on the Columbia, from its mouth to the Canadian border, to provide improved navigation and electric power

centuries will be submerged in the new reservoir. In compensation for their fishing rights, the U.S. Army Corps of Engineers under whose auspices the dam is being built is paying millions of dollars to Indian tribes in the area.

In addition to the powerhouse and spillway the new dam contains a navigation lock large enough to handle an eight-barge tow, and two fish ladders and a fish lock that will enable salmon to move upstream. Cost of the dam is in excess of \$270,000,000. Its first power units will be placed in service in 1957. ★ ★ ★



Celilo Indian fishes with safety line tied around him, for a swim in these churning waters would mean death

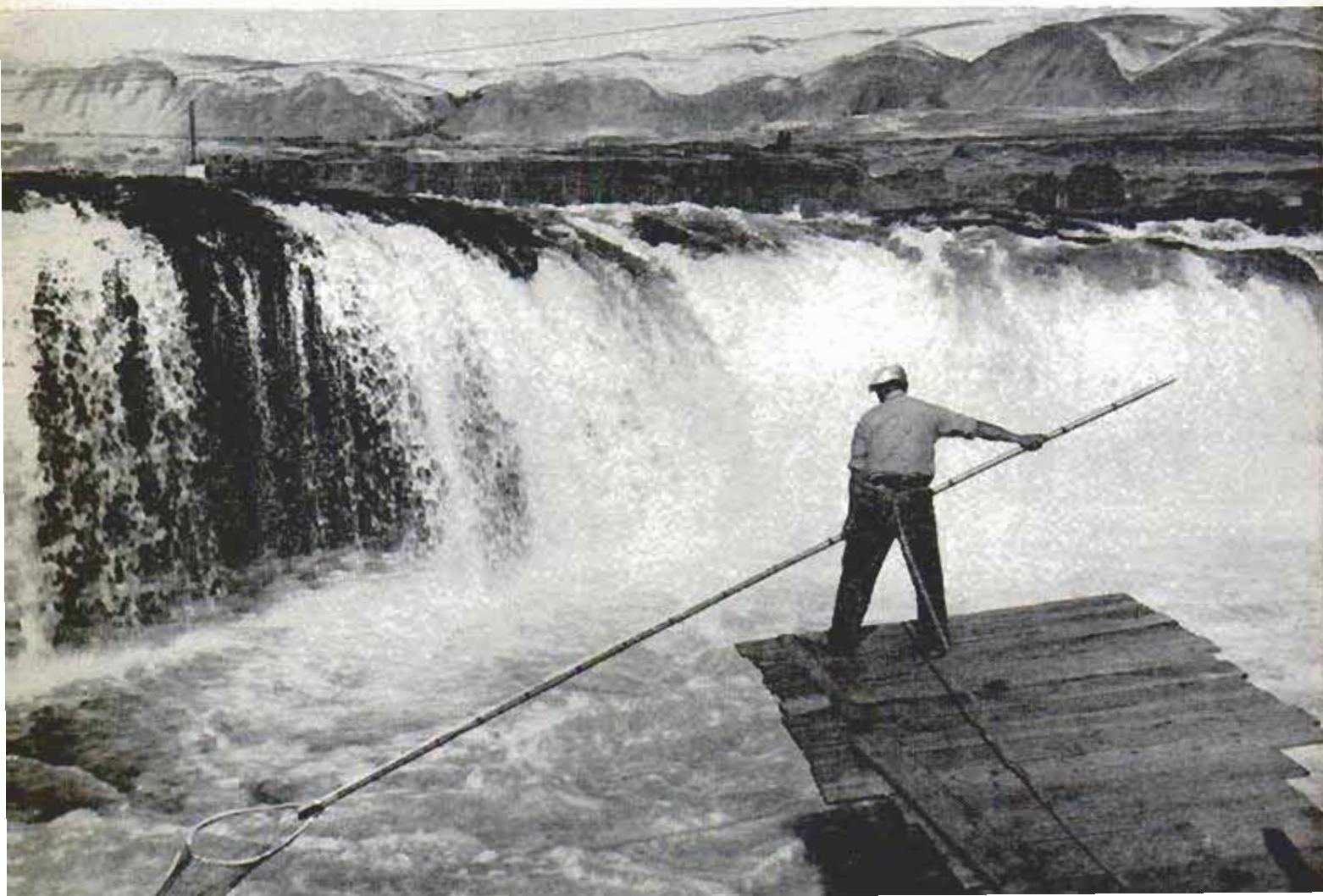

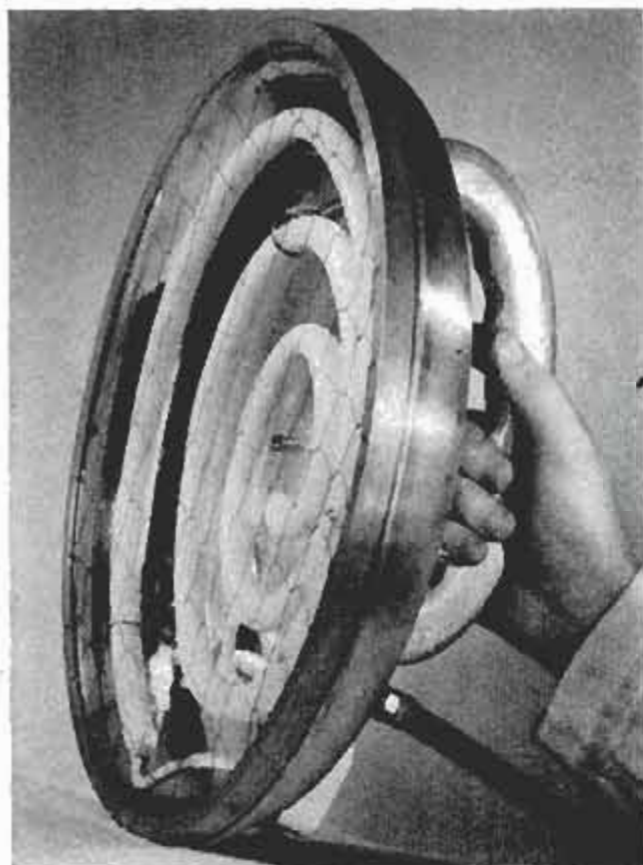

### Portable Paint Drier Uses Infrared Coils

You can dry paint quickly with a portable infrared unit made in Germany. A blower is housed in the hand-held unit behind circular quartz coils. The infrared rays combined with the blast of warm air allow faster, more even coats of primers, surfacers and enamels, and dry synthetic enamels in six to eight minutes. The 4½-pound unit has a capacity of 2500 watts.



### Magnifier Permits Focusing On Silver Grains of Negative

Ultrasharp enlargements are assured by a focusing device that magnifies the image so greatly the photographer can focus on the silver grains of the negative. The device does not use a ground glass. Instead, it uses the mirror-and-grid principle. This is said to produce such a bright image that it can be viewed in a brightly illuminated room instead of a darkroom.

### Wheels, Wheels and More Wheels Add Up to French Trailer

It's a good thing the tires on a mammoth French trailer are solid rubber—it would drive a man crazy checking air pressures if they were pneumatic. The long trailer

comes in two parts with 12 axles on each section. A 165-ton dynamo rides in a cradle suspended between the two trailers as it is transported through Paris.

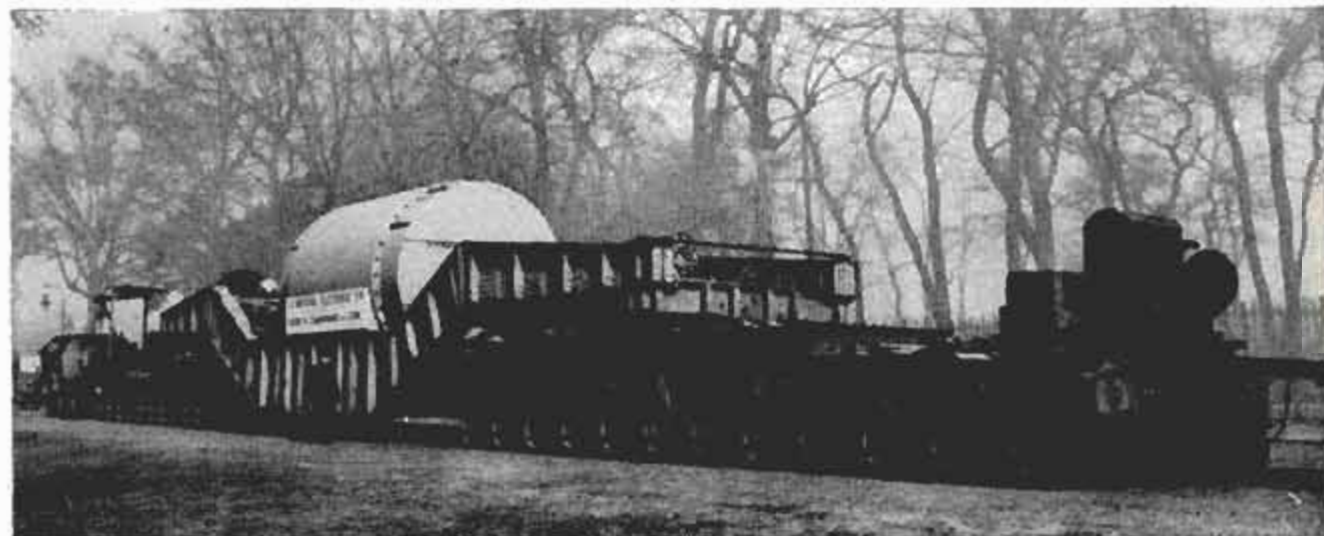

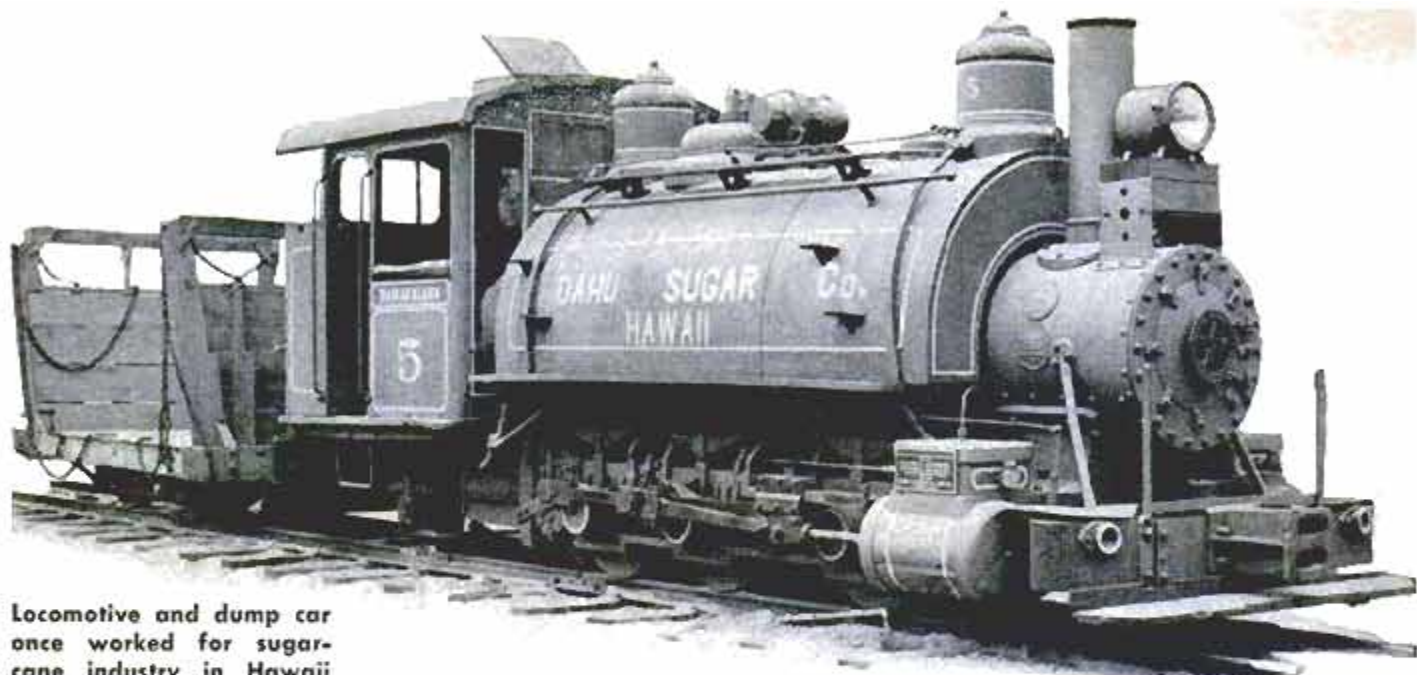

Locomotive and dump car once worked for sugarcane industry in Hawaii

## Paradise for Casey Jones, Jr.



Old-time electric locomotive did its share in restoring San Francisco after fire of 1906. Below, locomotive had streetcar-type body so it wouldn't scare horses



**E**VER KNOW a youngster who didn't sometime or other want to be an engineer? Kids in Los Angeles can get a real taste of railroading at Travel Town in Griffith Park. There the city's Park and Recreation Department has made it possible for boys and girls to play engineer to their heart's content.

In this unique town, several old iron horses that the railroads had turned out to pasture have been put back into service. A potential Casey Jones can climb up the big wheels, slide over the cowcatchers and clamber up on top to polish headlights and see what makes the bells ring. He can climb into the cabs and pull whistle cords and manipulate brake and throttle levers.

### Real Train Ride

If small-fry visitors grow tired of the stationary engines they can take a ride on a real train. The two cars and the engine came from the Oahu Railway and Land Company in Hawaii, and roll along one mile of track set up in Travel Town. Visitors board the train at a real station, donated by the Union Pacific Railroad. The station has an historical background, as it came from Promontory, the site where the golden spike was driven, joining eastern and western lines.

Other types of trains haven't been overlooked. There's a powerful electric locomotive which did its share in restoring San Francisco after the earthquake and fire of 1906. Another exhibit is the first interurban electric car that operated between Los Angeles and Long Beach. ★★





**Favorite spot for youngsters is top of a locomotive where they find out how whistles whistle and bells ring**

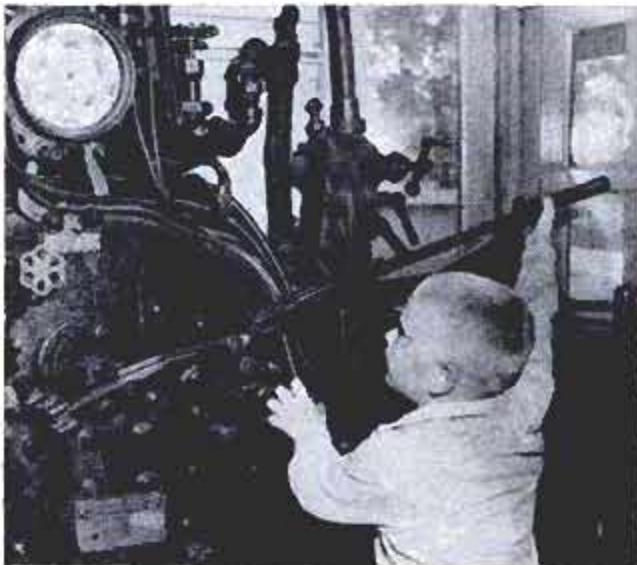

**Small boys ask unending questions: What does this do? What does the dial say? How fast will she go?**



**Who says railroading is for men only? These girls have just as much fun in the engines as the boys**

**Engines galore, freight and passenger cars, stations and even an old cannon lure youngsters to Travel Town**

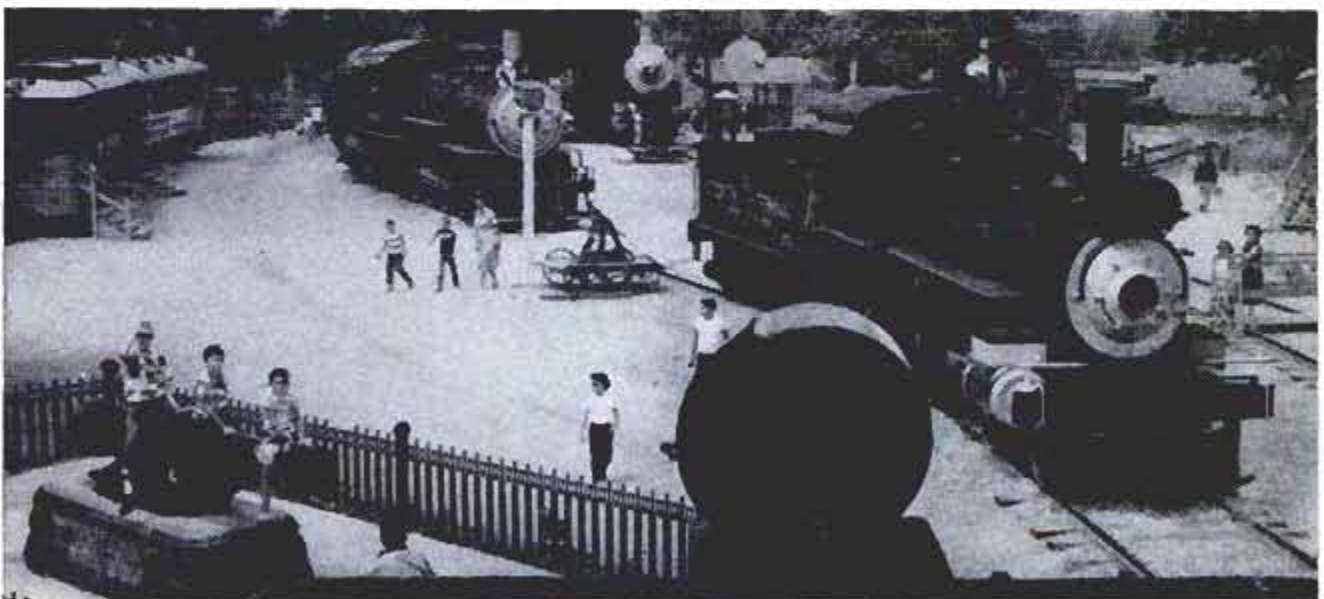

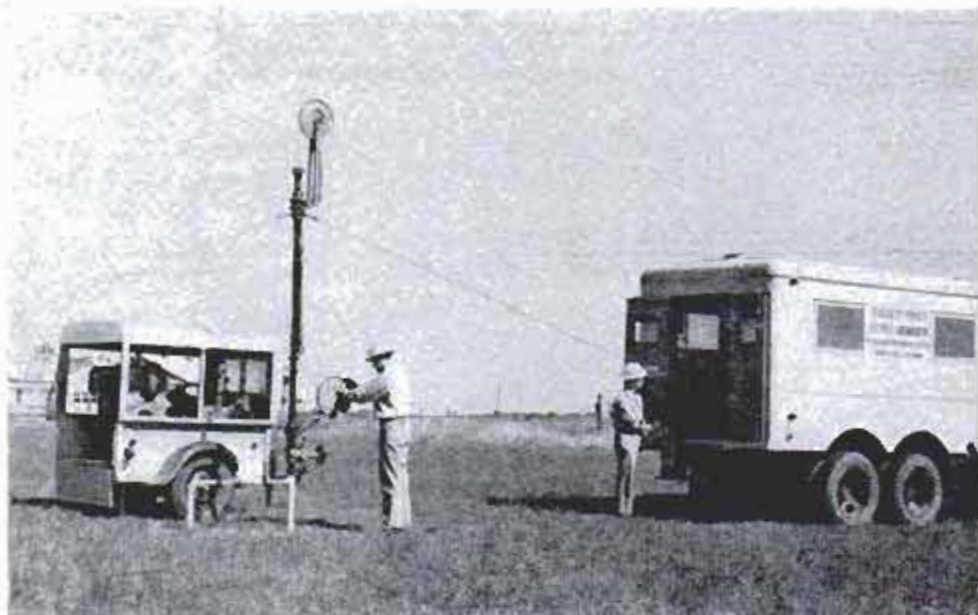
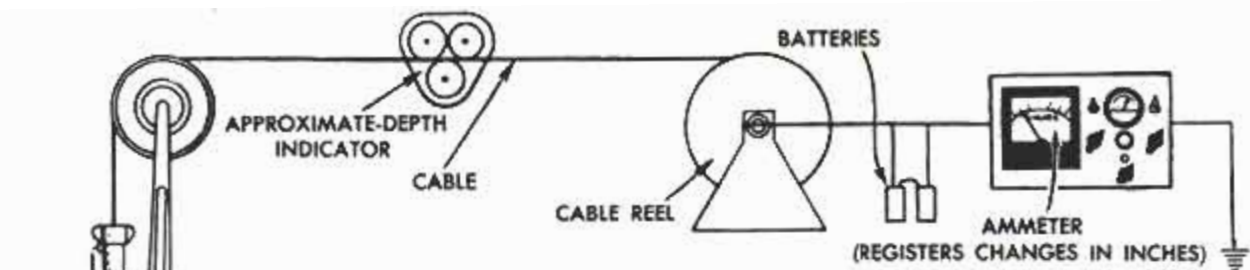

Mobile equipment at well head is used to check condition of well. The truck contains powered winch which regulates cable to keep cylinder at right level

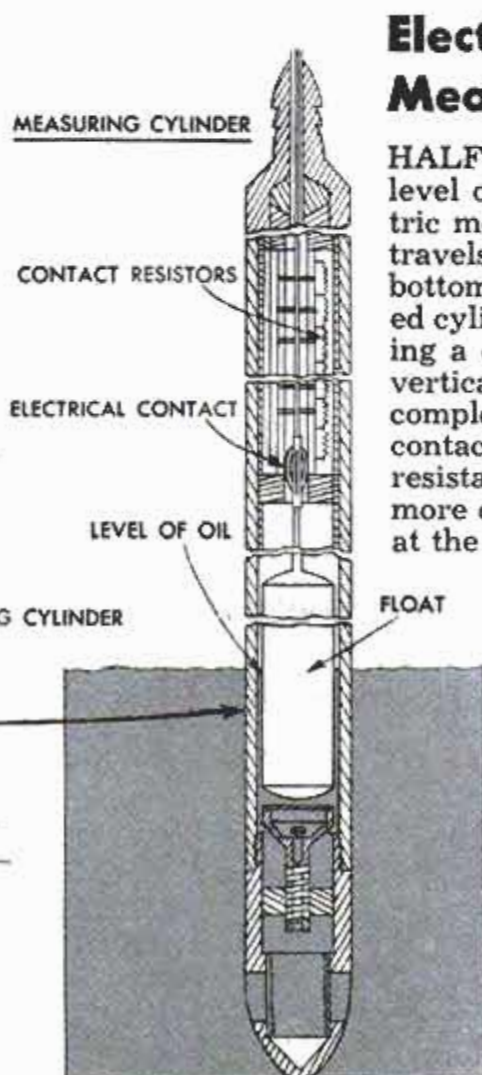
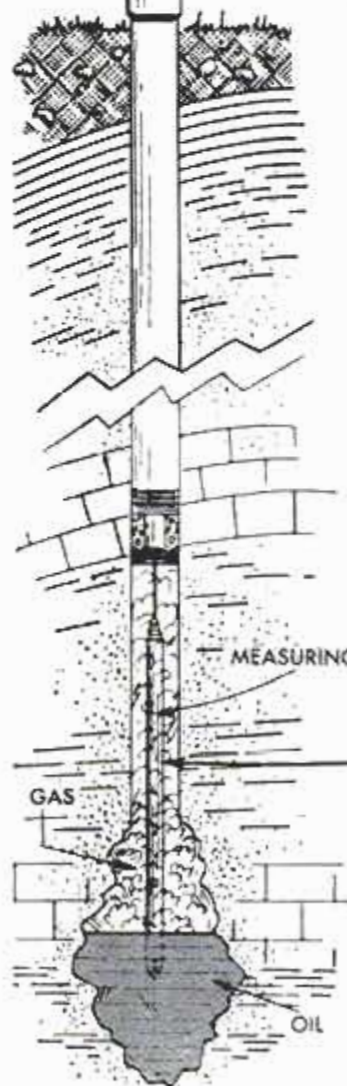

## Electric Oil Gauge Measures Well Level

HALF-INCH CHANGES in the liquid level of an oil well register on an electric measuring system. Electric current travels down a cable to a gauge at the bottom of the well. A float inside a vented cylinder rises with the oil level, causing a contact to slide up and engage a vertical series of contact resistors. This completes the circuit. The higher the contact is pushed by rising oil, the less resistance there is in the circuit and the more current flows back to an ammeter at the well head. This tells the operator the height of the oil level in the measuring cylinder. An "automatic pilot" measures the returned current and lowers or raises the measuring cylinder to keep it at the liquid level. The manufacturers of the unit state that it is the first accurate device for finding and following the liquid surface of an oil well. It replaces the standard echo meter.

Drawing shows how installation looks in a typical well. Cutaway of measuring cylinder is detail of main drawing



Screen house is ideal for outdoor eating or entertaining. Full construction details start on page 165

# Get Ready for Outdoor Living

FROM MAINE to California and from Minnesota to Alabama, thousands of families are taking up outdoor living for many months of the year. Patios, eating areas, places for play and relaxation are transforming back yards throughout the nation. The following pages point out some easy and inexpensive ways to get ready for outdoor living. With a few flagstones or a pile of bricks, a family working together can build a patio in a couple of week ends. Simple lamps and a bit of ingenuity extend outdoor-living hours into the night and create spots of real beauty. Portable grills make cooking out a cinch and as to yard furniture—you can make a lot of it yourself at low cost. ★ ★ ★

*Have Fun!*



*Entertain!*



*Relax!*

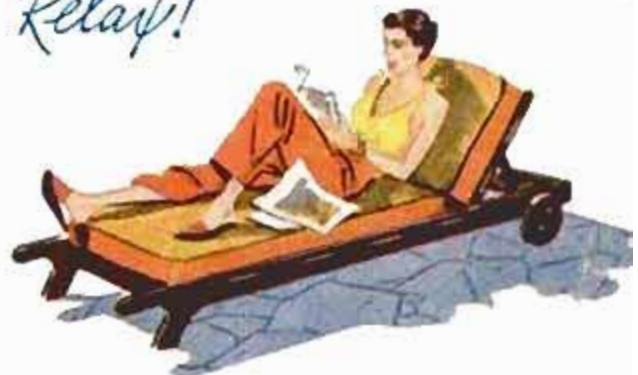

*Cool Off!*





## Eight Kinds of Patios

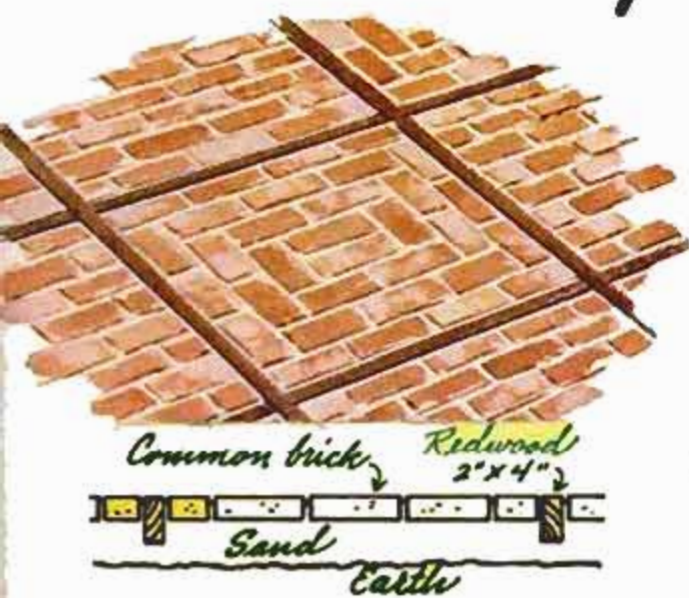

Brick patio is laid in a grid constructed of 2 x 4s over 2 in. of sand. Bricks should be flush with frame

This attractive aggregate patio uses redwood dividers which were covered with tar paper to prevent cement stains. Bright pebbles were scrubbed with a wire brush to bring out color

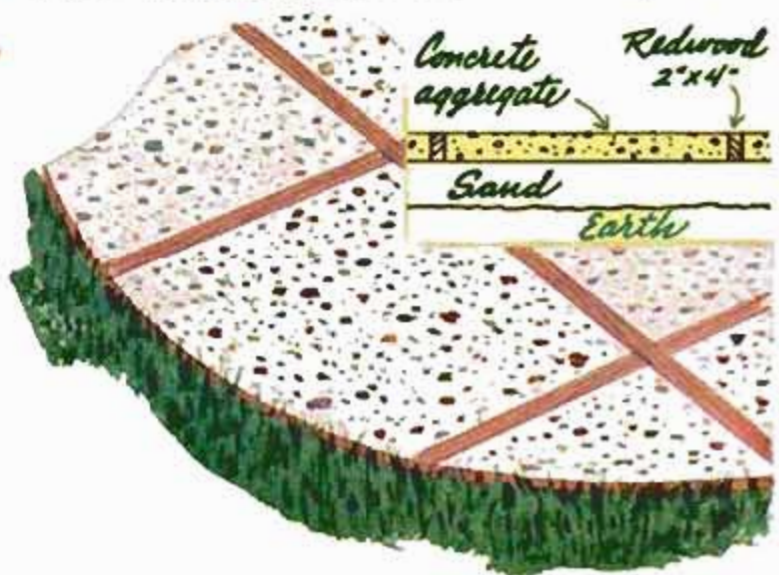

If you want a personalized patio you can cast concrete blocks yourself and impress designs of family interest. Forms of 2 x 2-in. lumber provide 2-in.-thick blocks. Designs are colored with concrete paint if desired. Use premixed concrete to make them

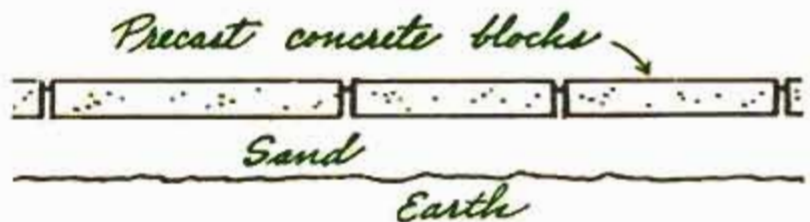

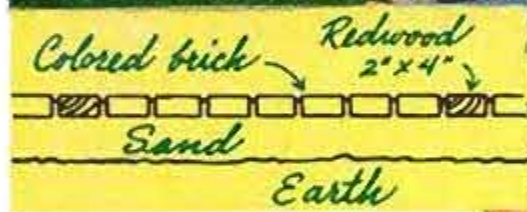
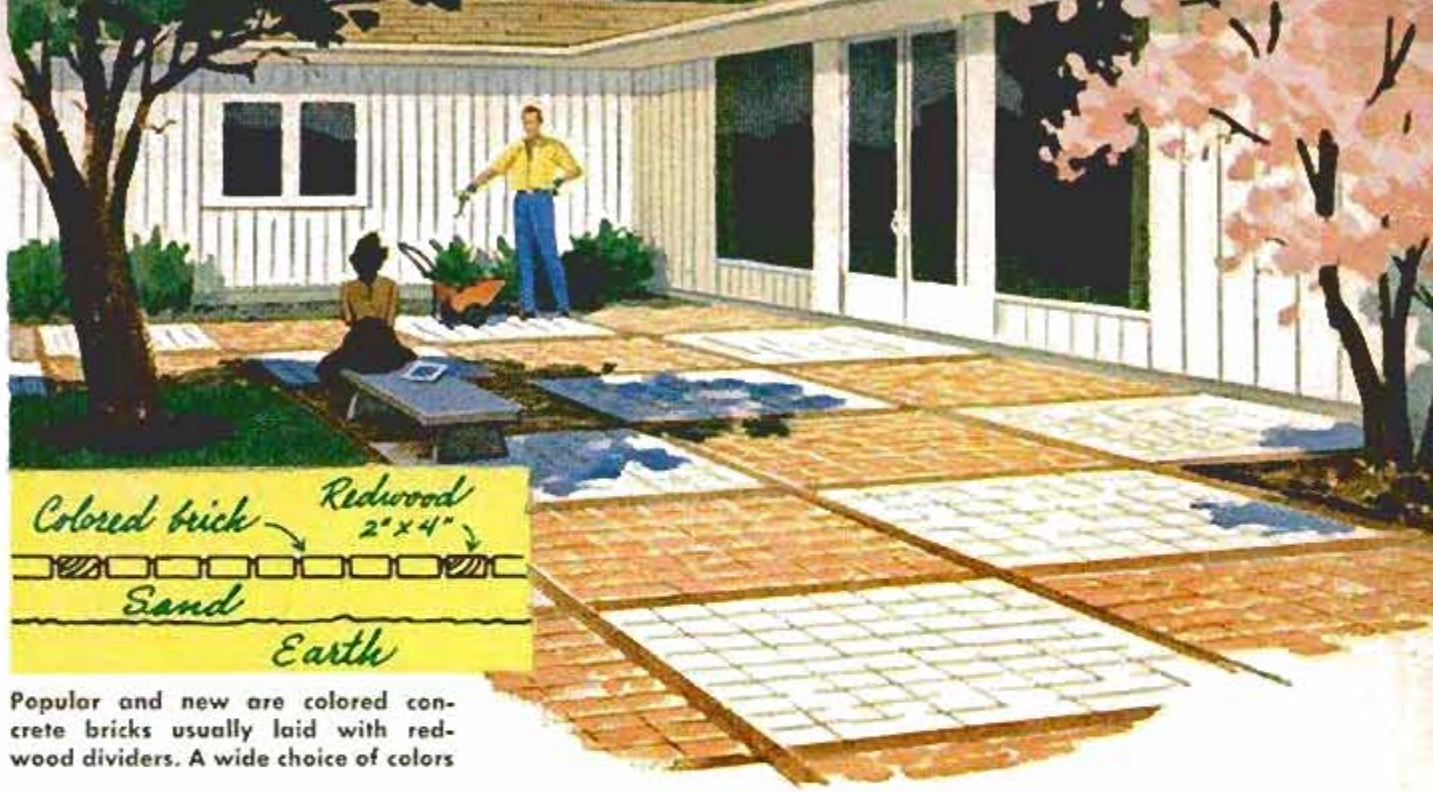

Popular and new are colored concrete bricks usually laid with redwood dividers. A wide choice of colors

## You Can Build Yourself



End-grain blocks of redwood give long service. The blocks are 4 in. thick and laid over 1 in. of sand. One-half inch spaces between the blocks are filled with sand and are then settled with water. Patio is edged with 2 x 6 strips

Unusual effect is achieved by making the blocks of colored concrete in individual forms and then laying over tamped sand

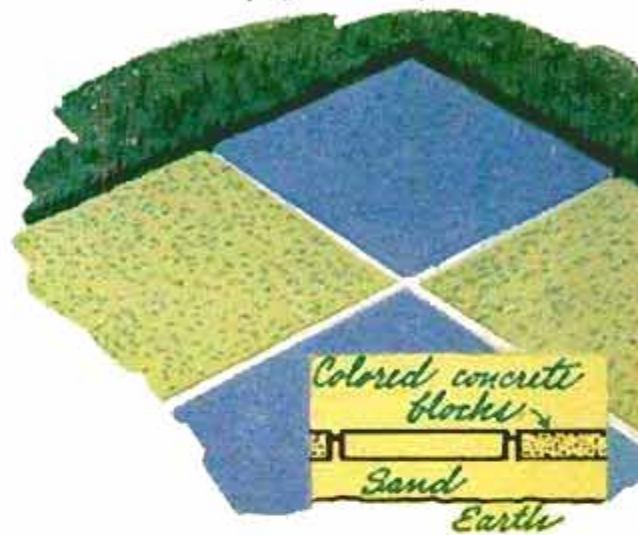

Redwood deck or patio provides good drainage and may be used on sloping sites where level must be raised to meet level of house floor. Deck squares can be laid in parquet pattern (as shown) or parallel strips





Courtesy of General Electric

Plastic screen illuminated from behind adds to effect of beautifully lighted patio and landscaped borders

Homemade lighting fixture over table was made from lamp and frame covered with a translucent material

## LIGHT UP THE OUTDOORS

**H**OMES ARE WELL LIGHTED today—indoors. Outdoors, a single glaring spotlight or a feeble porch light is too frequently the only source of illumination for patio or landscaping. At sundown, driveways and walks become murky traps for the unwary and the flower borders and shrubs on which you spend months of care are seldom anything but a black blob when the stars come out.

This needn't be. You can inexpensively transform the most ordinary yard into a place of beauty at night. You don't need complicated plans or layouts. Just borrow as many extension cords as you can find. On a dry night, use the cords to try various lighting arrangements with different lamps and at different places. An evening of lighting experiments will reveal exactly what you need in your particular yard.

With the bulbs and fixtures available today, you can obtain excellent results. Attractive nonrusting indoor fixtures can be used under covered roofs. A plastic terrace screen becomes a huge lighting fixture by just placing spot or flood lamps behind it. The popular plastic bubbles not only give soft illumination but provide a reading light below by using the "R" bulbs inside. PAR spots or floods can be hidden on a roof to reveal trees or the lawn. Fluorescent

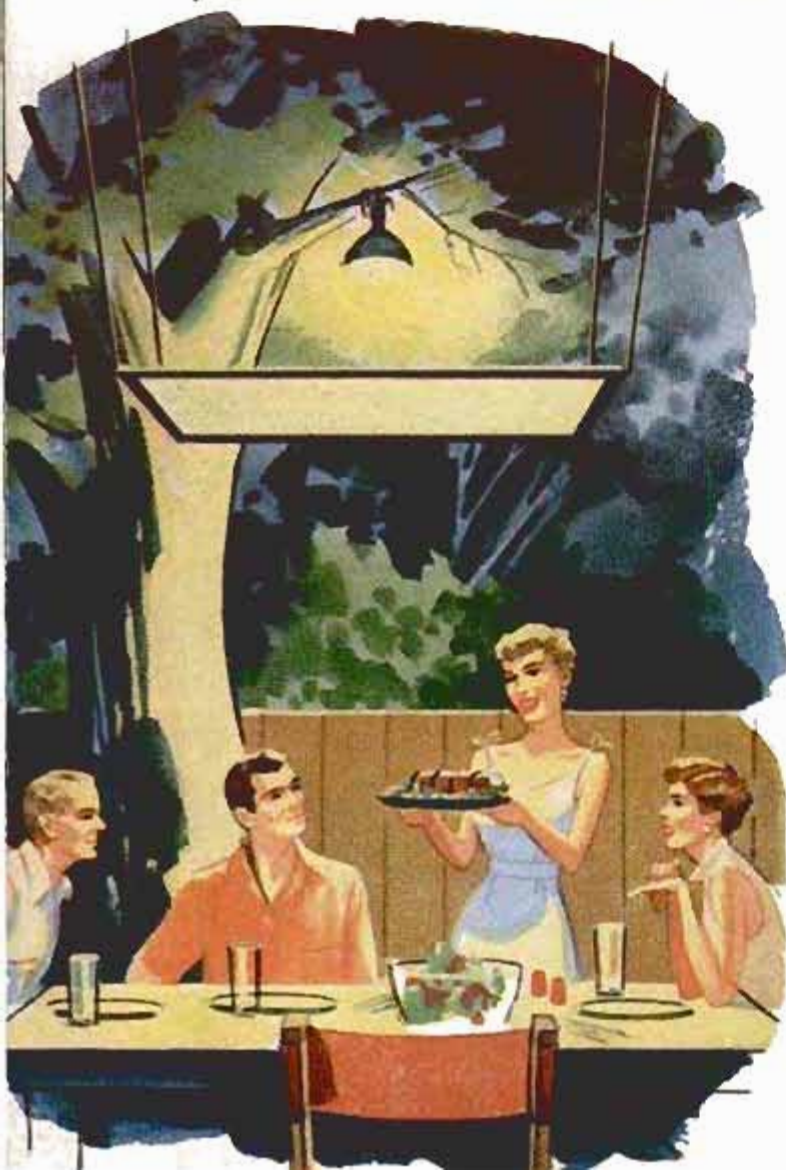

tubes (and outdoor Christmas strings) will bring a garden path or outlying fence into the nighttime scene. A small, low light at the top of steps will softly outline them for the visitor. A reflector bulb over a hanging screen of heavy fabric or translucent plastic above the barbecue table gives delightful dining illumination — and with freedom from insects. Another possibility is to clamp an upward-shining fixture to the stand of a table umbrella. The umbrella reflects light down on the table. Mushroom fixtures, available in a wide variety, are excellent wherever a fixture is exposed and for portable stands out on the lawn.

An important thing to remember in outdoor lighting is that most higher-wattage bulbs need some protection because the hot glass can explode when it is splattered by rain or snow. Fixtures 1, 2, 3 or 4 (see illustration above) take care of this problem. The PAR-38 bulbs need no protection, but in some places you may wish to shield them as in 5 or 7 (see illustration above) to eliminate glare.

For permanent wiring of lights, you have three choices: portable cords, overhead and underground wire. Of course, you may wish to use more than one type. Portable cords can be quite satisfactory for outdoor lights. Use an S, SJ, SJT, SO or SJO type of cord to withstand the weather. For overhead wiring, use type WP, RW or TW wire to run between buildings or posts—best supported about every 15 feet. Conduit should be used if the wires are lower than eight feet above ground. Underground wiring formerly had to be in conduit or lead cable. The new plastic cable is considerably less expensive. Type USE or UF can be buried directly in the ground. Place sand or gravel around the buried wire for drainage and a board over it to protect from a chance shovel. Run the wire up out of the ground to fixtures or up the sides of trees through short lengths of conduit. The National Electric Code allows 20-ampere fusing on an outdoor circuit, but check with your local building inspector. Also measure the circuit and find out what wire size is required with the fusing. ★ ★ ★

## OUTDOOR LIVING

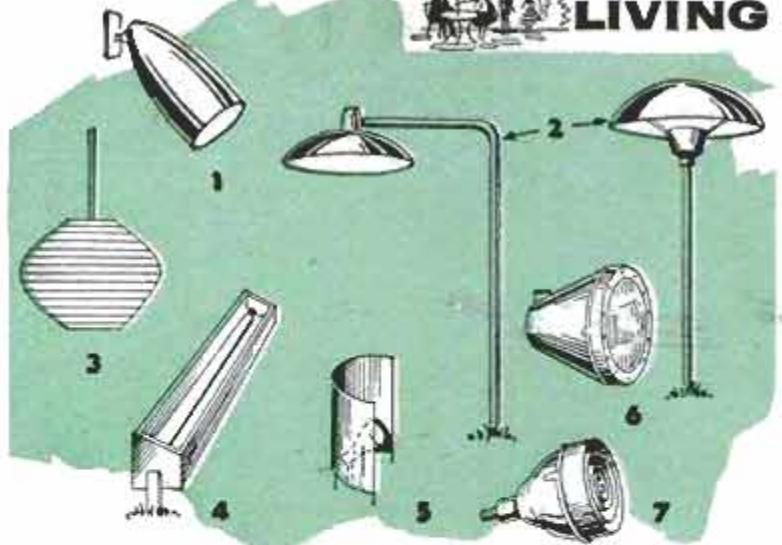

1. Bullet reflector for A and R bulbs; 2. Mushroom reflectors for A bulbs; 3. Plastic bubble for A and R bulbs; 4. Glass over fluorescent tube; 5. Homemade glare shield for PAR-38; 6. Underwater unit for A bulbs; 7. Clip-on shield for PAR bulbs



Plastic bubbles light patio, PAR-38 floods light the trees



A-type ordinary bulbs from 15 to 200 watts. If over 40 watts should be shielded from weather



R-type reflector lamps from 75 to 150 watts are used in spot or floods. Shield from the weather



PAR-38 outdoor reflector lamp, 150 watts, for spot or flood. The glass needs no protection



PAR-46 and 56 reflector lamps, 200 and 300 watts, spot or flood. Need special sockets, protection

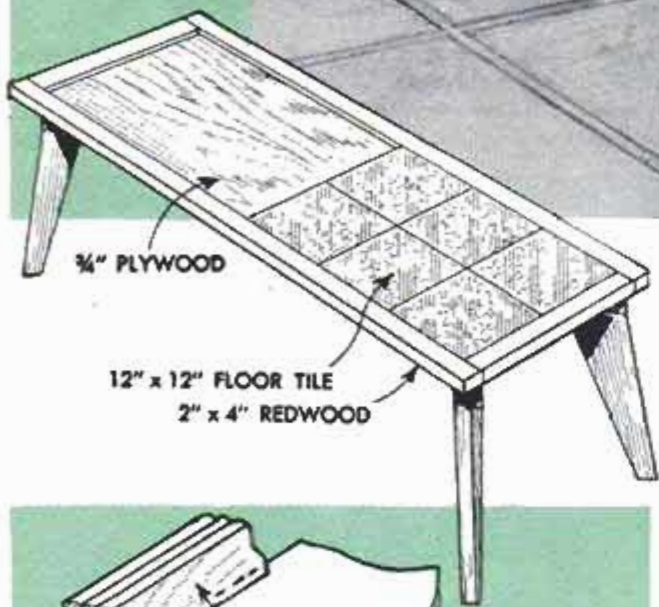

## Better Tables For Your Patio

THESE PATIO TABLES are well designed and easy to build yourself. The barbecue table (see details at left) has a top made of 12-inch floor tile which is resistant to both weather and hot pans. The tiles can be laid loose or cemented. Legs of the table can be removed for winter storage. The small tables below are made of inexpensive "sink cutouts"—plywood with counter-top plastic bonded to the tops. The legs are metal and easily attached. Tiles for the barbecue table above can be made from the same material as the small table tops for matching patio furniture.

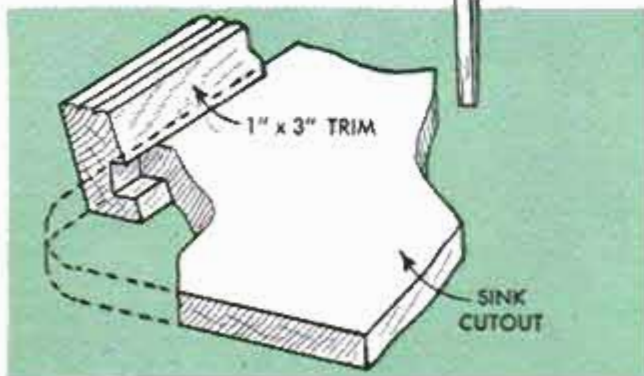





Glass-fiber panels woven around dowels form a fence that both enhances property and serves as wind screen

## More Than a Fence...

SINCE THE IDEA of living outdoors has taken hold, fences have become more important. They no longer merely enclose an area, but now are integrated right into the house design and landscaping layout. And they often do duty as wind screens, sun shades or area dividers, as well as providing privacy.



Woven fence of hardboard that is different and distinctive

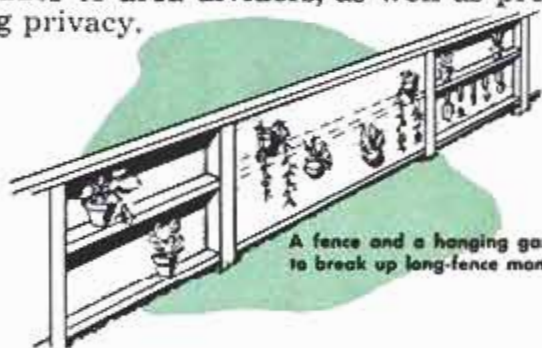

A fence and a hanging garden to break up long-fence monotony

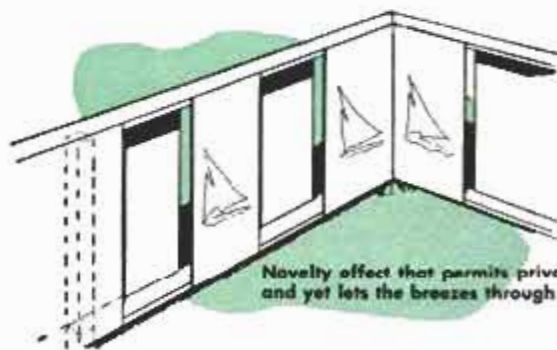

Novelty effect that permits privacy and yet lets the breezes through

If you're planning a fence for your home, let these sketches stimulate your imagination. In addition to a design that is novel and useful, look for unusual materials to get a decorative effect. The fences shown use standard and perforated hardboard on regular fence frames; glass-fiber panels would serve, too

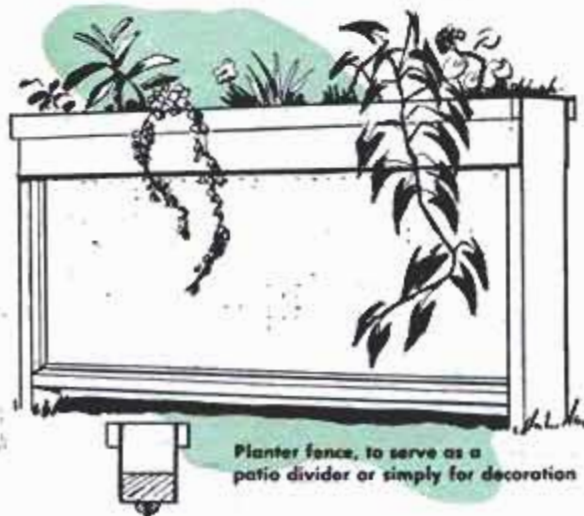

Planter fence, to serve as a patio divider or simply for decoration



Workbench for the outdoor cook decorates and divides the patio

# Portable Grills for Every Pocketbook



Deluxe wheeled grill with electrically driven rotisserie can barbecue a large turkey. Serving shelves fold out. On top is warming oven. Brazier adjusts. Doors open to service fire.

Big Boy, Inc., 59 E. Orange Grove Ave., Burbank, Calif.

Simple, inexpensive unit consists of bowl, grill and tripod. It can be set up quickly anywhere.

Bar-B-Bowl, 175 Fifth Ave., New York City 10



**M**ORE AND MORE portable grills are appearing in American back yards—and with good reason. Compact and inexpensive, they produce excellent results, can be moved to any part of the yard and are easily stored. The basic unit consists of a grill over an iron fire pot on legs. Additional refinements include wheels for the larger units, collapsible features, grills that move up and down to keep the food a proper distance from the fire and hoods that keep out wind and reflect heat. Rotisseries, warming ovens for rolls and side pockets for brewing coffee and heating additional food are on the more deluxe models. The units shown here range in price from a few dollars to slightly over a hundred. ★ ★ ★

Folding grill is easily stored when not in use. It is lightweight, easy to clean and move about.

Union Steel Products Co., Albion, Mich.



Suitcase model features steam-driven rotisserie, easy portability, folding legs. Weight: 32 pounds.

Buch Mfg. Co., Elizabethtown, Pa.



POPULAR MECHANICS



Two-wheeled grill is rolled about like a wheelbarrow. It has ample 21-inch bowl  
*Bar-B-Bowl*

"Covered wagon" grill has copper hood to reflect heat, rotisserie, warming bin, side cooking units

George Henry Co.,  
Morton Grove, Ill.

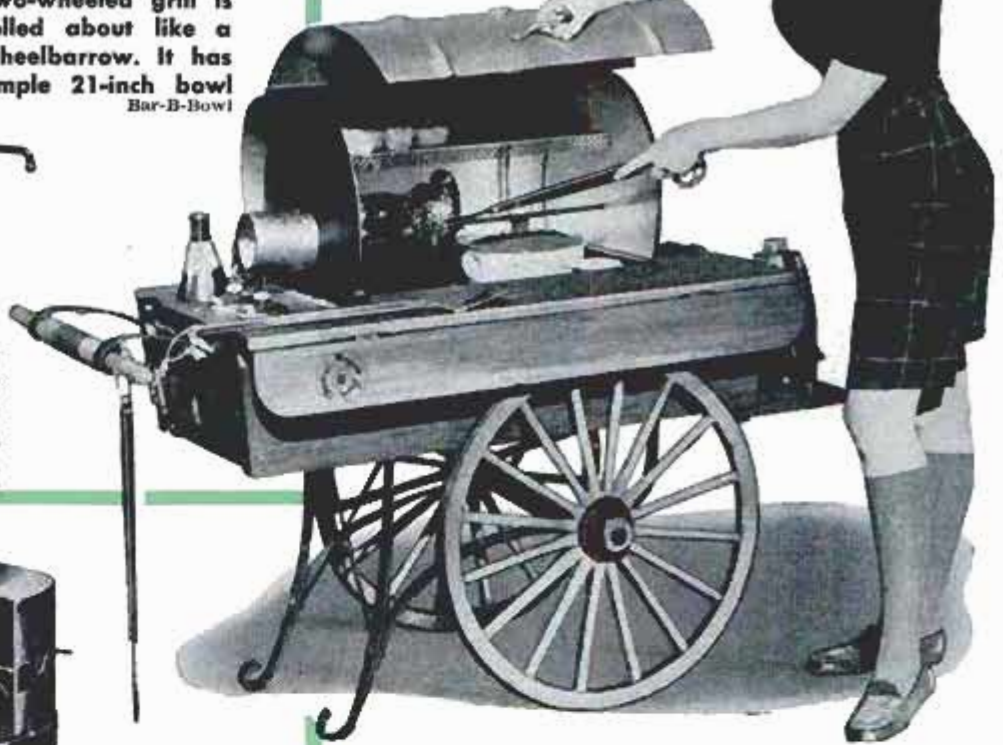

Large two-wheeled unit features a cylindrical hood, triangular base and hand-operated spit. Crank at the base adjusts height of the grill  
*Big Boy*

Bucket grill has a burnproof porcelainized fire pot that is removable. Air enters through holes in base and rushes up around sides of pot to create draft  
*Hamilton Metal Products, Hamilton, Ohio*



Large tripod unit cooks meat for several. Hand crank adjusts grill height. Unit is easily moved  
*Big Boy*



Battery-operated rotisserie is featured on unit that sits on a picnic table or in an unused fireplace. The long, low grill holds several steaks, many hamburgers  
*Barba-Charo, Ryder-Elliott Inc., 3227 Fowler St., Los Angeles 63, Calif.*

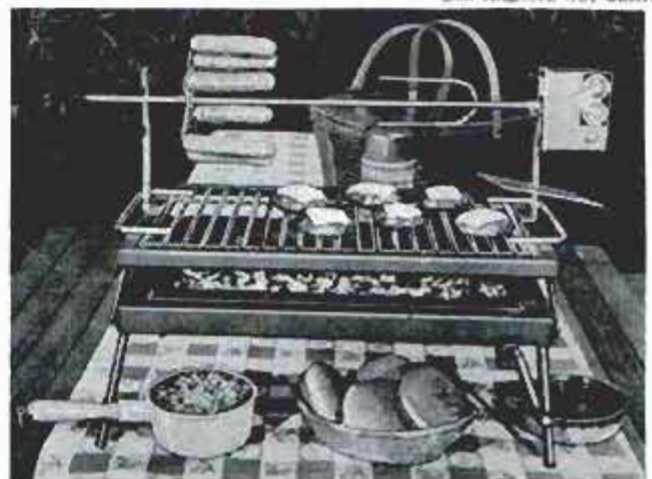

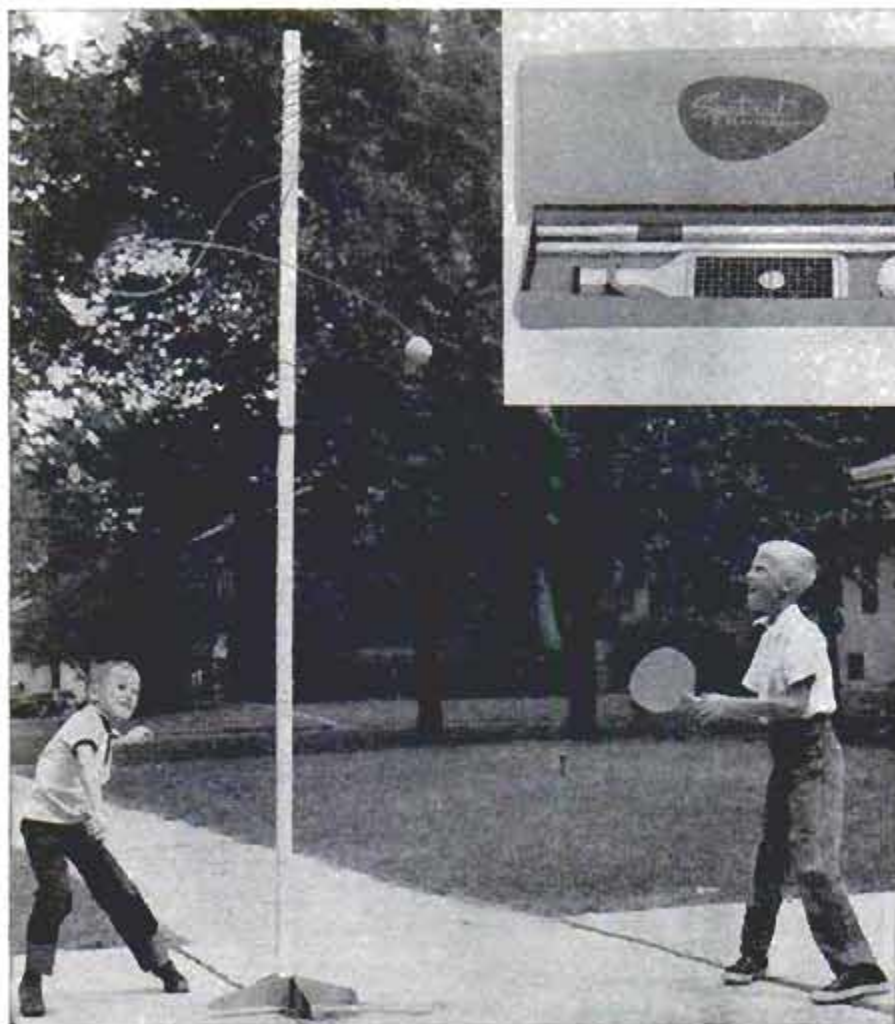

Courtesy General Sportcraft

### Tether Ball

Tied to the top of a 10-foot pole is a strong cord, with a rubber ball at the opposite end. Opponents try to wind the cord around the pole in opposite directions by hitting the ball with their paddles. Look easy? Try it, and you'll find yourself in one of the wildest, most strenuous games you've ever played! Above is commercial equipment, complete with collapsible pole which you can find in sports stores. At left is home-made version consisting of two-by-two pole with attached stand. Projecting from bottom of the pole is a spike that fits into a socket in lawn or driveway

## Have Fun in Your Back Yard!

**T**HERE'S A BACK-YARD SPORT or game for anyone in the family, from the smallest toddler right on up to Grandpa. And where can you find more bitter or better rivals than your own friends and neighbors?

Some of the older games, such as horseshoes, badminton and shuffleboard, require a court or special playing area. Six of

these court layouts are shown on page 157.

On these pages are some of the newer games. In many cases, no ready-made court is required, and you can put up or take down the equipment at a moment's notice whenever an opponent appears.

So choose your game, from the most strenuous to the most relaxing, and find excitement in your own back yard!



### One-Hole Golf Course

Here's fun for the confirmed golfer and a good chance for youngsters to learn the fine points of play on the green. A bent-grass lawn serves best, but any good stand of grass will do. Wait until the grass is long. Then, using a compass made of a string at least 10 feet long, mark off a circle with a small amount of lime. Bury a tin can in the middle of the circle. Cut the grass of the putting green close, but leave longer grass around the circle. From other parts of the lawn you can chip onto the green, then practice your putting game. The grass on the green should be well fed, watered and closely cut all season to keep it in perfect playing condition

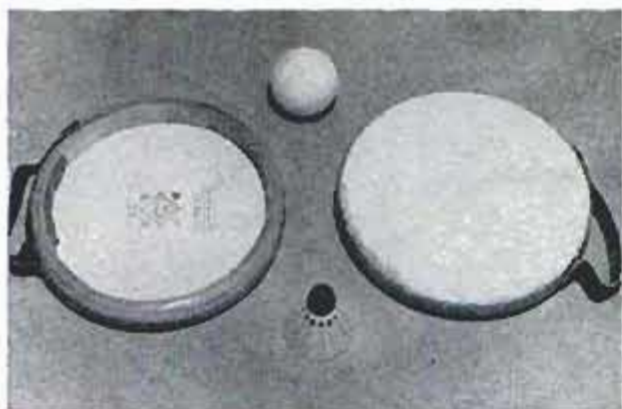

Courtesy General Sportcraft

### Tamburelli

This game is as fast as badminton, but also is satisfyingly noisy. The "racket" in this case is a wooden ring covered with a tightly stretched disk of thin leather. The game is played with a shuttlecock similar to a badminton "bird." Each time a player hits the shuttlecock he's rewarded with a good solid "bong." If you already have a badminton court, you can play Tamburelli on it without any alterations. The game however, can also be played without a net, but with rules similar to badminton rules. Another variation is to use a solid sponge-rubber ball instead of the shuttlecock, which speeds the game considerably. When the ball is used, the game can be played against a wall like handball



### Fi Fa

Imported from Germany, this game requires no court and is not as strenuous as most yard games. Kids like it, and it's ideal for adults who want a little exercise to settle that back-yard barbecue. What's more, one person can enjoy practicing by himself. Each player is armed with a cone-shaped catching net. The ball is an ordinary table-tennis ball. One player drops the ball into his cup and pulls a tripping lever which operates a spring at the base of the cup. The spring flips the ball through the air toward the other player, who tries to catch the ball in his net. Then as quickly as possible he aims his own net and pulls the trigger to return the ball. Player who misses catch loses point



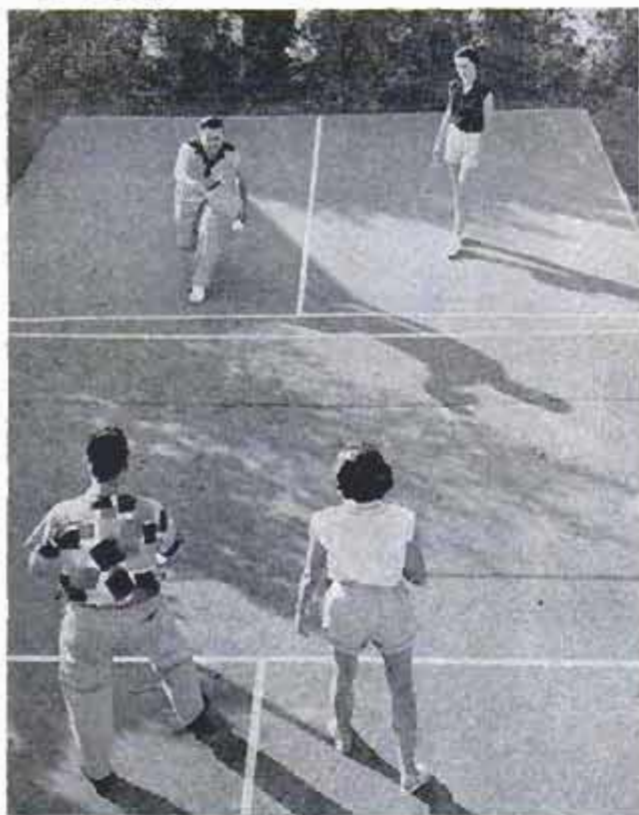

Courtesy General Sportcraft

### Bat Tennis

Here's another tennis-type game that can be played on a regulation badminton court. The equipment consists of four solid wooden paddles or bats and a solid sponge-rubber ball that is heavier than a tennis ball. The net is placed lower than a badminton net. Rules, in general, follow tennis rules and the scoring is the same. The advantage of the game over regular tennis is that it is played on a much smaller court and even a duffer can have fun. Don't look for a slow game, though. This is strenuous exercise, whether the game is doubles or singles.



Courtesy General Sportcraft

### Banball

You play with a "captive" ball, which eliminates a lot of chasing and keeps the kids out of the streets. Solid rubber ball is attached to an anchor block with a long elastic cord. Opponents stand side by side and alternately bat the ball, which rebounds and comes whizzing back, jerked by the elastic. You can play Banball by yourself, just for the exercise.

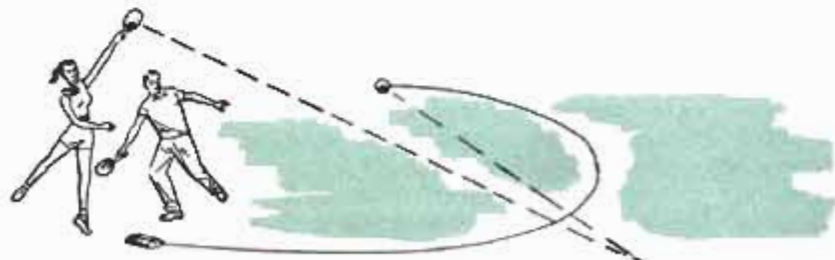

### Boccie Balls

One of Italy's most popular games, Boccie Balls is a variation of bowling on the green. It's a highly competitive, not-so-strenuous game that can be played by all age groups. All you need, in addition to the balls, is a stretch of smooth lawn. Recommended length of the court is at least 60 feet. Each

player (or team) rolls four large balls. A smaller ball called the jack is rolled to the far end of the court, and the object of the game is to roll the large balls as close as possible to the jack. Half the fun comes in trying to knock your opponent's counters away from the jack or knock the jack aside.

Courtesy General Sportcraft

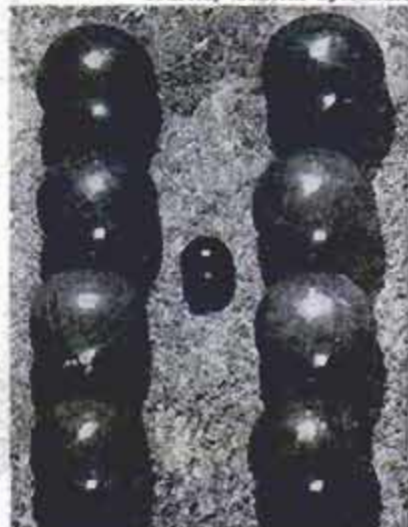

# COURT LAYOUTS

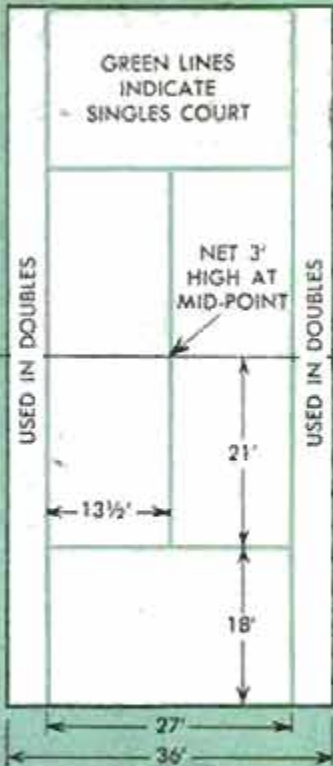

40' BETWEEN STAKES

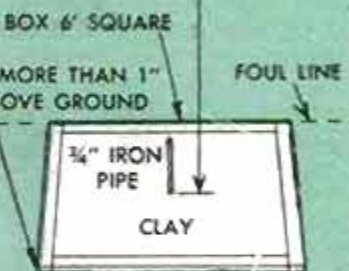

HORSESHOES

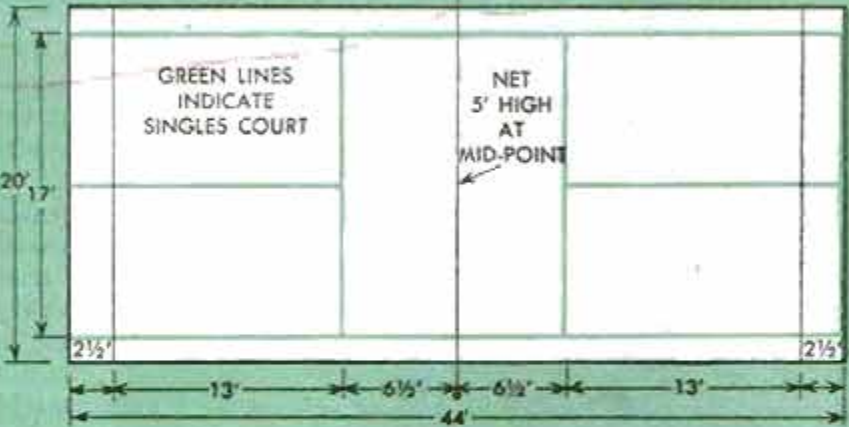

BADMINTON

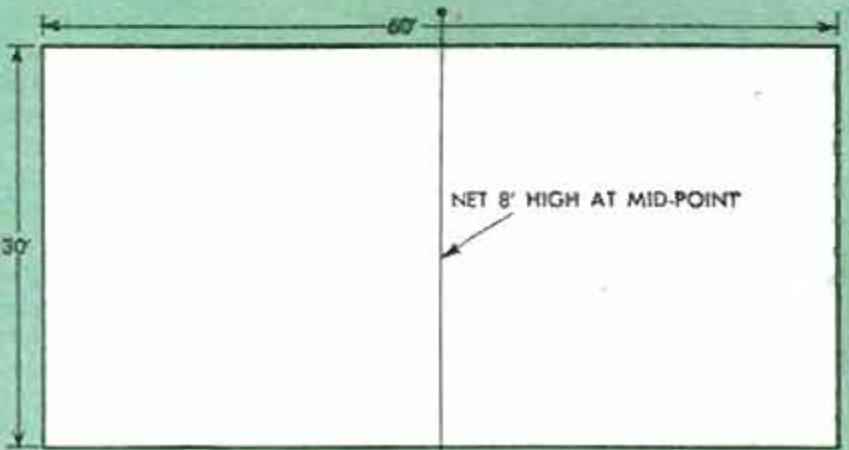

VOLLEYBALL

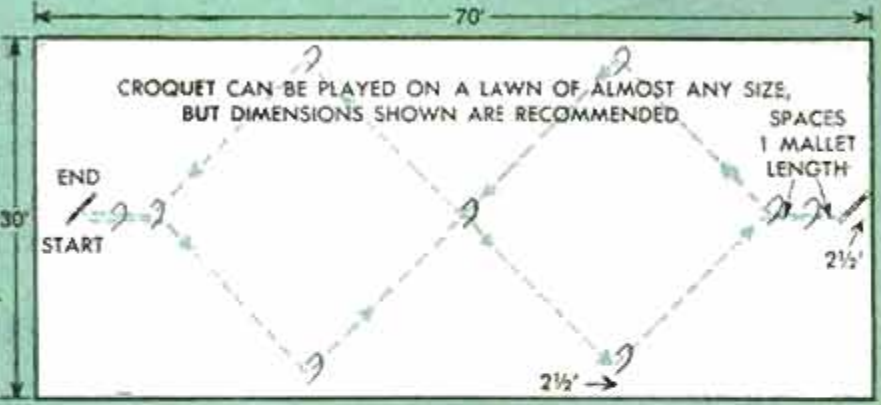

CROQUET

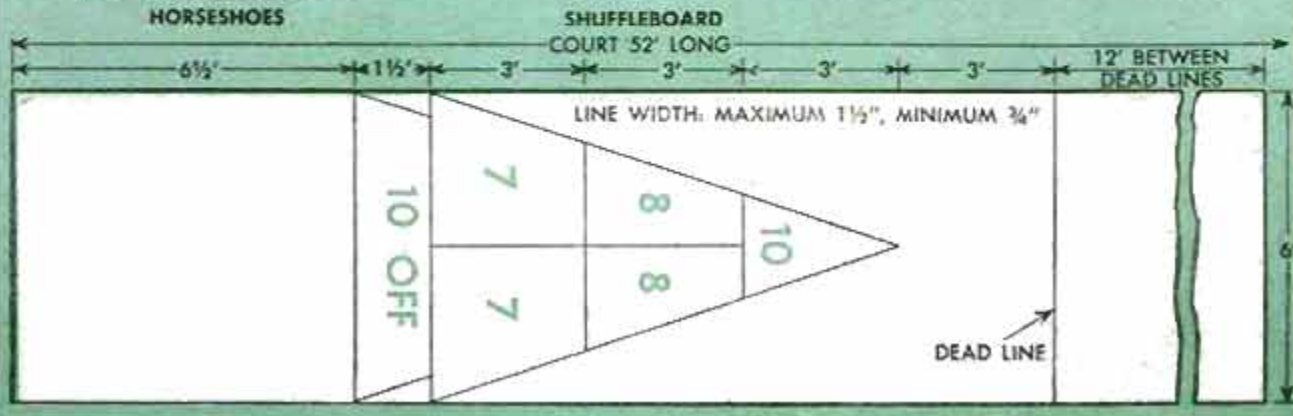

SHUFFLEBOARD COURT 52' LONG

## Rolling Cupboard For the Barbecue

WITH HUNGRY GUESTS arriving and the charcoal glowing hot in the barbecue pit, the back-yard cook has to be prepared to go into his act. And he will be, with this rolling storage cupboard to accompany him to the scene of the "crime." The cupboard contains everything he needs except cooking talent. There are dishes, utensils, towels, apron, condiments and mitts, handy for quick use.

Materials used in construction of the cupboard are pine or redwood scraps,  $\frac{1}{4}$ -in. plywood, and  $\frac{1}{8}$ -in. hardboard. All of the metal fittings are inexpensive and can be obtained at the hardware or five-and-ten. The total cost of the finished cupboard can be kept under \$5.

Top and bottom pieces are  $\frac{3}{4}$ -in. plywood, and the shelves are hardboard nailed to supporting frames made of 1 x 1-in. stock. The front legs on the original cupboard were cut from chair rungs, but could be sawed from a dowel or broom handle. The wheels are wooden disks with metal washers attached to each face. Other construction details are shown in the illustration.

To finish the cupboard, give it two coats of semigloss enamel in your favorite color. Use a complementary or contrasting color on the wheels and trim to complete the job. The last step is attaching metal fittings.



Rolling cupboard is fitted with every tool and utensil the back-yard cook is likely to need. Having everything conveniently stored in one cabinet saves many trips between patio and kitchen. Each cupboard should be equipped to suit owner's needs

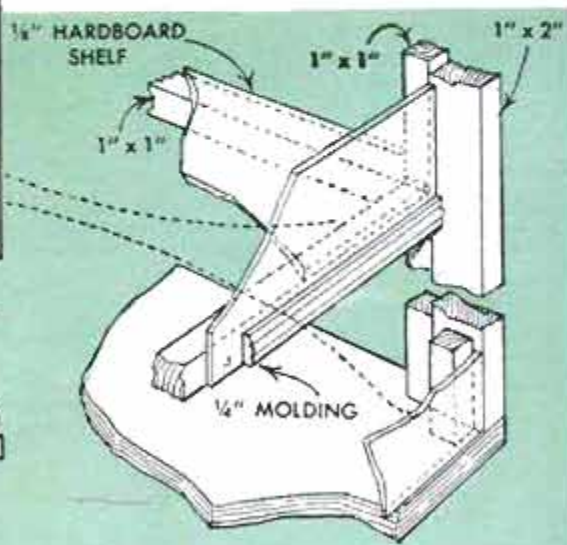
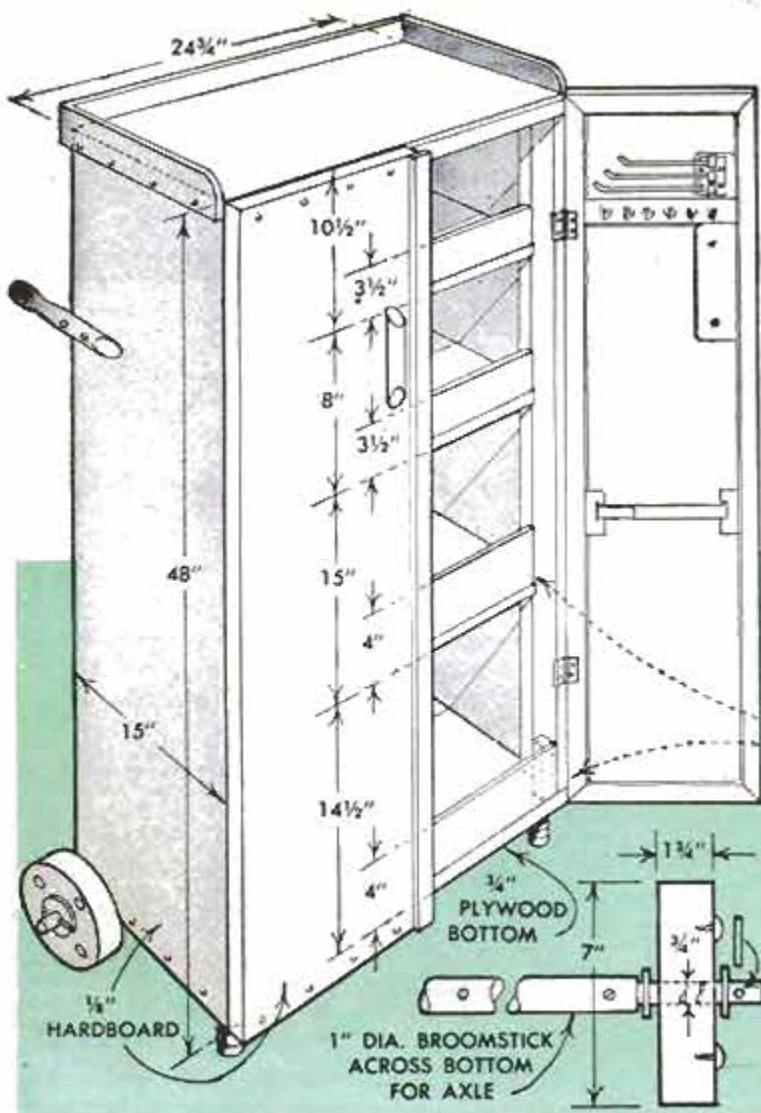



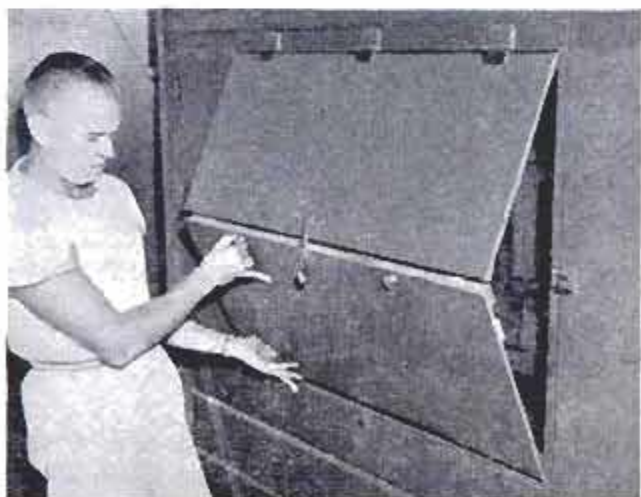
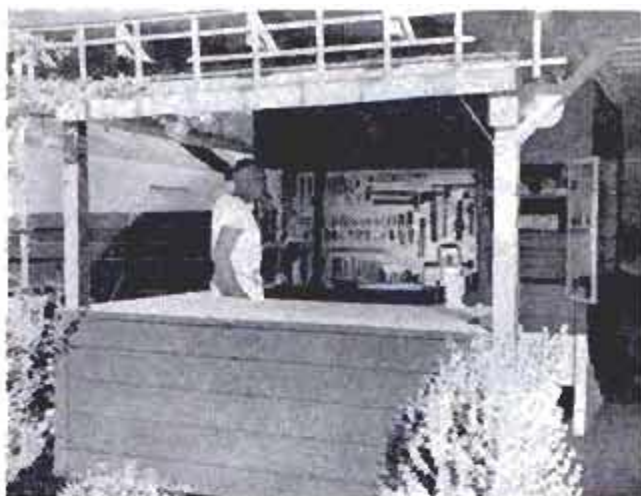

Sam Oldham of Phoenix, Ariz., shows off his outdoor workshop which locks up like a bank at night. Doors fold down over the tool cabinet in center. Catches in photos at right hold doors and saw out of the way

## Workshop Moves Outdoors

MANY A WORKSHOP FAN has wished he could move some or all of his projects to the outdoors during good weather. Sam Oldham, Red Cross safety director in Phoenix, Ariz., solved this problem by building an outdoor workshop behind the carport of his new home. A roof and bamboo curtains provide protection against the weather and ingenious cabinets lock up the tools in a jiffy.

Oldham used plywood to build the big tool cabinet which projects a foot into the carport storage shed. Folding doors, hinged in the center, are lifted up when the cabinet is in use. A wooden catch holds the doors open. All tools are neatly aligned with brackets made from coat hangers and metal strips. The cabinet holds 65 tools without crowding. His saw is held in place with a wood fastener which is turned to release it.

Smaller cabinets on either side of the big one are arranged with shelves and drawers to hold a variety of drills and small tools. Oldham devised a bar to close the side-cabinet doors which cannot be opened

when the big folding middle door is locked.

At one end of the shop, Oldham built shelves on which he has placed cigar boxes to hold nuts, screws and bolts. His six-foot bench is less than four feet from the storage cabinets. One side of the working surface of the bench lifts up and a power saw is quickly put into position. The saw platform is set into the steel frame of an auto seat and the motor rests on two U-bolts and swings under the table. A comfortable seat also swings out from under the workbench. Oldham has made holes for inserting his drill press on his workbench with a plate underneath to hold the press securely.

Other features of the workshop include a movie screen which can be rolled down for night showings on the adjoining patio, a hidden radio and a clock which can be swung around to be viewed from either the shop or patio. The workshop is lighted by fluorescent fixtures. Oldham has put in numerous electric outlets in the shop and all are connected to a main switch which turns off all current to the shop.



H. Leslie Hill Enterprises, Dallas, Tex.

Doors of living room and master bedroom open onto patio which more than doubles living area of this house

## PLAN FOR INDOOR-OUTDOOR LIVING

LEADING ARCHITECTS and designers, such as Cliff May and Chris Choate of Los Angeles, are planning houses that integrate indoor and outdoor living—you're not really sure where one leaves off and the other begins. With glass walls and doors and an extension of shading devices or overhang, they achieve a feeling of unity with patio areas and inner rooms. Access between the indoor and the outdoor living rooms is a vital factor in the planning.

Carefully planned outdoor areas give a feeling of spaciousness to a small home

that is usually associated with houses costing over \$25,000. The panelized Cliff May house on this page has elbow room to spare and was sold in Dallas for \$14,950. Its floor area is 1346 square feet, but the patio more than doubles the living space.

Privacy for outdoor living space is another important factor in the planning. This is easily effected with good landscaping and proper use of fences. Areas for play, quiet relaxation, eating and entertaining should be carefully planned. Also, patio colors should blend with adjoining interiors.

Integration of indoor and outdoor area is shown in photo. Floor and patio plan is for the house above



## TV for Trailers

TO ELIMINATE the unsightly antenna jungle and still provide best possible TV reception for its tenants, a mobile-home community on the outskirts of Philadelphia is equipped with this master-antenna installation. The system not only improves the park's appearance but also provides better reception than could be obtained with individual roof-top antennas.

Six separate channels, three from New York and three from Quaker City, are received by individually tuned, high-gain Yagi antennas atop a 50-foot mast, Fig. 1. Separate transmission lines from each antenna lead to a control box, Fig. 2, mounted at the bottom of the mast. Here, the individual signals are amplified, mixed and distributed, via underground cable, to a series of pint-sized TV outlets, Fig. 3, installed beside the a.c. power sources near each camp site. An additional length of underground cable leads from each outlet to the individual trailers, Fig. 4.

On opening day, the play area was monitored by a TV camera broadcasting over an assigned closed-circuit channel. This enabled mothers to watch the children from any TV-equipped trailer in the park.

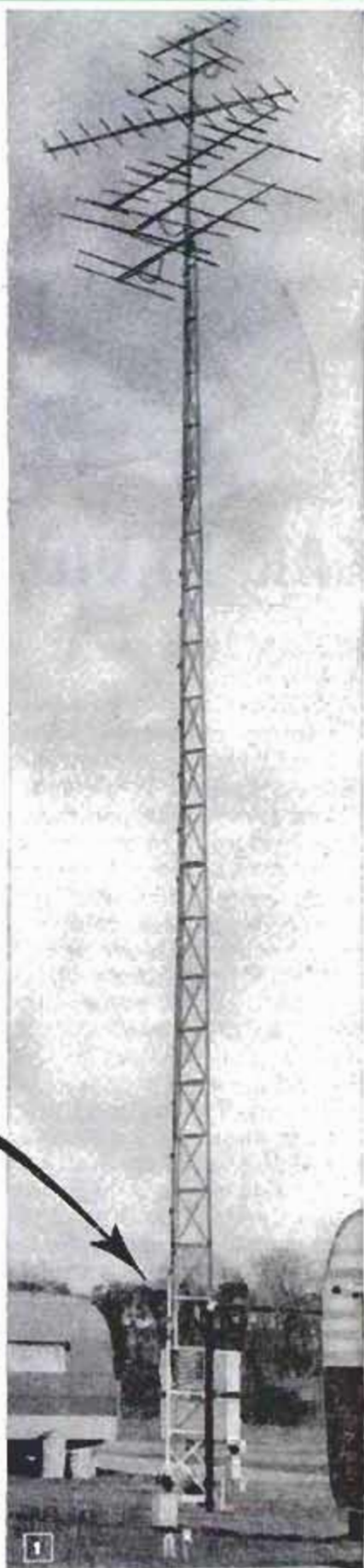
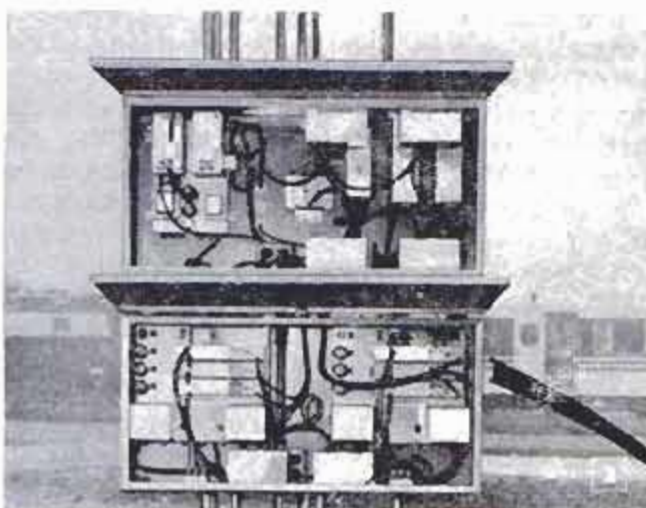



## CAR RADIO DOUBLES AS PA SYSTEM

By Byron G. Wells

ANYONE who has ever addressed a group of people, whether indoors or out, will testify to the merits of a public-address system. While indoor installations of this type are in common use today, outdoor systems are generally too expensive to be purchased for nonprofessional use. Nevertheless, such units are often very desirable for picnics, camping trips and dozens of other outdoor activities.

With a few simple wiring changes and the addition of some inexpensive parts, your car radio can easily double as a PA system. The conversion need not disfigure the radio, nor will it affect radio reception.

Essentially, the modifications consist of the addition of a control panel, and rewiring of the radio so that its audio amplifier can be used as a separate PA amplifier when desired. In this application, the amplifier input is switched to a microphone jack on the control panel, while its output is switched to a separate PA speaker.

The schematic and pictorial diagrams of the control panel are shown in Figs. 1 and 4, respectively. Figs. 2 and 3 illustrate the way in which the control panel is actually interconnected with a typical radio.

The construction of the control unit is simple. The various parts are mounted on a metal plate which, when completed, can be fastened to some convenient point on the dashboard of the car (see illustration

on page 246). The parts layout is not critical, so the mounting plate may be any desired size or shape.

Since the mounting plate acts as a common ground, it must make good contact with the bare metal of the dash. Any paint in the vicinity of the mounting screws should be carefully removed.

Careful consideration must be given to the length of the leads required for connecting the control panel to the radio and the external speaker. These must be sufficiently long to reach their designated connecting points.

When the control panel has been completely wired, remove the radio from the car and open the case to expose the various parts. Although the parts layout will vary in receivers of different manufacturers, the circuits involved in the modifications are very similar. The volume control has three lugs. One end lug is usually grounded, while the lug on the other end is connected to the last i.f. transformer with a piece of hookup wire. Disconnect one end of this wire from point A and solder lead 2 from the control panel in its place. Then detach the other end of the wire from the transformer, point B, and replace it with lead 1 from the control panel.

The receiver shown in the diagram, Motorola model 5M, was selected because its circuit differs somewhat from the con-

ventional. As shown in the schematic, the bottom end of the audio-grid resistor,  $R_g$ , is connected to the automatic-volume-control (a.v.c.) line. This is done to improve a.v.c. action. Since the a.v.c. resistor,  $R_1$ , is needed to return the grid of the 6CR6 tube to ground, it must be disconnected from the i.f. transformer, as shown, and resoldered to

the volume control at point A. In radios where the bottom of  $R_g$  is grounded, this change is not required.

In order to rewire the output circuit, the ungrounded lead of the output transformer's secondary winding must be located. This lead is usually connected to a

(Continued to page 246)

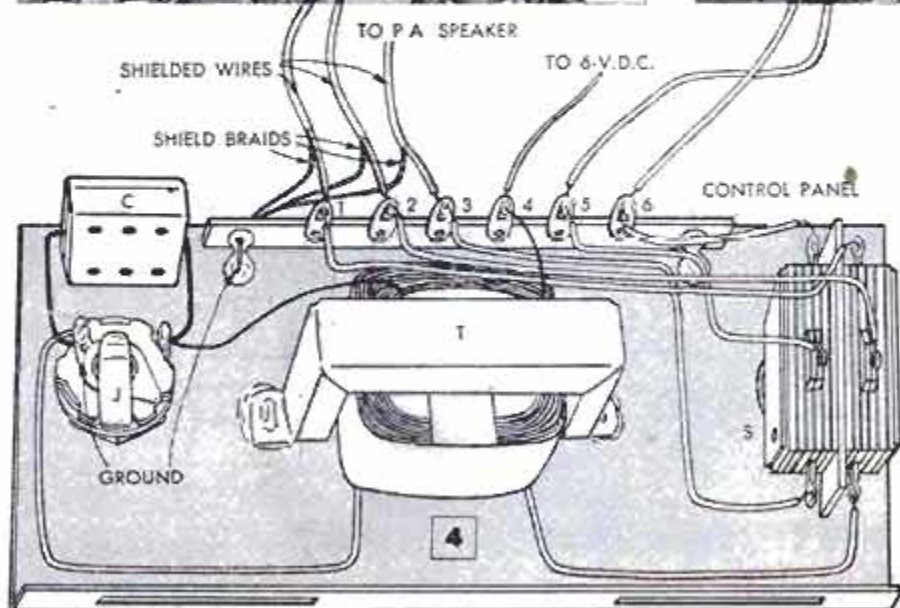
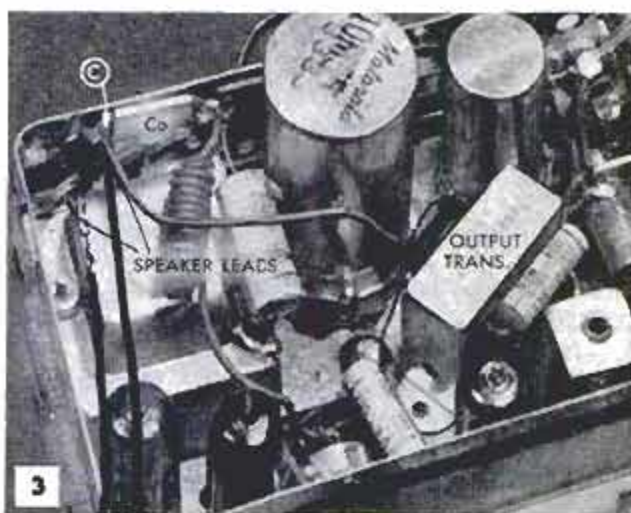
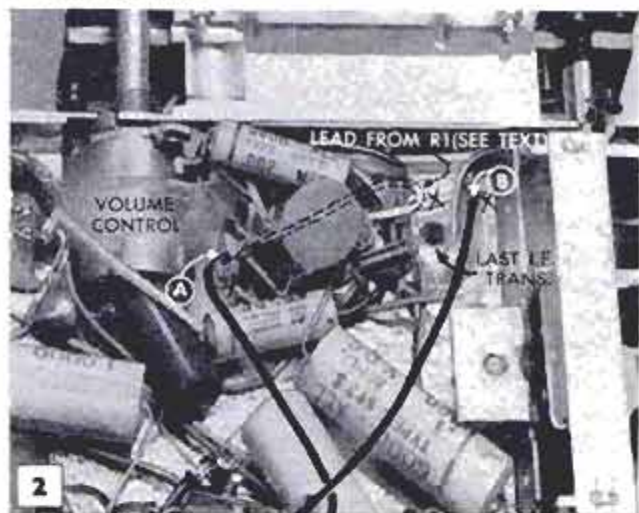
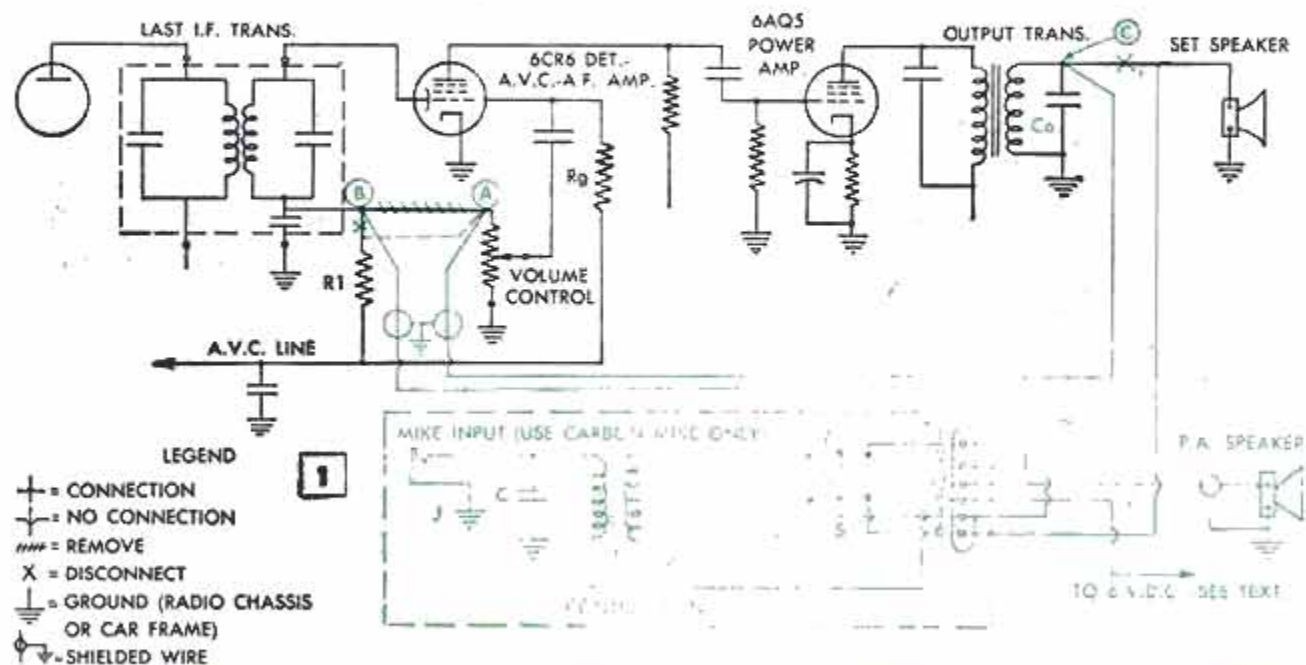

#### LIST OF MATERIALS

- J—OPEN-CIRCUIT JACK
- C—.005-MFD. MICA CAPACITOR
- T—INPUT TRANSFORMER, TURNS RATIO 20:1 OR GREATER
- S—D.P.D.T. TOGGLE SWITCH
- 6-POINT TERMINAL STRIP
- WEATHERPROOF SPEAKER AND HOUSING
- CARBON MICROPHONE
- METAL MOUNTING PLATE
- SHIELDED AND UNSHIELDED HOOKUP WIRE
- SOLDER (ROSIN CORE)



## Electronics and Hobbyists

AN APPARENT natural knack for electricity and electronics, plus an intense interest in his hobby, resulted in an expense-paid trip to the national 4-H Club Congress in Chicago for 17-year-old James G. Belle-son of Sinking Spring, Ohio. The trip, sponsored by the Westinghouse Educational Foundation, was an award for winning Ohio's 4-H Club electrical program.

Of special interest was Jim's "Aspirin Box Crystal Set" shown in Fig. 1. The little radio, which incorporates a small germanium crystal detector, is fixed-tuned to receive a single station. With a 300-ft. outside antenna, and a set of earphones, Jim picks up station WLW Cincinnati, some 50 miles away, with good volume.

A second crystal set, somewhat more elaborate than the first, has been taken on Boy Scout and 4-H camping trips to provide entertainment for Jim and his companions. With this set, Fig. 4, a total of 19

stations has been logged, over a radius of 360 miles. When used outdoors, the antenna is strung between trees.

Deviating from "radio," Jim puts his knowledge to use by building other electronic projects. In Fig. 2, he is putting the finishing touches to an electronic photo-print timer, to be used with an enlarger.

To show how "the comforts of home" can be increased through a knowledge of electricity, Jim has designed and built the portable control panel illustrated in Fig. 3. With this panel, he controls his bedroom lights, as well as his radio and phonograph, directly from his bedside. In addition, the built-in clock timer serves as an electrical alarm clock in conjunction with a special buzzer device.

In Chicago, Jim was joined by winners of the annual 4-H electric program from 40 other states. The winners were selected from more than 100,000 participants.

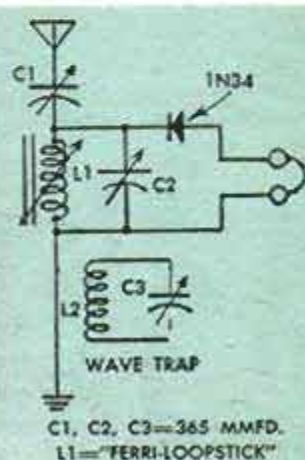
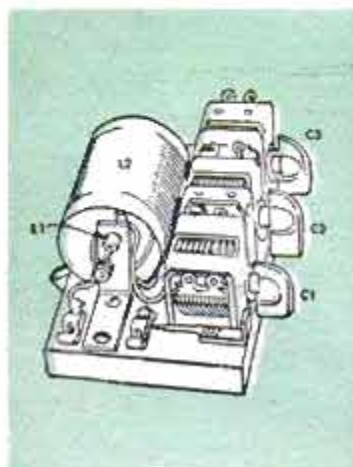



**OUTDOOR  
LIVING**

*WTM '57*

## KEEP COOL IN A SCREEN HOUSE

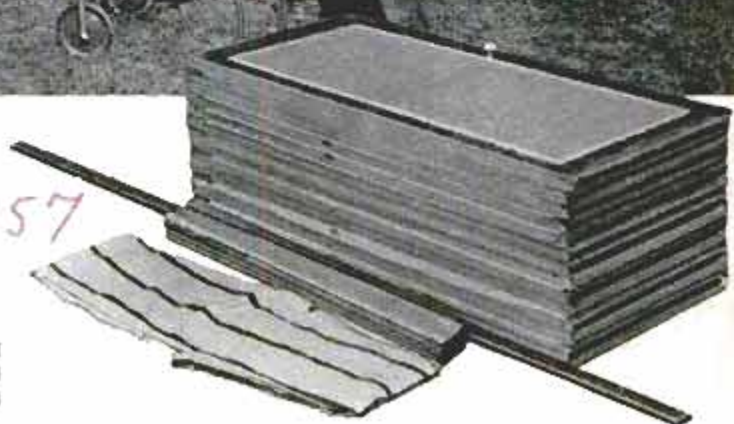

**WITH THIS SCREEN HOUSE** you can enjoy outdoor living at its best, with no worry about annoying insects or painful sunburn. Its canvas roof provides shade and its screened walls let in the breezes and keep out flies and mosquitoes. When summer is over, the house can be knocked down and stored like window screens, since the walls are made in 3 x 6½-ft. sections. The corner sections are hinged together so

they will stand alone to aid in assembling the house.

To begin construction, first cut 26 uprights 6½ ft. long from 1 x 2 stock. Next, cut 26 crosspieces 36 in. long from 1 x 2 stock and 13 crosspieces 36 in. long from 1 x 6 stock. Notch uprights as indicated and fit the three crosspieces so they are flush with the outer edges of the uprights. Assemble the frames with waterproof glue

Hinged corner sections of house stand alone while other sections are bolted to them. Canvas roof is held in place by hooking grommets over screw eyes driven into upper crosspiece of each wall section



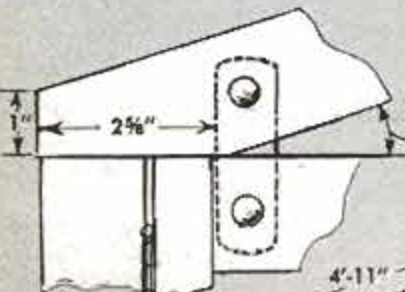
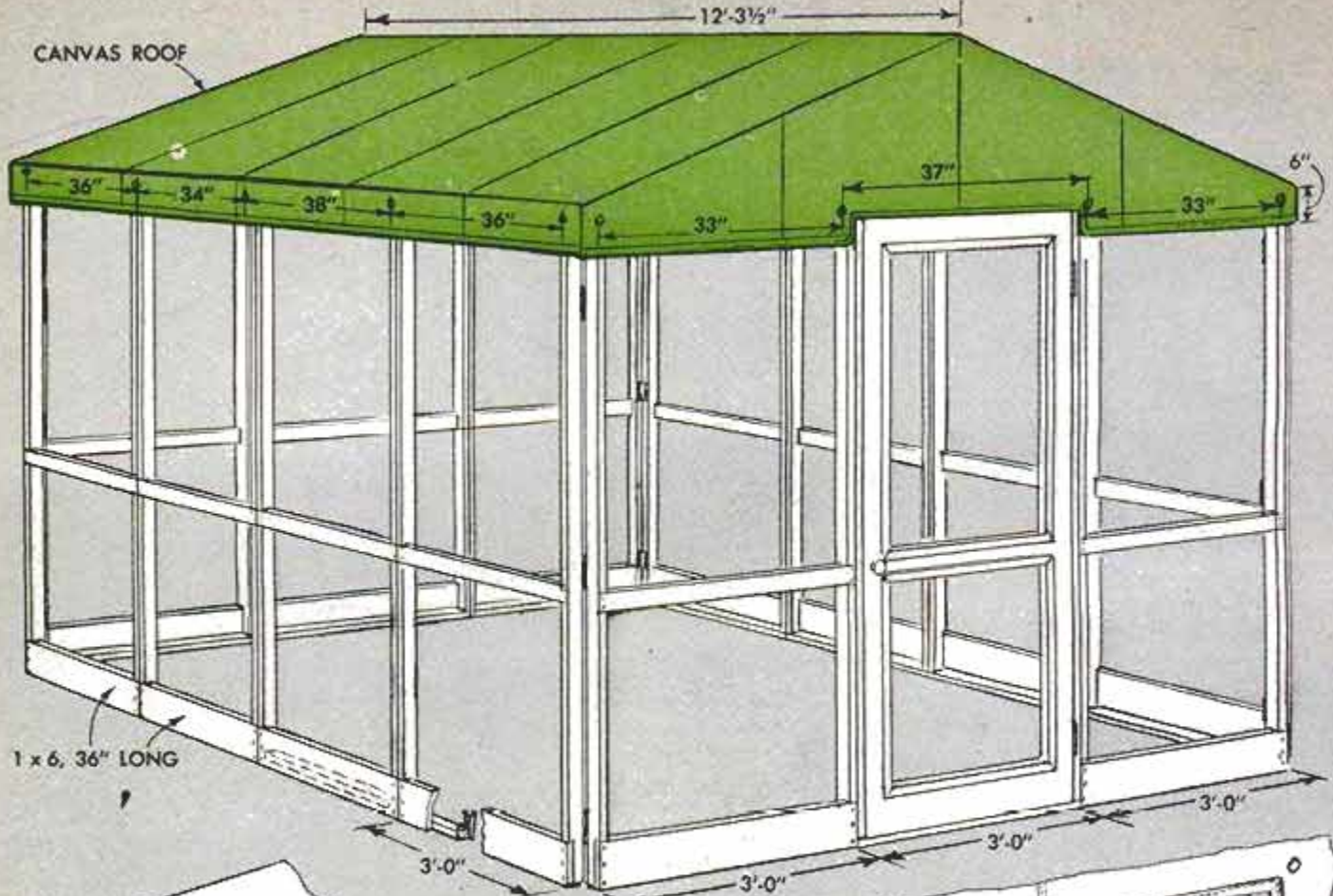

RAFTER DETAIL

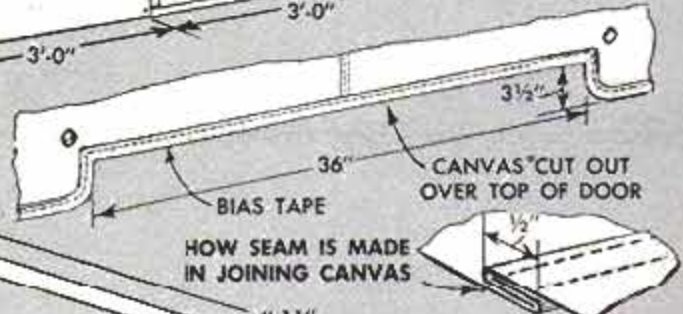

HOW SEAM IS MADE IN JOINING CANVAS

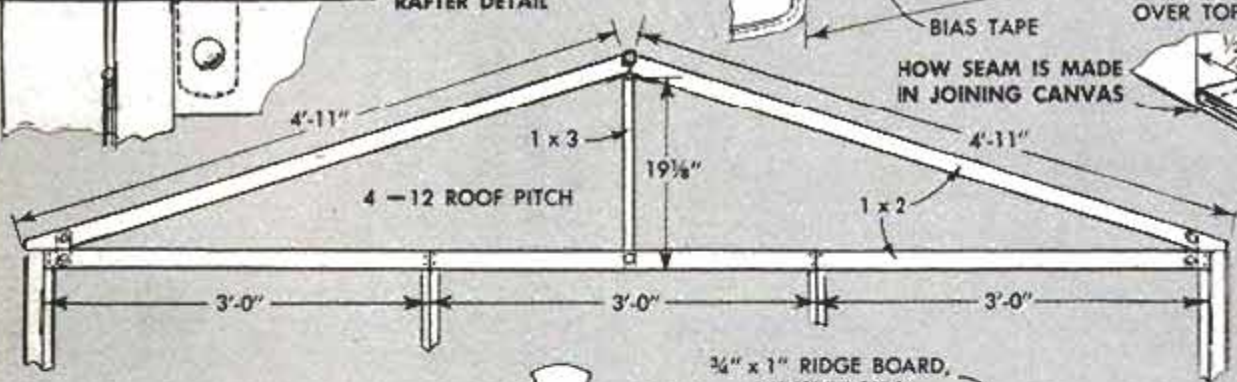

3/4" x 1" RIDGE BOARD, 12'-3 1/2" LONG

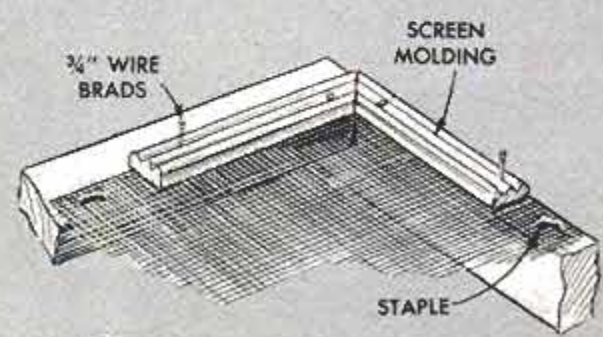
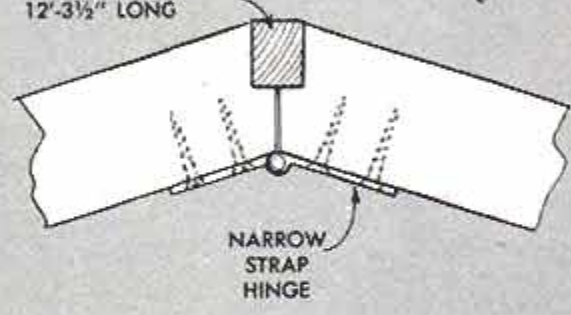
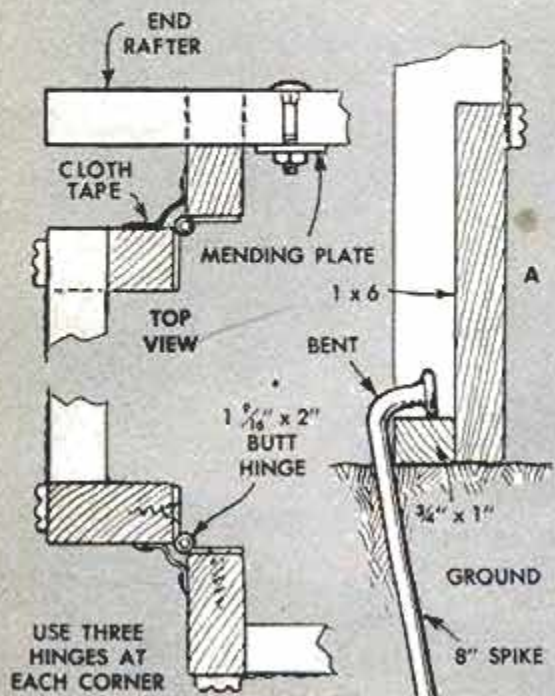



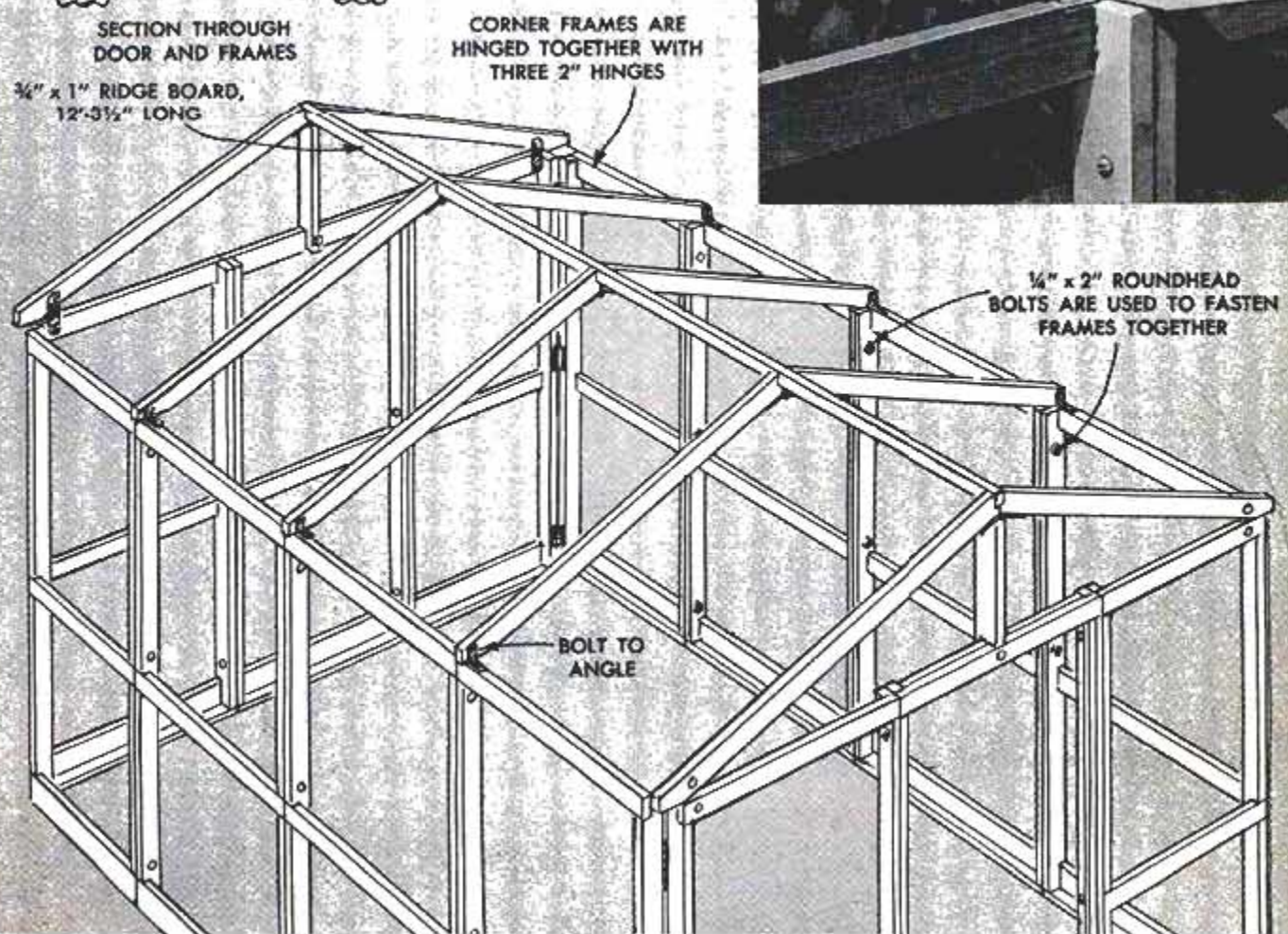
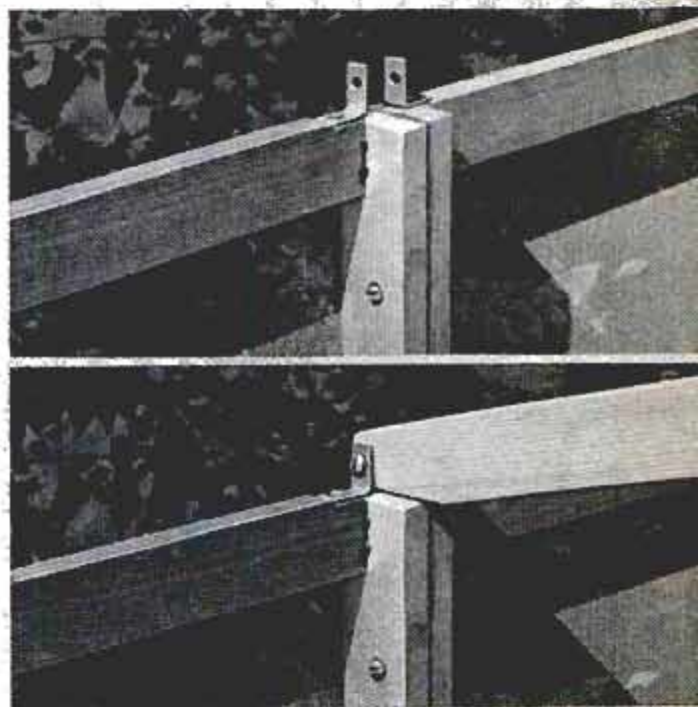
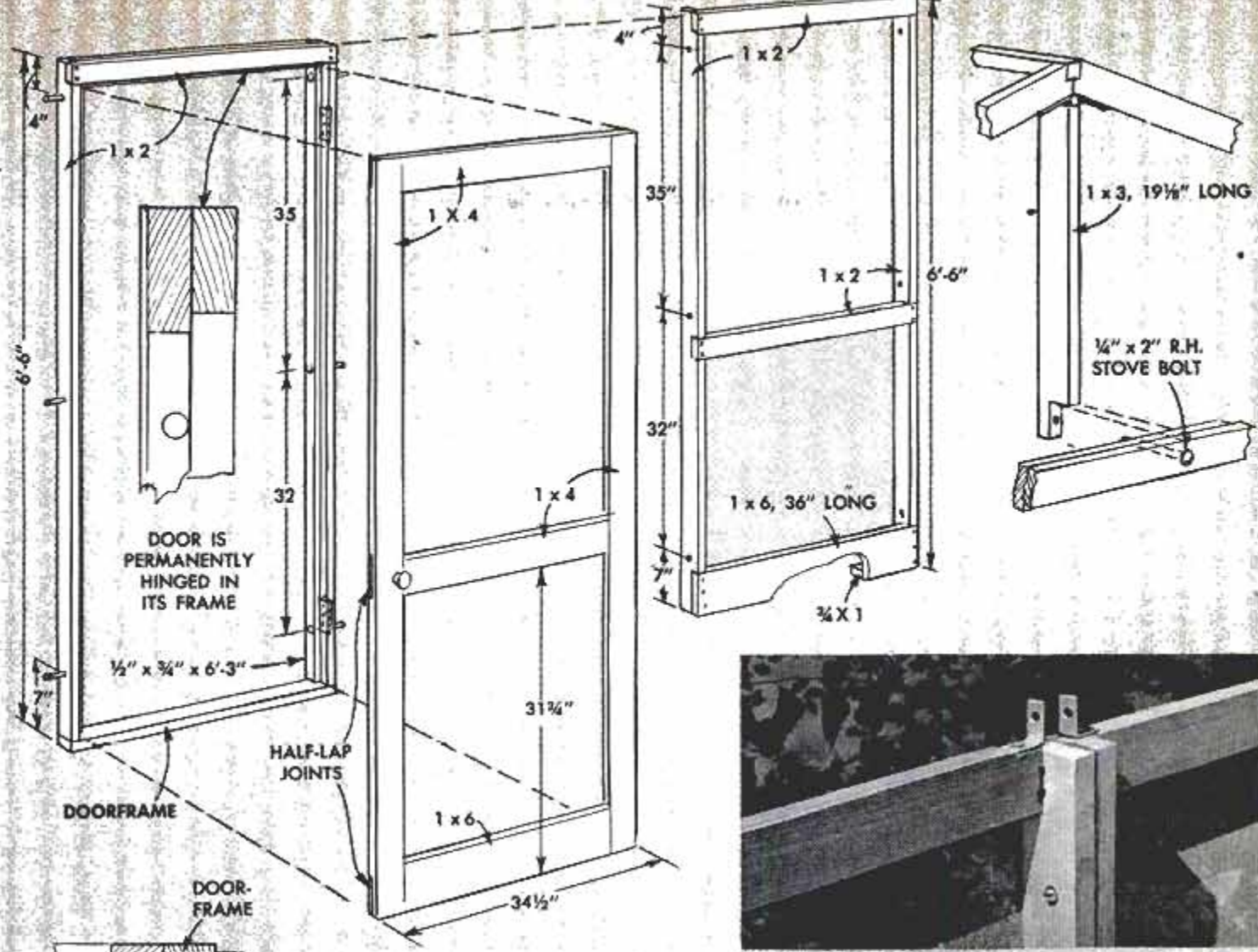

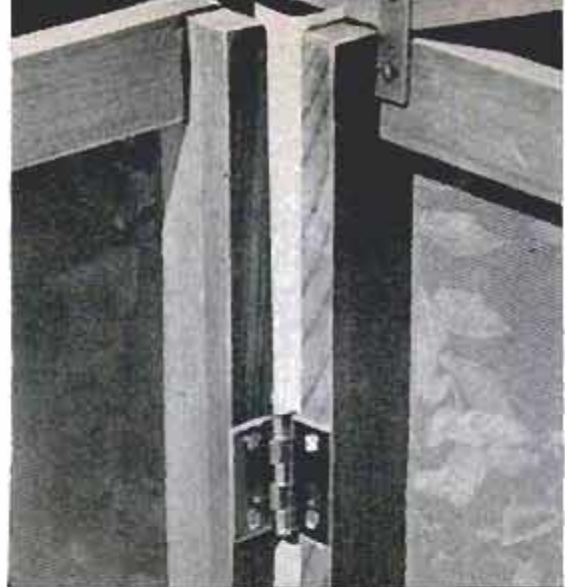

When assembling wall in which door is located, keep it as level as possible to assure doorframe does not twist out of shape. Photo at right shows how tape is stapled over hinged joint on corner sections of house

and coated nails. While any type screening can be used to cover the frames, glass-fiber screening, manufactured by the Lockset Screening Co., Inc., Canton, Mass., was used. This type screening is light in weight, requires no painting and does not stretch out of shape when objects are bumped against it. Staple the screening to the frames, then cover the edges with molding.

To permit "staking" the house to the ground, a fourth crosspiece, or anchor cleat, can be fitted in each section at the bottom, between the uprights and against the bottom crosspiece. Or, as an alternate method,  $\frac{3}{4}$  x 1-in. strips can be added at the bottoms of the corner sections only. Two methods of staking the house are shown in details A and B on page 166.

The doorframe is made as detailed on page 167. Note that the two uprights, or jambs, are cut  $\frac{3}{4}$  in. shorter than the other sections since the bottom member nailed to the ends makes the finished frame the same height as the other sections. Door-stops, consisting of  $\frac{1}{2}$  x  $\frac{3}{4}$ -in. strips, 6 ft.

Hinged rafters are bolted to corner angles on wall sections. End rafters bolt to flats on end walls

3 in. long, are fitted inside each jamb. The door is hinged permanently in the frame.

Use the frame to determine the dimensions of the door, which should have  $\frac{1}{8}$  in. clearance all around. The stiles, upper and middle rails of the door are 1 x 4 stock and the lower rail is 1 x 6 stock.

The 1 x 2 roof rafters are cut as shown and hinged together in pairs. Cut the notches at the ridge ends carefully so they clamp the ridge board when the roof framing is assembled. As indicated on pages 166 and 167, the rafter ends are bolted between corner angles screwed to the top corners of each wall section. The end rafters are held by pieces of flat steel bolted to the corner sections as indicated. A 1 x 3 vertical support is fitted between the undersides of the end rafter peaks and the end walls.

It is suggested that the canvas roof be made by an awning shop, since most home sewing machines cannot sew canvas and hand sewing would be a tedious task. The house is assembled with  $\frac{1}{4}$  x 2-in. round-headed stove bolts. ★ ★ ★

Support for peak of canvas roof is provided by ridge board fitted in notches cut in peak ends of rafters

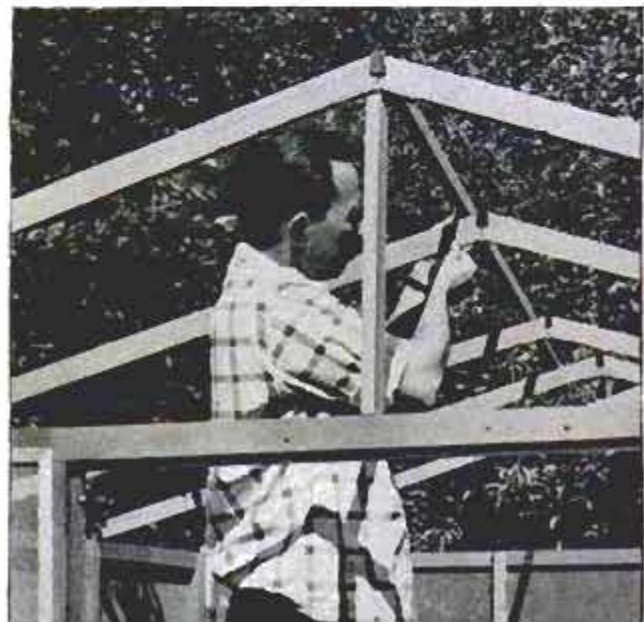

# Simple Table for Sickroom Slides on Bedrails

Ideal for holding food, magazines, a lamp and other items for a bed patient, this table can be slipped on or off the bedrail in a moment, or it may be slid along the rail and located at any point from the head of the bed to the foot ends of the bed. Made of  $\frac{1}{4}$ -in. plywood, the table has two "decks," the lower one for holding magazines. The bracket that holds the table is doubled at the bottom and fitted with a spacer so that it fits the bedrail snugly. Apply a durable, stain-proof material on the top of the table.

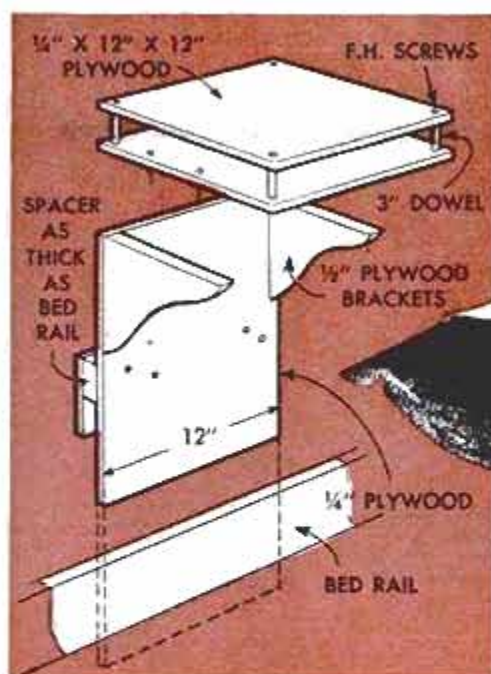

## Foil Shields Corsage Pin

Common pins used for attaching flowers, ribbons or identity cards to clothing at social meetings can be shielded with metal foil to prevent loosening and also possible injury. A strip of foil is held on the back of the fabric so that the pin is pushed through it at two points. Then the ends of the foil are wrapped around the head and point of the pin, as shown in the illustration.

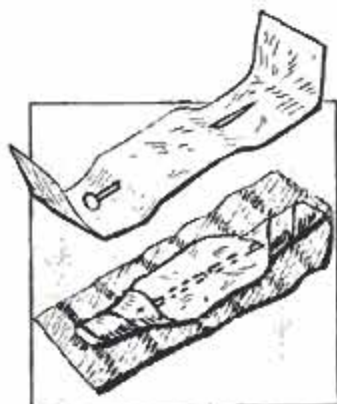

## Painting Ship's Water Line

Greater success in painting water lines on ship models is possible if masking tape is applied above and adjacent to water line and the hull is painted carefully up to the tape after painting the bulk of the surface. First, lay the hull upside down on blocks and scribe the water line with a surface gauge. Then apply the masking tape along the line and burnish it down until the contact is absolute. Next, brush on the paint, being sure it has the proper consistency. Cover the surface away from the tape first, then paint up to the line with a rather dry brush. There will be less tendency for the paint to crawl up under the tape causing an indistinct line. Remove the tape after the paint is dry.

Paul Strayer, River Forest, Ill.

## Soiled Book Edges Cleaned With Fine Sandpaper

When the edges of books become badly soiled, they can be cleaned by using fine sandpaper fitted around a curved sanding block (right). Use a block which has approximately the same curvature as the book edges. Sand lightly, using just enough pressure to remove the stained portion of the paper.—Ken Murray, Colon, Mich.

## Stop Brass Tarnish

Brass items that need constant polishing can be protected against tarnish with a coat of clear metal lacquer. Be sure the surface is clean and free of polish before applying the lacquer. A second coat will give added protection.





Material excavated for the basement is used as fill to raise the lower level of this lot above the street



Above, the height of the box at its corners corresponds to the elevations at the corners of the lot. Below, surface of the sand should be shaped to approximate the contours and grades found on the lot

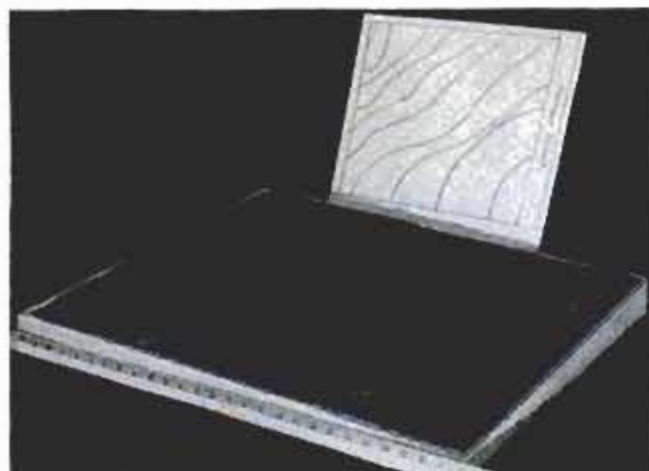

## Do You Have a

**WOULD YOU LIKE** to see how your new house will look on a landscaped lot—before the house is built? You can, simply by making a scale model of the house and lot selected. There will be many practical uses for the model in addition to showing the best position for the house on a lot that is below the street level or on a hillside, perfectly flat or a series of gentle slopes. For example, the scale model will make it possible to determine in advance whether the excavation for a basement will provide enough fill for the landscaping. Also, it will be easier to find the most suitable location on the lot for the house, and to decide whether to raise or lower the floor line above the present grade. Sometimes moving it a few inches up or down will save moving tons of earth and yet obtain the most pleasing landscape.

The model of the house can be built of cardboard, using the over-all dimensions as provided in the plans, on a scale of  $\frac{1}{4}$  in. to 1 ft. Fabricate complete walls and roof sections, glue the assembly together and decorate the exterior.

The first thing that is needed to reproduce the lot in miniature is a contour map of your lot. This must be drawn to the same scale as the model of the house. Show elevations at all corners of the lot as shown at the bottom of this page. With this information at hand, cut four sides and a bottom member from pieces of an orange crate and nail them together in the form of a box, such as the one shown on these



This house is set deep in the lot on a two-level terrace to accent its low profile and spaciousness

## LANDSCAPE PROBLEM?

pages. Each side will represent a boundary line of your lot with the top edge sloped to conform to the elevation indicated on the contour map. Fill the box with damp sand and shape the surface of it to approximate the actual grades and contours.

The real fun begins when the model of the house is placed on the miniature lot and the old surface is reshaped into new grades and contours which will accent important features of the design of your house and give it individuality.

Using the scale model as a basis for estimating ground-fill requirements for landscaping, balance the amount of soil excavated for a basement, driveways, etc., against the amount of soil required for fill. This will enable you to design a landscape that will require an amount of fill exactly equal to the amount of earth excavated.

H. H. Connelly, Pickens, S. C.



Above, the real fun begins when you experiment with different locations for the house on the scale model. Below, after positioning the house, reshape the surface of the lot to approximate the desired contours





### Stove Clock Fitted in Box Used as Darkroom Timer

The timer on the back panel of an old gas stove can be put to good use when it is fitted into a wooden cigar box and used as a darkroom timer, or in the office to make sure you do keep your promise to call back in ten minutes. Also, it can be used to keep the time down on long-distance telephone calls.

### Tape Makes Waterproof Seal Between Sink and Cabinet

To prevent water from dripping down between a sink and the cabinet next to it, close the gap with a strip of waterproof adhesive tape. First, a narrow strip is applied over the joint to act as a support, followed by a wider strip on top. To secure tape ends, cut them to follow the contours of the sink edge and the cabinet corner at the juncture.

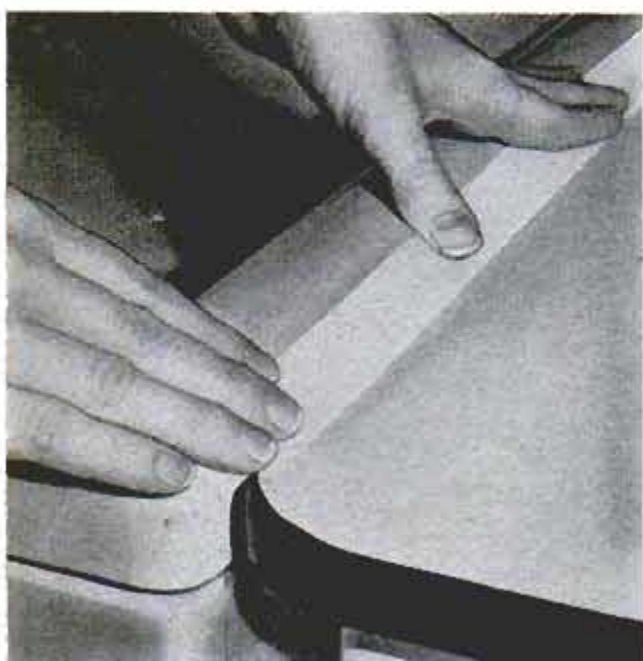

### Tank-Type Vacuum Cleaner Defrosts Home Freezer

Home-freezer defrosting can be accomplished more rapidly, after food has been removed, by blowing warm air into the box with a tank-type vacuum cleaner. Plug the attachment hose into the blower end of the cleaner and direct the air at the edge between the side of the box and the accumulated frost, starting at the top and working down. Scrape the frost from the side and bottom with a plastic scraper, such as the ones used to clean car windows in cold weather.—John Stankiewicz, Nixon, N. J.

### "Self Supporting" Paintbrush Keeps Paint off Surface

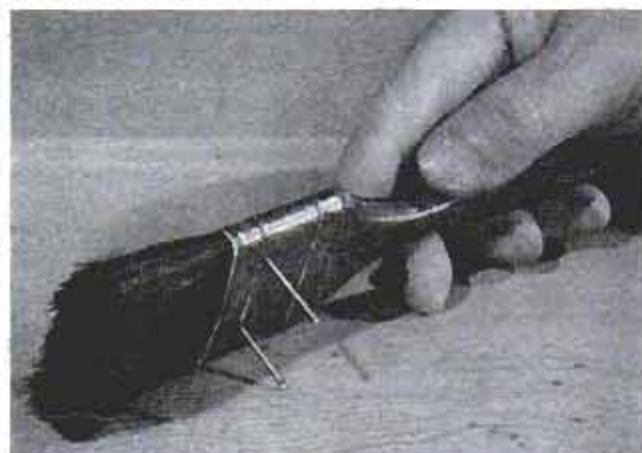

Drive a couple of small nails into the ferrule of your paintbrush as shown, and it can be laid on any surface without smearing it with paint. The nails serve as legs to support the bristles above the surface.

### Block of Insulation Board Holds Fishhooks Safely

Snelled fishhooks can be stored safely in the tackle box if they are inserted in one end of a small piece of insulation board. The other end of the board is slit to take the leaders. In addition to being a safe storage method, the board makes selection of hooks



easy and prevents them from becoming entangled with each other. Hooks to which leaders have not yet been attached can be pushed into the sides of the board. For convenience, fasten the board to the inside of the tackle-box lid.

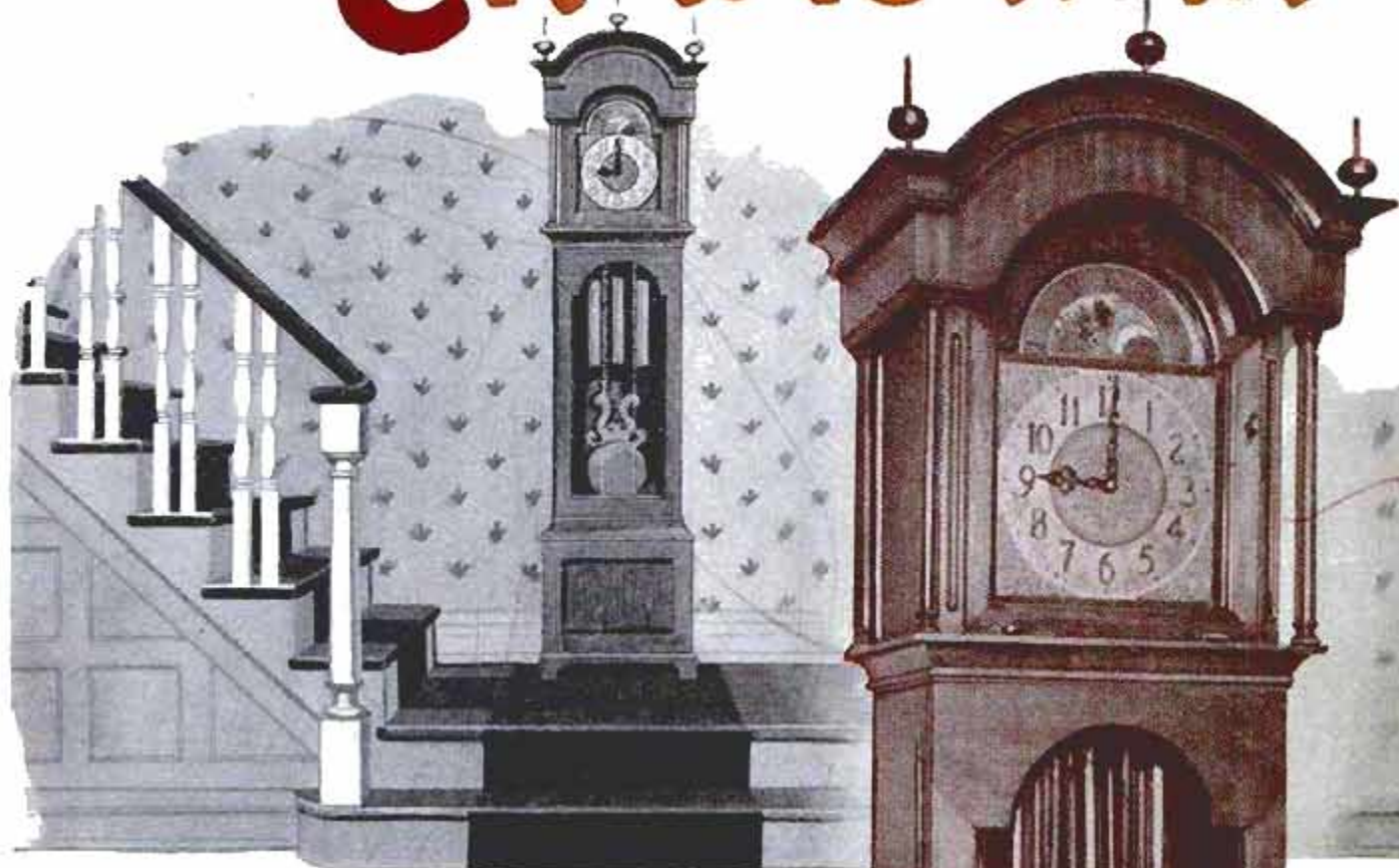

# TIME

## TO BUILD A CLOCKCASE

*Have you wanted a grandfather clock? They're a real luxury item if you buy one, but by making the case and installing a clock movement you can possess one at half the store cost*

### PART I

**A**LMOST EVERYONE has had the desire to own a beautiful grandfather clock. The charm and grace it radiates through the years reflect the character and personality of the proud owner. And pride of workmanship in building it yourself will give added enjoyment through the years. The movement in the case pictured at the right is a deluxe one, but less expensive movements are available. Cases in kit form to assemble and finish yourself also are available.

In this series of articles on clockcases you will be shown, in addition to the grandfather clock, how to build a grandmother clock, which is smaller in size, and two wall cases, one of modern design and the other traditional. Part I details the construction of the grandfather clock.

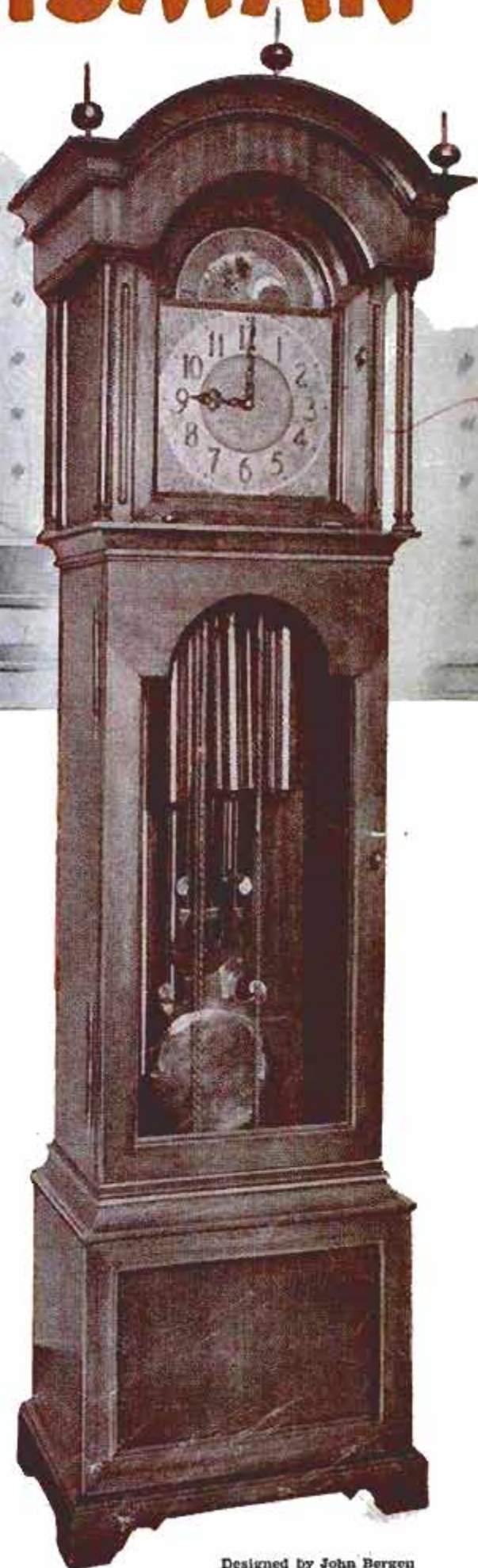

Designed by John Bergen

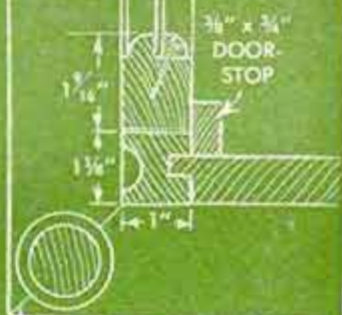
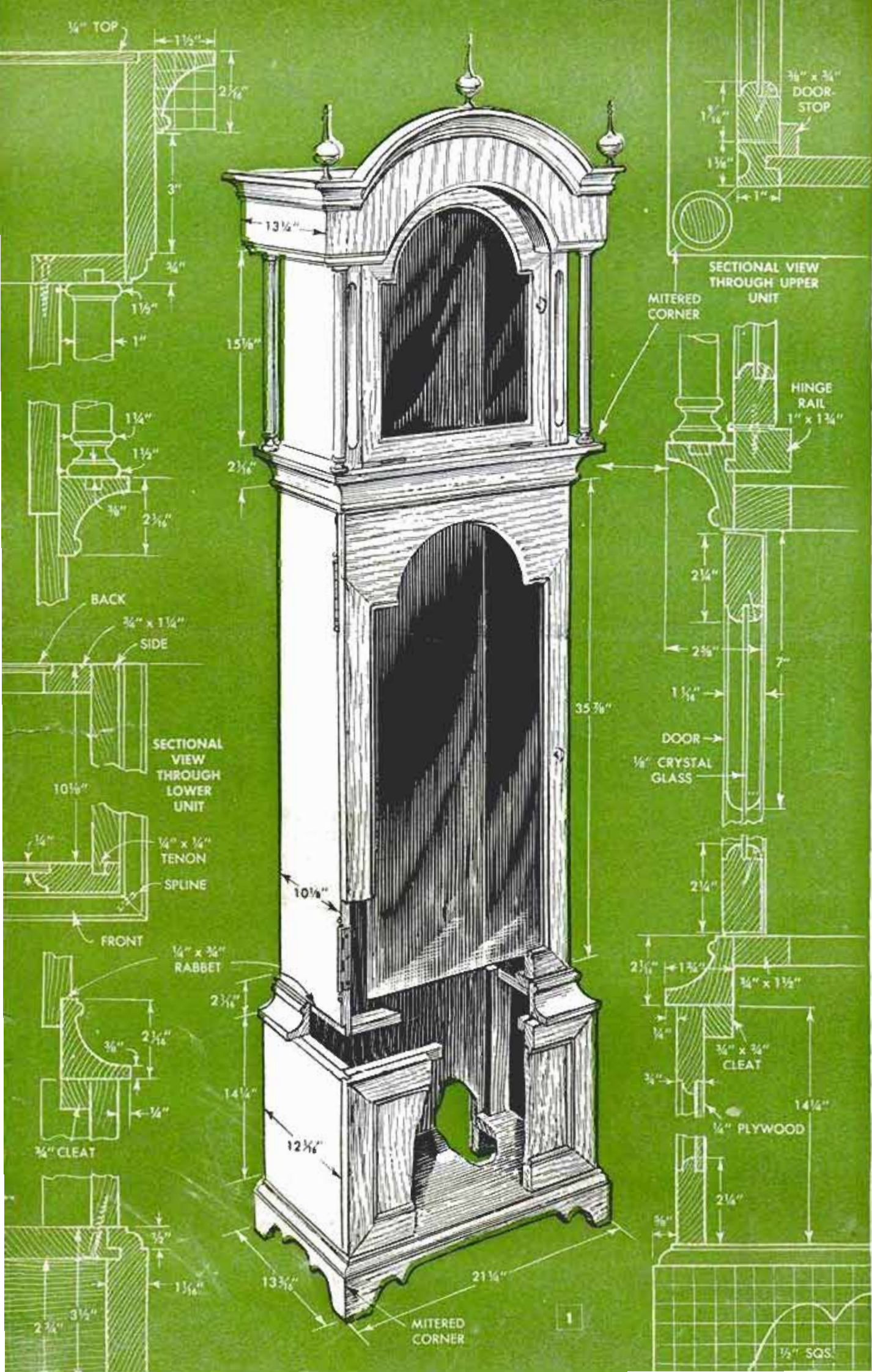

SECTIONAL VIEW THROUGH UPPER UNIT

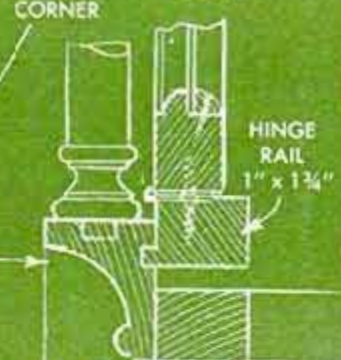

SECTIONAL VIEW THROUGH LOWER UNIT

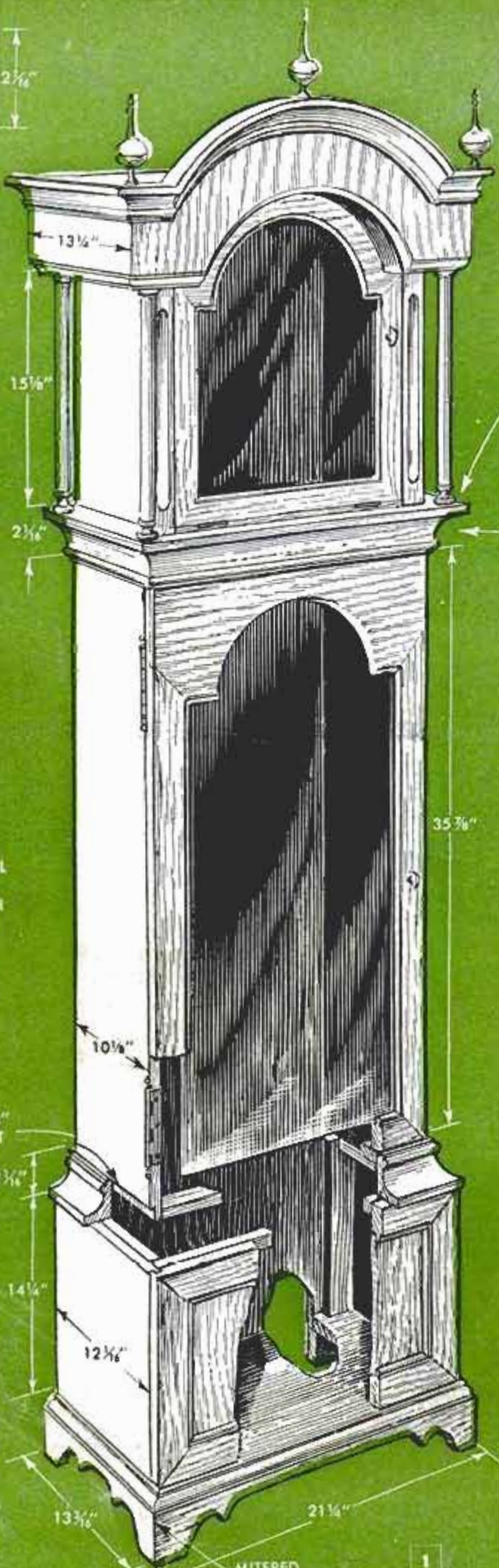
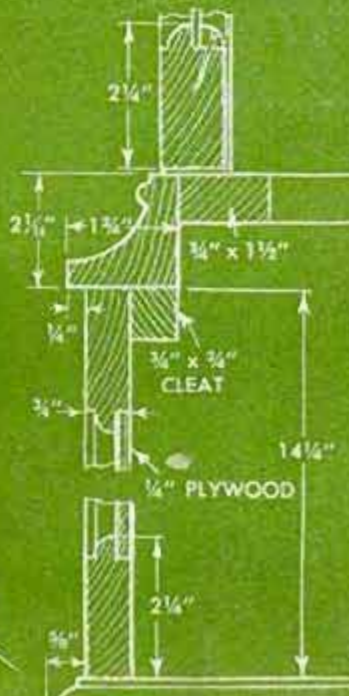
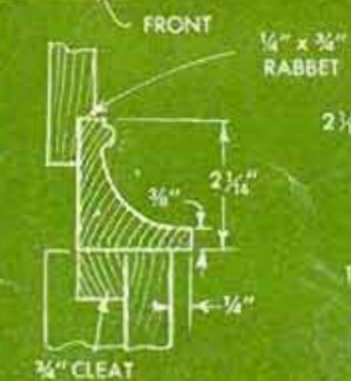
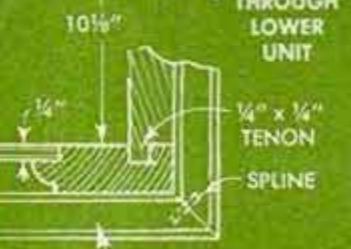



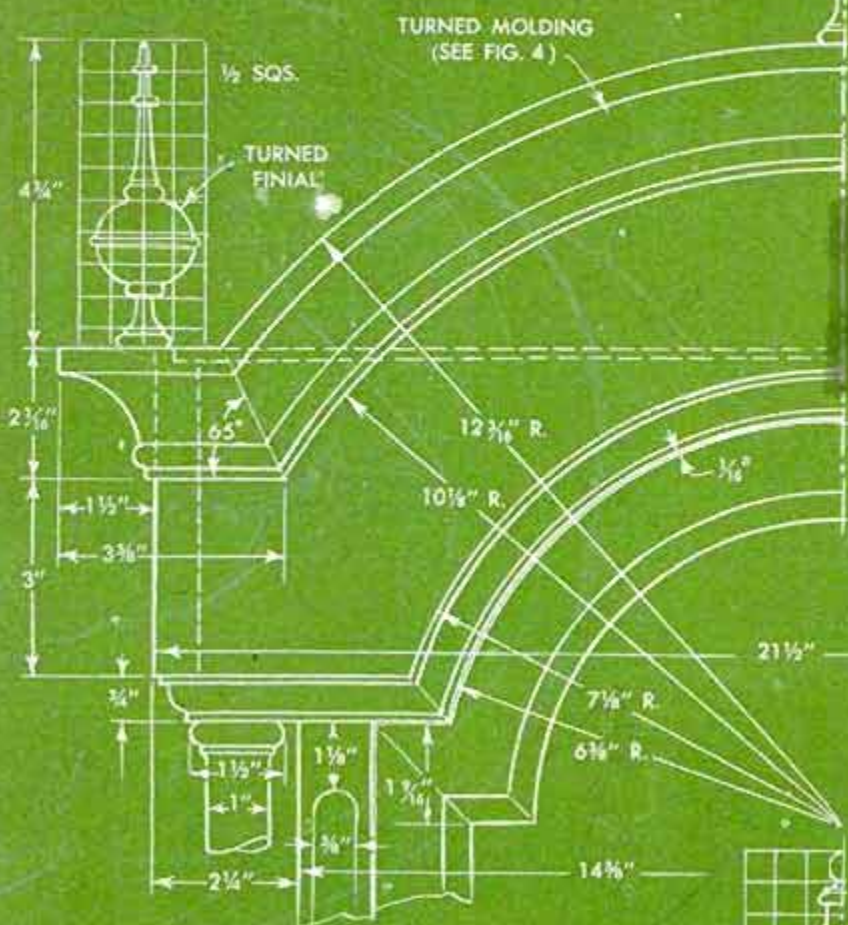

2

SECTION A-A

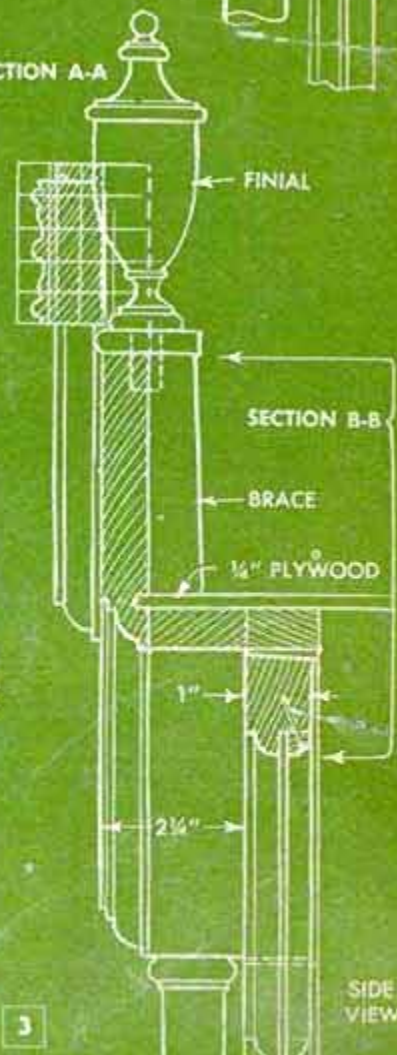
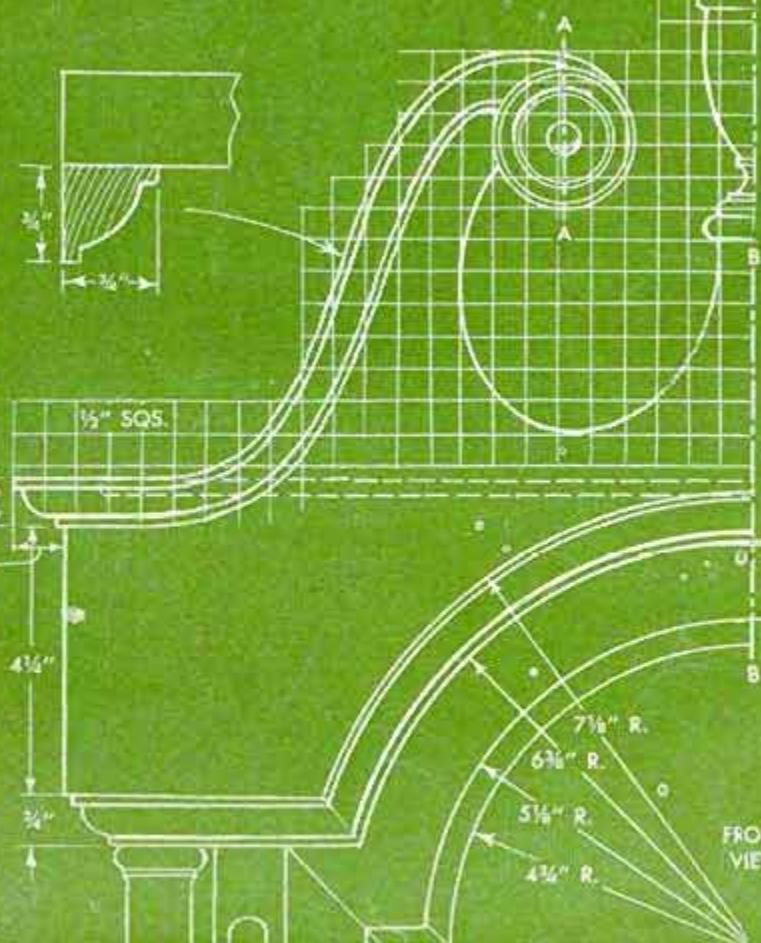

3

ALTERNATE HOOD DESIGN HOOD LAYOUT



ATTACH DISK TO LATHE FACIPLATE

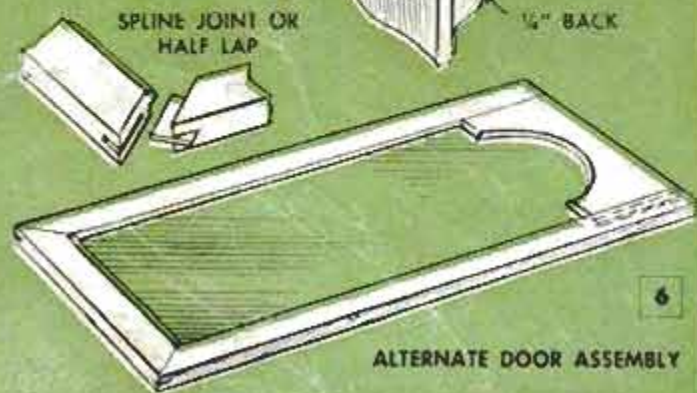
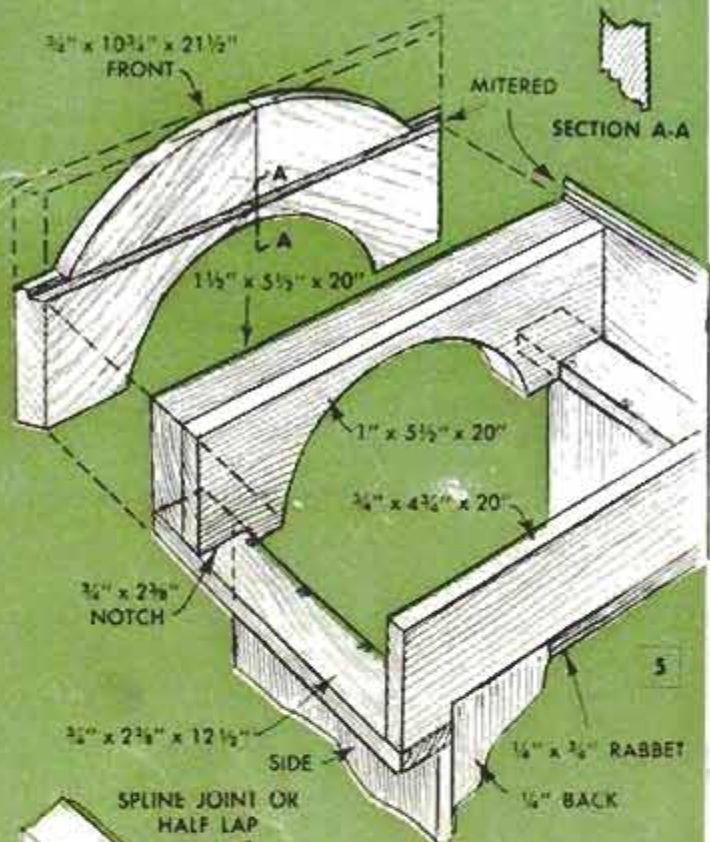
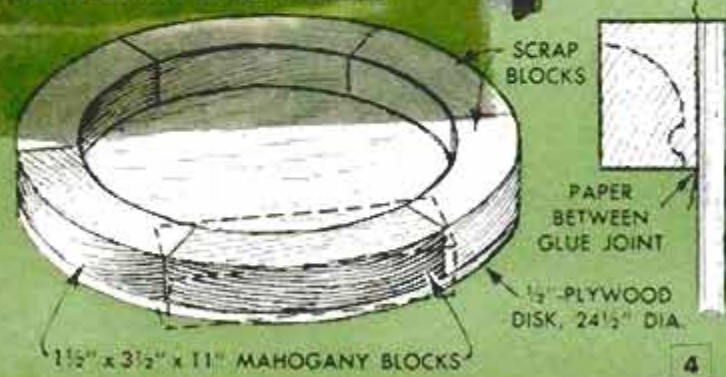

Beautiful Honduras mahogany is the wood to use in duplicating this elegant case. The case consists of three sections, namely, the base, waist and hood. After studying Fig. 1, begin making the base unit. As the bottom of the base is not exposed, it can be cut from less expensive wood, such as common fir plywood. This measures  $12\frac{3}{16}$  x  $19\frac{7}{8}$  in. and is rabbeted along three edges to form  $\frac{1}{4}$  x  $\frac{3}{8}$ -in. tenons. The scrolled members which are added to the sides and front of the bottom board are grooved on the back to house the rabbeted edges, shaped along the top edges and then mitered and splined at the front corners. The grooves should be located so as to bring the scrolled members flush with the top of the plywood bottom. A plain board supports the bottom across the back.

Next step is to make the front panel. When completed, this should measure  $14\frac{1}{4}$  in. high and 20 in. long so it will set in  $\frac{5}{8}$  in. at the sides. The frame itself is made of  $\frac{3}{4}$  x  $2\frac{1}{4}$ -in. mahogany and is shaped and rabbeted on one edge before mitering and assembling into a frame. A panel of  $\frac{1}{4}$ -in. veneer-faced plywood, selected for quality of grain, is nailed and glued in the rabbet provided. The sides of the base measure  $12\frac{3}{16}$  in. wide and  $14\frac{1}{4}$  in. high. This allows for tenons which are formed along the front edges to engage grooves cut in the back of the front panel. After gluing the side panels to the front, the sides are sanded to make the joints perfectly even. Now the assembly can be glued and screwed to the top of the base-board, driving the screws up into the edges from underneath. Cleats,  $\frac{3}{4}$  in. sq., are added to the front and sides at the top, on the inside, to increase the thickness of the edges, after which rabbeted members are fitted at the rear corners to support the plywood back. Cove molding is now mitered, glued and screwed to the top of the base to support the waist section. You can have the molding shaped at a local millhouse or you can make it yourself by first beveling a sufficient length of square mahogany and then forming the cove on the beveled face. This is done by passing the work repeatedly across the saw blade at an angle and keeping it against a wooden fence clamped to the table. The blade should project only about  $\frac{1}{16}$  in. above the saw table to begin and should not be raised more than  $\frac{1}{16}$  in. after each pass of the work. The angle of the fence should be such as to produce a cove cut which approximates the shape of the molding shown. This is found by experiment. No attempt is made to form the bead as a part of the cove; this is a separate strip which is glued and bradded in place after sanding the cove smooth. Making cove molding with a circular saw was fully

described in the October 1954 issue of *Popular Mechanics*.

### Waist Section Comes Next

The side members of the waist section measure  $10\frac{1}{8}$  in. wide and 38 in. high. A  $\frac{1}{4} \times \frac{3}{4}$ -in. rabbet is made at the lower ends to form shoulders to rest on the cove molding around the base section. The upper ends of the sides are rabbeted also for the cove molding that is added when the hood is ready to be attached to the waist. Next, a  $\frac{3}{4} \times 1\frac{1}{2}$ -in. strip is fitted across the front of the waist at the bottom, placing it between the sides and gluing and fastening it to the cove molding. A similar member,  $\frac{3}{4} \times 2$  in., is fitted between the sides at the top and in line with the shoulder of the rabbeted cut. After this, rabbeted uprights are added to the sides along the rear inside edges to receive the back panel of the case. This completes the waist section, except for the door, which is left until last.

### Hood Requires Most Work

Next comes the hood. This is the most involved part of the case. The sides for the hood measure  $\frac{3}{4} \times 10\frac{3}{8} \times 15\frac{1}{8}$  in. The width allows for a  $\frac{1}{4}$ -in. rabbeted tenon which is cut on the front edge to fit a grooved, fluted post measuring  $1 \times 1\frac{1}{8}$  in. The rear edges of the sides are rabbeted to receive the removable back panel. The sides can now be attached to the waist as shown in Fig. 7, driving screws into the cove molding from the inside. The molding across the front is supported by a rabbeted member that fits in a  $\frac{1}{4}$ -in. groove cut in the back of the molding. Fig. 5 details the upper part of the hood, and Fig. 4 shows how the stock for the turned portion of the crown molding is cut in segments and glued to a plywood disk for turning on the lathe. Notice that only two of the segments are of mahogany as these are the only two sections of the turning that are actually used in the curved part of the crown molding. The two mahogany blanks of the turning are glued to the plywood disk with paper between the joint so they may be easily pried free after being turned. Fig. 5 shows how the hood is built up, the thick block at the front being made of two separate thicknesses. These are glued together, and then the ends are notched. The front of the block is faced with  $\frac{3}{4}$ -in. material that is made up of two pieces  $10\frac{3}{4}$  in. wide and  $10\frac{3}{4}$  in. long. See detail in Fig. 5. These are glued together edgewise, with the grain running vertically, and a  $\frac{1}{4}$ -in. groove is run across the back  $5\frac{1}{2}$  in. up from the bottom for a plywood top. The top of the front piece is sawed on a  $12\frac{3}{16}$ -in. radius to match the radius of the turned molding and then the ends are beveled 45



Yatex-American Mfg. Co. photo

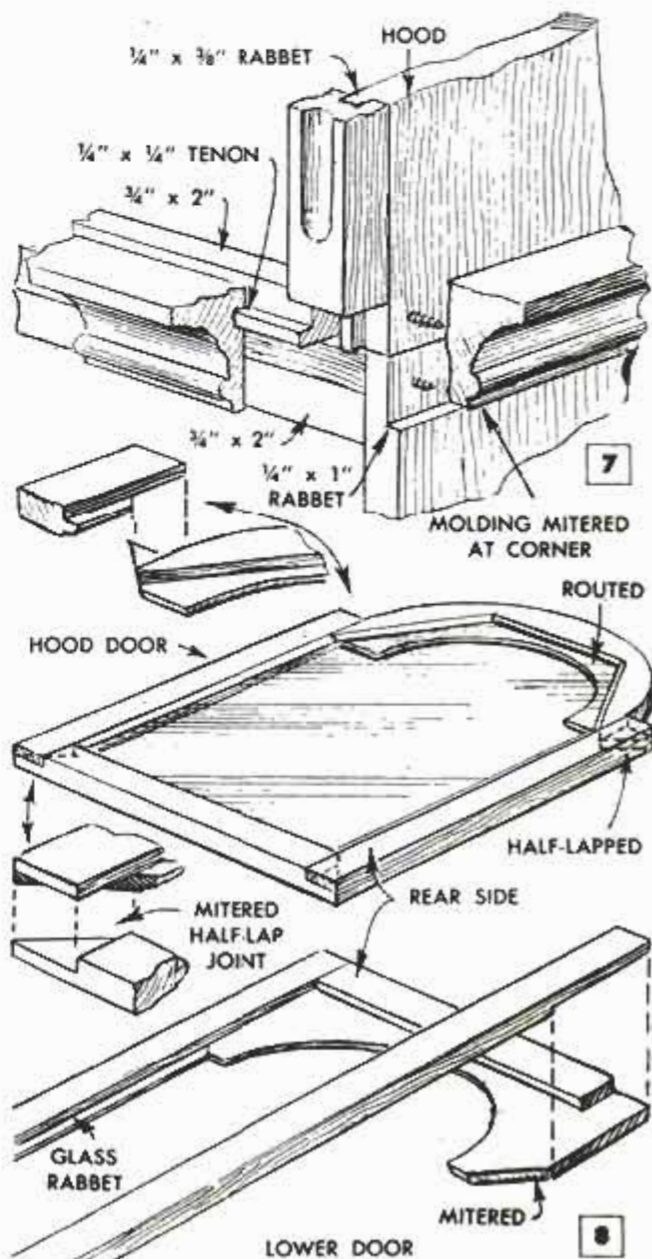



deg. When this is done, the front piece is glued to the face of the built-up block and the center of all three is sawed on a  $6\frac{3}{8}$ -in. radius. You'll notice in Fig. 2 that the front edge, including the curved portion, is shaped. This same cut is shaped along the side pieces of the hood. The back of the hood does not show and can be a piece of scrap wood,  $\frac{3}{4} \times 4\frac{3}{4} \times 20$  in. A blind rabbet is cut in the lower edge of this member to receive the plywood back panel.

The back and front members of the hood are supported by  $\frac{3}{4} \times 2\frac{3}{8} \times 12\frac{1}{2}$ -in. pieces which are screwed into the end grain of the side pieces of the hood. However, before these are permanently fastened, the four turned pillars which are mounted at the front and rear corners of the hood must be installed. Tenons are turned on the ends of the pillars to fit  $\frac{3}{8}$ -in. holes bored in the cove molding at the top of the waist and the underside of the  $2\frac{3}{8}$ -in. pieces. The pieces that cover the sides of the top assembly are mitered at the front ends, rabbeted along the upper edges and shaped along the lower edges to match the shaped edge across the front. The curved portion of the cove molding must be of the same section as the abutting molding so it



Here's what the upper part of the hood should look like when ready to install. Holes are yet to be made in the underside for the tenons on the pillars

matches perfectly where the two meet. The hood is completed by adding three turned finials. The details in Fig. 3 give an alternate hood design that is somewhat easier to make in that it does not involve the work of turning cove molding. Essentially, it is built up in the same way, a single finial being used at the center between two turned rosette overlays. In this design, the shaped molding that terminates in the rosettes is made by first shaping the edge of a wide board and then cutting off the edge  $\frac{3}{4}$  in. wide to match the contour of the scroll top.

#### Doors Are Fitted Last

Fig. 8 shows how the hood and waist doors are assembled. Mitered half-lap corners are used in assembling the frames of both doors. The waist door differs in the manner in which the frame is formed at the top. Here,  $\frac{3}{8}$ -in. plywood, with the grain running horizontally, is half-lapped into the frame after sawing out the curved section to provide a rabbet for the glass. The hood door, which fits between the sides, is hinged across the bottom and, therefore, the top of the frame must be beveled inward slightly for clearance. A strip is added to the right-hand side of the hood to provide a stop for the door. The waist door laps the edges of the waist section and is hinged along the side. Suitable clock hardware is available from suppliers of special hardware. The glass is held in the rabbeted edges of the doors with strips of quarter-round molding, tacking it in place on the inside.

Now, go over the completed case and sand it thoroughly, beginning with 2/0 paper and gradually changing to a finer grade. Always sand with the grain to avoid scratch marks. Slight dents in the wood can be raised level with surrounding wood by steaming. This is done by covering the dent with a damp cloth and applying heat with a household iron. Instructions for finishing the case will be given in Part II which will show how to build a grandmother clockcase, as well as two wall clocks.

(Continued next month)

## Lightweight Bathtub Seat Doubles as "Vanity"

Consisting of a piece of  $\frac{1}{4}$ -in. tempered hardboard screwed to two wooden cleats, this bathtub seat doubles as a bathtub "vanity." The hardboard fits directly on the tub and the curved ends of the cleats fit against the sides of the tub with only slight clearance. This arrangement prevents the seat from being dislodged accidentally from its right-angle relation to the tub sides. Finished in white or other color, the seat can be left on the tub when not in use, or can be conveniently stored in a closet.

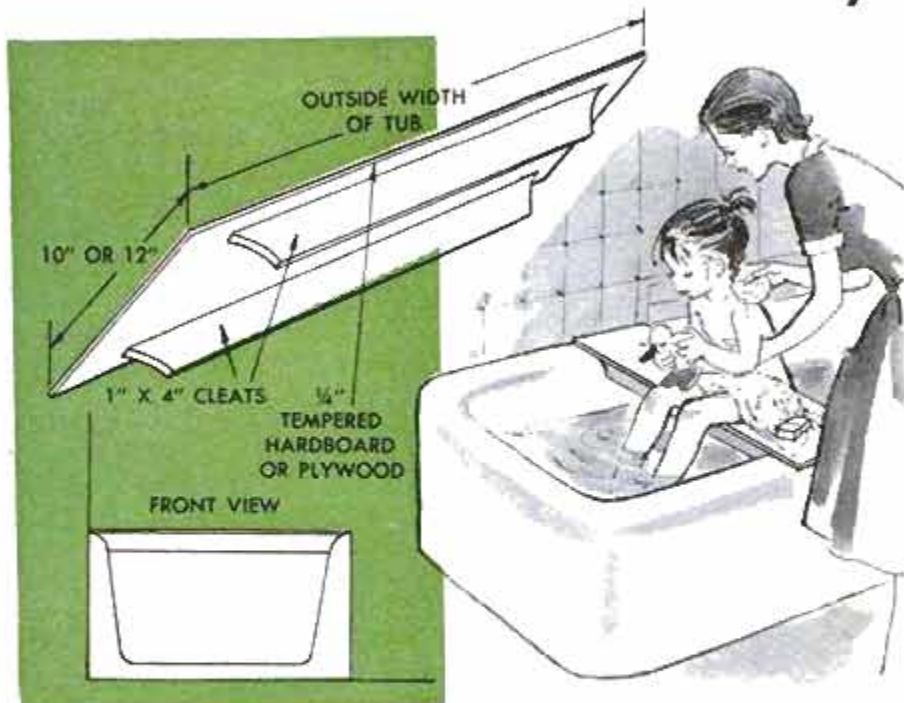

## Tools Kept Within Easy Reach On Improvised Stringer



Tools and materials used for home repair jobs can be kept conveniently at hand when attached to the stringer shown. A spring-type clothespin is tied to each end of a shoelace, which is then fastened to your trouser belt.

A roll of tape, screwdriver, hammer—with the handle inserted in the hole in the roll of tape—and other items can be slipped on the stringer or held by one of the clothespins, which can also be used as a spring clamp to hold wires together while making repairs.

## Rubber Grips Table-Saw Blade When Touching-up With File

When touching up the blade of a table saw with a file, the blade need not be removed from the arbor if a strip of sponge rubber is used to hold the blade firmly in position. Raise the blade to its highest setting,

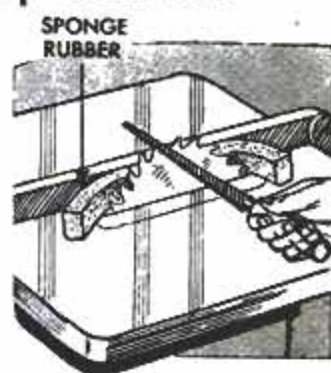

place the rubber next to it and force the rip fence against the rubber. The fence will have to be released and locked only a few times, since about one fourth of the blade can be filed before it must be turned to expose a new section. When not in use the rubber strip can be attached to the file with a rubber band.

## Small Holes Punched in Paper Bags Foil Noisemaking Urge

The urge of most children to blow up and "pop" empty popcorn bags can be defeated at get-togethers and church parties by punching holes in the sides of the bags in which popcorn and other refreshments are sold. A paper punch will do the job if only a few bags are used. If large quantities of bags are used they may be stacked and a drill run through them.

☐ If you want to know how much water a lawn is getting from a sprinkler, place an empty can within range and measure the water in it after a definite time interval.



## Air Conditioner in Living Room Cools Upstairs Bedroom

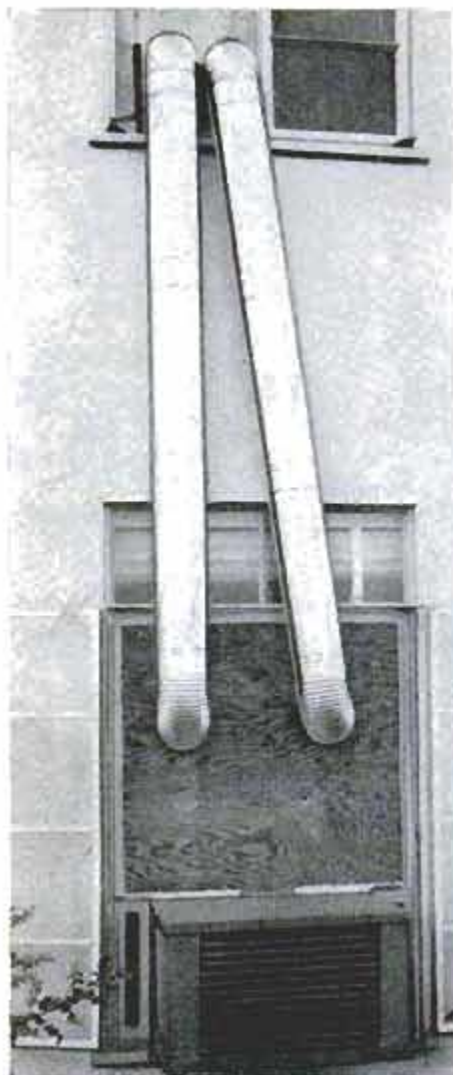

This room air conditioner was converted by one homeowner so that it can be used to cool his living room during the day and at night the same unit can provide air conditioning for a second-floor bedroom. The only materials needed to make the conversion are several square feet of plywood and a few lengths of stovepipe. First, an enclosure with a lid on one side is made that will fit snugly over the cool-air vent at the top of the machine, which is mounted on a living-room window sill. Then, one of the bedroom windows directly over the air conditioner is removed, a piece of plywood fitted in its place, and the stovepipes are installed as shown.

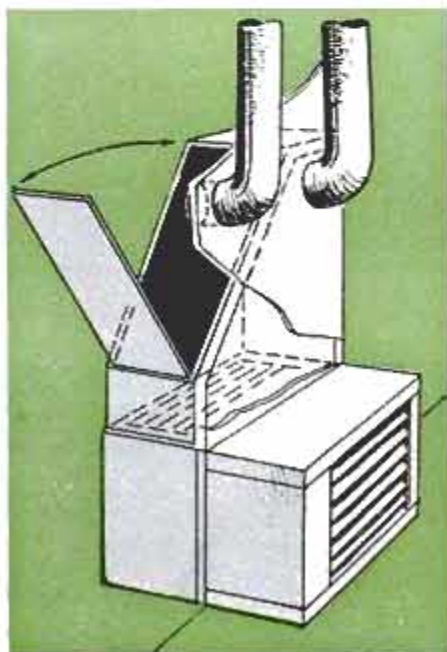

One pipe permits cool air to pass from the enclosure to the bedroom when the lid is on the enclosure and the machine is turned on. The other pipe permits warm air to pass from the bedroom to the living room below, where it is drawn in by the air conditioner and recirculated. When the living room is in use, the lid is removed and both pipe openings are covered with flue stops so that the cool air is circulated only in that room.—Capt. Arthur P. Thiesen, USAF.

## Legs for Modern Furniture Made From Spool Halves

Short legs with neatly flanged ends, ideal for use under small cabinets and chests of modern design, are made simply by sawing empty thread spools in half. Gluing is sufficient to hold the legs on lighter objects, while heavier furniture will require that the spool holes be countersunk or counter-bored to receive wood screws.

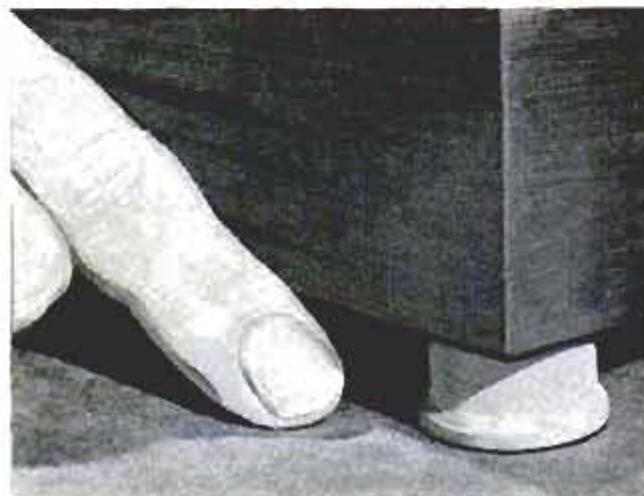

## Determining Approximate Speed Of Slowly Rotating Object

If a speed indicator is not available, the approximate r.p.m. of a slowly rotating shaft or wheel can be determined by counting lines scribed on it. While the object is rotating run a pencil across its face or down its length just fast enough to produce individual lines. Count the number of seconds re-

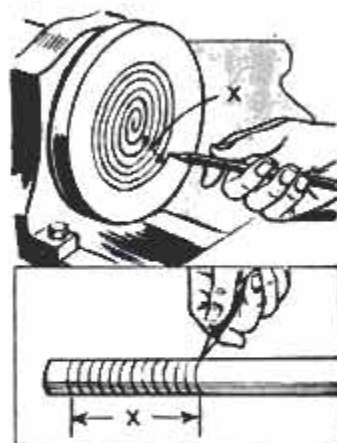

X IS NUMBER OF LINES  
SCRIBED IN MEASURED  
PART OF MINUTE

quired to mark across a specific distance, "X," and divide this number into 60. Multiply the resulting figure by the number of lines on the object and the product will be the approximate r.p.m. To increase accuracy, repeat the operation several times and take the average r.p.m. figure.

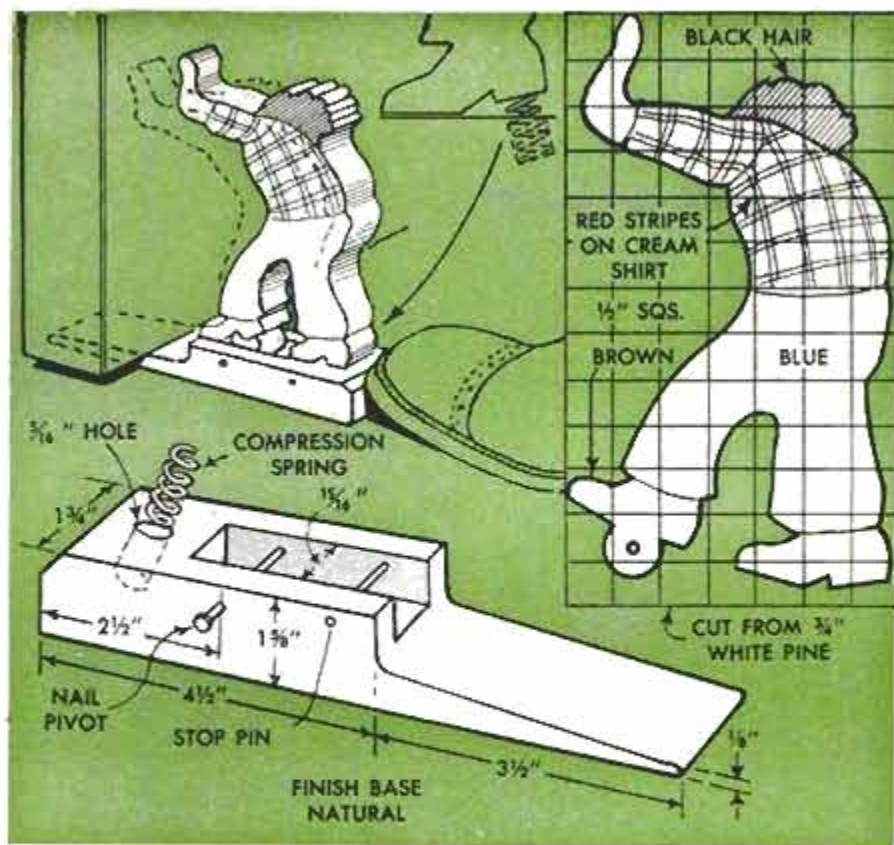

**Dan the Doorstop Man** is a colorful, animated worker you will enjoy having around the home. No matter how far the tapered base is shoved underneath the door, the little figure appears to be holding it open. A 3/16-in. compression spring under the heel of Dan's rear foot does the trick, forcing his hand against the door. An easy one-night project for the woodworking enthusiast.—Hi Sibley, Nuevo, Calif.

### Positive Steering "Gear" For Coaster Wagon

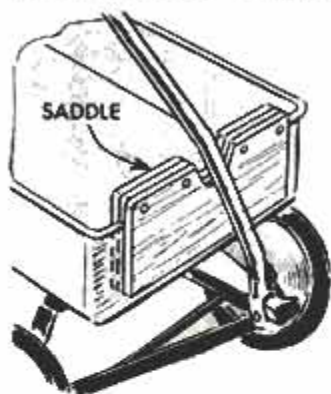

Steering of a coaster wagon is made surer and safer on the hills if the handle is centered in a notched guide which fits over the front end as shown in the detail. It consists of two lengths of plywood screwed to a spacer of a

thickness that will permit the assembly to fit over the front endgate snugly. If the wagon bed is of the type having sides and ends with wide top flanges, screw a single piece of plywood to the inside of the front end and make a notch at the center for the handle to rest on.

### Wax Marproofs Furniture Casters

A coating of floor wax applied to the treads of furniture casters will prevent scratches or streaks on hardwood floors. For heavy furniture, rub the wax on half of each caster, move it an inch and coat the remainder.

### Date Stamp Cleaned in Solution Of Dilute Ammonia Water

When a rubber date stamp has had much use it becomes coated with dried ink, making it difficult to turn the rubber strips to new positions. The stamp can be cleaned very easily by disassembling it and soaking the parts in a solution of dilute ammonia water until the ink is softened and can be brushed off. To take apart, push the retaining pin from the frame member, and the rubber bands, rollers and impression bar will lift away.



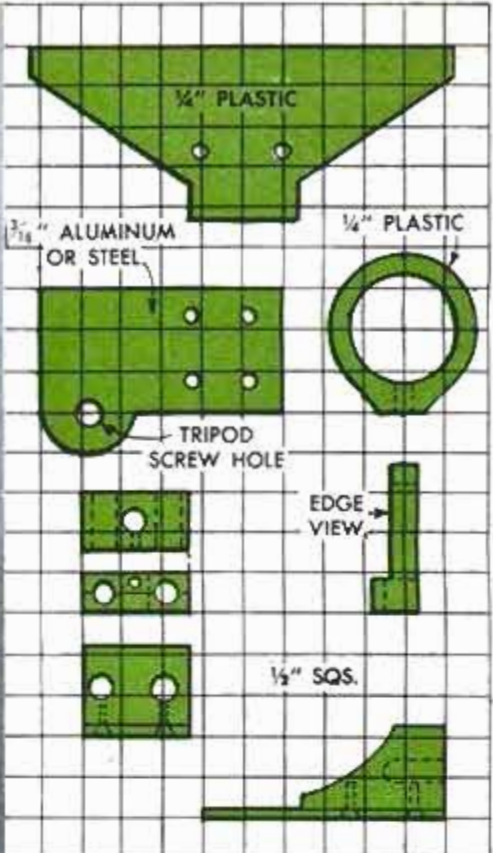

# Adjustable Sunshade for

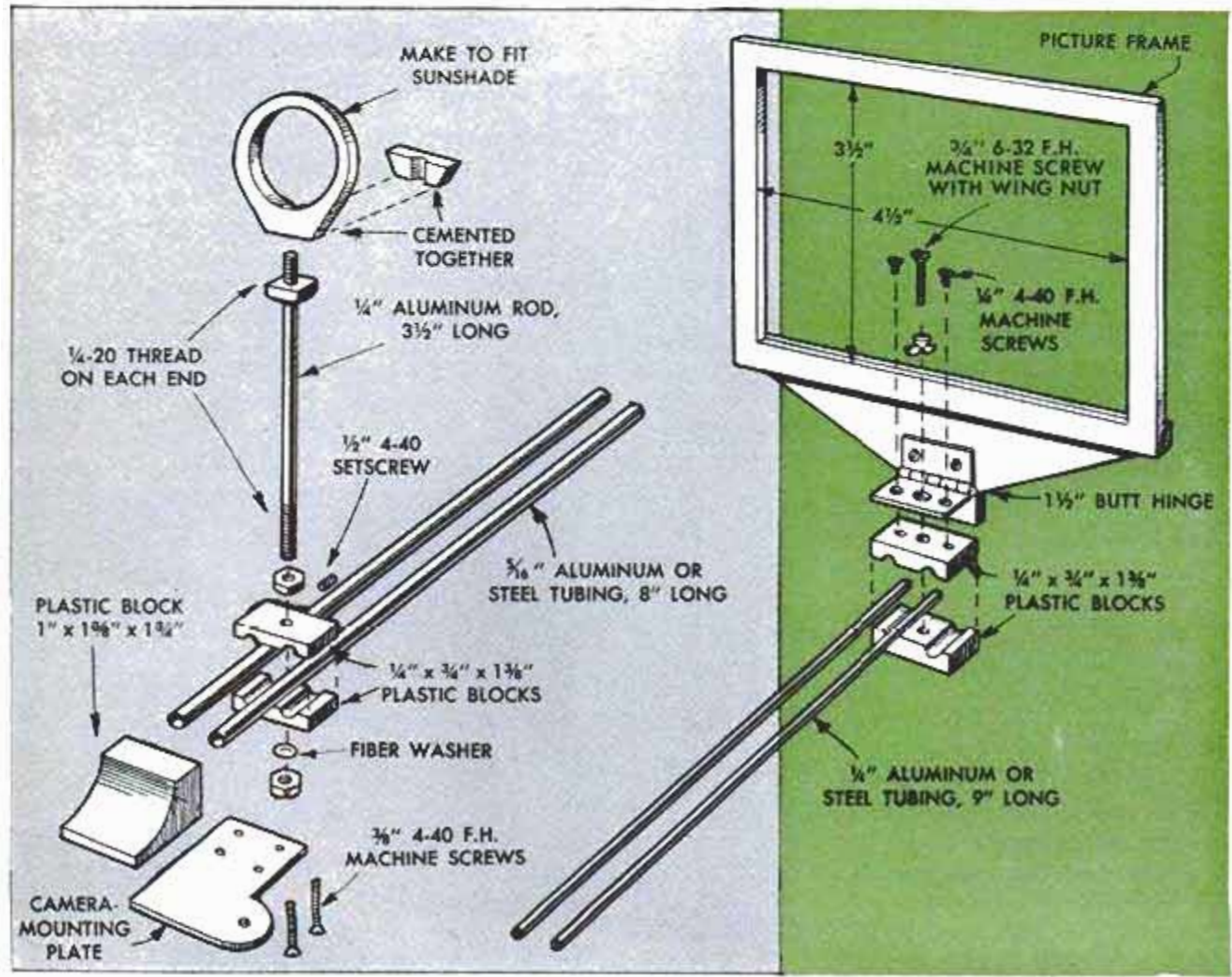



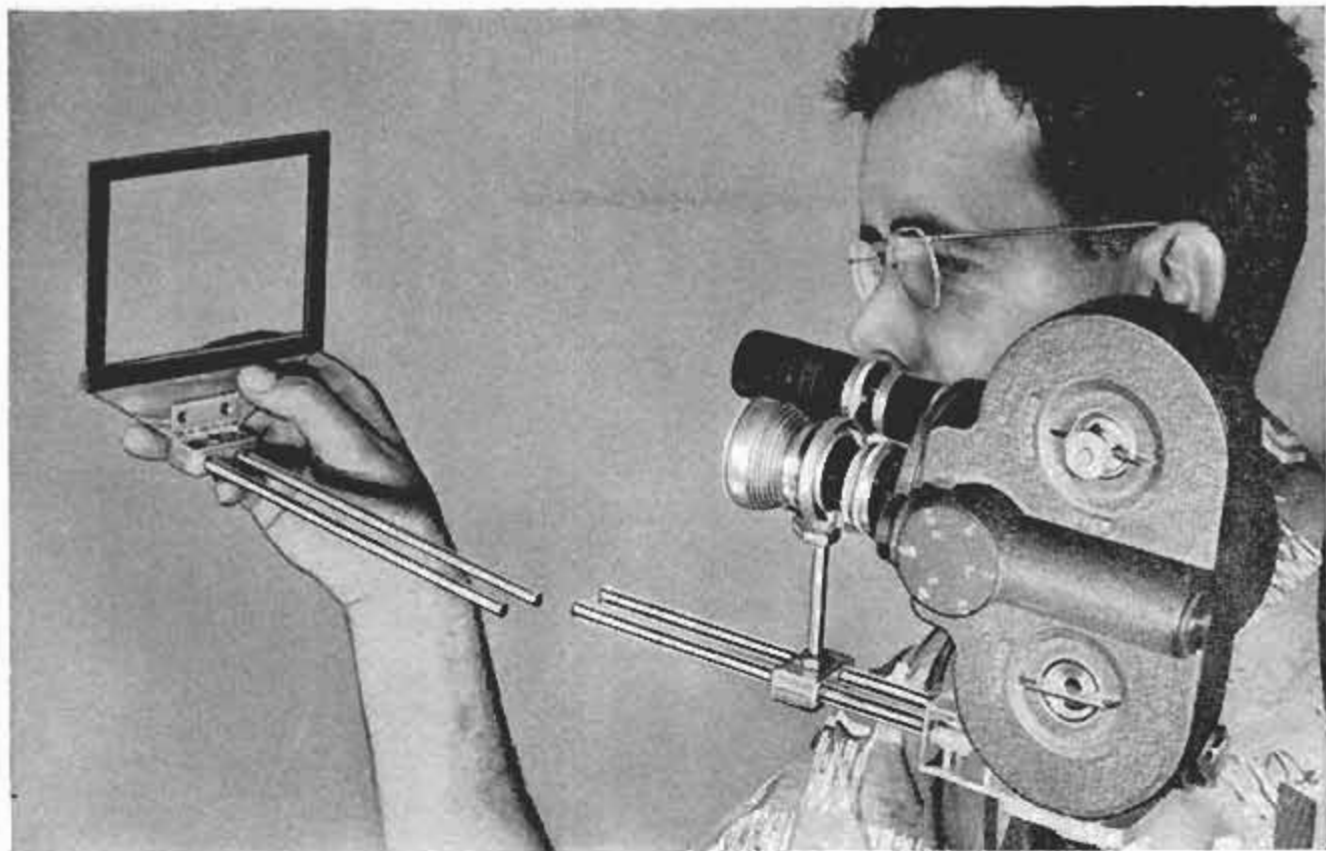

# Turret Camera

By M. G. Winterton

**T**HERE IS NO NEED for separate filters and sunshades for a movie camera equipped with trilenses when this sliding-sun-shade unit is attached to the camera. Unit consists of two parallel tubes or "rails" which are cemented in a block of plastic shaped to fit against the camera. Different makes of cameras will require the block to be shaped differently, but it should be located on the camera-mounting plate shown, so that it can be held on the camera by means of the tripod screw. A plastic clamp that slides on the rails supports a standard and plastic ring in which the sunshade is held. Filters may then be used in the sunshade. Sliding the clamp along the rails permits the sunshade to be adjusted so it will fit against any of the lenses, regardless of the length of the lens barrel. An additional advantage of the unit is that when a telephoto lens is used, the sunshade and rails act as a support to steady it against vibration from the camera motor.

Auxiliary close-up lenses also can be held in the sunshade by screwing an extra filter-adaptor ring into it. The regular view finder on the camera cannot be used when close-up lenses are fitted over the regular lenses, so it is necessary to add an auxiliary framing device to the sunshade unit. This

Above, picture-frame unit is mounted on slides that fit inside rails of sunshade unit. Frame centers subject and locates it at the correct focal point

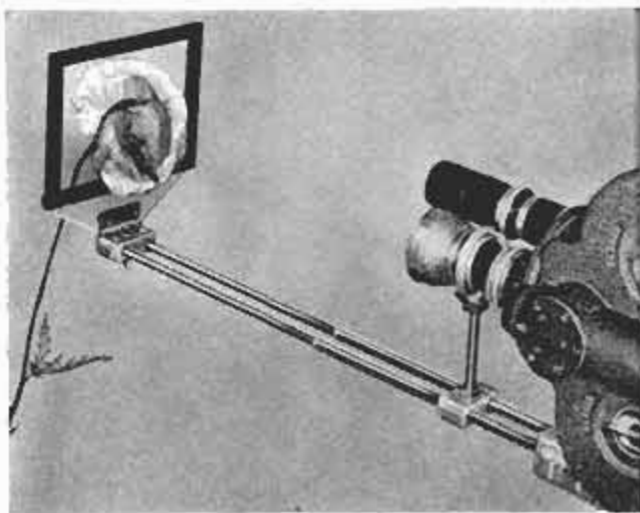

Use of frame permits holding subject fixed in relation to camera even though camera is unsteady

device consists of a wooden picture frame hinged to a plastic block in which are clamped a pair of parallel rods or tubes. These are designed to slide inside the rails of the sunshade unit. Subjects to be photographed then can be located the correct distance from any specific lens and centered in the picture as well.

As indicated in the detail, either steel or aluminum tubing can be used for the rails of the sunshade unit and the slides of the picture-frame unit. Aluminum is preferable, because of its lighter weight. Plastic used on the units should be an acrylic or other type which will take a sharp thread.

# 'Bookworm' Bookends Offer Novel Book Display

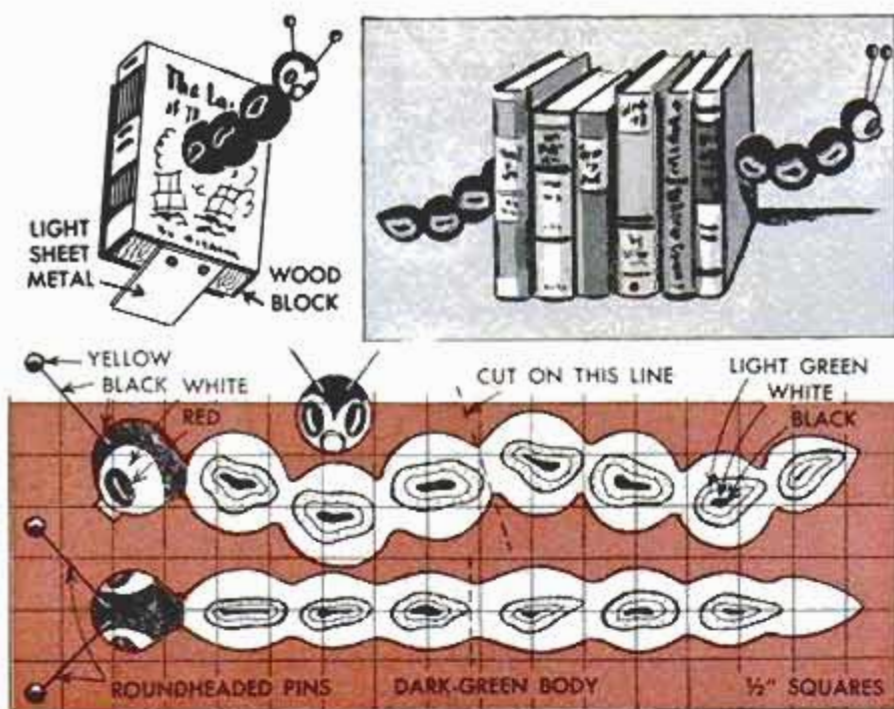

For an unusual yet practical display of pocket-size books one homeowner carved a "bookworm" from a length of  $\frac{3}{4}$ -in. lumber, painted it several colors as shown in the squared diagram, and fastened the "worm" on bookends made from book covers which were glued on squares of wood. After the covers are glued on, the "worm" is cut in half and one section is fastened on each book-end with a flatheaded screw. A piece of light sheet metal is fastened on the bottom of each book-end for support, as shown above.—A. M. Mortimer, Canton, Mass.

## Bevel on Butted Trim Boards Assures Tight-Fitting Joints

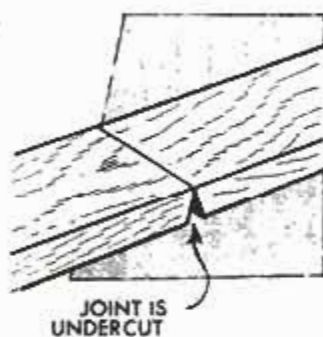

Butt and miter joints in wooden doorframes can be made to fit tight by undercutting the joint as shown. In actual practice, very slight bevel is made on the joining members for a better fit.

## Paper Cups and Tape Support Sales Cards

Paper cups are used by one sales clerk to hold small sales cards in an upright position on a showcase. The cups are taped to the backs of the cards flush with the bottom edge, as shown.

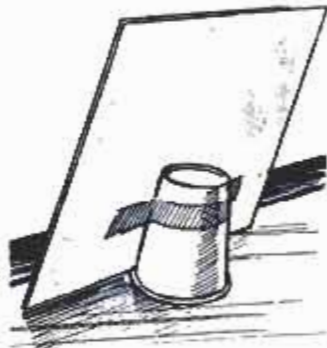

## Weather Vane Indicates Wind Direction on Vertical Dial

There is no guesswork about which way the wind is blowing with this weather vane that indicates wind direction on a large

dial face. The dial is cut from hardboard or plywood and bolted to a U-shaped bracket bent from  $\frac{1}{8}$  x  $\frac{3}{4}$ -in. flat steel. A shaft for the indicator needle rotates in a bushing soldered into a hole drilled in the bracket. The vertical shaft of the weather vane is a length of  $\frac{3}{16}$ -in. bronze welding rod. It rotates through the short arms of the U-shaped bracket and rests on a thrust bearing under the bottom arm. Pieces of sheet metal and  $\frac{1}{4}$ -in. tubing are used for the vane arrow. Bevel gears transmit wind direction from vane to dial.—James Whiteley, Olcott, N. Y.

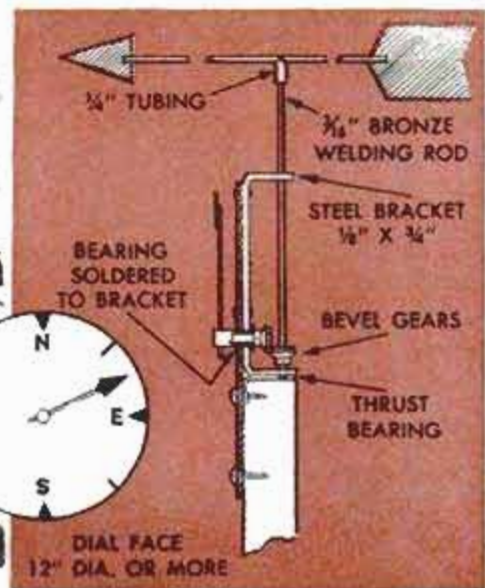

## Vacuum Fitting Cleans Camera

Cameras and other small devices are easy to clean with this vacuum-cleaner attachment. Cut a wooden disk that will fit snugly into the fitting on your vacuum-cleaner hose. Then, drill a hole in the disk, insert one end of a length of rubber tubing as shown, and secure it with glue. Various cleaning accessories, such as the brush and metal tubing shown, can be made for use with attachment.

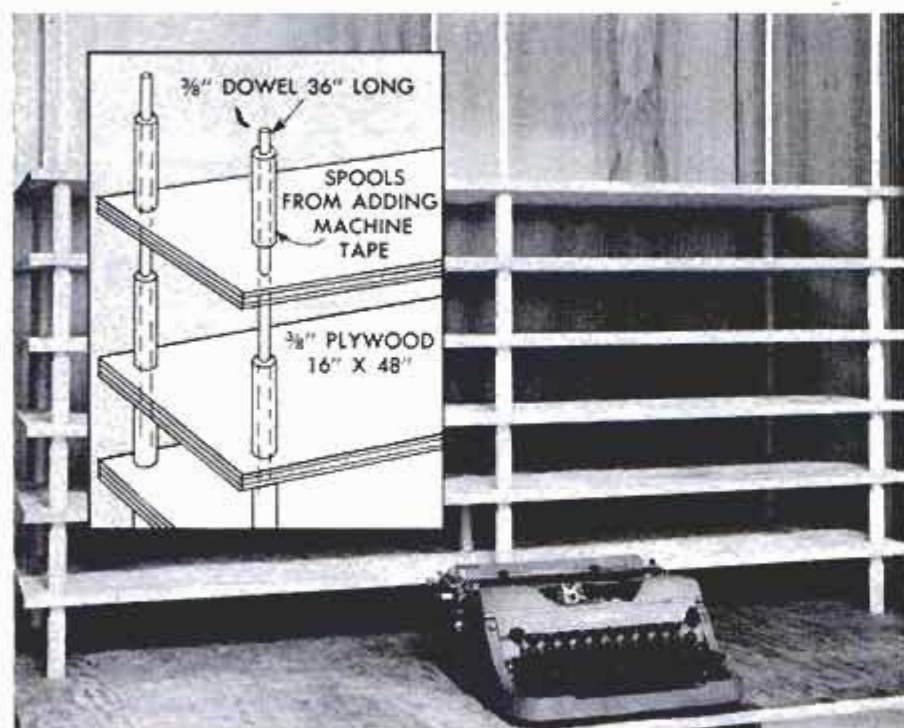
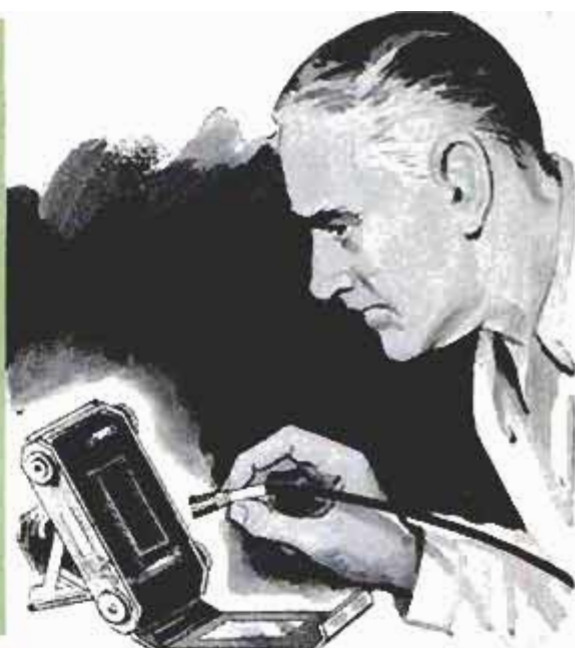
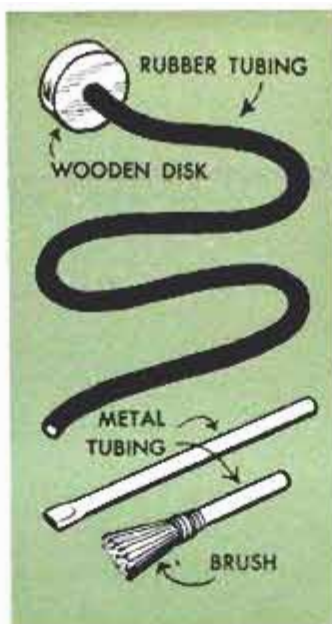

## Knockdown Shelves

Spools from adding-machine tape are used as spacers for these plywood knockdown shelves that are held in position with dowels. After the shelves have been cut and drilled and the finish applied, they are assembled with the spool spacers on  $\frac{3}{8}$ -in. dowels as shown in the detail. If you want a shelf with additional vertical space, to accommodate record albums and books in an upright position, slip two or three spools on each dowel before adding the next shelf.—F. Eliot Westlake, Cincinnati, Ohio.

## Rigid Workbench Joint

Extra rigidity and strength for workbenches and other assemblies can be obtained with the type of joint illustrated, if the joining parts are cut perfectly square. Other advantages are that the joint can be tightened to compensate for shrinkage of wood and can be disassembled and reassembled quickly. Holding power at the joint is provided by one bolt, while a short dowel or pin fitted in mating holes prevents rails from turning out of position.

☛ Keep a few candle stubs in a picnic basket to help start outdoor fires. A candle will keep reigniting a fire even when the paper and wood are slightly damp, and will be consumed itself when the fire is burning well.

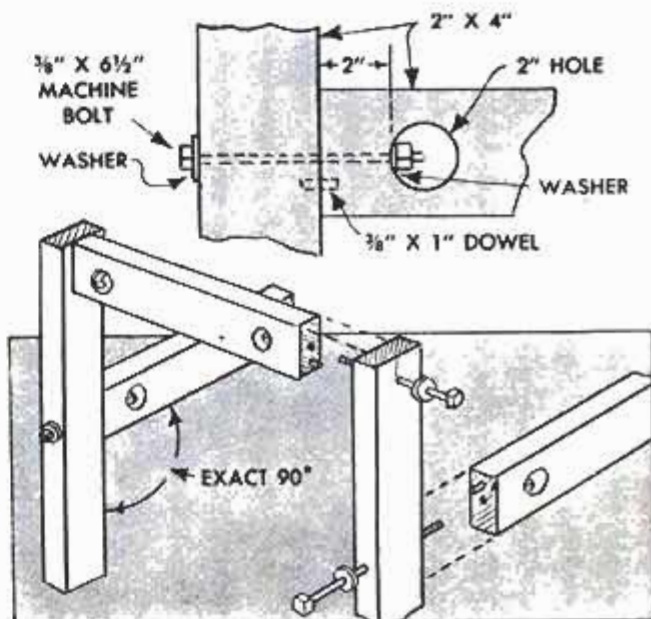

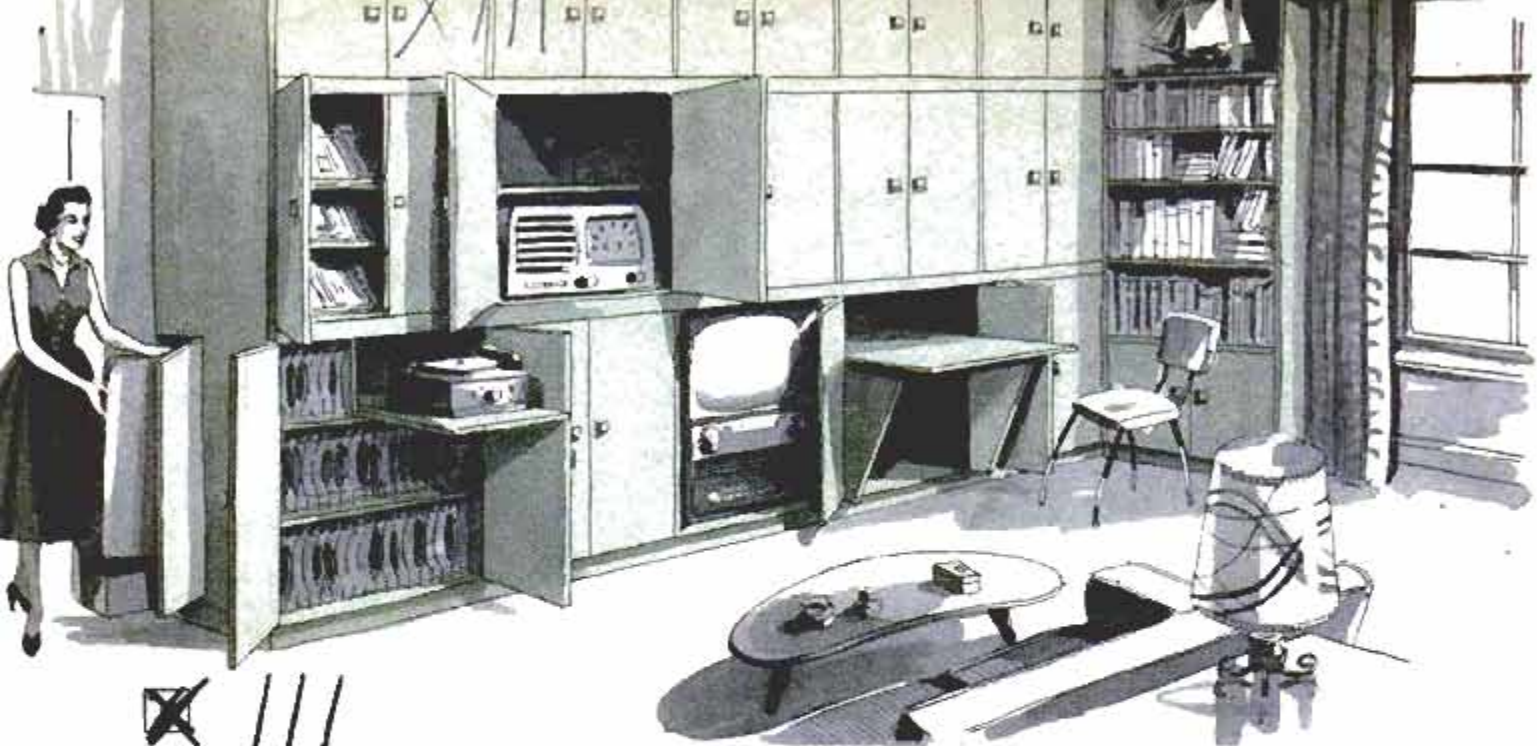

✕ |||

# MODERNIZE *Your Home*

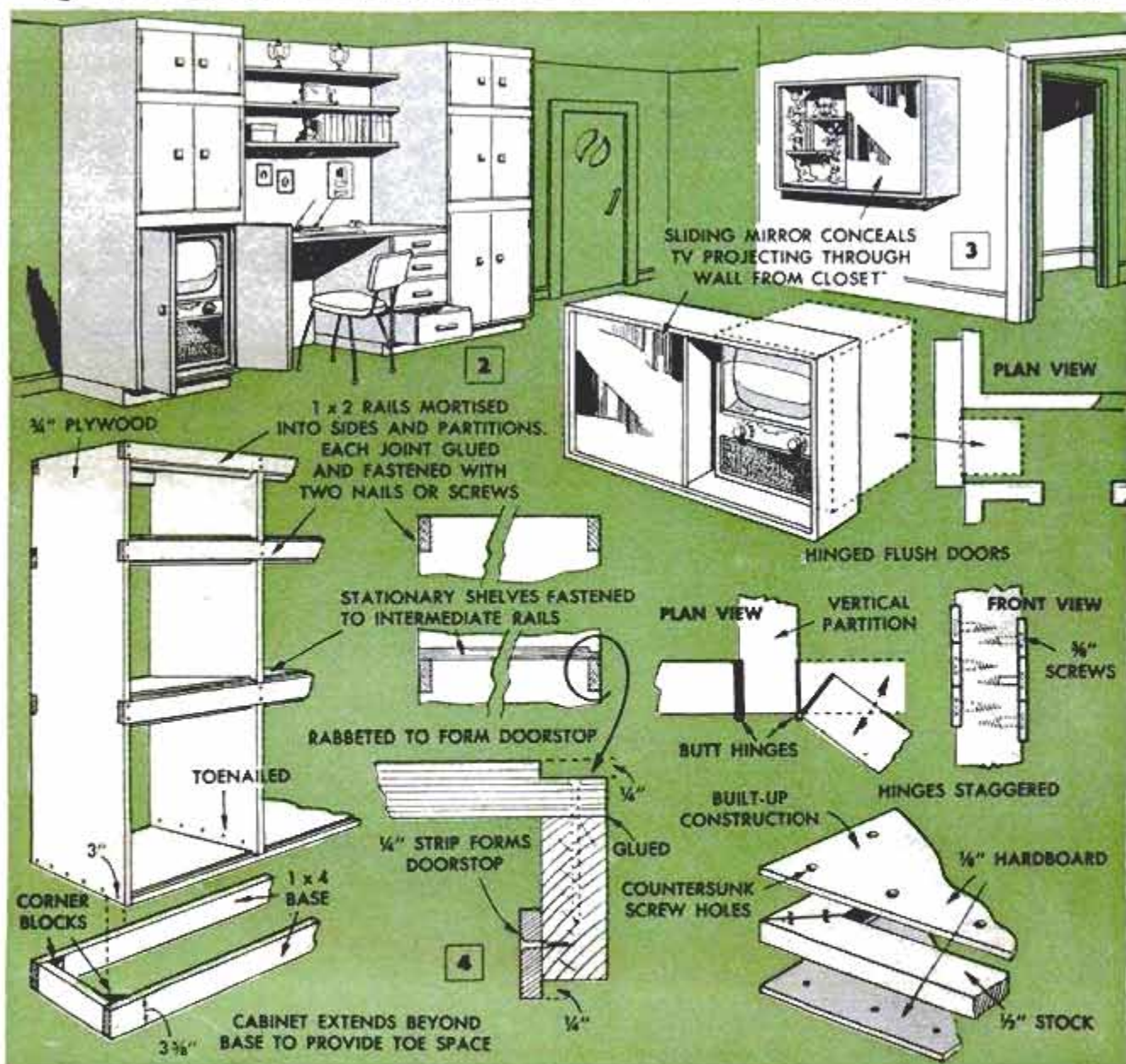

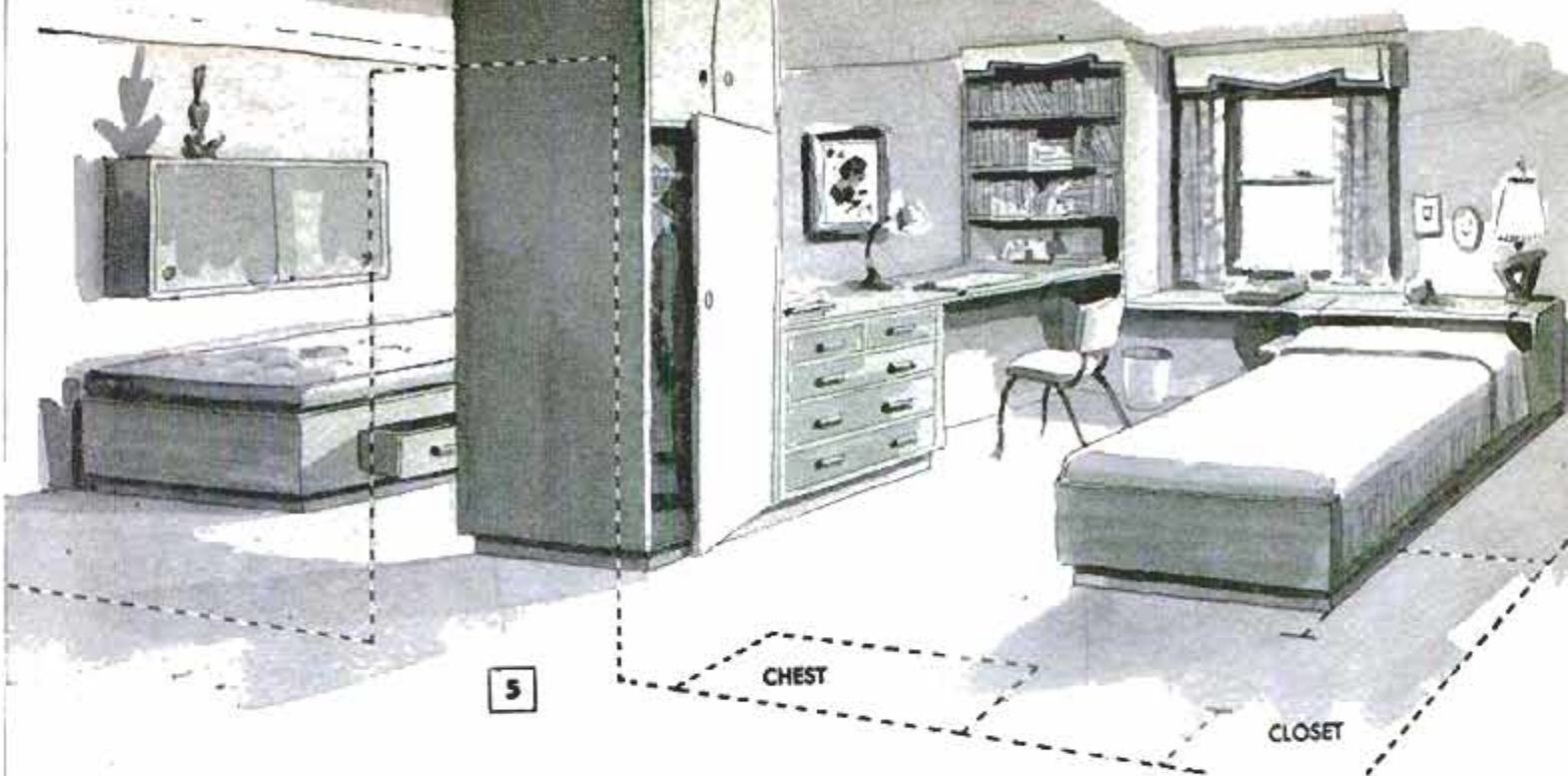

# with Practical **BUILT-INS**

by  
Enno R. Haan



*Rep'*  
*Home Improvement Guide*  
WHEN MAXIMUM LIVING and storage space in a minimum of floor area are required, built-in furniture and storage units are the answer. The cost of the built-ins is less than that of individual pieces of furniture, and very often they can be used to conceal unsightly utilities or bulky appliances such as TV sets.

## Living-Room Storage Wall

Running from floor to ceiling as in Fig. 1, a storage wall can be built against an existing wall or located so it acts as a partition between living and dining areas, or forms a vestibule at an entrance door. In the latter case a door is located on the entrance side of the partition, part of which then is used as a guest closet.

As illustrated in Fig. 1, card tables or folding chairs can be stored in a compartment behind the phonograph and record section. For convenience the phonograph may be mounted on a shelf fitted with roller-type drawer slides so that it can be pulled out for use. Inclined shelves provide a means of neatly filing your favorite periodicals. A radio installed in the wall is always available, yet may be hidden by closing two doors. Also concealed behind



Photo courtesy Wood Conversion Co.

Upper illustration shows how built-ins may be used to divide single, large bedroom for two occupants. Lower photo, built-in vanities are especially effective in adding practical beauty to a small bedroom

doors when not in use is a writing desk which consists of a sliding panel that rests on two hinged, triangular-shaped supports. If the storage wall is long enough it can also house a TV set, with or without its original cabinet.

## TV Storage Wall

A smaller, alternate storage wall that combines TV storage with bookshelves and



Photo courtesy Western Pine Assn.

Storage wall combined with vanity has closets with sliding doors, allowing built-ins on adjacent wall

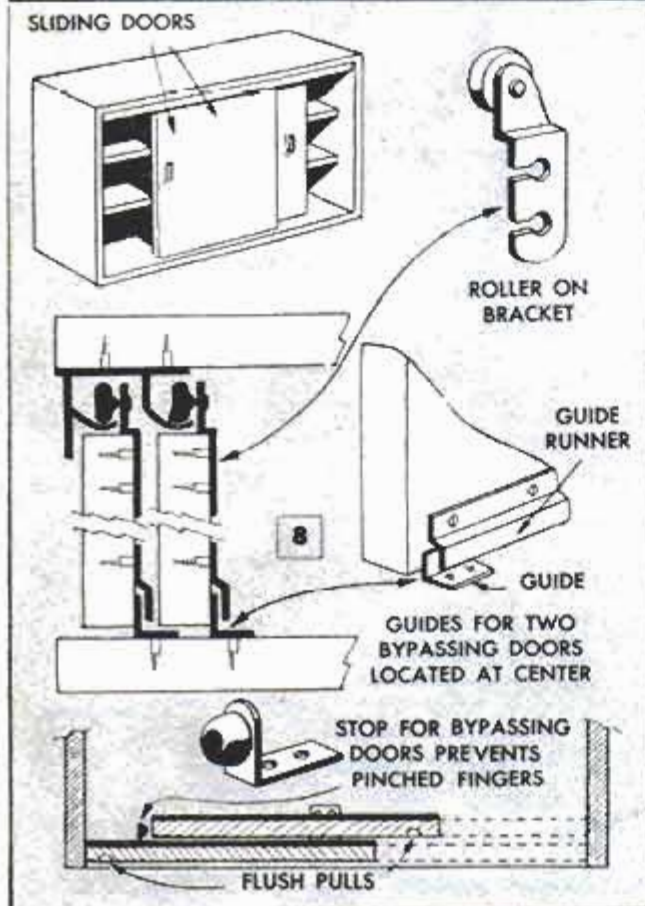

Sliding-door hardware is easily installed, comes in various sizes to suit size of door. No floor space is required to open door fitted with this hardware

a desk is shown in Fig. 2. Fig. 3 shows still another method of housing a TV set. A whatnot shelf fitted with a sliding mirror or panel is attached to the wall so that the mirror can conceal the TV. The back of the TV set projects into a closet.

Details of the cabinets from which the storage walls are assembled are shown in Fig. 4. Bases of the cabinets are set back

3 in. to allow toe space. The cabinet bottom is nailed or screwed to the base, after which the sides and partitions are cut to size and mortised to take reinforcing rails. Permanent shelves are nailed or screwed to the rails. Cabinet sides are fastened in the same manner.

Stops for the lower edges of the doors are formed by rabbeting the front edges of the bottom shelves. Strips screwed to the inside lower edges of the rails form stops for the upper edges of the doors. Adjustable shelves should be set back 1 in. from the front edge of the cabinet. They are held by steel shelf supports that fit holes in the sides and partitions of the cabinet.

Hinged doors should come flush with the surface of the walls. Butt hinges used for the doors are set in gains as shown in the detail in Fig. 4. Hinges which are opposite each other on a partition should be staggered slightly so that screws driven in from opposite sides will not interfere with each other.

As indicated in the right-hand detail in Fig. 4, panels built up from  $\frac{1}{2}$ -in. stock and sheets of hardboard can be used in constructing a storage wall in place of  $\frac{3}{4}$ -in. plywood ordinarily used. Core pieces should be installed inside the panels at points where shelves are to be attached.

### Bedroom Built-Ins

Real space savers are storage walls in a bedroom. Fig. 5 shows a large room divided by a semistorage wall consisting of cabinets and a double desk with tiers of drawers. The built-in bunks have spacious drawers underneath and cabinets for

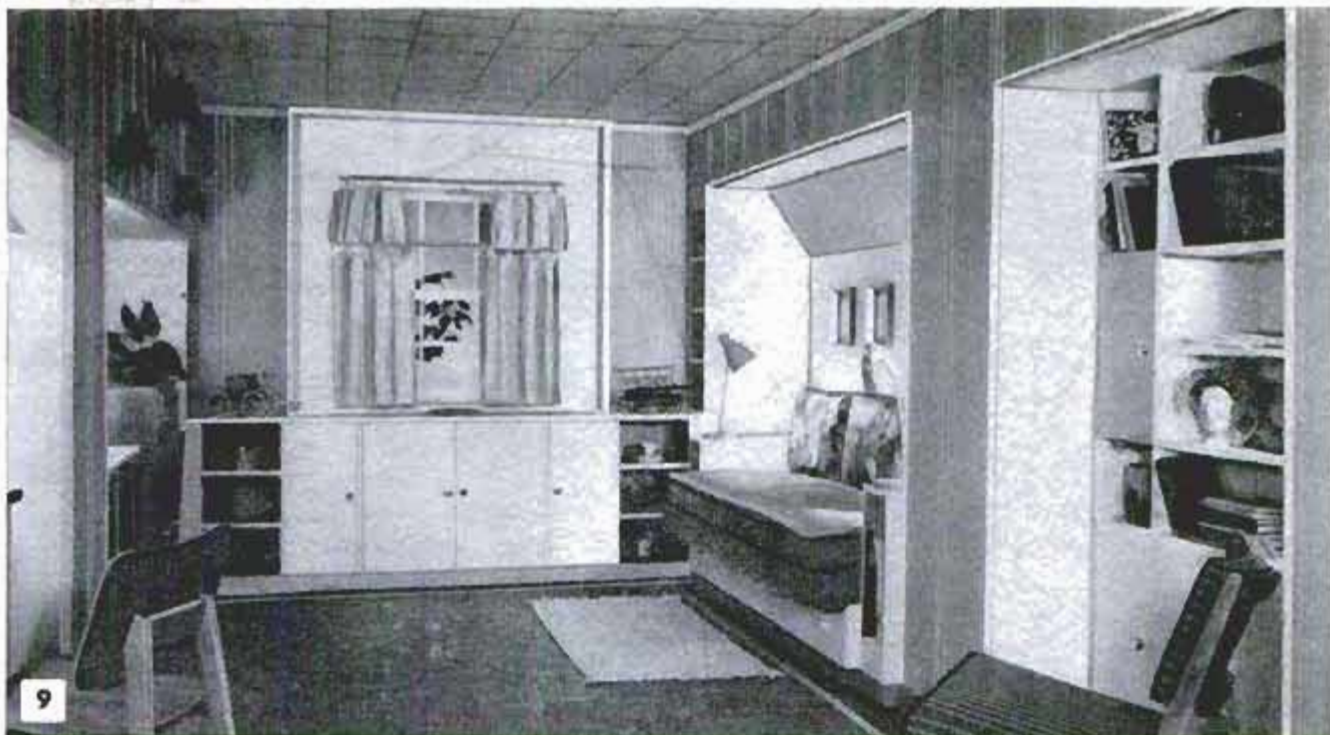

9

Photo courtesy Johns-Manville Co.

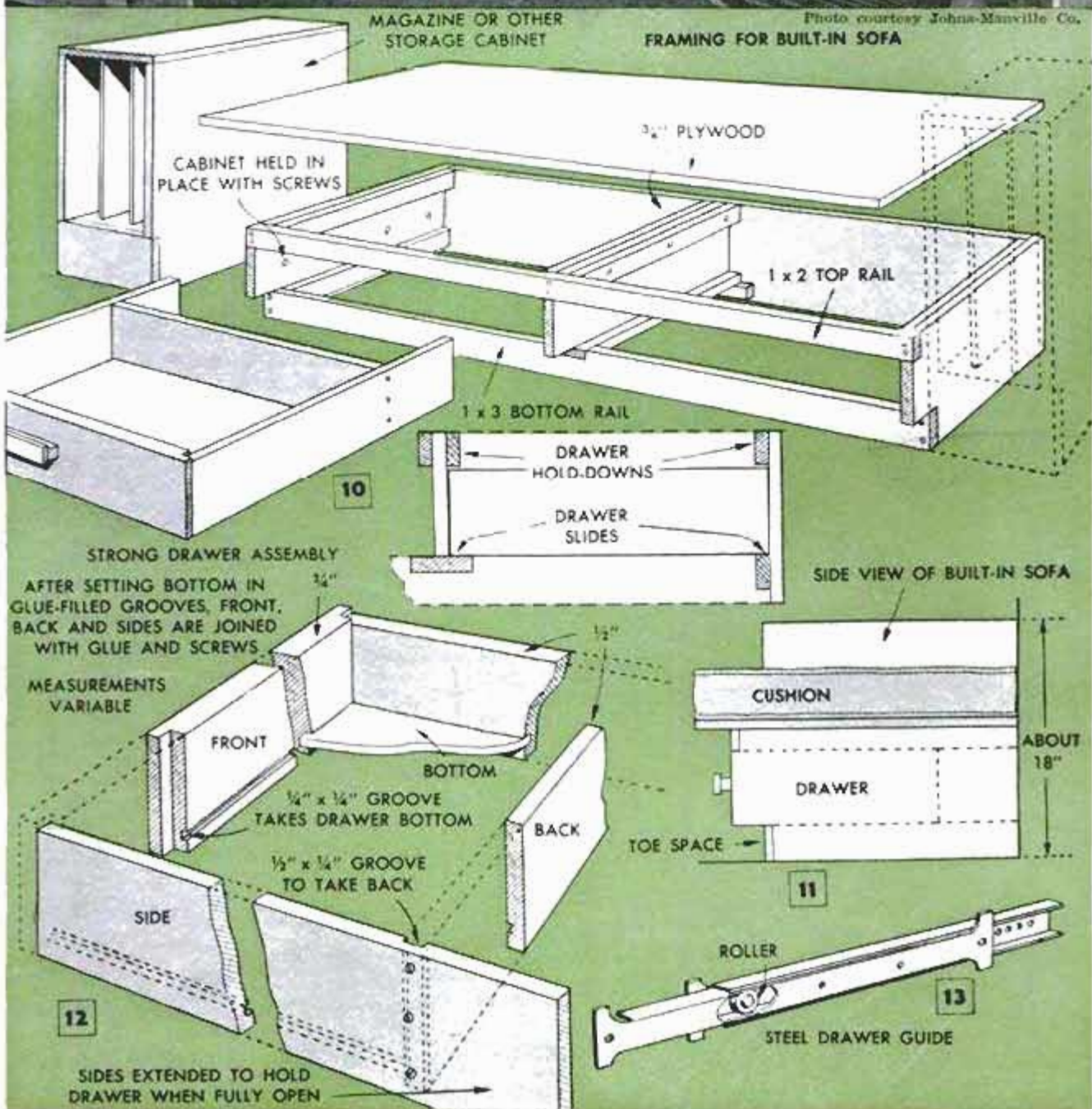



Douglas Fir Plywood Assn. photo

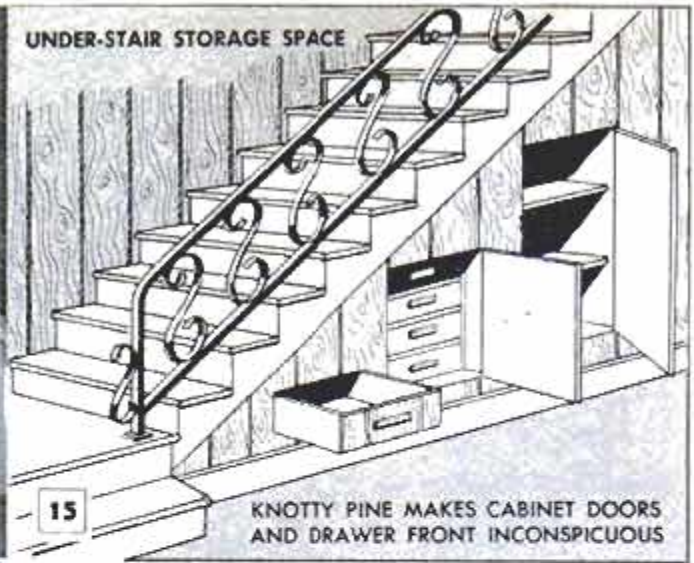

KNOTTY PINE MAKES CABINET DOORS AND DRAWER FRONT INCONSPICUOUS



Insulite Div., Minnesota and Ontario Paper Co. photo  
Douglas Fir Plywood Assn. photo

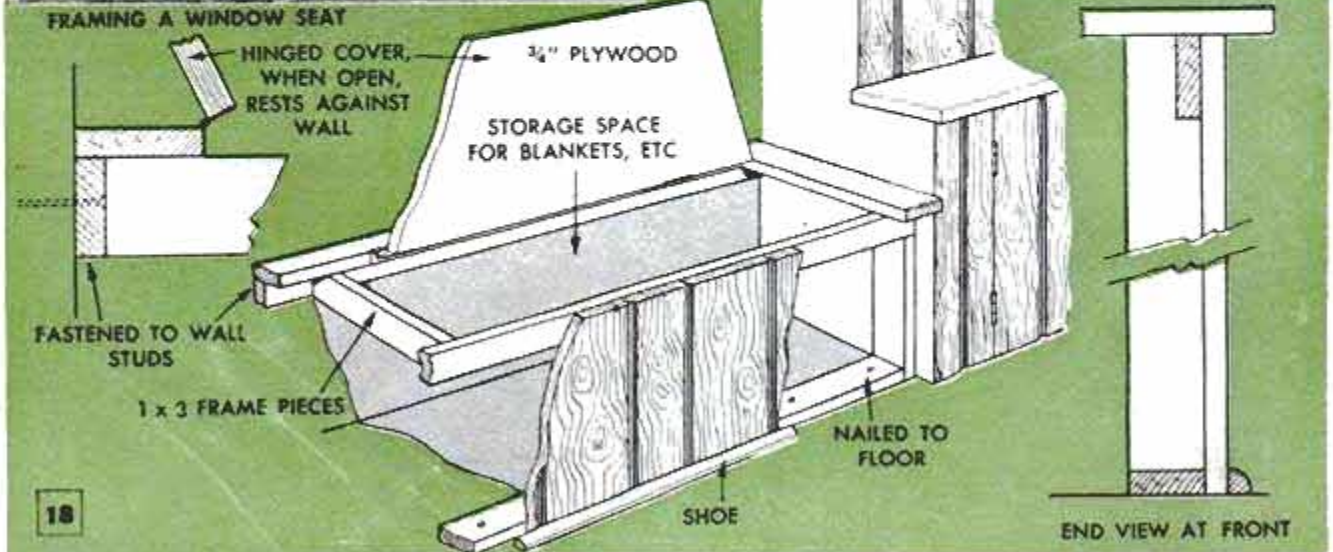

blanket storage at the heads. The latter cabinets are incorporated with shelves.

Built-in vanities such as shown in Fig. 6 are especially effective for improving bedrooms, particularly if they are backed with large mirrors and provided with recessed overhead lighting.

Often vanities are combined with small cabinets as shown in Fig. 7. Sliding doors for closets and cabinets, as detailed in Fig. 8, are easy to operate and do not require floor space as do hinged doors. Sliding-door hardware comes in sizes to fit small or large cabinet doors.

### Built-In Sofas and Drawers

Walls that have recesses or setbacks, as in some attic apartments, are ideal for built-in sofas and drawers. The sofa base may contain two large storage drawers. Magazine cabinets, which also serve as end tables, can be provided at the sofa ends. Framework assembly of such a sofa is shown in Figs. 10 and 11. Depth of the drawers depends on whether a single cushion or a cushion and spring are used. Drawer construction is detailed in Fig. 12.



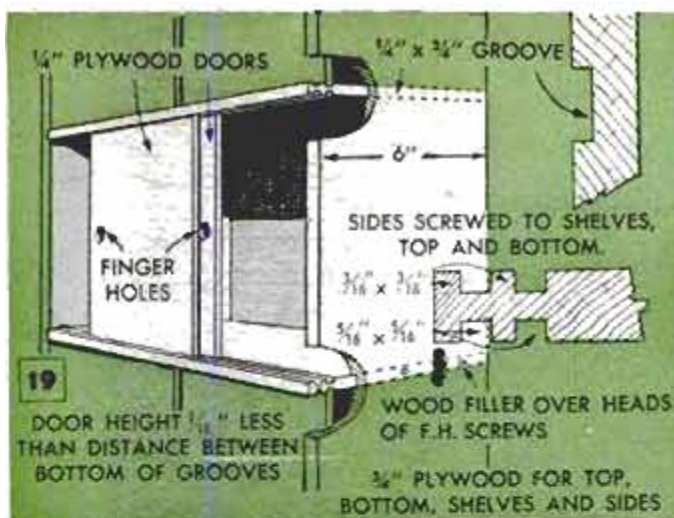

Narrow utility cabinets with sliding doors are practical in small bathroom where they require a minimum of space. Small doors do not require rollers, are simply set in grooves at tops and bottoms of cabinets

Roller drawer guides, Fig. 13, greatly reduce friction and make it possible to open and close drawers with very little effort.

#### Attic-Conversion Built-Ins

Space under the eaves that generally is not used in a finished attic is ideal for built-ins. The cabinet shown in Fig. 14 is an example. This unit contains a drop-leaf desk, a bookshelf and six storage compartments.

Almost any attic conversion can be planned to include clothes closets at the eaves. Small ones for children, Fig. 16, aid in teaching them to hang up their clothes.

#### Stairway Storage Space

Often overlooked as too small is the space under a stairway. However, by installing small cabinets and drawers as shown in Fig. 15 the space can be effectively utilized. To make such built-ins less noticeable, drawer fronts and cabinet doors should be covered with material that



Douglas Fir Plywood Assn. photo

matches and comes flush with the wall covering.

#### Storage Seats

Space under windows is a good place for storage seats. These may be combined with bookshelves or storage cabinets adjacent to the window as in Figs. 17 and 18. The seat cover should be hinged to a strip of wood extending a few inches from the wall so the opened cover rests against the wall.

Narrow utility cabinets, Figs. 19 and 20, are convenient in a bathroom. The small sliding doors fit in grooves.

Carport storage walls are handy for a house that has no basement or where a basement has no outside entrance. Fig. 21 shows a wall that acts as a windbreak. The wall in Fig. 22 is designed so a car cannot be parked so close to the house wall that the car door cannot be opened. ★ ★ ★

Carport storage walls are ideal for homes without basements, accommodate garden tools and bulky items

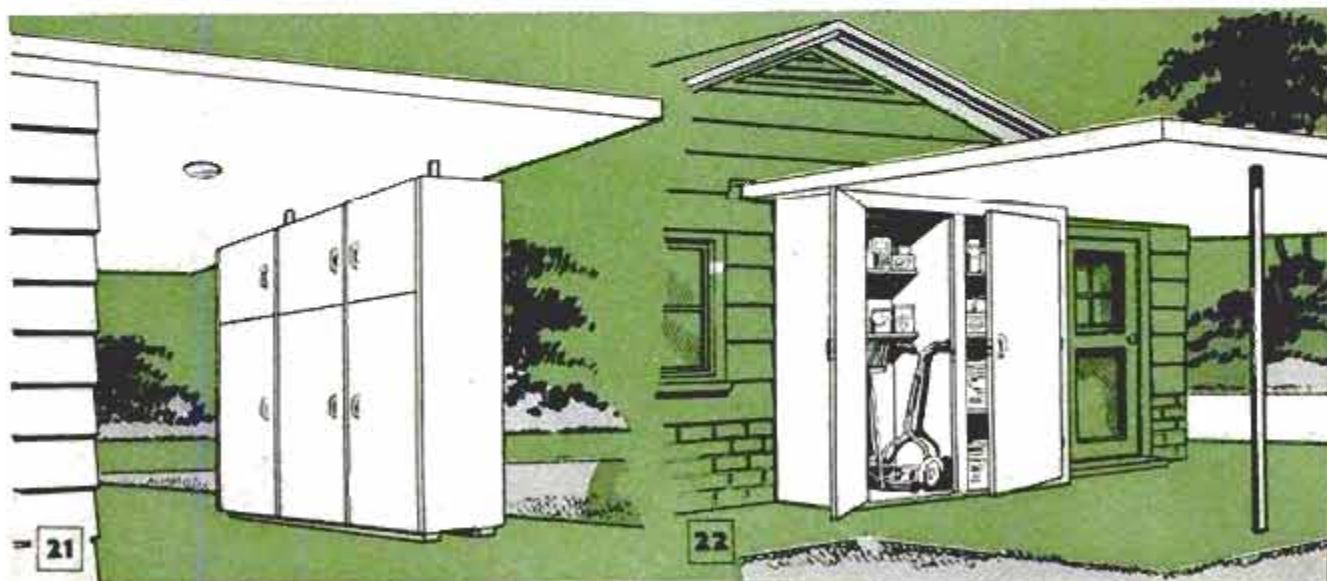

## Mirror "Stitched" on Tent Wall Is Convenient for Shaving



## Rough Gems Embedded in Plaster Easily Held While Cutting

One lapidary has found that gems are easier to hold for cutting when the stones are embedded in casting plaster. Cut a quart milk carton in-half and fill the bottom half with pure plaster of paris mixed with water. When the plaster is about half set, push the stone to be cut into the center of the carton until it is nearly submerged. After the plaster has been allowed to harden for at least 24 hr., clamp the car-

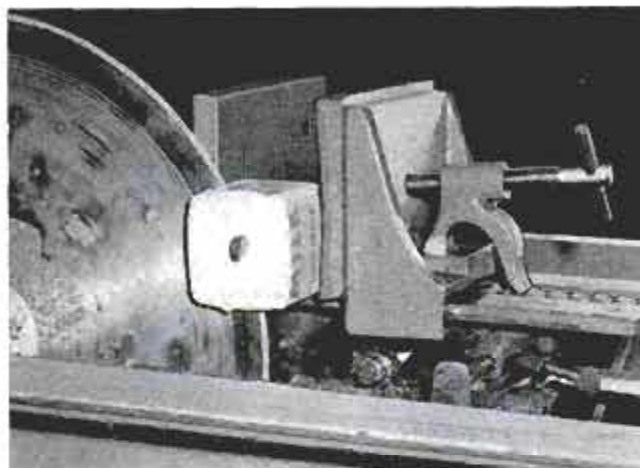

ton in the stone vise and cut the stone into slices of the desired thickness. If you have many small stones to cut at the same time, they can be embedded in plaster in a half-gallon carton by following the same procedure, except that two or three layers of stones can be laid in the carton. Place a mark on the outside of the carton to indicate the position of each layer and cut from either end.

V. Lee Oertle, Azusa, Calif.

Supporting a shaving mirror at the correct height is no problem for one camper who fits a large auto rear-view mirror on a tent wall. Fishline is stitched through the canvas in a rectangular shape and the mirror is slipped into four oversize stitches at the corners. A metal-backed mirror is used because it is more resistant to damage than a regular shaving mirror.

## Burrs Removed From New Keys To Protect Pockets

When new tumbler-lock keys are carried loose in the pocket they will soon cut through the fabric unless the burrs are removed from the machined edge of each key. This is easily done with fine emery cloth, a few strokes along the edge usually being sufficient. The amount of metal removed is so small that it does not affect the operation of the key in the lock.



## Paint Renews Worn Linoleum

When the surface of linoleum becomes worn and unsightly, it can be painted in a solid color or in a new pattern. Apply a coat of floor enamel in the color desired. For a marble effect, tap on another color with a sponge, after the base coat has dried, or paint in a pattern to simulate stone masonry.—I. M. Fenn, Chicago.

## Yarn Sample Attached to Box Identifies Contents

When wool, cotton and other yarns in various colors and grades are stored in individual boxes the contents of each can be identified at a glance if a sample is taped to the front of the box. Yarns that are removed for mending or other purposes are returned to the appropriate box each time, which prevents mixing them.

Mrs. M. Fey, New York City.



# Step Table

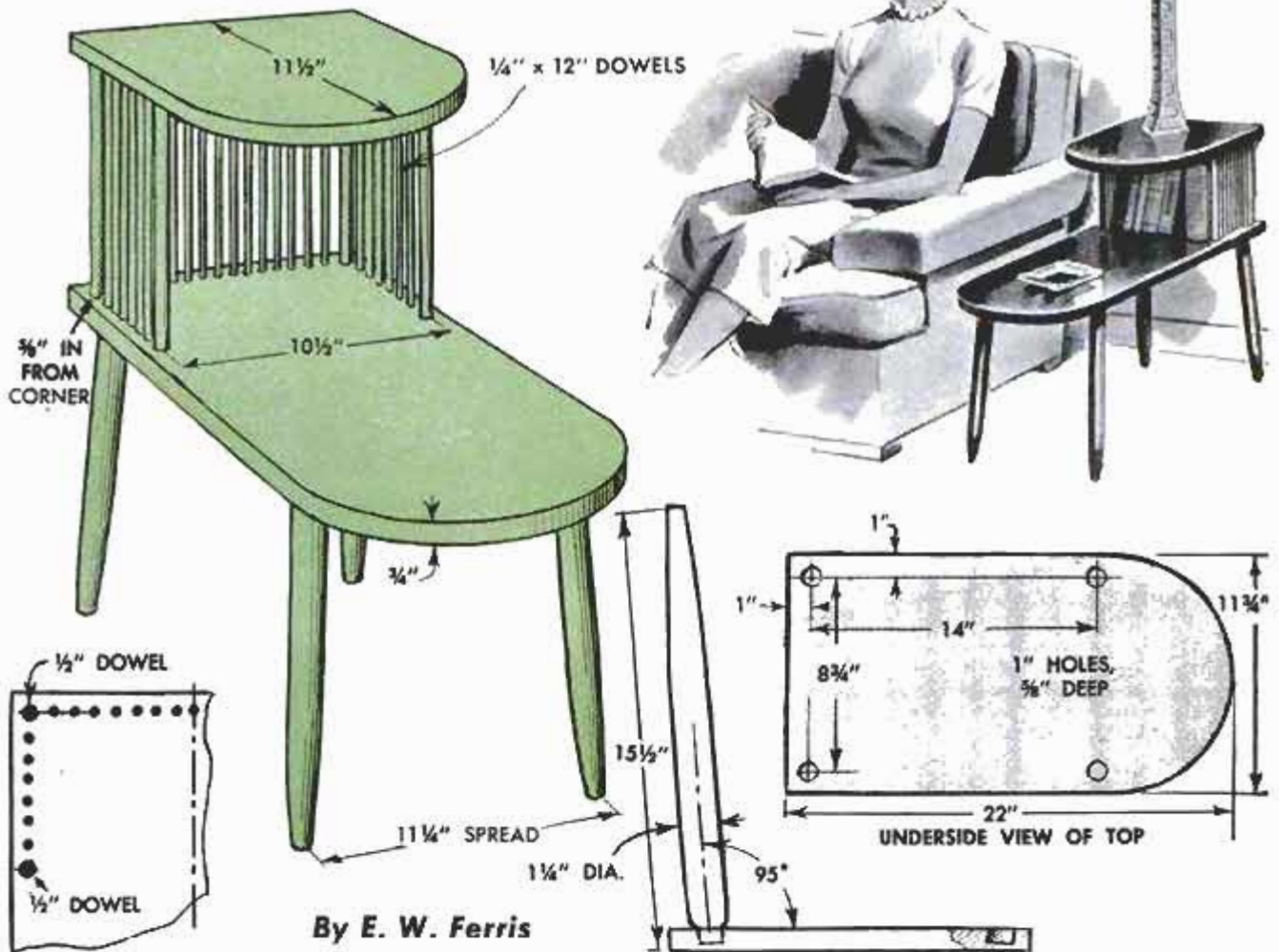

By E. W. Ferris

**THIS STEP TABLE** provides a real challenge to the craftsman who enjoys doing accurate work with a drill press. Construction of the table requires drilling 66 blind holes  $\frac{5}{8}$  in. deep.

First, cut the table top and step to size and shape from  $\frac{3}{4}$ -in. plywood or solid stock. The step measures  $11\frac{3}{4}$  in. wide and  $11\frac{1}{2}$  in. long, while the top is  $11\frac{3}{4}$  in. wide and 22 in. long. All dowels between top and step are fitted in holes centered  $\frac{5}{8}$  in. from the back and side edges of both top and step. Center spacing between the  $\frac{1}{4}$ -in. dowels is  $\frac{5}{8}$  in. on center. It is best to use a paper pattern to make certain the holes in step and top align. Each of the

dowels is 12 in. long, resulting in a spacing between top and step of  $10\frac{3}{4}$  in. Taper the ends of the dowels slightly to facilitate assembly.

Legs for the table are made from four  $1\frac{1}{4}$ -in. dowels  $15\frac{1}{2}$  in. long, with a taper turned on the lower portion of each. The upper ends of the legs are turned down to fit 1-in. holes drilled in the underside of the table top. The latter four holes are drilled at a 95-deg. angle by clamping the table top to the drill press and shimming the top to a 5-deg. angle. Use a Forster bit which permits drilling a square-end hole so the legs will fit deeper. Use only glue in assembling the table.

## Straightedge Is "Skidproofed" to Minimize Glass Breakage

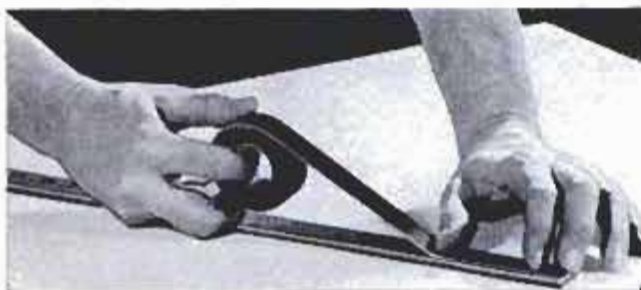

Possible spoilage of glass caused by having a straightedge slip while cutting it can be minimized by providing the straightedge with a slip-resistant surface. If the straightedge is made of unfinished wood, apply a coating of rubber cement to provide skidproofing. If the straightedge is made of finished wood or metal, apply friction or rubber tape as shown.



*Kills Rodents*

An old vacuum-cleaner hose attached to the engine's muffer can conduct deadly fumes to rodent's burrow

## Use the Engine on Your Power Mower for Other Jobs

By Tom Riley

SN58  
**T**HE ENGINE on your power lawn mower probably will deteriorate as much from lack of use as from wear, so why not put it to extra work turning a concrete mixer, sawing wood, running a paint sprayer and other jobs before the day of trading the mower in on a new model? Most reel-type mowers can be adapted for use with the accessories illustrated in this article. To mount some of the accessories and also to use the mower as a light hand truck, it is necessary to provide a simple platform such as the one shown in the detail on page 196.

### Engine Exhaust Kills Rodents

One of the simplest attachments for your mower is one that can be used to exterminate burrowing rodents. If an old vacuum-cleaner hose is available, cut several 2-in. slits in one end of its metal fitting so that the latter can be slipped over the exhaust pipe. Connect the hose to the end of the tube, place its other end in the entrance to a rodent's burrow and idle the engine for three to five minutes.

### Mower Headlight

A headlight is another handy accessory

to have on a mower for anyone who must cut his lawn after dark. For the necessary current to operate the light, mount a bicycle generator on the engine platform so that its drive wheel will bear against the mower's V-belt. The generator can be attached permanently by providing a two-position bracket that allows the generator to be pushed away from the belt when the light is not in use.

### Operates Paint Sprayer

A small air compressor of the diaphragm type can be attached to your mower for those occasional painting jobs or for applying certain types of insecticides. In addition to saving the cost of an electric motor, this installation will permit you to use a spray gun away from an electrical outlet. When a considerable volume of air is required, an air tank can be attached to the air hose between the compressor and the gun to supply the needed reserve.

### Drainage and Fire Pump

For a handy portable pump that can be used to drain a flooded basement, for irrigation, and many farm uses, mount a low-pressure big-volume centrifugal pump

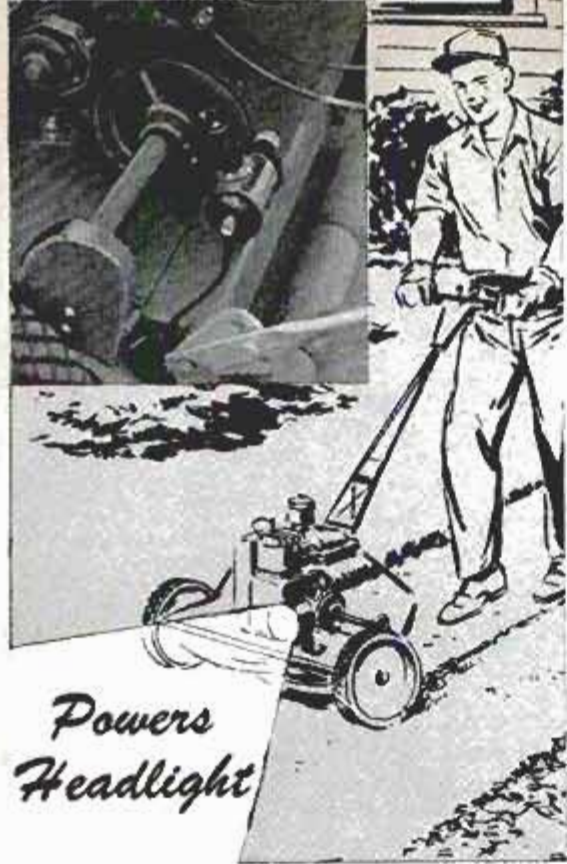

*Powers  
Headlight*

Friction-driven by V-belt, bicycle generator provides current for headlight

on the platform. A V-belt drive can be used, with the pump pulley about the same size as the one on the engine to give proper operating speeds. The pump can be removed when not in use.

If you would like to have some emergency fire protection handy, mount a small, high-pressure centrifugal pump on the mower so that a V-belt can be slipped on its pulley at a moment's notice. Garden-hose couplings should be fastened to the outlet and intake on the pump to permit quick connection of your garden hose in the event of a fire.

**Operates Generator**

A variety of power equipment can be operated when a 110-volt a.c. generator is attached to your mower. This accessory will permit you to use electric hedge clippers, sprayer, small power tools, etc., where no electrical outlet is available. A 600-watt generator is the maximum size that should be used with the average small lawn-mower engine.

For recharging auto batteries it is only necessary to replace the 110-volt generator with a used auto generator. The latter



Paint-sprayer compressor mounted on engine platform supplies spray gun with sufficient pressure, saves cost of an electric motor

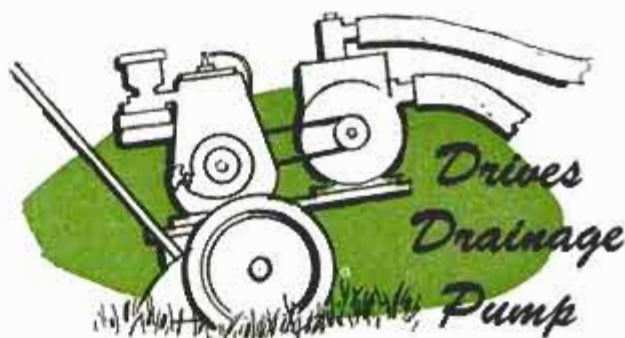

Attach drainage pump to a demountable, plywood platform for a handy unit that is easy to move to window of flooded basement

*Operates  
Fire  
Pump*



Small, high-pressure centrifugal pump with garden-hose fittings is mounted on engine platform for emergency fire-protection use



A 110-volt a.c. generator driven by mower engine provides portable supply of electricity for small power tools used outdoors



## Charges Car Battery

Used automobile generator powered by mower engine recharges car battery

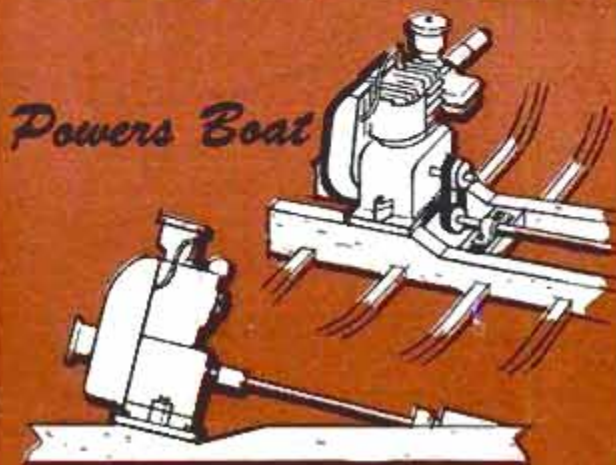

## Powers Boat

Detached engine powers boat. Mount it as shown above for direct or indirect drive



## Drives Cultivator

Above, engine can be used to drive garden cultivator or operate concrete mixer below

## Operates Concrete Mixer

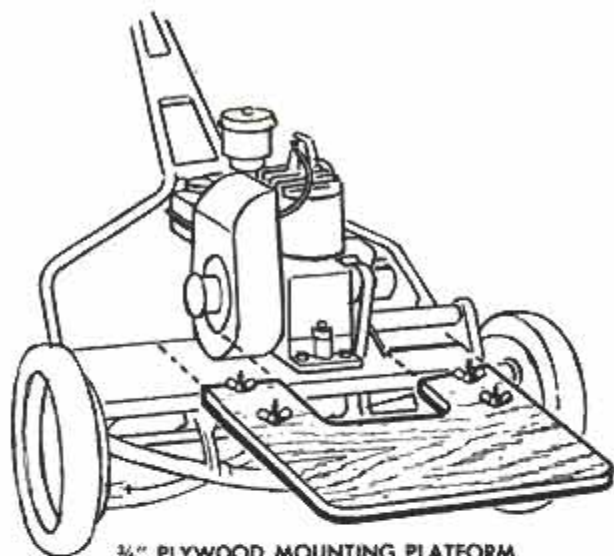

¾" PLYWOOD MOUNTING PLATFORM

Attach a piece of plywood to engine platform and you have a practical hand truck for light loads

can also be used to provide current for lighting away from an electrical source by rigging several auto headlights on extension cords.

### Detached Uses

Most reel-type mower engines can be removed from their platforms in a few minutes and used to power other equipment while the mower is not in use. Mounted on engine stringers in the stern of a rowboat or sailboat and fitted with a shaft, shaft box and propeller, the engine can provide ample auxiliary power. If you are a mechanic at heart and wish to build your own garden cultivator, the mower engine is a natural for powering it. A suburban dweller or farmer with a wood lot can put the engine to work powering a dragsaw or circle saw.

Many home-size concrete mixers are available without motors. Your mower engine will easily handle a 3½-cu.-ft.-capacity mixer, when it is mounted on a plywood platform on the mixer frame.

A sickle bar and a power edger are available for some reel-type mowers. Power for the sickle bar is transmitted by means of an eccentric wheel bolted to one end of the mower reel. ★ ★ ★

Mounted on a special wooden platform a mower engine can be used to power a small cordwood saw

## Saws Wood (See Oct 47, 211)



## Panels in Door Replaced With Glass to Lighten Dark Entryway

Very often there is an area in a home, such as a basement entryway, that is dark even during daylight hours because a wood-paneled door keeps out the light. The solution to this problem is to replace one or two of the wooden panels with glass. This can be done easily and without removing the door from its hinges. The panels are held between the molded edges of the stiles and rails of the door. To remove the panels, use a fairly wide wood chisel and cut off the shaped edges as shown in the upper left-hand photo. Drive the chisel gently into the wood and pry carefully so the molded edge splits away from the stile or rail. Since the wood used in doors is fairly straight grained, it is possible to split off the molded edge along a reasonably straight line. Next, trim off any excess wood from the rabbet formed by removing the molded edge, as in the upper right-hand photo. Before installing the glass in the opening, apply a layer of putty about  $\frac{1}{16}$  in. thick to both edges of the rabbet. Fit the glass in



place and secure it with glazier's points. To provide a finished appearance on the inside of the door, nail strips of quarter-round or stock molding that is similar to the molded edges removed around the edges of the glass.

John Dalen, Morton Grove, Ill.

## Lawn-Mower Roller Lubricated By Saturated Felt Disks

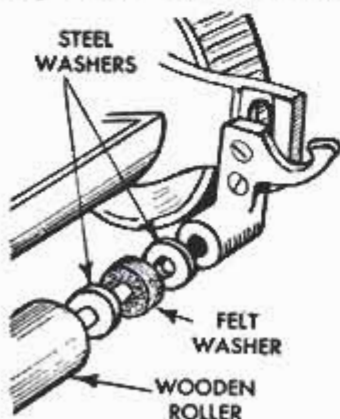

Oil-soaked felt disks installed between steel washers on the axle pins of a lawn-mower roller will keep the roller well lubricated. It may be necessary to cut down the length of the roller slightly in order to accommodate the arrangement. This

will not only eliminate squeaking but also will protect the pins against rust and excessive wear.

☐ A cedar closet or chest is kept fragrant and mothproof if the inside is sanded lightly once a year. Sanding reopens the pores, releasing the natural oil in the wood, which repels moths.

## Coat-Hanger "Clamps" Hold Cover on Car Seat

Protective cloths thrown over the back of a car seat to protect the upholstery while work is being done on the inside of a car often slip down and expose the upholstery to soiling. To prevent this, bend large "clamps" from coat hangers as indicated. When slipped over the top edge of the seat back they will hold the cloth in place and will not damage the upholstery.



SOLVING

# Home Problems



**1. ORDINARY SOAP** applied in a thin film to the bottom of pans and skillets before use will prevent formation of that sticky, sooty coating that takes so much scouring and polishing to remove. Warm the pan slightly and rub the bottom with a bar of soap as pictured. This coats metal with thin protective film

**2. SMALL JARS OR TUMBLERS** containing cheese, leftovers and baby foods won't tip when placed on refrigerator shelves if you take the precaution of setting each one in an inverted plastic jar lid. The jar lid takes up little more space than the container and does not interfere with air circulation



**3. STRIP OF SANDPAPER** taped to a thimble speeds up the slow, tedious job of plucking bastings threads from fabrics having a standing pile or nubby weave. Sandpaper strip should be cut about  $\frac{1}{4}$  in. wide and long enough to be taped to the thimble as shown, with sand side out. Draw strip tightly around end of thimble before taping so that it will stay in place while lifting the threads

**4. A COAT HANGER** will support your stepladder flush against the wall of the garage or utility room so that it takes up the least possible space when not in use. Set the ladder flush against the wall, measure and drive an L-hook so that it centers about 3 in. above the top step of ladder to catch the hanger hook. Then place the ladder against wall and drop the hanger over the top step in the manner pictured

**5. CLOTHESLINE PROP** won't slide sideways or fall from the line on the windiest spring day if you take time to slot a length of garden hose and slip it over the end of the pole with the slot gripping the line as pictured. Before slotting it's a good idea to drill a hole through the hose the size of the line, then cut the slot down to it. Bend the hose slightly to open the slot so it can be slipped over the line

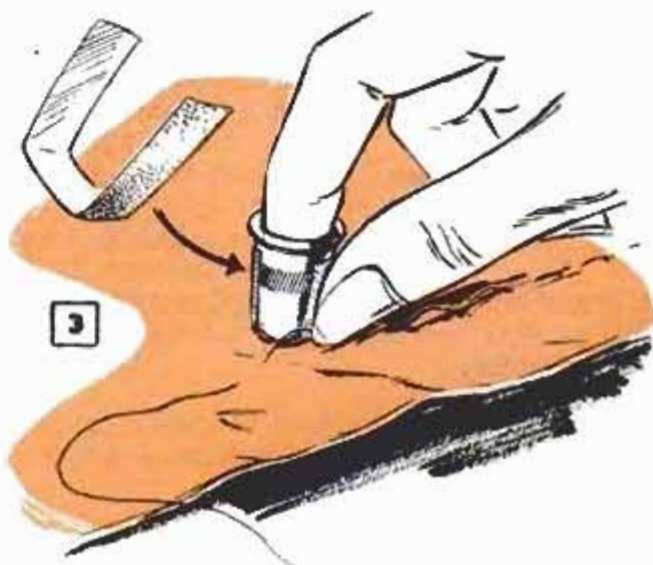



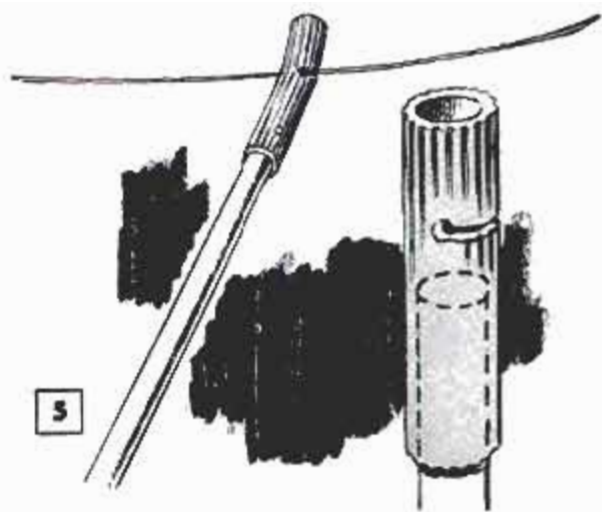
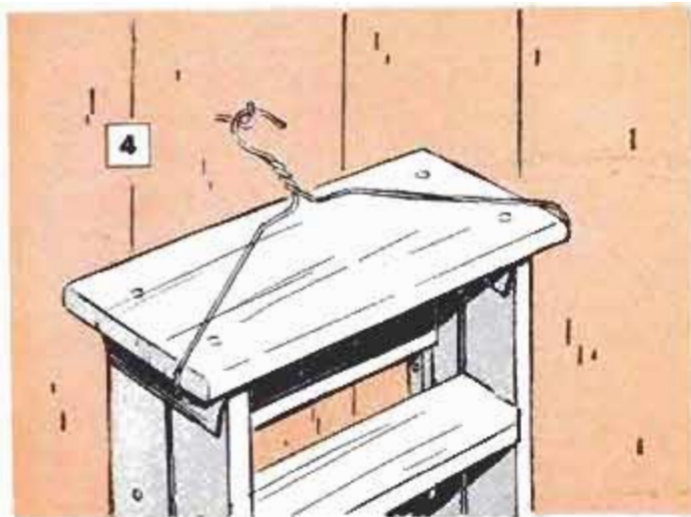

**6. STRIPS OF LUMINOUS TAPE** effectively warn against collisions with open doors in dark hallways, or anywhere in the home where it is necessary to leave a door slightly ajar at night. You can attach a short strip slightly below eye level as pictured, or place several short strips diagonally across the edge of the door at the same height

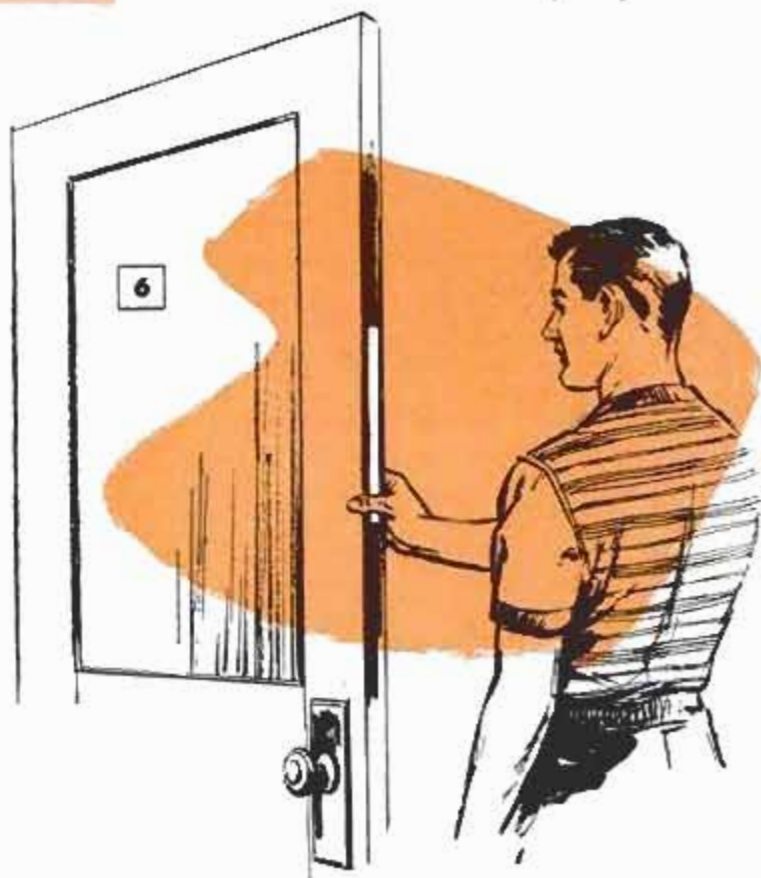

**7. BUTTONS** that have been sorted can be kept in order without mix-ups or loss if they are threaded onto a pipe cleaner. The brush-like fibers on the cleaner hold buttons securely in place and flexibility of wire permits bending into a loop and twisting ends for safekeeping. Selection of buttons of different sizes also can be kept in order



**8. SALT SOLUTION** left in a saucepan overnight will soften the hard residue that remains in the bottom of the pan when preserves and other foods are inadvertently permitted to boil dry. When this happens, fill the pan about two thirds full of cold water. Add a heaping teaspoonful of salt and stir into solution. Let stand overnight



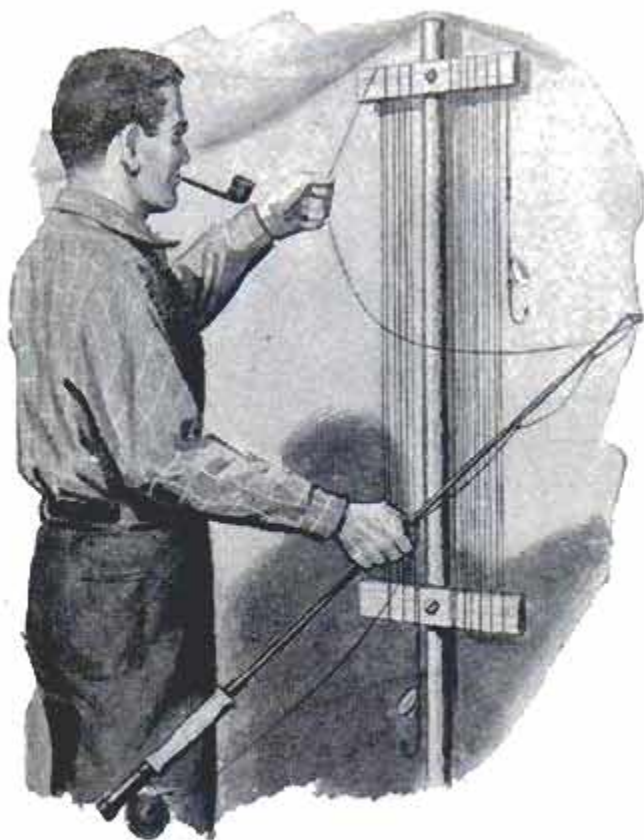

### Turn Buttons on Tent Pole Hold Fishline for Quick Drying

Two wooden turn buttons, screwed firmly to one of the poles of your tent, will serve as a drying reel for your fishlines. The buttons are turned vertically, in line with the pole, when not in use or when folding the tent.

### Wooden Plaster Trowel



A trowel that is adequate for occasional cement or plaster work, can be made by screwing a drawer pull to a short length of smooth wood as shown. Although this improvised trowel will not produce as smooth a finish as would

be possible with a metal one, it is quite satisfactory for many jobs.

### Got a Green Thumb?

You can get the jump on early spring planting by starting your transplants in a greenhouse of your own. A feature in the May issue shows how to build three types, all designed around the use of storm-window sash. One is a separate structure, another a lean-to that may be attached to garage or house and a third a window type that is accessible from the basement

### Match Holder to Light Gas Pilot Made From Alligator Clip

Heavy-gauge wire with a small alligator clip soldered to one end will provide a good match holder for lighting pilots in gas furnaces, incinerators and hot-water heaters, and with less fire hazard than using rolled paper or a stick of wood. The tool holds the match in line with the handle for easy insertion through the small opening provided in the units for lighting the pilot.

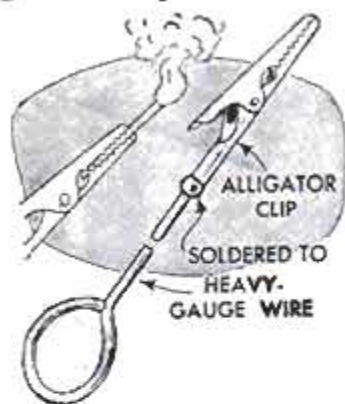

A. J. Repace, Canton, Ohio.

### Paraffin Lubricates Screws

Paraffin is a better lubricant for wood screws than soap because it not only helps in driving them into wood, but also prevents steel screws from rusting. Keep paraffin handy and use it for nails too.

### Paint Can Has Job-Data Label

Before storing partially used cans of paint, glue a slip of paper to each lid and write on it the date and the article on which the paint was used. When some object requires a touch-up paint job later, it is necessary only to check the data on the lids to find the correct paint. Also, the date will aid in judging the wearing qualities of the paint. Remember always to store the cans upside down.



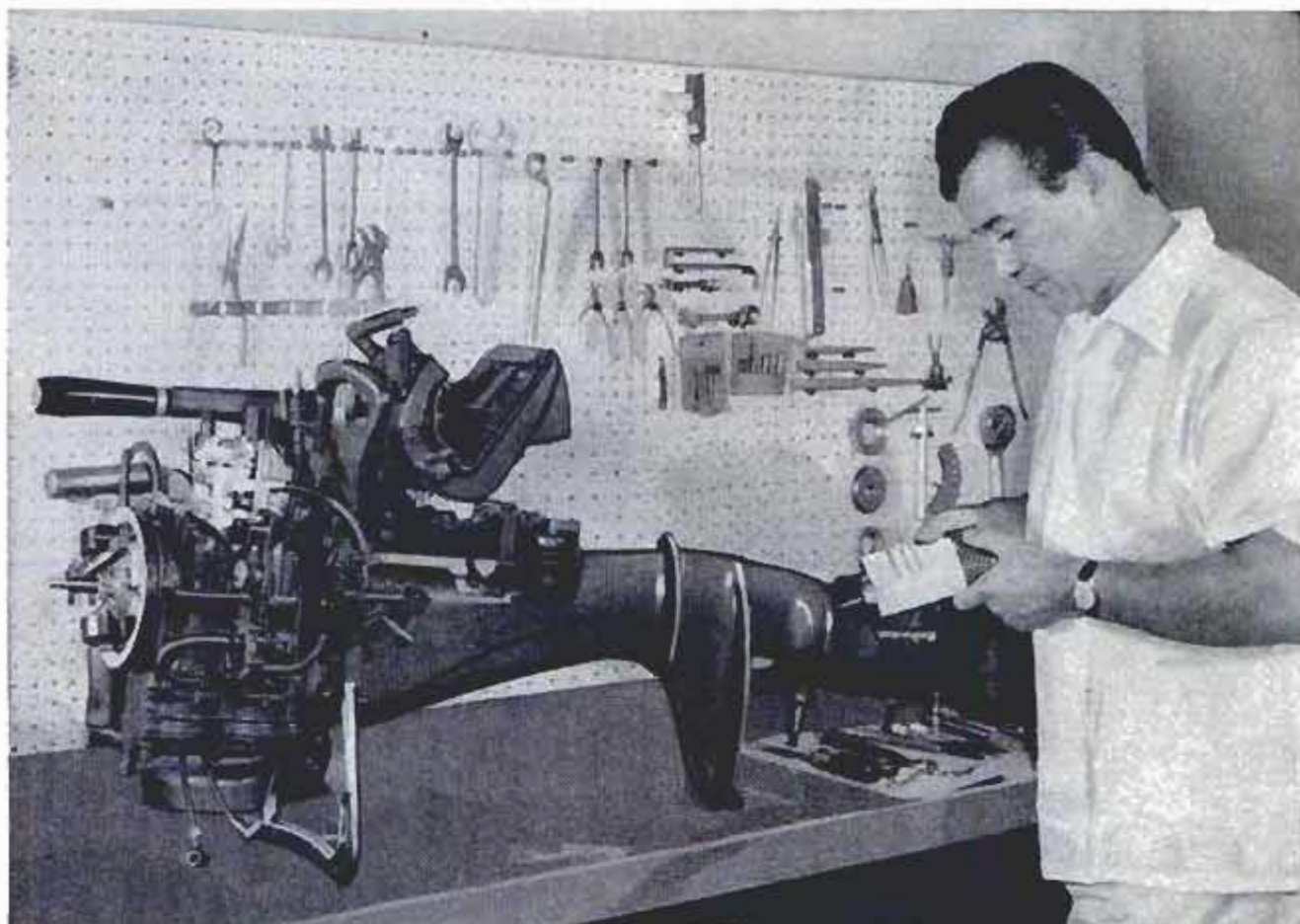

Photos by Scott-Atwater Mfg. Co.

## Regular Maintenance Checkups KEEP YOUR OUTBOARD HUMMING

**D**ON'T WAIT until it's time to get buzzing before giving your outboard motor those basic checks that keep it running smoothly throughout a long boating season. Just as it is with your car, it's careful attention to small maintenance details that keeps an outboard operating reliably and with a minimum of wear. You can carry out most of the maintenance checks and adjustments yourself with only a few tools. Major overhaul and repair should be left to your dealer's service department.

Mount the motor on a stand as in photo at the right, or on a block of wood clamped securely in a vise. Remove the motor housing to expose plugs, wiring, throttle linkage and flywheel.

The photo above serves to emphasize the importance of one step in lubrication procedure it is essential not to overlook. This step is to remove the vent plug above the filler plug which is located at the bottom of the lower unit. If oil is needed remove the filler plug and add the required amount, using only outboard lower-unit oil as recommended by the manufacturer in the owner's manual. Then carry out the steps pictured on the following pages. ★ ★ ★

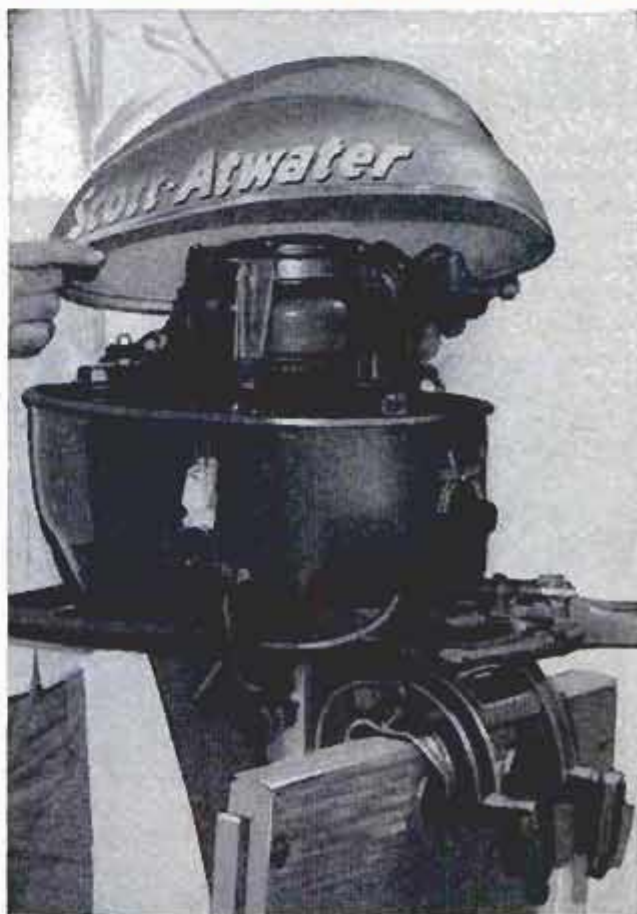



Usually a light tap with a soft hammer will loosen flywheel on tapered shaft so it is easily removed. Use care in this step, or you may damage bearings

Remove spark plugs and check electrode gap with gauge. If necessary, reset to the correct gap. Scrape away all carbon accumulation. Do not sandblast

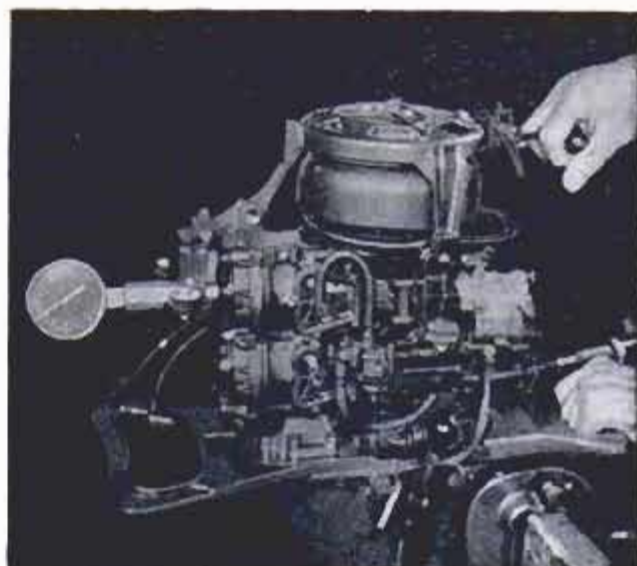

Take compression-gauge readings to detect scored cylinder walls or defective rings. To obtain correct reading, pull starter cord at least three times



Remove starter housing and check pawls. In photo inset, note that starter cord is held tightly in left hand to keep starter pawls raised for lubricating

Check magneto points with gauge recommended. If necessary, reset to proper clearance. Clean parts. Place drop of oil on shaft when replacing flywheel

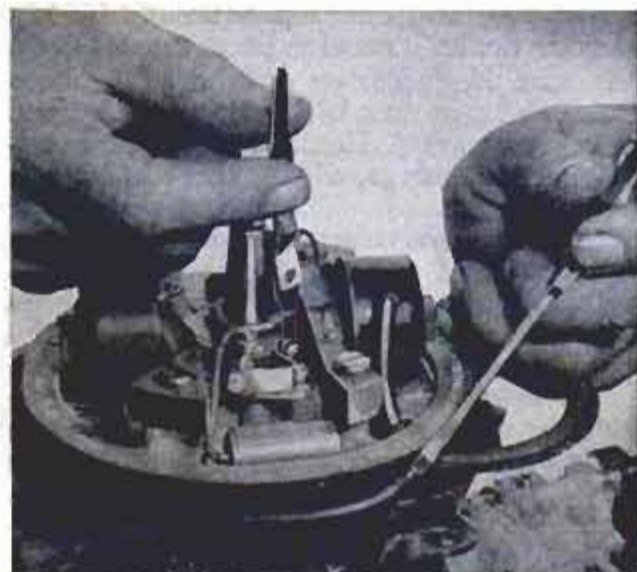

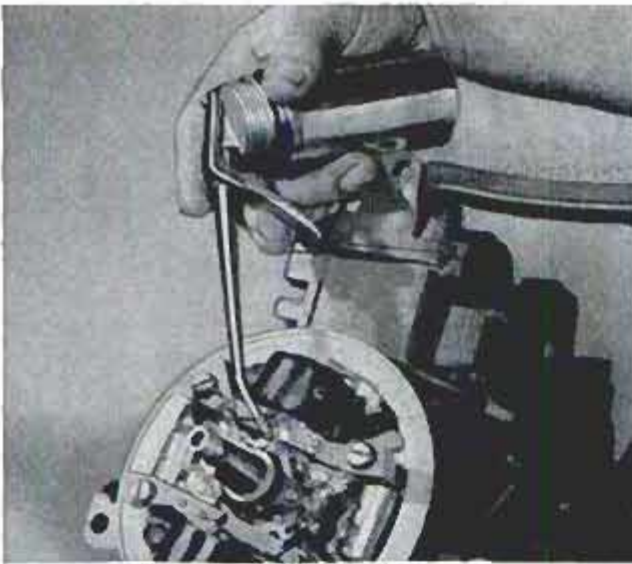

In some cases it is necessary to reoil the felt cam wiper. Use only a few drops of No. 10 oil. Be careful not to drop oil on any other part of the mechanism



If motor has fuel pump, clean the sediment bowl and check the fuel-pump line to detect any leakage. Also clean the diaphragm seat before replacing the bowl

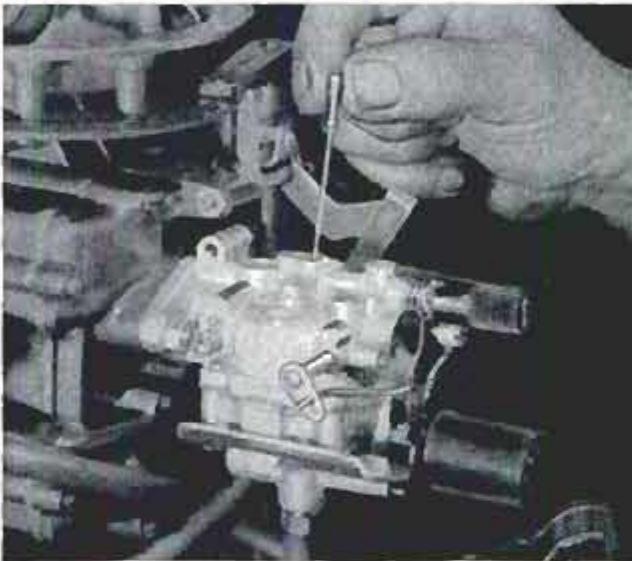

Unscrew the idle jet and blow through it lightly to clear. Motor will not idle smoothly if jet is clogged. Don't use compressed air without disassembling

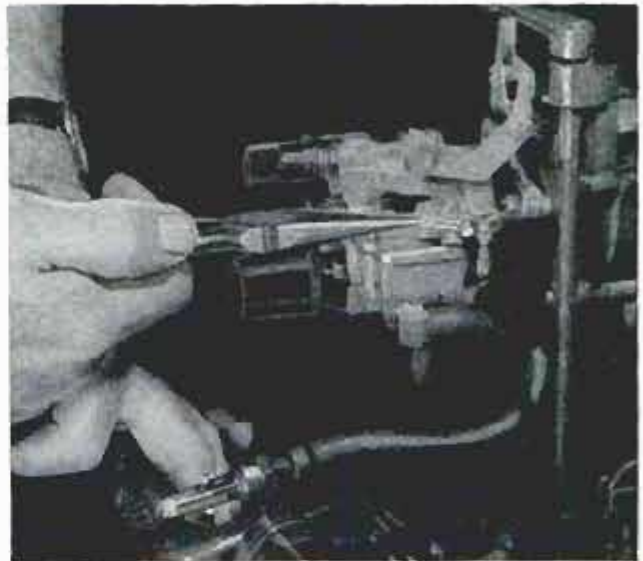

Go over linkage control, checking especially for loss of locking keys. Missing keys should be replaced immediately, also keys which show any looseness

Use a water-repellent grease of approved type on bevel gears of linkage. Apply enough to coat gear teeth. Check nuts, screws and pins for tightness

Remove propeller and check condition of shear pin. Replace a bent or worn pin. If prop is of the type having shock-absorber cushion, check for undue wear

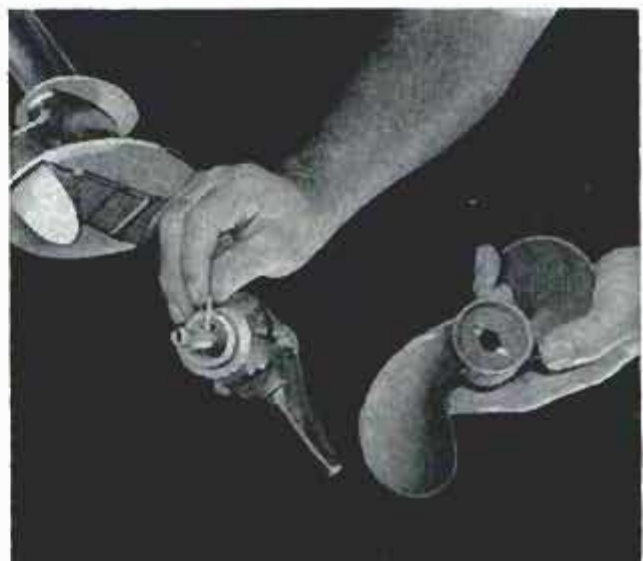
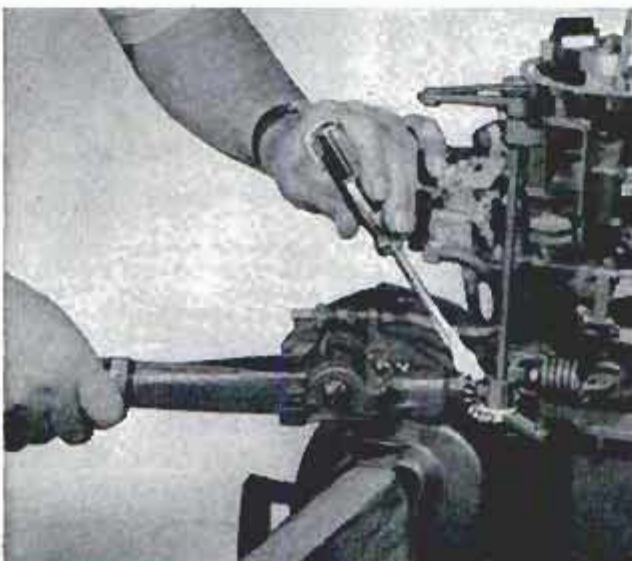

## Pedal-Driven Miniature Tractor Has V-Belt "Transmission"

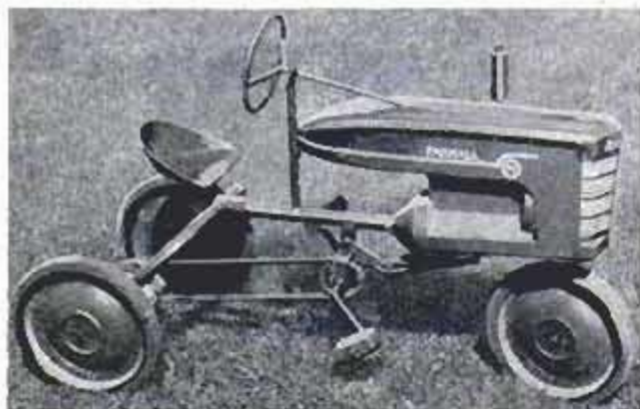

Dad's ingenuity and a welding machine, plus some  $\frac{3}{4}$ -in. pipe and sheet metal resulted in this realistic-looking miniature tractor for a junior farmer. One of the rear wheels is pinned solidly to the axle, while the other turns freely to provide a "differential" action. Speed changes in the belt drive are possible with a "transmission" consisting of a 3-step V-belt pulley on the rear axle. The pedal crank is suspended in a pivoted fork. A bevel gear on the steering column meshes with another on the front-wheel spindle.

## Screen Strip Used as Compass

A strip of screen wire secured at one end with a thumbtack makes a handy improvised compass. The mesh allows a pencil point to be inserted at any desired opening in the strip. Since the openings are greater in size than the diameter of the thumbtack, you should bear outward as you scribe the circle to keep the wire against the shank of the tack. The compass also can be used to scribe circles too large for an ordinary instrument.

☐ Aluminum-foil pans in which frozen pies are purchased can be used as "saucers" for flowerpots.

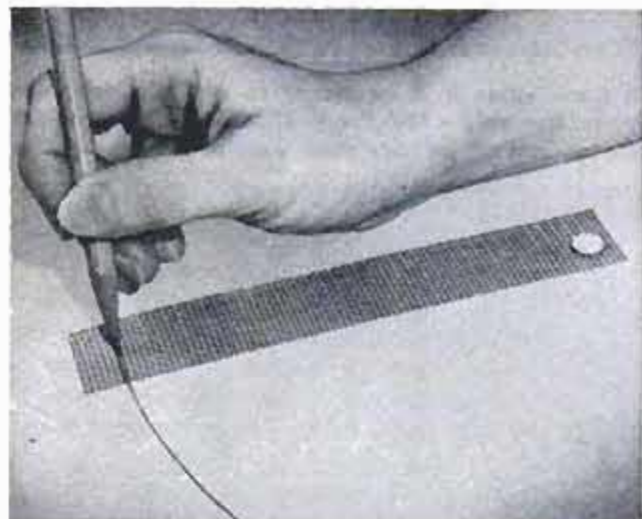

# Build This House Yourself!

## Save 65% Easily!

Two bedrooms, a spacious living room, bath, carport, compact dining room and kitchen all in a space 24 x 46 feet. You can build the Precut House in three stages, using any of numerous floor plans—all of which are designed to provide maximum comfort with minimum cost. Think of it! You can build that house you've always wanted. You can make a livable shell for only \$1800. The second stage will give you a summer home with all conveniences for only \$2800. When you add the third stage, you have a luxury home for year 'round living, in any climate, for only \$3800!



**Livable Shell—\$1800; Summer Home—\$2800; Luxury Home—\$3800; Simplified How-To-Do-It Instructions—Hundreds of Pictures—Working Blueprint Plans!**

You can build the house with the book alone. The plans make it easier. The book gives lists of materials required, all measurements and dimensions, suggestions for financing and tells in words and shows in pictures every detail of construction. Richard Dempewolf, author of the "Precut House" book, built the house in 1650 man hours for \$3731.23—complete!

Features of Expensive Homes are included: built-in furniture, unusual amount of closet space, adaptability to various interior arrangements, and materials designed especially for amateur builders. The book is \$2.50 and a complete set of 10 blueprints \$12.50 (a duplicate set is \$5.00). You can place a C.O.D. order or mail your remittance in full.

Order book and plans from

POPULAR MECHANICS BOOKSHOP

208 E. Ontario St.

Chicago 11, Ill.



## Build Your Own BELT SANDER

By David W. Murphy

**D**ESIGNED FOR THE MAN who likes to build his own power tools, this belt sander uses a standard 4 x 36-in. belt and has ample capacity for handling most metal or wood jobs in the average workshop. An added feature of the sander is a crosscut guide fitted into a groove cut in the table. The guide, which is borrowed from a table saw, takes the guesswork out of maintaining the correct angle on miters and square cuts being sanded. Also included in the design of the sander are adjustments to permit maintaining correct belt tension and for centering the rotating belt on the drums. Loosening the same two adjustments allows quick removal and replacement of the belt. Power is supplied by a ¼-hp., or larger, electric motor.

### Sander Frame

Begin construction of the sander by first cutting all the frame parts from ¾-in. plywood as detailed on page 206. Only one of each of the frame parts is required except for the table-support brackets and the ¾ x ¾ x 4⅝-in. spacer blocks that are fitted between the belt backup pieces. Make two of each of these. When laying out the 10 x 12-in. base of the sander, locate a hole in each corner so that it can be bolted or screwed to a workbench or table top.

The 1⅝-in. holes in the lower bearing housing and the left-hand drum support should be drilled slightly undersize to provide a press fit for the ⅜-in.-i.d., 1⅝-in.-o.d. flanged ball bearings in which the shaft of the lower drum rotates. Notch the upper end of each of the drum supports ¾ in. wide x ¼ in. deep to accommodate the upper-drum support plate, which is a piece of flat steel, ¼ x ¾ x 6⅛ in. Note that the upper spacer block is located ¼ in. below the upper ends of the backup pieces so it aligns with the notches in the supports.

Assemble the backup pieces on the spacer blocks and screw on both vertical supports. When attaching the bearing housing A to drum support B, make sure the bearing

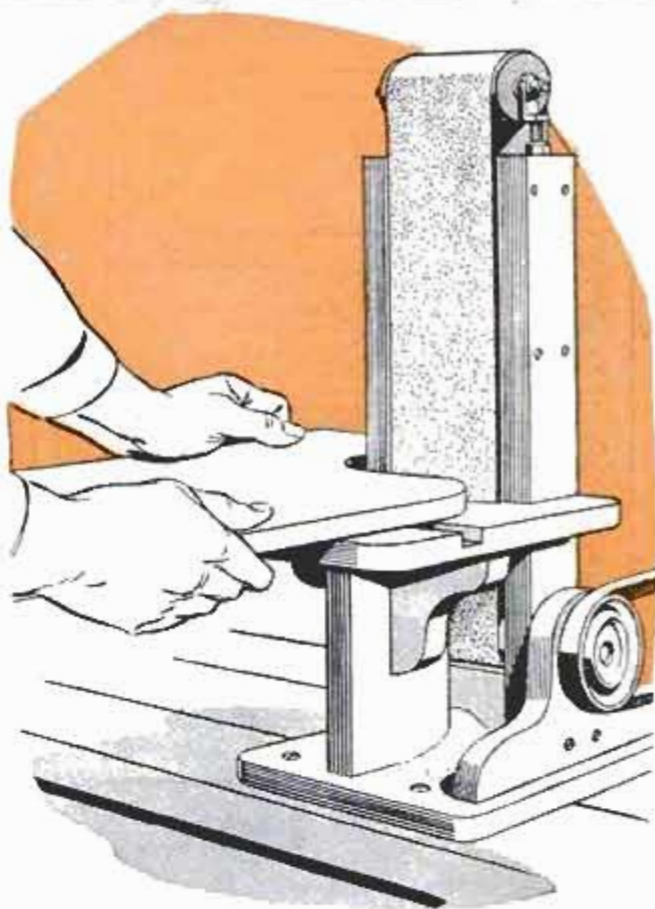

hole in the housing aligns with the bearing hole in the left-hand drum support. The drum-support assembly now can be screwed to the sander base. The detail of the base on page 206 indicates the relative positions of bearing housing A, drum support B and bracket C. Screw the table-support brackets to the table support and attach the table. The assembly now can be screwed to the sander base. Check to make sure the slot for the crosscut guide is parallel to the backup piece.

### Drum Construction

If a lathe is available, the drums for the sander can be turned from solid stock. An alternate method, when no lathe is available, is to fabricate the drums from plywood disks. Cut the disks about 2⅝ in. in diameter with a circle cutter and drill a ¼-in. hole in the center of each one. Coat the disks with glue, stack them 4 in. high and clamp them together by using a long ¼-in. bolt and nut. Use a washer under the bolt head and nut. The bolt should project enough so that it can be chucked in a drill press. When the glue has dried, each of the two drums then can be filed and sanded to size while rotated in a drill press. Bore out the hole in the lower, or driving, drum

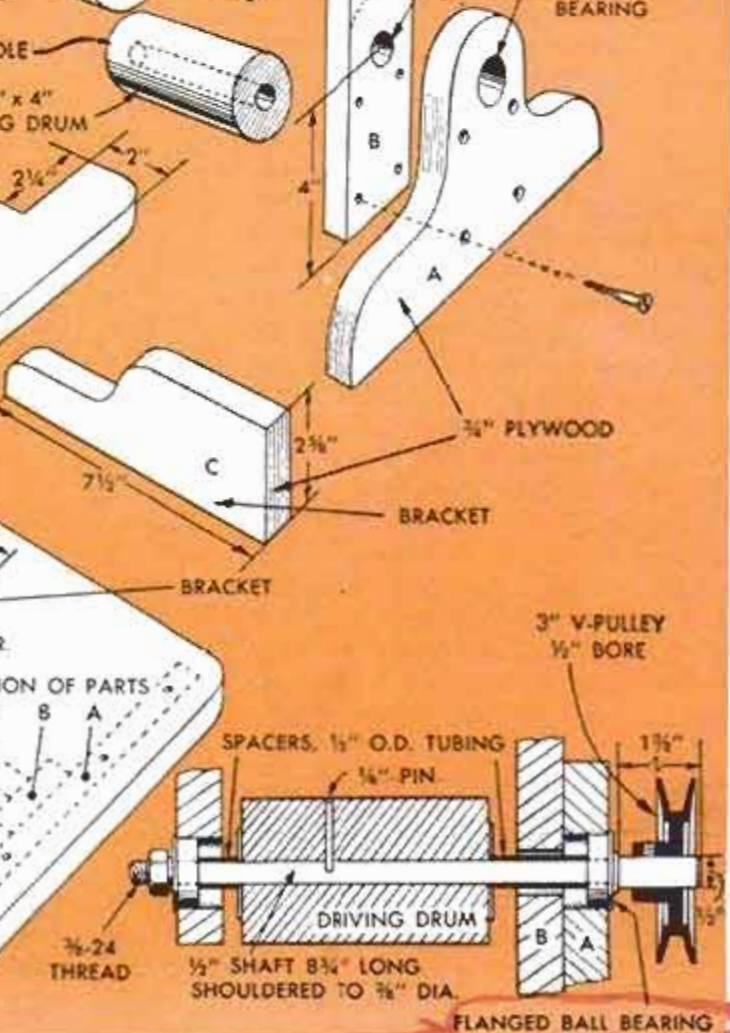
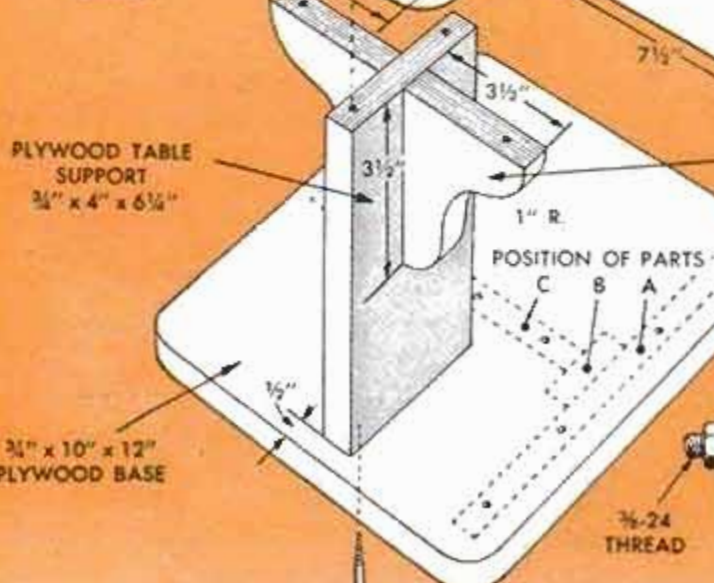
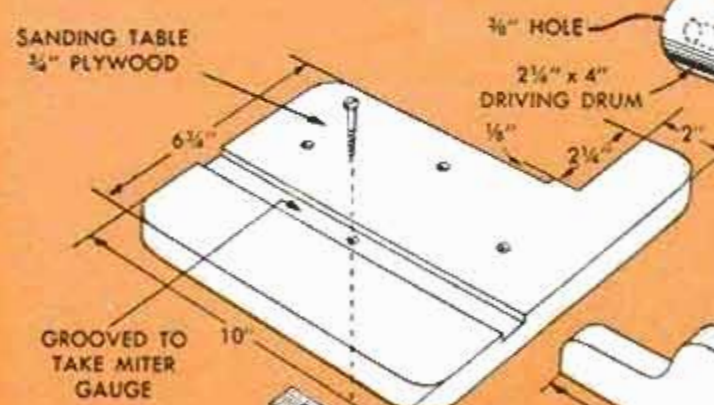
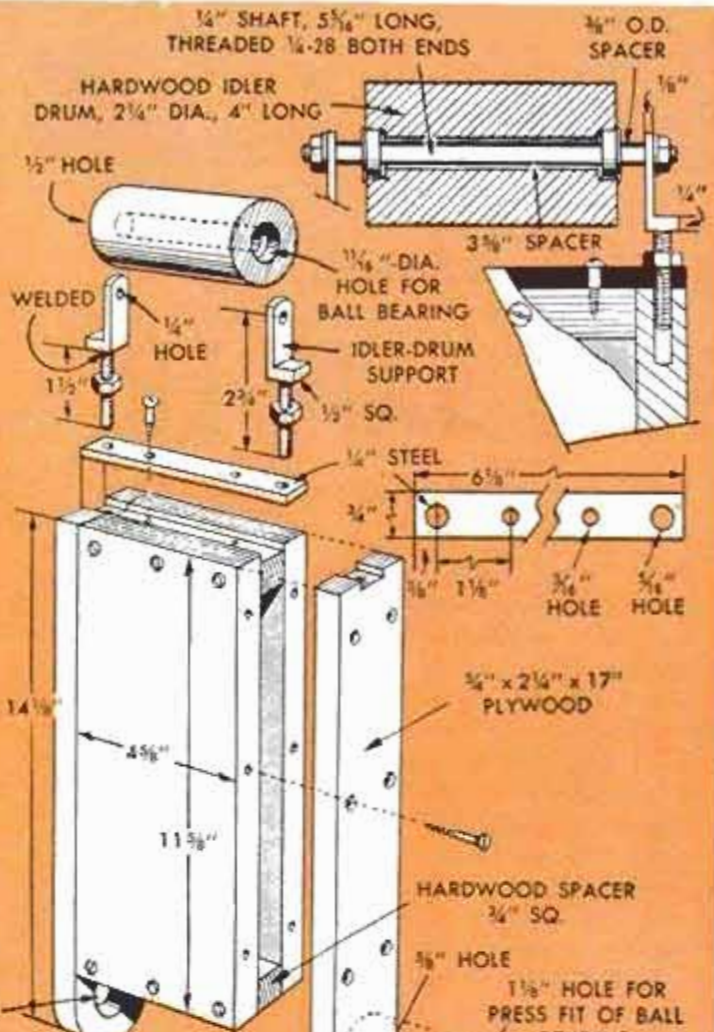
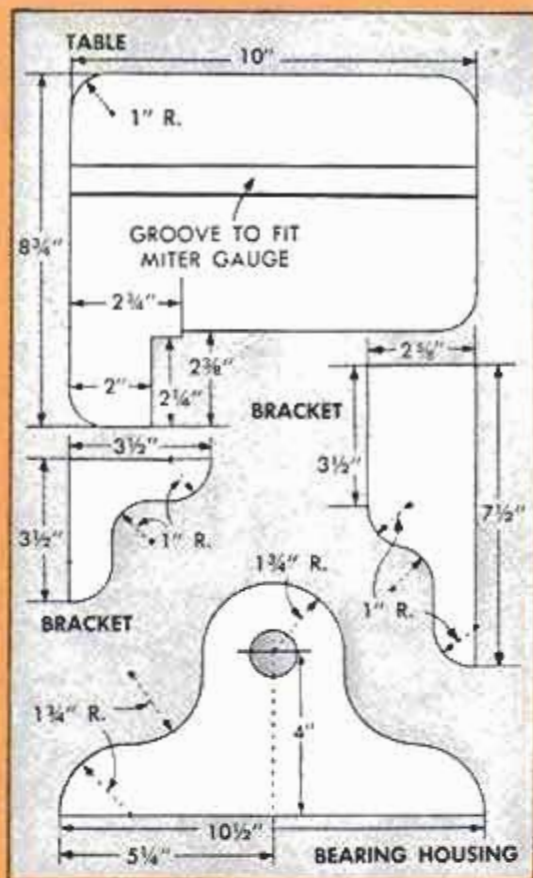



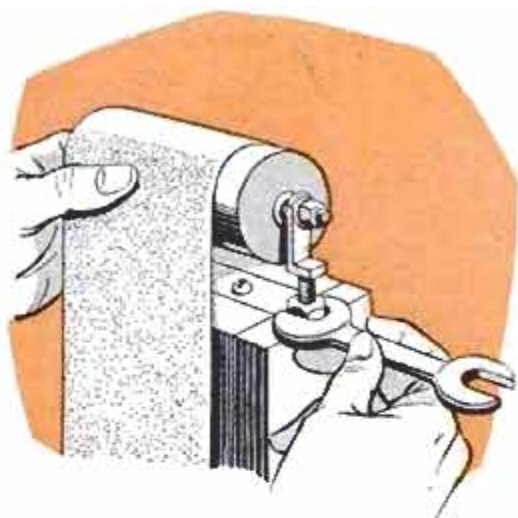

To install belt, lower upper-drum supports. Raising or lowering one of the supports centers rotating belt on drums

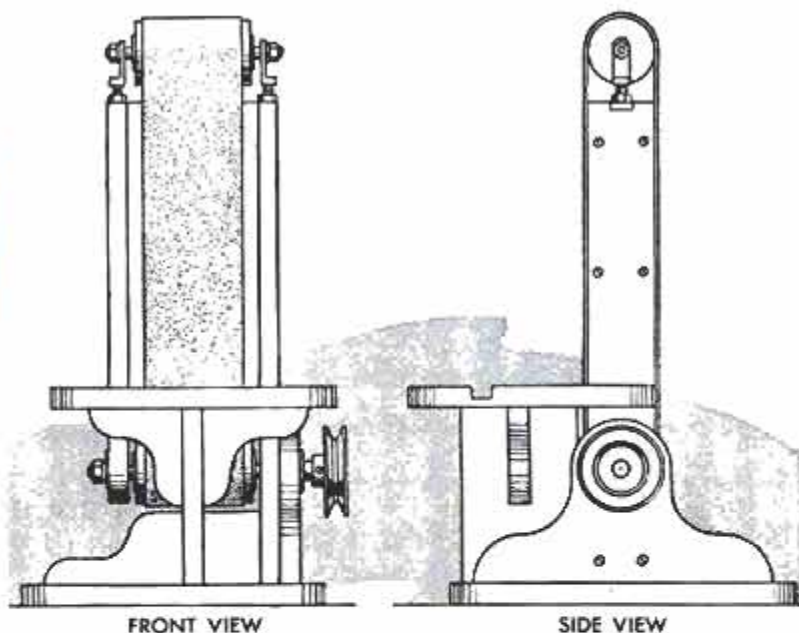

to  $\frac{3}{8}$  in., and the hole in the upper, or idler, drum to  $\frac{1}{2}$  in.

### Driving-Drum Assembly

The shaft for the driving drum is a length of  $\frac{1}{2}$ -in. rod  $8\frac{3}{4}$  in. long. It is shouldered to  $\frac{3}{8}$  in. in diameter, leaving  $1\frac{3}{8}$  in. at the original diameter to accommodate a 3-in. V-belt pulley that has a  $\frac{1}{2}$ -in. arbor hole. An alternate method for making this shaft is to use a  $\frac{3}{8}$ -in. rod and fit one end with a  $1\frac{3}{8}$ -in. length of tubing having a  $\frac{3}{8}$ -in. i.d. and a  $\frac{1}{2}$ -in. o.d. to accommodate the pulley. A hole is drilled through the tubing so the setscrew in the pulley will contact the shaft. One end of the shaft is threaded  $\frac{3}{8}$ -24 to receive a nut. The shaft now can be slipped through the ball bearings that are press-fitted in the drum supports, and the drum and spacers fitted on it. The spacers also are cut from  $\frac{3}{8}$ -in.-i.d. tubing. Between the drum and the bearing on the pulley end of the shaft, the spacer is  $1\frac{1}{2}$  in. long; between the drum and the opposite bearing, the spacer is  $\frac{5}{8}$  in. long. The spacers bear against steel washers fitted at each end of the drum. The drum is held on the shaft by a  $\frac{1}{8}$ -in. pin driven in through the side.

### Idler-Drum Assembly

Each end of the idler drum is counter-bored to a diameter of  $1\frac{1}{16}$  in., deep enough to accommodate the flanged ball bearings which have a  $\frac{1}{4}$ -in. i.d. and an  $1\frac{1}{16}$ -in. o.d. Before fitting the bearings in the drum, a spacer  $3\frac{5}{8}$  in. long is inserted. This spacer is cut from tubing having a  $\frac{1}{4}$ -in. i.d. and a  $\frac{3}{8}$ -in. o.d. Two spacers, also cut from the tubing, then are fitted on the drum bearings and the drum supports. The idler-drum shaft is a  $\frac{1}{4}$ -in. rod  $5\frac{5}{16}$  in. long, ends of which are threaded  $\frac{1}{4}$ -28 and fitted with nuts.

### Adjustable Idler-Drum Supports

Adjustable supports for the idler-drum shaft can be made by cutting sections from a steel angle and welding  $\frac{5}{16}$ -in. bolts to them. An alternate method is to use two clevises that will provide supports when one side of each clevis is cut off to form an L-shape.

After the drum-support plate is screwed in place, drill down through the two  $\frac{5}{16}$ -in. holes in it, into the spacer block, so the bolts of the drum supports can be inserted their full length. Fit the drum supports on the drum and turn on the shaft nuts until they are snug. Then insert the bolts of the supports into the holes of the support plate and tighten the shaft nuts firmly. This latter operation assures that the supports are parallel.

The completed sander now can be bolted to a bench or table and connected to a motor. A 3-in. V-belt pulley is used on both sander and motor so the sander runs at a standard 1750 r.p.m. If it is desirable to sand at slower speeds, use a 1 or 2-in. pulley on the motor. To install the belt, lower the idler-drum supports. When the belt is in place, raise the supports until the belt is snug. Start the motor and center the belt by turning the nut on one support to raise or lower one end of the drum. ★ ★ ★

### Photo Fluid on Lathe Faceplate Prevents Work From Slipping

When making faceplate turnings that are held only by the center screw on a woodworking lathe, one craftsman applies photo-retouching fluid to the faceplate so that the turnings will not slip. Since the fluid has a rosin base, a satisfactory substitute may be made by dissolving ordinary lump rosin in turpentine.

## Bolt Turned in Threaded Tubing Prevents Drill-Bit Breakage

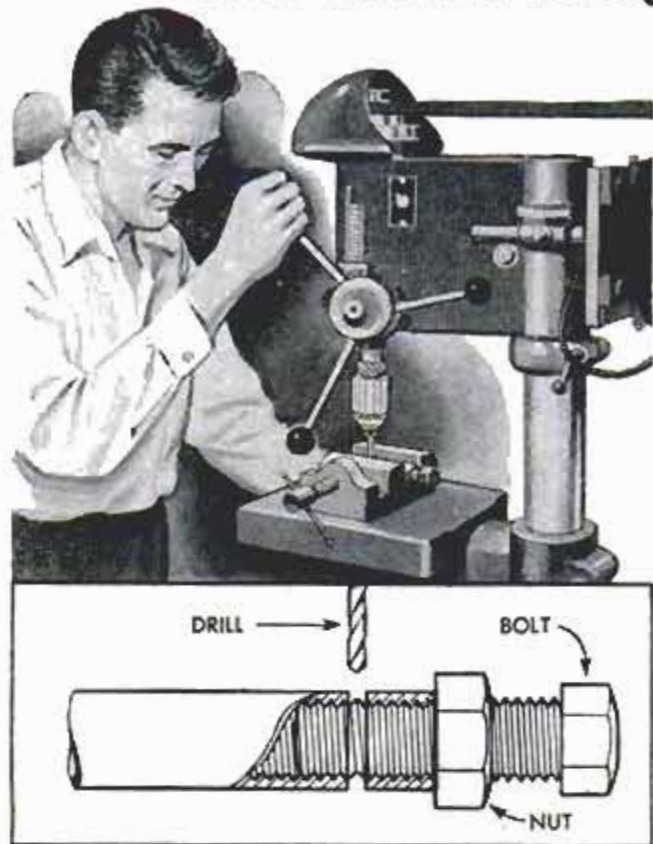

Drilling through a length of internally threaded tubing often results in a broken drill bit or misaligned holes, caused by the tip of the bit being forced to one side by the threads. To avoid these problems, simply screw a bolt having the same type threads into the tubing. A nut on the bolt is jammed against the end of the tubing to prevent the bolt from turning. Drill through both tubing and bolt. When the bolt is removed after the drilling, it also removes any burrs caused by the drilling.

## Aluminum Tea Infuser Used as Small-Parts Washer

Small parts from a disassembled clock, carburetor or other object are easy to clean when placed in a tea infuser of the type shown. Suspend the infuser containing the parts in a tall can filled with a cleaning fluid, allowing sufficient time for grit to soak loose. Then, dip it in the solution several times, until all foreign matter is rinsed from the parts. Holes in the infuser can be enlarged, if desired.



A. Zanelli, Tampa, Fla.

## Air Cleaner on Electric Motor

Fine screen wire coated with oil and fastened over the open bell ends of a small electric motor will help reduce dust deposits inside it, which may cause overheating, or even short circuits. The screen wire may be slipped under bolt heads to hold it in place. Foreign particles larger than the mesh openings of the wire will be excluded entirely and much of the fine dust will adhere to the oil-coated wire. It is necessary to keep the wire screen fairly clean to permit air circulation through the motor.

## Wrench for Socket-Head Screws Improved From File Tang



When necessary to adjust socket-head screws, such as the setscrew on the pulley of an electric motor or on other household appliances, the tang of a three-sided file can be used as a socket-head wrench.

Break off a part of the tang for the required fit and use a pair of pliers for leverage to turn the improvised wrench. Do not apply too much pressure on the file tang since the metal is quite brittle.

George C. Mattis, Birchwood, Wis.

## Cellulose Tape Holds Gasket When Assembling Engine

A few pieces of cellulose tape can be used to keep gaskets aligned when bolting units, such as the fuel pump shown, onto an automobile engine. The tape is so thin it need not be removed when the part is bolted down against the gasket.

O. A. Nelson, Seattle, Wash.

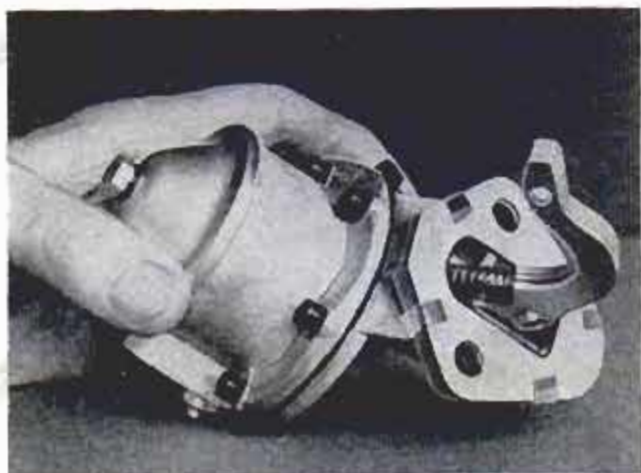



# KNOW YOUR SHOP MOTORS



By J. R. Williams

PART I

**A**LTHOUGH THERE ARE few wear parts in an electric motor, neglect and misuse can cause failure of the unit long before it has delivered a full measure of the hours of service built into it by the manufacturer. Common causes of failure are overlubricating, lack of lubrication, overloading and operation on excessively high or low voltages.

Fractional-hp. motors used on household appliances, home-shop machines and certain industrial applications usually are of the split-phase type or the capacitor-start type, Fig. 4. The motor selected depends

largely on the type of service required. Split-phase motors develop full power at constant speed but will start only very light loads, and the initial current surge during the starting period is very high. For medium-heavy starting loads and comparatively low current requirements during the starting period, the capacitor-start motor is usually the best selection. For starting exceptionally heavy loads with the minimum current requirement the repulsion-start induction motor is essential. These terms refer to the type of starting unit built into the motor. The motor's ability

3

## SAFE CURRENT-CARRYING CAPACITY OF EXTENSION CORDS

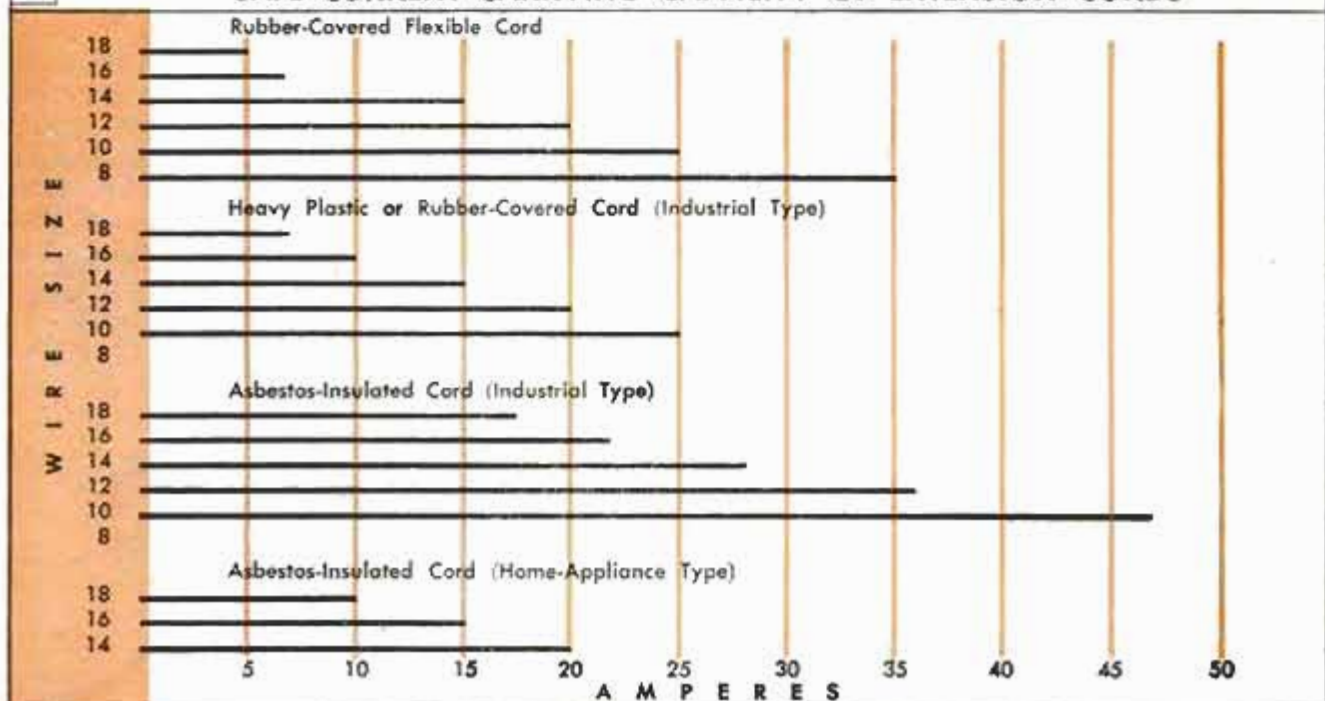

## COMPARISON CHART

### Motor Types and Characteristics

Motor Type	Characteristic	Starting Current Requirements (Approx.)	Suggested Application
Split-phase	Low starting torque; low initial cost	5 to 7 times greater than the current required for running	Washing machines, Ventilating fans, Polishing heads, Belt sanders
Capacitor-start	Starting torque 2 to 4 times greater than running torque	3½ to 4½ times greater than required for running	Water system, Small air compressor, Stoker, Large bench saws
Capacitor start-and-run	Starting torque comparable to capacitor-start type	Approximately the same as the capacitor-start	Suitable for units requiring frequent starting
Repulsion-start induction motor	Starting torque 3 to 5 times running torque	2 to 4 times the running current	Hard-starting equipment: Centrifugal pumps, Compressors

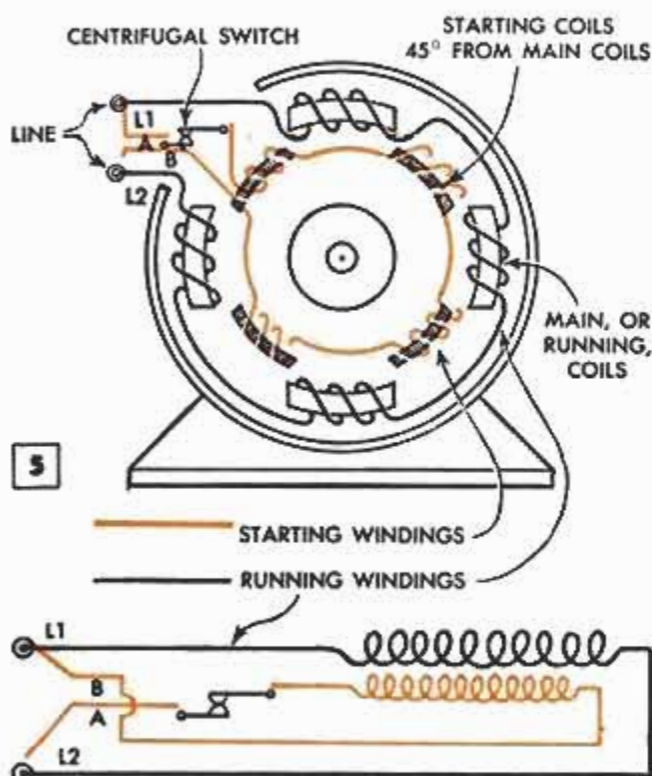

6

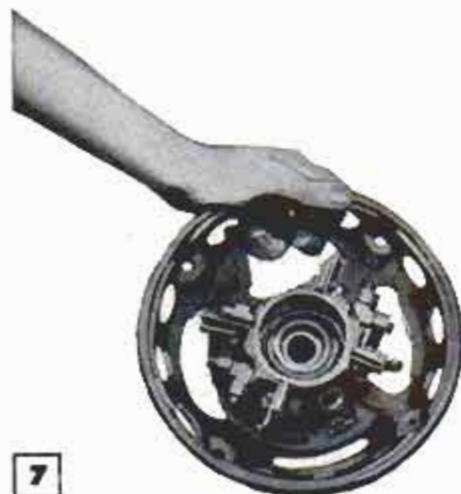

7

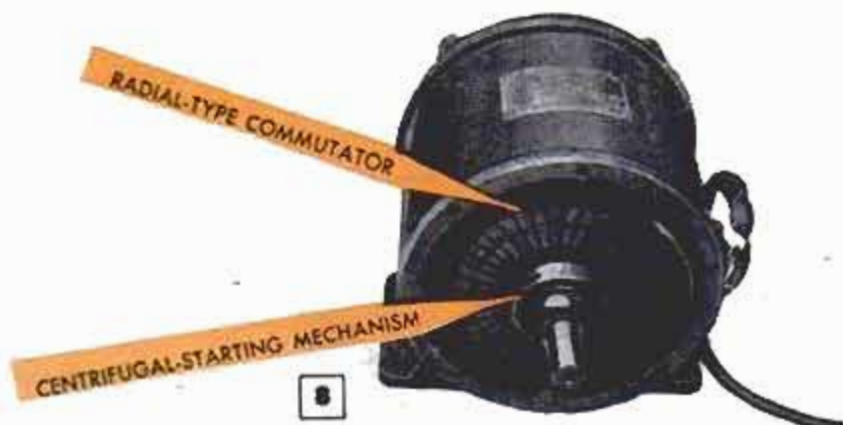

8

to drive the load at its rated speed after starting usually is determined by the hp. rating. Split-phase motors are not ordinarily supplied above ½ hp. The other two types come in a wide range of sizes. The capacitor-start, capacitor-run motor is not regularly made in the fractional-hp. sizes.

Before purchasing a used fractional-hp. motor, connect it to the power line and close the switch. If it fails to start, open the switch immediately and wrap a cord several turns around the pulley, Fig. 1. Spin the armature (rotor) by pulling on the cord and simultaneously close the line switch. If the motor then runs at full-rated speed, the trouble likely is in the centrifugal switch. This can be corrected later by removing the end shields, first unscrewing nuts on the bolts holding the shields in place. Before dismantling it's a good idea to punch-mark the shields and frame, Fig. 2, so that the parts can be properly located when reassembling. A light tap on the end of the shaft, Fig. 21, usually will loosen the end shield without damage. Removing the end shields will reveal the starting and running windings and the starting mechanism. On repulsion-start motors the starting mechanism will consist either of a

radial-type commutator, Fig. 8, or an axial type, and a brush assembly, Fig. 7. These parts should be thoroughly cleaned and the brushes replaced if worn. On capacitor motors surplus oil resulting from over-lubrication of the bearings may be thrown onto the centrifugal switch, causing arcing at the points. A thorough cleaning of the points usually cures the trouble, permitting the motor to start readily.

Nearly all split-phase, capacitor and repulsion-start motors can be reversed either by interchanging the leads on the terminal plate or by shifting the position of the brushes. Figs. 5, 6, 11, 12 and 13 show the common procedures in reversing fractional-hp. motors. As an example, reversing leads A and B, Fig. 5, to the positions shown in Fig. 6 will reverse the motor. On some types of repulsion-start motors the brushes are mounted on a movable ring, or spider, having a pointer moving between index marks at some point on the outside of the end shield. Loosening a screw and shifting the pointer from one mark to the other will reverse the motor. Certain fractional-hp. motors also can be arranged for operation on 110 or 220-v. current (115-230) either by shifting bus bars or by interchanging leads at the terminals. A and B in Figs. 14 and 15 are examples. However, it should be remembered that while principles remain the same, not all motor manufacturers' specifications are the same, especially when referring to older-type motors. In any case, it's a good idea to obtain from the manufacturer a wiring diagram showing how to reverse the motor or change the wiring for operation on a higher or lower voltage. When necessary to remove the terminal plate, be sure it is replaced in the same position, Fig. 20.

Distance From Motor to Meter	Recommended Wire Sizes				
	Using 115 Volts.		Using 230 Volts.		
	¼ HP.	½ HP.	¾ HP.	1 HP.	1 HP.
Up to 100 ft.	No. 14	No. 14	No. 14	No. 14	No. 14
100 to 200 ft.	No. 12	No. 10	No. 14	No. 14	No. 12
200 to 300 ft.	No. 10	No. 8	No. 14	No. 12	No. 12
300 to 400 ft.	No. 8	No. 6	No. 12	No. 10	No. 10

CURRENT-CARRYING CAPACITY OF FLEXIBLE CORDS			
Wire Size	Rubber-Covered Cord	Heavy-Rubber or Thermoplastic-Insulated	Asbestos-Type Cord
No. 18	5 amp.	7 amps.	10 amps.
No. 16	7 "	10 "	15 "
No. 14	15 "	15 "	20 "
No. 12	20 "	20 "	
No. 10	25 "	25 "	
No. 8	35 "		

Overloaded cords overheat, waste current and often fail to deliver sufficient current to run motors at top efficiency.

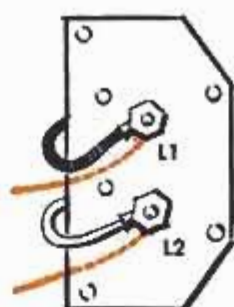

TERMINALS L1 AND L2 ARE THE LINE-CORD TERMINALS. IN CERTAIN MOTORS TWO LEADS ARE BROUGHT OUT TO FACE OF TERMINAL PANEL AS SHOWN. THESE MAY BE EITHER RUNNING-WINDING LEADS OR STARTING-WINDING LEADS. REVERSING THESE LEADS WILL REVERSE MOTOR

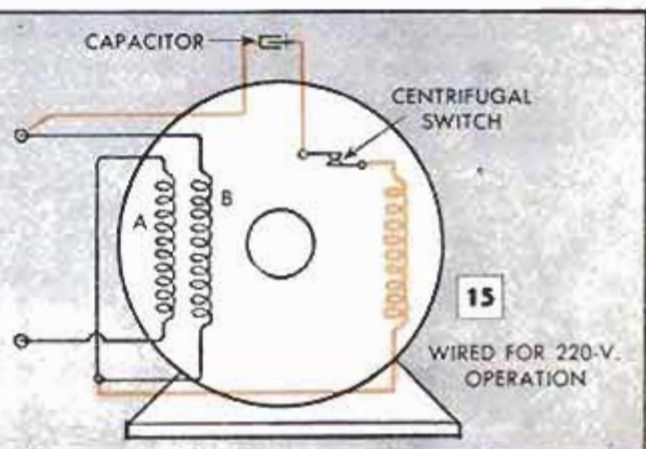
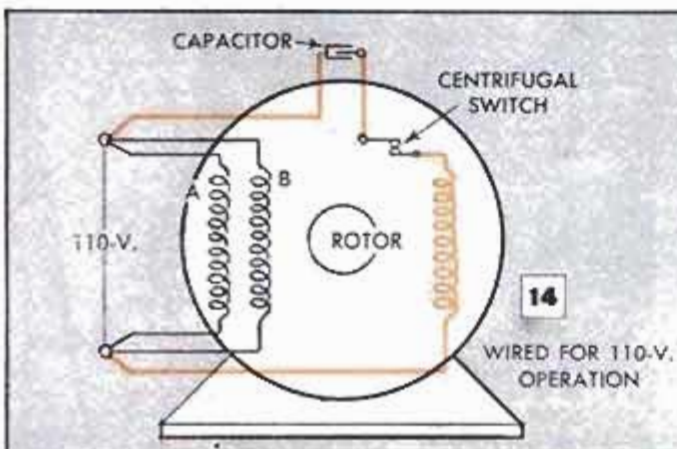
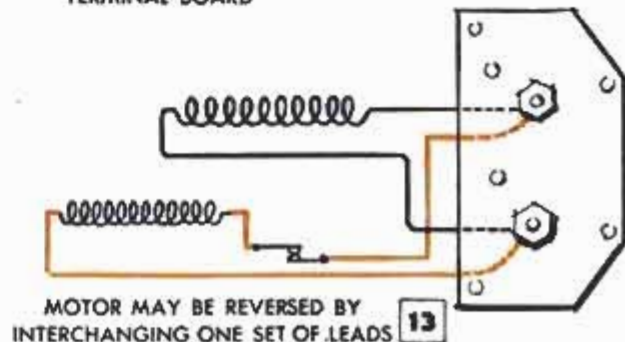
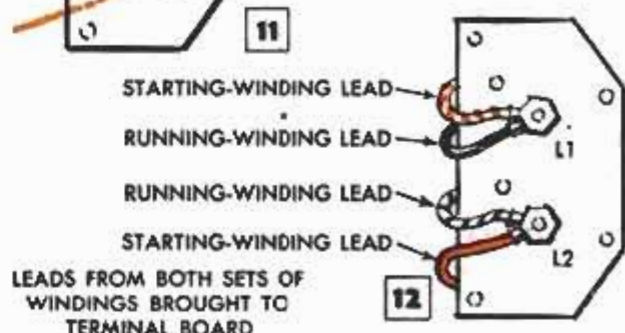

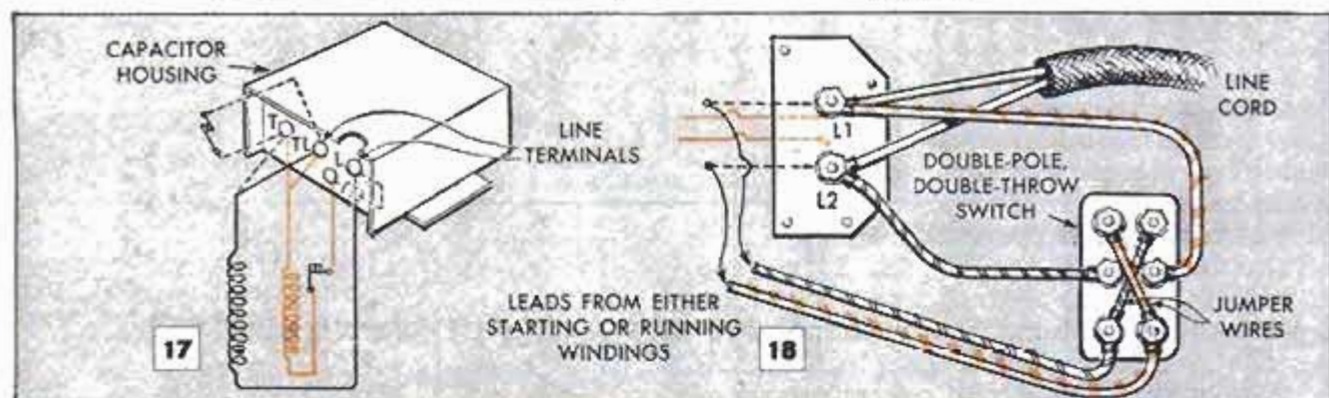
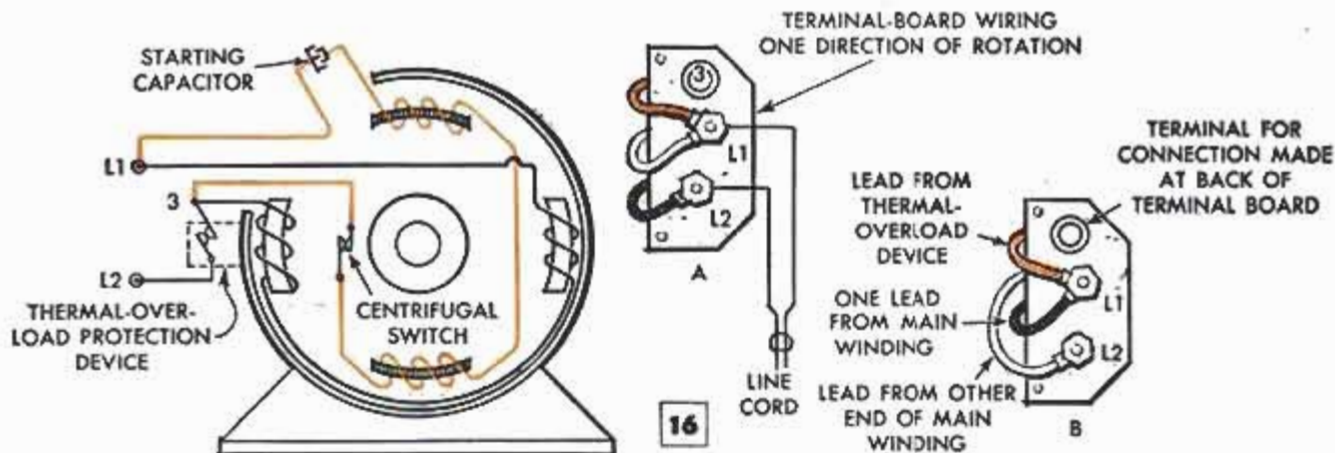

### 19 WIRE-SIZE REQUIREMENTS FOR ELECTRIC-MOTOR WIRING

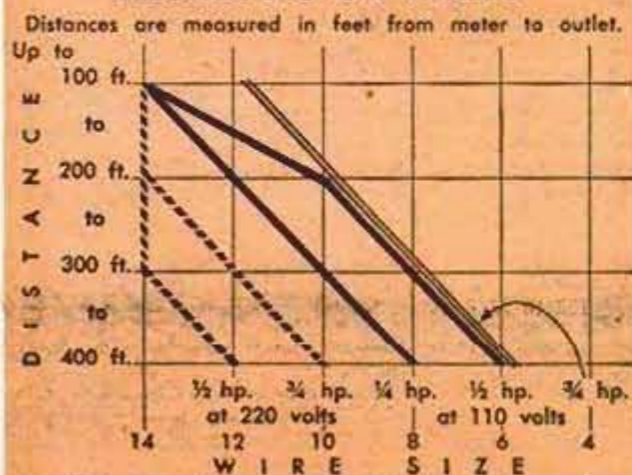

To determine wire size required follow distance line across until motor line is intersected, vertical line at point of intersection gives recommended wire size.

Some capacitor motors in fractional-hp. sizes are fitted with a thermal overload-protection device, Fig. 16. Details A and B show the terminal-plate connections for two directions of rotation. Note how the leads are interchanged to reverse the motor. On some older-type motors the terminal plate is mounted on the capacitor housing, Fig. 17. Terminal T is used when a thermal overload switch is wired in the circuit. Capacitor motors can be reversed by wiring a reversing switch, Fig. 18, into the circuit.

Figs. 3, 9, 10 and 19 give important information on recommended wire sizes and cord lengths. Use of the correct wire size prevents damage to the motor from low voltage and also prevents heating of the cord. Recommendations are only general.

(Continued next month)

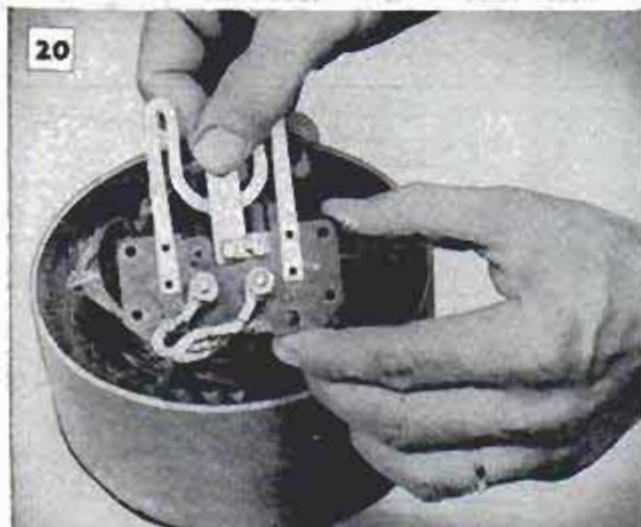

## "Backstop" on Drill-Press Table Prevents Work From Turning

A  $\frac{3}{4}$  x 2-in. length of wood clamped to the table of a drill press, as shown, will prevent work from rotating with the drill bit, or turning suddenly. The latter may happen when the work is held by hand and it turns free, which might cause personal injury. This "backstop" also will save drilling time, since nearly any shape of work can be accommodated, as shown in the diagram, while one hand is left free to operate the turnoff switch, move and replace stock. For very small work use a wider piece of wood, or clamp the backstop adjacent to one edge of the work to keep it from turning.

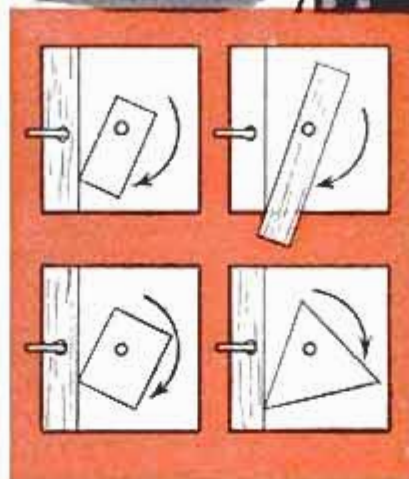

## Large Portable Feedbin Built on Spreader Frame

The large-capacity, completely portable feedbin shown in the photograph was built on the frame and running gear of an old manure spreader. The spreader bed was removed and a smooth floor laid over the metal frame. The framework of the bin then was built up from regular studding and covered with galvanized corrugated roofing. The roof is removable for easy refilling. The side and end doors can be partly boarded to allow the grain to settle as it is removed.



## Upturned Brush Is Soap Dish

Soap at the shop or farm wash-up sink gets wasted and messy because it is left on the sink edge in contact with water. A remedy for this is to turn a handbrush upside down and place the soap on the bristles. A small amount of soap is deposited on the bristles for later use.

## Soapy Water Softens Stiff Rope

Rope which has become stiff and difficult to use can be reconditioned by soaking it for a short time in a solution of very hot soapy water. When the rope appears soft and pliable remove it from the container and allow to dry.

Howard E. Moody, Upper Jay, N. Y.

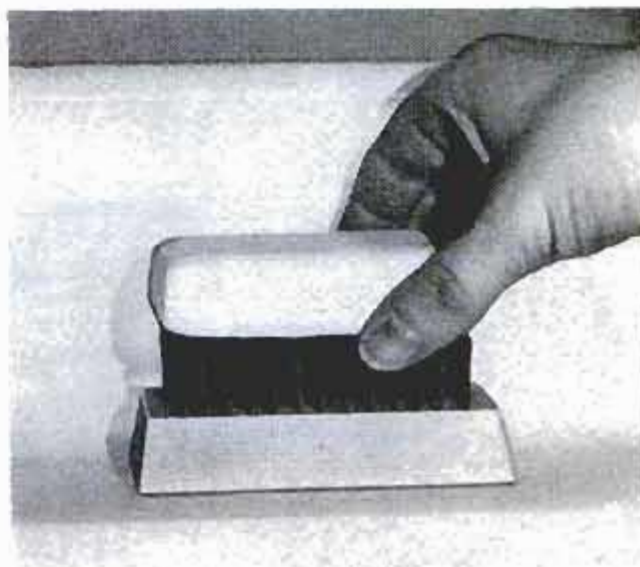

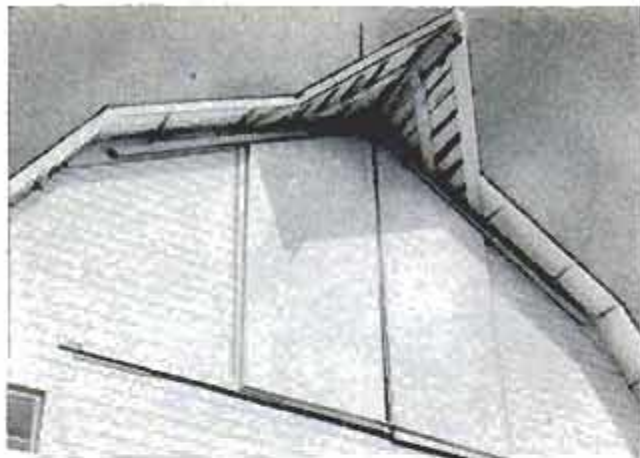

### Haymow Doors Counterweighted For Easier Operation

Lifting the counterweights attached to the doors of the haymow on this barn is all that is necessary to open them. The doors are suspended on rollers which run on enclosed tracks running beneath the roof overhang. A rope attached to each door near the peak runs to the doorframe on the side opposite the door and down to a heavy counterweight. The doors drop down behind a long wooden guide which keeps them from flapping whether open or closed.

### Feed Bunk "Roofed" on One End To Protect Mineral and Salt

One end of this outdoor grain and hay bunk built on one side of a cattle pen is partitioned and "roofed" for mineral feed and salt. This protection serves to keep out litter and chaff and prevents rain from falling on the water-soluble minerals contained in the special feeding bin. Capacity is one sackful.—Iowa State College, Ames, Iowa.



## CURVED RAFTERS Made Without Glue

By Louis Martin Reitz

**T**HIN WOODEN STRIPS spaced and bent in a jig of predetermined radius make rigid, serviceable rafters for farm outbuildings and other small structures which may be subjected to heavy snow loads or high winds. Rafters can be designed to form walls and roof in one unit, the lower ends anchored at the sills, or vertical walls can be carried to the desired height and the rafter ends anchored to plates. In either type of structure the rafter layout, shown in details A, B and C on the opposite page, is much the same. No glue is used in the construction, the two pairs of strips being nailed to spacer blocks.

As the first step, determine the required radius by striking the inner and outer arcs as in detail C. Then construct a jig by cleating several boards edge to edge to give the required width and length. Determine from this, and detail C, the size of the spacer blocks, noting especially that the top edge of the upper, or peak, block is cut at a tangent to the rafter curve, as in detail C and the view of the assembled rafter. Ends of the strips also extend beyond the peak spacer to half-lap the ridge board. Bending is done in the jig by means of blocks of hardwood attached to the jig with screws or bolts. When the parts have been wedged in place, the strips are nailed to the spacer blocks. Nails are driven into the spacers at an angle as in the lower left-hand detail on the opposite page.

Sills (also plates where used) are beveled to obtain a flush fit of the rafter strips at the lower end. A bolt passing through the lower ends of the strips and the sill holds each rafter unit securely in place. Some builders use a 4 x 4 sill to give a greater bearing surface.

On small structures the rafters can be assembled as single units and raised into position without attaching to a ridge board. When this is done it may be necessary to draw the lower ends into position with a twisted wire or rope as in detail D. In larger structures, a ridge board adds strength and rigidity to the framing. Note in the lower left-hand detail, opposite page, that the rafter units are tied at the peak with a strip of sheet metal nailed to the spacer blocks. Although not shown in the detail, a second strip of sheet metal nailed across the bottom of the arch will add to the strength of the structure. When a ridge board is not used rafters should be tied at the peak with 1/2-in. plywood gussets. ★★



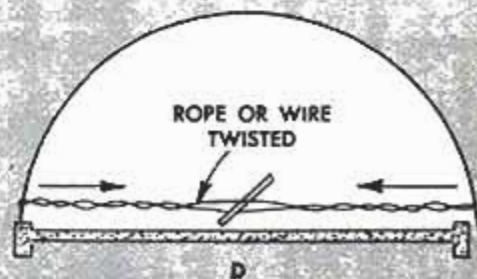
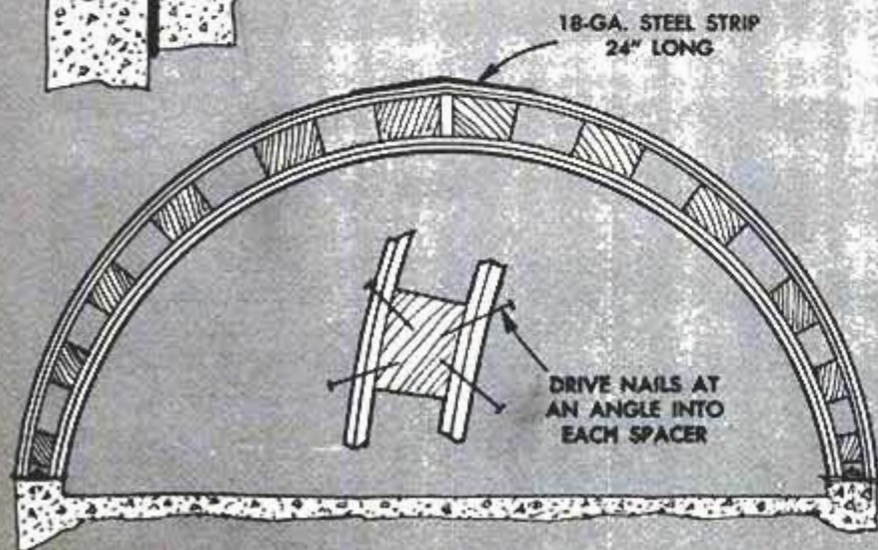
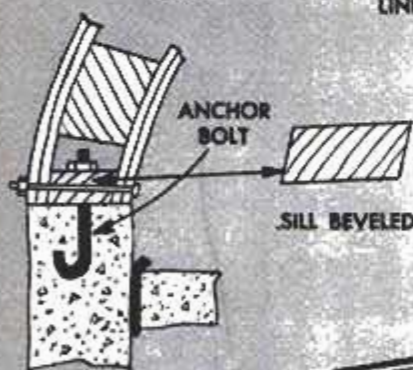
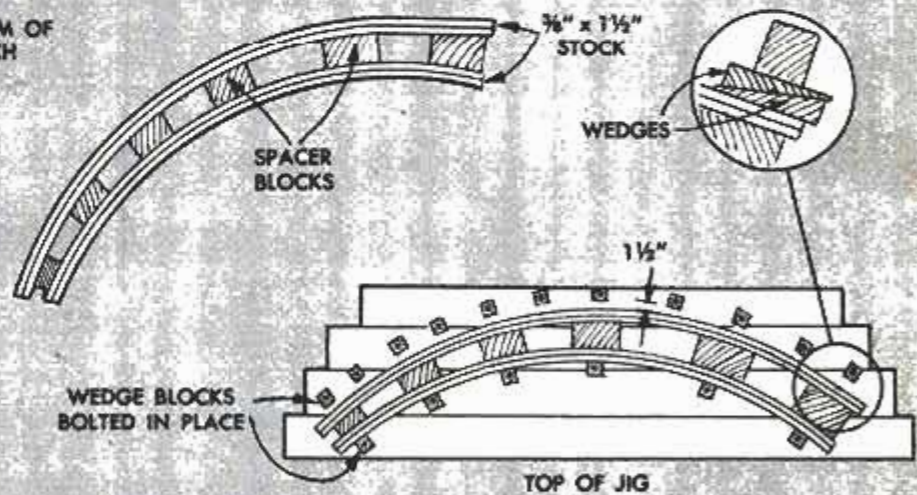
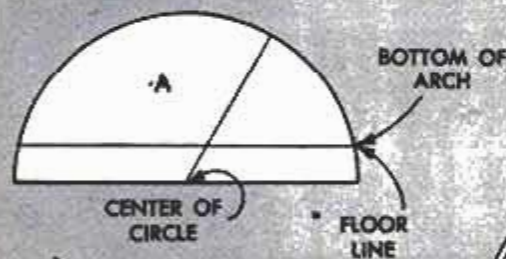
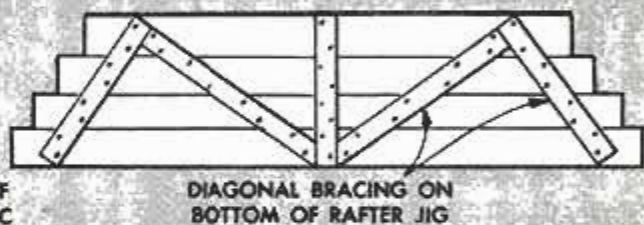
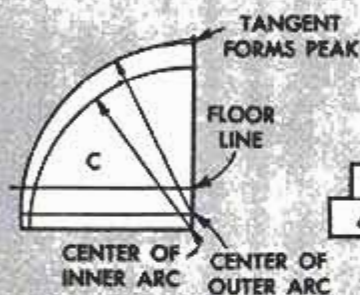
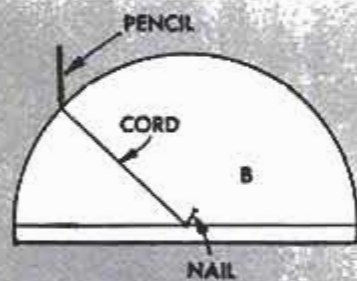
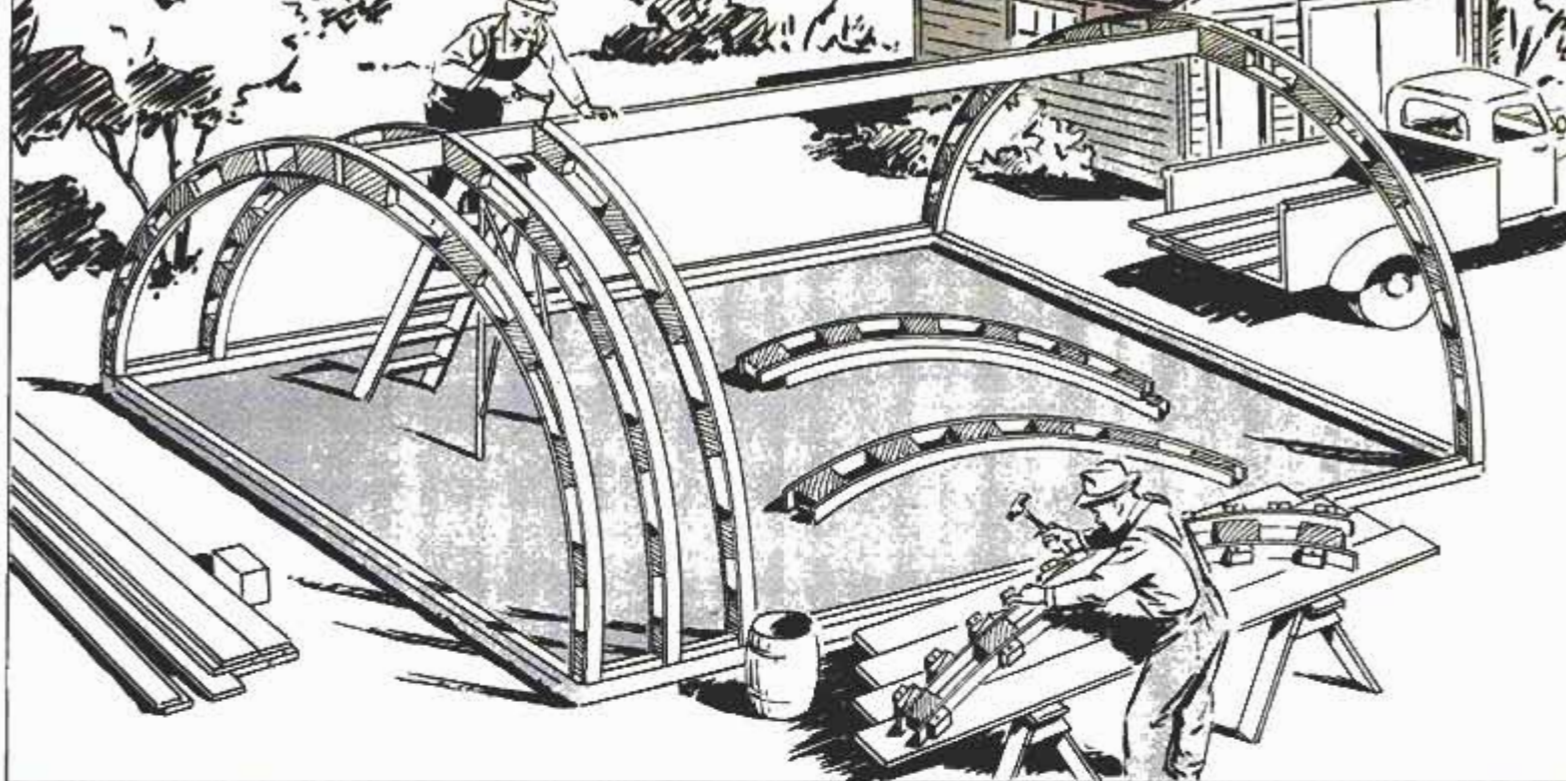

# Making Accurate Right-Angle Bends in Bar Stock

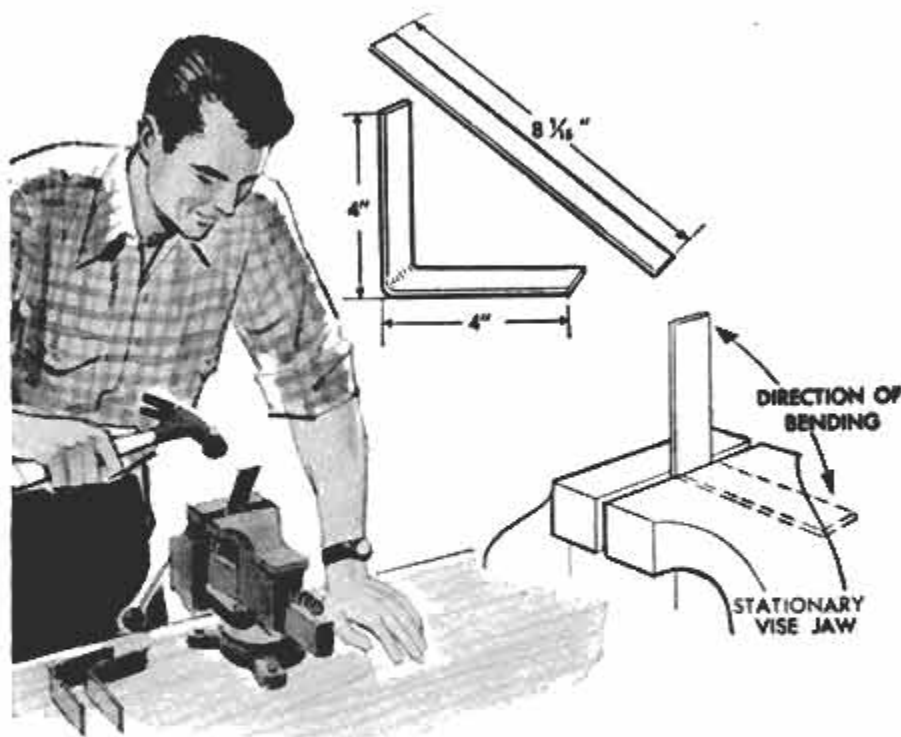

When a metal round or flat bar is to be bent at right angles, it is necessary to increase the length of a piece by one half its thickness. For very accurate results add a trifle more than one half of the stock thickness so that both ends can be filed down to exact dimensions. Mark stock at the point of the bend, then grip it in a vise so the mark comes to the edge of the stationary jaw. Hammer toward the stationary jaw of the vise, since that jaw can take more strain than the movable jaw. To keep the bend sharp, hammer the stock close to the vise jaws.

## Reflective Tape on Headlights Eliminates "One Eyed" Hazard

A small piece of reflective tape on each of the headlight lenses on your car will eliminate the "one eyed" danger presented if one of the lights burns out while driving on a highway. The tape indicates to approaching traffic which of the lights is burned out, thereby giving the exact position of the vehicle and assuring safe travel until the defective unit can be replaced.

R. C. Johns, Flint, Mich.

## Loose Slide Fastener Repaired

When a slide fastener on clothing will not stay closed, squeeze the slide with a pair of pliers to compress the grooves slightly. Be careful not to crush the slide.



Sometimes better control of compressing the grooves can be had by using a hammer instead of pliers.

## Distributor-Point "Lapped in" With Sandpaper on Cam



To assure that a distributor-point setting remains correct for a maximum length of time, one mechanic "laps in" the fiber block on the movable point to fit the cam. A strip of sandpaper is wrapped around the cam and the distributor shaft is rotated until a streak of white the width of the fiber block shows on the paper. The sandpaper then is removed and a small amount of light grease is wiped on the cam lobes to lubricate the fiber block.

## Removing Chips From Blind Hole

Filling a tapped blind hole with kerosene will dilute the cutting oil still clinging to the sides of the hole so the metal chips can be shaken out or otherwise removed. If the workpiece is small, move it in a circular manner while pouring out the oil. If the workpiece is large, absorb the oil with waste then blow out the chips with air.

# PROPORTIONAL DIVIDERS

If you have ever needed a quick method of accurately reducing or increasing the size of a drawing or plan, you will appreciate these proportional dividers. In use, the dividers are adjusted by locating the pivot screw to produce the desired ratio, then a dimension is taken from the original work with one end of the dividers and transferred to the copy with the other end. Accuracy of the dividers depends on the accuracy with which they are made. The arms, which are flat-ground tool steel, are clamped together and drilled. Next, the points are rough-ground, tempered to a dark straw-yellow and finally ground needle sharp.

Charles Schmidt, Silver Plume, Colo.

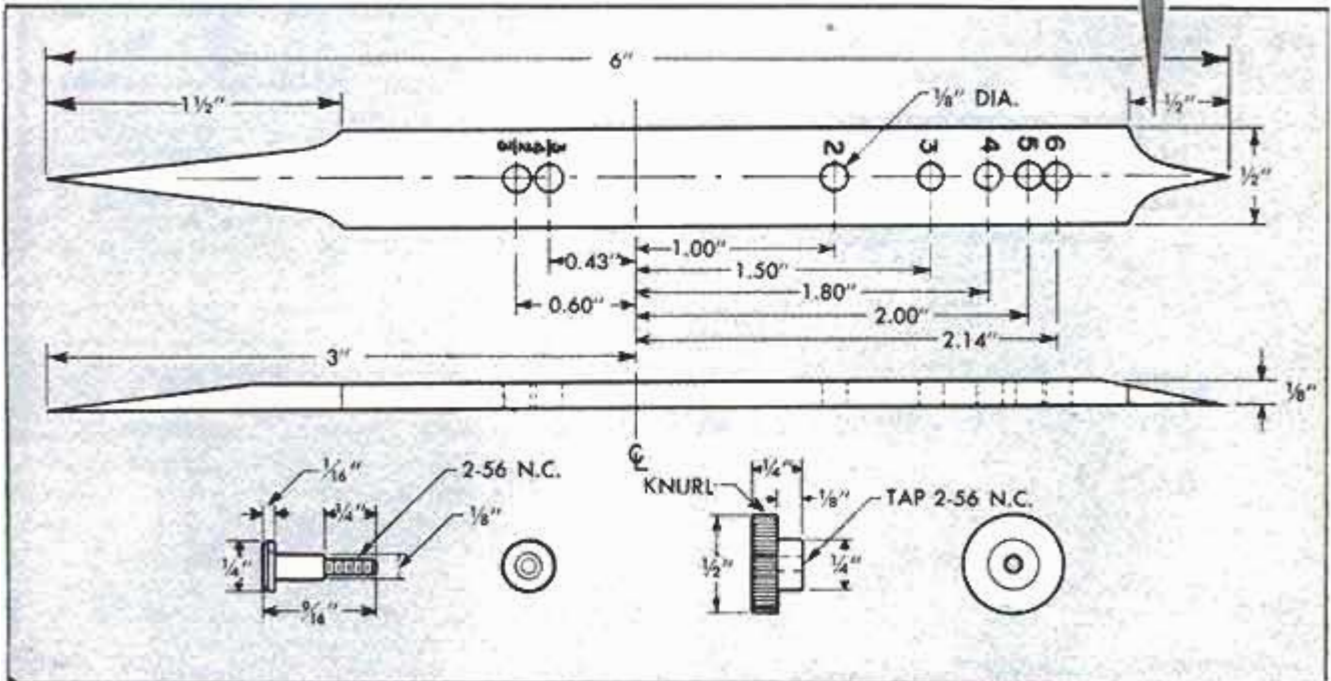
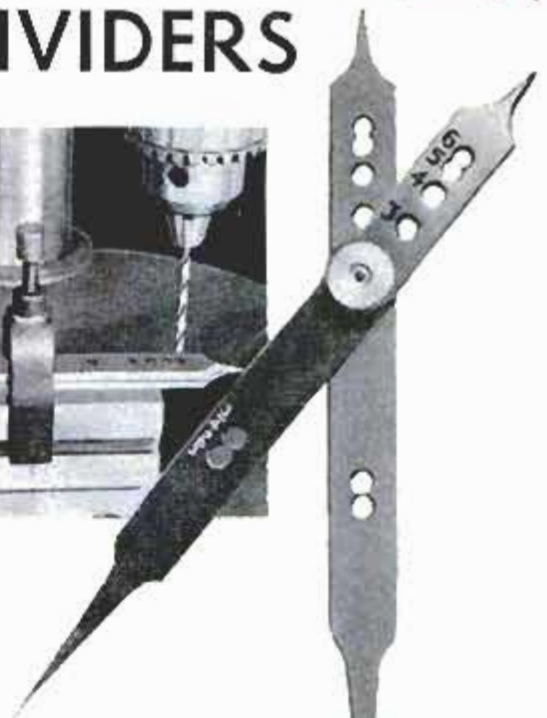
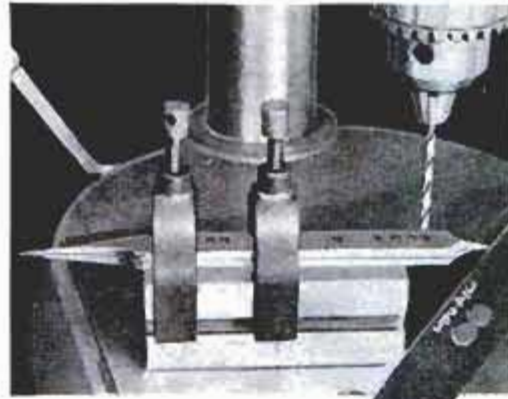

## Case Mounted on Shop Wall Stores Safety Glasses

If there is no clean, safe place to keep your safety glasses around the shop, mount an extra case on the wall or post near your bench and they will be readily available when needed. If the case is kept closed, the glasses will remain free of dust and they will always be ready for use.



## Leaks in Fuel-Pump Diaphragm Cause Oil Dilution

Excessive oil dilution may be caused by slight leakages of gasoline through small holes in the fuel-pump diaphragm. Although these tiny holes may not be large enough to cause a complete pump failure, installation of a new diaphragm will afford the best remedy for the trouble.

# SHOPPING FOR TOOLS



**1. MASONRY DRILL** is fitted with an integral water-injection system for cooling the diamond drill bit. Drills holes from  $\frac{1}{4}$  to 2 in. in dia. through concrete, glazed tile, brick and stone. Hose connects to any water faucet, or unit can be fitted with a special pressure tank which will supply water for 30 minutes

Moleo Drilling Machines, 110 20th St., N.W.,  
Washington 6, D. C.

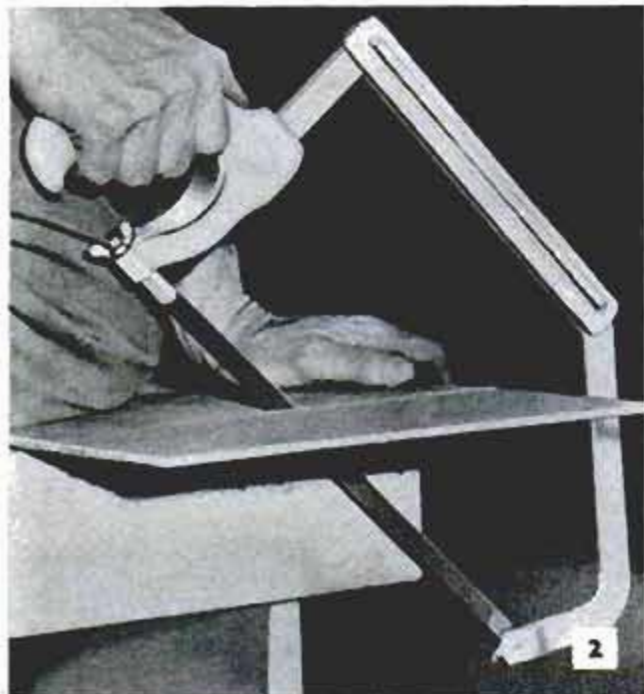

**2. HACKSAW** has a special frame which adjusts to increase blade-to-frame capacity 4 in. This feature permits user to cut wide stock. Adjustment from regular-depth frame to high position pictured is simple. No blade change is required. Equally rigid in both positions. Takes standard-length hacksaw blades

Mansfield-Zesiger Mfg. Co., 2060 Water St.,  
Cuyahoga Falls, Ohio

**3. BENCH-LEG BRACKET** holds angle-steel legs rigidly in position on tables, sawhorses and benches. Cut leg to length from 1 or  $1\frac{1}{2}$ -in. steel angle, slip the upper end between the two members of the bracket and tighten two bolts. Brackets attached to table or bench rails support leg at angle of about 10 deg.

The Lee Co., 406 Griswold St., Elgin, Ill.

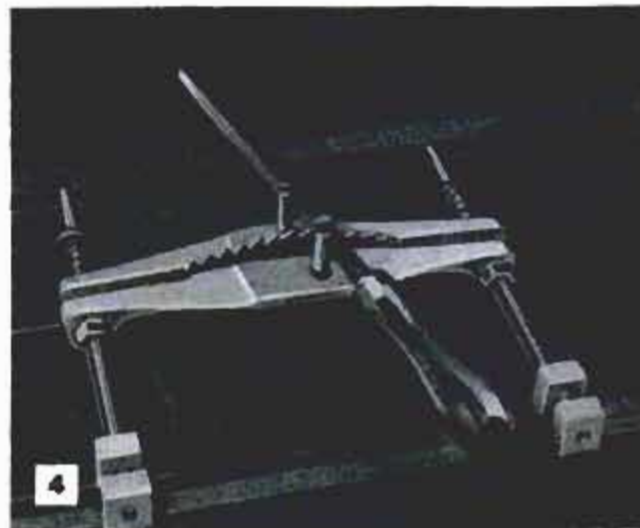
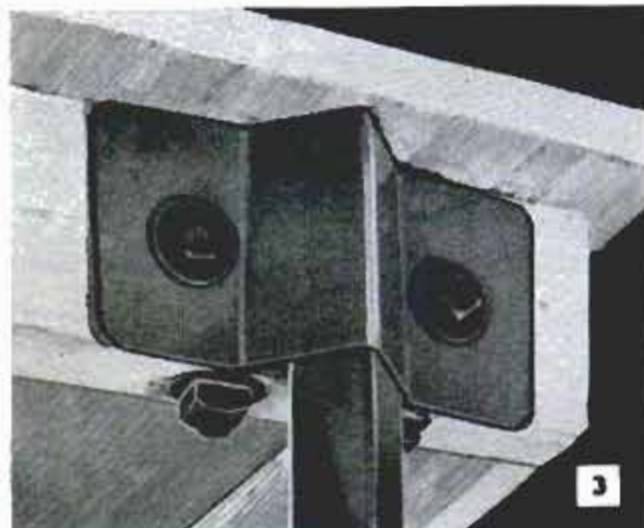

**4. FILE GUIDE** is designed to aid in sharpening circular-saw blades without removing blade from arbor. It consists of two specially shaped jaws which clamp onto that portion of blade above surface of saw table by spring action. Guide rods, positioned by slides which engage the miter-gauge grooves, keep jaws in same relative position. Hardened rollers serve as guides for the three-cornered file as pictured

Riverside Enterprises, 316 Riverside, Corning, N. Y.

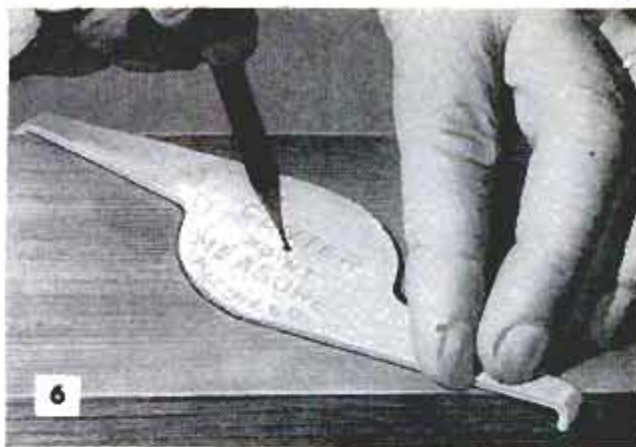

**5. SELF-EJECTING CHUCK KEY** provides positive protection against injury from a flying key inadvertently left in chuck as drill press is started. Self-ejecting key operates geared chuck in same manner as standard key, but it must be held in position against pressure of a spring-loaded plunger which is recessed into the side of the key spindle as pictured. A self-ejecting lathe chuck wrench also is available

Lindstrom Mfg. Co., 173 Water St., New York City 18

**6. CENTER-POINT LOCATOR** eliminates guesswork, also saves a lot of time measuring to find precise center of stock. Simply place tool on face of stock as pictured, with legs at the ends engaging the edges of the material. Then insert a pencil point through the hole and mark the center of the stock. To draw center line hold locator in same position and move along the length of the stock as indicated

F. V. Gard Tool Co., Box R23, Springfield, Ill.



**7. SOFT HAMMER** comes equipped with interchangeable heads of aluminum, brass, copper, nylon and three hardnesses of plastic, soft, medium and very hard. Weight of hammer with various heads ranges from 14 oz. to 2 lb., 2 oz. Two types of handles are available, one in varnished wood, the other with a special nonslip safety grip. Body of hammer is 1½ in. in dia., and 2½ in. long. With heads length is 4½ in.

Hi-Lok Mfg. Co., 1625 Mason Rd., Akron, Ohio

**8. SAWHORSE** made from steel tubing will support a 500-lb. load. Comes with tubular extensions which enable user to adjust from sawhorse height of 24 in. to table height of 30 in., a feature which greatly increases the range of usefulness beyond that of the ordinary sawhorse. The extensions adapt the units to use as legs for picnic tables, display tables, long banquet tables and portable shop benches

Tube and Metal Forming Corp., 940 N. 20th St., Columbus 19, Ohio

7

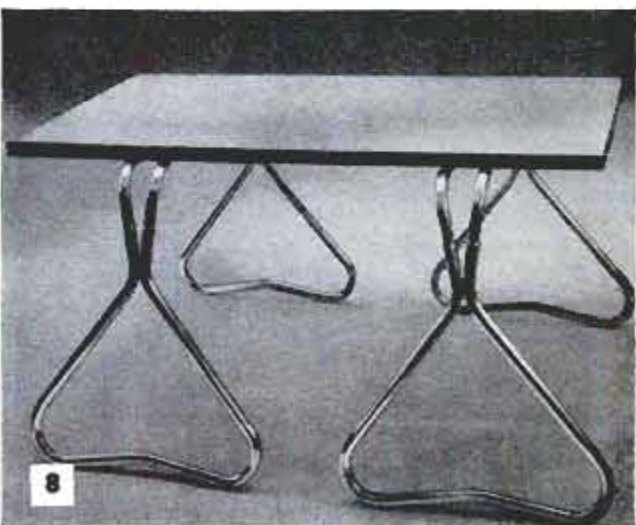
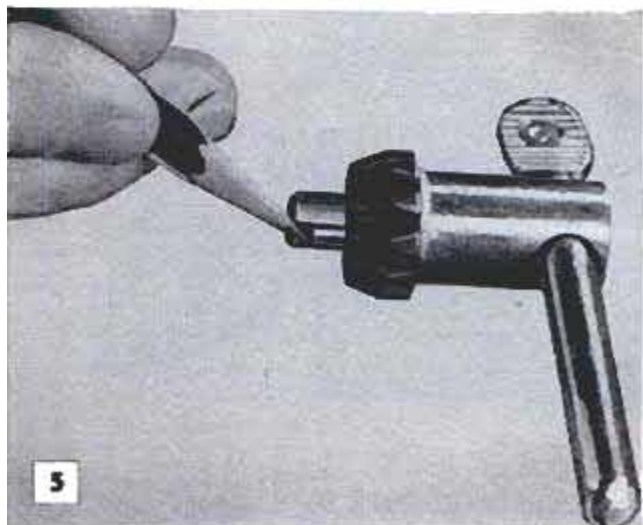

5

8

# SHOPPING FOR TOOLS

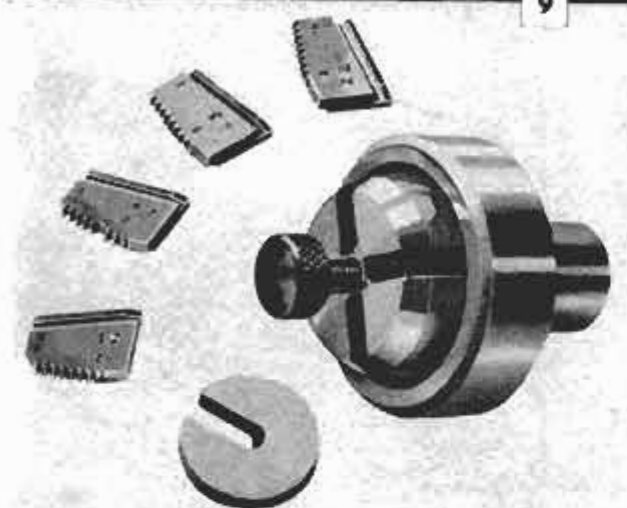

**9. TAP-CHASER HOLDER**, or chuck, has recently been developed for use with a universal form relieving fixture of the type shown in photo at the left. New holder permits radial relieving of a complete set of collapsible tap chasers in a single grinding operation, setup being made as pictured. Holder solves the problem of obtaining precisely the same radial relief on each of the four chaser blades in order to attain the correct cutting balance and prevent overloading and possible breakage of the blades

**PHOTO AT LEFT** is an enlarged view of the chaser holder pictured in the machine setup in the upper photo, No. 9. Holder, which is furnished as an accessory, consists of a slotted head into which the four chasers are inserted and held in place with a C-type retaining washer and knurled screw. Tightening the latter secures the four chaser blades in the head. The assembly is then inserted in the collet chuck of the fixture and the chamfers ground as in the upper photo to precise radial relief

Royal Oak Tool & Machine Co., 29800 Stephenson Highway, Royal Oak, Mich.



**10. VARIABLE-SPEED DRIVER** for wood screws is fitted with a cone clutch which not only enables user to control speed at which screws are driven, but also prevents stripping of screwheads and screw breakage due to undersized counterbores. Takes snap-in bits for ordinary slotted screwheads, Phillips heads, also countersinks and hex-head screw and bolt drivers. Cone-type friction clutch permits operator to seat screws to uniform tension required in certain types of assemblies. Used with 1/4-in. electric drill

The Stanley Works, New Britain, Conn.



**11. DRY LUBRICANT** comes in a squeeze-type dispenser and is used dry on bearing surfaces. Does not soil hands or clothing, a feature which makes it especially suitable for lubricating tools, locks, window channels, file cabinets, slide fasteners and sewing machines. For lubricating bearings on household appliances, small motors and motor-driven tools only a small quantity is required, usually one "puff" from the dispenser will do the job. Won't melt or freeze and can be added to light oils as a supplement

Reardon Products, 2109 S. Adams St., Peoria 2, Ill.

# High compression and high octane demand **BALANCED HEAT**



Today's high-compression engines and high-octane gasolines demand high-performance spark plugs with characteristics that prevent loss of compression and provide for burning away combustion deposits. AC Spark Plugs with *exclusive* Conductaseal and Hot Tip maintain this peak performance through *balanced heat*.

- 1. CONDUCTASEAL** eliminates gas leakage between the center electrode and the insulator. It's metal and ceramics fused to form the world's first current-conducting spark plug seal.
- 2. HOT TIP** is recessed around the center electrode to heat up fast and burn away combustion deposits as soon as they form. It stays cleaner longer — boosts power — saves up to one gallon of gasoline in ten.

To get the most from today's modern combination of high-compression engine and high-octane fuel — you'll want new *balanced heat* AC Spark Plugs installed in your car every 10,000 miles. Why not see your nearby AC dealer soon?

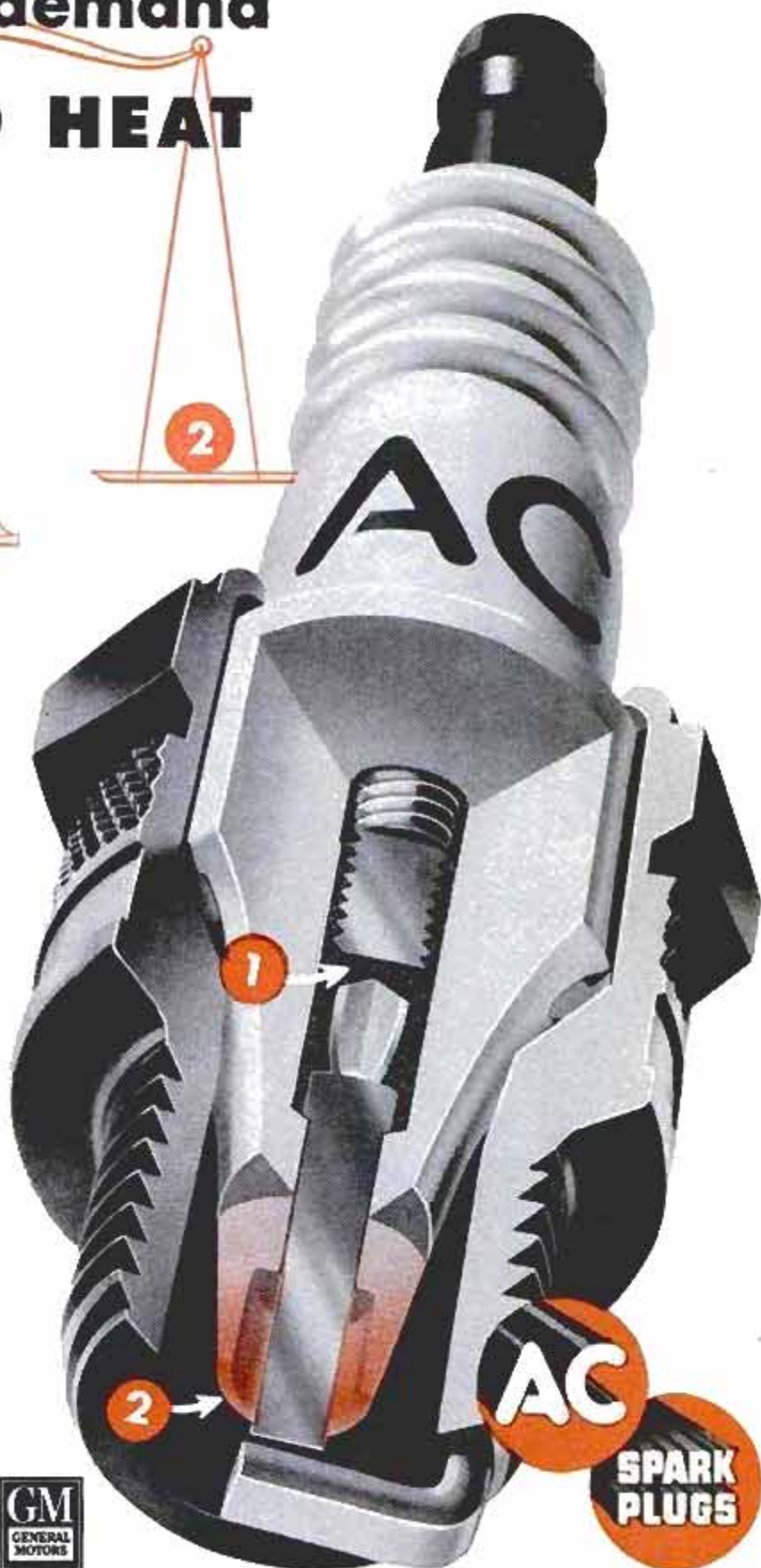

AC SPARK PLUG



THE ELECTRONICS DIVISION of GENERAL MOTORS

ANNOUNCING:

# 6 major changes

to bring great new scope





# in Kodak Films

to your picture taking!

## KODAK BLACK-AND-WHITE FILMS

### 1. Verichrome goes panchromatic!

*Kodak Verichrome Pan and Plus-X Films*—For all-around picture making, amateur or professional, indoors or out. *Verichrome Pan* has a brand-new emulsion which yields crisp snapshots, attractive enlargements. *Plus-X* (in 35mm size only) has also been improved. Both *Verichrome Pan* and *Plus-X* render *all* colors in pleasingly natural tones of black-and-white . . . both have been given extra speed without sacrificing fine grain or sharpness. Try them—they'll become your favorites for everyday use!

### 2. Panatomic-X is back again— and finer than ever!

*Kodak Panatomic-X Film*—For ultra-fine grain and extra sharpness. This all-new, thin-emulsion, micro-fine-grain film yields top quality prints and *big* enlargements of extra-image sharpness. Of special interest to those who process their own negatives is its wide latitude, rapid developing time. In the recommended Kodak developer, fixer, and hypo clearing agent, total processing time, including wash, is less than 20 minutes! Dries faster, too.

### 3. New Kodak Tri-X Film— fastest black-and-white roll film ever!

*Kodak Tri-X Film*—For true s-p-e-e-d when you need it! Perfect for getting fully exposed negatives under the toughest available light situations. Permits faster shutter speeds for action shots, smaller lens openings for depth of field. Kodak Tri-X negatives yield prints with high definition and a full tonal range throughout the shadow, middle, and highlight areas.

## KODAK COLOR FILMS

### 4. Kodacolor now works indoors and out!

*Kodacolor Film*—For big, full-color album prints. New dual-purpose Kodacolor Film is sharper, faster, easier than ever to use. You can shoot outdoor pictures in daylight, or indoor pictures by clear flash, on the same roll of film—without filters! Produces pleasing color prints even in simple cameras—as well as in cameras with adjustable shutters. Available in all popular roll-film sizes.

### 5. New Kodak Ektachrome— three times faster than ever!

*Kodak Ektachrome Film*—Produces brilliant color transparencies for hand-viewing or projection. Extra speed makes it ideal for shooting under difficult light conditions . . . or when you need extra shutter speed to stop fast action. Your dealer can have your Ektachrome Film processed into transparencies, or you can do it yourself with a Kodak E-2 Processing Kit. Color prints from Ektachrome transparencies can be ordered through your dealer. Available in miniature and popular roll-film sizes in both Daylight Type and new Type F.

### 6. New Type F for both Kodachrome and Ektachrome.

*Kodachrome Film*—For crisp, sparkling transparencies of finest image quality. Traditionally a favorite for making color slides to be hand-viewed or projected, Kodachrome Film, Type F, is now balanced for use with clear flash. Color prints from Kodachrome transparencies can be ordered through your dealer.

Kodak Color Films above are now priced without the cost of processing included.

**Eastman Kodak Company, Rochester 4, N. Y.**

**Kodak**  
TRADE MARK

# Why a 4-barrel?

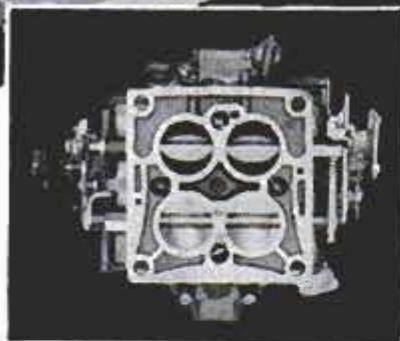
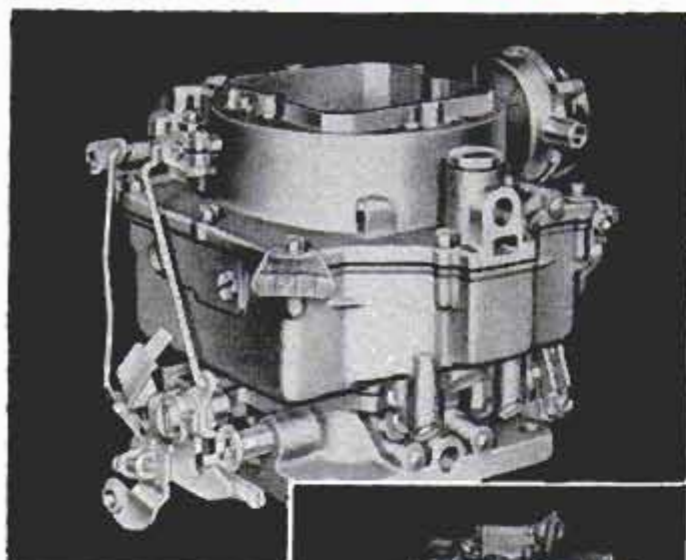

## CARTER CARBURETER

Remember when dual carburetion was the talk of automotive circles? It made possible new efficiency and economy in feeding fuel to the engine of your car. Today's mighty CARTER 4-Barrel Carbureter gives you still more: *two more barrels* that go into action *only when you need them* to meet the added demands of rapid acceleration and high speed. A unit of power and economy!

Carter, pioneer of the 4-Barrel Carbureter, proudly keeps pace with the latest developments of automotive engineering.



**CARTER CARBURETOR CORPORATION**

St. Louis 7, Missouri

Division of ACF INDUSTRIES, INCORPORATED

## Clinic for Homemakers



As a service to our readers in solving the hundreds of problems pertaining to a home—inside or out—the editors of *Popular Mechanics* invite you to present your problems to The Clinic Editor for help and advice. Address your questions to The Clinic Editor, *Popular Mechanics Magazine*, 200 East Ontario Street, Chicago 11, Ill.



### Control Insect Pests

**Q**—I've recently moved to a new location where I have a vacant lot adjoining that on which my home is built. I'm new at gardening and I want to know beforehand how to control the common insect pests, that is, those that attack vegetables during the growing season. I want to have the materials at hand so that I'm ready for them. What poisons do I buy? What sprayers and dusters should I have at hand?

—A. K., Ind.

**A**—Only a few years ago there were sprays and dusts composed of inert materials and rather violent poisons for just about every bug and blight that invaded the vegetable garden from the time the seed was planted until what was left of the crop was harvested. But nowadays your local dealer can supply you with dusts and sprays of a low toxicity to humans but very effective in holding insect invaders at bay. Some of these are multi-purpose, that is, they are useful against a number of insects when applied according to instructions. Many of the dusts and sprays are supplied in special containers having a built-in applicator and to use them effectively one must follow the instructions in all details. Usually full directions for use are printed right on the container, thus saving you the trouble of reading and remembering all the details that might be contained in a separate manual.



### Garden Tractor

**Q**—I have about  $\frac{1}{2}$  acre available for a garden and I would like to purchase a garden tractor to save myself a lot of hand labor in preparing the soil for the crop, also for cultivating and mowing and perhaps pulling a small trailer. But what size tractor and implements to buy has me puzzled. Can you list the equipment best for my purpose?—C. N., Ind.

**A**—We assume you plan to do intensive gardening for several years. If for only a season or two, then it will hardly pay you to purchase a tractor

(Continued to page 226)

## "Pro" Glue Gives Hobbyists "Pro" Results!

For years Weldwood® Plastic Resin Glue has been the "Old Reliable" of professional cabinetmakers. Now, more and more hobbyists are using this "pro" glue. It's the best wood glue made! Makes glued joints stronger than the wood itself. The joints actually grow stronger with age. Weldwood Plastic Resin Glue is highly water-resistant too! Try it today.



## YOU can machine Jobs 20 minutes after Gluing!

You save a lot of time when you can machine a job just 20 minutes after gluing! Hobbyists who use Weldwood Presto-Set® Glue often do just that! Presto-Set Glue is ready-to-use! Sets fast! Bonds like magic! It's the first white glue worthy of the Weldwood name. Bonds wood to wood, wood to cloth, cloth to paper, upholstery fabrics to wood, and many, many other combinations! Let this Wizard with Wood speed things up around your workshop!



## Keep a Presto-Set Glue Squeezer at your bench!

It's a real shop tool. Runs glue into grooves, dowel holes, hard-to-reach corners—quicker, cleaner. No waste. Get one today!



Weldwood Glues... Satinlac®, Firzite® are available at all hardware, lumber and paint dealers.

®Trademark



## Painters' Secret Revealed!

Many hobbyists have been wondering how professional painters get those beautiful natural wood finishes. The magic word is Satinlac! Satinlac gives a handsome, satiny effect which wears well and is easy to maintain. Dries so quickly it's ready for the next coat in just 3 or 4 hours. In a jiffy you have a "custom-finished" job!



## Clear Firzite tames Wild Wood Grain!



Now it's easy to give fir plywood the appearance of costlier woods. When staining, start with a coat of Clear Firzite. It soaks into the wood pores and subdues the wild grain. Practically eliminates grain raise and face checking. For oak, walnut and mahogany stains, add colors-in-oil.

## Weldwood has a Right Glue

For... The job saved there... of the glue... maker... and remember... specially... tackle... choice of... cause they're the... choice... men who know glues best...



## New Way to Bond Micarta without Clamps or Presses!

Now, it's really easy... even for an amateur... to apply plastic surfacing materials like Micarta to table tops, kitchen counters, bathroom and powder room surfaces. Sensational new Weldwood Contact Cement bonds instantly and permanently on contact—without clamps or presses. Has a thousand and one other uses around home, shop or garage. Also... it enables you to put up plywood without nails. This Wizard with Wood bonds all combinations of wood, cloth, leather, paper, glass and metal (including do-it-yourself aluminum).



## Blond Finish on Furniture? Use White Firzite!

Now you can give furniture a blond woodsy finish without a "painty" or artificial look! Finish it yourself with White Firzite. This Wizard with Wood is equally wonderful for getting an eye-catching pickled finish. For tinted effects add colors-in-oil. (On soft wood or fir plywood paint jobs, White Firzite as an undercoater helps prevent grain raise and checking.)



UNITED STATES PLYWOOD CORPORATION  
Box 525, New York 46, N. Y.

PM 4-6 1A

Send me leaflets on:

- Weldwood Plastic Resin Glue  Satinlac  
 Weldwood Presto-Set Glue  Firzite  
 Weldwood Contact Cement

NAME \_\_\_\_\_

ADDRESS \_\_\_\_\_

CITY \_\_\_\_\_ ZONE \_\_\_\_\_ STATE \_\_\_\_\_

**NOW**  
**FROM ALEMITE**  
**3** Revolutionary  
 new products give new  
 power and safety  
 to your car!

Fast on-the-road tune-up washes out engine sludge, frees valves and lifters. Add just one can to your crankcase for fresh, smooth power. Only \$1.35



Cleans carburetor and fuel system. Add just one can to gas tank to eliminate rough idling, stalling, sluggishness. Gives new power and performance. Only \$1.35

Cleans cooling system while you drive! Prevents rust and scale formation, lubricates water pump! \$1.00



Effective New Scientific Alemite Auto Aids Are on Sale Now at Your Service Station, Car Dealer or Auto Supply Store. Buy Them—Try Them—Today!

**ALEMITE**

World Leader in Lubrication!

Products of STEWART-WARNER CORPORATION

(Continued from page 224)

and equipment. You can hire plowing, disking, harrowing and rotary tilling done for a few dollars in most communities. However, if you enjoy working with a tractor, perhaps that will prove to be at least a partial return on the investment. Garden tractors come in a range of power sizes and types. Some small tractors are designed to pull all implements, plows, harrows, cultivators, lawn mowers and the like. Others are designed for front-mounted implements, that is, the units are mounted ahead of the drive wheels and are pushed rather than pulled. Both tractor types are good, but as a rule the selection should be made on the basis of the type of work to be done, rather than personal preference. Many gardeners prefer front-mounted implements for working in comparatively small, irregularly shaped plots, as the tractor and implement are somewhat easier to handle in close quarters. On the other hand, for working especially stubborn soils, the pull-type tractor may prove to be the most satisfactory. Some also prefer it for cultivating row crops where the rows are long and there is plenty of turning room at the headlands. Although not tractors in the strictest sense of the term, rotary tillers do classify as power-operated garden tools. These units also come in a range of sizes suitable for seedbed preparation and cultivating in both small and large plots.



**Linoleum Top**

Q—We have a linoleum counter top in our kitchen and lately I have noticed that it is beginning to crack at the points of greatest wear, around the sink and directly under the cabinets. The cracks are very fine, just visible on close examination. However, linoleum does not seem to be loose at any point. I've been told to apply linoleum lacquer, but will lacquer stand up under this kind of service? Is there any other finish?—R. E., Pa.

A—If we understand correctly your description of the condition of the top, we doubt that you would find regular linoleum lacquer satisfactory. Ordinarily we would recommend that you consider replacing the top either with linoleum or with one of the new surfacing materials that can be applied with pressure-sensitive adhesives. However, if you wish to extend the life of the present top for a time, then we would suggest that you apply one or more coats of boiled linseed oil. Linoleum will absorb boiled oil to a certain extent and, because of this, the oil will act as a rejuvenator. Apply a first coat and rub in with a soft cloth. Allow to dry for at least 24 hr. and apply a second coat, wiping off any excess oil at the end of a 12-hr. period. Use only boiled oil that is pure.

**Concrete Defect**

Q—Our basement walls are of solid concrete. The inside surface is unfinished, that is, not painted or plastered. However, I notice that the surface underneath seems to be loose and rather powdery. In several places the defective material has flaked off to a depth of 1 in. or more. Is there anything that can be applied to the wall to stop the flaking and powdering of the surface?—T. H., N. Y.

A—We're doubtful, especially if the defect is due to freezing of the concrete at the time the wall was poured. Of course, there are other possible causes, but freezing seems the most likely. If we understand your description correctly. However, before planning any other remedial procedures, we would brush the wall with a stiff-bristle brush to remove all loose particles and apply a masonry sealer, following the instructions on the container. This material may or may not turn the trick, but we think it is worth trying. We suggest that you permit the wall to stand untouched for a month or more. If the material holds then perhaps it will be possible to patch-plaster the areas affected.

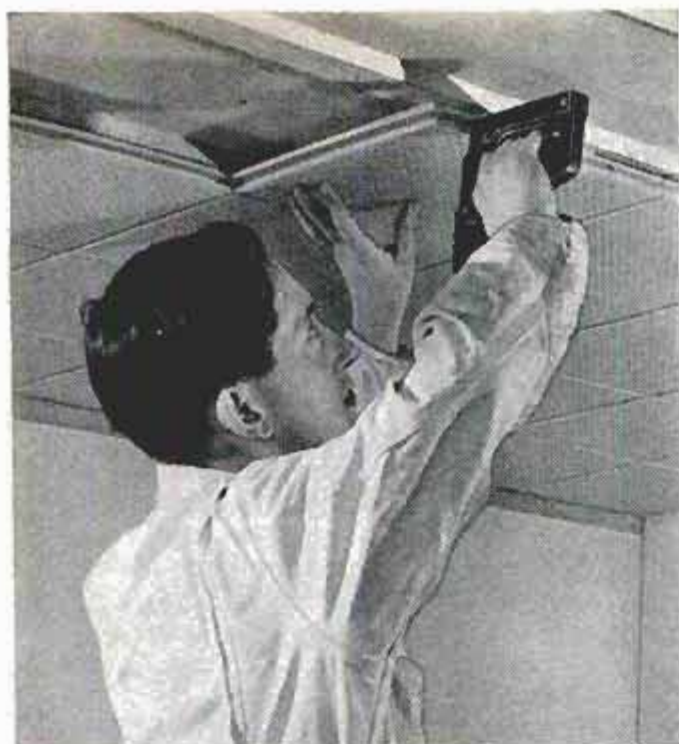

**Put up ceiling tile** with a Bostitch T5-8 Tacker with Bostitch 9/16" or 1/2" staples. Press nose of tacker firmly into cove formed by tile flange. Squeeze the lever. You can drive three staples 4" apart in about three seconds and go on to next tile. You never mar the face of the tiles, and you can wear gloves to keep them clean.



**Apply insulation** with either the Bostitch T5-8 Tacker or H2B Hammer, with Bostitch 3/8" staples. The hammer is faster with a little practice. You can drive staples with a flick of your wrist—*much* faster than hammer and nails. One hand is free to position the insulation. Ask your building supply dealer or Bostitch representative.

## Best way to install ceiling tile and insulation

In co-operation with leading makers of ceiling tile and insulation, Bostitch has prepared a booklet which gives detailed instructions for installing

- |  |  |
|--|--|
| <b>Armstrong Cork Company</b>                | makers of Temlok® Tile, Temlok® Plank and Cushiontone®.  |
| <b>The Celotex Corporation</b>               | makers of Celotex Tile Board and Finish Plank and Celotex Regular and Reflective Rock Wool Blankets. |
| <b>Infra Insulation, Inc.</b>                | makers of Infra Multiple Aluminum Thermal Insulation.  |
| <b>Minnesota &amp; Ontario Paper Company</b> | makers of Insulite Tile Board, Plank, and Interior Board.  |

these materials. The following firms have contributed information for this booklet and approve this method of installation.

- |  |   |
|--|---|
| <b>National Gypsum Company</b>         | makers of Gold Bond Insulation Board Products and Rock Wool Insulation.                                 |
| <b>Reynolds Metals Company</b>         | makers of Reynolds Reflective Aluminum Insulation.  |
| <b>United States Gypsum Company</b>    | makers of Twin-Tile, Panel-Tile, Quietone, Auditone, USG Insulation Plank, and Red Top Insulating Wool. |
| <b>American Sisalkraft Corporation</b> | makers of Sisalkraft and Sisalation.  |
| <b>Wood Conversion Company</b>         | makers of Balsam-Wool and Nu-Wood Ceiling Tile.   |

*Fasten it better and faster with*



**FREE BOOKLET—send coupon for your copy.**

**BOSTITCH, 544 Mechanic Street, Westerly, R. I.**

Please send me a free copy of your booklet on how to install ceiling tile and insulation.

Name \_\_\_\_\_

Address \_\_\_\_\_

City \_\_\_\_\_ Zone \_\_\_\_\_ State \_\_\_\_\_

# Looking for Something?



**SCHOOLS-  
DRIVING**



**FROM AUTOS TO SCHOOLS  
WHATEVER YOU NEED**

Find It Fast  
In The  
'Yellow Pages'



Ads with this symbol make your shopping easier

## Here's Fun From My Bag of Camera Tricks

(Continued from page 131)

to hold it in place if the fit isn't snug. Mirror and rim then sit atop your lens-board inside the enlarger. Experiment a little by shifting the mirror and the negative carrier to get almost unlimited multiple effects.

If this sounds like too much trouble, you can do practically the same thing simply by holding a tiny piece of mirror angled in front of your camera lens when you shoot a picture. The two-headed dachshund and upside-down automobile on page 128 were done this way.

Probably the most absurd and the easiest of trick photos are achieved in the dark-room during the printing and enlarging processes. By superimposing negatives, you can put people inside flash bulbs, bottles and other unexpected places. Elephants can be planted on the Capitol dome! How can you put Aunt Minnie in a flash bulb?

A No. 5 midget flash bulb is placed inside the enlarger where the negative usually goes, supported on a piece of glass. Load a piece of film in the enlarging easel, make the exposure, then develop the negative. You now have a negative of a flash-bulb picture. Expose it on a piece of enlarging paper. Now take your negative of Aunt Minnie and make another exposure on the

(Continued to page 230)

Several new slants on the Leaning Tower of Pisa are added by diamond pattern of glass in the enlarger

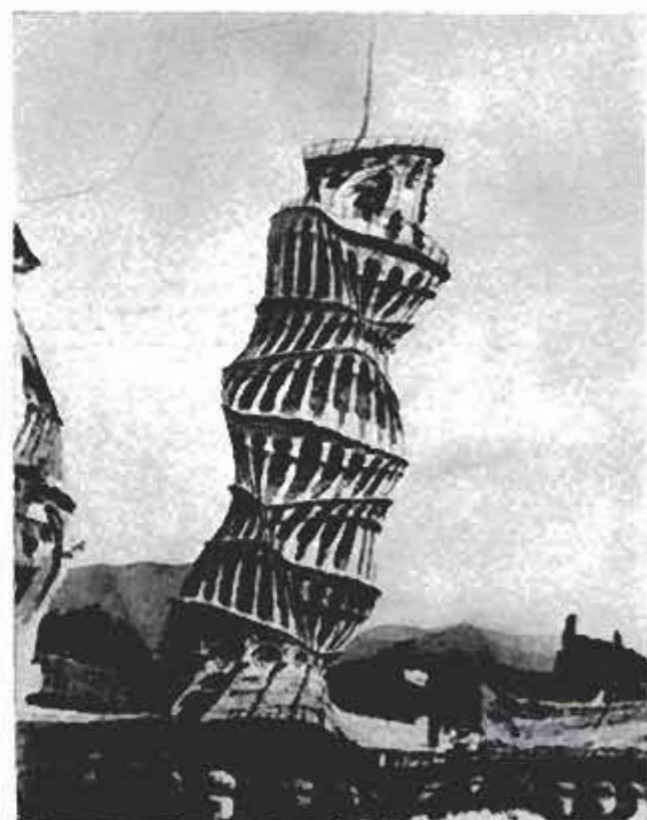

NOW... SPORTS CAR FUN IS FAMILY FUN!

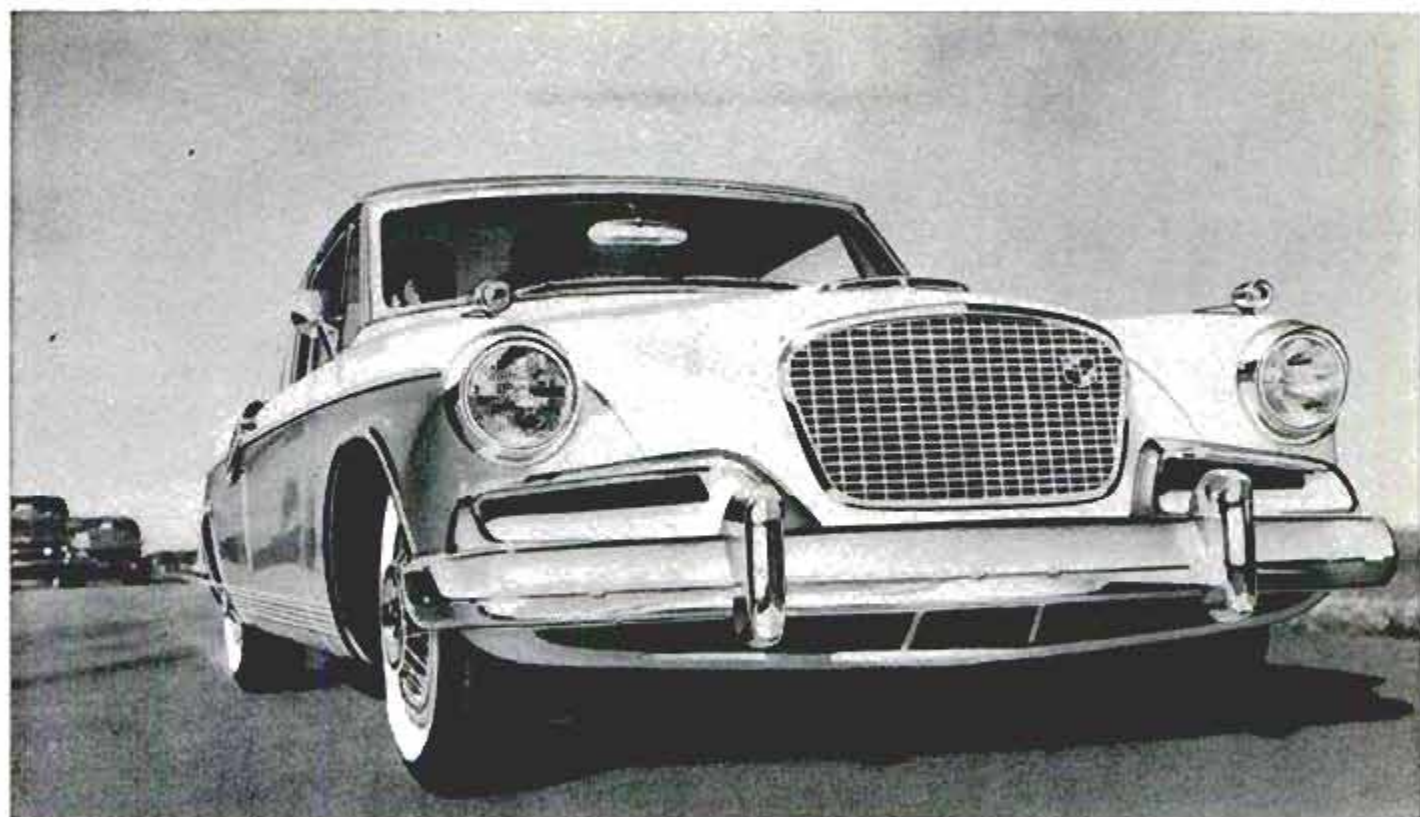

The fabulous **GOLDEN HAWK**—275 hp... most power-per-pound of any American car... room for 5!

*0 to 60 mph. in 8.7 seconds, 60 to 100 mph. in 17.7 seconds! Torque, 380 ft. lbs.—at 2800 rpm.; engine, 352 cu. in., V8; OHV; bore 4", stroke 3.50"; brake area, 195.3 sq. in.—biggest, safest, braking-to-weight ratio of any car. 4-barrel carburetion. Ultramatic Drive and all power assists available. Engineered to out-handle and out-run sports cars costing thousands more.*



Now you can have the true sports car you've always wanted—and share the fun with family and friends! Take a look at that 5-passenger spaciousness, the luxurious appointments, the

huge touring-car trunk—but don't be fooled. Behind that racing-type grille, under the sleek European styling is a *real* sports car—a hurricane of power that handles like a dream!

And there are four different Hawks to choose from—4 power choices, 4 degrees of luxury, 4 price ranges—including the lowest!

Put yourself in a Hawk—just for the fun of it—at your Studebaker Dealer's today!

Tune in "TV Reader's Digest" every week

**Studebaker**

*Hawks*

GOLDEN HAWK  
SKY HAWK  
POWER HAWK  
FLIGHT HAWK

Studebaker Division, Studebaker-Packard Corporation—Where pride of workmanship still comes first!

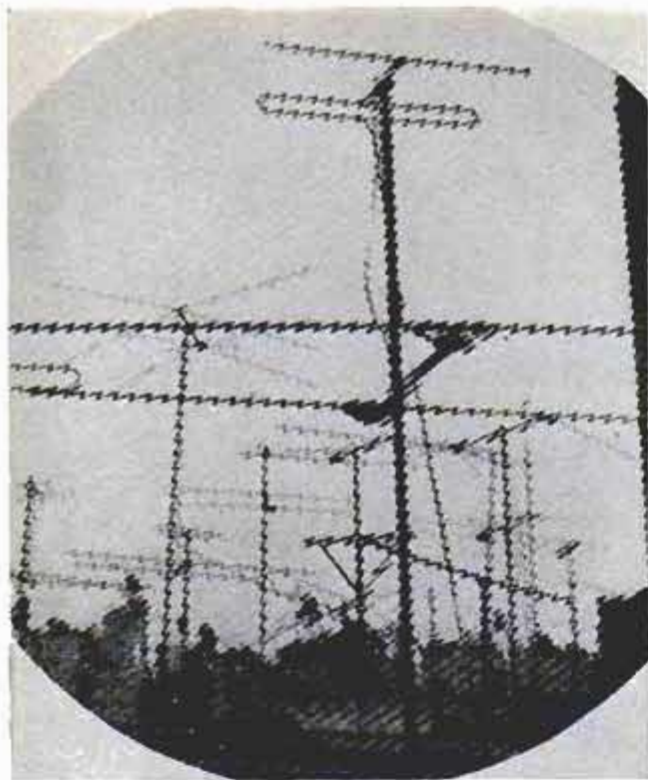

Lightninglike texture of these TV antennas was made by shooting negative through piece of striated glass

same sheet of paper. This requires careful marking on the focusing sheet to place the subject in the exact center of the flash bulb. It's a simple case of double-exposing two negatives on one sheet of paper.

The same kind of double printing can be done using a bottle instead of a flash bulb  
(Continued to page 232)

Two separate negatives projected onto the same paper produced startling photograph of kitten in bottle



## WANT A COOLER SMOKE? ...DISCOVER EDGEWORTH!

No other tobacco manufacturer can duplicate the Edgeworth cut—because it's actually "ready-rubbed" by an exclusive process. See in the picture what a difference this makes. Those even, slow burning chunks of cool smoking white burley are packed fresh in a special heat-sealed wrap-around pouch. Edgeworth smokes 8 to 10 degrees cooler by actual test. Famous for over 50 years as America's Finest Pipe Tobacco.

I DID...AND MADE  
A LIFETIME FRIEND.  
HERE'S WHY IT  
BURNS SO SLOW  
AND EVEN.



A. BITS AND FLAKES  
burn hot and fast, bite  
the tongue.



B. FINE CUT SHREDS  
all right for cigarettes—  
not so good for pipes.



C. ONLY EDGEWORTH  
gives you slow burning,  
cool smoking "chunks."

EDGEWORTH'S EXCLUSIVE  
wrap-around pouch is heat-  
sealed. Moisture can't get in  
... freshness can't get out.

Made by  
Larus & Brother Co., Inc.  
Richmond, Virginia



**EDGEWORTH** AMERICA'S FINEST PIPE TOBACCO...  
CANADA'S FINEST TOO!



# This ALADDIN Readi-Cut House



delivered to you

# \$1985

Slightly Higher West of Missouri River

## BUILD IT YOURSELF and SAVE!

All Aladdin Houses come to you with lumber cut to EXACT size and each piece plainly marked. You get easy-to-understand drawings and instructions so you can't go wrong. It's fun to build, and you SAVE up to 50% on the cost. Aladdin has

### YOU SAVE UP TO 30% ON

Your ALADDIN comes to you ready to nail together—you don't waste time measuring and cutting each piece of lumber. All that has been done by precision machines at our mill. That's why it fits together perfectly—why it takes less time and labor to build. Even if you hire a carpenter to help, his time is not spent in measuring and cutting. Aladdin's Readi-Cut System eliminates waste. No short ends are left over that cost you money. No wonder thousands of people WITHOUT any carpentry experience have built their own Aladdin Homes and saved thousands of dollars.

### WORLD'S LARGEST MANUFACTURER OF READI-CUT HOMES

been manufacturing readi-cut houses for 50 YEARS. Only the finest materials are used and all lumber is guaranteed THOROUGHLY DRY. 120 plans to choose from in 5 to 8 room modern styles.

IMMEDIATE DELIVERY

### LABOR—18% ON WASTE!



**BUY DIRECT from the Manufacturer**  
**SAVE Agents' & Dealers' Profits**

### WHAT READI-CUT MEANS!

The tedious work of measuring, sawing, mitering, and fitting has been done in our mill, assuring you of a perfect fit of all parts. Aladdin Houses are designed to meet the most exacting building standards. Our expert designers and engineers never offer a home to the public until every construction detail is carefully checked. Aladdin Homes are modern in design and plan arrangements. Write for your catalog today. 120 PLANS TO CHOOSE FROM

ALADDIN HOUSES ARE NOT PREFABRICATED



### WHAT YOU GET WHEN YOU BUY AN ALADDIN HOUSE

- ALL THE LUMBER accurately cut to fit, marked and numbered ready to erect practically without use of a saw.
- SIDING
- MILLWORK
- FLOORING
- WINDOWS
- DOORS
- TRIM
- COMPLETE DRAWINGS & INSTRUCTIONS
- MOULDINGS
- HARDWARE
- PAINT
- GLASS
- NAILS
- ROOFING



## EXCITING NEW HOME DESIGNS FOR 1956!

**SEND 25¢**

for Beautiful, New,  
Full Color  
72 Page Catalog

MAIL THIS  
COUPON TO  
**THE ALADDIN  
COMPANY**  
BAY CITY, MICH.

Name \_\_\_\_\_

Street \_\_\_\_\_

City \_\_\_\_\_ State \_\_\_\_\_

EM-37

# Fishermen's Favorite—



**THE FAMOUS,  
ORIGINAL  
ANTI-BACKLASH®  
REEL**

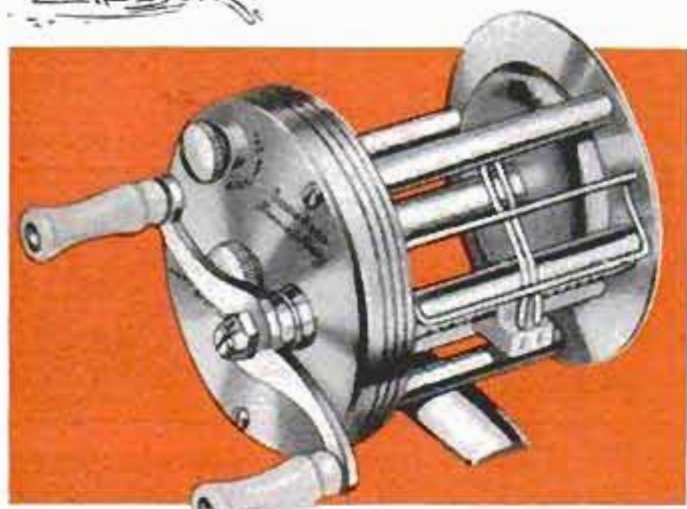

No. 300 Anti-Backlash® Reel—\$8.50—  
Others at \$10.00 and \$16.00

Foolproof—easy to use—long casting—  
that's why a million-plus fishermen have  
chosen South Bend Anti-Backlash® Reels.  
Exclusive device automatically "thumbs" spool  
when the line goes slack at end of cast.  
See all of them now at your dealer's.

No. 790 SmoothCast®  
Reel — direct drive  
and Nylon gears —  
\$12.00. Other models  
\$5.50 to \$16.00.

Prices slightly higher  
west of Rockies and in  
Canada.

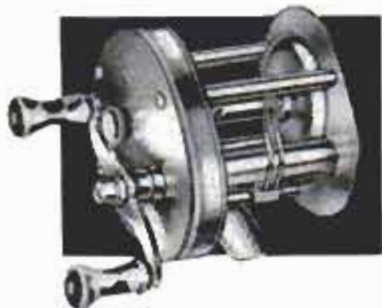

South Bend Tackle Company, Inc.  
891 High Street, South Bend 23, Indiana  
In Canada: Campbell Mfg. Co., Inc., Toronto (licensee)

**South Bend**  
THE BEST IN RODS • REELS • LINES • LURES

as "frame." It can be a perfume bottle, pop bottle, any kind at all. Opaque the negative in the center of the bottle where you'll be superimposing the subject, before making your first exposure on the print paper. Now, expose several enlargements of this opaqued negative and develop one of them immediately.

Put the negative of Aunt Minnie in the negative carrier. The developed print of the bottle goes into the easel. Move the enlarger up and down until Aunt Minnie is the right size to fit into the opaqued area. When the subject is properly focused and positioned, tape the easel to the enlarger baseboard and remove the developed print from the easel. Now slip one of the exposed but undeveloped prints into the easel and make a second exposure of the negative that's in the carrier. Develop this print, and Aunt Minnie is right inside the flash bulb or the bottle!

There are many ways this trick can be done. You can paint the bottle white before you photograph it—which does away with having to opaque the negative. Or you can shoot the bottle against a white background, lighting only the background. This negative also can be used without opaquing, and results in a ghostly effect. Experiment on your own. It won't be long before you come up with some striking new ideas.

Prints made with two or more negatives can be ludicrous, are simple to make, and the variety is endless. Go through your old negatives and look for two that will make a startling combination, such as a picture that seems to defy all laws of gravity. That's how I made my shot of the live elephant on the Capitol dome—and here's the technique I used.

First I eliminated the statue on top of my Capitol negative with reducer. After the negative dried, I made a print of the building alone. When the print dried, I focused the elephant negative on it, moving the enlarger down until I was able to reduce the elephant to the proper size. Then I made a print of the elephant which I later copied. Now I was ready to combine both negatives in a montage. I did it by taping them together—one atop the other in perfect position—and slipping them between two sheets of clear glass in a sort of sandwich that slipped into the enlarger neatly.

So much for the negatives in your files. If you're going to shoot new negatives for montage work, here are a few precautions to take.

Daylight shots are simple. Just expose the negative in the usual way. While developing, keep the density on the light side

(Continued to page 234)

FOR YOUR LAWN...buy

**Falls**

Light weight...easy handling...greater cutting power...extra strong steel housing...replaceable Econo-Blade cutting tips...choice of engines...ultra-modern styling.



Rotary and  
Reel Mowers

Falls Products, Inc.  
Genoa, Illinois



**NEW, IMPROVED CALCULATOR FOR WOODWORKERS only 25c**

Instantly gives information on lumber, nails, concrete mixes, painting materials, etc. Convenient, simple to read. Just set dial for nail specifications, to convert linear to board feet, find bit sizes for screws, compare characteristics of woods. 6" diameter heavily varnished cardboard. Send 25c, no stamps, please to Greenlee Tool Co., 2104 Columbia Avenue, Rockford, Illinois.



**ROAD TO RICHES**

You can be the next uranium millionaire! Government guarantees huge bonus! PRI instruments from \$29.95. See your local dealer today! FREE CATALOG! Write PRI, 4223 PM W. Jefferson Los Angeles 16, California

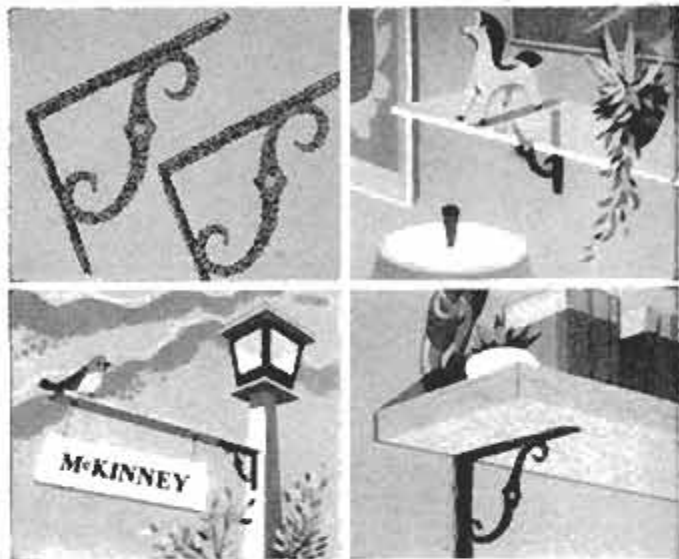

**McKINNEY FORGED IRON  
Ornamental  
Brackets**

You will want a pair or two of these artistic forged iron ornamental brackets. You can use them in a hundred different ways around your home—inside and outside. They are sturdy and durable—made of heavy gauge metal—with beautiful, textured, rust-resisting, dull black finish. Available in three sizes: 8" x 6"; 6" x 4½"; 4" x 3". Buy them at your local Hardware, Lumber or Building Supply Dealer. Make sure they're "McKINNEY."



Write for the Folder—"McKinney Forged Iron Hardware."  
McKINNEY MANUFACTURING CO. • Pittsburgh 33, Pa.

**PENN YAN  
BOATS...**



**New Striptites!  
All Wood—No Soaking, Work-Free!**

Outboards incl. Cartops®, Trailboats, Racing Runabouts; also canoes—all beautifully finished, masterfully built. Types for fishing, hunting, cruising. Choose from over 100 models of fine, small watercraft.

**Free CATALOG:** 44 pages, color illustrations. Write TODAY! Penn Yan Boats, Inc., 34th St., Penn Yan, N. Y.





Next time you use a Disston, note how easily it cuts through the wood. Its clean, sharp bite is due to the bevel-filed teeth, the double-taper ground blade perfectly tempered to hold its fine edge.

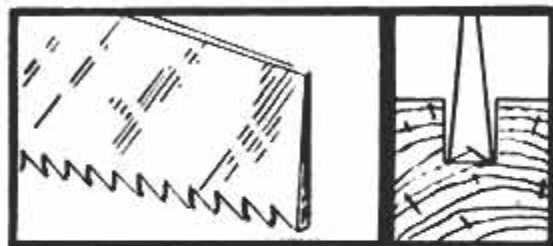

### you can see it's a DISSTON

Tapered to the point, tapered to the top, and with teeth the same width along the entire cutting edge.

There's so much extra satisfaction in using good tools, remember to ask your hardware dealer to show you DISSTON—

- Hand saws • Circular saw blades and dado heads •
- Band saws • Chisels and gouges • Garden tools and lawn rakes • Carlson steel tape rules.

#### Henry DISSTON DIVISION

H. K. PORTER COMPANY, INC.

411 Tacony, Phila. 35, Pa.

In Canada: 2-20 Fraser Ave.,

Toronto 3, Ont.



of the sky light, so that the other negative will get a chance to print through. For the second negative (a circus shot, for example) expose with available light. If you use flash or strobe, you'll pick up the background which you do not want. If, after taking the precaution of using only available light, you still pick up parts of the background, use local reduction methods with Farmer's reducer. That way, you'll be assured of a convincing and startling montage.

Now, let's leave the darkroom and go outside in the dark to take pictures! Believe it or not, you can take pictures in the dark without any visible flash, strobe or other lighting. Years ago I found a way to get prize-winning candid shots. I like people. I like to get them on film as they really are, but you can't if they know there's a camera around. There's no such thing as a "candid camera." It's the photographer who has to be candid. He must pick the right place and time to shoot. The right time is when they're relaxed—when they can hold hands, kiss, dream.

A movie theater was the logical choice for me. Under cover of darkness, people find escape, privacy and seclusion. Under the spell of the screen they are silent without their masks—they are themselves. What a golden opportunity for a photographer to be invisible here.

But one can't photograph in the pitch darkness of a movie theater. There is no lens or film that fast. One can't use flash. There are cash customers. Once a flash went off, it would blind them, probably start a riot. Everyone would know a photographer was on the loose. The obvious solution was to photograph them in the dark. A movie theater being private property, I had to get permission from the manager. And that I got only after I had demonstrated to his satisfaction that I could take pictures in the dark without disturbing anyone.

I used Kodak infrared film and Westinghouse No. 5R flash bulbs. These are midget-sized bulbs, coated with a dark-red color. They throw out infrared rays, which are hardly visible. As I had to walk through the aisles of the theater, I disguised myself as an ice-cream peddler. This was the perfect disguise.

Infrared film is made in only two sizes—4 by 5 and 35 millimeter. The larger size is good for general views, the smaller for close-ups. Infrared film is slow compared with today's high-speed snapshot films. What's more, the light from the bulbs does not carry very far. Because of this exposures on close-ups must be about  $\frac{1}{50}$  at

(Continued to page 236)

# "I'm making time in the Army!"

**"So can you—by choosing your training before enlistment!"**

"That's right—I chose my Army training. It's made me a personnel management specialist—a job that fits right in with my career plans. This way I'm making time, not marking time, in the Army. I've advised a lot of my high school friends to look into this terrific program. I think you'll find it's a fine opportunity for you, too. You see, the Army offers such a wide range of technical courses that you're sure to find one that will help you get ahead in your field. And the schools are excellent—offering really top level courses, taught in a campus atmosphere. I haven't wasted a moment in the Army, and neither will you—if you enlist now for the technical training you want."

PFC. RAYMOND F. MATULATIS, Kearny, New Jersey  
Graduate, Kearny High School



**Over 100 courses ready and waiting!** Yes, make time in the Army by selecting the training that interests you . . . and reserving it *before* enlistment! You're bound to find just what you want with over 100 courses to choose from. Electronics, radar, mechanics, medicine, chemistry—you name it, and it's *yours!* You'll attend one of the fine Army schools where you'll be taught by expert instructors—learn by using the most modern equipment in the world! And when your course ends, you'll be a skilled specialist in your field!

**How you can qualify.** If you have a high school diploma or its equivalent, or if you are a high school senior, you can reserve your Army schooling right away! Get the facts, now!

**Get CHOICE, not chance, in the ARMY!**

**FILL OUT COUPON AND MAIL IT TODAY!**

**THE ADJUTANT GENERAL** PM56-4  
Department of the Army, Washington 25, D. C.  
Attn: AGSN

Please send me the Army booklet describing special opportunities for high school graduates.

Mr. ....

Address .....

City ..... State ..... Date of Grad.....

## Prevents rust!

3-IN-ONE Oil is the perfect way to protect planes, chisels, other fine tools. Forms a lasting shield of rust protection and leaves no gummy deposit.

## "3-IN-ONE" OIL



**BUILD FINE GRANDFATHER CLOCK NOW**  
The simple sensible Red-i-Kut way as thousands have — **SAVE HALF. SHOP TESTED PLANS "SPIRIT OF THE CENTURY"** Narrow waist 83" tall or stately straight side **"SPIRIT OF AMERICA."** **EASY-TO-FOLLOW** photopack **PLANS** tell all—plus **BROCHURE** of heavy brass weight Westminster, tube chime, movements, gorgeous dials. 3/4" solid mahogany case kits. Send \$1.00 today—both plans \$1.50 NOW.  
KUEMPEL CHIME CLOCK CO., 27 Kuempel Bldg., Minneapolis 16, Minn.

Protect your home against power interruptions with an...

## ONAN Emergency ELECTRIC PLANT

Provides dependable stand-by electricity for heating system, pumps, freezer, lights, appliances. Keeps home safe, livable. Automatic start and stop. Find out how little it costs!

Write for Folder!

**D. W. ONAN & SONS, INC.**  
3636 University Ave. S. E. • Minneapolis 14, Minnesota

APRIL 1956

**A SIZE FOR EVERY NEED**  
500 to 50,000 watts.  
Compact, quiet-running.  
Gasoline-powered.  
Priced from \$255.00

**DIGS • WEEDS • CULTIVATES**

**Brown**

## Electro-Hoe

**FITS YOUR 1/4" DRILL**

ONLY **\$16<sup>95</sup>**

Takes work out of gardening—leaves just the fun! Self-propelled **Electro-Hoe** digs, weeds, cultivates in fraction of time and effort. Mixes in peat moss, soil conditioners, etc. Makes furrows for bulbs, seeds. Easily attaches to any popular 1/4-inch electric drill. **New low price!**

Ask your hardware, auto supply or gardening shop. Or order direct, giving dealer's name and address.

**W. R. BROWN CORP.**  
2635 N. Normandy Ave.  
Chicago 35, Ill.



**grips like a pipe wrench**

**a cinch  
to handle**

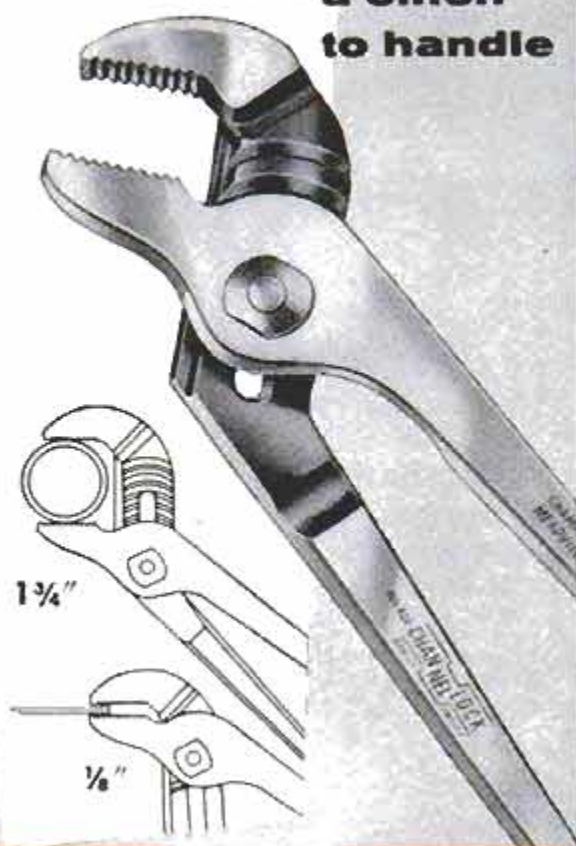

**CHAN NEL LOCK**

**No. 420**

Terrific gripping power on any shape  $\frac{1}{8}$ " to  $1\frac{3}{4}$ " size. Long and streamlined . . . easy to use in hard-to-get-at places! Some of the reasons why Channellock is the favorite plier of craftsmen everywhere. And Channellock will be your favorite, too . . . for the same reasons. No other plier does so many jobs so well. Ask your hardware man for a Channellock No. 420.

**BE SURE IT'S A GENUINE CHANNELLOCK**



**CHAMPION DEPARTMENT TOOL Co. MEADVILLE, PA.**

f: 8, at distances of 6 feet and less. For the long shots of 25 feet, which you may make from a theater balcony, use an extension that can be clamped to the railing. Then two bulbs will do the trick.

Focusing is critical in the dark. You can't use a range finder, and you must work fast. But with practice you can guess-focus as I do. For the close-ups I have everything ready—distance set, bulb in the reflector. When I spot something interesting, I snap it without anyone knowing—really candid photography.

Infrared film produces striking contrasts and needs something like Microdol at three fourths normal development time. And no matter how you expose or develop it, the film does not pick up black well. So, if you have a choice, pick a blonde.

To me, infrared produced the most thrilling set of pictures I ever took. Besides, I saw the show free and had ice cream on the house!

Cameras and enlargers and all of the rest of the gear we photographers use are wonderful inventions. They allow everyone to be inventive. But not everyone who uses them is! Don't do the things that everyone else has done—branch out, explore a little. The fact that something has been done before is one of the best reasons not to do it yourself. The tricks I've disclosed here won't do you any good unless you use them in new ways. Put your own imagination behind them and see if a little ingenuity doesn't put some exciting prints on your wall—and maybe even some blue ribbons in your scrapbook! ★ ★ ★

## Watertight Zipper

Watertight and airtight is a new slide fastener made in Germany. The arrow-shaped teeth lock together firmly when closed by a sliding clamp and are pulled apart by the action of a sliding unit which tilts them out of place. When closed, the zipper can be sealed with a wire fastener. The zipper is suitable for closing any package containing goods which might be damaged by moisture, and could be used on unsinkable airmail bags.

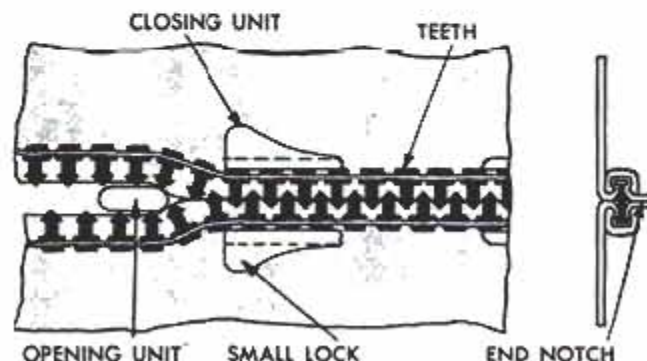

Specially designed for **Mailmen** ... just the shoe for you!

CARRIER  
No. 267

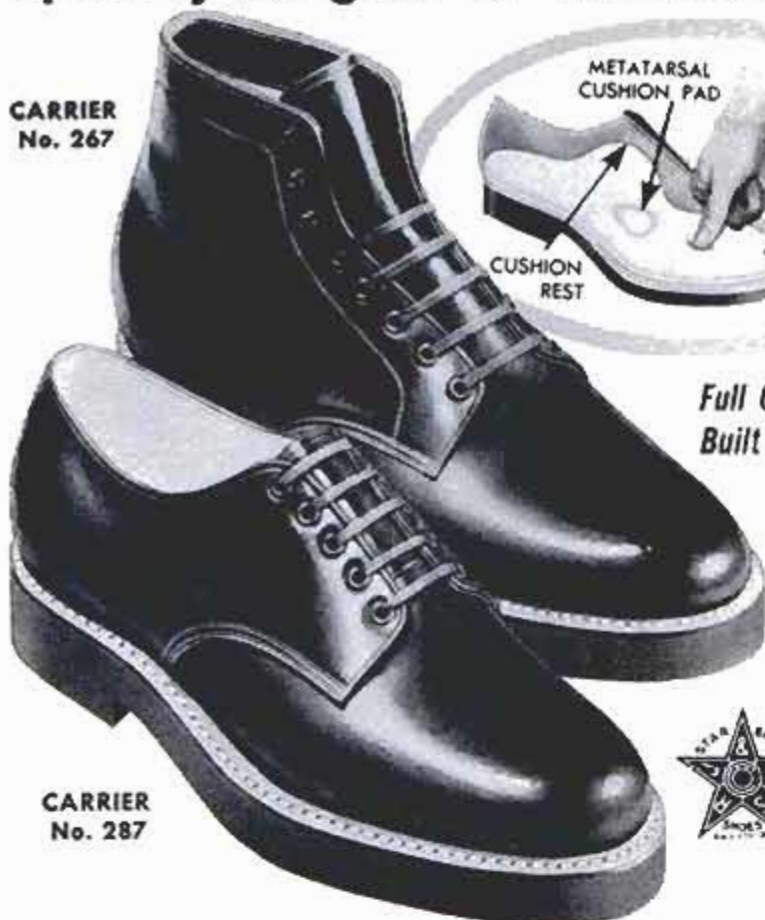

CARRIER  
No. 287

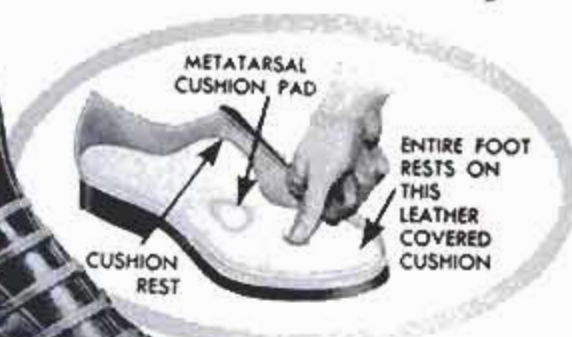

Full Cushion Insoles!  
Built for extra wear!

RESIST-OIL  
BLACK  
Cork  
SOLES & HEELS  
Sturdy, Rugged

Built to  
rest your feet  
as you work!



This specially built shoe absorbs shock of pounding steps, gives amazing comfort! Full cushion insole is soft, resilient, gives snug comfort all day long. Soft, pliable black upper leather, solid leather counters, built-in steel shank. Looks like a dress shoe, but solidly built for rugged service and extra long wear. Get a pair today!



Ask for the "Carrier"  
**STAR BRAND**  
*Cush-N-Bilt*  
**WORK SHOES**

For nearest dealer write: ROBERTS, JOHNSON & RAND, Div. of International Shoe Co., St. Louis 3, Mo.

**Cleans hard-caked brushes**

ACTS INSTANTLY — no long soaking. Leaves bristles like new. At paint and hardware stores.

**IMPERIAL Rapid Brush Cleaner**

Wilson-Imperial Co., 119 Chestnut St., Newark 5, N. J.



BE THE "KEY" MAN IN YOUR SHOP  
**MACHINE TOOL RECONDITIONING**  
& THE ART OF HAND SCRAPING (2nd printing)  
SEND FOR FOLDER DESCRIBING ILLUSTRATED BOOK  
MACHINE TOOL PUBLICATIONS, 382 Holly Ave., St. Paul 2, Minn.

THE ORIGINAL  
**PACKAGED BOAT KITS**

Made ONLY by *Custom-Craft*  
Top Performance,  
Design, Styling!  
Over 70 Models  
8 to 21 ft



World's largest line! Over 200  
Boats: Kits, Farmed-Hulls, Semi  
& Custom-finished! All types: Prams  
-Cruisers: Easy to build! Flying stern,  
Trednic bottom, Bulkhead construction!  
**Send 25¢ for KIT CATALOG**  
52 pages: Includes Victory Series, hardware, paint  
accessories, Fiberglas! Send \$1.00 for Catalog Plus  
"Boating Handbook". DEALERS-AGENTS INQUIRE

**BOAT PLANS & PATTERNS**  
**Frame-Pac Kits**

World's largest selection; over 200 plans, full-  
size patterns, frame-pac kits! Designed strictly  
for amateurs! All types: prams, kayaks, racers,  
runabouts, catamarans, houseboats, cruisers -  
inboard-outboard 6-40' wood-plywood-steel!  
**Send 25¢ for PLAN CATALOG**  
Catalog PLUS "Boatbuilding Handbook" \$1.00  
CUSTOM-CRAFT - BUFFALO 7, N. Y.

DEPT. A

it's a **NEW**  
**BIGGER**  
**CAPACITY**  
**LOWER COST**  
**HOME SHOP**  
**SAW**



a 6 1/2"  
CUTTING BLADE

by *Mall* **ONLY \$29.95**

Here's power, speed, balance and light weight with a 6 1/2" cutting capacity at a new low price. MALL—one of the nation's oldest and largest portable power tool manufacturers—has once again found the way to give you higher quality and dependable performance at lower cost in a home shop electric tool. This new saw—the MALL Model 65—cuts dressed 2 x 4's at 45° ... it has a maximum capacity of 2 1/4" deep. It's the ideal saw for your home construction and repair jobs and your hobby projects. 115 volts AC-DC (220 volts also available). Write for free literature and the name of your nearest MALL Dealer.

**THE MALL TOOL COMPANY**  
7805 South Chicago Avenue • Chicago 19, Illinois

HU-214

## Disaster Clinic

(Continued from page 101)

When the CAB teams compared findings, the pieces of the mystery fell into place quickly. All evidence indicated the cause of the crash was a bomb, probably home-made and very powerful, placed in Number Four baggage hold. When it exploded, it sheared off the tail and shattered the aft fuselage. The rest of the plane tumbled and twisted down, disintegrating as it fell. This accounted for the odd wreckage pattern and the peculiar wing-tip failures.

This meant sabotage, a deliberate criminal act, which was out of the realm of the CAB men, so the Federal Bureau of Investigation entered the case to find out who had placed the bomb—and why. Meanwhile, CAB men gathered up the wreckage, as they do at every accident, and trucked it into Denver. There, in a hangar, they pieced the fragments together as they would have worked a giant jigsaw puzzle—and proved the theory correct that a bomb was placed on the plane.

Using 500 men, the FBI began an intensive search for the bomb's maker. They began interviewing the relatives of all the victims, hunting for clues. Twelve days after the accident, they reported a confession from 23-year-old John Graham, of Denver, whose mother had been a passenger on the plane. They announced that he admitted putting 25 sticks of dynamite with two electrical caps and a timing device in her suitcase—though he later repudiated this confession. The authorities said he had taken out \$37,500 worth of trip insurance on her life.

The Longmont crash was the first proven case of sabotage to affect a United States air carrier, so the investigation there was not truly typical of the CAB's work. Usually a pilot factor, weather, or structural or mechanical failure is the cause of an accident. And it is here that the CAB's work shows long-term results.

In August 1948, the pilot of a Northwest Airlines' Martin 202 cleared with the Minneapolis tower to let down from his 8000-foot flight altitude and make a landing approach. Ten minutes later the plane crashed near Winona, Minn., killing all 37 occupants. From local weather sources, the CAB men learned that there had been a thunderstorm in the path of the plane. Apparently the plane had disintegrated in this storm. But why? The Martin was built to take the buffeting of a thunderstorm. Investigators found the answer two miles back along the flight path, where the remains of one of the wings had fallen.

(Continued to page 240)

**Man...  
ride your  
way to  
lawn  
care**



## **MOW Cycle** does the work for you

Machine handles job—operator goes along for the ride. That's lawn care MOW Cycle style. From cutting grass to hauling loads, you do it all without walking. Rotary mowing blades under platform, safely shielded; attachments pulled behind. MOW Cycle is integrally designed for riding; not a hybrid contraption. A complete success; practical, soundly engineered. Thousands in use. Simple enough for youngsters, sturdy for heaviest grownups. Self adjusting seat, most comfortable you ever rode on. Two models; each has 3 hp. Clinton engine and recoil starter. Cut 24" swath; speed up to 5 mph. See 1956 models at your dealers.



MOW Cycle "24"  
**\$289.50**

MOW Cycle  
"Cadet"  
**\$209.50**

Prices plus freight and local taxes—slightly higher in the far west.

Mail the coupon TODAY

Musgrave, Inc., Dept. 2456, Springfield, O.

Please send free catalog on MOW Cycle models and all attachments for same.

Name \_\_\_\_\_

Address \_\_\_\_\_





**WEEDS CAN'T STOP YOU!**

**JOHNSON'S SILVER MINNOW**

For Best Results Use Johnson's Pork Rind

100% Snag-proof, yet special weed-guard doesn't interfere with strikes. Casts like a bullet! Enticing action!

Send For FREE New CATALOG

**LOUIS JOHNSON CO.**  
1549-W Deerfield Rd., Highland Park, Ill.



**YIPEE - A SAWHORSE IN A Jiffy**

Jiffy Brackets and 2x4s are all you need. Set up and knocked down in a jiffy—no nails, screws, or bolts required. Easy to move or store. Sold by hardware and building supply stores everywhere, or order direct.

GRAND HAVEN STAMPED PRODUCTS CO., Grand Haven, Mich.



**CRESCENT TOOLS**  
*Five Wings to Work*

ASK YOUR HARDWARE DEALER

**GEARS**

In Stock - Immediate Delivery

Gears, speed reducers, sprockets, thrust bearings, flexible couplings, pulleys, etc. A complete line is carried in our Chicago stock. Can also quote on special gears of any kind. Send in your blueprints and inquiries.

Send for Complete Catalog No. 10

**CHICAGO GEAR WORKS**  
440-50 N. Oakley Blvd., CHICAGO 12, ILL.



SAY YOU SAW IT IN POPULAR MECHANICS

Insist on **Evans TAPES**  
"THE MATHEMATICAL GENIUS"  
AT YOUR HARDWARE STORE

6-ft. pocket tape only **98¢**

Available, too, in 8, 10, 12-ft. lengths. Each with FREE plastic utility case. Automatically figures for you in feet and inches or total inches.

Also in 6, 8, 10, 12-ft. King-Size Tapes.

**EVANS RULE CO., Elizabeth, N. J.** 3064



# "TWININSULATE" YOUR ATTIC NOW!



... and make your home up to **15° cooler this summer!**

That man's stapling up blankets of Gold Bond TWINSULATION®. He tucks 'em in place, staples 'em up! It's *that* easy to lower summer temperatures in your home as much as 15°. Next winter, TWINSULATION will cut your fuel bills up to 25%!

TWINSULATION *blocks* heat with fireproof rock wool. It *reflects* heat with an all-around covering of silvery aluminum. You get *twin insulating action* that makes your home more livable all year round!

You can "Twinsulate" your attic in a few hours. See your Gold Bond dealer. He'll show you samples, supply a stapler for application.

**NATIONAL GYPSUM COMPANY**  
Buffalo 2, N. Y.



Send for booklet that tells all about Gold Bond TWINSULATION, what it does for your home, how it cuts fuel bills.



NATIONAL GYPSUM COMPANY  
Dept. PM46, Buffalo 2, N. Y.

I enclose 10¢ for "Home Insulation" booklet.

Name \_\_\_\_\_

Address \_\_\_\_\_

City \_\_\_\_\_ Zone \_\_\_\_\_

County \_\_\_\_\_ State \_\_\_\_\_



Why  
wash  
those  
walls?

It's so easy to  
give them fresh new  
beauty with

**LATEX PAINT\***

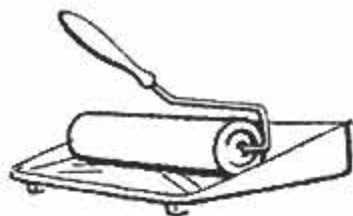

IT'S 6 WAYS BETTER:

1. no brush or lap marks
2. no painty odor
3. fast drying
4. rinses right out of brush or roller
5. tough and scrubbable on the walls
6. wonderful color choice

\*Dow does not manufacture paint but is the leading producer of latex for paint manufacturers.

THE DOW CHEMICAL COMPANY  
MIDLAND, MICHIGAN



Magnification of the edge that had separated from the plane showed that a small fitting between the wing and fuselage had broken under repeated stress. The turbulence in the thunderhead completed the job of tearing off the wing.

Northwest's fleet of 19 Martins was immediately withdrawn from service, and tests, using fluorescent dyes to bring out flaws, were run on the wings. Five of the planes showed fatigue cracks developing. The manufacturer immediately made structural changes in the wing—and no accident of this type has occurred since.

In August 1955, an American Airlines' Convair 240 left Springfield, Mo., for St. Louis. Shortly afterward, the plane plunged into a ravine near Fort Leonard Wood, Mo., with 30 casualties. From eye-witness reports, radarscope films and recordings of radio conversations, the CAB men put together the story of the flight.

A fire had developed in the plane's right engine while in flight. The pilot used his fire-extinguishing equipment, but this failed to put out the blaze. Aware of the seriousness of his condition, the pilot changed course and headed for Fort Leonard Wood to make an emergency landing. As the fire spread through the engine and into the wing structure, the flight became a race with death. It ended a half mile short of the runway; the burning wing fell from the plane. There were no survivors.

In the scorched and half-melted remains, CAB men traced the horizontal smoke streaks on parts from the right engine. These led them to the Number 12 cylinder, which was sent to the National Bureau of Standards Laboratory in Washington. The report indicated that metal fatigue had developed in the cylinder wall and cracks had resulted. Hot fuel sprayed through into the engine section, resulting in fire.

The CAB men were now faced with a tougher question: Why had the cylinder developed metal fatigue? Were other cylinders likely to do the same? Patiently they went to work tracing the life history of both engine and cylinder. The engine had just been given a major overhaul in the airline's shops at Tulsa, Okla., so they went to Tulsa and checked every step of the overhaul process. They surveyed the methods of record keeping. They reviewed procedures and talked to personnel. And finally they assembled the story.

Engines brought in for a major overhaul are torn down, cleaned, inspected and rebuilt. Damaged and worn parts are marked for discard, and replacements are made. When this engine was torn down, the mechanic found that the cylinder in question

(Continued to page 242)

# GRAVELY

## More for your Money!

### 5-HP GRAVELY Makes Tough Jobs EASY!

Gravely does jobs other tractors won't . . . because Gravely has *extra* power for tough mowing, gardening, field, farm jobs.

And you get *more* when you get Gravely: All-gear drive, power reverse, optional starter, power attachments *securely* mounted, quickly interchanged by only four bolts!

#### PLUS . . . 23 JOB-RIGHT TOOLS!

Your choice of 23 tools . . . used with one versatile tractor that saves you time, work and worry *all year long*. "Power vs. Drudgery" booklet shows how Gravely solves your upkeep and gardening problems.

**GRAVELY TRACTORS, INC.**  
BOX 463 DUNBAR, W. VA.

EASY  
PAY  
PLAN



### 24-Page Illustrated DO-IT-YOURSELF PROJECTS BOOK

Describes attic finishing, built-in cabinets, add-a-room, recreation room, kitchen remodeling, summer cottage and farm projects. Helpful information on how to get started, planning, cost estimating, materials purchasing, proper procedures, nail charts, moulding designs, etc. Send 25c and also receive 52-PAGE POWER TOOL CATALOG.

BOICE-CRANE CO., 943 Central - Toledo 6, Ohio



### make your own Gems 29.50 F.O.B.

The Gem Maker comes complete with all necessary equipment, including a super-charged diamond blade for sawing, and all wheels for grinding, shaping and polishing; also complete instructions. The complete equipment as shown, less motor and belt, for only \$29.50, f.o.b., Burlington, Wisconsin. Write today for information and literature.

**B & I MANUFACTURING CO.**  
Dept. S Burlington, Wis.

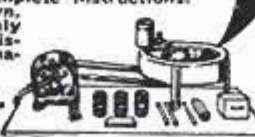

### do it faster...better!

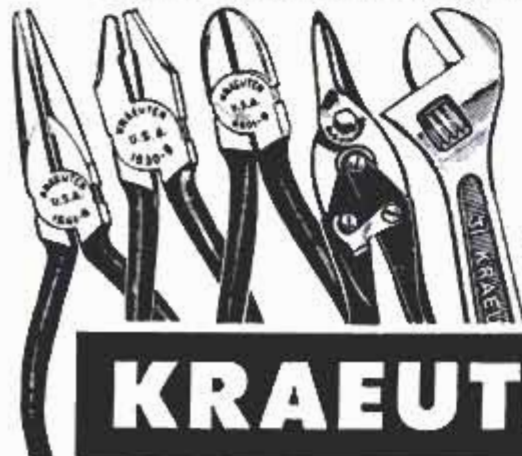

PLIERS,  
CHISELS,  
PUNCHES,  
SNIPS,  
ADJUSTABLE  
WRENCHES

Buy wherever fine tools are sold in U. S. and Canada.

# KRAEUTER

the flashing new 1956 **Cushman** **EAGLE**

America's BEST transportation BUY

- 7 major improvements for smooth riding, smart appearance
- Powered by Cushman Husky 4-cycle engine
- Up to 75 miles per gallon . . . 3/4c per mile total operating cost

Ask your dealer for a FREE demonstration or write for illustrated literature. Dealer inquiries invited.

935 No. 21st Lincoln, Nebraska CUSHMAN MOTOR WORKS, Incorporated

**Famous Antique Shop**  
uses and recommends  
**Klean-Strip Paint Remover**

KLEAN-STRIP, the non-inflammable paint remover, is used exclusively by Leonard's Antiques, Seekonk, Mass., to restore the beauty of wood heavily coated with paint and varnish. L. C. Leonard reports "KLEAN-STRIP has far exceeded expectations . . . and exceeded results obtained with other removers used. We are sure it's the best."

KLEAN-STRIP works best for any refinishing job. It's fast-acting, easy to use, needs no neutralizing or afterwash. Buy it when and where you buy paint.



**THE KLEAN-STRIP CO., INC.**  
2340 S. Lauderdale, Memphis 6, Tenn.

**NON-INFLAMMABLE**  
**KLEAN-STRIP**  
**"PEELS OFF PAINT"**



**Prevents Vapor Lock**  
**IN YOUR CAR OR TRUCK**

Vapor lock is not only annoying, but can burn out exhaust valves and result in expensive repair bills. The Bendix® Electric Fuel Pump positively prevents vapor lock. Simple to install. Get your Bendix Electric Fuel Pump at any independent garage or service station.

\*REG. U. S. PAT. OFF.



**FREE:** A complete descriptive folder is yours for the asking. Write us today.

**Bendix**

**ELECTRIC FUEL PUMP**

Grand Prix Winner  
ECLIPSE MACHINE DIVISION, BENDIX AVIATION CORP.  
ELMIRA, N. Y.

had suffered an eight-stud failure—that is, eight of the studs which hold the cylinder on the crankcase had loosened. Company regulations state that any cylinder with more than a two-stud failure must be discarded, because such failures create unusual stress, causing metal fatigue. In some manner, this cylinder, though it should have been discarded or rebarreled, was put back into service.

Investigation showed that there were three failures that could have happened to permit the cylinder to go back into service. At the engine disassembly point, a tag alerting inspectors to the damaged cylinder should have been attached. It might have been overlooked. Or, in the high-pressure cleaning process through which the cylinder goes, the tag may have been torn off. Or possibly the alert tag was overlooked by the inspector.

An immediate check was made to learn if other cylinders could have been passed in this manner—and the records showed that 23 had been. These cylinders were recalled before another accident could happen. And as a result of the CAB findings, the metal tags are no longer used. Instead the flange on faulty cylinders is broken with a chisel so they cannot possibly be reinstalled. Five weeks of steady, patient digging by the CAB men, working closely with the airline, solved this particular accident and prevented repetition.

In 1947, a United Air Lines DC-6 burned and crashed near Bryce Canyon, Utah, killing the 52 persons aboard. The cause of the accident baffled even the CAB men for some time. The only substantial clue found in the remains of the fuselage was white ash, indicating a fire with intense heat. Chemical analysis of the ash showed it came from the burning of the emergency landing flares on the plane. In some manner, a fire had reached the flares. Investigators ordered the flares removed from all DC-6s as a precautionary measure, though they knew that they had been only a contributing factor and not the primary cause of the accident.

The parts of the broken fuselage were gathered up and taken to the Douglas plant for a mock-up assembly. Often such an assembly after an accident will bring out facts that otherwise would be hidden.

Less than two weeks after the flares had been removed, a DC-6 belonging to American Airlines developed a fire in flight. This time the pilot made a safe emergency landing—thanks to the fact that the CAB men had taken the precautionary step of removing the flares. All the circumstances of this fire matched that of the Bryce Canyon

(Continued to page 248)

Why wish and wait?

...We'll ship this beautiful home complete

**YOU ERECT IT YOURSELF**

...at amazing savings!



**THE HAWTHORNE** A compact, livable floor plan. Every foot of space put to good use. No wasted building dollars—more closet space than many larger homes. House above shown with carport and planter.

**Only \$2775** (Without Basement)

Most complete House "Package" anywhere. Precut and panelized—ready for easy "Build-it-Yourself" Erection. Prices subject to change without notice. Freight paid in 11 Midwestern States.

Are you among the many who wish they could have a fine, attractive home of their own? Then wait no longer because you *can* afford the beautiful Pagemaster "Hawthorne" right now!

Perhaps you'd like to change the floor plan. Then you help plan your new home just the way you want it. When it arrives, you erect it yourself in just days and put the \$\$\$ you save in construction costs right in your own pocket. All exterior walls are panelized, all openings accurately cut in. Windows and doors are hung in frames and weather-stripped as complete units, ready for you to insert in prepared openings. Pre-manufactured roof trusses come in two sections—just nail them together. No other build-it-yourself home saves you so much construction time or helps you avoid costly on-the-job mistakes. Unmatched in value, unequalled in low cost, all Pagemaster quality-built Homes are eligible for VA and FHA financing.

Send 50¢ for our full-color catalog with many exciting new homes to choose from



**Pagemaster® HOMES**

202 PIERCE STREET, SHAKOPEE, MINN.

"EXCLUSIVE NORTHWEST PRODUCER" of — "THE PM PRECUT HOUSE" — "PANELIZED FOR EASY ERECTION"

• automatic •

**POWER TILL**

- ✦ Tills Automatically
- ✦ Works ALL SOILS!
- ✦ Width: 24" to 7"

SEE YOUR DEALER OR WRITE

**UNIVATOR**

UNIVATOR, INC., 2030-51 Center St., Berkeley, California



Loosens Rusted Bolts nuts, screws, "frozen" parts!

**LIQUID WRENCH**

AT HARDWARE STORES, GARAGES SERVICE STATIONS EVERYWHERE

For information write manufacturer Radiator Specialty Co., Charlotte, N. C.



Heavy Duty, All Steel **TOOL CHEST**

**\$24<sup>75</sup>** F.O.B. ST. PAUL

**WHERE ELSE** can you get 4 drawers with built-in-locking system, sliding on compound glides—at this price! Baked blue-gray enamel. 26" x 12<sup>1</sup>/<sub>2</sub>" x 12<sup>3</sup>/<sub>4</sub>". Your money back if not satisfied! Write for bulletin, describing this and 12 other models.

**HUOT MANUFACTURING CO.** 555 No. Wheeler St., St. Paul 4, Minn.

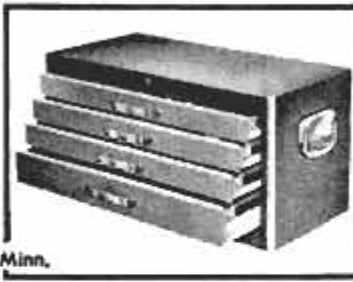

**EARN GOOD MONEY—Spare or Full Time IN A BUSINESS OF YOUR OWN...**

**SMALL INVESTMENT — NO EXPERIENCE NEEDED**

Thousands of men are making big money in their own business. You too, can have a fine income with an assured future in spare or full time with the Universal lawn mower grinder. Investigate our success plan now, it includes everything you need plus facts on how others have earned over \$3,600 in one season, working part time. Act now! Mail coupon today!

**ROGERS**  
MANUFACTURING CO.  
Lindsey, Ohio

ROGERS MFG. CO., Dept. M-46, Lindsey, Ohio  
Gentlemen: Rush me FREE details on easy inexpensive way to get into my own business.

Name \_\_\_\_\_  
Address \_\_\_\_\_  
City \_\_\_\_\_ State \_\_\_\_\_

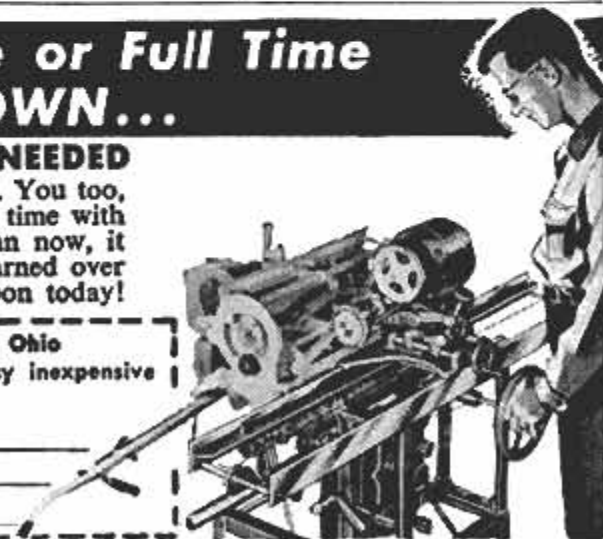

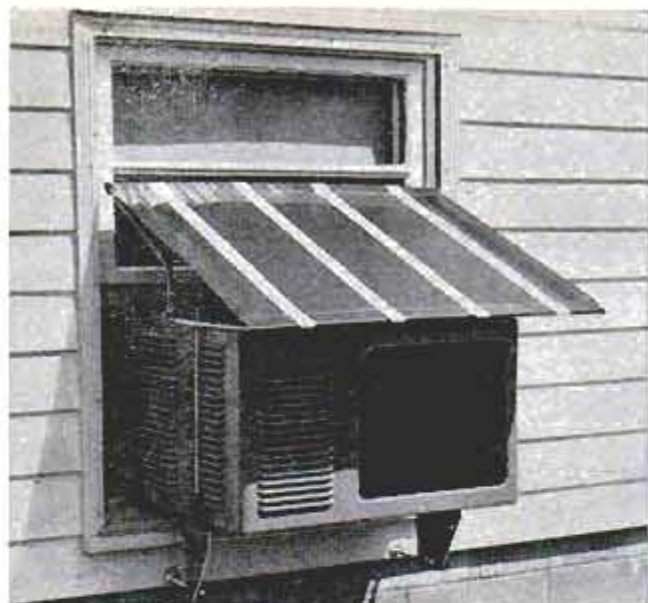

### Sun Shield for Air Conditioner Increases Efficiency

Air conditioners installed in windows where they receive direct sunlight may be as much as 40 percent more efficient when shaded from the sun, according to experiments conducted by the manufacturer of a sun shield. The shield prevents excess heat, which can interrupt the normal refrigeration cycle from building up within the conditioner, and permits the heat removed from interior air to be dissipated properly. It is said that a  $\frac{3}{4}$ -ton unit, when shielded, will cool up to 100 square feet more of floor space. Made of heavy canvas coated with a vinyl plastic, the shield is water and fire resistant and is adjustable to fit most conditioners.

### Sinking Town

Gradually the town of Lueneburg, Germany, is sinking into the ground. Houses are falling apart as they sink, and the town council is considering moving the entire town to another site. The present town stands on soil above a salt deposit and underground water gradually is carrying away the salt, causing the earth to cave in.

### Dictionary Stand



No matter where you open a large dictionary placed on a new twin-top bookstand, the pages remain level. The heavy side of the book sinks until the pages are leveled across the surface of the open book.

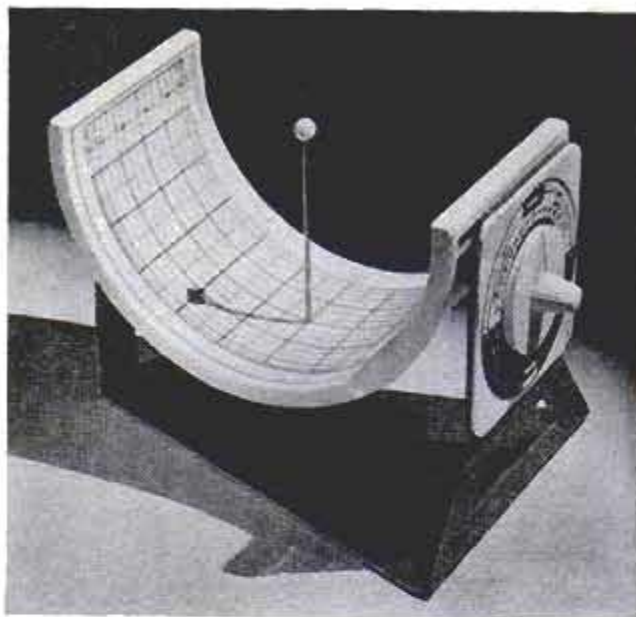

### Sun and Shade Around Home Measured on Model

Home builders can plan the location of a new home to take advantage of the best sunlight and shadow conditions by using a shadow-measuring device on a small model of the home before actual construction starts. The device, illuminated by either artificial light or sunlight, will show how the shadows can be expected to fall on the home at any hour of the day and in any season. A small ball mounted on an upright pin casts a shadow on a graph to indicate the month and hour which correspond with the sun's position at that time. A knob permits tilting for various latitudes, so that the device may be employed in the northern or southern hemisphere.

### Aerial-Camera Control System

Operation of aerial reconnaissance cameras is fully automatic with the use of an "electronic brain" developed for the Air Force. Shutter speed, iris opening and movement of the film to counteract movement of the aircraft are varied to meet changing conditions. At night, when photo-flash bombs are manually dropped, the control automatically snaps a picture. The control system, containing sensor units, computer units and servo mechanisms, is built in packaged units which are hooked up to control any number of cameras. Weight of a control system may vary from 137 pounds for a few cameras to 400 pounds for many.

☐ Pulverized synthetic mica bonded with glass makes up a "ceramoplastic" electrical insulation material that can withstand the effects of radiation and 1000-degree-Fahrenheit heat.

**Just what paste wax needed - a built-in cleaner!**



**Johnson's J-Wax  
new Paste Wax Discovery  
does the cleaning work for you!**

**Start right in waxing! No extra  
cleaner needed—nothing else to buy!**



Here's what you've been waiting for—a paste wax with a cleaner built right in! Johnson's new J-Wax saves you hours of pre-cleaning. J-Wax takes the dirt off for you—replaces grime with a crystal-clear coating of wax. Even the dirt you can't wash off loosens instantly and disappears as you rub on this new self-cleaning paste wax.

Then watch the high brilliant luster that comes as you buff. J-Wax sets smooth and hard—bonds itself into a long-lasting wax-tight seal. Gives your car tough wax protection it needs for any weather. And look! The colors are far brighter, truer—even the chrome glistens.

Get your car ready now for the months ahead—with J-Wax. It's the easiest, fastest way to genuine wax protection—*paste wax protection!*

# FAST

is the word for these efficient little

# RIGID

## Drop-Head Dies!



### Easy threading of your 1/8" to 2" pipe

Size head you want snaps into ratchet drive ring from either side—can't fall out. Dies reverse easily for close-to-wall threading. Ask for RIGID No. 00R for 1/8" to 1" pipe, or any combination of sizes to 2" pipe to fit your needs. Bolt die heads also, 1/4" to 1", fit your 00R. Free carrier with sets. For your shop, for your home—buy this handy threader at your Hardware Store.

Famous RIGID Pipe Wrench also gives you most service for your money!



The Ridge Tool Company, Elyria, Ohio, U. S. A.

## Car Radio Doubles as PA System

(Continued from page 163)

tie point where it joins a lead from the speaker. In the receiver shown, one of the lugs of capacitor Co is used as the tie point.

To make the necessary modifications, disconnect the speaker lead from the tie point at C, and solder wire 5 from the control panel in its place. The disconnected speaker lead is then spliced to wire 6 of the panel.

Lead 4 from the control panel can be soldered to any convenient 6-v. point in the receiver. It may be connected directly to the open contact of the on-off switch or to a filament lug on a tube socket.

### Note

Though not shown in the illustrations, the wires from the panel must pass through the perforated radio cover before being connected in the circuit. Otherwise, replacing the cover may damage the wires.

In the final connection, lead 3 from the control panel is soldered to a voice-coil lug on the PA speaker. This speaker should be mounted in a weatherproof enclosure, and the speaker itself should be moisture-resistant. Outdoor-theater speakers, available from most radio-parts distributors, are suitable. The speaker must be capable of handling the full power output of the radio.

If the speaker enclosure is made of metal and is fastened directly to the car frame, the other speaker voice-coil lug may be soldered to the enclosure. Otherwise, a wire must run from the voice coil to some point on the car frame.

This system is designed for use with a single or double-button carbon microphone. Most units of this type are provided with an on-off switch. This switch is essential to prevent battery drain when the PA system is not in use. Carbon microphones without such a switch should always be disconnected from the control panel when the PA system is not in operation. ★ ★ ★

Control panel mounted on auto dash. Noncritical parts layout permits design for any available space





# Every home workshop needs it!

# Thor SpeedSander Kit

**World's largest selling electric sander**



**D**O-IT-YOURSELF fans find this electric sander perfect for putting a professional finish on unpainted furniture or re-finishing old pieces. Handles irregular curves and flat surfaces. Makes tape sanding fast and easy in dry wall construction. Fine for smoothing metal, plaster or tile, too.

The durability of Thor SpeedSanders is proved by extensive use in industrial production—the world's largest selling sanders. Complete kit includes everything you need. See it at your hardware store. SpeedWay Manufacturing Company, a division of Thor Power Tool Company, Aurora, Illinois.

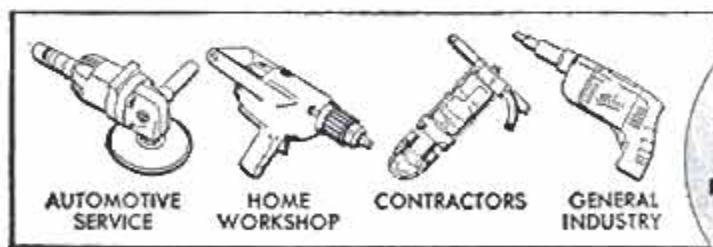

**THOR POWER TOOL COMPANY**  
Branches in all principal cities



**Thor**  
**SpeedSander**  
**15TK KIT**  
**\$29<sup>95</sup>**

**SPECIAL PRICE**  
for Hardware Week, April 12-21

Regular price **\$34<sup>95</sup>**

Includes:

- 1 No. 15T SpeedSander
- 6 grit covers 1/0 80
- 6 grit covers 3/0 120
- 6 grit covers 6/0 220
- 1 template for cutting covers from 9" x 11" sheets
- 2 free-abrasive felt pads
- 1 thick Neoprene contour pad
- 1 lambswool polisher
- 1 instruction manual
- Steel carrying case.

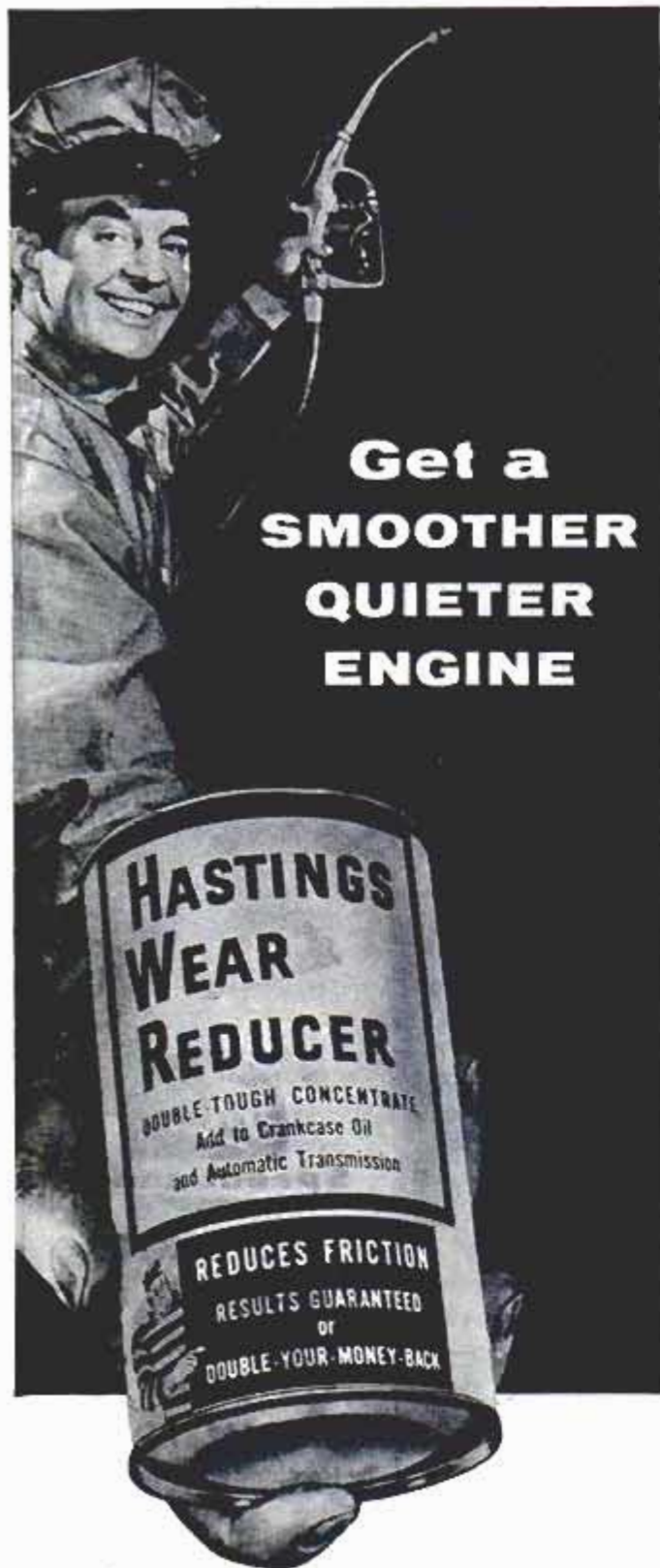

H-W-R keeps engines clean, restores power . . . stops hydraulic valve lifter noise . . . rids your automatic transmission of jar and jerk, too. Results guaranteed or *Double-Your-Money-Back!*

**HASTINGS**

HASTINGS MANUFACTURING CO., HASTINGS, MICHIGAN  
Wear Reducer, Casite, Piston Rings  
Oil Filters, Spark Plugs

accident except for the flares, so the CAB sleuths swarmed over the plane.

A long dark stain along the underside of the fuselage in front of the fire area looked suspicious. Chemical analysis showed it was made by aviation gasoline—and the sleuths had the answer to both fires. To keep a plane balanced in flight, the pilots try to maintain the same level of gasoline in each tank. The tanks are interconnected with gas lines, so the gas can be pumped from one tank to another as necessary. In the planes which had caught fire, there had been some overflow as gas was being transferred from one tank to another. Some of it had run along the belly of the plane. As it passed an air intake, it was sucked in and blown into the cabin heater in the "boiler room" under the cabin floor. That was where the fire started. In the Bryce Canyon accident, the heat from this fire had set off the high-intensity flares.

Douglas engineers relocated the gas overflow vent, insulated the landing flares so that outside heat could not set them off, and the procedure used by pilots to transfer fuel from one tank to another was modified. As a result, no similar troubles have occurred on any DC-6s.

Story after story could be told of the work of the CAB safety investigators, but the biggest story of all is in the safety record of the United States' air carriers. In 1938, there were 4.5 passenger fatalities for each 100,000,000 passenger-miles flown. By 1954, the rate had dropped to .075 fatalities per 100,000,000 passenger-miles—and in that year the airlines flew the fantastic total of 35,200,000 revenue passengers a total of 21,900,000,000 passenger-miles. That record tells the story of the CAB's Bureau of Safety Investigation better than anything else could. ★ ★ ★

### Case of Mistaken Identity In 44-Year-Old Explosion

Back in 1912 one of the most violent volcanic eruptions in recorded history shook Alaska. Seven cubic miles of rock and ash spewed out of the earth in 60 hours, nearly burying the city of Kodiak 100 miles away. So great was the destruction that a scientific expedition couldn't enter the area until 1916. At that time scientists decided that Mt. Katmai had blown its top. Recently Dr. G. H. Curtis and Jack Sheehan, two geologists of the University of California, measured the thickness of volcanic ash throughout the valley. They have come to the conclusion that a nearby volcano, Mt. Novarupta, was the real villain, and that the violence of its explosion caused the top of Mt. Katmai to cave in from shock.

*The startling facts about the new Lennox Stowaway Air Conditioner, a scientific development that offers you...*

## Air conditioning throughout your home for cigarette money!

Out in Iowa corn country, where summers really get hot, farsighted designers and engineers of Lennox Industries have tested and perfected a brand-new kind of low-cost, central air conditioning. Called the Lennox Stowaway Air Conditioner, it is so compact that it can be "stowed away" in an attic, basement, or crawl space; placed on a roof or outside of a home—yet so great is its capacity that it can cool off every room in an average-size home. It's easily installed in any home, but is particularly adaptable to one with a forced warm air heating system, because it can then use the same ducts and registers.

And the cost of this new air conditioner over the years you'll enjoy it? *No more than you pay for cigarettes, even if your family smokes as little as two packs a day!*

Here is the most significant development in home comfort since Lennox pioneered and perfected forced warm air heating. Now, millions of middle-income families can enjoy pleasantly cool, humidity-controlled homes throughout the summer. Lennox has been developing methods of conditioning air since 1895, until it now offers the most complete line of central air conditioning and warm air heating equipment in the world.

Because of its remarkable design, the new Lennox Stowaway Air Conditioner is almost unbelievably quiet, and surprisingly economical to operate and maintain. Air-cooled, it requires no plumbing or water tower; uses

less power than any similar type of equipment. Its big condenser is one-third larger than those found in other makes. Refrigeration circuits are 100% hermetically sealed for life—just as in a kitchen refrigerator.

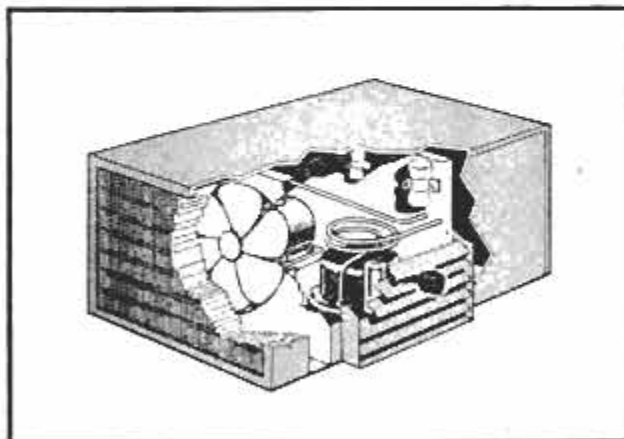

A new air-handling device called the Power Prop (it's another Lennox exclusive) delivers up to 25% more condenser air at 10% less cost than ordinary. Six overlapping balanced steel blades move floods of air quietly, smoothly—with never a trace of vibration. Two compressors assure a constant, comfortable temperature, properly balanced with humidity, even in 100° weather. One runs continuously for normal cooling, the other is on call for extra-hot days and nights.

Another performance-plus results from Lennox Pull-Through Design—still another Lennox exclusive. Air is "pulled through" the condenser coil, which acts as a highly efficient rain trap, preventing water from entering the compressor chamber and damaging electrical parts. Deep, overlapping exhaust louvers are also rainproof.

*No matter what type of heating equipment you now have, your Lennox dealer-expert can bring you whole-house cooling with the Lennox Stowaway Air Conditioner, available in two-ton, three-ton, and six-ton sizes—all on the Lennox Easy Pay Plan. Look for your Lennox dealer in the yellow pages of your phone directory or write Lennox for more details and application suggestions.*

*More families buy LENNOX, through 5,606 home comfort specialists*



*Lennox Industries Inc., heating and air conditioning, founded 1895; Marshalltown and Des Moines, Ia.; Syracuse, N.Y.; Columbus, O.; Ft. Worth, Texas; Los Angeles, Calif.; Salt Lake City, Utah; Decatur, Ga. In Canada: Toronto, Montreal, Calgary.*

© 1956 Lennox Industries Inc.

Advertisement

Sound your Z...enjoy

# GAS ECONOMY FOR KEEPS

because—

**Pennzoil with Z-7  
keeps engines clean**

Can motor oil really increase gasoline mileage? Yes! Pennzoil with Z-7 prevents deposits from forming in combustion chambers. This eliminates power-stealing knock and ping. By keeping engines clean, this different Pennsylvania motor oil with an all-oil body makes every drop of fuel work harder, unlocks full horsepower—not for just a few miles after an oil change, but for keeps. To make the gasoline you use take you farther on every tankful, get Pennzoil with Z-7, The Tough Film® oil, in the exact seasonal grade for your car!



IN EVERY STATE,  
AT DEALERS WHO  
**care** FOR YOUR CAR

MEMBER PENN. GRADE OIL ASSN., PERMIT NO. 2, OIL CITY, PA.

## Owners Praise Cadillac Performance

(Continued from page 108)

Ownership of a Cadillac does have social significance. It is a mark of success, like a mink coat. Who then are these Cadillac owners?

Nearly half of them are businessmen who either own their own business or are top-level executives in corporations (48.3 percent are in this category). Amazing as it may seem, the second most popular category (10.7 percent) is made up of retired persons. Third most popular occupation group includes doctors and dentists (9.0 percent). Farmers and ranchers are next with 6.7 percent to tie the salesmen with the same percentage. Lawyers account for only 2.0 percent of the owners.

### More Best-Liked Features

Fourth on the list of best-liked features is exterior styling with 21.0 percent mentioning it. After this in order are the new transmission (8.3 percent), the low depreciation (7.0 percent), power brakes (7.0 percent), prestige (6.7 percent), roadability (5.0 percent), economy of operation (4.7 percent) and quietness (4.0 percent).

The following quotations describe these and other best-liked features and are listed in order of frequency of mention:

"Cadillac never has made extreme changes in styling to outdate current models."—Iowa housewife.

"People turn and look at it all the time."  
—California grape grower.

"Massive appearance."—West Virginia owner.

"I like the improved transmission, but it still has a small jerk."—Georgia retired owner.

"Higher used-car value than any other car."—California vice-president.

"Best buy due to its high resale value."  
—Idaho contractor.

"I have always sold my Cadillacs to someone other than the dealer. You can make a better deal with no trade-in."—California contractor.

"I buy outright and always sell my used car myself and never have any trouble disposing of it."—New Hampshire community official.

"Power brakes are good."—Florida owner.

"No car seems to rate the respect that Cadillac does. It is a constant source of amazement to me. People always seem to be impressed by the magic word 'Cadillac.' I believe it impresses me, too."—Texas grocer's wife.

(Continued to page 252)

# FIRST

*any way you look at it!*

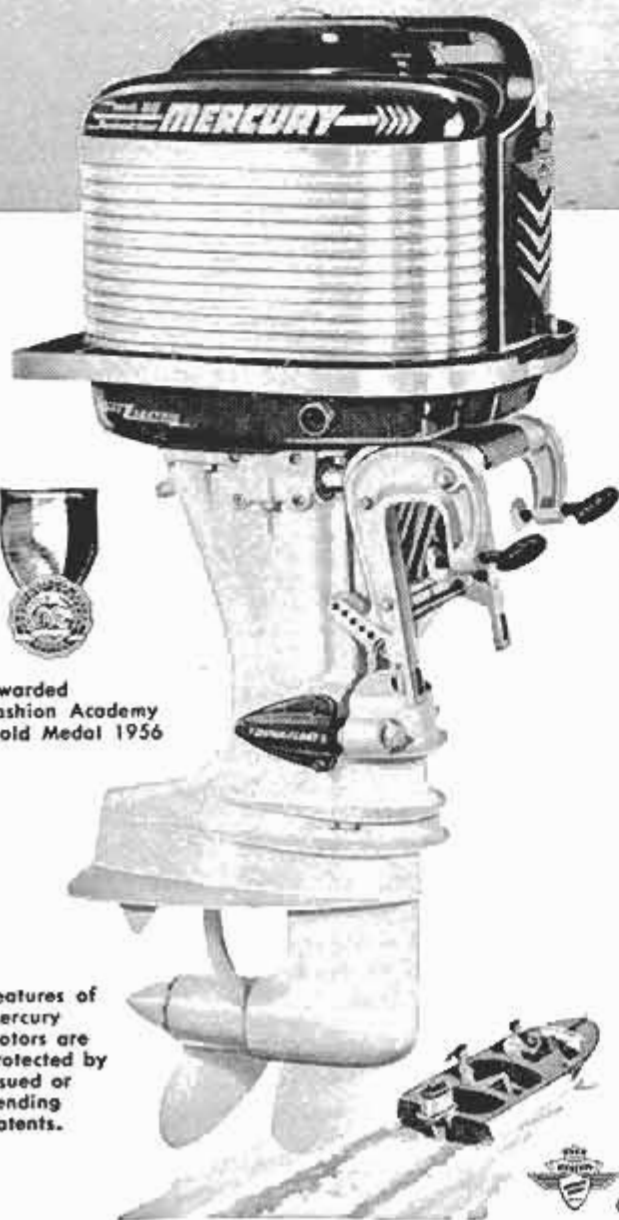

Awarded  
Fashion Academy  
Gold Medal 1956

Features of  
Mercury  
motors are  
protected by  
issued or  
pending  
patents.

## KIEKHAEFER **MERCURY** mark 55E

40 h.p. 4 Cylinder in Line, Alternate Firing  
Thunderbolt Engine; Reverse Gear and Neutral;  
Dyna-Float Suspension; Scientific Engine  
Silencing; Merchromatic 2-Tone Colors

**FIRST** with color styling. **FIRST** in power. **FIRST**  
in durability and reliability. **FIRST** in actual  
operating economy. **FIRST** with 12-volt elec-  
trical system. **FIRST** with permanent magnet  
generator. **FIRST** with super light weight starter.  
**FIRST** with aircraft alternate four integral  
magneto. **FIRST** with drop forged aluminum  
clamp and swivel brackets (unbreakable).  
**FIRST** with drop forged aluminum pistons.  
**FIRST** with rubber rotor water pump. **FIRST**  
with Ride-Guide steering. **FIRST** alternate firing  
four. And many others.

Write for **FREE** Illustrated Catalog

© 1956 KIEKHAEFER CORPORATION, Fond du Lac, Wisconsin

# AMAZING TUBELESS AND TUBE-TYPE TIRE REPAIR SYSTEM ANNOUNCED!

REPAIR YOUR OWN TUBE  
OR TUBELESS-TYPE TIRES  
IN 5 MIN. *Without Removing  
WHEEL OR TIRE!*

Tyron's pure latex compound when inserted in puncture forms a sealant and lubricant for —

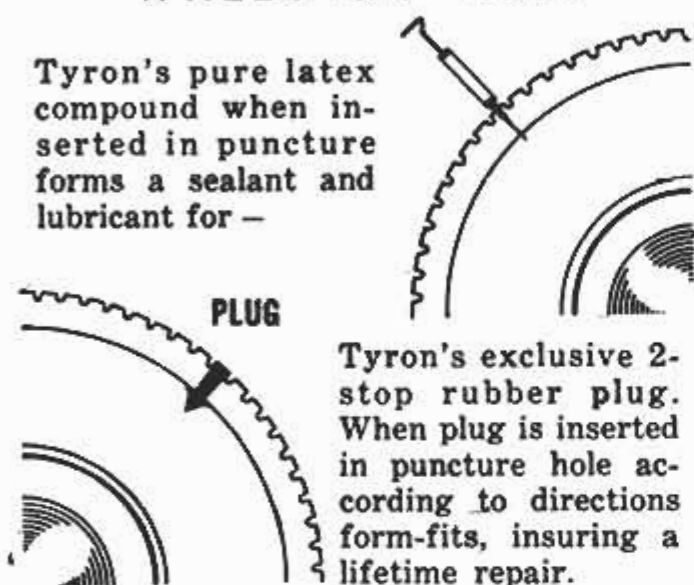

Tyron's exclusive 2-stop rubber plug. When plug is inserted in puncture hole according to directions form-fits, insuring a lifetime repair.

## TUBE-TYPE TIRE REPAIR

The use of Tyron's pure latex rubber compound alone will repair tube-type tires without removing the tube. Shown at left: lifetime patch made with Tyron pure latex compound.

**PLUS** ...

Truck Tire Repair  
Bicycle Tire Repair  
Motorcycle Tire Repair  
Tractor and Farm Implements

Automotive Kit **TMK-2** . . . \$1.98

**TYRON CORPORATION, Goodland, Kansas**

Dear Sirs: Please send me additional information about this amazing tire repair system.

For Tubeless Tires  For Conventional Tires

NAME \_\_\_\_\_

ADDRESS \_\_\_\_\_

CITY \_\_\_\_\_ STATE \_\_\_\_\_

"Let's face it: I like it because it's a Cadillac — America's most wanted automobile."—California contractor.

"A fine road car."—Ohio mortician.

"Doesn't break loose in hard cornering."—New York executive.

"I like the way it holds the road because of its extra weight."—Vermont housewife.

It doesn't seem to make much economic sense, but Cadillac owners generally brag about low operating costs.

"Once the initial cost is paid there is no constant repair bill."—Virginia housewife.

## 1956 CADILLAC SPECIFICATIONS

### ENGINE

Type .....8-cyl., V-type, OHV  
Bore and stroke.....4.000 x 3.625 in.  
Piston displacement.....365 cu. in.  
Compression ratio.....9.75:1  
Brake horsepower.....285 at 4600 r.p.m.  
(Eldorado—305 at 4700 r.p.m.)

### GENERAL

Shipping weight (4-dr. sedan unladen).....4430 lb. (62 sedan)  
4665 lb. (Eldorado)  
Steering ratio (over-all).....19.5:1 (Power steering standard)  
Steering wheel, lock-to-lock .....4.0  
Turn-circle diameter.....43.4 ft.  
Brakes .....Conventional hydraulic  
Wheelbase .....129 in.  
(133 in. on 60 Special; 149.75 in. on 75)

Height over-all (unladen) .....62.0 in.  
Width over-all.....80.0 in.  
Length over-all.....214.9 in. (62 Sedan)  
(222.2 in.—Eldorado)

Minimum road clearance...6.1 in.

### CAPACITIES

Oil .....6 qt. inc. filter  
Water with heater.....19.5 qt.  
Gasoline .....20 gal.

### INTERIOR DIMENSIONS

Front-seat width.....64.3 in.  
Rear-seat width.....65.2 in.  
Headroom, front.....35.8 in.  
Headroom, rear.....35.1 in.  
Legroom, front.....43.3 in.  
Legroom, rear.....46.3 in.

"Inexpensive to operate."—Vermont live-stock dealer.

"The model '75' should be kept about four years. In this way it makes an excellent family car and costs no more than the average car to own."—California dentist.

But there is an occasional owner who disputes this claim:

"I estimate depreciation at 10 cents per mile or \$1000 a year."—New Jersey banker.

Few owners seem to keep their Cadillacs very long. Almost one third traded in 1955 models to buy the 1956 car. Almost another third traded in 1954 models.

Here are more favorable quotations:

"Motor runs quietest of any new car I

(Continued to page 254)

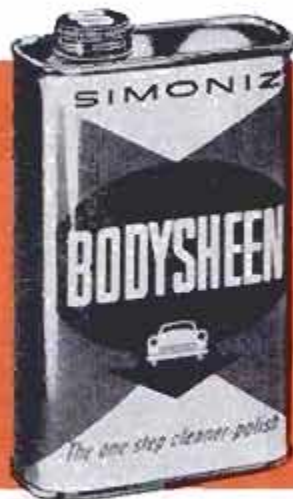

**Just wipe on, wipe off!**  
One step cleans, polishes your car with new Simoniz Bodysheen. Special offer! Get \$1.19 value Red Top Eveready Flashlight free of extra charge with purchase of Bodysheen. Get details at store. (97113).....\$1.49

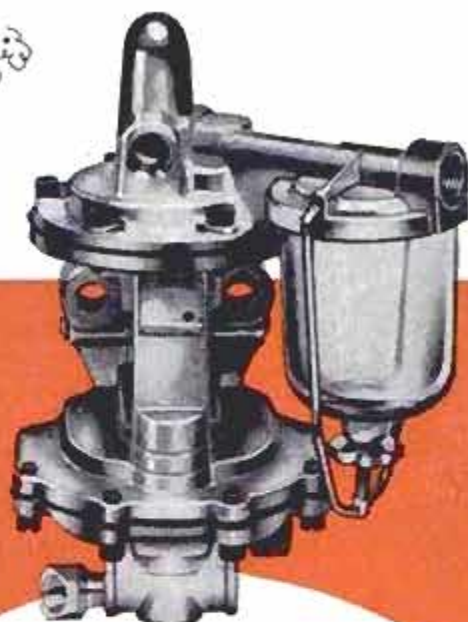

**New Wizard Fuel Pumps,** guaranteed original equipment quality. Precision machined parts; fully tested. Top quality diaphragm for long life. All popular cars. Single action pumps. (87202-50) From \$2.49 Dble. action (87203-35).....From \$7.59



**ALDOR**  
DRAIN-LIKE  
THERMOSTATIC  
REACTOR  
DISK



**Guaranteed to fire in oil!**  
Thermostatic control automatically adjusts spark gap for peak efficiency and performance at any heat range. Ideal for modern high compression engines and premium higher octane fuels. In sets. (11200-8) 95c ea.

## "Spring Condition" Your Car

with top quality parts and accessories from

**Western Auto**  
STORES AND ASSOCIATE STORES



**Repair your brakes,** quickly, easily — with Wizard Master and Wheel Cylinder Kits. Includes live rubber cups, boots, pistons, springs, etc. For most cars, trucks. Master Cyl. Kits, with piston (25700-85).....From 98c Wheel Cyl. Kits (25605-41).....From 37c



**New Wind Silencer,** clamps on front door edge . . . breaks up air flow, carries it away from car body. No more wind "roar" even with windows down! Chrome-plated, lustrous finish. Easily installed. Fits most cars. (11300).....Pair \$2.25



**Non-slip, non-stretch, cool running!** Top quality Wizard Fan Belts are guaranteed to fit. Inner core of endless rubber impregnated rayon cords. Tough rubber cushion assures efficient, peak performance. Carry a spare! (79105).....From 98c

NOTE: In some areas of the U.S., Hawaii, Alaska, and Mexico, prices slightly higher. Western Auto Associate Dealers own their stores, set their own prices, terms and conditions. (PM46)



Money-saving warning from Purolator

## It's oil filter check time—now!

Save costly engine repairs! With your Spring oil change, ask for a **FREE OIL FILTER CHECK!**

A dirty, choked-up old oil filter can't protect your new summer-weight oil! So, ask your serviceman to check it *before* he puts in that new oil! If you need a new refill . . . insist on a genuine Purolator Refill.

The Purolator Micronic is up to 10 times more efficient than many oil filters . . . stops grit as tiny as 39 millionths of an inch! There's one engineered specifically for *your car*. Refills installed in minutes. Cost as little as \$1.60.

© 1956, Purolator Products, Inc., Rahway, N. J.; Toronto, Canada.

"Purolator" and "Micronic" Reg. U. S. Pat. Off.

Proved best for every make of car

# PurOlator

**OIL FILTERS**

ever bought."—North Carolina contractor.

"I like because it is heavy and I feel safe in it."—California housewife.

"Superb workmanship gives me such an extremely confident feeling."—North Carolina housewife.

"I like the remote control of the outside rear-view mirror."—California serviceman.

"It has the best motor ever put together."—Nevada bartender.

"Autronic Eye is important. I wouldn't consider a car without it."—Massachusetts retired owner.

"People think more of you in a Cadillac."—Florida merchant.

### And More Complaints

The 1956 Cadillac apparently is thirstier than previous models and 10.7 percent of the owners complain about low gas mileage when compared with that of their previous Cadillacs.

"This year's car uses much more gas than the other Cads I have had since 1946."—California rancher.

"Should be less emphasis on horsepower, which our highways will not let us use, and more on gasoline mileage."—Washington merchant.

Next on the complaint list is engine trouble of various kinds. Most of the complaints in this category are minor.

"Noise in the motor. Sounds like a connecting-rod bearing."—Oklahoma owner.

"Serious pinging and oil leaks."—California retired owner.

Other common complaints (in order of frequency of mention) are poor dealer service (7.0 percent), improper door fits (6.0 percent), power-steering trouble (5.7 percent), sloppy interior work (4.7 percent) and brake troubles (4.3 percent).

The following quotations describe these (and other) complaints and are listed in order of frequency of mention:

"Service no good at my dealer's. They say they are going to fix it, but I always get the car back with the same trouble."—New York businessman.

"Cadillac owners deserve better treatment than most dealers give them. You don't get the same treatment from the bus lines as you do from the airlines."—Florida realtor.

"Doors fit very poorly."—New York distributor.

"Power steering noisy at end of stroke and too sensitive. Would prefer standard steering."—Connecticut engineer.

"Power steering too sensitive. Wanders at speeds over 55."—Idaho retired owner.

(Continued to page 256)



# New Bronson Spin-King

... the only reel that  
**CAN'T TWIST LINE!**

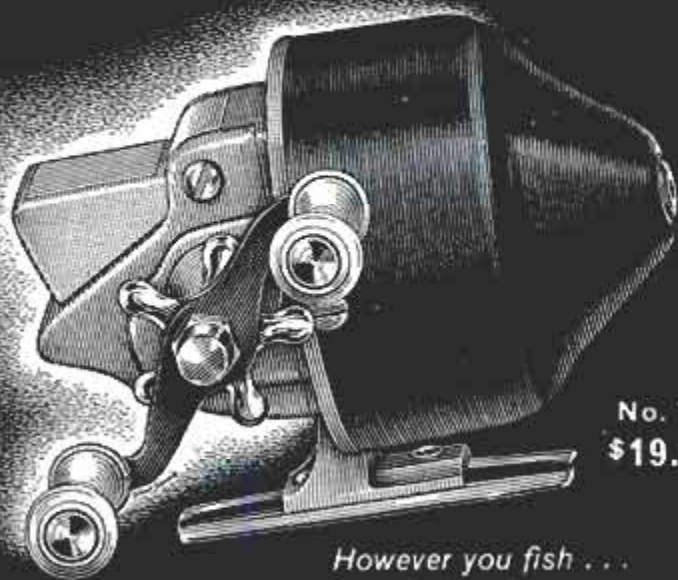

No. 700  
\$19.95

However you fish . . .  
spin, fly or bait cast . . .  
a Bronson Reel makes it more fun!

Designed for both fresh water  
and salt water fishing

It's fool-proof . . . the first push-button spinning reel with star drag! Placement of star drag means the "Spin-King" spool never turns, so line can't twist. Finger-tip drag adjustment, too! Special thumb-lever control assures perfect line feathering—no mid-air snapping. Reel fits on bait or spin rod—comes with line-filled spool. Write for free "Bronson Spinning Guide"—Bronson Reel Co., Bronson, Mich.



Div. of Higbie Mfg. Co.

## NEW! Giant AUTOMOTIVE CATALOG

1956 Edition! Everything for car, truck, custom-styled car, hot rod . . . at **LOWEST PRICES!**

**SAVE UP TO 50%** on all parts, accessories! Only complete automotive buying guide . . . 75,000 items . . . 180 pages! Thousands of **hard-to-find parts**; equipment, parts for 1920 to 1956 models; **Hollywood accessories** never before offered; **hi-speed parts**. Send your name and address and 25c (refundable with first \$5.00 order) to:  
J. C. Whitney & Co. 1917 Archer, Dept. P-4, Chicago 16, Ill.



Also Eshelman  
TRACTORS.  
Riding ROTARY  
MOWERS.  
ROTARY  
TILLERS  
at amazing  
savings. Write  
for Free  
Literature

## ESHELMAN TWO PASS CHILD'S AUTO MODEL

70 Miles Per Gal. Gas  
**UP TO 15 MILES PER HR.**  
STURDY, SAFE "Commended  
by Parents' Mag." Also 2  
Pass. Adult Sport  
and Golf Cars  
at 1/5 the cost of  
most other  
cars. Free literature.  
Write:  
ESHELMAN CO.,  
Dept. MC-54, 109 Light St., Balto. 2, Md.



Shipping Points: BALTIMORE -  
CHICAGO - RENO



## STURDY-SAFE Get this Old Town Skiff

• In salt or fresh water—in calm or rough seas—this boat handles equally well. From Maine to Florida, sportsmen say it's dependable in all kinds of weather. Its high bows and staunch construction make it ideal for family use. Built to carry outboard motors of 2½ to 16 H.P.

**FREE CATALOG** shows just the model you need. Write for one today! Also rowboats, dinghies, sailboats, canoes.

## OLD TOWN BOATS

Old Town Canoe Co., 344 Middle St., Old Town, Maine  
**PLEASE SEND ME FREE CATALOG**

Name \_\_\_\_\_  
Address \_\_\_\_\_  
City \_\_\_\_\_ State \_\_\_\_\_

## DANGER AHEAD!

It's a life saver—the Delta Flashing Powerlite. Brilliant red flashing top light. Powerful side spotlight—all in one compact unit! 4-way switch. 6-volt battery. Get one! \$6.95  
Less battery, only \$6.95  
Delta Electric Co., Marion, Ind.



**Delta** FLASHING POWERLITE  
ELECTRIC LANTERN

# NEW PRE-PASTED



*Bolta-Wall*

**WASHABLE  
VINYL TILE**

**"Just wet the back!"  
Goes up Easy!  
Cleans Easy!**

Beautiful, washable Bolta-Wall vinyl tile is stain and scuff resistant... the perfect worry-free wall covering for all the busy areas in your home. The pre-pasted adhesive backing makes it "postage-stamp-easy" to install... no messy pastes, just wet the back and stick it on!

Bolta-Wall tile is available in rich Mahogany or Bamboo patterns, both in colors that work beautifully with all decors.

Redecorate this easy low cost way... ask your flooring or building supply dealer for Bolta-Wall pre-pasted vinyl tile.

**Send for samples  
and  
illustrated folder**



WET THE BACK



IN KITCHENS



IN LIVING ROOMS



IN REC. ROOMS



**The General Tire & Rubber Co.** PM-4  
BOLTA PRODUCTS Division, Lawrence, Mass.  
Send me complete information on low cost  
Bolta-Wall Pre-Pasted Vinyl Tile

Name \_\_\_\_\_

Address \_\_\_\_\_

City \_\_\_\_\_ Zone \_\_\_\_\_ State \_\_\_\_\_

"Interiors should be of better quality."—California salesman.

"Brakes must be improved for weight and power of car."—California housewife.

"Poor brake linings. Too-low friction. Being in brake-supply business I know the trouble."—New York brake supplier.

"Has an extreme valve noise at about 7 miles per hour. Dealer said this was in all 1956 models."—California restaurateur.

"Poor paint job. Worst of any car I have owned."—Iowa farmer.

"Rust on rear bumper at 1000 miles."—New York veterinarian.

"Windows too hard to turn."—California wholesaler.

"Water leaks both sides."—California realtor.

"Difficult to fill gas tank. Station operators complain about inlet."—California contractor.

"Don't like exhaust-outlet locations. Deposits carbon on fender and bumper and I wipe it off with my clothing every time I walk past the car in the garage."—Kansas merchant.

"Trade-in allowance too low. I received \$300 more in cash than the Cadillac dealer was willing to pay by their book in trade."—Michigan businessman.

## Design Changes

In every survey we ask the owners to tell us what should be changed in their new cars. A large number of Cadillac owners say no changes are necessary (39.0 percent). The car is all right as it is. The most frequently mentioned changes cover the same areas as the complaints: more careful assembly; improve the transmission; better gas mileage.

The following suggestions are interesting enough to warrant quotation:

"Should be possible to shut off the front heater vents and throw all the heat to the rear seat."—Georgia sales manager.

"Driver's ash tray should be on the left."—California housewife.

"Should have electric windshield wipers."—California truck operator.

"Instrument panel really needs changing."—Mississippi retired owner.

"Front seat on two-door models should have separate controls so the passenger does not have to sit in the position the driver does."—Arkansas contractor.

"Move window-lift control panel on driver's side upward so my left leg won't keep operating the power windows."—Mississippi merchant.

"Install better heater-temperature control."—Texas builder.

(Continued to page 258)

## SAVE MONEY on LUMBER with the LOW-COST BELSAW PLANER

### Convert Rough and Random Size Lumber into Cabinet Finished Stock

Now anyone can make perfect cabinet finished stock from low-cost rough lumber... any size up to 12 1/4 inches wide and 6 inches thick. Turn out high grade finished material at a fraction of the cost you pay lumber yards. Big 42-inch-long bed makes it easy to plane heavy, wide and long pieces... BELSAW self-feeds at 14 to 34 feet per minute.



### USE THIS ONE LOW-COST MACHINE for Planing, Jointing, Sawing, Milling, Tongue and Groove.

You can easily make flooring, siding and many other popular patterns with your Belsaw. Your Belsaw quickly pays for itself with savings on raw materials and profits on finished stock... a highly profitable machine for custom work. Compare Belsaw with any 12-inch planer on the market... Belsaw gives you more essential features—yet costs you \$50 to \$125 less than others.

Send Today for Free Literature on the  
Belsaw Multi-Duty Planer.

BELSAW MACHINERY CO 2056 Field Bldg. Kansas City 11, Mo.

## MONEY MEN ALL FREE

DATA

THE PLASTEX Industry needs manufacturers on small scale and for big production of Lamp and Clock Stands, Art Goods and Novelties in Plastex and Marble imitation. Experience unnecessary. Big material makes regular 10¢ store sellers. Rubber moulds furnished for speed production. Small investment brings good returns. We are now placing big Chain Store Orders with manufacturers. Ambitious men have chance for real prosperity. Our Free booklet will interest and benefit you.

**PLASTEX INDUSTRIES, Dept. A**  
3400 Third Ave. New York 56, N. Y.

## Find HIDDEN TREASURES

GOLD, SILVER, PRECIOUS METALS with the Famous Model 27 Metal Detector. Lightweight, ultra-sensitive, low cost. None finer. Also GEIGER COUNTERS for uranium and the VIOLITE for tungsten. INFORMATION FREE

*The Detectron* CORP.  
5528 Vineland Ave., No. Hollywood, Calif.



## DITCH-WITCH TRENCHER

Portable DITCH-WITCH digs 4 1/2" or 6" clean, even ditches to 36" depth in all types of soil. Four rugged models. Complete unit — self-propelled. **OUTDIGS 8 MEN**  
Write for Illustrated Literature

The CHARLES MACHINE WORKS  
620 B Street Perry, Okla.



## Build a MOLDED PLYWOOD RUNABOUT With This Complete Kit...

by America's largest maker  
of molded plywood hulls

Save 75% construction time. Molded plywood hull has strength of steel of same weight... assured precision fit... no complex forms to erect... no framing... no planking. Pre-cut all mahogany parts mean factory built appearance inside and out.

Cruiser semi-kits also available.

See your dealer or write  
for information to

**U. S. MOLDED SHAPES, INC.**  
651 Market St. S.W. Grand Rapids 2, Michigan



Hardware Week Special

# NICHOLSON HANDY FILE only

69¢

(regularly 86¢)

You'll find it one of your  
most-used hand tools



- For household fix-ups
- For fast filing, smooth finishing on aluminum, other metals, wood, plastics

One side single-cut  
for sharpening, finishing

Other side double-cut  
for fast filing

Colorful, comfortable  
forged steel handle with  
hang-up hole

Buy several—for household, garage, workshop, sharpening garden tools—at this special low price during Hardware Week (April 12-21). Available at good hardware stores.

**NICHOLSON FILE CO.**
  
 Providence, R.I.

(In Canada: Nicholson File Company of Canada Ltd.,  
Port Hope, Ontario)

## NICHOLSON FILES

A FILE FOR EVERY PURPOSE

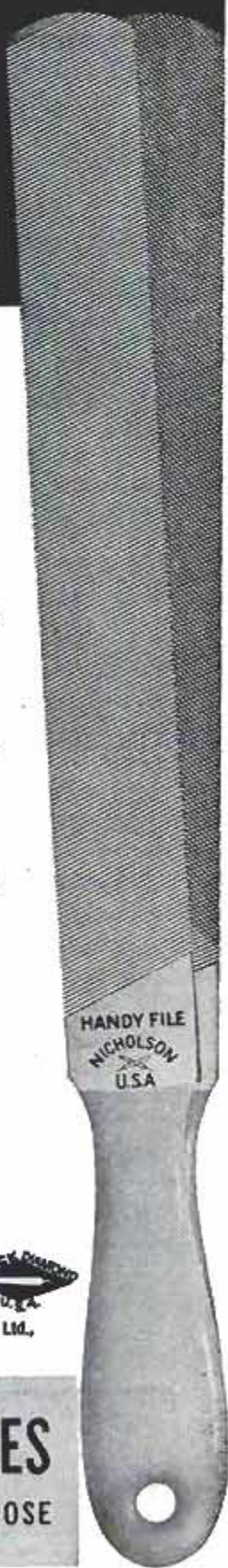

*"I've got a brand new boat in this Fiberglas<sup>®</sup> Boat-Covering Kit!"*



Yes, with a Fiberglas Boat-Covering Kit you can make your old boat hull like new—or your new boat better! Leakproof, strong and rigid, with less maintenance and more resistance to damage!

Everything you need—Fiberglas fabric, resin, color pigment, and activator—comes in a kit. And you can do an average runabout in roughly a day.

When the job is done, you'll never have to sand, scrape or caulk your hull again! Come spring, you just wash it down and launch!

Over 250,000 boat owners have covered their boats this easy way! How about you? For covering materials, just ask your local marine dealer. Or, for step-by-step information, write me for our special Fiberglas boat-covering booklet and a list of kit manufacturers. Charlie M., Dept. 178D, Essex, Conn.



OWENS-CORNING  
**FIBERGLAS**

®-M. (Reg. U.S. Pat. Off.) O-C. P. Corp.

### Styling Not Vital

More than half of the Cadillac owners say that exterior styling did not play an important part in their choice of the car. There's more to Cadillac's appeal than its appearance, obviously.

Only a small percentage (10.4 percent) object to the fact that the 1956 Cadillac is only slightly different in appearance from the 1955 Cadillac. In fact, most of them seem to like this unchanging nature of the car.

"I figure to sacrifice some style for low depreciation."—California businessman.

"I like Cadillac because of quality not styling. Mine was bought before seeing one or even a picture of one."—Ohio broker.

"Whatever changes Cadillac makes will be good. I ordered my 1956 Cadillac in January 1955."—Idaho lumberman.

"Styling not important to me. The only reason for trading was that my wife wanted a blue car."—California vineyard owner.

"I bought it for anticipated performance and service, not to 'four flush' for looks."—Oklahoma oil producer.

"Purchased car to please myself and not style-conscious public."—Massachusetts lawyer.

"I buy every two years regardless of styling."—Idaho motel owner.

There you have the owners' views of the 1956 Cadillac. They tell how their cars behave in everyday usage. Turn back to page 105 for Floyd Clymer's driving test and to page 106 for Dale Kelly's engineering report on performance. ★ ★ ★

### Clymer Road Tests the Cadillac

*(Continued from page 105)*

tread and further because of good shock absorbers. One soon becomes accustomed to this rather "soft" suspension system and the somewhat excessive movement of the steering wheel, which requires more movement than the faster and more direct steering of foreign and sports-type cars. Cad's overall steering ratio is 19.5 to 1, resulting in considerable "winding" of the wheel, which requires four turns from lock to lock.

The car handled well and loafed along at 90 to 100 miles per hour with effortless ease. It is fast and furious and top speedometer reading was 120 miles per hour. However, like all modern speedometers, it was on the high side by about eight percent. The car used no oil. Cadillac mileage is okay in my book.

The Hydra-Matic has been improved for 1956. This has made for much smoother shifting than on former models, and yet

*(Continued to page 260)*

**new screens for a  
whole house...  
Do-It-Yourself with  
Reynolds Aluminum**

*(not one will ever rust, warp or rot)*

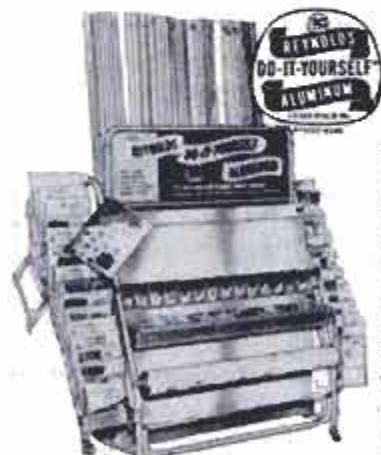

Available in  
Canada

**REYNOLDS Do-It-Yourself ALUMINUM**

Reynolds Metals Company, 2494 South Third St., Louisville 1, Ky.

You start with Reynolds *Do-It-Yourself* Aluminum screen sections. Then—**ONE**—you measure and cut—**TWO**—you snap the frames together—**THREE**—you put in screen cloth. And, honestly, you can make all the screens for your house in a single weekend. To put it another way—it's quick and it's easy! Best of all you'll have screens that are light weight, rust and warp-proof... ready for

a lifetime of aluminum service. Interchangeable with storm sash, too.

Ask Western Union Operator No. 25 for the name of the Reynolds *Do-It-Yourself* Aluminum dealer nearest you. Or see your favorite lumber or hardware dealer. He has complete materials and free instruction sheets.

**By the way**—the only tools you'll need are a mallet, saw and a file to smooth cut edges. Try a **Black Diamond** or **Nicholson** file—there's one for every purpose.

**DOES YOUR WATER RUN SLOW?**



*See Why*  
**BURKS  
PUMPS**

DELIVER FULL PRESSURE

DECATUR PUMP CO., 61-BELK ST., DECATUR, ILL.

**MAKE BIG MONEY!**

Be a floor surfacing contractor and sand both new and old floors. Sanders are easy to operate and better still, you're your own boss. Write for latest "sell-all" booklet entitled "Opportunities in Floor Surfacing", enclosing 25 cents in coin or stamps to cover handling.

**AMERICAN**

FLOOR SURFACING MACHINE CO.  
523 So. St. Clair Street - Toledo 3, Ohio

Insist on  
*Evans*  
**TAPES**

50 ft.-100 ft. long

At your  
hardware store

For building and  
gardening measuring.

from **\$4.98**

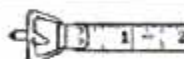

each with **FREE**  
plastic utility case  
and

**SPECIAL HOOK-RING ATTACHMENT  
FOR EASY ONE-MAN MEASURING**

EVANS RULE CO., Elizabeth, N. J. 3058

**REPAIR MUFFLER AND  
EXHAUST LEAKS in 10 min.**

The plastic gas-tight seal sets hard, withstands heat and vibration. Prevents carbon monoxide gas poisoning.

**SETS LIKE A WELD - NO TOOLS NEEDED**

\$1.69  
per can

*Holt's* **GUN-GUM**

**MUFFLER PLASTIC SEAL**

See Your Neighborhood Auto Accessory and Parts Replacement Store  
**TREGLOWN CO. INC, FANWOOD 67, N.J.**

\* TRADE MARK REGD.

CANADA: 1366 GREENE AVE. MONTREAL 5

Write for Full  
DETAILS

APRIL 1956

*Holt's* **HAVE  
THE ANSWER!**

**WORN ENGINE BURNING OIL!**

Increases miles per gallon!

Restores compression!

Reduces oil bills!

\$4.95 Tube for  
most cars

Forms self-lubricating seal at piston top. Inserted through spark plug holes. Used by millions of motorists. Tested and approved by motoring experts.

**PISTON SEAL**

# Arc Welding plus AC Power

for lights, tools, appliances, etc.

... a real profit maker for emergency repair jobs

TWO machines in ONE



AC Power-AC Welding Combination

**Easy Portability! Take it ANYWHERE. See how it PAYS!**

This rugged AC welder-AC power combination with 4 cylinder air-cooled engine gives you 250 amp. welding current and 5000 watt AC power alternately—it's the welder you need for "cashing in" on "big pay" jobs that call for on-the-spot service. Can be loaded on truck or trailer on a moment's notice.

**AC Welder-AC Power Combination**—save money—just connect this low cost generator only—to an old auto engine. It's ideal for 200 to 300 amp. welding operations, where power lines are unavailable, or for furnishing emergency power for lights, tools, etc.



"Husky Boy"

**"Husky Boy"** 200 amp. welder driven by a 2 cylinder air-cooled engine. Perfect for outside or in and around the shop welding. Handles the big pay jobs.

**Transformer Type AC Welder 200 amp.** a real welder for production and repair work in shops that have only single phase power available.



AC Transformer

Investigate these MONEY MAKERS today!

**"Pipeliner"** 250 amp. gasoline engine driven welder with plenty of power to maintain a hot, fast, dependable arc. Also equipped with a 1 KW DC auxiliary power receptacle.



"Pipeliner"

Learn arc welding quickly by actual on-the-job experience at the non-profit Hobart Trade School. Complete or partial courses. G. I. approved.

**Modern Arc Welding Lessons** 200 fully illustrated pages. Learn practical arc welding in your spare time . . . Only \$1.00.

**HOBART BROTHERS CO., BOX M-46**  
Troy, Ohio, Phone 21223

"One of the world's largest builders of arc welding equipment"



**HOBART BROTHERS CO., Box M-46, Troy, Ohio**  
Please send me additional data on items checked.

AC Power-AC Welding  "Husky Boy"  
 AC Transformer  "Pipeliner"  Hobart  
Welding School  Welding Lessons, \$1.00.

NAME \_\_\_\_\_ Welder's Vest Pocket Guide  
ADDRESS \_\_\_\_\_  
CITY \_\_\_\_\_ STATE \_\_\_\_\_

there is no mushiness or feeling of slippage as in some other makes of automatic transmissions. Hydra-Matic positive drive contributes to efficiency and performance without illusion of slippage. It engages immediately and with no fuss. There are two Drive ranges and a Low range and Reverse with, of course, the desirable kickdown feature.

Power brakes are standard equipment with the master brake cylinder and vacuum power cylinder in a unit. I found the brakes satisfactory, with light pedal pressure required, but there was some fading when decreasing from high speeds or in constant brake use on winding roads. Even though I beat the test car over all kinds of terrain, not a squeak or rattle developed and I was in almost a deluge of rain and found no water leaks. Vision in the rain is improved by a new vacuum-type windshield wiper. A second action which allows rapid, narrow-angle strokes has been added to the normal variable-speed adjustment—a fine idea. Cadillac assembly is better than it was a few years ago, and it always has been quite good. There is very little body noise or disturbing rumble even at high speeds. In a strong three-quarter wind in the desert there was a noticeable "wind wander."

The instrument panel is massive and instruments are well-located. Speedometer vision is excellent and I like the indicator gauges instead of the warning lights now popular on many makes. The hood is long and quite high and the operator has a feeling of driving a massive automobile which, of course, is true. Vision in every direction is good.

The ventilating system is extremely effective, permitting abundant fresh air to enter, and the heater is one of the best I have ever found in any automobile. Fresh air is taken in through a slot below the windshield.

The wide brake pedal, which is now lower than formerly, is better located in relation to the throttle than on previous models and can be operated more easily with either foot. The emergency hand-brake lever is well-located and easy to operate. I found the radio reception extremely good, even in the desert, which is quite a test of efficiency of any radio.

The interior finish is of excellent quality, as are the seat cushions and all appointments, which of course one has learned to expect from Cadillac. The electric windows and seat adjustment worked to perfection and the doors have a solid feel in opening or closing. The seating position is good and the driving comfort of the car for long-

(Continued to page 262)

# It's Great!



Nothing like being out on water with your fishing pal — especially when you're in an Arkansas Traveler. It's Everything That Makes a Boat Great! Fast!—Maneuverable! — Rugged! — Seaworthy! — Stable! — Trim! Write today for literature on the 18 great new Arkansas Traveler models for 1956.

## ARKANSAS TRAVELER BOATS

2006 East 14th Street, Little Rock, Arkansas

# Arkansas Traveler

CUSHION-AIRE-GLIDE ALUMINUM BOATS

## ELECTRIC WELDER

AC or DC  
110 Volts

The "Little Marvel" all-metal welder, 5-year written guarantee. Welds 1/8" metal or money back. Repairs tanks, tools, fenders, machine parts, etc. Complete with everything — rods, unit, eye shield, directions. \$6.95

**\$6.95**  
Complete

plus 50c postage. Flame torch accessory for soldering, cutting, brazing \$3.95 complete with carbons, brass rods, flux. \$2.00 Deposit on C.O.D. 75 ampere 1/4 inch Transformer Welder \$21.95 F.O.B.

ESSAY MFG. CO., Dept. 51, Quincy 69, Mass.

## Exclusive Double-Bearing HEAVY-DUTY PUMPS

IRRIGATE • DRAIN • CIRCULATE • SPRAY  
Up to 7,500 GPH, 3,000 GPH from 25' well. Use 1/4" to 1 HP motor, 1 1/4" inlet, 1" outlet. Stainless shafts.

TYPE X-2 oilless bronze bearings. **\$10.95**

Won't rust. TYPE X-8—Ball bearing model. \$12.95

Postpaid if cash with order. Rush your order today

MONEY BACK GUARANTEE

Centrifugal and Gear Pumps in All Sizes

LABAWCO PUMPS, Belle Mead 2, N. J.

## EXPLORE FOR TREASURE!

Find gold, silver, coins, jewelry, battle relics! Treasure-Metal-Mineral Detectors, M-SCOPE. Used worldwide for Treasure Hunting. Mineralights, Geiger, Scintillation Counters. Prices from \$14.75. Fully GUARANTEED. Time Payment Plan, FREE Treasure and Uranium booklets. New outfitting catalog. FISHER RESEARCH LAB., INC., Dept. PM-1, Palo Alto, Calif.

## Get This NEW Catalog of WOOD & WOODWORKING EQUIPMENT

WORLD'S LARGEST SELECTION OF FINEST DOMESTIC AND IMPORTED WOODS... MOULDINGS, HARDWARE, TOOLS,—ALL AT LOW MONEY SAVING PRICES!

Your complete wood buying guide and project book. Craftsman is your best, most complete source of finest kiln-dried domestic and rare imported woods, beautiful wood inlays, colorful bandings, matched plywoods, embossed mouldings, carved ornaments, newest woodworking tools, "hard to find" cabinet hardware and fittings... more than 1,500 items! Packed with newest scroll saw patterns, project ideas & money making plans. Enclose 25c (refunded with first order) to help pay mailing, handling cost. Write now! Craftsman Wood Service Co., Dept. A-4 2729 S. Mary Street - Chicago 8, Ill.

128 PAGES  
Many in full color

packed with rare, fancy & imported woods... veneers, plywoods, patterns, tools, ornaments, hardware... everything for the woodworker.



## This gang is dead against the MARLIN 39-A LEVER ACTION .22!

The fast-handling, fast-firing 39-A has always been famous for playing rough with varmints. Now it has Micro-Groove\* accuracy, too—so you can pick off these cagy pests with more certainty than ever!

See this pest-poison combination of lever action and Micro-Groove at your dealer's. Feel its fine balance, perfect snug-down into shooting position. You'll know you can go and get 'em, with a 39-A!

Solid-top receiver is drilled and tapped for all standard sights. Side ejection and low hammer spur allow low scope mounting. Take-down screw exposes all working parts. 24" barrel.

\*Patent applied for.

**\$65.95\*\***

## MARLIN 39-A "MOUNTIE"

World's fastest-handling .22! Saddle-model 39-A, with 20" barrel and Straight Grip—designed for lightning-draw from scabbard!

**\$65.95\*\***

\*\*Slightly higher west of the Rockies. Subject to change without notice.

THE NAME FOR GAME

# Marlin

FINE GUNS SINCE 1870

MARLIN FIREARMS COMPANY  
Dept. M-4, New Haven, Connecticut

Please send me your catalog with photo-illustrations and complete information on all Marlin Guns. Also send me a pack of (check preference) ( ) single- or ( ) double-edge Marlin Razor Blades. I enclose 10¢ for handling.

Name.....

Street.....

City.....Zone.....State.....

ride for pennies...  
 save dollars with  
 the New 1956  
**HARLEY-DAVIDSON**  
**HUMMER**

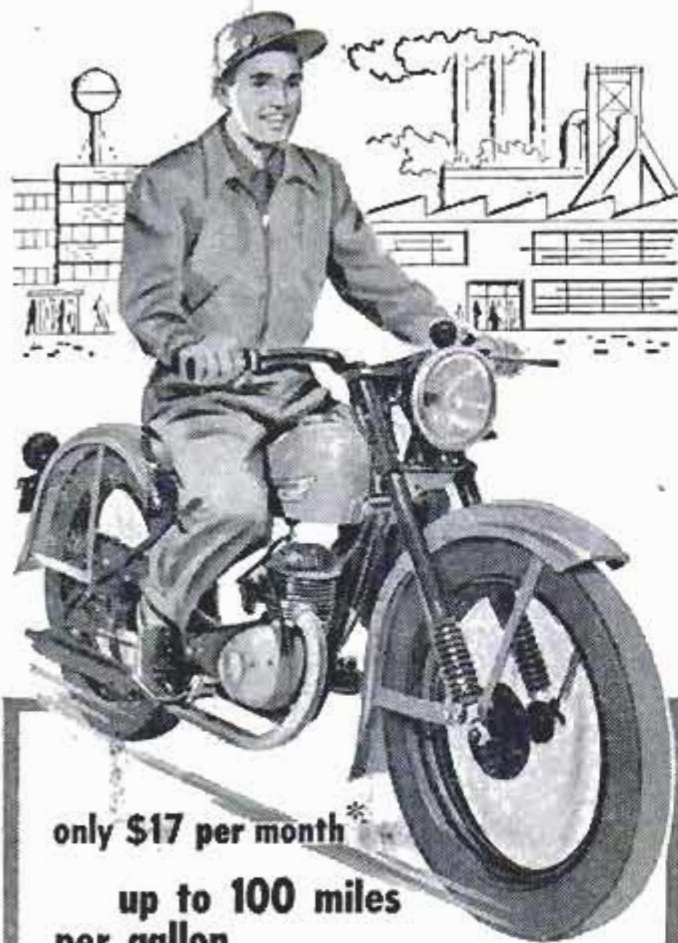

only \$17 per month\*  
 up to 100 miles  
 per gallon

You can buy and ride the Harley-Davidson Hummer for little more than the change in your pocket. And what an *easy* answer to your get-to-work problem. With a Hummer you leave home later . . . get back sooner. In and out of heavy traffic in a jiffy. No parking worries with a Hummer either. Try it . . . ride it — at your Harley-Davidson dealer today. Or, write us for FREE literature.

\*After minimum down payment, includes fire, theft, collision insurance; local tax; freight and carrying charge.

**HARLEY-DAVIDSON MOTOR CO.**  
 DEPT. P., MILWAUKEE 1, WISCONSIN

distance travel is tops. One can drive long distances with little fatigue and in luxurious comfort. A new six-way power seat adjuster provides for adjusting the angle of the seat back, in addition to the horizontal and vertical movement, and the horizontal adjustment is increased to five inches.

The large taillights mounted high on the rear fender tips are a safety feature and an excellent guide in backing out of driveways or in parking. The gas filler cap is located under the hinged left taillight, which is convenient and out of the way. Two reverse-flow mufflers and straight-through resonators are used. The rear twin exhaust pipes project out of both sides of the massive rear bumper. The arrangement is a neat one. However, soot and dirt do accumulate around the hole edges where the exhaust is emitted. Just watch your step around parking lots or your garage so that you don't brush against one, as the stain you'll get by touching it isn't easy to remove from clothing.

The front grille is massive. Cadillac engineers have done the best job in the industry of producing impractical bumpers. The bulletlike bumper extensions extend far forward and are the first part of the car to touch another car. It is the most impractical built when it comes to pushing a stalled car. No one is happy about pushing another car, but at times it is necessary. Cadillac's design has made it almost certain that no Cadillac owner is going to push another car without damaging the front end of the Cad or the rear end of the other car. Bumpers that are practical and that may be used in pushing another car should be required by law on all cars and the points where any bumper touches another bumper should be standardized.

The hood is counterbalanced, as is the trunk lid; both open and close easily. There is large rear compartment for luggage.

Certainly Cadillac for 1956 offers many worthwhile improvements over former models. Cadillac's traditional quality in both material and workmanship is noticeable. For over 50 years Cadillac has built quality products with very few models that could ever be classed as poor ones. It is a remarkable tribute to this company that year after year they have maintained their position and reputation. Many feel it is the best of any mass-produced car. ★ ★ ★

**COMING NEXT MONTH: PLYMOUTH**

Be sure to get your copy of *Popular Mechanics* next month when the owners, Floyd Clymer and Dale Kelly will tell you all about the 1956 Plymouth. It's on the newsstands April 26.



# Now You Can Own A Basic Home Workshop for Only

# \$49<sup>95</sup>



Not Just a Drill with Kit of Attachments, but Two Separate SKIL Power Tools!

- SKIL 4 1/4" Power Saw
- SKIL 1/4" Power Drill
- Plus 13 SKIL Accessories

## NEW 15-PIECE SKIL JACK-OF-ALL-KITS



### A Saw When You Need It!

Genuine SKIL 4 1/4" Saw has 3 times more power than most drill and saw attachment kits! No motor burn-out due to lack of power. Cuts plywood, lumber, wallboard with power to spare.



### A Drill When You Need It!

Never used for powering a saw! And SKIL Drill has the right power and speed to sand, polish, buff, with included accessories!

**PLUS** combination blade, sturdy rip fence, 7 high-speed twist bits, and 4 sanding-polishing accessories!

SKIL offers America's greatest workshop value! Imagine! For little more than the cost of a drill and saw attachment kit, you can own *two* separate SKIL Power Tools, *plus* 13 useful accessories!

Don't *under-power* your workshop with a drill and saw attachment! Now you can get a fully-powered SKIL 4 1/4" Saw and quality SKIL 1/4" drill. Each has the *right* power and speed for its job . . . and you never have the inconvenience of changing from a drill to a saw, then back to a drill.

Genuine SKIL Power Tools save you money on home repair and improvements . . . equip you for a hundred workshop and household jobs. The SKIL JACK-OF-ALL-KITS is a \$58.85 value for only \$49.95!

**See the SKIL Jack-Of-All-Kits today — at your hardware dealer, appliance dealer or department store.**

# SKIL

BUILDERS TOOLS

Made only by SKIL Corporation  
formerly SKILSAW, Inc.  
5033 Elston Avenue, Chicago 30, Illinois  
3601 Dundas Street West, Toronto 9, Ont.  
Factory Branches in All Leading Cities

# How FORD has upped V-8 h.p.

The 312-cubic inch **Thunderbird Special V-8**, biggest engine in the low-price field. Now available in all Fordomatic Fairlanes and Station Wagons.

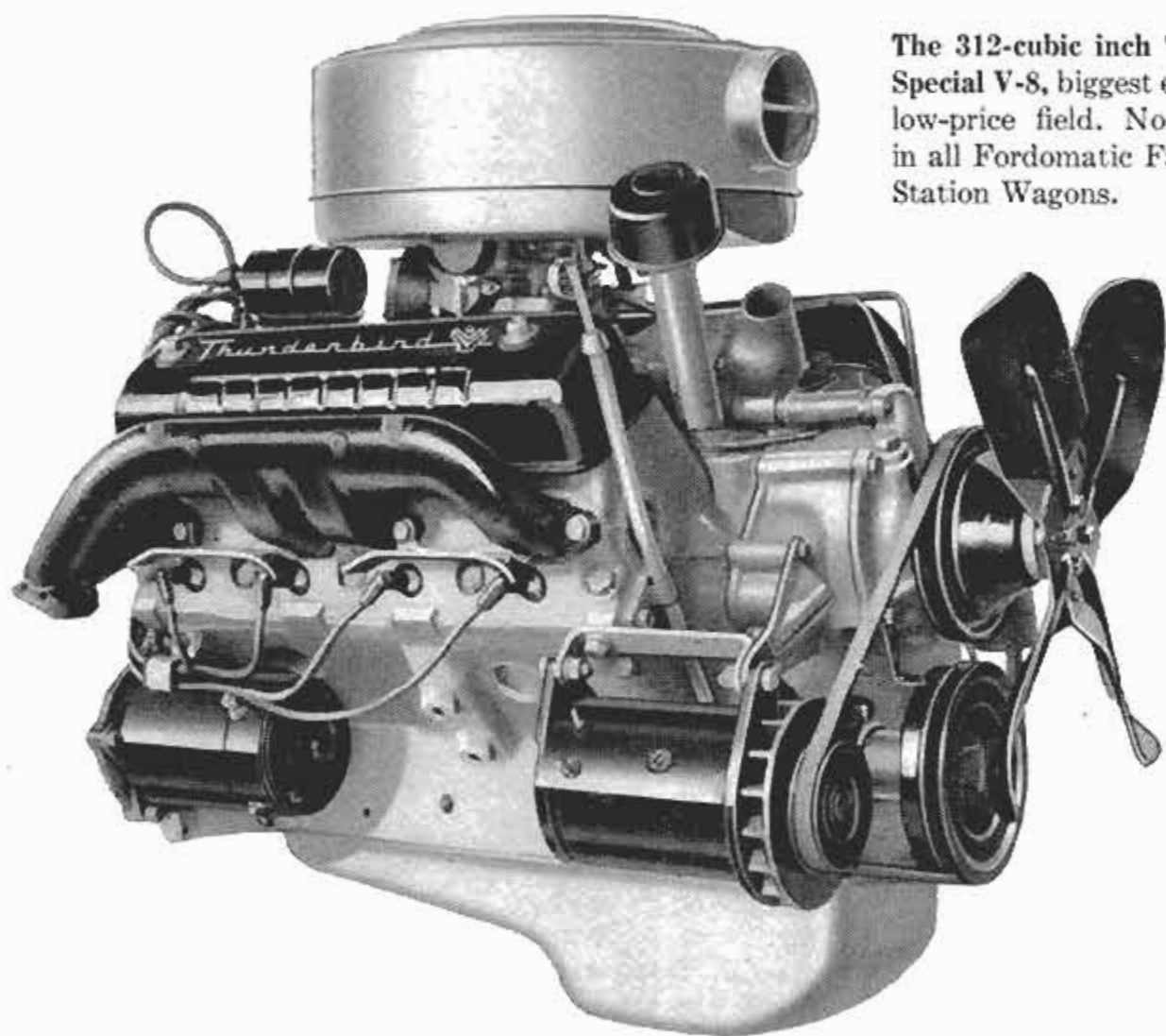

*The world's leading maker  
of V-8's now offers up to* **225 h.p.**

There is good news from Detroit for the man who appreciates the exciting feel of a lot of "horses" under the hood of his family automobile.

The management at Ford announced recently that its Thunderbird *Special* V-8, the job that revs up 225 h.p. and powers the mighty Fordomatic Thunderbird, now is available in Fairlane and Station Wagon models with Fordomatic Drive. This is the *biggest* engine in the entire low-price field with a displacement of 312 cubic inches! And it's number *one* in *torque*, too, which means you get top performance—for the kind of driving *you* do.

The standard V-8 engine for Fairlane and Station Wagon models already is the most powerful *standard* "eight" in the low-price field. It's the Thunderbird V-8 that develops 202 h.p. with Fordomatic. This is up to 32 *more* horsepower than other standard V-8's in Ford's field. What's more, this same engine has been made available in all Customline and Mainline model Fords, too.

What all of these power boosts amount to was perhaps best expressed by the automobile mechanic who, upon hearing of these new Ford engines said, "Looks to me like Ford means to stay Number *One* on the 'Git' Parade!"



The 292-cubic inch Thunderbird V-8, the standard eight for all Fairlanes and Station Wagons, is now available in all Customline and Mainline models, too. Has 4-barrel carburetor, dual exhausts.

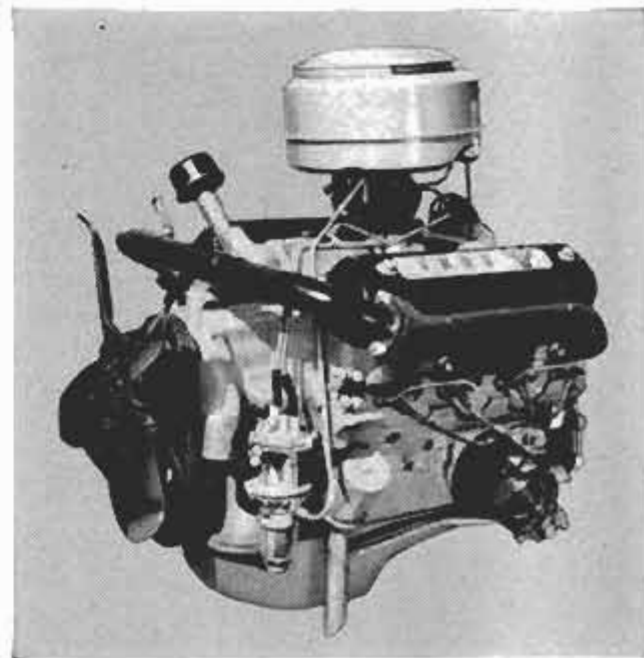

The 272-cubic inch Ford V-8, the standard eight for all Customline and Mainline Fords. Has modern dual carburetor, automatic choke, single exhaust.

**FORD Division of FORD MOTOR COMPANY**



**Easy..**  
**TO FILL ANY**  
**SPINNING**  
**REEL**  
 Quickly...  
 without twist!

Anyone can do it,  
 without help! Simply  
 fasten line to reel spool,  
 step on Spin-Pak,  
 and wind the line on  
 your reel. No twist!



*Shakespeare*  
**WEXFORD**  
**SPIN-PAK**

**NEW... EXTRA LIMP TYNEX MONOFILAMENT**

Dependable, uniform spinning monofilament for ANY spinning reel. Sensationally soft and manageable, No. 5400 is "limp as an old shoelace". Especially processed by Shakespeare line specialists from DuPont Tynex Nylon... for finest Shakespeare spinning reels when filled with line at factory.

**LOOK FOR THIS DISPENSER AT BETTER TACKLE DEALERS**  
 Packaged on plastic wheels; two wheels connected in plastic box. With Spin-Pak you save time and temper. Easy as loading a bait-casting reel! \$1.00 for 100 yds. of 6-lb!



**Free!** NEW 1956 "TIPS & TACKLE"

**BOOK-PAK WITH POCKET FISHING CALENDAR**

Catch more fish! These 4 new books show ways to fish, where to find 'em, tackle for:

- SPINNING • BAIT CASTING
- FLY FISHING • SALT WATER

**SHAKESPEARE COMPANY**

Dept. PM-4, Kalamazoo, Michigan.

Please send, FREE, new 1956 "TIPS and TACKLE" booklets and Joe Godfrey pocket fishing calendar.

Name \_\_\_\_\_

Address \_\_\_\_\_

City \_\_\_\_\_ Zone \_\_\_\_\_ State \_\_\_\_\_

**Seabees Build Town Under Ice**

(Continued from page 94)

Frank Jorgenson, aerological officer; Dick Bowers, in charge of construction operations; Dave Baker, communications officer. Rank and title meant nothing. Plumbers became carpenters, carpenters drove tractors, cooks piled cargo in the supply dump. Lieutenant Kanodler, Seabee dentist, found himself cargo master one night directing the unloading of mammoth 10-ton snow compactors. Canham hitched seven-ton yokes of steel bobsleds to tractors himself, rode beside "Cat" skidders bringing heavy equipment over hazardous trails and helped dig out bogged sleds.

Over at Little America, Lt. Dan Slosser, Seabee executive officer; Lt. Don Mehaffey and chief warrant officers Vic Young and George Purinton pitched in the same way.

**Polar Training in Summer Heat**

Last summer, when the mercury crowded 90 in Davisville, R. I., this team rehearsed every phase of its upcoming job like a football squad in spring training. "We went through daily polar survival routines," says Vic Young. "Six-man teams worked out hauling one-ton sleds on dry ground. The specially designed electrical and plumbing equipment was torn apart and reassembled for practice. Immersion heaters to melt snow for water were tried out. On kitchen equipment they'd be using, cooks prepared a full meal of polar rations and we ate it."

Meanwhile, out in Detroit Arsenal's cold room, 15-man crews in full polar regalia under Dick Bowers practiced assembling one of the 20 by 48-foot prefab buildings while temperature was lowered to minus 90 degrees, and a 12-knot wind was fanned through the cell. "Under normal conditions," Bowers recalls, "one group could erect a complete shell in three hours. In the refrigerator, the job took eight hours. It gave us a hint of what we'd face when we got to Antarctica."

**Antarctica Unpredictable**

Unfortunately, Antarctica has a hatful of dirty tricks that can't be synthesized in cold rooms and MCB Special ran afoul of most before they finished. First, they had to get there with 18,000 tons of equipment and supplies. That's enough to make a solid pile of material about a city block square and two stories high. The white continent is ringed by a narrow band of open water so cold (about 28 degrees) that an unprotected man falling in is dead within eight minutes. North of this lies the ice pack. Broken from the frozen bays and swept

(Continued to page 268)

Glidden Announces . . .

# New GLID-TONE products specially made for do-it-yourself wood finishing



Unfinished Furniture

Furniture Refinishing



Interior and Exterior Paneling



Floors



Pleasure Boats



Wood Hobby Products



Antiques



Picnic Tables, Benches, Lawn Furniture

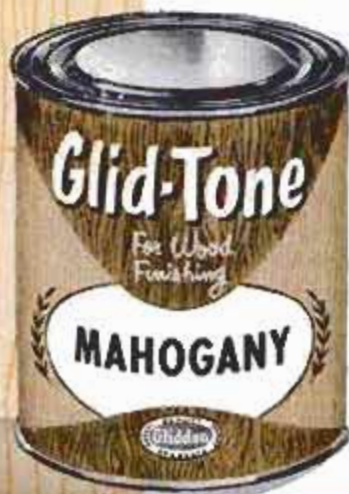

Now Glidden takes the "mystery" out of wood finishing, staining. The new array of Glid-Tone products have "built-in" features for amateur use; give *professional results*. Look for the Glid-Tone label at your paint store.

**New, easy-to-use stains in color!** Use *Glid-Tone Stains* either inside or out. Seals, does not raise grain. Extremely easy to use—just wipe or brush on, wipe off!

**For high gloss** and highest resistance to alcohol, acid, heat and abrasion, use all-purpose *Glid-Tone Gloss Varnish . . .* for floors, furniture, table tops, bars, cabinets!

**For exterior trim, paneling, boats and marine uses—***Glid-Tone Spar Varnish* is extremely tough, withstands effects of water, salt spray, heat, sun, cold.

**For modern, hand-rubbed effects** without laborious rubbing, use *Glid-Tone Satin Sheen Varnish*. Self-priming. No thinners or other extras required.

**Glid-Strip**—a safe, effective paint and varnish remover. Lets you work larger areas because it stays wet longer. Non-flammable. Cleans up with water!

**Glid-Tone Natural Wood Filler**—for filling open-grained woods . . . oak, chestnut, walnut, mahogany, pine, fir, redwood.

**Glid-Tone Crystalacq**—an all-purpose, crystal-clear brushing lacquer coat for beautifully grained light woods. Dries in only 20 minutes, provides lasting protection. Non-yellowing.

## Glidden

*Pacemaker in Paints*

THE GLIDDEN COMPANY • Cleveland 2, Ohio  
In Canada: The Glidden Company, Limited, Toronto





... like this space-saving  
Under Eaves Storage Unit

You can Afford  
Expensive Ideas with

## Fir Plywood

... or this handsome  
Music and TV Center



Give your home the "custom touch" with fir plywood. Whether you use it for smart, good-looking built-ins... strong, rigid subfloors and sheathing... or distinctive exterior siding—you'll find fir plywood fits your plans *and* your budget. Created by nature, improved by man, fir plywood is real wood made larger, stronger... better looking and more versatile.



Grademarked for your protection, fir plywood comes in standard grades as well as special textured or overlaid panels. DFPA industry grademarks attest quality, performance, value.

Plans Available; See your lumber dealer

or write (USA Only) Douglas Fir Plywood Association, Tacoma 2, Wash., Dept. 9. Please order plans by name, enclose 10c for each.

outward by winds, it circles the land like a halo 50 to 500 miles wide. Ships nosing into it risk crumpling their hulls like tissue in the pressure of wind-driven floes and towering million-ton icebergs.

The Seabees and their mountain of gear rode a seven-ship fleet through the pack in channels carved by three powerful ice-breakers (*Popular Mechanics*, March 1956). Even with open highways to follow, the tanker *Nespelen* tangled with an ice "cube" and tore great chunks from her propeller blades, slowing her to half speed.

### Ships Tie Up to Ice

Ships never get close enough to real land for mooring in Antarctica. Sea ice up to 15 feet thick covers bays and inlets until late in the season. So crews must chisel holes in the ice and freeze "deadmen" into them. Ships tie up to these at the ice edge. Then the fun begins. Supplies must be unloaded and hauled on sled trains across bay ice and up natural snow ramps to building sites on land or atop towering ice cliffs of the continental barrier.

In the old days, with dog sleds that rode lightly across the snow, moving a small expedition ashore was little trouble. But a cargo of five complete towns, some of which come in 50-ton packages, takes more than Siberian huskies to haul it. To make matters worse, the entire continent is buried in neve—Antarctica's special brand of snow. It has the consistency of granulated sugar. Normal tractors grind themselves cab-deep in it within minutes. As an experiment, Herb Whitney brought along a squat, heavy-set tracked vehicle called an "Ontos" (Greek for "the thing"), hoping it would prove a good reconnaissance buggy. The heavily armored cross between Jeep and tank got 50 feet from shipside and promptly dug its own grave in the snow. Balloon-tired forklifts met the same fate. But MCB Special's tracked Army Weasels and spidery Snocats—with four sets of steerable tracks set on like outriggers—did yeoman service. With strings of one-ton sleds lashed behind to carry freight, they heaved over drifts like rowboats on a choppy swell. A ride in a Weasel larruping over rutted trail, somewhere between snow and sky, is like being caught in a washing-machine tumbler with no handholds. But it gets there.

### 35-Ton Tractors Do Heavy Work

Stout as they are, Weasels and Snocats could never have hauled half the freight for this expedition. Antarctica has never seen anything like the 10 monstrous 35-ton tractors that crawled up snow ramps at

(Continued to page 270)

# NOW — A POWER WORKSHOP WITH REAL GUTS at a price you can afford!

Built around this

## DYNO-MITE

### NO. 888 POWER UNIT











Complete with  $\frac{3}{8}$ " Jacobs Geared Key Chuck, 6" Rubber Pad, three 6" Sanding Discs, 6" Polishing Bonnet, Wheel Arbor, and Reversible Side Handle.



ONLY

# \$44.95

Add these rugged, inexpensive attachments as you need them

	Jig Saw Table No. 887 \$1.95	
6 1/4" Bench Saw No. 883 \$26.40		6" Portable Saw No. 8811 \$17.95
	Portable Jig Saw No. 886 \$11.45 (with 4 blades)	
4" Bench Grinder No. 8810 \$6.80		Orbital Sander No. 882 \$15.95
	7-to-1 Speed Reducer No. 8815 \$12.45	
Bench Stand No. 881 \$3.40		Drill Press Vise No. 8816 \$5.95
	6" Bench Sander No. 889 \$8.95	Drill Press Stand No. 8814 \$19.95

No need now to choose between weak, under-powered attachment-type tools — and complicated, high-priced stationary units. In the remarkable Millers Falls "888" you get a really powerful (4.0 amp., 1/3 h.p.), fully portable power unit that drills, sands, polishes. Then, by adding beautifully engineered attachments, you can have all the power tools necessary for practically any job. And at a fraction of the cost of individually powered tools. See — and try — the "888" at your dealer's.

## Millers Falls

Finest Power  
Tools Made



FREE FOLDERS on the "888", its attachments, and the complete "Dyno-Mite" line of power tools. Ask for them at your dealer's, or write

MILLERS FALLS COMPANY  
Dept. PM-13, Greenfield, Mass.

### DON'T MISS THESE HARDWARE WEEK SPECIALS — April 12-21



#### POWER BIT SET

High-speed steel blades stay sharp 10 times longer than ordinary bits.  $\frac{3}{8}$ " to 1". Fit any  $\frac{1}{4}$ " electric drill. Regular \$6.45.  
**SPECIAL . . . \$5.79**

#### COMBINATION SQUARE

12-inch — professional quality. Deeply etched graduations. Precisely milled working faces. With scribe, level and plumb. Regular price \$1.80.



**SPECIAL  
\$1.59**

now! assemble your own

## ALUMINUM SCREENS



save up to

# 50%

LIFETIME PROTECTION—

YET IT'S ONLY MINUTES FROM PARTS TO FINISH WITH

## HOMESHIELD® easy-to-make SCREEN KITS

**Make your work shop pay off!** Assemble these maintenance-free aluminum window screens for your home, cabin, or shop and save money...make 'em for neighbors, apartment houses or businesses, and make money! It's a simple assembly job that requires no special tools.

**No more repairing or repainting!** Replace heavy, old-type screens or screen your new home with sparkling Homeshield screens that'll dress up your home for life. **Eliminates rust and stained walls.** Lightweight—install or remove in a jiffy. No ladders needed.

**Kits are complete** with sturdy aluminum frames, easy-to-handle Fiberglas® screening, corner locks, installation hardware — even a miter box. Sizes for full screens and sliding half screens (and storm sash, too!) Ask your department store, hardware or lumber yard dealer, or mail coupon for folder and name of nearest Homeshield distributor.



**AMERICAN SCREEN PRODUCTS CO.**

Dept. PMK-4, 807 N.W. 20th Street, Miami, Florida

Name.....

Street.....

City..... State.....

## MONEY in '314'

make \$3 to \$5 an hour  
in SPARE TIME

Start your own sharpening business in your basement or garage with this new low-cost Foley "314" Grinder. Make up to \$3 or \$5 an hour in spare time. Sharpens circular saws, dado heads, rotary power lawn mower blades, ice skates, scissors, sharp edged tools. Also does sanding, buffing, polishing. Easy to operate—no experience needed. Send postcard today for free literature. No salesman will call—we sell only by mail.

**FOLEY MFG. CO.**

473-6 Foley Bldg., Minneapolis 18, Minn.

with New  
FOLEY GRINDER



two miles per hour, each tugging two gigantic 11-ton steel sleds with broad V-shaped runners. They hauled everything from fuel drums to complete knockdown buildings. Their giant five-foot-wide tracks act like snowshoes, exerting a pressure of only four pounds per square inch on the snow—barely more than a man on foot.

Sitting beside a Seabee Cat skinner in the heated, glassed-in cab of one of those 14 by 25-foot Juggernauts, winding over snow trails through a blizzard, is like looking at a Cinerama sequence of the antarctic in a movie theater during an earthquake. We rode down the barrier trail one midnight (in broad daylight) when a blinding snowstorm obliterated everything beyond the stack that jutted from the roaring 1200-revolutions-per-minute diesel power plant out front. The tractor's king-size grousers bit the snow hummocks and pitched us from one end of the cab to the other. Our train of giant bobsleds rumbled as they slid sideways on the crevasse-ridden snow ramp leading from ice cliffs down to Kainan Bay. To find the next trail flag, the bearded skinner throttled down and stepped out on the broad deck every few seconds, peering through the gale so we wouldn't wander off track and wind up in a 100-foot crevasse.

### Ether Aids Minus-60 Starts

Proud of his charge, the Seabee kept praising its virtues. "She has an ether-aided starting system," he pointed out. "I can turn her up when the mercury drops to minus 60 this winter. The engine doesn't need to run to keep this heater going, either, so don't mind if we lose the trail and have to sweat out the storm." We heaved around a bend in the trail just in time to avoid mowing down a row of red flags marking a 100-foot-deep crevasse. "It's tough turning these outside tracks just by braking one and spinning the other," the skinner explained. "So this baby gets an extra kick from a hydraulic drawbar that I can move sideways against the load and help boost her rear end around—sort of like the tail wagging the dog." He indicated the panel in the cab roof. "Escape hatch," he said, soberly. "If we should need it, the last one out is a dope."

There were few snow inclines these wide-tracked prime movers couldn't climb. When they did have trouble, the method of pulling them out was simple. The powerful winch on the trail of a second tractor, planted on the crest of the hill, was used to drag the bogged train out of its predicament.

At McMurdo, one tractor crept off the trail in a storm and crashed into a deep crevasse, wedged on its side. Dave Baker

(Continued to page 272)



# Why grope your way like this in fog?



## Get a pair of G-E *All-Weather* Headlamps... see better in any weather

**N**EW General Electric *All-Weather* Headlamps are so revolutionary they make all ordinary headlamps obsolete.

With ordinary headlamps, upward light is uncontrolled. This light is reflected back into your eyes by millions of tiny moisture particles—that is why seeing at night in fog, rain, or snow, is so difficult. New G-E *All-Weather* Headlamps have a special shield over the lower beam filament that blocks out uncontrolled upward



ORDINARY HEADLAMPS

Ordinary Headlamps: Uncontrolled upward light bounces off moisture particles, causes kick-back glare, blinds driver.



G-E *All-Weather* HEADLAMPS

G-E *All-Weather* Headlamps: G-E filament shield controls upward light, reduces kick-back glare, makes seeing easier.

light. Kick-back glare is reduced to a minimum . . . you can see the road ahead more clearly.

On clear nights, the upper beam filament which is purposely not shielded, puts light farther down the road. You can see curves, dips and obstacles in time to slow down.

With a pair of G-E *All-Weather* Headlamps you get 25% more light. Passing oncoming cars is easier, too, because the light is concentrated where you need it—on the right-hand side of the road.

**Replace your present headlamps with a pair of new G-E *All-Weather* headlamps. They can be quickly installed and accurately aimed for a surprisingly modest cost. Ask for them by name: G-E *All-Weather* Headlamps.**

Miniature Lamp Dept., General Electric Co.,  
Nela Park, Cleveland 12, Ohio

*Progress Is Our Most Important Product*

**GENERAL  ELECTRIC**

# Turn your basement into a FUN-AND-HOBBY ROOM for only \$16<sup>00</sup> a month!\*



## It's easy to do with Gold Bond Building Products



Build a room like this in your basement—or in *any* waste space. It's a cinch with Gold Bond Building Products . . . made to *work together*.

Strong, sturdy walls are Gold Bond Gypsum Wallboard. Big, lightweight panels are easy to apply. Simply saw like lumber, or score with a knife and snap off. Conceal joints with Gold Bond Tape Joint Treatment.



On the ceilings use Gold Bond Insulation Tiles. Quickly applied; interlocking edges hide nails or staples.

Finish with Gold Bond Velvet—world's finest latex paint. Goes on with brush or roller, dries in minutes, washable. Clean equipment with water.

See your local Gold Bond Dealer for all building, remodeling materials.

### NATIONAL GYPSUM COMPANY

Buffalo 2, N. Y.



\* Based on cost of materials spread over 36 months. Prices vary slightly in some localities.



#### MAIL COUPON TODAY

National Gypsum Company,  
Dept. PM 46, Buffalo 2, N. Y.

Please send me Gold Bond "How-to-Do-It" Plan #18 showing me how to build a basement fun-and-hobby room. Enclosed is 10¢ to cover mailing.

Name \_\_\_\_\_

Address \_\_\_\_\_

City \_\_\_\_\_ Zone \_\_\_\_\_ State \_\_\_\_\_

had three skidders dig their Cats into the deep snow. Using these for deadmen, he rigged blocks and cable, and the juggernaut winched itself backward to solid snow, after a roped driver set gears turning and leaped off to safety. In general, however, those massive tracks kept the big machines afloat on the snow—over crevasses and all.

Even Deepfreeze's unique buildings must wear snowshoes to keep them from sinking in the neve. The structures sit on wooden platforms laid like ties under railroad tracks. The shells themselves are raised on projecting steel beams so escaping heat can't melt the snow beneath the underpinnings. Viewed from one end they look like grotesque splay-footed insects. The knockdown structures are made up of four-by-eight-foot panels with alternate tongued or grooved edges. Seabee work crews swarmed over foundations and slipped one panel against another to make floor, walls or roof. Each panel is a four-inch-thick sandwich of plywood stuffed with spun glass. Sheet aluminum, to reflect heat and light, lines the inside wall. Plasticized rubber joints seal cracks between panels, which then are clipped together instead of being nailed. "They were designed for speedy erection under worst possible conditions," Vic Young points out. "At minus 60 a man can only work an hour at a time since he inhales the frigid air faster than his body can warm his lungs." There's another reason for the clips. In sub-zero weather, nails or screws popped into a man's mouth will freeze to a man's tongue or lips, tearing flesh when pulled free.

#### Sites and Trails Established

Before MCB Special could even begin to drive sled trains or erect buildings, sites had to be picked and safe trails established. This job fell to Herb Whitney and Dr. Paul Siple, Deepfreeze's senior scientist. Siple is the strapping Boy Scout Byrd took with him on the 1928 expedition. He hasn't missed one since. Today, he is probably the world's outstanding expert on the make-up and movement of Antarctica's great ice-cap. Using helicopters, Weasels and finally skis, these men hit out across windswept wastes accompanied by small parties of men and bundles of red flags. They poked snow ahead of them with ski poles and stuck flags in safe snow as they went. At Little America, the route snaked six miles around pitfalls from ice edge to building site. At McMurdo it was 35 miles in to the black ridges or "nunataks"—hills swept clear of snow by polar winds.

One of the toughest problems in Antarctica is the ice that blankets it. The

(Continued to page 274)

# U.S. DEPT. OF AGRICULTURE PERFECTS NEW GRASS THAT SMOTHERS CRABGRASS & STAYS GREEN DESPITE DROUGHT!



ORIGINAL ZOYSIA FARM NURSERIES  
**AMAZOY**  
MEYER Z-52  
ZOYSIA GRASS

## AMAZOY GRASS WON'T BURN BROWN! THRIVES UNDER SCORCHING SUN!

At last a care-free lawn that stays lush green! AMAZOY MEYER Z-52 ZOYSIA Grass thrives in hottest drought. Its deep root system (2 ft. or more) holds underground water. Goes weeks without rain or watering. Eliminates ugly brown or bare spots due to scorching heat.

### U. S. GOVERNMENT APPROVED

Credit for amazing Meyer Z-52 Zoysia Grass belongs to U. S. Dept. of Agriculture and the U. S. Golf Assn., Greens Section. After years of research their specialists perfected this amazing grass with advantages never before available. Now thousands of lawn owners everywhere have proven that an AMAZOY lawn improves year after year.

### CHOKES OUT CRABGRASS, WEEDS. NEEDS 2/3 LESS MOWING!

AMAZOY Zoysia Grass spreads from root runners, forms a dense, velvety turf! Grows so thick that crabgrass, weeds, disease, insects cannot live in it. Grows on steep hills, sandy soils . . . even at ocean beaches. Never requires re-seeding. Goes off color after heavy frosts . . . survives sub-zero temperatures . . . reverts to deep rich green each spring. A true winter-hardy perennial! Resists "playground" punishment.

### AMAZOY GUARANTEED TO GROW!

AMAZOY is the finest pure strain of Meyer Z-52 Zoysia Grass. Guaranteed free of weeds. Scientifically prepared to reach you fresh, green, vigorous. We guarantee any AMAZOY plug which fails to grow will be replaced absolutely free of cost.

### Not Enough For Demand!

There is not enough Meyer Z-52 Zoysia Grass in the ground to supply the fast-growing demand. Order now for prompt delivery.

## MEYER Z-52 ZOYSIA GRASS Gives Rich Velvety Turf!

- For Present or New Lawns
  - Grows Well In Any Soil
  - Needs 2/3 Less Mowing
  - Never needs Re-seeding
- FEATURED in LOOK and Other Magazines. Also by GODFREY on TV



### EASY TO PLANT. NOT GROWN FROM SEED

AMAZOY comes in 2" plugs of living grass as recommended by U. S. Dept. of Agric. Once planted AMAZOY's flourishing root runners spread to form a thick velvety turf. ONCE ESTABLISHED YOU CAN TAKE 50 PLUG TRANSPLANTS FROM EACH SQUARE FOOT YEARLY.

### ORDER BY MAIL AT ADVANCE LOW PRICES

INCLUDES EXCLUSIVE \$4.95 2-WAY PLUGGER

**50**

PLUGS

**\$4.98**

With 100 or more plugs, we enclose new patented plugger . . . plugs lawn and destroys harmful competing grass at same time. Nowhere else can you get this work-saving, growth producing plugger.

100 plugs & plugger 11.98  
300 plugs & plugger 24.98  
650 plugs & plugger 49.98

Enclose check or money order. Sorry. No C.O.D.'s. West of Miss. add 7% per 50 plugs for shipping.

WRITE FOR PRICES ON LARGER QUANTITIES



SPECIAL NUTRI-20 WATER SOLUBLE FERTILIZER. Amazing scientific discovery ideal for shrubs, trees, gardens, lawns. 3 lbs. \$3.75 - 5 lbs. pkg. now \$5.00.

ORDER BY MAIL ZOYSIA FARM NURSERIES, Dept. 11DA  
333 N. Michigan Ave. Chicago 1, Ill. 602 N. Howard St. Baltimore 1, Md.

## FAST-DRYING LUMINALL concrete FLOOR PAINT

Decorates and preserves interior and exterior concrete floors, patios, primed wood porches and decks. Dries dust-proof in 40 minutes, walk-proof in an hour, traffic-proof overnight! Fast, easy application with brush, roller, floor brush. No special washes or etching needed. Nonflammable! Eight popular colors that wear like iron, last for years!

- COMMERCIAL GARAGES • PATIOS • GARAGES
- SHIPPING AREAS • BASEMENTS • FACTORIES

### FREE 62-CHIP COLOR CHART

Features Luminall Concrete Floor Paint, Satin Luminall and Ready-to-Use Luminall for walls, ceilings, trim; Outside Luminall for exterior masonry, asbestos shingles and siding. Write today for your free copy.



### LUMINALL PAINTS Dept. 102

3617 South May Street • Chicago 9, Illinois  
Newark 5 • Los Angeles 1 • Dallas 7

## Powered with the MODERN RECIPROCATING MOTOR

SEE AT STORES  
DURING  
SYNCR  
HARDWARE  
WEEK

(Apr. 12-21)



SANDER  
MODEL  
504

### The \*Multi-Motion Finish Sander

Sand the modern way with this light, powerful Syncro finish sander . . . powered by the modern new Syncro Reciprocating Motor—today's greatest achievement of all electro-mechanical research! Catalog Free!

\*Exclusive

**SYNCR** CORPORATION  
DEPT. 1-46  
OXFORD, MICHIGAN  
SANDERS

WORLD'S LARGEST  
MANUFACTURER OF  
RECIPROCATING MOTORS

# NEW CHILDERS DO-IT-YOURSELF CARPORT



The modern way to protect your car and beautify your home

*"We installed ours in four hours . . . saved \$95,"*

says Mr. Joseph Saladino, Houston, Texas.



The Saladinos' problem was more living space. So—they installed a new Childers Do-It-Yourself Carport for the family car, and converted their garage into a third bedroom. You save twice with the new Childers Carport. First, you deal directly with your local Childers factory outlet. Second, it's so simple and easy to erect the Childers Carport yourself. You can erect it in one afternoon! The new Childers Carport is America's most modern design. Architecturally approved, its beautiful, trim lines harmonize with any style home. It increases the value of your property. Precision-made from zinc-plated steel, it will last as long as your home.

New, modern car protection • Save up to \$95 • Erect in one afternoon • Full size, 20' x 10' • Pay nothing down • Only \$1.93 a week • Free standing or attached



## CHILDERS ALUMINUM AWNINGS GUARANTEED TO SAVE YOU 30%



Berkley



Windsor



Casement Awning



Door Canopy

We guarantee your cost of Childers Aluminum Awnings will be at least 30% less than your neighbor paid last year for his old fashioned, custom-made awnings. You save 30% or more because:

1. You get factory prices from your direct factory outlet.
2. You install Childers Aluminum Awnings yourself with just screw driver and pliers. Saves installation charges.
3. Childers Awnings are mass produced in the world's largest aluminum awning factory. Costly hand assembly is eliminated.

Your local Childers factory outlet can supply the correct size Childers Awning to fit any window, door or porch—at direct factory prices.

### FREE IDEA FOLDER

Childers Manufacturing Co., Dept. P-2  
3620 W. 11th St., Houston 8, Texas

Send me free literature on the Childers guaranteed products checked below; also name of my local Childers factory outlet.

Childers Carport  Childers Aluminum Awnings   
Childers Patio Cover

Name \_\_\_\_\_

Address \_\_\_\_\_

City \_\_\_\_\_ Zone \_\_\_\_\_ State \_\_\_\_\_

WORLD'S LARGEST ALUMINUM AWNING FACTORY

**CHILDERS**  
GUARANTEED  
**Products**

endless glacial mass on which men travel and build their camps never stays put. Driven by the Gargantuan pressures of a two-mile-thick continental ice plateau, the edges of the mass constantly ooze outward like a flattening lump of silicone putty. Those edges form the continental-barrier ice cliffs fronting the polar sea. "It flows outward a quarter of a mile each year," explains Siple. "Great chunks calve off and float away as icebergs—some of them hundreds of square miles in area." One piece, 220 miles long and 15 miles wide broke off the Bay of Whales recently, taking a chunk of Little America IV with it.

The movement of continental ice, as it flows over great mountains and valleys deep beneath the surface, opens yawning crevasses that quickly bridge over with wind-blown snow creating death traps for men and machines. We climbed into some of those chasms at a hazardous spot that the Seabees dubbed "Crevasse Valley," near Little America. We found ourselves in a maze of blue grottoes stretching off to infinity and intersected by other great rents, reaching down to what seemed bottomless gloom. Any of them could have swallowed a big tractor train whole.

### Trail Parties Needed Expert

Until recently, trail parties have depended entirely on a crevasse expert who walks ahead with a 14-foot probing rod that he spears into the snow to see if it's solid or hollow beneath. His sharp eyes pick up crevasse signs—snow-drainage areas where pressures heave up huge "haycocks" and crumble the thick icecap, or where Gargantuan tensions split it asunder. He looks for slight depressions or suspicious humps. Sometimes thin bands of snow slightly lighter or darker than surrounding snow tip him off to great voids beneath. In good weather he's almost infallible. But during blizzards or eerie polar whiteouts when all shadows blend into a solid sheet of white sky and snow, his experienced eyes are little better than the rankest amateur's.

This year, the Seabees brought along a strange-looking electronic crevasse detector developed by the Army Corps of Engineers at Ft. Belvoir. With it came Silas Bowling, chief warrant officer and technical advisor to Deepfreeze trail parties—a man with years of experience on the Greenland icecap. The detector, slung on a special "pathfinder" Weasel with built-in bunk and latest radio gear, consists of three metal plates in the form of toboggans, each about a yard square. One, sticking out front on a 20-foot nonconducting boom, bobs along the snow like a probing hand.

(Continued to page 276)



Biggest value ever!

## Sensational new heavy-duty saw

—only **\$69<sup>50</sup>**

At last—true heavy-duty design and precision engineering in a *professional quality* 6½" saw!

Porter-Cable's revolutionary new Model 146 has the *capacity* you need—makes every cut it takes to build a house! It slices through 2" dressed lumber—even at a 45° angle—with speed and power to spare. It does everything that bigger saws can do—does it *easier*—does it all day long without a whimper.

Model 146 is light and handy—just 11 lbs. of perfect "feel" and balance. And just **check** its features! Full ball-bearing construction, telescoping guard, exclusive new calibrated depth gauge, famous Porter-Cable Kick-Proof Clutch, husky 9-ampere Universal motor (1.3 equivalent h.p.) and many, many more.

See the new Model 146 at your dealer's *now*—or mail the coupon below. At only \$69.50, it's the saw "buy" of the century!

SEE YOUR DEALER — OR MAIL COUPON TODAY!

PORTER-CABLE MACHINE CO.  
6144 N. Salina St., Syracuse 8, N. Y.

Yes, send me a complete catalog sheet on the Model 146 Heavy-Duty Saw, and the name of my nearest dealer.

Name \_\_\_\_\_

Address \_\_\_\_\_

City \_\_\_\_\_ Zone \_\_\_\_\_ State \_\_\_\_\_

**Porter-Cable**

*Quality Electric Tools*

First with the finest for 50 years

★ AMERICA'S FAVORITE  
**H-I** Preferred at famous Fishing Spots  
 ★ AUTOMATIC REEL



*New improved model*

## HICO-MATIC

No. 9

\$8.50

A new model in H-I's world-famous line of automatic reels—especially designed and balanced for glass fly rods. Light weight—rigid aluminum construction... free-stripping... silent wind... right or left hand operation... striking anodized finish... all parts chromium plated. The finest "auto" reel you can buy. Also Utica Automatic No. 7 (upright) \$8.00 and No. 5 (standard) \$7.00.

Look for **H-I**  
 on the tackle you buy  
 Rods, Reels, Lines, Lures,  
 for every fisherman and  
 every kind of fishing



Valuable Fishing Guide. Send 25¢ to  
**HORROCKS-IBBOTSON CO.** Dept. PM-416, UTICA, N.Y.  
 Manufacturer of the largest line of fishing tackle in the world

### Say You Saw It in Popular Mechanics

THE  
 FINEST



Everywhere Gerstner Chests are  
 acclaimed the finest. Send for  
 Free Catalog.

**GERSTNER TOOL CHESTS**  
 456 Columbia St., Dayton 7, Ohio

## TORKARM

### SENSATIONAL DRILLING ATTACHMENT

Drill rotation causes side pressure on the drill producing non-productive heat. TORKARM eliminates this side pressure by absorbing the torque allowing higher drill speeds, faster feeds, less drill breakage and complete safety. TORKARM holds the work rigidly—yet the work floats on press table permitting drill to follow its point—no drift—no drill wander—more accurate holes. A much easier and faster way to drill. TORKARM has greatly reduced rejects and speeded up work in factories from coast to coast. Used by U.S. Navy. If you drill holes use TORKARM and drill them better. Hobbyists, Shops, Manufacturers, send for your TORKARM today!



View shows TORKARM fastened to drill vise—vise free to move on table yet held rigidly—full torque absorption. TORKARM can also be used with your worktable or fixture. (Patented).

#### PRICES

No. 200 for 1/2 HP 12" drill press... \$9.95  
 No. 201 for 1/2 HP 15" drill press... 13.50  
 No. 202 for 1/2 or 3/4 HP 17" press... 15.75  
 No. 300 for 1 or 2 HP up to 1 1/4" drill 29.50  
 No. 500 for over 1 1/4" drill—prices on request.

(LICENSED MANUFACTURER)

Make a TORKARM for your home-workshop. Complete prints, illustrations and instructions... \$1

FREE LITERATURE  
**DUNBAR MANUFACTURING CO., INC.**, 6604 Sylvan, Houston 23, Texas

Two others are dragged behind. An electrical field around these plates registers a constant voltage on a meter in the cab—as long as the snow is solid. But the minute that toboggan out front passes over a hidden pocket, the difference in conductivity between snow and thin air changes the electrical field, which is instantly registered by the needle in the cab. Bowling, heaving along in his odd rig, discovered eight hidden crevasses in five miles on the Little America trail. One was 100 feet deep. Another was 35 feet wide. Si dynamited each, and climbed inside to check firmness of the bottom so Seabees would know whether to bridge or fill it, for their ponderous sled trains to cross safely.

### Flags Still Best Markers

So far, flags are the best means of keeping overland polar parties from wandering aimlessly across snow prairies and coming to grief. Stuck in frozen neve, flags stay put for years. On the first trip across Kainan Bay ice this year we found trail markers left by the Atka expedition more than a year ago. Flags can be seen for miles across antarctic ice in good weather. But when polar storms roar across snowfields, obscuring everything beyond 10 feet, a trail party is forced to stop and sweat it out until the flags become visible again.

That may be changed soon. Up on the barrier near Little America this year, Amory H. "Uncle Bud" Waite, electrical engineer for Army Signal Corps laboratories in Fort Monmouth, has been clanking around in another strange Weasel with a large, curious antenna perched on its roof. Inside is a complete radar set with swivel scope suspended above and forward of the driver's head. The entire unit weighs only 150 pounds. By using wire-mesh markers on poles instead of flags to mark trail, Waite can pick up the route by a series of blips on his scope in daylight or dark, fair weather or foul. Uncle Bud, who gets his informal name from the call signal he uses on radio transmissions, is a rugged antarctic veteran who, with a handful of men, went out over the barrier through the winter night to rescue Byrd from his fume-ridden advance-base shack in 1928. This year he and his sharp crew of young technicians ran tests with buried antennas that may some day see radio signals transmitted through Antarctica's top layer of icing, eliminating the polar problem of radio blackout. How Waite's system works will be discussed in a later issue.

Next month, further problems confronting the Seabee base builders will appear in Popular Mechanics.

**Save SURPLUS & NEW MANUFACTURE EQUIPMENT**

at GROBAN'S

All Items Unconditionally Guaranteed

**BRAND NEW 1 H.P.  
12 Volt Electric Motor**

- For electric wheel chairs (Pop. Mech. design—Mar., 1955)
- For electric golf carts
- For self-propelled scooters, children's mid-et cars.

ITEM #308  
Ratol 1 H.P.—100 amps., 5600 R.P.M., 12 volts, D.C.—This double shaft motor has built-in construction may be run on 4 volts for lower horsepower requirements.—Standard 5/8" shafts, nut and bolt electrical terminals, flange mounting.—Dimensions: 9"x4 1/2"x4 1/2". Shls. wt. 19 lbs. A real **12.50** F.O.B. Chicago

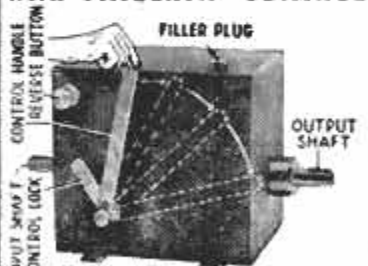
**GROBAN HYDRAULIC  
SPEED REDUCER  
with FINGERTIP CONTROL**

ITEM #115  
FOR: • Reamer Drives • Midget Cars • Feed Mills • Canning Machines • Conveyors • Lathes • Milling Machines • Motor Boats • Cream Separators • Garden Tractors • Pumps.  
Variable output speeds from 0 to input speed available by moving control handle. Locking handle maintains setting. Use input power of 1/2 to 1 1/2 H.P. Shafts 3/4" diam. Input rotation counter-clockwise facing shaft. Input speed 750 R.P.M. 7 1/2" x 7 1/2" x 11 1/2". Output rotation reversible. Shpg. wt. 31 lbs. Complete with 2 qts. of oil and full instructions. **54.50** F.O.B. Chicago

**GROBAN FOUR-WAY  
OPEN CENTER HYDRAULIC  
CONTROL VALVE**

ITEM #126—Four-way open center control valve, with built-in adjustable relief valve factory set at 1000 P.S.I. Spring loaded neutral position. For use with one double acting cylinder. In neutral position cylinder is locked and pump unloaded. Can be used as single unit or mounted in series. Has 3/4" pipe thread inlet and outlet. 1/2" pipe thread cylinder ports. Finger grip handle. Shpg. wt. 10 1/2 lbs. AN OUTSTANDING BUY! **21.50** F.O.B. Chicago

**FACTORY-TO-YOU-VALUE  
PORTABLE ELECTRIC  
LIGHT PLANTS**

BRAND  
NEW  
1956

ITEM  
#1008

- POWER TO OPERATE:**
- Electric Saw, Electric Drills, Pipe Bender.
  - Refrigerator, Deep Freezer, Incubator.
  - Water Pump, Radio, Lights, Air-conditioner.

**COMPACT — FITS IN THE TRUNK OF YOUR CAR**  
**1000 WATTS OUTPUT**, continuous duty. 115 Volts A.C. 60 cycles. 9 amps. Powered by husky, easy starting Clinton engine. Engine and generator operate at 3600 R.P.M. for maximum efficiency at minimum weight. Both units are mounted on steel base, with heavy sheet metal belt guard. Generator is self regulating, and is equipped with outlet box containing fuse and 2 A.C. convenience receptacles. Cost only 5c an hour to operate. Dimensions: Length 20 1/2". Width 12". Height 16". Shipping wt. 100 lbs. F.O.B. Chicago. **149.50**  
**700 WATT-GENERATOR SET**—same as above, slightly smaller—with Briggs-Stratton Engine—Model 708—F.O.B. Chicago. **129.50**  
**ITEM #2008—2000 WATTS**—115 V. A. C. generator set, powered by husky, fast starting Briggs-Stratton engine. Mounted on portable steel carrying base for easy handling. — Just right for small cottage and cabins needing inexpensive 2000 Watts of electricity. Shpg. Wt. 190 lbs. F.O.B. Chicago. **295.00**

**MASTER & SLAVE  
HYDRAULIC REMOTE CONTROL SET**

ITEM #415—Designed for remote operation of controls on engines, boats, special machinery, etc. Eliminates complicated mechanical linkages, cables, pulleys, etc. The master unit connects to the slave unit with a single 1/4" tube. When master control lever is moved, slave lever follows exactly. Light, compact, aluminum alloy construction. Dim. of both units: 5 1/4" W, 9" H, 1 3/4" D, (exclusive of handle) Shpg. Wt. 8 lbs. **27.50** per pair F.O.B. Chicago (Note — tubing not supplied)

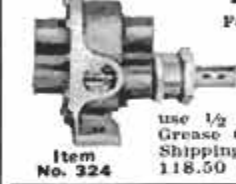
**Brand New — U. S. Navy Cost \$146.00  
OBERDORFER Self-Priming  
BRONZE PUMPS**

Item  
No. 324

- For: • Water Pumping • Sprinkling • Insecticide Spraying • Sump Pump • Fuel Transfer — Rated Speed — 500 to 2000 R.P.M.—Perfect for P.T.O., Direct or Belt Drive. Output —63 Gal. Per Min., 150 P.S.I.—use 1/2 to 6 H.P.—1 1/4" Pipe Thread Ports. 2 Grease Cups included. 1" Solid Bronze Shaft—Shipping Wt. 38 Lbs. Save **27.50** 118.50 F.O.B. Chicago

**ORDER DIRECT FROM AD  
SATISFACTION GUARANTEED**  
Send Payment or Purchase Order Today  
To place phone orders call WEBSTER 9-3793

**GROBAN SUPPLY CO.** Dept. PM-4  
1139 S. WABASH AVE., CHICAGO 5, ILL.

**BELT DRIVEN****A. C. GENERATORS**

Ideal for powering electric tools, oil burner, refrigerator, lights, or other appliances requiring up to 700 watts of power. **700 WATTS**, 115 Volts, 60 cycles A.C. 3600 R.P.M. Compact, self-regulating generator with V Belt pulley and double outlet receptacle. Rotation counterclockwise. May be driven by tractor or auxiliary gasoline engine. Requires 2 HP minimum. Dimensions: 10" long x 8" high x 6" wide. Shipping wt. 27 lbs. **59.50** F.O.B. Chicago



**Model 1010—1000 WATTS** (Same as above) **79.50** F.O.B. Chicago

**BERRY — HEAVY DUTY  
HYDRAULIC PUMP or MOTOR**

ITEM #166—Use on road machinery, vibrators, paper mills, wire reels, hydraulic presses, speed control units. Ball bearing construction, balanced cam design assures high efficiency performance. When used as a pump: delivers 8 G.P.M., 1000 P.S.I., 8 H.P. At 1200 R.P.M. as a HYDRAULIC MOTOR: Rated up to 12 H.P., up to 2400 R.P.M. Standard 3/4" pipe thread ports, 3/4" shaft with keyway. Dimensions: 14 1/2" x 8 1/2" x 7". Weight 63 lbs. Regularly \$212.00. **OUR SPECIAL PRICE**...ea. **59.50** F.O.B. Chicago 2 for 110.00

**DOUBLE ACTION  
HYDRAULIC CYLINDERS**

ITEM #31C—3 1/2" bore, 11" stroke. Alloy steel cylinder wall, Micro-Honed and all steel 1 1/8" diameter piston rod. 19 1/2" overall length closed. Clevis mounting at base and shaft. Will lift 9625 lbs. with 1000 P.S.I. Pump Pressure. Uses 3/8" tubing ( fittings, ) fittings to pipe thread: two 3/8" NPT @ 35c. 1 A \$102.00 value. Shipping weight **25.00** 11 lbs. F.O.B. Chicago  
ITEM #16-C—1 1/2" bore, 20" stroke. Will lift 1760 lbs. with 1000 lbs. pump pressure. Great for hay loaders, etc. 1" stainless steel piston rod. Postpaid. **16.95**  
ITEM No. 33C—1 1/2" bore, 4 1/2" stroke, alloy steel barrel, aluminum alloy ends, clevis mounting at both ends, lifting capacity 1760 lbs. in approximately 1/2 second using 1000 P.S.I., overall length closed 15 1/2", has 2-1/4" pipe thread **4.95** ports. Postpaid.

**FREE! — NEW CATALOG**

1956 EDITION, 52 PAGES, chock-full of unsurpassed War Surplus and newly manufactured Equipment Bargains for farm, home, factory, workshop. Write letter today.

**SPARE-TIME MONEYMAKING OPPORTUNITIES**  
**READ OUR CLASSIFIED ADS**  
HUNDREDS OF BARGAINS AMAZING OFFERS

**BUY IT** **WHOLESALE!**  
GET UP TO 40% OFF  
Agents—Start Buying Service at Home...  
Get big-name merchandise for clients up to 40% off. Sales easy as you can give sizeable discounts, still make fat commissions. Postcard brings FREE COPY "The Wholesale Plan."  
**FREE!** THE WHOLESALE PLAN!  
**American Buyers Service**  
HERTEL STATION, DEPT. R, BUFFALO 16, N. Y.

Say You Saw It in Popular Mechanics

**SPRA-RITE UNDERGROUND LAWN SPRINKLER SYSTEM**

covers 2000 sq. ft., operates on low pressure  
HERE IT IS! Home Owners now have the luxury of a top quality Underground Sprinkler System for as little as 2c per foot.  
Look—anyone can install; hooks up to garden hose faucet. Cast Brass Pop-Up Sprays Heads cover all angles, are no hazard to lawn mowers. Impervious to frost and freezing, will operate properly on pressures as low as 30g. A complete SPRA-RITE Kit, that will cover 2,000 sq. feet, is yours for only. **\$39.95**  
Also available—Complete handbook on how to install lawn Sprinkler Systems. Includes planning tools and a coupon which gives double your money back on a SPRA-RITE Kit. 81.00 brings handbook. Some territories available for Manufacturer's Agents and Distributors.  
**FREE LITERATURE AVAILABLE. Write—**  
**SPRA-RITE MANUFACTURING COMPANY** 738 W. SEVEN MILE ROAD DETROIT 3, MICHIGAN

## New Automatic Clutch modernizes power equipment

- Power Mowers
- Garden Tractors
- Midget Autos



Money Back Guarantee!

Install new Mercury clutch yourself on any gasoline driven equipment up to 3½ H.P. Engines start easier with exclusive VelveTorque automatic transmission. No troublesome controls. Load engages smoothly as you accelerate engine. No stalling. Engines do bigger jobs on less gas. Quickly installed with *one screw*. Available in ½", ⅝", ¾" bore sizes, with standard 3" x AB pulley assembly.

ONLY **\$7.95**

### MERCURY CLUTCH DIVISION

1205 Camden Ave., S.W., Canton 6, Ohio

Enclosed is \$7.95  Check  Money Order  
For Mercury Automatic Clutch

Shaft size  ½"  ⅝"  ¾"

Name \_\_\_\_\_

Address \_\_\_\_\_

City \_\_\_\_\_ State \_\_\_\_\_

## Red Devil FP33 HOME FLOOR CONDITIONER

The world's most popular  
style floor conditioner

Counter-rotating brushes mean perfect floor conditioning with a finger-tip touch. Eliminates all drudgery from scrubbing, waxing, polishing, buffing. Will steel wool dirt and grime from wood and all floor surfaces.



FREE

How to Maintain Wood Floors. Illustrated instructions on polishing, cleaning, varnishing, waxing and sanding wood floors.

**Red Devil Tools.** Dept. 143  
130 Coit Street, Irvington, N. J.

Please send FREE copy of "HOW TO MAINTAIN WOOD FLOORS."

NAME \_\_\_\_\_

ADDRESS \_\_\_\_\_

CITY \_\_\_\_\_ ZONE \_\_\_\_\_ STATE \_\_\_\_\_

1664



HERE'S YOUR  
CHANCE TO  
BE A

## HARLEY-DAVIDSON DEALER

Right now a few very desirable dealer franchises are available for selling and servicing world-famous Harley-Davidson pleasure, police and commercial motorcycles. These openings offer unusual opportunities to get into a stable, profitable, and successful business.

If you are now in business, or if you want to get into one of your own, write us and tell us all about yourself . . . including business background, previous motorcycle experience (if any), age, and how much money you can invest. You'll receive a prompt reply outlining our factory-dealer relationship and factory co-operation including our extensive national advertising support.

Write — MR. J. G. GILBERT, Sales Manager  
**HARLEY-DAVIDSON MOTOR CO.**  
MILWAUKEE 1, WISCONSIN

## FIND HIDDEN RICHES!

NOW—find buried treasure, gold, silver, and metal objects, with sensational 3½-lb. locator—GOLDAK'S "FIND-IT" . . . only \$49.50 complete with earphones, batteries, instructions.

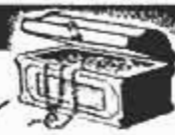

Manufacturers of metal detection devices since 1933

Write for FREE literature full line metal, mineral locators; geiger and scintillation counters.

**GOLDAK CO.** 1542 W. Glenoaks Blvd., Glendale, Calif.

## ONE-BAG MIXER THAT TRANSPORTS



Universal Transmix® transports, mixes and dumps cement, silage, dirt, etc. P. T. O. driven—no gears or chains. Can be installed or removed in 15 minutes. Fits Ford, Ferguson, AC-WD, IHC Super C, H&M, Case VAC, J.D.-40, Oliver 55, and other 2- and 3-plow tractors. Unconditionally guaranteed. See your dealer or write, giving tractor model, to

**UNIVERSAL PULLEYS COMPANY**  
371 NORTH MOSLEY • WICHITA, KANSAS

## HELPFUL BOOKS

Send post card asking for FREE catalog

Popular Mechanics Press, 200 E. Ontario, Dept. 601, Chicago 11

## NEW CONVENIENCE AND BEAUTY NEW HULL AUTO COMPASS

Enjoy greater-than-ever-convenience with the NEW Hull Auto Compass . . . easier installation, easier compensation, easier reading. Its sparkling, new beauty of styling is easy to admire, too. At better dealers everywhere. Write for literature.



NEW COMBINATION MOUNT STANDS ON DASH, OR HANGS FROM WINDSHIELD MOULDING OR GLASS

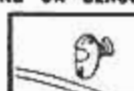
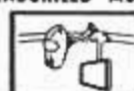

**Beaconlite**® \$6.50  
illuminated

**Streamline** \$4.95  
non-illuminated

**HULL MFG. CO.** P. O. Box 246 D-4 WARREN, OHIO



**RIDE and MOW**  
with the

**SHAW  
DU-ALL**

Model RM 24



**Biggest little mower on the market!**

**LOW PRICE, too.** Great for estates, farm and suburban homes, parks, cemeteries, etc. Trims smartest lawn; or tallest grass — 24 inch swath; turning radius only 45 inches. Sturdy 2½ to 3 H.P. air-cooled engine. 110 volt starting motor plugs into house current (optional).

**WRITE TODAY** for free folder, prices, and full details. Also walking and riding tractors, ½ to 14 H.P.

**SHAW MFG. CO.** 4504 Front St., Galesburg, Kansas  
668-GN 4th St., Columbus, Ohio

**Metal Turning Lathe for Model Makers**



Ball bearing headstock spindle. Bed length, 12"; swing, 4½"; between centers, 7"; adjustable tailstock; mounting bolts. Complete with face plate & driving dog. Ship. wt. 27 lbs. **\$29.95**  
Guaranteed. F.O.B. Lansing.

Send for Free Descriptive Folder

**ROSEMOOR MFG. CO.,** 2501 Bernice Rd., Lansing, Illinois

**180° OFFSET DRIVE**

(86 TO 1 REDUCTION GEAR)

For use where tremendous power at low take-off RPM is desired. 6 gears rotate on self lubricated Hi-Speed Ball Bearings. 3½"x1¼" Post shafts. 5"x6"x6" overall. **\$7.95** Post Paid  
Use with Fractional H.P. motors only.  
(Like vacuum sweeper type).



**KARL ORT, Dept. PMA, York, Pa.**

**MAGNETS**

5 Assorted Size Magnets \$1.00. Powerful Pocket Magnet W/case \$1.00. Hot Pad Magnets—large size 8"/\$1.00. Bulletin Board Magnets 8"/\$1.00. Slender Magnets—pencil type 2"/\$1.00. Car Compass—accurate, useful \$1.50. Retrieving Magnets—extra power, heavy duty—30 lb. pull \$4.00, also 50-75-100 lb. pull.

Explore, learn Electricity, Magnetism, Electro magnets, complete kit and instructions with 22 experiments and models. \$3.98  
Also — Rods, discs, bars, horseshoes. Send stamp for catalog — Specify your requirements — 100% SATISFACTION GUARANTEED.

**PARK MAGNETS, 264, 1557 GREENBAY RD., HIGHLAND PARK, ILL.**

**SAVE MONEY ON YOUR  
COMPRESSED AIR**

buy this complete  
**SMITH 45-P air compressor**



Right for spray painters, plumbers, contractors, monument shops, tire changing trucks, maintenance shops, quarries, utilities, many other users. Delivers 45 plus cu. ft. per minute; pressure up to 150 PSI. Powered by Wisconsin 4-cyl. air-cooled engine; uses less than 1 gal. gasoline an hour! Most compact, biggest-value compressor for its capacity anywhere! Other models to 230 cfm.

write for  
**FREE  
brochure**

**GORDON SMITH & COMPANY, Inc.**

411 College Street, Bowling Green, Ky.

**Most Popular Pair  
For Work and Leisure Wear**

**TEST**

UNION MADE

**M A T C H E D S E T S**

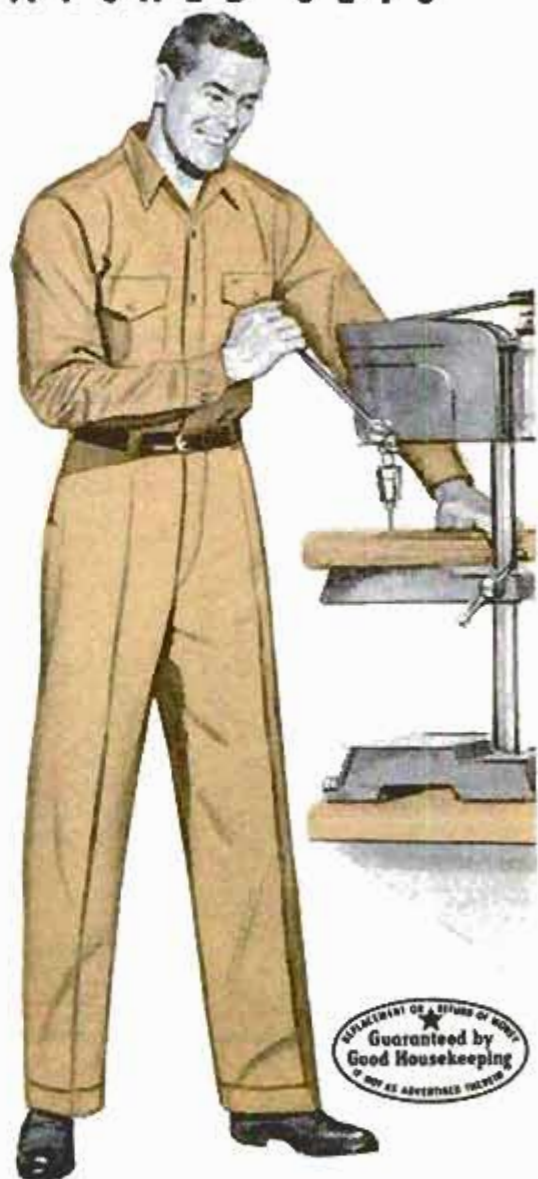

MEMBER OF A BUREAU OF HOME  
Guaranteed by  
Good Housekeeping  
IF NOT AS ADVERTISED THEREIN

**TEST MATCHED SETS** are the perfect companions for home or work. **TEST MATCHED SETS** are practical, Sanforized\* Army Twill pants and shirts that have quality tailoring for neat appearance and perfect fit. Ask for **TEST** . . . best for work and leisure. Available in popular vat-dyed colors at leading stores everywhere.

\*Maximum Shrinkage less than 1%

By **RICE-STIX St. Louis**  
Manufacturers of **TEST** Work Clothes,  
Dungarees, and Matched Sets.

**STAR ATTRACTION  
OF HARDWARE WEEK  
APRIL 12**

Williams Locking Adjustable is the most useful and favorite wrench of thousands of mechanics and home craftsmen. Featured in your neighborhood hardware store.

**THIS NEW PATENTED LOCKING FEATURE**

**AT  
NO  
EXTRA  
COST**



- 6" @ 2.08
  - 8" @ 2.45
  - 10" @ 3.10
  - 12" @ 4.50
- at most leading hardware stores

**WILLIAMS**  
**LOCKING ADJUSTABLE WRENCH**

- No obstructions
- Structurally sound
- Positive lock
- Increased safety
- Drop-forged from selected alloy steel and heat-treated
- Rapid adjustment
- One hand operation
- No fumbling
- Chrome plated finish

**THE  
HANDIEST  
WRENCH  
YOU'LL  
EVER OWN**



**J. H. WILLIAMS & CO. 417 Vulcan St., Buffalo 7, N.Y.**



**Dual-Purpose Glass Blocks**

Complete walls, without supporting framework, can be built of unique dual-purpose glass blocks which provide both insulation and a hard ceramic surface. Baked like cakes in stainless-steel pans, the blocks measure 12 by 18 inches and come in 3 and 4-inch thicknesses. The white ceramic surface has a marbled appearance and is washable, fireproof, acid-resistant and impervious to moisture, according to the manufacturer. For installation on an existing wall, the blocks are bonded to the old surface either with hot asphalt or a cold adhesive. Walls of this block are practical in refrigerated food-storage and processing rooms and in dairies, where sanitation is a necessity.



**DO IT BETTER . . .  
DO IT WITH DP**

**SEAL  
CAULK  
GLAZE  
PATCH**

Here's the answer to dozens of repair problems around the house: **D-P White Wonder Sealing Compound** . . . in a handy dispenser tube! For filling cracks in woodwork, around sinks, tubs, lavatories. For replacing loose or broken tiles. It's moisture-proof, heat-resistant . . . easy to work and stays put! At all good stores!

Ask your dealer for D-P Products.

**THE DICKS PONTIUS CO.**  
5301 Huberville Ave., Dayton 3, Ohio  
INSIST ON D-P BEST SINCE 1867

# Last year's profit \$3,000!

## with a FOLEY AUTOMATIC SAW FILER

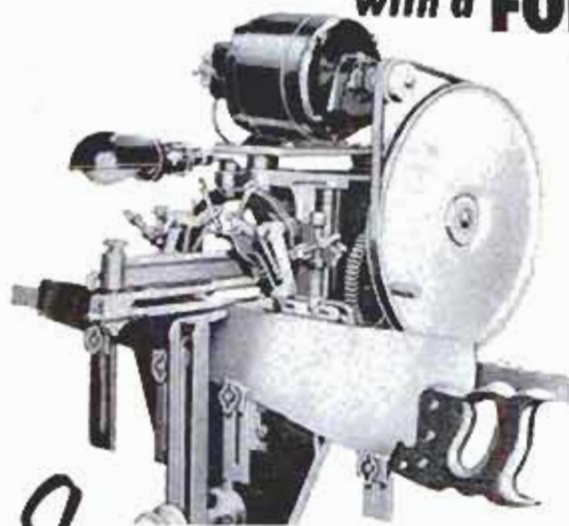

"Last year's profit amounted to \$3,000. Not so bad for a one-man outfit"—from Chas. C. Hough. James B. Williams wrote us—"I made \$765 last year filing saws, and it sure comes in handy. I do this work in my spare time." Men in communities of all sizes make up to \$3 or \$5 an hour with the Foley Saw Filer working full time or part time.

It's no trick to take care of the saw filing for your neighborhood hardware or lumber dealer — plus looking after the saws for farmers, townspeople, manual training departments and factories. The Foley files all hand saws, also band and cross-cut circular saws. It's a repeat cash business, no canvassing, no eyestrain and no experience needed.

Send Coupon for **FREE BOOK**  
SHOWS HOW TO START

"MONEY MAKING FACTS" shows just how you can start at home in your spare time working in your basement or garage. It's an immediate cash business that can develop into a full-time repair shop. Send coupon today—no salesman will call.

**FOLEY MFG. COMPANY**

416-G Foley Building, Minneapolis 18, Minnesota

Send me free book "MONEY MAKING FACTS"

Name \_\_\_\_\_

Address \_\_\_\_\_



**TILT ARBOR SAW \$16<sup>95</sup>**  
SOLD DIRECT  
FACTORY TO YOU



Save big money on this complete 8 in. Tilt Arbor Saw. Sold direct factory to you. All cast iron and steel construction. Big — Sturdy — weighs 25 lbs. Crosscuts, rips, bevels, mitres, cuts compound angles. Uses any 1/4 to 1/3 H.P. motor. Reg. \$4.95 — 8 in. Simonds Blade included. Try 10 days. If you are not satisfied FOR ANY REASON, return saw for absolute money back refund. Ship express collect. Send check, M.O. or sent C.O.D.

Write For  
**FREE CATALOG**  
Big Bargain  
On Power  
Tools

**AMERICAN MACHINE & TOOL CO.**

ROYERSFORD 10, PA.

SAY YOU SAW IT IN POPULAR MECHANICS

**PAGE Garden Tractors**  
1956 line now ready - low prices!

Ruggedly built riding and walking models, 2 to 6 HP. All gear drive with reverse, no belts or chains. Plow, till, harrow, disc, spray, remove snow, do dozens of other farm and home chores. Also new "Bantam" one-wheel model.  
**Fully Guaranteed**  
**LOW PRICES. EASY TERMS**



Free Catalog  
Shows over 60 attachments!

NEW "PAGE-BOY" TILLER  
Ask for Details!

**PAGE**

1904 S. 81st STREET  
MILWAUKEE, WISCONSIN

## FISH ON THE WAY UP GO FOR AIREX



**AIREX "MARK I" SPINNING LINE**

Braided nylon or monofilament.

**\$.90 to \$1.50**

**AIREX MASTEREEL ASTRA**

For right or left hand use, with 100 yds. of line.

**\$19.95**



**FREE FOR THE ASKING**

Brand new spin-fishing handbook for 1956. Packed with tips and helpful hints on how to catch more fish. Ask your dealer or write: Airex Corp., Dept. 0-4, P.O. Box 77, Brooklyn, N. Y.

**AIREX TUBULAR GLASS SPINNING ROD #239**  
2-piece, 6½ feet, with cork grip. **\$9.95**

**AIREX RODS • REELS • LINES • LURES** Made in America for American Fishermen 411 Fourth Ave., N. Y. 16

# Speedy Sprayer

## mobile paint sprayer

Choice of craftsmen for 35 years! Saves time, paint and money. Quickly gives flawless finish to walls, furniture, screens, fences and handiwork. Sprays all materials; ¼ H.P. motor. Diaphragm principle assures clean, oil-free air. Never needs lubrication. With gun, less motor. No. 890 Speedy Sprayer . . . \$38.50

Add wheels with Wheel Kit No. 909. Includes 6" wheels, handle, fittings. \$6.95

**FREE!**

Write for  
"How to Spray"  
Booklet and  
Literature.



At dealers everywhere

**W. R. BROWN CORPORATION**  
2635 N. NORMANDY AVE., CHICAGO 35, ILLINOIS



### Sheep Jacket

Sheep in the Southwest are being decked out in zippered jackets that keep out dirt and result in better-quality fleece. A pleat in the front can be taken up so that the jacket can be worn after shearing in chilly spring weather. Ranchers say that the jackets have a side benefit: Nonplussed coyotes keep away from the strangely attired sheep.

### Child's Safety Belt

Equipped with sliding D-rings, a safety belt for children permits them to stand, sit or lie down on the seat of a car, and at the same time protects them from being thrown to the floor or through the windshield in the event of an accident. The belt can withstand a 150-pound pull without breaking.



NOT BAD,  
EH?

**P&C**  
**SOCKETS**  
do your maintenance  
jobs faster, easier!



### SAVE YOU TIME, LIGHTEN YOUR LOAD

You'll work faster, better and easier with P&C sockets. They're strong, rugged, precision machined. Extra strong P&C walls are hot forged from special analysis alloy steel, and heat treated. Complete range of P&C sizes for both hex and square nuts from 3/16" to 3 1/2". Be sure you buy P&C ... the best tools money can buy.

### SHOP FROM COLORFUL P&C MERCHANDISERS

Buy your P&C tools from these famous blue, yellow and white merchandisers, in more than 10,000 stores coast to coast. Send 10c today for BIG TOOL CATALOG. P&C Tool Co., Dept. H1, Box 5926, Portland 22, Ore.

**P&C TOOL COMPANY**  
PORTLAND 22, OREGON • SCHILLER PARK, ILLINOIS

# BOLENS LAWN MOWING MAGIC

**SIDE TRIM** Reduces Hand Trimming

**MULCHES LEAVES** Eliminates Raking

**SIDE DISCHARGE** Windrows Vanish

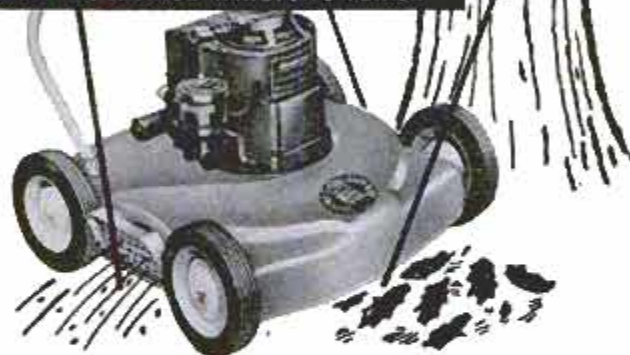

Bolens' power mowers have all the features that make lawn beauty care easy. Once over with a Bolens Rotary Mower leaves a carpet-like finish—no scalloping, no cuttings to rake. And you get a mulch that preserves moisture and protects against burnout. Write for free brochure.

## THIS IS NATIONAL BOLENS MONTH

Get the details on the 40 prize contest. Your chance to win a trip to Bermuda—a Weekend at the Waldorf—FREE!

**BOLENS PRODUCTS DIVISION**  
265-G Park St., So., Port Washington, Wis.



# SUPREME Versamatic

**REVERSIBLE SCREW DRIVER  
AND SPEED REDUCER**



fits all  
power  
drills

**First time ever! It REVERSES!**



Drive and remove screws with Supreme Versamatic. Versamatic reduces speed 7 to 1, increases power 7-fold. Reverses with one twist. Handles even the largest screws with ease. Also for nut running (adapter furnished); tapping; and all heavy duty drilling where speed reduction is needed. Fingertip control means safe, fast work. Complete set \$14.95.

(1/2" chuck extra). At better hardware stores.

SUPREME PRODUCTS, Inc., 2222 S. Calumet, Chicago 16

**"Tools For All Hands" Make The**

**ALL  
FAMILY  
FUNSHOP**



At last! An all-family, "at-home" hobby for everyone! Not only Dad, but Mom, Sis and Junior can enjoy hours of family fun with the amazing . . .

**NEW DREMEL MOTO-JIG SAW  
THE WHOLE FAMILY WILL LOVE IT**

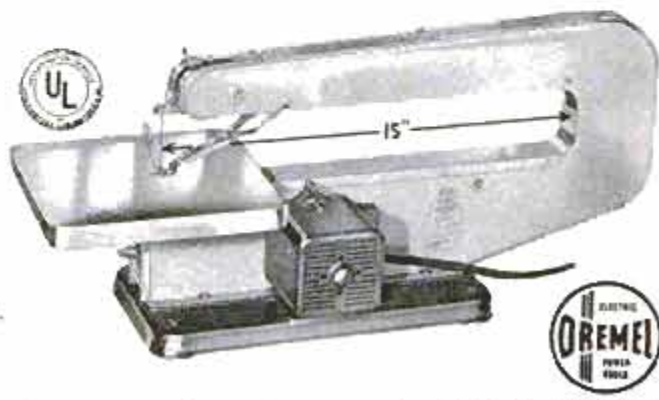

- Cuts even 2 x 4's, metal, plastics!
- Saws to center of 30" circle!
- Super-safe, even for kids!
- Blade adjustable 4 ways!

Model 15 (15" throat)  
Complete with POWER-  
FUL ROTARY MOTOR . . . \$29.95

Model 8 (8" throat)  
Free—10 exciting  
patterns furnished . . . \$23.50

The new Dremel Moto-Jig Saw is the perfect hobby and craft tool for the whole family; it out-performs cumbersome machines costing many dollars more!

This new Dremel Product is powered by a dependable rotary motor. When purchasing a jig saw be sure that it is not a vibrator-type. Buy a Dremel professional tool—not a toy.

Just set it up on the kitchen table, card-table, or workbench and watch the whole family come-a-runnin'. Build toys, furniture, valances, bookends. Everyone can learn or earn while enjoying America's fastest-growing new hobby.

**SEE YOUR DEALER.** If he cannot supply, order direct on 5 day trial, money-back guarantee. Remit in full for postpaid shipment; or send \$2.00, pay postman balance plus C.O.D. fee.

**WRITE FOR FREE CATALOG**

**DREMEL MANUFACTURING CO.**  
DEPT. 116-D RACINE, WIS.

**MAN- DON'T DO-IT-  
YOURSELF!**  
— unless you use Miracle

**PHILPLUG**  
ANCHORING  
COMPOUND



— TO ATTACH  
**HOUSEHOLD FIXTURES**  
TO TILE, BRICK, PLASTER or WOOD—  
SOLID OR HOLLOW WALLS

The handiest man can't fix fixtures firmly — and permanently — in most of these materials; or turn old, loose screw holes (for hinges, for instance) into tight, new ones... unless, of course, he uses magic PHIL-PLUG, the amazing new compound that grips screws fast in TILE, PLASTER, BRICK, CEMENT and WOOD — instantly and permanently!



**FIXES ANY SIZE  
SCREW INTO  
ANY SHAPE HOLE!**

Impervious to  
Water — (and Salt  
Water!) — Steam,  
Fire, Cold, Vermin  
and Vibrations.

"FIXES" INSTANTLY!

Just DRILL, FILL PIERCE and SCREW!

With PHILPLUG you can do a "professional" job of re-fixing loose fixtures — put up new ones in the toughest spots and materials, to stay put! — making old, "no-grip" screw holes start holding again. And — your PHILPLUG Compound will cost you about 1¢ per screw-fix! Junior package, 59¢ — at your hardware store.

**NEW ENGLAND CARBIDE TOOL CO., INC.**  
60 Brookline St., Cambridge 39, Mass.

**Don't Buy Single-Purpose  
Power Garden Equipment**

**Your Dollars Buy  
MORE with  
ROTO-HOE**



There's no need to buy two, three, or more separate power garden tools. The "ROTO-HOE IDEA" makes available to you one basic power unit and a wide variety of "customer-proven" attachments. All are integrally-designed to fit and

work perfectly with the same 2 h.p. ROTO-HOE power unit; all are interchangeable in a few seconds; all are thoroughly "use-tested," available NOW! Complete ROTO-HOE only..... **\$134.00**

**NEW 22" Self-Propelled Twin ROTO-CUTTER** helps keep lawn velvet-smooth, has easy-to-sharpen twin spindle blades. Attaches in seconds, costs only \$49.50 to add to ROTO-HOE power unit; or as a complete unit, ready to go to work for only **\$131.50**

**START YOUR OWN BUSINESS**

If you're handy with tools, you may be able to start a profitable part or full-time business selling and servicing ROTO-HOEs. Write today for details.

**FREE COLOR BROCHURE** illustrates all attachments in color, gives full information. Write today for a copy and for name of nearby ROTO-HOE dealer.

**ROTO-HOE & Sprayer Co., Box 19, Newbury, Ohio**  
"America's Leader in Lawn & Garden Equipment"



**Robot Salesman**

One German firm has put a robot to work — as a "zigaretten" salesman. Basically, the robot is a coin-operated cigarette machine. But a huge head on top has loudspeaker ears from which emerge advertising slogans. The eyes blink a series of sales pictures. It's on display in West Berlin.

**Clamps Hold Pan**

Here's a third arm for the housewife. Developed in Germany, a new kitchen helper is clamped to the counter top. Two spring arms fit over the edge of a pot, pan or bowl to hold it firmly, leaving both the housewife's hands free to stir up dinner at the same time she's tending the baby.



**It's QUICKER...Works SLICKER with**

**WISE-GRIP**

Does More Jobs Easier Than Any Other Tool Made!

No. 10W, 10 \$2.60

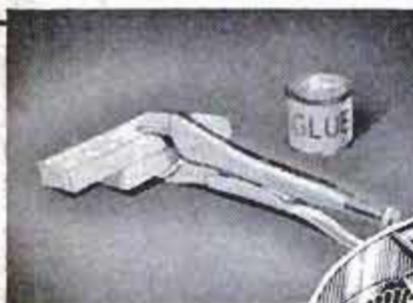

Ideal "jiffy clamp" for gluing, joining or clamping patterns to work. It HOLDS!



Made By PETERSEN MFG. CO., Dept. M-4, DeWitt, Nebr.

Makes EVERY JOB EASIER



A squeeze of the hand locks jaws onto work with ton-pressure! Quickly adjusts for use as All-Purpose Wrench, Super-Pliers, Clamp, Wire Cutter. 7" and 10" cutter optional. \$1.85 to \$2.60 at your dealer.



Convert Lawn Mowers into Power Units with this Briggs & Stratton **2-H.P., 4-Cycle GAS ENGINE** AIR COOLED FULLY GUARANTEED Reg. Price \$68.00 **SAVE! SPECIAL OFFER \$37.50** while they last... for Powers Farm, Home & Industrial Tools • Garden Equipment • Pumps • Compressors

**GOV'T SURPLUS** Briggs & Stratton leads the world in dependable, trouble-free performance. A precision-built 2-horsepower, 4-cycle engine with advance styling and economical operation. Easy rope start—sure fire ignition in all weather. Positive, automatic splash-lubrication system. 2 Qt. gas tank. Float feed carburetor with adjustable idle speed and automatic governor. Oil bath air cleaner. Complete with muffler. 3 Piston rings for added compression. 2000-3600 RPM adjustable speed range. **SUPPLY LIMITED! IMMEDIATE DELIVERY! ORDER FROM AD FREE CATALOG of Compressors, Generating Plants, Motors ROBERTS ELECTRIC CO., Dept. PM-414, 849 W. Grand, Chicago 22, Ill.**

SAY YOU SAW IT IN POPULAR MECHANICS

**"ARCO JIG-SAW"** WITH EXCLUSIVE NEW **CIRCLE-CUTTER & RIP GAGE!**



Another "ARCO" FIRST! "Arco Jig-Saw" (guaranteed to fit any 1/4" drill) with Adjustable Circle-Cutter & Rip Gage saves hours of work—assures professional-looking results everytime—whether cutting circles, curved patterns, or straight cutting. Cuts perfect circles any size up to 20" diameter; rips accurate widths any size up to 10" wide. Has same capacity and cutting speed as \$55 jig saws. Does work of Jig, Keyhole, Coping, Rip, Crosscut, Band & Hack-saw! Built-in "Air-Jet" blows away sawdust. Cuts intricate patterns—however large—in plywood, plastics, metals—even cuts 2x4's! Starts inside holes. Includes blade. Converts to Table Model with



RIPPING WITH GAGE

**ONLY \$9.95**

No. 401 "ARCO STAND" Sturdy Casting & Clamp.....\$2.75 **SOLD AT BETTER HOWE STORES EVERYWHERE.** If not available, order direct with handy coupon on our **MONEY BACK GUARANTEE.** Arrow Metal Products Co., Dept. PM-4, 140 West Broadway, N.Y. 13, N.Y.

**NOW! It's EASY To REMOVE STUMPS** With "MAGIC" STUMP REMOVER

All you do is pour "Magic" Stump Remover—a new, quick-acting chemical compound—into hole drilled in center of stump. Wood fibres soon decompose all way to root tips, making removal easy... even for women and youngsters! **SPECIAL TRIAL OFFER: 8-oz. Can (enough for one stump)—\$1.50; 16-oz.—\$2.50; 3 lbs. \$5.00.** Send no money! Pay postman, plus postage. (Or send full amount with order for postpaid delivery.) **Satisfaction Guaranteed or Money Refunded!** **FREE!** Generous sample of "GRO-GREEN," new liquid lawn fertilizer, with each Stump Remover order. **H. D. CAMPBELL CO. Rochelle 42, Ill.**



No Digging! No Chopping! No Blasting!

EASY TO USE! SAVES Time, Money!

SAY YOU SAW IT IN POPULAR MECHANICS

**A PRECISION LEVELING INSTRUMENT for only \$12.95**

With the New LEVELALL one man can do the work of two men and a transit, quickly, easily, accurately. All alone you can speedily level points for footings, forms, piping, batter boards, sills, lintels, floors, ceilings, roads, driveways, lawns—any type of construction work. Send for Free booklet or, better yet, order a DeLux Levelall today.

Name \_\_\_\_\_ Street \_\_\_\_\_ City \_\_\_\_\_ Zone \_\_\_\_\_ State \_\_\_\_\_  
 Mail 75' DeLux Levelall @ \$12.95  Regular 50' model @ \$9.95  Ship postpaid full price enclosed  Ship C.O.D. Money-back satisfaction guaranteed. **LEVELALL 89D Webster Street, Rockland, Mass.**

**MAIL THIS COUPON TODAY!**

Please send on Unconditional 10-Day Money Back Guarantee:

- No. 550 "Arco Jig-Saw" incl. 1 Blade.....\$9.95
- No. 401 "Arco Stand".....\$2.75
- 6 Extra Jig Saw Blades.....\$1.95

Name \_\_\_\_\_ Address \_\_\_\_\_

City \_\_\_\_\_ Zone \_\_\_\_\_ State \_\_\_\_\_  
 Check, M.O. Ship ppd.  C.O.D. plus post.

Arrow Metal Products Co., Dept. PM-4, 140 West Broadway, N.Y. 13, N.Y.

## SPECIAL FOR SPRING at buy 'em now prices

### BBR(s)

#### Auger Bit Set

Red plastic roll set of 6 Irwin solid center auger bits in red and white gift box. Sizes 4, 6, 8, 10, 12 and 16/18".

only **\$7.00** per set of 6



See Your  
Independent  
Hardware Dealer

### No. 21(s) Expansive Bit

Bores 19 standard size holes, from 5/8" to 1 3/4". Just dial your size. Fits all hand bit braces. Comes in colorful red and white gift box.

only **\$3.10** each



**IRWIN** the original solid center auger bit  
Wilmington, Ohio screw drivers, screw driver bits

## IT'S A SNAP! MANUFACTURING



### Ornamental Concrete

## BIG PROFITS

Imagine - A Business Of Your Own - so interesting and so much fun that it's like getting paid to play. That's what the Ornamental Concrete Business can mean for you. Products made in CMC Molds practically sell themselves on sight - truly an excellent Money-Making Opportunity - AND, starting costs are astoundingly low! OVER 200 DIFFERENT MOLDS TO CHOOSE FROM.

### IT'S A SIMPLE "DO-IT YOURSELF" PROJECT WHEN YOU USE DURABLE C M C ALUMINUM MOLDS

Perhaps you have wondered how the products are made. With CMC's new book as a guide, it's a SNAP! After a few minor preparations, you simply fill the mold with concrete, let it set, remove the mold, and there's your product. Could anything be easier?



### THIS BRAND-NEW BOOK TELLS YOU "HOW TO TURN CONCRETE INTO GOLD"

CMC, The World's Largest Manufacturer of Specialty Molds for Making Ornamental Concrete Products, has left nothing undone to make this Big, 80-Page (8 1/2" x 11") Book an "Indispensable MANUAL" for the Ornamental Concrete Industry. It describes the more than 200 different CMC Molds and presents large, clear photographs of the products you can make, AND... it gives complete "From Start To Finish Instructions" (Priceless Trade Secrets)! IT'S A MUST! GET THE FULL STORY TODAY.



SEND ONLY \$2.00 For YOUR COPY  
Rushed To You By First Class Mail

(All Foreign except Canada, Mexico, and Cuba - \$5.00)

CONCRETE MACHINERY COMPANY, INC.  
Dept. PM Hickory, North Carolina

## MORE \$\$\$ PER HOUR WITH MODERN IMPROVED LAWNMOWER SHARPENER



Write for  
free  
booklet  
10A

Grinds All Reel  
Type Mowers  
Hollow Grinds or  
Flat Grinds Bed Knives

Engine, oil, or gasoline  
are not removed from  
power mowers. Wheels,  
handle and roller re-  
main in place.  
Modern's precision  
grinding assures re-  
peat business.  
100% Steel Construction

Compare  
Before You Buy

Faster—Easier to  
operate

NO CHANGE IN PRICE FOR OVER 10 YRS.

**\$263.00** Complete with 1/2 H.P. Motor  
f.o.b. Pasadena, Calif.

MODERN MFG. CO.

160 N. FAIR OAKS, PASADENA, CALIF.

## BOAT KITS 28 MODELS—8 to 19 ft. \$39 up—FREE FREIGHT

SAVE 2/3! Easy-to-build MAHOGANY FRAMES—DECKS  
19' CRUISER KIT \$499.50!



SEND 10¢ for  
KIT CATALOG!  
Includes Hardware  
-Trailers-Fiberglass

### BOAT PLANS—Patterns—Frame Kits

Craig Craft  
Tonawanda, N. Y.

Build over 50 modern boats from large scale plans,  
available with FULL-SIZE patterns, new PRE-FAB  
frame kits! All types: prams to cruisers, 6 to 25 ft.  
Best buy for Amateurs! SEND 10¢ for CATALOG.



GENUINE ALNICO

## MAGNETS

AMAZING, PERMANENT, NON-ELECTRIC, HIGHLY PRACTICAL.  
Conduct interesting experiments. Hundreds of uses. Retrieve valuable  
steel items such as guns, tackle from fresh or salt water; tools  
from tanks & drains. GUARANTEED. Try any magnet one week.  
Money back if you are not well-pleased.

No. M-725 Has pull of 225 lbs. on flat steel block..... \$16.50  
No. M-625 Has pull of 125 lbs. on flat steel block..... \$9.50  
No. M-575 Has pull of 75 lbs. on flat steel block..... \$6.50  
No. M-500 Has pull of 50 lbs. on flat steel block..... \$4.50  
No. M-101 U-shaped Magnet. Has pull of 8 1/2 lbs..... 2 for \$1.50  
No. M-47 Hot Pad Magnets. 10 for \$1.00..... 50 for \$4.87  
No. M-35 Hobbyist assortment of 8 small magnets..... \$1.50

Send M.O. or check. We pay postage. Sorry no C.O.D.'s.

MIAMI MAGNET COMPANY, 3240 N.W. 27th Ave., Miami 42, Fla.

## SAY YOU SAW IT IN POPULAR MECHANICS



best hardware..  
for hard wear  
**GRIFFIN**  
HINGES

at your hardware or  
building supply store

GRIFFIN MFG. CO., ERIE, PA.



# READY CUT HOMES

**\$2150 AND UP DIRECT FROM MILL**

YOU SAVE the items which help make today's building cost expensive: high labor cost, contractor's profit and overhead, insurance, architect's fees. Cut-to-Fit eliminates usual lumber and material waste, also costly mistakes. Anyone can assemble. Simple, easy-to-follow plans furnished and each part numbered. Complete with all lumber, roofing, nails, glass, hardware, paint, doors, windows. Freight paid. Low-cost building plans sold separately if desired. 57 Homes and Floor Plans.



**5 EASY PAY PLANS  
COLOR CATALOG**



**INTERNATIONAL MILL & TIMBER CO.**  
Dept. PM-46 Bay City, Mich.

**695**

**FREE WIN A TRACTOR FREE**  
WRITE FOR ENTRY BLANK  
NOTHING TO BUY

**HEAVY OIL-PUMP BEARINGS  
PUMPS MILLIONS OF GALS.**

IRRIGATE, SPRAY, DRAIN OR FILL ANYTHING—ANYWHERE! Will not Rust—Clog—or Leak. Patented Seal. Pumps 2800 gph, 420 gph at 75' high or 1600 gph from 30' well. Six blade impeller. Threaded for pipe, 3/4" inlet, 1/2" outlet. Use 1/4 to 3/4 hp motor . . . 7500 gph 9.95  
Heavier 2800 gph 8.95 Heavier 11.95

Check, MO or COD—Money Back Guarantee  
FREE Literature—Comparison Charts  
**U. A. T. ENG. & MFG. CO.** HICKSVILLE 273,  
NEW YORK

## What Every Farmer Should Know About Taking Care of Farm Animals



**The Most Popular Veterinary Guide  
Ever Printed**

This practical and helpful VETERINARY GUIDE FOR FARMERS prepares the farmer to perform many routine veterinary tasks—provides quick information that can often save the life of an animal—prevents disease in herds—saves money on the farm in a hundred different ways.

Written in plain understandable language. It covers symptoms, causes of disease and prevention, and treatment of cattle, swine, sheep, horses and poultry and warns when to call in the professional veterinarian. Names, terms and phrases made clear in a separate section. Over 100,000 copies of this book are in use on American farms. 275 pages. Fully illustrated. Only \$3.95. Order today under money-back guarantee.

**POPULAR MECHANICS PRESS, Dept. PM13**  
200 E. Ontario St. Chicago 11, Ill.

Say You Saw It in Popular Mechanics

## FUN-WORK YARD TRACTOR WHEEL-HORSE RIDE-AWAY



Designed to turn work into FUN! . . . do a dozen back-breaking jobs in a jiffy. Yard-size tractor with 5 forward speeds and 1 reverse. 2 1/2 hp (or 3 1/2 hp) engine mounted on heavy channel steel chassis. Mow a 5-foot swath at 5 mph . . . plow snow . . . cultivate . . . pull any of 22 attaching tools for yard and garden. Write for complete details, and name of nearest dealer.

**SENSATIONALLY \$299.50  
PRICED AT**

**WHEEL-HORSE PRODUCTS COMPANY**

2643-K Dixie Way North

South Bend, Indiana

**BUY DIRECT and SAVE!**

You Save the Dealers' and Jobbers' Profits!

**COMPLETELY AUTOMATIC  
"SEA-HORSE"  
DIVING LUNGS**  
with exclusive SAFETY features  
Complete..Filled..Ready to Use

**\$169 Value**

**2-TANK UNIT**

**99<sup>50</sup>**

**COMPLETE**  
Approx. 2 Hours  
Underwater Time



**SINGLE TANK  
Outfit Complete**

**\$110 Value**  
Approx. 1 Hour  
Underwater Time **\$69**

The 2-stage demand REGULATOR automatically releases air as needed; effortless breathing in any position, includes both emergency and warning device; New I.C.C. approved TANKS with current dating . . . 84 cu. ft. cap. at 2000 psi; standard fittings; can be refilled anywhere; check valves in NON-RETURN MOUTHPIECE keep water out of hose. Complete comfort with full adjustable HARNESS. Rugged, rust-proof construction throughout. Parts and service available. Weight 55 lbs.

**FREE** Valuable Book on SAFETY in Skin Diving with each Diving Lung.

**SIGNED GUARANTEE of SATISFACTION**

Send Check or Money Order. If C.O.D., 25% with order. 10% deposit holds your purchase.

Write for Literature TODAY. Club Inquiries Invited

**DIVING INDUSTRIES** Division of  
HONUS WAGNER CO.  
Quality Sports Products since 1918

813 Liberty Ave. Dept PM-4 Pittsburgh 22, Pa.

## HELPFUL BOOKS

Send post card asking for FREE catalog

Popular Mechanics Press, 200 E. Ontario, Dept. 601, Chicago 11

## 115-Volt, A. C. ELECTRIC GENERATOR



1750-Watt, 60 Cycle

A.C., Single Phase

**BRAND NEW SURPLUS**

Government Cost \$185.00

**FULLY GUARANTEED!**

**Only \$99.50**  
fob

Ideal as a permanent or stand-by unit for electricity IDENTICAL to your house current. Perfect for farms, camps, aboard ship, oil fields, mines, etc. Easily handles lights, refrigerator, deep freeze, oil burner, radio; power for saws, floodlights, drills, pumps, etc.

All ball bearing. Operates at 3600 R.P.M. Drive with 3 1/2 HP or larger engine—or use power take-off. Voltage self regulating. Standard base mounting. Two outlets. Size 15" long, 8" dia. Weight 58 lbs. Delivers 1750 Watts CONTINUOUSLY!

**SUPPLY LIMITED! ORDER DIRECT FROM AD**

**FREE CATALOG OF OTHER SURPLUS, HYDRAULICS**

**ROBERTS ELECTRIC CO., Dept. PM-424, 849 W. Grand, Chicago 22, Ill.**

## NEW *electric* GARDEN TILLER

Thousands of gardeners get more fun out of gardening with a Moe Hoe. This electric tiller spades and cultivates quickly—is light, easy to handle. Is the power source for work-

saving attachments: trimmer, floor polisher, table saw, grinder and drill.



See this display at your Garden & Hardware dealers

Go in today—See the Moe Hoe display. Ask for free demonstration. For more information write: Moe Hoe, 2705 S. E. Milwaukie, Portland 2, Oregon.

**MOE** *electric* **HOE**  
an Iron Fireman product

## NOW—EASY, EFFICIENT PAINT REMOVERS THAT PEEL OLD FINISHES IN MINUTES



**DOW METHYLENE CHLORIDE** makes your paint-removing jobs much more effective, faster... and safe

New type paint removers, based on this high-power Dow solvent, give you "brush on—wait just ten minutes—peel off" results. Old finishes actually *lift*, require no hard scraping or rough sanding. And these removers are *nonflammable*, too. Be sure to ask your local paint or hardware dealer for a paint remover clearly marked "non-flammable or contains methylene chloride."

For further information, write to THE DOW CHEMICAL COMPANY, Dept. S944E, Midland, Mich.

you can depend on **DOW CHEMICALS** 

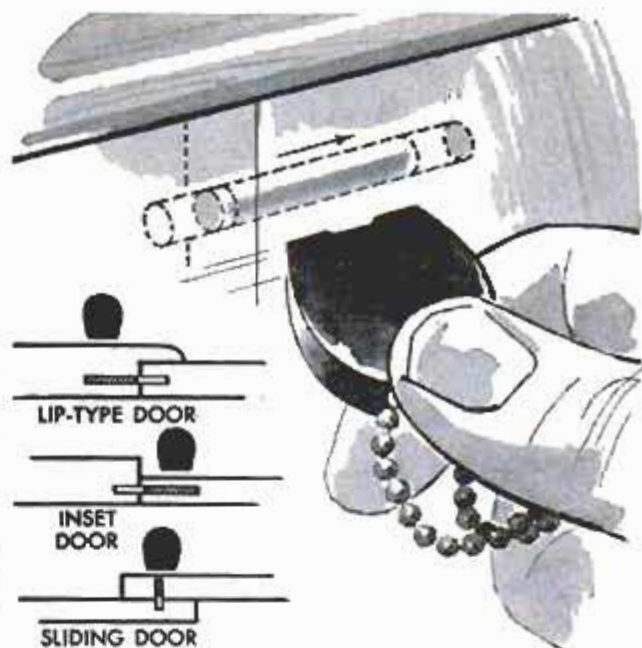

## Magnet Serves as Key For New Lock

Invisible because it has no keyhole, a new type of lock has a magnet for a key. The lock is installed by drilling  $\frac{1}{4}$ -inch holes in the edge of the door and in the doorjamb and inserting the bolt. To slide the bolt open or closed, the magnetic key is held near the surface of the door and moved in the desired direction. The lock can be used on doors, cabinets or drawers.

## Elastic Electric Wire

You can stretch a new electric wire to more than double its original length. When the wire is released it snaps back like a piece of rubber. The conductor is loosely braided from 21 strands of fine wire and is covered with woven rayon or nylon. The elastic wire is expected to be used in making connections on electric blankets, hair driers, hearing aids and TV sets. It is available in standard lengths of two, three and four feet, with various types of terminals.

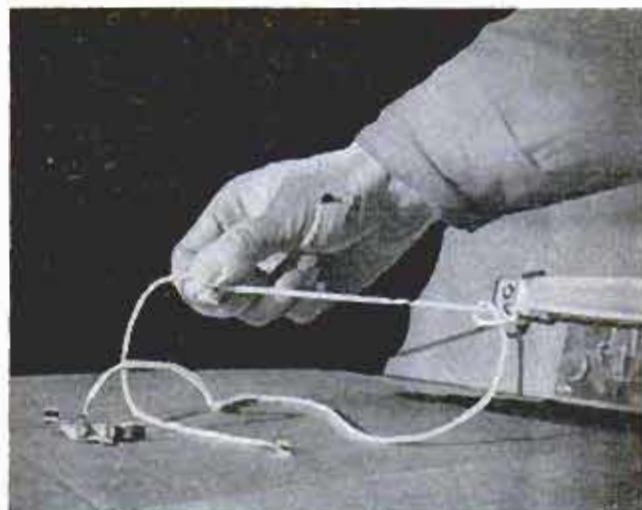

# WARNING!



Today's high-powered engines need frequent spark plug checks to prevent dilution of oil

## Don't change to summer oil without a spark plug check!

*If you haven't checked your plugs in the last 5000 miles, they may be misfiring—and will dilute your new oil with gasoline.*

Do you realize that every time a spark plug misses, raw gasoline remains in the cylinder and drains into your crankcase? This thins the oil so it can't properly protect costly engine parts . . . and may put you in line for a big repair bill.

So replace winter-worn plugs with new 5-rib Champions before you change to summer-grade oil! Champions will protect your oil from dilution. What's more—they'll give you greater horsepower and better gasoline mileage.

Ask your serviceman to check your spark plugs today. If you need new ones, insist on 5-rib Champions—the finest money can buy.





**WITHOUT DISMOUNTING  
TIRE FROM WHEEL**

**FIX TUBELESS TIRE PUNCTURES in 3 MINUTES**

Reach for a SO-TITE Instead of a JACK!

**Any Woman Can Repair Tire Virtually Without Soiling Hands**

Without jacking up your car. Without soiling clothes. Without exertion. The first tire repair ever invented enabling you to repair your tire ON THE WHEEL. Tubeless Tires usually hold more than enough air for complete repair long after a puncture. With So-Tite, you make your repair right now. In less than 3 minutes! Be prepared. Get a So-Tite kit for your glove compartment now. \$1.95 kit contains 12 repairs.

**for only 16 1/4¢**

Why risk being caught on the road with a tubeless tire flat? And no way to fix it! Carry a So-Tite Tubeless Tire Repair Kit in your glove compartment. Just like more than 100,000 other car owners now do! Got a flat? Stop car. Locate puncture with tire inflated and not dismounted. Insert So-Tite Tubeless Tire Seal with So-Tite needle. Cut flush with tire surface using So-Tite knife. That's all. Go right on running, SAFELY, without loss of air. A So-Tite Tubeless Tire Seal is guaranteed NEVER to come out!

**Be Prepared! ORDER TODAY!**

Ask your dealer for So-Tite. If he cannot supply you, write us direct. SEND NO MONEY. Your kit shipped C.O.D. for \$1.95 plus C.O.D. charge. Or send two one-dollar bills, check or money order and we pay shipping charges. Satisfaction guaranteed or money back.

**DISTRIBUTORS! DEALERS!**

One-in-a-lifetime opportunity. Write today.

MULLEN'S So-Tite CORP.  
Dept. PM, 2304 W. Ohio St.  
EVANSVILLE 12, INDIANA

Please send me:

..... So-Tite Tubeless Tire Repair Kits (\$1.95 each)

I enclose \$..... Please send prepaid.

Please send C.O.D., Plus Postage.

My Name .....

Address .....

City..... State.....

Dept. PM. Ohio St. EVANSVILLE 12, IND.

*Soldering is Easy*

with INSTANT STARTING

**Lenk**

LIQUEFIED LP PETROLEUM Torch

only **\$3.49**

THE ONLY THROW-AWAY FUEL-CONTAINER WITH SELF-SEALING SAFETY VALVE.

Here's what you can do:

- regular soldering.
- sweat fittings.
- silver soldering, refinish furniture.
- remove paint and putty.

Available at Hardware Counters Everywhere

Write for FREE Soldering Instructions

THE *Lenk* MFG. CO.  
BOSTON 15, MASS.

**Heavy Duty Bench Type ALLEN PUNCH PRESSES**

Model B-2  
2 ton - \$97.50  
Tilting model \$127.50  
less motor

Many Popular Models 1/2 to 5 ton capacities Moderate in price Fully guaranteed

See Your Supply Dealer or write for Free catalog showing all models with descriptions and prices. Easy terms available.

ALVA ALLEN INDUSTRIES, Dept. PM, Clinton, Mo.

**Save 50%! Assemble Your Own DIVING LUNG**

**FREE BOOK SHOWS HOW**

We furnish the parts and instructions. Complete outfits from \$53.95. Individual parts available. Write for our descriptive literature today.

**UNDERWATER SPORTS, INC.**  
Dept. K, 302 W. Adams  
O'Fallon, Ill., P.O. Box 65

**HOLD-E-ZEE SCREWDRIVERS**

The Original AUTOMATIC GRIP

**Top Quality—Plus!**

Finest materials and workmanship plus exclusive, much-wanted features

—YET COST NO MORE THAN ORDINARY SCREWDRIVERS!

At Leading Dealers Everywhere

UPSON BROS., INC., ROCHESTER 14, N. Y.

# SAVE UP TO \$8 WHEN YOU BUY SILENTONE—WORLD'S BEST MUFFLER

26 gauge inner shell—22 gauge outer shell.  
Double shell lasts longer.

Non-clogging extruded holes—  
no whistling, no restriction.

16 gauge, spun-locked,  
blowout-proof steel heads.

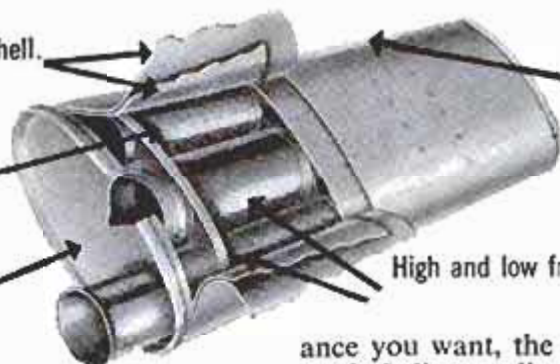

Know why so many new cars have duals? Modern engines demand better exhausts to conserve all the horsepower built into them. So if your car has but one muffler, think how important it is to have a good one. Ordinary mufflers silence your engine by throttling power. Every pound of back pressure wastes 2 horsepower of engine output.

Silentones are scientifically designed to keep back pressure at a minimum, give you the perform-

ance you want, the mileage you expect.  $\frac{1}{3}$  heavier steel shells on all oval types make Silentones safe and last thousands of miles longer. They're individually engineered for your car. Many stores install Silentones at big savings to you. Buy Silentone® and save up to \$8. P.S.: If you prefer that deep mellow tone, get Dynatones. They're engineered, not packed. Cost far less than Hollywood types. Dynatone duals and headers are available for use with any type muffler. Write for name of your nearest store.

Sold only by America's leading automotive chain stores

**SILENTONE MUFFLERS • DYNATONE • GLASS-PACKED**  
Dept. 2D, Toledo 1, Ohio

**NOW You Can DRILL, SAW, REAM, CUT  
... ALL WITH ONE BIT!**

Beaver's new improved Hi-Speed side cutting drill bit can be used on any electric drill, drill press, lathe, etc. Made from the finest American hi-speed steel.  $3\frac{1}{2}$ " long, 2" side cutting section,  $\frac{1}{4}$ " diameter. Designed to cut steel, wood, plastic, aluminum, etc. MONEY back guaranteed. Specify types desired. All Purpose, Wood and Heavy Metal. BUY From Your Dealer or send check or money order today. Dealer inquiries invited.

BEAVER DRILL & TOOL CO., 30088 McGo Trafficway, Kansas City, Mo.



**BEAVER  
Hi-Speed-Saw  
DRILL BITS**

ONLY  
**\$2.45** each 3 for \$7.00

**TAKE A TIP FROM**



**ED  
DODD**

creator of  
**MARK  
TRAIL**

See the sensational new Feather Crafts for '56. Nineteen models for sports and fishing, all built of rugged aluminum for lasting beauty, lasting pleasure. Write for brochure or contact your dealer.

**Feather Craft, Inc.**

445 BISHOP ST. N.W., ATLANTA, GA.  
IN CANADA: FLEET MFG. LTD., DEPT. PM  
BOX 300, FORT ERIE, ONTARIO

APRIL 1956

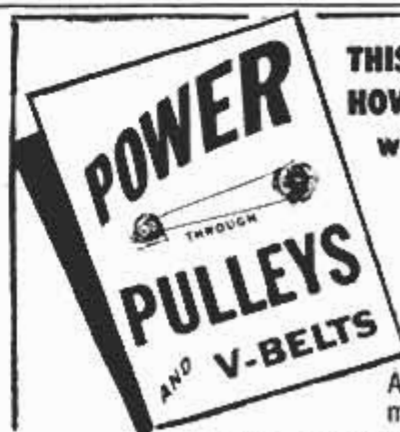

**THIS BOOK TELLS YOU  
HOW TO MAKE THINGS  
with PULLEYS and  
V-BELTS**

- HOME APPLIANCES
- POWER TOOLS
- MOTORIZED TOYS

**"MAKE IT YOURSELF"**

**CONTEST**

A \$50 prize every month—duplicate prize for your dealer. A grand \$100 prize every six (6) months. Get the details from your dealer or write direct.

A "must" for every home mechanic—this book is full of facts and figures on how to use pulleys for power.

You can make many useful things with pulleys and v-belts, a few gadgets and a spare motor or engine. Order your book today and start a useful project.

Win yourself a \$50 Savings Bond and make a useful tool or toy.

**SEE YOUR  
DEALER  
OR  
SEND THIS  
COUPON  
TODAY**

**CONGRESS DRIVES DIVISION  
TANN CORPORATION**  
1750 E. Outer Drive, Detroit 34, Mich.

Gentlemen:

Enclosed is 25c—please send me the book "POWER Through PULLEYS and V-BELTS"—also contest entry form.

Name \_\_\_\_\_

Address \_\_\_\_\_

City \_\_\_\_\_

Get your **FREE** copy of

## "LAWN BEAUTY SECRETS"



Want a thick, rich, velvety smooth lawn with a minimum of effort? Here is information that shows you how — along with helpful buying information on

### advanced design **EVERSHARP** power mowers

Exclusive automotive-type two tone styling...double-edged blade...more advanced features throughout for easier, better mowing. At leading stores, as low as **\$64.95**

Write for your **FREE BOOKLET** today

**MIDWEST MOWER CORP.**  
HANNIBAL 7, MO.

## The New Model 70 UTILITY TESTER FOR REPAIRING ALL ELECTRICAL APPLIANCES MOTORS • AUTOMOBILES • TV TUBES

As an electrical trouble shooter the Model 70:



- Measures A.C. and D.C. Voltages, A.C. and D.C. Current, Resistances, Leakage, etc.
- Will measure current consumption while the appliance under test is in operation.
- Incorporates a sensitive direct-reading resistance range which will measure all resistances commonly used in electrical appliances, motors, etc.
- Leakage detecting circuit will indicate continuity from zero ohms to 5 megohms (5,000,000 ohms).
- Will test toasters, irons, Brainers, Heating Pads, Clocks, Fans, Vacuum Cleaners, Refrigerators, Lamps, Fluorescents, Fans, Switches, Thermostats, etc.
- Will test all TV tubes for open filaments, inter-element shorts, burned out tubes, etc.

As an Automotive Tester the Model 70 will test:

- Both 6 Volt and 12 Volt Storage Batteries • Generators • Starters • Distributors • Ignition Coils • Regulators • Relays • Circuit Breakers • Cigarette Lighters • Stop Lights • Condensers • Directional Signal Systems • All Lamps and Bulbs • Fuses • Heating Systems • Horns • Also will locate poor grounds, breaks in wiring, poor connections, etc.

Handsome sound-cornered molded bakelite case, 3 1/2" x 5 1/2" x 2 1/4". Complete with all test leads. Also included is a **64 page book** giving detailed instructions for testing all electrical appliances, automotive equipment, TV tubes, etc. Only **\$15.85**

**SHIPPED ON APPROVAL  
NO MONEY WITH ORDER — NO C. O. D.**

Try it for 10 days before you buy. If completely satisfied then send \$3.85 and pay balance at rate of \$4.00 per month for 3 months — No Interest or Finance Charges Added! If not completely satisfied, return to us, no explanation necessary.

**MOSS ELECTRONIC DIST. CO., Inc.**  
Dept. D-221, 3849 Tenth Ave., N.Y. 34, N.Y.  
Please rush 1 Model 70. I agree to pay \$3.85 within 10 days after receipt and \$4.00 per month thereafter

Name \_\_\_\_\_  
Address \_\_\_\_\_  
City \_\_\_\_\_ Zone \_\_\_\_\_ State \_\_\_\_\_

# FORD Owners SAVE MONEY



Learn How to Make Your Ford Run Better . . . Last Longer . . . and Save Hundreds of Dollars!

Get this book, written especially for you, without one penny of risk and get more out of your car. Mail coupon for **MANUAL FOR FORD OWNERS** today. When the book comes, skip through the pages and see how your investment in one of America's most popular automobiles can be even a better investment than you thought. If you don't agree, send the book back and you'll get your money back.

### A Popular Mechanics Book Written Just for You

Not a re-hash of service manuals. A complete new Popular Mechanics book written for the Ford owner by an outstanding automotive authority with the full cooperation of Ford engineers and service directors. It will save you money on repairs and service; make your Ford last longer; give you safe, economical and trouble-free motoring. And this is true whether you take your Ford to a regular service station or service it at home.

### Prevents Trouble. Cuts Down on Repair Bills

Nothing like this manual anywhere. It covers all phases of operation, service and maintenance. It has entire chapters on the individual parts of your Ford—battery, ignition, starter, generator, regulator, lighting, fuel system, engine, lubrication, gasoline qualities, cooling systems, transmission, differential, rear axle, brakes, wheel alignment, tire care, body maintenance, trouble shooting on the road, etc. It covers your Ford, new and older models, step by step—bumper to bumper—showing you how parts operate; what can go wrong; how repairs and adjustments should be made and how to avoid all types of trouble.

### Money Back if Not Satisfied

Mail the coupon today. Send only \$3.50 or you can pay postman. Money back guarantee protects you.

### Official, Authoritative, Practical Information

Written by C. E. Packer, formerly service school instructor and auto show lecturer for automobile manufacturers, Member Society of Automotive Engineers, Special Services Editor of Automobile Digest, contributor to leading magazines, author of some of the biggest selling books on Automotive subjects.

### Entire Chapters on Fordomatic and Overdrive

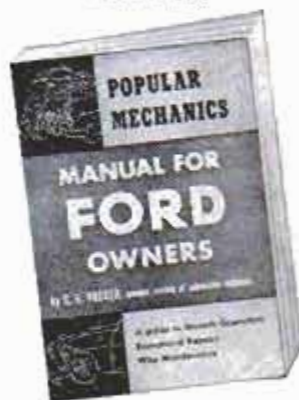

304 Pages. Hundreds of How-To-Do-It Illustrations and Diagrams

The entire book follows Popular Mechanics famous easy-to-read and easy-to-understand style. While primarily intended for the Ford owner, to help him get more out of his car at lower cost, it can be worth its weight in gold to the auto mechanic and service station operator who works, not only on Fords, but on all other makes as well, to which the information in the book can be easily applied.

## Order on this Coupon

**POPULAR MECHANICS PRESS, Dept. MF-2**  
200 E. Ontario St., Chicago 11, Ill.

Send Manual for Ford Owners at once. If not satisfactory I will return it within 7 days and you will refund full purchase price.

Remittance for \$3.50 enclosed.  Send C.O.D.

Name \_\_\_\_\_

Address \_\_\_\_\_

City \_\_\_\_\_ State \_\_\_\_\_

POPULAR MECHANICS

# DO IT YOURSELF DEGREASER!

engine shampoo



QT. SIZE CONCENTRATE  
MAKES 2 GALLONS



SPRAY OR BRUSH ON...

Takes cling out of oil and grease... emulsifies it... so that all dirt may be hosed off as easily as you rinse hands under water faucet. Launders engines faster, more completely, and safer than steam cleaning (warm the engine). Self scouring action brings out factory new appearance... provides accurate visual inspection... Gunked engines run cooler. Genuine Gunk is sold in BULK sizes at better automotive wholesalers everywhere. Retail sizes sold at WESTERN AUTO STORES and ASSOCIATE STORES. TRY IT TODAY!

The CURRAN CORPORATION, Lawrence, Mass.

SAY YOU SAW IT IN  
POPULAR MECHANICS

Better Than  
Your Own

SHOE STORE  
AT HOME



Two-  
Eyelet  
Hit With  
Cushioned  
Comfort

No investment, no experience needed. Just show magic cushion comfort to friends, neighbors, co-workers. Advance commissions to \$4.00 a pair, plus Cash Bonus, Paid Vacation, \$25.00 Reward Offer. Outstanding values for men, women, children. Money back guarantee. Shoe samples supplied without cost. Write TODAY for FREE new 64 page catalog and full details.

TANNERS SHOE CO., 795 BROCKTON, MASS.

## KING MIDGET

World's  
Lowest  
Priced  
Car!



NOW—32 PAGE BOOK filled with photos, drawings, specifications, records, wholesale price, and Rider Agents plan if no dealer near you. Send 25c for book, or send \$1 (refundable first order) for it plus actual operating book and service manual.

MIDGET MOTORS MFG. CO., ATHENS 1, OHIO

WAR SURPLUS AND OTHER BARGAINS SAVE UP TO 90%



### AUXILIARY POWER PLANT

Model C-2, Navy type 1. Engine comes complete with spark plugs, generator self starter, voltage regulator, reverse current relay, silencer case, dual settilite magnets, Stromberg carburetor. Use as portable welder. Develops 300 amps & more. Capacity up to 7 1/2 KW. Engine 14.5 HP. Up to 7500 Watts. Terrific as standby power supply, in boats, to power small cars, as a complete lighting system. Operates all DC equipment. Like NEW, all engines checked & run before shipment. Wt. cased 360 lbs.; wt. net 139 lbs. Approx. GOVT. COST \$4590. Now only \$187.75.



### GENERATOR RECTIFIER COMBINATION KIT

Consists of famous NEA 5 AC-DC Generator and Selenium Rectifier. Used to convert 110 AC, 880 cycles to straight 110 Volt DC which will run all AC-DC universal motors, power tools, radar, radios, refrigerators and TV sets. Kit also contains AC & DC voltage regulators and easy-to-follow diagram. Also makes up as an excellent 200 Amp, 24 Volt welder in conjunction with above used. Terrific unit for trailers, cabins, farms, ships & camps. Approx. GOVT. COST \$650. Like new. Special, \$49.95.

### HIGH SPEED HAND TAPS

10 assorted, precision-ground thread. National Mfr. Like NEW. From 3/16" up. Approx. GOVT. COST \$25. Now \$2.50.

### LONG-FLUTE, HIGH SPEED DRILLS

12 assorted sizes. Up to 1/2". Like NEW. Approx. GOVT. COST \$23. Now \$2.50.



### ARC WELDER KIT \$24.95—build your own

Complete make-up package consisting of 1 Aircraft DC Generator. Electric Auto-Lite, 200-250 Amps, 24 Volt, RPM from 2600 up. 1 Rheostat, 1 Giant Toggle Switch, 1 Ammeter, 1 Shunt, 0 to 240 Amps, 1 Voltmeter, 0 to 30 Volts, 1 Electrode Holder. Wiring diagram chart showing conversion of Aircraft Generator to Arc Welder. Shpg. Wt. under 100 lbs. Approx. GOVT. COST \$475. Buy of a lifetime. Like new, perfect, \$24.95. D.C. Generator—same as above, if purchased separately: \$12.50.



MICROMETERS Chrome plated, precision engineered, carefully tooled to give long life. All new 0-1" cap. \$2.25 ea., 1-2" cap. \$3.50.



### NEW IMPROVED MAUSER-TYPE VERNIER CALIPERS

Quick, handy, accurate. 6" Vernier Calipers. Glass hardened, lapped measuring surfaces. Fine engraved scales—1/1000" and 1/128" for inside, outside & depth measurements. Friction thumb release. Larger capacity, 2 gib adjustments. Reg. \$25. Now only \$7.95. Leather case \$1 extra.



### PIONEER MAGNETIC COMPASS

For boats, trucks, cars. By Pioneer Instrument Co., Div. of Bendix, No. 1829-2A. Contains screw-type heating compensator, removable drawer-type compensator, screw-type horizontal compensator and spider-type compensator. All devices for elimination of errors caused by effects of magnetism. Has constant deviation corrector and course setter. Rotable dial engraved with compass card graduations. Complete with book of instructions, light and mounting screws and shock mounts. Shpg. Wt. 10 lbs. Approx. GOVT cost \$400. NEW. \$13.95.

NEW! 1956 CATALOG Largest ever... just out... new low prices. Send 25c for your copy today. Prices F.O.B. Culver City unless otherwise stated. Check, cash or money order, 25% deposit for C.O.D.

AIRBORNE SALES CO., INC. DEPT. PM 456  
8501 Stellar Drive, Culver City, Calif.

## BIG PROFIT IN YOUR OWN BUSINESS

### GRINDRITE LAWNMOWER SHARPENER

Fastest, easiest to use sharpening machine available. GRINDRITE will sharpen any hand or power mower in 10 to 20 minutes. Set-up time less than 30 seconds. Make \$2.50 to \$6.00 a job in your basement or garage. Full or part time, work your own schedule. Lawnmowers everywhere need repeated sharpening. Investment returns in a few days. Write today for Money Making Plan.



\$28500

Complete with 110v. motor. Freight paid, U. S. A.

GRINDRITE, Dept. P-2, 9841 Alpaca, El Monte, Calif.

**now the**

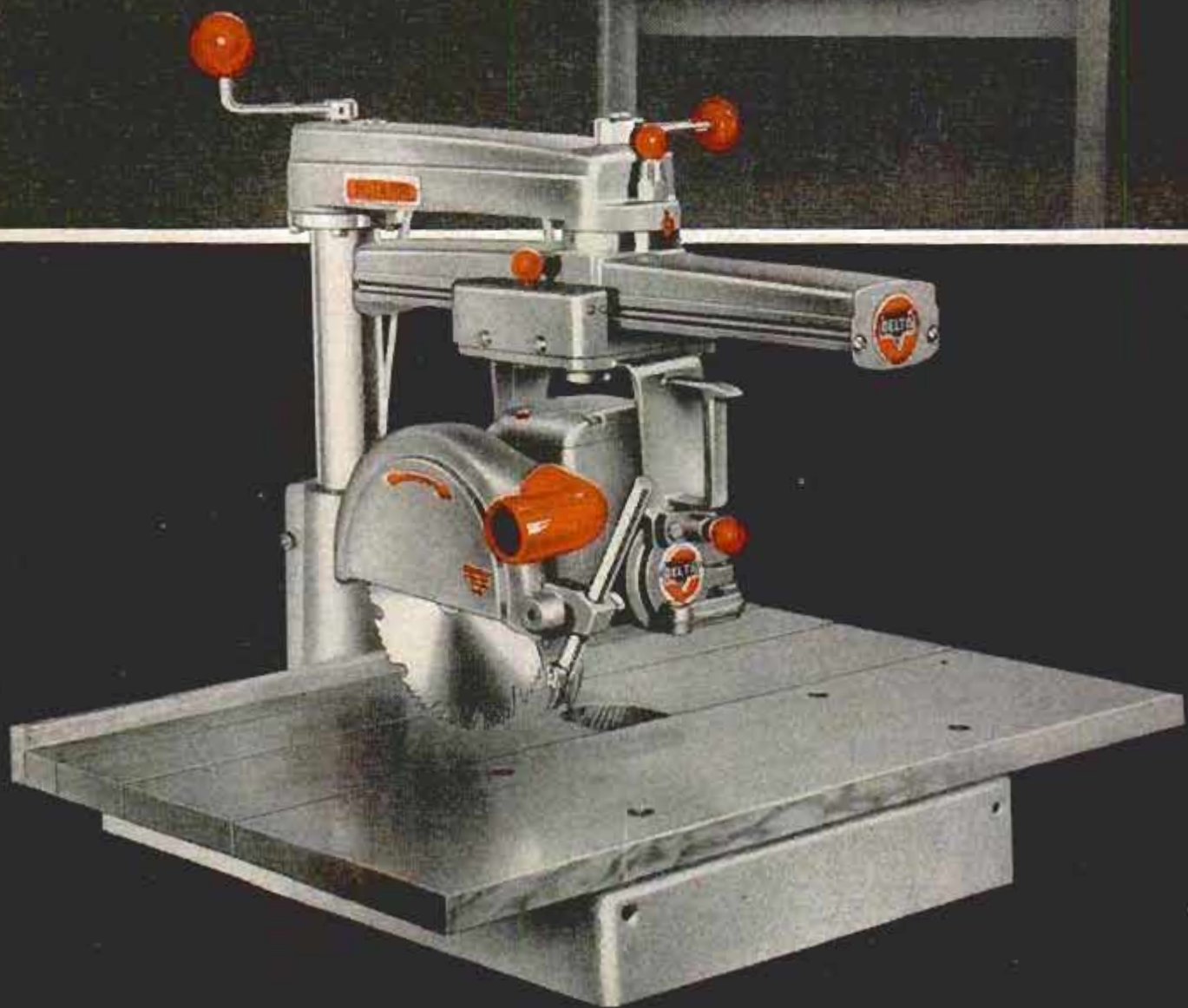
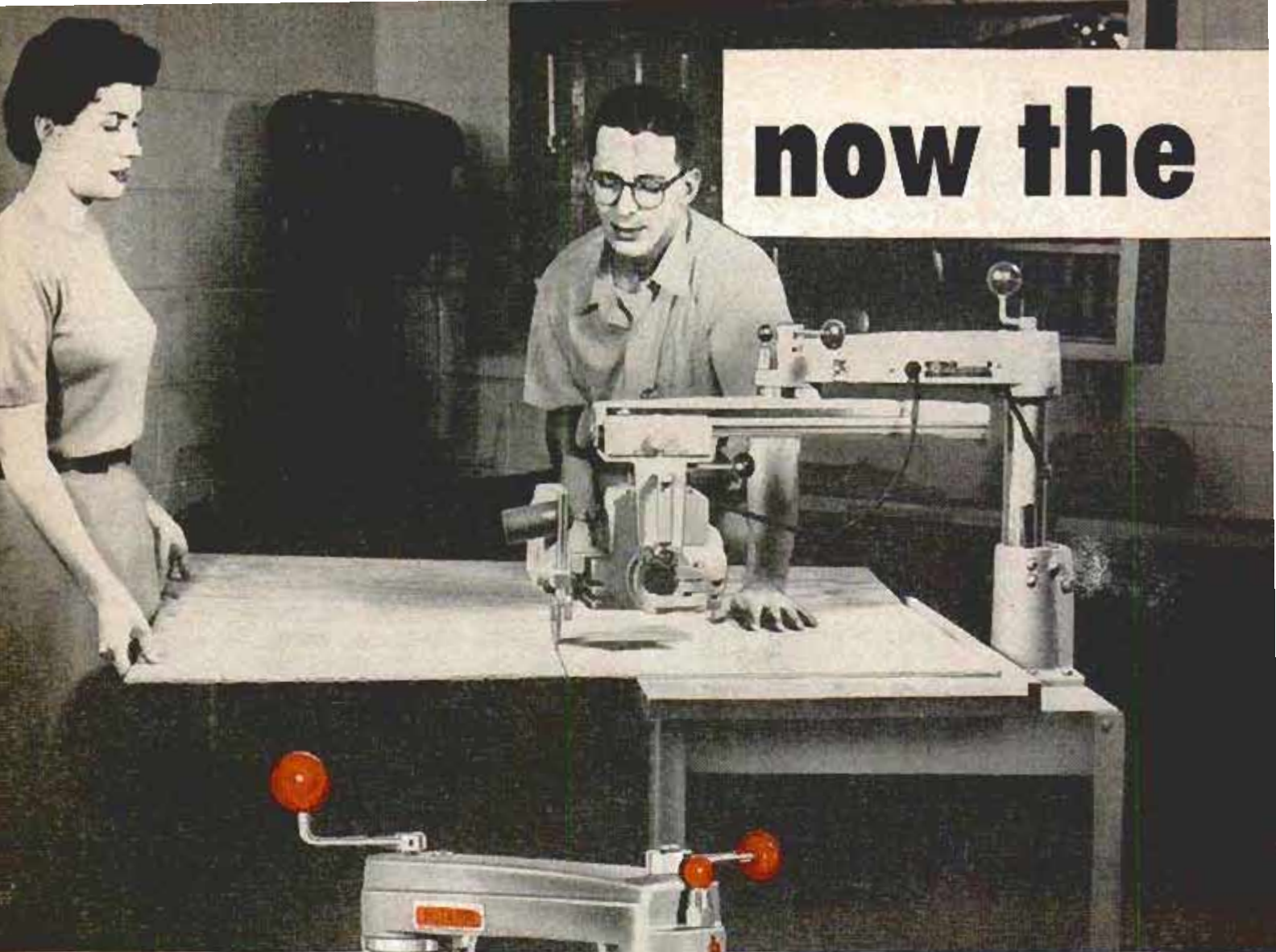

**DELTA . . . world's most complete power tool line  
53 machines . . . 246 models . . . over 1300 accessories**



**new**

# DELTA

## "900" radial saw

... for small shops and home workshops

*Delta's new "900" is the most powerful, most useful 9" radial saw ever built at any price! It's big, it's rugged—it does every job you ever wanted a radial saw to do. And it's the only 9" radial saw that gives you all these Delta "big saw" extras:*

**Exclusive "Turret Arm" Action**—The *only* 9" radial saw with the double over arm construction preferred in large industrial saws. Pivot point always stays over the center of the work table for greater versatility, accuracy—and safety.

**True 3/4 H. P. Motor**—Guaranteed for a full year! The most powerful motor on *any* 9" radial saw—you make heavy cuts faster, easier.

**Select Edge Grain Fir Table**—Only the *finest* grade prime wood is used to guarantee freedom from warp or distortion.

**Exclusive "Wide Bearing" Construction**—Carriage rolls on extra wide spaced bearings for greater rigidity, years of more accurate service.



Get all the facts about the new Delta "900"! And get all the facts about the easy Delta Budget Plan: As Little As **10%** Down...As Long As **24** Months To Pay! At all Delta Dealers' (under "TOOLS" in the yellow pages), and leading hardware stores.



### DELTA QUALITY POWER TOOLS

Another Product by **Rockwell**



**Send The Coupon for Catalog—TODAY!**

Delta Power Tool Division, Rockwell Manufacturing Co.  
502D N. Lexington Ave., Pittsburgh 8, Pa.

- Please send name of my nearest Delta Dealer.  
 Please send me Catalog on the new Delta "900" Radial Saw.

Name \_\_\_\_\_

Address \_\_\_\_\_



**DELTA  
QUALITY  
COSTS  
NO MORE**

# BIG NEW YANKEE HANDYMAN

No. 633H

Spiral Screw Driver

\$5.98

Just Push...  
Drive Screws Fast

Here's a new "Yankee" Tool with a built-in formula for faster, easier work — 1 push and you turn the screw a number of times — yes, every stroke turns the screw a number of times, and with the quick-return action you are ready for the next stroke immediately.

This Spiral Ratchet Screw Driver does more than drive and draw screws. It drills holes in wood, plastic or plaster, and countersinks for head of screw. In addition to Screw Driver Bit in chuck, 3 Drills and a Countersink come in magazine handle. A "Yankee" tool from the Tool Box of the World. At your hardware store now.

N.B. Special Price for Hardware Week  
(April 12-21) — \$5.69

# STANLEY

## TURN YOUR SPARE TIME INTO \$5 an HOUR EXTRA CASH

Earn Big Money in  
Your Own Home  
with the BELSAW  
SHARP SMITH



Thousands of Belsaw users have proved that sharpening circular saws, grinding planer and jointer knives is profitable. Many have given up regular jobs to devote their entire time to their own money-making business.

The initial investment is only \$15 down payment. The space required is small... 15 square feet in your home or garage.

No experience is necessary. A beginner can produce expert work the day his Belsaw arrives.

The demand is in your own neighborhood... constantly expanding. More and more circular saws are used by professionals, carpenters, contractors... plus the thousands with basement workshops. All these circular saws need dependable sharpening... the kind you can give them with a Belsaw.

You do the jobs in your own home in your own spare time. No punching the time clock. If you want to take the day off to go fishing, it's yours for the taking. Every man has dreamed of being his own boss. With your Belsaw you can make it possible.

Write today for actual experiences of Belsaw owners... and Free Book, "Lifetime Security with Your Own Business."

FREE  
Book



## BELSAW MACHINERY CO

1646 Field Bldg., 315 Westport Rd., Kansas City 11, Mo.

# 23 BOATS YOU CAN BUILD



### You Can Build These Boats Without Experience With Few Tools, and Little Time to Spare!

And the best part is that after you have completed your boat, you will know it is seaworthy as well as eyeworthy. This book, a few tools, and some time each day in your garage or basement, is all you'll need to complete the boat of your dreams. Nothing is left to the imagination. Everything is planned for you before you turn back the cover of the book. All you do is follow simple step-by-step instructions and show how photos and drawings.

#### Building and Service Hints Provided

You'll learn how to build your boat right the first time. Success in building a boat depends on two things. Knowing beforehand exactly what type boat you want to build and then getting started correctly on the construction. With this book it's simple. Material lists are supplied where essential, listing lumber required, hardware, sailcloth, fittings, etc. Also included are hundreds of hints for building your boat right, the best boat for beginners, and tips on servicing boats after they are built.

#### Special Chapter on Boats for Sportsmen

If you are a sportsman, hunter, fisherman, trapper, or just plan to use your boat for pleasure, this chapter contains ideal craft for your use. Perhaps you have a canoe in mind, or a rowboat that can be carried on your auto. Maybe you have always wanted a duckboat but have been reluctant to purchase one because of the expense. All these boats plus a 3-sec-

tion rowboat, and 12-foot plywood outboard, are available in this one chapter alone. All are easy to construct, and beautiful to own. Step-by-step instructions, photographs and illustrations, plus important material lists carry you right through from the forming of the keel to the last coat of paint and varnish.

#### Half a Million Persons Build Their Own

There are more than half a million persons in the United States who regularly build boats for pleasure or for profit. They form a cross section of American life. And theirs is a double reward—the fun of building the boat, and the thrill of using it when it is finished.

#### Partial Listing of Boats

Think of being able to build and own the following boats: "Su-Lu" the PT-type Plywood Dinghy, 11-ft. Skiff, "Sport" a V-Bottom Inboard, "Tramp" a 15-ft. Sailing Knockabout, "Sea Craft" a 25-ft. Cabin Cruiser, "Zephyr" a 14-ft Sailing Dinghy, "Arrowhead" a 21-ft. Sloop, a Bicycle Boat, Motor-driven Paddle Board, "Skimmer" a Sturdy Plywood Kayak, "Skip" a Pram-Type Dinghy, "Tiny" a 6-ft. Training Ship, and many more, from large to small and at a fraction of the purchase cost!

#### 7-Day Money Back Guarantee

Send for your copy of 23 BOATS YOU CAN BUILD today. Read and use it for 7 days. If it isn't entirely satisfactory return it for a full refund.

### Use This Handy Order Coupon

POPULAR MECHANICS PRESS

200 E. Ontario St., Chicago 11, Illinois

Gentlemen:

Please send my copy of 23 BOATS YOU CAN BUILD. Enclosed is my remittance of \$2.00. If I am not completely satisfied with the book I will return it for a full refund after 7 days.

Name \_\_\_\_\_

Address \_\_\_\_\_

City \_\_\_\_\_

Zone \_\_\_\_\_ State \_\_\_\_\_

## New "PULL-GEAR" SPEED-REDUCING PULLEY



**Provides Correct Speed and Power to Drill Up to 1 3/8" with 1/2 H.P. Motor**

Amazing new internally geared speed reducer doubles drill press capacity. Greater power, greater efficiency, greater productivity.

Provides the correct speed and power for larger drilling, reaming, tapping and boring on light presses. Easily installed in five minutes. Adaptable to all type machines. Spindle speed range approx. 45 to 3000 RPM. Made in 3 motor shaft sizes: 1/2" - 5/8" - 3/4". Write for literature.

WRITE FOR LITERATURE

**THE PULL-GEAR CO.**

25427 Mound Road  
Center Line, Mich.

## How to Build Your Own GARAGE



**Save as Much as 50% of Usual Construction Costs**

Get Popular Mechanics' brand new book *How to Build Your Own Garage* by Wayne Leckey, Assistant Shop Notes Editor, and find out how you can build your own garage at savings of 50% of usual cost. Leckey tells in famous step-by-step instructions and shows in big, clear photos, drawings and diagrams how to perform every building operation from laying the concrete to installing the final trim. There are 25 designs. Brick, frame, and concrete block fully covered. Send \$3.50 for your copy. 7-day money back guarantee.

POPULAR MECHANICS PRESS, 200 E. Ontario, Chicago 11, Ill.

HERE'S HOW AMAZING

MOTALOY WORKS RESTORES LOST POWER AND COMPRESSION HERE

SAVES FUEL HERE

FILLS SCORED CYLINDER WALLS HERE

STOPS PISTON SLAP HERE

STOPS OIL LEAKING PAST RINGS HERE



IMPROVES VALVE ACTION HERE



## MOTALOY ring and valve job replates parts while you drive!

Easy! Just drop MOTALOY tabs in fuel tank. Motaloy's scientific metalplating action takes place while you drive, eliminating expensive and old methods of replacing worn pistons, rings and valves. Simple! No equipment to buy. Increases gas mileage! Will last for 200,000 miles. Money-back guarantee!

**MOTALOY**

REG. U.S. PAT. OFF.

the only product of its kind in all the world!

ONLY

**\$6**

POST PAID

**ORDER MOTALOY NOW For Your Car**

Motaloy Manufacturing Corp., Dept. MF-2  
South Texas Bldg., San Antonio, Texas

( ) Enclosed is \$6 cash, check or money order. Please send me one package of Motaloy, postage paid.

NAME \_\_\_\_\_

ADDRESS \_\_\_\_\_

CITY \_\_\_\_\_

STATE \_\_\_\_\_

For Free Literature only, check here ( )

## BUILD D.C. WELDER!

BUILD 150-400 amp. DC WELDER without re-winding! Buy welder kits, aircraft generators, etc: DIRECT FROM MANUFACTURER. Easy illustrated plans & welding booklet 50c. Includes WHOLESALE CATALOG & questions on welding answered. Send 50c TODAY. Money back guarantee.



LEJAY MFG. CO., 1247 Le Jay Bldg., Minneapolis 8, Minn.

## TURBINES - NOW AVAILABLE FOR CIVILIAN USE KITS FROM - \$59.50



### FEATURES:

- ONE PRIMARY MOVING PART
- NO AUXILIARY COOLING
- USES LOW COST FUEL
- LIGHT WEIGHT SMALL VOLUME
- SELF CONTAINED GEARBOX
- .685 SQ. FT. FRONTAL AREA
- CORROSION RESISTANT CONST.

Having applied mass production techniques with sound engineering we have developed a series of low cost gas turbines. This type unit is applicable to automotive, aircraft, marine, and industrial usage. It is the engine of the future as well as the present. Its ultramodern design will remain current for years to come.

**TRECO PRODUCTS, DEPT. 20, 1364 WOODLAND HILLS DR., ATLANTA 5, GEORGIA**

Send \$1.00 for catalogue containing prices, photographs, technical data, etc., or send \$3.00 for catalogue plus a bound set of assembly and detailed blueprints. Catalogue or blueprint fee refunded on first order.



**60 LBS.**

**NOW FOR CITY LOT AND SUBURBAN GARDENER**

# Mow Tiller

TRADE MARK

**MOWS LAWNS, TILLS, CULTIVATES**

A New **ROTOTILLER**® Product

## 2 Machines In 1 for the Price of 1

Now everyone with a little garden and lawn can have all the advantages of ROTOTILLER rotary tillage and mowing ... for very little money. Mow-Tiller is an 18" lawnmower; tills 12" wide, 7" deep; cultivates. Rugged, with powerful 1 3/4 hp. 4 cycle motor. Easy to handle; so light you can hang it up in any convenient place. Guaranteed by ROTOTILLER, Inc., the leader since 1930.



Your Rototiller purchase can be financed on convenient terms through your local bank.



Only \$108.50  
Troy, N.Y.  
For Both  
Mower and  
Tiller Units

**MAIL THIS COUPON TODAY**

**ROTOTILLER, Inc., Dept. H-2, Troy, N. Y.**

Please send details of new, low price Mow-Tiller and FREE copy of Green Thumb Booklet, "How to Make Gardens Grow."

Name \_\_\_\_\_

Address \_\_\_\_\_

City \_\_\_\_\_ Co. \_\_\_\_\_ State \_\_\_\_\_

**\$50.00**  
**PER DAY**  
**AND MORE**

**SERRATING AND SHARPENING TABLE KNIVES**

**SAW-KEEN** PORTABLE, ELECTRIC, EASY - TO - OPERATE

Be your own boss, work anywhere, full or part time. Every restaurant, hotel, drive-in, etc., repeat customers. Serrated (saw-edged) table and steak knives in great demand. \$98.50 investment returns first week. Guaranteed. Write today for proven daily profit plan.

**CUTTER-CRAFT** 58-E SOUTH RAYMOND PASADENA 1, CALIF.

## 75c ea. for Finest Imported PRECISION PLIERS

- Flat Nose
- Combination
- Diagonal Cutter
- End Cutting Nippers
- Round Nose
- One Side Flat—
- One Side Round
- Snipe



FOR JEWELERS, OPTICAL WORKERS, HOBBYISTS, CRAFTSMEN OF ALL KINDS! These superb German instruments are of deep-forged, heat-treated high quality tool steel, fabricated to most exacting specifications. All-over ground and polished to smooth hard surfaces. Smooth working joints with just the right tension. Jaws meet perfectly to safely and securely hold even the most delicate objects in the hard-to-reach corners and angles. Each plier is 4" long and a veritable gem of precision and strength.

75c each... ALL 7 for \$5.00 ppd.

## AUTOMATIC PUSH DRILL



Does 1001 jobs in home and workshop. Heavy duty automatic push drill; nickel plated; strong, quick spring return. Complete with 8 standard drill points from 4/64" to 11/64" contained in handle. About 9" long. A \$5.98 value. NOW **\$2.98 ppd.**

## CHROME VANADIUM 29 Pc. DRILL SET

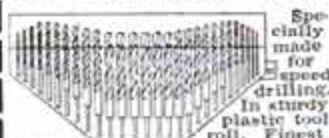

Specialty made for speed drilling. In sturdy plastic tool roll. Finest alloy steel drills hardened and precision ground to the sharpest, longest lasting cutting edge obtainable! Will easily and cleanly bite through hardwoods, plastics, aluminum, iron and the toughest steels. Unconditionally guaranteed for thousands of drillings. Full jobber length. Sizes by 64th from 1/16" to 1/2". NOW... **\$6.49 ppd.**

Also available with Turned Down Shanks to fit all 1/4" drills. In individual pocket roll... **\$8.95 ppd.**

## 60 Pc. Set WIRE GAUGE CHROME VANADIUM DRILLS

Top quality high test Chrome Vanadium Drills designed for speed drilling through toughest steels, woods, plastic, iron and aluminum. Precision ground, long-lasting cutting edges. Guaranteed to give years of satisfaction. A full 60 pc. set nos. 1 through 60. A \$14.95 value... **\$5.40 NOW ONLY** plus 35c pp. & hdg.

Same set above available with Huet Metal Index container. Only... **\$6.65** plus 35c pp. & hdg.

Send check or money order. If C.O.D. fee extra. Money Back Guarantee.

**SCOTT-MITCHELL HOUSE, INC.**

DEPT. M-177 611 BROADWAY N. Y. 12, N. Y.

## KAKEST MORTAR PLANE

"Amazing New Mason's Tool"

Makes it easy for amateurs to build masonry block walls. Lays smooth ribbon of mortar. Saves time and money. No waste of mortar. Send for FREE Folder.

**KAKEST COMPANY** Dept. PM  
Gurwensville, Penna.



**\$13.95**  
Money Back Guarantee

SAY YOU SAW IT IN POPULAR MECHANICS

## MAKE BIG CASH PROFITS ASSEMBLE YOUR OWN LAWN TRACTOR



**NEW!**  
YOU CAN NOW USE FERTILIZER, PULL LOADS, GRASS, DIRT, CUT PLYS, REMOVE SNOW

When your neighbors see the fun you have mowing your lawn with RIDE-TRAC, they'll want one too. Make Big Cash Profits in your own neighborhood with our Rider Agent Plan. Complete RIDE-TRAC kit goes together quickly with wrench and screw-driver. RIDE-TRAC makes fun out of all your lawn work. Write today for details of Rider Agent discount. **BELSAW RIDE-TRAC DIVISION**, 556 Field Bldg., 315 Westport Rd., Kansas City 11, Mo.

# SAY YOU SAW IT IN POPULAR MECHANICS



## WELD IT YOURSELF IN A JIFFY!

Weld, Cut, Brazo, Solder; Iron, Steel, Brass, Bronze, Aluminum and other metals safely and easily. Make your wrought iron furniture, porch railings, fences, knick-knacks and other metal specialties. With this fine equipment anyone can do professional-like work with little practice. Tool and equipment breakdowns are annoying and costly. Don't let them bother you. The Dynamic will pay for itself quickly in both time and money and is designed to operate from any properly wired 110 volt AC line.

Order your Dynamic Industrial type transformer Arc Welder for Workshop or Industrial use today. Order from this ad.

Literature on larger equipment available on request.

**DYNAMIC WELDER COMPANY**, 1808 S. Federal Street, Dept. D2-D, Chicago 16, Illinois

### EASY PAY PLAN

Low down-payment. Pay as you weld. Money back guarantee. Send for details. Complete outfit.

**Only \$38.50**  
F.O.B. Factory

with BIG  $\frac{3}{4}$  hp motor!



\$239 delivered (saw blade and  $\frac{3}{4}$  hp. motor included). EASY BUDGET TERMS

# New 1956 AMF DeWalt "Power Shop" makes all home woodworking easy!

Here, in one big-capacity machine, is a complete home workshop... that gives you...

- The *power* you need for any operation
- 3-D versatility to handle any home project
- The *professional accuracy* to do any job quickly, easily, *expertly*
- The built-in *safety* you *want* in your home

See a demonstration of the new 1956 AMF DeWalt Power Shop at your dealer's today. Now more than ever, it's the finest, safest, most complete home workshop you can buy.



New  $\frac{3}{4}$  hp. direct-drive, custom-built motor. Rugged, reserve power for the toughest jobs — staying power for steady use.



Easy, safe, top-side cutting. Always see your mark and your cut — never work "blind." Saw moves above the work.



Straight-line material handling. Arm swings 360° Motor rotates 360°—tilts past 90°. Material always moves straight on level table.



No floor space needed. Built into work bench, arm swings clear of work area... swings back when needed.



Exclusive New Shaper-Jointer Fence. Converts saw to a 2" jointer at 1/3rd the cost. Positions work for accuracy, safety.



Exclusive New Shaper Guard. A DeWalt "First" safety accessory. Totally encloses knives and spindle—raises for adjusting work.

Complete versatility. Simply change tool on motor shaft. Your AMF DeWalt saws, dados, shapes, sands, bores, routs, surfaces, joints. It buffs, grinds, turns, cuts curves... does everything in woodworking.

New safety. New safety key switch — one of many DeWalt home safety features — turns power on or off. **Take key with you and your family is completely protected.**



AMF DeWalt, Dept. PM-56-4, Lancaster, Pa.  
In Canada: DeWalt Canada, Ltd., Guelph, Ontario

- Please send me Free Colorful 20-page Booklet on how to do everything in woodworking... easily.
- Please send me Free plans on how to build a home workbench.

Name \_\_\_\_\_

Address \_\_\_\_\_

City \_\_\_\_\_ Zone \_\_\_\_\_ State \_\_\_\_\_

**SEND COUPON TODAY!**

At Last!

# The NEW RECLAIMO

A Wm. Schwelge Product

**ELECTRICALLY HEATED**  
(Automatic Control)

## Oil RE-REFINING Filter



**For CARS—TRUCKS—TRACTORS**

It's HERE! After many years in development—NEW Electrically Heated RECLAIMO—fully tested and GUARANTEED—the most efficient motor oil filter available. Filters and RE-REFINES OIL as you drive (by utilizing electric heat). Keeps oil at peak lubricating quality at all times. Proves beyond question U.S. Bureau of Standards (Bul 86) statement "Oil Does Not Wear Out Mechanically."

## New RECLAIMO

**Eliminates All Needless Oil Changes!**

REMOVES SOLIDS by filtration—REMOVES WATER by evaporation—PREVENTS excess fuel dilution—PREVENTS acid and sludge formation—MAINTAINS stable viscosity.

**NEW FEATURES:** #1. Electrically heated from generator. #2. Thermostatic control prevents overheating. #3. Dual Flow permits oil to pass when filter is clogged. #4. New non-corrosive steel body; built to last a lifetime. #5. Adjustable hinged mounting bracket, simplifies installation or transfer to other equipment.

Write at once for illustrated folder and **SIX MONTHS NO-RISK TRIAL OFFER.** Latest edition "Oil Facts", now in preparation, will be sent FREE later.



OLD MODEL Discontinued OBSOLETE

**Dealers' Money-maker!**

**RECLAIMO MFG. CO.**

6251 Touhy Ave., Dept. M-46, Chicago 30, Ill.

Old model "Reclaimos" (new or used) accepted for trade-in allowance on new model. Details on request.



**WM. SCHWELGE**  
Inventor of "RECLAIMO."  
Author of the famous booklet "Oil Facts."  
Pioneer in oil reclamation since 1910.  
MEMBER: Chicago Academy of Sciences.  
Microscopic Society of Ill.  
Chicago Automobile Trade Ass'n.

## Automatic Saw Set...

**MAKE EXTRA PROFITS!**

Set 400 teeth per minute on hand or band saws, 4 to 16 point, with the BeMaCo Automatic Saw Set. Fast, accurate, true hammer-anvil action sets teeth uniformly, eliminates tooth breakage. Used profitably by saw shops and manufacturers everywhere. Every machine positively guaranteed!

Write for details—today!

Saw Machine Division  
**BEAVER MFG. CO.**  
800 ISIS AVENUE • INGLEWOOD, CALIF.  
21-C



## PEE WEE BATTERYLESS "LIFETIME" RADIO

**TUBELESS**

**REALLY WORKS—FOR LIFE!**

Works WITHOUT TUBES, BATTERIES OR ELECTRICAL PLUGS. Will never run down or burn out! World's smallest, SMALLER THAN A PACK OF CIGARETTES! GUARANTEED TO RECEIVE LOCAL RADIO STATIONS ANYTIME—ANYWHERE YOU GO! Sensational new Ferrite Selective Tuner—Portable Crystal diode, Super SPEAKER—PHONE, durable black and gold plastic case.

**SEND ONLY \$2.00** (bill ck, mo) and pay postman \$4.99 COD postage on arrival or send \$6.00 for postpaid delivery. SENT COMPLETE READY TO LISTEN WITH LIFETIME GUARANTEE. Nothing extra to buy—ever. Available only from: MIDWAY COMPANY Dept. WPN-4 KEARNEY, NEBRASKA



**SPARE-TIME MONEYMAKING OPPORTUNITIES**

**READ OUR CLASSIFIED ADS**

**HUNDREDS OF BARGAINS AMAZING OFFERS**

## BUILD Your Own GARAGE



**Save Up to 50% of Usual Cost!**

Build your own garage and save! Wayne Leckey, Popular Mechanics Assistant Shop Notes Editor, tells and shows how in his new book *How to Build Your Own Garage*.

**No Previous Building Experience Required**

If you can use a hammer and a saw you can build your own garage. Leckey tells how in simple step-by-step instructions and shows how in big, clear photos, drawings and diagrams. Everything is covered from the laying of the foundation right up to and including applying the final trim.

**25 Designs—Brick, Frame and Concrete Block Construction. Complete Building Data**

There are 25 different designs from which you may choose. Brick, frame and concrete block construction is fully covered. Leckey tells and shows how to pour the foundation, erect the framework, erect the roof, apply insulation and shingles, lay the driveway, install trim, flower boxes, etc. It's all there for you to read and see.

**7-Day Money Back Guarantee**

Get your copy of this valuable book today. Read and use it for seven days and if it isn't entirely satisfactory return it for a full refund. Send only \$3.50 for your copy to Dept. 90

**POPULAR MECHANICS PRESS**  
200 E. Ontario, Chicago 11, Ill.



## The New TOOLITE

**THE COMPLETELY NEW TOOL THAT SEES IN THE DARK**

A brand new tool for electricians, and TV men, mechanics and servicemen. Lets you work in the dark with one hand... without a flashlight.



**Two Sizes 1/4" and 3/8"**

- EXTRUDED PLASTIC HANDLE
- 200 FOOT LIGHT BEAM
- NON-CONDUCTOR
- CADMIUM PLATED
- USES STANDARD BULB AND BATTERIES

Fits over 200 standard 1/4 or 3/8-inch drive tools.

Safety Signal Light

Light remains on exact point of tool at all times

Patented and fully Guaranteed

**TOOLITE MFG. CO.** Dept. P4  
1712 Warrior Road, BIRMINGHAM 8, ALABAMA

I enclose \$2.95 plus 5c for packing and handling costs (a total of \$3.00) for each TOOLITE. Specify size.  1/4-inch  3/8-inch

Note: Jobbers, distributors and agents write for price lists and discounts

NAME \_\_\_\_\_  
ADDRESS \_\_\_\_\_  
CITY \_\_\_\_\_ ZONE \_\_\_\_\_ STATE \_\_\_\_\_

**SEND TODAY**

GIGANTIC  
SAVE-TO-70%

# MAIL SALE

WAR SURPLUS  
EXCESS INVENTORY  
BANKRUPT STOCK

## GOLF CAR BATTERY MOTOR

● Powerful direct-current, heavy duty, Timken bearing motor with built-in precision 18-to-1 gear reductions. Runs on ordinary 6, 12 or 24-volt storage battery. 200 to 400 R.P.M.



● Build your own self-propelled golf car, warehouse cart, store lift truck, electric boat winch, boy's midget auto, garage door opener, motorized invalids wheel chair, etc.

● Output shaft 1" diameter. Wt. 22 lbs. Gov't. cost over \$200.

Special F.O.B. Lincoln. . . . . \$13.46

## AIR COMPRESSORS

● Piston Air Compressor, 150 lbs. . . \$19.95

● 2-Cylinder Air Compressor, 150 lbs. \$49.95

● Auto Pressure Switch for motor . . \$4.95

● Air Kit, Comprsr, Tank, Gun, etc. \$39.95

Save to 70%. FREE CATALOG.

## 6-Volt HYDRAULIC PUMP

● Complete hydraulic system. 6-v DC motor operates from truck battery. Drives 2,500 lb. per sq. in. pump. Has control valve, etc.

● Use for dump trucks, snow plows, jacks, lifts, special machinery, etc. Leading make. F.O.B. Wt. 48 lbs. List \$121.50. SALE \$45.95

## ARMY POWER PLANTS

● Marvelous buys in new condition Govt. surplus plants and generators. We pay freight!

● 1000-w, 115-v, 60-c, \$149.50

● 2000-w, 115-v, 60-c, \$289.50

● 3000-w, 115-v, 60-c, \$299.50

● 7500-w, 115-v, 60-c, \$595.00

● 3000-w, DC generator \$58.75

Many others. Send for Free Bulletin.

## HYDRAULIC BARGAINS

● Control Valve, 1 or 2 way. . . . . \$18.00

● Pump, 1000 lbs. 12 gpm. . . . . \$45.50

● Pressure Gauge, 1000, 1500, 3000 lb. Specify. . . . . \$3.49

● Cylinder, 2"x10" 3141 lbs. lift. . . \$17.50

Many other types, sizes and items. All brand new. Free catalog.

## IRRIGATION PUMP

2 1/2" size, 16,500 gph

● Brand new Navy bronze ball bearing hi-capacity centrifugal. Wonderful small farm and truck irrigation, many industrial uses.

● Capacity to 280 gpm. Pressure to 65". Speed 2100-2700. Clock-wise rotation. Complete with 6" pulley. Wt. 40 lbs. Size 10"x11"x9". Inlet 2 1/2", outlet 2".

● 2 units driven by single engine deliver almost 600 gpm or 33,000 gph. Natl. Adv. list \$98 each. SALE. Prepaid. . . . \$44.37

Many other types, sizes. Free catalog.



## SPECIAL OF THE MONTH! WEED SPRAY OUTFIT

● Leading make. Latest design. 5-row (17'). P.T.O. tractor-drive roller pump. T-jet nozzles, finest controls, gauges, hose. Complete. Only 48 units. List \$175. Ppd. in U.S.A. . . . \$97.65

Everything in weed spray outfit. FREE big weed spray catalog.



## SPECIALS FROM PREVIOUS ADS

● AC-DC Power Rectifiers (F.O.B.) . . \$15.61

● Electric Drills 110-V 1/2" (342) . . \$31.95

● Campers Power Plant 28-V (3425) . \$69.50

● Robot Control Cylinder . . . . . \$3.89

● Auto Trouble Safety Light . . . . . \$2.71

● Govt. Steel Tower. 30' F.O.B. Ky. . \$31.95

● Automatic Remote Control Switch. \$13.71

● Air Power Tree Trimmer . . . . . \$15.37

● Surveyors Level and Tripod . . . . \$42.95

● Surveyors Transit and Tripod . . . \$79.50

● Giant Flood Light . . . . . \$49.50

● Navy Bomb Hoist (150 lbs.) . . . . \$29.95

● Boat Winch, 150 lbs. . . . . \$8.95

● Finest Tractor Nitrogen Spray Pump \$54.50

● Electric Chain Saw, 12" . . . . . \$99.50

● Farm Wall Phone . . . . . \$9.95

● Portable Govt. Air and Spraying Tank \$13.49

ORDER FROM AD or write us for big

**FREE CATALOG** 1000s of items! Motors, sporting goods, hand and electric tools, watches, traps, etc., etc. We pay freight except where stated "F.O.B."

**BURDEN SALES COMPANY**  
806 "O" St., LINCOLN, NEBR.



## BRONZE FOUNDRY

Schools and Home Workshops

Make your own castings of aluminum, copper, bronze, silver. Foundry sets are available in three sizes including 2400 Deg. F. blast Furnaces. \$22.50; \$29.50; and \$42.00. f.o.b. Marysville, Kans. Free Circular.

KANSAS CITY SPECIALTIES CO. P. O. Box 6022, Dept. P-4 MARYSVILLE, KANS.

SAY YOU SAW IT IN POPULAR MECHANICS

Also Eshelman Adult 2 Pass. SPORT & GOLF Cars 1/5 the Price of most other Cars. 70 Miles Per Gal. Free Catalog.

## ESHELMAN TRACTORS

LOW \$99 AS

BAKES - FLOWS - CALIBRATES - SAWS  
DOZES - HARROWS - MOWS - ALUM - BELLS  
SPRAYS - REELS - MOWS - CUTS - TILLS

Eshelman Tractors, Tillers, Riding Rotary Mowers for Better Lawns and Gardens. Advertised in GOOD HOUSEKEEPING and Leading Magazines, Amazing Savings. Write for Free Literature.

ESHELMAN CO., Dept. R-54, 109 Light St., Balto. 2, Md.



Shipping Points: BALTIMORE - CHICAGO - DENVER

# HAVE FUN!



SAVE MONEY

GRINDER  
SANDER  
30" LATHE  
HORIZONTAL DRILL PRESS  
8" TILTING TABLE SAW

TRY SUPERSHOP FREE  
Factory To You — \$79.95

Think of the fun you'll have and the money you'll save with your own big capacity workshop. Picture yourself sawing with the 8" bal bearing saw. Or drilling in steel with the vertical drill press. You bore with the horizontal drill — exclusive with SUPERSHOP. You sand with the 8" disc sander. You turn with the 30" lathe. You sharpen tools on the 5" grinder.

You are invited to TRY SUPERSHOP FREE. We will pay all shipping expense. Write for full details of this amazing FREE TRIAL PLAN. Mail postcard now.

**POWER TOOLS INC.** 182 Yates Ave. Beloit, Wisc.

# NEW Easy-to-Use SOLDER\*



Solders in ONE operation... just apply Swif and heat

SWIF is a real 50/50 tin-lead solder in paste form with flux combined. Just apply Swif and heat. All extra preparatory steps are eliminated by its one-step cleaning, tinning and soldering action. It makes perfect soldered connections with the heat of a match, torch, or soldering iron. Tube holds enough Swif for hundreds of jobs. Swif has been used by professional plumbers for years. At hardware, hobby, plumbing and auto stores. 59¢ per tube.

Send For Free Literature  
**HERCULES CHEMICAL CO., Inc.**  
416 B'way., New York 13, N. Y.

# Finishing is fun...



## WITH NEW Behr-cat SANDPAPER HANDY PACKS

You can bring-up "silky," professional-looking finishes on all your home sanding jobs and enjoy every minute of it with Behr-cat Handy Pack sanding sheets. Each pack contains an assortment of grit sizes — from fine to coarse — assuring fast, easy sanding during every stage of your job. You'll find dozens of uses for Behr-cat Handy Pack sanding sheets in your home or shop. Look for them at Hardware and Paint Stores.

### HERE'S INSIDE INFORMATION ON FINISHING!

Finishing School for "DO-IT-YOURSELF" Folks is a 32-page illustrated book with "how-to" instructions for finishing wood and metal. Get a copy at your Hardware or Paint Store or send 25¢ to Behr-Manning, Troy, N. Y., Dept. PM-4.



C-4  **BEHR-MANNING**  
division of NORTON Company

Pressure-sensitive masking, strapping, freezer and many other tapes. Sandpaper, abrasive cloth and sharpening stones for home and industry.

# DO-IT-YOURSELF WITH

## REDI-RODS<sup>®</sup> STEEL BARS



COLD DRAWN ROUNDS      HOT ROLLED FLATS ANGLES

Use these handy steel bars for your repair and construction jobs around farm and home. ROUNDS: 36" long — 1/4" to 3/4" diam. FLATS: 36" long, 1/8" x 3/4", 1" & 1 1/4" wide. ANGLES: 1/8" x 1 1/4" x 1 1/4", in 36", 48", and 60" lengths.

**REDI-BOLT, Inc.** 5330 Indianapolis Blvd. East Chicago, Indiana

**NOW... at Your Hardware Store!**

## TORQUE Specifications

Engine Torque Recommendations (automobile, truck, tractor, Diesel and marine) tabulated for 70 different manufacturers' products plus handy chart with suggested torque values for all screws from No. 4 to and including large 2 inch bolts — also many torque tips.

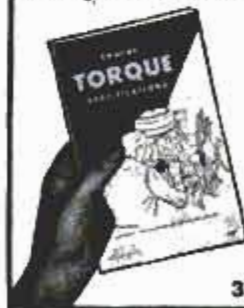

Send 50 cents to

**TORQUE WRENCH**  
335 W. First St. • Elmhurst, Ill.

Insist on  
*Evans*  
**TAPES**  
**KING-SIZE**  
At your  
hardware  
store



6-ft. **\$1.49**  
only

3/4" wide blade stands up straight for one-man upright measurement.



Also available in 8, 10, 12-ft. lengths with free plastic utility case.

**EVANS RULE CO., Elizabeth, N. J. 3066**



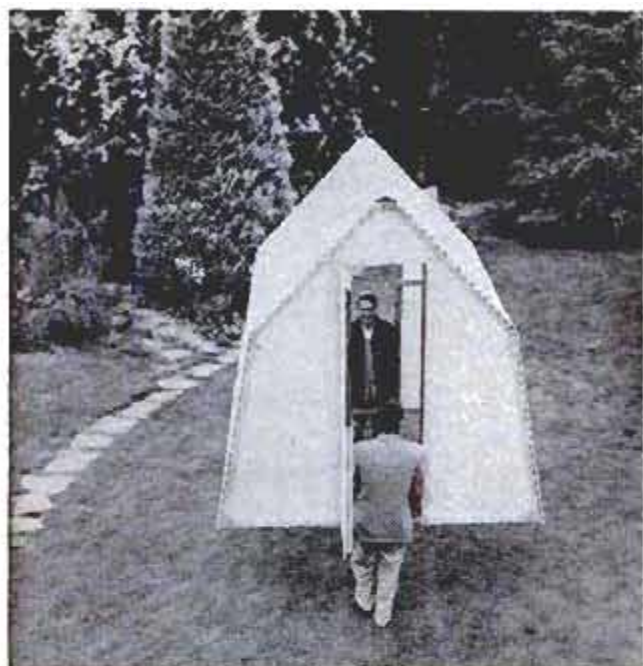

### Portable Plastic Greenhouse Extends Growing Season

If your green thumb has in the past flourished only in the summer months, a portable plastic greenhouse now available may cause it to stay green all winter. Made of specially developed plastic sheets prepared scientifically for maximum light transmission and diffusion, it can be set up



quickly and moved easily. The plastic has a low heat conductivity, making it economical to heat the greenhouse during the winter months. Total weight of the house is 150 pounds, and it measures 8 feet by 8 feet, by 7½ feet high. Because of the diffusing power of the plastic, it is possible to have two layers of benches in the greenhouse, doubling the growing area. The structure can also be used as a storage shed.

## Here's that new **MAGNA** **BELT SANDER**

This versatile 6" Magna Belt Sander has all the built-in features and precision you'd expect from the makers of SHOPSMITH®.

\* Exclusive Twin-Tube Mount for bench, Magna Power Stand, or SHOPSMITH. Timesaving *Instan-Tension* gives you convenient belt and tool height adjustment.

- ① Operates horizontally or vertically—big 6" x 16½" back-up plate provides greater ease.
- Single knob controls belt removal and tension.
- Belt tracking controlled by single knob.
- Table tilts 45°—side-mounts as a fence.
- Auxiliary shaft mounts disc sander, etc.

Only \$49.95. Low monthly payments on Magna-Tool-Time Plan. See the new Magna Belt Sander demonstrated at leading hardware and department stores or any Montgomery Ward Store.

For free literature, write Dept. 328-B, Magna Power Tool Corp., Box 2808, Fort Wayne, Indiana, or Menlo Park, California.

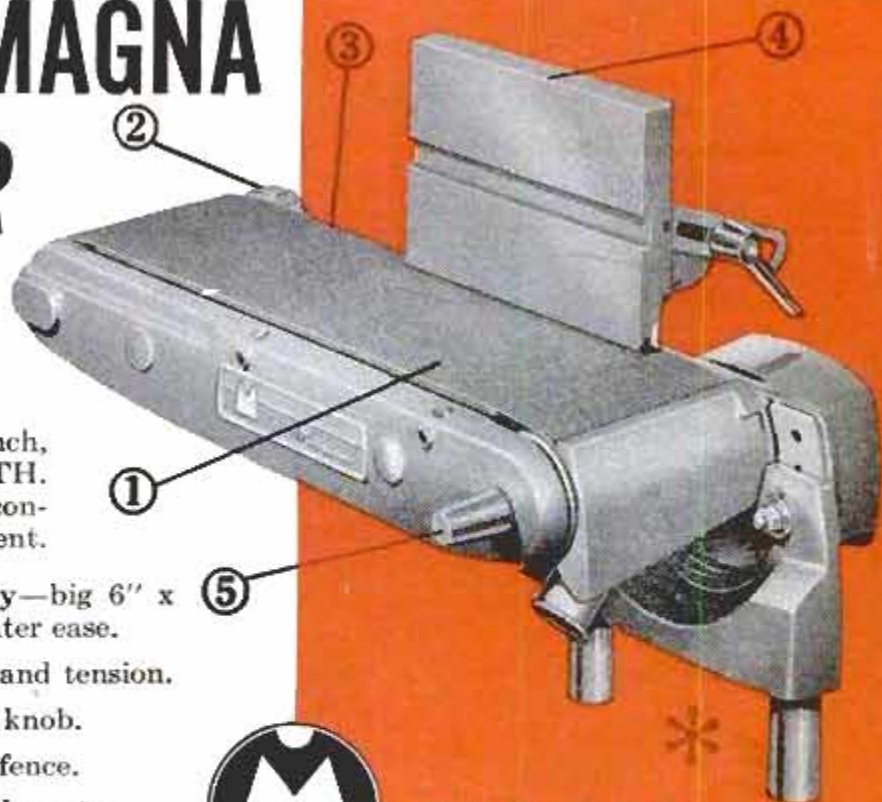

**MAGNA**  
POWER TOOL  
CORPORATION  
Manufacturers of  
SHOPSMITH

*Smoother casting  
longer lasting  
casting-spinning-squidding lines*



... Preferred  
at Famous Fishing Spots

Two great names in lines... **H-I-FLOAT**, the famous hollow center, non-sinkable fly line... and **SKIRR**, America's No. 1 fresh or salt water line for spinning, bait casting, surf casting and squidding.

H-I unconditionally guarantees these lines to be the finest on the market today, regardless of price! Prove it for yourself, at your dealer's.

Look for   
on the tackle you buy  
Rods, Reels, Lines, Lures,  
for every fisherman and  
every kind of fishing



Valuable Fishing Guide. Send 25¢ to  
**HORROCKS-IBBOTSON CO.** Dept. PM-426, UTICA, N. Y.  
Manufacturer of the largest line of fishing tackle in the world

**SPARE-TIME MONEymaking OPPORTUNITIES**  
**READ OUR CLASSIFIED ADS**

**HUNDREDS OF BARGAINS**      **AMAZING OFFERS**

**BUILD YOUR OWN POWER TOOLS-**

**PLANS**  
**only**  
**1.00**  
**EACH**  
**POSTPAID**

With **GIL-BILT PARTS-PLAN KITS**  
**10" TILT/ARBOR SAW**

Sturdy wood, steel, and aluminum construction, NEW DEPARTURE ball bearings. Capacity and performance of floor saws selling for \$150.00 and up. Plans, all metal parts in kit with 10" comb. blade **\$25.90**, less blade **\$22.95**. F.O.B. St. Louis. Detail PLANS—PATTERNS only \$1.00 postpaid.

**12-IN. BAND SAW**  
Ball bearing drive, rigid cast aluminum wheels, rubber tires. Handles stock up to 8 inches thick. Cuts to center of 24" circle. 18 x 18 inch tilt table. Capacity and performance of band saws selling for \$80 and up. Plans and all metal parts in kit with 1/4" blade **\$23.95**. Detail PLANS—PATTERNS only \$1.00 postpaid.

For shipments up to 600 miles, add 5%; over 600 add 10%. Amount in excess of actual postage will be refunded. Also Build-it-yourself 18" Band Saw, 6" Belt Sander, Shaper, 8" Tilt-Table Saw. Simplified plans, build easily with hand tools only. Advertised and sold for 8 years, over 30,000 units in use. Money back Guarantee. **FREE CATALOG.**

**GILLIOM POWER TOOLS** DEPT. 80-D, LAMBERT FIELD ST. LOUIS 21, MISSOURI

**Grips the screw!**

Drives it too!

**Quick-Wedge  
SCREW-HOLDING  
SCREWDRIVER**

2" to 14" blades, 4 bit sizes  
Available with shockproof  
plastic covered tubing  
Unconditionally guaranteed

**ASK FOR IT AT YOUR DEALER**

Kedman Co., 233 So. 5th W., Salt Lake City



**NEW-INTER-COM PHONE SET**  
**FULLY GUARANTEED**

For use between rooms, homes, garages, basements, backyards, offices, warehouses, schools, etc. . . Just press buzzer—pick up phone and talk long distances. Comes complete with 2 phones, wall hangers, double strand wire with plugs, 2 standard batteries—all ready for use.

Special Introductory Price **only \$4.98** Ppd. Complete  
**DELUXE MODEL—WITH BASE**... \$6.98 Ppd.  
Additional wire—30 ft. .... \$1.00  
**ROCO ENTERPRISES** P.O. Box 309  
Rutherford 2, N. J.

**HELPFUL BOOKS**

Send post card asking for **FREE** catalog

Popular Mechanics Press, 200 E. Ontario, Dept. 601, Chicago 11

14" Model Pictured  
**42 TOP PERFORMING MODELS, 8' thru 18'**  
...from \$39.25 incl. frt.

**FREE!**  
**BOAT KIT**  
**CATALOG**

Bunabouts, Cruisers, Convertibles, Fishing, etc. for every purpose with modern styling, advanced design. No experience necessary, amateurs can easily assemble. Save 1/2 to 3/4 "factory-built" prices!  
**FIBERGLAS, TRAILERS, ACCESSORIES**

**LUGER INDUSTRIES, INC.** DEPT. B-4 3404 Lyndale S. Minneapolis 8, Minn.

**115 VOLT A.C. GENERATOR**

**MAKES A GOOD LIGHT PLANT**

**SAVE 91% ON WAR SURPLUS!**  
Buy of the Year! Brand New Bendix generators in original cartons. Perfect—Guaranteed! A.C. output 115 V., 10.4 AMP, 1000 Watts, sing. Phase, 800 eye., 2400-4200 R.P.M. or D.C. output 30 V., 60 AMP. Splined drive shaft. Self excited. Aux. light plant or stand-by unit for farm, cottage, camp, boat or floodlight use. Drive from any power take-off. D. C. powers motors—charges batteries. A.C. powers lights and heaters but not motors. Shp. WT. 50 lbs.

Brand New (order #325A)..... **\$24.95** Good, Used (order #326A)..... **\$14.95**  
Prices are F.O.B. YORK. Send dime for big bargain Catalogue  
**KARL ORT, Dept. P.M. 4, York, Pa.**

Need an extra \$1,000, \$2,000, or more? Make it with an

**IDEAL LAWNMOWER SHARPENER**

There are thousands of lawnmowers in your locality; Average \$1,000 profit per 250 mowers with customer satisfaction and repeat business assured. Provide this essential service with an Ideal Lawnmower Sharpener, the only machine that grinds the reel to "fit" the bed knife. Compare by any standard. The Ideal, backed by 53 years of experience, costs no more. Write today for complete, free catalog.

**THE FATE-ROOT-HEATH COMPANY**  
Dept. PM-4 Plymouth, Ohio

# EXPERT WOOD FINISHING

made easy!

Now anyone can get a professional wood finish every time.

**deft**  
WOOD FINISH



A clear semi-gloss interior wood finish that SEALS, PRIMES and FINISHES. Nothing else to use. *Deft dries in 30 minutes.* No thinning. A 3-coat bar top finish can be had in a few hours instead of days. Use on paneling, floors, cabinets, furniture, any interior wood surface. See your dealer or write for free Deft booklet. D-M DESMOND'S 1826 W. 54th St., Los Angeles 62, Calif.

**WELD** **BRAZE** **4WAY**  
**SOLDER** **CUT** **ONLY \$14.75**  
f.o.b. factory



**WELDER**  
Complete with Twin Carbon Arc Torch and accessories... to handle all metal-craft work.

Acclaimed by thousands of Homeowners, Mechanics and Hobbyists as the welder of 1001 uses. Easily operated from properly wired 110 volt AC or DC line. The ideal gift with a life-long use... Order today on 10 day money back guarantee.

**FOUR-WAY WELDER CO., Dept. F2-D**  
1810 S. Federal St. • Chicago 16, Ill.

## HELPFUL BOOKS

Send post card asking for FREE catalog  
Popular Mechanics Press, 200 E. Ontario, Dept. 601, Chicago 11

## SENSATIONAL NEW HIGH SPEED DRILL MASTER

NOW turns the ordinary shop drill into HIGH SPEED DRILL. PRESS at a big saving. When DRILLMASTER is used on a 5,000 rpm drill press its top speed will be 20,000 rpm. Does the work of expensive high speed drill presses on brass, aluminum, plastics and cast iron where high speed drilling is necessary. Available for work of any size runs. Fits any 1/2" chuck, holding drills from 5/32 to #80. Shafts are heat treated and ground. Ball bearings and oil impregnated bearings and gear train are housed in cast aluminum. Precision made throughout. **\$62.50** Fob. Wt. MAIL ORDER TODAY only... 10% DEPOSIT. 25% ON C.O.D. ORDERS WE REQUIRE A 10% DEPOSIT. 25% DIRZIUS MACHINE SHOP "A", 1423-25 So. 52nd Ave., Cicero 50, Ill.

## L.P. (BOTTLEGAS) REGULATORS

FOR CABIN - TRAILER - BOAT OR HOME

Now! OWN YOUR OWN... AND BE FREE TO BUY GAS WHERE YOU GET THE BEST PRICE!

Approved! Finest Quality!

FOR ANY BRAND OF GAS

SINGLE CYLINDER REGULATOR WITH CYL CONNECTOR \$6.95

UNCONDITIONALLY GUARANTEED AGAINST MECHANICAL DEFECTS FOR ONE YEAR

TWO CYLINDER REGULATOR COMPLETE AS SHOWN \$9.95

PREPAID IF CASH WITH ORDER 25% Must Accompany C.O.D. Orders

**APPLIANCE SERVICE CO.** Dept. PM-4 WEST VIRGINIA, MINN

## Mammoth 1956 Wholesale Tool Catalog



**\$10**  
puts You In Business

The opportunity now awaits you to own and operate your own business on a part time or full time basis in the lucrative field of HARDWARE, HAND TOOLS, FANS, POWER TOOLS, MOTORS, PAINTS, etc.. or BUY TOOLS FOR YOUR INDUSTRIAL OR INSTITUTIONAL USES.



Buy Nationally Advertised Tools for Resale or Industrial or Institutional Use  
NO INVESTMENT REQUIRED, BUY AS YOU NEED IT. A MILLION DOLLAR INVENTORY AT YOUR FINGER TIPS.

Discount UP TO **50%**



\$1.00 refund on first purchase or refund if you are not 100% satisfied.

Every one needs tools. Meet the demands of the growing "Do-it Yourself" markets. Sell direct from the jumbo buying guide—your cost is known only to you.

JUST FILL OUT COUPON

ENCLOSE \$1.00 FOR DEALER'S 1956 MAMMOTH TOOL CATALOG.

**SILVO HARDWARE COMPANY**  
Dept. PM-4, 108 Market St., Philadelphia 6, Pa.

I am enclosing \$1.00. Rush me your dealer's mammoth Catalog Today. If I am not completely satisfied with your plan, I understand that I can return the Dealer's Catalog for refund, and if I decide to order, my \$1.00 will be deductible from my first order.

NAME .....

ADDRESS .....

CITY ..... ZONE ..... STATE .....

# FIXIT TIPS....

WITH "SCOTCH" BRAND  
MASKING TAPE



**REPAINTING BASEBOARDS?** Use this professional trick: protect carpeting with tight-sticking "SCOTCH" Brand Masking Tape and paper.



**STRIPING FURNITURE?** This stretchy tape hugs curved surfaces, strips off cleanly and leaves neat edge. Get "SCOTCH" Masking Tape in handy dispenser carton with cutter edge, wherever paint is sold.

© 1956, Minnesota Mining & Mfg. Co., St. Paul 6, Minn.

Also Eshelman  
Adult 2 Pass.  
**SPORT &  
GOLF Cars**  
**1/5**  
the Price of  
most other  
Cars. 70 Miles  
Per Gal.  
Free Catalog.

**ESHELMAN TRACTORS** LOW AS \$99

For Better Lawns and Gardens investigate Eshelman Riding Rotary Mowers, Trimmers, Tractors. Advertised in GOOD HOUSEKEEPING and leading magazines. Amazing Savings. Free Literature Write: ESHELMAN, Dept. M-54, 109 Light St. Balto. 2, Md.

Shipping Points: BALTIMORE - CHICAGO - BENO

send for  
**FREE**  
tool catalog

SNAP-ON TOOLS CORPORATION  
8062-D 28th Avenue, Kenosha, Wis.

Send me free catalog.

OCCUPATION .....

NAME .....

ADDRESS .....

CITY ..... ZONE ..... STATE .....



A big, fact-packed catalog full of pictures and tool information . . . yours for the asking.

- Snap-on tools help you handle repair jobs faster, easier, better.
- Snap-on tools LAST . . . pay for themselves over and over.
- Used and endorsed by America's top-earning mechanics in all fields.
- Start building your Snap-on set with basic units . . . add other tools any time.

**Snap-on Tools**  
THE CHOICE OF BETTER MECHANICS

## ... ACCESSORIES FOR ELECTRIC DRILLS ...

### HAND TOOLS — MOTOR AND FLEXIBLE SHAFTS

**90 MOUNTED WHEELS, CUTTERS & BURNISHERS**

For cutting and grinding on Wood, Metal and Plastic. Kit includes 30 Mounted Wheels and Points, 55 Miniature Cutters and 5 Burnishers. All on 3/32" Shanks. Made to sell for \$15.00. Our price . . . . . **\$4.98 pp.**

### 21 LARGE ROTARY CUTTERS

Assorted sizes—mounted on 1/2" and 3/32" shanks. For cutting Wood, Plastic and Metals. Will fit all hand grinders, Electric Drills and Flexible Shafts. Reg. \$12.50 value

Our Price **\$4.95 pp.**

### ADAPTER CHUCK

With two interchangeable collets. Openings 0 and 3/32". Price **\$1.19 pp.**

Also available: 0 & 1/8" on 1/2" shank Adapter chuck to hold drills from No. 60 to 80. . . . . **\$1.00 pp.**

### No. 61 to 80 DRILL SET IN A METAL INDEX

20 drills of CHROME VANADIUM STEEL especially hardened for precision drilling very tiny holes. For Tool Makers, Hobbyists, Model Makers, Jewelers, etc. Reg. price \$5.98. Our price . . . . . **\$4.25 pp.**

### MONEY BACK GUARANTEE

**MATTHEW DAY CO., INC.** DEPT. PM-4  
DUMONT, NEW JERSEY

There's a **Katolight**

### ELECTRIC PLANT

for every portable or standby power need.



### HOME • FARM • COTTAGE • COMMERCIAL

Katolight Portable Power Plants give you electric power anywhere . . . anytime. Standby Plants permit uninterrupted operation of all electrical equipment despite power failure. Extra high overload capacity. Long life, dependability. Full line from 350 Watts to 75 KW and larger.

WRITE FOR NEW FOLDER KATOLIGHT CORPORATION, Box 891-22 Mankato, Minn.

### "SPEEDY" DRILL GRINDING GUIDE

MAKE OLD DRILLS LIKE NEW...

For repointing dull and broken twist drills up to 1/2" in diameter. One piece cast Aluminum. Simple. Anyone can use it. Order yours to-day. \$1.00 post-paid.



BRASS CASTING CO. P. O. Box 3054 Memphis 9, Tenn.

**\$1.00**

### 24" ATTIC FAN KIT

Easy to assemble. Belt-driven. Blade, shaft, 2 self-aligning bearings, 2 pulleys, 2 collars, and V-belt. Everything you need, except frame and 1/4-hp motor, to make your own house cooler. Send for complete list of fan parts.

PENNA. WHOLESALE DISTRIBUTORS  
104 N. 6th St., Phila. 6, Pa.

ONLY **\$9.95**

SAVE \$46.00

**ARMY SURPLUS CAMP AXE**  
 Top quality. Has a 23" hardwood handle. Extra sturdy steel head. Complete with leather belt holster. With snap-down cover flap. . . . **2.95**

**U.S. ARMY FIELD PHONE**  
 A private phone or intercom system. Ideal for use on target range, farms, mountains, forest or any place where portable two-way communication is desired. This is the famous EE-8 field phone used to success by the Signal Corps. Gives clear reception up to 15 miles. Uses two standard batteries. Set consists of a ringing generator, one phone, all contained in the original handy carrying case. Several of these phones can be used on one line. Records checked out. Price per set. **14.95**  
 Price for a SYSTEM - two sets. . . **29.50**

**VICKERS HYDRAULIC TRANSMISSION**  
 Self-contained, constant torque at all speeds with variable volume, reversible piston pump which supplies piston hydraulic motor. Has 2 H.P. Automatic pressure dash pot for smooth control. Power output RPM - 0 to 1/3 input RPM in both directions. Input RPM 1800 continuous, 4000 intermittent. Ideal for Lathes, Dupli-cator setup on Mills, Conveyors, Small Cars, Drives, etc. **49.50**  
 4" SPLINE SHAFTS for input and power take-off on above. Pair **\$2.50**  
 INPUT & TAKE-OFF PLATE ASSEM. To adapt Trains, to pulley drives. Has 1/2" keyway shaft. High Speed bearings. **20.00 SET**

**NEW SURPLUS ELECTRIC LINEAR ACTUATOR**  
 Has a 5-1/4" stroke. Delivers an 800 pound thrust and will stand a 1750 lb. static load. Motor operates on 24 volt DC current at 11-1/2 amps - turns at 7500 RPM with 1/8 HP. The overall length, eye-to-eye is 13 inches. . . . **9.95**

**NEW 4-WAY OPEN CENTER CONTROL VALVE \$21.50**  
 Has built-in adjustable relief valve set at 1000 PSI. Spring loaded neutral position. For use with one double action cylinder. May be mounted in series. Has 3/4" pipe inlet and outlet with 1/2" pipe threaded cylinder ports. Shipping weight 10 1/2 lbs.

**SURPLUS BARGAIN**  
 No. 29 HYDRAULIC CYLINDER - Will give 20,000 pounds thrust using 1500 PSI line pressure as delivered from one of our hydraulic pumps. Gives up to 40,000 lbs. thrust with 3,000 PSI. Has a 4" bore and 18" stroke. Overall length 30 1/2 inches. **USED 29.95 NEW 43.95**  
**SAVE 50% ON NEW PALLEY HYDRAULIC CYLINDERS**

Send for Special HYDRAULIC CATALOG SUPPLEMENT - Shows entire line of new Hydraulic Equipment designed especially to fill the needs of Industry. Also SAVE up to 85% on War Surplus Hydraulic Equip. Including Pumps, Valves, Fittings, etc.

**Palley's** 2263 EAST VERNON AVE. DEPT. PM-4 LOS ANGELES 58, CALIF.

**NOW! A PROVEN FACT - SAFETY BELTS SAVE LIVES**  
**NYLON AUTO SAFETY BELTS**  
 MADE TO WITHSTAND A CRASH  
 LOAD OF 3000 POUNDS!!!  
 Meets CAA standards. Approved by Police, Safety Councils, Highway Patrol, Fleet Operators, etc. Made of finest NYLON webbing and fitted with Aircraft type buckle. Easily installed in any car. Special sizes for Sports Cars. Available in the following colors: Blue, Green, Gray and Maroon. Don't wait! You May Be Sorry!  
**9.95 VALUE ONLY 4.89 EACH**  
 SPECIFY COLOR AND ALTERNATE COLOR  
**3 SECONDS TO FASTEN - 1 SECOND TO UNFASTEN**  
 HOLDS YOU IN YOUR SEAT  
 PREVENTS THIS

**PHILIPPINE MAHOAGANY PLYWOOD**  
 AT PRICES LESS THAN WHOLESALE  
 For Paneling Dens, Offices, etc. Use in Cabinets, Furniture, etc. Rotary Cut. Both sides sanded. Banded with finest resin adhesive. Face side unjointed. Shipped at lowest rates.  
**FROM IMPORTER SAVE 50%**

**FREE SAMPLE ON REQUEST**  
 1/8" x 3 ft. x 6 ft. **\$500 VAL. 179 SHEET** MIN. ORDER 8 SHEETS  
 1/4" x 4 ft. x 8 ft. **90 VAL. 449 SHEET** MIN. ORDER 4 SHEETS  
**SAVE 40% - TRANSLUCENT FIBERGLAS PANELS**  
 Use it to cover patio, for interior decor, as walls, partitions and many other uses. Ideal for the Home or Office & in new construction. Finest quality, many widths and lengths. Variety of colors. FREE Sample and Booklet. An 85¢ per sq. foot value. **ONLY 99¢**

**3400 RPM - 1/2 HP POWER SAW**  
**RIPS - CROSSCUTS CUTS A FINISHED 2x4 LIKE A KNIFE THROUGH BUTTER**  
 COMPARES TO SAWS SELLING UP TO \$49.50 **19.98** Complete with 5-1/2" Blade  
 A rugged, professional type, adjustable saw. Will cut any angle from 0 to 45°. Has an adjustable 0 to 5" rip fence. Safety-trigger switch on handle. Full 1/2 HP Universal AC-DC, 110-120 Volt, 60 cycle motor. Weighs only 6 1/2 lbs. Thousands already sold. Your satisfaction guaranteed.  
 EXTRA SAW BLADES - Available in Rip, Crosscut or Combination. Please Specify. Price per each **ONLY 2.75 ea**

**SAVE UP TO 50% ON SPORT DIVING EQUIPMENT**  
**BUILD YOUR OWN DIVING LUNG - SAVE up to \$100.** Our special folder contains complete instructions showing how it's done. Kit includes: Air Bortles, Pressure Regulator, Hoses, Safety Belt, Shoulder Harness, Clamps, Mouth Piece, Valves, etc. . . .  
 Price for above kit . . . **45.95** (1 hour time)  
 Has latest info on Diving Equipment. Plus an illustrated and described article on "How to build your own Diving Lung". **\$150.00 value**

**ARMY CANTEN CUP & BELT**  
 Genuine U.S. Army equipment. The one quart canteen and aluminum cup fit into the insulated canvas cover. Cover hooks onto the web type pistol belt, which has metal grommets for hooking on other gear. **2.59**  
 IDEAL FOR BOY SCOUTS

**ARMY SURPLUS WADING SUIT**  
 Covers the entire body from the neck down. Protects you from mud, water, etc. Originally designed for overboard work in the Navy. Made of heavy duty rubberized canvas with vulcanized seams. Has built-in rubber boots and gloves. Sizes: Small, Med., and large. **\$35.00 value. 8.95**

**BOLO KNIFE**  
 Top quality steel, 15" long. Complete with sturdy belt sheath. Use for clearing brush, etc. **1.98**

**ARMY PICMATTOCK**  
 Small, easy to use, has a 12" steel head with Nutlock on one side, pick on other. 16 1/2" hardwood handle. With case. **ONLY 1.98**

**AIR CORPS SEXTANT**  
 Can be used for any navigational purpose. Contains many valuable optical lenses, prisms, gears, drives, spring motor, bubble level, etc. Can be used as is. Comes with sturdy plastic bag. **17.95**

**SPECIAL VARIABLE SPEED DRIVE**  
 Originally part of the turret gun sighting mechanism. A very valuable piece of precision machinery. Contains a gear reduction box, several bronze gears, a worm drive, many ball bearings, etc. This unit provides precise controlled output power which may be reversed while in operation. Forward and reverse output rpm may be controlled to closest tolerances. Can be adapted to many uses in machine work where exact, constant or variable output power is required. Sturdy bronze and magnesium castings, finest steel parts. **29.95**

**GENUINE AN6530 ARMY AVIATORS GOGGLES**  
 Has precision ground, interchangeable lenses. Your choice of 3 lens colors - Clear, Amber or Green. Frames are rubber covered with soft chamomile lining and built-in, non-fogging lens ventilators. Adjustable nose bar and elastic headband. WINDPROOF - DUSTPROOF!  
 Genuine Air Corps Surplus. NEW Give lens color choice . . . . . **2.49**  
 EXTRA LENSES - colors above. **1.00 PR**

**ARMY D-12 MAGNETIC COMPASS**  
 Designed as navigational equipment on Army Aircraft. Has a rotating verge range ring, calibrated in 1 degree increments from 0 to 360°. Two parallel grid wires for N-S alignment. For use in Airplanes, Boats, etc. New, low price. . . . **9.95**

**SELVYN TRIGGER MOTOR**  
 A Synchronous AC motor. The most accurate type of electric motor made. Will operate without speed variation for indefinite time. Ideal for precision work. 115 volt - 60 cycle. **ONLY 14.95**

**133 PIECE POWER TOOL ACCESSORY SET**  
 The complete accessory set for any small job. Can be used with any electric drill or grinder. Contains 133 pieces including grind, polish, cut-off & buffing wheels, sanding discs, steel cutters, mandrels, burnisher, mounted stones and knife edge rubber wheels. A very handy set for the model builder or hobbyist. Worth many times our price. **1.98**

**PRESSURE TANKS**  
 G1 Type Stainless Steel. Shatterproof and rustless. Has reinforcing ribs and is pressure tested up to 400 PSI. Has high safety factor, 1/4" girth ports. Ideal for use in air supply in underwater fishing, painting, spraying, etc. Also as buddy or for water supply. Size: 12 1/2" x 24". Stainless Steel. . . **12.95**  
 Corrosion Resistant Steel TANK - No. D-2 500 cu. in. capacity. . . **3.95**

**need concrete  
use SAKRETE**

Pre-mixed and packed in convenient sized bags for all home cement building, patching and repairing.

**QUICK  
CLEAN  
EASY**

Sand Mix . . . Gravel Mix . . . Mortar Mix. Just add water. SAKRETE MIXES are scientifically proportioned to give perfect results.

● For the SAKRETE 48-page booklet with photos, diagrams and instructions for "Do it yourself" cement jobs, see your building supply dealer, lumber dealer or hardware store or send 25 cents to —

**SAKRETE, Inc.**  
P. O. Box 11, Dept. A  
Cincinnati 17, Ohio

**CUTS PERFECT HOLES  
THROUGH WOOD, ALUMINUM  
PLASTICS, ETC. IN SECONDS!  
WITH EASE!**



**IN DRILL PRESS IN HAND DRILL**

**CUTTING BLADES ADJUST  
SIMULTANEOUSLY  
with Allen wrench  
from 2" to 6"**

**\$1975** Includes • VirCut Hole Cutter • Blades for cutting aluminum and other like metals to 1/2" • Blades for cutting wood to 1 3/4" deep.

The sensational heavy-duty, precision-made VirCut Hole Cutter is **GUARANTEED**. Order direct; send check, cash or money order.

**VIRCUT  
HOLE CUTTER**

Widely used throughout aircraft and ship building industry... **NOW AVAILABLE** to general public. **ORDER BY MAIL.**

**VIRONIC RESEARCH CORP.,** Box 125, Hermosa Beach, Calif.

**STOP "JERKY" STARTS! with an AUTOMATIC CLUTCH**

1956 Models have increased H.P. capacity. Improved design adds new belt grip under load and decreases creep at idling speed. Prevent stalling engine, cut belt wear, gain no-load idling. Quickly installed on 1/2, 5/8, 3/4 and 1" shafts. See your small engine dir. **\$595** and up

**NEW LOW PRICE**

**MOWERS TRACTORS SCOOTERS ELEVATORS**

**V-PLEX CLUTCH** • Hagerstown, Indiana

**SAVE MONEY on SURPLUS PARTS for MILITARY TYPE TRUCKS & JEEPS**

4 & 6 wheel drive. FREE catalog to Jeep owners. State make truck or Jeep. (New Jeep Tops, steel or canvas all models). **AMERICAN AUTO PARTS CO., Inc.,** 1830 Locust, Kansas City, Mo.

**Auxiliary Accelerator... LEFT FOOT PEDAL**

Step on the gas with either foot with equal ease. Drive relaxed. Guaranteed for the life of the car — which originally installed on. **FITS ALL CARS.**

**PRICE \$6.95** Pat. 4 ORDER FROM  
Delivered to You **R. V. LEHNER,** Ness City, Kansas

**"DO IT YOURSELF"  
IT'S EASY WITH  
KESTER SOLDER**

Soldering's really a "cinch" . . . when you use time-tested, reliable KESTER . . . available everywhere.

**FREE!** "Soldering Simplified" . . . 16-page how-to-solder booklet. At your dealer or write direct.

**KESTER SOLDER COMPANY**  
4251 Wrightwood Avenue Chicago 39, Illinois

**3 EASY GOING TILLERS and TILLER/MOWERS**

**CHOREMASTER** featuring the 60-second switch from tilling to mowing . . . no tools needed!

A CHOREMASTER Tiller/Mower or Tiller works up to 21" wide and 9" deep . . . mows grass and weeds 21" wide . . . switches quickly to edging, aerating and mulching. Priced for your budget.

● MOWS ● EDGES  
● SPADES ● WEEDS  
● FURROWS  
● AERATES  
● MULCHES

**CHOREMASTER Div.  
WEBER Eng. Prod., Inc.  
809 Evans Cin. 4, O**

**CHOREMASTER Div., Weber Engineered Products, Inc.**  
809 Evans Street, Cincinnati 4, Ohio

Send me new literature and nearby dealer's name.  
 I'm interested in a Choremaster dealership. Send me full details.

Name \_\_\_\_\_  
Street and No. \_\_\_\_\_  
City \_\_\_\_\_ Zone \_\_\_\_\_ State \_\_\_\_\_





CENTERS AND DRILL PADS



STEEL AND BRASS COLLETS



BALL BEARING LIVE CENTER



HANDWHEEL COLLET ATTACHMENT

**YOU CAN DO  
MORE**

**WITH SOUTH  
BEND LATHES**

because of the very complete line of practical attachments available. Only a few are shown here. Send for complete catalog.



SAFETY and STANDARD LATHE DOGS



FOLLOWER AND STEADY RESTS

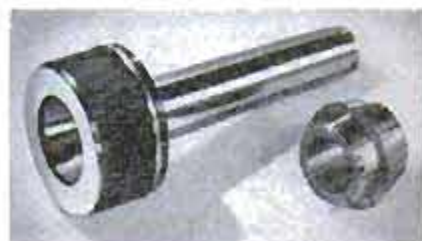

ADJUSTABLE COLLET BUSHING CHUCK

South Bend Attachments will enable you to do more and better lathe work. Write for new 50th Anniversary Catalog today.

**SOUTH BEND LATHE**  
BUILDING BETTER TOOLS SINCE 1906 • SOUTH BEND 22, INDIANA



HANDLEVER BED TURRET

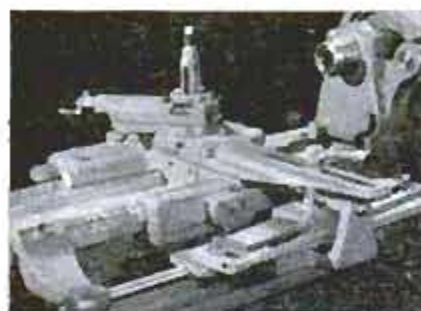

TELESCOPIC TAPER ATTACHMENT



EXTERNAL GRINDER



MILLING ATTACHMENT

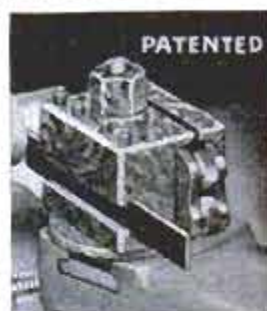

PATENTED  
10 in 1 TOOL BLOCK



PLEASE SEND INFORMATION CHECKED:

<input type="checkbox"/> 9" and 10" BENCH LATHES	<input type="checkbox"/> 10" to 16-24" FLOOR LATHES	<input type="checkbox"/> DRILL PRESSES	<input type="checkbox"/> 1/2" & 1" Collet TURRET LATHES	<input type="checkbox"/> TOOL GRINDERS	<input type="checkbox"/> 7" BENCH SHAPERS	<input type="checkbox"/> MILLING MACHINES
--	---	--	---	--	---	---

Name \_\_\_\_\_ Street \_\_\_\_\_  
City \_\_\_\_\_ State \_\_\_\_\_

Building Better Tools Since 1906 • SOUTH BEND LATHE • South Bend 22, Indiana

PRINTED  
IN  
U.S.A.





## trailer your boat to fun afloat!

*Seems like magic!* You're driving along — and suddenly *it's there!* Sunny miles of cool blue waters, tranquil woods, friendly beaches. Quickly your "Evinrude ship" is afloat and a new world of water sport opens to your family.

This *is* magic—the gypsy magic of trailer boating—that lets you launch a day of fun 'most anywhere! Lets you cruise far-away vacation waters, or whisk your boat to lovely shores in easy reach. Each eager launching starts a holiday of fresh adventure, new family fun.

And so easy, so inexpensive to enjoy. **SEE YOUR EVINRUDE DEALER.** He'll help you put together a budget-priced outfit that's just right for your needs. The right boat, the right trailer—and the sweetest, smoothest, *quietest* power on water—Evinrude Whispering Power! Look for his name under "Outboard Motors" in your phone book. **CATALOG FREE!** Write today for full-color catalog of the complete Evinrude line—nine great new models, 3 to 30 horsepower. **EVINRUDE MOTORS, 4222 North 27th Street, Milwaukee 16, Wisconsin.**

*A Division of Outboard, Marine & Mfg. Company*  
In Canada: Mfd. by Evinrude Motors, Peterborough



# Evinrude

*quiet Outboard Motors*



TV STAR PHIL SILVERS KNOWS: **PLEASURE HELPS YOUR DISPOSITION**

It's a  
Psychological  
Fact!



• "Sometimes we have to shoot one scene over and over", says Phil Silvers. "This can get pretty rough. That's when little pleasures—like smoking—sure help. If you smoke, try my cigarette—Camels—for *real* pleasure!"



E. J. Reynolds Tobacco Co., Winston-Salem, N. C.



*Phil Silvers*

AS SGT. BILKO IN TV'S  
FUNNIEST NEW COMEDY!

for more pure  
pleasure—have a  
**Camel**

**No other cigarette  
tastes so rich, yet  
smokes so mild!**

YOU BET I'D  
WALK A MILE FOR  
A CAMEL!



No other cigarette gives you the special kind of pleasure that's yours in Camels. So many modern smokers prefer the exclusive Camel blend of costly tobaccos that this cigarette is by far America's first choice. Make the 30-day Camel Mildness Test. See how Camels' real mildness and rich flavor give you the *full* enjoyment you want in a cigarette.