

POPULAR MECHANICS MAGAZINE

WRITTEN SO YOU CAN DO IT

REG. TRADE MARK, GREAT BRITAIN, NO. 80428

REG. U.S. PAT. OFF.

35 CENTS

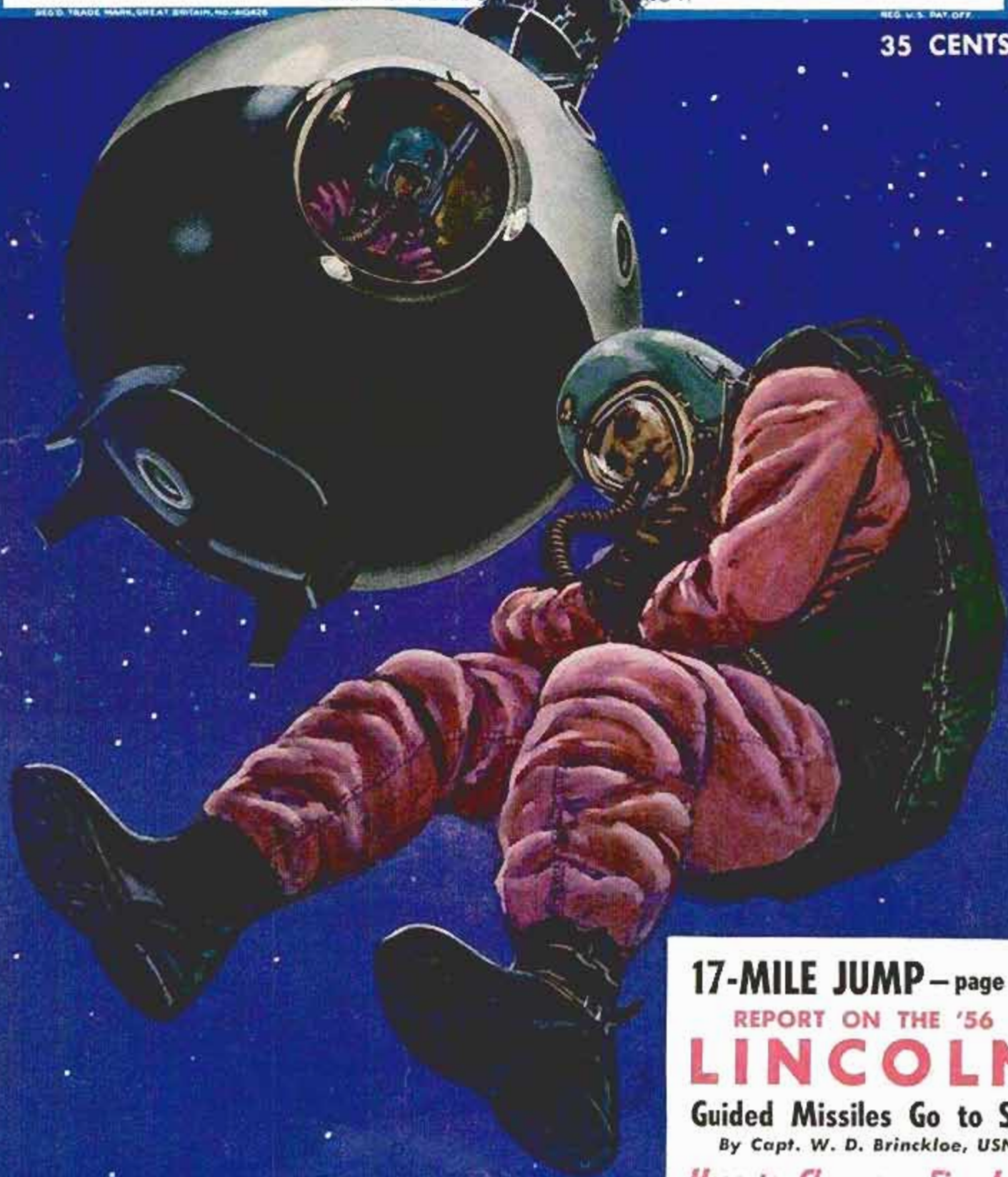

17-MILE JUMP — page 97

REPORT ON THE '56

LINCOLN

Guided Missiles Go to Sea

By Capt. W. D. Brinckloe, USN

How to Choose a Fireplace

5 MEN and 60 HORSES

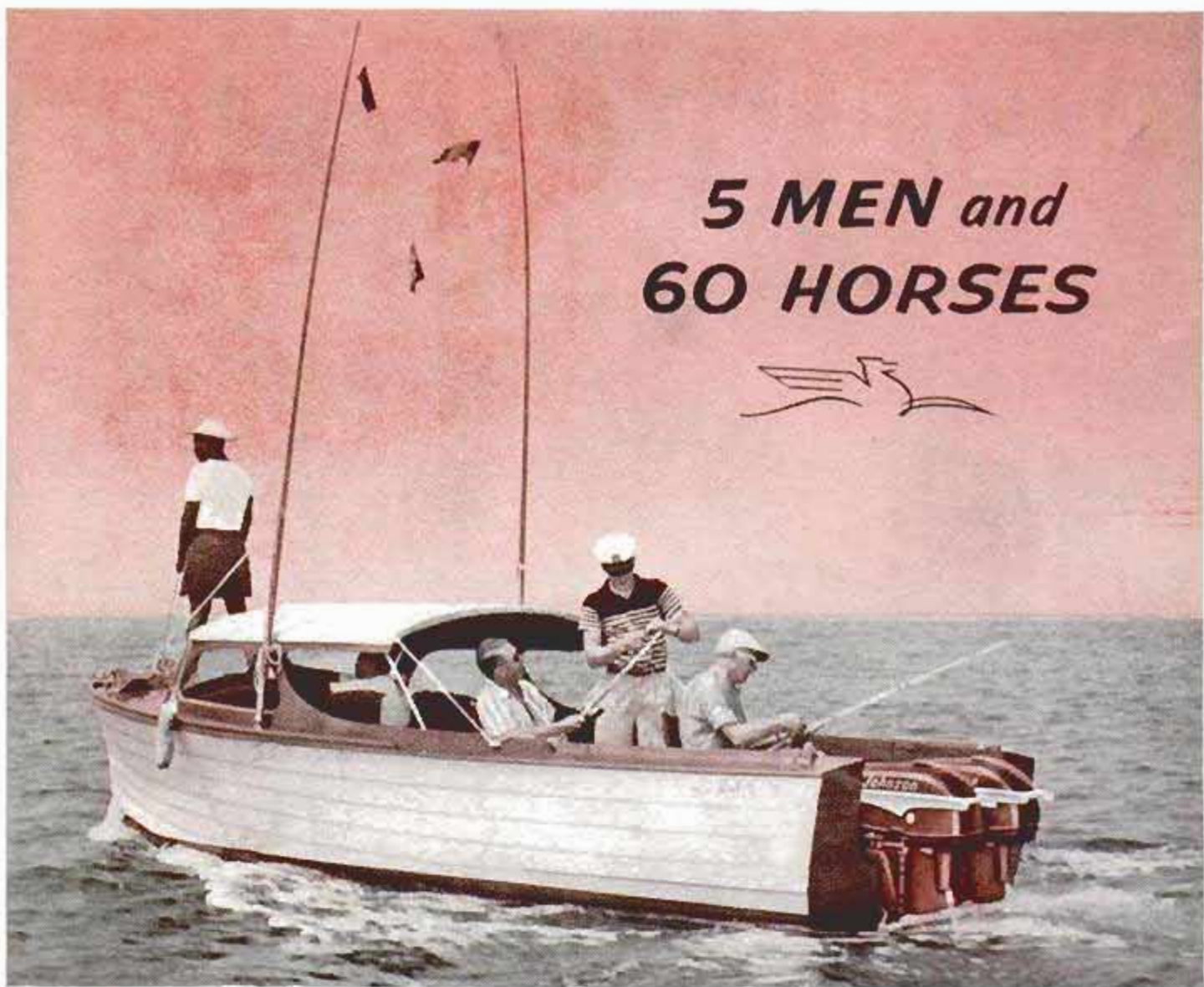
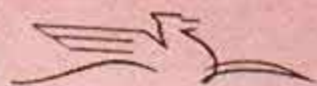

Who says big action lies beyond the range of average fishermen? Not with *today's* Sea-Horses. Their smooth and mighty power makes possible a new type of outboard fishing boat—fast, comfortable, seaworthy—with characteristic outboard maneuverability *and inherent outboard economy!* Ask your Johnson Dealer. Look for his name under "Outboard Motors" in your classified phone book. See the 1956 line — 9 models, 3 to 30 horsepower, all styled in beautiful Holiday Bronze. Featuring new Cruising-Range Fuel Saver (in the 30's) and Stall-Proof Idling. Easier Starting. And *quiet!*

FREE! Write for new 1956 Sea-Horse catalog.

JOHNSON MOTORS, 400 Pershing Road, Waukegan, Illinois
A DIVISION OF OUTBOARD, MARINE & MANUFACTURING COMPANY
In Canada: Manufactured by Johnson Motors, Peterborough



America's Most Beautiful Outboard Motors

JAVELIN*	30 hp.	\$582.00
SEA-HORSE 30"	30 hp.	552.00
SEA-HORSE 30	30 hp.	462.00
SEA-HORSE 15"	15 hp.	452.00
SEA-HORSE 15	15 hp.	362.00
SEA-HORSE 10	10 hp.	321.00
SEA-HORSE 7½"	7½ hp.	241.00
SEA-HORSE 5½"	5½ hp.	216.00
SEA-HORSE 3	3 hp.	146.00

*Electric Starting... Prices f.o.b. factory, subject to change... All models except the "3" have separate Mile-Master Fuel System... OBC certified brake hp at 4000 rpm (30's at 4500).

Johnson Sea-Horses are famous for **DEPENDability**

It takes *more* than a heavy foot to "flatten" Pikes Peak in record time.

by **Ed Cole**, Chevrolet Chief Engineer

A few days ago, I was talking to a neighbor of mine about Chevrolet's record-breaking run up Pikes Peak. "How," he asked, "does that make the new Chevrolet a better car for *me* to drive? I hardly ever drive on mountain roads, at least not on any as steep or high as Pikes Peak!"

Maybe this same question applies to *your* driving. But have you ever considered what it takes to climb Pikes Peak in a little over 17 minutes, the way Chevrolet did?

Well, it takes a lot more than a heavy foot on the accelerator. For one thing,

it takes superior cornering ability—a quality that involves not only the steering geometry, but the balance of the entire car. And how this new Chevy clings to the curves!

Then, it takes a ready reserve of power for acceleration. We've engineered that into all Chevrolet engines—both the 6 and the V8's. In fact, our horsepower now ranges up to a new high of 205!

Aren't these the very qualities you want in your car? Whether you drive in mountains or not, Chevrolet's inherent stability and lightning acceleration add up to more safety and pleasure for you.

Ask your Chevrolet dealer to lend you the key. . . . Chevrolet Division of General Motors, Detroit 2, Michigan.



Here's how Chevrolet proved its superior cornering ability.

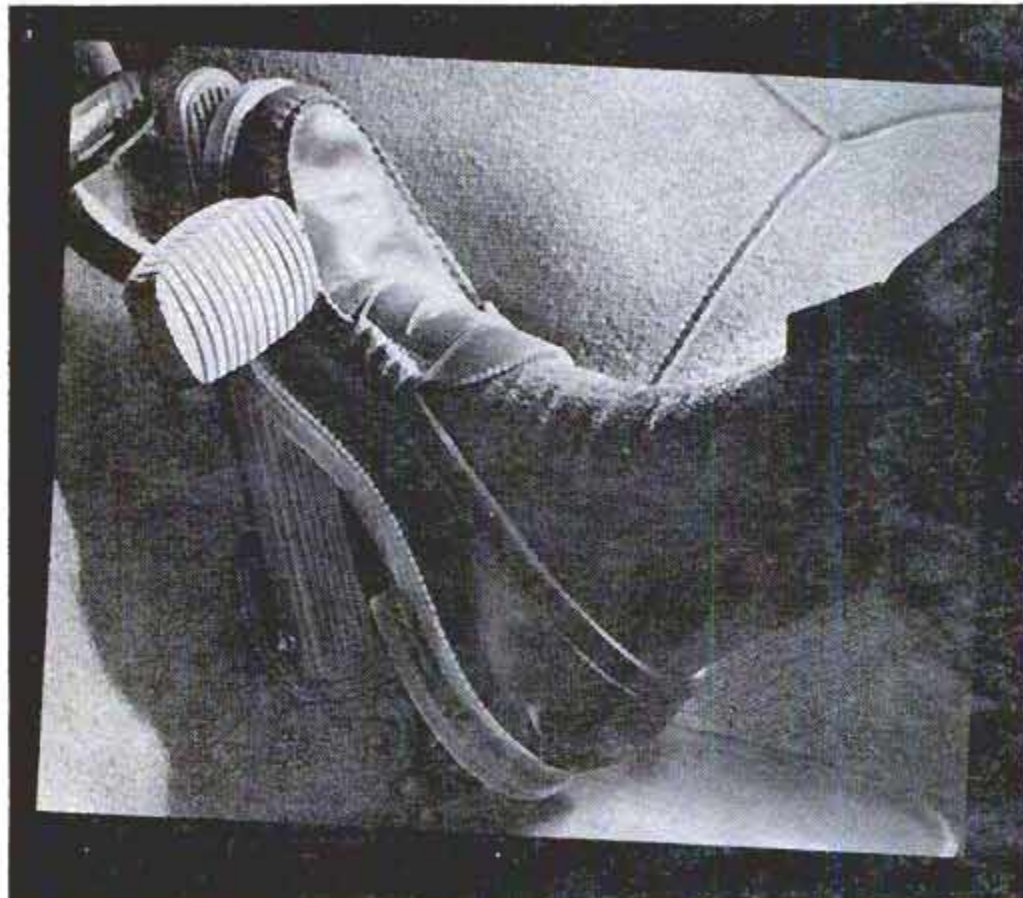

It takes power to sprint up this towering grade.



Chevrolet challenged a mountain—and won!



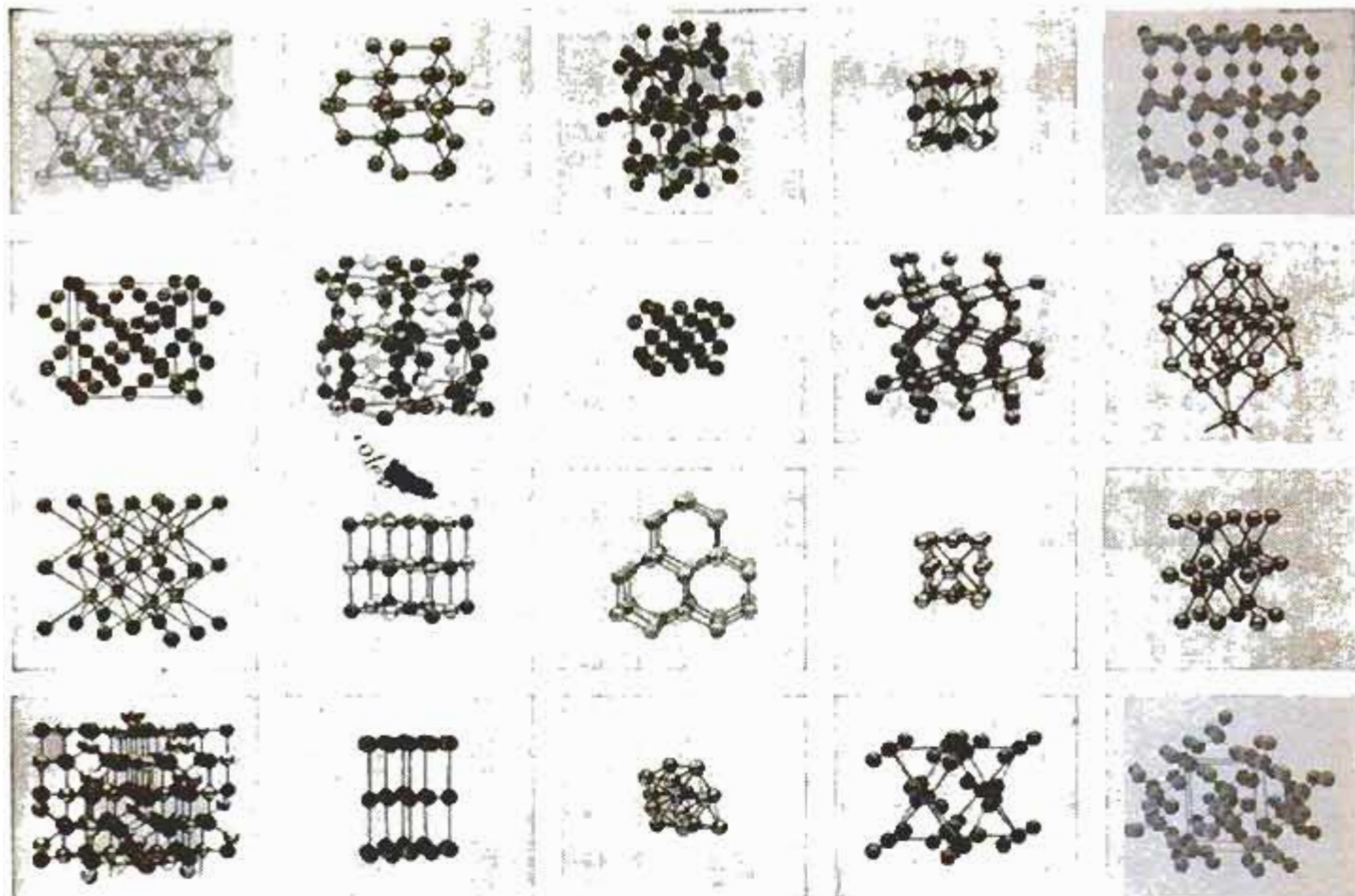

Crystal structure models. Top row, left to right: cuprite, zincblende, rutile, perovskite, tridymite. Second row: cristobalite, potassium dihydrogen phosphate, diamond, pyrites, arsenic. Third row: caesium chloride, sodium chloride, wurtzite, copper, niccolite. Fourth row: spinel, graphite, beryllium, carbon dioxide, alpha-quartz.

FROM ATOMS TO STARS

Research at Bell Telephone Laboratories ranges from the ultimate structure of solids to the radio signals from outer space. Radio interference research created the new science of radio astronomy; research in solids produced the transistor and the Bell Solar Battery.

Between atoms and stars lie great areas of effort and achievement in physics, electronics, metallurgy, chemistry and biology. Mechanical engineers visualize and design new devices. Mathematicians fore-

shadow new communications techniques.

Despite the diversity of their talents, Bell Laboratories scientists and engineers have much in common. A habit of teamwork channels these talents into great advances.

These men have developed the world's finest telephone system. In doing so, many have become leaders in their fields. Opportunities for achievement await qualified scientists and engineers at Bell Telephone Laboratories.

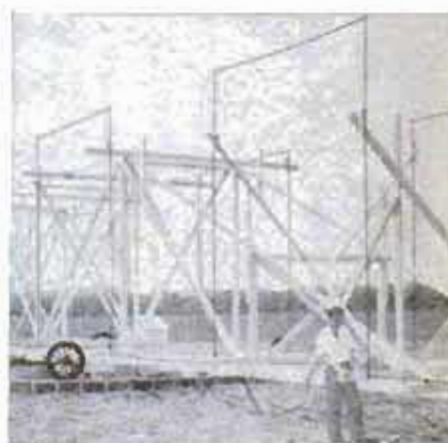

Directional antenna used by Karl G. Jansky in discovery of stellar radio signals at Bell Telephone Laboratories in 1932.

BELL TELEPHONE LABORATORIES

World center of communications research. Largest industrial laboratory in the United States.



Popular Mechanics Magazine

Registered in U. S. Patent Office and Canada

H. H. WINDSOR, *Founder*

H. H. WINDSOR, JR., *Editor and Publisher*



Next Month

SCREEN HOUSE of many uses—a real boon to families who like to move out in their yards in summer—is featured in our special outdoor-living section next month. The house is easy to build and full construction details make it a cinch for do-it-yourself fans. Floor area is 9 by 12 feet and over-all height of the panels is 6½ feet, providing a roomy space for dining, entertaining or just relaxing. Other features in the April outdoor-living section tell you how to build eight kinds of patios, how to go about lighting your yard, how to build a barbecue cabinet and other pieces of yard furniture, how to build an outdoor workshop and how to set up various yard games

Information not listed on articles in the index, starting on page 90, frequently is listed in the WHERE-TO-FIND-IT LIST, which is available to readers without charge. A copy may be obtained by writing to the Bureau of Information, *Popular Mechanics*, 200 E. Ontario, Chicago 11, Ill.

Published monthly by Popular Mechanics Company, 200 E. Ontario St., Chicago 11, Ill. H. H. Windsor, Jr., president; Wm. Harrison Feiridge, exec. vice-pres.; Franklin S. Forsberg, operations vice-pres.; D. F. Windsor, vice-president and secretary-treasurer; H. H. Windsor III, vice-president; W. T. Windsor, vice-president; Clover L. Perkins, advertising manager; Alan M. Deyoe, circulation manager. Single copy in the United States and Canada, 35 cents; subscription rates in the United States and possessions, Canada, Philippines and countries of the Pan-American Postal Union, 1 year \$3.50; 2 years, \$6.00; 3 years, \$8.00. To all other countries add \$1.00 a year over United States prices for overseas postage. If you plan to move, notify us at least 30 days in advance so you will not miss an issue. Give both your old and new addresses. Entered as Second Class Matter, September 15, 1903, at the Post Office at Chicago, Illinois, under Act of March 3, 1879. Entered as Second Class Matter at Post Office Dept., Canada. Registered as Second Class Matter at the Post Office at Mexico, D. F., Mexico, June 20, 1950. Copyright 1956 by Popular Mechanics Company. Copyright under International Copyright Union. Copyright in France. All rights reserved under Pan-American Copyright Union. Printed in the United States of America.

MARCH 1956

Volume 105

MARCH 1956

Number 3

Address all communications to: 200 E. Ontario St., Chicago 11, Ill.

Managing Editor.....	Roderick M. Grant
Assistant Managing Editor.....	Wayne Whittaker
Shop Notes and Crafts Editor.....	James R. Ward
Radio-Television, Electronics Editor.....	Lothar Stern
Associate Editor.....	Clifford B. Hicks
Associate Editor, Automotive.....	Arthur R. Railton
Associate Editor, Shop Notes and Crafts.....	Wayne C. Leckey
Assistant Editor, Shop Notes.....	W. Clyde Lamme
Assistant Editor, Crafts.....	Jay W. Hedden
Assistant Editor, Makeup.....	John C. Dalen
Automotive Correspondent.....	Leo Donovan
Art Director.....	Frank Beatty
Assistant Editors—Leonard F. Hills, Elliott H. McCleary, Emily Mullaney, Earl F. Wobeck	
Eastern Editor.....	Richard F. Dempewolf
Empire State Bldg., Room 2906, New York City 1	
Western Editor.....	Thomas E. Stimson, Jr.
Suite 1010, 3460 Wilshire Blvd., Los Angeles 5, Calif.	
London Manager.....	Douglas W. Wedderspoon
Eagle House, Jermyn St., London S. W. 1, England	
Director, Bureau of Information.....	Allan Carpenter
200 E. Ontario St., Chicago 11	

Advertising Offices
 Chicago: 200 E. Ontario St., Whitehall 4-0100; New York: Empire State Bldg., 350 Fifth Ave., Longacre 5-7580; Detroit: General Motors Bldg., TRinity 5-8711; Cleveland: Hanna Bldg., 1422 Euclid Ave., Prospect 1-0456; Los Angeles: Tishman Bldg., 3460 Wilshire, DUnkirk 2-8458; San Francisco: Russ Bldg., 235 Montgomery St., YUkon 2-0823.

In This Issue . . .

They'll Jump 17 Miles From the Sky	97
Why All These Hurricanes?	106
Detroit Listening Post	113
Ships That Buck the Polar Seas	114
Owners Report on the Lincoln	124
Guided Missiles Go to Sea	131
What's New for Your Home	138
Undercover Enemy—the Khapra Beetle	144
Model A on the Canal Beat	152
The Perfect Bass Boat	162
Keeping Up With the Atom	167
What's His Line?—Tube Bender	168
Radio, TV and Electronics	173

For the Craftsman . . .

Build Your Home Around a Fireplace	177
Darkroom Chemicals on Tap	185
Solving Home Problems	194
Control Termites	199
Easier and Safer Paint Removal	205
To Hang a Door	214
Better Filing	222
Shopping for Tools	234
On the Market	236
Clinic for Homemakers	238

See pages 90, 92 and 94

for other items and manufacturers of available products



Bill Lundigan* shows how the Automobile engine has improved

(*Your TV host on "Shower of Stars" and "Climax!")

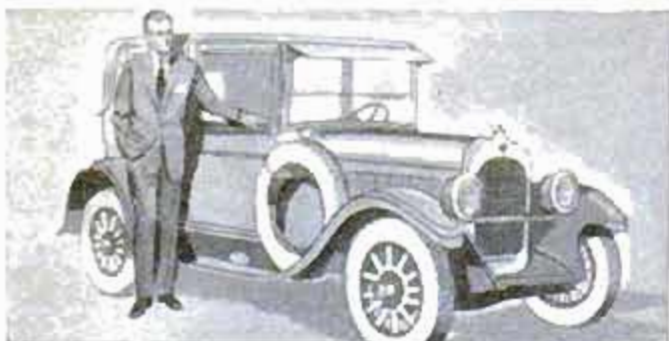

1. "BACK IN THE TWENTIES when the Charleston was the dance and cars had rumble seats, a young fellow named Walter P. Chrysler brought out a car with something the experts said wouldn't work—the high compression engine! It *did* work and became the standard engine for years to come.

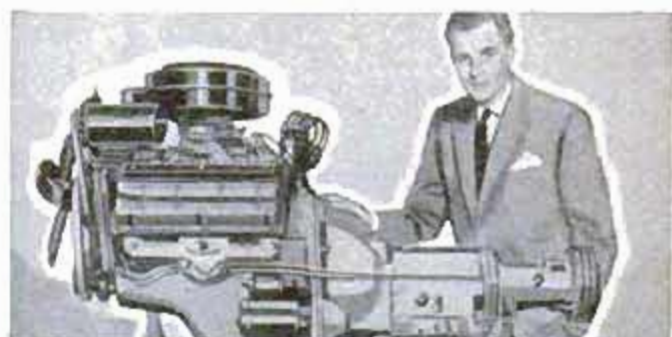

2. "THE NEXT MAJOR ENGINE IMPROVEMENT *also* came from Chrysler Corporation—the hemispherical combustion chamber! For the first time airplane engine principles were applied to quantity-produced automobile engines, offering far greater power, performance and economy.



3. "IN THIS EXCLUSIVE DOME-SHAPED CHAMBER fuel burns fast and clean and there are no corners to collect power-killing carbon deposits. No other engines operate at peak efficiency for so long a time. It's the first really new automobile engine design to appear in cars in 26 years!



4. "THE CHRYSLER '300'—boasting a 300 horsepower hemispherical combustion chamber engine—won almost four times as many races as the nearest competitor in the 1955 NASCAR and AAA competitions. Real testimony of this engine's outstanding performance and all-round superiority!



5. "THE ENGINE OF THE FUTURE already has been tested successfully in a stock car—Chrysler Corporation's *gasturbine* engine! It has no carburetor, no piston rings, no radiator . . . only one spark plug and runs on ordinary fuel without throwing flames from its specially designed exhaust.



6. "MORE AUTOMOTIVE 'FIRSTS' have been chalked up by Chrysler Corporation than any other car maker. Many have been copied, many are still exclusive with Plymouth, Dodge, De Soto, Chrysler and Imperial. All are reasons why you get more from a Chrysler Corporation car!"

CHRYSLER CORPORATION  **THE FORWARD LOOK**

PLYMOUTH • DODGE • DESOTO • CHRYSLER • IMPERIAL

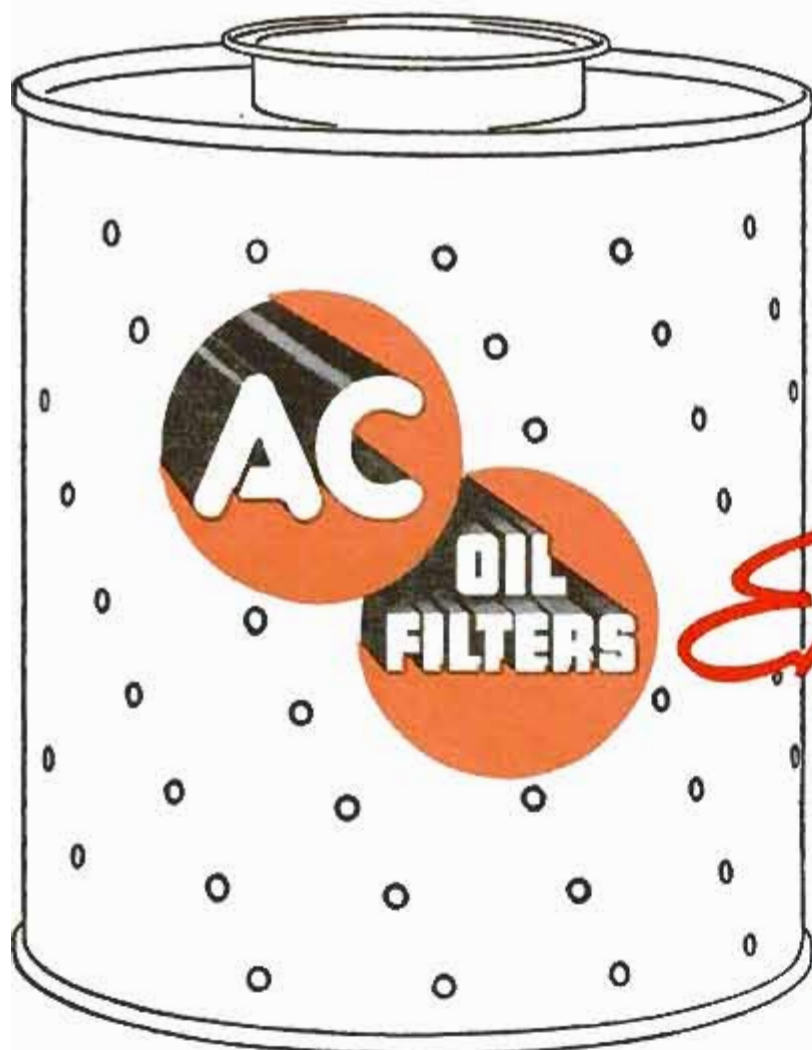

Engineered for

TODAY'S

Hi-Compression Engines

TODAY'S

Hi-Detergency Motor Oils

**AC BRINGS YOU FULL FILTERING EFFICIENCY THROUGHOUT
FILTER LIFE BY PARALLEL CHANNEL CONSTRUCTION**

**AC brings you oil filters
that take out the dirt—
not the **DETERGENTS!****

Today's premium motor oils contain additives that keep engines clean by suspending carbon in the oil and holding it there instead of letting it deposit in hard form inside the engine. Oil companies also put in additives to increase the oil's viscosity range—protect your engine over greater ranges of temperature change. AC Oil Filters are so engineered as to take out harmful dirt, dust, grit, metal particles and still not remove or alter the valuable detergents. Always say AC when you change your filter—and, remember to change every 5000 miles!



THIS AC
PARALLEL
FOLDING
ALLOWS

THIS
EVENLY
DEPOSITED
SLUDGE



AC Oil Filter inner construction is ingeniously designed to allow the filtered-out dirt to deposit *evenly* over the entire surface area. This is done by keeping the filter material in evenly-spaced parallel channels, as at left. On the right you see filtered-out sludge evenly depositing on the full filtering area, so that for the full 5000 miles all the filtering area is kept in useful service. None is blocked off. There is no tendency to pocket—AC's parallel construction assures uniform rate of flow. You need this extra AC protection.

AC SPARK PLUG  THE ELECTRONICS DIVISION OF GENERAL MOTORS

New! PROTO Ruby Line SCREWDRIVERS

*LOW Cost,
HIGH Quality*

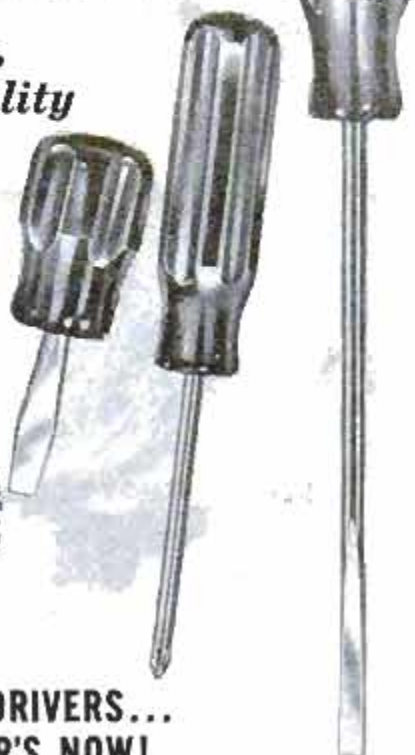

**37 NEW SCREWDRIVERS...
AT YOUR DEALER'S NOW!**

Ruby Red, Fire-Resistant Plastic Handles
Powerful, Comfortable Grips
High Grade, Heat-Treated Steel Bits ...
Hard and Tough
Fully Plated for Rust Protection
Sparkling Appearance
Keystone, Cabinet and Phillips Types
Meet Mil. Spec. GGG-S-121-C

"Ruby Line" screwdrivers were designed by PROTO to meet demands for high quality at low cost. Manufacturing economies give long service at modest prices. Complete line of 37 models. Bit widths from 1/8" to 5/16", blades from 1 1/2" to 9 3/4". In Keystone, Cabinet and #1 and #2 Phillips types.

See your nearby PROTO dealer today. Send 10¢ for catalog of entire PROTO line of tools to **PROTO TOOLS**
2203 Santa Fe Ave., Los Angeles 54, Calif. 5681

Eastern Factory,
Jamestown, N. Y.

Canadian Factory,
London, Ont.



ACROSS THE DESK



While working in Washington as head of the Battleship-Cruiser-Destroyer Branch, Bureau of Ships, Capt. W. D. Brinckloe, USN, was in close touch with development of the Navy's new guided-missile cruisers. His article, "Guided Missiles Go to Sea," on page 131 is based on his first-hand information and, to our knowledge, is the first



full-length feature article to appear in print on the subject. Captain Brinckloe, one of the Navy's youngest captains, was graduated from Annapolis in 1937 and in 1942 was graduated with top honors in engineering from Massachusetts Institute of Technology. He saw active duty in World War II and in the Korean War when he was awarded the Bronze Star. The accompanying photograph shows him at his desk in Subic Bay, the Philippines where, as the commanding officer of ship-repair facilities, he is in charge of 2300 men in the South-east Asia area.

To the Editor:

When Phil McCafferty of Stanwood, Iowa, sent us his story of "Model A on the Canal Beat," on page 152 of this issue, he told us his brother had more or less enjoyed a wild ride on the "Jitney" in pursuit of the photographs that illustrate the piece.

"They forgot to check the gas," wrote McCafferty, "and they ran out—right in the middle of a 3000-foot tunnel! They had to push her out. My brother commented he'd

(Continued to page 8)

Accounting Home-Study

made interesting and practical
thru problem method

MAIL COUPON FOR FREE BOOK

YOU know as well as we do that Accounting fits many men for positions that pay four to ten thousand dollars a year and up—gives many other men unusual opportunity to start a profitable growing business of their own.

You probably realize also that the accounting profession faces the greatest opportunity it has ever had.

The only question is—just how practical is it for *you* to train yourself adequately in Accounting through home study?

And the answer lies in the LaSalle Problem Method.

For this modern plan of training not only makes Accounting study at home thoroughly practical but makes it interesting as well.

And here's how:

You Learn by Doing

Suppose it were your privilege every day to sit in conference with the auditor of your company or the head of a successful accounting firm. Suppose every day he were to lay before you in systematic order the various problems he is compelled to solve, and were to explain to you the principles by which he solves them. Suppose that one by one you were to work those problems out—returning to him every day for counsel and assistance—

Granted that privilege, surely your advancement would be far faster than that of the man who is compelled to pick up his knowledge by study of theory alone.

Under the LaSalle Problem Method you pursue, to all intents and purposes, that identical plan. You advance by solving problems.

Only—instead of having at your command the counsel of a single individual—one accountant—you have back of you the organized experience of a great business training institution, the authoritative findings of scores of able accounting specialists, the actual procedure of the most successful accountants.

Thus—instead of fumbling and blundering—you are trained in the solving of the very problems you must face in the higher accounting positions or in an accounting practice of your own. Step by step, you work them out for yourself—until, at the end of your training, you have the kind of ability and experience for which business is willing and glad to pay real money.

One Out of Every 13 of All C.P.A.'s Is LaSalle Trained

If you want still more proof, remember that over 4,200 C.P.A.'s—one out of every 13 of all those in the United States who have passed the difficult examination for the C.P.A. Certificate—are LaSalle alumni.

And knowing these facts, ask yourself if there can be any further question about the practicability of this training for you—ask rather if the real question is not about the size of your own ambition and the quality of your determination.

For Accounting is no magic wand for the lazy or the fearful or the quitter—it offers success only to the alert adult who has the courage to face the facts and the will to carry on till the job is done.

If you are that individual, the coupon below, filled out and mailed, will bring you free the information that may open up to you the future of which you have dreamed—ability and income and success. Is it not worth getting that information?

Member, National Home Study Council

LASALLE EXTENSION UNIVERSITY

CHICAGO 5, ILLINOIS

A Correspondence Institution

LASALLE EXTENSION UNIVERSITY A CORRESPONDENCE INSTITUTION

Dept. 364H

417 S. Dearborn St., Chicago 5, Ill.

Please send me, free of all obligation, your illustrated book "Accountancy, the Profession That Pays," telling about the profession of accountancy and your training for success in that field.

Name.....

Address.....

City, Zone, State.....

This One



62NE-AEG-EQJW



Learn to Repair ELECTRIC APPLIANCES

at Home in Spare Time

**Fast Growing Field offers
Good Pay, Interesting
Work, Security**

Get into a field where you can do important work, have a secure future. Electrical appliance repair offers OPPORTUNITY FOR YOU. Every wired home has an average of 8 electrical appliances. Up to 10 million new appliances are being sold every year. Owners pay well to keep them in repair and enjoy the convenience they provide. That means a fast growing need for trained men.



Learn and Earn with Tester You Build

Our training includes the parts to build a sturdy, portable appliance tester following our illustrated, easy-to-understand instructions. This multi-use tester helps you locate electrical defects quickly and easily, equips you to do professional trouble-shooting. You use it to learn electrical appliance repair techniques. Gives you the practical training of actually building the tester and a valuable piece of equipment for future use.



Earn \$3, \$4, \$5 an Hour Spare Time

Start soon to repair electric toasters, fans, irons, mixers, vacuum cleaners, etc. for your neighbors and friends. Spare time work done at your convenience in your basement, garage, or spare room can earn you from \$3 to \$5 an hour. See how easy it is to increase your earning power—how you can pay for this training many times over with the money you'll earn in your spare time. Mail coupon.



Train Now for Greater Security Low Price—Easy Terms



Today's automatic electric appliances need expert servicing. The man who knows this good trade has a secure future. Put your spare time to good use. Enroll now for \$2.50 down and \$5.00 a month. A small investment can assure a better future. Address Electrical Appliance Training, National Radio Institute, Dept. AC6, Washington 9, D. C.



FREE Lesson and Book
MAIL this NOW

NATIONAL RADIO INSTITUTE

DEPT. AC6, WASHINGTON 9, D. C.

Please send me lesson and book free. (No salesman will call.)

Name _____ Age _____

Address _____

City _____ Zone _____ State _____

(Continued from page 6)

never seen anything so dark in his life. Of his high-speed run through the 12-mile tube he said "What a ride! That thing is like no Model A I ever drove—it's a monster in disguise!"

Five Tools in One

A New York City high-school student has invented a drafting instrument that does the work of five other drawing tools. Lawrence Kalmis, 16, calls it the "K square." It replaces the T square, the 30-



60-90-degree and the 45-90-degree triangles, the ruler and the protractor. Professional draftsmen say it's as accurate as the separate tools.

Larry took a standard T square, cut a half-inch slot down the middle of the arm and then designed a slide to fit into the slot. To the slide he attached an arm that is adjusted to any angle by a screw lock. The slide and short arm can be moved to any spot on the horizontal arm and locked in place. Larry plans to have the long horizontal arm marked off for lineal measurements. Right now, he's preparing plans to market the instrument.

Richard Petrow,
New York City

To the Editor:

I wish to send you the best compliments for the "Across Four Continents on Two Cylinders" story (PM, Dec. 1955).

It is very well narrated, full of amazing

(Continued to page 10)

Are you a prisoner in your present job?



Are you bored with your work? Do you go home at night tired from doing nothing? **THOSE CAN BE DANGER SIGNALS!**

If you're like the millions of other people before they turned to I.C.S. for help, these things are probably true about you:

You're caught between a job with no future and a family to support. You're sour on your job, hate to get up in the morning to go to work. At night, you're not much fun to have around.

Unless you do something about it, things are going to get worse. "Prisoners" aren't much good to their bosses or families.

And, of course, you can do something to "free" yourself . . . to get a better job, with more money. And insure yourself against layoffs

that come to untrained men. To develop interest in your work. To earn the respect of your family and community.

HOW I.C.S. CAN HELP

Faced with such a problem, six million people have turned to I.C.S. for help. They studied at home, in their spare time. They developed new skills and new knowledge.

Did it pay-off for them? Look at the record. In a single 120-day period, almost 2000 I.C.S. students were promoted to better jobs!

Take J. R. Todd. "Already I'm netting \$120 a month profit on my investment," he says. "And there's more to come."

John R. Musik jumped from \$180 to \$360 a month. O. O. Braun from \$120 to \$600 a month. H. A. Howell got a \$100 a month raise as a result of his I.C.S. training.

THESE OPPORTUNITIES OPEN FOR TRAINED MEN

Production in the field of Electronics has increased 20 times in 12 years. The Chemical business is increasing 10% a year. 2000 new TV stations have been authorized. Get your training while these opportunities still exist. Mail coupon for 3 free booklets today!



For Real Job Security—Get an I. C. S. Diploma! I. C. S., Scranton 9, Penna. Member, National Home Study Council

INTERNATIONAL CORRESPONDENCE SCHOOLS



BOX 02626C, SCRANTON 9, PENNA.

(Partial list of 277 courses)

Without cost or obligation, send me "HOW TO SUCCEED" and the opportunity booklet about the field BEFORE which I have marked X (plus sample lesson):

- | | | | | |
|--|---|--|---|--|
| <p>ARCHITECTURE and BUILDING CONSTRUCTION</p> <ul style="list-style-type: none"> <input type="checkbox"/> Air Conditioning—Refrig. <input type="checkbox"/> Architecture <input type="checkbox"/> Architectural Interior <input type="checkbox"/> Building Contractor <input type="checkbox"/> Building Maintenance <input type="checkbox"/> Carpenter and Mill Work <input type="checkbox"/> Estimating <input type="checkbox"/> Heating <input type="checkbox"/> Painting Contractor <input type="checkbox"/> Plumbing <input type="checkbox"/> Reading Arch. Blueprints <p>ART</p> <ul style="list-style-type: none"> <input type="checkbox"/> Cartooning <input type="checkbox"/> Commercial Art <input type="checkbox"/> Fashion Illustrating <input type="checkbox"/> Magazine Illustrating <input type="checkbox"/> Show Card and Sign Lettering <input type="checkbox"/> Sketching and Painting <p>AUTOMOTIVE</p> <ul style="list-style-type: none"> <input type="checkbox"/> Auto Body Rebuilding <input type="checkbox"/> Auto Elec. Technician <input type="checkbox"/> Auto-Engine Tune Up <input type="checkbox"/> Automobile | <p>AVIATION</p> <ul style="list-style-type: none"> <input type="checkbox"/> Aeronautical Engineering Jr. <input type="checkbox"/> Aircraft & Engine Mechanic <p>BUSINESS</p> <ul style="list-style-type: none"> <input type="checkbox"/> Advertising <input type="checkbox"/> Bookkeeping and Accounting <input type="checkbox"/> Business Administration <input type="checkbox"/> Business Correspondence <input type="checkbox"/> Public Accounting <input type="checkbox"/> Creative Salesmanship <input type="checkbox"/> Federal Tax <input type="checkbox"/> Letter-writing Improvement <input type="checkbox"/> Office Management <input type="checkbox"/> Professional Secretary <input type="checkbox"/> Retail Business Management <input type="checkbox"/> Sales Management <input type="checkbox"/> Stenographic-Secretarial <input type="checkbox"/> Traffic Management <p>CHEMISTRY</p> <ul style="list-style-type: none"> <input type="checkbox"/> Analytical Chemistry <input type="checkbox"/> Chemical Engineering <input type="checkbox"/> Chem. Lab. Technician <input type="checkbox"/> General Chemistry <input type="checkbox"/> Natural Gas Prod. & Trans. <input type="checkbox"/> Petroleum Engineering <input type="checkbox"/> Plastics <input type="checkbox"/> Pulp and Paper Making | <p>CIVIL, STRUCTURAL ENGINEERING</p> <ul style="list-style-type: none"> <input type="checkbox"/> Civil Engineering <input type="checkbox"/> Construction Engineering <input type="checkbox"/> Highway Engineering <input type="checkbox"/> Reading Struct. Blueprints <input type="checkbox"/> Sanitary Engineering <input type="checkbox"/> Structural Engineering <input type="checkbox"/> Surveying and Mapping <p>DRAFTING</p> <ul style="list-style-type: none"> <input type="checkbox"/> Aircraft Drafting <input type="checkbox"/> Architectural Drafting <input type="checkbox"/> Electrical Drafting <input type="checkbox"/> Mechanical Drafting <input type="checkbox"/> Mine Surveying and Mapping <input type="checkbox"/> Plumbing Drawing and Estimating <input type="checkbox"/> Structural Drafting <p>ELECTRICAL</p> <ul style="list-style-type: none"> <input type="checkbox"/> Electrical Engineering <input type="checkbox"/> Electrical Maintenance <input type="checkbox"/> Electrician <input type="checkbox"/> Contracting <input type="checkbox"/> Lineman <p>HIGH SCHOOL</p> <ul style="list-style-type: none"> <input type="checkbox"/> Commercial <input type="checkbox"/> Good English <input type="checkbox"/> High School Subjects <input type="checkbox"/> Mathematics | <p>LEADERSHIP</p> <ul style="list-style-type: none"> <input type="checkbox"/> Foremanship <input type="checkbox"/> Industrial Supervision <input type="checkbox"/> Leadership and Organization <input type="checkbox"/> Personnel-Labor Relations <p>MECHANICAL AND SHOP</p> <ul style="list-style-type: none"> <input type="checkbox"/> Gas—Electric Welding <input type="checkbox"/> Heat Treatment <input type="checkbox"/> Metallurgy <input type="checkbox"/> Industrial Engineering <input type="checkbox"/> Industrial Instrumentation <input type="checkbox"/> Industrial Supervision <input type="checkbox"/> Internal Combustion Engines <input type="checkbox"/> Machine Design—Drafting <input type="checkbox"/> Machine Shop Inspection <input type="checkbox"/> Machine Shop Practice <input type="checkbox"/> Mechanical Engineering <input type="checkbox"/> Quality Control <input type="checkbox"/> Reading Shop Blueprints <input type="checkbox"/> Refrigeration <input type="checkbox"/> Sheet Metal Worker <input type="checkbox"/> Tool Design <input type="checkbox"/> Toolmaking <p>RADIO, TELEVISION</p> <ul style="list-style-type: none"> <input type="checkbox"/> Industrial Electronics <input type="checkbox"/> Practical Radio TV Eng'ng <input type="checkbox"/> Radio and TV Servicing <input type="checkbox"/> Radio Operating | <ul style="list-style-type: none"> <input type="checkbox"/> Television Technician <p>RAILROAD</p> <ul style="list-style-type: none"> <input type="checkbox"/> Air Brakes <input type="checkbox"/> Car Inspector <input type="checkbox"/> Diesel Locomotive <input type="checkbox"/> Locomotive Engineer <input type="checkbox"/> Section Foreman <p>STEAM AND DIESEL POWER</p> <ul style="list-style-type: none"> <input type="checkbox"/> Combustion Engineering <input type="checkbox"/> Diesel—Elec. <input type="checkbox"/> Diesel Eng's <input type="checkbox"/> Electric Light and Power <input type="checkbox"/> Stationary Fireman <input type="checkbox"/> Stationary Steam Engineering <p>TEXTILE</p> <ul style="list-style-type: none"> <input type="checkbox"/> Carding and Spinning <input type="checkbox"/> Cotton, Rayon, Woolen Mfg. <input type="checkbox"/> Finishing and Dyeing <input type="checkbox"/> Loom Fix'g <input type="checkbox"/> Textile Des'ing <input type="checkbox"/> Textile Eng'g <input type="checkbox"/> Throwing <input type="checkbox"/> Warping and Weaving <p>MISCELLANEOUS</p> <ul style="list-style-type: none"> <input type="checkbox"/> Domestic Refrigeration <input type="checkbox"/> Marine Engineering <input type="checkbox"/> Ocean Navigation <input type="checkbox"/> Professional Engineering <input type="checkbox"/> Short Story Writing <input type="checkbox"/> Telephony |
|--|---|--|---|--|

Name _____ Age _____ Home Address _____

City _____ Zone _____ State _____ Working Hours _____ A.M. to P.M. _____

Occupation _____ Canadian residents send coupon to International Correspondence Schools, Canadian, Ltd., Montreal, Canada. . . . Special tuition rates to members of the U. S. Armed Forces.

AUDELS Carpenters and Builders Guides



4 vols \$6

Inside Trade Information for Carpenters, Builders, Joiners, Building Mechanics and all Woodworkers. These Guides give you the short-cut instructions that you want—including new methods, ideas, solutions, plans, systems and money saving suggestions. An easy progressive course for the apprentice and student. A practical daily helper and Quick Reference for the master worker. Carpenters everywhere are using these Guides as a Helping Hand to *Smarter Work, Better Work and Better Pay.* To get this assistance for yourself, simply fill in and mail **FREE COUPON** below.

Inside Trade Information On:

How to use the steel square—How to file and set saws—How to build furniture—How to use a mitre box—How to use the chalk line—How to use rules and scales—How to make joints—Carpenters arithmetic—Solving mensuration problems—Estimating strength of timbers—How to set girders and sills—How to frame houses and roofs—How to estimate costs—How to build houses, barns, garages, bungalows, etc.—How to read and draw plans—Drawing up specifications—How to excavate—How to use settings 12, 13 and 17 on the steel square—How to build hoists and scaffolds—skylights—How to build stairs—How to put on interior trim—How to hang doors—How to tath—lay floors—How to paint.



Step up your own skill with the facts and figures of your trade. Audel's Mechanics Guides contain Practical Inside Trade Information in a handy form. Fully illustrated and Easy to Understand. Highly Endorsed. Check the book you want for **7 DAYS FREE EXAMINATION.** Send No Money, Nothing to pay Postman.

MAIL ORDER



Check NOW!

You Can Look Over Any Guide In Your Own Home — Start the Easy Payments If Satisfied

MAIL THIS TODAY



AUDEL, Publishers, 49 W. 23 St., NEW YORK 10, N. Y.

Please send me for FREE EXAMINATION books marked (x) below. If I decide to keep them I agree to mail \$1 in 7 Days on each book or set ordered and further mail \$1 monthly on each book or set until I have paid price, otherwise I will return them.

- AUTOMOBILE MECHANICS GUIDE, 1664 Pages. \$4
- TRUCK & TRACTOR GUIDE, 1299 Pages . . . 4
- DIESEL ENGINE MANUAL, 575 Pages . . . 2
- MACHINISTS HANDY BOOK, 1650 Pages . . . 4
- WELDERS GUIDE, 400 Pages . . . 1
- BLUE PRINT READING, 416 Pages . . . 2
- MATHEMATICS & CALCULATIONS, 700 Pages. . . 2
- SHEET METAL PATTERN LAYOUTS, 1100 Pages. . . 4
- SHEET METAL WORKERS HANDY BOOK, 388 Pgs. . . 1
- MECHANICAL DRAWING GUIDE, 160 Pages . . . 1
- MECHANICAL DRAWING & DESIGN, 480 Pages . . . 2
- AIRCRAFT WORKER, 240 Pages . . . 1
- TELEVISION SERVICE MANUAL, 434 Pages . . . 2
- RADIOMANS GUIDE, 1040 Pages . . . 4
- ELECTRONIC DEVICES, 216 Pages . . . 2
- ELECTRIC MOTOR GUIDE, 1000 Pages . . . 4
- WIRING DIAGRAMS (Light & Power), 272 Pgs. . . 1
- ELECTRICIANS EXAMINATIONS, 250 Pages. . . 1
- ELECTRIC POWER CALCULATIONS, 425 Pages. . . 2
- HANDY BOOK OF ELECTRICITY, 1440 Pages. . . 4
- ELECTRIC DICTIONARY, 9000 Terms . . . 2
- ELECTRIC LIBRARY, 7000 Pages (12 Book Set) 18
- SHIPFITTERS HANDY BOOK, 250 Pages . . . 1
- REFRIGERATION & Air Conditioning, 1280 Pgs. . . 4
- MILLWRIGHTS & MECHANICS GUIDE, 1200 Pgs. . . 4
- POWER PLANT ENGINEERS GUIDE, 1500 Pages . . . 4
- ENGINEERS & FIREMANS EXAMS, 525 Pages . . . 1
- PUMPS, Hydraulics & Air Compressors, 1658 Pgs. . . 4
- OPERATING ENGINEERS LIBRARY (3 Books) . . . 9
- MECHANICAL DICTIONARY, 950 Pages . . . 4
- GARDENERS & GROWERS GUIDES (4 Book Set) . . . 6
- CARPENTERS & BUILDERS GUIDES (4 Book Set) . . . 6
- PLUMBERS & Steamfitters Guides (4 Book Set) . . . 6
- MASONS AND BUILDERS GUIDES (4 Book Set) . . . 6
- PAINTERS & DECORATORS MANUAL, 450 Pgs. . . 2
- HOUSE HEATING GUIDE, 1000 Pages . . . 4
- OIL BURNER GUIDE, 584 Pages . . . 1
- HOME APPLIANCE SERVICE GUIDE, 800 Pages . . . 4

Name _____

Address _____

Occupation _____

Employed by _____ P-3

(Continued from page 8)

photos; in brief, it is very well done. This is just to express my pleasure in the best story in your magazine for about eight years.

Fernando Barcelo Carvajal,
Santiago de Chile, S. A.

The Story Ends in Fargo

It occurred to us that you might be interested in what happened to the Rambler four-door hardtop that played the leading role in the picture story, "The Building of a Car," published in our February issue.



You will remember it as the car that PM followed from 7 a.m. until midnight, taking pictures as it was assembled.

Well, you'll be pleased to learn that the automobile has a happy home. It ended up in Fargo, N. D., the proud property of Mr. and Mrs. Harold Carstensen. Incidentally, this makes two Ramblers in the Carstensen family—the other model is a 1955 station wagon.

To the Editor:

I read with interest an article in your November 1955 issue entitled "Make Way for the Micro-Midgets." Our club, the Long Island Junior Racing Club, has over 20 members ranging in age from 5 to 12 years, both male and female, each of whom owns a car in a class limited to a maximum of 2½ hp. Some are home-built and some are built from kits and parts available through various manufacturers on the East and West Coast. This club has been in existence for almost two years. Race meets are held every Sunday afternoon in a paved parking lot behind the County Courthouse in

(Continued to page 78)



J. E. SMITH
President, National Radio Institute. 40 years' experience training men at home for Radio-TV.

I Will Send You A **SAMPLE LESSON FREE** to show you how easy, practical it is to **Train at Home for Good Radio-Television Jobs**



America's Fast Growing Industry Offers You Good Pay Plus a Bright Future

TRAINING plus OPPORTUNITY is the PERFECT combination for ambitious men. Let me send you a sample lesson from my course to prove you can keep your job while TRAINING at home in your spare time for better pay and a brighter future. I will also send my 64-page book to show you that Radio-Television is today's field of OPPORTUNITY for properly trained men.

Make \$10, \$15 a Week Extra
Many men I train fix neighbors' Radios, make extra money, soon after they enroll. Actual equipment you build gives you practical experience.

Television's Growth is Making More Jobs, Prosperity

Radio is bigger than ever and television is growing fast. Government, Aviation, Police, Ship, Microwave Relay, Two Way Communications for buses, taxis, railroads are other growing fields for Radio-Television trained men.



Mail Coupon—Find Out About This Tested Way to Better Pay

Take NRI training for as little as \$5 a month. Many NRI graduates make more in two weeks than the total cost of my training. Mail coupon today for Actual Lesson and 64-page Book—Both FREE. J. E. SMITH, National Radio Institute, Dept. 6CA, Washington 9, D. C. Our 40th Year.

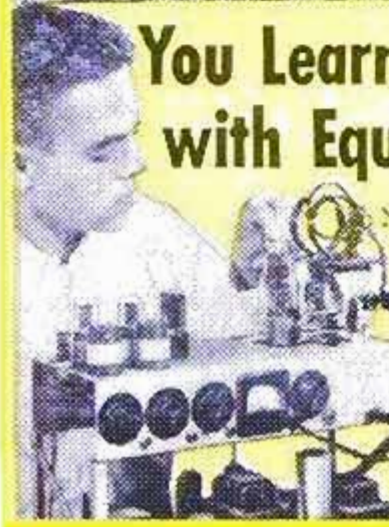

You Learn by Practicing with Equipment I Send

Nothing takes the place of practical experience. That's why NRI training is based on LEARNING BY DOING. My training includes kits of parts which you use to build equipment and get practical experience on circuits common to both Radio and Television. Shown at left is the low-power Broadcasting Transmitter you build as part of my Communications Course.

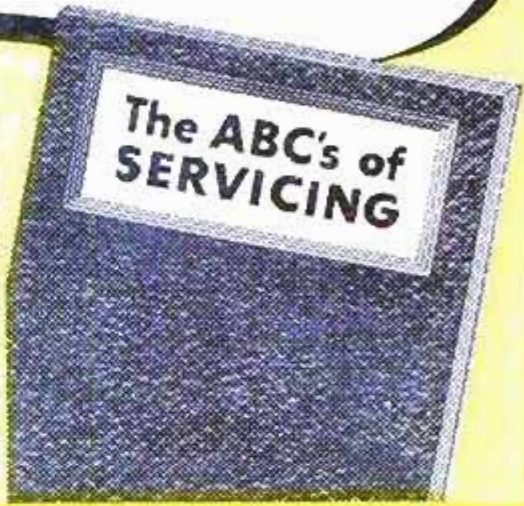

I Trained These Men



"I have a regular job as a police captain and also have a good spare time Radio and Television service business. Just opened my new showrooms and shop."—C. W. LEWIS, Pensacola, Florida.



"I decided to quit my job and do TV work full time. I love my work and am doing all right. If fellows knew what a wonderful investment NRI is, they would not hesitate."—W. F. KLINE, Cincinnati, Ohio.



"Thanks to NRI, I operated a successful Radio repair shop. Then I got a job with WPAQ, later WBOB and now am an engineer for WHPE."—VAN W. WORKMAN, High Point, N. Carolina.



AVAILABLE TO **VETERANS** UNDER G.I. BILLS

Good for Both—FREE

Mr. J. E. Smith, President, Dept. 6CA National Radio Institute, Washington 9, D.C. Mail me Sample Lesson and 64-page Book, FREE. (No salesman will call. Please write plainly.)

Name _____ Age _____
Address _____
City _____ Zone _____ State _____
VETS write in date of discharge _____
Approved Member, National Home Study Council

IMPORTER'S SACRIFICE SALE!

World Famous KORIAM Hunting Knives

from Solingen, Germany

REG. 3.95—NOW 1/2 PRICE

1.98

Take Your Pick— all one low price!



These unique hand forged hunting knives are made by world-renowned craftsmen of SOLINGEN, GERMANY. Sharp, rugged blades are genuine KORIAM steel. The handsome, unusual designs have won recognition in sports circles throught Europe. American hunters and fishermen, too, have been quick in expressing their enthusiastic approval. Over 100,000 already sold here! Now you, too, can get your favorite design—direct from the importer at a rock-bottom price! The blades are actually sharp enough to shave with; will stand up against most rugged treatment. Genuine leather scabbards tailored for each knife—metal tipped for sharp pointed models. Lengths 9 to 10 inches. The tough, sturdy KORIAM steel made in Germany assures you years of dependable service. Their sleek graceful lines also provide ideal rec room or den decorations. Dandy gifts for men—and a sportsman's delight! Import supply limited. The low \$1.98 price for both knife and scabbard means you'll have to act fast! Send \$1.98 for prompt prepaid delivery or order COD plus postage. Your money back if not delighted. Check desired model in coupon below.

A
Rhine
Maiden
Golden
Hued
Handle

B
Black
Forest
Hunting
Knife

NEW DELUXE
MODEL

C
Monarch
Stag &
Chrome
Handle
with
Tri-Color
Etched
Blade

MAIL TODAY!

THORESEN'S, Dept. 7-C-800
352 Fourth Avenue,
New York 10, N. Y.

RUSH Koriam Knife checked below at 1.98 ea. on 5-day home trial. Include deluxe leather sheath. If not satisfied, I'll return knife for quick refund.

CHECK MODEL DESIRED:

A (Rhine Maiden) B (Black Forest) C (Monarch)
 No. 88—Swiss Army Knife (3.95)

Name _____
Address _____
Town _____ Zone _____ State _____

3.95

SPECIAL!
Swiss Army
Knife

CAN
OPENER

10
TOOLS
IN
ONE

SCISSORS KNIFE

SAW

World-Famous Utility Knife

... deep-cut price ...

World famous utility knife used by Swiss Army Officers—now made by West Germany's cutlery craftsmen! Recognized by sportsmen as the most compact multi-purpose tool ever devised. Only 3 1/2 inches closed. No more searching for that needed tool! 10 precision-built tools always at hand! A "life-saver" for hunters, fishermen, hobbyists, motorists, mechanics. Terrific value at \$3.95. Order yours now!

INVENTORS

Learn how to protect your invention. The U. S. Patent Laws provide that any new and useful art, machine, article of manufacture, or composition of matter, or any new and useful improvement thereof, may be patented if the act of invention is involved. Therefore, every inventor with a valuable invention should take advantage of the Patent Laws and proceed for patent protection in order to safeguard his rights.

A patent gives the inventor the exclusive right to prevent others from making, using, or selling the invention claimed in the patent for a period of seventeen years.

The Patent Laws were enacted for the benefit of the inventor to give him protection for the features of his invention which are patentable. These features must be properly and concisely set forth and claimed in a formal application for patent, in order to comply with the requirements of the Patent Laws. For that reason, unless the inventor is familiar with patent matters, he should engage a competent registered patent attorney or agent to represent him. We are registered to practice before the U. S. Patent Office and are prepared to serve you in the handling of your patent matters.

A specially prepared booklet entitled "Patent Guide for the Inventor", containing detailed information with respect to patent protection and procedure, together with a "Record of Invention" form will be promptly forwarded to you without obligation upon request.

CLARENCE A. O'BRIEN & HARVEY JACOBSON

Registered Patent Attorneys

61-C DISTRICT NATIONAL BUILDING

WASHINGTON 5, D. C.

**"I'LL RIPPLE YOUR BODY
WITH MUSCLES — LOAD
T-N-T IN YOUR FISTS"**

says Joe Louis

**Add solid new muscle to your
body. Guaranteed in 10 days.**

Ten Champions are ready to help you build a body that men respect and women admire. They know you want action and they promise it fast...in their medically approved Conditioning Course.

Joe and other great Champions guarantee that in just ten days you'll feel better...be more aggressive. With their special Exercises you'll pack more power and gain new confidence — for only \$1.00—or your money back.

Your mirror will show new muscles in only ten days. That's the promise of world Champions.



**ONLY
\$1.00**

LET GREAT STARS HELP YOU...



WHITEY LOCKMAN explains his sure-fire method to stimulate circulation and loosen you up for action **LOTS OF FUN**



YOGI BERRA, the American League's most valuable player builds up your confidence . . . **QUICK**



KID GAVILAN sharpens your reflexes . . . develops stamina and toughens your body with his training camp workout . . . **WITH LITTLE EFFORT**

EXTRA! You'll also receive exciting material from the Champions' Manly Art of Self Defense Home Course **IT'S TRULY AMAZING**

FREE —Joe Louis' 24 page "Fight Secrets," free, if you act at once.



The National Sports Council, Dept. P-36
33 West 46th St., New York 36, N. Y.

Enclosed \$1 for the Planned Conditioning Course of the Champions. I must see results in 10 days or my money is refunded immediately. Fight Secrets is free.

NAME _____

ADDRESS _____

CITY _____ STATE _____

MAIL COUPON TODAY

**start a big profit business
with a small investment
EARN UP TO
\$200 a DAY**

Manufacturing Exciting New

RAINBOW ROCK

**Concrete Slump Brick
in your back yard**

Earn big building boom profits with Rainbow Rock, the colorful new building brick that's taking the country by storm. Sell all you can make to contractors, builders, building supply houses. **RAINBOW ROCK CUTS LABOR COSTS BY 1/3!** Amazing low cost machine makes modern slump brick 24" long (3 times the length of ordinary brick) in a variety of widths and pastel colors . . . up to 1500 bricks a day! **NEEDS NO SPECIAL SKILL.** Operates indoors or out. Full instructions and valuable mixing formulae supplied. **YOU CAN START EARNING BIG MONEY NOW. PAY AS YOU PROFIT!** A limited number of machines available on easy payment terms. **NOW** is the time to start. Write today for free literature and full information.

GENERAL ENGINES CO., INC.
Dept. MR-36—Route 130,
Thorofare, N. J. - Tilden 5-5401



STEEL PIER SENSATION
Luxurious RAINBOW ROCK fire-place wall in living room of the "Home of the Century" in Atlantic City, N. J.'s Steel Pier...acclaimed by over 500,000 Summer, 1953 visitors as the most beautiful they'd ever seen! Endorsed by the Pier's famous architect, William F. B. Koelle.



Makes beautiful, decorative fences, garden walls, garages, outside walls, room separators, etc.

LOOK!

A MILLION THRILLS!



High Power
BINOCULARS
33 Models: \$9.95 to \$125

Free! Catalog & Book
"How to Select Binoculars"

BUSHNELL Binoculars
Dept. M23 43 E. Green
Pasadena, Calif.

DRAINS cellars, cisterns, wash tubs; **\$7.95**
IRRIGATES - CIRCULATES - SPRAYS



Type P Pump has 1,001 uses. Up to 3000 GPH; 450 GPH 80' high; or 1800 GPH from 25' well. Use 1/6 to 3/4 HP motor. Coupling included free. 1" inlet; 3/4" outlet. Stainless shaft. Won't rust or clog! Postpaid if cash with order. Rush your order today.

MONEY BACK GUARANTEE
Centrifugal and Gear Pumps in All Sizes
LABAWCO PUMPS, Belle Meade 7. N. J.

Finish HIGH SCHOOL AT HOME

Complete 4 Yrs. in 12 Months

Learn More! Earn More! Enter professional or technical schools. Advance Socially. Live a Happier, Fuller Life. Individual Courses or complete schedule. **WRITE FOR SCHOOL BULLETIN.**

ACADEMY FOR ADULTS

30 W. Washington, Dept. PM-36, Chicago, Ill.

**YOU BUILD 'EM — WE SELL 'EM
EARN UP TO \$50.00 A DAY AT HOME**

Here is a new business for people who would like to make extra money full time or spare time. Our program enables you to work in your home and participate in national sales secured through our firm. You assemble luggage and special cases for photographic equipment—musical instruments—salesmen's samples and all types of portables. We supply complete instructions—materials—tools—everything. No previous experience is necessary. Write for free details. Abarsl Casecraft, Dept. AC, 807 W. Sunset Blvd., Los Angeles 12, Calif.

2 TOP OPPORTUNITY FIELDS

Either, or a Combination of Both Fields
Offer a World of Opportunity to Trained Men!

ELECTRICITY Electronics



Instructor explaining operation and testing of large Motor Generator.

TELEVISION Radio-Color TV



Instructor helping student check wiring and trace circuits of TV set.

In industry—in the home—electricity and electronics are playing a vastly larger, more vital role than ever before. New devices and inventions in our lives are putting a premium on trained Electrical men. The fabulous growth in this field is creating countless job opportunities. Prepare now for a future in Electricity.

The fastest growing industry in America! New stations by the hundreds... new sets by the millions... and now COLOR TV. The opportunities ahead in sales, installation and servicing of TV-Radio sets are unlimited. Get ready now, quickly, for A GOOD JOB OR INDEPENDENCE IN A BUSINESS OF YOUR OWN.

Train in the great shops of **COYNE**

Oldest, and Best Equipped School of Its Kind in the U. S.

VETERAN or NON-VETERAN—Whether 17 or up to 45 years of age, prepare for your future now. Don't be satisfied with a "no future" job. Train the Coyne way for a better job and a real future in **ELECTRICITY-ELECTRONICS, TELEVISION-RADIO**—or a combination of both fields—fields that offer a world of opportunities. Lifetime employment service to Coyne graduates.

WE TRAIN YOU IN CHICAGO—Learn the easier, practical way at Coyne, on real, full size equipment. No advanced education or previous experience needed. You learn *better* the Coyne way.

FINANCE PLAN—Enroll now, pay most of tuition later. Part-time employment help for students.

Mail Coupon for Big Free Book

CLIP COUPON NOW for big new illustrated Coyne book "Guide to Careers in **ELECTRICITY-ELECTRONICS** and **TELEVISION-RADIO**." No obligation; no salesman will call.



B. W. COOKE, President
COYNE ELECTRICAL SCHOOL
500 S. Paulina St., Chicago 12, Ill. Dept. 36-72H

Send **BIG FREE** book and details of all the training you offer in both fields. However, I am especially interested in:

ELECTRICITY-ELECTRONICS **TELEVISION-RADIO**

Name _____

Address _____

City _____ State _____



A TECHNICAL TRADE
INSTITUTE OPERATED
NOT FOR PROFIT

COYNE
ELECTRICAL SCHOOL

TRAINING
IN
REFRIGERATION
and
ELECTRIC
APPLIANCES
can be
INCLUDED

500 S. Paulina St., Dept. 36-72H, CHICAGO 12, ILL.

**FOR A REAL JOB OR A
BUSINESS OF YOUR OWN**

**LEARN
OIL BURNER
SERVICING**

at home—in your spare time!



GET THE FACTS FREE!

Let us send you — without obligation — a Sample Lesson plus all the information you'll need to get you started on the road to success in the automatic oil heating field. Let us prove to you that salaries are higher, opportunities greater, advancement quicker in the fast-growing Oil Burner industry.

5 PROGRAMS IN ONE. We offer you a complete and approved training program — available at no other school — prepared with the co-operation of America's leading heating system manufacturers. Covers Installation, Operation, Maintenance and Service plus Electrical Controls, Firebrick Construction and Sheet Metal Fabrication. Even includes a "Special Business" Plan to help you start your own service shop.

START NOW . . . TODAY! Put your spare time to work. Learn a skilled trade. No previous experience or special education required. Earn while learning, doing part-time jobs in your own area. Low tuition. Tools furnished. Send coupon now. No obligation.

MASS. TRADES "Training Thousands since 1936"

RESIDENT SCHOOL — APPROVED FOR VETS
LICENSED BY MASS. DEPT. OF EDUCATION

Member — Oil Heat
Institute of America



**Write NOW for
FREE SAMPLE**

lesson and booklet.
No obligation. Use
the coupon below.

MASS. TRADES

161-A High St., Boston 10, Mass.

Please rush FREE booklet and Sample Lesson on OIL BURNER SERVICING. I understand there is no obligation.

Name Age.....

Address

City Zone..... State.....

TRAINING AVAILABLE IN CANADA



**Instead of a job . . .
train for a Career**



Industrial growth . . . automation . . . technical advances create career opportunities for engineers, accountants, management experts. Share rewards awaiting college-trained men. Important firms visit campus regularly to employ Tri-State College graduates. Start any quarter in this world-famed college. Approved for veterans.

Bach. of Science degree in 27 months

in Mechanical, Civil, Electrical, Chemical, Aeronautical, Radio (TV-Electronics) Engineering. In 36 Months a B.S. in Business Administration (General Business, Accounting, Motor Transport Management majors). Capable students may accelerate, 30-weeks course in Drafting. Intensive program: technical fundamentals stressed; comprehensive courses with more professional class hours. Small classes; personalized instruction. For earnest, mature students whose time and budget requires accelerated courses and modest costs. Preparatory courses. Beautiful campus in friendly college town. Well-equipped, new and modernized buildings and laboratories. Enter March, June, Sept., Jan. Write Jean McCarthy, Director of Admissions, for "Your Career in Engineering and Commerce."



TRI-STATE COLLEGE

436 College Avenue

Angola, Indiana

LEARN AT HOME



Send
for
FREE BOOKLET

Learn this profitable business from experts in your spare time. Locksmiths have no "slow" seasons or layoffs; they are always in demand. Age or minor physical handicap can't stop you. America's only recognized locksmithing school can teach you easily and quickly. Simple, illustrated lessons plus materials and tools supplied. Make money while learning. Get into this uncrowded field now!

INSTITUTE OF LOCKSMITHING, Dept. P-76
15 Park Avenue RUTHERFORD, N. J.

Lic. by N. J. State Board of Education
Approved for Veterans



MECHANICAL DENTISTRY

A profession offering unlimited opportunities. Most modern and complete course embracing every branch from Plate to Porcelain Work, which prepares you to work for Dentists or start your own business. Individual instruction—practical training in day or night school. No books—no classes. Catalog upon request.

McCARRIE SCHOOL OF MECHANICAL DENTISTRY
207 N. Broad Street Dept. 51 Philadelphia 7, Penna.

**It's EASY to play The
MUSICAL SAW**



the Glass-O-Phone the Jazz-O-Nette,
Musical-Pitchfork, Flute-O-Phone

If you can whistle or hum a tune, you can play these remarkable Novelty Instruments. They are played entirely by ear. Low priced. Write for FREE literature.
MUSSEHL & WESTPHAL, Est. 1921
10 FORT ST., FORT ATKINSON, WISCONSIN



**AMERICA'S NEWEST
OPPORTUNITY**

New fur-bearing animal now being bred in U. S. Offers huge profits to breeders. This fur is next to Mink NOW in price and will soon surpass it. 15 to 20 young per year. Most easily and economically raised animal known. 1 1/2¢ per day to feed. ANY CLIMATE, disease resistant. Build yourself a sound future with this fine, registered stock. WRITE TODAY FOR FREE BOOKLET.

CABANA NUTRIA, INC.

636-A West Lemon Ave., Arcadia, Calif.

INVENTORS

If you believe that you have an invention, you should find out how to protect it. The first step is to have a search made of the prior pertinent U. S. patents. If a report on this search indicates that the invention appears patentable you can apply for a patent, and the specifications and claims should be prepared.

The firm of McMorrow, Berman & Davidson, with offices in Washington, D. C., is qualified to take the necessary steps for you. We can make a preliminary search on your invention, advise you whether we think it can be patented, and prepare your application for patent.

Unless you are fully familiar with the U. S. Patent Laws, we recommend that you engage the services of a Registered Patent Attorney to protect your interests. The patent laws are *your* laws. A patent gives you the right to prevent others from making, using or selling the invention claimed in your patent for a period of 17 years.

Use these patent laws for your protection. Investigate whether your invention can be patented. If you have what you believe to be an invention, we suggest that you have this firm make a search for you!

Send for a copy of our Patent Booklet entitled "How To Protect Your Invention," containing information about patent protection and patent procedure. Along with this we will also send you an "Invention Record" form, for your use in writing down and sketching details of your invention. We will mail them promptly. No obligation. They are yours for the asking.

McMORROW, BERMAN & DAVIDSON

Registered Patent Attorneys

PATENTS • COPYRIGHTS • PATENTS

135-T VICTOR BUILDING, WASHINGTON 1, D. C.

WHAT SECRET POWER DID THIS MAN POSSESS?



BENJAMIN FRANKLIN
(A Rosicrucian)

WHY was this man great? How does anyone—man or woman—achieve greatness? Is it not by mastery of the powers within ourselves?

Know the mysterious world within you! Attune yourself to the wisdom of the ages! Grasp the inner power of your mind! Learn the secrets of a full and peaceful life!

Benjamin Franklin—like many other learned and great men and women—was a Rosicrucian. The Rosicrucians (NOT a religious organization) first came to America in 1694. Today, headquarters of the Rosicrucians send over seven million pieces of mail annually to all parts of the world. Write for YOUR FREE COPY of "The Mastery of Life"—TODAY. No obligation. No salesmen. A non-profit organization. Address: Scribe S.J.T.

THIS BOOK FREE!



The ROSICRUCIANS
SAN JOSE • (AMORC) • CALIFORNIA

—SEND THIS COUPON—

Scribe S.J.T.
The ROSICRUCIANS (AMORC)
San Jose, California
Please send me the free book, *The Mastery of Life*, which explains how I may learn to use my faculties and powers of mind.

Name _____
Address _____
City _____

INSURED TIRE SERVICE
POPULAR BRANDS

FREE INSURANCE POLICY given with each used tire sold. We guarantee the amount of service you pay for.

YOU CAN'T LOSE!!

Special! Deduct 10% on orders for 2 or more used tires.

NOWHERE CAN SUCH QUALITY BE FOUND AT SUCH LOW PRICE!

Super Quality — Rugged Performance — 6 Months Insured Service			
600x16	\$3.65	670x15	\$3.95
650x15	3.85	670x16	4.05
650x16	4.25	700x15	3.95
700x16	4.45	700x16	4.35
		820x15	4.95
		550x17	4.65
Supreme Quality — Nothing Finer — 12 Months Insured Service			
600x16	\$5.25	475x19	\$5.45
600x16(6)	6.75	640x15	4.95
650x16	5.75	670x15	5.35
650x16(6)	7.25	710x15	5.45
700x16	6.35	760x15	5.95
750x16(6)	8.45	800x15	6.35
880x18	4.95	820x15	6.35
850x17	4.75	550x15	5.35
650x15	5.25	670x16	5.15
700x15	5.35	700x16(6)	10.25
		32x6-10	
		10.25	32x6-10
		12.75	1100x24
		22.75	
		25.95	
		19.95	900x20
		11.25	1000x20
		10.95	1100x20
		11.75	1000x22
		11.95	1100x22
		12.75	1100x24
		15.50	750x20(8)
		11.95	750x20(10)
		16.45	825x20
		10.95	900x20
		11.25	1000x20
		10.95	1100x20
		11.75	1000x22
		11.95	1100x22
		12.75	1100x24
		15.50	750x20(8)
		11.95	750x20(10)
		16.45	825x20
		10.95	900x20
		11.25	1000x20
		10.95	1100x20
		11.75	1000x22
		11.95	1100x22
		12.75	1100x24
		15.50	750x20(8)
		11.95	750x20(10)
		16.45	825x20
		10.95	900x20
		11.25	1000x20
		10.95	1100x20
		11.75	1000x22
		11.95	1100x22
		12.75	1100x24
		15.50	750x20(8)
		11.95	750x20(10)
		16.45	825x20
		10.95	900x20
		11.25	1000x20
		10.95	1100x20
		11.75	1000x22
		11.95	1100x22
		12.75	1100x24
		15.50	750x20(8)
		11.95	750x20(10)
		16.45	825x20
		10.95	900x20
		11.25	1000x20
		10.95	1100x20
		11.75	1000x22
		11.95	1100x22
		12.75	1100x24
		15.50	750x20(8)
		11.95	750x20(10)
		16.45	825x20
		10.95	900x20
		11.25	1000x20
		10.95	1100x20
		11.75	1000x22
		11.95	1100x22
		12.75	1100x24
		15.50	750x20(8)
		11.95	750x20(10)
		16.45	825x20
		10.95	900x20
		11.25	1000x20
		10.95	1100x20
		11.75	1000x22
		11.95	1100x22
		12.75	1100x24
		15.50	750x20(8)
		11.95	750x20(10)
		16.45	825x20
		10.95	900x20
		11.25	1000x20
		10.95	1100x20
		11.75	1000x22
		11.95	1100x22
		12.75	1100x24
		15.50	750x20(8)
		11.95	750x20(10)
		16.45	825x20
		10.95	900x20
		11.25	1000x20
		10.95	1100x20
		11.75	1000x22
		11.95	1100x22
		12.75	1100x24
		15.50	750x20(8)
		11.95	750x20(10)
		16.45	825x20
		10.95	900x20
		11.25	1000x20
		10.95	1100x20
		11.75	1000x22
		11.95	1100x22
		12.75	1100x24
		15.50	750x20(8)
		11.95	750x20(10)
		16.45	825x20
		10.95	900x20
		11.25	1000x20
		10.95	1100x20
		11.75	1000x22
		11.95	1100x22
		12.75	1100x24
		15.50	750x20(8)
		11.95	750x20(10)
		16.45	825x20
		10.95	900x20
		11.25	1000x20
		10.95	1100x20
		11.75	1000x22
		11.95	1100x22
		12.75	1100x24
		15.50	750x20(8)
		11.95	750x20(10)
		16.45	825x20
		10.95	900x20
		11.25	1000x20
		10.95	1100x20
		11.75	1000x22
		11.95	1100x22
		12.75	1100x24
		15.50	750x20(8)
		11.95	750x20(10)
		16.45	825x20
		10.95	900x20
		11.25	1000x20
		10.95	1100x20
		11.75	1000x22
		11.95	1100x22
		12.75	1100x24
		15.50	750x20(8)
		11.95	750x20(10)
		16.45	825x20
		10.95	900x20
		11.25	1000x20
		10.95	1100x20
		11.75	1000x22
		11.95	1100x22
		12.75	1100x24
		15.50	750x20(8)
		11.95	750x20(10)
		16.45	825x20
		10.95	900x20
		11.25	1000x20
		10.95	1100x20
		11.75	1000x22
		11.95	1100x22
		12.75	1100x24
		15.50	750x20(8)
		11.95	750x20(10)
		16.45	825x20
		10.95	900x20
		11.25	1000x20
		10.95	1100x20
		11.75	1000x22
		11.95	1100x22
		12.75	1100x24
		15.50	750x20(8)
		11.95	750x20(10)
		16.45	825x20
		10.95	900x20
		11.25	1000x20
		10.95	1100x20
		11.75	1000x22
		11.95	1100x22
		12.75	1100x24
		15.50	750x20(8)
		11.95	750x20(10)
		16.45	825x20
		10.95	900x20
		11.25	1000x20
		10.95	1100x20
		11.75	1000x22
		11.95	1100x22
		12.75	1100x24
		15.50	750x20(8)
		11.95	750x20(10)
		16.45	825x20
		10.95	900x20
		11.25	1000x20
		10.95	1100x20
		11.75	1000x22
		11.95	1100x22
		12.75	1100x24
		15.50	750x20(8)
		11.95	750x20(10)
		16.45	825x20
		10.95	900x20
		11.25	1000x20
		10.95	1100x20
		11.75	1000x22
		11.95	1100x22
		12.75	1100x24
		15.50	750x20(8)
		11.95	750x20(10)
		16.45	825x20
		10.95	900x20
		11.25	1000x20
		10.95	1100x20
		11.75	1000x22
		11.95	1100x22
		12.75	1100x24
		15.50	750x20(8)
		11.95	750x20(10)
		16.45	825x20
		10.95	900x20
		11.25	1000x20
		10.95	1100x20
		11.75	1000x22
		11.95	1100x22
		12.75	1100x24
		15.50	750x20(8)
		11.95	750x20(10)
		16.45	825x20
		10.95	900x20
		11.25	1000x20
		10.95	1100x20
		11.75	1000x22
		11.95	1100x22
		12.75	1100x24
		15.50	750x20(8)
		11.95	750x20(10)
		16.45	825x20
		10.95	900x20
		11.25	1000x20
		10.95	1100x20
		11.75	1000x22
		11.95	1100x22
		12.75	1100x24
		15.50	750x20(8)
		11.95	750x20(10)
		16.45	825x20
		10.95	900x20
		11.25	1000x20
		10.95	1100x20
		11.75	1000x22
		11.95	1100x22
		12.75	1100x24
		15.50	750x20(8)
		11.95	750x20(10)
		16.45	825x20
		10.95	900x20
		11.25	1000x20
		10.95	1100x20
		11.75	1000x22
		11.95	1100x22
		12.75	1100x24
		15.50	750x20(8)
		11.95	750x20(10)
		16.45	825x20
		10.95	900x20</



NOW! In Your OWN Home

GET D.T.I.'s AMAZINGLY EFFECTIVE **NEW** TRAINING in

AUTOMATION
ELECTRONICS

TELEVISION
ELECTRONICS and
RADIO!

Remarkable New Styrene ELECTRO-LAB*

It's as simple as this: Insert pictorial diagram on transparent styrene base. (See above.) Mount parts to follow pattern—using handy "snap in" fasteners. Eliminates wiring errors. Tops for speedy circuit changes . . . for providing maximum circuit experience in minimum time. Build and operate scores of interesting projects—such as the electronic circuit shown above.

NOTHING ELSE LIKE IT!

DeVry Tech training supplies you with the exclusive Electro-Lab plus the parts shown above, plus home movies, plus the equipment shown at right. There's nothing else like it for providing real LABORATORY-TYPE training at home. Get the kind of thorough, practical experience YOU NEED for the kind of progress YOU WANT in today's tremendous field of Television, Radio and Electronics. Qualify yourself for real money . . . interesting work . . . a wonderfully promising future. And when you finish, D.T.I.'s active Employment Service HELPS YOU GET STARTED! Or open your own profitable Television-Radio Service Business. *Trade-mark



Exclusive Home Movies

help you grasp important points **FASTER . . . EASIER . . . BETTER.** A tremendous advantage!

Member of National Home Study Council

"One of America's Foremost Electronics Training Centers"



DEVRY TECHNICAL INSTITUTE
CHICAGO 41, ILLINOIS
FORMERLY
DEFOREST'S TRAINING, INC.

FREE FOR THE ASKING!



DEVRY TECHNICAL INSTITUTE
4141 Belmont Ave., Chicago 41, Ill. Dept. PM-3-M

I would like complete facts including "89 Ways to Earn Money in Television-Radio-Electronics."

Name _____ Age _____
(PLEASE PRINT)
Street _____ Apt. _____
City _____ Zone _____ State _____
1020 D.T.I.'s training is available in Canada.



Work over **300** projects with your wonderful HOME LABORATORY

5 INCH "SCOPE"

OSCILLOSCOPE

ABOVE! Also build and keep this quality Oscilloscope — almost a "must" for Television servicing.

VACUUM TUBE VOLTMETER

Thousands of Successful Graduates

Why has D.T.I. become one of the largest training organizations of its kind? Because it provides EVERY MAJOR HOME TRAINING AID to help make the subject **EASIER** to learn . . . **EASIER** to remember — the kind of training so helpful for **REAL PROGRESS**. Students get thorough, up-to-date, practical training that **TAKES ADVANTAGE** of new and improved training developments. Study the **ADVANTAGES** shown on this page. Think what they can mean to YOU . . . to YOUR FUTURE! Or come to D.T.I.'s big Training Laboratories in Chicago. **MAIL COUPON TODAY** for complete facts—including valuable publication, "89 Ways to Earn Money in Television-Radio-Electronics." Also, valuable information for men subject to **MILITARY SERVICE**.

NEW!

Build and keep D.T.I.'s new **VACUUM TUBE VOLTMETER** . . . one of the most useful of all test instruments.

21 INCH

Build and keep D.T.I.'s **NEW 2 Unit TV Set**—ideal for custom installation. (D.T.I. also offers home training without the TV set.)



Pour YOURSELF INTO BIG PROFITS!

PAYS BIG MONEY & IT'S EXCITING!

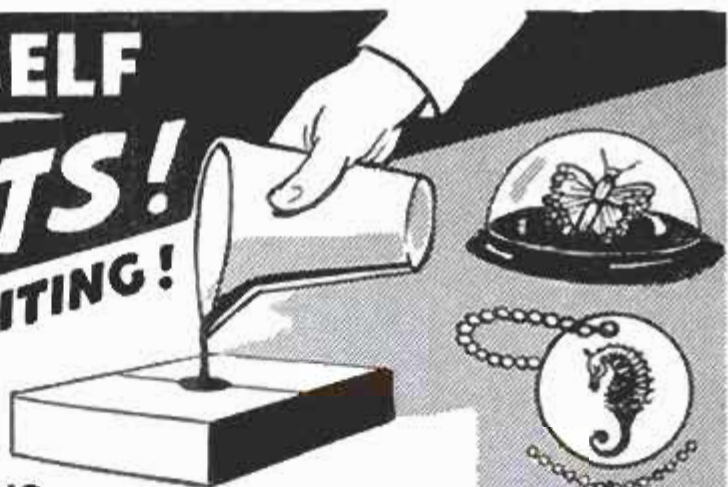

AS EASY AS POURING WATER OUT OF A GLASS!

Make Jewelry, Novelties, etc. Unlimited opportunities making beautiful and useful things out of LIQUID PLASTIC, LIQUID MARBLE, LIQUID IVORY, LIQUID GLASS, LIQUID GEMSTONE, LIQUID PORCELAIN, CERAMICS, ETC. without tools or machinery! Anyone can do it! PLASTICASTING costs you but pennies, the items you make sell for dollars! Thousands now prospering because of Liquid Plastics.

Make Novelties, Jewelry, Gifts, Artware, Toys, Tools, Dies, Gadgets, Ceramics, etc. A million useful things!

We supply everything you need MATERIALS and INSTRUCTIONS. Send only 25c for big 98 page catalog of casting materials, molds and accessories and we will include free of extra cost a remarkable book "THE WONDERS OF LIQUID PLASTICS" that will open your eyes to marvels you never even dreamed of! Send 25c today this may be just the lucky coin that will start you on the most fascinating and profitable phase of your entire life!

PLASTICAST COMPANY, 6612 N. Clark St., Dept. PC-502, Chicago 26, Ill.

High School at Home

MANY FINISH IN 2 YEARS

No classes. No time wasted going to and from school. Progress as fast as your time and abilities permit. Standard H. S. texts supplied. Thousands enroll each year in this 59-year-old school. Send for FREE descriptive booklet.

AMERICAN SCHOOL, Dept. H345
Drexel at 58th St., Chicago 37, Ill.

Without obligation, please send FREE descriptive booklet.

Name.....

Address.....

Canadian Residents: Complete Canadian Course Available.
Write American School, 1610 Sherbrooke St., West, Montreal.

GIANT STAMP ZOO FREE!

Snakes, Leopards, Rhinoceros, Zabu, Koalabear and other fierce jungle beasts, Approvals. Send 10c for handling. FREE STAMP MAGAZINE.

LINCOLN STAMP COMPANY,
St. Catharines 57, Ont., Canada



Grow authentic, LIVE dwarf trees!
Fascinating hobby! Fabulous profit!

GROW MINIATURE TREES

SEND FOR FREE SEED & INFORMATION!

MINIATURE NURSERY CLUB
Dept. JJ-3, P.O. Box 8794,
Los Angeles 8, Calif.

FOR BIG MEN ONLY!

SIZES 10-16 - WIDTHS AAA-EEE!

We SPECIALIZE in large sizes only — sizes 10 to 16; widths AAA to EEE. Low-Cuts; Wing Tips; Hand-Sewn Moccasins; Cordovans; Dress Oxfords; Work Shoes; Sox; Slippers; Rubbers. Enjoy the finest in fit, comfort, style at amazingly low cost. Mail only. Write for FREE Style Book TODAY!

KING-SIZE, INC. - 733 Brockton, Mass.
POPULAR MECHANICS



SEND FOR FREE CATALOG

Here's the **EASY, Step-by-Step Way to**

FIX ANY CAR IN A JIFFY!

Engines, Brakes, Transmissions, Rear Ends, Carburetors—Yes, Any Part

**BRAND-NEW
EDITION!**

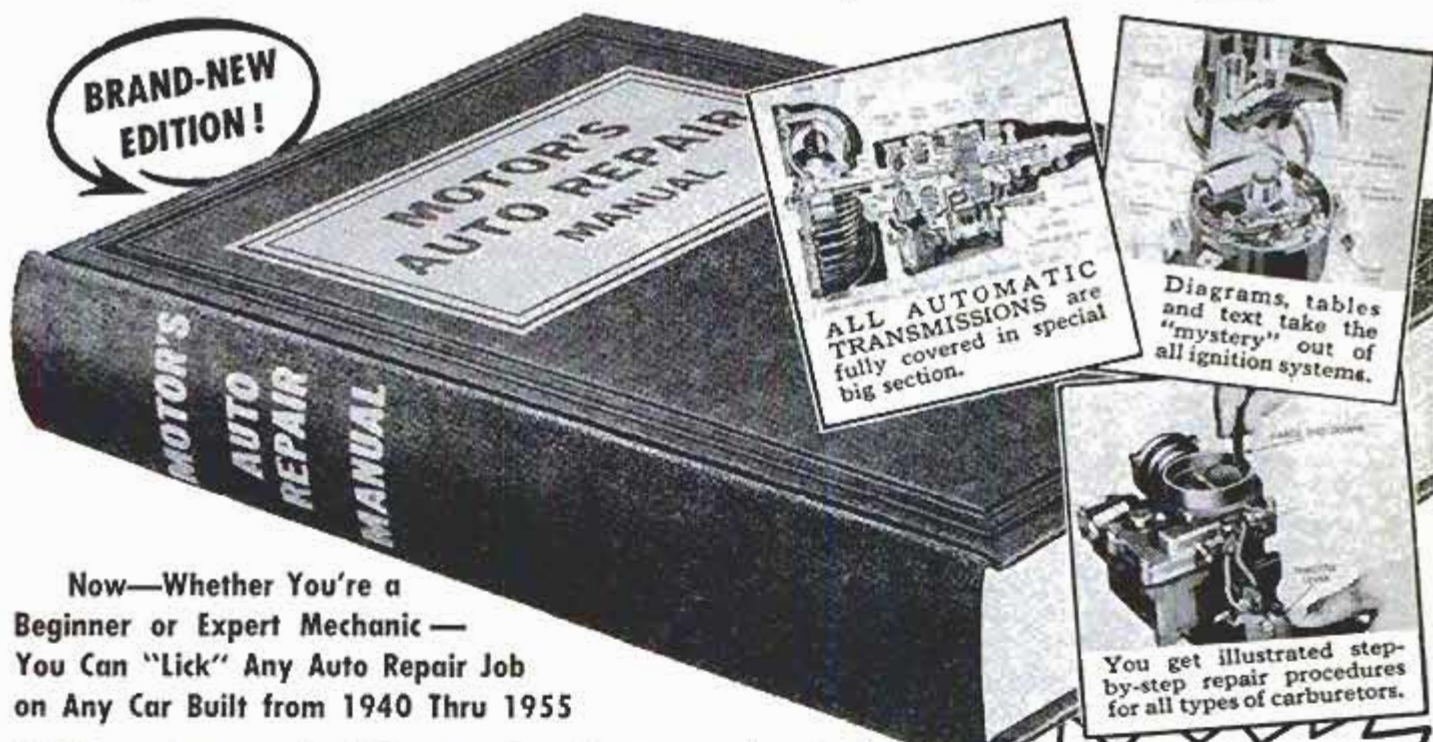

Now—Whether You're a Beginner or Expert Mechanic — You Can "Lick" Any Auto Repair Job on Any Car Built from 1940 Thru 1955

YES, now you can fix ANY part of ANY car—quickly, easily, and right! From carburetor adjustment to a complete overhaul, it's easy when you have MOTOR's famous Auto Repair Manual. It's like having a staff of factory experts and MOTOR's field-trained engineers beside you, guiding you every step of the way. No wonder so many thousands of beginner and expert mechanics alike use this step-by-step, illustrated giant manual.

MOTOR's Manual "starts from scratch"—leads you through entire job with easy step-by-step directions, clear "how-to" pictures. Tells you WHERE to start, what TOOLS to use. You just CAN'T go wrong!

2,900 Pictures! So Complete So Simple, You CAN'T Go Wrong!

NEW, REVISED edition covers everything you need to know to repair any car. Over ONE THOUSAND giant pages. 2900 "This-Is-How" pictures lead you every step of the way. 291 "Quick-Check" charts—23,436 essential repair specifications. Over 225,000 service and repair facts on ALL 737 chassis models from 1940 thru 1955. Instructions and pictures so clear you can't go wrong! Even a green beginner mechanic can do a good job. And if

you're a top-notch mechanic, you'll be amazed by the time and labor-saving methods!

The "Meat" of Over 160 Official Shop Manuals

**OVER
2 MILLION
COPIES
SOLD!**

The editors have put together the "know-how" from over 160 Official Shop Manuals and "boiled it down" into one fully-illustrated easy-to-understand guide.

Here's ILLUSTRATED step-by-step guidance on Automatic Transmissions, Tune Up, Ignition, Carburetors, Fuel Pumps, Clutches, Steering Gears, Rear End, Brakes, PLUS MUCH MORE.

SEND NO MONEY

Try Book for a Week FREE

Send no money. Pay nothing to postman.

Test book in your own garage or shop. It's **GUARANTEED** to pay for itself in 7 days. If it doesn't, just return the book, and owe nothing. **MOTOR Book Dept., Desk 1C, 250 West 55th St., New York 19, N. Y.**

USED BY U. S. ARMED FORCES

Covers 737 Models—All These Makes

Buick	Ford	Nash
Cadillac	Frazer	Oldsmobile
Chevrolet	Henry J	Packard
Chrysler	Hudson	Plymouth
Crosley	Kaiser	Pontiac
De Soto	Lincoln	Studebaker
Dodge	Mercury	Willlys

Try Book for a Week **FREE**

Beginner Raves About Book
"Never knew anything about repairing cars until I got this wonderful book. Easy to see close-up pictures of every part. Has paid for itself time and time again."
—P. Pemper, Wisc.

So Does Expert
"Have been a mechanic for 25 years. MOTOR's Manual still takes me out of the tight spots. And it's simple enough to be understood by average person."
—V. Lauria, Nev.

MAIL COUPON NOW FOR 7-DAY FREE TRIAL

**MOTOR BOOK DEPT.
Desk 1C, 250 W. 55th St., N. Y. 19, N. Y.**

Rush to me at once (check box opposite book you want):

MOTOR'S New AUTO REPAIR MANUAL. If O.K., I will remit \$2 in 7 days, \$2 monthly for 2 months and a final payment of \$6 (plus 35c delivery charges) one month after that. Otherwise I will return the book postpaid in 7 days. (Foreign price, remit \$9 cash with order.)

MOTOR'S New TRUCK REPAIR MANUAL. If O.K., I will remit \$2 in 7 days, and \$2 monthly for 8 months, plus 35c delivery charges with final payment. Otherwise I will return book postpaid in 7 days. (Foreign price, remit \$10 cash with order.)

Print Name..... Age.....

Address

City..... State.....

Check box and save 35c shipping charge by enclosing WITH coupon entire payment of \$6.95 for Auto Repair Manual (or \$8 for Truck Repair Manual.) Same 7-day return-refund privilege applies.

Same FREE Offer on MOTOR'S New TRUCK MANUAL

Covers EVERY job on EVERY popular make gasoline truck as well as GM and Cummins Diesels 1946 thru 1955. For FREE trial, check coupon.

DRAFTSMEN



**CASH BIG
PAY CHECKS!**

Train Now for
more success,
greater security

**LEARN AT HOME IN SPARE TIME
(or at college in Chicago)**

Check the want ads in any newspaper—SEE the big-pay opportunities open to you as a draftsman. What's more, you can learn this well-paid, prestige profession at home—quickly, easily! No special talent needed. Get complete, step-by-step Chicago Tech lessons in the mail, spend a few pleasant hours studying each week. In a short time you'll be a well-trained draftsman, ready to take your pick of many good jobs. Act now!



Free Information—Mail Coupon Today!

Get FREE TRIAL LESSON plus information about C.T.C. practical training. Learn what successful Chicago Tech graduates say about high pay and opportunities in drafting. No charge, or obligation.

CHICAGO TECHNICAL COLLEGE

C-254 Tech Bldg., 2000 So. Michigan Ave.
Chicago 16, Illinois

Mail me FREE lesson with facts about big opportunities
in DRAFTING.

Name _____ Age _____

Address _____

City _____ Zone _____ State _____

Say You Saw It in Popular Mechanics

CHEMISTRY



BIG LABORATORY GIVEN FREE!

Be a CHEMIST! One of the really GREAT professions! We teach you at home. Simplified (but thorough) course; no previous training required. Earn while you learn. This is a GOLDEN AGE for those with special knowledge! Diploma awarded! Send 25c for first lesson and KIT or \$1.00 for first 5 lessons and supplies including

FREE!

URANIUM TESTER, CHEMICAL
PUZZLE (worth \$2.50) and
HOW TO MAKE 100 NEW
CHEMICALS!

NATIONAL SCHOOL OF CHEMISTRY

P.O. BOX 606-D

REDWOOD CITY, CALIF.

SEND FOR Free Record

START SPEAKING
FRENCH
OR
SPANISH ALMOST OVERNIGHT!



HERE'S the easiest way to learn FRENCH, SPANISH, Russian, German, Italian, Japanese or Brazilian. Listen to FREE 2-side non-breakable record. Let your eyes follow words in FREE sample lesson. Almost at once you'll be chatting in a new language with a perfect accent! That's all you hear! No dull, tedious work. Just listen—imitate! It's that easy! Offer may end soon. Rush 25c to help cover cost of special packaging, shipping. State language you want. We'll also send free information on full Cortina course. CORTINA ACADEMY, Dept. 643, 136 W. 52nd St., New York 19.

GIANT BALLOONS



They're really BIG—surplus U.S. Govt. (new overage) Neoprene weather, target balloons. GREAT FUN in the backyard; at parties, picnics, dances, fairs. TERRIFIC for high school and college PROMS. They attract BIG CROWDS to business openings, civic events, conventions, exhibitions, trade shows. ORDER TODAY! Great for gift. Approx. inflated sizes:

18 in. dia., 3 for 70c
3 ft. dia., 49c—5 ft. dia., 99c
10 ft. dia., \$1.59—13 ft. dia., \$1.95

Postage paid on prepaid orders.
Calif. residents please add sales tax.

VOLUME SALES CO., War Assets Division
Dept. PM-356 3930 Sunset Blvd. Los Angeles 29, Calif.

Learn ACCOUNTING Business Administration

Bookkeeping, secretarial and allied subjects at home in your spare time or attend nationally approved resident school. Write for FREE Success Book giving complete details on courses, plans, rates and employment opportunities. G.I. approved. Write Dept. A.

**Hills BUSINESS UNIVERSITY AND
EXTENSION SCHOOL**

629 W. MAIN ST. OKLAHOMA CITY 2, OKLAHOMA

MAKE CRIME YOUR BUSINESS

ON THE SIDE OF THE LAW!

Help fight crime! . . . Earn steady good pay as a Finger Print Expert or Investigator. I. A. S. trains you—by easy, low-cost home study lessons. Learn this exciting work in spare time. Write for full details now!

OVER 800 POLICE BUREAUS . . . Employ I. A. S.-trained men . . . proof of what I. A. S. can do. Write today (state age) for details. No obligation. No salesmen will call. INST. OF APPLIED SCIENCE, 1920 Sunnyside Ave., Dept. 1353 Chicago 40, Ill.

REAL ESTATE BE A BROKER

PAYS BIG! SEND FOR FREE, BIG, ILLUSTRATED CATALOG NOW! Graduates report making substantial incomes. Start and run your own business quickly. Men, women of all ages, learn easily. Course covers Sales, Property Management, Appraising, Loans, Mortgages, and related subjects. **STUDY AT HOME** or in classrooms in leading cities. Diploma awarded. Write TODAY for free book! No obligation.

Approved for World War II and Korean Veterans
WEAVER SCHOOL OF REAL ESTATE (Est. 1936)
2020R Grand Avenue Kansas City, Mo.



FALSE TEETH

KLUTCH holds them tighter

KLUTCH forms a comfort cushion; holds dental plates so much firmer and snugger that one can eat and talk with greater comfort and security; in many cases almost as well as with natural teeth. Klutch lessens the constant fear of a dropping, rocking, chafing plate. 35c and 60c at druggists . . . If your druggist hasn't it, don't waste money on substitutes, but send us 10c and we will mail you a generous trial box.

KLUTCH CO. Box 693-C ELMIRA, N. Y.

LET MY STUDENTS AND GRADUATES TELL YOU

ABOUT MY TRAINING -

\$60 A WEEK IN SPARE TIME



I have the skill and know-how to do the work I love best and to enjoy better things in life, thanks to RTTA. I am working at TV servicing and making \$60 a week sparetime.

Harold Gimlen, Flint, Mich. 4/21/54

AIRCRAFT INSPECTOR



With RTTA training and through repairing radios and televisions for the right people at the right price, I was able to make the right contacts. I am now an Inspector for Douglas Aircraft at about \$125 a week.

Hugh Maddox, Los Angeles, Calif. 4/20/54

ELECTRICAL TESTER



RTTA training has helped me understand TV and many variations of simple circuits. The course covers all subjects very clearly. I am now an Electrical Tester for Western Electric Co. at \$83.42 a week.

Raymond Lapan, Burlington, N. C. 1/24/54

HAS OWN BUSINESS



I have a shop at home and have been working on radio and TV after working hours of my regular job. I average \$50 a week for this part time work. RTTA training helped me in making extra money and giving me experience in the electronic field.

Richard Hennis, Little Rock, Ark. 4/20/54

SERVICE MANAGER



I manage two radio and television shops, one here and one in Pompano Beach. RTTA training increased my knowledge of TV circuits and showed me new, quicker methods of repairing. Lessons as presented are very concise and clear.

William Phillips, Fort Lauderdale, Fla. 4/22/54

REPAIRED EVERY SET



RTTA training helped me to understand TV more thoroughly. I have repaired every set that I was called on to repair.

Andrew Busi, Jr., Iselin, Pa. 4/21/54

L. C. Lane, B.S., M.A.
President, Radio-Television Training Association. Executive Director, Pierce School of Radio & Television.



- ABOUT MY EQUIPMENT

YOU GET ALL THIS EQUIPMENT



"... a money making little gem."

I have completed kit #6 and was amazed at how it works. I showed it to a friend of mine and he asked me to set it up for one of the picnics his social club was having. That set is a money making little gem.

John Fernandez, Fresno, Calif. 4/22/54

"We get excellent pictures..."

I would like to compliment you on an excellent and complete course. We get excellent pictures on my TV set from WSYR (Syracuse, N.Y.), approximately 110 air miles away. The set is working good and I have had to replace only three tubes since I assembled it two years ago.

Larry H. Stafford, Kingston, Ont., Canada 7/2/54

"... very good reception..."

I have really enjoyed the course and have come a long way in TV servicing. I am getting very good reception on my TV station considering that the nearest VHF station is 120 miles.

J. W. Hanton, Jr., Henderson, Texas 7/12/54

YOU, TOO, CAN GET A BETTER-PAYING JOB IN THE EVER-EXPANDING RADIO-TELEVISION-ELECTRONICS FIELD

Why limit yourself and your earnings because of your lack of training. Learn AT HOME in your SPARE TIME to be an electronic technician, television repairman, or studio technician. You don't need any experience whatsoever. Many students earn up to \$25 weekly in spare time while learning.

After you finish my Radio-FM Television Course or FM-Television Course you can have, if you want it, two weeks of laboratory training at my associate resident school in New York City—AT NO EXTRA COST.

If you have had previous radio and television experience you can take my practical TV Cameraman and Studio Technician Course to qualify for a good-paying job in a TV studio.

Write to me today and let me show you how you can begin now to put yourself on the road to a better future.

VETERANS!

My school fully approved to train veterans under new Korean G.I. Bill. Don't lose your school benefits by waiting too long. Write discharge date on coupon.

Radio Television Training Association

52 EAST 19th STREET • NEW YORK 3, N. Y.

Licensed by the State of New York • Approved for Veteran Training

YOU GET THESE FREE



MAIL THIS COUPON TODAY!

Mr. Leonard C. Lane, President
RADIO-TELEVISION TRAINING ASSOCIATION
Dept. N-3C, 52 East 19th Street, New York 3, N. Y.

Dear Mr. Lane: Send me your NEW FREE BOOK, FREE SAMPLE LESSON, and FREE aids that will show me how I can make TOP MONEY IN TELEVISION. I understand I am under no obligation.

(PLEASE PRINT PLAINLY)

Name _____ Age _____

Address _____

City _____ Zone _____ State _____

- I AM INTERESTED IN:
- Radio-FM-TV Technician Course
 - FM-TV Technician Course
 - TV Cameraman & Studio Technician Course

VETERANS!

Write discharge date

BUY DIRECT and SAVE UP TO 1/2 on ITALIAN ACCORDIONS EASY TERMS

Act NOW!
Accordions of famous makes and breath-taking beauty now can be yours! Mail coupon for FREE Color Catalog and amazing Wholesale Prices.



5 DAYS
FREE
TRIAL
•
MONEY
BACK
GUARANTEE
•
MAIL
COUPON
NOW

TRY BEFORE YOU BUY

World's largest selection direct from Importer to you! 30 models to choose from. SATISFACTION GUARANTEED or your money back. Trade-ins accepted. Terms as low as \$10 monthly. Write today!

Big Color Catalog FREE! Send me Free Color Catalog—full details.

Name _____
Address _____
City _____ State _____

ACCORDION MANUFACTURERS & WHOLESALE OUTLET

2003 West Chicago Ave., Dept. R-36, Chicago 22, Ill.



OWN YOUR OWN BUSINESS

Free folder tells how! Build and operate this profitable roadside stand—seasonal or year 'round. Mail coupon now.



RICHARDSON CORPORATION
Dept. PM-3, P.O. Box 790, Rochester 3, N.Y.

Please send me FREE folder on your tested, franchised refreshment stand.

Name _____
Address _____
Place _____

THINK!

Thought alone is the magic that makes some men geniuses, some millionaires. Here now is the most fabulous product ever devised! THINK-O-GRAPH actually forces you to think—sharpen your wits. It's incredible but true: THINK-O-GRAPH gives you the ideas—all you do is concentrate! You create by thinking. Nothing like this ever has been available before. Whatever your position, THINK-O-GRAPH will help you.

WHAT WILL IT DO FOR YOU?

Inventors—idea men—gadgets
ATTENTION: THINK-O-GRAPH will inspire you, make you think of things you never could imagine before. The effects of THINK-O-GRAPH are impossible to describe. Every day without one is your loss. A perfect gift for a creative friend. Satisfaction guaranteed or your money refunded.



(or COD plus postage)

STUART PROCESS 3104 W. Roosevelt Road, Dept. P, Chicago, Ill.

TELEPHONES



Desk Stand Style

Slightly used but in excellent condition

Many Valuable Uses

- Inter-House Phones
- House to Barn, etc.
- Loud Speakers
- Microphones
- Educational Purposes, Toys, etc.

Come complete, ready to use with wiring diagrams included. Two complete for only \$5.00 \$2.75 Postpaid in U.S.A.

TELEPHONE LAMP KIT—with illustrated instructions for making Desk Telephone Lamp including all parts (lamp, nipples, push switch, cord, plug, etc.) \$6.50 Ppd. (Shade is not included).

MICROPHONE, Dept. X-3602, 1760 W. Lunt Ave., Chicago 26, Ill.

POW!!! hunting slingshot

- accurate—powerful—silent
- kills small game, pests
- hits like a rifle

\$1.50 postpaid (no cod's)



Used by expert marksmen! 7" hardwood stock, 45 lb. pull. Best rubber. FREE!!—extra rubber and big supply heaviest steel balls used by experts, illustrated catalog.

order today from— I. J. STONE DEPT. B-31616 Oak St. Santa Monica, Calif.

The finest of Gifts...

ENCYCLOPAEDIA BRITANNICA

AGENTS START BUYING SERVICE AT HOME

GET BIG NAME MERCHANDISE

for your clients up to 40% less than reg. price. Operate sparetime. Sales easy as you can give sizeable discounts, still make fat comm. Postcard brings free plan.

AMERICAN BUYERS SERVICE

HERTEL STATION, DEPT. R, BUFFALO 16, NEW YORK

GET UP TO 40% OFF

SAY YOU SAW IT IN POPULAR MECHANICS

POWER MOWERS & KITS

FREE PLANS

LOW FACTORY PRICES DIRECT TO YOU

Build your own quality mower with our LOW COST KITS, Parts, Engines. Free Plans guide you. 3 and 4 Wheel Kits, complete. Parts precision finished, ready to use. Write TODAY for Free Plans, Low Prices, Parts List and Guarantee.



3-WHEEL KIT NO. T-800



America's Finest Power Mowers completely assembled in 3 and 4 wheel models. Belt or direct drive. 18" and 20" sizes. Nationally known make engine. Latest improved features, sturdy construction and money back guarantee fully described in color folder. Write today.

▲ TRIANGLE MANUFACTURING CO., Dept. M-3, Fort Scott, Kansas



**Get more money!
More security! More out of life!**

Learn

**TELEVISION
• RADIO •
ELECTRONICS**



Get the best!

Get National Schools' SHOP-METHOD HOME TRAINING!

Start now! Why wait around for that raise or promotion that may never come? Get started *now* in high-paying TV-Radio-Electronics! National Schools' SHOP METHOD Home Training prepares you for success in a top-salary job or in your own business. You learn *all three*... Television, Radio, Electronics... in one complete course. Our Shop-Tested lessons and manuals help you master all phases in shortest possible time! Send coupon, find out today!

WHY NATIONAL SCHOOLS LEADS THE FIELD

Located in the "Television Center" of the world, our staff is in close touch with latest developments and opportunities. We give you personalized job placement assistance. We also give you confidential help with both technical and personal problems relating to your training. We show you how to make Part Time Earnings as you progress. Whether you live 30 miles away, or 3,000, you will always be pleased with our prompt, friendly service!

DRAFT AGE? Our home training helps you achieve specialized ratings and higher pay grades if you go in service.

We send you this precision-tested Multitester! Plus parts to build Oscillators, Receivers, Signal Generator, Continuity Checker, Combination Short Wave and Standard

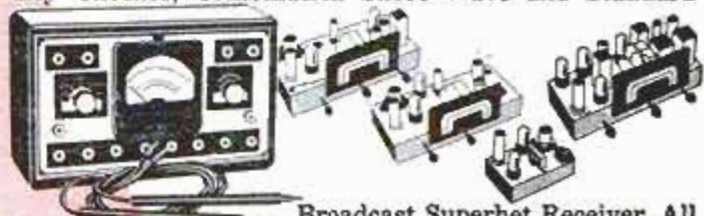

Broadcast Superhet Receiver. All this equipment is part of your National Schools' course. **NO EXTRA CHARGES!** Send coupon for free books!

NATIONAL SCHOOLS, world-famous technical trade school. Now in our 50th year!



NATIONAL SCHOOLS

TECHNICAL TRADE TRAINING SINCE 1906

LOS ANGELES 37, California • CHICAGO: 22 W. Madison St.

IN CANADA: 811 West Hastings Street, Vancouver, B. C.

• APPROVED FOR G. I. TRAINING

• BOTH HOME STUDY AND RESIDENT COURSES OFFERED

MAIL NOW TO OFFICE NEAREST YOU!

(mail in envelope or paste on postal card)

NATIONAL SCHOOLS, Dept. RB-36

4000 SOUTH FIGUEROA STREET OR 22 W. MADISON STREET
LOS ANGELES 37, CALIFORNIA CHICAGO 2, ILLINOIS

Please rush **FREE BOOK**, "My Future in Radio-Television-Electronics," and **FREE LESSON** at once. I understand there is no obligation, and no salesman will call.

NAME _____ BIRTHDAY _____ 19__

ADDRESS _____

CITY _____ ZONE _____ STATE _____

Check if interested **ONLY** in Resident Training at Los Angeles.

VETERANS: Give date of discharge _____

30 MILLION TV SETS

need regular repair! Color TV means more sets than ever before. NOW is the golden opportunity to cash in on this multi-billion-dollar industry Or "write your own ticket" in broadcasting, manufacturing, and other specialized phases!

**YOUR AGE
IS NO
OBSTACLE!**

**Send for
FREE LESSON!**

FREE BOOK & SAMPLE LESSON
will convince you!
SEND COUPON TODAY!



not everyone does as well, but E. O. Lockin, who started a business of his own, reports...

for 12 months I've averaged
\$800 PER MONTH
INCOME —
 most of it clear profit for me!

• Mr. Lockin expresses his grateful thanks for the opportunity to make a decent living on his own. Many men have discovered how to be independent, to be free of bosses and layoffs. L. A. Eagles grossed more than \$200 his first week. R. E. Traynor says, "I made \$62 gross in one day." Others report gross up to \$12,000 per year.

How much you make depends largely on you. You need no special skill, no large investment. Can start part time until you have full time.

No shop necessary

Our *Electric Rug Washer* cleans rugs, carpets right on floor... helps to show their natural color and beauty. So efficient and safe, used by largest hotels and railroads.

You take no risk. Machines fully guaranteed. Mail coupon today for complete information including how to start making big profits in your own business.



VON SCHRADER MFG. CO.
RACINE, WISCONSIN

You, too, can start your own business. No special skill, no large investment required. Mail coupon today for interesting FREE book.

VON SCHRADER MFG. CO.,
 310 "R" Pl., Racine, Wisconsin

Send at once (no obligation) your FREE booklet containing information about your *Electric Rug Washer* and how I can start my own permanent, profitable business.

Name.....
 Address.....
 City.....Zone.....State.....

Write Like This Complete OUTLINE FREE!
 YOUR penmanship can be improved in 3 hours or corrected to your satisfaction in 10 hours' practice with my **DEFINITE HAND CONTROLS**. New way!
 WRITE OZMENT BOX 665 34-P, ST. LOUIS, MISSOURI

AIR CONDITIONING
 MAKE \$3 TO \$5 AN HOUR AS YOU LEARN
FREE BOOKS Experts say that central air conditioning will be installed in 2 million new homes yearly. Already the shortage of mechanics is acute. Many earn to \$125 a week and up. New Shop Method trains you at home. You get 23 training kits—build and keep an air conditioner, freezer, refrigerator or milk cooler. Write for 2 FREE BOOKS.
COMMERCIAL TRADES INSTITUTE
 1400 Greenleaf Dept. R-238 Chicago 26, Ill.

REFRIGERATION

Shrinks Hemorrhoids
New Way Without Surgery

Science Finds Healing Substance That Relieves Pain—Shrinks Hemorrhoids

For the first time science has found a new healing substance with the astonishing ability to shrink hemorrhoids and to relieve pain — without surgery.

In case after case, while gently relieving pain, actual reduction (shrinkage) took place.

Most amazing of all — results were so thorough that sufferers made astonishing statements like "Piles have ceased to be a problem!"

The secret is a new healing substance (Bio-Dyne*) — discovery of a world-famous research institute.

This substance is now available in suppository or ointment form under the name *Preparation H.** Ask for it at all drug counters — money back guarantee. *Reg. U. S. Pat. Off.

STEEL PERSONAL FILE
 for Safekeeping Valuable Papers



Sleep free of worry — your valuable papers and records safe in this secure, heavy gauge steel personal file. Precision made to last a lifetime. With lock, key and carrying handle. Holds over 800 papers. Complete with A to Z folders; extra folders for budget, insurance, tax records, etc. Size 12½" x 10½" x 5½". For home, business, farm.

\$4.95 Postpaid. Send check or M.O. No C.O.D. **ALTON COMPANY**
 6510 N. 16th ST., PHILA. 26, PA.

Secrets of **VENTRILOQUISM**
Now Revealed!
 Easy to learn in 60 to 90 days with our Home Study Course. **RESULTS GUARANTEED.** Make Money! Be Popular! Have Fun! Big Opportunity! Radio, Television, Stage Appearances! For FREE information regarding price and terms WRITE. You must state your age. Dummy Catalog 25c.
FRED MAHER SCHOOL OF VENTRILOQUISM
 Box 36 Studio PM-3 Kensington Station Detroit 24, Michigan

LEARN PLASTICS
COMPLETE LOW COST SHOP METHOD HOME TRAINING NOW AVAILABLE
 Get in on Big Money opportunities in Plastic molding, casting, forming, carving, etc. Earn as you learn with Interstate's professionally prepared course. All plastic materials furnished.
WRITE FOR FREE BOOKLET **INTERSTATE TRAINING SERVICE**
 DEPT. C-3, PORTLAND 13, OREGON

250 POWER.....

 Complete only **\$3.49** postpaid
Telescope Lens Kit
 Conquer Space, Explore the Universe, Planets, Moon Craters, New Stars, etc. Complete Lens Kit consists of 80 inch focal length ground and polished objective lens, eyepiece lenses for 50 POWER, 100 POWER, 150 POWER, 200 POWER, 250 POWER, and all necessary lens fittings. Easy to make from simple step by step instructions. (Tripod and mount not included.) Money back guarantee.
BUSSE SALES CO., Hartford 1, Conn., Dept. PM 43

Learn BAKING At Home
 Baking is one of America's high industries in wages. Nearly DEPRESSION-PROOF. Thorough basic home course lays sound foundation. If you have aptitude, write for FREE Booklet, "Opportunities in Commercial Baking."
NATIONAL BAKING SCHOOL
 835 Diversey Parkway Dept. 1353 Chicago 14, Ill.



NOW... RCA trains you at home to be an expert technician in

RADIO TV ELECTRONICS • TV SERVICING • COLOR TV SERVICING

NOW THREE HOME STUDY COURSES . . . prepared by instructors of RCA Institutes in cooperation with technicians, engineers, and training specialists of RCA. Clearly written . . . easy to understand . . . the same high caliber instruction as given in resident classrooms of RCA INSTITUTES.

● **COURSE I—RADIO-TELEVISION ELECTRONICS**—starts you from the ground up to a solid working knowledge of electronics. Without any previous experience, you get a thorough training in radio theory and servicing techniques for AM, FM, home and car radios . . . plus an introduction to the fundamental theory and practices of television.

● **COURSE II—TELEVISION SERVICING**—prepares you to advance from radio into the expanding field of television servicing as a well-trained service technician. If you have completed Course I or are now working in the field of radio or TV, Course II will show you the many special techniques of trouble-shooting, aligning, checking, and repairing modern black and white TV sets.

NEW TV KIT AVAILABLE WITH COURSE II—there is no better way to learn than by *doing* and RCA Institutes has developed a large-screen TV KIT available to home study students to build while taking Course II. It has the most modern up-to-date circuitry, actually enabling you to apply at home all the latest servicing techniques.

● **COURSE III—COLOR TELEVISION SERVICING**—covers all phases of color servicing techniques. It is a practical, down-to-earth course . . . color theory as well as how-to-do-it servicing procedure. A natural move "up" from Course II or for those now employed in TV.

SINCE 1909, RCA INSTITUTES has trained thousands for successful careers in electronics. Many gradu-

ates have established their own paying business. Now this opportunity is available to you at home.

"PAY-AS-YOU-LEARN" PLAN . . . you pay for one study group at a time, as you progress through the course. Tuition costs are amazingly low. For full details, mail coupon.

A SERVICE OF RADIO CORPORATION OF AMERICA—RCA INSTITUTES is licensed by the N. Y. State Education Department . . . recommended by radio and television service organizations.

**SEND FOR
FREE
CATALOG
NOW**



RCA Institutes, Inc., Home Study PM-36
350 West Fourth Street, N.Y. 14, N. Y.
Without obligation, send me FREE CATALOG on Home Study
Courses in Radio, Television and Color TV. No salesman will call.

Name _____ Please Print

Address _____

City _____ Zone _____ State _____



RCA INSTITUTES, INC.
A SERVICE OF RADIO CORPORATION OF AMERICA
350 WEST FOURTH STREET, NEW YORK 14, N. Y.

Inventors

Take these necessary preliminary steps promptly to protect your invention by applying for a United States patent—

Sketch and describe your invention. Sign, date and have this disclosure witnessed by two people who understand your invention. Have us make a preliminary search among U. S. patents already granted for similar types of invention. We then report to you on the probable patentability of your invention and recommend your further course of action.

Write for our instructive booklet, "Patent Protection for Inventors" and our convenient "Evidence of Invention" disclosure form. No obligation.

VICTOR J. EVANS & Co. *Merlin M. Evans*
REGISTERED PATENT ATTORNEY
230-C MERLIN BUILDING, WASHINGTON 6, D. C.

FREE!
U. S.
AIRMAIL
STAMPS



FREE! 3 OTHER OFFERS FREE!

Rush coupon today for one of the most exciting offers we've ever made! Imagine... this scarce collection of beautiful, hard-to-get U. S. Airmail stamps all yours absolutely FREE! — all genuine, all different. And that's not all! Also yours FREE — handsome souvenir of the World's Rarest Stamp in color. PLUS! helpful "Stamp Collector's Guide", PLUS! valuable 1/2 penny Falkland Island Stamp and details on how to get 8 more. Other offers for your free inspection. Don't wait — it's a rare offer for a limited time only! If coupon has been clipped, send 10c for postage and handling direct to GARCELON STAMP CO., Dept. 3 PMA, Calais, Maine.

GARCELON STAMP CO., Dept. 3PMA, Calais, Maine
Rush FREE U. S. Airmail Stamps and other offers. Enclosed is 10c for postage and handling. (PLEASE PRINT)

NAME _____
ADDRESS _____
CITY _____ STATE _____

If Ruptured

For lasting relief your rupture must **BE HELD BACK DAY and NIGHT.**

Consult Your Doctor.

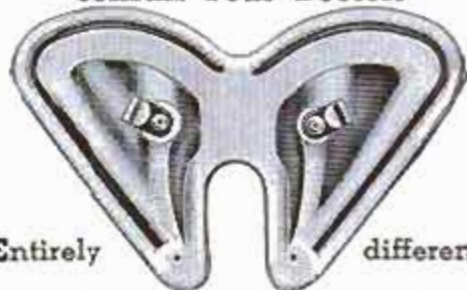

Entirely different

SOFT, FLEXIBLE, and fits neat as a glove. The famous Miller saves you **TIME, MONEY, DISAPPOINTMENT.**

Write for my FREE booklet today.

FRED B. MILLER Manufacturer
Dept. PM-A, Hagerstown, Maryland

SHINE WITHOUT 'POLISH'



Cars Glean Like Mirror

MEN! WOMEN! So easy a child can do it! Amazing "Dry" Polisher puts mirror-like shine on car WITHOUT 'POLISH'. No messy pastes, liquids, sprays. Simply glide over car. PRESTO! Leaves hard, lustrous, long-lasting protective Wax Coating. Take orders! Earn money!

SAMPLES FOR TRIAL

Sample offer sent immediately to all who send name at once. Just a postcard will do. SEND NO MONEY — just your name. KRISTEE CO., Dept. 688 Akron 8, Ohio

Learn SHELLCRAFT

Wonderful, New, Easy—Up to 5000% Profits! Make Shell Lamps, Shell Jewelry and Novelties. Sell for **BIG PROFITS!** Markets everywhere. Hand-in-Action Plan designed for you... to learn and earn as you succeed in Shellcraft.
FREE Genuine Sea Shells, full color pictures, and Hand-in-Action Plan Folder. Write: **NATIONAL SHELLCRAFT SCHOOL**
643-26th St. S., ST. PETERSBURG, FLA.



\$1300 BUILDS INCOME DUPLEX

FINANCIAL SECURITY!



Build your own 24'x36' concrete block duplex, complete for \$1300. Slab floor, steel windows, rock wool insulated, no block cutting necessary. Each side contains 11'x17' Living Room and Kitchenette, 10'x11' bedroom, 6'x9' bath and four closets. Genuine blueprint, scale 1/4"=1', step by step instructions, and material cost list. \$1.00 oppd. Money back guarantee. **\$1150 BLOCK GARAGE APARTMENT, 22'x24'. Liv. Room, Kit., bath and two bedrooms. Double garage below. Plan \$1.00.** MEMBER ARKANSAS HOME BUILDERS ASSOC.

BAILEY BUILDERS, 915 Pyramid Bldg., Little Rock, Ark.

Better Than
Your Own

**SHOE STORE
AT HOME**

No investment, no experience needed. Just show magic cushion comfort to friends, neighbors, co-workers. Advance commissions to \$4.00 a pair, plus Cash Bonus, Paid Vacation, \$25.00 Reward Offer. Outstanding values for men, women, children. Money back guarantee. Shoe samples supplied without cost. Write **TO-DAY** for FREE new 84 page catalog and full details.



**Two-Eyelet
Hit With
Cushioned
Comfort**

TANNERS SHOE CO., 776 Brockton, Mass.

FROM THOUSANDS OF ACTUAL LETTERS IN OUR FILES...

Amazing Proof That Anyone Can Play Music!



No Teacher or Special "Talent" Needed — We Show You How to Sit Right Down and START PLAYING REAL MUSIC at Once

IT'S not what we say about our wonderful easy way to learn music that really counts. It's what our 900,000 STUDENTS say. And THEY send us thousands of enthusiastic comments like those reprinted here — saying it's what they've always dreamed of! A quick, easy way of learning to play any musical instrument. WITHOUT suffering through dull "theories" first. WITHOUT practicing boring scales and exercises. WITHOUT spending time and money on a private teacher.

You just sit right down with the piano, guitar, accordion—or any instrument you're interested in—and actually begin to play. Simple songs at first. Then more advanced compositions. Soon you'll amaze your friends by playing almost anything they request!

Even Children "Catch on" At Once
No "trick" methods. You play real sheet music. Big, clear pictures and simple directions make every step simple as A-B-C. So

12-Year-Old Surprises Her Friends
"I am twelve years old. Thanks to your Course. I was able to play for the department in our church. All my friends were certainly surprised when they discovered I could play!" — *Patsy Jeffrey, Sweetwater, Texas.*

"Opened Door to Popularity"
"I was able to play pieces in a short time. Family and friends certainly surprised. Course opened door to popularity." — *Peter H. Kozyra, P. O. Brokenhead, Manitoba.* (Picture on other side of page)

Now Invited Out Lots
"It's been fun. Hasn't cost anywhere near as much as private teacher. Now invited to affairs, dances. Auditioned for 'Barn Dance Jamboree.'" — *Howard Hopkins, E. Syracuse, N. Y.* (Picture on other side of page)

clear, even children "catch on" right away. Whole family can learn for price of one. Costs only a few cents a lesson, including sheet music.

MAIL COUPON FOR FREE BOOK

The whole fascinating story of this revolutionary new way to learn music is told in a 36-page illustrated book. You may have a copy FREE simply by mailing coupon. No obligation; no salesman will call on you. U. S. SCHOOL OF MUSIC, Studio 303, Port Washington, N. Y. (Special Reduced Prices on instruments to our students.) Now in Our 58th Successful Year.



Our Former Student LAWRENCE WELK

Now Has Regular Full Hour TV Show Weekly — with his Own Orchestra!

Telecasts his famous "Champagne Music" from Hollywood Over ABC-TV Every Saturday Night

MR. WELK says: "I got my start in music with a U. S. School of Music course. How easy it is to learn to read notes and play an instrument this 'teach yourself' way! In fact this school did so much for me that I've enrolled my two daughters. I highly recommend your school. My best wishes for your continued success."

Lawrence Welk,
Hollywood, Calif.



U. S. SCHOOL OF MUSIC, Studio 303, Port Washington, N. Y.

I am interested in learning to play, particularly the instrument checked below. Please send me your free illustrated book. NO SALESMAN IS TO CALL ON ME.

- | | | |
|--|---|---|
| <input type="checkbox"/> Piano | <input type="checkbox"/> Pipe, Hammond, | <input type="checkbox"/> Piccolo |
| <input type="checkbox"/> Guitar | <input type="checkbox"/> Reed Organs | <input type="checkbox"/> Modern |
| <input type="checkbox"/> Hawaiian Guitar | <input type="checkbox"/> Tenor Banjo | <input type="checkbox"/> Elementary |
| <input type="checkbox"/> Violin | <input type="checkbox"/> Ukulele | <input type="checkbox"/> Harmony |
| <input type="checkbox"/> Piano Accordion | <input type="checkbox"/> Clarinet | <input type="checkbox"/> Mandolin |
| <input type="checkbox"/> Saxophone | <input type="checkbox"/> Trombone | <input type="checkbox"/> Practical Finger Control |
| <input type="checkbox"/> Trumpet, Cornet | <input type="checkbox"/> Flute | |

Do you have the instrument? _____

Mr. _____
Mrs. _____
Miss _____ (Please Print Carefully)
Address _____

City _____ State _____
(Insert Zone Number, if Any)

NOTE: If you are under 18 years of age parent must sign coupon.

Learn ELECTRIC APPLIANCE REPAIR IN YOUR SPARE TIME AT HOME



START YOUR OWN BUSINESS

ONE BUSINESS THAT IS NOT AFFECTED BY STRIKES, DEPRESSIONS OR POLITICS

WITH A POTENTIAL MARKET OF 50,000,000 CUSTOMERS

New shop-method, home-training system gives you electrical know-how that used to take years to learn. Learn at home by building valuable testing kits, repairing your own and neighbors' appliances. It is not unusual for appliance repairmen to charge on the basis of \$5.00-\$6.00 an hour.

FREE ILLUSTRATED BOOK
Shows you how you learn every phase of electrical appliance. How to make money while you learn. Write today for your FREE copy.

CHRISTY TRADES SCHOOL
Dept. D-5023
4804 North Kedzie Ave., Chicago 25

JITTERBUG

WORLD'S BEST HOOKER—DAY OR NIGHT



Here is Robert Cook of Maryville, Tenn., with two beauties he caught on a Musky Jitterbug. Weights are 8-1/2 and 9-1/4 lbs., with the big one 26-1/2" long and 19-3/4" around. Jitterbug's famous wobbling surface action and the gurgling, paddling effect of the big "lip" make surface feeders hit hard. Casting size (5/8 oz.), peanut size (3/8 oz.), or spinning and light tackle size (1/4 oz.)—\$1.25 each. Musky size (1-1/4 oz.)—\$2.00 each. Choice of body colors.



FREE WRITE TODAY FOR YOUR BIG FREE ARBOGAST COLOR CATALOG OF BAITS—FULL OF PICTURES OF CATCHES

FRED ARBOGAST COMPANY, INC.
2243 WEST NORTH STREET • AKRON 3, OHIO

You Can Be a Manufacturer of Gardencrete

Set of 18 Flagstones (below), Sells for \$8.25; Costs to make, \$3.00. Your markup, \$5.25.



Bird Baths
Jars and Vases
Flower Boxes
Flagstones
Lawn Seats

Your spare-time manufacture of Gardencrete can lead to a full-time business, with broad sales potentials and generous income possibilities. A small investment buys the Colorglazing machine and a few molds. Add more molds as your business continues to expand.

Gardencrete has wide sales appeal wherever people have pride of lawn and garden. Colors are fused on under air pressure. Stay put for years and years. Choice of 30 colors.

Your mark-up on basic costs is 200%—300%. Products easily made in shed or garage. We supply full instructions. Write for literature and information on costs and selling prices on complete line.

Colorcrete Industries, Inc.
710 Ottawa Ave., Holland, Mich.



A "GOOD HAND" HELPS YOU SUCCEED!

Your Name

LEARN TO WRITE WELL

beautifully written, plus special pen-point for shaded writing.

Handwriting quickly improves with our easy-to-understand picture lessons! Put your spare time to good use; send today for **FREE BOOKLET OF PENMANSHIP COURSES AND SUPPLIES** or check volumes wanted below at \$1 each:

- Business Writing
- Artistic Writing
- Card Writing
- Bird & Design Flourishing
- Engraving Alphabets. **COMPLETE SET \$4.50. Act now!**

Only 10¢

TAMBLYN SCHOOL OF PENMANSHIP
S.A. Ziller, Pres., 442 Ridge Bldg., Kansas City, Mo., USA

Learn LEATHERCRAFT

- Sell for big Profits. Markets Everywhere.
- Up to 500% Profit. Make Leather Goods, Billfolds, Bags, Belts, & 200 other items.
- EASY TO MAKE WITH THE NEW TANDY PROCESS.
- We supply complete instructions & materials.

WRITE FOR FREE DETAILS, FREE CATALOG

81 TANDY STORES COAST-TO-COAST
TANDY LEATHER CO. EST 1919
P.O. BOX 791-TJ FORT WORTH, TEXAS

FREE Catalog U-DO-IT KITS

SAY YOU SAW IT IN POPULAR MECHANICS

RUPTURED

BE FREE FROM TRUSS SLAVERY

NOW there is a new modern Non-Surgical treatment that permanently corrects rupture. These Non-Surgical treatments are so certain, that a Lifetime Certificate of Assurance is given. Write today for our **FREE Book** that gives facts that may save you painful and expensive surgery, and tells how non-surgically you may again work, live, play and love and enjoy life in the manner you desire. There is no obligation. Excelsior Hernia Clinic Dept. 8305 Excelsior Springs, Mo.



WORLD'S LOWEST PRICED ADDING MACHINE

IDEAL FOR BUSINESS AND PERSONAL USE—GUARANTEED ACCURATE. Not a toy. Operates with only a finger flick. Adds, subtracts, multiplies, divides. Counts up to one billion. Pays for itself over and over. Ideal Gift—for Business, Income Tax and School use. **MONEY BACK GUARANTEE.** Send name and address. Pay postman only \$2.95 plus postage. (Send full cash if outside U.S.) Beautiful rich-looking Leatherette Case included at no extra cost. Money back in 10 days if not delighted. **AGENTS WANTED.**

CALCULATOR MACHINE CO., (Mfgs.)
Box 84 Dept. M-56 Glenview, Illinois

Learn **PRACTICAL RADIO-TV**
with **25 BIG KITS**

of equipment I send you while you train with me . . . for valuable shop bench experience . . .



The new Sprayberry Training Television receiver, built and tested in sections.

I now offer this fine modern oscilloscope.

You build this powerful 2 Band superhet radio receiver.



You build the new Sprayberry Tester . . . 18-range Volt-Ohm-Milliammeter readings.

In addition to modern lesson training, I also give you plenty of home practice on actual Radio-Television equipment . . . you will build and use the units shown here plus many more. All this equipment is yours to keep . . . keep everything you need to set up your shop.

Prepare for a Good Paying Job — Or Your Own Business

"I Will Train You at Home in RADIO-TELEVISION on Liberal No Obligation Plan!"

New Equipment! New Lessons! Enlarged Course! The true facts are yours in my big new catalog . . . YOURS FREE . . . JUST MAIL COUPON!



Frank L. Sprayberry
President, Sprayberry
Academy of Radio

I can train and prepare you in as little as 10 months to step into the big opportunity Radio-Television service field. Train *without* signing a binding contract . . . without obligating yourself to pay any regular monthly amounts. You train entirely at home in spare hours . . . you train as fast or as slowly as you wish. You'll have your choice of **THREE SPRAYBERRY TRAINING PLANS** . . . planned for both beginners as well as the more experienced man. Get the true facts about the finest most modern Radio-Training available today . . . just mail the coupon for my big new 56 page fact-filled catalog plus sample lesson—both **FREE**.

Train the Practical Way—with Actual Radio-Television Equipment

My students do better because I train both the mind and the hands. Sprayberry Training is offered in 25 individual training units, each includes a practice giving kit of parts and equipment . . . all yours to keep. You will gain priceless practical experience building the specially engineered Sprayberry Television Training Receiver, Two-Band Radio Set, Signal Generator, Audio Tester and the new Sprayberry 18 range Multi-Tester, plus other test units. You will have a complete set of Radio-TV test equipment to start your own shop. My lessons are regularly revised and every important new development is covered. My students are completely trained Radio-Television Service Technicians.

NEWEST DEVELOPMENTS'

Your training covers UHF, Color Television, F M, Oscilloscope Servicing, High Fidelity Sound and Transistors.

See for Yourself . . . Make Your Own Decision . . . Mail Coupon Today!

The coupon below brings you my big new catalog plus an actual sample Sprayberry Lesson. I invite you to read the facts . . . to see that I actually illustrate every item I include in my training. With the facts in your hands, you will be able to decide. *No salesman will call on you.* The coupon places you under no obligation. Mail it now, today, and get ready for your place in Radio-Television.

SPRAYBERRY ACADEMY OF RADIO

111 North Canal Street, Dept. 10-J, Chicago 6, Illinois

Mail This Coupon For Free Facts and Sample Lesson



SPRAYBERRY ACADEMY OF RADIO
Dept. 10-J, 111 N. Canal St., Chicago 6, Ill.

Please rush all information on your **ALL-NEW** Radio-Television Training Plan. I understand this does not obligate me and that no salesman will call upon me. Include New Catalog and Sample Lesson **FREE**.

Name _____ Age _____

Address _____

City _____ Zone _____ State _____

"My selling time actually shows me a profit of

\$20 TO \$25 AN HOUR

with Science's New Midget Miracle, the
PRESTO Fire Extinguisher

says M. R. Stanley of Montana. Many others "cleaning up"—so can YOU!

THIS is an amazing new kind of fire extinguisher. Tiny "Presto" (about the size of a flashlight) does job of bulky extinguishers that cost 4 times as much, and are 8 times as heavy. Ends fires fast as 2 seconds. Fits in palm of hand. Never corrodes. Guaranteed for 20 years! Sells for only \$3.98! Over two million already sold!



Show it to civil defense workers, owners of homes, cars, boats, farms, etc., and to stores for re-sale. Make good income. C. S. Mellous made \$175 in just first 5 days. C. Kama, \$1,000 a month. Write for FREE Sales Kit. No obligation.

(If you want a regular Presto to use as a demonstrator, send \$2.50. Money back if you wish.)

MERLITE INDUSTRIES, Dept. 15-G, Presto Div.
114 East 32nd St., New York 16, N. Y.
(In Canada: Mopa Co., Ltd., 371 Dowd St., Montreal 1, P. Q.)

It's easy to . . .

OWN a business!

. . . Even if NOW Employed

We'll personally train and help you get established . . . starting part or full time.

**Clean & Mothproof
Rugs & Upholstery**



- No Shop Needed
- \$5 Hourly Gross Profit
- No Experience Needed
- Nationally Advertised
- World-wide Services

If reliable and diligent, you can become financially independent in a growing lifetime business of your own. Alert dealers can average \$5 hourly gross profit on service they render plus \$3 on EACH serviceman. Nationally advertised services rendered in homes, offices, clubs, institutions, etc. **DURACLEAN** (illustrated above) cleans by absorption. Eliminates scrubbing . . . soaking . . . shrinkage. Dirt, grease and many unsightly spots vanish as if by magic. Wool fibers come to life . . . matted pile rises . . . colors revive. Upholstery and floor coverings last longer.

DURAPROOF (not illustrated) is another year-round service. Kills moths and carpet beetles. Makes material resistant to both. Protects furnishings, clothing, and auto interiors. Only such service backed by international money-back, 6-year warranty.

Easy to learn. A Duraclean dealer will train and assist you. He'll reveal his successful Duraclean system and sales plan. He'll work with you. Your service dealership becomes part of a world-wide organization built upon repeat orders and recommendations from satisfied customers. You have the freedom, prestige and profits of YOUR OWN business.

Operate from your own home, a shop or office, as you prefer. We furnish enough materials to return your TOTAL INVESTMENT. We help finance reliable men. Start part or full time. Write TODAY for FREE booklet and full details while territory is available.

DURACLEAN CO., 6-163 Duraclean Bldg., Deerfield, Illinois



22 YEARS AT THIS ADDRESS

AN ESTABLISHED POLICY OF CAREFUL SELECTION ASSURES YOU MANY HAPPY MILES. BE WISE—TRY ONE—YOU'LL BUY MORE! WE WELCOME COMPETITION. NO ONE CAN TOUCH OUR QUALITY & PRICE! White Walls \$1.00 Ex. 50 Years of Combined family experience in High Quality tires. "FREE TUBE." PARTIALLY USED TIRES. FREE FACTORY-TESTED TUBE

DEDUCT \$1.00 from every Passenger Tire you buy—Does not include W.W., or Truck Tires.

12 MOS. WRITTEN GUARANTEE SPECIALISTS IN TRUCK TIRES—Selected for Toughest Jobs—Tops in Value

I FEEL FINE! How Do Your Tires Feel?

600-16	\$5.42	475-19	\$4.72	700-15(8)	\$7.72	700-20	\$8.72
600-18(6)	5.62	640-15	5.62	750-16(8)	8.92	750-20(10)	13.72
650-16	5.62	670-15	5.52	700-17	7.72	750-20(8)	10.72
650-18(6)	6.42	710-15	5.62	750-17	9.72	825-20	16.52
700-16	6.02	750-15	5.62	825x15	12.92	900-20	16.52
750-16(8)	7.52	800-15	5.92	600-20	9.52	1000-20	17.02
550-18	5.22	820-15	5.82	650-20	10.92	1100-20	17.02
550-17	5.22	670-16	5.32	32x6(8)	12.02	1100-22	21.72
650-15	5.42	780-16	7.72	32x6(10)	13.92	1000-22	19.22
700-15	4.92	700-16(6)	7.72	750-15	10.92	1100-24	23.72

"EXTRA SPECIAL" Fully guarantee all size 4-ply pass. DEDUCT \$1.00 from These also—W.W. \$1.00 Extra. Factory Tested Tube given. **GIANT TIRE SALE \$6.42 EA.**

MILITARY TIRES		MUD-GRIP TIRES	
900-16	\$9.32	900-16	\$13.67
750-20	12.72	750-20	17.02

Thousands of tires shipped all over the U.S.A. All tires shipped F.O.B. Phila. Send Check or M.O. with this ad. Dept. 2. No C.O.D.

STANDARD 834 N. Broad St., Philadelphia 30, Pa.

TASOPE PHOTO-ENGRAVING PLANTS



Material Cost of This Cut 3/4c Selling Price \$1.00 And Up

Establish your own profitable PHOTO-ENGRAVING business. Make cuts for newspapers, printers, and advertisers. Make etched name plates, plaques etc. Instructions furnished, no experience necessary. Sold direct from factory since 1931. First five hundred cuts sold locally or by mail will pay for plant and pay you well for your time. Write for FREE catalog.

TASOPE, DEPT. PM-3, AURORA, MO.



TRAIN WRECK STAMPS!

Cuba's famous stamps of 1946, showing actual train wreck scene! Complete set of 3, a dramatic display for your collection, only 10c. Handsome, exciting stamps to look over, too, without charge or obligation. **WINTHROP STAMP CO., Dept. P-3, GROTON, CONN.**

LEARN WATCH REPAIRING

AT HOME Modern, original instruction. Prepare for a position or start in business after completing our course. Write Today! **WISCONSIN SCHOOL OF WATCH REPAIRING** 2908 N. 44th St. Dept. M Milwaukee 10, Wis.

MAKE BIG MONEY AT HOME!

INVISIBLE REWEAVING

Pays up to \$10 in an Hour! **BEFORE** Make moth holes, cigarette burns, tears, rips, disappear from all fabrics. Little-known craft pays extra spare-time profits at home. Write today for exciting details FREE! **FABRICON 8342 S. Prairie Avenue** Dept. 323, Chicago 19, Ill. **AFTER**

SAY YOU SAW IT IN POPULAR MECHANICS

FALSE TEETH

That Loosen
Need Not Embarrass

Many wearers of false teeth have suffered real embarrassment because their plate dropped, slipped or wobbled at just the wrong time. Do not live in fear of this happening to you. Just sprinkle a little **FAST-TEETH**, the alkaline (non-acid) powder, on your plates. Holds false teeth more firmly, so they feel more comfortable. Does not sour. Checks "plate odor" (denture breath). Get **FAST-TEETH** at any drug counter.

LAW TRAINING *for* BUSINESS

[in spare time at home]

Earn LL.B. Degree

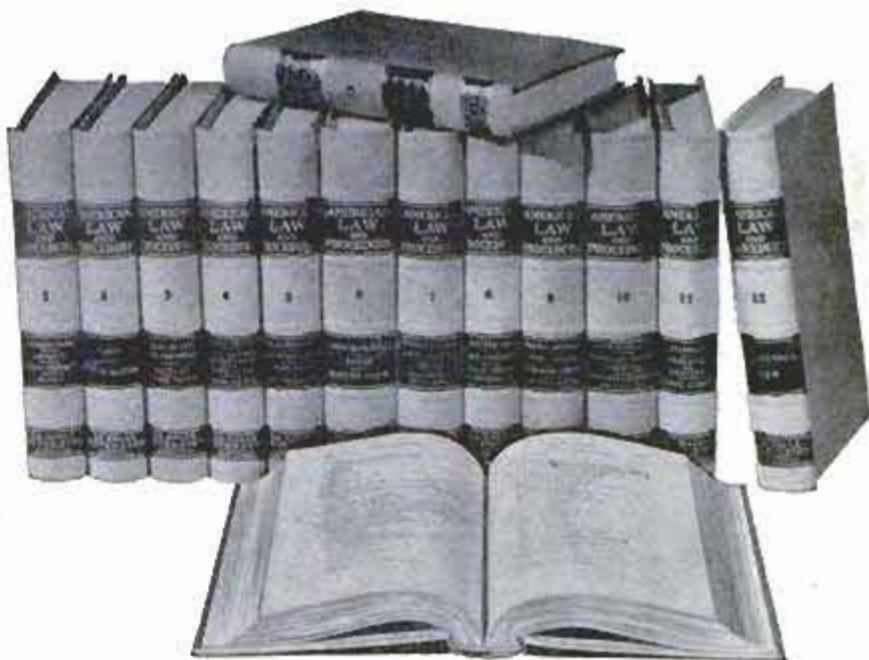

Thousands of men and women who never intend to practice are studying Law in spare time at home—not for a legal career but as an aid to business advancement.

Law today is involved in almost every major business decision. In many lines of work it is almost indispensable—credits and collections, accounting, traffic and transportation, employee relations, real estate, insurance, finance, taxation, etc. For all types of work, Law training develops keen, clear, quick, correct, and decisive thinking.

You can study LaSalle's American Law and Procedure right in the privacy of your own home—progressing as rapidly as your time and ability permit. LaSalle has, for nearly 50 years, helped more than 1,350,000 ambitious people get ahead in the business world. Thousands of letters in our files from grateful students and businessmen who have achieved greater success speak of—better jobs, more money and the satisfaction it brings, prestige and leadership.

A MOST UNUSUAL LAW LIBRARY

This training includes the fourteen-volume LaSalle Law library—AMERICAN LAW AND PROCEDURE, which is the basis of all the instruction service. This library has been compiled by leaders in the field of Law. It covers the whole basic field of Law in an orderly and simple manner that is easy to learn and understand. Collateral reading and printed lectures on legal problems which are furnished at regular intervals throughout the training, supplement the text. Law instructors personally supervise your program from the first assignment to the LL.B. degree or diploma. Under the LaSalle method you deal with legal problems—you learn by

doing—actually solving legal problems—not just memorizing rules.

WRITE TODAY FOR TWO FREE BOOKS

You are determined to get ahead—to prepare for greater future possibilities—and to earn more money. Send the coupon below and find out how to qualify yourself for the many openings available to the Law-trained man. In our FREE books, "Law Training for Leadership" and "Evidence," you will find answers to all your questions about the study of Law and the LaSalle method.

No investment is likely to pay higher returns than an investment in yourself, by enrolling in the American Law and Procedure training. Send coupon today for full information—no obligation, of course.

LaSalle Extension University A Correspondence Institution

Dept. 364L, 417 S. Dearborn St., Chicago 5, Ill.

Gentlemen: Please send me your two free booklets, "Law Training for Leadership" and "Evidence," which tell how I may study Law at home and qualify for the LL. B. degree.



Name.....Age.....

Street.....

City.....Zone.....State.....

Check the Kind of Body You Want

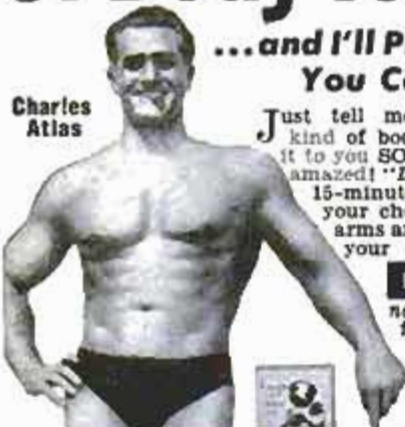

Charles Atlas

...and I'll Prove How EASILY You Can Have It!

Just tell me, in coupon below, the kind of body you want—and I'll give it to you SO FAST your friends will be amazed! "Dynamic Tension," my easy, 15-minutes-a-day method, will make your chest and shoulders bulge... arms and legs surge with power... your whole body feel "alive!"

FREE BOOK 32 pages on how "Dynamic Tension" changed me from a 97-pound weakling into "World's Most Perfectly Developed Man"—and how I'll prove it can change YOU too. Mail coupon NOW!

CHARLES ATLAS, Dept. 83,
115 East 23rd St., New York 10, N. Y.

Dear Charles Atlas: Here's the Kind of Body I want:
(Check as many as you like)

- | | |
|--|--|
| <input type="checkbox"/> More Weight—Solid—in The Right Places | <input type="checkbox"/> Powerful Arms, Legs, Grip |
| <input type="checkbox"/> Broader Chest, Shoulders | <input type="checkbox"/> Slimmer Waist, Hips |
| | <input type="checkbox"/> Better Sleep, More Energy |

Send me absolutely FREE a copy of your famous book "Everlasting Health and Strength"—32 pages, crammed with photographs, answers to vital questions, and valuable advice. No obligation.

NAME _____ AGE _____
(please print or write plainly)
ADDRESS _____
CITY _____ STATE _____

Free! VALUABLE U.S.A!

Sensational Get-Acquainted Offer! Get this scarce genuine centennial stamp, as illustrated, picturing first U.S.A. (issued in 1847!) PLUS big collection of 30 all-different United States: 19th century, valuable \$5 stamp, etc. PLUS collection beautiful Commemoratives including '93 Columbian, Boy Scouts, Wild West, many others. EXTRA: other exciting offers: 64-page Collector's Guide; Big Bargain Catalog of U.S. Stamps. Send 10c for mailing. ACT NOW! HARRIS, 2460 TRANSIT BLDG., BOSTON 17, MASS.



STUDY INDUSTRIAL DESIGN

You can train at Art Center School in California with practicing professionals for upper-level jobs in INDUSTRIAL DESIGN. Recent graduates have been added to the staff at General Motors, Chrysler, Raymond Loewy, Henry Dreyfuss, etc. Majors in transportation, general product design, structures, community development, furniture design, packaging, display, 4-year degree courses. Learn to combine imaginative design with technical proficiency, coordinate utility and beauty. Stimulating environment. Field trips. Advantages of mild Southern California climate and nearby holiday spots. Coed. Placement service. Established 25 years. New terms Feb., June, Sept. Write for catalog.

ART CENTER SCHOOL, Edward M. Adams, Director
5353 WEST THIRD STREET, LOS ANGELES 5, CALIFORNIA

IT'S EASY... MAKE MONEY IN PHOTOGRAPHY

If you are over 17—good pay and fascinating work await you in photography! Start making money quickly in sparetime—step into your own studio or exciting career job. LEARN BY DOING method trains you at home! Write TODAY for FREE catalog. Also Resident Training. 46th Year. Approved for Vets.

NEW YORK INSTITUTE OF PHOTOGRAPHY
Dept. 49, 10 West 33 Street, New York 1, New York
46th YEAR

SPEAK AND WRITE LIKE A College Graduate

If you lack complete college training in English you can now become an effective speaker, writer, and conversationalist—without going back to school. With the new CAREER INSTITUTE METHOD you can stop making mistakes in English, build up your vocabulary, speed up your reading, acquire real writing skill, learn the "secrets" of fluent conversation. Method successfully used by thousands. Takes only 15 minutes a day at home. Costs little. 32-page booklet mailed FREE upon request. Send card or letter NOW!

Career Institute, Dept. 1053, 25 E. Jackson, Chicago 4

CABINET MAKING



LOW COST HOME TRAINING COURSE FOR BEGINNERS & ADVANCED CRAFTSMEN

Make money. Learn skills and secrets of fine woodworking and tool use. Professionally prepared shop method training tells and shows how. Covers everything. Easy to master.

Write for Free Booklet INTERSTATE TRAINING SERVICE
DEPT. F3, PORTLAND 13, OREGON

Electrical Appliance Repairs MADE EASY

New Repair Manual Covers EVERY Repair on ALL Home Appliances

NO repair job is too tough with the help of this big new Guide. TELLS and SHOWS how to service ALL home appliances. SAVE MONEY keeping your own appliances like new—or MAKE MONEY with a home repair shop of your own... full or spare time.

OVER 850 "how-to-do-it" pages, packed with pictures, drawings, diagrams. Sectional charts locate "trouble spots" in a jiffy... make it easy to dismantle and reassemble appliances correctly. A-B-C directions tell "why" as well as "how" Book covers fundamentals of electricity for beginners. Over 150 manufacturers supplied the servicing and repair data.

FREE 10-DAY EXAMINATION—Coupon will bring you "Electrical Appliance Servicing" to examine FREE—without obligation. Mail it NOW!



Covers ANY Service or Repair on:

- Irons • Toasters • Heaters • Vacuum Cleaners • Sewing Machines • Refrigerators • Air-Conditioners • Fans • and much more.

McGraw-Hill Book Co., Inc., Dept. PM-3
327 West 41st St., New York 18, N. Y.

Send Cruise's Electrical Appliance Servicing for 10-DAY FREE EXAMINATION. If not satisfied I will return it—pay nothing. Otherwise, I will keep it—send only \$3.00 (plus small delivery charge) then—and \$3.00 a month for 2 months to complete payment.

Name _____
Address _____
Employed by _____
City _____ State _____
Zone No. _____ (if any)

WE'LL PAY DELIVERY if you remit (check or M.O.) WITH coupon. Same 10-day Return Privilege, for full refund.

ONLY \$495 (freight included) **FREE FOLDER**

18 FT. CRUISER

BOAT KITS
12 Models as low as \$39.95 (freight included). Fiberglass boat covering kits, marine supplies, etc. Free folders.

TAFT MARINE WOODCRAFT
DEPT. PM-3 636-39th Ave. N.E., Minneapolis 21, Minn.



SHEET METAL BRAKES

- Forms angles, locks, pans, etc. Quick eccentric clamp. All steel construction.
- 15" — 16 gauge steel \$23.50
 - 36" — 22 gauge steel 35.50
 - 48" — 24 gauge steel 52.00
 - 49" — 16 gauge Bender 32.00
 - 12" — 12 gauge Bender 18.00
 - 3/4" — 1/2" Pipe Bender 16.00
 - 1/4 x 3 Adjustable Bender 11.50
 - 14 gauge Bench Shear 29.00
 - 30" — 20 gauge Curve Former 9.50

ORDER DIRECT OR SEND FOR FREE CATALOG
YKKE MFG. CO., 4158-P Jason St., Denver 11, Colo.

Roy Loutzenhiser drives 38,000 miles...saves \$72. with 17 pt. Life-Time plugs

MESSAGE FROM FRANK WILLIAMS, INVENTOR OF LIFE-TIME SPARK PLUGS:

Dear Friends:

Some Life-Time Spark Plugs have now been out just about a year. Time enough for first users to start writing me about life and performance in their own cars. Roy Loutzenhiser of Antelope, Montana, writes that his set has fired hot and clean for over 38,000 miles in his 1953 Studebaker V-8. That's a saving in plug purchases of about \$22 when you add it up. But he also wrote me that his gas bill went down just about 10% which checks out almost on the button with Eddie Edmunds dynamometer test which shows 11% fuel improvement. The way I figure, that adds up to about \$72 depending upon what you pay for gas! I don't say you can save this much money in a car that's burning some oil or isn't rightly tuned, but you can save the cost of a couple sets of ordinary plugs and a barrel of gas any time. Try a set and let me hear how you like them. Many thanks.

Frank Williams



ORDER REGISTERED SET for any 6 or 8 cylinder engine. YOU RECEIVE BY MAIL, POSTAGE PAID, this matched set as shown in proper series (heat range and gap) for the car or cars you indicate in coupon. Tapered 18mm now available for late Ford products and others.



DEALERS AND DISTRIBUTORS WRITE FOR FULL INFORMATION

Here's Why 17 Pt. Firing Works:

Note the circular arcing area. Four concave segments with gap the same from all points. Electricity has the property of arcing from the coldest point. Current also arcs more readily from apex of two planes than from a flat surface. Note that there are 16 apexes (where two planes meet) — all the same distance from the center electrode. Normal heat and spark erosion are spread around the entire circle and around the whole circumference of the larger center electrode.

Actually 1700 Firing Points

or more, our engineers now tell us, because the spark actually "chooses" the most favorable single point on the top, bottom or side of any outer electrode! This is one reason why Life-Time Spark Plugs do not foul or miss, waste gas or power under heat and high compression. This spectacular spark plug research break through (the first revolutionary improvement in 50 years!) allows us to include this unique and unprecedented warranty with every set of plugs. **WE GUARANTEE GREATER GAS MILEAGE — GREATER ACCELERATION — A MAJOR POWER INCREASE — or your money back!**

Eddie Edmunds
CHASSIS DYNAMOMETER CHART

Make of car: _____ Model: _____ Year: _____

Make of plug: _____ Heat range: _____

Speed (mph)	Time (sec)	Rev. per min.	Gas (gals.)	HP
0-30	10.0	1500	0.5	10.0
30-40	10.0	1500	0.5	10.0
40-50	10.0	1500	0.5	10.0
50-60	10.0	1500	0.5	10.0
60-70	10.0	1500	0.5	10.0
70-80	10.0	1500	0.5	10.0
80-90	10.0	1500	0.5	10.0
90-100	10.0	1500	0.5	10.0
100-110	10.0	1500	0.5	10.0
110-120	10.0	1500	0.5	10.0
120-130	10.0	1500	0.5	10.0
130-140	10.0	1500	0.5	10.0
140-150	10.0	1500	0.5	10.0
150-160	10.0	1500	0.5	10.0
160-170	10.0	1500	0.5	10.0
170-180	10.0	1500	0.5	10.0
180-190	10.0	1500	0.5	10.0
190-200	10.0	1500	0.5	10.0

Recommended: _____

Signature: _____

Tustin Auto Parts

100 West Main Street, Tustin, California Phone: 552-1111

Make of car: _____ Model: _____ Year: _____

Make of plug: _____ Heat range: _____

Speed (mph)	Time (sec)	Rev. per min.	Gas (gals.)	HP
0-30	10.0	1500	0.5	10.0
30-40	10.0	1500	0.5	10.0
40-50	10.0	1500	0.5	10.0
50-60	10.0	1500	0.5	10.0
60-70	10.0	1500	0.5	10.0
70-80	10.0	1500	0.5	10.0
80-90	10.0	1500	0.5	10.0
90-100	10.0	1500	0.5	10.0
100-110	10.0	1500	0.5	10.0
110-120	10.0	1500	0.5	10.0
120-130	10.0	1500	0.5	10.0
130-140	10.0	1500	0.5	10.0
140-150	10.0	1500	0.5	10.0
150-160	10.0	1500	0.5	10.0
160-170	10.0	1500	0.5	10.0
170-180	10.0	1500	0.5	10.0
180-190	10.0	1500	0.5	10.0
190-200	10.0	1500	0.5	10.0

Signature: _____

8 hp increase!



7 mph increase!

NEW! SUPER-DISSIPATION INSULATOR. Made of gem-like sintered corundum. Conducts heat 40 times faster than porcelain. Special new contour vaporizes and exhausts wet carbon and oil.

SELF-CLEANING ON POWER STROKE. Confined gases exploding in chamber formed by multiple electrodes reclean arcing surfaces with each firing stroke. **INDIVIDUAL INSPECTION.** Each Life-Time Spark Plug is tested for firing in oil and for resistance to 30,000 volts/CM (The only plug which has been tested successfully at 15 to 1 compression) **PERMANENT GAP.** After months of use Life-Time Spark Plugs like at exact factory prepreg.

BOAT OWNERS. Life-Time Spark Plugs are now available for all outboards and marine engines. Specify make, model and year. \$1.19 per plug postpaid.

LIFE-TIME Spark Plug Division
CONTINENTAL MANUFACTURING CORP.
Washington Blvd. at Motor Ave., Culver City 120, California

Gentlemen: Please mail postpaid _____ set(s) (registered) of LIFE-TIME Spark Plugs in proper heat range and gap for my car at \$1.19 per plug (set of six, \$7.14; set of eight, \$9.52). Or send \$2 per set, balance C.O.D. California residents add 3% tax.

Make of my car is..... year.....

Model..... No. cyl.....

I enclose \$..... (cash, check or money order)

Name.....

Address.....

City..... Zone..... State.....



"Use My TESTED SALES PLAN to make an extra \$50.00 every week!"

Says CHARLES CHESTER EATON, JR., President
Charles Chester Shoe Company

JUST A FEW HOURS EACH WEEK — evenings, weekends, — can add \$50 to \$100 to your regular income. Be a factory representative for CHARLES CHESTER exclusive patented air-cushion shoes — bring wonderful new comfort to friends, neighbors, co-workers! A full line of dress, work, leisure shoes for all the family sold only direct from factory to wearer at low factory prices.

YOUR OWN BUSINESS WITH NO INVESTMENT!

No deliveries, no collections — we supply everything you need. You collect advance cash deposit from your customers — we do the rest — and you earn extra profit-sharing cash bonus monthly!



AIR CUSHION SHOES

STEADY AUTOMATIC REPEAT BUSINESS!

Satisfied customers reorder regularly! CHARLES CHESTER representatives offer more than 160 styles, in a tremendous size range: 1 to 18, AAA to EEE. No experience needed — our tested, proven Sales Plan shows you how! Write today for details and FREE SALES KIT!

CHARLES CHESTER SHOE COMPANY
7 Foundry St., Brockton, Mass.

... TURN CONCRETE INTO GOLD!



MAKE UP TO \$75 A DAY IN YOUR OWN BUSINESS

If you want to have your own business — to start a business on your own — here's your big opportunity! New high speed, low cost General block machine produces up to 1,000 concrete blocks a day. Sell all you make to builders, supply houses, and others for homes, factories, buildings, garages. Cash in on the building boom! You can make profits of 100% to 150% — up to \$75 a day! General block machine equipped with 1/2 h.p. electric motor — or can be supplied with gasoline engine — works anywhere, in little space, indoors or out. Operates from ordinary house light socket. Simple, foolproof 3 step operation — so easy a child can do it. Makes superior 3 core blocks any size from 4" to 12". Also makes chimney, tash, corner and other types. Blocks meet any building code anywhere in the country. Materials — sand, water, cement, available anywhere. Simple illustrated operating instructions and mixing formulae for cement and cinder blocks supplied with each machine. Write for FREE folder with full information.

MOTOR DRIVEN

R. L. T. of New York City reports: "MY GENERAL BLOCK MACHINE PAID FOR ITSELF IN FIRST 2 WEEKS!"
Hundreds now in use the world over!
Write for FREE details today!

EXTRA

Book gives floor plans for 6 sensational concrete block bungalows. Tells how to lay blocks, lay out building lines, mix concrete, build steps, porch and concrete floors all at great savings. Written by experts. Can save many times the cost of the machine! Get it now! No strings attached. Send \$1.

BOOK SENT FREE IF YOU BUY MACHINE.
\$1 REFUNDED IF YOU BUY LATER.

GENERAL ENGINES CO.

DEPT. M-36, ROUTE 130, THOROFARE, N. J.



INVENTORS

PROTECT YOUR INVENTION BY A U. S. PATENT. SEND FOR FREE "INVENTION RECORD" FORM AND "PATENT INFORMATION EVERY INVENTOR SHOULD HAVE".

CARL MILLER
REGISTERED PATENT ATTORNEY
WOOLWORTH BLDG., 35th FLOOR, 36A
NEW YORK CITY

INVENTORS

Whether an invention is patentable can be substantially determined by a search of the U. S. Patent records. Without obligation, write for information explaining the steps you should take to secure a patent.

JOHN N. RANDOLPH
Registered Patent Attorney
201 Columbian Building, Washington 1, D. C.

PATENTS
C. A. SNOW & CO.
REGISTERED PATENT ATTORNEYS
WRITE FOR INFORMATION TO
428 SNOW BUILDING, WASHINGTON 1, D. C.

INVENTORS

Send for **PATENT INFORMATION** Book and **INVENTOR'S RECORD** without obligation
GUSTAVE MILLER
36-PM WARNER BUILDING WASHINGTON 4, D. C.

REGISTERED PATENT ATTORNEY
ASSOCIATE EXAMINER
U. S. PAT. OFF. 1922-1929
Patent Attorney & Advisor
U. S. NAVY DEPT. 1930-1947
PATENT LAWYER

SPARE-TIME MONEYMAKING OPPORTUNITIES
READ OUR CLASSIFIED ADS
HUNDREDS OF BARGAINS AMAZING OFFERS

INVENTIONS WANTED

If you want to market, or sell, your invention for cash or royalties. Write for our Free Booklet. Send no drawings. We also welcome hearing from firms, or private capital, wishing to review inventions in any field. We will be glad to send notice of our clients' inventions.

GLOBAL MARKETING SERVICE
2420 77th Ave. Dept. PD Oakland 5, Calif.

INVENTORS

I shall be pleased to furnish you, upon request, with full information relative to patent procedure—without any obligation on your part.

PATRICK D. BEAVERS
Registered Patent Attorney
934 Columbian Building Washington 1, D. C.

BE A CLAIM INVESTIGATOR



INVESTIGATE ACCIDENTS! Many earning \$750 to \$1000 a month. Thousands of insurance companies, airlines, steamship lines and Government Offices need Claim Investigators. Also big opportunities for your own spare time business. We train you at home. National Placement Service FREE of extra charge. Bill King writes: "Your course has paid off for me with large earnings. You can quote me—your Adjuster Training Course is worth many times the cost." Write TODAY for FREE book.

UNIVERSAL SCHOOLS

University Park, Dept. PM-3, Box 8202, Dallas 5, Texas

EARN WHILE YOU LEARN



women. Write Dept. EC-309

UPHOLSTERY BE YOUR OWN BOSS

Practical low-cost LEARN-BY-DOING UTS Course, complete with tools, materials, frames, trains you quickly AT HOME in spare time. Start making money in Upholstery almost at once! Big FREE illustrated book and FREE sample lesson shows you how—gives full facts about business, job opportunities for men and women. Write TODAY! Also Resident Training, G.I. Approved. **UPHOLSTERY TRADES SCHOOL** 721 Broadway, New York 3.



NOW! Test Your Own TV AND RADIO TUBES

with new Omni-Tester. Save the cost of one TV service call and Omni-Tester pays for itself. Easy to operate—no technical knowledge required. Absolutely safe. Use 110 volts AC or DC. Complete with test cords and instructions.

\$3.98

Guaranteed. No C.O.D. Please. ONLY **OMNI-ELECTRONICS CORP.** 911 W. 53rd St., Dept. 11, CHICAGO 9, ILL.



LOCKSMITHING

Practical Up-to-Date Course — ONLY \$4.95

53 illustrated self-instruction lessons. Easy to learn. Full price only \$4.95 postpaid—or COD plus postage. Satisfaction guaranteed or full refund! Mail your order today. **NELSON HALL CO.,** 210 S. Clinton St., Dept. CU-2, Chicago 6, Ill.



Print Your Own

Cards, stationery, circulars, tags, labels, photo and movie titles, advertising, etc. Save money. **Print for Others, Good Profit!** Easy rules sent. Raised Printing like Engraving, too. Sold direct from factory only. Write for free catalog of outfits and all details. **KELSEY PRESSES, M-37, Meriden, Conn.**

JEEP OWNERS

STA. WAGONS • JEEPSTERS • PICK-UPS!

RE-POWER with Ford 6 or V-8 engines. Our F-J ADAPTOR-CONVERSION KITS fit ALL Willys Jeeps including 1956. Kit No. 4-K for 1949-56 Ford engines in 1954-56 Pickups & Sta-Wagons priced at \$52.85 incl. Fed. tax. Kits for 1932-56 Ford engines in ALL other Willys Jeeps . . . \$43.25 Tax incl. Write today for free details or send check or M.O. for prepaid shipment. Tell us your engine you will use and whether 2 or 4 Whl-Dr. **ORDER NOW FOR EARLY SHIPMENT.** **HOOSIER MACHINE PRODUCTS CO.** 312 S.E. 6th St. Pendleton, Oregon

SAY YOU SAW IT IN POPULAR MECHANICS

WARN HUBS for 4-WHEEL DRIVES

Make 2 Vehicles Out of 1!

Over 75,000 satisfied users! Warn Hubs disengage front power train for 2-wheel drive use—stop drag, gear whine, front end shimmy; save gas, gears, tires. Use your 4-wheel drive for any purpose, any time, with Warn Automatic or Locking Hubs. Models for all makes of 4 W. Ds. to 1½ tons at dealers, or write:

AUTOMATIC FREE-WHEELING 2-WHEEL DRIVE OR HIGH SPEED 4-WHEEL DRIVE AS YOU SHIFT!

WARN MFG. CO., Riverton Box 6064A3, Seattle 88, Wn.

Tune Up, Pep Up, Fix Up ANY CAR!

Handle any job on any make, model, or part!



FIX CARS EASIER than you may have thought possible . . . even if you've never even tried to tune up an engine before!

Just look up the make, model and part you want to repair. This giant 904-page Chilton "ALL CARS" Service Manual tells you just what to do . . . shows in almost 3,000 pictures exactly how to do it. Tells how to locate troubles—what work-saving short cuts to take—what mistakes to avoid—even what standard tools to use.

Gives complete service details on every model of these makes since 1940: BUICK, CADILLAC, CHEVROLET, CHRYSLER, DE SOTO, DODGE, FORD, FRAZER, HENRY J., HUDSON, KAISER, LINCOLN, MERCURY, NASH, OLDSMOBILE, PACKARD, PLYMOUTH, PONTIAC, STUDEBAKER, WILLYS—practically every car in use today! Includes 58 troubleshooting charts, 353 Quick Check Data Tables and thousands of specifications. Used for U. S. Army-Navy training. Published every year by Chilton—world's largest automotive publishers. Specify "ALL CARS" Manual in coupon. Practice 10 days at our risk!

Giant New Edition

Weights 4¾ pounds! Contains complete service details for practically every car on the road today.

Only \$6.95



FIX CHEVROLETS!

This 132-page special Manual makes it easy to repair ANY Chevrolet made from 1940 to the present! Complete service details include wiring diagram, engine trouble shooting charts, tune-up data; power steering and Powerglide service details, etc., etc. Specify Chevrolet Manual in coupon. Money-back guarantee! **Only \$2.95**

FIX FORDS!

Handle any Ford repair or tune-up easier, faster, than you may have dreamed! 132-page Manual gives step-by-step service instructions on every model since 1940. Complete service data covers practically every part including Fordomatic transmissions, power steering, etc. Order Chilton Ford Manual. Money-back guarantee. **Only \$2.95**

FIX PLYMOUTHS!

Here is your easy service guide to practically every part of every Plymouth model since 1940! Wiring—axes—brakes—carburetors—cooling—ignition—engines—steering—transmissions—suspensions—pumps—generators, etc. Specify Chilton Plymouth Manual. Money-back guarantee. **Only \$2.95**

PRACTICE 10 DAYS FREE!

THE CHILTON CO., Dept. PM-36
5605 Chestnut St., Philadelphia 39, Pa.

Send the big CHILTON "ALL CARS" MANUAL (price \$6.95) for 10-day FREE EXAMINATION. If O.K., I will promptly remit \$1.95 (plus 45c postage-handling); then send \$2.50 monthly for 2 months. Otherwise, I will return manual postpaid in 10 days and owe you nothing. **SAVE!** Send \$6.95 cash with order and we pay postage-handling charge. Same return privilege.

Check to order Chilton "CHEVROLET" Manual, Price \$2.95
 Chilton "FORD" Manual, Price \$2.95
 Chilton "PLYMOUTH" Manual, Price \$2.95

NOTE: Individual car make manuals sold for cash with order (we pay postage.) Or, we ship C.O.D. and you pay postman manual price plus post office charges. Specify which method desired. Any manual returnable in 10 days if not satisfactory and we guarantee to refund your \$2.95. (OUTSIDE U.S.A.—Cash only. Prices: "ALL CARS" Manual, \$8.95, individual manuals \$3.25 each. Same 10-day return privilege with money refunded.)

Name

Address

City, Zone, State

Chilton books are sold by leading book stores.

FREE CATALOG!

BUY GENUINE

Diamonds

From New York's Leading

DIAMOND SPECIALIST
SAVE UP TO 50% AND MORE

Buy For Cash or Easy Credit PLAN

Tremendous savings on diamonds from unredeemed loans, bankruptcy sales and other below market sources. All reset in smart brand new 14 Kt. gold & platinum modern mountings. One of the world's largest selections. Every diamond graded according to nationally accepted system. Grading explained in catalog. You are 100% protected by a SWORN BOND guaranteeing quality and 10 DAY UNCONDITIONAL MONEY BACK GUARANTEE. Easy payment lay-away plan, and . . . see-before-you-buy plan available. Send coupon for FREE CATALOG. Established 1882. Our references: your own bank or any mercantile agency. No Salesman Will Call.



KASKEL'S 41 West 57th St.
New York 19, Dept. 607-CA

Send FREE CATALOG and Advice about DIAMONDS without obligation.

NAME
ADDRESS
CITY STATE



CALL TO ADVENTURE

You're a wilderness ranger in your Old Town Canoe. Paddle to hidden pools and cast your line where the big ones rise. Trust to your Old Town Canoe to get you there - and back. Birchbark-light, yet wiry-strong. Perfectly balanced. Built to last.

FREE CATALOG shows all kinds of canoes for paddling, for sailing, for outboards. Also sailboats, outboard boats, dinghies, rowboats.

OLD TOWN CANOES

Old Town Canoe Co., 343 Middle St., Old Town, Maine
PLEASE SEND ME FREE CATALOG

Name

Address

City State

YOU MAY THINK YOU'RE TALL ENOUGH... BUT

It's easy to be taller! Change to "ELEVATORS", the amazing height-increasing shoes that make you almost 2 inches taller instantly . . . confidentially. Only you know "ELEVATORS" secret, but everyone notices the difference. So, don't just think you're tall enough; BE SURE! Wear "ELEVATORS"!

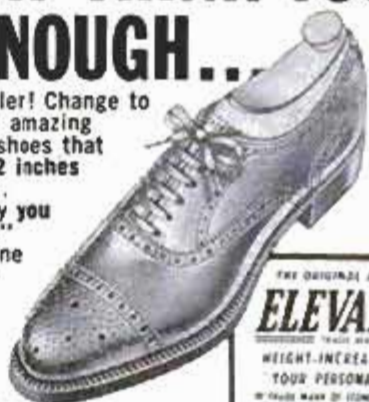

WHAT DO OTHERS THINK?

THE ORIGINAL AND GENUINE
ELEVATORS

WEIGHT-INCREASING SHOES
"YOUR PERSONAL PEDESTAL!"
© TRADE MARK OF STONE-TARLOW CO., INC.

Write for free booklet

STONE-TARLOW CO., INC., DEPT. PM3-56, BROCKTON 68, MASS.

LAW FREE BOOK THE LAW TRAINED MAN

Write today for a FREE copy of illustrated law book, "THE LAW TRAINED MAN," which shows how to earn the professional Bachelor of Laws (LL.B.) degree through home study of the famous Blackstone Law Course. All necessary books and lessons provided. Moderate cost; convenient monthly terms. Write for FREE law training book today.

Blackstone School of Law, 225 N. Michigan Ave.

Founded 1890

Dept. 53 Chicago 1, Ill.

GIANT FREE CATALOG of OPTICAL BARGAINS



ASTRONOMICAL TELESCOPE HEADQUARTERS

Complete Line of Astronomical Telescope Parts and Assembled Telescopes. Also huge selection of lenses, prisms, war surplus optical instruments, parts and accessories. Telescopes, microscopes, binoculars, etc. America's No. 1 source of supply for Telescope Makers. SEND ONLY \$1.00 for beginner's 10-lens kit and big instruction booklet Stock 2-H. Ask for FREE catalog H.

EDMUND SCIENTIFIC CORP., Barrington, N.J., U.S.A.

YES! SEND

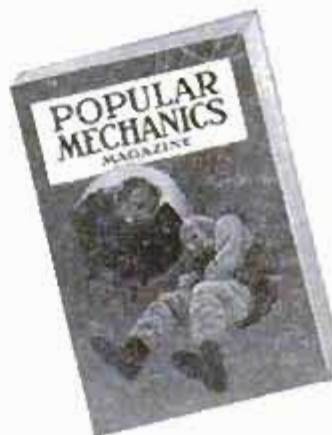

directly
to my door
every month

I am enclosing

- \$3.50 for 1 year
 \$8.00 for 3 years

name _____

address _____

city _____

zone _____

state _____

A-36

Hand this order to your newsdealer or send it to

POPULAR MECHANICS
200 East Ontario St. Chicago 11, Ill.

POPULAR MECHANICS

Make SURE, SAFE INSULATED ELECTRICAL CONNECTIONS

The New

SUPER ~~CLAMP~~ Hand Tool

The ONE Tool for ALL Wire Sizes used in Home Wiring, Appliances, Automobiles.

DOES ALL THESE THINGS BESIDES

CRIMPS Solderless Terminals and Connectors without solder or tape for safe connections.

STRIPS Wire sizes #22-#10. Gauges assure proper length for sure, safe crimp.

CUTS Wire, making clean, sharp cut through insulation and Conductor.

SHEARS Bolts and screws without damaging threads — no filing or hack sawing.

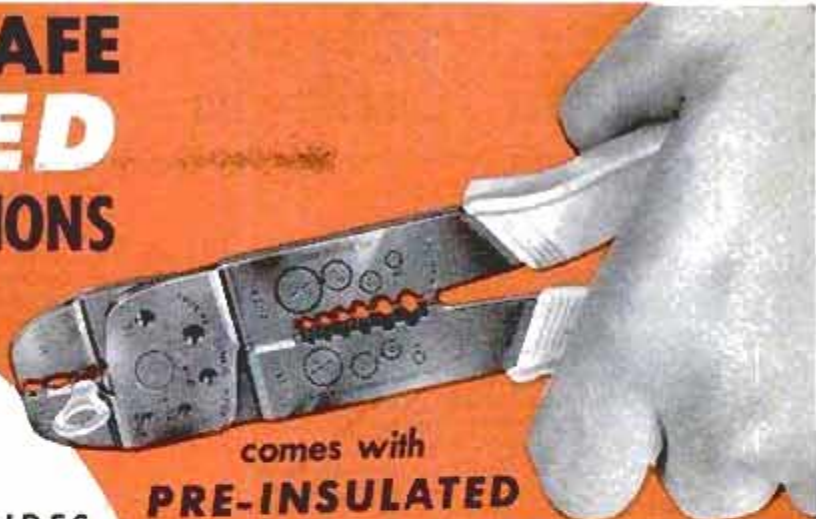

comes with
PRE-INSULATED



FREE with Each TOOL

ORDER DIRECT—USE COUPON

Only
\$3.95
Post Paid

Satisfaction guaranteed or money back. Send check or money order for \$3.95. (Ohio residents add 12c sales tax.)

T. W. Berger, Inc.
National Distributor Consumers and Dealers
AIRCRAFT-MARINE PRODUCTS, Inc.
210M Mairemont Center Bldg., Cincinnati 27, Ohio

T. W. Berger, Inc.
National Distributor Champ Tool
210M Mairemont Center Bldg., Cincinnati 27, Ohio

Send me post paid the new super Champ Hand Tool. I am enclosing \$3.95. (Ohio residents add 12c sales tax.)

check money order

NAME

ADDRESS

CITY..... ZONE..... STATE.....

STAMP COLLECTORS!

319 DIFFERENT STAMPS 25¢

This big imported collection includes: Giant glider aviation set showing real and toy gliders, Israel airport & ancient coin set, Fish & insect life from far-off Iran, Sahara, Guinea, Red Cross Flag, Nurse & Blood Transfusion, Jap Antelope & Bird, curious child artwork plus hundreds of fascinating issues from all parts of the world. Altogether 319 all different stamps cataloging \$7.25—for only 25¢ to introduce our bargain approvals. **BONUS: Valuable IMPERF. ERROR and 48-Page Stamp Dictionary** included free & long as they last. **STAMPEX CO., Dept. 8M, P.O. Box 47, White Plains, N.Y.**



How to Make Money with Simple Cartoons



A book everyone who likes to draw should have. It is free; no obligation. Simply address

FREE BOOK

CARTOONISTS' EXCHANGE
Dept. 93D Pleasant Hill, Ohio

PUMP WATER FAST!

Drains Wash Tubs, Cellars, Cisterns. Famous #7 pumps 2800 gph. 420 gph. at 75' high or 1600 gph. from 25' well. Sturdy rustproof alloy metal. Six blade impeller. 3/4" inlet, 1/2" outlet. Standard pipe threaded. Uses any 1/2 to 1/2 H.P. Motor. Will not leak or clog. Ironclad guarantee. Send check, M.O., or sent C.O.D. **\$695** IN U.S.

Irrigate, Fill Tanks, Draw Well Water. Heavy duty #8 pumps 7000 gph. —1000 gph. 75' high 3000 gph. from 25' well. Rustproof alloy metal. 8 blade impeller. 1" inlet, 1" outlet. Standard pipe threaded. Will not leak or clog. Iron clad guarantee. Send check, M.O., or sent C.O.D. **\$1095**

Free Catalogue—Gear Pumps, Large Centrifugal Pumps, Deep and Shallow Well Pumps, Sump Pumps.

MOORE MANUFACTURING CO.
SWEDESBORO 1, NEW JERSEY

PREPARE FOR BETTER JOB, BIGGER PAY IN SPARE TIME AT HOME

Today, choose the job you want—and prepare for it in time you might otherwise waste. Or if you are already in the work you like best, start training now for quicker promotion and increased pay. During more than 50 years AMERICAN SCHOOL has helped ambitious people to reach higher goals. Check subject that interests you and mail coupon for full information.

AMERICAN SCHOOL, Dept. G345, Drexel at 58th, Chicago 37, Ill.

Without obligation, please send FREE and postpaid, full particulars about the subject checked below.

- | | | |
|--|---|--|
| <input type="checkbox"/> Accounting | <input type="checkbox"/> Diesel Technician | <input type="checkbox"/> Mechanical Technology |
| <input type="checkbox"/> Apprenticeship Courses | <input type="checkbox"/> Drafting—Building | <input type="checkbox"/> Metalworking Courses |
| <input type="checkbox"/> Architecture & Building | <input type="checkbox"/> Drafting—Machine | <input type="checkbox"/> Plumbing—Practical |
| <input type="checkbox"/> Automotive Technician | <input type="checkbox"/> Electrical Engineering | <input type="checkbox"/> Private Secretary |
| <input type="checkbox"/> Better Foremanship | <input type="checkbox"/> Electricity—Practical | <input type="checkbox"/> Retail Merchandising |
| <input type="checkbox"/> Bookkeeping | <input type="checkbox"/> Electronics—Industrial | <input type="checkbox"/> Salesmanship—Outside |
| <input type="checkbox"/> Business Management | <input type="checkbox"/> HIGH SCHOOL COURSES | <input type="checkbox"/> Sheet Metal Work |
| <input type="checkbox"/> Civil Engineering | <input type="checkbox"/> Mechanical Engineering | <input type="checkbox"/> Tool Making |
| <input type="checkbox"/> Contracting | | |

NAME _____ OCCUPATION _____ AGE _____
HOME ADDRESS _____ STATE _____
CITY _____

Canadian Residents: Write American School, 1610 Sherbrooke St. West, Montreal

MAIL COUPON NOW



Home Operators Take Over Huge Rubber Stamp Profits

Men and Women Everywhere Now Can Start in a Big-Pay Business at Home in Spare Time

The multi-million dollar Rubber Stamp business is now being taken over by small, home operators throughout the U.S. Men and Women who operate this inexpensive machine can turn out large numbers of Rubber Stamps with special wording of all kinds. Material costing only 27¢ makes a stamp that sells for \$1.80. The machine is easy for anyone to operate. It molds as many as six Rubber Stamps at a time, each with different wording such as names, addresses, notices, stock numbers, prices and other "copy" needed by offices, factories and individuals. At full capacity, it can earn as much as **\$9.20 an hour for the operator!** You don't need experience to get into this big profit business at home. We supply everything, including complete instructions and eight ways to get orders for stamps coming in fast. Start making up to \$9.20 in one hour right away. We'll mail full particulars FREE and no salesman will call. Be first in your locality. Rush coupon today to **Rubber Stamp Div., 1512 Jarvis Ave., Dept. R-23, Chicago 26, Ill.**

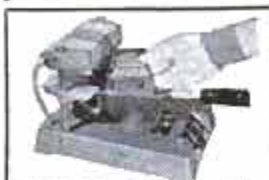

This Little Table Top Machine pays Home Workers up to \$9.20 AN HOUR.

Rubber Stamp Div., Dept. R-23, FREE!
1512 Jarvis, Chicago 26, Ill.

Please rush full particulars about the little machine that can get me started in the profitable Rubber Stamp business at home in spare time. Everything you send me is FREE and no salesman will call.

Name _____
Address _____
City _____ Zone _____ State _____

Let me PROVE to YOU
**THERE'S BIG MONEY
IN TROPICAL FISH**

Breed them at HOME!
SPARE TIME! FULL TIME!

FREE!

America's newest and most profitable Home-Business. Breed rare Tropicals in your living room, garage, basement—anywhere! No experience, no big investment required. Rush coupon below and we will send you all 4 things...

1 **HOW TO BUILD A \$10,000 BUSINESS IN YOUR LIVING ROOM—COMPLETE!** Revealing! Loaded with photos! Tells how to start spare-time or full-time. How to sell Tropicals by mail order. How much you can earn, how to charge, how many Tropicals you can breed, etc., etc.—loaded with amazing information.

2 **TROPICAL FISH MULTIPLICATION CHART.** Fascinating and factual. Proof of profits. Tells kinds of Tropicals, number of eggs produced at one birth, how many times a year Tropicals give birth—approximate retail prices of various kinds of Tropicals.

3 **THERE'S "BIG MONEY IN TROPICALS" STORY.** Interesting success story of a man who built big \$\$\$ business. Now ships to 48 states. Tells how it's possible to earn \$5,000 to 8,000 a year breeding one species of Tropicals only. You'll be amazed.

4 **HOW TO GET COMPLETE BUSINESS-IN-A-PACKAGE!** Unique plan that shows you how to start your own business and pay for it out of profits.

FREE!

TROPICAL FISH BREEDERS OF AMERICA
Dept. D-3
15121 S. Broadway,
Los Angeles 61,
Calif.

Please rush all 4 things immediately by mail. I lawfully certify that I am over 17 years old.

Name _____
Address _____
City _____ State _____

DON'T THROW IT AWAY

FLEX-O-FIX IT!

PATCH that torn rubber boot, wader, raincoat. **WATERPROOF** leather boots, shoes. **MEND** tents, sleeping bags, clothing. Plug holes in boats and canoes. Repair boat sails and tarpaulins.

Use Flex-O-Fix around home and car, too. **INSULATE** electrical connections, tool handles. Keep rugs, phones from skidding. **REPAIR** convertible car tops, weatherstripping, cuts in tires. **SEAL** leaks around windshields. Stops squeaks, rattles. Squeezes from tube. Dries into tough, elastic rubber. 75¢ a tube at dealers or send 1.00 direct. Prepaid to you.

PYROIL COMPANY, INC., Dept. PM-36
La Crosse, Wis., U.S.A.
Toronto, Canada

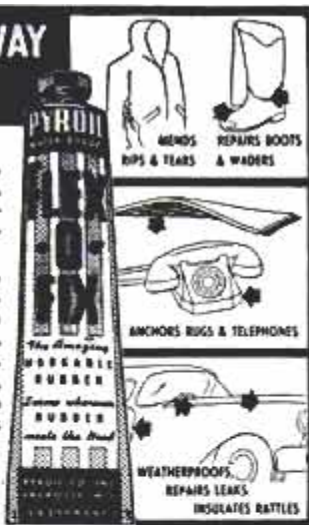

If Your Child Is A Poor Reader

See how **The Sound Way To Easy Reading** can help him to read and spell better in a few weeks. New home-tutoring course *drills* your child in phonics with records and cards. Easy to use. University tests and parents' reports show children gain up to **full year's grade in 6 weeks!** Write for free illustrated folder and low price. **Bremner-Davis Phonics, Dept. U-57, Wilmette, Ill.**

LEARN TO **BECOME A GAME WARDEN**
or GOVT. HUNTER. Join FORESTRY, FISHERY, or WILDLIFE Services. Excellent opportunities! Good pay (\$2500 to \$10,800 a year). Pleasant Work. Prestige, Real Security, Healthful Working Conditions, and Retirement Income can all be yours. Help fill the demand in your area. Make your love of the outdoors become your business. Learn at home in spare time—it's Easy! Fun! Fascinating!

FREE! (if over 17 years old.) Complete, illustrated booklet that gives you complete facts. **SUPPLY LIMITED—send your name and address now—TODAY!**

HOME STUDY EDUCATORS, Dept. R-3
1036 S. La Brea Los Angeles 19, Calif.

MONEY in DONUTS

Make new greaseless donuts. Start in kitchen. No smoke. Sell stores. **HALF PROFIT.** Cash daily. Free recipes. No obligation. Write! **MARTIN RAY CO., 3605 SO. 15th AVENUE, MINNEAPOLIS 7, MINN.**



Easy to make your own **BOWS—ARROWS—EQUIPMENT**

Illustrated Hand-Book 84 pgs. 75¢, tells you how! Large Colored Catalog 5¢—Send for it!

Ask your dealer for "Stemmler's Archery" (Oldest Mfr. in U.S.A.)

L. E. STEMMLER CO.

Manorville (Box 1) L. I., N. Y.

Send for **FREE** 112 page Illustrated Catalog of Farm, Home, and Workshop Bargains.

Write to Dept. F-3 **WELLWORTH TRADING COMPANY**

1832 S. WABASH AVE.

CHICAGO 16, ILL

Learn PHOTOGRAPHY at Home

Splendid opportunities. Prepare in spare time. Practical basic training. Long-established school. Send for free book, "Opportunities in Photography." No obligation. **American School of Photography, 835 Diversoy Parkway, Dept. 1353, Chicago 14, Ill.**

POPULAR MECHANICS



Picture yourself going places

You've done it often. Call it day-dreaming if you like, but you've seen yourself in a bigger job — giving orders and making decisions — driving off in a smart new car — buying your family a fine home.

There's nothing wrong with dreams. But how about making them come true? *You can do it*, if you're willing to try!

Look around you. The men who are going places are the *trained* men. They've learned

special skills that bring them better jobs and higher pay. It's the men *without* training whose dreams never come true.

What are you going to do about it? Just wait and wish? If you really *want to succeed*, you can get the training you need by studying at home in your spare time. International Correspondence Schools offer you a course in just about any field you choose, giving you the practical plus the bedrock facts and theory. No skimming or skimping! And you'll be earning while you learn. Students report better jobs and more pay within a few months.

Look over the list of subjects in the coupon below. Pick out the one that interests you most — the one that holds the greatest future for you. Then mark the coupon, and mail it today. *Find out* what I. C. S. can do for you. It costs only a stamp or postcard, but it's the first step if you want to go places!



SMARTEST THING HE EVER DID

"I noticed that the trained men held the better jobs. That's when I decided to take an I. C. S. course. Enrolling with I. C. S. was one of the smartest things I ever did. The position as Plant Engineer I hold today is largely due to the 'know-how' derived from my I. C. S. texts. I. C. S. can help any man who will study."

L. P. S., Elkhart, Ind.

FREE BOOKS

1. Thirty-six page pocket-size guide to advancement, "How to Succeed."
2. Big catalog on career that interests you.
3. Free sample lesson (Math).

For Real Job Security—Get an I. C. S. Diploma! I. C. S., Scranton 9, Penna. Member, National Home Study Council

INTERNATIONAL CORRESPONDENCE SCHOOLS

ICS

BOX 54626C, SCRANTON 9, PENNA.

(Partial list of 277 courses)

Without cost or obligation, send me "HOW TO SUCCEED" and the opportunity booklet about the field BEFORE which I have marked X (plus sample lesson):

- | | | | | |
|--|---|--|---|--|
| <p>ARCHITECTURE and BUILDING CONSTRUCTION</p> <ul style="list-style-type: none"> <input type="checkbox"/> Air Conditioning—Refrig. <input type="checkbox"/> Architecture <input type="checkbox"/> Architectural Interior <input type="checkbox"/> Building Contractor <input type="checkbox"/> Building Maintenance <input type="checkbox"/> Carpenter and Mill Work <input type="checkbox"/> Estimating <input type="checkbox"/> Heating <input type="checkbox"/> Painting Contractor <input type="checkbox"/> Plumbing <input type="checkbox"/> Reading Arch. Blueprints <p>ART</p> <ul style="list-style-type: none"> <input type="checkbox"/> Cartooning <input type="checkbox"/> Commercial Art <input type="checkbox"/> Fashion Illustrating <input type="checkbox"/> Magazine Illustrating <input type="checkbox"/> Show Card and Sign Lettering <input type="checkbox"/> Sketching and Painting <p>AUTOMOTIVE</p> <ul style="list-style-type: none"> <input type="checkbox"/> Auto Body Rebuilding <input type="checkbox"/> Auto Elec. Technician <input type="checkbox"/> Auto-Engine Tune Up <input type="checkbox"/> Automobile | <p>AVIATION</p> <ul style="list-style-type: none"> <input type="checkbox"/> Aeronautical Engineering Jr. <input type="checkbox"/> Aircraft & Engine Mechanic <p>BUSINESS</p> <ul style="list-style-type: none"> <input type="checkbox"/> Advertising <input type="checkbox"/> Bookkeeping and Accounting <input type="checkbox"/> Business Administration <input type="checkbox"/> Business Correspondence <input type="checkbox"/> Public Accounting <input type="checkbox"/> Creative Salesmanship <input type="checkbox"/> Federal Tax <input type="checkbox"/> Letter-writing Improvement <input type="checkbox"/> Office Management <input type="checkbox"/> Professional Secretary <input type="checkbox"/> Retail Business Management <input type="checkbox"/> Sales Management <input type="checkbox"/> Stenographic-Secretarial <input type="checkbox"/> Traffic Management <p>CHEMISTRY</p> <ul style="list-style-type: none"> <input type="checkbox"/> Analytical Chemistry <input type="checkbox"/> Chemical Engineering <input type="checkbox"/> Chem. Lab. Technician <input type="checkbox"/> General Chemistry <input type="checkbox"/> Natural Gas Prod. & Trans. <input type="checkbox"/> Petroleum Engineering <input type="checkbox"/> Plastics <input type="checkbox"/> Pulp and Paper Making | <p>CIVIL, STRUCTURAL ENGINEERING</p> <ul style="list-style-type: none"> <input type="checkbox"/> Civil Engineering <input type="checkbox"/> Construction Engineering <input type="checkbox"/> Highway Engineering <input type="checkbox"/> Reading Struct. Blueprints <input type="checkbox"/> Sanitary Engineering <input type="checkbox"/> Structural Engineering <input type="checkbox"/> Surveying and Mapping <p>DRAFTING</p> <ul style="list-style-type: none"> <input type="checkbox"/> Aircraft Drafting <input type="checkbox"/> Architectural Drafting <input type="checkbox"/> Electrical Drafting <input type="checkbox"/> Mechanical Drafting <input type="checkbox"/> Mine Surveying and Mapping <input type="checkbox"/> Plumbing Drawing and Estimating <input type="checkbox"/> Structural Drafting <p>ELECTRICAL</p> <ul style="list-style-type: none"> <input type="checkbox"/> Electrical Engineering <input type="checkbox"/> Electrical Maintenance <input type="checkbox"/> Electrician <input type="checkbox"/> Contracting <input type="checkbox"/> Lineman <p>HIGH SCHOOL</p> <ul style="list-style-type: none"> <input type="checkbox"/> Commercial <input type="checkbox"/> Good English <input type="checkbox"/> High School Subjects <input type="checkbox"/> Mathematics | <p>LEADERSHIP</p> <ul style="list-style-type: none"> <input type="checkbox"/> Foremanship <input type="checkbox"/> Industrial Supervision <input type="checkbox"/> Leadership and Organization <input type="checkbox"/> Personnel-Labor Relations <p>MECHANICAL AND SHOP</p> <ul style="list-style-type: none"> <input type="checkbox"/> Gas—Electric Welding <input type="checkbox"/> Heat Treatment <input type="checkbox"/> Metallurgy <input type="checkbox"/> Industrial Engineering <input type="checkbox"/> Industrial Instrumentation <input type="checkbox"/> Industrial Supervision <input type="checkbox"/> Internal Combustion Engines <input type="checkbox"/> Machine Design-Drafting <input type="checkbox"/> Machine Shop Inspection <input type="checkbox"/> Machine Shop Practice <input type="checkbox"/> Mechanical Engineering <input type="checkbox"/> Quality Control <input type="checkbox"/> Reading Shop Blueprints <input type="checkbox"/> Refrigeration <input type="checkbox"/> Sheet Metal Worker <input type="checkbox"/> Tool Design <input type="checkbox"/> Toolmaking <p>RADIO, TELEVISION</p> <ul style="list-style-type: none"> <input type="checkbox"/> Industrial Electronics <input type="checkbox"/> Practical Radio TV Eng'ng <input type="checkbox"/> Radio and TV Servicing <input type="checkbox"/> Radio Operating | <ul style="list-style-type: none"> <input type="checkbox"/> Television Technician <p>RAILROAD</p> <ul style="list-style-type: none"> <input type="checkbox"/> Air Brakes <input type="checkbox"/> Car Inspector <input type="checkbox"/> Diesel Locomotive <input type="checkbox"/> Locomotive Engineer <input type="checkbox"/> Section Foreman <p>STEAM AND DIESEL POWER</p> <ul style="list-style-type: none"> <input type="checkbox"/> Combustion Engineering <input type="checkbox"/> Diesel—Elec. <input type="checkbox"/> Diesel Eng's <input type="checkbox"/> Electric Light and Power <input type="checkbox"/> Stationary Fireman <input type="checkbox"/> Stationary Steam Engineering <p>TEXTILE</p> <ul style="list-style-type: none"> <input type="checkbox"/> Carding and Spinning <input type="checkbox"/> Cotton, Rayon, Woolen Mfg. <input type="checkbox"/> Finishing and Dyeing <input type="checkbox"/> Loom Fix'g <input type="checkbox"/> Textile Des'ing <input type="checkbox"/> Textile Eng'g <input type="checkbox"/> Throwing <input type="checkbox"/> Warping and Weaving <p>MISCELLANEOUS</p> <ul style="list-style-type: none"> <input type="checkbox"/> Domestic Refrigeration <input type="checkbox"/> Marine Engineering <input type="checkbox"/> Ocean Navigation <input type="checkbox"/> Professional Engineering <input type="checkbox"/> Short Story Writing <input type="checkbox"/> Telephony |
|--|---|--|---|--|

Name _____ Age _____ Home Address _____

City _____ Zone _____ State _____ Working Hours _____ A.M. to P.M. _____

Occupation _____

Canadian residents send coupon to International Correspondence Schools, Canadian, Ltd., Montreal, Canada. . . . Special tuition rates to members of the U. S. Armed Forces.



C7

Colorcreting Can Be Your Big Opportunity

Local Colorcretors are Needed Everywhere

Colorcreting is a small investment enterprise, rich in sales potentials, high in income possibilities. Work is easy and fascinating. No experience required; we supply complete instructions.

Colorcreting is a building-beautifying process, with Colorcrete being pneumatically applied to new or old masonry surfaces such as concrete or stucco. Lasts indefinitely—25 years or more. Easily cleaned. Gleaming white, or a choice of 30 colors.

Colorcrete equipment is compact and portable. Easy to operate and practically wear-proof. Easy-payment terms when desired. Write at once for Opportunity Book.

COLORCRETE

Colorcrete Industries, Inc.
578 Ottawa Ave., Holland, Michigan

IN CANADA: DUNN MASONRY MACHINERY LIMITED
1020 Dundas Highway, Cooksville, Ont.

NEW BENJAMIN SUPER CO₂ GAS CARBINE—\$16.50

HI-LO (2 Stage) Jet Power
Cal. .177 or .22

RIFLED
Shoots
Pellets
& Darts



IDEAL FOR TARGET & SMALL GAME

SAFE—ECONOMICAL—ACCURATE
CONVENIENT—PRACTICAL—NON TOXIC

EASY TO OPERATE—NO PUMPING—NO FLINCHING.
Get 40 SHOTS from each 10¢ STANDARD SIZE CO₂ (Soda) CARTRIDGE. Up to ¾" penetration.
Ask your DEALER for DEMONSTRATION.

FREE Folder

New Benjamin .177 or .22 CO₂ ROCKET Gas Pistol with HI-LO JET POWER..... \$15.00

BENJAMIN AIR RIFLE CO.
896 MARION ST., ST. LOUIS 4, MO., U.S.A.

RUPTURE



RELIEF...OR YOUR MONEY BACK
Write now for free booklet and pictures of rupture care. You can be helped...work steady, with low cost, easy to wear Web Truss, thousands satisfied.

WEB TRUSS CO. Dept. M-3, Hagerstown, Maryland

I'll Send You This Handsome SAMPLE CASE—FREE



and Show You How to Make Up to \$30.00 in a Day

Mail coupon for this Free Tailoring Sample Case packed with 150 beautiful, big-value suit and overcoat fabrics. Take orders from friends, fellow-workers, others, for fine quality, made-to-measure clothes. Pocket big cash profits in advance. Because wearing our suits and over-

coats brings more orders, we make it easy for you to get your own clothes without the cost. No experience is needed. SATISFACTION GUARANTEED. SEND NO MONEY. Just fill out and mail coupon—today!

PIONEER TAILORING COMPANY, Dept. P-1116
CONGRESS & THROOP STREETS - CHICAGO 7, ILLINOIS

PIONEER TAILORING CO., Dept. P-1116
Congress & Throop Sts., Chicago 7, Ill.

Dear Sir: I WANT A MADE-TO-MEASURE SUIT TO WEAR AND SHOW, without paying 1¢ for it. Rush details and Sample Kit of actual fabrics. ABSOLUTELY FREE.

NAME..... AGE.....

ADDRESS.....

CITY..... STATE.....

"WE'RE LOOKING FOR PEOPLE WHO LIKE TO DRAW"

... says Norman Rockwell, one of America's 12 Most Famous Artists. If you like to draw, you may have talent to become a successful artist, spare or full time. Find out for sure with our scientific, 8-page **Free Art Talent Test**. Thousands paid \$1 to take it. Get it FREE. No obligation. Send your name, address, age to: Famous Artists Schools, Dept. 6-C, Westport, Conn.



STOP Radio and TV Noises with NEW, IMPROVED FILTER PLUG

BALANCED CIRCUIT eliminates power line interference from household appliances, fluorescent lights, motors, oil burners, autos, etc. Simple to use. Don't despair if you've tried other filters without success. THIS ONE MODEL Money back guarantee. We pay postage.

\$150 DELUXE WORKS 5 day trial period.
SCOPE MFG. CO. Dept. PM-4, Box 23
Knickerbocker Sta., NYC 2, N.Y.

LAW

Men and women **STUDY AT HOME** for Business Success and **LARGER PERSONAL EARNINGS**, 44 years expert instruction—over 114,000 students enrolled. LL.B. Degree awarded. All text material furnished. Easy payment plan. Send for **FREE BOOK**—"Law and Executive Guidance"—NOW!

AMERICAN EXTENSION SCHOOL OF LAW
Dept. H-9, 201 N. Wells St., Chicago 6, Illinois



DEVELOP A HE-MAN VOICE!

Write for FREE book "How to Strengthen Your Voice for Greater Success" by Eugene Feuchtinger. No obligation. Book will be mailed at once in plain wrapper, postpaid. Just send your name and address. State age. **PREFECT VOICE INSTITUTE, 210 S. Clinton St., Studio CU-2, Chicago 6, Ill.**

PLEASE SEND ME

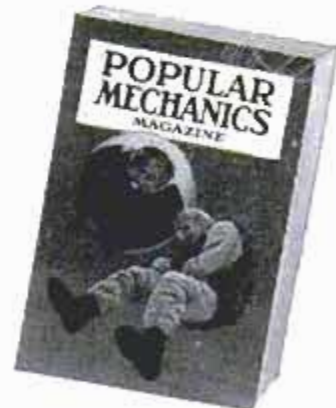

for the time checked.
I am enclosing . . .

- 1 year \$3.50
 2 years \$6.00

name

address

city

zone

state

Hand this order to your newsdealer or send it to

POPULAR MECHANICS
200 East Ontario St. Chicago 11, Ill.

Get on UNCLE SAM'S PAYROLL START HIGH AS \$4,525.00 YEAR



MEN — WOMEN, 18-55. Thousands of positions open. Prepare NOW for next examinations. Write immediately for free 36-page book, with list of positions and particulars telling how to prepare. Grade school education often sufficient. Veterans get preference.

FRANKLIN INSTITUTE

(Not Government Controlled)

Dept. N-93, Rochester 4, N. Y.

CARBURETOR SAVES GAS VACUATING OVERRICH MIXTURES



Car owners who are getting poor gas mileage, and wasting money due to overrich mixtures, will be pleased to learn how to save gas. Easily installed Vacu-matic invention is **Automatic** and operates on the supercharge principle. For cars, trucks, tractors. **SALESMEN WANTED! Big Profits!** FOR FREE PARTICULARS, HOW YOU CAN GET ONE ON YOUR OWN CAR FOR INTRODUCING, just send your name and address on a post card to—

VACU-MATIC CARBURETOR, Dept. 853, Wauwatosa, Wis.

BUILD YOUR OWN JENSEN HI-FI SPEAKER SYSTEM SEND FOR NEW BOOK TODAY!

Save money... build your choice of 18 different hi-fi speaker systems with 8 new 2-way and 3-way Jensen speaker kits. 36-page Manual 1060 gives complete instructions for building enclosures, selecting your Jensen speaker kit and assembling. *Send 50c in coin today!*



JENSEN MFG. CO., Dept. G, 6601 S. Laramie, Chicago 38



Stammering?

BREAK THAT HABIT NOW!
SUCCESSFUL EMERY CORRESPONDENCE COURSE FEATURED IN NEWSWEEK & MEDICAL RECORD. WRITE TODAY FOR FREE INFORMATION.

EMERY INSTITUTE

P.O. Box 867-PM3 Winter Park, Florida

SAVE MONEY ON U S GOV'T SURPLUS

Buy surplus direct from US Government. These are samples of the savings that can be made. Life boat \$12.00. Grinder \$4.69. Shaper \$15. Dump truck \$76.77. Tractor \$75.00. Typewriter \$7.51. Freezer \$50. Spray painter \$15.25. Motor \$4. Hunting, fishing, camping, sporting Equip, jeep, boat, tools. Hundreds others may be purchased at tremendous savings through our Bulletin "Surplus Sales." Price \$1.00. The Abacus Press, Box 169DDD, Dept. 4, East Hfd. 8, Conn.

FREE OUTFIT STARTS YOU IN BIG MONEY SHOE BUSINESS!

We furnish everything FREE to set you up in your own profitable full or spare time shoe business. Just 3 easy sales a day brings up to \$84 a week EXTRA! Repeat orders mean big, steady profits. No experience or investment needed. You feature over 150 fast-selling styles in dress, sport, work shoes for men, including beautiful Nylon mesh shoes with Air Cushion innersoles. Also special kinds of shoes for different occupations. Amazing range of sizes and widths. Fit customers stores are unable to take care of. Start now by selling to friends, neighbors, relatives. Everyone is your prospect. Send postcard today for FREE Selling Outfit!



WRITE TODAY!!

MASON SHOE MFG. CO., Dept. MA956, Chippewa Falls, Wis.



IF YOU "EAT, SLEEP AND LIVE" CARS...

TURN YOUR HOBBY INTO A CAREER!

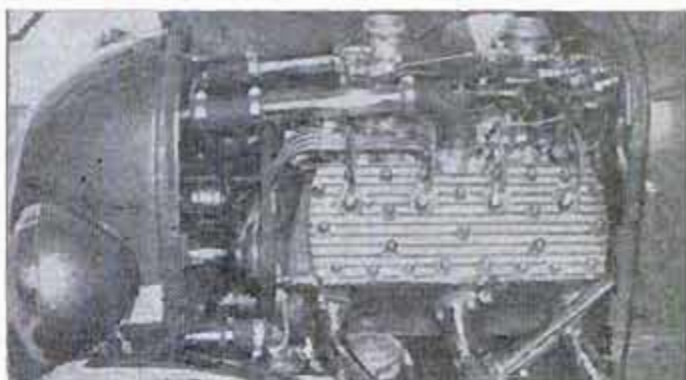

Get America's Big-time, Big-future

AUTO MECHANICS & DIESEL COURSE at home in your spare time!

Los Angeles' National Schools, America's automotive Technical Trade School since 1905, now brings its famous resident Shops and Faculty direct to you at home—to prepare you to earn more money, with job security, in today's fast-moving, opportunity-filled Auto Mechanics Industry! Get your home training from the "Car Capital of The World"—America's most auto-minded city, center of Hot Rod and Sports Car activity! Mail coupon right now!

"SHOP-METHOD" HOME TRAINING!

YOU MASTER ALL PHASES, INCLUDING DIESEL! All lessons fully illustrated. Latest equipment covered.



THIS SET OF LIFETIME TOOLS IS YOURS! Also all-metal tool box. Part of your course, yours to keep.

EARN WHILE YOU LEARN! We show you how to start Spare Time Earnings soon after enrollment.

ATTENTION MEN OF DRAFT AGE. Learn how you can achieve higher rating and pay. Mail coupon *at once!*

APPROVED FOR G. I. TRAINING. Both Home Study & Resident Courses. Free help with technical and personal problems—Job Placement Service.



Send for FREE FACT-BOOK AND SAMPLE LESSON!

NOW! 2 offices to serve you faster! Mail coupon today to one nearest you!

NATIONAL SCHOOLS

Technical Trade Training Since 1905

LOS ANGELES 37, CALIFORNIA

IN CANADA: 811 West Hastings Street, Vancouver, B. C.

MAIL NOW TO OFFICE NEAREST YOU!

(mail in envelope or paste on postal card)

NATIONAL SCHOOLS, Dept. DB-36

4000 S. FIGUEROA STREET
LOS ANGELES 37, CALIF.

OR 22 W. MADISON ST.
CHICAGO 2, ILLINOIS

Send **FREE** Auto-Mechanics Book and Sample Lesson. No obligation, no salesman will call.

NAME _____ BIRTHDAY _____ 19__

ADDRESS _____

CITY _____ ZONE _____ STATE _____

Check if interested ONLY in Resident School Training at Los Angeles. VETERANS: Give Date of Discharge _____

Get the Practical Help You Need With These

POPULAR MECHANICS BOOKS

Use Them to
Save Time and Money
Make Extra Money
Enjoy Hobbies and Pastimes
Build Your Own Home
Improve Farm Income
Get the Most Out of Your Home Workshop
Enjoy Better Living



You may examine any books that interest you. Full purchase price refunded on books returned in 7 days. Order by number in coupon below. All books are cloth bound and fully illustrated with photos, drawings, plans and working diagrams. Some in colors. Only Popular Mechanics with 53 years of publishing experience and tremendous facilities can give you such practical and helpful how-to-do-it books so moderately priced. Order today. Prompt shipment and guaranteed delivery. Order by number in coupon below.

HOME SHOP

SIXTY POWER TOOLS AND HOW TO BUILD THEM (1) How to turn scrap and discarded materials into power tools at little cost.\$2.50

POWER TOOLS AND HOW TO USE THEM (2) Expert advice on selection and use of power tools for the home shop\$2.50



PLANNING YOUR HOME WORKSHOP (3) The six basic power tools, floor plans, layouts, etc.\$2.50

PORTABLE POWER TOOLS (4) Practical information on the selection, care and use of portable power tools...\$2.00

WELDING, BRAZING AND SOLDERING (5) All the tricks and know-how of good soldering, welding, etc.\$1.75



HOMES · BUILDING

YOUR HOME AND HOW TO BUILD IT YOURSELF (6) Hundreds of amateur builders have built this six room house themselves\$3.00

CONCRETE BLOCK HOUSE (7) Built in many communities for less than \$4500. ..\$2.00

RANCH HOUSE BOOK (Build it Yourself) (8) Exciting new ranch type home with five or six rooms you can build yourself.\$3.50

PRECUT HOUSE BOOK (9) Smart, modern home featured in the March, 1935, issue...\$2.50

GUIDE TO HOME REPAIRS (10) Money and time saving information for home owners. \$2.50

HOW TO BUILD YOUR OWN GARAGE (11) Popular Mechanics own collection of designs, plans and building information for amateur builders.\$3.50

HOME PLUMBING GUIDE (12) Approved methods, materials and how-to-do-it instructions.\$3.50

LAWNS AND GARDENS (13) How to grow the best lawns and gardens in any neighborhood. \$2.50

HOW TO PAINT WITH BRUSH AND SPRAY (14) Includes interior and exterior painting, walls, woodwork and furniture finishing.\$2.50

AUTO BOOKS

AUTO OWNERS MANUALS
By C. E. Packer. Cover all models from 1940 to 1953.
MANUAL FOR PLYMOUTH OWNERS. (15) ...\$3.50
MANUAL FOR CHEVROLET OWNERS. (16) ...\$3.50
MANUAL FOR FORD OWNERS. (17) ...\$3.50

AUTO REPAIR MANUAL (18)

How to avert auto troubles, make repairs on all makes, models, years.\$2.50

POPULAR MECHANICS AUTO ALBUM (19) Most fascinating of all auto books. From the first cars to the cars of tomorrow.\$3.00

SAVE WITH THESE

TELEVISION MANUAL (20) New and timely money-saving complete repair guide for the TV set owner\$3.00

RADIO, TV AND ELECTRONICS HANDBOOK (21) Ideal book for the student, beginner and experimenter.\$2.50

ALL ABOUT UPHOLSTERY (22) How to do all types of upholstery and save 50% of the cost.\$3.50

ELECTRICAL FIX-IT BOOK (23) How to repair and service all types of electrical appliances. \$2.00

WHAT TO MAKE

WHAT TO MAKE AND HOW TO MAKE IT Volumes 1 to 12. Average 175 projects to volume. Each. Give volume number with prefix (WM)\$1.75

12 Volume set (24) There are over 3,000 projects in this 12 volume set. Complete instructions for each. \$18.00

1956 Volume. (25)\$2.50

1955 Volume. (26)\$2.00

WHAT TO MAKE FOR CHILDREN (27) 175 projects—things to make from discarded and inexpensive materials.\$2.00

100 BEST WOODWORKING PROJECTS (28) Cream-of-the-crop projects. Selected by Popular Mechanics editors for their popularity.\$2.00

100 BEAUTIFUL PIECES OF FURNITURE YOU CAN MAKE (29) Real furniture projects for the craftsman with few tools.\$3.00

23 BOATS YOU CAN BUILD (30) Build a boat for pleasure or profit — row boat, sail boat, power craft.\$2.00

YOU CAN MAKE A STRADIVARIUS VIOLIN (31) Full set of actual size plans in pocket in the cover.\$3.50

WHAT TO MAKE WITH CONCRETE (32) Covers walks, walls, pools, fireplaces and ornamental garden pottery. \$2.00



OUTDOORS · SPORTS

OUTDOOR SPORTS MANUAL (33) 200 helpful articles for hunters, fishermen, trappers, etc. Hundreds of ideas on fishing tackle, guns, traps, boats, motors, etc.\$2.00

FAMILY BOOK OF GAMES AND SPORTS (34) Treasury of over 500 outdoor and indoor games of all kinds for children and adults\$2.95

GUIDE TO GOOD HUNTING AND TRAPPING (35) How, where and when to hunt all game animals. Special section on birds, guns and hunting dogs. \$3.00

FOR GIFTS · FOR BETTER LIVING

HOW TO BUILD AND ENJOY YOUR OWN OUTDOOR KITCHEN (39) How to build and use outdoor living facilities.\$2.00

FOOD FOR HOME USE (40) How to produce and conserve food from farms and home gardens.\$3.00

FIFTY YEARS OF POPULAR MECHANICS (41) The fascinating story of invention, scientific discoveries and mechanical developments from the pages of.



Popular Mechanics during its first 50 years. ..\$5.00

ALBUM OF AVIATION (42) A history of famous flights and flyers commemorating the anniversary of 50 years of powered flight. Hundreds of thrilling photographs and drawings.\$3.00

PICTORIAL HISTORY OF AMERICAN TRANSPORTATION (43) Fascinating gift book featuring 50 years of an America on the move...\$5.00

FOR CHILDREN

MR. WIZARD'S SCIENCE SECRETS (44) By TV's famous Don Herbert. Collection of safe, simple experiments children easily make at home...\$2.95

BOY MECHANIC (45) New edition with all new material. Hundreds of things a boy can easily make at home...\$2.95

BOY SCIENTIST (46) Perfect introduction to wonders of science for young people, ages 10-16\$3.95

FOR FARMERS

HOG PROFITS FOR FARMERS (47) A "must" book for every hog producer.\$3.00

FARM MANUAL (48) A book every farm home should have. More than 150,000 sold to date.\$3.00

VETERINARY GUIDE FOR FARMERS (49) Enables farmers to perform most veterinary tasks. ..\$3.95



USE THIS MONEY BACK ORDER COUPON

POPULAR MECHANICS PRESS,
200 E. Ontario St., Chicago 11, Ill.

Send Popular Mechanics books as indicated by numbers.

Number				
Number				

Remittance for \$_____enclosed. Send postpaid.
 Send C.O.D. I will pay postman for books and delivery.

I understand I may return book within 7 days and you will refund the full purchase price. (Attach extra sheet to coupon if more space is needed.)

Name _____

Address _____

City _____ Zone _____ State _____



Make \$5.00 an Hour
**CASH
PROFIT**
The Day You Start!
Start Your Own Business
at Home... Sharpen
Household, Garden and
Shop Tools in Spare Time

Turn your spare time into Big Cash Profits with the new Belsaw Sharp-All. No experience needed to sharpen knives, scissors, shears, ice skates, mower blades, hedge trimmers, axes, chisels and circular saws... just about any household, garden and shop tool. Your own CASH business. No inventory... no calls to make.

Learn how easily you can start your own spare time business. Amazing low cost easy-payment plan. Send postcard for

FREE BOOK

BELSAW SHARP-ALL CO., 716 Field Bldg., Kansas City 11, Mo.



**NEW PENN YAN
BOAT CATALOG**

44 PAGES
OVER
100
MODELS

FREE! Get yours today. Many models illustrated in color. Cartops®, Trailboats, other outboards, canoes, rowboats described fully. Catalog features amazing new no-soak, work-free, all-wood *Stripites*. Penn Yan Boats, Inc., 34th St., Penn Yan, N. Y.



Save 60% on FAMOUS "TV - BIG TOP"

DAN LURIE BARBELLS

FREE— 60 MUSCLE BUILDING COURSES—
68 PHOTOS WITH YOUR ORDER
50 lb. set, \$ 8.48 • 150 lb. set, \$20.48
100 lb. set, \$13.98 • 200 lb. set, \$25.98

SEND FOR FREE CATALOG

Order by mail—50% with order. Balance
C.O.D. Extra wts. 13c lb. FOB Plant.

DAN LURIE BARBELL CO.
52M3 Bristol St., Dept. 659C,
Brooklyn 12, N. Y.

SEE DAN ON TV "BIG TOP" SHOW
LET STRONGMAN DAN MAKE YOU A MAN
Results guaranteed or money back

MAKE TREMENDOUS PROFITS

Have fun! Earn Big Money! Cast plaster figurines, bookends, plaques, novelties at home in your spare time with X.L. rubber molds! NO EXPERIENCE NEEDED! Models and rubber for 3 molds, only \$1.50 ppd. Send 25c (refunded with order) for 40 page catalog now!

**PLASTIC ARTS STUDIO 3403 SO. MADISON, DEPT. PM2
MUNCIE, INDIANA**

MONEY in WORMS

Big money made raising fishworms and crickets. Billions used yearly—unlimited market—sell by mail—We teach you how to raise and where to sell. Start in backyard or basement. Send \$2.95 for complete guaranteed instructions or write for free literature. **CARTER WORM RANCH, PLAINS, GEORGIA**

LEARN METALCRAFT

and JEWELRY MAKING

Low Cost Home Training Now Available

Make money. Learn profitable skills and arts of decorative metal and jewelry crafts. Course is complete. Professionally prepared. Easy to master. Special tools and materials furnished.

Write for **INTERSTATE TRAINING SERVICE**
Free Booklet DEPT. K-3 PORTLAND 13, OREGON

**How to Build Your Own
GARAGE**



Save as Much as 50%
of Usual Construction Costs

Get Popular Mechanics' brand new book *How to Build Your Own Garage* by Wayne Leckey, Assistant Shop Notes Editor, and find out how you can build your own garage at savings of 50% of usual cost. Leckey tells in famous step-by-step instructions and shows in big, clear photos, drawings and diagrams how to perform every building operation from laying the concrete to installing the final trim. There are 25 designs. Brick, frame, and concrete block fully covered. Send \$3.50 for your copy. 7-day money back guarantee.

POPULAR MECHANICS PRESS, 200 E. Ontario, Chicago 11, Ill.

**DIESEL
MECHANICS IN DEMAND**



Learn to earn big pay in DIESEL in our large, modern equipped Chicago school and shop. No previous experience or training necessary. We help you find living quarters and part time job while in school. Complete, practical courses taught in the following trades, under the supervision of experienced, expert technicians.

APPROVED FOR CIVILIANS OR GI'S

— CHOOSE YOUR TRADE —

CHECK HERE	WEEKS
<input type="checkbox"/> DIESEL MECHANICS	20
<input type="checkbox"/> AUTO MECHANICS	20
<input type="checkbox"/> BODY & FENDER	16½
<input type="checkbox"/> GAS-ARC WELDING	4 - 12
<input type="checkbox"/> REFRIGERATION	13½
<input type="checkbox"/> AIR CONDITIONING	8½
<input type="checkbox"/> MACHINIST TRADE	30
<input type="checkbox"/> ADVANCED MACHINIST (includes tool & die)	32½
<input type="checkbox"/> PIANO TUNING & REPAIR	36

CHOOSE YOUR ENGINEERING COURSE

These courses are intended as terminal education for men who wish to enter the Diesel-Automotive and Refrigeration-Air Conditioning fields as technicians. These courses are designed to prepare men for supervisory positions. Students with a high school education, or equivalent, will be accepted.

<input type="checkbox"/> DIESEL AUTOMOTIVE ENGINEERING	2 years
<input type="checkbox"/> REFRIGERATION & AIR COND. ENGINEERING	18 months

FREE EMPLOYMENT HELP

Start your career with Greer by checking your interest above and mail coupon for complete information at no obligation.

NAME _____ AGE _____
STREET _____
TOWN _____ ZONE _____ STATE _____

Established 1902 — Over 50,000 Graduates.
54 years of continuous trade school experience
to guide your training.

**GREER SHOP
TRAINING**

Box C, 2236 S. Michigan Ave.
Chicago 16, Illinois



For Fishermen A BOAT OF ALUMINUM

An aluminum boat built with you in mind! It's both wide and deep and steady as the Rock of Gibraltar and has permanent live boxes and other fittings fishermen like.

Put a kicker (up to 15 h.p.) on it and away you go . . . for trolling, casting or still fishing . . . it's quiet and easily maneuvered. Little maintenance.

Big as it is, this Starcraft is light and low cost! A real value buy!

Write for 1956 Boat Catalog

STARCRAFT BOAT COMPANY
DEPT. Q-3, GOSMEN, INDIANA

STARLITE
ALUMINUM
BOATS BY...

STARCRAFT

WAR SURPLUS BARGAINS

\$500,000.00 INVENTORY
for QUICK LIQUIDATION

Surplus items—hundreds of tons for home, shop, factory, farm and outdoor use. New items, used items, reconditioned items—all at tremendous savings—all priced for quick sale.

Page After Page of Values

This big catalog shows page after page of amazing money saving values. Write for your copy today. Send 10c to cover postage, mailing, etc. Write today! SEND TODAY FOR YOUR COPY

10c

STARK'S

212 W. Madison St.
Dept. PM-563
CHICAGO 6, ILL.

WE START YOU FREE

Get into DRAFTING

Look at the Help Wanted columns in newspapers. Note the big demand for Draftsmen. Plenty of good jobs at top pay. Easy, fascinating work. For facts on how to get free start, write:

R. C. ANDERSON, Dept. D-100
1400 Greenleaf Avenue • Chicago 26, Illinois

Enjoy Modern Living • Make Your Home Worth More With This Popular Mechanics Book . . .



759 PICTURES

Above: How to lay a new roof over the old.

Right: New walls over the tired old walls. A few of the 83 modern kitchen ideas.

Below: Modern ceilings for old basements.

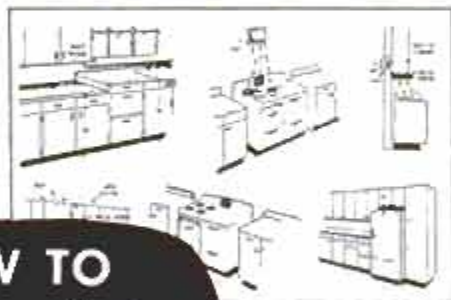

HOW TO Remodel Your Home

With Data on New Materials and Products Available to Home Owners

Here are hundreds of ways you can make a modern home out of an old house, make the house worth more and save money while doing it. If you own an old house or intend to buy one, get "How to Remodel Your Home" by E. R. Haan, formerly technical editor for Popular Mechanics. You can do the modernizing yourself or have it done for this vital book contains 547 methods and 759 illustrations covering complete modernization, adding rooms and living space, installing new kitchens and baths, adding closets, wardrobes, rumpus rooms. Complete face-lifting jobs for the outside and morale building jobs for the inside. Learn the joys and conveniences of modern living with this vital book prepared especially for the home owner. Mail coupon for your copy today.

Money Back if You Want It.

Get the book now. Check it for information that will help you improve your home for appearance, convenience and value. If not fully pleased return the book in 7 days and Popular Mechanics will refund every penny you have paid.

**Big Book.
Same Size as
This Magazine.**



**What to Do!
How to Do It!
How to Cut Costs
and Save**

In this book—17 big helpful sections. They are:

From old to new—Your modern kitchen—Better bathrooms—Basement rumpus rooms—Curing wet basements—Attic space and dormers—Adding rooms to the outside—Porches and breezeways—Utilizing idle space—New look for outside walls—Modern interior walls—Heat-loss and humidity controls—Roof framing and covering—Windows that modernize—Entrances and doors—Variety in floors—Wiring, plumbing heating. In all—547 money-saving articles you can use.

Use Coupon to Get Remodeling Book

POPULAR MECHANICS PRESS, 200 E. Ontario St., Chicago 11

Send at once "How to Remodel Your Home," postpaid for \$2.95. I understand I may return the book in 7 days for full refund.

Remittance for \$2.95 enclosed. Send book postpaid.
 Send COD. I will pay postman.

Name _____

Address _____

City _____ State _____

LEARN MEAT CUTTING AT NATIONAL

Pay After Graduation



The steady dependable trade of Meat Cutting taught easily in 8 short weeks. **YOU LEARN BY DOING** under actual meat market conditions in big modern school at Toledo.

For beginners or men with experience. Get a profitable store of your own. Remember, **PEOPLE MUST EAT!** Big pay jobs. Free employment help. Thousands of successful graduates.

Buying, cutting, percentage, pricing, advertising, selling, etc. A complete retail meat education. National School established 33 years. Get National training NOW. Pay your tuition in easy weekly payments

after you graduate. Send coupon for FREE 52 page school catalog — TODAY. G.I. approved.

National School of Meat Cutting, Inc., Dept. 50-B, Toledo 4, Ohio

Send me your FREE school catalog on National Training at Toledo in Meat Cutting, Meat Merchandising and Self Service Meats. No obligation. No salesman will call.

Name _____ Age _____

Address _____

City _____ State _____

Approved for training Korean Veterans

ENGINEERING DEGREE IN 27 MONTHS

INDIANA TECHNICAL COLLEGE

B. S. DEGREE, Aeronautical, Chemical, Civil, Electrical, Mechanical and Electronic Engineering (inc. Radio and TV), Drafting, One-year, G.I. Government approved. Low rate, Earn board. Large industrial center. Students from 48 states, 21 countries. Demand for graduates. Enter March, June, September, December. Write today for catalog, 1936 E. Washington Boulevard, Fort Wayne 2, Indiana.

HELPFUL BOOKS

Send post card asking for FREE catalog

Popular Mechanics Press, 200 E. Ontario, Dept. 601, Chicago 11

60 POWER TELESCOPE \$3.98

VARIABLE EYEPIECE 20X-40X-60X — BRASS BOUND NEW! Three telescopes in one. 3 different magnifications. 20 power for ultra-bright images with 40 and 60 power for extra long range. Guaranteed to bring distant objects, people, sports events, ships, moon, stars, etc. 60 times as close.

Most powerful for any where near the moon. 5 sections. Closes to 1 ft. long. Contains 4 ground and polished lenses. Also used as a powerful compound microscope. Directions included. Mass production enables us to offer this instrument at amazing price of \$3.98 complete. Money back guarantee. We pay postage. Get yours now.

CRITERION CO., 331 Church St., Hartford, Conn., Dept. PMB 32

Paint STRIPES with New "PAINT PEN"!

Straight, Curved or Parallel Lines

Use like a fountain pen with any color paint to stripe furniture, bikes, autos, model planes, toys, linoleum, wall board. Beautiful clean, crisp results every time. Can't clog or smear. Also use with glue, tempera, textile paint or ceramic under glaze. Paints on wood, glass, plastic, metals, fabrics and paper. Tool complete with tip for 1/16" stripe only \$1.25 postpaid. Other complete tools with following tips, 1/64", 1/32", 3/64", 5/64", 3/32", 1/4" — \$1.75 each. Extra tips 90c each. Entire kit with tool and 7 tips — \$5. A 1/4" tip only \$1.20 each. C.O.D.'s postage collect.

New! "DOUBLE-STRIP" 5 Way Combination Model only \$3.25

Double Stripes — one wide and one narrow or two wide or two narrow at the same time.

FREE Send postcard for complete information — or ORDER TODAY.

DEALERS: Master Paint Stripping Tool in display cartons of 1 doz. FAST, PROFITABLE SALES. Write for new discounts.

HOME CRAFTSMEN! New Paint Stripping Tool gives "professional" results every time, simple, easy to use. Send \$1.25 now.

MANUFACTURERS: Write today for information about industrial models and production stripping tools.

WENDELL MFG. CO., Dept. 315
4234 Lincoln Ave., Chicago 18, Ill.

WELDING may aid your SUCCESS

Arc and Acetylene; welding metallurgy; Heliarc, etc. This is home, spare-time training for men who appreciate the importance of welding and want to advance in the art, get promotion, enlarge own shop, etc. Send for FREE BOOK: Utilities Engineering, 2523 Sheffield, Dept. WC-12, Chicago 14

Auto Service Men . . .

STEP UP YOUR PAY!

Be an EXPERT in Scientific Engine Tune-Up and Service!

Sun-trained experts in the use of electronic engine test equipment are in demand now! They make MORE MONEY because they know how to use the "tools" which can quickly and profitably keep today's complex engines tuned up to their full power and economy levels!

You Can Provide This Service and Increase Your Earnings — it's easy the Sun way!

Sun Electric Corporation, Chicago — world's largest

Costs are LOW . . . plan NOW to increase your skill and position in the industry! Send for complete information . . . FREE Brochure!

manufacturer of automotive test equipment — Now offers a completely new service training program. Train with specialists in the fully-equipped Sun Technical Training School, at Sun's Chicago headquarters. Learn the latest on any or all of these subjects:

- Test Equipment Operation . . . on Modern engines! You use every piece of Sun equipment!
- Automotive Electricity . . . full coverage with accent on generators and regulators!
- Modern Tune-Up Procedures . . . Carburetion — how to do it; fast, accurately, prevent comebacks!
- Service Merchandising . . . how to sell all work needed by customer!

G. I. Bill Approved!

Sun Electric Corp., Dept. PM-4
Harlem & Avondale Ave., Chicago 31, Ill.

NAME _____

COMPANY _____

ADDRESS _____

CITY _____ ZONE _____ STATE _____

Make *Precise Drawings* + **FAST!** Easy! With the *Handee Dandee*

Sensational **NEW** Drawing Instrument contains the **BASIC MECHANICAL** features of equipment costing **10 TIMES MORE!** **START TODAY • MAKE FINE ACCURATE DRAWINGS • EASY-MORE PROFESSIONAL ORDER NOW! DEALERS INQUIRE!** Address

LOOK AT THESE FEATURES!

- ADJUSTABLE PROTRACTOR • SQUARE
- ANGULAR T SQUARE • 1/4 inch SCALE
- FULL 12 INCH RULER • TEMPLATES
- FRACTIONS and DECIMAL EQUIVALENTS
- PORTABLE • USE ON THE BOARD • OFFICE • AT HOME!

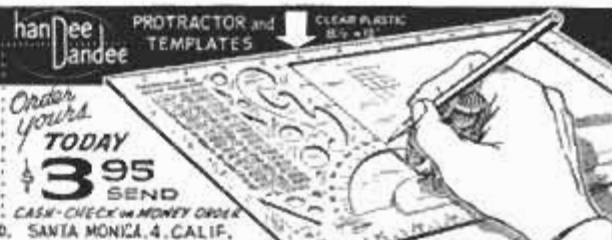

Order yours **TODAY** \$3.95 SEND CASH • CHECK or MONEY ORDER HANDEE DANDEE PRODUCTS, INC. - 3019 PICO BLVD. SANTA MONICA 4, CALIF.

Learn All About Cars!

**Auto Mechanics — Automatic Transmissions
Acetylene and Arc Welding
Body and Fender Repair**

Day-Night School 30 Years in the Same Location

WOLVERINE SCHOOL OF TRADES

Approved Under the G.I. Bill of Rights by the State Board of Education

**WOLVERINE SCHOOL OF TRADES, Dept. PM
1400 West Fort St., Detroit 16, Mich.**

Name _____
Address _____
City _____ State _____

ELECTROPLATE IT YOURSELF!

NOW using **NEW** plating kit. It's easy to electroplate any object with the same **LUSTER** and **DURABILITY** as done by the most expensive equip. Complete kit and instructions on plating metal and non-metal objects, with Nickel, Chrome, Copper, Gold, etc. **ONLY \$5.95. SEND NO MONEY**—everything sent C.O.D. plus postage. **OR** send \$5.95 now and receive it postpaid. Money back in 7 days if not satisfied.

EASY INSTRUCTIONS

TOOLS
CHROME WORK
BABY SHOES

M. Z. SALES CO., Dept. G-5, 113 W. 42nd St., New York 36, N. Y.

\$2.95 OR 2 FOR \$5.00!

Genuine Telephone Company Upright Telephones, tested and guaranteed with 50 ft. of wire and inter-communication instructions. Complete line of telephones, dial, magneto, etc. Write for free list. All shipments F.O.B. Simpson, Pa. 50% deposit required on all C.O.D. orders.

TELEPHONE ENGINEERING CO., Dept. 386, Simpson, Pa.

Build Your Own Professional Instruments — Save 50%

EICO®
World's largest manufacturer of Kits & Instruments

Vacuum Tube Voltmeter
KIT \$25.95 Easy Instructions 46 models to choose from
Factory Wired \$39.95

Write for **FREE** new 1956 Catalog PM-3
Electronic Instrument Co., Inc. 84 Withers St., B'klyn 11, N. Y.

Catalog of 3100 Novelties 10c

Send 10c for amazing catalog of novelties, live animals, scientific supplies, hobbies, funmakers, planes & boats, looms, magic tricks, joke articles, unusual seeds, gadget timesavers, cameras, optical goods, projectors, movies, lucky jewelry, religious novelties, disguises, musical instruments, stamps, coins, puzzles, fortune tellers, radios, auto & bike accessories, telescopes, magnifiers, compasses, banks, smokers' adducts, artists' supplies, printing sets, engines, motors, shockers, knives, billfolds, guns, rifles, sports, books, games, plants, etc. Send 10c (3 for 25c—get for friends!).

JOHNSON SMITH & CO., Dept. 307 Detroit 7, Michigan

256X AREA MAGNIFYING Telescope \$2.98

POWERFUL! Close-up view blocks or miles away! See without being seen. Examine craters of moon, sports, action, etc. Magnifies 256 times area. Precision ground 5-lens optical system, brass fittings, comfortable rubber moulded eyepiece. Imitation black leather finish, 14 1/2-in. closed; 19 1/4-in. open; 1 1/2-in. diameter. (Shoulder strap 50c extra.) Complete with black carrying case. **ONLY \$2.98**

JOHNSON SMITH COMPANY Dept. 307 DETROIT 7, MICHIGAN

Blast off with DUAL vacuum AIR HORNS!

ONLY \$9.95 POSTPAID
Money-back Guarantee

The voice of authority and commanding warning for safer highway driving. One BLAST and those "Road Hogs" really move over. Installed under the hood or on the front fender. Beautiful lacquer finish. Operates from intake manifold. No tank needed. Only \$9.95 complete with cylinder head bracket, steering column lever, hose, fittings, etc. Send check or money order today. We pay postage. \$1.00 deposit required on all C.O.D. orders.

THE PROTECTUROD CO.
Dept. 803, 2750 N.E. 19th Street, Fort Lauderdale, Fla.

UP TO \$10,000 PER YEAR FREE DETAILS

EARNED BY TIME STUDY EXPERTS

Break into amazing new field of **TIME** and **MOTION STUDY**. Big demand for **TECHNICALLY TRAINED TIME STUDY MEN** in Businesses, Factories, Industries. You can learn this fascinating and profitable profession at home in your spare time. Easy payment plan. Send for **FREE** details—Now! No obligation.

TECHNICAL TRAINING SERVICES 2149-A MELANTE DR., N.E. ATLANTA 5, GA.

WHEELS WHEELS WHEELS

7" Disc Wheel 3/4" Tire 1/2" sleeve	45c ea.
8" Disc Wheel 1 1/4" Tire 1/2" sleeve	70c ea.
7" Disc Wheel 1" Tire 1/2" ball bearing	80c ea.
8" Disc Wheel 1 1/4" Tire 1/2" ball bearing	\$1.00 ea.
6" Disc Wheel 1.50 semi-pneum. Tire 1/2" S.B.	\$1.35 ea.
8" Disc Wheel 2" semi-pneum. T. 1/2" S.B.	\$1.50 ea.
10" Disc Wheel 1.75 semi-pneum. T. 1/2" S.B.	\$1.50 ea.
10" Disc Wheel 2.75 semi-pneum. Tire 5/8" S.B.	\$3.30 ea.
12" Disc Wheel 1.75 semi-pneum. T. 1/2" S.B.	\$1.85 ea.

Above wheel prices includes hub cap. Plus Postage, C.O.D.'s accepted. AXLES—Sizes 5/16 in., 3/8 in., 1/2 in.—Cut to size—End holes drilled.

UNITED WHEEL STAMPING CO.
12131 S. PEORIA STREET PM-3 CHICAGO 43, ILLINOIS

SEND ME

every month so I am sure to see each new issue. Here's

\$3.50 for 1 year
 \$8.00 for 3 years

name _____
address _____
city _____ zone _____ state _____ B-36

Hand this order to your newsdealer or send it to

POPULAR MECHANICS
200 East Ontario St. Chicago 11, Ill.

NEW
Catalog



x-acto, Inc.

**x-acto
KNIVES • TOOLS • KITS**

for every hobby,
art & handicraft

Designed by craftsmen
and precision-made to
the highest quality
standards.

Write today for our 28-
page, fully illustrated
catalog—only 25c.

48-45 Van Dam Street, L.I.C. 1, New York

PORTABLE CAR COVER Heavy Vinyl Plastic
(formerly \$8.95)

Protect Against RAIN
• SUN • DUST. \$6.95

Long-lasting plastic,
folds compactly, off
and on in a jiffy,

sturdy elastic binding gives extra security. State
make, model and year—buy direct from mfr.

Send \$6.95 plus 35¢ postage or sent C.O.D.

MARCO SALES CORP., Dept. 6-59 480 LEXINGTON AVE. New York 17



FREE BOAT KIT CATALOG 8' to 14' Models from \$39.95 incl. freight

- Assemble your own boat
- No experience necessary
- Save 1/2 to 2/3 "factory built" prices



Write: Marine Hardware, Fiberglass, & Trailers
LUGER INDUSTRIES DEPT. B 4452 NICOLLET AVE. MINNEAPOLIS 9, MINN.

Learn To **MOUNT BIRDS**

TAN SKINS, MAKE UP FURS
Be a Taxidermist. We teach you at Home. Mount Birds, Animals, Pets, common specimens. Save your hunting trophies, decorate home and den. Make genuine **KROME LEATHER**, tan and make up furs for sparetime profit. **INVESTIGATE TODAY** 48 pages—tells all about it. Hunters, get your copy. It's Now Free. Send post card, state your Age.
N. W. SCHOOL OF TAXIDERMISTRY, DEPT. 2503, Omaha, Nebr.



IMMEDIATE DELIVERY **MARCOT KEY MACHINE**

Marcot No. 8 Key Machine, 1956 Model	\$123.00
Auto Code Book and Depth Keys	13.75
Yale Padlock Code Book and Depth Keys	6.25
45 Doz. Ass't. Cylinder Key Blanks	35.48
Set-Locksmithing Tools, Pins & Springs	10.50
& Locksmithing Manuals and Instruction Books	10.25
	\$199.21

SEND FOR CATALOG
A. J. MARCOTTE CO. 1200 N. KEDZIE AVE. DEPT. PM-3, CHICAGO 51, ILL.

CLEAR \$700 AND MORE AN HOUR

Finish famous Karle-Kraft Metalware in spare time, using revolutionary spinning machine designed for home use. We supply pre-formed food mixers, giftwares, planters, many more fast-selling items of distinctive design — you give them a fine custom look. Protective franchise helps you get quick return of original investment — steady profits thereafter. Learn about Karle-Kraft's unusual Profit Plan now! Write today for free particulars to

KARLE-KRAFT HOME SHOPS CO.
1 Cedar Blvd., Pittsburgh 28, Pa.

"Do-it-yourself" KITCHEN CABINETS

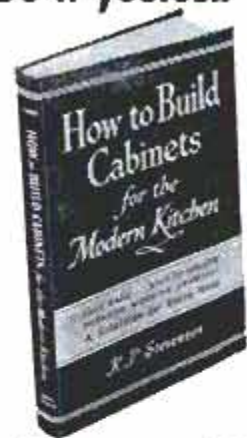

New book gives step-by-step directions, material lists, building pointers, "show-how" illustrations, for making every type of cabinet for the modern kitchen.

SAVE \$500 OR MORE

Now you can **SAVE HUNDREDS OF DOLLARS** on kitchen cabinets! Build your own with the aid of this great new "do-it-yourself" guide. Tells you everything you need to know. Large, clear drawings show every detail of construction. Easy-to-follow text gives you valuable pointers on how to save work, save on materials, and get a professionally-perfect job.

INCLUDES 70 TYPES OF CABINETS, plus dozens of ideas for ingenious labor-saving, step-saving kitchen units.
"HOW TO BUILD CABINETS FOR THE MODERN KITCHEN"

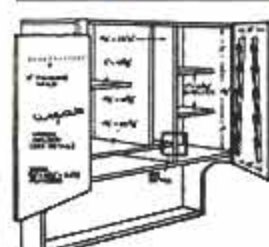

By **ROBT. P. STEVENSON**
Asst. Managing Editor, Popular Science

TELLS YOU HOW TO BUILD: Over-Refrigerator Cabinet, Over-the-Range Cabinet, Sliding-Door Cabinet, Adjustable Shelf Cabinet, Mix-Center Wall Cabinet, Over-the-Sink Cabinet, Wall Vegetable Bin, Tool Hanging Cabinet, Swing-Shelf Cabinet, Combination Sink Cabinet, Tray and Bread Cabinet, Platter Cabinet, Laundry Hamper, Screen-Bottom Vegetable Drawers, Pop-Up Mixer Shelf, Beside-the-Range Towel Rack, Rolling Vegetable Bin, Sink Pull-Out Racks, Revolving Wall Cabinet, Lifting-Counter Cabinet, Pass-Through Serving Center, Canned Goods Storage Cabinet, Storage Wall, Folding Wall Table, Under-the-Counter Table, Curved-Seat Breakfast Nook, Snack Bar, Kitchen Desk, **AND MUCH, MUCH MORE! FULLY ILLUSTRATED.**

FREE 10-DAY TRIAL, SEND NO MONEY
See for yourself how this great new book helps you save money and gives you expert guidance on how to build your own kitchen cabinets. Mail coupon below for free-trial copy. After 10 days' trial, keep it and pay only \$4.95, plus few cents postage. Or return book and owe not a penny. **MAIL COUPON NOW.**

SIMMONS-BOARDMAN BOOKS, Dept. PM-356
30 Church Street, New York 7, N. Y.

Send me for 10 DAYS' FREE EXAMINATION, "How to Build Cabinets for the Modern Kitchen." I will either return it in 10 days and owe nothing, or send only \$4.95 (plus shipping charge) in full payment.

Name _____

Address _____

City & State _____

SAVE! Send \$4.95 with this coupon and we will pay postage. Same return and refund privileges.

Plan your VACATION in TENNESSEE

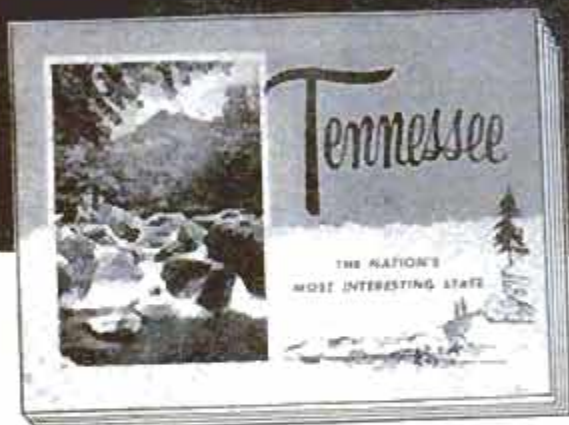

send for **FREE COLOR BOOK**

Treat your family to a 3-way vacation that includes mountains, lakes, and history. They'll ride highways into the sky in the Great Smoky Mountains National Park; fish, boat and swim in Tennessee's 20 Great Lakes; see the homes of three presidents, historic battlefields, TVA dams, and the world's only Atomic Energy Museum at Oak Ridge. Yes, for three vacations in one, see Tennessee. Send now for free 40-page color book.

MAIL COUPON TODAY

Tennessee Division of Information
1369 Cordell Hull Bldg., Nashville, Tennessee
Please send Free Color Book on Tennessee

NAME _____

ADDRESS _____

CITY & STATE _____

REPAIR ANY WATCH



... Swiss or American

No previous experience needed to learn modern watch repair. An enjoyable hobby or profitable career. Unique Sweazey System starts you making repairs right away. Develops your skill step by step. Teaches you modern shop methods . . . professional short cuts . . . mistakes to avoid. Learn by personal attendance or spare time home study. Individual training. Start any time. Free sample lesson. No obligation. Write today!

CHICAGO SCHOOL OF WATCHMAKING
2330 N. Milwaukee, Dept. 136, Chicago 47, Ill.
Founded 1908. Approved for veterans

MAIL COUPON TODAY!

CHICAGO SCHOOL OF WATCHMAKING
2330 Milwaukee, Dept. 136, Chicago 47, Ill.

Send FREE sample lesson. Home study
 Resident school

**FREE
SAMPLE
LESSON**

Name _____ Veteran

Address _____

City _____ Zone _____ State _____

People 60 to 80

APPLY FOR OLD LINE LEGAL RESERVE LIFE INSURANCE

Let us send you information about a \$1,000 whole life policy for people up to age 80.

No one will call on you. You handle entirely by mail. Write (giving age) to

OLD AMERICAN INSURANCE CO.

1 West Ninth Dept. L369M Kansas City, Mo.

What Every Mason Wants



We have important Masonic books and lodge supplies for Blue Lodge, Chapter, Commandery, Scottish Rite, and Shrine.

OUR RITUALS ARE USED THE WORLD OVER
Send for free catalog of books and rituals for Masons, Odd Fellows, Knights of Pythias, Knights of Columbus, etc.

EZRA A. COOK PUBLICATIONS, INC. P.O. Box 796, 15A, Chicago 90, Ill.

FREE - Amazing Book on

RHEUMATISM, ARTHRITIS

If you suffer the aches, pains and discomforts of Rheumatism, as manifested in ARTHRITIS, NEURITIS, SCIATICA or LUMBAGO, send today for the FREE Book. It reveals important facts about why drugs and medicine give only temporary relief without removing cause. Explains fully a proven, specialized system of treatment that may save you years of distress. No obligation. Write for this FREE Book today!

BALL CLINIC, Dept. 756, Excelsior Springs, Mo.

RADIO

Engineering. All phases radio & electronics theory & practice; television; FM; broadcasting; servicing; aviation, marine & police radio. Prepare for good pay; 18-month course. Graduates in demand by major companies. Enter Jan., March, June, Sept. Regular campus life. Write for catalog. **VALPARAISO TECHNICAL INSTITUTE, Dept. D, Valparaiso, Ind.**



WHOLESALE Electric Guitars - Parts - Factory to You

Solid-body Spanish amplifiers, double-necks, single-necks, triple-necks, 4-necks, solid-body mandolin, electric violin, pickup mixers, non electric instruments, etc. 1956 Models wholesale. FREE CATALOG. Free home study course with instruments. Parts & plans available to build your own.

CARVIN CO., Box 287, PM-3, Covino, Calif.

GEIGER COUNTERS

Rent by Mail

ONLY 50¢ A DAY

RENT OR BUY ANY MODEL DIRECT FROM FACTORY

NUCLEONIC CO. OF AMERICA

Dept. P.M. 34 196 DEGRAV ST. BROOKLYN 31, N.Y.

KING MIDGET

World's
Lowest
Priced
Car!



Lower priced, improved performance. Drive it for 75¢ per week. Also KING MIDGET JUNIOR, finely engineered, less than one-third cost of any comparable car, one twelfth cost of large cars. Agents wanted. IT WILL PAY YOU TO GET THE FACTS. Send 25¢ for literature and agents proposition on both cars, or \$1 (refunded first order) for this plus actual assembly book and service manual.

MIDGET MOTORS MFG. CO., Athens 1, Ohio

SPECIAL! WORLD'S GREATEST TIRE SALE!



Entire stock of our family-safe Top Grade, 40,000 mile Passenger Tires, (worn very slightly) released by Adjusters. Advertised for months at 7.86 ea., NOW at PRICES LISTED BELOW! IT'S CHEAPER THAN OFFERS OF \$1. OFF OF JUST ORDINARY TIRES or even a "FREE" tire. "The Blatt Name famous in tires for 40 Years—I don't just repair it, I offer a free fast REPLACEMENT guarantee on ANY defective tire within 12 months." Frt. Excl. CHOOSE YOUR FAVORITE BRAND. Not Recaps. FOOLISH TO PAY MORE, DANGEROUS TO PAY LESS!

GOOD YEAR **Firestone**

U.S. Goodrich, General, Atlas, Lee & others.

FREE This pictured tire ash tray given with 2 or more tires!

12 MONTH TIRE GUAR. & FREE FACTORY-TESTED TUBE
Many of our customers say our tires give as much as **36 MONTHS SERVICE.**

600-16 \$5.25	670-15 \$5.15	DEPENDABLE TRUCK TIRES
650-16 5.65	710-15 5.35	700-20 \$8.95
700-16 5.75	760-15 5.35	750-20 9.85
640-15 4.85	800-15 5.65	825-20 16.55
700-15 4.95	820-15 5.65	900-20 15.55
475-19 5.35	850-17 5.35	1000-20 17.25
	WHITWALLS 50c EXTRA	1100-20 17.25
		600-16 (6) \$5.85
		650-16 (6) 6.45
		700-16 (6) 7.05
		700-15 (6) 7.85
		850-20 8.95
		750-17 12.55

LO-PRICE USED TIRES \$3.45
12-MONTH "FREE REPAIR" any car
INSURANCE GUARANTEE any car

MILITARY MUD-GRIP \$8.65
JEEP, FULL RETREAD Guar. 12 Mos. any car

MILITARY MUD-GRIP TIRES
AA Guar. 6 Mos. AAA 12 Months
900-16 \$9.55 900-18 \$13.95
750-20 12.95 750-20 17.95

Send Check or M.O. & this ad for fast shipment. FOB Phila. I personally select your tires—as if my future depended on it. Read that top line again.

BOAT KITS 28 MODELS—8 to 19 ft. \$39 up—FREE FREIGHT

SAVE 2/3!
Easy-to-build MAHOGANY DECKS & FRAMES
SEND 10c for CATALOG
Includes Hardware—Trailers—Fiberglass



Boat Plans—Patterns—Frame Kits

Build over 50 modern boats from large scale plans, available with FULL-SIZE patterns, new PRE-FAB frame kits! All types: proms to cruisers, 6 to 25 ft. Best buy for Amateurs! SEND 10c for CATALOG.

Craig Craft
Tonawanda, N. Y.

MAKE \$5 PER HOUR WITHOUT A PRINTING PRESS

PRINTING **FREE** complete "BIG MONEY" Plan and SAMPLE!

REVOLUTIONARY NEW SCREEN METHOD
PRINT colorful signs, posters, banners, fabrics, wall paper, show cards—ANYTHING! Print on any surface. NO printing press or special equipment is needed with this amazing "approved" new printing secret. 300% profit on nearly every job. Easy to learn—NO EXPERIENCE or art ability necessary. Exceptional opportunity. Complete illustrated detailed plan and color sample FREE—Write:
SCREEN-PRINT COMPANY, Dept. 23
15127 S. Broadway, Los Angeles 61, Calif.

EARN AT HOME SPARE or FULL Time

MEN! TRAIN NOW FOR A BIG PAY FUTURE IN **DIESEL** & SCIENTIFIC MOTOR TUNE-UP

Go places with DIESEL! Farms, factories and power plants, trains, ships, trucks, busses all use DIESEL POWER... all need DIESEL-trained men! You can start your DIESEL training at home, in spare time, with tested, proved U E I training. Course includes practical work on Diesel engines under skilled instructors. You learn the operation, maintenance servicing of all types of Diesel engines, PLUS Scientific Motor Tune-up. **ACT NOW!** If you have mechanical ability, you'll like Diesel! High School diploma not necessary. Write now for Free book "EARNING POWER IN DIESEL." Act Today!

UTILITIES ENGINEERING INSTITUTE
2521 Sheffield Ave., Dept. DC-54, Chicago 14, Ill. (Founded 1927)

SAVE 1 GALLON IN 10!



Quickly Pays for Itself

Econ-o-Miser Carburetor Regulator

Here's a remarkable development that will soon be standard equipment on all new cars: the amazing new Econ-O-Miser eliminates gas waste, saves up to 25% on gas consumption!

The precision-built Econ-O-Miser incorporates a large and sensitive diaphragm which insures an absolutely even fuel flow under all conditions, permits the ideal fuel-air mixture for top carburetor efficiency.

GIVES FASTER STARTS AND SMOOTHER IDLING

The Econ-O-Miser is guaranteed to give you smoother, faster acceleration. It eliminates excessive pressure on the carburetor, takes out "surge," prevents stalling, vapor lock, and flooding. You can easily install the Econ-O-Miser yourself.

TRY THE ECON-O-MISER AT OUR RISK!

If it doesn't pay for itself in gasoline savings in the first 5,000 miles of driving, return it for a full refund of your purchase price!

Some car-owners report mileage gains of 20% to 25%. Think of the money saved—\$40 or \$50 every few months! Why not keep this money in your own pocket by installing an Econ-O-Miser right away? **USE THE COUPON NOW**



Econ-O-Miser is easily installed on the carburetor and fuel line attached.

Carburetor works at maximum efficiency at 2 lbs. pressure. Without pressure regulator, fuel pump at high speeds can develop pressures up to 20 lbs., forcing gasoline through carburetor and causing fuel waste, loading up, flooding, stalling.

What Econ-o-Miser Does for You:

- 1 Smooths out fuel pump pulsations — eliminates surge.
- 2 Eliminates excessive pressure and loading of carburetor.
- 3 Prevents annoying vapor lock.
- 4 Gives you smoother idling and faster starts.
- 5 Prevents flooding and stalling due to excessive pressure.
- 6 Saves gasoline — up to 25%!
- 7 Reduces carbon formation — helps keep engine clean.
- 8 Saves frequent carburetor adjustment.
- 9 Reduces fire hazard.
- 10 Automatically adjusts for any altitude.

DEALER AND DISTRIBUTOR OPPORTUNITY

A complete dealer-distributor network is now being set up. If you are interested in an exclusive protected territory, write, wire or phone today.

CARPARTS CORPORATION
140 Kansas Street, El Segundo, Calif.

Only \$6.95 FOR ALL MAKES AND MODELS OF CARS AND TRUCKS

CARPARTS CORPORATION, Dept. PM-36
140 Kansas Street, El Segundo, California

Here is my check or money order. Please rush me _____ Econ-O-Misers @ \$6.95 each, shipping charges prepaid, on money-back guarantee of satisfaction.

NAME _____

ADDRESS _____

CITY _____ ZONE _____

Free! AIRMAIL COLLECTION



Get this spectacular collection of all-different, genuine Airmails from strange, far-away countries in Asia, Africa, Europe, the exotic Orient! World's largest airmail, scarce \$27 stamp, old Zeppelin, many many others. A truly remarkable collection containing stamps worth up to 40¢ each at catalog prices! EXTRA: new illustrated booklet "Men Against the Sky." PLUS Bargain Catalog and other unusual offers. Send 10¢ for mailing costs. Supplies limited—mail coupon today!

JAMESTOWN STAMP CO. Dept. F3PM JAMESTOWN, N. Y.



RUSH my Free Airmail Collection and other offers. I enclose 10¢ for mailing costs.

Name _____
Street _____
City _____ State _____

HIGH WAGES!

Are being paid to Operators of Bulldozers, Draglines, Back Hoes, Earthmovers and Motor Graders. Contractors want our graduates. Learn these skills NOW

National School of Heavy Equipment Operation P.O. Box 8243-D-6, Charlotte, N. C.

Please send me your School Catalog FREE

Name _____
Street Address _____
City _____ State _____

SAY YOU SAW IT IN POPULAR MECHANICS

ENGINEERING DEGREE IN 27 MONTHS

Big Demand for Graduates

Aeronautical, Chemical, Civil, Electrical, Mechanical and Electronic Engineering (inc. Radio and TV)

Hundreds of young men are earning B. S. ENGINEERING DEGREES annually in this recognized institution — year around operation. New terms start quarterly. Many students earn a major part of their college expenses in this large industrial center.

Low tuition. Competent instruction. Thorough, intense practical program. Modern, well-equipped laboratories including new physics laboratory and modern wind tunnel. Individualized instruction emphasized.

Government approved for G.I.'s. Engineering preparatory courses. Students from 48 states and 21 foreign countries. Enter March, June, September and December. Send coupon for free catalog and full information. Enroll now.

INDIANA TECHNICAL COLLEGE

536 E. Washington Boulevard, Fort Wayne 2, Indiana

Please send me free information on B.S. Engineering Degree in 27 months as checked.

Aeronautical. Chemical. Civil. Electrical, Mechanical. Electronics

Name _____
Address _____

make it with 60¢ worth of sand & cement
SELL IT FOR \$2000

CONCRETE INCINERATORS

every home a prospect for these patented "LIFETIME" CONCRETE INCINERATORS

Make big profits manufacturing rust proof, fire proof, almost indestructible concrete incinerators in your own backyard or garage . . . full or part time. Sell to home-owners, hardware, department and garden supply stores. Phila. manufacturer doing big volume with Sears, Roebuck; large department stores. Easy to follow instructions and all needed equipment supplied. Exclusive protected franchise—No competition! Territories going fast. Write immediately for full details. Dept. PM36, T. C. TOR, 2113 Bellevue St., Phila. 40, Pa.



Save 50%! Assemble Your Own DIVING LUNG
FREE BOOK SHOWS HOW

We furnish the parts and instructions. Complete outfit \$49.95 and \$59.95. Write for our descriptive literature today!

UNDERWATER SPORTS, INC.
Dept. J, 302 W. Adams
O'Fallon, Ill. P.O. Box 65



MARCO 14 \$189.50 Delivered

WRITE FOR FREE FOLDER
or send 15¢ for complete catalog
ACCESSORIES • FIBERGLAS
Marine ASSOCIATES
BOX 6188 M. LONG BEACH 11, CALIF.

Marine KIT BOATS-DO IT YOURSELF-SAVE 50%

- Factory To You, No Dealers
- Mahogany Decks and Framework
- All Brass Fastenings
- Deluxe 14' Boats, \$159.50 Freight Incl.



MONUMENTS EASY TERMS
AS LOW AS \$4.52 DOWN
Monuments—Markers—Direct to you Satisfaction or money back—Lowest Prices—Freight Paid. Free Catalog.
ROCKDALE MONUMENT CO., Dept. 388, JOLIET, ILL.

FREE AMAZING NEW BOOK "HOW TO ANSWER ADS"



Never before have you seen anything like this. Tells you in simple language the correct way to answer ads. Gets you quicker replies—better results, and greater satisfaction. Will save you time and money and it's ABSOLUTELY FREE. No obligation whatever. Every reader of advertising should have this booklet. Send a postcard for your copy NOW. F. W. JOHNSON, Popular Mechanics Magazine, Room 600-A, 204 East Ontario Street, Chicago 11, Ill.

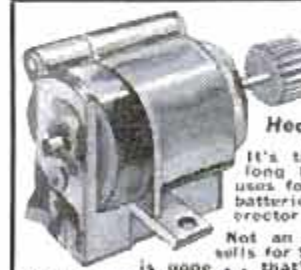

Attention Hobbyists
World's Great TINY MOTOR Value
New Heavy Duty MIGHTY MOTOR

It's tiny—but powerful. Weighs 2 oz. This long life MIGHTY MOTOR has hundreds of uses for hobbyists. Runs on 1 or 2 flashlight batteries. Fine for toy motor boats, airplanes, tractor sets, BarBQspitters, Elect. items, etc.

Not an import. American made. Motor alone sells for \$2.50 everywhere. When limited supply is gone . . . that's all. Better hurry. Motor, plus gear, reduction gear with shaft, battery holders and reversible switch. A \$3.65 value, sent postpaid for only \$1.00 (6 COMPLETE SETS FOR ONLY \$5.00)

SEND CASH, CHK. OR M.O. . . . NO C.O.D.'S Satisfaction Guaranteed
GENERAL TOOL CO. DEPT. M, 1439 GRAND AVE. KANSAS CITY 6, MO.

Let me show you how I made \$20,000 a year buying junk jewelry

Learn at home in one evening



No selling. Pay friends and neighbors good prices for old rings, watches, chains and bridges. U. S. Gov't pays you \$35 an ounce for the gold this junk contains.

THERE'S gold to be picked up on any street in any town any day of the year if you know my secrets. I teach you how to find it, how to buy it, what to pay for it, how to test and how to ship to Uncle Sam for cash. I supply you with testing outfit and weighing scale. Takes only one evening to learn at home. Next day you are ready to fill your pockets with gold at junk prices. I'll teach you the secrets by which I made \$20,000 a year. No charge for facts. Send name on postcard—no money. **Leslie Patton, 335 W. Madison Street, Dept. 93, Chicago 6, Illinois.**

SEWS LEATHER AND TOUGH TEXTILES LIKE A MACHINE

With **SPEEDY STITCHER** Automatic Sewing Awl, anyone can quickly and skillfully sew or repair anything made of **LEATHER, CANVAS, NYLON, PLASTIC**, or other heavy materials. Sews firm, even lock-stitches like a machine. Gets into hard-to-reach places. Specially made for heavy duty sewing on **LUGGAGE, FOOTWEAR, RUGS, AWNINGS, SAILS, SADDLERY, UPHOLSTERY, OVERALLS, AUTO-TOPS, SPORTS GEAR**, and other tough sewing jobs. Here's the handiest tool you'll ever own. Will save you many times its small cost. Comes ready for instant use... complete with bobbin of waxed thread and 3 different types of diamond-pointed needles. Easy-to-follow directions will make you an expert in minutes. Extra needles and waxed-thread always available. Save money, send \$1.98 for post-paid delivery. If C.O.D., \$1.98 plus postage. **MONEY BACK GUARANTEE.**

SPORTSMAN'S POST
366 Madison Ave., Dept. A-343, New York 17

ONLY **1.98**



SAVE MONEY on SURPLUS PARTS for MILITARY TYPE TRUCKS & JEEPS

4 & 6 wheel drive. FREE catalog to Jeep owners. State make truck or Jeep. (New Jeep Tops, steel or canvas all models). **AMERICAN AUTO PARTS CO., Inc., 1830 Locust, Kansas City, Mo.**

EXTRA MILEAGE USED TRUCK TIRES GUARANTEED IN WRITING FOR 12 MONTHS!

TRUCK TIRES 750-16(8)	\$10.10	825-20	\$18.55
600-16(6)	\$5.85	700-17	11.45
700-20(10)	12.45	700-20(10)	12.45
650-16(8)	7.85	750-17	12.45
900-20	18.15	750-20	12.45
600-20	9.45	1000-20	19.05
700-15(8)	9.10	650-20(8)	10.45
1100-20	20.55	700-16(6)	8.80
700-20(8)	11.45	1000-22	19.35

Brand New Military Tires. 750-20, each \$35.95 tax incl. Orders Rushed! Send chk. or M.O. Prices FOB, Phila. **BELMONT CO., 1001-PM, Spring Garden St., Phila. 23, Pa.**



SAY YOU SAW IT IN POPULAR MECHANICS

Why Buy Expensive Equipment?

MAKE THESE CONCRETE BLOCKS AT LOW COST FOR YOUR OWN USE OR FOR SALE WITH EQUIPMENT YOU CAN MAKE FOR LESS THAN \$3.00 AND A FEW HOURS TIME.

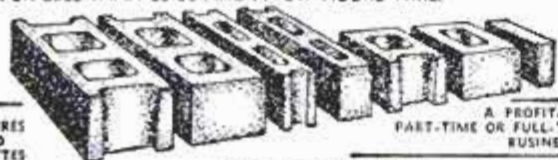

REQUIRES NO PALETTES

A PROFITABLE PART-TIME OR FULL-TIME BUSINESS

SEND FOR THIS COPYRIGHTED, LITHOGRAPHED BOOKLET "SIMPLIFIED CONCRETE BLOCK MAKING"

THIS BOOKLET CONTAINS SIMPLIFIED BLUEPRINTS, INSTRUCTIONS AND PHOTO-ILLUSTRATIONS FOR THE "PLANS SYSTEM" OF MAKING CONCRETE BLOCKS WITH A MINIMUM OF EFFORT AND EQUIPMENT

PLANS

PM4 WEST VIRGINIA, MINN.

PRICE ONLY \$1.00 Post Paid U. S. or Canada



STOP being **SKINNY** like I was in 10 MINUTES a day **GAIN 25 lbs.** of **HANDSOME Power-Packed MUSCLES** all over like I did

Pal!
WIN \$100.00 as I just did

Like me—**IMPROVE YOUR HE-MAN LOOKS 1000%! WIN NEW STRENGTH! WIN NEW POPULARITY!**



Millions became **BIG HE-MEN** through **JOWETT COURSES** so can **YOU!**

JIM NORMAN AFTER
He Mailed Coupon

Everybody admires Jim's build NOW He's a WINNER in ALL SPORTS



YOU CAN WIN a BIG 15" SILVER CUP as I just did! with **YOUR NAME** engraved on it!

I Mailed the Coupon and got these **5 PICTURE PACKED He-Man Courses** Which **YOU Can NOW get FREE**

Before \$1 price goes back Millions Sold for \$1.00



Come on **PAL**, Now **YOU** give me **10 PLEASANT MINUTES A DAY** In Your Own Home Like Jim Did and I'll give you **A NEW HE-MAN BODY** for your **OLD SKELETON FRAME**



NO! I don't care how skinny or flabby you are I'll make you **OVER** by the **SAME** method I turned myself from a wreck to the strongest of the strong.

Develop **YOUR 520 MUSCLES** Gain **POUNDS, INCHES FAST!**

YES! You'll see **INCHES** of **MIGHTY MUSCLE** added to your **ARMS** and **CHEST**. Your **BACK** and **SHOULDERS** broadened. From head to heels you'll be a **WINNER** in **EVERYTHING** you tackle.

Mail the **ALL FREE** Coupon and get **PHOTO BOOK**



LAST CHANCE — ALL FREE COUPON!

1. Photo Book of **STRONG MEN**
2. **MUSCLE METER**
3. **FIVE COURSES**

Tell Me How To WIN \$100. etc.

Dept. PM-63

"Jowett Courses greatest in World for Building All-Around HE-MEN"
—R. F. Keller Physical Director

JOWETT INSTITUTE OF PHYSICAL TRAINING
220 FIFTH AVENUE, NEW YORK 1, N. Y.

Dear George: Please mail to me **FREE** Jowett's Photo Book of Strong Men and a Muscle Meter, plus all 5 HE-MAN Building Courses: 1. How to Build a Mighty Chest. 2. How to Build a Mighty Arm. 3. How to Build a Mighty Grip. 4. How to Build a Mighty Back. 5. How to Build Mighty Legs—Now all in One Volume "How to become a Mighty HE-MAN." ENCLOSED FIND 10¢ FOR POSTAGE AND HANDLING (no C.O.D.'s).

NAME _____ AGE _____
PLEASE PRINT OR WRITE PLAINLY
ADDRESS _____
CITY _____ ZONE _____ STATE _____

BECOME AN Electrical Engineer



- Major in Electronics or Power
- Earn B. S. Degree in 36 Months

Over 50% of the nation's industrial leaders began their careers with engineering training. Prepare now for a rewarding future as an Electrical Engineer or Engineering Technician. Enroll at the Milwaukee School of Engineering.

Plan Your Career — Eight Courses Give You Wide Range of Study

ENGINEERING COURSES

Electrical Engineering-Bachelor of Science Degree
Save a valuable year through optional year 'round study.

Electronics major36 months
Power major36 months

TECHNICIAN COURSES

Electro Technician12 months
Electronic Technician12 months
Radio Technician12 months
Radio and Television Technician18 months

SERVICE COURSES

Electrical Service6 months
Radio and Television Service12 months

MECHANICAL TECHNOLOGY COURSES

— Also available, Service and Technician courses 6 to 18 months — Heating, Refrigeration, Welding, Air Conditioning and Mechanical — B.S. Degree in Mechanical Engineering with a major in Design, Metal Fabrication, or Plant Engineering. Also, general 3-month preparatory course.

Terms open April, July, September, January
Prior Military, Practical or Academic training evaluated for advanced credit. Faculty of specialists. 50,000 former students. Annual enrollment from 48 states and 23 overseas countries. 52nd year. Non-profit. Residence courses only. Send handy coupon today. MS-11A



MILWAUKEE

SCHOOL OF ENGINEERING

MILWAUKEE SCHOOL OF ENGINEERING
Dept. PM-356, 1025 Milwaukee St., Milwaukee, Wis.

Send free illustrated career booklets Electrical Technology Mechanical Technology Radio-Television.

I am interested in _____
(name of course)

Name _____ Age _____

Address _____

City _____ Zone _____ State _____

If veteran, indicate date of discharge _____

You Can Depend On STRONGER Yet SAFER ANACIN to relieve PAIN

Won't Upset The Stomach

Anacin® not only gives stronger, faster relief from pain of headache, neuritis and neuralgia—but is also safer. Won't upset the stomach and has no bad effects. You see, Anacin is like a doctor's prescription. That is, Anacin contains not just one but a combination of medically proven, active ingredients. Scientific research has proved no single drug can give such strong yet such safe relief as Anacin. Buy Anacin Tablets today!



KADET 4-WHEEL TRACTOR

LOW IN COST-HIGH IN QUALITY

Tillers, Mowers, Tractors low as **79⁵⁰**

This tractor is ideal for Farms, Estates, Schools, Nurseries, Parks, etc. 12 quick-hitch attachments available, including Snow Plow, Sickle Mower, Trailer, Turning Plow, etc.

FREE catalog write Dept. '21'

NATIONAL FARM EQUIPMENT CO., INC.
142 GREENE STREET • NEW YORK 12, N. Y.



EXPLORE FOR TREASURE!

Find wealth lost or buried for centuries! Battle relics, antiques, gold and silver coins, bullion, jewelry, treasure chests and other valuables can be yours with M-SCOPE Treasure-Metal Locators. Used worldwide for Treasure Hunting. GUARANTEED. Time Payment. Free literature. FISHER RESEARCH LAB., INC., Dept. PM-1, Palo Alto, Calif.

GREAT STRENGTH!

Easily Obtained. Send \$1 for Complete Arm, Chest and Back Muscle Building Course and apparatus. Noticeable Results guaranteed in 7 days or \$1 refunded. J. A. Dryer, Box 5527-A, Chicago 80, Ill.

Make your own Gems 29⁵⁰ F.O.B.

The Gem Maker comes complete with all necessary equipment, including a super-charged diamond blade for sawing, and all wheels for grinding, shaping and polishing; also complete instructions. The complete equipment as shown, less motor and belt, for only \$29.50, f.o.b., Burlington, Wisconsin. Write today for information and literature.

B & I MANUFACTURING CO.
Dept. 5 Burlington, Wis.



DON'T DIG 'TIL YOU KNOW WHERE

The most amazing instrument you've ever seen! MAGNA-PROBE traces water, gas and sewer lines. Saves hours of expensive and unnecessary digging. Just as efficient over concrete as bare ground. Works indoors or outside. MAGNA-PROBE will amaze you by the way the probes (each of a different type metal) are attracted to each other in the presence of linear moisture sources in pipe lines. Simple, unique, practical. Thousands of satisfied users include Public Utilities and Government Agencies. Money back guarantee. Send Check or money order. (No C.O.D.'s)

Complete with easy-to-use instructions.

THE MAGNA PROBE CO.
6022 Mayfield Road Cleveland 24, Ohio

ONLY \$2.98
Post-paid



**WORLD'S
BEST
WANT-AD
MEDIUM**

CLASSIFIED ADVERTISEMENTS



Advertisements in this section \$1.25 per word, each insertion, minimum 10 words, payable in advance.

To be inserted under proper classification, copy must be in our office the

20th of the second month preceding date of issue

F. W. Johnson, Manager, Classified Advertising

Popular Mechanics Magazine, 200 East Ontario Street, Chicago 11, Illinois

YOU'LL PROFIT

By reading and answering the classified ads in this section. Hundreds of opportunities for you to make and save money

AUTOMOBILES, MIDGET CARS

1956 PONTIACS By mail. Buy 1 or 20. Save 26%! Write for factory net prices. Pontiac Fleet Sales, Box 45144M, Airport Station, Los Angeles.

ANTIQUA Automobile color slides. 2x2. Illustrated catalog free. Universal, Box 779A, Beverly Hills, Calif.

BOYS' Power-driven auto. Build your own. Plans 25 cents. Sypher Co., Sta. F., Toledo, Ohio.

BUY Surplus cars, jeeps, parts, direct from government. List \$1.00. Box 1842J, Hartford 1, Connecticut.

BUILD Midget auto. Complete drawings, pictures and list of parts. \$1.00. Lee's Midget Autos, Avila, California.

MICRO Midget auto complete with 2 HP B&S engine, 10 in. wheels, 17 MPH. Runs on walk, lawn or street. Ideal for boys 12 to 16. Send \$100 to Micro Midget, 940 N. 23rd St., Omaha 2, Nebr. Guaranteed. Shipped by truck. Free literature.

NONPROFIT Organization offers automobile literature—Old, new and foreign; dealer books, service manuals, glossy photographs. Write today; get on free mailing list. Auto Maniacs, Stockbridge, Mich.

AUTO SUPPLIES AND EQUIPMENT

FORD T parts? Try best source old car parts anywhere. Wisneski, Milwaukee 7, Wis.

NEW And used parts at savings. Complete guaranteed parts service for all models cars and trucks, 1934 and later. Largest in the West. Army parts specialists. No catalog, write for quotations. Fast mail order service. Pioneer Auto and Truck Parts Co., 734 W. 13th Avenue, Denver, Colorado.

LATEST Custom accessories. Items not in stores. New low prices. Continental tire kits, push-button doors, trunks, etc. New illustrated catalog, biggest ever, 25c. Eastern Auto, 3319-A South Grand, Los Angeles 7, California.

AUTO Accessory and parts catalog. 1956 edition—All new! 164 pages. Save up to 50%—Over 50,000 items, including Hollywood accessories, hi-speed equipment, rebuilt engines, all parts and accessories for all cars and trucks; Hard-to-get parts! Send 25c (refundable). J. C. Whitney, 1919-PM Archer, Chicago 16, Illinois.

GM71-110 Discarded injector parts wanted. Bonus on HV. Buescher, 7120 Carnegie, Cleveland 3, Ohio.

BRAND New first quality tires. Tractor, truck, aircraft, passenger. Wholesale prices. Also all size army surplus used tires, at tremendous savings. Duddy's, 152 No. Beacon Street, Boston, Mass.

FREE, Illustrated, descriptive information "The Truth About Water Injection." Injector, Box 526, Burbank, California.

FREE Discount catalog—Speed, power, custom equipment. Almqvist Engineering, Milford 7P, Pennsylvania.

ELECTROPLATE Auto parts, novelties, mirrors. Easy, inexpensive home processes. Free booklet. Tyco Metals, Box 13231-BG, Houston 19, Texas.

STARVED For air? Poor mileage, loss of power result. Make two-minute test. Free information. Aqua-Jets Company, Florence, Ky.

JEEP Owners — V8 power. Read Jeep Owners ad, page 37.

REFLECTORIZED Plastic car-bumper stick-ons. Seen 1000 feet by headlight shine. Slow, stop; 50c. Glitterbugs, butterflies, spiders; 6 for \$1.00. Mailbox name-number; \$1.00. Free sample for self-addressed, stamped envelope. Glareback, Box 31, Sunland, California.

CUSTOMIZE Your car. Complete instruction booklet, \$1.00. Alanne, Box 135, Watertown 3, Conn.

RACE Fans! Learn speed of your favorite car and driver on 1/4 or 1/2 mile tracks. Copyrighted time and speed conversion tables. Converts elapsed time for one lap directly to speed in miles per hour. \$1.00. Mark Davis, 212 20th, Toledo 2, Ohio.

CRANKSHAFT Grinder, hand operated. Makes bearings fit without taking engine apart, \$3.75. Literature. L. D. McGee, 719 Cascade St., Wenatchee, Wash.

BUY Wholesale nationally advertised auto supply, thousands other products at big discount. Free "Wholesale Plan." American Buyers, Hertel Station, Buffalo 16-G, N. Y.

SENSATIONAL (Patented) 100,000 mile motor treatment. Lachapelle's. Renewes compression, power. Saves gas, oil, repairs. \$3.00 delivered. Money-back guarantee. You can't lose. Free circular. Write Joe Dillon, Authorized Warehouse, Agents Distributor, Box 32318, Bridgeport, Ohio. Exclusive agencies.

PARTS—Any make, any year. Antique, classic, foreign, modern. Otto's, Box 294, No. Hollywood, Calif.

SAVE 25% On auto parts, speed equipment accessories — Direct factory outlet. Free catalogue. Auto Accessories, 1819 S. Hackberry, San Antonio 10, Texas.

THUNDERBOLT Patented ignition attachment. Tremendous acceleration, quicker starting, saves gasoline, \$2.98. Free literature. Automobiler, 723 W. North Avenue, Baltimore 17, Maryland.

GET A "Shoe-Meter." Ideal for keys and coins. Hand carved leather. \$1.00. Satisfaction or money-back. Santuario's, 851 E. Madison, Brownsville, Texas.

SAVE Your oil, motor and dollars with sensational Refinol! End oil changing! Refines oil as you drive car, truck, tractor, marine engine. Free booklet. Dealers wanted. International Refinol Company, 9242 Broadway, Dept. PM 3, Brookfield, Illinois.

AUTO TRAILERS

BUILD Your own trailer! Plans for all kinds. Illustrated catalog 10c. Jim Dandy, 125-M, Wausau, Wisconsin.

EXCEPTIONAL Expanding eight foot trailer. Accommodates family of five. Build yourself. Literature 10c. Framar Company, Wilmington, Mass.

TRAILER Kits at amazingly low prices. Build your own and save. Free catalogue. Selma Trailer, P.O. Box 237-P, Selma, California.

TRAILER Parts catalog Largest in mid-west. Send 25c. Refundable. Hanna Trailer Supply, 615 West Layton, Milwaukee, Wis., Dept. M.P.

MOTORCYCLES, BICYCLES, MOTORSCOOTERS AND SUPPLIES

HARLEY-Davidsons — America's finest used bargains! We pay shipping on motorcycles. Genuine new, used parts, accessories for current and obsolete models. Send 25c for bulletin, catalog. Knuth's (factory dealer), 1753 Muskego, Milwaukee, Wis.

WHIZZER Motorbike engine \$5; midget car \$25; Micromidget racer \$65; Briggs Wagonmobile \$19; Doodlebug motorscooter \$15; (mailorder only). Send 25c (35c for first class mailing) for directory-catalogue Number 69, listing these and hundreds of other bargains. Midget Motors Directory, Athens, Ohio.

RECONDITIONED Motorcycles and motors. Chromium accessories. Complete stock Indian parts. Expert rebuilding. Fast service. Indian Motorcycle Sales, Kansas City 27, Missouri.

MOTORCYCLES, Supplies, free bulletins. Our 31st year. Cycle Co., 813 Ohio, Wichita Falls, Texas.

MOTOR Scooter parts — Send 25c for price list. Give year and model. Motor Scooter Parts Co., Box 7211, Indianapolis 1, Indiana.

SERVICYCLE \$20.00; Whizzer motorbike \$25.00; Cushman motorscooter \$25.00; midget auto \$25.00. Rush 25c (35c first class mail) for new catalog #958 listing many other amazing bargains in motors, midget cars, motorscooters, motorbikes, construction plans. Associated, Box 534, Toledo, Ohio.

PARTS, Pistons, new, used. Harley, Indian, Henderson, list 10c. Ballak, 811 N. 9th, St. Louis 1, Missouri.

AVIATION

PROPELLERS Specially designed for airboats and snow sleighs by the world's oldest manufacturer of aircraft propellers. Free literature. Plotorp Mfg. Co., G. R. Airport, Grand Rapids 8, Mich.

PROPELLERS, Plans, supplies—World's oldest and largest manufacturer of special design airboat, snow sleigh propellers. Prompt delivery. Satisfaction guaranteed. 48 page catalog 25c. Banks-Maxwell, Box 3301E, Ft. Worth 5, Texas.

PROPELLERS. Plans, supplies for air boats, snow sleighs. Catalog 10c. Gano Propellers, Box 3284-A, Ft. Worth, Texas.

AVIATION Surplus bargain catalogue. One dime. Box 22-S2, Thomasville, Penna.

SEND For a free copy of R.A.F. Flying Review. Europe's biggest selling aviation magazine. Packed with information, true flying adventure exploits, photos and exclusive factual articles. Essential for all air enthusiasts. Don't let the Atlantic stop you! Send for free copy now, to Flying Review (Dept. FGP), 180 Fleet Street, London, England.

AIRLINE Steward-purser. Fly 85 hours monthly. Starting salary \$235 up. G.I. approved. Free catalog. Air-Purser School, Room E, 1030 Nicollet Ave., Minneapolis, Minnesota.

SIX Giant airplane photographs 14 x 17 reproduced in full color. Decorate your den, etc., with color prints of war planes in action. Complete set of six assorted only \$1.00 postpaid. Jarvis Bros., Box 126-B, Bostonia, California.

BUILD Jet helicopter. Drawings, specs., \$1.00. Detailed blueprints, \$8.00. Apache Aircraft, St. David, Arizona.

MAKE \$100 A day with a lightplane. Practical plan. Brochure, \$1.00. Specialty House, 910 E. Main, Danville, Ill.

HELICOPTERS—1 And 3 man. Aviation marvels. Construct own. Instructions \$3.50, \$6.00 respectively. Mayberry Aircraft, Box 343, St. Clair Shores, Michigan.

BATTERIES, GENERATORS

EDISON Nickel storage batteries. Any voltage, any amperage. Unconditionally guaranteed. Power plants, generators, motors. Literature. Hawley Smith Co., Croton Falls 1, N. Y.

ELECTRICAL SUPPLIES

LAMP And electrical parts—Wholesale. Thousands of items for building, repairing, and converting lamps. Illustrated catalog 25c. Brown Lamp Co., Box 501, Wellston Sta., St. Louis 12, Mo.

ELECTRIC Pencil: Engraves all metals \$1.50. Beyer Mfg., 10511-H Springfield, Chicago 43.

NEW 1956 Lamp parts catalog showing everything you need to make and repair most types of lamps. Everything at lowest wholesale prices. Send only 25c today for both catalog and wholesale price list. Gearon Co., Dept. 503-B3, 27 S. Desplaines, Chicago 6, Ill.

SAVE—Make fluorescent fixtures Catalog of kits, parts, instructions, plans, 35c. Shoplite, Box 63M, Nutley 10, New Jersey.

TELEPHONE Transmitter. Hand set type. Suitable for inter-house phones, speakers or any communication purpose. Delivered two for \$1.00. No c.o.d.'s. Telephones, Dept. C-525, 1760 Lunt, Chicago 26.

NEON Stripping, straight tubing (straight electrodes). 89c per ft. (minimum order 40 ft.) transformer, tube supports, insulators and simple instructions on how to install included. Colors: white, green, blue, red and rose. Give measurements of building and colors desired. Hulme Neon Sign Co., 125 W. Earle St., Anderson, S.C.

LAMPS. Parts catalog containing wiring instructions 25c. Gyro Lamps, 5402P Clark, Chicago 40.

WELDING, SOLDERING, PLATING

BUILD—Ur-Own a.c. welder and a.c. power plant with a good used engine and low cost Hobart generator. Welds anywhere and supplies 5 KW stand-by power for any emergency. Write Hobartweld, Box M-363, Troy, Ohio.

NEW. Timesaving oxy-acetylene outfit welds, cuts, heats, brazes. Just change tips. Light, compact, portable. Thrifty to operate, ruggedly built. Complete outfit and instructions, only \$76.50. Special economy plan for supplying gas cylinders. Write for free literature: Dept. M, Linde Air Products Company, 30 East 42nd Street, New York 17, N. Y.

A.C. Welders. 4 sizes. Lowest prices. Free literature. Holgeron's Serv., Canton, Kan.

WELDERS. 110/220, \$39.50. Morris, 1070 Inner Drive, Schenectady 3, New York.

ACETYLENE Welding outfits, new \$49.00; used \$29.00; arcwelders \$56.50. Eagle Welding, Dept. PM, 5085 Broadway, Chicago 40, Ill.

ELECTROPLATING Equipment, anodes and solutions for all types of plating. Instructions. Assemble your own plater and save. Free catalog. Ramyr, Dept. E-4, 1624 East First Street, Los Angeles 33, California.

BUILD 300-Ampere welder using aircraft generator. Plans 10c including big catalog welder-kits, generators, winches, motors, hydraulics. Dunbar Mfg., 6600 Sylvan, Houston 23, Texas.

MACHINERY, TOOLS, SUPPLIES

HARDWARE. Tools, brass, steel, drill rod. Free catalog. Terek, 6304 Patterson, Chicago 34.

LAWNMOWER Grinder: New, fast, different. Heavy duty. Only complete mower shop. Includes grinder, lapper, "Lightning" bed knife grinder, built-in bench. Write Turner-Cline, 430 Yellowstone, Pocatello, Idaho.

BIG Factory catalog! Buy direct—Save middleman's profits; hundreds of labor saving tools and equipment; tremendous savings. Send 10c. Master Mechanic Mfg., Dept. CL-120, Burlington, Wis.

NEW Ratchet screwdriver. Different. Interchangeable blades. Free circular. Wiltron Co., Box 765, North Hollywood, Calif.

SURVEYING INSTRUMENTS

GUARANTEED Factory rebuilt transits and levels, sale or rent, with purchase option. We will repair, trade or buy old instruments. Write for list M-63, Warren-Knight Co. (Manufacturers of Surveying Instruments), 136 N. 12th St., Philadelphia 7, Penna.

ENGINES, MOTORS, DYNAMOS

REBUILT 1½ And 3 h.p. engines \$17.00 to \$37.00. Cauffiel Motors, Temperance, Michigan.

REWIND Motors yourself. Complete instructions \$1.00. Lewis Mfg., Howell, Michigan.

WINDING Data. 275 motors, single and three phase, \$1.10. Data Company, Box 7631, Kansas City 28, Mo.

A.C. generators. 750 watt \$42.50, 1500 watt \$67.50, motors ½ horse \$15.00, 1 horse \$35.00, 2 horse \$65.00. Butler, 1885 Milwaukee, Chicago.

PARTS For Briggs-Stratton, Clinton, Lauson, Power Products, Wisconsin, Continental engines. Weeden Company, Wakefield, R. I.

GAS Engines 1½ H.P. Ideal for rotary mowers, pumps etc. "Power Products." Brand new. Original cartons. Were priced \$46.50. Special price \$19.95 postpaid. Money back guarantee. Northern, 172 Merrimac Street, Boston 14, Mass.

BOATS, OUTBOARD MOTORS

OUTBOARD Motor parts—New, used for all makes. Send list of parts needed. Enclose stamp. We save you money. Outboard Motor Mart, Inc., 239M State Street, Boston, Mass.

FULL Size, cut-to-shape boat patterns, blueprints, 7½-38 feet. New 1956 illustrated "Build a Boat" catalog of 50 naval architect-designed cruisers, runabouts, sloops, skiffs, outboard boats, sailing, racing, houseboats. 50c. Small boat hardware catalog \$1.50. Bigger, better 1956 "How to Build Boats" book, \$2.50. Cleveland Boat Blueprint Co., Dept. A-66, Box 1651, Cleveland 4, Ohio.

FREE Instructions. Boat docks. Built, installed out of water. Dock Products Company, 3422 26th Avenue South, Minneapolis, Minnesota.

FREE Catalog! Boat kits, trailers, fiberglass marine hardware. Luger Industries, Dept. M, 4452 Nicollet, Minneapolis, Minn.

MARINE Conversion, Willys to Cadillac, engines, kits and parts. Catalogue and conversion hints free. Barr Marine, 2706 Castor Avenue, Philadelphia 34, Penna.

JOHNSON Outboard specialists. Used parts for all models at substantial savings. Prompt quotations. Specify model serial. Crandall-Hicks, 910 Commonwealth, Boston, Mass.

FIBERGLAS Permanent boat water-proofing. Lowest wholesale prices. Guaranteed materials. Easy application. Full instructions. Complete kits, \$12.60 up. Free literature. Ajax Plastics, Dept. PM, P.O. Box 1323, Fort Worth, Texas.

NEW. Used, rebuilt marine motors. Marine conversions, fittings. Free catalog. Stokes Marine Supply, Dept. 24, Coldwater, Michigan.

MARINE Conversions for Ford and Jeep engines. Catalog 25c. Lehman Manufacturing Company, 972D Broad Street, Newark 2, New Jersey.

BOAT Plans. Welded steel, wood, plywood. Inboards, cruisers, sail. Free literature. Please specify size-type. John B. Clark, N.A., Box 51, Bay Village, Ohio.

FORDS And Jeeps 100% marine engines with famous Convo-Kits. Deluxe catalogue 25c coin. Oscomotors, 3627B Lawrence, Philadelphia 40, Penna.

AIRPLANE Floats, pontoons. Rubber boats. Catalogue 10c. Box 22-S5, Thomasville, Penna.

FIBERGLASS Top marine grade. Yard or kit. Ontario Fiberglass Co., Ontario, N. Y.

"GLASBOTE" Plastic and glass cloth for boat covering. Complete information and material price list free. Buchanan Plastics, 1728 Hamilton Road, Okemos, Michigan.

AI Rebuilt marine engines. Chryslers, Chris Craft, G. M. diesels, parts. Helwege, 741 S. Ocean, Freeport, N. Y.

WHOLESALE! Sea Legs boat kits, factory prices from \$31.98. Savings to 25%. Pre-assembled frames, pre-cut parts, illustrated instructions. Penney Woodcraft Industries, Dept. C-49, Defiance, Ohio.

BOAT Plans, patterns, frame kits. Modern inboard and outboards 11'-22' for amateur builders. State requirements or send 40c for complete catalog. Glen Designs, Box 568, Compton, Calif.

BUY Wholesale nationally advertised outboards, thousands other products at big discount. Free "Wholesale Plan." American Buyers', Hertel Station, Buffalo 16-H, N. Y.

BIG Stock rebuilt inboard and outboard motors, 1½ to 50 h.p. All popular models, \$35 up. Boat supply catalog, send 25c. Masters, 212 W. Chicago Ave., Chicago 10.

PLANS. Patterns, boat kits. Large catalog, 50c. Marincraft, Box 161-M, Brighton, Mass.

WATER Skis, \$21.95; kits, \$9.95 up. Literature. Enterprise Products, 28400 Gilchrist, Willoughby, Ohio.

KIT Boats. Free folder. Marine Associates, Box 6188MM, Long Beach 11, Calif.

ATHLETIC EQUIPMENT, BODY BUILDING COURSES

100 TRICK Knockouts for self-defense \$1.—1c each. Priest, Box 251, Evanston 1, Illinois.

FREE Catalogue, 10c for postage appreciated. Dr. Thompson, 919 Fourth, Manhattan 30, Kansas.

BARBELLS. Exercise equipment. Courses. Free booklet. Good Barbell Co., Reading, Penna.

BUILD Your own weights for \$3.00! New idea! Easy! Don Sandberg, 5322 Mayview Rd., Hopkins, Minnesota.

BARBELLS. Dumbbells. Build them yourself! Inexpensive! Complete plans, \$1.00. Perfect Physique, 334 Sutter Street, San Francisco.

INCREASE Your height! Coach's "Inch-At-A-Time" system. \$1. Marty Snyder, Box 195-MB, Union City, New Jersey.

SPORTING GOODS, GUNS, FISHING TACKLE, ARCHERY, TRAPPING

NYLON Rope, lines, cords. Every description for all household and sportsmen's uses. Finest made. Free catalog and samples. Beebe Cordage Co., Cranford 8, N. J.

OLD Guns. Current prices. Free catalog. Pioneer Books, Harriman, Tennessee.

TENTS (Direct from manufacturer), camping equipment. World's largest selection. Send 15c for 100 page 1956 tent and camping equipment catalogue-handbook. Morsan Tents, 10-21R 50th Avenue, Long Island City 1, New York.

FREE. Fishing catalog. Luremaking tools, beads, spinners, sinker molds, bargain spinning outfits. FinnySports (MP), Toledo 6, Ohio.

180 PROFUSELY Illustrated pages antique pistols, swords, daggers, armor, etc. 50c. Robert Abels, M860 Lexington Ave., New York 21.

MOLDS—For making fishermen's sinkers. Free illustrated booklet. Reading Instrument Co., Box 78, Reading, Penna.

5000 BARGAINS. Firearms, binoculars, war relics. Catalog 50c. Smith Firearms, Runnede N. J.

JAP Rifle altering to 20-06, \$6.00. Japshells, \$3.75. Catalog 5c. T. P. Shop, West Branch 11, Mich.

FREE—Giant new 1956 govt. surplus catalog jam packed with 1000's of amazing values, for scouts, campers, hunters, outdoorsmen. Including complete line of tents, sleeping bags, camp and scout equipment. Write today. Goldberg's Army-Navy Store, 218 Market St., Philadelphia 6, Penna.

LARGE Red wigglers, fishermen's choice 500—\$2.50, 1000—\$3.75, 5000—\$17.50. Alamaance Worm Ranch, Route 1, Haw River, N. C.

FISHERMAN! Golden "Jumbo" grubs. Finest fresh water live bait. Keeps months. Live delivery guaranteed. Introductory offer, 200 extra large \$1.00 prepaid. Dealers, distributors wanted. SureBite, Box 1033, Culver City, California.

WHY Chase fish? Three drops of our lure on bait draws 'em. Guaranteed. Send \$1.00 to Fleeta Sales, Box 944, Kansas City, Kansas.

DIVING Equipment for skin divers and professional divers. Send 25c for catalog and decompression chart. Desco, 212 N. Broadway, Milwaukee 2, Wisconsin.

FISHING Tackle—30% to 50% off! Also guns and camping equipment. Cash or credit. Free bargain catalog. Write to: Klein's, Dept. C-M3, 227 W. Washington St., Chicago 6, Ill.

FREE Fishing catalog—132 pages. Over 3000 hard to find fishing specialties. Netcraft Company, Dept. PM3, Toledo 13, Ohio.

BUY Wholesale nationally advertised sporting goods, thousands other products at big discount. Free "Wholesale Plan." American Buyers, Hertel Station, Buffalo 16-I, N. Y.

BIL-SHOT For slingshots. Shoot straighter, hit harder 5/16" lead balls \$1.25 per 100. Bil-Shot, 315 S. Broadway, St. Louis 2, Mo.

"SHOCKING" Expose! Catfish caught with telephone apparatus! Complete details. \$1.00. Pop, Box 6122, Houston 6, Texas.

WORMS The modern way. Write for free information. Moore's Electric Bait Getter, Rushville, Illinois.

LEARN Gun repairing at home. Profitable business. Details 10c. Modern Gun Repair School, Box 430-P, Marshfield, Wis.

SAMPLE: 25c Copy of "The Archers' Magazine." Send 10c. 1200 Walnut Street, Philadelphia 7, Pennsylvania

SENSATIONAL Hunting-camping knife, blade 3 1/2, precision compass in simulated ivory handle, leather sheath. Only \$1.75. Money back guarantee. Dealers wanted. Land Company, 37 Buckley, Port Jervis, New York.

FISHERMEN! Golden jumbo grubs. Finest fresh water live bait. Keeps months. Live delivery guaranteed. Introductory offer—200 extra large, \$1.00 prepaid. Dealers, distributors wanted. SureBite, Box 1033, Culver City, California.

SKIN Diver's catalog. Free. Shows everything from aqua-pencil to submarine! Skis, Trunks, Books, Premiums, Aquafun P-M. Davenport, Iowa.

MANY Modern, antique guns. List 10c coin. Ed Howe, 52 Main, Coopers Mills, Maine.

JEEP Owners—V8 power. Read Jeep Owners ad. page 37.

MEN, Women, wear comfortable "Next-To-Skin-Wear." Earn commissions distributing keyed sales folders. Write Research, Gordon Speedie Advertising, West Medford 56, Mass.

BINOCULARS, TELESCOPES, MICROSCOPES, MAGNIFIERS

AMAZING Prices binoculars, gunsopes. Free trial. Folder "Binocular Selecting," catalog free. Prentiss Importers, Mercury Bldg., West Los Angeles 25, Calif.

REFLECTOR Telescope kits \$6.25 (3") to \$175. (12"). Mirrors, cells, focusing mounts, tripods, eye-systems. Anything, everything in telescopes. Free illustrated catalog. Also ready to use telescopes from \$26 to \$176. Inquiries to Esco Products, Dept. PM, 1428 Willow Ave., Hoboken, N. J. Sales showroom, 166 Church St., New York City.

SAVE 25%! America's largest selection. Free 56 page 1956 binocular catalog. \$3.95 to \$250.00! United, 9043 S. Western, A-9808, Chicago 20. Dealers wanted.

400 POWER Telescope easily made. Kit includes focusing tube, erector, five finished lenses and instructions—\$3.75. Giant astronomical telescope complete with tripod \$15.00. Free information. Suffolk Science, Mattituck 3, N. Y.

DYNASCOPE—Sensational new reflector telescope. Send for details. Criterion Co., Dept. DP18, Hartford, Conn.

REFLECTING Telescope, 60X, completely assembled \$29.75. Guaranteed observatory clearness. Free information. Skyscope, 475 Fifth Avenue, New York 17.

BUILD Your own reflector telescope. Complete kit: mirrors, eyepieces, tripod, all other accessories. Request free illustrated literature. Criterion Manufacturing, Dept. KPM15, Hartford, Conn.

6 THUMBS On each hand? Even you can assemble our telescope kits from our easy instructions. Enjoy the heavens with a high precision telescope assembled in less than an hour. You'll like our complete line of telescopes, microscopes and accessories, biological stains, etc. Send for free Catalog T of finest quality and newest design astronomical kits or free Catalog M of microscopes. Optical Engineering Co., 164-19 Northern Boulevard, Dept. PM, Flushing, New York.

BINOCULARS, Telescopes, microscopes, terrific values, \$3.98 up. Request free money saving catalog. Criterion, Dept. P39, Hartford, Conn.

MICROSCOPES, Binoculars, telescopes. Everything optical, photographic at importers price. Free catalog. Magnification Instrument Company, 2 East 43 Street, New York City.

WAR Surplus bargains! Millions of lenses, instruments, telescopes, binoculars, components and complete line of astronomical telescope items. World's greatest optical market place! Send only \$1.00 for beginner's 10-lens kit and big instruction booklet Stock 2-CH. Write for Catalog CH, free! Edmund Scientific Corp., Barrington, New Jersey.

PETS—DOGS, BIRDS, RABBITS, HAMSTERS, ETC.

RAISE Rabbits successfully by knowing facts. 48 page illustrated book describing 25 breeds. Housing, feeding, breeding, marketing, etc. Plus bulletin, 25 cents. American Rabbit Association, 36 Arba Building, Pittsburgh, Penna.

1000 BRED Mink—Booklet plans 20c. Wettauer, Gravel Road, Webster, N. Y.

HUNTERS! Raccoon Mountain and Short Creek kennels now combined. Large number of coonhounds, foxhounds, rabbit-hounds, beaglehounds, bird-dogs, puppies. Free literature and pictures. Trial, Dures Thomas, Owner, Box 464, Boaz, Alabama.

EXTRA Money raising Angora, New Zealand rabbits. Write Martin's Rabbitry, Morganfield, Ky.

STANDARD Rabbit Journal, Milton 3, Penna. Year \$1.00. Sample dime. Beginners manual 25c.

MINK Raising information free. Complete. Lake Superior Mink Farm, Superior, Eel, Wisconsin

CHINCHILLAS, Registered. Unbelievable prices. Far-West Chinchilla, 1446A Jones, San Francisco 9, California.

MAKE Big money! Raise Chinchilla rabbits. Cash markets supplied. Write today! Rockhill Ranch, Sellersville 15, Penna.

MONTHLY Bird magazine (budgies, canaries, finches, etc.). One year \$3.00. American Cage-Bird Magazine, 3449 N. Western Avenue, Dept. P.M., Chicago 18, Illinois.

\$5,199.90 WAS Paid to John Betts, in few weeks. Grow mushrooms. Cellar, shed. Spare, full time year round. We pay \$3.50 lb. Free book. Mushrooms, Dept. 171, 2954 Admiral Way, Seattle, Wash.

RAISE Moneymaking Angora, New Zealand rabbits, Particulars free. White's Rabbitry, Jackson, Mich.

CHINCHILLAS—Registered sturdy stock. Wholesale. One or one hundred pairs—\$75.00 pair. Slater Chinchillas, 1535 Ruhland Ave., Manhattan Beach, California.

MAKE Money raising chinchillas, mink, pigeons, rabbits, cavies for us. Free catalog. Keeney Brothers, New Freedom 2, Penna.

CHINCHILLAS, Registered. \$100.00 starts you, guarantee four mated pairs. Send 25c book on chinchillas, details free. H. A. Kumlaine, 214 W. Francis, Ontario, Calif.

DOG Whistle, high pitch sound, audible only to animals, especially dogs. Send \$1.00. Duval Company, Box 112, Midwood Station, Brooklyn 30, New York.

PEDIGREED Police puppies. White or cream, \$30 to \$60. Ansonia Kennels, Mose, N. Dak.

HAMSTERS—Golden; young, \$3.00 pair; fully developed, \$4.00 pair. Adirondack Hamstery, Prospect 142, New York.

DOUBLE Money selling wren houses. Sample \$1.50. Rudolph Kudrich, Blair, Kansas.

RAISE Nutria. America's newest, most economically and easily raised fur-bearing animal known. Registered. Guaranteed. Wonderful future. Kansas Nutria Farm, P.O. Box 914 A, Kansas City 1, Kansas.

ANGORAS, Chinchillas—World's most profitable rabbits! Catalog free. Grinsteads, Edwardsville, Illinois.

TERRIFIC Profits—Raising beautiful waterfowl! Sunny Creek Farms, Red Lake Falls, Minnesota.

HAMSTERS, Pair \$2.95. Booklet 10c. Jer-Fre's Hamstery, 2425 Hoyt, Muskegon Heights 13, Mich.

PLANTS, SEEDS, BULBS, NURSERY AND GARDEN SUPPLIES

TREES And shrubs. Raise your own from seed for shade, windbreak, snow fence, ornament, erosion control, etc. For free planting guide, pricelist, write Woodlot Seed Co., Norway 9, Michigan.

WORLD'S Greatest cash crop. Free information. Write Ginseng Gardens, Asheville, N. C.

GINSENG, Goldenseal Roots bring up to \$12 pound. Full information. P. M. Collins, Viola, Iowa.

TEN Years proved new method on lawn seeding and repairing. For full particulars send \$2.00. P. O. Box 36, Station F, Milwaukee 9, Wis. Patent pending.

100 REDWOOD Empire gladioli bulbs, fifty sweet corn, or giant muskmellon, \$1.00. Gladhaven, Sebastopol, California.

FARMS, FARM LANDS, REAL ESTATE

FLORIDA—Beautiful retirement homesites near gulf coast. Excellent hunting, fishing in 9 fresh and salt water rivers. 11 bays and gulf. \$250 to \$10 monthly. Free literature. V. M. Mathews, Box 1406, Asheville, N. C.

CANADIAN Tax sale lands for three dollars an acre and up. Small monthly payments. Farms, timber, hunting and fishing camps, minerals. Limited number of properties. Write at once for free catalogue. Tax Sale Service, Room 105, 120 Bloor St., West, Toronto 5, Canada

HOMESITES \$15 Monthly—California's finest garden section. Morro Bay's scenic shores. Wonderful fishing, boating. Fertile soil, softest water, temperate climate, congenial community. Free literature. Richard Otto, Department M, San Luis Obispo, California.

FLORIDA Lakefront homesites near Ocala forest. Excellent fishing-hunting, \$10.00 monthly without interest. Complete price \$195-\$995. Literature. Grace Parker, Paisley, Florida.

FLORIDA. Nice homesites, \$245 to \$10 monthly. Folder free. Howard Vernor, DeLand, Florida.

FLORIDA Waterfront homesites on famous Saint John's river. \$50.00 front foot. Also inland lakefront five miles from river \$195.00-\$995.00. Specify which literature. Easy monthly payments. Pine Lakes, Eustis, Florida.

SAVE, Buy direct from government, land, homes, islands, farms, etc. Listings \$1.00. Abacus, Box 169D, Dept. M, East Hartford 8, Conn.

OZARKS Fruit, grazing, retirement. \$6.00 acre. \$5.00 monthly. Descriptions free. Write Armstrongs, Shook, Missouri.

CALIFORNIA Ranch and farm lands \$15 to \$35 acre. Homesites \$395. Easy terms. Free catalog. Pacific Tax Sales, 1621-A Cahuenga, Hollywood 28, Calif.

NEW Strout catalog, just out! Mailed free! Farms, homes, businesses, coast-to-coast. Chock full of bargains. World's largest, 56 years service. Strout Realty, 7-MF So. Dearborn St., Chicago 3, Ill.

FLORIDA Winter Garden farms, money-making tung groves, and wooded homesites in beautiful Green Hills. Near famous Panama City pleasure resort. World's finest beaches. Many lakes. Best fishing, hunting, 10 and 20 acre farms. Bearing tung groves. Lowest prices, easy terms. Booklet free. Wendell Wood, Fountain, Florida.

FLORIDA Retirement in Gulf Highlands offers finest life anywhere for sportsmen, hobbyists. Established community adjoins heavily developed beach area in Florida's fastest growing county. All sports nearby. Lots low as \$345. Complete homesite (two lots) just \$14.37 down, \$14.37 monthly. No interest. Title insured. Color brochure free. Write today! Sam B. Hearn, Developer. Box V-177, Panama City Beach, Fla.

FLORIDA Bargain homes. Low taxes. Cummins Realty Agency, Box 848, Eustis, Florida.

MAKE Money in Texas. Get yourself a fine tract now near Houston for only \$345. \$15 cash and \$15 monthly. Fastest growing city and second largest seaport in U.S. Huge \$100 million steel plant. World's greatest oil producing, refining, chemical, manufacturing and shipping center. Many are making phenomenal profits here and you can too. These beautiful tracts located in Houston's desirable southside suburbs with all-weather streets, electricity, schools, bus service, etc. Insured title. Write today for maps, pictures, full information free. Bailey Wood, Owner, Box 6804, Houston 5, Texas.

FLORIDA—Several five acre tracts, grand climate and location near Gulf of Mexico for fishing, boating, and bathing. Priced at \$595.00, \$10.00 down, \$10.00 month. Information: Write G. B. Potterfield, Owner, Union Building, Dept. P, Charleston, W. Va.

POULTRY, FARM SUPPLIES

RAISE Turkeys the new way. Information explaining how to make up to \$3,000.00 in your own backyard. Literature 10c. Address—National Turkey Institute, Dept. 3, Columbus, Kansas.

GUINEAS, Ducks, pheasants; eggs and babies; 50 varieties chicks. Low prices. Gorgeous book free. Berry's Farm, Route 12, Clarinda, Iowa.

PROFITABLE OCCUPATIONS

HOME Mailorder sources, methods, opportunities, literature free. Carnahan Bros., 9610-D Acacia, Fontana, Calif.

HELP Wanted! Top money in California! Thousands needed! San Francisco, Los Angeles, San Diego, Sacramento, Fresno, or Oakland big Sunday classified ads airmailed only \$2.00 each or one week (seven) for \$5.00. No c.o.d. Write only Editor, 463 Northridge Road, San Francisco 24, Calif.

WELDING Pays big money. Learn easily at best equipped school in country. Non-profit school with low cost training. G.I. approved. Write Hobart Trade School, Box M-362, Troy, Ohio.

ANNOUNCING Home study course in commercial baking. Practical basic training. Good field for those with aptitude. Free booklet. "Opportunities in the Baking Industry." National Baking School, 835 Diversey Pkwy., Dept. 3433, Chicago 14.

\$5,199.90 WAS Paid to John Betts, in few weeks. Grow mushrooms. Cellar, shed. Spare, full time, year round. We pay \$3.50 lb. Free book. Mushrooms, Dept. 99, 2954 Admiral Way, Seattle, Wash.

RAISE Everbearing strawberries. Unlimited demand everywhere. Make thousands dollars from acre. Write, Samouce, 1668 Forsyth, Macon, Ga.

YOUR Own wholesale business with no investment. Free catalog. Jay Norris Co., 487X Broadway, New York City.

FOREIGN Jobs—Latin America, Alaska, Canada, up to \$1500 monthly. Up-to-date 1956 foreign service directory gives complete information; hot list of firms hiring for military and civilian construction, aircraft, oil, exporters-importers, mining, \$1.00. How-when-where to apply. 9th successful year! Global Reports, Box 883-S, Hollywood 28, Calif.

HOUSTON, Texas, current help wanted listings airmailed \$1. Houston 25c extra. Dempsey, 2818 Hardy, Houston 9, Texas.

FREE Folio "\$5,000-\$45,000; Unlimited Vacations." No merchandise, equipment. Unknown! Work home, sparetime! Haylings, Carlsbad, Calif.

SELL Frankfurters and refreshments from stainless steel mobile units and carts; good steady income. Write Admar, 16 Catherine St., New York City 38.

\$10,800 PROFITS! Your own mailorder business! No risk! Success plan free! Treasury, 709 Webster, New Rochelle L-34, N. Y.

BUY Wholesale thousands nationally advertised products at big discount. Free "Wholesale Plan." American Buyers, Hertel Station, Buffalo 16-B, N. Y.

FREE Book "505 Odd, Successful Businesses." Work home. Pacific, Oceanside, Calif.

ALASKA Police jobs open. Information \$1.00. Write now. ABCo, Box 282, Juneau, Alaska.

JOBS To \$1500 monthly. All trades. South America, The Islands, U.S. Fare paid. Application forms. Free information. Write Dept. 76G, National, 1020 Broad, Newark, N. J.

RAISE Pheasants on \$100 week plan. Little capital and space can make you independent. Free details. Great Central System, Columbus 1, Kansas.

MAKE New greaseless doughnuts in kitchen. Sell stores. Free recipes. Michael Ray, 3605 South 15th Ave., Minneapolis 7, Minnesota.

MONEY In saw and lawnmower sharpening sparetime at home. Repeat cash business. Experience unnecessary. No selling. Free booklet explains. Vernon Foley Company, Columbia Heights, Minnesota.

BE The Popular Mechanics representative in your neighborhood and earn big profits in your spare time. Write Popular Mechanics Magazine, Room 408M, 200 E. Ontario St., Chicago, Ill.

FORTUNE Possible raising fishworms and crickets. Free literature. Carter Wormery, Plains, Georgia.

WHOLESALE Catalog! 30-80% discounts! Appliances, musical instruments, typewriters, phonographs, watches, jewelry, recorders, housewares, etc. Consolidated Distributors, 21-14 Lafayette, Paterson 15, New Jersey.

AUCTIONEERING—Home study course. Diploma granted. Auction School, Ft. Smith, Ark.

MAKE Flexible molds. Cast figurines, plaques. Free sample. Tooker, 630-M Chestnut, Hamilton, Ohio.

FREE! "301 Profitable Small Businesses!" Amazing shoestring plans! Work home! Start sparetime! Deumant Surveys, Kenmore 23-PM, N. Y.

FOREIGN Employment construction work. If interested in foreign projects with high pay write Foreign Service Bureau, Dept. PM, Metuchen, N. J.

VENDING Machines earn big money! Request 32 page free catalogue. Parkway Machine Corporation, Dept. 25, 715 Ensor St., Baltimore 2, Maryland.

CONFIDENTIAL Reports on best paying jobs with travel, adventure, promotions. Construction, aviation, shipping, laborers, clerical, trades, supervisory, factory. Unusual opportunities, all types of work. Skilled and unskilled. Foreign and state-side openings for men and women. Only \$2.00, including year registration-advisory service. Reports airmailed same day order received. Guaranteed best service available or double your money back. Research Services, Suite 207-PMB, Brown Building, St. Louis 5, Missouri.

\$150 WEEK—Easy! Start home Venetian blind laundry. Revealing book free. A.T. Co., 101 S. 44th, Philadelphia 4, Penna.

ROOT Cuttings for profit or pleasure. \$1.00 illustrated booklet explains how. Orchard Nursery, Route 3, Mobile, Ala.

NORFOLK, Or Richmond help wanted columns airmailed, \$1.00 each, 7 days, \$2.00. Vandelinde, P.O. Box 202, Norfolk 1, Virginia.

APPRENTICE Training, nationwide opportunities, all trades. Get paid up to \$350 monthly to learn. Details free. Surveys, Box 181, Glastonbury, Conn.

INSPIRATIONAL, Newest, money making method. Distributor, 1305 West 46th, Los Angeles 37.

GET Job-packed Miami Classified, \$1.00. You'll be glad you did! Evans, Box 4325, Ft. Lauderdale, Florida.

CHINCHILLA Breeding for beginners. Read this important booklet about first steps at lowest cost. Expertly written, factual, not sales gimmick. Start lucrative future. True picture, \$1 ppd. Hollert, Dept. PM, 38-14 218 St., Bayside, N. Y.

PHILADELPHIA, Sunday classified airmailed \$1.00. The Ronoco Co., 178 W. Raymond, Philadelphia 40, Pa.

RAISE Nutria, America's newest, most economically and easily raised fur-bearing animal known. Registered. Guaranteed. Wonderful future. Kansas Nutria Farm, P.O. Box 914, Kansas City 1, Kansas.

JOBS, Latest lists New York-Paterson area, \$1.00. Gen, 207 West Broadway, Paterson, N. J.

MAGAZINE Subscriptions—Largest commissions, bonus. Qualified Agency, 451 CA Kingston, Brooklyn 25, N. Y.

COLORADO Calls. Jobs, jobs, jobs. Denver Post Classified \$1.00. Link, 4400 S. Broadway, Englewood, Colorado.

GOOD Jobs now available in Southern California. Send \$1.00 for latest list. California Jobs, Inc., 601-A South Vermont, Los Angeles 5, Calif.

FOREIGN, Alaskan, U.S.A., jobs! Earn to \$1500.00 monthly. Million Americans employed overseas. Opportunities galore. Latest copyrighted reports. Who to contact for highest paying jobs. Laborers, trades, truck drivers, equipment operators, helpers, clerks, engineers, many others. Over 52 countries—St. Lawrence project, Spain, Latin America, northern projects, Europe, Pacific, etc. Year registration-advisory service. Application forms. Unconditional money-back guarantee. Act today! Only \$2.00. Airmailed \$2.25. (C.O.D.'s accepted). International Reporter, St. Louis 1-PD, Missouri.

BOOKS, PERIODICALS, PICTURES, POSTCARDS

BOOKS, Free 1956 catalog, 100 pages. Text, vocational, educational, instructional subjects. Millions of volumes, new and used. Bargain prices. Books bought, Est. 1902. Long's College Book Co., Dept. PM, Columbus 1, Ohio.

RARE Magazines! Send 10c for prices. Nationwide Magazine Exchange, Box 1375-P, San Antonio 6, Texas.

POSITIVE Bargains! We send brand new 25c and 35c pocketbooks for just 11c each. All kinds! Rush 25c (refunded!) for catalogue. Breezy! Thrilling! Save! Keystone Book, 6882 Forrest Avenue, Philadelphia 38, Penna.

BRAD Lee's "Corporation Sociology." 25c. Box 8, Forest Hills 75, N. Y.

BOOKS Found! Any author, old or new. Rush titles wanted; no obligation. International Bookfinders, Box 3003-PM, Beverly Hills, California.

BOOKFINDERS! All subjects. Send wants! Jaher Book Service, 183 Hazelwood Drive, Westbury, N. Y.

"SCIENCE Milestones." Records march of science starting 400 years before Christ, right up to date. Amazing facts revealed. 312 pages packed with startling information that will thrill you. A real history of science. \$5.00. Literature free. Popular Mechanics Press, 200-SM East Ontario St., Chicago 11, Ill.

NATIONAL Geographic Magazines, 1888-1956. Periodical Service, Box 465-PM, Wilmington, Delaware.

"STREAMLINING the Feature." Book endorsed by noted writers. Write to sell. \$2.50. Ben Arid, 1141-7th, Hermosa, Calif.

BOOKHUNTERS! All subjects. Send wants! College Book Service, 52 W. Kingsbridge Rd., New York 68, N. Y.

BARGAINS Galore. All categories. Catalogue 10c. Books, 1324 Wilshire, Los Angeles 17.

BOOK Catalog, 1000 interesting titles. Send 10c. Books Publishing Co., Amityville 3, N. Y.

MAGIC TRICKS, PUZZLES, JOKER NOVELTIES

THRILLING 224 Page catalog, magician's tricks, Houdini escapes, handcuffs, amusement goods and "Mystery Review Book." All \$1.00 prepaid. Magician Heaney Co., Oshkosh, Wis.

LARGE Professional magic catalog 50c, and free trick. H. Seltzer, 1639 Fulton Ave., Bronx 57, N. Y.

GO Ventriloquist, all secrets told. Make money, surprise friends. Send 35c for information. Free \$1.00 catalogue of dummies, dialogues, etc. Limited supply. Gough, R. 3, Hartford City, Ind.

COMPLETELY Illustrated 500 trick magic catalog 25c. Stowell, Woodstock, New York.

LEARN Ventriloquism, easiest method. Details free. Smith, 801 Bigelow, Peoria, Ill.

3100 NOVELTIES, Jokes, tricks, gadgets, funmakers, hobbies. Big catalog 10c. Johnson-Smith, D-252, Detroit 7.

SMOKEBOMBS 25c. 7 For \$1.00. Terrific! 4463-PM Greene, Philadelphia 44.

BEST Magic, Joker's novelties. Lower prices. Catalog 10c. Top Hat, Evanston 12, Ill.

DOLLAR Magic set free with catalog 25c. 4462-PM Germantown, Philadelphia.

FREE Trick and professional catalog of 600 tricks, \$1.00. Terry's Magic Studio, 1921-66th Street, Brooklyn 4, New York.

SENSATIONAL Magician's wand 25c. Vanishes handkerchief! Catalog included. Box 1332-PM, Philadelphia 5.

500 TRICKS, Douglas famous catalog, 10c. Fastest magic service for 30 years. Douglas Magician, Dept. 1, Dallas, Texas.

PROFESSIONAL Catalog, 175 pages, 25c. Williams, 900 Plymouth, Ellwood City, Penna.

WOODEN Nickels, Magic catalog, free trick, 10c. Fun'n Magic, Box 1375, San Antonio, Texas.

SVENGALI Trick deck free with catalog 50c. 1746-PM Market, Philadelphia 3.

3 PARTY Fun gag handkerchiefs \$1.50. Send now to Steck's, 220 Center St., Cedarburg, Wis.

VENTRILLO, Professional voice-throwing instrument and catalog 25c. Box 971-PM, Philadelphia 5.

BE A magician! Large professional catalog of latest tricks, 35c. Ireland, C-109 North Dearborn, Chicago 2, Illinois.

COINS, TOKENS, CURRENCY

OLD Money wanted. Will pay \$100.00 for 1894 dime, S. mint, \$50.00 for 1913 Liberty Head nickel (not buffalo). Big premiums paid for all rare coins. Send 4c for large coin folder. May mean much profit to you. Numismatic Co., Dept. 20, Fort Worth, Texas.

COIN Collector's greatest magazine, huge illustrations. Sample 10c. Lawrences, Anamosa, Iowa.

\$3,000.00 FOR 1913 Liberty head nickel. Dimes 1894-S, 1895-O, 1916-D. Quarters 1827, 1896-S, 1901-S, 1913-S, 1923-S. we pay \$5.00 to \$1,500.00. Certain dates—Lincoln cents, \$60.00. Indianheads, \$60.00. Large cents, \$500.00. Eagle cents, \$200.00. 2c pieces, \$45.00. 3c pieces, \$60.00. Half-dimes, \$500.00. Shield nickels, \$100.00. Old dimes, \$300.00. 1875 Canadian quarter, \$50.00. Hundreds of others worth \$5.00-\$50.00. Wanted—Half dollars, dollars, gold coins, paper money, etc. Know their true value. Our large illustrated guarantee buying-selling catalogue, giving complete all coin information—Send \$1.00. Purchase catalogue before sending coins. Catalogue money refundable. Worthycoin Corporation, Leaders Numismatic Quotations, K-112-C, Boston 8, Massachusetts.

INTERNATIONAL Collection \$1.00 Confederate thousand dollar bill; ten coins; ten stamps; ten match book covers: Mostly new, mostly foreign; all different. Payne's Coin Shop, 803 Catalina, Alamo-gordo, New Mexico.

GET Profit and pleasure in collecting old coins. Send 10c for 56-page illustrated coin catalog. You'll be delighted with it. Send for it now. B. Max Mehl, 370 Mehl Building, Fort Worth, Texas. Largest rare coin establishment in U.S. Established 56 years.

6-IN-1 Special: Magnifying glass; check list; 25 coin envelopes; giant 60 page bargain catalog; ten different Indian pennies; Mexican ten-peso; All six, \$1.00 postpaid. Ben's Coin Shop, 31 North Clark, Chicago 2, Illinois.

U. S. Large cent, 2c piece and bargain list, only \$1. Delmaco, Box 1123, Wilmington, Del.

FREE! Foreign coin, banknote and coin collectors illustrated catalog to approval service applicants. Send 3c postage. Tatham Coinco, Springfield 30, Mass.

MORGAN Dollars; 1878, 1887, 1890, 1891, 1897 S mint unc. \$2.00 ea. Illustrated catalogue, 25c. Shultz, Salt Lake 10, Utah.

SAN Francisco mint closed! Made only cents and dimes in 1955. In short supply and great demand. One each, brilliant uncirculated, for 25c. Free coin lists with order. Bryson Stamp & Coin Company, 612 White, Toledo 5, Ohio.

FIVE Page bargain list. Five Indian-head cents, 25c. Economy Sales, Box 227, Mansfield, Mass.

HAVE You ever seen a United States proof coin? It has a brilliant, mirror-like surface and very sharp features. Made especially for coin collectors; never found in your change. Send \$1.00 now for a 1955 U.S. proof coin. L. Saffil, 211 Albion, Denver 20, Colorado.

LARGEST Coin magazine (160 pages) 35c. Scrapbook, 7320-J Milwaukee, Chicago 31.

GENUINE Silver dollar, banded with nickel silver, made up as key chain \$2.50. Necklace or bracelet, \$3.25 (including dollar, tax and postage). Reno Sales Co., 134 N. Sierra, Reno, Nev.

40 DIFFERENT Selected coins, \$1.00. Oddehon, Box 482, St. Louis, Mo.

COMMEMORATIVE Half dollar uncirculated \$1.00. Bargain lists free. Sayers, 1000 East Unaka, Johnson City, Tennessee.

SENSATIONAL 16 Page illustrated U.S. coin list, 10c. Stoney, 192 Washington, Boston 8, Mass.

1955 SAN Francisco coins are advancing in price. Per roll; cents, \$1.90; dimes, \$7.25. 100 different foreign coins, \$4.50. Oliver James, Box 299, San Francisco 1, Calif.

FOREIGN Coins, 10 diff., 25c. Foreign bills, 20 diff., 25c. Indian cents 10 diff., 50c. Lists. Oliver Arnold, Macon, Mo.

STAMP COLLECTING

QUARTER Brings 100 worldwide, Monaco triangles, bargain list. Iselle, 811 Sherman Place, Utica 4, New York.

100 DIFFERENT Stamps free with approvals. Martinsen, Box 115, New York 33, N. Y.

100 DIFFERENT Worldwide 10c; 500, 75c; 1000, \$1.75; 5000, \$13.75. Price list free. Philatelic House, Rockville Centre, N. Y.

ECONOMICAL 1/2c, 1c, 2c. Approvals, 22,000 varieties available. Dresel, Box 270-N, New York City 25.

100 JAPAN 10c. With approvals. Gould's Stamps, Box 631, San Francisco 1.

100 YEAR Old United States stamps are sent on approval together with all commemoratives, airmails, etc. Also all foreign, Roosevelts, etc. Send 10c for 50 different U. S. and approvals. Globus Stamp Co., 268-4th Ave., New York 10, N. Y., Dept. 213.

50 DIFFERENT Bulgaria 10c! Approvals. Ensign Stamp Company, Dept. M, Berdan Avenue, Paterson 2, New Jersey.

FREE! World's 10 ugliest! Weird colors, valuable cut design. Send 3c postage today! Norrisco, Milwaukee 7, Wis.

FIRST Complete German airmail set, 10 cents. Approvals. Boger, P.O. Box 152, North Wales, Penna.

FREE U.S. stamps, 1943 occupied nations flag, airmails, commemoratives included, collection of 25 different U.S., plus \$5.00 stamp. Everything for 10c mailing charge. Approvals. Willett Stamps, 141-A, E. Main St., Mount Kisco, N. Y.

OLYMPIC Set, 1000 hinges only 10c. Approvals, Buckley, 208 Ludlow Bldg., Dayton 2, Ohio.

FAMOUS Americans! 10 American beauties 10c. 7 other commemoratives included. Approvals. White, 516-A Avenue L, Brooklyn 30, New York.

12,000 PENNY Approvals waiting for you. Many from exotic countries, pictorials, airmails, new issues, Tilbury, Box 862, Newark 1, N. J.

STAMP Collecting outfit, includes packet worldwide stamps, package hinges, watermark detector, millimeter gauge. Everything, 10c with approvals. Lorain Brown, Marion 1, Michigan.

100 CHINA 10c. Approvals, gifts. Coast, P.O. 2137H, Santa Ana, California.

SELL Your surplus good grade stamps. Write, describing fully what you have. Vanroy Shirk, Lebanon, Pennsylvania.

FREE! Surprise packet with approvals. Pioneer, Box 414M, Pasadena, California.

GIANT Approvals, thousands different, 1c and 2c each. Wahl's Stamp Exchange, 7008P Farragut, Chicago 31, Ill.

30 DIFFERENT Commemoratives, 1893 up. 10c. U. S. approvals. K. & B., Box 5, Brooklyn 14, N. Y.

U.S. Mint 797 SPA sheet, 10c to U.S. approval applicants. M. Haycock, 153M 74th St., Brooklyn 9, N. Y.

FREE! Catalog! About stamps. Illustrated. Free! The Stampmart, Hartford 1, Connecticut.

WONDERFUL Offer. 7 complete mint sets only 10c with approvals. Reich (M26), 1033 Lawrence, Chicago 40.

FREE U.S. Illustrated bargain catalogue. Rothberg's, Box 60, Boston 1, Mass.

1000 DIFFERENT 95c. John Hourigan, 1500 Archer Road, New York 62, New York.

FREE United States price list. Mark Hanna, 335 Fifth Ave., Pittsburgh 22, Penna.

50 DIFFERENT Argentine 10c. Approvals. Reuter, 611 W. 40th Pl., Los Angeles 37.

100 DIFFERENT Spain 25c. Penny approvals included. Reed, Box 980, Chicago 90, Ill.

OLD Scarce U.S. seconds on approvals. Slight imperfections, lowest prices. Herfield, Clintonhill Sta., Newark 8, N. J.

THOUSANDS Of exciting stamps, all different, yours for 1c, 2c each. Fill your album for pennies! Big collection sent for free examination. Cole, 43-A Rinewalt, Buffalo 21, N. Y.

50 DIFFERENT United States 5c with bargain approvals, lists. Bookman, Box 8245-M, Madeira Beach, Fla.

U. S. Classics. Over 50 yrs. old, 15 selected old-timers. Missing in biggest collections. All 15 at less than 1c each. 10c with approvals. Jaro, Box 246-T, New York City 8.

AMAZING Offer! 200 United States stamps—including commemoratives, airmails, high denominations to \$1.00. Only 10c to approval applicants! Illustrated bargain lists free. Mystic Stamp Co., Dept. 80, Camden, New York.

FREE Sample! Interesting, illustrated, informative! National Stamp News, Anderson, South Carolina.

300 DIFF. World wide 25c, plus surprise packet. Packet list free. Econopackets, Box 168, Riverside 9, Calif.

WORLD'S Largest stamp (7 1/2 x 14 inches). A real curiosity! Retail for 50c, only 3c to approval applicants. Tatham Stamp Co., Springfield 30, Mass.

WEIRD Diamond shape coffee stamp! Lovely flower triangle! First American big commemorative, Greenland, idol dancer, etc. Free with approvals. Capital Stamp Co., Little Rock 2, Ark.

100 OLD United States between 1861 and 1935, \$1.00. Roush Stamps, 51 Chestnut, Mansfield, Ohio.

TWO \$5.00 U. S. stamps plus 20 different, 10c with U. S. approvals. Irwin Stamp Co., Box 1105, Brooklyn 30, N. Y.

225 STAMPS For only 10c! This mammoth value includes airmails, pictorials; stamps from strange countries cataloging up to 25c each! Also approvals. Mystic Stamp Company, Camden 80, New York.

FAMOUS Men, jungle scenes, zoo, United States commemoratives, 100 others. Ten cents with request for thrifty approvals. Casner Stamps, 247-A Riverside, El Paso, Texas.

14,000 DIFFERENT — Yours on our streamlined systematic club plan for only 50c weekly. Big shipment every two weeks. Details free. Sjoquist, Box 217, Valley Stream 75, New York.

MINT Commemoratives at face! Send 25c for surprise packet of all different, mint U. S. commemoratives. Mint U. S. approvals too. Western, Box 1689P, Salinas, California.

UNITED States approvals. Select copies, used—mint. Kingsbury, Fairfax, Vermont.

MONACO Nudes complete 10c. Approvals. Royal Stamp Company, Tamaqua, Penna.

ECONOMY Plus! U. S., foreign approvals, 1/2c to 2c each, in books of 1,000. Our free-with-purchase bonuses catalogue \$1 up, and accompany selection. Farmer, 6919 Camrose, Los Angeles 28.

TRINIDAD. 12 Different. 10c with approvals. Seminole Stamps, Box 1138-P, Coral Gables 34, Florida.

FREE Monthly stamp newspaper. Stories, contests, cartoons, etc., and an exciting stamp error. Send 25c for handling. TV Stamp News, Box 4L, New York City 36.

FREE U. S. plate block list. Simstaco, Box 63, Mattapan 26, Mass.

30,000 DIFFERENT Stamps. Worldwide, less than 1-1/2c each. \$12.50 brings each book 1,000 as wanted. Huppert, 1970 E. 18th, Brooklyn 29, N. Y.

NEW—Needed by every stamp collector and dealer. Write Armi L. Maki Co., 8928 Portland, Detroit 17, Mich.

UNHINGED U. S. mint approvals, by catalog number. Dale Dronso, 3647A Plankinton, Cudahy, Wisconsin.

PORTO Rico, 50 different \$2.50. Acevedo, 206 West 92 St., New York 25.

FABULOUS Collection—Large U. S. commemoratives. Only 10c. Approvals. Raymax, 39-Z Malden Lane, New York City 38.

FIRST U. N. set. Among world's prettiest. Only 10c. Approvals. Welles, Box 1246-R, New York City 8.

1,000 BEAUTIFUL Mounted stamps for you to look over. Pick and choose at 1c to 5c each! Wolverine Stamps, Dept. A-25, Fruitport, Mich.

ANTIGUA, Bermuda, Cayman Islands, Ceylon, Dominica, Egypt, Fiji, Grenada, Hong Kong, Indonesia, Jamaica, Malaya, Singapore, Suriname, are in our bargain packet. Bi-colors, topicals, high values. Every continent represented. 333 different beauties. 25c with attractive approvals. Roseland Stamps, Dept. A-37, Spring Lake, Mich.

PICTORIAL Angola, Mozambique, Hungary, a beautiful assortment of stamps, 3 sets depicting wildlife in color, plus 100 attractive stamps. 10c to approval applicants. Modern Stamp Co., Dept. A-1, Ferrysburg, Mich.

77 DIFFERENT U. S. — 25c approvals. Utechts, 1143A North Keeler, Chicago 51.

PACKETS! 10c each. Free lists. Karr Ross, 2614 Elmwood, Alexandria, Virginia.

25 DIFFERENT French 5c. Rogue Stamps, 390 Liberty, Ashland, Oregon.

315 DIFFERENT 25c. Approvals. Hathaway, P.O. Box 145, Garden City, N. Y.

MIXED Sample 10c with approvals. Box 52, Croydon, Penna.

AUSTRALIA — Fifty different exciting commemoratives. Animals, kings, queens. This valuable Australian collection only 10c with approvals. Viking, Great Neck 8, N. Y.

DEALERS—Wholesale list. Postage 3c. Frank, 5031 Queensberry, Baltimore 15, Maryland.

SUPERIOR Worldwide mission mixture. Amazing variety! Half pound only \$1.50. Baye Nielsen, 4545B Harvard, Montreal 28, Canada.

555 DIFFERENT 25c Colorful Cape of Good Hope triangle commemorative; Ruanda-Urundi jungle flower set, 3 vals.; plus multi-colored Portuguese West Africa map stamp. Included in Jayne's amazing collection of 555 different stamps, all off paper. Catalog value \$15.00. Special price to bargain approval applicants 25c. Jayne, Box 44-M, Brooklyn 23, N. Y.

POSTER Stamps, seals, 20 different 15c. Two different lots 35c. Green, 555 Drayton, Ferndale 20, Michigan.

CANADA — Newfoundland collection including early issues, commemoratives, pictorials and high values. Plus set of fascinating triangle stamps. Plus set of unused British Colonies. Plus large stamp book. All four offers free. Send 10c to cover postage. Empire Stamp Corp., Dept. PM, Toronto, Canada.

SWITZERLAND Prize package, 100 different—Trains, bridges, castles, commemoratives, bi-colors, pictorials. Unusual cancellations too! Only 25c with approvals. Edmund Molzan, 720 Pomona, El Cerrito 8, Calif.

WINTER Olympics 1956, San Marino bi-colored. Skier, skaters, bobsleds (ten); given approval customers. William Deem, Ravenswood, West Virginia.

11 MALAY, 10c. Free lists. Pinkerton, Box 81-PM, Bethlehem, Penna.

90 YEARS Old, famous Americans, flags, commemoratives, 25 stamps reg. \$1.00 value only 10c to new applicants for U. S. approvals. Metropolitan Stamps, Box 312K, Jackson Heights, N. Y.

GIANT Stamp zoo free! Snakes, leopards, rhinoceros, zebu, koalabear and other fierce jungle beasts. Approvals. Send 10c for handling. Free stamp magazine. Lincoln Stamp Co., St. Catharines 518, Ontario.

UNITED States stamps! Coins! Discounts! Unistate, 730-F North Lexington, St. Paul 4, Minn.

200 DIFFERENT, Including Macau, Rhodesia, Caymans, 10c to approval applicants. Evden, Box 128, Valley Stream 50, New York.

45 DIFFERENT United States 10c to approval applicants. Standard, 10846 Woodview, Parma Hts. 30, Ohio.

LOOK! Stamp togs, watermark detector, perforation gauge, hinges, 200 stamps only 15c with approvals. Montalto, New Church, Virginia.

OLD United States, 25 different before 1933, 10c. Approvals. Ladue Stamp Co., #2 Emerson Court, Creve Coeur, Mo.

AMERICAS, British, many countries 10c Accumulation \$1. Brist, Canton Center, Conn.

GAMBLER Collection 25c. No approvals! Merkel Stamps, 45 Cherry, Holyoke, Mass.

FREE! Giant catalog offering thousands of bargains. Sent with beautiful approvals. Jamestown Stamp Co., Dept. E3PMC, Jamestown, N. Y.

100 DIFFERENT British colonies or South America \$2.00. Catalog value \$7.50. Approvals on request. Universal Stamp Co., 5601 Klump, No. Hollywood, Calif.

WOW! 135 All different Germany 10c. Zeppelins, semi-postals, airmails, high values. Big bargain lists and approvals included. Jamestown Stamp, Dept. A3PMC, Jamestown, N. Y.

100 BRITISH Colonies 10c. Approvals. Neal, 5950 Tower, Riverside, Calif.

CANADA, Queens, wildlife, commemoratives, 9 var. 10c with attractive approvals. Rheau, 6591 11th Ave., Montreal 36, Canada.

100 DIFFERENT Austria 10c. Aronson, 91 Marion, Brookline 46, Mass.

1956 REFERENCE Catalog 25c deductible. Gernert, 4235-X Alton, Louisville 7, Kentucky.

500 AROUND The world mixture, 25c. Monjar, Fairmount, Cincinnati 14, Ohio.

SIX Mint Queen Elizabeth colonial sets—21 bicolors, 25c! Approvals. Gannon Stamps, Box 931, Canton 1, Ohio.

FREE—Scarce Diego Suarez! Tru-val-u approvals. Brunning, Donaldson St., Rutherford, N. J.

GERMAN Airmails, 20 different, 25c with approvals. Excello, Box 489, Red Bank, New Jersey.

SEVEN Mint sets 25c. Bargain approvals. Square Deal Teal, 663 Beach, Rochester 12, New York.

FREE U. S. mint. Used. Price list. Fred Ohl, Saugerties, New York.

U. S. Revenues on approval. El Jay Stamps, Box 286, New York 36, New York.

FREE! Flower triangles, others. Approvals. Delton Page, Box 201X, East Paterson, New Jersey.

CATALOG Disregarded: Giant approvals. Easy to fill sets, spaces. No stamp over 2c. Ask for Big Fellow. Frazer, 1093 "D" Street, Springfield, Oregon.

99 COLORFUL Latin American stamps, 10c. approvals included. Fred Pittsley, So. Montgomery, Napa, Calif.

500 FINE Mixed U. S. 15c. Wright, 201 Mealey, Hagerstown, Maryland.

1000 CANADA Bank package. Variety unlimited! Only \$1.00 cash. Ashton, 463 Radford, Winnipeg 4, Canada.

CORONATIONS, Triangles, animals, sports! Free with approvals. Exotic, Box 482-M, Coral Gables 34, Florida.

HUNDREDS Of free commemoratives and bi-colored stamps to buyers from our 1/2c, 1c and 2c approvals. Orana, Box 1775, Santa Ana, Calif.

SENSATIONAL U. S. 72 page catalogue free. Stone's, 192 Washington, Boston 8, Massachusetts.

HIGHEST Canadian mixture, 10 oz., postpaid \$1.00. Patro, 11 Simard, Quebec 6, Canada.

FREE Valuable premiums, triangles, pictorials, bi-colored, others with approvals. Nevil Otis, San Andreas, Calif.

MOZAMBIQUE Company set free. Approvals. Weitz, Box 83F, Orange, N. J.

CIPEX Souvenir sheet plus 25 different U. S., 10c. Approvals (used U. S.) accompany. Village Stamps, 90-39P 214 St., Queens Village 28, N. Y.

COLORFUL Pictorial assortment free with approvals. Variety Stamps, 57-M Circuit, Newton Highlands 61, Mass.

FREE United States illustrated catalog. Bailey, 44 Bromfield, Boston, Mass.

CZARIST Russia, 25 different mint, 10c with approvals. Excello, Box 489, Red Bank, New Jersey.

36 DIFF. U. S. commemoratives with 2c Yorktown, 10c. approvals. Hudson's, Box 4015, Fresno 4, Calif.

KOREAN Set free. Approvals. W. B. Stamp Co., Wilkes-Barre, Penna.

U. S. Price list free. Send 3c postage. Sale, Box 128, Highland Springs, Va.

66 DIFFERENT United States, 15c. Includes 19th century, commemoratives, dues, airm. 2 dollar values, etc. U. S. bargain approvals, 1c up, accompany. ESCO, Port Jervis, N. Y.

SPECIAL! U. S. mint flag set, #909-21, \$1.00. Free price list. Brooks, 2352B East 23rd Street, Brooklyn 29, New York.

FREE—Your choice of \$2.00 to \$10.00 from our sensational approvals every time you buy an equal amount. Bargain Stamp Service, Redlands, California.

ROMANTIC Spain! 100 different 10c including airmails, pictorials. Attractive approvals. Darling's, Ridgway 3, Penna.

PHILIPPINES: Japanese Occupation, 30 diff. \$1.00; 40 diff. \$2.00. Woolslair, 645-30th, Hermosa Beach, Calif.

OLD Stamps wanted. I will pay \$100.00 each for 1924 1c green Franklin stamps, rotary perforated eleven (up to \$1,000.00 each unused). Send 10c for large illustrated folders showing amazing prices paid for old stamps and coins. Scheuermann, (PM-63), 50 Berkshire, Rockville Centre, New York.

50 DIFFERENT A-Z countries 5c. Abyssinia-Zanzibar. To approval applicants. Avalon Stamp Co., Dept. M, Springfield, Mass.

WANTED—Stamp collections, accumulations. Murray Gold, 62-95p Saunders, Rego Park 74, N. Y.

SURPRISE Bundle! Stamp album, gifts, money-making offers, 10c. to serious approval applicants. Adventure, Buckland, Connecticut.

NEW U. S. regular series (13) 35c. Approvals. Gatewood, Box 346, Winston-Salem, N. C.

WILL Send you 20,000 collection, 1/2c to 3c. Many free. Cut Rate, Blue Springs 8, Missouri.

ASTONISHING Gift—35 U.S. with superior approvals. Sparta, Box 1082, Rochester 3, N. Y.

513 DIFFERENT Worldwide from Cunha, Sudan, Libya, etc., cataloging over \$10 only 35c. Approvals. Littleton Stamp Co., Littleton, Q1, N. H.

FREE Turkish pictorials, request approvals. Eagle, 6916 Roosevelt, Philadelphia 49, Penna.

BEAUTIFUL Multi-colored Indonesia set 10c with approvals. World, P.O. Box 815, San Francisco.

UNITED States stamp collection on approval. Enclose 10c fee. Peterson, Box 31, St. Paul 2, Minn.

ANTIQUES, RELICS, INDIAN GOODS, CURIOS

4 SELECTED Arrowheads \$1.00. List 5c. H. Taubert, Calico Rock, Ark.

SELLING 50,000 Indian relics. List free. Lear's, Glenwood, Arkansas.

3 EXTRA Fine war arrowheads \$1.00. Thunderbird \$2.00. Arrowhead, Box 1249, Hot Springs, Arkansas.

4 ARROWHEADS \$1.00, Axe \$2.50. Smith, 841 Tacoma, Indianapolis, Indiana.

GESUNDHEIT! Illinois. Selling 580 historical firearms, 30,000 prehistoric, stoneage Indian relics, collectors cartridges, Confederate money, coins, Revolutionary, Civil, Indian wars flintlocks, muskatoons, swords, bayonets, bullet molds, powder flasks, blunderbusses, pepperboxes, Kentucky rifles, Winchesters, buffalo-stagecoach carbines, frontiers, Derringers, duelling pistols, matchlocks, arrowheads, tomahawks, bannerstones, gempoints, spearheads, steer, deer, buffalo horns, mounted pheasants, owls, quail, squirrels, deerheads, Agates, fossils, mineral specimens, lapidary supplies, Daguerrotypes, gold dollars, bo-wood, bio-horns, violin wood. Send 35c for profusely illustrated catalog. Heikerson, Wenona, Illinois.

PRECIOUS STONES, MINERALS

GEMSTONES, Mineral specimens. Every variety. Lowest prices. Free booklet. Plummer's 4720 Point Loma Ave., San Diego 7 Calif.

SAPPHIRE, Topaz, tourmaline, garnet, peridot. Five uncut gem specimens, \$1.00. Ten polished gems, baroque shaped, \$1.00. Free big bargain list jewelry, gems, profitable, easy "do it yourself" projects. O'Brien's, 1116M Wilcox, Hollywood 38, Calif.

GEMCUTTING—Silvercraft illustrated magazine. Tells how to cut gems, make jewelry. 150 ads illustrating equipment, gems for collectors, cutters. Free literature. Lapidary Journal, Del Mar 2, Calif.

400,000,000 YEAR Ordovician fossils. Five classified \$1.00. Don MacKenzie, Northfield, Minn.

EARTH Science, the Rockhounds' national magazine. Subscription \$2.00, sample 25c. Box 1357, Chicago 90.

HOBBIES AND COLLECTIONS

KLONDIKE Novelty jewelry findings assorted, beads, pearls, jewels, 5 lb. lots \$7.50; sample \$2.00 lb. Merchandise, 19-A 16th St., New York City 3.

GENUINE Nazi medal \$1.00; 37 different American emblems \$1.00. Catalog 10c. Insignia Club, 550-B Fifth Avenue, New York.

65 ASSORTED Army patches, insignias, ribbons \$1. Surprise included. Lhgco, 19 East 16th St., New York City 3.

INVENTING Can be an interesting and profitable hobby. Write for complete particulars. Institute of American Inventors, Dept. 40-E 631-E St., N.W. Washington 4, D. C.

GROW Giant crystals! Free booklet. Crystocraft, Box 35, College Station, Texas.

NAZI Insignia, 12 different, \$1.00. Medals, armbands, flags, daggers. Illustrated lists. Medcrafts, 1923 34th St. S.W., Calgary 2, Canada.

UNUSUAL Hobby: Authentic army patches, insignias, ribbons, enameled crests, navy rates, 50 assorted for \$1.00. Rex Military, Dept. B, 1261 Broadway, New York City.

DECLARATION Of Independence, \$1.00. Howard Sawyer, 5813 Benton Hgts., Baltimore 6, Maryland.

FREE Three months' subscription Leathercraft News, write Tandy Leather Co., Box 791-F21, Fort Worth, Texas.

FREE! Leather-needlecraft catalogs. Do it yourself. Tandy Leather, Box 397AH, Tulsa, Okla.

MATCHBOOKS For collectors. Catalog 25c. Charles Edelman, 1311-C East 84, Cleveland 3, Ohio.

EXCITING New book, "How to Collect Stamps, Coins, Paper Money." Packed with amazing facts; information worth dollars. Fully illustrated, 160 pages. 75c. Popular Mechanics Press, 200-ST E. Ontario St., Chicago 11, Ill.

CAMERAS, PHOTO SUPPLIES

BASS Says: Quality cameras since 1910. When in Chicago visit the camera cross roads of the world, or write us for your favorite equipment, new or used. Satisfaction guaranteed. Bass Camera Co., Dept. AG, 179 W. Madison St., Chicago 2, Ill.

20 TO 50% Discount everything photographic, giftware. Free catalogue. Dart, 3812E Atlantic Avenue, Brooklyn 24, N. Y.

PHOTOGRAPHY For pleasure or profit. Learn at home. Practical basic training. Long established school. Free booklet. American School of Photography, 835 Diversey Parkway, Dept. 3441, Chicago 14.

FREE Flash cameras. Given away in our get acquainted campaign. Write today. Deico Film Lab, Box 362 T, Upper Darby, Penna.

BUY Wholesale nationally advertised cameras, photo supplies, thousands other products at big discount. Free "Wholesale Plan." American Buyers, Hertel Station, Buffalo 16-E, N. Y.

\$50.00 DAILY Profits. Learn candid wedding photography. Most complete course offered. Promotion, church etiquette, technical, posing, proof-passing, etc., complete \$20.00. Calco, Box 868, Beverly Hills, Calif.

CAMERA Repairmen greatly needed! You can learn manufacturers' service methods at home, in your spare time! Free, big illustrated book tells how: Write today. National Camera Repair School, Dept. PM6, Englewood, Colorado.

BUY Your new camera at European price. \$1. shows you how. Justin Hartley, Authorized Agent, Colchester 18, Conn.

ATTENTION 35MM. camera owners. Can you use several hundred dollars? See Polypix ad in "Moneymaking Opportunities."

NEW Invention projects, life-size, full color pictures with any flashlite. Lowlic, 4145 Broadway, Chicago 13, Ill.

FILM Special. Send \$1 for 3 fresh 620-120-127. Includes developing. Discount. Photo Lab, Box 56, Atlantic City, N. J.

PHOTO FINISHING

TOP Quality. Fast service. 8 jumbos 35c. 16 contacts 40c. Reprints—Jumbos 4c; contacts 3c. Satisfaction guaranteed. Free mailers, circulars. Fast-X-Photo, Box A, Jersey City, New Jersey.

8-HOUR Service on deluxe jumbo prints. 8-exposure roll developed and 8 jumbo prints 40c, 12 exposure 55c, 16 exposure 70c; 35mm. 20 exposure 75c, 36 exposure \$1.25. Jumbo deckledge reprints 4c each. Contact prints made if specified. Bay Photo Service, P.O. Box 210, Oakland, California.

FREE Superpak album with 8 jumbos only 35c. 12—50c. Prompt superior service. Quality guaranteed. Mailers and circulars free. Grand Fotos, GPOB 1410, New York City 1.

6 OR 8 Picture roll 35c. 12 or 16 picture roll 55c. Each roll developed and printed in handy pocket wallet. Send coin with roll. No c.o.d.'s. Mailing containers sent free. DeLux Film Service, Box 1268-A, Shreveport, Louisiana.

FROM Rolls or negatives. Jumbos 4c. Regulars 3c. This ad and \$1.00 for 30 jumbos or 8—5x7. Guaranteed. Square Deal Photos, Hutchinson, Kansas.

ENLARGEMENTS! Eight 5x7's or five 8x10's, \$1.00. Wilart Enlargers, Box 967, Little Rock, Ark.

8-12 EXPOSURE Rolls 39c, jumbo prints. Free 5x7 enlargement with each roll developed. Guaranteed work, one day service. Lincoln Studios, Dept. K, Box 13, Lincoln, Nebraska.

FREE 5x7 Enlargement of your favorite negative with 8 oversize album prints 35c, 12, 50c. Write for free mailer. Red Robin Studios, Box 573-B, Clifton Heights, Penna.

DELCO'S March special—Free! 5 reprints of one favorite negative if sent with roll for oversize album prints. 8 for 49c, 12, 59c, 20, \$1. Past first class return free. Write for color prices. Deico Film Lab, Box 362 S, Upper Darby, Penna.

SURPRISE Gift with first roll developed. 8 jumbo superpak album prints or 16 contact prints 40c. 12 exposure roll 50c. Certificate for 3 5x7 enlargements. Dept. B-21, Owl Photo Co., Weatherford, Okla.

ENLARGEMENTS: 5x7, 20c; 8x10, 40c. Koken Enlarging Service, Superior, Neb.

ENLARGEMENTS, Heavyweight, eight 5x7's or five 8x10's \$1.00. Jack Koons, Huntington Mills, Luzerne County, Penna.

SPECIAL Introductory offer. 8 jumbos 25c, 12—35c. Western Photo, PM38, Box 295, San Francisco 1, Calif.

MOTION PICTURES AND SOUND EQUIPMENT

TAPE Recorders, tapes, accessories. Un-usual values. Dressner, Box 66M, Peter Sturvesant Station, New York City 9.

MOVIE Camera film: 8mm. roll \$1.50, 16mm. 100' \$3.00. Free processing. Better Films, 742 New Lots, Brooklyn, N. Y.

SAVE 50%! Guaranteed-fresh color, b.&w. movie film! 8mm., 16mm. Free catalog! Eso-R, 47th Holly, Kansas City 12, Missouri.

8-16MM. Free catalogue (with sample film 10c). Garden, 690 Howard Ave., Brooklyn, N. Y.

TAPE Recorders, tapes; wholesale prices. Carstan, 215 E. 88, New York City 28.

16 MM. Sound-used projectors and films. Rental, sale, exchange, bargain prices. Free lists. National Cinema, 71 Day Street, New York City.

5,000 8-16MM. Movie films. Free catalogues. International, Greenvale, N. Y.

MOVIES Equipment. All sizes. Bought, sold, exchanged, rented. Catalogue dime. Reed, 1797 Seaman Neck, Seaford, N. Y.

ALL Kinds 16mm sound films. Rent, sale. Roshon, 335 Fifth, Pittsburgh 22, Penna.

FREE! Blackhawk's big sale catalog new and used 16mm., 8mm. films; 2"x2" color slides; used 16mm. sound projectors. Biggest stock in U.S.A. Blackhawk Films, 1200 Eastin, Davenport, Iowa.

16-35MM. Silent, sound bargains, exchanges. Variety Film, Box 207, Placerville, California.

EARN Money daily with your movie projector! Write: Metcalf, 10806 Glenroy, Chicago 43.

"ENTIRE Life of Christ." 8 mm. silent in color. 8 reels, 1600 feet, special price \$150.00 on order only. Hemenway Film Co., 424 Little Building, Boston 16, Mass.

MUSIC AND MUSICAL INSTRUMENTS

POPULAR Songs. How to write and sell them. Write for free booklet Successful Songwriting. Gateway Songs, Box 2470, Hollywood 28, Calif.

PLAY Piano the first day! Copyrighted secret. Details free. Miracle Method, Box 5203P, Phoenix, Arizona.

WHOLESALE Catalog! 30-80% discounts! Appliances musical instruments, typewriters, phonographs, watches, jewelry, recorders, housewares, etc. Consolidated Distributors, 21-80 Lafayette, Paterson, New Jersey.

SONGWRITERS! Send poems, songs. Music Service, 243 West 72nd St., PM, New York City 23.

FREE Records of your song. Your words, my melody. Free information. Johnny Mack's Melody Mart, 1094 West 39th Street, Dept. A, Los Angeles 37.

ACCORDIONS, Wholesale to everyone. Save up to 60%. All national known brands. Free catalogue. Del Principe, 29 South Cicero, Chicago 44.

POEMS Wanted for new songs. Send poems. Immediate consideration. Crown Music Company, 1476 Broadway, New York City 36.

WANTED! Poems for musical settings. Write Songwriters' Service, Clifton, N. J.

WRITE Songs. Big money and reputation. Write for information. J. Gordon Pub. Co., 4700 South California Avenue, Chicago.

VIOLINMAKERS. Repairers. Fine tone wood, and all violin supplies. Send for free wholesale price list. International Sales, 414-Mr M E. Baltimore St., Baltimore 2, Maryland.

SONGPOEMS And lyrics wanted. Mail to: TinPan Alley, Inc., 1650 Broadway, New York 19, N. Y.

SONGS — Poems wanted. Good opportunity. Lunessmiths, 1609 Vista Del Mar, Dept. U, Hollywood, Calif.

POEMS Wanted for musical setting. Send poems. Free examination. Five Star Music Masters, 630 Beacon Bldg., Boston, Mass.

1956 ACCORDIONS — Wholesale. Free catalog. American Accordion Center, PM-3, 5329 Belmont, Chicago.

ORGAN? Piano? Choir problems? Consult Griscom, Berkshire V, Sandy Hook, Conn.

POEMS Needed for new songs. Send poems for free examination, details. Immediate consideration. Songcrafters, 2724 Arcade Station, Nashville, Tenn.

POEMS Wanted to be set to music. Free examination. Send poems. McNeil, Master of Music, 510-PM S. Alexandria, Los Angeles, California.

ACCORDIONS — Direct from importer. Save 50% and more! Free trial. Lifetime guarantee. Trades accepted. Free catalog. Write Accordion Outlet, Dept. 36-R, 2003 Chicago, Chicago 22, Ill.

MUSIC Sheets, manuscripts photocopied. 50c (3 for \$1.00). Oakwood, Philadelphia 26.

SONGWRITERS: Recording company wants new songs. Royalty basis. National sales, promotion if selected. Send material. Music Makers, Dept. E-19, Box 2507, Hollywood, Calif.

ACCORDION Repair guide. Illustrated, indexed, explains reed making, bellows, bass mechanism, tools. Worth hundred times the price. Send \$3. Alfred Fischer, Box 402, Bellingham, Washington.

ACCORDIONS, Helikons, alpenorgels, harmonicas, recorder flutes, all other instruments direct from—Music Weiss, 7028 Normal, Chicago 21. Literature free.

SONGWRITERS: Discouraged? Can't sell songs? Yes you can! Booklet "A" free. Tele-Music Company, 152 Barrett, Schenectady, New York.

SONGWRITERS. Learn true facts! Get real results! Revealing information free. Noennig, 1149 St. Jean, Florissant, Mo.

POEMS. Songs wanted! Free examination. Bengol, 93 Jefferson, Chelsea 50, Massachusetts.

SWISS Musical movements, \$1.90. Helax, 218 West 72nd Street, New York 23.

SONGS Into dollars. Share \$29 million dollars yearly for new songwriters, poets. Songs composed, published, promoted by largest firm. Information, appraisal free. Send to Nordyke Publishing Co., 6000 Sunset Blvd., Hollywood 28PM, California.

SWISS Musical movements, all types, 50c up. Lutts, 705 Plaza PM, Ontario, Calif.

RADIO, TELEVISION AND ELECTRONICS

MAKE Simple, tubeless, batteryless, distance-getting radio. Genuine Melomite crystal, detector, illustrated instructions. 50c postpaid. Allen, 427-PM5, Clinton, Missouri.

TV Trade-in sets. Philco, Emerson, G.E., Admiral, Motorola, Tele-King, others. List available. 10"—\$17, 12"—\$20 up. Washtek Service Co., 956 Southern Blvd., Bronx, N. Y.

CRYSTAL Radio builders. Free information. Hulet, 305 Hope, Lakewood, N. J.

INVISIBLE TV antenna lays flat under rug. Not a midget gimmick but a full performance design that really works. Guaranteed. Only \$2.95 postpaid. Omni Electronics, Dept. 15, 911 W. 53rd, Chicago 9, Ill.

BUILD Radios, phono and hi-fi amplifiers. Plans \$1.00 each. Wolin's, Amazon Road, Peekskill, N. Y.

ILLUSTRATED Radio radio plans, \$1.00. Cook, 4003-M Roosevelt, Midland, Texas.

FREE Television and radio troubleshooting manuals and descriptive literature upon request. Build 16 radio circuits, using printed circuitry as well as professional punched metal chassis. "Edu-Kit" includes all radio parts, tubes, instructions, tester, soldering iron, quizzes, free consultation service—Only \$19.95 complete. Progressive Edu-Kits Inc., Room 43B, 497 Union Ave., Brooklyn 11, N. Y.

RECORDERS. Tapes. Sensational discounts! Free catalog. Towers, Box 155, Philadelphia 5.

SURPLUS Walkie-Talkies, radar, short-wave, parts. Fantastic prices. List 5c. Messina, 580 Lynn, Malden 28, Mass.

FAMOUS Make TV trade-in sets. 10", \$16.95; 12", 17", \$19.95 up. Complete listing. Electronic World, 237-PM Sunrise Highway, Rockville Center, L. I., N. Y.

SPEAKER Reconfig. McDonald's, 506 Ward, Benton, Illinois. Prices upon request.

AMAZING Crystal diode pocket radio kit, complete with earphone, \$5.95. Rotac Company, Salmon Falls, New Hampshire.

ANNOYING TV commercials eradicated with Cut-Off. Send \$3.95 check or money order. State color. C. V. Signorello, 155 Norwood Ave., Lodi, N. J.

FREE. New 1956 bargain filled bulletin. Includes 40 \$1.00 kits, meters, tubes, timers, microscopes, gadgets. Lektron Specialties, 131A Everett Avenue, Chelsea, Mass.

TRANSISTOR Pocket radio operates two months on single 10c penlite battery. Complete kit \$5.95. Transimite, Manteo, North Carolina.

BUSINESS OPPORTUNITIES

OPERATE Profitable mail business. "Money Getter's Bulletin" teaches how. Sample 25c. Hardy, Box 546, Cantonment, Florida.

DOLLARS: Baby record books, Kitty Kat shoes, My Baby's Album, eleven thousand new prospects daily, sold by mail, use our literature. No-Co-Ro, Capitola 6, Calif.

BUY Wholesale—Auto accessories, etc. Catalog 25c. Worldwide, 12-E3, New York City 60.

ADVERTISING Book matches—Cash in on big demand; sell union label matches. Cuts for all businesses and political parties. Free powerhouse selling kit, low prices, protection guaranteed on repeat orders. Cash commissions. Superior Match Co., Dept. MX-356, 7530 Greenwood, Chicago.

MEN Or women wanted to own and operate small drive-ins. Write Restaurant School, Dept. BU13, Fremont, Ohio.

INTERESTED Mail order? Read mail trade magazines. Copies several different 25c. Palm, Box 1221, Baton Rouge, La.

IMPORT Without capital. Details free. Georgia Overseas Trading Co., Dept. W, 714 Persons Bldg., Macon, Ga.

2000 SIGN Slogans and clock sign \$1.00. Make money with hobbies, book \$1.00. ABC, 2227P So. Park, Buffalo 20, N. Y.

TRADE. Business magazines help you get ahead. Late copies through our get acquainted service. 5,166 publications, all fields. Current list free. Commercial Engraving Publishing Company, 34C North Ritter, Indianapolis 19, Indiana.

LIKE To receive lots of cash in your mailbox? Sell by mail the right way! Write, Shafer, 130-M Linden St., So. Williamsport, Penna.

WANTED! Home workers to assemble luggage and cases for ready market. Instructions, materials, tools, everything supplied. Free details. Abarsl, 807-BC Sunset, Los Angeles 12.

START A buying service, buy wholesale thousands nationally advertised products. Make big profits selling at sizable discounts. Postcard brings details. American Buyers, Hertel Station, Buffalo 16-C, New York.

REWEAVE Damaged garments yourself! Harris Reweavers, Box 7112, New Orleans 19, La.

WHOLESALE Catalogue! Appliances, cameras, watches! Cam Company, 6806PM 20th Ave., Brooklyn 4, N. Y.

FREE! Complete mailorder business! Terrific profits! No investment! Vita-Mins, 2908PM Beverly, Los Angeles 57.

COLOR Concrete with chemicals. Marble-glaze cement benches, pottery, Home-shop. Hundred beautiful designs, made without molds. Birdbaths to waterfalls. Your chance for fame, fortune. 10c brings sample, pictures. Hollywood Cementcraft, 8527-R Wonderland, Hollywood 46, Calif.

DOLLARS Every day! Start amazing new mail order business. Complete details free. MCB, 405-R Gorham Bldg., Minneapolis 3, Minn.

MINIATURE Trees. Why pay \$2.00-\$10.00 for growing secrets? Free details. Tiny Trees, Box 3084-P, Chicago 54.

MAKE Flexible molds. Cast figurines, plaques. Free sample. Tooker, 630-R Chestnut, Hamilton, Ohio.

DOLLARS—In baby record books, Baby Gay shoe kits. Agents or mail order. Liebig Industries, Beaver Dam 5, Wis.

HOW And where to obtain capital. Particulars free. Star Service, Wapakoneta, Ohio.

PUT Success in your mailorder business. Write Carlstrom, Box 1293-M, Miami 8, Fla.

BUY Wholesale thousands nationally advertised products at big discounts. Over 3,000 suppliers. Free wholesale plan. Associated Wholesalers, 1016-D Starr, Burlington, Iowa.

EARN \$10,000 Yearly raising Angora rabbit wool for us. Information 25c coin. American Angora Company, Malta 12, Montana.

"MAILORDER Laws and Regulations." Discusses federal, state, local licenses, necessary taxes, legal requirements governing mailorder businesses, \$1.00. "Mail-order Rules for Beginners." Additional helpful information, \$1.00. Play safe. Order both. Tasker, 105 East Custis, Alexandria, Virginia.

GROW Expensive herbs for us! Big profits home-business of your own. Year around profitability! We supply everything necessary! Send for free rare seeds and revealing plan. National Herb Exchange, Dept. A, Gardena, Calif.

FREE! "301 Profitable Small Businesses!" Amazing shoestring plans! Work home! Start sparetime! Deumant Surveys, Kenmore 23-PM, N. Y.

BUY Wholesale! 100,000 name brand products! Save 66%! Big profits selling others spare time! Free catalogs! National Buyers Service, Box 426EE, Oakland, Calif.

WORK At home. Make money. Amazing opportunities. Free details. Coleman, Box 821, Newark 1, N. J.

MAILORDER Income everyday! Write Ballard's, 425 East Catherine, Louisville 3, Ky.

REBUILD Batteries; repair dolls; make rubber stamps; "60 Ideas" free. Universal, Box 1076-A, Peoria, Ill.

HAVE Home business! Get \$10.00 merchandise orders by mail. Keep \$8.00. Everything furnished. National, Box 88W, Dorchester 22, Massachusetts.

BOWES "Seal Fast" automotive supply distributorships available in a few states. Investment in truck and inventory, but no store required. Opportunity to join successful national distributing organization established over 35 years. For information write Bowes "Seal Fast" Corporation, Indianapolis 7, Indiana.

IMPORT-Export opportunity, profitable, world-wide, mail-order business from home, without capital; or travel abroad. Established world trader ships instructions for no-risk examination. Experience unnecessary. Free details. Mellinger F701, Los Angeles 24.

NATURAL Molding rubber, extra thick. Free sample. W. Wooley, 115-A Donald, Peoria, Illinois.

MAIL Sale Advertiser Magazine. Mail order plans and "how to" enterprises. Copy 10c. Year \$1.00. Ernest L. Gentry, 2623 Pollard Lane, Mobile 5, Alabama.

MONEY In saw and lawnmower sharpening sparetime at home. Free book. Virgil Foley Company, Columbia Heights, Minnesota.

BOOKKEEPING—Tax record distributorship. Sell merchants, farmers, accountants. Substantial profits. Handytax, 5632-C, Lankershim Blvd., North Hollywood, Calif.

POPCORN And potato chip equipment. Eakins, Box 933-A6, Springfield, Ohio.

FREE Folio "\$5,000-\$45,000. Unlimited Vacations." No merchandise, equipment. Unknown! Work home, sparetime! Haylings, Carlsbad, Calif.

OPERATE Profitable mail order business. Write—National Specialties, 5334 Pedley, Riverside, Calif.

\$250 WEEK Cleaning venetian blinds. Patented machinery. Free literature. Robinson, 7213B, Indianapolis 1, Indiana.

ARE YOU mechanically inclined? Amazing home business pays wonderful profits. Free book tells all. Belsaw, 756 Field Bldg., Kansas City 11, Mo.

LEARN Sewing machine "big money" repair. Machines, supplies wholesale. Write Taylor Service, Box 2126, San Bernardino, Calif.

TO \$100.00 Weekly. Sparetime, home operated mailorder business. Successful beginner's plan. Everything supplied. Lynn, 10420-M National, Los Angeles 34.

\$1,000 MONTHLY. Home, mailorder, free advertising method. Revealing information. Seidel, 6000-AM Sunset, Los Angeles 28.

"HOW TO Profitably Operate a Mail Order Business." Free literature. Lawrence J. Archer, Rt. #1, Navarre, Ohio.

MAKE-Sell polishes, cleaners, anything. Formula catalog free. Kemixer, Park Ridge, Ill.

EARN Money at home! Homemaker Magazine tells how. Sample 25c. Sizemore, 20-H East Delaware, Chicago 11.

MAKE Money helping others out of debt, stop garnishments, save jobs, re-establish credit. Details. Borum 57, 411 W. Walnut, Kalamazoo 42, Michigan.

WHOLESALE Catalog! 30-80% discounts! Appliances, musical instruments, typewriters, phonographs, watches, jewelry, recorders, housewares, etc. Consolidated Distributors, 21-11 Lafayette, Paterson 15, New Jersey.

BOOKKEEPERS. Keep books, small firms spare time. Manual latest technique by C.P.A., \$3.00. Modern Business, Box 406, Youngstown 1, Ohio.

PLASTERCRAFT Molds, liquid rubber, plasters, flocks, candle supplies. Catalog and manual free. Blue Rapids Supply, Blue Rapids, Kansas.

WHAT'S New in mailorder? Let "Mail-order World," published monthly, keep you informed. Sample, 25c. Wayte, 1233 Elden, Los Angeles 6, Calif.

ELECTROPLATE Auto parts, novelties, mirrors, baby shoes. Easy, inexpensive home processes. Free booklet. Tyco Metals, Box 13231-MM, Houston 19, Texas.

BREED Rare tropical fish at home. Earn big money! Learn secrets! Help fill huge demand. Amazing opportunity! Free plan. Tropical Fish Breeders, Los Angeles 61, Calif.

BE Appointed state notary public now. Write, Stationers, Helotes, Texas.

WE Love our mailman—He leaves over \$1000.00 monthly in our rural mailbox. My college professor husband drafted a scientific home mailorder method. We bought a Texas ranch, live as we always wanted. Now we sell the Ranch Mailorder Method. Operates anywhere. Inquire: Eveningshade Ranch, Helotes, Texas.

COPUBLISH Mail Sale Advertiser, leading mail order paper. Details, latest copy, dime. Vanroy Shirk, Lebanon, Penna.

MINK Raising information free. Complete. Lake Superior Mink Farm, Superior, Eel, Wisconsin.

FREE Book "505 Odd, Successful Businesses." Work home. Expect something odd! Pacific, Oceanside, Calif.

BRONZE Baby shoes. Instructions, equipment and mountings for genuine electroplated process. Free catalog. Hollywood Bronze Supply, Dept. B-3, 1624 East First Street, Los Angeles 33, Calif.

YOUR Own name brand business. No investment: no inventory. Part time or full time. Sell famous brands of appliances, housewares, silverware, radios, vacuum cleaners, lamps, tools, clocks, watches, jewelry, etc., etc., over 1000 items. Join thousands of successful independent dealers. Send for free catalog and dealer price list. H. B. Davis Corp., Dept. W, 145 W. 15 St., New York City.

GOOD Paying business silvering mirrors, plating articles in the shop and home by late method. No tanks or shop required. Free booklet. Gunmetal Co., Ave. H, Decatur, Illinois.

BIG Profits raising fishworms and crickets. Free literature. Carter Farms, Plains, Georgia.

GROW Orchids at home—Profitable, fascinating. Year 'round, Maine to California. No greenhouse. Gorgeous cactuses, cymbidiums, etc. Successful home grower shows you how. Full details free. Flowerland, 4622 Wilshire, Los Angeles 5.

PIX Typewriters. Inexpensive home course teaches factory secrets. Free booklet. Write, Typewriter, Tarentum 1, Penna.

METALIZE Baby shoes, jewelry, gifts. Free catalog. Publisher, Box 73136, Los Angeles 3.

NEWEST Spare, full-time home business. \$5 to \$10 hour possible. Paint with suede—The finish with touch and eye-appeal. Beautify auto dashboards, signs, radios, toys, figurines, lamps—1001 others. Complete, step-by-step instructions sent for no-risk examination. Free details, Coast, Los Angeles 61.

IMPORT-Export mailorder opportunities! Details. Warner, Box 6, Fort Scott, Kansas.

MAKE New greaseless doughnuts in kitchen. Sell stores. Half profit. Free recipes. M. Ray, 3605 South 15th, Minneapolis 7.

"23 WAYS To build a home mail business." Free details. Penn General Distributors, Monessen, Penna.

HUGE Sparetime home profits. It's easy! Details free! Stommel, Box 104, Detroit 31, Michigan.

A Monthly repeat business which you can operate in your own community. For free details write Grasak, Dept. A-101, P.O. Box 494, McKeesport, Penna.

\$46 FROM Square foot plywood; jigsaw necessary. Details free. Woodart, Bridgewater, Mass.

CAST Figurines! Novelties! Make production molds! New copyrighted course! Quick method! Illustrated! Only 25c! Castcraft Studios, 508-P Marion St., Brooklyn 33, N. Y.

VENDING Machines earn big money! Request 32 page free catalogue. Parkway Machine Corporation, Dept. 26, 715 Ensor St., Baltimore 2, Maryland.

\$16.00 POUND Hand spinning Angora wool at home. Angora House, PM, Springfield, Illinois.

FOREIGN Business opportunities. Home-steads open file—develop while living in U.S.A. Information \$1.00. Inter-American Land Development, P.O. Box 264D, Catalina Island, Calif.

\$70 WEEKLY—Home, spare time. Simplified mail bookkeeping. Immediate income—easy! Auditax, 34757A, Los Angeles 34.

\$150 WEEK—Easy! Start home Venetian blind laundry. Revealing book free. A. T. Co., 101 S. 44th, Philadelphia 4, Penna.

IMPORTING Without capital. Become successful U.S.A. resident agent for leading overseas manufacturers. High income, home operated, no risk. Complete arrangements furnished including U.S.A. distribution assistance. Impex, 1974-A Comstock, Los Angeles 25.

RAISE Nutria easily and economically. Lucrative future. Registered. Guaranteed. Tucker's Nutria Farm, 1137 Walker Avenue, Kansas City 2, Kansas.

IMPORTERS—Exporters, make more money. Subscribe Intertrade Inquiries. Free insertions. Houghton, 16 Victory Avenue, Kowloon, Hongkong.

105 EXPORTERS of Hawaiian products and plants. Send \$1.00. C S Sales, 1548 Liliha, Honolulu, Hawaii.

AUTOMOBILE Mechanics. \$10 hourly possible spare time. Profitable details \$2. If not experienced, save your money. Blessing's Co., Los Angeles 19, Calif.

PRINT Without a printing press! Amazing new method! Print colorful signs, banners, cards, posters, glasswear; anything at home. Big profits. Money-making opportunity! We supply everything. Beautiful sample, home-business plan free! Write Screen-Print Company, PM-3, Los Angeles 61, California.

HOW To make money in rubber stamp business. Nothing to sell. Complete truth. Details \$1.00. Johnson, 391 Highland, San Bernardino, Calif.

TRAIN Yourself for TV! Free information for each inexpensive complete course. How To Be Successful in Show Business, Practical Musicianship and Songwriting, Master Ventriloquism, Omnibus. 30C In-gramham, Newark 8, N. J.

NATURAL Latex rubber for molds. Cast statuettes, figurines as money-makers or hobby. Major Chemical Corp., 25 Allerton St., Boston 19, Mass.

EXECUTIVES Tell who gets hired and why. Details free. National Publications, Washington 7, D. C.

SELL Real merchandise by mail. Four ways. Everything supplied. Orders filled. Big profits. Charles, Box 32-P, New York 63, N. Y.

"FROG Raising!" Season just starting! Get this year's eggs. New book tells how. Folder 10c. Broel-A, Box 506, New Orleans 1, Louisiana.

FLORIDA Opportunities! Hundreds of jobs, businesses, farms, groves, homes. Free details! Florida Opportunity Journal, Vero Beach 14, Florida.

WANTED: Home producers, to be subcontractors. Cast plastic products for manufacturers in our clearing house service. Thousands of easily-made items required. Cash in at home, without previous experience. Plastic Service Associates, Dept. 3-PM, East Boston 28, Massachusetts.

YOUR Own business. Others work for you. Your profits pyramid. It's amazing. Free details. Clark, Box 2004, Cheyenne, Wyoming.

UP To 95% discount from guaranteed list of 30 lowest priced name brand wholesale catalogs in the world. Over 50,000 items. Rush \$2.00. B. Ruman Investigating Co., Niles, Ohio.

BECOME A foreign trader! Earn big money from home anywhere in U.S.A.-Canada. Permanent. Exciting. Profitable. International mail-order business. No experience, little capital necessary. Travel abroad. Part-full time. Satisfaction guaranteed. Write today! Foreign Traders, 7814 Forsyth, St. Louis 5-P, Missouri.

INTERNATIONAL Mailorder business. Complete setup service—not instructions only. Hermes, 152 West 42, New York City 36.

EXTRAORDINARY Business opportunities provided via inexpensive, self-teaching capsule course "Air Conditioning Simplified." Free impressive particulars. Kowalski, Box 409, New Britain 2, Conn.

CLOTHING Bargains up to 1/2 of regular retail price. Men's slacks \$3.95, men's suits \$13.95, sport jackets \$9.95. Ask our illustrated bargains folder! Cosmos Sales, 81 East 125th Street, New York 35, Dept. 26.

BUY Wholesale 750,000 products for personal use. Start a discount service for neighbors. Postcard brings details. Carter, Box 6011-DDD, Chicago 80.

COLORGLAZED Concrete pottery made without molds. Patented method. Cemetery products, novelties, tiles. Basement leak-sealing. Money-making projects. Booklet, details free. Men only. National Potteries Company, Grand Rapids, Minnesota.

BIG Money! Take orders religious articles. Illustrated 1956 catalog. Write Pette Co., 1554A W. 11th St., Brooklyn 4, N. Y.

FRANCHISE Opportunities nationwide! Distributorships, dealerships, agencies. Request information immediately. National Franchise Reports, 333 North Michigan, Chicago 1.

MAILORDER! Succeed with proven, professional money-making line. Houstex, 3026 East Holcombe, Houston, Texas.

DO It with "Floating Henryburgers." 10 million sold. Rare opportunity. Box 936, Wichita, Kansas.

YOU Are cordially invited to learn the secrets of operating a successful saw shop. Send for free literature. Max Manufacturing Company, Dept. A, 138 Stockton Avenue, San Jose 26, California.

\$5,199.90 WAS Paid to John Betts. In few weeks. Grow mushrooms. Cellar, shed. Spare, full time year round. We pay \$3.50 lb. Free book, Mushrooms, Dept. 172, 2954 Admiral Way, Seattle, Wash.

CASH From sawdust, seventy methods. Tin-cans, thirty methods. Newspapers, eighteen methods. Instructions 50c each. All three \$1.00. Charles Company, 12-DXV, Norwood, Ohio.

MAKE Your fortune in South America! Gold, uranium, oil, mahogany, precious gems, buried treasures. Free government land. Job opportunities galore. 1001 ways to get rich. For complete confidential report send \$2.00 to Explorer, Box 222, Miami 2, Florida.

FREE—Sales kit. Power mowers. Wholesale. Farm Products-PM, Excelsior Springs, Mo.

AMBITIOUS But lazy? Big money at home while others do most of work! Postcard OK. Maxson, Falls Church 17, Va.

BE A landscape contractor. Make \$20 to \$60 a day. Start with smaller projects and work into larger jobs. We show you how. Easy-to-follow home study course. Write for free book. National Landscape Institute, Dept. M-36-C, 310 South Robertson Blvd., Los Angeles 48.

BOOMING Swimming pool industry cries for new blood. New materials make opportunity for \$20,000 to \$40,000 income. Send \$1.00 for thoroughly tried plan to get started to: Northeast, Box 95, Hamilton Square, N. J.

CANNA Nursery for sale. 92 varieties. Profitable. Pettet's, 322 E. Oregon Ave., Phoenix, Ariz.

\$30.00 WEEKLY, Plastic sealing work. Easy. Write, Jansen, Sharon 9, Penna.

PRINT Colorful advertising, etc. Fascinating process, no press. 10c particulars. Remle, 2946 Tyburn, Los Angeles 39, Calif.

AMAZING Profits taking orders for nationally-advertised soaps, extracts, cosmetics, medicines, polishes. Advertising giveaways make selling easy. Exclusive territory. Write for free sales aid kit offer! We trust you. Sayman Products, (since 1877), 2101K Locust, St. Louis, Mo.

LEARN Sewing machine repair. "Money Secrets" Purdy's, 207-M, Weatherford, Texas.

BECOME Tax consultant. Our students earn to \$3,000 in 3-month season, part-time. We train you—help you start. State approved. Union Institute, 68 Hudson, Hoboken 2H, New Jersey.

\$30.00 A Day profits raising earthworms. Illustrated booklet 25c airmail postpaid. North St. Paul Worm Farm-D, North St. Paul 9, Minn.

WAXES Floors without wax. New invention. No more floor wax to buy. Sensational seller. Samples sent on trial. Kristee 118, Akron, Ohio.

LEARN To bronze baby shoes. Instruction \$2.00. Don Brady, 433 Market St., Topeka, Kans.

\$1,000 MONTHLY Possible in collection agency business. Free details. Write Cole Associates, Syracuse 2, N. Y.

3 SUGGESTIONS For sales-at-a-profit by mail, plus free counsel offer, 25c. Rawson Wood, 20 East Delaware, Chicago 11, Illinois.

MAKE Perfumes, other products—Sell mailorder. International, 6347 Parnell PM-3, Chicago 21, Illinois.

VENDING Machines—Every description. New or used. Lowest prices—Start a route or sell outright. Mack Postel, 2952 Milwaukee, Chicago 18.

FISHWORM Breeders' book—\$1.00. Postpaid. Literature free. Dixdok, Kent, Ohio.

EARN Up to \$2000.00 monthly with spare or full time route of automatic 3 in 1 hot drink merchandisers using Maxwell House coffee, Bakers chocolate, Tenderleaf tea, in your community. We train you. \$1190.00 starts you. Write Superior, 4555-BH East Warren, Denver, Colorado.

PAINT Novelties at home. Good earnings. N. Roland, R.D. 1-E, Vincentown, N. J.

AMAZING Home business. Build tubular glass fishing rods. Everything furnished. Wonderful profit. Free details. Rodman, Box 41, Wauwatosa, Wis.

OPERATE Profitable magazine subscription service. New telephone plan. Handle renewals for all magazines. No experience or investment needed. Rush name; send no money. McGregor Agency, Dept. 500-B, Mt. Morris, Illinois.

LIQUID Rubber. Make flexible molds. Free sample. Chaney, 1130 E. 16th St., Jacksonville 6, Fla.

WANT To make big money at home? \$5 profit in an hour possible with invisible reweaving. Make tears, holes disappear from clothing, fabrics. Steady year-round demand from cleaners, laundries, homes. Details free. Fabricon, 8334 Prairie, Chicago 19, Illinois.

AMBITIOUS? We establish you in your own business, supply catalogues, circulars, etc., ship orders under your name, paid or c.o.d., show you exactly what to do. Household items needed in every home. Sell direct, by mail or through agents. Catalogue, plans, details absolutely free. Write Topval Corp., Lindenhurst 318, N. Y.

SAVE Important dollars! Wholesale! Jewelry, luggage, appliances, etc. Discounts 30 to 80%! Premiums! Details 3c stamp. Alm Co., 38 Fair St., Paterson 4, New Jersey.

HAVE Your own mail order business at home! No advertising or inventory risk! Proven system. Send today for free details. Shanath Company, 340 West 11th Street, New York 14, N. Y.

STAY Home. Make big profits. Operate collection agency. No experience. Free details. Kipp, 608 Boone National, Boone, Ia.

MONEYMAKING OPPORTUNITIES

\$20.00 RETURNS \$400.00. Lifetime repeats. Sample \$1.00. Refundable. Ezee, Bayport 7, Mich.

WANT Up to \$300.00 monthly? Home mail order. Details free. Prinz, Box 402-P, Pico, California.

FREE! "301 Profitable Small Businesses!" Amazing shoestring plans! Work home! Start sparetime. Deumant Surveys, Kenmore 23-PM, N. Y.

BARGAIN Offers! Interesting mail! Earning plans! Free coupon! Nelson Sales, Elkhorn 99, Nebraska.

EARTHWORMS—Amazing reproduction makes you money. Breeders, supplies, spawn, new "senior kit" information plus newly published booklet and facts. Send 25c. Multiple Enterprises, P.M.-72, Kalkaska, Mich.

"MONEY Getter's Bulletin." sample 25c. Donovan, 791 Greenbelt, Levittown, N. Y.

PRINTING, Office supplies wholesale. Save 50%. Royal, Box 368-A, Cleveland 27, Ohio.

FREE "\$5,000-\$45,000; Unlimited Vacations." Work home! No merchandise, equipment! Haylings, Carlsbad, Calif.

TO \$100.00 Weekly, Sparetime, home operated mailorder business. Successful beginner's plan. Everything supplied. Lynn, 10420-M National, Los Angeles 34.

\$5.00 HOURLY Possible, spare time home mail order. Details free! Dempsey, Box 42237p, Los Angeles, Calif.

MONEY in saw and lawn mower sharpening sparetime at home. Repeat cash business. Experience unnecessary. No selling. Free booklet explains. V. Foley Company, Columbia Heights, Minnesota.

MAKE Spare time money preparing and mailing sales literature. Adams Surveys, 3513-AT Sunset Blvd., Los Angeles 26, Calif.

EARN \$50.00 Daily making mats, shoes and mud guards from old tires. S and S Patents Inc., 1307 North Clark St., Chicago 10, Ill.

GENERAL Contest Bulletin. Issued monthly. Sample. 25c. 1609 1/2 East 5th, Duluth, Minn.

FREE Book "505 Odd, Successful Businesses." Work home. Expect something odd! Pacific, Oceanside, Calif.

READ Progressive Mailtrade, the magazine that tells how to make money by mail. Dime brings sample and special offer. Progressive Mailtrade, Box 357, Sheboygan, Wisconsin.

ATTENTION! Typewriter owners. Make handsome profits. Write today. Groves Company, 682, Hastings 8, Nebraska.

SCHOOL Seniors—Sell classmates America's most beautiful graduation name cards. Largest selection. Highest commission. Outsells all others. Free sample kit. Printcraft, Dept. M, 1509 Maple Street, Scranton 5, Penna.

SELL Titania gems; far more brilliant than diamonds. Catalog free. Diamonite, 2420-M 77th, Oakland 5, California.

PLASTIC Laminating. Pleasure and profit. Self-sealing. No machines. Complete home kit, \$1.00. Mountainside 1, Springwater, New York.

PRIZE Contests provide fabulous and confidential home income opportunities! Here's how and where to win your share! Send stamp! National Contest Bulletin, Box 2685-P, Miami 16, Florida.

VENDING Machines earn big money! Request 32 page free catalogue. Parkway Machine Corporation, Dept. 27, 715 Ensor St., Baltimore 2, Maryland.

\$150 WEEK—Easy! Start home Venetian blind laundry. Revealing book free. A. T. Co., 101 S. 44th, Philadelphia 4, Penna.

MANUFACTURING Comb and sanitary vendors. Start vending today. White's Comb Vendor, Elgin, Illinois.

BE A winner; share in cash and merchandise prize contests; details free. J. B. J., 907 E. 55th St., Los Angeles 11, Calif.

MAKE Money writing short paragraphs! No tedious study. I tell you what to write, where and how to sell; and supply list of editors buying from beginners. Many small checks add up quickly. Write to sell, right away. Send for free facts. Benson Barrett, 1751 Morse, Dept. C-27-P, Chicago 26.

WORK From home in spare time. Start profitable magazine renewal service. We show you how; furnish everything free. No experience needed. Write McGregor Magazine Agency, Dept. 500-C, Mt. Morris, Illinois.

MEN And women wanted to start home business in spare time with little table-top rubber stamp machine. Easy to earn up to \$9.80 an hour without previous experience. Full particulars free by mail. Send postcard to Roberts, 1512 Jarvis, Room 73, Chicago 26, Ill.

CRACK The money barrier! Build yourself a new wheel of fortune! Win free cash and cars. Free details. Vernon (7-II), P.O. Box 449, Junction City, Oregon.

SELL Jewelry by mail. Hundred week possible. Free details. Gryder, Box 187, Barborton, Ohio.

SELL Hamburgers, sandwiches, pie. Use your own kitchen without capital. Operate small diner, cafe. Free details reveal plan. Restaurant School, MO13, Fremont, Ohio.

\$5,199.90 WAS Paid to John Betts, in few weeks. Grow mushrooms. Cellar, shed. Spare, full time year round. We pay \$3.50 lb. Free book, Mushrooms, Dept. 173, 2954 Admiral Way, Seattle, Wash.

BOYS, Earn \$1.80 hourly! Cleaning windows after school and Saturdays. Professional tools and instructions supplied. Kent Window Cleaning, Box 6807, Philadelphia 32, Penna.

FREE Vacation! "National Shopping Guide" tells how. Sample copy free. Agents wanted. Big earnings! Globe Publishers, 725-A Providence, Charlotte 7, N. C.

START A buying service, buy wholesale thousands nationally advertised products. Make big profits selling at sizable discounts. Postcard brings details. American Buyers, Hertel Station, Buffalo 16-D, New York.

97 SCHEMES To make a million you might! Information free. Ken-West Distributors, 7-K South Harlem, Worcester 4, Mass.

START Big-pay business at home in spare time. No experience needed to operate little table-top machine for bronzing baby shoes. Make \$5.46 profit on every pair. Full particulars free. Send postcard to Mason, 1512 Jarvis, Room 73, Chicago 26, Ill.

SELL Sparetime, fire extinguisher, extermiator, cleaner bargain, refillable by owner. Low cost, excellent commissions. Box 392, Rockville Centre, N. Y.

BUY Wholesale! Save 66 2/3%! Appliances, furniture, jewelry, toys, sporting goods, tools. Free catalog. National Buyers Service, Box 426EB, Oakland, Calif.

\$1,000 MONTHLY Possible raising earthworms! Backyard, garage, basement. Complete illustrated booklet explains raising, feeding, packing, marketing. 25c postpaid! Ozark Worm Farm-J, Willow Springs, Missouri.

WEAVE Rugs—Make big profits. Send for our free catalog, sample card, and low prices on carpet warp, rug filler, looms, parts, inexpensive beam counter. If you have loom, give make, weaving width please. OR. Rug Company, Dept. 3615, Lima, Ohio.

DOLLARS Daily! Clip articles from newspapers. Free details. News Service, 3252 W. 84th St., Cleveland 2, Ohio.

DON'T Miss this. 500 ways to earn money at home. Complete plans, ideas, instructions, only \$1.25. Order now. L. Witherspoon, 2032 N. Minneapolis, Wichita 14, Kansas.

CATALOG! Latest, successful, profitable, opportunities, 50c postpaid! Ridsen, 3468 Cass, Detroit 1, Mich.

OWN A mail-order envelope service. Tremendous demand. No investment. Omaha Envelope, 4721-A California, Omaha 3, Nebr.

EARN Money evenings copying and duplicating comic cartoons for advertisers. Adservice, Argyle 1, Wisconsin.

INCREASE Your income. Free literature. Excello, Box 500, Shreveport, Louisiana.

LEARN Technical metaphysics and insure your future. Easy, inexpensive correspondence course. Simplest method known. Diploma. Write: Premier College of Technical Metaphysics, 2532 McKenzie St., Vancouver 8, B. C., Canada.

FREE Information. Several profitable opportunities. Kennedy, R1, B76, San Bernardino, Calif.

EXCELLENT Profits selling good quality imports. Distributorships available. Importer: Kenmaur Trading Company, 10718 Renton Ave., Seattle 88, Wash.

START Money-making plastic laminating business at home in spare time. Material that costs 11c brings back \$2.58. No canvassing or selling but mail orders bring in \$20 a day. Write for full particulars free. Rush name on postcard to Warner, Room 73, 1512 Jarvis, Chicago 26, Ill.

MONEY In spare time. You supply information, most of which you can obtain free. No previous training needed. Frank H. Fix, 2056 Switzer Ave., St. Louis 21, Mo.

CASH In on contests now! Get facts that help. Write Sanders & Co., 1762 Euclid, Lincoln, Neb.

HELP Us! Help yourself! Get \$2.00 orders. Keep every cent! Complete details, 50c. Co-Operative, Box 278-P, Manchester, New Hampshire.

MAKE \$3.00 Hourly doing light assembly work at home. \$2.00 delivers all materials and equipment necessary to bring you \$10.85. Send to Gallaway Mfg. Co., Box R87, Osage Beach, Mo.

NEW General, religious, comedy 7"x11" signs—cost 7c, sell 50c. Sample free! Lowy, 812 Broadway, Dept. 917, New York City 3.

100,000 PRODUCTS Wholesale! Free catalogs! Econ-O-Mart, 8 Perry, Whippany 2, New Jersey.

GET Into your own big paying weather-strip business. E-Z-On 11, 1009 Harvard, Evanston, Ill.

INEXPERIENCED? Make money home! Little work! Literature free! Kreger, 3855-PM36 Howard, Skokie, Illinois.

MAKE Money with your 35mm. camera. Amazing new low cost color enlargements can bring you hundreds of dollars in spare time. Nothing else like it! Send 10c for samples and eye-opening facts. Dept. PM-3A, Polypix Co., 723 S. Wells Street, Chicago 7, Illinois.

NEW! Six cream of the crop ideas started now can bring you thousands for the one dollar you mail us today. Box 204, Dennisport, Massachusetts.

500 WAYS To earn money at home. Details 10c. A. Welch, Lake and Central Ave., Delaware, Ohio.

WANT To go in business for yourself without capital? We show you how. Start part time your own home. Postcard brings details absolutely free. Topval Corp., Lindenhurst 220, N. Y.

FORMULAS, PLANS, ETC.

FREE Formula catalog. Anything analyzed \$35.00. Western Chemical, Salem, Oregon.

ANY Formula desired, 25c! Elmer Hayes, B-31, Palo 8, Iowa.

FORMULAS; All kinds, latest, best. Literature free. Kemixal, Park Ridge, Ill.

PRODUCT Analysis, manufacturing formulas, processes developed. Moderate fees. Plastics, Box 1574, Boston 4, Mass.

PRACTICAL Formulas. Lists free. Cummings, Chemist, Gordon Ave., Syracuse 4, N. Y.

MILLER'S Modern manufacturing formulas make fastest-selling products that get the business and pay. Fifty years supplying the best. Valuable literature free. Miller, Chemist, 1517-M, Tampa, Florida.

FREE Formula catalog. Anything analyzed \$35.00. Western Chemical, Salem, Oregon.

FORMULAS, All products. Information, lists, free. Brockway, 1145 High, Topeka, Kansas.

PLASTICS

PLASTICS Home-craft course for men and women. Tells and shows how to make hundreds of fast selling plastics products. All plastics and materials for 23 projects included in course. No special tools needed. Course pays for itself. Write for free booklet. Interstate Training Service, Dept. D-3, Portland 13, Oregon.

LAMINATING Supplies. Free price list. Solomonson, 46 Cornhill, Boston 8, Mass.

PLEXIGLAS, Cut to size. Clear. Any thickness. Colors. Rods. Tubing. McClarin Plastics, P.O. Box 168H, Hanover, Penna.

NEW Liquid casting plastic, clear, colors. Embed real flowers, insects, photos, coins. Saw, drill, carve. Send 25c for handbook, "How to Cast with Liquid Plastic," and proved success plan showing how to make money at home. Castolite, Dept. C-101, Woodstock, Ill.

PLEXIGLAS, Lucite. Square foot cost, 1/16", \$1.15; 1/8", \$1.52; 3/16", \$1.86; 1/4", \$2.21; 3/8", \$3.23; 1/2", \$4.38. Colors add 10%. Send 15c for postage. Aristocrat Plastics, 23-25 Sussex Avenue, Newark, N. J.

CHEMISTRY

LABORATORY Apparatus, chemicals, microscopes, complete chemistry sets, minerals, uranium ore. 10c brings catalog. Porter Chemical Co., Hagerstown 4, Md.

ILLUSTRATED Catalog: Chemistry, mineralogy, biology 20c. Tracey Laboratories, Evanston, Illinois.

CHEMICALS And apparatus for industrial, analytical, and private laboratories. Catalog 25c. Dept. M-50, Biological Supply Co., 1176 Mt. Hope Ave., Rochester 20, N. Y.

FREE! Uranium detector and chemical puzzle (worth \$2.50) with first five lessons of diploma course on practical chemistry! Big package of chemicals, filtering equipment, charts, etc. Only \$1.00. National School of Chemistry, P.O. Box 606-G, Redwood City, Calif.

HOME Laboratory and apparatus kits, laboratory supplies. Catalog 25c. John H. Winn, 124A West 33rd St., New York, N. Y. Established 1931.

CHEMICALS, Supplies. Catalog 25c, refundable. Laboratory Sales, Box 161-E, Brighton, Mass.

CHEMICALS Unlimited! Catalogue 25c. Fabian Chemical Co., 3760 St. Catherine Road, Montreal 26, Canada.

BOOKLETS: 60 pages each! "Beginners Chemistry," "Chemistry," "Einstein's Relativity," "Physics," "Atomic Theory," "Electron Theory," "Scientific Oddities," "Light," "Sound," "Heat," "Electricity," "Radio," "Astronomy," "Useful Tables," "Geometry," "Mathematical Oddities," "Scientific Terms." Order by titles. 10c each. Franks, 3121 South Racine, Chicago 8.

AMAZING New book of science. Experiments, formulas and catalogue of laboratory supplies. Only 25c. National Scientific Co., Dept. PM-3, 2204 W. North Ave., Chicago 47, Illinois.

AGENTS WANTED

DO You call on churches? Every church is a prospect for individually designed church bulletins in colors—excellent commissions. Other fast selling printed items also. No postcards please. Write for samples, MWM Color Press, Dept. PM3, Aurora, Missouri.

MAKE Extra money with newest fast selling "Slit" and Photochrome" greeting card assortments. \$1.00, \$1.25 all occasion, birthday, religious, Easter boxes. Stationery, gift wrappings, gifts, gadgets. Experience unnecessary. Amazing profits. Bonus plan. Write today for samples on approval, free gift offer, catalog. Hedenkamp, 361 Broadway, Dept. PM-40, New York City.

NYLON Hosiery, start your own nylon routes. Buy direct and save. Free wholesale price list. Nylons, 2024 West Pratt St., Baltimore 23, Md.

GREETING Cards—\$50.00 cash from 40 boxes sensational all-purpose assortment. Big money all year from special occasion cards—Mother's, Father's Day, birthdays, Eastern Star. Best all-occasion assortments, stationery, gifts. Bargain specials. Color catalog. Samples on approval. Midwest, 1113 Washington, Dept. 699-K, St. Louis 1, Mo.

LET Us send you for free trial everything you need to make extra money. Show friends amazing value new type all occasion greeting card assortments. Profits to 100%. Bonus. Write for feature boxes on approval, 29 free samples personal stationery. New England Art Publishers, North Abington 333-P, Mass.

MAKE Your spare time profit! Over 600 beautiful, unusual gifts, greeting cards, household gadgets, toys, jewelry, baby items, and gift wraps you can sell to friends, neighbors, relatives. Write at once for big, bright free catalog just off the press. Samples on approval. Hurry, get details on sensational money-makers! Greetings Unlimited, 36C Park Square, St. Paul 1, Minnesota.

IF You want to earn money fast, I'll send you a free sample stocking of newest stretch duPont nylons to sell at only \$1 a pair. American Mills, Dept. 490, Indianapolis 7, Ind.

SHINE Cars without polish. New invention. Lightning seller. Cars gleam like mirror. Samples sent on trial. Kristee 84, Akron, Ohio.

BIG Money selling waitresses, beauticians, others guaranteed uniforms \$3.98 up. Dacrons, nylons, cottons. Sizes 9-52. Full, part time. Experience unnecessary. Bonus plan. Free full color catalog. Up-land Uniforms, 208 East 23rd, Dept. G-9, New York City.

THIS Ad worth money to you! Make big profits spare time or full time. Sell over 60c unusual gifts, gadgets, greeting cards, stationery, toys, jewelry to friends and neighbors. No big investment. Samples on approval. Write for big free catalog and tested money-making plan for organizations or individuals. North Star, Dept. 363, 251 E. 5th St., St. Paul 1, Minn.

\$1,000.00 A Month for making dramatic 3-second demonstration of amazing lightweight Presto fire extinguisher. New chemical used by Airforce snuffs out fires instantly. Only \$3.98. Terrific commissions. Millions want it. Free kit. Merlite, 114 E. 32nd, Dept. 50-G, New York City 16.

FREE! Beautiful feather pictures 200% profit! Apartado 9036, Mexico 1, D. F.

WHOLESALE Catalog! 30-80% discounts! Appliances, musical instruments, typewriters, phonographs, watches, jewelry, recorders, housewares, etc. Consolidated Distributors, 21-10 Lafayette, Paterson 15, New Jersey.

MEN, Women, make money spare time plus new car as bonus for encouragement. Amazing hosiery guaranteed to wear without holes, snags, and runs, or replaced free. For example, lovely 60 gauge nylons guaranteed for as long as 1 1/2 years, or replaced free. Write Wilknit, 1763 Wash., Greenfield, Ohio.

EUN A spare-time greeting card and gift shop at home. Show friends samples of our new 1956 all-occasion greeting cards and gifts. Take their orders and earn up to 100% profit. No experience necessary. Costs nothing to try. Write today for samples on approval. Regal Greetings, Dept. 59, Ferndale, Michigan.

GOLDMINE Of 600 money makers. Copy free. Specialty Salesman Magazine, Desk 5-E, 307 N. Michigan, Chicago 1.

MAKE Money at home as renewal headquarters for all magazines. Liberal commissions. No experience-capital needed. Supplies furnished. Write for free catalog. McGregor Magazine Agency, Dept. 500-A, Mount Morris, Illinois.

PROFITS To 150% selling finest everyday greeting cards. New 21 for \$1 tall cards, unusual gifts, 129 fast-sellers. Valuable gift bonuses. Assortments on approval, stationery samples free. \$1 gift free for promptness! Creative Cards, 4401 Cermak, Dept. 525-C, Chicago 23.

HOME Motorized massage. Big money! Mary Mac, 1012 Powhattan, Dallas 2, Tex.

YOUR Own business—Used suits \$1.50, overcoats 65c, mackinaws 35c, shoes 12½c, ladies coats 30c, dresses 15c. Enormous profits. Catalog free. Nathan Portnoy Associates, 605-AA West 12th Place. Chicago 7.

MAKE \$100 Up weekly—Demonstrate, take orders. Sensational new product. Prospects everywhere, part-full time. Campbell Company, Rochelle 53, Illinois.

SCHOOL Seniors—Be popular with classmates. Have spending money galore. Details free. Craftcards, Box 235-L, Pittsburgh 19, Pennsylvania.

GOLD Or silver letters, numbers. Windows, doors, trucks. 1" to 6". 500% profits. Free samples. Atlas-T, 544 West 79th. Chicago 20.

PRINTING, Advertising salesmen—Excellent moneymaking sideline selling decalcomania name plates, small quantities. Automobile initials, sign letters. Free samples. Ralco, XL, Boston 19, Mass.

\$1.00 PROFIT Selling \$2.95 photo enlargement deal. Allen Studio, Riegler Bldg., Little Rock, Ark.

AGENTS—300% Profit selling genuine gold window letters; stores and offices. Free samples. Metallic Sign Letter Co., 431-D North Clark, Chicago.

CALIFORNIA Sweet smelling beads. Sensational sellers. Particulars free. Mission, 2328 FR, W. Pico, Los Angeles 6, Calif.

USED And new watches \$2 up. Free list. Southern Watches, Gray, Georgia.

YOUR Ad in this space will get some good agents for you. Yes, I'll prove it. Write for Folder "A" right now. F. W. Johnson, Classified Advertising Manager, Popular Mechanics Magazine, 200 E. Ontario St., Chicago 11, Ill.

EASY Handwork makes fast-selling articles. Sample free. Sunmade Company, Brockton 64, Massachusetts.

\$18.75 NATIONALLY Advertisers perfume. Closeout price 60c. Sell for \$3. Profit \$2.40. Sample \$1. Details, advertisement reprint free. Esset 73-14L, 175 Flushing 66, New York.

GIVE Away plan pays you to \$5 hour! Your customers receive choice of wonderful gifts (silverware, hosiery, electric shavers, etc.) free with purchases! Show huge line with famous brands like Westbend, International Silver, Melmac unbreakable dinnerware, hosiery, shirts, underwear, etc. Nothing for you to buy. Just write orders. We deliver prepaid and collect. Also weekly payment club plan. Pocket advance cash plus big cash bonuses. Opportunity become manager appointing salespeople. Experience unnecessary. Full or spare time. Nothing to pay now or ever. Postcard brings you complete money-making outfit free. No obligation. Kenmart, Dept. 13, 108 Lawrence St., Brooklyn 1, N. Y.

SELL Sick call crucifixes. Big commission. The James Company, North Attleboro, Mass.

BUY Wholesale, 25,000 items, catalog 25c. Matthews, 1472-B6 Broadway, New York City 36.

STRANGE Dry window cleaner. Sells like wild. Replaces messy rags, liquids. Simply glide over glass. Samples sent on trial. Kristee 81, Akron, Ohio.

START Your own business on credit. Your own boss. 1135 dealers sold \$5,000 to \$30,000 in 1954. We supply stocks, equipment on credit. 200 home necessities. Sales experience unnecessary. Pleasant profitable business backed by world-wide industry. Write Rawleigh's, Dept. C-U-PPM, Freeport, Ill.

MONEY In minutes! Even beginners scoop up big earnings with Elmira—the greeting line so beautiful, it sells by itself! Friends, neighbors, even perfect strangers want to see and buy from Elmira's exciting array of all-occasion greeting cards, personalized stationery, napkins and gift wraps. Look no further, Elmira gives you everything to make your extra-money dream come true! Send today for free samples, catalog, assortments on approval. Request Elmira's fund-raising plan for churches and clubs! Elmira Greeting Card Co., Dept. 161, Elmira, N. Y.

FREE Sample outfit to agents of complete line of plastics, novelties, etc. Rose-text Mfg. Co., 43 Amboy Street, Brooklyn 12, New York.

60% PROFIT On cosmetics. Famous nationally advertised Hollywood cosmetics pay 60%! Make \$25 day up! Hire others. For free samples, details, write Studio Girl, Glendale, Calif., Dept. 1263G.

CALENDARS, Advertising novelties, matches. All styles, including religious, varnished, 12 sheet, girls. Hundreds of advertising novelties, book matches, etc. Fleming Calendar Co., Sales Division, 6539 Cottage Grove, Chicago 37, Ill.

MAKE Money introducing world's cutest children's dresses. Big selection, adorable styles. Low prices. Complete display free. Rush name. Harford, Dept. R-4341, Cincinnati 25, Ohio.

BUY Wholesale thousands nationally advertised products at big discount. Free "Wholesale Plan." American Buyers, Herfel Station, Buffalo 16-A, N. Y.

SELL Nameplates, 100% profit. Free information. Grioux Nameplates, 116 College St., Burlington, Vermont.

VITAMINS, Buy direct—Wholesale. Highest potency, lowest prices. Build very profitable repeat business. Complete sales program free. Write now! Daly Vitamins, 1001A Glendale Blvd., Los Angeles 26, Calif.

AGENTS Calling on industrial and/or school accounts to sell Vaporite pens and inks. There's a pen and ink for any marking purpose. Units have a high closing average. High potential. International company. For complete information write stating territory covered and types of accounts sold. Time Saving Specialties, Dept. 12, 2816 Dupont Ave. So., Minneapolis 8, Minn.

BEAUTIFUL Feather pictures. Big profits. Sample, framed, 50c. Robert Celaya, Brownsville, Texas.

SELL Exotic imported African wood carvings. Fabulous profits. Free details. Kempco, Box 4098, San Diego 4, California.

\$200-\$1000 WEEKLY: "Spark-O-Matic" lifetime spark plug. Exclusive territories. Alquist, Milford P16, Penna.

NEW Costume jewelry item. Latest fad. Fast seller. 300% profit. Free details. Packard (M), 550 Fifth, New York City.

EASY Selling, sensationally new. Taverns, gas stations, restaurants, stores. Tremendous earnings. Free samples and details. Fritch, 610 Coronado, Los Angeles 37.

IMPORTS! Knives, portable stoves, reels, Constructa-clocks. Send quarter, details, surprise gift included. Ameridauro, Box 162, West Englewood, New Jersey.

EARN To \$50 per day! New, amazing chemically-treated Foam-O-Cel sponge cleans rugs, upholstery like new. Fast \$1 seller, big profits. Free details. M & M, Dept. PM-4, 842-3rd Ave., New York City.

EVERYTHING For food! Unlimited demand for cookware, dinnerware and tableware. Make 75c profit on dollar! No stock to carry. We ship orders for you. Choice of ten money-making plans! Catalogue, plans free. Topval Corp., Lindenhurst 61, N. Y.

WANT More business? Here's an amazing opportunity to increase your sales. Talk to thousands of interested readers of "Mechanica Popular." Our Spanish Edition covers the Latin American countries like a blanket. They're real mailorder buyers. Classified rate 75c per word. Try an ad in our next issue. Classified Advertising Department, Popular Mechanics Magazine, 200 East Ontario Street, Chicago 11, Ill.

EARN \$30 A day! Sell Dab-It, amazing pocket-size, stick-form, "no ring" spot remover. Works like magic! Guaranteed! M & M, Dept. PM-7, 842 Third Ave., New York City 22.

VENDING Mchs.-mdse. Unbelievable prices. McDonald, 2416 Davis, Dallas, Tex.

UNUSUAL Mail order plan pays \$100.00 per car commission. No investment required. Take orders only. My agents may order their own cars less commission. Brand new 1956 automobiles equipped with windshield washers, turn indicators, outside rear-view mirror, tutone paint, oil filter, undercoating, federal taxes. Prices start at: Nash, \$1873; Ford, \$1733.09; Plymouth, \$1730.25; Chevrolet, \$1795.65; Studebaker, \$1858.98; Dodge, \$2095.99; Pontiac, \$2107.74; Mercury, \$2222; Buick, \$2341.15; Oldsmobile, \$2415.17. Other equipment additional. Also Lincoln, De Soto, Chrysler, Packard, Hudson, etc. Down payment layaway plan pays 4% interest on layaway payments until delivery. Send \$1.00 for complete details. Harry A. Harwoods, Box 4, 20058 Renfrew, Detroit 21, Michigan.

BUY IT WHOLESALE

1956 "PORTABLE Showroom" (catalog). Rush 50c to Edward Clemens, 318 W. Bridge St., Morrisville, Penna.

WHOLESALE Catalog! Appliances, cameras, watches. Postcard: Selbyco, Decatur 254, Illinois.

FREE! 25 Name brand wholesale catalogs. Get certified list of companies offering them for only \$1.00. Myers Research, 936 Ohio, Lawrence, Kansas.

PARACHUTES, Government surplus. Complete sample prices \$2.00. Smith, 1407 Genesee, Lansing 15, Michigan.

BUY Surplus wholesale. Catalogue 25c (refundable). Box 22-S7, Thomasville, Penna.

WHOLESALE Catalog! 30-80% discounts! Appliances, musical instruments, typewriters, phonographs, watches, jewelry, recorders, housewares, etc. Consolidated Distributors, 21-20 Lafayette, Paterson, New Jersey.

WHOLESALE Name brands, illustrated catalog 50c. Refundable. Distributors, Box 106A, Hudson, New York.

SAVE 30-50%! Buy direct from distributor at dealers wholesale prices! Name brand television, radios, hi-fi's, ranges, refrigerators, freezers, fans, tools, washers, housewares, etc. Illustrated catalog 25c. Marpat Distributors, Box 1485, Milwaukee, Wisconsin.

THOUSANDS Articles wholesale! Catalog \$1.00 refundable. J. Evanich, Stamford, New York.

ELECTRIC Guitars, amplifiers, parts. Wholesale. Free catalog. Carvin, PM287, Covina, Calif.

FREE Lists, 640,000 items wholesale. P. Cottage Industries, Omaha 12, Nebr.

WHOLESALE Coverage, complete! Amazing details. Mailtrader, Box 643, Ann Arbor, Michigan.

BUY Wholesale catalog \$1. Wholesale Service Company, Box 3237, Dept. 2129, Tulsa, Oklahoma.

YOUR Cost as little as 25c on dollar! Household items needed in every home. Sell direct, by mail or to agents. Catalogue, confidential distributors' wholesale prices and money-making plans absolutely free. Rush postcard to Topval Corp., Lindenhurst 924, N. Y.

SALESMEN—DISTRIBUTORS

MAKE Up to \$1,500.00 in month with sensational Motor Overhaul for cars, trucks. Laboratory test proves 58% power increase, 54% gas saving. Free money-making plans and laboratory report. Pope Chemical, 224 W. Huron, Dept. 6, Chicago.

GET Into the big money! Sell work uniforms that advertise to factories, garages, institutions, businesses. Prospects, profits galore! Write for big free outfit of styles, colors, actual fabrics including miracle Orion, Acrilan, Dynel. Topps, Rochester 613, Indiana.

POSTCARD Can put you in a fine business! Complete line of air cushion shoes. Big steady commissions. No experience or investment needed. Send postcard for free outfit. Mason Shoe, Dept. C3, Chippewa Falls, Wisconsin.

\$1,000.00 A Month for making dramatic 3-second demonstration of amazing lightweight Presto fire extinguisher. New chemical used by Airforce snuffs out fires instantly. Only \$3.98. Terrific commissions. Millions want it. Free kit. Merlite, 114 E. 32nd, Dept. 50-G, New York 16.

BIG Money-making opportunity. Exclusive line work uniforms. Jackets, pants, shirts, coveralls. Advertising embroidered. Every business prospect. Outfit free. Master Div., 686 Water, Ligonier, Ind.

NEW, Exciting, exclusive money-maker—Lifetime candles. Never burn down. No wax drip. No odor. Many beautiful colors, styles. Fit all candleholders. Every housewife loves them. Up to \$100 a week easy. Free sales kit. Write! Forever-Yours Candles, Merlite Co., 114 E. 32nd St., Dept. X-15, New York 16, N. Y.

WILL You wear new suits and topcoats without one penny cost and agree to show them to friends? You can make up to \$30.00 in a day even in spare time, without canvassing. Stone-Field, 532 South Troop Street, Dept. R-926, Chicago 7, Illinois.

WHOLESALE Catalog! 30-80% discounts! Appliances, musical instruments, typewriters, phonographs, watches, jewelry, recorders, housewares, etc. Consolidated Distributors, 21-12 Lafayette, Paterson 15, New Jersey.

AD Matches! Sell amazing designs—10, 20, 30, 40 and 240-light book matches. Bigger spot cash commissions; every business a prospect. Low prices for high quality. Repeats. Start without experience; men, women; full, part time. Buy nothing! Sales kit furnished. Match Corp., Dept. PM-75, Chicago 32, Illinois.

NEW Jobs open in selling! Send name, address for five free issues of Opportunity Magazine's money-making guide, listing hundreds of companies who'll pay you well, full or part-time. No experience needed. Opportunity, 850 N. Dearborn, Dept. 17, Chicago 40, Ill.

CASH In on 1956 elections! Big advance commission selling low priced union label political posters, cards, labels, book matches to candidates. Complete printing line for all businesses. Free kit. National Press, North Chicago 2, Ill.

BUILD Sales by recruiting productive distributors selling direct or to retail outlets. Secure most concentrated circulation through classified columns of Salesman's Opportunity. Write for facts. Gilbert, Salesman's Opportunity, Room 1700, 850 N. Dearborn, Chicago 10.

GET New shirt outfit free. Make \$90.00 weekly on 5 average orders a day. Famous quality made-to-measure dress and sport shirts at \$3.95 up sell fast to all men. No experience needed. Full or part time. Write: Packard Shirt Co., Dept. 264, Terre Haute, Ind.

ADVERTISING Book matches—Cash in on big demand! sell union label matches. Cuts for all businesses and political parties. Free powerhouse selling kit, low prices, protection guaranteed on repeat orders. Cash commissions. Superior Match Co., Dept. M-356, 7530 Greenwood, Chicago.

ANYONE Can sell famous Hoover uniforms for beauty shops, waitresses, nurses, doctors, others. All popular miracle fabrics, Nylon, dacron, orlon. Exclusive styles, top quality. Big cash income now, real future. Equipment free. Hoover, Dept. C-100, New York 11, N. Y.

BUY Wholesale thousands nationally advertised products at big discount. Free "Wholesale Plan." American Buyers, Hertel Station, Buffalo 16-J, N. Y.

SELL Calendars. You make big money daily. Giant line. Every business buys. Also business printing, book matches, advertising specialties. Big sales outfit free. Write, Arrow Press, 515-C Fourth Ave. So., Minneapolis, Minn.

SELL Grease that won't melt. Moly products also included in complete line of heavy duty lubricants. Our leading salesmen now earning over \$12,000 in a year. Write E. J. Baker, Dept. 6-C, P.O. Box 676, Dayton, Ohio.

USED And new watches \$2 up. Free list. Southern Watches, Gray, Georgia.

12,000 REAL Formulas. Any formula \$1.00 refundable. Box 433, Fort Gibson, Oklahoma.

ASSOCIATED Distributor — Unlimited profits sell waterproofings and dampproofings, allied building materials products, new and old construction work. Free literature. Volsonite, P.O. Box 628, Pasadena 19, Calif.

DISTRIBUTORS—Sell sensational Speedee Fabric Cement and Utility Cement to all type stores. Terrific free offer. Owosso Chemical, Davison, Michigan.

EVERYTHING For food! "Waterless" cookware to cook; unbreakable Melmac dinnerware to serve; stainless steel tableware to eat the food. Up to 75c profit on dollar! Write orders deposit-c.o.d.; sell time payments; have others sell for you; sell wholesale to agents; use mails; establish own business. There is a custom-made plan to suit you! Postcard brings everything needed to make money absolutely free. Topval Corp., Lindenhurst 425, N. Y.

EDUCATIONAL AND INSTRUCTION

INDUSTRY Needs draftsmen. We help you qualify. Free information. Industrial Training, 1704-A Frederick, Fort Worth 7, Texas.

COLLEGE Degrees—Independent study. Keep employed. Brentwood College, Box 19-721, Los Angeles 19.

APPLY For jobs by letter. Short folio shows how. Free trial offer. Telesis Company, Room 706, 507 Fifth Avenue, New York 17, New York.

STUDY For Doctor's degree of psychology, metaphysics and divinity. Correspondence courses only. College of Divine Metaphysics, Dept. P-M, 2811 North Illinois, Indianapolis 8, Indiana.

LEARN Mineralogy at home. Diploma course. Fortunes now being made in uranium and other minerals. Free catalog. Mineral Science Institute, Desk 2, 159 East Ontario, Chicago 11.

HIGH School diploma at home. Licensed teachers — Approved materials. Southern States Academy, Box 144-MX, Station E, Atlanta, Georgia.

BECOME A counsellor in personality engineering. A lucrative profession for those who qualify. Field is growing, uncrowded. Work is interesting, fulfilling. Write, enclose recent snapshot. More information in book, "Formula for Genius," \$1.00 (refundable). Kimball Foundation of Human Engineering, St. Louis (Brentwood) 17, Mo.

PIANO Tuning pays. Big money in spare time. Learn at home in 30 days. No musical knowledge necessary. Phonograph, records, tools and instructions furnished. Free catalog. Capital Tuning School, 16 Southwest Second, Fort Lauderdale, Fla.

I Want to send you proof of the wonderful pulling power of Popular Mechanics classified pages. What's your proposition? Write me today. Include literature if possible. F. W. Johnson, Manager Classified Advertising, Popular Mechanics Magazine, 200 E. Ontario St., Chicago 11, Ill.

\$5,199.90 WAS Paid to John Betts, in few weeks. Grow mushrooms. Cellar, shed. Spare, full time, year round. We pay \$3.50 lb. Free book. Mushrooms, Dept. 174, 2954 Admiral Way, Seattle, Wash.

BE A real estate broker. Study at home. Write for free book today. GI approved. Weaver School of Real Estate, 2018P Grand, Kansas City, Missouri.

INVESTIGATOR Training. Phillips Secret Service System, 1917-B North Kennebec, Chicago 39.

SECRET Investigation. Experience unnecessary. Investigators particulars free. George Wagner, M125 West 86th, New York 24.

EARN While you learn. Auto and diesel mechanics master this top paying trade. Many graduates earn \$100 a week and up. Approved for Korean veterans. For free information write Dept. No. 256, Nashville Auto-Diesel College, Nashville 3, Tenn.

BOOKKEEPERS! Increase your earnings! Operate your own simplified "Dollar-A-Week" bookkeeping and tax service. Full or spare time. Details free. No obligation. Ellis, Box 200, Cedar Grove, North Carolina.

USED Correspondence courses and books sold and rented. Money back guarantee. Catalog free. (Courses bought.) Lee Mountain, Pisgah, Alabama.

WANT A diesel job? New opportunities to increase income. Higher pay. More money. We can help you qualify. Tools. Shop method home training. Write today! Diesel, Tractor, Heavy Equipment Division, Interstate Training Service, Dept. B-3, Portland 13, Oregon.

PHYSICAL Therapy and massage. We train you at home. Earn big profits from your own private practice or work with hospitals and doctors. Free catalogue. National Institute, Desk 4, 159 E. Ontario, Chicago, Ill.

SPEAK. Sing with power, personality. Home self-training method on records. Amazing details free. Canfield, 2018-A 5th Ave. South, Minneapolis 4, Minn.

"CORRECT Your Thinking and Change Your Life." Large book. Send no money, pay postman \$1.98 plus postage. Bert King, P.O. Box 195(Z), Fort Wayne, Indiana.

PIANO Tuning pays. Learn this profitable profession at home easily with patented Tonometer and mechanical aids. No knowledge music necessary. Diploma granted. Write for booklet. Niles Bryant School, 3731 Stockton Blvd., Dept. P, Sacramento 20, California.

IT'S Easy learning a language by Linguaphone, world's standard conversational method. At home, quickly, easily learn to speak French, Spanish, German, Japanese, modern Greek — any of 34 languages. It's like living in another country. Save time, work, money. Send for free book. Linguaphone Institute, 83-036 Rock Plaza, New York City 20.

ONE Hundred electrical springs, assorted sizes postpaid \$1.00. Spring Service, Box 144, North Warren, Penna.

BECOME A doctor of psychology or metaphysics. Learn secret of contentment, happiness. Win degree of Ps.D. or Ms.D. Correspondence only. Free book. College of Universal Truth, 23-C East Jackson Blvd., Chicago 4, Ill.

LEARN Real estate business for highly profitable life-time career, study at home, pass any state exam. Low cost, money-back guarantee. Free literature. Act now for a profitable 1956. Seavy Realty Institute, 13346P Bessemer St., Van Nuys, Calif.

WELDING Training pays at Hobart Welding School, Box M-361, Troy, Ohio. VA contract. Best equipment. Catalog free.

BLUEPRINT Reading — Train at home. Learn to read blueprints with confidence in 10 easy lessons. Write today Belton School, 1059-J North Lawndale, Chicago 51.

GAG-Writing pays \$200.00-\$400.00 monthly. Amazing. Simple. Easily understood instructive folio tells how. Satisfaction guaranteed. \$1.00 (refundable). Fields, 406 Boundary, Portsmouth, Ohio.

OPPORTUNITY To earn \$15,000.00 or more annually. Business of your own. No selling nor merchandise to buy. Over 5000 persons operating these exclusive offices. Free booklet. Franklin Credit, Roanoke 7, Virginia.

HIGH School — No classes. Study at home. Spare time. Diploma awarded. Write for free catalog HF-62. Wayne School, 2527 Sheffield, Chicago 14, Ill.

LEARN While asleep! Fact-filled instruction booklet \$2.00. Research Association, Box 610, Omaha, Nebraska.

FINGERPRINTING Course, \$12.00. Details free. Alabama School of Fingerprinting, Box 185-A, Fairfield, Alabama.

USED Correspondence courses and educational books bought, sold, rented. Free catalog. Educational Exchange, Menlo, Georgia.

LEARN Printing, 100 book lessons, \$9.00. Paul Bonneau, Gravelbourg, Saskatchewan, Canada.

GET Into politics! Brand new course tells how. Get into the big money class. Details free. Realfact Publishers, Post-office Box 137-A, New York 51, New York.

COMPLETE Your high school at home in spare time with 59-year-old school. Texts furnished. No classes. Diploma. Information booklet free. American School, Dept. X345, Drexel at 58th, Chicago 37, Illinois.

HELP Yourself! Solve personal problems by self-mastery. Free information. The Leavitt Science, Clinton 5, Illinois.

JOB Counseling by experts. Approved methods. Plan for brighter future. Request free questionnaire. National Guidance Service, Bainbridge Road, Elizabethtown, Penna.

TRANSFORM Yourself via subconscious. Free brochure. Box 847 (H-3), Ocean Park, Calif.

U. S. Civil service tests! Training until appointed. Men-women, 18-55. Start high as \$377.00 month. Many jobs open. Qualify now! Get free 36-page illustrated book showing salaries, requirements, sample tests. Write: Franklin Institute, Dept. P24, Rochester, N. Y.

EARN To \$50 day as spare or full time claim adjuster for airlines, insurance companies, railroads, government offices. Urgent need. Train at home. Placement counsel. Free book—Now! No obligation. Universal Schools, Dept. 103, Box 8202, Dallas 5, Texas.

RAILROADS Need telegraphers and station agents. We train and place you in 22 weeks. State approved. GI approved, free information. Iowa Institute of Telegraphy, Dept. B, Marshalltown, Iowa.

WANT Strong, masculine voice? Send for free booklet. Prefect Voice Institute, 210 South Clinton, Studio 2CU-2, Chicago 6.

LET Powerful recorded suggestions via subconscious give you pleasing, dynamic, singing and speaking voice. New, amazing, unique and revolutionary. Details. Golden Plains, Box 785, Chicago 90, Illinois.

PLAYS, STORIES, MANUSCRIPTS

WANTED: Book manuscripts, all subjects considered. Greenwich Book Pub., Attn. Mr. Zealand, 489 Fifth Ave., New York City.

NO Luck finding a book publisher? Write for free Booklet PM. Vantage Press, 120 W. 31, New York.

SPECIAL SERVICES

WE'LL Buy every Swedish necklace you make for \$4.25. Guaranteed. Earn \$46.75 weekly, minimum. Instructions: \$1.00. Inquiries welcomed. Alix, 611 15th N.W., Albuquerque, New Mexico.

SEEKING Agencies? Wade 8/119 Hamilton Terrace, London N.W.8, England.

INFORMATION On any subject, \$1. Certified research! J. F. Griffith, Wynnewood, Pennsylvania.

INFORMATION On anything. Ferguson Research Specialists, 116-14 141 St., South Ozone Park 36, N. Y.

CARTOONING, COMMERCIAL ART, SHOWCARD & SIGN PAINTING, TATTOOING

YOU Can entertain with chalk talks. Catalog 10c. Balda The Cartoonist, Oshkosh, Wis.

9 ALPHABET, 3 Numeral pattern sets and raised wood letter catalog, \$1.00. Sign Letter Distributors, P.O. Box 101, Mineola, N. Y.

TATTOOING Supplies, licensed course, illustrated brochures 25c. Zeiss, 728 Lesley, Rockford, Illinois.

LEARN Sign painting at home. Particulars free. Bolger, 148 Concord, River Edge, New Jersey.

LEARN Cartooning from professionals. Details free. Cartoonists, 2776 California Court, Lincoln 10, Nebr.

"HOW To Make Money With Simple Cartoons"—A book everyone who likes to draw should have. It is free; no obligation. Simply address Cartoonists' Exchange, Dept. 93C, Pleasant Hill, Ohio.

LEARN Profitable modern sign painting, commercial lettering. Anyone can be successful. Earn \$40-\$160 per week, spare time. Sign Instruction, Box 187PM3, No. Chicago, Ill.

BARGAINS! Wonderful courses. Drawing, painting, lettering, posters. Literature free. Art Book Shop, Arnold 8, Missouri.

PAINT With fire. Glowing black light colors. Different as day from night because you literally paint with light! Water colors, oils, chalks, crayons—Blak-Ray lamps. Free—write today for idea packet. Black Light Corporation of America, San Gabriel M, Calif.

ADVERTISING AGENCIES, LETTER WRITERS, FOR ADVERTISERS

ADVERTISING Ratebook leading newspapers, magazines, 10c. Chicago Advertising Agency, Chicago 4.

UNUSED Lists. From proven publications. 500, \$3.50; 1000, \$6.00. Edlen Studios, Norwell, Mass.

ADS Placed in out of town newspapers and magazines. Low rates. Catalogue free. Ideas that pay. Baker Advertising Agency, Successors Ankrum Agency, 189 W. Madison, Chicago 2.

FREE! 1956 Advertisers Rate and Data Directory. 52 pages! E. H. Brown Advertising Agency, 20 N. Wacker, Chicago 6.

MAILING Lists, most any classification. 1000 names \$5.00, 1000 your circulars mailed with ours \$4.00, 5000 your circulars printed and mailed \$12.95. Write Dixie Mailers, King, North Carolina.

ADVERTISE: 24 Words, 100 Canadian newspapers \$5.50. Lists free. Advertising Bureau, 10511-C Springfield, Chicago 43.

ADVERTISING Placed in any newspaper or magazine. Expert analysis your present advertising free. Save money, get better results. Raymond, 102 E. 9th, Fort Worth 2, Texas.

RUBBER STAMPS AND OFFICE SUPPLIES

3 LINES, \$1.00. Fast service. Catalogue. Johnson, 443 MacDonough, Brooklyn 33, N. Y.

YOUR 3 Line rubber stamp \$1.00. Lentz, Box 402, Youngstown, Ohio.

LINE—35c; 4, \$1.00. Cushioned. Price list. Carlton, 3007 Wharton, Philadelphia 46, Penna.

RUBBER Stamps by professional craftsmen. 3 lines \$1.00. Price list. South Coast Press, 654 East Base Line, San Bernardino, Calif.

3 LINES, 85c. Self-inking pocket, \$1.00. Lee-Vall, 1208 Edgemont, Indianapolis 23, Indiana.

NAME, Address stamp, \$1.00. Quick service. Hawthorne Company, Otsego, Mich.

TYPEWRITERS, DUPLICATORS, OFFICE DEVICES

RECONDITIONED Typewriters, duplicating, printing devices, \$25.00 up. Supplies. Appliances. DixieGraph, King, N. C.

PRINTING, MULTIGRAPHING, MIMEOGRAPHING, GUMMED LABELS

LABELS! What sort? Samples free. Fred Hoffman, 2471 Yeager St., Port Huron, Mich.

QUALITY Printing since 1929. Free samples. Spender & Son, Millington, Mich.

100 LETTERHEADS (8 1/2 x 11) Printed neatly \$1.00 postpaid. Envelopes same. Blue or black ink. Stark Press, Capitola, Calif.

1000 EMBOSSED Business cards, one color \$3.95; two color \$4.50. Samples free. L. Watson, Box 162, St. Charles, Illinois.

MIMEOGRAPHING—Letters, pricelists, formulas, instructions. Lowest prices. Lem's Letter Shop, 5710 Stanton, Detroit 8.

ADS Running under this heading sell printing. Ask me for proof. I'll gladly send you amazing facts. Ask for Folder "P." F. W. Johnson, 200 E. Ontario St., Chicago 11, Ill.

LETTERHEADS, Business forms, 1000—\$4.95. Samples. D'Yarmett, 420 Columbian, Columbus 23, Ohio.

1,000 RAISED Letters business cards only \$2.95 postpaid. Samples free. Pioneer, 195 Quebec, Island Park, N. Y.

FREE Catalog. Printing, embossing. D & M Press, Sebastopol, California.

PRINTING, Diecutting. Rough ideas developed free. Lisk, Central Lake, Mich.

"HOW To Buy and Use Printing" Free booklet, samples and prices. R-K Press, 825 Powder Mill Lane, Philadelphia 31, Penna.

POSTPAID Stationery, business printing. Fast service, samples. Haines Press, Petersham, Mass.

SAVE 50%: Super quality business cards, letterheads, advertising sale-makers. Free samples. Estimates. Printer Lee, Box M-307, Sturgis, Michigan.

MIMEOGRAPHING—Reasonable. Any copy. Mailers Service, Box 606-B, Chicago 90, Ill.

DISTINCTIVE Stationery. 125 letterheads-envelopes, \$2.00. Blackwood, 3860 Van Ness, Dallas 20, Texas.

SPECIAL: 250 Letterheads, #10's \$4.95! Catalog. Postcard: Redoprint, Ojal, Calif.

200 LETTERHEADS, Envelopes \$4.95. 1000 cards \$2.99. Samples. Ridgecrafters, Glencoe, Mo.

AMERICA'S Finest economical printing. Illustrated catalog. Steinbergen Press, GPO Box 291C, New York City.

500 PRINTED Gummed name and address labels, \$1.00. No c.o.d.'s. Print clearly. Addison, 1840-D Addison, Chicago 13.

1000 EMBOSSED Cards \$2.90 postpaid. Samples. Coronet, B-879, Sherman Oaks 2, Calif.

MIMEOGRAPH Stencils cut electronically! Free samples. Bert's, 3603 W. North, Chicago 47, Ill.

BUSINESS Printing. Illustrated catalog free. Howprint, 723-G Eunice, Webster Groves 19, Missouri.

125 LETTERHEADS, \$1.00. The Caxton Press, Box 143, Cincinnati 11, Ohio.

PRINTING OUTFITS AND SUPPLIES

PRINT Gold embossed type stationery at home. Typewriter, rubber stamp, pen. Embossomagic powder 50c. MG, 8022 Trade Village, Dallas, Tex.

RUBBER Stamp making presses, supplies. Custom, Box 211-M, Springfield, Missouri.

DO Your own printing. Save money. Simple rules. We supply everything. Print for others; good profit. Raised printing like engraving too. Have home shop. Details free. Kelsey Presses, V-11, Meriden, Connecticut.

MAKE Your own self-molding rubber stamps and printing cuts. Plexirubber, Argyle 1, Wisconsin.

PRESSES, Type cabinets, supplies. List for stamp. Lincoln Press Company, 220-C Hartwell, Fall River, Mass.

USED Presses, cylinder, job. Linotype. Cheap. Lisk, Central Lake, Mich.

PATENT ATTORNEYS

INVENTORS—If you believe you have an invention, you should find out how to protect it. The firm of McMorrow, Berman & Davidson with offices in Washington, D. C., is qualified to take the necessary steps for you. Send for copy of our patent booklet "How to Protect Your Invention." We will also send you an "Invention Record" form. No obligation. They are yours for the asking. McMorrow, Berman & Davidson, Registered Attorneys, 134-W Victor Building, Washington 1, D. C.

INVENTORS—Take these preliminary steps toward patent protection. Sketch and describe your invention. Sign, date and have this disclosure witnessed by two people who understand your invention. Have us make a preliminary search among U.S. patents already granted for similar types of invention. We report on the probable patentability of your invention and recommend your further course of action. Write for our instructive booklet, "Patent Protection for Inventors" and convenient "Evidence of Invention" disclosure form. Victor J. Evans & Co., 231-C Merlin Building, Washington 6, D. C.

PATENTS—Irving L. McCathran, 315 McLachlen Bldg., Washington 1, D. C. Registered Patent Attorney.

INVENTION Record form free and "Patent Information Every Inventor Should Have." Carl Miller, Registered Patent Attorney, Woolworth Building, New York.

REGISTERED Patent attorney offers services. Sanders, 6430 Evans, Chicago 37, Illinois.

C. A. Snow & Co.—M427, Snow Building, Washington 1, D. C. Registered Patent Attorneys. Write for information.

INVENTORS: When you are satisfied that you have invented something of value write me, without obligation, for information as to what steps you should take to secure a patent. Write Patrick D. Beavers, Registered Patent Atty., 935 Columbian Bldg., Washington 1, D. C.

PATENTS, "Proof of Invention" free. E. E. Vrooman, Registered Patent Attorney, 507 McKim Building, Washington 5, D. C.

INVENTORS: Without obligation, write for information explaining the steps you should take to secure a patent. John Randolph, Registered Patent Attorney, 203 Columbian Bldg., Washington 1, D. C.

"INVENTOR'S Guide," "Record of Invention," sent free. Frank P. Ledermann, 154 Nassau Street, New York 38, N. Y.

HERMAN Lewis Gordon, registered patent attorney. Patent investigations and opinions. Warner Building, Washington 4, D. C.

INVENTORS: Learn how to protect your invention. Unless the inventor is familiar with patent matters, he should engage a competent registered patent attorney or agent to represent him. We are registered to practice before the U.S. patent office and prepared to serve you in handling your patent matters. "Patent Guide for the Inventor" containing detailed information concerning patent protection and procedure with "Record of Invention" form will be forwarded to you upon request—without obligation. Clarence A. O'Brien & Harvey Jacobson, Registered Patent Attorneys, 61B-A District National Building, Washington, D. C.

FOR INVENTORS

INVENTORS: If you have an invention for sale, patented or unpatented, write Institute of American Inventors, Dept. 40A, 631-E St. N.W., Washington 4, D. C.

SAVE Money on your patent application. Patents for any country. Free details. International, 25 McMaster, Toronto, Can.

INVENTORS: Learn how to protect your invention. Unless the inventor is familiar with patent matters, he should engage a competent registered patent attorney or agent to represent him. We are registered to practice before the U. S. patent office and prepared to serve you in handling your patent matters. "Patent Guide for the Inventor" containing detailed information concerning patent protection and procedure with "Record of Invention" form will be forwarded to you upon request—without obligation. Clarence A. O'Brien & Harvey Jacobson, Registered Patent Attorneys, 61A-A District National Building, Washington, D. C.

PATENT Searches, including copies of nearest patents, \$6.00. Reports airmailed within 48 hours. More than 100 registered patent attorneys use my service. For free invention protection forms, write Miss Ann Hastings, P.O. Box 176, Washington 4, D. C.

INVENTION Record form free and "Patent Information Every Inventor Should Have." Carl Miller, Registered Patent Attorney, Woolworth Building, New York.

SEARCHES—Put your patent searches in the hands of a registered patent attorney or agent, as he qualifies to give a worthwhile patentability report. Record of invention form upon request and information on patent protection. Patrick D. Beavers, Registered Patent Attorney, 936 Columbian Bldg., Washington 1, D. C.

INVENTORS: Information on patent procedure furnished on request without obligation. John Randolph, Registered Patent Attorney, 203 Columbian Building, Washington 1, D. C.

PATENT Searches \$5.00. 48-hour service. Free invention protection forms. Write Raymond L. Smith, Patent Searcher, 620 Sheraton Building, Washington 5, D. C.

FREE Invention protection form airmailed. Patent office search, plus advice on selling your invention, \$5. Inventors Sales & Engineering Service, Box 4973, Washington 8, D. C.

PATENT Searches \$5.00. 48-hour airmail service. Invention protection forms free. Write Patent Engineering Service, 711 14th Street N. W., Washington 5, D. C.

INVENTORS—Send for free patent information book and inventor's record. Registered Patent Attorney, Associate Examiner, Patent Office 1922-29, Patent Attorney & Advisor, Navy Department 1930-47. Gustave Miller, 36A Warner Building, Washington 4, D. C.

INVENTORS—If you believe you have an invention, you should find out how to protect it. The firm of McMorrow, Berman & Davidson with offices in Washington, D. C., is qualified to take the necessary steps for you. Send for copy of our patent booklet "How to Protect Your Invention." We will also send you an "Invention Record" form. No obligation. They are yours for the asking. McMorrow, Berman & Davidson, Registered Patent Attorneys, 134-V Victor Building, Washington 1, D. C.

INVENTORS—This firm is registered to practice before the United States Patent Office and available to assist you in the preparation and prosecution of your patent application. "Patent Protection for Inventors" booklet containing detailed information and steps to take toward patent protection sent promptly upon request. No obligation. Victor J. Evans & Co., 232C Merlin Building, Washington 6, D. C.

INVENTORS: Our invention promotion service is guaranteed. Write for free copy of plan and guarantee. Kessler Corporation, 53FI, Fremont, Ohio.

FREE Patent booklet. Lawrence Blasius, 15A Park Row, New York 38, N. Y.

PROBLEM? Licensed, graduate M.E. will assist you to perfect your invention. \$5.00 deposit required. Prompt reply. R. M. Vincent, Consulting Engineer, 2727 Stevens, Parsons, Kansas.

PATENT Searches, \$5.00. Free protection forms. Prompt airmail service. Complete reports. Patent Service Institute, 725-A Albee Building, Washington 5, D. C.

"INVENTOR'S Guide" sent free. Frank P. Ledermann, 154 Nassau Street, New York 38, N. Y.

PATENTS, Trademarks, copyrights, ideas. Protect them. Forms and necessary first steps for your protection sent postpaid to any address (local or foreign) upon receipt of \$5.00 check or money order. Satisfaction or money back. Rex Sales Co., 315 W. 9th St., Room 806-A, Los Angeles, California.

INVENTIONS WANTED

INVENTORS: Hundreds of manufacturers have requested our assistance in locating marketable new products. Complete information free. Institute of American Inventors, Dept. 40-D, 631-E St. N.W., Washington 4, D. C.

INVENTORS, Don't sell your invention patented or unpatented until you receive our offer. Write Cowgill, Box 298, Marion, Ohio.

CASH Buyers for ideas and inventions. Write National Inventors Institute, 457 Munsey Building, Washington 4, D. C., or 4900 Euclid Ave., Cleveland 3, Ohio.

INVENTIONS Wanted now by my manufacturer-clients. Patented, unpatented. Send for free form "S." Adams, Patent Broker, 80 Wall Street, Financial District, New York City.

THE Promotion service for patented and unpatented inventions. Full particulars, forms, guide, recording, etc., free. Superior, 338-344 North Rodeo, Beverly Hills, Calif.

WE Are interested in new products. If your idea, invention, or patent appeals to us we will finance it, giving you full protection. No advance fee charged. Only letters of interest answered. Send details today. National Research & Development Corp., Dept. M, 11 West 42 Street, New York City.

NO Prepayments. Patented inventions marketed, 10% of profits. Jerry Peters, Box 9238, Rosslyn Station, Arlington 9, Virginia.

INVENTIONS And patents promoted. A-1 service for inventors for many years. Write Adam Fisher Co., 5418 Idaho, St. Louis, Mo.

INVENTIONS Wanted. Patented or patent pending. 25 years experience promoting inventions. National Service Bureau, 3120 Meramec, St. Louis 18, Mo.

INVENTIONS Wanted. Patented; unpatented. Tremendous manufacturers lists. Global Marketing Service, 2420 77th, Oakland 5, California.

YOU May make a fortune on your invention! Learn how we contract on cash or royalties. Send name on postcard to Kessler Corporation, Dept. 531W, Fremont, Ohio.

YOUR Idea may be worth a fortune. For full and complete information write: Inventors, Box 1481, Milwaukee 1, Wisconsin.

PATENTS FOR SALE

INVENTORS: Test the commercial value of your patented or unpatented inventions, quickly and inexpensively. Write for free information. Institute of American Inventors, Dept. 40-B, 631-E St. N.W., Washington 4, D. C.

ELECTRIC Toothbrush machine 529,473. Improved one wire clothespin 538,379. S. Tsuda, 182 Mohouli St., Hilo, Hawaii.

MANUFACTURING

METAL Spinning to specifications. Triangle, 1909 Ave. M., Brooklyn, N. Y.

SHEET Metal items wanted to manufacture by production shop. Send us your ideas and we will develop them. H. Flanner, 2509 N. Reese St., Philadelphia 33, Penna.

FINELY Detailed metal castings from your metal original. Low cost short runs. Selley, 744 Clay, Winter Park 21, Fla.

MODELS—Small lot manufacturing. Metals, plastics, etc. Milburn, Burlington, Kentucky.

MODELS, MODEL SUPPLIES

NEW Truescale ship model kits cut building time to one-quarter—More detail than ever with castings and pre-cut pieces. Mahogany hulls and baseboards, brass mounting pegs, new simplified plans, parts keyed and numbered, genuine wood blocks and deadeyes. (No plastics.) Send 10c for brand new catalog 22 ships, 4 guns. All collectors' items. Marine Models, Dept. 564, Halesite, Long Island.

RAILROADERS Get 1956 catalog-reference manual. O gauge scale, tinplate 50c. HO 50c. Terminal Hobby, 247 Erie, Milwaukee 2, Wis.

SHIP Models. Most complete line in New England. Kits, fittings, plans, books, tools, engines, motors. Illustrated catalog 25c. James Bliss & Co., Inc., Dept. SM, 342 Atlantic Ave., Boston 10, Mass.

BALSA Wood and model aircraft. 40-page catalog 10c. Sig Co., Montezuma, Iowa.

SHIP And yacht model fittings; blueprints. Send 35c for illustrated catalog listing hundreds of items. A. J. Fisher, 1002-1 Etowah Ave., Royal Oak, Mich.

SHIP Model kits and fittings including clippers, trawler, fishermen, frigates, privateer, radio control tug, etc. Send 25c for 1956 catalog. Model Shipways, Box 85, Bogota, N. J.

1956 CAR Models, 1/25 scale, all metal, chrome trim. Send for catalog! Cars and Hobbies, Dept. PM-12, 2333 Haddon, Chicago.

MODEL Railroad catalog. Over 850 illustrations. O and HO. Only 10c. Selley, 744 Clay, Winter Park 23, Fla.

HOME CRAFTSMEN

GRANDFATHER Clocks. Build a tubular chime at factory prices. Send 50c. Wills Bros., 237 S. Ellwood Ave., Baltimore 24, Maryland.

FREE Catalog. 1560 patterns and designs. Craftplans, 1321-A South Michigan, Chicago 5.

PLASTICS Home-craft course for men and women. Tells and shows how to make hundreds of fast selling plastics products. All plastics and materials for 23 projects included in course. No special tools needed. Course pays for itself. Write for free booklet. Interstate Training Service, Dept. D-3, Portland 13, Oregon.

129 NEW Full-size jigsaw patterns. Artist-drawn. \$1. Craftplans, 1321-A South Michigan, Chicago 5.

WOODWORKING Course for home craftsmen. Twenty-two manuals. Over 1000 pages. 75 training projects. Only complete home training program available today. Carefully written, profusely illustrated. Covers everything from wood selection to final finishing. Complete instruction in care and use of all hand and power tools. Prepared by expert manual training instructors. Write for free booklet. Interstate Training Service, Dept. G-3, Portland 13, Oregon.

JIGSAW. Bandsaw owners, let your machine bring extra profits, fun. Free details. Nu-Art, Box 2235, Boston, Mass.

KNOCKDOWN Cedar chests. Lumber and veneers. Free price list. Giles & Kendall Company, Huntsville, Ala.

STYLECRAFT Sure fire hits. "Pre-traced" leather kits. Handbags, billfolds, filigree belts, over fifty other projects. Patterns on leather. Why trace? Just carve, assemble and lace. Large assortment "precarved" kits also available. Send 25c for catalog, free folder. Refunded first order. Apache Leather Company, 2804 E. Washington St., Phoenix, Arizona.

KNOCKDOWN Cedar chests and lumber. Free price list. Bedford Lumber Company, Shelbyville, Tennessee.

18 FULL-Size patterns. Save money with easy-to-use, professionally designed full-size patterns. Make money selling beautiful, useful furniture. Make modern step and cocktail tables; metal lamps; cupola; 12-foot outdoor. All patterns test-built; sold with money-back guarantee. Get your free list of these convenient, economical patterns today. Popular Mechanics Press, 200-HH E. Ontario Street, Chicago 11, Illinois.

FREE Handicraft supply and project catalog. American Handicrafts, Box 1479-EQ, Fort Worth, Texas.

VIOLINMAKERS, Amateurs, professionals. Fine toned, seasoned European wood. Materials, tools, patterns, instructions. Catalogue 10c. Premier Violin Supplies Division PVM, 430 South Broadway, Los Angeles 13, California.

ALL Crafts, supplies. Large free catalog. National Handicraft, 199 William Street, New York City 38.

FREE "Do-it-yourself" leathercraft catalog. Tandy Leather Company, Box 791-M13, Fort Worth, Texas.

16 NEW Lawn chairs, 22 picnic tables, benches, trellises, etc. All 38 plans with necessary full size patterns, \$1.00. Mastercraft 33M, 7041 Olcott, Chicago 31, Ill.

LAMP Size cypress knee with nipple installed, \$2.00. Cy Products, Dept. 2-R, Lafayette, La.

SELL Your handcraft profitably. Sell all you can make. "How and Where to Sell Handcraft," is the answer to your markets problem. Contains large list of gift shops who sell on commission and pay cash also. Price \$1.00 ppd. Money back if dissatisfied. Oliver Bell, 204 W. 5 St., Cle Elum, Wash.

LEATHERCRAFT. Send 10c for new 60-page catalog of tools, supplies, kits, including metalcrafts, enameling, ceramics, all other crafts. Complete stock. Reasonable. Since 1910. Sax Bros., Dept. PM1, 1111 N. 3rd, Milwaukee, Wis.

101 FULL Size patterns. Smart, new, gifts, novelties, lawn figures, shelves, action windmills, alphabets. Plus "Make Money Jig Saws." Only \$1.00. Mastercraft 35M, 7041 Olcott, Chicago 31, Illinois.

AMAZING Circle-Jig converts table saw to jig saw. \$11.95 postpaid. Money-back guarantee. Versa-Tool Company, 403 Lake, Racine, Wisconsin.

METALCRAFT. Big illustrated catalog free. Aluminum, copper, and enameling supplies. J. C. Larson Co., 820 S. Tripp, Dept. 6075, Chicago 24.

OLD Cape Cod finishers' formula gives professional results staining new wood, refinishing old with warm, mellow look, in antique pine, Guilford pine, Salem maple, driftwood, colonial cherry, natural. \$1.50 pint; \$2.00 quart postpaid. Color card, brochure on request. Cape Cod Finishes, Dept. 3B, 145 Main Street, Cambridge 42, Mass.

LEATHERCRAFT. Metal enameling, beadcraft, shellcraft, metal tooling, textile painting, many other crafts. Free big illustrated catalog. Kit Kraft, Dept. 233, Studio City 1, California.

BUY Wholesale nationally advertised power, hand tools, thousands other products at big discounts. Free "Wholesale Plan." American Buyers', Hertel Station, Buffalo 16-F, N. Y.

WROUGHT Iron legs. Make your own furniture. Plans, literature, 25c. Hibbard's, 624 Celey, Hampton 4, Va.

MITER Box, \$1.95. Formica laminated on 3/4" plywood, 3 1/2" x 15 1/2". Postpaid. State Plywood, 2606 No. San Fernando Blvd., Burbank, Calif.

MASTER Designer volume available for art craftsmen, illustrating 470 actual size ornamental tracing designs for leather, metals, wood. \$5.00. F. O. Baird, Box 1367, Manitou Springs, Colorado. Satisfaction guaranteed. Free folder.

DO IT YOURSELF

CUCKOO. Now you can build Cuckoo clocks like those imported from the Black Forest. All necessary parts available! No special tools required! Send \$1.00 (refundable first order) for illustrated instruction booklet and prices. House of Reich, 9804 E. 68th, Hickman Mills, Mo.

SAVE Money. Make electrical appliance tester. Diagram and instructions \$1.00. Walt's, 801 Leslie, Wood River, Illinois.

GEIGER Counter and metal detector kits. Inexpensive, educational. Free literature. Electronic Applications, 5034 Lee Highway, Arlington 7, Va.

CARPORTS. Patio roofs. Partitions, build them yourself with beautiful Fiberglass planks. Details free. Concourse, 4003 Dyre, New York 66, N. Y.

"HOW To Appraise Diamonds." Informative, complete, \$2 postpaid. Appraisers, Box 374 GK, Staten Island 8, N. Y.

"DO It Yourself Encyclopedia." 12 giant volumes (3,000 pages) packed with thousands of ideas, plans, gadgets and projects you can do yourself. How to weld, paint, repair most anything. How to make boats, deepfreeze, draperies, jigsaw projects and just scores of other items. How to do electric wiring, plumbing, room building. How to modernize kitchens, bathrooms. Greatest, most complete fix-it library ever offered. Written so you can understand it. You'll be thrilled when you see what these 12 big volumes contain. It's simply sensational. You must really see them to fully appreciate this exciting fix-it library. You'll fall in love with them just as soon as you open the first volume. I'll send you a descriptive circular that will open your eyes to the greatest, most complete and beautifully illustrated "Fix-it" library you ever laid your eyes on. Send a postal right now. Popular Mechanics Press, 200-DY East Ontario St., Chicago 11, Illinois.

BUILD A loom—Weave rugs, drapes, cloth. Complete instructions with 8 drawings \$1.00. OR. Rug Company, Dept. 3614, Lima, Ohio.

LUXURIOUS 10,000 Gallon swimming pool built for \$525.00. Send \$4.00 for engineered plans to: Cascade, Box 95, Hamilton Square, N.J.

FIGURINES. Unfinished. Catalog, Valencia Art, 1606 Grand Ave., Santa Barbara, California.

CLOCK Movements—Gorgeous dials, plans, kits. See ad page 267.

ATTENTION: Hard of hearing. Make your own hearing device, with articles you have at home. Hear radio, television, without your noisy hearing aid. Amazing reception guaranteed. Instructions 25 cents and stamped addressed envelope. Bedard, Base, Dept., 39 Lynnway, Lynn, Mass.

WATCHES, OLD GOLD, JEWELRY

WATCHMAKERS'—Jewelers' supplies, instructions. Catalog 20c. Bengale Company, Culver City, California.

COSTUME Jewelry supplies. Catalog and samples. 35c. Largest line in America. Milady-Fair Co., G.P.O. Box 1328, New York City 1.

USED And new watches \$2 up. Free list. Southern Watches, Gray, Georgia.

MAKE Rhinestone jewelry. Complete introductory kit and illustrated catalog \$1.00. Catalog alone 10c. J & M Novelties, Dept. CC-3, Griffith, Indiana.

WATCH And clock repairing books. Free information. North American, Dept. 16C, 2320 N. Milwaukee, Chicago 47, Illinois.

HIGHEST Cash for old gold, broken jewelry, gold teeth, watches, diamonds, silverware, spectacles, platinum, mercury. Free information. Satisfaction guaranteed. Rose Refiners, Heyworth Bldg., Chicago 2.

WATCHMAKING Jeweler. Learn instructions to start. Wholesale tool, watch, catalog \$1.50. Refund with first order. Stewart's, 727 Market, St. Louis, Mo.

WATCHMAKERS' Tools, materials, supplies, watches. Catalog. Gales, Box 1000, Chicago 90, Illinois.

DIAMOND Rings. Free catalog. Factory prices. Hedges, Amityville 187, N.Y.

10 SWISS Watches \$18.00. Catalog 10c. Berkowitz, 1150 Castlehill, New York City 62.

RHINESTONES. Send \$2.25 for five gross, value \$5.00, free catalog, bargain list. Ebert, Box P183, East Orange, New Jersey.

TOBACCO, SMOKERS' SUPPLIES

INTRODUCTORY Offer: pipe smoking, 3 pounds \$2.00 postpaid. Star Farms, Ralston, Tennessee.

PIPES. Semi-finished, for carvers. Tools, instructions. Walter Miller, Germantown, Ohio.

RAZORS, BLADES, SHARPENING

ELECTRIC Shavers, \$4.95 each. Were \$22.50. Warehouse clearance. Sold nationally. New in original boxes with written guarantee. Public Service Dept., Warehouse 27, Box 229, Downey, Calif. Make checks to E. B. Jeffries, Supt.

FOR THE HOME

HOW Septic tanks work and to keep working write Mandeville Specialty Co., Mandeville, La.

FREE Foam rubber catalog: Cushions, pillows, etc. 50% discount. Barry-Foam, 20F Ardley Ct., Newark 2, N. J.

FOAM Rubber furniture cushions. Factory seconds. 50% discount. Free catalog. Perma-Foam, 429C Central Ave., East Orange, New Jersey.

OF INTEREST TO WOMEN

UNUSUAL And attractive imported gifts. Free catalog. Itradco, Columbian Bldg., Washington 1, D. C.

PROFITABLE Home business. Make fast-seller chenille monkey trees, dolls, flowers. Terrific holiday demand. Information free. Velva, Bohemia 16, N. Y.

DRESSES 24c; Shoes 39c; men's suits \$4.95; trousers \$1.20. Better used clothing. Free catalog. Transworld, 164-S Christopher, Brooklyn 12, N. Y.

\$5,199.90 WAS Paid to John Betts, in few weeks. Grow mushrooms. Cellar, shed. Spare, full time, year round. We pay \$3.50 lb. Free book. Mushrooms, Dept. 176, 2954 Admiral Way, Seattle, Wash.

GOOD Money in weaving. Weave rugs at home for neighbors on \$69.50 Union Loom. Thousands doing it. Booklet free. Union Looms, 153 Post St., Boonville, N. Y.

SELL Fine fabrics. Get yours wholesale. Box 863, Norwalk, Conn.

WANT To make big money at home? \$5 profit in an hour possible with invisible reweaving. Make tears, holes disappear from clothing, fabrics. Steady year-round demand from cleaners, laundries, homes. Details free. Fabricon, 8332 Prairie, Chicago 19, Illinois.

"8 MISTAKES Parents Make." Every parent should have this new book about child training. It is free; no obligation. Simply address Parents Association, Dept. 673, Pleasant Hill, Ohio.

PROFITABLE Woodfibre flowers. Kit \$1.00. Catalog 25c. Artificial Flowers, 203 Worthington, Springfield, Mass.

FOR SALE—MISCELLANEOUS

1956 SHICK "25" Shaver \$15.90. Parker pens 40% off. Terrific discounts appliances, photo equipment. Free catalog. Mailers Mart, Box 135-A7, New Rochelle, New York.

WANTED—MISCELLANEOUS

SCRAP Mercury (quicksilver) containers supplied—Tantalum, bismuth, tungsten, Metallurgical Products Company. Established 1909, 35th and Moore Sts., Philadelphia 45, Penna.

QUICKSILVER, Sterling, silver solders, precious metals. Wholesale Terminal, Norwood, Massachusetts.

PERSONAL

SURPRISE Your friends! Honolulu remails 10c. Confidential receiving address available! Fobel, 3132 George Street, Honolulu.

LIKE Full mail boxes? Interesting "offer-tunities" galore 25c. Traylor's Enterprise, La Feria, Texas.

JOBS? Sunday classified section \$1.00. Letters remailed 25c. Hal Campbell, 200 W. Clarendon, Dallas, Texas.

ULTRA-Fabulous Las Vegas. Classifieds airmailed \$1.00. Remails 25c. Reairmails 40c. Message typewritten on multicolor postcard 50c. 15 multicolor postcards all different \$1.00. Box 248, Las Vegas, Nev.

WEALTH—Happiness. Fulfill all your desires with "The Seven Secrets to Success." Unconditionally guaranteed. Nothing more to buy. This is it. Send \$1.00 today. Cromwell, Box 343, Northridge, Calif.

BORDER Bulletin! Co-publish this little magazine for \$1 per month! Your thirty word advertisement free! Sample, details 5c! Border Bulletin, 910 Marion, Pharr 22, Texas.

CANADA Offers unlimited opportunities. Classifieds, three Toronto newspapers airmailed \$1.00. Canada Classified Service, 11 Edgemore Drive, Toronto 18, Canada.

"HOW Can I find out?" You can! Information confidentially developed. Any matter, person, problem. Worldwide. Officially licensed Established 1922 William Herman, 170 Broadway, New York City.

LETTERS Remailed 25c. Personal forwarding address. Monthly rates. Hicks Service, Box 1547, Washington 13, D. C.

GLOBAL Viewcard selection, worldwide remailing. Travelpost, Box 198, Nogales, Arizona.

REMAILING. Forwarding 25c each. Ace Service, Box 186, Tampa 1, Fla.

CLASSIFIED Section Denver Sunday paper \$1.00. Rose, 1645 Lafayette, Denver, Colorado.

SCENIC Utah remails 25c. Private receiving address \$2.00 month. Karma Lyons, 361-p East 2nd, South Logan, Utah.

YOU Have seen Arthur Godfrey's program about Miami. Send one dollar Miami Classifieds, Box 725, Miami Springs, Fla.

VITAMINS From California. Big savings. Buy direct. Free catalog. Hudson's, Box 4015, Fresno 4, Calif.

BORROWING By mail. Loans \$100 to \$600 to employed men and women. Easy, quick. Completely confidential. No endorsers. Repay in convenient monthly payments. Details free in plain envelope. Give occupation. State Finance Co., 323 Securities Bldg., Dept. S-227, Omaha 2, Nebraska.

BORROW By mail from Postal Finance Co. Employed men and women can easily obtain \$50 to \$600 fast, entirely by mail. Repay in small monthly payments. Friends, relatives, employer, tradespeople will not know you are applying for loan. Advise occupation, amount wanted. Postal Finance Co., 200 Keeline Bldg., Dept. TE, Omaha, Nebraska.

CONFIDENTIAL Address \$5.00 yearly. Letters remailed from anywhere within U.S.A. \$1.00. Specify postmark desired. Box 972, Santa Barbara, California.

WORCESTER Zooming. High wages, reasonable rents. Classified \$1.00. Remails 25c. Poire's, 31 Chadwick St., Worcester 5, Massachusetts.

WHAT Is your I.Q.? Take reliable intelligence test. Approved, scientific. Confidential report by mail. Free information. University Test Bureau, Desk M-5, Box 401, Palo Alto, California.

ANNOUNCING Our new psychological test that reveals your true vocational aptitude. If you long for real inner contentment, self-confidence, and better adequate income, send today for free full facts to Employment Counselors, Suite 507-AC, Professional Building, Baltimore 1, Md.

MIAMI Remailing, forwarding, 25c each. Lewellyn, Box 69, South Miami, Florida.

BUY Vitamins direct. Amazing savings. Catalog free. Matoska, White Bear, Minn.

MEXICAN Law. General Practice Attorney. Apartado 79, Juárez, Chih., México.

REMAILING SERVICE

LETTER Remailing, receiving-forwarding address for rent. McLaughlin, 800 Stewart, Columbus 6, Ohio.

FAMOUS Daytona Beach, Florida, cards mailed and letters remailed 25c. Carle, 263-15th St., Holly Hill, Fla.

SOUTH Africa, Rhodesia, Swaziland and Mozambique. 1/2 oz. letters rearmailed. Each country \$1.00. Send money order to S. D. Buis, 2 Drill Street, Barberton, East Transvaal, South Africa.

REMAILS 25c. Sunday classifieds \$1.00. Jordan, 1120 Chenevert, Houston, Texas.

CUBA—Mail received, forwarded, \$3.00 month. R. Morejón, Box 1291, Havana.

CONFIDENTIAL Address \$3 month. Details free. Box 830, Alhambra 23, Calif.

REMAILS 25c. Sunday classifieds \$1.00. Anderson, Box 1826, Milwaukee 1, Wis.

LETTERS Stamped, mailed from Pisa, Italy, 50c. Airmail \$1.00. Hostrop, Largo Bellavista 3, Livorno, Italia.

TREASURE FINDERS

GEIGER Counters and kits. Sensational values. Free literature. Roberts Mfg. Co., Cleburne, Texas.

URANIUM Finding made easy! Completely transistorized Geiger counters available for first time. Extra sensitive. Lightweight. Scientifically engineered. Unconditionally guaranteed. Also complete line prospecting instruments from \$19.95. Write for free information, maps, techniques. Universal Atomics Corp., Dept. PM2, 19 East 48th Street, New York City.

SCINTILLATORS, Geiger counters, metal detectors, mineralights. Retail only. Intl. Stamp Bureau, 125 W. Adams, Detroit 26, Michigan.

LITHIUM—The wonder metal. Free booklet describes prospecting information, uses, etc. Nu-Age, Box 142, North Battleford, Sask, Canada.

URANIUM—Radioactive analysis of rocks, clays, sands. \$2.00 per sample. Red Hill Uranium Ltd., 809-B Miles, Hereford, Texas.

FIND Buried treasure, gold and silver, with Goldak's sensational 3 1/2 lb. "find-it" locator, only \$49.50. Write for free literature on complete line of mineral, metal locators; Geiger and scintillation counters. Goldak, 1541 W. Glenoaks Blvd., Glendale, Calif.

URANIUM, Gold, silver treasure. New, power-packed, highly sensitive metal detectors, Geiger counters and mineralights, kits and assembled models from \$12.50. Lightest weight, guaranteed, free literature. Electronic Applications, 5024 Lee Highway, Arlington 7, Va.

GOLD, Silver, metal detectors. Geiger counters for uranium. Mineralights. Sensational new fully guaranteed models. None finer. Information free. Detectron Corp., 5528 Vineland Ave., North Hollywood, California.

URANIUM Prospector's guidebook; illustrated uranium handbooks; all \$2. Uranium Research, Box 788M, Washington, D. C.

JEEP Owners—V8 power. Read Jeep Owners ad, page 37.

POWERFUL Shirt-pocket transistor Geiger counter. Free literature. Transmiteme, Manteo, North Carolina.

TREASURE, Metal, mineral detectors. M-Scope. Used worldwide for treasure hunting. Mineralights, Geiger, scintillation counters. Prices from \$14.75. Fully guaranteed. Use our time payment plan. Free booklets on treasure hunting, uranium prospecting. Free catalog. Fisher Research Lab., Inc., Dept. PM-1, Palo Alto, Calif.

MISCELLANEOUS

PANNING Gold lesson—Free mail-order catalog, mining supplies, mineral books. Old Prospector, Box 729D1, Lodi, Calif.

STUPENDOUS Mental power. Adults. (Details 10c.) Delmar Wisdom, 846 Sunny-side, Chicago 40.

YOUR Name wanted. We'll send 1000 publishers, mailers, wholesalers your name, on our list one year 25c. Dixie Mailers, King, N. C.

WHOLESALE Catalog! 30-80% discounts! Appliances, musical instruments, typewriters, phonographs, watches, jewelry, recorders, housewares, etc. Consolidated Distributors, 21-13 Lafayette, Paterson 15, New Jersey.

CLOGGED Drains, cesspools and septic tanks cleaned by new powerful chemical. Sursolvent removes grease, soap, tree roots, etc., without expensive digging and electric rodding machines. No pumping necessary. Mix with water and pour down drain. Free details. Electric Drain Cleaning Co., Boston 34, Mass.

HOW To be saved, and know it. Free literature. Bible House, 2516 1/2 Jay, Sacramento, Calif.

CORN Popper steam engine unfinished castings, photo 25c. Rollo Every, Clarklake, Michigan.

RECEIVE Magazines, samples, catalogues. Mails from everywhere. Offers, hundreds. Get listed 25c. Rorick, Cincinnati 26, Ohio.

CIGARETTES—Roll 20 for 9c, guaranteed to please. Facts free. Pete Moberly, Box 797, Owensboro, Kentucky.

70 BIBLE Lessons, 25c. Bulletin, Box 87, Cathedral Station, New York City 25.

BUSINESS And job opportunities unlimited! Florida's boom town, Ft. Lauderdale. Population doubled last 5 years. Full details, \$1. Kemp, 823M N.E. 7th Ave., Ft. Lauderdale, Fla.

PICTURE Postcards made from your photograph. 1000 \$11.00. Raum's, 4154 Fifth Street, Philadelphia 40.

E-Z-Hang. The unique self adjusting window shade bracket that is easy to use! Has these advantages. Automatically adjusts, fits any window, any shade. No need to nail and re-nail. Each pair complete with screws and directions. Minimum order 4 pr. \$1.56 postpaid. Send check or m.o. Coleman Products Company, 3801 Belle Avenue, Baltimore 15, Maryland.

BE Your own plumber. You can. Few inexpensive tools and our instructive book, "Home Plumbing Guide," shows and tells you how. Hundreds of photographs and diagrams. Easy to follow. 160 pages. \$3.50. Catalog free. Popular Mechanics Press, 200PG East Ontario St., Chicago 11, Ill.

\$5,199.90 WAS Paid to John Betts in few weeks. Grow mushrooms. Cellar, shed. Spare, full time, year round. We pay \$3.50 lb. Free book. Mushrooms, Dept. 175, 2954 Admiral Way, Seattle, Wash.

SNAPU Doomed! Attention, vacationers, campers, tourists! Don't shoot your spouse for packing your stuff where you can't find it! Use my Houseboy and save arguments! Use in car, cabin, tent, outdoors. Saves expensive luggage! Make-it-yourself. Mail only \$1.00 for easy plans to William Gillette, Sweeny, Texas.

ORNAMENTAL Iron designs. 1500 beautiful, practical designs for railings, columns, etc. Free literature. Cunningham, 3841 South 3200 West, Salt Lake City, Utah.

REFILLS—Blue ink or black liquid graphite pencil, fit Paper-Mate and other ball pens. 5 for \$1.00. Complete retractable pens or pencils, 3 for \$1.00. Mail Mart, Box 617, St. Louis 1, Mo.

CONDEMNATION. Jude, John 3. Whitcomb, 308 Sycamore, Newport News.

FREE. Complete illustrated catalog, leathercraft kits, supplies. J. C. Larson Co., 820 S. Tripp, Dept. 5750, Chicago 24.

BUY Wholesale thousands nationally advertised products at big discount. Free "Wholesale Plan." American Buyers, Hertel Station, Buffalo 16-K, N. Y.

REMODEL Your own home. Save hundreds of dollars. New, amazing book shows you how. Written so you can understand it. Step by step instructions make it easy. Fully illustrated, 400 photographs, hundreds of diagrams. 160 pages. \$2.95. Literature free. Popular Mechanics Press, 200-RH East Ontario St., Chicago 11, Ill.

NAMEPLATES, Desk signs. Best deal. Samples. Whitney Signs, West Springfield, Mass.

BEAUTIFUL Florida cypress knees, \$1.00 each. Dozen, mixed, \$11.00 postpaid. Gipple's Giftwares, Dept. P3, DeLeon Springs, Fla.

FREE Booklet "Septic Aids—How it Works for You." Tells how to keep your septic tank trouble-free and save you money. Best Products, Box 893-p, Norfolk 1, Virginia.

SIX Bow-ties, beautiful clip-ons for every occasion. Only \$2.00 postpaid. Belthor Trading, 416 Broadway, New York City.

SELL! Buy! Trade! Anything. In "Trading Post Magazine." Sample 25c. Thorne's, 525 Dewey, Jackson 30, Michigan.

HOLLYWOOD! Letters remailed—25c. Sondars, 13031 Ventura, North Hollywood, California.

HAWAIIAN Sling fishing speargun, \$1.50. Guaranteed. Atlantic Dukent, 58 W. 31 St., New York 1, N. Y.

BUY Wholesale 750,000 products, for personal use—resale. Carter, Box 6011-HHH, Chicago 80.

BUSINESS And job opportunities unlimited! Florida's boom town—Ft. Lauderdale. Population doubled last 5 years. Full details, \$1. Kemp, 823M NE 7th Ave., Ft. Lauderdale, Fla.

JAPAN! Buy gifts direct from Japan. Kimono, pearls, children's reversible silk jackets, model jet engines, colored slides, novelties, hand paintings, others. Business information fee \$1.00. Send money orders. Clarence Yamaguchi, Room 302, Naka 7 Bldg., Marunouchi, Tokyo, Japan.

BIG Mails, four months listing, 25c. Wright Publications, 2270 Hubbard, Memphis 8, Tenn.

FREE! Exciting catalog packed with books covering most everything. Think of it—From cover to cover you will find described and illustrated hundreds of books telling how to fix and how to build almost anything. How to remodel your home; do your own decorating, plumbing, electrical work. Simplified books covering concrete work, carpentry, painting, furniture making and refinishing. How to build your own boat, home workshop tools. Best books on photography, welding, hobbies, homecraft. How to make a home freezer. Send for your free copy now. Popular Mechanics Press, 200-BC East Ontario St., Chicago 11, Ill.

WAKE Up your mind! Be what you desire! Know-how lecture and details free. Rush request today to Applied Christian Psychology, Inc., Box 1924-G, Louisville 1, Kentucky.

BOYS! Girls! Make hundreds of different things with Twist-Kraft. Make miniature flowers, figures, animals, furniture, houses and loads of other interesting things with these multi-colored fuzzy wires. To get your complete set send only \$1 to: E. T. Gilbert Mfg. Co., 228-236 South Ave., Rochester 4, New York.

BRAZIL! Glamorous, exotic, tropical! Details living conditions. Beautiful postcards, airletters remailed, \$1.00 money-order. R. M. Rey, Caixa Postal 1881, Sao Paulo, Brazil.

① I SHOW YOU HOW TO
MAKE MONEY AT ONCE

② **START YOUR OWN BUSINESS**
IN 2 WEEKS—
AT HOME
IN SPARE TIME



PLATE
Baby Shoes
IN
BRONZE
AND
COLORED
PEARL

**MILLIONS OF
NEW PROSPECTS
EVERY YEAR**



Now is the time to cash in on this big-paying, easy-to-operate, year-round business and you need no experience. **MATERIALS COST YOU ONLY 50c—YOU GET \$6.00!** With many actual "show-how" illustrations and step-by-step instructions, **YOU** can start earning money at once in one week. Working only a few hours you can make more money than many people make working an entire week.

IMMEDIATE RESULTS

- Big Income
- Huge Demand
- Sales Plan
- Future Security
- Your Own Business

We will send you full details absolutely free.

KIKTAVI COMPANY, Dept. PM-563
11029 S. Vermont, Los Angeles 44, Calif.

FREE!
MONEY
MAKING
PLAN
Full Details
Without
Obligation
**MAIL COUPON
TODAY!**

KIKTAVI COMPANY, Dept. PM-563
11029 S. Vermont, Los Angeles 44, Calif.
Send me **FREE** details of your **MONEY MAKING PLAN**, without obligation.

NAME _____

STREET _____

CITY _____ ZONE _____ STATE _____

Log Cabins,

Homes, Clubs, Lodges, Shops,
Restaurants, Motels, etc.

85% pre-cut and/or pre-lab, your plans—or ours—light, summer, vertical—or heavy, year 'round, log-on-log and vertical (patented) easily, quickly erected—low cost—extremely low maintenance. **NO** studs, rafters, plaster, paint, wallpaper, insulation or bearing partitions required. Log walls of genuine Michigan White Cedar, lightest and most unique wood in N. America . . . "rough, rugged and rustic"—or "streamlined," with beveled, paneled plank partitions. Definitely different, durable and distinctive!

Individual and Dealer inquiries invited.
Phone - WASHINGTON 7473

"The Log Cabin Man"

120 PM Delaware Ave.

Buffalo 2, N. Y.



700% PROFIT
taking & FINISHING PHOTOS
in 2 MINUTES with
CHAMPION PHOTOMASTER

Simple instructions. Easy to learn. Make nice photos of children, grownups, at 25c, costs 2c. For **FREE** information write
PDQ CAMERA CO., 1546 W. Cortez, Dept. PM
Chicago 22, Illinois

PURIFY YOUR WELL WATER

Economy Chlorinator feeds solution thru your pump. Kills germs, stops rust, sulphur odor . . . improves color and taste. Send \$9.95 for complete unit, instructions and year's guarantee. Dime brings further details.

ECONOMY 5717 Taft Hollywood, Florida

GEIGER COUNTERS BUY DIRECT FROM FACTORY

Write for time payment plan

NUCLEONIC COMPANY OF AMERICA
Dept. P.M.36, 196 Degraw St., Brooklyn 31, N. Y.

MAKE MORE THAN
\$20⁰⁰
PER HOUR

**SERRATING &
SHARPENING**



**TABLE AND
KITCHEN KNIVES**



SAW-KEEN

**PORTABLE ELECTRIC, EASY-TO-OPERATE, KNIFE
SERRATOR AND SHARPENER**

Be Your Own Boss! Every restaurant, cafeteria, drive-in, hotel, hospital are repeat customers. Serrated (saw-edged) table knives are in big demand. Your investment of \$98.50 returns the first day. Guaranteed! Write today for proven method of getting profit making jobs daily.

**CUTTER-CRAFT 58-C SOUTH RAYMOND
PASADENA 1, CALIFORNIA**

BEST JOBS ARE FILLED BY ALLIED TRAINED MEN

Yes, you can train now for the best paying jobs, and become one of the Builders of Industry! Due to the great present day industrial expansion programs throughout our country, Industry has been clamoring for Allied-trained men to fill important jobs. Shortages of Draftsmen, Designers, Tool Engineers, Machinists, Tool and Die Makers are so wide spread that you can pick one of these highly paid key jobs and then look forward to a life of security and success. Get started now -- take advantage of these opportunities to earn good money -- to build for your security and success.

Foundation of Industry is Built by the:

**DRAFTSMAN
MASTER MACHINIST
TOOL-DIE MAKER
TOOL-DIE DESIGNER
TOOL ENGINEER
MACHINE DESIGNER
MECH. ENGINEER**

Allied is the outstanding school of its kind -- the foremost school in its field. Allied is approved by Industry, Department of Registration and Education, Department of Public Instruction, State of Illinois, Department of Justice for Foreign Students, and the Veterans Administration. Accredited by Central Schools Association.

**Train at Home in Your Spare Time
or at The Allied Institute in Chicago**



Free employment service and housing assistance all through your training period and after your graduation. Our industrial contacts cover the U. S. A.

Allied's training program permits you to study right at home in your spare time or at the Allied Institute's fully equipped shops and laboratories. You can begin your training in short courses and continue progressively to a Bachelor Degree in 26 months.

ALLIED SCHOOL of MECHANICAL TRADES

Allied Institute of Technology
1338-42 South Michigan Ave., Dept PM-3, Chicago 5, Illinois

Gentlemen:

Mail me FREE BOOKS explaining ALLIED'S courses of instruction, and FREE SAMPLE lesson.

I am interested in resident training home study
VETS write in date of discharge _____

Name _____ Age _____

Address _____

City _____ State _____

SEND FOR **FREE BOOKS**

**ALLIED SCHOOL
of Mechanical Trades**
1338-42 South Michigan Ave
Chicago 5, Illinois



Pella®

WOOD FOLDING DOORS

Beautiful • Functional • Economical

Modernize with "folding walls"... use as room dividers, as closures for closets, bedrooms and kitchens. PELLA doors fold like an accordion... save floor and wall space. Door panels constructed of solid wood cores with beautiful veneers of birch, pine, oak and Philippine mahogany. **Anyone can install...** factory assembled and complete with all hardware. Easy instructions. Order unfinished and save. Free folder.

-----CLIP AND MAIL TODAY!-----

ROLSCREEN COMPANY, Dept. H-36, Pella, Iowa

Please send free 6-page folder on PELLA WOOD FOLDING DOORS.

NAME _____

ADDRESS _____

CITY _____

ZONE _____

STATE _____

YOU MUST READ THIS!

Before you pay out another COSTLY PLUMBING BILL—



How many times have you seen the clogged up SINK, the FLOODED BASEMENT, or the damage done by the overflow of the TOILET or URINAL? Then—I'm sure you remember the Costly Plumbing Bill! Now, do it yourself with our New Rodding Tool which cleans out roots, grease, rags up to 100 ft. Ideal for Home Owners, Apartments, and Factories.

But now I ask you—what is it worth to you when its cost is less than the bill your plumber sends! So hadn't you better Beat the High Cost of Plumbing Bills by writing us for FREE BOOKLET right now. Tear this ad out—while it's still before you—so we can have this money saving news off to you right-a-way! Obey that urge and write. No Salesman will call.

BUT NOW WE REPEAT—WHAT IS IT WORTH TO YOU WHEN ITS COST IS LESS THAN THE PLUMBING BILL! We sell Rodding Tools and Electric Root Cutters on **FREE TRIAL, DON'T WAIT!** Write for **FREE BOOKLET** this moment. The Money These Tools Will save you will amaze you! No agent will call. Mail coupon or postcard.

MILLER SEWER TOOLS, 4644 N. Central, Chicago 30, Illinois
Please send free booklet. (Chicago Phone: Kildare 5-1702)

Name _____

Address _____

REAL OPERATING SUBMARINE



SUBMERGES... SURFACES... UNDER ITS OWN POWER

Of course you recognize it! It's the famed U.S.S. NAUTILUS... an accurately detailed, authentic scale model (fully half-a-yard long) of the world's first atomic submarine. This exciting sub model actually speeds along the water surface... submerges to periscope depth... then automatically resurfaces. Easy to assemble kit includes power unit and all prefabricated parts. A cinch to assemble! Only some lead ballast needed (available at any hardware store).

ONLY \$198

Guaranteed to Work or Your Money Back

At Dealers or Order-By-Mail. Send \$2.00 and we pay postage
SCIENTIFIC, Dept. PM2, 115 Monroe St., Newark 5, N. J.

Wagemaker's WOLVERINE BOATS

RECOGNIZED LEADERSHIP OF AMERICA'S OUTBOARD FLEET



'SEAFARER 15' The Ultimate in Luxury

'SEAFARER 15' Luxury at a Popular Price. All the "extras" as standard equipment. lights, steering wheel, color keyed upholstery, cushioning, windshield, Boat-A-Ramie color styling. Aluminum boats. Molded Plywoods. See the big Wagemaker line at all major boat shows, or send for our free brochure.

WAGEMAKER COMPANY

Dept. 54

Grand Rapids, Michigan

LIPS SORE?

POCKET SIZE 39c HIGHER IN CANADA

BEST FOR COLD SORES, CHAPPED LIPS, FEVER BLISTERS

MEN WANTED

Earn \$100 Per Week and up

AUTO DIESEL MECHANICS

Master a trade with a future—learn Auto-Diesel mechanics in our shops. You learn with tools on real equipment. Earn while you learn. Many of our graduates earn \$100 per week and up. No previous experience necessary. Day and night courses. Approved for veterans. Write for free bulletin.

NASHVILLE AUTO-DIESEL COLLEGE

226 7th Ave., N., Dept. 75

Nashville 3, Tenn.

FOAM RUBBER 50% DISCOUNT

FURNITURE CUSHIONS

Factory Seconds



Do-it-Yourself. Replace old Sofa & Chair Cushions with comfortable **FOAM RUBBER** at 1/2 price. For complete listing of Furniture cushions. Cored and Solid **FOAM RUBBER**. Send for free Catalog.

PERMA-FOAM, 429 Central, Dept. PM, East Orange, N. J.

RADIO CONTROL YOUR MODEL

PLANES BOATS CARS

"CUSTOM MIDGET" RADIO \$9.98

LICENSE FREE BAND

OPERATES SAME AS \$50.00 SETS INCLUDES LONG RANGE TRANSMITTER RADIO, RECEIVER RADIO AND CONTROL ACTUATOR ALL 3

EASY ASSEMBLY WITH OUR PARTS AND PLANS \$9.98. PLANS ALONE \$1.

RADIOMODELS BOX 36 DEPT. PM BALTIMORE 6, MARYLAND

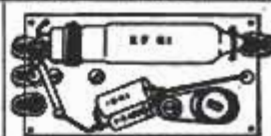

DETAILED INFORMATION IN & RADIO CATALOGUE 25c

SPECIAL "SUPPLY SOURCE DIRECTORY" & \$7.00 SUPPLY COUPON... \$1.00

BOOK "RADIO CONTROL OF MODEL AIRCRAFT" \$3.98

CONTAINS 14 PLANS

RADIO CONTROL GARAGE DOOR DETAILS... \$1.00

ITALIAN ACCORDIONS



Piano and Chromatic-Vienna & Italian System. Heligons-Irish-Club Models—Hohner & All button type. Also Concertinas & Bandonions. Buy direct from Factory Representative at Lowest Wholesale Prices and Save Money. We take any instrument in trade.

Expert repairing—Write for Free Catalog

ITALIAN ACCORDION MFG. CO.
7600 Cottage Grove Ave., Dept. PM-3, Chicago 19, Illinois

POPULAR MECHANICS

BUY DIRECT..SAVE!
Big Discounts on
**TILLERS · TRACTORS
MOWERS**



8 1/2 H.P.
Riding Tractor \$488.00



- Complete line of 2-wheel and 4-wheel tractors and implements.
- Clean cutting rotary power mowers handle all grass and weeds.
- Spade, hoe and rake in one operation with 12" or 8" tiller. Assemble-it-yourself Kit only \$59.00 less engine.

Write for complete catalog.

RED-E GARDEN TRACTORS
RICHFIELD 9, WISCONSIN

Do a Real Professional-Like Job
Yourself and SAVE

HOW to PAINT
With Brush and Spray

Covers All Painting Methods and
Materials

You can do professional-like painting and finishing jobs yourself and save about two-thirds of the cost. Sam Brown, noted craft authority, makes it so easy for you in his book, **HOW TO PAINT WITH BRUSH AND SPRAY**. Order your copy now and enjoy this tremendous saving. It covers exterior painting, wall and interior decorating, furniture finishing, concrete painting — every type of painting with brush, spray gun, roller and other methods. Tells what finish is best; what materials to use, etc. No previous experience needed. Fully illustrated. Order by mail. Only \$2.50. Money back if not pleased.

POPULAR MECHANICS PRESS, Dept. PM18
200 E. ONTARIO ST., CHICAGO 11, ILL.



Say You Saw It in Popular Mechanics

**GET UP AND GO WITH A
TRIUMPH**

**FUN! INDEPENDENCE!
ECONOMY!** Go where

you want to go; do what you want to do. Be independent. Have more fun! Enjoy the thrill of motorcycling at its BEST with a gleaming, precision-made Triumph! Easy to ride... exciting to own... real economy, 50-60 to 90 miles and up per gallon. Triumph's two-level cushion seat means real comfort for two! Priced surprisingly low, with easy terms available. See your nearest Triumph dealer for a free demonstration. He will teach you to ride.



RUSH THIS COUPON to nearest address below. Dept. P
THE TRIUMPH CORP. JOHNSON MOTORS, INC.
Towson, Baltimore 4, Maryland 287 W. Colorado St.
Pasadena 1, Calif.

Send me absolutely FREE the 1956 Triumph Motorcycle catalogue in full color. If under 16 years of age, check square for special pictures.

NAME _____

ADDRESS _____

PHONE _____

**NOW YOU CAN BUILD IT WITH
CONCRETE BLOCKS**

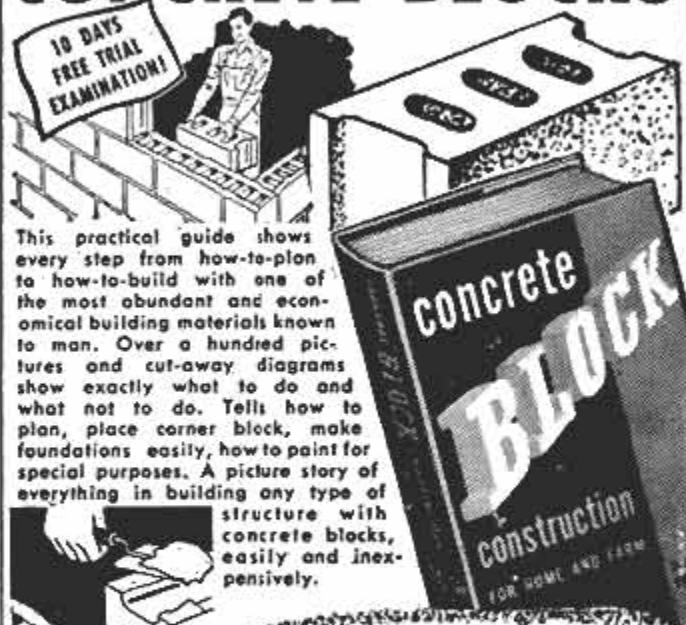

This practical guide shows every step from how-to-plan to how-to-build with one of the most abundant and economical building materials known to man. Over a hundred pictures and cut-away diagrams show exactly what to do and what not to do. Tells how to plan, place corner block, make foundations easily, how to paint for special purposes. A picture story of everything in building any type of structure with concrete blocks, easily and inexpensively.

Here's how little this book costs you...
or if you don't keep it after 10 days trial, return it and you owe nothing. **\$3.25**

Here's how to
apply Mortar

CARPENTRY FOR EVERYONE



A clear explanation of modern carpentry construction including framing, roof constructions, general carpentry work, exterior and interior finish of buildings, building forms and working drawings, and farm buildings. Covers everything you need to know about lumber, tools, joints and splices, floors, stairs, partitions, rafters, etc. Gives short cuts and tricks used by the master carpenter. Easy to understand. 504 pages, 580 illustrations. **\$2.50**. Use 10 day no-cost trial coupon below.

BRICKLAYING — WIRING — PLUMBING

Bricklaying Skill and Practice shows by clear explanations and actual on-the-job illustrations, simplifies the construction of everything from fireplaces to complete buildings. **\$3.50**
Electric Wiring—New book covers job-tested methods of residential and farm wiring, code changes. Show-how for amateur, valuable reference for tradesman, estimator, contractor. **\$4.25**
How to Design and Install Plumbing—Hundreds of how-to-do-it pictures, full-sized blueprints for most every plumbing job. 349 illustrations, 422 pages **\$4.25**

OTHER YOU-CAN-DO-IT BOOKS IN COUPON BELOW

Mail this coupon today—10 days trial at no cost to you
American Technical Society, Dept. C-319
848 East 58th Street, Chicago 37, Illinois

Please rush me the following books I'm checking below to examine at home. If I'm not convinced these books will help me save thousands of dollars by doing my own building and planning, I may return the books and owe nothing.

- | | | | |
|---------|--------------------------|--|--------|
| Examine | <input type="checkbox"/> | CONCRETE BLOCK CONSTRUCTION FOR HOME AND FARM..... | \$3.25 |
| | <input type="checkbox"/> | CARPENTRY..... | \$2.50 |
| at home | <input type="checkbox"/> | BRICKLAYING...Skill and Practice... | \$3.50 |
| | <input type="checkbox"/> | HOW TO DESIGN AND INSTALL PLUMBING..... | \$4.25 |
| at no | <input type="checkbox"/> | ELECTRIC WIRING— | |
| cost. | <input type="checkbox"/> | Residential and Farm..... | \$4.25 |
| | <input type="checkbox"/> | Cabinet Making and Millwork.... | \$4.95 |
| | <input type="checkbox"/> | Steel Square..... | \$2.50 |

Name _____

Address _____

City _____

State _____

Ten day no-cost-trial. If I keep books, will remit by check or money order.

Send C.O.D. Some return privilege—money refunded.

I'm enclosing \$_____ now in full payment to save postage—same return privilege—money refunded.

MEN - WOMEN RAISE ORCHIDS

IN YOUR LIVING ROOM!

YEAR 'ROUND

No Greenhouse Needed

Any Climate, Maine to California

BIG PROFITS!

Spare or Full Time. Loads of Fun for all the Family!

Fill your home with gorgeous Tropical Orchids. Thrill to the gorgeous beauty of your very own huge purple Cattleyas like those you see in nearly every flower shop. Exquisite Cymbidiums, sometimes with 30 or more blooms on each stalk. Hundreds of others—many grow without soil, getting food from the air. Yellow Orchids, greens, blues, pinks, browns, every rainbow color. No greenhouse needed. Start on card table in your living room. Any climate, Maine to California.



LOUIS SCHIRMER Orchidist

Successful Home Grower SHOWS YOU HOW

Louis Schirmer, successful home grower, shows you step-by-step how he and Mrs. Schirmer started with a few plants at home, developed a big-profit business, and grow an Orchid collection now worth a fortune. Learn how Orchids multiply—how one plant may become many, each as valuable as the first. No big investment.

No overhead. Takes few minutes a week. Big-profit orders come from individuals, florists, hotels, clubs, etc. Popular year-round gift. Millions sold by Mail-Order. Schirmer shows you how!

Complete Instructions and Living Orchid Plants Sent for You to Examine at Home Without Risk

Complete Directions—secrets of the experts—in simple language, jam-packed with "show-how" drawings, gorgeous full color pictures of Orchids. Also a real blooming-size Orchid plant from the Schirmer's own Gardens. Everything you need to start is yours to examine at home, without risk. FREE—full details. Learn how you may become an Orchid Grower. Send no money! Write today. Airmail is quickest.

TROPICAL FLOWERLAND DEPT. 313
4622 Wilshire, Los Angeles 5, Calif.

MAIL COUPON NOW!

Tropical Flowerland Dept. 313
4622 Wilshire, Los Angeles 5, Calif.

Rush me complete free details on your offer of Louis Schirmer's Instructions which show me how to grow Tropical Orchids at home. The instructions will include a blooming-size Orchid Plant and valuable home Profit-Plan. This request does not obligate me in any way.

Name _____
Address _____
City _____ Zone _____ State _____

Don't Buy Single-Purpose Power Garden Equipment



Your Dollars Buy MORE with ROTO-HOE

There's no need to buy two, three, or more separate power garden tools. The "ROTO-HOE IDEA" makes available to you one basic power unit and a wide variety of "customer-proven" attachments. All are integrally-designed to fit and

work perfectly with the same 2 h.p. ROTO-HOE power unit; all are interchangeable in a few seconds; all are thoroughly "use-tested," available NOW! Complete ROTO-HOE only..... **\$134.00**

NEW 22" Self-Propelled Twin ROTO-CUTTER helps keep lawn velvet-smooth, has easy-to-sharpen twin spindle blades. Attaches in seconds, costs only \$49.50 to add to ROTO-HOE power unit; or as a complete unit, ready to go to work for only **\$131.50**

START YOUR OWN BUSINESS

If you're handy with tools, you may be able to start a profitable part or full-time business selling and servicing ROTO-HOES. Write today for details.

FREE COLOR BROCHURE Illustrates all attachments in color, gives full information. Write today for a copy and for name of nearby ROTO-HOE dealer.

ROTO-HOE & Sprayer Co., Box 19, Newbury, Ohio
"America's Leader in Lawn & Garden Equipment"



YOU CAN BUILD A VIOLIN FOR PLEASURE OR PROFIT

Now you can build a rich toned mellow violin modeled after a famous "Strad." YOU CAN MAKE A STRADIVARIUS VIOLIN contains 8 full scale plans plus complete instructions. You work directly from the plans with no confusing scale of dimensions to translate. Detailed instructions for each step including varnishing and stringing—even shows how to build your own tools. Cloth bound. Order today from

POPULAR MECHANICS PRESS . . . \$3.50
200 EAST ONTARIO STREET, CHICAGO 11, ILLINOIS

AMAZING NEW TINY RADIO

Really Works—Small as a Pack of Cigarettes!



GETS LOCAL RADIO STATIONS WITH CLEAR BELL-LIKE TONE—NO STATIC OR INTERFERENCE! NEEDS NO TUBES, BATTERIES OR COMPLICATED HOOKUPS! NO AC PLUG INS! Nothing to wear out. Thousands of users—many report years of service. Uses new crystal diode and HI-Q coil. SELF-CONTAINED SPEAKER PHONE. Just the tiny radio to take with you ANYWHERE YOU GO—ON TRIPS, VISITING, ETC.—for real fun and enjoyment—ANYTIME. Merely hook to anything that can act as antenna for local reception. Free EX antenna kit included. **SEND ONLY \$1.00** (bill, ck., mo.) and pay postman \$4.00 C.O.D. postage or send \$5.00 for p.p. delivery. COMPLETE READY TO LISTEN. MIDWAY CO., Dept. PPM-3, Kearney, Nebr.

Success Requires Training! LEARN AIR CONDITIONING and REFRIGERATION

This great, modern industry is alive with opportunities for trained men. Installation, maintenance and servicing of home and industrial equipment is a well-established, paying trade and business. Now mechanically inclined men can get practical instruction in spare time at home, plus quick shop practice at U. E. I. (founded 1927).

IMPORTANT FACTS FREE — Write today
Find out all about these interesting opportunities without obligation. Send a postcard or short note right now.
UTILITIES ENGINEERING INSTITUTE, Dept. C-15
2525 SHEFFIELD AVENUE CHICAGO 14, ILLINOIS

END TRANSMISSION FAILURES



CAUSED BY LUBRICANT LOSS

A Neoprene sealing sleeve that positively ends dirt intrusion and the resultant lubricant loss at this coupling on all Chevrolet passenger cars and pick-ups from 1937 through 1954.

Patented features* lock sleeve on, dirt out, lubricant in. Installs in minutes. Unconditionally guaranteed to cure this leaking coupling permanently. Order direct if your repair shop cannot furnish. Chevrolets, 1937 through 1954 (as illustrated) only \$4.85.

Models for 1955 Chevrolets and Fords from 1949 through 1955 also available. Additional information on request.

*Patent No. 2,702,996

DAVIS BALL BOOT CO., INC.
2301 YALE STREET, HOUSTON 8, TEXAS

I HELPED T.E.H. MAKE \$14 A DAY WHILE STILL LEARNING!

T. E. H.—West Virginia. "By the time I finished half your course, I was making \$14.00 per day. I have made enough on the side to more than pay for the course."

H. T. ARMSTRONG

Learn

ELECTRIC APPLIANCE REPAIR & SERVICE

WE TEACH:

How to Repair
Washing Machines
Vacuum Cleaners
Electric Ranges
Lamps, Motors, Irons, etc.,
REFRIGERATION and House Wiring
At Home In Your Spare Time!

For a man handy with tools, and happiest when working with his hands, OPPORTUNITY is Wide Open Today in this great and growing field. Everyone is a customer for the man trained to service electric appliances.

Open Your Own Shop

Our practical HOME COURSE teaches you this business from A to Z—preparing you to take a well paid job or open your own shop. You can actually start in your basement or garage with the tools we send you . . . before finishing.

We Include An **ELECTRICAL APPLIANCE TESTER**
A Big Kit of Tools at NO EXTRA COST

MAIL THIS COUPON for FREE BOOK

H. T. ARMSTRONG
PACIFIC TRAINING SCHOOLS Dept. P-563
11029 S. Vermont, Los Angeles 44

Dear Sirs: Please send me, without obligation, your free booklet and complete details.

Name _____

Address _____

City _____

Zone _____

State _____

SAY YOU SAW IT IN POPULAR MECHANICS

Satin Smooth SANDING
ASSURED ONLY WITH
Straight Line Action
by



Model 53. A rugged heavy duty production tool with rotary motor. Pad size 3 3/4" x 7". Wt. 5 1/4 lbs. Price . . . **\$34.85**



Model 2000. The most popular, all-purpose home-workshop sander. Pad size 3 1/4" x 7". Wt. 5 lbs. Price (complete with steel case) . . . **\$24.50**



Model B. A combination sander—polisher—massager designed for all-family use. Pad size 2 3/4" x 5 3/4". Wt. 2 1/2 lbs. Price . . . **\$14.85**

WRITE FOR FREE CATALOG

THE ONLY SANDING MOTION RECOGNIZED BY PROFESSIONAL WOODWORKERS

There is only one way to do a perfect sanding job. It's the Dremel way. Flawless finishes—the mark of professional operation is guaranteed when you sand the **Straight-Line Action** way. Don't be misled by confusing sander action claims. You must sand with-the-grain to accomplish professional results. And only **Straight-Line Action** sands with-the-grain. Buy Dremel and you buy sanding perfection.

REMODELING? REDECORATING? REFINISHING?

DO IT THE Professional WAY DREMEL Straight-Line Action WAY

Dremel, originators of **Straight-Line Action Sanders**, offers a complete line of professional tools for your every sanding need. Priced for the all-family workshop.

Only DREMEL Straight-Line Action Banishes Scratches, Swirl Marks



The simple illustrations prove the unquestioned superiority of Dremel Sanders. Note that only Dremel **Straight-Line Action** gives a smooth, satin-like finish. Don't be misled by confusing sander claims.

SEE YOUR DEALER. If he cannot supply, order direct on a 5 day trial, money back guarantee. Remit in full and we'll ship postpaid. Or send \$2.00 now, pay postman balance plus postage and C.O.D. fee.

DREMEL MANUFACTURING CO., Dept. 116-C, Racine, Wis.

free!

1956 ALLIED

ELECTRONIC SUPPLY CATALOG

324
value-packed
pages

Save on Everything
in TV and Radio
Parts & Equipment



Everything for Experimenters,
Builders, Amateurs, Servicemen,
Engineers & Hi-Fi Specialists

Send for ALLIED's big 324-page value-packed guide to *everything* in TV, Radio and Electronics! Select from the world's largest stocks of High Fidelity systems and components; recorders and phono equipment; TV tubes, antennas and accessories; Amateur station equipment and supplies; P.A. systems; test instruments; latest build-your-own kits; industrial electronic supplies—plus *everything* in electronic parts, tubes, transistors, tools and books. Save on everything in Electronics—send today for your FREE 1956 ALLIED Catalog.

Everything in Electronics
From One Reliable Source

send for it

FREE
CATALOG

ALLIED RADIO

ALLIED RADIO CORP., Dept. 5-C-6
100 N. Western Ave., Chicago 80, Ill.

Rush FREE 1956 ALLIED 324-Page Catalog

Name _____

Address _____

City _____ Zone _____ State _____

(Continued from page 10)

Mineola, Long Island. The races are under the control, guidance and supervision of the local police department in order to guarantee maximum safety. The average speed is approximately 22 miles per hour for a 15-lap race equaling a distance of one mile.

Sid Barry, President,
Filtron Company, Inc.,
Flushing, N. Y.

Texas Tester

This month PM inaugurates another new service to our readers, a scientific test of new-car performance by Dale Kelly, San Antonio automotive engineer. As a regular feature of the "Owners Report" each month, Mr. Kelly will put the car of the month through its paces and report to you



on its gasoline mileage, acceleration, visibility and other aspects as shown by precision instruments.

A long-time student of automotive matters, Mr. Kelly tells us he first handled a steering wheel about 1914, at the age of seven. He was, however, in his father's lap at the time, in a Stevens-Duryea. He did the steering, but dad supplied the footwork. Since then he has grown quite a bit and his legs now reach the pedals easily.

Since 1940 he has been a full member of the Society of Automotive Engineers, has been an engineer for a leading truck manufacturer, a consultant at the Army's Aberdeen Proving Grounds, an assistant professor of mechanical engineering at Lehigh University, and, more recently, engineer for one of the nation's leading research centers. For his first report to you, turn to page 126.

**WHAT DO YOU
KNOW
ABOUT**



**HAND
SAWS?**

HIGH CROWN

... means that the tooth line is curved or arched. This arched tooth arrangement gets fewer teeth engaged in the wood at a time ... reducing friction, making cutting easier ... faster.

SANDVIK Swedish Charcoal Steel Hand Saws feature this high crown. This is only one of SANDVIK'S many exclusive advantages. Before you buy any hand saw, ask your dealer to show you a SANDVIK.



Want to know more? Write today for the new 16 page booklet that tells all. "Things You Should Know About Hand Saws." It's free! Dept. PM

Sandvik SAW & TOOL

Division of Sandvik Steel, Inc.
1702 NEVINS ROAD, FAIRLAWN, N. J.

**GET THE HABIT OF READING
OUR CLASSIFIED ADS.**

Wonderful Opportunities Amazing Bargains

**RIDE and MOW
with the**

**SHAW
DU-ALL**

Model RM 24



Biggest little mower on the market!

LOW PRICE, too. Great for estates, farm and suburban homes, parks, cemeteries, etc. Trims smartest lawn; or tallest grass — 24 inch swath; turning radius only 45 inches. Sturdy 2½ to 3 H.P. air-cooled engine. 110 volt starting motor plugs into house current (optional).

WRITE TODAY for free folder, prices, and full details. Also walking and riding tractors, ½ to 14 H.P.

SHAW MFG. CO. 4503 Front St., Galesburg, Kansas
668-GN 4th St., Columbus, Ohio

**94.6% OF BAILEY
GRADUATES ARE EMPLOYED
AT TOP PAY IN THE FIELDS
WHICH THEY WERE TRAINED!**



**DIESEL-AUTO MECHANICS
DESPERATELY NEEDED!**

We have a far greater demand for our students than we can fill!

We can show you an actual waiting list of leading companies throughout the world who have tried Bailey graduates — found them outstanding, and are coming back for more!

Bailey Graduates are Successful . . . **RECEIVE BIG PAY — HAVE SECURE FUTURE!**

The Famous Bailey Course prepares you for **BOTH Diesel and Gasoline Mechanics.**

This is a must—due to the advent of using Diesel principles, such as 'Fuel Injection' on passenger cars . . . use of gasoline engines for starting Diesel engines, etc. You learn all this at Bailey in the amount of time ordinarily required to learn just one of these subjects. **ALL FOR THE PRICE OF ONE.**

Don't be satisfied with a 'futureless', one-type job — learn how you can make **big money now!** Write today for Free Booklet that takes you on a step-by-step camera tour through our spacious, modern shops — See Bailey students in action as they Learn-by-doing with the Famous Bailey Method of training!

We provide you with housing and part time jobs while in school, plus nation-wide placement service for graduates.

BAILEY Technical SCHOOLS

1634 S. GRAND ST. LOUIS 4, MO.

MAIL TODAY!

Please mail immediately this free booklet without obligation.

FREE BOOKLET



Name.....

Address.....

City.....State.....

APPROVED FOR VETERAN . . . NON-VETERAN

now! assemble your own

ALUMINUM SCREENS

save up to
50%



LIFETIME PROTECTION—

YET IT'S ONLY MINUTES FROM PARTS TO FINISH WITH

easy-to-make

Make your work shop pay off! Assemble these maintenance-free aluminum window screens for your home, cabin, or shop and save money...make 'em for neighbors, apartment houses or businesses, and make money! It's a simple assembly job that requires no special tools.

No more repairing or repainting! Replace heavy, old-type screens or screen your new home with sparkling Homeshield screens that'll dress up your home for life.

Eliminates rust and stained walls. Lightweight—install or remove in a jiffy. No ladders needed.

Kits are complete with sturdy aluminum frames, easy-to-handle Fiberglas® screening, corner locks, installation hardware—even a miter box. Sizes for full screens and sliding half screens (and storm sash, too!) Ask your department store, hardware or lumber yard dealer, or mail coupon for folder and name of nearest Homeshield distributor.



AMERICAN SCREEN PRODUCTS CO.
Dept. PMK-3, 807 N.W. 20th Street, Miami, Florida

Name

Street

City State

Say You Saw It in POPULAR MECHANICS

Precision Grind Tools with A GRIND-IT



AND YOUR BENCH SAW

NOW ONLY
\$4.95

post paid in
U.S.A. only

Complete with instructions less grinding wheel. Send for catalog of other products.

Hollow grinds or straight grinds plane irons, wood chisels, jointer blades, cold chisels, drills, etc. Does a professional grinding job—simply and easily. Uses a standard grinding wheel. 10-day money back guarantee.

RIVERSIDE ENTERPRISES DEPT. 16-N6, RIVERSIDE, CORNING, NEW YORK

Handy Mail Order List

Little Library of Useful INFORMATION

5 for \$1.00
12 for \$2.00
25¢ Each

Here at amazingly low cost is the practical help and information you have always wanted. Articles in previous issues of Popular Mechanics have been classified according to subject and are now available in these handy reprint booklets.

- How to Use Measuring Tools—Micrometers, Calipers, etc.—106.
- Power Driven Saws—74.
- Drill Presses, Grinders, etc.—79.
- Wood, Metal-Turning Lathes—81.
- Filing Machine, Hacksaw, Cutoff Wheel, Shaper—82.
- Lathe Tools You Can Make—101.
- Workbenches—Tool Cabinets—47.
- Spray Painting—94.
- From Pattern to Casting—91.
- Tool and Saw Sharpening—92.
- Sharpening Drills, Wood Bits—90.
- Successful Wood Turning—32.
- How to Read Blueprints—71.
- Metal Turning Lathe Kinks—99.
- Operating a Metal Lathe—100.
- Heat Treating, Hardening—102.
- Working With Glass—103.
- Servicing Electric Motors—75.
- Electromagnets & Solenoids—44.
- Transformer Construction—41.
- The Boy Electrician—43.
- Soldering and Brazing—17.
- Arc and Spot Welders—5.
- Electroplating With Nickel, Chromium, Cadmium, etc.—86.
- Plating Leather, Wood, etc.—87.
- Lower Your Fuel Costs—31.
- Curing Leaky Basements—45.
- Fitting Home Game Room—55.
- Indoor & Outdoor Fireplaces—88.
- Backyard Gardening—39.
- Lawn and Garden Novelties—72.
- Trellises, Pergolas, Fences—78.
- Lawn and Garden Furniture—77.
- Playground Equipment—73.
- How to Use Your Drill Press—125.
- Making Serving Trays—53.
- Knots and Ropework—105.
- Sanders—80.
- House-Wiring—89.
- Hanging Wallpaper—38.
- Built-in Fixtures—78.
- Bird Houses—7.
- Magazine Racks—49.
- Clock Cases—50.
- Clock Ends—52.
- Small Tables—54.
- Smoking Stands—56.
- Books—58.
- Book Cases—59.
- Action Toys—66.
- High Flying Kites—67.
- Telescopes—20.
- Metal Craft—28.
- Small Looms—37.

- Working With Plastics—61.
- Simple Home Improvements—104.
- Ridding Home of Insect Pests—107.
- Children's Room Furniture—51.
- Jigsawed Novelties—57.
- Doll House & Doll Furniture—60.
- 25 Shelves You Can Make—64.
- Novelties Turned on Lathe—62.
- Inlay Pictures—Veneering—63.
- Wood, Soap Carving—65.
- Windmills & Weather-vanes—68.
- Lamps from Wood, Metal—69.
- Rustic Furniture—18.
- Wood Finishing—60.
- How to Fix Electrical Appliances—111.
- Painting Your House—117.
- Build Your Own Relays—123.
- Rowboats, Small Dinghy—83.
- Small Sail Boats—84.
- Two Outboard Runabouts—85.
- Build Own Canoe, Kayak—30.
- Build Class-K Ice Yacht—22.
- Auto Kinks, Shortcuts—10.
- Lawn and Garden Equipment—124.
- Motor-Driven Midget Cars—34.
- Stop Auto Electric Troubles—95.
- Photo Printers and Dryers—25.
- Photo Darkroom Equipment—96.
- Trick and Table Top Photos—97.
- Home Movie Equipment—118.
- Poultry Houses—108.
- Guns and Decoys—109.
- Re-Silvering Mirrors—70.
- Chemical Experiments—93.
- Log Cabins, Tourist Houses—14.
- Using Basic Tools—120.
- Farm and Garden Tractors—8.
- Building Extra Attic Rooms—23.
- Attractive Basement Rooms—24.
- Gem Cutting—42.
- Photo Enlargers—1.
- Photo Kinks—98.
- Cleaning Formulas—11.
- Taxidermy—9.
- Photo Lighting—119.
- Training Dogs—35.
- Small Furnaces—36.

Check Titles Wanted, Clip, Mail with Remittance to

POPULAR MECHANICS PRESS, Dept. 23, 200 E. Ontario, Chicago 11

You can work wonders with these

BLONDE WOOD FINISHES!



- Platinum • Driftwood
- Blonde • Bleached Mahogany
- Graywood • Light Oak • Fruitwood
- Maple • Cherry • Knotty Pine

only \$2.00
Postage prepaid

Anyone can get professional results with Pen-Chrome. Accents the natural beauty of wood. Ten colors. Easy to use. Dries quickly to a beautiful, wax-like finish. Waterproof! Send \$2.00 for enough Pen-Chrome and Clear Finish for table or 4 chairs.

The O'Brien Corp., Dept. PM-3
South Bend 21, Ind.

Enclosed is \$2.00

() check () money order.

Please send _____ color.

Name _____

Address _____

O'BRIEN
PAINTS
TOP QUALITY SINCE 1875

POPULAR MECHANICS

NEW! POCKET RADIO

LISTEN WHILE YOU
WALK, RIDE, WORK!



Slips in any pocket—Wt. only 7 ozs. Size 2 3/4" x 4 3/4" x 1 1/2". Beautiful Black Gold plastic case. NO HOOKUPS — NO WIRES — NO PLUG-INS! Self contained with 150 hour life flashlight batteries. (Available anywhere) and BUILT-IN ANTENNA!

GUARANTEED RECEPTION OF RADIO STATIONS TO 50 miles—up to 1500 miles for powerful stations! Has new Patented Super-regenerative Diode tube and transformer audio stages for sharp selectivity and sensitivity! Easy to use top controls (while walking)! Almost invisible plastic foam personal earplug lets you alone listen while you walk, visit, work, ride or sleep—anytime—anywhere. Money Back guarantee—1 year service guarantee.

SEND ONLY \$5.00 (Ck. Mo) and pay postman \$14.95 plus postage on delivery or send \$19.95 for postpaid delivery. Get YOUR Tinytone REAL pocket radio now and be ready to listen to Civil Defense alarms, news, music, sports, etc. on a moment's notice. Not an unworkable incomplete kit or plaything! Shipped complete with batteries—Ready to listen!—Available only from WESTERN RADIO Dept. APM-3 Kearney, Nebraska

• automatic •

POWER TILL

- ◆ Tills Automatically
- ◆ Works ALL SOILS!
- ◆ Width: 24" to 7"

SEE YOUR
DEALER
OR WRITE



UNIVATOR, INC., 2030-50 Center St., Berkeley, California

What Every Farmer Should Know About Taking Care of Farm Animals



The Most Popular Veterinary Guide Ever Printed

This practical and helpful VETERINARY GUIDE FOR FARMERS prepares the farmer to perform many routine veterinary tasks—provides quick information that can often save the life of an animal—prevents disease in herds—saves money on the farm in a hundred different ways.

Written in plain understandable language. It covers symptoms, causes of disease and prevention, and treatment of cattle, swine, sheep, horses and poultry and warns when to call in the professional veterinarian. Names, terms and phrases made clear in a separate section. Over 100,000 copies of this book are in use on American farms. 275 pages. Fully illustrated. Only \$3.95. Order today under money-back guarantee.

POPULAR MECHANICS PRESS, Dept. PM13
200 E. Ontario St. Chicago 11, Ill.

SAY YOU SAW IT IN
POPULAR MECHANICS



Do You Like art?

DRAW FOR MONEY!

Our Simple Method Proves You Can
Learn to Draw at Home in Spare Time

YOU can learn Commercial Art, Designing, Illustrating, Cartooning, etc. . . . right at home, in spare time. No previous art training necessary. Soon be your own boss — work at home, pick your own working hours. Or earn big money as staff artist for advertising agency, newspaper, magazine, dept. store, etc. Or make Art a profitable hobby. Earn while you learn. 22-piece art outfit given with your first lesson AT NO EXTRA CHARGE. (School est. 1914.)

FREE BOOK, "ART FOR PLEASURE AND PROFIT." Describes our methods.

Lists opportunities. Tells what our students say. No obligation. So mail coupon at once.



FREE
BOOK

Washington School of Art
Studio 143, Port Washington, N. Y.

Send me—FREE—your valuable illustrated Book, "Art for Pleasure and Profit." No obligation. No salesman will call.

Name.....Age.....

(PLEASE PRINT PLAINLY)

Street.....

City.....Zone.....State.....

AUTO MECHANICS

EARN AS YOU LEARN AT HOME

BIG PAY! SEND FOR 2 NEW FREE BOOKS

Learn the No. 1 trade—get into America's largest industry. Earn up to \$125 a week and more. Enjoy security—thousands of mechanics needed to service 50 million cars and 10 million trucks. New CTI Home Training prepares you in just a few months. Tools and Tune-Up Kit sent. Write for FREE BOOKS.

COMMERCIAL TRADES INSTITUTE Dept. A-247
1400 Greenleaf Avenue Chicago 26, Illinois

Get
into..

PLASTIC LAMINATING AT HOME!

Get ORDERS and CASH from your mailman—do work in SPARE TIME at home—or expand into FULL TIME business. Send coupon for Free facts about the newest and most fascinating of all home operated businesses. For the first time a simplified machine brings the fabulous profits of Plastic Sealing and Plastic Laminating within the reach of the small operator. Anyone can learn to operate the machine with a few minutes practice—then with our Magic Mail Plan can get mail orders pouring in daily with cash in every envelope. No canvassing—no selling. We even

Make \$20 to \$30 a Day by..
MAGIC MAIL PLAN!

supply the circulars you mail to bring back cash and orders. Don't waste a minute. Rush your name. We'll send you FREE and postpaid, pictures, prices, details, and all the facts you need to start. Mail coupon or send name on postcard. No charge. Warner Electric Co., 1512 Jarvis Av., Dept. L-103, Chicago 26, Ill.

Make Thousands of Beautiful Art Creations

COSTUME JEWELRY • CIGARETTE BOXES
TRAYS • CANDLESTICKS • COASTERS
LAMP BASES • BOOK ENDS...ALL IN
SPARKLING COLORED PLASTIC



THIS MAN... is taking out of the machine a Plastic Sealing Job—ordered by mail—only 11c in material cost brings back \$2.58 in cash by mail. Capacity of machine: \$25.00 profit per hour of operation.

WARNER ELECTRIC CO., 1512 Jarvis Av.
Dept. L-103, Chicago 26, Ill.
At no cost to me, please rush complete details postage prepaid. I am under no obligation.

Name.....

Address.....

City.....Zone.....State.....

Gov't Surplus **DUPONT NYLON CORDS**
Below Mfgs. Cost • Outwears Ordinary Cord 10 to 1

Light, strong, durable, quick-drying. Will not rot or mildew. Ideal for indoor or outdoor use. Camping, boating, hunting, clothesline and venetian blinds. Perfect for tent ropes, light anchors, deer cord, trotlines, crabbing, etc.

NYLON BRAIDED CORD
1/16" dia., 100 lb. test, 1 1/2c
1/8" dia., 375 lb. test, 2c
olive drab, per ft.
3/16" dia., 550 lb. test, 2 1/2c
olive drab, per ft.
In 50, 100, 200, 300, 400,
500 ft. and over lengths.

NYLON BRAIDED LINE
1/4" dia., 1000 lb. test, 3c
olive drab, per ft.
In 30, 50 and 100 ft. lengths.

NYLON ROPE
3/8" dia., 2,700 lb. test. Any
length to 600 ft., 17c
per ft.
7/16" dia., 3,800 lb. test. Any
length to 600 ft., 20c
per ft.

**SCREW-FAST, ADJUSTABLE
PILOT & COUNTERSINK DRILL**

Only one simple adjustment —
to length of screw!

Here's a sturdy pilot and drill
that works with equal facility
in hand drills or drill
presses. Can be used on wood,
plastic, fiber, aluminum and
plaster. Lets you drill pilot
hole for threads, shank clear-
ance, countersink for all heads
and countersink for recessed
heads to conceal with plastic
wood or wood plugs. . . . does
it all in one operation! Swift,
simple, accurate! Automatic
stop indicator. Available in
sizes 6-8-10-12. . . . 98c

SET OF 3 (sizes
8-10-12) only... \$2.75 ppd.

NYLON FISH LINE
Proven best by experienced fish-
ermen. Heat stretched. Will not
sink, twist or unravel. 25 lb.
test, 300 ft. reg. 50c
\$1-per spool NOW

NYLON WEB STRAPS
with sturdy steel buckle
Perfect for pas-
senger safety
belts, luggage
straps, car tow-
lines, car carrying straps, boat
trailer straps, etc. The heavy
equipment and machinery with
greater ease and safety . . . at far
less cost. Just the thing for the
garage or workshop.
1" wide, 3,000 lb. test, 10c
1 1/2" wide, 6,000 lb. 16c
test, per foot.
In 5, 6, 8, 10, 12 foot lengths.

**133 Pc. POWER TOOL
ACCESSORY SET**

The complete accessory set for
every small job. Designed for use
with all-electric drills and grind-
ers. Contains: grinding, polishing,
cut-off and buffing wheels, sand-
ing cartridges and discs, steel cut-
ters, mandrels, burnisher, mounted
stones; knife-edge rubber wheels.
A great buy for every home crafts-
man! Set, complete... \$2.00 ppd.
133 pieces, only...

**FLEXIBLE or STIFF
MAGNET PICKUP**

A combination unit that does three jobs! 1. Remove stiff wire rod and coil spring becomes a flexible 18-inch pickup for retrieving screws, nuts, etc. from otherwise inaccessible places. 2. When hardened steel wire rod is inserted pickup is stiffened. 3. Screw knurled handle of flexible spring pickup to handle of stiff wire rod and you have an extra-long (34-inch) flexible pickup. Tempered coil spring. Aluminum handle for light sturdiness. Permanent Alnico magnet.

Minimum order \$1.00. Send check or M.O. C.O.D. plus fee.
Money Back Guarantee.

SCOTT-MITCHELL HOUSE, INC.
Dept. M-155, 611 Broadway New York 12, N. Y.

**Become A ---
BUILDING CONTRACTOR!**

MAIL COUPON for FULL DETAILS
Simplified home study training program.
Learn every phase of building, estimating, contracting.
Fortunes are made in this line of work every year.
Use spare hours—no interference with present work.
Diploma awarded. Low tuition rates.

AMERICAN TECHNICAL SOCIETY
Dept. PM-36, 850 E. 58th Street, Chicago 37, Ill.
Please send me full details of your building, estimating and
contracting training program.

Name _____
Address _____
City _____ State _____



WELD IT YOURSELF IN A JIFFY!

Weld, Cut, Braze, Solder! Iron, Steel, Brass, Bronze, Aluminum and other metals safely and easily. Make your wrought iron furniture, porch railings, fences, knock-knacks and other metal specialties. With this fine equipment anyone can do professional-like work with little practice. Tool and equipment breakdowns are annoying and costly. Don't let them bother you. The Dynamic will pay for itself quickly in both time and money and is designed to operate from any properly wired 110 volt AC line.

Order your Dynamic Industrial type transformer Arc Welder for Workshop or Industrial use today. Order from this ad.
Literature on larger equipment available on request.

DYNAMIC WELDER COMPANY, 1808 S. Federal Street, Dept. D2-C, Chicago 16, Illinois

EASY PAY PLAN
Low down-payment.
Pay as you weld.
Money back guaran-
tee. Send for details.
Complete outfit.
Only \$38.50
F.O.B. Factory

Save on all PLUMBING JOBS

When You Build • When Making
Improvements • Repairs • Maintenance

Get
**POPULAR MECHANICS
Home Plumbing
Guide**



How to plan
plumbing in-
stallations, se-
lect materials
and fixtures.

How to save money on all plumbing
jobs using approved methods.
Easy to Do Professional-Like Jobs
and Save Over One-Half

Get the Popular Mechanics HOME
PLUMBING GUIDE. It shows how
you can do every kind of plumbing
job yourself and save from a few to
hundreds of dollars. Covers plans,
layouts, installation, maintenance
and repair. Shows what materials
to get and use, where to get them
and how to do a proper job with ap-
proved methods. Few, other than
the simplest tools are required and
some of these can be rented.
Don't pay high prices
for work you can do your-
self. Get the HOME
PLUMBING GUIDE for
only \$3.50. You will be
amazed how jobs you
thought difficult are sim-
plified.



Clip This Ad and Mail. Money
Back if Not Pleased
Invest only \$3.50. Use the
book for 7 days. Then if
you are not satisfied re-
turn it for full refund of
your money. Sent C.O.D.
(U.S.A. only) if you pre-
fer.

Over 500
How-to-do-it
Pictures Guide You

POPULAR MECHANICS PRESS, Dept. HPG-10, 200 E. Ontario St., Chicago 11

SURPLUS

New, in original cartons: 1/6th H.P. 24 V.
D.C. (or A.C. with brake springs removed).
Drives through gear reduction of 400 to 1-;
Linear stroke of 5", 750 lb. load, or Rotary
speed of 170 R.P.M. with linear mechanism
removed. Adjustable Limit switches for each
direction of travel. Government cost \$130.00
each. Bargain for garage door openers, gate
openers, etc. \$7.95 and postage on 10 lbs.
ORNA-METAL CO., Box 87, Amarillo, Texas



SAY YOU SAW IT IN POPULAR MECHANICS

**A MICHIGAN PROPELLER
MATCHED TO YOUR OUTBOARD
MOTOR, BOAT AND LOAD**

**GIVES BETTER PERFORMANCE
FOR SKIING, SPEED, CRUISING
or GENERAL OPERATION**

Write for FREE 1956 catalog. Con-
tains much helpful boating
data and carefully engineered propeller
recommendations; also, fine line of boat
fittings.
MICHIGAN WHEEL CO., Dept. P-3
GRAND RAPIDS 3, MICH.

PAGE TILLERS

New 1956 'Page-Boy'

- ★ FULLY GUARANTEED
- ★ LOW PRICED
- ★ EASY TERMS

Makes tough jobs easy!

3 Models—1½-2-3½ HP.
Tiller, mower, snow blow attachments easily shifted. Safe and easy to operate. Rugged steel frame, adjustable rubber tired wheels. So handy around the home or farm!

FREE CATALOG—Complete tractor line with all attachments



Tills.
Cuts Grass.
Blows Snow!

PAGE 1904 South 81st Street
Milwaukee, Wisconsin

BECOME AN EXPERT IN

TRAFFIC and TRANSPORTATION

Traffic men earn \$4,000 to \$10,000 and up. Thousands of firms need experts on rates, tariffs, regulations. We train you thoroughly in spare time at home for executive traffic jobs. Personal training under traffic authorities. Write for free book "Traffic and Transportation."

LASALLE Extension University, 417 So. Dearborn St.
A Correspondence Institution Dept. 3647 Chicago 5, Ill.

GET THE HABIT OF READING

OUR CLASSIFIED ADS.

Wonderful Opportunities Amazing Bargains



4x8 or 14x8?

BIG SHEETS mean BIG SAVINGS

When you cover an 8' x 14' area with *one* sheet of board, you obviously have 1/4 as many handling operations, 1/2 as many nailing operations, as if you had used 3 1/2 4' x 8' boards. And you have 3 fewer joints to cover.

This is one of 100 basic facts about home construction presented in the new 64-page Homasote Handbook. It shows you how to get lasting values in both new construction and modernization. It gives the

do'n'ts as well as the do's—for every part of the house—indoors and out.

Homasote is different—in its sizes, densities, strength, insulating and sound-deadening qualities. The Handbook shows you why—and how to use it. Mail the coupon to secure your copy—plus 3 fully illustrated folders suggesting 18 interesting and practical make-it-at-home projects, including furniture.

MAKE IT AT HOME—WITH HOMASOTE

HOMASOTE COMPANY
Department C-5, Trenton 3, N. J.

- I enclose 10¢ for Homasote Handbook.
 I enclose 10¢ for 3 Make-It-At-Home Folders.

Name _____
Address _____
City _____ Zone _____ State _____

FREE IMPORT BY RETURN MAIL!



To demonstrate your big money-making possibilities on my proved, successful import plan, I'll send you, without a penny's cost, a fisherman's hand-tied trout, crappie and blue gill casting fly. It costs just over a penny abroad, and sells by mail order or through stores in the U.S. for up to 30c. Think of it! Over 1500% mark-up. And there are more than 19 MILLION FISHERMEN IN THE U.S.—a huge and free-spending market.

GENUINE COACHMAN, HAND-TIED CASTING FLY YOURS FREE

And this is only one example of the foreign imports with fabulous profit opportunities for men and women. There are more than 25 Million amateur photographers interested in cameras, filters, lenses, enlargers, etc. Millions of foreign made watches, clocks and jewelry items are bought in the U.S. The overseas made gift market runs into millions of dollars. There are more than 16 Million hunters interested in guns, binoculars, knives and other accessories you can import. And consider the 30 to 40 Million homemakers interested in electric sewing machines, scissors, yarns, etc.

Other markets too numerous to mention await exploitation. Little wonder that World Traders make tremendous profits on low cost, high quality products. Now you too may enter this richly rewarding business with my personal guidance and help. I show you how and exactly where to get big profit imports.

GET CASH-IN-ADVANCE MAIL ORDERS

Receive orders with cash enclosed. Pocket your big profits in advance and pay traders abroad with the balance to ship direct to your customers. No face to face selling. No stocks to carry. Or if you like to make personal contacts with buyers, then import directly for department, sporting goods, camera and gift stores, etc.—without capital.

YOUR OWN BUSINESS FULL OR PART TIME

Never, to my knowledge, has there been such a fine opportunity to operate your own business without previous experience, spare or full time, from your own home; or travel abroad. There are also tremendous opportunities in export which you may handle.

ACT NOW—ALL 3 FREE!

Mail coupon below for FREE imported casting fly—plus new book, "Success Stories in World Trade" AND full details. (Only one free import to a person.) Air Mail reaches me overnight. B. L. Mellinger, The Mellinger Co., Dept. F253, 1717 Westwood Blvd., Los Angeles 24, Calif.

MAIL THIS COUPON TODAY.

B. L. Mellinger, The Mellinger Co., Dept. F253
1717 Westwood Blvd., Los Angeles 24, Calif.

Send me, without obligation, full details about the Mellinger World Trade Plan, your new book, "Success Stories in World Trade" and imported casting fly (only one to a person—none without coupon).

Name _____ Age _____
Address _____
City & Zone _____ State _____

MAKE up to \$10 AN HOUR
AT HOME with 50c worth of . . .

MICRO-FLUFF



HIGH COST OF LIVING GETTING YOU DOWN? Want an extra \$100 or more added to your monthly pay check in a few SPARE TIME hours AT HOME? That's what I wanted a few years ago when I ran across an Old-World formula for applying short cotton fibers to practically any surface, so that it looked and felt just like costly velvet or velour. I was amazed. I spent several years experimenting until I developed what I now call the FLOK-KRAFT MICRO-FLUFF method. This NEW METHOD is far removed from the Old-World way of applying these short fibers. Also it permits the use of tiny fibers of RAYON and other modern materials in MANY COLORS in addition to cotton.

NO OVERHEAD. NO EXPENSIVE EQUIPMENT. Start in your basement, garage, attic, service porch, or even on a card table in your bedroom. With an hour's practice you can apply a few pennies worth of FLOK-KRAFT MICRO-FLUFF to a yard or two of butcher paper, and make it look like \$15-a-yard velvet for window displays in the finest jewelry, gift, or department stores, etc. Takes only a few minutes and practically no effort.

MICRO-FLUFF IS BEAUTIFUL—LONG WEARING, the most amazing material you ever saw. It comes in every rainbow color, is long lasting, has the TOUCH appeal of luxurious velvet or suede, and goes on practically any surface—paper, metal, wood, glass, plastic, plaster, rubber, etc. Wonderful to line silverware or hosiery drawers, cover and line jewelry boxes, decorate lamps and lamp shades, finish the inside of auto trunks or glove compartments (to protect luggage and accessories from scratching) re-cover women's party shoes, phonograph turntables, etc. Apply to toys, figurines, wall plaques, signs, store displays—a thousand-and-one other items, new or old. MICRO-FLUFF makes old objects beautiful and salable—increases value of many new products by 50%.

Big-profit orders come from neighbors, gift shops, stores of all kinds. Every household has one or more items that can be saved from discard by a FLOK-KRAFT job. Decorate store display cases and windows (jewelers love this) and also supply them with fast-selling FLOK-KRAFTED gift items and other merchandise. Manufacturers are prospects for contracts to apply FLOK-KRAFT to furniture, instrument cases, luggage, and hundreds of other products. Every neighborhood needs a FLOK-KRAFTER. HELP US FILL HUGE DEMAND.

Since succeeding beyond my wildest dreams in my own FLOK-KRAFT business, I have concentrated on helping ambitious men get started the same way toward a successful future, free of time clocks and nagging bosses. My plan is designed to help you start at home in spare time, and build gradually toward a full-time business with employees working for you. And you can start RIGHT NOW. Just send me your name and address on a postcard, and I'll rush you a FREE SAMPLE OF FLOK-KRAFT MICRO-FLUFF and full FREE details. I'll also arrange to send you the complete FLOK-KRAFT MICRO-FLUFF outfit to try out right in your own home without risk. The outfit includes detailed instructions with hundreds of show-how photographs and drawings that make everything simple, right from the start. Also included is our specially designed, high-velocity Applicator and a generous supply of FLOK-KRAFT MICRO-FLUFF—everything you need to get going right away. You owe it to yourself to investigate. Rush me your name and address today by Airmail, and I'll show you how to start making money at once!

NELS IRWIN, Coast Industries, Dept. 23
Los Angeles 61, California

ALADDIN READI-CUT HOUSES

Choose from 120 modern plans. Save up to 30% on labor—18% on waste! SEND 25c for 72 page Catalog No. EM-34. THE ALADDIN CO., Bay City, Michigan.

HUNTERS! CONFISCATED RUSSIAN RIFLES

\$1495



AMMUNITION
FREE 20 rounds full jacketed ammo included with each rifle purchase. Additional cartridges: \$7.50 per 100 rds. This ammo is for the Russian Moisin 7.62 MM, and also for the Moisin Nagant as made during WW I by Remington and Westinghouse.



This is the late Russian Model 6 shot bolt action 7.62 MM Moisin Rifle, appr. 30" barrel. Mechanically perfect. Outside: good. Bore: fair. Ballistics: 2820 FPS with 150 grain bullet. An excellent hunting cartridge. Hinged floor plate. The Russians won the International Meet in Venezuela (1954) with this model rifle made for the Czar by Remington & Westinghouse. These guns were confiscated from Communist revolutionaries and placed on the free world market. They are of the type used by Red Chinese in Korea. The sale of these guns in no way aids any country behind the iron curtain. A once-in-a-lifetime collector's item. This is the lowest price we have ever seen which would allow a man to equip himself for big game hunting. For C.O.D. send \$5 deposit.

GOLDEN STATE ARMS CORPORATION 120 Armory Bldg., 1165 East Colorado St., Pasadena 1, Calif. Calif. resid. add 3% state tax.

TAPMASTER

Tap Reconditioner



The new, low-cost precision instrument for accurate tap reconditioning. No special equipment needed to operate.

SAVES MONEY — allows longer tap life and reduced breakage.

SAVES TIME — only a few minutes set-up time. Accommodates taps from #10 to 2 1/2".

Write today for complete details. A few choice dealer territories still available.

COMPONENT PARTS CO. INC.

613 W. Putnam Drive

Whittier, California

24" ATTIC FAN KIT



Easy to assemble. Belt-driven. Blade, shaft, 2 self-aligning bearings, 2 pulleys, 2 collars, and V-belt. Everything you need, except frame and 1/4-hp motor, to make your own house cooler.

ONLY \$9.95

SAVE \$46.00

Send for complete list of fan parts.
PENNA. WHOLESALE DISTRIBUTORS
104 N. 6th St., Phila. 6, Pa.

ONE-MAN SAWMILL LOW \$50.00 AS... DOWN



Take BELSAW Portable Sawmill right to the trees—turn out valuable lumber for home and farm—sell to local yards—make up to 150 a day custom sawing for neighbors. BELSAW lasts a lifetime. No crew needed. Power with tractor or auto engine. Beginners get excellent results. Send today for FREE BOOK.

BELSAW MACHINERY CO.
3456 Field Bldg., Kansas City 11, Missouri

BUILD YOUR OWN MIDGET ROADSTER \$25 BUILDS BODY & FRAME



Build a PONY ROADSTER or PICK-UP in few spare hours. Uses 2 hp engine, 450 lb. loads, 70 m.p.gal. Great for kids, sturdy utility car. Designed for VERY LOW COST assembly from PARTS BOUGHT IN YOUR NEIGHBORHOOD. Use home tools. No welding needed on body or frame. COMPLETE step-by-step plans, 17 large size pages, 30 "show-how" photos, parts list, and hood insignia. ORDER NOW. ONLY \$1.95 post-paid. Satisfied or money back.

PONY PLANS, DEPT. 43, 7641 TEXHOMA AVE., NORTHRIDGE, CALIF.

EARN AT LEAST \$7,500.00 ANNUALLY

or Double Your Money Back! Start a Buying Service. Buy to 80% off Retail. Sell at Tremendous Profits. Full or Part Time. Permanent. Profitable. Dignified. Deal in New Nationally Advertised Merchandise. Fully Guaranteed. Westinghouse, Parker, Bulova, Appliances, Housewares, Jewelry, Sporting Goods, Tools, Toys, Etc. Latest Wholesale Buyers Guide tells How-Where-When. 285 Product and Company Catalog Listings. Complete information. Year's Consultation Service. Free Wholesale Catalog. Unconditional Money-Back Guarantee! Everything only \$2.00. Airmailed \$2.25. (COD's Accepted.) Rush order today!

WHOLESALE BUYERS SERVICE
1720 MARKET ST., DEPT. 22 ST. LOUIS 3, MISSOURI

SAY YOU SAW IT IN POPULAR MECHANICS

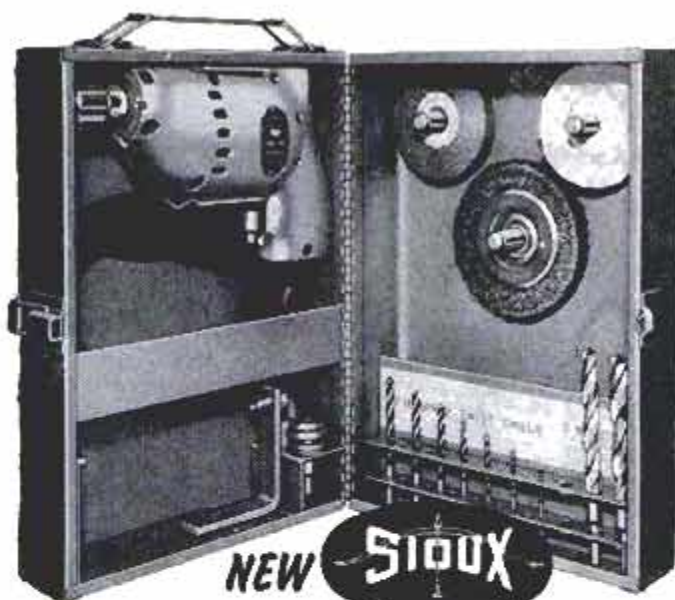

NEW SIOUX

1/4" DRILL KIT

Here's the powerful SIOUX 1/4" electric drill with accessories for sanding, drilling, grinding, sharpening, wire brushing, polishing, cleaning, etc., all in a handsome, fitted metal case that hangs on the wall or goes to the job... \$41.75 Complete Drill only \$24.95



WRITE TODAY FOR MORE INFORMATION

ALBERTSON & CO., INC., SIOUX CITY, IOWA, U.S.A.

POWER HACKSAW \$58.50



LESS MOTOR F.O.B. Benton Harbor
● Rugged cast iron construction. Wt. 56 lbs., bronze bearings. Draw cut. Auto. return lift. Auto. shut-off. Vise swivels 45°. Cap. 4"x4".

Send for full details and name of nearest dealer.

EXCEL MACHINE TOOLS BENTON HARBOR, MICHIGAN

Say You Saw It in
POPULAR MECHANICS

HOLD-E-ZEE SCREWDRIVERS

The Original AUTOMATIC GRIP

Top Quality—Plus!

Finest materials and workmanship plus exclusive, much-wanted features

—YET COST NO MORE THAN ORDINARY SCREWDRIVERS!

At Leading Dealers Everywhere

UPSON BROS., INC., ROCHESTER 14, N. Y.



WAR SURPLUS AND OTHER BARGAINS SAVE UP TO 90%

BUILD YOUR OWN ARC WELDER, LIGHT PLANT OR BATTERY CHARGER

Complete Kit \$39.95



Kit consists of: 1 Famous Navy NEA-5 Generator. New! Combination AC-DC Type. AC voltage—115 V. DC voltage—24 V. 200-300 Amps. 2 complete generators in 1... 2 separate fields & 2 separate armatures on same shaft yet no larger than reg. aircraft generator. Ideal for home, farm & shop lighting plants by hooking wires to AC side which will give 1200 watts. DC side can be used for charging batteries, welding & operating war surplus low voltage hobby motors & equipment. Also in kit: 1 Voltage Regulator DC. 1 Voltage Regulator AC. 1 Reverse Current Relay. 1 Ammeter. 1 Shunt. 0 to 240 Amps. 1 Voltmeter. 0 to 30 Volts. 1 Rheostat. 1 Electrode Holder. 1 Giant Toggle Switch. Wiring diagram for hookup as welder. Wt. under 100 lbs. Approx. GOVT. COST \$600. Kit, only \$39.95. Navy NEA-5 Generator—same as above, if purchased separately: New—\$27.50.

HIGH SPEED HAND TAPS

10 assorted, precision-ground thread. National Mfr. Like NEW. From 3/16" up. Approx. GOVT. COST \$25. Now \$2.50.

LONG-FLUTE, HIGH SPEED DRILLS

12 assorted sizes. Up to 1/2". Like NEW. Approx. GOVT. COST \$23. Now \$2.25.

"HELIOS" ORIGINAL TOOLMAKERS VERNIER CALIPERS

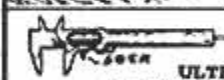

ULTRAPRECISION—Imported. Used by machinists at Lockheed, Douglas, Bendix, GM, RCA, GE. Model 51/2E. Genuine Helios. Hardened lapped precision surfaces. 1/1000" and 1/128" graduations. Handy slide roll and thumb lock. Quick, accurate depth. A \$35 value. Satin finish. ALL NEW. just \$6.95 Leather carrying case. \$1 extra.

REVERSIBLE RATCHET WRENCH



For diesels, ships, farm machinery, trucks, bridges, oil fields, all heavy equipment. Terrific leverage. 4' Lowell, safety steel, sockets for 2 3/8", 2 9/16" & 3 1/8" hexagon nuts. Navy surplus. Approx. GOVT. COST \$215 a set. Wt. 50 lbs. NEW! Now \$10.95 per set.

HOMELITE PORTABLE POWER PLANT

Buy power for pennies. Ideal for welding, battery charging, emergency lights for cabins, camps, trailers, aircraft or wherever power needed. Easy rope pull starting. Fully equipped, ready to start. 2000 W. 32 V. 5 HP. Complete, nothing else to buy. Like new, tested. Shock mounted. De Luxe type. Net wt. 115 lbs., gross wt. cased 200 lbs. Approx. GOVT. COST \$700. While they last—\$59.95.



MICROMETERS Chrome plated, precision engineered, carefully tool to give long life. All new 0-1" cap. \$2.25 ea., 1-2" cap. \$3.50.

PRECISION GROUND SQUARES



Production engineer's Squares. Accuracy guaranteed. Mfd. by Wright & Moore, Sheffield, Eng. Square blades hardened & tempered. Individually packed in wood box. Brand NEW. Fraction of original cost. 2"—\$2.75 3"—\$3.00. 4"—\$3.25. 5"—\$3.50. 6"—\$3.75. 9"—\$7.00. 12"—\$8.75.

FIELD COOKING UNIT & HEATER

Terrific for hunters, ranch, home, farm, civilian defense, boat, camp, trailer, barbecue, etc. Burns any type gasoline. NEW. Wt. 95 lbs. boxed. Approx. GOVT. COST \$150. Comp. with 2 spare energizers and orifice cleaner 50,000 BTU... only \$8.95.



PIONEER MAGNETIC COMPASS



For boats, trucks, cars. By Pioneer Instrument Co., Div. of Bendix. No. 1829-2A. Contains screw-type heeling compensator, removable drawer-type compensator, screw-type horizontal compensator and spider-type compensator. All devices for elimination of errors caused by effects of magnetism. Has constant deviation corrector and course setter. Rotable dial engraved with compass card graduations. Complete with book of instructions, light and mounting screws and shock mounts. Shpg. Wt. 10 lbs. Approx. GOVT. cost \$400. NEW. \$13.95

NEW! 1956 CATALOG Largest ever... just out... new low prices. Send 25c for your copy today. Prices F.O.B. Culver City unless otherwise stated. Check, cash or money order. 25% deposit for C.O.D.

AIRBORNE SALES CO., INC. DEPT. PM356
8501 Stellar Drive, Culver City, Calif.

Also Eshelman Adult 2 Pass. **SPORT & GOLF Cars 1/5** the Price of most other Cars. 70 Miles Per Gal. Free Catalog.

ESHELMAN TRACTORS LOW AS \$99

For Better Lawns and Gardens investigate Eshelman Riding Rotary Mowers, Tillers, Tractors. Advertised in GOOD HOUSEKEEPING and leading magazines. Amazing Savings. Free Literature Write: **ESHELMAN, Dept. M-53, 109 Light St. Balto. 2, Md.**

Shipping Points: BALTIMORE - CHICAGO - RENO

THE LITTLE STICKER



STRONGEST White Glue you ever used! Rated "EXCELLENT" by leading research organizations.

LEPAGE'S WHITE GLUE

Its **SURE GRIP** will stick ANYTHING!
NOW in handy refillable squeeze bottles

Economy Size 98¢
Regular Size 29¢



Try also LE PAGE'S Glue — Paste — Mucilage
Miracle Mender — Liquid Solder

LIFE-LONG DURABILITY



They last and last. Trouble-free service year in and year out. Free catalog.

GERSTNER TOOL CHESTS
456 Columbia St., Dayton 7, Ohio

The NEW ALL-METAL Razor Blade PLANE

The 3-in-1 Tool as seen on TV and at Do-It-Yourself Shows

ONLY \$1.50
POST PAID



For Planing Inside or Outside Curves



Use any double edge razor blade in plane. One of the handiest tools ever invented for use around the home and in the workshop. Planes soft or hard wood, plastics, linoleum, rubber, leather, tile, plaster-board, soft metals, etc. Can be adjusted for fine planing.



For Straight Planing

For Scraping old paint, putty or ice from windows or cleaning tile.

SEND CHECK OR MONEY ORDER (C.O.D. FEE EXTRA)
SATISFACTION GUARANTEED

NORTHEASTERN SALES CO. Box 188-Stafford Springs, Conn.

Enclosed is \$____ Please send me _____ Razor Planes @ \$1.50 each.

Please send me _____ planes C.O.D.

Name _____

Address _____

City _____ State _____

Schupack's Amazing Tool Bargains! Save up to 100%!

75 Mounted Wheels & Miniature Cutters. Regular \$11.00 value \$4.50 Post-paid
For cutting and grinding on wood, metal or plastic. Includes 26 mtd. wheels and points on 3/32" shanks; 24 miniature cutters on 3/32" shanks; 25 short shank min. cutters. Will fit all electric drills and hand grinders.

FLEXIBLE SHAFT—ONLY \$4.95 Post-paid
Fits all electric drills & hand power tools, 3/8" long. Oilite bearings. Core of specially wound, high carbon steel wire in flexible steel casing. Will accommodate tool shafts up to 1/4" dia. For lathes, electric drills, etc.

2 DRUM SANDERS
With 12 Bands in Assorted Grits. 1/4" dia. x 1" long on 1/4" arbor with 12 bands \$1.50 Post-paid
One drum, 1" dia. x 1" long on 1/4" arbor with 6 extra sleeves \$1.00 Post-paid

12 MOUNTED WHEELS and points on 1/4" Shank \$2.95
36 for \$7.50 P.P.
For grinding on plastic wood, soft & hard metals. Regular Value \$8.40.
18 Mounted points on 3/32" shank \$2.50; 12 mtd. wheels on 1/4" shank \$3.60

18 Rotary Cutters P.P. \$5.95
Assorted sizes cutter on 1/4" or 3/32" shank. Will fit all hand grinders. Ideal for cutting wood, metal, or plastic. Brand new.

ADAPTER CHUCK
With 3 interchangeable collets, opening from 3/32" to 3/8" on 1/4" mandrel. Price each only \$1.50 P.P.
Adapter Chuck. From 60 to 80 on 3/32" in. Mandrel \$1.00
4 Woodwork Drills from 1/4" to 1/2" on 1/4" shank \$2.00
No C.O.D.'s please
New Illustrated Catalog 10c

SCHUPACK SUPPLY CO. 7331 COTTAGE GROVE AVE. DEPT. PM-10 CHICAGO 12, ILL.

GET THE HABIT OF READING OUR CLASSIFIED ADS.
Wonderful Opportunities Amazing Bargains



Pays for Itself 100 Times Over

Beat the high cost of home upkeep. Save hundreds of dollars every year on carpentry, electrical, painting, plumbing and other jobs around the house with Popular Mechanics GUIDE TO HOME REPAIRS. Simplified how-to-do-it instruction and 646 pictures make all jobs, inside and out, easy. Covers construction, remodeling, modernizing, repairing that you can do yourself at small cost. 192 page cloth bound book only \$2.50 postpaid. Order today under our money back guarantee.

POPULAR MECHANICS PRESS, Dept. PM16
200 EAST ONTARIO STREET CHICAGO 11, ILLINOIS

OWN A... FORD?

FIX IT YOURSELF!

Popular Mechanics Magazine has published an Owners Manual covering all 1941 to 1952 models of Ford cars... So accurate mechanics use it... so simple a woman can understand it.



Save money on your Ford car repairs. Prevent trouble. Enjoy care-free driving. Increase trade-in value. Avoid major repairs by fixing minor troubles before they get serious. Get sparkling performance at all times. Has 272 pages, more than 350 photos, diagrams, tables, charts, breakdown drawings, plus clear, non-technical directions that make all repairs simple as A B C. Written by Ed Packer with the assistance of the Ford Motor Company. Shows you how to diagnose all Ford troubles by feel, sound, sight, smell and performance. Simple trouble shooting. Permanent repairs. Emergency repairs. Plus, "How to get value from garages."

MONEY BACK IF IT DOESN'T SAVE MORE THAN IT COSTS!

One minor repair will save the cost ten times over. Read it. Then you decide. If you don't see that you'll save more than the cost, send it back for refund. SEND NO MONEY. Send postcard. Ask for the Ford Manual. Postman will deliver C.O.D. for \$3.50 plus postage. Or, save postage by sending \$3.50 with order. Send today. Save its cost on your next repair.

POPULAR MECHANICS PRESS
200 E. Ontario, Dept. 90, Chicago 11, Illinois

BIGGEST SAW VALUE

in power tool history!

Completely NEW
DURO MASTER
8" Tilting Arbor Saw

Here is everything you ever wanted in a power saw. Design, quality, precision, ruggedness and low cost. The all new DURO MASTER 8" Tilting Arbor Saw includes all important features and operating advantages including: "floating" motor shift, rugged "quick lock" rip fence, handy blade raising and lowering knob, one piece steel frame, convenient blade tilting mechanism with graduated scale and modern safety guard. And only DURO MASTER offers built-in conversion and adaption features for tomorrow's needs, too!



Write for FREE Brochure and Catalog giving full details and specifications on this remarkable new saw plus other Duro models from \$59.95 to \$320.00.



only
\$4845

Less extensions, splitter and guard
\$53.45 as illustrated

DURO METAL PRODUCTS CO. 2657 N. KILDARE AVE.
World's Largest Manufacturers of Power and Hand Tools (Duro Chrome) CHICAGO 39, ILLINOIS

DITCH-WITCH TRENCHER



Portable DITCH-WITCH digs 4 1/2" or 6" clean, even ditches to 36" depth in all types of soil. Four rugged models. Complete unit — self-propelled. OUTDIGS 8 MEN
Write for Illustrated Literature

The CHARLES MACHINE WORKS
620 B Street Perry, Okla.



NEW SAW SHARPENER

Improved #64 Hand Gummer sharpens all types circular saws 4" to 20" diam. Ideal for saw shops. Self-Centering adjustment for quick, easy set-ups. Complete with 1/2 HP motor, 1 grinding wheel & cord. \$100.00 FOB Portland, WL 70±. SEND FOR FREE LITERATURE.

INTERSTATE SAW MACHINERY
8240 N. INTERSTATE AVE.
Dept. P.M.-63, PORTLAND 17, OREGON

1/2-HP Motor SPEED REDUCER

Reduces Speed at a 20-1 Ratio

Brand New!
Guaranteed!

Mfr'd. for Army radar equipment, this reducer is a masterpiece of design and precision workmanship



For experimental and laboratory uses . . . for building special equipment that saves valuable man hours. Ratio of 20-1 gives approximately 90-RPM with 1750 motor, direct drive . . . or can be belt driven to give ANY DESIRED SPEED! Use with any size motor up to 1/2-HP. Case is cast of aluminum alloy (not die cast) and has BALL BEARINGS throughout. Heavy duty, double reduction, spur gear drive built for continuous duty. Smooth, quiet running. Base to shaft is 4 1/2" high. Comes complete with couplings. Operates: conveyors, timing devices, revolving window displays and signs, tumbling equipment and machine tool drives . . . 1,001 uses!

Gov. Cost \$86

Only \$1650
Pre-paid

Order From AD! We Pay Shipping!

FREE CATALOG OF OTHER ELECTRICAL BUYS

ROBERTS ELECTRIC CO., Dept. PM-386, 849 W. Grand, Chicago 22, Ill.

It's QUICKER... Works SLICKER with



Put power into tough screwdriver jobs! Simply lock Viso-Grip onto shank, and rotate!

Does More Jobs Easier Than Any Other Tool Made!



No. 10W, 10"
\$2.60

A squeeze of the hand locks jaws onto work with ton-pressure! Quickly adjusts for use as All-Purpose Wrench, Super-Pliers, Clamp, Wire Cutter, 7" and 10" cutter optional. \$1.85 to \$2.60 at your dealer.

Made By PETERSEN MFG. CO., Dept. M-3, DeWitt, Nebr.

WISE-GRIP

Makes EVERY JOB EASIER

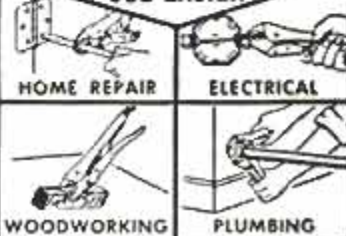



AMAZING NEW "ARCO-SAW" CUTS ANY GROOVE!

WHIZZES
THRU 2x4's!

Not even a \$100 Portable Saw has a dado cutter! "Arco-Saw" (guaranteed to fit any 1/2" electric drill) with sensational new "Dado-Arbor" adjusts easily to cut any size groove up to 1/2" wide x 1" deep in **ONE CUT!** Graduated Depth-Bevel-Rip Gages adjust for depth of cut up to 1 3/4", angle cuts to 45°. Amazing swivel action of "Dado-Arbor" (see sketch at right) cuts large grooves cleanly and accurately with little power. "Dado-Arbor" is easily removed to use the saw for straight ripping, crosscutting or angle cuts. Right angle steel gear drive and safety-yoke permit **ONE HAND** operation. Includes quick-cutting **5" Safecut Blade**.....



\$12.95

BLADES—5" Rip, Crosscut or Combination.....\$1.75

SOLD AT BETTER HOME STORES EVERYWHERE. If not available, order direct and try this amazing tool on our **UNCONDITIONAL 10-DAY MONEY BACK GUARANTEE.** Send check or M.O. (ppd.) C.O.D.'s—plus post.

ARROW METAL PRODUCTS CO.

Dept. PM-3, 140 WEST BROADWAY, NEW YORK 13, N. Y.

SAY YOU SAW IT IN POPULAR MECHANICS



BUILD 16 RADIO
CIRCUITS AT HOME WITH THE NEW DELUXE
1956 PROGRESSIVE RADIO "EDU-KIT"
ONLY **\$19.95** COMPLETE

All parts, instructions, punched metal chassis, printed circuit materials, electric Soldering Iron, Tester included. 30 Day Money-Back Guarantee. **PROGRESSIVE "EDU-KITS" INC.**, Room 543-B, Progressive Building, 497 Union Ave., Brooklyn 13, N. Y.

Please Rush me Free Descriptive Literature concerning "EDU-KIT." Also send me Free Radio-TV Servicing Literature. No obligation.

NAME _____
ADDRESS _____
CITY _____ ZONE _____ STATE _____

TURBINES — NOW AVAILABLE FOR CIVILIAN USE

KITS FROM — **\$59.50**



FEATURES:

- ONE PRIMARY MOVING PART
- NO AUXILIARY COOLING
- USES LOW COST FUEL
- LIGHT WEIGHT SMALL VOLUME
- SELF CONTAINED GEARBOX
- .685 SQ. FT. FRONTAL AREA
- CORROSION RESISTANT CONST.

Having applied mass production techniques with sound engineering we have developed a series of low cost gas turbines. This type unit is applicable to automotive, aircraft, marine, and industrial usage. It is the engine of the future as well as the present. Its ultramodern design will remain current for years to come.



START A BUSINESS this Quick Way

"I have taken in 100 mowers in 5 weeks since I got my Foley," says George C. Wise.

FOLEY LAWN MOWER SHARPENER

Start in spare time and make a quick CASH PROFIT. The Foley handles up to 3 or 4 mowers per hour—prices run \$1.50 to \$3.00 for hand mowers, \$4.00 to \$8.00 for power mowers. You make 99% profit!

FREE VALUABLE ILLUSTRATED BOOK shows how to sharpen all leading makes of power mowers. Foley prices are low—easy payments available. **FREE PLAN** tells how to start. Write today—no salesman will call.

FOLEY MFG. CO., 307-6 Foley Bldg., Mpls. 18, Minn.

"SPEEDY" DRILL GRINDING GUIDE

MAKE OLD DRILLS LIKE NEW...

For re-pointing dull and broken twist drills up to 1/2" in diameter. One piece cast Aluminum. Simple. Anyone can use it. Order yours today. \$1.00 post-paid.

BRASS CASTING CO. \$1.00
P. O. Box 3056 Memphis 9, Tenn.



Find HIDDEN TREASURES

GOLD, SILVER, PRECIOUS METALS with the Famous Model 27 Metal Detector. Lightweight, ultra-sensitive, low cost. None finer. Also GEIGER COUNTERS for uranium and the VIOLITE for tungsten. INFORMATION FREE

THE *Detection* CORP.

5528 Vineland Ave., No. Hollywood, Calif.



Accurate Easy LEVELING

for FOOTINGS..... FLOORS etc.

Accuracy and dependability of expensive instruments—simple, fast, durable. A professional builders' level.



WRITE FOR **FREE** DETAILS ON MODERN LIQUID LEVELING
HYDROLEVEL Suite 915, 407 S. Dearborn, Chicago 5

100 BEST Woodworking Projects

SELECTED FOR YOU BY POPULAR MECHANICS EDITORS
Enjoy the fun—the pride—of making things. Get 100 BEST WOODWORKING PROJECTS, complete with simplified instruction, plans, diagrams and more than 400 how-to-do-it pictures. Make all kinds of furniture, baby carriages, clocks, lamps, book shelves, fireplaces and other useful articles at little or no cost. Send only \$2.00 with name and address. Money back if not pleased.

POPULAR MECHANICS PRESS, Dept. PM6, 200 E. Ontario St., Chicago 11



60 LBS.

Send \$1.00 for catalogue containing prices, photographs, technical data, etc., or send \$3.00 for catalogue plus a bound set of assembly and detailed blueprints. Catalogue or blueprint fee refunded on first order.

TRECO PRODUCTS, DEPT. 20, 1364 WOODLAND HILLS DR., ATLANTA 5, GEORGIA
POPULAR MECHANICS

NEW *electric* GARDEN TILLER

Thousands of gardeners get more fun out of gardening with a Moe Hoe. This electric tiller spades and cultivates quickly—is light, easy to handle. Is the power source for work-

saving attachments: trimmer, floor polisher, table saw, grinder and drill.



See this display at your Garden & Hardware dealers

Go in today—See the Moe Hoe display. Ask for free demonstration. For more information write: Moe Hoe, 2705 S. E. Milwaukie, Portland 2, Oregon.

MOE *electric* **HOE**
an Iron Fireman product

MANUFACTURE THIS BEAUTIFUL CONCRETE OUTDOOR FIREPLACE

Right In Your Own Backyard

\$4.00 Worth of Sand & Cement produces this Attractive Fireplace.

Sells on Sight from \$60. to \$80. Easy to start your own Profitable Business.

The General Fireplace Molds and Process are the most amazing and foolproof ever invented. Simple to operate. Two men can produce five fireplaces a day.

BIG DEMAND!!

Sell all you produce to Department Stores, Homeowners, Parks, Nurseries and Picnic Groves. Fireplaces sell on sight. No experience necessary. We supply full operating instructions and equipment plus the know-how that spells BIG PROFITS. This is an outstanding opportunity for men of vision and small capital to get into a busy rich paying field. Don't delay, be the only exclusive manufacturer in your own home town. Mail coupon at once for full details as to how you can reserve your territory. Molds sold only on exclusive franchise.

GENERAL ENGINES CO., Inc., Dept. MF-36
ROUTE 130, THOROFARE, N. J.

Mr. Tor of Philadelphia writes: Sold 250 in first 4 months. Selling to Sears Roebuck, John Wanamaker, and Gimbel Bros. in Philadelphia area.

Name
Address
City Zone
State

Mammoth 1956 Wholesale Tool Catalog

TOOL CATALOG



YOUR NAME



The opportunity now awaits you to own and operate your own business on a part time or full time basis in the lucrative field of **HARDWARE, HAND TOOLS, FANS, POWER TOOLS, MOTORS, PAINTS, etc.,** or **BUY TOOLS FOR YOUR INDUSTRIAL OR INSTITUTIONAL USES.**



Buy Nationally Advertised Tools for Resale or Industrial or Institutional Use

NO INVESTMENT REQUIRED, BUY AS YOU NEED IT. A MILLION DOLLAR INVENTORY AT YOUR FINGER TIPS.

Discount UP TO **50%**

\$1.00 refund on first purchase or refund if you are not 100% satisfied.



Every one needs tools. Meet the demands of the growing "Do-it Yourself" markets. Sell direct from the jumbo buying guide—your cost is known only to you.

JUST FILL OUT COUPON

ENCLOSE \$1.00 FOR DEALER'S CARD & 1956 MAMMOTH TOOL CATALOG.

SILVO HARDWARE COMPANY

Dept. PM-3, 108 Market St., Philadelphia 6, Pa.

I am enclosing \$1.00. Rush me your dealer's card and big Catalog Today. If I am not completely satisfied with your plan, I understand that I can return the Dealer's Card and Catalog for refund, and if I decide to order, my \$1.00 will be deductible from my first order.

NAME
ADDRESS
CITY ZONE STATE

AMAZING TUBELESS AND TUBE-TYPE TIRE REPAIR SYSTEM ANNOUNCED!

REPAIR YOUR OWN TUBE
OR TUBELESS-TYPE TIRES
IN 5 MIN. *Without Removing
WHEEL OR TIRE!*

Tyron's pure latex compound when inserted in puncture forms a sealant and lubricant for —

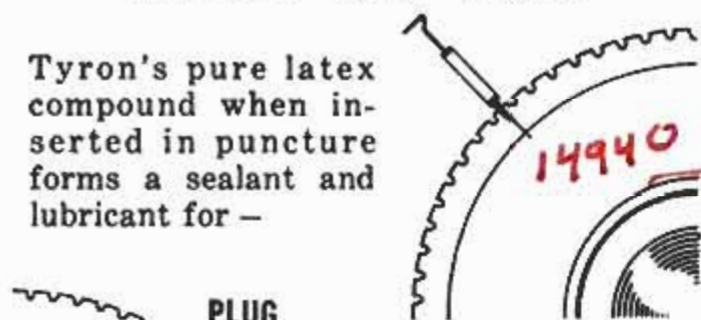

Tyron's exclusive 2-stop rubber plug. When plug is inserted in puncture hole according to directions form-fits, insuring a lifetime repair.

TUBE-TYPE TIRE REPAIR

The use of Tyron's pure latex rubber compound alone will repair tube-type tires without removing the tube. Shown at left: lifetime patch made with Tyron pure latex compound.

PLUS...

Truck Tire Repair
Bicycle Tire Repair
Motorcycle Tire Repair
Tractor and Farm Implements

TYRON CORPORATION
GOODLAND, KANSAS

Dear Sirs: Please send me additional information about this amazing tire repair system.

For Tubeless Tires For Conventional Tires

NAME _____

ADDRESS _____

CITY _____ STATE _____

WHERE-TO-BUY-IT INDEX

Source of supply appears after items commercially available

AUTOMOTIVE

Jeep train for tourists.....	104
Three-wheeled German car has all-plastic body.....	121
Mobile repair shop services truck trailers while they're loading (Pacific Intermountain Express, Denver, Colo.).....	129
Hollow crankshaft in German Ford.....	150
Tire remover (Automotive Equipment Mfg. Co., 1000 S. Alabama St., Lynwood, Calif.).....	160
Tow trailer replaces truck.....	161
Hose washes paint from auto bodies (Stripwash Corp., 11 Park Place, New York City 7).....	165
Battery-cable terminal (Bowes Sealfast Corp., 226 N. Pine, Indianapolis, Ind.).....	172

HOUSE AND HOME

Rubber dog-and-cat door closes behind pets (Don D. Johnson, 561 Alta Vista Way, Laguna Beach, Calif.).....	121
What's New for Your Home—	
Strip linoleum designed for easy installation.....	138
Tie press needs no electricity.....	138
Sewing guide attaches to sewing machine.....	138
Meat watcher is an automatic electric thermometer.....	139
Hooks that slip over steps of stepladder.....	139
Measuring spout.....	139
Molded plastic house.....	143
Basement flooding prevented by valve (Flood Control Valve Co., 1400 Wyoming, Detroit 38, Mich.).....	156
Roller coaster for the back yard (Scottidel, Inc., Box 5, Swanton, Ohio).....	156
Reusable filter for home furnace (Continental Air Filters, Inc., 2520 Helm St., P.O. Box 1647, Louisville 1, Ky.).....	160
Shadow box for medals (Cleaves-Range Enterprises, Inc., 8405 Ramsey Ave., Silver Spring, Md.).....	244

MISCELLANEOUS

Electric mopping machine covers two-foot circle (Utility Machine Works, 6339 1st Ave. S., Seattle, Wash.).....	102
Portable heater warms workmen (Master Vibrator Co., 362 Stanley Ave., Dayton 1, Ohio).....	104
Diesel locomotive also has third-rail electric pickup.....	105
Heavy-cargo helicopter carries 10-ton load (Aircraft Division, Hughes Tool Co., Culver City, Calif.).....	105
Home switchboard (Vintage Products Co., St. Louis 4, Mo.).....	112
Log shelters serve as havens for fish in Wisconsin lakes.....	112
Electric heating belt warms thick liquids (Pre-Fab Heater Co., Inc., Guilford, Conn.).....	129
"Tricycle" attachment lets you ride mower (E. F. Brewer Co., Butler, Wis.).....	130
Powdered coal operates gasoline or diesel engine.....	137
Circular digger claws out rock (W. G. Cullum Co., Fidelity Union Life Bldg., Dallas, Tex.).....	140
Cat tricksters.....	141
Proposed excursion boat features seawater swimming pool.....	142
Fish shipped in bags (National Container Corp. for Sunlan Aquatic Nurseries, Miami, Fla.).....	150
Mobile studio follows the fairs.....	151
Folding hinge for table legs (Bostrom Mfg. Co., 133 W. Oregon St., Milwaukee, Wis.).....	156
TACAN pinpoints position for airplane pilot.....	157
Balloon guitar.....	165
Earthmoving scoop is portable platform.....	166
Pedestal grips bottle (Otis Co., Wilmette, Ill.).....	166
Halves of extension ladder become back-yard gym set.....	171
Statues in living hedge shaped by clipper artist.....	171
Jets push cabin cruiser broadside through water.....	172
Silent wrist alarm (Zenith Radio Corp., 6001 W. Dickens Ave., Chicago 39).....	242
Seed germinator (National Agricultural Supply Co., Fort Atkinson, Wis.).....	244
Louvered sunglasses use no glass (New Products Enterprises, Inc., 115 S. Lafayette Blvd., South Bend, Ind.).....	250
Comb applies hair tonic through ball-point teeth (Call Combs, 400 Sixth St., Sioux City 1, Iowa).....	262

(Continued to page 92)

Do it Yourself and SAVE!

Std. Model ES-1
no blower or
fiber
hold-downs

Only
\$66⁵⁰

Model ED-1 \$88.50
Deluxe with blower
and fiber hold-downs

MOULDING, PLANING,
EDGING, SANDING,
JOINTING

On the Job!

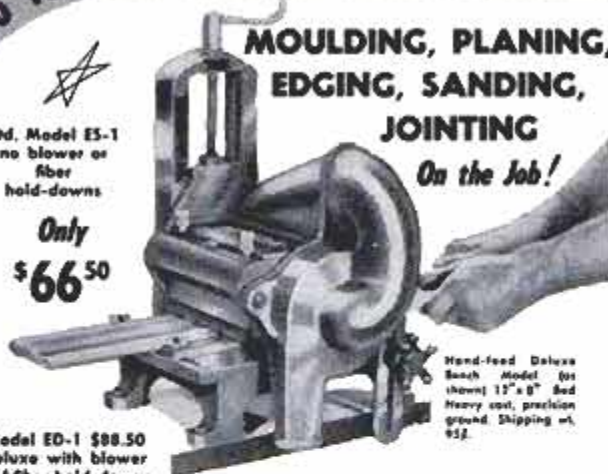

Hand-feed Deluxe
Bench Model ES-1
(shown) 17" x 8" Bed
Heavy cast, precision
ground. Shipping wt.
95 lb.

Here is the low-cost, hand-feed bench model Moulder-Planer you have been waiting for! Especially designed for the home workshop, hobbyist or specialty woodworking shop, this rugged machine produces fine finishes in equal stock capacities as larger, more expensive models. Selected moulding patterns can be produced in widths up to 5 3/4". Planing capacity 4" x 6" or 11" wide on second pass. Dealer franchises available.

SEND FOR FREE BROCHURE

of Complete Information

EASTMAN FOUNDRY

& Machine Co., Inc.

Dept. PH-356 113 Fair Street, Laconia, N. H.

Division of HEBERT MFG. CO., Est. 1913



24-Page Illustrated
**DO-IT-YOURSELF
PROJECTS BOOK**

Describes attic finishing, built-in cabinets, add-a-room, recreation room, kitchen remodeling, summer cottage and farm projects. Helpful information on how to get started, planning, cost estimating, materials purchasing, proper procedures, nail charts, moulding designs, etc. Send 25c and also receive 52-PAGE POWER TOOL CATALOG.

BOICE-CRANE CO., 943 Central - Toledo 6, Ohio



**Guaranteed Auto Parts
at Western Auto**

Hinge screws loose?

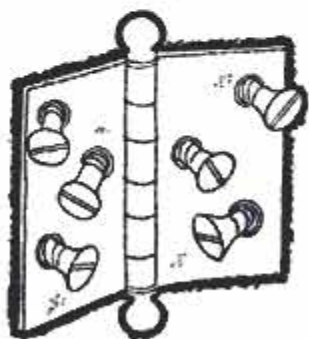

Reset them with New Plastic Wood. Makes a permanent fix that won't crack, chip or peel. And New Improved Plastic Wood has a finer grain—minimum shrinkage. Takes stain, lacquer and varnish with good results.

**NEW "PLASTIC
WOOD"**

Handles like putty—hardens into wood.



SPIN CAST[®]
700 Reel

Longer Casts with Lighter Lures

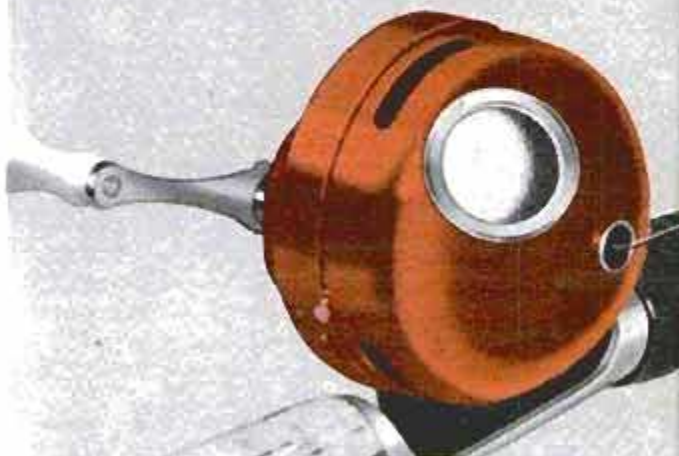

Smooth, Dependable Drag Control

Positive Click

Faster Retrieve
4-to-1 ratio

**BAIT CAST-
SPIN CAST**

...never a backlash!

Cast 1/4 or 5/8 oz. lures with equal ease. Adjustable 3-position thumb control. Precision-built throughout. Complete with 150 yds. of 6 lb. test Deceiver[®] monofil line. . . . \$12.50

(slightly higher west of Rockies and in Canada)



Fits any hand —
any rod



Use with Spinning or Fly Rods

South Bend Tackle Co., Inc.
891 High St., South Bend 23, Ind.
In Canada: Campbell Mfg. Co., Ltd., Toronto

South Bend
THE BEST IN RODS · REELS · LINES · LURES



Pacemaker GRAPHIC®

USES ALL TYPES OF FILM!

One of the greatest advantages of the Pacemaker Graphic is the wide selection of films that are available to fit it . . . allowing the photographer complete freedom from technical limitations. There are more than 40 different types and makes of sheet film alone, including many special-purpose films such as infrared, portrait, high contrast and fast press films. A variety of accessory film receptacles is made by Graflex so that you may also use roll film, film packs or Polaroid film. Glass plates frequently used for experimental work also can be used in the Graphic camera.

RITWAY® SHEET FILM HOLDERS

—Riteway holders are the only ones unconditionally guaranteed for 2 full years! Exceed ASA tolerances, assure perfect film plane registration. Fit all standard 4x5 camera backs. Hold 2 sheets film \$4.95 each.

GRAFOMATIC® SHEET FILM MAGAZINES

—Each of these semi-automatic film magazines holds six sheets of film. Simple pull-push motion changes film in a split second. Has safety catch, exposure counter, ready signal. Saves time. Slips under spring back like ordinary film holder. For "23" and "45" Graphics, from \$24.95.

ROLL FILM HOLDERS—Use inexpensive 120 size roll film. Have automatic film stop and exposure counter. Dark slide permits partially exposed roll to be taken from camera. Two types for 8 or 12 exposures. For "23," "34" and "45" Graphics, from \$21.50.

FILM PACK ADAPTERS—For Graphic 23, 34 and 45 cameras. Hold easy-to-use daylight-loading 12 exposure film packs that save space and weight when traveling and save time when taking sequence photos. Have dark slide so that partially exposed pack may be taken off camera. From \$9.75.

POLAROID BACK—Special accessory fits Graflok backs of 4x5 Graphics. Affords full use of all built-in Graphic features plus the advantages of picture-in-a-minute Polaroid films used frequently for checking lighting and composition or for covering spot news for television. \$83.50.



GRAFLEX® Price-Winning Control

For free booklet, write:

DEPT. PM-36, GRAFLEX, INC., ROCHESTER 8, N. Y.

Prices include federal tax where applicable and are subject to change without notice. Prices are slightly higher in Canada.

(Continued from page 90)

PHOTOGRAPHY

Zoomar lens for cameras (Zoomar Corp., 55 Sea Cliff Ave., Glen Cove, Long Island, N. Y.)	102
Slides ready in a minute	129
Tailor photographs customer to get exact measurements	150

SCIENCE

Sound waves are "knife" in brain-surgery tool	102
Sticks moved with head guide powered wheel chair	121
National observatory	129
Steel ingots heated white-hot by electromagnetic field	130
Driverless tractor guided by radio (Barret-Cravens Co., 630 Dundee Rd., Northbrook, Ill.)	140
Five-minute test for gold reveals minute deposits	146
Infrared "X ray"	160
Sun-powered radio promises "something for nothing"	161
Uranium umpires	161
Ultrasonic tester checks pipe walls (Blaw-Knox Co., Farmers Bank Bldg., Pittsburgh, Pa.)	165
Keeping up with the atom	167
Three-way light bulb (Duro-Test Corp., North Bergen, N. J.)	172
Aerial-camera control system (Bill Jack Scientific Instrument Co., Solana Beach, Calif.)	268

TOOLS

150 holes drilled in two minutes (Technical Sales Dept., Allen B. du Mont Laboratories, Inc., 760 Bloomfield Ave., Clifton, N. J.)	130
Dustless drill rig (Kadco Corp., 36-40 11th St., Long Island 1, N. Y.)	142
Magnet reveals flaws (Rice-Peterson Sales, Inc., P.O. Box 1114, Palo Alto, Calif.)	166

Radio-Television, Electronics

Transistors—the modern miracles	173
"Little giant" transistor radio	174
Transistors at work: Pocket-size transistorized radios (Sentinel Radio Corp., 2100 Dempster, Evanston, Ill.; Zenith Radio Corp., 6001 W. Dickens Ave., Chicago 39); transistorized phonograph (Philco Corp., C & Tioga Sts., Philadelphia 34, Pa.); transistor-operated car radio and Radio Pager (Motorola, Inc., 4545 W. Augusta Blvd., Chicago 51)	176

Craftsman and Shop Notes Index

FARM AND FARMING

"Bolt blocks" strengthen trough	221
Farm-trailer loading winch is automobile transmission	221
Stop chickens roosting in nests with pivoted fence	221
Dry chemicals for spraying mixed with rubber plunger	228

HOUSE AND HOME

Antique churn modified for use as wastepaper basket	184
Patio lounge	193
Attractive radiator covers provide added storage	196
Hang bowed door with concave surface facing outside	196
Home-built smokehouse	196
Clothes-drier standard held by stepping on footrest	198
Space-saving towel rack is ideal for small bathroom	203
Record shade size on roller	208
Spacer for wooden shingles attached to hammer handle	208
Spacer board permits easy shingle installation	212
Closet storage space can be increased by installing racks	213
Trellis hinged to swing down when painting house wall	213

HOUSEHOLD HINTS

Towel fogproofs mirror	184
Discolored enamel cleaned	188
Dried paint removed from shoes	192
Solving Home Problems—	
Cut flowers kept fresh	194
Exhaust fan utilized for ventilating damp basement	194
Improvised holder for small staples	194
Bent coat hanger makes handy paint-bucket hook	194
Cup hook above kitchen sink handy for rings	195
Whatnot shelf made from cake tins	195
Framed pictures prevented from tilting	195

(Continued to page 94)

LUFKIN

MICROMETERS

With NEW CAM LOCK

**LOCK EASIER
FASTER
MORE SECURELY**
Now, you can lock faster, more securely with just a flick of the thumb. This new cam-action lock positively secures the thimble from movement until the reading is made or transferred. An exclusive new feature, available only on Lufkin Big Barrel Micrometers.



BUY **LUFKIN** TAPES • RULES • PRECISION TOOLS 396
AT YOUR HARDWARE OR TOOL STORE

BETTER MEASURE WITH **LUFKIN**

THE LUFKIN RULE CO., SAGINAW, MICHIGAN

**SHARPEN LAWN MOWERS
EASILY—IN
MINUTES—
ANYONE CAN
DO IT**



A MONEY MAKER, TOO!

Just hold the brush and turn the crank while the special compound does the work. Quickly and easily attached to sharpen hand or power mowers. ROLAND JR. KIT, includes Hand Crank, Collet, Extra Size Bushings, Compound, Brush, and Instructions. \$4.95 prepaid. No C.O.D. Money back guarantee.

MAKES A FINE UNUSUAL GIFT

MARCUS MFG. CO. • P.O. Box 31 • Elk Rapids, Mich.

BE THE "KEY" MAN IN YOUR SHOP

MACHINE TOOL RECONDITIONING

& THE ART OF HAND SCRAPING (2nd printing)

SEND FOR FOLDER DESCRIBING ILLUSTRATED BOOK
MACHINE TOOL PUBLICATIONS, 382 Holly Ave., St. Paul 2, Minn.

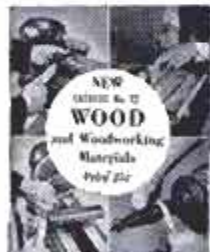

Get This NEW Catalog of
**WOOD & WOODWORKING
EQUIPMENT**

**WORLD'S LARGEST SELECTION OF FINEST
DOMESTIC AND IMPORTED WOODS . . .
MOULDINGS, HARDWARE, TOOLS,—ALL AT
LOW MONEY SAVING PRICES!**

Your complete wood buying guide and project book. Craftsman is your best, most complete source of finest kiln-dried domestic and rare imported woods, beautiful wood inlays, colorful bandings, matched plywoods, embossed mouldings, carved ornaments, newest woodworking tools, "hard to find" cabinet hardware and fittings . . . more than 1,500 items! Packed with newest scroll saw patterns, project ideas & money making plans. Enclose 25c (refunded with first order) to help pay mailing, handling cost. Write now! **Craftsman Wood Service Co., Dept. A-3
2729 S. Mary Street • Chicago 8, Ill.**

128 PAGES

**Many in
full color**

packed with rare, fancy & imported woods . . . veneers, plywoods, patterns, tools, ornaments, hardware . . . everything for the woodworker.

*Man...
ride your
way to
lawn
care*

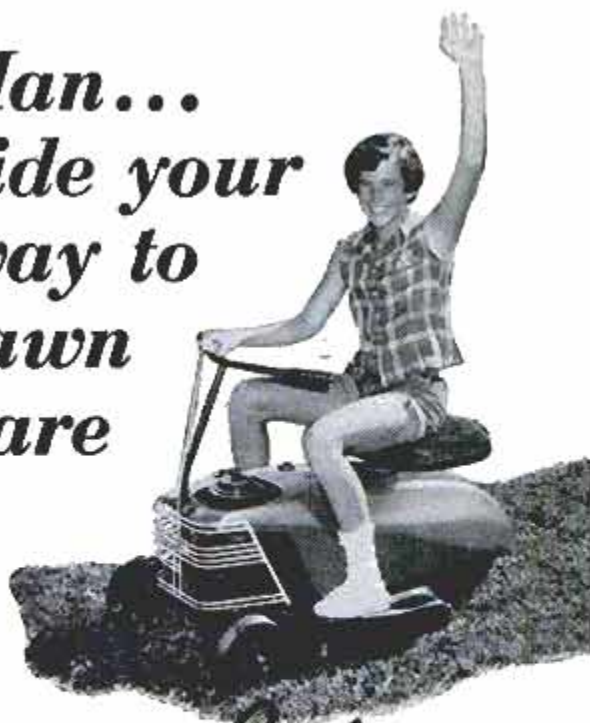

**MOW Cycle does
the work for you**

Machine handles job—operator goes along for the ride. That's lawn care MOW Cycle style. From cutting grass to hauling loads, you do it all without walking. Rotary mowing blades under platform, safely shielded; attachments pulled behind. MOW Cycle is integrally designed for riding; not a hybrid contraption. A complete success; practical, soundly engineered. Thousands in use. Simple enough for youngsters, sturdy for heaviest grownups. Self adjusting seat, most comfortable you ever rode on. Two models; each has 3 hp. Clinton engine and recoil starter. Cut 24" swath;

speed up to 5 mph.
See 1956 models at
your dealers.



MOW Cycle "24"
\$289.50

MOW Cycle
"Cadet"
\$209.50

Mail the
coupon TODAY

Prices plus freight and local
taxes—slightly higher in the
far west.

Musgrave, Inc., Dept. 2356, Springfield, O.

Please send free catalog on MOW Cycle
models and all attachments for same.

Name _____

Address _____



MARCH 1956

93

*For Maximum Warm Air Circulation
and Smokeless Operation, Build
Masonry Walls Around*

HEATFORM



Model "A" HEATFORM fireplace has side cool air inlets and front panel warm air outlet.

HEATFORM* retains the beauty and glow of the open fire. Heating chambers surround the firebox and upper throat. Air drawn from the floor into these chambers is heated by contact with the hot metal and returned and circulated uniformly to all parts of the room and adjoining rooms. This substantially increases the heat delivery with less fuel consumed.

HEATFORM is a perfect guide for the masonry (hearth to flue) preventing construction mistakes.

HEATFORM adds but little to the fireplace cost. It consists of firebox, throat, smoke dome, and properly operated damper, replacing some materials and labor necessary with the ordinary fireplace. Fuel savings will more than offset the small extra cost.



Model "S" HEATFORM affords view of fire from front and either side.



Write for free illustrated brochure

(*) Registered Trademark of

SUPERIOR FIREPLACE COMPANY

Dept. PM 561
1708 E. 15th St.
Los Angeles 21, Calif.

Dept. PM 561
601 North Point Road
Baltimore 6, Maryland

(Continued from page 92)

Scraps of bar soap can be made into flakes.....	195
Nut meat blends furniture finish to hide scratches.....	203
Mildew brushed from books with dry cloth.....	208
Table salt sprinkled in skillet extinguishes grease fire.....	208
Talcum removes grease spots.....	208

MISCELLANEOUS

Repair loose TV-control knobs with plastic keys.....	184
Tar-paper water shields protect automobile door-trim panels.....	184
King-size cigarette case.....	188
Decorative stand for pocket watch.....	189
"Harnessing" your spring.....	197
Campsite kept free of insects by dusting with chlordane.....	207
Clockworks subassemblies stored in aluminum foil.....	207
Controlling growth of evergreens.....	209
Sense and nonsense.....	210
Photo floodlamp suspended from boom on studio ceiling.....	212
Protective shade for plants made from Venetian blind.....	212
Make unique "tractor" mailbox by attaching toy parts.....	217
Aluminum foil protects car hood from bugs and gravel.....	218
Rectifier unit increases motor speed of electric razor.....	229
Tar-paper liners aid cleaning hen's laying nests.....	232
On the Market—	
Anchor nails for attaching furring strips to masonry.....	236
Glue packaged in flexible-plastic container.....	236
Prefinished hollow-core panels.....	236
Plastic screw anchors can be used in any type wall.....	236

OFFICE, SHOP AND STORE

Clamp prevents paper blowing when typing outdoors.....	192
Keyed typewriter platen assures uniform margins.....	198
Bottom margin on typing paper indicated with colored dot.....	203
Labels typed in envelope window.....	204

TOOLS

Punch-marked hex nut centers drill bit through machine bolt.....	232
Drill-press routing made easier by rough-routing work first.....	233
Shopping for Tools—	
Hand drill solves problem of drilling holes in hard-to-get-at places.....	234
Workbench top of laminated construction.....	234
Hub-cap tool makes quick work of removing hub caps.....	234
Carbide countersink is designed to eliminate chatter.....	234
Draftsman's T-square has a ball-bearing head.....	234
New hammer and hatchet have tubular alloy-steel handles.....	235
Hacksaw has tubular frame.....	235
Pistol-grip torch for soldering.....	235
Combination tool.....	235

WORKSHOP HINTS

Plane tight door on hinge side.....	184
Jig for cutting clamp-nail grooves on mitered corners.....	188
Versatile snack tray cut from light plywood.....	188
Rustic picture frame.....	192
Small-parts box easy to carry when fitted with saw handle.....	192
Talcum powder and linseed oil make emergency putty.....	192
Emergency paint remover.....	198
Irregular contours copied with stack of cards.....	198
Adjustable ladder step.....	203
Asbestos-covered block supports work while soldering.....	204
"Oiler" for clockworks is length of wire.....	204
Plywood cut on stiff support prevents saw binding.....	204
Straightening warped wood panel.....	204
Wall lamp features crescent-moon bracket.....	209
Wet paintbrushes stored in airtight plastic wrap.....	209
"Pistol grip" file handles cut from coat hangers.....	213
Plastic ketchup bottle used as workshop glue dispenser.....	218
Linseed oil secures hammer head.....	221
Rubber tip on mallet handle slides sheet metal safely.....	221
Mucilage bottle as tool oiler.....	227
Angle of metal square realigned by using ball-peen hammer.....	228
Clamp screwed to faceplate holds work accurately on center.....	228
"Cradled" wooden balls permit easier drilling.....	228
Multipurpose horses used for shelving and tables.....	229
V-block for drill press improvised from dowels.....	229
Floor mat retains small parts on repair bench.....	232
Paintbrush is handy duster.....	232

IMPORTANT NOTICE—It is the intention of this magazine to provide its readers with information regarding the latest developments in the mechanical arts. We take no responsibility as to whether the disclosures contained in our articles are covered by patents and advise readers to investigate this subject before making, using, or selling any of the products, machines, or processes described in order to avoid possible liability for patent infringements.

AMAZING ELECTRIC SPRAY GUN ELIMINATES EXPENSIVE AIR COMPRESSORS AND MOTORS

MAKE MONEY! SAVE MONEY! With Amazing SUPER JET Spray Kit!

No Experience Needed To Operate Easy-To-Use All Purpose Spray Gun.

Now anyone can own a professional, all-purpose spray gun. Homeowners! Hobbyists! Handymen! Paint the fast, easy way with the amazing new Super Jet Spray Gun. Save money spray painting shelves, closets, cabinets, furniture, bookcases, doors and other things around the house. Make money in your spare time spraying fine finishes on automobiles, fences, metalwork and hundreds of other projects for your friends, neighbors or customers. Super Jet can pay for itself on the very first job. It costs just \$1.00 a week — no money down!

This lightweight, self-contained spray gun makes painting the easiest thing in the world because there are no tanks, no compressors, no complicated equipment to cause trouble or confusion. Simply plug Super Jet into any 110 Volt A.C. electrical outlet, fill the non-breakable aluminum container with paint and pull the trigger to start spraying. Spray paint, enamel, lacquer, varnish, shellac, insecticide, deodorants, liquid fertilizer, oil and water as easily as pointing your finger! Just about any liquid that pours easily, sprays easily when you use Super Jet!



SELF-CLEANING!

Simply spray solvent through the gun after painting and Super Jet cleans itself in seconds... automatically!

ONE CONTROL KNOB!

A simple turn to the right or left instantly adjusts Super Jet to atomize the material you are spraying!

JEWEL NOZZLE

U.I. and C.S.A. approved

ALL METAL

No Breakable Glass Or Plastic Polished Aluminum Jar

AUTOMATIC PAINT STRAINER

Super Jet's ingenious fine-screen metal filter automatically strains paint and spray materials. Dirt, pigments, etc. are automatically filtered out and prevented from clogging gun!



FREE TRIAL IS BEST PROOF! SEND NO MONEY!



A COMPLETE SPRAY KIT!
Only \$29.95-\$1. a week!

- NEW SUPER JET SPRAY GUN
 - POLISHED ALUMINUM JAR
 - AUTOMATIC PAINT STRAINER
 - 15 FT. DISTANCE TUBING
 - 23 FT. NEOPRENE CORD SET
 - GEM NOZZLE DISC
 - WALL CHART & INSTRUCTIONS
 - STEEL CARRYING CASE
- PLUS Your Name In 23 KARAT GOLD

FREE!

Mail Coupon Today with order and get FREE. 5-piece Screw Driver Set.



EXTRA BONUS! Send \$29.95 in full payment of your SUPER JET SPRAY KIT and receive as extra bonus tool kit pictured! Tempered steel 6 inch wrench, 7 inch pliers, screw driver blades and chuck, complete with carrying case. Not a toy!

FULLY GUARANTEED! 10 Day Free Trial plus 90 Day Guarantee Against Mechanical Defects.

POWER PRODUCTS, 175 EAST 87th STREET, NEW YORK CITY



MAIL COUPON TODAY FOR 10 DAY FREE TRIAL

POWER PRODUCTS, Super Jet Division 3-A
175 East 87th Street, New York 28, N. Y.

Please send amazing new SUPER JET SPRAY KIT. I must be completely satisfied or I may return within 10 days for full purchase price refund. I am using payment plan checked below.

- PAYMENT IN FULL Enclosed is \$29.95 (check or money order) in full payment. Be sure to send my FREE GIFT plus EXTRA BONUS.
- SIMPLIFIED BUDGET PLAN. (No Money Down) I will pay \$29.95 at \$1.00 per week plus postage and small credit service charge. (No credit charge if paid within 60 days.) Be sure to send my FREE GIFT!

YOUR NAME will be written in 23 Karat Gold on your kit. Please Print

NAME _____

ADDRESS _____

CITY _____ ZONE _____ STATE _____

EMPLOYED BY _____ POSITION _____

ADDRESS _____



Here's where you

FEEL THE BIG DIFFERENCE

with new Perfect Circle 2-in-1 chrome piston rings in your engine!

Bring back the full power of your engine—power that flattens out the steepest hills!... flashing engine response that means safer "passing power" on the highway!

Perfect Circle's 2-in-1 Chrome set brings new life to tired engines. *Both* the top rings and the oil rings are plated with thick, solid chrome that resists the terrific heat, pressure and friction resulting from combustion.

Entire area of ring travel is protected against wear—life of cylinders, pistons and rings is more than doubled! That's why you will enjoy thousands of *extra* miles of sustained power with positive oil control. See your Doctor of Motors—your skilled automotive mechanic!

Perfect Circle Corporation, Hagerstown, Indiana; The Perfect Circle Co., Ltd., Toronto, Ontario.



PERFECT CIRCLE

2-in-1 chrome piston rings

THE STANDARD OF COMPARISON

POPULAR MARCH 1956 MECHANICS

WRITTEN SO YOU CAN UNDERSTAND IT
VOL. 105 NO. 3

Two crack parachutists of
the U. S. Air Force are ready
for their greatest venture



They'll Jump

17 MILES

From the Sky

By Thomas E. Stimson, Jr.

CAN A MAN fall out of the sky and live to tell about it?

Will he freeze to death on the way to earth?

Or will aerodynamic heating literally cook him?

Will his space suit provide the squeeze he needs to stay alive in air where the pressure is less than one pound per square inch? Falling freely, will he spin so fast his heart will go dry? Will his chute rip to pieces when it opens at low altitude?

Today the Air Force is face to face with these and similar questions. Some of the aircraft now on the drawing boards are

designed to fly so high that the possibility of bailouts from the top of the atmosphere must be considered.

To find out ahead of time what will happen to the pilot, the Air Research and Development Command is planning a bold and daring experiment. Two crack parachutists will make a series of jumps from balloons that may ascend as high as 90,000 feet.

Sometime this spring or summer, according to present plans, Capt. Edward G. Sperry and Lt. Henry P. Nielsen will ride the sealed gondola of the "Explorer III" to maximum altitude. There the escape hatch

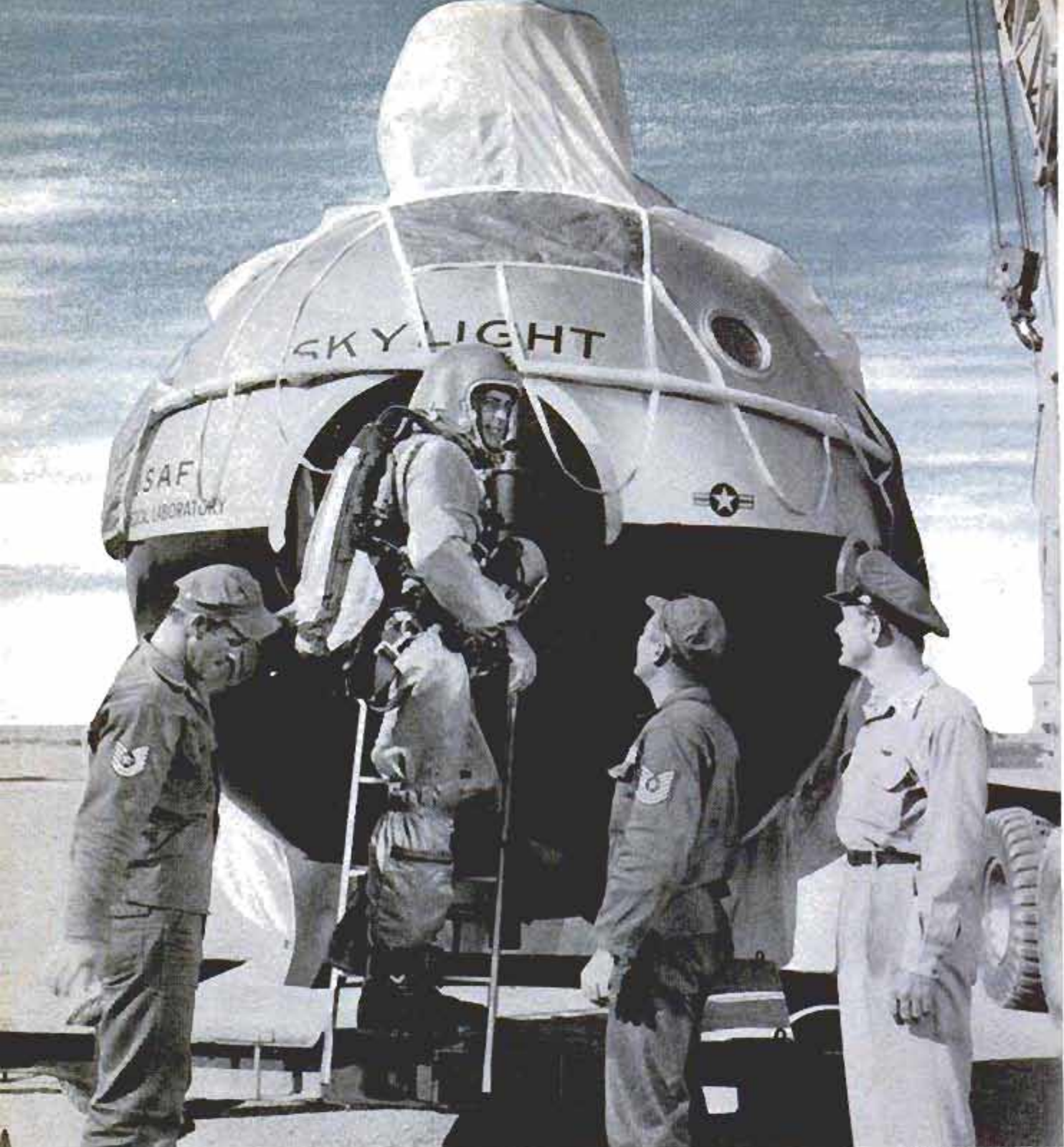

20th Century-Fox photo

In movie version of this real story, jumper climbs into nine-foot gondola that will carry him to 90,000 feet

will be unfastened and Capt. Sperry will take a long step, the longest ever made. He'll step out of the gondola and then, 10 or 12 minutes later, he'll put his feet on the earth some 17 miles below.

Although he'll be wearing a small drag chute, it is calculated that he will attain a velocity of 420 miles per hour in the thin upper air. This speed will be reached 35 seconds after he steps out of the gondola and has fallen about three miles. Below 75,000 feet the denser air will begin to cushion his fall and he'll gradually slow down. When he reaches 15,000 feet his speed will have dropped to 115 miles per hour. There

Sperry will open his main chute (or it will open automatically if he fails to do so) and he'll drift the rest of the way to earth at a slow, safe speed.

Every possible precaution is being taken to insure his safety. For one thing he'll be wearing a new type of space suit, far more comfortable than the T-1 suit in use today.

The suit will be pressurized against the vacuumlike stratosphere, will carry its own supply of breathing oxygen and will be insulated against the minus-65-degree temperature of the upper air. Meteorlike heating is not expected to be a problem during the 17-mile plunge to earth. The

suit, incidentally, may carry a few compact instruments to measure the jumper's speed and to record other data.

Another safety measure is the small drag chute Sperry will wear. Its purpose is to keep him from spinning violently. Otherwise these gyrations might force his blood out to his extremities and drain his heart dry. The chute will hold his body in a relatively upright position during the free fall.

Both Sperry and Nielsen are skilled jumpers. They hold, jointly, the world record for ejection at 45,200 feet. They know that a jumper dares not open his chute during the time he is falling through the thin upper air. He must wait until he is slowed down by the cushion of heavier air close to the ground. Otherwise the shock of opening might break his bones or rip his chute to pieces. Once he gets down to 20,000 feet or less the jumper can open his chute in safety.

After Sperry steps out of the gondola, Lieutenant Nielsen will operate a mechanism that cuts the gondola free from the balloon. Then the gondola will drop like a rock, trailing a small drag chute behind it. Nielsen plans to ride the sphere down to 20,000 feet, then allow the drag chute to pull out the main gondola parachute that will lower the big ball to a safe landing. Meanwhile Nielsen will step off and ride his own chute to the ground.

The jump from maximum altitude will be the culmination of six ascents, beginning at around 60,000 feet and working up by stages to the final drop. The whole project may require several months.

Unavoidably the balloon flights will be packed with drama even though, basically, they are pure scientific research. They are part of the big upper-air exploratory program that is being conducted by Air Research and Development Command.

Released by ground handlers, balloon starts its ascent to edge of space. Gas ball will expand as balloon rises



BALLOON CARRIES GONDOLA AS HIGH AS 90,000 FEET

MECHANISM WHICH SEPARATES GONDOLA FROM BALLOON

DRAG CHUTE OPENS MAIN CHUTE AT 20,000 FEET

MAIN PARACHUTE PACKED ABOVE GONDOLA



90,000 FEET

AIR PRESSURE HERE IS 1/2 POUND PER SQUARE INCH OR LESS

SPERRY JUMPS AT 90,000 FEET

BALLOON EXPANDS AS IT ASCENDS

70,000 FEET

BLOOD BOILS AT 63,000 FEET

SPERRY MAY DRIFT DUE TO STRONG UPPER-AIR WINDS

SKIN INFLATES LIKE A BALLOON AT 50,000 FEET

50,000 FEET

DURING FREE FALL, SPERRY'S SPEED MAY EXCEED 420 MILES PER HOUR

30,000 FEET

SPEED OF FALL DIMINISHES

MAN DIES FOR LACK OF OXYGEN ABOVE 20,000 FEET

SPERRY OPENS CHUTE AT 15,000 FEET

4300 FEET

HOLLOMAN AIR FORCE BASE

ALAMOGORDO

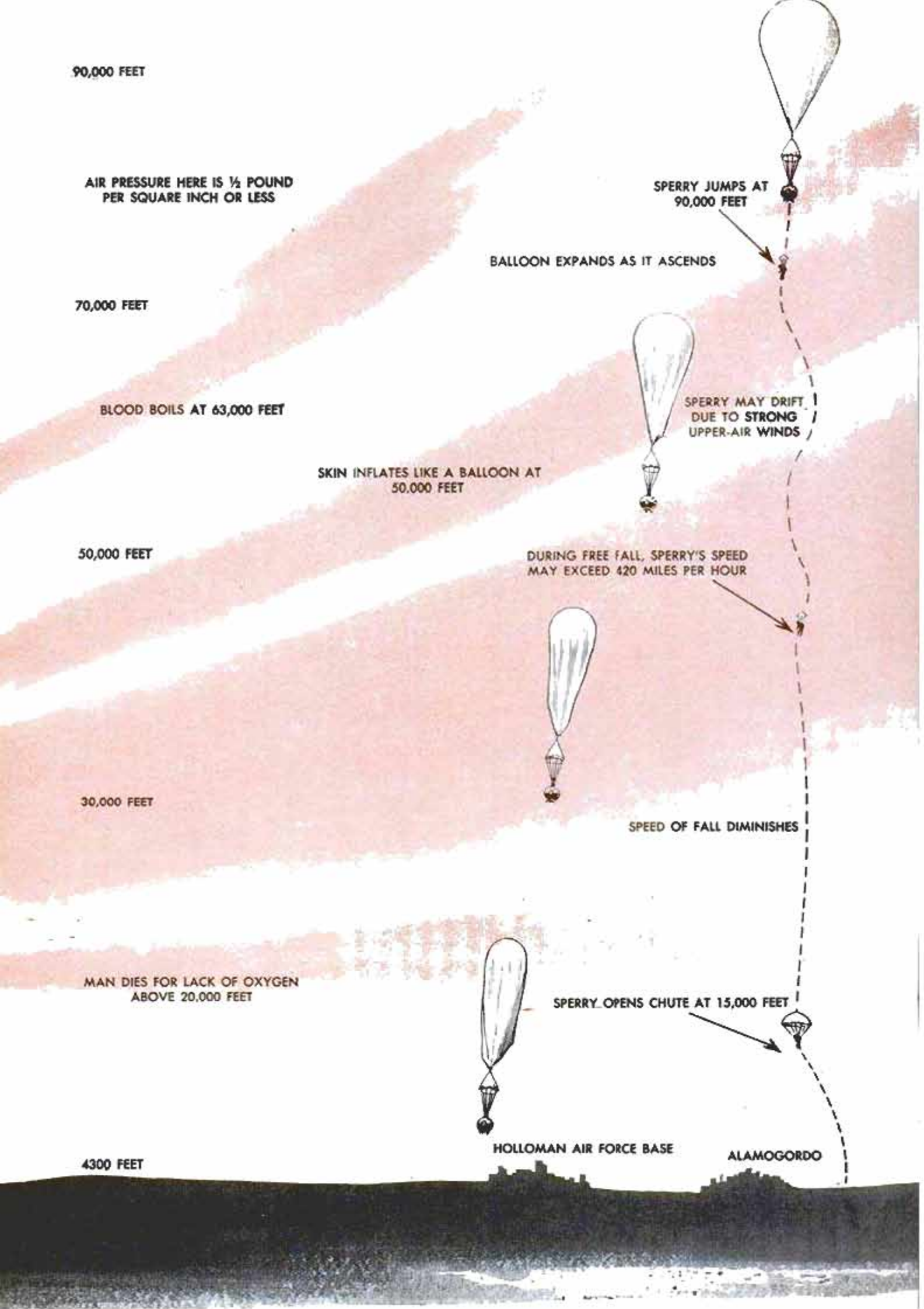



**NIELSEN CUTS
GONDOLA FREE
FROM BALLOON**



**GONDOLA FALLS
TOWARD EARTH UNDER
SMALL DRAG CHUTE**



**NIELSEN OPENS MAIN GONDOLA
CHUTE AT 20,000 FEET, THEN
LEAVES GONDOLA AND RIDES HIS
OWN CHUTE TO EARTH**



Drawing shows successive stages that will occur in the record jump. At 90,000 feet Sperry will step out of the gondola. He'll fall 14 miles, with only a small drag chute to keep him from spinning. Nielsen will ride falling gondola most of the way to earth

To give the public a picture of some of the work it is doing the ARDC recently cooperated with 20th Century-Fox in filming a color CinemaScope movie that tells the story of the high-altitude jumping project plus giving other highlights of its research. Not a documentary film, the movie has a fictional plot which emphasizes the hazards of some of the studies that the Air Force is conducting.

The picture, *On the Threshold of Space*, is due for release in early March. Parts of it were filmed at Holloman Air Force Base in New Mexico where the actual jumps are to be made. Some of it was filmed at Egin Air Force Base in Florida. Some of the photographs on these pages were made for *Popular Mechanics* during the filming of the picture.

In the movie Guy Madison plays the part of the high-altitude jumper and Martin Milner acts the part of the other occupant of the gondola. Among technical advisors for *On the Threshold of Space* were Col. Arthur M. Henderson ("I Made the First Jump," March 1955, *Popular Mechanics*) and Captain Sperry himself, the Air Force officer who is scheduled to make the actual final jump from maximum altitude.

Twentieth Century-Fox built its gondola oversize (nine feet in diameter) for easier photography, and assembled it in sections so the interior could be photographed. The movie balloon and its gondola are named "Skylight."

The actual Air Force balloon will be named "Explorer III" in honor of two earlier manned balloons that made record ascents some 20 years ago. Sponsored by the Army Air Corps and the National Geographic Society, the first "Explorer" carried three men to 60,613 feet in 1934. The men almost lost their lives in the venture, for the balloon ripped apart when 11½ miles above the earth. The crew rode it down part way like a parachute and then jumped separately with their own chutes just before the hydrogen that remained in the big bag exploded.

A year later "Explorer II," filled with nonexplosive helium, ascended to a new record of 72,295 feet. Two men and 64 instruments were carried in the balloon's magnesium gondola, and new information

(Continued to page 287)

SACRAMENTO PEAK



Zoomar Lens for Cameras

Extremely long focal length is combined with high picture quality in the new 20-inch Zoomar-Reflectar lens for still and movie cameras. A mirror-reflex housing is available for use on Leica-type cameras. For single-lens reflex cameras, it can be used without the housing. The speed of the lens is $f:5.6$. Lens mounts are available for use with motion-picture cameras.

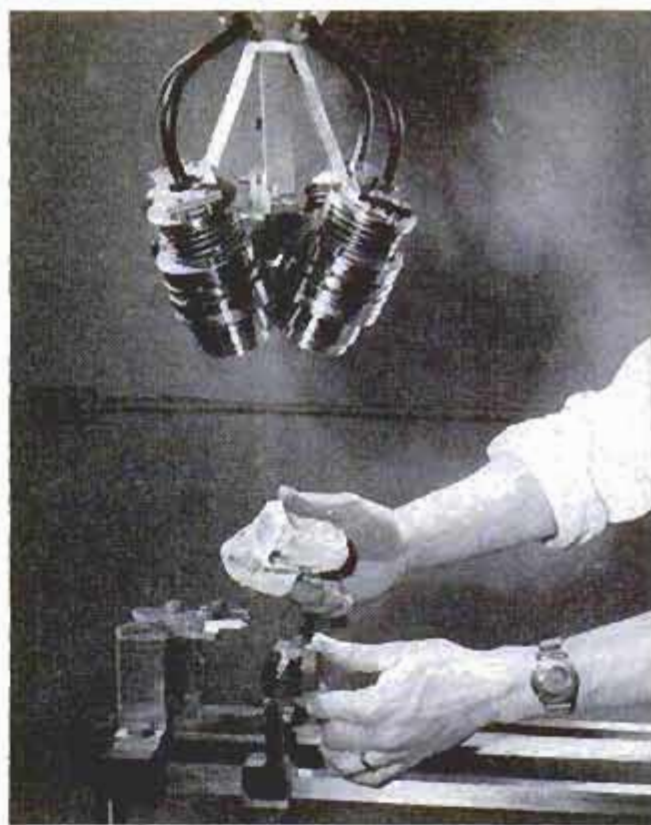

Laboratory technician, for purposes of illustration, holds monkey skull above headrest of \$50,000 unit

Sound Waves are "Knife" In Brain-Surgery Tool

Sound waves above the range of the human ear would be used to destroy diseased tissue in a new method of brain surgery. A group of University of Illinois scientists, headed by Prof. William Fry, has spent five years in developing equipment for this technique. The sound waves can be focused on tiny areas of the brain without injuring other tissue.

Electric Mopping Machine Covers Two-Foot Circle

With a new mopping machine (left) you can clean a large area in a hurry. Four mops are mounted on a spinning disk driven through pulleys by an electric motor. They cover a 24-inch circle. To clean the mops, you leave the motor running, dunk the spinning head in rinse water and wring the mops dry by revolving them in a perforated-metal cone. The unit, which can reach under tables and counters, is for commercial use.

☐ Promising results in the relief of pain in amputation stumps by the use of high-frequency sound waves are reported by the U.S. Veterans Administration.



Wingless Flight

Searching for a solution to the oversize airport problem, Dr. Alexander Lippisch, along with other aeronautical engineers, has decided that aircraft of the future will have to rise vertically, hover, and then be capable of high-speed, long-range flight. The German-born scientist's answer to the problem is the Aerodyne, a wingless craft that promises to do all these things. Four fans in the fuselage draw air in at the top and expel it past louvers in the bottom of the craft. Thus riding on a column of air, the ship hovers when the louvers are vertical, and goes forward when they are tilted toward the back. In prototypes, gas turbine engines may be used to drive the fans.

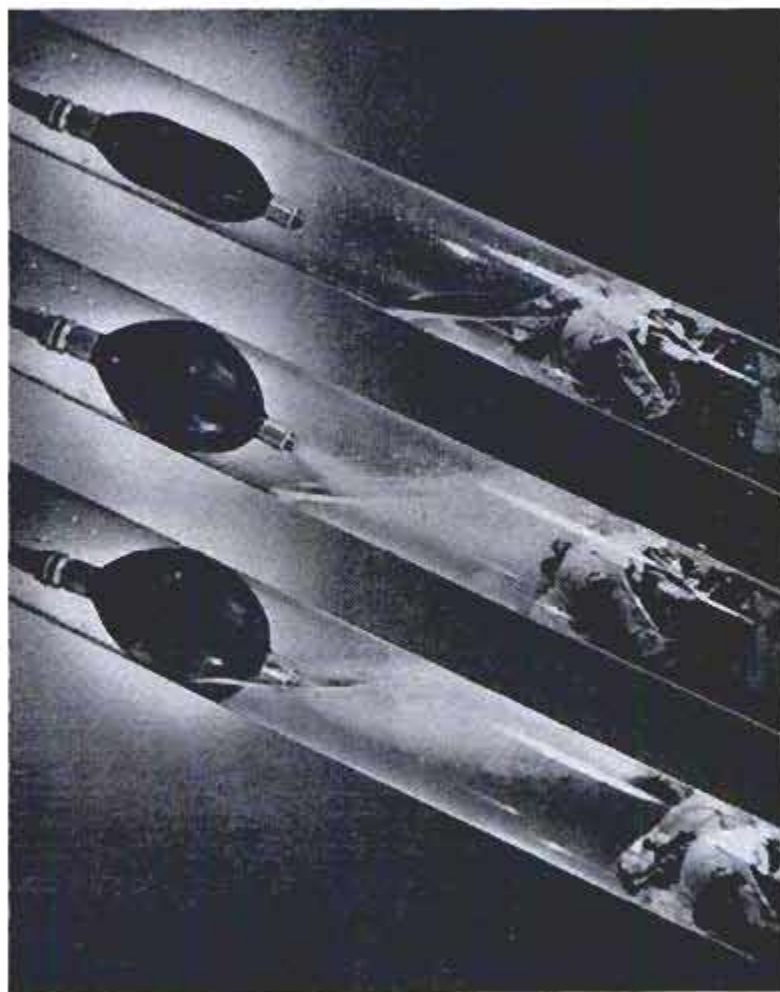
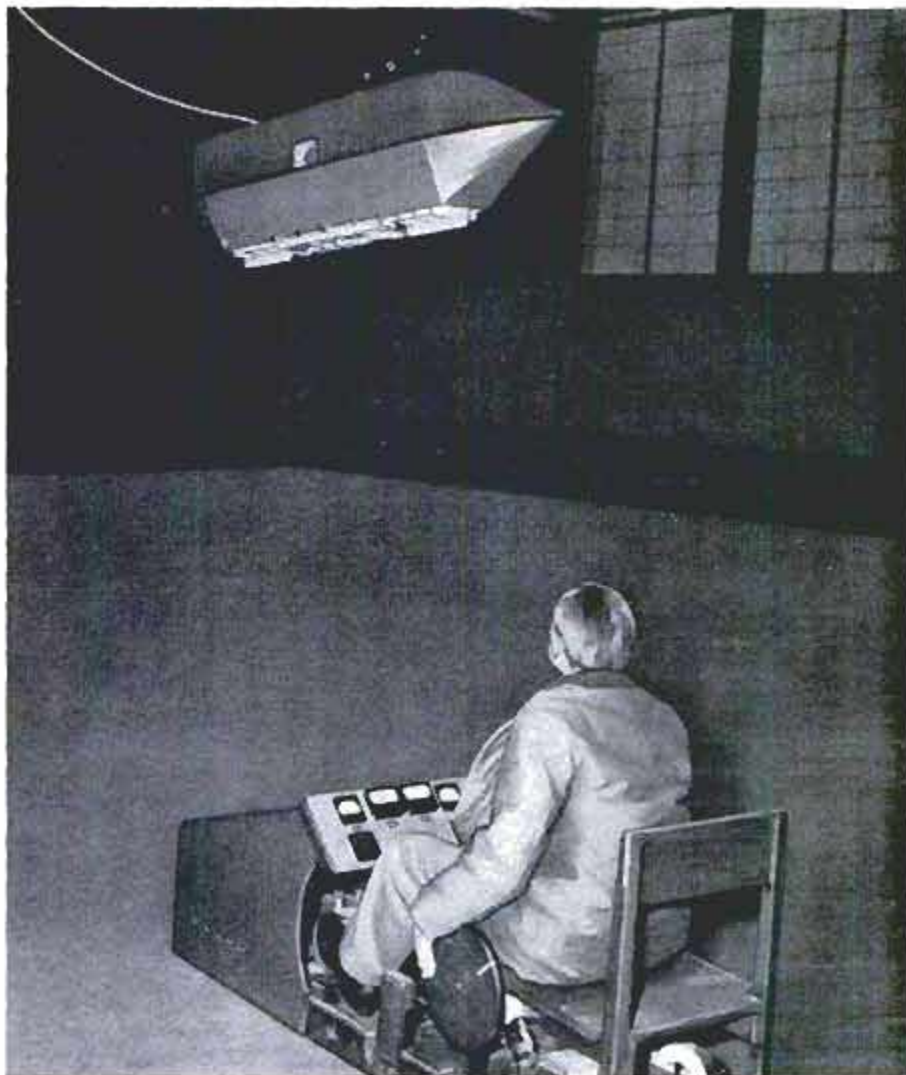

Plastic Defogs Aircraft Windshields

Operating like an electric heating element, a new electrically conductive plastic coating defogs aircraft windshields in seconds, instead of the much longer time required by the double-windshield hot-air system now in use. The coating also reflects 70 percent of the sun's infrared rays.

Drainpipe Flusher Uses Garden Hose

Sewers and drains are flushed free of obstructions with a plumbing device that mounts on an ordinary garden hose. The unit consists of a Neoprene bag with a nozzle on the end. Water from the hose first fills the bag, causing it to swell and seal off the area between bag and obstruction. Water spurting out the nozzle of the bag builds up pressure in front of the obstruction, forcing it free. The unit allows any householder to do a job usually reserved for plumbers.

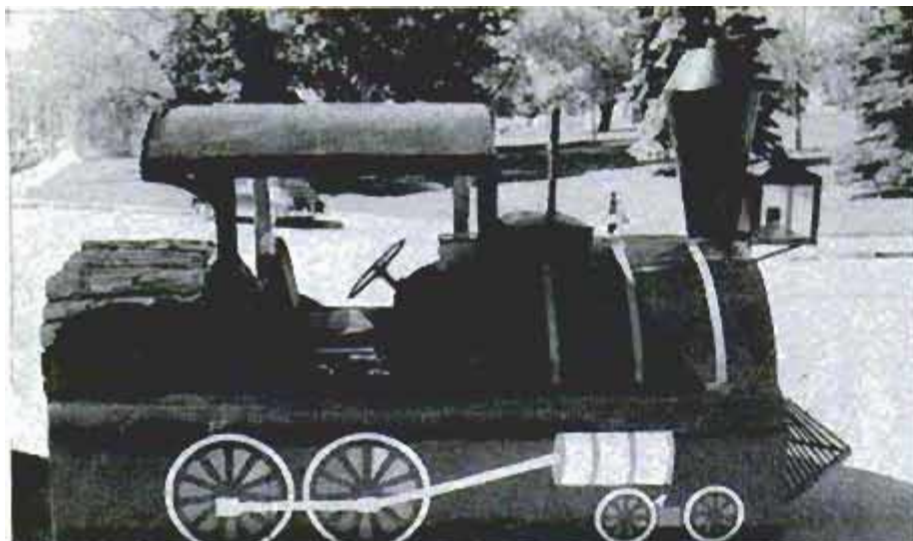

Jeep Train For Tourists

Built over a regulation quarter-ton Jeep, the locomotive is a replica of an old wood burner

During the tourist season, visitors to Helena crowd the tiny cars for sight-seeing excursions

During the tourist season in Helena, Mont., *The Last Chancer*, a replica of an old wood-burning locomotive built over a Jeep, pulls a sight-seeing train of open cars around the city at intervals during the day. Constructed over a regulation quarter-ton Jeep, the locomotive is named after Helena's main street, The Last Chance, where in pioneer times prospectors who had been unsuccessful in the hills panned a creek for gold as a last chance and struck it rich.

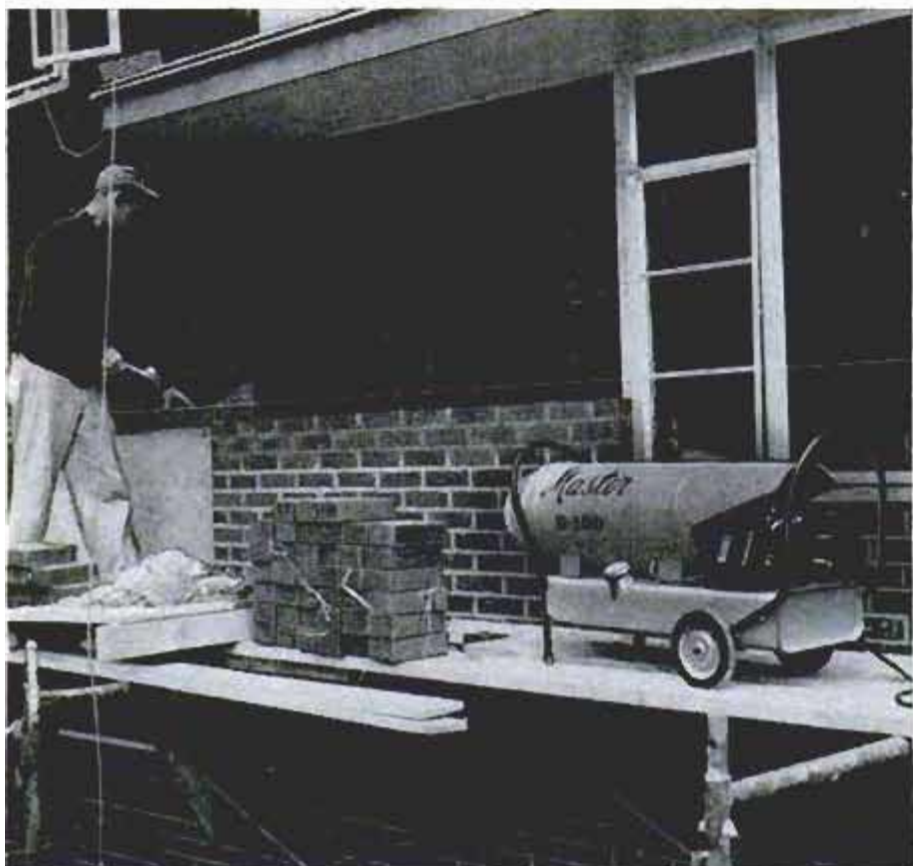
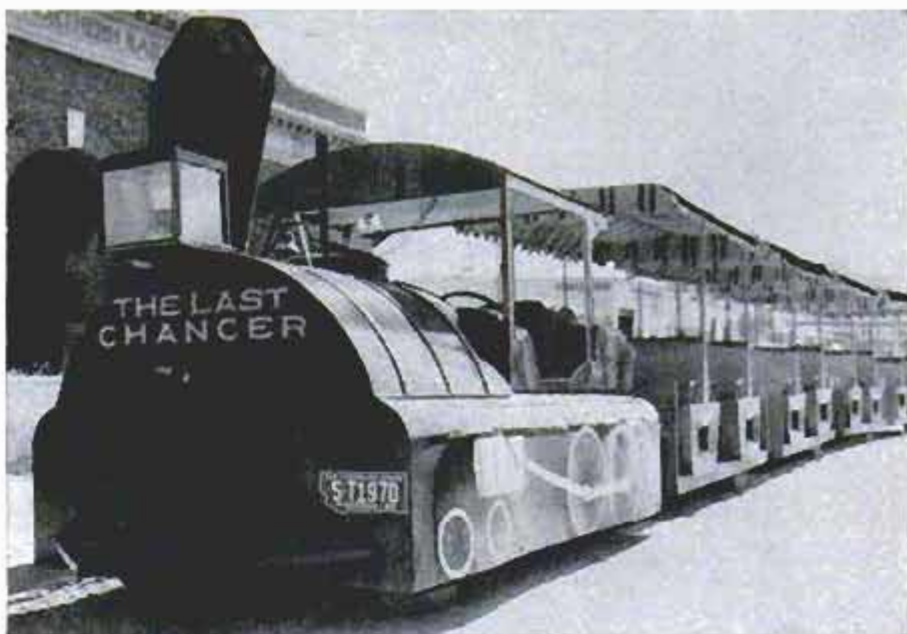

Portable Heater Warms Workmen

Workmen are warmed on the job by a small, 78-pound furnace on wheels that can be taken and used almost anywhere. The unit burns kerosene or fuel oil and is equipped with a fan that delivers 500 cubic feet of warm air per minute. The electric motor that powers the fan and pump is fed by regular household current. The heater has a 12-hour fuel capacity. Because there are no dangerous fumes, no vent is needed even when inside. The automatic ignition turns on with a flip of the switch.

The wheeled heater weighs only 78 pounds, can be taken almost anywhere

Heavy-Cargo Helicopter Carries 10-Ton Load



King-sized helicopters are coming. The latest and biggest whirlybird to get off the ground is the XH-17, an experimental heavy-cargo helicopter built by the Aircraft Division of the Hughes Tool Company.

The XH-17 straddles its load with stiltlike legs, grasps it with adjustable lift mechanisms and takes off. Powered by a pressure-jet, single-rotor, the big plane can carry loads of more than 10 tons.

Diesel Locomotive Also Has Third-Rail Electric Pickup

For the first time a diesel-electric main-line locomotive soon will roll right into New York's Grand Central Station. A city ordinance passed in 1903 requires all trains to convert to electric power when approaching Manhattan.

A new diesel-electric locomotive, also equipped to operate as a straight electric locomotive, will power the New Haven's Talgo-type train which is now under construction. The new combination locomotive, being built by Fairbanks Morse, will achieve a top speed of 115 miles per hour.

The locomotive for the new train actually consists of two units, one at each end of the train. Both can be controlled from either cab, so the train will have no front or rear but can be operated as well in either direction.

Each diesel unit produces 1720 horsepower. In addition, each unit has shoes for picking up power from the 600-volt d.c. third rail. This power passes through supplementary electrical control equipment and switch gear aboard the fast, light-weight locomotive.

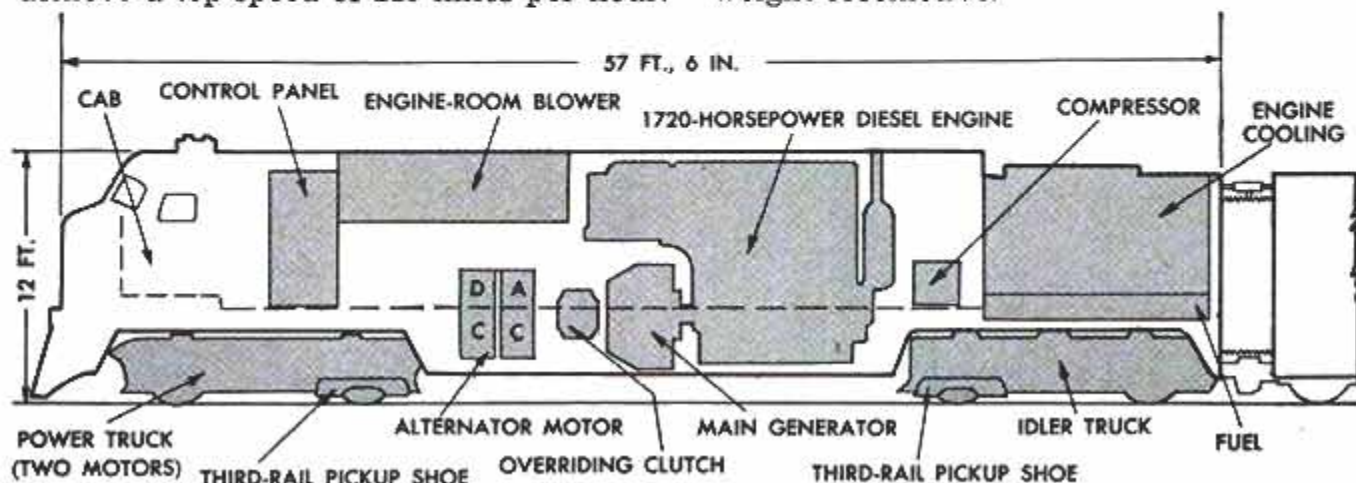

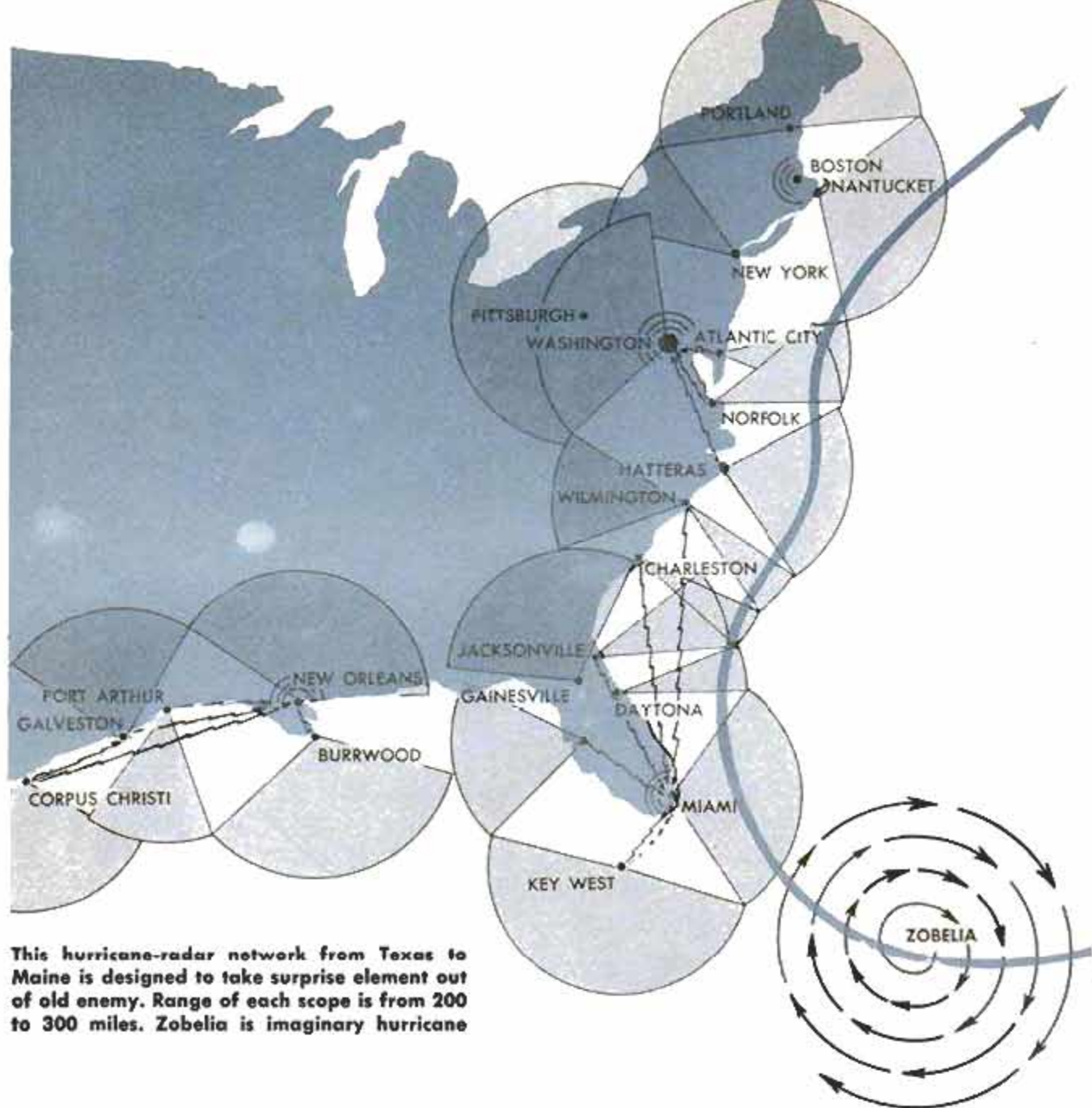

This hurricane-radar network from Texas to Maine is designed to take surprise element out of old enemy. Range of each scope is from 200 to 300 miles. Zobel is imaginary hurricane

Below, long-range-radar station at Hatteras is an important link in chain. Dome houses instruments

This radar-screen photo of Connie, taken at Hatteras at height of storm, spans 20 miles between rings

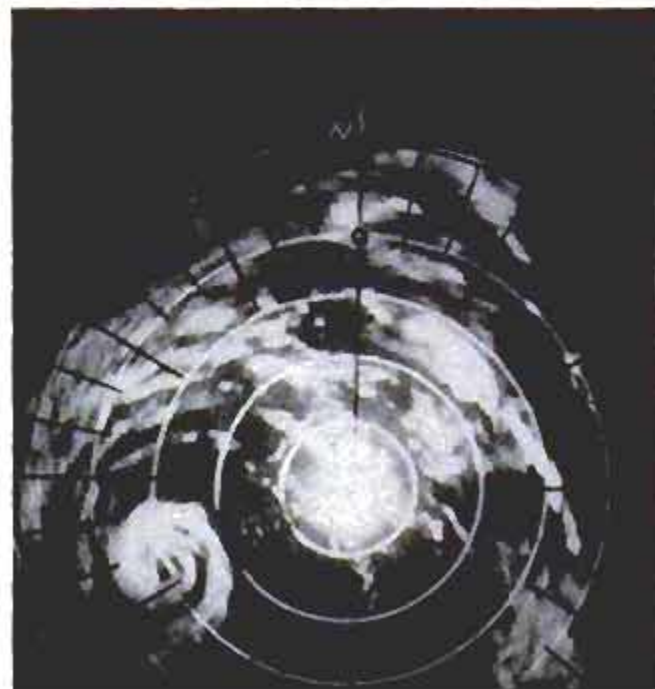



Why all these HURRICANES?

Nature has been smiting our East Coast with increasing fury in recent years. Radar eyes in a chain from Corpus Christi to Key West to Portland, Me., now peer seaward to tell where the next blow will strike

By Dick Frederic

DIANE WAS WINDING UP 300 miles off the Carolina coast when United States weatherman Vaughan Rockney drove his car from the last ferry to cross Oregon Inlet, and headed into the wild night on a narrow strip of sand surrounded by raging seas. His destination was Hatteras, lonely storm-battered settlement 40 miles south on a desolate spit skirting the North Carolina shores like a 250-mile bracket. To average citizens like you and me the trip down that isolated stretch of ocean-bound sand on such a night would have seemed suicidal. Diane's murderous eye was headed straight for this coastal area. Anyone with transportation had long since left the doomed shores.

"All the protective dunes were gone," Rockney recalls, "knocked flat by Connie the week before. So Diane's forward winds were pushing breakers and tide over the road two feet deep. Salt foam came over the floorboards. In half an hour the engine drowned seven times as the car sent spray geysering. Then, salt water got in the master cylinder and the brakes froze."

A plunging, high-wheeled Coast Guard patrol buggy caught the half-submerged car in its powerful searchlight beam, res-

cued the occupants and carried them to their goal—a squat group of white, storm-whipped buildings bristling with well-braced, domed antennas. There, while Diane lashed them with 100-mile-per-hour winds and stinging rain for three days, Rockney and his crew, including a radar engineer, a radio engineer and a general-facilities engineer, became the eyes and ears for the entire East Coast, watching the hurricane's every twist, turn and change in character as it moved in toward the continent and spent its fury over the New England states. In a room lit only by the eerie glow of a radarscope, Diane's monstrous circulation lay spread out before them on the range grid like a slowly revolving map viewed from a point some 100 miles above the earth's surface. Though power and telephone lines to the mainland had long since been swept away by the raging ocean, an auxiliary generator roared above the noise of the storm, supplying juice to run the 750-kilowatt radar, a powerful high-frequency radio transmitter and radio facsimile equipment capable of sending radio pictures hundreds of miles.

At stated intervals (usually every 30 minutes), Rockney, U. S. Weather Bureau



Powerful weather radar at University of Miami is loaned to hurricane network during storm periods



Storm is plotted on huge wall map as it is watched on radar screen. Rings of 50 miles show its speed

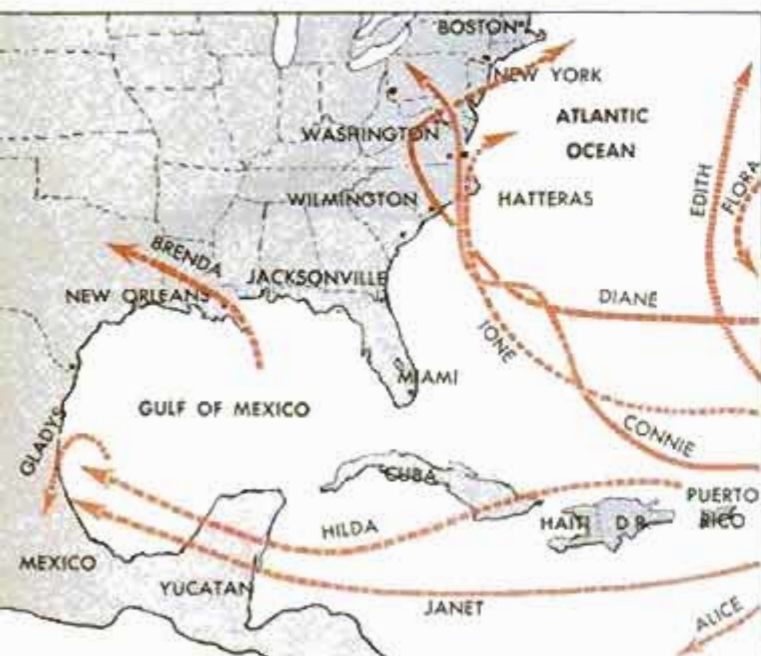

U.S. Weather Bureau chart above shows some of the 1955 hurricanes. Below, position of high-pressure troughs in 1955 helped swing the hurricanes inland

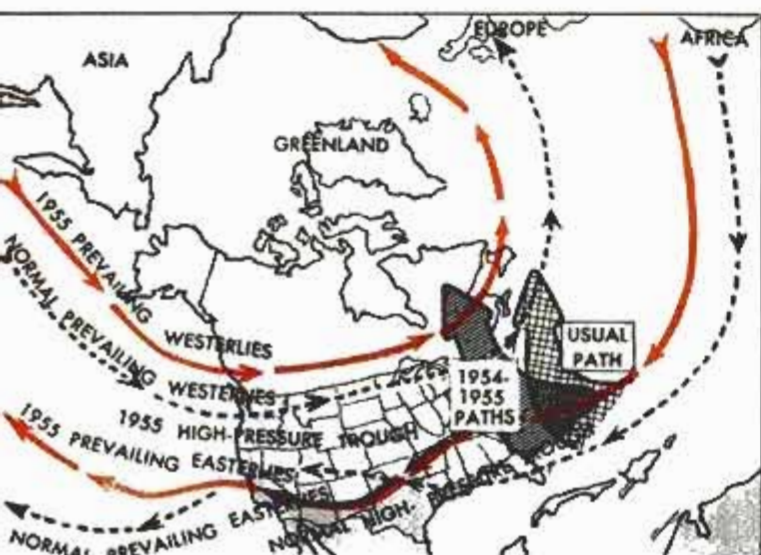

radar meteorologist, calculated the growth, speed and direction figures gleaned from watching the storm's progress on the scope, and went out on the air. His messages sounded like this: "We locate Diane, latitude $34^{\circ}15'$, longitude $74^{\circ}90'$; diameter of eye 20 miles; moving west northwest approximately 15 miles per hour; heavy spiral boundaries with massive precipitation extend out to north and northeast 200 miles; eye of the hurricane is clearly defined by precipitation pattern."

Every few minutes, Rockney clicked the shutter of a Polaroid camera mounted above the scope. Everything the camera saw on that scope was faithfully recorded on a piece of paper film that was quickly peeled from the back of the camera, fastened to the facsimile scanner and shot out across the ether.

Back in the bustling Weather Bureau forecast center at the Washington National Airport, startlingly clear pictures of what Diane had looked like only five minutes earlier rolled off the drum of a whirring facsimile receiver. These, together with Rockney's radio reports, ground observations from hundreds of coastal weather stations, reports of ships and planes in the hurricane area itself, were evaluated by chief forecaster Norquist and consolidated into bulletins. Out they went on the Hurricane network—a permanent storm-season Teletype land line feeding weather stations, Air Force bases, CAA Teletype, Navy bases, news and radio-broadcast services.

Because the big radar eye at Hatteras had a continual picture of the hurricane every moment, forecasters were able to predict with amazing accuracy what she'd

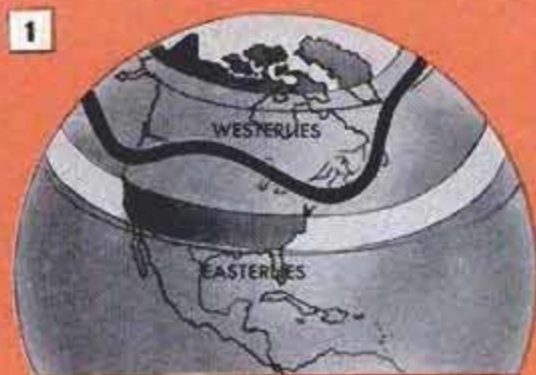

Charts show how changing position of the lofty jet stream has affected hurricane movements. Black line shows mean position of the stream during summer. Red arrows show variations from normal. No. 2 shows a hurricane headed over Gulf of Mexico. No. 3 shows

winds deflected north to Carolina coast and then out into the Atlantic. No. 4 shows what happened in '54 and '55 when dip in jet stream drew storms not only north but into the mid-Atlantic states. White band in No. 1 shows general area of doldrums

do and when she'd do it. Carolina coastal towns in the path of the storm had plenty of time to batten down their hatches and get ready.

"Officers at the Norfolk Naval Base feared a sound tide," says Rockney, "a reverse tide caused by gales that sometimes blow the bay water seaward against unprotected reefs and points, where Navy piers house millions of dollars' worth of ships and equipment. By analyzing Diane's progress on the scope we could tell the Navy she'd pass west of Norfolk and there'd be no sound tide. The information saved thousands of dollars in needless preparation against disaster that wouldn't occur."

Actually, weathermen even spotted Diane's infamous deluge on the big scope

and forecast it well in advance of the storm. "What the rain would do in local areas was not clearly enough interpreted by local forecasters," they explain. "But when new, more emphatic terms for forecast bulletins are worked out in the light of this new tool, even such disasters should be predicted with accuracy."

New last year, Hatteras radar is only one link in a \$5,000,000 coastal chain of high-powered weather-radar stations that soon will stretch from Brownsville, on the Gulf of Mexico, to Portland, Me. Already, nearly a dozen stations are swinging antennas across hurricane-ridden seas. Others, run in cooperation with military, Civil Defense and industrial establishments, help fill in. Twelve new ones (including Hatteras) will soon close the last coastal gaps through

The power of a hurricane is almost beyond the comprehension of mere man. Scientists measure it at five trillion horsepower, or the equal of 500 atom bombs. Figures still beyond our ken. Hurricane Diane brought home in 1955 another measure more readily understood—a single incident reported by the magazine *Compressed Air*. Fifty years ago men began digging a quarry near Easton, Pa. In a half century they had removed

25,000,000 tons of rock. When the rains of Diane fell on the Delaware River valley, the floodwaters spilled into the vast quarry pit and in just eight hours filled it to the brim. The quarry became a 600,000,000-gallon lake a half mile long and 105 feet deep at the center. A week later pumps were put to work draining the hole. What Diane had done in eight hours was undone in 47 days of pumping.



Scene of hurricane devastation in Connecticut was caused by storm that started in faraway Caribbean area

which a hurricane might sneak (see diagram page 106). When complete, any hurricane within 200 miles of shore will be clipped firmly to an electronic leash. "Once a storm is within range," explains Rockney, who is in charge of the weather-radar chain, "we'll have a continuous horizontal cross-section picture of it from then on. By tracking and timing its image across the scope grid we can calculate how fast it's moving and in what direction. We'll know exactly where the eye is at all times. Barring crazy shifts in direction, forecasters will be able to tell within a few miles and minutes just where and when she'll hit the coast. They can warn what direction winds will be blowing in different areas, and how hard. As the storm passes beyond range of one station, it will be pitched along to the next radar up the coast."

Reason for the big network is the hurricane threat to expensive East and Gulf Coast real estate. Not for nothing has the Atlantic Seaboard been dubbed "hurricane alley." Any doubts about the name fitting blew away in the big wind last August when Diane, fourth hurricane of 1955, smashed into the Carolinas. She sent people fleeing resorts and piled up seas that lashed and inundated the coasts. Roaring across northeastern states, her deluges turned placid streams to raging torrents, burst dams, crumbled concrete and steel bridges, thundered over factories and cities leaving a desolation of waste and death behind. In 24 hours she claimed 400 lives

(Text continued to page 252)

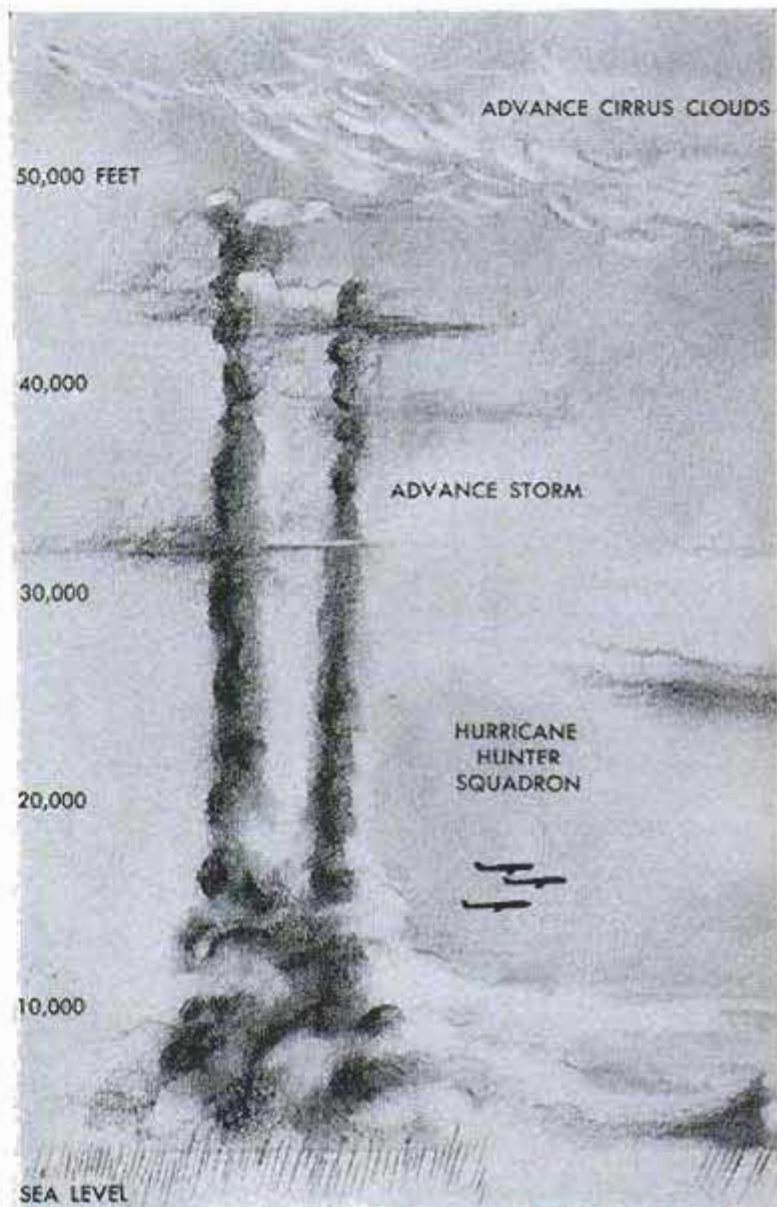



Airman inspects dropsonde that is dropped through storm by parachute and sends information by radio

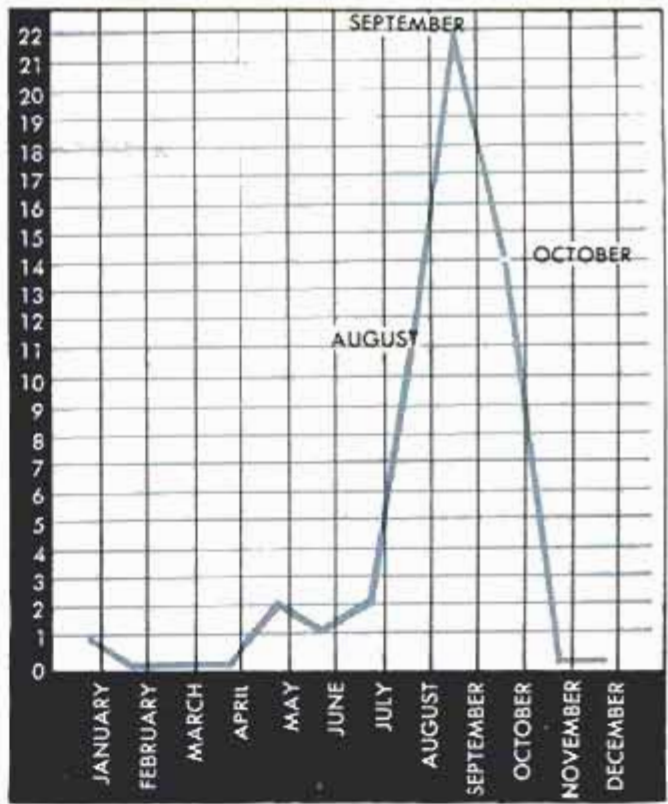
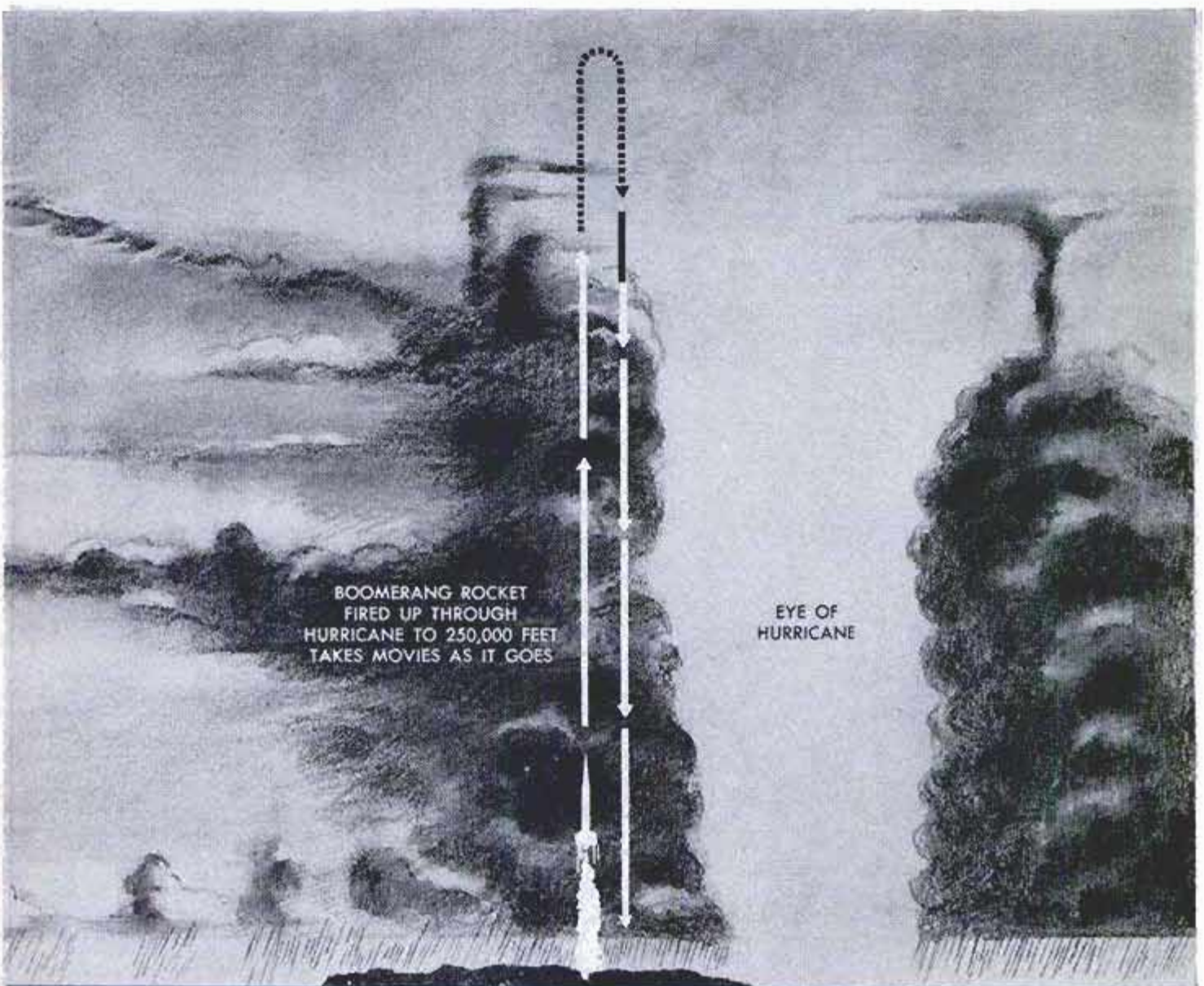

Chart shows 60-year frequency of hurricanes. Below, artist depicts scope of hurricane on ground, sea, air



BOOMERANG ROCKET
FIRED UP THROUGH
HURRICANE TO 250,000 FEET
TAKES MOVIES AS IT GOES

EYE OF
HURRICANE

CARIBBEAN ISLAND



Home Switchboard

Designed as a toy, a miniature switchboard can also be used as a telephone system within the home or between the house and outlying buildings. The set includes the switchboard, an operator's phone and one extension phone with 50 feet of wire. Three additional extension phones may be purchased and hooked into the system. To

call, the extension-phone user pushes a button on his phone. The light for that extension goes on at the switchboard, a signal flag drops and a bell rings. The operator then inserts the correct plug, presses a button and talks. The operator may also ring any extension phone. The system is powered by four flashlight batteries.

Log Shelters Serve as Havens for Fish in Wisconsin Lakes

Brush-filled "fish shelters" made of trussed logs are boosting fish population in Wisconsin lakes. Weighted with rocks and

placed on the ice during the winter, the shelters sink to the bottom with the first spring thaw. In clear lakes with few weed



beds or other hiding places, the shelters act as natural refuges for small fish. Large fish lurk outside the shelters to catch small fish that carelessly venture out. The resultant concentration of rock bass, perch, walleyed pike and other fish makes for better angling. Buoys are placed over the structures in the better-stocked lakes as guides for fishermen. The shelters, built by the state conservation department, are up to six feet high and 20 feet square. They are usually deposited at a depth of 10 to 15 feet in the clear, open water of the larger lakes.

THIS BUSINESS moves so fast in some directions that it becomes confusing at times. Already some of the dream-car styling tricks are obsolete, many others will be obsolete by this fall!

The Chrysler Plainsman, a dream station wagon, doesn't even have push-button shifting, an item that is standard on Chrysler products for 1956. The reason: When the Plainsman was styled by Chrysler about two years ago and the drawings sent to Italy for actual construction of the body, the corporation hadn't decided to switch to push buttons. So the 1956 dream car has a transmission shift arrangement that is already out of date!

The same situation holds in styling. The Plainsman and the other Chrysler dream cars now being displayed around the country will look very, very old-fashioned when the 1957 models come out this autumn.

Fact is that styling is moving so fast that nobody dares to predict more than a couple of years ahead and it takes that long to build an operating dream car.

General Motors plays it safe. Its dream cars don't have to operate. They are built up only a few months prior to actual showing. Being plastic-bodied and nonfunctioning, they can be finished quickly. But Chrysler's dream cars are drivable. In fact, they go out on the test track after their "circus days" are over.

GM has one operating dream car this year, its Firebird II. It has an air-oil suspension system that is not unlike the suspension used on the production Citroen DS19, France's newest car and, incidentally, the car that stole the show at Chicago in January.

Turbines Coming?

There's a lot of talk about turbines (as in the Firebird) and their future use in the family car. Don't expect them overnight. Engineers in convention at Detroit predict that the next step may be the free-piston engine which is sort of a hybrid, combining features of turbine and pistons.

Experts are still betting that the reciprocating engine will hold its top position for several years at least. The reasons are economic as well as scientific.

In its present state, the gas turbine operates at 30,000 to 40,000 revolutions per minute. It consumes fuel voraciously. It has an irritating whine and runs at such high temperatures that it creates insulation problems. In addition, of course, there is the extremely high cost of producing the turbine blades of a very expensive metal.

Prof. A. K. Lahti of the University of Michigan told the Society of Automotive Engineers that today's cars are too small for long family trips and yet too big for

Detroit Listening Post



By Leo Donovan

daily use around town. They are neither fish nor fowl, he implies. His solution is for each family of the future to have two cars—a highway cruiser, perhaps gas-turbine powered for the long trips, and a small runabout, perhaps electric powered for around town.

How to Get in

You can expect early introductions of 1957 models—all out by December 1, probably. One worry at the moment seems to be: Can the public bend over far enough to get inside the 1957 bodies? They will be so low that you will have to be a gymnast to get in gracefully. That is why the dream cars are showing roof panels that open.

We missed the bull's-eye a bit on the Chrysler 300B. We predicted 330 horsepower and a new three-speed automatic transmission. Horsepower turns out to be 340 and the new transmission failed to arrive in time for the 300B's introduction. It will be out in midseason (maybe even by the time you are reading this) on the 1956 Imperial. The new transmission will make an extra button necessary on the push-button console. There will be five buttons instead of four as presently.

Two cars offered by the so-called independents seem to be doing even better than expected in sales: The Rambler and the Studebaker Hawks. Rambler sales for the first few weeks are up about 20 percent over last year and are expected to increase as the cars become more available. Studebaker is months behind in supplying Hawks to customers and has had to set up a separate assembly line for Hawks.

Plymouth seems out to take the "hot one" tag away from Chevrolet. Its 240-horsepower Fury set a new record in acceleration runs at Daytona, beating the 1955 Cadillac record. Top speed for the Plymouth also set a record in its class: 124.01 miles per hour. The Fury has 303-cubic-inch displacement, considerably more than the 277 cubic inches in stock Plymouths.

FLASH: A 1956 Corvette averaged 150.5 miles per hour for one mile at Daytona.

SHIPS THAT BUCK THE POLAR SEAS

By Richard F. Dempewolff

PM Staff Editor With Task Force 43

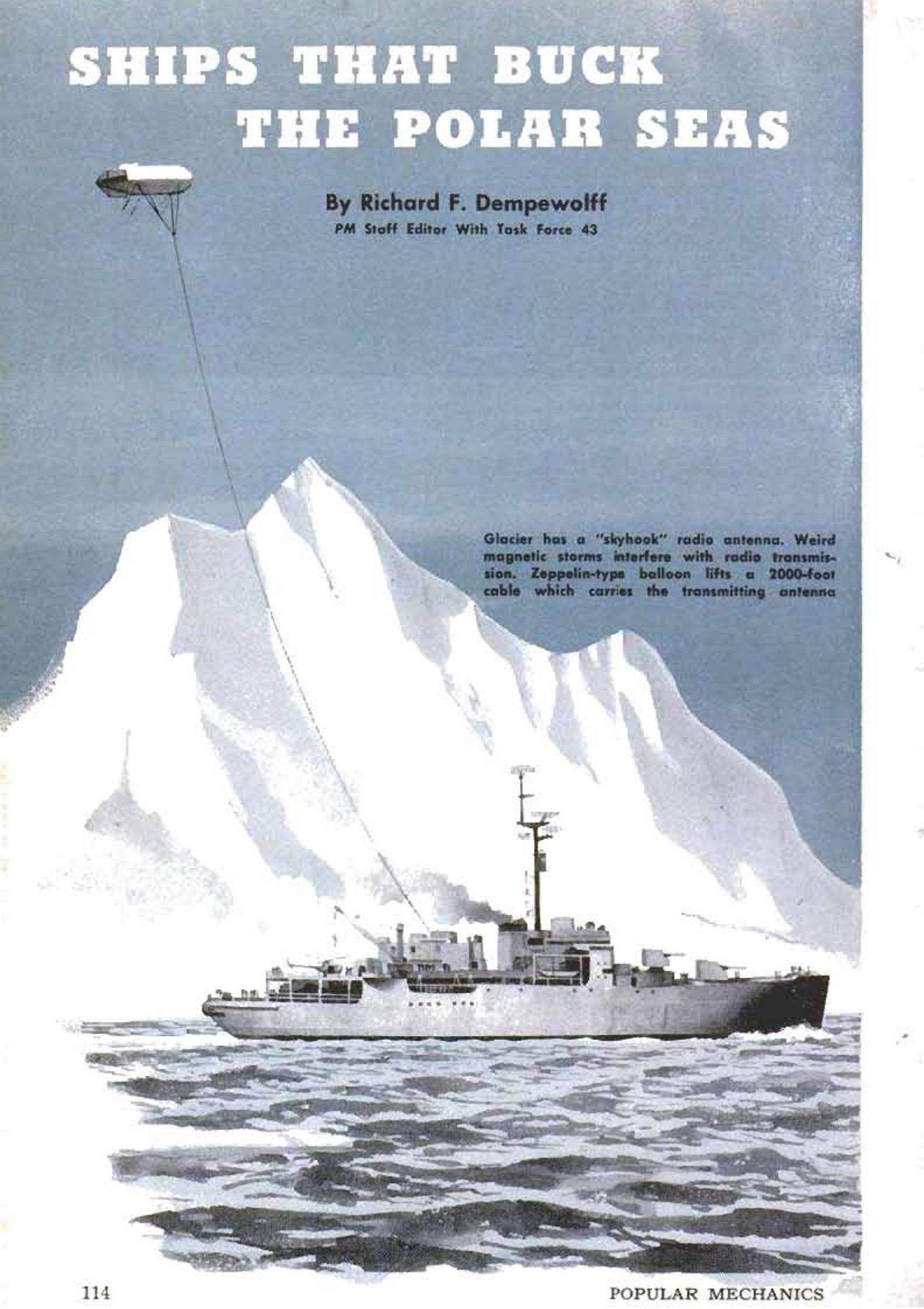

Glacier has a "skyhook" radio antenna. Weird magnetic storms interfere with radio transmission. Zeppelin-type balloon lifts a 2000-foot cable which carries the transmitting antenna



Icebreaker *Edisto* accumulated this tremendous load of ice on her five-inch mount during previous expedition

WITH GRINDING JOLTS, the squat bow of the USS *Glacier* rode up on endless fields of snow-covered blue ice six feet thick, forming the great antarctic pack. Fissures opened ahead of us like ragged fingers as the 8300-ton icebreaker crashed through to force her own leads in the jam. The forward crew's quarters reverberated to the thunder of multiton chunks of ice whamming the ship's tough hull of two-inch nickel steel.

After 386 miles of broken pack we were in the cold rock-hard ice whose crannies glow with pale blue luminescence. Up on the heated bridge, insulated against the crackling polar wind, Comdr. Eugene "Pat" Maher, captain of this rugged ship, moved back and forth quietly issuing speed and heading orders. High on the mast in a heated crow's-nest the "ice con" peered ahead for cracks or leads into which the *Glacier* could ram her tough steel prow, and reported what he saw via intercom. Over the radio speaker on the bridge came the garbled voice of a helicopter pilot, flying ahead of the ship on ice reconnaissance and reporting on open water miles to starboard.

Ahead of us lay Beaufort Island—last snowy rampart at the gateway of Antarctica. Beyond, muted by polar haze, the blue-white heights of Mount Erebus thrust a plume of volcanic steam into the frigid sky. The foot of that monolith was our first destination on the most ambitious penetra-

tion of the great white continent ever attempted.

The *Glacier* was a jam-packed ship when she headed for the ice pack from New Zealand last December. Instead of a normal complement of 339 her quarters bulged with 400, including polar experts, a special polar Seabee outfit, a helicopter squadron, scientists, correspondents, photographers and military observers.

Polar diesel oil, 100,000 gallons of it, sloshed in her big heeling tanks. More than 600 tons of extra gear spilled over the decks. Two helicopters and an Otter jammed the hangar deck. Well decks and fantail were a jumbled mass of bright orange Weasels, Snocats, tractors, sleds, skis and thick bamboo poles to make trail-marker flags for antarctic snowfields. Behind us sailed a string of other ships—all similarly loaded.

Everything will be used. The *Glacier* is the spearhead of Adm. George Dufek's Task Force 43, a seven-ship fleet for Operation Deepfreeze under Rear Adm. Richard E. Byrd, officer in charge. Our mission is to plow a furrow through the polar ice pack to the white coast of Antarctica, where foot parties and tractor trains will explore unknown highlands, find sites and build bases for United States participation in the International Geophysical Year (see *Popular Mechanics*, November, 1955).

Last fall during the preparation to get Deepfreeze under way, *Popular Mechanics*

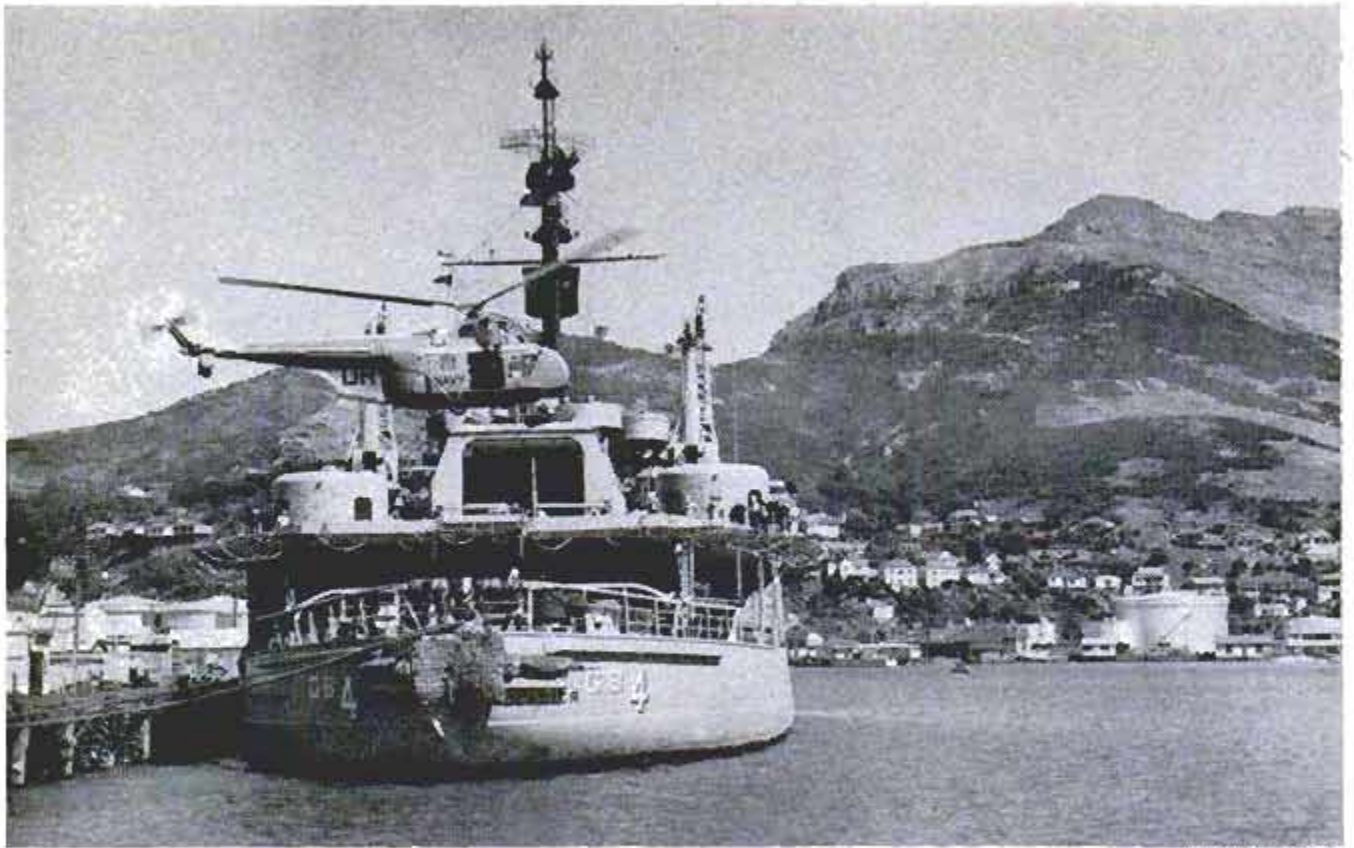

U.S. Navy photo

Helicopter comes in for a landing while *Glacier* is moored in New Zealand before rough trip to Antarctica

was invited to ride the Navy's newest, biggest and most powerful icebreaker on its rough maiden voyage as lead ship of the expedition. The journey promised to test her full punch in the world's toughest ice.

Modern icebreakers are a special breed of vessel manned by a special breed of

men—a far cry from the tiny wooden ships like the famous 700-ton *Terranova* in which Robert Scott bucked antarctic seas in 1910. For 38 cruel days Scott's ship was tossed by windlashed polar seas, racked by ice and fire, and badly swamped. Men worked waist deep in freezing water, throwing off

Icebreaker knifes through ice, splitting it to open up a channel for the convoy ships strung out behind



tons of coal to stay afloat.

To Scott, the *Glacier* would be a steam-heated luxury cruiser. Her thick hull can bounce off any ice, and freeze in without danger of being crushed. Layers of cork and glass wool insulate her against polar winds and water. It's hot, not cold, below decks. Tanks carry fuel enough to take us around the world nonstop and big freezers hold fresh food—enough to feed all on board for a year. Fresh water is no problem. The *Glacier's* own plant turns 1600 gallons of sea into fresh water daily, eliminating the need to scout polar seas for rare fresh-water ponds on the ice floes. A store, a barbershop and an air-conditioned hospital with complete facilities for surgery and X rays give us the feeling of belonging to a small community. Above the fantail sit the flight deck and hangar for two seven-passenger helicopters. To unload ship, cranes lift the removable flight deck away, exposing the holds below.

In spite of all that, ice-breakers are still the roughest, toughest ships afloat, and duty aboard them calls for a rugged constitution. Their job is forever to batter through white storm-ridden seas, bucking the howling darkness of the long polar night. In past years they opened sea lanes once frozen solid 9 out of 12 months. Day after day they grind through ice 15 feet thick, smashing open jeweled waterways. Behind trail convoys of thinner-skinned ships to feed the hard-won ports in polar lands, and open the way to build new ones.

The world's iceboxes are growing more important every year. Outposts of Dewline—the farflung Canadian-American radar defense net—spatter the Arctic with fine disregard for accessibility. A dozen new weather stations operated by Canada and the United States across the arctic islands must be supplied and fed. Greenland's ice-bound coasts swarm with new bases. It's the job of the icebreaker to keep these outposts alive.

Nine breakers work polar packs for this country today. Five are under Navy command, including the *Glacier*, the *Burton Island*, *Edisto* and *Staten Island*. Sailing



Supply ships of a previous expedition tie up to "dead men" sunk into the ice shelf. Then cargo nets start dipping out tons of supplies

under Coast Guard captains are the famous "Wind ships"—*East Wind*, *West Wind*, *North Wind* and the smaller lake icebuster *Mackinac*. Each looks as though someone trimmed up its lines with a meat ax.

The Wind ships, at 269 feet, are shorter than destroyers but wider than cruisers. Though the mammoth *Glacier* stretches to 310 feet she looks no different. Her generous beam spreads to 73 feet, enabling her to carve a broad highway in the ice for a convoy to follow. "She sits in the sea like a watermelon," one crewman aptly describes her. What's more, I know from experience that she behaves like a watermelon on the open ocean. Her round bottom lacks the stabilizing keel found on other ships. In polar seas where violent storms are the rule, she heels sickeningly with fast spasmodic rolls for days on end. On the run to Antarctica the *Glacier* spent nearly a week rolling wildly in a 35 to 40-degree



Icebergs are a great menace even to the sturdy icebreakers. Skippers move carefully through the big bergs

range. Chairs tumbled across the wardroom deck. Meals and men cascaded into one bulkhead, then bounced off the opposite side. The sleepless passengers and crew wedged books and blankets under mattresses to keep from tumbling out of bed. With every mammoth heave, the frigid sea surged over decks. On the third day the reeling ship swung a record 52 degrees to port then staggered back 48 to starboard, cutting a princely arc 100 degrees across the leaden sky.

Work under such conditions is hair-raising, but icebreaker men thrive on it. Bouncing from stanchion to bulkheads, they weave along decks with reckless abandon. Broken noses, black eyes and purple bruises from colliding with the superstructure are the marks of their trade. During the storm a member of the *Glacier* deck crew happened to be moving swiftly eastward as the gun turret was hurtling westward. They met head on. Despite concussion, he was sitting up smiling in a few days, looking at pictures of the ship entering the pack which he missed during his lengthy coma.

Once in the white pack for which she was designed, however, the icebreaker's ponderous weight and smooth round hull stand her in good stead. Her eight-inch steel stem reinforced by a massive buttressed spine of four-inch plate rams cold blue floes with devastating effect. That stem angles back at the water line, and in heavy pack she heaves up over the edge of the ice, crushing it downward in mighty surges. A sharp

step at the base of the bow gives the ice an additional crack. *Glacier's* ten big diesel generators driving two electric motors shove her into ice with a 21,000-horsepower wallop. She can crack through ice up to 30 feet thick.

I have seen her with one Gargantuan push cleave off a solid 20-acre chunk of hard blue ice five feet thick in McMurdo Sound and grind around into the crack she made, nudging the stupendous floe aside. Her stubby length gives her tight cornering ability to follow tortuous leads through the pack.

The heavy polar pack has one admirable feature. Generally it holds the heaving ocean flat. Hence the icebreaker crews, battered by weeks of pitching and rolling, become ecstatic over the prospect of nosing into the bitter cold grind of the ice world. The ship levels out. She heaves, jolts and trembles as heavy chunks nudge the bow this way or that. Now and then she may grind to a halt, back off and ram back into the wedge that stopped her.

Ice skippers will tell you the pack isn't always so kind. Up on the bridge, peering out on antarctic scud, Captain Maher recounts a terrifying example. He had taken *Edisto* up to the Arctic in the winter night of 1948 to see how far north she could crack her way. "We were off Greenland's sea coast," he recalls. "It was a brutal night with a howling 90-knot wind and zero visibility. The sea had been wild for days. Everyone was fed up with being lashed to his bunk or stanchion, so I turned and

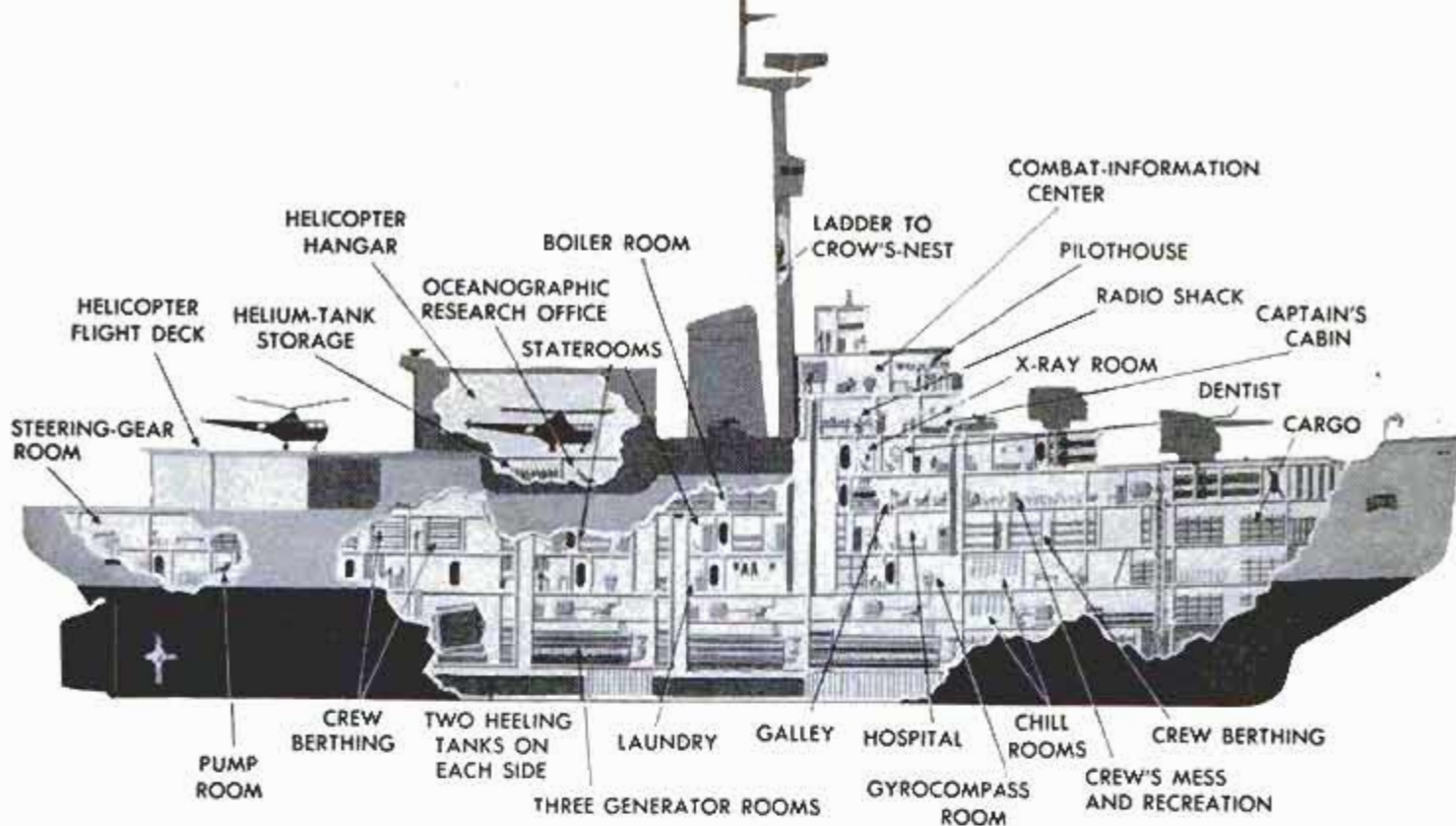

Glacier is the pride of the icebreaker's fleet. She's equipped with two helicopters and the finest instruments

headed into the pack for relief. We got in, but instead of flattening out, the wind and sea had broken the ice into 100-foot blocks and swept them into a grinding heaving mass of treachery. We were trapped in the pressure. All night gigantic cakes hurled against the ship in a thundering barrage that sounded just like shells exploding. Everyone prayed. No one undressed, though if we had sunk our lifeboats would have been crushed like eggshells. One of those big blocks over the deck would have swept away our entire superstructure. A curious thing saved us. Hurling cakes smashed apart against the sides and formed a cushion of chopped ice around the hull and allowed us to ride it out intact, except for mangled boats and deck gear."

Freezing in the pack is no problem for an icebreaker. An ordinary hull trapped in ice would crumple under pressure. But a breaker's round bottom is squeezed upward out of the pack as pressure closes in. This design was first tried on the Norwegian sailing vessel *Fram* in 1893. To test it, her hardy skipper froze her in the arctic pack that year, drifting with ice across the North Pole. Three times she squeezed out of the ice before she melted free near Spitzbergen three years later, sound and whole. Today she sits in the Oslo

Crew member strips thick layers of ice from a bulkhead on the ship's forecabin with a turbojet de-icer

Museum as a tribute to her designer.

Most interesting place on the breaker while bucking ice is the bridge with its row of double-paned windows kept clear of ice by a current passed through electrolytes in the center. Jets of hot water and fanning wipers brush away slush. Here in the nerve center the ship bustles with activity as she gouges along. Radar sweeps throw eerie light as they pinpoint bergs beyond the horizon.

Speakers and phones blare ice data from lookouts. Officers compare notes. The muted talk is another language. Ice is never just ice. Small chunks of green glacial ice through which the ship thumps without notice are "bergybits" or "blocks" or "cubes" and a motley, loose broken pack can be made up of "brash," "cakes" or "drift ice." When compacted by wind or running sea to make solid ice prairies across the sea it becomes "field ice" that



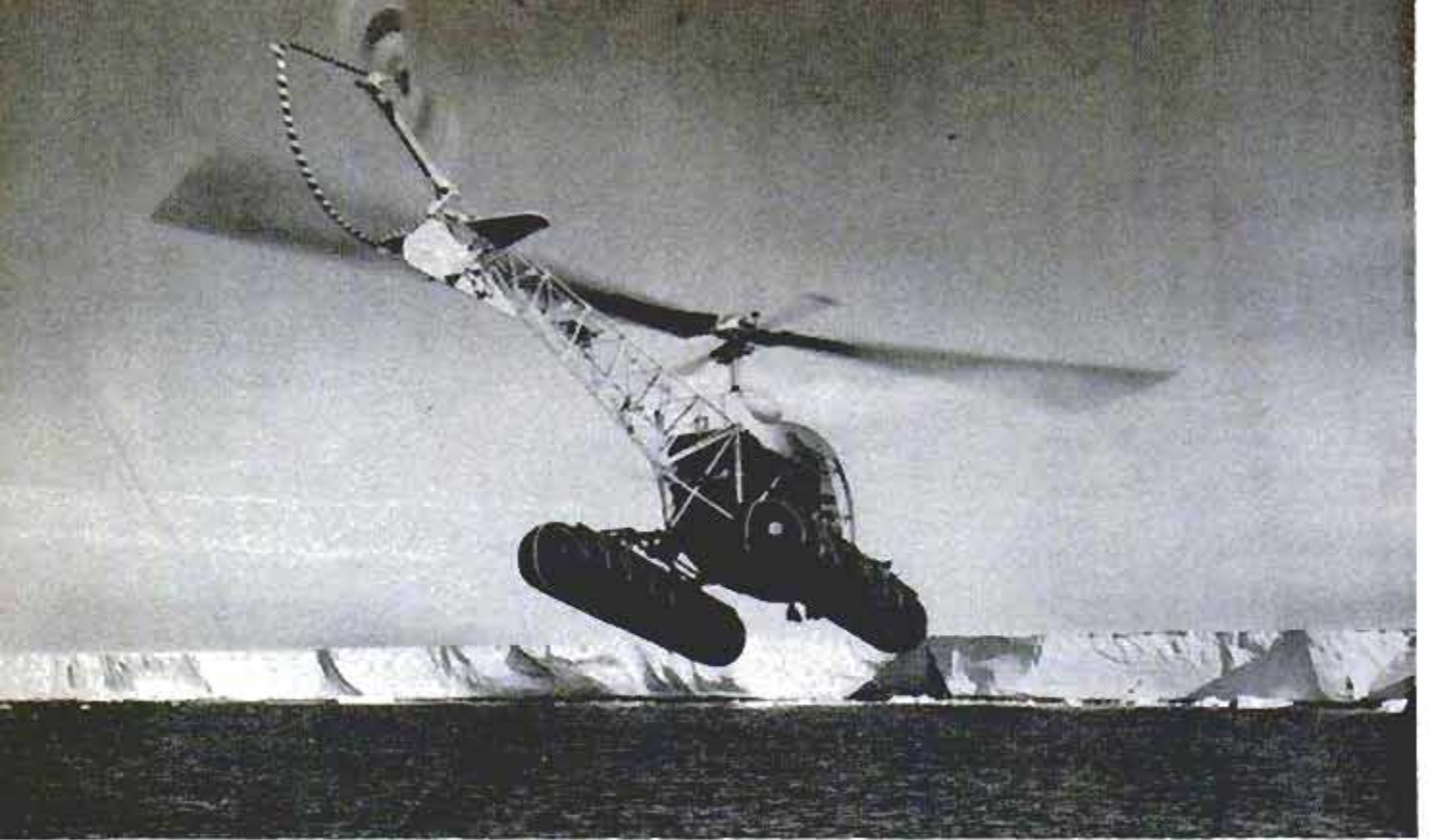

Helicopter leaves the deck of an icebreaker for an exploratory trip over the thick ice shelf of Antarctica

can be "rafted" or rumpled and overlapped where pressure heaves great pieces atop each other. When a thick sheet of solid ice is frozen fast to the bay shore it's called "fast" ice.

Up in the enclosed crow's-nest, reached via ladder inside the hollow mast, the ice conner doesn't look for open water; he looks for "polynyas"—open lakes in the ice mass. To find them he may study the sky instead of the sea, watching for signs of "water sky"—a blue reflection in the clouds from open water beyond the horizon. He alerts the bridge to avoid "ice blink," bright patches in the clouds reflected from glaring white ice and bergs below.

Twice below the Antarctic Circle we ran through armies of huge icebergs riddled with fluorescent blue caverns big enough to serve as airplane hangars. Some towered a hundred feet above the sea, indicating submarine basements twice as deep, with hidden rams or projections to trap the unwary. These monsters, some of them miles across, had broken from the last ice barriers on the Antarctic coast and floated north.

The *Glacier* steered a wide course around them. A single chunk breaking off or "calving" can weigh half a million tons and would smash this stout ship like a soup can under a sledge hammer.

We were treated to a spectacular sight one afternoon when, dead ahead, appeared a flat-topped iceberg more than three times the area of Manhattan Island! The berg measured at least 10 miles by 10 miles, and had a cliff 150 feet high. This convinced

some of the experts aboard that the berg extended 900 feet below the surface.

Maher's rule book for ice navigation is simple and direct. "The trick is to go around the big cubes," he says. "In close pack we hunt for leads and wedge king-sized floes apart. It's seldom necessary to bulldoze through. An ice captain develops a firm but respectful approach."

Following these principles, the *Glacier* whammed through five to ten-foot open pack at a steady 15 knots. And in the eight-foot fast ice of McMurdo Sound she rammed, backed and rammed again, crunching along an average ship length per sock.

"The secret is to have a place for the ice to go," explains Maher. Broken pack is easy because the bow wedges into big floes and shoves pieces aside. The vast plains of ice reaching to the horizons are tougher. Great crumbling cakes glide under the hull and tangle the propellers, are churned like cubes in a kitchen blender and have been known to smash a blade. "When you're thousands of miles from a shipyard and battling the pressure pack it's no time to lose a paddle," Pat Maher points out. He should know. "When I was new in the ice," he says apologetically, "I clipped a big cube too hard, snapped two blades and bent the shaft in the housing. Getting out of there was touch and go.

"Actually a broken prop is usable but the stern humps around at certain speeds. And to turn the ship away from the crippled screw you must bounce the bow off big

(Continued to page 266)

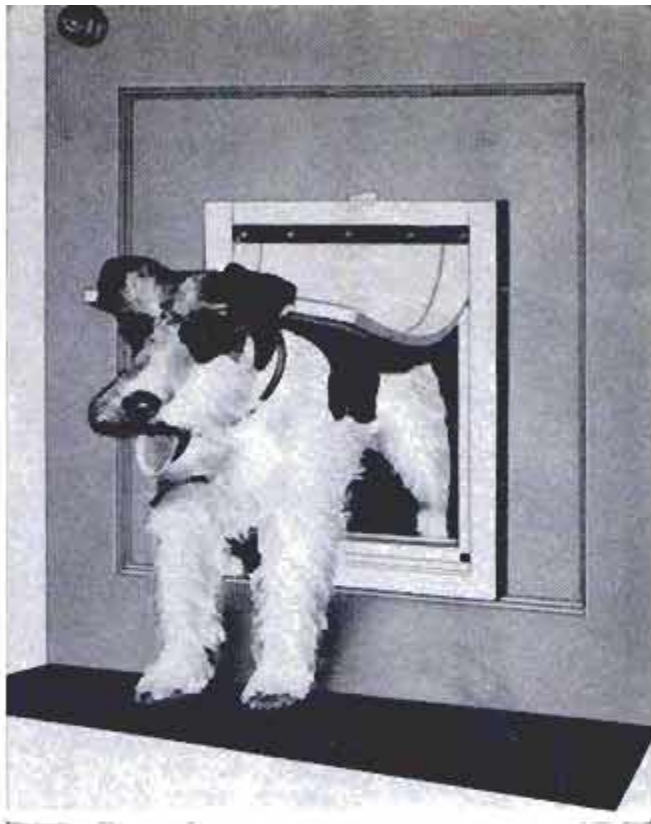

Rubber Dog-and-Cat Door Closes Behind Pets

Dogs and cats can enter and leave the house through a swinging rubber door set in the bottom panel of a regular door. The rubber curtain hangs in a wooden frame that is easily installed in any flush panel. Six permanent magnets immediately retract the swinging door to keep out insects and drafts. Sliding wooden panels close up both sides of the pet entrance when no use is being made of it.



Sticks Moved With Head Guide Powered Wheel Chair

Paralyzed persons who can move only their neck and mouth can operate a wheel chair designed especially for them. A patient operates the chair with a stick held in the mouth. By touching an extended stick with his nose, he can operate forward and reverse controls. A portable respirator can be carried by the electrically powered chair. Inventor Ed Tilden Adkins used discarded airplane and jet parts in the unit.

Three-Wheeled German Car Has All-Plastic Body

Powered by a tiny engine, a small German car has an all-plastic body. The 9.5-horsepower engine is mounted directly above the single rear wheel of the three-wheeled vehicle. Entrance into the plastic body is through a door in front. Two per-

sons can ride in the front seat and one adult (or two small children) in the rear. It will turn around in a 10-foot circle, making it an ideal car in congested areas and for parking. Called the Meyra 200, the car has a top speed of 50 miles per hour.

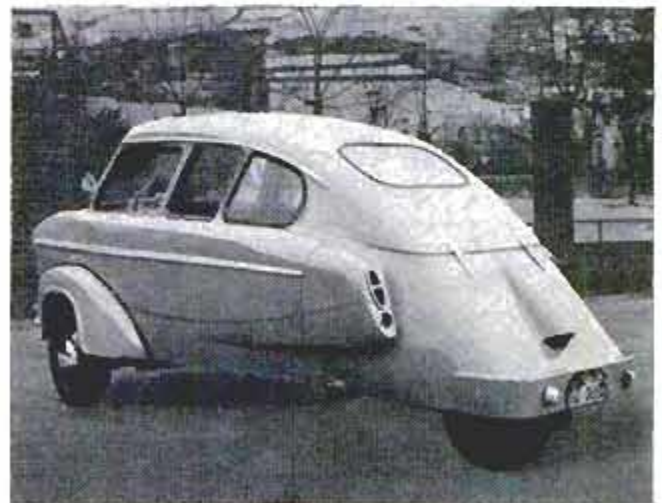



He Built a Locomotive

By Robert Van Der Velde

OF ALL THE HOBBYISTS today building model railroads—and the estimates run up to 50,000—E. E. Palmer probably holds the world's record for constructing the largest locomotive. It is so big that an entire building on U. S. Route 30 just west of Wooster, Ohio, had to be erected to house it.

"She's really a monster," boasts the 83-year-old railroad enthusiast, "about 40 feet long and more than 11 feet tall. The boiler alone is 18 feet in length and has a circumference of 14 feet."

Even to the forewarned visitor the actual sight of it comes as a shock. Inside the Palmer residence—which resembles a fire station sandwiched between two old railroad cars—the huge engine and its tender tower almost to the ceiling.

Old 999—named to commemorate the New York Central's record-breaker,—is a copy of no particular locomotive.

At the age of 70, Palmer began work on the ingenious combination of metal, fiberboard, wood and cut glass. Constructing it in his garage, he soon had to tear down the building to make room for his hobby.

Realistic-appearing rivets were made by hammering hundreds of chair-leg gliders into the boiler and bulkheads. A few old gauges from wrecked locomotives lent an air of authenticity to the cab—so much so that visiting engineers have remarked that they "feel right at home up there." Red reflectors give the appearance of an actual fire roaring in the firebox. Powered by an old truck motor, the mammoth model rests

on 12 rubber-tired wheels, and can be driven on the highway "with the ease of an automobile" according to Palmer.

The ex-carnival man, traveling salesman, inventor and one-time "Chipped Glass Name Plate King" has worked at about every conceivable occupation. "But the one I missed was the one I wanted most—railroad engineer," he sighed.

Known locally as the "Locomotive Works," Palmer's house was built especially for the E. E. Palmer Overland Limited. Actual living quarters are squeezed into an ancient railroad car on the right side of the building. Once the private car of some railroad president (even Palmer doesn't know which one), it was according to its owner "one of the most ornate ever to glide over the rails." Its antique atmosphere of faded carpets, dangling chandeliers and fringed curtains delights Palmer and, though wealthy, he would live nowhere else.

Attached to the left side of the main structure, an old interurban coach purchased for \$80 serves as workshop and office for Palmer's name-plate business. In the old relic, which once ran on the old Northern Ohio Traction between Cleveland and Akron, he continues to manufacture chipped glass, sparkling signs and house numbers by the method he patented in 1898.

"During one holiday week end some 300 visitors came to see me and my monster streamliner," he says. Then with a shrug he adds, "But after all, what's more fascinating than a trackless locomotive! ★★"

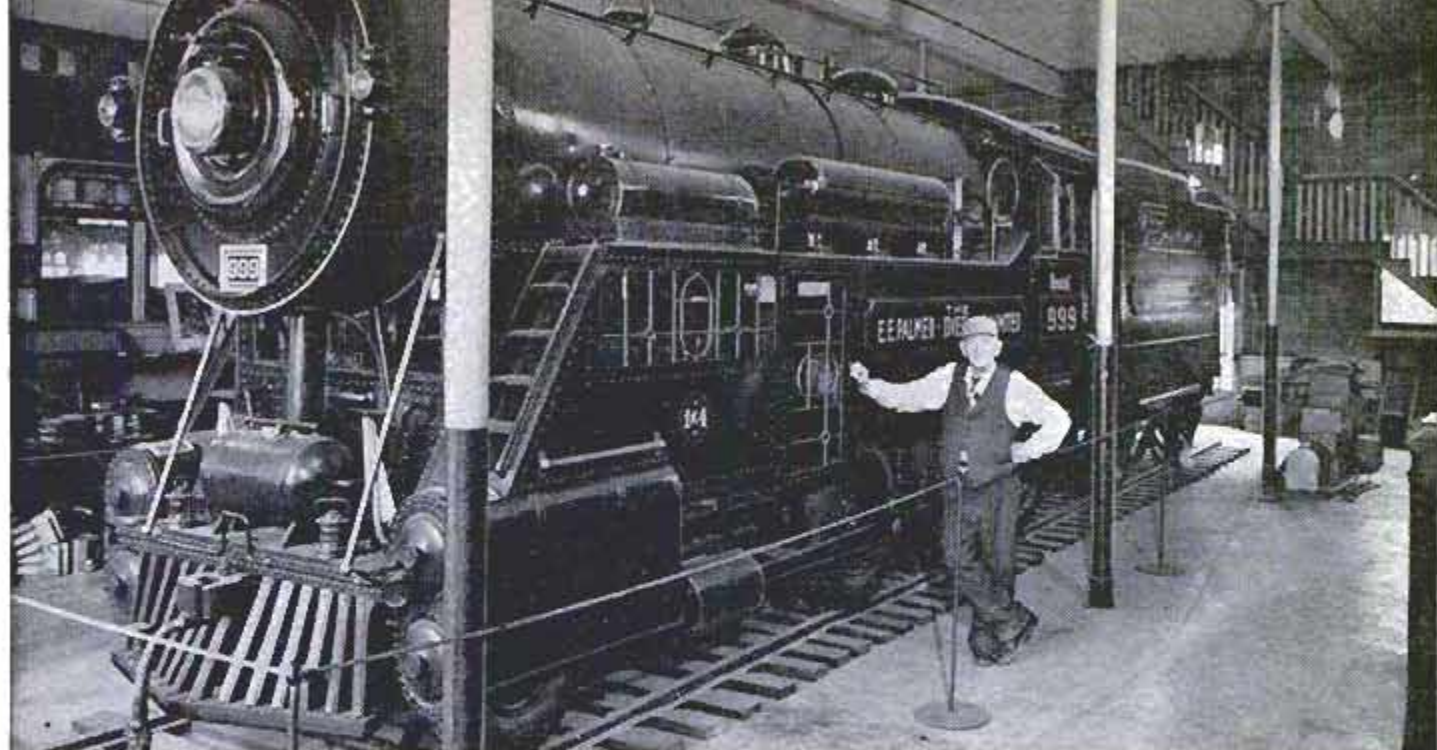

for a Roommate

Palmer's locomotive rests on imitation tracks laid on the floor of "The Locomotive Works." He keeps it roped off like a museum exhibit. Engine is 40 feet in length

Old railroad cars flank the engine's house. Palmer lives in ex-private luxury car at right. Old interurban coach at left is workshop for name-plate business

Below, left, Palmer relaxes in his living room—antique and ornate railroad car. Right, fitted with old gauges, cab of Palmer's engine has an authentic air

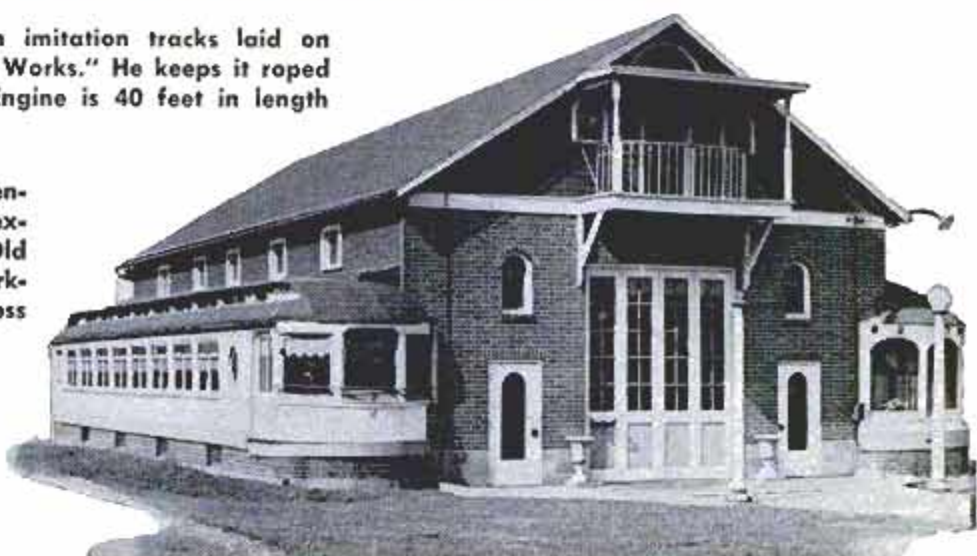

OWNERS REPORT:

Who knows most about a car? Its owners? The automotive engineer? Or the experienced road tester? *Popular Mechanics* lets you hear from all three in this report on the 1956 Lincoln

What do owners like best about Lincoln?

"Handles with no effort and I feel no fatigue when driving!"	NEW JERSEY DENTIST	HANDLING EASE	48.3%
"Beautifully designed automobile that puts competitors to shame. Simple yet dramatic and definitely new."	NEW YORK ARCHITECT	STYLING	46.9%
"I like the easy way it gets around curves and up hills and mountains."	VIRGINIA CONTRACTOR	PERFORMANCE	41.4%

What do owners dislike about Lincoln?

"Very poor assembly quality. Sheet metal not well finished prior to painting. Imperfections show."	MICHIGAN MANUFACTURER	CARELESS ASSEMBLY	32.9%
"Trouble with squeaks, rattles and leaks. Coach work could be better."	CALIFORNIA PHYSICIAN	BODY NOISES	15.4%
"Displeased with our dealer service. They do not take care of a customer the way they should."	CALIFORNIA CONTRACTOR	POOR DEALER SERVICE	14.9%

What was most popular reason for buying Lincoln?

"We bought our Lincoln because it looks beautiful."	NEW YORK HOUSEWIFE	NEW STYLING	37.4%
---	--------------------	-------------	-------

What do Lincoln owners say about seat belts?

"Had them on my last car and I transferred them to this one. Would not be without them."	CALIFORNIA INSURANCE BROKER
"Fine for trips but can't always remember to use them around town."	KANSAS SALESMAN
"Careful driver does not need belts."	GEORGIA RETIRED OWNER
"Belts don't interest me. Just something to talk about."	ILLINOIS MANUFACTURER

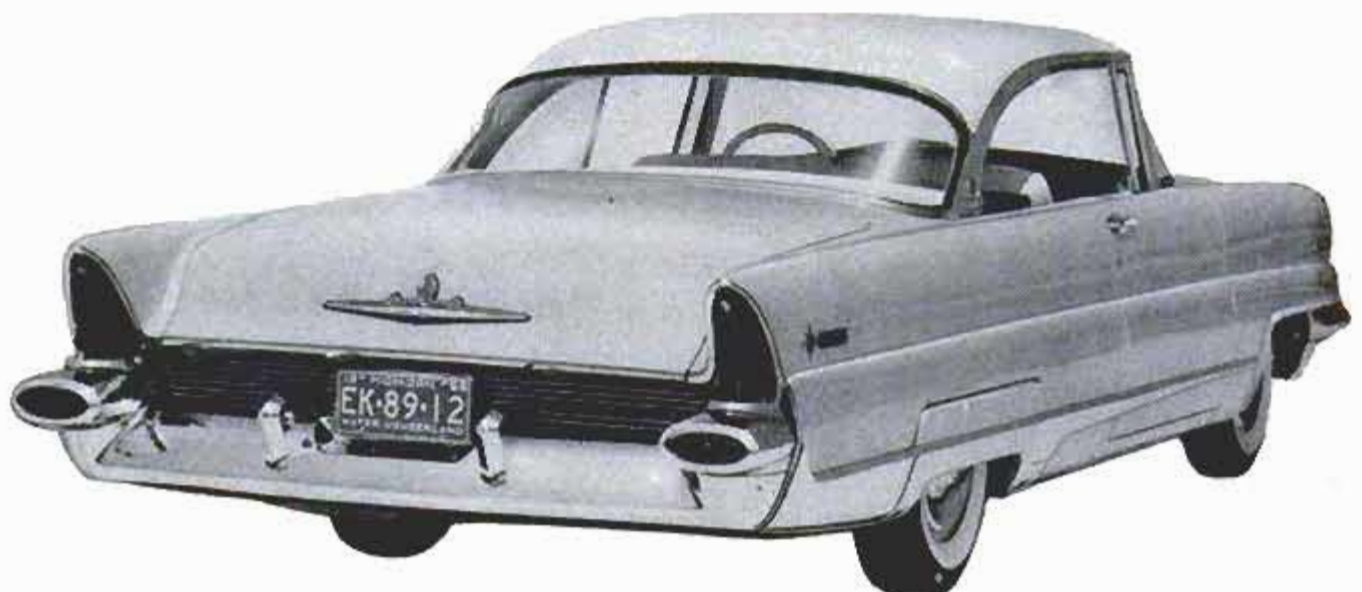

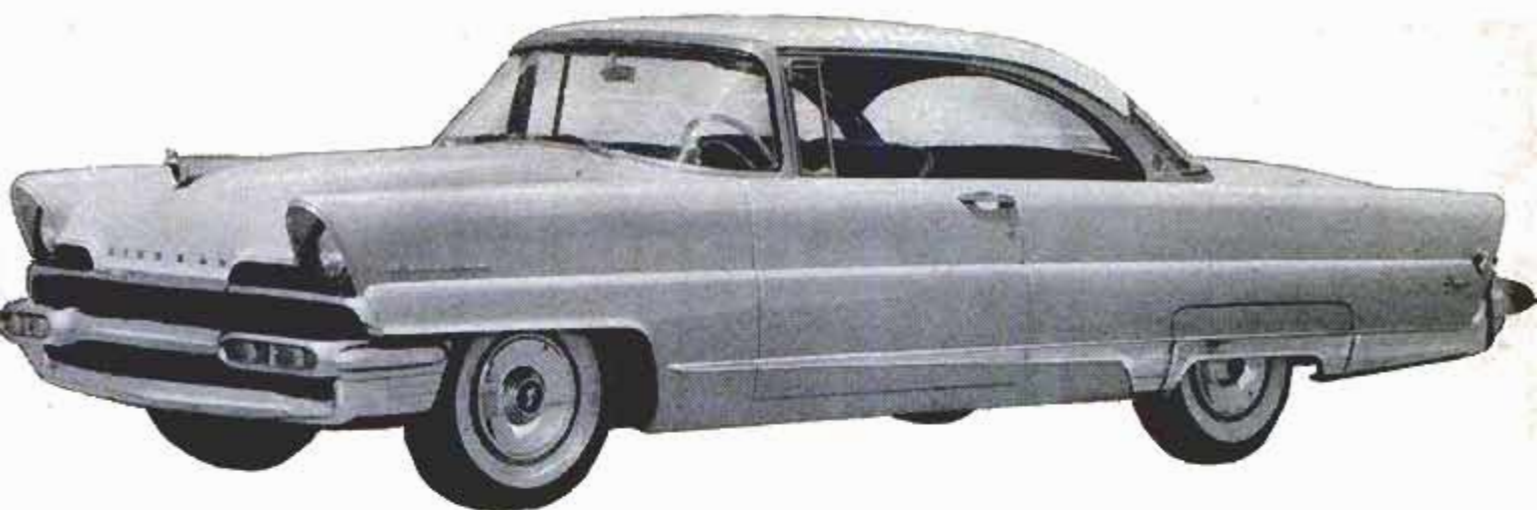

Lincoln Owners Praise Handling Ease Despite Increased Size of 1956 Model

As Told by Owners of 1956 Lincolns

LINCOLN is all new for 1956. It is longer, wider and heavier. But Lincoln engineers have accomplished a miracle, say owners. Despite being bigger, the new Lincoln is outstanding in its ease of handling.

Almost half of the owners in the survey list handling ease as the best-liked feature (48.3 percent).

"It has the looks and ride of a large, fine car, yet retains handling and agility of a light car."—Washington farmer.

"Handles easily. Parks like a small car."
—California housewife.

"I feel no fatigue in driving."—New Jersey dentist.

"My 4-foot-11-inch wife can drive it with ease."—California foreman.

Only a whisker behind handling ease in the list of best-liked features comes styling. Lincoln is one of few 1956 models that have completely new exterior styling and the owners are enthusiastic about it, with 46.9

(Continued to page 126)



CLYMER ROAD TESTS THE 1956 LINCOLN

By Floyd Clymer

Owners say the new windshield has excessive distortion and this picture seems to bear them out (arrow)

I DROVE the test car, a 1956 Premiere Coupe (Lincoln's top line) 567 miles which included some testing over regular highways, mountain and desert roads. The engine is extremely flexible, with minimum vibration and the economy with high-test gasoline was reasonable for a car of its size and power.

Outstanding is the way it handles at high speeds, in cornering and over rough roads. Part of this is due to the ball-joint front suspension, which I consider excellent. There is a minimum corner roll (slightly more than last year's Capri) for

a soft-sprung, easy-riding car. The car is low (2½ inches lower at roofline than the 1955 model). However, due to more weight and more overhang the 1956 model is more cumbersome and cannot be handled as quickly around corners as the 1955 Capri. In a severe crosswind I noticed more tendency for wind-wander than in previous Lincolns and I'm sure the longer and higher rear overhang helps contribute to this.

The power steering required a little more effort than most power-steering units, having some "drag".

(Continued to page 284)

An Engineer Analyzes the 1956 Lincoln

By Dale Kelly, SAE

Model tested: Premiere two-door hardtop equipped with automatic transmission, power brakes, power steering, power seat and windows, air conditioning. Rear-axle ratio 3.31:1 (measured). Curb weight 4740 pounds with gas tank half full (56 percent front wheels, 44 percent rear wheels).

ACCELERATION



(Time in seconds)
0 to 20 0 to 40 0 to 60 0 to 80 ¼ mile

Ignition timed for regular gasoline	3.6	8.3	14.2	22.7	20.4
Ignition timed for premium gasoline	3.5	8.1	13.6	22.5	20.3

(Watch started instant accelerator floored. Engine was not run up against brakes before the start. Low and Drive ranges were used.)

FUEL ECONOMY



(Miles per gallon)
Steady 30 m.p.h. Steady 50 m.p.h. Steady 70 m.p.h. Traffic Route

Ignition timed for regular gasoline	18.3	14.1	11.9	8.8
Ignition timed for premium gasoline	17.7	14.6	12.4	8.8

(On traffic route, car makes 10 full stops per mile and has an over-all average of 15 miles per hour.)

Estimated Annual Gasoline Bill: \$211 for 10,000 miles of driving. (2000 miles at 30 m.p.h., 5000 miles at 50 m.p.h., 1500 miles at 70 m.p.h. and 1500 miles in traffic, with gasoline priced at 27 cents a gallon regular, 29 cents a gallon premium.)

SPEEDOMETER ERROR



Indicated speed, m.p.h.	20.0	30.0	40.0	50.0	60.0	70.0	80.0
True speed, m.p.h.	18.0	27.5	37.5	47.0	56.5	66.0	76.5

Odometer error: Odometer indicated 2½ percent more than the actual distance traveled (102.5 miles per 100).

DRIVER'S VISIBILITY



Some portion of the road could be seen 17 feet in front of the car (A in sketch) by an average driver (5 feet 9 inches tall); full width of the road could be seen 23 feet in front of the car (B in sketch).

MISCELLANEOUS

Steering: From straight ahead, the steering wheel had to be turned 0.8 of a revolution to complete a circle with an outside radius of 50 feet. Lock to lock, the wheel required 3.75 turns. Turn-circle diameter, curb-to-curb, was 45.4 feet; from wall-to-wall, it was 48.8 feet. Diameter of steering wheel: 18 inches.

Trunk capacity: In addition to spare tire and tools, the trunk accommodated 14 cardboard cartons of size used to ship 48 large cans of evaporated milk.

Interior sound level: Inside the car the noise level with all windows closed was 95 decibels at 40 and 60 miles per hour on a smooth road.

Center of gravity: Center of gravity of unloaded car was 23 inches above the ground.

Water resistance: No water entered trunk or passenger area during an automatic high-pressure car wash. Five runs at 20 miles per hour were made through a splash pan containing 2½ inches of water. No water leaks resulted. Ignition was not affected.

Gasoline fill rate: The fuel tank could be filled at a rate of 12.5 gallons per minute when almost empty. No filling-station pump used during the test was capable of pumping faster than the inlet pipe could take it.

percent listing it as a best-liked feature. (And 37.4% say styling is the reason they bought Lincoln.)

"Beautifully designed. Puts competitors to shame. Simple, yet dramatic and definitely new."—New York architect.

"Absolutely the finest car I have owned. Longer, lower, big-car look. As a designer, I can say it has great beauty because of its simplicity and refinement of line."—California engineer.

"Plain, simple, clean lines without a lot of frills."—Michigan carpenter.

"Dignity of style and good taste plus dash and verve."—California physician.

This month, *PM* adds a new feature to its auto section. Dale Kelly, right, provides scientific engineering data on each car we test (as above). Kelly is an experienced expert, having been an engineer in the auto industry, professor of engineering at Lehigh University, and, most recently, automotive test engineer at one of the nation's top research laboratories. He is a full member of the Society of Automotive Engineers.



From coast to coast, owners in 32 states (in color) tell you what's good and bad about their '56 Lincoln

THE OWNERS ANALYZE THE 1956 LINCOLN

OVER-ALL RATING

Excellent	84.6%
Average	12.8%
Poor	2.6%

Had trouble with engine?

No trouble	84.1%
Some trouble	12.1%
Considerable trouble	3.8%

What was engine trouble?

Valves	6.3%
Carburetor	3.4%
Hard starting	3.1%
Timing	2.3%
Electrical	1.7%

Over-all performance is

Outstanding	82.0%
Average	15.8%
Below average	2.2%

Over-all handling is

Outstanding	90.7%
Average	8.0%
Below average	1.3%

Had owned Lincoln previously?

Yes	69.9%
Had not	30.1%

Dealer service is

Excellent	52.1%
Average	27.3%
Poor	20.6%

Trade-in allowance was

Excellent	39.5%
Average	51.7%
Poor	8.8%

Would buy another Lincoln?

Yes	66.4%
Might	24.9%
Would not	8.7%

Safety Features

Have safety belts in car	9.5%
Do not have belts in car	90.5%
Use belts all the time	1.3%
Use belts some of time	3.4%
Use belts rarely	1.3%
Did not say how often they use belts	3.5%

Best-Liked Features

Handling ease	48.3%
Exterior styling	46.9%
Power, performance	41.4%
Riding comfort	37.7%
Roadability	20.3%
Automatic transmission	10.6%
Visibility	6.0%
Roominess	5.4%

Most-Frequent Complaints

No complaints at all	30.6%
Careless assembly work	32.9%
Body rattles	15.4%
Poor dealer service	14.9%
Water leaks in the body	9.4%
Poor-fitting doors	8.0%
Windshield distortion	5.7%
Poor gas mileage	5.7%
Inadequate glove compartment	5.4%

What Should Be Changed?

Needs no changes	38.0%
Improve body work	10.3%
Change windshield	4.6%
Improve glove compartment	3.4%
Redesign backup lights	3.1%
Change dashboard	3.1%

Why Did They Buy Lincoln?

New styling	37.4%
Previous ownership	15.1%
Handling ease	3.7%
Performance	3.7%
Riding quality	2.9%
Roadability	2.0%

As these quotations show, the owners are excited about the simplicity of the styling and the restrained use of chrome.

Third on the best-liked list is performance. There are 41.4 percent of the Lincoln owners who list this characteristic. (Only 3.7 percent say they bought Lincoln for its performance.)

"Terrific power in higher speed range."
—New York manufacturer.

"Plenty of power. More than you need."
—Wisconsin dentist.

"Takes off like a jet, drives like a dream, admired by small fry and adults."
—Illinois retired owner.

"I like the easy way it gets around curves and over hills and mountains."
—Virginia contractor.

Fourth best-liked feature is riding comfort with 37.7 percent listing it.

"Comfort is indescribable. One must experience its over-all comfort."
—New Jersey housewife.

"Takes bumps without notice."
—Idaho farmer.

"Like riding on air."
—Wisconsin owner.

Enthusiastic as Lincoln owners are about the good features of their cars, they still have complaints. And some of them are



unhappy enough to write at length about certain of the car's failings. However, almost a third of the owners (30.6 percent) have no complaints at all. They are completely happy.

Among owners, the most frequently mentioned complaint is careless assembly (32.9 percent). Many owners point out that this is particularly bad in view of the high price of the Lincoln and its claim of top quality.

"I was surprised, after listening to a sales talk stressing supreme quality, at the number of bolts to tighten, doors to adjust, lights to adjust and the innumerable small items the dealer is supposed to take care of but does not have time for with the volume sales today."
—Iowa distributor.

"I made the mistake of buying one of the first Lincolns off the line. It takes a few thousand cars to get the wrinkles out, such as lining up moldings, eliminating rattles, etc."
—Michigan grocer.

"Shoddy assembly and inspection are inexcusable for a \$5000 Lincoln."
—Ohio physician.

"Assembly work very poor. There were loose bolts, missing bolts and bolts that were cross-threaded."
—California retired automobile dealer.



Lincoln's backup lights are mounted on the rear-deck overhang and depend on bumper to reflect light rays backward (arrows). Owners say light is inadequate



Carburetor air is drawn through grille via duct in foreground. Despite crowded compartment, long dipstick is easy to use. Below, accelerator linkage is "suspended" to eliminate need for hole in floor mat

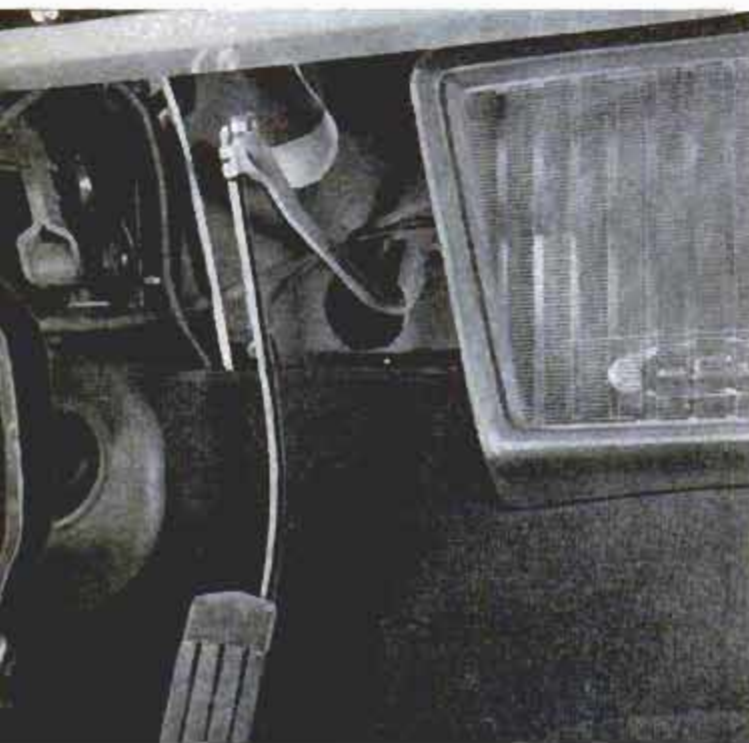

Second most frequently mentioned complaint is closely related to the first one: Too many rattles, say 15.4 percent.

"Windows rattle. Bumpers rattle."—California contractor.

"Body rattles. The body should be tighter."—California aircraft engineer.

Third on the complaint list is poor dealer service with 14.9 percent of the owners mentioning it.

"We are very displeased with our service. The dealer does not take care of a customer the way he should. When we buy our next Lincoln it will be from a different dealer."—California construction executive.

"Service department could not locate electrical trouble until three trips were made. Can't get rattles out of car. Have had car in service department three times for leaky radiator and it still leaks. I will take car to an independent garage when I have time."—Texas superintendent.

"Dealer is not equipped to service the cars he sells. There are more salesmen than mechanics."—Wisconsin merchant.

Fourth most-frequent complaint also involved body work: Water leaks (9.4 percent).

"Water leaks in around windows and around floor in front and back. Floor mat under carpeting is always wet as an old dish rag. Not able to carry luggage in trunk because of wet condition. Dealer has used so much dub-dub trying to stop the leaks that my car smells like a tar kettle."—Michigan engineer.

"With every rain the whole floor becomes water-soaked."—New York physician.

Owner Comments on Safety

Because Ford Motor Company is stressing safety devices in its advertising and because Lincoln is the first Ford product we have surveyed in 1956, several questions were asked about safety.

Only 9.5 percent of the Lincoln owners state that they have safety belts in their new cars, 90.5 percent do not. A number of owners state that they would have bought belts but they were not available in colors to match the upholstery at the time the car was delivered. Some say they are going to have belts installed later.

A tiny 1.3 percent of the owners state that they wear the belts all the time they are in the car; 3.4 percent wear them some of the time (usually for high-speed driving only); and 1.3 percent say they wear them rarely or never (another 3.5 percent did not answer).

Opinion about the value of belts and other safety features varies considerably. Here are some sample quotations on the

(Continued to page 278)

Electric Heating Belt Warms Thick Liquids

Electric heating belts that snap around 55-gallon drums and 5-gallon containers make thick liquids flow easily in cold weather. The belts, which plug into an electrical outlet, maintain a temperature that insures free flow without damaging the most sensitive material. They can be used to warm oil, grease, wax and some paints. Wrap-around glass-fiber covers may be used to speed the heat-up time.

National Observatory

American astronomers long have hoped for a national observatory which would serve scientists from all over the country. According to a recent announcement, construction of such an observatory will be started within two years. It probably will be run jointly by several institutions, and will provide much better facilities for studying the universe than individual institutions can afford. The site now is being selected under a grant by the National Science Foundation. The observatory probably will be located in the Southwest.



Mobile Repair Shop Services Truck Trailers While They're Loading

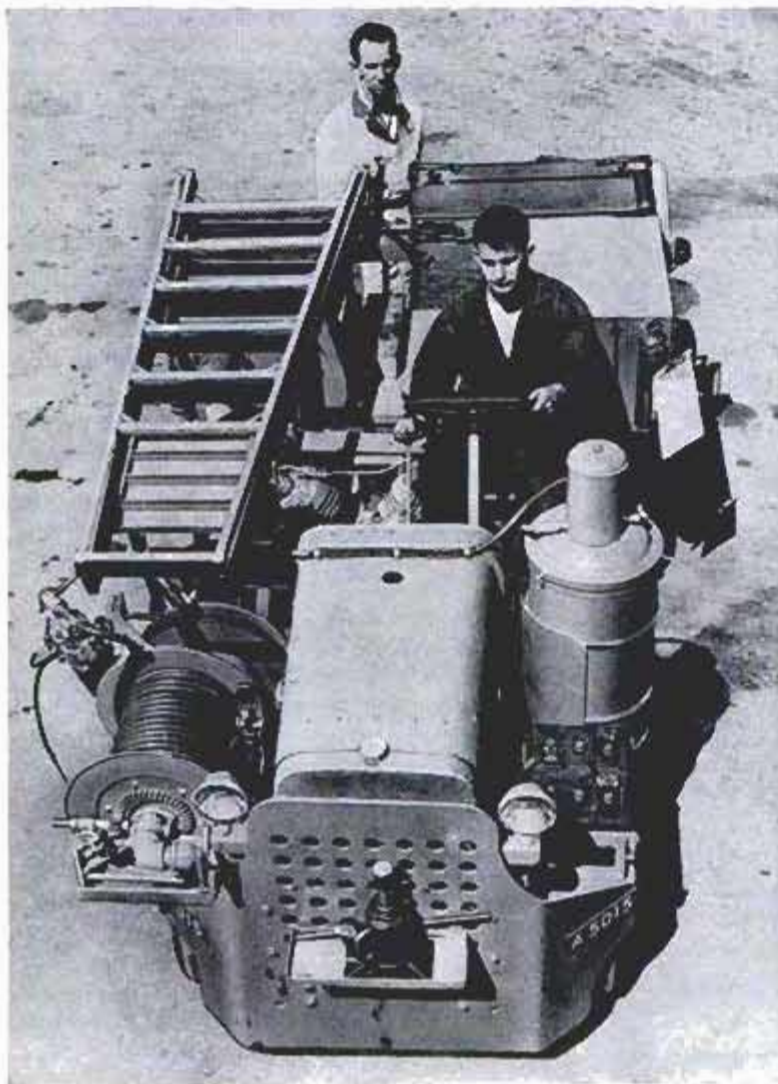

Ailing truck trailers can be repaired during loading operations with a mobile shop and service unit. Greasing, inflating or changing tires, wheel packing, checking and repairing air-brake and electrical systems and many other jobs can be accomplished while a trailer is being loaded for its next trip. The unit mounts a compressor, air tank, grease tank, tire rack, ladder, a hose for greasing, one for inflating tires and another for operating pneumatic tools such as a lug-nut wrench. Built by the Pacific Intermountain Express from Army surplus chassis, six units are used at the company's terminals.

Slides Ready in a Minute

Black-and-white transparent slides can be projected on a screen within a minute or two after the picture is snapped with a new film to be introduced shortly. The film has an ASA meter rating of 1000, the fastest of any film ever marketed, and has an ultrafine grain, which permits projection on screens as large as 12 feet high without showing grain structure. The film can be used in any of the existing Polaroid Land cameras.

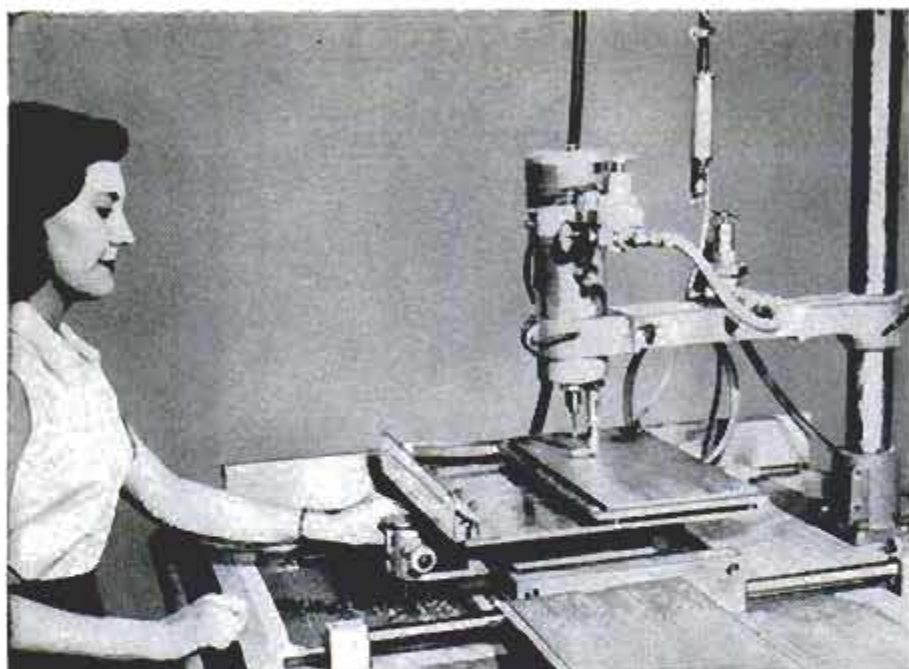

150 Holes Drilled In Two Minutes

Semiautomatic drill presses, designed to perforate boards on which printed radio circuits have been stamped, complete the drilling operation on a board requiring 150 holes in $1\frac{1}{2}$ to $2\frac{1}{2}$ minutes. The board to be drilled is placed on the drill-press table, and a template is inserted under a stylus in front of the table. When the stylus is pushed over a hole in the template, the table moves, pantograph fashion.

"Tricycle" Attachment Lets You Ride Mower

You can ride your own power mower by attaching a new "tricycle" to it. Then you sit on a tractor seat and ride around the lawn while you're mowing. The attachment can be installed on any reel-type power mower from the 18-inch to the 30-inch size. It is bolted to the top of the mower so the mower's wheels become the rear wheels of the tricycle. The unit has a clutch lever and a throttle-mounting clip. The operator's weight is directly over the power wheels, improving the traction. This permits mower and rider to go anywhere the mower could go without the driver's weight.



Steel Ingots Heated White-Hot by Electromagnetic Field

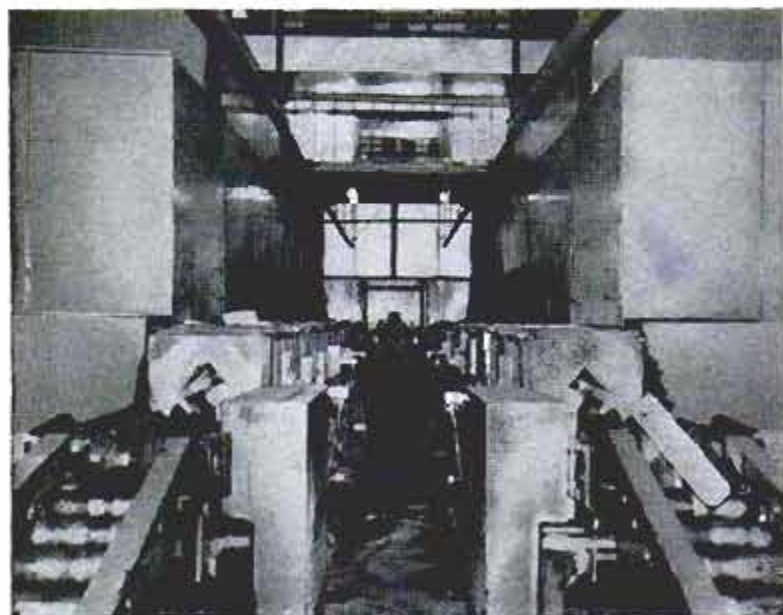

Steel ingots heat themselves white-hot as they pass through an electromagnetic field on the production line of a Canadian mill. The ingots are sped by rollers through two tunnels wrapped with 700 miles of current-carrying copper wire. The magnetic field created causes a current to be induced in the steel ingots. Resistance to the current heats the metal to 2300 degrees Fahrenheit in eight to twelve minutes—one fourth the time it takes in a conventional oil-fired furnace. The rolling mill, at Vancouver, B.C., is said to be the first so equipped. The induction-heating unit reportedly has raised production by 30 percent.

GUIDED MISSILES GO TO SEA

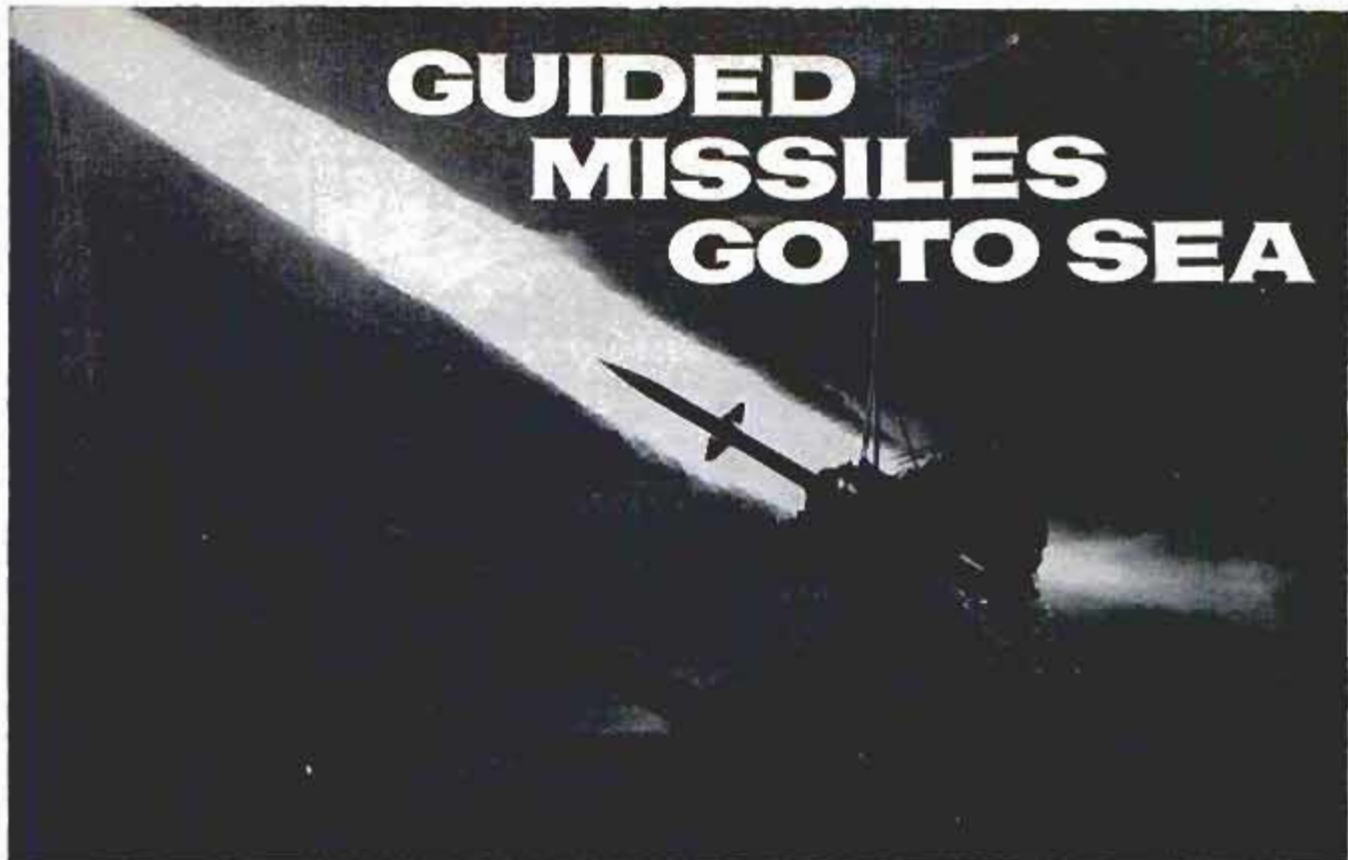

Official U. S. Navy photos

Outlined in blast glare are the deadly missile weapons of the U.S. Navy's new guided-missile cruisers

By Capt. W. D. Brinckloe, USN

THE COLD-EYED SQUADRON PILOT, his face lined with fatigue from the strain of the search, turns suddenly alert as his instruments pick up something from the gray ocean beneath. His radarscope tells him there are many ships. It can only be the United States task force carrying the big weapon—the fleet for which his aircraft have been searching and the jackpot for which their murderous weapons are primed. He presses the button on his

microphone and barks guttural words in a foreign tongue to the planes of his squadron.

Swiftly the blunt-nosed bombers regroup, orienting their force around the approach axis. Bombsights are readied, weapons unlimbered, computers set to humming and air crews alerted to razor-edge keenness. The force drives through the air with relentless purpose toward the distant fleet it can not yet see.

Needle-nosed Terriers point skyward from afterdeck of rebuilt USS *Boston*, first of the missile cruisers





JAPANESE SUICIDE BOMBERS

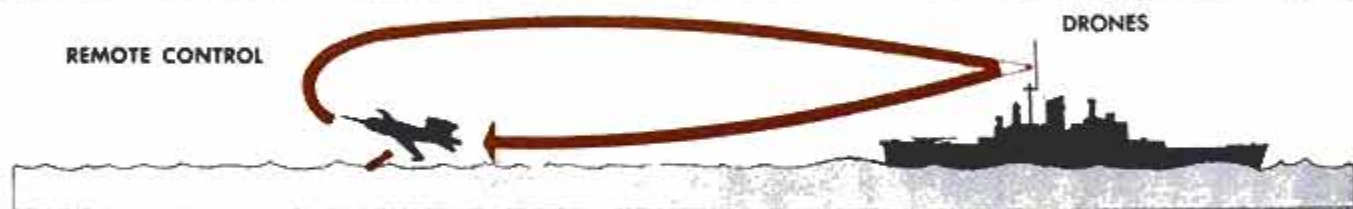

SEQUENCE OF GUIDANCE DEVELOPMENT

Guided missiles launched automatically from Missile Control of new cruisers are last word in guidance



Tests of the supersonic Terrier missile were conducted from the USS Mississippi (above) before the USS Boston (below) was reconditioned as first guided-missile cruiser. The Boston is 673 feet long

The squadron leader grunts his satisfaction and looks about him. Suddenly his eyes meet a chilling sight. One moment his wing plane flies steadily toward the target—the next instant it erupts into a huge fireball that trails burning debris out behind. Even as he watches, another bomber explodes in the air and is gone.

Instinctively the shaken flier peers ahead, squinting down the unseen radar beam to the distant target. His searching eyes find nothing—then, straining desperately, they catch a tiny speck that wobbles slightly as it grows swiftly in size. Cold with horror, he realizes the significance of what he sees. He pulls the big bomber into a violent evasive



BEAM-RIDER GUIDANCE

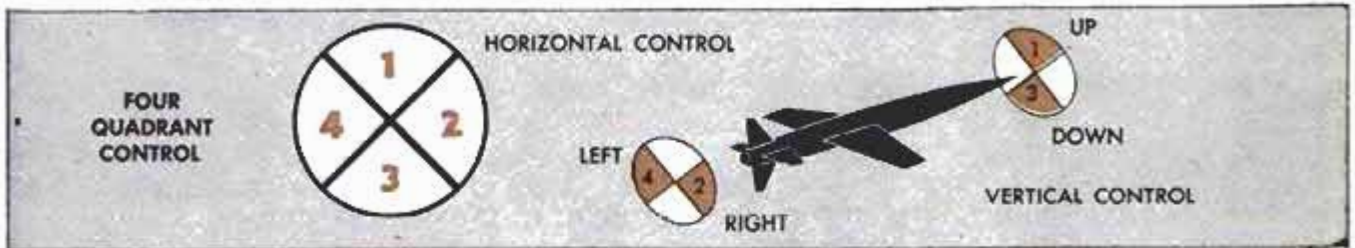
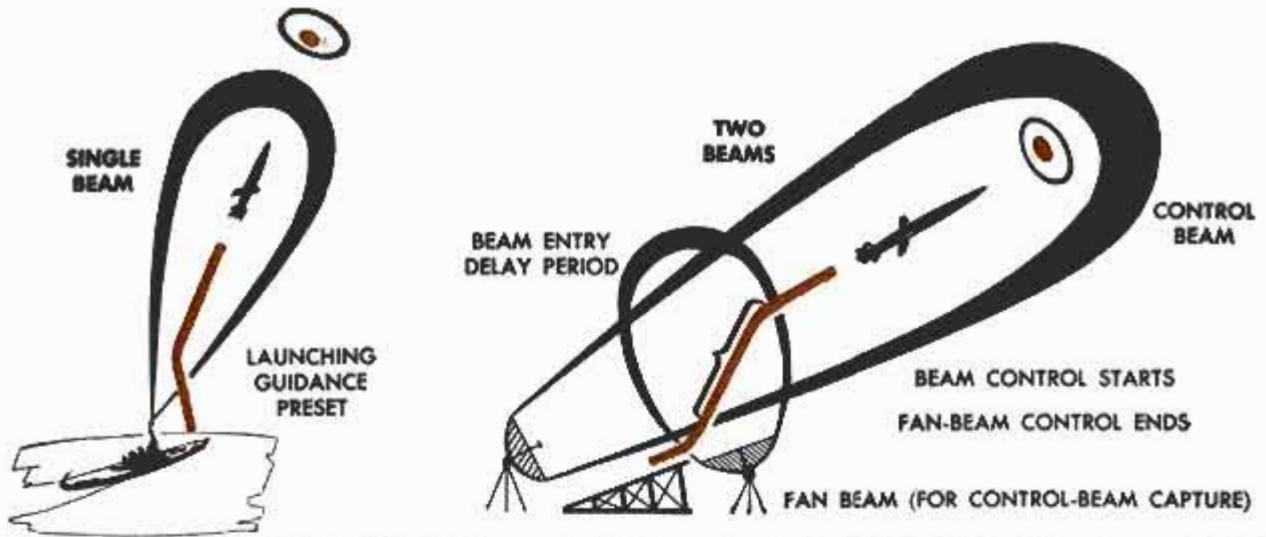

With radar beams trained on a target, guided missiles like the Terrier can destroy an unseen enemy plane

maneuver, all thought of attack forgotten. A chilling panic clutches his heart. Scarcely has he turned in escape when a searing explosion engulfs him, and he knows no more. . . .

Task Force Pulls a Surprise

Below in the task force, within the sheltering antisub screen of lean destroyers, steams a hybrid ship. Her lines are those of a heavy cruiser. She bears a cruiser's powerful turrets forward, and amidships her superstructure bristles with a heavy's

antiaircraft armament—but aft her design is totally new. There, like the take-off site of an interplanetary movie, is an installation new to naval warfare. On the broad afterdeck squats a twin missile launcher, its double snouts momentarily depressed for reloading. Forward and above, a second launcher restlessly searches the sky for another victim.

This new ship, the guided-missile cruiser, brings a third dimension to the age-old battle for supremacy at sea. Heretofore the heavy naval ship, seabound in the age

Precise and sturdy mechanisms of missile must withstand jar of take-off blast and hold course at high speed

PITCH-CONTROL SYSTEM

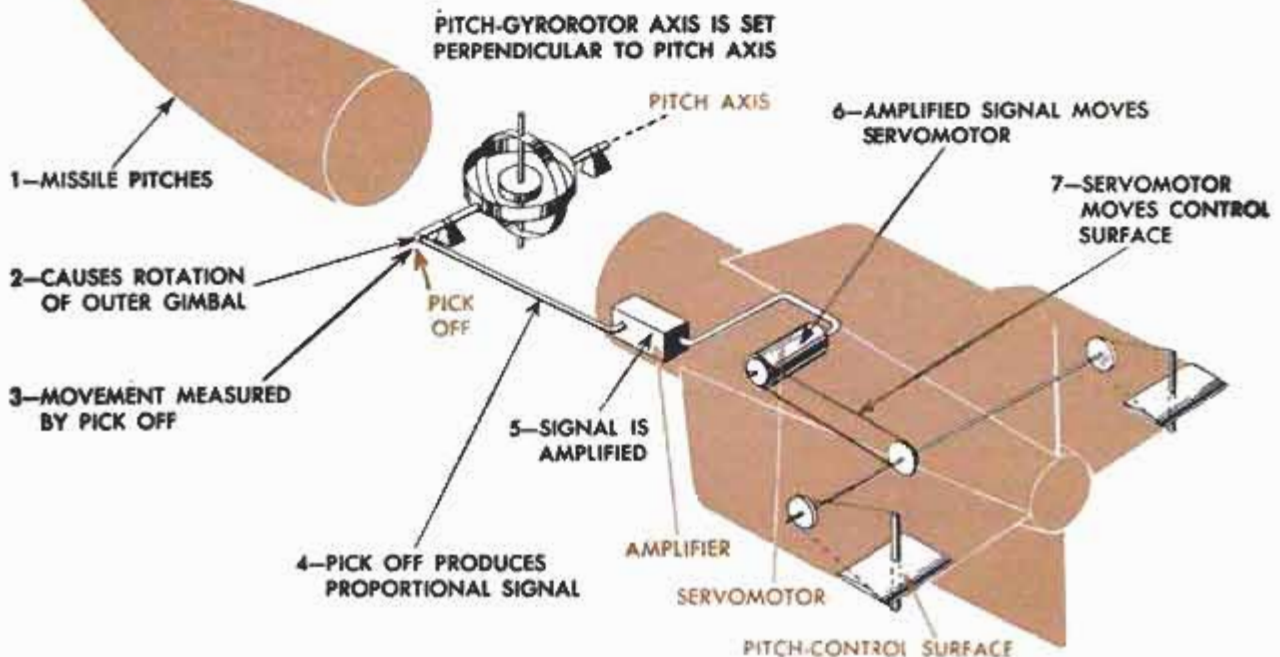

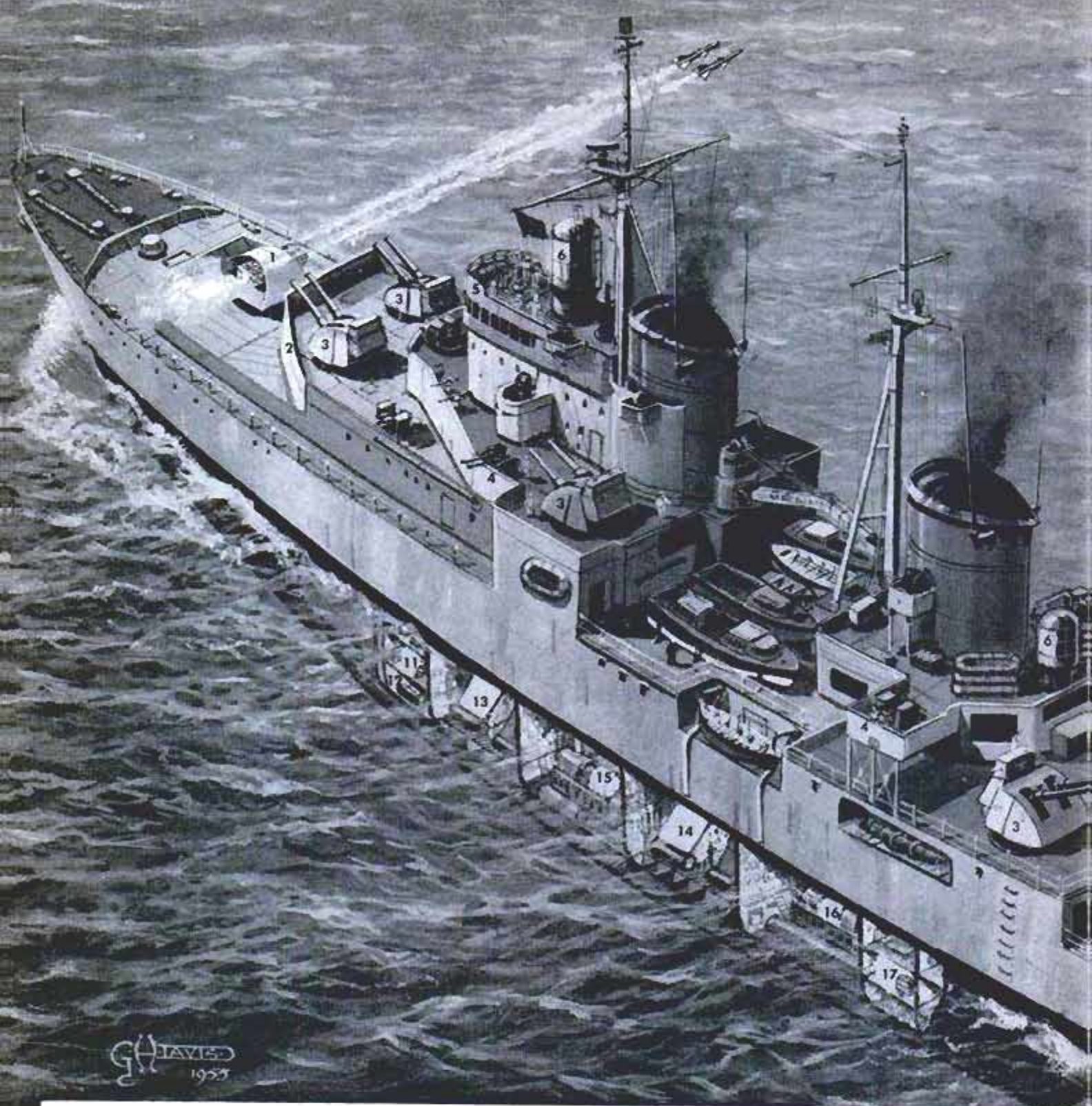

G. H. Davis, noted London illustrator, gives readers of *Popular Mechanics* a preview on these pages of a design for a guided-missile cruiser for the British Navy. "Behind the scenes in the British Admiralty," Davis writes, "the department of the director of naval construction is formulating plans for the new guided-missile ships. Recently, suggested plans for one of these ships were released from the veil of secrecy and from them this drawing was made. I do not suggest that the drawing exactly follows the lines of these future ships, but it has been stated by experts that it is substantially correct." Britain's missile cruisers will have a displacement of 10,000 to 12,000 tons and will be armed with guided-missile batteries both fore and aft with a new secret system of fire control. (The USS *Boston* described in the accompanying article by Captain Brinckloe has missile launchers only on the afterdeck. The Admiralty's secret system of fire control is probably similar to the electronic Missile Control on the *Boston* which is de-

scribed in the article.) Davis reports that the British cruisers will have a speed of 35 knots and that in addition to the guided-missile batteries will have powerful armament including a main battery of five-inch dual-purpose guns. These guns have radar control and tremendous fire power. Secondary armament includes anti-aircraft guns "of a new and secret type" in multiple mountings, also the latest weapons for anti-submarine warfare. The cruisers will be equipped with elaborate radar installations, stabilizers and even atomic-atmosphere control rooms fitted with radiation-detection devices. The Admiralty has rebuilt a Landing Craft Maintenance Ship as an experimental guided-missile "cruiser" and is conducting extensive tests. (The U.S. Navy held similar tests over a period of many months on the battleship USS *Mississippi*.) Britain's proposed guided-missile cruiser is "the obvious successor to the cruisers of today," according to the First Lord of the Admiralty.



SECOND STEPS

FIRST STEPS FALLING

HELICOPTER SPOTTING

GUIDED-MISSILE CRUISER ENGAGING SHORE INSTALLATIONS



1. Forward guided-missile battery; 2. Flash screens; 3. Five-inch dual-purpose guns with radar control; 4. Antiaircraft guns; 5. Bridge; 6. Fire-control towers; 7. Aft control tower; 8. Guided-missile hoist from magazines; 9. Aft missile battery; 10. Helicopter landing area; 11. Atomic-atmosphere control room; 12. Port stabilizer; 13, 14. Boiler rooms; 15, 16. Portside turbine rooms; 17. Aft atomic-atmosphere (radiation-detection devices) control room

CVA—CARRIER
 CG—GUIDED-MISSILE CRUISER
 DD—DESTROYER
 BB—BATTLESHIP
 DDE—DESTROYER ESCORT
 DDR—RADAR SHIP

REGULUS MISSILES AGAINST SURFACE SHIPS FAR OVER HORIZON

TERRIER MISSILES AGAINST HIGH-FLYING PLANES

DDR RADAR PICKET SEARCH

DDE GUIDED TORPEDOES AGAINST SUBS

GUIDED-MISSILE CRUISERS IN NAVAL ACTION

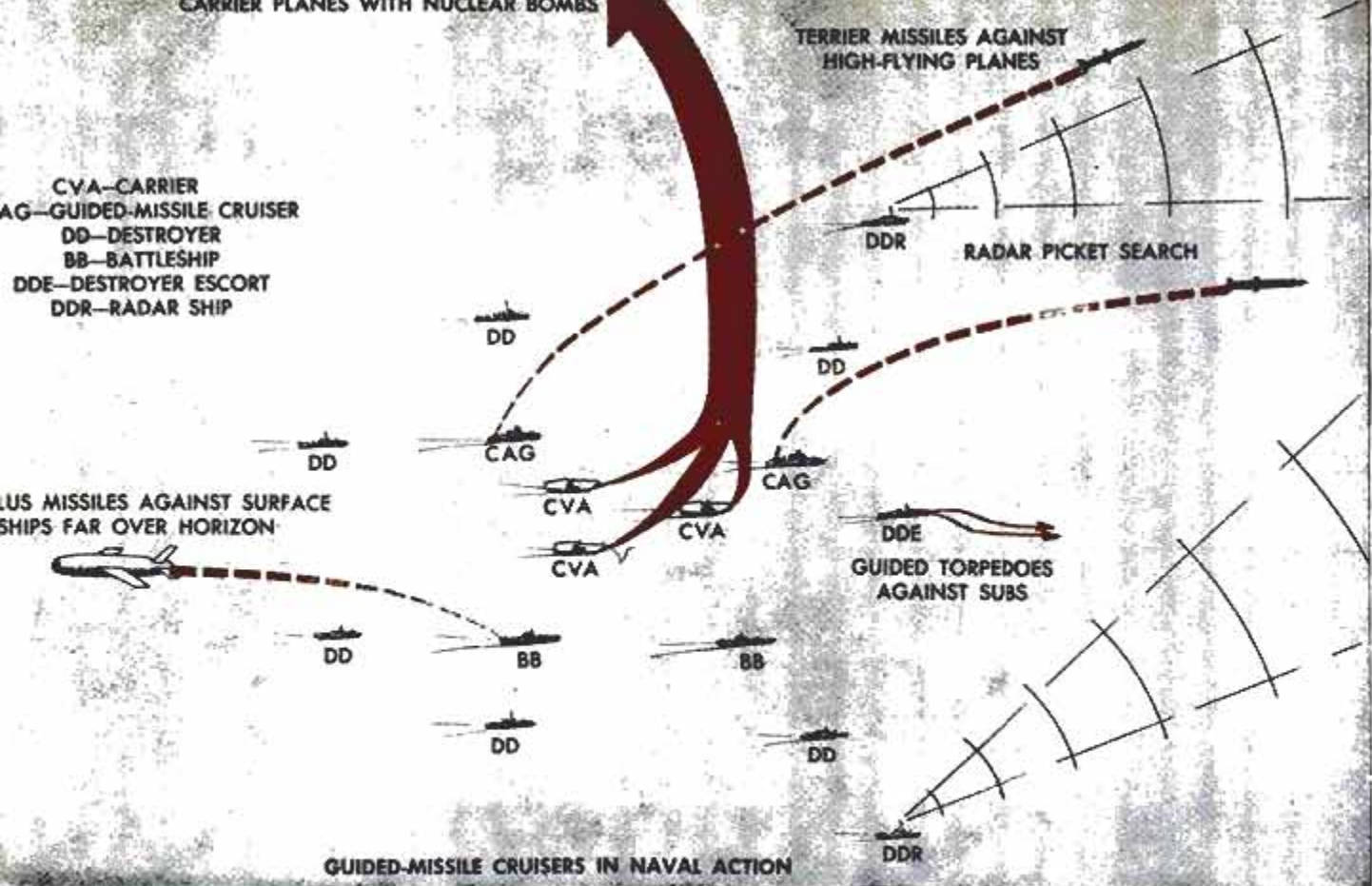

Naval strategy makes room for the guided-missile cruisers to take part in any future action on high seas

of air, has been likened by scornful critics to the mythical bird that flies backward because he's not interested in where he's going, but only in where he's been. Similarly the big warship is charged with living forever in its past glories, not daring to face its vanishing role in a jet future. This accusation may have some merit—but not for USS *Boston* and USS *Canberra*, the Navy's two new guided-missile cruisers.

Planners Burn Midnight Oil

Over in the Pentagon, the naval planners who dope out the Fleet's air defense have been burning midnight oil the last few years. Guns alone aren't enough. Acting Assistant Secretary of Defense Macauley, who heads up research, points out that "as

our potential enemies improve their airplanes, it gets to be a fairly easy problem to fly outside the effective range of any artillery that we have." Nor are there any other easy solutions—weight and space limitations severely restrict the size of any radical new weapons that can go to sea; and the perils of fire afloat rule out many of the best rocket fuels, such as hydrogen peroxide, fuming nitric acid, hydrazine and the like. Rear Adm. J. H. Sides, the Navy's guided-missile chief, has this to say to those who would write off the Navy for missilry, "Let me assure you that this would be the mistake of a lifetime! We are accustomed to this specialized environment and we know how to cope with it."

(Continued to page 246)

Twin mount holds Terrier missiles on warship deck. Release and aiming are automatic. The mount tips down for reloading

Surface-to-surface Regulus is shown leaving launcher on carrier deck during maneuvers Official U. S. Navy photos

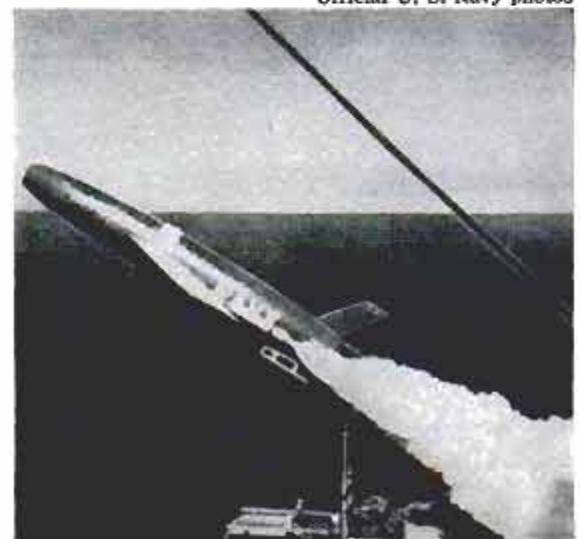

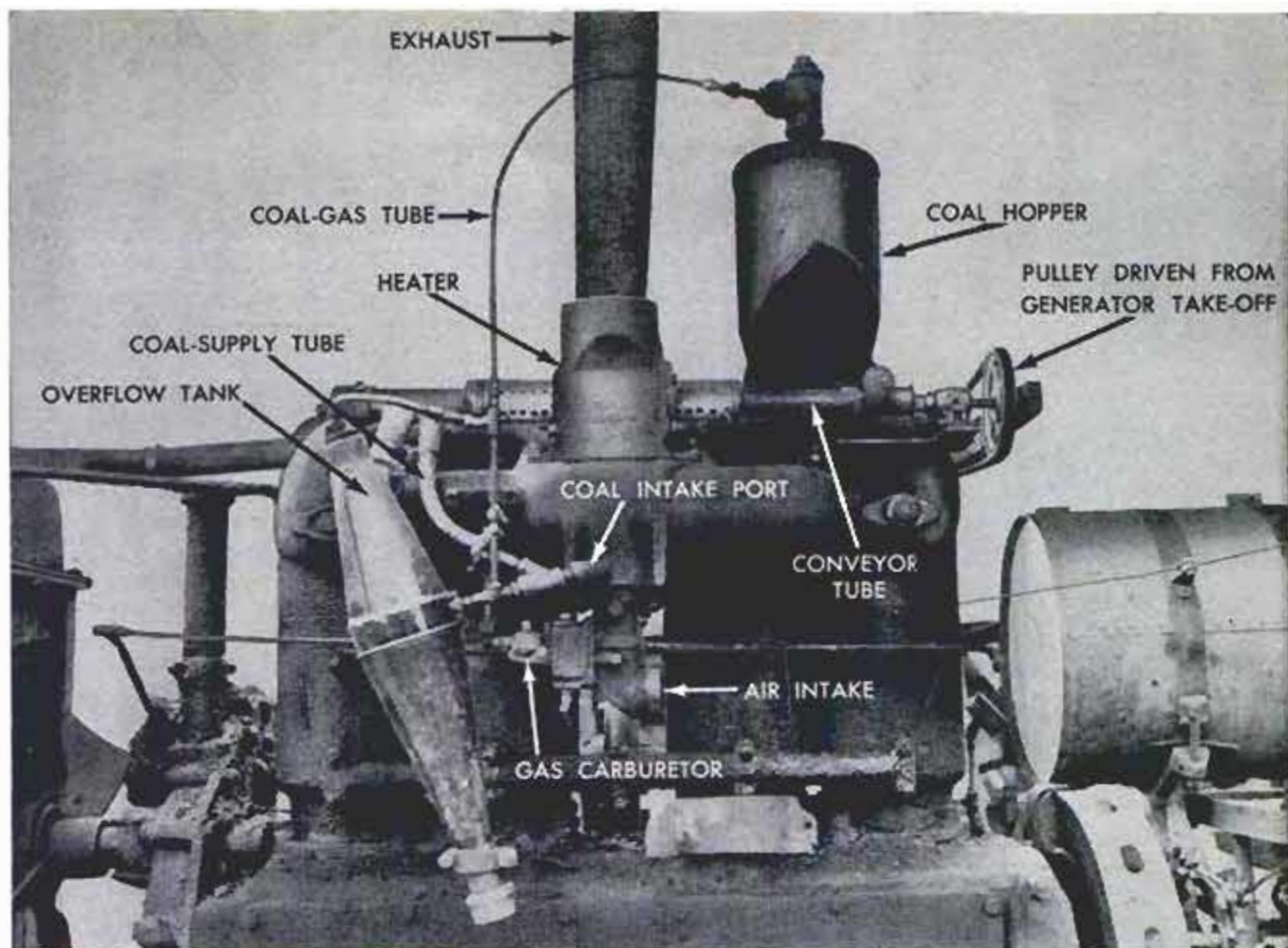

Harvey converted this old diesel engine into a coalburner by adding or altering the parts shown here

Powdered Coal Operates Gasoline or Diesel Engine

WHEN COAL DUST exploded, wrecking the home of a friend, Russell E. Harvey of Roanoke, Va., decided to put the destructive force to work. As a result he has developed both a gasoline engine and a diesel engine that burn powdered coal as fuel.

Harvey first went to work on a 1940 Buick motor. After months of experimentation he developed an attachment that fed pulverized coal into the auto engine without any alteration to the design of the engine itself. The engine was started in the conventional manner, using gasoline. Then pulverized coal was fed into the engine through a flow valve, and the gasoline intake was gradually reduced until the engine was receiving 90 percent coal and 10 percent gasoline.

Next Harvey applied the attachment to a diesel engine, which now is being used to assemble test figures. A screw conveyor moves the coal through the exhaust vent where it is heated. It then enters the intake manifold, and is burned.

Harvey says the attachment can be applied to any internal-combustion engine, particularly a diesel, without impairing the engine's normal method of operation. The engine may be operated on conventional

fuel or on powdered coal simply by opening or closing a valve. Acceleration is accomplished by feeding more coal into the compression chamber. It is necessary that the engine be started in the conventional way. As the temperature rises, the coal percentage can be increased.

According to Harvey, there are no increased carbon deposits, nor is there undue wear.

Inventor (right) loads the hopper with pulverized coal, which is heated as it passes over the exhaust



WHAT'S NEW FOR

Your Home



STRIP LINOLEUM 24 inches wide is designed for easy installation by homeowners. The edges are precision-trimmed at factory. Patterns match easily, giving the floor a seamless appearance. The strips can be laid down much faster than block linoleum

Armstrong Cork Co., Lancaster, Pa.

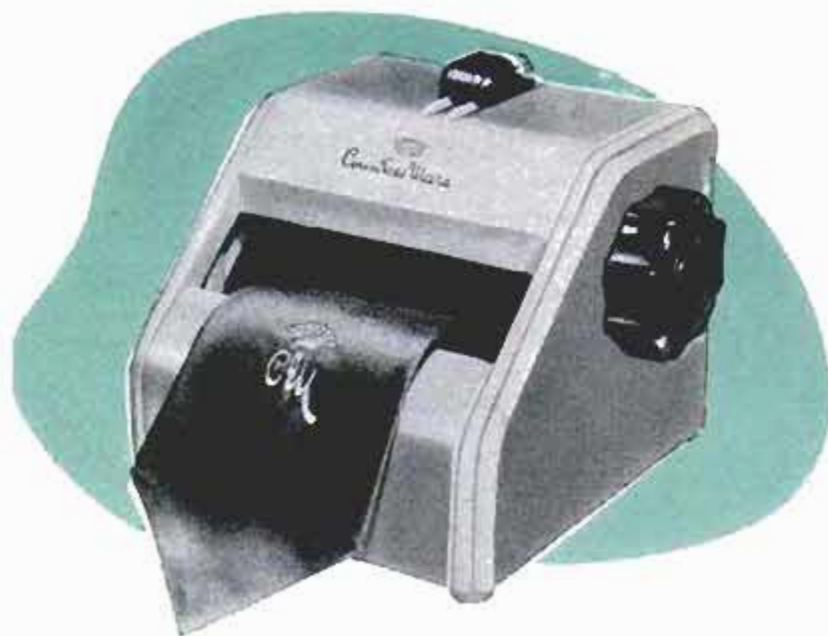

TIE PRESS needs no electricity or heat to remove wrinkles. Tie is cranked into press immediately after wearing. There it is clamped against a pressing cloth and held for a full day. Pressing lever at the top ejects the pressed tie. Freshness is restored

Countess Mara, Inc., 445 Park Ave.,
New York City 22

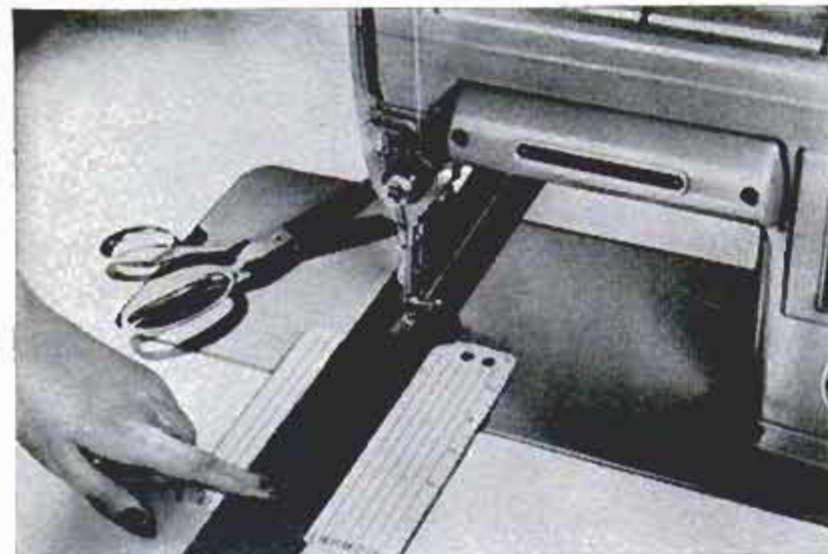

SEWING GUIDE, a grooved plastic plate that attaches to a sewing machine, enables anyone to make straight seams. As cloth feeds into machine, operator keeps a finger pressed over groove to maintain alignment. Edges are calibrated in various measurements

Sew Strate Co., 18 N. Warren St.,
Trenton, N. J.



MEAT WATCHER is an automatic electric thermometer inserted in the meat which turns off the oven when the roast is ready. It can be set for well done, medium or rare. A cord connects the thermometer, a feature on a newly introduced range, to an oven outlet

Kelvinator Div.,
American Motors Corp.,
Detroit 32, Mich.



HOOKS that slip over the steps of a stepladder transform it into a sturdy easel for holding material during the washing, glazing or repairing of storm windows and screens. Hooks can also be used to hold planks being sawed. Made of metal, they are easily removed

Bill Foster, 3340 48th Ave. South,
Minneapolis, Minn.

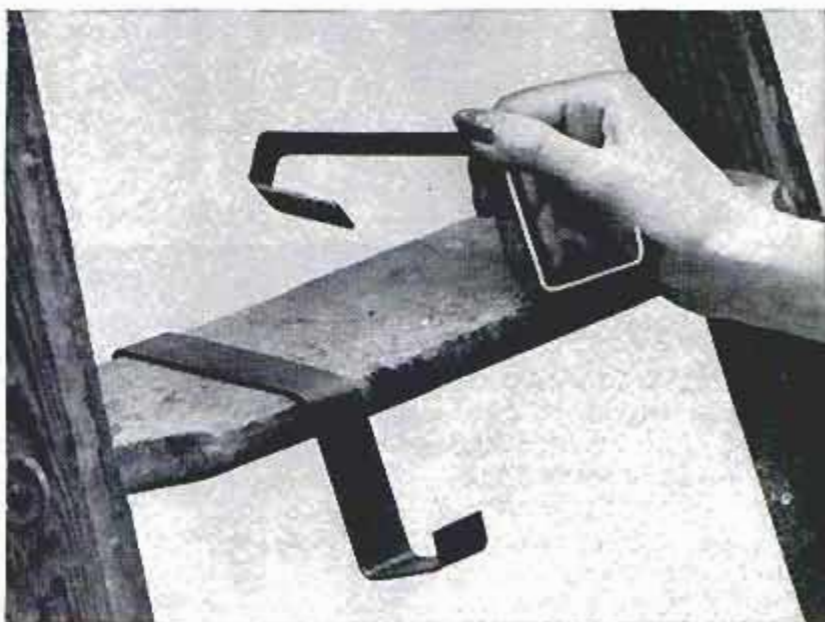

MEASURING SPOUT for soap and food boxes doles out one, two, three or four exact tablespoonfuls of the material at a time. Spout is punched into unopened box and a slide is set for the amount to be measured. The spout remains on box until it's empty

Sure-Por Co., Inc.,
1921 Shepherd St., N. W.,
Washington 11, D. C.

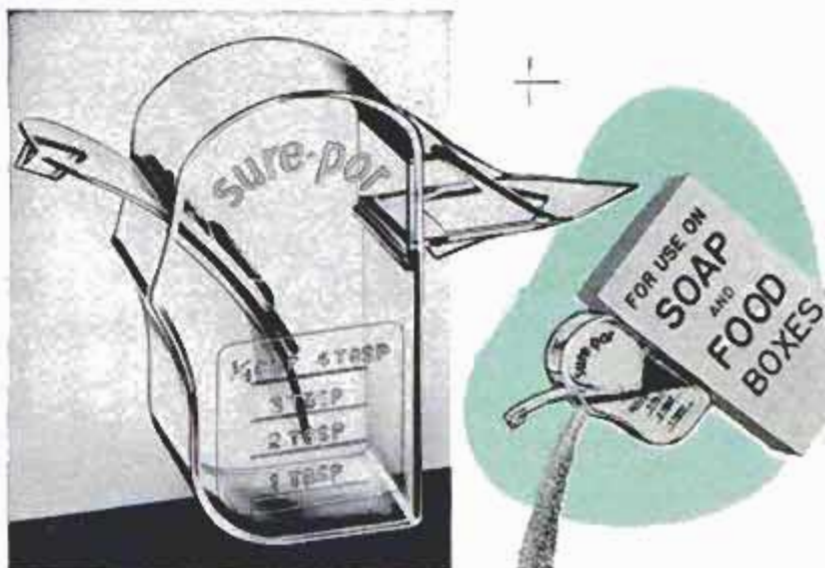

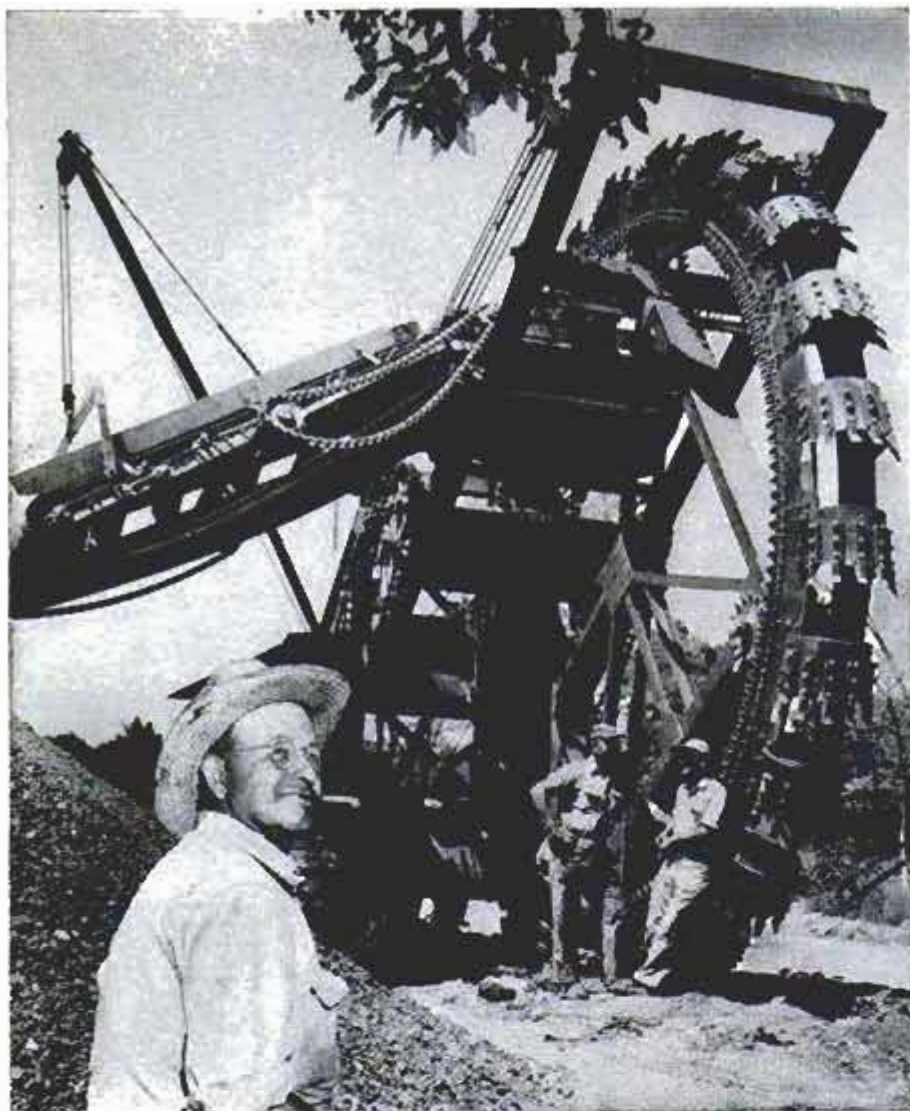

Circular Digger Claws Out Rock

Ditches 16 feet deep can be dug in rocky terrain by a giant custom-built machine in Dallas, Tex. Toothed buckets on a digging wheel with a diameter of 22 feet crunch through sand, rock and gravel, carrying their loads to the top and dumping them on a big moving belt. The digging machine was designed by contractor W. G. Cullum, Sr., built by two local steel companies and assembled on the job site in a period of more than a year. Each part of the machine was specially forged. Powered by a 250-horsepower engine, the mammoth excavating machine covers 600 feet per day and is being used to dig sewer lines.

Driverless Tractor Guided by Radio

Electric tractors equipped with a new control can follow twisting routes by themselves. An overhead wire strung along the predetermined route keeps tractors "on the beam" by radio waves. To call a tractor, you simply push a button on one of several control boxes along the route. The tractor comes immediately to your station. The system is convenient and flexible. Guide wires can be extended easily. There is no trolley or other physical connection between tractor and wire.

Ⓢ Promising reports have been made on an experimental toothpaste, not yet on the market, containing tin fluoride as a decay-checking agent.

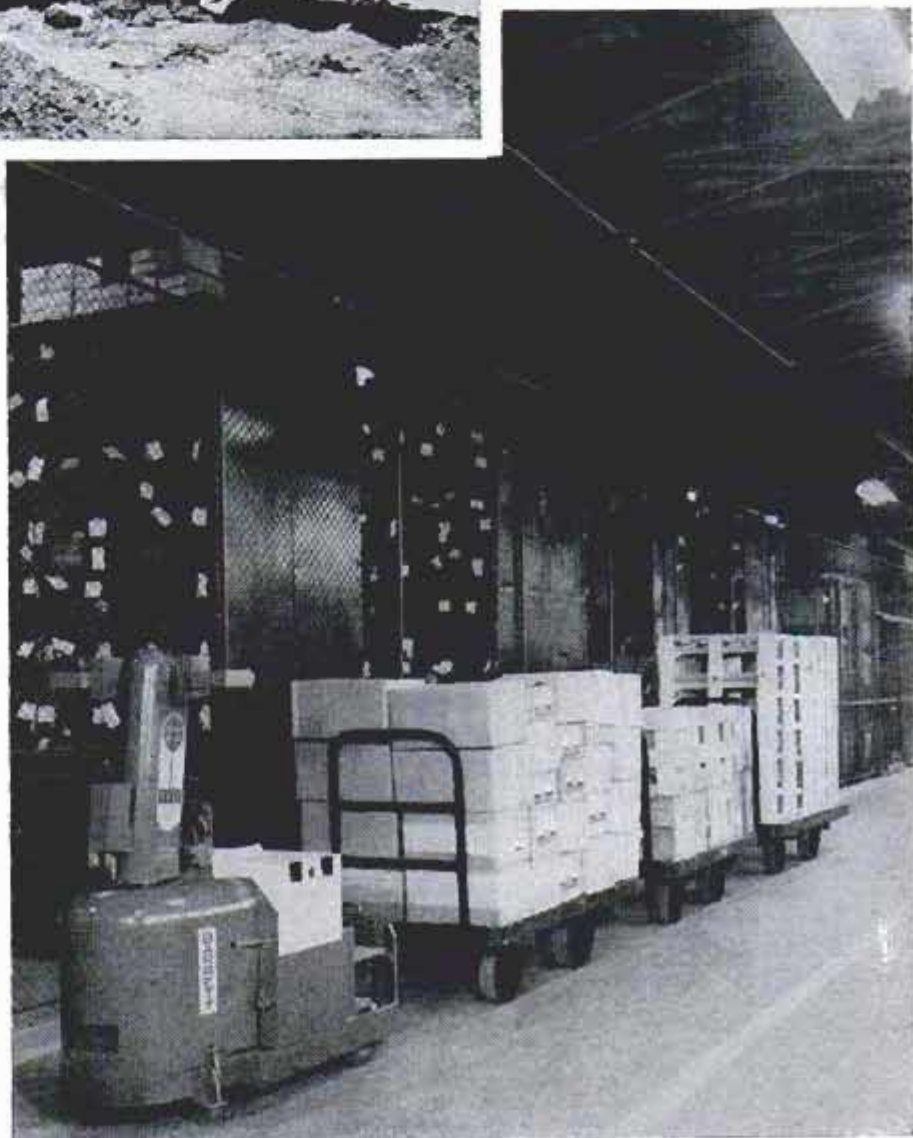

Cat Tricksters

AT 9½ NORTH MOUSE STREET, a little two-bedroom apartment in the rear of Ivan Messenger's home in San Diego, Calif., live two unusual cats. They're adept at tricks that only dogs usually perform.

Messenger, an artist, has taught his young Siamese Tai-Lai to wheel a tiny "mouse carriage" down the street. Prissy, an alley cat, bows his head and folds his paws on a little lectern upon command. Tai-Lai leaps through a small opening in an easel tripod as if it were a circus hoop. Prissy has been trained to ring for his supper by yanking a lever on a small bell stand.

Both cats can jump on a barrel and keep it rolling backward or forward. Other favorite tricks of the feline performers are jumping over a stick and climbing ladders. When not occupied with their tricks, the cats serve as willing models for the paintings and lithographs of their artist owner.

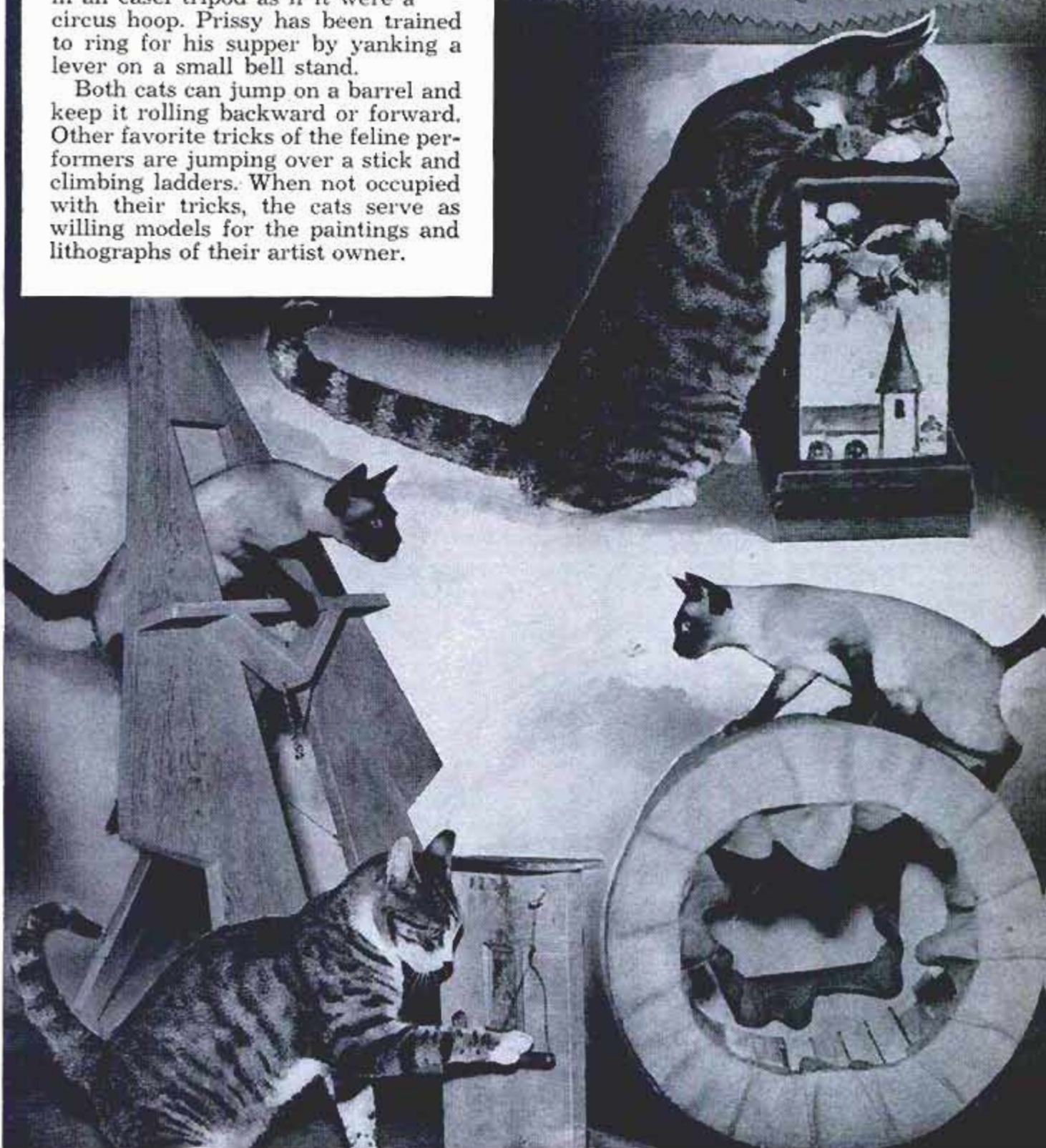



Drill rig, right, has hose leading to big "vacuum cleaner" above which packages dust for disposal



Rock dust and chips are sucked out of the drill hole by a huge vacuum machine that protects workmen from silicosis during rock drilling or quarry operation. The machine also speeds drilling because "down time"

Dustless Drill Rig

is held to a minimum as bits require less-frequent sharpening and changing. It also eliminates the need for "blow backs," another time-consuming operation. The dust is dumped into special collection bags for safe disposal.

Proposed Excursion Boat Features Seawater Swimming Pool

Safe swimming in the middle of the ocean is possible in a seagoing swimming pool proposed in Mexico. The 80 by 40-foot pool has steel-mesh sides and bottom and is part of a 244 by 107-foot excursion boat. A deck around the pool permits sunning and fishing, while the engine room, bar,

dining room, dance hall and other facilities are in the forward section. The proposed craft is moved by a propeller in front that forces water backward through a tube on either side of the bow. Steering is accomplished by closing either one of the two tubes. There is no rudder.

Swimming pool in rear half of boat is actually like a huge strainer that protects those inside from danger



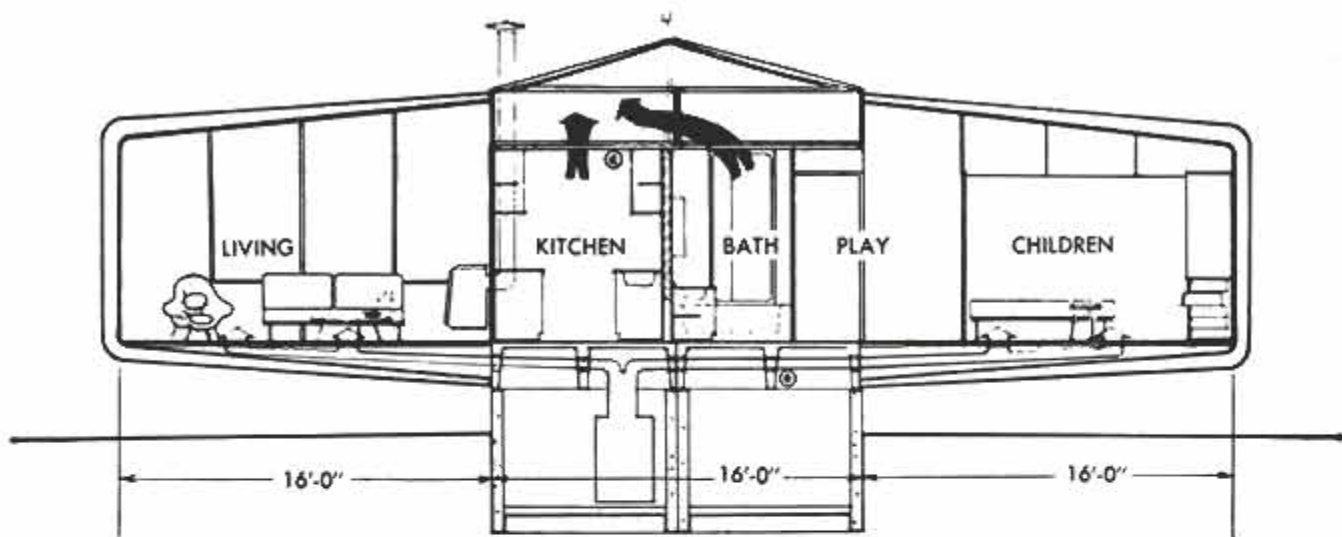

Molded Plastic House

ROOMS MAY BE EASILY added or removed to meet family needs in an experimental house made of molded plastic sections. These sections, 8 by 16 feet, are bent to form ceiling, walls and floor. Eight of the sections are cantilevered in pairs from a 16-foot-square central utility core to form four rooms. Features include movable partitions, curtain walls, varicolored panels to control light, conduits and ducts formed into wall and floor sections, foam plastics for insulation, and specially designed appliances. The design is being refined at the Massachusetts Institute of Technology in a project sponsored by the Monsanto Chemical Company.

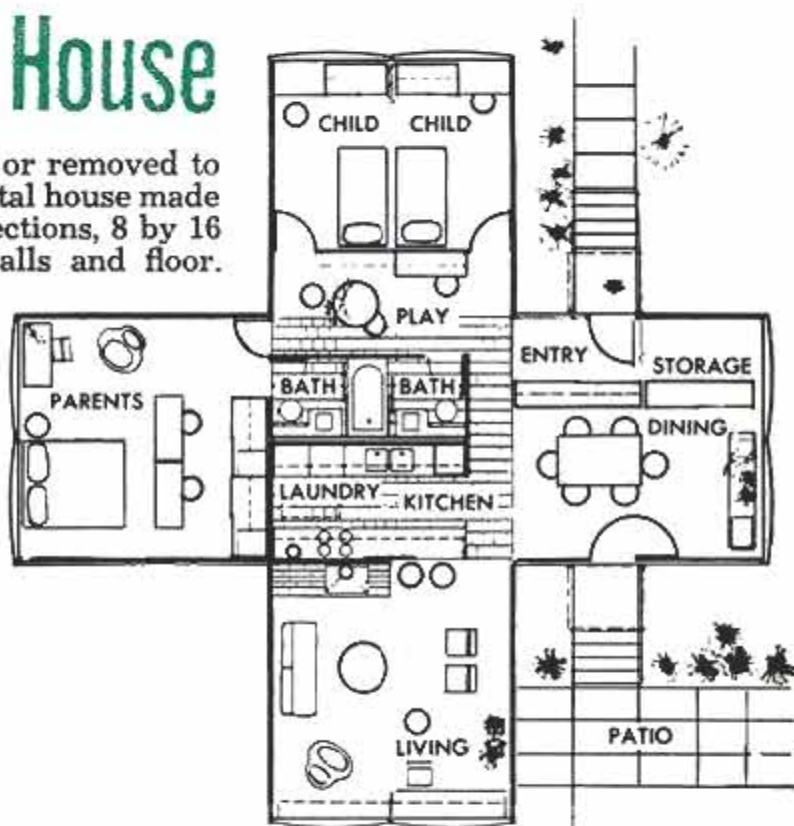

Arrows in top drawing show how air is exhausted from central core. Ceiling in this section is translucent. Home will have radiant heat

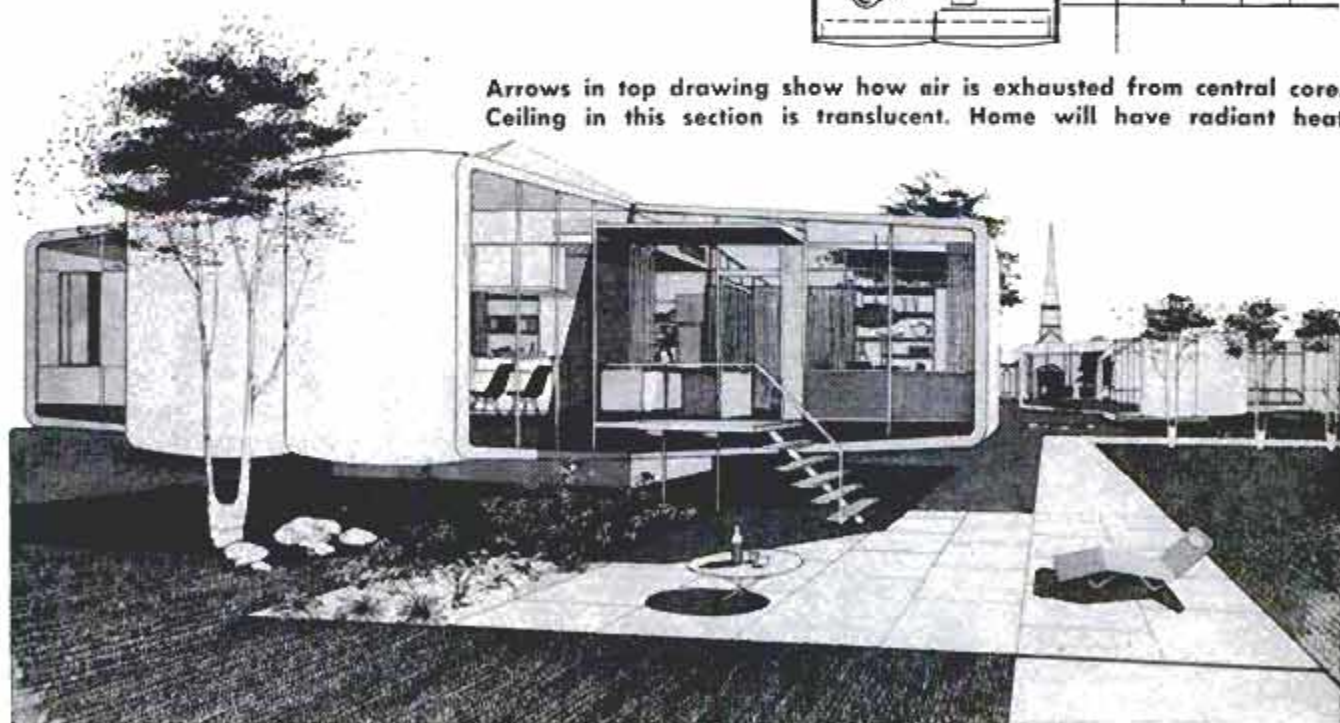

Undercover Enemy— the Khapra Beetle

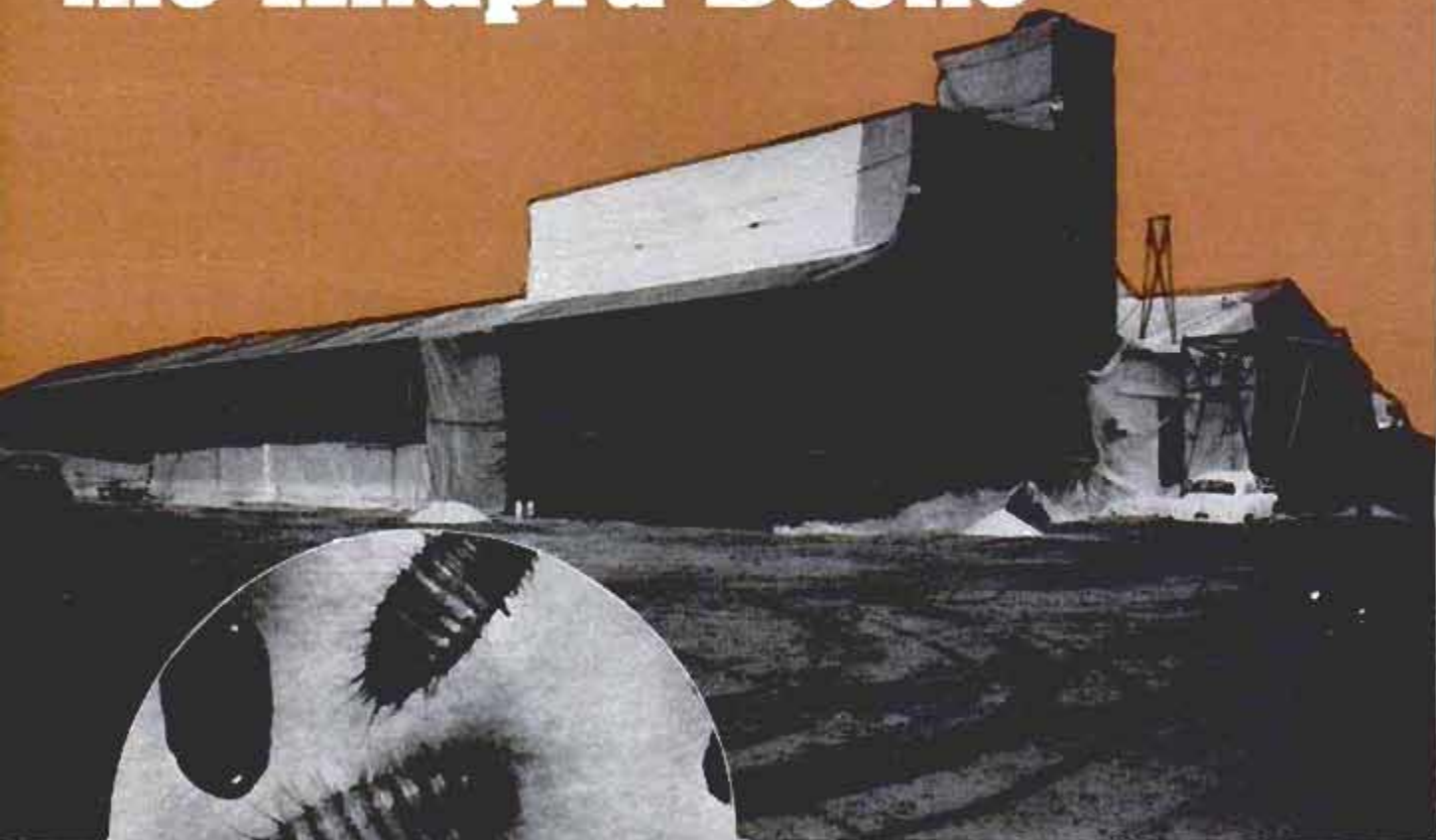

Dow Chemical Co. photos

Warehouse was wrapped with 100,000 square feet of plastic sheeting before fumigation test started

By H. H. Slawson

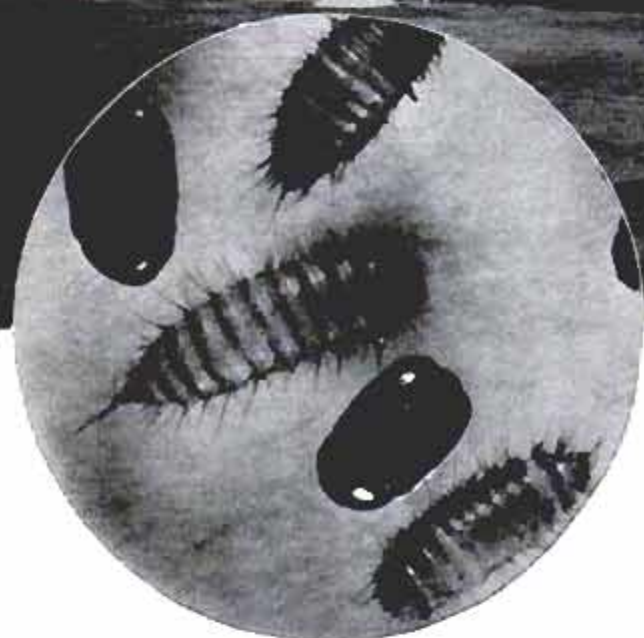

Adults and larvae, enlarged. Below, beetles were placed between bolted boards sealed on three sides. Gas entered through fourth side to kill insects

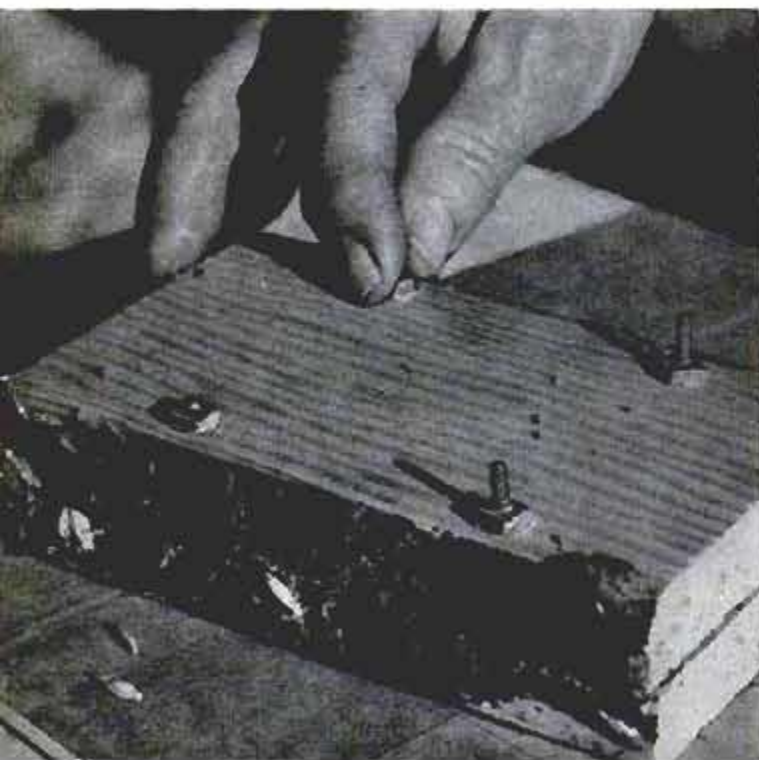

FROM CALIFORNIA to Kansas to Texas, a grim battle is being waged to save the nation's stored grains and processed foods from one of the most destructive insect enemies of the human race.

The villain is the khapra beetle, known to scientists as *Trogoderma granarium*. From its native India, it has spread to Ceylon, Malaya, Asia, Australia, Europe, Africa and now North America. It does not fly, but owes its far-flung travels to human transportation of infested materials.

Halted many times at United States ports by quarantine officials, the khapra beetle in 1946 gained entry to a warehouse in Fresno, Calif. The infestation was erroneously ascribed to the black carpet beetle.

Three years later, the infested warehouse was abandoned, together with the 300 tons of stored grain it contained. But insect-bearing burlap sacks from the warehouse were shipped to other California grain-storage buildings, which soon became infested.

In the fall of 1953, the beetle was correctly identified in the central San Joaquin Valley of California.

Hastily organized crews spread out to

look for the pale red-brown bug, which measures only $\frac{1}{10}$ in. long. Latest reports describe it thriving in 111 places: 80 in California, 28 in Arizona and 3 in New Mexico. Another infestation was found in a feed mill at Mexicali, south of the border.

The affected states applied quarantine measures, and federal authorities clamped stricter regulations on California, Arizona and New Mexico. Now, specified grains, seeds and food products must be cleared by Department of Agriculture specialists before they are shipped across state lines.

Meanwhile, the khapra beetle continued to multiply. According to one authority, the average female lays about 50 eggs. A generation can complete its life cycle in 30 days. In six months, under ideal conditions, the offspring of one female total 20,000,000 beetles.

The khapra beetle can live for three years without food, and for some time without water. It resists heat and cold and scoffs at many potent insecticides. Powerful fumigation with methyl bromide, however, might do the trick.

The insect fighters decided to wrap an entire building with gastight tarpaulins and pump it so full of gas that every last larva in every cranny and crevice would be killed.

An infested 1,000,000-cubic-foot grain elevator at Imperial, Calif., was selected as the test project. The corrugated-iron building, resting on a concrete slab, measured 120 feet by 280 feet with a height varying from 20 feet at the eaves to a 65-foot tower.

A five-acre area around the building was saturated with heavy malathion spray to kill any displaced beetles. Then came the task of wrapping the huge building in gastight tarpaulins. Seven men worked three days to cover the elevator with 100,000 square feet of canvas.

Polyethylene and vinyl-coated tarps were used at all points under any stress. Heavy spring clamps on the edges of the cover provided a gastight seal. The tarpaulin was anchored on all sides of the building in a tamped-earth trench. Four-inch bands of burlap covered the entire tarpaulin to protect it.



Live khapra beetles in screened Mason jar are placed in screw conveyor. Channel was then covered for test of gas penetration

One of the many cylinders of "cold" methyl-bromide gas placed in the warehouse discharges its spray through a riser tube

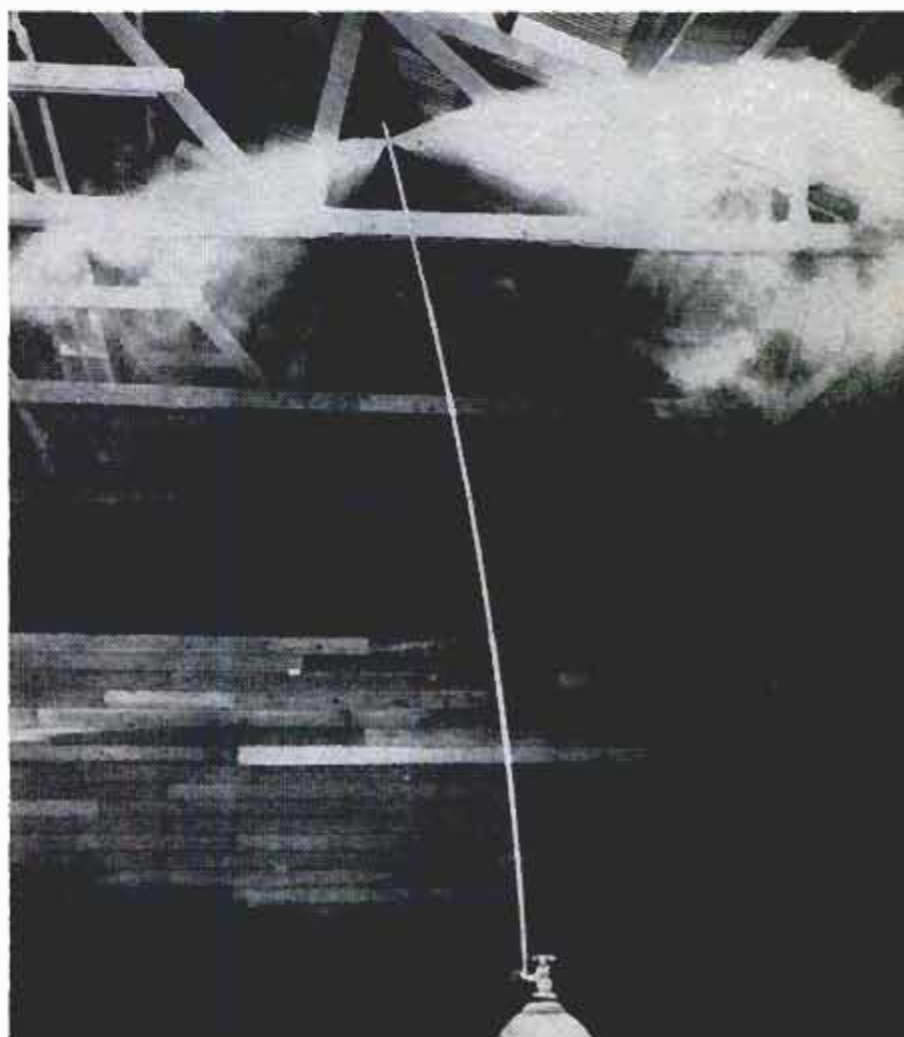



Test cages contained in cloth bags were placed in remote places to test effectiveness of fumigator

When all was ready, a 48-hour fumigation period began. Over 2½ tons of methylbromide gas were pumped into the building. One ton of methyl bromide and a fumigation period of four hours would theoretically kill all beetles, but the insect fighters wanted to be sure.

About 30 percent of the poison gas was sprayed "cold" from spray nozzles fastened to interior rafters and connected by hoses to cylinders. The rest was released "hot." The liquid methyl bromide was poured into five gas-fired boilers. After passing through copper coils inside the steam chest, the vapor traveled through garden hose to scattered outlets in the building.

As the gas was pumped into the building, the tarpaulins near the ground swelled out some six feet from the building's sides and remained so for 24 hours, indicating that pressure was being maintained.

Elaborate measures tested the killing effect of the fumigation. Beetles were wrapped in paper and placed in screened Mason jars suspended in cloth bags at remote spots. Other cloth bags contained short boards bolted together. Three sides

More than 5000 feet of plastic tubing were used to connect test cages with gas-analysis station outside

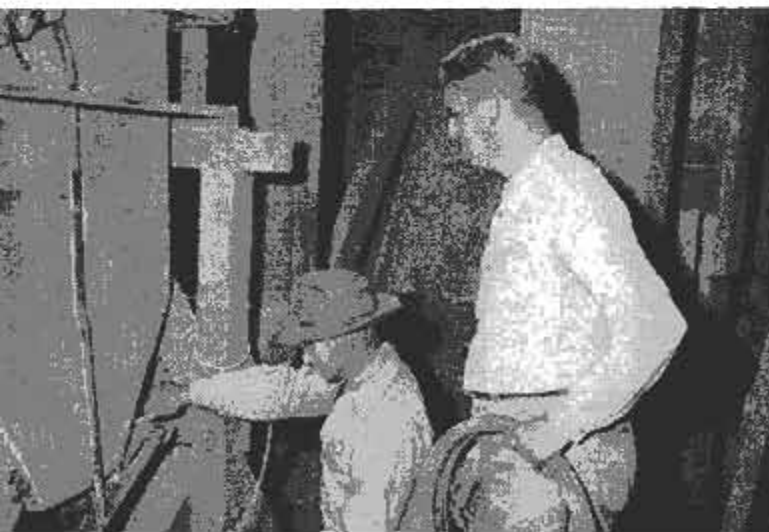

of the bolted boards were tarred so that gas could only enter through the short fourth edge and kill the live beetles placed between the boards.

Plastic tubes brought atmospheric samples from test cages inside the building to analysis instruments outside. Caged beetles were placed near the ends of the tubes so that mortality could be correlated with the gas intensity the instruments registered.

At the end of the 48-hour fumigation, the tarpaulins were removed. Test cages were collected and examined after a 10-day waiting period. Every one of the 166,541 beetles placed in them, including adults, larvae and pupae, was dead. The test cages were again closed and set aside for 30 days to allow live eggs to hatch. A total of 491,191 beetles had been hatched, but all were dead.

The Imperial project, directed by California's chief entomologist, H. M. Armitage, gave definite proof that a quarantined building could be returned to service safely. But much remains to be done. The khapra beetle is a hardy foe.

It has been reported living on grain of almost every variety; on dried blood, dried fruit, dried insects; on flour, noodles, nutmeats, tomato, flax and bean seeds, on grain straw, alfalfa hay and other materials.

It's a pest in English malting houses that use grain from North Africa, Syria, Iran and Iraq. British confectioners find the bug in peanuts imported from Nigeria, Burma and India. Infestations in Holland, Germany, France, Russia and other European countries have been traced to Japan, Korea, the Philippine Islands and Madagascar.

So far, economic damage by the khapra beetle in the United States has been felt only in the western coastal and intermountain areas. But if it ever gets beyond control, it would cause major trouble among a host of the nation's food-processing industries. The next 10 years will tell the tale, authorities say. Persons who believe they've spotted the beetle are warned to call the nearest professional pest-control operator, who will notify government specialists if it is the deadly khapra. ★ ★ ★

Five-Minute Test for Gold Reveals Minute Deposits

Prospectors, chemical researchers and doctors can save precious hours with a five-minute test for gold. The only materials needed are two test tubes, a medicine dropper, a reagent, acid and butyl alcohol. As little as one thousandth of a millionth of an ounce of gold indicates its presence by turning the sample a violet color.

Emergency Bailout

SIX-FOOT, 200-POUND DUMMIES, as nearly like the human body as sponge rubber, steel skeleton and cast aluminum can make them, have been taking rides on a supersonic rocket sled to test the emergency bailout system of the Convair F-102A. The sled screams down a 10,000-foot track at the Air Force Flight Test Center in California's Mojave Desert, reaching speeds of up to 750 miles per hour. The speed is so great that engineers cannot see what happens, but must depend on high-speed movie cameras to record the dummy's ejection from the plane. The sled hits its peak velocity, powered by eight rockets, 3000 feet down the track. Sustainer rockets keep this speed until the ejection is complete. In the last 2000 feet, the rocketing sled runs into a 2-foot-wide trough of water which acts as a brake and halts it.



1. Ejection begins as canopy is blown off. Total time between pictures one and four is five seconds



2. Next, pilot in seat is ejected by explosive charge. 3. At this point the seat detaches, opening parachute

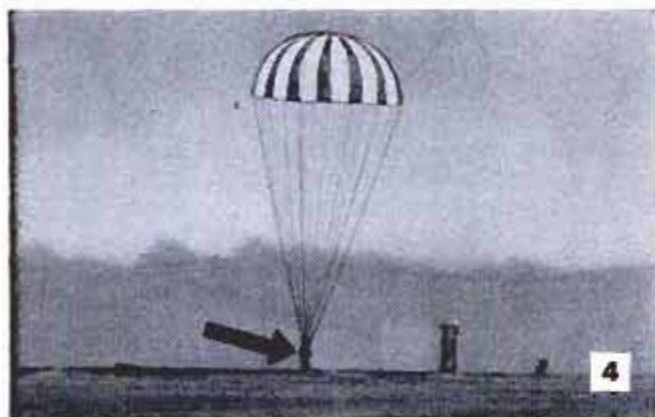

4. Pilot coming down safely under parachute. Below, sled is built for 16 rockets, but so far no more than eight have been used. Two of 10 rockets shown are used to sustain top speed. Water brake stops sled

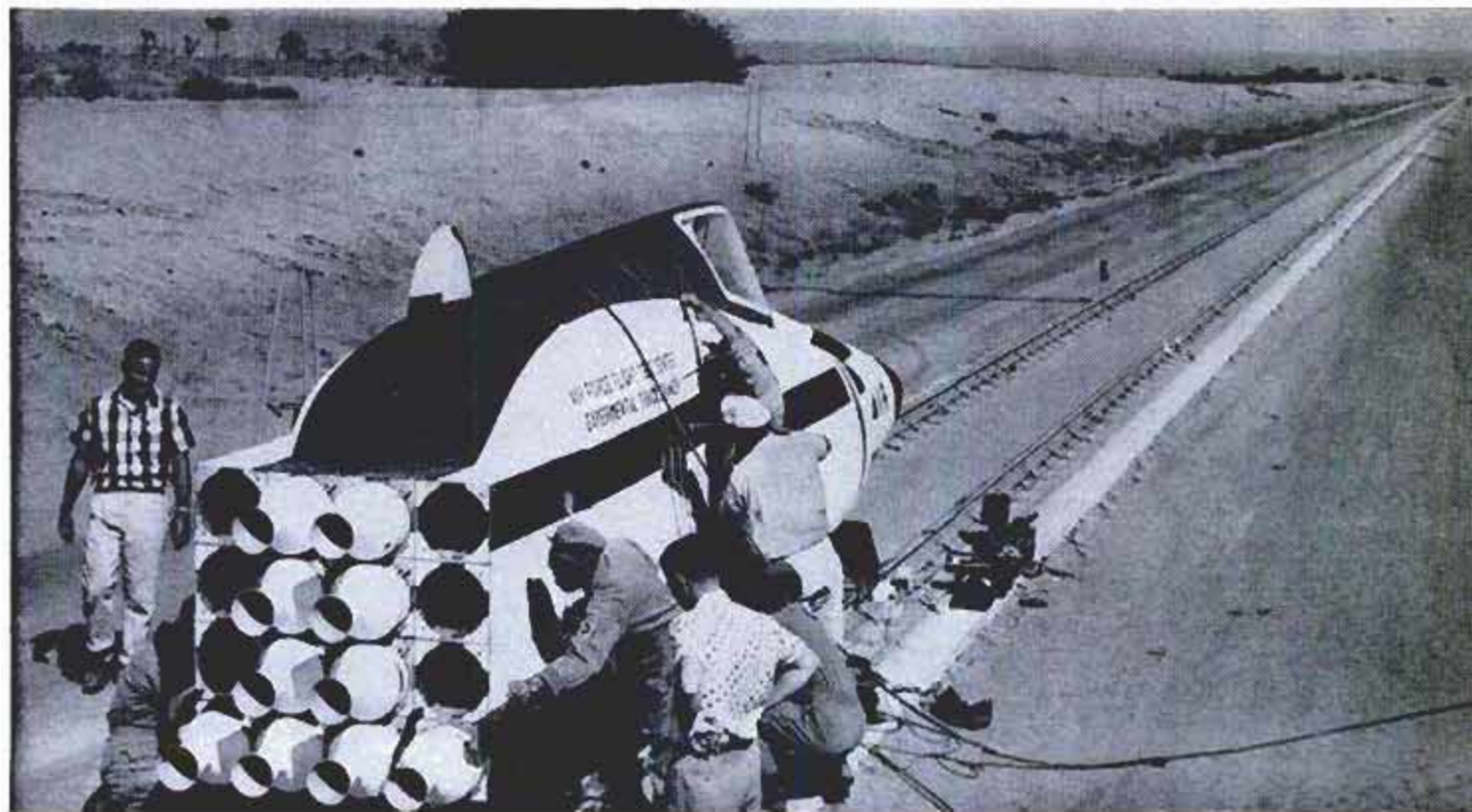
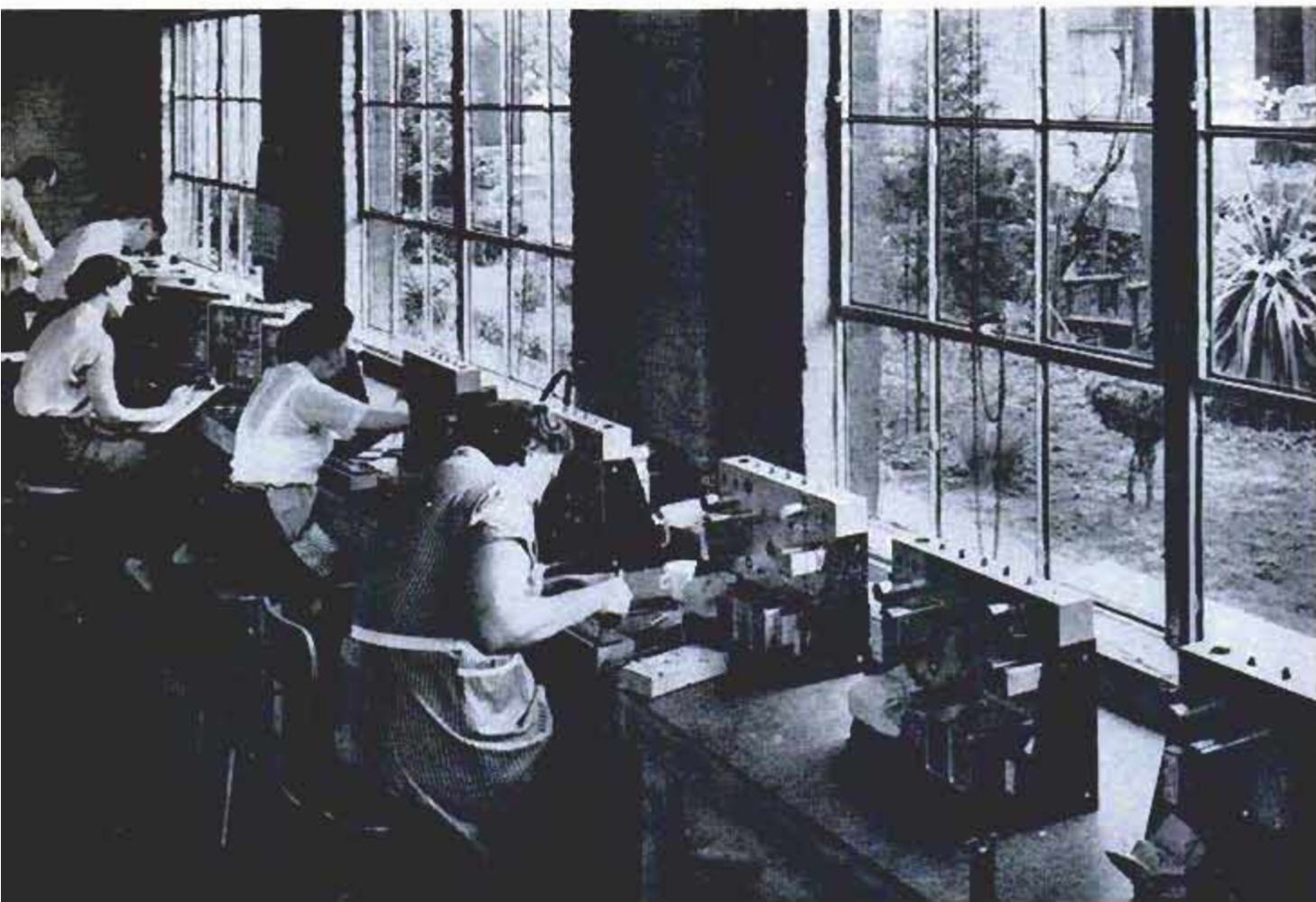
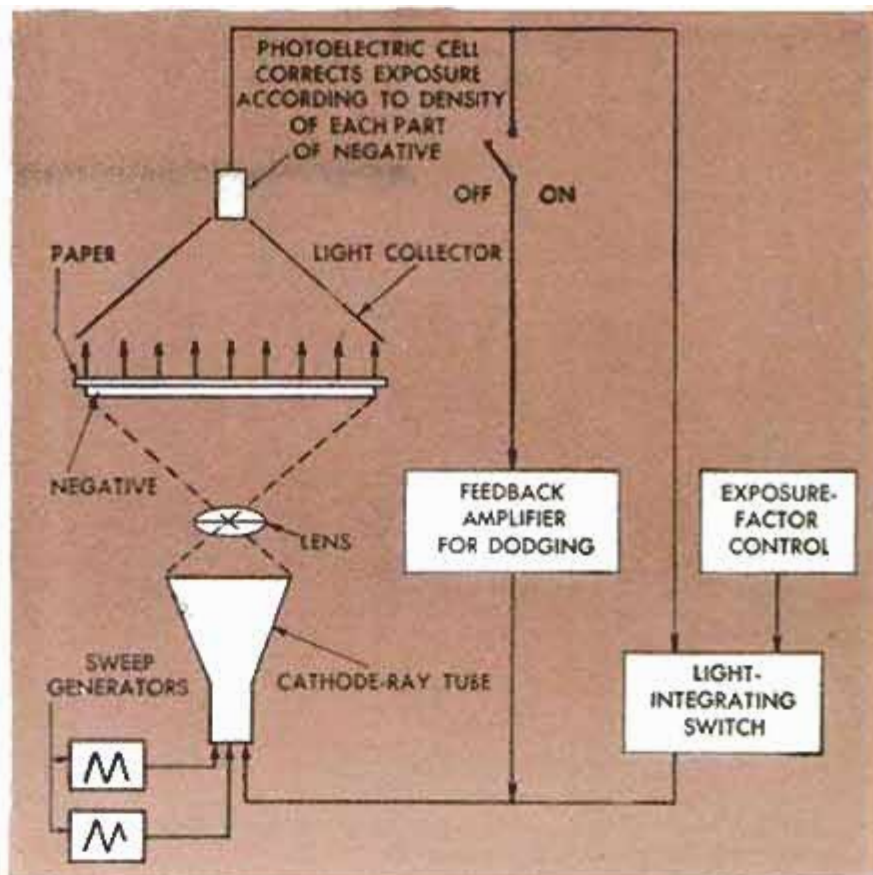
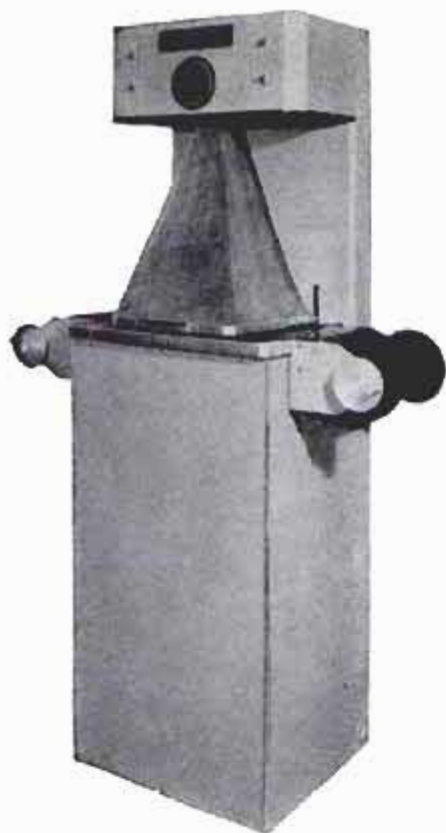



Photo printed by conventional methods has little detail in dark foreground or in bright area through windows

Same negative produced this print in the electronic printer. Note fine detail here that is missing in photo above





Photoprinter, built into a metal cabinet, has a feedback system which varies light according to the negative

Electronic Printer Brings High Fidelity to Photography

ELECTRONICS HAS been applied to photography to bring out the greatest possible detail in photoprints.

The two photos shown on the facing page were printed from the same negative, yet even a glance shows a surprising difference in detail. The top photo was made by conventional photoprinting methods, the bottom by a new electronic printer.

The printer uses an electronic scanner to record faithfully all the detail in a photographic negative. The system eliminates dodging and all other trial-and-error darkroom techniques designed to bring out the maximum contrast in each small portion of the negative.

Cathode-Ray Tube

Incorporated in the electronic printer is a cathode-ray tube. Coupled to the tube are sweep generators which produce the scanning light.

Built into the lower part of a cabinet, the tube projects its scanning beam through a lens and then through the negative. The print paper is placed above the negative, and above the paper is a photoelectric cell. The cell in turn is connected to a feedback amplifier which completes the circuit back to the cathode-ray tube.

In effect, the amplifier and cell correct the exposure according to the density of

each part of the negative. They do this dodging automatically through the feedback amplifier. Each print made with the negative is exactly the same, and each has the fullest possible detail.

One Setting Required

The printer requires only one manual setting, according to the speed of the paper which is being used. No further settings are required even when negatives are changed, as uniform prints are produced automatically from dense and thin negatives.

The printer has special value in the field of aerial photography. Photographs from the air frequently reveal intricate patterns of light and shadow on small areas of the negative. The electronic printer is capable of bringing out many such details which would be lost if the negative were printed by the conventional process. This results, of course, in more reliable interpretation of the aerial photographs.

The new printer also is used for commercial, scientific and industrial photography, where lighting is a problem.

A special model of the printer is used by hospitals and medical laboratories to produce replicas of radiographs and X-ray films. The process brings out greater detail in such films, detail which may be important to accurate diagnosis. ★ ★ ★

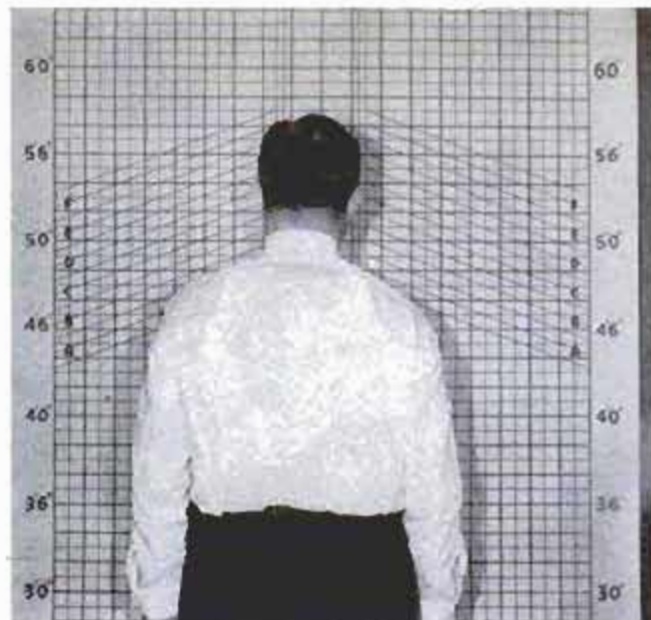
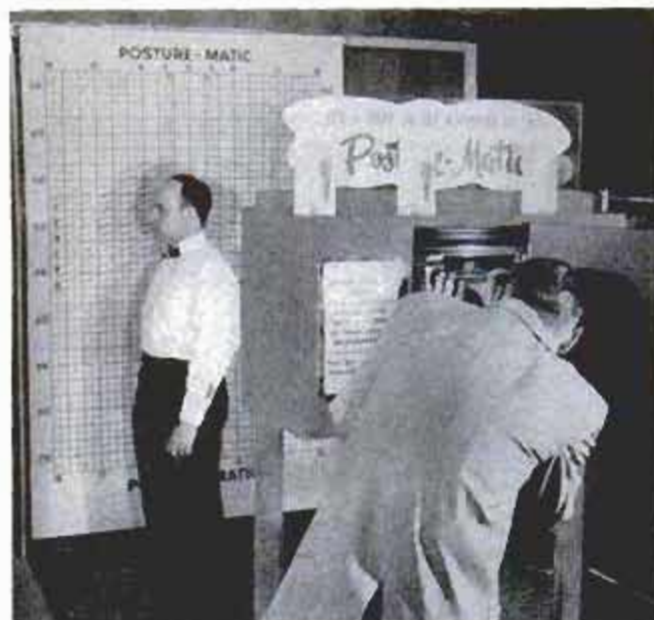

Tailor takes various photos to record customer's measurements, including slope of his shoulders and back

Tailor Photographs Customer to Get Exact Measurements

Tailors have taken a hint from the police and now photograph customers in front of a chart to get precise measurements. The camera used is a Land print-a-minute model and the prints are attached to the order

blank. Lines on the chart show the exact size of the customer and the degree of slope in his shoulders and back. The photos show how much lower one shoulder is than the other, a variation common to most persons.

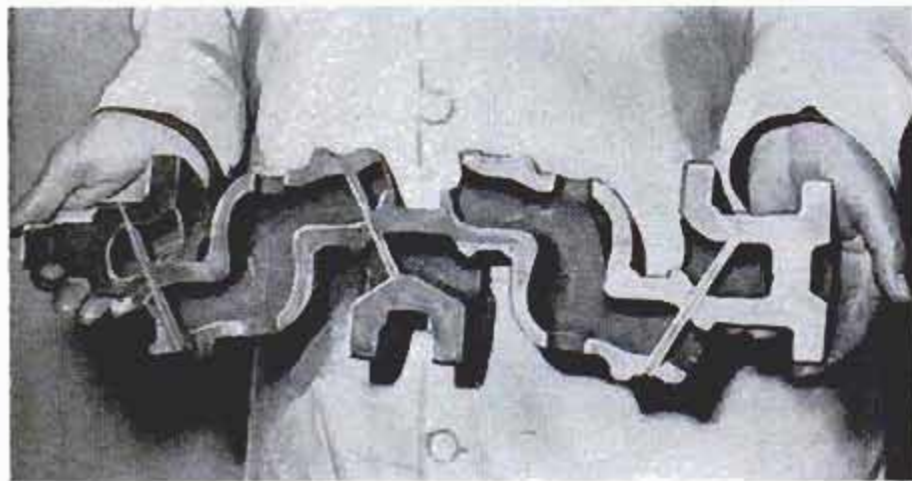

Hollow crankshaft is lighter in weight and is said to be better balanced than a solid one. Below, steel tubes in the casting carry lubrication

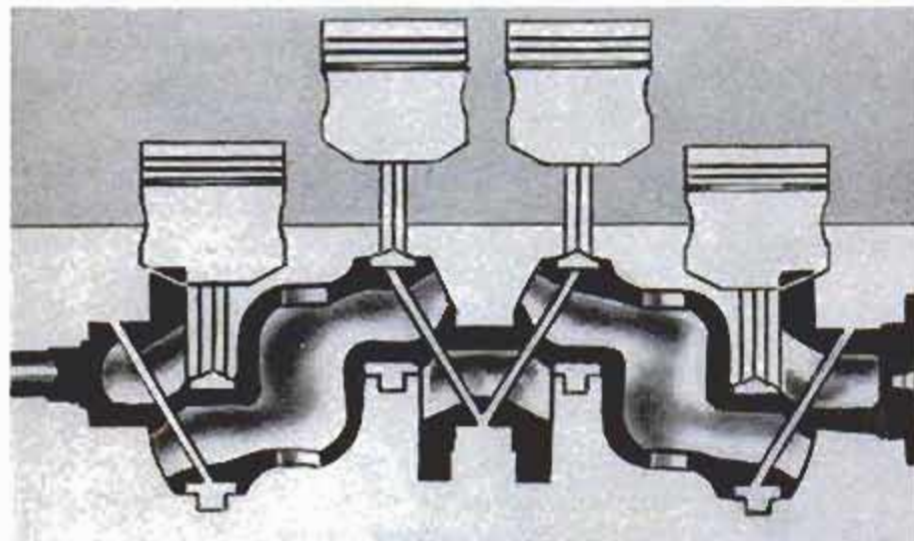

Hollow Crankshaft In German Ford

Many advantages are claimed for the hollow crankshaft now being used in the engine of the German Ford, the Taunus. Steel tubes are embedded in the iron during casting for the forced lubrication system. Among the advantages claimed for the hollow crankshaft are a 35-percent weight reduction, better balance due to improved metal distribution, greater rigidity and a lower cost.

Fish Shipped in Bags

Tropical fish are now transported with less loss in new shipping aquariums composed of plastic bags set in cardboard cartons. The container, accommodating 400 fish, consists of an outer carton, two inner cartons and two bags. The sides of the inner cartons are folded to cushion shocks and provide aeration.



Trailer studio equipped with loudspeakers entertains visitors at fair

Mobile Studio Follows the Fairs

FAIRS, SPORTS EVENTS and carnivals around Massachusetts are enlivened by music and programs from a traveling studio. Although the trailer unit "broadcasts" with loudspeakers, its interior looks like a miniature radio station. A glass partition splits the unit into an engineer's compartment and an announcer's studio. The engineer has a control panel, amplifiers, recording equipment and air conditioner. In the announcer's room are two turntables, two microphones, a playback announcer system, phone, speakers and a hi-fi unit. Michael Wynne-Wilson, owner of the studio, finances the speeches, club programs and music he dispenses with the paid commercials of local and national firms.

Capable of operating either indoors or outdoors, the studio has been in steady use since its start in 1954



MARCH 1956



Owner Michael Wynne-Wilson MCs programs from the announcer's booth inside the traveling studio

Chief engineer Alex Troy operates the control panel. Troy, together with Wynne-Wilson, designed interior

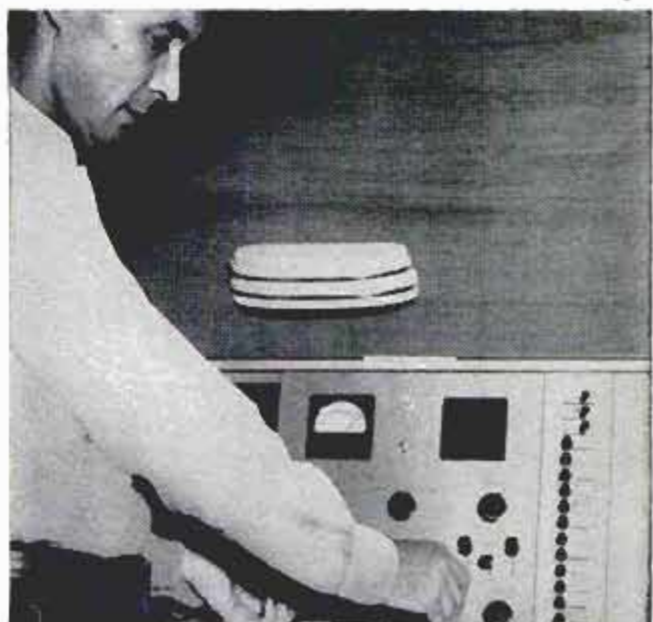

151

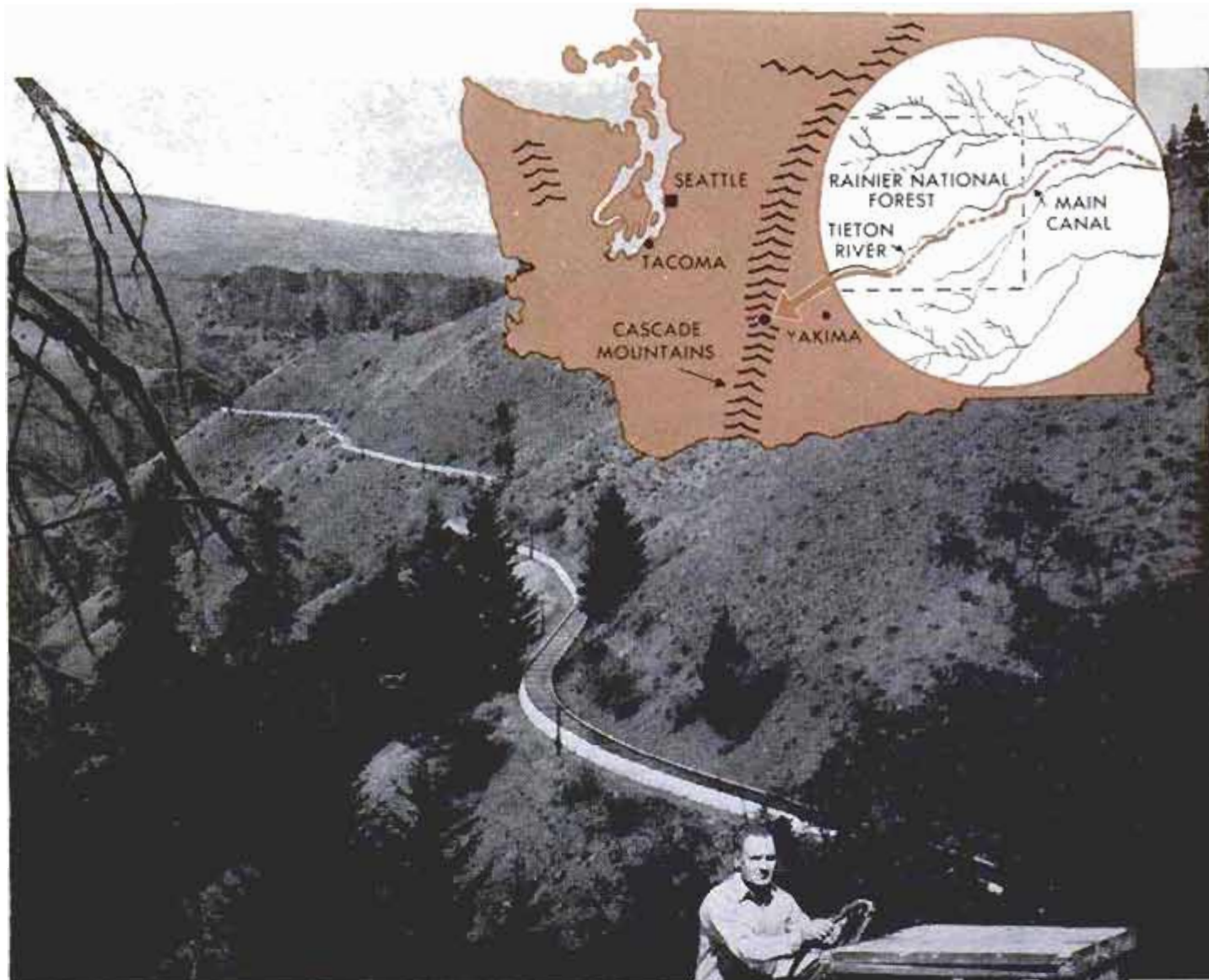

Canal snakes along mountainside, through tunnels, for 12 miles. Water irrigates 30,000 acres of fruit

Jim Stevenson rides the tunnel-running "Jitney." Only non-Model-A parts are the gas tank, '35 Ford wheels, Chevrolet spring shackles

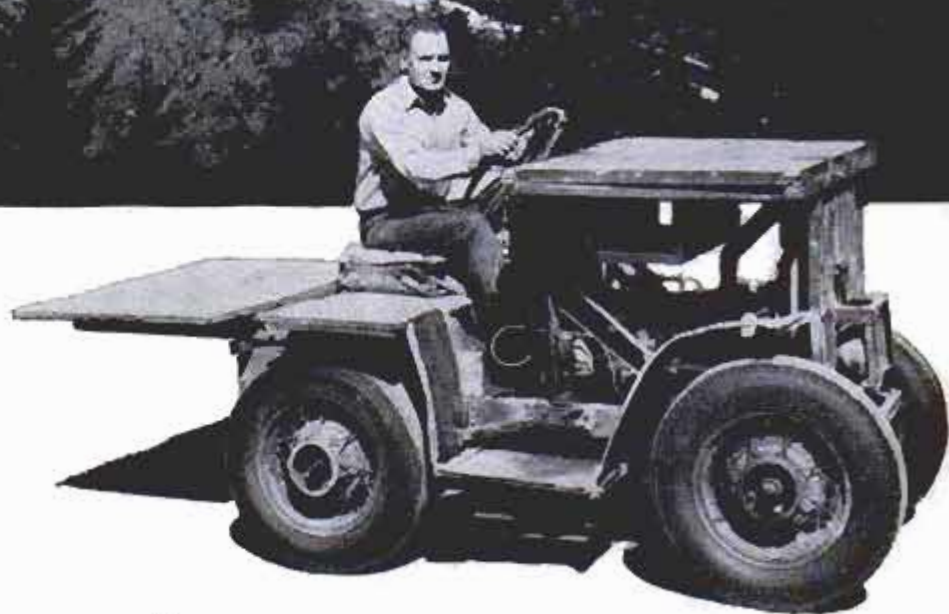

By Phil McCafferty

**For a wild ride
no carnival thriller can equal,
climb aboard the**

MODEL A on the CANAL BEAT

TAKE A MODEL-A FORD, remove the body, one headlight and the drive shaft, cut 4½ feet out of the frame, chop 20 inches out of the front and rear axles and you've got a "Jitney."

Jitney is the name lovingly bestowed on this condensed little car by her owners and builders, the Yakima-Tieton Irrigation

District near the city of Yakima, Wash.

At first glance, perhaps even Henry Ford could not identify the Jitney's breed, but Don Northcott, one of the men who helped build her says, "she's about 99 percent Model A." She is, too—all Model A save gas tank, wheels and rear spring shackles.

Hop on the seat to test the Jitney and

you're sure it's an "A." Punch the horn button and you get the Model A's distinctive "Ah-oo-huh." Remember how to start her up? Reach under, turn the gas pet cock, push the spark quadrant up for full retard, pull the throttle quadrant down just a bit, crack the mixture control about a quarter turn, belt the choke rod twice while depressing the starter button and she's off, cluck-cluck-cluck-clucking with metronomic precision.

A look at the Jitney would probably fail to arouse the emotions of the Hollywood custom fender-benders, and she certainly would not win a horsepower race. But she was custom built for a special purpose. She is the sole vehicle capable of ministering to the needs of the Irrigation District's 12-mile main canal.

The canal, a circular-shaped 7¼-foot-diameter concrete tube, carries water from Washington's Cascade Mountains to a branch system and finally into some 30,000 acres of apples, peaches, apricots, cherries and pears in the Yakima-Tieton area.

About eight miles of the canal have a six-foot-wide opening at the top. The remaining four miles plunge through five tunnels blasted out of the solid rock. All of it winds along a nearly vertical mountainside, accessible in only three places by normal-sized car or truck.

So the men at the district figured if they couldn't get to the canal, they'd get into it. They did too. During the winter months, from October to April—when the canal is dry—the Jitney runs back and forth through the canal carrying men and supplies needed for inspecting, cleaning and repairing the system.

Ordinary cars just can't travel through such a tube. They had to trim the Model A down to fit the canal. Wheelbase is 54 inches, tread is 38 inches. Those dimensions are just that for a purpose. If the Jitney were any bigger they'd never get it home!

Getting the Jitney in and out of the canal is quite a procedure—turning her around is just as wild. On a small flat area near the "A's" garage they built a ramp across the canal. Planks are run off the side of this ramp under an A-frame built over the canal. The Jitney is driven out on the planks, a block and tackle is attached to a hook directly in front of the steering wheel

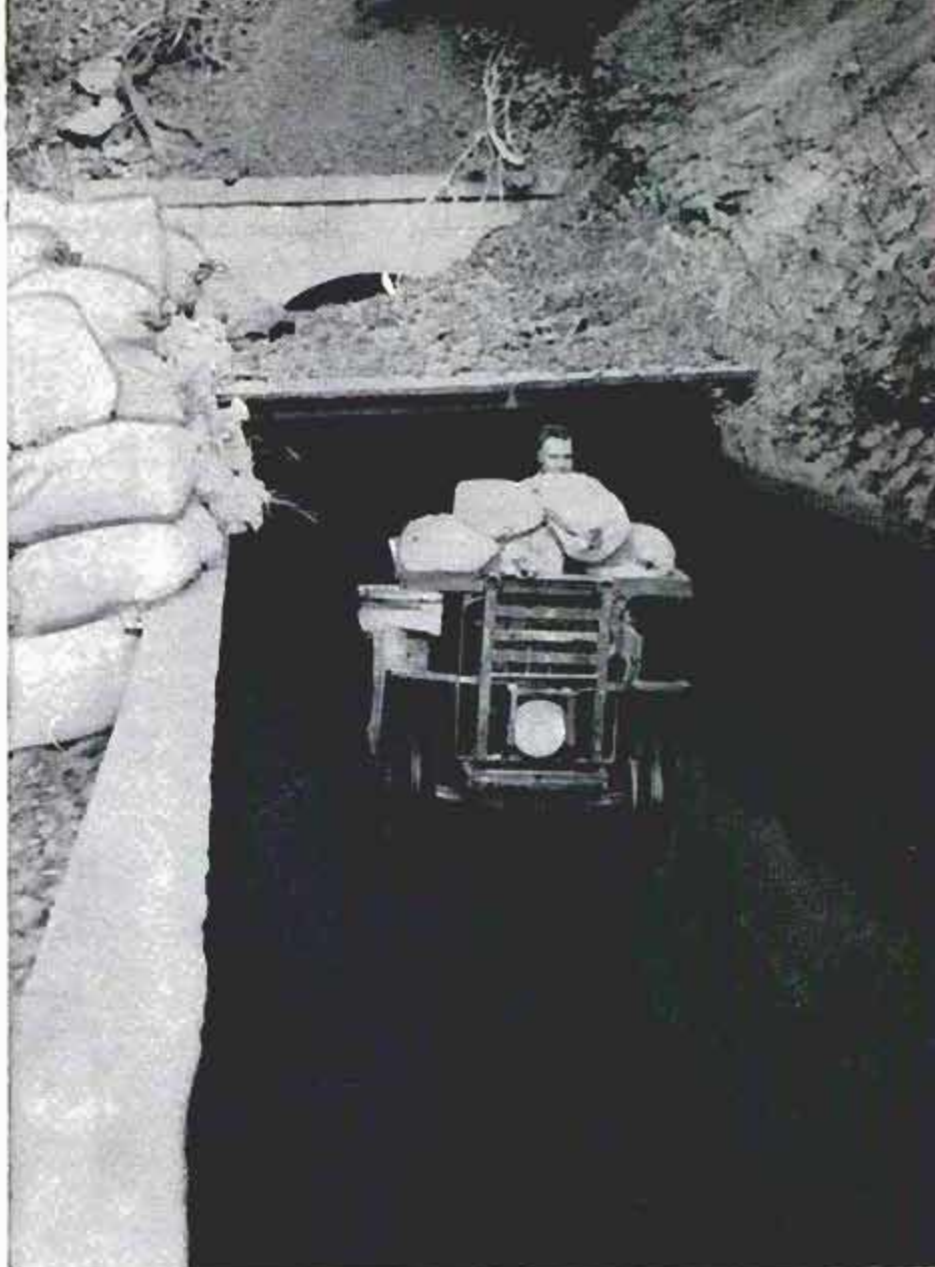

Laden with bags of sand for concrete work, the Model A clatters out of an inky black, 3000-foot tunnel. It often pulls the mixer

and the car is lifted up. The planks are slid aside and the car is lowered into the canal, ready to go.

Similar A-frames were built at several points along the canal. When the ditch rider wants to go home, he drives to a turn-around point and hooks up the hoist. By tipping up the back-deck section, taking off the extra front platform, turning the front wheels hard right and lifting the Jitney to the exact center of the canal it will just clear as he swings it around—heading it in the opposite direction for the trip home.

Keeping the Jitney in ready-to-go condition during crop-irrigating season is as important as maintaining a fire truck in a fireworks factory. Water flows through the canal at about 8,000,000 gallons per hour. Mercury-switched floats, located at strategic points along the canal, sound the alarm in case of trouble. If there is a break or obstruction in the canal—this is serious business to the 5000 water users—the



Car is hoisted to the widest point in the tube and turned around with aid of A-frame, block and tackle

water is shut off at the head gate and remaining water is dumped into the river below through huge 22-foot by 25-foot sump valves. The Jitney and a crew go out to locate and repair the damage in the drained canal.

In addition to her duties as year-round patrol car, the Jitney becomes a beast of burden in the winter when major repairs are made in the dry canal. She proudly totes a load that would probably break the spirit—if not the back—of some of Detroit's more modern productions. Almost daily during repairs, workers load her down with twenty-five 100-pound sacks of cement and sand—then they get on! Triumphantly she pulls this load—and pulls a chopped-down cement mixer behind!

Conservation men think she's about the greatest gal alive. Last winter the lives of 138 deer and elk were saved by the Jitney's operators during the dry canal season. The A's owners have built several game bridges across the canal opening, but the animals seem to prefer jumping into the canal on their way down the mountainside, especially during the harried hunting and mating seasons.

When cobuilder Don Northcott was asked if he still takes his creation for a spin, he answered, "No, I'm getting too old, I guess—I just haven't got the nerve any more!"

A test ride in the tube is perhaps somewhat more thrilling than taking a first ride on a bobsled. Though the car never at-



Planks are laid over opening of huge sump valves to allow car to pass. Valves release water in emergency

tains a speed over 40, a spin on the Jitney is well calculated to scare the socks off an Indianapolis "500" driver.

Driving in the canal is a bit different from a Sunday spin. Ordinarily the canal is strangely silent. But wind up the Jitney and the echoing roar of its unmuffled exhaust is almost deafening. Since the Jitney's tires wedge against the canal's circular sides, steering is difficult.

When you ask the Jitney's driver-care-taker Jim Stevenson for a ride he gives you a knowing grin. "Just pull up a sack of cement and hang on," he says. There are no passenger seats. Even the driver sits on a cement sack when she's loaded. Starting out is effortless even in high gear (the canal only drops seven feet per mile). As you gain speed you'll note with some displeasure the steel bars holding the top of the canal together at four-foot intervals are whizzing by at an alarming rate. Don't stand up—they're only 18 inches above your head now!

Going into the first sharp curve is the real sensation. First thing you'll note (after the hair on the back of your neck stands up), is that your hands are locking themselves onto the deck edges. Stevenson says he'd rather take a curve on the highway wide open in his car than take a canal curve at 25 with the A.

Because of the curved canal sides it is necessary to bank the Jitney up on the side to take a curve at any speed. If there were more room in the canal, and if the car



Jitney plunges into tunnel as it makes first canal inspection trip after fall water shutoff

could turn more than about 15 degrees (because the tires are so close to the frame) more speed could be attained. Then centrifugal force would plaster you out against the wall, but taking a curve with the chopped A gives you a sickening feeling that you're going to tip over—which is entirely possible.

With the exhaust roar you couldn't talk to the driver if you wanted to, but by now he's wearing the same smile you get from the onlookers as you stagger off a roller coaster.

Bank through one 90-degree turn right into another one—wham—you're in the Rail Creek tunnel, probably the blackest you've ever seen. The Jitney's one headlight switches on. Better keep your head down because jagged rock is only eight inches above your head.

Future heart-stoppers will be about the same for the rest of the trip, but the chances are pretty good you'll come roaring out of a curve and meet face to face with a 1400-pound bull elk who has mistakenly jumped into the tube. By now you've had your thrills, so Stevenson will slow down and gently nudge the big fellow down the canal with the A's nose so he can get out. That's what the Jitney's heavy steel grille is for.

"Henry," first canal car, was a cut-down Model-T Ford of about 1920 vintage. When the "T" wore out, they

(Continued to page 242)

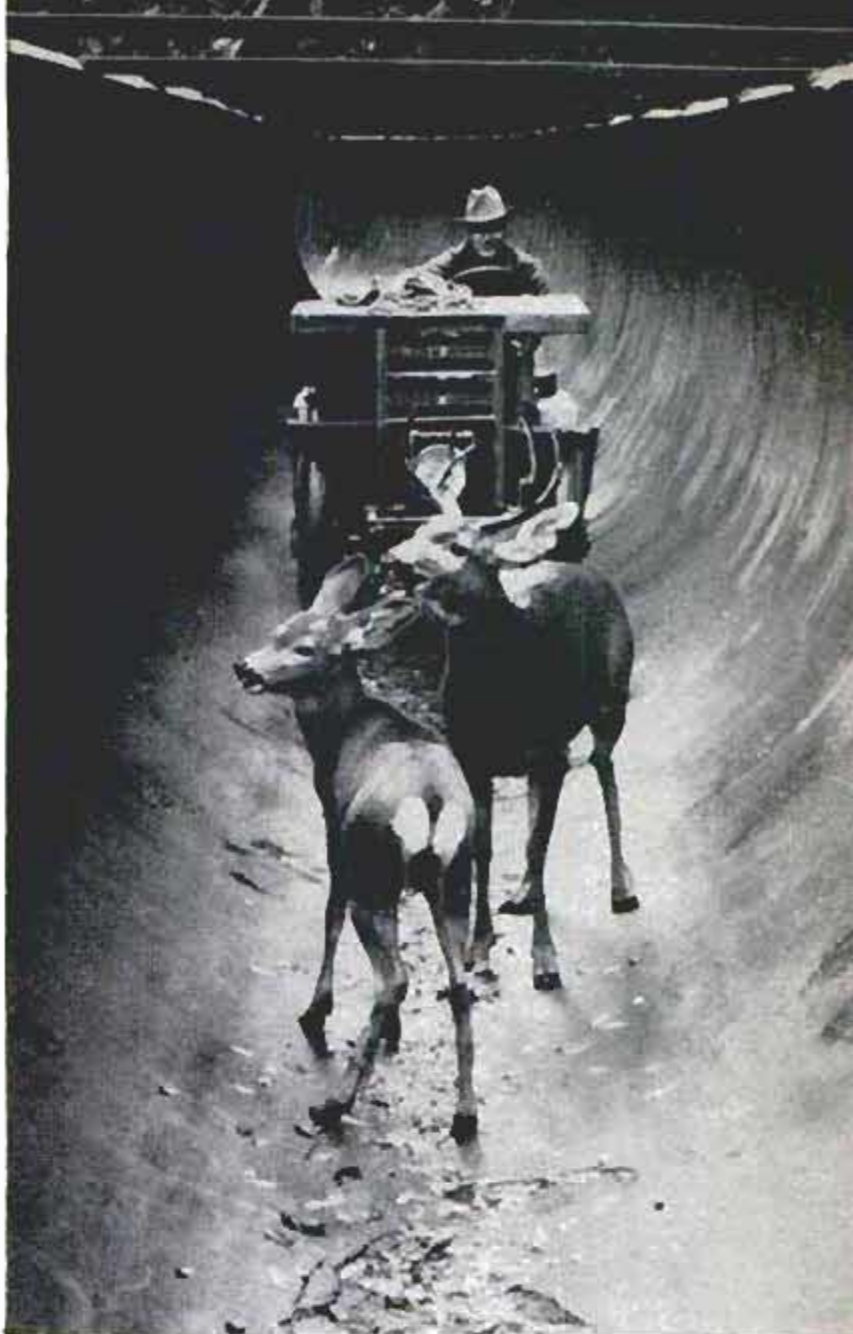

Bewildered game animals like these deer get into tunnel, which is dry during winter, and have to be lifted out or driven out. Below, shape of tunnel makes travel rough on tires. Driver Stevenson points to worn outer tire edges

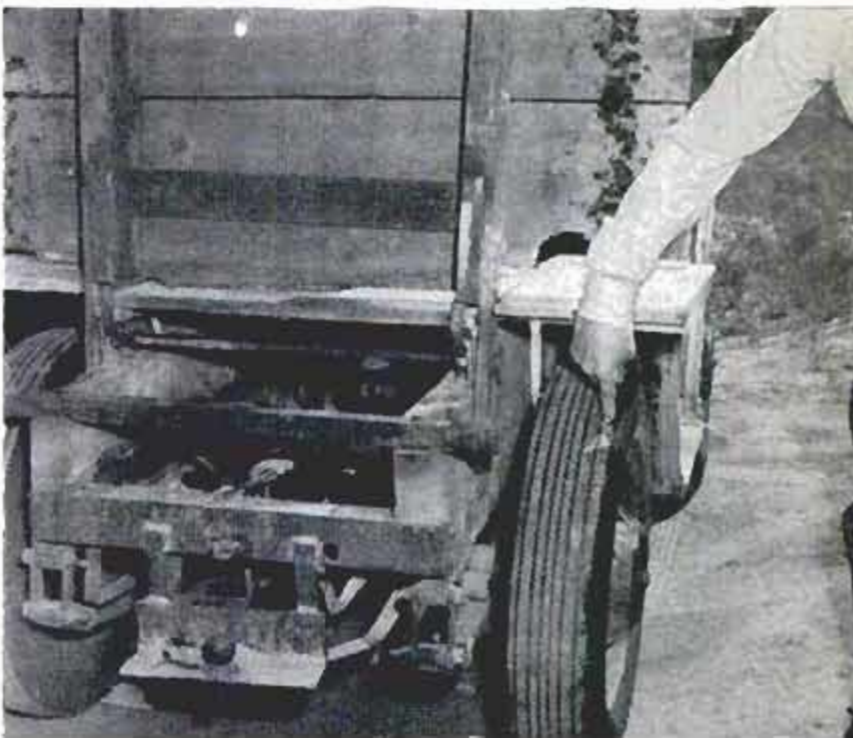

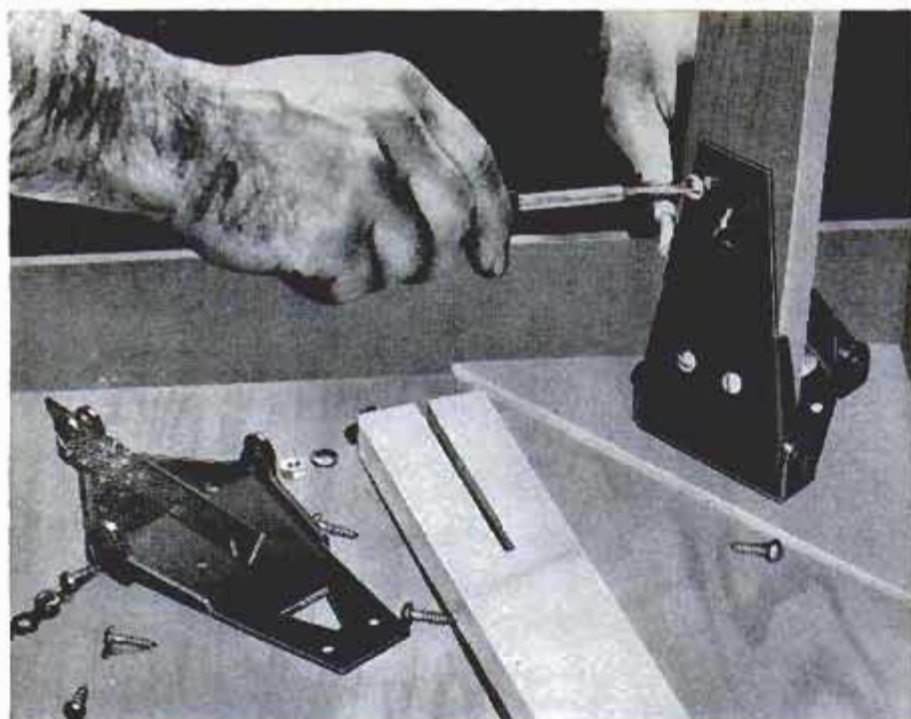

Folding Hinge For Table Legs

With the aid of a special hinge, craftsmen can make their own folding furniture. The heavy-duty hinge is designed for tables requiring strong, rigid support such as model-railroad layouts, table-tennis tables and picnic tables. A brace locks the hinge in the open position. Installation requires only the drilling of a hole and the cutting of a slot in each leg.

Folding table leg is fastened to the heavy-duty hinge with four screws

Basement Flooding Prevented by Valve

Basements are protected against flooding by an automatic valve mechanism which is installed over clean-out openings in the floor. The valve is encased in a long tube which extends down into the storm-drain line. The upper part of the mechanism is connected to a motor and pump. When flood waters or back-pressure water from the sewer or sanitary lines tend to rise, the valve automatically locks, making it impossible for the water to back up into the basement. At the same time, the pump and motor remove any seepage water that collects in the drain line behind the closed

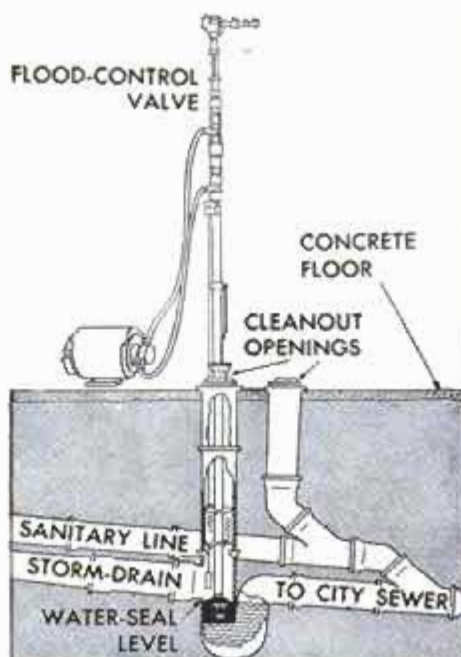

valve, pumping it out through the valve and into the city sewer, thus clearing the line of all water.

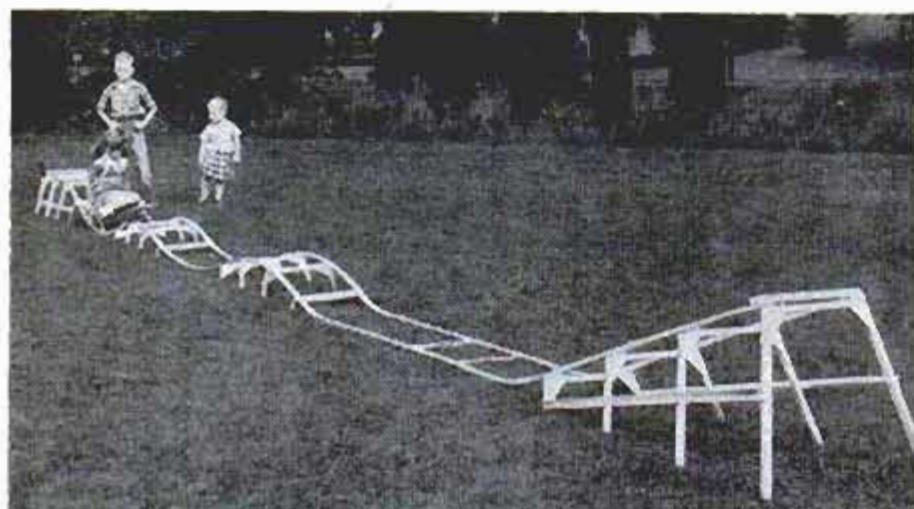

Roller Coaster For the Back Yard

Back-yard play areas can now have all the thrills of a midget roller coaster. This ride isn't as big or as steep as the real thing, but it has enough "waves" to give the children a lot of fun. It can be assembled in lengths of 20 to 200 feet and three models are available for different age groups.

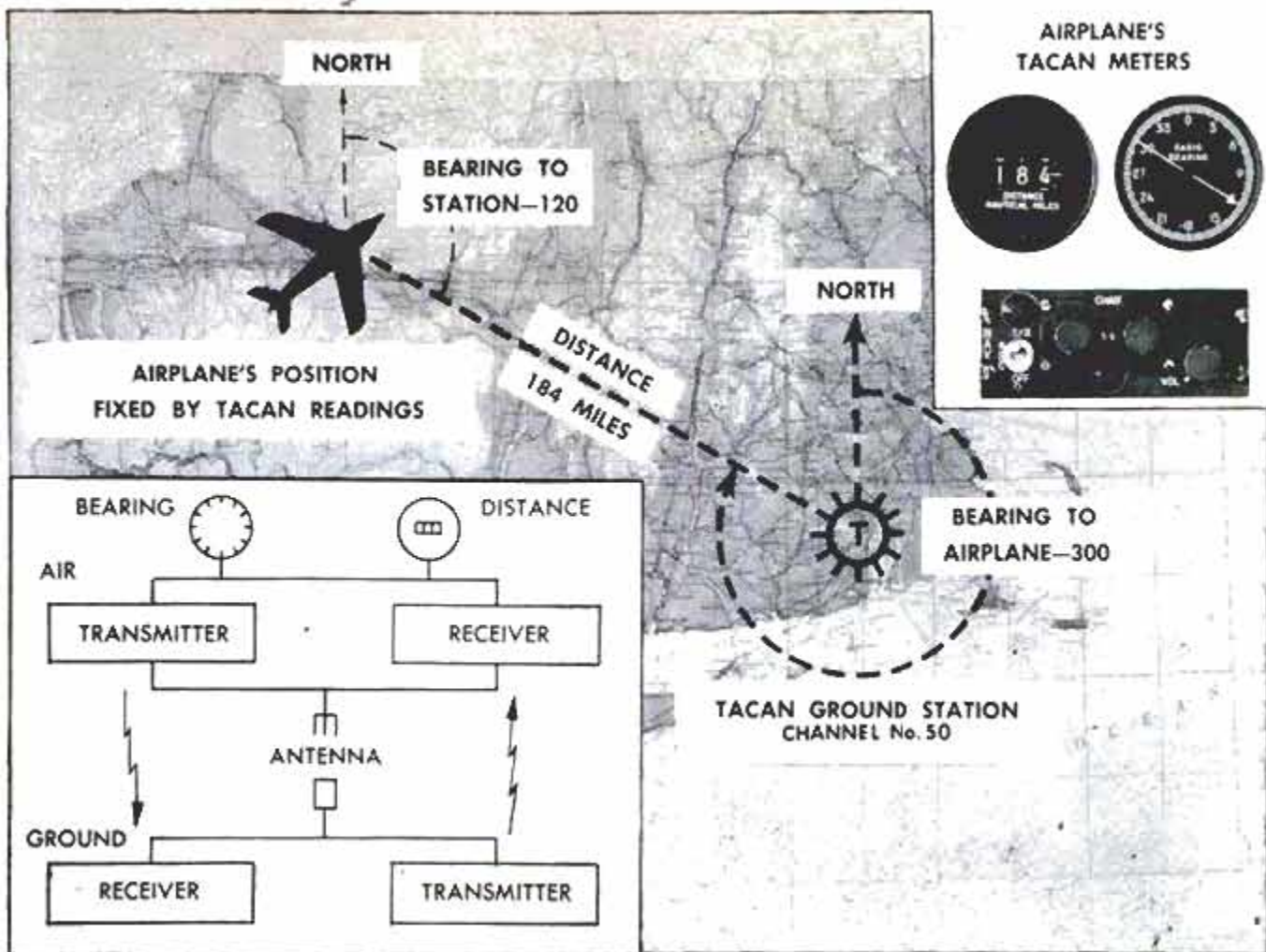

Diagram and map show how TACAN computes plane's bearing and distance. Meters give figures to pilot

TACAN Pinpoints Position For Airplane Pilot

MILITARY pilots now are using a new all-weather navigation system that determines a plane's position with pinpoint accuracy. The system may also be used for commercial flying in the future.

Called TACAN (tactical air navigation), the system requires only one radio channel instead of the several needed for other instruments which perform the same functions. A transmitter-receiver aboard the plane sends out a series of radio signals to a TACAN ground station. An electronic computer measures the interval between the query and the reply signal from the ground, and converts the information into nautical miles. At the same time the cylinder-shaped antenna on the ground is sending out direction signals as it rotates. The result is that the pilot can read his distance from the ground station on a taxi-type meter and his bearing on a dial.

The Air Force and the Navy now are using TACAN and the Civil Aeronautics Administration is studying the system for possible use on commercial airways. A light, compact TACAN unit has been developed for use in private aircraft.

Cylindrical antenna revolves atop an experimental TACAN ground station. It sends out direction signals





The rink of this skating troupe in California was on a trailer on the highway last night, put in place on the fair grounds in the morning and now the skaters are ready with the first show of the evening

Panels that are actually sandwiches consisting of Freon-gas tubes in mastic bound between two layers of sheet steel are laid out and the tubing is connected. Compressor unit in truck provides refrigeration

During the day, when the hot sun would have the compressor running wild trying to keep the ice frozen, aluminum reflector panels are used to cover the rink. Trailer in background is used to transport rink





Ice Rinks on Wheels

ICE SKATERS no longer wait for a freeze before getting their blades sharpened, and they don't have to go searching for a pond or river to cut their figure-eights. Now, whatever the weather, a crew of men unrolls a few miles of flexible pipe on a playground or at a county fair, truck-mounted compressors start chugging and the next thing you know, the skaters are pirouetting on a slick rink.

Manmade rinks aren't new, but until recently the equipment was so bulky and difficult to handle that moving a rink from one spot to another was undertaken with about the same zest as moving the Empire State Building would be. Then inventive minds went to work. In Wilmington, Del., where normally no more than two or three weeks of ice skating could be expected in a year, a civic-minded recreational group installed a portable rink in a field used for baseball during the summer months. Using flexible plastic piping made from Du Pont's "Alathon," they set up an 85 by 185-foot rink that provides outdoor skating when temperatures reach the upper 60s.

An ice-skating show, anxious to play before audiences at county fairs along the West Coast, came up with another version of a portable rink. This one consisted of Freon tubes packed in a mastic and sandwiched between steel plates. A number of these panels are laid side by side and interconnected. Then water is sprayed over the sandwiches until a thickness of ice is built up. This rink has been used in areas where the temperature reached 110 degrees in the daytime. Aluminum reflector panels are used to protect the ice from the sun under these conditions. But the panels are removed long enough before the show goes on to permit the hard ice to soften slightly, so the skates can bite in for control. ★ ★ ★



Plastic tubing to carry refrigerant is connected to the supply pipe in Wilmington, Del., playground rink



Above, truck carries four compressors to provide 140 tons of cooling for 85 by 185-foot rink. Below, after pipes are covered with sawdust, water is sprayed on to build a layer of ice three to four inches deep



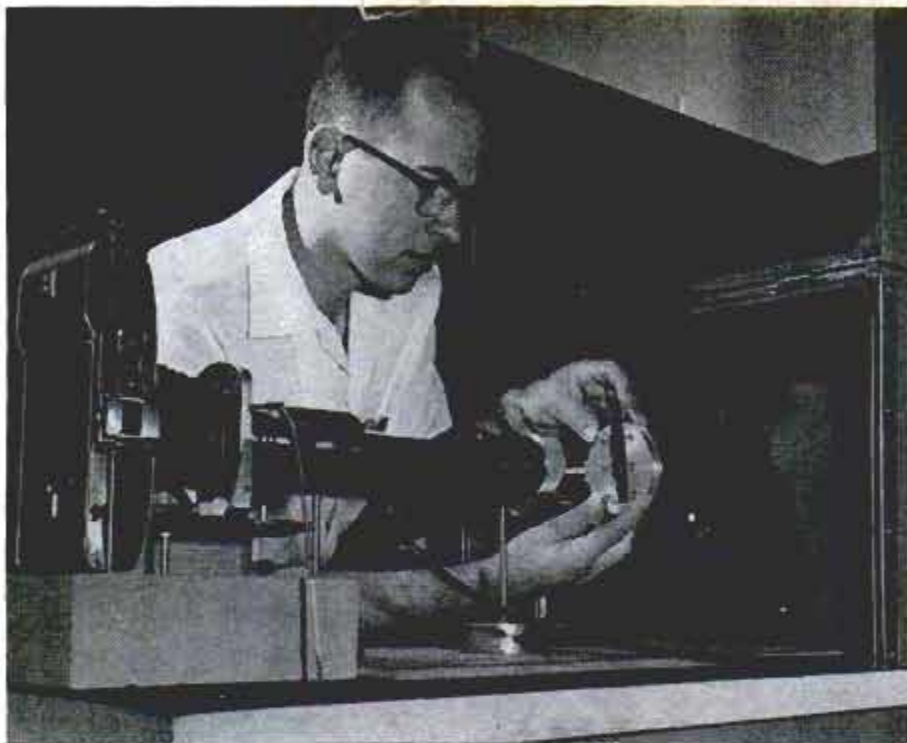

Infrared "X Ray"

With a modified World War II "snooperscope," physicist William Dash finds that he can look through purest silicon—which has the appearance of stainless steel. The wartime device enables the General Electric scientist to study the interior of silicon sections microscopically, in polarized light. An ordinary incandescent lamp is placed on one side of the silicon section. The silicon stops all visible light, but allows infrared rays to pass through and be changed to visible light by the scope.

Reusable Filter For Home Furnace

You can rinse the dirt from a new air filter and reuse it indefinitely in your furnace or air-conditioning system. An un-oiled filter of selected synthetic fibers, it removes and retains dust particles from the air stream by means of an accumulated static charge. The unit is rinsed with a stream of cold water from a faucet or hose. It is said to last the life of the furnace.

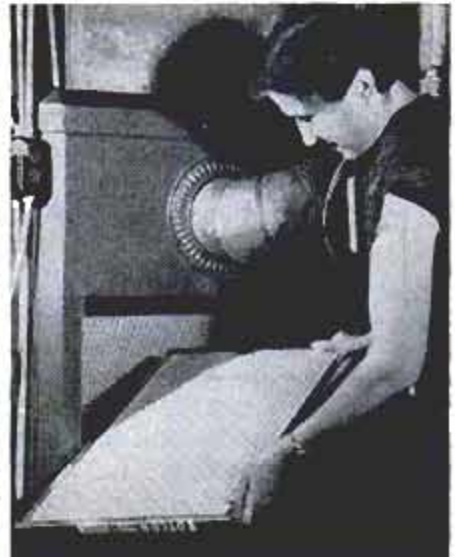
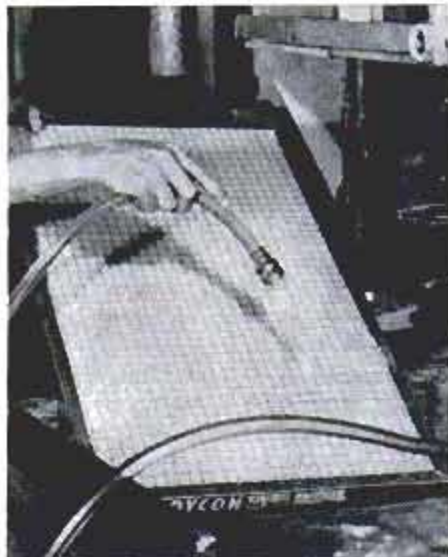

Tire Remover

Flat tires can be removed without taking the wheel off the car with an air-powered tool. The device, equipped with two stationary prongs and one movable prong, breaks the outside bead of the tire for easy removal. The tire remover is said to save time and to work equally well on tubeless or regular tires. It can be used on any wheel, including those with safety rims.

☞ Since 1932, more than 1,000,000,000 passengers have been carried by 166 elevators in New York's Rockefeller Center.

Tow Trailer Replaces Truck

Any car equipped with a new tow trailer can replace a tow truck in transporting wrecked or disabled autos. A hand crank on the winch of the trailer is used to elevate the damaged end of the auto to be towed. The two-wheeled trailer was developed by the owner of an Oregon body shop who found that long drives in his wrecker were tiring and expensive. Now he uses the trailer to haul wrecks behind his passenger car. The unit is now in production.



Sun-Powered Radio Promises "Something for Nothing"

Solar batteries and transistors combine in this experimental receiver that might last a lifetime. It has no external power sources, requires no repairs and makes the replacement of batteries a thing of the past. The set is powered by seven solar cells which are activated entirely by energy obtained from the sun. These provide enough power to drive a high-gain eight-transistor circuit to full loudspeaker vol-

ume. The small amount of voltage required for properly operating these transistors, less than 1.5 volts, assures virtually unlimited life by eliminating temperature and voltage breakdowns. Cloudy days, or dark-room operation, would create no problem in providing power for the set. A turn of the selector switch, located on the end of the cabinet, puts in operation the receiver's rechargeable stand-by battery. This battery, the size of an ordinary flashlight cell, provides about 50 hours of continuous operation and is recharged by the solar batteries. The current cost of suitable solar cells (about \$25 apiece) makes impractical the immediate production of a commercial version of this receiver.



Uranium Umpires

When a uranium miner and the Atomic Energy Commission disagree on the uranium content of the miner's ore, both parties call for the umpire. Commercial research laboratories throughout the West have been designated by AEC as "umpires," and when the AEC and a miner don't agree, a sample of the ore is sent to one of the labs. Both parties agree in advance to abide by the umpire's decision. The umpire gets the ore without names or details, and doesn't know whether it belongs to a miner or is a test batch put through by the AEC. This way, his impartiality is assured.

Arthur E. Reynolds of Rye, N. Y., likes to troll for striped bass. What he wanted was a custom-made rowboat with the works. So he built it himself . . .

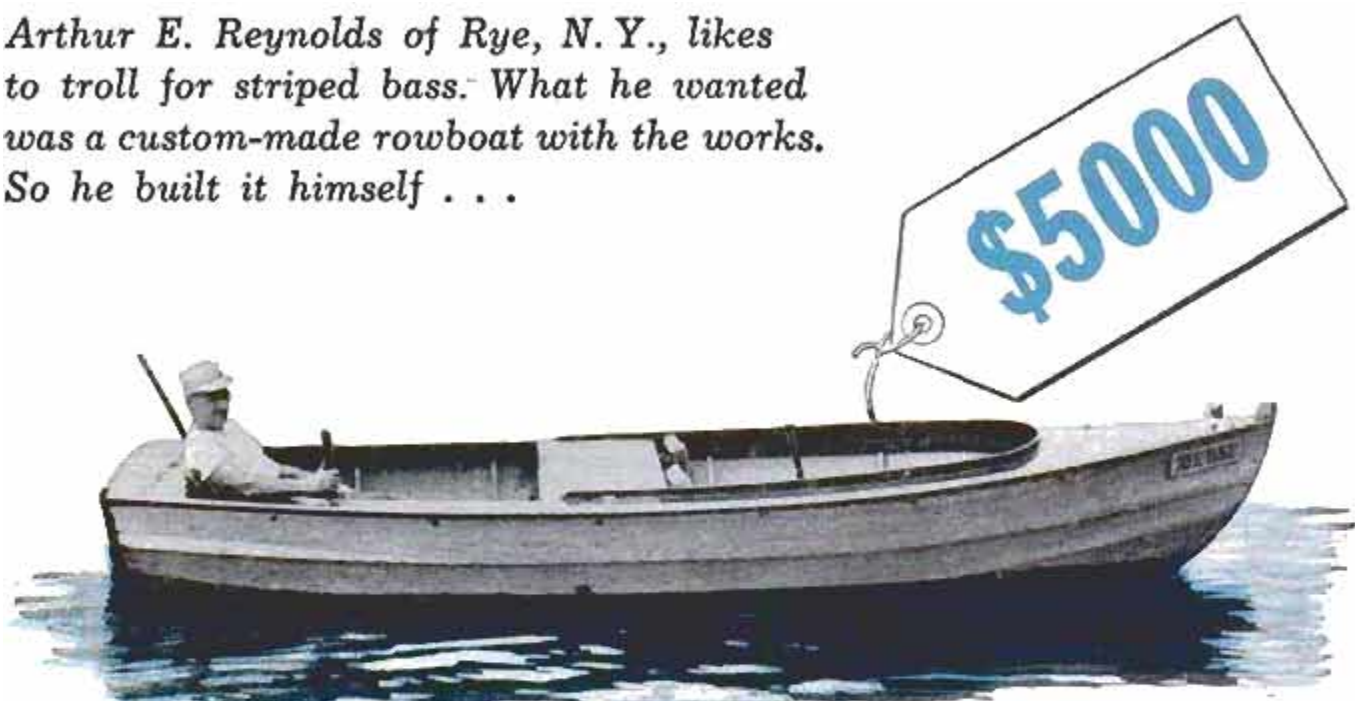

THE PERFECT BASS BOAT

A LONG THE rock-strewn shore near Rye, N. Y., lives a special breed of fishermen, addicts of the intricate sport of night-trolling for striped bass. Enthusiasm runs high and reaches its peak in Arthur E. Reynolds.

Two years ago Reynolds bought some lumber to build the ideal rowboat for striper fishing. By the time he had finished designing, working, fretting and sweating

By Gene Casey

in his two-car garage he had constructed a boat that was a work of art. He values the craft in excess of \$5000. Some rowboat!

An optician by trade, Reynolds is a stickler for precision and perfection. He couldn't find a ready-made boat embodying the features he wanted so he decided to do the job himself.

His objective was a boat that would troll

Special tillers, just the right height, permit Reynolds to control boat with knee while playing fish

Seat is exactly the right length so he can operate the vernier or fine-throttle adjustment with his toe

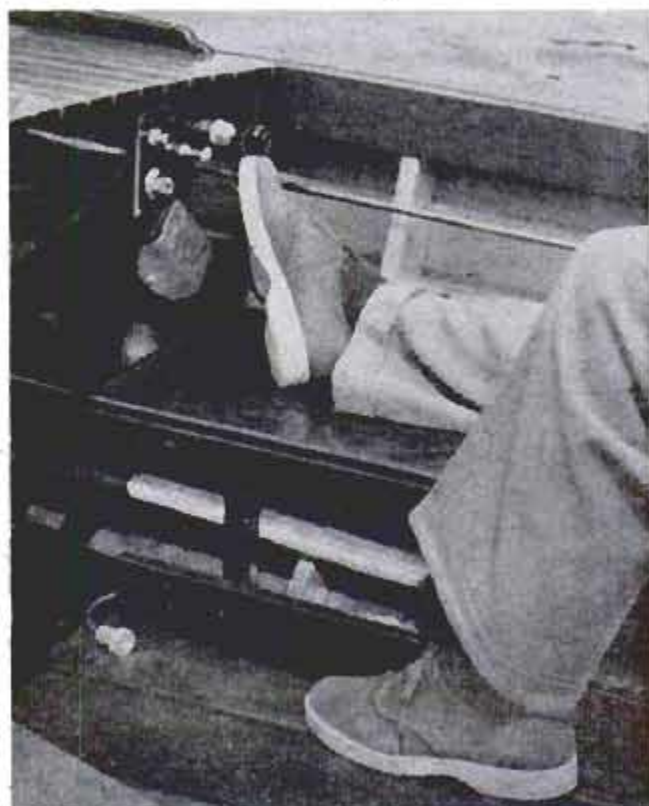
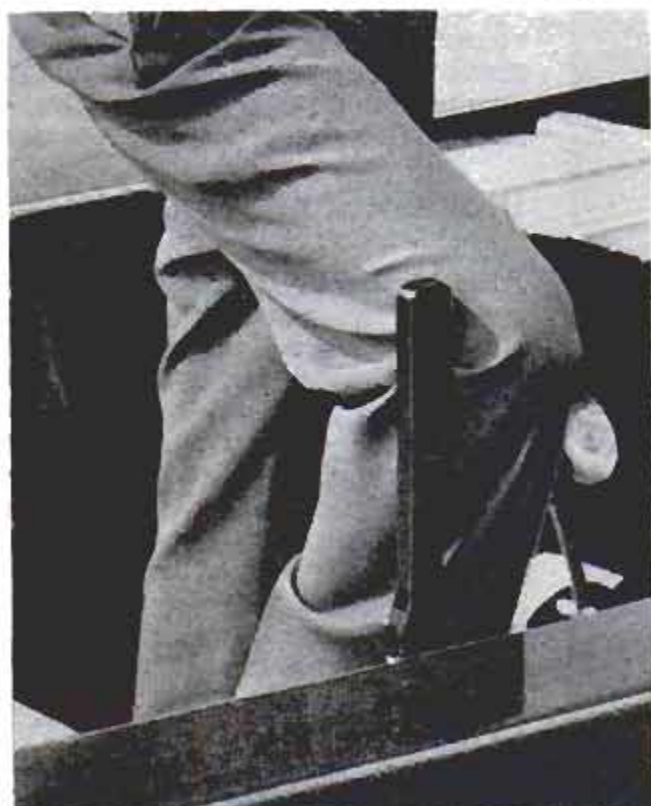



Deadwood area of the keel is cut away, making the boat respond more quickly to the oversize rudder

extra slowly without losing way in fast-running tides. The craft had to be able to maintain an unerring course to avoid the sharp reefs and rocks where the stripers lurk. It had to have a low nose and sheer line for minimum wind resistance, and a keel flaring to nine inches under the rear cockpit to give the greatest stability in rough water. Finally, it must quickly respond to the tiller so Reynolds can avoid the underwater obstacles that might otherwise tear a hole in the hull.

There's no doubt that the resulting boat is unique. Reynolds cut a large area of

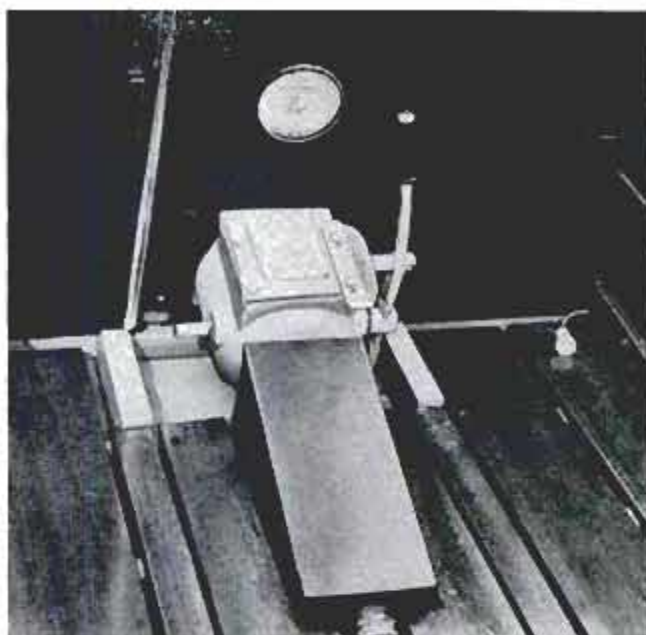

Positive neutral position of gearshift leaves no room for doubt that prop might be turning at slow speeds

"deadwood" out of the skeg end of the keel and installed an oversize rudder. He made dual tillers for front and rear cockpits. Through his control system he can control the boat with his knee while playing a fish. The length of the rear cockpit was determined by the length of his legs while seated, enabling him to manipulate the vernier or fine-adjustment throttle with his feet while trolling. He also developed a special neutral gear.

Reynolds selected an 18-horsepower motor which will troll at slow speed hour after hour, yet moves the boat at a good

Here's sheer comfort on the water. Reynolds can start the motor, control speed and shift gears with his feet

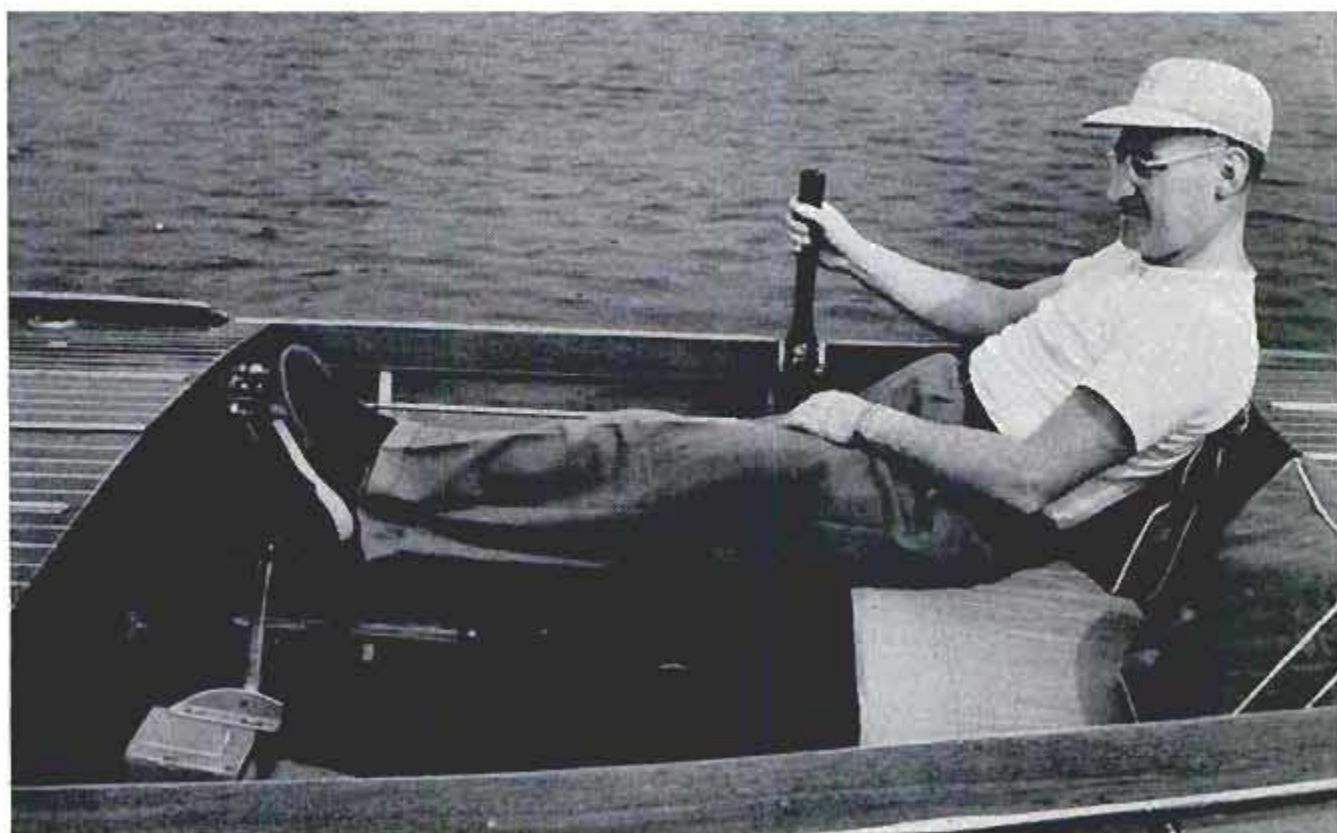

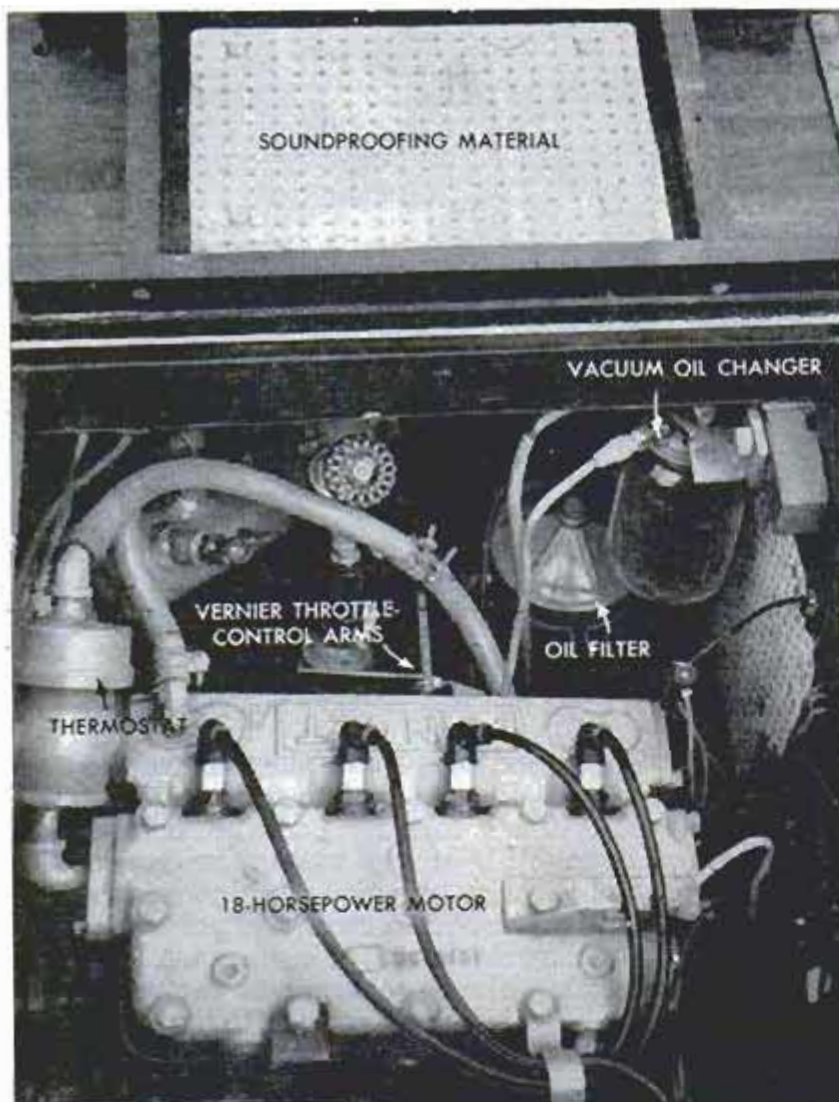

Reynolds has added special parts to the 18-horsepower motor including thermostat, oil filter, vacuum oil changer and vernier throttle. The motor hatch is lined with soundproofing material. Also on hand is a jointed sweep for sculling the boat if the motor should fail

Removable seat in forward cockpit gives complete access to motor. Crank can be used if the battery fails

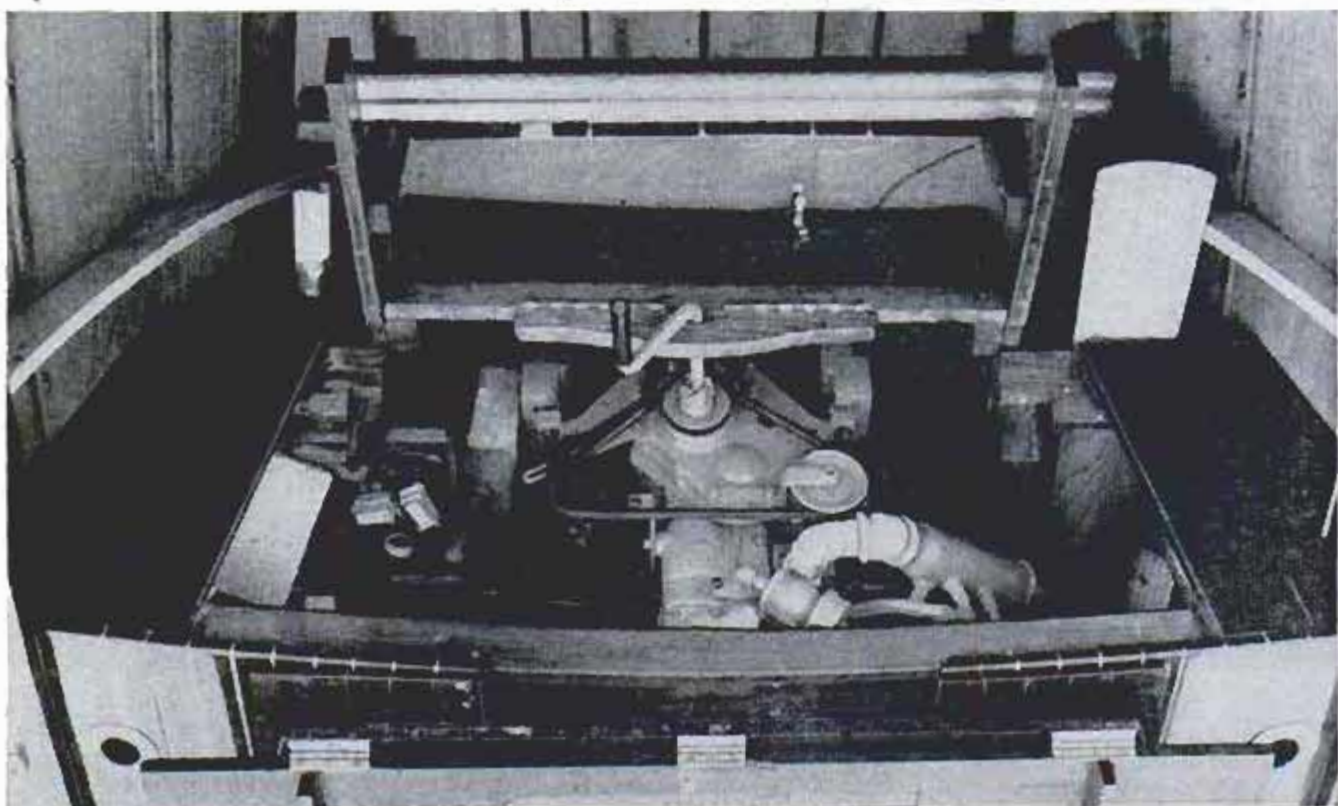

clip between trolling areas. He lined the motor hatch with soundproofing material. A special vacuum oil changer speeds that job. He made a jointed nine-foot sweep with which he can scull the boat at a surprising rate.

Experience had taught Reynolds that a trolling motor runs cold and builds up condensation, so he installed a thermostat to make the motor run hot.

The craft has an over-all length of 17 feet and a 6-foot 4-inch beam amidships. The ribs are oak. The transom, seats, and floor boards are all made of mahogany, but of four different kinds—Honduran, African, Mexican and Philippine. The hull is $\frac{3}{4}$ -inch cedar.

There are four red antiglare lights for baiting set into the cockpits. The aft locker is rainproofed by a gutter that runs around the seat.

What did the boat cost?

"I don't want to know," says Reynolds, "so I've never added up the bills. But I figure I couldn't get it built for \$5000."

To Art Reynolds the boat is worth more than money. He catches stripers when nobody else can. How can you put a price on that? ★ ★ ★

Ultrasonic Tester Checks Pipe Walls

Ultrasonic waves from a lightweight machine are used to check for flaws in metal pipe. The flaws cause a wave reflection which shows on a "reflec-toscope." Pipe-wall thick-ness to within .005 inch is tested at bends—spots usually difficult to check. Two men can carry the portable machine around to various parts of a factory.

Flaws in thickness of a pipe wall show up on the scope of portable tester



Balloon Guitar

Invented by a Paris night-club musician, a pneumatic guitar takes up very little room when not in use. The body of the guitar collapses like a balloon. It is inflated by mouth when the instrument is to be played. According to Felix Barrel, the inventor, the guitar produces the same sounds as those produced by an ordinary instrument.

←French musician pre-pares for a performance by blowing up his guitar



Hose Washes Paint From Auto Bodies

Eliminating the need for hand-sanding, a chemical paint remover prepares an automobile body for repainting in a few hours. The chemical is brushed or sprayed onto the surface to be repainted. After one to three hours, the digested paint can be washed off with a hose. Several coats of paint are removed at a time, leaving no residue to contaminate the new paint job. The bare metal is ready for painting.





Earthmoving Scoop Is Portable Platform

Drilling holes in rock 15 feet above the ground seemed no easy task to Tom Terry, road superintendent of Idaho County in Idaho. Then he hit upon using an earthmoving scoop as a portable scaffold. He took the drill from its wheels, bolted it to the side of the scoop, and towed the air compressor behind. The driller stood on the scoop and completed the job in a short time. The scoop could be tilted to the desired working angle, provided an excellent platform for the operator, and also furnished a place where he could store drill steels, bits and other supplies.

Magnet Reveals Flaws

Magnetism is used to detect flaws in metal with an 11-pound instrument. The area to be inspected is sprayed with iron-oxide solution. When the area is magnetized with the inspection tool, the iron particles regroup themselves along the lines of magnetic force. Surface or subsurface flaws cause the lines to be broken at the defective point. The flexible tool adjusts to fit any irregular surface. Its source of energy is a permanent magnet.

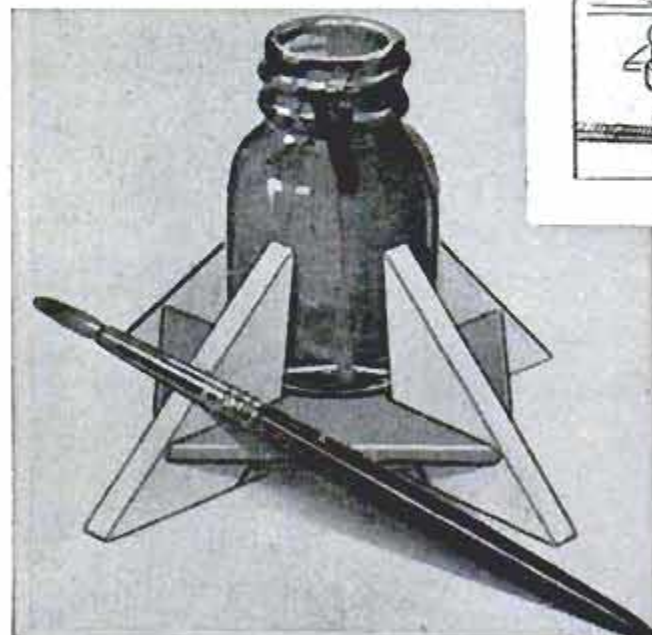
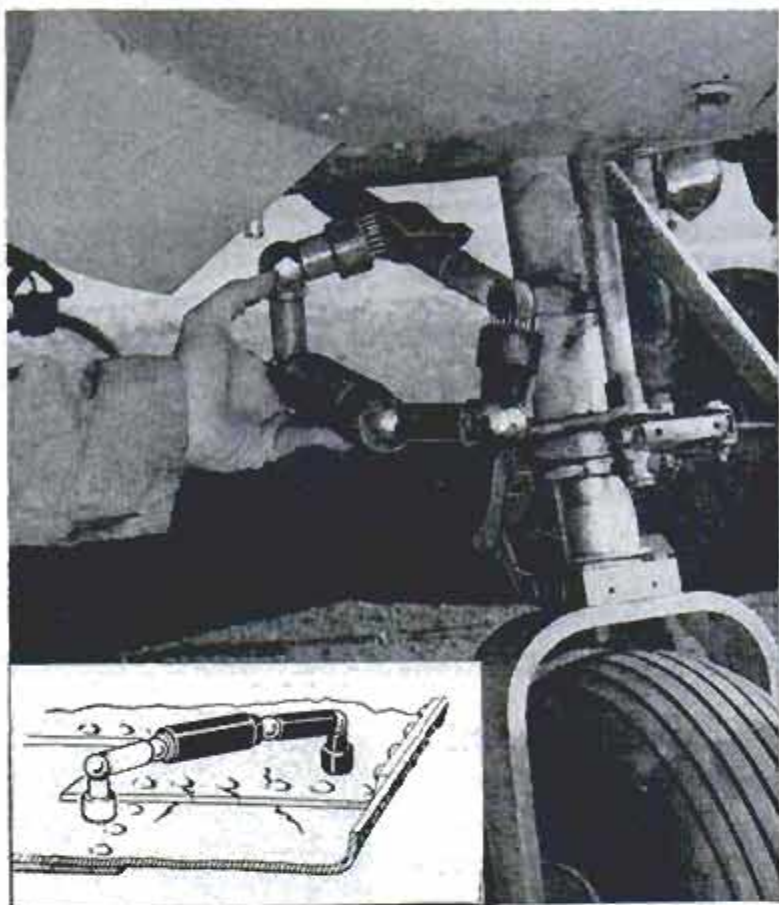

Pedestal Grips Bottle

Small bottles won't tip easily when they are mounted in a little holder with a sturdy base. The platform of the wooden holder rests on four right triangles that fit into slots and act as legs. Ordinary rubber bands beneath the platform cause the triangles to press firmly against the sides of the bottle. Three different sizes are made: One for bottles up to two inches in diameter, one for bottles with sloping sides, and one for test tubes.

KEEPING UP WITH THE ATOM

YOUR FAMILY DOCTOR is rapidly becoming an atomic physician, according to Dr. Sidney Rubinfeld, Professor of Clinical Radiology of New York University. Dr. Rubinfeld points out that the different rays emitted by each element have a selective action on various tissues. Thus a particular isotope provides radiation that affects only the desired spot in the patient's body. Iodine has an affinity for the thyroid gland, making it possible to treat hyperthyroidism. It also is used to control angina pectoris, a disease of the heart. Radioactive phosphorus has an affinity for the bone marrow and is useful in the treatment of chronic leukemia. Radioactive cobalt is used to treat deep-seated cancer, and gold to treat cancer of the prostate and chest.

☆☆☆

Gasoline has been extracted from oil through the use of gamma rays, according to the Esso Research and Engineering Company. High temperatures, high pressures and catalysts now are used in the cracking process, but scientists are seeking a fourth method, the use of radiation. An atomic pile has been used experimentally to produce gasoline from crude oil.

☆☆☆

Will world production of uranium soon reach the saturation point when all that can be used safely is produced? This is suggested by Prof. George W. Bain of Amherst College, who points out that the surface of the earth can dissipate radioactive by-products from the fission of a maximum of 15,000 tons of uranium annually. Within a year or two, new sources of ore coupled with the existing sources will be producing this much uranium. There are only two possible solutions, according to Professor Bain: Either discover a more efficient method of fission, or limit the amount of uranium that is used each year.

☆☆☆

Probably the world's smallest atom smasher

(see photo) now is helping to locate underground oil deposits. The instrument, only three inches in diameter and 47 inches long, develops up to 20,000 volts. Lowered into a well hole, the unit fires neutrons which penetrate the surrounding earth. Radiation-detecting equipment is used to measure the earth's reaction. This, correlated with known data, helps geologists determine whether oil is present.

☆☆☆

Results of an early cruise of the *Nautilus*, the Navy's nuclear-powered submarine, have been revealed. The craft cruised totally submerged from New London, Conn., to San Juan, Puerto Rico—a distance of more than 1300 miles—in 84 hours. The average speed was 16 knots, a speed attained for only one hour by any other combatant submarine. The cruise was 10 times the distance of the former undersea record. Eighty-four hours is also the longest period that any U. S. submarine has cruised completely submerged.

☆☆☆

Wood products may someday be coated with a gamma-irradiated plastic, according to Timber Engineering Company. The gamma rays would alter the plastic's molecular structure, producing a hardened material that would be moistureproof, fireproof and insectproof.

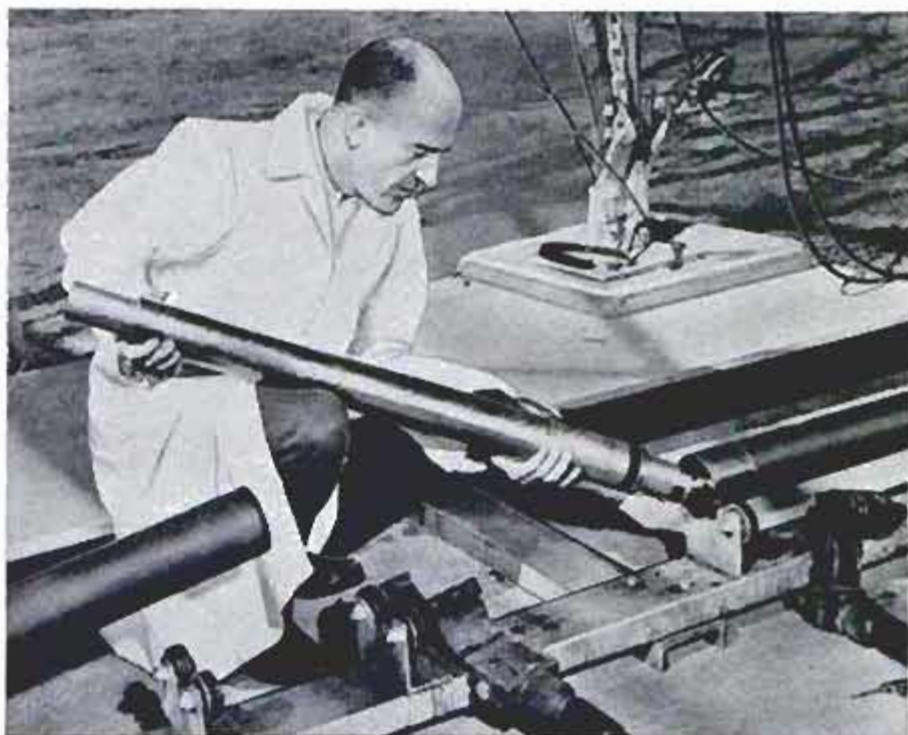

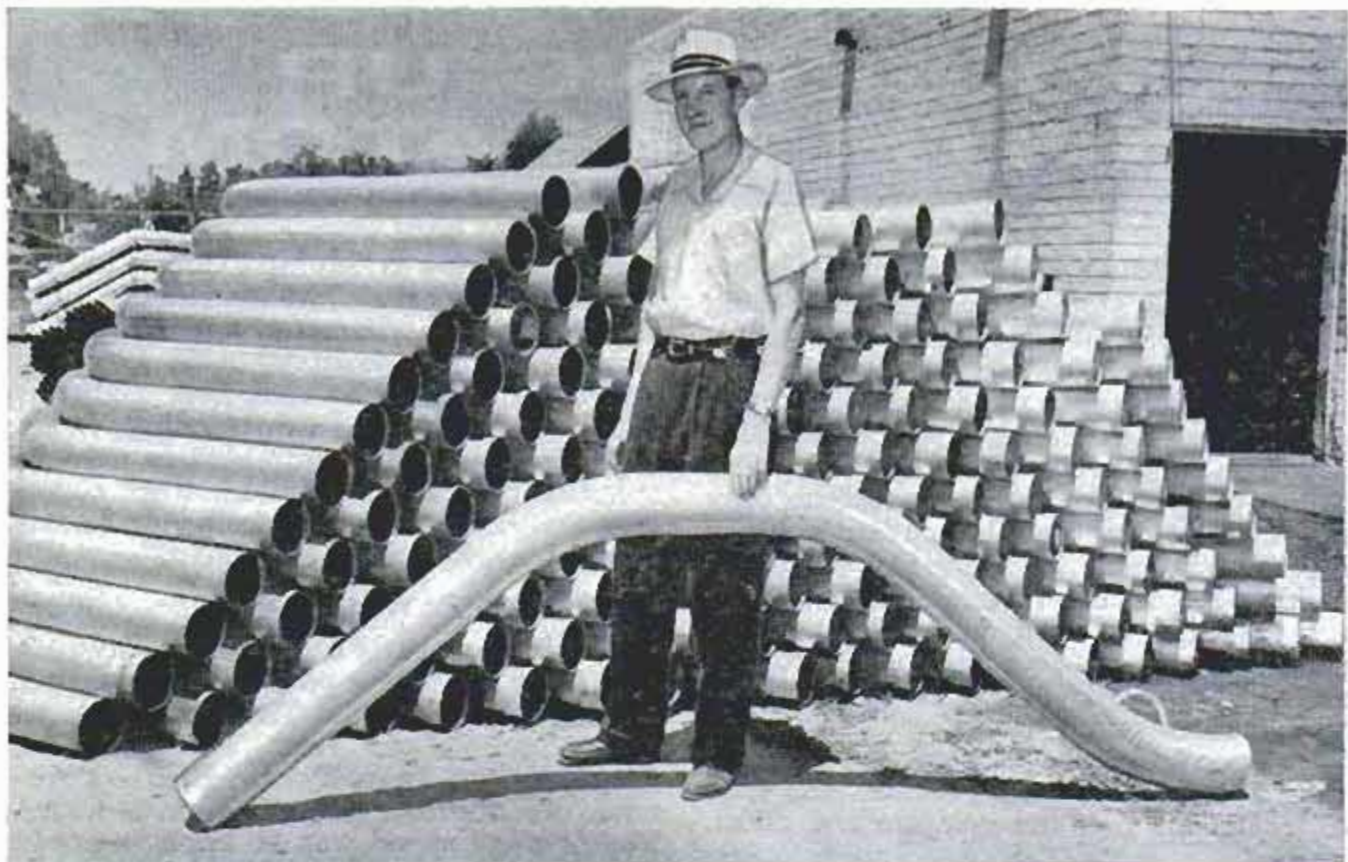

William Swanson, manufacturer of aluminum irrigation tubing, poses with 10-foot tube having three bends

What's His Line? --- Tube Bender

By Don Urry

To start siphon process, tube is filled with water by submerging it. After tube is filled, one end is capped



ONE DAY IN 1947 a Western farm manager asked William Swanson, a Phoenix, Ariz., fabrication shop owner, if he could bend some aluminum tubing. It sounded easy until the purpose was known. The farm man wanted the tubes—scores of them for just an average farm—to siphon water from irrigation ditches onto farmland.

To produce the tubes needed meant working with metal which in some instances was only .028 inch thick (.062 in the larger tubes). It meant preserving the roundness of the tube so that the water would flow freely. Above all, it meant bending the tubes quickly and cheaply enough for mass-production profits. The job was neither easy nor simple.

It took months of experimenting with hydraulic bending machines by Swanson. But finally he learned how to bring up to 1600 pounds of pressure to bear on a straight tube, nestled in a grooved quadrant and supported within by a steel rod up to the point of curvature, and produced the desired result.

Since that time, Swanson has turned out nearly 2,000,000 of the shiny irrigation tubes which are quietly revolutionizing ditch farming in the 17 dry Western states, parts of Mexico, and will soon make an appearance overseas in the modernized agriculture of Israel. He has developed 43 different diameters and lengths of tubing, curved into one, two or three bends, complete with lip flanges at either end, and handles to facilitate the curious knack of capturing water from a flowing ditch.

The aluminum tubes come to the Phoenix factory in straight lengths of 30 or 40 feet. They are cut to the varying irrigation lengths, from four to ten feet, depending on the thickness of the ditch bank they are to span. Tube diameters varying from ½ inch to six inches take care of the different flows of water required by different crops and irrigating conditions.

During the bending process the concave side of each bend gains perhaps 15 percent in metal thickness. Both ends of each bent

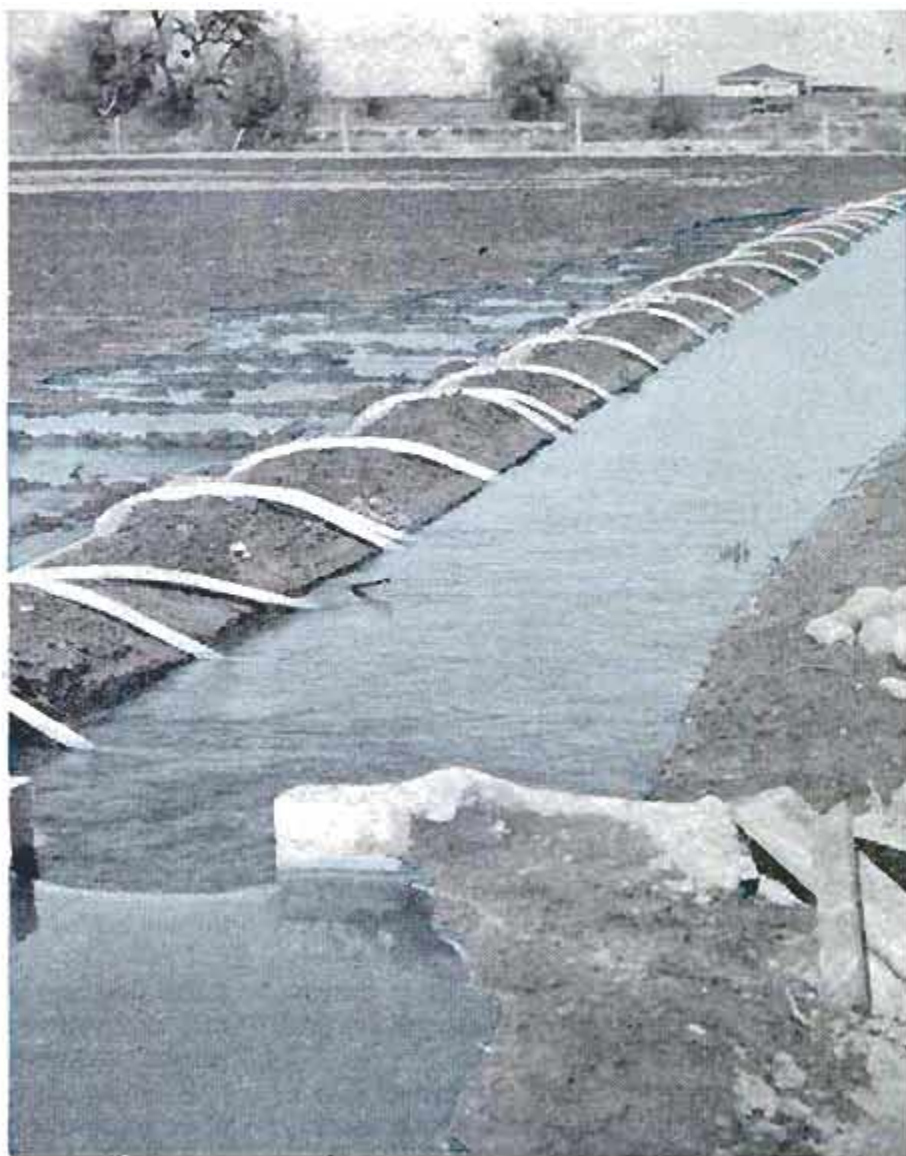

Field containing border crop is flooded by siphoning water from irrigation ditch over the bank by means of regularly spaced six-inch aluminum pipes

tube are then held against a revolving disk which literally rolls the soft metal back into a smooth flange for protection against denting and crushing during field use. Finally the tubes, resembling bizarre musical instruments, get sickle-shaped handles by Heliarc welding.

This strange farm "implement" takes its place along with the standard equipment of the farmer who must bring water to his land in default of normal rainfall. On an average Arizona cotton farm, 75 such tubes will be required at an initial cost of perhaps \$175. They pay for themselves, and more, through savings in labor otherwise required to cut holes in ditch banks and maintain them against the constant erosion of loose soil battered by swift water flow.

The farm worker completely submerges the siphon tube in the irrigation ditch, lengthwise to the flow. When the water has filled the tube, its field end is tightly covered by one of three methods. In the case of the smaller tubes (three-inch diameter or less) the hand is placed over the end. For larger tubes, either a rubber stopper



Tubes of small diameter, used to irrigate a single furrow, are bent two at a time in hydraulic presses

is fitted into the tube mouth or a canvas sleeve, previously clamped to the tube end, is twisted tight by hand.

With the vacuum thus maintained inside, the tube is quickly inverted by its handle and the field end is drawn over the ditch bank. The other end of the tube must remain under water. The bends of the tube conform to the contour of the bank, the field end of the tube lies level with the ground to be irrigated, and the stoppage of that end is suddenly removed. That starts the siphon process. The water flows steadily through the tube and the worker repeats the process with the next tube a few feet farther down the ditch.

Except for the more costly installation of a sprinkler system, the siphon-tube method of irrigation provides the best possible control of precious irrigation water. With the curved aluminum tubes in place at proper intervals along the ditch for the length of his field, the farmer can turn his water on or off for each crop row as easily as if he were manning the faucets of a series of bathtubs. No water is wasted. His ditch bank stays firm from one irrigation to the next.

For cotton, potatoes and other row-planted crops he uses the smaller tubes. Here he must pinpoint the flow down a single furrow of earth. For so-called border crops, like alfalfa and barley, he has a huge field expanse to flood. For these he uses the bigger tubes for their quick flow. A



Array of different shapes for irrigation tubes can be seen behind the press, above, which produces them

tube size has been adapted for every standard irrigation need, and some are custom-made for special needs.

Swanson also makes plastic or canvas sheets for damming irrigation ditches, since the ditch level of water must be higher than the land on which it is to be siphoned. These dams are simple and effective. A two-by-four is run through a sleeve at the top of the sheet, and the bottom is weighted by rocks under the water. When one field has been irrigated, the dam is moved down the ditch for the next.

The wide variety of tube sizes is necessitated by several factors: The size of the ditch bank, the kind of crop, how fast the particular soil absorbs water, and whether the land is level or sloping. With the right tubes, the farmer can deliver his water where and as fast as he wants. Gadgets called flow reducers can be fitted into the tube for even finer control.

By developing a process for bending aluminum tubing, Swanson made it possible to take advantage of that metal's noncorrosive qualities and its lightness of weight. The biggest tubes weigh only 13½ pounds, while the smallest are only a few ounces.

Since the labor saving over the old method of cutting holes in ditch banks runs from 33 to as high as 80 percent, long rows of bright aluminum tubes are likely to be a more and more familiar sight on the numerous irrigated farms of the water-short West. ★ ★ ★



Rickey Wilson, Yearicks' five-year-old grandson, keeps tight rein on his team of hedge horses as he rides privet chariot. Below, Rickey poses as model while Yearick finishes shaping of cyclist hedge form

Statues in Living Hedge Shaped by Clipper Artist

Gus Yearicks of Wildwood, N. J., has spent 26 years of spare time in trimming and shaping the privet hedges of his garden into "living statues." More than 100 examples of his work are on view in his one-acre lot, including a cyclist, a wagon pulled by two horses, a ship and a baseball game. Yearicks estimates that he spends 40 hours a week on his garden and that a total of 75,000 people have visited it. Yearicks has a full-time job in a magnesite plant.



Halves of Extension Ladder Become Back-Yard Gym Set

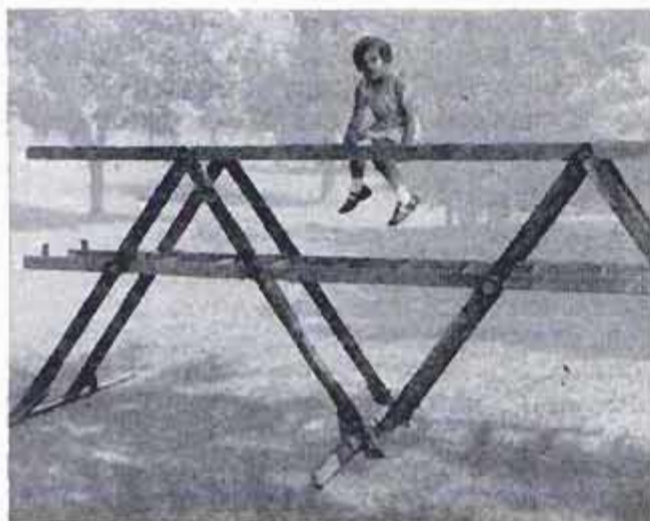

Two halves of an extension ladder serve as horizontal bars for youngsters to play and climb on in Ben Brown's back yard in Ballwin, Mo. Two double triangles of one by three-inch hardwood, bolted to the ladder sides with $\frac{3}{8}$ -inch carriage bolts, support the ladder sections a few feet above the ground. The rungs of the ladder serve as horizontal bars for climbing, swinging youngsters. Large wooden "washers" make up the difference in width between the top and bottom halves of the ladder, which can be returned to service any time by simply removing the bolts. Five-foot supports across the bottom of the legs can be buried to prevent tipping.

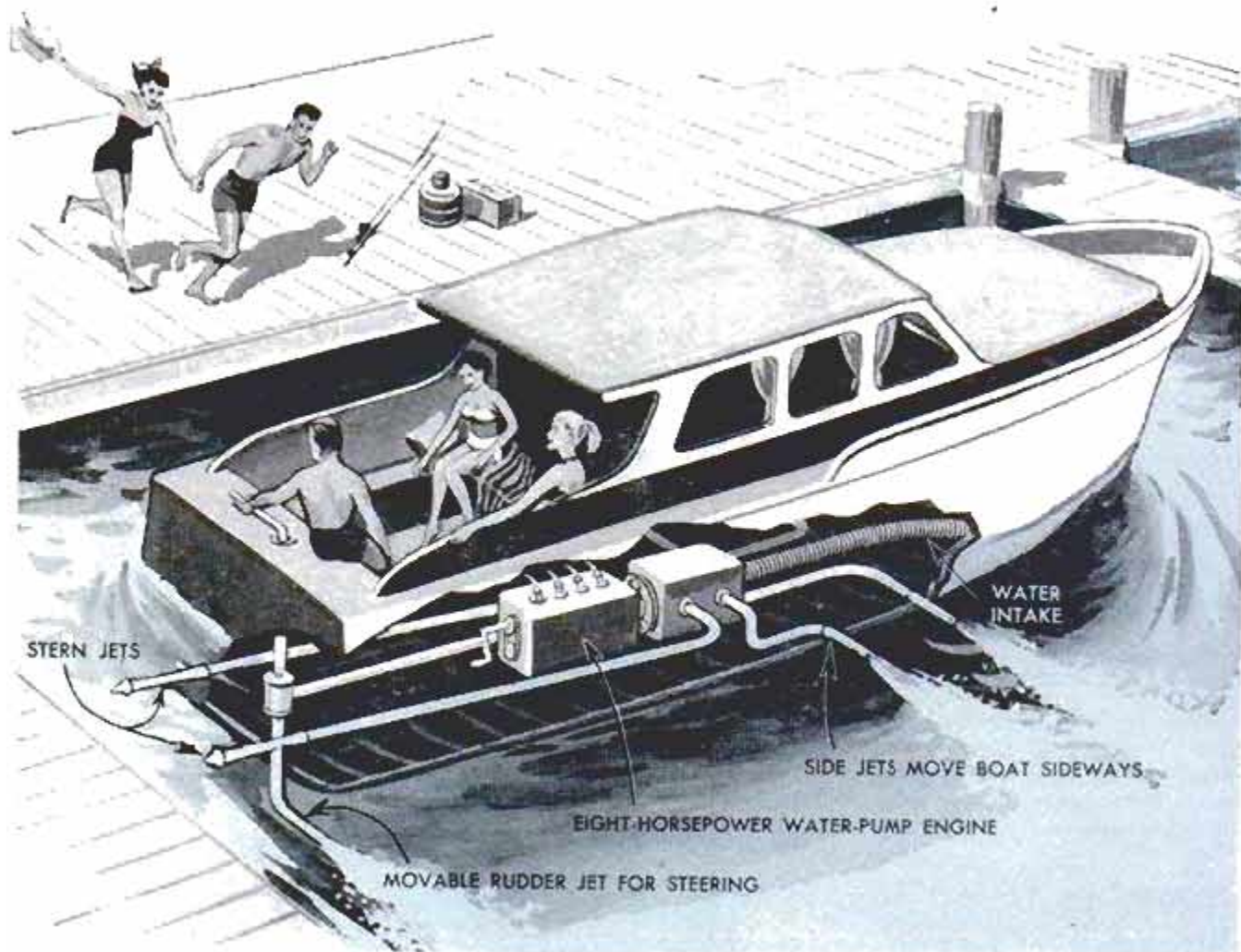

Jets Push Cabin Cruiser Broadside Through Water

Ships go forward and ships go backward, but ordinary ships just won't move sideways. Now a retired navy commander in England has developed a cabin cruiser that actually will move broadside through the water. Comdr. George Wheeler believes that a big ship, using the same power system, would require no tugs to move it into a pier.

In Commander Wheeler's cabin cruiser, an eight-horsepower pump draws in sea water and ejects it under pressure through nozzles at the stern, forcing the boat through the water. On each side of the craft are two more jets, powered by a separate motor. These jets push the craft sideways at the turn of a switch, enabling the skipper to slide up to the dock.

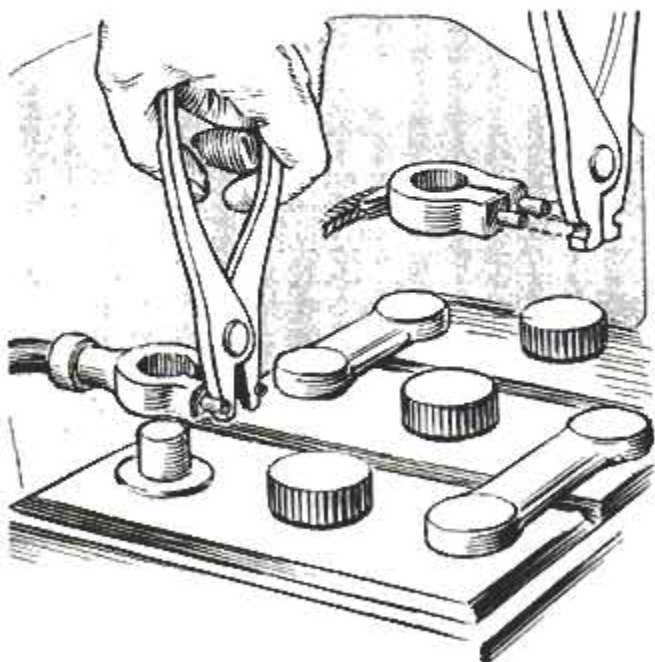

Battery-Cable Terminal

Spring action holds a new battery-cable terminal to the post of an auto battery. A specially designed reverse pliers is used to clamp the rugged spring-steel loop to the post or to pull it off. The new terminal does away with the bolt and nut, which frequently corrode and can't be separated.

Three-Way Light Bulb

Any standard electric socket holds a light bulb that combines incandescent, fluorescent and mercury-vapor illumination. It contains an incandescent tungsten filament, a mercury-vapor arc discharge tube and fluorescent phosphors activated by ultraviolet rays from the arc tube. The "fluomeric" lamp has a life of 12,000 hours and needs no external transformers.

Transistors— The Modern Miracles

ABOUT EIGHT YEARS AGO, a new electronic component emerged from one of the nation's foremost laboratories; a unit which promises to revolutionize the entire industry. It is called the transistor.

The transistor is a tiny device which threatens the position of the vacuum tube as the basis of all electronics. It can perform many of the tube functions, as amplifier, oscillator, etc., and it can do the job better, cheaper and more efficiently.

The transistor's advantages lie in its small size, Fig. 1, low power requirements, extreme ruggedness and relatively long life. These make possible the design of battery-operated, portable equipment with remarkable characteristics. Some of the many transistorized items which have recently made their appearances on the commercial market are illustrated and described on page 176.

Unlike a vacuum tube, the transistor's elements are embedded in a solid material. As a result, it can take shock and vibrations which would quickly ruin even the most rugged of tubes. Equally important, the operating life expectancy of transistors will exceed even that of the equipment in which they are used.

Transistors have no filaments, and give off very little heat. This not only eliminates the ventilation problem, but assures longer



Tiny transistor, left, is dwarfed by conventional subminiature, miniature and standard vacuum tubes

life for any components in the associated circuitry.

Many transistors are now available at prices comparable to those of popular vacuum tubes. As production techniques improve, even lower prices are anticipated.

With all their advantages, transistors still have some limitations. They are, as yet, unable to provide the large amounts of power of which vacuum tubes are capable. Furthermore, special units which can operate at very high frequencies are still relatively expensive, and all transistors are somewhat susceptible to heat and temperature variations. As the state of the art progresses, however, these problems will undoubtedly be solved and the uses of transistors will be further expanded. In this electronic age, transistors can truly be classified as electronic miracles.

Experimental transmitter, Fig. 2, built into golf ball which broadcasts its position to receiver-carrying owner is proof of transistor ruggedness. Simplicity of transistor structure compared with tube in Fig. 3

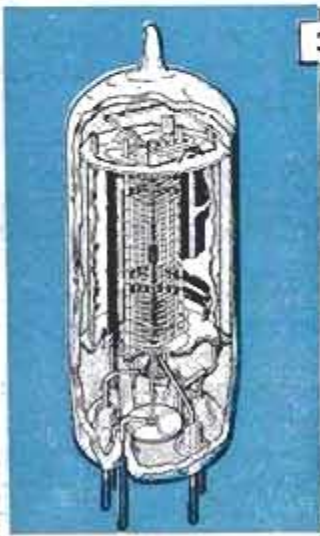



"Little Giant" Transistor Radio

By L. M. Dezettel

Small in size but giant in performance, this little radio makes an ideal project for beginners, students and experimenters. Beginners will appreciate its simplicity which practically eliminates the possibility of wiring errors, while experimenters will welcome the opportunity to work with transistors which have only recently come into general use.

For so small a set, this "Little Giant" offers surprising selectivity. Even stations which are very close together can be separated without difficulty, and strong stations will come in with sufficient power to drive the built-in loudspeaker to room-volume levels. A headphone jack is provided for reception of the more distant stations.

The little radio is completely divorced from the power line and, therefore, presents no shock hazard. All of the necessary operating power is supplied by a single long-lasting 4½-volt battery.

Construction: The simplicity of this little set is illustrated by the schematic diagram in Fig. 1. In order to prevent crowding of parts and to simplify construction, the model was built into a commercially available aluminum case which is actually much larger than necessary. Since the placement of parts is not at all critical, the receiver could be built into a much smaller housing.

Assembly and wiring of the receiver can easily be accomplished by following the illustrations in Figs. 2 through 5. The spac-

ing and diameters of the case mounting holes are shown in Fig. 2. Unless otherwise marked, all hole diameters are made to clear No. 6 screws. Before drilling the case, all of the necessary parts should be purchased. If it is necessary to substitute some of the components listed in the parts list with units by other manufacturers, some of the hole spacings may need to be changed to accommodate the parts on hand.

The speaker opening can be cut out with a circle cutter or an ordinary coping saw and file. The latter tools can also be used for the rectangular switch cutout and for the ½-in. holes. A tapered reamer, if available, will simplify the job of making the ½-in. holes by enlarging No. 6 holes to the required sizes.

After drilling the case, the large parts can be fastened in place as shown in Fig. 4. The hardboard block which mounts the transistors should be prewired before being fastened in place by means of the two lower speaker-mounting screws and nuts. To prevent damaging the transistors while soldering, the leads should be left long and, during the soldering operation, each lead should be held firmly with a pair of long-nosed pliers. The pliers will conduct some of the heat away from the transistor.

The variable capacitor is fastened to the front of the case with two 6-32 x ¼-in. machine screws which fit into corresponding holes in the capacitor frame. If these screws are too long, so that they interfere with the rotation of the capacitor plates, one or more small washers can be inserted between the capacitor frame and the case to eliminate this difficulty.

The battery is fastened to the case cover with a homemade bracket, as shown in Fig. 3. The positive (+) battery terminal is grounded to a solder lug.

Final assembly and wiring are shown in Fig. 5. The r.f. coil is soldered securely to the grounded lug of the antenna terminal strip. It is important that the coil be mounted by its No. 1 lug which can be identified from the detailed coil drawing.

Operation: A good outdoor aerial and ground are essential for proper operation of this simple receiver. While excellent results have been obtained with an outdoor TV antenna (by disconnecting the lead from the TV set, twisting the two wires together, and connecting this to the "antenna" terminal of the radio), reception will be even better with a good radio aerial. A cold-water tap or a rod driven into the earth will serve as a ground.

Broadcast-band aeriels are available in kit form from most radio-parts distributors. These kits, some of which cost less than one dollar, are complete with all parts and installation instructions. ★ ★ ★

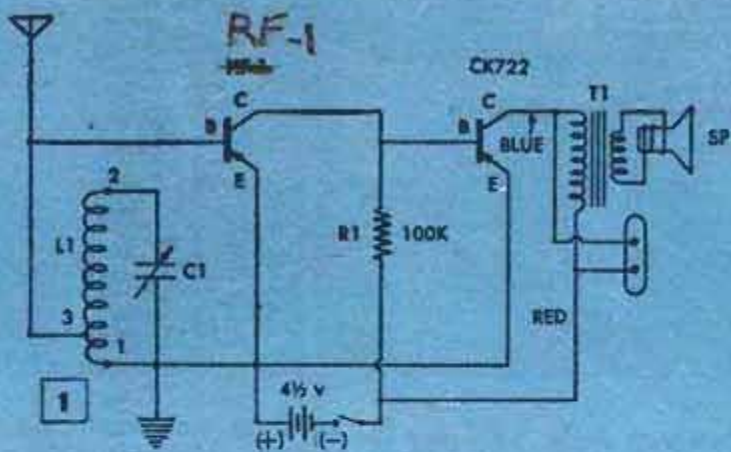

LIST OF MATERIAL

- | | |
|--|--|
| 1—High-frequency transistor
Marvako 1000 RF-1 | 1—Single gang, midget variable capacitor (C1),
365 or 375 mmfd. Allied 61H009 or equiv. |
| 1—Audio-frequency transistor,
Raytheon CK722 | 1—Transistor r.f. coil, Allied RK-121101 (L1) |
| 1—3-in. loudspeaker, Jensen 3J6 (SP) | 1—Aluminum case, 3 x 5 x 4 in. ICA 29340 |
| 1—Resistor, 100,000 ohm, 1/2 watt (R1) | 1—Knob with setscrew, for 1/4-in. shaft |
| 1—4 1/2-volt battery, Burgess 5361 | 1—Antenna-ground term. strip |
| 1—Slide switch, S.P.D.T. | 1—Headphone jack strip |
| 1—Output transformer (T1), 8000 ohm to
3.2 ohm, Stancor A3329 or equiv. | 2—1-terminal tie-points |
| | 1—6-terminal tie-point |
| | 2—Angle brackets |
| | 4—Solder lugs |

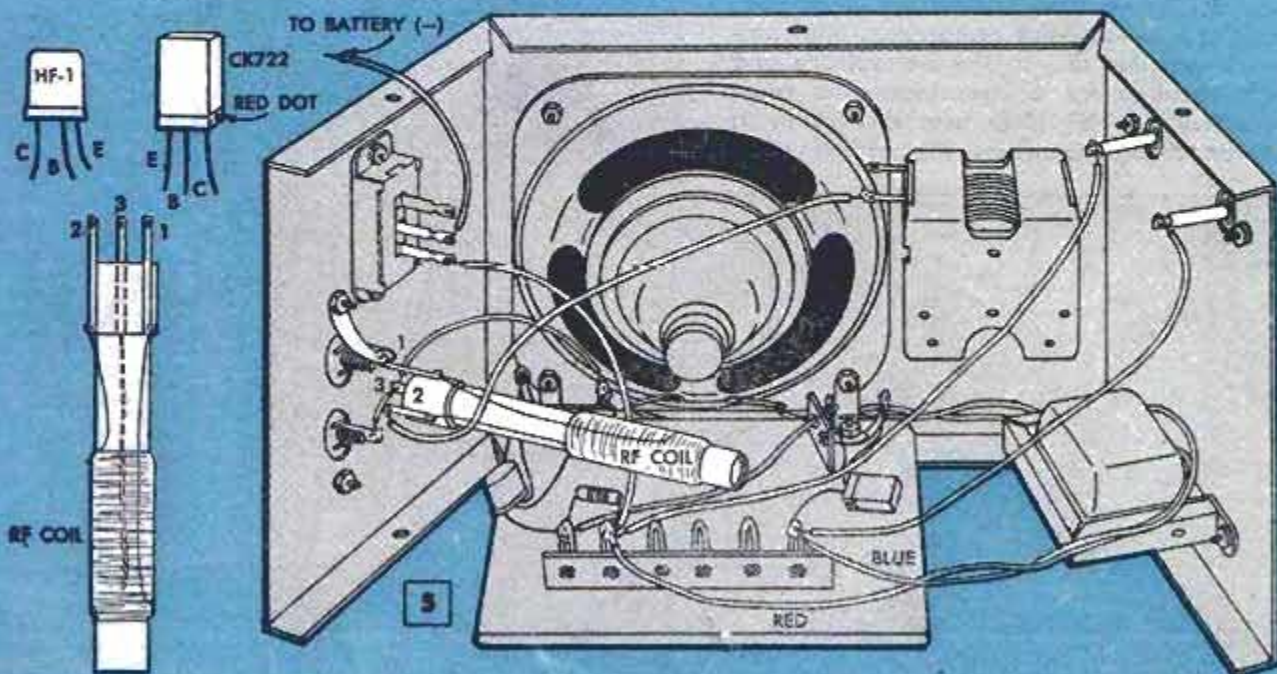
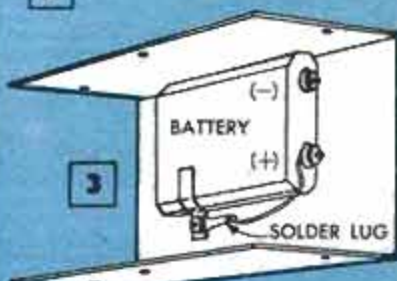
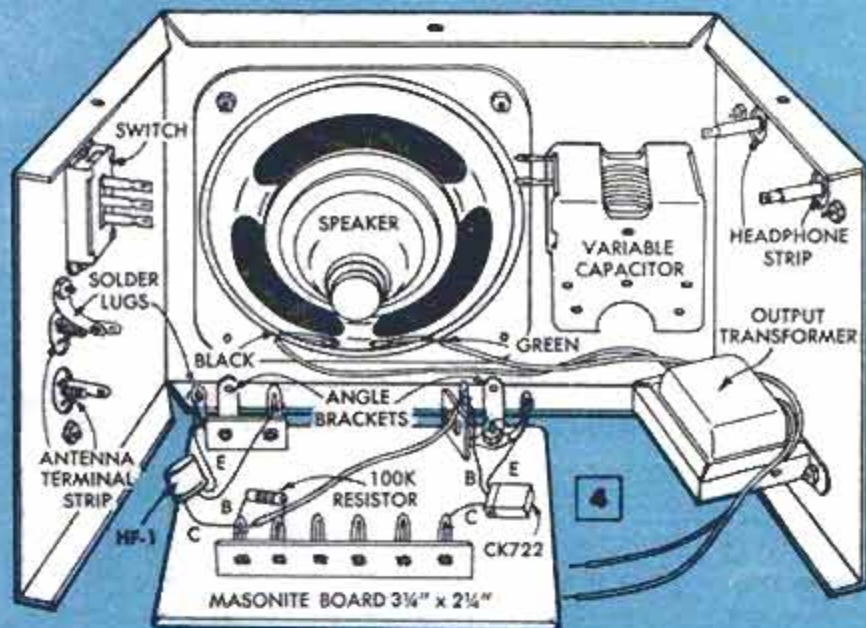
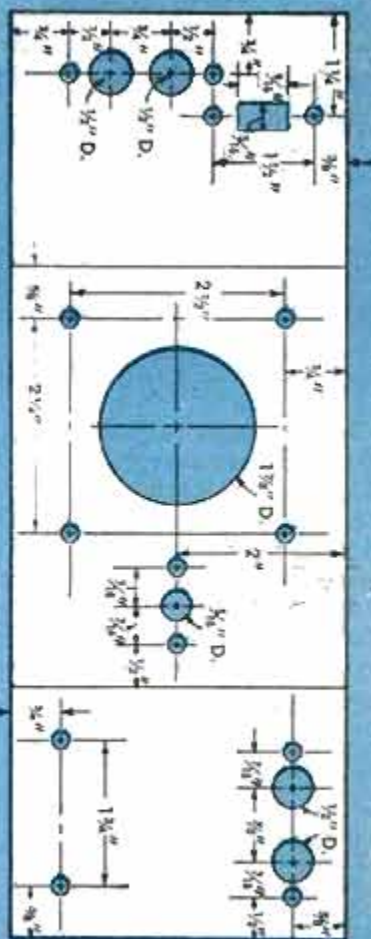

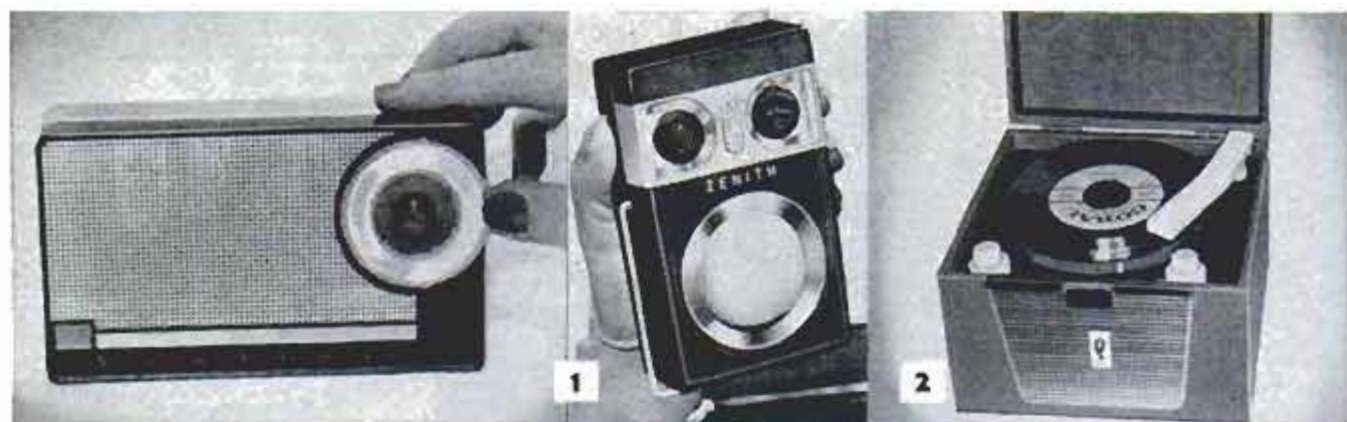

Due to numerous advantages, transistors are replacing tubes in many commercial products, some of which are shown here. Fig. 1 shows two of many transistorized radios which are small enough to fit into pocket or purse. Battery drain is much less than for equivalent vacuum-tube portables. The portable phonograph of Fig. 2 utilizes an all-transistor amplifier. It will play 3000 standard 45 r.p.m. records on a set of four ordinary flashlight

Transistors at Work

cells. Fig. 3 shows the latest car radio. Transistor operation eliminates vibrator power supply, reduces battery drain and cuts service needs. The transistorized Radiò Pager, Fig. 4, is the latest in short-distance communications. Pocket receiver permits instant contact between control unit and paged person regardless of his location. Tiny hearing aid in Fig. 5 can be hidden behind a man's tie or in a woman's hair. Operates for 10 cents a week



Tiny Parts Aid Miniaturization

To enable designers to take full advantage of transistors, complete new lines of miniature components have been developed. Some of these are shown in Fig. 6. The coin in the illustration permits approximate-size comparison. Miniaturization is possible due to the low voltage and current requirements of transistors and associated circuitry. Negligible heat dissipation in transistor circuits increases life of all parts

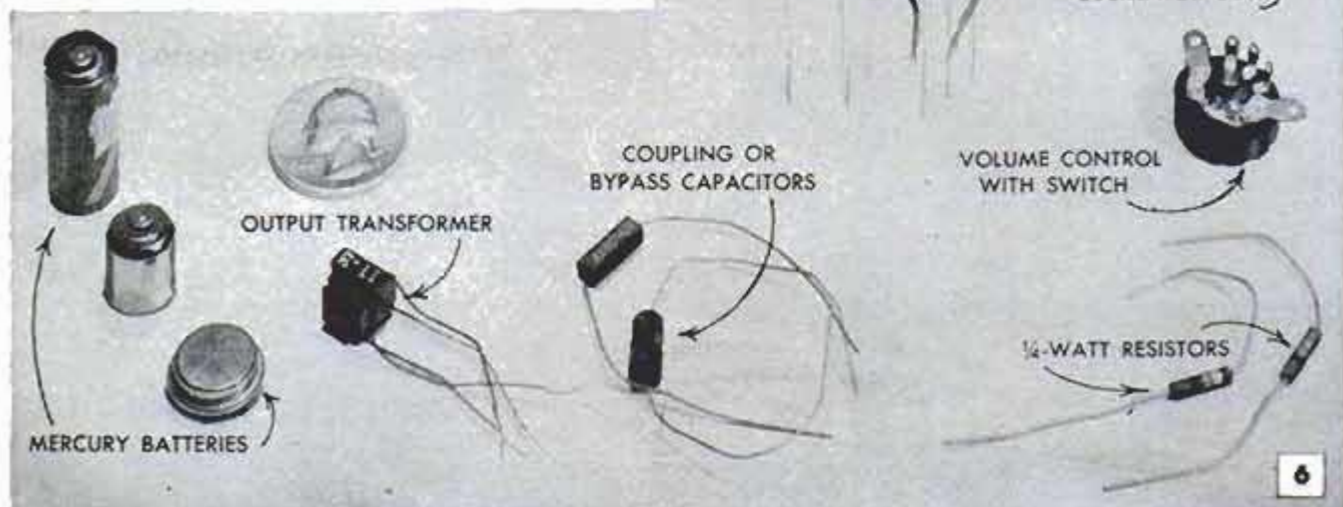

the

POPULAR
MECHANICS

CRAFTSMAN



BUILD YOUR HOME AROUND A FIREPLACE

By Tom Riley

FEW HOMEOWNERS actually build their own fireplaces, which is a job for the experienced mason. But knowing how one should be built and what types are popular will be helpful when you decide to have a fireplace.

When planning to build or remodel it is important to choose a fireplace that will create the atmosphere you desire. A few years ago there was little choice. The fireplaces in all the homes along your block generally were quite similar, differing perhaps in their brick or tile facing and bookcase or shelf treatment at each side. Today you have a wonderful variety of types and designs from which to choose and can have a fireplace

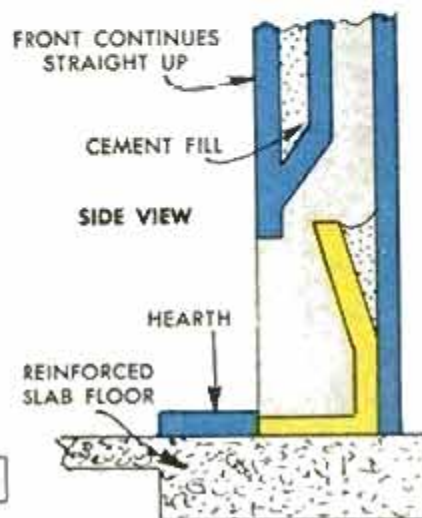



Excellent blend of modern and traditional. Raised hearth is most popular feature of today's fireplaces



Above, copper hood replaces considerable brickwork in this corner-type fireplace. Below, this fireplace is part of a curved living-room wall of Arizona fieldstone. Shelf-type hearth is black marble



that definitely belongs in a particular room of your home.

Most fireplaces built today, whether of brick, block or stone, use a conventional, time-tested firebox. Thus, manufactured dampers can be utilized, the firebrick lining is simple to install and there is a smoke shelf above (to baffle chimney down-drafts). This standardization of the firebox design has very little to do with the fireplace's exterior, which can vary in a hundred ways. In general, the traditional finish was intended to hide the masonry behind wood or plaster walls, leaving only a little masonry exposed around the edge of the fireplace and perhaps up to a mantel. The trend today is to expose as much of the brickwork as possible—the masonry is attractive so why not show it? And so, instead of slanting the brickwork back to slim it down to the size of the chimney, the brickwork of the front and sides of the fireplace now often continues straight up to the ceiling, or on up through the roof to have a generous-sized chimney on the exterior. Thus, some large spaces will appear between the brick of the upper fireplace shell and the chimney proper, which seems confusing when you look at a half-completed job. The spaces are often used for extra flues for the furnace or they may be filled with rubble and cement. If not exposed through the roof, these spaces often are simply left open in the attic.

Exposing all the masonry of a fireplace

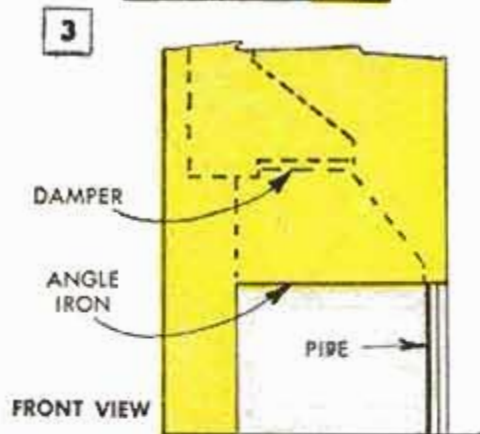
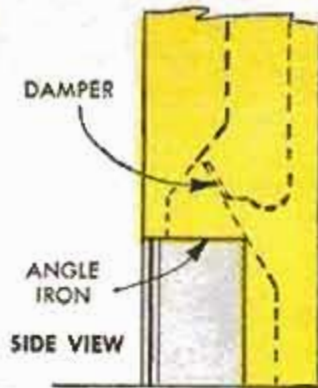

Above, two ways Swedish fireplaces can be built. Below, triangular-shaped back-wall forms smoke shelf to corner fireplace

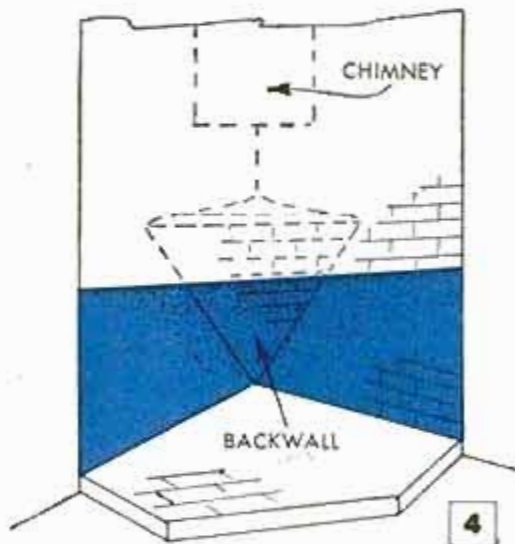

does give a saving in that there will be much less plaster and wood wall in the house to construct. When the fireplace is located along an interior wall, it also means that you can have brickwork in the kitchen or dining room as well as in the living room. Then, another or a barbecue fireplace can be added on the back side at considerably less cost than that of building two separate fireplaces. Fig. 2 and the photo show such a barbecue fireplace designed for a manufactured grill. As grills vary in size, it is always a good idea to obtain the size of the grill first and build the firebox accordingly. Because a barbecue



Black iron and concrete blocks give dramatic modernity to this Swedish fireplace. Note how raised hearth incorporates bench



Above, serving as a room divider, this variation of the Swedish fireplace gives firelight to both living and dining rooms. Flue must be extra large so cross drafts won't force smoke sidewise. Below, corner type takes little floor space





Island-wall fireplace of used brick divides living and dining rooms. Dining-room side of fireplace has charcoal grill and wood box

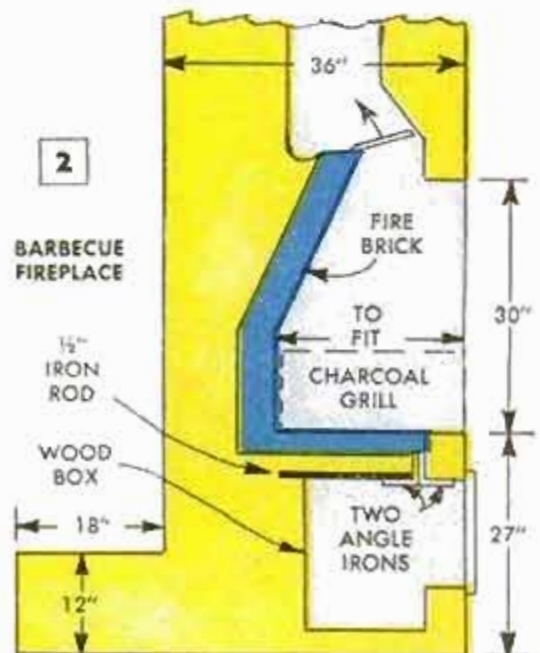

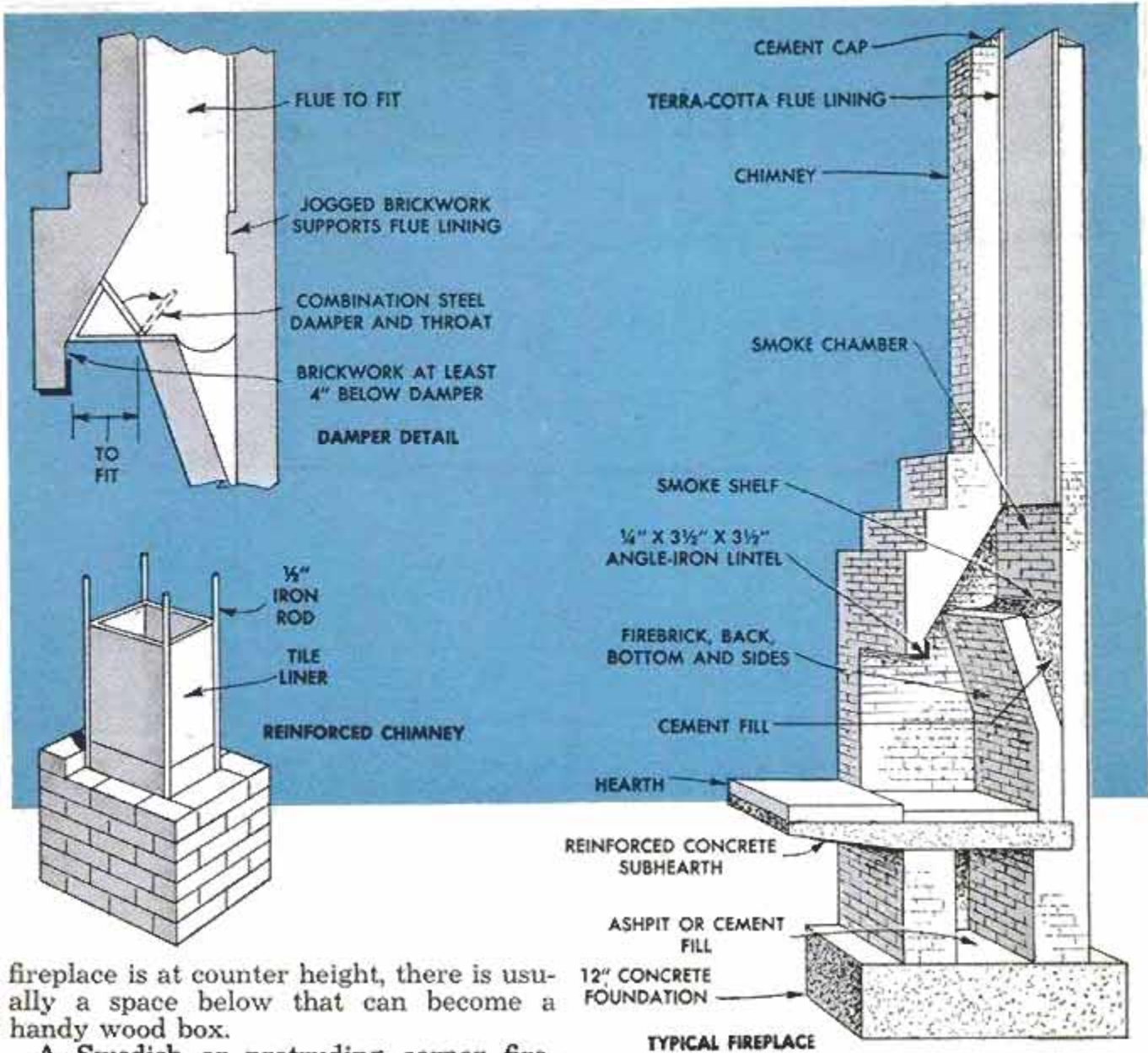

fireplace is at counter height, there is usually a space below that can become a handy wood box.

A Swedish or protruding corner fireplace is a somewhat different type very popular today. These give a view of the fire from two directions. They can nestle into a corner of a room or accent the end of a partition wall. As shown in Fig. 3, the Swedish can be built with the conventional firebox design, having one side left open back to the slanting rear wall. Or the side can be fully open and the rear wall vertical. Then the flue above should be offset, as shown, to the rear or the side to give a shelf to baffle down-drafts. On all Swedish designs, the angle-iron lintel must extend around the corner to support the side opening, and the corner needs a 1 to 2-in. iron-pipe upright to support it. An attractive finish is obtained here by sliding an equal length of thin-wall brass or copper tubing over the pipe before erecting.

Corner fireplaces are receiving deserved popularity today because they can be seen from any part of a room and because they require little floor space for their hearths. Slanting across a corner, they will also break up the squareness of a room and will

TYPICAL FIREPLACE

The two details below show different ways of building a hood into a fireplace. In detail A the partial hood replaces only part of the front and side brickwork, whereas in detail B, the complete hood and iron-pipe chimney replaces all the brick above firebox

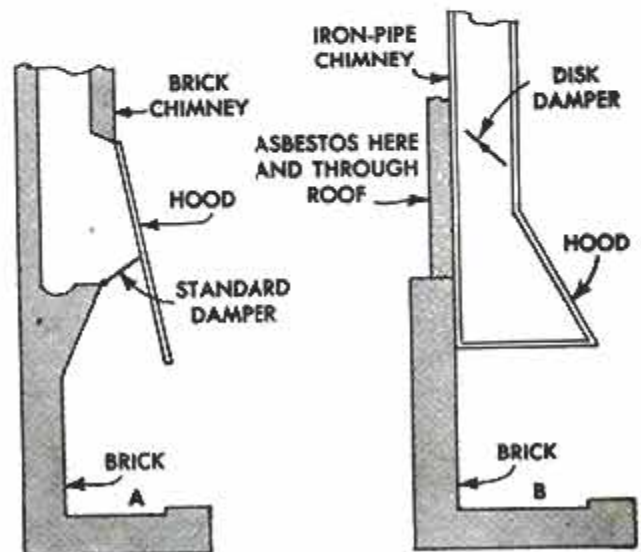



Above, this corner location allows warmth of fire and view through window to be enjoyed at same time. Upper right, purchased metal form for circulating fireplace simplifies actual masonry construction for ambitious do-it-yourself homeowner



This fireplace with its raised hearth was built around a metal form. Note warm and cold-air inlet and outlet in the masonry

brighten a dark corner. Fig. 4 shows how a triangle of firebrick in the corner can protrude to give a smoke shelf. Or the chimney can be offset to the rear, as with a Swedish fireplace, to give the smoke shelf. The chimney above a corner fireplace can be square with the walls of the room or it may be built so it slants across the corner.

Most hooded fireplaces will give a very dramatic touch. Such a fireplace will also give considerably more heat, because of



the radiation from the large hood. A hooded fireplace can be built in two quite different ways, one as a conventional fireplace with the metal hood simply replacing some brickwork at the front and sides directly above the firebox. The other utilizes a complete hood and metal-pipe chimney that is made up in a sheet-metal shop and which replaces all brickwork above the firebox.

Not to be ignored are the circulating fireplaces. Their manufactured shells make these fireplaces fairly easy to build yourself and they are efficient heaters. Often considered objectionable is the warm-air grillwork exposed above the fireplace. A small hood can be made to cover the grillwork, to direct the heat upward. Or, the grillwork can be hidden in a mantel in the form of a shallow trough or planter box.

On almost any type of fireplace, a raised hearth can be an enjoyable feature. Built 12 to 16 in. above the floor and about 18 in. wide, the hearth will become a huge bench for serving guests and for placing decorations, as well as the best place to sit close by the

fire. Many of today's fireplaces have the floor of the firebox lower than the hearth. Then, sparks cannot sneak out beneath a fire screen and ashes are much less noticeable.

Constructionwise, the first thing about the fireplace you choose is its foundation. Its foundation concrete should be at least 12 in. thick and the bottom must be below frost level of your climate to prevent movement in freezing weather. The foundation can be simply a thickening of a concrete



Although of good size, this fireplace is kept subdued by incorporating it in a long Roman-brick wall

slab floor, or a separate slab in the crawl space or basement. The concrete subhearth detailed in the drawings on page 181 is the cantilever type. Note it is keyed into the rear brick wall and has the firebrick backwall resting on it. The cantilevering is done merely to simplify the wood-floor construction in a house. The hearth can also be built with a third brick wall supporting it on the front edge; that construction is best on a wide hearth. Either way, the concrete subhearth must be reinforced generously with wire mesh or rods.

To have a fireplace that works properly, there are several points to keep in mind. The height of most fireplace openings should not exceed 33 in.—the average height is 29 to 30 in. The bottom of the damper assembly should be placed at least 4 in. above the fireplace opening. Most dampers today come in a heavy metal box called the throat. These usually are the easiest to install and their metal throats are smoother than brickwork, giving best passage for the smoke through this important spot. The damper should extend the full width of the fireplace opening, if possible, and must have a cross-sectional area not less than that of the flue.

The smoke shelf behind the damper should be 6 to 12 in. deep and have a smooth concave surface. The smoke shelf should extend the full length of the throat or damper. The smoke chamber above the damper should have smoothly plastered sides that slope in at an angle of not more than 30 deg. from the vertical.

The most important thing is to have a chimney flue of adequate size. The cross-sectional area of your rectangular flue should be at least $\frac{1}{10}$ the fireplace opening's area. For a fireplace 40 in. wide and 30 in. high, you thus would use an $11\frac{1}{4} \times 11\frac{1}{4}$ -in. (inside diameter) clay tile for the flue. Because round flue tile is more efficient, you can use $\frac{1}{2}$ the area to compute for round. On a Swedish or hooded fireplace, add the area of any open side as well as the front opening of the fireplace to compute the flue size. The chimney should extend a good 2 ft. above the ridge of a pitched roof and 3 ft. above a flat roof.

In localities subject to high winds or earthquakes, reinforcing rods in a chimney are a good safeguard against expensive repairs. For winds, the rods can start at the bottom of the tile flue liner, extending to within 6 in. of top of chimney. For earthquakes, these rods are tied to other reinforcing rods that are anchored in the concrete foundation and are bent to extend up through the fireplace walls to the chimney. Along with the rods, a chimney on an outside wall of a house can be held securely against the house by two $\frac{1}{8} \times 1\frac{1}{4}$ -in. iron straps, tied to two rods, passed through the brickwork and anchored to ceiling joists or upper plates of the house frame. The straps will give slightly when the house settles. Never key any rigid wood members of the house frame into the brickwork. That can give a fire hazard, and the difference in settling of the fireplace and house frame will cause cracks or other troubles. ★ ★ ★

Tar-Paper Water Shields Protect Automobile Door-Trim Panels

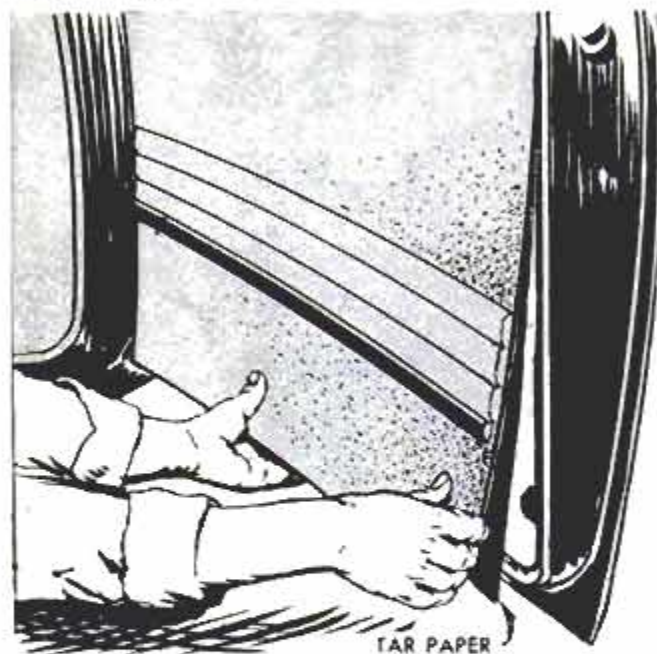

If the trim panels on the inside of your car doors are becoming warped or stained there is probably no water shield behind them. A sheet of tar paper, easily installed between the trim panel and the door, makes an excellent shield. To do this, remove the trim panel and cut a sheet of tar paper to cover the inside surface of the door but leaving one inch of the outer edge of the metal exposed. With this shield taped in place, cut holes for the window and door controls and replace the trim panel. Use cleaning fluid to remove smudges.

Antique Churn Modified for Use As Wastepaper Basket



Towel Fogproofs Mirror

To prevent a mirror on a bathroom cabinet from becoming fogged when taking a bath or hot shower, open the cabinet door and hang a dry towel over it. The towel will prevent moisture from condensing on the cool mirror, while the open door will permit the warm, humid air to circulate freely around the mirror, heating it to room temperature by the time you have stepped out of the bath.

George P. Pearce, Albuquerque, N. Mex.

Repair Loose TV-Control Knobs With Plastic Keys

Plastic knobs on a TV set that slip can be repaired by cutting a flat key from thin, clear plastic and using it to engage the slotted shaft and opposing slots in the knob. If the slots in the knob are too shallow or narrow for a secure fit, they can be enlarged with a fingernail file or a flat needlepoint file.

Charles H. Hardy, Los Angeles, Calif.

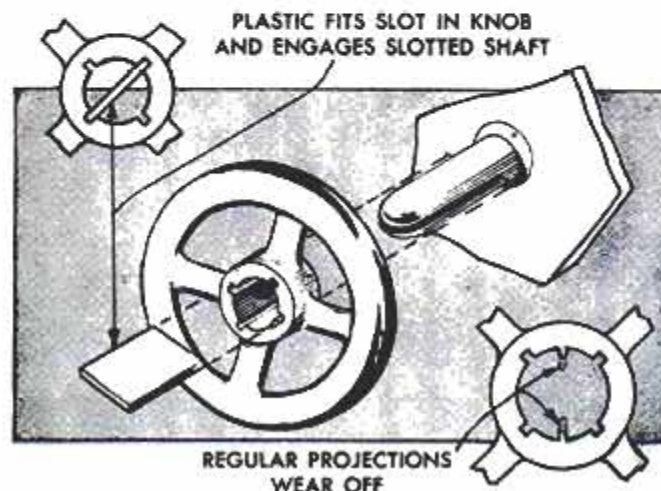

One homeowner who has colonial-style furniture adapted an antique butter churn for use as a wastebasket. The paddles were removed and the shaft cut off just inside the churn. The modification retains the original appearance of the churn, but provides more space inside for wastepaper. A coat of wax protects the natural finish.

Plane Tight Door on Hinge Side

When it is necessary to plane a door that is too wide, plane the hinged edge instead of the edge carrying the latch. This is especially advisable if a considerable amount of wood has to be removed, which would necessitate resetting the latch. It is much simpler to relocate the hinge screw holes than it is to reset the latch.

☐ The harsh ringing of a doorbell can be softened by fitting a piece of adhesive tape on the edge of the bell so the clapper strikes the tape instead of metal.

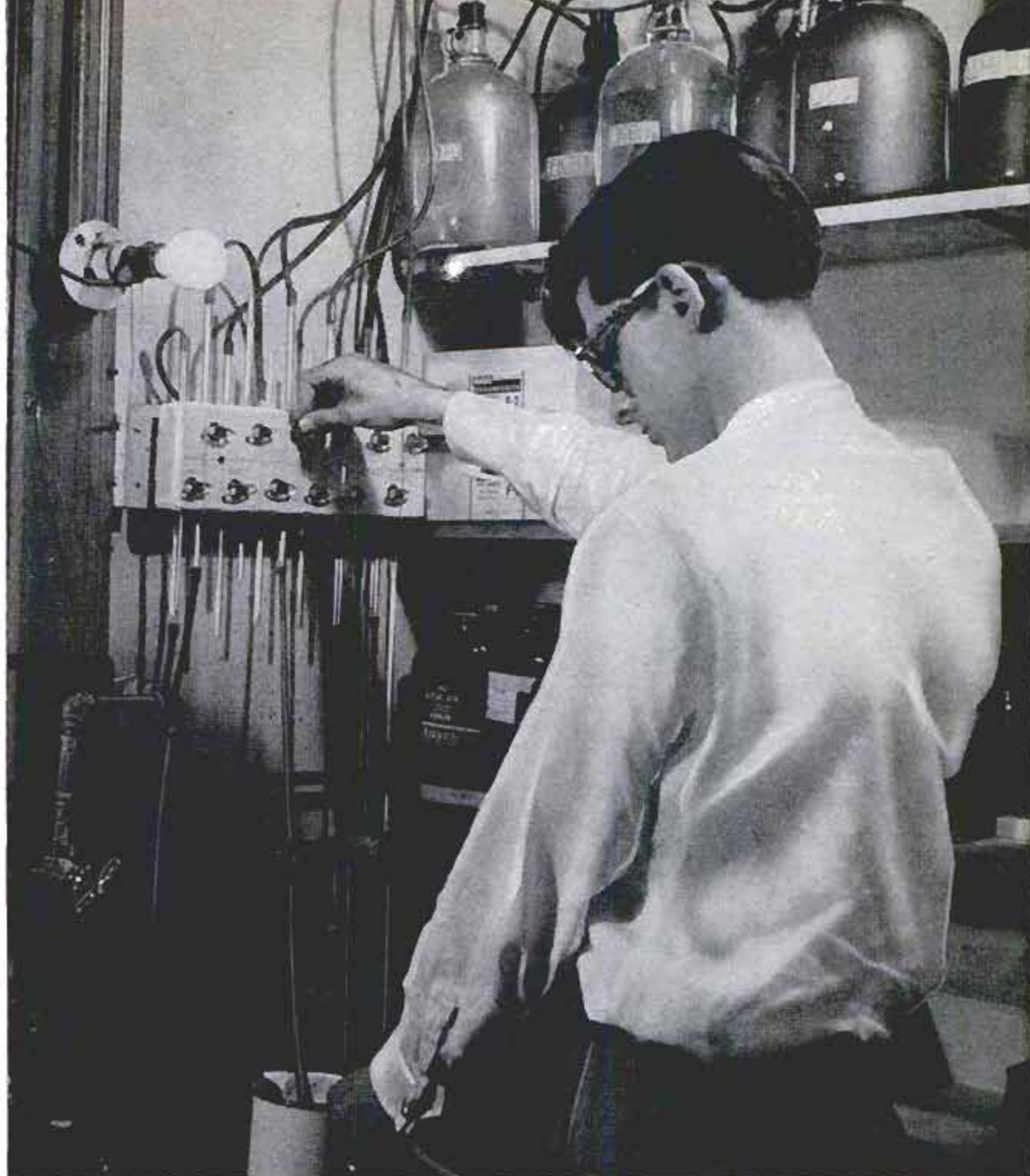

There are no bottles to handle in measuring out photo chemicals when they are kept on tap—just turn a cock

PHOTO CHEMICALS KEPT ON TAP

By John Hoke

TURNING A VALVE to measure out photo solutions as you would a water faucet is a real darkroom convenience that will appeal to anyone who processes his photos at home. This is made possible with an easily installed vacuum-siphoning system which permits solutions to be tapped from stock bottles stored out of the way on an overhead shelf. The vacuum in the system is maintained by a device called an aspirator which is attached to the darkroom-sink faucet. Vacuum is created by

running water through the aspirator. The vacuum also makes it possible to operate an efficient film agitator that is improvised from a windshield-wiper motor.

To install this system in your darkroom you'll need at least four 1-gal. bottles, seven glass stopcocks, four 2-hole corks to fit the bottles, five glass branch tubes, an aspirator and $\frac{1}{4}$ -in. rubber and glass tubing. The glass stopcocks are the valves which control the flow of solutions kept on tap. All seven stopcocks are cast in a

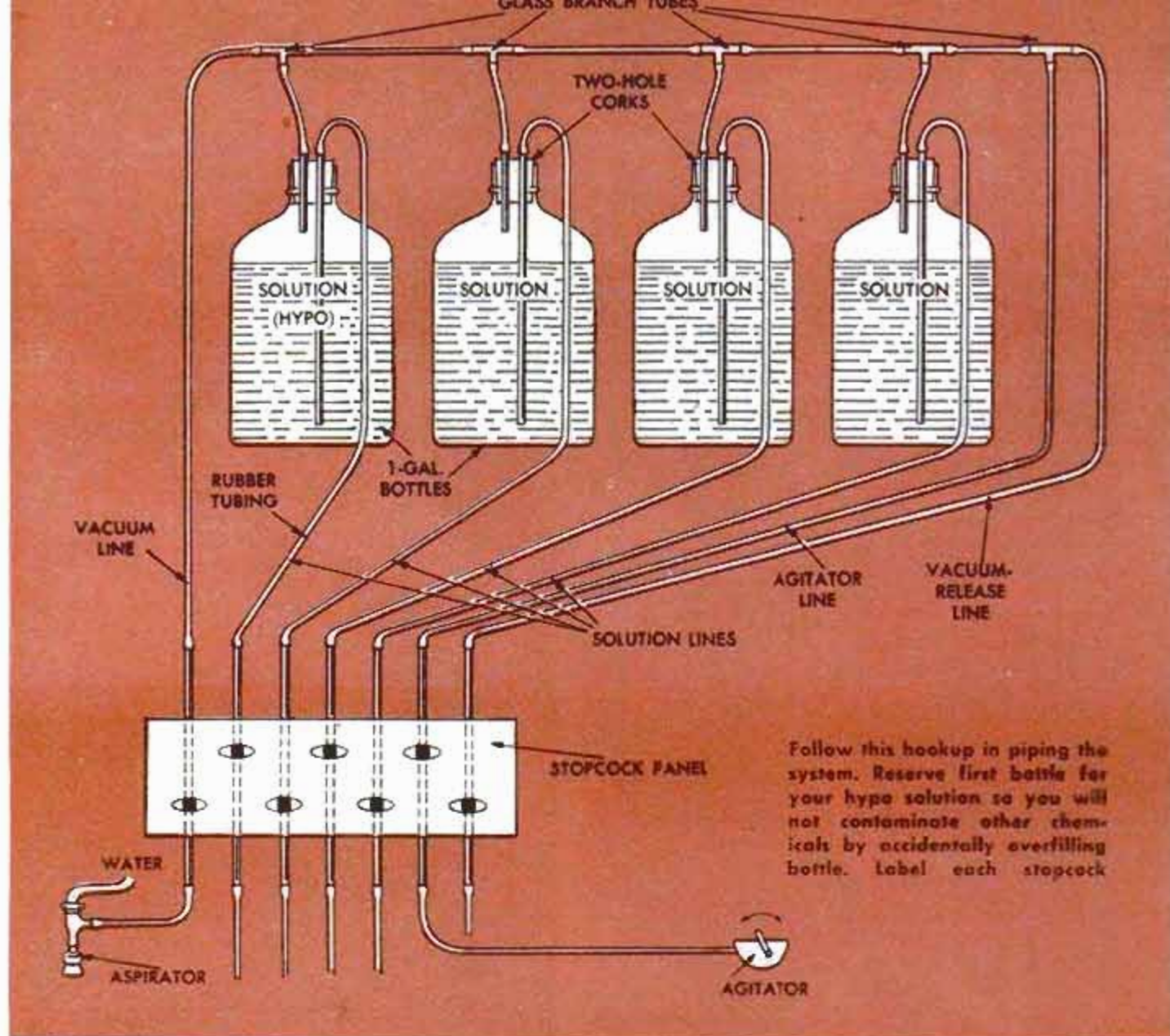

plaster-of-paris panel. A shallow cardboard box makes a good form for the casting as it can be easily stripped off. Holes are made in the sides of the cardboard box to insert the glass tubes attached to the stopcocks and the latter are positioned in the box in the manner shown in the drawing above. Pieces of wire and bits of metal mixed in with the plaster will reinforce the finished casting. Finally, each stopcock is labeled with the name of the solution it is to deliver, and the block is mounted at a convenient height on the darkroom wall.

Piping the System

The diagram above shows clearly how the stopcocks are connected with rubber tubing to the bottles, aspirator and agitator. You'll notice that each bottle cork is fitted with two lengths of glass tubing, one being long enough to nearly touch the bottom of the bottle.

Be careful in pushing the glass tubes through the holes in the corks. Wetting the corks with water will help make the tubes slide through easily, but you should

take the added precaution of wrapping the tube and cork with a towel to protect the hands in the event a tube should break.

The vacuum of the system is controlled by the stopcocks at the ends of the panel, the one on the left being labeled vacuum and the one on the right, vacuum release. After each bottle is hooked into the vacuum line and connected to its respective stopcock in the manner shown in the diagram, the aspirator is connected to its stopcock and the agitator to its stopcock. The rubber tubing at the lower ends of the stopcocks should be long enough to reach into the darkroom sink.

The windshield-wiper motor is rigged up to rock a tray platform placed in the bottom of the darkroom sink. A bracket to hook it over the edge of the sink can be formed of coat-hanger wire and another piece of wire is used to connect the platform to the rocker arm of the motor. The platform can be either wood or metal, and a cork fastened to the underside at each end will provide pivots on which it can rock. To make the agitator work, turn on

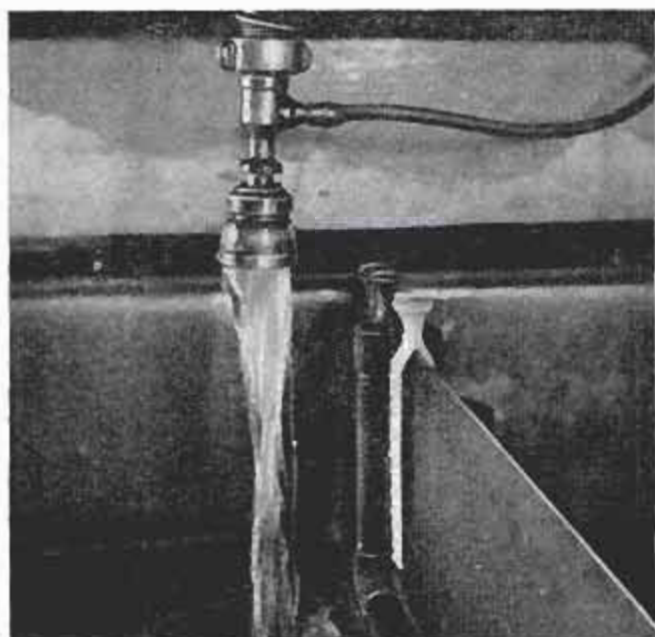

Aspirator screws onto sink faucet and is connected to stopcock panel with length of rubber tubing

the water faucet so water will run through the aspirator and open the stopcock labeled agitator. Adjust the flow of water through the aspirator so the agitator will rock the tray with a slow periodic movement. Avoid rapid agitation when developing film as this may cause flow lines on the surface.

Operating the System

To siphon solutions into the bottles, a vacuum must be created by running water through the aspirator. All stopcocks must be closed except the one which controls the bottle you are filling. As the vacuum increases, the solution will flow more rapidly into the bottle. Do not attempt to fill the bottle too close to the top or you run the risk of pulling the solution into the vacuum line and out through the aspirator. When the bottle is full, close the stopcock.

Don't let the container from which you are drawing the liquid become completely empty so as to draw air into the bottle. A column of solution must be left standing in the glass tube of each stopcock that delivers solution.

Let the first bottle of the group hold hypo. This will prevent any chance of the other solutions becoming contaminated should you accidentally overfill the hypo bottle. By keeping it first in line, any excess hypo will merely flow out through the aspirator. To insure cleanliness of the

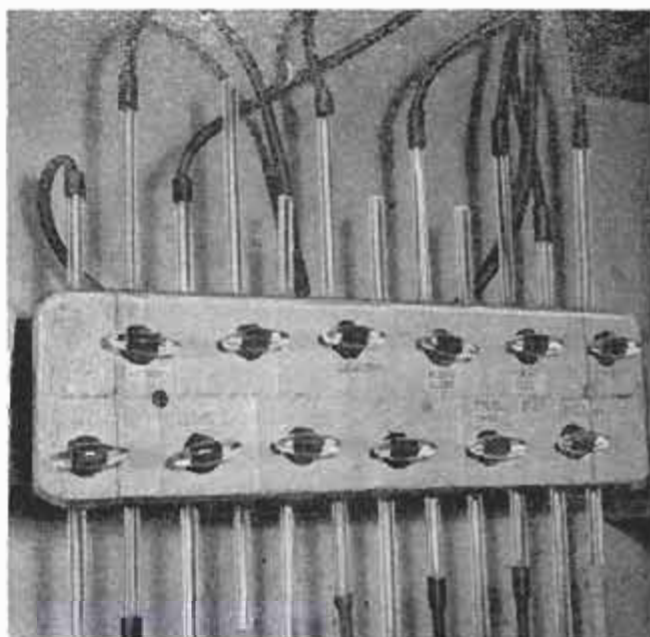

Stopcock panel controls flow of siphoned chemicals. Rubber tubing slips over ends of the glass tubes

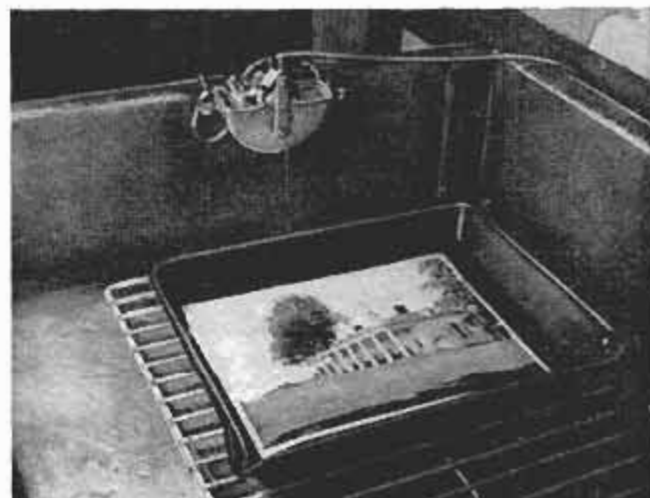

Agitator is made from windshield-wiper motor and vacuum-operated by running water through aspirator

bottles after having exhausted the supply, draw some clean water into the bottle and drain it out again before refilling.

To tap the stock bottles, first open the vacuum-release stopcock and then the stopcock of the particular solution you wish to use. Should the tubing have no solution standing in it, turn on the water faucet and pull some water into the tube. Then release the vacuum again and the solution will flow. When not being used, seal off the system under a vacuum. This will help prevent oxidation of the chemicals that oxidate under normal air pressures. ★ ★ ★

Metal Primer Prevents Peeling Paint on Steel Casements

When paint peels from steel casement doors and windows it is a pretty good indication that the steel was not entirely free from oil and grease when originally painted, or that a metal primer was not used. To eliminate this condition remove

the old paint, clean the bare metal with fine steel wool, and wipe clean with a cloth dipped in turpentine. Then apply a metal primer and allow it plenty of time to dry. Finish with one or two coats of outside paint.

Versatile Snack Tray Cut From Light Plywood



This large all-purpose wooden snack tray is a versatile item that can be used for both indoor and outdoor entertainment. The original was made from $\frac{1}{4}$ -in. plywood, with the ends cut from a pattern laid out on a grid of $\frac{1}{2}$ -in. squares, as shown, although this design can easily be modified. The length of the tray may be varied to suit its intended use, keeping in mind the problem of storage. The tray can be left natural, or finished in a number of ways. Decals can be attached to the tray for a decorative touch.

I. M. Fenn, Chicago.

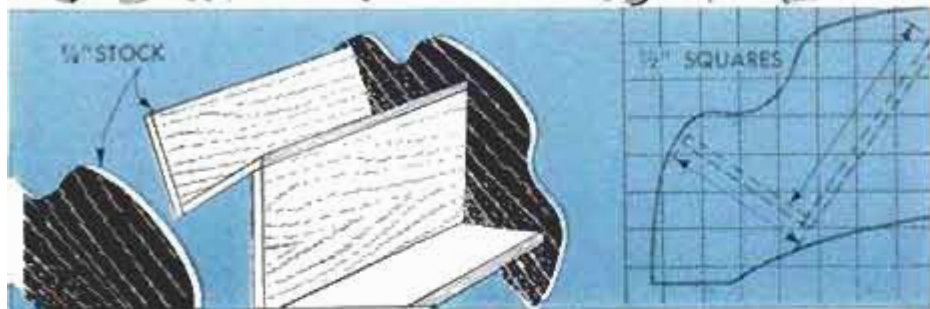

Discolored Enamel Cleaned

To remove surface discolorations on a bathtub or sink, use a mixture of baking powder and peroxide. Make a paste of the two materials and apply it to the discolored areas with a cloth. After the paste has dried, wash it away and the original luster will be restored. The mixture also can be used to brighten the finish on a refrigerator.

Barbara Pritchard, Syracuse, N. Y.

King-Size Cigarette Case

A medium-size adhesive-bandage box is excellent for carrying a pack of king-size cigarettes. The sturdy metal box with hinged lid protects cigarettes from moisture and crushing when carried in a shirt or trouser pocket at work or while hunting or fishing. Give the outside of the box two coats of enamel.

Herbert Kondo, Champaign, Ill.

Jig for Cutting Clamp-Nail Grooves on Mitered Corners

This wooden jig permits easy and accurate cutting of clamp-nail grooves on the mitered ends of a bookcase, cabinet base or corner blocks on a table. The three members are cut from $\frac{3}{4}$ x $2\frac{1}{2}$ -in. stock and fastened together with wood screws as shown. In use, the jig is attached to the miter gauge of a bench saw. Use a thin

saw blade for cutting the grooves, which should be made slightly deeper than half the width of the clamp nails, to permit secure fastening. Grooves for splines also may be cut with the jig by using a thicker blade, such as the outside blade of a dado head or groover saw blade.—Gordon D. Carlson, Minneapolis, Minn.

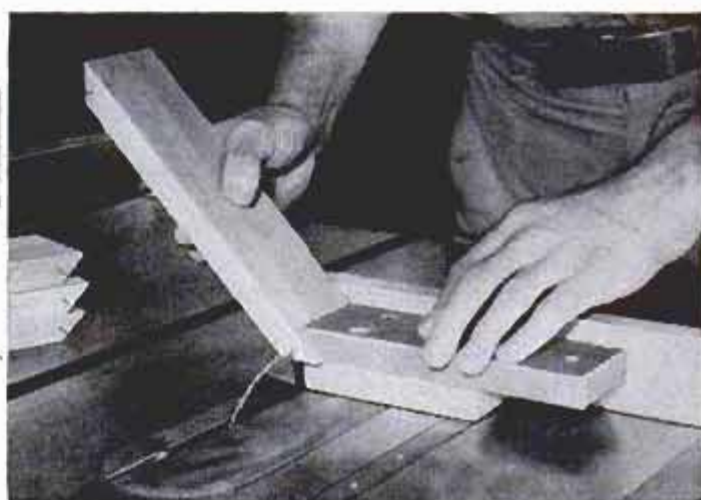
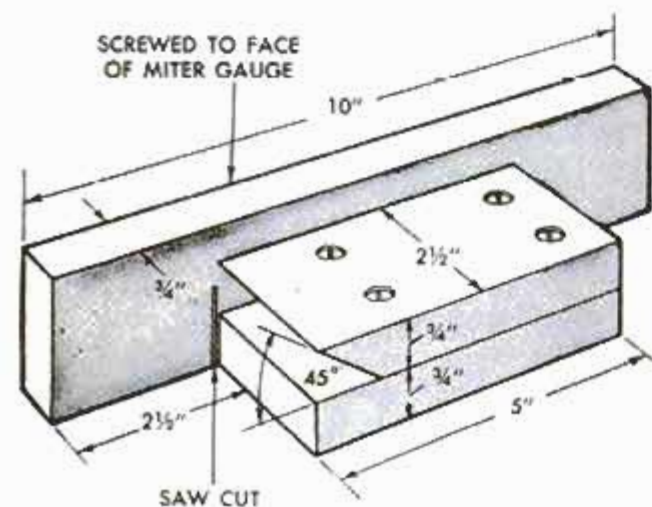

DECORATIVE STAND FOR POCKET WATCH

By *Bertram Brownold*

AN INEXPENSIVE pocket watch suspended from the arch of this decorative stand serves as a novel and useful mantel timepiece. Or, your grandfather's watch with its heavy gold case (if you have one), can be used for this purpose and be given prominent display rather than collect dust in a drawer with other forgotten mementos.

The wooden base in which the ends of a 9-ga. brass-wire arch are set is hollow and filled with lead for stability. The base is assembled with glue from four pieces of wood, two of which have their centers cut out as shown in the squared pattern below. The wire used for the arch can be shaped on a piece of wood, with the contour of the arch cut on one end, and peened and burnished if an antique finish is desired. Three pieces of sheet brass shaped as shown are riveted to the arch for ornamentation. The design painted on these pieces is in black enamel, applied with a fine brush. An ordinary pen also can be used, if the enamel is thinned with turpentine

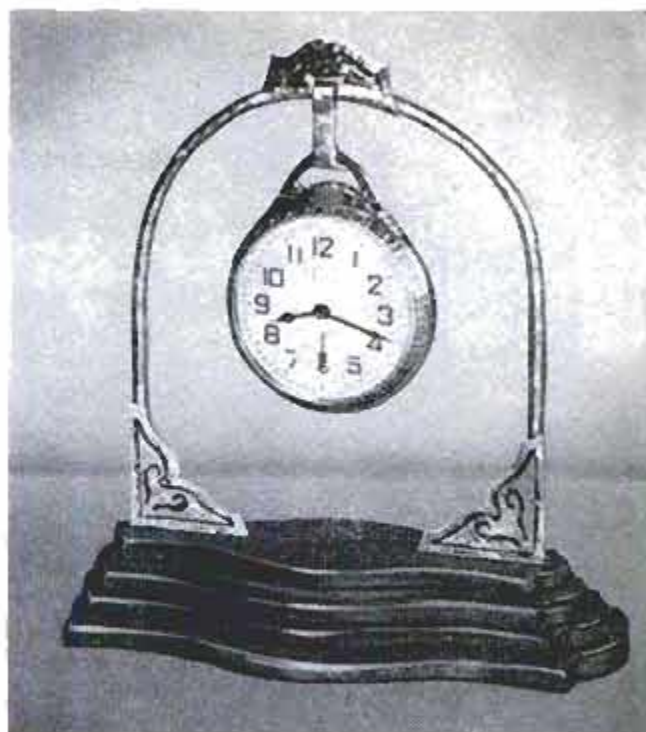

Apply a finish on the base of the stand that will harmonize with the furniture on which it is placed

so that it will flow easily. When the enamel is dry apply a protective coat of lacquer. The watch hangs on a hook made from a strip of brass the lower end of which is bent to form a hook. The upper end of the strip is bent around the arch. Finish the base in a suitable color.

Patterns of base pieces below are $\frac{1}{3}$ smaller than full size. To enlarge, redraw the patterns on grid of $\frac{1}{8}$ -in. squares. Use only glue in base assembly

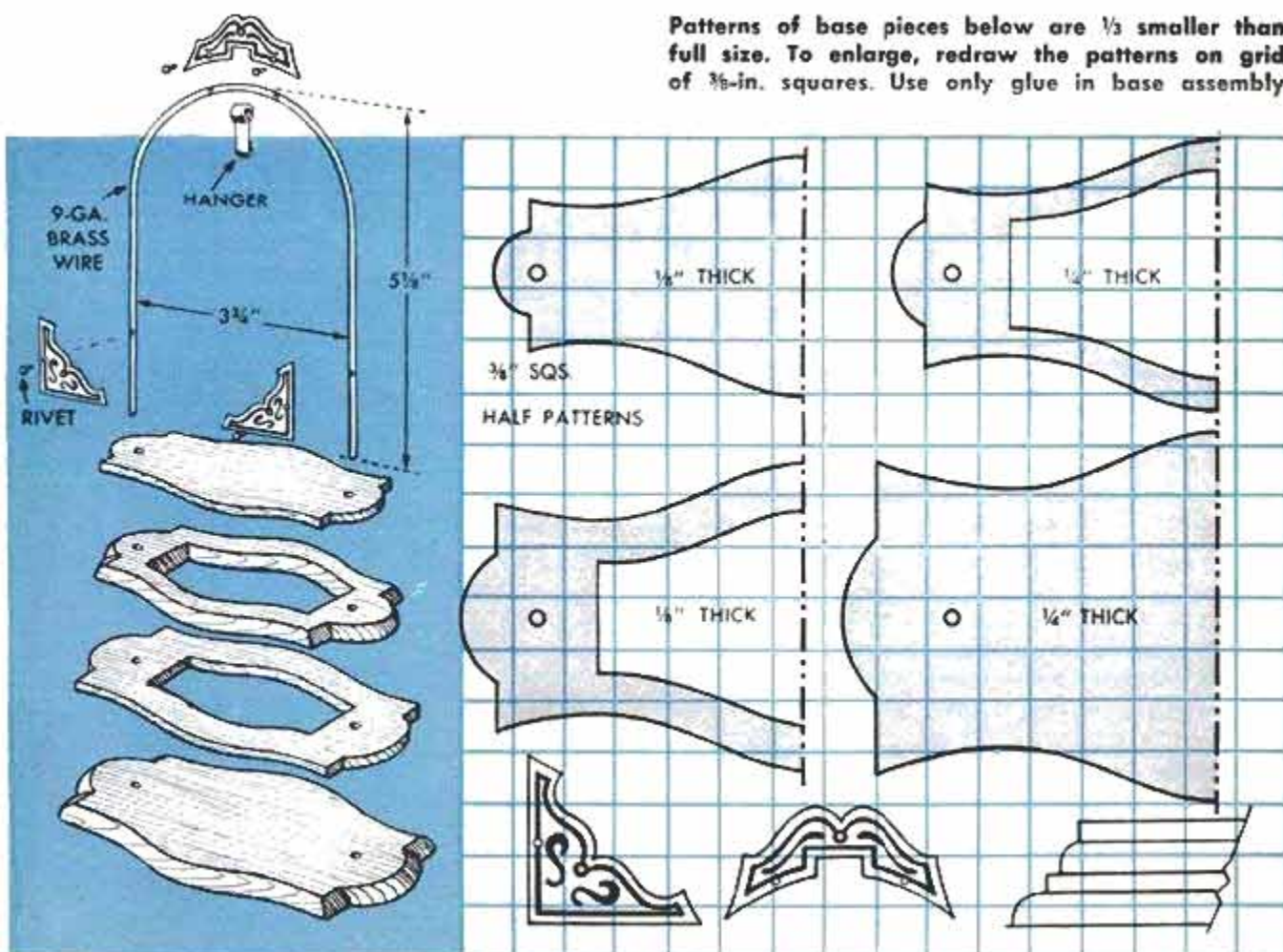

By Ed Packer



Keep Home Appliances RUNNING SMOOTHLY

OIL-STARVED BEARINGS can cause failure of a home appliance long before its time. But too much oil also can damage seriously such motor-driven units as fans, washers and mixers. Excess oil thrown from sleeve bearings of a motor tends to creep, or migrate, to the commutator and windings where it can become both an insulator and conductor. Eventually the motor burns out and must be replaced. Take time to count the motors on duty in the various appliances in your home. These motors alone represent a considerable investment. Lubricants applied properly can mean extra long life and satisfactory performance, but incorrect lubrication can be the cause of replacement. Nearly all motors in older units require periodic lubrication, but appliances of a later model may come equipped with motors having lubricated-for-life bearings.

Manufacturer's instructions usually are quite specific as to the kind and quantity of lubricant to be used. In addition to light machine oil, several other special lubricants supplied in dry powder, stick, semisolid and liquid forms are well suited to use on household appliances and fittings. These are pictured above in the containers in which they are regularly available. A one-drop oil can is essential for oiling food mixers, cooling fans and sewing machines having small motors requiring only a drop

or two of oil at each servicing. Some small motors are equipped with wool-packed bearings, others with wick-type oilers designed to use either a very light grease or a light oil. These usually are fitted with a spring-loaded wick, or wiper, which carries the lubricant to the shaft.

Kitchen ventilating fans often operate with the motor in a vertical position and it is important to follow the manufacturer's instructions when lubricating. Fan motors gather much lint and dust at best so it is especially important to clean the motor thoroughly after servicing to remove any oil or grease from the end housings and frame. In some cases it is permissible to equip centrifugal blowers with continuous oilers of the type pictured in the upper right-hand photo on the opposite page. The oiler must be adjusted to give only a single drop of oil at fairly long intervals.

Dry graphite lubricants are just the thing for easing the operation of tumbler locks. Graphite lubricant is supplied in a special gun which simplifies application. Use a nondripping lubricant on hinge pins, also on lock bolts to prevent the latter from jamming against the striker plate. Stick lubricant makes drawers slide easily. It also can be used on metal weather stripping to make doors close easier. Window sash open and close more readily when the weather stripping is lubricated. ★ ★ ★



Use special care when oiling food-mixer motor and be sure to follow the manufacturer's instructions



The oscillating mechanism of an electric fan usually requires a special gear oil applied sparingly

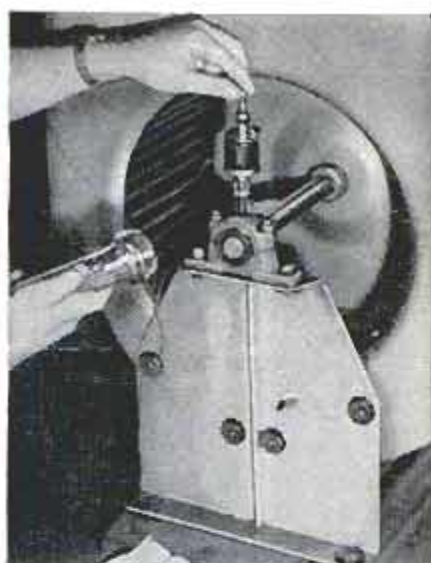

Often it is permissible to equip bearings of centrifugal fans with continuous oilers of type pictured

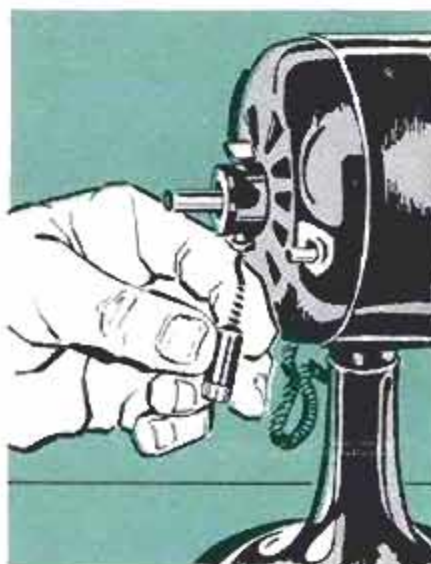

Older fan motors generally are equipped with oilers having spring-loaded wick to carry oil to bearing

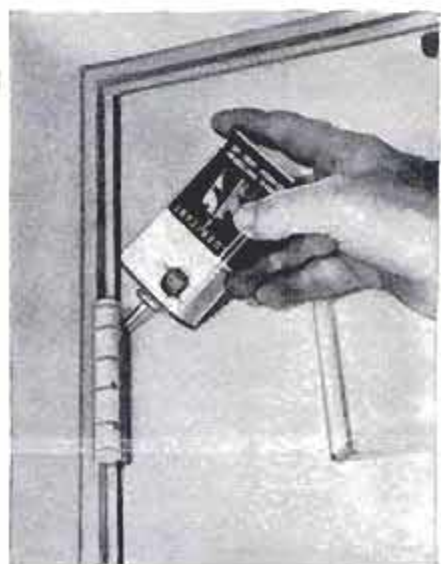

Use nondrip lubricant on hinge pins. Wipe away excess lubricant to prevent it from gathering dust



Some kitchen fans have motors operating in a vertical position. Clean motor thoroughly after servicing

Stick lubricants are useful on wood as well as metal surfaces. Use to ease closing of doors and drawers

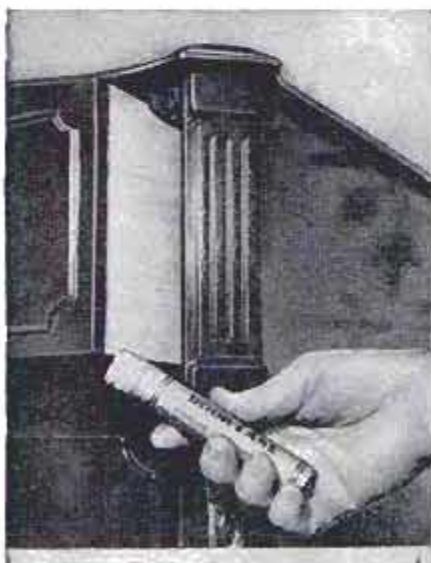

Dry graphite, supplied in a special gun, lubricates tumbler locks. Only a very small quantity is necessary

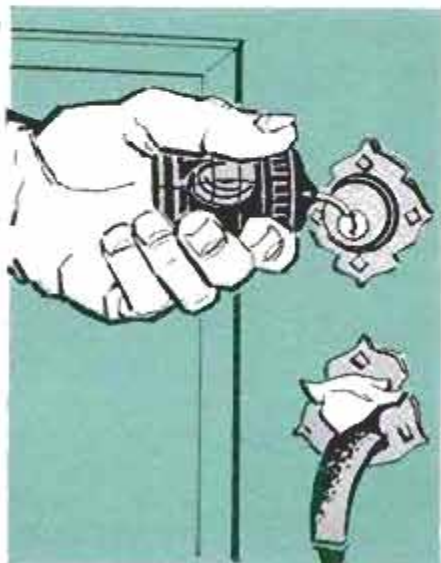

Tiny motors that operate clocks, gas valves and similar units require application of special oils



Small-Parts Box Easy to Carry When Fitted With Saw Handle



An old saw handle fitted to a wide strip of metal and strapped around a small-parts cabinet makes it easier to carry from one job to the next. With this handle it is not necessary to stoop to pick up the cabinet and the ease with which it can be carried in a horizontal position prevents drawers from sliding out on the floor.

Dried Paint Removed From Shoes

Removing dried paint from leather shoes can be done with shoe polish and steel wool. A generous application of paste polish is put on the shoes without polishing, and then the individual paint spots are rubbed gently with grade 0 steel wool until they are removed. Brush the steel-wool particles from the shoes, apply another coat of polish and buff to desired gloss.

E. F. Brandt, St. Augustine, Fla.

Talcum Powder and Linseed Oil Make Emergency Putty

A mixture of talcum powder and linseed oil can be used as a satisfactory substitute for putty when only a small amount is needed to finish a job. Mix the two ingredients to a puttylike consistency and apply in the usual manner. A stick of chalk ground to powder can be used instead of talcum, if the latter is not available. Left-over material can be kept in a covered jar.

Rustic Picture Frame

For a picture frame that will have a "grainy" look, use plywood strips cut across the grain for the frame members, which can be glued or stapled together. Thickness of the plywood used should be determined on the basis of size of picture to be framed and the effect desired.

Arthur Shults, South Bend, Ind.

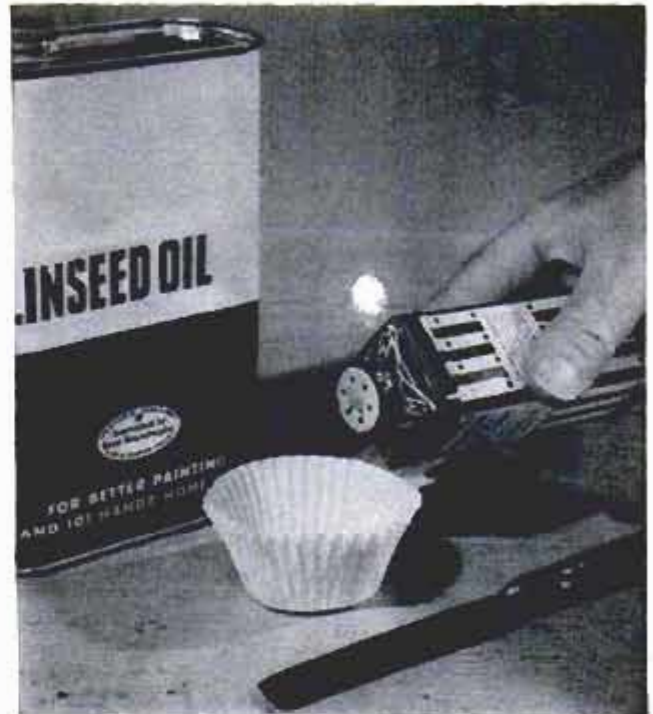

Clamp Prevents Paper Blowing When Typing Outdoors

If you like to use your portable typewriter outdoors but find that a breeze keeps flipping the end of the paper over the keys, try adding a little weight to the free end. Simply clip a spring-type paper clamp over the projecting bottom of the sheet after it is inserted in the machine. When the paper has rolled slightly more than halfway through the typewriter, transfer the clamp to the top edge of the sheet and continue with your typing.

☞ To preserve the original appearance of the cover of a much-used book, brush on a thin coat of shellac.

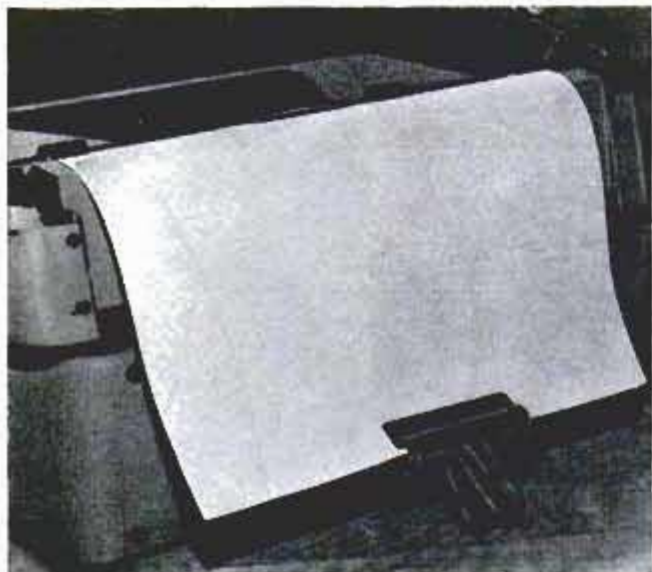

Patio Lounge

By Hi Sibley

LOTS OF LAZY COMFORT is built into this contour patio lounge, and it's a fairly simple thing to make if you have a band-saw to cut out the curved parts. Staves from nail kegs, which are used to cover the top, add to its body-conforming comfort. Except for the wheels and the member to which they are attached, all parts are cut from $\frac{3}{4}$ -in. material. The side rails are cut from ~~1 x 8~~ boards and consist of two separate pieces butted together and held securely by screws in the rear legs. The drawing shows at a glance how the other parts go together. Give it two coats of exterior paint, add a padded cushion and lean back in solid comfort.

1 x 10

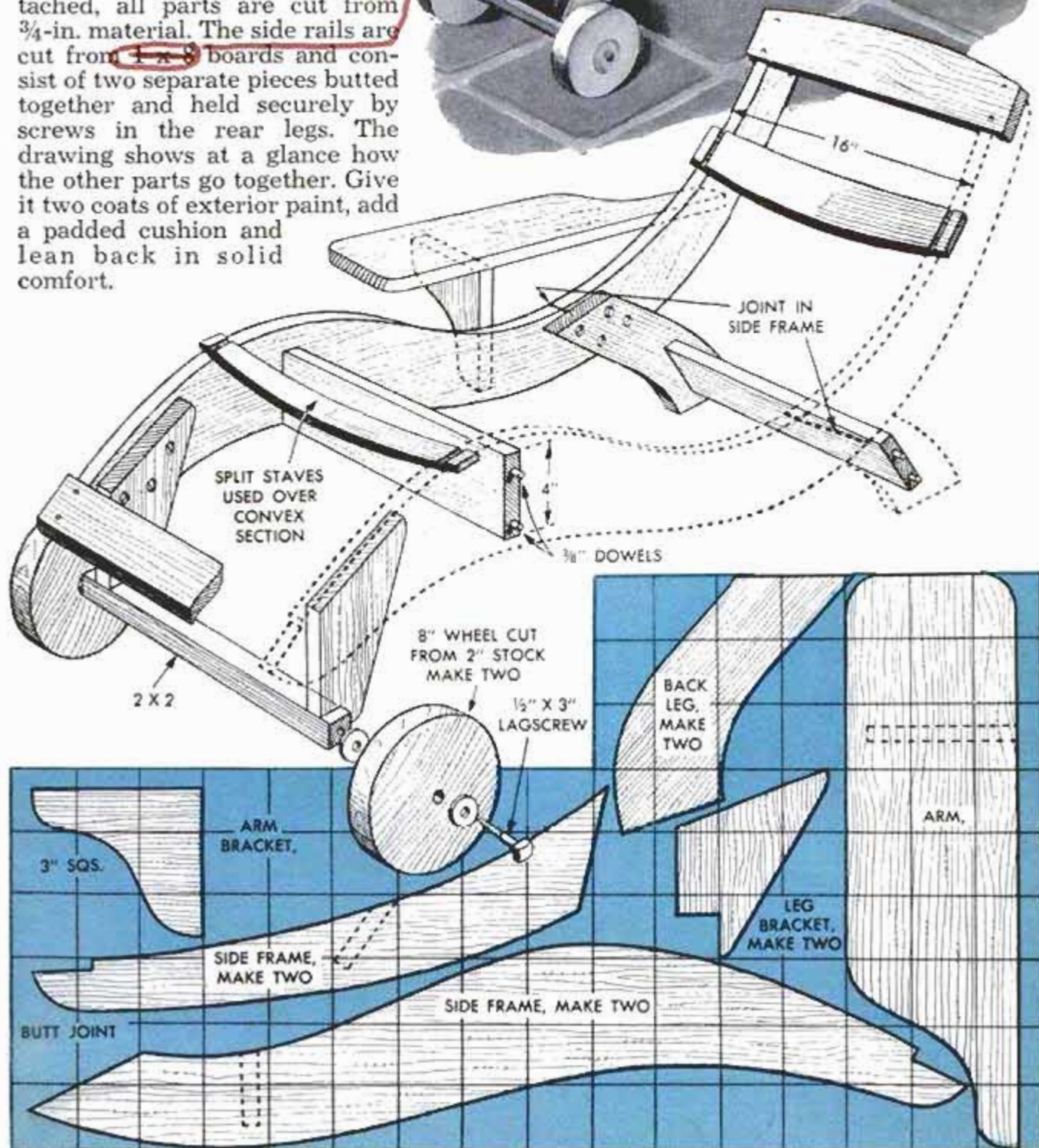

SOLVING

Home Problems



1. CUT FLOWERS will keep that fresh, on-the-vine look hours, even days, longer if you add a pinch of ordinary table salt to the water in the vase at the time the blooms are arranged. The exact amount of salt is not too important. If vase holds a pint of water then a small pinch of salt is sufficient

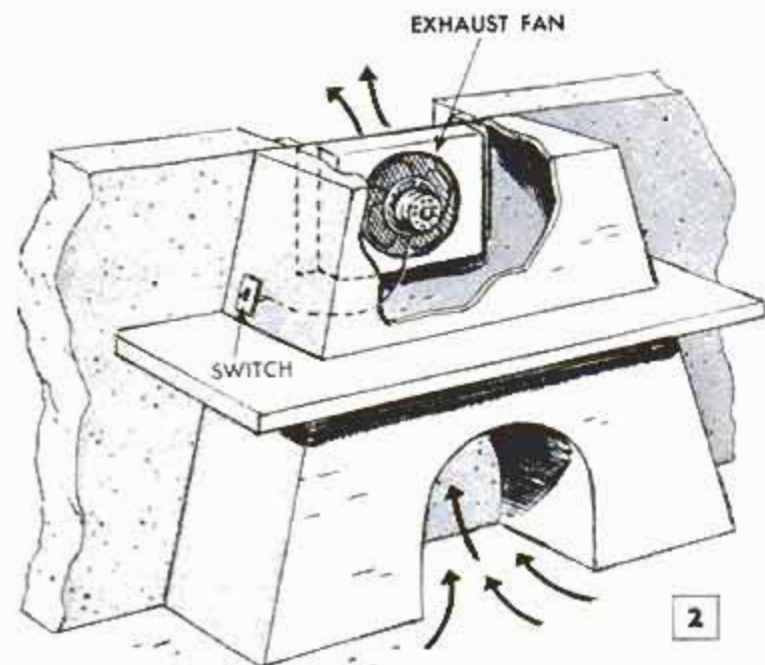

2. AN EXHAUST FAN utilized for ventilating a damp basement can be made inconspicuous and the noise less objectionable by an imitation fireplace mantel extending from floor to ceiling. Mantel and fireplace can be built from 3/4-in. plywood. Cover with imitation brick

3. IMPROVED HOLDER for small staples saves tempers and fingers when starting the staples in hard-to-reach places. Holder is bobby pin of crimped type. One leg of staple is passed through opening between crimped and straight leg of pin, then started with hammer

4. A COAT HANGER, bent as shown in the detail, makes a handy hook for supporting a bucket of paint on the rung of a ladder. It's better and steadier than a hook bent from a single wire. First, straighten the wire hanger to form a long loop. Then bend loop into a hook

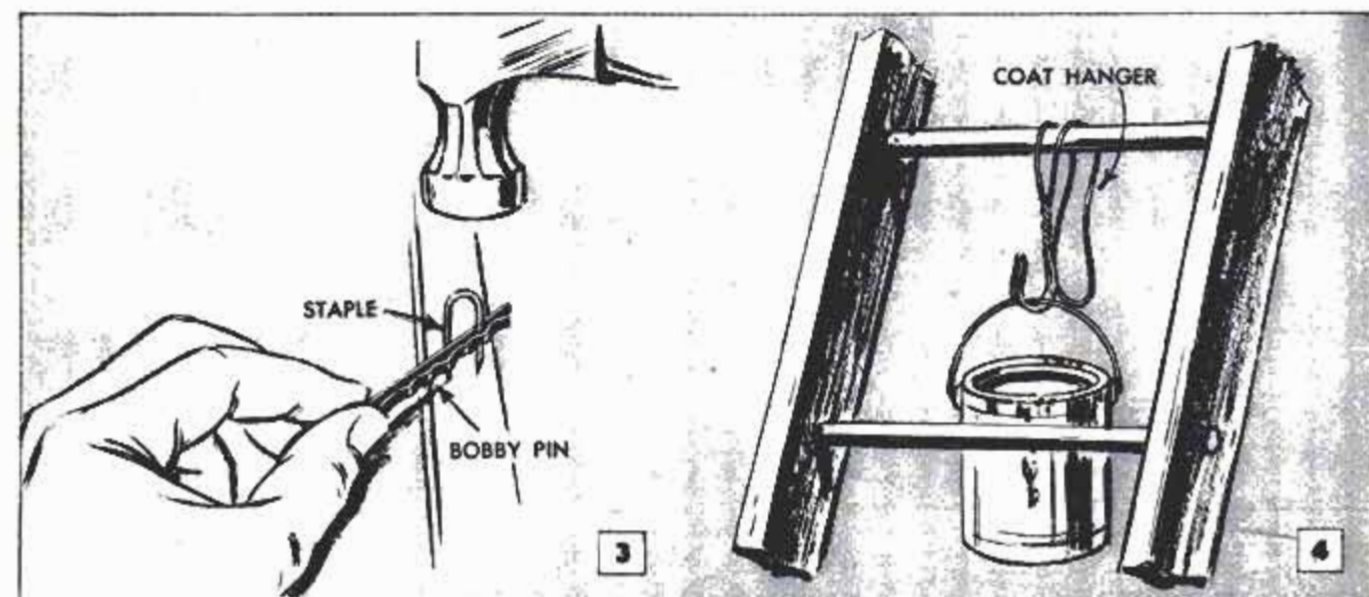

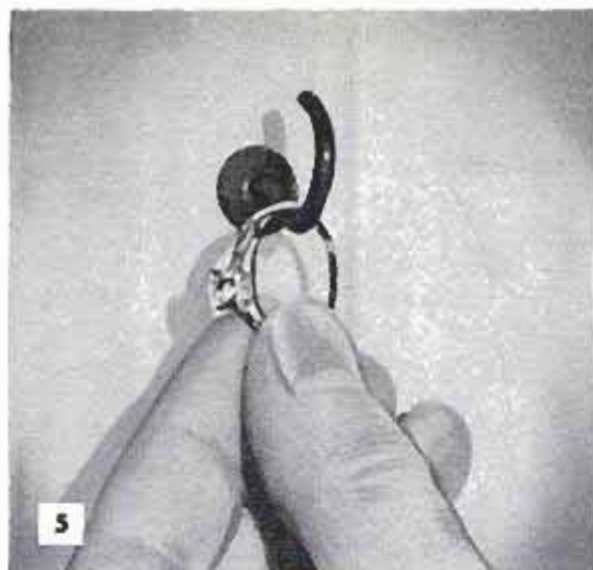

5. CUP HOOK screwed into the wall above the kitchen sink makes a handy keeper for the ring you always remove when washing dishes. Ring is not easily removed or knocked off the hook inadvertently and, in case you forget to replace it, it is less likely to be lost on the floor or down the drain. Locate the hook out of reach of small children

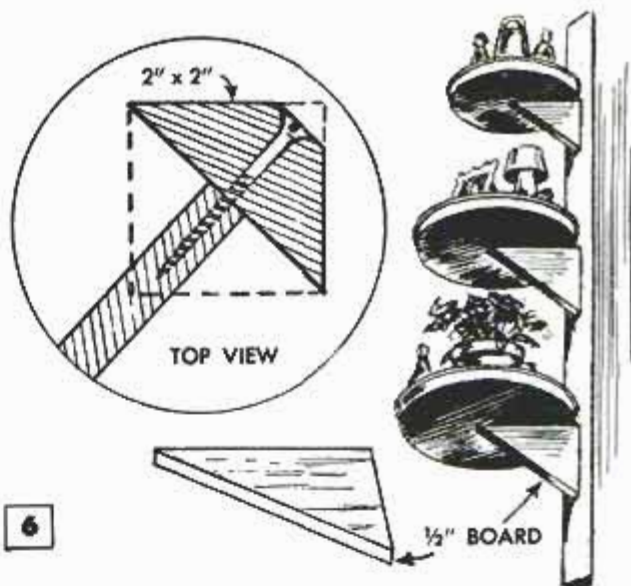

6. CAKE TINS of graduated sizes form shelves of this three-tier whatnot. To make the frame with brackets, rip a 2 x 2 diagonally to form vertical member and then cut three brackets from 1/2-in. stock, the sizes graduated to suit varying sizes of shelves. Space brackets and screw to vertical member. Then attach shelves with screws

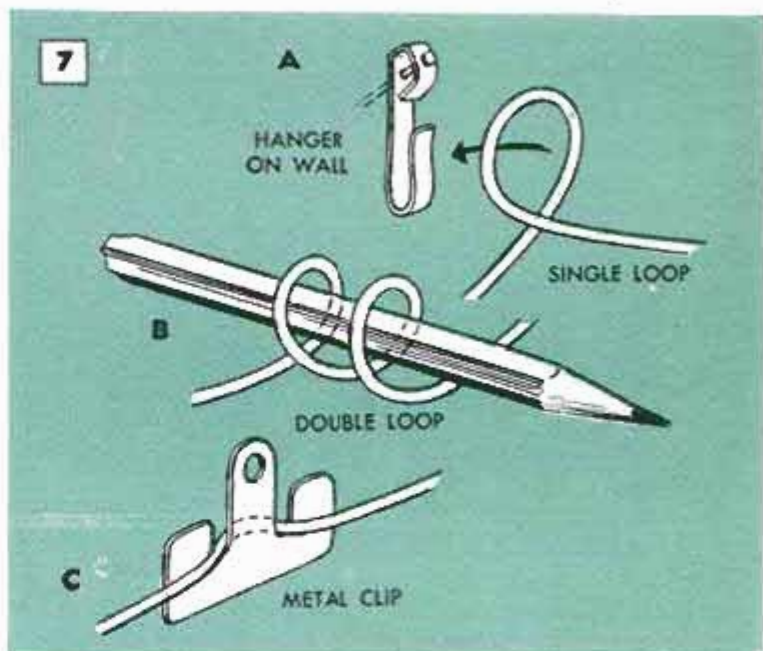

7. FRAMED PICTURES can be prevented from tilting by the simple trick of snubbing the cord or wire around the hanger. A single loop, detail A, usually does it, but in some cases a double loop formed as in detail B is more effective. Also available for this purpose are the special clips shown in detail C. These are slotted to slip over wire

8. SCRAPS OF BAR SOAP from the laundry and bathroom can be salvaged by running them through a meat grinder as pictured. This procedure reduces the scraps to flakes which can be utilized without waste. The job of running the scraps through the grinder can be made somewhat easier by heating soap slightly before feeding into the grinder



Home-Built Smokehouse

Smoke-flavored fish and game are home products of one man who built his own smokehouse using a refrigerator cabinet from which the mechanism had been removed. A 4-in. hole cut in the cabinet top permits inserting a length of 4-in. stovepipe which projects 2 in. inside the cabinet liner. A 4-in. hole in the cabinet bottom accommodates a 4-in. stovepipe elbow. The firebox for the smokehouse is a small steel oil drum that has a 4-in. hole cut in one end. The other end is cut out, then hinged and used for a lid. A damper is fitted in the first length of pipe. Two lengths of stovepipe are used for fish and meats, four for sausage. — Earl Stowell, Milwaukee, Wis.

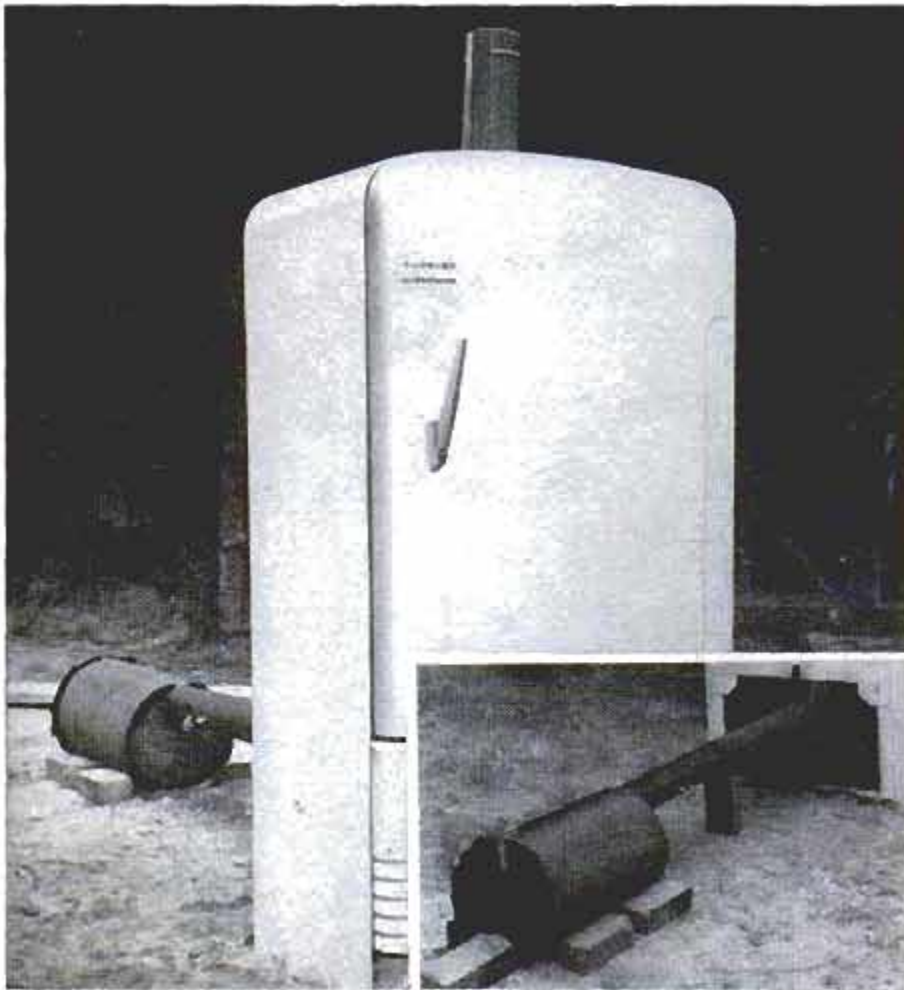

Hang Bowed Door With Concave Surface Facing Outside

When installing a wooden door that is bowed slightly, be sure the concave surface faces away from the doorstop, for a good fit. Sight down the top or bottom edge of the door to determine the direction of the bow and install the hardware on the door and doorjamb. There will be a slight

amount of tension on the door when it is in the closed position, but the latter condition will eliminate rattling and also will cause the door to straighten perfectly and fit flush against the doorjamb after it has been in use a short time.

Walter L. Stein, Kenosha, Wis.

Attractive Radiator Covers Provide Added Storage

If your home has cast-iron radiators, one of these two cover styles can be adapted to make them more attractive. The undersides of the cover tops should be insulated with blanket or rigid-type insulation so that books and bric-a-brac can be placed on the covers. Style No. 1 has a perforated-sheet-metal grille; this material can be purchased in sheet form at most hardware stores. Both cover styles should be 1 in. longer than the radiator, 1 in. higher plus space for insulation, and $\frac{1}{2}$ in. wider than the distance from the wall to the outer edge of the radiator. The length dimension of style No. 2 will vary to permit fitting around the valve and steam pipe.

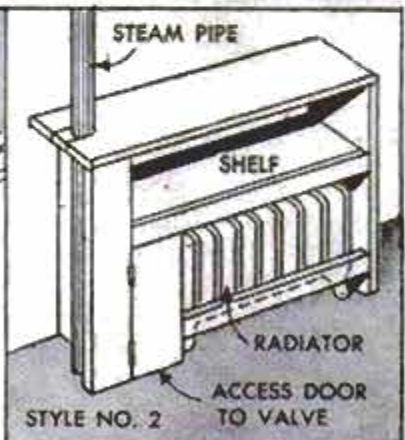
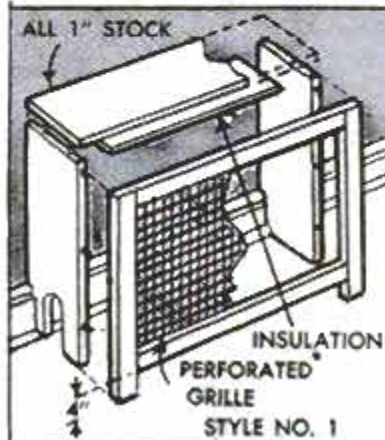

"HARNESSING" YOUR SPRING

IF YOU ARE LUCKY enough to have a free-flowing spring on your property, this concrete enclosure can be constructed over it to reduce contamination by surface seepage and assure a more constant supply of reasonably clean water. First, dig a trench that will drain all the water from the spring to a depth sufficient to permit excavation of earth to admit forms for the concrete enclosure. Later, the delivery pipe will be laid in the same trench as shown in the detail. The lower half of the wall that faces "upstream" is built up of flat, loose-fitting stones. An overflow pipe discharges water on a concrete apron. As an additional precaution against contamination of the water, build a fence around the spring to keep stock at least 25 ft. away, and divert surface water by providing a ditch inside the fenced-in area as shown.



Nipples for the overflow and delivery pipes should be positioned in the forms at the desired levels before the concrete is poured

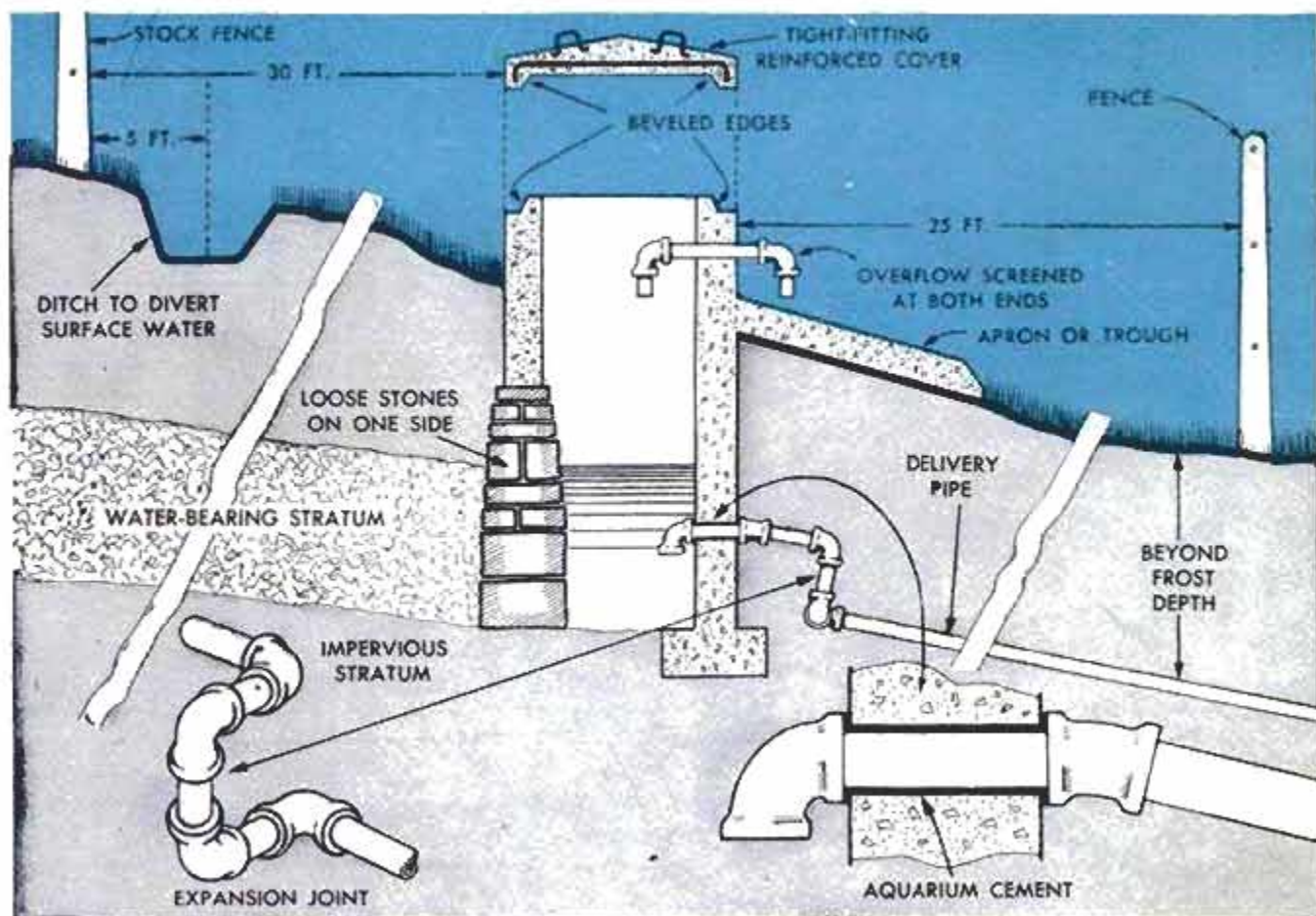

Clothes-Drier Standard Held by Stepping on Footrest



Holding the standard of an outdoor folding-type clothes drier in its socket while raising the line-holding arms is no problem when a footrest is provided. The rest is an L-shaped length of $\frac{1}{4}$ -in. steel rod fitted into a hole drilled through the standard just above ground level. Standing on the rest with one foot holds the standard in place. When the clothes drier is folded for storage, the rest pivots against the standard. A similar footrest also can be used to hold the standard of a large beach or patio umbrella while opening it.

Andrew Vena, Philadelphia, Pa.

Keyed Typewriter Platen Assures Uniform Margins

Here's a simple method of assuring the same margin at the bottom of typewritten sheets. Use two small strips of masking tape, sticking one short piece horizontally to the left-hand end of the platen for the starting strip. Whenever an 11-in. sheet of

Emergency Paint Remover

When commercial paint remover is not available, try a mixture of turpentine, 1 part, and household ammonia, 2 parts. While not as effective as modern paint removers, this solution will soften most oil-based paints so they can be scraped off.

Irregular Contours Copied With Stack of Cards

Usually it is difficult to make a profile template of an irregular contour such as a baseboard molding. However, an easy way of obtaining the exact contour is to place two or more decks of playing cards in a stack and tap the ends against the surface to be copied. Identical contour is reproduced on the outer edge of the stack and the contour profile is easily traced on paper.

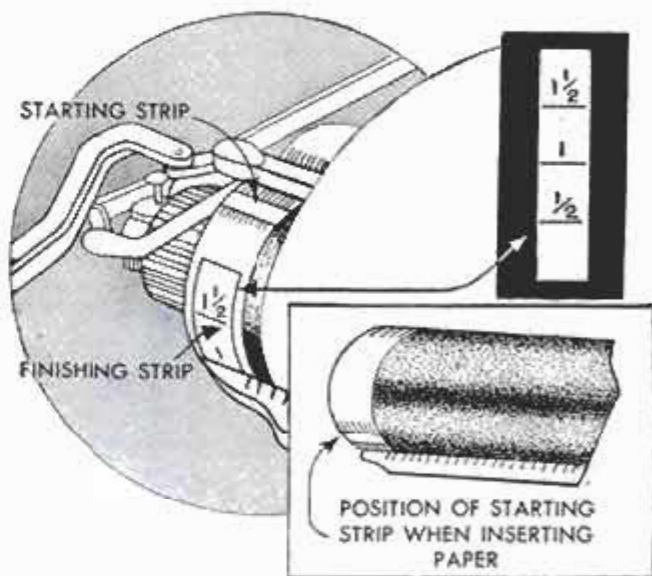
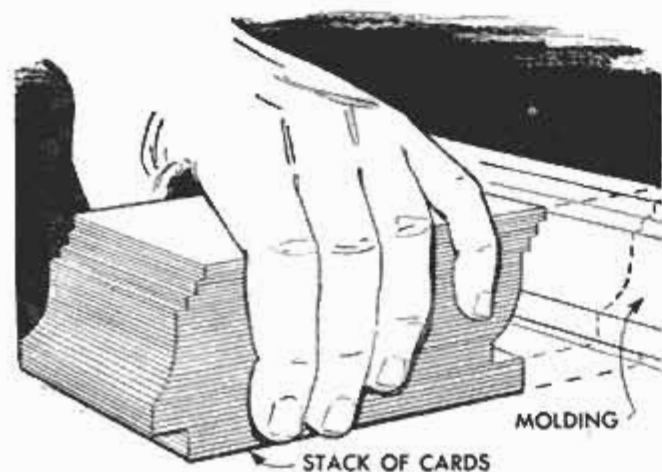

paper is inserted in the typewriter, and the spacing at the bottom is to be observed, the platen is adjusted to bring the strip to the position shown in the lower detail. Next, rule lines $\frac{1}{2}$ in. apart on a 2-in. length of tape and letter these $1\frac{1}{2}$, 1 and $\frac{1}{2}$ as shown. This is the finishing strip. Now, insert a standard 11-in. sheet of paper after adjusting the platen for starting. When this sheet is rolled through almost to the end, hold it carefully against the platen as it comes free. Then stick the second length of tape on the platen vertically along the edge so its lower end comes in line with the lower edge of the paper. When the lower end of a sheet being typed is concealed by the platen, the finishing strip comes into view and indicates the distance from the lower edge.

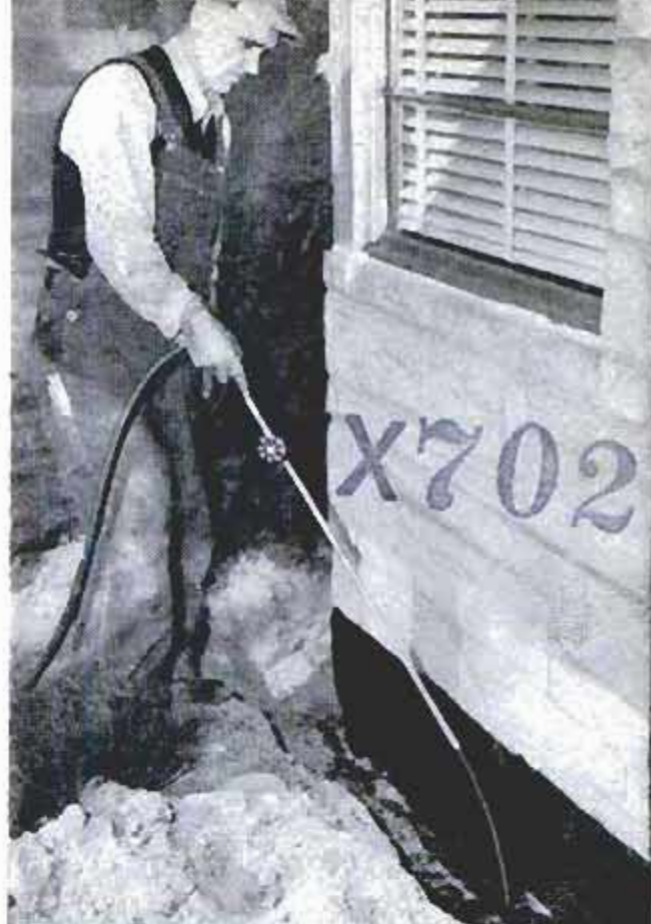

After trenching around foundation to depth of 12 to 30 in. earth is saturated with a special insecticide

CONTROL TERMITES

By Grover Brinkman

THOSE CURIOUS WINGED ANTS you saw at the corner of the house, and those earthlike tunnels leading from the grade level to the weatherboard on the outside of the foundation usually are the first warning signs of the presence of a colony of subterranean termites. Already your home may be seriously damaged, and then again it may not be. Much depends on how long the colony had been established before you discovered its presence.

Adult Termites

Termites are social insects that live in colonies in damp earth and every established colony is made up of three castes known to entomologists as reproductives, workers and soldiers. The fellow pictured at the right is an adult worker, greatly enlarged, and he is the one who does the real damage to the building frame. Workers are rarely seen in the light. They will only be exposed by breaking into the earthlike shelter tunnels along the foundation walls or by cutting into infested framing members to reveal the honeycomblike tunnels and galleries which are characteristic of extensive termite damage. The winged individuals you see, either inside or outside the building, are reproductives that have emerged for the purpose of establishing a

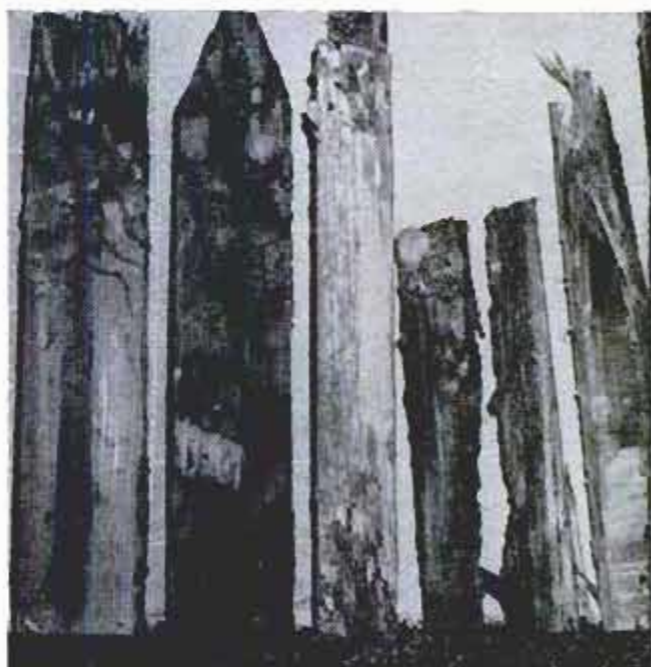

Above, honeycombed form boards taken from concrete stoop. Below, worker termite greatly enlarged

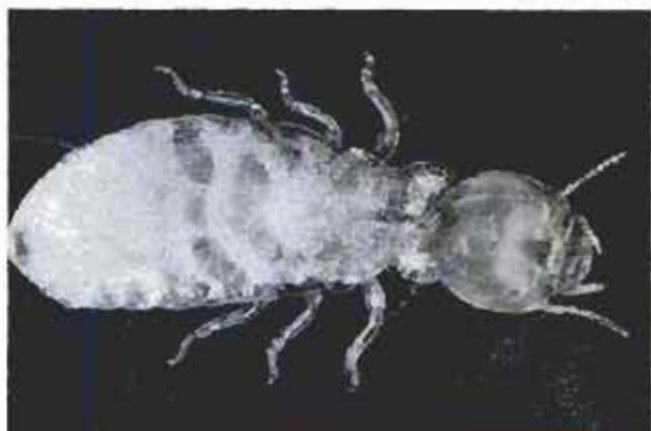



After trench has been filled, fresh earth is thoroughly saturated with a suitable chemical solution



U. S. Dept. of Agriculture

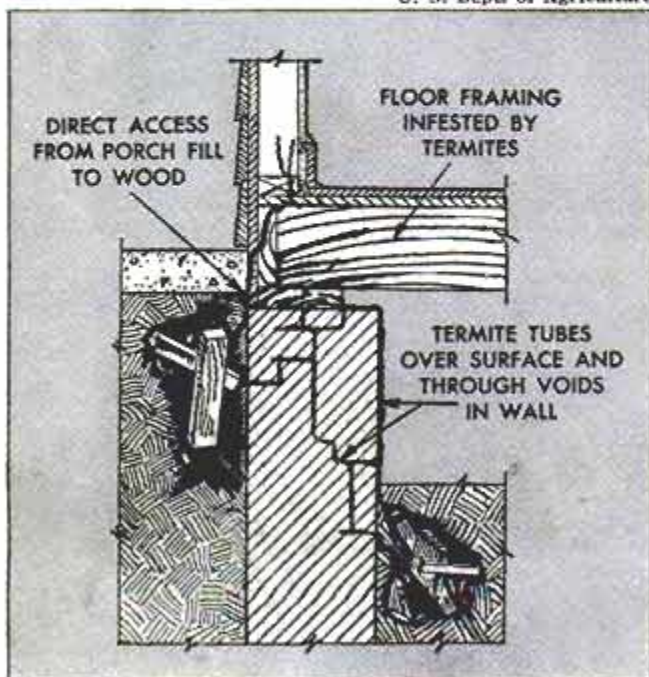

new colony, possibly near the building already infested but more likely at a distance. Examine one of the insects closely and you will see that the body is comparatively short and thick, unlike the wasp-waisted body of the common ant. Also that there are two pairs of gauzelike wings of the same shape and length. Here again the winged termite differs from the winged ant in that the latter has two pairs of wings that vary in size and extend from the body very nearly at right angles when in flight.

Character of Damage

Entomologists are quite generally agreed that extensive damage to a building is unlikely to be caused by a termite colony less than 5 to 7 years old. However, they warn that this time interval cannot always be relied on as especially favorable conditions may enable a colony to build up a large force of workers in a much shorter time. Once termites have bridged the foundation and have established a system of tunnels (note the upper photo on page 202) that protect the workers from exposure to the light, they attack sills, joists and studding, the cellulose content of the wood supplying the colony with food. From then on it is likely that damage will steadily increase in degree and extent.

Conditions That Favor Infestation

The presence of food in the form of damp, partially rotted wood is an open invitation to winged adult termites to establish a new colony. This can be anywhere near the building or inside the structure itself. Remnants of concrete forms, wooden shingles, fireplace logs, lumber cuttings from new buildings, grade stakes, tree stumps and outbuildings having sills or wooden piers in contact with damp earth

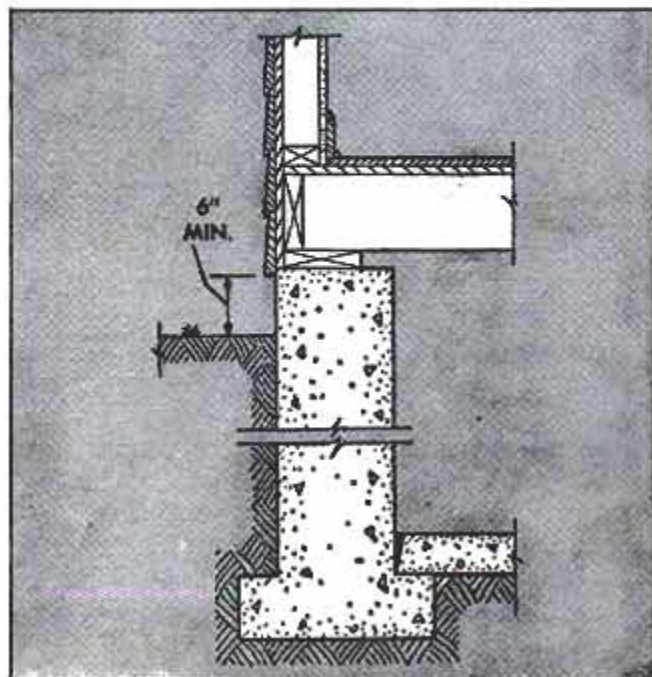

POPULAR MECHANICS

are food for termites. Cracks in concrete walls and small voids in concrete-block, brick and stone masonry often permit the insects to enter the building and attack wooden members of the structure. In new construction, wood buried below grade near foundations and particularly the remnants of forms left in enclosures such as those under concrete stoops are likely places for termite colonization.

Preventive Measures

Destroy all sources of food in and near both old and new construction. Provide new buildings with approved termite shields as illustrated in several of the details. If the building has been constructed without vents to areas enclosed by concrete or masonry foundations extending above grade, chisel manholes in the foundations and install protective grilles to provide ventilation and access for regular inspections. Basementless homes should be constructed with sufficient crawl space beneath the floor to permit easy access should a colony be discovered nearby or within the area enclosed. Heated basements favor a much longer period of termite activity, even in the colder climates, and homeowners with older-type homes having damp basements should avoid accumulations of kindling wood, fireplace logs, old books and papers and keep a close watch for winged adult termites and the beginnings of shelter tunnels on the foundation walls.

Destroying a Colony

The dotted map on page 200 shows roughly the known limits of termite activity in the United States. Although in some cases it may be rather difficult and costly to apply control measures that completely eradicate well-established colonies, most termite



When applying hot tar to foundation walls be sure that coating is brushed to uniform thickness

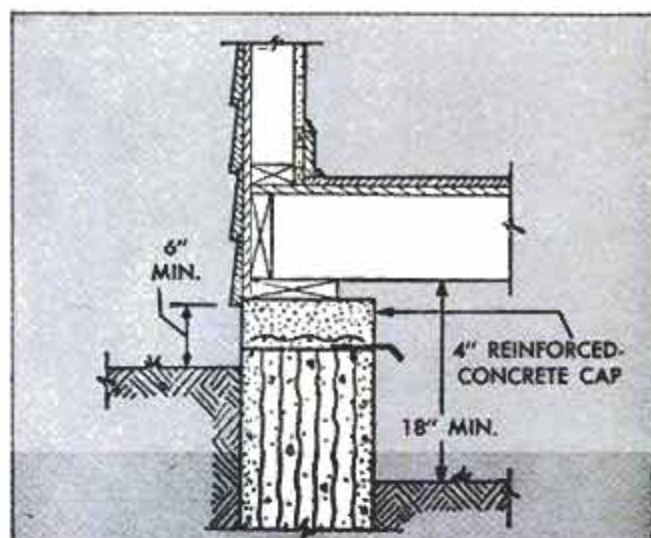

U. S. Dept. of Agriculture

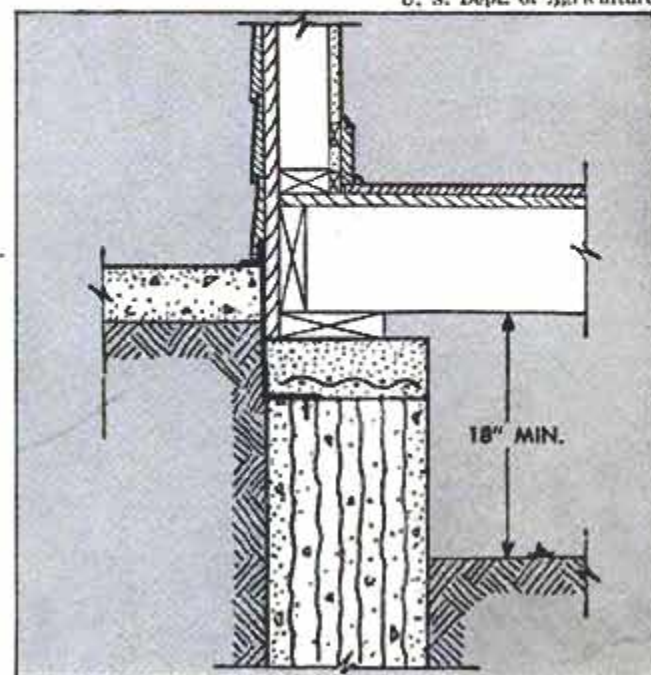
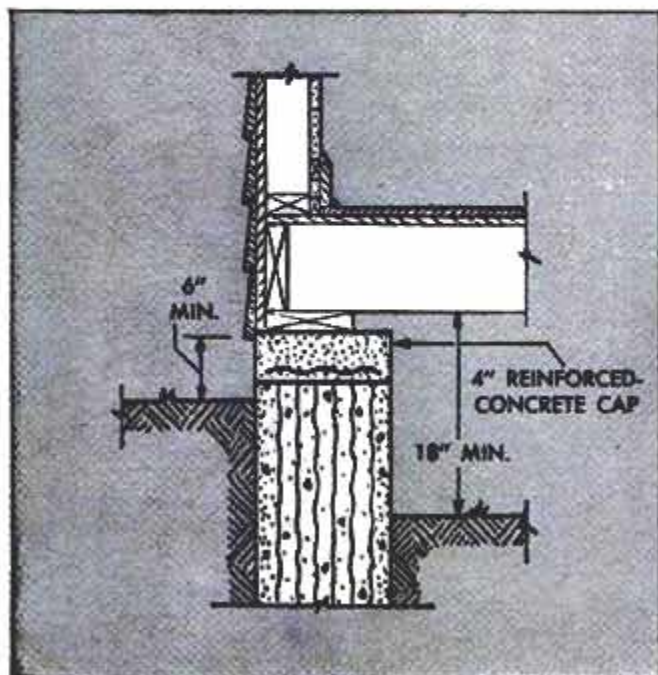



Shelter tunnels built by a termite colony on the inside of basement wall in order to reach wood above



Above, cut manholes into any areas completely enclosed by concrete foundation walls. Remove all wooden form members. Below, after treating soil under floor, fit opening with grille to provide access



infestations are quite readily destroyed by chemical treatment of the soil around the foundation and damage to the structural members is comparatively easy and inexpensive to repair. The first steps are to determine the location of the colony and the extent of the damage. Where the infestation appears to be fairly extensive it is the regular practice to trench around the building to expose the foundation walls below grade. Note the series of photos which picture these procedures. Usually the trench is made about 12 x 12 in. but in some cases it is dug as deep as 30 in. Then the foundation wall is thoroughly cleaned and coated with a hot-asphalt solution. In most cases it is advisable to apply a fabric and coat again with the hot asphalt. Then the trench is partially filled with a solution containing pentachlorophenol. Solution is added until the soil is thoroughly saturated. Then the trench is refilled with the earth which was removed and the latter thoroughly soaked with solution. Protect shrubbery root systems with tar-paper barriers.

Inside the structure drill holes in all infested floor joists and force the solution into the wood under pressure. Treat wooden sills in the same manner. If the infestation proves to be widespread rather than localized in a small area, it's a good idea to drill holes through the basement floor and force the solution underneath. Cut manholes into any areas enclosed by foundation walls, such as the concrete foundations of a stoop, and treat thoroughly with solution. Remove all wood in contact with the ground.

Caution: Handle chemicals with special care, either in or out of solution. Wear rubber gloves when handling solutions and avoid inhaling the fumes. Most solutions require use of a fuel-oil carrier. Take precautions against fire. Apply solutions only when soil is dry and warm. ★ ★ ★

Drill holes into infested floor joists, headers and sills and force solution into the wood under pressure



Adjustable Ladder Step

Quickly hooked over or removed from two ladder rungs on which it is fitted, this platform, or step, combines safety with comfort for the man who must spend considerable time on a ladder. The platform is a piece of $\frac{3}{4}$ -in. plywood bolted to flat-iron brackets as indicated. Platform width is determined by ladder width, and length by the distance required to provide a comfortable foot support. The lower platform brackets are bolted to strap hinges so the platform can be folded compactly for storage when not in use.



Bottom Margin on Typing Paper Indicated With Colored Dot



your typing paper to expose the edges slightly as shown, and draw a line down the side with a colored pencil. A dot will be left on each sheet where it can be readily seen when typing the bottom line.

The annoying problem of trying to maintain the same bottom margin throughout a multipage letter or a manuscript can be avoided by placing a mark on the lower, left edge of the paper. Flex a pack of

Nut Meat Blends Furniture Finish To Hide Scratches

The meat of a walnut or pecan is an excellent material for concealing shallow scratches or nicks in the finish of wooden furniture. Simply rub the oily meat over the scratch until it blends with the finish, then wipe the surface lightly with a polishing cloth. Be sure the nut meats are fresh, because stale, dry meats would cause more scratches.



Space-Saving Towel Rack Is Ideal for Small Bathroom

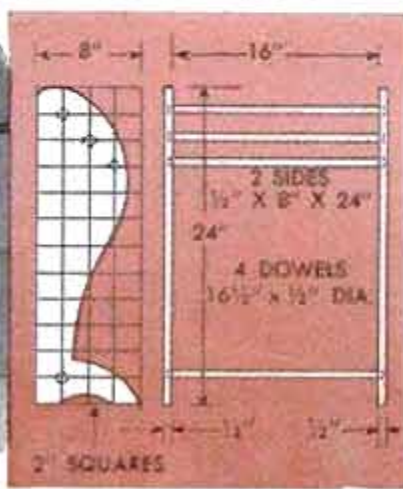

If your bathroom does not have enough towel racks, and wall space is limited, this rack is the answer to your problem. Cut the ends from $\frac{1}{2}$ -in. plywood, using a pattern drawn on 2-in. squares. The towel bars are lengths of $\frac{1}{2}$ -in. wooden dowels. Brush on several coats of varnish to protect the rack against moisture from the towels.—Ted Fenn, Chicago.

Plywood Cut on Stiff Support Prevents Saw Binding



Asbestos-Covered Block Supports Work While Soldering

To protect his workbench top and provide a nonskid surface for work to be soldered, one craftsman uses a wooden block as a support. The top surface of the block is covered with two layers of sheet asbestos, either tacked or cemented in place. If the block has a tendency to slip around on the bench top, cover the underside with asbestos.



Labels Typed in Envelope Window

The next time you encounter difficulty in typing a small card or label, remember that it can be held in an envelope. Cut a window in one side of an envelope large enough to expose all but a small border around the card to be typed and slip the card in the envelope as shown.



When cutting a large sheet of thin plywood or hardboard with a handsaw, the severed pieces will not bind if the material is placed on a 2 x 4 braced against a wall as shown. The support will prevent the plywood or hardboard from bending and permit a better and easier job.

E. Wooden, West Wareham, Mass.

"Oiler" for Clockworks Is Length of Wire

When the spout of an oil can is too short, or the can is too large to enter a restricted location such as the works of a clock, a length of wire can be used as an "oiler." The wire is bent as necessary to contact the point to be oiled.

Oil dropped on the wire will run down to the end and lubricate the spot. To permit easier manipulation of the wire, force one end into a cork.

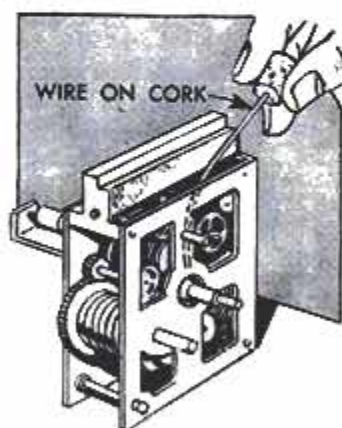

Straightening Warped Wood Panel

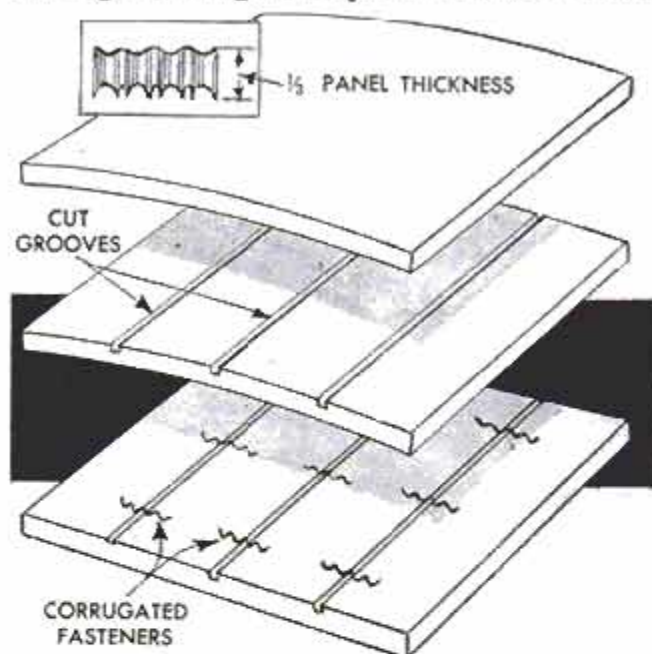

A warped, solid wooden panel can be straightened by using the method shown. First, make several saw cuts about half-way through the panel on the convex side at right angles to the warp. Press the panel on a flat surface and drive corrugated fasteners into the panel across the grooves. Fasteners should be of a size that will drive about one third of the way through the panel.—Kenneth Loo, Lawndale, Calif.

X 462

SN 58

Easier and Safer PAINT REMOVAL

By E. R. Haan

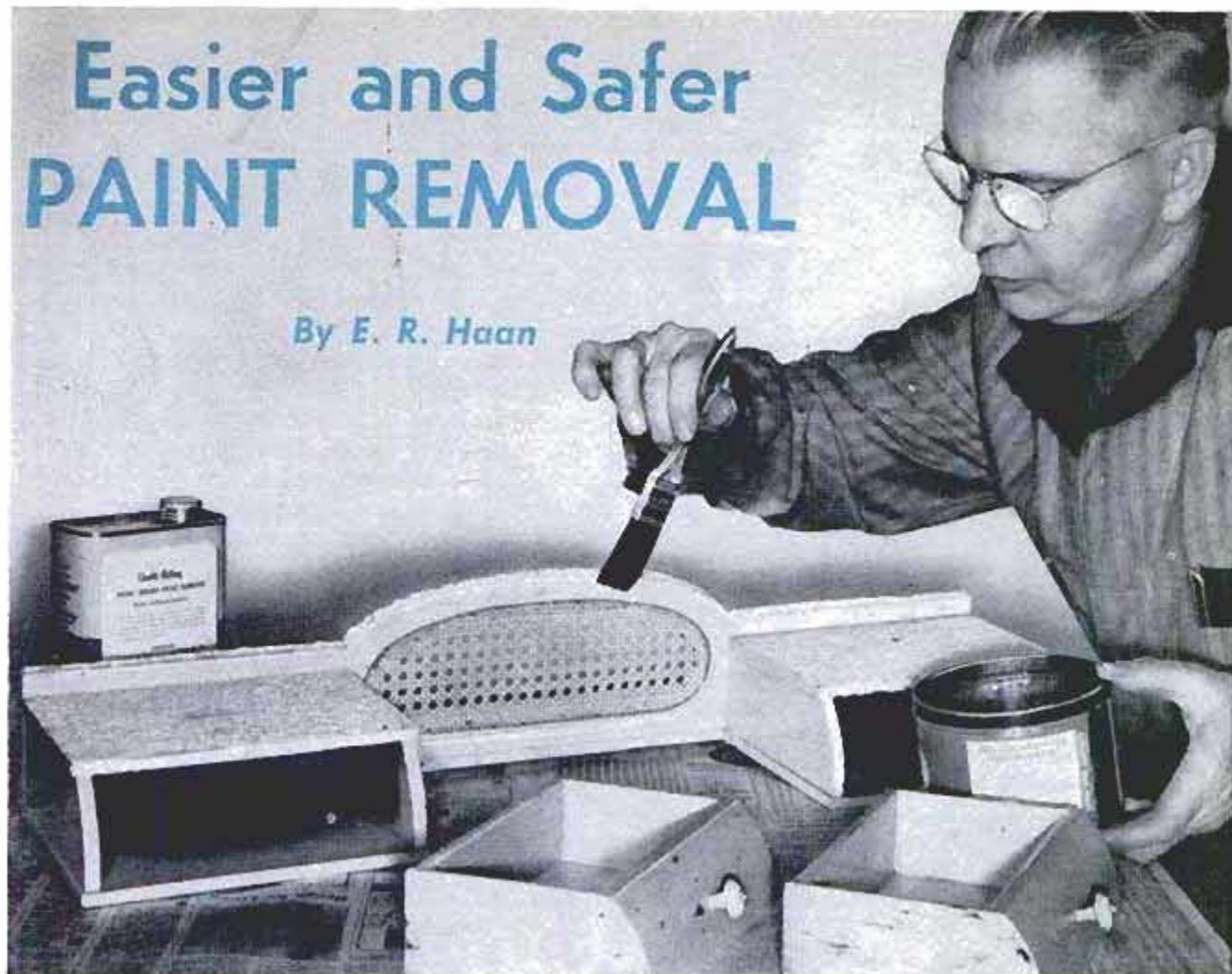

New nonflammable paint removers take off old finishes right down to bare wood—paint, enamel or varnish

HAVE YOU TRIED the new liquid paint removers that are nonflammable, have faster action and a deeper bite and do not require any "after wash" or neutralizing? If not, there's a distinct surprise in store for you!

For years paint removal has been looked upon as a difficult chore—one to be avoided if at all possible because of the slowness, messiness and fire hazard. Now, since paint removal has become so much easier, it is considered a desirable basic step in standard refinishing procedure. There's no need for inferior paint jobs over old, cracked and broken finishes.

The New Liquid Removers

These are available in two forms, the free-flowing kind and the heavy-bodied variety. The first is a nonviscous liquid which you apply to horizontal surfaces, like floors and window sills. The second is a semipaste designed to stick to vertical and overhead surfaces without spattering, dripping or running.

Often referred to as "strippers," the new improved removers don't just dissolve or soften finishes, but loosen them from the base to which they adhere, permitting them to be actually stripped or peeled off with



Courtesy the Klean-Strip Co., Inc.

Here's the way old finish comes off in a "blistered" film easily scraped from surface with putty knife

very little mess. Stickiness and gumminess have been largely eliminated, making the removers so much cleaner and easier to use. Most of them evaporate more slowly



New removers are especially effective on carvings and moldings as finish is lifted, not merely softened



Above, when removing the paint film from a flat surface begin at the center and work out to the edges. Below, by working from the center out you avoid scraping loosened material over wet surface of work



than the old removers. Because of this you need not be in a hurry to loosen the paint before it dries and hardens again.

Some of the new removers are capable of removing several coats of hardened paint, enamel, shellac or varnish with a single heavy application. Others, especially designed for automotive and aircraft work and other industrial use, are capable of removing any type finish, including baked enamel and synthetic finishes, from metal.

Nonflammable removers do not involve fire hazards like most old-time removers and, therefore, contribute to safety when used indoors. Practically all modern nonflammable removers contain a paintable retardant instead of paraffin wax. The elimination of wax does away with the need to wash the surface with turpentine or benzene before applying the new finish. Nor do they raise the wood grain or attack the filler. As a rule, they do not stain or bleach the wood and they are noncorrosive to metals.

How to Use Them

Before attempting to use a paint remover, read the manufacturer's instructions. After making provisions for adequate ventilation, as will be explained, you flow on a heavy, even coat of remover liberally, using a soft-bristle brush. Brushing should be done in one direction only—not back and forth, which breaks up the film that is formed and which should be kept intact so the gases formed will not escape but will share in the softening process.

The time required before an old finish is loosened from a surface varies with the kind of finish, its age, thickness and condition—generally from 10 to 30 min. You let the remover stand until the old finish becomes blistered completely and peels away readily when scraped lightly with a putty knife. Use a putty knife or painter's scraper to remove loosened paint from flat surfaces. Steel wool, excelsior or rags are most convenient on curved surfaces. Small spots of the old finish that still adhere are quickly rubbed off with steel wool dipped in remover. After all traces of the old finish are gone, you wipe the surface with a cloth and allow the work to dry before applying a new finish. No neutralizing is necessary except for removers that contain wax.

Adequate Ventilation

Paint removers contain volatile solvents that produce fumes which should not be inhaled. However, modern removers based on methylene chloride are not nearly as toxic as the benzol used in many older removers. To avoid inhalation, a positive circulation of air is important. The current of air should flow away from the worker and

out an open window or door. An exhaust fan of suitable size will assure enough circulation.

Advisable Removal of Old Finishes

There are numerous conditions that make it highly advisable to remove the old finish instead of applying a new one over it. Mars, scratches, checks, cracks, brush marks, runs and sags, wrinkles and many other surface imperfections in an old finish cannot be effectively concealed simply by covering them up with another coat. In such cases, a good refinishing job is possible only after the old finish has been removed.

Feathering down edges of old paint along bare spots with fine sandpaper in order to make the edges inconspicuous when covered by a new coat takes considerable time and effort. You'll find it just as easy and generally better to remove an old, defective coat up to the nearest stopping edge or corner. This treatment applies particularly to jobs such as refinishing window sills.

Delicately carved or molded surfaces and edges of furniture and woodwork frequently are ruined by a thick accumulation of varnish or enamel. This should be removed completely in order to restore the original sharp lines and contours. On legs of chairs and tables and other vertical surfaces, it is best to use heavy-bodied remover.

On the outside of a house, it is advisable to remove excessively thick coats of paint that are beginning to check and crack, particularly on horizontal surfaces, such as window sills, and then repaint. Remember that any fracture in the paint film exposes wood underneath to moisture, which causes further destruction of the paint film. Instead of using a torch flame for softening paint to remove it, which may void fire-insurance benefits, it is better to use a good liquid paint remover.

Removal of Finish Standard Routine

The complete removal of hardened old finishes is now often considered an essential step in routine procedure for producing good new finishes. The reason for this is that the quality and durability of a new finish over an old one are greatly influenced by the condition of the latter. There is only one way to prevent an old coat from having any effect on a new finish applied over it, and that is to remove the old coat. A new finish over an old coat seldom adheres as tenaciously as it would if applied to the original base, even if the surface is sanded to provide a "tooth" for the new coat. More effective than sanding is the application of a paint softener (either as a separate chemical or contained in some enamel undercoaters), which allows the new coat to bond with the old one. ★ ★ ★

Campsite Kept Free of Insects By Dusting With Chlordane



Ants and other insect pests will not invade a campsite, cottage or trailer if an ordinary garden dust gun loaded with a powder containing 20 to 40-percent chlordane is used to dust the surrounding grounds. Chlordane, available at most garden-supply stores, is effective against spiders, beetles, wasps, roaches and flies. Dust all anthills and other possible sources of insects near a campsite, as well as beneath a tent or trailer. Although the chlordane powder is only mildly toxic for human beings, it is best to wash immediately after using the dusting gun.

Clockworks Subassemblies Stored in Aluminum Foil

When disassembling an instrument such as a camera or clock, loss or mixup of small parts can be avoided if related parts or subassemblies are packaged in aluminum foil. A free end of each piece of foil can be folded to make a narrow strip and wrapped around an open member of the frame as shown for safekeeping.

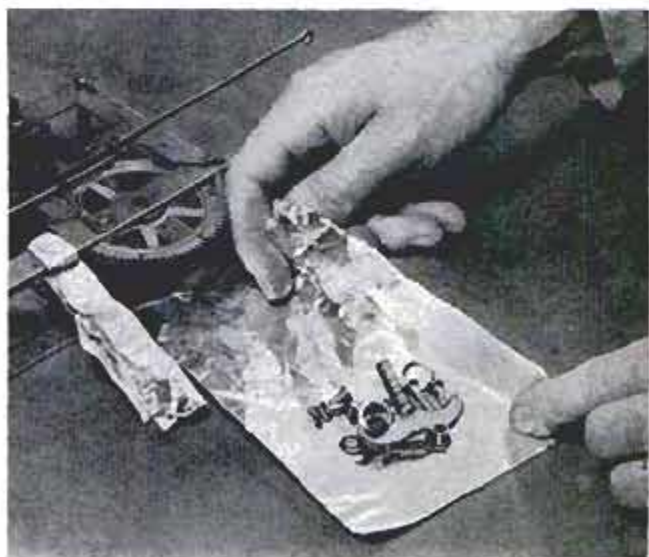

Spacer for Wooden Shingles Attached to Hammer Handle



With this adjustable metal shingle spacer fastened to the handle of your hammer and the first row of cedar shingles secured in a straight line, every succeeding row will be properly spaced if it is used to position each shingle as it is nailed. To mount the spacer, use a roundhead wood screw and a small washer.

Clinton R. Hull, Santa Ana, Calif.

Mildew Brushed From Books With Dry Cloth

In most instances, mildew may be removed from a book by merely brushing it off with a soft, dry cloth, after which the book is set on end with the pages loosely opened and aired in a sunny place. If some pages are stained badly, sprinkle them with chalk and close the book for several days. Then brush off the chalk. If necessary, repeat the chalk treatment and then follow with drying in the sun.

Helen Kay Harris, Showlow, Ariz.

Talcum Removes Grease Spots

Grease spots that are difficult to remove from heavy woolen clothing with ordinary cleaning fluids usually can be removed with talcum powder. Just turn the garment inside out and sprinkle the powder on the spot, allow a few minutes for it to absorb the grease and then shake it out. Repeat the application until the powder takes up no more grease, and then complete removal of the spot with cleaning fluid. Use a clothes brush or your vacuum cleaner fitted with the furniture-cleaning attachment to remove any traces of powder smudges left on the garment.

Eleanor E. Lynch, Syracuse, N. Y.

Record Shade Size on Roller

To facilitate re-ordering or repairing a window shade, record all the dimensions and other necessary information on a slip of paper and tape it on the wooden roller.

The data you will need to know should include the length, width, color and brand name of the shade, and the dealer's name and address.

Mrs. M. Fey, New York City.

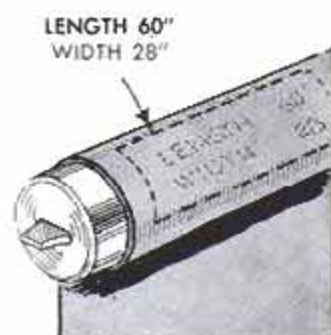
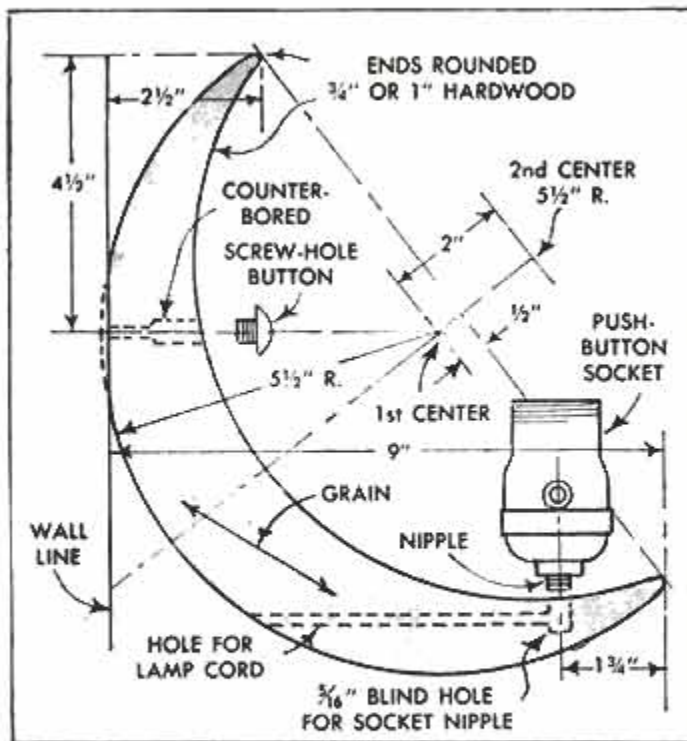

Table Salt Sprinkled in Skillet Extinguishes Grease Fire

Table salt in an open container can be used effectively to extinguish a grease blaze when an open skillet catches fire on a gas range. Kept within easy reach, the salt is sprinkled on the flames, with little damage to the food being fried and quelling the fire before it spreads, which might happen when water is used. Use of commercial fire extinguishers or sand destroys the food.

Do not discard the expendable inner disk of a two-piece fruit-jar lid. Instead, mark it with an "X" and keep it on the jar during storage to protect the edge against possible chipping and to keep the jar clean inside.

Wall Lamp Features Crescent-Moon Bracket



One evening in the workshop should do this wall lamp complete. The moon is cut from hardwood having an attractive grain for finishing in the natural color, or from a close-grained wood such as poplar for finishing in bright-gold paint. Note from the detail that the crescent must be laid out from two centers. It's a good idea to make the layout on a sheet of paper and then transfer the pattern to the stock. Be sure to use the same radius for both arcs.

After jigsawing to the pattern lines take time to sand the cut edges thoroughly to remove the last trace of saw marks. Then drill blind holes and counterbore as in the detail. Before installing the lamp cord, finish the crescent either with gold paint or varnish as desired. Attach to the wall with a screw driven through the counterbore and into the lath. Conceal the hole with a screw-hole button finished to match.

Enno R. Haan, Evanston, Ill.

Wet Paintbrushes Stored in Airtight Plastic Wrap

If you cannot finish a paint job in one day, time and trouble cleaning brushes can be avoided by storing them overnight in an airtight package. To do this, wrap the brush in aluminum foil, plastic kitchen wrap or cellophane and secure the ends around the handle with tape or string. This method of storage can also be used when you don't have time to clean the brushes after completing a job and must let them go until the next day.



Controlling Growth of Evergreens

The growth of evergreens can be regulated so as to cut down on pruning, by controlling the nitrogen content in the soil. Soil that is too high in nitrogen and low in other elements, such as potash and phosphorus, might alter the beautiful dwarf form of some ornamental evergreens, or it may produce "leggy" evergreens or "long neck" shoots. When this occurs, apply a balanced fertilizer once a year.



1

2

3

Sense and Nonsense

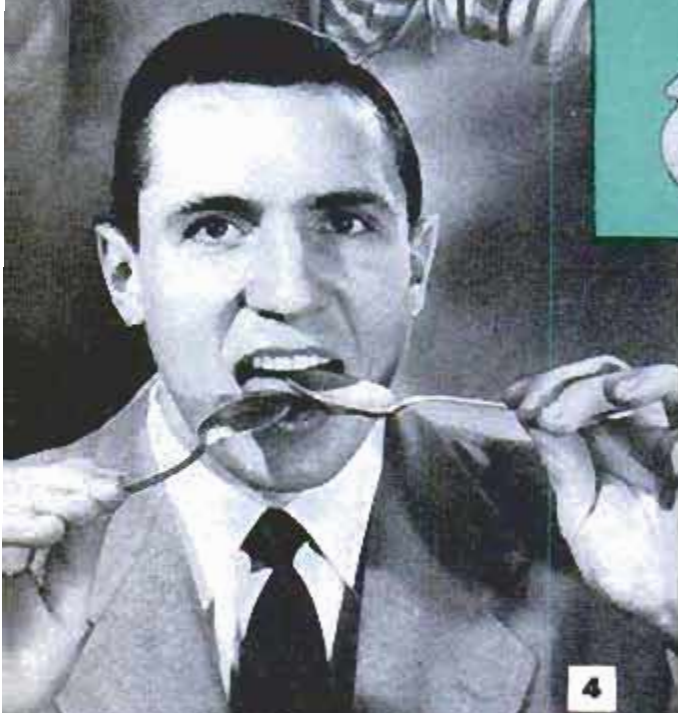

4

1. Trust your senses? When a ripe pear is held close to your nose the slice of apple you eat will taste like pear

2. Sense of touch indicates to blindfolded person that he is touching two balls when index fingers are held as shown

3. Accurate depth perception requires two eyes. Close one and attempt to touch points of pencils held in each hand

4. Stainless-steel spoon held on bottom of tongue and silver on top causes tiny electric charge due to galvanic action

5. Back has few tactile nerves, therefore girl will feel only one point, although both scissor points touch her



5



6



7



8

6. How does clean stick taste? Taste buds in tip of tongue will indicate sweetness, those in base of tongue, bitterness

7. Trust your ears? Timepieces have visual association, so blindfolded person seldom knows direction of ticking clock

8. Is it hot or cold? When ice cube fresh from freezer is touched to back of neck, most people feel they are burned

9. When your eyes are closed, your ears have difficulty telling whether brush or fingernails are used on your coat

10. Hands have many nerves close to the skin surface. When scissor points touch the skin, they feel like a knife blade

11. While you are blindfolded, have someone pass an onion, tobacco and coffee grounds under your nose. Identify items



9



10



11

Spacer Board Permits Easy Shingle Installation

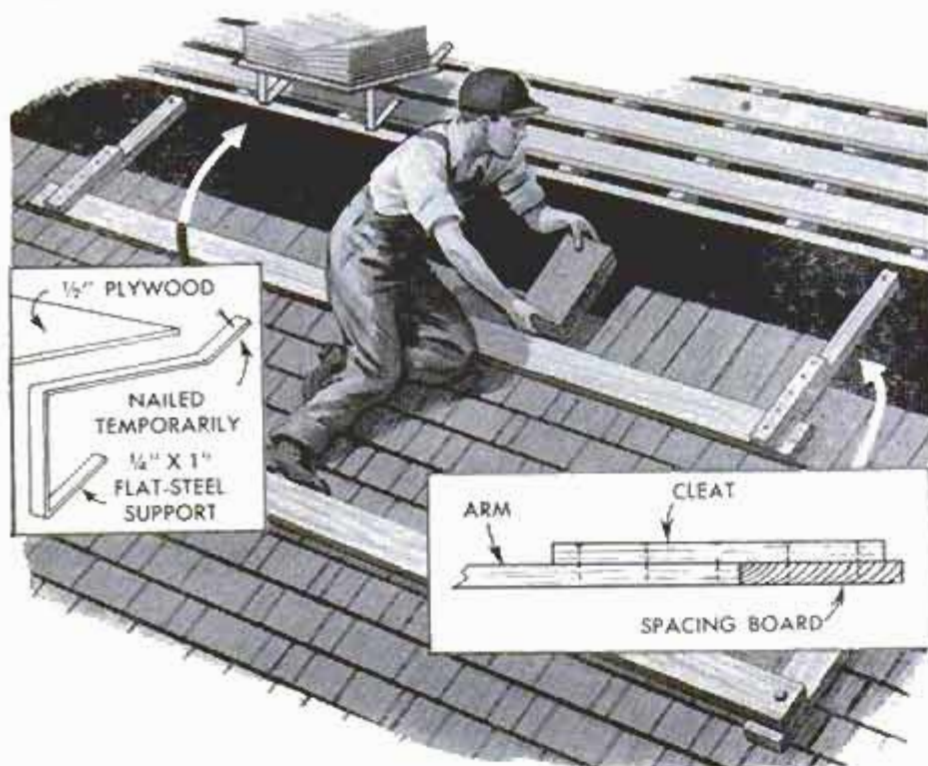

Wood shingles can be installed with speed and ease by use of a spacing board as shown. The board assures both getting equal weather exposure on all shingles and keeping each course in a straight line. The width of the spacing board must equal the required amount of weather exposure of the shingles. A wooden arm at each end of the board should extend about 2 ft. In use, the spacer board is placed on the last course of shingles laid, so its lower edge aligns with the butt ends. The arms are tacked to the roof and shingles placed on the spacer board.

Protective Shade for Plants Made From Venetian Blind

Slats salvaged from discarded Venetian blinds are ideal for quick assembly of a "lath house" which is used to protect plants from the direct rays of the sun. A simple wooden frame made from 1-in. stock is all that is required. The house can be made large enough to cover a number of plants or shrubs in a bed, or made smaller and fitted with shelves to hold potted plants. If the frame is not wide enough to accommodate the full length of the blind slats, they should be cut off flush, since the thin slats, if wood, will break easily. Metal slats, when cut, present a thin, sharp edge that may cut hands or tear clothing. Give the finished frame two coats of house paint.

Grace Gannon, Glendale, Calif.



Photo Floodlamp Suspended From Boom on Studio Ceiling

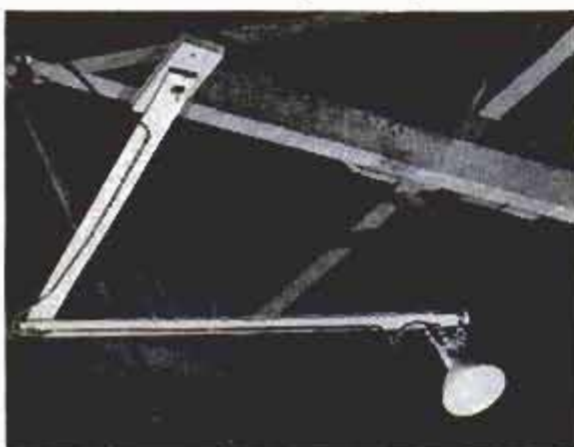

Easily reached, yet out of the way when not needed, this photoflood boom lamp is ideal for a low-ceiling studio. Two 36-in. lengths of 1 x 2 are pivoted together to form the boom, one end of which is pivoted to a block nailed to the ceiling. The socket is held on the boom by a clamp bolted to a corner angle screwed to the boom end.

Closet Storage Space Can Be Increased By Installing Racks

There is almost always a need for more closet space in the home. One method of gaining added clothes storage in existing closets is to install racks that utilize space not generally used. Quite a number of coat hangers can be hung from a simple rack made of 1-in. lumber and fitted with screw eyes as shown in the upper detail. Hats, gloves and other light articles can be held by spring-type clothespins hung on a cord or wire strung between two hooks on the inside of the door as indicated. Several umbrellas can be stored neatly in a hall closet by attaching a number of broom clamps at a suitable height on the inside of the door to hold the handles. A narrow shelf, in which blind holes have been drilled, then is screwed to the door near the bottom edge to hold umbrellas. The trouser rack shown

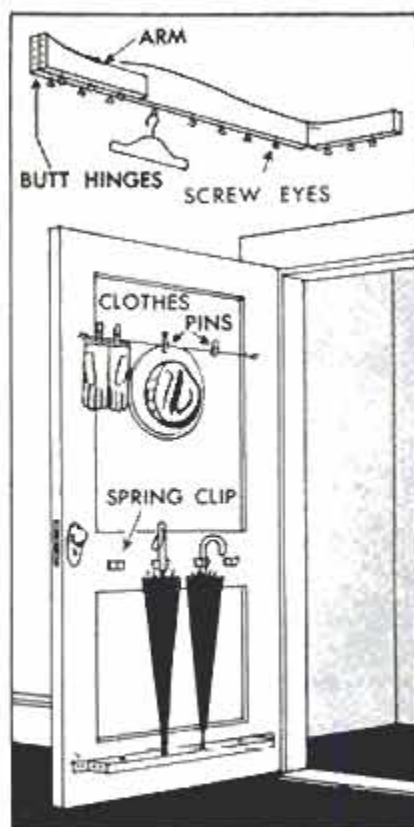

in the illustration holds several pairs, yet folds compactly against the inside of the door when not in use.

"Pistol Grip" File Handles Cut From Coat Hangers

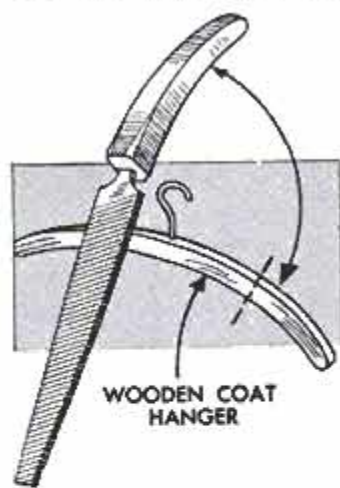

providing a handle with a positive "pistol type" grip. Several handles can be cut from each hanger.—Robert L. Sargisson, Berwyn, Ill.

Hardwood file handles can be made by cutting sections from a wooden coat hanger of the type shown. Drill a hole in one end of each section to receive a file tang and file the opposite end and edges smooth. The curve of the coat-hanger section fits naturally in the hand, providing a handle with a positive "pistol type" grip.

Trellis Hinged to Swing Down When Painting House Wall

Painting the house wall behind a rose-bush trellis is no problem for one homeowner who hinged the lower end of the trellis so it can be swung down out of the way. The hinges are screwed to a 1 x 2 nailed to the lower end of the trellis, and to a second 1 x 2 mounted on the side of the house or, as in this case, to 1 x 2s set vertically in concrete. Hooks and screw eyes are used to hold the top of the trellis against the wall.

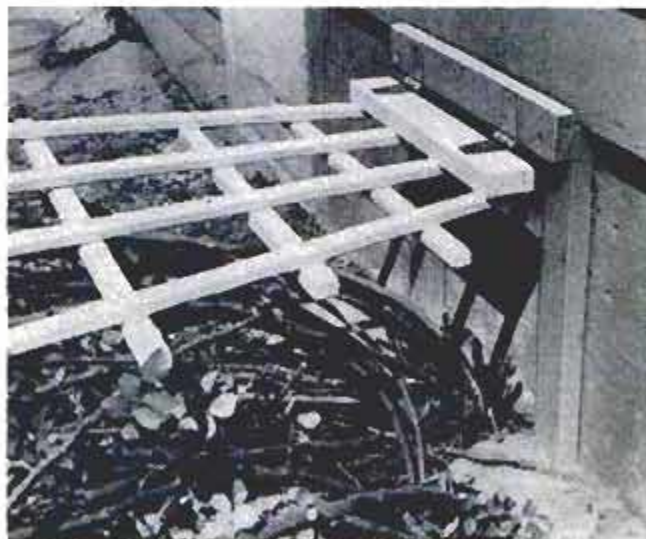

A Grandfather's Clock . . .

may be something you have always wanted. If so, you'll be told how to build one in a series of articles beginning in the April issue. The series also will give details for building a grandmother's clockcase and modern and traditional wall cases in which you install kit movements



PORTION TO BE CUT OFF

2

MARKING
DOOR
FOR
LENGTH

DOOR
INVERTED

THICKNESS OF BLOCK
EQUALS REQUIRED
CLEARANCE

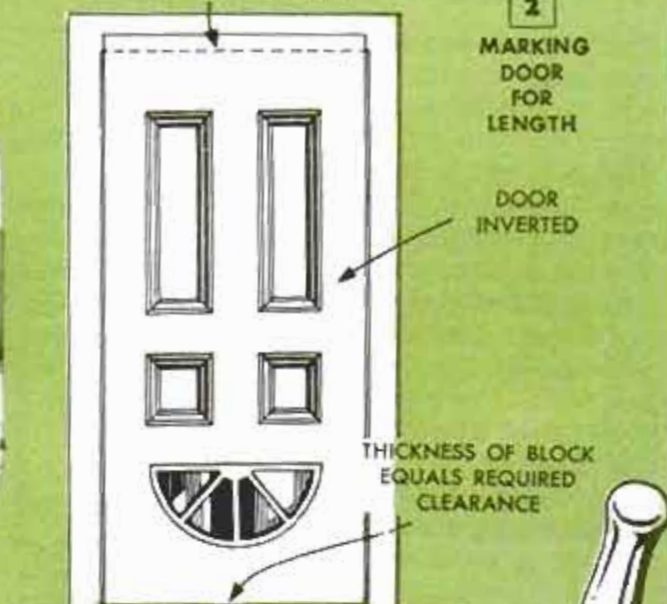

LOCK EDGE OF DOOR BEVELED

DOOR

3

5°
BEVEL

FITTING BUTT HINGE TO DOOR

SCORING
WASTE

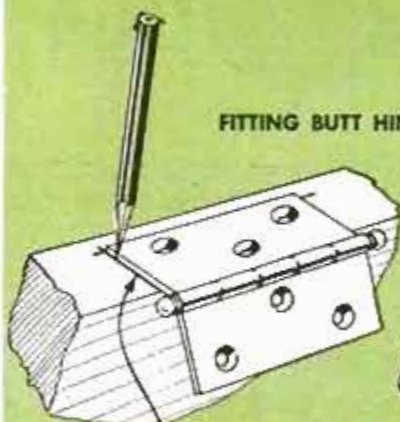

MARKING FOR
LOCATION

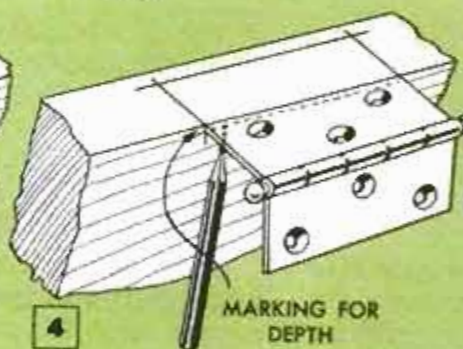

MARKING FOR
DEPTH

4

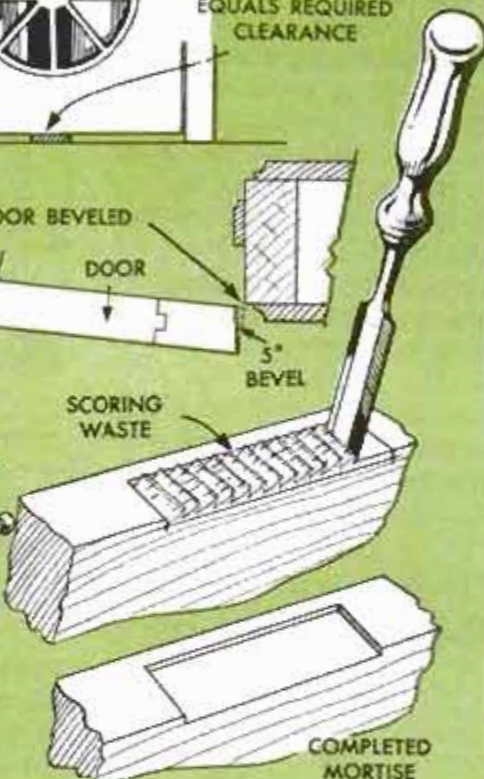

COMPLETED
MORTISE

5

WHAT TO AVOID WHEN HANGING DOOR



MORTISE
TOO NARROW

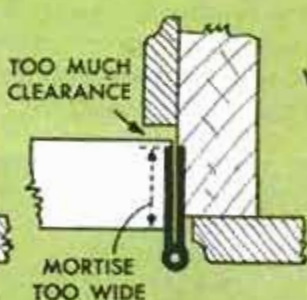

MORTISE
TOO WIDE



MORTISES
TOO SHALLOW



HINGE
BENT



MORTISES
BEVELED



MORTISES
BEVELED

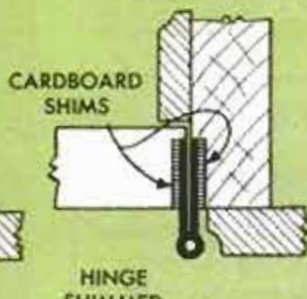

HINGE
SHIMMED

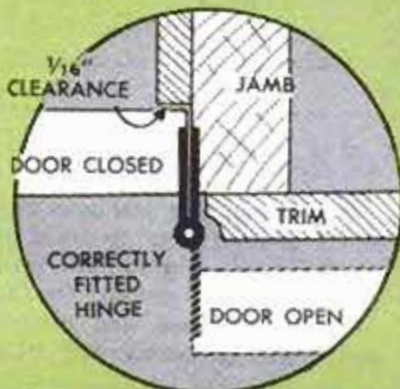

1/16"
CLEARANCE

JAMB

DOOR CLOSED

TRIM

CORRECTLY
FITTED
HINGE

DOOR OPEN

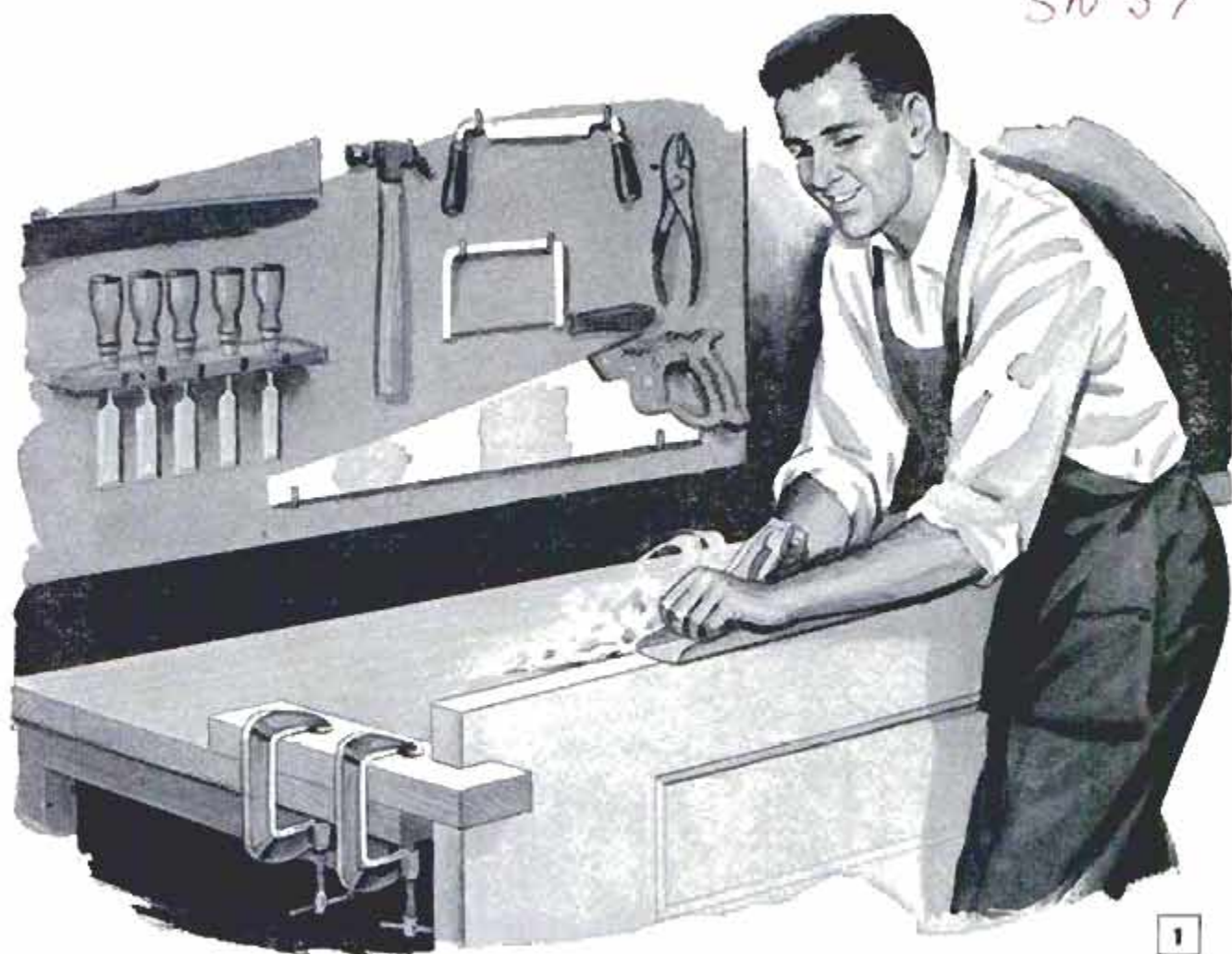

An experienced carpenter can hang a door in an hour — complete with lock. A knowledge of the methods he uses will help you —

TO HANG A DOOR

By William B. Eagan

ALTHOUGH YOU MAY not be able to hang a door as quickly as an experienced carpenter, you can come up with a workmanlike job by using the basic techniques and short cuts employed by carpenters. The main objectives in hanging a door are, first, to fit it within the opening so it has proper clearance all around and, second, to attach the hardware so it functions freely and presents a neat appearance.

If a doorframe, or casing, is square at the corners, the quickest method of determining the correct length of a door is to invert it and hold it against the casing as in Fig. 2. Fit a $\frac{1}{4}$ -in. block under it to provide the required $\frac{1}{8}$ -in. clearance at top and bottom. However, if the casing is not square, measure the height of the hinge side of the casing and cut the door to a length $\frac{1}{4}$ in. less than the height. When marking the door for height, hold the square on the hinge edge. This edge must be kept straight to assure that when the hinges are attached

they are parallel to each other and will work freely.

Unless the jambs (sides of the door casing) are absolutely parallel, which is not common, the width of the door should be determined by actually fitting it in the casing. To do this, hold the hinge edge against the hinge jamb and fit a $\frac{1}{8}$ -in. shim under the bottom edge of the door. Now, mark it for width by running a pencil line along the lock side, holding a $\frac{1}{8}$ -in. block between the pencil and jamb to provide the necessary clearance. This method of determining width is more accurate than measuring the casing at top and bottom and transferring these measurements to the door, since running the pencil parallel to the jamb will automatically compensate for any irregularities. If the amount of material to be removed is only about $\frac{1}{8}$ in., the door can be marked for fitting after it has been hung on the hinges. Swing it against the jamb and mark it in the same manner



as described on page 215. If the amount of material to be removed is appreciable on a door that has a stile, window or decoration that would be placed off-center by trimming only one edge, it will be necessary to trim both edges an amount equal to one half the width of the material to be removed. The lock edge of the trimmed door should be planed to about a 5-deg. angle as indicated in Fig. 3 so it will clear the jamb when the door is swung shut.

Holding a door in position for planing the edges is best done by using one or two wooden stops clamped to a workbench or similar surface as shown in Fig. 1.

After the door has been fitted in the casing, the next step is to install the hardware. Measure 7 in. down from the top of the door and 7 1/8 in. down from the underside of the casing top and mark the locations of the top edge of the upper hinge. Repeat this operation at the bottom, using 11 in.

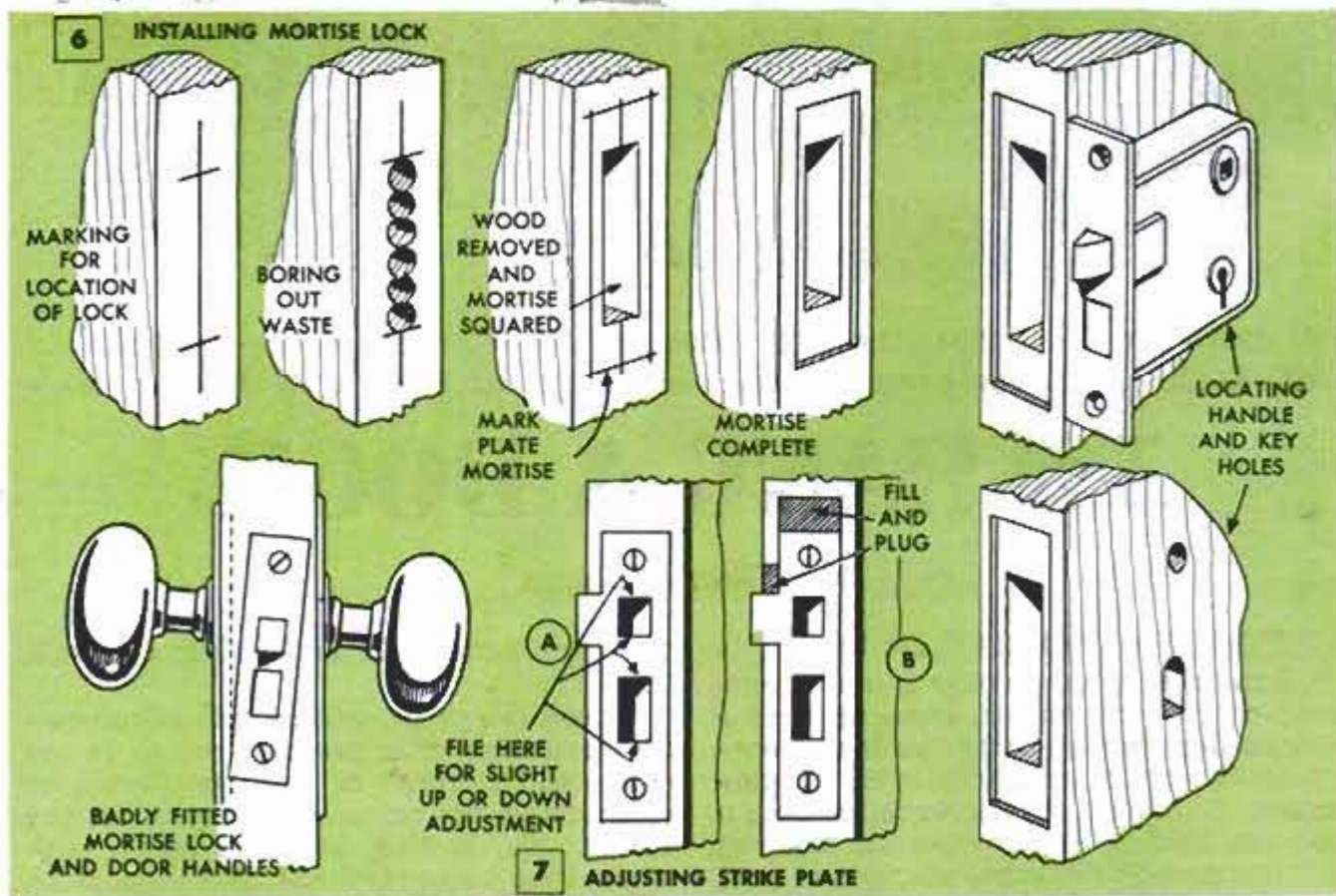

on the door and 11 1/8 in. from the floor or threshold on the hinge jamb to determine the location of the bottom edge of the lower hinge. If three hinges are used, locate the third hinge halfway between the other two. Fig. 4 shows the progressive steps in marking and cutting the hinge mortises on both the door and jamb. Be sure that all mortises are the same width and length and are parallel to the surfaces in which they are cut to avoid the conditions shown in Fig. 5. If an incorrect fitting requires recutting a mortise, the hinge can be fitted by shimming under it with cardboard and filling

the unused portion of the mortise with wood putty. The lower right-hand detail in Fig. 5 shows a correctly fitted hinge.

If the mortises are cut properly, but the hinges still bind, it is due to the jamb being bowed or distorted. In such cases, it will be necessary to shim under one edge of the leaf hinge on the jamb to align it parallel with the leaf hinge on the door edge.

Installing a lock, the most difficult operation in hanging a door, can be done almost as simply as mortising a hinge. Careful measuring and patience, as with any woodworking project, are all that are required in addition to sharp tools. Although there are many kinds of door locks on the market, they fall into two general types, the mortise and the tubular.

A mortise-type lock requires the most fitting as detailed in Fig. 6. First, mark the door 3 ft. from the floor to indicate the position of the center of the knob. Next, mark the center of the door edge and over this line indicate the length and width of the lock body. Use a drill bit having a diameter equal to the width of the lock and drill a series of holes along the center line to a depth equal to that of the lock. Then chisel out the wood to provide a squared recess. Fit the lock into the recess and mark the mortise for the lock plate. Cut it as indicated in Fig. 6. Finally, mark the locations of the holes for the handle or doorknob shaft and key as indicated in Fig. 6. Then drill through the door, making sure that the hole for the knob shaft is at right angles to the surfaces of the door. The condition illustrated in the left-hand detail in Fig. 7 is a result of not doing this. After the lock has been screwed in place, the strike plate can be held against the doorjamb and the door closed on it to accurately locate its position. Move the plate so the latch is held firmly against the front edge of the latch opening and there is clearance above and below it. Also, turn the key so the lock

bolt fits freely in the lock opening of the strike plate. Now, mark around the front corners of the strike plate. When the door is opened, these marks can be used to locate the plate in its correct position. Mark around it for the mortise and cut it just deep enough to permit the strike plate to fit flush with the surface. At this point also drill and chisel out the recesses to accommodate the latch and lock bolt.

A tubular lock is installed in a somewhat similar manner, except that two holes are drilled at right angles for the lock, one being in the edge of the door to take the tubular latch, and the other through the face of the door for the knob shaft. Then the strike plate is located and installed in the same manner as the plate for the mortise-type lock.

After a door has been hung for some time, it may be necessary to readjust or reposition the strike plate. Misalignment of the plate may result when the house foundation settles or the frame of the house becomes slightly distorted for other reasons and affects the alignment of the door casing. If the adjustment is slight, the strike-plate openings can be filed at top or bottom as indicated in the center detail in Fig. 7. If the misalignment is considerable, it will be necessary to lengthen the mortise for the plate. The unused portion of the mortise then should be filled with a wood putty. After the putty has hardened, sand it smooth and apply one or two coats of paint to match the door casing.

With some types of loose-pin butt hinges, it is necessary to know whether they are to be used on a left-hand or right-hand door. To determine the "hand" of a door, stand on the side from which it is pushed away from you to open. If the door is hinged on the right side it is a right-hand door and requires right-hand hinges. If left-hand, the hinges are on the left side.

★ ★ ★

Make Unique "Tractor" Mailbox by Attaching Toy Parts

The addition of wheels, steering wheel and a little sheet metal to this rural mailbox gave it the appearance of a farm tractor. A sheet-metal extension supports the rear wheels, steering wheel and controls. Front and rear wheels were salvaged from children's toys. A clever paint job adds to the "tractor" appearance of the box.

A. M. Wettach, Mt. Pleasant, Iowa.

☐ A bench knife can be made from the broken blade of a jackknife by flattening one end of a piece of brass tube of suitable diameter and soldering the blade into the flattened end. Wrap the handle with friction tape for a good grip.

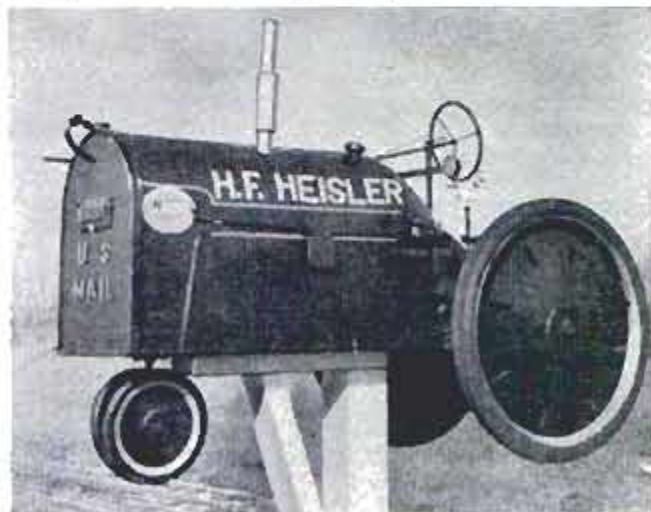



Aluminum Foil Protects Car Hood From Bugs and Gravel

The disagreeable job of cleaning bugs off the front of a car can be eliminated by taping heavy aluminum foil on the front of the hood and the small areas around the headlights. When the foil becomes badly soiled or torn, it can be replaced easily and quickly. All edges should be taped securely to prevent the wind from tearing the foil when the car is in motion.

G. H. Elliott, Lincoln, Neb.

Plastic Ketchup Bottle Used As Workshop Glue Dispenser

A plastic "squeeze" bottle of the type used for ketchup provides an ideal glue dispenser for the workshop. No applicator or brush is required, since the small opening in the nozzle permits applying glue in a thin line or inserting it in dowel holes. A nonferrous nail is used as a stopper in the dispenser.

❏ Mulch should not be removed from around rosebushes during March, as the alternate freezing and thawing which occur in this month often kills the plants.

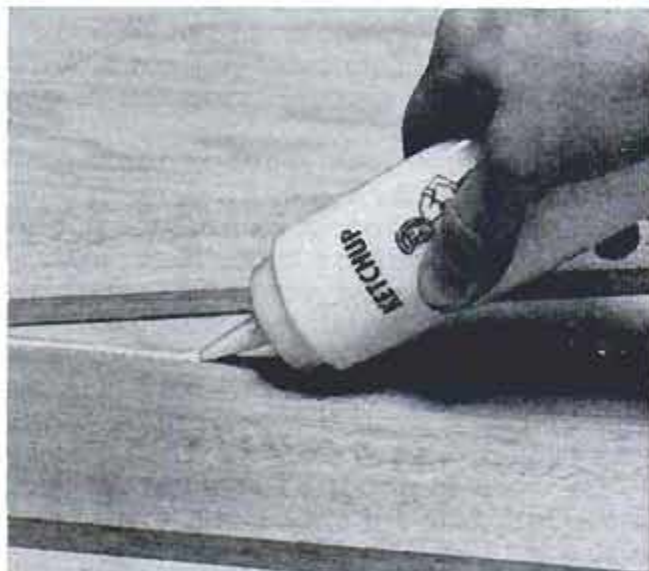

FIX-IT-YOURSELF TELEVISION MANUAL

For less than the cost of most new parts, you can learn how to maintain your TV set — and make many repairs yourself!

**INCLUDES LATEST DATA ON COLOR AND
ULTRA-HIGH-FREQUENCY TELEVISION**

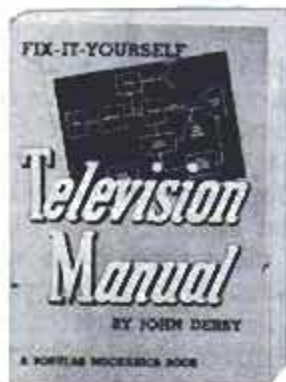

Complete, Reliable, Authoritative

John Derby, famous electronics engineer, has written another fact-filled, money-saving book. ALL ABOUT TELEVISION was bought by 200,000 savings-minded people, and the demand for it is larger than ever. But, with so many new developments in the field, Mr. Derby and Popular Mechanics Press realized a completely new book should be published. One aimed directly at the man who wants to make his own repairs.

Covers the Entire Subject

TELEVISION MANUAL will tell you, with no technical doubletalk, *everything* about television transmission and reception. It will expand your knowledge and enable you to handle 3 out of 4 TV repairs. Never again will you not understand what you're doing with a TV set. You'll know whether to call a professional or do the job yourself.

All the Latest Information

Now you can learn how color TV works, how to care for, and how to enjoy most fully that color set when you get it. TELEVISION MANUAL will show you how to take advantage of the new UHF networks and how to convert your present set to ultra-high-frequency. It will answer almost any question you may have about television.

MONEY-BACK GUARANTEE

TELEVISION MANUAL is guaranteed to satisfy you, to save you money—if not, you can return it within ten days for a full refund of the purchase price. So send your order, with a remittance of only \$3.00, today!

Popular Mechanics Bookshop

208 East Ontario Street
Chicago 11, Illinois



SHOP NOTES

Mount your power tools on these space-saving

CABINET STANDS

INDIVIDUAL POWER-TOOL STANDS that incorporate storage space make good use of space generally wasted in regular open-type stands. This feature is of particular importance in a workshop that is cramped for space. There's the convenience angle, too, of being able to store related accessories close to the tool itself.

The basic design shown below is adaptable to any power tool and can be made in several ways interior-wise. It can be made with open shelves, or fitted with a full-length door or provided with an enclosed lower compartment. If the stand is to support a drill press, the top can be fitted with a large, overhanging tool tray. Construction is simple, with 3/4-in. plywood being used throughout. Use glue on all joints and nail securely with 2 1/2-in. finishing nails. The cabinet stand pictured and detailed on the following page might be called a "workshop on wheels" and is

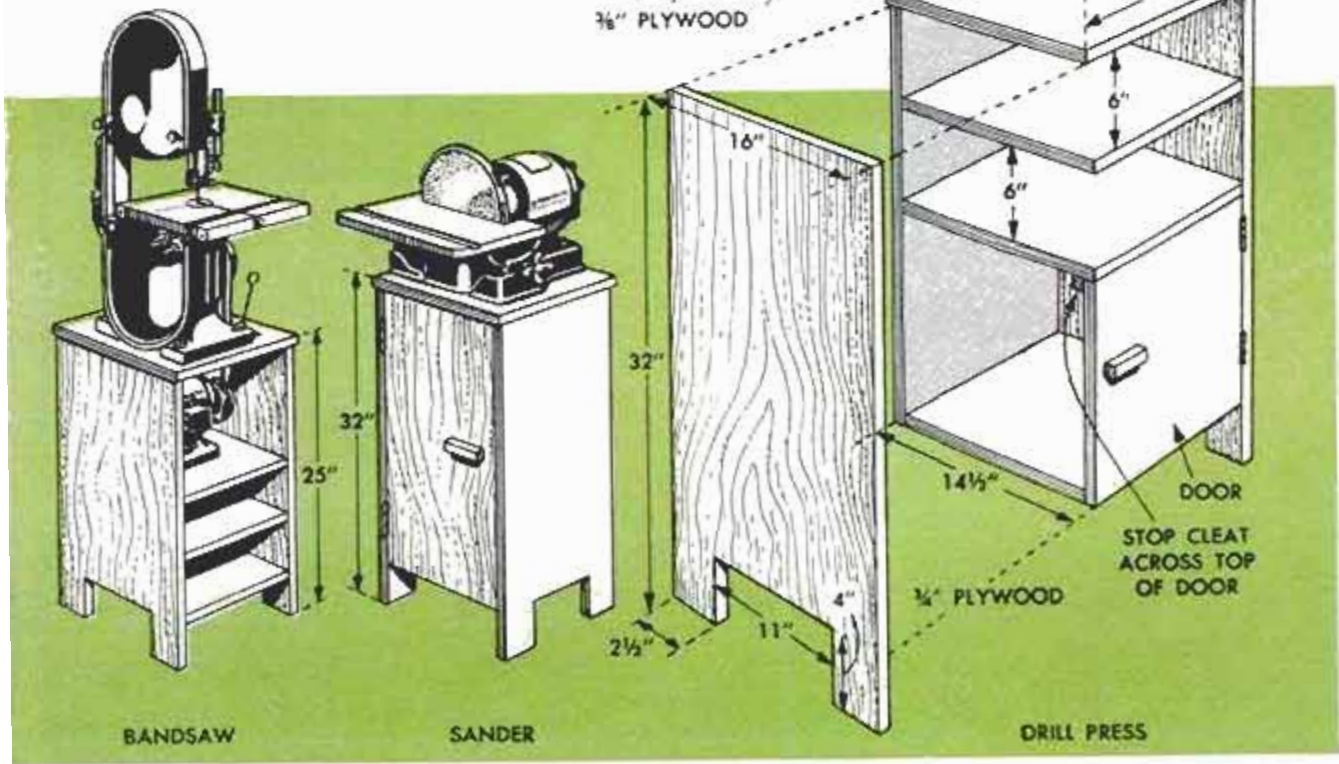
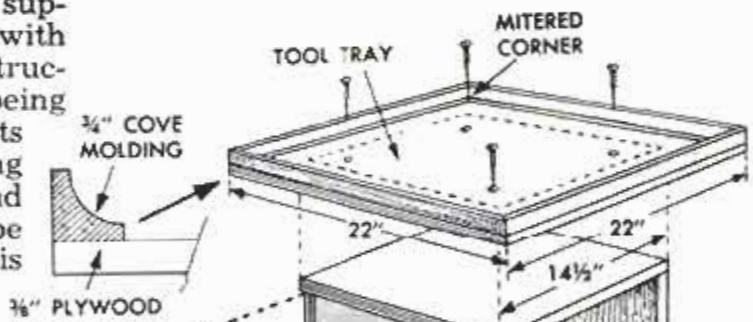
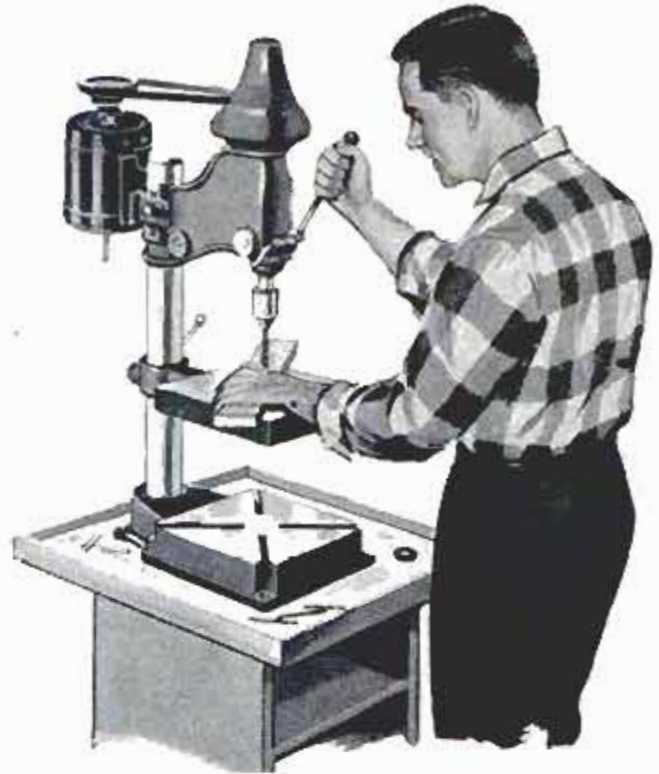



Designed by Clement S. Pepper

especially suitable for holding a circular saw. Occupying about the same space as an automatic washer, this cabinet mounted on casters will appeal to the home craftsman who has only the corner of a utility room or small garage at his disposal. Five drawers in the cabinet provide storage for hand tools, nails, screws and other workshop materials. A circular saw or other power tool can be mounted on the cabinet or the top can be used simply as a work surface. As indicated in the details, the cabinet frame consists of half-lapped 2 x 4s. The cabinet back and sides are $\frac{1}{4}$ -in. plywood and the top is $\frac{3}{4}$ -in. plywood. The L-shaped drawer guides are made by nailing $\frac{1}{2}$ x $\frac{1}{2}$ -in. strips of wood to $\frac{3}{4}$ x $\frac{3}{4}$ -in. strips. All drawers are identical in size except for their height, the two top drawers being 5 in. and the lower three drawers being 3 in. high. Fitting the drawers with compartments extends their usefulness. Vibration can be minimized by mounting the power tool on rubber pads. Rubber heels, as well as short pieces of thick rubber belting, can be used for the pads. ★★

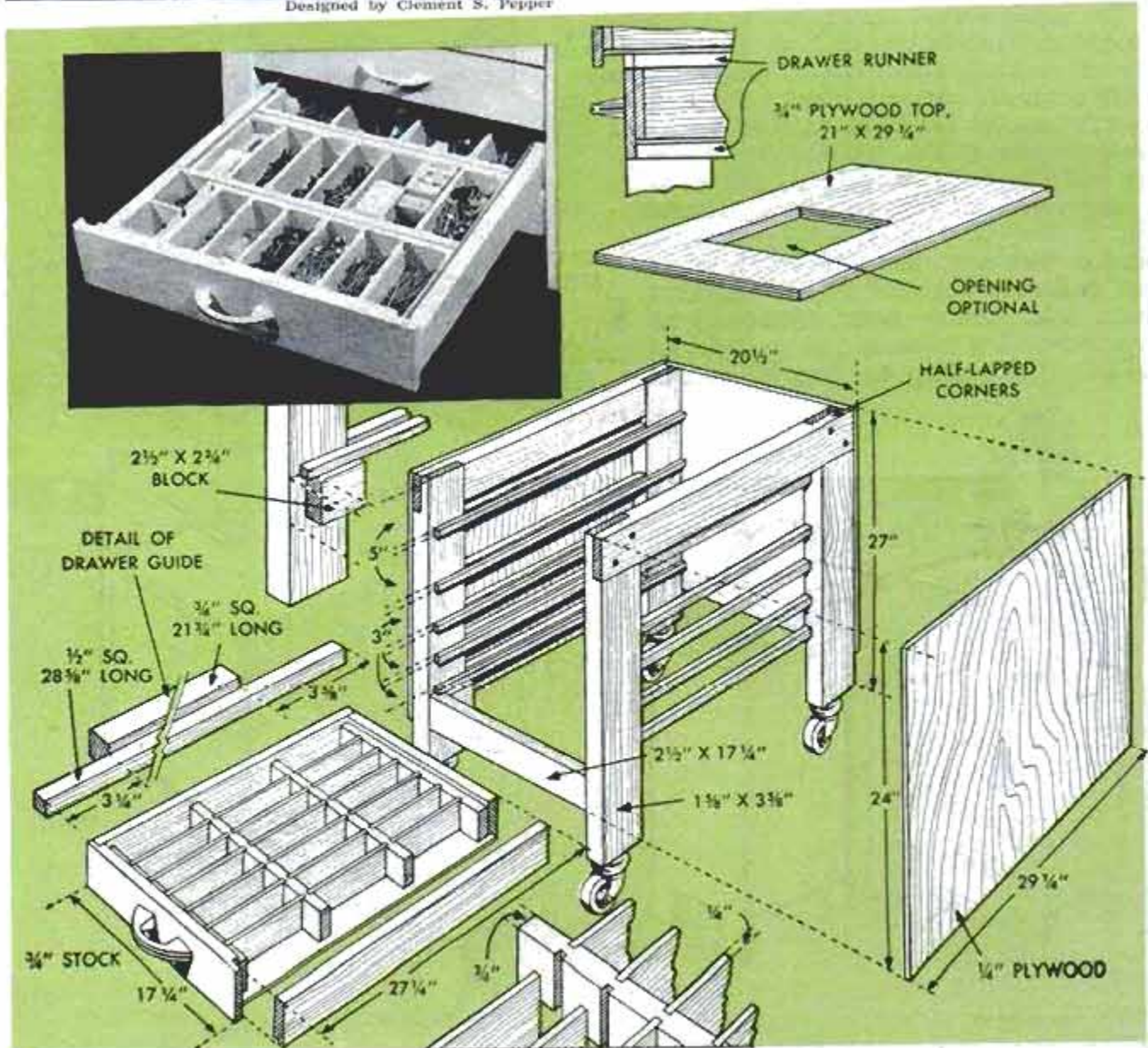

Stop Chickens Roosting in Nests With Pivoted Fence

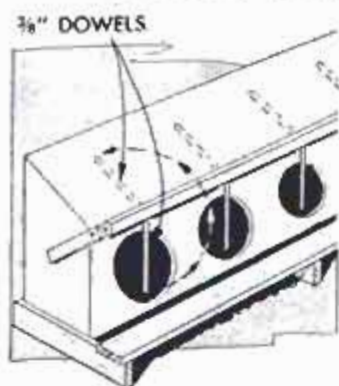

To prevent the chickens from roosting in the nests of his poultry house, one farmer devised a pivoted fence which can be dropped down to close the nest openings at night, or folded up over the top to leave them accessible in

the daytime. The fence is made of a wooden strip drilled to receive lengths of dowels which are spaced to fit over the centers of the nest openings when the fence is down. Two wooden brackets hold the strip in position and permit it to pivot on screws turned into each end.

Linseed Oil Secures Hammer Head

To keep the head of a hammer from loosening on the handle, stand the head end in a can of linseed oil overnight. Then wipe off the excess oil and repeat the process whenever the head loosens. If the head is excessively loose, secure it with the usual wedges before giving the linseed-oil treatment to the wood.

"Bolt Blocks" Strengthen Trough

Hardwood blocks at each end of this hog trough make it possible to bolt the end-pieces in place. Short lengths of 2 x 4 are bolted to both the trough boards and to the end boards. Carriage bolts are best for trough boards, the heads being placed on the inside of the trough to prevent injury to hogs when feeding.

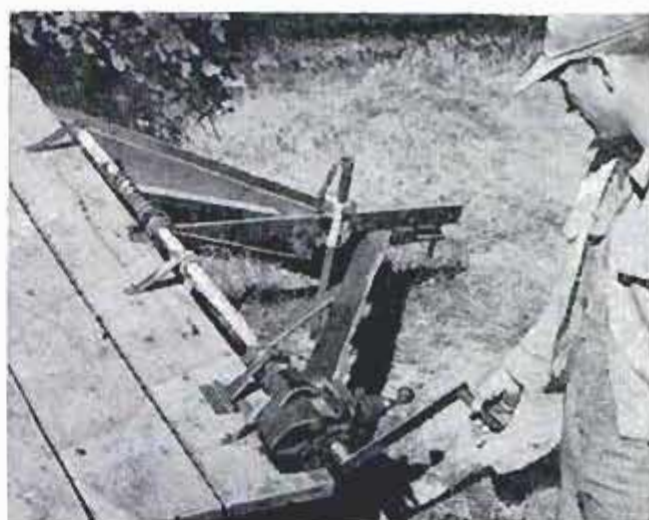

Farm-Trailer Loading Winch Is Automobile Transmission

The hand-powered winch on this trailer makes loading farm machinery onto its bed a one-man job. The winch is a discarded auto transmission with a crank fitted to the clutch-shaft end. The winch cable is wound on a length of pipe coupled to the drive-shaft end. A strap hinge bears against the teeth of a small gear wheel on the shaft to provide a ratchet. The transmission gears are shifted to provide the required power, and neutral gear allows the cable to be run out freely. The heavy trailer frame is built from a discarded livestock scale and has a drawbar jack. The jack is a length of pipe with a welded foot which slides inside a sleeve made from a short length of pipe welded to the drawbar. A setscrew in the sleeve locks the jack. The winch can be used to raise the trailer drawbar by passing the cable through a sheave on the drawbar and dropping the hook into the top end of the jack, as shown in the photo.

Rubber Tip on Mallet Handle Slides Sheet Metal Safely

Large metal sheets are difficult to pick up and move around on a workbench or squaring shears and often inflict painful cuts and bruises. Time can be saved and much of the hazard removed from this operation when a rubber crutch or cane tip is fitted on a mallet handle and used to slide the sheet

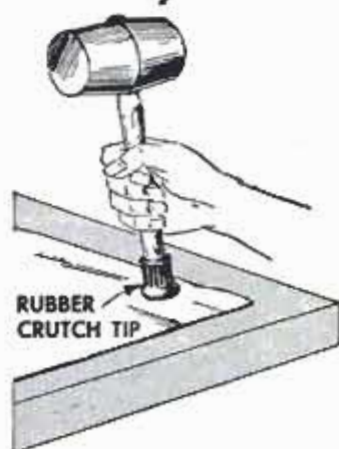

quickly to the desired position. The friction created by the soft rubber is sufficient to move the metal with little effort.



BETTER

By E. R. Haan

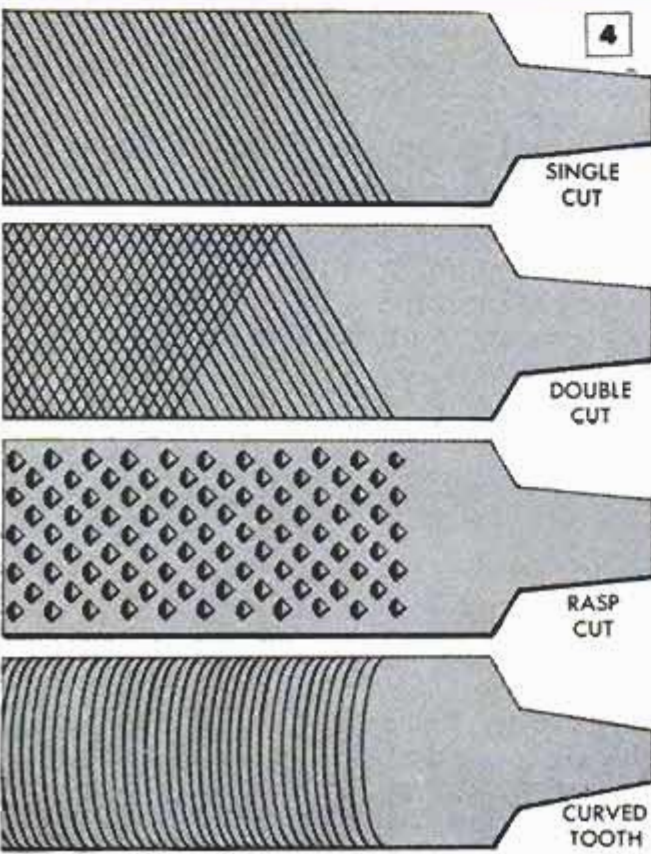
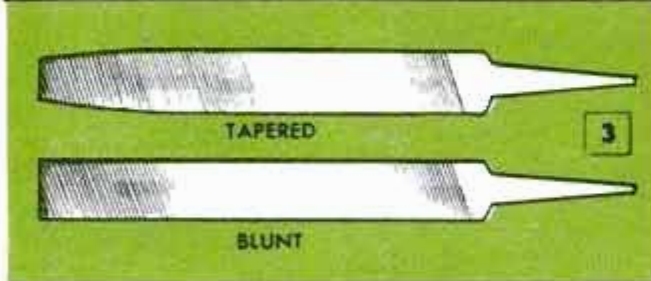
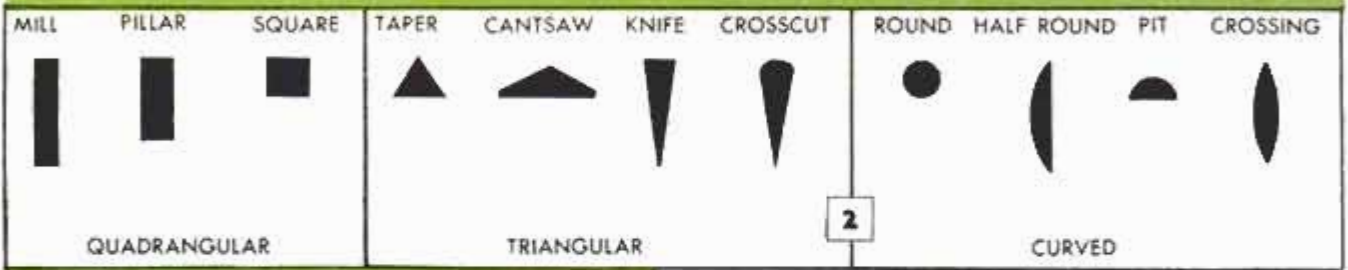

A GOOD WORKING KNOWLEDGE of files and filing will pay you substantial workshop dividends in the form of better home projects and devices completed with less effort at lower cost. No homeowner's toolkit is complete without one or more of several types of files.

For occasional all-around use you can get a household utility file, which is a flat, 8-in. file having a fine cut on one side, a coarser cut on the other and a safe edge. A handle is cast at one end instead of a tang. Other files varying in size and shape and coarseness can be acquired from time to time as needed. Most files in common use vary from 4 to 10 in. in length. These lengths refer to body length as shown in Fig. 1, excluding the tang.

A File for Every Purpose

The various types of files are classified according to the shape of the body and type and cut of the teeth. An important consideration when selecting a file for a job is the kind of material to be filed. In respect to the shape, or cross section of the body, files are rectangular, square, triangular, round and half round. There are several variations of these shapes, most of which are referred to by words developed by trade usage, which indicate purpose and shape of a file as shown in Fig. 2. Concerning their lengthwise design files may be

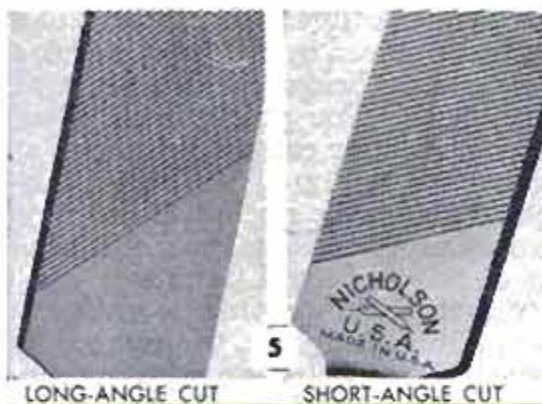

FILING

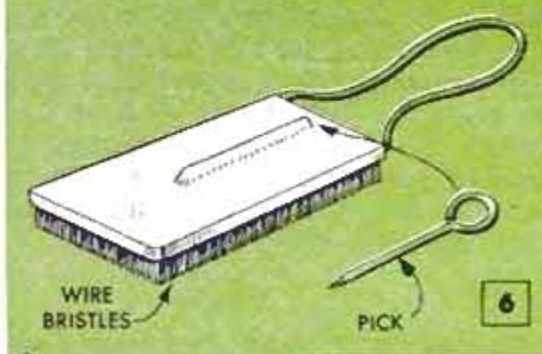

tapered toward the tip or they may be blunt as shown in Fig. 3.

Kinds of Teeth

File teeth may be single cut, double cut, rasp type or curved as shown in Fig. 4. Usually, single-cut files are used for finishing under light pressure. Double-cut files remove metal faster but require more pressure. The angle of the cut on a file varies as shown in Fig. 5. This may be a "long-angle cut," or a "short-angle cut." The checker-board arrangement of teeth on a rasp-cut file is designed for extremely rough work on wood, leather and some soft metals. Files having curved teeth are single cut and are used mostly for soft metals. File teeth generally classify into sizes that vary in degree of coarseness, such as the following: dead smooth, smooth, second cut, bastard, coarse and rough. Each of these varies in proportion to the size of a file. Thus, a 10-in. second-cut file will be coarser than a 6-in. second-cut file. Most files have a smooth, second or bastard cut.

For superfine finishing work, Swiss-pattern files, also referred to as diemakers' files, are made within closer tolerances than the conventional American-pattern files. Both have similar cross sections but differ in shape. Swiss-pattern files usually have longer tapers and smaller points. Also, they are available in finer cuts ranging from No. 00, the coarsest, to No. 6, the finest.

Cutting Action of Files

The sharp, hardened teeth of files are pointed toward the tip and cut only on forward strokes, which produce chips or filings. A sharp file will cut with very little downward pressure, although this will vary somewhat with the depth of bite and the material being worked. With a sharp file, practically no pressure is required for finishing work. Excessive pressure dulls the teeth. Insufficient pressure, which allows the teeth to slide over the work without cutting it, also tends to dull the teeth. Sliding also may be caused by clogged teeth.

Keep Files Clean

Files cease to cut properly and tend to scratch the work when the gullets between the teeth fill with chips or filings. When the latter condition exists, remove filings with a wire brush or file card as shown in Figs. 6 and 7. To remove filings that are compacted tightly in the gullets forming "pins," use a soft-iron pick shown in Fig. 6. To minimize formation of "pins," rub chalk on the file. This is especially good for fine finishing. For rough filing, the file should be "chalked" and then brushed clean.

Support and Height of Work

Work should be supported rigidly when any appreciable filing is done, and particularly when accurate filing is required. For

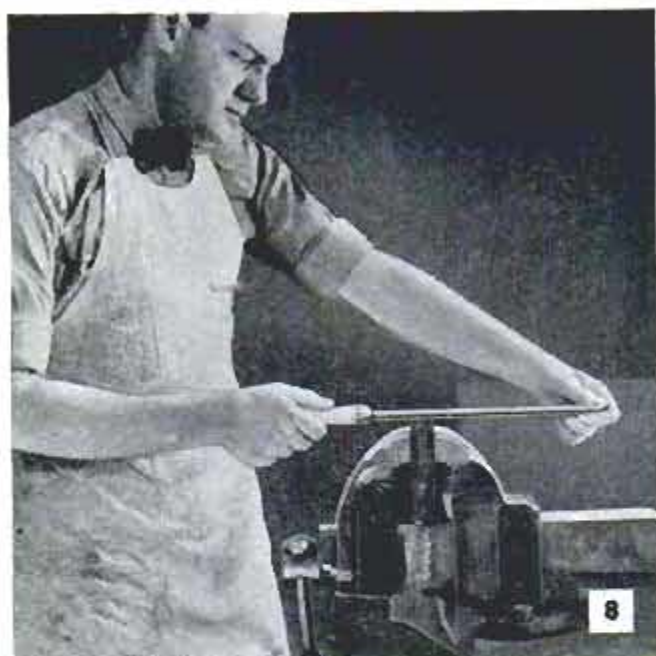

this a vise is most convenient for work of a size that can be placed in it. The work edge should be a little below elbow height as shown in Fig. 8. For precision filing of small work, the latter can be positioned at a higher level as in Fig. 9. For better control, arrange the work so that the surface to be filed is on a horizontal plane, if construction of the work will permit.

Narrow, brittle work should be uniformly gripped, although lightly, throughout its entire length. Heavy pieces can extend beyond the jaws of a vise. Thin, flexible material is adjusted so that the edge to be filed is close to the vise jaws, as in Fig. 10, which prevents it from vibrating.

Special vises are made for filing saws. An improvised method of holding a circular-saw blade between two wooden disks is shown in Fig. 11. A handsaw vise is shown in Fig. 12. Work that cannot be held in a vise should be otherwise supported so that it will be rigid. C-clamps can be used for this purpose. To avoid marring plated or other finished work with checkered jaws of a vise, use wood pads or slip-on auxiliary jaws of soft metal as in Fig. 13.

Fit Files With Handles

Don't attempt to use a file without first providing a suitable handle, because the sharp tang can injure your hands. A handle is pushed on the tang so that it lines up squarely with the file. Then the handle is brought down sharply on the bench top as shown in Fig. 14. Never hammer a file into a handle as in Fig. 15. The file might chip or break. A handle that is not aligned properly may cause inaccurate filing.

How to Grip a File

A file is used with both hands, generally. Grasp the handle lightly so it rests in the palm of one hand. The thumb should be on top of the handle and the ends of the

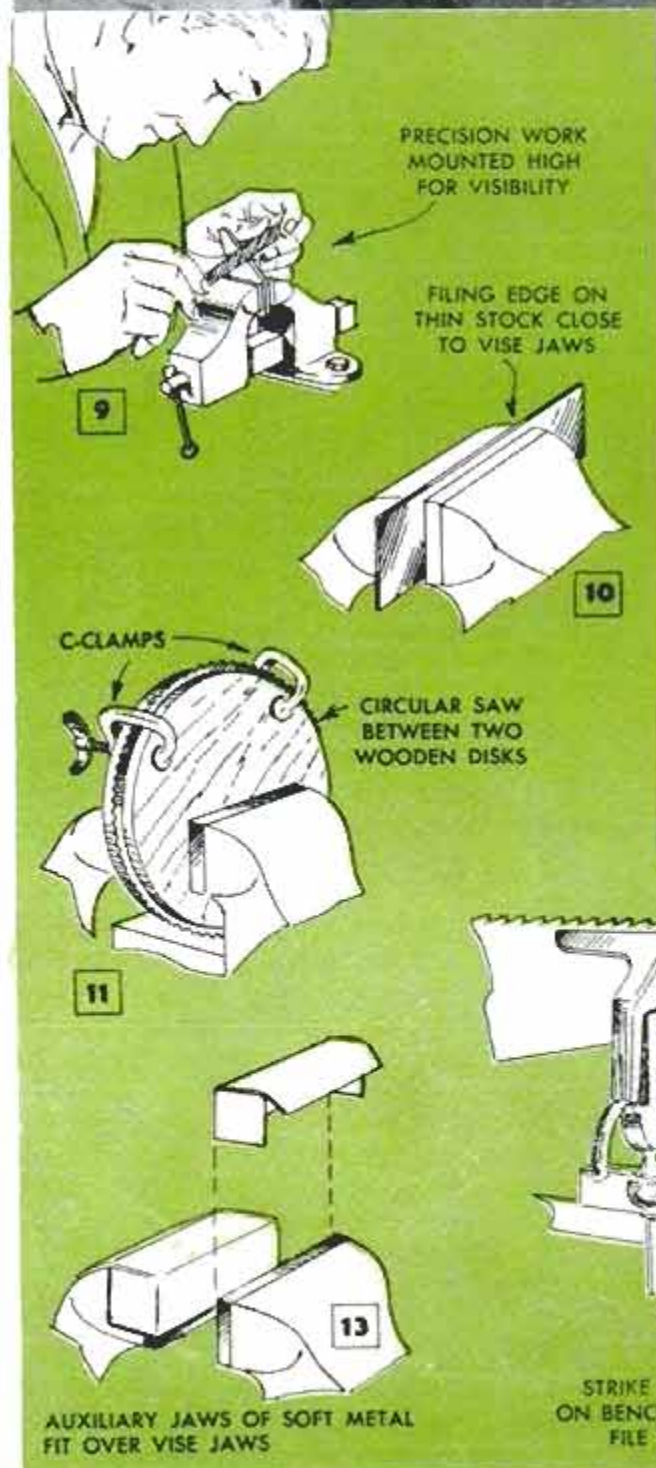

PRECISION WORK MOUNTED HIGH FOR VISIBILITY

FILING EDGE ON THIN STOCK CLOSE TO VISE JAWS

C-CLAMPS

CIRCULAR SAW BETWEEN TWO WOODEN DISKS

VISE FOR FILING HANDSAWS

DON'T HAMMER FILE TO DRIVE TANG INTO HANDLE

AUXILIARY JAWS OF SOFT METAL FIT OVER VISE JAWS

STRIKE HANDLE ON BENCH TO SINK FILE TANG

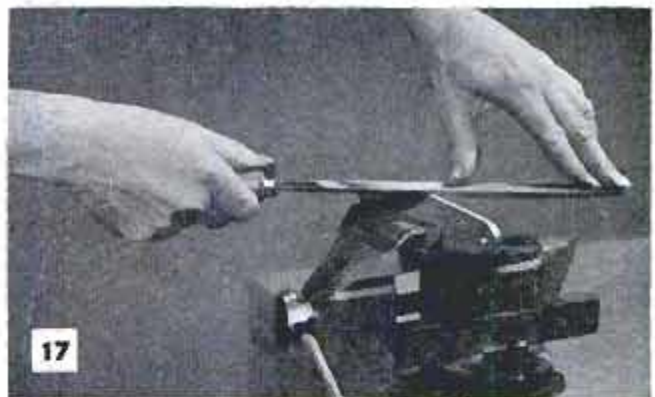
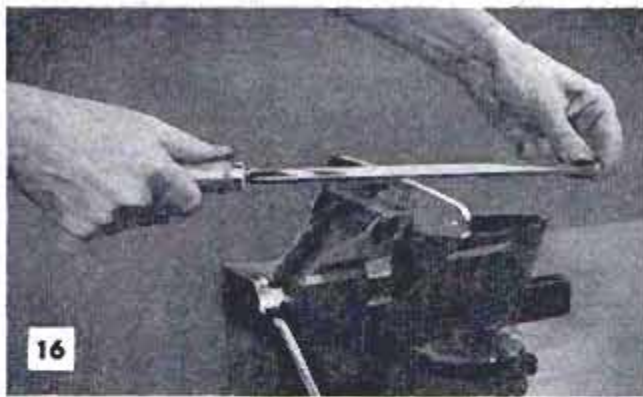

fingers should point toward your face. With the thumb and fingers of the other hand take a light hold on the tip as shown in Fig. 16, or rest them on it as in Fig. 17. A tight, clumsy grip, as in Fig. 18, can make accurate filing almost impossible. Start the forward stroke at the top of the file. It should be a full-length stroke, ending at the heel as in Fig. 19. At the beginning of a stroke on flat work the downward pressure on the tip should be a trifle more than that on the heel. At the center of a stroke the pressure should be equalized and at the end of a stroke it should be slightly greater at the heel. Short strokes wear down the teeth on only a portion of a file and shorten its useful life.

The two most common errors committed by beginners are: Rocking a file on straight work and dragging it over the work on backstrokes. Even when the rocking movement is barely perceptible, the work surface becomes rounded as shown in Fig. 22. It is necessary to rock the file on round work, however. Then the handle is held high when the tip contacts the work. Bring the handle down as the stroke is continued. When filing hard metals, raise the file on the backstroke to clear the work. This is not necessary on soft metals where file contact with the work is an advantage, since it helps to dislodge filings.

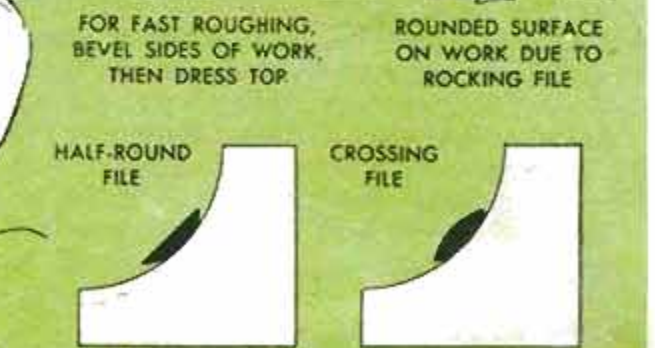
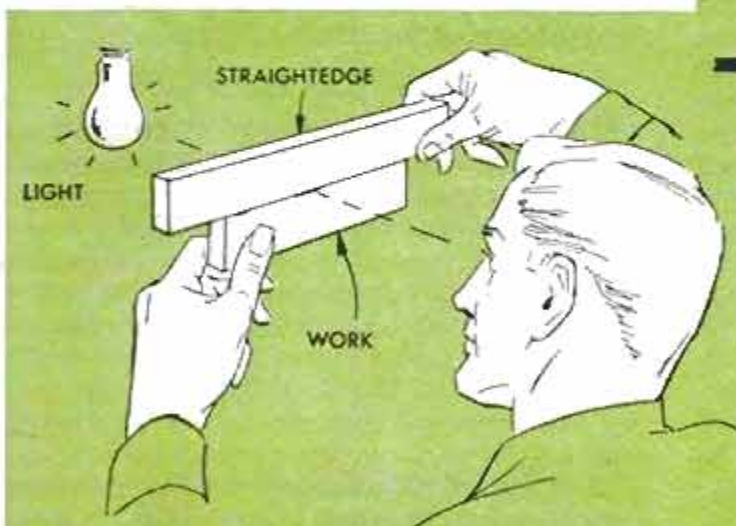
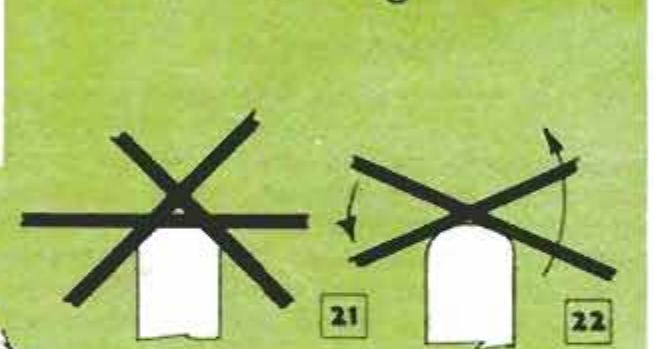
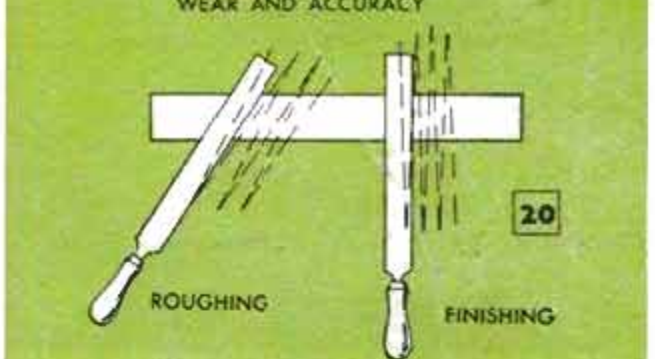
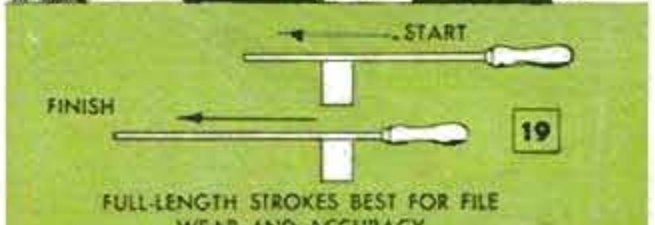

24 TESTING STRAIGHTNESS OF FILED WORK

23 FILING CONCAVE SURFACES

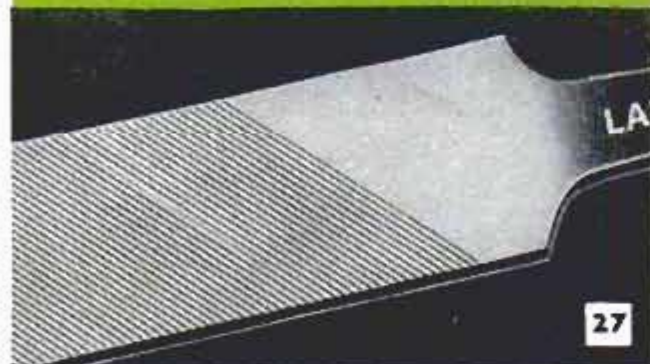
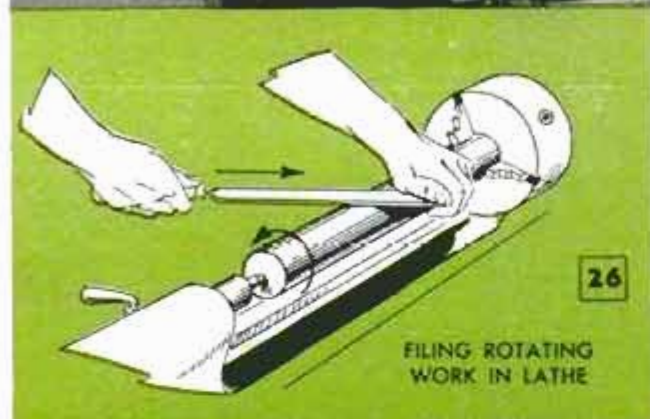

What File to Use

When starting a job, first remove humps and high spots from the work with a relatively coarse, double-cut file. Then dress down the entire surface, using diagonal strokes as shown in Fig. 20, to a very short distance from the finish line. Considerable metal can be removed quickly by filing the work edges at a bevel and then dressing down the top as in Fig. 21. Finishing is done with a single-cut file, using strokes almost straight across the work as shown in Fig. 20.

When filing concave surfaces you can use a round or half-round file as shown in Fig. 23. Sweep the file along the curve in both directions while stroking. A crossing file often is preferred for this purpose. For best results the radius of the file should be slightly less than that of the work so that the file will cut at its center.

Filing grooves, notches and inside corners can be done with a file having a "safe,"

or uncut, edge. With the latter, each adjoining edge of the work can be dressed down to the finish line separately. An attempt to file down two adjoining surfaces of a corner at once often results in excessive filing on one surface.

Instead of guessing at the amount of metal to be removed by filing, scribe the work so that the depth of cutting can be governed accordingly. When a filing job nears completion, hold a straightedge or square on the surface. Humps and hollows will show up plainly if you hold the work between your line of vision and a source of light as shown in Fig. 24. Then, the surface can be trued by means of drawfiling.

Drawfiling differs from crossfiling in that both ends of the file are grasped as shown in Fig. 25, and pushed and pulled over the work with a lengthwise stroke. Drawfiling eliminates irregularities and scratches of crossfiling, and results in a straight, smooth surface if done properly. When a considerable amount of stock must be removed you can use a flat, double-cut or bastard file first. Then finish with a mill file. Files with a long-angle cut are best for this purpose since they are least likely to leave marks. However, the same effect can be obtained with a file having a short-angle cut if it is held so that the cut is at a 45-deg. angle to the work edges.

Filing Rotating Work

When filing round stock rotating in a drill press, or in a lathe as in Fig. 26, keep the file moving forward as the work rotates toward you. Also, move it toward one side during the forward stroke. This minimizes grooving and helps to discharge filings. Never hold a file stationary against the work. Work mounted in a drill press should be supported with a "dead center" or a bearing at its lower end to take side strain. The best file to use on rotating work is a long-angle-cut lathe file shown in Fig. 27, which gives shearing action when held straight across the work.

Filing Soft Metals

Most files clog excessively when used on soft, ductile metals such as aluminum, copper, brass, lead and babbitt. An ordinary double-cut file is shown in Fig. 28, for comparison with special-purpose files as shown in Figs. 29 to 32, inclusive. The aluminum file has a tooth construction that resists clogging. The first series of cuts, the overcut, is fine, and the crossing cuts, the upcut, are deep and open-throated. The small scallops formed on the upcut break chips so that the file cleans itself readily and does not chatter or take too large a bite. A good finish is obtained by moving the file toward the left to get a shearing action on strokes.



28 REGULAR



29 ALUMINUM



30 BRASS



31 LEAD - COPPER



32 OTHER SOFT METALS

Fig. 30 shows a file for brass. Note the long-angle overcut and the short-angle up-cut. This file has sharp, sturdy, nonclogging teeth that minimize grooving and do not tend to run the file off the work. A file for cutting exceptionally soft metals, such as lead, babbitt and pure copper is shown in Fig. 31. The single, short-angle cut removes metal rapidly under light pressure, and with even less pressure produces a smooth finish.

A shear-tooth file, shown in Fig. 32, combines fast cutting action with good finish on many other types of soft metals, alloys, plastics, hard rubber and wood. On a forward stroke this file is pushed slightly toward the right to prevent running toward the left.

The tough, dense composition of stainless steel dulls ordinary files rapidly. Therefore, files having unusually high wearing qualities are used on this type of metal. They require only light pressure with slow, even strokes to remove metal quickly and to produce a smooth finish.

The teeth of ordinary files are not tough enough to withstand hard, rough surfaces and sharp edges of iron and steel castings, since only a few teeth contact the work at one time. For such work foundry files are used. The teeth on these files are more rugged and have massive backing to support the cutting edges, but they cut more slowly than regular files.

Another special type of file is used for die castings, which also tend to damage and clog teeth of ordinary files. A small, pointed file having a safe edge is used for sharpening augers as shown in Fig. 33. Other small, flat files are made especially for cleaning ignition points and similar small work.

File Care

A file should never be thrown on a bench, since this might chip or break it. Store files in notched crosspieces or place them vertically in a wall rack of the kind shown in Fig. 34. Rust destroys the sharp edges of

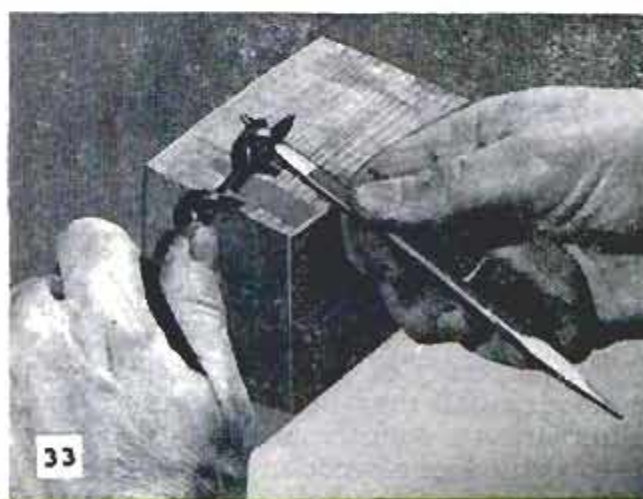

33

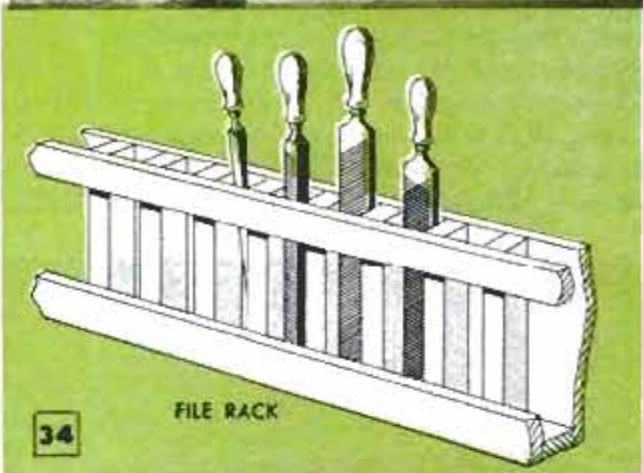

34

FILE RACK

the teeth. Where humid conditions prevail, files not in use should be wrapped in moistureproof material. Excessive oil and grease accumulating on files can be absorbed by chalk. After rubbing chalk on a file it should be brushed clean with a file card. ★★★

Mucilage Bottle as Tool Oiler

The spreader tip on a mucilage bottle filled with oil provides a clean and handy means of applying a preservative film of oil on tools and shop equipment. This removes the temptation to put tools away without oiling because of the old method of wiping with an oily rag.

R. G. Cooper, Trenton, Ont., Canada

Clamp Screwed to Faceplate Holds Work Accurately on Center

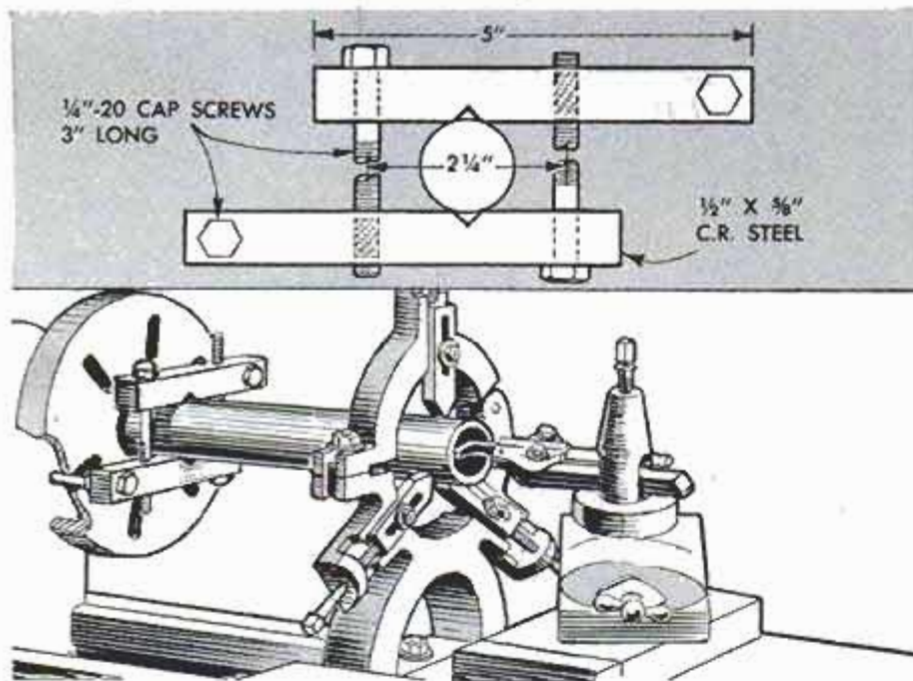

A clamp screwed to the faceplate of a lathe will provide a more positive means than rawhide laces of holding work when the end of the work to be machined is held in a steady rest. A clamp made of $\frac{1}{2}$ x $\frac{5}{8}$ -in. steel bar to the dimensions given in the detail will accept work up to 2 in. in dia. Both capscrews used in the clamp should be the same length and weight, and the two screws used to hold the clamp to the faceplate also should match to assure a well-balanced unit, especially when the lathe is run at high speed.

"Cradled" Wooden Balls Permit Easier Drilling

The difficulty of drilling a hole through a wooden ball may be overcome by "cradling" it on a countersunk hole which has been drilled in a wooden block. Preparatory to drilling, the ball is placed over the hole and positioned under the drill bit, with the block clamped tightly to the drill table. To accommodate balls of varying diameters, drill a number of countersunk holes in a range of sizes sufficient for your needs.

William J. Kadi, Long Beach, Calif.



Dry Chemicals for Spraying Mixed With Rubber Plunger

Mixing large quantities of chemicals, in powder or crystal form, with water for farm or orchard spraying can be speeded up when a plumber's plunger is used to "churn" the mixture in a barrel. A



row of holes is cut around the lower part of the plunger as shown, and a long handle attached. After the right quantities of chemicals and water have been poured into the barrel, move the plunger up and down on the bottom. This action creates vigorous circulation of water with the chemicals, dissolving them quickly.

Angle of Metal Square Realigned By Using Ball-Peen Hammer

If a carpenter's square has been bent so its angle is greater than 90 deg., place it flat on a metal surface and peen it near the outside corner. This will expand the metal at this point to reduce the angle. If the angle is less than 90 deg., increase it by peening the square near the inside corner. To check the accuracy of the angle, hold the long leg of the square on a horizontal surface and scribe a line along the short one on a vertical surface. Then swing the square 180 deg. so the short leg is on the opposite side of the vertical line. If this line and the short leg are parallel, the angle is correct.

Rectifier Unit Increases Motor Speed of Electric Razor

If your electric razor lacks some of the speed with which it ran when it was new, and it has an a.c.-d.c. type motor, this simple rectifier unit will convert alternating current to direct current and permit the razor to operate at a higher speed.

Obtain the following parts from a radio supply house: a 20-mfd. 150-volt capacitor, a 65 to 100-ma. selenium rectifier, an Amphenol type 61-F receptacle, an Amphenol type 61-M plug, a metal box $3\frac{1}{4} \times 2\frac{1}{8} \times 1\frac{5}{8}$ in., assemble them in the box and wire them as shown in the diagram.

If your supplier does not have the parts as listed, he can suggest substitutes, since the components are not in the least critical.

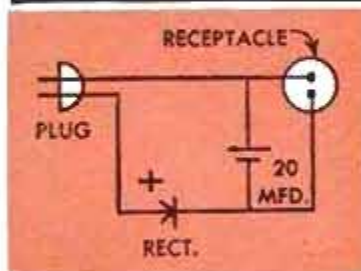
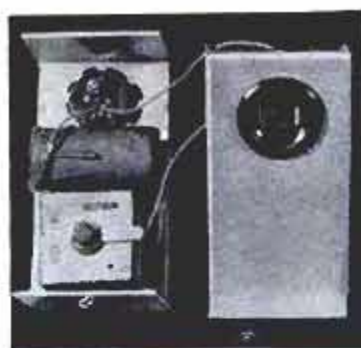

Use a good grade of electrical tape to insulate all wires in the box and paint the unit to match the color on the wall.

Francis Wright, San Carlos, Calif.
Box 793

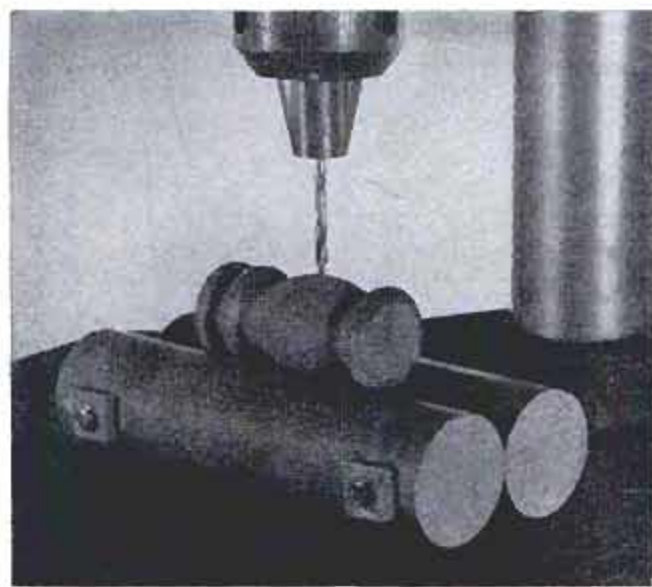

V-Block for Drill Press Improvised From Dowels

When there is immediate need for a V-block to hold round work on a drill press, and none is available, a suitable one can be improvised from two lengths of large-diameter dowel. Aligning holes are drilled in the dowels after the two members have been cut to the desired length. Then fasten the members together with bolts as shown. To assure good hole alignment, clamp the dowels together between two pieces of scrap wood and drill through the diameter of both dowels while they are in that position. For a nonslip surface wind several turns of friction tape around each member before assembling.

Multipurpose Horses Used for Shelving and Tables

These utility horses can be used for an endless number of jobs around the home or shop. Planks laid across the two lower crosspieces and top provide easily knocked-down shelving. Although the suggested dimensions show the horses to be 24 in. wide and 30 in. high with 14-in. feet, the measurements can be increased or lessened for any particular situation.

—Michael Ligocki, Gary, Ind.

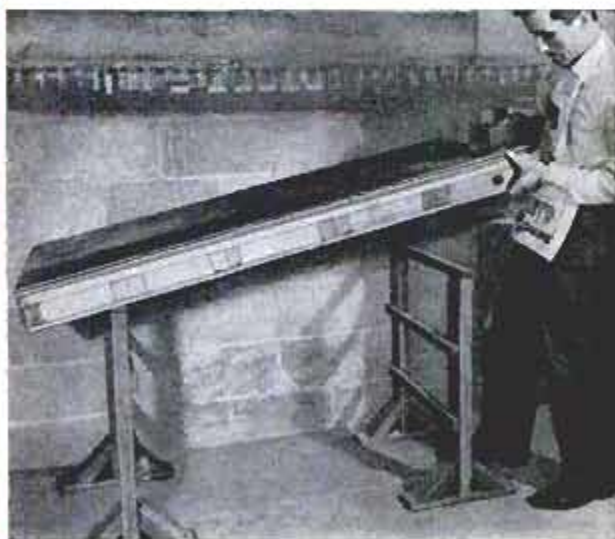
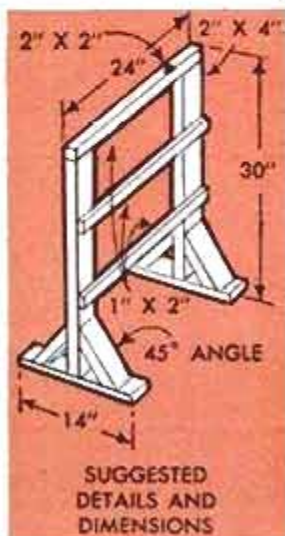

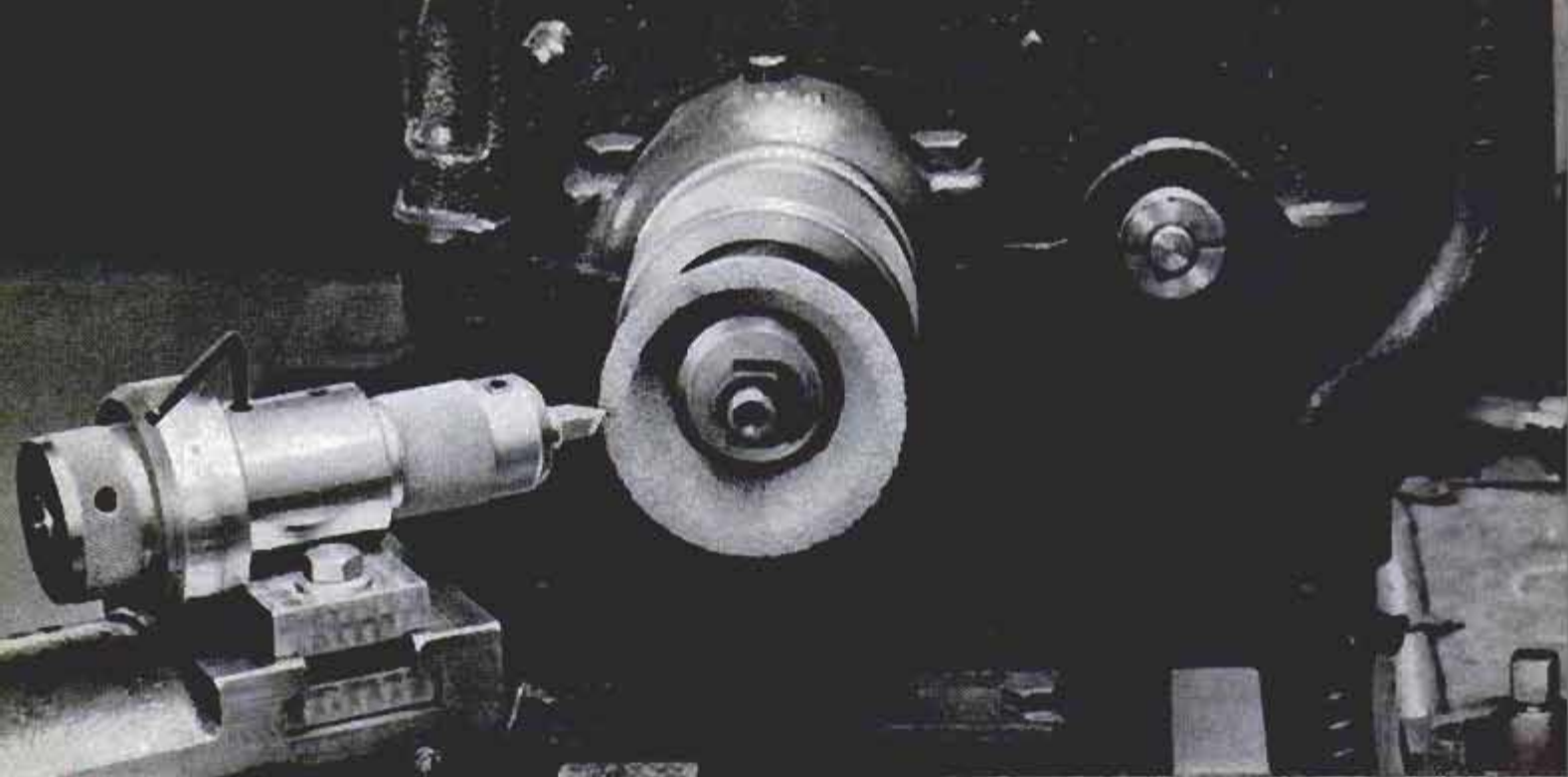

TOOL-GRINDING FIXTURE

By
Rodney B. Wyatt

*SN 58
Error somewhere - see Jimmy*

FREEHAND GRINDING of lathe tools is not always satisfactory due to the difficulty of maintaining uniformity of rake and clearance angles, especially in production runs where continuous use of cutting tools shortens the time between regrinds to a matter of hours or even minutes. The tool-grinding fixture pictured is designed to eliminate inaccuracies and speed up grinding of cutting tools. It is shown mounted on the tool post of the lathe, but can be adapted to use with a conventional grinder. It consists of a spindle, a "chuck," spindle bearing, a stationary disk carrying a witness mark and a graduated quadrant and locking sleeve. The quadrant is divided into four equal segments as in the insert in the photo on the opposite page. The segments are graduated into nine divisions of 10 deg. each and numbered 0, 1, 2, 3, 4, 4, 3, 2, 1, 0. Note from the insert that the segments also are numbered 1, 2, 3, 4.

To use, the fixture is mounted in the

tool post, as pictured, with the compound set at 0. Now, note the settings for tool face A in the left-hand column in the data table below. Swing the compound 30 deg. to the right as directed, turn the fixture quadrant to the segment marked 1 and set at 0. Then turn the quadrant 20 deg. to the right and lock the setscrews to hold the spindle. Settings for grind faces B, C and D are made in the same manner.

It should be remembered that the data table given below is not all-inclusive. It is merely a generalization of common tool-grinding practice. Several tools are shown with sharp points when in actual practice the points are rounded freehand to a radius varying from $\frac{1}{64}$ to $\frac{1}{16}$ in., depending on the type of work being done and the degree of finish desired. Also, in certain types of work it has been found impractical to use a tool that is ground with all angles theoretically correct. This can be due to other factors, such as flexibility of the work. ★★★

Side-clearance angles for right and left-hand threads will vary with pitch of thread and diameter of work. Compound setting is swing of handle to right or left in deg. Make grinds in order shown by key letters

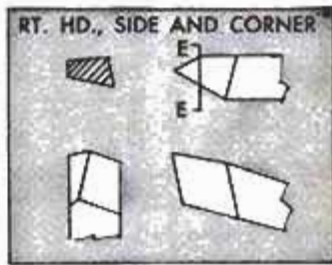
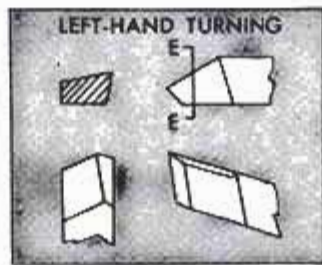
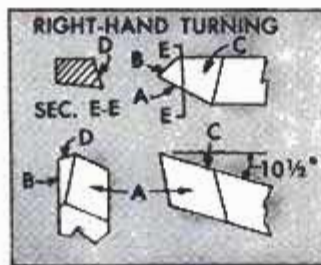

SETTING FOR _____
COMPOUND _____
QUADRANT _____
DEGREES _____

A	B	C	D
30° R.	45° R.	None	0°
1	3	None	2
20° R.	10° L.	None	12° L.

A	B	C	D
30° R.	45° R.	None	0°
3	1	None	2
20° L.	10° R.	None	12° R.

A	B	C	D
30° R.	30° R.	12° L.	0°
1	3	2	2
20° R.	10° L.	0°	14° L.

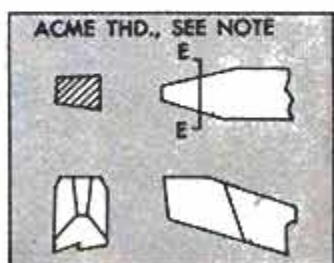
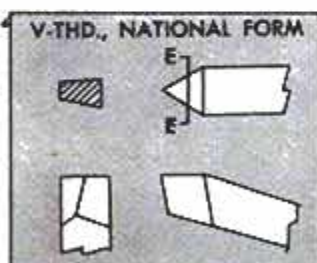
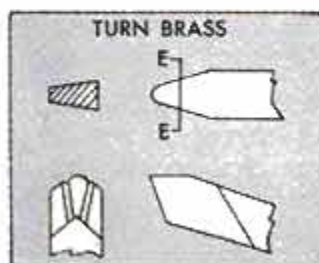
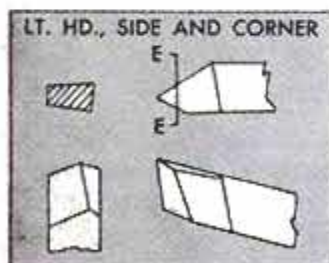
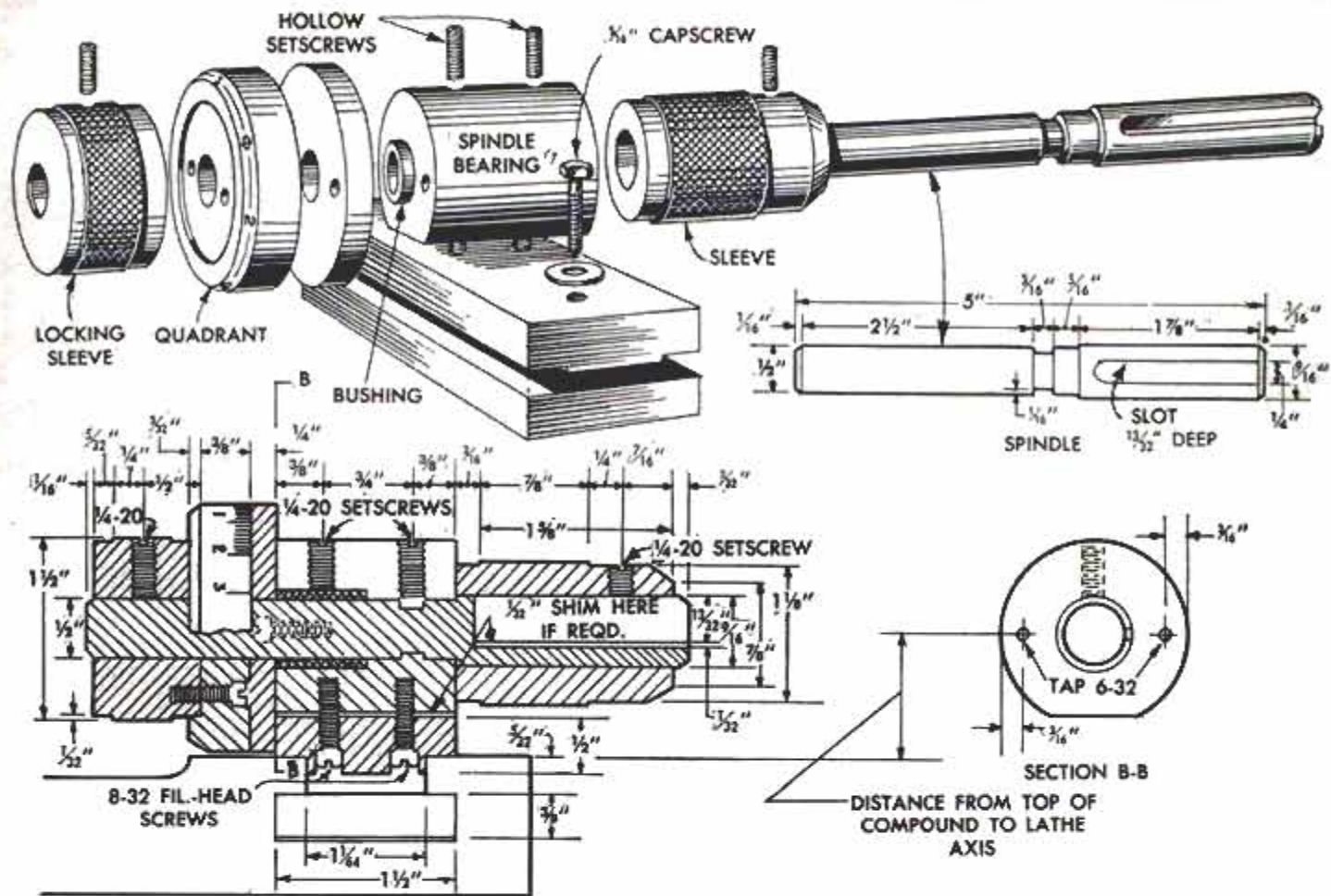
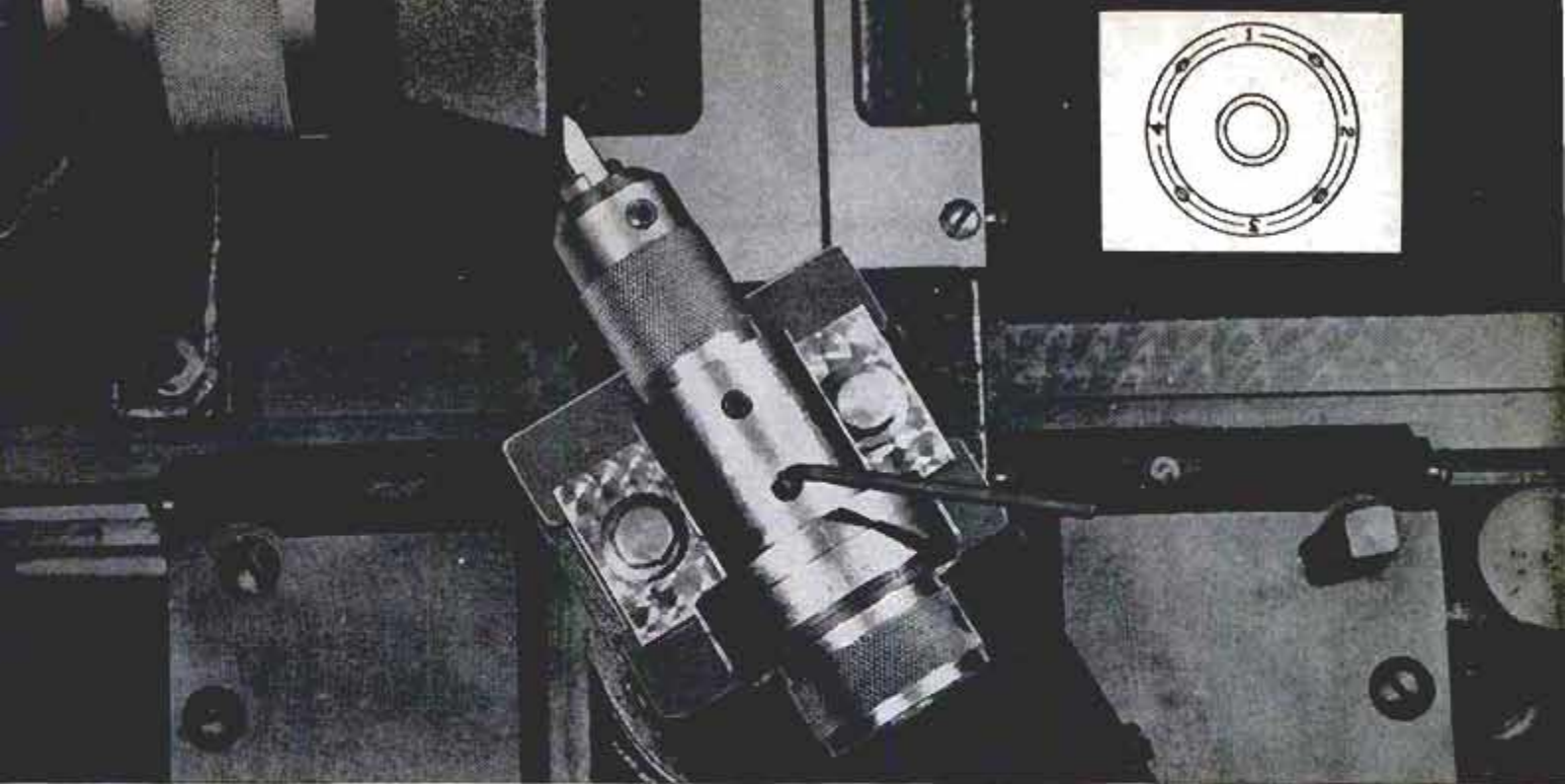

A	B	C	D
30° R.	30° R.	12° L.	0°
3	1	2	2
20° L.	10° R.	0°	14° R.

A	B	C	D
14° R.	14° R.	12° L.	None
1	3	2	None
10° R.	10° L.	0°	None

A	B	C	D
30° R.	30° R.	15° L.	None
1	3	2	None
10° R.	8° L.	0°	None

A	B	C	D
14½° R.	14½° R.	16½° L.	None
1	3	2	None
5° R.	5° L.	0°	None

Punch-Marked Hex Nut Centers Drill Bit Through Machine Bolt

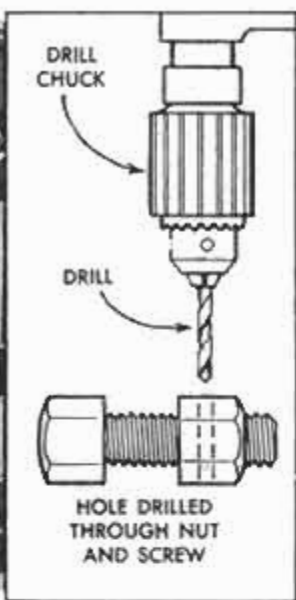

Drilling a cotter-key hole through a bolt without having the drill bit slip to one side is no problem if a nut is used as a simple jig. Run the nut on the bolt to the point where the hole is to be drilled, center-punch the side of the nut and drill through both nut and bolt.

Frank LaSaracina, New York City.

Floor Mat Retains Small Parts On Repair Bench

When disassembling a clock, doorbell, radio, or other small machine or instrument, the small parts will not roll off your workbench and get lost on the floor if a rubber auto floor mat is placed under the work. Then, small parts which are deposited on the mat will remain in the depressions until they are needed or placed in containers for later use. Parts can also be arranged in subassemblies in the order of removal, to facilitate reassembly. Only mats with deep ridges or squares are suitable.—A. J. Calandra, Gloversville, N. Y.

Tar-Paper Liners Aid Cleaning Hen's Laying Nests

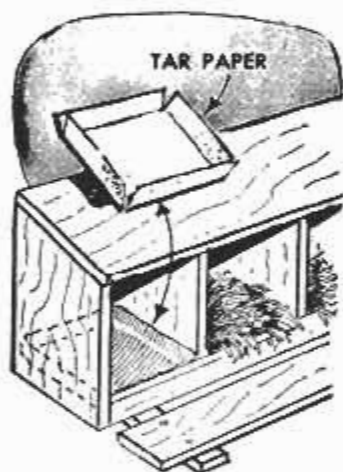

Vermin will be discouraged from infesting the nests in your poultry house, when tar-paper liners, as shown in the detail, are fitted into the nests before adding straw or other nesting material. To make a liner trace an outline of the floor of a nest on a sheet of

tar paper, add 2 in. on each side and slit the corners. When it is necessary to give the nesting units a thorough cleaning, simply remove the liners.

Paintbrush is Handy Duster

For general dusting around the shop an old paintbrush with the handle sawed off just above the ferrule makes a serviceable dusting brush that is especially handy to use in tight corners. When thoroughly



cleaned of hardened paint, the fine bristles are ideally suited for dusting furniture or other woodwork that is being sanded preparatory to finishing.

Hydraulic Cylinder on Combine Replaces Cutter-Bar Lever

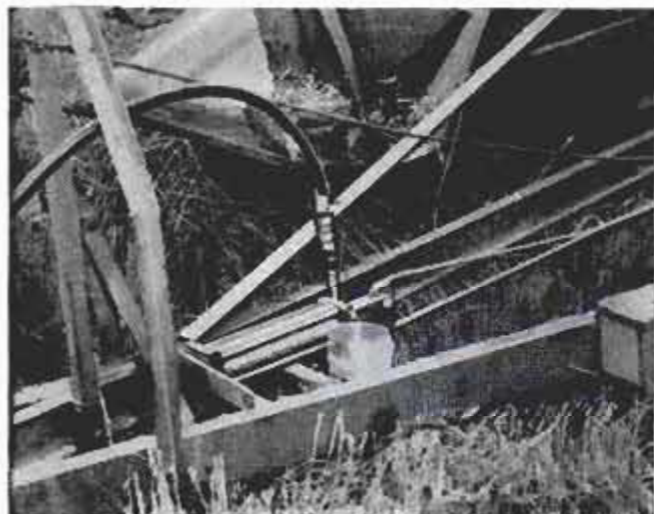

The cutter bar on this combine is raised and lowered from the tractor seat by means of a single-action hydraulic cylinder that replaces the original hand lever. To connect the lever rod to the cylinder it was necessary to shorten the rod and weld it to the lower end of a length of steel flat fitted vertically in the piston-rod clevis. The flat, which measures approximately 2 x 4 in., was drilled at the center to receive the piston-rod clevis pin. A lighter rod was welded to the upper end of the flat and to the lever rod to provide a brace. The hydraulic cylinder was bolted to angle-steel brackets so it was in line with the rod.

A. M. Wettach, Mt. Pleasant, Iowa.

Expansive Reamer Enlarges Auger-Bit Holes

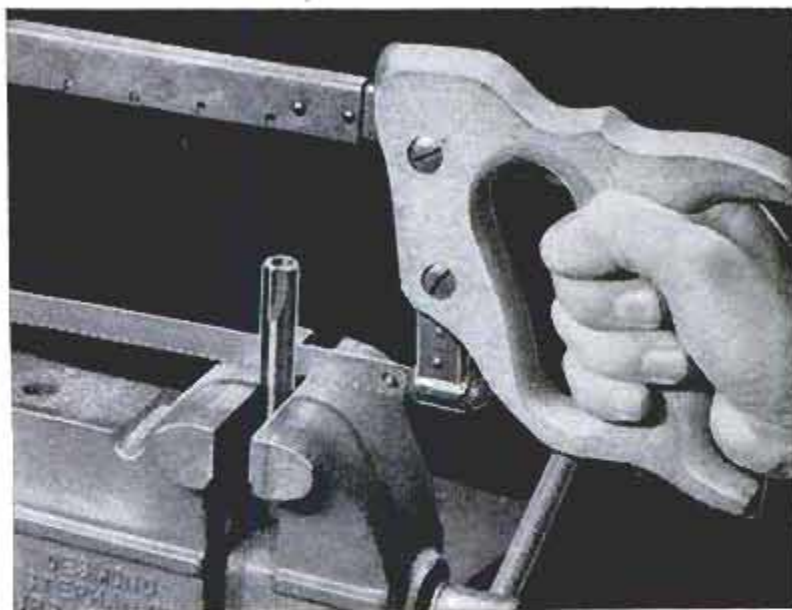
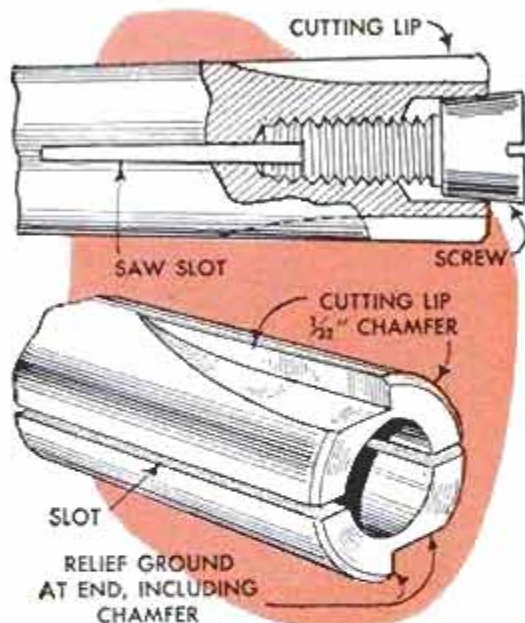

Have you ever wished for a bit that would drill holes in wood just slightly larger than are possible with standard-diameter auger bits, such as when assembling with dowels? Then you'll appreciate this reamer that can be adjusted to enlarge $\frac{1}{2}$ -in. holes up to $\frac{3}{32}$ in. oversize.

Hand tools can be used to make the reamer, although use of a lathe would reduce the required time and labor. The reamer described is designed to enlarge $\frac{1}{2}$ -in. holes. Reamers for smaller or larger holes would be sized proportionately. First, a length of $\frac{1}{2}$ -in. steel rod is drilled and tapped lengthwise to receive a $\frac{1}{4}$ -20 machine screw, then counterbored to provide a recess for the tapered head of the screw. Next, the two cutting edges, which are $\frac{3}{4}$ in. long, are formed, either by milling or sawing and filing, to produce square-edge grooves as indicated. Longer edges would be better if deep holes are to be reamed,

although the shorter edges will work well if the tool is withdrawn occasionally and cleaned of wood chips. The lower end is chamfered and the cutting edges are relieved by grinding away a small amount.

The rod then is split lengthwise by sawing at right angles to the plane of the cutting edges, making the cut just long enough to permit the adjusting screw in the end to readily spread the two halves. The taper-headed adjusting screw is made from any screw that has a head that can be turned to the shape shown. If no lathe is available, chuck the screw in an electric drill and file the head to shape while it is rotating. The reamer can be used in a drill press, electric drill or hand drill, so the next operation is to shoulder the upper end of the reamer to a diameter that will fit the chuck of the tool in which it will be used. Cutting end of the reamer should be hardened.

W. E. Burton, Akron, Ohio.

Drill-Press Routing Made Easier By Rough-Routing Work First

When work is routed on a drill press, much time can be saved if the routing bit is first used as a drill for roughing out the area, moving the work a step at a time. While doing this, the work is held in place by a wood auxiliary table with a coarse sandpaper facing, which affords a nonslip surface. After the work is roughed-out, the wood table is removed and the work finish-routed in the usual way. With this method of routing there is practically no side thrust on the router bit and much of the vibration and noise is eliminated.

Keep a magnet in your toolbox for retrieving steel items from hard-to-reach spots, or parts dropped in sawdust.



SHOPPING FOR TOOLS



HAND DRILL solves the problem of drilling holes in hard-to-get-at places on work that has been partially or wholly assembled but which requires holes to be drilled for additional fasteners, such as screws or nails. The drill chuck, 1/4-in. capacity, swivels through 270 deg. and the handle turns through a 180-deg. arc at right angles to chuck movement. There is storage space in the handle for extra drill bits



P & C Hand Forged Tool Co., P.O. Box 5926, Portland 22, Ore.

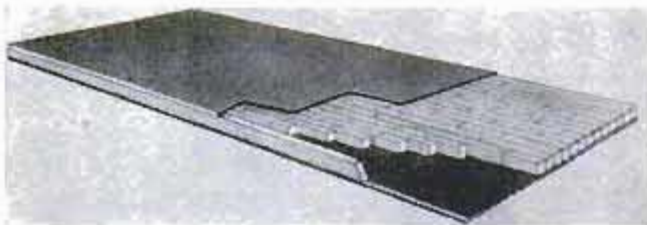

WORKBENCH TOP is of laminated construction having a core of wooden blocks faced with a special hard-board which is oil-and-grease resistant, splinterproof and warp-free. Available in a wide range of sizes

Rock Island Millwork Co., Rock Island, Ill.



HUB-CAP TOOL makes quick work of removing hub caps and wheel disks from car and truck wheels. Will not damage cap or wheel. Also is useful for loosening quarter round, chrome moldings and friction can lids

Maymac Co., 79 W. Grand St., Mt. Vernon, N. Y.

CARBIDE COUNTERSINK is designed to eliminate chatter. A round chip-clearance hole is centered in the cutting edge, permitting chip to curl away without clogging cutting edge. Speed is 250 to 500 r.p.m.

Raymac Div., Dexco Corp., 15490 Dale Ave., Detroit 23, Mich.

DRAFTSMAN'S T-SQUARE has a ball-bearing head which aligns automatically on an angle guide that can be attached to drawing board. Slides over board with slight pressure. Snaps on and off angle guide

Align-O-Matic Co., Box 2001, Durham, N. C.

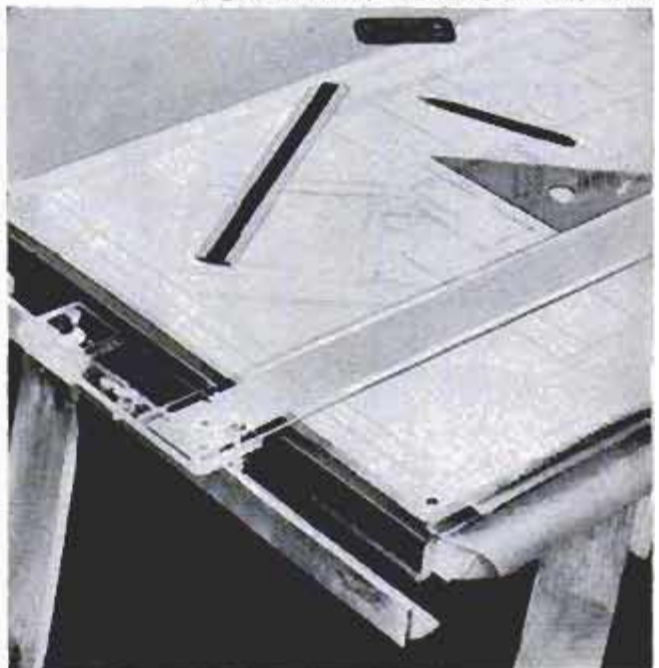



NEW HAMMER AND HATCHET have tubular alloy-steel handles fitted with rubber-cushion grips which are said to be positively nonslip even when wet or when the user is wearing gloves. Handle shafts are wedged into the toolheads and are pinned in such a way as to prevent breakage and reduce impact shock

True Temper Corp., Cleveland, Ohio



HACKSAW HAS TUBULAR FRAME that is light, rigid and balanced for a wide range of work. Can be adjusted for 10 or 12-in. blades by sliding tubular frame in handle. The latter has convenient thumb rest for control when making cuts to close dimensions

Forsberg Mfg. Co., 125 Seaview Ave., Bridgeport 1, Conn.

PISTOL-GRIP TORCH for soldering, burning and sweat-soldering is designed for use with propane gas. Pressure on trigger produces instantaneous ignition. Length of flame is controlled by varying pressure on trigger. When trigger is released flame snaps out

Velocity Power Tool Co., 201 N. Braddock Ave., Pittsburgh 8, Pa.

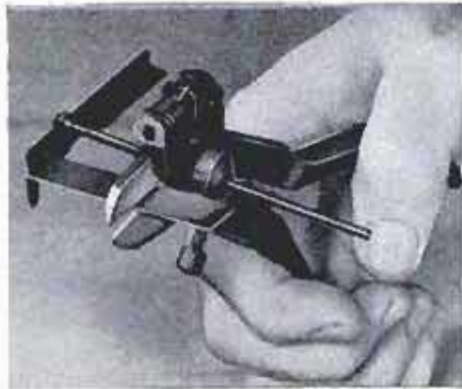
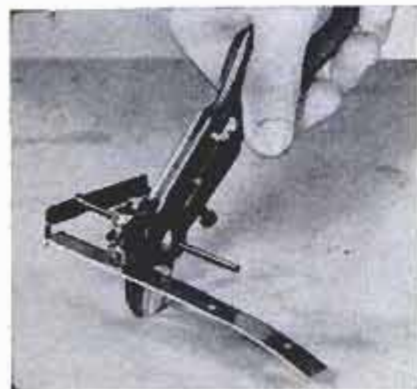

COMBINATION TOOL is a tin snips, metal punch, metal bender, or "brake," and wire straightener in one. The hanging planter pictured is an example of the range of work that can be done. Unit comes with a stop for spacing holes and cutting to length as in photos above. Bending operation is shown below

The Holly Co., 2737 N. Pine Grove Ave., Chicago 14

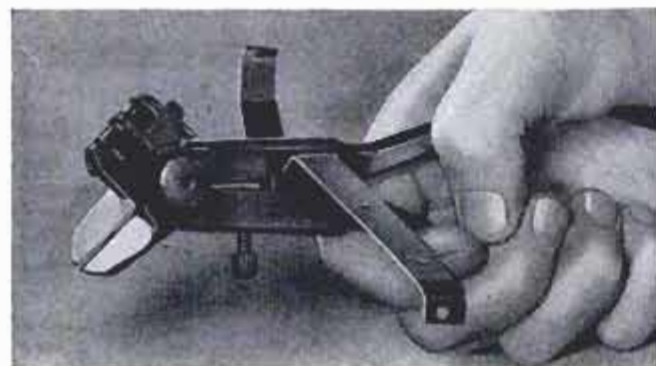

On the MARKET

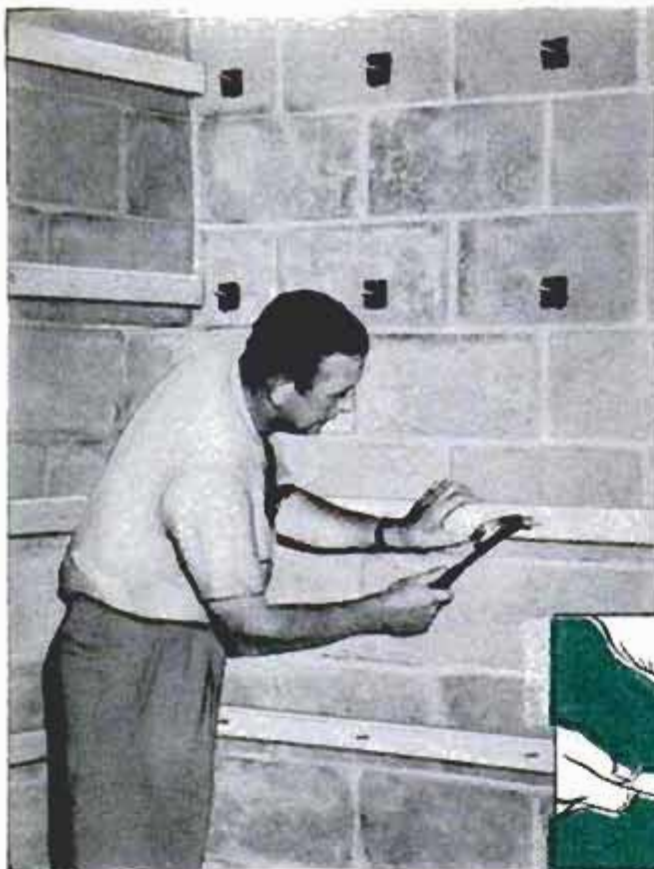

ANCHOR NAILS provide a means of attaching furring strips to masonry and concrete walls. The perforated nail plate is coated with special waterproof adhesive, then pushed against wall with twisting motion. When the adhesive dries, furring strips are driven onto nails which then are clinched as indicated

Goodloe E. Moore, Inc., Danville, Ill.

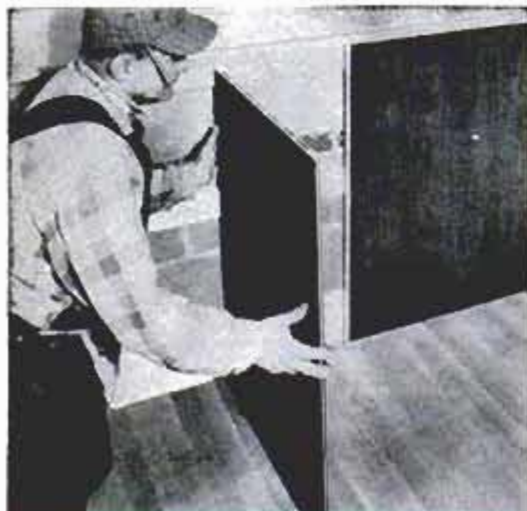
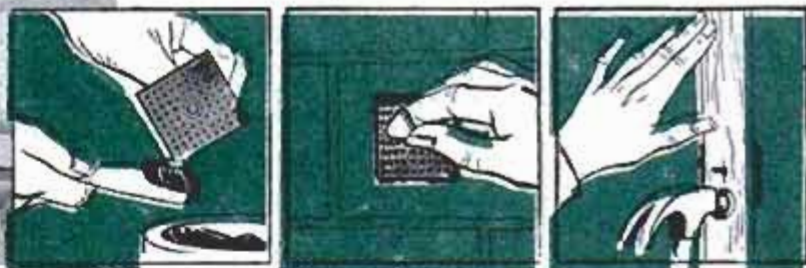

FLEXIBLE-PLASTIC CONTAINER in which this glue is packaged also is applicator. Squeezing sides of container forces glue through tapered nozzle so that narrow bead of glue can be laid on edge of wood or small amount can be applied to one spot in hard-to-reach location

Midcontinent Adhesive Co.,
Gore City, Ohio



PREFINISHED HOLLOW-CORE PANELS consist of two sheets of tempered hardboard on wood core. Tongue-and-groove ends and edges aid assembly. Predrilled tongues speed installation with screw-type nails as indicated in detail. Panels are $\frac{3}{8}$ in. thick, come in 2 x 4-ft. and 2 x 8-ft. sizes

Marsh Wall Products, Inc., Dover, Ohio

PLASTIC SCREW ANCHORS can be used in any type wall, hollow or solid. In hollow wall, anchor body snaps apart and spreads to lock itself in place as in upper detail. In solid wall, anchor expands as indicated in lower detail. Ribs on outer surface prevent anchor from rotating when installed

Wall Plugs, Inc., 1216 W. 79th St., Chicago 20

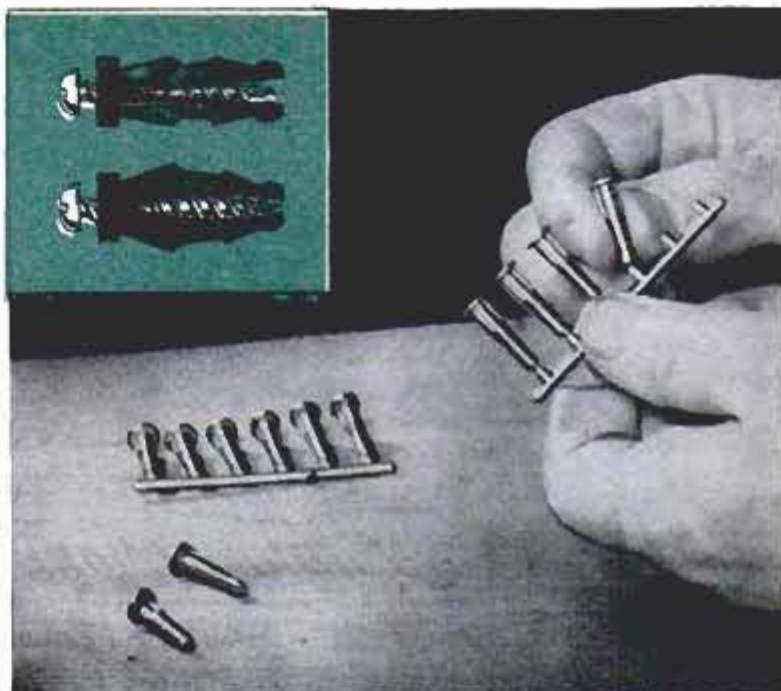

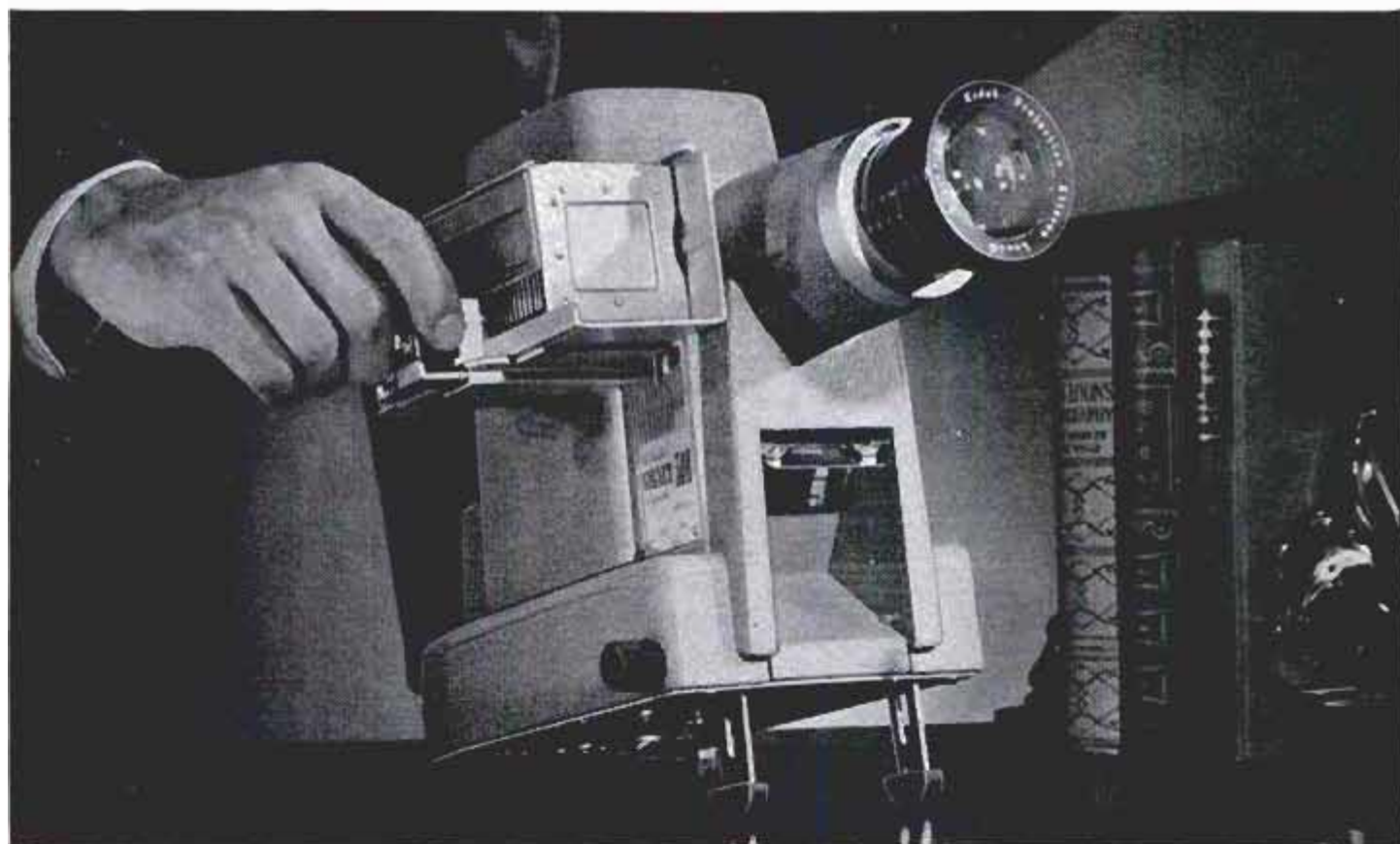

What makes a Kodaslide Signet an outstanding slide projector?



Quick, positive focusing for needle-sharp images



All major controls grouped conveniently together

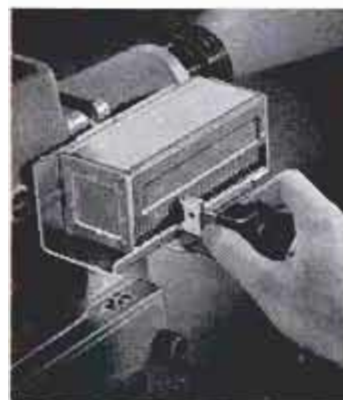

Changer to feed, restore slides, with push-pull ease



Air-cooled for your slides—never even hot to the touch!

That's easy. Top-quality performance. For the thrill of brilliant, big-screen slide projection, you can't beat a Kodaslide Signet Projector. A fine Ektanon Lumenized Lens, together with close-coupled condensers, is your assurance of sharp, bright images of highest color purity.

And thanks to a 6-way selection of models, your Kodak dealer can show you a Signet with the features you want . . . at the price you want to pay. Prices range from \$59.50 for a Signet 300 with $f/3.5$ lens and single-slide changer, to \$89.50 for the Signet 500 Projector with $f/2.8$ lens and automatic changer. (Signet 300 with automatic changer, shown above, \$69.50.)

Prices are list, include Federal Tax, and are subject to change without notice.

Eastman Kodak Company
Rochester 4, N. Y.

Kodak
TRADE MARK

Care and Feeding of Engines



BY
S. P. CORP

CONCERNING PISTONS

The piston's job is to transfer the force of combustion into rotary motion through connecting rod and crankshaft. To do this, it must support the rings that seal combustion. Most pistons today are of aluminum alloy, to reduce the load on connecting rod bearing.

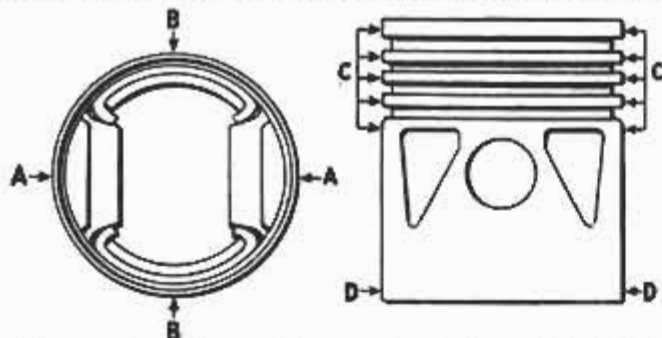

Diameter A should be .010" to .012" less than diameter B.

Diameter C should be .0005" to .0015" less than diameter D.

The piston is elliptical in shape to allow for expansion and to control side thrust on cylinder wall as piston gets hot in operation, when it becomes round. All pistons must be fitted to specifications, using a feeler gauge on the B dimension. The top is narrower than the bottom; always measure about 1/4" up from bottom.

When fitting new rings to old pistons, inspect to see that ring lands are square. A worn top land will prevent a new top ring from sealing properly. The Sealed Power GI-60 Insert is the best means of correcting this condition, permanently and economically.

CARBURETOR AIR LEAKS

A carburetor air leak may cause hard starting by making mixture too lean. To check, connect a vacuum gauge to intake manifold, removing air cleaner from carburetor and high tension wire from coil. Have someone step on starter. Place hand over carburetor so air can't enter. Gauge should show 12 to 14 inches of vacuum. If less, remove carburetor and repeat test with hand over intake manifold. If reading is still low, replace manifold gaskets. If second reading is above first, look for leaks in carburetor body or at throttle valve shaft. Check all gaskets—between air horn and float body, between float body and throttle body, and the main gasket at bottom of carburetor.

FREE BOOKLET FOR YOU

This illustrated booklet contains a world of valuable facts about car care. It's yours for the asking. And be sure to use Sealed Power KromeX Ring Sets when you re-ring—for easier starting, for greater oil economy, and for double ring life. Your dealer has them or can get them for you. Sealed Power, Dept. G-3, Muskegon, Michigan



Sealed Power

PISTON RINGS

Clinic for Homemakers



As a service to our readers in solving the hundreds of problems pertaining to a home—inside or out—the editors of *Popular Mechanics* invite you to present your problems to The Clinic Editor for help and advice. Address your questions to The Clinic Editor, *Popular Mechanics Magazine*, 200 East Ontario Street, Chicago 11, Ill.

Tile Over Linoleum

Q—The inlaid linoleum on my kitchen floor is about 30 years old and of course it is badly worn—appears to be cracking and breaking up in several places, in front of the range and sink especially. It has seemed to me practical to lay rubber tile over it. Certainly this procedure would save a lot of work. I'm told this is not advisable, but no one seems to know exactly why. The old linoleum was cemented to the wooden floor. Why can't I lay the tile right over it?

—Y. K., N. J.

A—You can. But we hesitate to recommend this procedure. Some tile cements tend to soften old linoleum. The added thickness of the new top floor may prevent doors from closing, especially if the floor is slightly uneven. Heavy fixtures, such as stoves and refrigerators, will cut quickly through the new tile due to the "softness" of the double floor. The new tile will wear more rapidly in heavily traveled areas due to lack of a solid underlayment. However, we do know of one homeowner who laid hardboard underlayment over old linoleum and then tiled the floor. So far as we know the job was satisfactory. But we still think it advisable to remove old linoleum before laying new covering.

Zoysia Grass

Q—What is Zoysia grass? I've heard about it from several sources, but want to know more specifically what it is, how it grows and where. Is it started from seed? How far north in the United States will it winter successfully? Will it withstand the wearing effects of normal foot travel in a manner equal to other common lawn grasses? Will it grow in moderate shade? Is there more than one variety?

—H. J., Md.

A—There are several varieties of Zoysia grass, but a newly developed hybrid, Emerald Zoysia, shows considerable promise of a wider adaptation.

(Continued to page 240)



got a

MECHANICAL SKILL?

You'll go places
FASTER in the

U.S. AIR FORCE!

HERE'S WHY: Men with mechanical skills find that they can get ahead in the U. S. Air Force. As an Airman, you'll have the chance to develop your technical ability and learn a skill that will pay well – and win you extra stripes. Such interesting

career fields as Aircraft and Engine Maintenance, Rocket Propulsion and Intricate Equipment Maintenance are open to you, if you qualify.

Don't delay—visit your local Air Force Recruiter, or mail the coupon.

SEND FOR YOUR FREE BOOKLET

Entitled: Pocket Guide to Air Force Opportunities



M-28-PM2

Paste coupon on postcard and mail to

AIRMAN RECRUITING INFORMATION BRANCH
BOX 2202, WRIGHT-PATTERSON AFB, OHIO

Please send more information on my opportunities for enlisting in the U. S. Air Force. I am between the ages of 17-34 and reside in U. S. A. or possessions.

Name _____

Address _____ Age _____

City _____ Zone _____ State _____

U. S. AIR FORCE

Makes Masking fast and easy!



THE NEW Behr-cat[®] BRAND HANDY-GRIP DISPENSER ROLL

Now you can mask off those "non-painting" spots in a jiffy and get the clean-cut, professional-looking paint job you want! Behr-cat Masking Tape now comes packaged in a handy dispenser box...easy-to-grip and quick-to-use. A quick pull against the built-in cutter bar tears off the tape at the length you want. Save time with Behr-cat Masking Tape also in wrapping, sealing, holding and many other jobs around the house or shop.



Look for
this display!

at better Hardware
and Paint Stores
everywhere.

C-2
BEHR-MANNING
TROY, N. Y.
division of MORTON Company

Pressure-sensitive masking, strapping, freezer and many other tapes. Sandpaper, abrasive cloth and sharpening stones for home and industry.

(Continued from page 238)

However, its northern limits of successful growth in the United States have not yet been determined. Experiments have shown Emerald Zoysia to be a highly desirable lawn grass, fine-leaved, dense-growing, and of a uniformly dark-green color. Once the grass is well established, it is highly resistant to weed invasion. It is shade-tolerant and withstands foot travel exceptionally well. In the southern and southeastern states it remains green late into the fall. Emerald Zoysia is started in a manner similar to the method of starting bent grass, by means of what are known as sprigs. Summer is the generally accepted time for starting a new lawn. First, the soil should be tested and should it show more than ordinary acidity, lime must be applied to correct the condition. Also, if the test shows the soil to be deficient in plant food, a complete lawn fertilizer should be applied. Then the soil is worked into a well-compacted, finely pulverized bed and the sprigs spaced 6 in. in rows 6 in. apart, in other words, a 6-in. planting. Ordinarily the sprigs are set at an angle with one end 2 in. below the surface. The new planting must be well watered and weeds kept down during the first season.

Evergreens Die

Q—For two years I've tried without success to start evergreens along the front of my new home. They die out during the winter, both the high and low-growing types. I watered them regularly during the summer months but this didn't prevent loss. I also had them checked for red-spider infestation in the fall. What do you think is the cause?—D. S., Wis.



A—Even though you say you watered the new plantings regularly, we still believe that lack of water is the most likely cause. We'd suspect that the fill around the foundation may contain such inert materials as large stones, broken concrete, possibly gravel or sand and comparatively little compacted soil. If this is the case, then water applied to the area near the foundation walls would drain away to a low level in a comparatively short time, leaving the roots of the new plantings without sufficient moisture. Thus the value of watering just before the ground freezes is largely, if not entirely, lost. Evergreens will not ordinarily live through the winter if the root system freezes dry, as a certain amount of growth takes place throughout the cold months. We suggest that you investigate the character of the soil where the planting was made. This usually can be determined by trenching to a depth of 20 or 30 in. If you discover large stones, broken concrete and the like, this should be removed and fresh soil, preferably clay, substituted as fill. This done, it probably will be safe to go ahead with another planting. If the house has wide cornices, keep the plantings outside the line of the eaves. In addition to the probable cause outlined there are others, remote, but still possibilities. One is that the soil may somehow have been contaminated with crankcase drainings, fuel oil, or some other chemical that would "poison" the soil for a period of time, preventing normal growth of evergreens.

Masonry Bond

Q—In estimating a repair job my mason contractor stated that he would have to clean a portion of one wall with acid so that cement plaster would bond to it. What does he mean by "bond"?

—V. D., Mich.

A—Your description does not make it entirely clear just what is to be done, whether the wall is to be cleaned or etched by the acid. Ordinarily acid (generally a mild solution of muriatic acid) is used to etch the surface of smooth concrete (monolithic) walls, also floors. If the mason is referring to cleaning the wall he means that some surface coating, such as oil, grease or paint spatters, must be removed in order to obtain a surface to which the plaster will adhere.

Texaco Tips On Car Care



If one of your lamps burns out at night...

and there isn't a nearby station to replace it, put white reflecting tape across the lamp in a criss-cross position. By reflecting the rays of oncoming lights, it indicates the outline of your car. Carry a small quantity of this tape with you for such an emergency. Another good tip—be sure to keep your headlights clean. Surprisingly, a single day's accumulation of dirt may cut their effectiveness as much as 50 per cent.

If your car feels like this...

it's time for *Marfak* chassis lubrication. *Marfak* is what you get—always, at no extra cost—when you get your car lubricated by a Texaco Dealer. It's the famous lubricant that lasts for a thousand miles or more—delivers more miles of *cushiony*, comfortable driving. So forget rough going! Get *Marfak* chassis lubrication today. See your Texaco Dealer, the best friend your car has ever had!



MARFAK
Lubrication



TEXACO DEALERS IN ALL 48 STATES

Texaco Products are also distributed in Canada and in Latin America

THE
TEXAS
COMPANY

TUNE IN: TEXACO STAR THEATER starring JIMMY DURANTE, on TV Saturday nights, NBC.
Metropolitan Opera radio broadcasts Saturday afternoons, ABC. See newspaper for time and station.

From attic gloom to extra room!



NOW YOU CAN TURN that waste space into a cozy extra room with Gold Bond Insulation Plank and Ceiling Tiles. Use them in your attic, basement, house extension, or anywhere. They'll keep you warmer in winter, cooler in summer, too!

COSTS LITTLE. Gold Bond Insulation Planks come ready to install . . . no painting or papering needed. Just nail or staple them in place. Special edges hide the fastenings. You can choose ivory or a blend of four harmonizing colors. The cost? Far less than you'd think possible!

FOR THE CEILING use Gold Bond Insulation Tiles. They absorb sound just like the Insulation Planks . . . perfect for a bedroom, add restful quiet to a den or game room.

YOUR GOLD BOND DEALER has all the material and know-how you'll need . . . he'll even help you with easy terms.

NATIONAL GYPSUM COMPANY Buffalo 2, N. Y.

FREE LITERATURE . . . Mail the coupon for Gold Bond Plan #14 . . . complete illustrated instructions that show how you can build a room just as attractive as this!



MAIL THIS COUPON TODAY!

National Gypsum Co., Dept. PM 36, Buffalo 2, N. Y.
Please send me Gold Bond "How-to-Do-It" Plan #14, giving complete instructions on how to apply Gold Bond Insulation Planks and Tiles.

Name _____

Address _____

City _____ Zone _____

County _____ State _____

Model A on the Canal Beat

(Continued from page 155)

built the Jitney about the same but added more platform and beefed it up for handling greater loads. Mules were used to haul material through the canal, built in 1909, in the pre-T days.

Little trouble was encountered while cutting down the 1929 Model-A sedan to size. After a section of one rear axle was removed and the shortened axle welded, it broke. Better welding took care of that difficulty.

In short-coupling the A, the transmission was coupled directly to the differential, eliminating the drive shaft and torque tube.

Northcott says they choose a Model A because it was rugged and dependable, and added, "It just wouldn't be right to replace a Model T with anything but a Model A, would it?"

Plans have been formed in the back of Northcott's mind for a new ditch buggy when the Jitney reaches retirement age. His idea calls for a special frame, built to take two Jeep four-wheel-drive front axles. He'd whip the biggest problem—turning in the ditch—with this setup. The proposed car would have two steering wheels, each provided with a locking mechanism. You would just lock one set of wheels and drive as far as you wish. When a return trip is desired, you'd simply lock that steering system, unlock the other and drive home.

No mention of a motor to power Jitney II was made, but from the obvious nostalgic love for the four-jug Ford it seems a safe bet to say if there's a way of incorporating it into the new design, the motor will be a Model A. It should truly be a *Modern A*.

★ ★ ★

Silent Wrist Alarm



Instead of ringing, a wrist alarm for the hard of hearing "tingles" the wearer's arm. A special vibrating back does the trick. The 17-jewel watch, designed to wake a person in the morning and remind him of appointments during the day, has equal value for those

with normal hearing. It has luminous dial and hands, a stainless-steel back, antimagnetic movement and dual unbreakable mainsprings.

SOMETHING *NEW!*

**30% THINNER
TWICE AS STRONG
GRIPS LIKE A PIPE WRENCH**

CLEAN, SHARP
TEETH

FLUSH RIVET
NO PROJECTIONS

BOX JOINT ADJUSTABLE TO
4 POSITIONS UP TO 1½" CAPACITY

EXTRA THIN—ONLY ½"
AT THICKEST POINT

NON-SLIP CHECKERNUT
KNURLING

Crescent's No. P210 Utility Plier is completely new... revolutionary! It's not a "slip-joint" plier and not to be confused with conventional lap-joint "pump" pliers. Its *double-strong* box joint design is absolutely unique and assures a powerful grip like that of a pipe wrench without sideways twist or strain. It will grip flat, square, hex or round objects with powerful leverage.

QUICK, POSITIVE ADJUSTMENT

This cut-away view shows joint construction with its extra generous bearing surface at the arrow point. Adjustment is made by simply "walking" the rivet recess over the bearing point with a pumping action of the handles. Easy, positive, capable of heavy loads.

Handsomely finished in rust-resistant zinc plate. Overall length 9½ inches.

Sold by hardware dealers and industrial distributors everywhere.



CRESCENT TOOLS
Give Wings to Work

*Sign of the Artisan
Symbol of Excellence*

Crescent is our trade-mark, registered in the United States and abroad, for wrenches and other tools. Sold by leading distributors and retailers everywhere and made only by **CRESCENT TOOL COMPANY, JAMESTOWN, NEW YORK**

"IT COULD ONLY BE A
Shakespeare
WONDEROD"

THE
STRAIGHT-FIBER
GLASS ROD WITH
THE SPIRAL
MARKINGS



*Feel the
Difference!*

Only Shakespeare, using the patented Howald Process, laminates thousands of parallel glass fibers compactly, under tension, so they run *straight and continuous* from butt to tip—for strength! No crisscrossed or ground-off strands.

ACTION Built-in Wonderod has the slimmest-strongest tip possible... vibrant and lively, for "catapult-action" casting; responsive, to work the bait.

POWER Built-in Here is "backbone" that lets the rod do the work. Springy glass fibers cast for you—and stand the gaff to fight the fish.

ACCURACY Built-in The faster, more responsive tip unerringly puts lure or bait where you aim. No wishy-washy sway. You cast more accurately!

No. 1266 SPIN-WONDEROD

You'll feel the difference the moment you pick up this beauty. White rod, dressy winds, Carboloy top. Choice of light action or medium action; lengths, 6'6" or 7'... **\$2250**



No. 1266

Free! NEW 1956 "TIPS and TACKLE" BOOK-PAK WITH POCKET FISHING CALENDAR

Catch more fish! These 4 new books show ways to fish, where to find 'em, tackle for:

SPINNING • BAIT CASTING
FLY FISHING • SALT WATER



SHAKESPEARE COMPANY

Dept. PM-3, Kalamazoo, Michigan.

Please send, FREE, new 1956 "TIPS and TACKLE" booklets and Joe Godfrey pocket fishing calendar.

Name _____

Address _____

City _____ Zone _____ State _____



Shadow Box for Medals

Heirlooms and war medals can be displayed in a new plastic shadow box. The unit has no clamps or screws, but clips together by simple hand pressure. Glass protects the enclosed keepsake and the velvet cushion on which it rests. The shadow box can be hung vertically or horizontally, and is made in black plastic and red velvet or ivory plastic and blue velvet.

Seed Germinator

Farmers and gardeners can test the germination of plant seed with a small, electrically heated unit. Made almost entirely of aluminum, it has a sturdy glass observation top, sensitive heat controls and a moisture system. Tests closely simulating actual soil conditions and temperatures can be made in a short time.

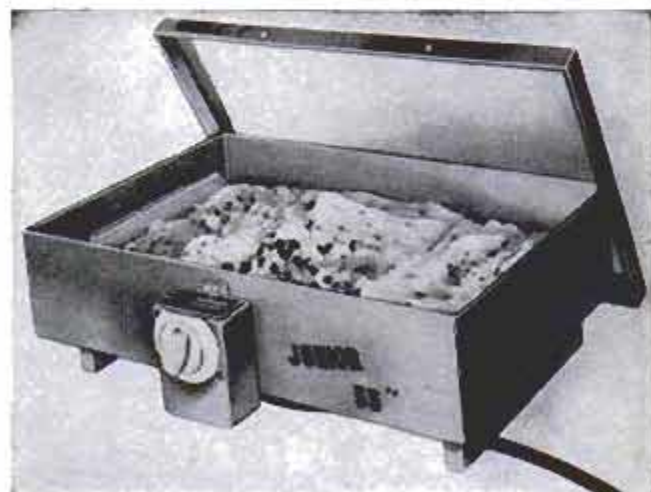

GRAVELY

More for your Money!



GRAVELY MAKES TOUGH JOBS EASY!

Gravely does jobs other tractors won't . . . because Gravely has that *extra* power you need for the tougher mowing, gardening, field and farm jobs. Does a better job, even on *steep slopes!*

You get *more* when you get Gravely. All-gear drive, power reverse, simple operation. More traction from easy-handled, *balanced* weight.

NEW FOR 1956

An optional ELECTRIC STARTER . . . push-button power! A new STEERING SULKY for finger-tip handling of your Gravely . . . a small dozer blade . . . and tractor improvements for MORE value . . . new cooling system, chrome rings, engine improvements for *more* power . . . see the improved Gravely!

- ALL-GEAR DRIVE
- POWER REVERSE
- Power Attachments Securely Mounted by Only 4 Bolts



5-HP

SINCE
1922

PLUS . . . 23 JOB-RIGHT TOOLS!

Your choice of 23 tools for a versatile tractor that saves time, work and worry *all year long*. Tools to do every mowing, gardening, field and farm job.

Send coupon today for "Power vs. Drudgery", the big booklet that shows how Gravely equipment solves your upkeep and gardening problems . . . *faster, easier, better!* (EASY PAY PLAN, TOO!)

GRAVELY TRACTORS, INC.
BOX 363 DUNBAR, W. VA.

Please send me "Power vs. Drudgery" Booklet and dealer's name.

NAME _____

ADDRESS _____

CITY _____ STATE _____



Guided Missiles Go to Sea

(Continued from page 136)

The need for guided missiles became brutally apparent at Leyte Gulf, when the first "Divine Wind" pilots crashed their kamikazes into our ships. The research program, thrown into top gear at that time, just now is grinding out usable missiles for the Fleet. There is the Sparrow missile, for launching from airplanes against aerial targets. There's Regulus, a surface-to-surface missile that increases the striking range against enemy ships from thousands of yards to hundreds of miles. There's the Petrel, an air-to-surface guided missile. And there's Terrier, the deadly surface-to-air weapon that spark-plugs *Boston's* and *Canberra's* challenge to aerial attackers of the Fleet.

This slim, needle-nosed missile, designed for ranges that would make a conventional gun curl up and die, and effective in fog or blackest night, first flamed into life from the seared decks of the *USS Norton Sound*, the Navy's guided-missile test ship, in late 1951. Countless firings since that first tentative flight have brought the precocious infant to swift maturity. Most of the test firings have been made without the explosive warhead, but with a device to signal a "kill" by releasing a puff of smoke near

the target plane. Even without warheads, Terrier has smashed many target drone aircraft by direct collision. Today it is a rugged and tested weapon, ready to take its place in the battle line.

Enemy Found Electronically

When the searching radars pick up unknown planes far over the horizon, the signal instantly flashes to Missile Control. Outdated and forgotten is the colorful "Bogey at three o'clock!" lingo of the last war. Instead the news travels electronically by instruments of unbelievable speed and complexity, and the unknown target is located and classified by the control radar without a word being spoken. The circuit closes—and in a flash a deadly missile roars off into the radar's beam.

Unaided, a rocket starts very sluggishly. But Terrier needs a fast start, because its stubby airfoils can't control it at low speeds. So the designers tie a "can" to its tail—a booster propelled by a slow-burning explosive, which gives a tremendous initial push and drops off exhausted. As it falls away, Terrier's rocket motor brings the speed up swiftly to its supersonic cruising speed and it streaks out toward the target.

The problems of designing guided missiles are staggering. Accelerations in
(Continued to page 248)

IT SMELLS GRAND



FRESH AND FRAGRANT AS A
NORTH WOODS BREEZE

IT PACKS RIGHT



CUT JUST RIGHT TO PACK WITH EASE

IT SMOKES SWEET



COOL AND SMOOTH—IT'S SURE TO PLEASE

IT CAN'T BITE!

SIR WALTER RALEIGH'S BLEND OF CHOICE
KENTUCKY BURLEYS IS EXTRA-AGED
TO GUARD AGAINST TONGUE BITE.

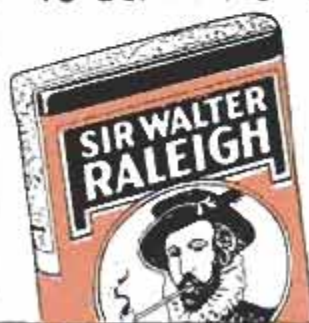

FREE!

24-PAGE BOOKLET ON
PIPE CARE. JUST WRITE
TO: SIR WALTER RALEIGH
DEPT. G6, LOUISVILLE, KY.

APPROXIMATELY

* **22**
DIFFERENT BRANDS OF SANDERS TO CHOOSE FROM

14 13 12 11 10 9 8 7 6 5 4 3 2 1
15

WHICH IS THE BEST SANDER FOR YOU ... ?

Professionals claim it's the sanding pad motion that counts in surface removal. Today's army of over 22 sanders use 1 of 4 different "motions"! Which motion will do that sanding job *best* in your home *away* from advertising claims and salesmen? We say exclusive Syncro MULTI-MOTION will *BECAUSE*—most wood grain being naturally crooked and irregular—only Syncro "Multi-Motion" sanding pad action *can* sand *with* such grain and completely *finish* the *whole* surface! See for yourself—accept our sporting offer shown below—and get your *next* home sanding job done *without* having to buy *any* sander!

* Maybe More Any Day!



"Mine is Best!"
"No—My Sander is Better!"
"Don't Believe Their Claims!"
"Ours Sands Perfectly!"
"X-Sander is Cheaper and Better!"

RENT—TRY THIS SANDER ON YOUR OWN JOB... RETURN FOR PROMPT RENT FEE REFUND... OR BUY IF IT SATISFIES YOU!



SEND NO MONEY

DO THIS: (1) Send coupon, your tool dealer name, address—we'll ship No. 900 Sander, Sanding Handbook, Sandpapers to you. (2) Pay postman \$20 (10 days rental fee), COD fee, postage charge, on arrival. (3) Use sander 10 days, return it prepaid—we'll refund your \$20 promptly. (4) To buy it, pay dealer (named on coupon) balance of \$19.95. Send us *receipt of purchase* from dealer, we'll ship you \$3 worth of sandpapers as our Gift!

Free

OF EXTRA COST

In addition to the Free Sandpaper included with your Rental 900 Sander, if you buy sander after trying on this offer—send us receipt of purchase from dealer, we'll ship you \$3 worth of sandpaper FREE.



"900" SANDER FACTS

Outlasts and outsands others. Jump-Free. Easiest of all to use. Exclusive Multi-Motion sanding pad action. Heavy-duty. Guaranteed against burn-out during rental use and ownership. Full 6 months Warranty. Retail Price only \$39.95.

OFFER ENDS JULY 1, 1956

TO: SYNCRO CORPORATION
Dept. 1-36, Oxford, Michigan, U.S.A.

Send me Syncro #900 Sander COD on 10 Day Rent Fee Refunded Offer. Within 10 days after Rental Period I may either (1) return Sander prepaid to factory only (Syncro Corporation, Oxford, Mich.) for prompt \$20 refund. Or (2) I may pay dealer direct (named below) balance of \$19.95 and I will own Sander. Offer ends July 1, 1956.

Name of Hardware Store or Tool Dealer: _____

ADDRESS _____

MY NAME _____

ST. & NO. _____

CITY _____ ZONE _____ STATE _____

(Offer Good Only In Continental U.S.A.)

DEALERS WRITE!

Dealers write on letterhead for complete Rental Sander details... for entirely different store-operated "Rent or Buy" Plan that can increase sander sales 60% at Full Dealer Profits!

Don't buy before you try

SYNCRO

SAWS AND SANDERS

SYNCRO POWER UNITS
GUARANTEED
AGAINST BURN-OUT DURING
YOUR OWNERSHIP OR
REPLACED FREE!

SYNCRO CORPORATION, Dept. 1-36, Oxford, Michigan, U. S. A.

Just Mail This



© SYNCRO CORP. 1956

Makes it a cinch to
DO-IT-YOURSELF



**NOW! APPLY MICARTA
or other Plastic Surfacing
WITHOUT CLAMPS
OR PRESSES!**

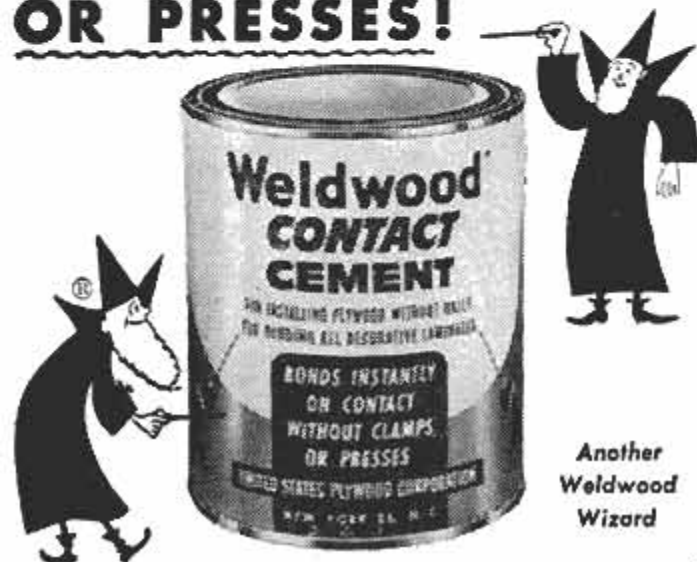

Another
Weldwood
Wizard

**Use amazing new Weldwood®
Contact Cement! Bonds instantly...
permanently on contact! Makes it
easy to modernize table tops, kit-
chen counters, bathroom surfaces!**

Weldwood Contact Cement works like magic! No need for clamps or presses. Just apply... let dry... then bring laminate and surface together! Instantly you get a permanent bond!

PUT UP PLYWOOD WITHOUT NAILS! Do it yourself with Weldwood Contact Cement. Revolutionary new method—faster, easier. No nail holes to spoil finished surfaces!

1001 JOBS MADE EASIER around home, shop, garage. Weldwood Contact Cement bonds any combination of wood, glass, leather, paper, cloth, Fiberglas® and metal (including do-it-yourself aluminum).

In tubes, bottles, cans. 25¢, 35¢, 60¢ and larger sizes at hardware, paint and lumber dealers and variety stores. Mail coupon for leaflet!

United States Plywood Corporation

Box 525, New York 46

PM 3-6

Please send me information on Weldwood Contact Cement.

Name _____

Address _____

City _____ Zone _____ State _____

launching impose brutal shocks on delicate control gear. The tremendous flight speed produces, in addition to the heat from the inner works, external heating from skin friction. At speeds of Mach 2 or 3, dust particles or even raindrops can chew up materials normally proof against such trifling obstacles. The maintenance problems are no less rugged—elaborate schooling and practical training are necessary for the missile teams. A two-year draftee has little place in a missile organization.

The gadgetry in some of our missiles would turn Rube Goldberg green with envy. Missiles can do celestial navigation, using star-tracking telescopes that activate "educated" photocells or can steer by measuring the earth's magnetic currents. Some "smell out" the target by radar, by measuring its heat emission, or by sensing its electromagnetic activity. Some even rival CBS—they scan the target and send a TV picture back to the launching point, where the bombardier can watch the screen and guide the missile into the target.

How accurate are these new weapons? Are they dependable enough to hit the targets time after time? Those who are in a position to know answer with studied vagueness: "We think all we can say is that we are not going to shoot any until they are accurate enough to deliver the payload with a fair probability into the target area." When you couple that with the fact that we're shooting Terrier now, it turns out to be a pretty reassuring reply.

War Veterans Join the Act

Boston and *Canberra* both are war veterans. The latter, named for the gallant Australian cruiser which went down at Savo Island, herself took a torpedo, but lived to fight again. Awakened from the torpor of moth balls, they were towed from the West Coast around to New York Shipbuilding Company's Camden yard to be ripped apart in the most complete conversion a ship could undergo.

Our streamlined task forces in any future war will have the elusiveness of a bantam and the Sunday punch of a heavyweight. When the bell sounds, chances are they'll already be far at sea, carrying the fight into the enemy's corner and smothering him with blows he never saw coming. The Fleet's task is threefold: Maintain control of the seas so convoys keep moving, support amphibious landings, and deliver the nuclear weapon on enemy strong points. For each of these jobs, the versatile task force gets the nod.

Star of the act, the queen bee surrounded by her fierce fighters, is the supercarrier;

(Continued to page 250)

NO MATTER WHAT YOUR JOB
Friedman-Shelby HAS A WORK SHOE
 THAT WILL FIT IT TO A "T"



Your particular trade calls for a particular shoe to give the best service. That's where your Friedman-Shelby dealer is ready to serve you. He has the perfect shoe to fit your job . . . and fit your feet, too!



No. 8053
 Brown glove; leather lined; lace-to-toe; Boltan sweat-resistant insole; Vulcork sole and heel. For Roofers, Riggers, Carpenters, Painters.



No. 8047
 Brown glove; cushioned insole; brown neo-cork (oil resistant) sole and heel. For Truckers, Meat Packers, Mechanics, etc.



No. 8022
 Black glove blucher oxford; cushioned insole; black neo-cork (oil resistant) sole and heel. For Filling Station Operators, Machinists, Factory Workers, Postal Workers.

For finer dress shoes ask for JOHN C. ROBERTS and KINGSWAY

Friedman-Shelby DIVISION • INTERNATIONAL SHOE COMPANY • ST. LOUIS 3, MISSOURI

and dispersed around her are the screening ships who stand ready, like the fighter bees, to sacrifice themselves in her defense. The rangy destroyers, aided by helicopters with "dunking" sonars, probe the waters for lurking subs. The radar pickets out on the flanks peer aloft, endlessly searching the fathomless skies. And the missile cruisers, proudly bearing their brave new weapons, stand ready to strike down the marauders who attack from the air.

One gnawing worry creeps occasionally into the bull sessions of these missile teams as they pause for coffee—what would happen if the enemy should manage to slide a missile of his own down their radar beam? The practical problems of doing this are well-nigh insuperable, but still. . . .

The opinions and assertions contained herein are those of the author, and do not necessarily reflect the views of the Navy Department or the naval service at large. ★ ★ ★

Louvered Sunglasses Use No Glass

Louverlike slats replace glass in a new type of sunglasses. The slats shield the eyes from sunlight but do not darken the user's field of vision. Both frames and slats

are made of lightweight plastic in a variety of colors. In seconds, one set of slats can be removed from the frames and another inserted to harmonize with a change in dress or sports costume. Available are 21 different color combinations.



The boat to take on any lake



If you plan to own a boat or rent a boat...take an Aluma Craft, everytime. Always dry, always ready...always fast, always steady...there's no boat quite like an Aluma Craft. Erich Swenson designs assure top performance, top speeds, seaworthiness, stability. If you rent your boats—look for the man with a fleet of Aluma Craft. If you want your own, see your dealer or write for nearest dealer's name. Aluma Craft may be purchased on easy terms.



Send for free full color catalog with complete specifications.

ALUMA CRAFT BOAT COMPANY

2625 27th Avenue South ★ Minneapolis, Minnesota

DO IT BETTER
DO IT WITH DP



GLAZE
 CAULK
 SEAL
 PATCH

Don't putter around with just any putty! Take the trouble to specify **D-P Putty** . . . you'll get the best. And, for **Glazing Compound** (that won't dry out or harden in the container) . . . it's **D-P** . . . quick, easy, economical to use for a smooth, permanent, elastic seal between glass and sash. Always look for the **D-P** trade mark, at all good stores!

Ask your dealer for **D-P** Products.

THE DICKS
 5301 Huberville
 INSIST ON D-P

PONTIUS CO.
 Ave., Dayton 3, Ohio
 BEST SINCE 1867

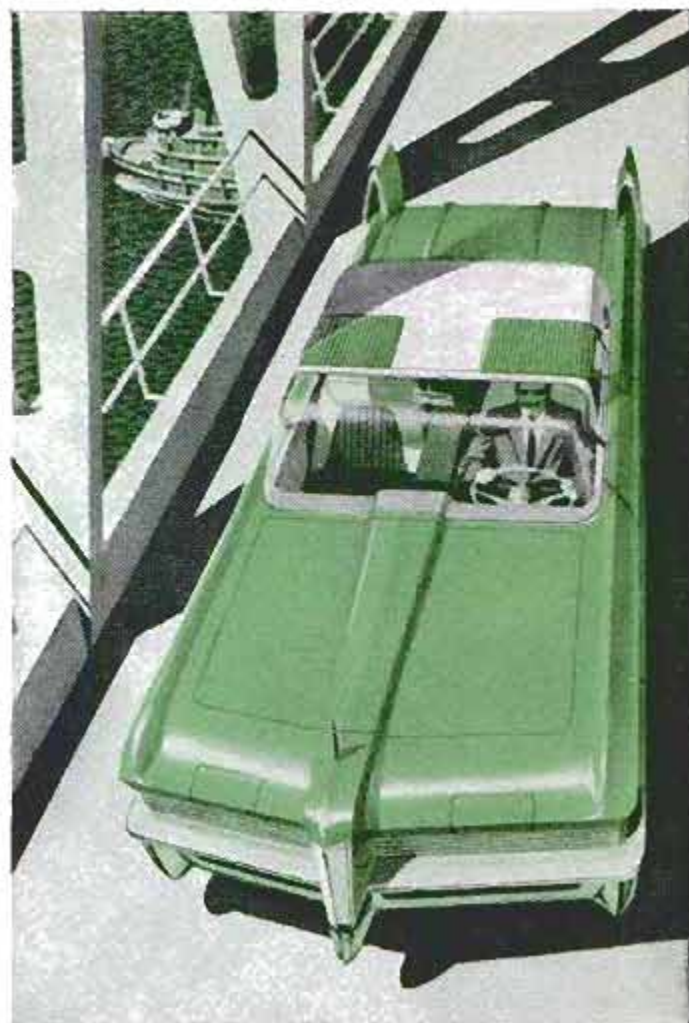

For finest lubrication,
 change to years-ahead
Quaker State Motor Oil

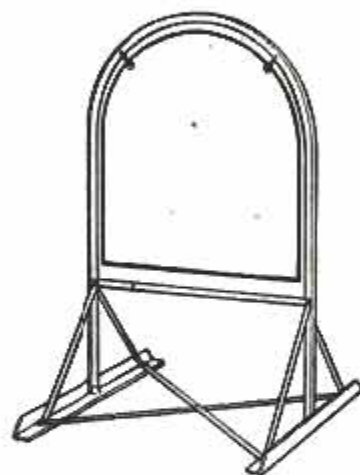

Super-refined from Pure Pennsylvania Grade Crude Oil, world's finest. Famous for performance, protection, economy! Try it!

QUAKER STATE OIL REFINING CORP., OIL CITY, PA.
 Member Pennsylvania Grade Crude Oil Association

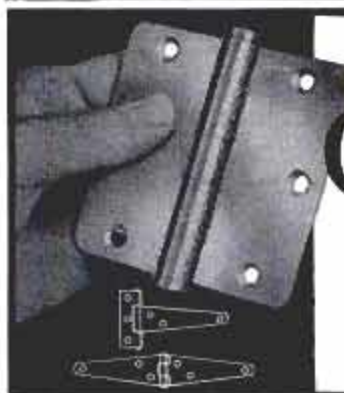

best hardware . .
 for hard wear

GRIFFIN
 HINGES

at your hardware or
 building supply store

GRIFFIN MFG. CO., ERIE, PA.

SMALL! POWERFUL!

ECONOMY TRACTOR

Unequaled value! Low price!
 America's finest tractor. Ruggedly built. Easy to operate. 790 lbs. Borg-Warner clutch, trans. and diff 140 to 1 reduction. 40% more drawbar pull than ordinary tractors 8-1/4 H.P. engine. 20 quick change implements. HOOD, FENDERS.

Thousands In Use Write for complete details.
 Engineering Products Co.
 915-K-3 Niagara Ct. Waukesha, Wisconsin

Professional Mechanics'
TOOL CHEST FOR YOUR HOME WORKSHOP



This may be the lowest cost full-sized chest in America! 4 sliding drawers in blue-gray rugged steel cabinet. 26" x 12 1/2" x 12 1/4". Free bulletin describes this and 12 other models!

\$24⁷⁵ F.O.B. ST. PAUL
HUOT MANUFACTURING CO.
 555 No. Wheeler St., St. Paul 4, Minn.



air-cooled
gas engine drive

"Husky Boy" arc welder

welds
anywhere

earns
bigger
profits

A small
investment
puts you
in business!



"Husky Boy"

"Husky Boy" 200 amp. welder driven by a 2 cylinder air-cooled engine. Perfect for outside or around the shop welding. Handles the big pay jobs.

200 Amp. AC Welder-AC Power Combination, four cylinder air-cooled engine. Furnishes 200 amperes of welding current and 5,000 watts of AC power alternately. Easily mounted on your truck or trailer for quickly getting to where it's needed on a moment's notice.

AC Power or AC Welder. An excellent dual purpose combination available in 200 or 300 amp. welding sizes. Can be belted or coupled direct to your own gas engine.

Transformer Type AC Welder 250 amp. A real welder for production and repair work in shops that have only single phase power available.

Investigate these money makers today!

Fill out and mail coupon for complete information on these machines—learn how they can earn bigger profits for you.



Hobart School of Arc Welding

Learn arc welding quickly by actual on the job experience at the non-profit Hobart Trade School. Complete or partial courses. G. I. approved.

HOBART BROTHERS CO., BOX M-36, Troy, Ohio, Phone 21223

"One of the world's largest builders of arc welding equipment"



AC Power—AC Welding



AC Power—AC Welding



AC Transformer

Modern Arc Welding Lessons

200 fully illustrated page lessons. Learn practical arc welding in your spare time... Only \$1.00

Clip and Mail!

free!

HOBART BROTHERS CO., Box M-36, Troy, Ohio

Please send additional data on items checked:

"Husky Boy" AC Power—AC Welding

AC Transformer Hobart Welding School

Welding Lessons, \$1.00

Welder's Vest Pocket Guide

NAME _____

ADDRESS _____

CITY _____

STATE _____

Why All These Hurricanes?

(Continued from page 110)

and \$1,000,000,000 worth of property. Diane had come close on the heels of Connie, who tore up much the same path, pushing tides over land and strewing wreckage before her winds. And after Diane came Ione.

These, on top of '54 hurricanes Carol, Edna and Hazel, which battered New England to a billion-dollar pulp, are an indication to some weathermen that East Coast hurricanes are no longer freaks. Philadelphians, New Yorkers and Bostonians, who never noticed news items about a hurricane brewing unless they owned Florida real estate, now twitch visibly when the announcer reports a "disturbance 800 miles east of Guadaloupe." Since 1938, storms that used to spend themselves at sea are smashing inland with increasing regularity, until they've now hit a rate of two or three a year. Whether it is a cycle or a permanent trend, experts won't say.

Why is it happening? Meteorologists aren't sure. Some suspect a shift of jet streams is responsible. These rivers of polar air, 25 miles wide and a half mile deep, travel 300 miles per hour across the skies at 40,000 feet. Until recently, one curved out over the Atlantic well beyond Long Island and down across the Caribbean. Since the 1930s, that stream has shifted steadily inland. No one knows why. But some weathermen believe its new position may have something to do with warmer eastern winters—and the change in hurricane routes. Another theory is that a vast new high-pressure area that has drifted in and squatted on the North Atlantic may be acting as a hurricane road block, forcing the big storms inland.

Many schemes for throwing the switch on New England-bound hurricanes have been suggested. One involves saturating the ocean under the storm with oil, making a huge slick to simulate rolling landscape. The delicately balanced air currents of hurricanes break up when crossing land. By creating land effects at sea, sponsors of the plan hope to fool the hurricane and disperse it before it comes ashore. Another idea is to "over seed" hurricane clouds. Usually, rainmakers spray just enough particles to make raindrops form and fall earthward. By overseeding a hurricane, some think no single seed could gather enough moisture to fall. Hence, rain would stop, the storm's balance would be destroyed and the show would be over. The most drastic suggestion is to blow up the storms with atom bombs.

Cautious weathermen view all these

(Continued to page 254)

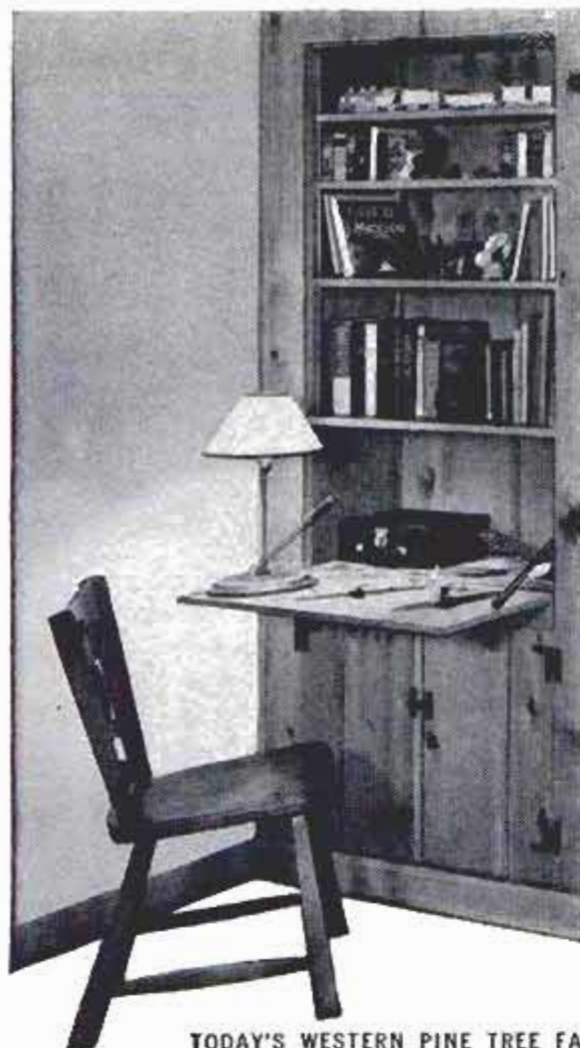

TODAY'S WESTERN PINE TREE FARMING GUARANTEES LUMBER TOMORROW

A handsome, useful desk you'll be proud to build!

This attractive study corner, built with mellow Western Pine* woods, makes a satisfying project. Compact, convenient desk, book shelves and cabinets fit beautifully into living room, den or child's room.

You'll enjoy using these even-grained, smooth-surfaced Western Pines. They cut cleanly and accurately with hand or machine tools, take any finish, and *cost so little*. See these well-seasoned, carefully selected woods at your local lumber dealer's—ask him for an estimate.



FREE—"INSTALLING AND COLORING YOUR WALLS OF WESTERN PINES." Also, "FRIENDLY HOME IDEAS IN WESTERN PINE," a new booklet of building and remodeling ideas—88 pictures! Write to Western Pine Association, Dept. 502-N, Yeon Building, Portland 4, Oregon.

the **Western Pines**

- *IDAHO WHITE PINE
- *PONDEROSA PINE
- *SUGAR PINE

FISHERMEN
SEND FOR
FREE
CATALOGUE
TODAY!
FULLY ILLUSTRATED
FULLY DESCRIPTIVE
ALL PRICES LISTED

**Make Your Own SINKERS!
JIGS! SOUIDS! CASTING
AND SPINNING LURES!**

It's fun, it's easy with Sweet's
ALUMINUM MOLDS

Molds for fresh and salt water fishermen. Handled and hinged for easy, fast operation. Over 100 types, 500 sizes. Write for free catalogue.

AS LOW AS
\$2.95
PER MOLD

SWEET'S MOLDS
Tonawanda 16, N. Y.



SAY YOU SAW IT IN POPULAR MECHANICS

A BETTER DOCK
without working in water

with
**PERMA-DOCK
METAL
BRACKETS**

Here's a quick, low cost way to erect and take down a stronger dock. You build wooden dock in sections, attach "Perma-Dock" Brackets, float into place on boat, drive steel pipes thru brackets, lock with set screws. "Perma-Dock" Mooring Bars safely hold boats near dock. Write for circular.

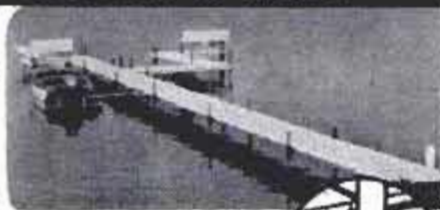

CENTRAL MACHINE WORKS CO. 1235 Central Avenue
Minneapolis 13, Minn.
DEALERS, DISTRIBUTORS: WRITE FOR SALES PLAN

For
QUICK STARTS
in any weather...
install a
Stewart-Warner
electric fuel pump



—for cars, trucks and buses

Enjoy dependable *fast* starting every time you step on your starter! From the moment you turn your key, the Stewart-Warner

Electric Fuel Pump delivers a steady, uninterrupted flow of gas to your engine. Ends vapor lock, gives positive starting and more reliable performance the year 'round, regardless of weather. Operates independently of engine. Easy to install. In use today on hundreds of thousands of vehicles. Ask about the Stewart-Warner Electric Fuel Pump at your garage or car dealer today!

STEWART-WARNER

Also manufacturers of Speedometers, Tachometers and Gauges for Automotive, Farm and Marine Use
Instrument Division, Dept. N-36
1840 Diversey Parkway, Chicago 14, Illinois

How to choose a paintbrush that does faster, streak-free work



Here's why it pays you to use a brush with Du Pont TYNEX nylon bristles



1. No break-in! You don't have to soak or flex a new brush . . . if it has "Tynex" nylon bristles.



2. Full paint pickup! Specially tipped and flagged "Tynex" bristles hold a full load of paint.



3. Smooth, even flow! Anyone can do streak-free work, because each tapered "Tynex" bristle provides better, more even flow.



4. Easier to clean! They're the easiest-to-clean bristles there are! Paint loosens quickly in any commercial cleaner, rinses out thoroughly.

FREE! 8-page booklet full of helpful painting tips. Write Du Pont Company, Polychemicals Dept. PM-3, Wilmington 98, Del.



"Tynex" is the registered trade-mark for Du Pont nylon bristles.

BETTER THINGS FOR BETTER LIVING . . . THROUGH CHEMISTRY

ideas with jaundiced eye. The vastness of a hurricane involves forces so tremendous that even atom bombs seem like pinpricks. A full-blown storm may cover an area the size of Georgia. It all begins, meteorologists now believe, when two huge masses of air in the easterly trade winds converge on the edge of the doldrums. The wedge of warm, moisture-laden Caribbean air between them is squeezed and forced upward 40,000 feet against the frigid jet stream sweeping down from the Arctic. Moisture, wrung from the Caribbean air by condensation, pours down rain, whipping the seas into myriad squalls that slowly join and swell into a single circulation. "For every gram of rain produced," explains William Haggard, research meteorologist at the Washington, D. C., forecast office, "600 calories of heat are released. The earth's rotation starts spinning the massive circulation of complex air currents—clockwise south of the equator, counterclockwise north of it. The released heat energy roars in to help push it faster and build cyclonic action, until winds swirling around the open core, or eye, reach a howling 150 to 200 miles per hour, with gales extending as far out as 300 miles from the center."

Into the vortex of the huge doughnut-shaped storm, 2,000,000,000 gallons of water may be sucked and flung skyward in a single day. "Once under way," says Haggard, "a mature hurricane is a thundering, self-perpetuating thermodynamic engine generating up to five trillion horsepower—the equal of 500 atom bombs. That's more than we've fired in this country so far. We're not likely to break up or stop such Gargantuan forces even with atom bombs which, incidentally, would pose a serious fall-out problem, even if they worked."

The answer, according to such top meteorologists as R. H. Simpson, special assistant to the bureau's chief, is forecasting. "With proper warning, people can be evacuated from danger areas," he points out. "Buildings and property can be secured. Ships can be detoured. Small boats can be hauled ashore and lashed down to prevent damage—like the \$20,000,000 worth of such craft that were smashed by 1954's hurricanes. If people know where the storm's headed, vast sums can be saved, too, by preventing needless preparation in areas it won't hit."

So, like DEW Line's far-flung radar net, providing early warning of any plane that has no business here, the hurricane-radar net will put the electronic eye on any cyclonic storm approaching within 200 to 300 miles of the coast. Weathermen won't

(Continued to page 256)



Enlist for Electronics GUIDED MISSILES

RIGHT NOW, you can take a giant step into the future with specialized Army training in electronics and guided missiles. Enter these wide open fields now, and prepare for the Space Age! Develop invaluable skills—*already* in great demand both in military and civilian life!

Training money can't buy—Here is training money can't buy! Instruction and equipment so advanced they are not yet available in most civilian courses. That's because the Army has pioneered the development of guided missiles and elec-

tronics for national defense. You benefit from this leadership with training designed to make you tops in your field.

New command—new opportunity—You'll take this training in the Army's latest, most modern command—the "command of the future"—the Army Anti-aircraft Command. This is a young elite organization specializing in new supersonic weapons, and offering unlimited opportunities for advancement. Join these key men in America's future! To get in on the ground floor, apply *now!*

**ARMY
ANTI-AIRCRAFT
COMMAND**
" . . . PIONEERING
TOMORROW "

FOR FULL DETAILS MAIL THIS COUPON TODAY!

THE ADJUTANT GENERAL
Department of the Army
Washington 25, D. C.
Attn: AGSN



PM56-3

Please send me further information on my opportunities in the new Antiaircraft Command.

Name

Address

City State

MONEY for MEN ALL DATA FREE

THE PLASTEX Industry needs manufacturers on small scale and for big production of Lamp and Clock Stands, Art Goods and Novelties in Plastex and Marble imitation. Experience unnecessary. Use material makes regular 10¢ store sellers. Rubber moulds furnished for speed production. Small investment brings good returns. We are now placing big Chain Store Orders with manufacturers. Ambitious men have chance for real prosperity. Our Free booklet will interest and benefit you.

PLASTEX INDUSTRIES, Dept. A
3400 Third Ave. New York 56, N. Y.

HOW TO VENEER MAHOGANY TO PINE OR CHESTNUT . . . 1) USE ROGERS glue

2) Soak the veneer thoroughly in hot water, then allow it to dry . . .

3) When veneer is practically dry, be sure to keep both parts warm and apply glue evenly.

4) Join the veneer to other surface and rub veneer with a hot wet cloth to force out air and allow moist heat to permeate the glue and increase its structural grip and coverage.

5) Clamp glued surfaces together under as great pressure as possible, eliminating air from glued surfaces, and allow to set, thoroughly hard before removing clamps or working.

Get other valuable woodworking and glueing tips from "Rogers Book of Woodworking Shop Notes" for 1955, a set of woodworking project plans and a full-size jar of Rogers Glue. Send 15 cents with your name and address to Rogers Glue, Gloucester, Mass.

ROGERS
the best LIQUID FISH GLUE
GLOUCESTER, MASS

Over 3,885 lbs. Actual Tensile Strength per Square Inch.

Soldering is Easy
with
INSTANT STARTING

Lenk
LIQUEFIED LP PETROLEUM
Torch

only **\$3.49**

THE ONLY THROW-AWAY FUEL-CONTAINER WITH SELF-SEALING SAFETY VALVE.

Here's what you can do:

- regular soldering.
- sweat fittings.
- silver soldering.
- refinish furniture.
- remove paint and putty.

Available at Hardware Counters Everywhere

Write for FREE Soldering Instructions

THE **Lenk** MFG CO.
BOSTON 15, MASS

REPLACE YOUR

OLD WOOD CELLAR DOOR



WITH A
MODERN
ALL-STEEL
BILCO
DOOR



DO IT YOURSELF

IN JUST 3 TO 4 HOURS

Think of it! Only a few hours of pleasant work to replace your unsightly, troublesome wood hatchway with a lifetime, weathertight BILCO . . . the door installed on tens of thousands of new homes.

PAYS FOR ITSELF! Cost so little, yet never needs repair or replacement. Operates at a touch. Smooth, trim appearance adds amazing new beauty to your home.

Rush coupon TODAY for free folder and "Do It Yourself" pamphlet showing step by step replacement of wood hatchway.

Bilco®

AMERICA'S FINEST
BASEMENT DOOR

THE BILCO CO.
DEPT. 343C
NEW HAVEN, CONN.

Gentlemen: Please send me "Do It Yourself Pamphlet" along with other literature showing sizes.

Name _____

Street _____

City _____ State _____

depend on radar alone, however. Advance information from the net will be evaluated along with data from many other sources. With all the pieces fitted, each community the storm is destined to touch will be "alerted" 48 hours in advance. If the hurricane stays on course, the bureau will wave the red flag, or "warning," for each doomed community 24 hours ahead of the wind. That one means she's definitely coming through.

Here's how the over-all hurricane net works: Map makers toiling over the day's charts in the San Juan weather office are busily plotting wind and barometer readings broadcast every six hours by hundreds of ships and planes crossing the Caribbean. Suddenly a few reports drawn into the map show two odd things: 1. There's a faint westerly breeze smack in the middle of the easterly trade winds 300 miles southeast of Puerto Rico; 2. Over the same area a small hump, or wave, appears in the smooth-flowing isobar lines (contour lines of equal barometric pressure you've seen on weather maps). Weathermen call this an "easterly wave." Accompanied by that westerly breeze, it can mean only one thing: A huge eddy in the trade winds.

Fresh reports of troubled weather in the same region remove any doubts that this is a "suspicious area." So, at the Navy's San Juan base, a hurricane-hunter pilot climbs into his gear and heads out in a storm-reconnaissance plane to scout the area. Roller-coastering his plane through a mass of murky clouds and horrendous winds that twist, torture and toss it about like a leaf in an autumn gale, he knives the storm at various altitudes and radios the bad news back to San Juan: "Well-defined circulation at longitude 62°48'; latitude 15°1'; open to southwest; maximum wind 45 miles per hour in northeast sector."

There's a bustle at San Juan, and out over the circuit to Miami goes "Advisory No. 1 Zobelina, a tropical storm located by reconnaissance aircraft." It contains all available information about the storm.

Every six hours from now on, hurricane squadrons of Navy and Air Force ride through the storm out of San Juan (later out of Miami, Jacksonville, Bermuda and northern bases) as Zobelina moves up her course.

Buffeted and battered, they fly around the whirling monster to get wind forces and direction in all sectors up to 18,000 feet. Lashed to seats, crews catch their breath as the planes are tossed, or dropped, 1000 feet at a clip while they penetrate the storm to get a center fix on the "eye." After each flight, an advisory is sent out. Many

(Continued to page 258)

AMAZING PROOF*

YOU CAN'T MATCH HOLIDAY PIPE MIXTURE

EVEN AT \$6⁰⁰ A POUND



CUSTOM BLENDED FOR MILDNESS

More men every year switch to Holiday, because it contains these five famous tobaccos from all over the world skillfully blended into a mixture of unequalled flavor, aroma and mildness. Each tobacco adds its own distinctive flavor and aroma, to make Holiday America's finest pipe mixture. Try a pipeful—enjoy its coolness, flavor and aroma—and see for yourself why more and more men who smoke mixtures are switching to Holiday as a steady smoke.



*PROOF from an EXPERT

The custom blender in a nationally famous tobacco shop was asked, "Can you duplicate this tobacco?" After examination, he said, frankly, that he couldn't guess the secret of the blend, although he could supply the types of tobacco used at \$6 a pound!

LARUS & BROTHER CO., INC., RICHMOND, VIRGINIA



AMERICA'S FINEST PIPE MIXTURE

FIND HIDDEN RICHES!

NOW—find buried treasure, gold, silver, and metal objects, with sensational 3 1/2-lb. locator—GOLDAK'S "FIND-IT" ... only \$49.50 complete with earphones, batteries, instructions.



Manufacturers of metal detection devices since 1933.

Write for FREE literature full line metal, mineral locators, geiger and scintillation counters.

GOLDAK CO. 1542 W. Glenoaks Blvd., Glendale, Calif.

ENJOY TRAVELING WITH AMERICA'S FINEST AUTO COMPASSES



TRAVELITE \$5.95
ILLUMINATED

GUIDEWAY \$4.95
NON-ILLUMINATED

ONLY COMPASS APPROVED BY AUTO MAKERS

DINSMORE...

Shows you the right way—the short cuts. Always accurate and dependable anywhere. Fits all cars. Send for free folder—**Pants, Knives and Compasses** and name of nearest dealer.

DINSMORE INSTRUMENT CO., 1802-25 Kelso Street, Flint 1, Mich.

Strip off OLD finish

Make it like NEW

It's easy to make furniture, wood trim, floors, etc. like new. Strip off the old finish with quick-working Wonder-Paste. Applied with a paint brush. Won't run on upright surfaces. Softens paint, varnish, enamel so it comes off easily. Leaves perfect surface for new finish. At paint and hardware stores.

• Write for leaflet and advice on your removing problem.
Wilson-Imperial Co.
119 Chestnut St., Newark 5, N. J.



WONDER-PASTE 5 MILLION CANS SOLD

MARCH 1956

handy
for the
handy
man

Cushman 780 TRUCKSTER



- Handles hundreds of jobs... 500 lb. payload capacity
- Big vehicle shaft drive
- Just 3/4c per mile total operating cost.

Ask your dealer for a FREE demonstration or write for illustrated literature. Dealer inquiries invited.

934 No. 21st
Lincoln, Nebraska

CUSHMAN MOTOR
WORKS, Incorporated

Famous Antique Shop
uses and recommends
Klean-Strip Paint Remover

KLEAN-STRIP, the non-inflammable paint remover, is used exclusively by Leonard's Antiques, Seekonk, Mass., to restore the beauty of wood heavily coated with paint and varnish. L. C. Leonard reports "KLEAN-STRIP has far exceeded expectations . . . and exceeded results obtained with other removers used. We are sure it's the best."

KLEAN-STRIP works best for any refinishing job. It's fast-acting, easy to use, needs no neutralizing or afterwash. Buy it when and where you buy paint.



THE KLEAN-STRIP CO., INC.
2340 S. Lauderdale, Memphis 6, Tenn.

NON-INFLAMMABLE
KLEAN-STRIP
"PEELS OFF PAINT"

Red Devil
FP33 HOME
FLOOR CONDITIONER

The world's most popular
style floor conditioner

Counter-rotating brushes mean perfect floor conditioning with a finger-tip touch. Eliminates all drudgery from scrubbing, waxing, polishing, buffing. Will steel wool dirt and grime from wood and all floor surfaces.



How to Maintain
Wood Floors. Illustrated
instructions on polishing,
cleaning, varnishing, waxing
and sanding wood floors.

FREE

Red Devil Tools. Dept. 142
130 Coit Street, Irvington, N. J.

Please send FREE copy of "HOW TO MAINTAIN WOOD FLOORS."

NAME _____
ADDRESS _____
CITY _____ ZONE _____ STATE _____

1964

hurricanes have reached advisory 40 or 45 before they finally blew themselves out over Nova Scotia.

As these reports fly over radio and land line nets to Florida, Miami forecasters make up maps, adding data from ships, planes and ground observers throughout the Caribbean. Bulletins on Zobelgia go out on a special hurricane net to some 75 weather stations up and down the coast.

One of four coastal "forecast centers" in the hurricane belt, Miami Weather Bureau, under veteran meteorologist Gordon Dunn, operates much like a filter center in Civil Defense. Weather reports flutter in from everywhere on a "paper snowstorm" of radio, Teletype and telephone dispatches. Out of the mess rises a vast picture of all United States weather south of Hatteras and east of Florida. Hence, as Zobelgia moves in and booms up the coast, all reports on her from the hurricane hunters, ships, planes, ground observers—and hurricane-radar stations as well—will filter through Miami until she passes Hatteras. Then, Washington, D. C., Forecast Center takes over until the hurricane gets to Block Island, off New York. Above this point, bulletins come from the forecast center in Boston. For Gulf cyclones, a big weather center in New Orleans issues the official word.

All this is why, when Zobelgia creeps over the scope rim on Adm. William Freseman's powerful 750,000-watt weather-radar set in Coral Gables, the word you get does not come from him. What he sees is flashed over land line to Dunn's forecast center, evaluated with all other weather data, and Dunn's forecast is the "hurricane bulletin" you'll read in the paper.

Freseman, retired Navy admiral, operates the southernmost radar in the East Coast hurricane net. On loan from the Navy, the 300-mile-range set is operated by the University of Miami and is one of many privately owned stations currently helping to fill gaps in the weather fence. As Zobelgia spins slowly across the grid of the big plot tube, movie cameras whir, recording her every move. The gleaming banks of powerful transmitters hum and whistle, and 11,000 volts spit crackling blue charges across the arcs. Hunched over the scope with slide rules, radar meteorologists plot Zobelgia's speed, size, direction, location of eye, force of her winds and mass of her rain. Communication lines to Miami Weather hum with their findings.

As she moves northward out of range, the whirling storm will be passed from station to station up the coast. As she drifts off the limits of Coral Gable's set, she

(Continued to page 260)

SMALL INVESTMENT PUTS YOU IN GOOD PAYING BUSINESS OF YOUR OWN

ROGERS MANUFACTURING CO.
Dept. M-36, Lindsey, Ohio
Gentlemen: Please rush complete details about
the big-profit possibilities of the Universal **FREE**
Lawn Mower Grinder.

Name _____
Address _____ State _____
City _____

SHARPENING LAWN MOWERS IN SPARE OR FULL TIME . . . AT GOOD PROFIT.

Thousands are successfully earning good money with the Universal plan of a spare or full time business in their garage or basement. Previous experience not necessary. Age no handicap. C.H.R. of Ohio made \$3,688.20 working part time, in one season. The new Universal is the only grinder in the world that enables you to grind both the bed knife and reel blades . . . **IN A SINGLE SET-UP**

. . . without removing them from the mower. Just put the mower in the grinder, follow a few simple instructions and you can do an expert job sharpening hand or power mowers without removing engine, handle, or roller. **SEND COUPON** today for success plan of this low investment big pay business of your own.



ROGERS MANUFACTURING CO.
LINDSEY, OHIO

NO. 286

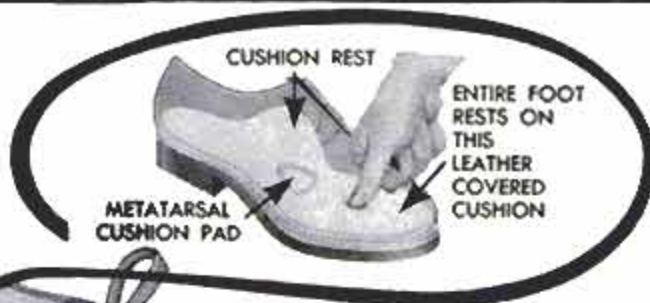

**Non-marking
Oil Resistant
corded soles and heels**

• Full Cushion Foot Comfort

Amazing, the comfort you get from these Star Brand Work Shoes! Full cushion insole is soft, resilient, gives snug support, floating comfort, even as you work! And they feature: soft, pliable Burgundy leather uppers—solid leather counters—built in steel shank—yet they look like dress shoes. Try a pair on—soon.



Ask for

STAR BRAND

Cush-N-Bilt work shoes

For nearest dealer write:

ROBERTS, JOHNSON & RAND, Div. of International Shoe Co., St. Louis 3, Mo.

the plier you'll reach for
9 times
out of 10*

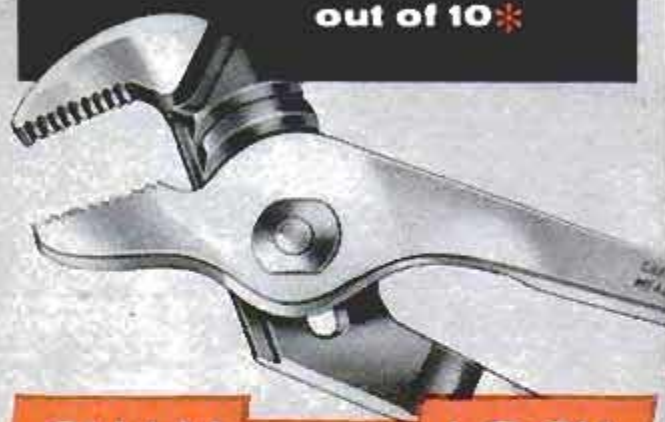

CHAN NEL LOCK

No. 420

*because no other plier
does so many jobs so well

GRIPS LIKE A
PIPE WRENCH

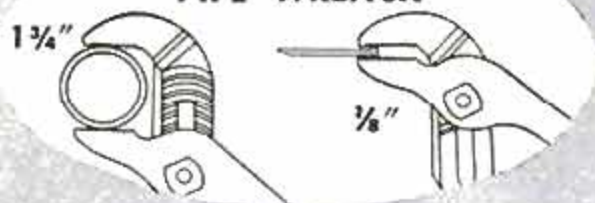

Mechanics tell us that our Channellock No. 420 is the handiest plier of them all . . . the plier they reach for more often than any other. They like its all 'round usefulness . . . its pipe-wrench grip . . . its big jaw-opening . . . its streamlined design for hard-to-get-at jobs. And you'll like Channellock for the same reasons. Ask your hardware man for a Channellock 420.

BE SURE IT'S A GENUINE CHANNELLOCK



CHAMPION DEPARTMENT TOOL Co. MEADVILLE, PA.

probably will creep into view on the next scope on the University of Florida's radar at Gainesville. Here, Marinus Latour and Nelson Rosier, with their crew of three student assistants, are all set for a stretch of duty. "If a storm looks promising," says Latour, "we fill the food locker, bring cots and blankets and set up relief schedules. We check the toolbox for spare parts and ammeters. An extra phone goes in. All the brass shows up to watch the scopes from behind the barrier."

Operating since 1949, Florida University's towering transmitter is one of the oldest weather-radar stations in the net, and the boys have had experience. During the famous 1949 Cedar Key storm that corkscrewed all over Florida, the crew ran an unbroken watch for 35 hours.

Life in a weather-radar shack at the height of a storm is never a picnic. Frequently the eye of a howler will pass right over the transmitter, and 150-mile winds will batter everything to a shambles. A Gulf hurricane that moved square across the station at Freeport, Tex., in 1949, blew winds so powerful the antenna couldn't move against them and the radar had to go off the air. During a 1950 whopper over Florida, winds tore a chunk of the roof from the Florida University shack. "There were three inches of water in the transmitter room," recalls Latour. "Rosier put raincoats over the equipment and worked like a demon to keep us on the air. Slopping around with high voltage leaking all around him, he finally had to quit and build tents over everything. We went back into operation an hour later. Besides all that, the anemometer atop the tower tore apart. Rosier climbed the 200-foot structure, lashed himself to it while 100-mile gales tore at him, and repaired the thing."

If hurricanes would start out on a course and follow it decently, the new radar network would very nearly solve the problem of these destructive storms. Unfortunately they don't. The Cedar Key storm is a great example of how unpredictable a hurricane can be. Born in the Gulf, it wandered aimlessly up toward the Gulf states. Then suddenly it veered and boomed into Florida, whammed across the little town of Cedar Key, stopped, described a complete loop, came back and hit Cedar Key again. There it sat, for 24 hours solid, whirling the town away in a devastating maelstrom of flying splinters and wreckage. Wandering on back to the Gulf, it described a few more loops and staggered away over the Gulf states to die.

Weathermen are the first to admit they know little about the big storms. But

(Continued to page 262)



most
anyone

who's
been in
school
knows...

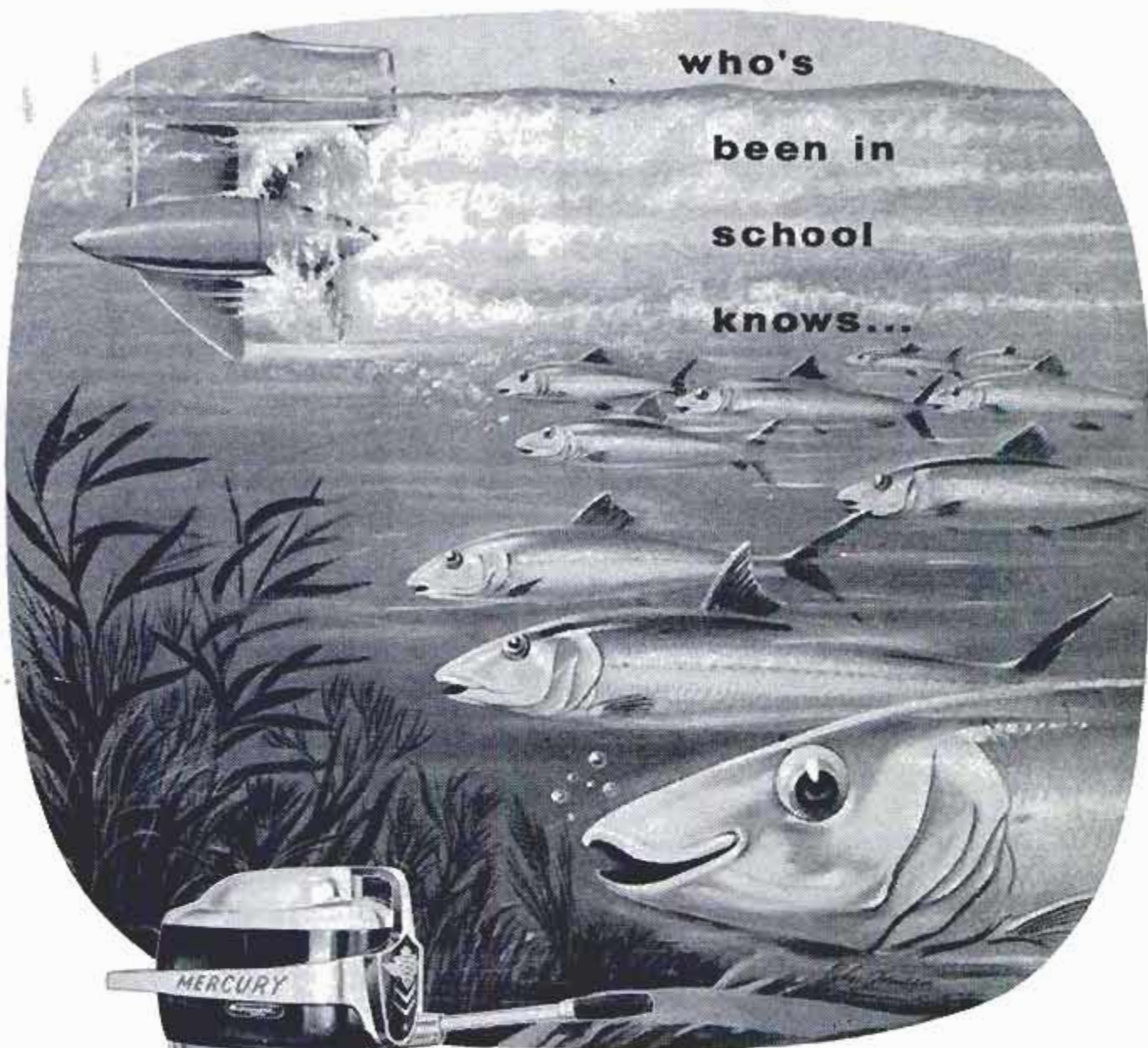

mark 25

20 h.p. Alternate Firing Hurricane Engine; Reverse Gear and Neutral; Available with 12-volt MercElectric Starter (Mark 25E model)



Winner 1956 Fashion Academy Gold Medal Award.

Features of Mercury motors are protected by issued or pending patents.

KIEKHAEFER
MERCURY outruns and
outlasts ordinary outboards

Here's 20 Hurricane horsepower — Full Jeweled Power that travels on ball and roller bearings for easier starts, smoother running, fewer repairs, longer engine life! With complete engine silencing plus Dyna-Float Suspension, all you hear is a murmur of sound, with no boat vibration.

Troll, cruise or ski — the Mark 25's performance proves it outperforms, outruns *and* outlasts any outboard of comparable horsepower.

See all ten Mercurys for 1956 at your dealer's now. He's listed in your classified telephone book.



Write for **FREE** illustrated catalog

©1956 KIEKHAEFER CORPORATION, Fond du Lac, Wisconsin

REYNOLDS endorses NICHOLSON FILES for "Do-It-Yourself"* ALUMINUM



It's quick and easy to make things from aluminum with *ordinary home tools* when you use Reynolds "Do-It-Yourself" Aluminum. For most projects, you need only hammer, saw, shears and file.

The file is very important for removing rough edges which are formed when aluminum, like any metal, is cut or sawed. Some files do the job better than others, Reynolds has found. And the best files for the job are made by Nicholson.

For best results, ask your hardwareman for Nicholson files when you buy Reynolds Aluminum.

Nicholson 8" Handy File: double-cut side for fast metal removal; single-cut side for finishing. Ideal for aluminum and for wood, metal, plastic. **Not shown: 6" Half Round File,** for removing burrs inside aluminum tubing after cutting.

Reynolds products and Nicholson-made Black Diamond files are also available in Canada



NICHOLSON FILE COMPANY
Providence, R. I.



NICHOLSON FILES

A FILE FOR EVERY PURPOSE

*T. M. Reynolds Metals Co.



they're about to find out some secrets. Under a stepped-up research program, lots of things will be happening.

From island stations in the Caribbean next year, "boomerang" rockets will roar up 250,000 feet through hurricanes, with movie cameras grinding away in the nose to record everything they see. "The pictures will be studied by forecasters to learn more about hurricane structure and improve forecasting techniques," explains R. H. Simpson. The picture-taking missiles, designed to fall within a mile of launching site, will be tracked during the journey.

More planes with Navy and Air Force hurricane hunters will penetrate each storm, investigating the complex air currents at a wide variety of levels. While two tabulate data for the usual forecast purposes, a third will be bouncing around on a wild but revealing research mission.

Meanwhile, at Princeton's Laboratory for Advanced Research, the hum of a huge electronic brain will be gulping figures and data from thousands of observations, trying to discover if there are any constant factors about the most inconstant science known to man. If there are, meteorologists will be well on their way toward doing something about the weather in general, and hurricanes in particular. ★ ★ ★

Comb Applies Hair Tonic Through Ball-Point Teeth

Tonic is applied directly to the scalp with a comb that feeds fluid from a reservoir through hollow teeth like ball-point pens. Used to apply medication to human scalps without moistening the hair, it is also useful when grooming pets. Flea and mange medicine can be applied under the fur where it will do the most good. The comb has a 1½-ounce plastic reservoir, chrome teeth, bronze springs in the teeth and metal ball points.

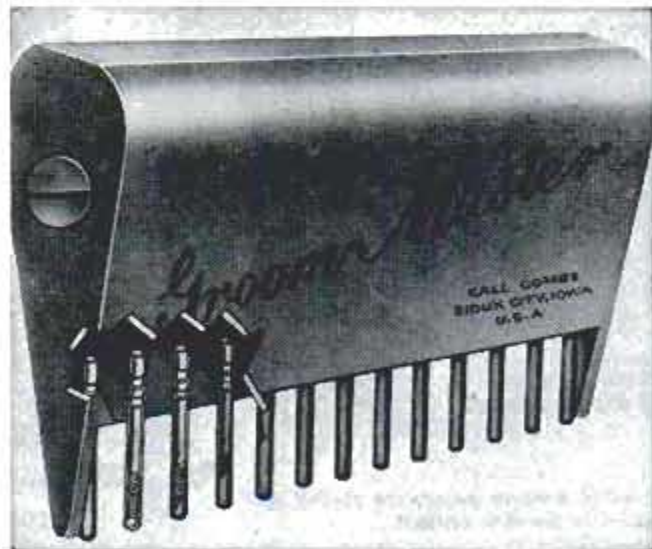



See what Weldwood V-Plank can do! Warm cherry transformed the drab scene (below) into this picture-book family room. And all the V-Plank shown, including facing those practical built-ins, costs only \$105.

See how you and wood panels can make a room lie about its age

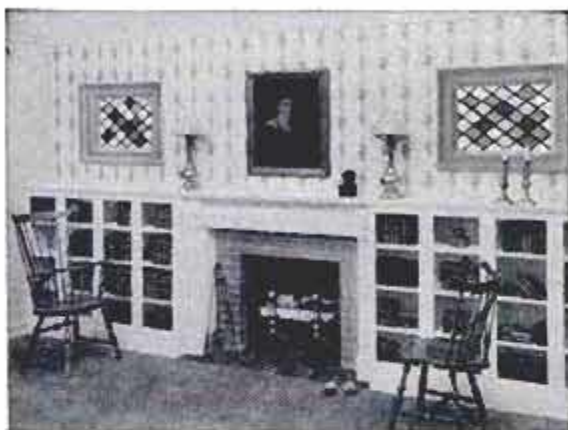

Before Weldwood, here's what this fireplace wall of a 35-year-old house looked like.

Here's a 1920 living room with 1956 ideas. Look how Weldwood Cherry V-Plank panels helped make it warm, cheerful and more livable. New built-ins tell you this is a room for *today's* living. At right: a handy desk-bookcase unit. At left: a neat nook for kindling and logs, plus a home entertainment center.

You and Weldwood paneling can do the same in your home. See pre-finished V-Plank and other paneling at your lumber dealer's, or at any of our 87 offices in principal cities. Or send coupon for booklets.

Choose from 6 fine woods in Weldwood V-Plank*: walnut, \$85; Korina®, \$79; mahogany, \$79; Samara*, \$52; cherry, \$79; prices are for a wall 12' x 8'.

Weldwood® Paneling

A product of

United States Plywood Corporation
WELDWOOD—The Best Known Name in Plywood
In Canada—Weldwood Plywood, Ltd.

*Trademark

United States Plywood Corporation
Box 61, New York 46, N. Y.



() Enclosed is 10¢ for full-color 20-page book of home decorating ideas, "Beautify Your Home with Weldwood Paneling."

() Enclosed is 25¢ for 40-page book "Do It Yourself with Weldwood Plywood," plus directions for making desk and turntable compartments shown above.

PM-3-56

Name.....

Address.....

City..... State.....

NOW—a professional priced for a

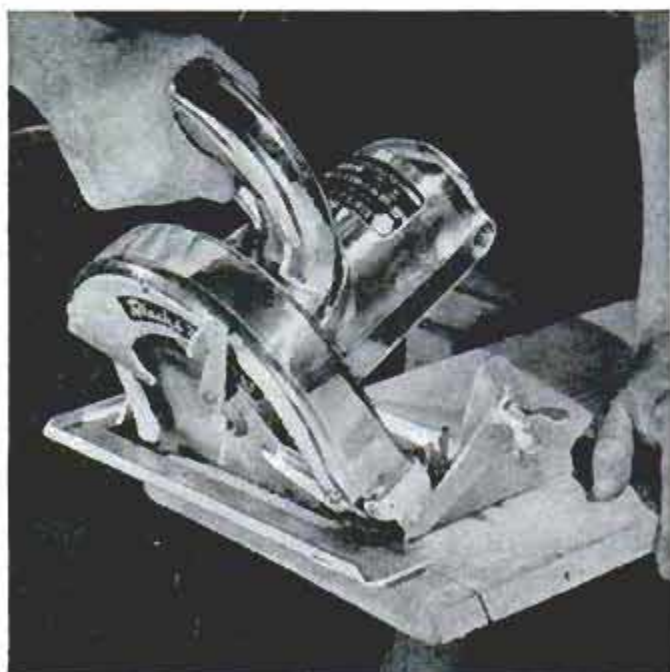

- Larger steel shoe with clear cutting view—for safer, easier cuts from either side. Cuts to hairline accuracy!
- Calibrated quadrant for precise bevel cutting. Even at 45°, cuts through a dressed 2 x 4 with blade to spare!

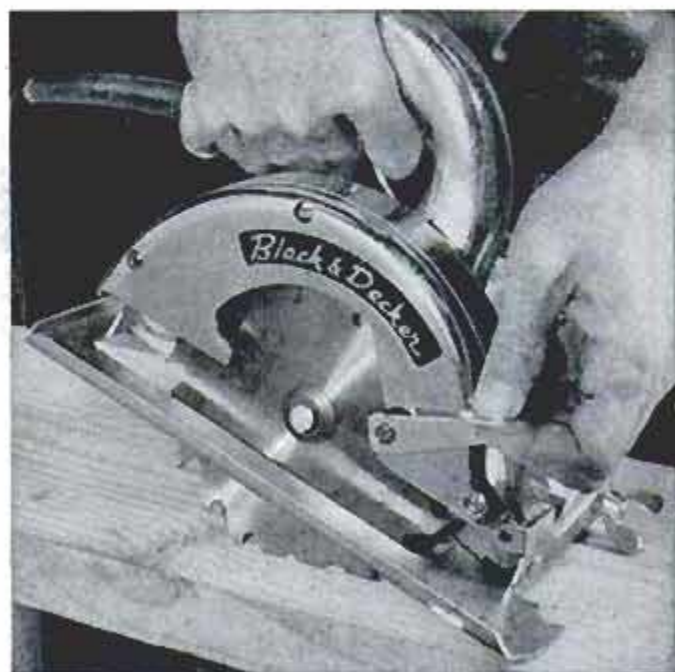

- Starts pocket cuts, makes jack rafter cuts, compound angles—every professional cut needed!
- Cuts practically any building material with correct blade—handles "tough spots" without overheating!

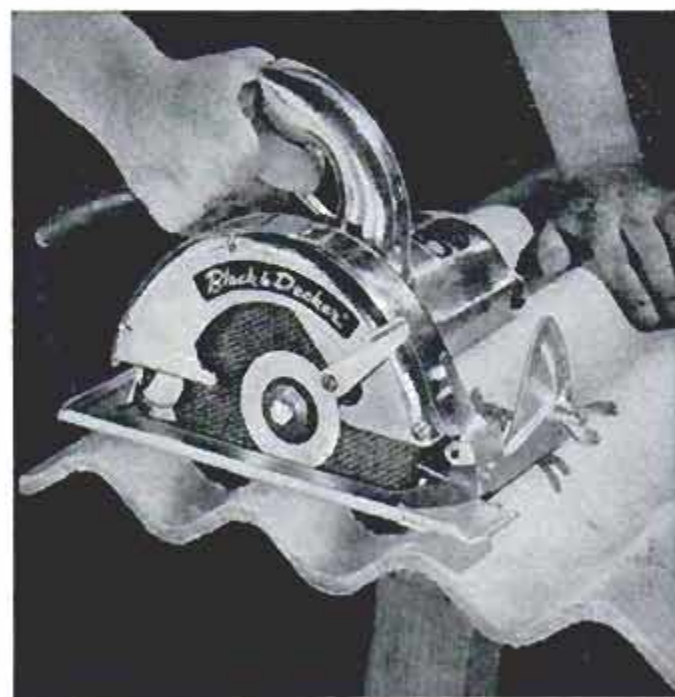

6 1/2" Heavy-Duty Saw home workshop budget!

Races through a 2x4 even at
a 45° angle, with blade to spare!

Here's *more* saw for your money! This sensational new B&D 6 1/2" Heavy-Duty Saw offers you: *extra capacity* ... cuts 2 3/4" at 90°, 1 7/8" at 45° ... *extra power* ... custom-built B&D motor; runs cool, without stalling ... *extra safety* ... automatic telescoping guard with larger retracting lever; instant-release trigger switch with guard; open-end handle; grounding wire in cable ...

extra adjustment features ... larger wing nuts for fast, positive depth and bevel adjustment ... *extra convenience* ... clear view operation, with sawdust blown away from operator and work! See your B&D dealer, or write for free details: THE BLACK & DECKER MFG. Co., Dept. M-36, Towson 4, Md.

Only
\$64.50



SPECIAL COMBINATION OFFER
For Limited Time Only!

B&D 6 1/2" Saw .. Reg. \$64.50	Save \$5.00— Both for only
B&D Saw Table .. Reg. 39.50	
\$104.00	\$99.00

Check these New All-Steel Saw Table Features!

Converts B&D Saws to tilt arbor saws—complete saw table operation at low cost! More work surface than on many costlier models. Exclusive sawdust deflection; knee-action safety switch; mitre gauge; rip fence. On display today at your B&D dealer's!

LOOK IN YELLOW PAGES UNDER "TOOLS-ELECTRIC"



Black & Decker®

PORTABLE ELECTRIC TOOLS

"I've got a brand new boat in this Fiberglas Boat-Covering Kit!"*



Yes, with a Fiberglas Boat-Covering Kit you can make your old boat hull like new—or your new boat better! Leakproof, strong and rigid, with less maintenance and more resistance to damage!

Everything you need—Fiberglas fabric, resin, color pigment, and activator—comes in a kit. And you can do an average runabout in roughly a day.

When the job is done, you'll never have to sand, scrape or caulk your hull again! Come spring, you just wash it down and launch!

Over 250,000 boat owners have covered their boats this easy way! How about you? For covering materials, just ask your local marine dealer. Or, for step-by-step information, write me for our special Fiberglas boat-covering booklet and a list of kit manufacturers. Charlie M., Dept. 178C, Essex, Conn.



OWENS-CORNING
FIBERGLAS

*T-M. (Reg. U.S. Pat. Off.) O-G. F. Corp.

Ships That Buck the Polar Seas

(Continued from page 120)

chunks of ice to make her swing over."

Propellers or no, it's not always possible to find open water from the bridge 30 feet above the waves. And that's where the helicopters come in. They are the ice-breaker's long-distance "eyes." *Glacier's* two Sikorskys under Cmdr. William Shockley are squadron HU2 assigned to the task force. Their job is to whirl through the bleak sky while the ship is in ice, scouting for leads beyond the horizon. They wind-milled away over the barrier ice to Antarctica's treacherous mainland carrying passengers in and out of the base sites, hunting sites for airstrips.

Pilots live under a constant threat. The polar regions have a treacherous phenomenon—whiteout. Like the blinding blizzards that sweep down without notice, whiteouts can develop out of clear sky in a matter of minutes. There's sudden overcast, and brilliant light reflected from the snow illuminates the clouds, obliterating any semblance of the horizon. Everything is dead white. Distance and shadow are lost. A baseball 10 miles away may look like a big blimp. A Weasel a few hundred yards

(Continued to page 268)



Make her happy — INSTALL BEAUTIFUL JALOUSIES

Add an extra room with jalousie windows installed in porch or breezeway. Win-Dor jalousies fit any opening, are easily screwed in place. Requires no special tools. Any homeowner can do it. Win-Dor jalousie hardware package includes complete instructions for making your own jalousie windows and doors, all hardware needed including screws. Satisfaction guaranteed.

Please send me information on how to order Win-Dor jalousie hardware by mail.

NAME _____
ADDRESS _____
CITY _____ ZONE _____ STATE _____

CASEMENT HARDWARE COMPANY
612 N. Michigan Ave. ● Chicago 11, Ill.

WANT TO KNOW WHAT GRADE OF LUMBER to use for different jobs?

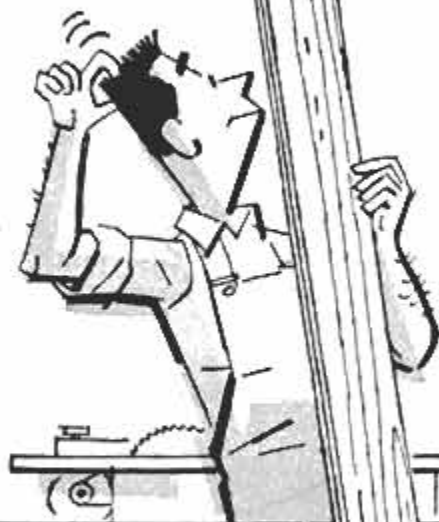

Just off the press, this valuable folder describes the various grades of West Coast lumber together with their appearance and uses. Also shows new grade stamps, patterns and actual sizes of all commonly used West Coast lumber. A handy reference guide for any hobbyist or do-it-yourself builder.

Order your Free Copy Today!



INCLUDES INFORMATION ON THE NEW GRADE NAMES FOR WEST COAST LUMBER EFFECTIVE MARCH 15, 1956

WEST COAST LUMBERMEN'S ASSOCIATION
1410 S. W. Morrison Street, Room 1, Portland, Oregon
Please send me free copy of "West Coast Lumber Grade Guide"

Name _____
Address _____
City _____ Zone _____
State _____

I'M AS GOOD AS NEW
IMPERIAL Rapid Brush Cleaner
Cleans hard-caked brushes in a jiffy.
Acts instantly—no long soaking.
Nothing like it. At paint and hardware stores.
Wilson-Imperial Co., 119 Chestnut St., Newark 5, N. J.

BUILD FINE GRANDFATHER CLOCK NOW
The simple sensible Red-i-Kut way as thousands have—
SAVE HALF. SHOP TESTED PLANS "SPIRIT OF THE CENTURY" Narrow waist, 83" tall or stately straight side
"SPIRIT OF AMERICA," EASY-to-FOLLOW photograph plans tell all—plus **BROCHURE** of heavy brass weight Westminster, tube chime, movements, gorgeous dials, 3/4" solid mahogany case kits. Send \$1.00 today—Both plans \$1.50 NOW.
KUEMPEL CHIME CLOCK CO., 27 Kuempel Bldg., Minneapolis 16, Minn.

Protect your home against power interruptions with an...

ONAN Emergency ELECTRIC PLANT

Provides dependable stand-by electricity for heating system, pumps, freezer, lights, appliances. Keeps home safe, livable. Automatic start and stop. Find out how little it costs!

Write for Folder!

D. W. ONAN & SONS, INC.
3634 University Ave. S. E. • Minneapolis 14, Minnesota

A SIZE FOR EVERY NEED
500 to 50,000 watts.
Compact, quiet-running.
Gasoline-powered.
Priced from \$255.00

FACTORY · HOME · SHOP

UTICA is your best buy
in quality tools

UTICA's process of electronic induction hardening on cutting pliers and wrenches gives you top quality tools that last up to ten times longer for that added service.

UTICA Tools *Remember the name*

UTICA DROP FORGE & TOOL CORP., UTICA 4, N. Y.

**LOOKS
DIFFERENT
BEFORE
YOU PAINT**



LOOK TWICE
at an Exploded-Tip brush
... and you'll never paint
with an ordinary brush again!

See those thousands of soft, silky contact points? That's the reason Exploded-Tip Brushes are *different* . . . why they hold more paint, spread it faster, give perfect finishes. Buy these amazing new Exploded-Tip Brushes at better paint, hardware, department and building supply stores. You'll never paint with an *ordinary* brush again! The Wooster Brush Company, Wooster, Ohio.



off may seem a scrap of a trail flag flying in the snow. "Moving an aircraft in that stuff is like flying around in a bottle of milk," one whirlybird pilot told me.

Chuck Knight, *Glacier* copter pilot, explains vividly how all sense of balance and direction are gone when he is hovering in whiteout. "You look for shadows where there are none. Even buildings and people vanish from the ground. You think your instruments lie, then vertigo takes over and the next thing you're flying upside down helping gravity finish you off." As an example of what can happen, a helicopter pilot caught in the whiteout during Operation Hijump in 1948 flew his craft right into an ice shelf. He was still certain he was high in the air.

As a matter of fact, whiteout touched off the first flight of this expedition across the South Pole. Lt. Col. H. R. Kolp, commander of a four-engine Navy transport, ran into a whiteout on an exploratory flight over Wilkes Land. He turned aside and explored an unknown area running clear to the Pole. The crew dropped aviation smoke bombs, lamp black, a die marker and a piece of cardboard on the Pole. Returning at low level on another sweep, the crew could see no sign of the markers, leading

(Continued to page 270)

**The New Model 70 UTILITY TESTER
FOR REPAIRING ALL
ELECTRICAL APPLIANCES
MOTORS • AUTOMOBILES • TV TUBES**

As an electrical trouble shooter the Model 70:

- Measures A.C. and D.C. Voltages, A.C. and D.C. Current, Resistances, Leakage, etc.
- Will measure current consumption while the appliance under test is in operation.
- Incorporates a sensitive direct-reading resistance range which will measure all resistances commonly used in electrical appliances, motors, etc.
- Leakage detecting circuit will indicate continuity from zero ohms to 5 megohms (5,000,000 ohms).
- Will test toasters, irons, Broilers, Heating Pads, Clocks, Fans, Vacuum Cleaners, Refrigerators, Lamps, Fluorescents, Fans, Switches, Thermostats, etc.
- Will test all TV tubes for open filaments, inter-element shorts, burned out tubes, etc.



As an Automotive Tester the Model 70 will test:

- Both 6 Volt and 12 Volt Storage Batteries • Generators • Starters • Distributors • Ignition Coils • Regulators • Relays • Circuit Breakers • Cigarette Lighters • Stop Lights • Condensers • Directional Signal Systems • All Lamps and Bulbs • Fuses • Heating Systems • Horns • Also will locate poor grounds, breaks in wiring, poor connections, etc.

Handsome round-cornered molded bakelite case, 3 1/2" x 5 1/2" x 2 1/4". Complete with all test leads. Also included is a 66 page book giving detailed instructions for testing all electrical appliances, automotive equipment, TV tubes, etc. Only

15⁹⁵
SHIPPED ON APPROVAL
NO MONEY WITH ORDER - NO C. O. D.

Try it for 10 days before you buy. If completely satisfied then send \$3.95 and pay balance at rate of \$4.00 per month for 3 months — No Interest or Finance Charges Added! If not completely satisfied, return to us, no explanation necessary.

MOSS ELECTRONIC DIST. CO., Inc.
Dept. D-212, 3849 Tenth Ave., N.Y. 34, N.Y.

Please rush 1 Model 70. I agree to pay \$3.95 within 10 days after receipt and \$4.00 per month thereafter

Name _____
Address _____
City _____ State _____

Save this Spring with Sears

on

Instant Lighting

PROPANE TORCH

CRAFTSMAN

REG. TRADE MARK



PLUS

Soldering Tip and Solder . . FREE when you buy Torch

GUTTER WORK

TILING FLOORS

PAINT BURNING

HOME WORKSHOP

Cylinder with Burner Head	\$6.95
Soldering Tip	\$1.75
Box of Solder	\$.25
Total Price	\$8.95
Spring Special	\$6.95

Spring Special
\$6.95

Save \$2.00

through April 30, 1956 Torch plus FREE Offer

**BURNS CLEAN AND HOT
IN ANY POSITION . . EVEN
UPSIDE DOWN . . AT 2300° F**

**Do It Yourself . . Home Owners . .
Hobbyists . . Mechanics . . Farmers**

Powered by clean-burning propane, the fuel used in city buses! So safe, women use it every day for soldering jewelry, etc. Lightweight—a little less than 3 lbs.—you can use it with one hand. Lights instantly . . with no pumping, priming or preheating! Strike a match and it's lit. Flame adjusts from needle-fine to coarse. When long-lasting 10 x 2³/₄-in. cylinder is empty, throw it away! (Replacement cylinders cost \$1.69.) UL listed. ICC approved for safety. Accessories also available to handle special jobs. Shop and save at your nearest Sears Retail Store \$6.95

A Few of the Many Jobs You Can Do:

- Solder wire and silver • Sweat copper fittings
- Soften putty, burn weeds • Remove paint
- Melt lead • Thaw frozen pipes, free bolts

CRAFTSMAN Hand and Power Tools by **SEARS, ROEBUCK and CO.**
Famous for fine quality . . . precision performance . . . low price!

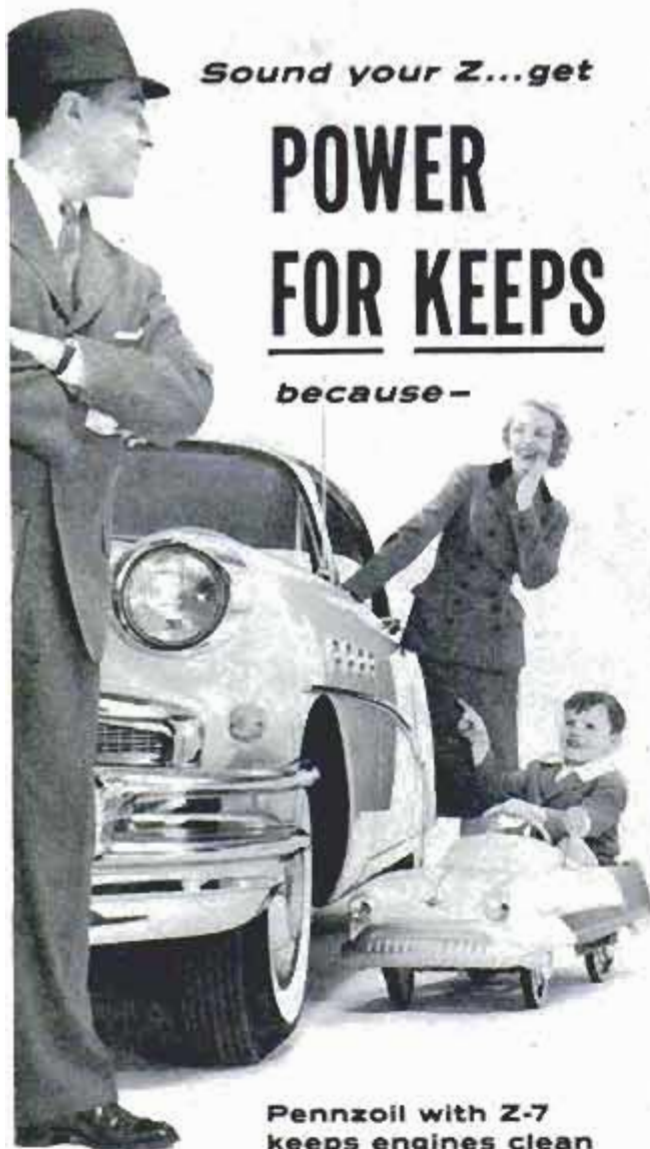

Sound your Z...get

POWER FOR KEEPS

because—

**Pennzoil with Z-7
keeps engines clean**

Pennzoil with Z-7 is The Tough-Film[®] oil with an all-oil lubricating body. It stays tough under engine heat and pressures, prevents build-up of power-stealing deposits. By keeping engines clean, this different Pennsylvania motor oil controls carbon completely. There's no knock, no ping. Horsepower stays unlocked—not for just a few miles after an oil change, but for keeps. To enjoy all the smooth power you bought, get Pennzoil with Z-7 now in the exact seasonal grade for your car!



IN EVERY STATE,
AT DEALERS WHO
CARE FOR YOUR CAR



MEMBER PENN. GRADE CRUDE OIL ASSN., PERMIT NO. 2, OIL CITY, PA.

them to believe the Pole is covered with fine, powdery snow.

Polar navigation for icebreakers is just as tough and hazardous as it is for helicopters and airplanes. The radio goes haywire due to weird magnetic storms, especially in the Antarctic. None of Deepfreeze's breakers are able to transmit from McMurdo to ships at sea, yet an aircraft transmitter 40 miles out on the ice threw a signal clear over our heads to New Zealand, where it was rebroadcast and picked up. To help overcome atmospheric witchery, the *Glacier* has a 2000-foot cable skylifted by a 20-foot blimp. Even this spire is no use in many of Antarctica's strange invisible storms.

On top of this hazard, days of overcast give the navigator no chance to shoot the sun for a fix. Howling wind sends the pack and ship drifting at unknown speeds in unknown directions.

The *Glacier* nearly missed a task force rendezvous at Scott Island due to such a situation on the fogbound morning of December 23. For 30 hours we'd been zig-zagging through the pack on a crazy course through a freezing "pea soup," while harried navigator Lt. Bob Newcomb went mad trying to keep a fix made two days before.

(Continued to page 272)

GROW PRIZE WINNING VEGETABLES, FRUITS & FLOWERS WITH A BOLENS M-E SUPER MUSTANG ROTARY TILLER

Produce bigger and better yields by preparing the ideal seed bed in one operation.

The SUPER MUSTANG is used to till, weed, cultivate and mulch better, easier and faster. It's simple to operate and economical too.

Self-sharpening hoe blades are completely guaranteed against breakage.

See your BOLENS DEALER today and mail the coupon below.



NATIONAL BOLENS MONTH IS NEAR
MAIL COUPON TODAY

BOLENS PRODUCTS DIVISION

Food Machinery & Chemical Corp.
265-F Park Street, South, Port Washington, Wisc

Please send me full details of the
M-E Super Mustang Garden Tractors Chain Saws
New RIDE-a-matic Power Mowers

NAME _____

ADDRESS _____

CITY _____ STATE _____

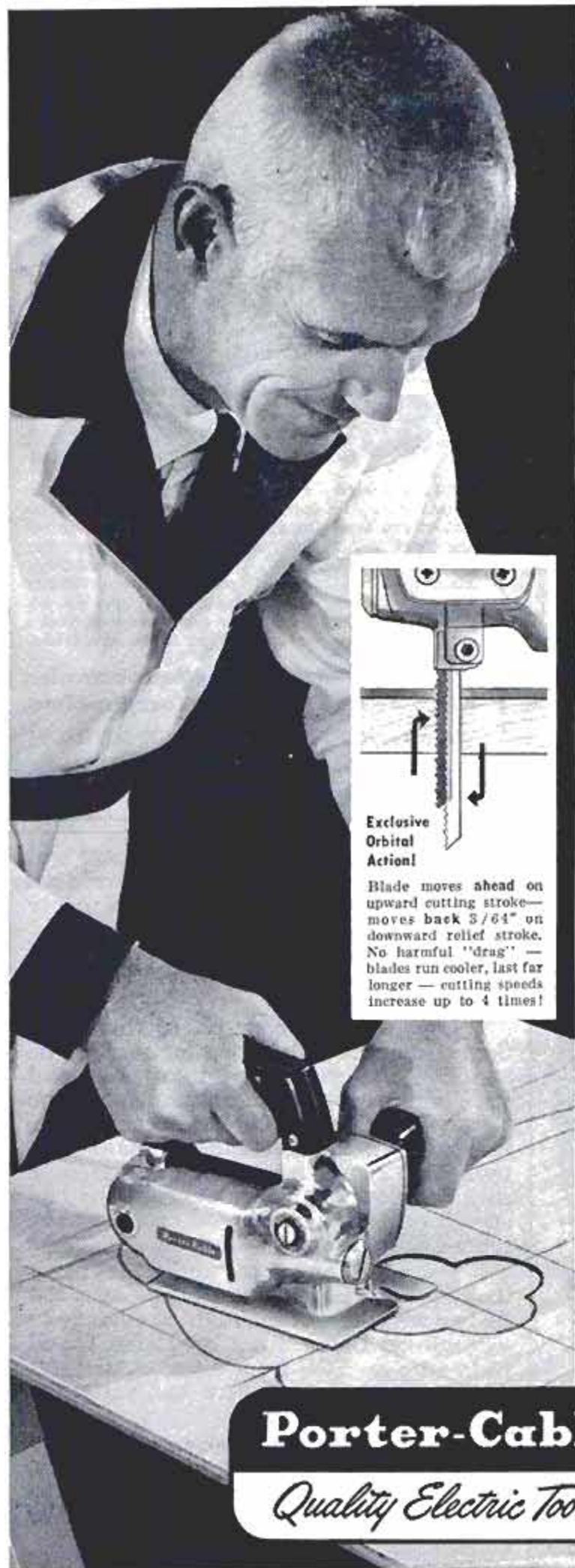

New! Just \$99⁵⁰!

World's only orbital-action bayonet saw!

Now—the first *real* improvement since portable jig saws were invented! It's Porter-Cable's revolutionary new Model 148—designed around a wholly new principle, *guaranteed to outperform any other portable jig saw at any price.*

Orbital action makes the difference. Blade teeth are in contact *only* on the cutting stroke—*back away* on the relief stroke. Harmful "drag" is completely gone—and performance reaches a new high.

By actual test, the Model 148 cuts up to 4 times faster than the best conventional up-and-down saws. It has a full 2" capacity in wood— $\frac{3}{4}$ " in aluminum, $\frac{1}{4}$ " in steel. Its cool, comfortable grip and perfect balance make easy work of any job. Get the whole amazing story from your Porter-Cable dealer—or write today for full information and name of your nearest Dealer.

**Exclusive
Orbital
Action!**

Blade moves ahead on upward cutting stroke—moves back $\frac{3}{64}$ " on downward relief stroke. No harmful "drag"—blades run cooler, last far longer—cutting speeds increase up to 4 times!

Porter-Cable

Quality Electric Tools

PORTER-CABLE MACHINE COMPANY

6143 N. Salina Street, Syracuse 8, N. Y.

belt sanders • finishing sanders
saws • drills • routers • planes

In Canada, write Porter-Cable, Ltd., Box 5019, London, Ont. Canadian prices slightly higher.

FREE! New 180 PAGE CATALOG



NEW
LOW
PRICES

THOUSANDS
OF NEW
ITEMS

1956
EDITION
JUST
OUT!

World's Largest
and Most Complete
Automotive Catalog
Parts and Accessories for
all makes and models of
cars from 1920 thru 1956!

Saves
UP TO **50%**
OVER 75,000
AUTOMOTIVE
ITEMS

Get your FREE copy now . . . everything you need for your car, truck, custom styled car or hot rod. Save up to 50% buying-by-mail from Whitney! Thousands of hard-to-find items for cars from 1920 to 1956. See newest Hollywood accessories not offered in stores; high speed and power parts, custom styling equipment . . . all at lowest prices! Guaranteed satisfaction or money back. Our 20th year. Mail coupon.

RUSH COUPON

Please send 25¢ to help pay catalog mailing and handling costs. We will credit 25¢ on your first order for \$5.00 or more. Mail coupon NOW!

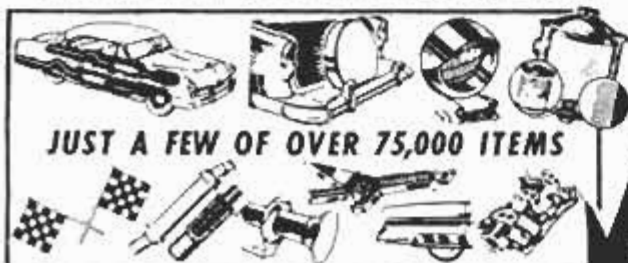

JUST A FEW OF OVER 75,000 ITEMS

J. C. WHITNEY & CO., 1917 P-3 Archer Ave., Chicago 16, Illinois

Mail This Coupon Today!

J. C. WHITNEY & CO., 1917 P-3 Archer Avenue, Chicago 16, Illinois

Rush giant 1956 catalog of auto parts and accessories at sale prices. I enclose 25¢ to cover part of mailing and handling cost, which will be credited to me on my first \$5.00-or-more order.

Name _____

Address _____

City _____

State _____

WATER AT LOWER COST!

WITH A

General Motors
DELCO
Wellmaster Jr.
Water Pump

ONLY

\$89.95

f.a.b.
Rochester

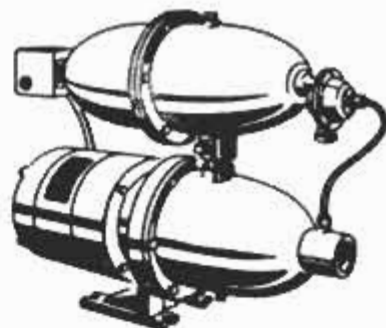

Suggested List Price
Model S33T2 as illustrated

Now, a Delco Jet unmatched for Price and Quality . . . in the 1/2 H.P. class! This Delco Jet offers the simplicity of only ONE moving part . . . plus, self-adjusting capacity, greater compactness . . . greater durability. Here is a shallow well pump to bring water at a low, low cost. Built and backed by General Motors . . . your assurance of years of trouble-free service. Other sizes available.

FREE! Water Systems Demonstration
and Survey of Your Problem.

Write Today! DELCO APPLIANCE DIVISION
GENERAL MOTORS CORPORATION
Dept. PM, Rochester 1, N. Y.

Radio contact was perfect but there was no way to tell if the ships were a hundred miles or yards away. Radar showed plenty of blips but were they ships or icebergs? A misty ship turned out to be a ship-shaped iceberg. Newcomb's canny ability pulled us back on course.

Taking a contour graph of the ocean floor from the ship's depth sounder, he matched the submarine mountains and valleys to depth marks on nautical charts of the area. Thus, using the ocean bottom for a map, he calculated the *Glacier's* position. Two hours later dim outlines of a ship grew out of the sea ahead. If he had stayed on the previous course we'd have missed Scott Island by 25 miles.

It's usually Yankee ingenuity that saves the day on the breaker's mission. Pat Maher won't forget the night the *Edisto* in ice-jammed Davis Strait off Baffin Island picked up an SOS from a tiny settlement in a Greenland fjord. Fire had destroyed the winter oil supply.

"We headed for it through one of the wildest nights I ever saw," Capt. Maher recalls. "It was black as pitch with a roaring blizzard so thick we couldn't see the bow. We

(Continued to page 274)



\$239 delivered (saw blade and $\frac{3}{4}$ hp. motor included), EASY BUDGET TERMS

New 1956 AMF DeWalt "Power Shop" makes all home woodworking easy!

Here, in one big-capacity machine, is a complete home workshop... that gives you...

- The *power* you need for any operation
- 3-D versatility to handle any home project
- The *professional accuracy* to do any job quickly, easily, *expertly*
- The built-in *safety* you *want* in your home

See a demonstration of the new 1956 AMF DeWalt Power Shop at your dealer's today. Now more than ever, it's the finest, safest, most complete home workshop you can buy.



New $\frac{3}{4}$ hp. direct-drive, custom-built motor. Rugged, reserve power for the toughest jobs — staying power for steady use.



Easy, safe, top-side cutting. Always see your mark and your cut — never work "blind." Saw moves above the work.



Straight-line material handling. Arm swings 360°. Motor rotates 360°—tilts past 90°. Material always moves straight on level table.



No floor space needed. Built into work bench, arm swings clear of work area — swings back when needed.



Exclusive New Shaper-Jointer Fence. Converts saw to a 2" jointer at 1/3rd the cost. Positions work for accuracy, safety.



Exclusive New Shaper Guard. A DeWalt "First" safety accessory. Totally encloses knives and spindle—raises for adjusting work.

Complete versatility. Simply change tool on motor shaft. Your AMF DeWalt saws, dados, shapes, sands, bores, routs, surfaces, joints. It buffs, grinds, turns, cuts curves... does everything in woodworking.

New safety. New safety key switch — one of many DeWalt home safety features — turns power on or off. Take key with you and your family is completely protected.



SEND COUPON TODAY!



AMF DeWalt, Dept. PM-56-3, Lancaster, Pa.
In Canada: DeWalt Canada, Ltd., Guelph, Ontario

- Please send me Free Colorful 20-page Booklet on how to do everything in woodworking... easily.
- Please send me Free plans on how to build a home workbench.

Name _____

Address _____

City _____ Zone _____ State _____



Why
wash
those
walls?

It's so easy to
give them fresh new
beauty with

LATEX PAINT*



IT'S 6 WAYS BETTER:

1. no brush or lap marks
2. no painty odor
3. fast drying
4. rinses right out of brush or roller
5. tough and scrubbable on the walls
6. wonderful color choice

*Dow does not manufacture paint but is the leading producer of latex for paint manufacturers.

THE DOW CHEMICAL COMPANY
MIDLAND, MICHIGAN



got to the mouth of the fjord when our radar blew. Charts showed a narrow channel in the center but an attempt to navigate it blind would put us hard aground on jagged shoals. Then the navigators had an idea. The ship was equipped with sonar, used to detect and locate submarines in wartime by sending out sound waves and picking up reflected echoes. Why not use it to detect channel walls? It worked. We rode five miles up the channel by listening and timing pings bouncing off the banks and holes until the storm abated. Then we went in to help the stricken town."

Occasionally, when the ice is heavy and thundering winds are packing it against the headlands, even rugged icebreakers may be "nipped"—frozen in. "Sometimes we dynamite the ice," says Maher, "but the best thing is just to throw a party on the ice and sit it out. Packs resembling solid snowbound land today will break up tomorrow when the wind shifts."

Actually it would take a tough "nip" to immobilize the *Glacier*. When all else fails, her heeling system goes to work. There is a row of three massive tanks on each side, and 140,000 gallons of sea water are sucked aboard to fill them halfway. Powerful pumps then throw nearly half a million

(Continued to page 276)

**LAWN..SHRUBS..
FLOWERS..TREES**
Carry Costly Price Tags!

Why Let Them Wither Away In
HEAVY or SANDY SOIL
When Pennies For Terra-Lite
Saves Garden Dollars..

Valuable plantings can slowly wither and die in heavy or sandy soil. But why worry? A few pennies worth of Terra-Lite vermiculite performs a garden miracle...loosens, aerates soil...lets roots stretch, breathe. Holds water in sandy soil, too. Plants thrive...turn deep green again! For example an evergreen worth \$20.00 can be protected with as little as 10¢ worth of Terra-Lite.



Terra-Lite®
Nature's Own Soil Conditioner

FREE BOOKLET
...tells how ¼
Terra-Lite mixed
with ¾ soil can
keep your garden
gloriously green. As
little as \$2.35 of
Terra-Lite condi-
tions 200 sq. ft. of
soil.

Terra-Lite Division
Zonolite Company, Dept. PM-36
135 S. LaSalle St., Chicago 3, Ill.
Please rush me free booklet telling how
pennies for Terra-Lite will protect the
dollars I spend for garden shrubs, flowers,
etc.
Name _____
Address _____
City _____ Zone _____ State _____

ON SALE AT GARDEN SUPPLY DEALERS

SHOP BY MAIL AND
SAVE
at **GROBAN'S**

SURPLUS & NEW MANUFACTURE
FOR HOME, FARM AND FACTORY EQUIPMENT

ALL
ITEMS
Unconditionally
GUARANTEED!

**GROBAN FOUR-WAY
OPEN CENTER HYDRAULIC
CONTROL VALVE**

ITEM #126 — Four-way open center control valve, with built-in adjustable relief valve factory set at 1000 P.S.I. Spring loaded neutral position. For use with one double acting cylinder. In neutral position cylinder is locked and pump unloaded. Can be used as single unit or mounted in series. Has 3/4" pipe thread inlet and outlet. 1/2" pipe thread cylinder ports. Finger grip handle. Ship. wt. 10 1/2 lbs. **AN OUTSTANDING BUY!**
P.O.B. **21.50**
Chicago

**PESCO GEAR TYPE
HYDRAULIC PUMP**

Compact — Powerful — Reliable
ITEM #160 — Especially designed for belt drive from fan belt, power take-off, drive pulley, electric motor or small gas engine. Equally suitable for direct coupling. Pedestal type mounting with two bolt holes for 3/4" hold-down bolts. Standard 1/2" pipe thread inlet and outlet ports. Delivers 4.5 GPM at 1000 PSI at 2800 RPM with 4 HP. Hardened steel gears turn in dense nitrite bronze bearings. Rotation—clockwise facing shaft. Guaranteed trouble-free service. Ship. wt. 6 lbs. **F.O.B. Chicago 22.50**

**HYDRAULIC
LIFT CYLINDERS**

• For Fork Lift Trucks • For Presses • Loading Ramps • Lifts 12500 lbs. heavy duty hydraulic cylinders, at big savings.
ITEM #502—3" Bore—36" Stroke—1 3/4" Piston Rod. Wt. 95 lbs. **F.O.B. Chicago 72.00**
ITEM #503—4" Bore—54" Stroke—1 3/4" Piston Rod. Wt. 135 lbs. **F.O.B. Chicago 96.00**



FREE! — NEW CATALOG
1956 EDITION, 56 PAGES. chock-full of unsurpassed War Surplus and newly manufactured Equipment Bargains for farm, home, factory, workshop. Write letter today.

**FACTORY-TO-YOU-VALUE
PORTABLE ELECTRIC
LIGHT PLANTS**

POWER TO OPERATE:
• Electric Saw, Electric Drills, Pipe Bender.
• Refrigerator, Deep Freezer, Incubator.
• Water Pump, Radio, Lights, Air-conditioner.
BRAND NEW 1956 **ITEM #1008**
COMPACT — FITS IN THE TRUNK OF YOUR CAR
1000 WATTS OUTPUT, continuous duty. 115 Volts A.C. 60 cycles, 9 amps. Powered by husky, easy starting Clinton engine. Engine and generator operate at 3600 R.P.M. for maximum efficiency at minimum weight. Both units are mounted on steel base, with heavy sheet metal belt guard. Generator is self regulating, and is equipped with outlet box containing fuse and 2 A.C. convenience receptacles. Cost only 5c an hour to operate. Dimensions: Length 20 1/2", Width 12", Height 16". Shipping **149.50** wt. 100 lbs. **F.O.B. Chicago**
700 WATT-GENERATOR SET—same as above, slightly smaller—with Briggs-Stratton Engine—Model 708—**F.O.B. Chicago 129.50**

GROBAN HYDRAULIC SPEED REDUCER

WITH FINGERTIP CONTROL
USE FOR: • Reamer Drives • Midcut Cars • Feed Mills • Canning Machines • Conveyors • Lathes • Milling Machines • Motor Boats • Cream Separator • Garden Tractor Shafts • Pumps.
Variable output speeds from 0 to input speed available by moving control handle. Locking handle maintains setting. Use input power of 1/2 to 1 1/2 H.P. Shafts 3/8" diam. Input rotation counter-clockwise facing shaft. Input speed 750 R.P.M. 7 1/2" x 7 1/2" x 11 1/2". Gov't acquisition cost \$428.00. Ship. wt. 31 lbs. Complete with 2 qts. of oil and full instructions. **F.O.B. Chicago 54.50**

U. S. NAVY ALL BRONZE CENTRIFUGAL PUMP

These all bronze Centrifugal Pumps are ideal for use as marine bilge pumps, circulating pumps, fire protection or irrigation, car-washing, dewatering, basement sump pumping, lawn sprinkling. Will pump water, oil, brine, gasoline, DDT and sulphur compounds. Equipped with 6" adjustable "V" pulley, 2" dia. inlet and outlet, 180 GPM capacity. Inlet and outlet take hose with 2 1/4" inside diameter. Dimensions 11" x 8" x 11".
Total head-feet **Speed** **H.P.** **GPM**
25 3600 RPM 3 180
35 3600 RPM 1 1/2 90
20 2400 RPM 1 1/2 75
Back plate may be rotated for most convenient inlet position. Shipping weight 31 lbs. Gov't. cost 96.00. **F.O.B. Chicago 29.50** **ITEM #384**

GROBAN SUPPLY CO. Dept. PM-3
1139 S. WABASH AVE., CHICAGO 5, ILL.

**SELF-PRIMING
ROTARY PUMP**

Item #104A — A fine pump for gasoline, fuel oil, water, kerosene. For fuel transfer, sump pumping, for draining basements. Capacity, 400 gallons per hour. 3/4" pipe thread inlet and outlet. Has built-in, adjustable relief valve, set at 30 P.S.I. Adjustable to 100 P.S.I. Rotation in either direction; use 1/2" Hp. motor; 1 1/2" standard shaft, ball-bearing supported. Dimensions: 5 1/2" x 11" x 10". Shipping weight 8 lbs. **A \$25.00 VALUE** **F.O.B. Chicago 16.50**



**BRAND NEW 1 H.P.
12 Volt Electric Motor**

• For electric wheel chairs (Pop. Mech. dealer—Mar.-1963)
• For electric golf carts
• For self-propelled scooters, children's mid-let cars.
ITEM #308
Rated 1 H.P.—100 amps., 2600 R.P.M., 12 volts, D.C.—This double shaft motor of ball-bearing construction may be run on 6 volts for lower horsepower requirements.—Standard 3/8" shafts, nut and bolt electrical terminals, flange mounting—Dimensions: 9" x 4 1/2" x 4 1/2". Ship. wt. 10 lbs. **A real 12.50 F.O.B. value at...** **F.O.B. Chicago**



**BELT DRIVEN
A. C. GENERATORS**

Ideal for powering electric tools, oil burner, refrigerator, lights, or other appliances requiring up to 700 watts of power. **700 WATTS**, 115 Volts, 60 cycles A.C. 3600 R.P.M. Compact, self-regulating generator with V Belt pulley and double outlet receptacle. Rotation counterclockwise. May be driven by tractor or auxiliary gasoline engine. Requires 2 HP minimum. Dimensions: 10" long x 8" high x 6" wide. Shipping wt. 27 lbs. **F.O.B. Chicago 59.50**

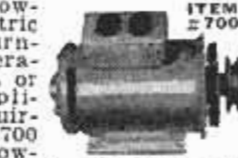

Model 1010 — 1000 WATTS
(Same as above) **79.50**
F.O.B. Chicago

ORDER DIRECT FROM AD
SATISFACTION GUARANTEED
Send Payment Or Purchase Order Today
For Phone Orders call WEbster 9-3793

READY CUT HOMES DO-IT-YOURSELF \$SAVE! \$\$\$

BUY DIRECT FROM MILL & SAVE ON LABOR COSTS

You can assemble any of the 57 designs from easy-to-follow plans. Every piece marked, easily identified, ready to erect. You don't have to measure, or cut. It's all done economically by precision production machinery (not prefabricated). Save high skilled labor costs and material wastes. Save contractor's profits and overhead. Complete with all hardware, paint, nails, roofing, glass, etc. Sterling Homes are mod-

ern designed for comfort and convenience. Plans sold separately.
FIVE EASY PAYMENT PLANS INCLUDING MONTHLY PAYMENT

ORDER TODAY - SAVE UP TO 40%

PRICED FROM \$2150.00 AND UP

Send 25c
Color Catalog including Floor Plans



INTERNATIONAL MILL & TIMBER CO., BAY CITY, MICH. DEPT. PM 36



This Winter
Put Part of Your
Fuel Bill in the Bank!

REYNOLDS Do-It-Yourself ALUMINUM REFLECTIVE INSULATION

This aluminum foil bonded to both sides of sturdy kraft paper is as easy to handle as famous Reynolds Wrap.

All you do is staple it—or tack it—to your attic studding. Because aluminum reflects up to 95% of all radiant heat, this insulation keeps heat in, locks moisture out—saves dollars every month. (Attics are up to 15° cooler in summer, too.) Call Western Union Operator No. 25 for the name of your nearest hardware or lumber dealer.



Look for this rack—
Reynolds Aluminum
by the makers of
Reynolds Wrap

REYNOLDS METALS COMPANY
2494 South Third Street, Louisville 1, Kentucky

See Reynolds new show "Frontier"—Sundays on NBC-TV

FIXIT TIPS

WITH "SCOTCH"
33 PLASTIC TAPE

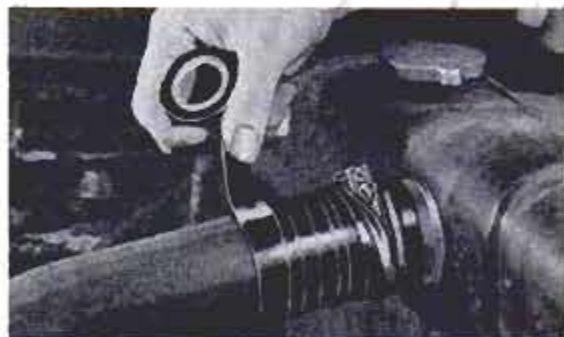

MEND AUTO HOSES with tight wrap of stretchy, waterproof "SCOTCH" 33 Plastic Tape. Stretchy plastic seals tight, resists corrosion.



WRAP TOOL HANDLES. Tough, long-wearing plastic tape covers rough handles, makes smooth non-slip grip. Get "SCOTCH" Brand 33 Plastic Tape, 39¢ or 79¢ at stores everywhere.

MINNESOTA MINING & MFG. CO.,
ST. PAUL 6, MINN.



pounds of water alternately from tanks on one side to the other in 80 seconds. The whole ship begins to rock 10 degrees in the crush. "Then we wind up the screws," says Maher, "and with everything going at once, the ship humping and heaving, something has to give. We hope it's the ice, and usually we can pry her out of there."

Crunching through the pack with her string of four supply ships tagging behind at 400-yard intervals, the *Glacier* and convoy made an impressive picture. With a "family" to consider, the icebreaker had an even tougher job. With their thin skins the freighters couldn't cut sharp corners without cautious backing and filling. One jagged cake could cut a hole in a hull or mangle a screw, so progress was slow as we moved through the solid ice.

Often, for this reason, two breakers work in tandem with a convoy. The first breaks the lead, the second peels corners off the

(Continued to page 288)

**Now! The builders of over a million
power saws offer a
GENUINE SKIL SAW
for only \$29.95**

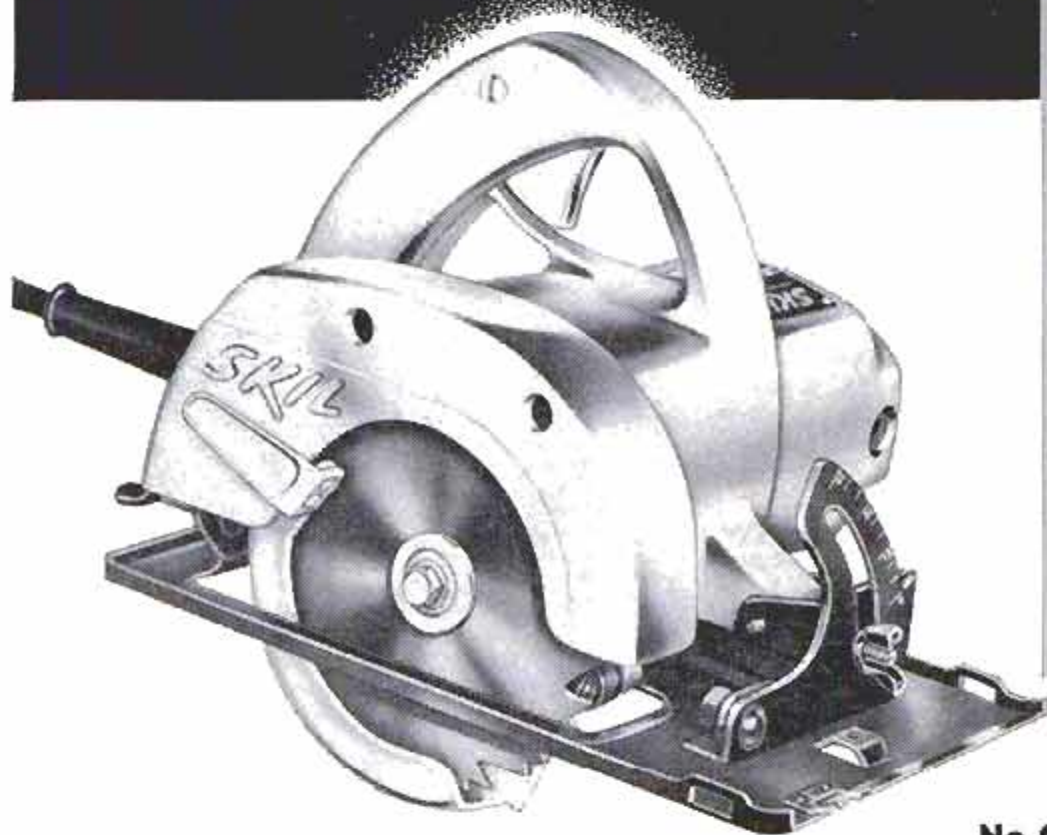

Why settle for less when you can own a *guaranteed* SKIL Saw for only \$29.95! At this low price no craftsman can afford *not* to have a SKIL. The real thing in portable saws—with all the power and performance you'd expect of a SKIL! More cutting ability than any other saw in its price range regardless of size . . . speeds through the toughest materials without stalling or burning out.

Capacity to spare, too. This highest-quality SKIL will cut paneling, wall-board, Formica and other materials. Handle 2 x 4's with the 4 1/4" blade saw simply by flipping the board. Make 45° cuts to a depth of 1"! Vertical cutting depth is 1 5/32". Here is an ideal investment for home or shop. Let this new SKIL help you clean up all the hobby or building jobs that need doing. Ask for demonstration at your Hardware Dealer's today.



• Make cabinets, cupboards, closets, an easy weekend project with SKIL Saw!



• Extra rooms, extra storage space. It's easy to build them with SKIL Saw!



• Cut paneling, shelving, siding, or plywood. SKIL handles them all.

**Model 504
No Other Saw in This
Price Range Offers These
Famous SKIL Features**

- Powerpacked motor
- Guard-lift-Depth and bevel adjustments
- Trigger-type switch
- Built-in sawdust blower
- Telescoping blade guard
- Comfort-grip handle
- Fully backed by the famous SKIL standard guarantee.

SKIL
BUILDERS TOOLS

Made Only by SKIL Corporation, Formerly SKILSAW, Inc.
5033 Elston Ave., Chicago 30, Illinois
3601 Dundas Street West, Toronto 9, Ontario
Factory Branches in ALL Leading Cities

Lincoln Owners Praise Handling

(Continued from page 128)

subject by owners who wear belts all the time.

"I have belts and wear them all the time. It's a habit now. I have never been in an accident but believe firmly in prevention."
—Illinois life-insurance executive.

"In addition to safety angle, I use the belt to hold me in the correct driving position on long drives."
—California owner.

1956 LINCOLN SPECIFICATIONS

ENGINE	PREMIERE
Type	8-cyl., OHV, V-type
Bore and stroke	4.00 x 3.66 in.
Piston displacement	368 cu. in.
Brake horsepower	285 at 4600 r.p.m.
Compression ratio	9 to 1
Transmission	Turbo-Drive—Torque converter with gears

GENERAL

Steering ratio (over-all)	20.9 to 1
Steering wheel, lock-to-lock	3.3 turns
Turning radius (curb-to-curb)	22.7 ft.
Brakes	conventional hydraulic
Tire size	8.00 x 15 tubeless (8.20 on air-conditioned cars)

Recommended tire pressure	24 lb. front and rear
Ship. wt., 4-dr. sedan	
unladen	4362 lb.
Capri	4289 lb.
Wheelbase	126 in.
Tread, front	58.5 in.
Tread, rear	60.0 in.
Height over-all (unladen)	61.2 in.
Width over-all	79.9 in.
Length over-all	222.8 in.
Road clearance	6.8 in.

CAPACITIES

Oil (less filter)	5 qt.
Water (less heater)	23.3 qt.
Gasoline	20 gal.

INTERIOR DIMENSIONS

Front-seat width	61.7 in.
Rear-seat width	63.8 in.
Headroom, front	35.4 in.
Headroom, rear	34.1 in.
Legroom, front	44.8 in.
Legroom, rear	42.5 in.

"Belts are the only way severe injuries can be avoided."
—Wisconsin surgeon.

"With excellent brakes, quick stops cannot always be avoided in city traffic. I wear the belt all the time."
—California insurance-company executive.

It is perhaps only a coincidence, but two of the above four quotations are from insurance executives, one from a medical man, the fourth owner did not list his occupation.

The following quotations are from owners who have safety belts but wear them only part of the time:

"I wear them any time I am going out of the city. They should be compulsory on all cars."
—California van operator.

(Continued to page 280)



solves woodworking problems in seconds!

Speed your jobs, get answers to countless building and woodworking questions immediately! Improved

GREENLEE Woodworking Calculator converts linear to board feet, gives nail specifications, tool sharpening tips. Compares woods, gives bit sizes for screws, concrete mixes, painting information, etc. Convenient . . . simple to read. 6" diameter . . . heavily varnished cardboard. Special offer by

the makers of famous GREENLEE tools . . . **Only 25c**
(no stamps please)



The GREENLEE line of fine tools includes auger bits, electric drill bits, chisels, gouges, spiral screw drivers, drawknives, and many more. At leading hardware and building supply dealers.

GREENLEE TOOL CO.,
2103 Columbia Ave., Rockford, Ill.



AAA Champion Bob Sweikert—won at Indianapolis and placed in six other "big car" races.

Biggest winners in AAA and NASCAR races prove Champions best for your car!

Bob Sweikert and Tim Flock used 5-rib Champion Spark Plugs in every one of 43 races!

Here's solid proof of what Champion Spark Plugs can do for your car:

Not only in racing cars, but in NASCAR races with all makes of standard cars—regular passenger sedans just like the one you drive—98% of the winners were powered by *Champions*.

Bob Sweikert, 1955's AAA champion—who finished first in the Indianapolis "500"—powered his racing car with *Champions*.

Tim Flock, the year's top NASCAR winner, drove his Chrysler "300" with *Champions*. In fact, virtually every racing

driver in America insists on Champion Spark Plugs—*regardless of the make of car he drives.*

These men really know cars and know engines. What stronger evidence could there be that *Champions* are best for your car, too!

No matter what car you drive, new *Champion Spark Plugs* will give you quicker starts, fuller power, better gas mileage.

Remember—even the best plugs become inefficient after about 10,000 miles. Have yours checked today. If you need new spark plugs, get the best—5-rib *Champions*.



CHAMPION

LOOK
FOR THE 5 RIBS

NASCAR Champion Tim Flock—*Champions* powered his Chrysler "300" to 18 wins, 15 placings.





Next time you use a Disston, note how easily it cuts through the wood. Its clean, sharp bite is due to the bevel-filed teeth, the double-taper ground blade perfectly tempered to hold its fine edge.

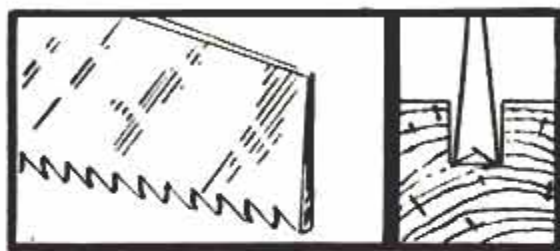

you can see it's a DISSTON

Tapered to the point, tapered to the top, and with teeth the same width along the entire cutting edge.

There's so much extra satisfaction in using good tools, remember to ask your hardware dealer to show you DISSTON—

- Hand saws • Circular saw blades and dado heads • Band saws • Chisels and gouges • Garden tools and lawn rakes • Carlson steel tape rules.

Henry DISSTON DIVISION

H. K. PORTER COMPANY, INC.

311 Tacony, Phila. 35, Pa.

In Canada: 2-20 Fraser Ave.,

Toronto 3, Ont.



"Fine for trips. Can't always remember to use them around town. Keep me from sliding on corners."—Kansas salesman.

"Had them on my last car and transferred them to new car. Would not want to be without them."—California insurance broker.

Here are some typical quotations from those owners who do not have belts on their 1956 Lincolns:

"With the new door latches, belts are superfluous."—Massachusetts retired owner.

"Safety belts defeat their purpose. Give teen-age drivers more false security."—New York food broker.

"I would have belts if I drove at very high speeds."—California retired owner.

"Belts are good but slightly over-rated."—New York airline pilot.

"Careful driver does not need belts."—Georgia retired owner.

"The selling point of safety is silly. They cut down vision with tinted glass and distorted windshield."—Wisconsin doctor.

"Why did Ford leave safety dash and padded visors off its finest car?"—California appliance dealer.

"Dashboard is a disgrace. It is the only car built with a built-in guillotine."—California executive.

What About New Engine?

Lincoln offers a new engine for 1956: It has a 368-cubic-inch displacement, a 9.0:1 compression ratio and develops 285 horsepower. What do owners say about it?

Of the owners taking part in our survey, 84.1 percent report no trouble with their engines, 12.1 percent report some trouble, and 3.8 percent have had considerable trouble. The most frequent trouble seemed to be with the valves—usually of a minor nature. Second most frequent trouble is carburetor adjustment. Third is starting difficulty, especially in cold weather. The following quotations illustrate the various types of trouble in order of frequency of mention:

"Valves noisy, engine won't idle smooth."—North Carolina accountant.

"Constant adjustment to carburetor and timing."—Michigan regional manager.

"Hard starting on cold mornings."—Indiana retired owner.

"Distributor diaphragm defective."—California doctor.

"Excessive oil consumption."—California salesman.

Additional Best-Liked Features

The following quotations from Lincoln owners describe additional best-liked fea-

(Continued to page 282)

WORN ENGINE BURNING OIL!

Reduces oil bills!
Restores compression!
Increases miles per gallon!
 Forms self-lubricating seal at piston top. Inserted through spark plug holes. Used by millions of motorists. Tested and approved by motoring experts.



\$4.95
 Tube for most cars

* PISTON SEAL



Applies like putty
Sets metal hard

Fills dents, holes, cracks, etc. File or sand smooth. Water, oil and gasoline proof. Takes enamel or lacquer.

LOY COLD METAL

LOY TWIN PACK Tube \$1.00
 8 oz. Can Metal; 2 oz. Jar Solvent. \$1.79

REPAIR CRACKED CYLINDER BLOCK without dismantling

For internal or external cylinder cracks—cast iron or aluminium. Vibration, heat, pressure proof.



HOLTWELD

Can \$1.59

REPAIR LEAKY RADIATOR While you drive!

... permanently cured, non-corrosive, non-blocking, unaffected by heat or pressure.



RADWELD

Can .69

Holt's HAVE THE ANSWER!

REPAIR MUFFLER AND EXHAUST LEAKS in 10 min.

The plastic gas-tight seal sets hard, withstands heat and vibration. Prevents carbon monoxide gas poisoning.



Holt's GUN-GUM

* MUFFLER SEAL

PLASTIC

SETS LIKE A WELD — NO TOOLS NEEDED

At Auto, Accessory and Montgomery Ward Stores

TREGLOWN CO. INC, FANWOOD 63, N.J.

* TRADE MARK REGD.

CANADA: 1366 GREENE AVE, MONTREAL 6

Write for Full DETAILS

\$1.69 per can



EARN EXTRA MONEY the IDEAL way!

SHARPEN POWER OR HAND MOWERS LIKE AN EXPERT!

NO EXPERIENCE NEEDED

You can sharpen your first lawnmower expertly on an Ideal® Sharpener. Just put the mower in your Ideal—no need to take it apart—and you'll have a perfect cutting mower in minutes.

CASH-IN ON THE POWER MOWER BOOM

Start a profitable business full-time, or in your spare time at home. Hundreds of power and hand mowers are in use in your area. It's a real opportunity. Be ready for spring and summer business . . . get your Ideal Lawnmower Sharpener now!

Write for FREE catalog to:

The FATE-ROOT-HEATH CO.

Dept. PM-3, Plymouth, Ohio

IDEAL LAWNMOWER SHARPENERS, THE QUALITY LEADER FOR 52 YEARS!



Need more closet space? This one's easy to build. Made from Upson $\frac{3}{16}$ ". Just nail Upson in place and paint. Upson's easy to work, edges sand smooth.

save 50% and more wherever your projects call for wall board

Upson wall board is perfect for all kinds of do-it-yourself projects. The list is endless: make cabinets, chests, closets, use Upson to finish your basement walls and ceilings, garage, add-a-room. Or make cut-out toys, a model train table. In fact, use Upson like plywood. Only with Upson you save money. Save up to 50% on each square foot you buy. And Upson is easy to work, light, strong. Saws like wood, paints beautifully.

Upson comes in a large variety of thicknesses and sizes. From $\frac{1}{10}$ ", $\frac{1}{4}$ ", $\frac{3}{16}$ " to waterproofed, super-strong $\frac{3}{8}$ " for outside use. Pebbled, smooth and striated surfaces. Sizes from 4' x 6' to huge 8' x 20'; plus 12" sq. Ceiling Tiles.

There are many imitations, so ask for Upson wall board by name!

See your lumber dealer



Upson wall board saws easily, edges sand clean, smooth!

UPSON

WALL AND
CEILING PRODUCTS
SIDING, SHEATHING



99% new spruce wood fibers laminated for great strength
THE UPSON COMPANY, LOCKPORT, NEW YORK

tures in order of frequency of mention. For the exact percentages of owners mentioning each of these items refer to the table on page 127.

"Will take curves at higher speed than any other car."—Idaho truck contractor.

"On snow and icy streets it holds the road with no sliding or slipping. Well balanced."—Michigan plant manager.

"Transmission is tops. Smooth shifting and no jerks when you slow down to stop."—New York farmer.

"Excellent visibility. No blind spot. No steering wheel in front of your eyes."—New York housewife.

"Roomiest I ever had."—Ohio salesman.

"I like the power accessories: Power steering, power brakes, one-shot lubrication, safety steering wheel."—Nebraska contractor.

"Interior color schemes and upholstery."—New York welder.

"I like safety features."—Minnesota lawyer.

"Roomy trunk."—Michigan gas-station operator.

"I want dependability and I have always found it in a Lincoln."—Illinois advertising director.

"Praise must be given Ford's service policy, especially when on the road."—Illinois mechanical engineer.

"Exclusive distinction. They aren't a dime a dozen on the highway."—Michigan owner.

"Quietness."—California tool specialist.

Additional Complaints

Also in order of frequency of mention are the following owners' complaints:

"Doors will not close tightly. Drafty."—Michigan motel owner.

"When I look through the curve of the new windshield my eyes feel as though they were crossed. Extreme distortion."—Ohio service-station operator.

"Low gas mileage, but with all the power and weight I really didn't expect it would be good."—Washington rancher.

"Glove compartment won't even hold a flashlight when open. Everything falls out. Also too sharp a point in case of an accident."—California trucker and logger.

"Backup lights poorly designed. Actually worthless."—Ohio merchant.

"Too much overhang in rear. Should be shorter."—Illinois manufacturer.

"Almost impossible to get up many driveways without scraping back end."—Georgia manufacturer.

"Uncomfortable position for dimmer switch."—Michigan owner.

(Continued to page 284)

BE PRECISE

Say **STANLEY**

It's A Good Rule



**FREE
MAGNA
VIEW BOX**

Easy to use 8' tape rule- Model 1208W
\$1.19 at your hardware store.

Other Stanley Rules from 75¢ up, 6 ft. to 12 ft., and each in the reuseable plastic box with the magnifying lens. You'll use the rule — you'll use the box.

Write Stanley Tools, 2603 Elm St., New Britain, Conn., for free booklet on measuring tools and how to use them.

STANLEY

Also Eshelman
Adult 2 Pass.
**SPORT &
GOLF Cars**
1/5
the Price of
most other
Cars. 70 Miles
Per Gal.
Free Catalog.

ESHELMAN TRACTORS

LOW AS \$99

RAKES - PLOWS - CULTIVATORS - SAWS
DOZER - HARROWS - SNOW - PLOW - BELLS
SPRAYS - MANGLES - MOWERS - CUTS - TILLS

Eshelman Tractors, Tillers, Riding Rotary Mowers for Better Lawns and Gardens. Advertised in GOOD HOUSEKEEPING and Leading Magazines, Amazing Savings. Write for Free Literature. ESHELMAN CO., Dept. R-53, 109 Light St., Balto. 2, Md.



1 to 8 HP

Shipping Points: BALTIMORE - CHICAGO - RENO

new!

BULLDOG
Screw Type
Top Crank
JACK

- Fits Any Tongue
- Makes Hitching and Parking One-Man Job
- Adaptable to Channel, Angle or Wood Tongues Up to 4" Thick
- Solid Steel Threaded Shaft With 6" Steel Wheel

With its interchangeable mounting bracket, it is easy to install and move from one piece of equipment to another... handle folds, Model 52-F illustrated \$18.50 F.O.B. Wausau... prompt delivery.

\$18⁵⁰

Also full line of trailer axle assemblies and trailer couplers. Write today for FREE Catalog 13-C.



**HAMMERBLOW
TOOL COMPANY**
WAUSAU • WISCONSIN

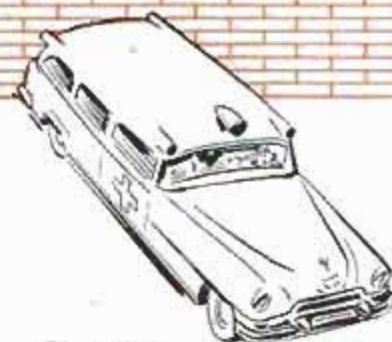
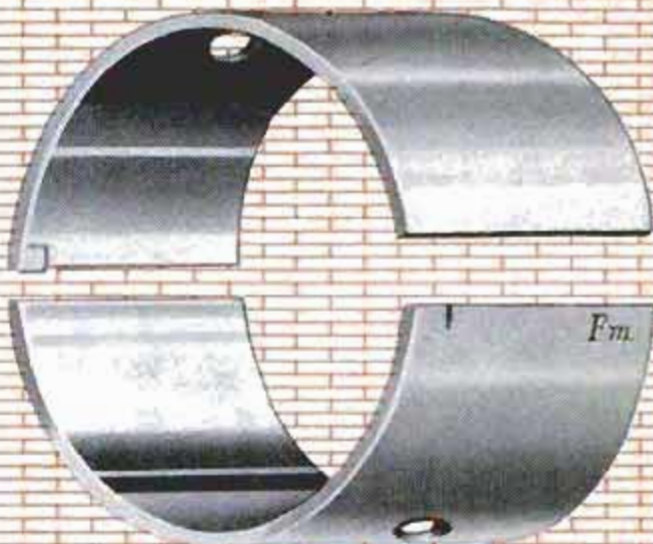

Smooth
Engine Power
calls for Quality Bearings . . .

**FEDERAL-MOGUL
QUALITY!**

You, too, can have the same lively, dependable power vital for emergency vehicles, when you replace worn engine bearings with Federal-Mogul QUALITY bearings. They are *engineered* to stand up under heavy explosive impact loads and to restore snappy power, pick-up and economy!

FEDERAL-MOGUL SERVICE
Federal - Mogul - Bower Bearings, Inc.

Ask your Mechanic!

RESEARCH • DESIGN • METALLURGY
PRECISION MANUFACTURING • SERVICE



NOW AUTOMATIC POWER LUBRICATION FOR YOUR CAR

WITH THE NEW

Multi-Luber



If you own a late model Ford or Chevrolet, this is for you. With a mere press of a button on your dash, all chassis points are high pressure lubricated in seconds . . . guarantees that smooth "Just Lubricated" ride every day . . . provides wonderful, time-saving convenience . . . adds years of economical car operation. The Multi-Luber has been exhaustively tested and is available on current models of one of the largest car manufacturers.

Buy it installed from your car dealer, garage, or service station—or install it yourself. Kit includes complete instructions for quick and easy installation.

IN KITS
AS LOW AS
\$46⁹⁵
PLUS
INSTALLATION



**LINCOLN ENGINEERING
COMPANY, St. Louis 20, Mo.**

Please send me your illustrated leaflet describing MULTI-LUBER, and the name and address of my nearest Multi-Luber Dealer.

NAME.....

STREET.....

CITY.....STATE.....
(Please print or typewrite)

"Not enough headroom. I can't drive with my hat on."—Texas attorney.

"Ash tray too far from driver."—Washington salesman.

"Disappointing on the highway when windy. Seems to get caught in the wind and is hard to keep steady."—Minnesota businessman.

"Easy to overload with four or five passengers and full tank of gasoline."—Ohio contractor.

"Ridiculous position for battery under floorboard where it is inaccessible for quick servicing."—California owner.

"My only objection is the protruding section of windshield that makes it hard to get into the front seat."—Ohio publisher.

"Exhaust smoke stains back end."—California farmer.

There you have it: The full story of the 1956 Lincoln as told by the people who know the car best—the owners themselves. For test data on the Lincoln turn back to page 126. Clymer's driving impressions begin on page 125. ★ ★ ★

Clymer Tests the Lincoln

(Continued from page 125)

There was but little evidence of brake fading when used at high speeds. I also tested the car over mountain trails, back roads and desert stretches. Even with higher horsepower, however, I found the all-around performance no better than that of the Lincoln Capri which I last tested.

At top speed the speedometer needle showed 114 miles per hour, which I consider a trifle slow. The car loafs along at 90 to 95 miles per hour, but on rough roads there is considerable hood flutter and some front-fender vibration—more than on previous Lincoln test cars.

The automatic transmission, which Lincoln calls Turbo-Drive, is a torque converter with planetary gears. It is a little spongy on the take-off (not as positive as the Hydra-Matic used on earlier Lincolns) and acceleration in Drive is moderate, but more rapid in Low. Incidentally, the gearing of the Low range is such that the test car would run 95 miles per hour in Low. Use of Low range is excellent for descending steep hills. It can also be used for emergency braking as the shift lever can be thrown into Low at quite high speeds with no resulting damage.

If the throttle is held to the floorboard in Drive range, the upshift to top ratio occurs at approximately 70 miles per hour. Below 63 miles per hour, by depressing the throttle, the downshift is fast and smooth.

(Continued to page 286)



ONLY SHOPSMITH

"Dials" the Guesswork out of Woodworking

First—SHOPSMITH® takes the guesswork out of selecting the right power tool! Because only SHOPSMITH is all the important power tools you need—in one compact unit: 9" saw, 12" disc sander, 16½" vertical drill, 34" lathe, and a horizontal drill!

Then SHOPSMITH dials the guesswork out of woodworking itself by giving you accuracy and precision you can control!

Simply turn exclusive SHOPSMITH Speed-Dial to any speed you need, from powerful 700 rpm for drilling metal to clean-cutting 5200 rpm for shaping hardwood.



For drilling, mortising, end-sanding, and other operations requiring carefully controlled depth—SHOPSMITH'S depth dial lets you quickly and accurately pre-set quill feed up to 4¼". Just a twist of the wrist dials precision depth! Speed you can dial, coupled with hairline-precise depth, give you greater accuracy than ever before, give your projects that professional look you've been working for!

Turning perfectly tapered legs? On SHOPSMITH (as a lathe), just dial the taper you want with the calibrated eccentric lathe center. Set it once and all the other legs will be identically tapered.

SEE SHOPSMITH DEMONSTRATED at leading hardware and department stores or any Montgomery Ward store. Complete 5-tool unit with built-in ¾-hp motor, ready to plug in... only \$289.50. Or pay as little as \$3 per week on Magna's Tool-Time-Plan.



MAIL COUPON FOR 3 FREE BOOKS

1. "Project Digest," 36 pages of modern woodworking projects.
2. The valuable home-shop guide: "What to Look for When You Buy Power Tools."
3. Illustrated 20-page SHOPSMITH catalog.



MAGNA POWER TOOL CORPORATION

Dept. 320-B, at factory nearest you:
Box 2808, Fort Wayne, Indiana, OR Menlo Park, Calif.

Please send me the three free SHOPSMITH books.

Name _____

Address _____

City _____ Zone _____ State _____

If you already own SHOPSMITH, please check whether you have SHOPSMITH Mark 5 or SHOPSMITH Model 10 ER

PAINT SMOOTHER, EASIER with Brushes by Baker!



Use Baker Brushes and paint easier, faster, better! Enjoy smoother painting, use fewer strokes, get more coverage. Next time you paint choose the right Baker Brush size most practical for the job.



learn
to paint
like an
expert . . .

Free booklet tells "HOW TO DO A GOOD PAINT JOB." Today, send card to Baker Brush Co., Inc., 83 Grand Street, New York 13.



BRUSHES BY BAKER

AMERICA'S FINEST PAINTING TOOLS

The first upshift takes place at about 38 miles per hour. Upshifting in normal driving is noticeable and could be smoother.

The interior of the car is luxurious, with top-flight styling. The driving position is comfortable. The seat cushions and seat backs are well padded and very comfortable for long-distance driving. The two handholds on the steering wheel are novel and desirable.

Front vision is good even though the hood is higher in front and longer than on previous Lincolns. There is some glass distortion at each end of the windshield, but Lincoln's distortion is no worse and no better than other makes using the wide wrap-around design. Even though there is a full-circle horn ring, it is small and speedometer vision is good. The numerals, which are white against a beige background, are artistic, but a little difficult to read. I prefer black numerals. The finish of the shroud covering the instruments is dark, which reduces reflection. The mileage numerals are magnified and very easy to read. The trip odometer is easily reset.

The glove compartment is small. The slanting design of the cowl prohibits taking full advantage of the storage space which might be utilized if a drawer were used.

The wide brake pedal is located close to the throttle and little foot movement is necessary to move the right foot quickly to operate the brake. The hand-brake lever is mounted quite far forward, is easy to operate, and out of the way of the driver's legs when entering.

Door closing is a little on the heavy side. One feature I certainly do not like is that the ignition switch must be turned on before the electric windows can be raised or lowered.

For a car of its size, it is easy to park and back out of tight driveways as the fender tips are easily seen.

The bumpers, front and rear, are large and I like the fact that they do not have the bulletlike projections that are on so many modern cars. The front license plate attaches to the center of the bumper. It is the first piece of metal to touch the rear bumper of another car making for denting and disfiguring the plate. Car manufacturers of all makes seem to think that license plates need no protection. Exhaust is emitted through twin exhaust pipes mounted high and within the bumper tip on each side. This is becoming common, but I can't say I like it, due to the fact that the bumper soon becomes black with soot. It is too easy to dirty a suit or dress when a person accidentally touches the outlets while walking around the car in a garage or parking lot.

They'll Jump 17 Miles

(Continued from page 101)

about the upper air, cosmic rays and radio transmission was obtained.

The new "Explorer III" gondola consists of a seven-foot shell of laminated glass fibers and plastic. Aside from the escape hatch it has three small ports through which the earth and sky may be observed. Complete with crew and stripped-down equipment, it will weigh between 1200 and 1300 pounds. Carrying this weight, the calculated ceiling of the balloon will be somewhere between 85,000 and 90,000 feet.

A few recording instruments will be carried, as well as a radio transmitter and trailing antenna. A large supply of liquid oxygen plus a converter for changing it into gas at the proper rate will provide both the pressure and oxygen required by the two occupants of the gondola. Chemicals will absorb the moisture and carbon dioxide that the men exhale.

The ascents are to be made under one of the huge polyethylene-plastic balloons with which the Air Force has been conducting upper-air studies for several years. Instruments and even small animals have been carried aloft, some to 120,000 feet and for as long as a day and a half.

These flights helped pave the way for the

forthcoming balloon jumps. They proved that some of the hazards of the upper air are not as dangerous as had been supposed.

Primary cosmic radiation, for instance, is no longer regarded as a big threat to health. Once it was thought that these high-speed particles might destroy nerve cells, damage the skin and cause eye cataracts and loss of hair.

Only one adverse result has been reported: Black rats that have been sent aloft are found later to have a sprinkling of white hairs in their pelts. Presumably cosmic rays caused damage to the pigment cells of hair follicles.

The conclusion is that a spaceman has little to fear from cosmic radiation aside from the chance that some of his hair will turn white.

The balloon jumps will answer some but not all of the problems in getting a man safely back to earth. They will be made from a vehicle that is drifting at slow speed. What about a pilot who has to leave a high-flying airplane that is traveling at, say, Mach 2 or 3? Even at 125,000 feet the ram temperature at Mach 2 is a couple of hundred degrees. At Mach 3 it is about 600 degrees. One of the next steps in space research will be to find a way of cooling the pilot if he has to eject at high speed and high altitude. ★ ★ ★

Here's that new MAGNA JIGSAW

This big-capacity Magna Jigsaw has all the built-in features and precision you'd expect from the makers of SHOPSMITH®.

* Exclusive *Twin-Tube Mount* for bench, Magna Power Stand, or SHOPSMITH. Time-saving *Instan-Tension* gives you convenient belt and tool height adjustment.

PLUS:

- 1 Full 18" throat
- 2 Ball-bearing shaft
- 3 Quick blade tension
- 4 Chucks index 90 degrees
- 5 Swing-down arm for saber sawing

Only \$49.95. Low monthly payments on Magna-Tool-Time-Plan. See the new Magna Jigsaw demonstrated at leading hardware and department stores or any Montgomery Ward store.

For free literature write Department 327-B, Magna Power Tool Corp., Box 2808, Fort Wayne, Indiana, or Menlo Park, California.

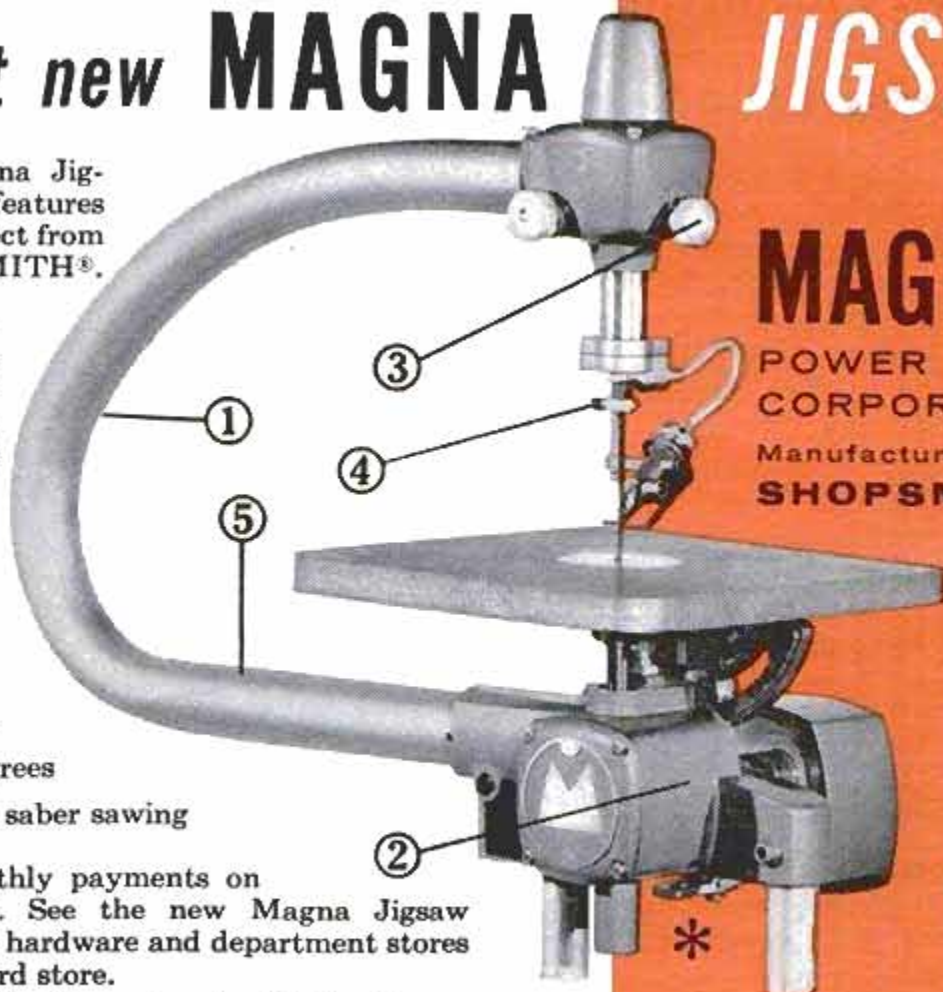

MAGNA
POWER TOOL
CORPORATION
Manufacturers of
SHOPSMITH



NOW IT'S EASY TO HAVE Beautiful Oak Floors

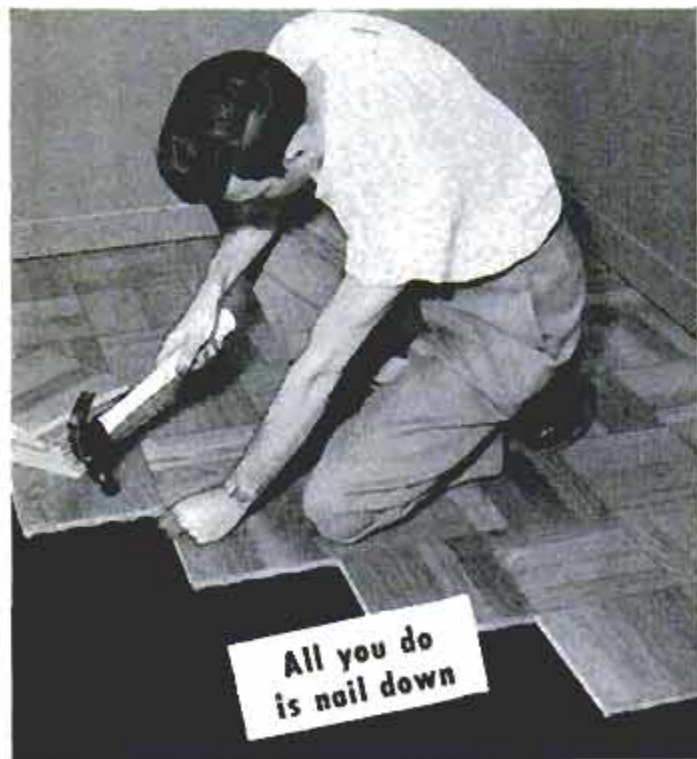

Bruce Prefinished Flooring

IS ALREADY SANDED AND FINISHED

- Lay right over your old floors . . . ready for use immediately without sanding or finishing
- Ideal for attic rooms and additions, too . . . install over wood subfloor or concrete slab
- Finish is baked in the wood for beauty and easy upkeep . . . won't scratch, chip or mar
- Select from four distinctive styles . . . Block, Ranch Plank, Fireside Plank and Strip
- Economical . . . Bruce Prefinished Floor costs less than a good rug or carpet
- Ask your lumber dealer for a cost estimate . . . mail coupon below for color literature

SEND FOR COLOR FOLDER



E. L. Bruce Co.
Box 397-G, Memphis 1, Tenn.
Send complete information on Bruce
Prefinished Oak Floors

Name _____

Address _____

Bruce PREFINISHED Oak Floors

By the world's largest hardwood flooring maker

curves. Easing through drift at eight knots, and dead slow in solid pack, the train of ships snakes gently along.

When a freighter gets caught in the ice on too sharp a curve, it's something to watch. The ship backwaters furiously. The whole convoy halts while the breaker backs down on the bow of the stuck ship, slowly grinding ice in front of it with stern weight and screws. The ice on either side of the jammed bow is cracked up the same way. Then with a mighty surge the breaker moves forward at full speed so the propeller wash will clear the channel of heaving cakes.

Slowly the stuck ship moves into the breaker's wake and the show is back on the road.

In really bad ice, the *Glacier* may run out a tow cable and winch a following ship up close until she's snubbed into a V-shaped groove on the fantail. Then the two move through the pack ice with coordination of engine and tender. The *Glacier's* big tow already has had a workout. She hauled a tiny oil barge carrying 225,000 gallons of aviation gas 7000 miles across the Pacific at the end of a quarter-mile cable. It was the longest distance any ship known to the Navy ever was towed. The winch was exercised by hauling in a baby tanker for resupply when the weather was good.

In rough seas the provisions went back by highline. When the seas reached 20 feet at Thanksgiving, the turkeys were life jacketed and floated back on a line. Four times during the voyage cable moorings snapped, and the barge kited all over the sea before she was retrieved. But, to the crews' relief, both vessels made the long journey intact.

For all its hazards, icebreaker duty is considered enviable by crewmen. Four thousand of them applied to fill 300 berths on the *Glacier* before she departed Norfolk last November. What's lost in skin on the heaving decks is gained in recreation, camaraderie, beard contests and far-famed chow. The crew's chow on the *Glacier* is prepared by a man who was chef on the presidential yacht *Williamsburg* and who cooked for leaders at the Potsdam Conference. The ice jockeys earn and look forward to good refueling. And the men know the rich value of the experiences they live at the bottom of the world. They know if Operation Deepfreeze succeeds in establishing the base it plans right on top of the South Pole, it will be the icebreakers and their rugged crews who made it possible for men, materials and machines to plunge through icy barriers and get to the jump-off place. ★ ★ ★

For your Ford—always specify the muffler with the

TWIN SKINS!



Peter de Paolo, former Indianapolis Speedway winner and now president of his own engineering research firm, recommends Genuine Ford Parts—the parts that are made *right* for your Ford.

“It’s just good sense to insist on Genuine Ford Mufflers!” says Peter de Paolo. “They’re double-wrapped with two layers of 26-gauge steel to give you greater quiet and longer muffler life.”

Genuine Ford Parts are made right to fit right to last longer!

You know you’re doing right by your Ford when you tell your serviceman you want Genuine Ford Parts. Every one is made to the exact specifications set by the men who first built your Ford. All Genuine Ford Parts must pass rigorous and exacting tests before being approved for manufacture.

When a new muffler or other replacement will add to your Ford’s performance, always specify Genuine Ford Parts!



Keep your Ford all Ford

FREE →

SEND FOR THE
WORLD'S MOST
COMPLETE
ELECTRONIC
BUYING GUIDE



1956 ALLIED ELECTRONIC SUPPLY CATALOG

Save on Everything in TV and
Radio Parts & Equipment

324 value-packed pages

World's Largest Stocks...
Everything for Experimenters,
Builders, Amateurs, Servicemen,
Engineers & Hi-Fi Experts...

Send for ALLIED'S value-packed 324-page guide to everything in TV, Radio and Electronics! See the newest High Fidelity music systems and components; recording and phono equipment; TV tubes, antennas and accessories; Amateur station equipment; P.A. systems; test instruments; latest build-your-own kits; industrial electronic supplies—plus the world's largest stocks of electronic parts, tubes, transistors, tools and books. Get more for your money—send today for your FREE 1956 ALLIED Catalog!

Everything in Electronics
From One Reliable Source

send for
FREE
CATALOG

ALLIED RADIO

ALLIED RADIO CORP., Dept. 5-CC-6
100 N. Western Ave., Chicago 80, Ill.

Rush FREE 1956 ALLIED 324-Page Catalog

Name _____

Address _____

City _____ Zone _____ State _____

USE LUBRIPLATE
ON CATCHES AND HINGES
TO CHASE THE SQUEAKS
THE GREASEMAN MISSES



TRY LUBRIPLATE! It's a new, white and clean, semi-fluid lubricant that stays put. Stops squeaks, prevents rust and corrosion. Works wonders on your car and around your home.

• In handy 25¢, 50¢ and \$1.00 tubes at Sporting Goods, Hardware, Marine and Auto Supply Stores.

• Dealers write to LUBRIPLATE DIVISION, Fiske Bros. Refining Co., Newark 5, N.J.

LUBRIPLATE
THE MODERN LUBRICANT

VARIABLE SPEED HYDRAULIC POWER TRANSMISSION



It has Infinite Speeds 0 to 550, Reverse, Automatic Overload Protection; Adjustable Torque up to 180 inch pounds. 5/8" Input and Output Shafts. It will handle 1/4 to 1 1/2 H.P. Motor. Case measures 7 1/2" long, 7" high, 6 1/2" wide. VALUE OVER \$300. Shipping Wt. 25#. On C.O.D. Orders we require a 10% only \$54.50 Deposit. Feb. Chicago

DIRZIUS MACHINE SHOP "L" 1423-25 So. 52nd Ave., Cicero 50, Ill.

Works in seconds!



Loosens Rusted Bolts
nuts, screws, "frozen" parts!

LIQUID WRENCH

AT HARDWARE STORES, GARAGES
SERVICE STATIONS EVERYWHERE

For information write manufacturer
Radiator Specialty Co., Charlotte, N. C.

MAGNETS

5 Assorted Size Magnets \$1.00. Powerful Pocket Magnet W/case \$1.00. Hot Pad Magnets—large size 8/\$1.00. Bulletin Board Magnets 8/\$1.00. Slender Magnets—pencil size 2/\$1.00. Car Compass—accurate, useful \$1.50. Retrieving Magnets—extra power, heavy duty—30 lb. pull \$4.00, also 50-75-100 lb. pull.

Explore, learn Electricity, Magnetism, Electro magnets, complete kit and instructions with 22 experiments and models... \$3.95

Also—Rods, discs, bars, horseshoes. Send stamp for catalog—Specify your requirements—100% SATISFACTION GUARANTEED.

PARK MAGNETS, 263, 1557 GREENBAY RD., HIGHLAND PARK, ILL.

HARGRAVE CLAMPS

A Complete Line for All Purposes

Hargrave Industrial Type Clamps are ideal for the home workshop. Economical—sturdy to give you a life-time of service. Made in openings from 3/4" to 12" and depths from 1/2" to 16".

WRITE FOR FREE CATALOG No. 116 Showing Clamps, Chisels, Punches, Masonry Drills for hand and power hammers, Carbide Drills, Washer Cutters, etc.

On sale at all leading Hardware Stores

THE CINCINNATI TOOL CO.

1987 Waverly Ave., Cincinnati 12, Ohio



ROCKWELL-BUILT

DELTA

power tools

NOW as little as **10%** down • up to **24** months to pay



Now you can own the finest power tools in America—real DELTA Quality Power Tools—on terms designed for you!

SO EASY! Easy on your *pocketbook*—as little as 10% down! Easy on your *budget*—up to 24 months to pay! And on terms that suit you!

SO FAST! No waiting. Just choose the tools you want, arrange the terms—and you get *immediate* delivery!

WHY WAIT? Start, add to, or complete your workshop *now!* The easy Delta Budget Plan is available at all Delta Dealers' (under "TOOLS" in the yellow pages), and leading hardware stores. Send the coupon for free catalog.

Send the Coupon for Catalog—TODAY!



DELTA QUALITY POWER TOOLS

Another Product by **Rockwell**



DELTA QUALITY COSTS NO MORE

Delta Power Tool Division
Rockwell Manufacturing Co.
502C N. Lexington Avenue, Pittsburgh 8, Pa.

- Please send name of my nearest Delta Dealer.
- Please send me Delta Industrial Catalog.
- Please send me Delta Homecraft Catalog.

Name _____

Address _____

City _____ County _____ State _____

NEW!

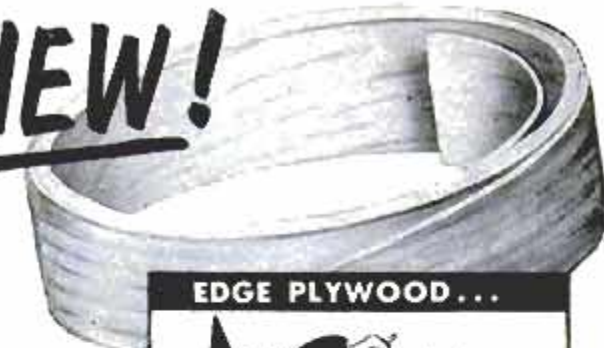

EDGE PLYWOOD ...



DECORATE THINGS ...



with new Flexible Weldwood® Wood-Trim®

No more exposed edges when you make things of plywood—things like tables, desks, cabinets or other projects. Wood-Trim covers the edge with real wood veneer... gives a real "pro" finish. Apply it in minutes—without clamping, ironing, sawing, nailing, using Weldwood Contact Cement or Weldwood Presto-Set Glue.

And you'll invent countless decorative uses for Wood-Trim, too! For instance, you'll trim lamp shades and picture frames with Wood-Trim, decorate coffee tables, clocks, waste baskets, etc.

At hardware, paint and lumber dealers or write for free leaflet. Dept. PM 3-6WT

Box 525, UNITED STATES PLYWOOD CORP., N.Y. 46

8 Ft. rolls 1" wide, 79¢ each. Oak, African Mahogany, Walnut, Birch or Fir.



Another Weldwood Wizard

NOW YOU CAN REVERSE YOUR LATHE INSTANTLY



Make your workshop lathe operate like a factory model. With this Gayston IR drum switch connected to your lathe, you can stop it or reverse it instantly, positively without coasting. Do thread chasing or cut up to a shoulder under complete control. Works on all makes of lathes and workshop tools where reversing is desired.

\$845

POST PAID Order today. Send check or money order. Money back guarantee.

GAYSTON CORP. • 1225 RAY ST. • DAYTON, OHIO

NAME _____
 ADDRESS _____
 CITY _____ STATE _____
 MAKE OF MOTOR _____

16 PC. DRUM SANDER KIT

Contains 4 Drum Sanders: 1/4", 3/8", 1/2", 3/4". Comes with 12 bands in assorted grits. Each drum sander mounted on 1/2" Arbor. \$3.50 value.

Our Price \$195 pp.



21 LARGE ROTARY CUTTERS

Assorted sizes—mounted on 1/2" and 3/32" shanks. For cutting Wood, Plastics and metals. Will fit all hand grinders, Electric Drills and Flexible Shafts. Reg. \$12.50 value

Our Price \$495 pp.



CAMEL HAIR BRUSHES! 20 FOR \$1.00

Imagine! New Camel Hair Brushes that cost many times this low price. You actually buy these brushes at less than manufacturing cost. For the home, office, shop or store. For touch-up, pasting, drawing, lens cleaner, typewriter cleaner, cleaning precision instruments, guns, tools, sporting equipment, hundreds of other uses. Assorted sizes: 20 brushes, \$1.00. 42 brushes \$2.00 plus 10¢ PP

ADJUSTABLE TAPERED DRILL \$1.98

Now! Drill the proper size and length hole, countersink, counterbore all in one operation... plus-shaft adjusts for different lengths of screw. Eliminates three operations, does a better job. Screws hold tight all joints. Easy to use, adjust shaft to screw length and drill right down to collar. For wood, plastic, or fiber. Each adjustable drill does work of 8. If 5 lengths of countersinks and 3 lengths of counterbores were to be bought separately total cost would be \$11.25. Screw sizes No. 6, 8, 10 and 12. State size wanted. Only \$1.98 each size, or set of 4 to fit all screws, \$6.95.



18 MOUNTED WHEELS only \$1.98

Assorted sizes and shapes, ALL WITH 1/8" SHANKS. For Grinding, Buffing, Cleaning, Deburring, Sharpening, Polishing, Sawing, Carving, Forming, Shaping, etc. These precision tools permit delicate operation on plastics, wood and metals. Easy access to hard-to-reach places. All 18 assorted wheels only \$1.98 Postage Paid. Regularly \$9.00.

Money Back Guarantee DEPT. PM-3
MATTHEW DAY CO., INC. DUMONT, NEW JERSEY

SHOOT "BAZOOK" HI-POWER SLING GUN!!

TOPS FOR HUNTING AND TARGET FUN

SHOOTS EVERYTHING — Arrows, nails, steel balls, pebbles, mud, etc.



PATENTED PISTOL ACCURATE, RIFLE FAST. SAFE INDOOR with soft clay balls. POWER-FUL gum rubber sling. GUARANTEED. Quick delivery. Extra rubber and ammo. included.

1350 - 1/2" sl. balls \$1) ORDER NOW! MACO MFG. CO., P.O. Box 4133-Z, LONG BEACH, CALIF.

Exclusive Double-Bearing HEAVY-DUTY PUMPS

IRRIGATE • DRAIN • CIRCULATE • SPRAY
 Up to 7,500 GPH, 3,000 GPH from 25' well. Use 1/4 to 1 HP motor. 1 1/4" inlet; 1" outlet. Stainless shaft. TYPE X-2 oilless bronze bearings. \$10.95

TYPE X8—Ball bearing model..... \$12.95
 Postpaid if cash with order. Rush your order today

MONEY BACK GUARANTEE
 Centrifugal and Gear Pumps in All Sizes

LABAWCO PUMPS, Belle Mead 2, N. J.

BUILD YOUR OWN ARC WELDER

35 to 110 amps. A. C.
 20 Different Heats

BUILD LOW COST WELDER the easy, quick, method used by over 100,000 LeJay customers. Save money on own repairs and welding for others. PLANS 35c includes free Electrical Information pamphlet and wholesale catalog. Send today.

LEJAY MFG. CO., 1947 LEJAY BLDG., MINNEAPOLIS, MINN.

AGENTS — SELL

TOOLS! GUNS! CAMERAS!

Buy tools, photo equipment, sporting goods, jewelry and thousand other nationally advertised products at big discounts. Big profits selling to others. Postcard brings free plan.



AMERICAN BUYERS SERVICE HERTEL STATION, DEPT. 18
 BUFFALO 16, NEW YORK

AUTOMATIC

MAKES NEW PROFITS

RETOOTHER

for HAND SAWS

Cuts new teeth in 30 seconds — any size 1 to 16 points. Old teeth fall off as chips. Easy to operate. A perfect job.

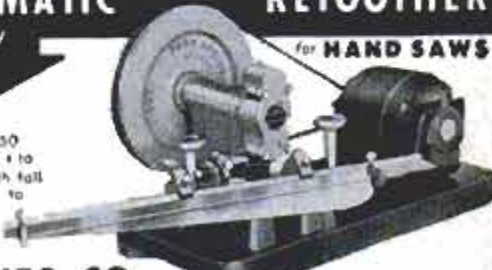

BURR MFG. CO.

8933-W VENICE BLVD. LOS ANGELES 34, CALIFORNIA



At Last!
The NEW
RECLAIMO

A Wm. Schwalge Product

ELECTRICALLY HEATED
(Automatic Control)

Oil RE-REFINING Filter

For CARS—TRUCKS—TRACTORS

It's HERE! After many years in development—NEW Electrically Heated RECLAIMO—fully tested and GUARANTEED—the most efficient motor oil filter available. Filters and RE-REFINES OIL as you drive (by utilizing electric heat). Keeps oil at peak lubricating quality at all times. Proves beyond question U.S. Bureau of Standards (Bul 86) statement "Oil Does Not Wear Out Mechanically."

New RECLAIMO

Eliminates All Needless Oil Changes!

REMOVES SOLIDS by filtration—REMOVES WATER by evaporation—PREVENTS excess fuel dilution—PREVENTS acid and sludge formation—MAINTAINS stable viscosity.

NEW FEATURES: #1. Electrically heated from generator. #2. Thermostatic control prevents overheating. #3. Dual Flow permits oil by-pass when filter is clogged. #4. New non-corrosive steel body; built to last a lifetime. #5. Adjustable hinged mounting bracket, simplifies installation or transfer to other equipment.



Write at once for illustrated folder and SIX MONTHS NO-RISK TRIAL OFFER. Latest edition "Oil Facts", now in preparation, will be sent FREE later.

DEALERS WANTED
RECLAIMO CO.,

6251 TOUHY AVE., DEPT. M-36, CHICAGO 30, ILL.
Old diecast aluminum, exhaust-heated "Reclaimos" (new or used) accepted for "trade-in" allowance on the new model. Details on request.

OLD MODEL
Discontinued.
OBSOLETE

WM. SCHWALGE
Inventor of
"RECLAIMO,"
Author of the
famous booklet
"Oil Facts."
Pioneer in
oil reclamation
since 1910.
MEMBER:
Chicago Academy
of Sciences.
Microscopic
Society of Ill.
Chicago Automobile
Trade Ass'n.

ACT NOW! SAVE \$10

on this

Cummins.

**MAXAW and SAW TABLE
COMBINATION**

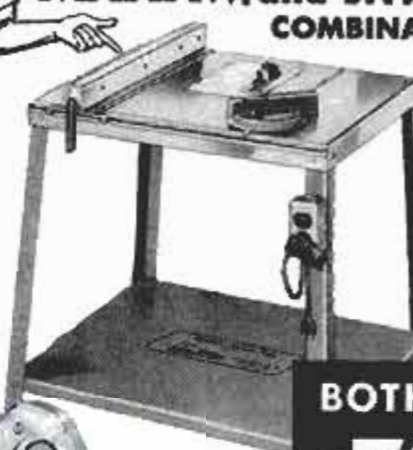

- New
Cam Lock
Rip Fence
-
- Precision
Miter Gauge
-
- Built-in
Off-On
Switch

**BOTH FOR
\$79.90**

Regular Price
\$89.90

Slightly higher in Canada

**MAKES ALL CUTS
IN 2" DRESSED LUMBER**

BIG BONUS BUY FOR THE DO-IT GUY

A saw table one minute, a portable saw the next! Both for what you'd expect to pay for the saw alone. Now! Get real professional results on all building and home improvement jobs. \$49.95 MAXAW plus \$39.95 saw table at special \$10.00 savings. Act now! Offer expires June 30, 1956.



Saw shoe slips flush into table in seconds.



Same cutting capacity as 8-in. Table Saw.



True-Course Guide* automatically guides saw, prevents woodbind. *Patent Applied For



Rip Fence Guide FREE. Regular \$2 value.

MAXAW 777 SAW TABLE
Rugged, all-steel; oversize top, 24" x 20". 34" height. New Cam Lock rip fence and 7" calibrated miter gauge operate from either side of saw blade.

MAXAW 717 POWER SAW
Famous magic pivot gives MAXAW deeper cuts—1 1/2" at 45°, 2 1/2" at 90°—with 6 1/2" blade. Hardened steel gears: snap-back telescope guard. Lighter, easier to handle.

In Canada: 334 Lauder Ave., Toronto 10, Ontario

COPYRIGHT 1956 J. O. M. C.

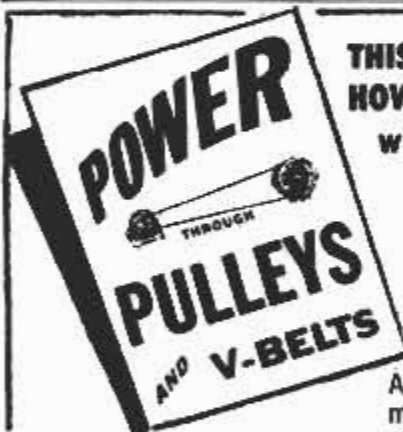

**THIS BOOK TELLS YOU
HOW TO MAKE THINGS
with PULLEYS and
V-BELTS**

- HOME APPLIANCES
- POWER TOOLS
- MOTORIZED TOYS

**"MAKE IT YOURSELF"
CONTEST**

A \$50 prize every month—duplicate prize for your dealer. A grand \$100 prize every six (6) months. Get the details from your dealer or write direct.

A "must" for every home mechanic—this book is full of facts and figures on how to use pulleys for power.

You can make many useful things with pulleys and v-belts, a few gadgets and a spare motor or engine. Order your book today and start a useful project.

Win yourself a \$50 Savings Bond and make a useful tool or toy.

**SEE YOUR
DEALER
OR
SEND THIS
COUPON
TODAY**

CONGRESS DRIVES DIVISION
TANN CORPORATION
3750 E. Outer Drive, Detroit 34, Mich.

Gentlemen:

Enclosed is 25c—please send me the book "POWER Through PULLEYS and V-BELTS"—also contest entry form.

Name _____

Address _____

City _____

Get
FREE
Power
Tools
Book

John Oster

MANUFACTURING CO.
Dept. CP2, 5055 N. Lydell
Milwaukee 17, Wis.

Please send full-color booklet showing 64 ways to use power tools.

Name _____

Address _____

City _____ State _____

AT LAST! Make Floors, Patios, Driveways and Walks Look Different — use ROX

TESTED FOR YEARS

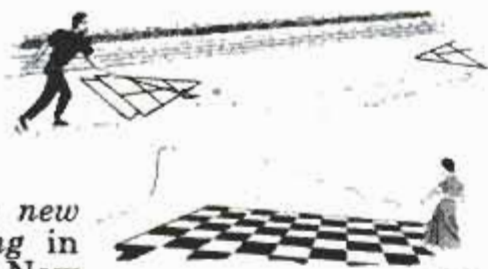

Something new and exciting in decorating! Now

Rox shows you how to design a shuffleboard, a hopscotch block and many other interesting or decorative patterns for porches, basement floors, driveways and patios. Or, if you are tiling your floor, seal out moisture with Rox first. And remember . . . Rox is guaranteed not to blister or peel!

Beautiful, Durable Exteriors with ROX

Masonry walls absorb tons of water—this water, if not kept out, can deteriorate masonry. Rox becomes part of the masonry surface itself as it seals this surface and protects against water even in gale driven rains. Rox adds distinctive exterior beauty.



Guaranteed Protection Against Water Leakage!

Rox guarantees to protect your basement against water leakage. Convert



it to a usable recreation room or workshop where tools are safe from moisture with Rox.

Helpful Booklet

Illustrated in color to help you apply that professional decorator touch as you protect and beautify your basement and masonry surfaces. Diagrams and explanations to make shuffleboard and other games or decorative designs on floors, patios, driveways, walks, etc., and give new interest to masonry walls. Send 15c for handling. Available in 5 colors and white at authorized Rox dealers in U. S. and Canada or write Rox Products Co., Dept. M3, Detroit 27, Michigan.

© ROX PRODUCTS CO.



MODERN

LAWN MOWER SHARPENER

COMPARE BEFORE YOU BUY



Write for free booklet 10E

Start your own business—increase your income

Oil remains in engine while sharpening. Bed knife sharpened in same centers — no attachments needed.

Sharpens any mower in ten to twenty minutes. Handles complete assembly of all reel types including 36 in. power mowers. Handle, wheels, roller, and engine are not removed.

\$26300

MODERN MFG. CO.

F.O.B. PASADENA

160 N. FAIR OAKS, PASADENA, CALIF.

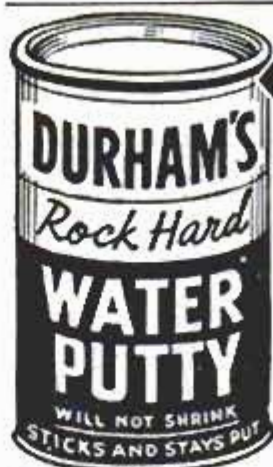

The Modern PLASTIC for lasting Home Repairs

PERMANENTLY mends cracks or holes in wood, tile, stone or plaster. Sticks and stays put—Does not chip, shrink or fall out. Easy to use. Economical. Mold it, chisel it, polish or paint it. The big 4-lb. can is obtainable from your lumber, paint or hardware dealer at \$1.25; or will be shipped direct postpaid (in U. S.) for \$1.50. Complete satisfaction guaranteed or your money refunded.

DONALD DURHAM CO.

Box 804-T Des Moines, Iowa

MOWERS

STOP "JERKY" STARTS! with an AUTOMATIC CLUTCH

TRACTORS

1956 Models have increased H.P. capacity. Improved design adds new belt grip under load and decreases creep at idling speed. NEW Prevent stalling engine, cut belt wear, gain LOW no-load idling. Quickly installed on 1/2, 3/4, 1 and 1 1/2" shafts. See your small engine dir. \$595 and up

SCOOTERS

ELEVATORS

V-PLEX CLUTCH • Hagerstown, Indiana



DO IT YOURSELF

It's Easy With ...



Soldering's really a "cinch" . . . when you use time-tested, reliable KESTER . . . available everywhere.

FREE! "Soldering Simplified" . . . 16-page how-to-solder booklet. At your dealer or write direct.

KESTER SOLDER COMPANY

4251 Wrightwood Avenue Chicago 39, Illinois

Before you buy...try the

"feather touch"

ball-bearing
rip-fence

on the

Yates-American Saw-Jointer-Sander Combination



\$274⁵⁰

complete with $\frac{3}{4}$ -hp,
totally enclosed, dust-proof
motor that runs everything

(Less saw-guard and table extensions)

It's just one of many revolutionary improvements in design that you get in this new Yates-American Saw-Jointer-Sander Combination.

There's nothing else like the Yates-American — absolutely nothing! It's an entirely different combination of the three woodworking power tools you use most often.

Only the Yates-American gives you the extra safety of "see-saw" operation . . . the extra convenience of instant changeover . . . the extra usefulness of a power take-off.

You've got to see it, to believe it! Stop in to see your Yates-American dealer today.



Free!

Illustrated catalog
and interesting
booklet, "Short Talks
on Wood." Send
coupon for your copies.

Yates-American

Dept. C, 781 North Fourth Street, Beloit, Wisconsin

PT-7

Send me catalog on Saw-Jointer-Sander Combination and free booklet, "Short Talks on Wood."

Name

Address

City Zone State

NEW CHILDERS DO-IT-YOURSELF CARPORT

DO-IT-YOURSELF

Patent Pending



The modern way to protect your car and beautify your home

"We installed ours in four hours... saved \$95,"

says Mr. Joseph Saladino, Houston, Texas.



The Saladinos' problem was more living space. So—they installed a new Childers Do-It-Yourself Carport for the family car, and converted their garage into a third bedroom. You save twice with the new Childers Carport. First, you deal directly with your local Childers factory outlet. Second, it's so simple and easy to erect the Childers Carport yourself. You can erect it in one afternoon! The new Childers Carport is America's most modern design. Architecturally approved, its beautiful, trim lines harmonize with any style home. It increases the value of your property. Precision-made from zinc-plated steel, it will last as long as your home.

New, modern car protection • Save up to \$95 • Erect in one afternoon • Full size, 20' x 10' • Pay nothing down • Only \$1.93 a week • Free standing or attached



CHILDERS ALUMINUM AWNINGS GUARANTEED TO SAVE YOU 30%



Berkley



Windsor



Casement Awning



Door Canopy

We guarantee your cost of Childers Aluminum Awnings will be at least 30% less than your neighbor paid last year for his old fashioned, custom-made awnings. You save 30% or more because:

1. You get factory prices from your direct factory outlet.
2. You install Childers Aluminum Awnings yourself with just screw driver and pliers. Saves installation charges.
3. Childers Awnings are mass produced in the world's largest aluminum awning factory. Costly hand assembly is eliminated.

Your local Childers factory outlet can supply the correct size Childers Awning to fit any window, door or porch—at direct factory prices.

FREE IDEA FOLDER

Childers Manufacturing Co., Dept. P-1
3620 W. 11th St., Houston 8, Texas

Send me free literature on the Childers guaranteed products checked below; also name of my local Childers factory outlet.

Childers Carport Childers Aluminum Awnings
Childers Patio Cover

Name _____

Address _____

City _____ Zone _____ State _____

WORLD'S LARGEST ALUMINUM AWNING FACTORY

CHILDERS
GUARANTEED
Products

DO MORE PLANING JOBS WITH LOW COST BELSAW

Exclusive MONEY-MAKING features:



- Full 12 1/4 in. x 6 in. capacity
- Power feeds at 24 ft. a minute. (Easily adjusted for lower feed rate)
- Machined cast iron bed; adjustable rolls, total bed length 42 in.
- Provides for Grinding Knives in the Cutterhead.
- Attachments for Jointing, Rabbeting, Tongue, Groove, Matching.

Belsaw Multi-Duty Planer for cabinet shops, builders, lumber yards, woodworking plants and spare time work shops... Now you can convert low cost rough and random size lumber into high priced cabinet finished stock... Easy to make flooring and popular patterns. Belsaw quickly returns cost with savings on raw material... profits on finished stock.

Send Today for FREE literature on Belsaw, the LOW COST, high speed production planer.

BELSAW MACHINERY CO

2056 Field Bldg

Kansas City 11, Missouri

LOW DOWN
PAYMENT
EASY
TERMS

I CAN SAVE YOU 94%!

REAL LOW PRICES

Send for NEW 1956 Illustrated BOOK of BIG WAR SURPLUS BARGAINS for mechanics, farmers, gadgeteers.



AIRCRAFT STARTERS

Makes excellent wrench for lifting, wagon unloaders, pulling stumps, stretching fence or moving heavy objects—1001 uses at home, farm or factory. Operates on 6 to 32 volts or manually. Built-in reduction gear (300 to 1) and clutch. High torque, low speed. Mfg. by Bendix at many times this price.



F.O.B. York (wght. 42 lbs.)
only \$14.89

WAR SURPLUS BARGAIN BOOK FREE!

Make your own conversion
K. ORT, Dept. PM3, York, Pa.

FREE CATALOG STEEL

STEEL • BRASS • ALUMINUM and ALLOYS
ANGLES, CHANNELS, TEES, "1" x 5. FLATS, ROUNDS, SQUARES, & SHAFTING. ALSO BEARINGS, GEARS, PULLEYS, SPROCKETS, ROLLER & WELDED LINK CHAIN, BOLTS FROM 1/8" TO 2" DIA. PIPE FROM 2 1/2" TO 24" DIA., STEEL CABLE. GET YOUR FREE CATALOG NOW!

EVERY DIMENSION ANY QUANTITY AVCO - 879 Broadway, Cleveland 15, O.



BRONZE FOUNDRY

Schools and Home Workshops

Make your own castings of aluminum, copper, bronze, silver. Foundry sets are available in three sizes including 2400 Deg. F. blast Furnaces. \$22.50; \$29.50; and \$42.00. f.o.b. Marysville, Kans. Free Circular.

KANSAS CITY SPECIALTIES CO. P. O. Box 6022, Dept. P-3 MARYSVILLE, KANS.

FUN-WORK YARD TRACTOR WHEEL-HORSE RIDE-AWAY



Designed to turn work into FUN! ... do a dozen back-breaking jobs in a jiffy. Yard-size tractor with 5 forward speeds and 1 reverse. 2 1/2 hp (or 3 1/2 hp) engine mounted on heavy channel steel chassis. Mow a 5-foot swath at 5 mph ... plow snow ... cultivate ... pull any of 22 attaching tools for yard and garden. Write for complete details, and name of nearest dealer.

SENSATIONALLY \$29950 PRICED AT

WHEEL-HORSE PRODUCTS COMPANY

2643-K Dixie Way North

South Bend, Indiana

Amazing Tyler
SPYRAL BLADE

A MUST for every Workshop!



SAWS ANY MATERIAL
metal, wood, plastics etc.
... IN ANY DIRECTION
up or down, right or left, even in circles!

Does what no other Blade can Do.
Fits Standard Coping Saw or Hacksaw Frames.
NO special adapters needed! • World's safest saw blade.

You'll find hundreds of uses for Tyler Spyral Blades. There's nothing like them! The first important improvement in blades since the invention of the saw. Fun to use...cuts so fast and easy; no chipping or tearing—leaves clean smooth edge.

At your Hardware dealer or send **\$1.00** for package of 12 Spyral Coping Saw Blades or 3 Spyral Hacksaw Blades.

TYLER MANUFACTURING COMPANY
1005 W. Arbor Vitae Ave., Inglewood, Calif.

SUPER-LIGHT LEVEL HAS MAGNIFIED VIALS!



EMPIRE ACRA-LITE No. 1521

A craftsman's dream! Acra-Lite Magnesium Level is ONE THIRD Lighter — for easier, faster handling. Easier to read, too. Super-accurate vials have "Full-View" magnifying cover plates. Get YOURS today — at your dealer, or order direct.

New Empire Acra-Lite Magnesium Level No. 1521,
24" Only 28" 48"
\$6.70 \$7.60 \$13.50

EMPIRE LEVEL MFG. CO.
10930 W. POTTER RD., DEPT. PM, MILWAUKEE 13, WIS.

WELD BRAZE SOLDER CUT

4WAY

ONLY \$14.75
f.o.b. factory

WELDER

Complete with Twin Carbon Arc Torch and accessories... to handle all metal-craft work.

Acclaimed by thousands of Homeowners, Mechanics and Hobbyists as the welder of 1001 uses. Easily operated from properly wired 110 volt AC or DC line. The ideal gift with a life-long use... Order today on 10 day money back guarantee.

FOUR-WAY WELDER CO., Dept. F2-C
1810 S. Federal St. • Chicago 16, Ill.

NEW, AMAZING DEVICE STOPS NOISY, RUNNING TOILETS!



Gives quick, quiet, complete flush every time. Complete unit... nothing else to buy. Cuts water bills. Saves embarrassing noise. Prevents cesspool overflow. Fits all tanks.

INSTALL IT YOURSELF IN 10 MINUTES
Simple directions tell you how to install "Alert" Tank Ball and Guide. Rubber ball on rustproof chain seats perfectly. Operates in plastic guide cylinder. Nothing to get out of order. Over 6,000,000 satisfied users.

Order now—only **\$2.50 ea. ppd.**
Check or money order. Money back guarantee.

DO-IT-YOURSELF PRODUCTS CO., Dept. A
P. O. Box #20, Wayne, Pa.

RED TOP INSULATING WOOL
with the

Silver Shield



NEW

way to cut air conditioning costs!

RED Top wool with the "Silver Shield" (real aluminum foil) can save you big money on air conditioning. Properly installed in ceilings or attic roof rafters, it turns back up to 95% of sun-generated heat rays that hit its surface, because it's wrapped in reflective aluminum. The aluminum is perforated on the outer (breather) side; solid on the inner side to serve as an effective vapor barrier.

Hundreds of dollars can be saved on original central air conditioning equipment, since a smaller unit will do the job. Savings on operating expense during the first year alone often equal one-half the cost of your insulating job. Pre-formed batts and blankets are easy to install; save winter fuel too. For full details see your local building material dealer, or write Dept. PM-2, 300 W. Adams St., Chicago 6, Ill.



UNITED STATES GYPSUM



YOU NEED THIS **QUALITY SAW!**

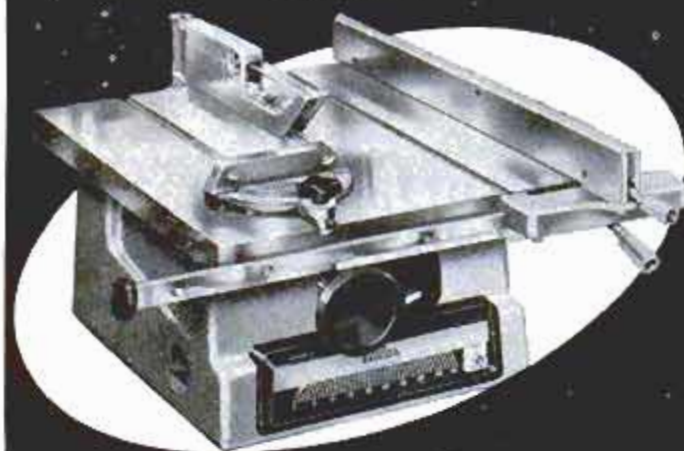

-TO DO QUALITY WOODWORKING

With this ATLAS 8" saw you can crosscut, rip, miter, dado and shape with greater accuracy and smoothness. This great saw, the crowning achievement of 45 years of precision machine tool building, is really solid . . . with massive grey iron table, bigger arbor, balanced tilt mechanism, triangular arbor support, sealed-for-life ball bearings, and many other exclusive features.

Atlas BUILDS A COMPLETE LINE OF WOOD AND METALWORKING TOOLS

ATLAS enjoys a worldwide reputation for quality machine tools . . . wood and metalworking tools that excel in precision and performance. See your nearest franchised ATLAS Dealer.

WRITE FOR **FREE CATALOG**

Atlas 8" TILT/ARBOR BALL BEARING Circular SAW



ADVANCED BOX CONSTRUCTION and TRIANGULAR BOX ARM combine to maintain absolute maximum rigidity. You always cut true regardless of angle of tilt or depth of cut.



NEW BIGGER ARBOR and sealed-for-life ball bearings . . . for smoother performance and longer life.



FAMOUS DOUBLE-LOCKING LIFT-OFF FENCE — a single lever quickly locks or releases both ends . . . lifts off at any position.



NEW PUSH-PULL DUAL CONTROL — one convenient handwheel sets blade height and angle.

STOP SAGGING REARS!



with **LOW-COST**

AIR LIFT PNEUMATIC SPRING BOOSTERS

Car got that "middle age spread" look? Even new cars need help for overloads of luggage, equipment or extra passengers. AIR LIFTS fit between leaf springs and frame — inflate with air to support overloads up to 1000 lbs! Perfect for vacation trips, and so easy to install. See your dealer or write for his name.

Most Models **\$20**



FREE! . . . tip-packed literature on Air Lift remedies for sagging rears. Write Dept. 43.



AIR LIFT COMPANY, LANSING, MICHIGAN

MARLITE-IT-YOURSELF



You can afford beautiful ideas with economical **MARLITE walls**



A few days ago this was an unused porch! But a little imagination and Marlite Plank and Block made the difference. So easy to install you can do it yourself, this beautiful paneling has a tongue and groove joint. Fitting is easy. All fastenings are concealed. And Marlite's soilproof melamine plastic finish cleans with a damp cloth; never needs painting.

NEW! Send 10c for do-it-yourself instructions and full-color folder with over 40 "idea" rooms using Marlite "Companion Colors" and distinctive wood and marble patterns . . . or see your lumber dealer. Marsh Wall Products, Inc., Dept. 342 Dover, Ohio.

Another Quality Product of Masonite® Research

Marlite®
plastic-finished
WALL and CEILING PANELING



Atlas Press Company

Quality Machine Tools Since 1911

ATLAS WOODWORKING POWER TOOLS
ATLAS METALWORKING MACHINE TOOLS
CLAUSING HEAVY DUTY MACHINE TOOLS
3-24 N. PITCHER ST., KALAMAZOO, MICHIGAN

GIGANTIC
SAVE-TO-70%

MAIL SALE

WAR SURPLUS
EXCESS INVENTORY
BANKRUPT STOCK

AIR POWERED TREE TRIMMER

Simply press button. Powerful air cylinder cuts limbs to 3/4" or better. Operates from any small home air compressor. Works on 40-70 lbs. air. 10'. Reg. list. \$69.50. SALE, \$15.37 Ppd.

AIR COMPRESSORS - TANKS, Etc.

Save to 70% on air fittings, tanks, compressors, etc. See our catalog.

- Piston Air Compressor, 150 lb. \$18.91
- Air Pressure Gauge \$1.89
- Auto Pressure Switch for Motor \$4.95
- Professional Paint Spray Gun \$9.95
- Air Kit complete \$39.95

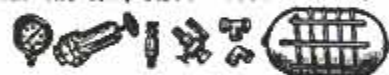

CONTRACTOR-ARCHITECT LEVEL

Excellent highly accurate professional instrument made by leading manufacturer. Ideal for setting foundations, grading, farm contouring, surveying, etc.

- Powerful erecting optical telescope, polished graduated degree scale, sensitive spirit bubble, etc.
- Furnished complete with 8 1/2-ft. 3-sec. rod, fine tripod and polished wood carrying case. Our 4-star buy! Prepaid to you. \$42.95
- Level-Transit. Combination unit suitable for either leveling or lining up. Finest scope, etc. With 9' rod. SPECIAL, Prepaid. . . \$79.50



HYDRAULIC BARGAINS

- Pump, 1000 lbs., 12 g.p.m., 400 r.p.m. \$45.50
 - Cylinder, 3" bore, 24" stroke, 7000 lb. lift. Double Acting \$39.95
 - Cylinder, 2" bore, 10" stroke, 3141 lb. lift. Single Acting \$16.95
 - Control Valve. For single or double acting cylinders. Sale. \$17.98
 - Pressure Gauges, 1000 lb., 1500 lb., 3000 lb. Specify Range. \$3.49
- Many other types, sizes and items. Write for catalog. All Brand New.

6-Volt HYDRAULIC PUMP

- Complete hydraulic system. 6-volt DC motor operates from truck battery. Drives 2,500 lb. per sq. in. pump. Has control valve, etc.
 - Use for dump trucks, snow plows, jacks, lifts, special machinery, etc.
- Leading make. F.O.B. Wt. 48 lbs. List \$121.50. SALE. \$45.95



ARMY POWER PLANTS

- Marvellous buys in new condition Govt. surplus plants and generators. We pay freight!
 - 1000-w, 115-v, 60-c, \$149.50
 - 2000-w, 115-v, 60-c, \$289.50
 - 3000-w, 115-v, 60-c, \$299.50
 - 7500-w, 115-v, 60-c, \$595.00
 - 3000-w, DC generator \$58.75
- Many others. Send for Free Bulletin.



HAND & POWER WINCHES

- Ideal for loading and lifting boats, farm mach., engines. Leading make. Brand New.
- 1500 lb. SALE, Prepaid \$8.95
 - 1500 lb., 2 Speeds. SALE, Prepaid \$19.95
 - 2000 lb., 2 Ratio. SALE, Prepaid \$31.90
 - 1000 lb. Motor Driven. 115-v A-C. Reversible. Gov't. Cost \$495.00. SALE, Prepaid \$69.50
 - 3000 lb. Snatch Block. \$5.99

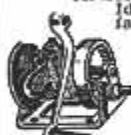

GIANT FLOOD LIGHT

- Amazing 110-Volt unit with intensifier fresnel. Throws wide beam over large area. Wonderful for parking lots, advertising site, small airports, etc.
- Comes in \$30 trunk with extra bulbs, 12 ft. extension tripod, anchors, etc.
- Govt. cost over \$200.
- SALE-Prepaid \$49.50



SPECIALS FROM PREVIOUS ADS

- AC-DC Power Rectifiers (F.O.B.) \$15.61
- Electric Drills, 110 volt (1/2") \$42. \$29.95
- Dual Amplifier (\$295) \$13.51
- Campers Power Plant, 28 volt (8425) \$69.50
- Robot Control Cylinder \$3.89
- Auto Trouble Safety Light \$2.71
- Govt. Steel Tower, 30', F.O.B. Ky. \$31.95
- Automatic Remote Control Switch. \$13.71
- Portable Govt. Air Tank \$15.95

IRRIGATION PUMP

- 2 1/2" size, 16,500 gph
 - Brand new Navy bronze ball bearing hi-capacity centrifugal. Wonderful small farm and truck irrigation, many industrial uses.
 - Capacity to 280 gpm. Pressure to 65'. Speed 2100-2700. Clock-wise rotation. Complete with 6" pulley. Wt. 40 lbs. Size 10"x11"x9". Inlet 2 1/2", outlet 2".
 - Note—2 of these units driven by single engine will deliver almost 600 gpm or 33,000 gph. Natl. Adv. list \$98 each.
 - SALE, Prepaid \$44.37
- Many other types, sizes.



SPECIAL OF THE MONTH!

GOLF CAR BATTERY MOTOR
Govt. Surplus
1300 available
Powerful, brand new, gear reduction, slow-speed battery motor. Runs on ordinary 6, 12 or 24-volt storage battery. 200 to 400 R. P. M.



- Build your own
- Self-propelled golf car
- Warehouse carts
- Store lift trucks
- Electric boat winch
- Boy's midget auto
- Garage door opener
- Motorized invalids wheel chair

Many other private and industrial applications.
Unit consists of powerful direct-current, heavy duty, finest Timken roller bearing motor with built-in precision 18 to 1 gear reduction. Output shaft is 1" diameter. Speed is easily controlled. Exceptionally high torque. Will pull two men in cart at speeds up to seven miles per hour. This expensive unit was designed for a high torque aviation application. It is exceptionally powerful and will last for years. Very efficient. Draws minimum current and batteries require minimum charging. Buy promptly. This is already one of our most popular items. Instructions furnished. Wt. 22 lbs. Gov't. cost over \$200.00. Special F.O.B. Lincoln **\$13.46**

WEED SPRAY OUTFIT

- Leading make. Latest design. 5-row (17'). F. T. O. tractor-drive roller pump. T-jet nozzles, finest controls, gauges, hose. Complete. Only 50 units. List \$175. Ppd. in U.S.A. \$97.65



IRRIGATION PUMP

- Genuine Deming new Navy surplus high head centrifugal heavy duty pump. Useful for farm sprinkler or ditch systems.
- Head pressure 220' (approx. 100 g) at 150 gpm. Heavy double ball bearings, finest seal, dynamically balanced impeller, etc. 2" size. 1 1/2" dia. 1" shaft. 181 g. 16"x15"x27" Natl. Adv. List \$170. SPECIAL, \$79.50 F.O.B.



ORDER FROM AD or write us for big **FREE CATALOG** 1000s of items! Motors, sporting goods, hand and electric tools, watches, tarps, etc., etc. We pay freight except where stated "F.O.B."

BURDEN SALES COMPANY
805 "O" St., LINCOLN, NEBR.

3 Bedrooms
\$5378

2 Bedrooms
\$4610



**SAVE 30% to 40%
BY BUILDING A "LIBERTY" HOME!**

You can save several thousand dollars by building a Liberty Home and, at the same time, own a home of which you will always be proud. Smart-looking on the outside, homey on the inside. Carefully planned for convenience and comfort, with kitchens that are really a "dream."

Build the Economical Way!

Buy direct from our mill at our low factory freight-paid price. We ship you the lumber cut-to-fit, ready to erect. Doors, windows, roofing, paint, glass, hardware, nails, etc., all included

in the price. Plans furnished—also complete building instructions. No wonder our customers write us that we saved them 30% to 40%. Easy terms—monthly payments. Architecturally approved construction. (Not prefabricated.)

HANDSOME BIG CATALOGUE

Pictures wonderful homes in colors at money-saving prices. Designs to suit everyone. Send 25c for catalogue today.



LEWIS MANUFACTURING CO. 1263 Lafayette Bay City, Mich.



"We never believed a fireplace could warm our room so comfortably and evenly"

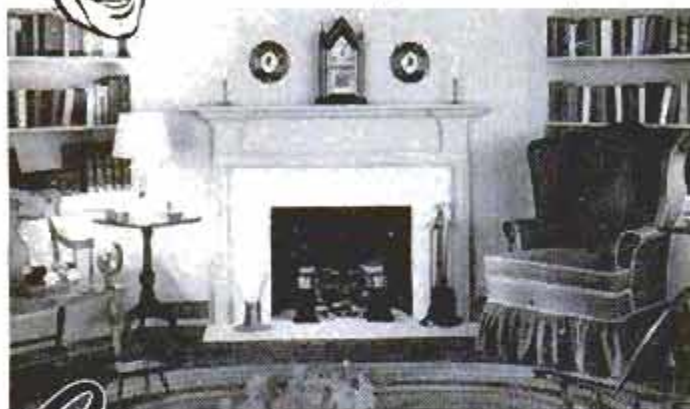

New FIREPLACE

circulates heat, will not smoke, damper seals air-tight!

Build your fireplace around the new Heatilator unit, the only fireplace especially designed for modern homes. It is the fireplace that gives you all 3 of these features.

1. Circulates Heat. Draws cool air from floor level, warms it and circulates it gently to far corners even to adjoining rooms. Provides cozy comfort in cool spring or fall weather or in emergencies.

2. Will Not Smoke. Because the Heatilator unit is a scientifically designed steel form, it does away with guess-work and rule-of-thumb construction. Adds little to the cost of the finished fireplace.

3. Damper Seals Air-Tight. The new Pressure-Seal Damper seals air-tight when the fireplace is not in use. In cold weather it prevents costly house heat from escaping up the chimney—stops cold drafts from blowing into the room. In summer it is an absolute "must" to prevent waste of cooled air in air-conditioned homes.



The All-Purpose Fireplace.

The Heatilator Fireplace is ideal for living rooms, basement rooms, camps or cabins. Be sure you get the genuine. Look for the name on damper handle and dome. At building material dealers. Mail coupon for booklet.

HEATILATOR® FIREPLACE

Heatilator Inc.
443 E. Brighton Ave.
Syracuse 5, N. Y.

Send free booklet on new 3-Star Heatilator Fireplace.



Name.....
Street.....
City..... Zone..... State.....

SAVE UP TO \$20! 8" TILT ARBOR SAW

SOLD ONLY DIRECT FROM
FACTORY TO YOU!



ONLY
\$29.95
Less
Guard

FAMOUS AMERICAN IRONCLAD GUARANTEE — Try any Plana Centric power tool for 10 days. If you are dissatisfied, return for full and complete refund — no questions asked. Guarantee offered on more than 3½ million power tools, and never violated.

Save big money. Buy this fine 8 inch Tilt Arbor Power Saw direct from manufacturer. All cast iron and steel construction. Will last a lifetime; shipping weight 30 lbs. Cross-cuts, rips, bevels, mitres, dadoes, cuts compound angles. Massive cast mitre gauge. Heavy steel base fastens to any workbench. Uses any standard ¼ to ½ H.P. motor. INCLUDED at no extra charge: 8" Simonds Combination Blade that sells for \$4.95. Buy direct and save almost \$20. Send check, M.O., or sent C.O.D.

LOOK AT ALL THESE SPECIAL FEATURES

- Heavy, long lasting cast iron and steel construction
- Precision ground cast iron table with mitre gauge slots on both sides of blade for operating convenience
- Famous patented tilt arbor construction. Blade tilts 0° to 50°; table is always level
- Automatic depth of cut control from 0" to 2¾"
- blade locks in any setting
- Single hand wheel control. Tilts blade and locks at chosen angle
- Saw insert quickly removable for dadoing
- Motor rides on patented ball bearing roller drive
- Self-aligning patented cam action rip fence is always straight. Locks rigidly against table surface.

FREE CATALOG—Write for big bargains in home power tools.

All power tools sent express collect

AMERICAN MACHINE & TOOL CO.
ROYERSFORD 6, PA.

Not an "ACHE in an acre"
gardening with... **Yardster**
ROTARY TILLER

Your handiest tool to save time and work! Interchangeable attachments for mowing lawns, spraying trees, plants... clearing snow from walks, drives.

Ariens Yardster rotary tiller prepares garden without spading... cultivates all season without hoeing! Priced at only \$179.00. Self-propelled with 2-speed wheel drive — merely guide it! With mower, sprayer and sno-thro attachments it's unequalled for construction, looks, performance and price. Ask your dealer for free demonstration.

LOOK! Only \$139.50 for the amazing



Ariens
JR

rotary tiller with "paring knife" tines. See it... and you'll buy it! Visit your dealer or write:

Ariens COMPANY

161 Calumet Street

Brillion, Wisconsin

Be Your Own Boss in the Profitable Excavating Business!

Custom Operators of Sherman Power Diggers Earn Up to \$1,000 and More Per Month

Wherever you live, you'll find plenty of profitable work the whole year 'round for this versatile outfit . . . not just a "trencher" but an all-purpose excavating machine! Custom operators everywhere are making big money with Sherman Power Diggers. One bought a farm with just 3 years' profits! Work for builders, contractors, utilities, and municipalities on such jobs as

- SEPTIC TANKS and DRAINFIELDS
- SEWER LINES
- FUEL TANK INSTALLATIONS
- FOUNDATIONS and FOOTINGS
- GAS and WATER LINES
- FIELD TILLING

and many others. The Sherman Power Digger travels quickly from job to job, digs at a fraction of the cost of manual labor. It's simple to operate, easy to maintain, built to last.

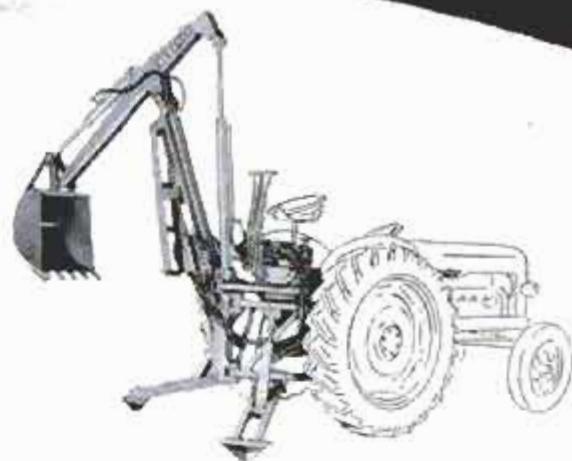

Send now for complete information about the easy-to-get jobs for your Sherman Power Digger. Let us tell you—without obligation—how you can go into business for yourself with an investment of less than \$5000.

SHERMAN PRODUCTS, Inc.
Dept. 1736 Royal Oak, Michigan



OWN YOUR BUSINESS

Start in Spare Time with a FOLEY SAW FILER

Here is a steady repeat CASH business you can start at home in your basement or garage, while you are working at your regular job. No experience is necessary to turn out perfect cutting saws—"the first saw I sharpened came out 100%." I think the Foley Saw Filer is a marvel of perfection," writes Clarence E. Parsons. Every saw you sharpen will bring you new customers. You will find you can make up to \$3 or \$5 an hour—\$20 to \$30 a week in your spare time as a starter. With a Foley Saw Filer you can file all hand saws, also band and cross-cut circular saws. It is easy to operate—simple adjustments—no eyestrain. Patented jointing principle evens up all irregular teeth and makes an old saw cut just like new.

This Free Book Shows How To Start "MONEY MAKING FACTS" shows you how to get plenty of saws to file without canvassing, and how you can develop into a general repair shop that will be your own business. This is a helpful, practical book that tells just what to do—send for your free copy today. No salesman will call.

**FOLEY MFG. CO., 316-6 Foley Bldg.
Minneapolis 18, Minn.**

Send me free book "MONEY MAKING FACTS."

Name _____

Address _____

City _____ State _____



choose your ride



SOFT

MEDIUM

FIRM

This is the only genuine adjustable shock absorber. A twist of the wrist gives the ride you want—for your make of car, your kind of driving. Only Gabriel has it... Adjustomatic!

Gabriel

AJUST-O-MATIC

SHOCK ABSORBERS

The Gabriel Company • Cleveland, O.



**HERE'S YOUR
CHANCE TO
BE A**

HARLEY-DAVIDSON DEALER

Right now a few very desirable dealer franchises are available for selling and servicing world-famous Harley-Davidson pleasure, police and commercial motorcycles. These openings offer unusual opportunities to get into a stable, profitable, and successful business.

If you are now in business, or if you want to get into one of your own, write us and tell us all about yourself... including business background, previous motorcycle experience (if any), age, and how much money you can invest. You'll receive a prompt reply outlining our factory-dealer relationship and factory co-operation including our extensive national advertising support.

Write — MR. J. G. KILBERT, Sales Manager
HARLEY-DAVIDSON MOTOR CO.
MILWAUKEE 1, WISCONSIN



ROAD TO RICHES

You can be the next uranium millionaire! Government guarantees huge bonus! PRI instruments from \$29.95. See your local dealer today! FREE CATALOG!

Write PRI, 4223 PM W. Jefferson
Los Angeles 16, California



ALADDINIZE IN 1 HOUR

CLEANS AND WAXES in one easy operation. Aladdin, a guaranteed Auto Paste Wax, makes a luster that LASTS for MONTHS. 8 oz. net weight. \$1.98 postpaid.

ALADDIN PRODUCTS CO., P.O. Box 691, Salinas, Calif.



ELECTRIC WELDER

AC or DC
110 Volts

The "Little Marvel" all-metal welder, 5-year written guarantee. Welds 1/4" metal or money back. Repairs tanks, tools, fenders, machine parts, etc. Complete with everything—rods, unit, eye shield, directions. \$6.95 plus 50c postage. Flame torch accessory for soldering, cutting, brazing \$3.95 complete with carbons, brass rods, flux. \$2.00 Deposit on C.O.D. 75 ampere 1/4 inch Transformer Welder \$21.95 F.O.B.

ESSAY MFG. CO., Dept. 51, Quincy 69, Mass.

\$6.95
Complete

Say You Saw It in Popular Mechanics

Build a MOLDED PLYWOOD RUNABOUT With This Complete Kit...



by America's largest maker
of molded plywood hulls

Save 75% construction time. Molded plywood hull has strength of steel of same weight... assured precision fit... no complex forms to erect... no framing... no planking. Pre-cut all mahogany parts mean factory built appearance inside and out.

Cruiser semi-kits also available.

See your dealer or write
for information to



U. S. MOLDED SHAPES, INC.

651 Market St. S.W.

Grand Rapids 2, Michigan

Speedy Sprayer

mobile paint sprayer



FREE!

Write for
"How to Spray"
Booklet and
Literature.

Choice of craftsmen for 35 years! Saves time, paint and money. Quickly gives flawless finish to walls, furniture, screens, fences and handiwork. Sprays all materials; 1/4 H.P. motor. Diaphragm principle assures clean, oil-free air. Never needs lubrication. With gun, less motor.
No. 890 Speedy Sprayer . . . \$38.50

Add wheels with Wheel Kit No. 909. Includes 6" wheels, handle, fittings. **\$6.95**

At dealers everywhere

W. R. BROWN CORPORATION
2635 N. NORMANDY AVE., CHICAGO 35, ILLINOIS



GEARS

In Stock - Immediate Delivery
Gears, speed reducers, sprockets, thrust bearings, flexible couplings, pulleys, etc. A complete line is carried in our Chicago stock. Can also quote on special gears of any kind. Send in your blueprints and inquiries.

Send for Complete Catalog No. 10
CHICAGO GEAR WORKS
440-50 N. Oakley Blvd., CHICAGO 12, ILL.

KEEP ALL SAWS SHARP



SO EASY: With this new filing jig and jointer anyone can now sharpen any handsaw like new! When file hits hardened steel rollers teeth are finished and EXACTLY SAME HEIGHT. All teeth cut and saw runs true and smooth. Jig and instructions \$2.95 postpaid. Free literature.
SAVE TIME AND \$\$\$



JOINT & SHARPEN CIRCULAR SAWS

Sensational new Super Filer No. 11 joints and sharpens both hand and circular saws 6" to 10" with all teeth the correct height, depth, pitch and bevel. Easy to use—when file hits hardened steel roller, teeth are finished. Saw runs true and smooth with no side pull. Complete with special 8" file \$9.95 ppd. "TRU-CIRCLE" saw set automatically sets teeth at 10° or more \$2.95.

Guaranteed

SUPER SAW FILER NO. 6

Automatically controls



SUPER DRILL GRINDER

Sharpens round shank drills from 3/32" to 1/2" in diameter, up to 6" long. Grinds old drills like new in 4 different point angles, using hand or power grinding wheels . . . \$2.95

DEPTH ANGLE PITCH
Automatic DEPTH CONTROL Rollers



IT'S NEW!

Perfect bevel and angle maintained, and fool-proof depth control for all Rip, Crosscut and Handsaws. Precision made and calibrated for instant setting at desired angle. Can be used in any vise or clamp. Complete with file, only \$6.50 ppd. SEND FOR FREE CATALOG

A. D. McBURNEY, 5908 Hollywood Blvd., Hollywood 28, Cal., Dept. A-36

LOOK! All New - All Precision - All Deluxe SUPERSHOP MODEL X

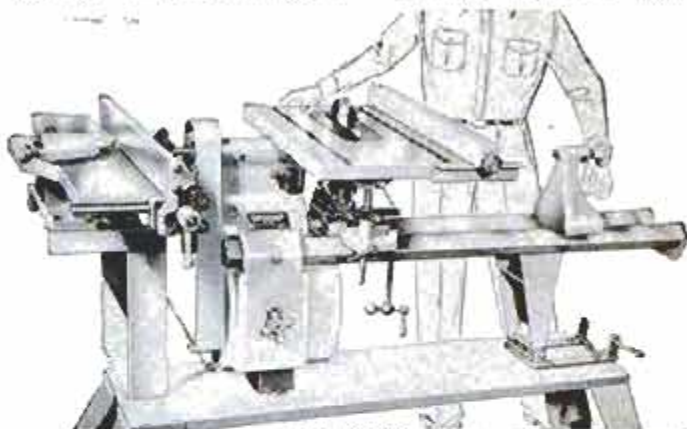

8" SAW

WE PAY ALL FREIGHT FOR YOUR FREE HOME TRIAL

ONLY \$139.50 EASY PAY PLAN

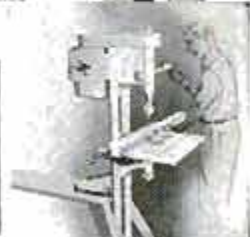

Vert. Drill Press

Never before have you seen so much deluxe, precision-built power tool workshop at any price! Designed for the man who wants the best. Massive cast and precision-machined headstock, self-centering inverted "V" bedways (like precision metal lathes), exclusive non-friction speed changer, extra-large cast and precision-ground saw table. 100% ball bearing, lifetime-lubricated. You save by ordering direct from factory. You are invited to test Supershop Model X in your home FREE. Mail coupon or postcard for FREE brochures, photos, details, specifications, accessory list — and amazing freight prepaid FREE HOME TRIAL PLAN. All free.



Hor. Drill Press



8" Sander



30" Lathe



5" Grinder

MAIL COUPON OR POSTCARD TODAY

POWER TOOLS, INC. 181 Yates Avenue
Beloit, Wisconsin

NAME _____
ADDRESS _____
CITY _____ STATE _____



**ONE
ENGINE
drives
a dozen
tools**

GEORGE

GOOD DESIGN FOR GOOD PERFORMANCE

... in lawn and garden. One sturdy power unit—with the tools you need. Perfect lawns, productive gardens and snow-free sidewalks are easy with the 2 3/4 h.p. self-propelled George unit (with reverse)—just walk behind and steer. Tools change in 30 sec. without even a wrench.



many other work-saving tools available
Write for your dealer's name!

GEORGE GARDEN TOOLS
Sullivan, Illinois

695



FREE WIN A TRACTOR FREE
WRITE FOR ENTRY BLANK
NOTHING TO BUY

**HEAVY OIL-PUMP BEARINGS
PUMPS MILLIONS OF GALS.**

IRRIGATE, SPRAY, DRAIN OR FILL ANYTHING—ANYWHERE! Will not Rust—Clog—or Leak. Patented Seal. Pumps 2800 gph, 420 gph at 75' high or 1800 gph from 25' well. Six blade impeller. Threaded for pipe, 3/4" inlet, 1/2" outlet. Use 1/4 to 3/4 hp motor. Heavier 2800 gph 8.95 Heavier 11.95

Check, MO or COD—Money Back Guarantee
FREE Literature—Comparison Charts
U. A. T. ENG. & MFG. CO. HICKSVILLE 273,
NEW YORK

send for
FREE
tool catalog

SNAP-ON TOOLS CORPORATION
8062-C 28th Avenue, Kenosha, Wis.

Send me free catalog.

OCCUPATION

NAME

ADDRESS

CITYZONESTATE

304



A big, fact-packed catalog full of pictures and tool information . . . yours for the asking.

- Snap-on tools help you handle repair jobs faster, easier, better.
- Snap-on tools LAST . . . pay for themselves over and over.
- Used and endorsed by America's top-earning mechanics in all fields.
- Start building your Snap-on set with basic units . . . add other tools any time.

Snap-on Tools
THE CHOICE OF BETTER MECHANICS

POPULAR MECHANICS

It's Great!



Nothing like being out on water with your fishing pal — especially when you're in an Arkansas Traveler. It's Everything That Makes a Boat Great! Fast!—Maneuverable! — Rugged! — Seaworthy! — Stable! — Trim! Write today for literature on the 18 great new Arkansas Traveler models for 1956.

ARKANSAS TRAVELER BOATS
2006 East 14th Street, Little Rock, Arkansas

Arkansas Traveler
CUSHION-AIRE-GLIDE ALUMINUM BOATS

Better Than
Your Own

**SHOE STORE
AT HOME**



Two-Eyelet
Hit With
Cushioned
Comfort

No investment, no experience needed. Just show magic cushion comfort to friends, neighbors, co-workers. Advance commissions to \$4.00 a pair, plus Cash Bonus, Paid Vacation, \$25.00 Reward Offer. Outstanding values for men, women, children. Money back guarantee. Shoe samples supplied without cost. Write TODAY for FREE new 84 page catalog and full details.

TANNERS SHOE CO., 777 BROCKTON, MASS.

Say You Saw It in Popular Mechanics

ONE-BAG MIXER THAT TRANSPORTS



Universal Transmix® transports, mixes and dumps cement, silage, dirt, etc. P. T. O. driven—no gears or chains. Can be installed or removed in 15 minutes. Fits Ford, Ferguson, AC-WD, IHC Super C, H&M, Case VAC, J.D.-40, Oliver 55, and other 2- and 3-plow tractors. Unconditionally guaranteed. See your dealer or write, giving tractor model, to

UNIVERSAL PULLEYS COMPANY
371 NORTH MOSLEY • WICHITA, KANSAS

ARMY PILOT'S BRIEFCASE
 Made to Gov't Standards.
 Genuine leather with heavy
 duty zipper around three
 sides. Fabric lined and has
 five large inner pockets.
 Size 17" x 13". New. **375 EA**

SOUND POWER PHONES
 Used by Navy for Gun Control.
 An ideal emergency commun-
 ication system because each
 set is 'sound' powered—no
 other power needed. Will reach
 any point-to-point in a radius of 1/2 mile.
 Each set includes 2 phones on chest plate,
 1 headset, button switches and
 approx. 35 ft. of wire. **PER SET 995**

RS38A MICROPHONE
 Carbon type with push-to-
 talk button. Ideal for use
 where background noise
 is high. Can be operated
 with 1 1/2 dry cell. Comes
 6 ft., 3 conductor,
 shielded cable & plug. **249**

HS-30U Signal Corps HEADSET—Low
 impedance. Two earphones & band. **345**

**STEEL FRAME BRUSH
 PACK RACK**
 Has extra light—eight tubular steel frame.
 Originally designed for British Army Moun-
 tain troops. Frame has fold-down pack shelf
 at bottom. Rack is designed so that
 weight is carried at hips. Weight
 only 3-1/2 lbs. Folds flat when not
 in use. Like New. \$12.00 value. **450**

**NEW 2 IN 1
 MECHANICS GLOVES**
 Actually TWO gloves in one!
 Outside is durable horsehide with
 woven wool inner liner. Liner is
 removable to become second pair.
 Outer glove is ideal for driving. **PAIR 298**
 Sizes: Small, medium and large.

SURPLUS HOISTS
5 TON HOIST
SHOUL VALUE 6995
 A real heavy duty
 hoist. Mfd. by the
 Seattle Chain &
 Mfg. Co. Crank operated. Has two speeds,
 one for rapid lift—other for heavy duty.
 Drum size: 8-3/8" x 5" diameter. Comple-
 te with hand brake and handle. **3995**

3 TON WINCH HOIST—With crank type
 handle and ratchet brake. In
 excellent condition. Ideal for
 truck or jeep mounting. **3995**

10 TON WINCH HOIST—Has 17" drum.
 Used by Signal Corps. In good
 condition. With brake and handle. **8950**

180.00 VALUE HOIST
ONLY 3250
 Lifts 2500 lbs. with 24 to
 1 gear ratio. Bronze worm
 gear drive. Has 18 ft. of
 3/16" steel cable.

**PORTABLE
 WINCH HOIST**
 A 'swing around' type hoist. Will lift
 up to 1500 lbs. with 21 to 1 gear ratio.
 Has 12 ft. of 3/16" steel cable.
 40" dia. with 3" pulley. **2250**

**NEW 4-SPEED
 HOBBY MOTOR**
 Has four take-off shafts turning at 5,
 25, 150 & 4000 RPM. Operates
 on 110 volt, 60 cycle current.
 Ideal for home shop, barbecue. **995**

**PHILIPPINE MAHOGANY
 LUAN PLYWOOD**
AT LESS THAN WHOLESALE
 For Paneling Dens, Offices, etc. Use in Cabinets,
 Furniture, etc. Rotary cut. Both sides sanded,
 Banded with finest resin adhesive. Face side unjointed. Shipped at lowest rates.

SAVE 50%
3MM (1/8") X 3 FT. X 6 FT. 179 PER SHEET
\$500 VALUE
FREE SAMPLE ON REQUEST
1/4" X 4 FT X 8 FT. 990 VAL. 449 PER SHEET
 MIN. ORDER 4 SHEETS

SAVE 40% ON TRANSLUCENT FIBERGLAS PANELS
 Finest quality Fiberglas panelling. Available in most widths and
 lengths. Excellent range of colors. Write for FREE Booklet and
 Sample. This is an 85c a square foot value. **ONLY 49c SQ. FT.**

3400 RPM 1/2 HP POWER SAW
**COMPARES TO SAWS
 SELLING UP TO \$49.50
 WITH A 5 1/2" BLADE ONLY 1995**
**RIPS - CROSSCUTS
 CUTS A FINISHED 2x4 LIKE A
 KNIFE THROUGH BUTTER**
 A rugged, professional type, adjustable saw. Will cut any angle from 0 to 45°
 Has an adjustable (0 to 6") rip fence. Safety-trigger switch on handle. Full HP
 Universal AC-DC, 110-120 Volt, 60 cycle motor. Weighs only 6 1/2 lbs.

NEW 60-450X MICROSCOPE
**FEATURING 60, 120, 150, 180, 300
 AND 450 POWER MAGNIFICATION**
**NEWLY DEVELOPED—Self-Contained
 SUB-STAGE LIGHT ELIMINATES
 NEED FOR EXTERNAL LIGHT SOURCE**
 Take advantage of our tremendous foreign purchase.
 Ideal for use by Amateur Scientist, Student, in Home
 Laboratory for study of insects, plant life, etc.

CHECK THESE FEATURES

- 1-Tripix, revolving turret with 10X, 20X, 30X
 precision ground & polished lenses.
- 2-Two interchangeable eyepieces, 6X and 15X
 with precision ground and polished lenses.
- 3-SIX MAGNIFICATIONS for all purposes—
 60X, 120X, 150X, 180X, 300X and 450X.
- 4-NEW! Sub-stage with SELF-CONTAINED
 LIGHT. No external light source needed.
- 5-Large sub-stage mirror for use with external
 light sources.
- 6-All Metal Body—Inclines through 90 degrees.
- 7-Special Hardwood Case and 3 glass slides.

**FREE! with MICROSCOPE—
 8 Pc. DISSECTING SET with
 hardwood case. 1295**

IMPORTED 26" SPORT BIKES
 The 'Jaguar' of Sports Bikes. Built with
 all the technical know-how of Europe's
 finest Bicycle Craftsmen. Has a 2-tone
 grey & cream bakad enamel finish—
 plus other de-luxe features such as...
3995

**GEAR SHIFT with handlebar
 controls to choose gear ratio.**

2—TWO-WHEEL CALIPER HAND BRAKES.
 3—De-Luxe Saddle Bag. 4—Pump and Tools.
 5—Kickstand and Sport Tires.

**BICYCLE HEADLIGHT GENERATOR KIT—
 Includes Generator, Headlight and
 Taillight, 6 volts. Needs no batteries. 595 EXTRA**

**NEW Special 12 Pc.
 SPORTSMAN'S
 KNIFE**
**4 5/8" BONE
 HANDLE**
**Eliminates 12
 Items from Pack
 or Tool Kit 495**

Here is the Perfect Combination Knife-Tool
 for every Outdoor Man. 11 Fine Quality,
 Steel Tools precision made to fold easily
 into the heavy bone covered body. In this
 one compact unit you have (1) regulas-knife
 (2) a fork (3) a spoon (4) a draw-knife (5) a bone saw and fish scaler (6) scissors
 (7) can & bottle opener (8) cork-screw (9) punch (10) screw-driver (11) metal file.

**COMPLETE
 WITH LEATHER
 BELT CASE**

Order From This Ad. Pay by M.O.
 or check. P.O.'s except from D&B
 firms. Deposit with C.O.D.'s. All
 Prices FOB Los Angeles

FAMOUS PALLEY MIXES
PALLEY FAMOUS MIXES!! Prepared
 especially for the HOME CRAFTS-
 MAN, HOBBYIST, INVENTOR,
 GADGETEER or SHOP MECHANIC.

GADGET MIX—Consists of 5 pounds of
 Rivets, Spacers, Bolts, Screws, Gears,
 Wheel Bearings, Springs, Clamps,
 and many more. ALL for ONLY... **119**

BEARING MIX—Approximately 20 needle
 and Ball and Roller bearings. New and
 Used. Sizes: 1/2" to 4". Some of these
 cost the Gov't \$10 apiece. Never
 such a value. 5 lbs. ONLY... **159**

FILE MIX—Ten assorted Files, 4" to
 12". Includes 3 Vixens, half rounds
 bastard, mills, etc., in seconds and used
 but in good condition. 1 Vixen alone
 worth our price for entire mix. F-1 **109**

PULLEY MIX, No. PM-1—You'll want
 this one around. 10 micarta & metal pul-
 leys ranging from 1" to 5" with ball and
 one piece bearings. These are aircraft
 pulleys, the best made with 100's
 of uses. A WONDERFUL BUY!! **2.95**

**ARMY
 MACHETTE**
 Has 22" Vanadium steel blade. Hard-
 wood handle. 27" overall. Complete
 in rugged belt sheath. **198**

PORTABLE SHOVEL
 Has 20" hardwood handle.
 Blade folds to form pick or
 shovel. Ideal for emergency. **175**

65 to 3 GEAR DRIVE
 A precision gear drive for
 light, accurate work. Has a
 65 to 3 gear ratio. Gears
 rotate on self-lubri-
 cating ball bear-
 ings. Shafts are 1/2"
 & a 2" coupling plate. **995**

180° OFFSET DRIVE
 For use where
 tremendous power at
 low r.p.m.'s desired.
 6 gears rotate on self-lubri-
 cating, hi-speed roller bearings.
 85 to 1 gear ratio. Shafts are
 1/4" & 3/8" dia. USED **595**
 NEW in excellent condition... **895**

**PRESSURE
 TANKS**
 G1 Type Stainless Steel.
 Shatterproof and rustless.
 Has reinforcing ribs and
 is pressure tested up to 400
 PSI. Has high safety factor.
 1/4" pipe ports. Ideal for use
 in air supply in underwater
 fishing, painting, spraying, etc. Also as
 buoy or for water supply. Size:
 12 1/2" x 24". Stainless Steel. **1295**

Corrosion Resistant Steel TANK—395
 No. D-2, 500 cu. in. capacity. . . .

PALLEY HYDRAULIC BUY
 One of our many Hydraulic Bargains.
 Use for opening & closing doors, etc.
 1500 PSI constant—3000 PSI inter-
 mittent. Will lift or push 1100 lbs. Has
 adjustable stroke from 2 1/2"
 to 4". Bore 1". Shaft 5/8". **575**

**SAVE 50% ON NEW PALLEY
 HYDRAULIC
 CYLINDERS**

Send for our New CATALOG SUPPLEMENT
 exclusively showing our complete line of
 HYDRAULIC SUPPLIES and EQUIPMENT.
 Contains many new items now being man-
 ufactured by us to meet most rigid industrial
 specifications. Also Save up to 85% on our
 War Surplus Hydraulics and Industrial stocks.

Palley's
 2263 E. VERNON AVE., DEPT. PM-3
 LOS ANGELES 58, CALIF.

You can Afford
Expensive Ideas with

Fir Plywood

... like this smart modern
storage unit



... or this convenient built-in
cooking center



WHEREVER you use it, fir plywood complements your good taste. For built-ins, sub-floors, sheathing or siding—for any building or remodeling job—it gives you lasting value and the look of luxury at a cost most pleasing to your budget. Created by nature, improved by man, fir plywood is wood made larger, stronger . . . better looking, more versatile.



Grademarked for your protection, fir plywood comes in standard grades as well as special textured or overlaid panels. DFPA industry grademarks attest quality, performance and value.

Plans Available; See your lumber dealer or write (USA Only) Douglas Fir Plywood Association, Tacoma 2, Wash., Dept. 9. Please order plans by name, enclose 10c for each.

BUILD YOUR OWN POWER TOOLS - GIL-BILT PARTS KITS

TILT/ARBOR SAW



- 27x28 in. table, 13 1/2 in. capacity in front of blade
 - 10 in. blade cuts 3 1/4 in. deep, tilts full 45 degrees
 - Floor model 34" high, table always stays level
 - New Departure ball bearing arbor, 3/4" precision shaft turned down for 3/8" bore blades, alum. housing, shipped ready to run
 - Jackscrew and 4 1/2 in. dia. handwheel lowers and raises blade
 - Cast aluminum miter gauge and self-aligning rip fence guide
- GIL-BILT Metal Parts Kit includes Plans, ball bearing arbor, miter gauge and bar, rip fence guide, dado insert, lock knobs, jackscrew mechanism and handwheel, and all other metal parts (less blade) . . . **\$22.95**
Same Kit with 10" Combination Blade . . . **\$25.90**
Same Kit with 8" Combination Blade . . . **\$24.90**

GIL-BILT 12-INCH BAND SAW

Ball bearing drive, rigid cast aluminum wheels, rubber tires. Handles stock up to 6 inches thick. Cuts to center of 24" circle, 18 x 18 inch tilt table. Capacity and performance of band saws selling for \$80 and up. Plans and all metal parts in kit with 1/4" blade **\$23.95**

Return Kits in 10 days for refund if not satisfied. For shipments up to 600 miles, add 5%; over 600 add 10%. Amount in excess of actual postage will be refunded. Order Kit now, or order Plans at \$1.00 each and Kit later less cost of plans.



Write for FREE Catalog.

Also Available: Plans & Parts Kits for 18" Band Saw, Belt Sander, Spindle Shaper, 8" Tilt-Table Saw



GILLIOM POWER TOOLS

Dept. 80-C, Lambert Field
St. Louis 21, Missouri



GENUINE ALNICO MAGNETS

AMAZING, PERMANENT, NON-ELECTRIC, HIGHLY PRACTICAL. Conduct interesting experiments. Hundreds of uses. Retrieve valuable steel items such as guns, tackle from fresh or salt water; tools from tanks & drains. **GUARANTEED.** Try any magnet one week. Money back if you are not well-pleased.

- No. M-800 Has pull of 350 lbs. on flat steel block . . . **\$34.50**
 - No. M-725 Has pull of 225 lbs. on flat steel block . . . **\$16.50**
 - No. M-625 Has pull of 125 lbs. on flat steel block . . . **\$9.50**
 - No. M-575 Has pull of 75 lbs. on flat steel block . . . **\$6.50**
 - No. M-500 Has pull of 50 lbs. on flat steel block . . . **\$4.50**
 - No. M-101 U-shaped Magnet. Has pull of 67 1/2 lbs. . . **2 for \$1.50**
 - No. M-47 Hot Pad Magnets, 10 for \$1.00 . . . **50 for \$4.87**
 - No. M-35 Hobbyist assortment of 8 small magnets . . . **\$1.50**
- Send M.O. or check. We pay postage. Sorry no C.O.D.'s.

MIAMI MAGNET COMPANY, 3240 N.W. 27th Ave., Miami 42, Fla.



MASTER THE EASY ART
OF SURE-DIRECTION DRIVING
DRIVE BY

HULL AUTO COMPASS

Be sure it's a Hull
—for famous fine
instrument accuracy,
LASTING dependability.
Used by hundreds
of thousands. At better
dealers everywhere.
Write for free literature.



Beaconite
REGISTERED
STREAMLINE
U.S. PATENTED

HULL MFG. CO. P.O. Box 246, D-3, WARREN, OHIO

BARRON Drill Press TOOLS

FOR WORKSHOP AND INDUSTRIAL USES . . .



ROTARY PLANER

- Planes • Rabbits
- Tenons • Panels
- Routs • Bevels

Only \$8.50 COMPLETE

Over 40 precision built woodworking tools and accessories . . . Hi-Speed Router Bits—Rotary Surface Sanders & Drum Sanders—Safety Shaper Cutters—Dovetail Cutters—Large Auxiliary Metal Tables—All Metal Shaper Fences—Spindle Adapters—Handy Bench Vises. Many other items indispensable for accurate, useful, versatile workshop use. Every tool sold on complete satisfaction or your money back. See your Barron Dealer. Ask for special folder—"24 Extra Uses for Your Drill Press."

BARRON TOOL CO. INC.

302 Architects Bldg., Detroit 1, Mich.



PORTABLE LIGHT PLANTS

1300-1500 WATT PLANT

115 v. 60 cyc. AC Push Button Start. Powered by a 3 1/2 HP. Clinton engine. Combines big output with easy portability. Provides emergency power for operating any oil burner, sump pump, freezer, television, lights, communications systems, etc. which require up to 1500 watts. (Item 22), Wt. 110 lbs. Reg. \$475 value, Factory price... **\$239.50**

1750 Watt Plant Powered by 4.5 Briggs engine. Electric starting & battery charging built-in. Factory price... **\$279.50**

MASTER-LITE 2500 Watt Plant

110/120 v. 60 cyc. AC. A powerful plant, ruggedly constructed and yet designed for easy portability. Can be started by rope or built-in 12 v. electric push button starter. Built-in winding to charge battery. Powered by a big 5.10 HP Briggs engine, complete with all accessories. Includes control box, voltmeter, and handy plug-in power receptacle. An ideal plant for permanent or stand-by service. Wt. 225 lb. Reg. price \$645.00 (Item 21) Factory Price... **\$329.50**

3500 Watt Plant Push Button Start (Item 23)

115 v. 60 cyc. AC. Similar to above, but larger and 33% more capacity. Wt. 270 lbs. Reg. \$760. Factory Price... **\$379.50**

DUAL VOLTAGE 110/220 for any of above plants—\$30 additional.

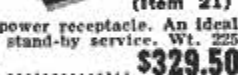
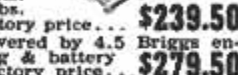

(Item 21)

(Item 23)

(Item 24)

TERRIFIC SAVINGS at MASTER MECHANIC'S bedrock factory prices!

600-700 WATT PLANT

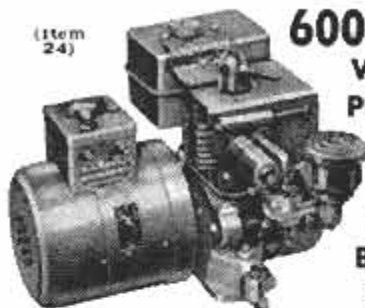

115 v. 60 cyc. AC Powered by a rugged 2 HP. easy starting Briggs engine. No wiring necessary: just plug in and operate. Plenty of current for any oil burner, freezer, brooder, emergency lights, etc. which require up to 700 watts. Ideal for television and radios. Complete with voltmeter and built-in winding to charge 6 v. auto batteries. (Item 24) Wt. 7.5 lbs. Easily fits in car trunk. Be prepared if storm knocks out power lines. Regular \$275.00 value... **\$143.50**
1000-1200 Watt Plant (Item 45) same as Item 24 but larger generator and engine... **\$199.50** with 50% greater output.

PUSH BUTTON START

LESS THAN WHOLESALE

GIANT 2000-2500 WATT PLANT

110-120 v. 60 cyc. AC. Absolutely the best made — exclusive dynamically balanced armature; heavy windings develop up to 3000 watt overload for motor starting. Skid mounted — portable. Powered by an easy starting Briggs or Wisconsin 6 HP engine—complete with all accessories; engine easily disconnected for other uses. Big outlet box, voltmeter, no wiring necessary. Ample current for all purposes. Factory warranty. (Item 31) Wt. 210 lb. Reg. price \$585. Special at... **\$299.50**

Same plant with electric self starter (Item 31a)... **\$359.50**

Generator only and control box... **\$169.50**

DUAL VOLTAGE 110-220 available on any of above models for \$28.00 additional.

NEW 1000-1200 WATT

Belt drive, 115/130 v. 60 cyc. AC. Powered by a rugged 2.75 HP Briggs engine. Excellent for portable or standby emergency power. Produces current for any power tools, oil burner, freezer, radio lights, etc., which require up to 1200 watts. Engine easily disconnected for other uses. Control box and voltmeter included (Item 19)... **\$179.50**

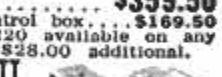
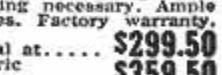
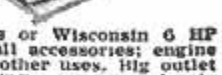

Recoil Starter

RUBBER HOSE



TERRIFIC VALUES!

Genuine Neoprene Hose—outlasts ordinary rubber 3 to 1. Reinforced with super tough cotton cord plies—yet completely flexible. Equipped with standard thread male and female fittings. Pump water for irrigation, stock tanks, home, barn, fire fighting, etc.—or pump gas and fuel oil. Volume factory prices—save more than 60%.

Inside Dia.	Length	Price
1"	10 ft.	5.95
1 1/4"	25 ft.	13.95
1 1/2"	50 ft.	24.75
1 3/4"	100 ft.	40.95
1 1/2"	10 ft.	10.95
1 1/4"	25 ft.	14.75
1"	10 ft.	17.50
2"	14 ft.	22.50

1 1/2" I.D. HIGH PRESSURE STEAM HOSE per ft. \$1.00

AIR HOSE Heavy duty, 1/4" I.D., 2 braided (150 lb. pressure) with standard couplings, 20 ft. lengths, ea... **\$2.95**

PAINT SPRAY MATERIAL HOSE

3/8" I.D. Synthetic thickened inertube and neoprene cover—finest made! 25 ft. lengths with standard couplings, (Item 62) each... **\$7.50**



MASTER DC ARC WELDERS

Now! a portable, rugged, industrial type welder with terrific performance, yet

at a price hundreds of dollars less than you'd expect. Senior model made for years of trouble-free, continuous service. High capacity DC welding unit enables you to tackle any job with confidence—easily welds anything up to 2" plate using from 1/16" to 1/4" rods. Built-in stabilizer and cooling system makes arc easy to strike and hold. Dual control rheostat provides low heat soldering, brazing and welding from 30 to 300 amps. Complete with instructions, guarantee and triple V-belt or flat pulley. Easy to hook up and easy to operate. **WELDER ONLY—DUAL CONTROL MODEL.** Same as above, but drive with your tractor, jeep or gas engine of 14 HP or more. (Item 35a.) Wt. 110 lbs. \$450 value... **\$119.50**

WELDER ONLY—STANDARD MODEL. Same as above but with single rheostat for heavy metal welding only. (Item 38.) Wt. 110 lbs. \$400 value. Special... **\$99.75**

COMPLETE POWER MASTER (Illustrated above) powered by a 14.6 hp. air cooled Wisconsin engine. Wt. 480 lbs. (Item 280) Compares with welder costing \$1200. **\$449.50** Factory Special.

WELDING KIT Two 10 ft. leads, welding helmet, electrode holder, ground clamp. Sold only with welder at... **\$10.50**

"MASTER" CENTRIFUGAL PUMPS



For pumping out basements, and excavations, filling fish ponds or stock tanks, fighting rural fires, irrigating, spraying, pumping petroleum and countless other uses. "MASTER" Centrifugal pumps deliver more gallons per dollar! Ideal for builders, plumbing, sewer and road contractors. The "MASTER" special impeller design enables our pumps to handle water with a high content of mud, sand or gravel, yet at practically no loss in pumping efficiency! And direct factory prices save you money on every model!

HI-FLO CENTRIFUGAL PUMP (Item 502)

Completely self-priming! No foot valve required. Tremendous capacity—100 gal. per minute! Simple to operate—simply start engine and watch the water go. Powered by a rugged, easy-starting 2 HP Briggs engine. Pre-lubricated sealed bearings for years of heavy low-cost service. Big 1 1/2" Model. (Item 502) Wt. 70 lbs. **\$134.50**
2" Model (150 gal. per min.) with 2 3/4 HP engine. Item 502a. 90 lbs. Fact. Spec. **\$154.50**

BIG JOE Portable Pump

A powerful pump that handles up to 10,000 gal. per hour. Easy to operate. Self-priming (after initial prime), no foot valve needed—resulting in 20% more capacity. Exclusive impeller design provides maximum rate of water per horsepower, yet handles water containing a large percentage of stone, gravel and mud. 2 in. suction and discharge. Powered by an easy starting 6 hp. Wisconsin engine and mounted on steel skids. Wt. 250 lbs. (Item 503) Factory price... **\$275.00**
Big rubber tired wheels. \$20.00 additional.

EXTENSION CORD

Heavy duty and very flexible. Neoprene 14-2 cable. 20 year quality. Wt. 12 lbs. (Item 185) 100 ft. Complete with rubber plug and outlet. A terrific buy at only **\$8.95**

NO. 10-2 POWER CABLE. Heavy duty, very flexible, rubber covered, 50 ft. with male and female fittings. Wt. 9 lbs. (Item 502a) \$10.45

50 ft. without fittings (Item 502)... **\$9.45**

NO. 12-2 POWER CABLE. Very flexible rubber covered, special outside shield for grounding power tools, etc. 50 ft. (Item 190) Wt. 8 lbs. \$6.95. 100 ft. (Item 200)... **\$12.95**

JET STEAM MASTER

Now, a super efficient portable steam generator that produces live steam at 100 lbs. pressure in 60 seconds from a cold start! Produces large volume of high pressure steam on 2 pints of fuel oil. Instantly cleans sticky grease, dirt, rust, old paint, etc. off implements and road machinery. Pays for itself in a few weeks. Sterilizes soil. Sterilizes as it cleans—milk equipment, etc. Fully automatic—oil fired with new, built-in lifetime bronze water circulating pump. Draws water from faucet or bucket. Simple and safe—anyone can use it; built-in safety valve. Complete with 12 ft. of hi-pressure steam hose and new triple efficiency steam gun that automatically mixes in soap solution if desired. Wt. 250 lbs. Item 463... **\$329.50** Special factory price.



Send check or M.O. Prices I.o.b. Factory. 10 day Money back guarantee. SEND 10c for... **816** 1956 **MASTER MECHANIC MFG. CO., DEPT. 28-M Burlington, Wis. Catalog**

HEATING & VENTILATING FAN



(Item 10) Easily installed in furnace pipes. Forces even heat to all rooms. Overrange removes kitchen smoke and odors. Powerful continuous duty motor. 110-120 v. AC. Mount in wall or ceiling to ventilate any area. Quiet, super efficient fan moves huge volume of air. (400 to 600 c.f.m.)

8" Pipe, wt. 5 lb. **\$6.85**

9" Pipe, wt. 6 lb. **\$7.85**

10" Pipe, wt. 7 lb. **\$8.85**

12" Pipe, wt. 8 lb. **\$9.85**

HEAVY DUTY FAN. Semi-enclosed motor, suitable for spray booths, restaurant exhausts, poultry houses, etc. 10" Fan. Wt. 8 lbs. (Item 10F) \$11.95.

12" Fan. Wt. 10 lbs. (Item 10D) **\$12.95**

52 pc. SOCKET SET



LIFE-TIME GUARANTEE

Highest quality, guaranteed nonbreakable sockets made by Husky. Beautifully matched chrome thin wall alloy absolutely the best. Contains a complete set of 28 sockets in 1/4" drive, 3/8" drive and 1/2" drive, plus all necessary extensions, handles, speeders, reversible ratchets, etc.; all uncond. guaranteed against breakage. A beautiful set of tools that will handle any job; in a big doghouse steel box. Wt. 17 lbs. (Item 203) List price \$62.90, Special... **\$27.95**

MASTER AIR COMPRESSOR

COMPARE! This is the only compressor built with a NO RUST stainless steel tank. Safe up to 500 lbs. (Item 209) High pressure type (4 c.f.m.) Large volume of air for heavy duty service. For paint spraying, inflating truck & auto tires, greasing, sand blasting, etc. Piston type 2 1/2" bore compressor with built-in air filter. Master built with high strength alloys and precision bearings. Tank, 12"x24", 2100 cu. in. cap. Equipped with automatic switch that starts and stops motor to maintain desired pressure (up to 150 lbs.) and check valve, safety valve, gauge, shut-off valve, 20 ft. air hose and tire chuck. Beautifully balanced on ball bearing wheels and rubber tires. Don't take chances with used or surplus equipment. Our compressors are factory new and are guaranteed SAFE. Low factory prices. 1 1/2 HP Model (cap. 85 lbs.) Reg. \$175. (Item 209)... **\$99.50**



1/2 HP heavy duty model, Rep. Ind. motor & unloader switch (Item 209a) **\$129.50**

Tank Tested up to 500 lbs. per sq. in.

1 1/2 HP Model (cap. 85 lbs.) Reg. \$175. (Item 209)... **\$99.50**

1/2 HP heavy duty model, Rep. Ind. motor & unloader switch (Item 209a) **\$129.50**

1 1/2 HP Model (cap. 85 lbs.) Reg. \$175. (Item 209)... **\$99.50**

1/2 HP heavy duty model, Rep. Ind. motor & unloader switch (Item 209a) **\$129.50**

New

SOUTH BEND PRECISION VERTICAL MILLING MACHINE

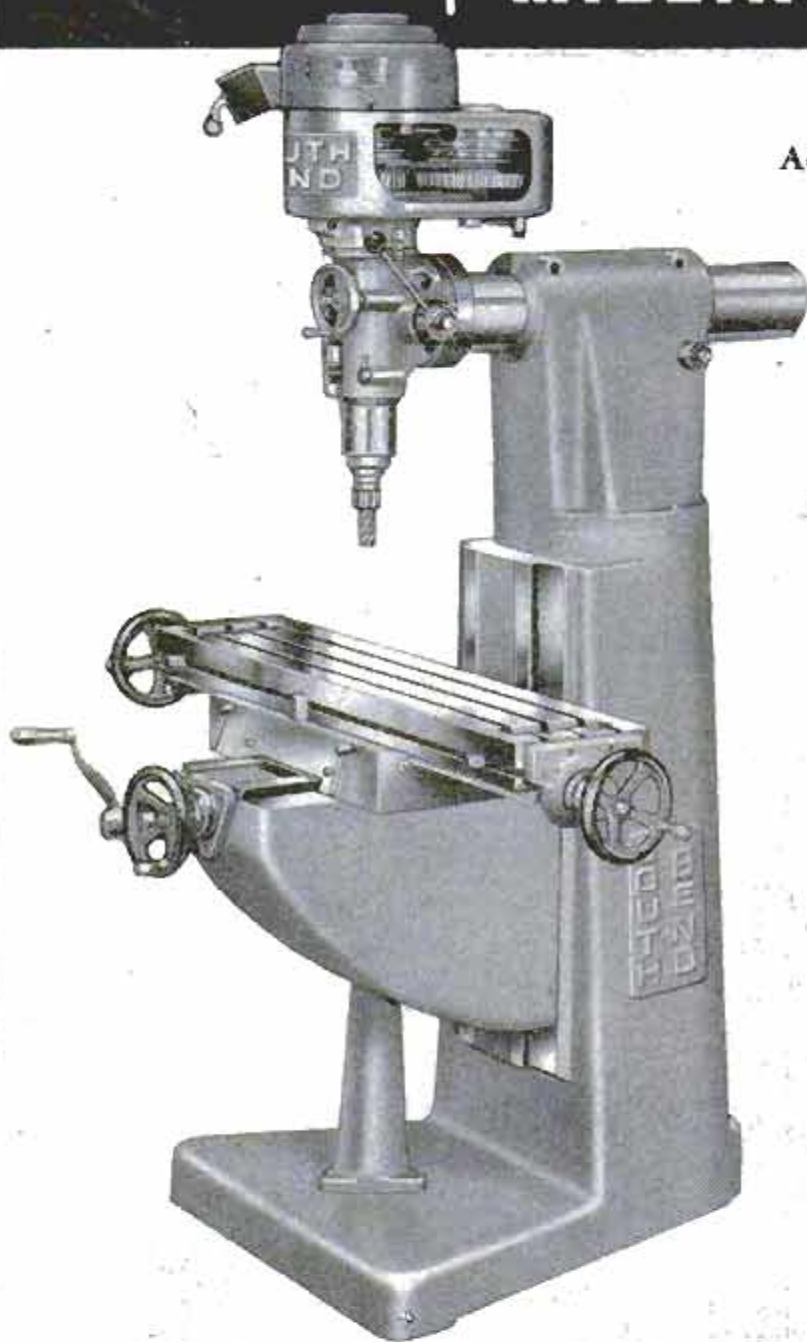

Adequate capacity, accuracy and speed give this new milling machine the ability to keep machining costs low on a wide variety of work. Its simplicity of design provides ease of accessibility and set-up. Reduces operation and job change-over time to a minimum. Ideal for toolroom, production and maintenance work. *Write for information.*

LO-LOSS spindle drive. Precision ground and fitted quill.

Positive action controls with large, adjustable, graduated collars.

Power longitudinal table feed and automatic quill feed optional.



SPECIFICATIONS

Table travel.....	20 or 30"
Cross feed.....	9½"
Spindle to table (max.).....	20"
Spindle to column (max.).....	20"
Ram travel.....	15"
Spindle speeds.....	8
Head rotation.....	360°



SOUTH BEND LATHE South Bend 22, Indiana
Builders of lathes, milling machines, shapers, drill presses, pedestal grinders



with Evinrude *Whispering Power!*

ALL'S CLEAR — you're set for years of pleasure ahead — with your fast and reliable Evinrude-powered cruiser! Delightful runs to lovely coves far up the shore. Carefree week ends afloat. Family vacations brimming with happy adventure. At modest cost you enjoy the comforts of larger inboard cruisers. And performance that is *luxury afloat!* You speed in the tranquil quiet of Whispering Power. You relax in blissful smoothness that makes riding seem like sailing. SEE YOUR EVINRUDE DEALER. Look for his name under "Outboard Motors" in your phone book. Learn how easily you can join in the fast growing sport of outboard cruising. He will gladly help you choose the boat and motor exactly suited to your needs. Write for free catalog of the complete Evinrude line—9 models, 3 to 30 horsepower—3 models with finger-touch electric starting. EVINRUDE MOTORS, 4246 North 27th Street, Milwaukee 16, Wisconsin.

A Division of Outboard, Marine & Mfg. Company
In Canada: Mfd. by Evinrude Motors, Peterborough



Evinrude

quiet Outboard Motors



IT'S A PSYCHOLOGICAL FACT. PLEASURE HELPS YOUR DISPOSITION

How's your disposition today?

EVER YIP LIKE A TERRIER when things go wrong? That's only natural. But — it's a psychological fact that pleasure helps your disposition! So, if you're a smoker, it's important to smoke the most pleasure-giving cigarette — Camel.



For more pure
pleasure — have a
Camel

*"I've tried 'em all —
but it's Camels for me!"
Rock Hudson*



YOU CAN SEE RUGGED ROCK HUDSON STARRING IN U-I's "NEVER SAY GOODBYE"



No other cigarette
is so rich-tasting
yet so mild!

ROCK HUDSON AGREES with Camel smokers everywhere: there is more pure pleasure in Camels! More flavor, genuine mildness! Good reasons why today more people smoke Camels than any other cigarette.

Remember this: pleasure helps your disposition. And for more pure pleasure — have a Camel!

.. J. Reynolds Tobacco Co., Winston-Salem, N. C.