

POPULAR MECHANICS

MAGAZINE

WRITTEN SO YOU CAN UNDERSTAND

**49-PAGE SPECIAL
AUTO
SECTION**

FEB. 1956
35 CENTS

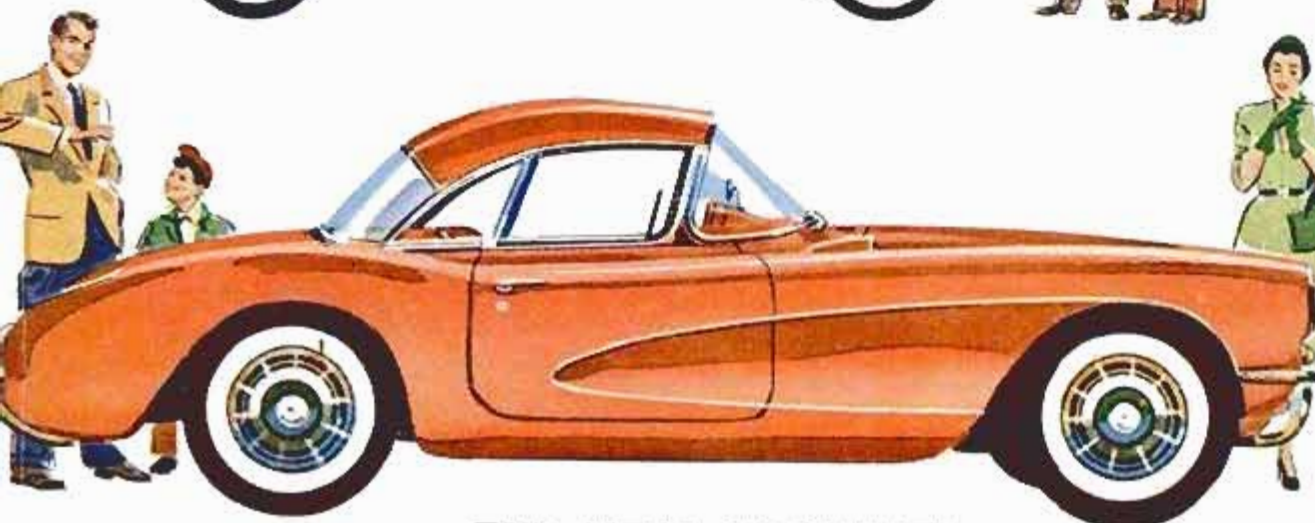
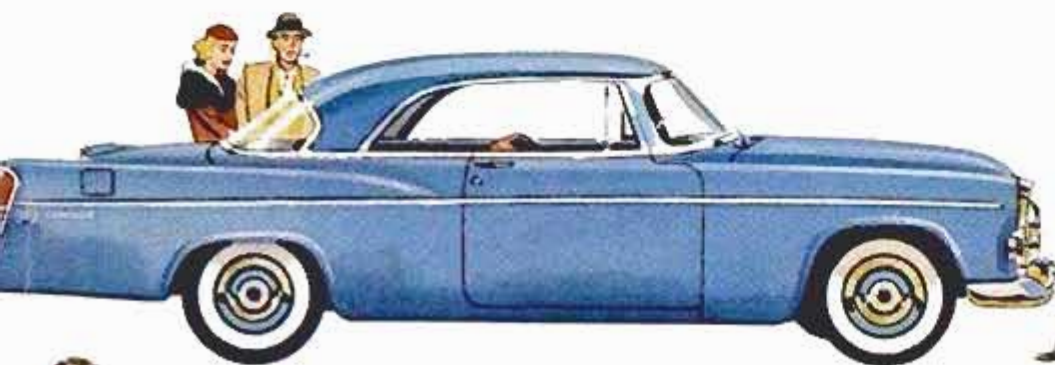
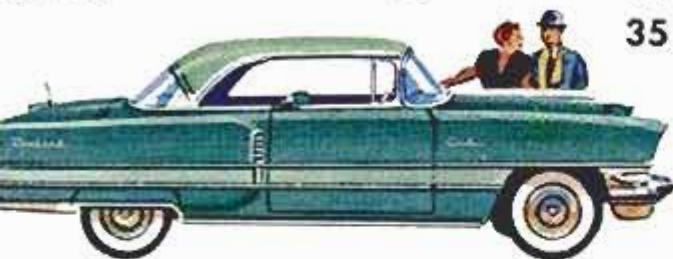

ALL ABOUT THE '56 MODELS

World's leading **SPORTS CARS**
in full color . . . How to win a
stock-car championship

**WHY DO PEOPLE BUY
THE CARS THEY DO?**

BONUS!
HANDY INSERT
for your wallet -
Specification Chart
of all '56 cars

**AMERICA'S
FAVORITE
FISHING
MOTORS!**

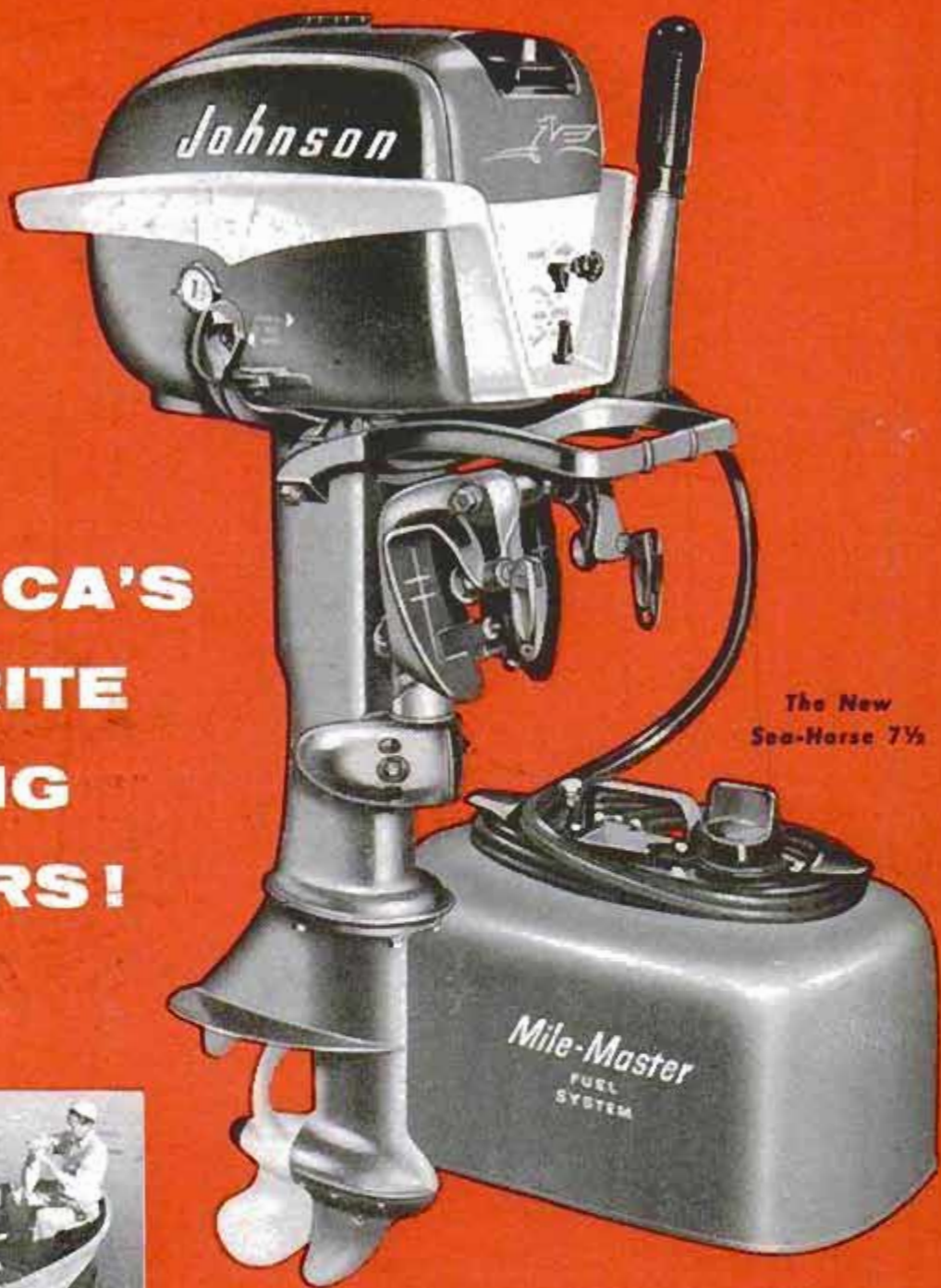

The New
Sea-Horse 7 1/2



JAVELIN®	30 hp ..	\$582.00
SEA-HORSE 30®	30 hp ...	552.00
SEA-HORSE 30	30 hp ...	462.00
SEA-HORSE 15®	15 hp ...	452.00
SEA-HORSE 15	15 hp ...	362.00
SEA-HORSE 10	10 hp ...	321.00
SEA-HORSE 7 1/2	7 1/2 hp ...	241.00
SEA-HORSE 5 1/2	5 1/2 hp ...	216.00
SEA-HORSE 3	3 hp ...	146.00

*Electric Starting... Prices f.o.b. factory, subject to change... Mile Master Fuel System included with all models except the "3"... OBC certified brake hp at 4000 rpm (30's at 4500).

More fishermen use Johnson Sea-Horse outboard motors than any other make. Because they are **DEPENDABLE**... Now **NINE** models—from 3 to 30 hp—all styled in beautiful Holiday Bronze! See your Johnson Dealer. Look for his name under "Outboard Motors" in your classified telephone directory.

FREE: For complete details on all new Johnson Motors and all new features for 1956, write for the new Johnson Sea-Horse Booklet.

JOHNSON MOTORS, 400 Pershing Road, Waukegan, Illinois
A DIVISION OF OUTBOARD, MARINE & MANUFACTURING COMPANY
In Canada: Manufactured by Johnson Motors, Peterborough

Johnson
SEA-HORSES
FOR DEPENDABILITY

PACKED WITH POWER
...and ready to prove it!



The secret of Pontiac's *blazing go* is in the teamwork of *two* engineering masterpieces . . . the mighty Strato-Streak V-8 . . . and the revolutionary new Strato-Flight Hydra-Matic*!

It's the sort of power and go you dream about. But this time it's real.

Behind the wheel of the flashing '56 Pontiac you command an engine virtually alive with spirit . . . and a terrific urge to be on the move. A cubic displacement of 316.6 inches gives you terrific take-off! A whopping big 8.9 to 1 compression ratio squeezes the last ounce of *go* out of every drop of gas. *That's power . . . blazing 227 horsepower!*

You purr along peacefully, completely unaware of the other half of Pontiac's great power team . . . the fluid-smooth Strato-Flight Hydra-Matic. There's perfect harmony here (it was carefully engineered that way) . . . for this great new automatic transmission takes the tremendous thrust from the engine and utilizes every ounce of it, passing it on, smooth as silk, to the rear wheels. An amazing new controlled fluid coupling combined with the efficiency of gears does the trick!

Test the flashing new '56 Pontiac yourself. But hold on to your hat, you'll be piloting the greatest "go team" on wheels.

**An extra cost option.*

PONTIAC

This One



F6DZ-KY3-NL2B

and the price won't stop you!

Look for  the man who makes the difference

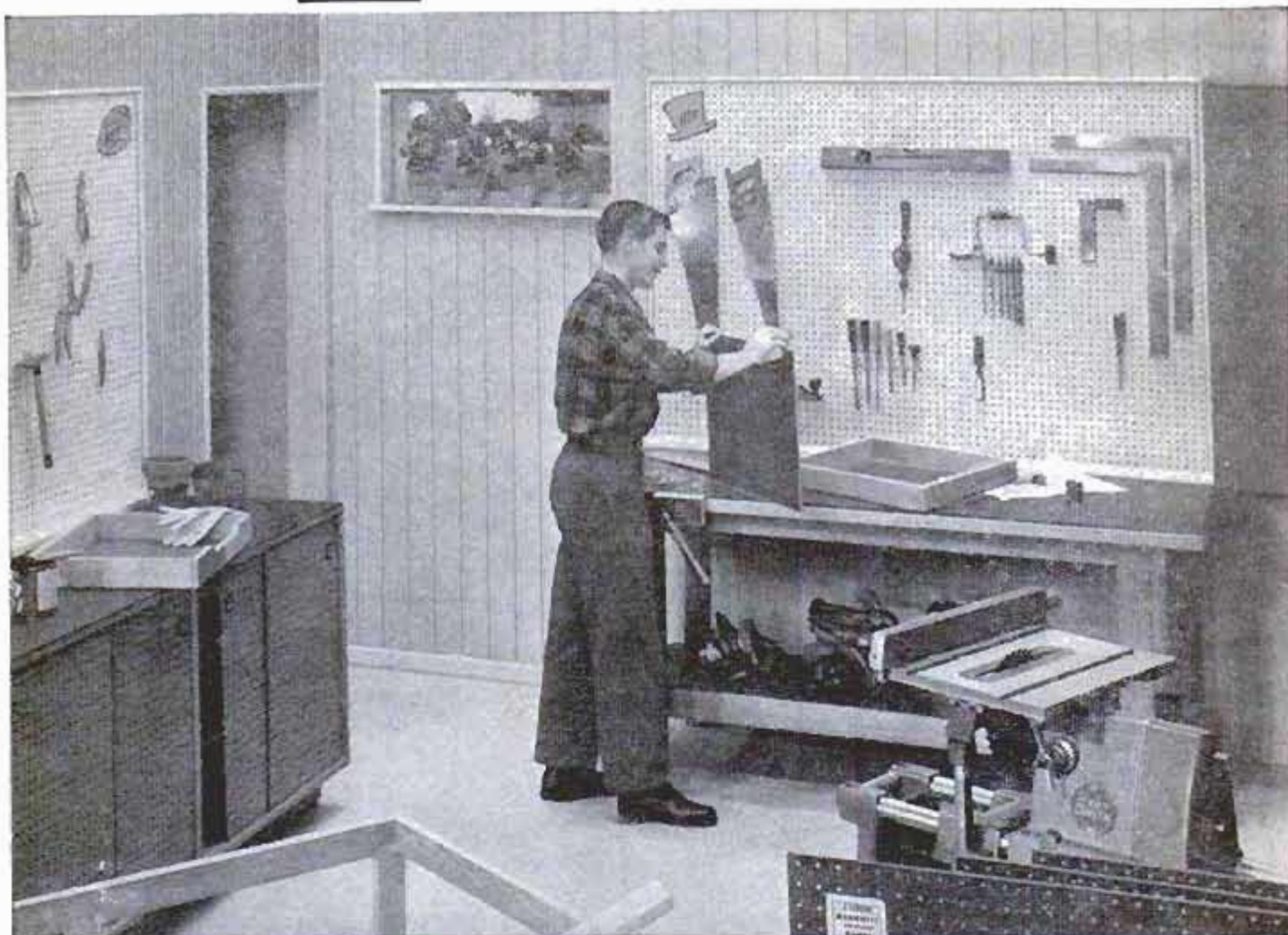

Build This "His and Hers" Workshop— Free Plans from Masonite Show How

A workbench that the beginner will find easy to build...and will please the most experienced wood craftsman.

A separate area for the lady of the house. A place where she can putter with plants and paint the projects she makes.

Everywhere—plenty of storage room. For most-used tools. For once-in-awhile supplies.

That's just an introduction to the brand new plan for a "His and Hers" workshop, now available without charge. It's jam-packed with ideas, including applications of Masonite Presdwood®. This sturdy, smooth

and grainless panel material is economical, durable and easy to work with.

The tough, dent-resisting, splinter-free bench top and cabinets are Tempered Presdwood. The Masonite® Peg-Board* panel that keeps tools at your finger tips is a Presdwood product, too. Even the wall shown here is a Presdwood product—Masonite Panelgroove, the low-cost, high-style panel that goes up quickly.

For any project that calls for a panel, ask your lumber dealer which Presdwood to use.

© Masonite Corporation

*Reg. T. M. U. S. Pat. Off. B. B. Butler Mfg. Co., Inc.



MASONITE
PRESDWOOD PRODUCTS

MASONITE CORPORATION
Dept. PM-2, Box 777, Chicago 90, Ill.
In Canada: Masonite Corporation, Gatineau, Quebec
Please send me your free plan folder for the "His and Hers" workshop and more information about Presdwood.

Name.....
Address.....
Town..... Zone.....
County..... State.....

Popular Mechanics Magazine

Registered in U. S. Patent Office and Canada

H. H. WINDSOR, Founder

H. H. WINDSOR, JR., Editor and Publisher



Next Month

ONE OF THE MOST dramatic weapons of the postwar years is the Terrier guided missile pictured above. This ground-to-air missile, which rides a radar beam to its target high in the sky, is the principal armament on the Navy's two new guided-missile cruisers, the rebuilt USS *Boston* and USS *Cannberra*. As these vessels join the Fleet, a whole new concept of naval strategy is in the making. When searching radars pick up unknown planes far over the horizon, electronic instruments take over and launch the Terrier. Enemy planes in the radar beam will be destroyed in the time it would take a World War II lookout to pass the word: "Bogey at three o'clock!" In the March issue, a Navy commander gives an exciting account on how "Guided Missiles Go to Sea"

Information not listed on articles in the index, starting on page 106, frequently is listed in the WHERE-TO-FIND-IT LIST, which is available to readers without charge. A copy may be obtained by writing to the Bureau of Information, Popular Mechanics, 200 E. Ontario, Chicago 11, Ill.

Published monthly by Popular Mechanics Company, 200 E. Ontario St., Chicago 11, Ill. H. H. Windsor, Jr., president; Wm. Harrison Feitridge, exec. vice-pres.; Franklin S. Forsberg, operations vice-pres.; D. F. Windsor, vice-president and secretary-treasurer; H. H. Windsor III, vice-president; W. T. Windsor, vice-president; Clover L. Perkins, advertising manager; Alan M. Doyon, circulation manager. Single copy in the United States and Canada, 35 cents; subscription rates in the United States and possessions, Canada, Philippines and countries of the Pan-American Postal Union, 1 year \$3.50; 2 years, \$6.00; 3 years, \$8.00. To all other countries add \$1.00 a year over United States prices for overseas postage. If you plan to move, notify us at least 30 days in advance so you will not miss an issue. Give both your old and new addresses. Entered as Second Class Matter, September 15, 1903, at the Post Office at Chicago, Illinois, under Act of March 3, 1879. Entered as Second Class Matter at Post Office Dept., Canada, Registered as Second Class Matter at the Post Office at Mexico, D. F., Mexico, June 20, 1950. Copyright 1956 by Popular Mechanics Company, Copyright under International Copyright Union. Copyright in France. All rights reserved under Pan-American Copyright Union. Printed in the United States of America.

Volume 105

FEBRUARY 1956

Number 2

Address all communications to: 200 E. Ontario St., Chicago 11, Ill.

Managing Editor.....	Roderick M. Grant
Assistant Managing Editor.....	Wayne Whittaker
Shop Notes and Crafts Editor.....	James R. Ward
Radio-Television, Electronics Editor.....	Lothar Stern
Associate Editor.....	Clifford B. Hicks
Associate Editor, Automotive.....	Arthur R. Railton
Associate Editor, Shop Notes and Crafts.....	Wayne C. Lecky
Assistant Editor, Shop Notes.....	W. Clyde Lamme
Assistant Editor, Crafts.....	Jay W. Hedden
Assistant Editor, Makeup.....	John C. Dalen
Automotive Correspondent.....	Leo Donovan
Art Director.....	Frank Beatty
Assistant Editors—Leonard F. Hiltz, Elliott H. McCleary, Emily Mullaney, Earl F. Wobek	
Eastern Editor.....	Richard F. Dempewolff
Empire State Bldg., Room 2906, New York City 1	
Western Editor.....	Thomas E. Stimson, Jr.
Suite 1010, 3460 Wilshire Blvd., Los Angeles 5, Calif.	
London Manager.....	Douglas W. Wedderspoon
Eagle House, Jermyn St., London S. W. 1, England	
Director, Bureau of Information.....	Allan Carpenter
200 E. Ontario St., Chicago 11	

Advertising Offices
Chicago: 200 E. Ontario St., Whitehall 4-0100; New York: Empire State Bldg., 350 Fifth Ave., Longacre 5-7580; Detroit: General Motors Bldg., Trinity 5-8711; Cleveland: Hanna Bldg., 1422 Euclid Ave., Prospect 1-0456; Los Angeles: Tishman Bldg., 3460 Wilshire, DUnkirk 2-8458; San Francisco: Russ Bldg., 235 Montgomery St., YUkon 2-0823.

In This Issue . . .

The Race of the Airliners - - - - -	113
We'll Plant a Village on the South Pole - - - - -	120
First Aid for an Ailing Bridge - - - - -	126
What's New for Your Home - - - - -	148
Seattle Police Patrol an Underwater Beat - - - - -	152

SPECIAL
AUTO
SECTION

Sports Cars of the World - - - - -	160
Parade of the '56 Cars - - - - -	170
Specifications of the '56 Cars - - - - -	184
This Year's Dream Cars - - - - -	186
How to Win Stock-Car Races - - - - -	188
Why People Buy the Cars They Do - - - - -	194
Building a New Car - - - - -	196
More Miles to the Gallon - - - - -	201
Power-Tune Your Car - - - - -	205

For the Craftsman . . .

Planter-Desk - - - - -	209
Solving Home Problems - - - - -	214
Chili—Superhot Midget Hydroplane - - - - -	226
Heavy-Duty Drill Press - - - - -	241
Do Your Own Home-Plumbing Jobs - - - - -	250
Shopping for Tools - - - - -	258
Radio, TV and Electronics - - - - -	261
Clinic for Homemakers - - - - -	272

See pages 106, 108 and 110

for other items and manufacturers of available products

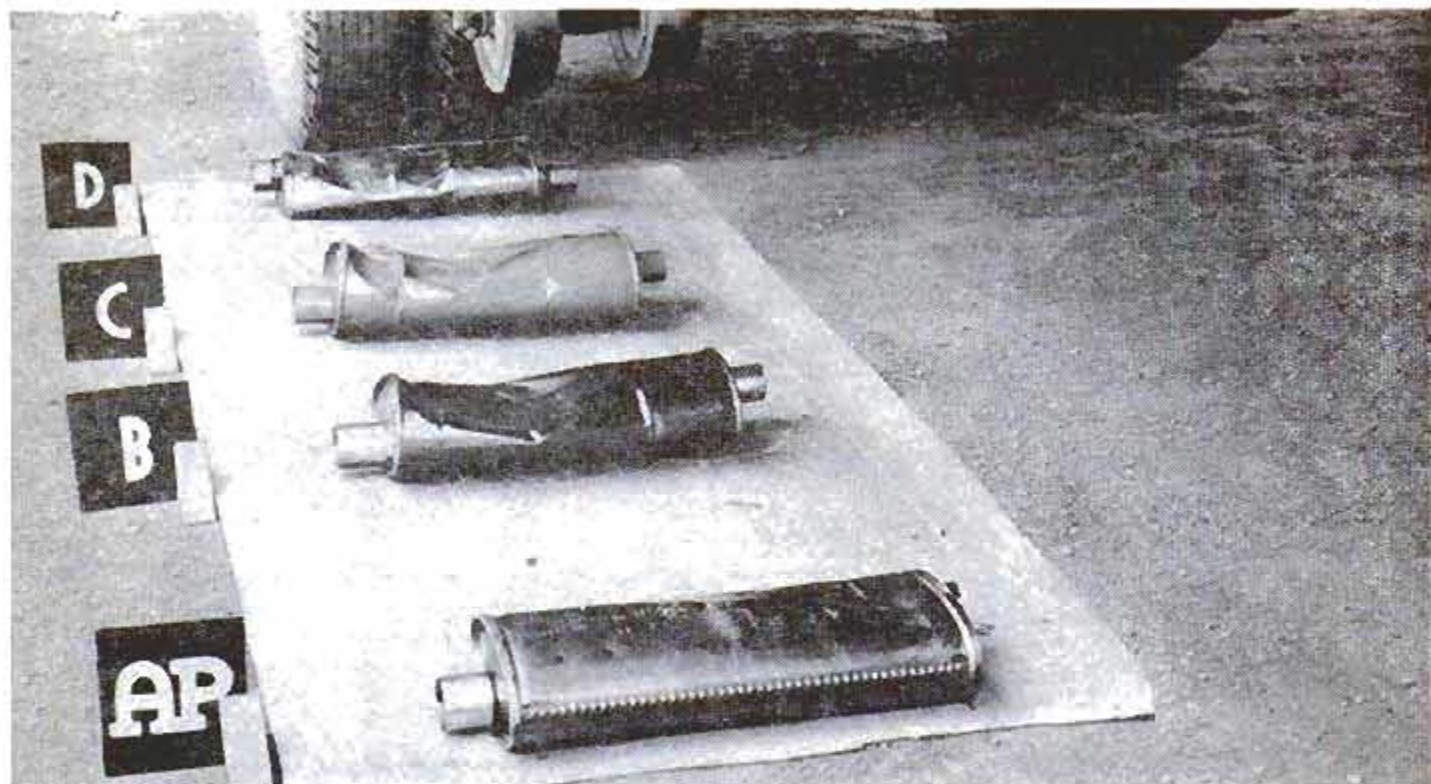

In recent comparative tests made by Motor Vehicle Research, the AP passenger car muffler (foreground) withstood this crushing 4720 lb. wheel load far better than other leading makes.

AP MUFFLERS WILL GIVE YOUR CAR MORE POWER MORE GAS MILEAGE... LAST $\frac{1}{3}$ LONGER

Dual exhaust systems are being featured this year by the big majority of car manufacturers on their new models. Without them they couldn't deliver their increased power, because powerful engines put tremendous demands on mufflers. This fact points up the vital need of having the best muffler on the market—especially if your car has only one muffler. The dramatic tests illustrated on this page were made by Motor Vehicle Research, an independent testing laboratory. They recently won AP the coveted MVR "Certified Test Award" and help explain why AP, at no extra cost, is your best buy.

An ordinary muffler builds up excessive back pressure—puts a strain on an engine—and robs you of horsepower, gas mileage, pick-up and acceleration. It will even cancel out the effects of a motor tune-up and all the high-test gasoline you buy.

The advance-design AP muffler has up to 40% heavier steels, lasts $\frac{1}{3}$ longer. Its superb inner construction makes it practically clogproof. AP's patented double "Air Liner" shell creates sound-deadening chambers that insulate against both heat and noise. You can count on this muffler to give you the power, silence, mileage and longer life you want—plus better protection against carbon monoxide gas.

Make sure you get AP, the longer-lasting muffler. See the AP Muffler Specialist in your neighborhood today. You'll find him a good friend to your car.

THE AP PARTS CORPORATION

14-O AP Building, Toledo 1, Ohio

Mufflers and Pipes •  Miracle Power • dgf 123



The AP and its 3 leading competitive makes have been soaked in corrosive acid like that found in actual operation. Compare the results!



The big trend to dual exhaust systems to prevent engine-stifling back pressure proves the need of the AP muffler for single systems.



See your AP Muffler Specialist today. He will TAP, LOOK and LISTEN for signs of power loss and leaking carbon monoxide gas.

NEW! *the motor you asked for...*

KIEKHAEFER
MERCURY

MARK 30 turbo 4

See it at your dealer's now!

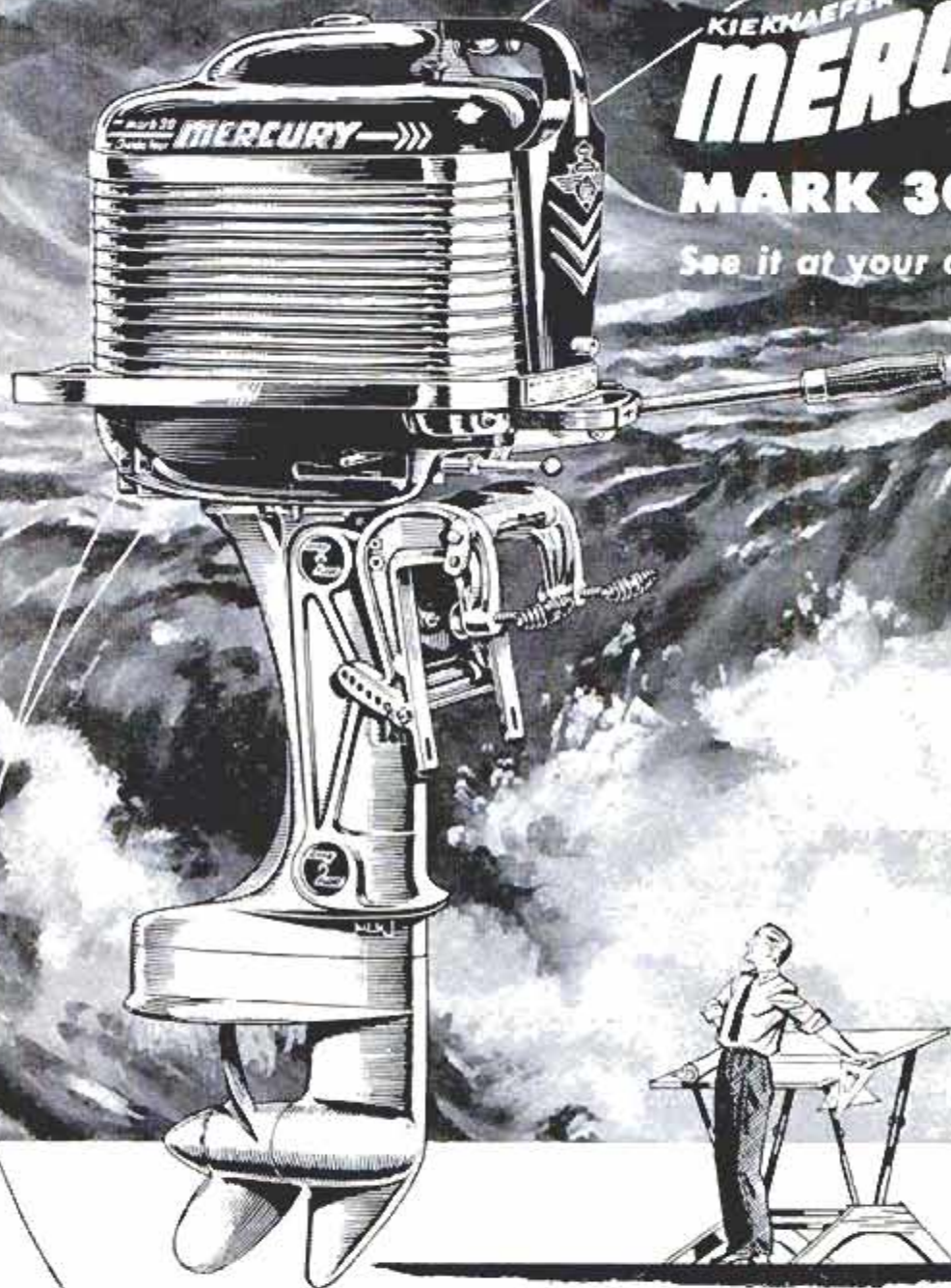

A 30 h.p. Alternate Four, weighing only 110 lbs. . . the exclusive Mercury carrying handles actually make it seem lighter . . . available with 12-volt electric starter and generator . . . all the quality Mercury features.

Proved by years of brutal field testing, backed by experience only Mercury has from building more than two million horsepower of famous 4 cylinder Thunderbolt engines! The finest, smoothest, most powerful engine in its class . . . fully qualified to wear the Mercury trade mark.

MERCURY . . . THE MOST POWERFUL NAME IN OUTBOARDS
REMEMBER . . . A FOUR IS BOUND TO BE BETTER

6½ gal. remote fuel tank
standard equipment

©1956 KIEKHAEFER CORPORATION, Fond du Lac, Wis. Features of Mercury motors are protected by issued or pending patents.

Genuine DIAMONDS Direct from N. Y. Leading Pawnbroker



**In Latest Style Mountings
From \$25 to \$5,000
Remarkable Savings**

Buy for Cash or On Easy Credit Terms

Diamonds never get old! Kaskel's, New York's leading diamond specialist since 1882, have originated a novel plan for you to enjoy great savings on diamonds reset in brand new 14 Kt. gold or platinum mountings. Kaskel's plan is simple. They fine-comb the many outlets where diamonds can be secured at much lower than regular wholesale prices. These markets uncover first grade diamonds at amazingly low bargain prices. Kaskel's resets them into beautiful diamond rings, diamond bracelets, diamond pins, diamond earrings, diamond watches . . . AND . . . Kaskel's grades them for you according to nationally accepted standards. These unusual beauties are yours for a fraction of the usual market cost. You take no risk. You are 100% protected by a written bond and a money back guarantee. You can see your selection before you buy. Any size genuine diamond can be yours on a pay as you like lay-away plan. There are no extra charges.

FREE BIG CATALOG Diamond Advice FREE!

Send today for the big illustrated catalog just off the press. It illustrates many wonderful diamond bargains. All in most fashionable, up to the minute mountings, of 14 Kt. gold or platinum. You also get important advice about diamonds that is in itself a diamond buying safeguard and education. Send coupon below for your copy today and learn all the facts which includes Kaskel's special pay as you like lay-away plan. There's no obligation. SEND COUPON TODAY.

References: Your own bank or any Mercantile Agency

KASKEL'S, Dept. 607B	(Diamond
Kaskel Building, 41 West 57th St.	Specialists
New York 19, New York	since 1882)
Send FREE CATALOG and advice about DIAMONDS without obligation.	
Name _____	
Address _____	
City _____	State _____

ACROSS THE DESK



To the Editor:

There are a great many partially color-blind people in the country who can't pass the driver's color test but could drive safely, if the plain signal lights were changed to bar lights, as shown in the accompanying drawing. This would make it possible for any driver, color-blind or with perfect eyes to observe the signals.

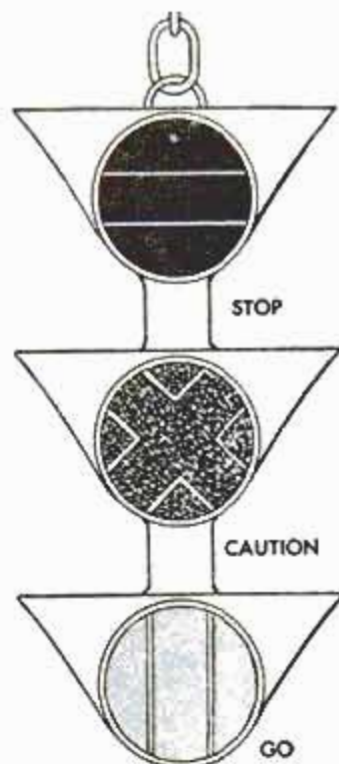

The signal lights should be of larger diameter and have the two parallel bars in different directions to be of the greatest value. A circle of light would be a help to distinguish them from surrounding lights.

See accompanying drawing.

The stop light (red) should have two parallel bars running horizontally.

The caution (amber) should have two parallel bars running diagonally.

The go light (green) should have two parallel bars running vertically.

W. G. Fletcher, M.E.,
218 Linwood Ave.,
Bogota, N. J.

Correction

An account in our December issue describing a "mobile animal clinic" of New York's Speyer Hospital erred in stating that the "ambulance" cost \$84,000. Speyer Hospital authorities state that the truck cost about \$9000 and is not an emergency unit to be called by individuals but gives a regular service through several youth organizations.

Tidings from "Down Under"

I wish to express my appreciation of your fine publication which, among other things, keeps me informed ahead of progress in various industries . . . often ahead of the

(Continued to page 8)

GOOD SALARY

FINE CAR

**To the man who wants to enjoy
an ACCOUNTANT'S CAREER**

A NICE HOME

BANK ACCOUNT

FREE SAMPLE LESSON

IF you're that man, here's something that will interest you.

Not a magic formula—not a get-rich-quick scheme—but something more substantial, more practical.

Of course, you need something more than just the desire to be an accountant. You've got to pay the price—be willing to study earnestly, thoroughly.

Still, wouldn't it be worth your while to sacrifice some of your leisure in favor of interesting home study—over a comparatively brief period? Always provided that the rewards were good—a salary of \$4,000 to \$10,000 and up?

An accountant's duties are interesting, varied and of real worth to his employers. He has *standing!*

Do you feel that such things aren't for you? Well, don't be too sure. Very possibly they *can* be!

Why not, like so many before you, investigate LaSalle's modern Problem Method of training for an accountancy position?

Just suppose you were permitted to work in an accounting firm under the personal supervision of an expert accountant. Suppose, with his aid, you studied accounting principles and solved problems day by day—easy ones at first—then more difficult ones. If you could do this—and could turn to him for advice as the problems became complex—soon you'd master them all.

That's the training you follow in principle under the LaSalle Problem Method.

**Over 4,200 Certified
Public Accountants among
LaSalle alumni**

Member, National Home Study Council

You cover accountancy from Basic Accounting right through Accounting Systems and Income Tax Procedure. As you go along, you absorb the principles of General Accounting, Auditing and Basic Cost Accounting. Then you may choose Commercial Accounting, Industrial Accounting or Public Accounting and prepare for the C. P. A. examinations.

Your progress is as speedy as you care to make it—depending on your own eagerness to learn and the time you spend in study.

Will recognition come? The only answer, as you know, is that success *does* come to the man who is really *trained*. It's possible your employers will notice your improvement in a very few weeks or months. Indeed, many LaSalle graduates have paid for their training—with increased earnings—before they have completed it! For accountants, who are trained in organization and management, are the executives of the future.

Get Free Sample Lesson—Also

"Accountancy, The Profession That Pays"

For your own good get all the facts about this completely new and modern accounting training. Write for Free Sample Lesson—also 48-page book "Accountancy, The Profession That Pays." They will prove that Accountancy offers brilliant futures to those who aren't afraid of serious home study, and will show the wide range of opportunities that exist today. No cost or obligation. If you want a position of higher income, greater prestige and professional standing . . . MAIL THE COUPON NOW!

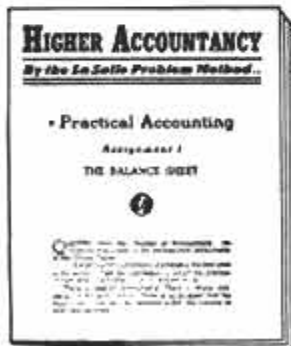

LASALLE EXTENSION UNIVERSITY
A CORRESPONDENCE INSTITUTION

417 S. Dearborn St. Dept. 264H Chicago 5, Ill.

I want to be an accountant. Send me without obligation, Free Sample Lesson—also "Accountancy, The Profession that Pays."

Name.....Age.....

Address.....

City, Zone & State.....



(Continued from page 6)

daily newspapers. I find often I am in possession of information from *Popular Mechanics* that is unique in my group of friends (except a couple who also subscribe).

Secondly, I thought you may be interested in my 1928 Chrysler which, according to American standards, is almost a vintage car. It is still as sound as a bell and can haul both long distances and heavy loads. I can cart about 15 cwt. of sand with ease (for terracing my new home) and I recently completed a 550-mile tour of the southwest on all sorts of roads with no more trouble than a broken fan belt—average speed 30 to 35 (you see the country better, also less rattles), average consumption of petrol 26 m.p.g., Australian measure. Current market price of a job like mine is about 50 pounds Australian, but I wouldn't sell; she's good for years yet and it's very handy for me.

R. Clark,
41 Pier St.,
E. Fremantle,
West Australia

To the Editor:

We wish to point out a correction on your article "Across Four Continents on Two Cylinders" by Jacques Cornet in your

December 1955 issue, centering on the remark: "at Tehuantepec we ran out of hard-surface highway and never saw any again until Oran, 20,000 miles later."

The Pan American Highway from Tumbes to Nazca, which is the stretch they took along the Peruvian coast, the highway from Santos to Rio de Janeiro and the road from Bahia Blanca to Buenos Aires are all very well asphalted and can compare favorably with the best of American highways. The combined mileages of the above mentioned highways is about 2000 miles and we are quite sure we have missed quite a few other good highways in South America.

Adrian Reti (Argentina),
Geraldo Abdo (Brazil),
Allen Novak (Peru),
Alberto Velaochaga (Peru),
Alberto Dumas (Argentina),
Massachusetts Institute of Technology,
Cambridge, Mass.

To the Editor:

On page 138 of the December issue it is stated that the *Graf Spee* was sunk by British warships. I think you will find that after running battle with the British warships *Ajax*, *Achilles* and *Exeter*, the *Graf Spee* took refuge in Montevideo harbor.

(Continued to page 20)

New greaseless way to keep your hair neat all day



TV sportscaster Bud Palmer and friend

Prevents dry, unruly
"gorilla hair"

New Vitalis keeps hair in place and prevents dryness with V-7, the *greaseless* grooming discovery.

You never have an overslick, plastered-down look. Try it. You'll like it.



ANOTHER FINE PRODUCT
OF BRISTOL-MYERS

New VITALIS® Hair Tonic with V-7®

POPULAR MECHANICS



When the other kids ask...

WHAT DOES YOUR DAD DO?

How does your boy answer them?

Sure... you're his hero. You *know* that. But sometimes it can get kinda tough if the other kids don't seem to understand about the "old man."

It's not that you *like* to be chained to the same old job. Maybe you just *had* to leave school too soon. Maybe the war inter-

fered. Anyway, here you are, stuck because you just don't have enough formal training.

Well, Mister, You Can Still Make the Grade!

It isn't easy. You've got to have grit and determination and the will to succeed. As long as you have

these, I.C.S. can put you on the road to real prestige, advancement and security. Your family can really be proud of you!

Spare-time I.C.S. Study Pays Off!

I.C.S. gives you practical, dollars-and-sense training — the kind that pays off. You choose from 277 courses. You get personalized, sympathetic guidance. You advance as rapidly as your time and ability permit. Does it work? Thomas Dyke was a coal miner with no high school education. He studied with I.C.S., worked his way up to licensed engineer. Today, his income is above the average for college trained engineers. *And this kind of training can work for you!*

THREE FREE BOOKS— SEND TODAY!

BOOK No. 1 — "How to Succeed."
A gold mine of helpful job tips.

BOOK No. 2 — An outline of job opportunities in the field that interests you most.

BOOK No. 3 — A sample I.C.S. (math) lesson text that shows you the I.C.S. clear, step-by-step teaching method. Send the coupon today—no obligation!

For Real Job Security—Get an I. C. S. Diploma!

I. C. S., Scranton 9, Penna.

Member, National Home Study Council

INTERNATIONAL CORRESPONDENCE SCHOOLS

ICS

BOX 58626B, SCRANTON 9, PENNA.

(Partial list of 277 courses)

Without cost or obligation, send me "NOW TO SUCCEED" and the opportunity booklet about the field BEFORE which I have marked X (plus sample lesson):

<p>ARCHITECTURE and BUILDING CONSTRUCTION</p> <p><input type="checkbox"/> Air Conditioning—Refrig.</p> <p><input type="checkbox"/> Architecture</p> <p><input type="checkbox"/> Architectural Interior</p> <p><input type="checkbox"/> Building Contractor</p> <p><input type="checkbox"/> Building Maintenance</p> <p><input type="checkbox"/> Carpenter and Mill Work</p> <p><input type="checkbox"/> Estimating</p> <p><input type="checkbox"/> Heating</p> <p><input type="checkbox"/> Painting Contractor</p> <p><input type="checkbox"/> Plumbing</p> <p><input type="checkbox"/> Reading Arch. Blueprints</p> <p>ART</p> <p><input type="checkbox"/> Cartooning</p> <p><input type="checkbox"/> Commercial Art</p> <p><input type="checkbox"/> Fashion Illustrating</p> <p><input type="checkbox"/> Magazine Illustrating</p> <p><input type="checkbox"/> Show Card and Sign Lettering</p> <p><input type="checkbox"/> Sketching and Painting</p> <p>AUTOMOTIVE</p> <p><input type="checkbox"/> Auto Body Rebuilding</p> <p><input type="checkbox"/> Auto Elec. Technician</p> <p><input type="checkbox"/> Auto-Engine Tune Up</p> <p><input type="checkbox"/> Automobile</p>	<p>AVIATION</p> <p><input type="checkbox"/> Aeronautical Engineering Jr.</p> <p><input type="checkbox"/> Aircraft & Engine Mechanic</p> <p>BUSINESS</p> <p><input type="checkbox"/> Advertising</p> <p><input type="checkbox"/> Bookkeeping and Accounting</p> <p><input type="checkbox"/> Business Administration</p> <p><input type="checkbox"/> Business Correspondence</p> <p><input type="checkbox"/> Public Accounting</p> <p><input type="checkbox"/> Creative Salesmanship</p> <p><input type="checkbox"/> Federal Tax</p> <p><input type="checkbox"/> Letter-writing Improvement</p> <p><input type="checkbox"/> Office Management</p> <p><input type="checkbox"/> Professional Secretary</p> <p><input type="checkbox"/> Retail Business Management</p> <p><input type="checkbox"/> Sales Management</p> <p><input type="checkbox"/> Stenographic-Secretarial</p> <p><input type="checkbox"/> Traffic Management</p> <p>CHEMISTRY</p> <p><input type="checkbox"/> Analytical Chemistry</p> <p><input type="checkbox"/> Chemical Engineering</p> <p><input type="checkbox"/> Chem. Lab. Technician</p> <p><input type="checkbox"/> General Chemistry</p> <p><input type="checkbox"/> Natural Gas Prod. & Trans.</p> <p><input type="checkbox"/> Petroleum Engineering</p> <p><input type="checkbox"/> Plastics</p> <p><input type="checkbox"/> Pulp and Paper Making</p>	<p>CIVIL, STRUCTURAL ENGINEERING</p> <p><input type="checkbox"/> Civil Engineering</p> <p><input type="checkbox"/> Construction Engineering</p> <p><input type="checkbox"/> Highway Engineering</p> <p><input type="checkbox"/> Reading Struct. Blueprints</p> <p><input type="checkbox"/> Sanitary Engineering</p> <p><input type="checkbox"/> Structural Engineering</p> <p><input type="checkbox"/> Surveying and Mapping</p> <p>DRAFTING</p> <p><input type="checkbox"/> Aircraft Drafting</p> <p><input type="checkbox"/> Architectural Drafting</p> <p><input type="checkbox"/> Electrical Drafting</p> <p><input type="checkbox"/> Mechanical Drafting</p> <p><input type="checkbox"/> Mine Surveying and Mapping</p> <p><input type="checkbox"/> Plumbing Drawing and Estimating</p> <p><input type="checkbox"/> Structural Drafting</p> <p>ELECTRICAL</p> <p><input type="checkbox"/> Electrical Engineering</p> <p><input type="checkbox"/> Electrical Maintenance</p> <p><input type="checkbox"/> Electrician <input type="checkbox"/> Contracting</p> <p><input type="checkbox"/> Lineman</p> <p>HIGH SCHOOL</p> <p><input type="checkbox"/> Commercial <input type="checkbox"/> Good English</p> <p><input type="checkbox"/> High School Subjects</p> <p><input type="checkbox"/> Mathematics</p>	<p>LEADERSHIP</p> <p><input type="checkbox"/> Foremanship</p> <p><input type="checkbox"/> Industrial Supervision</p> <p><input type="checkbox"/> Leadership and Organization</p> <p><input type="checkbox"/> Personnel-Labor Relations</p> <p>MECHANICAL AND SHOP</p> <p><input type="checkbox"/> Gas—Electric Welding</p> <p><input type="checkbox"/> Heat Treatment <input type="checkbox"/> Metallurgy</p> <p><input type="checkbox"/> Industrial Engineering</p> <p><input type="checkbox"/> Industrial Instrumentation</p> <p><input type="checkbox"/> Industrial Supervision</p> <p><input type="checkbox"/> Internal Combustion Engines</p> <p><input type="checkbox"/> Machine Design-Drafting</p> <p><input type="checkbox"/> Machine Shop Inspection</p> <p><input type="checkbox"/> Machine Shop Practice</p> <p><input type="checkbox"/> Mechanical Engineering</p> <p><input type="checkbox"/> Quality Control</p> <p><input type="checkbox"/> Reading Shop Blueprints</p> <p><input type="checkbox"/> Refrigeration</p> <p><input type="checkbox"/> Sheet Metal Worker</p> <p><input type="checkbox"/> Tool Design <input type="checkbox"/> Toolmaking</p> <p>RADIO, TELEVISION</p> <p><input type="checkbox"/> Industrial Electronics</p> <p><input type="checkbox"/> Practical Radio TV Eng'ng</p> <p><input type="checkbox"/> Radio and TV Servicing</p> <p><input type="checkbox"/> Radio Operating</p>	<p><input type="checkbox"/> Television Technician</p> <p>RAILROAD</p> <p><input type="checkbox"/> Air Brakes <input type="checkbox"/> Car Inspector</p> <p><input type="checkbox"/> Diesel Locomotive</p> <p><input type="checkbox"/> Locomotive Engineer</p> <p><input type="checkbox"/> Section Foreman</p> <p>STEAM AND DIESEL POWER</p> <p><input type="checkbox"/> Combustion Engineering</p> <p><input type="checkbox"/> Diesel—Elec. <input type="checkbox"/> Diesel Eng's</p> <p><input type="checkbox"/> Electric Light and Power</p> <p><input type="checkbox"/> Stationary Fireman</p> <p><input type="checkbox"/> Stationary Steam Engineering</p> <p>TEXTILE</p> <p><input type="checkbox"/> Carding and Spinning</p> <p><input type="checkbox"/> Cotton, Rayon, Woolen Mfg.</p> <p><input type="checkbox"/> Finishing and Dyeing</p> <p><input type="checkbox"/> Loom Fix'g <input type="checkbox"/> Textile Des'ing</p> <p><input type="checkbox"/> Textile Eng'g <input type="checkbox"/> Throwing</p> <p><input type="checkbox"/> Warping and Weaving</p> <p>MISCELLANEOUS</p> <p><input type="checkbox"/> Domestic Refrigeration</p> <p><input type="checkbox"/> Marine Engineering</p> <p><input type="checkbox"/> Ocean Navigation</p> <p><input type="checkbox"/> Professional Engineering</p> <p><input type="checkbox"/> Short Story Writing</p> <p><input type="checkbox"/> Telephony</p>
---	--	--	--	---

Name _____ Age _____ Home Address _____

City _____ Zone _____ State _____ Working Hours _____ A.M. to P.M. _____

Occupation _____

Canadian residents send coupon to International Correspondence Schools, Canadian, Ltd., Montreal, Canada. . . . Special tuition rates to members of the U. S. Armed Forces.

Our 40th Year

NRI training is thorough, practical, up-to-date. When you enroll with NRI you benefit from our 40 years of successful experience training men at home.

J. E. Smith

President
National Radio Institute
Washington, D. C.



I'll Train You RADIO-

You Practice Broadcasting with Parts I Send

As part of my Communications Course I send you parts to build low-power Broadcasting Transmitter at left, and other equipment. Use it to get practical experience. You put this station "on the air," perform procedures demanded of station operators. An FCC Commercial Operator's License can be your ticket to a bright future. My Course trains you to get your license. Mail Coupon now!



Television Is Today's Good Job Maker

Television now reaches from coast-to-coast. More than 25 million Television sets are already in use and require servicing: thousands more sets are being sold every week. About 200 TV stations are now on the air with hundreds more being built. This means new jobs, more jobs, better pay for trained men. The time to act is NOW! Start learning Radio-Television servicing or communications.

Make Extra Money in Spare Time While Learning

Keep your job while training. Many NRI students make \$10, \$15 and more a week extra fixing neighbors' Radios in spare

time. The day you enroll I start sending you special booklets that show you how to service sets. Multi-tester you build helps discover and correct Radio troubles, gives PRACTICAL EXPERIENCE on circuits common to radio and TV. Mail coupon today.

You Practice Servicing with Parts I Send

Nothing takes the place of PRACTICAL EXPERIENCE. NRI training is based on LEARNING BY DOING. You use parts I send to build many circuits common to Radio and TV. You build the modern radio at right. Use Multi-tester you build to make money fixing sets. Many students make \$10, \$15 a week extra fixing neighbors' sets in spare time, starting soon after enrolling. All equipment I send is yours to keep.



I Trained these Men at Home



Thanks
NRI for
Wonderful
Start

"Right now I am doing spare-time repairs on radios and television. In the near future I intend to go into full-time servicing."—C. Higgins, Waltham, Mass.



Switched
from Studio
Work to
Service

"I switched from studio work and am now holding a position as TV service technician. Enjoy my work more and more."—Norman Ward, Ridgefield Park, N. J.



Paid for
Course
Before
Graduation

"By the time I graduated I had paid for my course, a car and testing equipment. Can service toughest jobs."—E. J. Streitemberger, New Boston, Ohio.



\$10 to \$15
Week
Spare Time

"Four months after enrolling, was able to service Radios . . . averaged \$10 to \$15 a week spare time. Now have full time business."—W. Weyde, Brooklyn, N. Y.



Employed as
Transmitter
Operator

"A former employer recommended NRI training to me. Now employed as transmitter operator in Harrisburg."—Albert Herr, New Cumberland, Penna.

AT HOME for Good Jobs in TELEVISION

There is Success-Good Pay-Security for You in America's Fast Growing Industry



DO YOU want good pay, a job with a bright future, security? Would you like to have a profitable business of your own? If so, find out how you can realize your ambition in the fast-growing RADIO-TELEVISION industry. Even without Television, the industry is bigger than ever before. Just think, over 115 million home and auto Radios, 3000 Radio Broadcasting Stations, plus 25 million Television sets and about 200 Television Broadcasting Stations. Expanding use of Aviation and Police Radio, Micro-wave Relay, Two-way Radio for busses, taxis etc., are making opportunities for Servicing and Communications technicians and FCC Licensed Operators.

Find Out What Radio-Television Offers You

What will YOU be doing one year from today? Decide now that you are going to know more and earn more. **ACT NOW.** Send the coupon below NOW for my **FREE DOUBLE OFFER.** You get Actual Servicing Lesson. Also my 64-page Book, "How to Be a Success in Radio-Television." Read what my graduates are doing, earning, see equipment you practice with at home. Mail coupon now. Send in envelope or paste on postal. J. E. SMITH, President, Dept. 6BA, National Radio Institute, Washington 9, D. C. Our 40th Year.

NRI Training Leads to These Jobs in RADIO-TELEVISION

- | | |
|--|---|
| BROADCASTING
Chief Technician
Chief Operator
Power Monitor
Recording Operator | GOVERNMENT RADIO
Operator in Army, Navy, Marine Corps
Always Operator
Forestry Dispatcher |
| SERVICING
Home and Auto Radios
Television Receivers
P.A. Systems | AVIATION RADIO
Transmitter Technician
Airport Transmitter Operator |
| MANUFACTURING
Design Technician
Service Manager
Tester
Research Assistant | TELEVISION
Pick-up Operator
Television Technician
Remote Control Operator
Service and Maintenance Technician |
| SHIP AND HARBOR RADIO
Chief Operator
Radiotelephone Operator
Assistant Operator | POLICE RADIO
Transmitter Operator
Receiver Serviceman |

My Training Includes Television

You get practical experience by working on circuits common to both Radio and Television. My graduates are filling jobs, making good money in both Radio and Television. Many NRI trained men start their own Radio and Television servicing business with capital earned in spare time. Let me show you how you can be your own boss; earn \$10 to \$15 a week extra even while still learning. Now is the time to get ready for success in Radio-Television. Coupon below brings you Actual Lesson and 64-page book.

Actual Lesson and 64-page Book

BOTH FREE

The ABC's of SERVICING

MAIL THIS NOW!

MR. J. E. SMITH, President, Dept. 6BA
National Radio Institute, Washington 9, D. C.

Mail me Sample Lesson and 64-page Book, FREE. (No salesman will call. Please write plainly.)

Name Age

Address

City Zone State

VETS write in date of discharge

"APPROVED MEMBER, NATIONAL HOME STUDY COUNCIL."



Chief Engineer with Station

"I received my License and worked on ships. Am Chief Engineer at WARA, Attleboro, Mass. I am grateful to NRI for preparing me for this position."—R. D. Arnold, Rumford, R. I.

Available to **VETERANS** under G. I. Bills

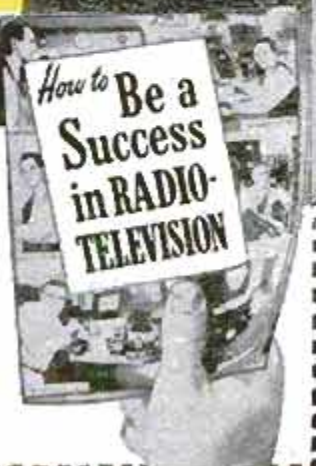

VALUES TO \$5
YOUR
CHOICE
ANY
ARTICLE **99c**
ANY 4 FOR 2.99

IMPORTER'S SACRIFICE SALE

VALUES TO \$5
YOUR
CHOICE
ANY
ARTICLE **99c**
ANY 4 FOR 2.99



TINY!

German Binoculars

The ISOLAN Binocular fits in the palm of your hand but it gives clear, sharp, magnified viewing. Optical lenses are precision made. Wonderful for theatre and watching sports. Reg. 1.98. Made in West Germany.

No. 8 99c

MUST RAISE \$250,000

We placed orders for over \$250,000 with various European manufacturers and the bulk of the shipments are arriving within the next few weeks. We have to pay cash on arrival and as a result we're sacrificing the items listed below in order to get the ready cash. **YOU GET THE BENEFIT!** Some of the items have sold for up to \$5.00. Buy 4 for only 2.99. Send the handy coupon below and take advantage of these once-in-a-lifetime bargains before it's too late!

REG. 1.98



NOW **99c**

POCKET MICROSCOPE GIVES 2,500 TIMES AREA MAGNIFICATION!

Measures but 2 1/4 inches—but this microscope from West Germany gives **GIANT POWER & PERFORMANCE!** Metal design—optically ground precision lenses. Gives 2,500 times area magnification! Clear, sharp images—see Nature's wonders, examine liquids, textiles, insects, cells, stains, tissue, etc. 2 special slides given. Simple eyepiece focusing. No. 12 99c

REG. 1.98



GET 30 BETTER SHAVES FROM ONE BLADE!

HONIKRON—new marvel of German ingenuity—gives you 30 OR MORE SHAVES FROM A SINGLE BLADE! Hones & conditions old & new double-edge blades to an unbelievable sharpness. Does it in a few seconds—just whisk the plunger back & forth a few times and you have a factory sharp blade!

No. 3 99c

A
E
R
O
M
A
T

washes
cars

like magic!

The AEROMAT fountain spray attaches to your garden hose—washes your car in minutes. 3-foot telescope handle. Special built-in suds chamber. Detergent supplied. Soft, silky Durostyrene brush head. Sold for up to \$5—**NOW 99c.** Order by No. 444.



3-color POLICE FLASHLIGHT throws red, white & green beam!

1/2
PRICE!
Reg. 1.98

The famous 3-Color Police Flashlight can now be yours! Police & fire departments have been ordering 'em by the carload—N.Y. City policemen alone have ordered thousands! Pushbuttons give you red, green or white beam instantly. Hi-Glo reflector increases beam intensity—visible miles away! Great for highway emergencies. Formerly sold for as much as \$5.00. **ALL-METAL DESIGN.** No. 75 99c



10 - IN - 1

All-Purpose
OPTICAL
GLASS

REG. 1.98



IMAGINE! 10 separate optical instruments in ONE compact unit—magnifying glass, reading glass, telescope, compass, binoculars, mirror, solar watch, campfire lighter, magnifying mirror and textile tester. Folds into small space—carry it in your pocket. One of the most amazing gadgets in years! Imported from West Germany. No. 93.....only 99c

4-STAR SPECIALS

- ☆ 10-IN-1 Army Officer's Knife — 99c — No. 880
- ☆ \$2.98 Walking Doll — 99c — No. 540
- ☆ Imported Power Telescope—99c—No. 160
- ☆ \$3.98 Black Forest Hunting Knife—99c—No. 80-C
- ☆ \$1.98 Famous Spectoscopes—TWO PAIR 99c—No. 90
- ☆ Regular \$4.95 Trans-Kleer Storm Window Kit — 1.99 — No. 47

(ENOUGH TO MAKE 10 WINDOWS)

THORESEN'S, Dept. 6-B 352 FOURTH AVE., NEW YORK 10, N. Y.

SPECIAL COUPON FOR THIS SALE ONLY!

THORESEN'S, Dept. 6-B
352 Fourth Ave., New York 10, N. Y.

Please rush me the items listed below on 5-day free home trial. I must be absolutely satisfied with the merchandise or I will return it in 5 days for full refund. Payment enclosed. Send prepaid. Send C.O.D. I'll pay charges. (NOTE: C.O.D.'s sent ONLY on orders for 2.99 or more.)

LIST ITEM NUMBERS HERE

NAME _____

ADDRESS _____

CITY _____ STATE _____



INVENTORS

Learn how to protect your invention. The U. S. Patent Laws provide that any new and useful art, machine, article of manufacture, or composition of matter, or any new and useful improvement thereof, may be patented if the act of invention is involved. Therefore, every inventor with a valuable invention should take advantage of the Patent Laws and proceed for patent protection in order to safeguard his rights.

A patent gives the inventor the exclusive right to prevent others from making, using, or selling the invention claimed in the patent for a period of seventeen years.

The Patent Laws were enacted for the benefit of the inventor to give him protection for the features of his invention which are patentable. These features must be properly and concisely set forth and claimed in a formal application for patent, in order to comply with the requirements of the Patent Laws. For that reason, unless the inventor is familiar with patent matters, he should engage a competent registered patent attorney or agent to represent him. We are registered to practice before the U. S. Patent Office and are prepared to serve you in the handling of your patent matters.

A specially prepared booklet entitled "Patent Guide for the Inventor", containing detailed information with respect to patent protection and procedure, together with a "Record of Invention" form will be promptly forwarded to you without obligation upon request.

CLARENCE A. O'BRIEN & HARVEY JACOBSON

Registered Patent Attorneys

61-B DISTRICT NATIONAL BUILDING

WASHINGTON 5, D. C.

"OWN a Business" CouponStart Now . . .
while employed**DURACLEAN CO., 6-162 Duraclean Bldg., Deerfield, Ill., U.S.A.**

Without obligation to me, send booklet and letter giving full details. Tell me how I may OWN a growing business of my own built upon satisfied customers.

Name _____

Address _____

City _____

Zone _____ State _____



Are You The Man?

If you have longed for the prestige and financial independence of YOUR OWN business, you can now realize this desire . . . if you can qualify for a Duraclean dealership. We are now enlarging this 26-year-old chain of independently-owned service dealerships which has rapidly grown to a world-wide service.

You must however be reliable, honest, diligent, and able to make a small investment in a business of your own . . . a profession for which we will personally and quickly train you. If needed, we will help finance you.

We want to assure your success. A Duraclean dealer will train and assist you. He'll reveal his successful plan of building customers. He will work with you. This business is easy to learn . . . quickly established.

This is a sound, lifetime business that grows from REPEAT ORDERS and customer RECOMMENDATIONS. Alert dealers can gross an hourly profit of \$5.00 on own service plus \$3.00 on EACH service man at National Price Guide charges. Mail coupon today for full details.

You are Trained in a New Profession . . . to Revive, Clean, Protect Home Furnishings

You have the opportunity to steadily increase the income for your family month after month and year after year without waiting for a raise. Duraclean dealers enjoy unusual profit on both materials and labor . . . after paying servicemen or salesmen. Service is rendered IN the home . . . some have shops or offices . . . others operate from their home with no overhead expense. No experience is needed. We show you 27 ways to bring customers to you.

Our **MUTUAL COOPERATION** program gives you many unique and continuous advantages: National Advertising in Life, McCall's, House & Garden, MacLean's (Canada) and a dozen others. Copyright and trademark protection. Certificate approves equipment and materials. Products Insurance. Six-year Warranty. Pocket Demonstrators. Sales Book. Advertising Folders & Cards. Tested Ads. Ad Cuts & Mats. Store Display Cards. Radio & TV Musical Commercials. Home Show Booth Display. Publicity Program gets Free Local newspaper stories. Prizes. Laboratory research and development. Duragram bulletins. Resale Service. Annual Conventions. Behind all this is a headquarters interested in YOUR personal success.

Almost every building houses a customer needing one or both services. Furniture stores, department stores, interior decorators, upholsterers and carpet stores, develop Duracleaning and Duraproofing jobs from their customers. Auto dealers take orders and have used cars Duracleaned. You have a high hourly income from the day you start . . . even while still employed.

Duraclean Revolutionizes Old Methods

Duraclean's growth to a world-wide service resulted from customer convenience plus its many superiorities over ordinary cleaning. Housewives, clubs, hotels, offices and institutions deeply appreciate not having furnishings out of use for days and weeks.

They are thrilled to see their upholstery and floor coverings cleaned and revived with a new consideration for its life and beauty. Duraclean doesn't merely clean . . . it restores natural lubrication to wool and other fibers. Colors revive. The re-enlivened rug and carpet pile unsmats and rises.

Aerated foam created by the electric Foamovator (right) banishes dirt, grease and many unsightly spots . . . without scrubbing. Customers tell friends how Duraclean has eliminated customary soaking, shrinking and breaking of fibers from scrubbing . . . how the mild quick action foam, lightly applied, provides safety from color runs and roughened fabric they have previously experienced . . . how fabrics look fresher, brighter, cleaner . . . how convenient it is not to have furnishings gone.

They appreciate the courteous, personalized service of Duraclean craftsmen. Such service is NEWS . . . it spreads to friends and neighbors. Customers become your best salesmen.

The companion Duraproof service not only kills moths and carpet beetles . . . it is WARRANTED to make fabric repellent to both. Damage to household goods and wearing apparel is greater from moths than fire. This modern treatment (illustrated above) PROTECTS rugs, carpets, upholstery, furs, clothing, blankets, piano-felts, auto-interiors, etc.

EASY TERMS: A modest payment establishes your business . . . pay balance from sales. We furnish everything from electric machines to introduction slips including enough materials to return TOTAL investment.

FREE Booklet . . . Send for it NOW

Our first letter and illustrated booklet will explain everything . . . modern services, waiting market, how business grows, your large profit and PROTECTED territory. You can have your business operating in a very few days. Mail above coupon today while you can still get a dealership in YOUR location.

DURACLEAN® CO., 6-162 Duraclean Bldg., Deerfield, Illinois

What Dealers Say

W. Abbott: "In past 7 months I've grossed over \$12,000 almost entirely from cleaning auto interiors."

T. Komari (Japan): "Have 1,000,000 yen contract Duracleaning for U. S. Army."

W. Lookiebill: "We've had 20 years of pleasant dealings. I'm 65 but am setting my sights for 20 more years."

P. Freidinger: "Had a big moth-proof business last year; one job was \$322.25."

R. Kimbrough: "Finished First White House of Confederacy and am to Duraclean the Governor's Mansion."

L. B. Hayes: "My first month I grossed \$770.17. I am now a full time dealer."

E. Schenk: "The customers I had on House and Garden ads were very pleased. Their furnishings came out beautiful."

Earl Davis: "Our sales increased \$17,600 this year over last."

L. Johnson: "Each customer leads to 3 or 4 more. One job two of us cleaned \$125 worth in 5 hours."

More quotations in our literature.

OWN a Growing BUSINESS



**FREE
Booklet
tells
how!**

Mail
Coupon
TODAY

A Duraclean dealer will
work with you in your town.

Train in Big
COYNE
Shops

GREAT OPPORTUNITY FIELDS!



Instructor helping students check the wiring and trace the circuits of television receivers.

This big fire-proof building is occupied entirely by Coyne.

Instructor explaining operation and testing of a large Motor Generator.

YOUNG MEN AND OLDER MEN— PREPARE FOR A CAREER WITH A FUTURE!

Conditions are changing. Many "one operation" jobs will not last. Don't be satisfied with a "no future" job. Whether 17 or up to 45 years of age, train the Coyne way for a better job and a real future in **ELECTRICITY** or **TELEVISION-RADIO**, fields that offer a world of opportunities.

LARGEST, OLDEST, BEST EQUIPPED SCHOOL OF ITS KIND IN THE U.S.

TELEVISION-RADIO **ELECTRICITY**

Here at Coyne you're trained for Television, Testing, Trouble-Shooting on Radio, Public Address, F. M. Sound Units, etc. Many Coyne trained men in good jobs or own well paying Television-Radio businesses of their own.

Big future in Power Plant Work, Motors, Industrial Electronics, Armature Winding, Home and Factory Wiring, Appliances, Refrigeration, Maintenance, Illumination, etc. Lifetime job service to Coyne graduates.

WE TRAIN YOU IN CHICAGO

Our famous Practical-Technical method gives you practical experience on a massive outlay of equipment. Actual shop work plus necessary technical training. You are trained right here in the great Coyne shops. Send for **BIG FREE BOOK**.

**APPROVED
FOR
VETERANS**

START NOW—PAY LATER

Enroll now, pay most of tuition after graduation. Special plan for men of draft age. We'll help you get part-time work, if you need it to help pay living costs while at Coyne.



Mail Coupon for Big FREE Book!

Whether you prefer Television-Radio or Electricity, train on actual equipment at Coyne. We will send you a Big, fully illustrated Book "Guide To Careers in Electricity and Television-Radio". No salesman will call. Mail coupon TODAY.

B. W. COOKE, President

COYNE
ELECTRICAL SCHOOL

FOUNDED 1899

A TECHNICAL TRADE INSTITUTE OPERATED NOT FOR PROFIT
500 S. PAULINA STREET, CHICAGO, Dept. 6-72H
ELECTRICITY ★ RADIO ★ TELEVISION ★ REFRIGERATION ★ ELECTRONICS

B. W. Cooke, President
COYNE ELECTRICAL SCHOOL 500 S. Paulina
Dept. 26-72H, Chicago 12, Ill.

Send me your Big Free book. I am interested in field checked below. This does not obligate me.

TELEVISION-RADIO ELECTRICITY

NAME.....

ADDRESS.....

CITY.....STATE.....



**Want better pay,
steady work and
a way to make
extra money?**

Learn at Home IN YOUR SPARE TIME to Fix Electrical Appliances

To build a better future, get into a field where there's much important work and the security that comes from knowing a good trade. Servicing electrical appliances offers that OPPORTUNITY. Every wired home has an average of 8 electrical appliances. Up to 10 million new appliances are sold every year and owners pay well to keep them in repair. That's making a fast-growing need for trained men.

Start Soon to Earn \$3, \$4, \$5 an Hour Extra in Your Spare Time

Start soon to fix electric toasters, clocks, fans, vacuum cleaners and other appliances for neighbors and friends. Work in your basement, garage or spare room. Pick up \$3 to \$5 an Hour *extra that way*. It's easy to increase your earning power—to pay for this training many times over with your spare time earnings.

Learn and Earn with Multi-Use Tester Built with Parts We Send

This course includes the parts to build a portable, sturdy Appliance Tester that helps you locate electrical defects quickly and easily. You use it to learn and do actual electrical appliance repair jobs. If you want better pay learn this good

trade. No need to give up your present job. You can train at home in your spare time for only \$2.50 down and \$5.00 a month. A small price to pay for increased earnings, a more secure future. Paste coupon below on a 2c postal or mail in envelope for free book and sample lesson. Address National Radio Institute, Dept. AB6, Washington 9, D. C.

**2c TO MAIL THIS
COUPON MAY START
YOU TO SUCCESS
LESSON AND BOOK
FREE**



**NATIONAL RADIO INSTITUTE
Dept. AB6, Washington 9, D. C.**

Please send me Electric Appliance Training lesson and book free.
(No salesman will call.)

Name _____ Age _____

Address _____

City _____ Zone _____ State _____

APPROVED MEMBER NATIONAL HOME STUDY COUNCIL

INVENTORS

If you believe that you have an invention, you should find out how to protect it. The first step is to have a search made of the prior pertinent U. S. patents. If a report on this search indicates that the invention appears patentable you can apply for a patent, and the specifications and claims should be prepared.

The firm of McMorrow, Berman & Davidson, with offices in Washington, D. C., is qualified to take the necessary steps for you. We can make a preliminary search on your invention, advise you whether we think it can be patented, and prepare your application for patent.

Unless you are fully familiar with the U. S. Patent Laws, we recommend that you engage the services of a Registered Patent Attorney to protect your interests. The patent laws are *your* laws. A patent gives you the right to prevent others from making, using or selling the invention claimed in your patent for a period of 17 years.

Use these patent laws for your protection. Investigate whether your invention can be patented. If you have what you believe to be an invention, we suggest that you have this firm make a search for you.

Send for a copy of our Patent Booklet entitled "How To Protect Your Invention," containing information about patent protection and patent procedure. Along with this we will also send you an "Invention Record" form, for your use in writing down and sketching details of your invention. We will mail them promptly. No obligation. They are yours for the asking.

McMORROW, BERMAN & DAVIDSON

Registered Patent Attorneys

PATENTS



COPYRIGHTS



PATENTS

135-S VICTOR BUILDING, WASHINGTON 1, D. C.

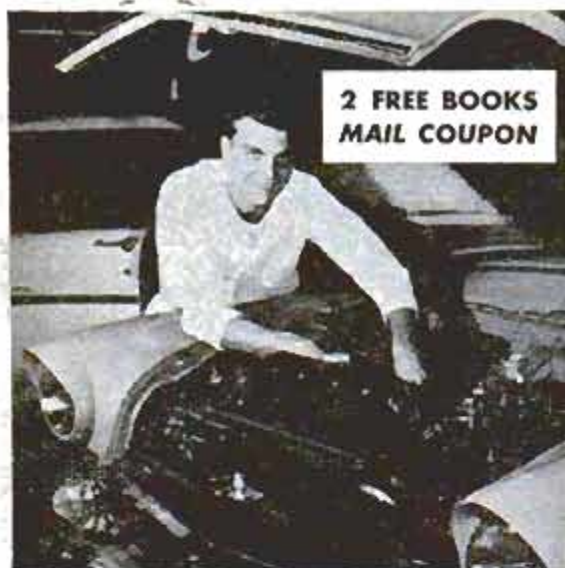

Make Big Pay-Feel Secure-Work Steady

New Shop-Method Way To Learn AUTO MECHANICS At Home In Your Spare Time

A NATIONAL MAGAZINE reports that an auto mechanic has the "brightest future" . . . that his prospects for success are "very good" . . . that he has "opportunity to open his own shop." This is no surprise because Auto Mechanics ranks as America's No. 1 trade. *It offers you good pay, lifelong security and steady work.* Here's why: There are 600,000 auto repair shops and supply stores in the U. S. These shops need thousands of trained mechanics to keep the 50 million cars and 10 million trucks on the road in operation. As a leading automotive magazine said: "About two-thirds of all cars in use are in the heavy repair age classification." It adds, "Aside from the prosperity generated by the huge flood of new cars, the service potential they create is tremendous." If YOU are a man of action—if you want to earn up to \$125 a week and more—we suggest you mail coupon below for two new, free books. These books tell you about the good jobs now waiting . . . show you how to qualify at home in spare time in just a few months.

Start Earning Spare Time Cash Soon After You Start Training



CTI Shop-Method training is so practical you take on repair jobs with confidence long before you graduate. After just a few lessons, many students do repair work in their communities. Their earnings often pay tuition, buy equipment, and start some in a full-time business. You, too, can make up to \$5 an hour while training, and get valuable experience besides.

You Get Practical Experience Using Tools and Tune-Up Kit

YOURS—THIS FINE SET OF MECHANIC'S TOOLS

As part of your training, CTI sends you this set of fine quality mechanic's tools. You'll soon be using these tools—getting practical experience and earning spare time dollars, just as many students do. Tools make you proud of your craft, keep your interest high, develop your skill. CTI's illustrated, easy-to-understand lessons show you when and how to use your tools. You will put action into your training—see your knowledge "come alive."



Start A Business - Be The Boss

If you like independence, Auto Mechanics can make your dream come true. Start in your own back yard as you train and rent a building when you have a large enough list of satisfied customers. Or, work in a local repair shop, make friends, and in time begin "on your own." Graduates have opened shops with just a few hundred dollars.



Diesel or Body-Fender Training Also

So complete is CTI training in Auto Mechanics that you become not just a mechanic but a specialist in tune-up; overhaul; automatic transmissions; power steering; power brakes; clutches; electric, cooling and lubricating systems; etc. And that isn't all: If you wish, CTI will send you instruction on either Diesel Mechanics or Body & Fender Rebuilding at no extra cost.

High Praise From Industry

One of the largest auto trade associations in America said: "CTI has the best school in the U.S.A." Another association reported: "Your graduates are making excellent progress . . . are highly thought of."

FREE BOOKS TELL HOW

COMMERCIAL TRADES INSTITUTE Dept. A-238
1400 Greenleaf Ave., Chicago 26, Ill.

Mail me your book *Big Money In Auto Mechanics* and Lesson Sample. Both FREE.

Name _____ Age _____

Address _____

City _____ Zone _____ State _____

Member: National Home Study Council



MAKE GOOD LIKE THESE CTI MEN



"Without CTI training, I would not have the job I hold today. When I showed my CTI diploma, I was given a chance to work as a mechanic."
—W. O'NEIL, PA.

"Went to work in a garage repairing generators, starters, other electrical equipment. Training is complete and thorough."
—J. EDWARDS, ILL.

"After completion of training, I started as a full-fledged mechanic in a Buick garage."
—W. CARTWRIGHT, IND.

"Have bettered myself nearly 100%. Am in partnership with another fellow and we have 24 cars of our own."
—A. H. CATES, MR.



"Have had 3 pay raises in 8 months. Before I took the course, I knew very little about a car engine."
—W. LONG, PA.

MEN 17-55!

HERE'S A NEW
OPPORTUNITY
FOR YOU!



Industrial Processing

PREPARE AT HOME FOR A
PROFITABLE CAREER IN
AUTOMATION
ELECTRONICS*

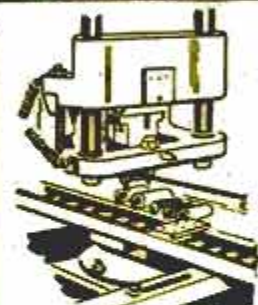

Making Electronic devices



Recording and billing



Anti-aircraft gun control



Traffic control signals

**Get in on the Ground Floor of this
Fast-Moving Field**

Want a better job? . . . more money? . . . better working conditions? These are the things that can come to a man when he has a skill to offer . . . especially when that skill is in a newer field where ground floor opportunities often lead to well-paying positions. Such a field is the Electronic applications to **AUTOMATION** — and what a field!

Many plants, large and small, in various parts of the country are looking for ways of using automatic electronic control equipment to help turn out a better product and at lower cost. This equipment must be designed, installed and maintained — calling for well trained men. That's where **YOU** may come in!

You need no special technical experience . . . no previous knowledge of Automation Electronics . . . to prepare for a future that can be bright and more secure. For now there is a proved way to get this important know-how. Mail coupon for complete details. Men 17 to 55 preferred.

***WHAT IS AUTOMATION ELECTRONICS?**

Simply stated, this refers to the marvelous electronic controls that will help regulate the much talked about "automatic factory" — as well as other amazing automatic equipment in plants, offices and elsewhere. It is a gateway to some of the most desirable opportunities in the amazing, newer field of Automation.

ONE OF AMERICA'S
FOREMOST ELECTRONICS
TRAINING CENTERS



DEVRY TECHNICAL INSTITUTE

CHICAGO 41, ILLINOIS

FORMERLY

DEFOREST'S TRAINING, INC.

A New Training Program!

As one of the leading organizations of its kind, the DeVry Technical Institute has years of experience in teaching Electronics, Television and Radio. So it is only natural for this training institute to develop a new program to prepare men for good jobs in instrumentation — as well as in the design, installation and maintenance of Electronic controls — as applied to Automation.

EMPLOYMENT SERVICE

Following the same proved method used to train thousands of other men, you get valuable practical experience from actual electronic equipment. You also receive well-illustrated texts and effective moving pictures to show important basic principles—a wonderful home training advantage! To top that off, D.T.I. provides actual employment help when you have completed the training—all of which can open the way to many new and exciting opportunities.

Member of
National Home Study Council

MAIL THIS COUPON TODAY!

DEVRY TECHNICAL INSTITUTE, Dept. PM-2-M

4141 Belmont Avenue, Chicago 41, Ill.

I would like further information about the newer Electronic opportunities in **AUTOMATION**, also facts on how you may help me to prepare.

Name _____ Age _____

Please Print

Street _____ Apt. _____

City _____ Zone _____ State _____

S

DTI's training is available in Canada

CLEAN YOUR CARBURETOR

Feel the difference!



- ✓ Smoother idling
- ✓ Faster pick-up
- ✓ No stalling



GUMOUT

- Cleans carburetors quickly and easily.
- Saves time and money.
- Nothing to take apart. Anyone can use it.
- Add it to your gas tank regularly . . . or have your serviceman run it through your carburetor.
- Available at service stations, garages, auto supply stores, and hardware stores everywhere.

SEND FOR **FREE**

46-page

"CARBURETOR HANDBOOK"

GUMOUT DIVISION
 Pennsylvania Refining Co.
 2671 Lisbon Road
 Cleveland 4, Ohio



(Continued from page 8)

There she was scuttled by her own crew. The model shown is very fine.

William L. Fisher,
 Racine, Wis.

To the Editor:

I'm enclosing three snapshots of my float on which I have applied for a patent.

James E. Davis,
 Huntsville, Tex.



Editor on 17-Hour Shift

Art Railton, our Automotive Editor, probably will tell you he spent a good many 17-hour shifts putting to bed the Annual Automobile Section in this issue. But right

(Continued to page 34)



L. C. Lane, B.S., M.A.
President, Radio-Television
Training Association,
Executive Director, Pierce
School of Radio & Television.

VETERANS! NON-VETERANS!
Study AT HOME in your SPARE TIME to be a TELEVISION TECHNICIAN

**YOU LEARN MORE
because I GIVE YOU MORE!**



Super-Het
Radio Receiver



C-W Telephone Transmitter



Public Address System



Combination Voltmeter-
Ammeter-Ohmmeter



AF-RF Signal Generator

LEARN BY DOING

Every one of my students gets enough equipment to set up his own home laboratory. You learn to be a television technician by actually doing what a TV technician must do on the job. With the equipment I send you, you build and keep an Electromagnetic TV RECEIVER designed and engineered to take any size picture tube up to 21-inch. (10-inch tube furnished. Slight extra cost for larger sizes) . . . Also a Super-Het Radio Receiver, AF-RF Signal Generator, Combination Voltmeter-Ammeter-Ohmmeter, C-W Telephone Transmitter, Public Address System, AC-DC Power Supply. Everything supplied, including all tubes. No experience is necessary . . . My practical, easy-to-understand lessons have brought success to hundreds of men, many with no more than a grammar school education.

CHOOSE FROM 3 COMPLETE COURSES

My Courses cover all phases of radio, FM and television.

1 Radio, FM and Television Technician Course
(No Previous Experience Necessary)

You learn by practicing with the professional equipment I send you. Many of my graduates now hold down good paying technician jobs with such firms as RCA, NBC-TV, CBS-TV, DUMONT TV and numerous other TV studios and plants.

2 FM-TV Technician Course
(Previous Training or Experience in Radio Required)

You can save months of time if you have previous Armed Forces or civilian radio experience! Train at home with kits of parts, plus equipment to build BIG SCREEN TV RECEIVER. ALL FURNISHED AT NO EXTRA COST!

EXTRA TRAINING IN NEW YORK CITY AT NO EXTRA COST!

After you finish your home study training in Course 1 or 2 you get two weeks, 50 hours, of intensive Laboratory work on modern electronic equipment at our associate school in New York City, Pierce School of Radio & Television. THIS EXTRA TRAINING IS YOURS AT NO EXTRA COST WHATSOEVER. My courses are complete without this extra training, however. It is just an added opportunity for review and practice.

3 TV Cameraman and Studio Technician Course
(Advanced Training for Men with Radio or TV Training or Experience)

I train you at home for an exciting high pay job as the man behind the TV camera. Work with TV stars in TV studios or "on location" at remote pick-ups!

An optional 30 hour one-week course of practical work on TV studio equipment at Pierce School is offered upon completion of Course 3.

EARN WHILE YOU LEARN

Almost from the very start you can earn extra money while learning by repairing Radio-TV sets for friends and neighbors. Many of my students earn up to \$25 a week . . . pay for their entire training from spare time earnings. . . start their own profitable service business.

FCC COACHING COURSE!

Important for BETTER PAY JOBS requiring FCC License. You get this training AT NO EXTRA COST. Top TV jobs go to FCC-licensed technicians.

VETERANS!

My school fully approved to train veterans under new Korean G. I. Bill. Don't lose your school benefits by waiting too long. Write discharge date on coupon.

YOU GET THESE FREE

MAIL THIS COUPON TODAY!



Mr. Leonard C. Lane, President
RADIO-TELEVISION TRAINING ASSOCIATION
Dept. M-2C, S2 East 19th Street, New York 3, N.Y.

Dear Mr. Lane: Send me your NEW FREE BOOK, FREE SAMPLE LESSON, and FREE aids that will show me how I can make TOP MONEY IN TELEVISION. I understand I am under no obligation.

(PLEASE PRINT PLAINLY)

Name _____ Age _____

Address _____

City _____ Zone _____ State _____

- I AM INTERESTED IN:
- Radio-FM-TV Technician Course
- FM-TV Technician Course
- TV Cameraman & Studio Technician Course

VETERANS!
Write discharge date

Radio Television Training Association

52 EAST 19th STREET • NEW YORK 3, N. Y.

Licensed by the State of New York • Approved for Veteran Training

Now! Turn Your Waste Gas Into SUPER POWER!

IT'S TRUE! Now you can get the breath-taking acceleration . . . jack-rabbit starts . . . blazing new power that you've dreamed about for years—*simply by harnessing the raw, unburnt gasoline that your engine is wasting today!*

You can get performance from your present car that will make your friends gasp with astonishment—and you can save \$25, \$50, even \$75 a year on gas bills alone doing it!

Yes! You, yourself, can fit this amazing GASOLINE ATOMIZER onto your car in as little as 20 easy minutes! And it is guaranteed to pay you back your full purchase price, in gas savings alone, in the first 3 to 4 short months that you use it.

By RICHARD JOHNS

Mr. Car Owner! How would you like to have the driving thrill of your life next weekend?

Picture this yourself! Next weekend go down to your car—the same tired car you've been driving for years. You've made one simple change to that car, so easy your 16-year-old son could do it! But now, when you turn on the ignition, a modern miracle of engineering science comes to life under your hood.

From the very first moment, you'll see and feel the difference in that engine. That engine will hum with new, throbbing power. When you release the emergency brake, your car will glide out of its parking space . . . roll down the street with your foot hardly touching the pedal. Every 30 or 40 seconds, give that car an extra shot of gas . . . feel it spurt ahead . . . test the new power that's singing under your foot!

We ask you to pull up to another car at the stop light, of approximately the same year and make as your own! Wait until the light changes to green. Let the other car start first. Wait till the other car gets half way across the street. And then slam your foot down on the gas pedal!

Before that other car has even crossed the street, you will have caught up with him. For one brief second, you and that other car will race fender to fender. Then you will flash away from him . . . you will leave him a full block behind . . . you will look in your rear view mirror and see the startled look of amazement in the other driver's eyes!

FREE!

UP TO \$3 RETAIL VALUE! UP TO 2 TO 4 MILES MORE PER GALLON INSTANTLY, SAY THOUSANDS OF USERS.

THIS is probably the most widely sold piece of automotive equipment in the world! OVER HALF A MILLION DRIVERS have paid up to \$3 a set to put these amazing Air Bleed Needles on their cars! But we bought out an entire factory at a sacrifice price! For this one advertisement only, we can offer you these exact same needles as a FREE gift, even if you return the MINI-SUPERCHARGER!

1. They fit onto the carburetor of your car, where they replace the standard Idling Adjustment Screw. Six-cylinder cars need only one Air Bleed Needle (regular price \$1.50). Eight-cylinder cars need two needles (regular price \$3.00). In either case, you simply unscrew the old needle and put in the new. THAT'S ALL THERE IS TO IT! Even if you never looked under your hood be-



fore, you can do it in 60 seconds . . . without touching a tool, without even getting your hands dirty!

2. The purpose of these Air Bleed Needles is to STOP YOUR CAR FROM WASTING GAS IN STOP-AND-GO DRIVING . . . and to save you up to 2 to 4 miles a gallon. And at the same time it can give you easier, quieter performance and pick-up and smoother, more economical idling!

REMEMBER, THIS IS PROBABLY YOUR ONLY CHANCE TO GET THESE AMAZING AIR BLEED NEEDLES AS A FREE GIFT—and a gift that is yours to keep even if you return the MINI-SUPERCHARGER!

But our supply is limited! We can make this offer only once in this magazine. Simply send us the make and year of your car, and this gift is yours! BUT ACT TODAY!

WE GUARANTEE YOUR GAS SAVINGS!

Save this guarantee section. It authorizes you to try this amazing new MINI-SUPERCHARGER for a full four months ENTIRELY AT OUR RISK! This device must save you — on gas alone — EVERY SINGLE CENT OF THE MONEY THAT YOU PAID FOR IT — OR YOUR FULL MONEY WILL BE REFUNDED! This offer is good for a full four months! It is probably the most amazing offer in car history! You have nothing to lose! ACT TODAY!

Eugene Stevens, Inc.

TEST THIS NEW POWER A HUNDRED DIFFERENT WAYS!

But this is just the beginning! Test this equipment for one full month—entirely at our risk! Use it to flash away from other cars . . . spurt up the steepest hills . . . actually pass other cars in 2, 4, 6 and even 8 seconds LESS than you could have done formerly!

See the enormous gas savings it gives you at high speeds! Prove to yourself that at 50 . . . 60 . . . even 70 miles an hour, your foot is still half-way up on the pedal—you still have all the reserve power you need to get out of any emergency on the highway!

Yes, and test it in stop-and-go city driving! Prove to yourself that it gives you the instant acceleration you need to get out in front of the crowd . . . with far less gas than you're using today! Prove to yourself that it can actually save you \$25 to \$50 to \$75 on your gas bills each year . . . that it actually pays back its full cost, in gas savings alone, during the first three or four months — or your full money back!

HOW DOES THIS PRODUCT GIVE YOU SUCH TREMENDOUS NEW POWER?

And you get all this performance—and more—from a small, polished machine of bronze and aluminum that you can hold in your hand! Here's why:

Gasoline in its liquid form is



YES! THIS AMAZING "MINI-SUPERCHARGER" GIVES YOU AS MUCH AS 20 MORE HORSEPOWER FROM YOUR ENGINE! Gives you the gas economy you've dreamed about for years! This Power Booster works on exactly the same principle as superchargers selling for as high as \$600. Its whirlwind propeller (A) breaks up the raw, unburnt gas that your engine is wasting today . . . gives you blazing new power from every drop! Its emergency breather valve (B) forces huge quantities of fresh air into your engine . . . forces that engine to breathe deeper . . . push harder . . . pile up more mileage from every gallon you buy! No won-



der dozens of leading car magazines call this the "money saving discovery of the year." Test this amazing gas-saver yourself — without risking a penny! THE THRILLING FACTS ARE ON THIS PAGE!

not explosive. If you accidentally drop a lighted match into a bucket full of gasoline, the chances are 10 to 1 that that gasoline will actually put out that match. But simply mix that same bucket full of gas with the proper amount of air, and you will have enough explosive power to drive a ten ton truck!

This machine SUPER-MIXES SUPER-VAPORIZES . . . SUPER-ATOMIZES your gas in exactly that way! Squeezes the hidden power out of that gas! Mixes that gas with much greater volumes of air! Makes that gas more explosive in your engine!

Men have paid up to \$600 for Superchargers! This is a MINI-SUPERCHARGER — easier to install — less expensive! But still the only power product you can buy with all these tremendous advantages:

1. Install it yourself, in just 20 minutes, even if you never picked up a tool before in your life!
2. Never needs further adjustments, for the life of your car!
3. Takes up no room in your car, makes no "souped-up" noise!

SO EASY TO INSTALL THAT EVEN YOUR 16-YEAR-OLD SON CAN DO IT!

Step 1. Locate Air Cleaner and Carburetor on top of your engine. Take an ordinary wrench, and loosen the two or three bolts that hold the carburetor to the engine!

Step 2. Lift up the carburetor. Put MINI-SUPERCHARGER in place. What could be easier?

Step 3. Replace carburetor. Now turn on your engine! Then get in and take the most thrilling drive of your life!

TRY IT ENTIRELY AT OUR RISK

This MINI-SUPERCHARGER (U.S. Patent No. 2,409,937) sells for only \$11.95 for most cars or \$14.95 if your car has a special four barrel carburetor. This is your total cost—there is no installation fee! And, most important of all, we guarantee that you will save this full purchase in gas bills alone—in the first 3 to 4 months that you own this device.

You have nothing to lose! Try it entirely at our risk. You must get a whole new world of driving pleasure and economy or your full money back! Act today!

MAIL NO-RISK COUPON TODAY!

EUGENE STEVENS, INC.
132 WEST 21 STREET, DEPT. PR-65
NEW YORK 11, N. Y.

IMPORTANT:
For Fast Service,
Be Sure Coupon Is
Completely Filled In.

Yes, I want to try your amazing MINI-SUPERCHARGER entirely at your risk! I will pay postman only amount checked below plus low C.O.D. charges:

- \$11.95 (My car does not have a four barrel carburetor).
 \$14.95 (My car is equipped with a special four barrel carburetor).

I understand that it must do everything you say or my full money back! Also send me as your Extra Gift Premium, the Free Air Bleed Needle Set. I may keep the needles even if I return the MINI-SUPERCHARGER.

MAKE OF CAR _____ YEAR _____ Please Print

MODEL _____ 4 DOOR OR 2 DOOR _____

6 CYLINDERS _____ STRAIGHT 8 _____ V-8 _____

STANDARD TRANSMISSION _____ AUTOMATIC _____

ADDRESS _____

CITY _____ ZONE _____ STATE _____

CHECK HERE TO SAVE MORE! Enclose check or money order, and we pay all postage and handling charges! You save as much as \$1.00. Same money-back guarantee, of course! ©Copyright By Eugene Stevens, Inc., 1955

DEALERS! DISTRIBUTORS! CASH IN ON HUGE, FULL PAGE NEWSPAPER AND TELEVISION CAMPAIGN! WRITE FOR FREE DETAILS.



GEE! IT MUST HAVE TAKEN YEARS TO LEARN TO PLAY LIKE THAT!



NOT AT ALL! I DIDN'T KNOW A NOTE. YET I STARTED PLAYING WHOLE PIECES RIGHT AWAY!

Wonderful, Easy Way to Learn Enables You To PLAY REAL MUSIC Almost Overnight!

**ANY INSTRUMENT
EVEN IF YOU DON'T KNOW
A SINGLE NOTE OF MUSIC NOW!**

Yes, it's TRUE! In just a few weeks, you can be playing REAL MUSIC on your favorite instrument. Not by just a "trick" method that merely seems to teach you music. But really reading and playing actual sheet music—so easily and confidently that your friends will suspect that you've actually "known how" for years!



NO TEDIOUS PRACTICING OF BORING SCALES AND EXERCISES REQUIRED. Even if you don't know a single note now, you'll "start right in on pieces." This builds up your skill and confidence so rapidly that soon you'll be able to play ALL your favorite songs and compositions by note. It's all so clearly explained—so EASY to understand—that even children "catch on" at once.

No Special "Talent" Needed
No wonder OVER 900,000 PEOPLE all over the world have turned to the U.S. School of Music method to make their dreams of playing music come true! No special "talent" is needed. And you learn right at home, in the spare time of YOUR OWN

CHOOSING—free from the rigid schedule imposed by a teacher. Costs only a few cents per lesson, including sheet music.

Stop Cheating Yourself of These Joys!

Why not let this famous home-study method bring the many pleasures of music into YOUR life? Popularity! New friends. Gay parties. Good times. Career. Extra Money... understand, appreciate, converse about. Learn lives and compositions of modern and great masters. Relax! Banish worries and frustrations. Satisfy self-expression, creative urge. Gain self-confidence.

SEND FOR Free Book



Let us SHOW you why our way to learn music is so EASY—and so much fun! See why our method has been so successful for 58 years. Mail the coupon below for our valuable 36-page FREE BOOK. No obligation; no salesman will call on you. It can mean so much to you for the rest of your entire life—if you will mail the coupon TODAY! **U. S. SCHOOL OF MUSIC, Studio 302, Port Washington, N. Y.** Our 58th successful year!

(Reduced Prices on Instruments to our students.)

Thousands Now Play Who Never Thought They Could!

How Famous Orchestra Leader Got His Start!
"I got my start in music with your Course. How easy it is to learn to read notes and play this 'teach-yourself' way! You did so much for me, I've enrolled my two daughters."
—Lawrence Welk.

Mother Fulfills Desire
"After I had been married 13 years I saw my chance to fulfill my desire to play piano. In a few weeks I could play pieces a friend couldn't who took lessons for 3 years from a teacher."
—Mrs. J. L. Newton, Louisville, Ky.

Amazes Friends
"In a few weeks I could play several pieces. Everyone was amazed, also friends who had had lessons for years and whom it took 6 months to a year to play simple pieces."
—Mrs. J. P. Perry, Princeton, W. Va.

Friends Astonished
"I bet friends I could learn piano quickly. They didn't believe me—because I am slow learning. Imagine their surprise last night when I played. One said, 'Sounds like you've played for years!'"
—L. Gomez, Oakland, Cal.



**U. S. School of Music,
Studio 302, Port Washington, N. Y.**

I am interested in learning to play, particularly the instrument checked here. Please send me your free illustrated booklet, "How to Learn Music at Home." **NO SALESMAN IS TO CALL UPON ME.**

Mr. } _____
Mrs. } _____
Miss } _____
(Please Print Carefully)

Address _____

City _____ State _____
(Zone Number, If Any)

NOTE: If you are under 18 years of age parent must sign.

- Piano
- Guitar
- Hawaiian Guitar
- Violin
- Piano Accordion
- Saxophone
- Clarinet
- Trumpet, Cornet
- Pipe, Hammond, Reed Organ
- Tenor Banjo
- Ukulele
- Trombone
- Flute, Piccolo
- Modern Elementary Harmony
- Mandolin
- Practical Finger Control

Do you have the instrument?

WHAT SECRET POWER DID THIS MAN POSSESS?



BENJAMIN FRANKLIN
(A Rosicrucian)

WHY was this man great? How does anyone—man or woman—achieve greatness? Is it not by mastery of the powers within ourselves? Know the mysterious world within you! Attune yourself to the wisdom of the ages! Grasp the inner power of your mind! Learn the secrets of a full and peaceful life!

Benjamin Franklin—like many other learned and great men and women—was a Rosicrucian. The Rosicrucians (NOT a religious organization) first came to America in 1694. Today, headquarters of the Rosicrucians send over seven million pieces of mail annually to all parts of the world. Write for YOUR FREE COPY of "The Mastery of Life"—TODAY. No obligation. No salesmen. A non-profit organization. Address: Scribe S.F.B.

THIS BOOK FREE!



The ROSICRUCIANS

SAN JOSE • (AMORC) • CALIFORNIA

—SEND THIS COUPON—

Scribe S.F.B.
The ROSICRUCIANS (AMORC)
San Jose, California
Please send me the free book, *The Mastery of Life*, which explains how I may learn to use my faculties and powers of mind.

Name _____
Address _____
City _____

318 Different STAMPS—25¢

Monaco—Fantastic Jules Verne Commem. (3)
United Nations First Issues (2)
Azerbaijan—1922 Famine Imperf. (2)
Israel—Giant Immigration Comm. (2)
Australia—Unique South Pole Seals (2)
Ethiopia—Unissued Red Cross set (3)

Plus: Germany 1923 Air's; Czechoslovakia, Lenin-Stalin and hundreds more! Total 318 all-different stamps. Catalog value \$7.15—yours for 25¢ to introduce our Bargain Approvals. Also included FREE, Midget Encyclopedia of Stamps.
Send 25¢ today. ASK FOR LOT FU-23

ZENITH CO. 81 Willoughby St., Brooklyn 1, N. Y.

FOR BIG MEN ONLY!



SEND FOR FREE CATALOG

SIZES 10 to 16 **WIDTHS AAA to EEE**

We SPECIALIZE in large sizes only... sizes 10 to 16; widths AAA to EEE. Low Cuts; Wing Tips; Hand-Sewn Moccasins; Cordovans; Dress Oxfords; Work Shoes; Sox; Slippers; Rubbers. Enjoy the finest in fit, comfort, style at amazingly low cost. Mail only. Write TODAY for FREE Style Book!

KING-SIZE, INC.
699 BROCKTON, MASS.

LEARN METALCRAFT and JEWELRY MAKING



Low Cost Home Training Now Available

Make money. Learn profitable skills and arts of decorative metal and jewelry crafts. Course is complete. Professionally prepared. Easy to master. Special tools and materials furnished.

Write for Free Booklet **INTERSTATE TRAINING SERVICE**
DEPT. K-3 PORTLAND 13, OREGON

EAT ANYTHING WITH FALSE TEETH

If you have trouble with plates that slip, rock and cause sore gums—try Brimms Plasti-Liner. One application makes plates fit snugly without powder or paste, because Brimms Plasti-Liner hardens permanently to your plate. It relines and refits loose plates in a way no powder or paste can do. No need to pass up your favorite foods. With plates held firmly by Plasti-Liner, **YOU CAN EAT ANYTHING!** Simply lay soft strip of Plasti-Liner on troublesome upper or lower. Bite and it molds perfectly. Easy to use, tasteless, odorless, harmless to you and your plates. Removable as directed. Money back guarantee. At your drug counter. Only \$1.50.



BRIMMS PLASTI-LINER
THE PERMANENT DENTURE RELINER

**Get more money!
More security! More out of life!**



Learn

**TELEVISION
• RADIO •
ELECTRONICS**

Get the best!

Get National Schools' SHOP-METHOD HOME TRAINING!

Start now! Why wait around for that raise or promotion that may never come? Get started *now* in high-paying TV-Radio-Electronics! National Schools' SHOP METHOD Home Training prepares you for success in a top-salary job or in your own business. You learn *all three*... Television, Radio, Electronics... in one complete course. Our Shop-Tested lessons and manuals help you master all phases in shortest possible time! Send coupon, find out today!

We send you this precision-tested Multitester! Plus parts to build Oscillators, Receivers, Signal Generator, Continuity Checker, Combination Short Wave and Standard

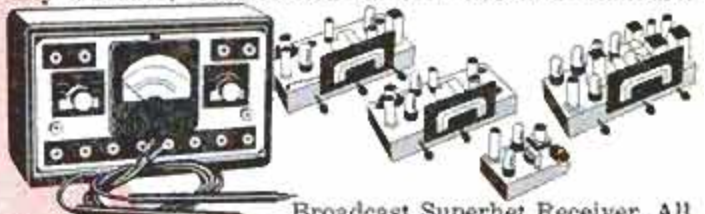

Broadcast Superhet Receiver. All this equipment is part of your National Schools course. **NO EXTRA CHARGES!** Send coupon for free books!

NATIONAL SCHOOLS, world-famous technical trade school. Now in our 50th year!



WHY NATIONAL SCHOOLS LEADS THE FIELD

Located in the "Television Center" of the world, our staff is in close touch with latest developments and opportunities. We give you personalized job placement assistance. We also give you confidential help with both technical and personal problems relating to your training. We show you how to make Part Time Earnings as you progress. Whether you live 30 miles away, or 3,000, you will always be pleased with our prompt, friendly service!

DRAFT AGE? Our home training helps you achieve specialized ratings and higher pay grades if you go in service.

NATIONAL SCHOOLS

TECHNICAL TRADE TRAINING SINCE 1905
LOS ANGELES 37, California - CHICAGO: 323 West Polk St.
IN CANADA: 811 West Hastings Street, Vancouver, B. C.

- APPROVED FOR G. I. TRAINING
- BOTH HOME STUDY AND RESIDENT COURSES OFFERED

30 MILLION TV SETS

need regular repair! Color TV means more sets than ever before. NOW is the golden opportunity to cash in on this multi-billion-dollar industry Or "write your own ticket" in broadcasting, manufacturing, and other specialized phases!

**YOUR AGE
IS NO
OBSTACLE!**



**Send for
FREE LESSON!**
FREE BOOK & SAMPLE LESSON
will convince you!
SEND COUPON TODAY!

MAIL NOW TO OFFICE NEAREST YOU!

(mail in envelope or paste on postal card)

NATIONAL SCHOOLS, Dept. RB-26

4000 SOUTH FIGUEROA STREET LOS ANGELES 37, CALIFORNIA OR 323 WEST POLK STREET CHICAGO 7, ILLINOIS

Please rush **FREE BOOK**, "My Future in Radio-Television-Electronics," and **FREE LESSON** at once. I understand there is no obligation, and no salesman will call.

NAME _____ BIRTHDAY _____ 19____

ADDRESS _____

CITY _____ ZONE _____ STATE _____

Check if interested **ONLY** in Resident Training at Los Angeles.

VETERANS: Give date of discharge _____

**"TOOK IN \$217
FIRST 10 DAYS"**

Some make more, some less...

**We help you to start Your
Own All-Year Business**

Make Big Money! With our easily operated, highly efficient wall washer, Charles Stelle took in \$217 gross in first ten days. E. L. Goss took in more than \$10,000 in one year. E. C. Taber wrote, "I made \$400 gross in two weeks."



And no wonder... this machine washes walls 6 times faster and better than by hand.

Your Money-making Opportunity. We want more men to go into this profitable business for themselves and enjoy independence—freedom from bosses, layoffs. Customers everywhere—homes, offices, schools, churches, hotels, etc. How much you earn depends largely on you. What you take in is mostly profit. No need to rent shop or office; operate business from home. Can start spare time until your full time is available.

Lose no time. Get all facts without obligation

FREE BOOK! MAIL COUPON TODAY!

• **VON SCHRADER MFG. CO.**
• 210 "W" Pl., Racine, Wisconsin

• Send at once (no obligation) your **FREE** booklet containing information about your **WALL WASHING MACHINE** and how I can start my own permanent, profitable business.

• Name _____
• Address _____
• City _____ Zone _____ State _____

Write Like This

YOUR penmanship can be improved in 3 hours or corrected to your satisfaction in 10 hours' practice with my **DEFINITE HAND CONTROLS**. New way!

WRITE **OZMENT** BOX 665
34-P, ST. LOUIS, MISSOURI

**Complete
OUTLINE
FREE!**

LEARN AT HOME

Key to Success
LOCKSMITHING

Learn this profitable business from experts in your spare time. Locksmiths have no "slow" seasons or layoffs; they are always in demand. Age or minor physical handicap can't stop you. America's only recognized locksmithing school can teach you easily and quickly. Simple, illustrated lessons plus materials and tools supplied. Make money while learning. Get into this uncrowded field now!

Send for **FREE BOOKLET**
INSTITUTE OF LOCKSMITHING, Dept. P-75
15 Park Avenue RUTHERFORD, N. J.
Etc. by N. J. State Board of Education
Approved for Veterans



**Instead of a job . . .
train for a Career**



Industrial growth . . . automation . . . technical advances create career opportunities for engineers, accountants, management experts. Share rewards awaiting college-trained men. Important firms visit campus regularly to employ Tri-State College graduates. Start any quarter in this world-famed college. *Approved for veterans.*

Bach. of Science degree in 27 months

In Mechanical, Civil, Electrical Chemical, Aeronautical, Radio (TV-Electronics) Engineering. In 36 Months a B.S. in Business Administration (General Business, Accounting, Motor Transport Management majors). Capable students may accelerate. 36-weeks course in Drafting. *Intensive program: technical fundamentals stressed; comprehensive courses with more professional class hours. Small classes: personalized instruction. For earnest, mature students whose time and budget requires accelerated courses and modest costs. Preparatory courses. Beautiful campus in friendly college town. Well-equipped, new and modernized buildings and laboratories. Enter March, June, Sept., Jan. Write Jean McCarthy, Director of Admissions, for "Your Career in Engineering and Commerce."*



TRI-STATE COLLEGE

426 College Avenue Angola, Indiana



**I Made \$14,839 in 1 Year
SERVICING RADIATORS!**

Rex Ryan (Iowa) and hundreds of others earn \$8,000-\$20,000 a year servicing auto-truck-tractor radiators the Inland way. Inland, largest radiator servicing equipment mfr., offers the complete package—equipment, merchandising, "Pays-for-itself" financing, and Free training school for customers.

WRITE for **FREE Radiator Servicing Folder.**

INLAND MFG. COMPANY Dept. PM-2
1108 Jackson St., Omaha 8, Nebr.



SEND FOR THIS FREE!

Make money. Know how to break and train horses. Write today for this book **FREE**, together with special offer of a course in Animal Breeding. If you are interested in Galting and Riding the saddle horse, check here () *Do it today—now.*

BEERY SCHOOL OF HORSEMANSHIP
Dept. 1102 Pleasant Hill, Ohio



MECHANICAL DENTISTRY

To make Crowns, Plates, Bridgework, etc., for Dentists. Easy practical way to learn mechanical dentistry at home in spare time. **FULL EQUIPMENT OF TOOLS AND MATERIALS INCLUDED WITH COURSE.** Low tuition. Easy terms. Write for **FREE BOOK** about this money making profession that is not affected by machine age.

MCCARRIE SCHOOL OF MECHANICAL DENTISTRY
207 N. Broad St., Dept. 50, Philadelphia 7, Pa.



Grow authentic, **LIVE** dwarf trees!
Fascinating hobby! **Fabulous profit!**

GROW MINIATURE TREES

SEND FOR **FREE SEED & INFORMATION!**

MINIATURE NURSERY CLUB
Dept. JJ-2, P.O. Box 8794,
Los Angeles 8, Calif.

RUPTURED

BE FREE FROM TRUSS SLAVERY

NOW there is a new modern Non-Surgical treatment that permanently corrects rupture. These Non-Surgical treatments are so certain, that a Lifetime Certificate of Assurance is given. Write today for our New **FREE** Book that gives facts that may save you painful and expensive surgery, and tells how non-surgically you may again work, live, play and love and enjoy life in the manner you desire. There is no obligation. Excelsior Hernia Clinic Dept. 8305 Excelsior Springs, Mo.

HERE'S A READY-MADE FUTURE FOR YOU

MILLIONS OF HOMES IN U.S. HAVE 6-12 SMALL APPLIANCES YEAR. MILLIONS MORE SOLD EVERY YEAR. MILLIONS NEED REPAIR NOW WITH THE NEED INCREASING DAILY!

Start Your own Business IN

ELECTRICAL APPLIANCE REPAIRING

IN YOUR OWN KITCHEN, BASEMENT OR GARAGE

Learn at home in your spare time this fascinating big paying profession.

If you are mechanically inclined, can hold and use tools, we can give you the training and time saving kits that will enable you to . . . Command More Money At Work . . . A Better Paying Job Elsewhere . . . Or A Business Of Your Own!

New Shop Method Home Training teaches you both the technical and practical side of Electricity by having you work with your hands, Building, Testing, Repairing. All instruction manuals are written in easy-to-understand language chock full of hundreds of detailed photos and drawings.

We show you how to quickly locate the trouble, how to fix it and what to charge. ALSO, how to solicit business and keep business coming to you!

\$5.00 TO \$6.00 AN HOUR

Often charged for making ordinary repairs. We show you how to repair refrigerators, vacuum cleaners, washing machines, motors, etc.

CHRISTY TRADES SCHOOL, Dept. D-5103, 4804 N. Kedzie, Chicago 25

SEND FOR FREE BOOK!

CHRISTY TRADES SCHOOL, Dept. D-5103
4804 N. Kedzie Ave., Chicago 25, Ill.

Please send me FREE Illustrated Book on Electrical Appliance Repairing and special form for paying later from earnings.

NAME _____ Age _____

ADDRESS _____

CITY _____ Zone _____ State _____

EARN WHILE YOU LEARN

Only had your course a few short weeks and have already made \$800.00. Going to quit my job paying \$250.00 straight salary to operate my own business. — J. D. S., St. Louis, Mo.

Make \$15.00 Saturdays and more. Am only able to operate in my spare time. It is just what a mechanical minded man needs. — G.O.F., Thomasville, Ga.

3 EASY STEPS

1 We send you the "CHRISTY" Electronic Kit. A multi-purpose trouble tracer. Indicates current consumption, shorts, breaks, etc.

2 We teach you Electrical Appliance Repairing with cross indexed illustrated Manuals. The Easy-To-Remember-Way.

3 We show you how to Get Business and Keep Business Coming to you.

WE GIVE YOU THIS ELECTRONIC KIT TROUBLE FINDER



DRAFTSMEN



CASH BIG PAY CHECKS!

Train Now for more success, greater security

LEARN AT HOME IN SPARE TIME (or at college in Chicago)

Check the want ads in any newspaper—SEE the big-pay opportunities open to you as a draftsman. What's more, you can learn this well-paid, prestige profession at home—quickly, easily! No special talent needed. Get complete, step-by-step Chicago Tech lessons in the mail, spend a few pleasant hours studying each week. In a short time you'll be a well-trained draftsman, ready to take your pick of many good jobs. Act now!



Free Information—Mail Coupon Today!

Get FREE TRIAL LESSON plus information about C.T.C. practical training. Learn what successful Chicago Tech graduates say about high pay and opportunities in drafting. No charge, or obligation.

CHICAGO TECHNICAL COLLEGE

B-254 Tech Bldg., 2000 So. Michigan Ave. Chicago 16, Illinois

Mail me FREE lesson with facts about big opportunities in DRAFTING.

Name _____ Age _____
Address _____
City _____ Zone _____ State _____

SAY YOU SAW IT IN POPULAR MECHANICS

SAVE 75% ON



WORK CLOTHES!

SURPLUS STOCK FROM MIDWEST SUPPLY FIRM!

Terrific values you've got to see to believe!

SHIRTS 79c

Made to sell for 2.99! Now Only 4 for \$2.99

What a buy! 4 for the price of one! These shirts, though used, are washed, sterilized and ready for long, tough wear. In blue, tan or green. Send name, address, neck size.

PANTS to match Unbelievable Bargains! Sold for 3.95. Now only 4 for \$3.75

COVERALLS... wear 'em used and save plenty! Originally 5.95. Now only 3 for \$5.75

SHOP COATS... fully reconditioned. Take advantage of this rock-bottom price. Send chest measurement. Now only 3 for \$5.00

SATISFACTION GUARANTEED! Your money back if you can beat these bargains anywhere! You can't lose so order TODAY for immediate delivery! Pay postman or send money with your order and save postage. \$1.00 deposit on C.O.D. orders.

GALCO SALES CO. Dept. 132
7120 Harvard Ave. • Cleveland 5, Ohio



INSURED TIRE SERVICE POPULAR BRANDS

FREE INSURANCE POLICY given with each used tire sold. We guarantee the amount of service you pay for.

NOWHERE CAN SUCH QUALITY BE FOUND AT SUCH LOW PRICE!

SPECIAL! Deduct 10% on orders for two or more used tires

YOU CAN'T LOSE!!

GOODYEAR SUBURBANITE TYPE SNOW TIRES

New Tire Guarantee—Factory Rebuilt BEST WINTER TRACTION OF ALL!

670x15 \$9.95 | 710x15 650x16 \$10.90
600x16 650x16 650x15

Super Quality — Rugged Performance — 6 Months Insured Service		Supreme Quality — Nothing Finer — 12 Months Insured Service	
600x16	\$3.65	670x15	\$3.95
650x15	3.85	670x16	4.05
650x16	4.25	700x15	3.95
		700x16	4.45
		750x16	4.55

Supreme Quality — Nothing Finer — 12 Months Insured Service		Supreme Quality — Nothing Finer — 12 Months Insured Service	
600x16	\$5.25	475x19	\$8.45
600x16	6.75	640x15	4.95
650x16	5.75	670x15	5.35
650x16	7.25	710x15	5.45
700x16	6.35	760x15	5.95
750x16	8.45	800x15	6.35
550x18	4.95	820x15	6.35
550x17	4.75	550x15	5.35
650x15	5.25	670x16	5.15
700x15	5.35	700x16	10.25
		32x6-10	12.75
		1100x22	25.95

Whitewalls \$1.00 extra.

MIDLAND TIRE SALES

Speedy shipments on Mail Orders. F.O.B. Chicago. Insurance policy sent with each order. Deduct 10% on orders for 2 or more used tires. Send CHECK or MONEY ORDER.—No COD's. 3701 S. Normal, Dept. PM-43, Chicago 9, Ill.

"ROLL" WALL CLEANER



DRY roll wallcleaner. No mess. No fuss. Simply glide over walls. Removes dirt like magic from Wallpaper, Painted Walls, Ceilings, Window Shades, Leaves beautiful lustrous finish. Take orders. Earn money!

SAMPLES for TRIAL

Sample offer sent at once to all who send name. Hurry—just a postcard will do. SEND NO MONEY—Just your name.

KRISTEE CO., Dept. 689, Akron 8, Ohio

AGENTS START BUYING SERVICE AT HOME

GET BIG NAME MERCHANDISE

for your clients up to 40% less than reg. price. Operate sparetime. Sales easy as you can give sizeable discounts, still make fat comm. Postcard brings free plan.

AMERICAN BUYERS SERVICE
HERTEL STATION, DEPT. R, BUFFALO 16, NEW YORK

GET UP TO 40% OFF



MAGIC TRICKS

IT'S FUN TO DO MAGIC

Be popular! Amaze—mystify—amuse! For 30 years Douglas has satisfied customers all over the world. Now, you can enjoy this fascinating hobby. Only 10c brings our Catalog 500 Tricks, containing brand new tricks for pocket, parlor, stage. Join in the fun—send 10c today!

Douglas Magicland, Dept. A, Dallas, Texas



AMERICA'S NEWEST OPPORTUNITY

New fur-bearing animal now being bred in U. S. Offers huge profits to breeders. This fur is next to Mink NOW in price and will soon surpass it. 15 to 20 young per year. Most easily and economically raised animal known. 1 1/2c per day to feed. ANY CLIMATE, disease resistant. Build yourself a sound future with this fine, registered stock. WRITE TODAY FOR FREE BOOKLET.

CABANA NUTRIA, INC.
636 West Lemon Ave., Arcadia, Calif.

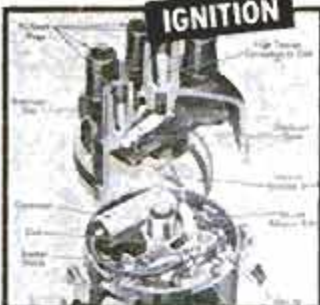
CLUTCH**IGNITION****CARBURETORS****AUTOMATIC TRANSMISSIONS**

2000 photos and diagrams, plus crystal-clear directions, make every operation easy as A-B-C.

Diagrams, tables and text take the "mystery" out of all ignition systems.

You get illustrated repair procedures for all types of carburetors.

ALL AUTOMATIC TRANSMISSIONS are fully covered in special big section. (NOTE: All pictures shown here are greatly reduced in size. Actually, this giant book is almost a foot high!)

Here's the EASY Step-by-Step Way to FIX ANY PART OF ANY CAR

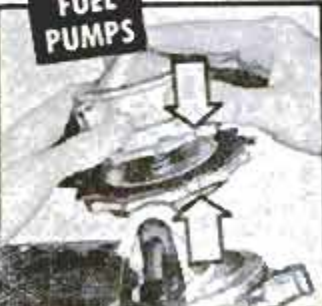
FUEL PUMPS

Fuel pumps can cause trouble. Pictures show exactly how to take them apart, fix them.

Now—Whether You're a Beginner or Expert Mechanic—You Can "Lick" Any Auto Repair Job On Any Car Built from 1940 Through 1955!

in a jiffy!

Now you can tackle any repair job, and do it quickly, easily, right—the first time! MOTOR'S BRAND-NEW AUTO REPAIR MANUAL shows you how—with crystal-clear pictures and step-by-step directions you can easily follow.

No guesswork. This giant guide tells you where to start; what tools to use. Leads you easily and quickly through the entire operation. Covers everything from a simple carburetor adjustment to a complete overhaul.

Everything You Need to Know

BIG, NEW REVISED Edition has MORE REPAIR INFORMATION THAN EVER! OVER 1,000 giant pages, 2,900 "This-Is-How" pictures—clear drawings, diagrams, cutaway photos—make every step EASY. 291 "Quick Check" charts—23,436 essential repair specifications. Over 225,000 service and repair facts. Instructions and pictures so COMPLETE, so CLEAR—you CAN'T go wrong!

Brakes, Power Steering, Shock Absorbers, etc.

Factory Specifications and Adjustment Tables, Tune-up Charts, Table of Measurements and Clearances, Overhauling, Replacement Facts—AND MUCH MORE.

Used by Armed Forces, hundreds of thousands of auto service men! Now try it on this GUARANTEE:

Try Book for a Week FREE SEND NO MONEY

Pay nothing to postman. Test book in your own garage or shop. It's GUARANTEED to pay for itself in 7 days. If it doesn't just return the book, and owe nothing. Rush coupon for your free-trial copy of this great money-saving Manual. MOTOR Book Dept., Desk 1B, 250 West 55th St., New York 19, N. Y.

Even a green beginner can do a good job. And top mechanics will be amazed at the time-saving procedures.

The "Meat" of Over 160 Official Shop Manuals

The editors have put together the "Know-How" from over 160 Official Shop Manuals; "boiled it down" into one handy indexed book.

Includes ALL Automatic Transmissions. Covers new Carburetors, Engines (including new Chevrolet, Nash, Hudson, Plymouth, Packard, V-8s), Chokes, Fuel Pumps, Oil Filters, Starting Motors, Generators, Distributors, Clutches, Universals, Axles,

USED BY U.S. ARMY NAVY MARINES

BRAND-NEW EDITION!



SEND NO MONEY! TRY BOOK FREE!



No guesswork. Clear pictures show how to fix starting motor, generator, brakes, etc.

Just 2 of the Many Letters of Praise
Does Every Job. "My MOTOR Manual is a wonderful help. It has put me in a position to do every job."—S. L. Sharpless, Los Angeles, Calif.
Amazed Self and Friends. "I amazed myself and my friends, too. Now do jobs that stumped me before."—Michael Balitsky, Newark, N. J.

Some FREE 7-Day Offer on MOTOR'S Brand-New TRUCK REPAIR MANUAL
Covers EVERY job on EVERY gasoline-powered truck made from 1946 thru 1955—including GM and Cummins Diesels. Over 2,000 Illustrations, over 300,000 facts. Check proper box in coupon for free trial.

COVERS 737 MODELS—ALL THESE MAKES

- | | | |
|-----------|---------|------------|
| Buick | Ford | Nash |
| Cadillac | Frazier | Oldsmobile |
| Chevrolet | Henry J | Packard |
| Chrysler | Hudson | Plymouth |
| Crosley | Kaiser | Pontiac |
| De Soto | Lincoln | Studebaker |
| Dodge | Mercury | Willys |

2,000,000 COPIES SOLD!

MAIL COUPON NOW FOR 7-DAY FREE TRIAL

MOTOR Book Dept., Desk 1B, 250 West 55th Street, New York 19, N. Y.

Rush to me at once: (Check box opposite book you want).

MOTOR'S New AUTO REPAIR MANUAL. If okay, I'll remit just \$2.00 in seven days, then \$2.00 monthly for two months and a final payment of 95c (plus 35c delivery charges) one month after that. Otherwise, I'll return the book postpaid in seven days. (Foreign price: Remit \$9.00 cash with order.)

MOTOR'S New TRUCK REPAIR MANUAL. (Described at left.) If okay I will remit \$2.00 in seven days, and \$2.00 monthly for three months, plus 35c delivery charge with final payment. Otherwise I will return book promptly. (Foreign price: Remit \$10.00 cash with order.)

Print Name..... Age.....

Print Address.....

City & Zone No..... State.....

SAVE 35c delivery charge by enclosing WITH COUPON check or money order for full payment of \$6.95 for Auto Repair Manual (or \$8.00 for Truck Manual). Same 7-day return-for-refund privilege applies.

FREE

A NEW HOME INDUSTRY



GEARS



FISHING LURES



JEWELRY
GEMS

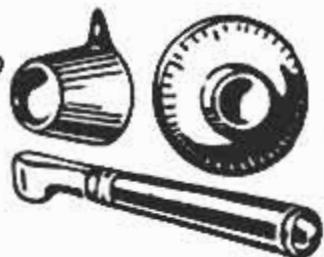

HANDLES
KNIVES - DIALS



STATUES
FIGURINES

Let us show you how extremely easy and PROFITABLE it is to make beautiful and useful things out of LIQUID PLASTIC, LIQUID MARBLE, LIQUID IVORY, LIQUID GLASS, LIQUID EBONY, LIQUID PORCELAIN, LIQUID GEMSTONE, CERAMICS, ETC. . . . as easy as pouring water out of a glass! Make tools, dies, gadgets, novelties, jewelry, gifts, artware, ceramics a million useful things! Valuable products that sell themselves on sight because of their exciting beauty and practical utility.

For years we have been teaching and guiding ambitious people in how to acquire profitable and fascinating occupations, starting at home or in your own shop (with only a few dollars investment), how to make more money than ever before! We now offer YOU the same unlimited opportunities!

MANUFACTURE WITHOUT TOOLS OR MACHINERY!

No previous experience or special ability is needed in order to manufacture with PLASTICAST Liquid Plastics. Our special book the "WONDERS OF LIQUID PLASTICS" reveals all. Our Liquid Plastics serve so many diverse and useful functions, and can so easily be converted into beautiful and attractive products that thousands of our customers are now actively engaged in a wide variety of pride giving and profitable businesses established with the aid of our products and instructions!

FREE Catalog 19 is devoted exclusively (108 pages) to the art of manufacturing **EVERYTHING** without tools or machinery! Send for it today! We will include valuable book **THE WONDERS OF LIQUID PLASTICS** absolutely **FREE**. Catalog No. 19 - 25c.

PLASTICAST CO., Dept. PC-402
6612 N. Clark St. Chicago 26, Ill.

WE BUY THOUSANDS OF PLASTICAST ITEMS ANNUALLY

Let us start you in business! We always need GEMCRAFT stones, made from PLASTICASTINGS, for our regular customers. We guarantee to buy your output too, when made from PLASTICAST MATERIALS.

MATERIALS and INSTRUCTIONS

We can supply you with everything you need. MATERIALS in single or gross lots. As much or as little as you want. INSTRUCTIONS included with all shipments. In addition, we carry a complete library of beginners and advanced technical books on the manufacture and sale of plastics, from which you can select.

Send only 25c for big, giant-sized catalog of Casting Materials, Molds and Accessories and we will include **FREE** our remarkable book "The Wonders of Liquid Plastics."

PLASTICAST CO., Dept. PC-402
6612 N. Clark St., Chicago 26, Ill.

I am enclosing 25c for PLASTICAST Catalog No. 19 and include **FREE** of extra cost the book "THE WONDERS OF LIQUID PLASTICS."

Name _____ Age _____

Address _____

City _____ Zone _____ State _____



Have Fun
and Gain
Popularity!

YOU can own and play
a famous make Italian
ACCORDION
Buy Direct—Save 50%

No Risk Plan . . .
5 DAYS FREE TRIAL

There's a whole new world of pleasure, satisfaction and popularity waiting for you the day you start playing your accordion. It's easy to learn and it costs so little to own and play a fine Italian Accordion under our famous No Risk Plan. Play simple tunes with few minutes practice. You select the accordion you want from dozens of smart new models . . . and we'll send it to you on FIVE DAYS FREE TRIAL. We are direct factory importers and distributors . . . and because of our huge volume and great buying advantages, actually **SAVE YOU UP TO 50% AND MORE OFF REGULAR PRICES.** You may have long terms with a low down payment. Trade-ins accepted. Complete Home Study Course included FREE with every instrument. Lifetime guarantee!



Low Down Payment—Easy Terms

It pays to deal direct with an accordion specialist! Our buyers travel regularly to Italy where the finest accordions in the world are made. We select only the most outstanding instruments and, each accordion is tested and carefully returned in our own shops before shipment to you. We invite you to Mail Coupon below for big new color catalog of accordions and facts about this exciting

instrument . . . plus lowest wholesale prices . . . ALL FREE. No obligation. Write today.

ACCORDION MANUFACTURERS AND WHOLESALERS OUTLET
DEPT. R-26, 2003 W. CHICAGO AVE., CHICAGO 22, ILL.

Mail Coupon Today!

Accordion Manufacturers and Wholesalers
Outlet, Dept. R-26, 2003 W. Chicago Ave.,
Chicago 22, Ill.

Please rush Color Catalog of newest Italian
Accordions and low wholesale prices.

Name _____

Address _____

City _____ Zone _____ State _____

FREE!

**BIG COLOR
CATALOG**

and new
Low Wholesale
Prices

**SHORTHAND
IN 6 WEEKS**

Write 120 words per minute
Age no obstacle—LOWEST COST

Famous SPEEDWRITING shorthand. No symbols; no machines; uses ABC's. Easiest to learn and use. Fast preparation for a better position. Nationally used in leading offices and Civil Service. 120 words per minute—50% FASTER than Civil Service requirements. Over 300,000 taught by mail or through classroom instruction. The very low cost will surprise you. Typing available. 33rd Year. Schools in over 400 cities in U.S., Canada, Cuba, and Hawaii.

WRITE FOR FREE BOOKLET TO: SCHOOL OF

Speedwriting
Dept. 1502-6, 55 W. 42 St., N.Y. 36

LEARN TO MOUNT BIRDS



ANIMALS, FISH, PETS

Be a Taxidermist. Save your hunting TROPHIES. Have a fine home-museum. Hunters, save and MOUNT your beautiful DUCKS, QUAIL, DEER, TAN skins, FURS. Great Fun. Spare-time PROFITS.

FREE BOOK Tells ALL about it. 100 fine wild-game pictures, 48 pages. SEND TODAY, don't delay. Get this WONDERFUL FREE BOOK, MEN AND BOYS. Learn Taxidermy. Double your hunting pleasure. Rush letter or POSTAL today. STATE YOUR AGE.

N. W. SCHOOL OF TAXIDERMISTRY, Dept. 2502, Omaha, Neb.

MECHANICAL ADDRESSER COMPLETE
30 DAY TRIAL OFFER \$10⁹⁵



Addresses anything mailable—easily, quickly, professionally. Thousands in use. Complete with supplies for 250 names. Money-back guarantee. Send check or money order or write for additional information to:
JACOBI ADVTG. 208 S. LA SALLE, CHICAGO 4

MONEY in DONUTS

Make new greaseless donuts. Start in kitchen. No smoke. Sell stores. HALF PROFIT. Cash daily. Free recipes. No obligation. Write!
MARTIN BAY CO., 3606 SO. 14th AVENUE, MINNEAPOLIS 7, MINN.

**ARTHRITIS—RHEUMATISM
VITAL FACTS EXPLAINED**

FREE DESCRIPTIVE BOOK

How crippling deformities may be avoided. This amazing FREE BOOK explains why ordinary methods give only temporary relief—if that. Describes a drugless method of treatment successfully applied in thousands of cases. Write for this 44-page FREE BOOK today. No obligation.
BALL CLINIC, DEPT. 756, EXCELSIOR SPRINGS, MO.



EXTRA MONEY

Selling EXCLUSIVE
PARAGON Cushion Shoes

Even If Now Employed

Enjoy your own lifetime, independent shoe business without investment. Steady repeats. To \$4.00 pair advance commissions. Big bonus. Make \$50 and more a week in full or spare time. 144 latest smart styles. Magic cushion. Easy to start. Write for FREE OUTFIT today!

No. 574
Lo-Line
2 Eyelet
Crushed
Grain

PARAGON SHOE COMPANY
79 Sudbury St., Dept. 20, Boston 18, Mass.

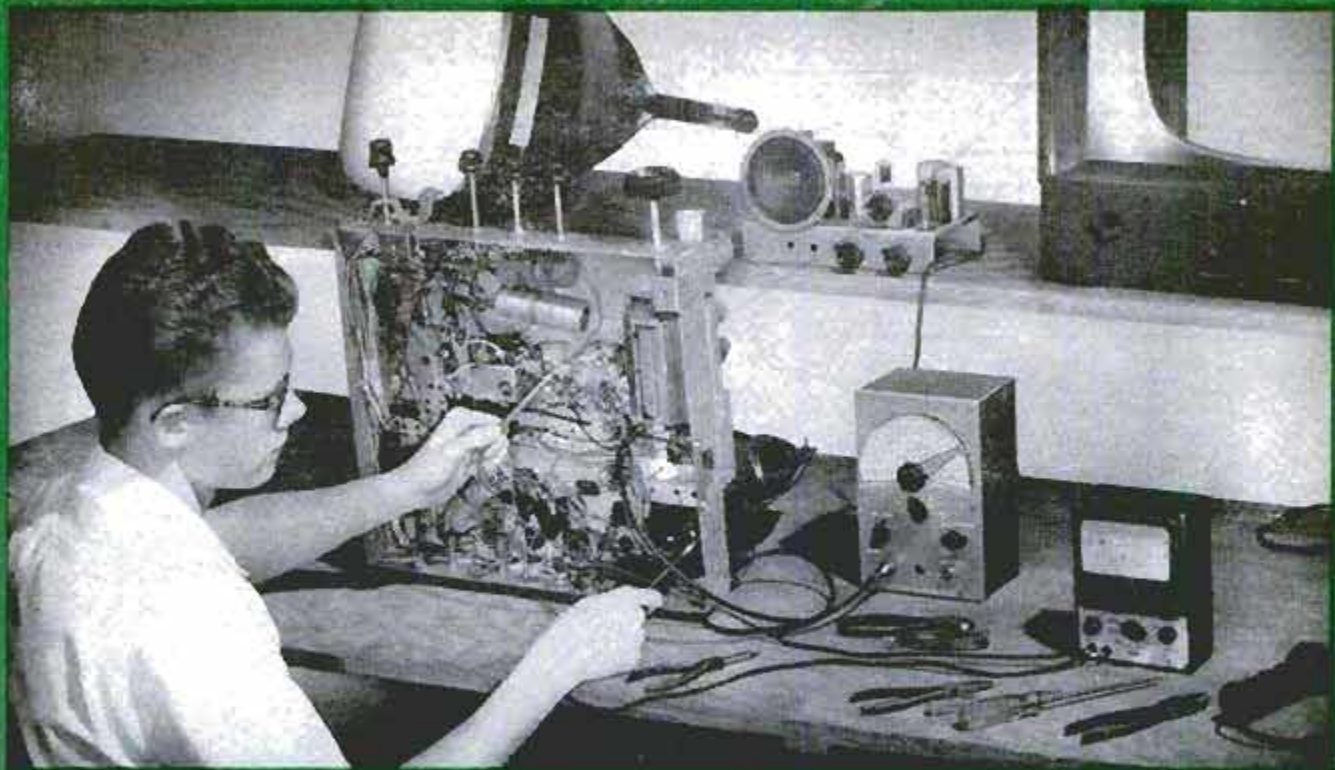

NOW...RCA trains you at home to be an expert technician in

RADIO TV ELECTRONICS • TV SERVICING • COLOR TV SERVICING

NOW THREE HOME STUDY COURSES . . . prepared by instructors of RCA Institutes in cooperation with technicians, engineers, and training specialists of RCA. Clearly written . . . easy to understand . . . the same high caliber instruction as given in resident classrooms of RCA INSTITUTES.

● **COURSE I—RADIO-TELEVISION ELECTRONICS**—starts you from the ground up to a solid working knowledge of electronics. Without any previous experience, you get a thorough training in radio theory and servicing techniques for AM, FM, home and car radios . . . plus an introduction to the fundamental theory and practices of television.

● **COURSE II—TELEVISION SERVICING**—prepares you to advance from radio into the expanding field of television servicing as a well-trained service technician. If you have completed Course I or are now working in the field of radio or TV, Course II will show you the many special techniques of trouble-shooting, aligning, checking, and repairing modern black and white TV sets.

NEW TV KIT AVAILABLE WITH COURSE II—there is no better way to learn than by *doing* and RCA Institutes has developed a large-screen TV KIT available to home study students to build while taking Course II. It has the most modern up-to-date circuitry, actually enabling you to apply at home all the latest servicing techniques.

● **COURSE III—COLOR TELEVISION SERVICING**—covers all phases of color servicing techniques. It is a practical, down-to-earth course in color theory as well as how-to-do-it servicing procedure. A natural move "up" from Course II or for those now employed in TV.

SINCE 1909, RCA INSTITUTES has trained thousands for successful careers in electronics. Many gradu-

ates have established their own paying business. Now this opportunity is available to you at home.

"PAY-AS-YOU-LEARN" PLAN . . . you pay for one study group at a time, as you progress through the course. Tuition costs are amazingly low. For full details, mail coupon.

A SERVICE OF RADIO CORPORATION OF AMERICA—RCA INSTITUTES is licensed by the N. Y. State Education Department . . . recommended by radio and television service organizations.

**SEND FOR
FREE
CATALOG
NOW**



RCA Institutes, Inc., Home Study PM-26
350 West Fourth Street, N.Y. 14, N. Y.

Without obligation, send me FREE CATALOG on Home Study Courses in Radio, Television and Color TV. No salesman will call.

Name _____
Please Print

Address _____

City _____ Zone _____ State _____



RCA INSTITUTES, INC.

A SERVICE OF RADIO CORPORATION OF AMERICA
350 WEST FOURTH STREET, NEW YORK 14, N. Y.

**NOW FOR CITY LOT AND
SUBURBAN GARDENER**

Mow Tiller

TRADE MARK

MOWS LAWNS, TILLS, CULTIVATES

A New **ROTOTILLER**® Product

2 Machines for the Price of 1



Now everyone with a little garden and lawn can have all the advantages of ROTOTILLER rotary tillage and mowing... for very little money. Mow-Tiller mows lawns, tills, cultivates. Rugged, with powerful 1 3/4 hp 4 cycle motor. Easy to handle; so light you can hang it up in any convenient place. Not one machine, but 2 for the price of 1. Guaranteed by ROTOTILLER, Inc., the leader in power garden equipment since 1930.

Only \$168.50 FOB Troy, N.Y.

Your Rototiller purchase can be financed on convenient terms through your local bank.

ROTOTILLER, Inc.
Dept. H1, Troy, N. Y.

Please send details of new, low price Mow-Tiller and FREE copy of "Green Thumb" Booklet.

Name _____

Address _____

City _____ Co. _____ State _____

Inventors

Take these necessary preliminary steps promptly to protect your invention by applying for a United States patent—

Sketch and describe your invention. Sign, date and have this disclosure witnessed by two people who understand your invention. Have us make a preliminary search among U. S. patents already granted for similar types of invention. We then report to you on the probable patentability of your invention and recommend your further course of action.

Write for our instructive booklet, "Patent Protection for Inventors" and our convenient "Evidence of Invention" disclosure form. No obligation.

VICTOR J.
EVANS & Co. *Merlin M. Evans*
REGISTERED PATENT ATTORNEY

230-B MERLIN BUILDING, WASHINGTON 6, D. C.

(Continued from page 20)

here is where he spent one 17-hour shift—perched on a stepladder in the Nash assembly plant at Kenosha, Wis., supervising the photographs and writing the diary of "The Building of a Car" (see page 196) as a new Rambler moved from beginning to end of the assembly line.



To the Editor:

You've heard of "teardrop" streamlining? This picture (below) tends to prove there is no such thing. It shows a perfectly round drop of milk falling into a cup full of milk. Directly beneath it is a column rising from another drop that has just hit the surface. I took the picture to test the action-stopping characteristics of an electronic flash unit I built. Its speed, I estimate, is 1/10,000 second.

Clarence Leino,
West Allis, Wis.

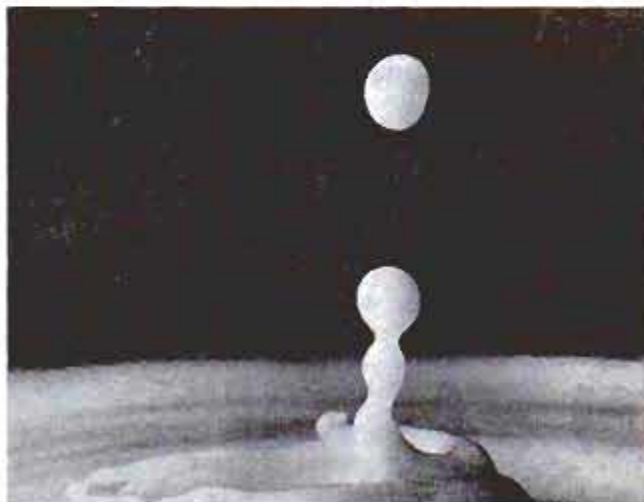

Tune Up, Pep Up, Fix Up ANY CAR!



NOW! Even beginners can handle practically ANY job on ANY make, model or part!

TUNE UP, PEP UP, *fix up* ANY automobile . . . even if you've never repaired a car before!

Handle practically any job "slick as a whistle."

A tune up? New rings? Ignition or carburetor troubles? Brake or clutch problems? A valve job? Something wrong with power steering or one of those tricky new automatic transmissions?

Just look up the job you want to do!

This giant, 4 $\frac{3}{4}$ pound CHILTON REPAIR MANUAL tells what to do. Then it shows you step by step just how to do it. No guess work. No lost time. You handle auto repairs easier, faster and better than you may have dreamed.

There's a "secret" to easy auto service and this giant manual is it!

YOU WON'T MISS

with how-to-fix-it data like this to guide you!

Chilton covers practically every part of every car on the road today. Gives complete service details on every model of the leading 22 car makes from June 1940 to the present. Over 600 models in all!

Tells how to locate troubles. Shows what work-saving shortcuts to take . . . what adjustments to make . . . what parts to use . . . what mistakes to avoid . . . *even what tools to use.*

"Minor" details, often so puzzling to beginners, are fully explained.

From beginning to end, it's an honest-to-goodness HOW-TO-FIX-IT guide. NOT a "study" book. You use it right at the bench when you've got a car to fix!

Use the CHILTON MANUAL 10 days . . . FREE. If it's not all you expect . . . and more . . . return it AND DON'T OWE US A PENNY! Send coupon today to: Chilton Co., Dept. PM-26, 56th & Chestnut Sts., Philadelphia 39, Pa.

GIANT NEW ENLARGED 1956 EDITION

BY CHILTON, WORLD'S LARGEST AUTOMOTIVE PUBLISHERS

- Over 850 Big Pages
- Weighs 4 $\frac{3}{4}$ pounds
- Almost 3,000 clear pictures
- 58 Troubleshooting Charts
- 353 Quick Check Data Tables
- Thousands upon thousands of parts and service specifications
- The original book of its kind . . . and still the best! Published for 27 years.

Covers Every Model of These 22 Makes Since 1940:

BUICK	FORD	OLDSMOBILE
CADILLAC	FRAZER	PACKARD
CHEVROLET	HENRY J.	PLYMOUTH
CHRYSLER	HUDSON	PONTIAC
CONTINENTAL	KAISER	RAMBLER
DE SOTO	LINCOLN	STUDEBAKER
DODGE	MERCURY	NASH
		WILLYS

Read What These Users Say!



EASY! "The Chilton how-to-do-it pictures are worth the entire price of the Manual!"
MELVIN WADE, Penna.

FAST! "Thanks to my Chilton Manual, I did a job in an hour another mechanic had worked on all day!"



GENE ARNOLD, Iowa

(CHILTON BOOKS ARE SOLD BY LEADING BOOK STORES)

PRACTICE 10 DAYS FREE!

THE CHILTON CO., Dept. PM-26
5605 Chestnut St., Philadelphia 39, Pa.

Send me the giant new CHILTON "ALL CARS" REPAIR MANUAL (Price \$6.95) for 10-day FREE EXAMINATION. If I like Manual, I will then promptly remit \$1.95 (plus 45¢ postage and handling); then send \$2.50 each month for two months. Otherwise, I will return manual postpaid in 10 days and owe you nothing. **SAVE!** Send \$6.95 with order and we pay postage-handling charge. Same return privilege.

Name

Address

City, Zone, State

(OUTSIDE U.S.A.—Price \$8.95 cash with order. 10-day return privilege with money refunded.)

DIESEL MECHANICS IN DEMAND

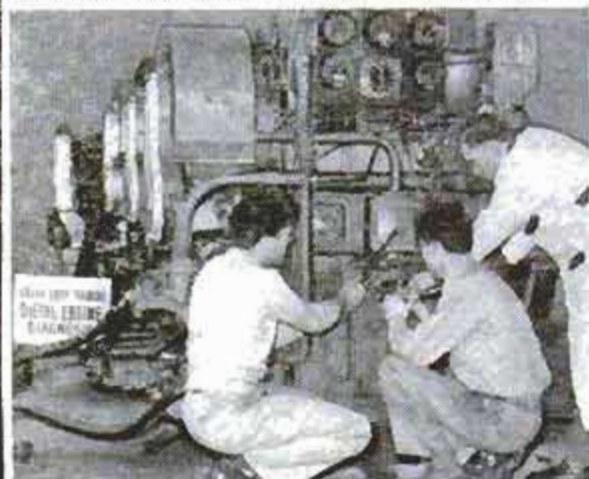

Learn to earn big pay in DIESEL in our large, modern equipped Chicago school and shop. No previous experience or training necessary. We help you find living quarters and part time job while in school. Complete, practical courses taught in the following trades, under the supervision of experienced, expert technicians.

APPROVED FOR CIVILIANS OR GI'S

— CHOOSE YOUR TRADE —

CHECK HERE	WEEKS
<input type="checkbox"/> DIESEL MECHANICS	20
<input type="checkbox"/> AUTO MECHANICS	20
<input type="checkbox"/> BODY & FENDER	16½
<input type="checkbox"/> GAS-ARC WELDING	4-12
<input type="checkbox"/> REFRIGERATION	13½
<input type="checkbox"/> AIR CONDITIONING	8½
<input type="checkbox"/> MACHINIST TRADE	30
<input type="checkbox"/> ADVANCED MACHINIST (includes tool & die)	32½
<input type="checkbox"/> PIANO TUNING & REPAIR	36

CHOOSE YOUR ENGINEERING COURSE

These courses are intended as terminal education for men who wish to enter the Diesel-Automotive and Refrigeration-Air Conditioning fields as technicians. These courses are designed to prepare men for supervisory positions. Students with a high school education, or equivalent, will be accepted.

<input type="checkbox"/> DIESEL AUTOMOTIVE ENGINEERING	2 years
<input type="checkbox"/> REFRIGERATION & AIR COND. ENGINEERING	18 months

FREE EMPLOYMENT HELP

Start your career with Greer by checking your interest above and mail coupon for complete information at no obligation.

NAME _____ AGE _____
STREET _____
TOWN _____ ZONE _____ STATE _____

Established 1902 — Over 50,000 Graduates.
54 years of continuous trade school experience to guide your training.

GREER SHOP TRAINING
Box B, 2236 S. Michigan Ave.
Chicago 16, Illinois

INVENTORS

PROTECT YOUR INVENTION BY A U. S. PATENT. SEND FOR FREE "INVENTION RECORD" FORM AND "PATENT INFORMATION EVERY INVENTOR SHOULD HAVE".

CARL MILLER
REGISTERED PATENT ATTORNEY
WOOLWORTH BLDG., 35th FLOOR, 26A
NEW YORK CITY

INVENTORS

Whether an invention is patentable can be substantially determined by a search of the U. S. Patent records. Without obligation, write for information explaining the steps you should take to secure a patent.

JOHN N. RANDOLPH
Registered Patent Attorney
201 Columbian Building, Washington 1, D. C.

PATENTS

C. A. SNOW & CO.

REGISTERED PATENT ATTORNEYS
WRITE FOR INFORMATION TO
428 SNOW BUILDING, WASHINGTON 1, D. C.

INVENTORS

Send for PATENT INFORMATION Book and INVENTOR'S RECORD without obligation

GUSTAVE MILLER
26-PM WARNER BUILDING WASHINGTON 4, D.C.

REGISTERED PATENT ATTORNEY
ASSOCIATE EXAMINER
U.S. PAT. OFF. 1922-1929
Patent Attorney & Advisor
U. S. NAVY DEPT. 1930-1947
PATENT LAWYER

INVENTORS

I shall be pleased to furnish you, upon request, with full information relative to patent procedure—without any obligation on your part.

PATRICK D. BEAVERS
Registered Patent Attorney
934 Columbian Building Washington 1, D. C.

SAY YOU SAW IT IN POPULAR MECHANICS TELEPHONES

Desk Stand Style
Slightly used but in excellent condition
Many Valuable Uses
Inter-House Phones House to Barn, etc.
Loud Speakers Microphones
Educational Purposes, Toys, etc.

Come complete, ready to use with wiring diagrams included. **\$2.75** Postpaid in U.S.A.
Two complete for only \$5.00
TELEPHONE LAMP KIT—with illustrated instructions for making Desk Telephone Lamp including all parts (harp, nipples, push switch, cord, plug, etc.)
... \$6.50 Ppd. (Shade is not included).

MICROPHONE, Dept. X-3502, 1760 W. Lunt Ave., Chicago 26, Ill.

MEN—WOMEN!

Paint it with Suede!

SPRAY ON RAINBOW COLORS

for PROFIT and Pleasure...

A SENSATIONAL NEW HOME BUSINESS!!

A NEW INDUSTRY... A NEW MIRACLE FINISH!!
MAKE \$500 to \$1000 PER HOUR and more!

Flok-Kraft Covers:
Fabric, Metal, Glass, Plaster,
Wood, Plastic or—any surface!

PROFESSIONAL SECRETS CAN BE YOURS

At last the carefully guarded secrets of this amazing miracle finish can be yours. Huge profits are waiting to be tapped in this tremendous new field. Flok-Kraft gives a velvety, luxurious surface to radios, lamps, toys, signs, store displays, figurines, auto dash boards—actually a thousand and one items to be seen on every hand can easily and quickly be beautified, enriched, increased in value with Flok-Kraft. Make old objects beautiful and saleable. Make new things worth more with this soft, rich covering that can be applied to any surface, even if old and worn.

YOU CAN LEARN IN A FEW DAYS

Yes, you can learn in a few days to start making money—big money! Make to \$5.00—yes! even \$10.00 and more per hour. Everything you need is furnished, including fully detailed instructions that are complete and easy to understand. Every point is explained to show you how to start on the road to big money, full or spare time.

WE FURNISH EVERYTHING YOU NEED TO START

In addition to the full step-by-step instructions you get a complete set of materials and equipment that enables you to start at once. A few cents worth of materials can mean many dollars in returns to you. You can make big profits, spare or full time—add to your income from your regular job or begin to build your own successful future with a full time business of your own and do it all right in your own home! A corner of your basement, garage, service porch, kitchen or living-room is all the space you need to start.

GRASP THIS LIFETIME OPPORTUNITY TODAY

This is one too good to miss. Fill out the coupon below and mail it today for full free details. I'll arrange to send you the complete outfit—everything you need to start—for leisurely, no-risk examination right in your own home. You owe it to yourself to investigate. Write now for full, free details, samples, etc. Fill out and mail the coupon below. Do it today! Everything I send you is FREE.

SEND NO MONEY—MAIL COUPON NOW!

COAST INDUSTRIES, Dept. 22
1004 S. Los Angeles St., Los Angeles 15, California
Gentlemen:
Please rush me FREE details, sample, etc., I understand that everything you send is free and that I'll be under no obligation now or ever.

NAME _____
STREET _____
CITY _____ STATE _____

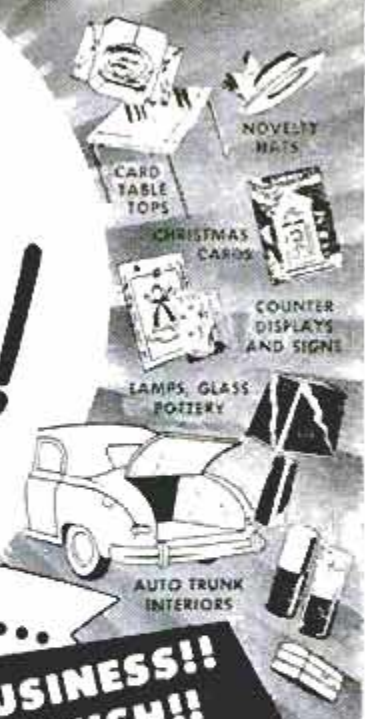

Read What Others Say About Flok-Kraft

"Received the flok-kraft outfit and everyone that saw it is very enthused. I only had it about thirty minutes and got an order for a hundred dollar job."
Mr. C. H. Maryland.



"... I have received my order of Flok and Adhesives and believe me, I'm very pleased and happy as I've made myself MORE than the cost of my supplies already, and I've still got more jobs to do."
Cpl. G. W., S. Carolina



"Got \$52.50 for those 7 trunk interiors for about 4 hours work. \$7.50 per trunk."
J. O., Mo.



"... pleased with your course and I'm being swamped with work to do."
W. F.,



YOURS TO EXAMINE WITHOUT RISK!!

Examine in your own home—then decide. The complete instructions, the full starting kit of materials and equipment and full details on how you can open your own business, spare or full time—EVERYTHING will be sent you to EXAMINE AT OUR RISK!



FLOK-KRAFT IN INDUSTRY

This amazing miracle finish is of inestimable value for use on hundreds of manufactured products. Flok-Kraft offers you a way to big, extra money, assisting manufacturers in many lines as well as filling a big demand among home owners.

Coast Industries, Dept. 22
1004 Los Angeles St., Los Angeles 15, Calif.



IF YOU "EAT, SLEEP AND LIVE" CARS...

TURN YOUR HOBBY INTO A CAREER!

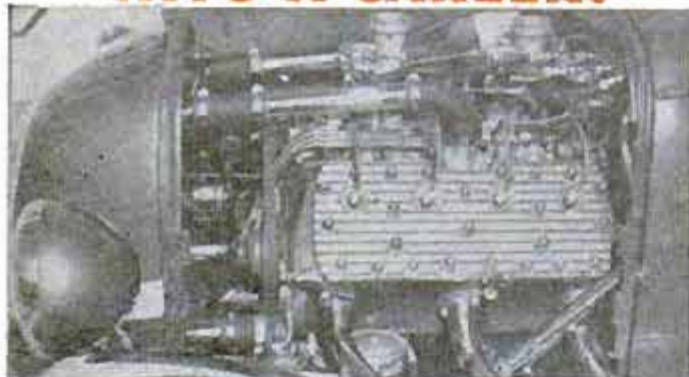

Get America's Big-time, Big-future

AUTO MECHANICS & DIESEL COURSE

at home in your spare time!

Los Angeles' National Schools, America's automotive Technical Trade School since 1905, now brings its famous resident Shops and Faculty direct to you at home—to prepare you to earn more money, with job security, in today's fast-moving, opportunity-filled Auto Mechanics Industry! Get your home training from the "Car Capital of The World"—America's most auto-minded city, center of Hot Rod and Sports Car activity! Mail coupon right now!

"SHOP-METHOD" HOME TRAINING!

YOU MASTER ALL PHASES, INCLUDING DIESEL! All lessons fully illustrated. Latest equipment covered.



THIS SET OF LIFETIME TOOLS IS YOURS! Also all-metal tool box. Part of your course, yours to keep. **EARN WHILE YOU LEARN!** We show you how to start Spare Time Earnings soon after enrollment.

ATTENTION MEN OF DRAFT AGE. Learn how you can achieve higher rating and pay. Mail coupon at once!

APPROVED FOR G. I. TRAINING. Both Home Study & Resident Courses. Free help with technical and personal problems—Job Placement Service.



Send for FREE FACT-BOOK AND SAMPLE LESSON!

NOW! 2 offices to serve you faster! Mail coupon today to one nearest you!

NATIONAL SCHOOLS

Technical Trade Training Since 1905

LOS ANGELES 37, CALIFORNIA

IN CANADA: 811 West Hastings Street, Vancouver, B. C.

MAIL NOW TO OFFICE NEAREST YOU!

(mail in envelope or paste on postal card)

NATIONAL SCHOOLS, Dept. DB-26

4000 S. FIGUEROA STREET
LOS ANGELES 37, CALIF.

OR 323 WEST POLK STREET
CHICAGO 7, ILLINOIS

Send FREE Auto-Mechanics Book and Sample Lesson. No obligation, no salesman will call.

NAME _____ BIRTHDAY _____ 19 _____

ADDRESS _____

CITY _____ ZONE _____ STATE _____

Check if interested ONLY in Resident School Training at Los Angeles.

VETERANS: Give Date of Discharge _____

PRESTO MASTER GLAZE

--FOR ALL CARS--



Car Owners! Meet Master Glaze—the sensationally different luster for new and used cars! Not a wax—not an oil polish—not a paint!—nothing that "smears" over the surface.

AGENTS

An unusual opportunity! Quick, flashy demonstrator. Big profits. Good territory. Write today!

MASTER GLAZE is a unique discovery—quick and easy to apply! Gives a hard, glass-like surface. Even gasoline cannot dull it! Lasts six months to a year! Amazing luster—beautiful, sparkling clean and brilliant! Doesn't finger-mark—doesn't smear! A match box full glazes an entire car. Seals the pores, protects! NOTHING LIKE IT!

FREE SAMPLE

Send name, address on postcard for details and free sample MASTER GLAZE. 7720-840 Marwood Ave., Milwaukee 13, Wis.

Learn SHELLCRAFT

Wonderful, New, Easy—Up to 500% Profits! Make Shell Lamps, Shell Jewelry and Novelties. Sell for BIG PROFITS! Markets everywhere. Hand-in-Action PLAN designed for you to learn and earn as you succeed in Shellcraft.

FREE Genuine Sea Shells, full color pictures, and Hand-in-Action Plan Folder. Write. NATIONAL SHELLCRAFT SCHOOL 641-26th ST. S., ST. PETERSBURG, FLA.



TASOPE PHOTO-ENGRAVING PLANTS



Material Cost Of This Cut 34c Selling Price \$1.00 And Up

Establish your own profitable PHOTO-ENGRAVING business. Make cuts for newspapers, printers, and advertisers. Make etched name plates, plaques etc. Instructions furnished, no experience necessary. Sold direct from factory since 1931. First five hundred cuts sold locally or by mail will pay for plant and pay you well for your time. Write for FREE catalog.

TASOPE, DEPT. PM-2, AURORA, MO.

LAW FREE BOOK



Write today for a FREE copy of illustrated law book. "THE LAW-TRAINED MAN," which shows how to earn the professional Bachelor of Laws (LL.B.) degree through home study of the famous Blackstone Law Course. All necessary books and lessons provided. Moderate cost; convenient monthly terms. Write for FREE law training book today.

Blackstone School of Law, 225 N. Michigan Ave.

Founded 1890

Dept. 52 Chicago 1, Ill.

Super Powerful All Channel TV RECEPTION IN ALL DIRECTIONS



Rocket DIRECTRONIC MOTORLESS TV ANTENNA

- 360° Electronically Switched Beam
- No Motors
- No Roof
- Orientation
- No Electric Power
- No Ghosts
- Flick of Switch Clears Picture Instantly

In the city or in an ultra-fringe area, the Directronic will outperform ordinary antennas. Only the Motorless 360° Directronic TV Antenna offers "around the compass" reception WITHOUT Rotors. Clarity of picture will amaze, it's so bright, so sharply defined. AX-599 "Serviceman's Array" contains Hi-Pac molded insulator of extremely high tensile strength, 18 hi-tensile aluminum alloy elements, 1 set of connecting stubs (3), Universal U-Clamps for masts to 1 1/2". Directronic Beam Selector, 75 feet of Tri-X Cable, 25% deposit on C.O.D. orders, please. Money Back Guarantee.

NATIONAL ELECTRONICS OF CLEVELAND 6608 Euclid Ave. Dept. P-2 Cleveland 3, Ohio

Free!

WITH THIS OFFER

60% to 75% of all TV failures are caused by faulty tubes. This amazing new giant-sized "Detect-O-Scope" tells you, at a glance, exactly how to spot bad tubes in any TV set. Saves time, money — makes you an "expert" TV trouble-shooter! Gives

YOURS FREE WITH THE FAMOUS MANUAL DESCRIBED BELOW

Amazing New TV "DETECT-O-SCOPE"

Enables You to
**Spot Bad TV Tubes
in a jiffy!**

identification numbers of tubes that may be causing trouble; shows you how to locate, check and replace them safely. 16 x 21 inches; copy-righted. Sells for \$1.00 but yours absolutely **FREE** on this offer!



FIX TV AND RADIO SETS RIGHT AWAY

—even if you never fixed a lamp or doorbell before!

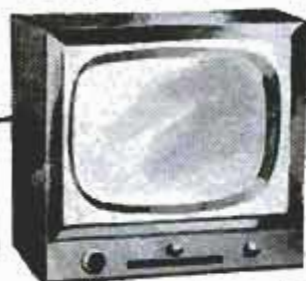

McGraw-Hill's Amazing New
Low-Cost Instruction Manual Skips
Hard-to-Understand "Theories"
and Formulas — Tells **HOW-TO-DO-IT** in **PLAIN ENGLISH**

TELEVISION AND RADIO REPAIRING

TRY IT
FREE
ON YOUR OWN SET
FOR 10 DAYS

AT LAST—a well-known **EXPERT** tells you in **PLAIN ENGLISH** how to fix TV or radio sets! Right from the very first chapters you can start doing simple repairs... and before you're **HALF** way through the manual, you can fix **HALF** the television and radio sets that you encounter. In just a few weeks you can start fixing your own and friends' sets... even start your own money-making business at home.

NO complicated formulas! **NOT** a study book! Deals only with parts that go wrong in sets—tells **HOW** to find the trouble — and the **EASY** way to **FIX IT!**

Why It's So EASY

John Markus, Associate Editor of Electronics Magazine, spent **FOUR** years making this one-volume manual practical and easy-to-follow — even



Save Money on Your Own Set

Save \$50 to \$100 a year installing and servicing your own set. Book tells what to do if picture is blurred—split—distorted—tilted—wiggles—too pale or black — jitters — "snow"—drifts—etc.

for the most "unhandy" beginner. A-B-C directions and 700 clear photos, diagrams, and drawings show exactly **WHAT** and **HOW** to fix, step-by-step. Includes everything you need to know: *where* and *how* to buy tubes and parts; where and how to get an official circuit diagram of any set; how to choose and use basic tools; how to test tubes **WITHOUT** a tube tester;

how to use 58 common TV controls; simple "cures" for common TV and radio troubles; how to fix loudspeakers, phono pickups, install and check antennas—and much more.

SEND NO MONEY

Mail coupon below—*without money!* When book arrives try it out on your own or neighbors' sets. See how simple and easy it makes nearly every repair job. Make it pay for itself in 10 days or don't keep it. Mail coupon **NOW** to: **McGraw-Hill Book Co., Dept. PM-2, 327 West 41st St., New York 36, N. Y.**

PARTIAL CONTENTS

How to Remove and Replace Tubes • Testing Tubes without a Tester • Using a Table Tester • Power Supply Troubles • How to Test and Replace Resistors, Controls, Switches, Condensers, Coils, Transformers • Speakers • Phono Pickups • Antennas and **MUCH MORE.**

FREE 10-DAY TRIAL COUPON

McGraw-Hill Book Co., Dept. PM-2, 327 West 41st St., New York 36, N. Y.
Please send me the big TV **DETECT-O-SCOPE** Chart **FREE**, with a copy of John Markus' Television and Radio Repairing for 10 days' **FREE EXAMINATION.** If not delighted, I may return book, pay nothing. Otherwise, I will send only \$1.95, plus few cents delivery charges; then 3 monthly installments of \$2.00 each. The Detect-O-Scope Chart is to be mine to keep **FREE**, in any case.

Name.....
Address.....PM-2

City.....Zone.....State.....

SAVE MONEY. Check here if enclosing \$7.95 **WITH** coupon. Then **WE** pay all delivery charges. Same 10-day return privilege. (*Offer good in U.S.A. only.*)

Tells HOW To "Cash In" ON THE BIG DEMAND FOR RADIO-TV REPAIRMEN

Over 25 million TV sets... over 100 million radios! Make nice extra money just fixing sets for friends and neighbors in your spare time... or start your own full-time repair business.

Book tells exactly how to get started; which tubes to stock; how to make a service call. Actually start fixing sets and making money before you're half-way through book.



Hey SKINNY!

...YER RIBS ARE SHOWING!



I Can Make YOU a New Man, Too
In Only 15 Minutes a Day!

PEOPLE once laughed at my skinny 97-lb. body. I was ashamed to strip for sports. Girls made fun of me behind my back. THEN I discovered "Dynamic Tension." It made me such a complete specimen of manhood that I hold the title, "The World's Most Perfectly Developed Man."

What's My Secret?

When you look in the mirror and see a healthy, husky, handsome, fellow smiling back at you—you'll be amazed at how fast "Dynamic Tension" GETS RESULTS. It's the easy, NATURAL method you can practice in your own room—JUST 15 MINUTES EACH DAY. No gadgets to fool with. You simply use the dormant muscle-power in your own body—watch it grow into solid LIVE MUSCLE. See your shoulders broaden... your scrawny chest swell with inches of new muscle...

CHARLES ATLAS
Holder of title, "The World's Most Perfectly Developed Man"

those spindly legs and arms bulge with new power... and your whole body starts to feel "alive," full of zip and go!

FREE MY 32-PAGE ILLUSTRATED BOOK IS YOURS—NOT FOR \$1 OR 10c—BUT FREE

Send now for my book, *Everlasting Health and Strength*. 32 pages of photos, valuable advice. Shows what "Dynamic Tension" can do for YOU. Answers vital questions for fellows who want a better build. It's yours—ABSOLUTELY FREE! Rush coupon to me personally: **CHARLES ATLAS, Dept. 82, 115 East 23rd St., New York 10, N. Y.**



CHARLES ATLAS, Dept. 82, 115 East 23 St., New York 10, N. Y.

Send me—absolutely FREE—a copy of your famous book, *Everlasting Health and Strength*—32 pages, crammed with photographs, answers to vital questions and valuable advice. This book is mine to keep, and sending for it does not obligate me in any way.

Name _____ Age _____
(Please print or write plainly)
Address _____
City _____ State _____

Make Money Manufacturing Concrete Drain Tile



Manufacturers of concrete drain tile are in the driver's seat. Why? Because their basic costs are not burdened by freight, distribution and breakage costs—items which the clay tile people have to pass along. Net results: concrete tile can sell for less, yet show a generous profit.

The market is big—and getting bigger. Not only because of increased farm drainage, but also because drain tile are needed in home building, reclamation projects, highway construction, and many other purposes.

Tile made on the Champion are outstanding in quality—dense, strong, uniform and truly round. All sizes up to 12" diameter. Easy to make, because the Champion Machine is simple, compact, and requires no skilled labor. Business is a low-investment opportunity, with equipment available on terms. Write for catalog.



W. E. DUNN MFG. CO.
522 W. 24th Street, Holland, Mich.



IN CANADA: DUNN MASONRY MACHINERY LIMITED
970 Dundas Highway, Cookville, Ont.

POW!!! hunting slingshot

- accurate—powerful—silent
- kills small game, pests
- hits like a rifle

\$1.50
postpaid
(no cod's)



Used by expert marksmen! 7" hardwood stock, 45 lb. pull. Best rubber. FREE!!—extra rubber and big supply heaviest steel balls used by experts, illustrated catalog.

order today from— I. I. STONE DEPT. B-21616 Oak St. Santa Monica, Calif.

LEARN WATCH REPAIRING

AT HOME Modern, original instruction. Prepare for a position or start in business after completing our course. Write Today! **WISCONSIN SCHOOL OF WATCH REPAIRING**
2908 N. 44th St. Dept. M Milwaukee 10, Wis.

CABINET MAKING



LOW COST HOME TRAINING COURSE FOR BEGINNERS & ADVANCED CRAFTSMEN

Make money. Learn skills and secrets of fine woodworking and tool use. Professionally prepared shop method training tells and shows how. Covers everything. Easy to master.

Write for Free Booklet

INTERSTATE TRAINING SERVICE
DEPT. F3, PORTLAND 13, OREGON

EARN \$50 TO \$100 A WEEK IN SPARE TIME

... No Selling To Do!



With Guaranteed JETMATIC Venetian Blind Laundry

No experience or large investment necessary. Start your own business in spare time in your basement or garage. Big profits. Tremendous demand for venetian blind cleaning service for homes, offices and factories. Enough profits to develop into full time business. Perfect results guaranteed without hand rubbing. Even a woman can operate it. Hundreds of successful JETMATIC patented laundries all over U. S., but many choice locations still open.

We furnish complete directions for operating, for getting business quickly, easily. (Reg. U. S. Pat. Off.)

WRITE TODAY for details.

L. C. ROBINSON MANUFACTURING CO.
522 North Rural St. DEPT. M20 Indianapolis 1, Ind.

PICK YOUR OWN SUCCESS STORY FROM THIS PAGE

These are the true stories of people who seemed trapped in routine, low-pay shaky jobs. Handicapped by lack of proper training, they couldn't get the things they wanted out of life—more money, a job they liked, security and happiness.

They are a small sample of the thousands of men and women—young and old—who turn to I. C. S. for help. Their will-to-learn plus I. C. S. training have changed the course of their lives.

Are you discouraged with your job and pay and feel you can't improve yourself because of lack of specialized education? Well, these men and women were in the same boat. With I. C. S. training, one of these success stories could be about you.

I. C. S. is the oldest and largest correspondence school. 277 courses. Business, industrial, engineering, academic, high school. One for you. Direct, job-related. Bedrock facts and theory plus practical application. Complete lesson and answer service. No skimping. Diploma to graduates.



Wins \$3000 contest—"After my I. C. S. courses I secured a new position," says Mr. Cecil Rhodes. "My income has more than doubled and I recently won a \$3000 sales contest."



From clerk to Assistant Estimator, thanks to I.C.S. "Any way you look at it," writes Mrs. Edna James, "the time and money one spends for I. C. S. Courses will be repaid a thousandfold."



"As a college graduate, I found I.C.S. very valuable." Robert Lee took the I. C. S. Course in Advertising, is now Promotion Manager for a large corporation. "I. C. S. got me started on the way up," he says.



From \$152 to \$395 a month—"I.C.S. made my engineering work more interesting," Frank Bachtik tells us. "I was a Jr. Draftsman making \$152 a month. My present income is \$395.25 a month."

3 FREE BOOKS—a 36-page pocket-size guide to advancement, a gold mine of tips on "How to Succeed." Also a big catalog outlining opportunities in your field of interest and a sample I.C.S. lesson (Math.).

For Real Job Security—Get an I. C. S. Diploma! I. C. S., Scranton 9, Penna. Member, National Home Study Council

INTERNATIONAL CORRESPONDENCE SCHOOLS

ICS

BOX 926268, SCRANTON 9, PENNA.

Without cost or obligation, send me "HOW TO SUCCEED" and the opportunity booklet about the field BEFORE which I have marked X (plus sample lesson):

- | | | | | |
|---|--|--|--|---|
| <p>ARCHITECTURE and BUILDING CONSTRUCTION</p> <p><input type="checkbox"/> Air Conditioning—Refrig.</p> <p><input type="checkbox"/> Architecture</p> <p><input type="checkbox"/> Architectural Interior</p> <p><input type="checkbox"/> Building Contractor</p> <p><input type="checkbox"/> Building Maintenance</p> <p><input type="checkbox"/> Carpenter and Mill Work</p> <p><input type="checkbox"/> Estimating</p> <p><input type="checkbox"/> Heating</p> <p><input type="checkbox"/> Painting Contractor</p> <p><input type="checkbox"/> Plumbing</p> <p><input type="checkbox"/> Reading Arch. Blueprints</p> <p>ART</p> <p><input type="checkbox"/> Cartooning</p> <p><input type="checkbox"/> Commercial Art</p> <p><input type="checkbox"/> Fashion Illustrating</p> <p><input type="checkbox"/> Magazine Illustrating</p> <p><input type="checkbox"/> Show Card and Sign Lettering</p> <p><input type="checkbox"/> Sketching and Painting</p> <p>AUTOMOTIVE</p> <p><input type="checkbox"/> Auto Body Rebuilding</p> <p><input type="checkbox"/> Auto Elec. Technician</p> <p><input type="checkbox"/> Auto-Engine Tune Up</p> <p><input type="checkbox"/> Automobile</p> | <p>AVIATION</p> <p><input type="checkbox"/> Aeronautical Engineering Jr.</p> <p><input type="checkbox"/> Aircraft & Engine Mechanic</p> <p>BUSINESS</p> <p><input type="checkbox"/> Advertising</p> <p><input type="checkbox"/> Bookkeeping and Accounting</p> <p><input type="checkbox"/> Business Administration</p> <p><input type="checkbox"/> Business Correspondence</p> <p><input type="checkbox"/> Public Accounting</p> <p><input type="checkbox"/> Creative Salesmanship</p> <p><input type="checkbox"/> Federal Tax</p> <p><input type="checkbox"/> Letter-writing Improvement</p> <p><input type="checkbox"/> Office Management</p> <p><input type="checkbox"/> Professional Secretary</p> <p><input type="checkbox"/> Retail Business Management</p> <p><input type="checkbox"/> Sales Management</p> <p><input type="checkbox"/> Stenographic-Secretarial</p> <p><input type="checkbox"/> Traffic Management</p> <p>CHEMISTRY</p> <p><input type="checkbox"/> Analytical Chemistry</p> <p><input type="checkbox"/> Chemical Engineering</p> <p><input type="checkbox"/> Chem. Lab. Technician</p> <p><input type="checkbox"/> General Chemistry</p> <p><input type="checkbox"/> Natural Gas Prod. & Trans.</p> <p><input type="checkbox"/> Petroleum Engineering</p> <p><input type="checkbox"/> Plastics</p> <p><input type="checkbox"/> Pulp and Paper Making</p> | <p>CIVIL, STRUCTURAL ENGINEERING</p> <p><input type="checkbox"/> Civil Engineering</p> <p><input type="checkbox"/> Construction Engineering</p> <p><input type="checkbox"/> Highway Engineering</p> <p><input type="checkbox"/> Reading Struct. Blueprints</p> <p><input type="checkbox"/> Sanitary Engineering</p> <p><input type="checkbox"/> Structural Engineering</p> <p><input type="checkbox"/> Surveying and Mapping</p> <p>DRAFTING</p> <p><input type="checkbox"/> Aircraft Drafting</p> <p><input type="checkbox"/> Architectural Drafting</p> <p><input type="checkbox"/> Electrical Drafting</p> <p><input type="checkbox"/> Mechanical Drafting</p> <p><input type="checkbox"/> Mine Surveying and Mapping</p> <p><input type="checkbox"/> Plumbing Drawing and Estimating</p> <p><input type="checkbox"/> Structural Drafting</p> <p>ELECTRICAL</p> <p><input type="checkbox"/> Electrical Engineering</p> <p><input type="checkbox"/> Electrical Maintenance</p> <p><input type="checkbox"/> Electrician <input type="checkbox"/> Contracting</p> <p><input type="checkbox"/> Lineman</p> <p>HIGH SCHOOL</p> <p><input type="checkbox"/> Commercial <input type="checkbox"/> Good English</p> <p><input type="checkbox"/> High School Subjects</p> <p><input type="checkbox"/> Mathematics</p> | <p>LEADERSHIP</p> <p><input type="checkbox"/> Foremanship</p> <p><input type="checkbox"/> Industrial Supervision</p> <p><input type="checkbox"/> Leadership and Organization</p> <p><input type="checkbox"/> Personnel-Labor Relations</p> <p>MECHANICAL AND SHOP</p> <p><input type="checkbox"/> Gas—Electric Welding</p> <p><input type="checkbox"/> Heat Treatment <input type="checkbox"/> Metallurgy</p> <p><input type="checkbox"/> Industrial Engineering</p> <p><input type="checkbox"/> Industrial Instrumentation</p> <p><input type="checkbox"/> Industrial Supervision</p> <p><input type="checkbox"/> Internal Combustion Engines</p> <p><input type="checkbox"/> Machine Design-Drafting</p> <p><input type="checkbox"/> Machine Shop Inspection</p> <p><input type="checkbox"/> Machine Shop Practice</p> <p><input type="checkbox"/> Mechanical Engineering</p> <p><input type="checkbox"/> Quality Control</p> <p><input type="checkbox"/> Reading Shop Blueprints</p> <p><input type="checkbox"/> Refrigeration</p> <p><input type="checkbox"/> Sheet Metal Worker</p> <p><input type="checkbox"/> Tool Design <input type="checkbox"/> Toolmaking</p> <p>RADIO, TELEVISION</p> <p><input type="checkbox"/> Industrial Electronics</p> <p><input type="checkbox"/> Practical Radio TV Eng'ng</p> <p><input type="checkbox"/> Radio and TV Servicing</p> <p><input type="checkbox"/> Radio Operating</p> | <p><input type="checkbox"/> Television Technician</p> <p>RAILROAD</p> <p><input type="checkbox"/> Air Brakes <input type="checkbox"/> Car Inspector</p> <p><input type="checkbox"/> Diesel Locomotive</p> <p><input type="checkbox"/> Locomotive Engineer</p> <p><input type="checkbox"/> Section Foreman</p> <p>STEAM AND DIESEL POWER</p> <p><input type="checkbox"/> Combustion Engineering</p> <p><input type="checkbox"/> Diesel—Elec. <input type="checkbox"/> Diesel Eng's</p> <p><input type="checkbox"/> Electric Light and Power</p> <p><input type="checkbox"/> Stationary Fireman</p> <p><input type="checkbox"/> Stationary Steam Engineering</p> <p>TEXTILE</p> <p><input type="checkbox"/> Carding and Spinning</p> <p><input type="checkbox"/> Cotton, Rayon, Woolen Mfg.</p> <p><input type="checkbox"/> Finishing and Dyeing</p> <p><input type="checkbox"/> Loom Fix'g <input type="checkbox"/> Textile Des'ing</p> <p><input type="checkbox"/> Textile Eng'g <input type="checkbox"/> Throwing</p> <p><input type="checkbox"/> Warping and Weaving</p> <p>MISCELLANEOUS</p> <p><input type="checkbox"/> Domestic Refrigeration</p> <p><input type="checkbox"/> Marine Engineering</p> <p><input type="checkbox"/> Ocean Navigation</p> <p><input type="checkbox"/> Professional Engineering</p> <p><input type="checkbox"/> Short Story Writing</p> <p><input type="checkbox"/> Telephony</p> |
|---|--|--|--|---|

Name _____ Age _____ Home Address _____

City _____ Zone _____ State _____ Working Hours _____ A.M. to P.M. _____

Occupation _____ Canadian residents send coupon to International Correspondence Schools, Canadian, Ltd., Montreal, Canada. . . . Special tuition rates to members of the U. S. Armed Forces.

FREE! BRITISH ROYAL FAMILY STAMPS

other big offers!



Rush coupon below at once! Here's a once-in-a-lifetime, generous collection of scarce Royal Family stamps — beautiful, exciting stamps from the days of Queen Victoria to the present reign of popular Queen Elizabeth II. This rare offer includes George VI's Coronation, Edward VII and VIII, George V's Silver Jubilee, 3 Royal Visits to the far corners of the Empire and many others — all genuine, all different.

Also, free copy of helpful "Stamp Collector's Guide" plus free color reproduction and story of the World's Rarest Stamp. Other valuable offers included for your free inspection. Offer may be withdrawn soon, so rush coupon today! If coupon is clipped, write direct for big offer to GARCELON STAMP CO., Dept. 2PMR, Calais, Maine.

Stamp Collector's Guide

GARCELON STAMP CO., Dept. 2PMR, Calais, Maine

Rush FREE Royal Family Stamps and other offers. (PLEASE PRINT)

Name _____

Address _____

City _____ State _____

Hundreds of Companies Want Advertising Work Uniforms LIKE THESE!

We need men to take their orders

Perhaps you have wondered where gas station attendants get the uniforms they wear—the ones with company names embroidered above the pocket and on the back. Geo. Master originated the idea of advertising work uniforms 25 years ago. Giant companies use them, "little fellows" buy them too. We have so many customers, we need more men to take orders.

If you qualify, we will set you up in business FREE. We give you everything you need to operate right from your own home—plus year-round advertising to pre-sell prospects.

One of our men, on his first call, took an order from a small dairy. His profit—\$788. He is almost sure to get repeat business automatically.

Master uniforms and work garments are sold and serviced all over the world. We ship direct to the customer from our factory. You work with one of the most complete kits ever devised. It's an expensive kit to prepare, but it costs you nothing.

Try our method for 10 days. Then, if you don't like the business, simply return the kit and forget the entire matter. This could well be the BIG OPPORTUNITY you have been looking for. Certainly, you have nothing to lose by trying it out. So fill out and mail coupon below today.

The Geo. MASTER GARMENT DIV.
700 WATER STREET - LIGONIER, INDIANA

Del V. Bergstrom, President
The Geo. MASTER GARMENT DIV.
700 Water Street, Ligonier, Indiana

Dear Mr. Bergstrom: Please send me a Complete Order Kit, with instructions, so I can make a 10-Day Test. I understand everything you send is FREE. If, after 10 days, I'm not delighted with the money I've made, I'll send the kit back.

NAME _____

ADDRESS _____

CITY _____ ZONE _____ STATE _____

SCIENTIFIC CRIME DETECTION



There's a Thrill in Bringing
a Crook to Justice.

A Steady Pay Profession
Good Times or Bad.

We have taught thousands this exciting, profitable, pleasant profession. Let us teach you, too, in your own home. Learn

Finger Printing, Firearms Identification, Police Photography and Criminal Investigation thoroughly, quickly and at small cost.

Over 800 of All U. S. Bureaus

of Identification employ students or graduates of I. A. S. You, too, can fit yourself to fill a responsible crime detection job with good pay and steady employment. But don't delay—get the details now. Let us show you how easily and completely I can prepare you for this fascinating work, during spare time, in your own home. You may pay as you learn. Write today, stating age. No salesman will call.

(A Correspondence School Since 1916)

Be A
FINGER
PRINT
Expert

FREE!!!
Send for Thrilling
"BLUE BOOK
OF CRIME"

INSTITUTE OF APPLIED SCIENCE
1920 Sunnyside Ave., Dept. 1352, Chicago 40, Ill.



WORLD'S LOWEST PRICED ADDING MACHINE

Best Pocket
Size
FREE TRIAL
\$2.95

IDEAL FOR BUSINESS AND PERSONAL USE—GUARANTEED ACCURATE. Not a toy. Operates with only a finger flick. Adds, subtracts, multiplies, divides. Counts up to one billion. Pays for itself over and over. Ideal Gift—for Business, Income Tax and School use. MONEY BACK GUARANTEE. Send name and address. Pay postman only \$2.95 plus postage. (Send full cash if outside U.S.) Beautiful rich-looking Leatherette Case included at no extra cost. Money back in 10 days if not delighted. AGENTS WANTED.

CALCULATOR MACHINE CO., (Mfgs.)
Box 84 Dept. F-56 Glenview, Illinois

Save 60% on FAMOUS "TV - BIG TOP"

DAN LURIE BARBELLS

FREE—60 MUSCLE BUILDING COURSES—68 PHOTOS WITH YOUR ORDER

50 lb. set, \$ 8.48 + 150 lb. set, \$20.48
100 lb. set, \$13.98 + 200 lb. set, \$25.98

SEND FOR FREE CATALOG

Order by mail—50% with order. Balance C.O.D. Extra wts. 13c lb. FOB Plant.

DAN LURIE BARBELL CO.
52M1 Bristol St., Dept. 659B,
Brooklyn 12, N. Y.

SEE DAN ON TV "BIG TOP" SHOW
LET STRONGMAN DAN MAKE YOU A MAN
Results guaranteed or money back

LOOK! A MILLION THRILLS!



High Power
BINOCULARS

33 Models: \$9.95 to \$125

Free! Catalog & Book
"How to Select Binoculars"

BUSHNELL Binoculars

Dept. M22 43 E. Green
Pasadena, Calif.

NEW, NATURAL LIGHTWEIGHT DENTAL PLATE



MADE FROM YOUR OLD ONE—New, Professional Method gives you natural-looking, perfect-fitting plastic plate—upper, lower or partial—from your old cracked or loose plate without an impression. CLINICAL method means fast service, huge savings. Try new plate full 30 days at our risk. New plates sent you Air Mail same day.

Now Priced
Low As
\$15.95

SEND NO MONEY—just your name and address for full particulars FREE. No cost. No obligation. Act now.
CLINICAL DENTAL LAB., 335 W. Madison St., Dept. C28-B Chicago 6, Ill.

Send for FREE 112 page
Illustrated Catalog of Farm, Home,
and Workshop Bargains.

Write to
Dept. F-2 **WELLWORTH COMPANY**

1832 S. WABASH AVE.

CHICAGO 16, ILL

Learn BAKING At Home

Baking is one of America's high industries in wages. Nearly DEPRESSION-PROOF. Thorough basic home course lays sound foundation. If you have aptitude, write for FREE Booklet, "Opportunities in Commercial Baking."

NATIONAL BAKING SCHOOL
835 Diversey Pkwy. Dept. 1352 Chicago 14



AUDELS Carpenters and Builders Guides 4 vols. \$6



Inside Trade Information for Carpenters, Builders, Joiners, Building Mechanics and all Woodworkers. These Guides give you the short-cut instructions that you want—including new methods, ideas, solutions, plans, systems and money saving suggestions. An easy progressive course for the apprentice and student. A practical daily helper and quick reference for the master worker. Carpenters everywhere are using these Guides as a Helping Hand to Easier Work, Better Work and Better Pay. To get this assistance for yourself, simply fill in and mail **FREE COUPON** below.

Inside Trade Information On:

How to use the steel square—How to file and set saws—How to build furniture—How to use a mitre box—How to use the chalk line—How to use rules and scales—How to make joints—Carpenters arithmetic—Solving mensuration problems—Estimating strength of timbers—How to set girders and sills—How to frame houses and roofs—How to estimate costs—How to build houses, barns, garages, bungalows, etc.—How to read and draw plans—Drawing up specifications—How to excavate—How to use settings 12, 13 and 17 on the steel square—How to build hoists and scaffolds—skylights—How to build stairs—How to put on interior trim—How to hang doors—How to lath—lay floors—How to paint.



AUDEL, Publishers, 49 W. 23rd St., New York 10, N. Y. Mail Audels Carpenters and Builders Guides, 4 vols., on 7 days' free trial. If O.K. I will remit \$1 in 7 days and \$1 monthly until \$6 is paid. Otherwise I will return them. No obligation unless I am satisfied.

Name _____
 Address _____
 Occupation _____
 Employed by _____ P2

HOW TO REPAIR Electric Appliances



This HANDBY, Practical "How to Do It" book for Electric & Gas Home Appliance Servicemen, Mechanics & Users covers Principles, Servicing & Repairs. Tells How to Locate Troubles, How to take Appliances Apart, How to Make Repairs, How to Assemble and Connect. Gives up to date testing methods, wiring diagrams and complete data on each appliance.

SAVE TIME, TROUBLE, MONEY WITH AUDELS BIG 800 PAGE HOME APPLIANCE SERVICE GUIDE

Toasters—Pressing Irons—Waffle Bakers—Casseroles—Roasters—Broilers—Coffee Makers—Space Heaters—Water Heaters—Ranges—Home Wiring—Shop Work—Appliance Testing—Fundamental Electricity—Fractional H.P. Motors—Food Mixers—Fans & Blowers—Vacuum Cleaners—Washing Machines—Clothes Dryers—Ironers—Dishwashers—Garbage Disposers—Refrigeration—Window Air Conditioners—Oil Burners—Drainage Pumps—Gas Ranges, Furnaces & Water Heaters—Bottled Gas Appliances. A SHOP COMPANION THAT ANSWERS YOUR QUESTIONS. Easy to read and understand—over 800 pages fully illustrated—with 500 photos and diagrams—1001 Facts. A ready reference.

\$4 COMPLETE • PAY \$1 A MONTH TO GET THIS SERVICE INFORMATION FOR YOURSELF—FILL IN AND MAIL 7 DAY TRIAL COUPON TODAY.



AUDEL, Publishers, 49 W. 23rd St., New York 10, N. Y. Mail AUDELS HOME APPLIANCE SERVICE GUIDE (\$4) for free examination. If O.K. I will send you \$1 in 7 days; then remit \$1 monthly until \$4 is paid. Otherwise, I will return book promptly.

Name _____
 Address _____
 Occupation _____
 Employed by _____ P2

WHAT ALL AUTO MECHANICS WANT TO KNOW

1664 PAGES

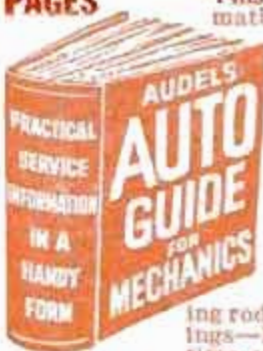

This Big Practical Book gives full information with working diagrams covering the principles, construction, ignition, service and repair of modern cars, trucks and buses.

Diesel Engines, Hydramatic & Fluid Drives Fully Explained.

A complete Guide of 1664 pages, with over 1500 illustrations showing inside views of working parts, with instructions for service jobs.

IT PAYS TO KNOW

How to fit pistons—How to locate engine knocks, How to fit connecting rod bearings—How to service main bearings—How to recondition valves—How to time valves—How to adjust fan belts—How to adjust carburetors and chokes, How

to rebuild a clutch—How to service automatic transmissions—How to service brakes—How to adjust steering gear—How to cope with ignition troubles—How to service distributors—How to time ignition—How to "tune up" an engine.

\$4 COMPLETE • PAY \$1 A MO. TO GET THIS ASSISTANCE FOR YOURSELF SIMPLY FILL IN AND MAIL COUPON TODAY.



Step up your own skill with the facts and figures of your trade. Audels Mechanics Guides contain Practical Inside Trade Information in a Handy Form. Fully illustrated and Easy to Understand. Highly Endorsed. Check the book you want for 7 DAYS FREE EXAMINATION. Send No Money. Nothing to pay postman.

MAIL ORDER



Check NOW!

You Can Look Over Any Guide In Your Own Home — Start the Easy Payments If Satisfied

MAIL THIS TODAY



AUDEL, Publishers, 49 W. 23 St., NEW YORK 10, N. Y.

Please send me for FREE EXAMINATION books marked (X) below. If I decide to keep them I agree to mail \$1 in 7 Days on each book or set ordered and further mail \$1 monthly on each book or set until I have paid price, otherwise I will return them.

- AUTOMOBILE MECHANICS GUIDE, 1664 Pages. \$4
- TRUCK & TRACTOR GUIDE, 1299 Pages . . . 4
- DIESEL ENGINE MANUAL, 575 Pages . . . 2
- MACHINISTS HANDBY BOOK, 1650 Pages . . . 4
- WELDERS GUIDE, 400 Pages . . . 1
- BLUE PRINT READING, 416 Pages . . . 2
- MATHEMATICS & CALCULATIONS, 700 Pages. . . 2
- SHEET METAL PATTERN LAYOUTS, 1100 Pages. . . 4
- SHEET METAL WORKERS HANDBY BOOK, 388 Pgs. . . 1
- MECHANICAL DRAWING GUIDE, 160 Pages . . . 1
- MECHANICAL DRAWING & DESIGN, 480 Pages . . . 2
- AIRCRAFT WORKER, 240 Pages . . . 1
- TELEVISION SERVICE MANUAL, 434 Pages. . . 2
- RADIOMANS GUIDE, 1040 Pages . . . 4
- ELECTRONIC DEVICES, 216 Pages . . . 2
- ELECTRIC MOTOR GUIDE, 1000 Pages . . . 4
- WIRING DIAGRAMS (Light & Power), 272 Pgs. . . 1
- ELECTRICIANS EXAMINATIONS, 250 Pages. . . 1
- ELECTRIC POWER CALCULATIONS, 425 Pages. . . 2
- HANDBY BOOK OF ELECTRICITY, 1440 Pages. . . 4
- ELECTRIC DICTIONARY, 9000 Terms . . . 2
- ELECTRIC LIBRARY, 7000 Pages (12 Book Set) 18
- SHIPFITTERS HANDBY BOOK, 250 Pages . . . 1
- REFRIGERATION & Air Conditioning, 1280 Pgs. . . 4
- MILLWRIGHTS & MECHANICS GUIDE, 1200 Pgs. . . 4
- POWER PLANT ENGINEERS GUIDE, 1500 Pages . . . 4
- ENGINEERS & FIREMANS EXAMS, 525 Pages . . . 1
- PUMPS, Hydraulics & Air Compressors, 1658 Pgs. . . 4
- OPERATING ENGINEERS LIBRARY (3 Books) . . . 9
- MECHANICAL DICTIONARY, 950 Pages . . . 4
- GARDENERS & GROWERS GUIDES (4 Book Set) . . . 6
- CARPENTERS & BUILDERS GUIDES (4 Book Set) . . . 6
- PLUMBERS & Steamfitters Guides (4 Book Set) . . . 6
- MASONS AND BUILDERS GUIDES (4 Book Set) . . . 6
- PAINTERS & DECORATORS MANUAL, 450 Pgs. . . 2
- HOUSE HEATING GUIDE, 1900 Pages . . . 4
- OIL BURNER GUIDE, 384 Pages . . . 1
- HOME APPLIANCE SERVICE GUIDE, 800 Pages . . . 4

Name _____
 Address _____
 Occupation _____
 Employed by _____ P2



**YOU
can
acquire**

**LAW NIGHTS AT HOME!
L. B. DEGREE**

LaSalle's famous Law Library—used as reference in many Law libraries and Law offices—has enabled thousands to master Law surprisingly fast, in spare hours at home, for business and professional advancement.

These 14 remarkable volumes, compiled by leading professors and lawyers, cover the whole basic field of Law in condensed, orderly, simplified manner.

You advance rapidly with this great library, plus special lectures furnished. We guide you step-by-step with personalized Problem Method of instruction... you learn by doing—handling legal problems—not by memorizing rules.

Send for two FREE 48-page booklets, "Law Training for Leadership," and "Evidence," answering questions about Law and its value to you, and telling how LaSalle Law graduates are winning rapid advancement in business and public life. Mail coupon below. No obligation.

**LA SALLE EXTENSION UNIVERSITY
A Correspondence Institution**

417 S. Dearborn St. Dept. 264L Chicago 5, ILL.

Send me your two FREE booklets described above, without obligation.

Name..... Age.....

Street.....

City, Zone & State.....

Say You Saw It in Popular Mechanics

CHEMISTRY



BIG LABORATORY GIVEN FREE!

Be a CHEMIST! One of the really GREAT professionals! We teach you at home. Simplified (but thorough) course; no previous training required. Earn while you learn. This is a GOLDEN AGE for those with special knowledge! Diploma awarded! Send 25c for first lesson and KIT or \$1.00 for first 5 lessons and supplies including

FREE!

URANIUM TESTER, CHEMICAL PUZZLE (worth \$2.50) and HOW TO MAKE 100 NEW CHEMICALS!

NATIONAL SCHOOL OF CHEMISTRY
P.O. BOX 608-D REDWOOD CITY, CALIF.

you may think you're
TALL enough..but
what do others think?

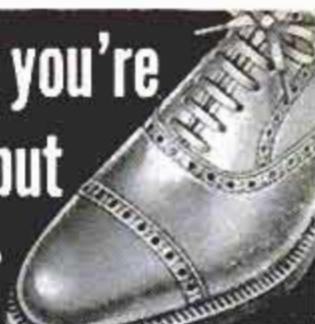

If you're always overlooked when the boss looks for a "take-charge-man", DO SOMETHING ABOUT IT! Step into "ELEVATORS", step up and be noticed! These amazing height-increasing shoes make you almost 2 inches taller, instantly...confidentially. Only you know the secret, but everyone notices the difference in your looks. So, don't just think you're tall enough—BE SURE! For free booklet write

STONE-TARLOW CO., INC., DEPT. PM2-56, BROCKTON 68, MASS.

**Do You Make These Mistakes
in English?**

MANY persons say "between you and I"—use "who" for "whom"—don't know whether to use one or two "e's" or "m's" or "r's." Every time you speak or write you show what you are. A command of effective English brings you added advantages, better opportunities.

You can improve your English through Sherwin Cody's 100% self-correcting invention. If you are ever embarrassed by mistakes in grammar, spelling, punctuation, or pronunciation, write for FREE book "How You Can Master Good English in 15 Minutes a Day." No obligation. SHERWIN CODY COURSE IN ENGLISH, 582 Central Drive, Port Washington, N. Y.

'How to MAKE MONEY with Simple CARTOONS'



A book everyone who likes to draw should have. It is free; no obligation. Simply address **FREE BOOK**

CARTOONISTS' EXCHANGE
Dept. 92D Pleasant Hill, Ohio



**Easy to make your own
BOWS—ARROWS—EQUIPMENT**

Illustrated Hand-Book 84 pgs. 75c, tells you how! Large Colored Catalog 5c—Send for it!

Ask your dealer for "Stemmler's Archery" (Oldest Mfr. in U.S.A.)

L. E. STEMMLER CO.
Manorville (Box 1) L. I., N. Y.



TRAIN WRECK STAMPS!

Cuba's famous stamps of 1946, showing actual train wreck scene! Complete set of 3, a dramatic display for your collection, only 10c. Handsome, exciting stamps to look over, too, without charge or obligation.
WINTHROP STAMP CO., Dept. P-2, GROTON, CONN.

**See the Greatest Show on Earth with this
GIANT ASTRONOMICAL TELESCOPE**

\$15.00
FULL PRICE



Delivered ready for use. Has 45X, 75X and 100 power individually mounted eyepieces with brass focusing tube plus sun projector lens for observing sun spots and solar storms. Steel telescope tube 50 in. long. Rigid 6 ft. tripod adjustable to any height. Steel forked mounting with closely machined aluminum tripod head assembly assures extra fine adjustments. This professional type instrument provides full power with clear vision at all times. See the moons of Jupiter, our own moon, planets, milky way, double stars, star clusters, etc. All for only \$15.00 FOB Mattituck. Sent express. COD orders require \$5.00 deposit. Satisfaction guaranteed. 200X and 400X eyepieces available at \$2.00 ea.

SUFFOLK SCIENCE SERVICE
Dept. TD-2 MATTITUCK, N. Y.

Prepare for a Good Paying Job — Or Your Own Business

Learn PRACTICAL RADIO-TV
with 25 BIG KITS

of equipment I send you while
you train with me . . . for valuable
shop bench experience . . .



The new Sprayberry Training Television receiver, built and tested in sections.

I now offer this fine modern oscilloscope.

You build this powerful 2 Band superbet radio receiver.

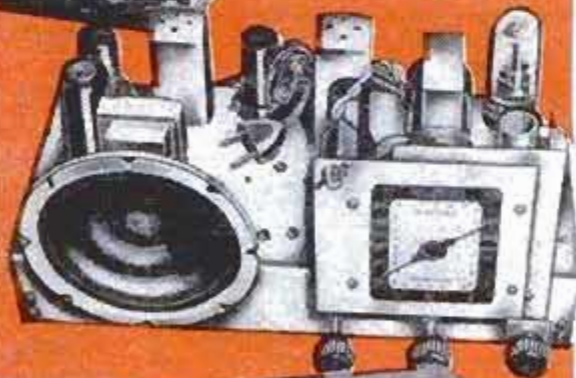

You build the new Sprayberry Tester . . . 18-range Volt-Ohm-Milliammeter readings.

In addition to modern lesson training, I also give you plenty of home practice on actual Radio-Television equipment . . . you will build and use the units shown here plus many more. All this equipment is yours to keep . . . keep everything you need to set up your shop.

"I Will Train You at Home in
RADIO-TELEVISION
on Liberal No Obligation Plan!"

New Equipment! New Lessons! Enlarged Course! The true facts are yours in my big new catalog . . . YOURS FREE . . . JUST MAIL COUPON!



Frank L. Sprayberry
President, Sprayberry
Academy of Radio

I can train and prepare you in as little as 10 months to step into the big opportunity Radio-Television service field. Train *without* signing a binding contract . . . without obligating yourself to pay any regular monthly amounts. You train entirely at home in spare hours . . . you train as fast or as slowly as you wish. You'll have your choice of THREE SPRAYBERRY TRAINING PLANS . . . planned for both beginners as well as the more experienced man. Get the true facts about the finest most modern Radio-Training available today . . . just mail the coupon for my big new 56 page fact-filled catalog plus sample lesson—both FREE.

Train the Practical Way—with Actual Radio-Television Equipment

My students do better because I train both the mind and the hands. Sprayberry Training is offered in 25 individual training units, each includes a practice giving kit of parts and equipment . . . all yours to keep. You will gain priceless practical experience building the specially engineered Sprayberry Television Training Receiver, Two-Band Radio Set, Signal Generator, Audio Tester and the new Sprayberry 18 range Multi-Tester, plus other test units. You will have a complete set of Radio-TV test equipment to start your own shop. My lessons are regularly revised and every important new development is covered. My students are completely trained Radio-Television Service Technicians.

NEWEST DEVELOPMENTS

Your training covers U H F, Color Television, F M, Oscilloscope Servicing, High Fidelity Sound and Transistors.

See for Yourself . . . Make Your Own Decision . . . Mail Coupon Today!

The coupon below brings you my big new catalog plus an actual sample Sprayberry Lesson, I invite you to read the facts . . . to see that I actually illustrate every item I include in my training. With the facts in your hands, you will be able to decide. *No salesman will call on you.* The coupon places you under no obligation. Mail it now, today, and get ready for your place in Radio-Television.

SPRAYBERRY ACADEMY OF RADIO

111 North Canal Street, Dept. 10-H, Chicago 6, Illinois

Mail This Coupon For Free Facts and Sample Lesson



SPRAYBERRY ACADEMY OF RADIO
Dept. 10-H, 111 N. Canal St., Chicago 6, Ill.

Please rush all information on your ALL-NEW Radio-Television Training Plan. I understand this does not obligate me and that no salesman will call upon me. Include New Catalog and Sample Lesson FREE.

Name _____ Age _____

Address _____

City _____ Zone _____ State _____

MAKE \$18⁰⁰ AN HOUR WITH
New



PLASTIC SANDWICH MACHINE

This new, remarkable PLASTIC SANDWICH MACHINE does a permanent, beautiful, professional, protective, plastic lamination job in exactly three minutes time! Amazing earnings possible in your own home or shop permanently sandwiching PHOTOS, SOCIAL SECURITY CARDS, IDENTIFICATION CARDS, CLIPPINGS, DIPLOMAS, etc. between sheets of clear plastic. Make PLASTIC SANDWICHES that cost you only 8c each, take 2-3 minutes time—yet sell for 50c to \$1.00 each! Laminating machines range from \$35.00 up.

PLASTIC SANDWICH MACHINE CO.
 6612 N. Clark St. Dept. LM-601 Chicago 26

FREE SAMPLE
 and illustrated literature, NO obligation.

SEND FOR

Free Record

START SPEAKING

SPANISH or FRENCH



ALMOST OVERNIGHT!



MORE MONEY



NEW CAREER



TRAVEL FUN

HERE'S the easiest way to learn a new language. Listen to FREE 2-sided non-breakable record. Let your eyes follow words in FREE sample lesson. Almost at once you'll be chatting whole sentences in your new language with a perfect accent! Offer may end soon. Rush 25c to help cover cost of special packaging, shipping of free record, lesson. State language you want. We'll also send free information on full Cortina course. No obligation.

CORTINA ACADEMY

"Originators of the Phonograph Method"

Dept. 642, 136 W. 52nd St., New York 19, N.Y.

Also:
 GERMAN
 ITALIAN
 RUSSIAN
 JAPANESE
 BRAZILIAN

If Ruptured

For lasting relief your rupture must
BE HELD BACK DAY and NIGHT.
 Consult Your Doctor.

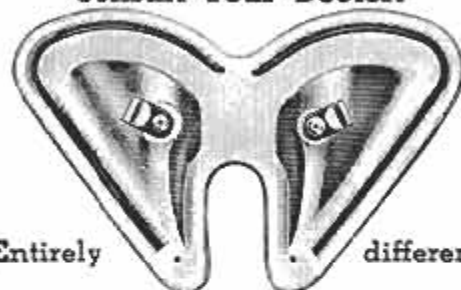

Entirely different

SOFT, FLEXIBLE, and fits neat as a glove. The famous Miller saves you TIME, MONEY, DISAPPOINTMENT.

Write for my FREE booklet today.
FRED B. MILLER Manufacturer
 Dept. PM-A, Hagerstown, Maryland

GIANT BALLOONS 49c



They're really BIG—surplus U.S. Govt. (new average) Neoprene weather, target balloons. GREAT FUN in the backyard; at parties, picnics, dances, fairs. TERRIFIC for high school and college PROMS. They attract BIG CROWDS to business openings, civic events, conventions, exhibitions, trade shows. ORDER TODAY! Great for gift. Approx. inflated sizes:

18 in. dia., 3 for 70c
 3 ft. dia., 49c—5 ft. dia., 99c
 10 ft. dia., \$1.59
 13 ft. dia., \$1.95

Postage paid on prepaid orders.
 Calif. residents please add sales tax.

VOLUME SALES CO., War Assets Division
 Dept. PM-256 3930 Sunset Blvd. Los Angeles 29, Calif.

FREE BERRY'S NEW POULTRY BOOK



Gorgonously illustrated, describing DAY-OLD and 4-WEEK CHICKS, 50 varieties, sexed or unsexed, AMERICA'S FINEST; also Ducks, Geese, Guinea, ORIGINAL BERRY'S FARM, for over 50 years. Beautiful book and LOW PRICE LIST FREE, stamps appreciated. BERRY'S POULTRY FARM, Box 29, Clarinda, Iowa

Say You Saw It in Popular Mechanics

SAVE MONEY ON U S GOV'T SURPLUS

Buy surplus direct from US Government. These are samples of the savings that can be made. Life boat \$12.00. Grinder \$4.69. Shaper \$15. Dump truck \$76.77. Tractor \$75.00. Typewriter \$7.51. Freezer \$50. Spray painter \$15.25. Motor \$4. Hunting, fishing, camping, sporting Equip, jeep, boat, tools. Hundreds others may be purchased at tremendous savings through our Bulletin "Surplus Sales." Price \$1.00.

The Abacus Press, Box 169DDD, Dept. 4, East Hfd. 8, Conn.

Only TWO \$5 Jobs a Day At Home

PAYS \$240⁰⁰ A MONTH!

BEFORE AFTER INVISIBLE REWEAVING

Makes Cuts, Tears, Holes DISAPPEAR from Suits, Coats, Dresses—ALL FABRICS!

Fabricon Reweavers who do only two \$5 jobs a day can earn \$240.00 a month. And a \$5 job can be done at home in about 1/2 hour by an expert Fabricon Reweaver. In many communities qualified reweavers are scarce; service is expensive—often unavailable. Can you learn to do this fascinating, profitable work? Can you earn \$240 monthly in your community? We'll tell you what it takes to learn invisible reweaving; we'll tell you what to do to check the opportunity for profit in your town. Get the answers to these questions free... and complete information too... all free! Write for details today! FABRICON CO., 8342 S. Prairie Ave., Dept. 322, Chicago 19, Ill.

BEST JOBS ARE FILLED BY ALLIED TRAINED MEN

Yes, you can train now for the best paying jobs, and become one of the Builders of Industry! Due to the great present day industrial expansion programs throughout our country, Industry has been clamoring for Allied-trained men to fill important jobs. Shortages of Draftsmen, Designers, Tool Engineers, Machinists, Tool and Die Makers are so wide spread that you can pick one of these highly paid key jobs and then look forward to a life of security and success. Get started now -- take advantage of these opportunities to earn good money -- to build for your security and success.

Allied is the outstanding school of its kind -- the foremost school in its field. Allied is approved by Industry, Department of Registration and Education, Department of Public Instruction, State of Illinois, Department of Justice for Foreign Students, and the Veterans Administration. Accredited by Central Schools Association.

Train at Home in Your Spare Time or at The Allied Institute in Chicago



Free employment service and housing assistance all through your training period and after your graduation. Our industrial contacts cover the U.S.A.

SEND FOR FREE BOOKS

ALLIED SCHOOL of Mechanical Trades
1338-42 South Michigan Ave
Chicago 5, Illinois

Foundation of Industry is Built by the:

**DRAFTSMAN
MASTER MACHINIST
TOOL-DIE MAKER
TOOL-DIE DESIGNER
TOOL ENGINEER
MACHINE DESIGNER
MECH. ENGINEER**



Allied's training program permits you to study right at home in your spare time or at the Allied Institute's fully equipped shops and laboratories. You can begin your training in short courses and continue progressively to a Bachelor Degree in 26 months.

ALLIED SCHOOL of MECHANICAL TRADES

Allied Institute of Technology
1338-42 South Michigan Ave., Dept PM 2, Chicago 5, Illinois

Gentlemen:

Send me without obligation your FREE BOOKS explaining Allied's Courses of Instruction.

I am interested in Resident Training Home Study

I am eligible for the G.I. Bill I am not eligible

Name _____ Age _____

Address _____

City _____ State _____

DRAFTING *pays* BIG MONEY!



Draftsmen earn more, enjoy pleasanter working conditions. Get into DRAFTING and Blue-Printing, the starting point of all production. Trained Draftsmen are needed everywhere. Machines can never replace the draftsman.

LEARN AT HOME IN SPARE TIME

Revolutionary new method teaches you quickly the hows and whys of Mechanical, Structural, Machine, Architectural, etc. Drafting. You are sent professional drafting instruments, drafting equipment, portable drafting table, etc., at no extra cost. You learn by making actual drawings.

BIG MONEY... ADVANCEMENT OPPORTUNITIES offered trained draftsmen. Drafting is light, pleasant work, paying big salaries. Is a stepping stone to top managerial jobs. The draftsman plans the World of Tomorrow. That is why drafting is such interesting work.

OWN YOUR OWN DRAFTING FIRM

The investment requirement is small, the earning possibilities great. Many draftsmen eventually branch out into manufacturing the products they created. Learn of the opportunities in Drafting.

MAIL THIS COUPON TODAY!

CHRISTY TRADES SCHOOL, Dept. DB-3003
4804 N. Kedzie Ave., Chicago 25

Mail at once your big FREE book on Drafting and Blue-Printing. Tell me how your Home Training and Professional Drafting Instruments, Portable Drafting Table, Drafting Equipment, etc. can be had on a PAY AS YOU LEARN plan.

NAME _____ Age _____
ADDRESS _____ CITY _____ STATE _____

105 POWER SUPER TELESCOPE



Everything for the Astronomer, Hobbyist, Student, & Scout in this complete astronomical super value telescope combination. Comes ready for immediate use, consists of brilliant 33x-65x-105x telescope, 5 foot hardwood Tripod, carrying case for scope, Star Explorer map, 108 page book "Discover the Stars." 3 foot telescope (closes to 16 inches) is brass bound, has 4 precision lenses that will bring distant objects, people, moon, stars, ships, etc., 105 times closer, 11,025 area magnification. All images erect. Sturdily built tripod is equipped with universal mount that has 360 degree horizontal range & 180 degree vertical range. Locks in any position with one simple adjustment. The Star Explorer map enables you to find any star automatically. This marvelous all purpose instrument is proclaimed by Scientists as a most unusual development. Everyone that has used it is amazed at its performance and value. It will fascinate the entire family. Shipped to you complete, nothing else to buy, at the amazing low price of.....

\$11.95
POST PAID

Satisfaction guaranteed or money refunded. We pay all delivery charges. Send check or money order to DEPT. PMS14

CRITERION CO. 331 CHURCH ST., HARTFORD 1, CONN.

EXPERIENCE IS THE BEST TEACHER. OUR MANY YEARS PROVE YOU CAN'T GET MORE. WHY PAY MORE?

22 YEARS AT THIS ADDRESS

AN ESTABLISHED POLICY OF CAREFUL SELECTION ASSURES YOU, MANY HAPPY MILES. BE WISE - TRY ONE - YOU'LL BUY MORE! WE WELCOME COMPETITION. NO ONE CAN TOUCH OUR QUALITY & PRICE! White Walls \$1.00 EX. 50 Years of Combined family experience in High Quality tires. Free tube. PARTIALLY USED TIRES - AND OTHERS

FREE if you buy 2 or more Passenger 4-ply tires, WE GIVE ONE tire FREE, on each order, on request. Does not include W.W. or Truck Tires. Free Tube with Mail Order.

Specialists in Truck Tires—Selected for Younearest Jobs—Tops in Value

12 MOS. WRITTEN GUARANTEE WITH EVERY TIRE	12 MOS. WRITTEN GUARANTEE WITH EVERY TIRE	12 MOS. WRITTEN GUARANTEE WITH EVERY TIRE
600-16 \$5.52 (475-19 3.42 700-15 (6) 57.52 700-20 \$9.92	800-16 (6) 5.92 640-15 4.22 750-16 (8) 8.72 750-20 (10) 15.72	650-16 5.72 670-15 5.52 700-17 8.82 750-20 (8) 11.92
650-16 (6) 6.62 710-15 5.52 750-17 10.32 825-20 18.92	700-16 6.02 760-15 5.82 825-15 12.92 900-20 17.92	750-16 (6) 7.52 800-15 5.92 600-20 9.02 1000-20 17.92
850-18 4.52 820-15 5.92 650-20 9.82 1100-20 19.92	850-17 3.72 670-16 5.32 32x6 (10) 12.02 1100-22 18.92	650-15 5.52 760-16 7.02 32x6 (10) 13.92 1000-22 20.02
700-15 4.92 700-16 (6) 7.32 750-15 10.72 1100-24 23.02		

"EXTRA SPECIAL" SOME NEAR NEW all size 4-ply pass. FREE TIRE with 2 or more of these also.—W.W. \$1.00 EA. Extra Factory Tested Tube given—GIANT TIRE SALE.

Thousands of tires shipped all over the U.S.A. All tires shipped F.O.B. Phila. Send Check or M.O. with this ad. Dept. 2. No C.O.D. **STANDARD 834 N. Broad St., Philadelphia 30, Pa.**

Secrets of VENTRILOQUISM Now Revealed!



Easy to learn in 60 to 90 days with our Home Study Course. **RESULTS GUARANTEED.** Make Money! Be Popular! Have Fun! Big Opportunity! Radio, Television, Stage Appearances! For FREE Information regarding price and terms WRITE. You must state your age. Dummy Catalog 25c. **FRED MAHER SCHOOL OF VENTRILOQUISM** Box 36, Studio PM-2 Kensington Station Detroit 24, Michigan

STUDY INDUSTRIAL DESIGN

You can train at Art Center School in California with practicing-professionals for upper-level jobs in INDUSTRIAL DESIGN. Recent graduates have been added to the staff at General Motors, Chrysler, Raymond Loewy, Henry Dreyfuss, etc. Majors in transportation, general product design, structures, community development, furniture design, packaging, display, 4-year degree courses. Learn to combine imaginative design with technical proficiency, coordinate utility and beauty. Stimulating environment. Field trips. Advantages of mild Southern California climate and nearby holiday spots. Coed. Placement service. Established 25 years. New terms Feb., June, Sept. Write for catalog.

ART CENTER SCHOOL, Edward M. Adams, Director
5353 WEST THIRD STREET, LOS ANGELES 5, CALIFORNIA

IT'S EASY... MAKE MONEY IN PHOTOGRAPHY

If you are over 17—good pay and fascinating work await you in photography! Start making money quickly in sparetime—step into your own studio or exciting career job. **LEARN BY DOING** method trains you at home! Write TODAY for FREE catalog. Also Resident Training. 46th Year. Approved for Vets.
NEW YORK INSTITUTE OF PHOTOGRAPHY
Dept. 49, 10 West 33 Street, New York 1, New York
46th YEAR

RUPTURE!



An amazing Air-Cushion Invention allows body freedom at work or play. Light, neat, cool, sanitary. Durable, cheap. Day and night protection helps Nature support weakened muscles gently but surely. No risk. **Sent on Trial! Write NOW** for free Booklet and **Proof of Results.** All correspondence confidential.
Brooks Company, 373-D State St., Marshall, Mich.

YOU BUILD 'EM — WE SELL 'EM EARN UP TO \$50.00 A DAY AT HOME

Here is a new business for people who would like to make extra money full time or spare time. Our program enables you to work in your home and participate in national sales secured through our firm. You assemble luggage and special cases for photographic equipment—musical instruments—salesmen's samples and all types of portables. We supply complete instructions—materials—tools—everything. No previous experience is necessary. **Write for free details.**
ABARSI CASECRAFT
Dept. AB, 807 W. Sunset Blvd., Los Angeles 12, Calif.

NOW—Through The Miracle of Long Play Records

Complete FRENCH or SPANISH LANGUAGE COURSE

Slashed from \$29⁹⁵ to \$9⁹⁵!

ALSO: ITALIAN or GERMAN if you prefer

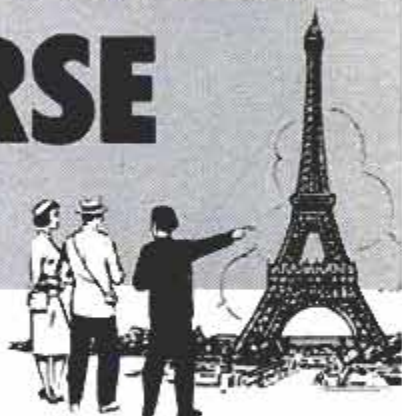

Thanks to the miracle of long-playing records, you can now learn to speak French or Spanish from NATIVE instructors, quickly—at home and in your spare time—and not for the \$29.95 this Course has always cost, but for only \$9.95—a savings to you of exactly \$20.00! Or if you prefer, you may learn Italian or German for the same low price.

Why is this remarkable savings possible? Because now the "LIVING LANGUAGE" Course, originally in French and Spanish, consisting of 40 lessons which formerly occupied 20 standard-size 78 RPM records, has been reproduced on only 4 long-playing 33 1/3 RPM records! This is the identical Course for which thousands have long paid \$29.95! Not a word changed—not a syllable left out! But because of the miracle of long-playing records we can now offer it at a 2/3 reduction—only \$9.95, and on a no-risk, free-trial basis!

No Rules! No Schools! Just Relax and Listen!

Whether you plan a trip abroad or want to speak a second language for business and cultural rewards, there's no easier, faster way than the "LIVING LANGUAGE" method! You learn naturally, just as you would if living in a foreign land.

You simply turn on a record, relax in your easy chair and listen to the recorded voices of people conversing in their native tongue! You hear words, phrases, sentences, clearly spoken in faultless accents by expert instructors. And as you listen, you look at the Conversation Manual provided, to see the words you hear. You get the double impact of both seeing and hearing.

In a few days, you understand key words—you become familiar with common-usage phrases. The language GROWS on you. Soon, you could go abroad and actually converse with the people almost as if you were one of them!

Here's All You Need to Learn to Speak FRENCH, SPANISH, ITALIAN OR GERMAN FAST!

4 Long-Playing Records

The entire Course (40 complete lessons) is contained in these 4 long-playing 33 1/3 RPM discs of unbreakable vinylite. You hear and become familiar with thousands of words and phrases to help you speak a foreign language yourself.



Unique Companion Volumes

The Conversation Manual you receive repeats in print each recorded lesson; you constantly see the

words you hear! The Common Usage Dictionary you also receive provides over 16,000 frequently used words and phrases for quick reference.

Why You Learn So Quickly This "Living Language" Way!

The best proof of this "Living Language" method is this: In World War II the Army had to teach over a hundred thousand soldiers to speak and understand foreign languages in a fraction of the usual time! The country's best experts devised a method which is the basis for the "Living Language" Course. In fact, the same man who headed the U. S. War Dept. Language Section—Mr. Ralph R. Weiman—also developed the "Living Language" Course! So you can be sure you are receiving one of the best methods of speedy language instruction ever devised!

FREE 7-DAY OFFER! SEND NO MONEY!

Prove to yourself—at no risk—how amazingly easy it is to learn a foreign language the "Living Language" way. Just mail the coupon below, and we will ship the entire "Living Language" Course of 4 long-playing 33 1/3 RPM records together with the Conversation Manual and the Common-Usage Dictionary of over 16,000 basic terms and essential words—for 7 days free trial!

Send no money—not a cent! After receiving the Course, start using it for a few minutes a day. If in 7 days you do not find that you are already learning to speak this foreign language even better than we say—return it and owe nothing. Otherwise, we will bill you only \$9.95 plus U. S. tax and mailing charge—a 2/3 reduction from the original cost of \$29.95, and a saving to you of a full \$20.00. And you need remit only \$2.00 monthly.

Did you ever hear of a more remarkable offer? You do not risk a thing by mailing the coupon. But do it today; this offer cannot be held open indefinitely. Fill in the coupon, indicate your choice of language and mail today. We'll ship the Course immediately. So act NOW!

See These Remarkable Advantages of Learning the "LIVING LANGUAGE" Way!

Your Home Is Your Classroom! When you learn to speak French, Spanish, Italian or German the "LIVING LANGUAGE" way, you simply relax in an easy chair at home, start the record, open the manual—and you're learning! It's easy, it's pleasant—it's fast!

Set Your Own Class Hours! Learn at your own convenience. Most people find it best to spend no less than 15 minutes a day on the Course, but you can set your own time.

Choose Your Own "Classmates!" Learn by yourself—or in the company of friends, business associates, or your family. No matter how large your class, the cost is the same—just \$9.95, a saving of \$20.00!

Your Instructors Never Lose Patience! They are always on call. Because your entire course is on records, they "repeat" any lesson as often as you please.

"Living Language" Course Includes
40 Lessons Recorded on 33-1/3 RPM L.P.'s—
CONVERSATION MANUAL—
COMMON USAGE DICTIONARY—
Full \$29.95 Value at TWO-THIRDS REDUCTION!
You Save \$20.00!

LIVING LANGUAGE COURSE, Dept. 62 PMX-2
100 Avenue of the Americas, New York 13, N. Y.

Without obligation to me, please ship me on approval the Course for language checked below. If not entirely satisfied within 7 days, I may return Course and owe you nothing. Otherwise, you may bill me only \$9.95 plus U. S. tax and mailing charge which I may pay \$2.00 monthly.

Important! Check FRENCH SPANISH
Here ITALIAN GERMAN

Name _____ (please print)

Address _____

City & Zone _____ State _____

SAVE Enclose only \$10.00 with this coupon to save shipping charges. Immediate refund and return privilege guaranteed.

MORE \$11.95 in Canada: 1184 Centrefield Ave., Toronto 10, Ont.

Come on, Buddy, Quit being a BAG of BONES Weakling

Hi
Pal!

WIN
\$100.00
as I
just
did

LIKE I WAS →
IN 10 MINUTES OF
FUN A DAY

You can do ALL I did!
I gained 25 Terrific LBS. of
**HANDSOME POWER-PACKED
MUSCLES** all Over!

I improved My
HE-MAN LOOKS 1000%
I won **NEW STRENGTH**
I won **NEW POPULARITY**



**JIM
NORMAN
AFTER**
He
Mailed
(Coupon)



Everybody
admires
Jim's build
NOW
He's a
WINNER
in ALL
SPORTS

I Mailed the
Coupon and
got these
**5 PICTURE
PACKED**
He-Man Courses
Which YOU
Can NOW get
FREE

Before \$1 price
goes back
Millions Sold
for \$1.00



YOU CAN
WIN
a BIG 15"
SILVER CUP—
as I just did!
with YOUR
NAME
engraved on it!



1 HOW TO MOLD A
MIGHTY CHEST

Come on PAL, Now YOU give me
10 PLEASANT MINUTES A DAY
In Your Own Home Like Jim Did
and I'll give you A NEW HE-MAN BODY
for your OLD SKELETON FRAME

NO! I don't care how
skinny or flabby you
are I'll make you **OVER** by
the SAME method I turned my-
self from a wreck to the strong-
est of the strong.

Develop YOUR 520 MUSCLES
Gain POUNDS, INCHES FAST!

YES! You'll see INCHES
of MIGHTY MUS-
CLE added to your ARMS
and CHEST. Your BACK and
SHOULDERS broadened.
From head to heels you'll
be A WINNER in EVERY-
THING you tackle.

Mail the ALL FREE Cou-
pon and get PHOTO BOOK



2 HOW TO MOLD A
MIGHTY ARM



3 HOW TO MOLD A
MIGHTY BACK



4 HOW TO MOLD A
MIGHTY GRIP

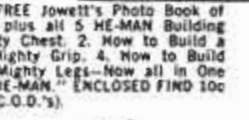

5 HOW TO MOLD
MIGHTY LEGS

LAST CHANCE — ALL FREE COUPON!

1. Photo Book of STRONG MEN
2. MUSCLE METER
3. FIVE COURSES

Dept. PM-62

Tell Me How To
WIN \$100, etc.

"Jowett Covers
greatest in
World for
Building
All-Around
HE-MEN"
—R. F. Kalliv
Physical
Director

JOWETT INSTITUTE OF PHYSICAL TRAINING
220 FIFTH AVENUE, NEW YORK 1, N. Y.

Dear George: Please mail to me FREE Jowett's Photo Book of
Strong Men and a Muscle Meter, plus all 5 HE-MAN Building
Courses: 1. How to Build a Mighty Chest. 2. How to Build a
Mighty Arm. 3. How to Build a Mighty Grip. 4. How to Build
a Mighty Back. 5. How to Build Mighty Legs—Now all in One
volume "How to become a Mighty HE-MAN." ENCLOSED FIND 10c
FOR POSTAGE AND HANDLING (no C.O.D.'s).

NAME _____

AGE _____

ADDRESS _____

CITY _____

ZONE _____ STATE _____

Learn CARBURETOR and IGNITION



Start Training at Home For This
Clean, High-Class Type of Position

Get in line for a raise—or for more profits in
your own shop. Learn testing and adjusting
with latest-type scientific motor tune-up equip-
ment. This enables you to locate the trouble
exactly, and fix it fast—handling and getting
paid for more jobs per day. There's money in
this, and it's clean, high-class work which gets
the respect and confidence of your customers.

Send for FREE SAMPLE LESSON
Carburetor and Ignition Specialization offers
very superior opportunities for better pay and
bigger profits because relatively few mechanics
know anything about this time-saving, money-
making new test equipment. Now our spare-
time home-study method teaches you the
principles and shortens your shop training.
Ambitious men (age 18-55): Send for full
FACTS and FREE SAMPLE LESSON at
once. Write today to

UTILITIES ENGINEERING INSTITUTE
2525 Sheffield Ave., Dept. OC-2, Chicago 14



GIANT FREE CATALOG of OPTICAL BARGAINS

ASTRONOMICAL TELESCOPE HEADQUARTERS

Complete Line of Astronomical Telescope Parts
and Assembled Telescopes. Also huge selection
of lenses, prisms, war surplus optical instru-
ments, parts and accessories. Telescopes, micro-
scopes, binoculars, etc. America's No. 1 source of
supply for Telescope Makers. SEND ONLY \$1.00
for beginner's 10-lens kit and big instruction
booklet Stock 2-H. Ask for FREE catalog H.

EDMUND SCIENTIFIC CORP., Barrington, N.J., U.S.A.



Stammering?

BREAK THAT HABIT NOW!
SUCCESSFUL EMERY CORRESPONDENCE
COURSE FEATURED IN NEWSWEEK & MED-
ICAL RECORD. WRITE TODAY FOR FREE
INFORMATION.

EMERY INSTITUTE

P.O. Box 867-PM2 Winter Park, Florida

\$1300 BUILDS INCOME DUPLEX



Build your own 24'x36' con-
crete block duplex, complete for
\$1300. Slab floor, steel win-
dows, wall furnaces, rock wool
insulated, no block cutting nec-
essary. Each side contains 11'x
17' living room and kitchenette,

10'x11' bedroom, 6'x9' bath, and four closets. Genuine blueprint, scale
1/4"=1', step by step instructions, and material cost list \$1.00 ppd.
Money back guarantee. \$2850 Deluxe Duplex, brick veneer construction,
gable roof. Two sheets blueprints and Mat. List \$3.00. \$1150 Block
Garage Apartment, 22'x24', Liv. Room, Kit., bath and two bedrooms.
Double garage below. Plan \$1.00. Member Ark. Home Bldrs. Assoc.
BAILEY BUILDERS, 915 Pyramid Bldg., Little Rock, Ark.

FREE 8' to 14' Models from \$39.95 incl. freight

**FREE
BOAT
KIT
CATALOG**

- Assemble your
own boat
- No experience
necessary
- Save 1/3 to 2/3
factory built
prices



Write:

Marine Hardware, Fiberglass, & Trailers

UGER INDUSTRIES MINNEAPOLIS 9, MINN.

LAW

Men and women **STUDY AT HOME** for
Business Success and **LARGER PERSONAL
EARNINGS**, 44 years expert instruction—
over 114,000 students enrolled. LL.B. De-
gree awarded. All text material furnished.
Easy payment plan. Send for **FREE BOOK**
—"Law and Executive Guidance"—NOW!

AMERICAN EXTENSION SCHOOL OF LAW

Dept. H-8, 201 N. Wells St., Chicago 6, Illinois

Learn PHOTOGRAPHY at Home

Splendid opportunities. Prepare in spare time. Practical
basic training. Long-established school. Send for free
book, "Opportunities in Photography." No obligation.
AMERICAN SCHOOL OF PHOTOGRAPHY, 835 Diversy Pkwy., Dept. 1352, Chicago 14, Ill.

POPULAR MECHANICS

DO IT YOURSELF
THIS NEW BOOK
MAKES EVERY STEP **EASY!**



Fix Electrical Appliances

Handle ANY job on ANY make or model!

... Even if you've never repaired an appliance before ...

This big, new how-to-fix-it book shows you how to do the toughest electrical appliance repair jobs as well as the easy ones. Step-by-step instructions PLUS almost 200 pictures guide you all the way!

ELECTRICAL APPLIANCE SERVICE MANUAL is a real "show-me-how" book. Just look up the appliance you want to fix.

Then go right ahead and fix it! From complicated thermostat and timing assemblies, to appliances that get too hot, not hot enough or won't heat at all ...

From automatic washers, dryers to electric clocks, razors and all the other appliances used around the house it is a complete, easy-to-understand service guide ... Even tells how to stop radio-television interference caused by appliances.

SAVE SERVICE COSTS UP TO \$10 AN HOUR!

Fix your own home appliances! Avoid costly service charges! This big Manual can more than pay for itself the first time you use it!

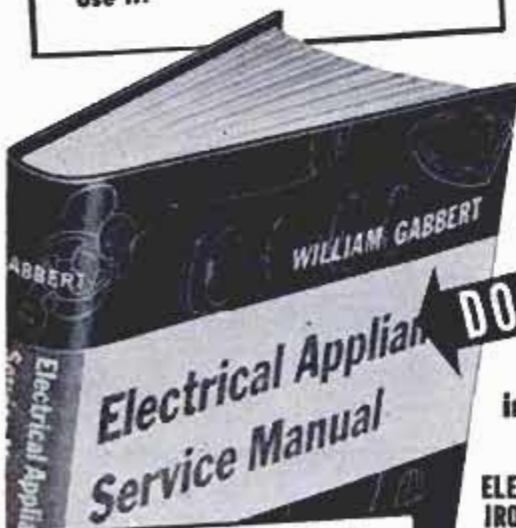

DON'T THROW BROKEN APPLIANCES AWAY!

This book shows how to fix them good as new!

Troubleshooting charts help you locate troubles fast ... show how to make easy tests where necessary. Basic electrical principles are explained. Simple test instruments, tools and wiring problems are fully described.

Above all, you learn to work safely ... what dangers and mistakes to avoid.

IN ADDITION, you learn about servicing appliance motors PLUS appliance refinishing methods.

Everything is explained so clearly it's next to impossible to go wrong. And the complete price is only \$5.00.

Practice 10 days FREE. If book is not all you'd expect ... even of a "course" costing many times as much ... return it and don't owe us a cent!

Easy instructions cover:

- ELECTRIC RAZORS
- IRONS CLOCKS
- FOOD MIXERS
- HOT PLATES
- ROASTERS
- COFFEE MAKERS
- JUICE EXTRACTORS
- HOT PADS
- TOASTERS
- WAFFLE IRONS
- RANGES FANS
- GRILLS
- IRONERS
- DRYERS
- WASHERS
- (Std. & automatic)
- CHIMES
- WATER HEATERS
- CLEANERS
- FLUORESCENT LAMPS
- ... and others

PRACTICE 10 DAYS FREE!

Dept. PM-26, RINEHART & CO., INC.,
232 Madison Ave., New York 16, N. Y.

Send ELECTRICAL APPLIANCE SERVICE MANUAL for 10-day FREE EXAMINATION. If I like book, I will promptly remit the full price of only \$5.00 plus postage. If not, I will return book and owe you nothing. (Send cash with order and we pay postage. Same 10-day return privilege with money refunded.)

Name.....

Address.....

City, Zone, State.....

OUTSIDE U.S.A.—Price \$5.50 cash only. Same 10-day return privilege with money refunded.

Only \$5.00

NO LESSONS TO WAIT FOR!

Everything is complete in this one 370-page book. TELLS you how ... SHOWS you how!

MAKE EXTRA MONEY!

This book gives you the "know how" you need to earn spare-time money repairing electrical appliances for friends and neighbors ... or to build a good-paying, full time repair business of your own.

RINEHART BOOKS ARE SOLD BY LEADING BOOK STORES

FREE

1956 CATALOG

WORLD RADIO LABORATORIES

"The World's Largest Distributor of Amateur Radio Equipment"

Jam packed with bargains — everything in Radio, TV, and Hi Fi — for Handyman, Ham, Experimenter or Serviceman!

- Pay Only 10% Down
- Easy Terms
- Liberal Trade-Ins
- Save Over 50% on Recond. Equipment
- Over 800 Guaranteed Reconditioned Items



WORLD RADIO LABORATORIES

3415 W. Broadway — Council Bluffs, Iowa

Leo I. Meyerson

PERSONALIZED SERVICE

MAIL HANDY COUPON

WORLD RADIO LABORATORIES, INC. PM-2

3415 W. Broadway — Council Bluffs, Iowa

- Free 1956 Catalog Recond. Eq't. List
- 3'x4' U. S. Radio Map 25c

NAME _____

ADDRESS _____

CITY _____

STATE _____

Even if You CAN'T DRAW

Anyone Can Draw With This Amazing New Invention—Instantly The "Magic Art Reproducer"

A STRAIGHT LINE DRAW the FIRST DAY!

NO LESSONS! NO TALENT! Also Excellent for Every Other Type of Drawing!



Complete for only \$1.98

FREE with order

A.B.C. Guidance of Figure Drawing This valuable illustrated guide contains simple guidance on drawing human figures. Includes techniques, shading, proportions, etc., to use with your "Magic Art Reproducer" for added touches to your drawings.



- Human Figures • Outdoor Scenes, landscapes, buildings • Still life, vases, bowls of fruit, lamps, furniture, all objects • Copy photos, other pictures, portraits, etc. • Copy blueprints, designs, decorations, etc., for woodwork, machine, for needlework, crocheting, knitting • Copy all cartoons.

Yes, anyone from 5 to 80 can draw or sketch or paint anything now... the very first time you use the "Magic Art Reproducer" like a professional artist — no matter how "hopeless" you think you are! Anything you want to draw is automatically seen on any sheet of paper instantly! Then easily and quickly follow the lines of the "picture image" with your pencil... and you have an accurate original drawing that anyone would think an artist had done. Also makes drawing larger or smaller as you wish. Anyone can use it on any desk, table, board, etc.—indoors or outdoors! No other lessons or practice or talent needed!

Have fun! Be popular! Everyone will ask you to draw them. You'll be in demand! After a short time, you may find you can draw well without the "Magic Art Reproducer" because you have developed a "knack" and feeling artists have—which may lead to a good paying art career.

NORTON PRODUCTS, Dept. 5802W, 286 Broadway, N.Y.C.

Earn \$217 a Month EXTRA With My FREE SHOE OUTFIT!

Just 2 Sales a Day Does It!

Rush a postcard today for my powerful FREE Shoe Selling Outfit. It contains everything you need to start a steady profit, repeat-order shoe business! Just 2 sales a day earns you up to \$217 a month EXTRA! It's amazingly easy! Just show friends, relatives Mason's famous shoes with comfortable Air-Cushion innersoles. People like buying the Mason way because they choose from over 160 dress, sport, work styles for men and women—including Nylon mesh, Cush-N-Crepe and Safety Toe work shoe styles. Because you draw from stock of 200,000 pairs, in an amazing range of sizes and widths, customers get the exact size, width and style they order! Our shoes are not sold in stores... people must buy from YOU! Start making BIG MONEY now... send for your FREE Special Outfit TODAY!



Write TODAY!

MASON SHOE MFG. CO. DEPT. MA955 CHIPPEWA FALLS, WIS.

NEW BENJAMIN SUPER CO2 GAS CARBINE — \$16.50

HI-LO (2 Stage) Jet Power Cal. .177 or .22

RIFLED Shoots Pellets & Darts



IDEAL FOR TARGET & SMALL GAME

SAFE — ECONOMICAL — ACCURATE CONVENIENT — PRACTICAL — NON TOXIC

EASY TO OPERATE — NO PUMPING — NO FLINCHING. Get 40 SHOTS from each 10¢ STANDARD SIZE CO2 (Soda) CARTRIDGE. Up to 3/4" penetration. Ask your DEALER for DEMONSTRATION.

New Benjamin .177 or .22 CO2 ROCKET Gun Pistol with HI-LO JET POWER.....\$15.00

BENJAMIN AIR RIFLE CO. 896 MARION ST., ST. LOUIS 4, MO., U.S.A.

FREE Folder

FREE! 107 BRITISH COLONY STAMPS

All different from Britain's farflung colonial empire. Catalog value \$2.50. FREE STAMP MAGAZINE. Approvals. Send 10c for handling. Act now! NIAGARA STAMP COMPANY St. Catharines 77, Ont., Canada



MAKE TREMENDOUS PROFITS

Have fun! Earn Big Money! Cast plaster figurines, bookends, plaques, novelties at home in your spare time with N.L. rubber molds! NO EXPERIENCE NEEDED! Models and rubber for 3 molds, only \$1.50 ppd. Send 25c (refunded with order) for 40 page catalog now!

PLASTIC ARTS STUDIO 3403 50. MADISON, DEPT. PM2 MUNCIE, INDIANA

JEEP OWNERS

STA. WAGONS • JEEPSTERS • PICK-UPS!

Take full advantage of 4-wheel drive by installing a Ford V-8 engine —MORE POWER—means less shifting, better traction at lower speeds, greater safety, plenty of power in high. All this is now possible by using our F-J adaptor plate. Conversion Kit \$43.25 incl. FED. TAX. Please indicate year of engine you will use and whether 2 or 4 wheel drive. Write for free details or send check or M.O. for prepaid delivery. Order now for early shipment.

HOOSIER MACHINE PRODUCTS CO.

312 S.E. 6th St.

Pendleton, Oregon

WARN HUBS for 4-WHEEL DRIVES

Make 2 Vehicles Out of 1!

Over 75,000 satisfied users! Warn Hubs disengage front power train for 2-wheel drive use—stop drag, gear whine, front end shimmy; save gas, gears, tires. Use your 4-wheel drive for any purpose, any time, with Warn Automatic or Locking Hubs. Models for all makes of 4 W. Ds. to 1 1/2 tons at dealers, or write:



WARN MFG. CO., Riverton Box

AUTOMATIC FREE-WHEELING 2-WHEEL DRIVE OR HIGH SPEED 4-WHEEL DRIVE AS YOU SHIFT!

Seattle 88, Wn.

What about YOUR Future?



"What can be in it for me?"

PLENTY! Better Job!—
Bigger Pay!—Brighter Future!

"How can I be so lucky?"

EASY! On the coupon check the subject that interests you most, then—sign and mail it.



"Then What?"

FACTS! We will send facts which show Your Big Opportunities can be closer than you think!

FULL INFORMATION... NO COST... NO OBLIGATION

Yes, what about your future? Do you look forward into a rather hazy and distant time that you hope will bring you big job promotions, much higher pay, and lasting security? Or are you a realist and know that you are standing at the gateway to your *real* future right now, and that what's ahead for you depends on what you *do today*?

TODAY you can make the *big* decision of your life. You can make the choice that can start you toward richer goals. From the list in the coupon below, choose the career you want and decide to find out

how you can prepare for progress in it, in spare time, at home. Or if you are now in the work you like best, learn how you can start training for quicker promotion and higher earnings. Just *mark and mail* the coupon without delay.

American School, since 1897 an educational institution *not for profit*, has enabled others to *earn* more while they *learned* more. That opportunity is offered to you *now*. Learn *all* about it by sending the coupon immediately.

AMERICAN SCHOOL, Dept. G245, Drexel at 58th, Chicago 37, Ill.

Canadian Residents: Write to American School, 1610 Sherbrooke St. West, Montreal

AMERICAN SCHOOL, Dept. G245, Drexel at 58th, Chicago 37, Ill.

Without obligation, please send FREE and postpaid, full particulars about the subject checked below.

- | | | |
|--|---|---|
| <input type="checkbox"/> Accounting | <input type="checkbox"/> Diesel Technician | <input type="checkbox"/> Metalworking Courses |
| <input type="checkbox"/> Apprenticeship Courses | <input type="checkbox"/> Drafting—Building Trades | <input type="checkbox"/> Plumbing—Practical |
| <input type="checkbox"/> Architecture & Building | <input type="checkbox"/> Drafting—Machine Trades | <input type="checkbox"/> Private Secretary |
| <input type="checkbox"/> Automotive Technician | <input type="checkbox"/> Electrical Engineering | <input type="checkbox"/> Retail Merchandising |
| <input type="checkbox"/> Better Foremanship | <input type="checkbox"/> Electricity—Practical | <input type="checkbox"/> Salesmanship—Outside |
| <input type="checkbox"/> Bookkeeping | <input type="checkbox"/> Electronics—Industrial | <input type="checkbox"/> Sheet Metal Work |
| <input type="checkbox"/> Business Management | <input type="checkbox"/> HIGH SCHOOL COURSES | <input type="checkbox"/> Tool Making |
| <input type="checkbox"/> Civil Engineering | <input type="checkbox"/> Mechanical Engineering | |
| <input type="checkbox"/> Contracting | <input type="checkbox"/> Mechanical Technology | |

NAME _____ OCCUPATION _____

HOME ADDRESS _____ AGE _____

CITY _____ STATE _____

The sooner
you ACT,
the sooner
YOUR GOAL
can be
REACHED

... TURN CONCRETE INTO GOLD!

MOTOR DRIVEN

MAKE UP TO \$75 A DAY IN YOUR OWN BUSINESS

If you want to have your own business — to start a business on your own — here's your big opportunity! New high speed, low cost General block machine produces up to 1,000 concrete blocks a day. Sell all you make to builders, supply houses, and others for homes, factories, buildings, garages. Cash in on the building boom! You can make profits of 100% to 150% — up to \$75 a day! General block machine equipped with 1/2 h.p. electric motor — or can be supplied with gasoline engine — works anywhere, in little space, indoors or out. Operates from ordinary house light socket. Simple, foolproof 3 step operation — so easy a child can do it. Makes superior 3 core blocks any size from 4" to 12". Also makes chimney, ash, corner and other types. Blocks meet any building code anywhere in the country. Materials — sand, water, cement, available anywhere. Simple illustrated operating instructions and mixing formulas for cement and cinder blocks supplied with each machine. Write for FREE folder with full information.

R.L.T. of New York City reports: "MY GENERAL BLOCK MACHINE PAID FOR ITSELF IN FIRST 2 WEEKS!" Hundreds now in use the world over! Write for FREE details today!

EXTRA Amazing illustrated book gives floor plans for 6 sensational concrete block bungalows. Tells how to lay blocks, lay out building lines, mix concrete, build steps, porch and concrete floors all at great savings. Written by experts. Can save many times the cost of the machine! Get it now! No strings attached. Send \$1. BOOK SENT FREE IF YOU BUY MACHINE. \$1 REFUNDED IF YOU BUY LATER.



GENERAL ENGINES CO.
DEPT. M-26, ROUTE 130, THOROFARE, N. J.



HOME PLAN BOOKS

CHOOSE YOUR NEW HOME FROM HUNDREDS of Garlinghouse HOME PLANS SHOWN IN THESE 5 LATEST PLAN BOOKS

- "RANCH & SUBURBAN" 125 plans most practical for town and country. Many in color50c
 - "CHOICE SELECTED HOMES" 82 designs (12 are split-levels) 2 and 3 bedrooms. 32 in color ..50c
 - "NEW SMALL HOMES" Over 80 new plans. Sizes 650 to 1175 sq. ft. floor space. 1, 2 and 3 bedrooms. 32 in color.....50c
 - "NEW BRICK HOMES" 64 genuine beauties, brick exteriors. Varied styles and sizes. 50c
 - "PLANS FOR NEW HOMES" 84 very desirable homes in wide variety of styles and sizes. 32 in full color.....50c
- All 5 above books for \$2.00

ORDER YOUR BOOKS TODAY
All Books Mailed POSTPAID. No C.O.D.'s Please
Our Plan Service used by Builders and Lumber Dealers for over 45 years—America's Pioneer Home Plan Service.

L. F. GARLINGHOUSE CO., INC., Box PM-26 TOPEKA, KANSAS

FULLY GUARANTEED TIRES COST LESS!

Nationally famous FIRESTONE, GOODRICH, U. S. ROYAL, GOODYEAR, and other makes. Every tire selected and inspected for your safety.

BUY WITH CONFIDENCE FROM PYRAMID TIRE

WHITE WALL TIRES \$1 EXTRA

HIGH GRADE TIRES GUARANTEED 12 MONTHS

600x16	4.14	700x16	5.14	32x6(8)	8.84	825x20	14.24
650x16	4.54	670x15	4.74	32x6(10)	10.84	900x20	13.34
650x15	4.34	650x20	7.84	750x20(8)	8.54	1000x20	14.14
700x15	4.64	700x20(8)	8.94	750x20(10)	9.94	1100x20	16.14

AAA PREMIUM GRADE GUARANTEED 12 MONTHS

550x15	5.48	700x15	5.98	760x15	5.58	750x20(10)	14.98
600x16	5.28	700x16	6.78	550x17	5.48	825x20	18.68
600x16(4)	6.58	700x16(6)	7.98	600x20	9.78	900x20	18.98
640x15	5.68	750x16(6)	8.98	650x20	10.88	1000x20	19.98
650x16	5.78	800x15	6.88	700x20	12.88	1000x22	21.98
650x16(6)	6.98	820x15	7.48	32x6(8)	10.48	1100x20	20.98
650x15	5.98	710x15	6.09	32x6(10)	12.48	1100x22	21.98
670x16	6.18	550x18	5.98	750x20(8)	12.98	1100x24	23.98

MILITARY SPECIAL AA Guaranteed 12 Months—

900x15	10.69	1000x20	19.98
750x20	10.98	1100x20	21.98

AAA GUARANTEED 12 MONTHS

900x15	14.98	750x20	16.48
--------	-------	--------	-------

NEW TREAD GUAR. 12 MOS.

600x16	8.98
600x16(6)	9.98
700x15(6)	15.05
750x20(8)	24.98

Largest stock of used tires in the East. Thousands of satisfied customers. Write for Free Catalogue. MONEY ORDER OR CHECK WITH ORDER. NO C.O.D.'s

PYRAMID TIRE CO.
1333-35 North 5th St.
Dept. M., Phila. 22, Pa.

Learn LEATHERCRAFT

• Sell for big Profits. Markets Everywhere.
• Up to 500% Profit. Make Leather Goods, Billfolds, Bags, Belts, & 200 other items.
• EASY TO MAKE WITH THE NEW TANDY PROCESS.
• We supply complete instructions & materials.
WRITE FOR FREE DETAILS, FREE CATALOG

81 TANDY STORES COAST-TO-COAST

TANDY LEATHER CO. EST. 1919
P.O. BOX 791-TJ FORT WORTH, TEXAS

FREE Catalog U-DO-IT KITS

OWN a BUSINESS without INVESTMENT

There's big money in your community taking easy orders from garages, service stations, lumber yards for Work Uniforms that advertise! Easy sales, big profits. Repeat business insures future. Represent finest, largest line in the field. Show huge selection of styles, embroidery fabrics, including miracle "wash and wear" Dacron, Orlon, etc. Everything you need to get started sent FREE.

TOPPS, Dept. 532, Rochester, Ind.

DEVELOP A HE-MAN VOICE!

Write for FREE book "How to Strengthen Your Voice for Greater Success" by Eugene Feuchtinger. No obligation. Book will be mailed at once in plain wrapper, postpaid. Just send your name and address. State age.

PREFECT VOICE INSTITUTE, 210 S. Clinton St., Studio BU-2, Chicago 6, Ill.

ENGINEERING DEGREE IN 27 MONTHS

B. S. DEGREE, Aeronautical, Chemical, Civil, Electrical, Mechanical and Electronic Engineering (inc. Radio and TV), Drafting, One-year, G.I. Government approved. Low rate. Earn board. Large industrial center. Students from 48 states, 21 countries. Demand for graduates. Enter—March, June, September, December. Write today for catalog. 1626 E. Washington Boulevard, Fort Wayne 2, Indiana.

INDIANA TECHNICAL COLLEGE

SAY YOU SAW IT IN POPULAR MECHANICS

60 POWER TELESCOPE \$3.98

VARIABLE EYEPIECE 20X-40X-60X — BRASS BOUND NEW! Three telescopes in one. 3 different magnifications. 20 power for ultra-bright images with 40 and 60 power for extra long range. Guaranteed to bring distant objects, people, sports events, ships, moon, stars, etc. 60 times as close.

Most powerful for anywhere near the moon. Contains 4 ground and polished lenses. Also used as a powerful compound microscope. Directions included. Mass production enables us to offer this instrument at amazing price of \$3.98 complete. Money back guarantee. We pay postage. Get yours now.

CRITERION CO., 331 Church St., Hartford, Conn., Dept. PMB 31

CAN YOU THINK FASTER THAN GENIAC?

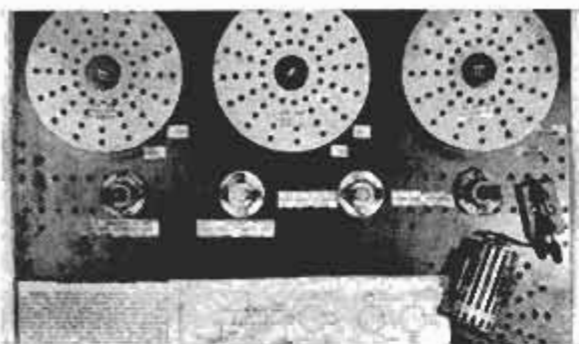

Be careful before you answer. GENIAC, the First electrical brain construction kit is equipped to play tic-tac-toe, cipher and decipher codes, convert from binary to decimal, reason in syllogisms as well as add, subtract, multiply and divide. Specific problems in a variety of fields can be set up and solved with the components.

BUILD YOUR OWN GENIACS

Connections are solderless and are completely explained with templates and a step by step manual of instructions. This covers thirty three basic circuits and shows how new ones can be designed by you.

GENIACS are fun for you and for your family. At parties or in school you will enjoy demonstrating a machine which does such a variety of computing, game playing and prob-

lem solving operations. For example one of the "problems" is "THE PROBLEM OF THE TWO JEALOUS WIVES" who try to keep tabs on their husbands at a summer place. Another problem "THE URANIUM SHIPMENT AND THE SPACE PIRATES" lets you move step by step on an exciting interplanetary chase pitting yourself against the machine. When GENIAC is set up to play "TIC-TAC-TOE" your moves are matched play by play by the instant reaction of special circuits trying to out-think you. GENIAC can be set up to test your intelligence, to invent codes, figure out the best circuits for complicated household or experimental wiring; it reasons, compares, solves complicated legal problems, dozens of others.

You will find building and using GENIACS a wonderful experience; one kit user wrote us "this kit has opened up a new world of thinking to me." You actually see how computing, problem solving and game playing (Tic-tac-toe, Nim) are set up for a machine and then you build the circuits yourself. When you have finished with the manual you have had experience with all the basic types of digital circuits and can then go on to your own designs.

If you have been intrigued by the new developments in computers, circuitry, Boolean Algebra, cybernetics and automation, GENIAC is the perfect way to get into the midst of the field and know what you are talking about.

Each kit comes complete with a manual, an introduction to the use of Boolean Algebra in electrical circuit analysis, all necessary wiring diagrams and a 200 page text "Minds and Machines".

Every kit is guaranteed to satisfy you even after you have used it for a week or you can return it for a full refund.

The GENIAC ELECTRICAL BRAIN CONSTRUCTION KIT contains complete, easy-to-follow instructions for assembling all materials necessary including precision made parts that would cost over \$40 if bought separately. Plus the manual which contains over 30 exciting brain teasing games, problems, puzzles, etc. This educational hobby brings hours of fun and adult entertainment yet GENIAC is so simple even a youngster can put it together.

SOME FIRMS AND INSTITUTIONS THAT HAVE ORDERED GENIAC:

Aillis-Chalmers
Remington-Rand
International Business Machines
Wheellex Mfg. Co.
Manuel Missionary College
Walter V. Clark Associates
Barnard College
Westinghouse Electric
Phillips Laboratories
General Insurance Co. of America
Lafayette Radio
Rohr Aircraft Co.
Southwest Missouri State College
Fibreglass Corp.
Stamford Research Institute
The Heath Co.
American Management Assoc.
De Paul University Hydro Electric Tower
Adams State Teachers College
Abercrombie and Fitch
Kleinschmidt Laboratories
Kansas State Teachers College
Albert Einstein Medical College
Naval Research Laboratories
Board of Education, Tecumseh, Nebraska
Marshfield Public Schools
Los Angeles Public Schools
Jefferson Union High School
Oklahoma A&M
Kansas State University
Duke University
Coral Gables Senior High School
Courtland Jr. High School
Bell Telephone Laboratories
Lovell Public Schools
Clearwater High School
St. John's Seminary
Orange County Community College
Morningside College
New Hampshire Public School
Kentucky Wesleyan College
University of Ottawa
... and hundreds of other individuals and institutions

Some of the 33 GENIACS you can build from the completely detailed instruction manual are:

LOGIC MACHINES: Comparing; Reasoning; Syllogism Machine; Intelligence Tester.
GAME PLAYING MACHINES: Tic-Tac-Toe; Nim (Think you can beat the machine?).
ARITHMETICAL MACHINES (Binary and Decimal): Adder; Subtractor; Multiplier; Divider; Arithmetical Carrying.
CODE MACHINES: Secret Coder; Secret Decoder; Combination Locks.
SIMPLE MACHINES: Burglar Alarm; Automatic Oil Furnace Circuit.
PUZZLE SOLVERS: The Space Ship Airlock; The Fox, the Hen, the Hired Man and the Corn; The Uranium Shipment and the Space Pirates.
ACTUARIAL: Douglas MacDonalid's Will.
GENIAC parts are specially manufactured to high tolerance; they include a special six deck switch of unique design and over 400 components plus a book "GENIACS SIMPLE ELECTRICAL BRAIN MACHINES AND HOW TO MAKE THEM." GENIAC is a remarkable buy for.....

Only \$19.95

MAIL THIS COUPON

SCIENCE KITS, Dept. PM 26,
Oliver Garfield Co., 126 Lexington Ave., New York 3, N. Y.

Please send me:

1 GENIAC Electric Brain Construction Kit and Manual.

\$19.95 (East of Mississippi)

\$20.95 (Elsewhere in United States)

\$21.95 (Outside the United States)

Returnable in seven days for full refund if not satisfied. I enclose \$..... in full payment.

My name and address are attached.

Some make more, some less: T. THORN reports:

\$690 gross in single
MONTH
IN MY OWN BUSINESS!

Start your own business!

Here's YOUR chance to start a money-making, year-'round business of your own and make the success you've dreamed about.

R. O. Donnelly took in \$40 in seven hours. O. W. Ware landed a \$750 hotel job. J. S. Corbit grossed \$279.50 his first month. Homes, hotels, offices, clubs, offer you big profit possibilities. Auto upholstery also.

NO SHOP OR OFFICE NECESSARY. You clean furniture on customers' premises. No hauling. No high rents. Supplies inexpensive; operate from your home. What you take in is mostly profit.

● If you want to be your own boss—free from layoffs, strikes and bosses, we will help you to start and succeed. Don't delay...read the facts, then decide for yourself.

MAIL COUPON TODAY FOR FREE BOOK

VON SCHRADER MFG. CO.
210 "D" Pl., Racine, Wisconsin

Without obligation rush your **FREE** booklet about how I can start my own permanent, profitable electric Upholstery Cleaning business.

Name _____

Address _____

City _____ Zone _____ State _____



"Use My TESTED SALES PLAN to make an extra \$50.00 every week!"

Says **CHARLES CHESTER EATON, JR.**, President
Charles Chester Shoe Company

JUST A FEW HOURS EACH WEEK — evenings, weekends, — can add \$50 to \$100 to your regular income. Be a factory representative for **CHARLES CHESTER** exclusive patented air-cushion shoes — bring wonderful new comfort to friends, neighbors, co-workers! A full line of dress, work, leisure shoes for *all* the family sold *only* direct from factory to wearer at *low* factory prices.

YOUR OWN BUSINESS WITH NO INVESTMENT!

No deliveries, no collections — we supply everything you need. You collect advance cash deposit from your customers — we do the rest — and you earn extra profit-sharing cash bonus monthly!



AIR CUSHION SHOES

STEADY AUTOMATIC REPEAT BUSINESS!

Satisfied customers reorder regularly! **CHARLES CHESTER** representatives offer more than 160 styles, in a tremendous size range: 1 to 18, AAA to EEE. *No experience needed* — our tested, proven Sales Plan shows you how! Write today for details and **FREE SALES KIT!**

CHARLES CHESTER SHOE COMPANY
6 Foundry St., Brockton, Mass.

STEEL PERSONAL FILE
for Safekeeping Valuable Papers



Sleep free of worry — your valuable papers and records safe in this secure, heavy gauge steel personal file. Precision made to last a lifetime. With lock, key and carrying handle. Holds over 800 papers. Complete with A to Z folders; extra folders for budget, insurance, tax records, etc. Size 12½" x 10½" x 5½". For home, business, farm.

\$4.95 Postpaid. Send check or M.O. No C.O.D.

ALTON COMPANY
6510 N. 16th St., Phila. 26, Pa.



NEW JENSEN MANUAL TELLS HOW TO BUILD YOUR OWN HI-FI SPEAKER SYSTEMS

Save money... have fun building your own Jensen 2-way or 3-way hi-fi speaker system. New 36-page manual tells how to make enclosures and assemble 18 different systems with 8 new Jensen speaker kits. Send 60c today for Jensen Manual 1000.

JENSEN MFG. CO. Dept. G 6601 S. Laramie, Chicago 38

IMPORTED KNIVES

Daggers, Stiletos, Bowies, Throwing, Hunting, Pocket Knives, Fencing Equipment, Etc. The finest from 10 countries. Send for your **FREE CATALOG** today.

J. D. CLINTON

Mt. Clemens 2, Mich.



DRAINS cellars, cisterns, wash tubs; **\$6.95**
IRRIGATES - CIRCULATES - SPRAYS

Type P Pump has 1,001 uses. Up to 3000 GPH; 450 GPH 80' high; or 1800 GPH from 25' well. Use 1/6 to 3/4 HP motor. Coupling included free. 1" inlet; 3/4" outlet. Stainless shaft. Won't rust or clog! Postpaid if cash with order. (West of Miss. add 50c)

MONEY BACK GUARANTEE
Centrifugal and Gear Pumps in All Sizes
LABAWCO PUMPS, Belle Meade 7, N. J.

PLEASE SEND ME



for the
time checked.
I am enclosing . . .

1 year \$3.50

2 years \$6.00

name _____

address _____

city _____

zone _____

state _____

C-26

Hand this order to your newsdealer or send it to

POPULAR MECHANICS
200 East Ontario St. Chicago 11, Ill.

SAVE GAS! I'LL SEND YOU THIS FREE!

HOLES FOR AIR FLOW

10 DAY FREE TRIAL! SEND NO MONEY! PAY POSTMAN NOTHING!

Users Report 4, 5, 6 Extra Miles per Gallon with New Miracle Game Air-flow Needle. (\$1.50 Value)

Up to 25% MORE MILEAGE, FASTER PICK-UP, QUICKER STARTING reported. Phenomenal money-saving results coming from 1/2 MILLION USERS. Carburetor Engineering Co. reports SAVING OF 72¢ PER DAY. YELLOW CAB CO., FLEET OWNERS, POLICE, EMERGENCY vehicle users. Outstanding performance "approved". FITS ALL CARS AND TRUCKS. INSTALL YOURSELF IN 2 MINUTES with simple twist-of-the-wrist. (Replaces present idle adjustment screw in your carburetor.) **AMAZINGLY EASY TO DO!**

● TRY IT FREE! JUST SEND NAME AND ADDRESS! ●

PAY NOTHING! Test this revolutionary new automotive discovery in your car AT OUR EXPENSE! Check mileage. (Some users report no improvement—so TRY BEFORE YOU BUY.) If amazed at increased mileage—SEND ONLY \$1.50 EA. Otherwise, just return the "little stinkers" and you owe us nothing. Fair enough? Specify make of car, # cyl., and year (8 cyl. cars use 2.) Rush, Free Trial SUPPLY LIMITED.

NEWHOUSE AUTOMOTIVE INDUSTRIES
5805 E. Beverly Blvd. Los Angeles 22, Calif.

also FREE!
Receive valuable revealing booklet if you WRITE TODAY without delay.

HOW TO OBTAIN OVER 47 MILES PER GALLON

Dept. 483

Learn ACCOUNTING Business Administration

Bookkeeping, secretarial and allied subjects at home in your spare time or attend nationally approved resident school. Write for FREE Success Book giving complete details on courses, plans, rates and employment opportunities. G.I. approved. Write Dept. A.

Hills BUSINESS UNIVERSITY AND EXTENSION SCHOOL
629 W. MAIN ST. OKLAHOMA CITY 2, OKLAHOMA

WHEELS WHEELS WHEELS

7" Disc Wheel 3/4" Tire 3/4" sleeve	45c ea.
8" Disc Wheel 1 1/8" Tire 1/2" sleeve	70c ea.
7" Disc Wheel 1 1/4" Tire 1/2" ball bearing	\$1.00 ea.
8" Disc Wheel 1 1/4" Tire 1/2" ball bearing	\$1.00 ea.
6" Disc Wheel 1.50 semi-pneum. Tire 1/2" B.S.	\$1.35 ea.
8" Disc Wheel 2" semi-pneum. T. 1/2" B.S.	\$1.50 ea.
10" Disc Wheel 1.75 semi-pneum. T. 1/2" B.S.	\$1.50 ea.
10" Disc Wheel 2.75 semi-pneum. Tire 5/8" B.S.	\$3.50 ea.
12" Disc Wheel 1.75 semi-pneum. T. 1/2" B.S.	\$1.85 ea.

Above wheel prices includes hub cap. Plus Postage. C.O.D.'s accepted. AXLES—Sizes 5/16 in., 3/8 in., 1/2 in.—Cut to size—End holes drilled.

UNITED WHEEL STAMPING CO.
12131 S. PEORIA STREET PM-2 CHICAGO 43, ILLINOIS

Blast off with DUAL vacuum AIR HORNS!

ONLY \$9.95 POSTPAID Money-back Guarantee

Compares with \$25 to \$100 Air Horns

The voice of authority and commanding warning for safer highway driving. One BLAST and those "Road Hogs" really move over. Installed under the hood or on the front fender. Beautiful lacquer finish. Operates from intake manifold. No tank needed. Only \$9.95 complete with cylinder head bracket, steering column lever, hose, fittings, etc. Send check or money order today. We pay postage. \$1.00 deposit required on all C.O.D. orders.

THE PROTECTUROS CO.
Dept. 802, 2750 N.E. 19th Street, Fort Lauderdale, Fla.

LEARN PLASTICS

COMPLETE LOW COST SHOP METHOD HOME TRAINING NOW AVAILABLE

Get in on Big Money opportunities in Plastic molding, casting, forming, carving, etc. Earn as you learn with Interstate's professionally prepared course. All plastic materials furnished.

INTERSTATE TRAINING SERVICE
DEPT. C-3, PORTLAND 13, OREGON

WRITE FOR FREE BOOKLET

Let me show you

HOW TO SPEAK AND WRITE LIKE A COLLEGE GRADUATE

I have helped thousands of men and women who have not had college training in English to become effective speakers, writers, and conversationalists. With my new C.I. METHOD, you can stop making mistakes, build up your vocabulary, speed up your reading, develop writing skill, learn the "secrets" of conversation. You don't have to go back to school. Takes only 15 minutes a day at home. Costs little. 32-page booklet mailed FREE upon request. Send me a card or letter TODAY!

Don Bolander, Career Institute
Dept. 1052 25 East Jackson Chicago 4, Illinois

FOR A REAL JOB OR A BUSINESS OF YOUR OWN

LEARN OIL BURNER SERVICING

at home—in your spare time!

GET THE FACTS FREE!

Let us send you—without obligation—a Sample Lesson plus all the information you'll need to get you started on the road to success in the automatic oil heating field. Let us prove to you that salaries are higher, opportunities greater, advancement quicker in the fast-growing Oil Burner industry.

5 PROGRAMS IN ONE. We offer you a complete and approved training program—available at no other school—prepared with the co-operation of America's leading heating system manufacturers. Covers Installation, Operation, Maintenance and Service plus Electrical Controls, Firebrick Construction and Sheet Metal Fabrication. Even includes a "Special Business" Plan to help you start your own service shop.

START NOW . . . TODAY! Put your spare time to work. Learn a skilled trade. No previous experience or special education required. Earn while learning, doing part-time jobs in your own area. Low tuition. Tools furnished. Send coupon now. No obligation.

MASS. TRADES "Training Thousands since 1936"

RESIDENT SCHOOL — APPROVED FOR VETS
LICENSED BY MASS. DEPT. OF EDUCATION

Member — Oil Heat Institute of America

Write NOW for FREE SAMPLE lesson and booklet. No obligation. Use the coupon below.

MASS. TRADES
161-A High St., Boston 10, Mass.

Please rush FREE booklet and Sample Lesson on OIL BURNER SERVICING. I understand there is no obligation.

Name Age.....
Address
City Zone..... State.....

TRAINING AVAILABLE IN CANADA

Grow with Diesel

and SCIENTIFIC MOTOR TUNE-UP
— One of America's Fastest-Growing Big-Pay Industries!

Get ready now . . . Make a place for yourself in the mighty Diesel industry. Be there to take advantage of the opportunities ahead. The U.E.I. Plan for learning Diesel is simple, practical and is based upon the principle of learning-to-do-by-doing. Includes Auto Engine Tune-Up. You get fundamentals through spare-time home-study, followed by actual shop practice on modern Diesel engines. Experienced instructors guide you step-by-step — you learn the HOW and WHY of Diesel operation, service and maintenance. Get all the facts—mail the coupon and we'll send you a free copy of "Earning Power in Diesel." Mail coupon today!



UTILITIES ENGINEERING INSTITUTE

Dept. DC-53 (Founded 1927) Chicago 14, Ill.

UTILITIES ENGINEERING INSTITUTE, Dept. DC-53
2521 Sheffield Ave., Chicago 14, Illinois

"Earning Power in Diesel."

Please send me, without obligation, your free book.

NAME (print).....AGE.....

ADDRESS

CITY..... Zone..... State.....

Check here for information if you are under 17

Dress for the Job and do it BETTER



MANY times you've noticed that the better you feel the better your work. That goes for a job at home or at regular occupation. And when you dress in Tom Long sportswear or Anvil Brand tough utility clothes you're tooled up to go!

Designed to fit without binding; styled for good looks. Big variety of denims, twills and other rugged materials in many colors.

Select the style of Anvilwear you like best at your favorite store and see if you don't like it better.

ANVIL BRAND FACTORIES HIGH POINT, N. C.

Let me show you how I made \$20,000 a year buying junk jewelry

Learn at home in one evening



No selling. Pay friends and neighbors good prices for old rings, watches, chains and bridges. U. S. Gov't pays you \$35 an ounce for the gold this junk contains.

THERE'S gold to be picked up on any street in any town any day of the year if you know my secrets. I teach you how to find it, how to buy it, what to pay for it, how to test and how to ship to Uncle Sam for cash. I supply you with testing outfit and weighing scale. Takes only one evening to learn at home. Next day you are ready to fill your pockets with gold at junk prices. I'll teach you the secrets by which I made \$20,000 a year. No charge for facts. Send name on postcard—no money. Leslie Patton, 335 W. Madison Street, Dept. 92, Chicago 6, Illinois.

Watch Repairing Pays Big Money Learn at home



Watch repairers in great demand. Train step-by-step in 10 easy lessons. We furnish all tools and 15 jewel watch and practice movement. Turn spare time into cash. A licensed school. Low cost. Send for FREE book today.

ILLINOIS SCHOOL OF WATCH REPAIRING
2870 Elston Ave., Dept. PM26, Chicago 18, Ill.

BECOME AN EXPERT IN TRAFFIC

Traffic men earn \$4,000 to \$10,000 and up. Thousands of firms need experts on rates, tariffs, regulations. We train you thoroughly in spare time at home for executive traffic jobs. Personal training under traffic authorities. Placement counsel and help. Write for free 48-page book "Traffic Management—the Fast Growing Profession."

LASALLE Extension University, 417 So. Dearborn St.
A Correspondence Institution Dept. 264T Chicago 5, Ill.

HOW TO BUY WHOLESALE

Start a buying service. Make to \$10,000.00 annually. No experience and little capital necessary. Buy New Nationally Advertised Merchandise Wholesale. Sell to others at fabulous profits. Complete Satisfaction Guaranteed. "Free" details. **WHOLESALE BUYERS' SERVICE, Box 22, Dept. 24, St. Louis 3, Mo.**

MAGIC IS FUN! MAKE MAGIC YOUR HOBBY!

CHANGE NICKELS INTO DIMES!

Place MAGIC CAP over 4 nickels . . . Presto! Nickels vanish and 4 dimes appear! Cap may be examined. No skill required! Precision-made device. ONLY \$1.00 POSTPAID. Remit money order or cash. Satisfaction Guaranteed.

FREE! WITH YOUR ORDER
LARGE CATALOG of 500 Amateur and Professional Magic Tricks. WRITE TODAY!

D. ROBBINS & CO., Dept. D-349
127 W. 17 St. New York 11, N. Y.



FREE!

Select-A-Job Chart

HOW TO SUCCEED

Tells Whether You May Qualify for

GAME WARDEN

FORESTER, or join WILDLIFE SERVICES!

Matches your background, knowledge and interests against available outdoor positions. HELP FILL JOB DEMAND IN YOUR AREA! Enjoy pleasant, healthful work, prestige, retirement income, good pay (up to \$10,800 yr.). Excellent opportunities open! Also FREE "How to" Booklet! Tells how to go after and get job of choice. Learn at home, SPARE TIME. Both Free! Write for "Select-A-Job" Chart details, and Free Revealing Booklet. Rush! SUPPLY LIMITED!

HOME STUDY EDUCATORS, Dept. R-2, 1038 S. La Brea, Los Angeles, Calif



If You Write Checks...

You can be robbed!



by D. W. Craighead

You and I and thousands of other Americans are being robbed of \$600,000,000 every year by an army of check forgers, and most of us don't even realize we're being taken! Why?—because the check forger, or "raiser" is not always a professional crook. Your check can be altered by any of the 5 to 8 people who will probably handle it before it clears the bank.

ANY CHECK CAN BE ALTERED

Most of us don't examine our statements too closely, and the methods these amateur penmen use to swindle us are ridiculously simple. The illustration shows how an easy stroke of the pen can mark up the amount of your check from six dollars to sixty.

<i>Sixty</i>	6 TO 60	<i>60⁰⁰/100</i>
<i>Eighty</i>	8 TO 80	<i>80⁰⁰/100</i>
<i>Fifty</i>	10 TO 50	<i>50⁰⁰/100</i>
<i>One Hundred</i>	100 TO 400	<i>400⁰⁰/100</i>

Eight dollars readily becomes eighty, and one hundred can be "upped" to a whopping four hundred! There is hardly any amount that the careful forger cannot alter, and unless the "mark up" causes an overdraft, the crook rarely gets caught. American Banking Association statistics show that over 90% of these losses come out of the pockets of small depositors, the very people who can least afford it!

OPPORTUNITY FOR DEALERS AND DISTRIBUTORS

A dealer and distributor network is now being formed to handle the demand for the Magna Checkmaster being generated by our national advertising. If you can qualify, you have an opportunity to build a substantial business with this unique new product. Franchises will not be sold; they are being awarded on the basis of your ability to grow with us. For complete details, write or wire the address above.

NEW INVENTION PROTECTS YOU

The check writing machine, as used in big offices, was formerly the only guarantee against forgery loss. The high cost of this protection has kept it beyond the reach of the small business or the individual. *Now, the Magna Checkmaster, an ingenious new product, makes complete check protection available to everyone.* It was especially designed for the family account, for professional people, small manufacturers, and retail businesses. Its price is only a fraction what you'd pay for a bulky office machine.

The Checkmaster is compact and foolproof in operation. It automatically spaces and perforates each number and word into the paper with indelible red ink, making it impossible to alter. (See arrow above). Takes any size check. Has positive locking selector and self contained inker that can't spill or smear. The Magna Checkmaster is a precision machine built to last a lifetime and give the same positive protection and prestige to your checks as other machines costing up to \$500.

MONEY BACK UNLESS YOU'RE SATISFIED

If for any reason, you're not completely pleased with the Magna Checkmaster, simply return it within 10 days for full refund.

Send cash, check, or money order for your Magna Checkmaster today. Only \$14.95 Postpaid.

MAGNA INDUSTRIES, INC., Dept. PM-2
1060 Crenshaw Blvd. • Los Angeles 19, California

Magna Industries, Inc. Dept. PM-2
1060 Crenshaw Blvd. • Los Angeles 19, California
Gentlemen: Please send _____ Magna Checkmasters @ \$14.95 ea. today.

Enclosed is cash, check, or money order for \$_____ (full amount) Please ship postpaid.

Enclosed is \$5.00 deposit for each Checkmaster. I'll pay postman the balance, plus C.O.D. charges.

NAME _____
ADDRESS _____
CITY _____ ZONE _____ STATE _____

"My selling time actually shows me a profit of

\$20 TO \$25 AN HOUR

with Science's New Midget Miracle, the
PRESTO Fire Extinguisher

says M. R. Stanley of Montana. Many others "cleaning up"—so can YOU!

THIS is an amazing new kind of fire extinguisher. Tiny "Presto" (about the size of a flashlight) does job of bulky extinguishers that cost 4 times as much, and are 8 times as heavy. Ends fires fast as 2 seconds. Fits in palm of hand. Never corrodes. Guaranteed for 20 years! Sells for only \$3.98! Over two million already sold!



Show it to civil defense workers, owners of homes, cars, boats, farms, etc., and to stores for re-sale. Make good income. C. S. Mellous made \$175 in just first 5 days. C. Kama, \$1,000 a month. Write for FREE Sales Kit. No obligation.

(If you want a regular Presto to use as a demonstrator, send \$2.50. Money back if you wish.)

MERLITE INDUSTRIES, Dept. 15-F, Presto Div.
114 East 32nd St., New York 16, N. Y.
(In Canada: Mopa Co., Ltd., 371 Dowd St., Montreal 1, P. Q.)



M. R. STANLEY

TECHNICIANS WANTED

GAPS IN INDUSTRY MUST BE FILLED BY MEN TRAINED TO HIGH STANDARDS . . .

The man who really has the "know-how" will win the best position and highest pay. "Engineering Opportunities" lists many specialized home study courses written by world authorities in: Aeronautical, Civil, Mechanical, Mining, Petroleum, Structural, Electrical, Radio, Television and Plastics etc. Send today for your FREE copy of "Engineering Opportunities" to Canadian Institute of Science and Technology Ltd., Century Building, Washington, D.C.

Canadian Institute of Science & Technology Limited, 608 Century Building, 412, 5th Street, N.W., Washington, D.C.
Please forward FREE of cost or obligation of any kind your 105-page handbook, "ENGINEERING OPPORTUNITIES".

Name.....
Address.....
Course interested in..... Age.....

Canadian enquiries: 263 Adelaide St. W. Toronto

THE MASONIC CASUALTY COMPANY

OFFERS

ACCIDENT—HEALTH—HOSPITALIZATION
INSURANCE AT COST



CHARTERED
1895

- Non Cancellable
 - Benefits Not Prorated
 - No Medical Examination
 - No Paid Agents
 - Coverage On or Off the Job
- FIRST 3 MONTHS PROTECTION FOR MEMBERSHIP FEE \$2.00
FOR MASONS ONLY under 56 yrs. of age
WRITE AT ONCE
THE MASONIC CASUALTY COMPANY
80 BOYLSTON STREET, Dept. P-2, BOSTON 16, MASS.
NO AGENT WILL CALL

WHAT TREASURES WILL YOU FIND?

BIG BAG of more than **1000 FOREIGN STAMPS**

Big cloth bag contains over 1,000 genuine foreign postage stamps—from more than 30 strange countries in Asia, Europe, Africa, South Seas, etc. Unpicked, unsorted—just as received from foreign natives, banks, missionaries. Nobody knows what's inside! Guaranteed worth over \$10 at Catalog prices or money back.

Only \$1.00 ppd

HARRIS CO. 2136 Transit Bldg., Boston 17, Mass.

ROLLER RULE "PENCIL WITH A BRAIN"

Precision made, accurate, handy. Roll it over any surface. Measures curves and straight lines, any shape, any distance. Excellent pencil too.

\$1.49 A must for architects, engineers, carpenters, plumbers, painters, students, pilots, navigators, etc. Available in inch or nautical measurements. Specify choice. "IN ATTRACTIVE GIFT BOX"

POST PAID **ROLLER RULE MFG. CO.**
1319 Gaviota Ave. Long Beach 13, Calif.

LOCKSMITHING

Practical Up-to-Date Course — ONLY \$4.95

53 illustrated self-instruction lessons. Easy to learn. Full price only \$4.95 postpaid—or COD plus postage. Satisfaction guaranteed or full refund! **NELSON HALL CO.**, 210 S. Clinton St., Dept. BU-2, Chicago 6, Ill.

TRAVEL DREAMS COME TRUE!

HOW TO GET THE MOST OUT OF TRAVEL FREE write dept H

Cast loose to follow the sun... explore the byways, relax by a rippling stream... enjoy the sea, the woods, the mountains, with all the comforts of home. Write for free booklet!

AIRSTREAM TRAILERS INC.
110 CHURCH ST., JACKSON CENTER, OHIO
1765 N. MAIN ST., LOS ANGELES 31, CALIF.

Learn All About Cars!

Auto Mechanics — Automatic Transmissions
Acetylene and Arc Welding
Body and Fender Repair

Day-Night School 30 Years in the Same Location

WOLVERINE SCHOOL OF TRADES

Approved Under the G.I. Bill of Rights by the State Board of Education

WOLVERINE SCHOOL OF TRADES, Dept. PM
1400 West Fort St., Detroit 16, Mich.

Name.....
Address.....
City..... State.....

Roy Loutzenhiser drives 38,000 miles...saves \$72. with 17 pt. Life-Time plugs

MESSAGE FROM FRANK WILLIAMS, INVENTOR OF LIFE-TIME SPARK PLUGS:

Dear Friends:

Some Life-Time Spark Plugs have now been out just about a year. Time enough for first users to start writing me about life and performance in their own cars. Roy Loutzenhiser of Antelope, Montana, writes that his set has fired hot and clean for over 38,000 miles in his 1953 Studebaker V-8. That's a saving in plug purchases of about \$22 when you add it up. But he also wrote me that his gas bill went down just about 10% which checks out almost on the button with Eddie Edmunds dynamometer test which shows 11% fuel improvement. The way I figure, that adds up to about \$72 depending upon what you pay for gas! I don't say you can save this much money in a car that's burning some oil or isn't rightly tuned, but you can save the cost of a couple sets of ordinary plugs and a barrel of gas any time. Try a set and let me hear how you like them.

Many thanks.

Frank Williams



Here's Why 17 Pt. Firing Works:

Note the circular arcing area. Four concave segments with gap the same from all points. Electricity has the property of arcing from the coldest point. Current also arcs more readily from apex of two planes than from a flat surface. Note that there are 16 apexes (where two planes meet) — all the same distance from the center electrode. Normal heat and spark erosion are spread around the entire circle and around the whole circumference of the larger center electrode.

Actually 1700 Firing Points

or more, our engineers now tell us, because the spark actually "chooses" the most favorable single point on the top, bottom or side of any outer electrode! This is one reason why Life-Time Spark Plugs do not foul or miss, waste gas or power under heat and high compression. This spectacular spark plug research breakthrough (the first revolutionary improvement in 50 years) allows us to include this unique and unprecedented warranty with every set of plugs. **WE GUARANTEE GREATER GAS MILEAGE — GREATER ACCELERATION — A MAJOR POWER INCREASE — or your money back!**



ORDER REGISTERED SET

for any 6 or 8 cylinder engine. YOU RECEIVE BY MAIL, POSTAGE PAID, this matched set as shown in proper series (heat range and gap) for the car or cars you indicate in coupon.

Tapered 18mm now available for late Ford products and others.

Eddie Edmunds
11033 DYNAMOMETER SHOP

11033 Dynamometer Shop
11033 Dynamometer Shop
11033 Dynamometer Shop

Power Test

Make	Model	Year	Engine

Recommendation

Tustin Auto Parts

119 West Main Street, Tustin, California. Phone Klamath 2222

119 West Main Street
119 West Main Street
119 West Main Street

8 hp increase!

7 mph increase!

NEW! SUPER-DISSIPATION INSULATOR. Made of gem-like sintered corundum. Conducts heat 40 times faster than porcelain. Special new contour vaporizes and exhausts wet carbon and oil.

SELF-CLEANING ON POWER STROKE. Confined gases exploding in chamber formed by multiple electrodes reclean arcing surfaces with each firing stroke. **INDIVIDUAL INSPECTION.** Each Life-Time Spark Plug is tested for firing in oil and for resistance to 30,000 volts/CM (The only plug which has been tested successfully at 15 to 1 compression) **PERMANENT GAP.** After months of use Life-Time Spark Plugs mike at exact factory prepap.

BOAT OWNERS. Life-Time Spark Plugs are now available for all outboards and marine engines. Specify make, model and year. \$1.19 per plug postpaid.

LIFE-TIME Spark Plug Division
CONTINENTAL MANUFACTURING CORP.
Washington Blvd. at Motor Ave., Culver City 118, California

Gentlemen: Please mail postpaid _____ set (s) (registered) of LIFE-TIME Spark Plugs in proper heat range and gap for my car at \$1.19 per plug (set of six, \$7.14; set of eight, \$9.52). Or send \$2 per set, balance C.O.D. California residents add 3% tax.

Make of my car is, year.....

Model No. cyl.....

I enclose \$ (cash, check or money order)

Name

Address

City Zone State

LEARN UPHOLSTERY

in your spare time
run your own
business
AT HOME



FREE BOOK
with
sample
lessons

with course

YOU MAKE
SLIPPER
CHAIR



CLUB
CHAIR



OTTOMAN

WITH
SLIP COVERS
Yours to Keep
or Sell

BE YOUR OWN BOSS

Earn more from the start! Set up your own profitable business. In your own home, enjoy steady income, independence for life—in the booming field of Custom Furniture Upholstery. Right off you start learning with tools, complete frames, fabrics and materials, included FREE with your UTS course. You learn skilled professional custom upholstery, reupholstery, furniture finishing, repairs, how to make beautiful slip covers, window cornices, cushions and draperies. EARN WHILE YOU LEARN, in your spare time . . . the UTS easy way.

FREE illustrated book, with sample lessons. Get ready for well-paid job and big profits, from steady work, as your own boss, running your own business. Mail coupon NOW! Training in N. Y. School also available.

APPROVED FOR VETERAN TRAINING

UPHOLSTERY TRADES SCHOOL
Dept. ER-310, 721 B'way, N. Y. 3, N. Y.

Send me FREE book "Your New Way to a Successful Career," and FREE sample lesson. No obligation—no salesman will call.
 Home Study N. Y. School Training

Name _____
Address _____
City _____ Zone _____ State _____
 Check if Korean Veteran

SPUTTERBUG

"WORKED FINE TILL A MUSKY STOLE IT"



—writes C. D. Gilchrist, Tallmadge, O., who took this string of bass at Omeme Lodge, Pigeon Lake, Ont., on a 5/8-oz. Sputterbug. Weights ran to 6-1/4 lbs. This new floating lure has a large head spinner that makes a terrific commotion on the surface when reeled in fast. Retrieve slow for paddling sound. Can be fished in jerks like a popper.

Many different effects possible by working your rod. Spinning and light tackle size (1/4 oz.) or bait-casting size (5/8 oz.)—\$1.35 each. Choice of 9 body colors. Rubber Hula Skirt.



NOISY
TOP-WATER
LURE

FREE WRITE TODAY FOR YOUR BIG FREE ARBOGAST COLOR CATALOG OF BAITS—FULL OF PICTURES OF CATCHES

FRED ARBOGAST COMPANY, INC.
2262 WEST NORTH STREET • AKRON 3, OHIO

start a big profit business
with a small investment
EARN UP TO
\$200 a DAY

Manufacturing Exciting New RAINBOW ROCK Concrete Slump Brick in your back yard

Earn big building boom profits with Rainbow Rock, the colorful new building brick that's taking the country by storm. Sell all you can make to contractors, builders, building supply houses. RAINBOW ROCK CUTS LABOR COSTS BY 1/3! Amazing low cost machine makes modern slump brick 24" long (3 times the length of ordinary brick) in a variety of widths and pastel colors . . . up to 1500 bricks a day! NEEDS NO SPECIAL SKILL. Operates indoors or out. Full instructions and valuable mixing formulae supplied. YOU CAN START EARNING BIG MONEY NOW. PAY AS YOU PROFIT! A limited number of machines available on easy payment terms. NOW is the time to start. Write today for free literature and full information.

GENERAL ENGINES CO., INC.
Dept. MR-26—Route 130,
Thorofare, N. J. • Tilden 5-5401



STEEL PIER SENSATION
Luxurious RAINBOW ROCK fireplace wall in living room of the "Home of the Century" in Atlantic City, N. J.'s Steel Pier . . . acclaimed by over 500,000 Summer, 1953 visitors as the most beautiful they'd ever seen! Endorsed by the Pier's famous architect, William F. B. Koolie.



Make beautiful, decorative fences, garden walls, garages, outside walls, room separators, etc.

MEN WANTED

Earn \$100 Per
Week and up
AUTO DIESEL
MECHANICS

Master a trade with a future—learn Auto-Diesel mechanics in our shops. You learn with tools on real equipment. Earn while you learn. Many of our graduates earn \$100 per week and up. No previous experience necessary. Day and night courses. Approved for veterans. Write for free bulletin.

NASHVILLE AUTO-DIESEL COLLEGE

226 7th Ave., N., Dept. 75

Nashville 3, Tenn.

RADIO

Engineering. All phases radio & electronics theory & practice; television; FM; broadcasting; servicing; aviation, marine & police radio. Prepare for good pay; 18-month course. Graduates in demand by major companies. Enter Jan., March, June, Sept. Regular campus life. Write for catalog. **VALPARAISO TECHNICAL INSTITUTE, Dept. D, Valparaiso, Ind.**

FREE GERMAN HUNTING KNIFE



4-INCH BLADE

We give you handiest hunting and fishing knife you've ever had! Has 4-INCH LONG highly tempered steel blade—VERY SHARP! Attractive handle. We send knife FREE to acquaint you with our below-wholesale bargains. Please send 25¢ for handling. NO LIMIT—but send 25¢ handling for each knife. Order TODAY!
HUNTING KNIFE, Dept. K-78, Box 881, St. Louis, Mo.

SAY YOU SAW IT IN
POPULAR MECHANICS

Better Than
Your Own

SHOE STORE
AT HOME



Two-
Eyelot
Hit With
Cushioned
Comfort

No investment, no experience needed. Just show magic cushion comfort to friends, neighbors, co-workers. Advance commissions to \$4.00 a pair, plus Cash Bonus, Paid Vacation, \$25.00 Reward Offer. Outstanding values for men, women, children. Money back guarantee. Shoe samples supplied without cost. Write TODAY for FREE new 84 page catalog and full details.

TANNERS SHOE CO., 666 Brackton, Mass.

POPULAR MECHANICS

Make SURE, SAFE INSULATED ELECTRICAL CONNECTIONS

The New

SUPER ~~CLAMP~~ Hand Tool

The ONE Tool for ALL Wire Sizes used in Home Wiring, Appliances, Automobiles.

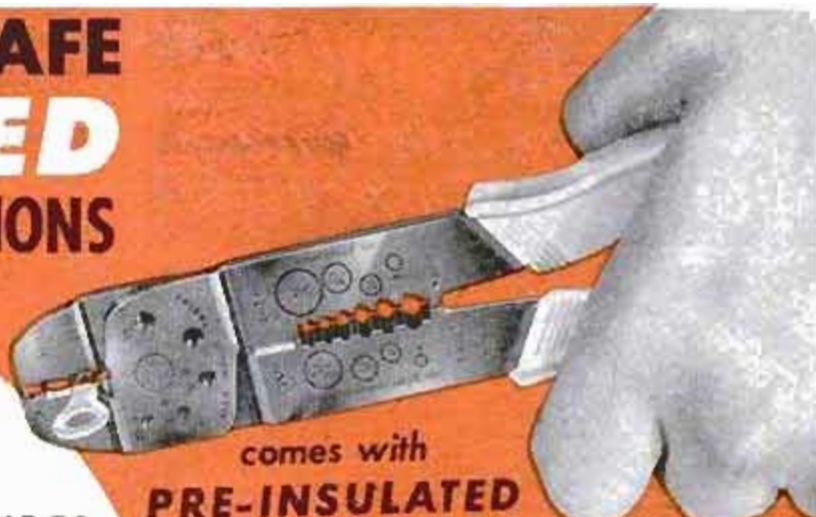

comes with
PRE-INSULATED



FREE with Each TOOL

DOES ALL THESE THINGS BESIDES

CRIMPS Solderless Terminals and Connectors without solder or tape for safe connections.

CUTS Wire, making clean, sharp cut through insulation and Conductor.

STRIPS Wire sizes #22-#10. Gauges assure proper length for sure, safe crimp.

SHEARS Bolts and screws without damaging threads — no filing or hack sawing.

ORDER DIRECT — USE COUPON

Satisfaction guaranteed or money back. Send check or money order for \$3.95. (Ohio residents add 12c sales tax.)

T. W. Berger, Inc.
National Distributor Consumers and Dealers
AIRCRAFT-MARINE PRODUCTS, Inc.
210 Mairemont Center Bldg., Cincinnati 27, Ohio

Only
\$3.95
Post Paid

T. W. Berger, Inc.
National Distributor Champ Tool
210 Mairemont Center Bldg., Cincinnati 27, Ohio
Send me post paid the new super Champ Hand Tool. I am enclosing \$3.95. (Ohio residents add 12c sales tax.)
 check money order

NAME _____
ADDRESS _____
CITY _____ ZONE _____ STATE _____

Finish HIGH SCHOOL AT HOME

Complete 4 Yrs. in 12 Months

Learn More! Earn More! Enter professional or technical schools. Advance Socially. Live a Happier, Fuller Life. Individual Courses or complete schedule. **WRITE FOR SCHOOL BULLETIN.**

ACADEMY FOR ADULTS
30 W. Washington, Dept. PM-26, Chicago, Ill.

250 POWER



Complete **Telescope Lens Kit** only **\$3.49** postpaid

Conquer Space. Explore the Universe. Planets, Moon Craters, New Stars, etc. Complete Lens Kit consists of 80 inch focal length ground and polished objective lens, eyepiece lenses for 50 POWER, 100 POWER, 150 POWER, 200 POWER, 250 POWER, and all necessary lens fittings. Easy to make from simple step by step instructions. (Tripod and mount not included.) Money back guarantee.

BUSSE SALES CO., Hartford 1, Conn., Dept. PM 42

MAKE BIG MONEY AS A LANDSCAPE CONTRACTOR

Make \$20 to \$60 a day. Millions of new and old homes, estates, etc. need modern landscaping. Easy-to-follow Home Study Course trains you to handle all types of Landscape Contracting. Earn while learning. Hundreds of successful graduates.

NATIONAL LANDSCAPE INST.
310 S. Robertson Blvd.,
Los Angeles 48, Calif.
Dept. M26.

Write for
FREE Book.



Prepare Now for Next Civil Service Examinations

MEN — WOMEN
Postoffice Clerks—Carriers
Railway Postal Clerks
Stenographers
Accountants
Immigrant Inspectors
Typists
Customs Inspectors
Many Other Early
Jobs
Veterans Get
Preference

Franklin Institute
Dept. M-93
Rochester 4, N. Y.

Sirs: Rush to me, FREE of charge, partial list of U. S. Civil Service big pay jobs. Send FREE 36-page illustrated booklet describing salaries, vacations, benefits, work, etc. Tell me how to prepare for one of these tests.

Mail
**COUPON
TODAY
SURE**

Name _____

Address _____ Age? _____

Make COPPER ENAMELLED JEWELRY at Home in Spare Time



TREMENDOUS EARNINGS!

America's latest sensational fad—**ENAMELLED JEWELRY!** Enamel copper, steel and silver in 3 to 4 minutes time. Make hundreds of dollars worth of earrings, cuff links, brooches, lapel pins, tie clasps, etc., in your own kitchen! No previous experience needed. **VITRO-NAMEL OUTFIT** includes improved, faster heating, larger capacity kiln with many patented features; 6 powdered enamels, tongs, asbestos pad, 12 jewelry findings, assortment of 10 heavy copper blanks, solder, sand paper, polishing material, oil filter, screens, electric cord, instruction manual, **SILVERPLATING COMPOUND.** Everything you need to begin making jewelry at once. Rush order today or send **\$9.75** for free illustrated book.

VITRO-NAMEL CO.

6612 N. Clark St., Dept. VE-203, Chicago 26

AIR CONDITIONING

MAKE \$3 TO \$5 AN HOUR AS YOU LEARN

FREE
BOOKS

Experts say that central air conditioning will be installed in 2 million new homes yearly. Already the shortage of mechanics is acute. Many earn to \$125 a week and up. New Shop Method trains you at home. You get 23 training kits—build and keep an air conditioner, freezer, refrigerator or milk cooler. Write for 2 FREE BOOKS.

COMMERCIAL TRADES INSTITUTE
1400 Greenleaf Dept. R-207 Chicago 26, Ill.

REFRIGERATION

Build Your Own Professional Instruments — Save 50%

EICO

World's largest manufacturer of Kits & Instruments
Vacuum Tube Voltmeter

KIT \$25.95 Easy Instructions
46 models to choose from
Factory Wired \$39.95

Write for FREE new 1956 Catalog PM-2

Electronic Instrument Co., Inc. 84 Withers St., B'klyn 11, N. Y.

LEARN TV in KC

UNIVERSAL TV FAMOUS FOR 24 YEARS
1,000's OF SUCCESSFUL GRADS COAST TO COAST



Easy, quick, fascinating. Learn TELEVISION in 36 short weeks of enjoyable companionship in shop training. Wonderful job opportunities. Graduates have choice of many jobs or can establish their own TV repair shop. **YOU CAN START EARNING AS MUCH AS \$150 PER WEEK.** NO limit as time goes on. U.T.S. is an old established school (TV exclusive for 24 years) staffed by expert instructors, headed by one of America's first TV broadcasters. Costs so little to prepare yourself for life. No previous experience needed. Fully approved for Korean Veterans. Also fully approved course in color TV (1st in US). Send coupon now for FREE book on TV Electronic opportunities.

WRITE FOR

**FREE
CATALOG**

FILL OUT COUPON

UNIVERSAL TV SCHOOL
1220M Admiral Boulevard, Kansas City, Missouri
PLEASE SEND ME INFORMATION FREE

Name _____ Age _____

Address _____

City _____ State _____

Check here if Korean Veteran

CARPENTERS — HANDYMEN!

NO LAYOFFS! — NO SLACK SEASON!

Your Fix-it "KNOW HOW" is a gold mine. 1956 has been nationally proclaimed as the YEAR TO FIX.

1956 will be a MULTI-BILLION DOLLAR Remodeling and Modernization Year. Our New Book, "BUILDERS TREASURE GUIDE," complete with facts, figures, and illustrations, describes step by step plans for a successful and highly profitable business. Short and to the point, this book shows you how to find the customer, how to sell, estimate and finance remodeling jobs. **DON'T WAIT — MAKE 1956 YOUR PROFIT YEAR!** Send only \$2.00 with your name and address. 7 day money back guarantee.

BUILDERS TREASURE GUIDE

P.O. Box 243

Del Paso Heights, Calif.

AMAZING NEW TINY RADIO

Really Works—Small as a Pack of Cigarettes!



GETS LOCAL RADIO STATIONS WITH CLEAR BELL-LIKE TONE—NO STATIC OR INTERFERENCE! NEEDS NO TUBES, BATTERIES OR COMPLICATED HOOKUPS! NO AC PLUG INS! Nothing to wear out. Thousands of users—many report years of service. Uses new crystal diode and HI-Q coil. **SELF-CONTAINED SPEAKER PHONE.** Just the tiny radio to take with you ANYWHERE YOU GO—ON TRIPS, VISITING, ETC.—for real fun and enjoyment—ANYTIME. Merely hook to anything that can get an antenna for local reception. Free DX antenna kit included. **SEND ONLY \$1.00** (bill, ck., mo.) and pay postman \$4.99 C.O.D. postage or send \$5.99 for p.p. delivery. **COMPLETE READY TO LISTEN.** MIDWAY CO., Dept. PPM-2, Kearney, Nebr.

Become a Doctor of PSYCHOLOGY

Win the degree of Ph.D. Learn the secret of contentment, happiness. Solve mental worries. Experience the revelation of truth. Correspondence only. Individual help. Write for FREE book. **COLLEGE OF UNIVERSAL TRUTH, 23B E. Jackson Blvd., Chicago.**

SEND ME



every month so I am sure to see each new issue. Here's

- \$3.50 for 1 year
 \$8.00 for 3 years

name _____

address _____

city _____

zone _____

state _____

Hand this order to your newsdealer or send it to

POPULAR MECHANICS
200 East Ontario St. Chicago 11, Ill.

**INCREASE HORSEPOWER 15%
GET HIGHER RPMs WITH**

PYROIL

TOP OILER
Automatic, Adjustable
No Moving Parts
Easy to Install



SPECIAL... \$9.95
Mail Order Price

Included FREE...1 qt. Pyroil "A"
AND 1 qt. Pyroil "B" retail value \$3.38

Meter Pyroil "A" super lubricant through top oiler to your upper engine. Step up horsepower 15%. Get smoother operation. Keep valves and rings free. Eliminate carbon deposits. Use Pyroil "B" super lubricant in crankcase to protect bearings, cams, lifters, valves, cylinders, rings. Save reardowns. Save gas and oil. Send \$9.95, (\$12.95 in Canada) today for your Pyroil Top Oiler. Money back if not satisfied. Quarts (\$1.69), pints (\$.98) at all auto supply stores. Slightly higher in Canada.



PYROIL COMPANY, Dept. PM-26
La. Crosse, Wis., U.S.A. • Toronto, Canada

SUPER LUBRICANTS • WORLD FAMOUS SINCE 1929

**"WE'RE LOOKING FOR PEOPLE
WHO LIKE TO DRAW" ... says**

Norman Rockwell, one of America's 12 Most Famous Artists. If you like to draw, you may have talent to become a successful artist, spare or full time. Find out for sure with our scientific, 8-page **Free Art Talent Test**. Thousands paid \$1 to take it. Get it FREE. No obligation. Send your name, address, age to: Famous Artists Schools, Dept. 6-B, Westport, Conn.



**NO TANKS USED
NEW SIMPLIFIED METHOD
SUCCESS IN THE
ELECTROPLATING
BUSINESS**



ELECTROPLATE

ANY OBJECT IN HOME, SHOP, GARAGE OR STAIR
YOUR OWN WELL PAYING ELECTROPLATING BUSINESS

NOW, using NEW plating kit.

It's easy to electroplate any object. Complete kit and instructions on plating metal and non-metal objects, with nickel, copper, chrome, gold, etc., plus full data on obtaining all the business you desire and make **BIG MONEY** full or spare time. **ONLY \$5.95 SEND NO MONEY**—everything sent C.O.D. plus postage—OR

send \$5.95 now and receive it postpaid. Money back in 7 days if not satisfied.
M. Z. SALES CO., Dept. PM-23, 113 W. 42 St., New York 36, N. Y.

TOOLS
SILVERWARE
HOUSEHOLD
ARTICLES
REPAIR
BODY PARTS
AUTO PARTS
& TOOL
ARTICLES



**WAR
SURPLUS
BARGAINS**

**\$500,000.00 INVENTORY
for QUICK LIQUIDATION**

Surplus items—hundreds of them for home, shop, factory, farm and outdoor use. New items, used items, reconditioned items—all at tremendous savings—all priced for quick sale.

Page After Page of Values

This big catalog shows page after page of amazing money saving values. Write for your copy today. Send 10c to cover postage, mailing, etc. Write today! **SEND TODAY FOR YOUR COPY**

STARK'S

212 W. Madison St.
Dept. PM-562
CHICAGO 6, ILL.

10c

New positions now open:

TOOLING MEN: JOIN

the long-range production
and development program at
Lockheed in California

Forty-six major projects are in progress at Lockheed. Thirteen aircraft are already on assembly lines. It's the biggest production and development program in Lockheed's history — and it's expanding rapidly.

It has created new positions for:

TOOLING MEN

Tool Designers — with at least three years' major jig aircraft experience
Tool Planners — with at least four years' aircraft tool planning experience
Jig and Fixture Builders — with aircraft major jig experience
Tool and Die Makers • Plaster Pattern Makers • Template Makers

MACHINISTS

Duplicating and Profiling Machinists • General Machinists • Horizontal Boring Mill Machinists • Jig Borer Machinists • Milling Machine Machinists • Shaper Machinists • Turret Lathe Machinists

To qualify you need at least three years' journeyman experience in your field.

Lockheed offers Tooling Men:

Top pay • A wide range of extra employee benefits including an outstanding pension plan, free insurance, paid vacations and sick leave with pay • Liberal Travel and moving allowances.

Use coupon below to request job application blank and illustrated brochure describing life and work at Lockheed in California.

TOOLING MEN PROGRAM

Mr. E. W. Des Lauriers, Dept. T-24-2
Lockheed Aircraft Corporation
Burbank, California

Please send me a job application blank and brochure.

NAME _____

YOUR FIELD OF WORK _____

NUMBER OF YEARS' JOURNEYMAN EXPERIENCE _____

STREET ADDRESS _____

CITY AND STATE _____



**I HELPED T.E.H. MAKE \$14 A DAY
WHILE STILL LEARNING!**

T. E. H.—West Virginia. "By the time I finished half your course, I was making \$14.00 per day. I have made enough on the side to more than pay for the course."

H. T. ARMSTRONG

Learn

ELECTRIC APPLIANCE REPAIR & SERVICE

WE TEACH:

How to Repair
Washing Machines
Vacuum Cleaners
Electric Ranges
Lamps, Motors,
Irons, etc.,
REFRIGERATION
and
House Wiring
At Home
In Your
Spare Time!

For a man handy with tools, and happiest when working with his hands, OPPORTUNITY is Wide Open Today in this great and growing field. Everyone is a customer for the man trained to service electric appliances.

Open Your Own Shop

Our practical HOME COURSE teaches you this business from A to Z—preparing you to take a well paid job or open your own shop. You can actually start in your basement or garage with the tools we send you . . . before finishing.

We
Include An
**ELECTRICAL
APPLIANCE
TESTER**

A Big Kit of Tools
at NO EXTRA
COST

MAIL THIS COUPON for FREE BOOK

H. T. ARMSTRONG
PACIFIC TRAINING SCHOOLS Dept. P-562
11029 S. Vermont, Los Angeles 44

Dear Sirs: Please send me, without obligation, your free booklet and complete details.

Name _____

Address _____

City _____

Zone _____

State _____

make it with 60c worth of sand & cement!

SELL IT FOR \$2000

every home a prospect for these "LIFETIME"

CONCRETE INCINERATORS

Make big profits manufacturing rust proof, fire proof, almost indestructible concrete incinerators in your own backyard or garage . . . full or part time. Sell to home-owners, hardware, department and garden supply stores, Phila. manufacturer doing big volume with Sears, Roebuck; large department stores. Easy to follow instructions and all needed equipment supplied. Exclusive protected franchise—No competition! Territories going fast. Write immediately for full details.



Dept. PM-26, T. C. TOR, 2113
Bellevue St., Phila. 40, Penna.

Gentlemen:

Rush full information about your concrete incinerator protected franchise offer.

Name _____

Street No. or R.D. _____

City _____

Zone _____

State _____

RUN A BIG-MONEY DINER



I'll show you how
to start with little
or no capital

Even a small hamburger or road-side stand can pay fabulous profits once you know the money-making "angles" of the food business. Don't worry about a lot of cash because there are seven ways to finance your first place and with my Plan you can start to make money within an hour after you open your doors for business. Learn at home. Even start at home. My course is based on my own success. My 20 fact-filled lessons make everything easy. Free Book gives full details. Just send me your name and I'll mail you a copy, postage paid. No cost or obligation. No salesman will call to bother you. Send today.

SCHOOL of RESTAURANT ARTS, Dept. 12D, Fremont, Ohio

BE A CLAIM INVESTIGATOR



INVESTIGATE ACCIDENTS! Many earning \$750 to \$1000 a month. Thousands of insurance companies, airlines, steamship lines and Government Offices need Claim Investigators. Also big opportunities for your own spare time business. We train you at home. National Placement Service FREE of extra charge. Bill King writes: "Your course has paid off for me with large earnings. You can quote me—your Adjuster Training Course is worth many times the cost." Write TODAY for FREE book.

UNIVERSAL SCHOOLS

University Park, Dept. PM-2, Box 8202, Dallas 5, Texas

WHOLESALE Electric Guitars - Parts - Factory to You
Solid-body Spanish, amplifiers, double-necks, single-necks, triple-necks, 4-necks, solid-body mandolin, electric violin, pickup mikes, non-electric instruments, etc. 1958 Models wholesale. FREE CATALOG. Free home study course with instruments. Parts & plans available to build your own.
CARVIN CO., Box 287, PM-2, Covina, Calif.

BUILD YOUR OWN MIDGET ROADSTER \$25 BUILDS BODY & FRAME

BUILD A PONY ROADSTER or Pick-Up in few spare hours. Uses 2 hp engine, 450 lb. loads, 70 m.p.gal., plenty of speed. Designed for VERY LOW-COST assembly from PARTS BOUGHT IN YOUR NEIGHBORHOOD. Use home tools. Great for kids, sturdy utility car. COMPLETE step-by-step plans, 17 large-size photos, 30 "show-how" photos. Body templates, complete material and parts list. ONLY \$1.95 POST-PAID. Satisfied or money back.

PONY PLANS. 7641-W TEXHOMA AVE.. NORTHRIDGE, CALIF.

Say You Saw It in Popular Mechanics

Golfers WHAM-O® for practice

NEW! GROOVE YOUR SWING AT HOME!
DEVELOP FORM - CORRECT HOOK AND SLICE!



USED BY PROS

\$1.95
post
paid

No ball to chase! Simply push into ground and hit. Returns to position after club swing. Hooking, slicing, or topping is indicated by action of Wham-O. Practice just 5 minutes a day with our instructions and play 100% better on Sunday! Folds to 8" for golf bag. Use to warm up at starting tee. Tough pliable plastic, ash hardwood stock, 5" steel spikes. Withstands violent abuse. Only \$1.95 complete. Guaranteed. Ideal for gift. At dealers or send to: **WAMO MFG CO., Box A-12, San Gabriel, Calif.**

Bass Fishermen will Say I'm Crazy . . . until they try my method!



But, after an honest trial, if you're at all like the other men to whom I've told my strange plan, you'll guard it with your last breath.

Don't jump at conclusions. I'm not a manufacturer of any fancy new lure. I have no reels or lines to sell. I'm a professional man and make a good living in my profession. But my all-absorbing hobby is fishing. And, quite by accident, I've discovered how to go to waters that everyone else says are fished out and come in with a limit catch of the biggest bass that you ever saw. The savage old bass that got so big, because they were "wise" to every ordinary way of fishing.

This METHOD is NOT spinning, trolling, casting, fly fishing, trot line fishing, set line fishing, hand line fishing, live bait fishing, jugging, netting, trapping, seining, and does not even faintly resemble any of these standard methods of fishing. No live bait or prepared bait is used. You can carry all of the equipment you need in one hand.

The whole method can be learned in twenty minutes—twenty minutes of fascinating reading. All the extra equipment you need, you can buy locally at a cost of less than a dollar. Yet with it, you can come in after an hour or two of the greatest excitement of your life, with a stringer full. Not one or two miserable 12 or 14 inch over-sized keepers—but five or six real beauties with real poundage behind them. The kind that don't need a word of explanation of the professional skill of the man who caught them. Absolutely legal, too—in every state.

This amazing method was developed by a little group of professional fishermen. Though they are public guides, they rarely divulge their method to their patrons. They use it only when fishing for their own tables. It is probable that no man on your waters has ever seen it, ever heard of it, or ever used it. And when you have given it the first trial, you will be as closed-mouthed as a man who has suddenly discovered

a gold mine. Because with this method you can fish within a hundred feet of the best fishermen in the county and pull in ferocious big ones while they come home empty handed. No special skill is required. The method is just as deadly in the hands of a novice as in the hands of an old timer. My method will be disclosed only to those few men in each area who will give me their word of honor not to give the method to anyone else.

Send me your name. Let me tell you how you can try out this deadly method of bringing in big bass from your "fished out" waters. Let me tell you why I let you try out my unusual method for the whole fishing season without risking a penny of your money. Send your name for details of my money-back trial offer. There is no charge for this information, now or at any other time. Just your name is all I need. But I guarantee that the information I send you will make you a complete skeptic—until you decide to try my method! And then, your own catches will fill you with disbelief. Send your name, today. This will be fun.

ERIC H. FARE, Libertyville 17, Illinois

Eric H. Fare, Libertyville 17, Illinois

Dear Mr. Fare: Send me complete information without any charge and without the slightest obligation. Tell me how I can learn your method of catching big bass from "fished out" waters, even when the old timers are reporting "No Luck."

Name _____

Address _____

City _____ Zone _____ State _____

LEARN MEAT CUTTING AT NATIONAL Pay After Graduation



The steady dependable trade of Meat Cutting taught easily in 8 short weeks. YOU LEARN BY DOING under actual meat market conditions in big modern school at Toledo.

For beginners or men with experience. Get a profitable store of your own. Remember, PEOPLE MUST EAT! Big pay jobs. Free employment help. Thousands of successful graduates.

Buying, cutting, percentage, pricing, advertising, selling, etc. A complete retail meat education. National School established 33 years. Get National training NOW. Pay your tuition in easy weekly payments

after you graduate. Send coupon for FREE 52 page school catalog — TODAY. G.I. approved.

National School of Meat Cutting, Inc., Dept. 50-A, Toledo 4, Ohio

Send me your FREE school catalog on National Training at Toledo in Meat Cutting, Meat Merchandising and Self Service Meats. No obligation. No salesman will call.

Name _____ Age _____

Address _____

City _____ State _____

Approved for training Korean Veterans

FOUND IN EUROPE . . . OUTLAWED HITLER JUGEND DAGGER . . . \$5.95 ppd

Identical to pre-1939 official ceremonial dagger of Hitler's Youth (Jugend) Corps. Assembled post World War II, now illegal in Germany. 9 1/2" overall with a fine steel blade. Checkered black grip has Nazi swastika (black on silver)

on red and white diamond. Imported by us from Europe. Sheaths are black steel and leather. An excellent hunting knife. Add 80c per knife for U. S. A. P. O. or F. P. O. air mail.



COMPLETE WITH SHEATH

ANTIQUE ROYAL SPANISH CAVALRY SABRES \$9.95 ppd.

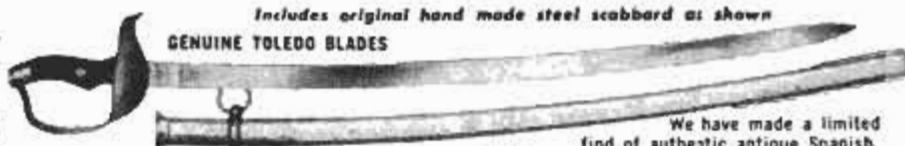

Includes original hand made steel scabbard as shown

GENUINE TOLEDO BLADES

Cavalry Sabres. They are just over three feet long overall. Blades are engraved with the Royal Spanish crown with "Toledo," major Spanish arms center and for over 1000 years the world's leading sword-making city. All are used, guaranteed in good condition. Our European agent informs us that these sabres are about 1875 vintage. They were imported directly by us. For C.O.D. send \$3 deposit. Send check, cash or money order. Calif. residents only send 3% state tax.



The Wordsman 118 Armory Bldg., 1165 E. Colorado Street, Pasadena 1, Calif.

PRINTS POST CARDS

Learn how both large and small businesses are boosting sales with new advertising machine. Write today for FREE illustrated BOOK of unique advertising plans, money-making ideas for your business. **Cardmaster, 1920 Sunnyside, Dept. 122, Chicago 40, Ill.**



High School at Home

MANY FINISH IN 2 YEARS

No classes. No time wasted going to and from school. Progress as fast as your time and abilities permit. Standard H. S. texts supplied. Thousands enroll each year in this 59-year-old school. Send for FREE descriptive booklet.

AMERICAN SCHOOL, Dept. H245
Drexel at 58th St., Chicago 37, Ill.

Without obligation, please send FREE descriptive booklet.

Name

Address

Canadian Residents: Complete Canadian Course Available. Write American School, 1610 Sherbrooke St., West, Montreal.

SAY YOU SAW IT IN POPULAR MECHANICS

REPAIR ANY WATCH

. . . Swiss or American

No previous experience needed to learn modern watch repair. An enjoyable hobby or profitable career. Unique Sweazey System starts you making repairs right away. Develops your skill step by step. Teaches you modern shop methods . . . professional short cuts . . . mistakes to avoid. Learn by personal attendance or spare time home study. Individual training. Start any time. Free sample lesson. No obligation. Write today!

CHICAGO SCHOOL OF WATCHMAKING
2330 N. Milwaukee, Dept. 126, Chicago 47, Ill.
Founded 1908. Approved for veterans

MAIL COUPON TODAY!

CHICAGO SCHOOL OF WATCHMAKING
2330 Milwaukee, Dept. 126, Chicago 47, Ill.
Send FREE sample lesson. Home study
 Resident school

**FREE
SAMPLE
LESSON**

Name _____ Veteran

Address _____

City _____ Zone _____ State _____

ITALIAN ACCORDIONS



Piano and Chromatic-Vienna & Italian System. Heligons-Irish-Club Models—Hohner & All button type. Also Concertinas & Bandonions. Buy direct from Factory Representative at Lowest Wholesale Prices and Save Money. We take any instrument in trade.

Expert repairing—Write for Free Catalog

ITALIAN ACCORDION MFG. CO.
7600 Cottage Grove Ave., Dept. PM-2, Chicago 19, Illinois

PORTABLE CAR COVER Heavy Vinyl Plastic (formerly \$8.95)

Protect Against RAIN
• SUN • DUST. \$6.95

Long-lasting plastic, folds compactly, off and on in a jiffy.

sturdy elastic binding gives extra security. State make, model and year—buy direct from mfr. Send \$6.95 plus 35¢ postage or sent C.O.D.

BEA SALES, Dept. G-63, 125 E. 46th St., New York 17



FREE AMAZING NEW BOOK "HOW TO ANSWER ADS"



Never before have you seen anything like this. Tells you in simple language the correct way to answer ads. Gets you quicker replies—better results, and greater satisfaction. Will save you time and money and it's ABSOLUTELY FREE. No obligation whatever. Every reader of advertising should have this booklet. Send a postcard for your copy NOW. F. W. Johnson, Popular Mechanics Magazine, Room 600-A, 204 East Ontario Street, Chicago 11, Illinois.

I HAVE BEEN AVERAGING

\$73,067.93 gross in cash every month

during 1955, in my Mail Order business, which I started with a very limited capital, in 1953. Because I am not covering even 1% of the market, I can supply you with merchandise, sales letters, and valuable advice based on experience. Can be operated on a small scale by man or woman. I began in my home—now employ thirty-seven. My firm belongs to Chamber of Commerce, well-rated financially by my bank and suppliers. This is not a crazy scheme, but a legitimate business. If you are looking for an outstanding, worthwhile Mail Order opportunity—then I'll prove to you that this is it. The fact that I am grossing almost a million dollars annually in my own Mail Order business should be of interest to you. One refundable dollar (to eliminate curiosity seekers and children), will bring you the most amazing Mail Order success opportunity you have ever read. Mail Order, P. O. Box 1715 PM Dallas, Texas.

DIESEL - AUTO MECHANICS DESPERATELY NEEDED

Big Pay... Good Future

NEVER IN HISTORY has there been such a tremendous demand for Diesel and Gasoline Mechanics. Authorities report a shortage of 150,000 auto mechanics. Virtually all heavy power equipment such as stationary power plants, farm tractors, boats, trucks, buses, earth moving and construction equipment is rapidly converting to Diesel Power, creating the greatest demand in history for Diesel Mechanics.

YOUR SUCCESS IN THIS FIELD depends upon the reputation of the school you attend and the quality of training you receive. It is only natural you will want and should have the very best in training. We urge you to send for our big free booklet, which is almost like visiting with us.

THIS BOOKLET clearly emphasizes the advantages of THE WORLD FAMOUS BAILEY METHOD of "LEARN-BY-DOING" on the most modern equipment...

TAKES YOU ON A STEP BY

STEP CAMERA TOUR through our spacious modern shops, where you see BAILEY students in action.

IT EXPLAINS WHY IT IS NECESSARY TO KNOW BOTH DIESEL AND GASOLINE MECHANICS, in order to get the **BIG PAY JOBS** and advance rapidly in these fields!

IT POINTS OUT HOW OUR BAILEY METHOD permits you to learn both Diesel and Gasoline Mechanics for the price of one... in the amount of time ordinarily required to learn just one of these subjects... and finally it explains completely how you are provided with part time employment and housing during your training period and the success we are having in the placement of Bailey Graduates with America's leading companies.

WE ARE CONFIDENT after reading the material we send you... you will agree we offer the finest training in the country.



Students learning trouble shooting on Motor Analyzer.

Students learning Diesel operation.

MAIL TODAY!

Please mail immediately this free booklet without obligation.

FREE BOOKLET



Name _____

Address _____

City _____ State _____

Approved for Veteran and Non-Veteran

BAILEY TECHNICAL SCHOOLS

1634 S. Grand St. Louis 4, Mo.



Leo Kerber, Shakopee, Minn. "Awhile ago I tried for one of these scholarships. I didn't think my sketch could win, but it did! I've learned a lot from the art course—and have already sold quite a bit of my work."

April 20, 1955

DRAW ME!

TRY FOR A FREE 2-YEAR ART SCHOLARSHIP WORTH \$335⁰⁰

Prize: Two years of free training for career in advertising art or illustrating—plus a series of art textbooks and a professional drawing outfit!

Scholarship is offered by the world's largest home study art school. Many of its graduates are earning real money, today, in the art field.

You're trained by professional artists. You get individual coaching, guidance. Mail your drawing today!



DRAW THIS GIRL'S HEAD

5 inches high. Use pencil only. All drawings must be received by March 31, 1956. None returned. Winner notified. Amateurs only. Our students not eligible.

(PLEASE PRINT)

Name _____ AGE _____

Address _____ City _____

Zone _____ County _____ State _____

Occupation _____ Phone _____

ART INSTRUCTION, INC.

Studio 2136—500 S. 4th Street
Minneapolis 15, Minnesota

Please enter my attached drawing in your "Draw Me" contest.

Make Money as a Manufacturer of REDIBRIK

This is Home Improvement year—the beginning of a period in which building activity keynotes will be Remodel, Renovate, Repair, Modernize. And the program applies to every type of construction—residential, commercial and industrial. Millions of jobs are due to be undertaken—hundreds or thousands in every community. Broad markets are being created for Redibrik—masonry to fit today's needs.

What is Redibrik?



Redibrik is masonry. Specifically, it's brick. Long and narrow like "Roman Brick," but thin and light enough to be applied directly to the existing wall. No changing of footings or foundations. Easy and inexpensive to apply over frame, block or almost any other old wall. Self-contained mortar joints. Range of 15 colors. Machine-made for two big reasons; excellence of quality and low production costs.

Timely Manufacturing Opportunity

Sound economics justify Redibrik being manufactured in a chain of local plants, each serving the needs of a community. 100-150% mark-up on basic cost. Choice of territories await those who apply early. Franchise protection with exclusive privileges. Redibrik machines available on lease, making this a real low-investment opportunity. Write or wire for Redibrik portfolio and tentative reservation of territory.



Redibrik Industries, Inc.
652 Ottawa Avenue, Holland, Mich.



An Introduction to Wonderful
Worlds for Young Americans!

One pound
Uranium Equal
to 2,600,000 pounds of coal



A Space Platform May
Look Something Like This

—the Boy Scientist

New Popular Mechanics Book Packed With Thrilling Facts and Fascinating Information

Get this thrilling Popular Mechanics book for every boy you know. In it, your own boy scientist can pore over the world-shaking discoveries in astronomy, physics, chemistry, sound, electricity, atomic theory and relativity. In the same thrilling pages, he can meet the greats of the world of science such as Galileo, Newton, Franklin, Faraday, Einstein and many others. With its help, he can participate in monumental discoveries by performing the many experiments which are suggested in the book and explained in word and picture.

The Spark That Opens Up a New World

Written by John Lewellen, noted writer of a dozen books on science and natural history, Preface by Dr. Wilbur Beauchamp, Professor of Education, University of Chicago, who says "the Boy Scientist may well be the spark that starts some boy on the way to becoming a scientist and the Nation's need for scientists is very great."

Finest Gift for Boys Use "Money Back" Coupon

Is there a boy in your family? Then get him the Boy Scientist. It could be one of the most important books he ever reads. Want to send the supreme gift to some boy you know? Then give him the Boy Scientist too. There is no finer gift for any occasion. Sent postpaid to any address for only \$3.95. Order on Money Back coupon now. If not immensely pleased with the book return in 5 days and the entire purchase price will be refunded.



Meet These Greats ... Know Their Achievements

Galileo . . . the first modern scientist
Newton . . . the law of gravity and famous three laws of motion
Boyle . . . and how gases behave
Archimedes } . . . and
Pascal } Liquids
Bernoulli }
Huygens . . . and light
Benjamin Franklin . . . and electricity
Bequerel . . . radioactive fog
Einstein . . . theory of relativity
Rumford . . . heat
Mersenne . . . the laws of sound
Tomorrow . . . will bring new discoveries



Prepared in the famous Popular Mechanics easy-to-read and easy-to-understand style. Adults too, will find this a fascinating book.

Library Cloth
Binding
6 3/4 x 10 In.
264 Pages
277
Illustrations

Use This "On Approval" Coupon

POPULAR MECHANICS PRESS

Dept. 256, 200 E. Ontario Street, Chicago 11

Send at once _____ copies The Boy Scientist. \$3.95 each. I understand I may return books in 5 days and you will refund full purchase price.

- Remittance for \$ _____ enclosed. Send postpaid.
 Send COD. I will pay postman.

Name _____
Address _____
City _____ Zone _____ State _____

RADIO CONTROL YOUR MODEL PLANE BOATS CARS

"CUSTOM ONLY
MIDGET" RADIO \$9.98

LICENSE FREE BAND
OPERATES SAME AS \$50.00
SETS, INCLUDES LONG RANGE

TRANSMITTER RADIO, RECEIVER RADIO AND CONTROL ACTUATOR ALL 3
EASY ASSEMBLY WITH OUR PARTS AND PLANS \$9.95. PLANS ALONE \$1.

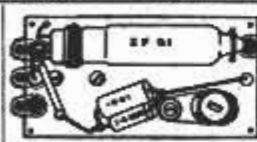

DETAILED INFORMATION & RADIO CATALOGUE 25c

SPECIAL "SUPPLY SOURCE
DIRECTORY" & \$7.00
SUPPLY COUPON... \$1.00

BOOK "RADIO CONTROL OF
MODEL AIRCRAFT" \$3.98
CONTAINS 14 PLANS

RADIO CONTROL
GARAGE DOOR
DETAILS..... \$1.00

RADIOMODELS BOX 36 DEPT. PM BALTIMORE 6, MARYLAND

I'll Send You This Handsome SAMPLE CASE—FREE



and Show You How to Make
Up to \$30.00 in a Day

Mail coupon for this Free Tailoring Sample Case packed with 150 beautiful, big-value suit and overcoat fabrics. Take orders from friends, fellow-workers, others, for fine quality, made-to-measure clothes. Pocket big cash profits in advance. Because wearing our suits and overcoats brings more orders, we make it easy for you to get your own clothes without the cost. No experience is needed. SATISFACTION GUARANTEED. SEND NO MONEY. Just fill out and mail coupon—today!

PIONEER TAILORING COMPANY, Dept. N-1116
CONGRESS & THROOP STREETS - CHICAGO 7, ILLINOIS

PIONEER TAILORING CO., Dept. N-1116
Congress & Throop Sts., Chicago 7, Ill.

Dear Sir: I WANT A MADE-TO-MEASURE SUIT TO WEAR
AND SHOW, without paying 1c for it. Rush details and Sample
Kit of actual fabrics, ABSOLUTELY FREE.

NAME _____ AGE _____

ADDRESS _____

CITY _____ STATE _____

NEW INVENTION **REPLATES** by **ELECTROPLATING** RESTORES HOME, AUTO METALS **CHROME-SILVER-GOLD!**

NEW BRILLIANCE WITH SAME PROCESS AS PROFESSIONAL PLATERS
SILVER-CHROME-GOLD, ETC.



REPLATED, Quickly, Easily Now—with an amazing new invention, APPL-I-COTER, you plate hundreds of items, using the mild, safe current of 2 flashlight batteries in its handle. ALL YOU DO is simply hold disk on Applicator to metal, dip brush into solution—and plate as you brush. It's Easy, Quick, Genuine plating.

RESTORES METALS LIKE NEW Replates Silver, Chrome, Nickel, Steel, Gold and Brass—all worn Spots, Stains, "Blisters," Silverware, Trays, Teapots, Rims of Holloware and other items can look like new again with this exclusive Electroplating process. Restore all your valuable Gold jewelry with amazing APPL-I-COTER. The plating you apply becomes an indestructible part of the metal itself!



QUICKLY BUILDS-UP A THICK NEW PLATING WITH EACH APPLICATION.



COMPLETE PLATING KITS:
MET-L-COTE: For Chrome & other white metals... **\$3.95**
SILV-R-COTE: For Silver plating with pure Silver... **\$3.95**
GOLD-COTE: Gold Plate with 24 K. Gold... **\$6.25**
Copper **\$3.95**; Rhodium **\$7.95**
ALL 5 METALS... \$19.95 (You Save \$6.10)



BRILLIANT AUTO TRIM — You'll be mighty proud of the Dazzling new finish on your car's bumpers and trim after replating with MET-L-COTE... and remember, each time you electroplate worn areas you build up a lasting layer of coating that tremendously lengthens the life of original trim.

MET-L-COTE is constantly used in leading hospitals, and in doctors and dentists offices to Replate surgical instruments—Also in hotels and restaurants to RESTORE cutlery.



A THICKER PLATING WITH EACH COAT!

MET-L-COTE — Replates, Restores worn **CHROME, NICKEL, AUTO TRIM, APPLIANCES**, etc.

SILV-R-COTE—Replates Silver with Sterling.

COPPER-COTE — Replates all copper.

GOLD-COTE—Replates with 24 Karat gold.

RHODIUM — Replates with hardest metal known.

Make money at home Replate jewelry, silver, chrome. Earn up to \$10 per hour.

EMPIRE MERCHANDISING CO.

Dept. J-23

28 E. First St., Mt. Vernon, N.Y.

MONEY-BACK GUARANTEE

Please rush the Complete Plating Kits including Solution, New Pocket Applicator & full simple instructions I have checked below. I enclose full price, sent postpaid, or send C.O.D. plus postage.

MET-L-COTE—\$3.95

GOLD-COTE—\$6.25

RHODIUM—\$7.95

SILV-R-COTE—\$3.95

COPPER-COTE—\$3.95

ALL 5 METALS—\$19.95 (Save \$6.10)

NAME _____

ADDRESS _____

CITY _____

STATE _____

RESTORE YOUR TREASURES— MAKE THEM VALUABLE AGAIN

Empire Mds. Co., 28 E. First St., Mt. Vernon, N.Y.

AUTOMOBILE RACING—Sixth Edition

Full description with over 100 illustrations of new fast racing creations. Working drawings with step by step building instructions for successful Ford 60 Midget—Model A Roadster—Offenhauser Dirt Track Racer—Miller 158.5 m.p.h. Racer. Details on axles, frames, engines, bodies, etc., etc. Entrance Blank with rules and regulations. A book full of interest for every Auto Racing Fan, Driver, Mechanic and Owner. Money back if not satisfied.



ORDER NOW! \$1.00 POSTPAID; Sorry, No C.O.D.'s

POPULAR MECHANICS PRESS, 202 E. Ontario St., Chicago 11, Ill.

Amazing new weapon for sportsmen! **HUNTING BLOWGUN**

32" precision steel barrel

Shoots like a rifle

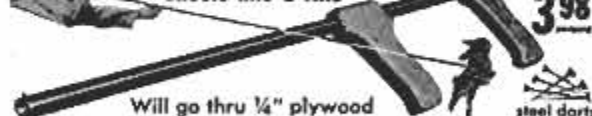

Will go thru 1/4" plywood

3.98

Exciting new sport based on an improved version of the most accurate native weapon ever devised - the hunting blowgun of Borneo! Silent and very powerful - American sportsmen who first try it cannot believe their eyes! Compression of breath in tube gives amazing air power! Shoots over 300 feet. Enjoy target fun with friends. Average person can hit 2" bullseye at 30 ft. Precision made of the finest deep-blued steel 32 in. long. Hardwood grips. Rubber mouthpiece. Beautiful finish. Excellent for destroying varmints. Kills without poison. Comes with target, instructions. Comes with 6 5" steel hunting darts. Extra darts 6 for \$1. At dealers or Send to: **WAMO MFG. CO., Box B-82, San Gabriel, Calif.**

Free! Fabulous Collection from **SOUTH of the BORDER**



Start TODAY to enjoy an exciting new hobby! Rush Coupon for big, valuable collection of genuine, all-different postage stamps from the exciting land of the mysterious Amazon... scarce airmails, gorgeous commemoratives, giant-sized stamps picturing wild horses, covered wagons, action-packed fights, native war heroes; PLUS sensational train stamp, beautiful "Christ of the Andes"; many others. EXTRA! Bargain Catalog, "Collector's Manual" plus other exciting offers for your inspection. Enclose 10c for mailing expenses... ACT NOW!

JAMESTOWN STAMP CO. DEPT. N2PM, JAMESTOWN, N. Y.

RUSH my Free "South of the Border" Collection and other offers. I enclose 10c for mailing costs.



Name _____

Street _____

City _____ State _____

Paint STRIPES with New "PAINT PEN"!

Straight, Curved or Parallel Lines

Use like a fountain pen with any color paint to stripe furniture, bikes, autos, model planes, toys, linoleum, wall board. Beautiful clean, crisp results every time. Can't clog or smear. Also use with glue, tempera, textile paint or ceramic under glaze. Paints on wood, glass, plastic, metals, fabrics and paper. Tool complete with tip for 1/16" stripe only \$1.25 postpaid. Other complete tools with following tips, 1/64", 1/32", 3/64", 5/64", 3/32", 3/16" — \$1.75 each. Extra tips 90c each. Entire kit with tool and 7 tips — \$5. A 3/4" tip only \$1.20 each. C.O.D.'s postage collect.

New! "DOUBLE-STRIP" 5 Way Combination Model only \$3.25

Double Stripes — one wide and one narrow or two wide or two narrow at the same time.

FREE Send postcard for complete information — or **ORDER TODAY.**



\$1.25

DEALERS: Master Paint Striping Tool in display cartons of 1 doz. **FAST, PROFITABLE SALES.** Write for new discounts.

HOME CRAFTSMEN! New Paint Striping Tool gives "professional" results every time, simple, easy to use. Send \$1.25 now.

MANUFACTURERS: Write today for information about industrial models and production striping tools.

WENDELL MFG. CO., Dept. 314
4234 Lincoln Ave., Chicago 18, Ill.

Wanted! HOME PRODUCERS

BY MANUFACTURERS IN OUR CLEARING HOUSE SERVICE

Become a subcontractor, casting plastic products for important companies. These manufacturers are anxious to place big and small orders for consumer and industrial demand. Thousands of easy-to-make items required now. YOU can make them.

YOU SET YOUR OWN HOURS

Run this profitable business in your home, spare or full time. No previous experience necessary. Here at last is opportunity to have your own successful business. Write today. Information free.



PLASTIC SERVICE ASSOCIATES, DEPT. PC
EAST BOSTON 28, MASS.

ENGINEERING DEGREE IN 27 MONTHS

Big Demand for Graduates

Aeronautical, Chemical, Civil, Electrical, Mechanical and Electronic Engineering (inc. Radio and TV)

Hundreds of young men are earning B. S. ENGINEERING DEGREES annually in this recognized institution — year around operation. New terms start quarterly. Many students earn a major part of their college expenses in this large industrial center.

Low tuition. Competent instruction. Thorough, intense practical program. Modern, well-equipped laboratories including new physics laboratory and modern wind tunnel. Individualized instruction emphasized.

Government approved for G.I.'s. Engineering preparatory courses. Students from 48 states and 21 foreign countries. Enter March, June, September and December. Send coupon for free catalog and full information. Enroll now.

INDIANA TECHNICAL COLLEGE

526 E. Washington Boulevard, Fort Wayne 2, Indiana

Please send me free information on B.S. Engineering Degree in 27 months as checked.

Aeronautical, Chemical, Civil, Electrical,
 Mechanical, Electronics

Name _____

Address _____

Enjoy Modern Living · Make Your Home Worth More With This Popular Mechanics Book . . .



759 PICTURES

Above: How to lay a new roof over the old.

Right: New walls over the tired old walls. A few of the 83 modern kitchen ideas.

Below: Modern ceilings for old basements.

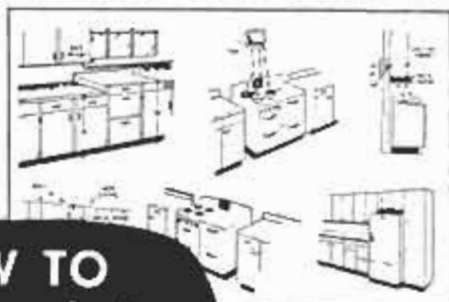

HOW TO Remodel Your Home

With Data on New Materials and Products Available to Home Owners

Here are hundreds of ways you can make a modern home out of an old house, make the house worth more and save money while doing it. If you own an old house or intend to buy one, get "How to Remodel Your Home" by E. R. Haan, formerly technical editor for Popular Mechanics. You can do the modernizing yourself or have it done for this vital book contains 547 methods and 759 illustrations covering complete modernization, adding rooms and living space, installing new kitchens and baths, adding closets, wardrobes, rumpus rooms. Complete face-lifting jobs for the outside and morale building jobs for the inside.

Learn the joys and conveniences of modern living with this vital book prepared especially for the home owner. Mail coupon for your copy today.

Money Back if You Want It.

Get the book now. Check it for information that will help you improve your home for appearance, convenience and value. If not fully pleased, return the book in 7 days and Popular Mechanics will refund every penny you have paid.

Big Book.
Same Size as
This Magazine.



What to Do! How to Do It! How to Cut Costs and Save

In this book — 17 big helpful sections. They are:

From old to new — Your modern kitchen — Better bathrooms — Basement rumpus rooms — Curing wet basements — Attic space and dormers — Adding rooms to the outside — Porches and breezeways — Utilizing idle space — New look for outside walls — Modern interior walls — Heat-loss and humidity controls — Roof framing and covering — Windows that modernize — Entrances and doors — Variety in floors — Wiring, plumbing heating. In all — 547 money-saving articles you can use.

Use Coupon to Get Remodeling Book

POPULAR MECHANICS PRESS, 200 E. Ontario St., Chicago 11

Send at once "How to Remodel Your Home," postpaid for \$2.95. I understand I may return the book in 7 days for full refund.

Remittance for \$2.95 enclosed. Send book postpaid.
 Send COD. I will pay postman.

Name _____

Address _____

City _____

State _____

New PROFIT-PROVEN* Home-Business!

"I make \$400⁰⁰ a week!"



SCREEN PRINT
TRADE-MARK BIG

SCREEN PRINT CO.

Dept. 22

15127 S. Broadway, Los Angeles 61, Calif.

Gentlemen: Please mail me Free Revealing Details, samples, Opportunity Plan, etc.—All this is sent absolutely Free and sent to me by return mail. I am under no obligation now or ever.

NAME _____

ADDRESS _____

CITY _____

ZONE _____

STATE _____

free!

Complete REVEALING DETAILS, Authentic SAMPLES, Proven Big-Money OPPORTUNITY PLAN, "HOW-TO" BOOKLET. Learn the secrets. Rush this coupon TODAY!

*Proves MR. J. T. ANDERSON, Inglewood, Calif. (Notorized statement on file in our office and open to inspection)

Big Money?—sure it is—because Huge Profits are waiting to be "tapped" with this **MIRACLE NEW PRINTING METHOD**. Now, you may share the exciting secrets and build a big-paying **FULL OR SPARE TIME** Screen Printing Business right in **YOUR OWN HOME**. Yes, we'll teach you, too, how to turn pennies into dollars in this newest, most sensational printing method ever invented. **WHAT IS SCREEN-PRINT?** It's an exciting new printing technique—amazingly simple and fascinating. (It may soon revolutionize the entire printing industry) **NO EXPENSIVE EQUIPMENT**, no printing press, no "cuts," no art ability, no experience is necessary—yet you can print beautiful professional jobs on **PAPER, GLASS, LEATHER, CLOTH—ANYTHING!** You print in all colors—even new "glowing" **FLUORESCENT**

COLORS. It's amazing—but true! **EARN PROFITS IMMEDIATELY—IN YOUR OWN HOME!** Start in your garage, basement, kitchen, spare room—anywhere! It's much easier than you think. Then expand as this new printing industry grows. **300% PROFIT** on some jobs—earn up to **\$12.50 per hr.** **HELP FILL THE HUGE GROWING DEMAND**. No selling because every business in your area needs Screen-Printing. You can save them up to **50%** on printing, too. **WE SUPPLY EVERYTHING YOU NEED**. Never before has such a profit opportunity been offered to anyone wishing to start a full-time or spare-time "business of his own." Don't Hesitate! All the **CONFIDENTIAL FACTS** are yours if you **MAIL COUPON TODAY**—before it's too late.

READ WHAT OTHERS ARE SAYING—Investigate! "Would not take \$1000.00 for secret... just what I have been searching the world over for." C.S., Nev.: "Making 75% of living expenses already in spare time." E.L., Ontario: "Made \$80 first week—terrific opportunity"—W.S., Iowa.

Mail Coupon and Learn Secrets Too!

Print colorful ADVERTISING DISPLAYS, SIGNS, BANNERS, POSTERS, LABELS, WALLPAPER, NOVELTIES, INSTRUMENTS, ETC. ET

welcome
your
heart
fund
volunteer

FEB. 26
**HEART
SUNDAY**



POWER MOWER KITS FREE PLANS

Have one of the finest mowers money can buy. Write for **FREE PLANS** and **PARTS LIST** showing you how to **SAVE MONEY** by assembling Triangle's **POWER MOWERS**.

SPECIAL FACTORY PRICES

Kits, Parts, Engines, Wheel, etc. 18" and 20" sizes; 3 or 4-wheel models; belt or direct drive. Latest improvements, sturdy construction, money-back guarantee fully told in

FREE color folder. Also complete **TRIANGLE MOWERS** ready to mow at low Factory Prices. Write today.

▲ **TRIANGLE MFG. CO., Dept. MA-2, Ft. Scott, Kan.**

3 or 4
Wheel
Model

NEW! PERSONAL POCKET RADIO

LISTEN WHILE YOU
WALK, RIDE, WORK!



Slips in any pocket—Wt. only 7 ozs. Size 2 3/4" x 4 3/4" x 1 1/2". Beautiful Black Gold plastic case. **NO HOOKUPS—NO WIRES—NO PLUG-INS!** Self contained with 150 hour life flashlight batteries. (Available anywhere) and **BUILT-IN ANTENNA!**

GUARANTEED RECEPTION OF RADIO STATIONS TO 50 miles—up to 1500 miles for powerful stations! Has new Patented Super-regenerative Diode tube and transformer audio stages for sharp selectivity and sensitivity. Easy to use top controls (while walking). Almost invisible plastic foam personal earplug lets you alone listen while you walk, visit, work, ride or sleep—anytime—anywhere. Money Back guarantee—1 year service guarantee.

SEND ONLY \$5.00 (Ck. Mo) and pay postman \$14.95 plus postage on delivery or send \$19.95 for prepaid delivery. Get YOUR Tinyton REAL pocket radio now and be ready to listen to Civil Defense Alarms, news, music, sports, etc. on a moment's notice. Not an unworkable incomplete kit or plaything! Shipped complete with batteries—Ready to listen!—Available only from **WESTERN RADIO Dept. APM-2 Kearney, Nebraska**

EARN BIG MONEY!

GROW "LIVING" MIDGET TREES!

AT HOME — SPARE TIME — NO EXPERIENCE NEEDED!

It's new! Amazing! At last, the secret of growing miniature (MING) trees can be yours. **FULL GROWN**, dwarf trees—only a few inches high. Beautiful miniature fir, orange, oak, Chinese elm, peach, pine, cypress—any kind! All **BLOOM** and even **BEAR FRUIT**. All perfect healthy specimens—our miniature in size! Make costly home decorations and expensive centerpieces. (SOLD FOR OVER \$1,500 EACH.) Big demand. Costs only pennies—takes only minutes per week. **IT'S EASY!** Fun! A new fascinating hobby—a new fabulous \$\$\$\$ business. Send for free secret plan details and real seed.

HELP US FILL HUGE DEMAND

These trees are being demanded by **STORES · CLUBS · HOTELS · FLORISTS · HOUSEWIVES · INTERIOR DECORATORS · COLLECTORS · HOBBYISTS**—Big Money Opportunity for you.

CYPRESS TREE



SPINER TREE



FIR TREE

HOW TO LEARN
GROWING
SECRETS

\$
BOTH SEED
FREE

MAIL TODAY FOR FREE
SEED AND PLAN!

NATIONAL NURSERY GARDENS, Dept. M-2
8463 South Van Ness, Inglewood 4, California
Rush me **FREE PLAN** and **SEED** IMMEDIATELY!

Name _____

Address _____

City _____

Zone _____

State _____

Completed Popular Mechanics Ranch Type House and exact scale pictorial room and suggested furnishing layout. To right of dotted line is BASIC HOUSE. Expansion to the left. Designed for easy building in two convenient steps.



Basic house includes living room, dining area, two bedrooms, kitchen, bath, utility room and car port. Can be built for about \$5000.

More than 100,000 families have built their own homes in the past few years, doing all of the work, or most of it themselves. Right now, one of every five homes being built is at least partially owner-built. This proves that you too, if you can use hammer and saw, can build your own home and save more than one-half of the cost.



Build the Basic House First



Add When You Need More Room

When expanding you add garage and breezeway, and car port becomes third bedroom. About \$2500.

Get this Newest Popular Mechanics "Build-It-Yourself" Book and Building Plans and Save Many Thousands of Dollars

Book gives complete step by step instruction in simple language. Hundreds of pictures, actual photos and diagrams, showing every phase of construction, guide you from start to finish. Ten working size blueprints give floor plans, elevations, notes on construction, framing, lumber list, specifications, plumbing and wiring diagrams.

part of it. And at the same time, save in labor costs, more than he spends for material.

Order Book and Plans Now

Use the handy coupon below to order your copy of the RANCH-TYPE HOUSE BOOK AND PLANS. Read the book; study the plans and then you will be prepared to go right ahead when you are ready to build. Even if you have the house mainly built by others, you can still enjoy a tremendous savings by using the instructions and blueprints from Popular Mechanics.

Read Now and See How — Simplified Instruction

You read "how-to-do-it" in the book. You see how it looks in actual pictures. You follow the plans for dimensions and details. You make use of labor-saving kinks and special methods developed especially for the project.

No Previous Building Experience Required

Any ordinary handy man, using only simple tools, can build this house with little or no assistance and enjoy every

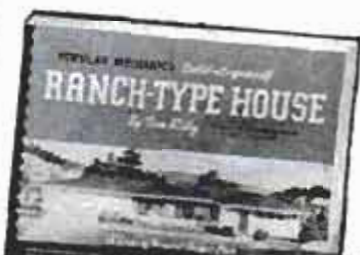

Build this Popular Mechanics RANCH HOUSE Yourself! Save Over One-Half

Beat the High Cost of Home Owning It's Easier Than You Think

Here is a dream home that can become a reality without too much worry about money. Build this beautiful Ranch Type Home yourself. Simply follow the Popular Mechanics RANCH TYPE HOUSE BOOK AND PLANS. You can save \$7,000 to \$10,000 and have one of the most desired homes of these times. You can build it all now—or part of it—and add garage, breezeway and another bedroom later on without affecting the basic house.

Modern Design • Fully Finished • All-Season Build this Home Anywhere and Save

Designed for Popular Mechanics by John F. Whelan, famous West Coast architect and designer of homes and entire villages. It's a year 'round house, 81 feet long and 29 feet wide. Fully insulated. Finished outside and inside with durable plywood and requires no plastering. Brick "island wall" and big fireplace in living room. Heating, unique ventilating system and latest development in electric wiring included. A dream home that can easily come true and a home that can grow with the family.

Reduced size illustrations from book. Building roof truss on floor for easy construction. Mrs. Tom Riley, Portland, Oregon, shingles the roof on her Popular Mechanics Ranch Type House

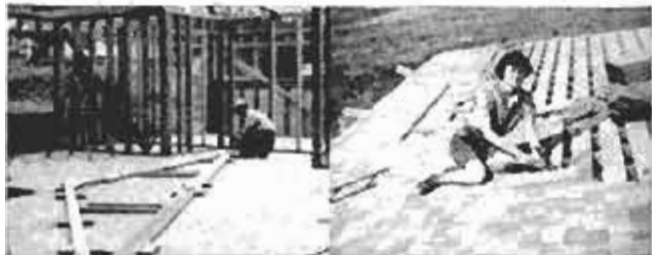

Use This Handy Order Coupon

POPULAR MECHANICS PRESS

200 E. Ontario St., Chicago 11, Ill.

Send at once my copy of the Ranch-Type House Book and Plans as checked below:

- Remittance enclosed Send C.O.D. (postage extra)
- Ranch Type House Book \$ 3.50
- Set of 10 Blueprints 13.50
- Book and Blueprints 15.00
- Duplicate Set of Blueprints 5.00

Name _____

Address _____

City _____ Zone _____ State _____

You Can Be a Local Manufacturer of CAVITEX

**SUPERFINE
MASONRY**

Local production explains why Cavitex can offer so much in quality for so little money, yet is so generous in profit potentials. It's a case of streamlined manufacturing—processing local materials for local building—cutting out the high costs of freight and distribution.

Cavitex creates new standards of beauty—in size, proportion and color. "Puts emphasis on the horizontal." Cored-out design for lighter weight and greater insulation values. Available in 8-inch and 4-inch.

Hundreds of territories are available to men looking for a local manufacturing enterprise. Franchise privileges. Responsible operators can obtain basic equipment on attractive rental terms. The Cavitex industry is sponsored by a million-dollar company backgrounded by fifty years of experience and reputation. Write or wire at once for "Opportunity, Unlimited" and tentative reservation of territory.



W. E. DUNN MFG. CO.
409 W. 24 St., Holland, Mich.
In Canada
Dunn Masonry Machinery, Ltd.
844 Dundas Highway
Cooksville, Ont.

X-6

PROFITS IN EXPORT-IMPORT

Earn big money from your home anywhere in USA or Canada. Opportunities Galore in this Exciting International Mail-Order Business. No experience and little capital necessary. Travel abroad. Complete Satisfaction Guaranteed. "Free" details. **UNIVERSAL SERVICES**, Dept. 41, Clayton 5, Missouri.

YES! SEND



directly
to my door
every month

I am enclosing

- \$3.50 for 1 year
 \$8.00 for 3 years

name _____

address _____

city _____ zone _____ state _____
A-26

Hand this order to your newsdealer or send it to

POPULAR MECHANICS
200 East Ontario St. Chicago 11, Ill.

1 I SHOW YOU HOW TO **MAKE MONEY** AT ONCE

2 START YOUR OWN BUSINESS

IN 2 WEEKS—
AT HOME
IN SPARE TIME



PLATE
Baby Shoes
IN
BRONZE
AND
COLORED
PEARL

**MILLIONS OF
NEW PROSPECTS
EVERY YEAR**



Now is the time to cash in on this big-paying, easy-to-operate, year-round business and you need no experience. **MATERIALS COST YOU ONLY 50c — YOU GET \$6.00!** With many actual "show-how" illustrations and step-by-step instructions, **YOU** can start earning money at once in one week. Working only a few hours you can make more money than many people make working an entire week.

IMMEDIATE RESULTS

- Big Income
- Huge Demand
- Sales Plan
- Future Security
- Your Own Business

We will send you full details absolutely free.

FREE!

**MONEY
MAKING
PLAN**

Full Details
Without
Obligation

**MAIL COUPON
TODAY!**

KIKTAVI COMPANY, Dept. PM-562
11029 S. Vermont, Los Angeles 44, Calif.

KIKTAVI COMPANY, Dept. PM-562
11029 S. Vermont, Los Angeles 44, Calif.

Send me **FREE** details of your **MONEY MAKING PLAN**, without obligation.

NAME _____

STREET _____

CITY _____ ZONE _____ STATE _____



Roof has a stepped-up cantilever design. Gap between the two roof levels is louvered to ventilate interior

IS THIS TOMORROW'S FAMILY CAR?

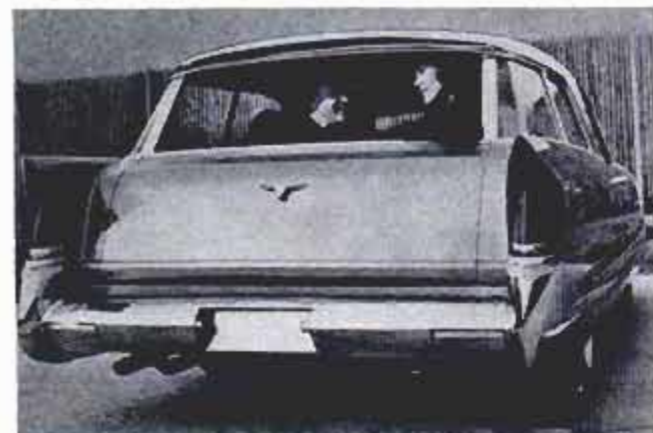

Rear-facing passengers have observation-car view. Retracted steps are visible at each end of bumper

CHRYSLER'S newest "idea car" is a novel station wagon, the Plainsman (see page 186 for more dream cars). Some experts believe the six or eight-passenger station wagon will be the family car of tomorrow. The four-door sedan will soon be an under-slung four-seater, too small for many families, they say.

Features of the Plainsman include: The third seat (in extreme rear) faces backward and is entered via power-operated steps that retract in the bumper, cantilevered roof requires no thick pillars in rear, spare tire stands vertically behind right rear wheel hidden by a hinged wheel flap.

Spare tire is carried upright behind rear wheel. A built-in elevator lowers the spare for effortless handling



THIS TANK HOLDS

4,538 TROPICAL FISH
WORTH \$2,456.65!

EARN BIG PROFITS
In Your Spare Time!

WOW!

—AND YOU BREED THEM IN YOUR SPARE TIME—IN YOUR HOME

If you have a little space in a SPARE ROOM, PORCH, BASEMENT, GARAGE ... ANYWHERE. Investigate this "chance of a lifetime" opportunity of breeding rare tropical fish for profit. The tropical fish "BOOM" IS JUST BEGINNING and here's your opportunity to cash in on it now. Experts estimate \$780 MILLION DOLLARS will be spent on tropical fish within next ten years. Investigate now—Rush coupon below.

YES BOB, I BREED THEM IN MY BACK PORCH. THEY ALMOST SELL THEMSELVES. TOO. BELIEVE ME THE "BOOM" HAS STARTED

DID IT COST YOU MUCH TO START?

NO—ONLY A FEW DOLLARS, A LITTLE SPACE AND MY SPARE TIME AND THE LITTLE KNOWN BREEDING SECRETS ARE ALL YOU NEED TO START. IF YOU'RE INTERESTED—LEARN THE FACTS TODAY!—THE "BIG BOOM" HAS STARTED SO CASH IN ON IT NOW!

Join others that are saying: "Business prospects amazing," J. K., Ga. "Dealers want all I can breed," J. P., Ore. "Pays off large dividends," R. D., N. Y., etc.

IT'S EASY! Once you know the SECRETS you may breed exotic ANGEL FISH; Zebra striped DANIO; beautiful GOURAMI; majestic FIGHTING FISH; the mysterious weather predictors—and BRILLIANTLY BEAUTIFUL rare tropicals of every kind. Sell for up to \$35.00 pr. *Amazing Profits!*

SOME TROPICAL FISH LAY TO 600 EGGS AT A TIME. That's why tropical fish breeding is so profitable. Nature multiplies your \$5.

This advertisement is an **URGENT APPEAL OPPORTUNITY** Orders backlogged in many areas. RUSH coupon NOW!

1 and 2 FREE! (BOTH)

MAIL THIS COUPON BELOW TODAY!

1 "How to Learn Breeding Secrets" Booklet. VUER-PROJECTOR KIT WITH COLDR slides (\$4.95 value) Yours FREE for writing for FACTS.

Tropical Fish Breeders of America, Dept. D2 15121 S. Broadway, Los Angeles 61, Calif. Please Rush FREE COLORFUL BOOKLET and amazing VUER-PROJECTOR KIT details to me. Both Free! Sending for these does not obligate me in any way.

Name _____ Age _____
Address _____
City _____ Zone _____ State _____

TROPICAL FISH BREEDERS OF AMERICA, Dept. D2, 15121 S. Broadway, Los Angeles 61, Cal.

SAY YOU SAW IT IN POPULAR MECHANICS

Delehanty Books Have Helped Thousands to **SUCCEED IN POST OFFICE EXAMS!**

Home study books prepared by experts in the Post Office field expressly for the new type exams for **CLERK-CARRIER or RAILWAY POSTAL CLERK**. 160 pages of Study Material. Practice Drills and Sample Questions. Return within 5 days of receipt for **FULL CASH REFUND** if not satisfied. **\$3.50** Post Paid

DELEHANTY INSTITUTE — Estab. Nearly 50 Yrs. DEPT. P.M. 115 EAST 15 ST. NEW YORK 3, N. Y.



BUILD 16 RADIO CIRCUITS AT HOME WITH THE NEW DELUXE 1956 PROGRESSIVE RADIO "EDU-KIT"

ONLY **\$19.95** COMPLETE

All parts, instructions, Soldering Iron, Tester included. 30 Day Money Back Guarantee. **PROGRESSIVE "EDU-KITS" INC.** Room 542-B, Progressive Building 497 Union Ave., Brooklyn 11, N. Y.

Gentlemen: Please Rush me Free Descriptive Literature concerning "EDU-KIT." Also send me Free Radio-TV Servicing Literature. No obligation.

NAME _____
ADDRESS _____
CITY _____ ZONE _____ STATE _____

Get info..

PLASTIC LAMINATING AT HOME!



THIS MAN ... is taking out of the machine a Plastic Sealing Job — ordered by mail — only 11c in material cost brings back \$2.58 in cash by mail. Capacity of machine: **\$25.00 profit per hour of operation.**

Get **ORDERS** and **CASH** from your mailman—do work in **SPARE TIME** at home—or expand into **FULL TIME** business. Send coupon for Free facts about the newest and most fascinating of all home operated businesses. For the first time a simplified machine brings the fabulous profits of Plastic Sealing and Plastic Laminating within the reach of the small operator. Anyone can learn to operate the machine with a few minutes practice—then with our **Magic Mail Plan** can get mail orders pouring in daily with cash in every envelope. **No canvassing—no selling.** We even

Make \$20 to \$30 a Day by..
MAGIC MAIL PLAN!

supply the circulars you mail to bring back cash and orders. Don't waste a minute. Rush your name. We'll send you **FREE** and postpaid, pictures, prices, details, and all the facts you need to start. Mail coupon or send name on postcard. No charge. **Warner Electric Co., 1512 Jarvis Av., Dept. L-102, Chicago 26, Ill.**

Make Thousands of Beautiful Art Creations

COSTUME JEWELRY • CIGARETTE BOXES TRAYS • CANDLESTICKS • COASTERS LAMP BASES • BOOK ENDS...ALL IN SPARKLING COLORED PLASTIC



WARNER ELECTRIC CO., 1512 Jarvis Av. Dept. L-102, Chicago 26, Ill.

At no cost to me, please rush complete details postage prepaid. I am under no obligation.

Name _____
Address _____
City _____ Zone _____ State _____

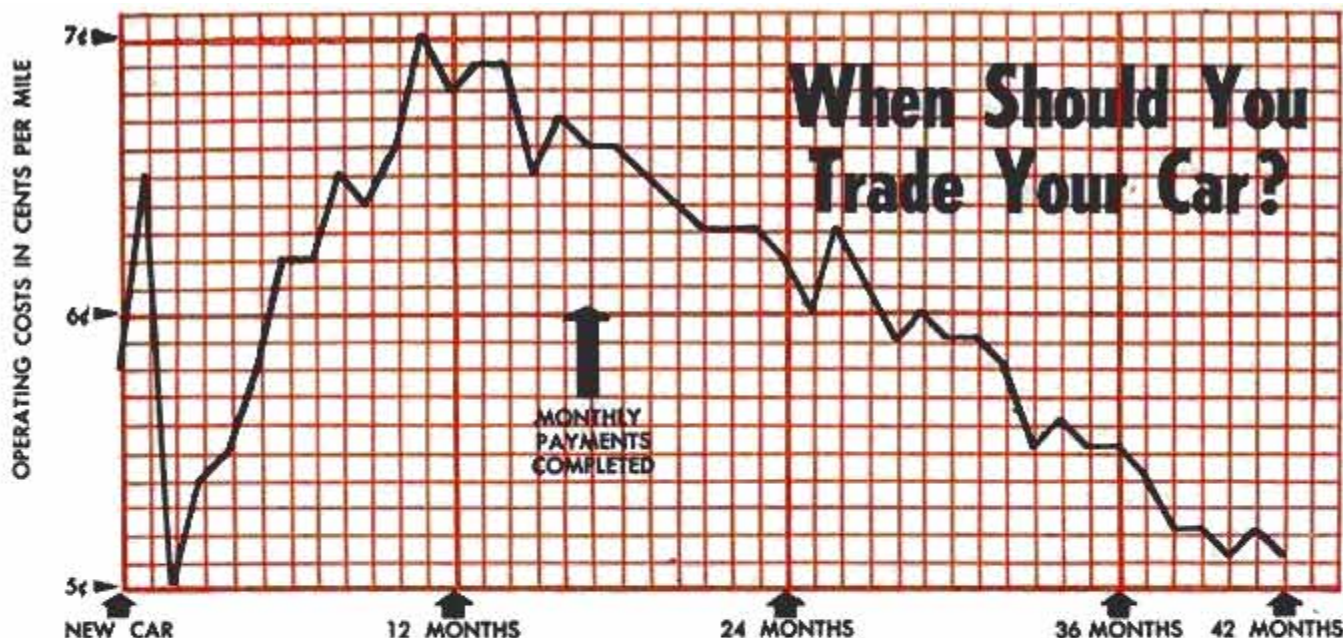

Every month, A. B. Kennerly of College Station, Tex., draws a short line on a graph to help him decide when to buy a new car. He plots on the graph the cost per mile of operating his car. At the end of each month he totals his expenses (he pays all car bills by check for convenience in record keeping) and divides the amount by the number

of miles traveled. The resulting figure is plotted on the graph. Not included is depreciation because he believes it would affect monthly variations little. It would merely raise the whole line on the scale. Costs leveled off at about the 38th month. If they begin to climb again, he plans to consider trading for a new car.

\$9500 Worth of Instruments on Hobbyist's \$5600 Automobile

Instruments on dashboard on car of Ralph E. Davis, Port Arthur, Tex., tell everything about car except blood pressure of passengers. The 53 gauges took eight years to install, even reveal tire temperatures

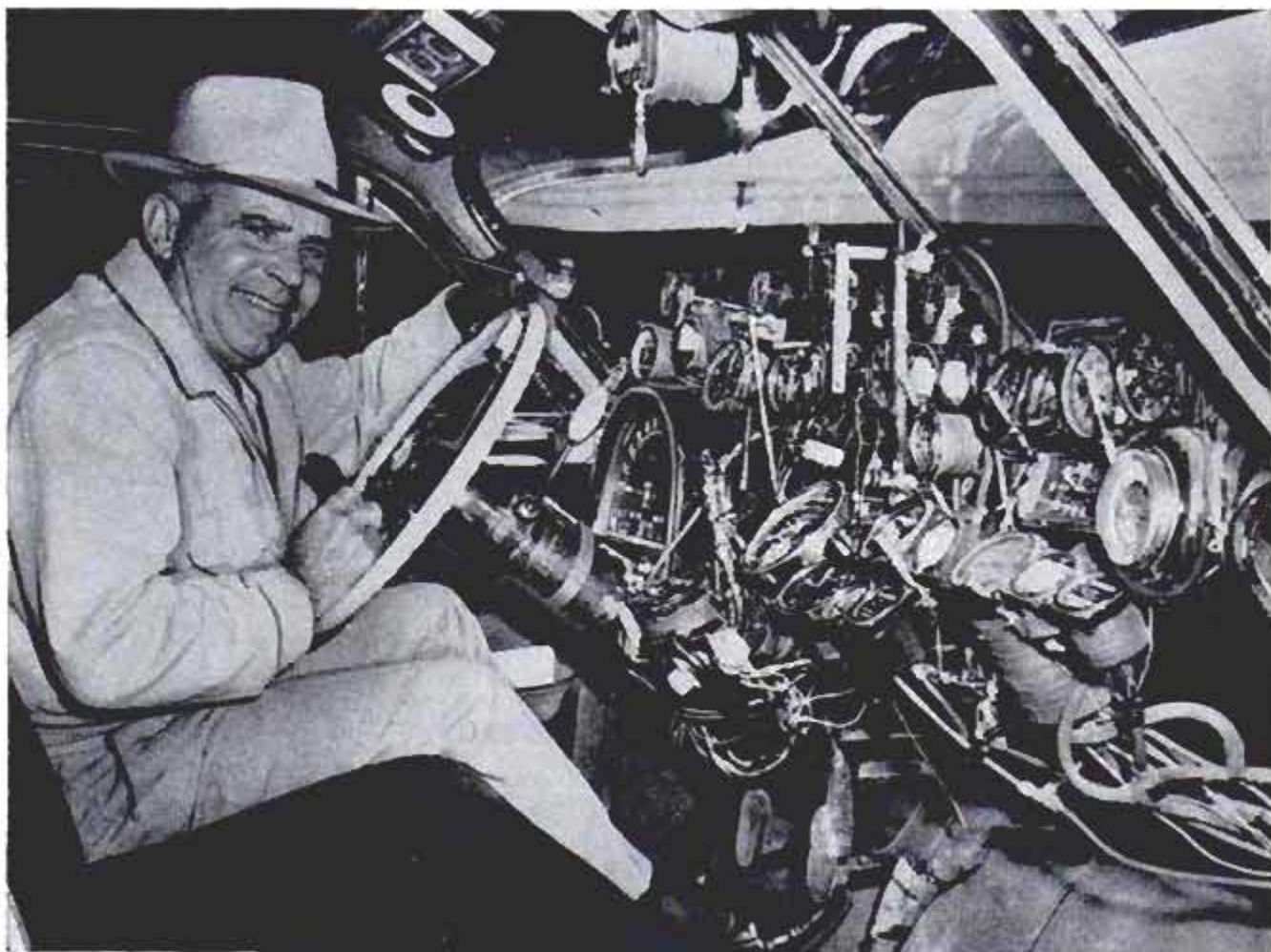

TAKE A TIP FROM

ED
DODD

creator of
MARK
TRAIL



See the sensational new Feather Crafts for '56. Nineteen models for sports and fishing, all built of rugged aluminum for lasting beauty, lasting pleasure. Write for brochure or contact your dealer.

Feather Craft, Inc.

445 BISHOP ST. N.W., ATLANTA, GA.
IN CANADA: FLEET MFG. LTD., DEPT. PM
BOX 300, FORT ERIE, ONTARIO

MAKE UP TO \$20 A DAY WITH



EASISHARP

Big profits in your spare time sharpening scissors. We show you how to start making money immediately. This is your chance now to have your own business and a steady income. Sharpen a pair of scissors in less than two minutes. A child can operate it. Weighs only 10 lbs. Every home, barber,

MONEY
MAKING
SALES PLAN FREE

tailor, dressmaker—everybody uses scissors and all need sharpening two to four times a year. Don't let some one else beat you to this opportunity. Write immediately to
SERR-EDGE MACHINE CO., 9731 Lorain Ave., Cleveland, Ohio

HELPFUL BOOKS

Send post card asking for **FREE** catalog

Popular Mechanics Press, 200 E. Ontario, Dept. 601, Chicago 11

SALE

15 X 65 Regularly \$59.50
Save \$10.00

Tremendous power. Brings objects 15 times closer! Wide field 65mm objective lens... almost 3" across! Easy to hold—focus. 8 1/2" x 9". Exclusive with UNITED. Regularly \$59.50. **SALE PRICE \$49.50** FOR THIS SALE ONLY. Made in Japan. USE including case, straps! Made in Japan. USE 30 DAYS. If not satisfied return for refund.

UNITED BINOCULAR CO.
9043 S. Western, Dept. ARS-9908,
Chicago 20. DEALERS WANTED.



Pocket Hundreds of Extra Dollars With New

AUTO SAFETY BELTS

H.H. Emerson of Ohio
sold 48 Belts
first day out!



G. Krane of Texas
sold 288 belts
in 3 weeks!

Salesmen urgently needed to fill big demand for new **FUTURELINE** Safety Belts. 3 average sales in a day can bring you up to \$45.00 cash profit. Big opportunity open for you introducing newest, safest 100% nylon Safety Belts. We give you everything you need to start earning quickly. Write for all details **TODAY!**

FUTURELINE 173 West Madison Street
Dept. W-8, Chicago 2, Ill.



FREE IMPORT
FLOWN from
the **ORIENT**



To demonstrate your big money-making opportunities on my proved mail order import plan, I'll send you at once *without a penny's cost*, a hand-made import. It sells in the U. S. at 1500% over its cost abroad and there are more than 19 Million customers for products in that line here.

THOUSANDS OF BIG-PROFIT IMPORTS

The import I'll send to you Free is only one example with a huge market in the U. S. Perfumes and accessories from Paris—gift specialties from almost every country in the world—clocks and cameras from Germany—Sheffield silverware from England—hand-wrought brassware from India—steel cutlery from Sweden—all costing less than \$1, have values up to \$5 or more here and are big sellers by mail order.

EXPORT PAYS WELL TOO

Little wonder that World Traders make tremendous profits on these low cost, high quality products. Now you, too, may enter this richly rewarding business with my personal guidance and help. I'll show you *how—and exactly where*—to get big profit imports. Also how to export needed products made near your home to cash buyers in foreign lands.



GET CASH-IN-ADVANCE MAIL ORDERS . . .

. . . with cash enclosed. Pocket your big profits in advance. Pay traders abroad with the balance, to ship direct to your customers. No face-to-face selling. No stocks to carry. Or if you like to make personal contacts with buyers, then import for department or gift stores, etc.—without capital.

YOUR OWN BUSINESS FULL OR PART TIME

Never, to my knowledge, has there been such a fine opportunity for men and women to operate their own businesses without previous experience, spare or full time, from home; or travel abroad. *It's all so exciting and interesting.*

Act Now—ALL 3 FREE!

Mail coupon today for **FREE**, big-profit import—**PLUS** new book "Success Stories in World Trade" **AND** full details. (Only one free import to a person). Air Mail reaches me overnight.

B. L. Mellinger, The Mellinger Co, Dept. F252
1717 Westwood Blvd., Los Angeles 24, Calif.

MAIL COUPON **Now!**

B. L. Mellinger Dept. F252
The Mellinger Co.
1717 Westwood, Los Angeles 24

Send me, without obligation, full details about the mail order import plan, your new book, "Success Stories in World Trade" and **FREE** big-profit import, (only one to a person—none without coupon).

Name _____ Age _____

Address _____

City & Zone _____ State _____

"I made it!"

"I sold it!"

"I bought it!"



"I'M A MANUFACTURER

I make a product that has made a name for itself—and I'm proud of it. What's more, I'm always working to make it better. That's my responsibility *and* my satisfaction—to manufacture *quality* that will always satisfy those who buy my goods

"I'M A DEALER

The best way I know to make my customers my *friends* is to sell brands that have made a name for themselves. A shopper just naturally feels more comfortable buying a brand that has known quality, proved value. And *I* feel more comfortable letting her walk out with it. I know she'll be satisfied—and be back again."

"I'M A CUSTOMER

Every woman wants to feel she's spending her dollars for the right things. This is only good sense and good home management. So I pick brands I feel confident about. A product that's good enough to have made a name for itself is exactly the quality for me. That's what satisfies me most."



"I'm always satisfied most with a Brand that's made a Name for itself!"

BRAND NAMES FOUNDATION, INC.

437 FIFTH AVENUE, NEW YORK 16, N. Y.



For Fishermen A BOAT OF ALUMINUM

An aluminum boat built with you in mind! It's both wide and deep and steady as the Rock of Gibraltar and has permanent live boxes and other fittings fishermen like.

Put a kicker (up to 15 h.p.) on it and away you go . . . for trolling, casting or still fishing . . . it's quiet and easily maneuvered. Little maintenance.

Big as it is, this Starcraft is light and low cost! A real value buy!

Write for 1956 Boat Catalog

STARCRAFT BOAT COMPANY
DEPT. Q-2, GOSHEN, INDIANA

STARLITE
ALUMINUM
BOATS BY...

STARCRAFT

Save on all PLUMBING JOBS

When You Build - When Making
Improvements - Repairs - Maintenance

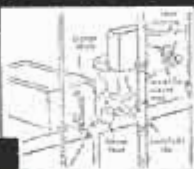

How to plan
plumbing
installations, select
materials
and fixtures.



How to save money on all plumbing
jobs using approved methods.

Easy to Do Professional-Like Jobs
and Save Over One-Half

Get the Popular Mechanics HOME PLUMBING GUIDE. It shows how you can do every kind of plumbing job yourself and save from a few to hundreds of dollars. Covers plans, layouts, installation, maintenance and repair. Shows what materials to get and use, where to get them and how to do a proper job with approved methods. Few, other than the simplest tools are required and some of these can be rented. Don't pay high prices for work you can do yourself. Get the HOME PLUMBING GUIDE for only \$3.50. You will be amazed how jobs you thought difficult are simplified.

Clip This Ad and Mail. Money

Back if Not Pleased
Invest only \$3.50. Use the book for 7 days. Then if you are not satisfied return it for full refund of your money. Sent C.O.D. (U.S.A. only) if you prefer.



Get POPULAR MECHANICS Home Plumbing Guide

15 Ways to Save Money
All about modern home plumbing
How to use plumbing tools
Getting acquainted with pipe
Planning home plumbing systems
Installing and maintaining home drainage systems
Private sewage disposal systems
Causes and cures of drainage troubles
Installing home water lines
Private water supply systems
Water Heaters
Water Conditioning
Water system troubles and cures
Installing and caring for fixtures
What to do with valves and faucets

Over 500 How-to-do-it Pictures Guide You

POPULAR MECHANICS PRESS, Dept. HPG-10, 200 E. Ontario St., Chicago 11

HOW TO GROW ORCHIDS IN YOUR HOME!!!

NO GREENHOUSE NEEDED
YEAR 'ROUND - ANY
CLIMATE - MAINE
TO CALIFORNIA

Home
Growers
Coast to
Coast
Benefit
from
the
Schirmers'
Help

Most enjoyable hobby I know. People drove 100 miles to see this plant . . . 10 flowers, 8 1/2 inches across!

THOMAS HURST—Utah



FILL YOUR HOME WITH ORCHIDS... EVERY MONTH OF THE YEAR.

Successful family of home growers now reveal their secrets for your pleasure and profit. Learn the exciting facts about raising beautiful Orchids at home . . . how to grow dozens of varieties in every rainbow color . . . have Orchids in full bloom every month of the year! Many grow without soil, getting food from the air. No Greenhouse Needed. Start on table or window ledge.

THRILLING HOBBY—EXCITING HOME BUSINESS. Imagine the delight of watching gorgeous Orchids burst into bloom right in your own living room! The big lavender corsage Orchids you see in every flower shop—also many others in all sizes and colors. Orchids for your own enjoyment, for gifts or to sell at good profits.

FINE PROFITS—ANY LOCATION—RETAIL—WHOLESALE—MAIL ORDER. Learn how to market your Orchids for profit, no matter where you live—small town, big city, or on a farm. Millions sold by mail order, year 'round. Tropical Flowerland's "Quick-Profit Plan" helps you get started at once, without investment in stock. No overhead.



My Orchids are doing fine. I sell many blooms and haven't really started to try yet. I owe my success to the Schirmers.

MRS. FRANK HARWOOD—Oregon



LOUIS and GLADYS SCHIRMER
SUCCESSFUL HOME-GROWERS, SAY:
"We'll Show You How We Raised
Orchid Plants Worth a Fortune—
Starting At Home in Spare Time."



Orchids offer rich reward in beauty. There is financial reward for one interested commercially, as I am. Thanks a million for everything.

MR. S. V. SMART—Colorado

FUN FOR ALL THE FAMILY. It's great fun to grow Orchids. And the whole family can help—from teen-agers up. Mr. Schirmer himself is over 60—was nearly 50 when he and Mrs. Schirmer first started to grow Orchids for profit.

LEARN HOW ORCHIDS MULTIPLY. Learn how one plant may become many, each as valuable as the first! Flower production and plant stock should both increase steadily—year after year—and so should your profits!

COMPLETE INSTRUCTIONS and Blooming-Size Orchid Plant Sent for You to Examine at Home without Risk!

Airmail coupon today for amazing offer of Complete Home Course and a real blooming-size Orchid plant for you to examine at home without risk! Nearly 300 large-size pages, filled with "show-how" drawings and photos—many in full color. Shows you how to grow 30 different kinds of Orchids at home, and market them for extra income—spare or full time. Send no money—fill out and send in the coupon. Airmail is quickest.

TROPICAL FLOWERLAND, Dept. 312, 4422 Wilshire, Los Angeles 5, Calif.

FREE—AIRMAIL THIS COUPON NOW!

TROPICAL FLOWERLAND, Dept. 312
4422 Wilshire Blvd., Los Angeles 5, Calif.
Please rush FREE details on your offer of Louis & Gladys Schirmers' instructions which show me how to grow Orchids at home. The instructions will include a real blooming-size Orchid plant and valuable "Quick-Profit Plan"—all sent for me to examine at home without risk. This request does not obligate me in any way.

Name _____
Street _____
Town _____ Zone _____ State _____

I have standing orders for future flowers and divisions of this plant. I shall always be grateful to the Schirmers.
MRS. ROBERT E. LEE—Ohio
Los Angeles 3, Calif.

USE ALL 24 VOLUMES NOW

Pay on Easy

Book a Month Payment Plan

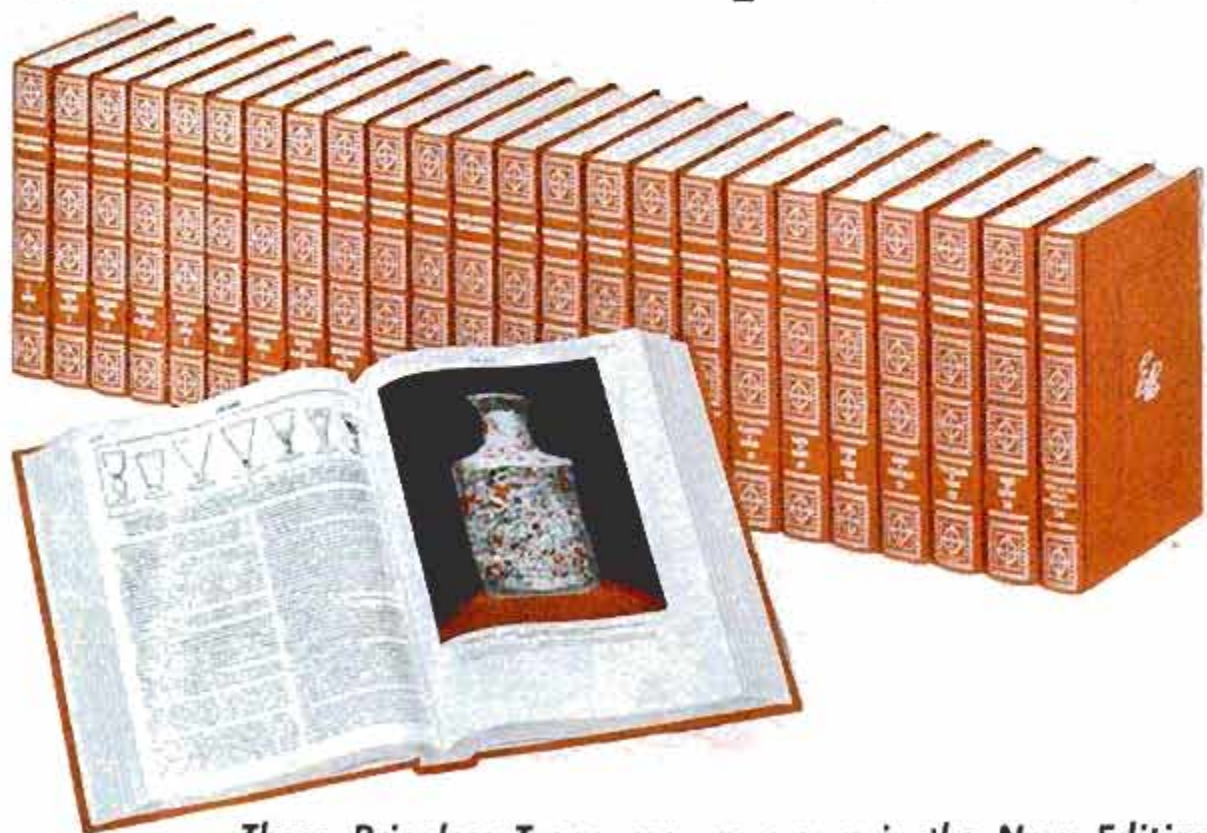

These Priceless Treasures are yours in the New Edition of

ENCYCLOPAEDIA BRITANNICA

**ACCEPT
PREVIEW
BOOKLET OF
NEWEST
EDITION**

Britannica will provide instant and authentic information on every conceivable subject . . . thought . . . or study.

It will assure every member of your family the constant companionship of the world's greatest minds as your consultant or teacher.

It will build self-confidence . . . help all members of your family to understand . . . and talk intelligently upon *every* subject that enters into the lives of successful men and women.

Britannica will enable parents to work more closely with their children at home . . . helping them build a more solid foundation in today's highly competitive society. Leading educators say too many parents leave the entire educational job up to the teacher at school.

Britannica will help every member of your family to develop informed and sound thinking.

ACCEPT PREVIEW BOOKLET OF NEWEST EDITION

Send now for Free 32-page Preview Booklet, giving you, without obligation, a new conception of how valuable the ENCYCLOPAEDIA BRITANNICA can be in your home.

**Mail Coupon
today! HURRY!
While beautiful
FREE
Booklet
Lasts!**



ENCYCLOPAEDIA BRITANNICA INC., DEPT. 6-D
425 N. Michigan Avenue, Chicago 11, Illinois

Please let me have the FREE PREVIEW BOOKLET and complete details about the Book a Month Payment Plan. There is no obligation.

NAME

ADDRESS

CITY ZONE STATE

In Canada, write E. B. Ltd., Terminal Bldg., Toronto, Ont.

**WORLD'S
BEST
WANT-AD
MEDIUM**

CLASSIFIED ADVERTISEMENTS



Advertisements in this section \$1.25 per word, each insertion, minimum 10 words, payable in advance.

To be inserted under proper classification, copy must be in our office the

20th of the second month preceding date of issue

F. W. Johnson, Manager, Classified Advertising

Popular Mechanics Magazine, 200 East Ontario Street, Chicago 11, Illinois

YOU'LL PROFIT

By reading and answering the classified ads in this section. Hundreds of opportunities for you to make and save money

AUTOMOBILES, MIDGET CARS

WORLD'S Lowest priced children's electric driven autos. Send 25c for details. Dealers wanted. Frankford Products, Dept. A, 3331 Frankford Ave., Philadelphia 34, Penna.

NON-Profit organization offers automobile literature—Old, new and foreign; dealer books, service manuals, glossy photographs. Write today: get on free mailing list. Auto Maniacs, Stockbridge, Mich.

AUTOMOBILES, Brand new 1956, 15% discount. Proposition, stamped envelope. Auto Dyer, Livonia Branch, Detroit, Mich.

ENGINES, Wheels and equipment for midget cars \$10.00 up. Cauffiel Motors, Temperance, Mich.

BUY Surplus cars, Jeeps, parts; direct from government. List \$1.00. Box 1842C, Hartford 1, Conn.

1956 SUPERIGNITIONER Starting, pep, mileage \$4.50. Barbells wholesale. EG, Elmsford, N. Y.

1956 PONTIACS By mail. Buy 1 or 20. Save 26%! Write for factory net prices. Pontiac Fleet Sales, Box 45144M, Airport Station, Los Angeles.

ANTIQUA Automobile color slides. 2x2. Illustrated catalog free. Universal. Box 779A, Beverly Hills, Calif.

BOYS' Power-driven auto. Build your own. Plans 25 cents. Sypher Co., Sta. F., Toledo, Ohio.

AUTO SUPPLIES AND EQUIPMENT

AMAZING Invention. "Lachapelle's" 100,000 mile motor treatment. Renews older motors. Increases compression, power. Saves gas, oil, repairs. Only \$3.00 delivered. Money-back guarantee. "You can't lose." Free circular. Write Joe Dillon, Authorized Warehouse, Agents Distributor, Box 23217, Bridgeport, Ohio. Exclusive agencies open.

AMAZING Patented device guaranteed, prevents corrosion, saves battery cables, voltage regulator points, generator, quicker starts, anyone install, big profits, sample \$1.00. Auto Specialty Company, 1227 Wilmington, Salt Lake City, Utah.

CAR Drivers: Amazing chemically treated cloth ends danger of windshield fogging. Keeps car glass crystal clear all year. A must in every glove compartment. Be safe. Protect your own and your family's lives. Satisfaction guaranteed. Large size only \$1. Send \$1.00 cash, check or money order to No Fog, Dept. PM, Box 25, Portland, Conn.

"TRUTH About Safety Belts!" Free. A-P-A, Suite 201-E, 55 East Washington, Chicago 2.

RADIOS, Custom for 1952 through 1956, Fords \$38.90. Free literature. Nordic Radio, Box 582, Evanston, Illinois.

BUY Wholesale 750,000 products. Details free. Carter, Box 6011-AS, Chicago 80.

JEEP Owners—V8 power. Read Jeep Owners ad, page 52.

SENSATIONAL GE-Subzero automobile engine heater starts coldest cars, trucks, tractors immediately. Special \$3.95 (regularly \$8.95). Order for yourself, sell others locally and mailorder. Huge profits. Terrific quantity discounts. Act now! Wisniewski PM Inc., Milwaukee 7, Wisconsin.

KEEP Luggage clean with spare tire cover. Keeps road dirt and grease out of your automobile trunk. Only \$2.50 prepaid. Frankford Products, Dept. C, 3331 Frankford Avenue, Philadelphia 34, Penna.

FORD T parts? Try best source old car parts anywhere. Wisneski, Milwaukee 7, Wis.

BUY Wholesale nationally advertised auto supply, thousands other products at big discount. Free "Wholesale Plan." American Buyers, Hertel Station, Buffalo 16-G1, N. Y.

LATEST Custom accessories. Items not in stores. New low prices. Continental tire kits, push-button doors, trunks, etc. New illustrated catalog, biggest ever, 25c. Eastern Auto, 3319-A South Grand, Los Angeles 7, California.

AUTO Accessory and parts catalog, 1956 edition—All new! 184 pages. Save up to 50%—Over 50,000 items, including Hollywood accessories, hi-speed equipment, rebuilt engines, all parts and accessories for all cars and trucks; Hard-to-get parts! Send 25c (refundable). J. C. Whitney, 1919-PM Archer, Chicago 16, Illinois.

GM71-110 Discarded injector parts wanted. Bonus on HV. Buescher, 7120 Carnegie, Cleveland 3, Ohio.

BRAND New first quality tires. Tractor, truck, aircraft, passenger. Wholesale prices. Also all size army surplus used tires, at tremendous savings. Duddy's, 152 No. Beacon Street, Boston, Mass.

FREE, Illustrated, descriptive information "The Truth About Water Injection." Injector, Box 526, Burbank, California.

ELECTROPLATE Auto parts, novelties, mirrors. Easy, inexpensive home processes. Free booklet, Tyco Metals, Box 13231-BG, Houston 19, Texas.

FREE Discount catalog—Speed, power, custom equipment. Almquist Engineering, Milford TP, Pennsylvania.

NEW And used parts at savings. Complete guaranteed parts service for all models cars and trucks, 1924 and later. Largest in the West. Army parts specialists. No catalog, write for quotations. Fast mail order service. Pioneer Auto and Truck Parts Co., 734 W. 13th Avenue, Denver, Colorado.

AUTO TRAILERS

PICKUP Canopies and coach kits. Trailer blueprints. Literature 10c. Comstock Trailers, 646, Parsons, Kansas.

BUILD Your own trailer! Plans for all kinds. Illustrated catalog 10c. Jim Dandy, 125-M, Wausau, Wisconsin.

TRAILER Manual construction plans \$1.00. Booklet 25c. Craftsmann Books, Box 1153, Milwaukee 1, Wis.

EXCEPTIONAL Expanding eight foot trailer. Accommodates family of five. Build yourself. Literature 10c. Framar Company, Wilmington, Mass.

MOTORCYCLES, BICYCLES, MOTORSCOOTERS AND SUPPLIES

WHIZZER Motors \$20.00; midget race car reasonable; motorscooter \$6.00; Cushman two-speed \$20.00. Send 25c (35c first class mail) for catalog #29 jammed with sensational bargains in wheels, motors, motorscooters, midget cars, motorbikes, construction plans, etc. Gail, 1313 Jefferson, Toledo, Ohio.

MOTORCYCLES And supplies. Complete service. Free bulletins. Cycle Co., 813 Ohio Ave., Wichita Falls, Texas.

HARLEY-Davidsons—America's finest used bargains! We pay shipping on motorcycles. Genuine new, used parts, accessories for current and obsolete models. Send 25c for bulletin, catalog. Knuth's (factory dealer), 1753 Muskego, Milwaukee, Wis.

WHIZZER Motorbike engine \$5; midget car \$25; Micromidget racer \$65; Briggs Wagonmobile \$19; Doodlebug motorscooter \$15; (mailorder only). Send 25c (35c for first class mailing) for directory-catalogue Number 69, listing these and hundreds of other bargains. Midget Motors Directory, Athens, Ohio.

MOTORSCOOTER Parts—Send 50 cents for price list, refunded first order. Give year and model. MotorScooter Parts Co., Box 7211, Indianapolis 1, Ind.

RECONDITIONED Motorcycles and motors. Chromium accessories. Complete stock Indian parts. Expert rebuilding. Fast service. Indian Motorcycle Sales, Kansas City 21, Missouri.

AVIATION

PROPELLERS Specially designed for airboats and snow sleighs by the world's oldest manufacturer of aircraft propellers. Free literature. Flottorp Mfg. Co., G. R. Airport, Grand Rapids 8, Mich.

LIGHTPLANE Manual construction plans \$2.00. Circular 25c. Craftsmann Books, Box 1153, Milwaukee 1, Wis.

PROPELLERS, Plans, supplies for air boats, snow sleighs. Catalog 10c. Gano Propellers, Box 3284-A, Ft. Worth, Texas.

AIRLINE Steward-purser. Fly 85 hours monthly. Starting salary \$235 up. G.I. approved. Free catalog. Air-Purser School, Room R, 1030 Nicollet Ave., Minneapolis, Minnesota.

MAKE Big money with light plane. \$1.00 tells how. Charles Eichhorst, Dakota City, Nebraska.

PROPELLERS, Plans, supplies—World's oldest and largest manufacturer of special design airboat, snow sleigh propellers. Prompt delivery. Satisfaction guaranteed. 48 page catalog 25c. Banks-Maxwell, Box 3301E, Ft. Worth 5, Texas.

AVIATION Surplus bargain catalogue. One dime. Box 22-S2, Thomasville, Penna.

BATTERIES, GENERATORS

EDISON Nickel storage batteries. Any voltage, any amperage. Unconditionally guaranteed. Power plants, generators, motors. Literature. Hawley Smith Co., Croton Falls 1, N. Y.

ELECTRICAL SUPPLIES

LAMPS—25c Brings bargain catalog showing all parts for repairing, building. Contains instructions for electrifying vases, oil lamps, etc. Gyro Lamps, 5402P Clark, Chicago 40.

LAMP And electrical parts—Wholesale. Thousands of items for building, repairing, and converting lamps. Illustrated catalog 25c. Brown Lamp Co., Box 501, Wellston Sta., St. Louis 12, Mo.

ELECTRIC Pencil: Engraves all metals \$1.50. Beyer Mfg., 10511-H Springfield, Chicago 43.

NEW 1956 Lamp parts catalog showing everything you need to make and repair most types of lamps. Everything at lowest wholesale prices. Send only 25c today for both catalog and wholesale price list. Gearon Co., Dept. 503-B2, 27 S. Desplaines, Chicago 6, Ill.

TELEPHONE Transmitter. Hand set type. Suitable for inter-house phones, speakers or any communication purpose. Delivered two for \$1.00. No. c.o.d.'s. Telephones, Dept. C-425, 1760 Lunt, Chicago 26.

WELDING, SOLDERING, PLATING

A.C. Welders. 4 sizes. Lowest prices. Free literature. Holgeron's Serv., Canton, Kan.

WELDERS, 110/220, \$39.50. Morris, 1070 Inner Drive, Schenectady 3, New York.

ACETYLENE Welding outfits, new \$49.00; used \$29.00; arcwelders \$56.50. Eagle Welding, Dept. PM, 5085 Broadway, Chicago 40, Ill.

ELECTROPLATING Equipment, anodes and solutions for all types of plating. Instructions. Assemble your own plater and save. Free catalog. Ramyr, Dept. E-4, 1624 East First Street, Los Angeles 33, California.

"BUILD-UR-OWN" a.c. welder and a.c. power plant with a good used engine and low cost Hobart generator. Welds anywhere and supplies 5 kw stand-by power for any emergency. Write Hobartweld, Box M-263, Troy, Ohio.

NEW All-in-one oxyacetylene outfit welds sheet, plate; cuts heavy steel; heats; brazes. Uses interchangeable tips. Portable, easy to operate. Complete with instructions, \$76.50. Gas cylinders on special moneysaving plan. Write for free information: Dept. M, Linde Air Products Company, 30 East 42nd Street, New York 17, New York.

MACHINERY, TOOLS, SUPPLIES

MAGNETIC Tool—Pencil type. New, amazing, powerful. Picks up small parts. Hundreds of uses. Ideal for mechanics, radio-television repairmen and hobbyists. 69c post paid. Empire Magnetics, Inc., 107 E. Clinton Street, Maumee, Ohio.

TREE Farmer chain saws, new, 20" size \$169.50. Aircraft Specialties, Coatesville, Penna.

WHOLESALE Tool catalog. Send \$1.00. Yuhas, 3350 Theodore, Detroit 11, Mich.

BIG Factory catalog! Buy direct—Save middleman's profits; hundreds of labor saving tools and equipment; tremendous savings. Send 10c. Master Mechanic Mfg., Dept. CL-112, Burlington, Wis.

HARDWARE Tools, brass, steel, drill rod. Free catalog. Terek, 6304 Patterson, Chicago 34.

LAWNMOWER Grinder: New, fast, different. Heavy duty. Only complete mower shop. Includes grinder, lapper, "Lightning" bed knife grinder, built-in bench. Write Turner-Cline, 430 Yellowstone, Pocatello, Idaho.

BUILD-UR-OWN hydraulics. Plans 10c including big catalog hydraulic-kits, welder-kits, motors, generators, winches. Dunbar Mfg., 6602 Sylvan, Houston 23, Texas.

AIR Compressor. Build yourself. Circular AC-2. Little Machines, Hamilton, Michigan.

MILLING Attachment, South Bend, Atlas 9", 10" lathes. Castings, stock, instructions \$7.50 postpaid. Literature: Floyd McGuckin, 314 Monroe, Ridgewood, N. J.

SURVEYING INSTRUMENTS

GUARANTEED Factory rebuilt transit and levels, sale or rent, with purchase option. We will repair, trade or buy old instruments. Write for list M-62, Warren-Knight Co. (Manufacturers of Surveying Instruments), 136 N. 12th St., Philadelphia 7, Penna.

ENGINES, MOTORS, DYNAMOS

STANLEY Steamer engines for sale. Write, Jack Gaughan, Sistersville, West Virginia.

REBUILT 1½ And 3 h.p. engines \$17.00 to \$37.00. Cauffiel Motors, Temperance, Michigan.

WINDING Data. 225 motors, single and three phase, \$1.00. Data Company, Box 7631, Kansas City 28, Mo.

REWIND Motors yourself. Complete instructions \$1.00. Lewis Mfg., Howell, Michigan.

BOATS, OUTBOARD MOTORS

BOAT Plans, patterns, frame kits. Modern inboard and outboards 11'-22' for amateur builders. State requirements or send 40c for complete catalog. Glen Designs, Box 568, Compton, Calif.

OUTBOARD Motor parts—New, used for all makes. Send list of parts needed. Enclose stamp. We save you money. Outboard Motor Mart, Inc., 229M State Street, Boston, Mass.

WHOLESALE! Sea Legs boat kits, factory prices from \$31.98. Savings to 25%. Pre-assembled frames, pre-cut parts, illustrated instructions. Penney Woodcraft Industries, Dept. C-48, Defiance, Ohio.

BUY Wholesale nationally advertised outboards, thousands other products at big discount. Free "Wholesale Plan." American Buyers', Hertel Station, Buffalo 16-HI, N. Y.

FULL Size, cut-to-shape boat patterns, blueprints, 7½-38 feet. New 1956 illustrated "Build a Boat" catalog of 50 naval architect-designed cruisers, runabouts, sloops, skiffs, outboard boats, sailing, racing, houseboats, 50c. Small boat hardware catalog, \$1.50. Bigger, better 1956 "How to Build Boats" book, \$2.50. Cleveland Boat Blueprint Co., Dept. A-66, Box 1651, Cleveland 4, Ohio.

FREE Instructions. Boat docks. Built, installed out of water. Dock Products Company, 3422 26th Avenue South, Minneapolis, Minnesota.

FREE Catalog! Boat kits, trailers, fiberglass, marine hardware. Luger Industries, Dept. M, 4452 Nicollet, Minneapolis, Minn.

MARINE Conversion, Willys to Cadillac, engines, kits and parts. Catalogue and conversion hints free. Barr Marine, 2706 Castor Avenue, Philadelphia 34, Penna.

JOHNSON Outboard specialists. Used parts for all models at substantial savings. Prompt quotations. Specify model serial. Crandall-Hicks, 910 Commonwealth, Boston, Mass.

PLYWOOD Boat plans, 21 for \$1.00. Catalog boat building plans 25c. The Rudder, 15 Murray Street, New York 7.

FIBERGLAS Permanent boat waterproofing. Lowest wholesale prices. Guaranteed materials. Easy application. Full instructions. Complete kits, \$12.60 up. Free literature. Ajax Plastics, Dept. PM, P.O. Box 1323, Fort Worth, Texas.

NEW, Used, rebuilt marine motors. Marine conversions, fittings. Free catalog. Stokes Marine Supply, Dept. 24, Coldwater, Michigan.

MARINE Conversions for Ford and Jeep engines. Catalog 25c. Lehman Manufacturing Company, 972D Broad Street, Newark 2, New Jersey.

BOAT Plans. Welded steel, wood, plywood. Inboards, cruisers, sail. Free literature. Please specify size-type. John B. Clark, N.A., Box 51, Bay Village, Ohio.

NEW! High performance kit boats, Fiberglass, paint, boat hardware, and accessories. Catalog 35c. Marine Associates, Box 6188MP, Long Beach 11, California.

FORDS And Jeeps 100% marine engines with famous Convo-Kits. Deluxe catalogue 25c coin. Oscomotors, 3627B Lawrence, Philadelphia 40, Penna.

AIRPLANE Floats, pontoons. Rubber boats. Catalogue 10c. Box 22-S5, Thomasville, Penna.

FIBERGLAS boat coating. Plexiglas boat windshields—clear, blue, green tints. Wholesale-retail. Complete information catalog—15c. Gem-O-Lite, Box 686M, North Hollywood, California.

MARINE Conversions Ford and Jeep. Catalog 25c. Discounts. Gershel, Ocean-side, N. Y.

FIBERGLASS Top marine grade. Yard or kit. Ontario Fiberglass Co., Ontario, N. Y.

ATHLETIC EQUIPMENT, BODY BUILDING COURSES

OUTSTANDING Physical development! "All you need is a rope!" Oriental secret discovered! Strength, health, gain, reduce. Free exercise. Roperise, 4834 Art St., Room 105, San Diego 15, California.

MUSCLE Development while sitting any car or chair through "Applied Pressure." Amazingly simple method shown in copy-righted, illustrated booklet. No equipment used! Refund guarantee. \$2.00 to Mathias, Box 206, Miami 47, Florida.

INCREASE Your height! Coach's "Inch-At-A-Time" system, \$1. Marty Snyder, Box 195, Union City, New Jersey.

100 TRICK Knockouts for self-defense \$1.—1c each. Priest, Box 251, Evanston 1, Illinois.

FREE Catalogue. 10c for postage appreciated. Dr. Thompson, 919 Fourth, Manhattan 30, Kansas.

SPORTING GOODS, GUNS, FISHING TACKLE, ARCHERY, TRAPPING

FISHERMEN Catch your limit every time. Our free 1956 catalog tells you how. Hergert Company, Box 741, Coral Gables, Fla.

MOLDS For fisherman's sinkers, jigs, squids, casting and spinning lures. Free catalog. Sweet's Molds, Tonawanda 1, New York.

NYLON Rope, lines, cords. Every description for all household and sportsmen's uses. Finest made. Free catalog and samples. Beebe Cordage Co., Cranford 8, N. J.

GUNS! 3000 Guns! Winchester, Colts, Lugers, arms, armor, big bargains! Catalog 50 cents. Agramonte's, 201 Warburton Avenue, Yonkers 2G, N. Y.

BUY Wholesale nationally advertised sporting goods, thousands other products at big discount. Free "Wholesale Plan." American Buyers', Hertel Station, Buffalo 16-II, N. Y.

TENTS (Direct from manufacturer), camping equipment. World's largest selection. Send 15c for 100 page 1956 tent and camping equipment catalogue-handbook. Morsan Tents, 10-21R 50th Avenue, Long Island City 1, New York.

OLD Guns. Current prices. Free catalog. Pioneer Books, Harriman, Tennessee.

LEARN Gun repairing at home. Profitable business. Details 10c. Modern Gun Repair School, Box 430-P, Marshfield, Wis.

FREE. Fishing catalog. Luremaking tools, beads, spinners, sinker molds, bargain spinning outfits. FinnySports (MP), Toledo 6, Ohio.

ARCHER'S Free new illustrated catalog. Pride Archery Company, R.F.D. #1, Danbury, Connecticut.

180 PROFUSELY Illustrated pages antique pistols, swords, daggers, armor, etc. 50c. Robert Abels, M860 Lexington Ave., New York 21.

MOLDS—For making fishermen's sinkers. Free illustrated booklet. Reading Instrument Co., Box 78, Reading, Penna.

5000 BARGAINS, Firearms, binoculars, war relics. Catalog 50c. Smith Firearms, Runnemedde, N. J.

BUY Wholesale 750,000 products. Details free. Carter, Box 6011-SG, Chicago 80.

JEEP Owners—V8 power. Read Jeep Owners ad, page 52.

JAP Rifle altering to 30-06, \$6.00. Japshells, \$3.75. Catalog 5c. T. P. Shop, West Branch 11, Mich.

FISHING Tackle—30% to 50% off! Also guns and camping equipment. Cash or credit. Free bargain catalog. Write to: Klein's, Dept. C-M, 227 W. Washington St., Chicago 6, Ill.

FREE Fishing catalog—132 pages. Over 3000 hard to find fishing specialties. Netcraft Company, Dept. PM2, Toledo 13, Ohio.

OUTDOORSMEN, Most warmth, least cumbersome weight, tested in Korea. Weierbach, 605 N. Eighth St., Allentown, Penna.

BINOCULARS, TELESCOPES, MICROSCOPES, MAGNIFIERS

BINOCULARS, Telescopes, microscopes. Terrific values, \$3.98 up. Request free money saving catalog. Criterion, Dept. P-38, Hartford, Conn.

AMAZING Prices binoculars, gunscopes. Free trial. Folder "Binocular Selecting," catalog free. Prentiss Importers, Mercury Bldg., West Los Angeles 25, Calif.

DYNASCOPE—Sensational new reflector telescope. Send for details. Criterion Co., Dept. DP-17, Hartford, Conn.

REFLECTOR Telescope kits \$6.25 (3") to \$175. (12"). Mirrors, cells, focusing mounts, tripods, eye-systems. Anything, everything in telescopes. Free illustrated catalog. Also ready to use telescopes from \$26 to \$176. Inquiries to Esco Products, Dept. PM, 1428 Willow Ave., Hoboken, N. J. Sales showroom, 166 Church St., New York City.

SAVE 25%! America's largest selection. Free 56 page 1956 binocular catalog. \$3.95 to \$250.00! United, 9043 S. Western, A-9808, Chicago 20. Dealers wanted.

400 POWER Telescope easily made. Kit includes focusing tube, erector, five finished lenses and instructions—\$3.75. Giant astronomical telescope complete with tripod \$15.00. Free information. Suffolk Science, Mattituck 3, N. Y.

BUILD Your own reflector telescope. Complete kit: mirrors, eyepieces, tripod, all other accessories. Request free illustrated literature. Criterion Manufacturing, Dept. KPM-14, Hartford, Conn.

WAR Surplus bargains! Millions of lenses, instruments, telescopes, binoculars, components and complete line of astronomical telescope items. World's greatest optical market place! Send only \$1.00 for beginner's 10-lens kit and big instruction booklet Stock 2-CH. Write for catalog CH. free! Edmund Scientific Corp., Barrington, New Jersey.

MICROSCOPES, Binoculars, telescopes, everything optical and photographic at importers price. 25c catalog. Magnification Instrument Co., 2 East 45, New York City.

PETS—DOGS, BIRDS, RABBITS, HAMSTERS, ETC.

HAMSTERS—Golden: young, \$3.00 pair; fully developed, \$4.00 pair. Adirondack Hamstery, Prospect 136, New York.

MAKE Money. Learn to breed pets, any kind. Monthly magazine over 114 pages monthly. Sample 35c. Year \$3. Catalogue 10 listing 400 pet book titles. 25c. All-Pets Magazine, 10 Darling Place, Fond du Lac, Wisconsin.

AMERICAN Pigeon Journal, Warrenton 3, Missouri. Raise pigeons profitably. \$2 year.

RAISE Rabbits successfully by knowing facts. 48 page illustrated book describing 25 breeds. Housing, feeding, breeding, marketing, etc. Plus bulletin. 25 cents. American Rabbit Association, 36 Arba Building, Pittsburgh, Penna.

1000 BRED Mink—Booklet plans 20c. Wettlaufer, Gravel Road, Webster, N. Y.

HUNTERS! Raccoon Mountain and Short Creek kennels now combined. Large number of coonhounds, foxhounds, rabbit-hounds, beaglehounds, bird-dogs, puppies. Free literature and pictures. Trial. Dures Thomas, Owner, Box 464, Boaz, Alabama.

RACCOONS, Minks—Bred females. Baby skunks. Catalog 25c. Shady Fur Farm, Springfield, Minnesota.

EXTRA Money raising Angora, New Zealand rabbits. Write Martin's Rabbitry, Morganfield, Ky.

BEAUTIFUL Pure white pedigreed police puppies. Ansonia Kennels, Mose, N. Dak.

STANDARD Rabbit Journal, Milton 3, Penna. Year \$1.00. Sample dime. Beginners manual 25c.

MINK Raising information free. Complete. Lake Superior Mink Farm, Superior, EE1, Wisconsin.

MAKE Big money! Raise Chinchilla rabbits. Cash markets supplied. Write today! Rockhill Ranch, Sellersville 15, Penna.

CHINCHILLAS—Registered sturdy stock. Wholesale. One or one hundred pairs—\$75.00 pair. Slater Chinchillas, 1535 Ruhland Ave., Manhattan Beach, California.

CHINCHILLAS, Registered. Unbelievable prices. Far-West Chinchilla, 1446A Jones, San Francisco 9, California.

RAISE Moneymaking Angora, New Zealand rabbits. Particulars free. White's Rabbitry, Jackson, Mich.

MAKE Money raising chinchillas, mink, pigeons, rabbits, cavies for us. Free catalog. Keeney Brothers, New Freedom 2, Penna.

MONKEY Special \$19.95. Demused skunks, pigmy skunks, \$12.00. Baby alligators \$3.50 postpaid. Free price list. Thompson Wild Animal Farm, Clewiston, Fla.

COLLIES, Shepherds, bulldogs, rat terriers, monkeys. Pete Motley, Wadley, Ala.

\$5,199.90 WAS Paid to John Betts, in few weeks. Grow mushrooms. Cellar, shed. Spare, full time year round. We pay \$3.50 lb. Free book. Mushrooms, Dept. 171, 2954 Admiral Way, Seattle, Wash.

AMERICAN Rabbit Journal, Warrenton 3, Missouri. Raise rabbits profitably. \$1 year.

PLANTS, SEEDS, NURSERY AND GARDEN SUPPLIES

GREEN Thumb opportunity. Hobbyist offers entire Canna crop. 88 varieties including pastels, mutations, new rare varieties. Many thousand bulbs. Special selections: Grand opera suite pastels, five varieties \$3.95. Fifty leading varieties \$19.95 postpaid. Z. Pettet, 322 E. Oregon Ave., Phoenix, Ariz.

TREES And shrubs. Raise your own from seed for shade, windbreak, snow fence, ornament, erosion control, etc. For free planting guide, pricelist, write Woodlot Seed Co., Norway 9, Michigan.

WORLD'S Greatest cash crop. Free information. Write Ginseng Gardens, Asheville, N. C.

TEN Years proved new method on lawn seeding and repairing. For full particulars, send \$2.00. P.O. Box 36, Station F. Milwaukee 9, Wis.

GLADIOLUS Hundred Redwood Empire bulbs, or fifty Giant Muskmelon or Rainbow Sweetcorn \$1.00. Gadhaven, Sebastopol, California.

FARMS, FARM LANDS, REAL ESTATE

A Large tract of land in northern Wisconsin with frontage on the Turtle Chain on a wide channel between several lakes. 3 acres of land, beautiful timber; commute to many lakes by boat or canoe from this location. Price \$480. \$10 down, \$10 per month. If property is found unsatisfactory after looking it over, all money paid in will be refunded. Art Schmidt, Park Falls, Wis.

FLORIDA—Beautiful retirement homesites near gulf coast. Excellent hunting, fishing in 9 fresh and salt water rivers. 11 bays and gulf. \$250 at \$10 monthly. Free literature. V. M. Mathews, Box 1406, Asheville, N. C.

FLORIDA Bargain homes. Low taxes. L. O. Cummins, Box 848, Eustis, Florida.

STROUT Catalog—Mailed free! Farms, homes, businesses, 36 states, coast-to-coast, 2,914 bargains described. World's largest; 55 years service. Strout Realty, 7-MF So. Dearborn St., Chicago 3, Ill.

CANADIAN Tax sale lands for three dollars an acre and up. Small monthly payments. Farms, timber, hunting and fishing camps, minerals. Limited number of properties. Write at once for free catalogue. Tax Sale Service, Room 105, 120 Bloor St., West, Toronto 5, Canada.

HOMESITES \$15 Monthly—California's finest garden section. Morro Bay's scenic shores. Wonderful fishing, boating. Fertile soil, softest water, temperate climate, congenial community. Free literature. Richard Otto, Department M, San Luis Obispo, California.

FLORIDA Lakefront homesites near Ocala forest. Excellent fishing-hunting. \$10.00 monthly without interest. Complete price \$195-\$395. Literature. Grace Parker, Paisley, Florida.

FLORIDA Nice homesites, \$245 at \$10 monthly. Folder free. Howard Vernor, DeLand, Florida.

FLORIDA Waterfront homesites on famous Saint John's river, \$50.00 front foot. Also inland lakefront five miles from river \$195.00-\$995.00. Specify which literature. Easy monthly payments. Pine Lakes, Eustis, Florida.

SAVE, Buy direct from government, land, homes, islands, farms, etc. Listings \$1.00. Abacus, Box 169D, Dept. M, East Hartford 8, Conn.

OZARKS, Fruit, grazing, retirement. \$6.00 acre. \$5.00 monthly. Descriptions free. Write Armstrongs, Shook, Missouri.

FLORIDA Fishing, hunting, boating right outside your door. Gulf Highlands low-cost homesites perfect for now, later retirement. Complete homesites low as \$18.65 down, \$18.65 monthly. Property high and dry, pine wooded. In heavily developed Gulf beach area, walking distance from beach. Brochure. Write today! Sam B. Hearn, Developer, Box B-177, Panama City Beach, Florida.

FLORIDA Winter garden farms and homesites. Beautifully wooded. Near famous Panama City pleasure resort. World's finest beaches. Many lovely lakes. Finest fishing, hunting. Sportsman's paradise. 10-acre berry, fruit, poultry farms. Money-making tung groves. Lowest prices, easy terms. Booklet free. Wendell Wood, Pountain, Florida.

FLORIDA—Several five acre tracts, grand climate and location near Gulf Mexico for fishing, boating, and bathing. Priced at \$95.00, \$10.00 down, \$10.00 month. Information write G. B. Potterfield, Owner, Union Building, Dept. P, Charleston, West Virginia.

CALIFORNIA Ranch and farm lands \$15 to \$35 acre. Homesites \$395. Easy terms. Free catalog. Pacific Tax Sales, 1621-A Cahuenga, Hollywood 28, Calif.

POULTRY, FARM SUPPLIES

RAISE Turkeys the new way. Information explaining how to make up to \$3,000.00 in your own backyard. Literature 10c. Address—National Turkey Institute, Dept. 3, Columbus, Kansas.

POULTRY Farmers—Broiler growers—Turkey raisers read the new American Poultry Journal for latest ideas and greater profits. 12 months, 50c. Special offer, 4 years \$1.00. American Poultry Journal, 182 North Wabash, Chicago.

PROFITABLE OCCUPATIONS

ALASKA Jobs—Up to \$1500 monthly. 1956 business directory and government map—\$1.00. Includes military and civilian construction, mining, aircraft, lumber, fur-farming, homestead and highway facts. Hot list of firms hiring! Line up your spring job now! Bayer, Box 424-PM, Hollywood 28, Calif.

FOREIGN Jobs—Latin America, Alaska, Canada, up to \$1500 monthly. Up-to-date 1956 foreign service directory gives complete information; hot list of firms hiring for military and civilian construction, aircraft, oil, exporters-importers, mining, \$1.00. How-when-where to apply. 9th successful year! Global Reports, Box 883-S, Hollywood 28, Calif.

JOB Guidance. What job are you suited for? Send for free questionnaire. National Guidance Service, Bainbridge Road, Elizabethtown, Penna.

HOUSTON, Texas, current help wanted listings airmailed \$1. Housing 25c extra. Dempsey, 2818 Hardy, Houston 9, Texas.

FREE Folio "\$5,000-\$45,000; Unlimited Vacations." No merchandise, equipment. Unknown! Work home, sparetime! Haylings, Carlsbad, Calif.

FREE Book "505 Odd, Successful Businesses." Work home. Pacific. Oceanside, Calif.

ALASKA Police jobs open. Information \$1.00. Write now. ABCO, Box 282, Juneau, Alaska.

JOBS To \$1500 monthly. All trades. South America, The Islands, U.S. Fare paid. Application forms. Free information. Write Dept. 76G, National, 1020 Broad, Newark, N. J.

RAISE Pheasants on \$100 week plan. Little capital and space can make you independent. Free details. Great Central System, Columbus 1, Kansas.

MAKE New greaseless doughnuts in kitchen. Sell stores. Free recipes. Michael Ray, 3605 South 15th Ave., Minneapolis 7, Minnesota.

MONEY In saw and lawnmower sharpening sparetime at home. Repeat cash business. Experience unnecessary. No selling. Free booklet explains. Vernon Foley Company, Columbia Heights, Minnesota.

BE The Popular Mechanics representative in your neighborhood and earn big profits in your spare time. Write Popular Mechanics Magazine, Room 408M, 200 E. Ontario St., Chicago, Ill.

FORTUNE Possible raising fishworms and crickets. Free literature. Carter Wormery, Plains, Georgia.

WHOLESALE Catalog! 30-80% discounts! Appliances, musical instruments, typewriters, phonographs, watches, jewelry, recorders, housewares, etc. Consolidated Distributors, 21-14 Lafayette, Paterson 15, New Jersey.

AUCTIONEERING—Home study course. Diploma granted. Auction School, Ft. Smith, Ark.

EVERYBODY Likes candy. Learn to make professionally home. Our 45th year. Ragsdale Candies, D6, East Orange, New Jersey.

JOB Opportunities in Detroit. Send \$1.00 for particulars. A. D. Chisholm, 3667 Baldwin St., Detroit 14, Mich.

ANNOUNCING Home study course in commercial baking. Practical basic training. Good field for those with aptitude. Free booklet. "Opportunities in the Baking Industry." National Baking School, 835 Diversey Pkwy., Dept. 3432, Chicago 14.

MAKE Flexible molds. Cast figurines, plaques. Free sample. Tooker, 630-M Chestnut, Hamilton, Ohio.

WELDING Pays big money. Learn easily at best equipped school in country. Non-profit school with low cost training. G.I. approved. Write Hobart Trade School, Box M-262, Troy, Ohio.

INVESTIGATORS Wanted. Work furnished. Credit Correspondent Service, 517-M New York Bldg., St. Paul 1, Minn.

BUY Wholesale thousands nationally advertised products at big discount. Free "Wholesale Plan." American Buyers', Hertel Station, Buffalo 16-B1, N. Y.

JOB Seekers — Servicemen, students! Your own complete personal history-portfolio. Timesaving, factual, convenient. Only \$2.00 c.o.d. Neaco, R-1, Batavia, Ill.

NEED More money? Get new start! Read "How and When to Change Your Job Successfully" by leading expert. Send only \$2.95. Personnel Consultants, 16 Commodore, Rochester 10, N. Y.

FREE! "301 Profitable Small Businesses!" Amazing shoeing plans! Work home! Start sparetime! Deumant Surveys, Kenmore 23-PM, N. Y.

INSPIRATIONAL—Newest money making method. Distributor, 1305 West 46th, Los Angeles 37.

\$10,800 PROFITS! Your own mailorder business! No risk! Success plan free! Treasury, 709 Webster, New Rochelle L-33, N. Y.

MUSHROOM Spawn plus manureless process \$1.00. Luxur, 641 South 19th, Newark 3, New Jersey.

ON Job training and apprenticeships. Best nationwide opportunities all trades. Listings \$2.00. Surveys, Box 181, Glastonbury, Conn.

SUNSHINE And economical living! Columns Florida jobs airmailed \$1.00. Evans, Box 4325, Fort Lauderdale, Florida.

FOREIGN Employment construction work. If interested in foreign projects with high pay write Foreign Service Bureau, Dept. PM, Metuchen, N. J.

MAGAZINE Subscriptions—Largest commissions, bonus. Qualified Agency, 451BA Kingston, Brooklyn 25, N. Y.

MUSHROOMS Grown boxes. Manureless process. Spawn \$1.00. Gordons, 553 William, Winnipeg, Manitoba.

FOREIGN, Alaskan, U.S.A., jobs! Earn to \$1500.00 monthly. Million Americans employed overseas. Opportunities galore. Latest copyrighted reports. Who to contact for highest paying jobs. Laborers, trades, truck drivers, equipment operators, helpers, clerks, engineers, many others. Over 52 countries—St. Lawrence project, Spain, Latin America, northern projects, Europe, Pacific, etc. Year registration-advisory service. Application forms. Unconditional money-back guarantee. Act today! Only \$2.00. Airmailed \$2.25. (C.O.D.'s accepted). International Reporter, St. Louis 1-PC, Missouri.

\$5,199.90 WAS Paid to John Betts. In few weeks. Grow mushrooms. Cellar, shed. Spare, full time, year round. We pay \$3.50 lb. Free book. Mushrooms, Dept. 99, 2954 Admiral Way, Seattle, Wash.

VENDING Machines earn big money! Request 32 page free catalogue. Parkway Machine Corporation, Dept. 25, 715 Ensor St., Baltimore 2, Maryland.

AMAZING Profits mailing postcards offering fast selling merchandise. Everything furnished. 3c stamp brings details. Liska Co., 102-PM Birchwood, Cranford, N. J.

\$1300.00 MONTHLY For truck drivers, \$1400.00 monthly for carpenters, electricians, plumbers, mechanics, \$1200.00 for clerks and laborers. Full information and complete foreign listings, with current information on Spain, Korea, Australia, Alaska and Canada, \$1.00. Current information on stateside projects, \$1.00. Dept. 3-B. Opportunities Unlimited, 1110 Commerce Bldg., St. Paul, Minn.

\$150 WEEK—Easy! Start home Venetian blind laundry. Revealing book free. A.T. Co., 101 S. 44th, Philadelphia 4, Penna.

JOBS On ships. Experience unnecessary. Complete information and employment instructions \$2.00. Transoceanic, Box 494-P, Baltimore 3, Maryland.

JOBS Paying to \$350 weekly now available on overseas and American projects. Men and women. All trades. Transportation paid. Free information. Write Transworld, Dept. M1, 200 W. 34th St., New York, N. Y.

BOOKS, PERIODICALS, PICTURES, POSTCARDS

BOOKS Found! Any author, old or new. Rush titles wanted; no obligation. International Bookfinders, Box 3003-PM, Beverly Hills, California.

BOOKFINDERS! All subjects. Send wants! Jaher Book Service, 183 Hazelwood Drive, Westbury, N. Y.

"SCIENCE Milestones." Records march of science starting 400 years before Christ, right up to date. Amazing facts revealed. 312 pages packed with startling information that will thrill you. A real history of science. \$5.00. Literature free. Popular Mechanics Press, 200-8M East Ontario St., Chicago 11, Ill.

ANY Craftbooks you need, shipped promptly or located by free search service. Catalog. Artcraft, Baldwin, Maryland.

SHIPS Photographs, lists 10c. Scozafava, 1648 59th St., Brooklyn 4, N. Y.

GERMAN Books. Free price list. International, 25 McMaster, Toronto, Canada.

NATIONAL Geographic Magazines, 1888-1956. Periodical Service, Box 465-PM, Wilmington, Delaware.

BOOK Catalog. 1000 interesting titles. Send 10c. Books Publishing Co., Amityville 3, N. Y.

LOOKING For unusual books? Indicate subjects desired. Eladio, Apartado 3498, Havana, Cuba.

MAGIC TRICKS, PUZZLES, JOKER NOVELTIES

GO Ventriloquist, all secrets told. Make money, surprise friends. Send 35c for information. Free \$1.00 catalogue of dummies, dialogues, etc. Limited supply. Gough, R. 3, Hartford City, Ind.

COMPLETELY Illustrated 500 trick magic catalog 25c. Stowell, Woodstock, New York.

LEARN Ventriloquism, easiest method. Details free. Smith, 801 Bigelow, Peoria, Ill.

3100 NOVELTIES. Jokes, tricks, gadgets, funmakers, hobbies. Big catalog 10c. Johnson-Smith, D-252, Detroit 7.

SMOKEBOMBS 25c. 7 For \$1.00. Terrific! 4463-PM Greene, Philadelphia 44.

EARN Money as a magician; fine hobby. Large professional catalog \$1.25. Holden's, 120 Boylston Street, Boston, Mass.

VENTRILLO, Professional voice-throwing instrument and catalog 25c. Box 971-PM, Philadelphia 5.

BEST Magic. Joker's novelties. Lower prices. Catalog 10c. Top Hat, Evanston 12, Ill.

DOLLAR Magic set free with catalog 25c. 4462-PM Germantown, Philadelphia.

FREE Trick and professional catalog of 600 tricks, \$1.00. Terry's Magic Studio, 1921—66th Street, Brooklyn 4, New York.

SENSATIONAL Magician's wand 25c. Vanishes handkerchief! Catalog included. Box 1352-PM, Philadelphia 5.

500 TRICKS. Douglas famous catalog. 10c. Fastest magic service for 30 years. Douglas Magician, Dept. 1, Dallas, Texas.

LEARN Ventriloquism. Details without obligations. Harry Harmon, Box 33, Mint Spring, Va.

PROFESSIONAL Catalog. 175 pages, 25c. Williams, 900 Plymouth, Ellwood City, Penna.

WOODEN Nickels. Magic catalog, free trick, 10c. Fun'n Magic, Box 1375, San Antonio, Texas.

FREE Deck trick cards with catalog 50c. 1746-PM Market, Philadelphia 3.

TRICKS—Magic. Big catalog 10c. Jasper Joke Shop, 804 South Wesley, Oak Park, Illinois.

COINS, TOKENS, CURRENCY

GET Profit and pleasure in collecting old coins. Send 10c for 56-page illustrated coin catalog. You'll be delighted with it. Send for it now. B. Max Mehl, 370 Mehl Building, Fort Worth, Texas. Largest rare coin establishment in U.S. Established 56 years.

6-IN-1 Special! Magnifying glass; check list; 25 coin envelopes; giant 60 page bargain catalog; ten different Indian pennies; Mexican ten-peso! All six, \$1.00 postpaid. Ben's Coin Shop, 31 North Clark, Chicago 2, Illinois.

U. S. Large cent, 2c piece and bargain list, only \$1. Delmaco, Box 1123, Wilmington, Del.

FREE! Foreign coin, banknote and coin collectors illustrated catalog to approval service applicants. Send 3c postage. Tatham Coinco, Springfield 30, Mass.

MORGAN Dollars; 1878, 1887, 1890, 1891, 1897 S mint unc. \$2.00 ea. Illustrated catalogue, 25c. Shultz, Salt Lake 10, Utah.

101 DIFFERENT Foreign bills—\$1.00 postpaid. Dwight Musser, Dunbar, West Virginia.

SAN Francisco mint closed! Made only cents and dimes in 1955. In short supply and great demand. One each, brilliant uncirculated, for 25c. Free coin lists with order. Bryson Stamp & Coin Company, 612 White, Toledo 5, Ohio.

LINCOLN Pennies wanted, paying \$15.00 for 48 Lincoln cents, send 50c for list of pennies wanted, full information mailed together with coin folders for returning pennies. Fred Ferguson, P. O. Box 15, Fort Lee, New Jersey.

FIVE Foreign coins from Switzerland, Belgian East Africa, etc., plus foreign banknote, only 10c with coin approvals. Littleton Stamp & Coin Co., Littleton R1, New Hampshire.

OLD Money wanted. Do you know that coin collectors pay up to \$100.00 for certain U. S. cents? And high premiums for all rare coins? We buy all kinds. Send 4c for large coin folder. May mean much profit to you. Numismatic Co., Dept. 20, Fort Worth, Texas.

COIN Collector's greatest magazine, huge illustrated pages, 10c. Lawrence Brothers, Anamosa, Iowa.

1955 SAN Francisco coins are advancing in price. Per roll: cents, \$1.85; dimes, \$7.25. 100 different foreign coins, \$4.50. Oliver James, Box 299, San Francisco 1, Calif.

UNITED States coins. Buy, sell, trade. Want lists solicited. Clint Hester, Box 64534, Los Angeles 64, Calif.

CONFEDERATE Currency, bonds, old coins wanted. Cook Coins, Jackson 5, Mississippi.

TWENTY Different Indian cents \$1.00. Sayers, 1000 East Unaka, Johnson City, Tennessee.

FOREIGN Coins, 35 different \$1.00. 100 different \$4.00. Claud Denney, 3406 S. Harwood, Dallas 15, Texas.

TOP Cash for all rare coins, currency. Coin premium book \$1.00, currency \$1.50. You get the most when we get your coins. Describe fully. Bebee's, 4514 North 30th, Omaha 11, Nebraska.

FIVE Page bargain list. Five Indian-head cents, 25c. Economy Sales, Box 227, Mansfield, Mass.

\$3,000.00 FOR 1913 Liberty head nickel. Dimes 1894-S, 1895-O, 1918-D. Quarters 1827, 1896-S, 1901-S, 1913-S, 1923-S. We pay \$5.00 to \$1,500.00. Certain dates—Lincoln cents, \$60.00. Indianheads, \$60.00. Large cents, \$500.00. Eagle cents, \$200.00. 2c pieces, \$45.00. 3c pieces, \$60.00. Half-dimes, \$500.00. Shield nickels, \$100.00. Old dimes, \$300.00. 1875 Canadian quarter, \$50.00. Hundreds of others worth \$5.00-\$500.00. Wanted—Half dollars, dollars, gold coins, paper money, etc. Know their true value. Our large illustrated guarantee buying-selling catalogue, giving complete all coin information—Send \$1.00. Purchase catalogue before sending coins. Catalogue money refundable. Worthycoin Corporation, Leaders Numismatic Quotations, K-140-C, Boston 8, Massachusetts.

HAVE You ever seen a United States proof coin? It has a brilliant, mirror-like surface and very sharp features. Made especially for coin collectors; never found in your change. Send \$1.00 now for a 1955 U.S. proof coin. L. Saffil, 211 Albion, Denver 20, Colorado.

\$50.00 FOR Certain Lincoln pennies. Indianheads \$100.00. Booklet showing prices paid, 25c. Lincoln Coins, D-29, Glendale, Arizona.

LARGEST Coin magazine (160 pages) 35c. Scrapbook, 7320-J Milwaukee, Chicago 31.

BARGAIN 16 Page illustrated U.S. coin list 10c. Stoney, 192 Washington, Boston 8, Mass.

40 DIFFERENT Selected coins, \$1.00. Oddehon, Box 482, St. Louis, Mo.

STAMP COLLECTING

MIXTURES. Only pictorials and commemoratives off paper; 300 Australia \$1.00; 200 Canada \$1.00; 300 bigger variety Canada \$2.00; 100 Dominican Republic \$1.00; 200 France \$2.50; 125 New Zealand \$1.00; 300 U.S.A. large commemoratives 1935-1955 \$2.00. Odias Demers, Sanford, Maine.

KOREA Flowers. Formosa Chiang Kai-shek birthday issue, Hungary pictorials, Ceylon (elephant) Royal Visit, South Africa Cape of Good Hope triangle centennial, Italian Colony flowers, Niue bi-color maps, African wild animal set. Many more beauties. All for 25c with interesting approvals. Every continent represented in this collection. Modern Stamp Co., Dept. A-3, Ferrysburg, Mich.

AIRMAILS. \$5.00 Catalog only 50c to introduce approvals. Warden Company, 139 Bonita, Sierra Madre, California.

125 DIFFERENT United States \$1.00. Approvals. Utechts, 1143D North Keeler, Chicago 51.

APPROVAL Applicants special 20c government reproduction, 15 different commemoratives, obsolete dollar presidential, surprise packet, illustrated catalog. Standard, 10840 Woodview, Parma Hts. 30, Ohio.

BIG Profits in U. S. stamps. Easy money-making sales plan. No stock required. Free circulars. Raymax, 37-TZ Maiden Lane, New York City 38.

312 MIXED U. S. only 10c to "Gold Nugget Approval" applicants! Nothing like them. Kessel's, Box 6116, Tucson, Arizona.

OLD Stamps wanted. I will pay \$100.00 each for 1924 1c green Franklin stamps, rotary perforated eleven (up to \$1,000.00 each unused). Send 10c for large illustrated folders showing amazing prices paid for old stamps and coins. Scheuermann, (PM-62), 50 Berkshire, Rockville Centre, New York.

SWITZERLAND Prize package, 50 different—Trains, bridges, castles, commemoratives, bi-colors, pictorials. Unusual cancellations too! Only 10c with approvals. Molzan, 720 Pomona, El Cerrito 8, California.

CASH For your duplicate used U.S. commemoratives. Send dime for catalog. Unicorn Stamp, Greene Ave., Bound Brook, N. J.

QUEER Country collection from Baden, Camerons, Indo-China, Indonesia, Hong Kong, Madagascar, Malaya, Monaco, Rheinland-Pfalz, Saar, Saint Pierre, Togo. High values, low values. Bi-colors, topicals. A collection in itself. Only 10c with beautiful inexpensive approvals. Clark Stamps, Dept. A-47, Muskegon Heights, Mich.

MIXED Sample 10c with approvals. Box 52, Croydon, Penna.

CATALOG Disregarded: Giant approvals. Easy to fill sets, spaces. No stamp over 2c. Ask for Big Fellow Frazer, 1093 "D" Street, Springfield, Oregon.

UNHINGED U. S. mint approvals. Dale Dronso, 3647A Plankinton, Cudahy, Wis.

QUARTER Brings 100 worldwide, Monaco triangles, bargain list. Isele, 811 Sherman Place, Utica 4, New York.

FREE—Scarce Diego Suarez! Tru-val-u approvals. Brunning. Donaldson St., Rutherford, N. J.

BRITISH Colonials—Commemoratives, hivalues. Free, approval buyers. Pleasure Stamps, 1865P—52nd, Brooklyn 4, New York.

VATICAN Cardinals mint set 10c with approvals. H. Thompson, Box 552, Monmouth, Illinois.

100 DIFFERENT Stamps free with approvals. Martinsen, Box 115, New York 33, N. Y.

150 DIFFERENT Britain and empire 25c. Anthony Daley, Buckland, Connecticut.

WHY Pay more? Pick stamps from our large collections. 2c each. Just as purchased. Be first. Premiums given U. S. also available. Roseland Stamps, Dept. A-35, Spring Lake, Mich.

FREE: Mint British Colonies from Brunel, Papua, New Guinea, Caymans, Gilbert Ellice, Seychelles, Sarawak, Grenada. Free with approvals. Viking, Great Neck 8, N. Y.

100 DIFFERENT Worldwide 10c; 500, 75c; 1000, \$1.75; 5000, \$13.75. Price list free. Philatelic House, Rockville Centre, N. Y.

FIRST U.N. set. Among world's prettiest. Only 10c. Approvals. Welles, Box 1246-R, New York City 8.

ECONOMICAL 1/2c, 1c, 2c. Approvals, 22,000 varieties available. Dresel, Box 270-N, New York City 25.

RUSSIAN Occupational set mint 10c. Approvals. B & B Stamps, Memphis, Michigan.

25 GREECE Free with approvals. Scheerer, Box 301, Pottsville, Penna.

100 JAPAN 10c, With approvals. Gould's Stamps, Box 631, San Francisco 1.

FREE! 107 British Colony stamps. All different, from Britain's farflung colonial empire. Catalog value \$2.50. Free stamp magazine. Approvals. Send 10c for handling. Act now! Niagara Stamp Co., St. Catharine's 71, Ontario.

FREE. Scott's International album. Other premiums. Details with approvals. Raymax, 35-Z Maiden Lane, New York City 38.

TOPS! Free book, "How to Collect Stamps." Send for your copy today! Approvals. Littleton Stamp Co., Littleton El, N. H.

100 YEAR Old United States stamps are sent on approval together with all commemoratives, airmails, etc. Also all foreign, Roosevelts, etc. Send 10c for 50 different U. S. and approvals. Globus Stamp Co., 268-4th Ave., New York 10, N. Y. Dept. 213.

50 DIFFERENT Bulgaria 10c! Approvals. Ensign Stamp Company, Dept. M, Berdan Avenue, Paterson 2, New Jersey.

50 DIFFERENT A-Z countries 3c. Abyssinia-Zanzibar. To approval applicants. Avalon Stamp Co., Dept. M, Springfield, Mass.

FREE! World's 10 ugliest! Weird colors, valuable cut design. Send 3c postage today! Norrisco, Milwaukee 7, Wis.

SUPERIOR Worldwide mission mixture. Amazing variety! Half pound only \$1.50. Baye Nielsen, 4545B Harvard, Montreal 28, Canada.

FIRST Complete German airpost set. 10 cents. Approvals. Boger, P.O. Box 152, North Wales, Penna.

FREE U.S. stamps, 1943 occupied nations flag, airmails, commemoratives included, collection of 25 different U.S., plus \$5.00 stamp. Everything for 10c mailing charge. Approvals. Willett Stamps, 141-A, E. Main St., Mount Kisco, N. Y.

OLYMPIC Set, 1000 hinges only 10c. Approvals. Buckley, 208 Ludlow Bldg., Dayton 2, Ohio.

FAMOUS Americans! 10 American beauties 10c. 7 other commemoratives included. Approvals. White, 516-A Avenue L, Brooklyn 30, New York.

100 DIFFERENT Austria 10c. Approvals. Aronson, 91 Marion, Brookline 46, Mass.

12,000 PENNY Approvals waiting for you. Many from exotic countries, pictorials, airmails, new issues. Tilbury, Box 862, Newark 1, N. J.

STAMP Collecting outfit, includes packet worldwide stamps, package hinges, watermark detector, millimeter gauge. Everything, 10c with approvals. Lorain Brown, Marion 1, Michigan.

100 CHINA 10c, Approvals, gifts. Coast, P.O. 2187H, Santa Ana, California.

SELL Your surplus good grade stamps. Write, describing fully what you have. Vanroy Shirk, Lebanon, Pennsylvania.

FREE! Surprise packet with approvals. Pioneer, Box 414M, Pasadena, California.

GIANT Approvals, thousands different, 1c and 2c each. Wahl's Stamp Exchange, 7088P Farragut, Chicago 31, Ill.

U.S. Mint commemoratives, 13 different. 25c. Free price list. Brooks, 2352A East 23rd Street, Brooklyn 29, New York.

30 DIFFERENT Commemoratives, 1893 up 10c. U. S. approvals. K. & B., Box 5, Brooklyn 14, N. Y.

U.S. Mint 797 SPA sheet, 10c to U.S. approval applicants. M. Haycock, 153M 74th St., Brooklyn 9, N. Y.

WANTED—Stamp collections, Accumulations. Murray Gold, 62-95P Saunders, Rego Park 74, N. Y.

CORONATIONS, Triangles, sports, animals, free with approvals. Exotic, Box 482-M, Coral Gables 34, Florida.

DIFFERENT, 500, 50c; 1000, \$1.25; 2000, \$3.00; 5000, \$11.00. Clearing approvals wholesale. K. S. Holmes, London, Canada.

FREE! Catalog! About stamps, illustrated. Free! The Stampmart, Hartford 1, Connecticut.

WONDERFUL Offer. 7 complete mint sets only 10c with approvals. Reich (M26), 1033 Lawrence, Chicago 40.

FREE U.S. Illustrated bargain catalogue. Rothberg's, Box 60, Boston 1, Mass.

1000 DIFFERENT 95c. John Hourigan, 1500 Archer Road, New York 62, New York.

FREE United States price list. Mark Hanna, 335 Fifth Ave., Pittsburgh 22, Penna.

50 DIFFERENT Argentine 10c. Approvals. Reuter, 611 W. 40th Pl., Los Angeles 37.

100 DIFFERENT Spain 25c. Penny approvals included. Reed, Box 980, Chicago 90, Ill.

OLD Scarce U.S. seconds on approvals. Slight imperfections, lowest prices. Hernefield, Clintonhill Sta., Newark 8, N. J.

THOUSANDS Of exciting stamps, all different, yours for 1c, 2c each. Fill your album for pennies! Big collection sent for free examination. Cole, 43-A Rinewalt, Buffalo 21, N. Y.

50 DIFFERENT United States 5c with bargain approvals, lists. Bookman, Box 8245-M, Madeira Beach, Fla.

U. S. Classics. Over 50 yrs. old. 15 selected old-timers. Missing in biggest collections. All 15 at less than 1c each. 10c with approvals. Jaro, Box 248-T, New York City 8.

AMAZING Offer! 200 United States stamps—including commemoratives, airmails, high denominations to \$1.00. Only 10c to approval applicants! Illustrated bargain lists free. Mystic Stamp Co., Dept. 80, Camden New York.

FREE Sample! Interesting, illustrated, informative! National Stamp News, Anderson, South Carolina.

300 DIFF. World wide 25c. plus surprise packet. Packet list free. Econopackets, Box 168, Riverside 9, Calif.

WORLD'S Largest stamp (7 1/2 x 14 inches). A real curiosity! Retail for 50c, only 3c to approval applicants. Tatham Stamp Co., Springfield 30, Mass.

WEIRD Diamond shape coffee stamp! Lovely flower triangle! First American big commemorative, Greenland, idol dancer, etc. Free with approvals. Capital Stamp Co., Little Rock 2, Ark.

100 OLD United States between 1861 and 1935, \$1.00. Roush Stamps, 51 Chestnut, Mansfield, Ohio.

SELL Stamps to our readers. Your ad in this space will be read by thousands of stamp buyers. I'll prove that to you. Write now for Folder "S." P. W. Johnson, Classified Advertising Manager, Popular Mechanics, 200 E. Ontario St., Chicago 11, Ill.

TWO \$5.00 U. S. stamps plus 20 different, 10c with U. S. approvals. Irwin Stamp Co., Box 1105, Brooklyn 30, N. Y.

225 STAMPS For only 10¢! This mammoth value includes airmails, pictorials; stamps from strange countries cataloging up to 25¢ each! Also approvals. Mystic Stamp Company, Camden 30, New York.

FAMOUS Men, jungle scenes, zoo, United States commemoratives, 100 others. Ten cents with request for thrifty approvals. Casner Stamps, 247-A Riverside, El Paso, Texas.

14,000 DIFFERENT—Yours on our streamlined systematic club plan for only 50¢ weekly. Big shipment every two weeks. Details free. Sjoquist, Box 217, Valley Stream 75, New York.

MINT Commemoratives at face! Send 25¢ for surprise packet of all different, mint U.S. commemoratives. Mint U.S. approvals 100. Western, Box 1689P, Salinas, California.

UNITED States commemorative price list free. James Cunningham, 101 Terrace, Hasbrouck Heights, N. J.

UNITED States approvals. Select copies, used—mint. Kingsbury, Fairfax, Vermont.

\$20.250 PROFIT Selling stamps by mail. How we did it book; send only \$2.00. Free details. Fahsing, Atascadero, California.

CANADIAN Wildlife depicted in natural surroundings. Four attractive, complete sets 10¢. Worldwide pictorial approvals accompany. Firland Stamp Co., Box 493, Seattle 11, Washington.

U.S. Commemoratives only. 100 diff. 45¢; 150 diff. \$1.00; 200 diff. \$2.00; 250 diff. \$3.75. Hudson's, Box 4015, Fresno 44, Calif.

FREE! Giant catalog offering thousands of bargains. Sent with beautiful approvals. Jamestown Stamp Co., Dept. E2PMC, Jamestown, N. Y.

8 CANAL Zone 10¢. Approvals. Merkel Stamps, 45 Cherry, Holyoke, Mass.

100 FOREIGN, 20 U. S. commemoratives, 10¢. Approvals. Weckerling, Box 4422, La Feria, Texas.

QUALITY U.S. mixture, 2 lb. \$1.00. Clift, 1040 N. Irving, Scranton 10, Penna.

SENSATIONAL U.S. 72 page catalogue free. Stone's, 192 Washington, Boston 8, Mass.

GIGANTIC Collection free. Includes triangles, early United States, animals, commemoratives, British Colonies, high value pictorials, etc. Complete collection plus big illustrated magazine all free. Send 5¢ for postage. Gray Stamp Company, Dept. PM, Toronto, Canada.

50 U.S. Commemoratives—Old, new, 25¢. Lists. Weatherby, Fort Myers, Florida.

FREE—Illustrated U.S. price list, Bailey, 45 Bromfield, Boston, Mass.

SPACEPHOBIA? Fill your pages from our 1c-2c books of 1000. BKJ, Box 324, Astor Sta., Boston 23, Mass.

500 WORLDWIDE Mixture. Big variety, 25¢. Monjar, Fairmount, Cincinnati 14, Ohio.

ESTATE Clearance. Big variety packet \$2.00. Hotchkiss Stamps, Montpelier, Vermont.

NATIONAL Parks, superb mint complete set, special \$1.00, to introduce our specially priced U.S. approvals. Give age, employment, references. Merritt Brundige, Cambridge, New York.

FREE U.S. price list, 100 pages, 700 illustrations. Thom, 4808 15th Avenue, Minneapolis 17, Minnesota.

300 DIFFERENT Given free with approvals. Particulars. Windsor Stamps, 8834 Cornell Ave., Chicago 17.

AMERICAN Stamps! Coins! Extensively! Sullivan, 127-F East 4th, St. Paul 1, Minn.

WOW! 135 All different Germany 10¢. Zeppelins, semi-postals, airmails, high values. Big bargain lists and approvals included. Jamestown Stamp, Dept. A2PMC, Jamestown, N. Y.

FAROUK, 25 Different Egypt, 10¢ with approvals. Excello, Box 489, Red Bank, N. J.

MONACO Nudes complete 10¢. Approvals. Royal Stamp Company, Tamaqua, Penna.

ECONOMY Plus! U. S., foreign approvals, 1/2c to 2c each, in books of 1,000. Our free-with-purchase bonuses catalogue \$1 up, and accompany selection. Farmer, 6919 Camrose, Los Angeles 28.

BRITISH Approvals your best investment. Neumeister, Box 166, Harrison, N. Y.

CANADIAN And Newfoundland stamps. Price list 15¢. Webb, 27 Parkside, Toronto 3, Canada.

CIPEX Souvenir sheet plus 25 different U.S., 10¢. Approvals (used U.S.) accompany. Village Stamps, 90-39P 214 St., Queens Village 28, N. Y.

FREE—Your choice of \$2.00 to \$10.00 from our sensational approvals, every time you buy an equal amount, Bargain Stamp Service, Redlands, California.

21 SPARKLING Queen Elizabeth mint bicolors—25¢! Attractive approvals. Order yours today! Gannon Stamps, Box 931, Canton 1, Ohio.

1956 CATALOGUE (U.S.A.), \$2 Harding, \$5 Coolidge—\$1.00, approvals. Gatewood, Box 346, Winston-Salem, N. C.

TRINIDAD 12 Different, 10¢ with approvals. Seminole Stamps, Box 1138-P, Coral Gables 34, Florida.

99 COLORFUL Stamps from Latin America, 10¢, with approvals, Fred Pittsley, So. Montgomery, Napa, Calif.

FREE Monthly stamp newspaper. Stories, contests, cartoons, etc., and an exciting stamp error. Send 25¢ for handling. TV Stamp News, Box 4L, New York City 36.

GERMAN Airmails, 20 different, 15¢ with approvals. Excello, Box 489, Red Bank, N. J.

ICELAND 10 Different beautiful stamps for only 10 cents to applicants for our good old fashioned approvals. Old Colony Stamp Co., Dept. A, Milford, Connecticut.

FREE U.S. plate block list. Simstaco, Box 63, Mattapan 26, Mass.

UNITED States. Fine mint airmails, #C7, #C8, #C9, #C10. Only \$1.00. Approvals accompany. Whiton Paine, Westport 11, Connecticut.

ZEPPELIN Set free with approvals. Variety Stamps, 57-P Circuit, Newton Highlands 61, Mass.

AUSTRALIA—50 Different 10¢. Approvals. Moffat's, 740 Milton, Rock Hill 18, South Carolina.

UNITED States stamp collection on approval. Enclose 10¢ fee. Peterson, Box 31, St. Paul 2, Minn.

30,000 DIFFERENT Stamps. Worldwide, less than 1-1/2¢ each. \$12.50 brings each book 1,000 as wanted. Huppert, 1970 E. 18th, Brooklyn 29, N. Y.

100 BRITISH Colonies 10¢. Approvals. Neal, 5950 Tower, Riverside, Calif.

200 DIFFERENT Including Macau, Rhodesia, Mauritius, 10¢ to approval applicants. Evden, Box 128, Valley Stream 50, New York.

ANTIQUES, RELICS, INDIAN GOODS, CURIOS

4 FINE Arrowheads \$1.00. Thunderbird \$2.00. List free. Arrowhead, Box 1249, Hot Springs, Arkansas.

4 TINY Ancient bird arrowheads \$2.00. List free. Lear's, Glenwood, Arkansas.

GESUNDHEIT! Illinois. Selling 580 historical firearms, 30,000 prehistoric, stoneage Indian relics, collectors cartridges, Confederate money, coins, Revolutionary, Civil, Indian wars flintlocks, muskatoons, swords, bayonets, bullet molds, powder flasks, blunderbusses, pepperboxes, Kentucky rifles, Winchesters, buffalo-stagecoach carbines, frontiers, Derringers, duelling pistols, matchlocks, arrowheads, tomahawks, bannerstones, gempoints, spearheads, steer, deer, buffalo horns, mounted pheasants, owls, quail, squirrels, deerheads, Agates, fossils, mineral specimens, lapidary supplies, Daguerrotypes, gold dollars, bo-wood, blo-horns, violin wood. Send 35¢ for profusely illustrated catalog. Heike, Shopton, Wenona, Illinois.

4 ARROWHEADS \$1.00. Axe \$2.50. Smith, 841 Tacoma, Indianapolis, Ind.

CURIOS Direct from Tahiti. Yves Jarsillon, Box 467, Papeete, Tahiti.

4 SELECTED Arrowheads \$1.00. List 5¢. H. Talburt, Calico Rock, Ark.

PRECIOUS STONES, MINERALS

GEMCUTTING—Silvercraft illustrated magazine. Tells how to cut gems, make jewelry. 150 ads illustrating equipment, gems for collectors, cutters. Free literature. Lapidary Journal, Del Mar 3, Calif.

GEMSTONES. Mineral specimens. Every variety. Lowest prices. Free booklet. Plummer's, 4720 Point Loma Ave., San Diego 7, Calif.

SAPPHIRE, Topaz, tourmaline, garnet, peridot. Five uncut gem specimens, \$1.00. Ten polished gems, baroque shaped, \$1.00. Free big bargain list jewelry, gems, profitable, easy "do it yourself" projects. O'Brien's, 1116M Wilcox, Hollywood 38, Calif.

20 COLORFUL And basic U.S. mineral specimens, attractively boxed. Descriptive folder included. \$1.00 prepaid. Rock Haven Mineral Co., Whitefield, N. H.

HOBBIES AND COLLECTIONS

UNUSUAL Hobby: Authentic army patches, insignias, ribbons, enameled crests, navy rates, 50 assorted for \$1.00. Rex Military, Dept. B, 1261 Broadway, New York City.

WANTED—Cigarette, tobacco cards. Write Charles Bray, East Bangor, Penna.

50 ARMY Insignia \$1.00. Insignia Mart, 703A Broadway, New York 3, N. Y.

NAZI Insignia, 12 different, \$1.00. Medals, armbands, flags, daggers. Illustrated lists. Medcrafts, 1923 34th St. S.W., Calgary 2, Canada.

GROW Giant crystals! Free booklet. Crystocraft, Box 35, College Station, Texas.

INVENTING Can be an interesting and profitable hobby. Write for complete particulars. Institute of American Inventors, Dept. 40-E 631-E St., N.W. Washington 4, D. C.

65 ASSORTED Army patches, insignias, ribbons \$1. Surprise included. Lhgco, 19 East 16th St., New York City 3.

GENUINE Nazi medal \$1.00; 37 different American emblems \$1.00. Catalog 10¢. Insignia Club, 550-B Fifth Avenue, New York.

EXCITING New book, "How to Collect Stamps, Coins, Paper Money." Packed with amazing facts; information worth dollars. Fully illustrated, 160 pages, 75¢. Popular Mechanics Press, 200-ST E. Ontario St., Chicago 11, Ill.

HOBBIES. Craft sets, model planes, ships, cars, guns. Daters, 821 Divisadero, San Francisco 17, California.

KLONDIKE Novelty jewelry findings assorted, beads, pearls, jewels, 5 lb. lots \$7.50; sample \$2.00 lb. Merchandise, 19-A 16th St., New York City 3.

CAMERAS, PHOTO SUPPLIES

BUY Wholesale nationally advertised cameras, photo supplies, thousands other products at big discount. Free "Wholesale Plan." American Buyers, Hertel Station, Buffalo 16-El, N. Y.

FREE! Free! Free! Central Camera Co., photographic headquarters since 1899, saves you money on all photographic equipment. Send for Central Camera Co.'s free photographic bargain list today! Central Camera Co., Dept. 13-B, 230 S. Wabash, Chicago 4, Ill.

BASS Says: Quality cameras since 1910. When in Chicago visit the camera cross roads of the world, or write us for your favorite equipment, new or used. Satisfaction guaranteed. Bass Camera Co., Dept. AG, 179 W. Madison St., Chicago 2, Ill.

20 TO 50% Discount everything photographic, giftware. Free catalogue. Dart, 3812E Atlantic Avenue, Brooklyn 24, N. Y.

CAMERA Repairmen greatly needed! You can learn manufacturers' service methods at home, in your spare time! Free, big illustrated book tells how: Write today. National Camera Repair School, Dept. PMS, Englewood, Colorado.

ATTENTION 35MM. camera owners. Can you use several hundred dollars? See Polypix ad in "Moneymaking Opportunities."

PHOTOGRAPHY For pleasure or profit. Learn at home. Practical basic training. Long established school. Free booklet. American School of Photography, 835 Diversey Parkway, Dept. 3441, Chicago 14.

BUY Wholesale 750,000 products. Details free. Carter, Box 6011-CP, Chicago 80.

NEW Argus C-3 outfit \$48.90. Terrific discounts, photo equipment, appliances. Free catalog. Mallers Mart, Box 135-A5, New Rochelle, New York.

PHOTO FINISHING

DELCO'S February special—Free plastic camera cover, eliminates dust, dampness. Send name. 8 oversize album prints 49c; 12—59c; 20—\$1. Fast first class return free. Delco Film Lab., Box 362R, Upper Darby, Penna.

QUALITY Copies from your photos, linotypes, polaroids, documents, etc. No negative needed. Two dollars. Also finest enlargements from your negatives at low cost. Jack Koons, Huntington Mills, Penna.

TOP Quality. Fast service. 8 jumbos 35c, 16 contacts 40c. Reprints—Jumbos 4c; contacts 3c. Satisfaction guaranteed. Free mailers, circulars. Fast-X-Photo, Box A, Jersey City, New Jersey.

SPECIAL Introductory offer. 8 jumbos 25c, 12—35c. Western Photo, PM26, Box 298, San Francisco 1, Calif.

FREE Superpak album with 8 jumbos only 35c. 12—50c. Prompt superior service. Quality guaranteed. Mailers and circulars free. Grand Fotos, GPOB 1410, New York City 1.

8 OR 8 Picture roll 35c. 12 or 16 picture roll 55c. Each roll developed and printed in handy pocket wallet. Send coin with roll. No c.o.d.'s. Mailing containers sent free. DeLuxe Film Service, Box 1268-A, Shreveport, Louisiana.

FROM Rolls or negatives. Jumbos 4c. Regulars 3c. This ad and \$1.00 for 30 jumbos or 8—5x7. Guaranteed. Square Deal Photos, Hutchinson, Kansas.

8-HOUR Service on deluxe jumbo prints. 8-exposure roll developed and 8 jumbo prints 40c, 12 exposure 55c, 16 exposure 70c; 35mm. 20 exposure 75c, 36 exposure \$1.25. Jumbo decklegrade reprints 4c each. Contact prints made if specified. Bay Photo Service, P.O. Box 210, Oakland, California.

COMPARE Our film developing at one-half price. Extra large prints, 40 cents per eight-exposure roll, any size. Vermont Prints, Box 151 P, Rutland, Vt.

ENLARGEMENTS! Eight 5x7's or five 8x10's, \$1.00. Wilart Enlargers, Box 967, Little Rock, Ark.

QUALITY Kodak finishing. 8 exposure roll 35c; 12 exposure 50c; 16 exposure 60c. Reprints 4c. Fast service. Guaranteed quality. 40 years continuous operation. Be a satisfied customer. We do color. Send for mailers. Mail Order Photo Service, Box 297, Watertown, Wisconsin.

8-12 EXPOSURE Rolls 39c, jumbo prints. Free 5x7 enlargement with each roll developed. Guaranteed work, one day service. Lincoln Studios, Dept. K, Box 13, Lincoln, Nebraska.

FREE 5x7 Enlargement of your favorite negative, with 8 oversize album prints 35c. 12—50c. Send name for mailer. Red Robin Studios, Box 573B, Clifton Heights, Penna.

MOTION PICTURES AND SOUND EQUIPMENT

5,000 8-16MM. Movie films. Free catalogues. International, Greenvale, N. Y.

MOVIES Equipment. All sizes. Bought, sold, exchanged, rented. Catalogue dime. Reed, 1797 Seaman Neck, Seaford, N. Y.

ALL Kinds 16mm sound films. Rent, sale. Roshon, 335 Fifth, Pittsburgh 22, Penna.

FREE! Blackhawk's big sale catalog new and used 16mm., 8mm. films; 2"x2" color slides; used 16mm. sound projectors. Biggest stock in U.S.A. Blackhawk Films, 1200 Eastin, Davenport, Iowa.

TAPE Recorders, tapes, accessories. Unusual values. Dressner, Box 66M, Peter Stuyvesant Station, New York City 9.

MOVIE Camera film: 8mm. roll \$1.50, 16mm. 100' \$3.00. Free processing. Better Films, 742 New Lots, Brooklyn, N. Y.

SAVE 50%! Guaranteed-fresh color, b.&w. movie film! 8mm., 16mm. Free catalog! Eso-R, 47th Holly, Kansas City 12, Missouri.

8-16MM. Free catalogue (with sample film 10c). Garden, 690 Howard Ave., Brooklyn, N. Y.

TAPE Recorders, tapes; wholesale prices. Carstan, 215 E. 88, New York City 28.

MOVIE Film—New Eastman TriX ASA 250 indoors. 8/8mm.—\$2.79; 16mm. 100' \$6.79; 16mm. magazine \$3.89. Free catalog. Superior Bulk Film Co., 442 N. Wells, Chicago 10.

35MM. Sound features! \$17.50 and up! John Logue, Carnegie, Pennsylvania.

MUSIC AND MUSICAL INSTRUMENTS

SONGWRITERS — Outstanding ethical offer. Hibbler, C-5, 6808 Oleander, Chicago 31, Illinois.

NEW Suitcase organs, easily played, such pleasure \$195. Organ Shop, 3805 Fulton, Canton, Ohio.

POEMS, Songs wanted! Free examination. Bengol, 93 Jefferson, Chelsea 50, Massachusetts.

SONGWRITERS: Recording company wants new songs. Royalty basis. National sales, promotion if selected. No charge for melodies. Send material. Music Makers, Dept. E-18, Box 2507, Hollywood, Calif.

POPULAR Songs. How to write and sell them. Write for free booklet Successful Songwriting. Gateway Songs, Box 2470, Hollywood 28, Calif.

PROFESSIONAL Songwriting tips can open doors—\$2. Pritchett Publications, Box 2908-A, Hollywood 28, Calif.

PLAY Piano the first day! Copyrighted secret. Details free. Miracle Method, Box 5203P, Phoenix, Arizona.

WHOLESALE Catalog! 30-80% discounts! Appliances, musical instruments, typewriters, phonographs, watches, jewelry, recorders, housewares, etc. Consolidated Distributors, 21-80 Lafayette, Paterson, New Jersey.

1955 ACCORDIONS — Wholesale. Free catalog. American Accordion Center, PM-3, 5329 Belmont, Chicago.

SONGWRITERS! Send poems, songs. Music Service, 243 West 72nd St., PM, New York City 23.

FREE Records of your song. Your words, my melody. Free information. Johnny Mack's Melody Mart, 1094 West 39th Street, Dept. A, Los Angeles 37.

ACCORDIONS, Wholesale to everyone. Save up to 60%. All national known brands. Free catalogue. Del Principe, 29 South Cicero, Chicago 44.

POEMS Wanted for new songs. Send poems. Immediate consideration. Crown Music Company, 1476 Broadway, New York City 36.

WANTED! Poems for musical settings. Write Songwriters' Service, Clifton, N. J.

WRITE Songs. Big money and reputation. Write for information. J. Gordon Pub. Co., 4700 South California Avenue, Chicago.

VIOLINMAKERS, Repaters. Fine tone wood, and all violin supplies. Send for free wholesale price list. International Sales, 414-MPM E. Baltimore St., Baltimore 2, Maryland.

SONGPOEMS And lyrics wanted. Mail to: TinPan Alley, Inc., 1650 Broadway, New York 19, N. Y.

SONGS Poems wanted. Good opportunity. Tunemasters, 1609 Vista Del Mar, Dept. U, Hollywood, Calif.

SONGWRITERS, Free details, melody \$5.00. Paramount, Box 1, Station C, Toledo, Ohio.

ACCORDIONS — Direct from importer. Save 50% and more! Free trial. Lifetime guarantee. Trades accepted. Free catalog. Write Accordion Outlet, Dept. 26-R, 2003 Chicago, Chicago 22, Ill.

10 BOOKLETS, 591 Pages! "Musical Terms," "Harmony," "Orchestra," "Piano," "Jazz," "Sound," "Music," "Rhyming," "Writing," "Poetry." All \$1.00. Separately 10c each. (Order by titles.) Franks, 3121 South Racine, Chicago 8.

POEMS Wanted for musical setting. Send poems. Immediate consideration. Five Star Music Masters, 630 Beacon Bldg., Boston, Mass.

AFFILIATED Songwriters. Collaboration. Publishing. Recording. Details. Latest record, \$1.00. 149 W48, New York City 36.

RADIO, TELEVISION AND ELECTRONICS

FREE 324 Page 1956 Television, Radio, Hi-Fi, Electronics catalog! World's largest stocks, lowest prices. Everything for experimenters, builders, amateurs, servicemen. Latest build-your-own kits, Hi-Fi, phonos, recorders, P. A., TV accessories. Thousands of parts, tubes, test instruments, tools and books. Write for free copy! Allied Radio Corp., 100 N. Western Ave., Dept. 34-B-6, Chicago 80, Ill.

ANNOYING TV commercials eradicated with Stop-Blab. Send \$3.95 check or money order. State color. C. Signorello, 155 Norwood Ave., Lodi, N. J.

SAVE On TV repairs. Details free. Blakesley, Box 686D2, Syracuse, Indiana.

FREE Television and radio troubleshooting manuals and descriptive literature upon request. Build 16 radio circuits, using printed circuitry as well as professional punched metal chassis. "Edu-Kit" includes all radio parts, tubes, instructions, tester, soldering iron, quizzes, free consultation service—Only \$19.95 complete. Progressive Edu-Kits Inc., Room 42B, 497 Union Ave., Brooklyn 11, N. Y.

TRANSISTOR Radio kit, complete, \$4.99. Cook, 4003-M Roosevelt, Midland, Texas.

AMAZING Device tests tubes, TV, picture, radio. Guaranteed, \$6.95. Artronics Co., 2826 Park, St. Louis 4, Missouri.

DIAGRAMS—Repair information, illustrations! Radios, changers, recorders \$1.00. Televisions \$2.00. Rush? (Air-mail +20c). Send make chassis, model. TV Miltie, Box 101-B, Hicksville, New York.

FREE! Newark's new 1956 catalog. A postcard will bring you 260 pages full of the latest releases and largest selections of the world's finest radio, TV, amateur, electronics and high fidelity equipment. Write today to: Newark Electric Company, 223 W. Madison St., Dept. PM-2, Chicago 6, Ill.

TV Picture tube brightener corrects weak or dark tubes, increases contrast—95c. Wholesale Radio Parts Company, 311 West Baltimore Street, Baltimore 1, Md.

20 DX Crystal set plans, catalog and "Radiobuilder" magazine—25c. Laboratories, 328-C Fuller, Redwood City, Calif.

PICTURE Tube briteners. Guaranteed, \$3.50. Nick Kasparian, 229 Burnham St., Lowell, Ind.

RECORDERS, Tapes, radios, phonographs! Wholesale! Catalog. Towers, Box 155, Philadelphia 5.

MAKE Simple, tubeless, batteryless, distance-getting radio. Genuine Melomite crystal, detector, illustrated instructions. 50c postpaid. Allen, 427-PM5, Clinton, Missouri.

TV Trade-in sets. Philco, Emerson, G.E., Admiral, Motorola, Tele-King, others. List available. 10"—\$17, 12" to 17"—\$20 up. Washtek Service Co., 956 Southern Blvd., Bronx, N. Y.

CRYSTAL Radio builders. Free information. Hulet, 305 Hope, Lakewood, N. J.

BUSINESS OPPORTUNITIES

COLOR Concrete with chemicals. Marble-glaze cement benches, pottery. Home-shop. Hundred beautiful designs, made without molds. Birdbaths to waterfalls. Your chance for fame, fortune, 10c brings sample, pictures. Hollywood Cementcraft, 8527-R Wonderland, Hollywood 46, Calif.

MAKE Perfumes, other products. Sell mailorder. International, 6347 Parnell PM-2, Chicago 21, Illinois.

TRADE Magazines keep you posted. Late copies through our get-acquainted service. 5,166 publications—all fields. Current list free. Commercial Engraving Publishing Company, 34C North Ritter, Indianapolis 19, Indiana.

LEARN Sewing machine repair. Money secrets. Purdy's, 207-M, Weatherford, Texas.

DOLLARS Every day! Start amazing new mail order business. Complete details free. MCB, 405-R Gorham Bldg., Minneapolis 3, Minn.

NATURAL Latex rubber for molds. Cast statuettes, figurines as moneymaker or hobby. Major Chemical Corp., 25 Allerton St., Boston 19, Mass.

MINIATURE Trees. Why pay \$2.00-\$10.00 for growing secrets? Free details. Tiny Trees, Box 3084-P, Chicago 54.

OPERATE Profitable mail order business. Write Walter Service, 4159A East 112th, Cleveland 5, Ohio.

BIG Profits selling over 60 money-making books from 24 page catalog. Samples 50c. CMDS, Box 278-PM, Manchester, New Hampshire.

SHINE Cars without polish. New invention. Lighting seller. Cars gleam like mirror. Samples sent on trial. Kristee, 117, Akron, Ohio.

START Home mail order business. Earn wonderful profits right in your own home. Eye-opening information, free. I. W. Service, 4315—6th Ave., Tacoma 6, Wash.

FISHWORM Breeders' book — \$1.00. Postpaid. Literature free. Dixdok, Kent, Ohio.

EARTHWORM Growers needed! Good paying business. You raise, we sell. Send for free booklet revealing terrific new raising, marketing plan! National Earthworm Growers' Co-Op., 4163 Pedley Avenue, Norco, California.

I Made \$10,000.00 typing at home. Guaranteed proof. Free details. Lenore Felgen, Box 1125-PM, Oak Park, Ill.

MAKE Money growing miniature trees on your window sill. Free seed and plan. National Nursery, Dept. PP, Inglewood 4, Calif.

MAKE Money at home as renewal headquarters for all magazines. Big profits now. Liberal commissions. Supplies furnished. Experience unnecessary. Write for free catalog. McGregor Magazine Agency, Dept. 500-B, Mount Morris, Illinois.

UNTOUCHED Mailorder opportunity. Establish industrial supplies mailorder business. High income, more repeats, lower overhead. Complete setup offered. Stewart Advertising, 1625 S.W. 19th St., Miami, Florida.

START A buying service, buy wholesale thousands nationally advertised products. Make big profits selling at sizable discounts. Postcard brings details. American Buyers, Hertel Station, Buffalo 16-C1, New York.

MAKE Flexible molds. Cast figurines, plaques. Free sample. Tooker, 630-R Chestnut, Hamilton, Ohio.

DOLLARS—In baby record books. Baby Gay shoe kits. Agents or mail order. Liebig Industries, Beaver Dam 5, Wis.

PROVEN, Legitimate home factory plan. We furnish materials. Investigate. Hanco, Box 97E, Lombard, Ill.

PROFITABLE Mail order business. Details free. Corrihers', Mill St., Landis, N. C.

WANTED! Home workers to assemble luggage and cases for ready market. Instructions, materials, tools, everything supplied. Free details. Abarst, 807-BB Sunset, Los Angeles 12.

HOW And where to obtain capital. Particulars free. Star Service, Wapakoneta, Ohio.

PUT Success in your mailorder business. Write Carlstrom, Box 1293-M, Miami 8, Fla.

BE A landscape contractor. Make \$20 to \$60 a day. Start with smaller projects and work into larger jobs. We show you how. Easy-to-follow home study course. Write for free book. National Landscape Institute, Dept. M-26-C, 310 S. Robertson Blvd., Los Angeles 48.

PROFITS Stamping social security plates. Catalog free. General Products, 188-PM State, Albany 10, N. Y.

SELL Hamburgers, sandwiches, pie. Use your own kitchen without capital. Or operate small diner, cafe. Free details reveals plan. Restaurant School, BU12, Fremont, Ohio.

BUY Wholesale thousands nationally advertised products at big discounts. Over 3,000 suppliers. Free wholesale plan. Associated Wholesalers, 1016-D Starr, Burlington, Iowa.

GERMAN Address lists. Anything manufactured 25c. Burke Associates, Manchester, Mass.

\$25 DAILY Profits sharpening discs on farm without dismantling or moving. No experience necessary. Free plan explains. C. T. Foley Company, Columbia Heights, Minnesota.

BECOME A game warden, professional hunter! Join forestry, park, fishery services. Good pay! Opportunities open! Free revealing "Select-Job Chart," details, job-getting secrets. Write Home Study Institute 1038-RFY, Los Angeles 19, California.

UP To 95% discount from investigated list of 30 lowest priced name brand wholesale catalogs in the world. Rush \$2.00. B. Ruman Investigating Co., 573 Sheridan, Niles, Ohio.

\$200 WEEKLY Reported! No selling. Free booklet. T. J. Surface, Roanoke 4, Virginia.

FREE Information, numerous profitable opportunities. Kennedy, R1, B76, San Bernardino, Calif.

EARN \$10,000 Yearly raising Angora rabbit wool for us. Information 25c coin. American Angora Company, Malta 12, Montana.

"MAILORDER Laws and Regulations." Discusses federal, state, local, licenses, necessary taxes, legal requirements governing mailorder businesses, \$1.00. "Mailorder Rules for Beginners." Additional helpful information, \$1.00. Play safe. Order both. Tasker, 105 East Custis, Alexandria, Virginia.

GROW Expensive herbs for us! Big profits home-business of your own. Year around profitability! We supply everything necessary! Send for free rare seeds and revealing plan. National Herb Exchange, Dept. A, Gardena, Calif.

BUY Wholesale — \$75,000 merchandise. Catalog 25c. Worldwide, Box 12-E2, New York City 60.

EARN Up to \$200.00 monthly, spare time mail order. Clyde, Box 635, Beaumont, California.

FREE! "301 Profitable Small Businesses!" Amazing shoestring plans! Work home! Start sparetime! Deumant Surveys, Kenmore 23-PM, N. Y.

BUY Wholesale! 100,000 name brand products! Save 66%!! Big profits selling others spare time! Free catalogs! National Buyers Service, Box 426EE, Oakland, Calif.

WORK At home. Make money. Amazing opportunities. Free details. Coleman, Box 821, Newark 1, N. J.

\$5,199.90 WAS Paid to John Betts, in few weeks. Grow mushrooms. Cellar, shed. Spare, full time year round. We pay \$3.50 lb. Free book. Mushrooms, Dept. 172, 2054 Admiral Way, Seattle, Wash.

DIRECT Selling business made easy. Complete setup arrangement furnished—Not only instructions. Harold, 69-A Bennett, New York City 33.

YOU Can earn extra cash selling our rubber stamps. Easy. Average \$1.00 profit per stamp. Free details. Green Bay Mail Order, 613 Phoebe Street, Green Bay, Wis.

MAILORDER Income everyday! Write Ballard's, 425 East Catherine, Louisville 3, Ky.

INTERNATIONAL Mailorder business. Complete setup service—Not just instructions. Hermes, 152 West 42, New York City 36.

BECOME A perfumer. Big profits right away with our fine French perfumes. Introductory kit enough for four ounces; \$5. Melody de Paris, 350 Lincoln Road, Miami Beach, Fla.

CASH For sawdust. Seventy methods. Tin-cans, thirty methods. Newspapers, eighteen methods. Instructions 50c each. All three \$1.00. Charles Company, 12-DXW, Norwood, Ohio.

A Big-paying business for a man in his 50's. One of our men makes \$11,000 in a year. Other top men in their 50's earn up to \$5,000 to \$8,000 right from the start. We pay earnings in advance. Require no investment. Write confidential letter to Vice President, Dept. PM, Box 676, Dayton 1, Ohio.

PROFIT By my 20 years experience when choosing or improving your business. \$1.00 (refundable) for information and business improvement questionnaire. Write Goodrich Advertising Agency, 310 South Lock Street, Waverly, Ohio.

REBUILD Batteries; repair dolls; make rubber stamps; "60 Ideas" free. Universal, Box 1076-A, Peoria, Ill.

"FROG Raising!" Season just starting. Get this year's eggs. New book tells how. Folder 10c. Broel-A, Box 506, New Orleans 1, Louisiana.

ADVERTISING Book matches—Cash in on big demand; sell union label matches. Cuts for all businesses and political parties. Free powerhouse selling kit, low prices, protection guaranteed on repeat orders. Cash commissions. Superior Match Co., Dept. MX-256, 7530 Greenwood, Chicago.

HAVE Home business! Get \$10.00 merchandise orders by mail. Keep \$8.00. Everything furnished. National, Box 88W, Dorchester 22, Massachusetts.

SPECIAL Appointment as a state notary public can be yours immediately if you write. Eastern, 378 Baldwin, Jersey City 6, N. J.

ANCIENT Art of candlemaking, fascinating, profitable. New instructions only \$1.00. Hans Kaufmann, 273-5 Lake Drive, Berkeley 8, California.

2000 SIGN Slogans, clock sign \$1.00. Make money with hobbies. Book \$1.00. ABC, 2227 So. Park, Buffalo 20, N. Y.

GEMCO Power mowers. Famous. Beautiful catalog sheets—free. Farm Products-51, Excelsior Springs, Missouri.

FREE! Complete mailorder business! Terrific profits! No investment! VitaMins, 2908PM Beverly, Los Angeles 57.

LIKE To receive lots of cash in your mailbox? Sell by mail the right way! Write, Shafer, 130-B Linden St., So. Williamsport, Penna.

EUROPEAN Manufacturing formulas, guaranteed. Free list. Uribe, Garcia Paredes, 66, Madrid, Spain.

AMBITIOUS But lazy? Big money at home while others do most of work! Postcard OK. Maxson, Falls Church 17, Va.

HIGHEST Commissions all magazines. Free catalogue, supplies, prizes, exclusive extras. Subscription Service Co., Box 2070, Birmingham, Alabama.

BOWES "Seal Fast" automotive supply distributorships available in a few states. Investment in truck and inventory, but no store required. Opportunity to join successful national distributing organization established over 35 years. For information write Bowes "Seal Fast" Corporation, Indianapolis 7, Indiana.

IMPORT-Export opportunity, profitable, world-wide, mail-order business from home, without capital; or travel abroad. Established world trader ships instructions for no-risk examination. Experience unnecessary. Free details. Mellinger F701, Los Angeles 24.

WANT To make big money at home? \$5 profit in an hour possible with invisible reweaving. Make tears, holes disappear from clothing, fabrics. Steady year-round demand from cleaners, laundries, homes. Details free. Fabricon, 8334-S Prairie, Chicago 19, Illinois.

WHOLESALE Catalogue! Appliances, cameras, watches! Cam Company, 6806PM 20th Ave., Brooklyn 4, N. Y.

IMPRINTS For mail dealers; samples, dime. Sell advertising by mail; details, dime. Volchok, 1098 Gerard, New York City 52.

NATURAL Molding rubber, extra thick. Free sample. W. Wooley, 115-A Donald, Peoria, Illinois.

MAIL Sale Advertiser Magazine. Mail order plans and "how to" enterprises. Copy 10c. Year \$1.00. Ernest L. Gentry, 2623 Pollard Lane, Mobile 5, Alabama.

INTERESTED Mail order? Read mail trade magazines. Copies several different 25c. Palm, Box 1221-A, Baton Rouge, La.

MONEY In saw and lawnmower sharpening sparetime at home. Free book. Virgil Foley Company, Columbia Heights, Minnesota.

BOOKKEEPING—Tax record distributorship. Sell merchants, farmers, accountants. Substantial profits. Handytax, 5632-C, Lankershim Blvd., North Hollywood, Calif.

START A doll hospital at home. Big profits. No expensive equipment. Illustrated secrets never before revealed, everything you need to start. Free details. Hollywood Doll House, 6617 Hollywood Blvd., Hollywood 28, California.

POPCORN And potato chip equipment. Eakins, Box 933-A6, Springfield, Ohio.

FREE Folio "\$5,000-\$45,000, Unlimited Vacations." No merchandise, equipment. Unknown! Work home, sparetime! Haylings, Carlsbad, Calif.

OPERATE Profitable mail order business. Write—National Specialties, 5334 Pedley, Riverside, Calif.

\$250 WEEK Cleaning venetian blinds. Patented machinery. Free literature. Robinson, 7213B, Indianapolis 1, Indiana.

BUY Wholesale thousands products. Free literature. Triple J Industries, 132 Berkshire, Bridgeport 8, Conn.

ARE You mechanically inclined? Amazing home business pays wonderful profits. Free book tells all. Belsaw, 756 Field Bldg., Kansas City 11, Mo.

I Want to send you proof of the wonderful pulling power of Popular Mechanics classified pages. What's your proposition? Write me today. Include literature if possible. F. W. Johnson, Manager Classified Advertising, Popular Mechanics Magazine, 200 E. Ontario St., Chicago 11, Ill.

LEARN Sewing machine "big money" repair. Machines, supplies wholesale. Write Taylor Service, Box 2126, San Bernardino, Calif.

TO \$100.00 Weekly. Sparetime, home operated mailorder business. Successful beginner's plan. Everything supplied. Lynn, 10420-M National, Los Angeles 34.

137 SUCCESSFUL Money making plans. Details free. Capitol Specialties, Box 413A, Springfield, Illinois.

23 WAYS For home mail business with lifetime repeat income. Free details. Hardy, Box 546, Cantonment, Florida.

\$1,000 MONTHLY. Home, mailorder, free advertising method. Revealing information. Seidel, 6000-AM Sunset, Los Angeles 28.

"HOW To Profitably Operate a Mail Order Business." Free literature. Lawrence J. Archer, Rt. #1, Navarre, Ohio.

MAKE-Sell polishes, cleaners, anything. Formula catalog free. Kemixer, Park Ridge, Ill.

EARN Money at home! Homemaker Magazine tells how. Sample 25c. Sizemore, 20-H East Delaware, Chicago 11.

MAKE Money helping others out of debt. Stop garnishments, save jobs, re-establish credit. Details. Borum 87, 411 W. Walnut, Kalamazoo 42, Michigan.

WHOLESALE Catalog! 30-80% discounts! Appliances, musical instruments, typewriters, phonographs, watches, jewelry, recorders, housewares, etc. Consolidated Distributors, 21-11 Lafayette, Paterson 15, New Jersey.

BOOKKEEPERS. Keep books, small firms spare time. Manual latest technique by C.P.A., \$3.00. Modern Business, Box 406, Youngstown 1, Ohio.

PLASTERCRAFT Molds, liquid rubber, plasters, floccs, candle supplies. Catalog and manual free. Blue Rapids Supply, Blue Rapids, Kansas.

WHAT'S New in mailorder? Let "Mail-order World," published monthly, keep you informed. Sample, 25c. Wayte, 1233 Elden, Los Angeles 6, Calif.

DOLLARS: Baby record books, Kitty Kat shoes, My Baby albums, eleven thousand new prospects daily. Sold by mail, use our literature. No-Co-Ro, Oakland 6, Calif.

WANT Up to \$100.00 weekly deposited in your mail box? Details free! Smith, 2708-P Ladera, San Bernardino, Calif.

ELECTROPLATE Auto parts, novelties, mirrors, baby shoes. Easy, inexpensive home processes. Free booklet. Tyco Metals, Box 13231-MM, Houston 19, Texas.

BREED Rare tropical fish at home. Earn big money! Learn secrets! Help fill huge demand. Amazing opportunity! Free plan. Tropical Fish Breeders, Los Angeles 61, Calif.

BE Appointed state notary public now. Write. Stationers, Helotes, Texas.

WE Love our mailman—He leaves over \$1000.00 monthly in our rural mailbox. My college professor husband drafted a scientific home mailorder method. We bought a Texas ranch, live as we always wanted. Now we sell the Ranch Mailorder Method. Operate anywhere. Inquire: Eveningshade Ranch, Helotes, Texas.

COPUBLISH Mail Sale Advertiser, leading mail order paper. Details, latest copy, dime. Vanroy Shirk, Lebanon, Penna.

COLORGLAZED Concrete pottery made without molds. Patented method. Cemetery products, novelties, tiles. Basement leak-sealing. Money-making projects. Booklet, details free. Men only. National Potteries Company, Grand Rapids, Minnesota.

MINK Raising information free. Complete. Lake Superior Mink Farm, Superior, E.E.I., Wisconsin.

FREE Book "505 Odd, Successful Businesses." Work home. Expect something odd! Pacific, Oceanside, Calif.

BRONZE Baby shoes. Instructions, equipment and mountings for genuine electroplated process. Free catalog. Hollywood Bronze Supply, Dept. B-3, 1624 East First Street, Los Angeles 33, Calif.

YOUR Own name brand business. No investment; no inventory. Part time or full time. Sell famous brands of appliances, housewares, silverware, radios, vacuum cleaners, lamps, tools, clocks, watches, jewelry, etc., etc., over 1000 items. Join thousands of successful independent dealers. Send for free catalog and dealer price list. H. B. Davis Corp., Dept. W, 145 W. 15 St., New York City.

LIQUID Rubber. Make flexible molds. Free sample. Chaney, 1130 E. 16th St., Jacksonville 6, Fla.

GOOD Paying business silvering mirrors, plating articles in the shop and home by late method. No tanks or shop required. Free booklet. Gunmetal Co., Ave. H, Decatur, Illinois.

BIG Profits raising fishworms and crickets. Free literature. Carter Farms, Plains, Georgia.

GROW Orchids at home—Profitable, fascinating. Year 'round, Maine to California. No greenhouse. Gorgeous cactleys, cymbidiums, etc. Successful home grower shows you how. Full details free. Flowerland, 4622 Wilshire, Los Angeles 5.

FIX Typewriters. Inexpensive home course teaches factory secrets. Free booklet. Write, Typewriter, Tarentum 1, Penna.

METALIZE Baby shoes, jewelry, gifts. Free catalog. Publisher, Box 73136, Los Angeles 3.

NEWEST Spare, full-time home business. \$5 to \$10 hour possible. Paint with suede—The finish with touch and eye-appeal. Beautify auto dashboards, signs, radios, toys, figurines, lamps—1001 others. Complete, step-by-step instructions sent for no-risk examination. Free details. Coast, Los Angeles 61.

IMPORT-Export mailorder opportunities! Details. Warner, Box 6, Fort Scott, Kansas.

MAKE New greaseless doughnuts in kitchen. Sell stores. Half profit. Free recipes. M. Ray, 3605 South 15th, Minneapolis 7.

VENDING Machines—Every description. New or used. Lowest prices. Mack Postel, 2952 Milwaukee, Chicago 18.

"23 WAYS To build a home mail business." Free details. Penn General Distributors, Monessen, Penna.

HUGE Sparetime home profits. It's easy! Details free! Stommel, Box 104, Detroit 31, Michigan.

A Monthly repeat business which you can operate in your own community. For free details write Grasak, Dept. A-101, P.O. Box 494, McKeesport, Penna.

SELL From your own large wholesale catalog. Rush name! C-S, Box 9091, Kansas City 18, Missouri.

\$20,250 PROFIT Selling stamps by mail. How we did it book; send only \$2.00. Free details. Fahsing, Atascadero, California.

\$46 FROM Square foot plywood; jigsaw necessary. Details free. Woodart, Bridgewater, Mass.

CAST Figurines! Novelties! Make production molds! New copyrighted course! Quick method! Illustrated! Only 25c! Castcraft Studios, 508-P Marion St., Brooklyn 33, N. Y.

NUTRIA Raising information free. Herb Miller, 513 Kent, Lubbock, Texas.

VENDING Machines earn big money! Request 32 page free catalogue. Parkway Machine Corporation, Dept. 26, 715 Ensor St., Baltimore 2, Maryland.

BIG Money! Take orders religious articles. Illustrated 1956 catalog. Write Pette Co., 1554A W. 11th St., Brooklyn 4, N. Y.

WHOLESALE Buyers' service! Buy nationally advertised merchandise wholesale. Sell way below retail. Fabulous profits. Write Wholesale Buyers, Box 22-PB, St. Louis 3, Missouri.

EXPORT, Import! Unlimited opportunities. Free literature. Write Universal Services, Clayton 5-PB, Missouri.

OWN A large business. No investment. Products with your own name on labels. We furnish everything. Fabulous profits! Send \$1.00 to start you immediately. Refundable. Plumer, P.O. Box 832, Inglewood, California.

\$16.00 POUND Hand spinning Angora wool at home. Angora House, PM, Springfield, Illinois.

FOREIGN Business opportunities. Homesteads open file—develop while living in U.S.A. Information \$1.00. Inter-American Land Development, P.O. Box 264D, Catalina Island, Calif.

\$20,000 INCOME. Started nothing. You can do same. New sensational book "Make Money and Then Manage It" will be whirlwind seller. Become dealer. Clean up. Advertising only investment. We drop ship orders. Sells \$4.95. Send no money. But reserve your dealership copy now. Full details sent when published soon. Real opportunity. Write today. Bruno Enterprises, Chandlerville, Illinois.

BUY Wholesale 750,000 products. Details free. Carter, Box 6011-D, Chicago 80.

\$70 WEEKLY—Home, spare time. Simplified mail bookkeeping. Immediate income—easy! Auditax, 34757A, Los Angeles 34.

BECOME Tax consultant. Our students earn to \$3,000 in 3-month season, part-time. We train you—help you start. State approved. Union Institute, 68 Hudson, Hoboken 20, New Jersey.

\$150 WEEK—Easy! Start home Venetian blind laundry. Revealing book free. A. T. Co., 101 S. 44th, Philadelphia 4, Penna.

MAKE \$50 Week to \$1000 month in own business. \$15.00 invested, in four months was making \$2000 monthly. Our step by step plans will show you. Opportunities plentiful if you know how. Business can be operated by men and women. Mail \$1.00 today for complete plans. Edward O. Burns, Box 54, Dept. 111, Dallas 21, Texas.

FRANCHISE Opportunities nationwide! Request details immediately. National Franchise Reports, 333 North Michigan, Chicago 1.

BRONZED Baby shoe mountings, supplies, instructions. Foster, 1520 Ardmore, Chicago 26.

UP To \$50.00 weekly, spare time, home mail order. Details free. Yeager, 601-P South Vermont, Los Angeles 5, Calif.

IMPORTING Without capital. Become successful U.S.A. resident agent for leading overseas manufacturers. High income, home operated, no risk. Complete arrangements furnished including U.S.A. distribution assistance. Impex, 1974-A Comstock, Los Angeles 25.

YOU'LL Be amazed at the tremendous profit possibilities in selling the finest quality Bibles available anywhere! Many men make \$30,000 yearly and more! Get my free proven Bible sales course plus catalog of many Morocco grain genuine leather covered Bibles and related items. Joseph W. Cain, Wholesaler, Box 5065, PM, San Antonio 1, Texas.

LEARN Sharpen scissors. Complete instructions. Leiser, Box 85, New York 51, N. Y.

NEW \$1,000,000 Invention. Home insulation. Material cost \$5.00. Do it yourself, save \$100.00. Elkins, 3314 Knight, Dallas, Texas.

TREMENDOUS Profits selling Titania jewels—the diamond-like gem that's more brilliant than diamond. Not an imitation but the real gem created by the magic of chemistry. They have all the beauty, sparkle and lasting qualities of diamonds. Only an expert can tell the difference. Retail for \$20 a carat, cost only \$8.50 a carat. Imperial Gem Company, Spotswood, N. J.

UP To \$2.00 hourly part-time work at home. Murphy's, Bearsville Rd., Woodstock, N. Y.

MONEYMAKING OPPORTUNITIES

MEN And women wanted to start home business in spare time with little table-top rubber stamp machine. Easy to earn up to \$9.80 an hour without previous experience. Full particulars free by mail. Send postcard to Roberts, 1512 Jarvis, Room 72, Chicago 26, Ill.

FREE Wholesale catalog, 30%-80% discounts. Jewelry, appliances, housewares, etc.; Sheldon's, 8405 Cedarbrake, Houston 24, Texas.

NEW Ultra-blue 7"x11" signs, 7c, retail 50c. Sample free! Lowy, 812 Broadway, Dept. 912, New York City 3.

OPERATE Profitable magazine subscription service. New telephone plan. Handle renewals for all magazines. No experience or investment needed. Rush name; send no money. McGregor Agency, Dept. 500-C, Mt. Morris, Illinois.

START A buying service, buy wholesale thousands nationally advertised products. Make big profits selling at sizable discounts. Postcard brings details. American Buyers, Hertel Station, Buffalo 16-D1, New York.

\$20.00 RETURNS \$400.00. Lifetime repeats. Sample \$1.00. Refundable. Ezee, Barport 7, Mich.

MAKE Money writing short paragraphs! No tedious study. I tell you what to write, where and how to sell; and supply list of editors buying from beginners. Many small checks add up quickly. Write to sell, right away. Send for free facts. Benson Barrett, 1751 Morse, Dept. C-27-O, Chicago 26.

START Big-pay business at home in spare time. No experience needed to operate little table-top machine for bronzing baby shoes. Make \$5.46 profit on every pair. Full particulars free. Send postcard to Mason, 1512 Jarvis, Room 72, Chicago 26, Ill.

WANT Up to \$300.00 monthly? Home mail order. Details free. Prinz, Box 402-P, Pico, California.

START Money-making plastic laminating business at home in spare time. Material that costs 11c brings back \$2.58. No canvassing or selling but mail orders bring in \$20 a day. Write for full particulars free. Rush name on postcard to Warner, Room 72, 1512 Jarvis, Chicago 26, Ill.

BE Your own boss—Make money at home, sparetime! Easy-to-start mailorder business! Extra dollars come in fast! Free catalog describes many money-making instruction folios. Write today! Llanerch Shop, 538-PM Wales, Havertown, Penna.

FREE! "301 Profitable Small Businesses!" Amazing shoestring plans! Work home! Start sparetime. Deumant Surveys, Kenmore 23-PM, N. Y.

INCREASE Your income. Free literature. Excello, Box 500, Shreveport, Louisiana.

OPERATE Your own cafe, diner. Only minor investment needed. Guide reveals how. Write Restaurant School, MO12, Fremont, Ohio.

MAKE Millions with thrilling outdoor hobby. Others have. Complete information \$2.00. Holland, 166-B2 Crescent Place, Ithaca, N. Y.

\$1,000 MONTHLY Possible raising earthworms! Backyard, garage, basement. Complete illustrated booklet explains raising, feeding, packing, marketing. 25c postpaid! Ozark Worm Farm-J. Willow Springs, Missouri.

\$5,199.90 WAS Paid to John Betts, in few weeks. Grow mushrooms. Cellar, shed. Spare, full time year round. We pay \$3.50 lb. Free book. Mushrooms, Dept. 173, 2954 Admiral Way, Seattle, Wash.

BARGAIN Offers! Interesting mail! Earning plans! Free coupon! Nelson Sales, Elkhorn 99, Nebraska.

BE Your own boss. Choose from 301 little businesses. Crawford's, Anthony 1, Kansas.

FREE Formula catalog. Anything analyzed \$35.00. Western Chemical, Salem, Oregon.

EARTHWORMS—Amazing reproduction makes you money. Breeders, supplies, spawn, new "senior kit" information plus newly published booklet and facts. Send 25c. Multiple Enterprises, P.M.-72, Kalkaska, Mich.

"MONEY Getter's Bulletin," sample 25c. Donovan, 791 Greenbelt, Levittown, N. Y.

PRINTING, Office supplies wholesale. Save 50%. Royal, Box 368-A, Cleveland 27, Ohio.

FREE "\$5,000-\$45,000; Unlimited Vacations." Work home! No merchandise, equipment! Haylings, Carlsbad, Calif.

TO \$100.00 Weekly Sparetime, home operated mailorder business. Successful beginner's plan. Everything supplied. Lynn, 10420-M National, Los Angeles 34.

\$5.00 HOURLY Possible, spare time home mail order. Details free! Dempsey, Box 42237p, Los Angeles, Calif.

DON'T Let the millionaire outsmart you. Enjoy Florida sunshine, bathing, fishing. Live longer. Be boss. 25 ways to make extra cash to thousands. Send \$1.00. Sun Associates, Wildwood, Fla.

MONEY In saw and lawn mower sharpening sparetime at home. Repeat cash business. Experience unnecessary. No selling. Free booklet explains. V. Foley Company, Columbia Heights, Minnesota.

MAKE Spare time money preparing and mailing sales literature. Adams Surveys, 3513-AT Sunset Blvd., Los Angeles 26, Calif.

EARN \$50.00 Daily making mats, shoes and mud guards from old tires. S and S Patents Inc., 1307 North Clark St., Chicago 10, Ill.

GENERAL Contest Bulletin. Issued monthly. Sample, 25c. 1609 1/2 East 5th, Duluth, Minn.

FREE Book "505 Odd, Successful Businesses." Work home. Expect something odd! Pacific, Oceanside, Calif.

READ Progressive Mailtrade, the magazine that tells how to make money by mail. Dime brings sample and special offer. Progressive Mailtrade, Box 357, Sheboygan, Wisconsin.

ATTENTION: Typewriter owners. Make handsome profits. Write today. Groves Company, 682, Hastings 8, Nebraska.

SCHOOL Seniors—Sell classmates America's most beautiful graduation name cards. Largest selection. Highest commission. Outsell all others. Free sample kit. Printcraft, Dept. M, 1509 Maple Street, Scranton 5, Penna.

SELL Titania gems; far more brilliant than diamonds. Catalog free. Diamonite, 2420-M 77th, Oakland 5, California.

PLASTIC Laminating. Pleasure and profit. Self-sealing. No machines. Complete home kit, \$1.00. Mountainside 1, Springwater, New York.

BUY Wholesale! Thousands products—Everything. Free catalogs! Econ-O-Mart, 8 Perry, Whippany, New Jersey.

PRIZE Contests provide fabulous and confidential home income opportunities! Here's how and where to win your share! Send stamp! National Contest Bulletin, Box 3685-P, Miami 16, Florida.

BOYS—Earn \$1.80 hourly! Cleaning windows after school and Saturdays. Professional tools and instructions supplied. Kent Window Cleaning, Box 6807, Philadelphia 32, Penna.

VENDING Machines, merchandise, wholesale, makes money while sleeping. Ameridaurio, Box 162, West Englewood, N. J.

EARN Money evenings copying and duplicating comic cartoons for advertisers. Adservice, Argyle 1, Wisconsin.

YOU Can win prize contests. New manual only \$1.00. Hans Kaufmann, 273-4 Lake Drive, Berkeley 8, California.

VENDING Machines earn big money! Request 32 page free catalogue. Parkway Machine Corporation, Dept. 27, 715 Ensor St., Baltimore 2, Maryland.

MAKE Money with your 35mm camera. Amazing new low cost color enlargements can bring you hundreds of dollars in spare time. Nothing else like it! Send 10c for samples and eye-opening facts. Dept. PM-2A, Polypix Co., 723 S. Wells Street, Chicago 7, Illinois.

CLOSEOUT 50,000 GE subzero automobile engine heaters. Listed \$8.95, sample \$3.95. Terrific quantity discounts. Illustrated literature and mailorder plans \$1.00 (refundable first order). Wisniewski, PM, Milwaukee 7, Wisconsin.

500 WAYS To earn money at home. Write. Bunton Industries, P.O. Box 354-B, Philadelphia 5, Penna.

\$3.00 RETURNS \$30.00. Seven gets ninety. Free particulars. Feteze, 474p Sinclair, Atlanta 7, Georgia.

MONEY For box-tops, labels! Complete information, current prices! 50c. Midwest Sales, Box 156-M, Pontiac, Illinois.

CATALOG! Profitable opportunities. Rush 35c! Ridsen, 3468 Cass, Detroit 1, Michigan.

UP To \$300. monthly. Home mail order. Complete programs. Details free. La Tourrette's, Box 261-B, Redlands, Calif.

\$150 WEEK—Easy! Start home Venetian blind laundry. Revealing book free. A. T. Co., 101 S. 44th, Philadelphia 4, Penna.

MAKE Your own wheel of fortune! Here's where and how to win your share of cash, cars and merchandise awards! Send your name and address today for free details. Vernon, (7-II) Box 449, Junction City, Oregon.

MAKE Money in mail order. Send for free profit facts. Whitecomp, Box 74635, Los Angeles 4, Calif.

MANUFACTURING Comb and sanitary vendors. Start vending today. White's Comb Vendor, Elgin, Illinois.

FORMULAS. PLANS. ETC.

FORMULAS: All kinds, latest, best. Literature free. Kemixal, Park Ridge, Ill.

PRODUCT Analysis, manufacturing formulas, processes developed. Moderate fees. Plastics, Box 1574, Boston 4, Mass.

PRACTICAL Formulas. Lists free. Cummings, Chemist, Gordon Ave., Syracuse 4, N. Y.

HOUSE Plan booklet—30 modern designs of available plans. \$1.00. Melman Homes, Box 62, Mt. Pleasant, Penna.

MILLER'S Modern manufacturing formulas make fastest-selling products that get the business and pay. Fifty years supplying the best. Valuable literature free. Miller, Chemist, 1517-M, Tampa, Florida.

10,000 AUTHENTIC Formulas. Information, lists free. Brockway, 1145 High, Topeka, Kansas.

PLASTICS

NEW Liquid casting plastic, clear, colors. Embed real flowers, insects, photos, coins. Saw, drill, carve. Send 25c for handbook. "How to Cast with Liquid Plastic," and proved success plan showing how to make money at home. Castolite, Dept. B-101, Woodstock, Ill.

PLASTICS Home-craft course for men and women. Tells and shows how to make hundreds of fast selling plastics products. All plastics and materials for 23 projects included in course. No special tools needed. Course pays for itself. Write for free booklet. Interstate Training Service, Dept. D-3, Portland 13, Oregon.

LAMINATING Supplies. Free price list. Solomson, 46 Cornhill, Boston 8, Mass.

PLEXIGLAS. Cut to size. Clear. Any thickness. Colors. Rods. Tubing. McClarin Plastics, P.O. Box 168H, Hanover, Penna.

PLEXIGLAS. Fiberglass, polyester, acetate. Unique wholesale-retail catalog—15c. Gem-O-Lite, Box 686M, North Hollywood, California.

PLEXIGLAS. Lucite. Square foot cost 1/16", \$1.10; 1/8", \$1.30; 3/16", \$1.65; 1/4", \$1.95; 3/8", \$3.23; 1/2", \$4.38. Colors add 10c. Send 15c for postage. Aristocrat Plastics, 23-25 Sussex Avenue, Newark, N. J.

CHEMISTRY

FREE! Uranium detector and chemical puzzle (worth \$2.50) with first five lessons of diploma course on practical chemistry! Big package of chemicals, filtering equipment, charts, etc. Only \$1.00. National School of Chemistry, P.O. Box 606-G, Redwood City, Calif.

HOME Laboratory and apparatus kits, laboratory supplies. Catalog 25c. John H. Winn, 124A West 23rd St., New York, N. Y. Established 1931.

NEW. Used apparatus, chemicals. Catalog 25c, refundable. Laboratory Sales, Box 161-E, Brighton, Mass.

SPECTROSCOPE For quick chemical analysis \$3.00. Kutting Sons, Los Altos, Calif.

LABORATORY Apparatus, chemicals, microscopes, complete chemistry sets, minerals, uranium ore. 10c brings catalog. Porter Chemical Co., Hagerstown 4, Md.

ILLUSTRATED Catalog: Chemistry, mineralogy, biology 20c. Tracey Laboratories, Evanston, Illinois.

CHEMICALS And apparatus for industrial, analytical, and private laboratories. Catalog 25c. Dept. M-50, Biological Supply Co., 1176 Mt. Hope Ave., Rochester 20, N. Y.

60 PAGE Booklets! "Chemistry," "Physics," "Relativity," "Atomic Theory," "Scientific Oddities," "Light," "Sound," "Heat," "Electricity," "Radio," "Astronomy," "Botany," "Zoology," "Weather," "Useful Tables," "Geometry," "Mechanical Problems," "Nautical Dictionary," "Mathematical Oddities," "Scientific Terms." (Order by titles.) 10c each. Franks, 3121 South Racine, Chicago 8.

AGENTS WANTED

RUN A spare-time greeting card and gift shop at home. Show friends samples of our new 1956 all-occasion greeting cards and gifts. Take their orders and earn up to 100% profit. No experience necessary. Costs nothing to try. Write today for samples on approval. Regal Greetings, Dept. 59, Ferndale, Michigan.

GOLDMINE Of 600 money makers. Copy free. Specialty Salesman Magazine, Desk 5-B, 307 N. Michigan, Chicago 1.

MAKE Money at home as renewal headquarters for all magazines. Liberal commissions. No experience-capital needed. Supplies furnished. Write for free catalog. McGregor Magazine Agency, Dept. 500-A, Mount Morris, Illinois.

YOUR Own wholesale business with no investment. Free catalog. Jay Norris Co., 487-X Broadway, New York City.

HOME Motorized massage. Big money! Mary Mac, 1012 Powhattan, Dallas 2, Tex.

PROFITS To 150% selling finest everyday greeting cards. New 21 for \$1 tall cards, unusual gifts, 129 fast-sellers. Valuable gift bonuses. Assortments on approval, stationery samples free. \$1 gift free for promptness! Creative Cards, 4401 Cermak, Dept. 525-C, Chicago 23.

YOUR Own business—Used suits \$1.50, overcoats 85c, mackinaws 35c, shoes 12½c, ladies coats 30c, dresses 15c. Enormous profits. Catalog free. Nathan Portnoy Associates, 605-AA West 12th Place, Chicago 7.

MAKE \$100 Up weekly—Demonstrate, take orders. Sensational new product. Prospects everywhere, part-full time. Campbell Company, Rochelle 53, Illinois.

SCHOOL Seniors—Be popular with classmates. Have spending money galore. Details free. Craftcards, Box 235-L, Pittsburgh 19, Pennsylvania.

GOLD Or silver letters, numbers. Windows, doors, trucks, 1" to 6". 500% profits. Free samples. Atlas-T, 544 West 79th, Chicago 20.

PRINTING. Advertising salesmen—Excellent moneymaking sideline selling decalcomania name plates, small quantities. Automobile initials, sign letters. Free samples. Ralco, XL, Boston 19, Mass.

\$1.00 PROFIT Selling \$2.95 photo enlargement deal. Allen Studio, Riegler Bldg., Little Rock, Ark.

AGENTS—300% Profit selling genuine gold window letters; stores and offices. Free samples. Metallic Sign Letter Co., 431-D North Clark, Chicago.

CALIFORNIA Sweet smelling beads. Sensational sellers. Particulars free. Mission, 2328 FR, W. Pico, Los Angeles 6, Calif.

USED And new watches \$2 up. Free list. Southern Watches, Gray, Georgia.

YOUR Ad in this space will get some good agents for you. Yes, I'll prove it. Write for Folder "A" right now. F. W. Johnson, Classified Advertising Manager, Popular Mechanics Magazine, 200 E. Ontario St., Chicago 11, Ill.

MAKE Up to 100% profit in your spare time! Sell over 600 exciting, unusual gifts, gadgets, greeting cards, gift wraps. Send for sensational money-making plan and brand new free catalog at once. Samples on approval. Hurry—get in on big profits now! North Star, Dept. 362, 251 E. 5th St., St. Paul 1, Minn.

PROFIT With your own wholesale, name brand catalog. Appliances, watches, jewelry, gifts, tools. Imprint your name on cover. Full or part-time sales. Details free. Robel Sales, Dept. P.M., 487 Broadway, New York 13, N. Y.

IF You want to earn money fast, I'll send you free sample stocking of newest stretch duPont nylons to sell at only \$1 a pair. American Mills, Dept. 482, Indianapolis 7, Ind.

WAXES Floors without "wax." New invention. No more floor wax to buy. Sensational seller. Samples sent on trial. Kristee 83, Akron, Ohio.

MAKE Your spare time profit time! Over 600 beautiful, unusual gifts, greeting cards, household gadgets, toys, jewelry, baby items, and gift wraps you can sell to friends, neighbors, relatives. Write at once for big, bright free catalog just off the press. Samples on approval. Hurry—get details on sensational money-makers! Greetings Unlimited, 36B Park Square, St. Paul 1, Minnesota.

MEN, Women, make money spare time plus new car as bonus for encouragement. Amazing hosiery guaranteed to wear without holes, snags, and runs, or replaced free. For example, lovely 60 gauge nylons guaranteed for as long as 1½ years, or replaced free. Write Wilknit, 1762 Wash., Greenfield, Ohio.

FREE! Beautiful feather pictures, 200% profit! Apartado 9036, Mexico 1, D. F.

IS \$50 A day worth a postcard to you? Urgently need salesmen to fill big demand for new Futureline auto safety belts. We give you everything needed to start your earning quickly. Write Futureline, Dept. W-16, 173 W. Madison, Chicago 2, Ill.

SHINE Cars without polish. New invention. Lightning seller. Cars gleam like mirror. Samples sent on trial. Kristee 85, Akron, Ohio.

GREETING Cards—\$50.00 cash from 40 boxes sensational all-purpose assortment. Big money all year from special occasion cards—Mother's, Father's Day, birthdays, Eastern Star. Best all-occasion assortments, stationery, gifts. Bargain specials. Color catalog. Samples on approval. Midwest, 1113 Washington, Dept. 699-J, St. Louis 1, Mo.

MAKE Money selling outstanding line of regular ties, square ends, reversibles, feather, pleated, bows, knitted, kerchief sets. Free catalog. Philip's Neckwear, 20 W. 22nd, Dept. 415, New York City 10.

CLEANS Windows without mess. Strange dry cleaning-cloth. Replaces liquids. Windows gleam. Samples sent on trial. Kristee 82, Akron, Ohio.

\$1,000.00 A Month for making dramatic 3-second demonstration of amazing light-weight Presto fire extinguisher. New chemical used by airforce snuffs out fires instantly. Only \$3.98. Terrific commissions. Millions want it. Free kit. Merlite, 114 E. 32nd, Dept. 50-F, New York City 16.

MONEY in minutes! Even beginners scoop up big earnings with Elmira—the greeting line so beautiful, it sells by itself! Friends, neighbors—even perfect strangers want to see and buy from Elmira's exciting array of all-occasion greeting cards, personalized stationery, napkins and gift wraps. Look no further—Elmira gives you everything to make your extra-money dream come true! Send today for free samples, catalog, assortments on approval. Request Elmira's fund-raising plan for churches and clubs! Elmira Greeting Card Co., Dept. 160, Elmira, N. Y.

BUY Wholesale thousands nationally advertised products at big discount. Free "Wholesale Plan." American Buyers, Hertel Station, Buffalo 16-A1, N. Y.

FREE! Sunshine's petite everyday assortment—Special introductory offer to big profits available selling exclusive everyday cards, imprinted stationery, gift wraps, deluxe 21 card assortment, etc. Free catalog. Send postcard today for sample kit on approval. Sunshine Art Studios, Inc., Dept. PM-2, Springfield 1, Mass.; Pasadena 1, California. (East of Rockies address Springfield).

CUCKOO Clocks, 5"x11". Drop-shipped. Demonstrator \$3.25. Amick's Imports, 2440 Kinnickinnic, Milwaukee 7, Wis.

EASY Handwork makes fast-selling articles. Sample free. Sunmade Company, Brockton 64, Massachusetts.

START Your own business on credit. Your own boss. 1135 dealers sold \$5,000 to \$30,000 in 1954. We supply stocks, equipment on credit. 200 home necessities. Sales experience unnecessary. Pleasant profitable business backed by world-wide industry. Write Rawleigh's, Dept. B-U-PPM, Freeport, Ill.

BIGGER Profits, better service, most famous brands from investigated list of 30 lowest priced wholesale catalogs in the world. Rush \$2.00. Ruman Investigating Co., 573 Sheridan, Niles, Ohio.

FREE Deodorizer. 100% profit showing Odor-Zone the new disinfectant to homes, restaurants. Write Norwich Chemical Company, Dept. 6, Norwich, Conn.

SELL World famous documents. Declaration of Independence, Bill of Rights, U. S. Constitution, Lincoln's Gettysburg Address, on genuine aged parchment. Free information. Four samples \$1.00. Sherry's Ltd., Dept. 202, 2126 Boyer, Seattle 2, Wash.

NYLONS—Lowest prices! Essential Products Co., 210 Fifth Ave., New York 10, N. Y.

BUY Wholesale, 25,000 items, catalog 25c. Matthews, 1472-B5 Broadway, New York City 36.

MAKE Money introducing world's cutest children's dresses. Big selection, adorable styles. Low prices. Complete display free. Rush name. Harford, Dept. R-3341, Cincinnati 25, Ohio.

KEEP 60c Out of every dollar. You make as high as 60% profit on famous, nationally advertised Studio Girl Hollywood cosmetics. No experience necessary. I teach you at home, free, in a few pleasant hours how to be a beauty advisor. Then demonstrate to friends and neighbors correct way to use these cosmetics to appear more glamorous. Make up to \$5.00 an hour or more for spare time—\$25.00 a day full time. Then hire others and double your earnings. Write today and I will include actual usable samples free. Send name on postcard to Harry Taylor, President, Studio Girl Cosmetics, Dept. 1262-L, Glendale, Calif.

EXCLUSIVE Sales plan. New profitable field. Immediate, permanent, growing income. Full, spare time. \$1.00 brings samples, details. Cerco Products, Salem, Conn.

EARN \$30 A day! Sell Dab-It, amazing pocket-size, stick-form, "no ring" spot remover. Works like magic! Guaranteed! M & M, Dept. PM-22, 842 Third Ave., New York City 22.

\$18.75 NATIONALLY Advertised perfume. Closeout price 60c. Sell for \$3. Profit \$2.40. Sample \$1. Details, advertisement reprint free. Essef 73-14L, 175 Flushing 66, New York.

GIVE Away plan pays you to \$5 hour! Your customers receive choice of wonderful gifts (silverware, hosiery, electric shavers, etc.) free with purchases! Show huge line with famous brands like Westbend, International Silver, Melmac unbreakable dinnerware, hosiery, shirts, underwear, etc. Nothing for you to buy. Just write orders. We deliver prepaid and collect. Also weekly payment club plan. Pocket advance cash plus big cash bonuses. Opportunity become manager appointing salespeople. Experience unnecessary. Full or spare time. Nothing to pay now or ever. Postcard brings you complete money-making outfit free. No obligation. Kenmart, Dept. 13, 108 Lawrence St., Brooklyn 1, N. Y.

GENEROUS Commission selling personalized cast aluminum estate and mail box signs. Write Doucette Foundry, Worthington, Mass.

INDUSTRIAL Floor brushes. Branded, with your name. Pirring Mfg. Co., 1918 Larrabee St., Chicago 14, Ill.

SELL Miniature spy cameras. One of the world's smallest, \$18.50 per dozen, samples \$2.95. Harold Bell, 246 N. Broadway, Lexington, Ky.

EARN To \$50 per day! New, amazing chemically-treated Foam-O-Cel sponge cleans rugs, upholstery like new. Fast \$1 seller, big profits. Free details, M & M, Dept. PM-2, 842-3rd Ave., New York City.

SELL Sick call crucifixes. Big commission. The James Company, North Attleboro, Mass.

A Dress shop in your home. No investment. Good selling. Commissions. Write Modern Manner, Hanover YS, Penna.

BUY IT WHOLESALE

BUY Surplus wholesale. Catalogue 25c (refundable). Box 22-87, Thomasville, Penna.

BUY Wholesale! Nationally known merchandise. Catalog \$1.00. (Refundable.) D'Auria, Box 355-M, Jackson, Michigan.

WHOLESALE Catalog! Appliances, cameras, watches. Postcard: Selbyco, Decatur 253, Illinois.

THOUSANDS Nationally advertised brand name products, including new 1956 automobiles—Discounts to 80%. Meder, 550-PM Fifth Avenue, New York City 36.

BARGAINS, Joblots, closeouts, 2000 items. Tremendous savings, clothing, toys, gifts, jewelry, television, etc. 25c brings wholesale catalog. \$1.00 merchandise certificate included free. Reliable Jobbing, 311-B North Desplaines, Chicago.

BUY Wholesale! Television, radios, refrigerators, freezers, water heaters, air conditioners, sewing machines, power tools, housewares, etc. Catalog 10c. Marpat, Box 1485, D-PPM, Milwaukee, Wis.

APPLIANCES, Housewares, watches, jewelry, giftwares. Wholesale catalogue \$1.00 deposit, refundable. Laconia, P.O. Box 6014, Bridgeport 6, Conn.

WHOLESALE Catalog! 30-80% discounts! Appliances, musical instruments, typewriters, phonographs, watches, jewelry, recorders, housewares, etc. Consolidated Distributors, 21-20 Lafayette, Paterson, New Jersey.

WHOLESALE Name brands, illustrated catalog 50c. Refundable. Distributors, Box 106A, Hudson, New York.

UNCLAIMED Cleaned, pressed men's shirts. \$5.00 dozen. Fairview, 2447 Southern Boulevard, New York City.

ELECTRIC Guitars, amplifiers, parts, wholesale. Free catalog. Carvin PM287, Covina, Calif.

SALESMEN—DISTRIBUTORS

BRAND New product. Needed by millions. 250% profit. Information free. Vita-Cell Corporation, 929 Sheridan, Saginaw, Michigan.

NEW Jobs open in selling! Send name, address for five free issues of Opportunity Magazine's money-making guide, listing hundreds of companies who'll pay you well, full or part-time. No experience needed. Opportunity, 850 N. Dearborn, Dept. 17, Chicago 40, Ill.

IT'S New, Jiffy Snug-Fit car cover \$24.95. Fits all cars. Phenomenal sales via demonstrations. Averaging ten daily. Sample \$16.95. Distributors, jobbers, big lot buyers less. General Carcover Sales, 1936 Burgundy, New Orleans 16, La.

ANYONE Can sell famous Hoover uniforms for beauty shops, waitresses, nurses, doctors, others. All popular miracle fabrics—Nylon, dacron, orlon. Exclusive styles, top quality. Big cash income now, real future. Equipment free. Hoover, Dept. B-100, New York 11, N. Y.

SELL Grease that won't melt. Moly products also included in complete line of heavy duty lubricants. Our leading salesmen now earning over \$12,000 in a year. Write E. J. Baker, Dept. 6-B, P.O. Box 676, Dayton, Ohio.

MONEY-Making opportunity! Take big profit orders for world famous patented varieties fruit trees. Also flowering shrubs, roses, vines. Big sales outfit free. Stark Bro's, Desk 30126, Louisiana, Missouri.

SELL Calendars. You make big money daily. Giant line. Every business buys. Also business printing, book matches, advertising specialties. Big sales outfit free. Write, Arrow Press, 515-B Fourth Ave. So., Minneapolis, Minn.

BIG Money! Buy wholesale, sell retail. Dresses, children's wear, family apparel. Lowest factory prices. No stock to carry. No samples to buy. Big sales kit with actual fabrics free. C. E. Israel, Dept. R-3703, Cincinnati 25, Ohio.

GET New shirt outfit free. Make \$90.00 weekly on 5 average orders a day. Famous quality made-to-measure dress and sport shirts at \$3.95 up sell fast to all men. No experience needed. Full or part time. Write: Packard Shirt Co., Dept. 263, Terre Haute, Ind.

BUY Wholesale thousands nationally advertised products at big discount. Free "Wholesale Plan." American Buyers, Hertel Station, Buffalo 16-J1, N. Y.

ADVERTISING Book matches—Cash in on big demand; sell union label matches. Cuts for all businesses and political parties. Free powerhouse selling kit, low prices, protection guaranteed on repeat orders. Cash commissions. Superior Match Co., Dept. M-256, 7530 Greenwood, Chicago.

\$50.00 WILL Earn \$10,000. Long needed invention. Proved sales plan. Big profits. Send no money. Details free. Write Cyclo, Dept. 104, 3816 Dahlia Street, Denver, Colorado.

GOOD Man can make \$3,000.00 next 90 days. Every house in town wants amazing NiLite glowing curbside house numbers. Automatic selling plan pays profits every day. Write today for details free. NiLite, 173 W. Madison, Dept. 301, Chicago.

BUY Wholesale 750,000 products. Details free. Carter, Box 6011-MD, Chicago 80.

\$1,000.00 A Month for making dramatic 3-second demonstration of amazing lightweight Presto fire extinguisher. New chemical used by airforce snuffs out fires instantly. Only \$3.98. Terrific commissions. Millions want it. Free kit. Merlite, 114 E. 32nd, Dept. 50-F, New York City 16.

BIG Money-making opportunity. Exclusive line work uniforms. Jackets, pants, shirts, coveralls. Advertising embroidered. Every business prospect. Outfit free. Master Div., 685 Water, Ligonier, Ind.

ADVERTISING Work uniforms sell fast. Easy sales, huge profits selling service stations, garages, industry, almost everyone! Complete selection colors, styles, fabrics, including miracle Orlon, Acrilan, Dynel. Prospects, profits galore! Big selling outfit free. Topps, Rochester 612, Ind.

MY Free outfit puts you in a fine business! Just 2 sales a day brings you up to \$217 extra a month in big money shoe business! Complete line of air cushion shoes for men, women. Just rush postcard for your powerful free selling outfit! Mason Shoe, Dept. C2, Chippewa Falls, Wisconsin.

AD Matches! Sell amazing designs—10, 20, 30, 40 and 240-light book matches. Big spot cash commissions; every business a prospect. Low prices for high quality. Repeats. Start without experience; men, women; full, part time. Buy nothing! Sales kit furnished. Match Corp., Dept. PM-79, Chicago 32, Illinois.

CASH In on 1956 elections! Big advance commission selling low priced union label political posters, cards, labels, book matches to candidates. Complete printing line for all businesses. Free kit. National Press, North Chicago 2, Ill.

AMAZING Discovery, Master Glaze, puts brilliant glass like surface on cars. Free sample, information. Big commissions. Master Glaze, Dept. 847, 7720 Harwood, Milwaukee, Wis.

WILL You wear new suits and topcoats without one penny cost and agree to show them to friends? You can make up to \$30.00 in a day even in spare time, without canvassing. Pioneer Tailoring Co., Congress & Throop Sts., Dept. N-1236, Chicago 7, Illinois.

DAY Glo signs, 100% profit. Agent-service, Box 1039, New Haven, Conn.

BUILD Sales by recruiting productive distributors selling direct or to retail outlets. Secure most concentrated circulation through classified columns of Salesman's Opportunity. Write for facts. Gilbert, Salesman's Opportunity, Room 1700, 850 N. Dearborn, Chicago 10.

EDUCATIONAL AND INSTRUCTION

OFFICE Automation: Prepare for the future with the only home study course instructing application of electronic computers to business clerical operations. Free information. Business Electronics, Computer Dept., Box 3330 Rincon Annex, San Francisco, California.

LEARN Printing, 112 lessons, book form, registered mail, \$9.00. Paul Bonneau, Gravelbourg, Saskatchewan, Canada.

HIGH School—No classes. Study at home. Spare time. Diploma awarded. Write for free catalog HF-61. Wayne School, 2527 Sheffield, Chicago 14, Ill.

BLUEPRINT Reading—Train at home. Learn to read blueprints with confidence in 10 easy lessons. Write today Belton School, 1059-G North Lawndale, Chicago 51.

WELDING Training pays at Hobart Welding School, Box M-261, Troy, Ohio. VA contract. Best equipment. Catalog free.

MEDICAL Laboratory technicians in great demand. We train you in your own home. Catalogue free. Imperial Technical Institute, Box 973-J, Austin, Texas.

INDUSTRY Needs draftsmen. We help you qualify. Free information. Industrial Training, 1704-A Frederick, Fort Worth 7, Texas.

APPLY For jobs by letter. Short folio shows how. Free trial offer. Telesis Company, Room 706, 507 Fifth Avenue, New York 17, New York.

STUDY For Doctor's degree of psychology, metaphysics and divinity. Correspondence courses only. College of Divine Metaphysics, Dept. P-M, 2811 North Illinois, Indianapolis 8, Indiana.

LEARN Mineralogy at home. Diploma course. Fortunes now being made in uranium and other minerals. Free catalog. Mineral Science Institute, Desk 2, 169 East Ontario, Chicago 11.

HIGH School diploma at home. Licensed teachers—Approved materials. Southern States Academy, Box 144-MX, Station E, Atlanta, Georgia.

BECOME A counsellor in personality engineering. A lucrative profession for those who qualify. Field is growing, uncrowded. Work is interesting, fulfilling. Write, enclose recent snapshot. More information in book, "Formula for Genius," \$1.00 (refundable). Kimball Foundation of Human Engineering, St. Louis (Brentwood) 17, Mo.

MIDLAND Linotype School. Charles City, Iowa. Civilian and Veteran Courses. Free placement. Established 1909.

COLLEGE Degrees—Independent study. Keep employed. Brentwood College, Box 19-721, Los Angeles 19.

PIANO Tuning pays. Big money in spare time. Learn at home in 30 days. No musical knowledge necessary. Phonograph, records, tools and instructions furnished. Free catalog. Capital Tuning School, 16 Southwest Second, Fort Lauderdale, Fla.

I Want to send you proof of the wonderful pulling power of Popular Mechanics classified pages. What's your proposition? Write me today. Include literature if possible. F. W. Johnson, Manager Classified Advertising, Popular Mechanics Magazine, 200 E. Ontario St., Chicago 11, Ill.

BE A real estate broker. Study at home. Write for free book today. GI approved. Weaver School of Real Estate, 2018P Grand, Kansas City, Missouri.

INVESTIGATOR Training. Phillips Secret Service System, 1917-B North Kennebec, Chicago 39.

SECRET Investigation. Experience unnecessary. Investigators particulars free. George Wagner, M125 West 86th, New York 24.

EARN While you learn. Auto and diesel mechanics master this top paying trade. Many graduates earn \$100 a week and up. Approved for Korean veterans. For free information write Dept. No. 256, Nashville Auto-Diesel College, Nashville 3, Tenn.

BOOKKEEPERS! Increase your earnings! Operate your own simplified "Dollar-A-Week" bookkeeping and tax service. Full or spare time. Details free. No obligation. Ellis, Box 200, Cedar Grove, North Carolina.

USED Correspondence courses and books sold and rented. Money back guarantee. Catalog free. (Courses bought.) Lee Mountain, Pisgah, Alabama.

WANT A diesel job? New opportunities to increase income. Higher pay. More money. We can help you qualify. Tools. Shop method home training. Write today! Diesel, Tractor, Heavy Equipment Division, Interstate Training Service, Dept. B-3, Portland 13, Oregon.

PHYSICAL Therapy and massage. We train you at home. Earn big profits from your own private practice or work with hospitals and doctors. Free catalogue. National Institute, Desk 4, 159 E. Ontario, Chicago, Ill.

INVESTIGATE Accidents—Earn \$750 to \$1000 month. Thousands of insurance companies, airlines, and steamship lines urgently need claim investigators. We train you at home spare time. Placement counsel and help. Free book. Now! Universal Schools, Dept. 102, Box 8202, Dallas 5, Texas.

SPEAK, Sing with power, personality. Home self-training method on records. Amazing details free. Canfield, 2018-A 5th Ave. South, Minneapolis 4, Minn.

COMPLETE Your high school at home in spare time with 59-year-old school. Texts furnished. No classes. Diploma. Information booklet free. American School, Dept. X245, Drexel at 58th, Chicago 37, Illinois.

"SELLING One's Services" knowhow increases income. Complete course \$1.00, prepaid. Aywon, 624 East 20th Street, SEP, New York 9, N. Y.

USED Correspondence courses and educational books bought, sold rented. Free catalog. Educational Exchange, Menlo, Georgia.

ABACUS \$2.50. Instruction book \$1.25. Perkins, 3527 Nottingham, Hamilton Square, N. J.

BOOKS, 100 Page free catalog. Text, vocational, educational, instructional subjects. Millions of volumes, new and used. Bargain prices. Books bought. Est. 1902. Long's College Book Co., Dept. PM, Columbus 1, Ohio.

\$5,199.90 WAS Paid to John Betts, in few weeks. Grow mushrooms. Cellar, shed, spare, full time, year round. We pay \$3.50 lb. Free book. Mushrooms, Dept. 174, 2954 Admiral Way, Seattle, Wash.

WANT Strong, masculine voice? Send for free booklet. Perfect Voice Institute, 210 South Clinton, Studio 2BU-2, Chicago 6.

HELP Yourself! Solve personal problems by self-mastery. Free information. The Leavitt Science, Clinton 5, Illinois.

CORRESPONDENCE Courses, books bought, sold. Free catalog. Bayles, 211 Essex, Hackensack, New Jersey.

"CORRECT Your Thinking and Change Your Life." Large book. Send no money, pay postman \$1.98 plus postage. Bert King, P.O. Box 195(Z), Fort Wayne, Indiana.

U.S. Civil service tests! Training until appointed. Men-women, 18-55. Start high as \$377.00 month. Many jobs open. Qualify now! Get free 36-page illustrated book showing salaries, requirements, sample tests. Write: Franklin Institute, Dept. N-24, Rochester, N. Y.

OFFICE Automation: Prepare for the future with the only home study course instructing application of electronic computers to business clerical operations. Free information. Business Electronics, Computer Department, Box 3330, Rincon Annex, San Francisco 19, California.

LET Powerful recorded suggestions via subconscious give you pleasing, dynamic, singing and speaking voice. New, amazing, unique and revolutionary. Details 10c. Box 765, Chicago 90, Illinois.

FINGERPRINTING Course, \$12.00. Details free. Alabama School of Fingerprinting, Box 185-A, Fairfield, Alabama.

PIANO Tuning pays. Learn this profitable profession at home easily with patented Tonometer and mechanical aids. No knowledge music necessary. Diploma granted. Write for booklet. Niles Bryant School, 3731 Stockton Blvd., Dept. P, Sacramento 20, California.

PLAYS, STORIES, MANUSCRIPTS

WANTED: Book manuscripts, all subjects considered. Greenwich Book Pub., Atten. Mr. Zealand, 489 Fifth Ave., New York City.

NO Luck finding a book publisher? Write for free Booklet PM. Vantage Press, 120 W. 31. New York.

ARTICLES Published, fiction, nonfiction. Cosidiary. Inquire: Aureas, 156 West 73rd Street, New York City.

SPECIAL SERVICES

BOOKKEEPING — Each month \$1.00. Bradshaw, 110 E. 32nd St., Boise, Idaho.

INFORMATION On any subject, \$1. Certified research! J. F. Griffith, Wynnewood, Pennsylvania.

INFORMATION On anything. Ferguson Research Specialists, 116-14 141 St., South Ozone Park 36, N. Y.

WE'LL Buy every Swedish necklace you make for \$4.25. Guaranteed. Earn \$46.75 weekly, minimum. Instructions: \$1.00. Inquiries welcomed. Altx, 611 15th N.W., Albuquerque, New Mexico.

MATHEMATICAL Calculations performed—Analytical Associates, P.O. Box 394, Ft. Wayne, Ind.

CARTOONING, COMMERCIAL ART, SHOWCARD & SIGN PAINTING, TATTOOING

LEARN Cartooning from professionals. Details free. Cartoonists, 2776 California Court, Lincoln 10, Nebraska.

"HOW To Make Money With Simple Cartoons"—A book everyone who likes to draw should have. It is free; no obligation. Simply address Cartoonists' Exchange, Dept. 92C, Pleasant Hill, Ohio.

PAINT With fire. Glowing black light colors. Different as day from night because you literally paint with light! Water colors, oils, chalks, crayons—Blak-Ray lamps. Free—write today for dealer's idea packet. Black Light Corporation of America, San Gabriel M. Calif.

YOU Can entertain with chalk talks. Catalog 10c. Balda The Cartoonist, Oshkosh, Wis.

PAINT Signs—Master die cut, outline letter patterns. Complete assortment 1 1/2" to 12" high, prepaid \$2.00. Eyerly, 583, Newton, Iowa.

9 ALPHABET, 3 Numeral pattern sets and raised wood letter catalog. \$1.00. Sign Letter Distributors, P.O. Box 101, Mineola, N. Y.

CARTOONISTS: Amateur, professional. Prepare for animation with Max Fleischer's plan. Write Vera Coleman, Lincoln Building, New York, N. Y.

TATTOOING Supplies, licensed course, illustrated brochures 25c. Zeiss, 728 Lesley, Rockford, Illinois.

LEARN Profitable modern sign painting, commercial lettering. Anyone can be successful. Earn \$40-\$160 per week, spare time. Sign Instruction, Box 187, PM2, North Chicago, Ill.

ADVERTISING AGENCIES, LETTER WRITERS, FOR ADVERTISERS

FREE! 1956 Advertisers Rate and Data Directory. 52 pages! E. H. Brown Advertising Agency, 20 N. Wacker, Chicago 6.

MAILING Lists, most any classification, 1000 names \$5.00, 1000 your circulars mailed with ours \$4.00, 5000 your circulars printed and mailed \$12.95. Write Dixie Mailers, King, North Carolina.

BEFORE Advertising—Get Instructive Ad-Guide and newspaper-magazine ratebook. 10c. Chicago Advertising Agency, Chicago 4.

HUNDREDS Of radio stations accepting advertising on commission approved. List \$2.00. Radiotest, P.O. Box 4024C, Normandy Branch, Miami Beach, Fla.

ADVERTISE: 24 Words, 100 Canadian newspapers \$5.50. Lists free. Advertising Bureau, 10511-C Springfield, Chicago 43.

RENO Mailing list 1000 names, addresses, \$1.00 bill. Address Mailsales, Box 1121, Reno, Nevada.

ADS Placed in out of town newspapers and magazines. Low rates. Catalogue free. Ideas that pay. Baker Advertising Agency, Successors Ankrum Agency, 189 W. Madison, Chicago 2.

RUBBER STAMPS AND OFFICE SUPPLIES

RUBBER Stamps, professional one day service, 15c word, minimum \$1. Hawthorne Company, Otsego 5, Mich.

THREE Lines \$1.00. Free stamp pad. Barber, 596 Girard, Marion, Ohio.

RUBBER Stamps by professional craftsmen, 3 lines \$1.00. Price list. South Coast Press, 654 East Base Line, San Bernardino, Calif.

3 LINES, \$1.00. Fast service. Catalogue. Johnson, 443 MacDonough, Brooklyn 33, N. Y.

YOUR 3 Line rubber stamp \$1.00. Lentz, Box 402, Youngstown, Ohio.

TYPEWRITERS, DUPLICATORS, OFFICE DEVICES

RECONDITIONED Typewriters, duplicating, printing devices. \$25.00 up. Supplies. Appliances, DixieGraph, King, N. C.

SMITH-Corona typewriter \$39.50. Other bargains. Typewriter Exchange, Bedford, Penna.

PRINTING, MULTIGRAPHING, MIMEOGRAPHING, GUMMED LABELS

1000 EMBOSSED Business cards, \$2.95, 23 kinds available. Samples. Jaynar, Box 723B, Oak Lawn, Illinois.

100 LETTERHEADS (8 1/2 x 11) Printed carefully, \$1.00, postpaid. Envelopes same. Race Printers, Hudson, New York.

"HOW To Buy and Use Printing"—Free booklet tells how to cut costs, choose paper, type, etc. Samples and prices included. R-K Press, 825 Powder Mill Lane, Philadelphia 31, Penna.

LABELS! What sort? Samples free. Fred Hoffman, 3471 Yeager St., Port Huron, Mich.

QUALITY Printing since 1929. Free samples. Spender & Son, Millington, Mich.

100 LETTERHEADS (8 1/2 x 11) Printed neatly \$1.00 postpaid. Envelopes same. Blue or black ink. Stark Press, Capitola, Calif.

1000 EMBOSSED Business cards, one color \$3.95; two color \$4.50. Samples free. L. Watson, Box 162, St. Charles, Illinois.

MIMEOGRAPHING—Letters, pricelists, formulas, instructions. Lowest prices. Lem's Letter Shop, 5710 Stanton, Detroit 8.

ADS Running under this heading sell printing. Ask me for proof. I'll gladly send you amazing facts. Ask for Folder "P." F. W. Johnson, 200 E. Ontario St., Chicago 11, Ill.

10,000 ATTRACTIVE Circulars \$10.00 up. Labels, stickers, Samples. Fame, 291 Ellis, San Francisco 2, Calif.

OFFSET, Letterpress, mimeographing. Economical prices, samples. Litho-Press, Madison, Tenn.

SENSIBLY Priced business printing. Special! 250 8 1/2 x 11 bond letterheads, 250 #10 heavyweight envelopes, \$6.95. Postpaid, guaranteed. Free samples, quotations. Sparks Company, Box 4096, Austin, Texas.

500 PRINTED Gummed name and address labels, \$1.00. No c.o.d.'s. Print clearly. Addison, 1840-B Addison, Chicago 13.

BUSINESS Letterheads. Illustrated catalog free. Howprint, 723-G Eunice, Webster Groves 19, Missouri.

100 BUSINESS Cards, neatly printed \$1.00. Arthur Grote, Walkerton, Indiana.

100 SHEETS 5 1/2 x 8 1/2, 50 Envelopes, three lines, black, \$1.00. Bunker, 88 Abbott Road, Dedham, Mass.

OFFSET Printing \$6.50—1000, 8 1/2 x 11, 16 lb. National Letter, 1463 Broadway, New York City 36.

BUSINESS Cards. Free samples, style chart. Harold Osterhoudt, Poughkeepsie 2, N. Y.

LETTERHEADS, 500 Quality 8 1/2 x 11, \$2.95. Schroeder, 218 Ellington, Peoria, Illinois.

STATIONERY, Business printing. Fast service, quality, samples. Haines Press, Petersham, Mass.

125 LETTERHEADS \$1.00. Caxton Press, Box 143, Cincinnati 11, Ohio.

FREE. Valuable booklet—"Cutting Your Printing Costs." Postcard: Redoprint, Ojai, Calif.

WE Illustrate stencils with drawings, lettering, advertising layouts, letter heads. No other stencil like it. Work not done on stencil. Write for free sample. State type of mimeograph. Save time send \$5.00 and copy to: Illustration Stencil Service, 3019 A, North Haskell Ave., Dallas, Texas.

LETTERHEADS, Business forms, 1000—\$4.95. Samples. D'Yarmett, 420 Columbian, Columbus 23, Ohio.

BETTER Printing—Low in cost. Direct or offset. Publishing, 1018 South Central, Burlington, Iowa.

1,000 RAISED Letters business cards only \$2.95 postpaid. Samples free. Pioneer, 195 Quebec, Island Park, N. Y.

PRINTING Specials, list 10c. Selco Products, Department PM-256, Danvers, Massachusetts.

FREE Catalog. Printing, embossing, D & M Press, Sebastopol, California.

PRINTING OUTFITS AND SUPPLIES

DO Your own printing. Save money. Simple rules. We supply everything. Print for others; good profit. Raised printing like engraving too. Have home shop. Details free. Kelsey Presses, V-11, Meriden, Connecticut.

PRESSES, Type cabinets, supplies. List for stamp. Lincoln Press Company, 220-B Hartwell, Fall River, Mass.

MAKE Your own self-molding rubber stamps and printing cuts. Plexirubber, Argyle 1, Wisconsin.

RUBBER Stamp making presses, supplies. Custom, Box 211-M, Springfield, Missouri.

PATENT ATTORNEYS

INVENTORS: Learn how to protect your invention. Unless the inventor is familiar with patent matters, he should engage a competent registered patent attorney or agent to represent him. We are registered to practice before the U.S. patent office and prepared to serve you in handling your patent matters. "Patent Guide for the Inventor" containing detailed information concerning patent protection and procedure with "Record of Invention" form will be forwarded to you upon request—without obligation. Clarence A. O'Brien & Harvey Jacobson, Registered Patent Attorneys, 61B-A District National Building, Washington, D. C.

PATENTS—Irving L. McCathran, 315 McLachlen Bldg., Washington 1, D. C. Registered Patent Attorney.

INVENTION Record form free and "Patent Information Every Inventor Should Have." Carl Miller, Registered Patent Attorney, Woolworth Building, New York.

REGISTERED Patent attorney offers services. Sanders, 6430 Evans, Chicago 37, Illinois.

C. A. Snow & Co.—M427, Snow Building, Washington 1, D. C. Registered Patent Attorneys. Write for information.

INVENTORS: When you are satisfied that you have invented something of value write me, without obligation, for information as to what steps you should take to secure a patent. Write Patrick D. Beavers, Registered Patent Atty., 935 Columbian Bldg., Washington 1, D. C.

PATENTS. "Proof of Invention" free. E. E. Vrooman, Registered Patent Attorney, 507 McKim Building, Washington 5, D. C.

"INVENTOR'S Guide" and "Record of Invention" free on request. Frank P. Ledermann, Registered Patent Attorney, 154 Nassau Street, New York City.

INVENTORS: Without obligation, write for information explaining the steps you should take to secure a patent. John Randolph, Registered Patent Attorney, 203 Columbian Bldg., Washington 1, D. C.

INVENTORS—If you believe you have an invention, you should find out how to protect it. The firm of McMorro, Berman & Davidson with offices in Washington, D. C., is qualified to take the necessary steps for you. Send for copy of our patent booklet "How to Protect Your Invention." We will also send you an "Invention Record" form. No obligation. They are yours for the asking. McMorro, Berman & Davidson, Registered Patent Attorneys, 134-T Victor Building, Washington 1, D. C.

INVENTORS—Take these preliminary steps toward patent protection. Sketch and describe your invention. Sign, date and have this disclosure witnessed by two people who understand your invention. Have us make a preliminary search among U.S. patents already granted for similar types of invention. We report on the probable patentability of your invention and recommend your further course of action. Write for our instructive booklet, "Patent Protection for Inventors" and convenient "Evidence of Invention" disclosure form. Victor J. Evans & Co., 231-B Merlin Building, Washington 6, D. C.

FOR INVENTORS

INVENTORS—Send for free patent information book and inventor's record. Registered Patent Attorney. Associate Examiner, Patent Office 1922-29. Patent Attorney & Advisor, Navy Department 1930-47. Gustave Miller, 17A Warner Building, Washington 4, D. C.

INVENTORS—If you believe you have an invention, you should find out how to protect it. The firm of McMorrow, Berman & Davidson with offices in Washington, D. C., is qualified to take the necessary steps for you. Send for copy of our patent booklet "How to Protect Your Invention." We will also send you an "Invention Record" form. No obligation. They are yours for the asking. McMorrow, Berman & Davidson, Registered Patent Attorneys, 134-S Victor Building, Washington 1, D. C.

INVENTORS: If you have an invention for sale, patented or unpatented, write Institute of American Inventors, Dept. 40A, 631-E St. N.W., Washington 4, D. C.

INVENTORS: Learn how to protect your invention. Unless the inventor is familiar with patent matters, he should engage a competent registered patent attorney or agent to represent him. We are registered to practice before the U. S. patent office and prepared to serve you in handling your patent matters. "Patent Guide for the Inventor" containing detailed information concerning patent protection and procedure with "Record of Invention" form will be forwarded to you upon request—without obligation. Clarence A. O'Brien & Harvey Jacobson, Registered Patent Attorneys, 61A-A District National Building, Washington, D. C.

PATENT Searches, including copies of nearest patents, \$8.00. Reports airmailed within 48 hours. More than 100 registered patent attorneys use my service. For free invention protection forms, write Miss Ann Hastings, P.O. Box 176, Washington 4, D. C.

SAVE Money on your patent application. Patents for any country. Free details. International, 25 McMaster, Toronto, Can.

"**INVENTOR'S Guide**" and "Record of Invention" free on request. Frank P. Ledermann, 154 Nassau Street, New York 38, N. Y.

INVENTION Record form free and "Patent Information Every Inventor Should Have." Carl Miller, Registered Patent Attorney, Woolworth Building, New York.

SEARCHES—Put your patent searches in the hands of a registered patent attorney or agent, as he qualifies to give a worthwhile patentability report. Record of invention form upon request and information on patent protection. Patrick D. Beavers, Registered Patent Attorney, 936 Columbian Bldg., Washington 1, D. C.

INVENTORS: Information on patent procedure furnished on request, without obligation. John Randolph, Registered Patent Attorney, 202 Columbian Building, Washington 1, D. C.

PATENT Searches \$5.00. 48-hour service. Free invention protection forms. Write Raymond L. Smith, Patent Searcher, 620 Sheraton Building, Washington 5, D. C.

INVENTORS—This firm is registered to practice before the United States Patent Office and available to assist you in the preparation and prosecution of your patent application. "Patent Protection for Inventors" booklet containing detailed information and steps to take toward patent protection sent promptly upon request. No obligation. Victor J. Evans & Co., 232-B Merlin Building, Washington 6, D. C.

INVENTORS: Our invention promotion service is guaranteed. Write for free copy of plan and guarantee. Kessler Corporation, 52F1, Fremont, Ohio.

FREE Patent booklet and invention record form on request. H. Lawrence Blasius, 15 Park Row, New York City.

FREE Invention protection form airmailed. Patent office search, plus advice on selling your invention, \$5. Inventors Sales & Engineering Service, Box 4973, Washington 8, D. C.

PATENT Searches \$5.00. 48-hour airmail service. Invention protection forms free. Write Patent Engineering Service, 711 14th Street N. W., Washington 5, D. C.

INVENTIONS WANTED

THE Promotion service for patented and unpatented inventions. Full particulars, forms, guide, recording, etc., free. Superior, 338-344 North Rodeo, Beverly Hills, Calif.

INVENTORS: If your invention is adaptable to promoting we will contract on cash or royalty. If not, we will attempt selling it for you. Special booklet free. Kessler Corporation, 521W, Fremont, Ohio.

WE Are interested in new products. If your idea, invention, or patent appeals to us we will finance it, giving you full protection. No advance fee charged. Only letters of interest answered. Send details today. National Research & Development Corp., Dept. M, 11 West 42 Street, New York City.

NO Prepayments. Patented inventions marketed, 10% of profits. Jerry Peters, Box 9238, Rosslyn Station, Arlington 9, Virginia.

INVENTIONS And patents promoted. A-1 service for inventors for many years. Write Adam Fisher Co., 5418 Idaho, St. Louis, Mo.

INVENTIONS Wanted. Patented or patent pending. 25 years experience promoting inventions. National Service Bureau, 3120 Meramec, St. Louis 18, Mo.

INVENTIONS Wanted. Patented; unpatented. Tremendous manufacturers lists. Global Marketing Service, 2420 77th, Oakland 5, California.

INVENTORS: Hundreds of manufacturers have requested our assistance in locating marketable new products. Complete information free. Institute of American Inventors, Dept. 40-D, 631-E St. N.W., Washington 4, D. C.

INVENTORS. Don't sell your invention patented or unpatented until you receive our offer. Write Cowgill, Box 298, Marion, Ohio.

CASH Buyers for ideas and inventions. Write National Inventors Institute, 457 Munsey Building, Washington 4, D. C., or 4900 Euclid Ave., Cleveland 3, Ohio.

INVENTIONS Wanted now by my manufacturer-clients. Patented, unpatented. Send for free form "S." Adams, Patent Broker, 80 Wall Street, Financial District, New York City.

PATENTS FOR SALE

INVENTION For sale. Millions could use everyday. Pat. pend. Send \$1.00 for samples and complete details. Jeney Electric, 1027 Farmington Ave., West Hartford 7, Conn.

INVENTORS: Test the commercial value of your patented or unpatented inventions, quickly and inexpensively. Write for free information. Institute of American Inventors, Dept. 40-B, 631-E St., N.W., Washington 4, D. C.

MANUFACTURING

MODELS—Small lot manufacturing. Metals, plastics, etc. Milburn, Burlington, Kentucky.

FINELY Detailed white metal castings from your metal pattern. Low cost short runs. Selley, 744 Clay, Winter Park 19, Fla.

MODELS, MODEL SUPPLIES

MODEL Railroads O and HO cast metal items. Over 850 illustrations. Catalog only 10c. Selley, 744 Clay, Winter Park 17, Fla.

NEW Truescale ship model kits cut building time to one-quarter—More detail than ever with castings and pre-cut pieces. Mahogany hulls and baseboards, brass mounting pegs, new simplified plans, parts keyed and numbered, genuine wood blocks and deadeyes. (No plastics.) Send 10c for brand new catalog 22 ships, 4 guns. All collectors' items. Marine Models, Dept. 564, Halesite, Long Island.

RAILROADERS Get 1956 catalog-reference manual. O gauge scale, tinplate 50c. HO 50c. Terminal Hobby, 247 Erie, Milwaukee 2, Wis.

SHIP Models. Most complete line in New England. Kits, fittings, plans, books, tools, engines, motors. Illustrated catalog 25c. James Bliss & Co., Inc., Dept. 8M, 342 Atlantic Ave., Boston 10, Mass.

BALSA Wood and model aircraft. 40-page catalog 10c. Sig Co., Montezuma, Iowa.

SHIP Models and yacht supplies. Complete, large 68 page catalogue 50c. Bill Wild's, 510 East 11 St., New York City 9.

SHIP And yacht model fittings; blueprints. Send 35c for illustrated catalog listing hundreds of items. A. J. Fisher, 1002-1 Etowah Ave., Royal Oak, Mich.

1956 CAR Models, 1/25 scale, all metal, chrome trim. Send for catalog! Cars and Hobbies, Dept. PM-11, 2333 Haddon, Chicago.

HOME CRAFTSMEN

LAMP Size cypress knee with nipple installed, \$2.00. Cy Products, Dept. 2-P, Lafayette, La.

101 FULL Size patterns. Smart, new, gifts, novelties, lawn figures, shelves, action windmills, alphabets. Plus "Make Money Jig Sawing." Only \$1.00. Mastercraft 28M, 7041 Olcott, Chicago 31, Illinois.

GRANDFATHER Clocks. Build a tubular chime at factory prices. Send 50c. Wills Bros., 237 S. Ellwood Ave., Baltimore 24, Maryland.

DRILL Straight holes every time with your hand drill. Magnetic drill aligner. Only \$1.00. Money-back guarantee. New Patent Devices, 5100 E. Dartmouth, Denver 22, Colorado.

16 NEW Lawn chairs, 22 picnic tables, benches, trellises, etc. All 38 plans with necessary full size patterns, \$1.00. Mastercraft 23M, 7041 Olcott, Chicago 31, Ill.

OVER 900 Woodworking projects. Books and patterns. Free catalog. Craftsman, 115 Worth Street, New York City 13.

FREE Catalog. 1560 patterns and designs. Craftplans, 1321-A South Michigan, Chicago 5.

PLASTICS Home-craft course for men and women. Tells and shows how to make hundreds of fast selling plastics products. All plastics and materials for 23 projects included in course. No special tools needed. Course pays for itself. Write for free booklet. Interstate Training Service, Dept. D-3, Portland 13, Oregon.

MITER Box, \$1.95. Formica laminated on 3/4" plywood, 3 1/2"x15 1/8". Postpaid. State Plywood, 3719 Cahuenga, North Hollywood, California.

LEATHERCRAFT, Metal enameling, beadcraft, shellcraft, metal tooling, textile painting, many other crafts. Free big illustrated catalog. Kit Kraft, Dept. 232, Studio City 1, California.

AMAZING Matched jigsaw patterns. Combinations galore. Motifs, alphabets for plaques, nameplates, decorations, other sure-sellers. Book, only \$1.00. Hoover, Grand Marais, Minn.

LEATHERCRAFT Quality supplies at lowest prices. Send 10c (refundable) for most complete catalog containing 16 other crafts. Russo Handicrafts, Box 29-P-2, Los Angeles 12, California.

BUY Wholesale nationally advertised power, hand tools, thousands other products at big discounts. Free "Wholesale Plan." American Buyers', Hertel Station, Buffalo 16-F1, N. Y.

METALCRAFT. Big illustrated catalog free. Aluminum, copper, and enameling supplies. J. C. Larson Co., 820 S. Tripp, Dept. 5975, Chicago 24.

129 NEW Full-size jigsaw patterns. Artist-drawn. \$1. Craftplans, 1321-A South Michigan, Chicago 5.

WOODWORKING Course for home craftsmen. Twenty-two manuals. Over 1000 pages. 75 training projects. Only complete home training program available today. Carefully written, profusely illustrated. Covers everything from wood selection to final finishing. Complete instruction in care and use of all hand and power tools. Prepared by expert manual training instructors. Write for free booklet. Interstate Training Service, Dept. G-3, Portland 13, Oregon.

JIGSAW, Bandsaw owners, let your machine bring extra profits, fun. Free details. Nu-Art, Box 2235, Boston, Mass.

FREE Handicraft supply and project catalog. American Handicrafts, Box 1479-EQ, Fort Worth, Texas.

VIOLINMAKERS, Amateurs, professionals. Fine toned, seasoned European wood. Materials, tools, patterns, instructions. Catalogue 10c. Premier Violin Supplies Division PVM, 430 South Broadway, Los Angeles 13, California.

ALL Crafts, supplies. Large free catalog. National Handicraft, 199 William Street, New York City 38.

FREE "Do-it-yourself" leathercraft catalog. Tandy Leather Company, Box 791-M13, Fort Worth, Texas.

KNOCKDOWN Cedar chests. Lumber and veneers. Free price list. Giles & Kendall Company, Huntsville, Ala.

STYLECRAFT Sure fire hits. "Pre-traced" leather kits. Handbags, billfolds, filigree belts, over fifty other projects. Patterns on leather. Why trace? Just carve, assemble and lace. Large assortment "precarved" kits also available. Send 25c for catalog, free folder. Refunded first order. Apache Leather Company, 2804 E. Washington St., Phoenix, Arizona.

KNOCKDOWN Cedar chests and lumber. Free price list. Bedford Lumber Company, Shelbyville, Tennessee.

18 FULL-Size patterns. Save money with easy-to-use, professionally designed full-size patterns. Make money selling beautiful, useful furniture. Make modern step and cocktail tables; metal lamps; cupola; 12-foot outboard. All patterns test-built; sold with money-back guarantee. Get your free list of these convenient, economical patterns today. Popular Mechanics Press, 200-HH E. Ontario Street, Chicago 11, Illinois.

100 NEW Woodworking plans. Only \$1.00! Craftmaster, 2977 North Shepard, Milwaukee, Wisconsin.

DOWEL Price list and useful information free. Queens Dowel House, Rosedale 22, N. Y.

WOODCRAFTERS—We buy what you make from our patterns; easy to make, no special tools needed, send \$1 for patterns and complete instructions. Wm. Rice, 188 Pine, Kingston 15, N. Y.

DO IT YOURSELF

BUILD Four wheel drive, hydraulic steered tractor. Plans and details, \$1.00. Hunter's Products, P.O. Box 31, Garrett, Ind.

GEIGER Counter and metal detector kits. Inexpensive, educational. Free literature. Electronic Applications, 5024 Lee Highway, Arlington 7, Va.

CARPORTS. Patio roofs. Partitions, build them yourself with beautiful Fiberglass planks. Details free. Concourse, 4003 Dyre, New York 66, N. Y.

MAKE Money marblizing plywood beautiful colors natural grain finish instructions \$1.00. E-Z-Knee Co., Brightwood, Oregon.

SEND Card for free formulas for paints, insecticides, deodorants, germicides, etc. Worlds Products, Cleveland 13, Ohio.

CLOCK Movements—Gorgeous dials, plans, kits. See ad page 289.

PLANS For 36" handloom \$2.00. Robert Hertz, Epping, N. H.

"HOW To Appraise Diamonds." Informative, complete, \$2 postpaid. Appraisers, Box 374 GK, Staten Island 8, N. Y.

BUILD Inexpensive concrete blockmaker. Motor. Hand. Then make blocks for 5 room house for \$95. Write: C. Lee, Mountain View, Oklahoma.

"DO It Yourself Encyclopedia." 12 giant volumes (3,000 pages) packed with thousands of ideas, plans, gadgets and projects you can do yourself. How to weld, paint, repair most anything. How to make boats, deepfreeze, draperies, jigsaw projects and just scores of other items. How to do electric wiring, plumbing, room building. How to modernize kitchens, bathrooms. Greatest, most complete fix-it library ever offered. Written so you can understand it. You'll be thrilled when you see what these 12 big volumes contain. It's simply sensational. You must really see them to fully appreciate this exciting fix-it library. You'll fall in love with them just as soon as you open the first volume. I'll send you a descriptive circular that will open your eyes to the greatest, most complete and beautifully illustrated "Fix-it" library you ever laid your eyes on. Send a postal right now. Popular Mechanics Press, 200-DY East Ontario St., Chicago 11, Illinois.

WATCHES, OLD GOLD, JEWELRY

RHINESTONES. Jewelry settings, copper enameling, hobby kits. Illustrated catalog 10c. J & M Novelties, Dept. CB-3, Griffith, Indiana.

RHINESTONES. Send \$2.25 for five gross, value \$5.00, free catalog, bargain list. Ebert, Box P183, East Orange, New Jersey.

FIRE Your photographs for delightful enameled jewelry, beautiful ceramics. Send stamp for literature. Battjes Photoceramic Decals, 1453 Lyon, Grand Rapids 3, Mich.

WATCH And clock repairing books. Free information. North American, Dept. 16B, 2320 N. Milwaukee, Chicago 47, Illinois.

HIGHEST Cash for old gold, broken jewelry, gold teeth, watches, diamonds, silverware, spectacles, platinum. Free information. Satisfaction guaranteed. Rose Refiners, Heyworth Bldg., Chicago 2.

WATCHMAKERS'—Jewelers' supplies, instructions. Catalog 20c. Bengale Company, Culver City, California.

COSTUME Jewelry supplies. Catalog and samples. 35c. Largest line in America. Milady-Fair Co., G.P.O. Box 1328, New York City 1.

USED And new watches \$2 up. Free list. Southern Watches, Gray, Georgia.

EXPANSION Bands. Newest styles of American made 1/20-10K gold filled, \$2.50 each while quantity lasts. Moneyback guarantee. Name Brand Bands Co., 5212 23rd St., Cicero 50, Illinois.

WE Pay cash—For your old watches, old gold, silver, scrap jewelry. Ship what you have. Highest prices paid by return mail. St. Louis Refining Co., Holland Bldg., St. Louis 1, Mo.

HIGHEST Prices for gold, silver, platinum, diamonds, watches, gold teeth. Satisfaction assured. Goods returned if offer unsatisfactory. United Smelting Works (Old Reliable), 6-B East Monroe, Chicago 3.

TOBACCO, SMOKERS' SUPPLIES

PIPE Smokers! Cigar smokers! Free illustrated catalog offers fabulous savings on choice imported and domestic pipes, cigars, tobaccos, supplies. Write Wally Frank, Dept. 25, 150 Nassau Street, New York 38, N. Y.

INTRODUCTORY Offer: pipe smoking, 3 pounds \$2.00 postpaid. Star Farms, Ralston, Tennessee.

CUSTOM Pipes. Pipe-making supplies. Tools. Instructions. Walter Miller, Germantown, Ohio.

RAZORS, BLADES, SHARPENING

ELECTRIC Shavers, \$4.95 each while they last. Sold nationally. Retail price \$22.50. All brand new in original boxes with written guarantee. Postage paid to your address. Send to Public Service Department, Warehouse No. 27, Postoffice Box 229, Downey, California. Make all checks or money orders payable to E. B. Jeffries, Supt.

SPECIAL! Full year's supply double-edge blue blades. Electronically honed. 225, \$2.00. Trial 100, \$1.00. Guaranteed. (postpaid). Dansonay, Carle Place 28, N. Y.

FREE—100 Double edge razor blades, to new customers. Randolph Co., Box 3406, Detroit 3, Mich.

FOR THE HOME

FOAM Rubber furniture cushions. Factory seconds. 50% discount. Free catalog. Perma-Foam, 429C Central Ave., East Orange, New Jersey.

PORTRAIT. Memorial. Painted. Booklet. "Guaranteeing Your Remembrances" free. Write: Dorstudios, Ojai, Calif.

OF INTEREST TO WOMEN

EMBROIDERED Stamped linens. Buy direct from manufacturer and save. Send for free catalog. Dept. 950, Merribee, 16 West 19th Street, New York 11, N. Y.

"8 MISTAKES Parents Make." Every parent should have this new book about child training. It is free; no obligation. Simply address Parents Association, Dept. 672, Pleasant Hill, Ohio.

\$5,199.90 WAS Paid to John Betts, in few weeks. Grow mushrooms. Cellar, shed. Spare, full time, year round. We pay \$3.50 lb. Free book. Mushrooms, Dept. 176, 2954 Admiral Way, Seattle, Wash.

UNUSUAL And attractive imported gifts. Free catalog. Itradco, Columbian Bldg., Washington 1, D. C.

300 WAYS Women make money at home, \$1.25. Ellis, Box 95, Moline, Illinois.

TREASURES From India. Silk and Zari scarfs. Other items. Box 5051, Beacon Hill Station, San Antonio 1, Texas.

PROFITABLE Home business. Make fast-seller chenille monkey trees, dolls, flowers. Terrific holiday demand. Information free. Velva, Bohemia 16, N. Y.

WANT To make big money at home? \$5 profit in an hour possible with invisible reweaving. Make tears, holes disappear from clothing, fabrics. Steady year-round demand from cleaners, laundries, homes. Details free. Fabricon, 8332 S. Prairie, Chicago 19, Illinois.

DRESSES 24c; Shoes 39c; men's suits \$4.95; trousers \$1.20. Better used clothing. Free catalog. Transworld, 164-S Christopher, Brooklyn 12, N. Y.

GOOD Money in weaving. Weave rugs at home for neighbors on \$69.50 Union Loom. Thousands doing it. Booklet free. Union Looms, 153 Post St., Boonville, N. Y.

SELL Fine fabrics. Get yours wholesale. Box 863, Norwalk, Conn.

FOR SALE—MISCELLANEOUS

WRIST Cigarette lighter. Man's or woman's expansion band. \$4.50 postpaid. Ward's, Glenview, W. Va.

15,000 NEW Schatz commercial ball-bearings, 3/8" od. R. Lieber, 802 Forestdale, Royal Oak, Mich.

HEARING Aid batteries, wholesale. Free list. Habs, Box 51, York, Penna.

WANTED—MISCELLANEOUS

SCRAP Mercury (quicksilver) containers supplied—Tantalum, bismuth, tungsten. Metallurgical Products Company, Established 1909, 35th and Moore Sts., Philadelphia 45, Penna.

QUICKSILVER, Sterling, silver solders, precious metals. Wholesale Terminal, Norwood, Massachusetts.

PERSONAL

BORDER Bulletin! Co-publish this little magazine for \$1 per month! Your thirty word advertisement free! Sample, details 5c! Border Bulletin, 910 Marion, Pharr 22, Texas.

BUY Vitamins direct. Amazing savings. Catalog free. Matoska, White Bear, Minn.

CANADA Offers unlimited opportunities. Classifieds, three Toronto newspapers airmailed \$1.00. Canada Classified Service, 11 Edgemore Drive, Toronto 18, Canada.

ANNOUNCING Our new psychological test that reveals your true vocational aptitude. If you long for real inner contentment, self-confidence, and better, adequate income, send today for free full facts to Employment Counselors, Suite 507-AA, Professional Building, Baltimore 1, Md.

"HOW Can I find out?" You can! Information confidentially developed. Any matter, person, problem. Worldwide. Officially licensed. Established 1922. William Herman, 170 Broadway, New York City.

LETTERS Remailed 25c. Personal forwarding address. Monthly rates. Hicks Service, Box 1547, Washington 13, D. C.

GLOBAL Viewcard selection, worldwide remailing. Travelpost, Box 198, Nogales, Arizona.

REMAILING, Forwarding 25c each. Ace Service, Box 186, Tampa 1, Fla.

ALASKA'S Capital exclusive business directory, \$1.00. Air mail 30c. ABCo, Box 282, Juneau, Alaska.

EXCITING New book, "How to Collect Stamps, Coins, Paper Money." Packed with amazing facts; information worth dollars. Fully illustrated, 160 pages. 75c. Popular Mechanics Press, 200-ST E. Ontario St., Chicago 11, Ill.

BORROWING By mail. Loans \$100 to \$600 to employed men and women. Easy, quick. Completely confidential. No endorsers. Repay in convenient monthly payments. Details free in plain envelope. Give occupation. State Finance Co., 323 Securities Bldg., Dept. R-227, Omaha 2, Nebraska.

WHAT Is your I.Q.? Take reliable intelligence test. Approved, scientific. Confidential report by mail. Free information. University Test Bureau, Desk M-2, Box 401, Palo Alto, California.

SURPRISE Your friends! Honolulu remails 10c. Confidential receiving address available! Fobel, 3132 George Street, Honolulu.

MAIL Received, forwarded. \$3 month. Hedgpath, Box 830, Alhambra 23, Calif.

LIKE Pull mail boxes? Interesting "offer-tunities" galore 25c. Traylor's Enterprise, La Feria, Texas.

JOBS? Sunday classified section \$1.00. Letters remailed 25c. Hal Campbell, 200 W. Clarendon, Dallas, Texas.

WORK In New York City! Help wanted ads \$1.00. Remails 25c. James, P.O. Box 512, New York 1, N. Y.

BORROW By mail from Postal Finance Co. Employed men and women can easily obtain \$50 to \$600 fast, entirely by mail. Repay in small monthly payments. Friends, relatives, employer, tradespeople will not know you are applying for loan. Advise occupation, amount wanted. Postal Finance Co., 200 Keeline Bldg., Dept. 7B, Omaha, Nebraska.

REMAILING 25c. Replies forwarded. Ashton, 627 So. Normandie, Los Angeles 5, California.

ULTRA-Fabulous Las Vegas. Classifieds airmailed \$1.00. Remails 25c. Reairmails 40c. Message typewritten on multicolor postcard 50c. 15 multicolor postcards all different \$1.00. Box 228, Las Vegas, Nev.

WAIKIKI—Reairmails \$1.00; others 50c. Confidential. Message typewritten on postcard 75c. Queen s, Box 1017, Honolulu 8, T. H.

MIAMI Remails 25c. Complete classified \$1.00. Lewellyn, Box 69, South Miami, Florida.

WEALTH—Happiness. Fulfill all your desires with "The Seven Secrets to Success." Unconditionally guaranteed. Nothing more to buy. This is it. Send \$1.00 today. Cromwell, Box 343, Northridge, Calif.

NEW England is booming. New York, Boston, Hartford or Springfield employment ads airmailed \$1.00. Remails 20c. monthly \$2.50. Aswood, 172 East Quincy, North Adams, Mass.

DELAWARE Valley booming. Complete Sunday's classified \$1.00. Your line filed free. Confidential. RenRaw Sales Agency, 19 Irvington Pl., Trenton 10, N. J.

MYSTIFICATION Entertainment. Practice thought transmission. Mental instructions executed instantaneously. Instruction treatise \$10.00. Box 972, Santa Barbara, California.

SEND Your friends or yourself tree ripened oranges and grapefruit from Florida. 1/2 bushel, \$4.50; 1 bushel, \$6.50; 1/2 box, \$6.00; 1 box, \$9.00. All prices include delivery charges, delivery west of Mississippi add 10%. Free jar tropical jam with each item. Money-order or check, no c.o.d. Send for free price list on many other package combinations. Caribbean Shippers, 3801 N. W. 64th Ave., Miami Springs, Florida.

WORK And live in beautiful, exotic Miami. Jobs, houses, apartment sales and rentals, classified sections Miami newspapers \$1.00, remail letters 25c, cards 10c, monthly rates upon request. Your personal representative, Paul Terwilliger, P. O. Box 725, Miami Springs, Florida.

RESURRECTION On earth—Not heaven. Free. Write: Harvest, Jefferson City, Mo.

NEW York City, souvenirs \$1.00; letters remailed 25c; typewritten message on scenic postcard 50c; employment ads \$1.00. Douglas, 550 5th Avenue, New York 36, N. Y.

REMAILING SERVICE

LETTERS Remailed from New York City 25c, 10 postcards \$1.25. Remailed free. S. H. Brown, 178-39 Leslie Rd., St. Albans, Long Island 34, N. Y.

SURPRISE! Your letters remailed post-marked London, England. I affix British airmail stamp. 50c, three \$1. Major Kroger, 7th Air Division, A.P.O. 125, New York City.

LETTERS Reairmailed 25c. Receiving-forwarding address, \$2.00 monthly. International Courier Service, Box 6480-PM, Los Angeles 55, California.

LETTER Remailing, receiving-forwarding address for rent. McLaughlin, 800 Stewart, Columbus 6, Ohio.

LETTERS Remailed from Phoenix, Arizona. Lilart Co., Box 965, Scottsdale, Arizona.

TREASURE FINDERS

LITHIUM—The wonder metal. Free booklet describes prospecting information, uses, etc. Nu-Age, Box 142, North Battleford, Sask, Canada.

URANIUM—Radioactive analysis of rocks, clays, sands. \$2.00 per sample. Red Hill Uranium Ltd., 809-B Miles, Hereford, Texas.

FIND Buried treasure, gold and silver, with Goldak's sensational 3 1/2 lb. "find-it" locator, only \$49.50. Write for free literature on complete line of mineral, metal locators; Geiger and scintillation counters. Goldak, 1541 W. Glenoaks Blvd., Glendale, Calif.

URANIUM, Gold, silver treasure. New, power-packed, highly sensitive metal detectors, Geiger counters and mineralights, kits and assembled models from \$12.50. Lightest weight, guaranteed, free literature. Electronic Applications, 5024 Lee Highway, Arlington 7, Va.

GOLD, Silver, metal detectors. Geiger counters for uranium. Mineralights. Sensational new fully guaranteed models. None finer. Information free. Detecron Corp., 5528 Vineland Ave., North Hollywood, California.

GEIGER Counters and kits. Sensational values. Free literature. Roberts Mfg. Co., Cleburne, Texas.

URANIUM Finding made easy! Completely transistorized Geiger counters available for first time. Extra sensitive. Lightweight. Scientifically engineered. Unconditionally guaranteed. Also complete line prospecting instruments from \$19.95. Write for free information, maps, techniques. Universal Atomics Corp., Dept. PM2, 19 East 48th Street, New York City.

NEW! Uranium detector kit, \$8.49. Free catalog. CMG, Box 611-PM, Laramie, Wyo.

SCINTILLATORS, Geiger counters, metal detectors, mineralights. Retail only. Intl. Stamp Bureau, 135 W. Adams, Detroit 26, Michigan.

JEOP Owners—V8 power. Read Jeep Owners ad, page 52.

URANIUM Near home? 50c tests six 2" rocks. Rocktest, Elkton, Kentucky.

MISCELLANEOUS

SENSATIONAL Offer! Exciting, miniature tree growing secrets; new, catch-all fishing formula; money-saving, "Home Dental Care" booklet. Rush \$1.00 for all. Revealer, 1749 Grand Concourse, New York City 53.

SENSATIONAL Waterless hand cleaner. 2 pound can 89c. 4 pound \$1.69. Sunway, Box 811, St. Louis, Mo.

PANNING Gold lesson—Free mail-order catalog, mining supplies, mineral books. Old Prospector, Box 729D1, Lodi, Calif.

STUPENDOUS Mental power. Adults. (Details 10c.) Delmar Wisdom, 846 Sunnyside, Chicago 40.

YOUR Name wanted. We'll send 1000 publishers, mailers, wholesalers your name, on our list one year 25c. Dixie Mailers, King, N. C.

HEAT Your home or business for almost nothing. Amazing method, thousands satisfied. Valuable information free. A. Enault, R.F.D. #1, White River Junction, Vermont.

WHOLESALE Catalog! 30-80% discounts! Appliances, musical instruments, typewriters, phonographs, watches, jewelry, recorders, housewares, etc. Consolidated Distributors, 21-13 Lafayette, Paterson 15, New Jersey.

CLOGGED Drains, cesspools and septic tanks cleaned by new powerful chemical. Sursolvent removes grease, soap, tree roots, etc., without expensive digging and electric rodding machines. No pumping necessary. Mix with water and pour down drain. Free details. Electric Drain Cleaning Co., Boston 34, Mass.

300 BIG Mails guaranteed. Samples, plans, offers, propositions, 12 months listing, \$1.00 refundable. Wright Publications, 2270 Hubbard, Memphis 8, Tenn.

SEPTIC Tanks. Get the facts about septic tank cleaners and proper method to prevent plugging. Send 25c to Chippewa Products Co., Burnt Bridge, Chippewa Falls, Wis.

DOG Whistle, high pitch sound, audible only to animals, especially dogs. Send \$1.00. Duval Company, Box 112, Midwood Station, Brooklyn 30, New York.

EMBLEMS, Pennants, special design, suede or felt, plain or flocked. Pease Emblems, 18126 Fielding, Detroit 19, Michigan.

HOW To be saved, and know it. Free literature. Bible House, 2516 1/2 Jay, Sacramento, Calif.

DIALRITE Automatic phone light, free details. Northeast Research Corporation, 67-A Franklin Street, Allston, Mass.

FLORIDA'S Boom town—Ft. Lauderdale! Population doubled last 5 years. Business and job opportunities unlimited. Full details, \$1. Kemp, 823M N.E. 7th Ave., Ft. Lauderdale, Fla.

FREE. Complete illustrated catalog, leathercraft kits, supplies. J. C. Larson Co., 820 S. Tripp, Dept. 5650, Chicago 24.

CORN Popper steam engine unfinished castings, photo 25c. Rollo Every, Clarklake, Michigan.

\$5,199.90 WAS Paid to John Betts in few weeks. Grow mushrooms. Cellar, shed. Spare, full time, year round. We pay \$3.50 lb. Free book. Mushrooms, Dept. 175, 2954 Admiral Way, Seattle, Wash.

BUY Wholesale thousands nationally advertised products at big discount. Free "Wholesale Plan." American Buyers, Hertel Station, Buffalo 16-K1, N. Y.

HAIRCUT As you like it. Booklet 25c. Mastrolia, 32-20CK 89th Street, Jackson Heights 69, New York.

RECEIVE Hundreds offers, samples, magazines. Large list 25c. Mail Center of Los Angeles, 7101 Apperson, Tujunga, Calif.

GERMAN Address lists. Anything manufactured 25c. Burke Associates, Manchester, Mass.

WHIS-Nix, shaving powder 50c. L. Wimberly, 7931 Laurel Canyon, N. Hollywood, Calif.

RECEIVE Magazines, samples, catalogues. Mails from everywhere. Offers, hundreds. Get listed 25c. Rorick, Cincinnati 26, Ohio.

PROTECT Your property with amazing new combination fire and burglar alarm kit. Everything needed for simple installation. Save hundreds dollars. Home model \$54.95, business model with 7 day timing device, \$69.95. Free literature. Agents wanted. Arthur Automatic Alarms, 2826 Park, St. Louis 4, Missouri.

CESSPOOL, Septic tank troubles? Use "Septi-Magic." Complete treatment. Save pumping, digging, stop odor. Non-toxic. Simply flush down toilet. \$3.98 lb. post-paid. Details free. Agents wanted. Manufactured and guaranteed by Cerco Products Co., Salem, Connecticut.

TENSE Excitement, drama, human interest. 1956 Olympic games, Melbourne, Australia. Information on this land of opportunity and Olympiad. Also including official program in color. Post \$1.00 to: Austral Sports Company, Box 21377, G.P.O., Melbourne, Australia.

CIGARETTES—Roll 20 for 9c, guaranteed to please. Facts free. Pete Moberly, Box 797, Owensboro, Kentucky.

FLORIDA'S Boom town—Ft. Lauderdale! Population doubled last 5 years. Business and job opportunities unlimited. Full details, \$1. Kemp, 823M N.E. 7th Ave., Ft. Lauderdale, Fla.

CESSPOOL, Septic tank, troubles? Use "Septi-Magic." Simply flush down toilet. Save pumping, digging. Stop odor. Non-toxic. Complete treatment. \$3.98 lb. post-paid. Details free. Guaranteed. Home, Farm, Garden Research, Box 4542, Noroton, Conn.

BIG interesting mails. Month 10c, year \$1.00. Harvey Teeple, Decatur, Ind.

DECORATIVE Ship's wheel 25" mahogany. Circular free. Concourse, 4003 Dyre, New York 66, N. Y.

KEYS—Send me your car key. I will make a duplicate for 25c. Ernest W. Mayer, Veterans Hospital, Ward 9, San Fernando, Calif.

BUY Wholesale 750,000 products. Details free. Carter, Box 6011-H, Chicago 80.

WORLD'S Smallest Bible, 50c. Specialties, 130 Linden St., So. Williamsport, Penna.

FREE. Get our offers. Durr & Durr, 6521-N Pine Point, Tinley Park, Ill.

FOR Beautiful engraved name plate send \$1.00 and name. Mail-N-Post, Wapping, Conn.

I call this machine "My Little Money Maker"



It can be put anywhere in the house—in the kitchen, the basement, or the attic and it goes on making money for you whether you're there or not. Three times a day—while you're at work, while you're asleep, or at the movies—it turns out a product that sells for \$6 and the cost of raw materials is only 54c. It will make 6 a day, and the profit on each is more than \$5.00. I'll be glad to tell you how to get one of these little money makers working for you.

What a fellow makes in his regular job today is hardly enough to make ends meet. Higher taxes, higher costs of food and rent and almost everything else raise hob with the savings account. And I say that what a fellow puts away is even more important than what he makes. It would worry me sick if I couldn't save a little against a rainy day.



And that makes it almost necessary to make some extra money. There are lots of ways to do it, too. The magazines and newspapers are full of ads for agents to sell things. But if I had to make a living by selling, from house-to-house, I'm afraid I'd starve to death. I like to make something with my hands and

either sell it by mail or let the stores sell it for me. There are lots of people like me.

Another thing: Lots of men—and women; too—don't want to get mixed up with something that might hurt them on their jobs. They want a plan they can operate at home—in spare time—one that they can work at any time they please and one that doesn't need any rented store or hired help. And that's where my little money maker rings the bell.



Let's say you're like me. You want to make some extra money but you don't want to do any selling. All right—take a look at what you can do with this machine. I'll give you some facts that I discovered and your own common sense will tell you they're true.

If you're going to make something, it ought to be something that lots of people want—something that lots of people buy. It shouldn't be something that sells at just certain seasons—but all year round. And, it shouldn't be any flash in the pan. It's got to be steady—year after year—something that's not here today and gone tomorrow.

Well, give a thought to this: What's more permanent than babies? Ever since I can remember there's been more and more babies born every year. Last year three and a half million. This year more. Next year, more yet. Then answer this question and tie it in with your thinking: What's stronger than mother's love for her baby? And what is more powerful than love or sentiment in making people buy things. Now you've got the idea.

Every year millions of mothers want their babies' first shoes preserved as mementos. These mothers have the shoes "bronzed" as they call it—by electroplating. Electroplating coats the shoes with copper and preserves them forever. And there's no big company that has a corner on the business of metalizing baby shoes. Almost all of this work is done by little fellows in their kitchens



or basements. Lots of orders come to you by mail when you send out circulars letting mothers know you can do the work. Lots of stores take orders, but they have to turn the work over to you. There are six or seven ways to get orders without making any house-to-house calls. The big job is keeping up with them.

You see, you can clean up six pair shoes in a few minutes. In a few minutes more you can dip them in the hardening solution like you see in the picture. Then you spray them with a conductive coating and hang two pair in the tank on copper wires. Just turn the switch and walk away. The machine does the rest. Eight hours later those shoes are ready to take out of the tank, burnish and mount and ship or deliver. Two pair every eight hours, whether you are asleep, awake or at the movies. The materials cost 54c a pair.

The retail price you get for electroplating is \$6.00—so the profit is more than \$5.00 a pair. Since you can do six pair a day you can see what the profit is, and the beauty of it is that the machine doesn't cost much. Almost anyone can afford the equipment. The book tells how to run the machine and how to get orders without house-to-house selling.

If you'll just put your name and address on the coupon and mail it to me, I'll send you all the information right away by mail. After you have read all this you will know what you want to do. It will be easy to decide whether you would like to have a "Little Money Maker" of your own. Everything I send you now is free. There is no catch to it and nobody will call to try to sell you anything. I'll send everything free and postage paid. All you have to do is mail the coupon, get the facts and then decide. Mail the coupon right away so I can help you get started making money!

CARL A. MASON, 1512 Jarvis Ave., Chicago 12, Ill.

CARL A. MASON

1512 Jarvis Ave., Chicago 26, Ill.

Please tell me about the seven different ways to make money at home in spare time with your "Little Money Maker." It is understood that no salesman will call and it is up to me to decide what I want to do. Everything you send me now is free and will not cost me a penny now or ever.

Name

Address

City.....Zone.....State.....

Parade of Station Wagons

IF YOU NEED MORE ROOM in your car (room for children, lumber, trash or fertilizer), you'll probably look at station wagons. Owners find them handy for doing the week-end jobs common to the suburbs.

Here, for you to look over, are three pages of 1956 wagons. Eleven companies offer this body style, ranging in price from Rambler to Chrysler New Yorker.

Remember that while you do gain room, you lose certain advantages to get it. Wagons are noisier than sedans because the rear end is directly below the passenger compartment, not muffled under a trunk. A wagon is slow to heat because it has

more space. It has no trunk for hiding valuable (or embarrassing) cargo from curious pedestrians. On trips you either put luggage inside and lose the extra space you bought the car to get or you put it on the roof where it must be covered against weather—a nuisance if you have to get at it daily. Wagons are heavier, cost more to run. No company has yet solved the fume problem. With the rear transom open (desirable in hot weather), suction drags exhaust fumes inside the car. Finally, if you expect the wagon to solve the problem of obstreperous children, it won't. It just gives them more room to be obstreperous in. ★ ★ ★

Buick Special
Four-door Estate Wagon



Chevrolet Bel Air
Four-door Station Wagon

Chrysler New Yorker
Four-door
Town and Country



(Continued to page 102)



Catalog of 3,100 Novelties, Gadgets, Jokes & Tricks

Send 10c for amazing catalog of novelties, joke articles, funmakers, tricks, gadgets, live animals, scientific supplies, hobbies, planes & boats, unusual seeds, time-savers, cameras, optical goods, projectors, movies, lucky jewelry, religious goods, disguises, masks, musical instruments, stamps, coins, puzzles, fortune tellers, radios, auto & bike accessories, telescopes, magnifiers, compasses, banks, smokers' items, artist supplies, printing sets, engines, motors, shockers, knives, billfolds, guns, rifles, sports, books, games, plants, pennants, emblems, etc. Send name, address and 10c to:

JOHNSON SMITH & CO.
Dept. 295 Detroit 7, Mich.

Here's 10c. Rush me New Catalog!

Johnson Smith & Co., Dept. 295, Detroit 7, Mich.

Name _____

Address _____

**New
1956 Issue**

Build This Beautiful Corner Table

**Full-Size Pattern
Now Available**

To make this attractive table, you merely trace the design on wood, saw, smooth the edges and assemble. It's so easy it takes all the guesswork out of furniture building. Designed as a companion piece for the step and cocktail tables detailed in Full-Size Patterns Nos. 103 and 104, this table can be used alone or with any grouping of contemporary furniture.



Other Patterns In This Series

There are 14 other full-size patterns in stock. These include a 12-foot boat, a work bench and toys for the children. For details, send coupon.

Guaranteed to Please

Designed by John Bergen, noted furniture designer, this table will be a handsome addition to your home. If, however, you are not thoroughly pleased with the pattern, you may return it within 7 days for a full refund. The price is only 50c.

Order on this Handy Coupon

POPULAR MECHANICS PRESS, 200 E. Ontario St., Chicago 11

Please send postpaid the Full-Size Corner Table Pattern. If not satisfied, I will return it within 7 days for a full refund of the purchase price.

- Send the Corner Table Pattern (I enclose 50c)
 Send information on other full-size patterns

Name _____

Address _____

City _____ State _____

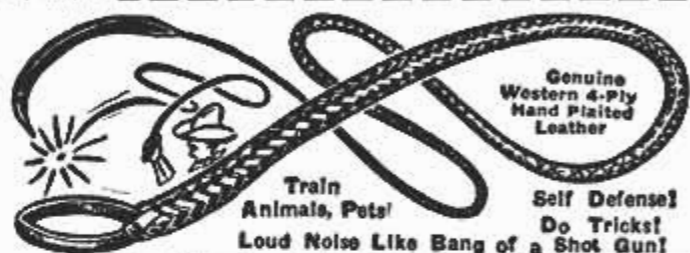

PLAITED LEATHER BIG BULL WHIP

Experts knock ashes off cigaret, run out of hand, yank people off feet, etc. Used by trainers, ranchmen, etc. Grip lightly (pressure is on loop), then crack or coil; snake out or back; overhand, underhand, side-arm. Neat's oil finished for pliability & long life. "Cracker" or tongue on end. Solid grip handle with loop.

6-ft. Whip \$1.98; 8-ft. Whip \$2.69.

JOHNSON SMITH & CO., Dept. 295, Detroit 7, Michigan POWERFUL ELECTRIC GENERATOR

Cost Over \$20.00 New; While They Last, \$3.95

Generates Up To 75 Volts. Use to generate electricity, to ring bells, light up lights, as a medical battery, deliver terrific electric shock as joke, many electrical experiments, classroom uses, etc. Cost over \$20 new. Used but excellent operating condition. Hand crank or gear wheel drive. Made by leading electrical companies. Each has 3 or 4 five-inch 1-lb. bar magnets (alone worth more than total cost), generating armature, wire leads, gear crank, ready for use. Originally used in crank phones. Complete unit weighs over 5 lbs. Each Postpaid \$3.95 (Over 1000 miles from Detroit, send \$4.95, otherwise shipped express charges collect). Telephone Mike \$1.75. Mail order to Johnson Smith Company, Dept. 295, Detroit 7, Mich.

100X Area Magnifying Projector

— Enlarges Pictures, Printing, & Objects! — Full Color!

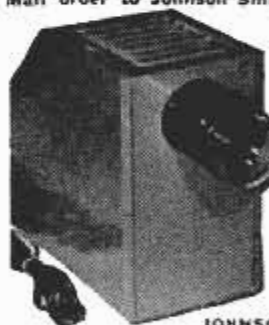

NEW! Electric Magna-Vue Optical Instrument projects & enlarges clippings, pictures, sketches, objects in full natural color, correctly & readable. Project on wall, screen or table, **MAGNIFIES 100 AREAS.** Enlarges any material up to 3 1/2 x 4 in. to 32 x 40 in. For home, school, class, business, shop use. Also make signs, sketches easy from any copy. Enameled steel, 10x7 1/2 in. high. Quality 2" focusing lens. Operates on standard 110 volt current. Money back guarantee. Price Postpaid..... **\$4.98**

JOHNSON SMITH CO., Dept. 295, Detroit 7, Mich.

GET THE HABIT OF READING OUR CLASSIFIED ADS.
Wonderful Opportunities Amazing Bargains



WELD IT YOURSELF IN A JIFFY!

Weld, Cut, Braze, Solder: Iron, Steel, Brass, Bronze, Aluminum and other metals safely and easily. Make your wrought iron furniture, porch railings, fences, knick-knacks and other metal specialties. With this fine equipment anyone can do professional-like work with little practice. Tool and equipment breakdowns are annoying and costly. Don't let them bother you. The Dynamic will pay for itself quickly in both time and money and is designed to operate from any properly wired 110 volt AC line.

Order your Dynamic Industrial type transformer Arc Welder for Workshop or Industrial use today. Order from this ad.

Literature on larger equipment available on request.

DYNAMIC WELDER COMPANY, 1808 S. Federal Street, Dept. D2-B, Chicago 16, Illinois

EASY PAY PLAN

Low down-payment. Pay as you weld. Money back guarantee. Send for details. Complete outfit.

Only \$38.50

F.O.B. Factory

PARADE OF STATION WAGONS (Continued from page 100)



De Soto Firedome
Four-door Station Wagon

Dodge Sierra Custom
Four-door Station Wagon



Ford Parklane
Two-door Station Wagon

Mercury Custom
Four-door Station Wagon



(Continued to page 104)

THEY'RE **NEW!**

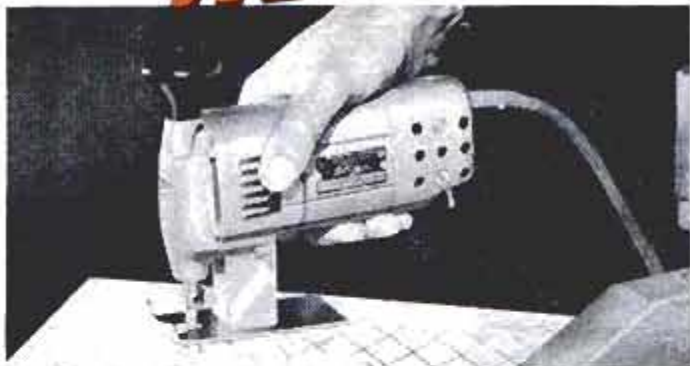

FASTEST-CUTTING JIG SAW MADE! This powerful new Millers Falls tool is a jig saw, hack saw, coping saw, ripsaw, crosscut and keyhole saw all in one. Makes curved, straight or irregular cuts in wood, metal, all kinds of material—in places often inaccessible to other saws! Exclusive design features and special blades result in far greater cutting speed than any similar saw.

No. 480 Dyno-Mite Electric Jig Saw — \$44.95

THEY'RE **DYNO-MITE**



FOR THAT PROFESSIONAL FINISH! This new Millers Falls Orbital Sander finish-sands furniture, cabinets, interior trim . . . removes paint, varnish or surface imperfections . . . all without tracking, scoring or burning surface. High-speed orbital action permits sanding with or across the grain. Light weight makes it easy to use on overhead and vertical as well as horizontal surfaces.

No. 580 Dyno-Mite Orbital Sander — \$44.95

THEY'RE

Millers Falls

Finest Power Tools Made



FREE AT YOUR HARDWARE DEALER'S Ask for these folders on the whole power-packed line of Millers Falls Dyno-Mite electric tools including the remarkable new Dyno-Mite Power Workshop, or write direct.

MILLERS FALLS CO. • Dept. PM-12 • Greenfield, Mass.

Here's How... **ONE HAND WASHES the OTHER WITHOUT SOAP or WATER!**

Open a ZIP PACK Rub on STAPO—wipe off—your hands are... **CLEAN**

Stapo

THE MIRACLE HAND CLEANER
CLEANS GRIMIEST HANDS QUICKLY and EASILY

DISPENSER CARTON CONTAINS 40 ZIP PACKS

STAPO (pronounced STAY-POE)—the original waterless hand cleaner especially compounded to remove stubborn grime and grease from the hands without the need of soap and water. Sold since 1933 to industry and known to be the

finest and most effective product of its kind wherever it is used. To answer an increasing demand, we have developed a new Dispenser carton containing 40 aluminum-foil ZIP PACKS of STAPO—a full 6 month supply for average user.

Carry this Dispenser carton of STAPO ZIP PACKS in the car—hang one in your garage or home shop. Keep a few STAPO ZIP PACKS in your tool box or in your office desk and be sure you always have a quick, easy and effective means of really cleansing your hands even though soap and water are not available. STAPO actually dissolves grease and grime and floats it off the skin—removes it from the creases in knuckles—from under fingernails and around the cuticle—STAPO removes grease that ordinary soap and water won't touch. This wonderfully efficient product in its handy modern package will be doubly appreciated for that difficult clean-up job after roadside auto repairs or when working around your car on your day off. Nothing beats STAPO for fast and easy and complete removal of grease, paint, tar, plaster, printers ink, gasket cement, and other stubborn grimes from the hands.

STAPO not only cleans with tremendous effectiveness but conditions the hands with repeated use—it is soothing to the skin.

You don't need to send money to try STAPO. Just fill out the handy order coupon below and we will forward your Dispenser carton of 40 ZIP PACKS of STAPO at once. Pay the postman only \$1.79 plus small postage and C.O.D. charge upon arrival. If you prefer, send \$1.79 plus 21 cents for postage and your STAPO Dispenser carton will be shipped postpaid. The purchase price will be cheerfully refunded if you are not completely satisfied the first time you use STAPO. Order one or more STAPO Dispenser cartons today.

STAPO Chemical Co., Dept. 12, 2710 So. Indiana St., Los Angeles 23, Calif.

ORDER TODAY send no money

STAPO Chemical Co., Dept. 12, 2710 So. Indiana St., Los Angeles 23, Calif.

Please rush me _____
Dispenser carton(s) of STAPO in ZIP PACK foil containers.

Send C.O.D. I will pay postman \$1.79 for each carton ordered plus small postage and C.O.D. charge.

I enclose \$1.79 plus 21¢ for postage for each carton ordered. You will ship PREPAID.

I MAY RETURN IT FOR REFUND OF MONEY PAID YOU IF I AM NOT SATISFIED AFTER USING MY FIRST ZIP PACK

NAME _____
STREET _____
CITY _____ ZONE _____ STATE _____

PARADE OF STATION WAGONS (Continued from page 102)



*Plymouth
Sport Suburban*
Four-door Station Wagon

Pontiac 870
Four-door Station Wagon



*Rambler
Cross Country*
Four-door Station Wagon



*Studebaker
Pinehurst*
Two-door Station Wagon



♦ For the newest idea in station wagons see page 76.

DO IT YOURSELF DEGREASER!

engine shampoo



QT. SIZE CONCENTRATE
MAKES 2 GALLONS



SPRAY OR BRUSH ON . . .

Takes cling out of oil and grease . . . emulsifies it . . . so that all dirt may be hosed off as easily as you rinse hands under water faucet. Launders engines faster, more completely, and safer than steam cleaning (warm the engine). Self scouring action brings out factory new appearance . . . provides accurate visual inspection . . . Gunked engines run cooler. Genuine Gunk is sold in BULK sizes at better automotive wholesalers everywhere. Retail sizes sold at WESTERN AUTO STORES and ASSOCIATE STORES. TRY IT TODAY!

The CURRAN CORPORATION, Lawrence, Mass.

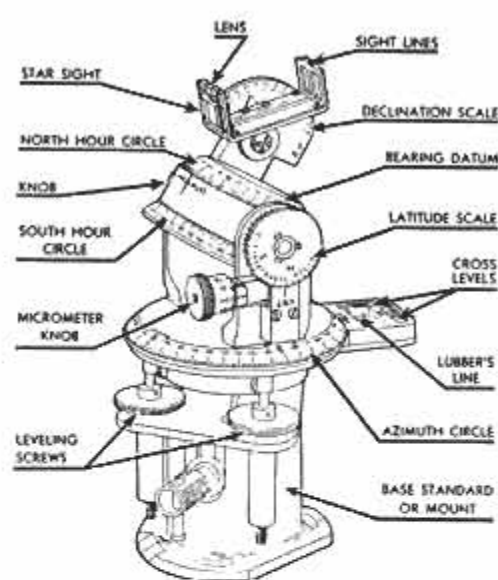

ASTRO COMPASS

Used for Navigation, Surveying, Star location, Telescope Mount.

Govt. cost \$150. Precision Built with Substantial Carrying Case.

Postpaid.
Used . . . \$10.95
New . . . \$14.95
Quick Release mounting \$1.95

Limited quantity.

SET J12A



HIGH SPEED DRILLS WITH 1/2" SHANKS
5 Different Size H.S. Drills 1/2" to 1". These H.S. Precision Drills with 1/2" Shanks can be used in a 1/2" Electric Drill or a 1/2" capacity lathe or Drill Press, only . . . \$7.95

Used good — our selection of sizes.



NEW SLITTING SAWS WITH MANDREL
ASS'T of 18 Slitting Saws, plus mandrel. Diam. 1 1/4" to 2 3/4" . . . \$4.49

Free Catalog — Hundreds of Electrical, Mechanical & Tool Bargains
PRACTICAL ENGINEERING CO. 707 N. Sheridan
Tulsa, Okla.

MANUFACTURE THIS BEAUTIFUL CONCRETE OUTDOOR FIREPLACE

Right In Your
Own Backyard

\$4.00 Worth of
Sand & Cement
produces this
Attractive
Fireplace.

Sells on Sight
from \$60. to \$80.
Easy to start your
own Profitable
Business.

The General Fireplace
Molds and Process are the most
amazing and foolproof ever invented.
Simple to operate. Two men can produce five fireplaces a day.

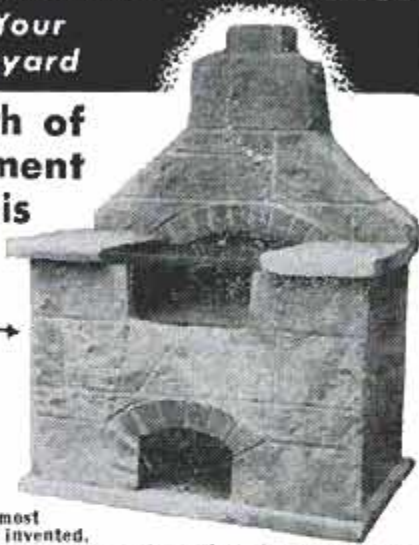

BIG DEMAND!!

Sell all you produce to Department Stores, Homeowners, Parks, Nurseries and Picnic Groves. Fireplaces sell on sight. No experience necessary. We supply full operating instructions and equipment plus the know-how that spells BIG PROFITS. This is an outstanding opportunity for men of vision and small capital to get into a busy rich paying field. Don't delay, be the only exclusive manufacturer in your own home town. Mail coupon at once for full details as to how you can reserve your territory. **Molds sold only on exclusive franchise.**

GENERAL ENGINES CO., Inc., Dept. MF-26
ROUTE 130, THOROFARE, N. J.

Mr. Tor of Philadelphia writes: Sold 250 in first 4 months. Selling to Sears Roebuck, John Wanamaker, and Gimbel Bros. in Philadelphia area.

Name

Address

City Zone

State

For the Man who "TREATS 'EM ROUGH" Parker's new H-75 Tubular Frame Hack Saw

The most rugged Hack Saw on the market

Steel handle covered with tough, unbreakable plastic formed into full-size comfort grip.

Extra strong, 4" deep, shockproof frame of heavy steel tubing — double plated chrome finish.

Adjusts for both 10" and 12" blades.

Adjustable thumb rest for easier, truer sawing.

Exclusive, patented, forged blade holders lock in four sawing directions.

Wherever good tools are stocked

\$2.49

Manufacturers of World-famous Trojan Saw Blades and Frames

Buy the **Parker** Line

PARKER MANUFACTURING CO.
WORCESTER 1, MASS., U. S. A.

Break into the profitable RUBBER STAMP BUSINESS at home in spare time

with this
**INEXPENSIVE
TABLE TOP
MACHINE**

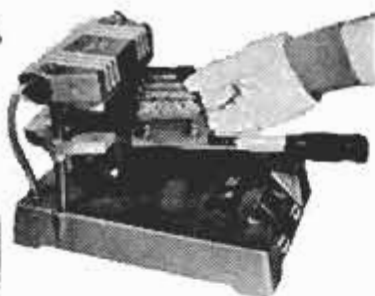

Home operators now **MAKE \$9.20 AN HOUR**
in business once controlled by a few big companies

Amazing new rubber molding invention puts you in business for yourself. Now, for the first time, the profitable rubber stamp industry is open to individuals. Here is an opportunity to start small in spare time in your own home. Keep your job until you're making enough to be independent of time clocks and bosses.

At one time only big companies could make rubber stamps because it required expensive machinery. People who wanted special stamps had to send cash in advance, wait days, or even weeks, and still run the chance of disappointment. This sensational invention changes all that.

Today, home operators like yourself can make rubber stamps. You take 27 cents of material, run it through this machine, and come up with a perfect stamp worth \$1.80. That's a \$1.53 profit on every stamp. Anyone can do it—it's not hard at all. This machine runs on an ordinary electrical outlet and it will fit your kitchen table top. You can make special stamps like the ones for people's names and addresses, the ones offices use to mark packages, identify products—in fact, any kind of stamp at all.

Now, the big manufacturers still use expensive machines costing as much as \$3,000. They set the high prices for rubber stamps, ranging from \$1.80 up. You can make these stamps much cheaper with this inexpensive machine. So your profit is much greater—as much as \$9.20 every hour.

Act quickly to take advantage of this offer. Get a head start. Just fill out the coupon below. We'll mail you free information without obligation. We tell you all about this machine, how to get started in spare time, how to get orders coming in eight different ways—everything you need to know to succeed.

Here is your chance to get out in front and stay there in a fascinating new branch of an old, established highly profitable business. Mail this coupon for free facts today.

**RUBBER STAMP DIV., 1512 Jarvis Ave.
DEPT. R-22 CHICAGO 26, ILLINOIS**

MAIL COUPON TODAY!

**RUBBER STAMP DIV., Dept. R-22
1512 Jarvis Ave., Chicago 26, Ill.**

Please rush free information. Tell me how I can get into the profitable rubber stamp business in spare time on very small investment. Mail all information, Free. No salesman is to call.

Name.....
Address.....
City..... Zone..... State.....

WHERE-TO-BUY-IT INDEX

Source of supply appears after items commercially available

AUTOMOTIVE

Tire-sealing compound (Pera Products, Inc., 14700 Grandmont Ave., Detroit, Mich.).....	119
German camping trailer.....	134
Pontiac's Junior Star Chief for '56 has plastic body.....	136
Automatic backup horn (Sleetex Co., Inc., 404 Fourth, New York City 16).....	147
Sun, oxygen and water ruin car finish.....	296

AVIATION

Real flying saucer?.....	119
Jeep turns on the faucet to cool jet engines during tests.....	140
Wasplike glider wins world championship for German model builder.....	157

HOUSE AND HOME

Home built from waste lumber.....	125
What's New for Your Home—	
Creeper for baby too young to use a walker.....	148
Floor waxer is a can of liquid wax attached to a long handle.....	148
Hanger for trousers and skirts.....	148
Glazing putty.....	149
Laundry cart.....	149
Book holder.....	149
Opener for awning-type windows.....	149
Sliding plastic panels assembled from kit enclose bathtub (Duraflex Corp., East Hartford, Conn.).....	156

MISCELLANEOUS

Mississippi "mattress" holds river bottom in place.....	119
Dial shows valve clearance (P & G Mfg. Co., 2362 N. Albina, Portland 12, Ore.).....	124
Sharp teeth on bulldozer blade bite through thick trees.....	124
Old locomotive makes last trip on low-slung truck trailer.....	134
Plastic golf-club "woods" (Nadco Sporting Goods Co., 3635 W. Touhy, Chicago).....	134
"Circarama".....	135
Sailboat "stilts" boost speed.....	136
Tall signs on buried hydrants locate them in snow.....	140
Marlin .22-caliber rifle has short lever stroke (Marlin Firearms Co., 11 W. 42nd, New York City 36).....	147
Motor moves fish bait while angler relaxes.....	147
Stern-wheeler plies lake.....	147
Impromptu aerial circus.....	150
Pivoting lamppost.....	150

SCIENCE

Supersonic wind tunnel discloses new heat problems.....	110
Navy tests first midget submarine as close-in weapon.....	124
Hawaii was once North Pole.....	140
Sun powers telephone line (Bell Telephone Laboratories, 463 West St., New York City 14).....	141
Fiberboard shelters keep out poison gas and radioactive dust.....	147
Miniature exhaust fan for Navy suits.....	150
Tests show antibiotics can be used to preserve food.....	156
TV camera on telescope provides better image.....	157
Freezing water protects food.....	284
Instrument counts a million objects per second.....	324

Radio-Television, Electronics

Personal telephone amplifier (Remler Co., Ltd., 3101 Bryant St., San Francisco 10, Calif.).....	261
"Registered" music (Kodiak Corp., 3515 Prospect Ave., Cleveland 15, Ohio).....	261
All-purpose radio (Darb, 1316 Yale Pl., Minneapolis 3, Minn.).....	261
Versatile installation "unhitches" TV receiver.....	262
Recipe-box continuity checker finds open filaments.....	264

(Continued to page 108)



...before it TALKS

...is the way our doctors put it—"Our chances of curing cancer are so much better when we have an opportunity to detect it *before it talks.*"

That's why we urge you to have periodic health check-ups that *always* include a thorough examination of the skin, mouth, lungs and rectum and, in women, the breasts and generative tract. Very often doctors can detect cancer in these areas long before the patient has noticed any symptoms.

For more life-saving facts phone the American Cancer Society office nearest you, or write to "Cancer"—in care of your local Post Office.

American Cancer Society 

HELPFUL BOOKS

Send post card asking for **FREE** catalog

Popular Mechanics Press, 200 E. Ontario, Dept. 601, Chicago 11

Do You Like art?

DRAW FOR MONEY!

Our Simple Method Proves You Can Learn to Draw at Home in Spare Time

YOU can learn Commercial Art, Designing, Illustrating, Cartooning, etc. . . . right at home, in spare time. No previous art training necessary. Soon be your own boss—work at home, pick your own working hours. Or earn big money as staff artist for advertising agency, newspaper, magazine, dept. store, etc. Or make Art a profitable hobby. Earn while you learn. 22-piece art outfit given with your first lesson **AT NO EXTRA CHARGE.** (School est. 1914.)

FREE BOOK, "ART FOR PLEASURE AND PROFIT." Describes our methods.

Lists opportunities. Tells what our students say. No obligation. So mail coupon *at once.*

FREE BOOK



Washington School of Art
Studio 142, Port Washington, N. Y.
 Send me—**FREE**—your valuable illustrated Book, "Art for Pleasure and Profit." No obligation. No salesman will call.
 Name.....Age.....
 (PLEASE PRINT PLAINLY)
 Street.....
 City.....Zone.....State.....

PICTURE MOULDINGS FRAME YOUR OWN PICTURES & SAVE
 It's easy to frame your own "favorites." Write for **FREE** catalog of beautiful mouldings—various types—at low mail order prices. Mailable. Send Post Card today.
GEM PRODUCTS, 6 West 10th St., Kansas City, Mo.

CARBURETOR SAVES GAS VACUATING OVERRICH MIXTURES



Car owners who are getting poor gas mileage, and wasting money due to overrich mixtures, will be pleased to learn how to save gas. Easily installed **Vacu-matic** invention is **Automatic** and operates on the supercharge principle. For cars, trucks, tractors
SALESMEN WANTED! Big Profits!
FOR FREE PARTICULARS, HOW YOU CAN GET ONE ON YOUR OWN CAR FOR INTRODUCING, just send your name and address on a post card to—
VACU-MATIC CARBURETOR, Dept. 844, Wauwatosa, Wis.

Roman Trireme
56 B.C.



NOW... the first NEW OARS in 2000 years

FIBER-GLASS OARS

3 PERMANENT COLORS
Red Blue Green

THEY FLOAT

ORDER DIRECT

FROM FACTORY... AND SAVE!

only \$15.95 pr.

"Sturdy" model 6 1/2 ft. long
Other models and lengths available

Not in 20 centuries a really new oar, but now ... "Glasrin" oars that last a lifetime—won't warp or split... never need painting... PLUS a full length, BUILT-IN...

ROD COMPARTMENT

ORDER TODAY for immediate shipment or write for **FREE** folder

PLASTIC AGE SALES, INC., 649 Arroyo Ave., San Fernando, Calif. Please send **FREE** folder of all models—sizes
 Please ship _____ pr. Sturdy model, _____ color, 6 1/2 ft. @ \$15.95 pr.
 I am enclosing check or M.O. for \$ _____ If California resident add state sales tax

NAME _____

ADDRESS _____

CITY _____

STATE _____

free!

1956 ALLIED

ELECTRONIC SUPPLY CATALOG

324
value-packed
pages

Save on Everything
in TV and Radio
Parts & Equipment



Everything for Experimenters,
Builders, Amateurs, Servicemen,
Engineers & Hi-Fi Specialists

Send for ALLIED's big 324-page value-packed guide to *everything* in TV, Radio and Electronics! Select from the world's largest stocks of High Fidelity systems and components; recorders and phono equipment; TV tubes, antennas and accessories; Amateur station equipment and supplies; P.A. systems; test instruments; latest build-your-own kits; industrial electronic supplies—plus *everything* in electronic parts, tubes, transistors, tools and books. Save on everything in Electronics—send today for your FREE 1956 ALLIED Catalog.

Everything in Electronics
From One Reliable Source

send for it

FREE
CATALOG

ALLIED RADIO

ALLIED RADIO CORP., Dept. 5-B-6
100 N. Western Ave., Chicago 80, Ill.

Rush FREE 1956 ALLIED 324-Page Catalog

Name _____

Address _____

City _____ Zone _____ State _____

(Continued from page 106)

Craftsman and Shop Notes Index

AUTOMOTIVE

Boards aid tire changing.....	224
Simplify engine maintenance.....	246
Sanding renews wiper blades.....	256

FARM AND FARMING

Belt-driven auto transmission powers portable elevator.....	245
Combination hog-feed house.....	245
Cover over feed-lot wagon box protects feed from weather.....	246
Warped doors straightened with turnbuckle and rods.....	255
Bushel basket used as "persuader" to drive hog up truck ramp.....	256
Portable concrete platform towed behind tractor.....	256
Hay-bale dump truck sets its load down.....	323

HOUSE AND HOME

Perforated hardboard used for eaves boxing.....	223
Gateposts braced underground.....	224
Metal extension arm locks window over air-conditioner unit.....	224
Wall cabinet has mail rack.....	225
Paint-roller cover protected by cellulose wrapping.....	230
Wire animals for your den or cabin walls.....	231
Bunk beds built into partition used to divide large bedroom.....	232
Saw for home-freezer owner cuts meats and bones.....	237
"Shadow box" stair rail and partition add to basement beauty.....	237
Corner spice shelf saves kitchen-cabinet space.....	238
Plastic "squeeze" bottle used as paint-solvent dispenser.....	238

HOUSEHOLD HINTS

Solving Home Problems—	
How to remove a cork pushed into a bottle.....	214
Dustcloth around broom made secure.....	214
Removing rings on varnished table.....	214
More daylight admitted to basement.....	214
Store trays and cookie sheets on underside of wall cabinet.....	214
Airtight seal on jar.....	214
Dog-feed dish can be firmly anchored.....	215
Two-way door wedge.....	215
Note for the milkman.....	215
Kneepads for working on floors made from synthetic sponges.....	216
Aluminum foil is reusable.....	220
Glass fragments picked up with modeling clay.....	230
Individual "greenhouse" from jug.....	230
Colored drawing inks used as wood stain touch-up.....	232
Automobile-chrome polish useful for cleaning household items.....	234
Punched hole in container cap avoids window-cleaner waste.....	240
Cleaning tall, slender vases.....	245

MISCELLANEOUS

Children's construction blocks improvised from lumber scraps.....	213
Nail polish does it.....	218
Thread spools provide holder for long bicycle padlock.....	220
Whale modeled from shrub.....	220
Broad-line lettering pens cut from bamboo strips.....	223
"Roll-a-ball" game utilizes egg carton, plywood.....	223
Small seeds are easy to plant with moistened matchstick.....	224
Cotter pin provides means of locking sea bag.....	232
Unusual and attractive book jackets made from seat covers.....	238
Make your own copying table.....	239
Lengthening chain-hoist life.....	254
On the Market—	
Wallpaper cleaner removes oil-base stains.....	260
Wall-screw anchor secures bathroom fixture.....	260
Lubricant for wooden objects.....	260
Natural-wood-finishing material gives a soft lasting sheen.....	260
Plastic-resin paint.....	260

(Continued to page 110)

IMPORTANT NOTICE—It is the intention of this magazine to provide its readers with information regarding the latest developments in the mechanical arts. We take no responsibility as to whether the disclosures contained in our articles are covered by patents and advise readers to investigate this subject before making, using, or selling any of the products, machines, or processes described in order to avoid possible liability for patent infringements.

SPECIAL! WORLD'S GREATEST TIRE SALE!

LO-PRICE USED TIRES \$3.45 ANY CAR 12 month guar.

MILITARY FULL RETREAD \$8.65 ANY CAR guar. 12 mos.



Limited Time! Entire Stock of our Top-Grade, 40,000 mile Passenger Tires, (worn very slightly) Released by Adjusters. Advertised for months at 7.86 ea., NOW at PRICES LISTED BELOW! IT'S CHEAPER THAN GETTING \$1 OFF JUST ORDINARY TIRES! Family safe, partially used tires. Check my golden rule guarantee. "The Blatt Name famous in tires for 40 years." Only Blatt offers a free fast replacement guarantee on ANY defective tire within 36 months. Frt. Excl. CHOOSE YOUR FAVORITE BRAND. Not Recaps. Foolish to pay more—dangerous to pay less!

GOOD YEAR **Firestone**

U.S. Goodrich, Lee & others. **FREE** This pictured tire ash tray given with 2 or more tires!

12 MONTH GUAR. & FREE FACTORY-TESTED TUBE

600-16		670-15		DEPENDABLE TRUCK TIRES	
5.84	710-15	5.34	700-20	\$8.94	600-16 (1)
5.74	780-15	5.34	750-20	9.84	650-16 (1)
4.84	800-15	5.64	825-20	16.54	700-16 (1)
4.94	820-15	5.64	900-20	15.54	700-15 (1)
5.34	850-17	5.34	1000-20	17.24	700-17
5.34	825-18	5.34	1100-20	17.24	750-17
			850-20	8.24	750-16
					7.54

MARVIN **BLATT** 6th & Spring Garden Sts. Philadelphia, Pa.

MILITARY MUD-GRIP TIRES
AA Guar. 6 Mos. AAA 12 Months
900-16 \$9.54 900-18 \$13.94
750-20 12.94 750-20 17.34

Send Check or M.O. & this ad for fast shipment, FOB Phila. I personally select your tires—no if my future depended on it. Read that top line again.

help your **HEART FUND** help your **HEART**

Handy Mail Order List

Little Library of Useful INFORMATION

5 for \$1.00
12 for \$2.00
25¢ Each

- Here at amazingly low cost is the practical help and information you have always wanted. Articles in previous issues of Popular Mechanics have been classified according to subject and are now available in these handy reprint booklets.
- How to Use Measuring Tools—Micrometers, Calipers, etc.—108.
 - Power Driven Saws—74.
 - Drill Presses, Grinders, etc.—79.
 - Wood, Metal-Turning Lathes—81.
 - Filing Machine, Hack Saw, Cutoff Wheel, Shaper—82.
 - Lathe Tools You Can Make—101.
 - Workbenches—Tool Cabinets—47.
 - Spray Painting—94.
 - From Pattern to Casting—91.
 - Tool and Saw Sharpening—92.
 - Sharpening Drills, Wood Bits—90.
 - Successful Wood Turning—32.
 - How to Read Blueprints—71.
 - Metal Turning Lathe Kinks—99.
 - Operating a Metal Lathe—100.
 - Heat Treating, Hardening—102.
 - Working With Glass—103.
 - Servicing Electric Motors—75.
 - Electromagnets & Solenoids—44.
 - Transformer Construction—41.
 - The Boy Electrician—43.
 - Soldering and Brazing—17.
 - Arc and Spot Welders—5.
 - Electroplating With Nickel, Chromium, Cadmium, etc.—86.
 - Plating Leather, Wood, etc.—87.
 - Lower Your Fuel Costs—31.
 - Curing Leaky Basements—45.
 - Fitting Home Game Room—55.
 - Indoor & Outdoor Fireplaces—88.
 - Backyard Gardening—39.
 - Lawn and Garden Novelties—72.
 - Trellises, Pergolas, Fences—76.
 - Lawn and Garden Furniture—77.
 - Playground Equipment—73.
 - How to Use Your Drill Press—125.
 - Making Serving Trays—53.
 - Knots and Ropework—105.
 - Sanders—80.
 - House-Wiring—89.
 - Hanging Wallpaper—38.
 - Built-in Fixtures—78.
 - Bird Houses—7.
 - Magazine Racks—49.
 - Clock Cases—50.
 - Book Ends—52.
 - Check Titles Wanted, Clip, Mail with Remittance to

- Working With Plastics—61.
- Simple Home Improvements—104.
- Ridding Home of Insect Pests—107.
- Children's Room Furniture—51.
- Jigsawed Novelties—57.
- Doll House & Doll Furniture—60.
- 25 Shelves You Can Make—64.
- Novelties Turned on Lathe—62.
- Inlay Pictures—Veneering—63.
- Wood, Soap Carving—65.
- Windmills & Weather Vanes—68.
- Lamps from Wood, Metal—69.
- Rustic Furniture—18.
- Wood Finishing—40.
- How to Fix Electrical Appliances—111.
- Painting Your House—117.
- Build Your Own Relays—123.
- Rowboats, Small Dinghy—83.
- Small Sail Boats—84.
- Two Outboard Runabouts—85.
- Build Own Canoe, Kayak—30.
- Build Class-E Ice Yacht—22.
- Auto Kinks, Shortcuts—10.
- Lawn and Garden Equipment—124.
- Motor-Driven Midget Cars—34.
- Stop Auto Electric Troubles—95.
- Photo Printers and Dryers—25.
- Photo Darkroom Equipment—96.
- Trick and Table Top Photos—97.
- Home Movie Equipment—118.
- Poultry Houses—108.
- Guns and Decoys—109.
- Re-Silvering Mirrors—70.
- Chemical Experiments—93.
- Log Cabins, Tourist Houses—14.
- Using Basic Tools—120.
- Farm and Garden Tractors—8.
- Building Extra Attic Rooms—23.
- Attractive Basement Rooms—24.
- Gem Cutting—42.
- Photo Enlargers—1.
- Photo Kinks—98.
- Cleaning Formulas—11.
- Taxidermy—9.
- Photo Lighting—119.
- Training Dogs—35.
- Small Furnaces—36.

POPULAR MECHANICS PRESS, Dept. 23, 200 E. Ontario, Chicago 11

AMAZING... VERSATILE ARROW GUN TACKER

No. T-50 12.00

THE MODERN METHOD FOR 1001 DO-IT-YOURSELF NAILING JOBS

FASTER! CHEAPER!



Same machine takes all 4 sizes.

The most sensational tool ever devised for fastening insulation, ceiling tile, screens, cornices, linings, etc. Self-feeding, automatic action permits user to staple-tack at desired rate of speed. One-hand operation frees other hand to hold material in place. It all adds up to savings of time, money and effort. Sold at Hardware, Building and Lumber Material Dealers.

ARROW FASTENER COMPANY, INC. ONE JUNIUS ST. BROOKLYN 12 NEW YORK

U-MAK-IT BOAT KITS

TWICE THE FUN—HALF THE COST!

MOST COMPLETE LINE OF BOAT KITS 8 TO 23'—PRAMS, ROWBOATS, OUTBOARDS, CABIN CRUISERS

Finest hobby with unequalled rewards for you, your family and friends.



Start building! Stop wishing! Be shipshape for the first break of the season.

Ask for your copy of our completely ILLUSTRATED CATALOG showing all models, accessories, all you need to build your own.

Send 25¢ (coin) for postage and handling

U-MAK-IT products 703P WHITTIER ST., BRONX 59, NEW YORK



Pete Penn asks:

"What's \$3,500?"

It's what a new car costs, on the average . . . and you'll agree with Pete Penn that it's an investment worth protecting.

Naturally, *the best protection* for the highest precision, hardest working part of your car is Pennsylvania motor oil in the crankcase. Every brand of Pennsylvania motor oil is made from *Nature's finest crude* . . . Pennsylvania.

At your next oil change, refill with a brand of Pennsylvania motor oil . . . *naturally* the finest oil in the world. Carried by good dealers everywhere.

Today's BEST Oils

Start with Nature's BEST Crude
...and that means Pennsylvania!

PENNSYLVANIA
Motor Oil

INSIST ON A BRAND OF



© 1966

PENNSYLVANIA GRADE CRUDE OIL ASSOCIATION, Oil City, Pa.

(Continued from page 108)

TOOLS

Elevated coping-saw table.....	213
Hand tools used to make coffee table of Hawaiian woods.....	213
Linseed oil in end of hammer handle preserves wood fibers.....	230
Improvised tool gauges slope of concrete-sidewalk forms.....	230
Taped linoleum-knife edge prevents dulling.....	237
Teeth on backsaw protected by wooden guard on blade.....	249
Special cotter-pin extractor for use in restricted space.....	255
Shopping for Tools—	
Combination shop power tool.....	257
Rotary index milling table.....	257
Portable power-saw-blade adapter.....	257
Chalk-line reel.....	258
Locking adjustable wrench.....	258
Pry bar for metal repair work.....	258
Carbide tool grinder.....	258
Ribbed rubber caps for vise jaws.....	259
Precision-machined parts.....	259
Paintbrush holder.....	259
High-temperature control switch.....	259
Glass cutter for the home workshop.....	259

WORKSHOP HINTS

Rubber tape over oilstone edge reduces chance of breakage.....	213
Trimming board end with saw aided by scrap lumber.....	213
Dispenser bottle provides oiler.....	216
Oil-treated concrete forms.....	216
Slots sawed in paint paddle speed mixing operation.....	216
Sludge cleaned out of oil drums by silt-rubber-hose "broom".....	216
Clothespin is handy file handle.....	220
Sandpaper cleaned with brush.....	220
Glue treatment renews mallet faces.....	224
Reel for long extension cord made from can and hardboard.....	232
Determining the center of a circular segment.....	234
Reinforcing rods in concrete held by wire supports.....	234
Dust caps for oilholes.....	236
Focal length of lens determined by using clamp and ruler.....	240
Clamps made from radiator hose hold tape measure.....	245
Diameter of cylinder reduced with bench grinder.....	245
End of shaft marked with letter indicates left-hand thread.....	246
How to straighten wire quickly.....	246
Working drawings kept flat on board under bench top.....	246
Folded magazine used as vise for holding pipe.....	249
Modified saw-table extension assures duplicate cuts.....	249
Nail holder for one-hand starting.....	249
Threaded rod and tubing provide stud assembly.....	249
Covers for bench-vise jaws protect tubing.....	255

Supersonic Wind Tunnel Discloses New Heat Problems

University of California researchers, working with a new supersonic wind tunnel, have discovered an aeronautical heat problem not previously suspected. Projectiles traveling at 760 miles per hour, they learned, get hotter at altitudes above 20 miles than when flying low. This was surprising because it had been thought that the friction caused by dense air at low altitudes produced greater heat. Now they find that the thin air is actually more viscid and that the heat generated in the stratosphere cannot be dissipated as easily, causing a high-flying object to heat up more than a low-flying one.

Sweden's State Power Board last July began construction of a 150,000-kilowatt steam-power station in a bombproof chamber being hewn out of solid granite nearly 300 feet below the surface.

133 Piece POWER TOOL ACCESSORY KIT

For Sanding, Grinding, Polishing, Carving, Burnishing, Etching, Milling, Cleaning, Cutting Off, Hole Cleaning, Deburring, etc. Contains Grinding, Polishing Cut Off and Buffing Wheels, Sanding Cartridges and Discs, Steel Cutters, Mandrels, Burnisher, Mounted Stones, Knife-edge rubber wheels. All with 3/32" Mandrels. The complete accessory \$1.98 plus 25c PP for any small job. Reg. \$6.00. **OUR PRICE.**



12 HONING STONES

OF VARIOUS TYPES—SIZES—SHAPES
Govt. Surplus worth many times our low price. A varied assortment of sizes, shapes and lengths for sharpening Tools; Instruments, Fish Hooks, Knives, Cutlery, other uses. Also used for deburring, removing light scratches. Our assortment permits one to hone in hard-to-get places. Made to sell for up to 75c each. **Our LOW PRICE—12 stones..... \$1.98 plus 25c PP**

18 MOUNTED WHEELS only \$1.98
Assorted shapes and sizes. ALL WITH 1/8" SHANKS. Designed for Grinding, Buffing, Cleaning, Deburring, Sharpening, Polishing, Sawing, Carving, Forming, Shaping, etc. These precision tools permit delicate operation on plastics, wood and metals. Easy access to hard-to-reach places. A regular \$9.00 value. **\$1.98 post paid**
All 18 assorted wheels only.....

ROTO HOLESAW Four Different Size Holes any 3/4" Stock... Wood, Plastic or Metal! Cuts thru only holesaw attachment for 1/4" electric drills at this low price! Cut 1", 1 1/2", 2" and 2 1/2" holes thru any 3/4" stock. Light but rugged aluminum arbor and 4 saw blades of top quality, high carbon steel furnished..... **\$4.95 complete**

Money Back Guarantee

MATTHEW DAY CO., INC. DEPT. PM20 DUMONT, NEW JERSEY

FREE WIN A TRACTOR FREE

WRITE FOR ENTRY BLANK NOTHING TO BUY
HEAVY OIL-PUMP BALL BEARINGS PUMPS MILLIONS OF GALS.

IRRIGATE, SPRAY, DRAIN OR FILL ANYTHING—ANYWHERE! Will not Rust—Clog—or Leak. Patented Seal. Pumps 2800 gph, 420 gph at 75' high or 1600 gph from 25' well. SIX blade impeller. Threaded for pipe, 3/4" inlet, 1/2" outlet. Use 1/4 to 3/4 hp motor... **7500 gph 9.95**
Heavier 2800 gph 8.95 **Heavier 11.95**
Check, MO or COD—Money Back Guarantee
FREE Literature—Comparison Charts
U. A. T. ENG. & MFG. CO. HICKSVILLE 273, NEW YORK

BUILD D.C. WELDER!

WE SHOW YOU HOW to build this powerful welder without rewinding. Uses most any surplus aircraft generator. Produces 75-350 amps. Easy to build. **PLANS 35c** includes **NEW** booklet "HOW TO WELD," and **FREE WAR SURPLUS AND ELECTRICAL CATALOG.**

LEJAY MFG. CO., 1247 LeJay Bldg., Minneapolis 8, Minn.

100 BEST Woodworking Projects

SELECTED FOR YOU BY POPULAR MECHANICS EDITORS
Enjoy the fun — the pride — of making things. Get **100 BEST WOODWORKING PROJECTS**, complete with simplified instruction, plans, diagrams and more than 400 how-to-do-it pictures. Make all kinds of furniture, baby carriages, clocks, lamps, book shelves, fireplaces and other useful articles at little or no cost. Send only \$2.00 with name and address. Money back if not pleased.

POPULAR MECHANICS PRESS, Dept. PM6, 200 E. Ontario St., Chicago 11



A COMPLETE LINE OF DEEP SEA AND SKIN DIVING GEAR WATERWEAR SUITS AND KITS, BAL-BUOYANT SWIM WEAR, WATER SKIS — BOOKS — GIFTS.

Send 50c for our **NEW 1956 Catalog**
SPORTS UNLIMITED divers supply
6902 Coast Highway, Newport Beach, California

Building?
Repairing?
Indoors?
Outdoors?



Make this bookcase "Hide-a-Desk" with

ELMER'S® GLUE-ALL

A handsome piece in any room! Build it strong with ELMER'S modern plastic glue. Handy squeeze bottle speeds job. Quick-setting. Won't stain. Ideal for wood, paper cloth.



EASI-BILD® Pattern #18. Just trace, saw, assemble. Send 35c in cash or money order to Elmer's Pattern Dept., P. O. Box 26, Pleasantville, N.Y. *T.M. Reg. Easi-Bild Pattern Co., Inc.



Build or repair boats, outdoor furniture with

ELMER'S® Waterproof Glue

It's the glue that boating experts use. Resistant to acids, alkalis, fungus, rot. Super bond is stronger than wood itself.



Bond plastic laminates to plywood with

ELMER'S® CONTACT CEMENT

Does professional job quickly, without clamps, nails, presses. Highly resistant to heat, water. Outperforms other contact cements in stress tests.



At hardware, lumber, paint, marine supply dealers. The Borden Company, Chemical Division

IF IT'S **Borden's** IT'S GOT TO BE GOOD

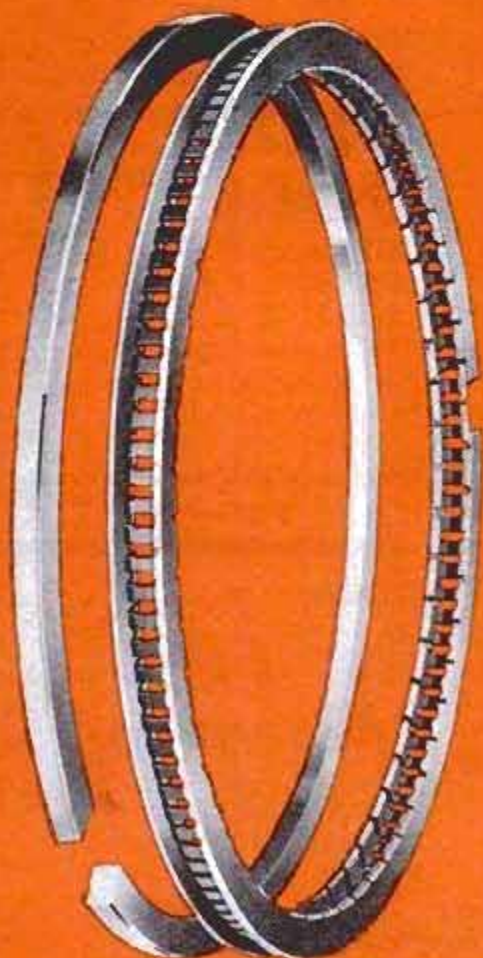

Type "98" oil ring—U. S. patent numbers 2,626,992 and 2,645,225

Engineering triumphs that again raise the standard of engine performance...add thousands of extra miles with sustained power and greater oil economy

In Perfect Circle's 2-in-1 Chrome piston ring set, the top compression ring was specially designed to perform where pressures are greatest, heat is highest, and lubrication poorest. The new Type "98" oil ring with self-expanding spacer assures a uniform seal against the cylinder wall plus a side sealing action on the ring groove. Both the top compression rings

and the oil rings are plated with thick, solid chrome that resists wear, more than doubles the life of cylinders, pistons and rings. For thousands of extra miles of sustained power with positive oil control, ask your Doctor of Motors to install Perfect Circles in your car. Perfect Circle Corporation, Hagerstown, Indiana; The Perfect Circle Co., Ltd., Toronto, Can.

Better Mechanics everywhere install

PERFECT CIRCLE 2-in-1 chrome piston rings

THE STANDARD OF COMPARISON



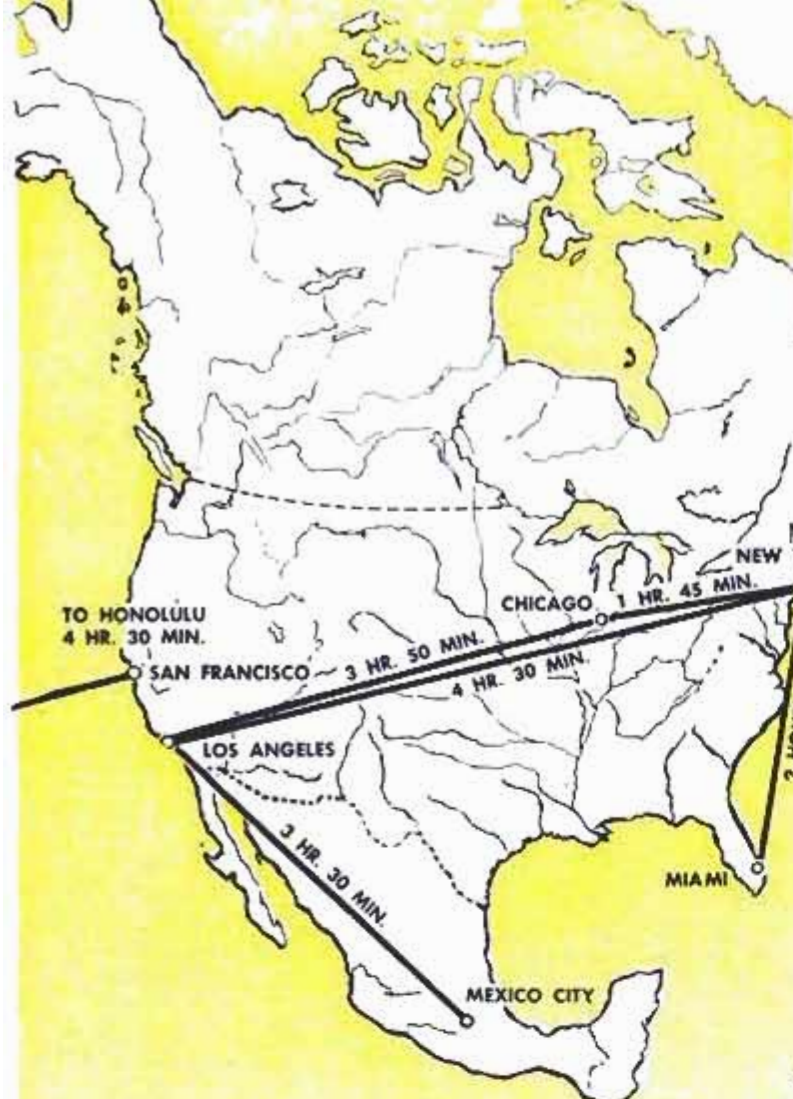

NEW YORK TO PARIS	TODAY'S TIME	12 HOURS
	JET TIME	6 HR. 30 MIN.
LOS ANGELES TO NEW YORK	TODAY'S TIME	8 HOURS
	JET TIME	4 HR. 30 MIN.
NEW YORK TO CHICAGO	TODAY'S TIME	3 HR. 15 MIN.
	JET	1 HR. 45 MIN.
HONOLULU TO SAN FRANCISCO	TODAY'S TIME	9 HOURS
	JET TIME	4 HR. 30 MIN.

The Race of the Airliners

By Thomas E. Stimson, Jr.

MR. AVERAGE AIR TRAVELER has become pretty tired of dawdling across the United States in 10 hours or more. He proved it by grabbing every seat when the airlines began their 7½ to 8½-hour nonstop flights that chopped more than two hours from the old coast-to-coast schedules.

But he isn't satisfied. "Waste most of a

day from New York to Hollywood? Ridiculous!" he snorts. "Put me on a plane that will get me there for lunch!"

And that's what the airlines are preparing to do.

Speed is their business and they are ordering new aircraft that will carry you across the country or around the world faster than ever before. New jet airliners,

Passengers at Los Angeles boarding DC-7 for non-stop transcontinental trip, typical of new service





Turbocompound engines are now in use on many airliners, such as the Douglas DC-7B at the left and the Lockheed Super Constellation below

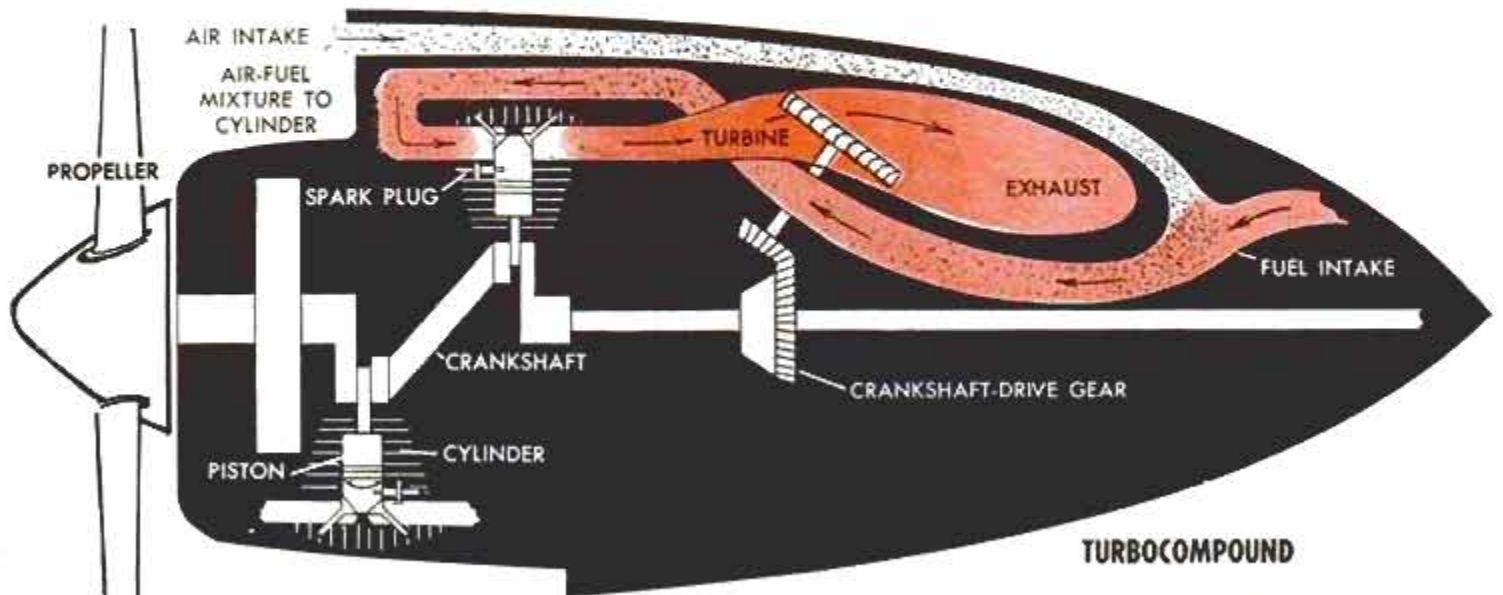

The turbocompound actually is a piston engine with a turbine added. Exhaust gases turn the turbine as they leave the engine. Geared to the crankshaft, the turbine passes extra horsepower along to the propeller



turboprops and vastly improved piston-engine transports are under construction.

Some 33,000,000 passengers traveled on domestic airlines in 1955. When final totals are added up it may be that American Airlines will have displaced Pennsylvania Railroad as the world's leading passenger-transportation concern, disregarding short commuter trips. Of the six leading passenger carriers in the United States, four are airlines. Air travel is growing by fantastic leaps and bounds.

Already in service are three new large airliners of advanced design, better than the best transports of a couple of years ago. One of these is the English-built Viscount, used on this continent by Capital Airlines and Trans-Canada Airlines. The Viscount has four turboprop engines and carries some 40 passengers at 355 miles per hour for distances up to 1500 miles.

The other new big transports are the

Lockheed Super Constellation and the Douglas DC-7, each larger and faster than earlier models. Each cruises at about 335 miles per hour; each carries a comparable number of passengers (up to 97 in aircoach service). Each is powered by four Wright turbocompound piston engines developing a total of 13,000 horsepower. Range of the DC-7 is 4430 miles, while that of the Super Connie is 5580 miles.

In this newest Lockheed you can fly nonstop from New York to Paris in 12 hours, as against the two-stop, 19-hour trip of only a few years ago.

Even newer and longer-range versions of these two aircraft will be flying soon. The DC-7C "Seven Seas" for continent-to-continent travel is scheduled for delivery in 1956. It will carry up to 62 passengers for distances up to 5000 miles at a cruising speed of 350 miles per hour. British Overseas Airways Corp. has ordered 10 of

them for various routes, including a one-day, one-stop service between Los Angeles and London.

In 1957 the "1649" series of Super Constellations will go into service. Comparable to the DC-7C in accommodations and speed, this super long-range transport will be able to cruise nonstop for 6500 miles, about a quarter of the way around the globe.

For the first time, airlines will be able to schedule nonstop flights between such points as New York and Rome (4281 miles), Seattle and Tokyo (4793 miles), and Honolulu and Lima (6070 miles).

In the turboprop field Lockheed is building the 64-passenger Electra transport that will cruise in excess of 400 miles per hour for distances up to 2000 miles. American Airlines and Eastern Air Lines have ordered a total of 75 Electras for delivery beginning in 1958. These will be the first domestic turboprop airliners although Lockheed and Convair, Boeing and Douglas all have built turboprop transports for the military.

The "blue ribbon" airliners, the jets, will

be introduced to the public in 1958. Boeing already has more than 200 hours of flight time on its jet airliner prototype, the 707, that recently flew from Seattle to Washington, D. C., in less than four hours. Douglas is now building and testing complete sections of its jet airliner, the DC-8. Pan American World Airways has ordered 20 of the Boeing jet airliners, 25 of the DC-8s. In addition, United Air Lines is purchasing 30 DC-8s with deliveries to begin in 1959. American Airlines has ordered 30 of the Boeings for 1959 delivery.

The jets will be large, heavy, fast transports. The DC-8, for instance, will have a span of 134 feet, a length of 140 feet. With 18,000 gallons of fuel aboard to feed its thirsty jets and carrying 125 passengers, it will weigh more than 127 tons. This compares with the less-than-70-ton weight of the DC-7.

Both planes will cruise at about 550 miles per hour at altitudes of about 35,000 feet. Each will literally race the sun on westbound trips. The five-hour flight from New York to San Francisco will be cap- suled into a two-hour difference in the



The turboprop is a gas-turbine engine. Air is drawn in at front, compressed, and then forced into the combustion chamber where it is mixed with fuel and ignited. The burning mixture drives a turbine which is geared to the propeller shaft. Fuel used is kerosene. Extra power is gained by jet action of exhaust

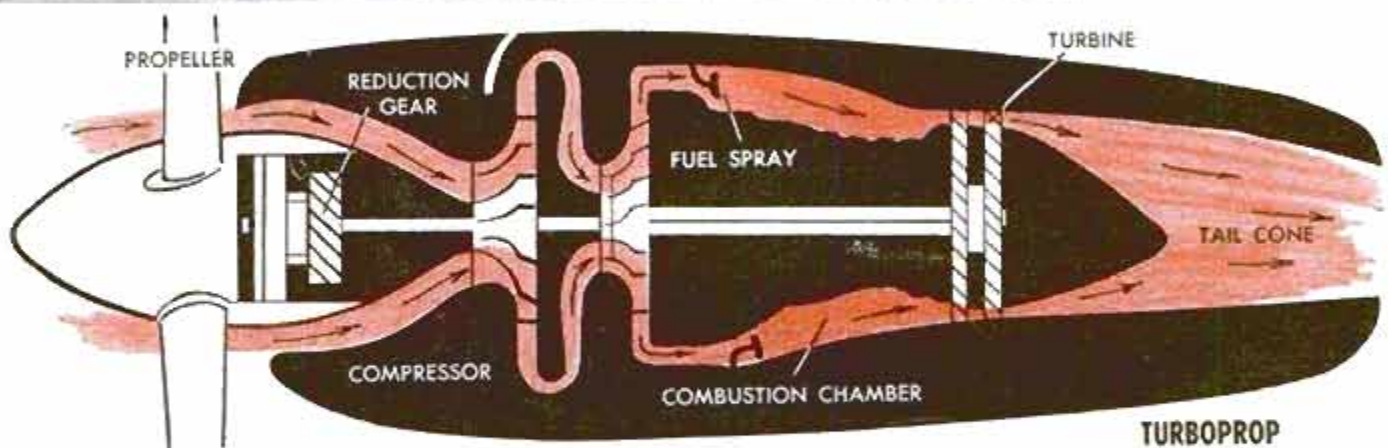

Above, the Lockheed Electra, a turboprop liner ordered by American Airlines for delivery in 1958. At the right, Capital Airlines is now flying the Vickers Viscount Turboliner on its U. S. routes





Two new jetliners due for service in 1958 are the Boeing 707 and Douglas DC-8. Both have engines suspended under wings

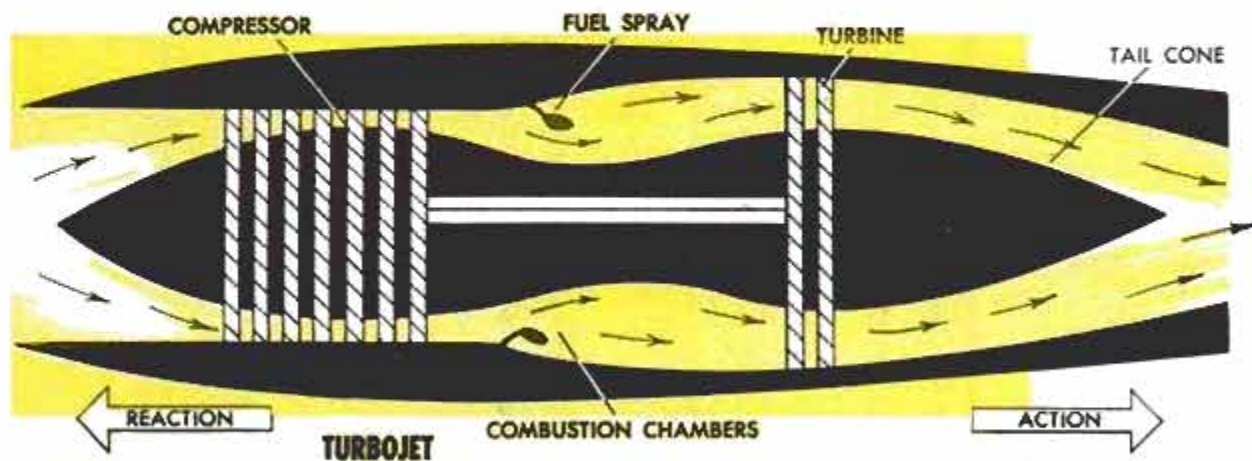

A turbojet is a jet engine with a turbine added to operate a compressor. Air enters at the front, is compressed and forced past fuel nozzles into combustion chambers where it is ignited. Hot exhaust turns the turbine as it passes. The sole purpose of the turbine is to operate the jet's compressor section

AIRLINER SPECIFICATIONS

AIRLINER	Engine Type	Number of Passengers	Cruising Speed (M.P.H.)	Range (Miles)	Cruising Altitude (Feet)	Engines (4)	Total Thrust	Wing-span (Feet)	Length (Feet)	Gross Weight (Pounds)
DOUGLAS DC-7 (In use)	Piston	64-97	335	4430	15,000	Wright Turbo-compound	13,000 HP.	117	108	122,000
LOCKHEED SUPER CONSTELLATION (In use)	Piston	47-94	335	5580	12,500	Wright Turbo-compound	13,000 HP	123	116	137,500
VISCOUNT (BRITISH) (In use)	Turbo-prop	44	320	1500	20,000	Rolls-Royce Dart	6,200 HP	98	81	60,000
DOUGLAS DC-7C (1956)	Piston	62	350	5000	20,000	Wright Turbo-compound	13,600 HP	127	112	140,000
LOCKHEED SUPER CONSTELLATION, 1649 Series (1957)	Piston	58-64	350	6500	N.A.	Wright Turbo-compound	13,600 HP	150	120	156,000
BRITANNIA (BRITISH) (1957)	Turbo-prop	93	360	5350	30,000	Proteus 705	14,800 HP	140	114	165,000
LOCKHEED ELECTRA	Turbo-prop	64	414	2000	25,000	Allison T-56	15,000 HP	95	101	98,500
BOEING JET STRATOCRUISER (1958)	Turbo-jet	104-125	575	5000	30,000	Pratt & Whitney J-57	44,000 LB.	136	135	230,000
DOUGLAS DC-8 (1958)	Turbo-jet	108-131	575	5000	30,000	Pratt & Whitney J-57	44,000 LB.	134	140	257,000
COMET 4 (BRITISH) (1958)	Turbo-jet	58	500	2870	35,000	Rolls-Royce Avon	42,000 LB.	N.A.	N.A.	152,500

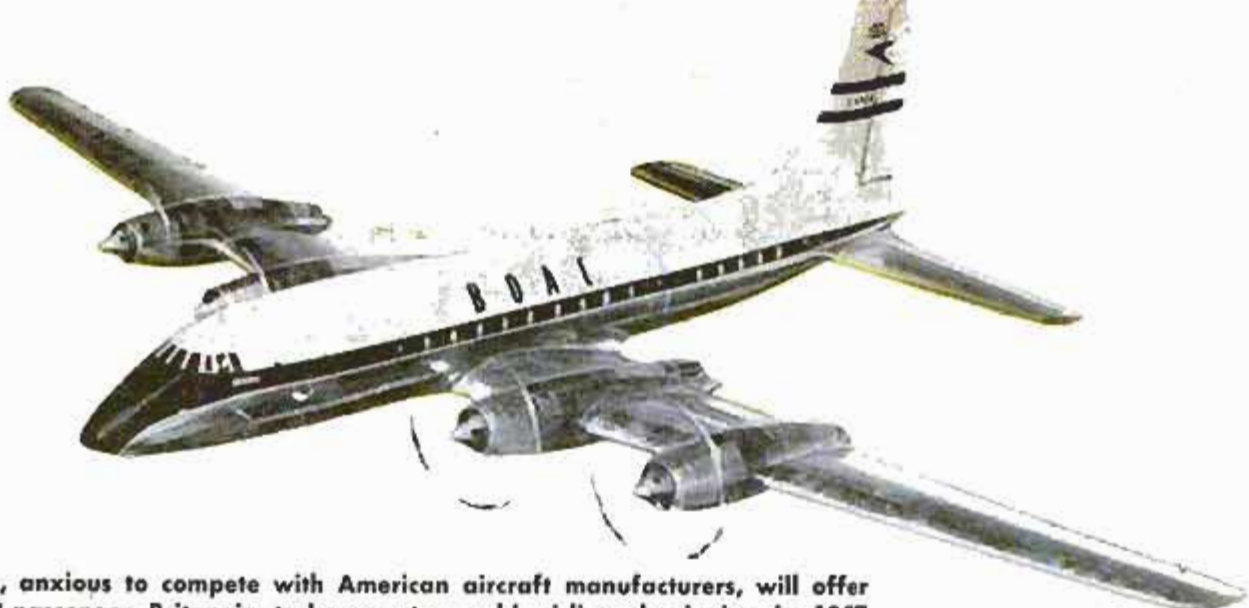

Britain, anxious to compete with American aircraft manufacturers, will offer the 93-passenger Britannia turboprop to world airlines beginning in 1957

time zones. The eastbound trip will be made in $4\frac{1}{2}$ hours instead of 5 because of prevailing winds. Paris will be only $6\frac{1}{2}$ hours away from New York. Passengers boarding the new jets in London after breakfast will be able to take a coffee break in New York, have lunch in San Francisco, and still have time for a swim before dinner in Honolulu.

Some have wondered why America has been "slow" in going to jet transportation when the British flew jet airliners several years ago. There are some very good engineering reasons for this.

Our own aircraft builders have been designing jet passenger liners for years. As far back as 1945 Douglas made a drawing-board study of a jetliner that would be powered with the best engines available at that time. It was an excellent aircraft with only one fault: Its maximum range was about 400 miles. It would need to refuel every hour or less.

Since then Douglas has made almost 700 studies of a jet airliner. Each study was complete to block speed, passenger accommodations, and operating costs. Each time a new jet engine with greater thrust and reduced fuel consumption became available, the paper airliner acquired greater speed and longer range.

Other manufacturers were doing similar research, all shooting for the same goal. They wanted a safe aircraft that would carry a lot of passengers across the United States in less than five hours or across the

Atlantic in a little more than six hours.

Meanwhile England went ahead with its Comet jet airliners and got into trouble. Metal fatigue slowly weakened the fuselages until two Comets finally exploded in mid-air. They weren't strong enough to hold comfortable cabin pressures in the thin air above 30,000 feet. American manufacturers continued to wait for a jet engine that would give their more-rugged construction the high performance they desired.

The engine finally materialized in the J-57, a Pratt and Whitney twin-spool turbojet that develops 11,000 pounds of thrust. It is called a twin-spool engine because one group of its compressor blades and one group of its turbine blades are fixed to a shaft that rotates freely inside a shorter, hollow shaft to which the rest of the compressor and turbine blades are attached. Specific fuel consumption is less than single-spool types and take-off performance at high-altitude airports is better.

The J-57 with afterburner powers four different supersonic Air Force fighter planes. With it, the F-100 recently set a new world speed record of 822 miles per hour, well above the speed of sound. The huge and fast 650-mile-per-hour B-52 jet bomber is powered with J-57s. Still partly secret, the engine has been in military use for more than three years.

Both the DC-8 and Boeing's Jet Strato-cruiser will use these power plants. The DC-8 and the 707 have much in common.

Comet 4 will be Britain's bid for the jet-transport market. Completely redesigned after earlier Comets developed metal fatigue, it will be ready in 1958





Present-day airliners, like the Convair above, are being tested for operation with turboprop engines

To a casual eye, they are practically identical. Each has a swept wing. Each has a fuselage that is longer than the wingspan, indicative of the trend toward longer, narrower aircraft. Each will carry its four jet engines outboard instead of burying them in the wing. This safety feature is a characteristic of all American multijet aircraft.

It is noteworthy that when two different groups of competent engineers (Boeing and Douglas) were given the same engines and the same airline requirements, and then were asked to design the best jet airliner, both groups came up with essentially the same answer.

The Boeing 707 was fully described in the August 1954 issue of *Popular Mechanics*. Like it, the DC-8 will be as conventional as possible to avoid the unknown hazards of untried design.

The DC-8 will have two passenger entrances instead of the usual single door. This will speed the loading and unloading of passengers at terminals and cut the

time required for stops. A high-pressure underwing fueling system will fill all fuel tanks while the passengers are boarding.

To avoid any chance of explosive decompression in the high altitudes at which it will operate, the DC-8 has small windows that structurally are stronger than large windows. New knowledge about structural fatigue is being used in the design. The fuselage will be beefed up with a "stop rip" type of construction in the window areas. In effect, the passenger cabin becomes a spaceship. All doors and other closures are of a plug type that effectively seal themselves when cabin pressure becomes greater than the pressure outside.

Meanwhile England is about to return to the jet-airliner field after having made exhaustive studies of its Comet failures. Already being tested is the Bristol Britannia, a 93-passenger turboprop airliner due to go into service in 1956. Too, jet prototypes are being used in studies of the

(Continued to page 306)

The current trend in aircraft design is toward longer, narrower fuselages and shorter, swept-back wings

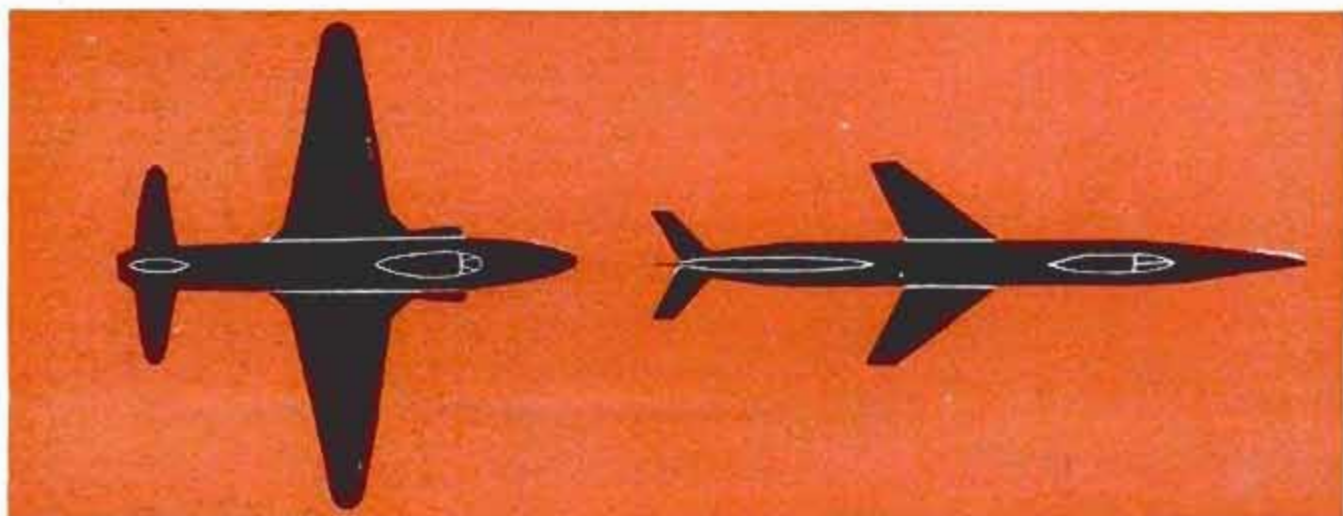

REAL Flying Saucer?

According to the U.S. Air Force, flying saucers just don't exist—but they soon will. The Air Force has under development several vertical-rising, high-speed aircraft. One of these, it says, will have a true disk or saucer shape. An Air Force artist's conception of the craft looks like popular notion of a flying saucer.

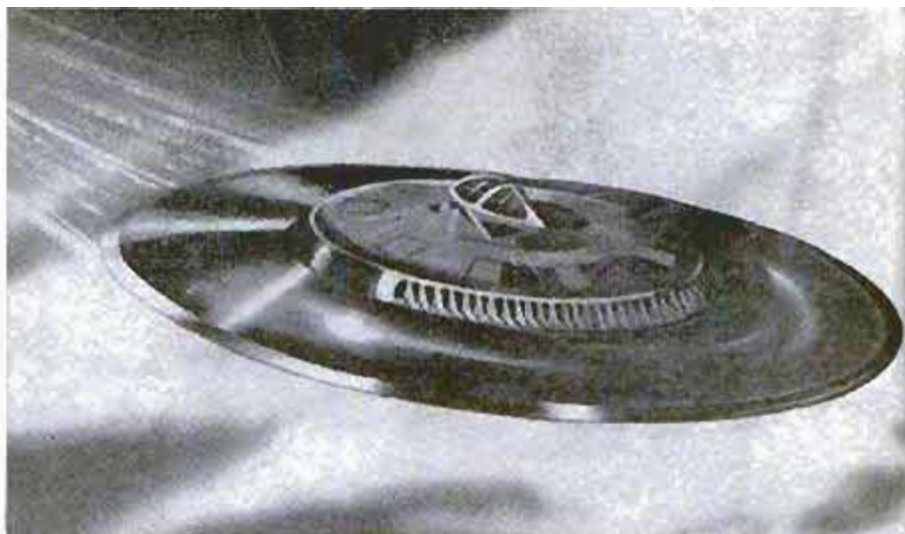

Air Force drawing



Tire-Sealing Compound

Punctureproof tires are said to result when the inside of the tube or tubeless tire is coated with a sealing compound. The coating becomes activated when a break occurs and permanently seals the puncture with little loss of air. The coating contains no rubber and will not clog the tire valve. It is applied by attaching an air hose to a pastry-tube-type metal gun and shooting the compound through the tire valve to coat the inside of the tire. Four tires can be processed in 15 minutes and the maker claims that tires run cooler when treated than when untreated.

Mississippi "Mattress" Holds River Bottom in Place

Covering $3\frac{1}{2}$ acres, a "mattress" woven of willow trees has been towed into position and sunk to the bottom of the Mississippi River at New Orleans. The mattress is being used to prevent scour of the river

bottom during construction of a huge pier for a \$65,000,000 bridge. The 300 by 500-foot mattress was ballasted with rock so it would sink. Without it, the current would wash mud from around the pier.





Bower Hills, bleak and snow-covered, rise out of Antarctica. In some places the glacial ice is two miles thick

We'll Plant a Village on the

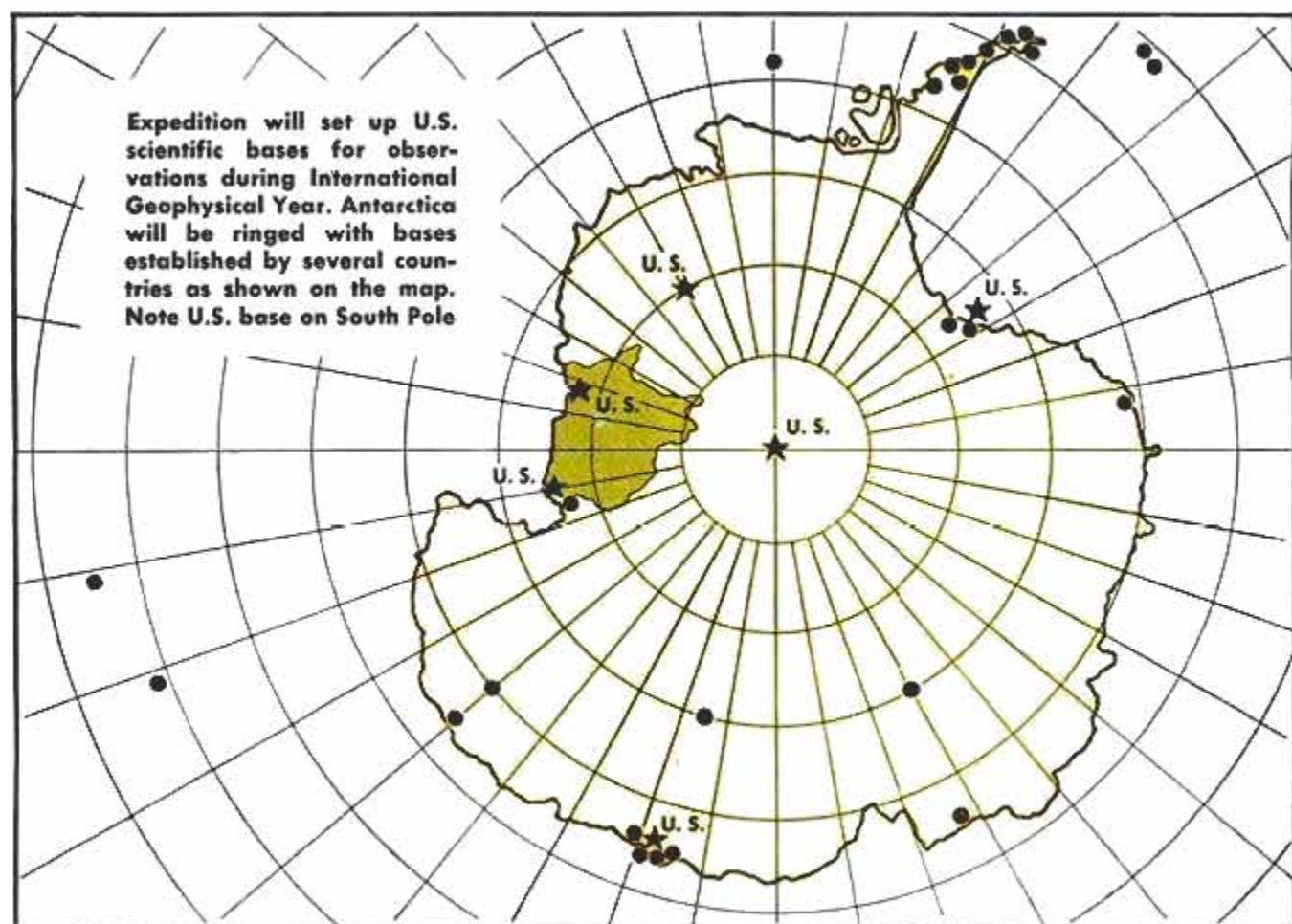

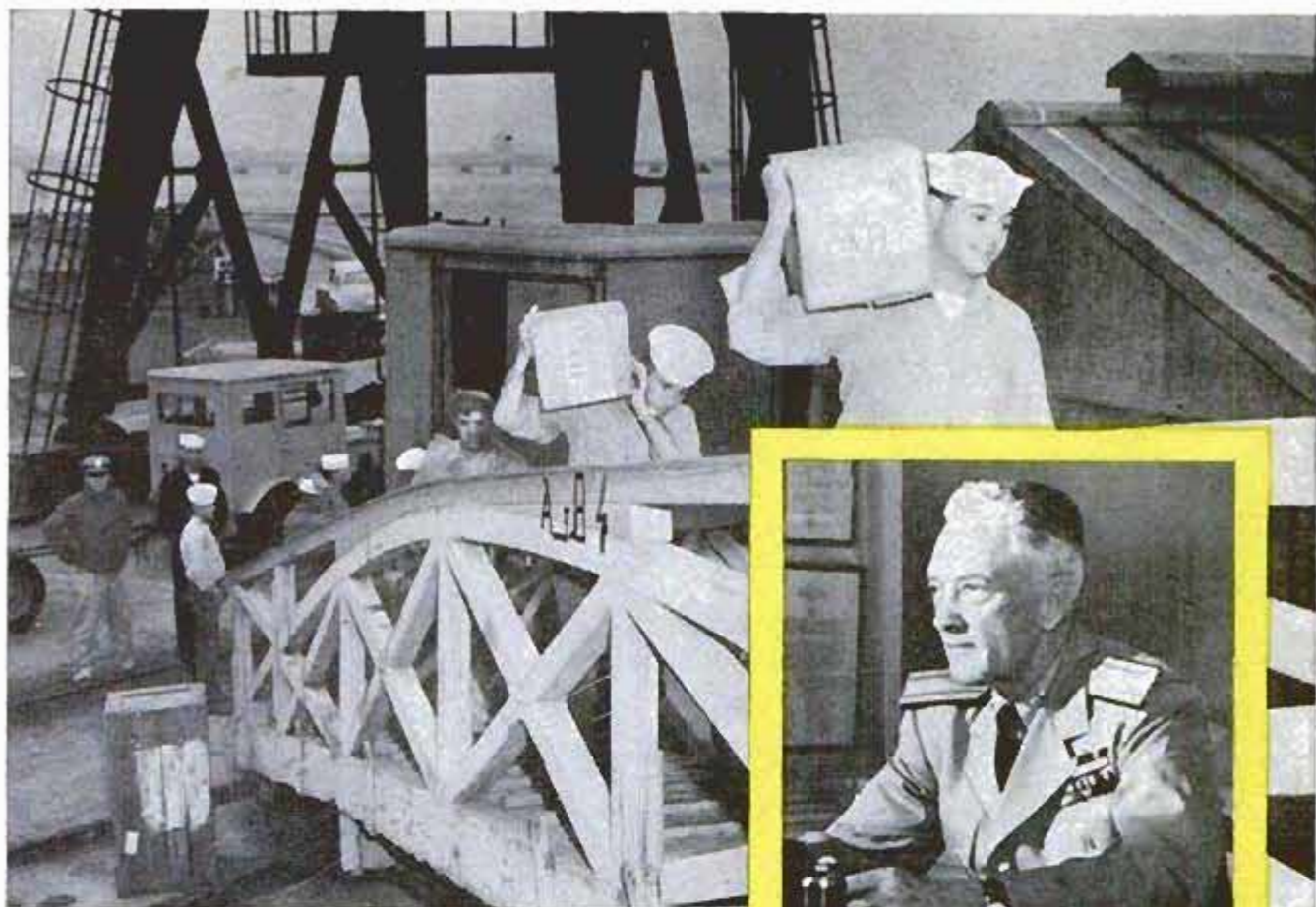

Sailors load food prior to ship's departure for Antarctica

South Pole

By Rear Adm. Richard E. Byrd, USN (Ret.)

BY THE TIME THIS is printed, I will have disembarked in Antarctica for the fifth time since 1928, when I first looked out over this immense continent of ice and snow, scarred by crevasses and punctuated by jagged 15,000-foot mountains. A fleet of about a dozen ships—more than half from the United States—will have breached the Antarctic Circle at many points. In the lead, broad-brimmed icebreakers with angular bows of heavy, reinforced steel plate will have heaved up on 10-foot ice and, by sheer weight and power, broken through to form passages of open water to the mysterious white continent at the bottom of the world.

In addition, if the elements do not interfere with our plans, a squadron of ski-equipped medium-range planes will have made the first nonstop flight from another country (New Zealand) to Antarctica, along a flight path of picket ships strung out on the polar seas beneath them. They will have landed on a specially prepared snow-

and-ice runway constructed in Antarctica.

After the landing of the aircraft, the ships will have rendezvoused and proceeded to the antarctic, and there a fantastic array of vehicles and machines will have rumbled ashore. Ponderous orange-painted tractors with five-foot-wide "snowshoe" tracks, towing sled trains laden with knock-down buildings, supplies and crews dressed like overpadded "space men," will have roared away through the subzero cold in blinding swirls of drift kicked up by their own spinning grousers. Out ahead of them, foot parties and heated Weasels will have crisscrossed the snowy wastes, scouting and marking trail with orange flags to guide the heavy trains around the bottomless

crevasses that lie concealed by their deceptive roofs of thin, drifted snow. In a race against the lowering antarctic night, with its months of star-studded darkness, temperatures down to 80 degrees below zero and breathtaking auroral displays, the rugged

Popular Mechanics has joined the U.S. Antarctic expedition in the person of Richard F. Dempewolf, Eastern Editor, who sailed with Admiral Byrd from New Zealand aboard the USS *Glacier* early in December. His first-hand reports will bring you vivid pictures of this greatest American adventure on the ice-clad antarctic continent. Watch for his articles in forthcoming issues.



Officer makes a last-minute check of helicopter destined to hover over the thick glacial ice of Antarctica

crews will have begun to erect part of a series of historic bases for what may be one of the most remarkable international projects of all time.

Expedition Has Double Purpose

The new United States antarctic undertaking will be the first operation to be set up within the framework of the United States antarctic program, of which I was

Bound for polar seas, the USS *Glacier*, the Navy's newest and most powerful icebreaker, leaves Norfolk



recently designated officer in charge. The purpose of the expedition, in the first place, will be to carry out the antarctic phase of the total United States program for the International Geophysical Year (1957-58) in cooperation with the other participating nations. The second purpose will be to carry forward the work of exploration initiated by previous American expeditions.

The IGY (*Popular Mechanics*, Nov. 1955) is a worldwide program of scientific research involving, as of the present count, 39 nations. Actually it will get under way in 1956 when, all over the globe, from the arctic to the antarctic and at every latitude, scientific groups from participating nations will man observation stations in cities, remote wildernesses and at sea. Some will manipulate telescopes, complex all-sky cameras, intricate geomagnetic and seismographic instruments. Others will launch rockets laden with electronic gear far into the outer atmosphere. The much-publicized space-satellite project is part of this vast program. At given radio signals or at prescribed times these scientists will make simultaneous observations of such natural phenomena as weather, auroral activity, air glow, sun flares, ionospheric disturbances, cosmic rays, geomagnetism, glaciers, earthquakes, gravity, ocean currents and many other things that will help man to understand better the world in which he lives. To complete the network of IGY sta-

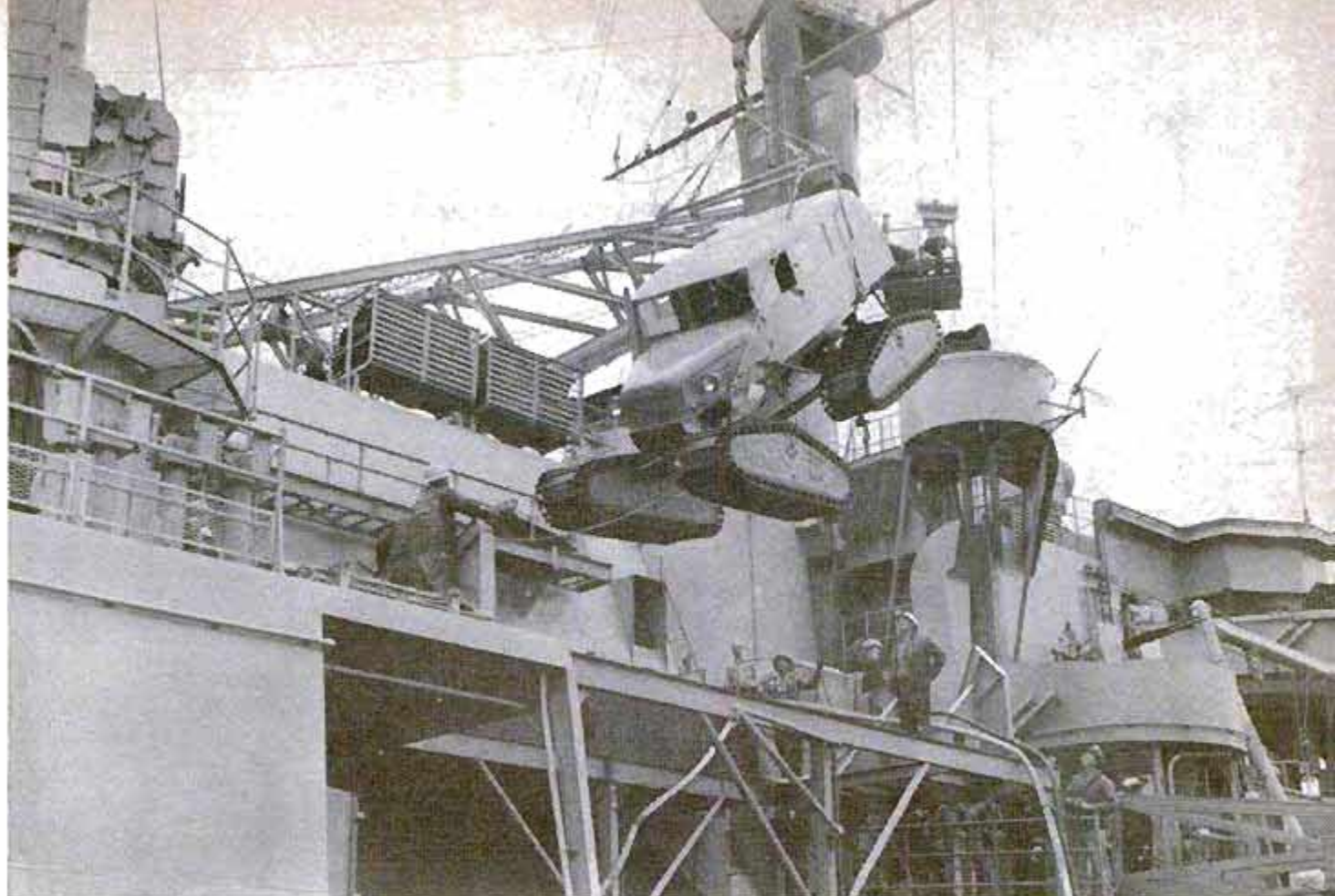

Sno-Cat, a tracked vehicle designed for polar wastes, is hoisted aboard. Right, Admiral Byrd, accompanied by Dr. Paul Siple (left), senior scientist of the expedition, and Richard F. Dempewolff, Eastern Editor of *Popular Mechanics*, departs by air to join ships

tions, at least 11 nations will establish more than 20 bases on Antarctica. Apart from our own bases, stations will be built and manned by Argentina, Australia, Chile, England, France, Japan, New Zealand, Norway, Russia and South Africa. Belgium and Spain may come into the program, too.

Navy Task Force

The new United States expedition will have two distinct operational parts. One is United States Navy Task Force 43, consisting of some 1800 men, three icebreakers, three cargo ships, a tanker and two towed YOGs, or small tankers which, as you read this, will be ready to freeze in the ice, thus providing us with a 400,000-gallon fuel farm. Commanded by Rear Adm. George J. Dufek, who accompanied me on two previous antarctic expeditions, the Task Force will construct and maintain an air-operating facility at McMurdo Sound and three United States bases for the IGY—one at Little America, another some 600 miles distant in Marie Byrd Land and the third, we hope, on the geographical South Pole itself. Bases may also be placed in the Weddell

(Continued to page 286)



Pan American World Airways photo



Famous photo was taken in shack at base where author lived alone for six months and almost perished



Sharp Teeth on Bulldozer Blade Bite Through Thick Trees

Full-grown trees are sliced off at ground level by the notched edges of a V-shaped cutting blade that is mounted on a bulldozer. A contractor using the blade to clear woodland in the Red River Valley of Texas is able to cut eight to ten acres per

day. Most of the trees in the woods are under a foot in diameter, but trees with diameters of three feet can be cut by alternately slicing the sides and pushing the trees with a long beam that projects from the point of the blade. The fallen trees are pushed into piles with a special rake blade. Because the trees are cut flush with the ground, they don't impede disking and sowing equipment.

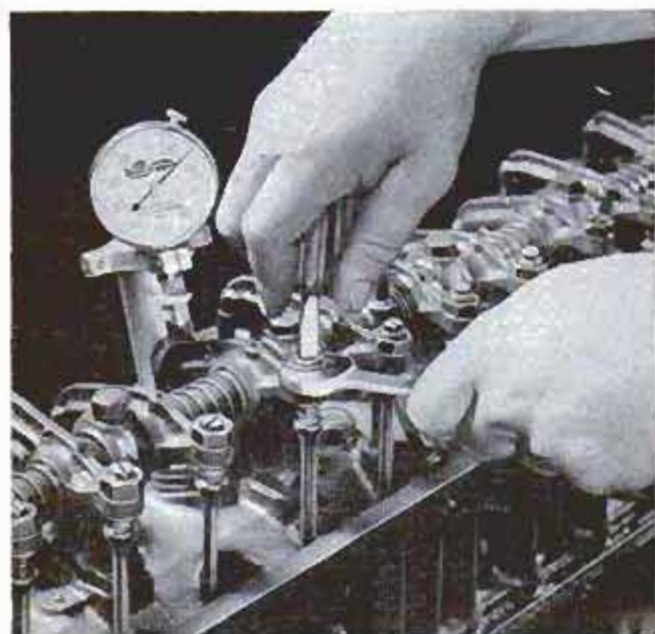

←Dial Shows Valve Clearance

Overhead valves can be adjusted in half the usual time and with greater accuracy when using a dial indicator that measures rocker-arm clearance. The valve gapper leaves both hands free to make adjustments and indicates valve clearance before, during and after the adjustment is made. It can be used to locate weak or noisy valve lifters and shows when hydraulic lifters are sticking or need replacement. Fuel injectors may be timed with the gapper and fuel racks on diesel engines may be balanced with it. Adapters fit it to most passenger and truck engines.

Navy Tests First Midget Submarine As Close-In Weapon

Built in an airplane hanger, the Navy's first midget submarine, the X-1, took to the water recently for a series of tests and shakedown cruises. The tiny sub is 50

feet long and 7 feet in diameter, and will be manned by a crew of five. Displacing 25 tons, it was designed to test harbor defenses and for close-in attacks.





Shell of the house was made of scrap two by fours pinned together with nails. Right, interior walls were the same

Home Built From Waste Lumber

JESS STIENER of Kamiah, Idaho, built his five-room home almost entirely of scrap two by fours from six inches to six feet long. The finished home cost him only \$1700. Heavy eight-by-eight fir timbers were bolted to the top of the concrete foundation and the odd-length two by fours were laid on the timbers like brick. They were fastened together with 10-penny nails. At each corner every other piece was cut short for tight interlocking. Inside partitions were also made of the two by fours. Due to the tight construction of the exterior walls, Stiener reports that a minimum amount of fuel heats the house.

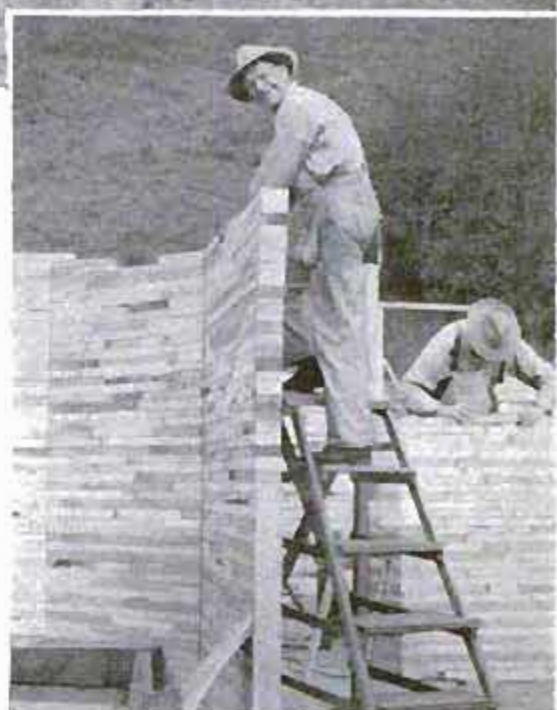

Finished house, covered with conventional siding, gives no clue to the unique construction of building





Manhattan Bridge, like Brooklyn Bridge in background, spans East River to link Manhattan with Brooklyn



Here's what happens to tired suspender cables. Uneven load on bridge has broken some cable strands. Cable is as thick as a man's arm

Manhattan Bridge will have to take a hitch in its suspenders. Every time a subway train rolls across, one side of the span sags three feet. Under way is a \$30,000,000 job —

FIRST AID FOR AN AILING BRIDGE

By Edward Edelsberg and Philip Cane

Colored arrow points to top of Williamsburg Bridge in background. Only the top half is visible . . .



LIKE MORTAL New Yorkers the Manhattan Bridge is working under strain. This melancholy news came to light in the recent report on New York City's youngest East River suspension bridge. There is cause enough. Ever since it opened on December 31, 1909, it has vibrated to the heightening tempo of modern life. The original trickle of autos across its back has grown to a flood of cars and giant trucks. But the most painful burden has been the subway train.

For 39 of its 45 years, the bridge has groaned under the daily exodus and homecoming of 400,000 people by BMT train. Because of the unusual arrangement of tracks at the Manhattan end, almost all trains use one side of the bridge and have been as hard on the steel structure as they have been on the straphangers. Now a \$30,000,000 operation is indicated for the world's hardest-working suspension bridge. The bridge will work while the operation goes on.

Looking west from the center

Men, right, install test cable bands before squeeze test of main cable



But when a train comes, Manhattan Bridge dips three feet. Entire roadway of Williamsburg Bridge appears

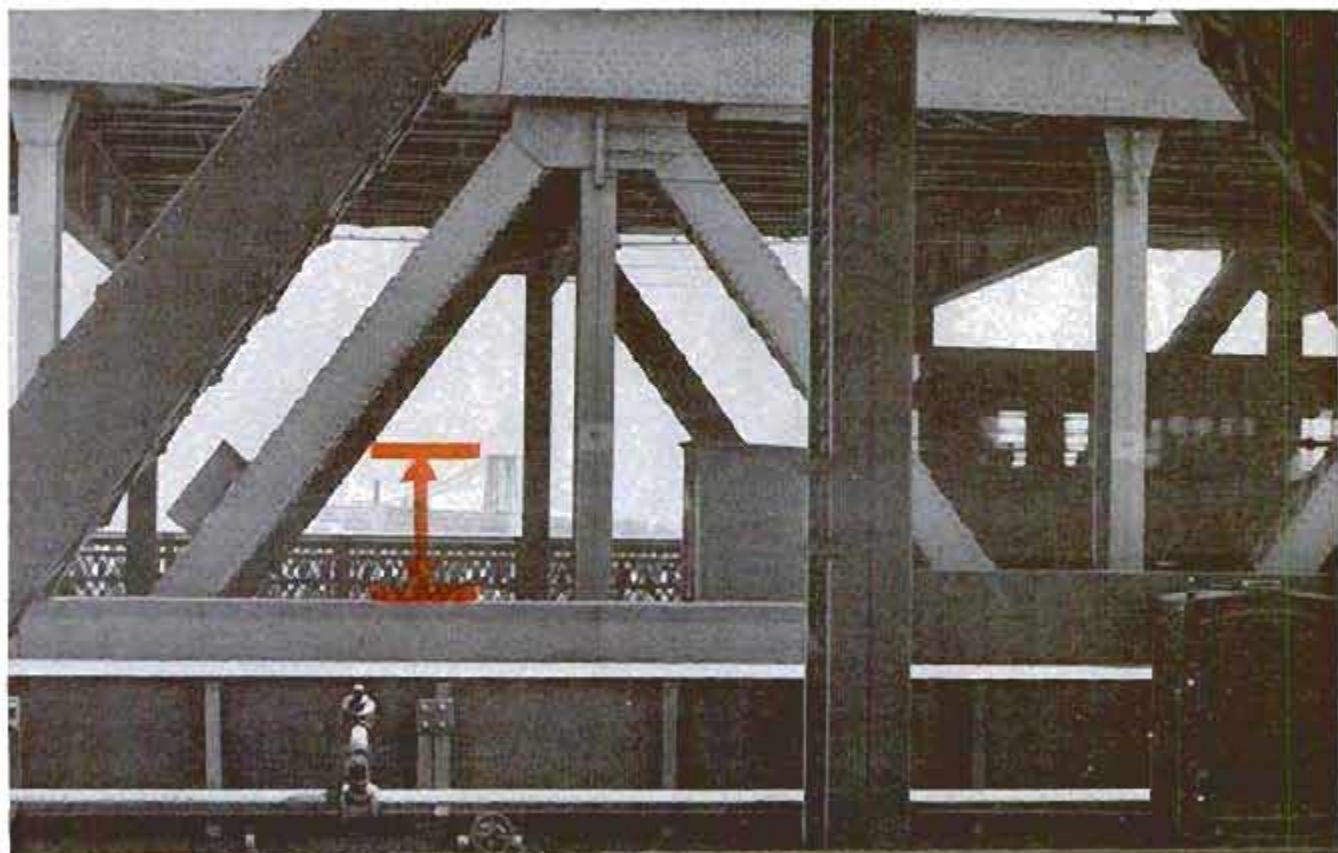



Investigators measure elongation of band bolts under stress, to determine maximum allowable stress in bolts

Workmen testing strength of the Manhattan Bridge tighten bolts of cable band in squeeze test of main cable





Automotive traffic rides on two decks of roadways. Double subway tracks flank each side of lower level

of the promenade, the Gothic towers and web of cables of Brooklyn Bridge seem only a long stone's throw away. Beyond them stand the granite towers of lower Manhattan and, farther still, the Statue of Liberty. Off to the east, Williamsburg Bridge, just up the river, links slum area to slum area.

If you stand on the west promenade and look across the 120 feet of Manhattan Bridge to the outer railing on the other side, you will see that it lines up with the roadway of the Williamsburg Bridge in the distance. Then, like the rolling deck of an ocean liner, the railing starts dipping, showing more and more of the East River near the Williamsburg Bridge and the land behind it.

This is a sure sign that a train has come onto the bridge. By the time the first car blocks your view, the easterly side of the bridge (called also "heavy side" because of its train load) has dipped almost three feet. When the last car passes, the railing starts its strained rise, and in about 30 seconds regains its level. The Manhattan Bridge bows to the Williamsburg Bridge hundreds of times each day.

That's a lot of movement, but does it make the bridge unsafe? J. Frank Johnson, who as director of the Division of Bridges rides herd over the city's 49 bridges, says: "There's no reason for the public to be scared. What's happening is this: Only two of the four cables are doing the work. Cables are flexible, and when the two on the heavy side stretch under the weight

of a train, the cables on the light side hold up their side of the bridge. That puts a strain on the steel girders spaced every 20 feet and running the width of the bridge."

Forrest Cowan, who heads the Office of East River Bridges and inspects the bridge daily, explains that the dipping could go on for years without any danger to the public.

It's a rare suspension bridge that takes a dive, for this type of span is one of man's greatest engineering achievements. Just what is a suspension bridge? Suppose that New York's East River were a narrow stream, and you nailed long planks of wood together to stretch from Brooklyn to Manhattan. This "bridge" would sag in the middle. But if there were a tree on the Brooklyn side and a tree on the Manhattan side, you could tie the ends of a long rope to each tree and it would hang above the planks in a long arc. Then, using short pieces of rope, you could connect the long rope, at intervals, to the bridge of planks. If there weren't too much "give" in your rope, the bridge would be firm, and able to hold a lot of weight.

Now your stream becomes the East River, so you substitute steel for the rope, and steel and concrete for the planks and trees — and you have the Manhattan Bridge's 1470-foot span.

The Manhattan Bridge was built during the years 1901-1910. Its steel towers rise 321 feet above the water and are based in rock 62 feet below the river bottom. They are designed to move a little under

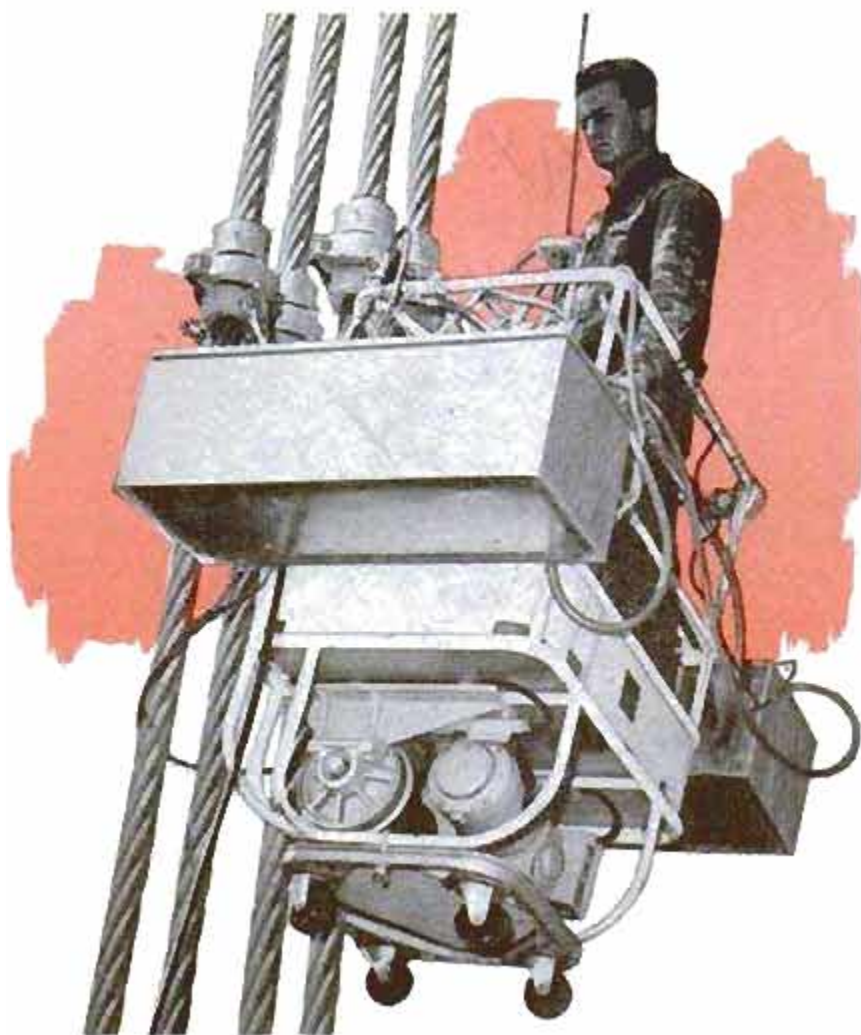

Bridge painter rides spider staging that carries him up and down. Below, plate is bolted into position to repair break in truss. Work is done at night to avoid disrupting traffic. The total revamping will take 2½ years and will cost \$30,000,000



different weights and temperatures; when they do, they shift some of the load to the massive bulwarks behind them.

The two anchorages look like medieval battlements standing at the water's edge. Each consists of 115,000 cubic yards of masonry. There is enough concrete in one anchorage to build a sidewalk four feet wide stretching from New York to Chicago. Each weighs 232,000 tons (twice the weight of the Chrysler Building).

The backbone of the Manhattan Bridge, like any suspension bridge, is its cable system. How do you transport a 3000-foot cable weighing almost 2000 tons to a bridge and lift it in place atop its tower? You don't. The cable is spun in place. First a footbridge is hung on wire ropes tied to the towers. Wheels with grooved rims (sheaves) shuttle between the two ends of the bridge tirelessly stringing one wire next to another. The wires are arranged in neat bundles and a giant "squeezer" makes one great package of them all. Huge clamps are put on to hold the cable firmly and connect it with the small vertical cables (suspenders) that hold up the roadways. Finally, the cable is greased, wrapped with steel wire and ready for its debut.

Each of the Manhattan Bridge's four main cables is almost two feet in diameter and has almost 10,000 wires. It would take a load of 30,000 tons to break one. (Golden Gate Bridge has only two cables, but each totals 27,572 wires.)

The cables ride over "saddles" atop the towers and then descend into the massive masonry of the anchorages. Here each bundle of wire in the cable goes around a steel structure called an eyebar, and the 37 eyebars holding one cable are connected to steel girders embedded deeply in the concrete. The system of eyebars distributes over a wide area the great demands being made on a cable. If a cable had only one connection in an anchorage, it would increase the danger of pulling itself loose.

It is hard to believe those threadlike cables in the New York sky hold up Manhattan

(Continued to page 278)



Okinawa's fireman at the controls of his "tankdozer" puts out brush fires by smothering them with earth

OKINAWA'S FIREMAN IN ARMOR

By SFC Joseph T. Hargrave

SUMMER IS THE BUSIEST TIME of the year for Okinawa's "armored fireman," SFC Philip R. Moody, Lexington, Ky., who answers local fire alarms in a 35-ton medium tank equipped with a scraper blade. Moody, who operates his fire station in the RyCom Ordnance Service Ammunition Facility at Chibana, north of the Kadena Air Base, answers at least two fire calls a week. Sometimes he gets several calls in a single day.

Surrounding the ammunition facility is a 100-acre abandoned area which is covered with deep matted grass, bamboo and scrub pine. Here on July 5, 1945, a huge fire destroyed a big ammunition stock pile being prepared for the assault on the Japanese mainland. The resulting explosions scattered thousands of high-explosive and white-phosphorus projectiles, grenades and rockets across the area.

For 10 years now, the torrential rains and blazing sun have been rusting the casings of this ammunition. The most dangerous are the thin-shelled white-phosphorus projectiles and grenades. When one of these is rusted through, oxygen in the air contacts the white-phosphorus charge and a trickle of white smoke rises. In a matter of minutes a full-fledged brush

fire is blazing and other shells and grenades start exploding from the heat.

Because of the danger, Moody's "tankdozer" is the only equipment authorized to enter the area. The armored hull protects him as he first circles the fire, cutting wide firebreaks to keep it from spreading.

This year for the first time, members of the overworked 5th Explosive Ordnance Disposal Squad found time to follow Moody into the restricted area after a fire. In one small section, they picked up 750 pieces of unexploded ammunition. Now a new plan has been formed, in which Moody will cut firebreaks through the area, dividing it into small plots which will be burned off one at a time with controlled fires. Then the explosives will be cleared and the land returned to normal use.



Exploding ammunition is so dangerous that no vehicles other than Moody's tank can enter

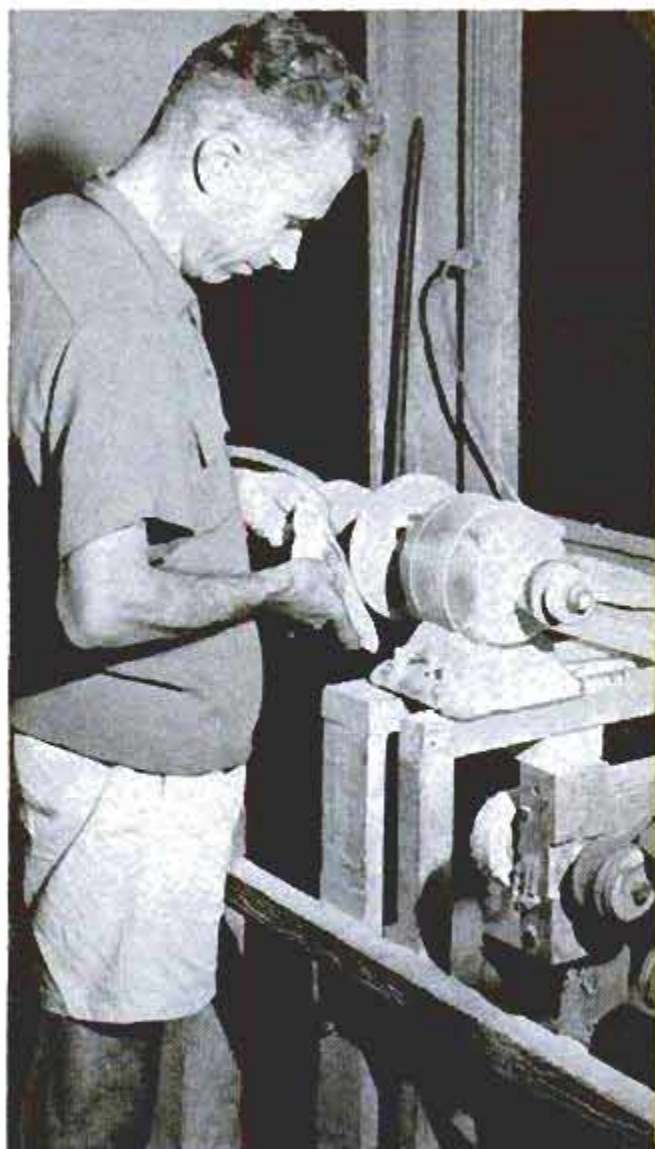

Working with hand tools he made himself, artist carefully carves shell away to form his own designs. Light beneath shell helps gauge thickness
 ←Bouvier uses an electric grinder to remove the encrusted coral and rough exterior of the shell, leaving only iridescent mother-of-pearl

Tahiti Artist Carves Pearl Shells

By Lyn Harrington
 Photos by Richard Harrington

Pendant is carved in "Tiki" design representing a lesser native god



EVEN IN TAHITI, most artists can't live on what they make from their paintings. Ask Henri Bouvier, who was lured to the South Sea Islands by the books written about them. An artist, Bouvier left Paris for Tahiti 23 years ago and says he's there to stay. To support himself, he has developed a unique craft which turns his talent to good use. Bouvier carves pearl shells.

Pearl shell is fairly abundant in the Society Islands, the best of it found in the Tuamotu group east of Tahiti. Some pearls are found, but they are only a by-product of an industry chiefly interested in the iridescent mother-of-pearl lining the shell.

Bouvier buys the shell in its natural state from the divers, then grinds, polishes and carves it into objects of art. Most of the shells found in the area are about seven inches in diameter. Bouvier incorporates the natural shading of the shell into his own designs to achieve an interesting play of light and shadow.

In shallower waters, divers bring up the less-valuable Trochus shell, a cone-shaped univalve which is widely used for inexpensive pearl buttons. Because of its shape it is easily made into bracelets, which Bouvier carves and sells for \$20 apiece.

Polynesian Designs

An enthusiastic student of Polynesian art, Bouvier works native designs into his carving. Each piece he makes is unique; he produces no two items that are alike.

Bouvier made all his own carving tools, using tough native wood for the handles. The tools must be strong to withstand the pressure exerted in carving the shell, which Bouvier says is about as hard as stone. Handles of the tools are flattened on one side for a better grip.

Using Papeete's regular power lines, he rigged up his own grinders and buffers.

Shell Is Transparent

With a light bulb fastened under the edge of his bench, Bouvier can see through the shell as he works. Often he has a design on an easel in front of him.

Most of his work is sold to tourists or visiting yachtsmen. Brooches, slides for belts and ash trays sell well, the latter bringing \$8 apiece. A pendant frequently will bring \$20 to \$30.

Since pearl shell is abundant and inexpensive, why don't more South Pacific craftsmen work with it? Probably because of the tedious hours involved. Bouvier's prices are relatively high compared to the price tags on pearl-shell costume jewelry now featured in shops in this country. But each of Bouvier's pieces is a work of art which he will never duplicate. ★ ★ ★



Pearl shell, brought from ocean floor by Polynesian divers, has a colorful and beautifully shaded lining



Here are examples of Bouvier's art. Bracelets are made of Trochus shell, brooches and pendants of pearl shell. Below, a Tahitian beauty wears a beautiful shell collar carved with Polynesian designs





Old Locomotive Makes Last Trip on Low-Slung Truck Trailer

Moving old No. 1673 was the problem. She weighed 159,700 pounds and had outlived her usefulness. On the 75th anniversary of railroad service to Tucson, Ariz., the Southern Pacific Railroad presented the venerable old loco to the Arizona Pioneer Historical Society, and she had to be moved from the railroad yards to the society's museum. It was a big moving job, one of

the biggest in the city's history, and was finally accomplished by bringing a giant lowboy truck trailer alongside the ancient locomotive and then moving up one of the Southern Pacific's big wreckers. The wrecker first lifted the front of the engine onto the trailer and then, with a couple of mighty tugs, hoisted the back up. Old No. 1673 was ready for her last trip.



← German Camping Trailer

No bigger than a small luggage trailer, a German trailer opens up to reveal two beds, a cookstove and a wardrobe. During the day, the beds convert into seats for five persons. There is even a small dining table. Telescoping pillars raise the roof to a convenient height and a fabric curtain, equipped with plastic windows, provides waterproof side walls.

Plastic Golf-Club "Woods"

Golf-club "woods" with plastic heads are now available. The heads, said to be stronger than wood, will not change shape or weight because of moisture. The uniform nature of the plastic permits precise manufacture of the head, so that every club in a set has the same feel and timing.

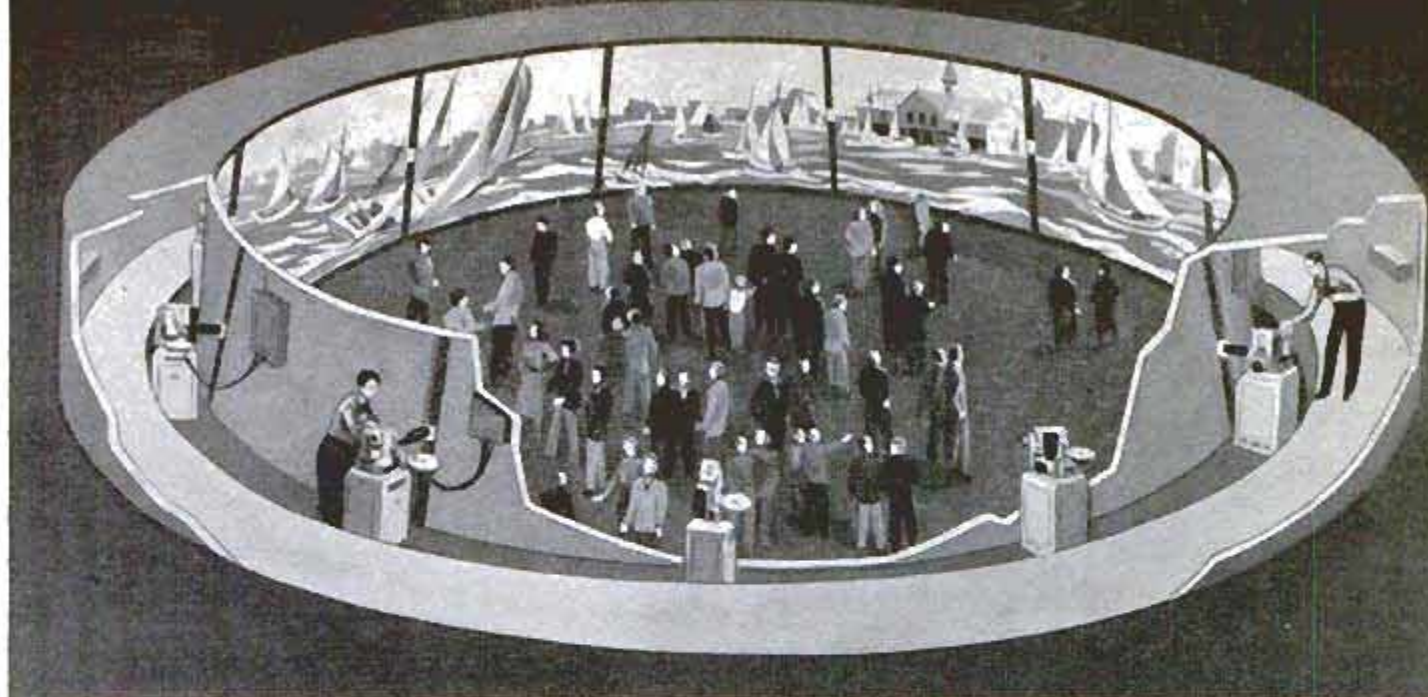

Eleven projectors are electrically synchronized to show one continuous picture on the "Circarama" theater screen

"Circarama"

HOW WIDE can a wide screen for motion-picture projection get? According to Walt Disney, the screen eventually will encircle the audience and, to demonstrate this, his engineers have designed and installed "Circarama" at Disneyland in Anaheim, Calif. The Tomorrowland section attempts to show what life will be like in 1986, with Circarama, sponsored by American Motors, as the theater of the future. Eleven cameras film Circarama, and 11 projectors screen the films.

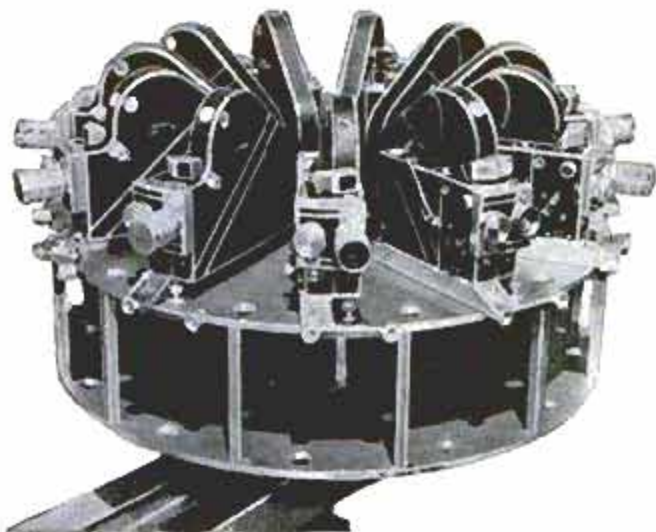

Above right is the mount and boom for the 16-millimeter Eastman Cine-Kodak Specials used to film Circarama





Sailboat "Stilts" Boost Speed

In trial runs recently, a sailboat achieved the phenomenal speed of 30 miles per hour in a moderate wind. This is nearly double the best speed of the American Cup boats, and about 50 percent faster than the all-time clipper-ship record. The new boat literally sails right up and out of the water, riding on hydrofoils. As the boat picks up speed, the hydrofoils lift the hull clear of the water in the same way an airplane wing produces lift. The boat is being used as part of a Navy research project.

Pontiac Junior Star Chief for '56 Has Plastic Body

Here's another new-car announcement—Pontiac's Junior Star Chief. A convertible, the car is designed for eye appeal to young drivers. Standard equipment includes two-tone body styling and white sidewall tires. The specifications: bumper-to-bumper length, six feet; over-all width, 28 inches; empty weight, 150 pounds. No Owners Reports are available on this new model as yet.

The Junior Star Chief, designed for the sidewalk set, is a one-third size replica of Pontiac's 1956 Star Chief convertible. It is complete with a real motor, brakes, gearshift, head and tail lights. The tot-size car has a maximum speed of eight miles per hour and is powered by a Pontiac starting motor running on a 12-volt auto battery. A trickle charger is supplied with the little auto. The body is

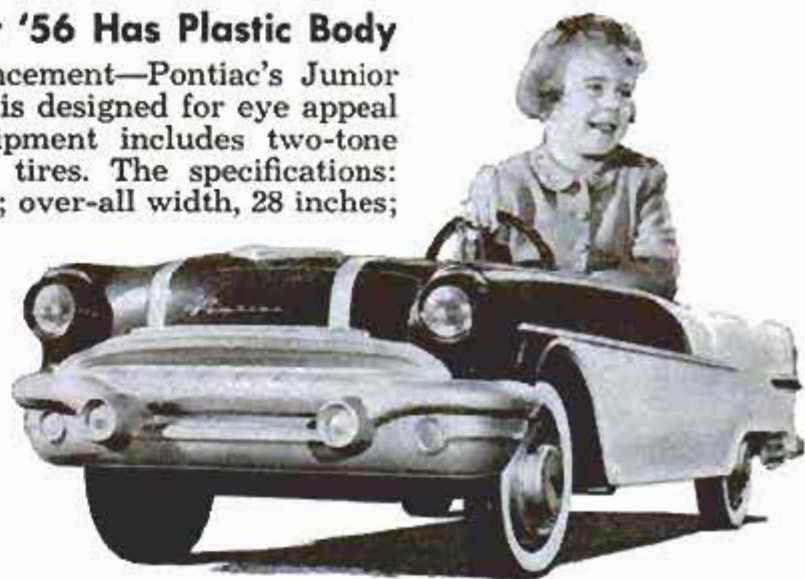

molded in plastic, shown in pictures below.

Pontiac dealers are using the miniature cars for promotion only, not for sale.

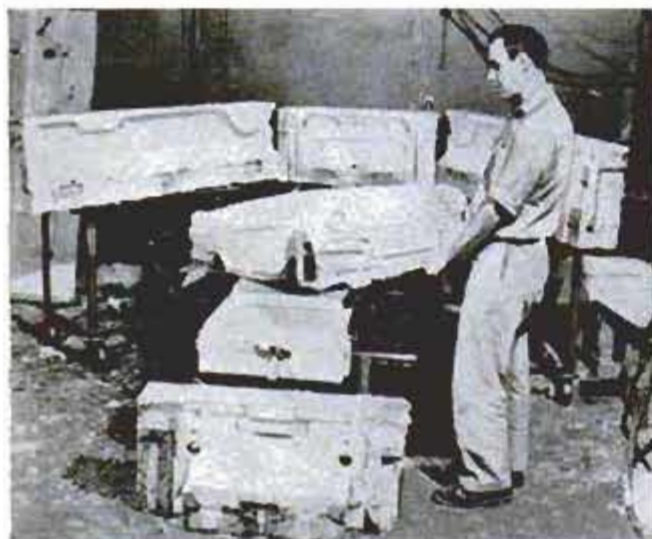

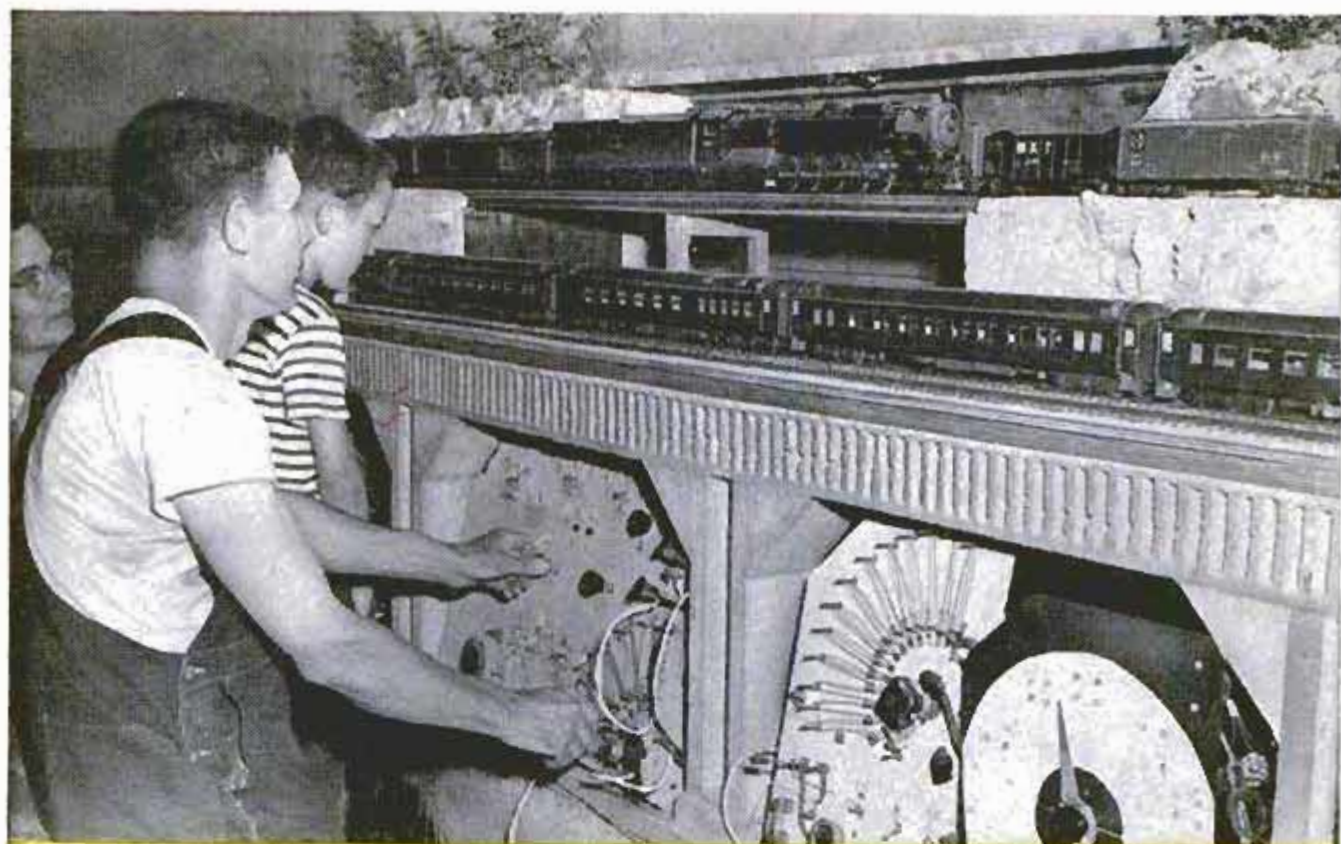

Gail operates his homemade control system. Panel at right contains color indications for block signals

Model Railroad in a Chicken House

By Louis Martin Reitz

REINHARD GAIL of Leasburg, Mo., a rugged individualist, is the sole owner and builder of perhaps the biggest $1\frac{7}{64}$ -inch-gauge model railroad in the land.

The majority of model railroaders build from kits. Some few claim to be "scratch" builders even though they buy such items as couplers, wheels and side frames. But Gail is a true scratch man. Perhaps this comes from being in the chicken business for almost 25 years. The only "store bought" items in his chicken-house layout

are the brass rails, paint and a few decals.

Gail built his railroad with the idea of watching it run and did not try to achieve the jeweler's precision seen on some fine models. He attached more importance to overcoming another problem that stumps most model railroaders: How to get close coupling of cars approximating that found on the prototypes. Ever look at a beautifully built model and notice that there is a void between the engine and tender big enough to run a scale-model car through?

Trains run outside on this long trestle. Guard rail protects them from falling off in case of derailment



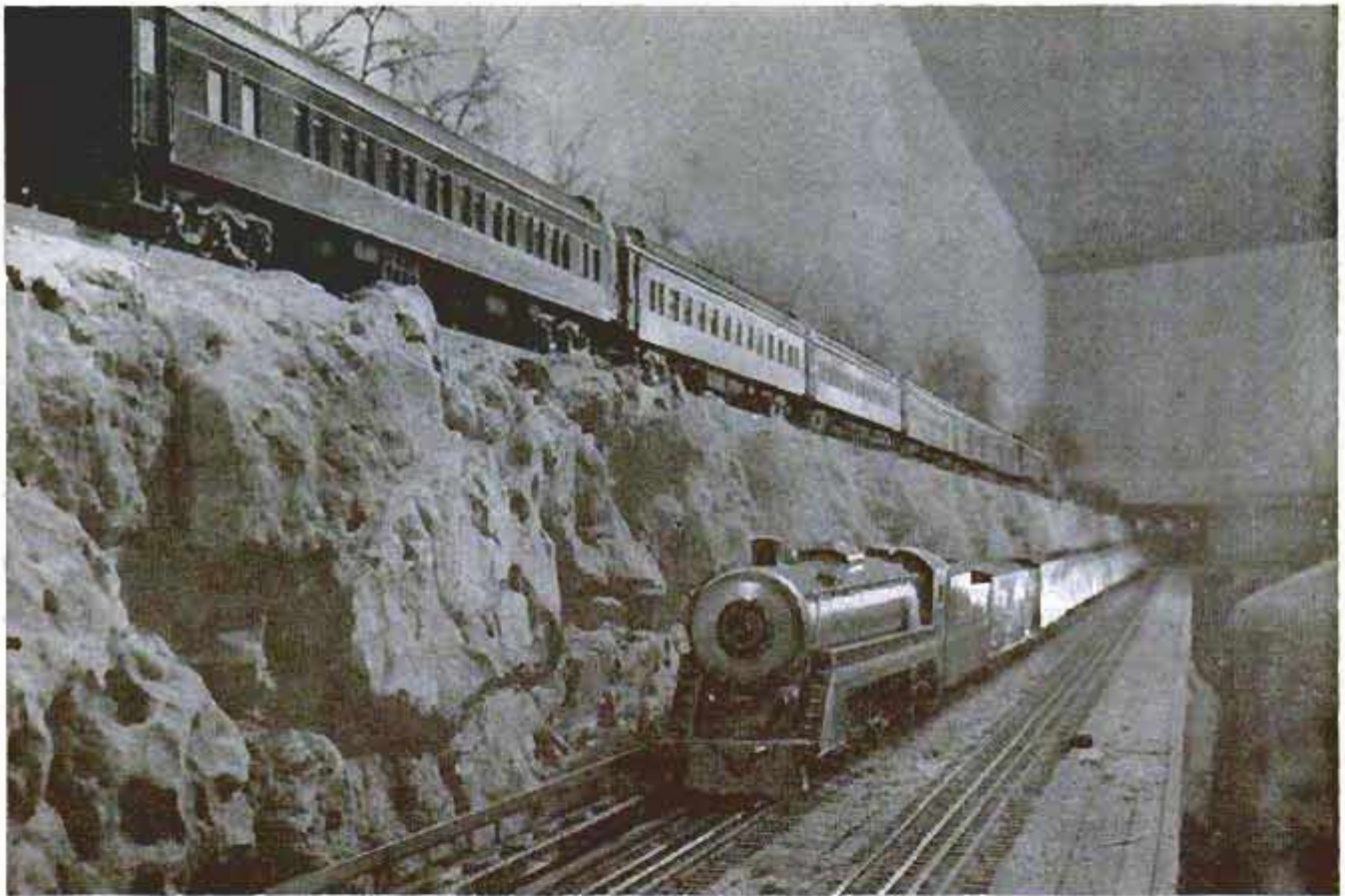

Inside tracks run alongside and on top of genuine rock "bluff." At far end is simulated signal bridge

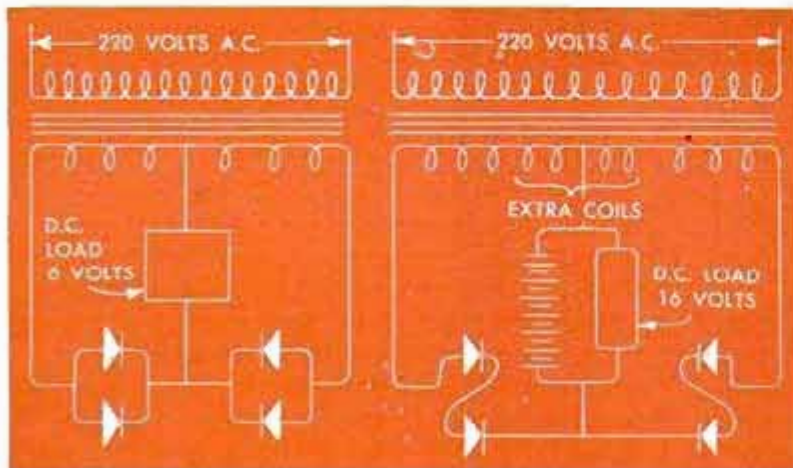

Battery charger, shown left above, was modified, right, to give more voltage to power model trains. Below, full-length view

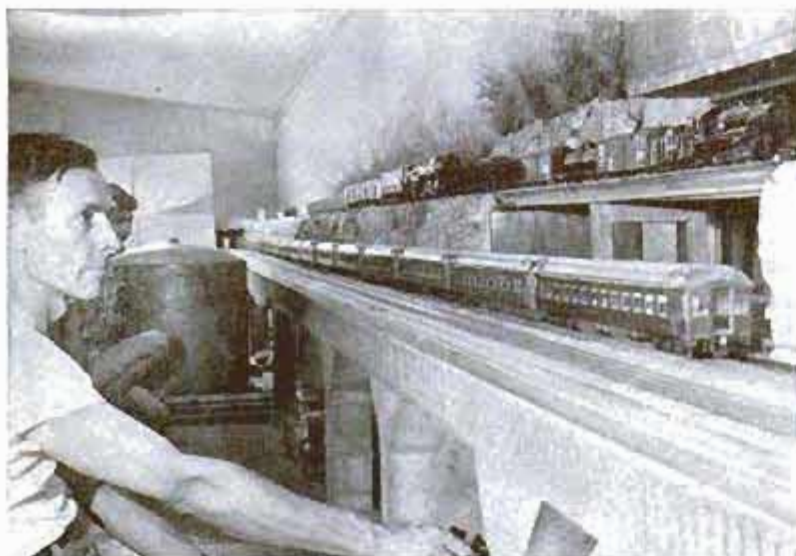

The reason is that on a model that runs you need large-radius curves and this means plenty of space. Gail had lots of room, so he used 15-foot-radius curves (30 feet across) and ran most of his track outside. The only part inside the building is the tangent (straight track) on one side of the oval. This part runs along the outside wall of a special building he erected on one side of the brooder house and is some 42 feet long. Visitors are startled when they stand at one end and look down the length of a train that usually consists of 17 passenger cars, each some 21 inches in length.

Layout All at Eye Level

The two curves and the other tangent are outside and are mounted on a framework made of 1½-inch iron pipe. When you stand in the observation pit and look across the inside track, out through the window and over to the track on the far side, the latter is also at eye level. You don't see any of the supporting members but only the trains with the natural scenery for a background. This gives the illusion of looking at a real train in the



Cars, including engines and tenders, are closely coupled. Size of layout permits this detail to be scale

distance, especially at night when the lights are on in the coaches and the dim blue nighttime lights are on inside the layout room.

There are no switches or crossovers on the tracks—just the double-track oval running outside and the upper-level double track that is inside the building in addition to the other track. To most model railroaders, this simple oval is known as a “fool’s delight,” which indeed it can be in

an 8 by 10-foot layout. But on one as big as Gail’s and with three or more detailed trains running at one time, each with sound effects, light flashing in the firebox of the “oil burner” and the appearance of the completely finished car interiors, the impression is anything but that.

Gail started construction on his road during the last war and built most of it right after, when materials were still hard to get.

(Continued to page 300)

Diagram shows dimensions of the track layout. The track is mostly outside. Only one stretch is inside

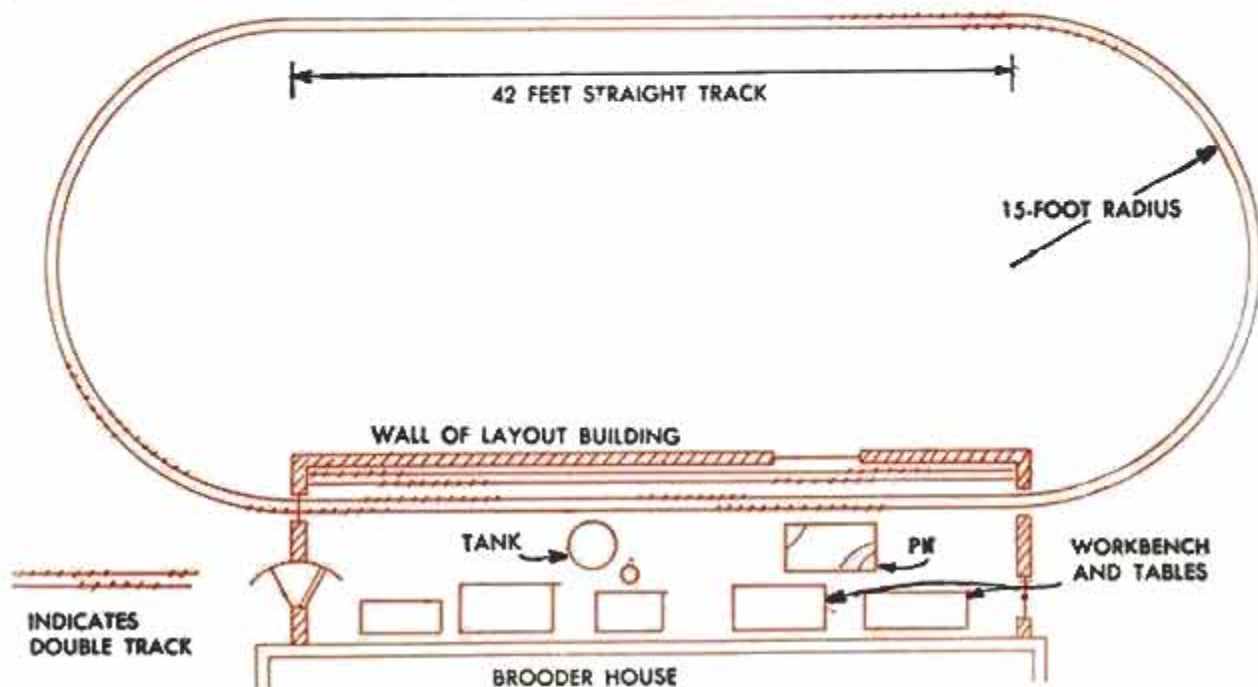

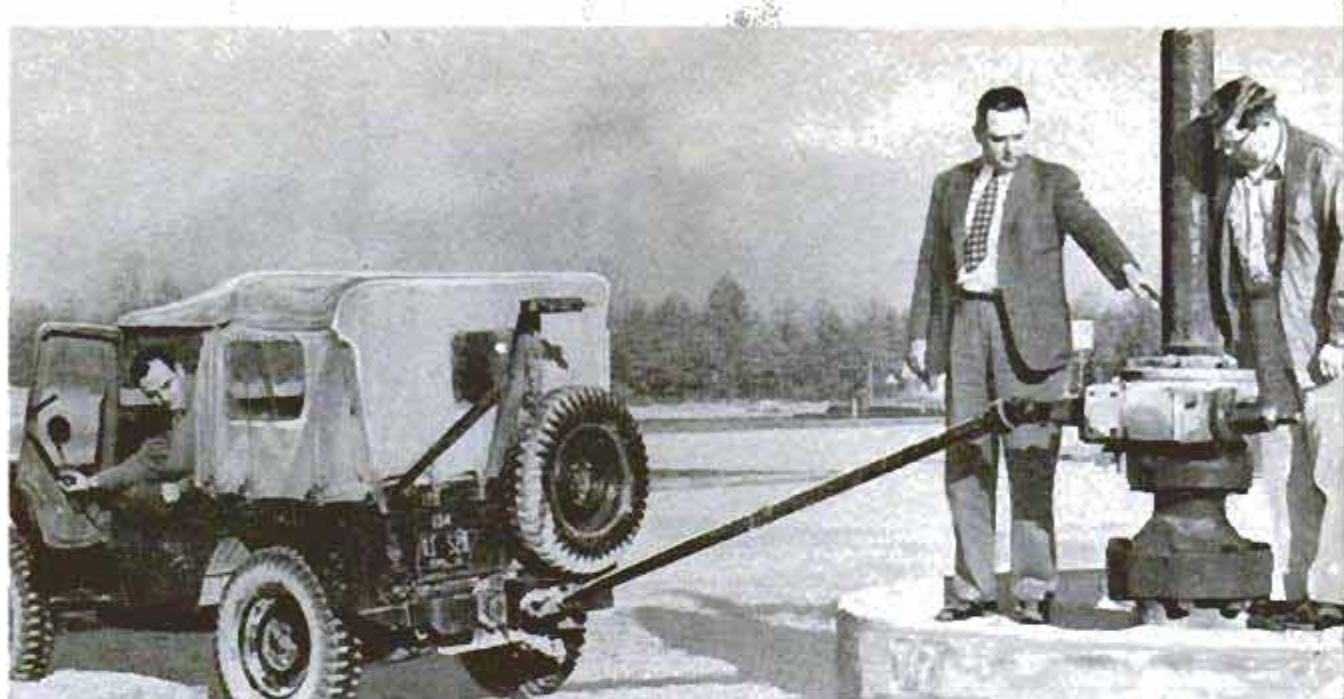

Jeep Turns on the Faucet to Cool Jet Engines During Test

Jeeps can do just about anything and to prove it the Air Force has put one to work turning a faucet on and off. The faucet, actually a giant valve, controls the torrential flow of cooling water required in tests of jet engines. The master valves can be turned by hand, but since 4980 turns are

needed to open or close one of them, the job would take eight hours. Instead, the power take-off on the Jeep is connected to the valve by a telescopic shaft and in less than 11 minutes the valve can be opened or closed. The giant valve controls the flow of 125,000 gallons per minute.

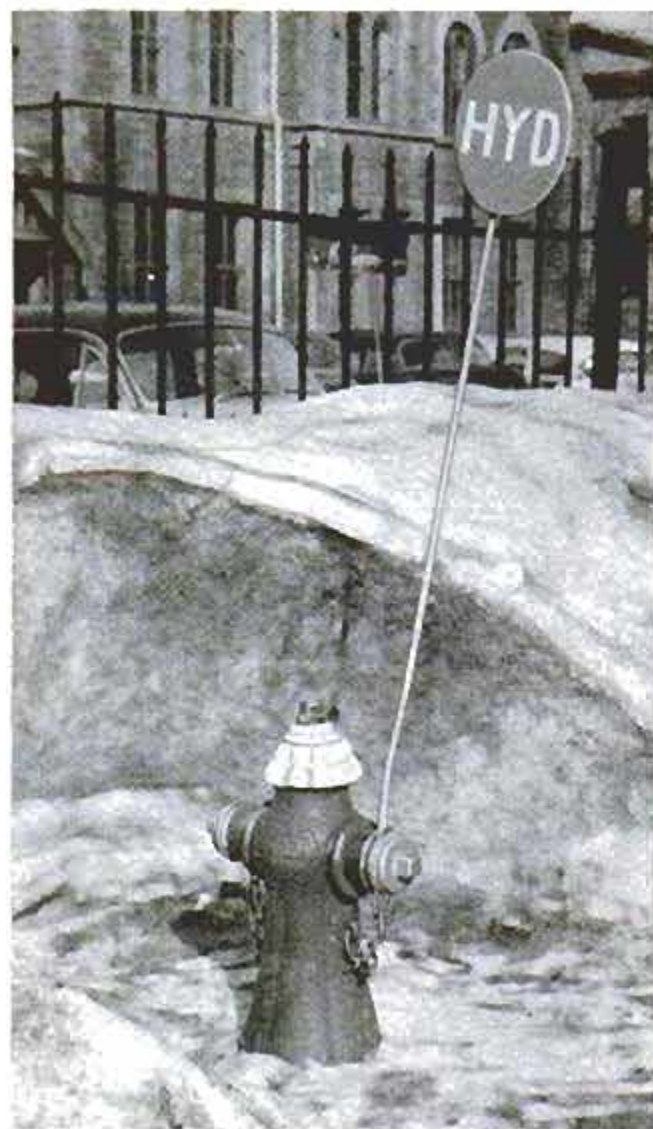

Tall Signs on Buried Hydrants Locate Them in Snow

Plowed or drifted snow can easily hide fire hydrants, making them difficult for the fire department to find and liable to damage from plowing bulldozers or other snow-removal equipment. Faced with the hidden-hydrant problem, the city of Ottawa came up with a simple, practical solution. Round hardboard signs were mounted on 54-inch steel rods terminating in rings that could be fastened to hydrant lugs. The signs were clearly visible above all but the deepest snows.

Hawaii Was Once North Pole

Hawaii 600,000,000 years ago was the bleak, frigid North Pole of the world, says Dr. S. K. Runcorn of Cambridge University and the Museum of Northern Arizona at Flagstaff. By plotting the directions of the "north" poles of magnetic rocks buried in the earth through the ages, Doctor Runcorn has been able to trace the rambling and irregular but constant shifting of the magnetic North Pole. It reached its present site 80,000,000 years ago, he has found. Evidence that the earth has shifted on its axis is the presence of fossil remains of tropical life in Greenland and Alaska. Runcorn believes jet streams and swirling currents in the earth's fluid core may account for the earth's magnetic-field changes.

Stern-Wheeler Plies Lake

Well-loaded houseboat churns through the water of Lake Tainter. It cruises above five miles per hour



Stern-wheelers are scarce these days along the Mississippi, but there's one on little Lake Tainter in northern Wisconsin. A 16 by 30-foot houseboat built by retired businessman Leo Williams of Menominee, Wis., it features an eight-bladed wheel six

feet in diameter and ten feet wide. A Jeep motor turns the wheel to give a speed of five to six miles per hour. The 10 by 16-foot cabin houses complete living and sleeping quarters. Ten sealed oil drums built into the hull aid buoyancy.

Owner and builder Leo Williams, retired Menominee, Wis., businessman, backs boat out for a cruise

Jeep motor with chain drive turns the paddle wheel. Wheel is six feet in diameter and has eight paddles

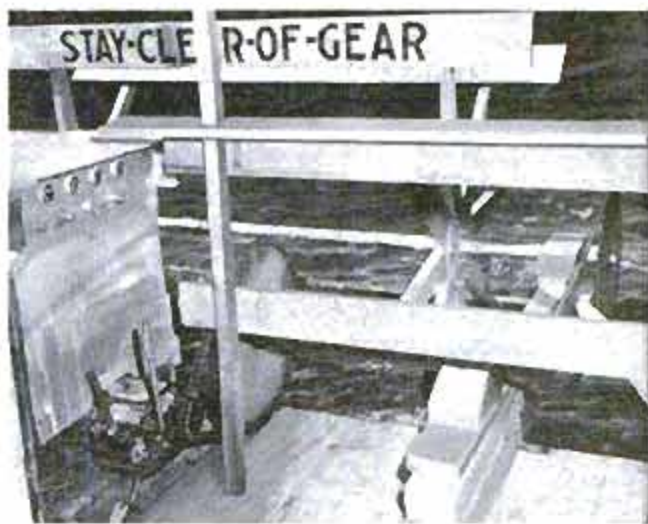

Sun Powers Telephone Line

Electricity from the sun powers a rural telephone line near Americus, Ga., in the first use of the Bell solar battery. The unit, mounted atop a telephone pole, contains 432 silicon cells which produce electricity when they are struck by light. The inch-diameter wafers, cushioned in oil and covered by glass, are linked together to produce at the rate of 100 watts per square yard of effective surface. Excess current feeds into a storage battery that provides power at night and on dark days.

ⓁPaper impregnated with an insecticide is being sold for lining home drawers and shelves by a Dallas, Tex., firm.

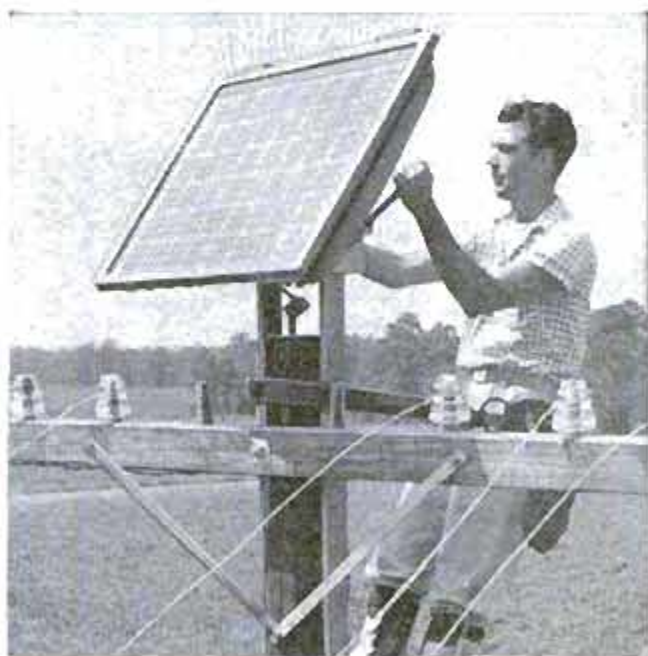

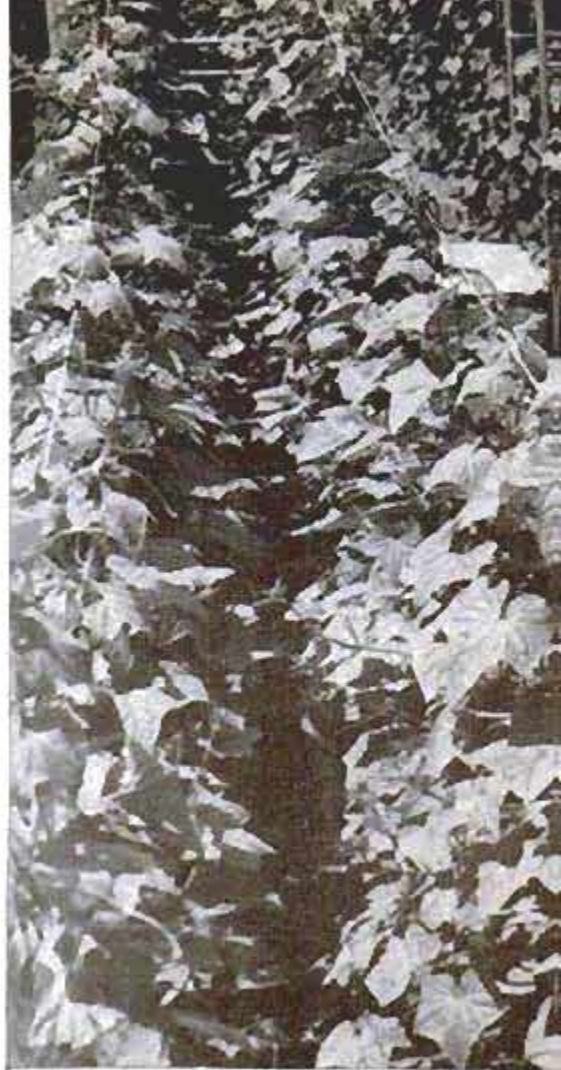

Soilless

By Elliott H. McCleary

GROWING FOOD without soil is not just a scientific stunt but a commercial reality on a little farm in Miami, Fla.

The farm, which has no barn or silo, no tractor or plow, is only four fifths of an acre. Yet its cash crop is equal to that of a truck farm of 20 acres.

The farm consists of 3 by 100-foot concrete beds filled with moist gravel, from which sprouts a luxuriant profusion of

Mrs. Deatrick hauls in a load of cucumbers grown during summer season on the hydroponic farm





Cucumber vines climb strings supported by pipe structures. Eventually they stretch as high as a man can reach

Farm on a City Lot

tomato and cucumber vines. The plants receive all their nourishment from mineral-enriched water which is pumped through the gravel.

Over a score of such hydroponic (soilless) farms exist in southern Florida, where the warm climate permits controlled bumper crops to be harvested the year 'round. All are commercial farms, started in the belief that the age of hydroponic farming has arrived. According to Arthur Deatrick, owner of the Miami farm, much of the na-

tion's garden produce could today be produced profitably by means of hydroponics.

Deatrick mixes 12 different minerals, in various chemical combinations, with the water which is pumped into the beds. The minerals include virtually all the soil elements which have been proved necessary to growing plants and animals: Calcium, phosphorus, potassium, nitrogen, magnesium, boron, zinc, manganese, copper, iron, sulphur and molybdenum.

The core of the Miami operation is a

Represented below are elements fed to plants: (in beakers) calcium, phosphorus, potassium, nitrogen, magnesium; (on pads) boron, zinc, manganese, copper, molybdenum and iron. Many elements are in compounds



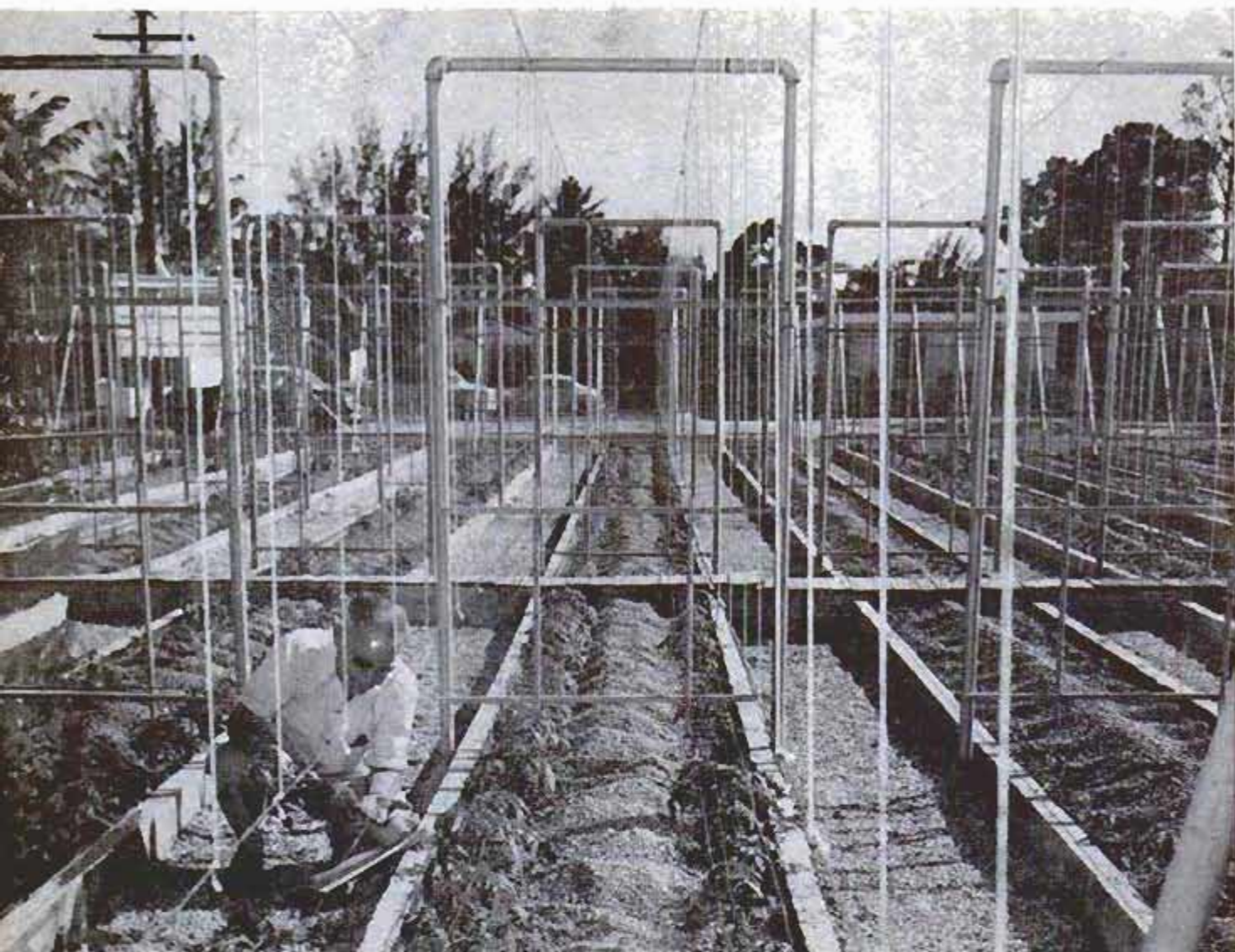

Deatrick inspects five-week-old tomato plants in one of the 3 by 100-foot beds. The gravel contains no soil

pump house, where water is pumped up from an underground stream, where it is mixed with minerals and where the water-control equipment is located. Every day the plants get a "breakfast," a "luncheon" and a "dinner" of enriched water. In between feedings, the gravel in the beds stays moist and the plants absorb the dissolved food.

Valves in pump house are turned to regulate water supply. Minerals are dumped into hole in the floor

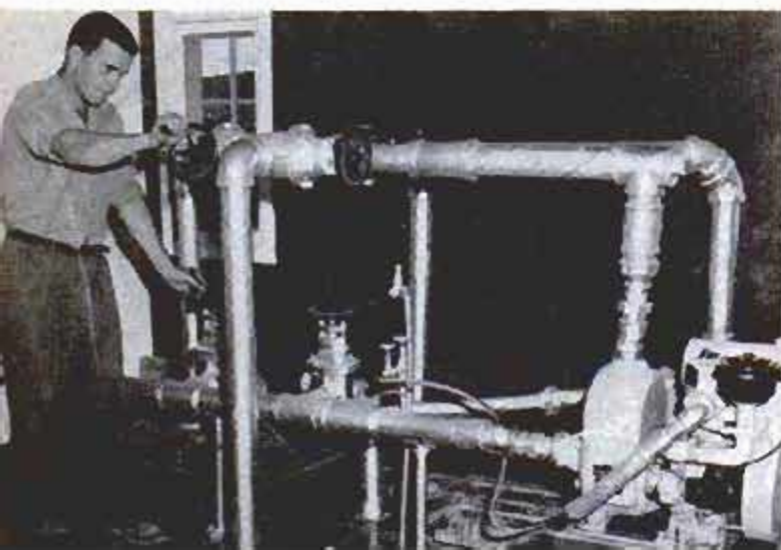

Twice a week, Deatrick mixes his plant food and pours it into a tank that supplies an agitator. The agitator thoroughly mixes the minerals with the water, which is then pumped into water mains that feed into the beds. On a typical sunny day, the plants will consume 1000 gallons of water and 28 pounds of plant food.

Water is carried through the shallow, gravel-filled concrete beds in sloping V-troughs covered with half-round tiles. The tiles keep the gravel out and permit the water to escape around their edges into the gravel, which is several inches deep.

HYDROPONIC NUTRIENT SOLUTION For 50 Gallons of Water

Potassium Nitrate (pure)	Potassium Sulphate (fertilizer grade)	Triple Superphosphate	Calcium Sulphate
3.6 oz.	3.2 oz.	4 oz.	3 oz.
Magnesium Sulphate	Iron (pure)	Copper Sulphate (pure)	Zinc Sulphate (pure)
2 oz.	2 grams	.1 gram	.1 gram
Boric Acid	Manganese Sulphate (pure)	Molybdenum trace	
1 gram	.3 gram		



Picking is fast when vines are loaded like these. A 3 by 100-foot bed yields three tons of tomatoes a season

Tomatoes in the winter and cucumbers in the summer are the chief crops of the Deatricks farm. One tomato crop lasts for eight months, one cucumber crop for three months. Once a year, in between crops, the beds are sterilized with a sulphuric acid solution to kill root diseases. The beds are then washed clean. Insecticides and minerals which have accumulated during the year are rinsed away.

The advantages of hydroponic farming are many, according to Deatricks. The plants get all the moisture and food they need, in controlled amounts. The Deatricks farm does not have to depend upon the weather, so a bumper crop of vitamin-and-mineral-packed vegetables is always being produced. Because plantings are staggered and more plants are grown in a given area, only one man is needed to take care of the farm, which grosses at least \$10,000 a year and contains equipment worth \$20,000. Occasionally, an extra helper is called in when peak yields reach as much as 54 bushels per day. All of the produce is sold from a stand on the edge of the farm, to customers who willingly pay premium prices.

Instead of throwing away a large part of their crop in culls, the Deatricks are able to market practically all of their produce. According to Deatricks, vegetables grown in the soilless plots are "more nutritious, have less disease, keep and taste better than normal vegetables. A hydroponic tomato," says Deatricks, "will last three weeks at room temperature—three to five times as long as a standard tomato."

Worms and other crawling parasites can't get into the concrete beds, thus decreasing damage to the plants. Frequent sprayings, of course, are needed to control airborne insects and diseases.

"Plant growth is speeded," Deatricks says. "Hydroponic tomatoes start to bear 70 days after the seed is planted. Conventional growers get a yield 120 to 130 days after tomato slips—not seeds—are put into the ground. Cucumbers grown hydroponically start to produce 36 days after the seed is planted. Under conventional methods, the time would be 62 days. Once the tomato vines start producing, they yield months longer than do ordinary vines. Time-consuming replantings are not necessary."

★ ★ ★



Above, a traffic engineer watches the screens of two television monitors, prepared to direct emergency operations the moment an accident or slowdown occurs. Below, in the tests cameras were mounted on towers to determine best height for observing Freeway traffic

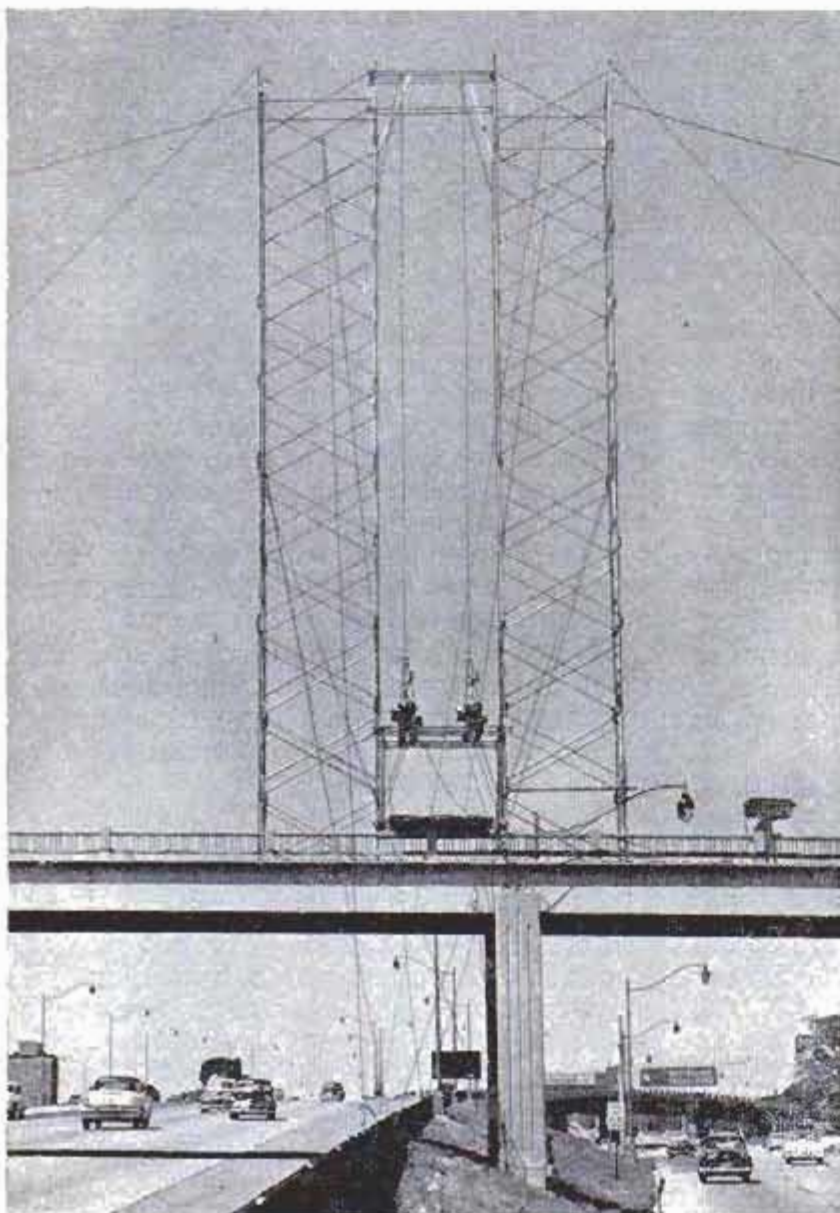

Test TV Traffic Control

AT 5:07 P.M., as the rush-hour traffic sings along the Edsel Ford Expressway in Detroit, there is a sudden squeal of brakes and a metallic crash. Two cars involved in a collision careen across several lanes and the traffic behind them comes to a halt. In a few moments the traffic jam has built up for blocks. On most major highways it would be a half hour or more before the damaged cars could be removed and traffic restored to its normal pace. But on the Ford Freeway things are different. A traffic engineer sitting in a control booth peers at a television screen. He spots the collision as it happens and, before the cars have come to a standstill, he reaches for his phone. Two minutes later, its red light flashing, an emergency tow truck arrives at the scene of the accident and begins towing operations. At the same time, police guarding the entrance ramps to the freeway are alerted to slow down or stop all cars approaching the jammed-up section. By 5:11 p.m., four minutes after the crash, traffic is once again flowing normally—thanks to the closed-circuit TV monitors that keep a constant watch on the speeding cars. Not only are the engineers alerted to accidents through the TV circuit, but they also can spot traffic overloads and slowdowns as they begin to build up. By shunting traffic away from the expressway soon enough, they can prevent jams.

Test Closed Circuits

The closed circuits are being tested in Detroit on two one-mile stretches of high-speed highways. If the tests show the system to be as successful as traffic engineers believe, a traffic-control pattern will be set for the future.

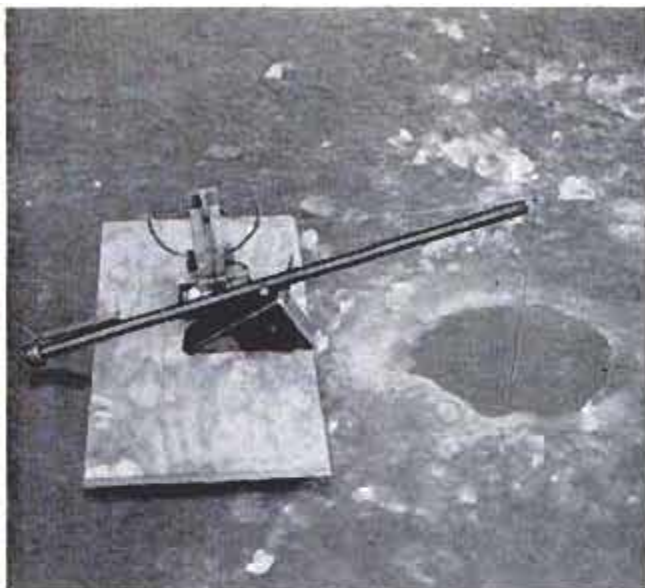

Battery-powered motor raises and lowers bait to attract the fish while angler takes life easy on a chair

Motor Moves Fish Bait While Angler Relaxes

When John T. Larou goes ice fishing, he relaxes in a chair while his bait moves realistically to attract the fish. Larou, of Detroit, Mich., mounted a small motor (formerly used to move an animated sign) on

a board. A flashlight battery powers the motor, which raises and lowers the bait $\frac{3}{4}$ inch twice each second. The moving bait attracts the fish beneath the ice while Larou relaxes above.

Fiberboard Shelters Keep Out Poison Gas and Radioactive Dust

Poison gas, disease-laden particles, and atomic fall-out are stopped by fiberboard developed at the U. S. Forest Products Laboratory. With the material, says the laboratory, shelters can be built to protect troops and civilians from some of the worst effects of modern war. Oxygen, carbon di-

oxide given off in breathing and respiratory vapors pass through the board, so there is no danger of suffocation in a closed shelter. But secret chemicals in the fibers screen out deadly gases and particles. Developed for the Army Chemical Corps, the fiberboard is undergoing extensive tests.

Marlin .22-Caliber Rifle Has Short Lever Stroke

Sportsmen have a new .22-caliber lever-action rifle—the Marlin 56-Levermatic. The throw of the lever is so short that the hunter's hand need never leave the pistol grip. The lever moves only in a 25-degree arc compared to the 90-degree arc of most lever actions of the past. The new model has a seven-shot clip and will handle all standard and high-velocity rim-fire ammunition.

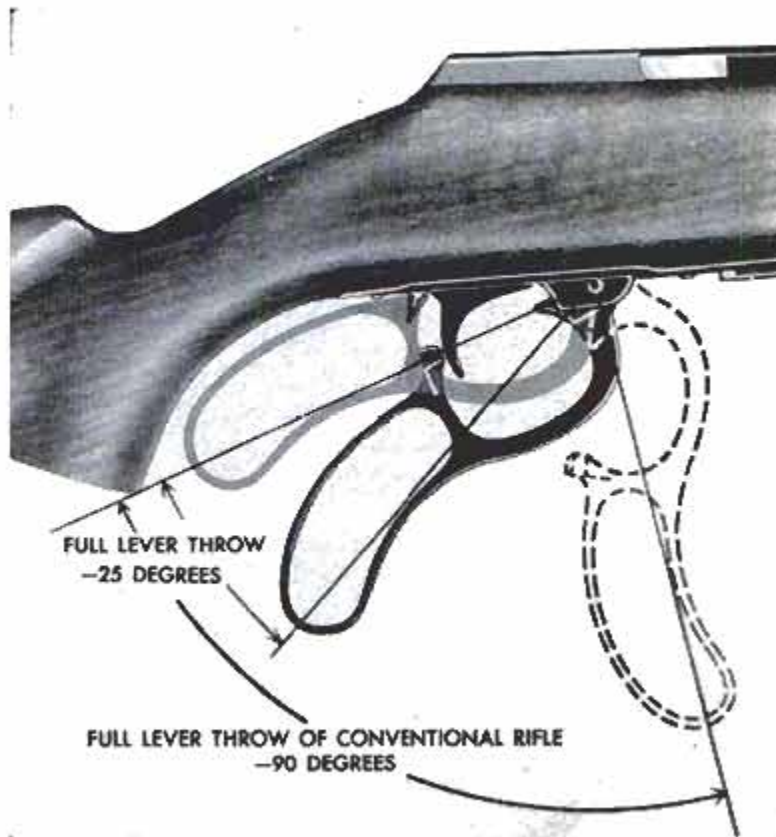

Automatic Backup Horn

Installed in the car trunk, an automatic horn warns pedestrians that the driver is backing up. Installation takes less than a minute and is accomplished without stripping any wiring. The horn, a loud buzzer, hooks into the backup-light circuit.

WHAT'S NEW FOR Your Home



CREEPER is for baby too young to use a walker. Ball-bearing casters allow him to scoot around the house while keeping off the floor. Baby can't fall out or tip over. Height adjusts to fit infants of six weeks and older. Seat and chest rest are padded.

Fridell Mfg. Co., P.O. Box 721, Galveston, Tex.

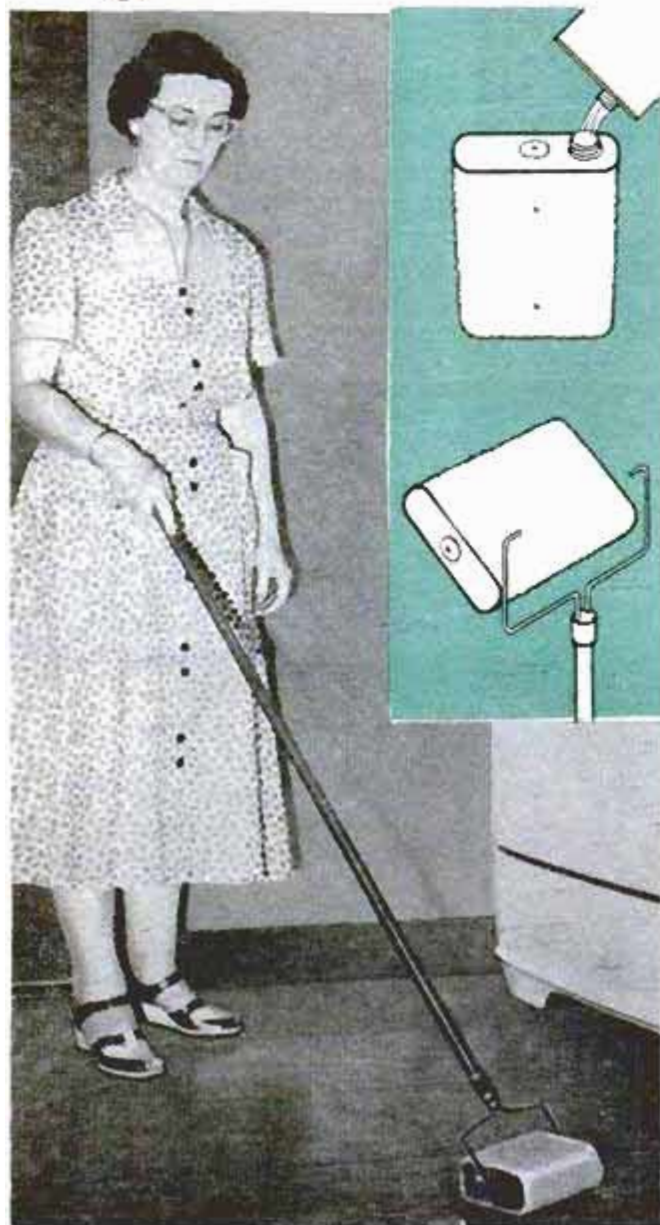

FLOOR WAXER is a can of liquid wax attached to a long handle. Wax flows out through two holes in one side of can to soak the cloth. Can is flipped over and other side used if too much wax is flowing out. Can is easily filled. The cover is washable.

Master Waxer, Inc., 4419 Troost, Kansas City, Mo.

HANGER for trousers and skirts is an L-shaped steel loop that firmly grasps the garment which is slipped into it. Pants are hung from the cuff and skirts by the waist. Despite its off-center appearance, the unit hangs evenly and does not tip or lean.

Slip-On Hanger Co., 7315 N.E. Glisan, Portland, Ore.

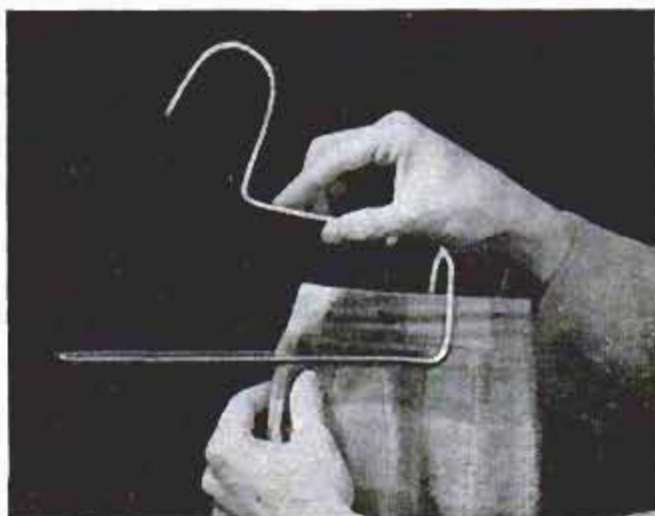

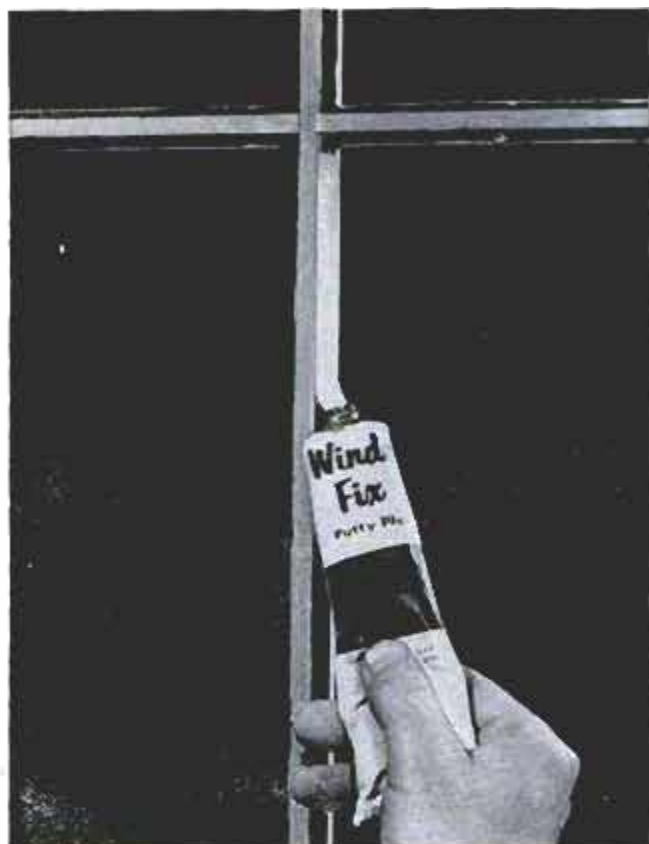

GLAZING PUTTY is squeezed out of its tube in a continuous triangular strip that fits exactly into angle between pane and sash. Tube holds 150 feet
Goodell Co., Antrim, N. H.



LAUNDRY CART that goes upstairs, downstairs, indoors and outdoors has a wrought-iron frame that acts as a pair of skis to let it slide on stairs
Leisurehouse, Inc., P.O. Box 492, Wichita, Kans.

BOOK HOLDER for students, typists and those who like to read while eating keeps pages in place but frees hands for other uses. The lightweight metal holder accommodates a small pocket-size book, a magazine or an encyclopedia. It folds for compact storage and is sturdy
Maymac Co., Dept. PM, 79 West Grand St., Mount Vernon, N. Y.



OPENER for awning-type windows is cranked to reel out rigid chain that acts as firm support in any open position. Special hinge drops sash for washing
H. S. Getty & Co., Inc., 3348 N. 10th St., Philadelphia 40, Pa.

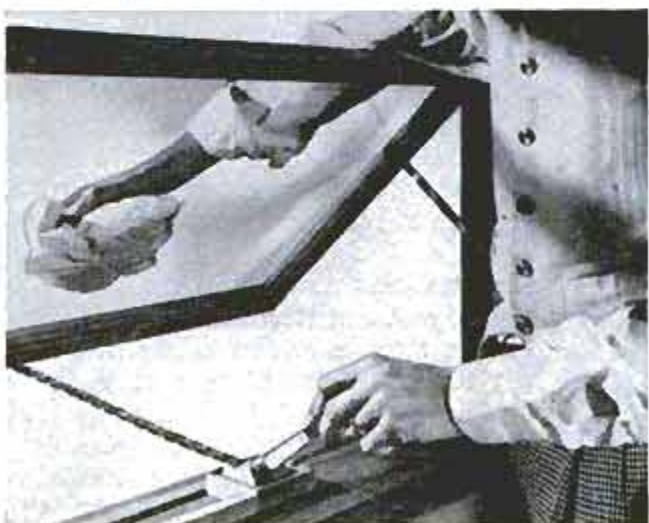

MOTORIZED SPIT makes barbecuing possible in oven of any range. Two thumbscrews fasten unit to oven rack. Oven door shuts against arm holding motor
Party-Q Corp., 218 Sullivan St., New York City 12

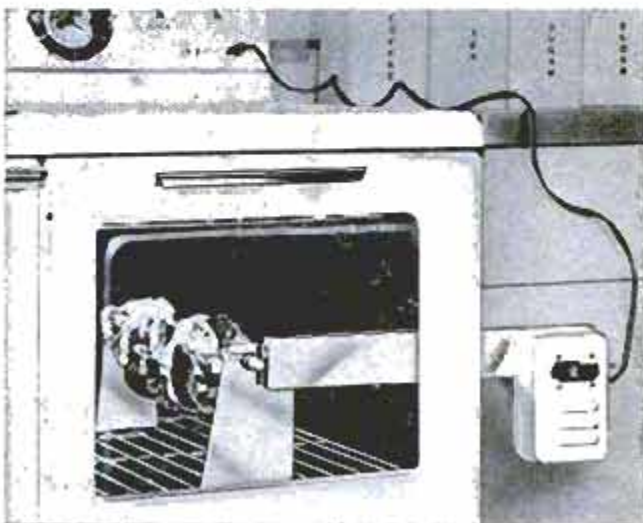

Impromptu Aerial Circus



Completely unrehearsed, a group of pilots who had never flown together before took their jets up at a French national air meet at Metz and did precision acrobatic maneuvers. Aerobatic teams from Britain's Royal Air Force, the Royal Canadian Air Force and the U. S. Air Force had performed at the meet. Members of these

teams made up the impromptu aerial circus. USAF Capt. Richard Immig, serving with the RAF, led the group in a Hawker Hunter. His wing men were Flying Officers L. N. Eisler and B. R. Campbell, of the RCAF "Sky Lancers," flying Sabre Jets. Capt. R. W. Jellison, of the USAF, flying a Lockheed T-33, completed the formation.



Pivoting Lamppost

Old-time lamplighters, who had to raise a long pole or climb a ladder to do their work, would have liked a modern arrangement that brings the lamp down to the ground. A lamppost that swings on a pivot in its base is supported by a rope as the trouble shooter strolls up the post to adjust or change a bulb. It is in London.

Miniature Exhaust Fan For Navy Suits

Rubberized suits worn by Navy decontamination squads are vented of moist air by a tiny fan attached to the back of the suit. A midget battery powers the 18-ounce, 1 by 1 $\frac{3}{8}$ by 1 $\frac{1}{2}$ -inch unit for as long as 24 hours. As it can reduce humidity inside a suit from 90 to 50 percent in three minutes, it is used for only short periods. When perfected, it may be used to ventilate other types of clothing, such as fire-fighting suits and arctic wear.

Balloon Wheel Dumps Leaflets

RAZOR BLADES, alarm clocks and a bicycle wheel went into the first model of a unique device that's being used successfully to drop millions of leaflets from huge balloons behind the Iron Curtain.

The balloons, launched in Western Germany by the Free Europe Committee, Inc., drift across Red-held Europe with the prevailing winds, dropping packets of leaflets at fixed intervals.

Chief feature of the leaflet-carrying device attached to each 34-foot plastic balloon is the wheel. Nine-pound packets of leaflets suspended by cord are attached to the rim at regularly spaced points. An alarm clock causes two motor-powered razor blades to move slowly around the rim of the wheel and cut off cords that were holding the packets at fixed intervals.

Formerly, a small cannon was used on the balloons to explode the cord loose. But word came back from Europe that the Communists were using the cannon device for counter propaganda. Residents of Iron Curtain countries where the leaflets were dropped were told that the cannon units were deadly.

Workers in Germany ready a balloon for take-off. Each 34-foot balloon can carry 100,000 leaflets



Yost and Macgowan examine their creation. Alarm clocks are encased in box below wheel. Pamphlets hang from rim of wheel

A new unit had to be developed—quickly. Two engineers of General Mills in Minneapolis were assigned to the job on a Friday. By Monday Paul Yost and John Macgowan had developed a working model of their unusual unit. To date, several hundred of the units, each capable of dropping 100,000 pamphlets totaling 450 pounds, have been wafted over Red Europe.

Balloon laden with leaflets soars away. It will reach 25,000 feet as it drifts over Red-held Europe

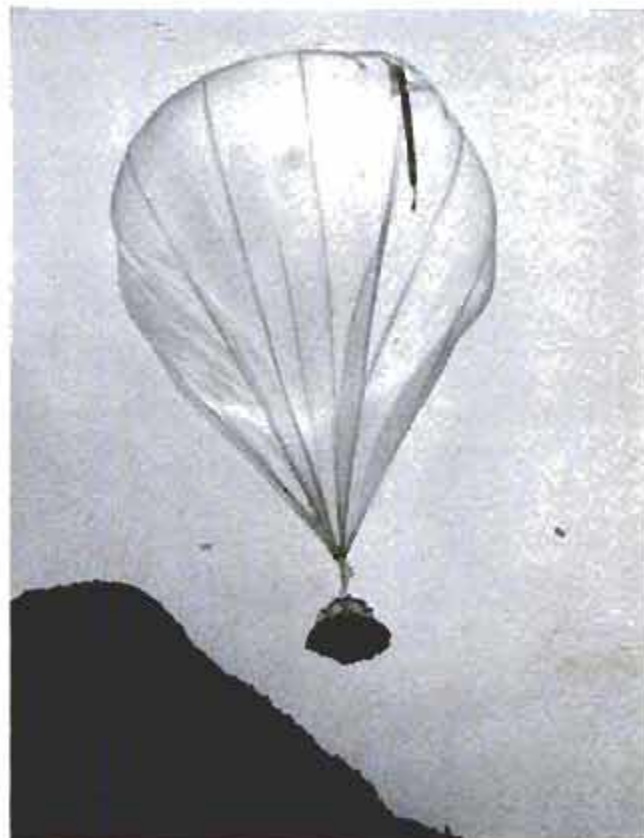

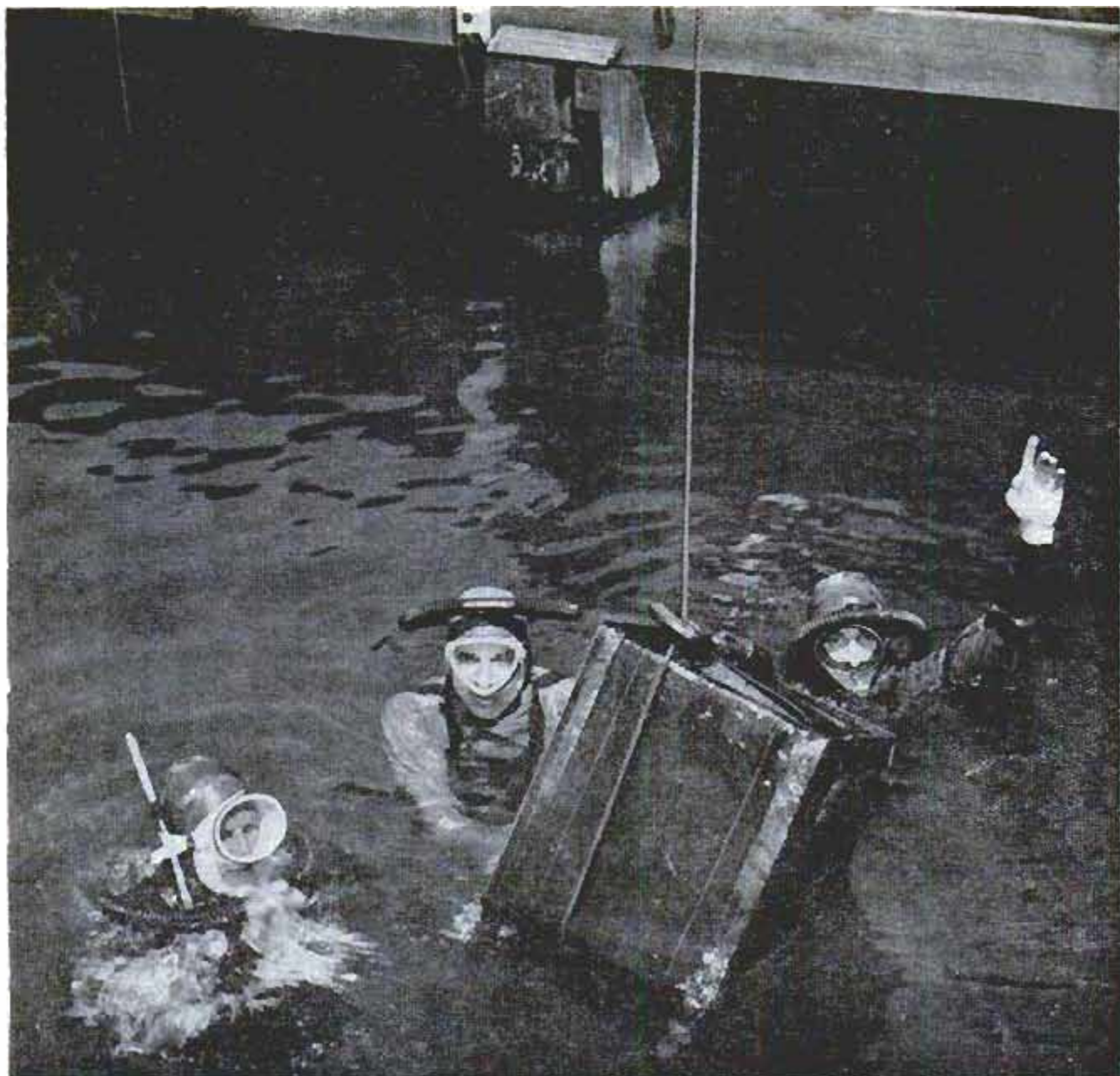

A stolen safe that robbers thought was hidden for all time is brought to the surface by police frogmen

SEATTLE POLICE PATROL

By Rafe Gibbs

PATROLMAN RON FAIRES of the Seattle Police Department moved slowly through the enveloping darkness to the automobile, yanked open a rear door and shot the beam of his flashlight inside. There they were—stacked on the floor—the stolen Army rifles from Spokane.

All this would have been pretty routine for a police officer, except that the car happened to be under 30 feet of water in Hicks Lake. Faired was in uniform, but an odd one for a patrolman . . . a frogman diving outfit.

Two young men had stolen both car and rifles in the eastern Washington city, then raced across the broad and flat expanse of

the Columbia Basin and up the winding highway over the Cascade Mountains to Seattle. There the heat was on, and the fleeing thieves decided to "cool off" the car with its arsenal by running it into the lake.

A report that a driverless car had been seen plunging into the lake brought police to the scene, then a call for Seattle's frogman police unit. Result: Recovery of the sunken loot and jail for the looters, who were later picked up.

The frogman unit drifted into the Seattle Police Department like a stranger looking for a berth for the night. At first the diving activities were just an off-duty hobby of Patrolman Faired. Then Patrolmen Ted



Frogmen frequently dive from a harbor-patrol boat. Members of the police department have 200 miles of shore line to patrol. Frogmen, however, are confined to land duty most of the time. Their services are also available to other towns

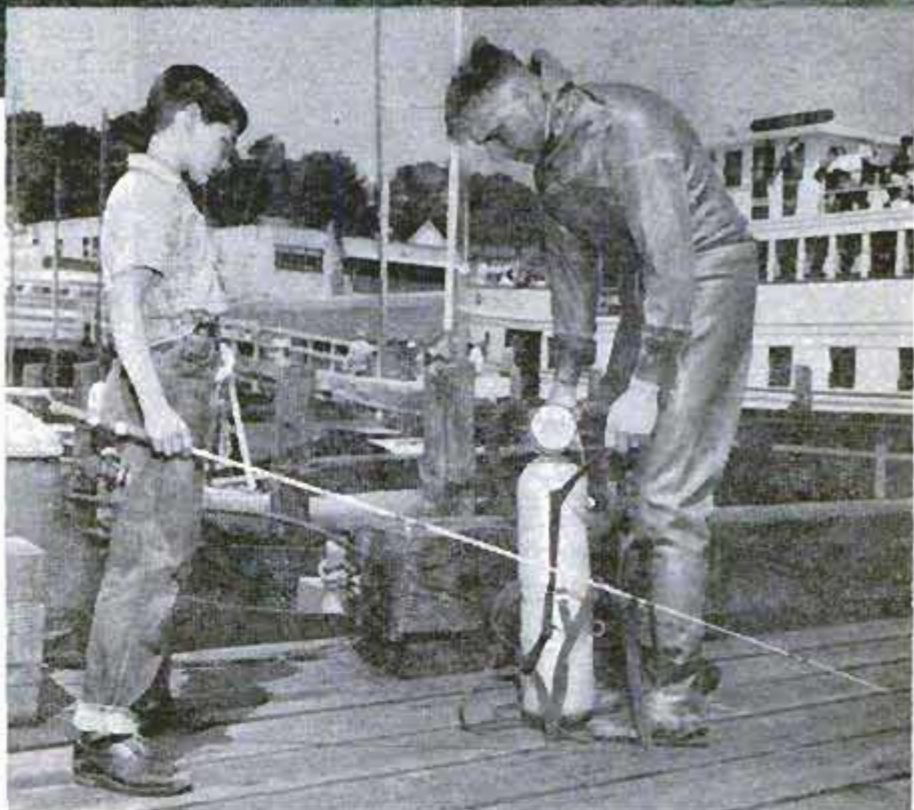

Seattle's police methods on the water front intrigue the youngsters. Patrolman Theodore Yerabek, equipped with oxygen tank and rubber suit, prepares to go below. Frogmen are all expert swimmers and divers, started as boys

AN UNDERWATER BEAT

Yerabek and Ed Francis became interested, and there were three frogmen looking for opportunities to don rubber suits, masks, lead weights and air tanks.

The opportunities came fast—so fast that Chief of Police H. J. Lawrence decided to make the frogman duties official. The unit—Underwater Search and Recovery—is now part of the Patrol Division, of which Captain Jack Porter is chief.

"With all the shore line we've got to patrol around here—about 200 miles—it's not hard to guess where a killer is going to toss the murder weapon," said Porter, "or where yeggs are going to dump a safe after they have looted it. The water is handy for getting rid of the evidence—like the bottom of a theater seat for parking chewing

gum. But, once we can determine the general vicinity, the frogmen more often than not can do the rest.

"The murder weapon may be wet, but the fingerprints are likely to be still there. The cash may be gone from the safe, but valuable records may be recovered.

"Then there are the drownings—with the grief-stricken members of the family. They search. They wait. They know that death has come, but they don't start to readjust their own lives until the body is found. Nothing is definite without the body.

"There's a woman who has been coming out here each summer for the last seven years from Tennessee—3000 miles—to search in the mountains for the body of her son, a Navy pilot who cracked up his plane

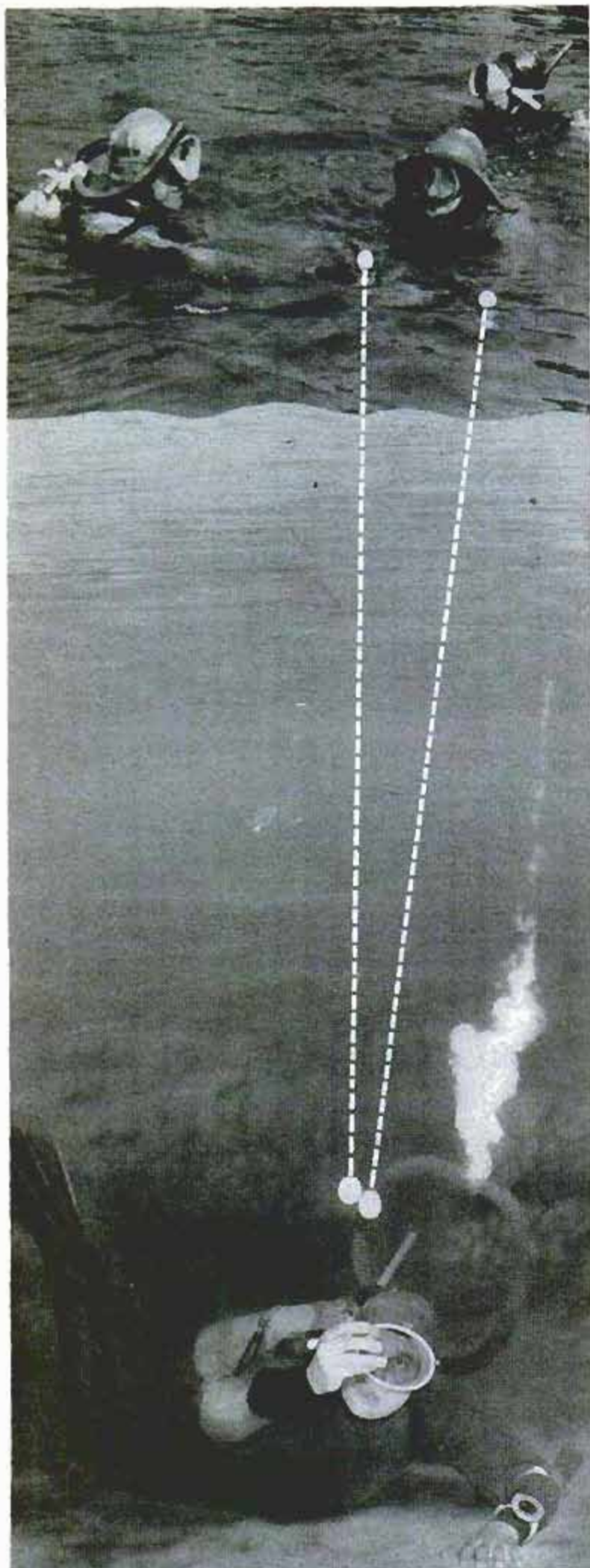

somewhere. Relatives of drowning victims feel about the same way. Usually, the frogmen can find the body quickly and, if for no other reason than aid in drownings, the frogmen are worth their diving weight to the police department."

The frogmen are now used to recovering bodies of drowning victims; that is, as used to sudden death as one can get.

"When I find the body down there in the blackness," said Officer Faires, "I switch off my light and come up without seeing. You've got to be impersonal about death, or it will get you."

The frogmen just don't sit around headquarters playing pinochle and waiting for a waterfront call. All of them have other duties. Faires rides a prowler car, and Yerabek and Francis walk beats. But take a night like this one. . . .

It had started in a routine fashion for Faires and his partner in their prowler car . . . a speeder ticketed . . . a sidewalk-sleeping "wino" prodded into wakefulness and told to go home . . . a drunk in a tavern threatening other customers.

The drunk was carted off to the station and booked for disorderly conduct. Faires was just getting back into the prowler car when the loudspeaker intoned:

"Drowning at Lake Union Dock. Man fell into water stepping from boat to dock. Frogman job . . . Faires. . . ."

Whine of the siren as the prowler car raced to Faires' home . . . there Faires transferred to his own car, its trunk compartment always loaded with complete diving equipment.

At the dock, the Harbor Patrol was already on the job, but its grappling hooks had become fouled in old cable at the bottom of the lake. Cable . . . it can embrace and trap a diver sometimes like the tentacles of an octopus.

Wary of what he might run into below, Faires slipped into the black water with his diving outfit. At 28 feet, he touched bottom, and

Diver in trouble signals his mates above by releasing Ping-Pong balls, which float to the surface and bring a quick rescue

began to move in a pattern designed to cover every foot of the designated area.

His light showed him a snarl of cable dead ahead. Carefully, he circled. Then he came to a tangle of barbed wire . . . as treacherous as that placed before a war trench. More so for a frogman, because the barbs can tear holes in the rubber suit.

Faires felt for the pouch at his side to be sure it was loaded. This is an innovation of his own—a pouch with Ping-Pong balls. If he should become trapped, he would release the balls, and when they floated to the surface the people above would know he was in trouble.

The Ping-Pong balls were in the pouch all right, and Faires glided over the wire to resume the pattern. An old piece of piling, one end stuck in the mud, loomed up. The other end seemed to point. The drowning victim lay just a few feet away. Faires grasped the body around the waist, turned off his light, and groped upward.

Standing alone on the dock as he struggled out of his clinging, dripping rubber suit, Faires heard someone say:

“. . . father of seven children.”

Then there was the week before Christmas . . . cold with traces of snow on the

sidewalk as Officer Francis walked his beat on upper Pike. A Santa Claus jingled his bell beside a money pot, and a young punk loitered beside the pot with his eye on the money. Francis told the loiterer to move on, then checked with headquarters at a call box.

Detective Homer Tipton wanted him for a frogman job . . . Duwamish River . . . cold or not . . . now. Francis grinned. He had a special outfit for diving at this time of year. It was a heated Air Force pilot's suit. That is, it was once electrically heated, but all the wires had been pulled out. Still, it provided a comforting shield of warmth between body and rubber suit.

Burglars had stolen a safe from the Vance Cafe, and Detective Tipton had a tip that the safe was at the bottom of the Duwamish River. The cold, swirling waters of the stream did not look too inviting when Frogman Francis stepped in. But he moved with the determination of a patrolman on duty—underwater duty.

He had not been long beneath the surface when some slowly moving object bumped him, knocked him down. Francis turned his light, and what he saw was the

(Continued to page 302)

A revolver pitched into the water is picked up carefully by trigger guard to avoid smudging fingerprints 318



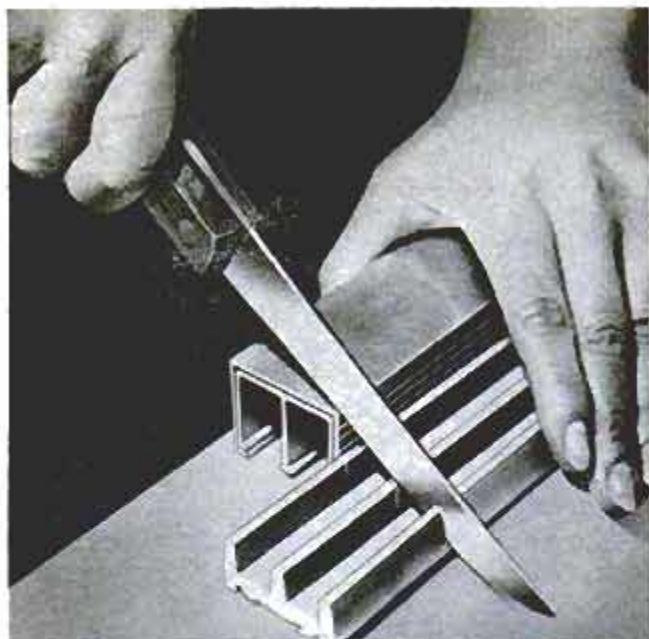

Plastic track is trimmed to length of aluminum track



Screwdriver tightens adjustable track for snug fit



Assembled aluminum frame keeps plastic panel taut



Plastic panels are easy to clean, keep bathroom neat

Sliding Plastic Panels Assembled From Kit Enclose Bathtub

In a short time, using a kit, you can custom-fit and install sliding plastic panels to enclose your bathtub. The panels consist of flexible vinyl stretched between aluminum frames. They slide in an overhead rail of aluminum and a plastic base rail that is cemented to the tub rim. The

overhead rail telescopes and is locked with a screw to fit snugly between brackets cemented to the walls. The lower plastic track is cut with a kitchen knife to match the length of the overhead rail. A knife and screwdriver are the only tools needed to install the unit.

Tests Show Antibiotics Can Be Used to Preserve Food

Antibiotics may soon be used to preserve food, according to staff scientists of a leading drug manufacturer. In tests, minute traces of an antibiotic like terramycin lengthened the life of pasteurized milk

from two days to several weeks. Dipping mixed salad greens in a solution of terramycin or streptomycin before packaging doubled their shelf life. Aureomycin is being used to preserve poultry.



Pyro, Ltd. photos

Picture of the moon taken with TV equipment shows craters in sharp detail. Right, monitor used in process

TV Camera on Telescope Provides Better Image

Television is extending the range of a 12-inch and a 25-inch telescope at England's Cambridge University. A TV camera in the base of a telescope "shoots" a faint image which is greatly boosted in strength by electron multipliers. The picture passes through an image-storage tube and appears on a TV-picture screen. The image can then be photographed for future reference. Results indicate that similar electron telescopes may someday extend man's view of the universe. The nature of light is such that sensitive receivers like the human eye or film plate are capable of responding to only a fraction of the light particles, or photons, reaching them. The new technique has been used in photographing the moon, Jupiter and Saturn.

TV equipment is mounted directly on the telescope, a 12-inch reflector. A 25-inch scope is also used



Wasplike Glider Wins World Championship for German Builder



Winner of the glider event of the 1955 model-airplane world championships in Mainz, Germany, is Rudolf Lindner (at right in photo, holding winning glider). The 24-year-old Bavarian took 886 points out of a possible 900 with his wasplike glider. Lindner also was the 1954 champion.

☐ Nature has simplified uranium hunting on the Colorado plateaus where mineralized zones, exposed by erosion on steep cliff walls, can be detected without costly drilling.



Hughes works on small version of snow sweeper that once ran on New York City's Third Avenue trolley line

He Keeps the Trolleys Alive

By Albert Pione

TROLLEYS were in their heyday when Alfred L. Hughes of Wilmington, Del., was a young man.

His favorite week-end sport consisted of riding swaying, wheel-clacking interurbans to the end of connecting lines after exhausting all transfer possibilities.

In the 1920s, Hughes' trolley ramblings took on a "requiem" air as line after line suspended operations.

For a time Hughes consoled himself by making the last run and preserving a souvenir of the sad occasion. Lights, straps, bells and destination signs—the makings of a potential museum of trolley lore—are stored in his basement.

Then, one day in 1947, Hughes decided his favorite but fading form of transportation deserved a more fitting memorial.

He decided to build trolley models. His

first was a Wilmington trolley—scaled $\frac{1}{2}$ inch to a foot, as are 6 subsequent models.

The car was equipped with reversible seats, signs, fare collectors, windows, brakes and couplings. Wheels, trucks and axles were turned on a lathe.

Bodies were fabricated of wood and metal and painted with original colors, names and destination signs. Old snapshots, visits to former trolley-car operators, pilgrimages to remaining trolley cars and Hughes' memory provided working plans.

The models take Hughes a year each to construct, working several hours a night—but he's in no hurry.

Hughes is devoted to his mission of constructing accurate reproductions. Through them he hopes to preserve memories and to show today's youngsters how Dad used to travel. ★ ★ ★

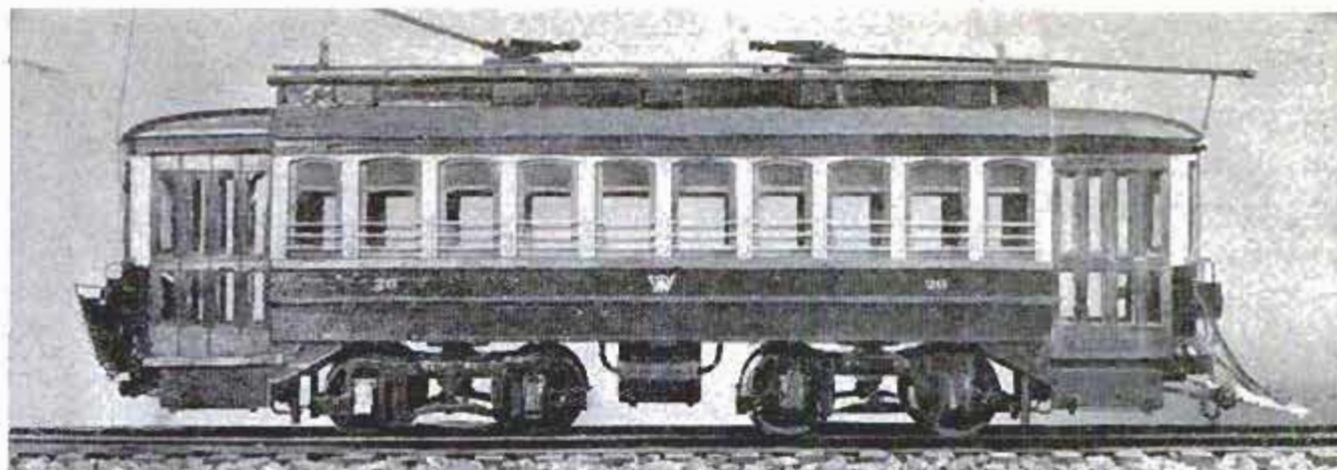

First model made by Hughes was this trolley from the Wilmington and Philadelphia Traction Co., which last ran in 1941



Composite model of a trolley repair car



Model of a typical car used on the Southern Pennsylvania Traction Company's line

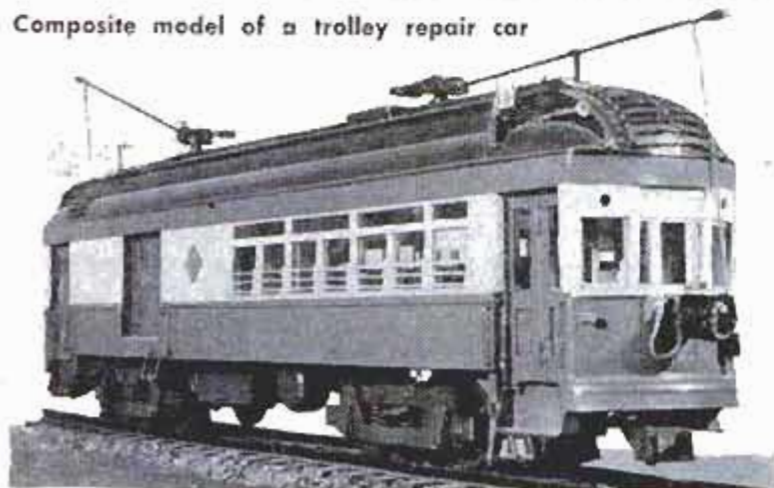

Streamlined car from the Philadelphia Suburban Co. went 80 miles per hour

Above is a typical interurban baggage and passenger car. At the right, an open-air summer trolley that was once used in Wilmington by the Wilmington and Brandywine Springs Railway Co. for excursions and outings. This is Hughes' favorite



THIS IS YOUR YEARBOOK of automobiles for 1956. On these 49 pages *Popular Mechanics* presents its Annual Auto Section, the story of the industry in a package. The story begins with an eight-page portfolio of paintings depicting the outstanding sports cars of the world in full color, shown against authentic backgrounds of great sports-car events. This special section brings you also photographs of all the 1956 cars, engine specifications, body dimensions and prices. Other features cover stock-car racing, a picture story of a car on the production line, and a survey telling why motorists choose the cars they buy.

THE 10 MOST REPRESENTATIVE



By **ARTHUR R. RAILTON**, *Automotive Editor*

WRAP UP THE FEELINGS of a thousand sports-car fans—and they are a worshipful, fanatic lot!—in one neat paragraph and you have this:

“A sports car is an uncomfortable, hard-riding, magnificently made hunk of iron with acceleration, cornering ability and positive control.”

You can say it in a thousand different ways, and a thousand sports-car owners have done just that. But this one definition wraps up the subject fully and finally.

In a motor-mad land, the sports-car folks are a race apart and, as a special feature of this Annual Automobile Section, *Popular Mechanics* presents a portfolio of paintings of the most representative sports cars of the world. They were chosen by the owners themselves—not as the most popular, or the most powerful, or the fastest or best. Simply the most representative.

We put that question by ballot to several thousand owners of the glamorous breed of automobiles and

asked them at the same time to give us their definition. What is a sports car?

The 10 most representative sports cars are portrayed on these pages. Here is the way the enthusiasts of the cult ranked them, based on the frequency of listing on the ballots:

1. Jaguar
2. Porsche
3. MG
4. Ferrari
5. Austin-Healey 100
6. Mercedes-Benz 300SL
7. Triumph TR2
8. Aston Martin DB2-4
9. Lancia
10. Alfa Romeo

Here are the second 10 cars in order:

Cunningham, Bugatti, Allard, Morgan, Thunderbird, Siata, A.C. Ace, Frazer-Nash, Corvette and Pegaso.

Popular Mechanics commissioned artist Paul Hamlin to paint portraits of the

(Continued to page 169)

Reprints of these sports-car paintings printed on one side only and suitable for framing are available (as long as the supply lasts) for 25 cents in coin to cover costs. Address your request to Bureau of Information, Popular Mechanics, 200 East Ontario St., Chicago 11, Ill.

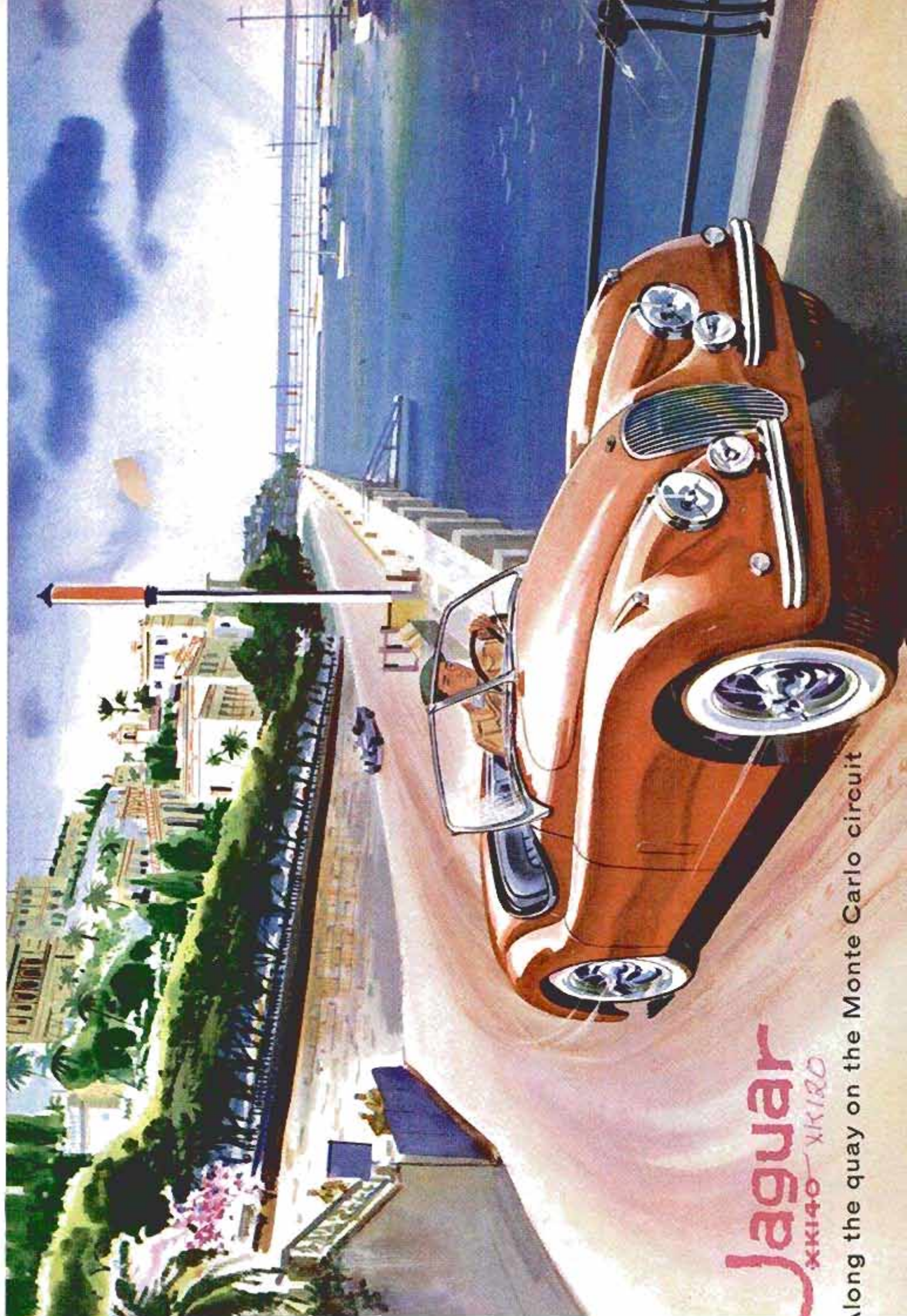

Jaguar
XK140 XK120

along the quay on the Monte Carlo circuit



Porsche
CONTINENTAL COUPE

Ordo Pass, Italy, in the Alpine Rally

THIS IS YOUR YEARBOOK of automobiles for 1956. On these 49 pages *Popular Mechanics* presents its Annual Auto Section, the story of the industry in a package. The story begins with an eight-page portfolio of paintings depicting the outstanding sports cars of the world in full color, shown against authentic backgrounds of great sports-car events. This special section brings you also photographs of all the 1956 cars, engine specifications, body dimensions and prices. Other features cover stock-car racing, a picture story of a car on the production line, and a survey telling why motorists choose the cars they buy.

THE 10 MOST REPRESENTATIVE



By **ARTHUR R. RAILTON**, *Automotive Editor*

WRAP UP THE FEELINGS of a thousand sports-car fans—and they are a worshipful, fanatic lot!—in one neat paragraph and you have this:

"A sports car is an uncomfortable, hard-riding, magnificently made hunk of iron with acceleration, cornering ability and positive control."

You can say it in a thousand different ways, and a thousand sports-car owners have done just that. But this one definition wraps up the subject fully and finally.

In a motor-mad land, the sports-car folks are a race apart and, as a special feature of this Annual Automobile Section, *Popular Mechanics* presents a portfolio of paintings of the most representative sports cars of the world. They were chosen by the owners themselves—not as the most popular, or the most powerful, or the fastest or best. Simply the most representative.

We put that question by ballot to several thousand owners of the glamorous breed of automobiles and

asked them at the same time to give us their definition. What is a sports car?

The 10 most representative sports cars are portrayed on these pages. Here is the way the enthusiasts of the cult ranked them, based on the frequency of listing on the ballots:

1. Jaguar
2. Porsche
3. MG
4. Ferrari
5. Austin-Healey 100
6. Mercedes-Benz 300SL
7. Triumph TR2
8. Aston Martin DB2-4
9. Lancia
10. Alfa Romeo

Here are the second 10 cars in order:

Cunningham, Bugatti, Allard, Morgan, Thunderbird, Siata, A.C. Ace, Frazer-Nash, Corvette and Pegaso.

Popular Mechanics commissioned artist Paul Hamlin to paint portraits of the

(Continued to page 169)

Reprints of these sports-car paintings printed on one side only and suitable for framing are available (as long as the supply lasts) for 25 cents in coin to cover costs. Address your request to Bureau of Information, Popular Mechanics, 200 East Ontario St., Chicago 11, Ill.



First model made by Hughes was this trolley from the Wilmington and Philadelphia Traction Co., which last ran in 1941



Composite model of a trolley repair car



Model of a typical car used on the Southern Pennsylvania Traction Company's line



Above is a typical interurban baggage and passenger car. At the right, an open-air summer trolley that was once used in Wilmington by the Wilmington and Brandywine Springs Railway Co. for excursions and outings. This is Hughes' favorite



Streamlined car from the Philadelphia Suburban Co. went 80 miles per hour



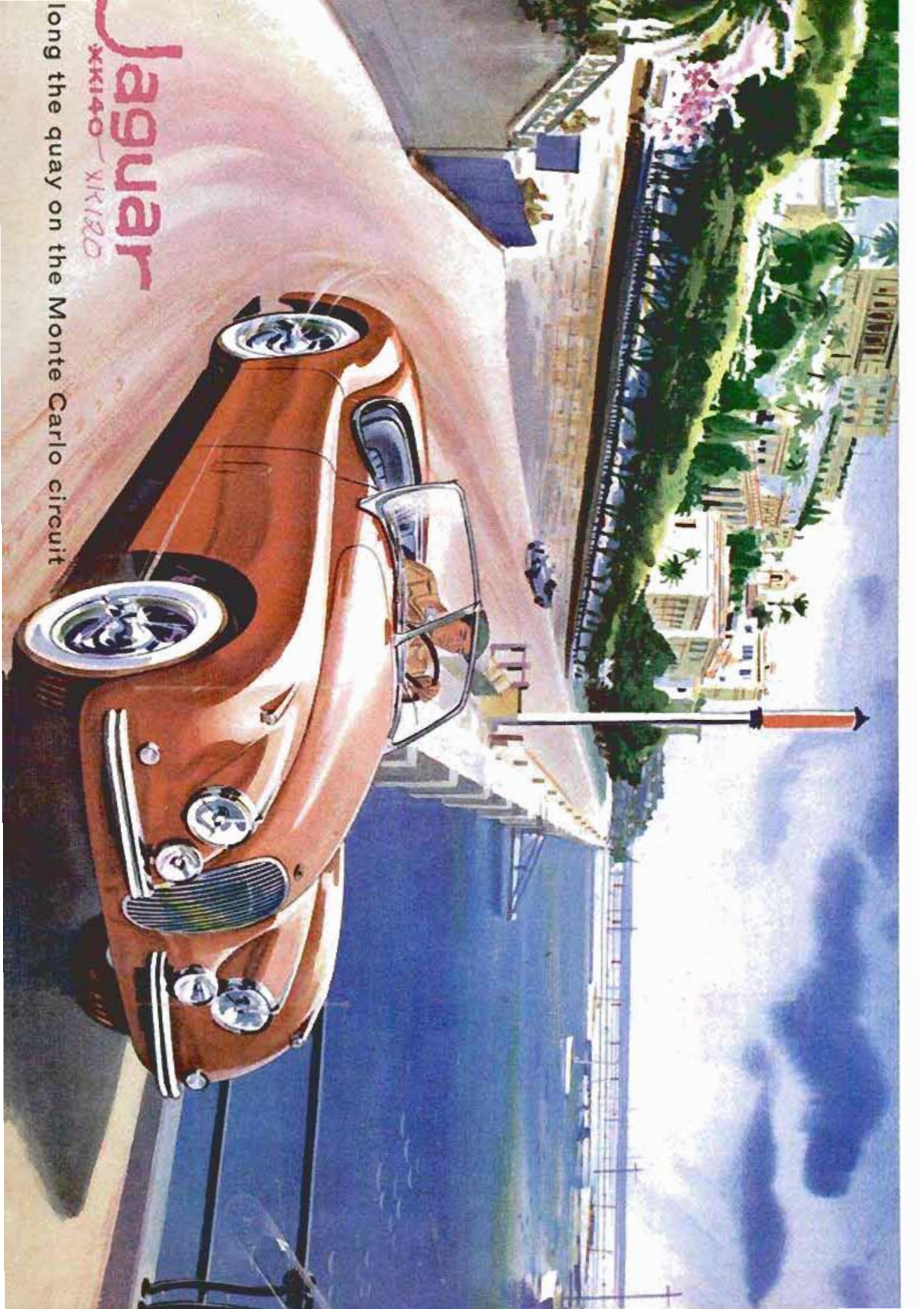

Jaguar

XK140 — XK150

long the quay on the Monte Carlo circuit

Porsche

CONTINENTAL COUPE

at Pordoi Pass, Italy, in the Alpine Rally



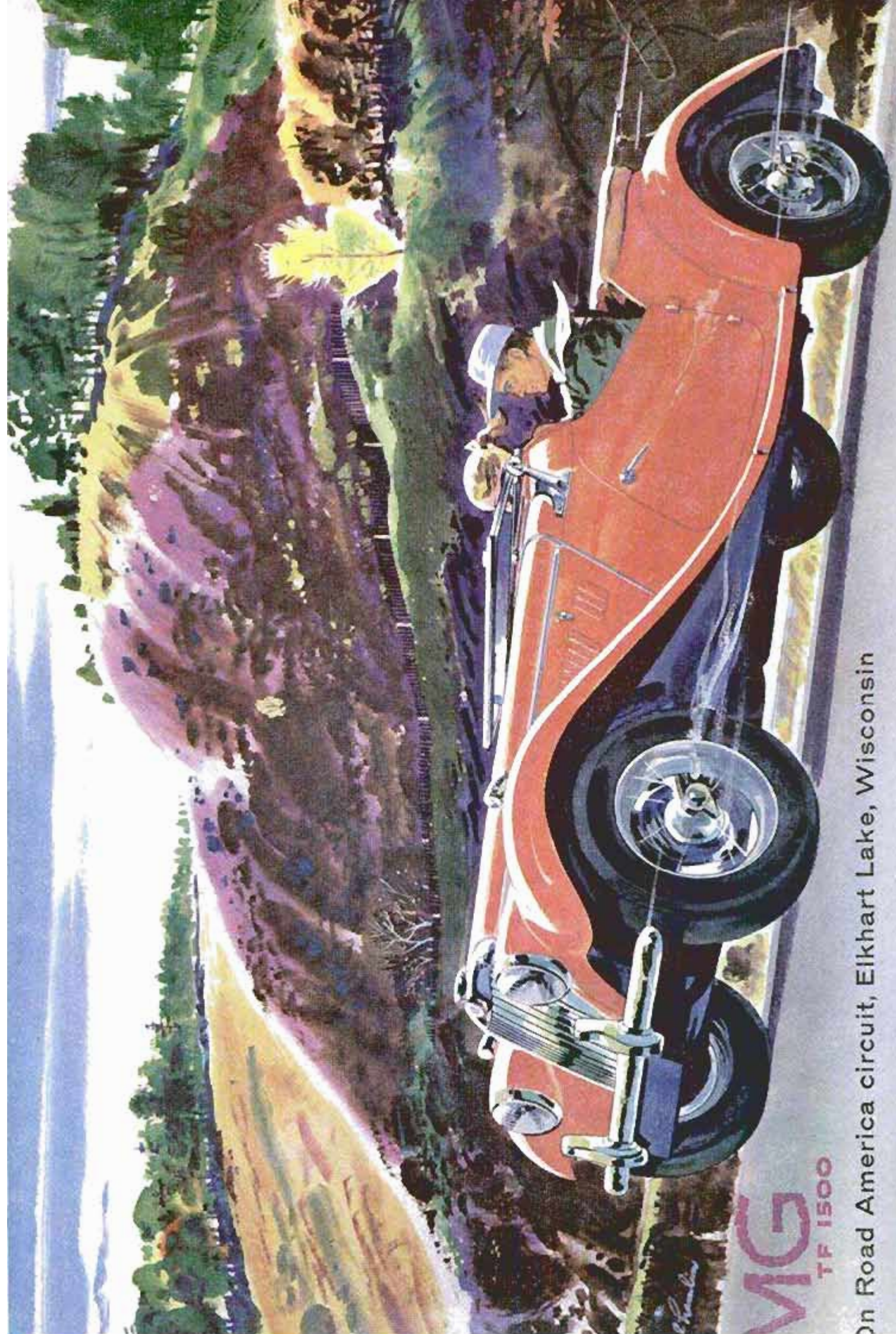

MG
TF 1500

On Road America circuit, Elkhart Lake, Wisconsin

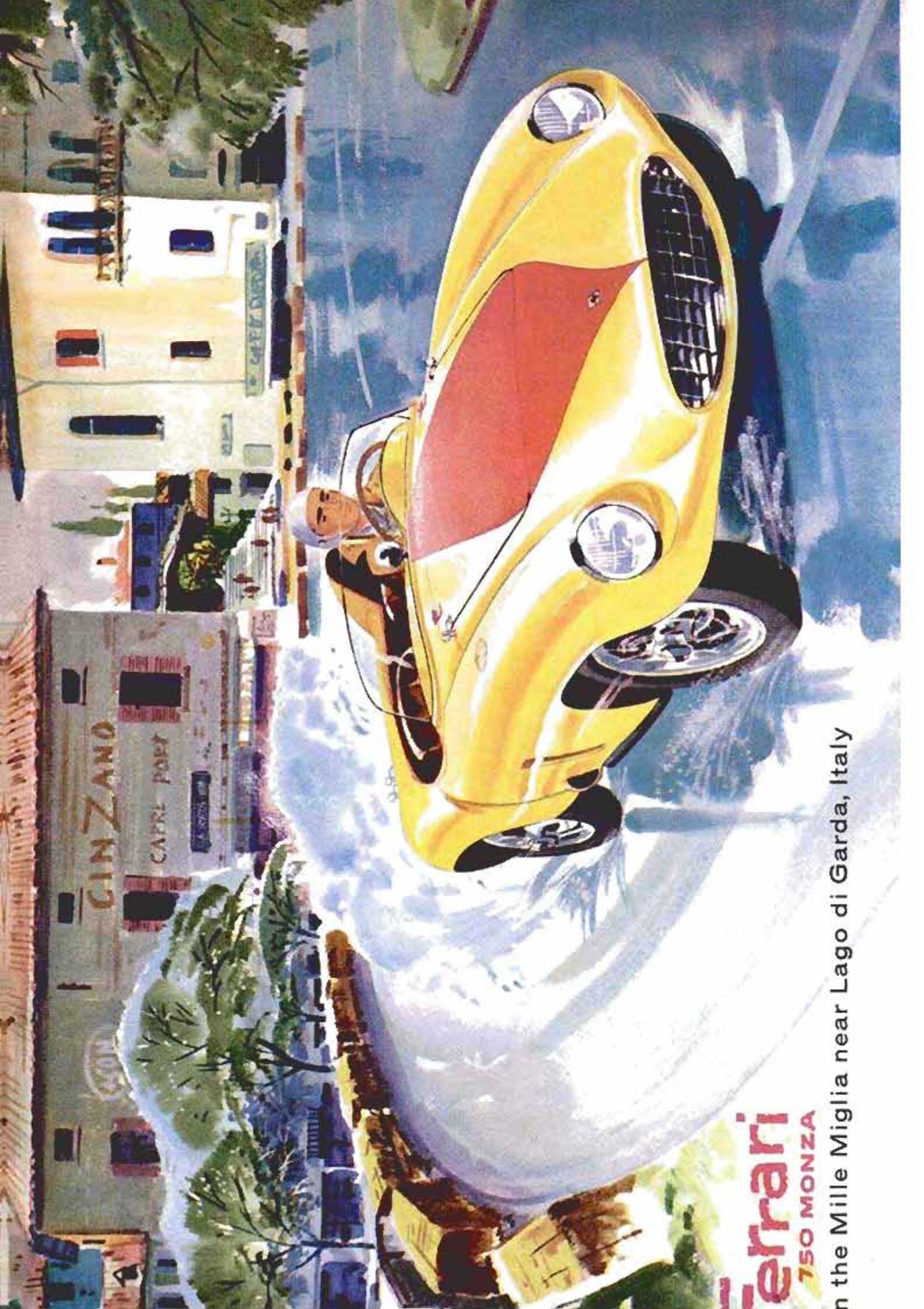

Ferrari
750 MONZA

in the Mille Miglia near Lago di Garda, Italy

Austin-Healey 100

the Mulsanne Straight, Le Mans, France



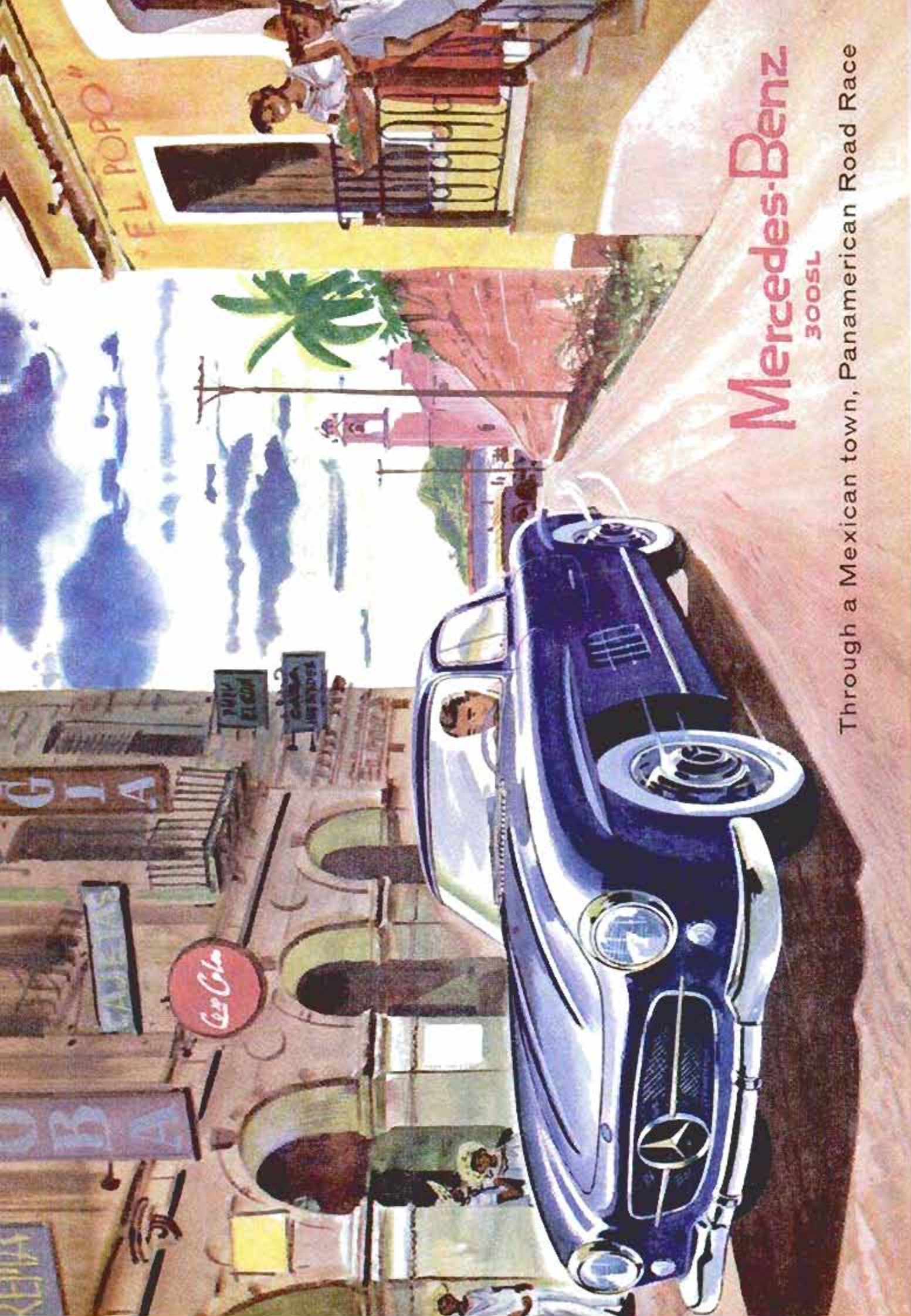

Mercedes-Benz 300SL

Through a Mexican town, Panamerican Road Race



Triumph
TR2

Aston Martin
DB2-4

Passing the stands on England's Aintree circuit



Lancia
SPYDER

Cornering on the hilly Targa Florio in Sicily

Alfa Romeo

GIULIETTA SPRINT

Sport Cars of the World

(Continued from page 160)

first 10 cars. He has pictured them in settings appropriate to the sport.

Each of the eight settings is a famed sports-car racing circuit. All are European except for the newly opened Road America course near Elkhart Lake, Wis., and the PanAmerican course in Mexico.

What Is a Sports Car?

Definitions sent in by the enthusiasts range from terse statements of mechanical formulas to lyrical paragraphs of poetic praise.

Most enthusiasts look upon the sports car as more than a machine—although it must be a fine piece of machinery first of all. It is more than steel, rubber and glass, it is something to be experienced. Like a good dancing partner, it seems to anticipate the driver's actions. Yet it demands something of the driver. It is not, and must never be, automatic. Together, the car and driver are a team—like a polo player and his pony.

A sports car is a vehicle that makes driving fun. It is not, as many persons think, a car that must be driven fast to be fun—although driving fast is certainly part of the fun. But it's a car that makes you a bit reluctant to get out when you arrive at your destination. After you have driven from A to B, you are likely to find yourself wishing you were back at A so you could make the trip over again.

It's a car that makes driving on crowned, winding, narrow roads an adventure rather than a chore. Sports-car drivers don't head for the straight-as-string super-highways. They prefer the back roads, the winding, hilly roads. This preference may help explain why sports cars are less popular in the flat lands of the mid-continent than on the coasts.

The more turns—corners, the enthusiast calls them—the better; the sharper the corner, the better. Because it is in cornering that the sports car excels. The corner is to the sports-car driver what Hamlet is to the actor—it provides a stage to display his talents.

But if any single word defines the sports car, that word is probably *fun*. A sports car is fun—fun to own, fun to drive and fun to take care of.

And, say the enthusiasts, fun is something that has disappeared from the family car of 1956. The family car has performance (many will out-accelerate and out-run most sports cars). The family car has speed and comfort, but the fun is gone.

And it is that one commodity, fun, which makes addicts of the sports-car owners, despite the inconvenience of size, the discomfort of leaky side curtains and the stony silence of outraged wives.

It is an odd man indeed who, after an hour at the wheel of a sports car, isn't a bit regretful as he turns back to his comfortable, fast, roomy family car.

Enthusiasts' Definitions

The most common definition by the owners in our survey stresses the dual qualities of the sports car: the fact that you can race it on Saturday, take it to church on Sunday and to work the rest of the week. Here are some quotations from the ballots:

"A car which can be used both for everyday driving and racing."—Westport, Conn.

"A car capable of running a closed circuit and of being used daily. It must accelerate from 0 to 100 and stop in under 60 seconds."—Houston, Tex.

The one sports-car characteristic the owners mention most frequently is roadability—all sports cars must have plenty of that. Excellence of handling is the second most important attribute, owners say.

Here are some more quotations from the sports-car enthusiasts:

"A car that through acceleration, braking and suspension puts the sport back into driving."—Salt Lake City, Utah.

"A car whose characteristics make it outstandingly fun to drive because it becomes a part of one's own reflexes."—Albuquerque, N. Mex.

"It starts, stops and corners when the driver commands."—Kansas City, Mo.

"An uncomfortable, hard-riding, magnificently made hunk of iron with acceleration, cornering stability and positive control."—Waukesha, Wis.

"You don't define it, you feel it."—Buchanan, Mich.

"A love on wheels."—Buffalo, N. Y.

"When you can't wait for the next hairpin curve you're driving one."—Scranton, Pa.

"Applied economy of terse motions."—Detroit, Mich.

"A car which you drive instead of the car driving you."—Geneva, N. Y.

"Fun to drive. Becomes an extension of your arms and legs."—St. Louis, Mo.

"Quick. Firm in its ride. And quite safe even at extremes in driving conditions."—Sheboygan, Wis.

(Continued to page 298)

Parade of '56 Cars

THIS IS a face-lift year, in the vernacular of the industry. The alternate year in the two-year cycle is a year devoted mainly to minor modifications in appearance and performance. Cynically, some of them might be termed simply corrections of last year's mistakes.

But 1956 is the year of at least four uniform changes in the industry: License-plate sizes were standardized to 6 by 16 inches, all cars have the new sealed-beam headlamps and directional signals, and the industry is wholly on a 12-volt-battery system.

(Continued to page 328)

WHAT IS A **Spec**Rating?

To help you decide which car is most suitable for you, *PM* offers a system of ratings by specifications. Here is what it consists of:

Interior—the total inches (front and rear) of headroom, legroom, hiproom, shoulder room, seat height and clearance between the steering wheel and front seat. The larger the total, the more room you will find inside the car.

Exterior—the sum, in inches, of the over-all length and over-all width. The larger the number, the more room the car will take up on the street or in your garage.

Power factor—a mathematical indication of performance. It is the shipping weight divided by the horsepower. The smaller the number, the faster the car should respond to the throttle.

All ratings and prices are for four-door sedans only, except in sports-type cars and the Continental. For a listing of cars as they are grouped in price classes see page 328.

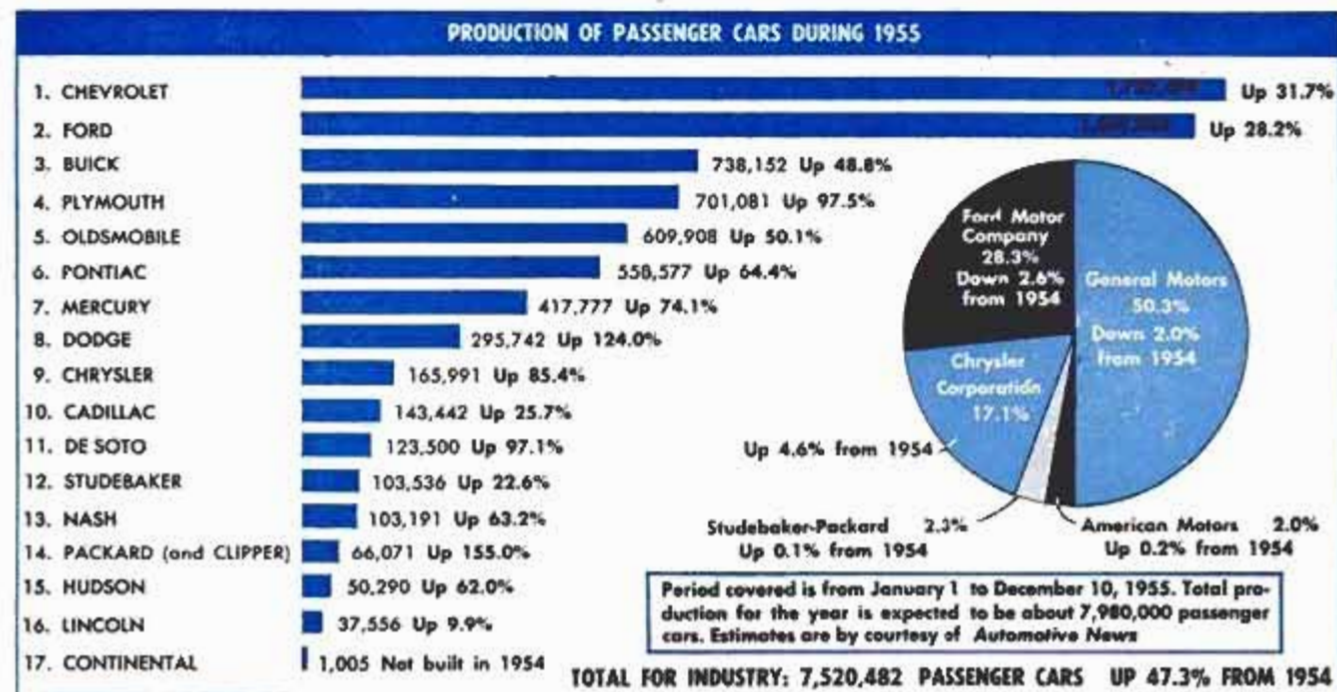



Most that's new at Buick is in the chassis: 352-cubic-inch V8 engine in all series, new rear axle, new front suspension, direct-acting shocks in the rear, a second-stator in Dynaflow transmission

Buick

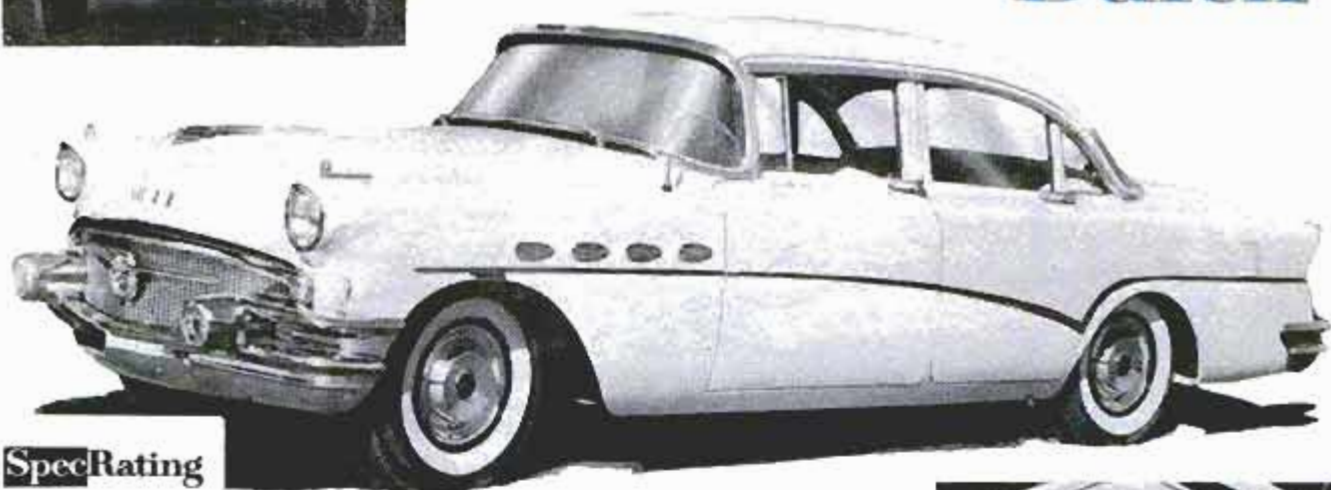

SpecRating

Interior: Special V8: 422.4 inches, 8th roomiest of 10 in Class B
 Century V8: 422.4 inches, 8th roomiest of 9 in Class C
 Super V8: 440.3 inches, 3rd roomiest of 9 in Class C
 Roadmaster V8: 442.6 inches, 2nd roomiest of 9 in Class D

Exterior: Special V8: 280.6 inches, 9th largest of 11 in Class B
 Century V8: 280.6 inches, 9th largest of 9 in Class C
 Super V8: 293.6 inches, 3rd largest of 9 in Class C
 Roadmaster V8: 293.6 inches, 10th largest of 10 in Class D

Power factor: Special V8: 17.2 pounds, 16th best of 25 in Class B
 Century V8: 16.1 pounds, 7th best of 13 in Class C
 Super V8: 16.5 pounds, 8th best of 13 in Class C
 Roadmaster V8: 16.8 pounds, 8th best of 10 in Class D



As at Buick, most of the Cadillac story this year is out of sight. Styling changes are minor, but under the hood is a new engine and a re-engineered Hydra-Matic that shifts with the help of a dump-and-fill clutch

Cadillac

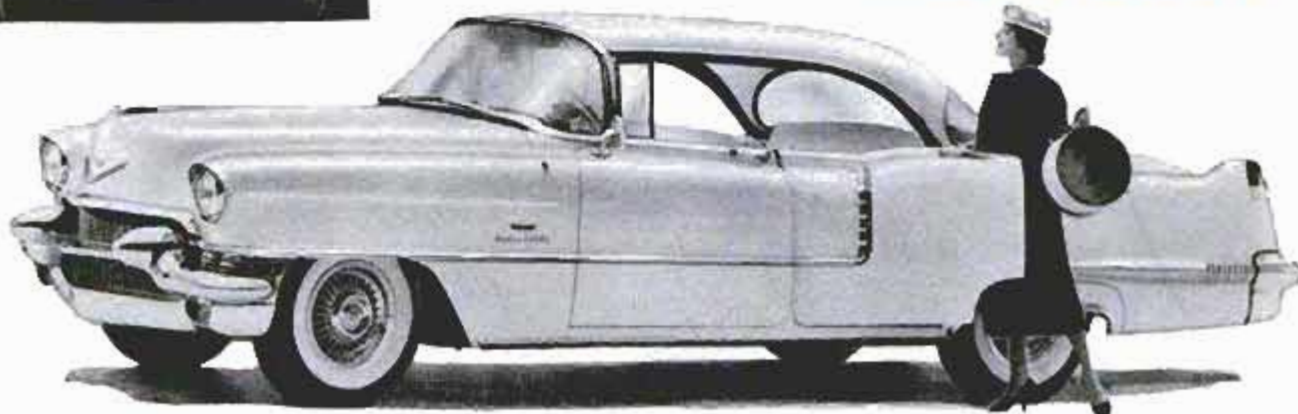

SpecRating

Interior:
 62 and 60 Special V8: 440.9 inches, 3rd roomiest of 9 in Class D
 75 V8: 470.5 inches, roomiest of 9 in Class D

Exterior:
 62 V8: 294.9 inches, 9th largest of 10 in Class D
 60 Special V8: 305.9 inches, 4th largest of 10 in Class D
 75 V8: 315.7 inches, 2nd largest of 10 in Class D

Power factor:
 62 V8: 15.6 pounds, 5th best of 10 in Class D
 60 Special V8: 16.2 pounds, 6th best of 10 in Class D
 75 V8: 17.8 pounds, 9th best of 10 in Class D



Packard is grooming a superprestige line of Caribbeans. Initially just a convertible, it now has added a hardtop. Featured are reversible seat cushions (fabric on one side, leather on the other) and 310 hp.



Caribbean



SpecRating

Interior: 418.2 inches, 3rd roomiest of 5 in Class E
Exterior: 296.5 inches, 3rd largest of 5 in Class E
Power factor: 14.0 pounds, 4th best of 10 in Class E

Once a car for conservative Charlies, Chevie is now a bomb! With power pack, it has the top horsepower-weight ratio in its field. Gone this year is its plain, compact grille. Now it's bigger, more conventional



Chevrolet



SpecRating

Interior: 426.1 inches, 2nd roomiest of 5 in Class A
Exterior: 271.5 inches, 4th largest of 5 in Class A
Power factor:
One-Fifty V8 with pack: 15.5 pounds, best of 16 in Class A
Bel Air V8: 19.5 pounds, 10th best of 16 in Class A
Two-Ten V8: 19.7 pounds, 11th best of 16 in Class A
One-Fifty 6: 22.9 pounds, 13th best of 16 in Class A



For the first time, Chrysler has given its Windsor series a different grille treatment from the New Yorker. Left is the Windsor; below, the New Yorker. New styling trick at Chrysler is the upswept tailfin

Chrysler



SpecRating

Interior: Windsor V8: 436.4 inches, 4th roomiest of 9 in Class C
 New Yorker V8: 436.4 inches, 4th roomiest of 9 in Class D
 Exterior: Windsor V8: 298.7 inches, largest of 9 in Class C
 New Yorker V8: 302.2 inches, 6th largest of 10 in Class D
 Power factor:
 Windsor with pack: 15.6 pounds, 4th best of 13 in Class C
 Windsor V8: 17.3 pounds, 11th best of 13 in Class C
 New Yorker V8: 14.7 pounds, best of 10 in Class D



With two championships behind it (see page 188), the Chrysler 300 offers a new version, the 300B. At this writing, horsepower is unannounced, but informed and conservative opinion is that it will be a big 330

Chrysler 300



SpecRating

Interior: 422.2 inches, 2nd roomiest of 5 in Class E
 Exterior: 301.5 inches, 2nd largest of 6 in Class E
 Power factor: 12.3 pounds (estimated), 3rd best of 10 in Class E



On its own this year, the Clipper is no longer billed as a small Packard. It features torsion-bar suspension, push-button shift and electric door locks—you press a button and lock all four doors at one time

Clipper



SpecRating

Interior: 427.4 inches, 6th roomiest of 9 in Class C
Exterior: 292.8 inches, 4th largest of 9 in Class C
Power factor:
Custom V8: 14.1 pounds, best of 13 in Class C
Super V8: 15.3 pounds, 3rd best of 13 in Class C
Deluxe V8: 15.3 pounds, 2nd best of 13 in Class C

Retaining the flavor of the original Continental, the Mark II has an important extra—engineering. It is no secret that the original was weak under its handsome body. Mark II is a thoroughbred all the way

Continental



SpecRating

Interior: 408.5 inches, 9th roomiest of 9 in Class D
Exterior: 296.0 inches, 8th largest of 10 in Class D
Power factor: unknown due to undisclosed horsepower



After taking a beating from the Thunderbird in sales during 1955, the Corvette is coming back with a Sunday punch. Loaded with power and comfort features (page 193), the '56 model aims to cut into its rival's market

Corvette

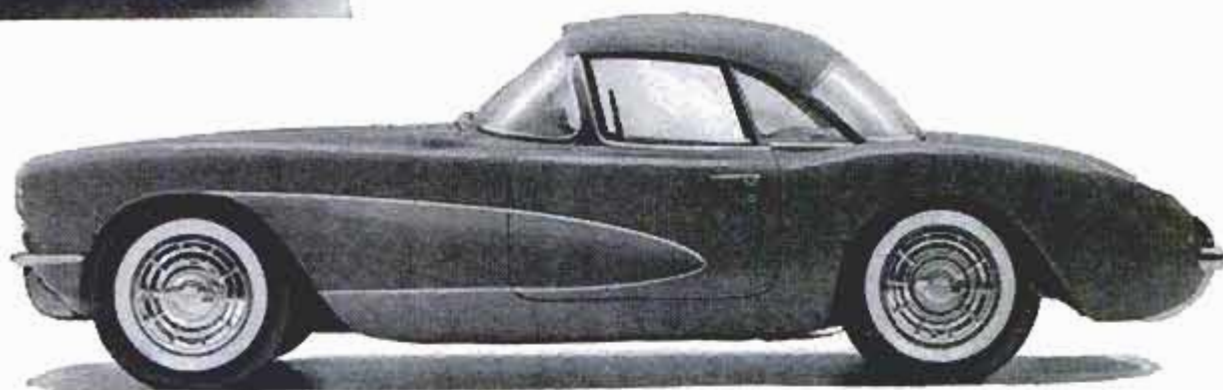

SpecRating

Interior: Not available
Exterior: 238.5 inches, 6th largest of 6 in Class E
Power factor: 11.9 pounds, best of 10 in Class E



For the first time in years, the De Soto appears in public without its front teeth! The new front grille has a simple mesh pattern that makes the car seem lower and wider. De Soto also has four separate taillights

De Soto

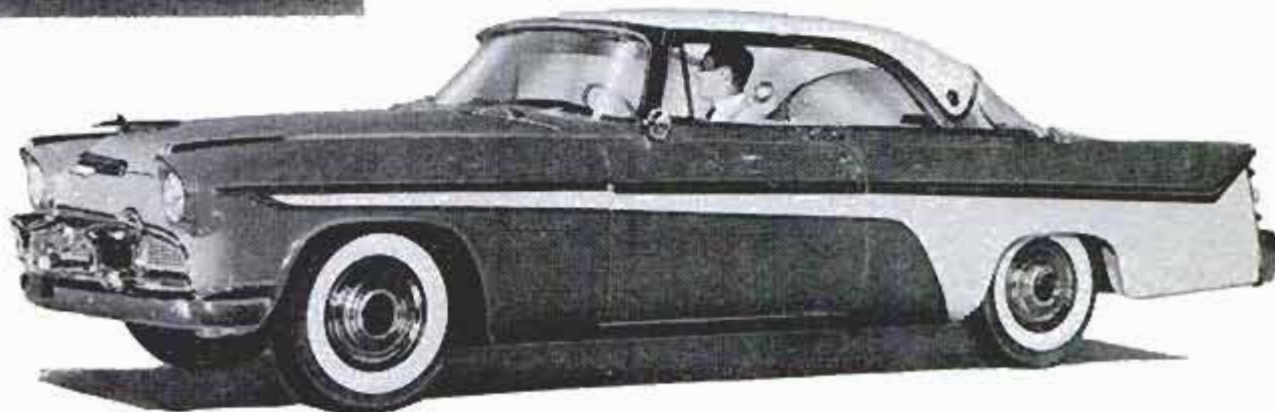

SpecRating

Interior:
Firedome V8: 436.4 inches, 3rd roomiest of 10 in Class B
Fireflite V8: 436.4 inches, 4th roomiest of 9 in Class C
Exterior:
Firedome V8: 296.2 inches, largest of 11 in Class B
Fireflite V8: 296.2 inches, 2nd largest of 9 in Class C
Power factor:
Firedome V8: 16.8 pounds, 13th best of 25 in Class B
Fireflite V8: 15.7 pounds, 5th best of 13 in Class C



With jutting rear fenders and an emphatic color sweep along the side, Dodge looks like an airplane. And it almost went like one on the Utah salt flats when it covered the flying mile at a record 114.05 m. p. h.



Dodge

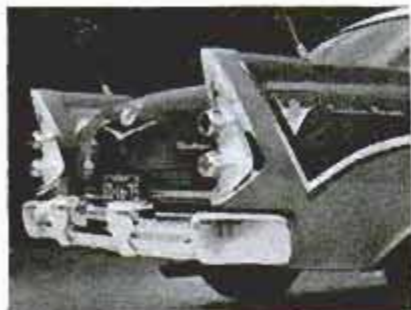

SpecRating

Interior: 432.6 inches, 4th roomiest of 10 in Class B

Exterior: 286.6 inches, 5th largest of 11 in Class B

Power factors:

Super Royal V8 with pack: 15.2 pounds, best of 25 in Class B

Custom Royal V8 with pack: 15.4 pounds, 2nd best of 25 in Class B

Super Royal V8: 16.1 pounds, 6th best of 25 in Class B

Custom Royal V8: 16.3 pounds, 8th best of 25 in Class B

Coronet V8: 18.3 pounds, 17th best of 25 in Class B

Coronet 6: 25.4 pounds, 23rd best of 25 in Class B

Now a "mere" souped-up Cadillac with fins (right, bottom), soon the very elegant Eldorado Brougham (center) will vie with the swank Continental



Eldorado

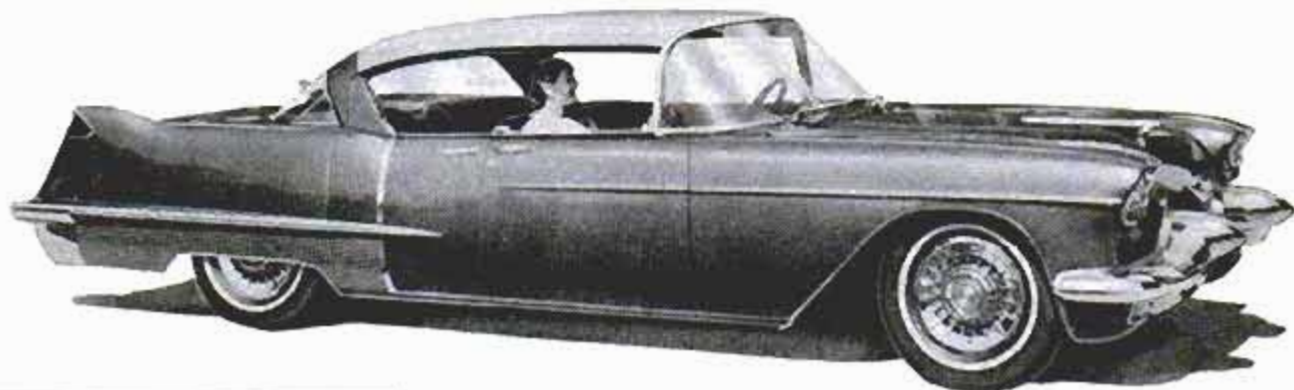

SpecRating

Interior: 424.9 inches, roomiest of 5 in Class E

Exterior: 302.2 inches, largest of 6 in Class E

Power factor: 15.3 pounds, 6th best of 10 in Class E



Styling changes on the Ford are minor. Emphasis this year is on safety (door latches, concave steering wheel, interior padding, seat belts) and increased performance from its big 292-cubic-inch V8 engine

Ford



SpecRating

Interior: 420.7 inches, 4th roomiest of 5 in Class A

Exterior: 274.4 inches, 2nd largest of 5 in Class A

Power factor:

Fairlane V8 with pack: 16.3 pounds, 3rd best of 16 in Class A

Fairlane V8: 16.5 pounds, 4th best of 16 in Class A

Customline V8: 18.7 pounds, 9th best of 16 in Class A

Mainline 6: 22.8 pounds, 12th best of 16 in Class A



Even in the all-new front grille, Hudson stresses the "V" of its styling theme. It will bring out its own American Motors V8 shortly—specifications are as yet undisclosed. Its V8 engines now come from Packard

Hudson



SpecRating

Interior:

All 6s: 440.9 inches, roomiest of 10 in Class B

Hornet V8: 440.9 inches, roomiest of 9 in Class C

Exterior:

All 6s: 287.3 inches, 3rd largest of 11 in Class B

Hornet V8: 287.3 inches, 6th largest of 9 in Class C

Power factor:

Hornet V8: 17.6 pounds, 13th best of 13 in Class C

Hornet 6 with pack: 20.2 pounds, 18th best of 25 in Class B

Wasp 6: 27.3 pounds, 25th best of 25 in Class B



Longer by five inches than in 1955, the Imperial, Chrysler's prestige car, retains its distinctive taillights atop larger rear fenders. Sales in 1955 totaled about 12,000. Sights are set on selling 16,000 this year



Imperial



SpecRating

Interior:

Imperial V8: 433.9 inches, 5th roomiest of 9 in Class D

Crown Imperial V8: 433.1 inches, 6th roomiest of 9 in Class D

Exterior:

Imperial V8: 308.4 inches, 3rd largest of 10 in Class D

Crown Imperial V8: 322.7 inches, largest of 10 in Class D

Power factor:

Imperial V8: 16.2 pounds, 7th best of 10 in Class D

Crown Imperial V8: 18.4 pounds, 10th best of 10 in Class D

One of the few all-new cars in 1956, the Lincoln is longer, lower and lusher. Horizontal lines, in front and rear, make it appear even lower than it is. The Premiere is the name of the top-price model in the line



Lincoln



SpecRating

Interior: 429.4 inches, 8th roomiest of 9 in Class D

Exterior: 302.7 inches, 5th largest of 10 in Class D

Power factor:

Capri V8: 15.0 pounds, 3rd best of 10 in Class D

Premiere V8: 15.3 pounds, 4th best of 10 in Class D



Mercury is introducing a new body style in midseason. It is the four-door hardtop model shown below. Also new this year is the Medalist, left, an austere, two-door sedan priced to compete with the low-price field

Mercury



SpecRating

Interior: Montclair V8: 416.7 inches, 9th roomiest of 9 in Class C
 Other models: 421.0 inches, 9th roomiest of 10 in Class B
Exterior: Montclair V8: 282.8 inches, 8th largest of 9 in Class C
 Other models: 282.2 inches, 6th largest of 11 in Class B
Power factor:
 Montclair with pack: 15.7 pounds, 6th best of 13 in Class C
 Montclair V8: 16.9 pounds, 9th best of 13 in Class C
 Monterey V8: 16.8 pounds, 11th best of 25 in Class B
 Custom V8 with pack: 15.7 pounds, 4th best of 25 in Class B



Nash has given its front end a sharper look by enlarging and slanting the parking lights. Headlights are inboard again. Taillights are larger. Still available is the convenient around-town two-seater, the Metropolitan, left

Nash



SpecRating

Interior: 440.9 inches, roomiest of 10 in Class B
 Ambassador V8: 440.9 inches, roomiest of 9 in Class C
Exterior: Ambassador 6: 287.3 inches, 3rd largest of 11 in Class B
 Statesman: 280.3 inches, 10th largest of 11 in Class B
 Ambassador V8: 287.3 inches, 6th largest of 9 in Class C
Power factor: Statesman 6: 24.4 pounds, 20th best of 25 in Class B
 Ambassador 6 with pack: 24.6 pounds, 21st best of 25
 Ambassador 6: 26.4 pounds, 24th best of 25
 Ambassador V8: 17.4 pounds, 12th best of 13 in Class C



Top gainer in sales of the GM family, Oldsmobile continues its simple grille treatments in 1956. New is the re-engineered Hydra-Matic transmission, which combines four-speed performance with smoothness

Oldsmobile

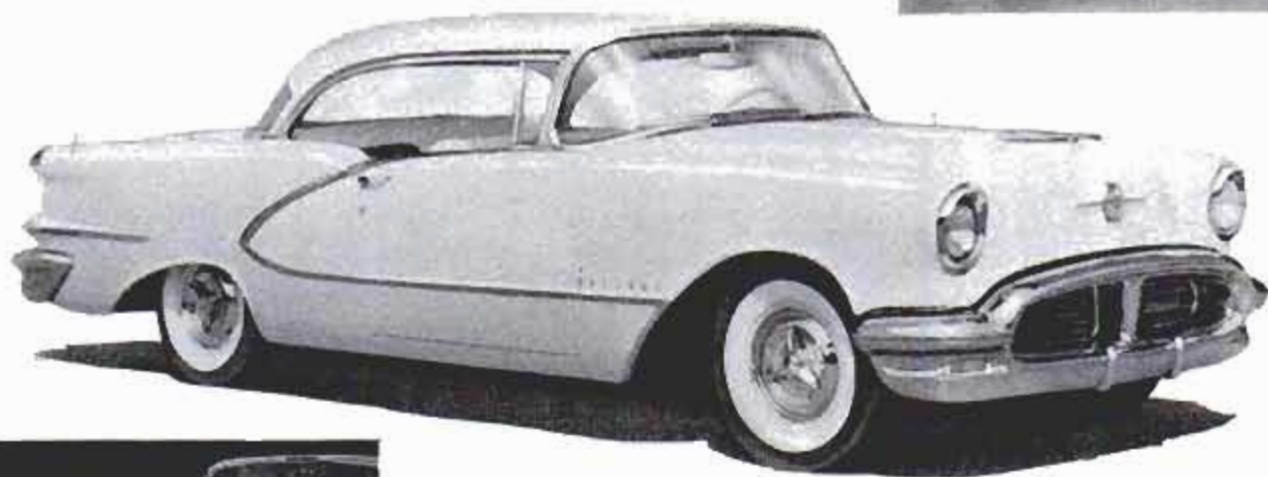

SpecRating

Interior: 88 V8: 426.6 inches, 5th roomiest of 10 in Class B
Super 88 V8: 424.7 inches, 7th roomiest of 10 in Class B
98 V8: 424.9 inches, 7th roomiest of 9 in Class C

Exterior:

88 and Super 88 V8: 281.9 inches, 7th largest of 11 in Class B
98 V8: 290.9 inches, 5th largest of 9 in Class C
Power factor: 88 V8: 16.4 pounds, 9th best of 25 in Class B
Super 88 V8: 16.2 pounds, 7th best of 25 in Class B
98 V8: 16.9 pounds, 10th best of 13 in Class C

Packard has some important firsts this year. It offers a 10:1 compression ratio, a figure engineers have been aiming at for years. It also has a nonslip differential to keep you from getting stuck when one wheel is on ice

Packard



SpecRating

Interior: 432.5 inches, 7th roomiest of 9 in Class D
Exterior: 296.5 inches, 7th largest of 10 in Class D
Power factor: 14.7 pounds, 2nd best of 10 in Class D



Hoping to continue its spectacular sales rise of 1955, Plymouth has restyled its rear fenders to give them an aerodynamic look. Also has a push-button transmission control and a dash-mounted long-playing phonograph

Plymouth



SpecRating

Interior: 431.0 inches, roomiest of 5 in Class A

Exterior: 279.4 inches, largest of 5 in Class A

Power factor:

Belvedere V8 with pack: 16.6 pounds, 5th best of 16 in Class A

Belvedere V8: 17.8 pounds, 6th best of 16 in Class A

Savoy V8: 18.2 pounds, 7th best of 16 in Class A

Plaza 6: 25.1 pounds, 15th best of 16 in Class A



Along with other General Motors cars, Pontiac has a four-door hardtop sedan. It still retains its trademark, the Silver Streaks that run down the hood. This year they are recessed so they are flush with the surface

Pontiac



SpecRating

Interior: 426.4 inches, 6th roomiest of 10 in Class B

Exterior: Star Chief: 287.7 inches, 2nd largest of 11 in Class B

860, 870: 280.7 inches, 8th largest of 11 in Class B

Power factor:

Star Chief V8: 15.7 pounds, 3rd best of 25 in Class B

860 V8: 17.0 pounds, 14th best of 25 in Class B

870 V8: 17.0 pounds, 15th best of 25 in Class B



Distinct and different, the all-new Rambler can be recognized at any angle from its wide-open competition-type grille to the pronounced arch over rear window. It has four coil springs and torque-tube drive this year



Rambler

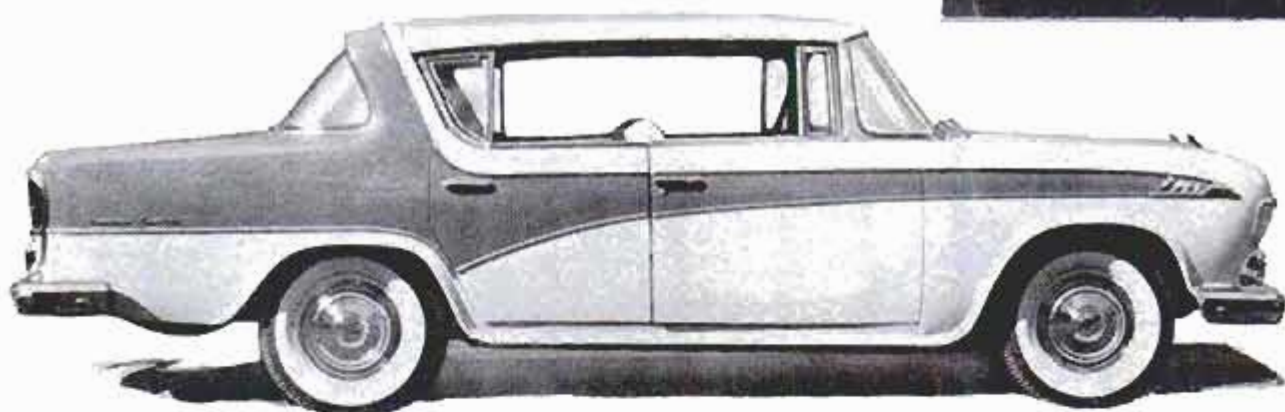

SpecRating

Interior: 421.8 inches, 3rd roomiest of 5 in Class A
 Exterior: 262.4 inches, 5th largest of 5 in Class A
 Power factor: 23.6 pounds, 14th best of 16 in Class A

One of the big stories of the year is the speed with which Studebaker stylists reshaped the body without dropping the basic shell. New also is the President Classic, four inches longer, much lusher than the others



Studebaker



SpecRating

Interior:
 All except Classic: 412.9 inches, 5th roomiest of 5 in Class A
 Classic V8: 414.9 inches, 10th roomiest of 10 in Class B
 Exterior:
 All except Classic: 272.1 inches, 3rd largest of 5 in Class A
 Classic V8: 276.1 inches, 11th largest of 11 in Class B
 Power factor:
 President V8: 15.7 pounds, 2nd best of 16 in Class A
 Commander V8: 18.5 pounds, 8th best of 16 in Class A
 Champion 6: 28.1 pounds, 16th best of 16 in Class A
 Classic V8: 16.5 pounds, 10th best of 25 in Class B



First American company to offer a full line of sports-type cars, Studebaker has named its low-slung models the Hawks. Bombshell of the line is the Golden Hawk which has the second best power factor in the industry

Studebaker Hawk



SpecRating

Interior: 401.2 inches, 4th roomiest of 5 in Class E

Exterior: 274.3 inches, 4th largest of 6 in Class E

Power factor:

Golden Hawk V8: 12.2 pounds, 2nd best of 10 in Class E

Power Hawk V8: 18.2 pounds, 8th best of 10 in Class E

Skyhawk V8: 18.9 pounds, 9th best of 10 in Class E

Flight Hawk 6: 27.5 pounds, 10th best of 10 in Class E



After its initial success (and with 16,155 of them sold it certainly was!), Ford made only minor styling changes in the Thunderbird. Most obvious is mounting spare tire outside the trunk to increase luggage space

Thunderbird



SpecRating

Interior: 203.6 inches, 5th roomiest of 5 in Class E

Exterior: 256.4 inches, 5th largest of 6 in Class E

Power factor:

Handshift V8: 15.8 pounds, 7th best of 10 in Class E

Fordomatic V8: 14.6 pounds, 5th best of 10 in Class E

Note: Interior dimensions are for front seat only



SPECIFICATIONS OF THE 1956 CARS

	RETAIL PRICE 4-DOOR SEDAN	SHIPPING WEIGHT	WHEELBASE	OVER-ALL LENGTH	OVER-ALL WIDTH	OVER-ALL HEIGHT	TURN-CIRCLE DIAMETER	DISPLACEMENT	MAXIMUM HORSEPOWER	COMPRESSION RATIO	MAXIMUM TORQUE	BORE AND STROKE	
RAMBLER Deluxe Six	\$1795	2891	108.0	191	71	58.0	38	195.6	120	7.4	170	3.125x4.25	RAMBLER Six
CHEVROLET 150 Six	\$1835	3205	115.0	198	73	60.5	41.5	235.5	140	8.0	210	3.563x3.938	CHEVROLET 150 Six
210 V8	\$2020	3190	115.0	198	73	60.5	41.5	265.0	162†	8.0	257	3.75 x 3.00	210 V8
*Bel Air V8	\$2223	3310	115.0	198	73	60.5	41.5	265.0	170†	8.0	257	3.75 x 3.00	*Bel Air V8
FORD Mainline Six	\$1858	3127	115.5	199	76	60.4	41.2	223.0	137	8.0	202	3.62 x 3.60	FORD Mainline Six
Customline V8	\$2051	3258	115.5	199	76	60.4	41.2	272.0	173†	8.0	260	3.62 x 3.30	Customline V8
*Fairlane V8	\$2322	3377	115.5	199	76	60.4	41.2	292.0	200†	8.0	285	3.75 x 3.30	*Fairlane V8
PLYMOUTH Plaza Six	\$1893	3143	115.0	205	75	60.1	41.1	230.0	125†	7.6	200	3.25 x 4.63	PLYMOUTH Plaza Six
Savoy V8	\$2095	3296	115.0	205	75	60.1	40.5	270.0	180†	8.0	260	3.63 x 3.256	Savoy V8
*Belvedere V8	\$2362	3371	115.0	205	75	60.1	40.5	277.0	187†	8.0	265	3.75 x 3.13	*Belvedere V8
STUDEBAKER Champion Six	\$1993	2834	116.5	201	71	60.0	38.5	185.6	101	7.8	152	3.00 x 4.38	STUDEBAKER Champion Six
Commander V8	\$2121	3139	116.5	201	71	60.0	39.0	259.2	170	7.8	260	3.56 x 3.25	Commander V8
*Pres. Classic V8	\$2674	3371	120.5	205	71	60.0	40.5	289.0	210	7.8	292	3.56 x 3.63	*Pres. Classic V8
Flight Hawk Six	\$1982	2780	120.5	204	70	56.3	40.5	185.6	101	7.8	152	3.00 x 4.38	Flight Hawk Six
Power Hawk V8	\$2097	3095	120.5	204	70	56.3	40.5	259.2	170	7.8	260	3.56 x 3.25	Power Hawk V8
Sky Hawk V8	\$2473	3217	120.5	204	70	56.3	40.5	289.0	210	7.8	292	3.56 x 3.63	Sky Hawk V8
Golden Hawk V8	\$3057	3360	120.5	204	70	56.3	40.5	352.0	275	9.5	380	4.00 x 3.50	Golden Hawk V8
DODGE Coronet Six	\$2229	3323	120	212	75	60.3	42.9	230.0	131	7.6	203	3.25 x 4.63	DODGE Coronet Six
Coronet V8	\$2336	3465	120	212	75	60.6	42.3	270.0	189	8.0	266	3.63 x 3.256	Coronet V8
*Custom Royal V8	\$2771	3542	120	212	75	60.8	42.3	315.0	218†	8.0	309	3.63 x 3.80	*Custom Royal V8
PONTIAC 860 V8	\$2259	3496	122	206	75	60.5	42.4	316.6	192	8.9	297	3.94 x 3.25	PONTIAC 860 V8
*870 V8	\$2579	3601	122	206	75	60.5	42.4	316.6	205	8.9	294	3.94 x 3.25	*870 V8
*Star Chief V8	\$2693	3681	124	213	75	60.5	43.0	316.6	227	8.9	312	3.94 x 3.25	*Star Chief V8
NASH Statesman Six	\$2345	3174	114.3	202	78	61.8	42.8	195.6	130	7.5	175	3.125x4.250	NASH Statesman Six
Ambassador Six	\$2644	3520	121.3	209	78	62.3	44.3	252.6	135†	7.6	220	3.50 x 4.375	Ambassador Six
*Ambassador V8	\$3394	3690	121.3	209	78	62.3	44.3	352.0	220	9.6	320	4.00 x 3.50	*Ambassador V8
MERCURY Custom V8	\$2370	3522	119	206	76	60.6	43.2	312.0	210†	8.0	312	3.80 x 3.44	MERCURY Custom V8
Monterey V8	\$2515	3536	119	206	76	60.6	43.2	312.0	210†	8.0	312	3.80 x 3.44	Monterey V8
*Montclair V8	\$2935	3690	119	206	76	58.8	43.2	312.0	210†	8.0	312	3.80 x 3.44	*Montclair V8
BUICK Special V8	\$2372	3790	122	205	76	60.4	41.6	322.0	220	7.6	319	4.00 x 3.20	BUICK Special V8
*Century V8	\$2980	4000	122	205	76	59.8	41.6	322.0	255	9.5	341	4.00 x 3.20	*Century V8
*Super V8	\$3205	4200	127	214	80	62.5	43.0	322.0	255	9.5	341	4.00 x 3.20	*Super V8
*Roadmaster V8	\$3458	4280	127	214	80	62.7	43.0	322.0	255	9.5	341	4.00 x 3.20	*Roadmaster V8
HUDSON Wasp Six	\$2380	3235	114.3	202	78	61.8	39.3	202.0	120†	7.5	158	3.00 x 4.75	HUDSON Wasp Six
Hornet Six	\$2729	3505	121.3	209	78	62.3	42.6	308.0	165†	7.5	264	3.813x4.50	Hornet Six
*Hornet V8	\$3444	3804	121.3	209	78	62.3	42.6	352.0	220	9.6	320	4.00 x 3.50	*Hornet V8
OLDSMOBILE 88 V8	\$2443	3761	122.0	203	79	60.5	42.0	324.3	230	9.3	340	3.875x3.438	OLDSMOBILE 88 V8
Super 88 V8	\$2595	3897	122.0	203	79	60.5	42.0	324.3	240	9.3	350	3.875x3.438	Super 88 V8
*98 V8	\$3253	4047	126.0	212	79	60.5	43.0	324.3	240	9.3	350	3.875x3.438	*98 V8
DE SOTO Firelane V8	\$2632	3875	126.0	218	78	60.6	43.8	330.4	230	8.5	305	3.72 x 3.80	DE SOTO Firelane V8
*Firelite V8	\$3074	4005	126.0	218	78	60.6	43.8	330.4	255	8.5	350	3.72 x 3.80	*Firelite V8
CLIPPER Deluxe V8	\$2731	3670	122.0	215	78	62.0	43.0	352.0	240	9.5	350	4.00 x 3.50	CLIPPER Deluxe V8
Super V8	\$2866	3680	122.0	215	78	62.0	43.0	352.0	240	9.5	350	4.00 x 3.50	Super V8
*Custom V8	\$3268	4155	122.0	215	78	62.0	43.0	352.0	275	9.5	380	4.00 x 3.50	*Custom V8
CHRYSLER Windsor V8	\$2825	3900	126.0	220	79	60.6	43.8	331.0	225†	8.5	310	3.81 x 3.63	CHRYSLER Windsor V8
*New Yorker V8	\$3728	4110	126.0	221	81	60.9	43.8	354.0	280	9.0	380	3.94 x 3.63	*New Yorker V8
300B V8	N.A.	4050	126.0	223	79	58.6	43.8	354.0	N.A.	9.0	N.A.	3.94 x 3.63	300B V8
LINCOLN *Capri V8	\$4157	4289	126.0	223	80	60.2	45.5	368.0	285	9.0	402	4.00 x 3.66	LINCOLN *Capri V8
*Premiere V8	\$4546	4362	126.0	223	80	60.2	45.5	368.0	285	9.0	402	4.00 x 3.66	*Premiere V8
PACKARD *Patrician V8	\$4160	4275	127.0	219	78	62.3	45.0	374.0	290	10.0	405	4.125x3.50	PACKARD *Patrician V8
*Caribbean V8	\$5495	4355	127.0	219	78	61.7	45.0	374.0	310	10.0	405	4.125x3.50	*Caribbean V8
CADILLAC *62 V8	\$4241	4430	129.0	215	80	62.0	43.4	365.0	285	9.8	400	4.00 x 3.625	CADILLAC *62 V8
*60 Special V8	\$4992	4610	133.0	226	80	62.0	45.0	365.0	285	9.8	400	4.00 x 3.625	*60 Special V8
*75 V8	\$6558	5050	149.8	236	80	63.9	51.7	365.0	285	9.8	400	4.00 x 3.625	*75 V8
*Eldorado V8	\$6501	4665	129.0	222	80	59.8	43.4	365.0	305	9.8	400	4.00 x 3.625	*Eldorado V8
IMPERIAL *V8	\$4780	4565	133.0	230	79	61.2	45.2	354.0	280	9.0	380	3.94 x 3.63	IMPERIAL *V8
*Crown V8	\$7551	5145	149.5	244	79	61.8	52.0	354.0	280	9.0	380	3.94 x 3.63	*Crown V8
CONTINENTAL *Hardtop V8	\$9507	4825	126.0	219	78	56.0	45.3	368.0	N.A.	9.0	N.A.	4.00 x 3.66	CONTINENTAL *Hardtop V8
THUNDERBIRD Handshift V8	\$3102	3186	102.0	185	71	52.2	38.5	292.0	202	8.4	289	3.75 x 3.30	THUNDERBIRD Handshift V8
*Fordomatic V8	\$3317	3294	102.0	185	71	52.2	38.5	312.0	225	9.0	324	3.80 x 3.44	*Fordomatic V8
CORVETTE V8	N.A.	2680	102.0	168	71	51.0	36.8	265.0	225	9.3	270	3.75 x 3.00	CORVETTE V8

NOTES AND EXPLANATIONS

All specifications (except Studebaker Hawks, Chrysler 300B, Packard Caribbean, Cadillac Eldorado, Continental, Thunderbird and Corvette) are for four-door sedans. All dimensions are in inches except turn-circle diameter (feet). Prices include all charges except freight to your city, state and local taxes (federal tax is included) and optional equipment.

† Power packs: Chevrolet 205 hp., Ford 176 hp. and 202 hp., Plymouth 131 hp. and 200 hp., Dodge 230 hp., Nash 145 hp., Mercury 225 hp., Hudson 130 hp. and 175 hp., Chrysler 250 hp.

* Price quoted includes automatic transmission.

FRONT-SEAT HEADROOM	
Hudson (in.)	37.5
Nash	37.5
Buick Roadmaster	37.4
Crown Imperial	37.0
Buick Super	36.6
Cadillac 75	36.5
Studebaker	36.5
Clipper	36.2
Packard	36.2
Plymouth	36.1
Rambler	36.0
Pontiac	36.0
Average: 35.9 inches	
Cadillac 62, 60	35.8
Chevrolet	35.6
Buick Special	35.6
Dodge	35.5
Oldsmobile	35.5
Lincoln	35.4
Buick Century	35.3
Mercury	35.2
Chrysler	35.1
De Soto	35.1
Imperial	35.1
Ford	34.9
Mercury Montclair	33.8

REAR-SEAT HEADROOM	
Crown Imperial (in.)	36.3
Hudson	36.0
Nash	36.0
Pontiac	35.9
Buick Roadmaster	35.7
Chevrolet	35.6
Studebaker	35.5
Plymouth	35.4
Buick Super	35.2
Cadillac	35.1
Imperial	35.0
Rambler	35.0
Dodge	34.9
Packard	34.9
Average: 34.8 inches	
Oldsmobile 88	34.6
Chrysler	34.5
De Soto	34.5
Clipper	34.5
Buick Century	34.4
Lincoln	34.1
Buick Special	34.0
Ford	33.9
Mercury	33.9
Olds. Super 88, 98	33.8
Mercury Montclair	32.5

DISPLACEMENT	
Packard	374.0
Continental	368.0
Lincoln	368.0
Cadillac	365.0
Chrysler	
New Yorker	354.0
Imperial	354.0
Clipper	352.0
Studebaker	
Golden Hawk	352.0
Hudson V8	352.0
Nash V8	352.0
Chrysler Windsor	331.0
De Soto	330.4
Oldsmobile	324.3
Buick	322.0
Pontiac	316.6
Dodge	
Custom Royal	315.0
Mercury	312.0
Thunderbird	
(auto. trans.)	312.0
Hudson Hornet 6	308.0
Ford Fairlane V8	292.0
Thunderbird	
(handshift)	292.0
Average: 290.2 cubic in.	
Stude. Pres. Classic	289.0
Stude. Sky Hawk	289.0
Plymouth	
Belvedere V8	277.0
Ford Customline V8	272.0
Dodge Coronet V8	270.0
Plymouth Savoy V8	270.0
Chevrolet V8	265.0
Corvette	265.0
Stude. Commander	259.2
Stude. Power Hawk	259.2
Nash Ambassador 6	252.6
Chevrolet 6	235.5
Dodge Coronet 6	230.0
Plymouth 6	230.0
Ford 6	223.0
Hudson Wasp 6	202.0
Nash Statesman 6	195.6
Rambler 6	195.6
Stude. Champion 6	185.6
Studebaker	
Flight Hawk 6	185.6

FRONT-SEAT LEGROOM	
Chrysler (in.)	45.7
De Soto	45.7
Imperial	45.7
Lincoln	44.8
Dodge	44.5
Oldsmobile 88	44.4
Ford	44.3
Plymouth	44.0
Mercury	43.8
Chevrolet	43.7
Mercury Montclair	43.7
Average: 43.6 inches	
Cadillac 75	43.4
Pontiac	43.4
Cadillac 62, 60	43.3
Clipper	43.3
Buick Roadmaster	43.2
Buick Super	43.1
Olds. Super 88, 98	43.1
Packard	43.0
Rambler	43.0
Buick Special	42.9
Buick Century	42.8
Crown Imperial	42.5
Hudson	42.5
Nash	42.5
Studebaker	42.5

REAR-SEAT LEGROOM	
Cadillac 75 (in.)	81.9
Crown Imperial	52.5
Packard	48.8
Cadillac 62, 60	46.3
Buick Roadmaster	46.3
Buick Super	45.8
Imperial	45.7
Dodge	45.0
Average: 44.8 inches	
Chrysler	44.7
De Soto	44.7
Clipper	43.8
Plymouth	43.6
Mercury	42.8
Oldsmobile 98	42.8
Chevrolet	42.6
Olds. Super 88	42.6
Oldsmobile 88	42.5
Lincoln	42.5
Pontiac	42.0
Rambler	42.0
Ford	41.9
Stude. Pres. Classic	41.0
Buick Special	40.9
Buick Century	40.6
Mercury Montclair	40.6
Hudson	40.1
Nash	40.1
Studebaker	39.0

HORSEPOWER	
(standard equip. only)	
Chrysler 300B	
(est. hp.)	330
Packard Caribbean	310
Cadillac Eldorado	305
Packard	290
Cadillac	285
Lincoln	285
Chrysler New Yorker	280
Imperial	280
Clipper Custom	275
Stude. Golden Hawk	275
Buick Century	255
Buick Super	
Roadmaster	255
De Soto Fireflite	255
Clipper Super, Deluxe	240
Olds. Super 88 and 98	240
De Soto Firedome	230
Oldsmobile 88	230
Pontiac Star Chief	227
Chrysler Windsor	225
Corvette	225
Thunderbird	
(auto. trans.)	225
Hudson V8	220
Nash V8	220
Buick Special	220
Dodge Custom Royal	218
Stude. Pres. Classic	210
Stude. Sky Hawk	210
Mercury	210
Average: 209.4 horsepower	
Thunderbird	
(handshift)	202
Ford Fairlane V8	200
Pontiac (handshift)	192
Dodge Coronet V8	189
Plymouth Belv. V8	187
Plymouth Savoy V8	180
Ford V8	173
Stude. Commander	170
Stude. Power Hawk	170
Hudson Hornet 6	165
Chevrolet V8	
(handshift)	162
Chevrolet 6	140
Ford 6	137
Nash Ambassador 6	135
Dodge Coronet 6	131
Nash Statesman 6	130
Plymouth 6	125
Hudson Wasp 6	120
Rambler	120
Stude. Flight Hawk 6	101

FRONT-SEAT HIPROOM	
Hudson (in.)	65.0
Nash	65.0
Buick Roadmaster	64.9
Buick Super	64.9
Cadillac 75	64.4
Cadillac 62, 60	64.3
Crown Imperial	63.5
Chrysler	63.3
De Soto	63.3
Clipper	62.8
Packard	62.8
Average: 62.8 inches	
Buick Special	62.5
Buick Century	62.5
Dodge	62.5
Imperial	62.5
Plymouth	62.5
Oldsmobile	62.4
Chevrolet	62.0
Pontiac	61.9
Lincoln	61.7
Mercury	60.6
Ford	60.5
Rambler	59.8
Studebaker	59.5

REAR-SEAT HIPROOM	
Buick Super (in.)	65.7
Buick Roadmaster	65.7
Cadillac 62, 60	65.2
Hudson	64.5
Nash	64.5
Chrysler	64.0
De Soto	64.0
Lincoln	63.8
Pontiac	63.1
Chevrolet	63.0
Dodge	62.8
Plymouth	62.8
Buick Century	62.6
Buick Special	62.4
Olds. Super 88	62.4
Oldsmobile 98	62.1
Average: 62.1 inches	
Clipper	62.0
Imperial	62.0
Packard	62.0
Mercury Montclair	60.5
Ford	60.3
Mercury	60.3
Rambler	60.1
Cadillac 75	59.1
Studebaker	59.0
Crown Imperial	54.5

POUNDS PER HP.	
(standard equip. only)	
Corvette	11.9
Chrysler 300B (est.)	12.3
Stude. Golden Hawk	13.3
Packard Caribbean	14.0
Clipper Custom	14.1
Thunderbird	
(auto. trans.)	14.6
Chrysler N. Yorker	14.7
Packard	14.7
Lincoln	15.0
Cadillac Eldorado	15.3
Clipper Super	
Deluxe	15.3
Stude. Sky Hawk	15.3
Cadillac	15.5
Buick Century	15.7
De Soto Fireflite	15.7
Pontiac Star Chief	15.7
Stude. Pres. Classic	15.7
T-Bird (handshift)	15.8
Olds. Super 88	16.2
Imperial	16.3
Dodge Custom Royal	16.3
Oldsmobile 88	16.4
Buick Super	16.5
Ford Fairlane V8	16.5
Buick Roadmaster	16.8
De Soto Firedome	16.8
Mercury	16.8
Oldsmobile 98	16.9
Buick Special	17.2
Chrysler Windsor	17.3
Hudson V8	17.3
Nash V8	17.4
Plymouth Belv. V8	17.8
Pontiac (handshift)	18.2
Plymouth Savoy V8	18.2
Stude. Power Hawk	18.2
Dodge Coronet V8	18.3
Crown Imperial	18.4
Average: 18.4 pounds	
Stude. Commander	18.5
Ford V8	18.7
Chev. V8 (handshift)	19.7
Hudson Hornet 6	21.2
Ford 6	22.8
Chevrolet 6	23.0
Rambler 6	23.6
Nash Statesman 6	24.4
Plymouth 6	25.1
Dodge Coronet 6	25.4
Nash Ambassador 6	26.4
Stude. Flight Hawk	27.5
Stude. Champion	28.1

COMPARE

The 1956 CARS

HIPROOM

HEADROOM

LEGROOM



MERCURY Turnpike Cruiser is only 53 inches high. It seats four. Roof sections lift when doors open. Stoplights are recessed into edge of roof above the full-wrap side windows

This Year's Crop of DREAM CARS

THERE ARE varied opinions about dream cars. Some say they forecast designs of tomorrow; some say they are more ballyhoo than science, designed for publicity, not performance; others claim they must be the discarded doodlings of frustrated stylists. Whatever they are, they come out every year at this time and here, for your reaction, is the current crop. ★ ★ ★



CADILLAC Eldorado Town car has roofless chauffeur's seat. Rear interior is as lush as a boudoir. When you lock one door, all windows go up, other door locks itself. When car is moving, rear doors are always locked for owner's protection

PACKARD Projector has stylized version of famed Packard radiator as vertical bar in front to act as grille guard, eliminating line-breaking bulges on bumper. Lights retract to enhance clean look. No chrome is used, not even around glass. Roof rolls back as door opens



CHEVROLET Impala, right, seats four, is closest of GM cars to what you may see on street. It has brushed aluminum top, receding-hairline windshield



PONTIAC Club de Mer, left, is one example of sports-car styling. It's a two seater, has small tailfin for high-speed stability, say stylists. Front-end assembly pivots, bringing lights outward when you flip switch

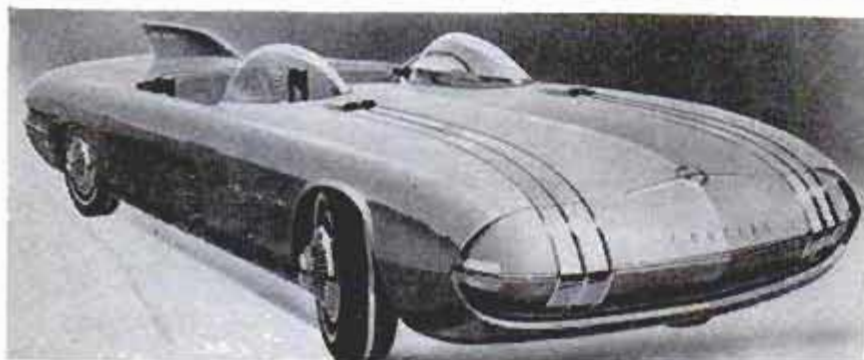

OLDSMOBILE Golden Rocket is also a two seater. Open the door, the roof raises electrically, then the seat swivels toward you and lifts up. Get in, close the door (you have to do that yourself) and the seat pivots back, lowers itself and the roof swings shut. As the name implies, it's gold colored



BUICK Centurion is a four seater with a transparent roof. There's no rear-view mirror. A TV camera in trunk lid scans the view behind and driver sees it on a screen in dashboard—just in black and white, however. Steering column is in center of car; wheel is cantilevered over to be in front of driver. Taillights are in chrome-appearing cap on end of conical tail



FIREBIRD II

Suited for the highway, Firebird II is even air conditioned. Its features: Transmission at rear between swing axles; central hydraulic system with air-oil suspension (see page 192 for a similar system); plus, of course, its gas-turbine engine with fuel-saving regenerator that makes it as cheap to run as your car—only hitch being high cost of making the blades.

HYDRAULICALLY POWERED
TAILFIN AND TRUNK RISE
TO WAIST LEVEL WHEN
BUTTON IS PRESSED

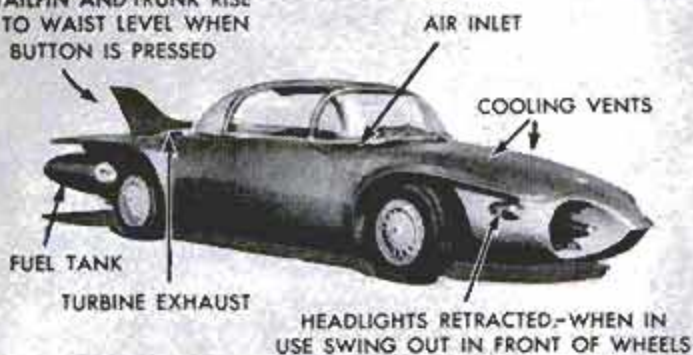

AIR CONDITIONER
INLETS

AIR CONDITIONER

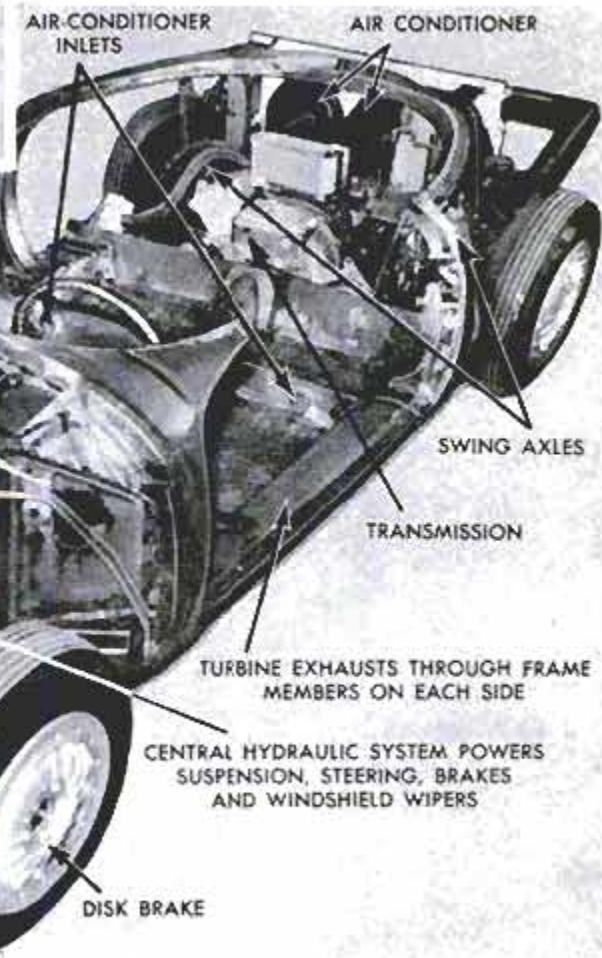

AIR-OIL SUSPENSION UNITS

REGENERATOR HOUSING

TURBINE INTAKE

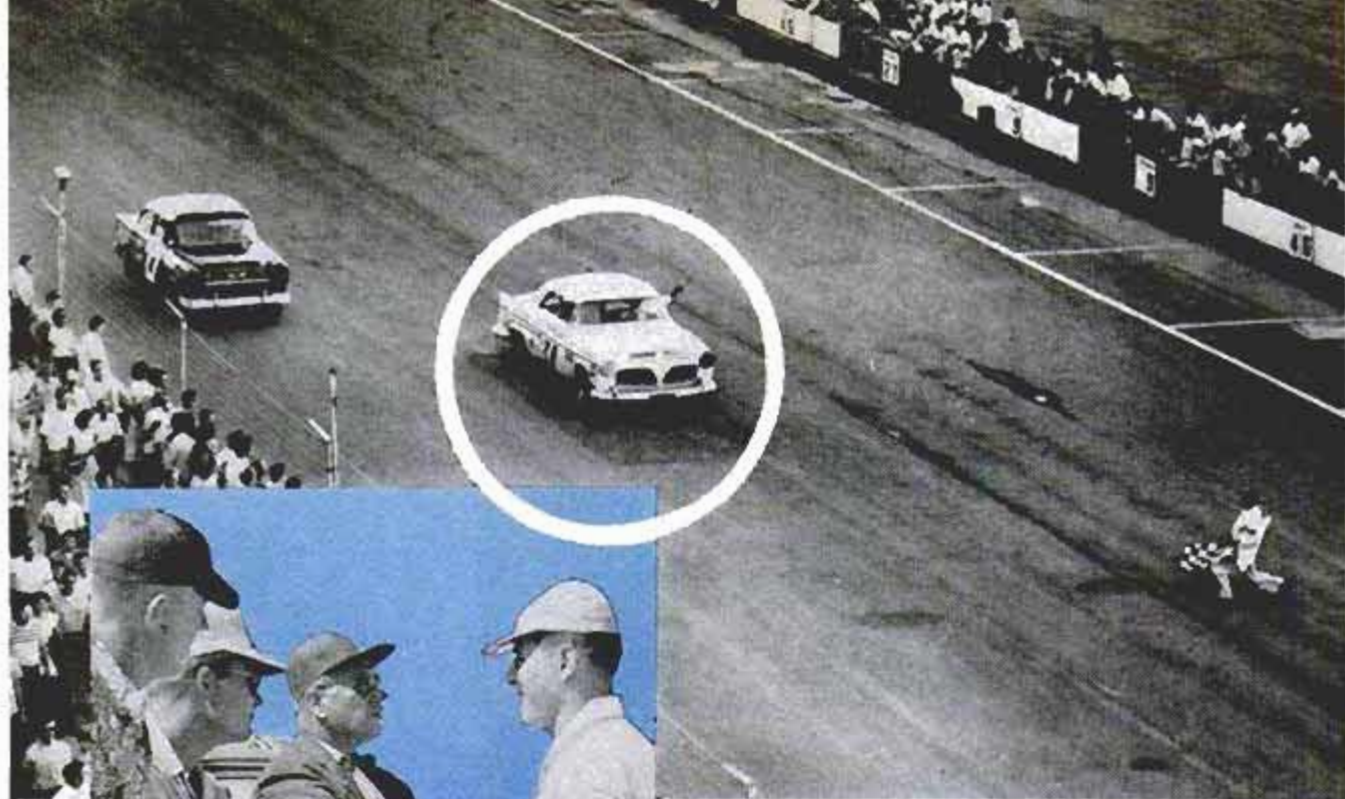

It takes more than good driving to get the checkered flag on the track. There must be plenty of prerace work by experts, one of whom is the author, shown at left (with cigar) talking to a few of his crew

By Carl Kiekhaefer

How to Win Stock-Car Races

MOST OF THE STOCK in stock-car racing is financial, not mechanical. It is the stuff the race promoter pays dividends on. There is much less that is stock in the cars!

We should know. We, at Mercury Outboard Motors, since 1951 have sponsored

various stock race cars including makes such as Chrysler, Chevrolet, Ford and Lincoln.

In 1955, our Chrysler C300s won both stock-car championships: Tim Flock winning NASCAR and Frank Mundy winning AAA. Together, Flock and Mundy won 37

Kiekhaefer poses with the two champions: Flock at left and Mundy at right, amidst their cars and trophies





Each car rides to the track in its truck. There's no point in wearing them out by towing, says the author

racers with their Chrysler C300s in the '55 season.

At this writing in the '56 season, these same cars have been in the first two NASCAR races with Tim Flock winning one and Fonty Flock, his brother, winning the other.

But we never would have won a race if our cars had been strictly stock in the sense that the public thinks of stock.

No race car can be stock if it is to win a race. A stock car would be as out of place at a "stock car" race as a midget on a college basketball team. We found that out very early.

Actually, our cars, the Chrysler C300s, are closer to stock than others on the track because the C300 engine is designed for high performance. It is a competition engine when it leaves the factory. It does not

need to be souped-up. We put it in top tune with a few minor adjustments. Even the chassis is rugged and it has exceptional handling qualities. That's why we chose the C300. Mathematically, it looked like it had the best chance.

Many other cars, especially the lighter makes, not only have to have the entire running gear completely stripped and replaced with stronger, more rugged and special parts, but have to have special engine parts installed to "hot them up."

All this is considered legal and is common knowledge in the business, or sport, if you prefer. I am not trying to say that setting-up is illegal. That would be self-incrimination! Kiekhaefer cars are the best set-up in the business. Our record proves that.

Setting-up is officially sanctioned. Cars

Kiekhaefer scraped dirt samples from engines after each race, analyzed them, came up with new air cleaners

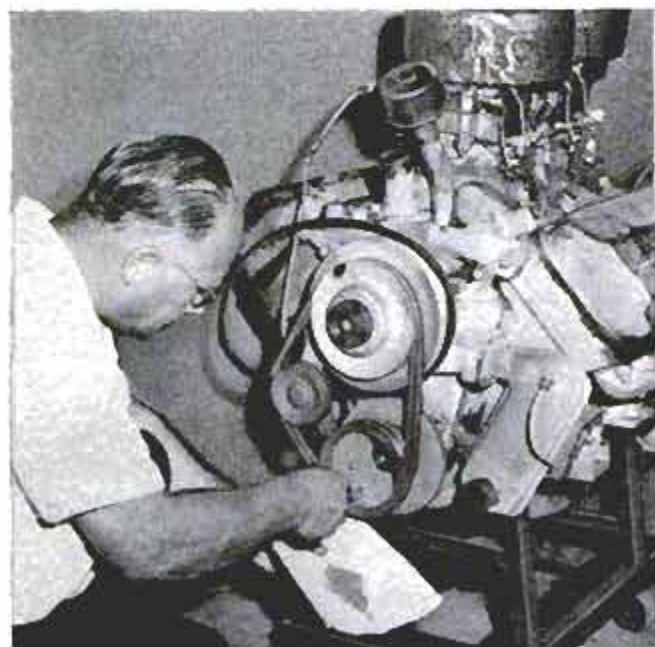

NASCAR INSPECTOR

BYSTANDERS
WATER BOY HANDS
DRIVER FLOCK A DRINK

BRINGS UP FIRE
EXTINGUISHER

STARTS TO
UNLOCK HOOD

KIEKHAEFER
TROTS UP

CHECKS FRONT TIRE

TWO-MAN FUEL TEAM

HOOD LATCH
GIVES TROUBLE

KIEKHAEFER
TALKS TO FLOCK

SECOND CAN OF GAS

JUST CLEANED
WINDSHIELD

KIEKHAEFER CHECKS
ENGINE

CLEANS REST OF WINDSHIELD

SPRAYS CO₂ ON
FUEL PUMP TO
PREVENT
VAPOR LOCK

LISTENS TO
EXHAUSTS

DUMPS IN SECOND
CAN OF GAS

KIEKHAEFER
LOCKS HOOD

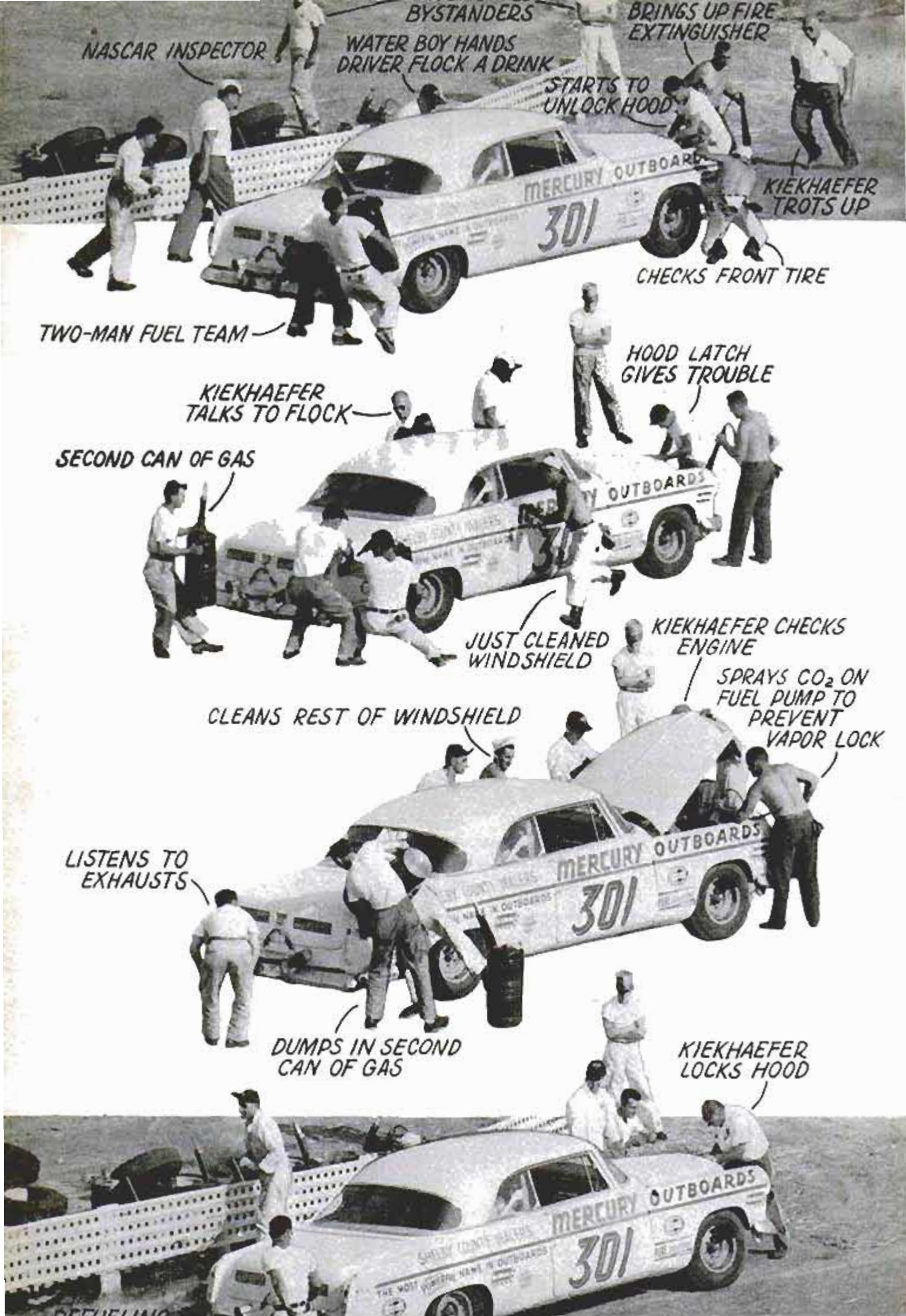

◀ Races are, as drivers know, often won and lost in the pits. These five sequence shots show precision with which the Kiekhaefer crew handles refueling

must pass inspection before or after each race, except when races are held so close together that it is impractical. Winning cars must be okayed before prize money is paid to the drivers.

However, inspection is rapid and superficial at best. Inspectors are not usually engineers. Most of the inspection consists of pulling one cylinder head and inspecting the combustion chamber, bore and stroke. There is a lot the inspectors don't (and can't) see. After all, you can't look inside a casting, nor is there time to degree the cam on all winners.

And, anyway, it is impossible to be certain what is stock, now that the auto-factory teams have arrived and are in racing for keeps.

A car manufacturer can make any part "stock" simply by notifying race headquarters that the part is available for his cars. In this way, any manufacturer who is out to win races can put a "stock" car on the track loaded with high-performance parts. Such a car is almost entirely unlike the cars his dealers sell the public. But it will win races and that makes good advertising copy. And the ads don't always list specifications.

Something else confuses the matter even more: You can make modifications that mean increased safety. So you add all sorts of bracing to the chassis in the interest of safety. You use the biggest-available tires, brakes, axles, spindles, springs and shocks, all in the interest of safety. Of course, these parts help win races. After all, you can't win a race if you break an axle or if a wheel fails due to structural inadequacy.

Let me describe the things we do to set-up our Chryslers. Much of this is standard procedure for all makes.

We reinforce the rear-axle housing by welding three angle irons along its length. We install new draglinks which we make of strong aircraft tubing. We use a front sway bar of our own manufacture. It is formed of heavier stock than the original. We inspect every factory weld we can see in the frame and reweld any that appears to need it. We reinforce the pads under and

(Continued to page 302)



Top, Ford tailpipe crossover lets the driver hear the exhaust of troublesome right bank of cylinders. The Chrysler tailpipes run straight back through trunk



Rules require safety rollbar. Kiekhaefer adds three braces to stiffen frame and make car corner better



STILL-INTERESTED BYSTANDER

KIEKHAEFER WAVES
FLOCK AWAY

FLOCK WENT ON TO WIN.
MEMPHIS, TENN.
AUG. 14, 1955

Citroen DS19—The Year's Most Original Car

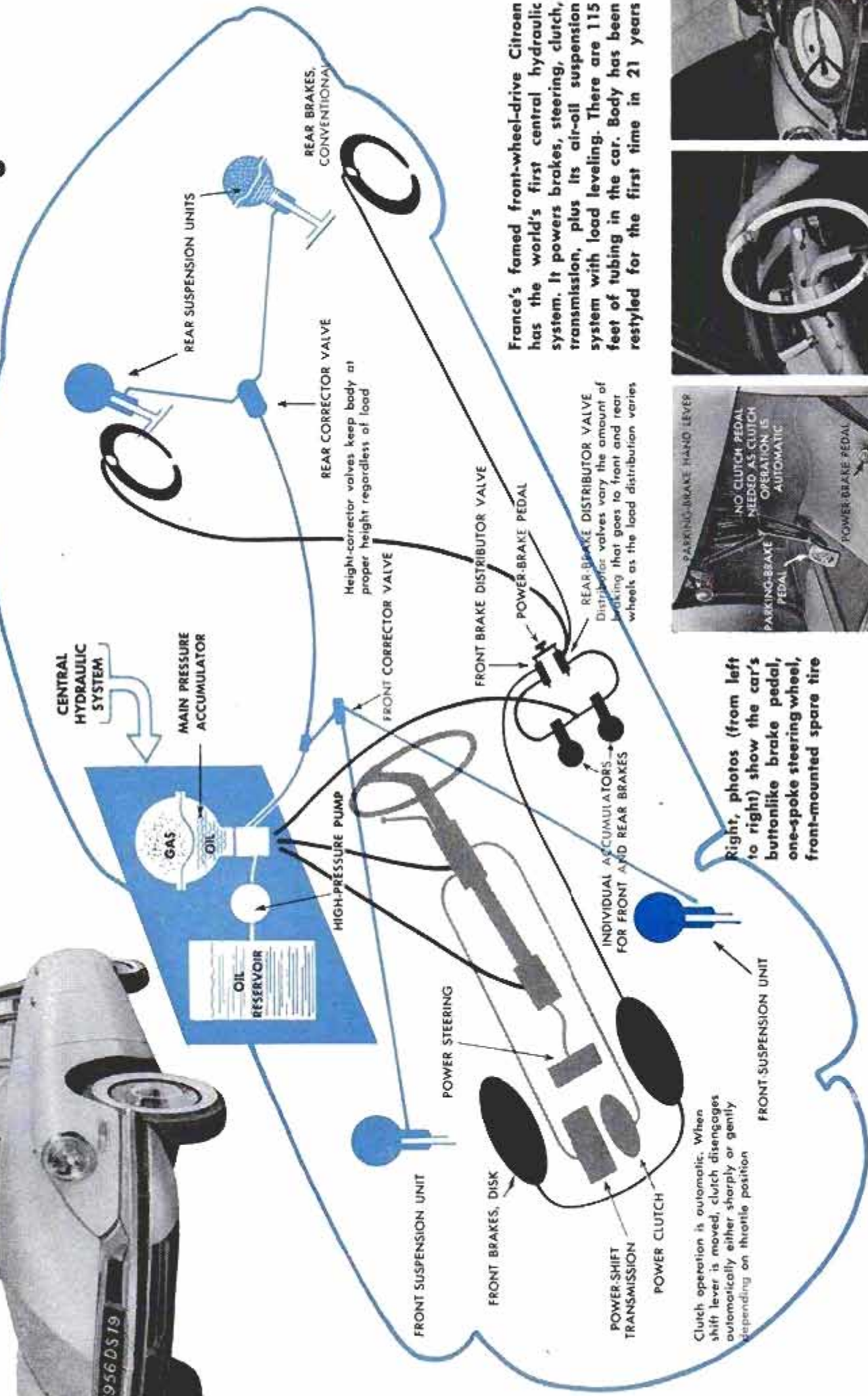
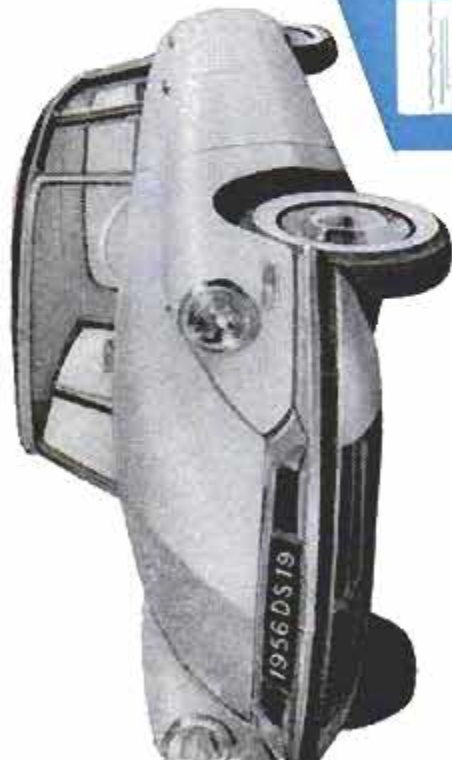

France's famed front-wheel-drive Citroen has the world's first central hydraulic system. It powers brakes, steering, clutch, transmission, plus its air-oil suspension system with load leveling. There are 115 feet of tubing in the car. Body has been restyled for the first time in 21 years

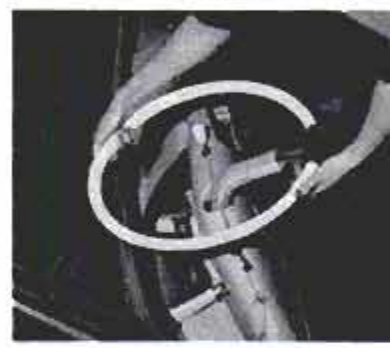

Right, photos (from left to right) show the car's buttonlike brake pedal, one-spoke steering wheel, front-mounted spare tire

Clutch operation is automatic. When shift lever is moved, clutch disengages automatically either sharply or gently depending on throttle position

THEY'VE ADDED COMFORT TO THE CORVETTE —



AND **POWER** TOO!

THREATENING RAIN clouds won't worry the 1956 Corvette owner. He simply presses a button and the power-operated top comes up from its hiding place under the rear deck. Pushing another button or two rolls up the power windows, making the sportster as snug as a luxurious sedan.

But all this comfort hasn't made a sissy of the plastic bomb—no, sir! It now has 225 horsepower and, coupled with a weight of only 2680 pounds, that makes the best power-to-weight ratio in the industry—a mere 11.9 pounds per horsepower.

You can now get it with a three-speed handshift transmission, if you don't care for the Powerglide automatic unit. The V8 engine has a special high-lift cam and two four-barrel carburetors. Performance is still a secret, but it's a safe bet that it'll do 0 to 60 in a whisker under nine seconds!

For winter driving, there is an optional plastic hardtop that has fixed quarter windows and a wraparound rear window for good backward vision.

Side panels on the plastic body have been made concave in a style reminiscent of the Biscayne dream car of 1955. For other photographs of the Corvette turn to page 175.

With a 9.25:1 compression, the V8 develops 225 hp. Metal seen at rear shields radio from ignition noise

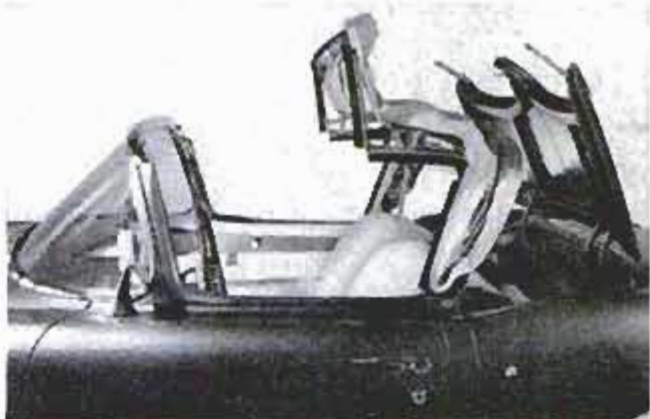
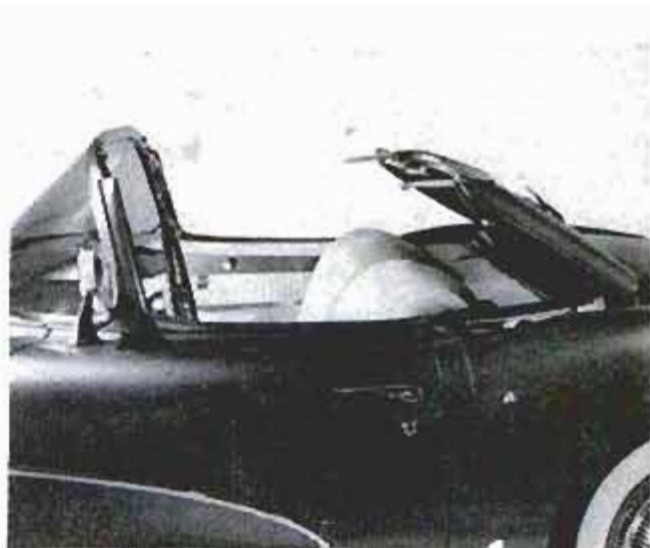
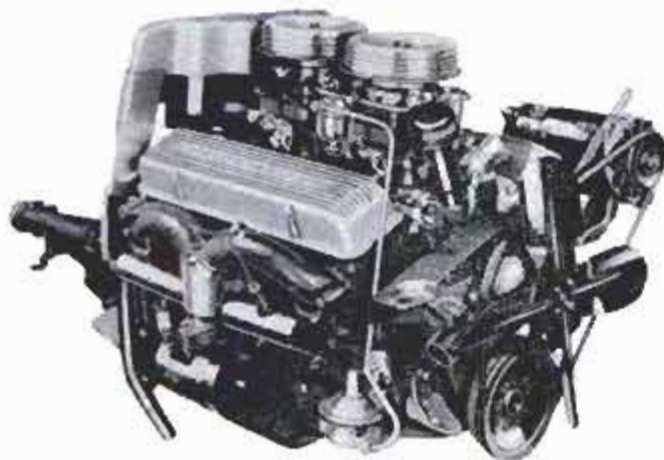

Top operation is automatic: First, the lid lifts up; next, up comes the top; finally, the lid closes itself

Steering wheel of the Corvette is a functional competition type, unadorned by chrome embellishments



HOW WAS THIS SURVEY MADE?

Questionnaires were mailed to 10,000 buyers of 1955 cars of all makes. The names were chosen at random from registration lists all over the country.

From the thousands of questionnaires that were returned to us, we made up a 1000-owner sample. This sampling was done at random with this exception: Geographical distribution was controlled to match the nation's car-population areas to be sure the sample was representative of the whole country.

The 1000-owner sample was then analyzed to make this report.

Why Do People Buy

✓ Who are the people who bought new cars in 1955?

<i>Income</i>		<i>Family</i>	
Under \$5000 a year.....	30.2%	Married.....	85.7%
\$5000 to \$10,000.....	54.9%	No children at home.....	29.6%
Over \$10,000 a year.....	14.9%	One child at home.....	19.0%
<i>Age</i>		Two children at home.....	21.8%
18-21 years.....	1.6%	Three children at home.....	9.5%
22-30 years.....	23.2%	Four children at home.....	4.4%
31-40 years.....	32.7%	Five children at home.....	1.1%
41-50 years.....	22.5%	More than five children.....	.3%
51-65 years.....	16.5%	Not married.....	14.3%
Over 65 years.....	3.5%		

✓ Why did these people buy new cars in 1955 anyway?

Income under \$5000 a year

Previous car no longer dependable.....	42.5%
Previous car all right but just wanted a new car.....	41.5%
Previous car used too much gasoline, oil.....	13.8%
Previous car all right but looked out of style.....	8.6%

Income from \$5000 to \$10,000

Previous car all right but just wanted a new car.....	42.0%
Previous car no longer dependable.....	41.1%
Previous car used too much gas, oil.....	8.6%
Previous car had too many miles on it.....	7.9%

Income over \$10,000 a year

Previous car all right but just wanted a new one.....	45.1%
Previous car no longer dependable.....	31.4%
Previous car looked shabby.....	10.5%
Previous car all right but looked out of style.....	8.6%

Only when the income level climbs to above \$10,000 a year is there any important difference in the reasons the owners give for buying a new car. And even then the differences are less than you might expect. Apparently people buy new cars for pretty much the same reasons, regardless of income. (Percentages above total more or less than 100 because some gave more than one answer and because only the four top reasons are listed.)

✓ Once they have decided to buy a new car, what is the most important factor the buyers consider in making their choice?

Previous experience with the make.....	25.3%
Trade-in allowance on old car.....	14.3%
Exterior styling of the new car.....	13.6%
Price of the new car.....	12.1%
Operating cost of the new car.....	10.6%
Handling ease of the new car.....	10.0%

OWNERS REPORT

the Cars They Do?

✓ What is the second most important factor in making their choice?

Exterior styling of the new car.....	16.2%
Trade-in allowance on old car.....	14.0%
Operating cost of the new car.....	12.0%
Handling ease of the new car.....	11.9%

Buyers are apparently more concerned about the looks of the car than its performance. A very small number (less than one percent) mentioned horsepower or top speed as either the first or second most-important factor. Acceleration was mentioned more frequently, but it was still far down on the list with only 2.0% listing it as most important and 2.7% listing it as the second most-important factor. It is interesting that handling ease is the most frequently mentioned performance characteristic, far exceeding speed and acceleration in popularity.

✓ What was the average age of the cars traded in?

Under \$5000 a year income.....	Car traded was 3.9 years old
\$5000 to \$10,000 a year.....	Car traded was 3.6 years old
Over \$10,000 a year.....	Car traded was 3.4 years old

Income status does affect the frequency of car buying, but not so much as you might think. In all three income groups, for instance, the most-frequently traded year-model was the same—the 1953 model. Also of interest is the fact that in the low-income group 8% traded 1954 cars (only one year old), in the middle-income group 9% traded 1954 cars, and in the high-income group 12% traded 1954 cars.

✓ Does the make of car Dad owns (or owned) influence the make of car selected?

When father owns a General Motors car:		Sons buying a Chrysler Corp. car.....	18.0%
◆ Sons buying a General Motors car.....	56.6%	Sons buying other makes.....	7.1%
Sons buying a Ford Motor Co. car.....	21.8%	When father owns a Chrysler Corp. car:	
Sons buying a Chrysler Corp. car.....	14.2%	Sons buying a General Motors car.....	46.4%
Sons buying other makes.....	7.4%	Sons buying a Ford Motor Co. car.....	19.6%
When father owns a Ford Motor Co. car:		◆ Sons buying a Chrysler Corp. car.....	28.1%
◆ Sons buying a General Motors car.....	38.8%	Sons buying other makes.....	5.9%
◆ Sons buying a Ford Motor Co. car.....	36.1%		

There is considerable evidence here that the make of car the father owns influences the son in his choice of car. And this seems to be true regardless of age group or marital status.

✓ Does the make of car the Boss owns influence the make selected?

When the Boss owns a General Motors car, employees buy:		When the Boss owns a Chrysler Corp. car, employees buy:	
◆ General Motors cars.....	49.8%	General Motors cars.....	35.1%
Ford Motor Co. cars.....	22.4%	Ford Motor Co. cars.....	20.9%
Chrysler Corp. cars.....	18.9%	◆ Chrysler Corp. cars.....	38.8%
Other makes.....	8.8%	Other makes.....	5.2%
When the Boss owns a Ford Motor Co. car, employees buy:		Another example emphasizes the influence of the Boss:	
General Motors cars.....	42.7%	When the Boss owns an Oldsmobile:	
◆ Ford Motor Co. cars.....	31.5%	◆ Employees buying Chevrolet.....	18.7%
Chrysler Corp. cars.....	18.9%	Employees buying Ford.....	12.1%
Other makes.....	7.0%	Employees buying Plymouth.....	2.2%

(Continued to page 310)



From 7 a.m. to midnight a *PM* camera followed the assembly line in an automobile factory. Here is its picture story of

The Building of a Car

HOW LONG does it take to build a car? At 7 o'clock one morning a clock was hung on an underbody as it was lowered onto the assembly line at Kenosha, Wis. A *PM* photographer took a picture, marking the start of a 1956 Rambler. One minute before midnight, 17 hours and

many, many pictures later, the clock and underbody (the latter hidden under a shiny Rambler body) were photographed for the last time on a conveyor, leaving the plant en route to a new owner. The following pages show what took place in those 17 hours.

Photos by *PM* photographer Don Honick

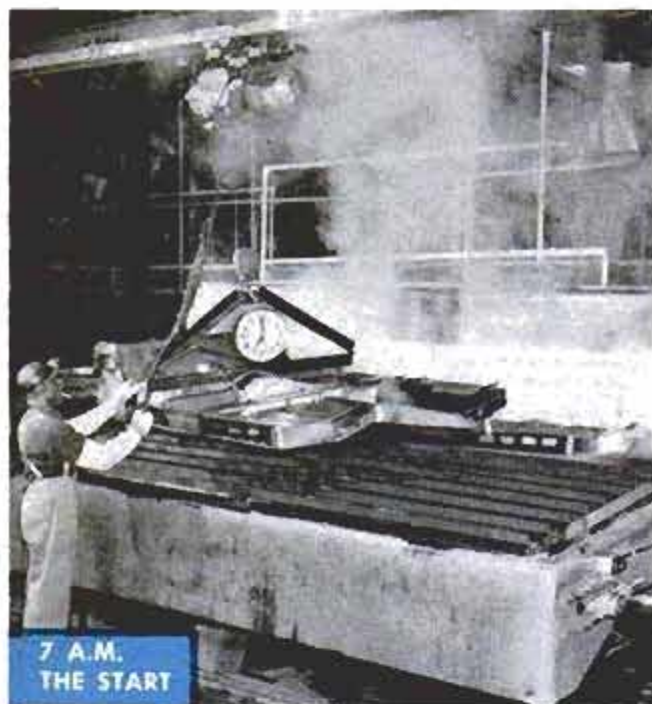

7 A.M.
THE START

7 a.m. First step in the assembly of the Rambler. Underbody goes into the wash tank to be degreased

7:52 a.m. On goes the roof. There are about 6000 welding operations in the Rambler's unitized body

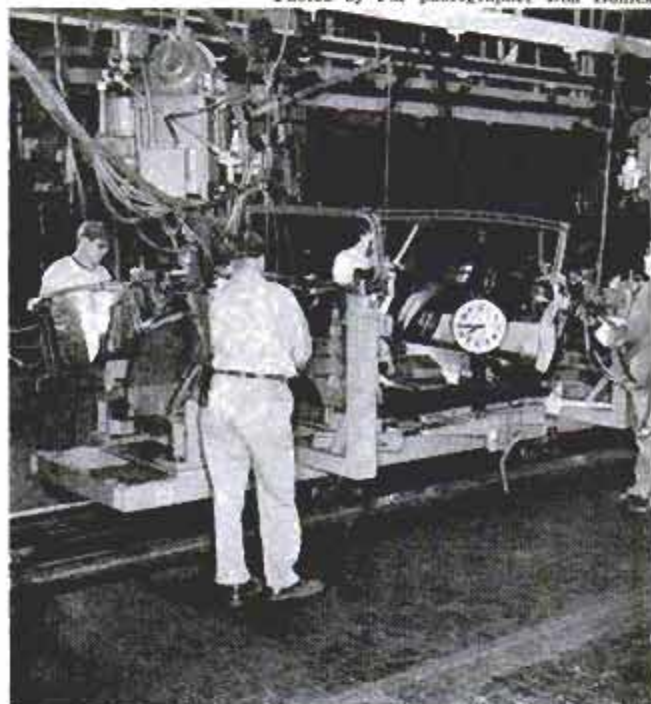
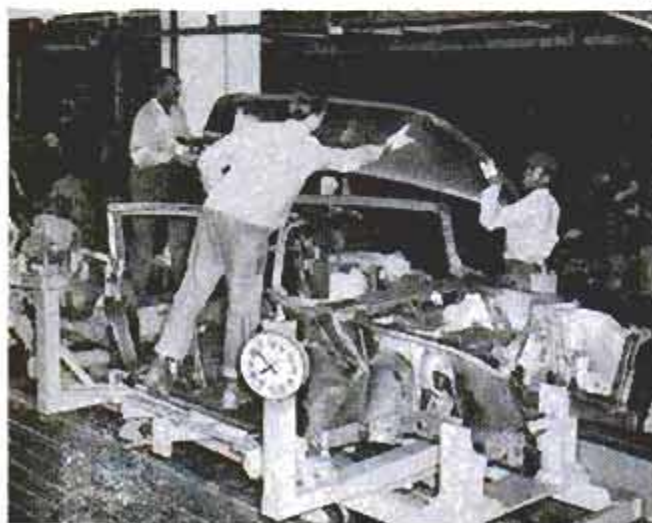

7:44 a.m. Sides are welded to underbody. Rambler is held together by welds, virtually no bolts are used

8:30 a.m. Front fenders are installed. These go on with bolts, the only major parts that aren't welded

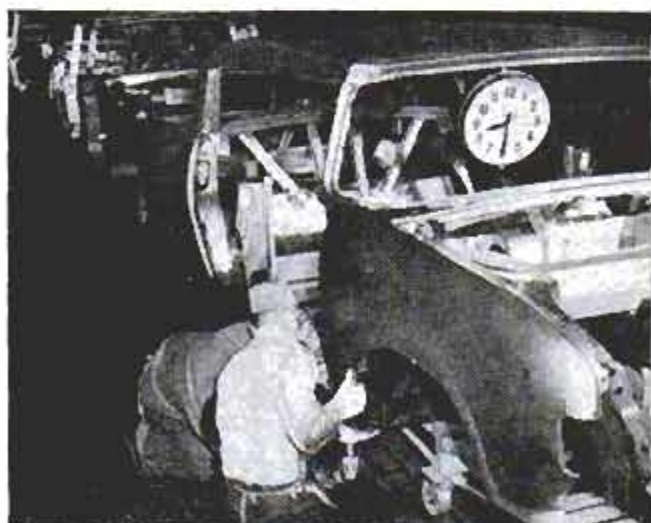

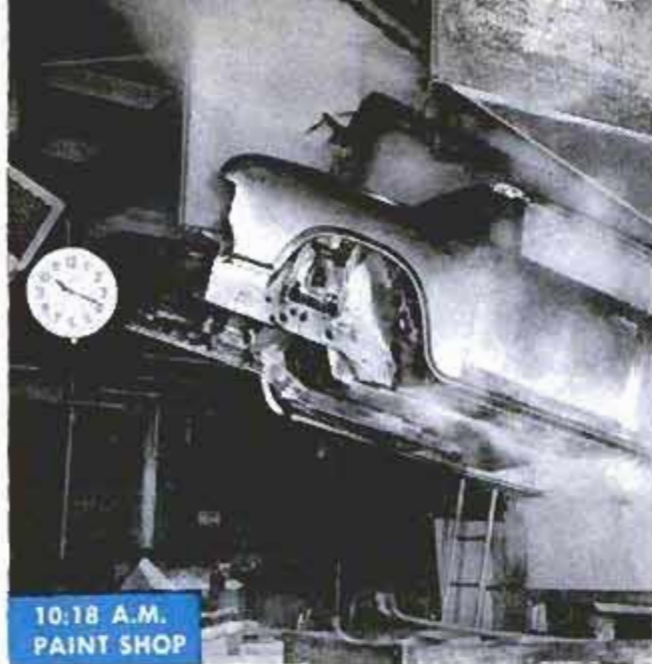

10:18 a.m. Metal work done, body backs into steaming tank of Bonderite to be cleaned before painting

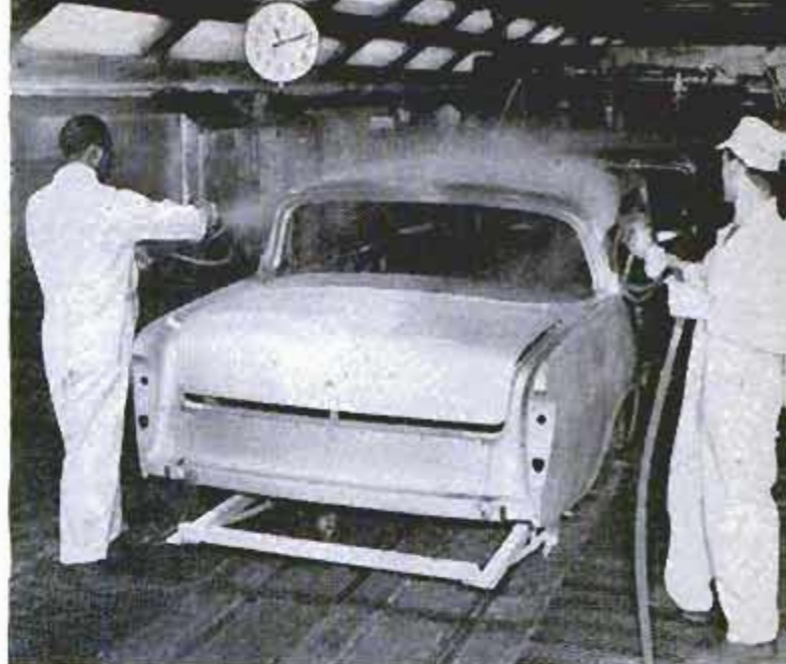

11:11 a.m. On goes the prime coat. The painters do hard-to-reach spots, machines paint the big areas



12:50 p.m. As body leaves drying oven after prime coat, it is sanded down to ready it for first color



12:58 p.m. First color (dark green) goes on. Arch in background is an automatic paint-spraying machine

1:58 p.m. Masking for second color (light green). This is a big operation now because of two-tone fad

4:25 p.m. The third color (white) is applied. All the body except roof has to be masked for this coat

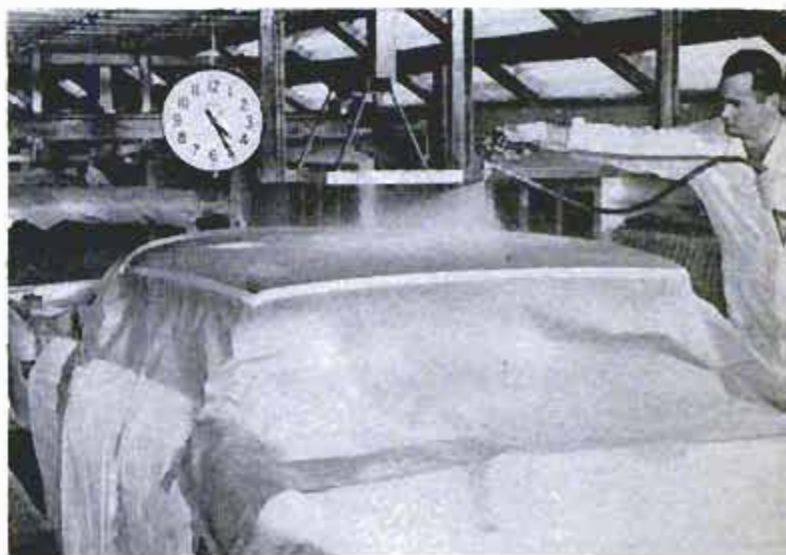

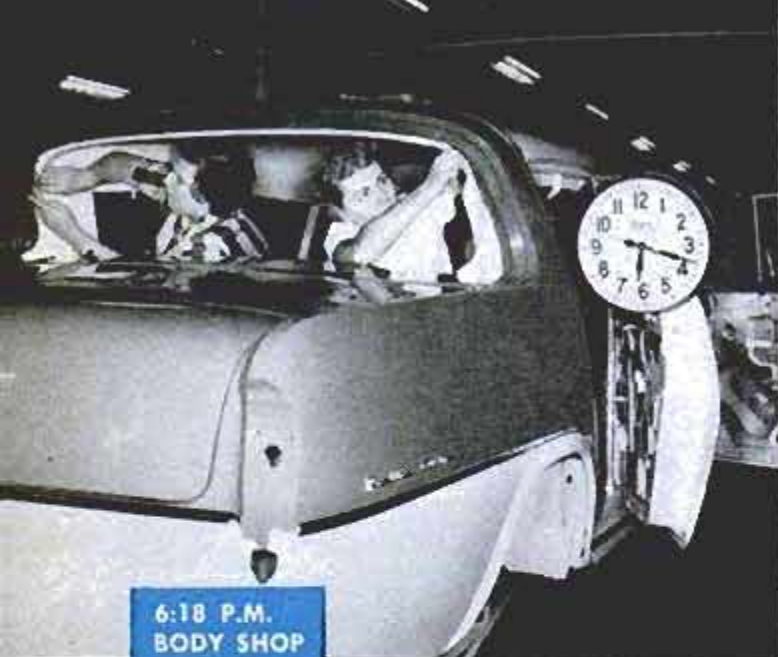

6:18 P.M.
BODY SHOP

6:18 p.m. Interior work is under way. The girls fit headlining to the roof as body moves along the line



6:35 p.m. Dashboard goes in as a unit. It has been assembled elsewhere in plant, delivered by conveyor



6:46 p.m. Installing windshield. Girl pulls on two strings to lift the lip of gasket over metal bead

7:14 p.m. Door panels go on. Body rides on wheeled frame and moves continuously as work is being done



7:08 p.m. Steaming headlining. All wrinkles vanish when headlining is shrunk tight by the steam bath

7:41 p.m. Door latches are pounded to give precise fit. Seats are in body. Interior is almost finished

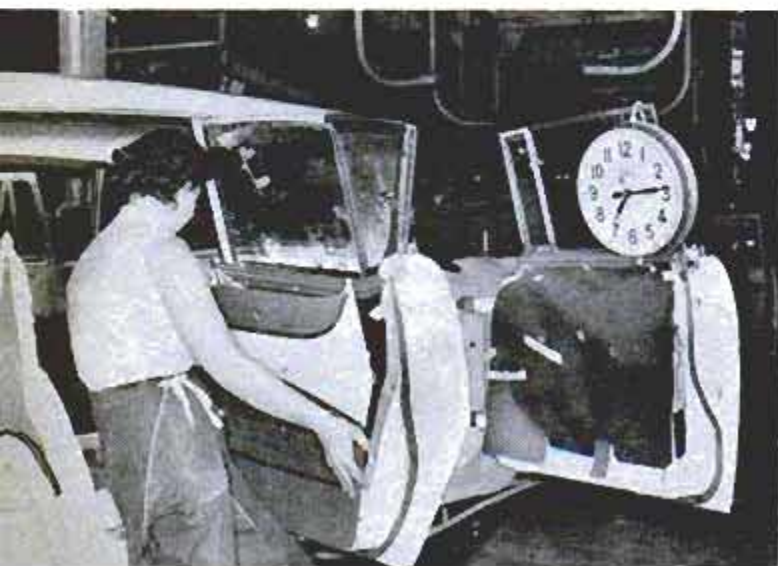

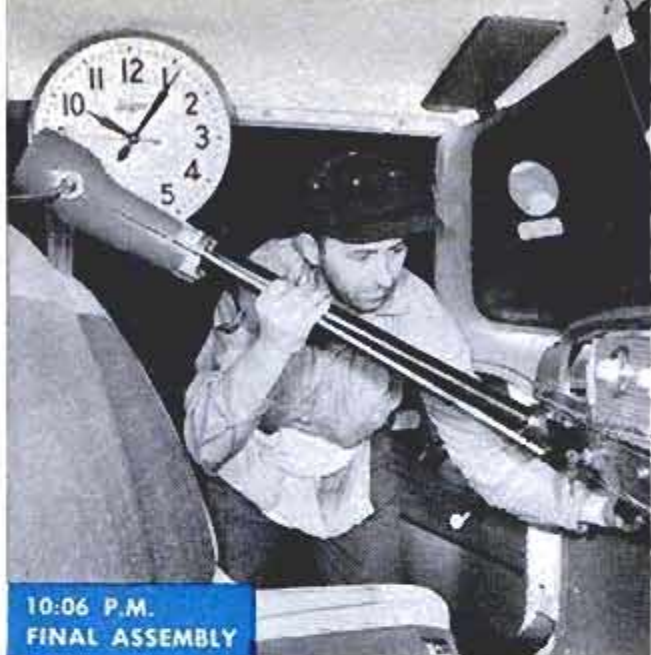

**10:06 P.M.
FINAL ASSEMBLY**

10:06 p.m. Now the running gear is added. Steering column is first of mechanical parts to be installed



10:23 p.m. Gas tank is strapped on. Body is carried along by big hooks, suspended over well-lighted pit



10:29 p.m. Front suspension is installed. Blanket draped on fender keeps workers from marring paint

10:51 p.m. Grille is bolted to fenders. Workers roll on castored seats at same speed as line moves



10:35 p.m. Engine mount. Entire drive train (engine, driveshaft, rear axle) is lifted and bolted to body

11:12 p.m. Wheels go on. Precise timing brings the matching wheels to this spot at moment body arrives





11:20 p.m. Wheels touch down for first time. Tank gets first taste of gasoline—five gallons of it



11:26 p.m. Hood is bolted on. It must have proper color, must wear the right emblem, Hudson or Nash



11:35 p.m. First time it moves under own power. It is now run through gears with rear wheels on rollers

11:57 p.m. End of line! Front wheels are aligned; headlights focused and another Rambler is set to go



11:48 p.m. Final inspection. Any tiny blemishes in paint are touched up as car moves toward end of line

11:59 p.m. One minute under 17 hours from the start, the complete Rambler rides up conveyor for shipment

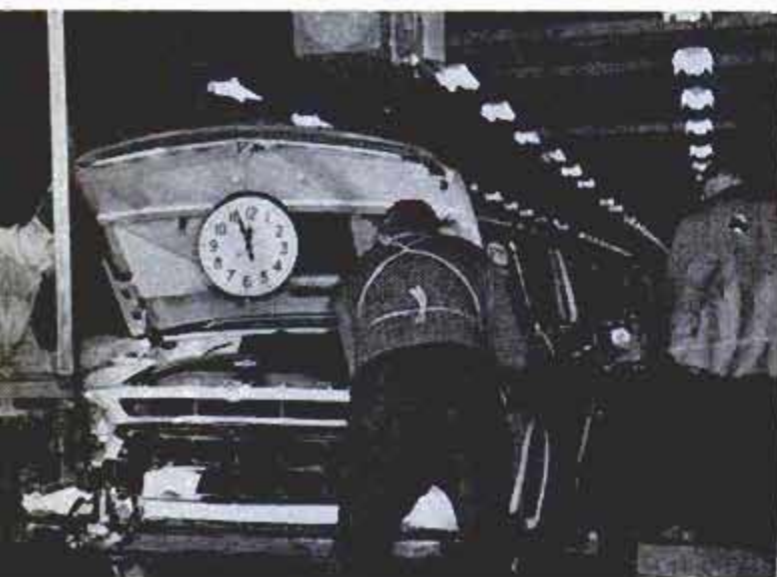



MORE MILES TO THE GALLON

By Dale Kelly

THIRTY YEARS AGO the average United States motorist was getting about 15 miles per gallon of gasoline. Today he is getting close to the same mileage, but with engines that have several times the horsepower and a total mileage potential of many thousands of miles more than cars built thirty years ago.

But increased horsepower and perform-

ance require more gasoline, despite greatly increased efficiency in engines and tremendous improvements in the quality of gasoline. Therefore, any increase in gasoline economy is up to you, the driver.

Correct driving habits, proper maintenance and the use of quality petroleum products are the three main factors in gasoline economy. A fourth factor is optional

As can be seen by graph below, gasoline mileage has improved only slightly in 30 years. Note the low mileage obtained by cars in the late '20s when prosperity reduced demand for real economy

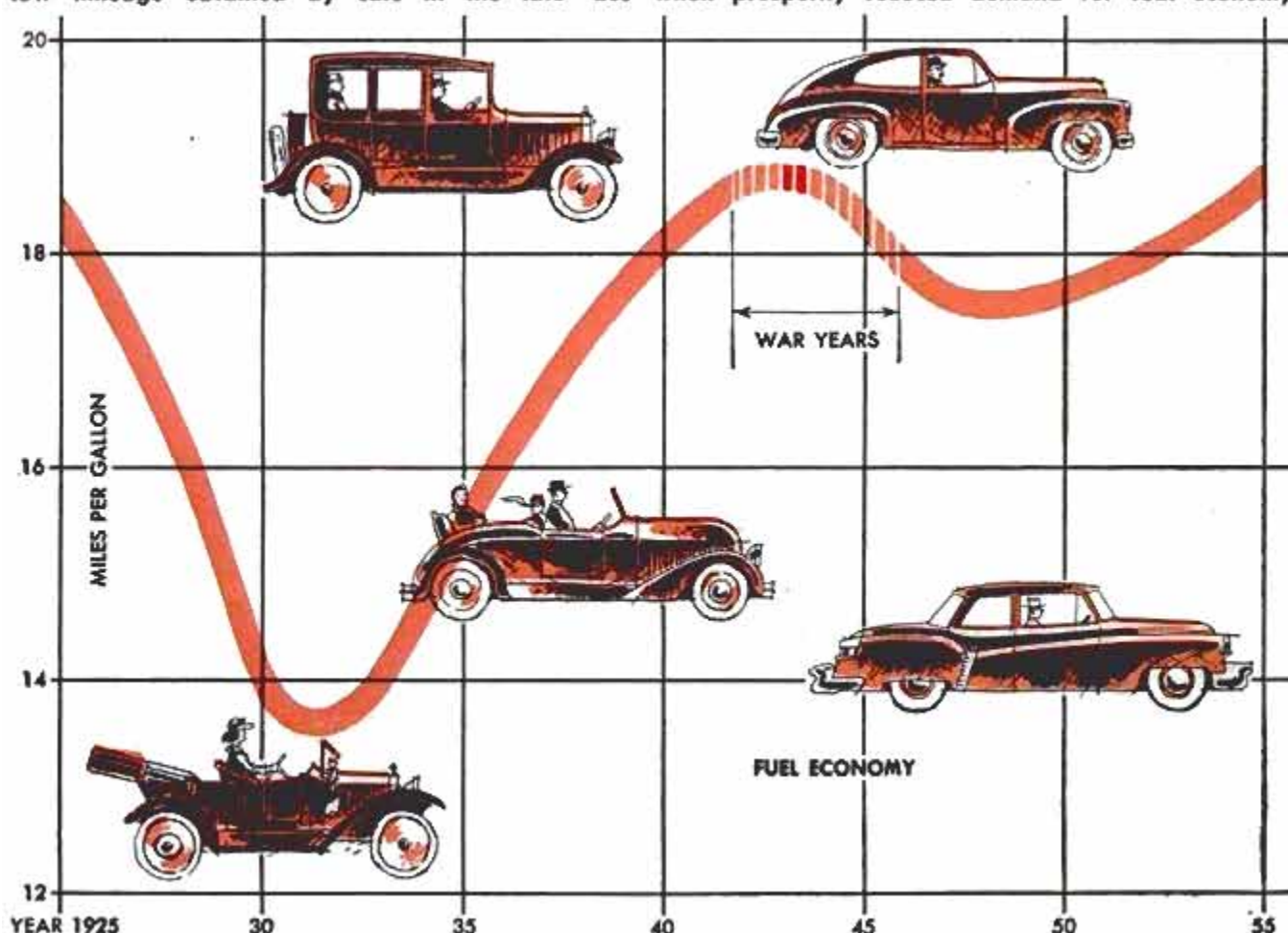

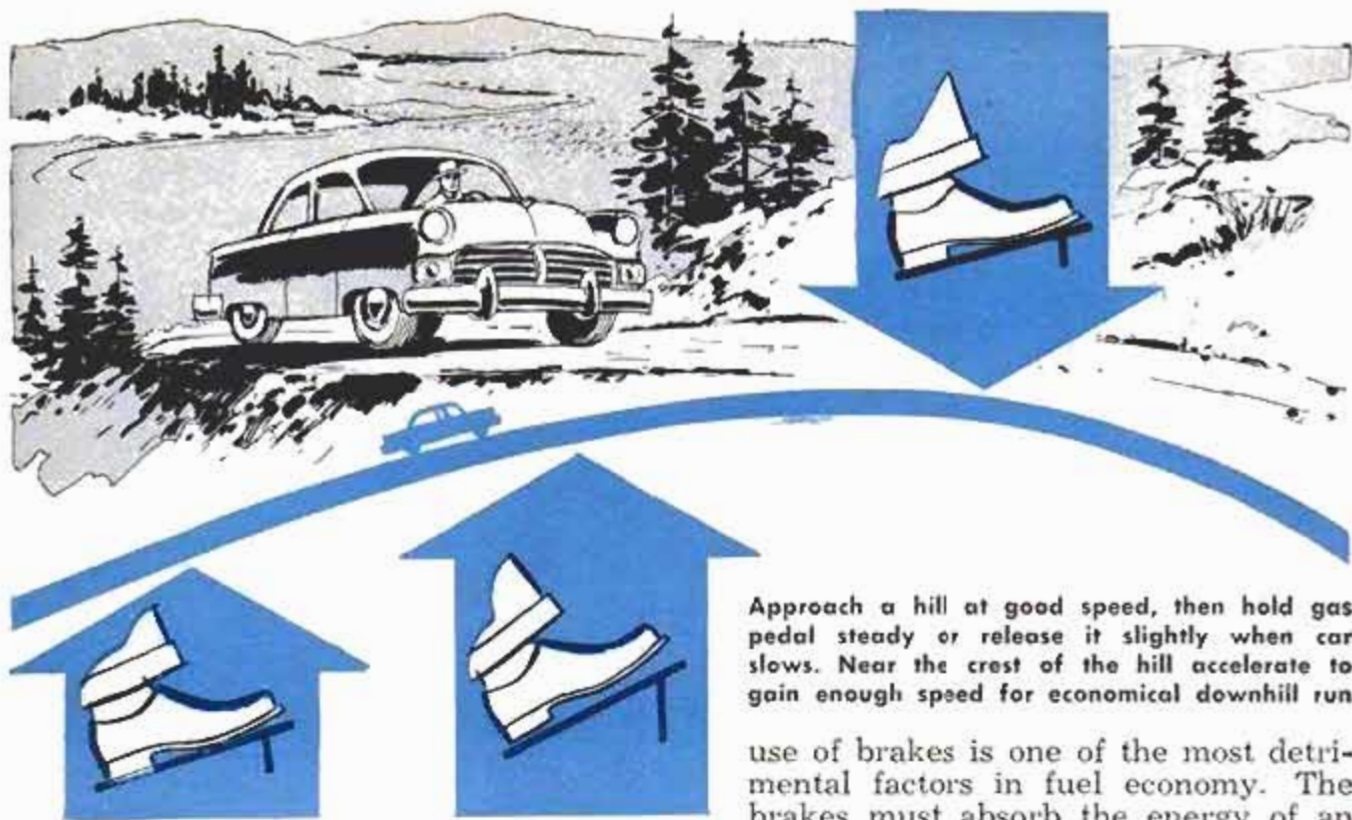

equipment that provides economy through mechanical assistance.

When starting your car from a standstill: If the car has a manual-shift transmission, shift into high gear as soon as practical without causing the engine to "lug" or labor. If your car has an automatic transmission, keep a light foot on the throttle and the transmission will quickly upshift. An easy start keeps down engine r.p.m. A slowly rotating engine uses considerably less fuel than one turning over at high speed.

Drive the road ahead: Avoid sudden stops at stoplights and time your speed to drive through on the green light. Heavy

Correct ignition timing permits using regular instead of premium gasoline, saves 2 or 3 cents a gallon

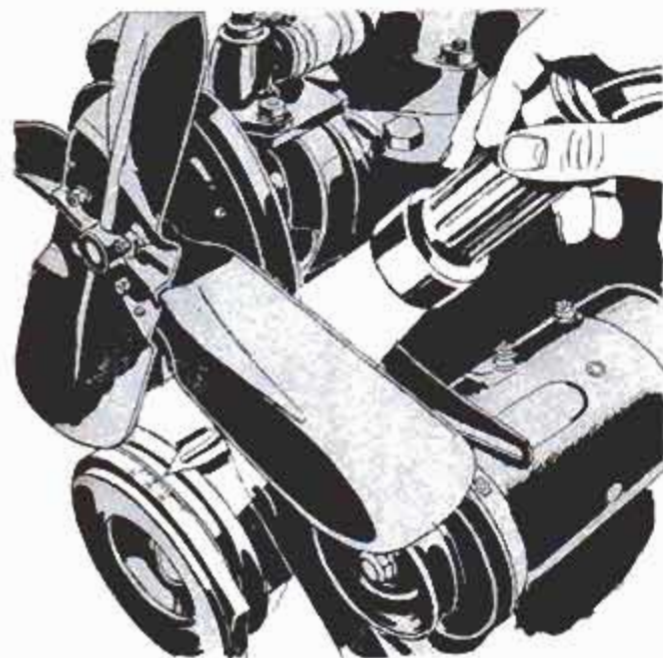

Approach a hill at good speed, then hold gas pedal steady or release it slightly when car slows. Near the crest of the hill accelerate to gain enough speed for economical downhill run

use of brakes is one of the most detrimental factors in fuel economy. The brakes must absorb the energy of an automobile in motion and, in effect, you are running the engine with a brake on each time you stop suddenly.

Climbing a hill: Approach a hill at a fairly good speed, then as the car slows down hold the accelerator steady, or release it slightly. When near the top of the hill, accelerate to build up speed for the downhill run which is made with the throttle closed. Most automatic transmissions coast free to some extent, even when left in gear, so the closed throttle on the downhill run will more than save the amount of fuel required for driving up the hill. In the Mobilgas Economy Run, some cars made 100 miles per gallon on a downhill run, definitely compensating for the 7 miles per gallon required when going uphill.

It is not suggested that techniques used in economy runs be adopted in full by the average motorist. However, variations of the techniques can successfully be used to improve economy.

Steady foot on the accelerator: A comfortable posture with the right leg held in a relaxed position is important. The leg should be supported in such a manner that your foot will not bounce up and down on the throttle when the car is driven over bumps. Frequent changes in throttle position have a definite adverse effect on gasoline mileage.

Automatic transmissions: Generally speaking, automatic transmissions are at a mileage disadvantage when running at low speeds. A torque converter or fluid coupling is more efficient at higher r.p.m. This is the reason some automatic transmissions seem to downshift at fairly high speeds.

They are engineered to provide peak performance and economy, and the shift speeds cannot be changed without adversely affecting both. Engineering improvements in the latest automatic transmissions have given them an economy potential equal to manual-shift transmissions. As an example, with some automatics, at an engine speed of 2000 r.p.m., the road speed is 55 m.p.h. At 2000 r.p.m. with a manual-shift transmission, the road speed is only 40 m.p.h.

A principal cause of poor gasoline economy is a rich mixture in the carburetor. In modern carburetors any air-fuel mixture for engine speeds above idling speeds cannot be adjusted from outside the carburetor. If your carburetor is running rich, it should be cleaned and overhauled, or smaller jets or larger metering rods should be installed. Only an expert carburetor man should be allowed to change carburetor calibration.

Air filter: A dirt-clogged air filter, because it reduces the air supply to the carburetor, produces the same effect as oversize jets. The air cleaner should always be cleaned when the engine is tuned.

Faulty ignition: An engine with faulty ignition wastes gasoline. A single spark plug not firing properly increases gasoline consumption by about 3 miles per gallon. To forestall ignition trouble, have the engine tuned periodically. When the engine is tuned, have it timed to match the grade of gasoline you are using. Simply changing the timing often will permit savings of a couple of cents a gallon since regular grade instead of premium can be used. On many cars, timing marks indicate settings for both regular and premium-grade gasoline. As a rule of the thumb: if your car is a 1948 model or older, or has a compression ratio of 7.5 to 1 or less, it can use regular. If the compression is 8 to 1 or higher, use premium-grade gasoline.

There is, of course, more to gasoline than octane number. However, United States Government reports show that in all respects but octane number, regular gasoline is substantially equal to premium.

Other causes of poor mileage: All other causes of poor mileage can be lumped under the heading of excessive friction or resistance to motion. This includes such defects as dragging brakes, misaligned front wheels, soft tires and, less frequently, lack of lubrication. With any of these conditions present, the throttle has to be opened more than normal to develop enough engine power to move the car at a given speed.

Within certain limits a gasoline engine develops a given horsepower on the least gasoline when it runs slowly and pulls

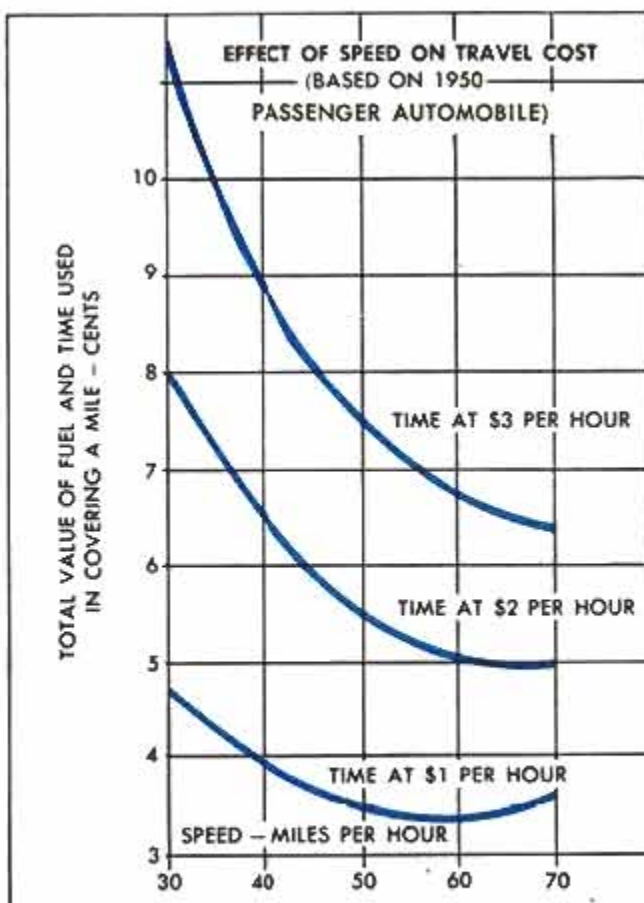

Graph above shows that when cost of time is considered, higher speeds may be more economical

Below, unbalance in fuel-air ratio caused by dirty air cleaner results in excessive gasoline consumption

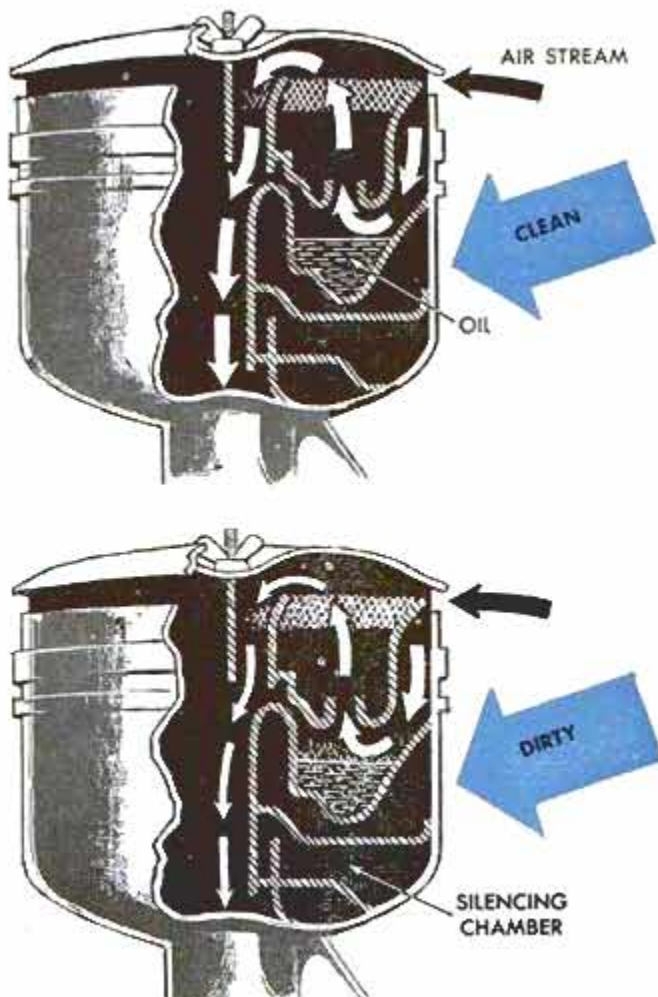

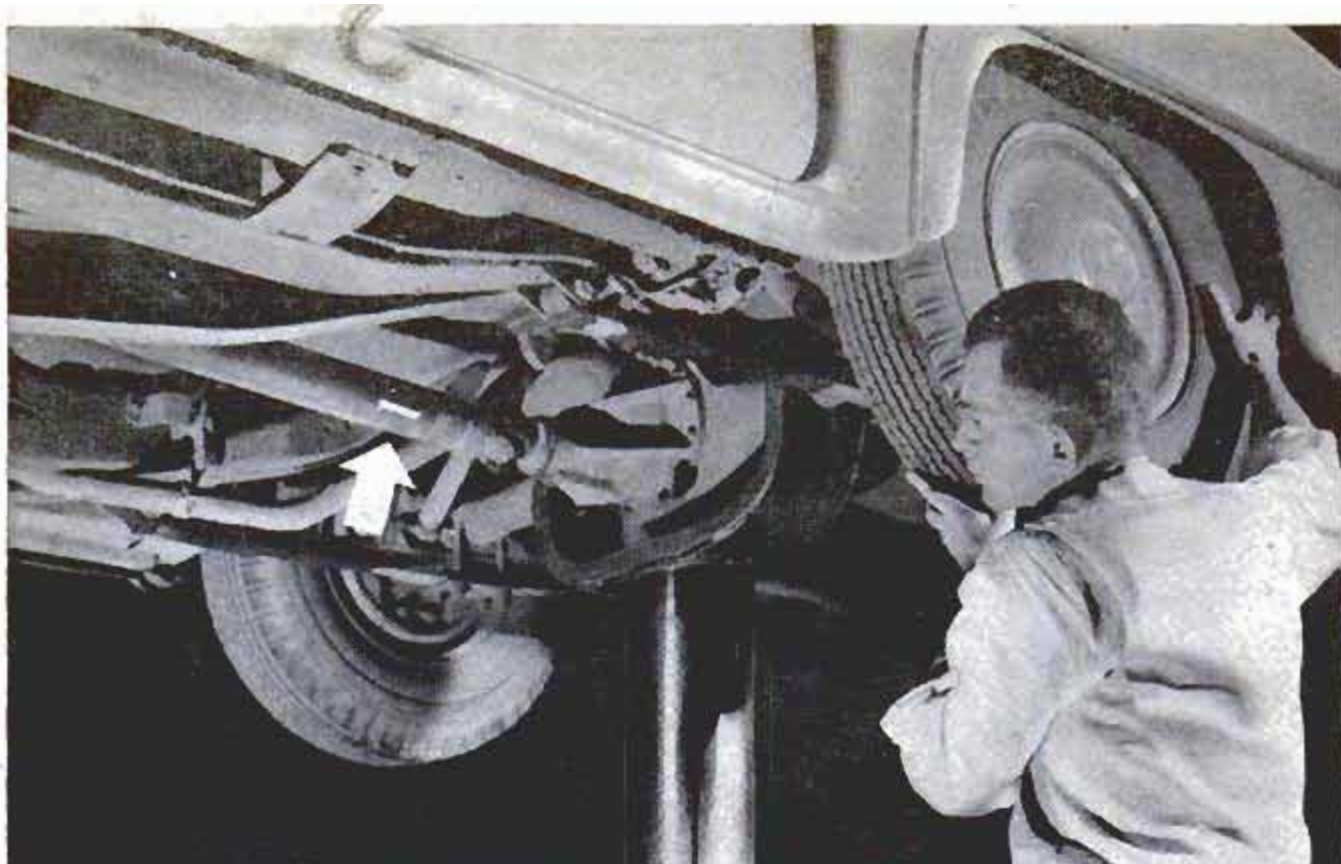

To check rear-axle ratio, rotate rear wheel twice, note number of times chalk-marked driveshaft rotates

hard. This is the reason an engine will give its best mileage when its r.p.m.s are kept low by an overdrive or low-ratio rear axle. A properly installed overdrive unit will permit approximately a 30 percent reduction in engine revolutions for a given road speed, and at low and medium speeds will produce about 24 percent reduction in gasoline consumption. At higher speeds economy drops off, because the engine becomes overloaded and starts to labor. For this reason, when a car is used to haul a trailer, or is heavily loaded, an overdrive unit should be locked out.

Some of the economy potential of overdrive usually is sacrificed because of the desire for smoothness in high gear when the car is running at fairly low speed. This is accomplished by using a rear axle with a higher gear ratio than is used with a standard transmission. If the same axle ratio that is used with a standard transmission is installed in an overdrive-equipped car, almost 34 percent reduction in gasoline con-

sumption can be realized over a standard transmission. This latter setup will save gas and oil, prolong engine life and reduce engine noise. The only disadvantage is the increased need for shifting gears at lower speeds or when climbing fairly steep hills.

If you order a special rear-axle ratio and want to check to see if it was installed, raise the car on a hoist of the type that permits the wheels to rotate. Make a chalk mark on the driveshaft and turn one wheel through two complete revolutions. (Because of differential action, two revolutions of one rear wheel are equal to one revolution when the wheels rotate simultaneously.) The number of times the driveshaft rotates, to one, is the rear-axle ratio.

Although speed increases gasoline consumption, other factors must be considered when a driver uses his car for business. The examples shown in chart at top of page 203 demonstrate that when cost of time also is figured, it sometimes is less expensive to drive at higher speeds. ★ ★ ★

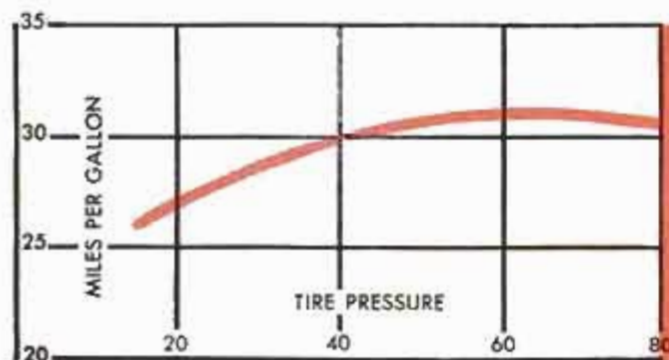

FUEL ECONOMY INCREASES IN ALMOST DIRECT PROPORTION TO THE INCREASE IN TIRE PRESSURE UP TO ABOUT 60 LB. PER SQ. IN., THEN LEVELS OFF HOWEVER, DUE TO THE GREATER ROADHOLDING QUALITIES OF A SOFTER TIRE, AND IN CONSIDERATION OF PASSENGER COMFORT, LESS PRESSURE IS RECOMMENDED IN A PASSENGER-CAR TIRE.

Power Tune-Up for Peak Performance

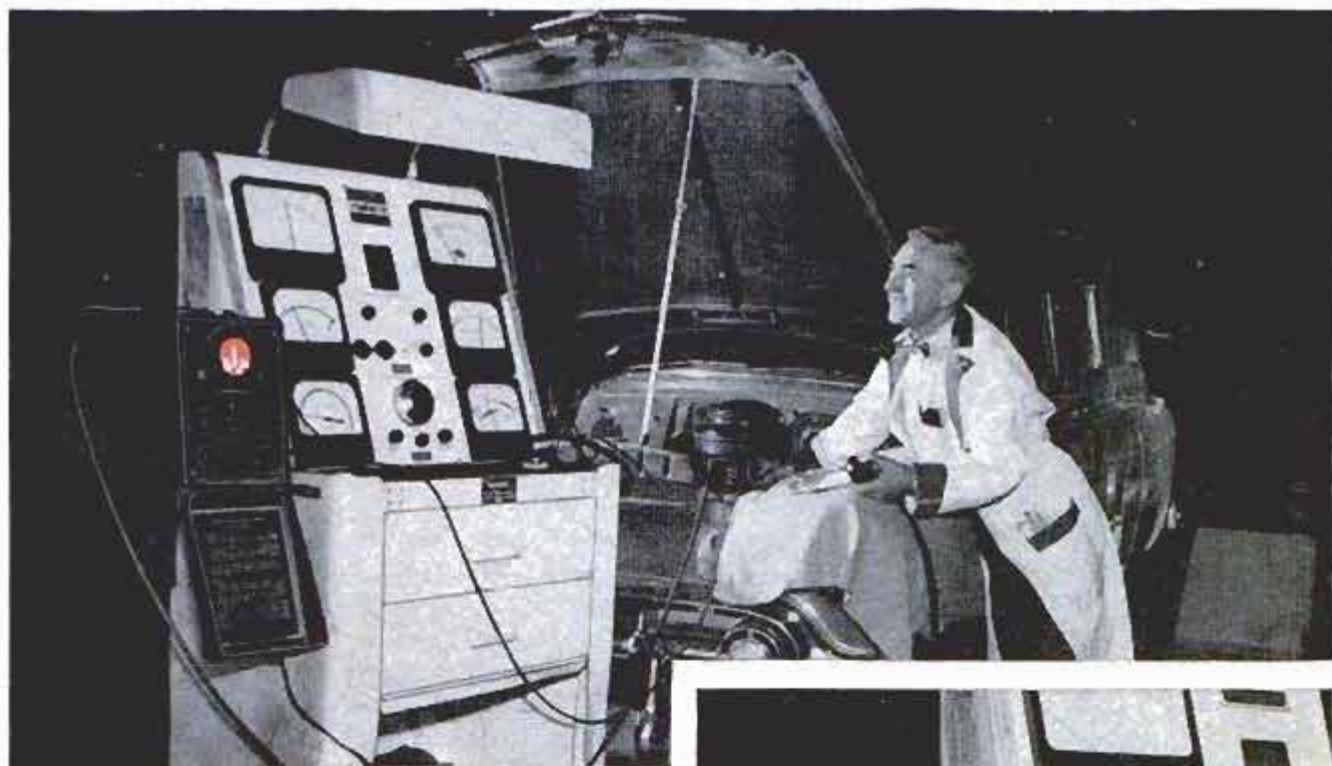

1. Willys power-tunes an engine on dynamometer

By Jay W. Hedden

MY NEIGHBOR'S CAR is the same make and model as mine, but the general performance of his car is better. It has greater pickup and is faster on the highway. What's the matter with my car?"

Similar questions are asked of automobile mechanics every day. To get the answers, *Popular Mechanics* went to George R. Willys, a man who has built a business on knowing the answers. Mr. Willys has tuned record-breaking, stock-engine cars, is a member of the S.A.E., and is the founder of a school in Blue Island, Ill., where experienced mechanics are taught advanced techniques in engine

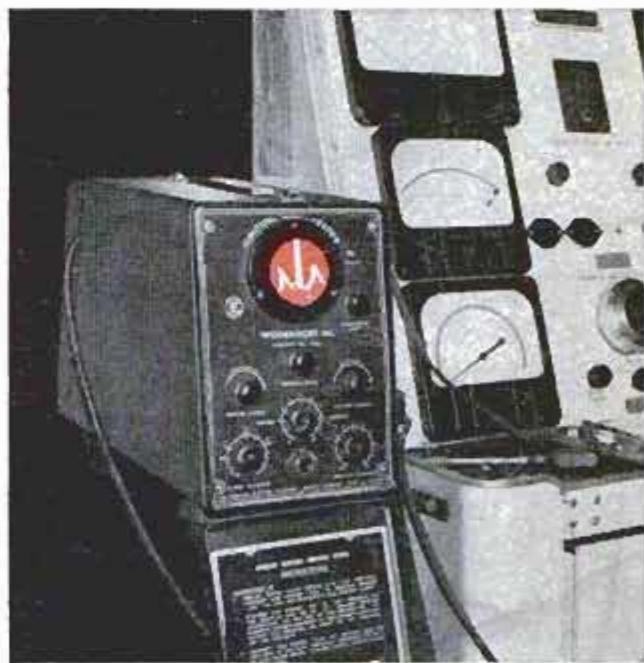

2. Upper photo, oscilloscope used with dynamometer gives picture of condition of ignition system. Below, key to image shape and two images which result when condenser leaks and contact points are dirty





3. Calibrating distributor on tester synchronizes spark so it reaches each cylinder at right time

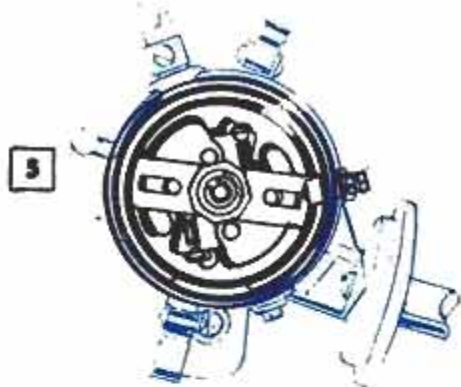
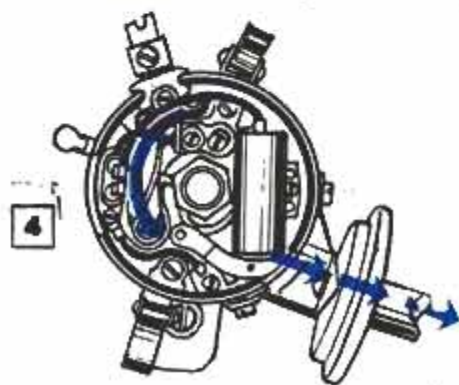

6. Below, recalibrating voltage regulator on tester

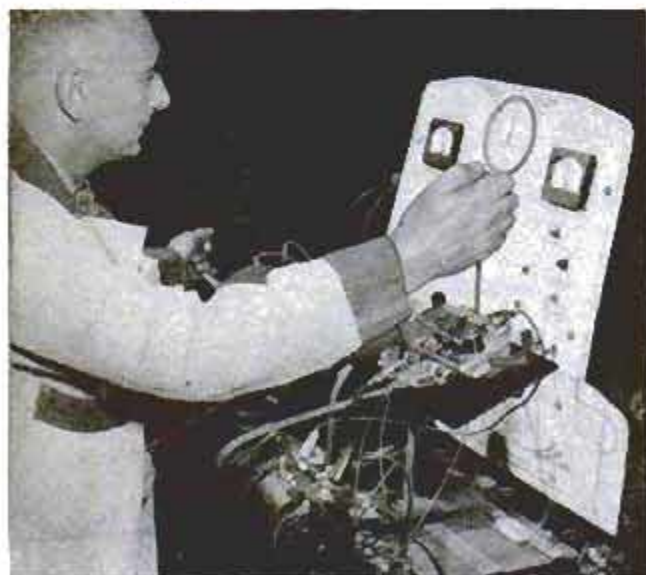

7. Tune-up includes cleaning and reoiling air cleaner. Cleaner has direct effect on carburetor efficiency

trouble shooting and the use of a dynamometer for power tuning.

To obtain peak performance, Willys told us, an engine first should be tuned as close to factory specifications as possible. After the tune-up, other performance-gaining adjustments can be made.

When you take your car in for a periodic engine tune-up make sure that in addition to the usual cleaning and regapping of the spark plugs and installation of new points, the following tests and adjustments are made: A complete check of the ignition system, a compression test of each cylinder, readjustment of the tappets if nonhydraulic lifters are used and readjustment of the carburetor. Also, the air cleaner should be cleaned thoroughly inside and out and reoiled. The air cleaner, especially if it is the oil-bath type, seldom is serviced properly. Generally, too much oil of too light a weight is used. The excess oil spills over into the carburetor when the car starts or stops quickly or turns a sharp corner. Lightweight oils tend to vaporize and are drawn into tiny carburetor openings which quickly become clogged.

Another mechanism that has a direct effect on engine performance, and often is overlooked, is the heat-riser valve. Have your tune-up mechanic operate the valve manually to make sure it rotates freely and that the thermostatic spring is not broken. The valve not only assures faster engine warm-ups, but maintains the proper heat under the carburetor to help vaporize gasoline entering the intake manifold.

For a regular tune-up, generally a timing light is the only instrument required, although a vacuum gauge may be used to adjust the carburetor and a dwell-angle meter sometimes is employed to set the distributor-point gap. The latter instrument permits more accurate spacing of

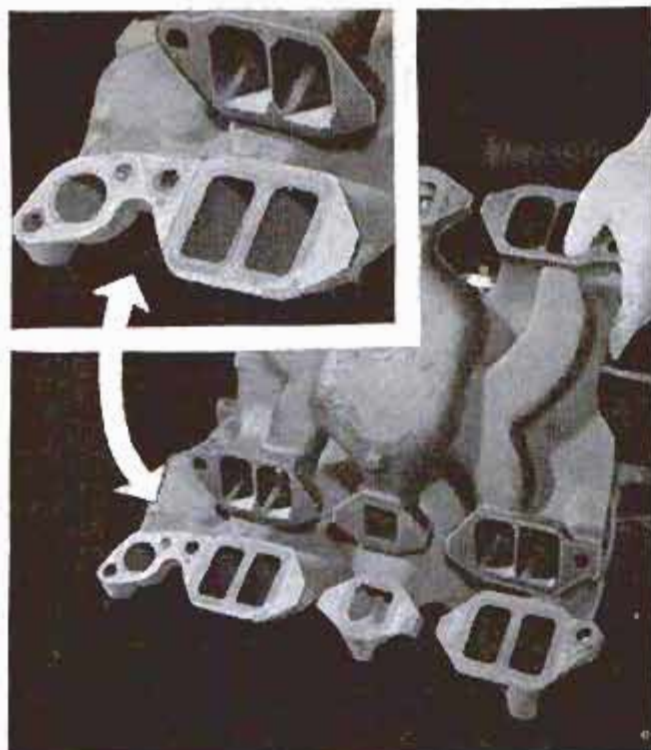

8. Stock and filed manifold compared to show size increase. Inset is close-up of end intake ports

the points than the use of a feeler gauge, since it indicates the length of time the points dwell closed on each lobe of the distributor cam. Point dwell is a specification listed by auto manufacturers.

A tune-up that includes all the above assures that the engine is in top condition, and any malfunctioning of the ignition system will be found by the checks and tests. The compression test will indicate any valves that are not seating properly, or rings that are not doing an efficient job of sealing in compression.

For true power tuning, however, when the last fraction of horsepower is to be squeezed from an engine, a dynamometer should be used. A chassis dynamometer, the type used in tune-up shops, is basically a set of rollers onto which the back wheels of the car are driven. The engine is started, the car put in gear and the rear wheels then rotate the rollers. Gauges connected to the rollers translate their rotation to "road horsepower," or the actual amount of power transmitted to the rear wheels of the car at any definite engine r.p.m. Any changes in horsepower that occur when adjustments or modifications are made to the engine show immediately on the dynamometer gauges.

In conjunction with the dynamometer, an oscilloscope also may be used. When this instrument is connected to the ignition system of the engine, it projects an image on a cathode-ray tube which can be interpreted to indicate the condition of the spark plugs, points, condenser and coil. Charts furnished with the oscilloscope

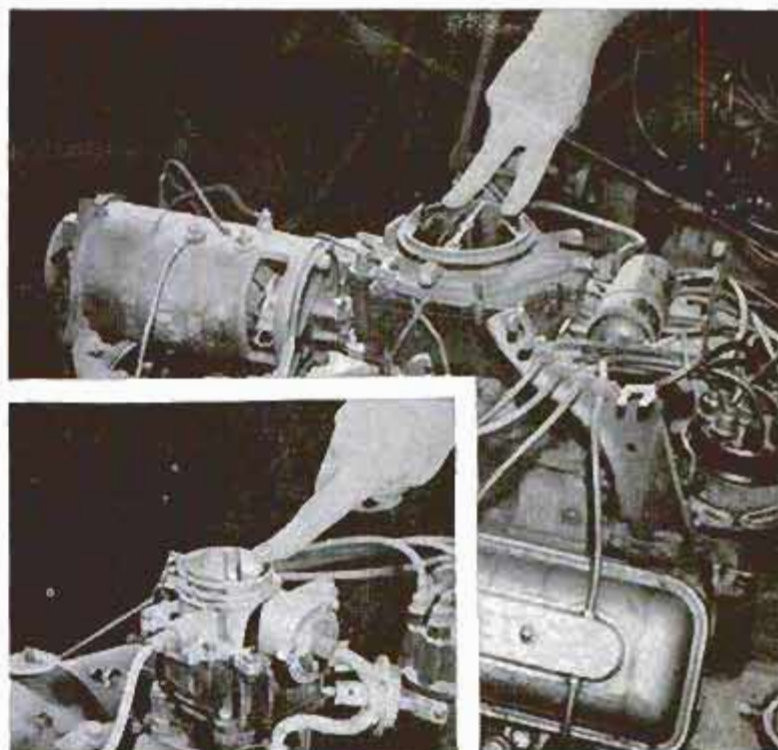

9. Replacing one or two-throat carburetor with four-throat results in appreciable horsepower increase

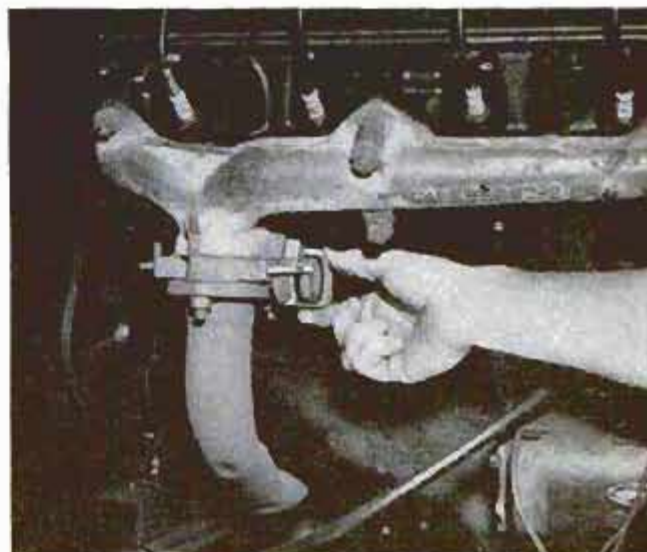

10. Heat-riser valve must rotate freely to assure fast starting and aid vaporizing of gasoline in manifold

show pictures of the way the image should look when the ignition is functioning properly, and what ignition malfunctioning will cause the image to change shape.

For example, the oscilloscope image may indicate that the distributor shaft is wobbling. This condition causes variations in distributor-point setting. To correct this, depending on the type of ignition system used, the distributor is either repaired or replaced. Some types of distributors can be renewed by replacing the shaft bushings, which eliminates the shaft wobble. The distributor then is calibrated on a distributor-testing machine.

While the distributor is out of the engine, the vacuum chamber is tested to make sure it is airtight. A disk-shaped object



11. Timing light flashes each time No. 1 spark plug fires, showing mark on flywheel or vibration dampener

screwed to one side of the distributor housing, vacuum chamber is connected to the intake manifold by copper tubing. A spring-loaded metal diaphragm inside the chamber flexes in direct proportion to the vacuum in the intake manifold. An arm fixed to the side of the diaphragm opposite the vacuum side is pivoted to the distributor plate. When the diaphragm flexes, it rotates the distributor plate to advance the spark. When the engine is running at cruising speed, the vacuum is high and the diaphragm arm holds the distributor plate in an advance position that provides maximum economy, but relatively low power. When the throttle suddenly is opened, as when accelerating, manifold vacuum drops and the diaphragm is forced back by its spring; the centrifugal-advance mechanism, which functions at all speeds, now takes complete control of spark advance. The latter mechanism is connected directly to the cam of the distributor and rotates it to provide spark advance. Both the vacuum and centrifugal-advance mechanisms work independently of each other, but both advance the spark according to engine needs under different conditions.

When the distributor is reinstalled in the engine, the dynamometer can be used to recheck both advance mechanisms. The engine then is "power timed," as well as "power tuned." After an engine has been tuned to peak horsepower, on the dynamometer, what does Willys suggest be done for added power?

One method of gaining horsepower on an engine equipped with a 6-volt ignition system is to have the voltage regulator recalibrated so the generator charges 8 instead of 6 volts and at a lower amperage. The regulator has to be calibrated with a regulator tester. The higher voltage provides stronger spark to the plugs, and the

lower amperage requirement reduces the horsepower needed to rotate the generator. The disadvantage of this arrangement is that the headlights and other lamps burn out more quickly.

The simplest and least expensive way of gaining added horsepower from engines before 1956 is to mill the cylinder heads. The amount of metal that can be removed safely varies from about .050 to .090 in., depending on the engine. On an overhead-valve V8 engine, the intake manifold also would have to be milled since the ports in the milled heads would be located in a lower position in relation to the manifold. After the heads are milled, the engine no longer is stock and the original factory specifications do not hold true. Your tune-up man would install spark plugs with a different heat range and recalibrate the distributor to match the compression.

Multiple carburetion is another means of increasing horsepower. Dual carburetors can be used on in-line engines, while a 4-throat carburetor can be used on V8s to replace the usual single or double-throat carburetor. In all cases, linkage should be arranged so that half the number of throats do not open except at full throttle. The reason for this is that when the number of carburetor venturis is double, the air velocity in each is reduced by half. The lowered air velocity results in sluggish engine response at low speeds.

Multiple carburetion is more effective when the intake manifold is enlarged. This can be done with a rotary file chucked in an electric drill. Ports in the engine or heads and manifold can be aligned at the same time. Port misalignment is readily checked by examining the impressions on the manifold gasket. Most of the filing should be done on the manifold. If a mistake is made, it can be repaired for much less than an engine head or block.

An operation that produces startling results is to tune the tail pipe. First, cut a length of tubing about 23 in. long that will slip inside the end of the tail pipe. If a tachometer is available, hook it to the engine and run the engine at 2000 r.p.m. Slide the tubing in and out of the tail pipe while a partner tells you at what point the tachometer shows the highest reading. Usually 200 to 300 r.p.m. can be gained. If no tachometer is available, run the car on a hoist that permits the wheels to rotate. Have your partner put the car in high gear and run the engine so a steady 40 m.p.h. is indicated on the speedometer. Repeat as with the tachometer to get the highest reading. The correct length of pipe extending beyond the tail pipe then can be cut off and clamped or welded to the tail pipe. ★ ★ ★

By Tom Riley

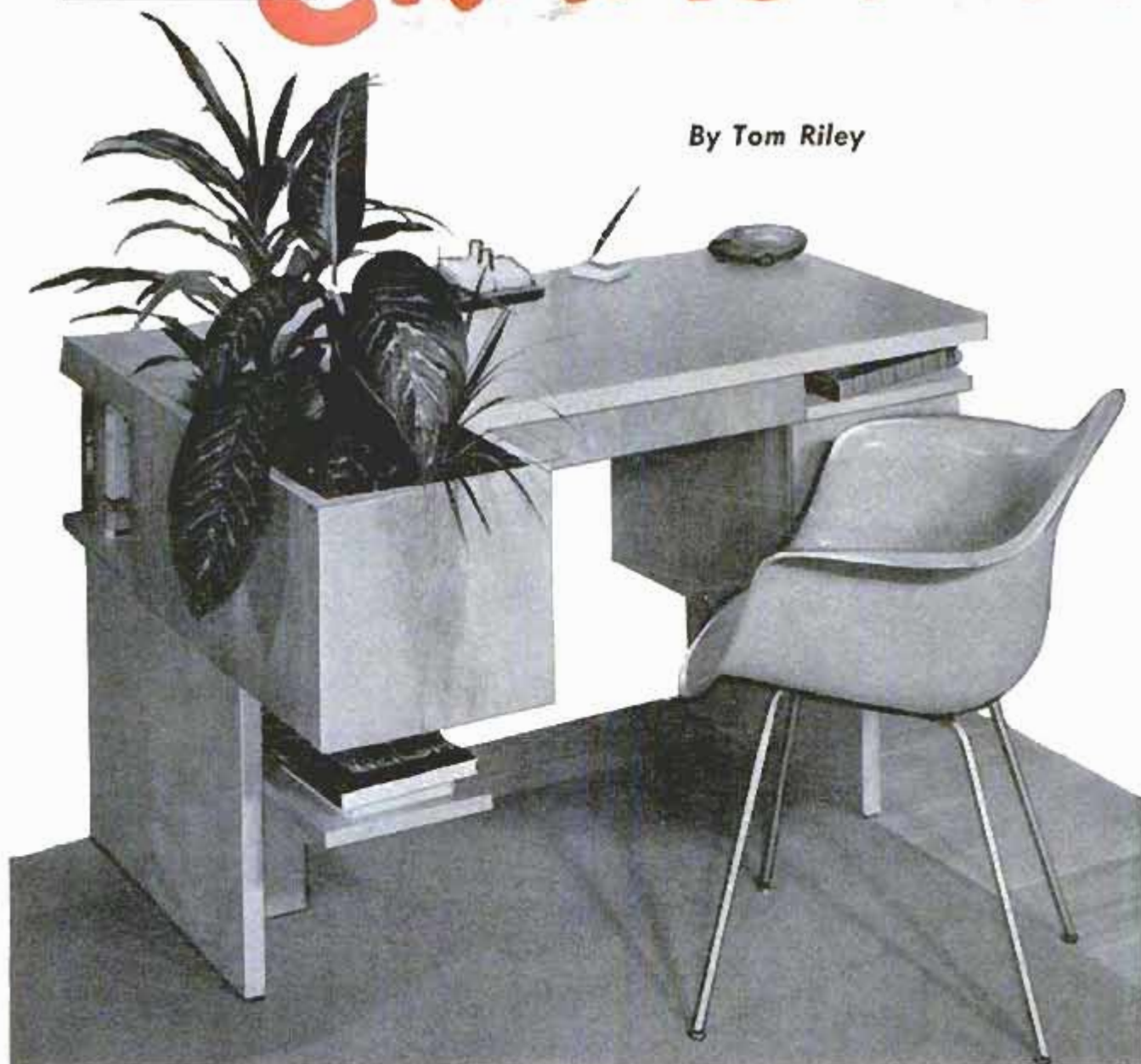

PLANTER- DESK

FOR THE PROBLEM of a desk in the living room, family room or bedroom, this modern design presents a new answer—a planter box which lets a desk add to a room's appearance and which screens the study area to give a bit of seclusion from the rest of the room. The design includes a handy place for the telephone book or dictionary and a bookshelf on the side for the miscellaneous. The planter box is dimensioned so that it can be converted into a desk-height filing drawer at any time by simply adding the lid as shown at the right.

If you prefer to use the planter as a filing drawer, the well is fitted with double-hinged lids as shown below. Special pin-type hinges are used to attach the lids to the desk. Note that the top of the planter well extends $\frac{1}{4}$ in. above the writing surface



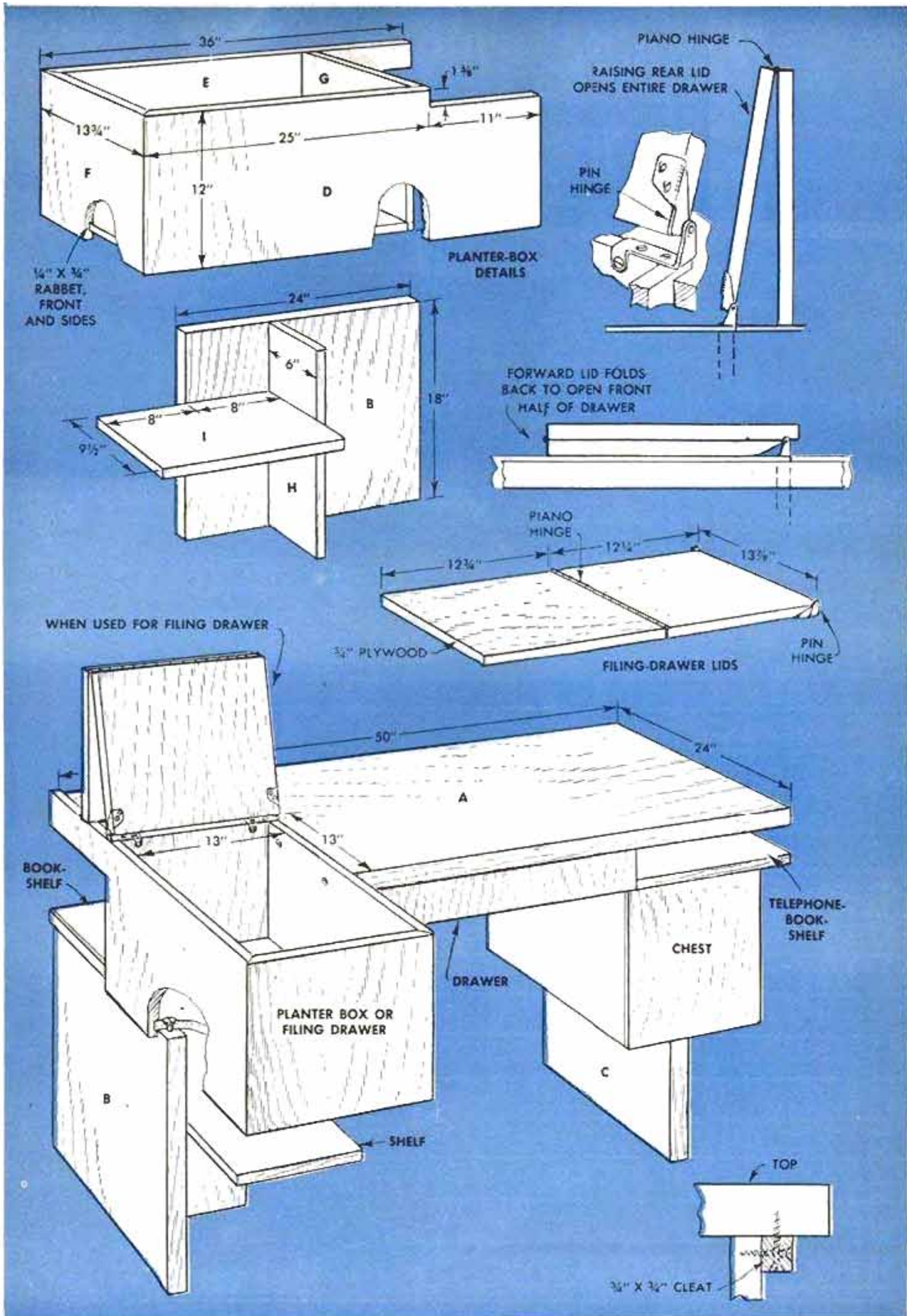

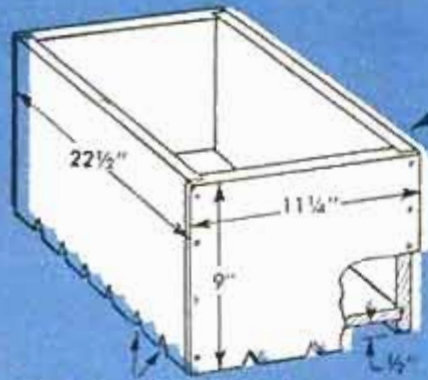

NOTCH ALL FOUR SIDES FOR VENTILATION

INNER BOX IF USED AS PLANTER

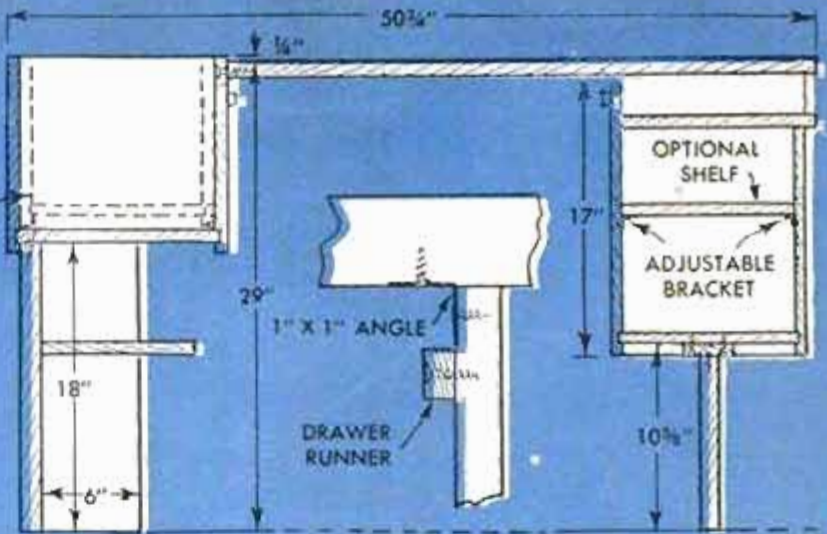

SECTIONAL VIEW

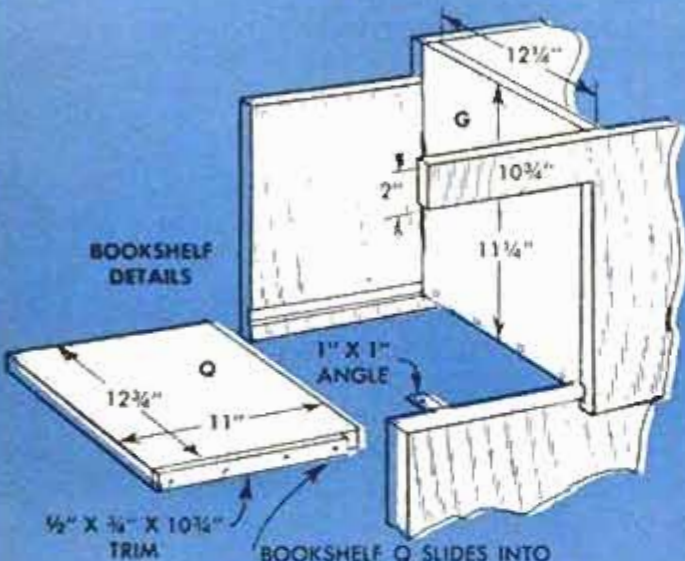

BOOKSHELF DETAILS

BOOKSHELF Q SLIDES INTO SAME RABBETS AS BOX BOTTOM

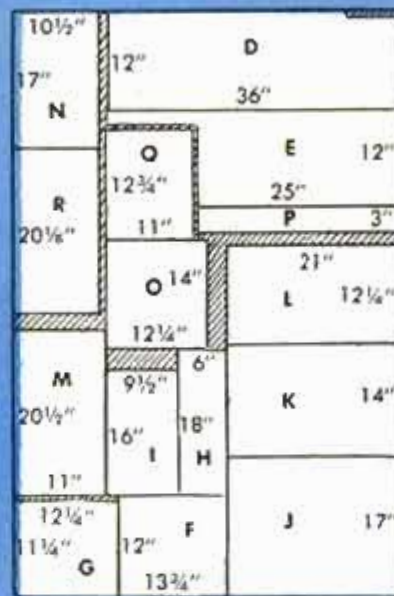

4 X 6-FT. PIECE OF 3/4" HARDWOOD PLYWOOD

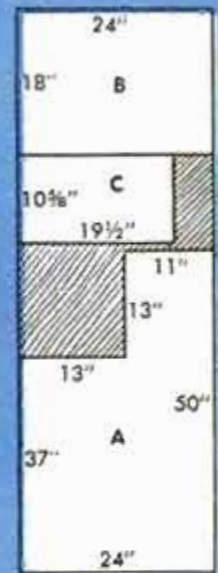

STANDARD 1 1/8" X 24" X 80" HARDWOOD FLUSH DOOR

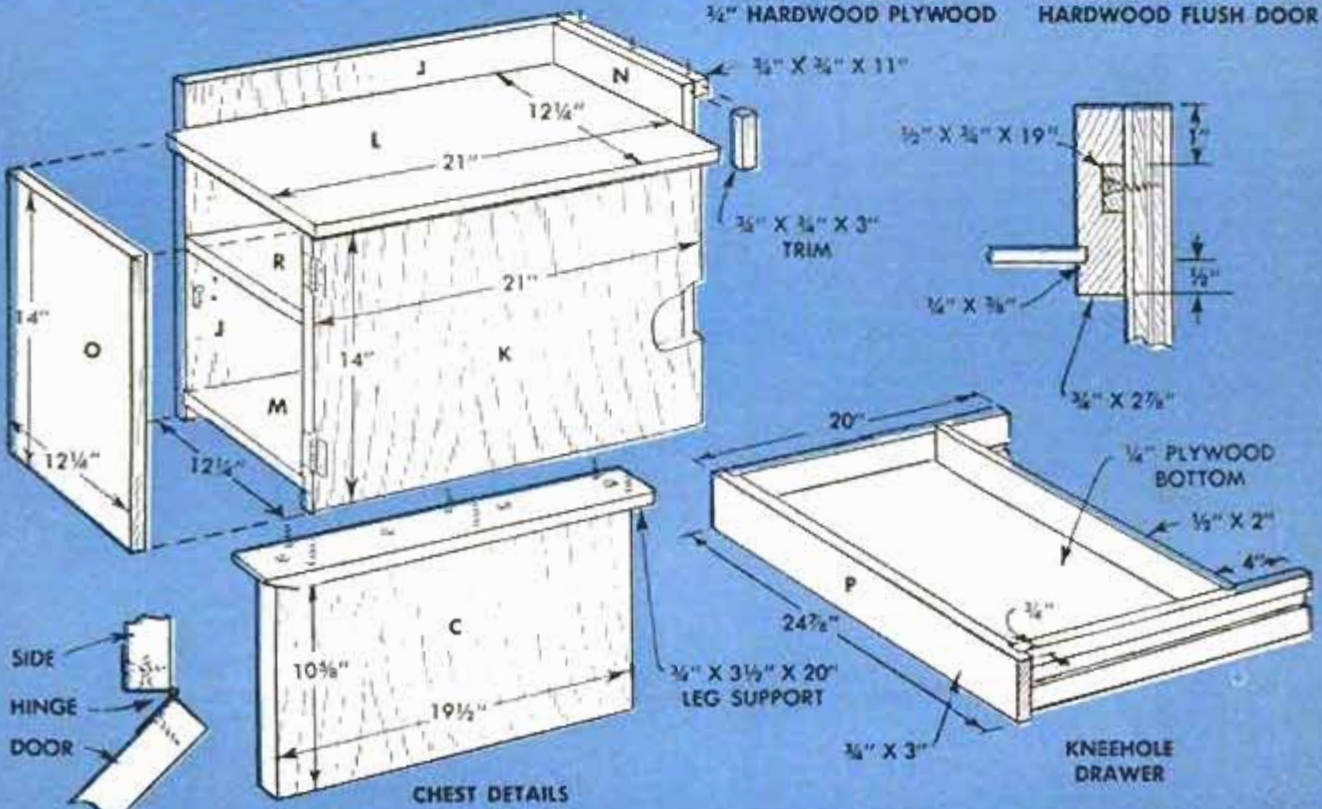

CHEST DETAILS

KNEE-HOLE DRAWER

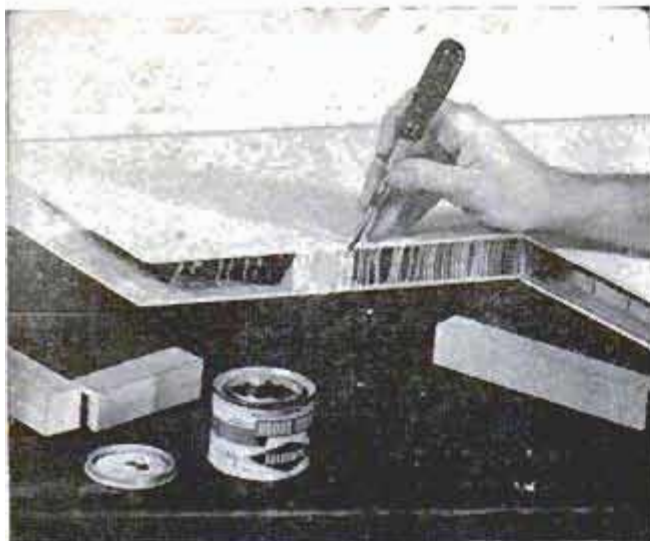

Wood putty is used to fill spaces between the cores along the lengthwise cut in the hollow-core desk top

A 24 x 80-in. interior-type flush door provides the desk top and both legs. All other major parts are obtained from a 4 x 6-ft. panel of $\frac{3}{4}$ -in. hardwood plywood. The flush door and the plywood should be of matching hardwood. By asking for a door with hardwood edges, which is no more expensive, you can eliminate any need for trim along the edges.

How to Start

Begin by marking out all the parts on the 4 x 6-ft. plywood. Dimensions for these parts are given in the cutting diagram which shows how the parts can be laid out with the least amount of waste and still have the grain running in the proper direction. Allow enough space between pieces for the saw cuts and use a planer or fine-tooth crosscut blade on your saw. Note that all parts on the cutting diagram are keyed alphabetically with the assembly drawing.

After cutting the door you will be able to see its hollow-core construction which may vary from thin wood strips to rings of cardboard tubing. Whatever type it may be, chisel or snip out enough of the core to provide space along the edges for $1\frac{1}{8}$ -sq. wooden blocking. The blocking is glued into the cut edges to reinforce them. Wood putty is used to strengthen the crosscut coring of the one lengthwise cut in the desk.

A study of the drawings will show how each separate unit of the desk is put together. Using a dado blade, cut $\frac{1}{4}$ x $\frac{3}{4}$ -in. grooves $\frac{3}{4}$ in. up from the bottom edges of sides J and K and back N of the chest to house the bottom shelf. Then groove parts F, D and E of the planter box for its bottom. Back G is simply butt-fitted. Note that the grooves run full length on D and E to also hold the bookshelf. The planter bottom is a $12\frac{3}{4}$ x $24\frac{1}{2}$ -in. piece of $\frac{3}{4}$ -in. plywood.

If exposed edges are to be finished with-

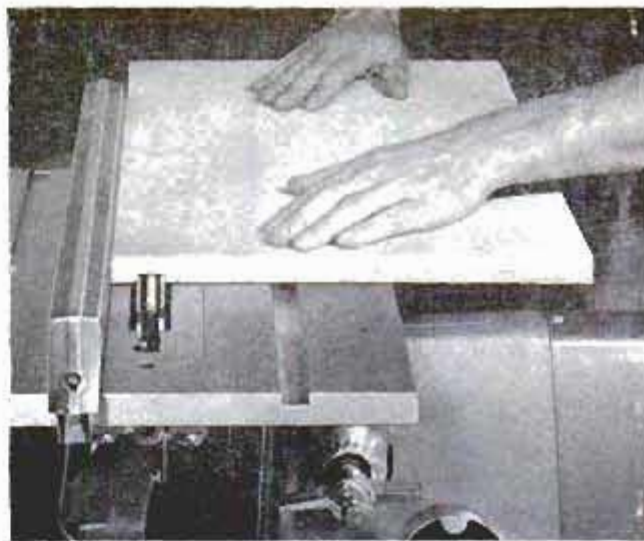

A dado or wobble saw is used to cut the $\frac{3}{4}$ -in.-wide grooves in the planter box and chest where indicated

out hardwood facings, fill any small voids in the plywood layers with wood putty before sanding. Use glue and No. 5 finish nails to assemble the chest and planter, filling all nail holes carefully with wood putty.

Leg B below the planter box and parts H and I are assembled before attaching to the box. Use 1 x 1-in. angle brackets and sheet-metal screws to attach H and I to part B. Fasten the assembled leg to the bottom of the box with glue and No. 12 $1\frac{3}{4}$ -in. screws. The inner shelf R of the chest is optional and can be omitted. Note that the upper shelf L is the same length as side J and extends $\frac{3}{4}$ in. past the side. The chest door overhangs one side $\frac{1}{4}$ in. to provide an edge to grip. A magnetic or ordinary catch holds the door shut.

Making the Kneehole Drawer

The sides of the kneehole drawer are made $\frac{1}{8}$ in. narrower than the drawer front, to provide clearance for the angle brackets. After the rest of the desk is completed, attach the drawer runners to the planter box and chest with screws, not nails, since they may need trimming or thickening with washers to position the drawer precisely.

Finishing the exposed plywood edges of the shelves, planter-box top and chest door is a matter of choice. It is preferred to face the exposed edges with matching hardwood strips, sliced off $\frac{1}{16}$ in. thick on your saw and glued to the edge. A new wood tape expressly made for this purpose and which is applied with the heat of a pressing iron, also may be used to cover the laminations of the plywood. A sheet-metal liner should be made to fit the planter box. Finally add furniture glides to the legs. Special easy-to-install pin hinges are suggested for hinging the lids when the planter box is used as a file drawer. ★ ★ ★

Hand Tools Used to Make Coffee Table of Hawaiian Woods

Only hand tools were used in constructing this attractive coffee table, including the use of a hand plane to fit the center joint of the top. Rain-tree wood is used for the top and the legs are of bugac wood. Neither of these woods is native to the United States, but can be obtained from some hardwood suppliers who import rare woods for woodworking hobbyists.

Hi Sibley, Nuevo, Calif.

Elevated Coping-Saw Table

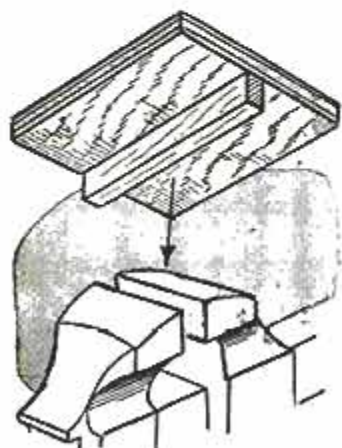

Use of a coping saw will be found more convenient when the work is held flat on an elevated table clamped in a vise. Not only is the work brought to a handy working height, but the setup gives more freedom in manipulation of both the

work and the saw. The table consists of a square piece of $\frac{3}{4}$ -in. plywood with a wooden cleat screwed to the underside which is gripped by the vise jaws.

Trimming Board End With Saw Aided by Scrap Lumber

When it is necessary to trim only $\frac{1}{16}$ or $\frac{1}{8}$ in. from the end of a board, the saw can be kept from slipping by using a piece of scrap wood. Clamp the scrap on top of the work piece, allowing it to project a couple of inches, as shown in the photo. When starting the cut, hold the saw horizontal to assure a straight cut, then lift the handle to about a 45-deg. angle. The angle will assure that the saw remains aligned with the cut by sawing through both the scrap wood and work at the same time. Because of its inherent rigidity and fine teeth, a backsaw of the type shown should be used, if available.

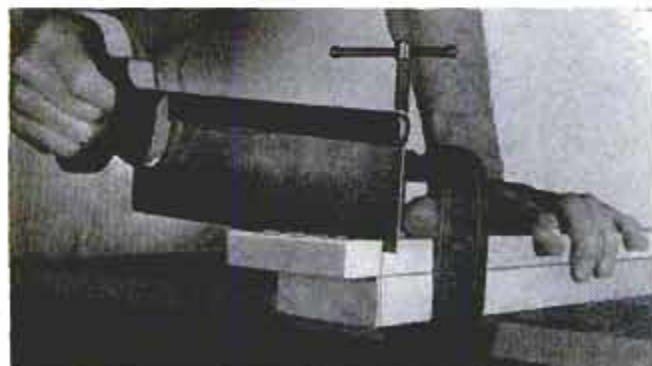

Children's Construction Blocks Improved From Lumber Scraps

Building blocks for youngsters can be improvised from scraps of lumber usually found around lumberyards and at places where construction is in progress. These small pieces of assorted sizes and shapes are sanded smooth and can be left unpainted or finished in several colors. Painted or plain, they will provide hours of enjoyable and constructive play.—Mrs. George H. Tucker, Minneapolis, Minn.

Rubber Tape Over Oilstone Edge Reduces Chance of Breakage

To minimize the possibility of breaking an unprotected oilstone in case it is pushed off a bench top or dropped accidentally on a concrete floor, wrap it with three layers of rubber tape as shown. Narrow strips cut from an old inner tube also can be used. After applying the rubber tape, bind it in place with a single layer of friction tape. If the rubber is too wide it can be trimmed flush with the oilstone surface with a pair of tin snips.

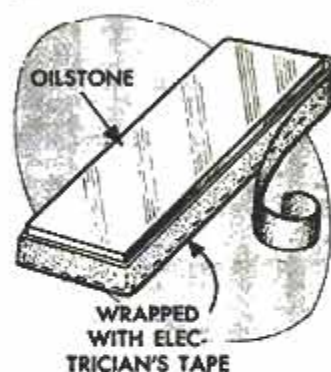

□ A rubber mat of the type used on a kitchen-sink drainboard, placed on a car seat for tiny tots to stand on, saves wear and tear on upholstery and seat covers. The mat is easily cleaned with soap and warm water.

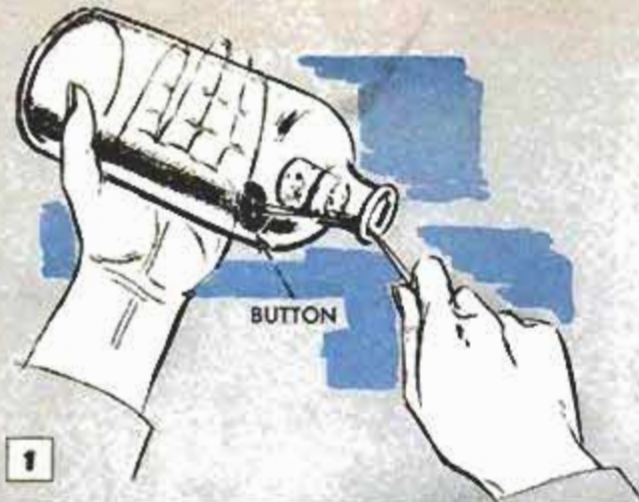

1. A CORK which has been pushed into a bottle can be removed with the aid of a button threaded on strong cord as shown. Lower the button into the bottle and manipulate the cork into position near the neck. A quick pull will usually remove it intact

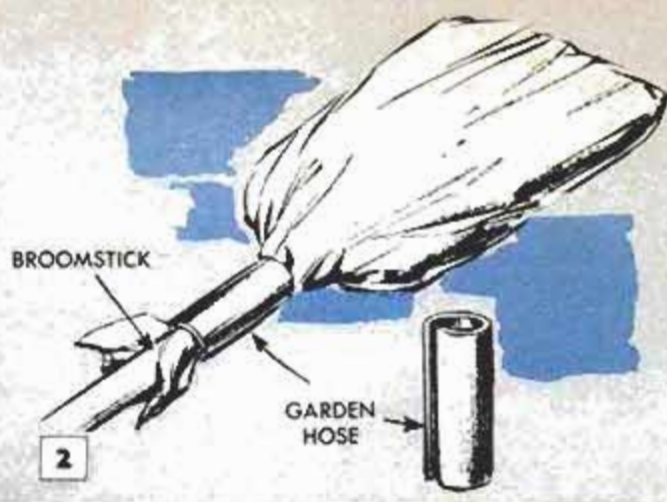

2. DUSTCLOTH IS WRAPPED around a broom and clamped in place quickly when a short length of radiator hose is used to secure it. Simply slit the hose and slip it over the loose ends of the dustcloth, which have been twisted around the handle

Solving

HOME PROBLEMS

3. RINGS ON VARNISHED TABLE caused by hot utensils are removed by applying a paste of olive oil and salt. Leave for few minutes, wipe off and polish

4. MORE DAYLIGHT is admitted to basement when wall of well parallel with window is slanted. Paint well walls white to increase reflection of light



5. TRAYS AND COOKIE SHEETS are stored on underside of wall cabinet by attaching four towel bars as shown. Same idea is used to store trays on side of cabinet with a length of wood fastened under lowest bar for a bottom

6. AIRTIGHT SEAL ON JAR is assured by depressing the lid with a wooden drawer knob while tightening the band as shown. When vacuum keeps the lid depressed, after releasing the knob, the jar has an airtight seal

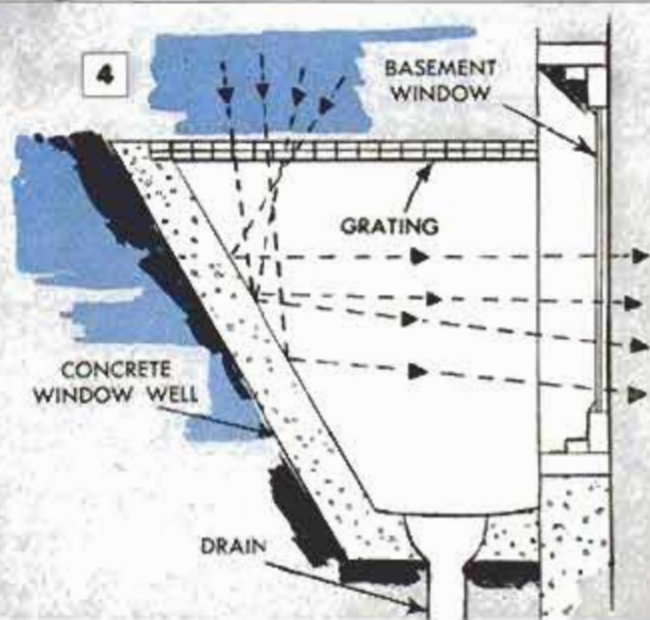

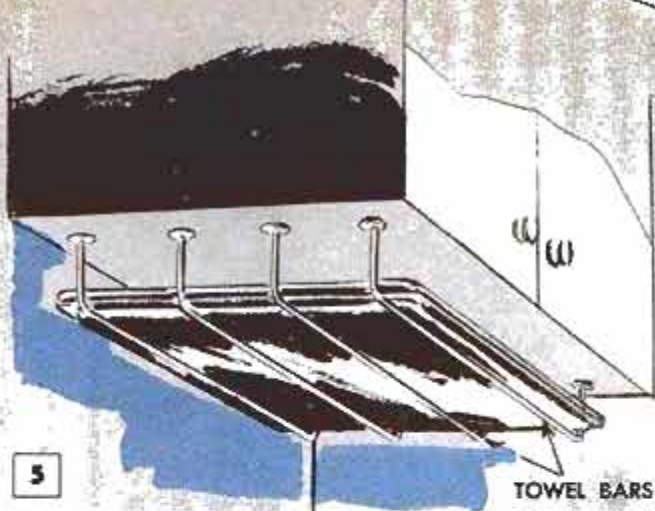

TOWEL BARS



6



7. DOG-FOOD DISH can be anchored and the food kept free of ants if small angel-food tin used as dish is placed inside large one. The tins are slipped over a broomstick stake driven in the ground and the outer one is filled with water

8. TWO-WAY DOOR WEDGE made from a length of heavy rubber hose holds door open at desired position while preventing it from swinging in either direction. Slit the hose, open flat and wedge it under the bottom edge of the door as shown. If there is unusual clearance at the bottom edge of the door, use another length of hose of the same size on top of the first length

9. NOTE FOR THE MILKMAN can be displayed so that it will not be overlooked or blown away, by placing it in a heavy glass tumbler inverted over an empty bottle as shown. Prominent display of note also prevents error in delivery

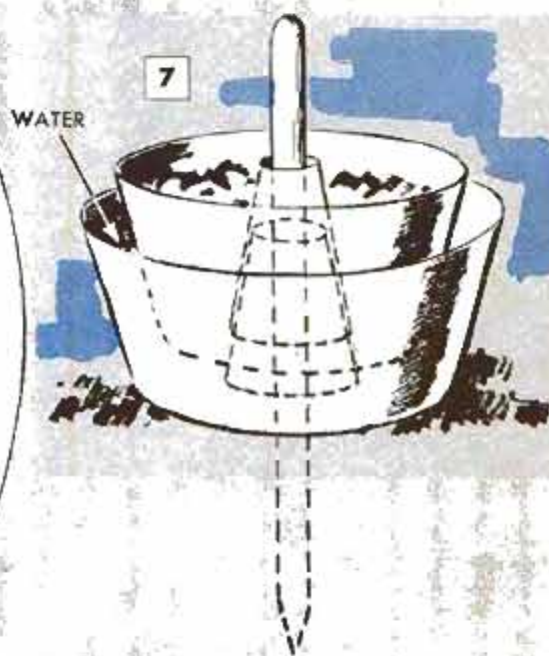

8

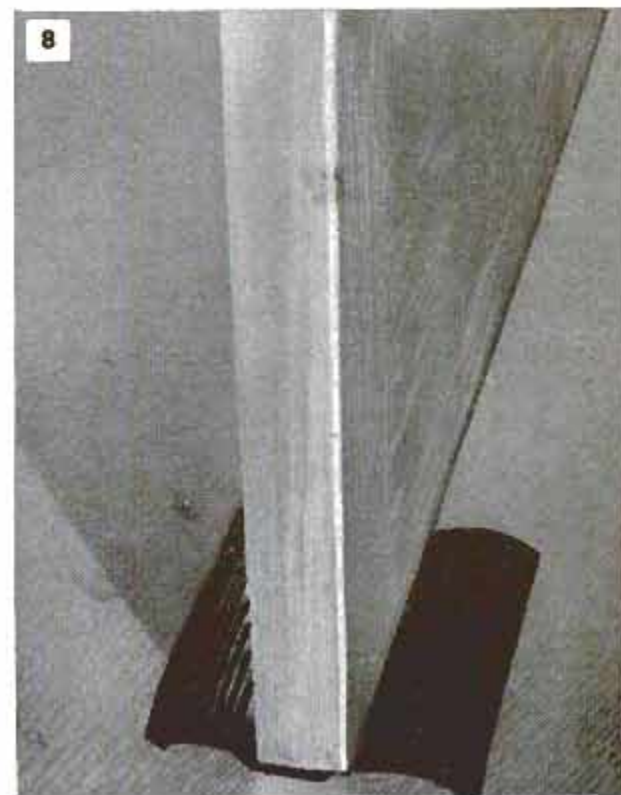

9



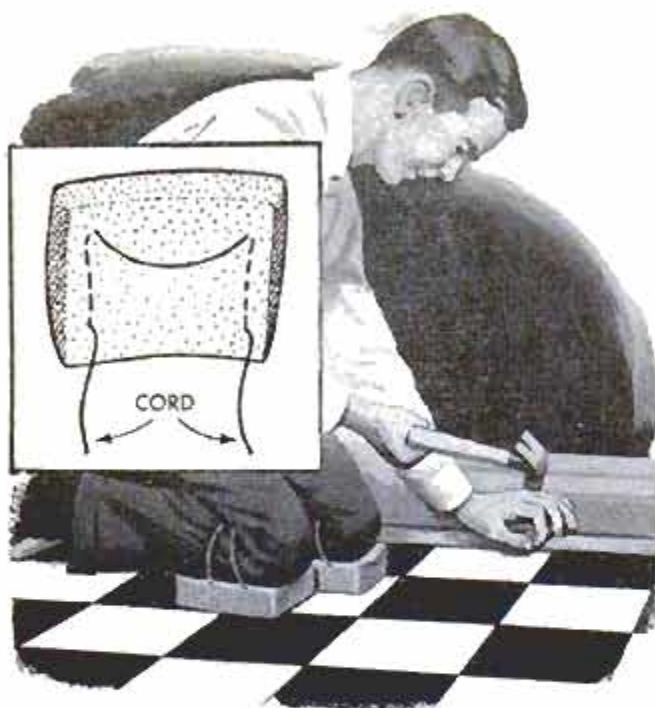

Kneepads for Working on Floors Made From Synthetic Sponges

The discomfort associated with kneeling on a floor for long periods can be avoided by wearing a pair of kneepads improvised from foam-rubber sponges. A cord is threaded through one side of the sponge as shown, leaving a loop and two free ends which are used to tie the pad to the knee.

Oil-Treated Concrete Forms

Forms will slip from hardened concrete more easily if they are painted with a mixture consisting of equal parts motor oil and kerosene. The oil repels the moisture and prevents the concrete from sticking to the forms. For better results, forms should be treated each time they are used.

Slots Sawed in Paint Paddle Speed Mixing Operation



Mixing a large can of paint is a slow and tedious process when a plain wooden paddle is used. To speed up the job, make a stout wooden paddle and saw several lengthwise slots in mixing surface. The slots

will not weaken the paddle to any extent but will permit the paint to flow through the open spaces for a more thorough mixing. Before mixing the paint, pour most of the linseed oil off the top into a pail. Then slowly pour it back as the paint is mixed.

Sludge Cleaned Out of Oil Drums By Slit-Rubber-Hose "Broom"

Attached to the end of a broom handle, a length of rubber hose, slit on one end, makes an excellent implement for loosening sludge that has settled on the bottom of an oil drum. The end of the handle with the hose attached is inserted through the large bung on the top of the drum and agitated vigorously against the bottom until all the dirt is freed. Then the drum is tipped over and allowed to drain. For a thorough cleaning the drum should be rinsed with gasoline one or more times, observing the usual precautions when working with a flammable liquid.

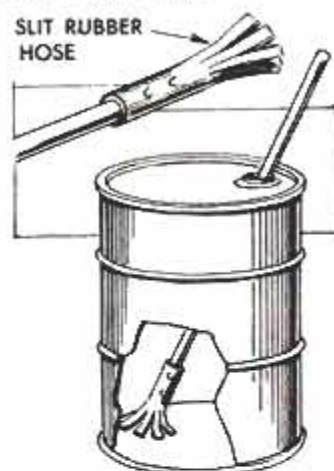

Dispenser Bottle Provides Oiler

An empty lotion-dispenser bottle filled with oil is ideal for lubricating an oil burner and other motorized equipment that has difficult-to-reach oil cups. One press on the dispensing button provides sufficient oil for most jobs, and the bottle holds enough to last a long time without refilling. The plastic pump nozzle should be heated and straightened to a horizontal position. A length of plastic tubing then is slipped over the nozzle to extend its length.

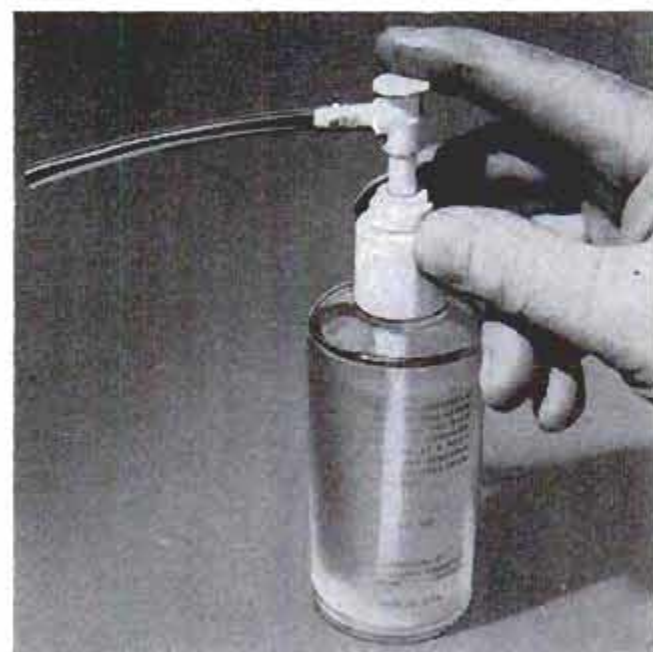

When installing seat covers in a car, first fasten one side, then moisten with a sponge and fasten the other side. As the cover dries, it will shrink and fit snugly.

HAND-CARVED MIRROR FRAME

By John Bergen

HAND CARVING on furniture built in the home workshop gives a definite personal touch to what might ordinarily be a run-of-the-mill woodworking project. This hand-carved mirror is an excellent example of this type of work, being made in four pieces which first are carved, then assembled. It is much easier to handle and carve the individual pieces.

All stock used in the frame is $1\frac{1}{8}$ in. The top piece is $4\frac{5}{8}$ in. x 26 in., the sides are $1\frac{3}{8}$ in. x $29\frac{7}{16}$ in. and the bottom cross-piece of the frame measures $3\frac{5}{8}$ in. x 26 in.

Before doing any carving, the ends of side members are cut to form a tenon as indicated in the detail. The upper and lower crosspieces of the frame then are grooved to receive the tenon, so that a "half-lap tenon joint" results.

Use a Pattern

The next step is to make a pattern for the carving by drawing a copy of the squared pattern on a sheet of paper with 1-in. squares. After tracing the pattern onto the wood, cut out the areas that are marked with an "x" in the top crosspiece. A jigsaw or hand coping saw can be used for this. At least two sizes of wood chisels and a gouge are required to do the carving, although with much patience, an ordinary pocketknife and a straight wood chisel will give the same results.

Do not worry too much about slight mistakes or irregularities in the carving. Such irregularities are what give hand carving its personality, setting it apart from machine-made work.

Finishing the Frame

When the carving is completed, assemble the frame before applying a finish. Only glue should be used in assembly, and the frame should be clamped or held firmly until the glue is well set. The finish to be used on the frame is strictly a personal matter, which might be influenced by the type or style of furniture used in a home. An antique finish, however, is most appropriate. Wipe-on oil stains are available to produce almost any type antique finish. In some cases, it might be desirable to accentuate the carving, which can be done by wiping a light-colored pigment over the frame, allowing it to dry slightly, then wiping it off with a soft cloth. Finally, apply one or more coats of varnish.

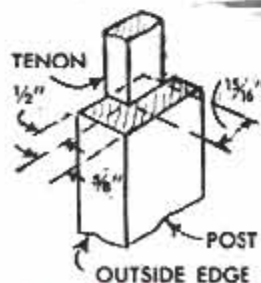

Tenons are cut on the ends of each side rail as indicated at left. They then are fitted in grooves cut in the top and bottom pieces of mirror frame to form "half-lap tenon joints"

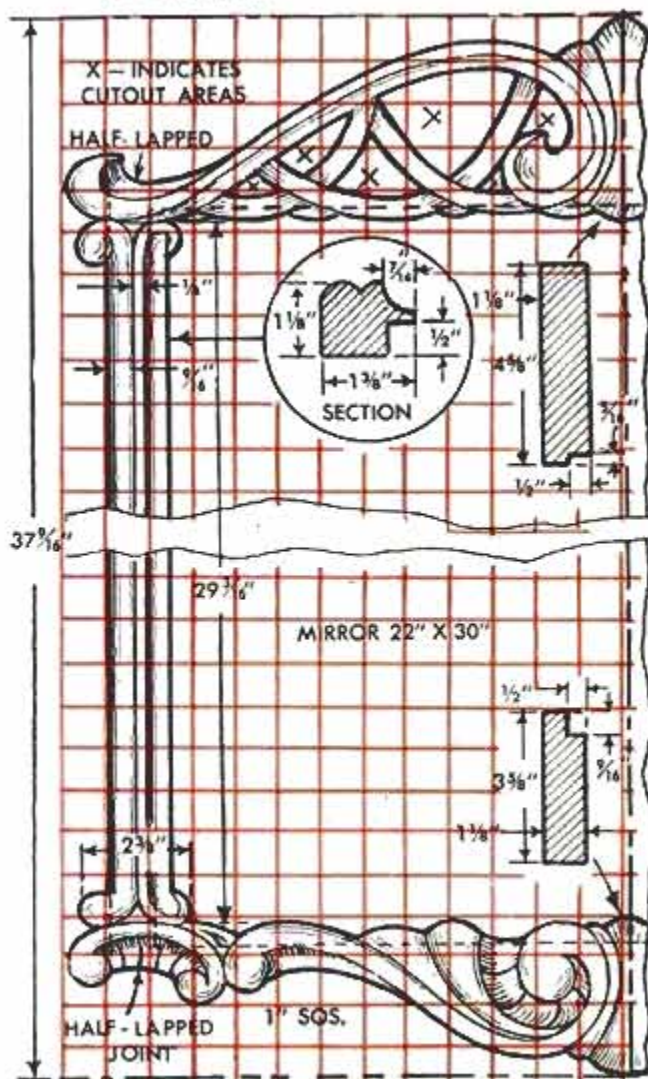

NAIL POLISH DOES IT



1. Personalize children's drinking glasses by painting initials on them with nail polish. Same idea is handy for an adult party. Clean off initials with polish remover



2. Emergency repairs on pots and pans are made by painting holes with nail polish, and drying at low temperature. Utensil cannot be used over flame or near heat

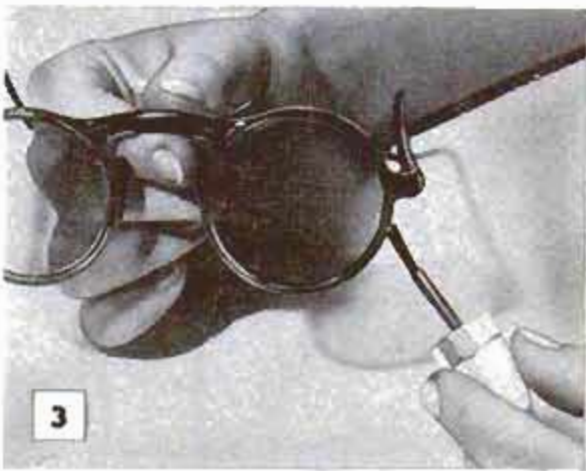

3. Streaked and faded frames of sunglasses can be renewed and made colorful by painting with bright-colored nail polish. The hard finish of the polish easily wipes clean

4. Finger marks and grease stains around light switches often show through new wallpaper. To prevent this, paint stains with nail polish before applying the new paper

5. Wooden coat hangers that have sharp-edged joints or rough spots that may damage clothing can be kept usable by coating the rough areas with clear nail polish

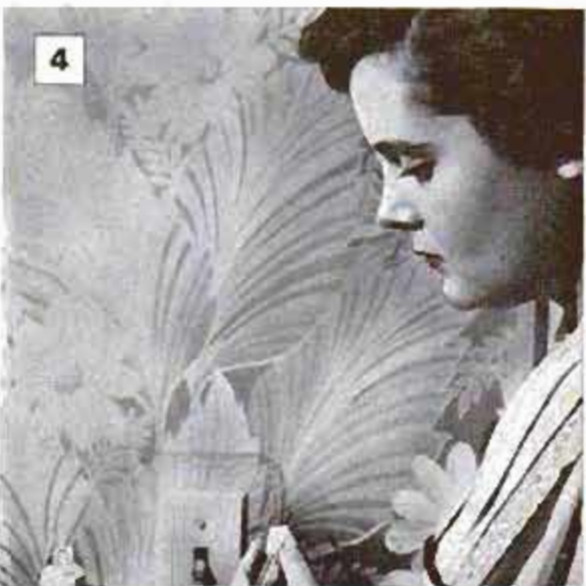

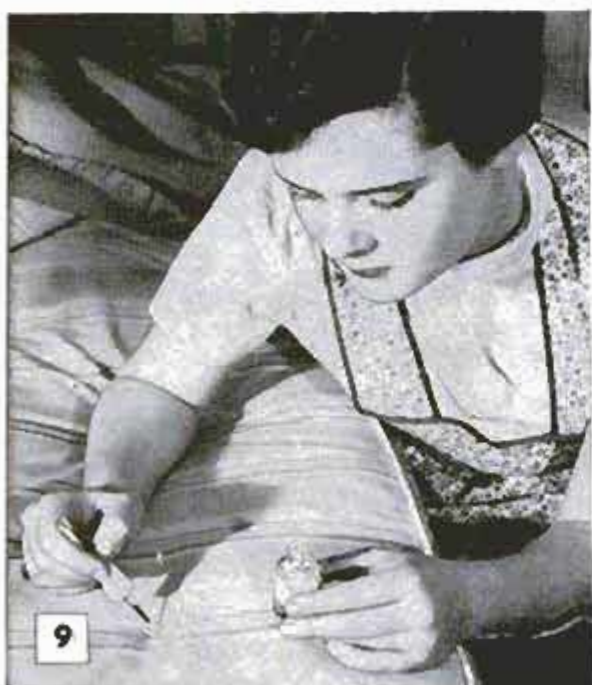

6. Buttons that have become dimmed by many washings will regain luster when painted with clear nail polish. To avoid staining clothing, use paper under the buttons

7. To prevent upholsterer's nails on chair backs from making marks on walls when the chairs are rubbed against them, coat the nailheads with clear fingernail polish

8. Painted wooden handles of mixing spoons and other kitchen utensils will retain their color even after repeated washings if they are coated with clear nail polish

9. Clear fingernail polish brushed over worn mattress buttons will eliminate the possibility of the buttons ruining good bed sheets by tearing or discoloring them

10. When a wooden crochet hook has become roughened so that it snags the yarn, don't discard it. Sand it lightly and coat with clear nail polish to restore its usefulness

11. To prevent tipping the bottle when using nail polish, fit bottle in a stand made by cutting a hollow rubber ball in half. Bottle fits in hole cut in ball half as shown.

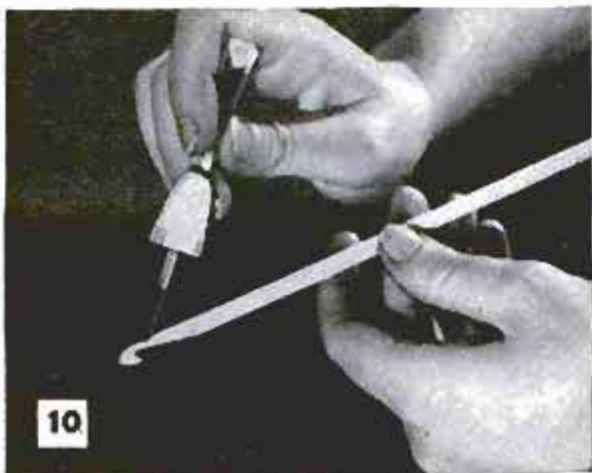

Linseed Oil in End of Hammer Handle Preserves Wood Fibers



One craftsman keeps his hammer handles in good condition by treating them periodically with linseed oil. A small hole drilled into the end of a handle to a depth of 2 in. and fitted with a plug is filled with linseed oil, which permeates the wood to keep it from drying out and becoming brittle. Other wooden tool handles can be given the same treatment for longer service.

Aluminum Foil is Reusable

Aluminum foil need not be discarded after being used only once to wrap food. Simply wash it in warm, soapy water to remove food stains and odors, rinse in clear water and pat dry. Smooth it on a flat surface and it is ready for use again.

Helen Kay Harris, Show Low, Ariz.

Clothespin is Handy File Handle

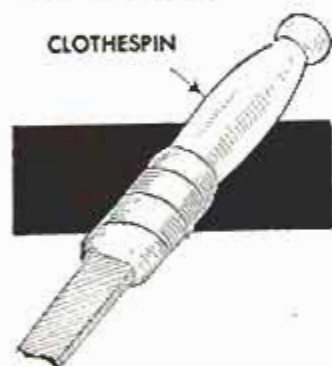

Wooden handles can be made for your files by fitting a round clothespin over each of the tangs. To do this, drill a small hole through the center of the clothespin. Saw the tips of the legs off, insert the file

tang and tape the two units together as shown. For a larger grip, slip a length of garden hose over the handle and wrap tape around the ends to fasten it in place.

Thread Spools Provide Holder For Long Bicycle Padlock

Taped to the handle bars or frame of a bicycle, two large thread spools provide a holder for a long padlock. Aligning V-notches are cut in the spools before taping them in place. For a more-permanent installation, use sheet-metal clamps, such as are used for auto-radiator hose. Locate clamp screws so they are clear of the rider's legs.

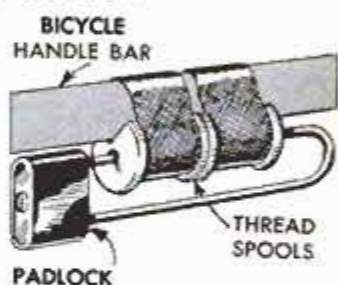

D. H. Jones, Sault Ste. Marie, Can.

Whale Modeled From Shrub

This unusually shaped lawn shrub is a 25-foot whale fashioned from a growth of Australian pine. Since it wouldn't be a whale without spouting water, a home-made mechanism squirts a column every few minutes as reliably as Yellowstone's Old Faithful.—Donald Carr, Sarasota, Fla.

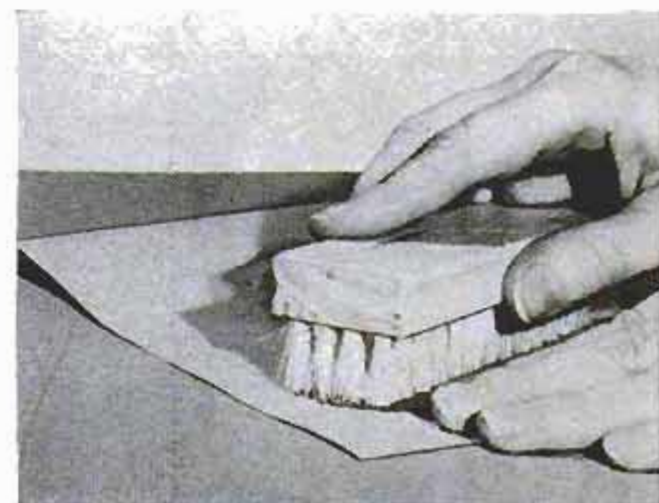

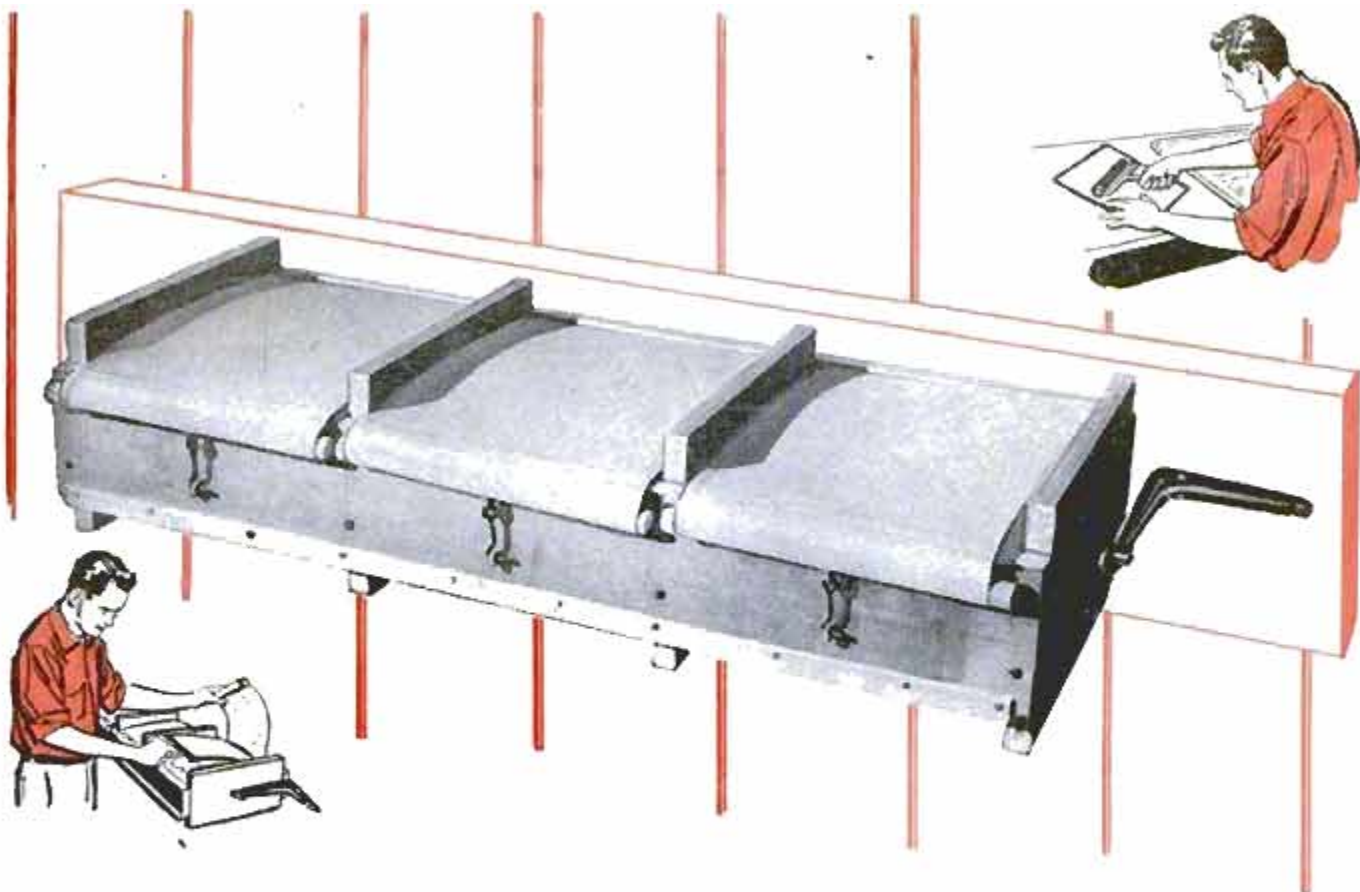

High-Speed Print Drier

By Ron Anderson

UP TO 50 PHOTOPRINTS per hour can be run through this "flop over" drier that is designed to hold standard 10 x 14-in. ferrotype tins. Heat is provided by nine 100-watt lamps held in porcelain sockets as indicated in the lower left-hand photo. A $\frac{1}{4}$ -in. stove bolt is centered in each end of the drier to provide an "axle" on which it rotates. Sockets on the ends must be located accordingly.

Heat supplied by nine 100-watt lamps fitted in porcelain sockets assures rapid drying of photoprints

The ends and partitions of the drier are $7\frac{1}{2}$ x $33\frac{1}{2}$ -in. pieces of $\frac{3}{4}$ -in. plywood with $\frac{3}{8}$ -in. holes drilled in opposite corners as shown in the lower right-hand detail on page 222.

To begin construction, the front and back, which are $4\frac{1}{2}$ x $33\frac{1}{2}$ -in. pieces of 1-in. stock, are screwed to one end. Two 36-in. lengths of $\frac{3}{8}$ -in. dowel are inserted in the holes, and the two partitions and

Canvas aprons are stretched over ferrotype tins to obtain correct tension, then clamped with angle

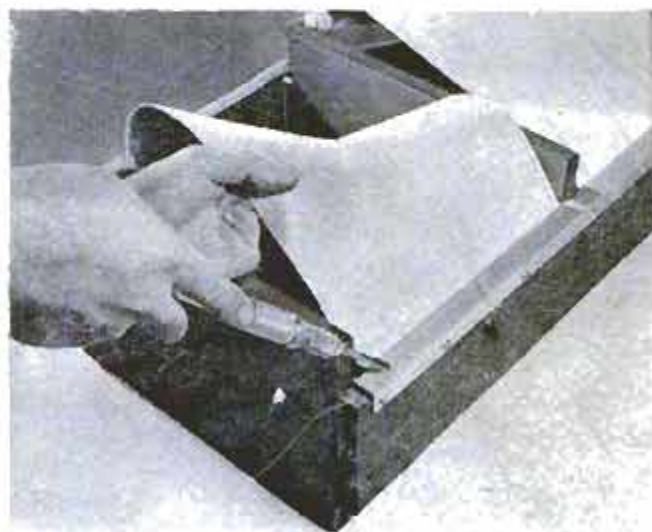
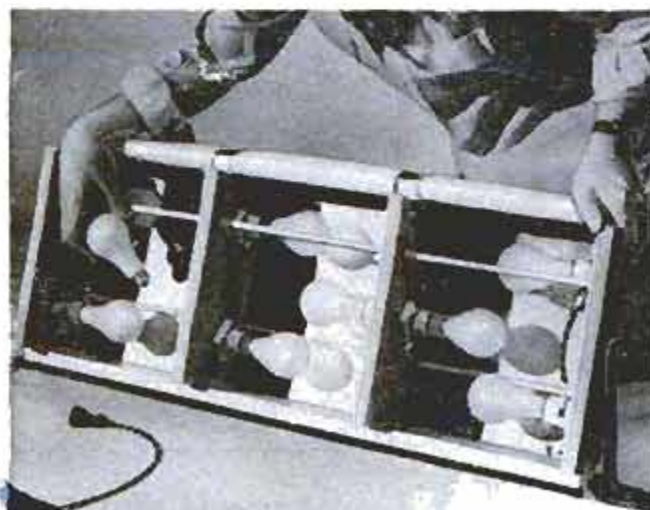



Drier rotates on "axles" consisting of $\frac{1}{4}$ -in. bolts. Axles fit in slotted holes in metal shelf brackets

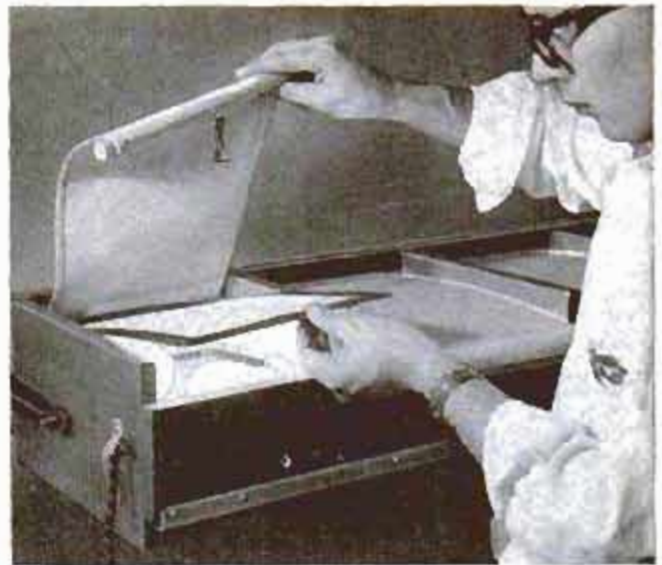

Single-weight 8 x 10s dry in 6 to 8 minutes. Metal or asbestos lining of drier protects wood against heat

end are fitted on the dowels. Hold a ferrotype tin between the fixed end and the first partition to determine the correct spacing, then screw the partition in place. Repeat this operation with the other partition and end. When finished, cut off the projecting ends of the dowels.

Next, install the $10\frac{1}{2}$ x 17-in. canvas aprons. A wide hem in the bottom of each apron permits inserting a 10-in. length of $\frac{3}{4}$ -in. dowel into which is screwed a screen-door hook that fits in a screw eye driven into the drier frame. Pull each apron over a ferrotype tin in the drier to obtain the correct tension, then tack the end to the frame. When all aprons are in place, screw aluminum angles to the frame for a permanent clamp, as in the lower right-hand photo on page 221.

Two shelf brackets are used to support the drier on a wall, the screw hole in one arm of each bracket being slotted so the drier can be lifted. Two pipe clamps, each held by a screw, act as stops. ★ ★ ★

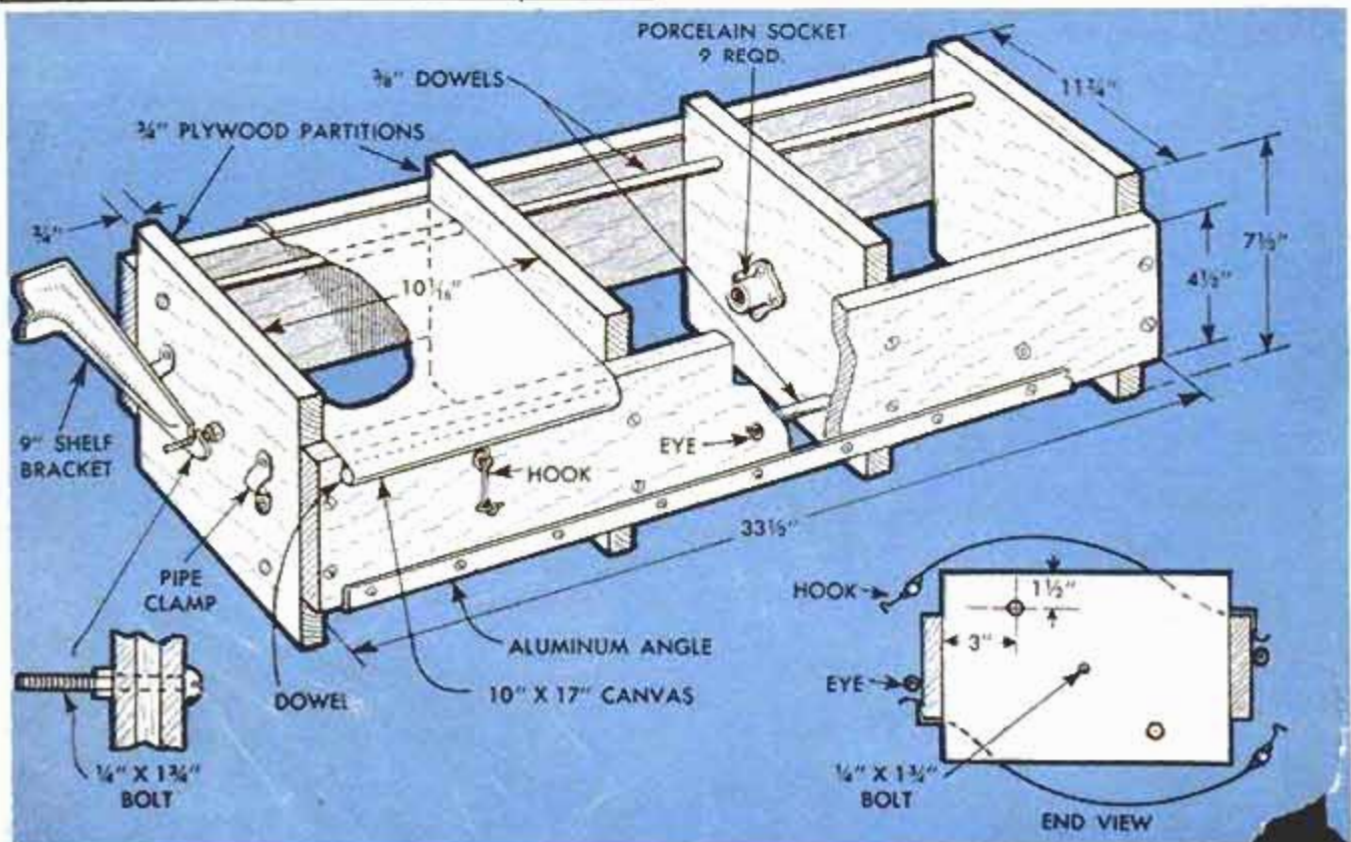
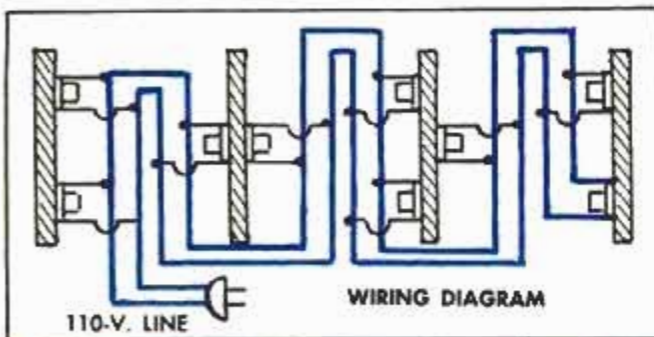

"Roll-a-Ball" Game Utilizes Egg Carton, Plywood

A game that will provide hours of fun for the youngsters requires only an ordinary papier-mache egg carton and a few scraps of wood to build. The lip at the front edge of the carton is tacked to a piece of plywood that forms a ramp. Support for the ramp and rigidity for the carton are provided by a wooden strip under the end of the ramp. A similar strip is attached under the lip of the carton lid. Bevel the end of the ramp so the ball rolls smoothly onto it from the floor. Number the carton indentations from one to twelve for scoring. Landing the ball in the cover may be considered



an out. Bottom parts of two cartons can be fastened together, for additional scoring. Ben Ollman, Milwaukee, Wis.



Perforated Hardboard Used For Eaves Boxing

Adequate roof ventilation is easily accomplished when perforated-hardboard panels are used for boxing material. The panels are nailed on the exposed rafters in 8-ft. lengths which permits considerable saving of labor over the more conventional method of installing lumber and screen vents. The Masonite Corporation recommends $\frac{1}{4}$ -in. material for this use. To keep out insects, window screening is stapled inside the perforated hardboard on the framing members and facing strip.

Broad-Line Lettering Pens Cut From Bamboo Strips

Pens for lettering packages, tags and labels can be made from bamboo strips. Use strips which are about $\frac{1}{4}$ in. wide and 5 in. long. Form a penpoint on one end of each strip by shaving the inside surface to a thickness of $\frac{1}{32}$ in. at the very tip, and tapering the sides for a distance of $\frac{3}{8}$ in. back from the tip. Then drill a $\frac{1}{16}$ -in. hole about $\frac{3}{8}$ in. from the tip and make a slit extending from the hole to the tip. Several such pens having points of various widths can be made to give a good range of sizes for future use.

☛ To skidproof his icy walk, one homeowner uses sawdust, which is cleaner to handle and easier to obtain than ashes. If tracked into the house, sawdust will not damage floors and rugs and it is easy to pick up with a vacuum cleaner.



Metal Extension Arm Locks Window Over Air-Conditioner Unit

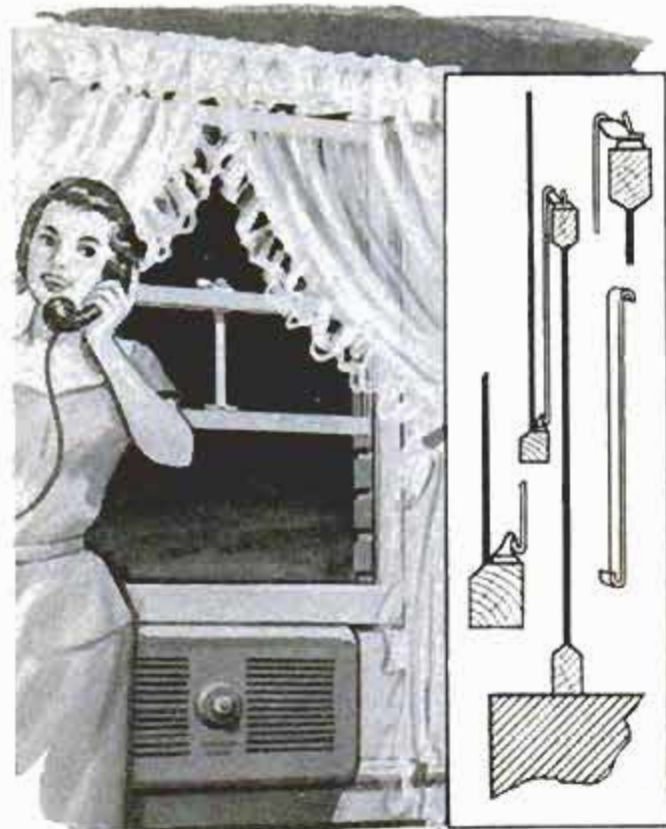

A double-hung window can be locked when an air-conditioning unit is mounted on the sill if a flat of steel $\frac{1}{2}$ in. wide and $\frac{3}{32}$ in. thick with a short hook bent on each end of it, as shown in the detail, is fitted on the window locks to serve as an extension. The over-all length of the device is determined by measuring the distance between the members of the lock with the top half of the window closed and the bottom half resting on the air conditioner, and adding $\frac{3}{8}$ in. for each bend.—M/Sgt. M. E. Welty, Harlingen AFB, Harlingen, Tex.

Small Seeds Are Easy to Plant With Moistened Matchstick

If you find handling small seeds difficult when planting them, moisten the end of a matchstick so the seeds will cling to it. Then, push the stick into the soil to the desired depth and twirl it between your fingers. When the stick is withdrawn, the seeds will remain where they have been deposited.—Arlene M. Schultz, Cicero, Ill.

Boards Aid Tire Changing

If three short boards are carried in your car trunk you will find them useful when it is necessary to change a tire. One can be used under the jack to give it a firm foundation, another provides a clean, dry place on which to kneel where it is graveled or muddy and the third one serves as a tray, keeping the tools, nuts and other parts together out of the dirt until the tire is changed.—Mrs. M. Fey, New York City.

Gateposts Braced Underground



An excellent method of bracing wooden gateposts without interfering with the design of the fence is to use an underground brace or "sleeper" between the bottoms of the posts as indicated in the drawing. It is recommended that the gateposts be at least 4 x 4s that have been treated with a chemical preservative, such as creosote. Material for the sleeper can be either a 2 x 4 or a 1 x 6, and should be treated with preservative.

Ted Otsu, Vancouver, B. C., Canada.

Glue Treatment Renews Mallet Faces

When the faces of his wooden mallet became worn and uneven, one craftsman gave them a tough, new surface with polyvinyl-resin glue. First, the faces were sanded down, after which two turns of masking tape were placed around the circumference of the one face as a retaining form. The glue was then poured on in a thick layer, which dries to a smooth, slightly resilient material that lasts under repeated hammering. When the glue has set, remove the tape and repeat the process on the other striking surface.



WALL CABINET

Has Mail Rack

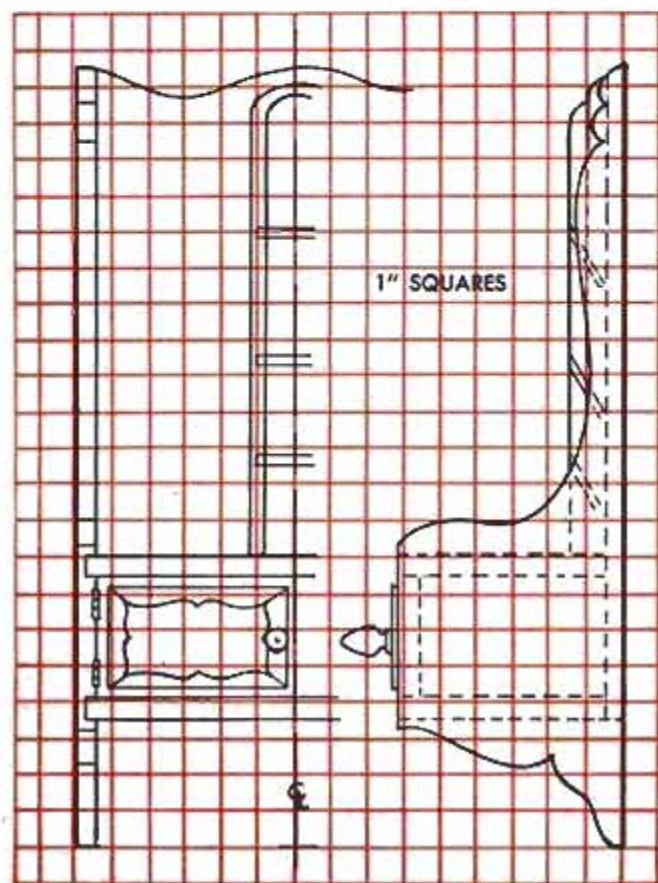
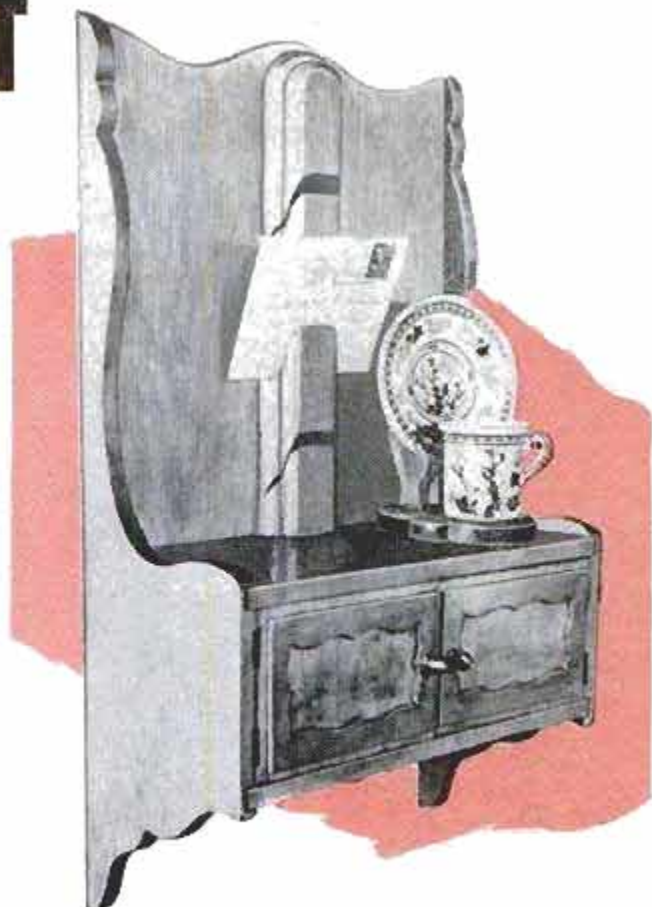

THIS MULTIPURPOSE cabinet offers a handy storage place for playing cards, score pads, cigarettes, mail and other miscellaneous items when fastened to a living-room wall. All of the members can be cut from $\frac{1}{2}$ -in. solid lumber or plywood and assembled by means of grooves, glue and wood screws. The mail rack consists of two lengths of wood glued together and fastened to the back of the cabinet with screws as shown. When cutting the mail slots, use a rip saw with a wide kerf. An ornamental overlay is cut from $\frac{1}{8}$ -in. wood and glued to the doors.

Bertram Brownold, Cedarhurst, N. Y.

While the glue is drying hold the work in a clamp improvised from scrap wood and two threaded rods

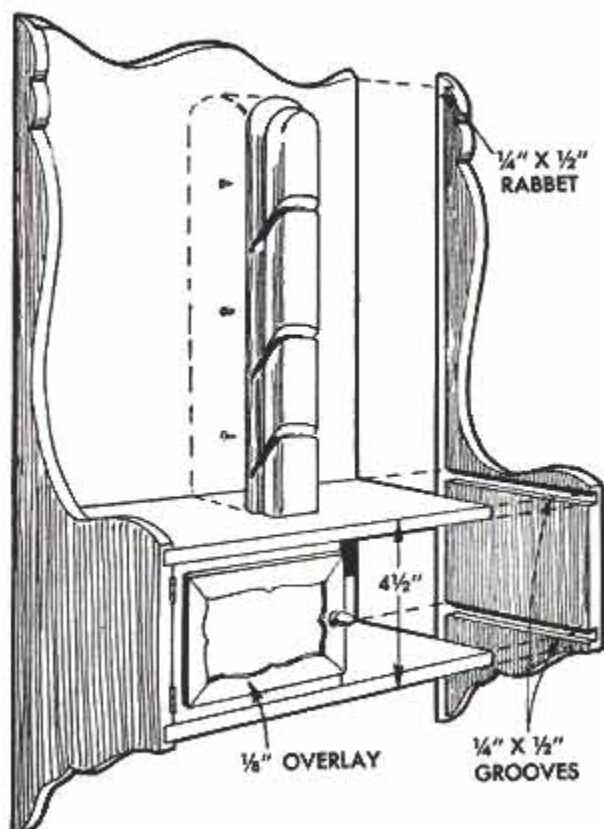

W T M '57 + Book for Boys

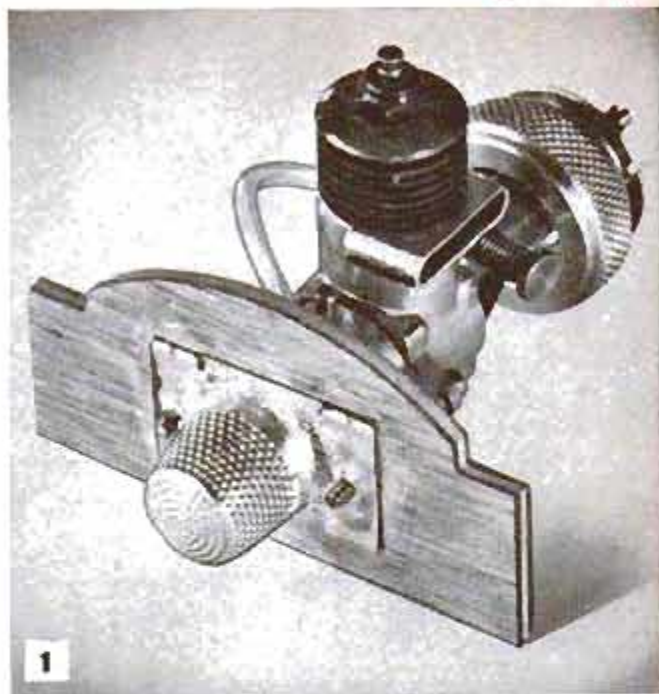

CHILI

Superhot Midget Hydroplane

Chili classes with the fastest midget spray burners—more go than you ever saw before packed into a 6-oz. hull

By Jack Wilson

CHILI'S A SHARP PERFORMER with the $\frac{1}{2}$ -A model-plane engine, sufficiently sleek and light for the tiny .020 engine and rugged enough to ride out the full power of the .049 without doing flips. Clean outline and a low center of gravity are obtained by mounting the engine with the shaft horizontal. A simple drag-spring arrangement holds the rudder setting, eliminating the unsightly tiller

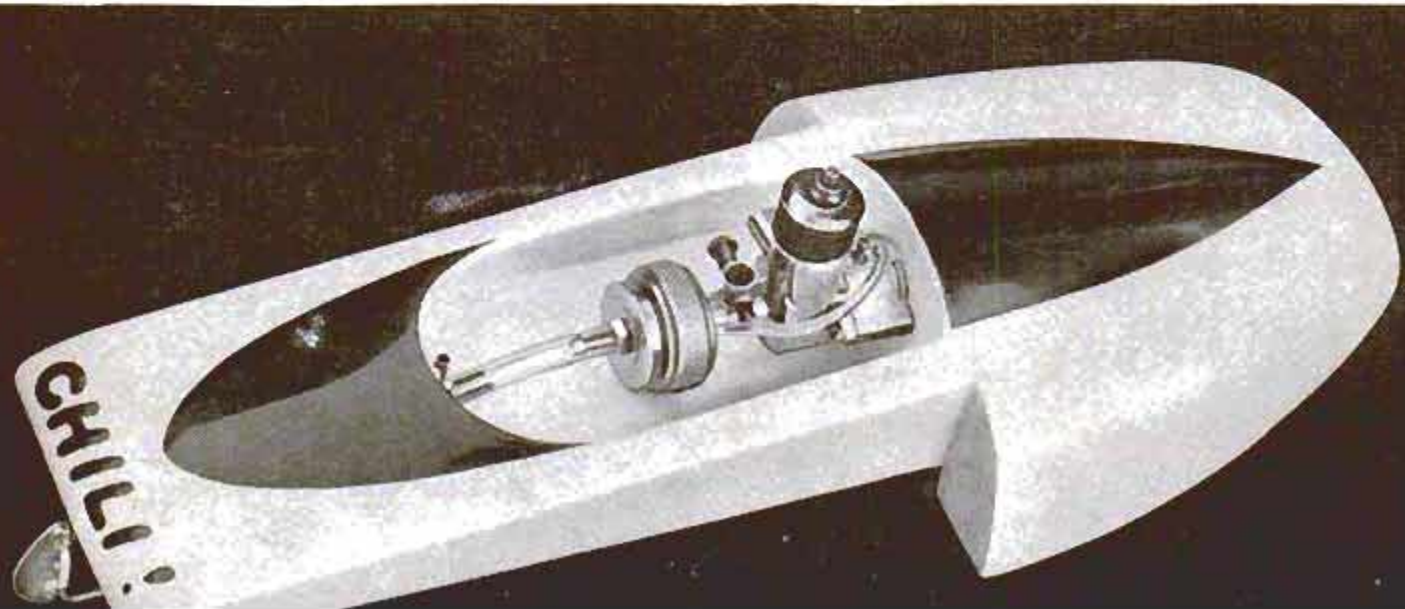
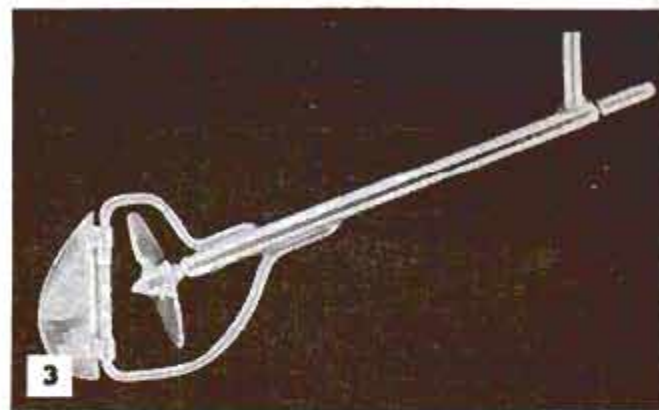

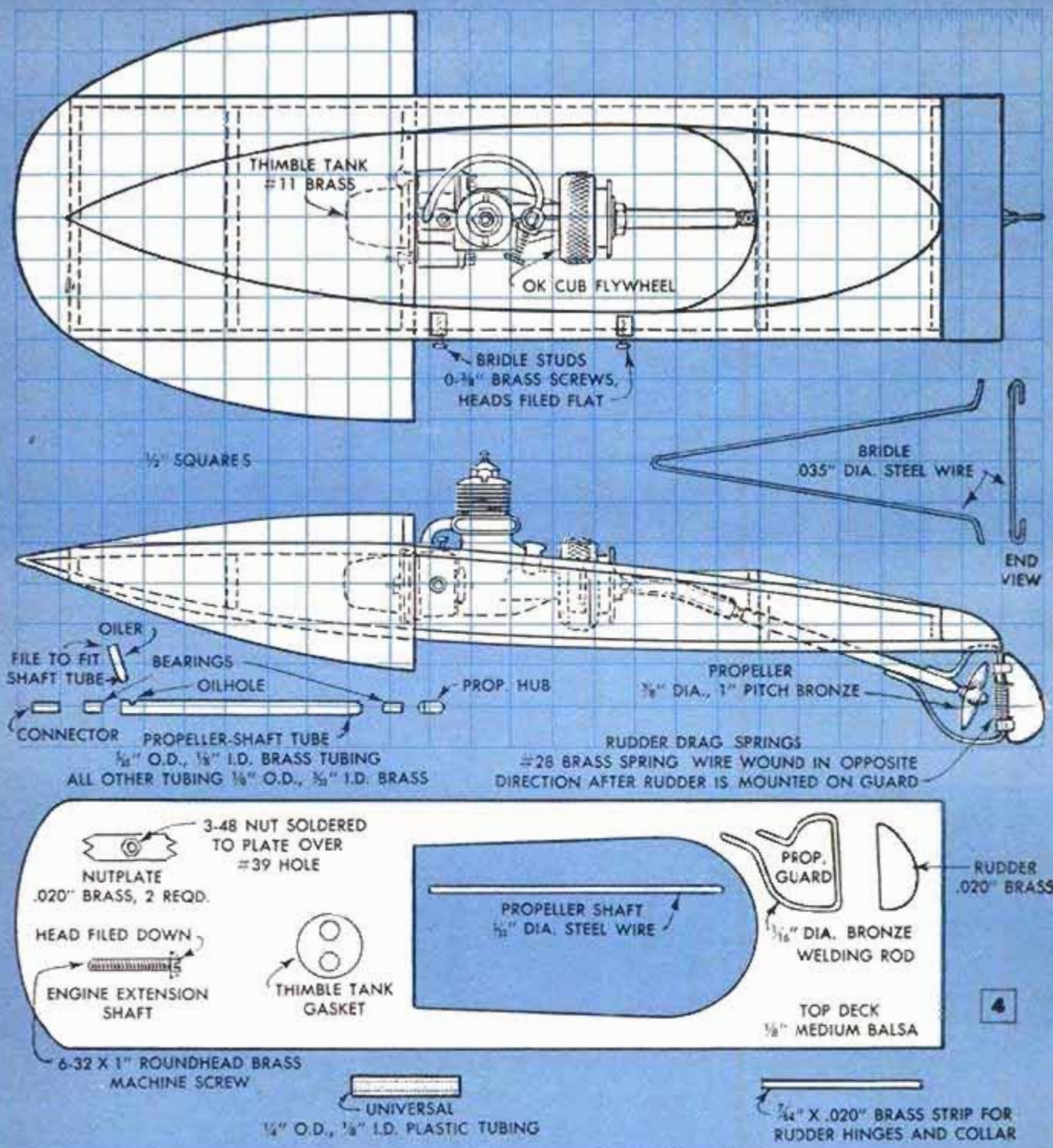

ordinarily used. Fuel capacity is doubled by adding a fuel-tank extension made from a No. 11 thimble and attached to the back of the fire wall as in Fig. 1. This added capacity ordinarily gives a full-speed run of about three minutes.

Building the Hull

The hull structure is built up in a simple box form with no bending or difficult fitting, Fig. 2. Sponsons and stern block do not involve complex curves. Jigsaw the fire wall from 1/8-in. aircraft plywood and cut the other bulkheads and the sides from 1/8-in. medium-hard balsa wood. Before as-

sembling the hull, trial-mount the engine on the fire wall, fitting the thimble auxiliary tank and cementing the nut plates, Fig. 4, in place. The latter are pronged strips of .020 brass to which the engine-mounting nuts are soldered. Bevel the sides of the hole to take the thimble in a snug, press fit with the rim projecting slightly so that the rear-cover gasket will make a leakproof seal when the engine is in place. Punch two 1/4-in. holes in the engine-cover gasket to permit the passage of fuel and air. Engines other than the .049 pictured will require a smaller thimble tank, and engines without integral tank



mounts will require the use of a separate model-airplane tank that can be mounted in the cockpit.

To aid in obtaining a square assembly of the hull draw a $3 \times 10^{19/32}$ -in. rectangle on a sheet of paper as in Fig. 2, cover with wax paper and cement the sides, bulkheads and fire wall together. Position the parts, Figs. 2 and 7, over the penciled lines and hold with pins until the cement is dry. Cut top and bottom panels from $1/8$ -in. medium-hard sheet balsa. Cement and pin the bottom panel in place.

Propeller-and-Rudder Assembly

This is shown completed in Fig. 3 and detailed in Fig. 4. Cut the propeller-shaft tube to length and sweat-solder the bushings in the ends. Then solder the oiler tube in place, taking care to keep the oil passage clear of solder. Insert a $1/16$ -in. drill in the oiler tube and drill through the wall of the propeller tube and the bushing. It is necessary to bush the $1/8$ -in. hole in the propeller hub down to $3/32$ in. to fit the prop shaft. Cut the rudder, the

strip for the rudder hinges and the collar from .020 brass. Tin the inner side of the collar strip with solder and form the hinges and collar around a $1/16$ -in. rod. The prop guard, Figs. 4, 6 and 10, is bent from a length of bronze welding rod to the shape indicated on the crosshatched detail, Fig. 4. Before making the final bend slip the collar and hinge loops over the rod. Solder the rudder to the hinge loops and sweat-solder the collar in position. The collar keeps the rudder from sliding down when the drag springs are installed. The latter are made from No. 28 brass spring wire. Wind sufficient turns on the guard to fill half the space between the collar and the bottom hinge loop. Then cut the wire, leaving a $1/16$ -in. projection to prevent it from unwinding. Wind the second spring in the opposite direction in the same manner. Solder the propeller-shaft bushing onto the propeller shaft and then sweat-solder the propeller in place, making sure that it turns true before soldering.

Solder the rudder guard in place after inserting the shaft in the tube. Horizontal

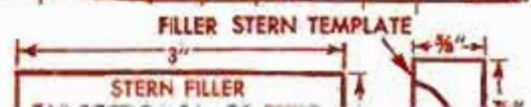
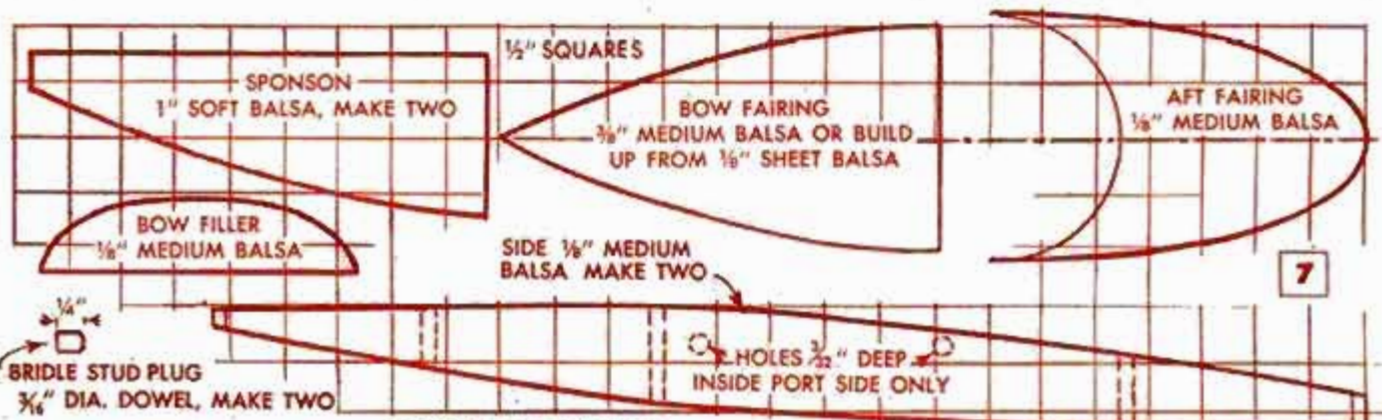
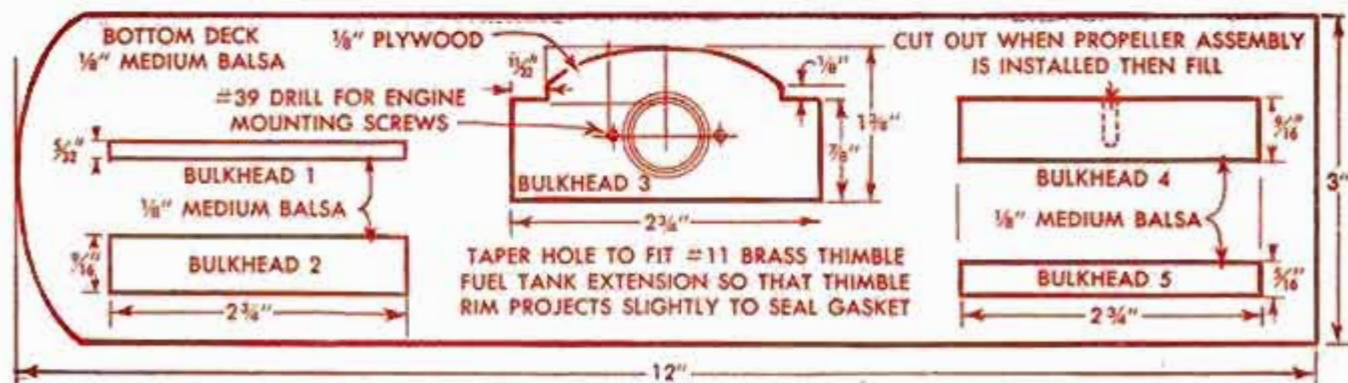

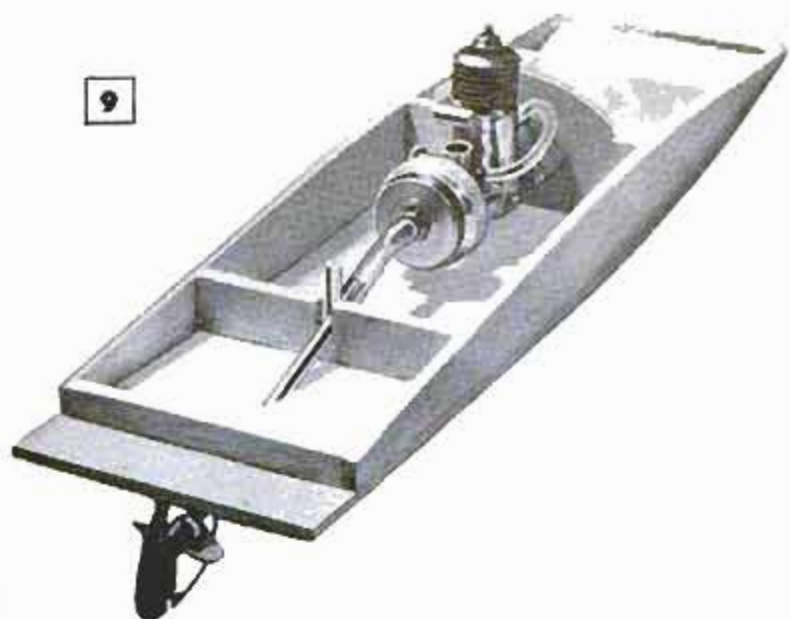
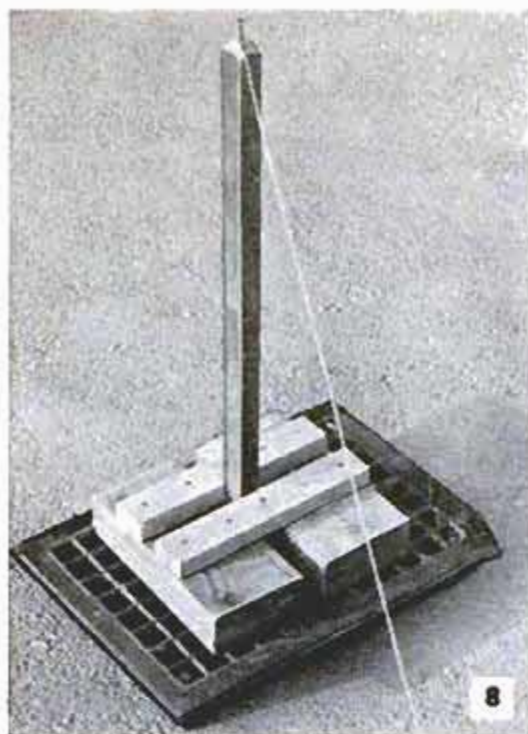

8 Above, Chili with power plant in a temporary mounting. Left, tether "island" made from discarded warm-air register

mounting of the engine in the cockpit requires use of a universal coupling which is made from a 1 $\frac{3}{8}$ -in. length of plastic fuel-line tubing. An engine-shaft extension is necessary to hold the flywheel and also form a projection to take the end of the universal coupling. For most engines, this can be made from a 6-32 brass screw, 1 in. long. Grind the head down to the diameter of the screw body. Thread a brass nut onto the screw, insert the screw through the flywheel and tighten. Lock the flywheel by tightening the nut. Note in Fig. 9 how the bulkhead is slotted for the propeller-shaft housing, also how the shaft is inserted through an elongated hole in the bottom. After the shaft has been fitted the slot is filled with a piece of balsa cemented in place and sanded smooth. The opening in the bottom is sealed watertight with cement after the shaft has been installed and aligned. Mounting the engine temporarily will aid in checking the alignment.

Cement the $\frac{1}{8}$ -in. bow filler to the forward bulkhead and follow with deck panels, stern filler block and the sponson

blocks, Figs. 4 to 7 inclusive. Carve the sponsons and stern filler, then add bow and afterdeck fairing. Sand the entire hull smooth, rounding corners and edges on the top but leaving sharp edges on the bottom of the hull and sponsons. If the boat is to be operated on a tether, install the bridle studs, Figs. 4 and 11. The $\frac{3}{8}$ -in. screws are anchored in hardwood plugs cut from $\frac{3}{16}$ -in. dowel and cemented into blind holes drilled into the port side of the hull. After insertion file or grind off the screwheads as indicated in Fig. 4. The bridle is made from .035 steel wire as in Fig. 4. When the completed boat is suspended from the bridle it should hang horizontally. With a different engine or flywheel it may be necessary to readjust the bridle.

Finish the hull with two or more coats of balsa filler and fuelproof dope, sanding lightly between coats. For operation from a tether, a center-post "island" can be made as in Fig. 8 by forcing a 1 x 1-in. center post into the grille of a discarded warm-air register. Brace the post with wooden blocks as shown. ★ ★ ★

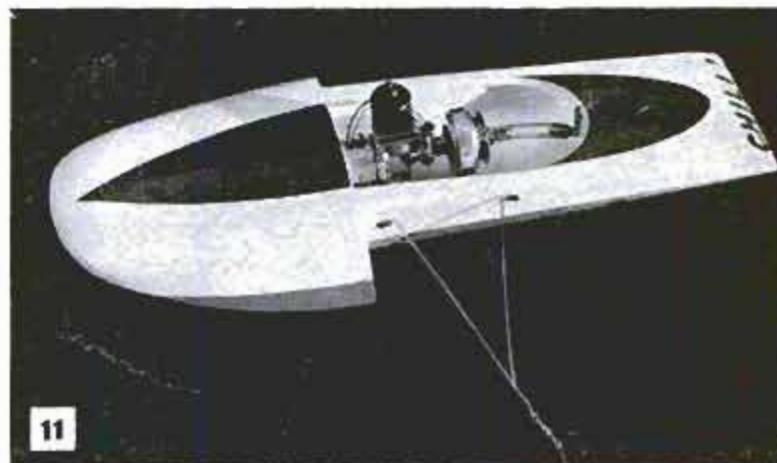
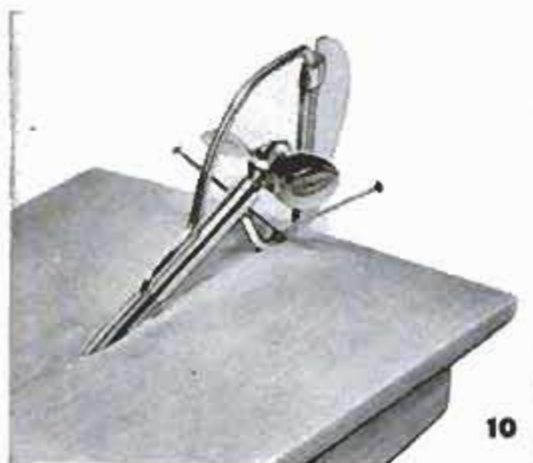

Glass Fragments Picked Up With Modeling Clay



Fine bits of broken glass may be removed safely from the deep nap of a rug by using a lump of modeling clay. First run a vacuum cleaner over the rug to lift the nap and remove small pieces that cannot be picked up with the fingers. Then pat the modeling clay over the area. The finest bits of glass will cling to the clay, which should be discarded.

Improved Tool Gauges Slope Of Concrete-Sidewalk Forms

A tool for accurately setting concrete forms to provide drainage slope when pouring sidewalks and driveways can be improvised from a straightedge and a level. The straightedge should be long enough to span the full width of the forms. As shown in the diagram, the level is clamped to the straightedge with a small block under one edge of the level. The angle between the straightedge and the level will determine the angle of the drainage slope. In use, the straightedge is placed across the forms which are adjusted until the bubble in the level is centered.

Individual "Greenhouse" From Jug

Portable "greenhouses" for single plants can be made from 1-gal. glass jugs. To remove only the bottom yet leave the curved lower edge for extra support, use the following method: Remove the cap and place the jug in a shallow pan. Pour boiling water into the pan to a depth of $\frac{1}{4}$ in. and let the jug stand for 2 or 3 min. to heat the bottom of the jug. Remove the jug and immediately place it in another pan which contains ice water. The bottom of the jug will fracture and drop out. Because the open mouth of the jug acts as a vent, there is no problem of condensing moisture.

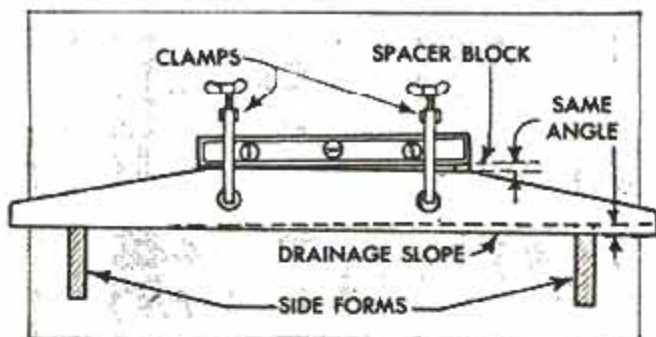

Paint-Roller Cover Protected By Cellulose Wrapping

One homeowner keeps his paint roller in good condition from one job to the next by storing the covers in a dustproof cellulose wrapping, after they have been thoroughly cleaned. The entire roller assembly and tray should be cleaned with a thinner that is recommended by the paint manufacturer. If the cover is cleaned in water, it should be dry before wrapping.

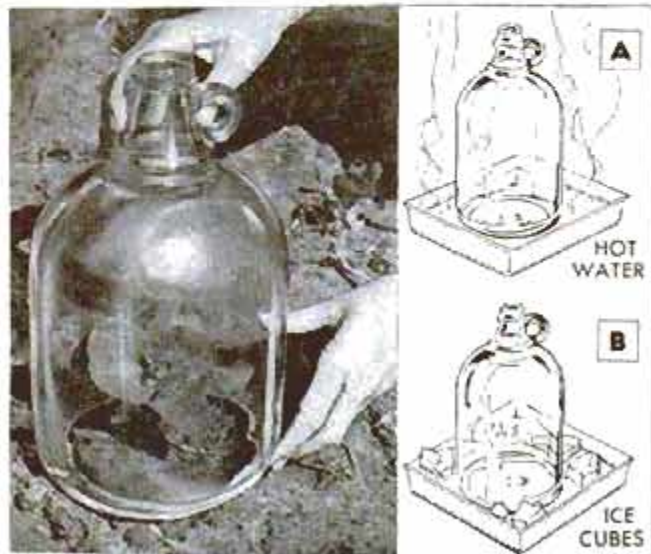

Wire Animals For Your Den or Cabin Walls

WITH A FEW FEET OF WIRE, solder and black paint you can make these decorative figures or others that are representative of your favorite sport and fasten them to the walls of your den or cabin. Draw an outline of each figure on a sheet of paper, indicating each segment as shown below. Then bend and cut the wire to duplicate the segments, assemble them on a board with thumbtacks, solder the joints and remove the board. Remove excess solder with a small file and coat each figure with dull-black paint applied with a camel's-hair brush. Use 12-ga. wire for figures of average size, heavier wire for larger ones. Steel wire is suitable, but copper is easier to work with.

Clifton Morris, Albuquerque, N. Mex.

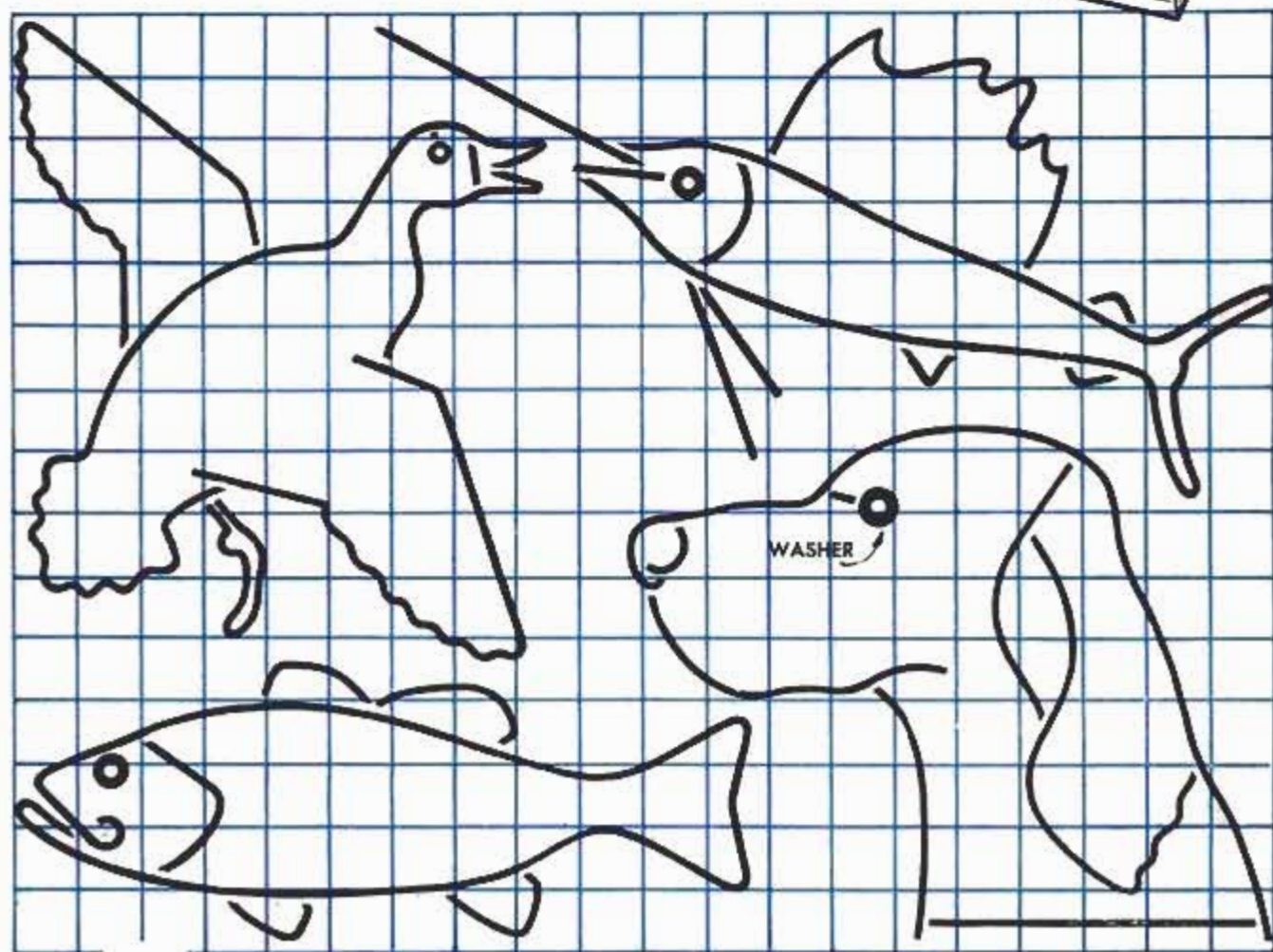
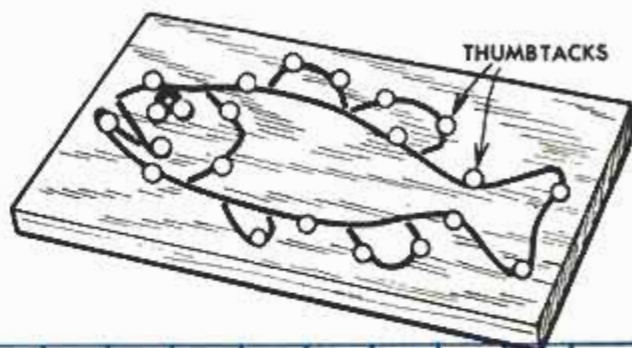

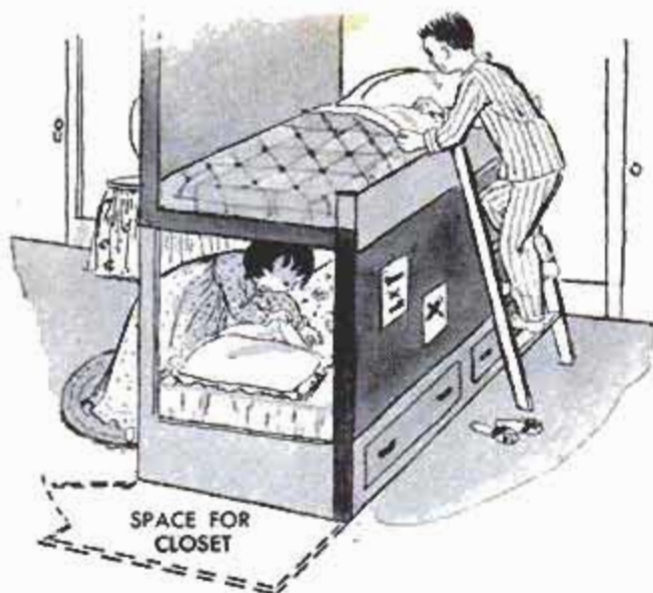

Bunk Beds Built Into Partition Used to Divide Large Bedroom

When a large bedroom used by children must be divided for greater privacy as they grow older, the partition can be combined with a double-decker bed, an arrangement that saves considerable space. One side of each bunk, as well as the deck between them, is closed by suitable framing and wallboard. Drawers are easily installed under the lower bunk and space between the foot of the bunks and the opposite wall of the room can be utilized for closet space as shown. An entrance door to the closed part of the divided room completes the accommodation. Bunks and partitions can be finished to suit the individual decor of the rooms.

Cotter Pin Provides Means Of Locking Sea Bag

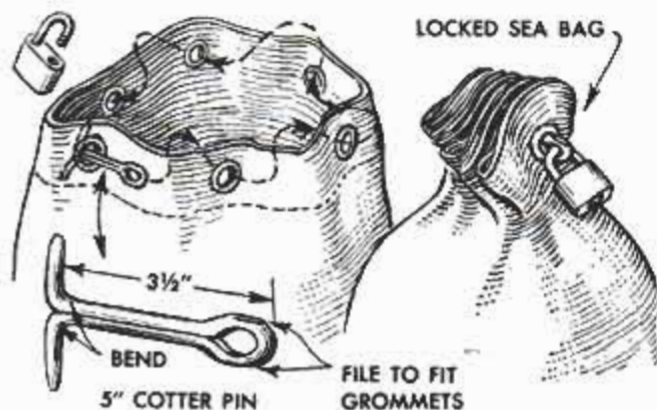

Sea bags that are shipped by express must be locked before they can be insured. A good way to do this is to use a 5-in. cotter pin with $1\frac{1}{2}$ in. of the ends bent at right angles. The eye of the pin is threaded through each grommet and then secured by passing the open end of a padlock shackle through the eye and closing the lock as shown.

Reel for Long Extension Cord Made From Can and Hardboard

Long extension cords of the kind used with electric lawn mowers, hedge clippers and home appliances can be kept in good order on this homemade reel. Cut two disks 6 in. or larger in diameter from $\frac{1}{4}$ -in. hardboard or plywood and drill or saw a 2-in. hole in the center of each one. Cut a notch in one of the disks to secure one end of the cord on the reel. Force the disks over a small frozen-juice can after cutting the rim from the opened end. Peen over the cut edge of the can so the disk on that end cannot slip off, then fix both disks in place with household cement and paint the entire unit.

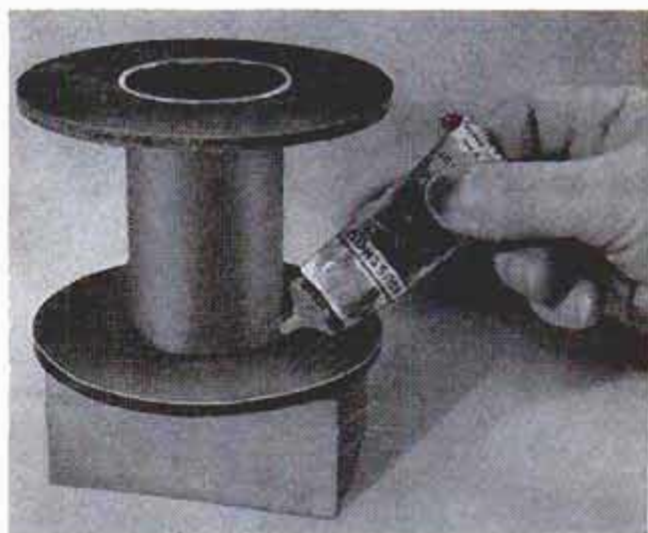

Colored Drawing Inks Used as Wood Stain Touch-Up

Colored drawing inks are good substitute wood stains when only small amounts are needed to touch up marred furniture or woodwork. The small bottles of ink are less expensive than whole cans of wood stain and are available in a variety of colors, which can be mixed to produce an exact match of the work. A short-bristle paintbrush, of the type shown, should be used to apply the stain.



RUSTIC NAMEBOARD

FAMILY NAMES, such as Carr, Fish, Stone, House and others which are suitable for pictorial representation can be worked into a pictograph and incorporated in a rustic silhouette design for a gatepost nameboard similar to the examples shown. Trace an outline for a silhouette appropriate for your family name, if you possess a suitable one, on a piece of sheet metal as indicated in the illustrations. Make the cutouts on a scroll-saw that has been fitted with a metal-cutting blade.

Fine details and small openings can be worked into the silhouette with a three-sided file. Letters for the name are cut into solid areas of the board as the individual design permits. House number may be included also, if there is sufficient space available. When copper is used as a material, and left unpainted, the metal will "weather" into a greenish-black finish,

which will add to the rustic effect. Other metals should be painted black or a very dark color. An iron bracket, from which the nameboard is suspended on two chains as shown, can be made from lengths of flat steel bolted together. Scrolls and other decorative lines are bent into members of the bracket as desired. The chains for hanging the board should be short.



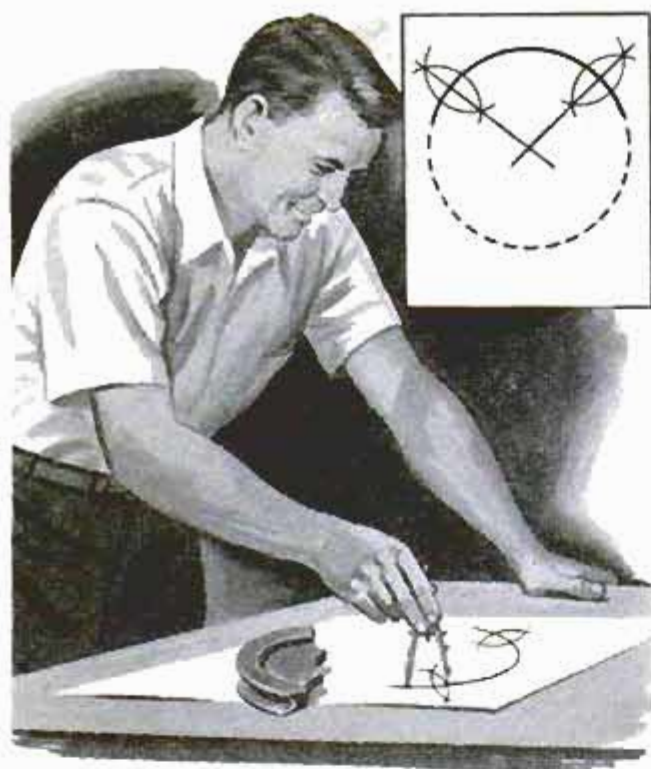

Determining the Center Of a Circular Segment

To determine the center of a broken pulley, gear or sprocket when you have only a segment to work with, trace an outline of the outer circumference on a sheet of heavy paper. Then, adjust a small compass so that its span is less than the radius of the work, swing two pairs of arcs across the circumference and draw a line exactly through each pair as shown in the drawing. The point at which the two lines join is the center of the circle, and marks the distance from the axis of rotation to outside circumference of the work, or the radius. For greater accuracy, the arc described by the two radii should be as close to 90 deg. as the segment of the broken part will permit. Now, you have the measurements necessary for rebuilding the broken part or ordering a replacement.

Arthur F. Lirot, Meriden, Conn.

Reinforcing Rods in Concrete Held by Wire Supports

When casting concrete posts the reinforcing rods or wires can be held in position by means of wire supports of the kind shown. They are bent from No. 8 or 9-ga. wire, three or four being required for each post. The two lower reinforcing rods are pressed into the loops of the wire supports and the two upper rods are laid in the U-shaped bends. For greater rigidity, the legs of the supports may be set in holes drilled in the bottom of the forms. When the latter method is used, the ends of the wire that extend from the posts must be cut off after the concrete has hardened. Four $\frac{1}{4}$ -in. steel rods should be used for heavy-duty fence posts. Reinforcing rods or wires should be buried in the concrete no less than $\frac{3}{4}$ in. from the surface.

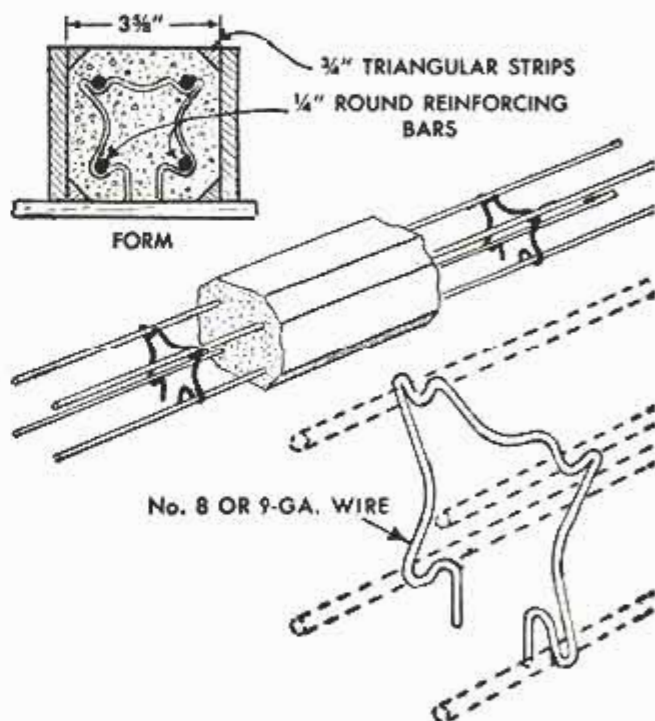

Automobile-Chrome Polish Useful For Cleaning Household Items

Automobile-chrome polish, generally used to clean rust and corrosion from bumpers and other chrome-plated parts of a car, can be used equally as well for metal-polishing jobs in the home. Any metal-plated surface which has lost its shine or become corroded, such as trim on a range or refrigerator, can be cleaned and shined with the polish. Because the polish contains some silicones, which are heat-resistant, metal ash trays cleaned with it stay clean and shiny much longer.

☐ A large cotton handkerchief used as a washcloth when traveling dries quicker and folds more compactly than terry cloth.



Photos by Eleanor Gilman

YEAR-ROUND USES for weed burner

By William Gilman

ALTHOUGH KILLING WEEDS is the main purpose of a flame-throwing weed burner, it has several other practical year-round uses. For example, its 2000-deg. flame will melt snow and ice in a driveway almost as fast as you can walk. That's something to think about when you have to get the car rolling early on a cold winter morning. Burning brush, leaves and trash, splitting rocks, eradicating tent caterpillars, sterilizing soils and thawing frozen water pipes are only a few of the other ordinarily difficult jobs easily carried through with the aid of the intense heat from the burner. The unit can even serve as an improvised farm forge in a pinch.

Take Special Precautions

One thing to keep always in mind is that the 2000-deg. flame heats flammable materials to the ignition point in a hurry. If you have to work near a building, as in sterilizing soil in a given area or thawing a water pipe, take special precautions. Combustible materials must be effectively shielded, not only from the flame itself but from the blast of intense heat beyond the tip of the flame. Protect wooden siding and any shrubbery nearby with sheets of asbestos and clear away all loose trash from the area where the flame is to be applied.

Never touch off a grass or leaf fire with



Above, winter uses for a weed burner are clearing snow and ice from driveways and walks and thawing the frozen water pipe you forgot to drain the night before. Below, flame-girdling kills unwanted shrubs





A single colony of tent caterpillars can completely defoliate a valuable shrub in no time at all. But you can effectively dispose of the pests with a single sweep of flame without injuring the small twigs



Orchardists use the burner to ignite green trimmings from trees. Note fire extinguisher close at hand

the burner on a windy day. A ground-running fire with even a moderate wind behind it can get out of hand in seconds. Always have portable fire-fighting equipment handy and be sure it's in working order.

Thawing that frozen water pipe you forgot to drain the night before takes only a minute after you get the burner going. But again there are precautions to be observed if you are to do the job safely and effectively. First open the faucet or valve that drains the pipe line. Be sure that it's clear of ice. Then, if it is impossible to determine precisely where the pipe is frozen, begin at the faucet or valve and play the flame along the length of the pipe, continuing the procedure until water runs at the faucet. If you can determine the point at which the pipe is frozen, begin by playing

the flame near one end of the frozen portion and work back along the length. Don't apply the flame at the center of the frozen portion as the heat will melt the ice quickly, may turn the water to steam at this point and burst the pipe. While carrying out this job, take full precautions against igniting any flammable material.

Many Other Uses

Orchardists and estate owners use weed burners to kill sprouts and set fire to piles of green trimmings from fruit trees after spring pruning. Unwanted saplings up to an inch in diameter growing in fence rows can be killed by flame-girdling in early spring. Just play the flame on the trunks near the ground level until the bark scorches and peels. Large rocks can be broken up to handling size by playing the flame from the burner along the seams, or "grain." After heating in this manner, a blow from a sledge usually will break the rock into several pieces. One quick sweep of the flame, as in the photo above, generally will dispose of a colony of tent caterpillars. Keep the flame moving rapidly or you may seriously damage the tree or shrub. ★ ★ ★

Dust Caps for Oilholes

Brass paper fasteners inserted into small, open oilholes on motors and machines prevent entry of foreign material. Simply cut off the fastener about a quarter of an inch from the head and expand it to fit snugly in the oilhole.

Howard E. Moody, Upper Jay, N. Y.

"Shadow Box" Stair Rail and Partition Add to Basement Beauty

Basement steps that formerly presented a rather plain appearance now add to the over-all beauty of an attractive basement when fitted with a "shadow box" railing. The shadow-box motif is included in a partition that separates the dining nook from the rest of the basement. Both railing and partition are built of 1 x 6-in. stock spaced on 12-in. centers. Both projects can be painted to harmonize with the color scheme in the basement. A second color inside the boxes will provide contrast.



Taped Linoleum-Knife Edge Prevents Dulling

When a linoleum knife is stored in a toolbox or drawer, cover the cutting edge with masking tape to protect it against being damaged by other tools. Masking tape, which is rubberized, also seals out moisture that would cause the blade to rust.



Planning a fireplace . . .

for your home? You'll be shown the latest in fireplace design, including both window-wall and island-wall types, as well as the popular raised-hearth models, in a four-color feature next month. Read "Build Your Home Around a Fireplace"

Saw for Home-Freezer Owner Cuts Meats and Bones

If the ownership of a food freezer has presented the problem of cutting ice-hard meats taken directly from the freezer, this easily made meat saw is what you need. The saw frame is a length of $\frac{1}{8}$ x $\frac{3}{4}$ -in. flat steel, long enough to bend into a U-shape at least 6 in. deep. Both ends of the frame are slotted. The front end is bent upward slightly and the handle end is bent upward to a full U-shape as indicated in the lower detail. A handle is formed by fitting a split length of hose over the frame and wrapping it with adhesive tape. The tape is shellacked to assure a moistureproof and slip-proof handle. An ordinary hacksaw blade is used, the ends being hooked into the frame by means of machine screws and nuts. The saw is equally useful for cutting the bones in hams and other pieces of meat.

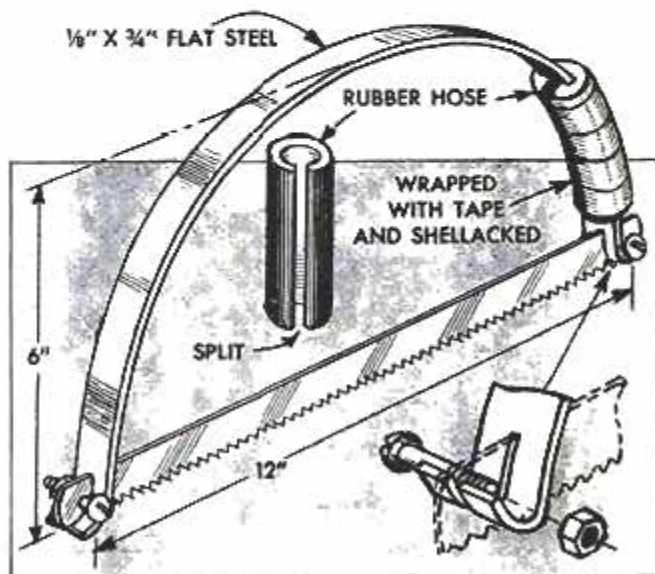

Corner Spice Shelf Saves Kitchen-Cabinet Space

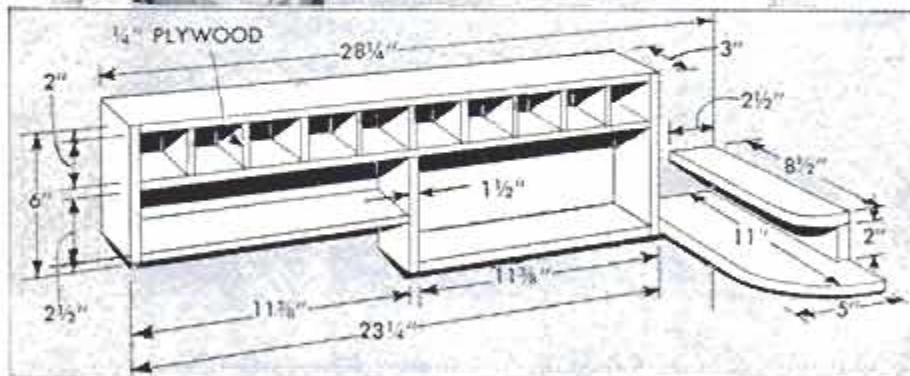

This shelf will accommodate a large number of condiments and still lend a modern decorative touch to the kitchen. It is made of $\frac{1}{2}$ -in. white pine throughout except for the partitions of the top shelf, which are $\frac{1}{4}$ -in. plywood held in place by casein glue. An additional shelf or two can be added on top of the partitioned one if desired. When completed, the shelf may be painted a color which harmonizes with the rest of the kitchen and attached to a wall at a convenient height with wood screws or small metal brackets. — Ray Long, Riverside, Conn.

Plastic "Squeeze" Bottle Used As Paint-Solvent Dispenser

Before you start your next painting job, fill an empty plastic "squeeze" bottle with turpentine or other paint solvent. When it is time to clean up, simply spray a small amount of the solvent on hands and arms to remove paint splatters. The solvent dispenser also can be kept handy for removing paint splatters from floors and trim when painting walls and ceilings. Fill the bottle with the solvent in the same way that you would fill a syringe.

Mark C. Fleming, Pittsburgh, Pa.



Unusual and Attractive Book Jackets Made From Seat Covers

Material to make unusual and attractive book jackets can be salvaged from automobile-seat covers. Usually the cover of the back seat will provide the largest area

of clean, unworn material. Nylon or plastic-coated fabrics are preferable to fiber because they can be scrubbed with soap and water whereas the fiber cannot. To

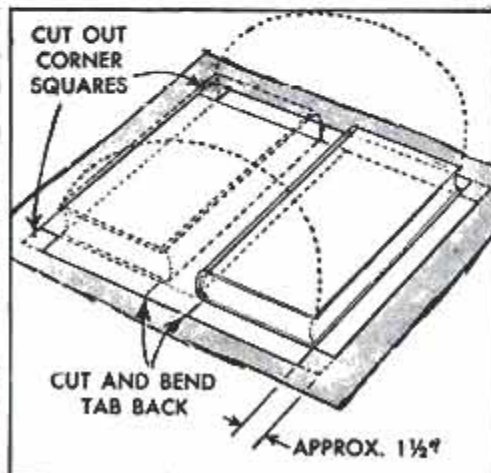

make the book jacket, place a piece of material on a flat surface and locate the back of the closed book in the center. Lay the book over, first to right, then to the left, being careful not to let the back slip from its position. Mark the outline of the book on each side, add $1\frac{1}{2}$ in. all around and cut out the shape. Notch the corners as shown in the detail, and glue or rubber-cement jacket to book.

Make Your Own COPYING TABLE

SIMPLE TO CONSTRUCT, this photo-copy table features three adjustments and can be used with any focusing-back camera. One adjustment is at the lens barrel, the second in camera-support height, and the third in the height of the shelf. Two 24-in. squares of $\frac{1}{2}$ -in. plywood form the top and shelf, lattice strips being nailed to the edges of the top to form a $\frac{1}{4}$ -in. lip. Four $1\frac{1}{16}$ -in. holes drilled in the shelf permit it to slide on legs of $\frac{1}{2}$ -in. pipe turned into floor flanges screwed to the underside of the table top. Each leg is fitted with a shaft collar so the shelf can be locked at any desired height. Adjustable lamp brackets, made from $\frac{3}{8}$ -in. pipe fittings as indicated, are fitted in floor flanges also screwed to the underside of the top, and each two lights are wired to a separate switch. The camera-support arm, cut from wood or metal, slides on an 8-in. length of $\frac{1}{2}$ -in. pipe. Size of table-top opening is determined by camera size.

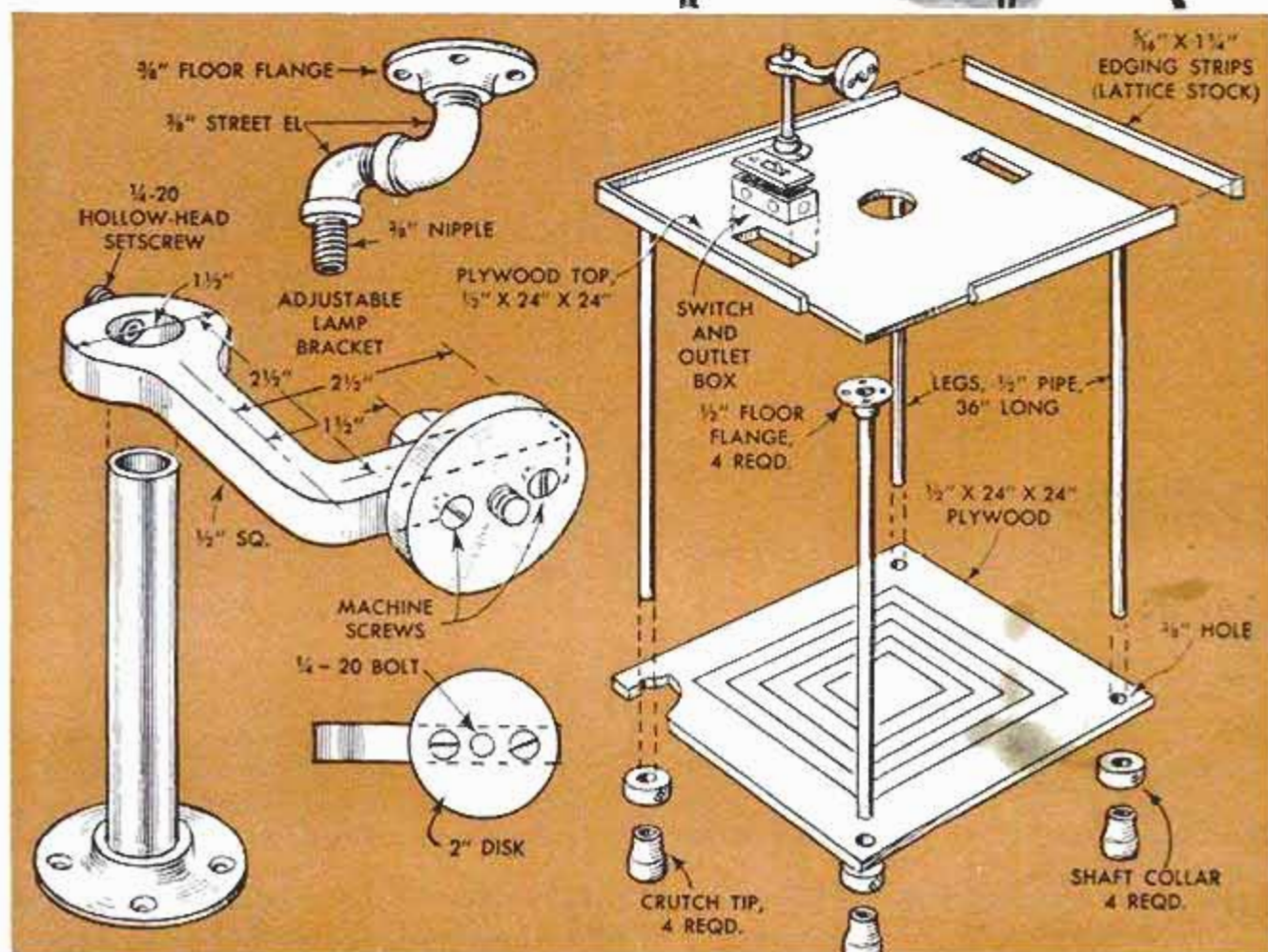
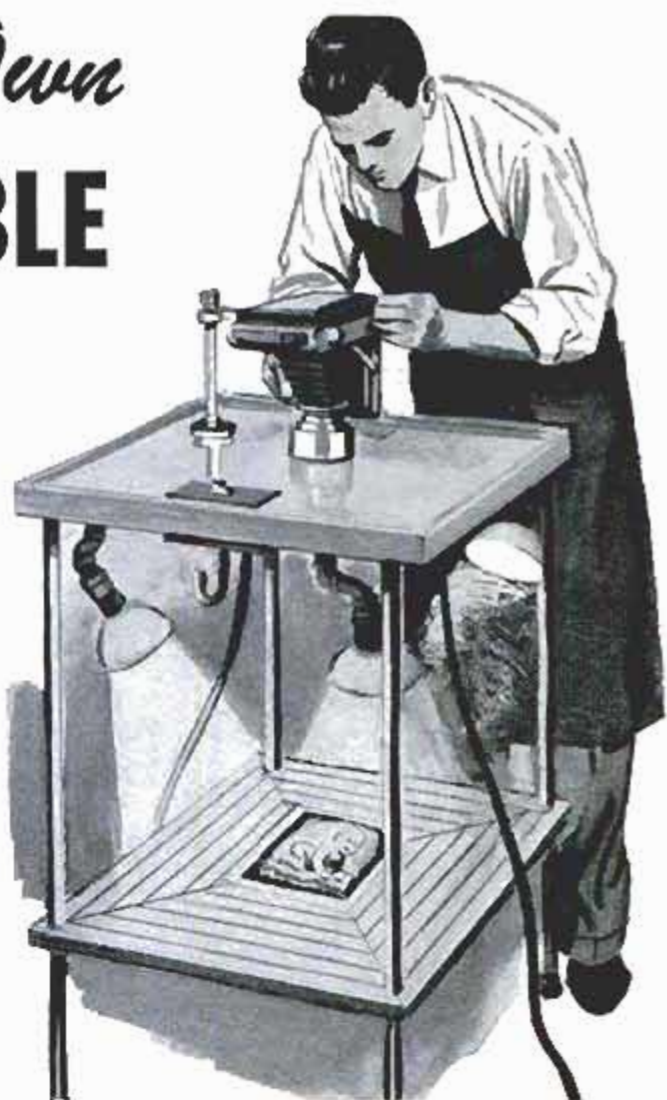

Punched Hole in Container Cap Avoids Window-Cleaner Waste

When you want to control the quantity of window-cleaning wax dispensed from the can, punch a hole in the cap with an ice pick. The can then may be inverted and the sides squeezed to deliver the exact amount

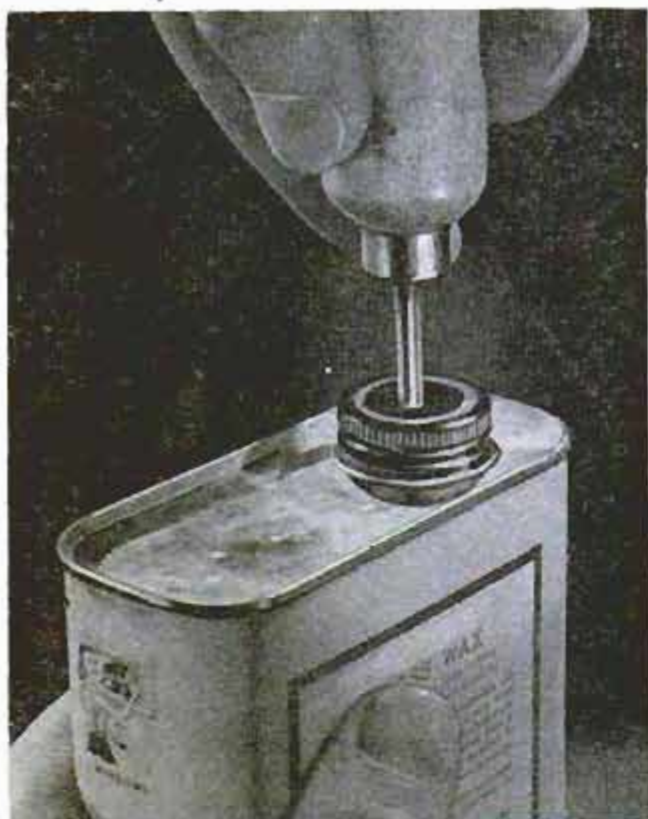

of cleaner needed. To seal the can, cut a disk of cardboard and insert it in the lid to cover the punched hole.

Focal Length of Lens Determined By Using Clamp and Ruler

Before putting a lens to some practical use, its focal length must be known so that the lens can be mounted the correct distance away from a plane on which it is desired to focus an image. With a small lens, the focal length can be determined by moving it up and

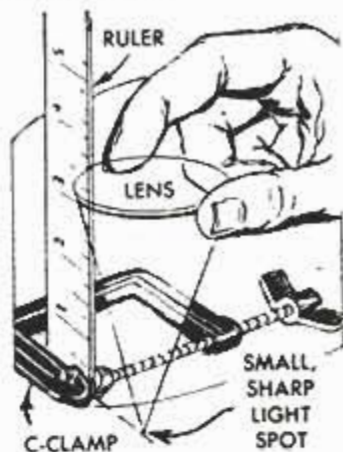

down along the edge of a ruler clamped vertically to a flat surface such as a table. When the spot of light under the lens, produced by a bright lamp located several feet above it, is as small and as sharply defined as possible, the focal length can be read on the ruler. The shorter the focal length of a lens, the greater will be the magnification of the lens.

Build This House Yourself!

Save 65% Easily!

Two bedrooms, a spacious living room, bath, carport, compact dining room and kitchen all in a space 24 x 46 feet. You can build the Precut House in three stages, using any of numerous floor plans—all of which are designed to provide maximum comfort with minimum cost. Think of it! You can build that house you've always wanted. You can make a livable shell for only \$1800. The second stage will give you a summer home with all conveniences for only \$2800. When you add the third stage, you have a luxury home for year 'round living, in any climate, for only \$3800!



Livable Shell—\$1800; Summer Home—\$2800; Luxury Home—\$3800; Simplified How-To-Do-It Instructions—Hundreds of Pictures—Working Blueprint Plans!

You can build the house with the book alone. The plans make it easier. The book gives lists of materials required, all measurements and dimensions, suggestions for financing and tells in words and shows in pictures every detail of construction. Richard Dempewolf, author of the "Precut House" book, built the house in 1650 man hours for \$3731.23—complete!

Features of Expensive Homes are included: built-in furniture, unusual amount of closet space, adaptability to various interior arrangements, and materials designed especially for amateur builders. The book is \$2.50 and a complete set of 10 blueprints \$12.50 (a duplicate set is \$5.00). You can place a C.O.D. order or mail your remittance in full.

Order book and plans from

POPULAR MECHANICS BOOKSHOP

208 E. Ontario St.

Chicago 11, Ill.

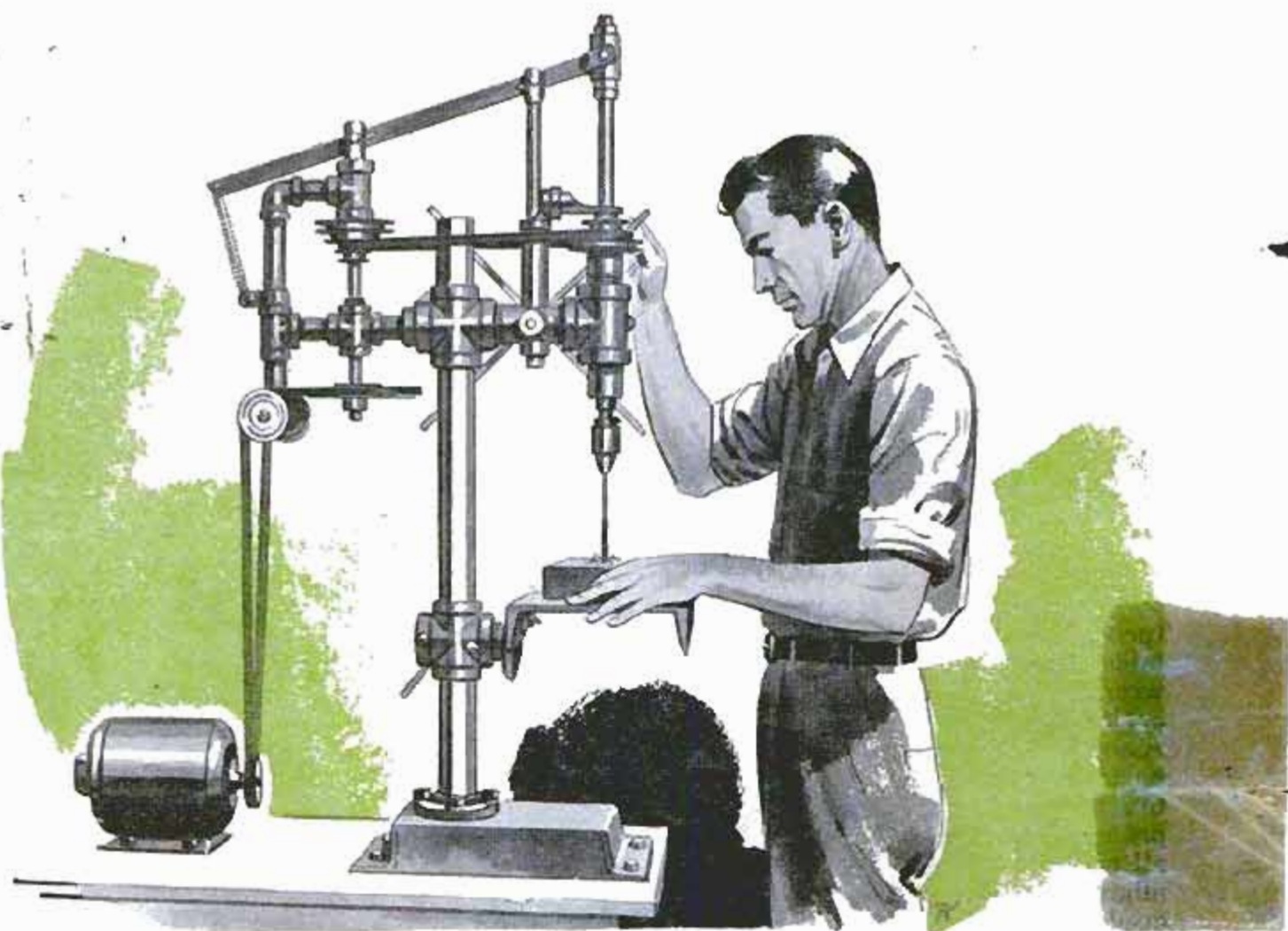

HEAVY-DUTY DRILL PRESS

By Arthur B. Farwell

SPECIAL BUILT-IN FEATURES adapt this heavy-duty drill press to a wide range of shop work. The 7-in. vertical travel of the spindle permits deep drilling and reaming and the slow-speed jackshaft drive and 0 to 1-in. capacity provide power for heavy drilling in metals and wood. Any type motor can be used as it is mounted horizontally rather than vertically.

Frame Construction

The frame is constructed of extra-strong pipe and fittings of the wide-flange type. At the outset it should be kept in mind that there are allowable variations in the manufacture of standard pipe and fittings. This makes it necessary to determine certain dimensions by trial assembly. Some filing must be done when fitting the spindle and spindle-lowering mechanism, also the

column must be draw-filed and smoothed with abrasive so that the pipe crosses will slide easily. Threads in the crosses are reamed out in the lathe to give an easy, sliding fit over the column. Both crosses are slotted and fitted with clamping bolts. Note particularly the assembly of the parts indicated in A in Fig. 1, also shown in detail A in Fig. 2. This assembly permits the jackshaft frame to slide, thus providing a means of adjusting the belt tension. Note also that the distance between the flats filed into the jackshaft and drill spindle is not specified. These flats provide space for the setscrews holding the shaft collars and the spacing must be determined when the parts are assembled.

Usually it's best to begin with the base and column and then assemble the spindle and jackshaft frames as separate units. Fit

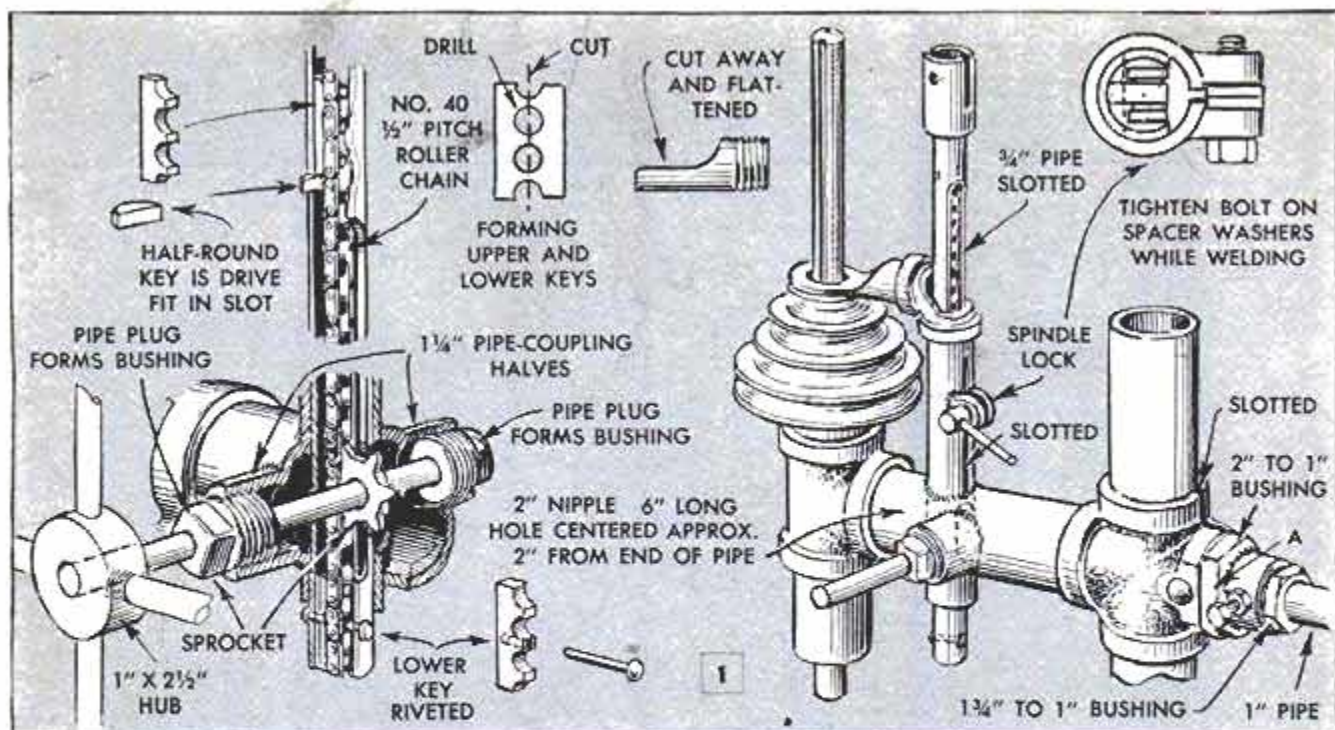

the sliding crosses on the column, bolt a flange union to the base and screw the second flange union onto a close nipple turned into the lower cross. Attach the table. Draw the column tight with a strap wrench (borrowed from your local plumber) to avoid marring the polished surface. Assemble the jackshaft frame and the parts A, Figs. 1, 2 and 3. Then assemble the spindle frame. The purpose of this preliminary assembly is to make sure that all pipe and fittings fit together in correct alignment when drawn tight. Before proceeding, note the assembly of the spindle raising-and-lowering device shown cut away in the left-hand detail, Fig. 1. Mark the location of the hole for the slotted pipe sleeve which passes through the hole in the arm and serves as a guide for the raising and lowering rack. The sleeve is 1-in. pipe, 8 in. long, and only the top end is threaded. A length of 3/4-in. pipe, 12 in. long, telescopes inside the sleeve and carries the roller-chain rack. This length of pipe is slotted with a hacksaw as in Fig. 2 to permit travel of the sprocket, which is carried on a 1/2-in. horizontal shaft turning in bushings made from solid pipe plugs. The bushings are mounted in pipe-coupling halves welded to the frame arm as indicated in Fig. 1.

Spindle-Lowering Assembly

As shown from the left-hand detail in Fig. 1 the roller-chain rack is pinned at the lower end and supported at the top end by a toothed *rag* of key held in place in the pipe by a standard half-moon key. Care must be taken in the location of the slot for the half-moon key to assure that the chain is supported inside the slotted

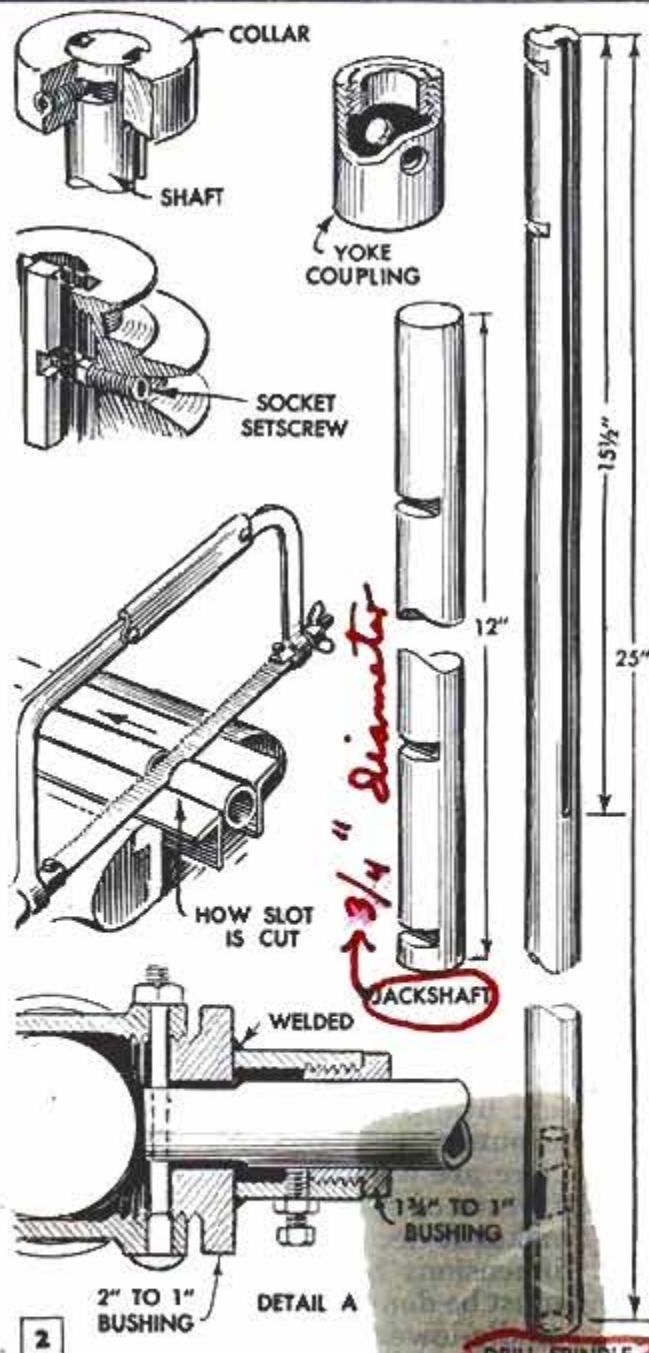

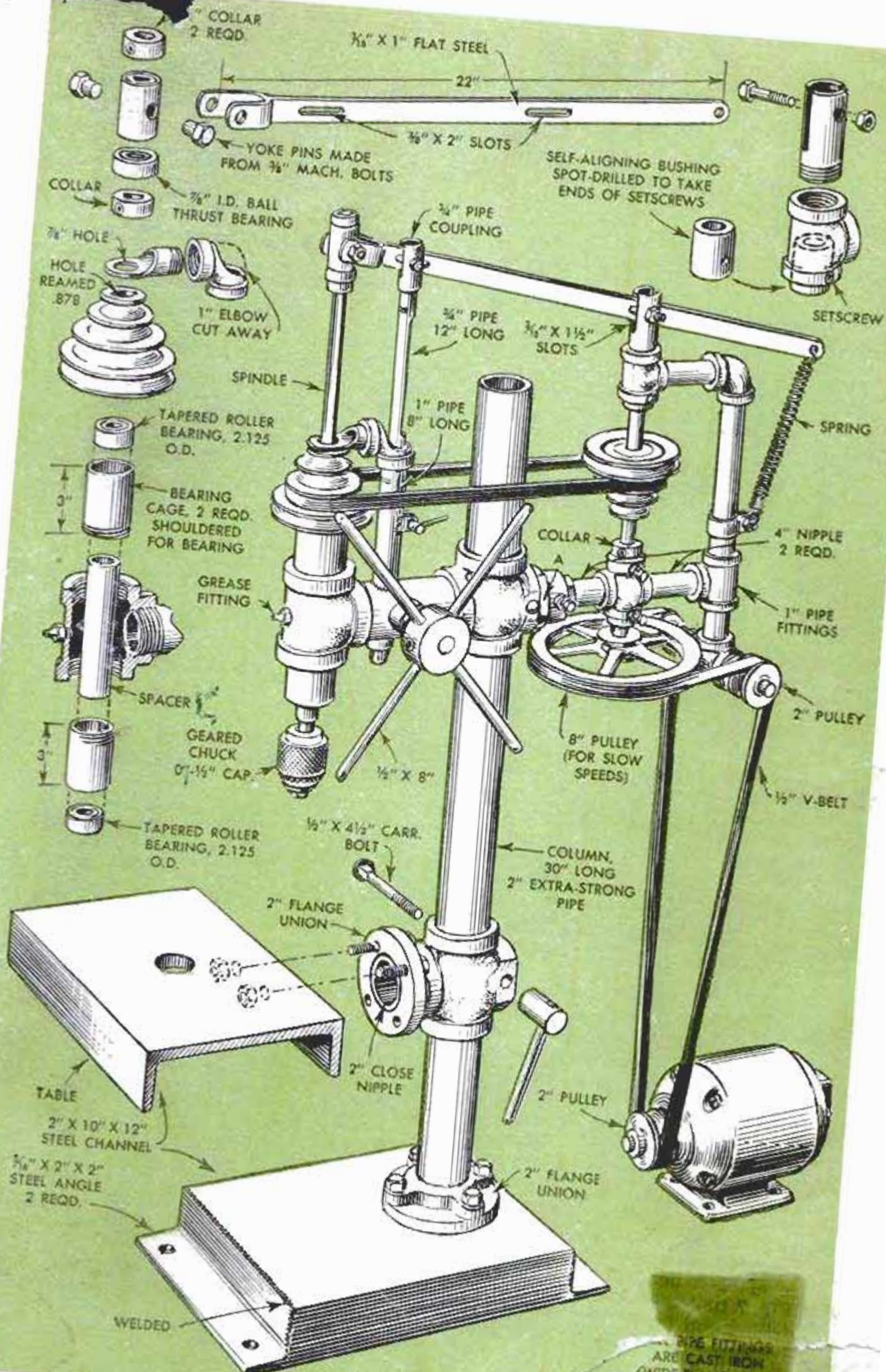

PIPE FITTINGS ARE CAST IRON (WIDE-FLANGE TYPE)

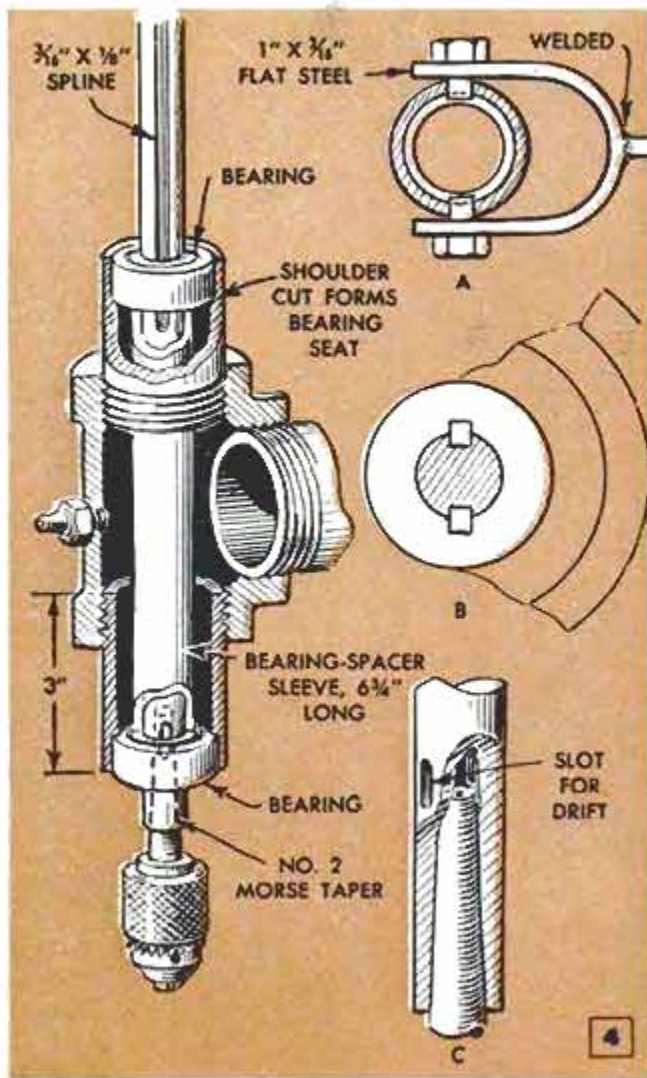

pipe without slack. Drive-fit the key in place and grind flush. The slotted-pipe carrier should be an easy sliding fit inside the sleeve. The sprocket is pinned to the 1/2-in. shaft and on completion of the assembly the sleeve is tack-welded to the arm. Two lugs are welded to the sleeve, one tapped, the other drilled with a body hole for a locking screw.

Spindle Assembly

Details of the spindle assembly are shown in Figs. 2, 3 and 4. The pulled-apart view shows quite clearly the relationship of the parts. Matching 4-step V-pulleys are used on the spindle and jackshaft, but the hole in the pulley used on the spindle must be reamed to a sliding fit and it may be necessary to file the keyways deeper. The tapered roller bearings carrying the spindle are mounted in "cages" made by turning a shoulder into the plain ends of 3-in. lengths of pipe to receive the outer race of each bearing in a press fit. Note in Fig. 2 that the lower end of the spindle is drilled and taper-reamed to take taper-shank drill bits, detail C, Fig. 4, or a chuck fitted with a No. 2 Morse-taper adapter, Fig. 3. The two milled splines (have this job done at a machine shop) in the drill

spindle take notched sliding to the pulley and held in place with socket setscrews as in the lower of the two upper left-hand details in Fig. 2. Note also the detail B in Fig. 4. The keys should be drawn-filed so that they slide freely in the splines throughout the full length. Note also that the spindle assembly includes the yoke bearing, or coupling, Fig. 3, and the upper-center detail in Fig. 2.

Jackshaft Assembly

The jackshaft, Figs. 2 and 5, is fitted with self-aligning bushings spot-drilled as indicated in Fig. 3 to take the pointed ends of setscrews held in position with locknuts. The idler shaft turns in bushings made by drilling solid pipe plugs and turning them into a pipe tee. The idler pulleys turn freely on the shaft and are held by washers and cotter pins. The lowering yoke, Fig. 3, pivots on the top end of the jackshaft frame. Location of the slots in the yoke arm must be determined at the time of assembly. The yoke pins, Fig. 3 and detail A in Fig. 4, should be a drive fit.

Note that before the lowering arm is placed in final position the hold-down, which consists of a short length of pipe and an elbow, must be made and placed in position. This part bears against the top of the spindle pulley and is shown in place in the right-hand detail in Fig. 1, also in Fig. 3. Assembling this part in position and adding the lowering wheel, or spider, completes the job. ★ ★ ★

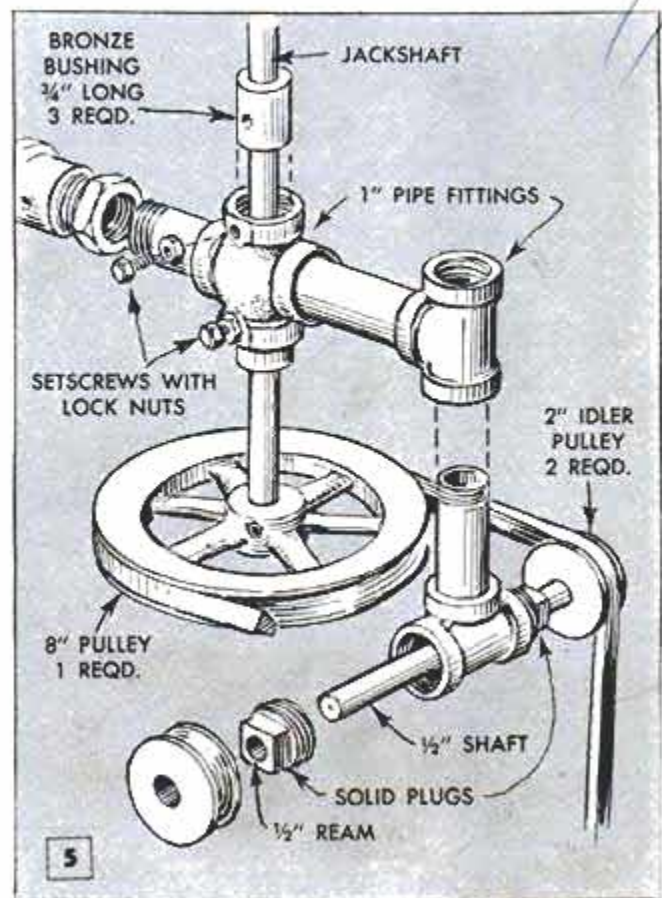

Belt-Driven Auto Transmission Powers Portable Elevator

An automobile transmission, belt driven by a one-cylinder gasoline engine, is used as the power unit for a portable hay and grain elevator. A constant engine speed is used, the speed of the elevator being changed by shifting gears in the transmission. The controlled speeds are especially useful when the elevator is used for soy beans. The power unit is mounted on wooden skids so it can be towed easily when the elevator is moved. The man in the photograph is standing astride the motionless tumbling rod to illustrate a common but hazardous practice around farm machinery. If the power unit were running, he would stand to one side of the tumbling rod and the rod would be enclosed in a guard.



Clamps Made From Radiator Hose Hold Tape Measure

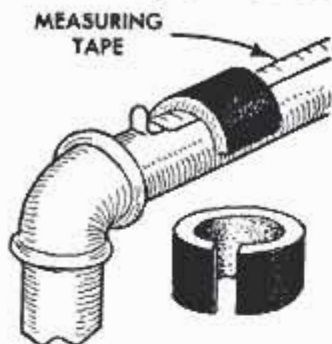

A helper is unnecessary when using a long measuring tape if clamps are provided to hold the free end of the tape on the work in a manner similar to that shown. The clamps are short sections

of discarded hose slit along one side, garden hose or radiator hose being used depending on the diameter required.

Combination Hog-Feed House

This walk-in combination hog-feed house and self-feeder can be used for self-feeding of grain or ground feed, or hand-feeding supplement when new corn is fed off the wagon. Utilizing wood materials the outside feeding doors are hinged along the sides, which allows the supply of feed to be shut off from the hogs at will. The building is constructed on skids for easy moving from one field or lot to another.

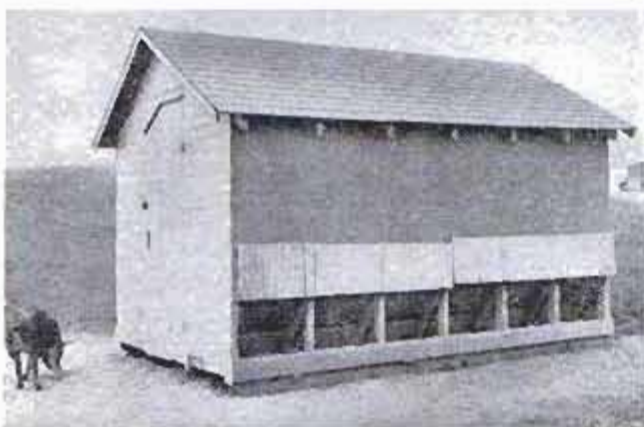

Cleaning Tall, Slender Vases

Stains in the bottom of a tall, slender vase that is difficult to clean can be removed by using tea leaves soaked in vinegar. Drop the moistened leaves into the vase and shake until the stains have disappeared. Then wash and rinse the vase.

Diameter of Cylinder Reduced With Bench Grinder

Where accuracy is not important, a bench grinder may be used in place of a lathe for reducing a cylinder's outside diameter. A rod is slipped into the cylinder and fitted with two short pieces of pipe taped in place to prevent lateral movement. Hold one end of the rod in each hand and press the cylinder against the wheel, with the rod parallel to the grinder shaft. When the cylinder begins to turn, tilt the rod at an angle, so the wheel will start cutting. Do not tilt the rod too much or the cylinder will stall and cause a "flat." After the correct angle has been found, move the cylinder slowly from side to side across the wheel until the desired diameter is ground. A cylindrical, rounded or conical surface may be ground by varying the pressure and lateral movement.

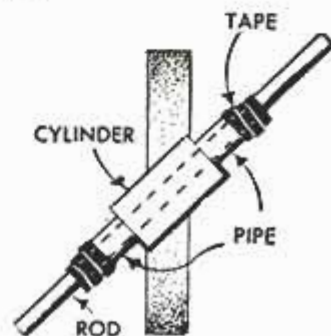

Ray S. Brown, Columbus, Ind.



Working Drawings Kept Flat On Board Under Bench Top

Working drawings and sketches that quickly become wrinkled and soiled when used in a workshop can be kept clean and flat by thumbtacking them to a paddle board fitted in slides under a workbench top. When working at the bench, the board can be pulled part way out, as indicated, so a drawing can be studied. A hole drilled in the paddle-board handle permits hanging the board on a nail driven into a wall, when such a location is more convenient to the work.

Cover Over Feed-Lot Wagon Box Protects Feed From Weather

A wagon box used for feed-lot purposes offers the most protection for the feed it contains when it is equipped with a waterproof hinged cover elevated on one side to permit rainwater runoff. The cover is hinged on one side and has a chain brace to allow it to be tipped back when feeding or filling. As a safeguard against wind a hinged hasp can be fitted to the lid and the corners wired to the wagon bolsters.

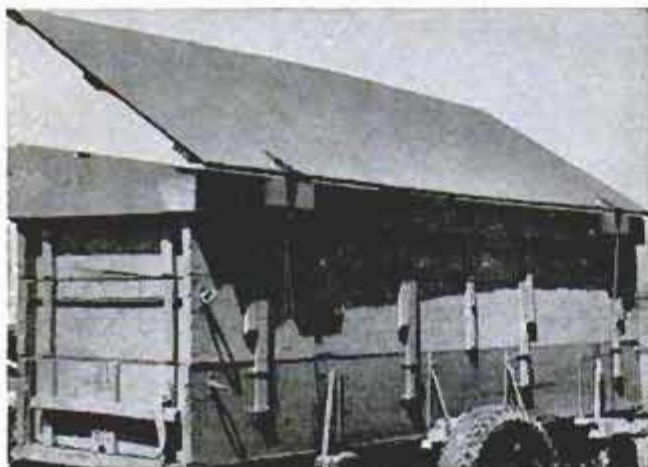

End of Shaft Marked With Letter Indicates Left-Hand Thread

On arbors, mandrels and other machine parts that have left-hand threads, it is advisable to provide an identifying mark to aid in preventing an attempt to remove the nut by turning it the wrong way. One method is to mark an "L" on the end of the threaded shaft. This can be done by using a letter die or by using a fine-pointed center punch to outline the letter in small punch marks.—R. Hanscom, Elmhurst, Ill.

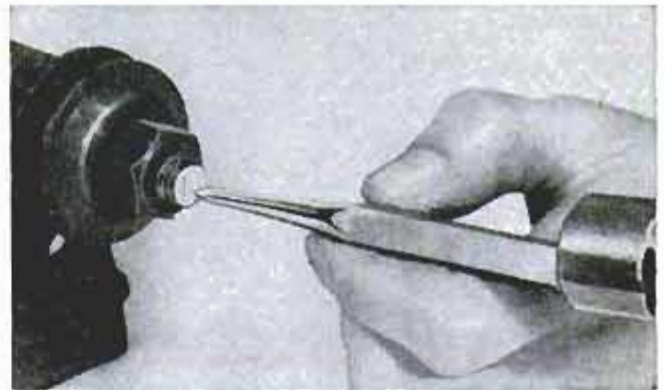

Simplify Engine Maintenance

To simplify maintenance on an automobile engine, when installing the head, first thoroughly clean the studs or head bolts, and the bolt holes in the block or head. Best results are obtained by using a tap and die and a wire brush. When all parts are cleaned, and before head installation, wipe graphite grease on all bolts and in bolt holes. The grease will provide lubrication to permit turning the bolts to even tension and, since graphite grease is not affected by heat, will keep the bolts corrosion-free to permit easy removal at a later date.

How to Straighten Wire Quickly

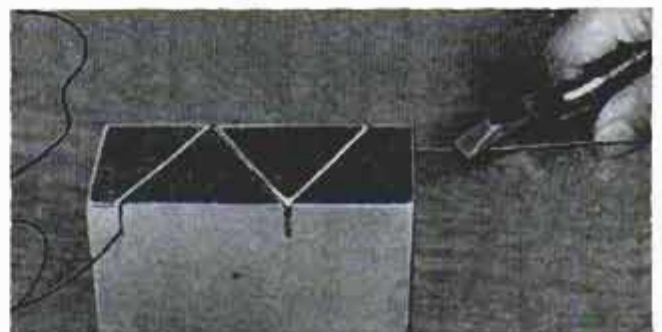

When working with small-diameter wire in modelmaking, keep it straight for easier handling. One way to straighten it is to use a block like the one shown. This is merely a short piece of 2 x 4 having a Z-shaped saw slot $\frac{1}{2}$ in. deep in the narrow side. Thread the wire through the slot and pull with pliers.—Phil McCafferty, Stanwood, Iowa.

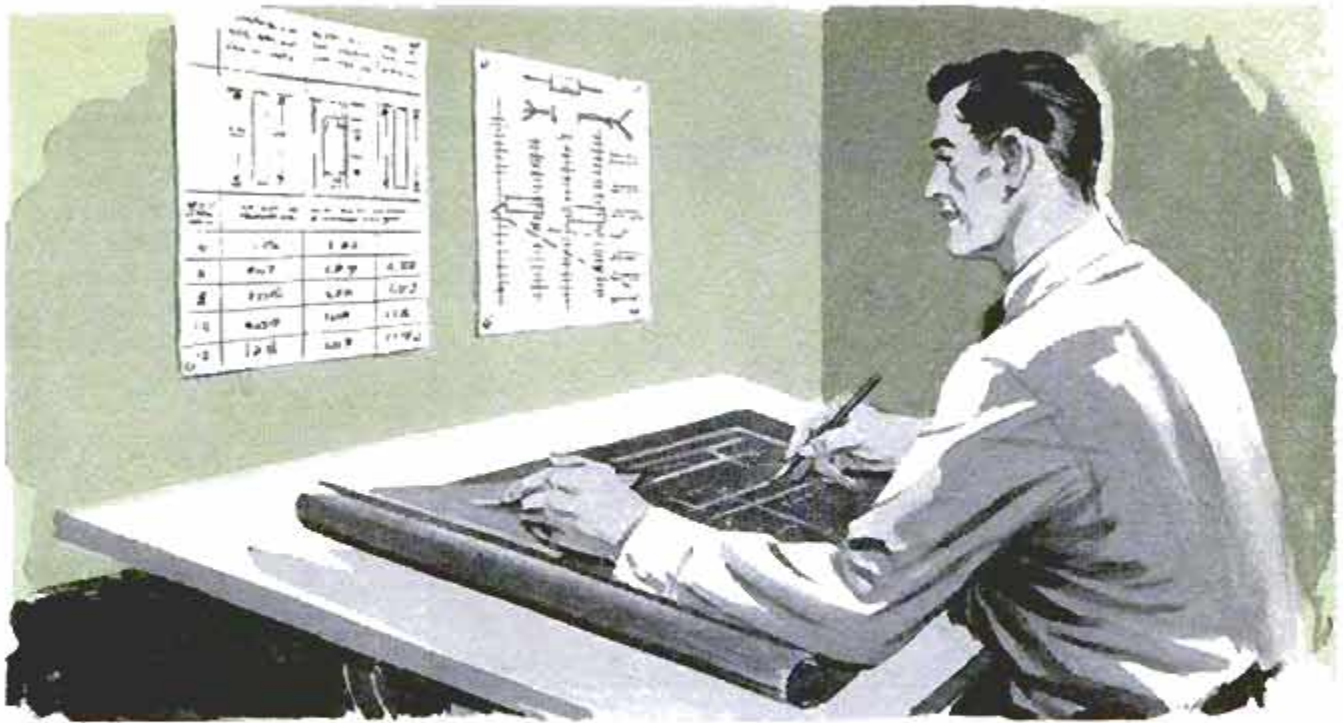

Alignment Chart Calculator for Lumber

By J. B. Mullen

Table below is used in conjunction with alignment charts to figure number of identical timbers needed

THE USE of alignment charts will reduce the ordinarily time-consuming job of figuring the amount of lumber needed for a construction job to a simple matter of holding a straightedge across the correct figures on the charts.

Because lumber generally is sold on the basis of so many dollars per thousand board feet, the alignment charts permit converting building dimensions and lumber sizes into board feet. It then is a simple matter to convert board feet to dollars and cents.

When using the alignment charts, it is necessary to know the number of identical timbers. Use of the table in Fig. 1 permits doing this quickly. The formula used in the table is: N, the number of timbers, equals D, the length of the wall or structure, multiplied by S, which represents the spacing used, plus 1, plus X. The X factor must include 2 for each door or window opening, plus 2 more if double studs or beams are used in the ends of the structure.

Lumber requirements fall into two general categories. One covers "dimensioned lumber" used for framing, such as 2 x 4 studs and 2 x 8 joists. The second includes 1-in. lumber, commonly used for sheathing, siding and flooring.

Fig. 2 shows an example of using the alignment charts to figure the board feet

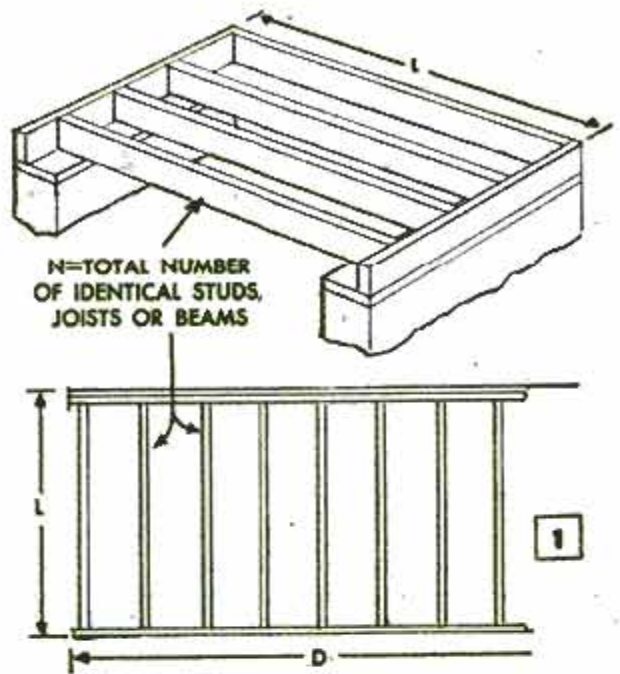

FOR UNIFORMLY SPACED STUDS TO COVER A DISTANCE "D" $N = (D \times S) + 1 + X$		
SPACING CENTER TO CENTER	S	X
12"	1	2 IF ENDS ARE DOUBLE, PLUS 2 FOR EACH DOOR OR WINDOW OPENING
16"	$\frac{3}{4}$	
24"	$\frac{1}{2}$	

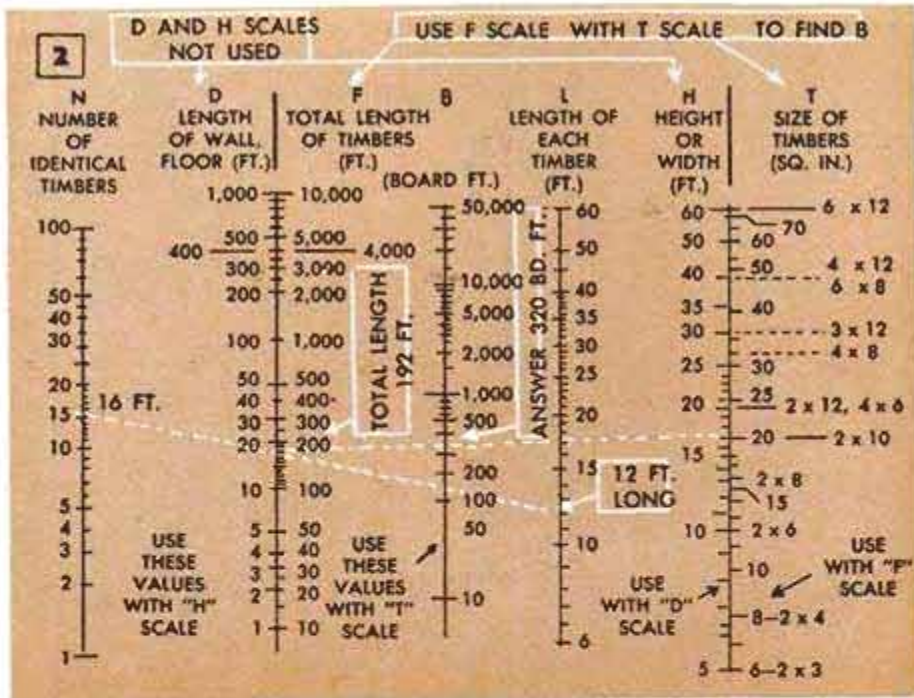

The example shown above indicates the required timbers in board feet

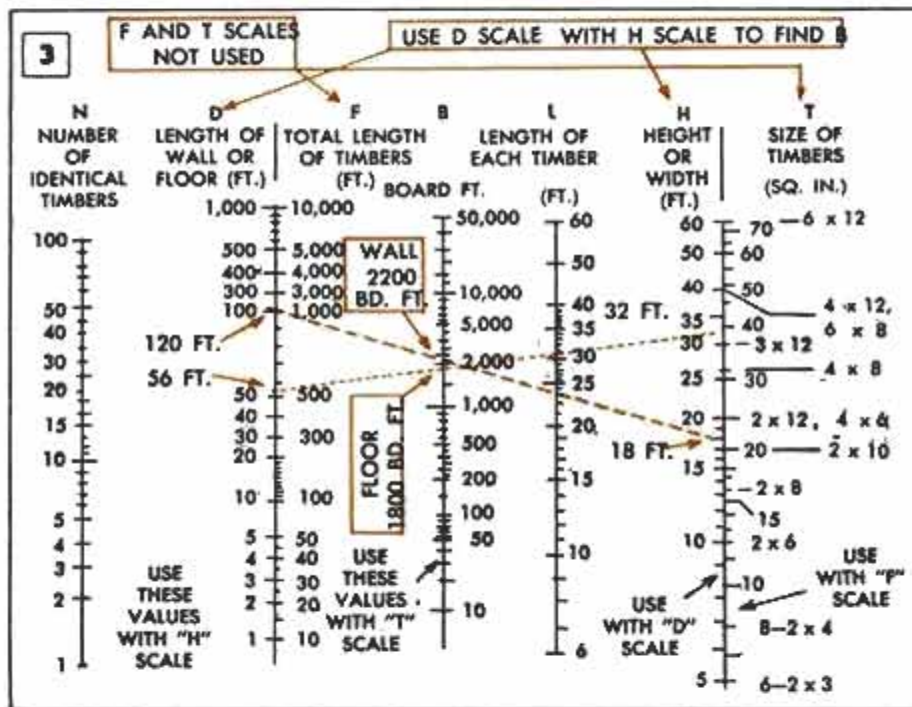

The board feet of siding that are needed is shown in the above example. In Fig. 4, below, is the factor table for finished 1-in. lumber shapes

4

	COMMON BOARDS	TONGUE-AND-GROOVE ROUGH FLOORING	BEVEL SIDING
	NOMINAL WIDTH ACTUAL WIDTH = (NOMINAL - 3/8")	NOMINAL WIDTH ACTUAL WIDTH = (NOMINAL - 1/4")	NOM. WIDTH ACT. WIDTH EXPOSED WIDTH = (NOMINAL - 1 1/2")
NOMINAL WIDTH	TRIMMING AND OVERLAP FACTOR		
4	1.10	1.23	
6	1.07	1.14	1.33
8	1.05	1.10	1.23
10	1.04	1.08	1.18
12	1.03		1.14

required when 16 joists 12 ft. long are needed, the joists to be 2 x 10s. The figure 16 (number of joists) is located on the N scale and a straightedge is placed from it to the number 12 (length) on the L scale. Total footage is indicated at the point the straightedge crosses line F, in this case 192 linear feet. Next, the straightedge is placed on 192 ft. on the D line and across to the T line on 2 x 10. The point at which the straightedge crosses the B line indicates the number of board feet required. If a 2 x 10 was not indicated on the T line, an equivalent cross-sectional area would be used, in this case 20 (2 x 10).

Fig. 3 shows an example of using an alignment chart to figure the amount of sheathing required to cover the four walls of a house. The house is 28 ft. wide and 32 ft. long, with a wall height of 18 ft. On chart D is 120 ft. (2 x 28 plus 2 x 32), and H is 18. When a straightedge is held between these points, board feet can be read directly from the B scale.

The nominal size of lumber is its unfinished size. Finished lumber bought at a yard is considerably reduced in dimension, for example a 2 x 4 actually measures about 1 5/8 in. x 3 5/8 in. The reduced dimension makes no difference in dimensioned lumber used for framing, but does affect sheathing, siding and flooring where a definite area must be covered. Fig. 4 shows the approximate amount lost in trimming and overlap for several lumber types. The number of board feet determined by using the chart must be multiplied by the proper trim or overlap factor to get the number of board feet of finished lumber. ★ ★ ★

Folded Magazine Used as Vise For Holding Pipe



When it is necessary to drill a hole through a pipe or rod and there is no vise or clamp available, the work can be held firmly with a magazine. Simply fold the magazine around the pipe and hold it with one knee as shown. The same method can be used when cutting

pipe or rod with a hacksaw. If the work is of a small diameter, several magazine pages should be rolled tightly around the circumference before placing it in the magazine fold for drilling or cutting.

James Harris, Tucson, Ariz.

Nail Holder for One-Hand Starting

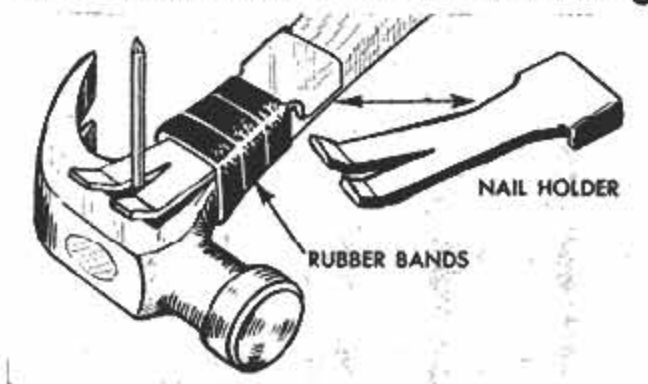

A nail holder cut from a strip of metal and lashed to the side of a hammer with rubber bands will permit starting a nail in a hard-to-reach place. There is the added advantage of not interfering with the normal use of the hammer if the holder is left attached. The rubber bands can be cut from a discarded bicycle inner tube.

Threaded Rod and Tubing Provide Stud Assembly

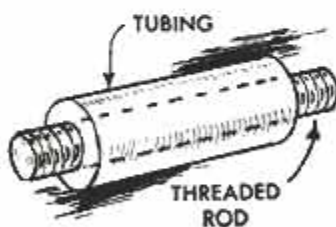

When making a stud bolt of the type used to space parts or members, some of the labor involved can be avoided by fitting a piece of tubing

over a length of threaded rod. Cut the rod equal to the over-all length of the stud required. Then cut a piece of tubing to a length equal to the required spacing and slip it over the rod.

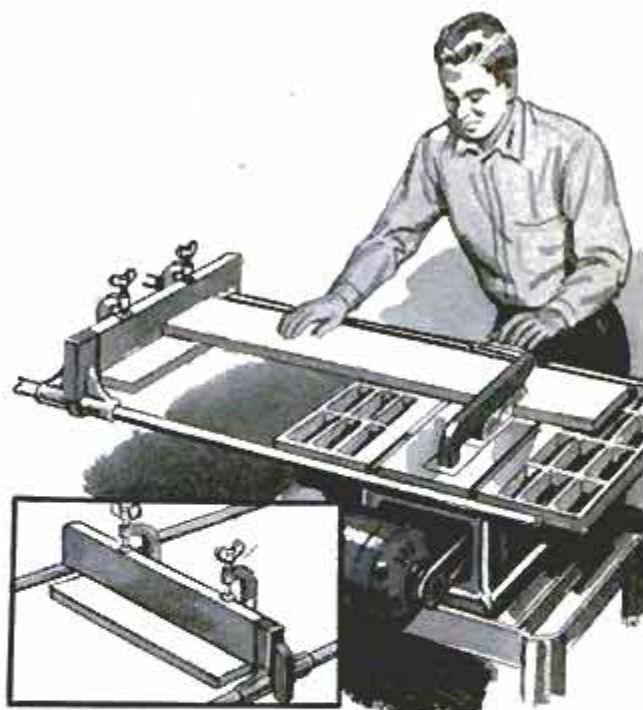

Modified Saw-Table Extension Assures Duplicate Cuts

Duplicate pieces of fairly long stock can be crosscut quickly and accurately on a table saw if the table is equipped with long ripping-fence guides. Clamp a short piece of scrap wood to the bottom of the ripping fence and allow it to project enough to support the free end of the work. Locate the fence so the end of the work just touches it as it is being cut. Hold the work firmly against the crosscut guide and keep the free end aligned so the saw does not bind. N. C. Dickie, Johannesburg, South Africa.

Teeth on Backsaw Protected By Wooden Guard on Blade

A wooden guard is used by one craftsman to protect the teeth of a backsaw when it is carried in a box with other tools. The guard is merely a grooved length of wood, which is held in place by a couple of rubber bands.

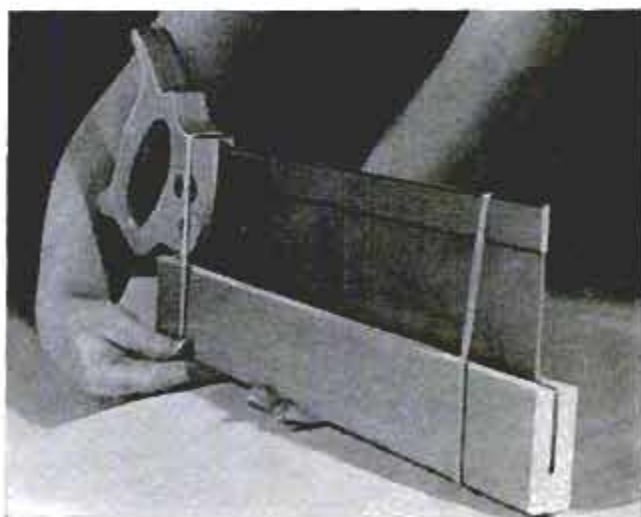

Knowing what pipe and fittings to use and how to measure pipe runs enables any homeowner to do simple home-plumbing jobs

Do Your Own Home-Plumbing Jobs



ARE YOU PLANNING to extend a water-supply or drainage pipe, or are you about to replace part or all of it because of tree-root invasion or general deterioration? In either case, you will want to know more about what type of pipe to select and how to install it properly.

Water-Supply and Drainage Pipe

Threaded, galvanized-steel or wrought-iron pipe is used for water-supply lines, although brass or copper pipe will last much longer. Copper tubing and in some cases plastic pipe also can be used. For drainage lines up to 3-in. dia., wrought-iron pipe and special drainage fittings are used. For larger drainage lines inside the house, most plumbing codes require the use of bell-and-spigot, cast-iron pipe. You can use vitrified-clay, cast-iron, asbestos-cement or bituminized-fiber pipe for outside drainage lines such as a house sewer.

A pipe vise and two pipe wrenches are needed to handle threaded pipe. Cutting is done with a pipe cutter, and threading with a stock and pipe dies. Burrs left by the cutter on the inside of

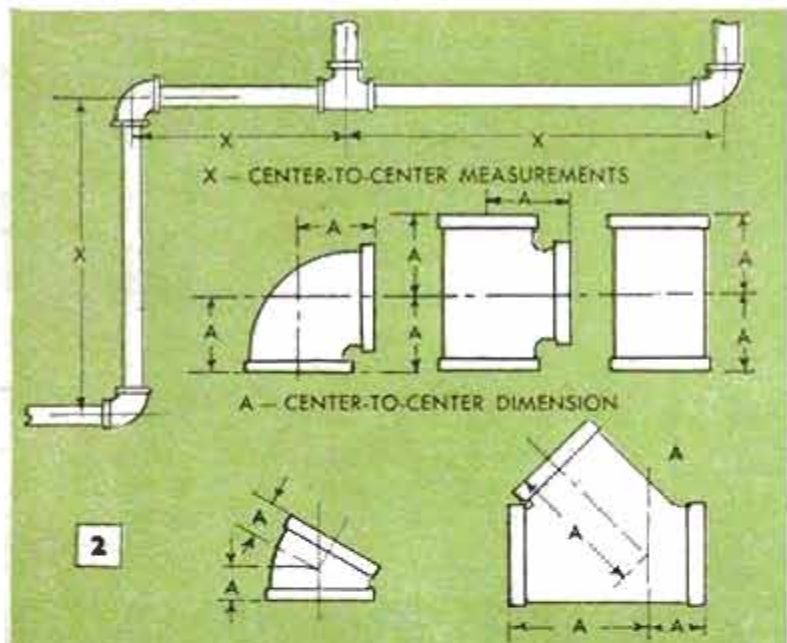

NOMINAL PIPE SIZE (in.)	NORMAL ENGAGEMENT FOR TIGHT FIT (in.) (W)
1/8	3/4
1/4	5/8
3/8	3/4
1/2	7/8
3/4	1
1	1 1/8
1 1/4	1 1/4
1 1/2	1 5/8
2	2
2 1/2	2 3/4

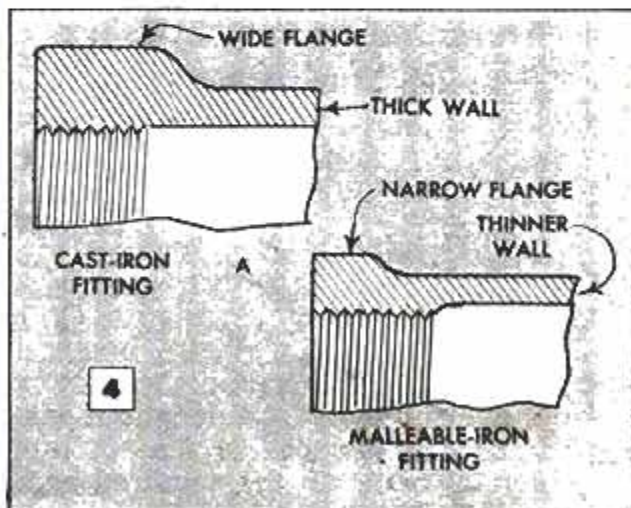
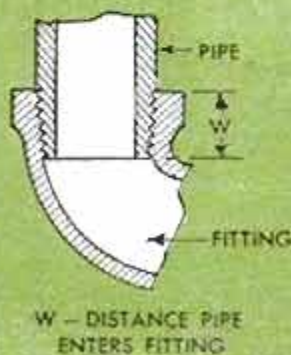

the pipe are removed with a reamer. Cutting oil should be applied when cutting or threading.

To measure lengths of pipe for an installation, take the dimensions as shown in Fig. 2. From each dimension "X" subtract dimension "A" of the fitting to which the pipe connects at each end. Dimension "A" is taken along the center line of the fitting and is the distance from the face of the opening to the point where two center lines intersect. Next, add the distance "W" at both ends of the pipe. This is the distance that the pipe will enter the fittings, and varies with the nominal pipe size as given in Fig. 3.

Assembling Threaded Pipe

Before assembling pipe and fittings, brush threads clean and apply joint-sealing compound on two or three of the outer threads of the pipe. Do not coat the inside of a fitting, since the compound might collect at the end of the pipe and obstruct the flow of water. Avoid excessive pressure on a pipe wrench, and apply it at least 2 in. from the end of a pipe to prevent bending the pipe out of round. When pipe is assembled with close return bends and there is not enough clearance to use a conventional pipe wrench, it may be necessary to use a girth wrench as shown in Fig. 1.

Threaded Pipe Fittings

Pipe fittings of malleable iron are preferred to cast iron generally, as they are tougher and less brittle. Fig. 4 shows the difference between the two types. Cast-iron fittings have thicker walls and wider bands and are used mostly

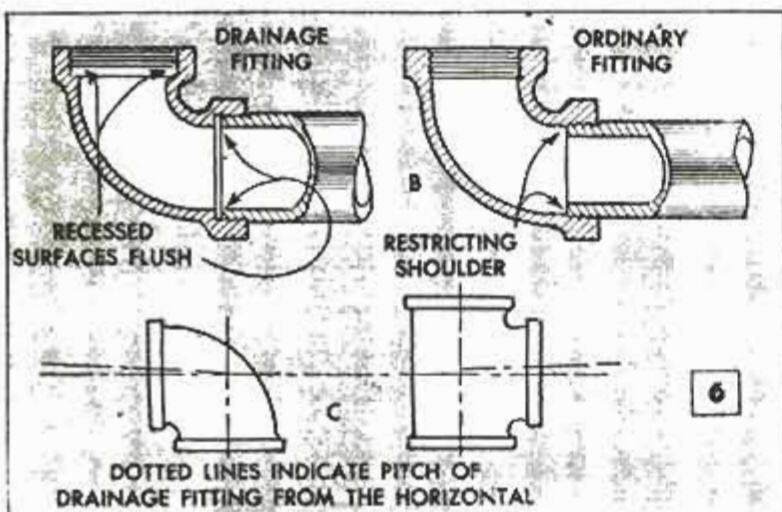
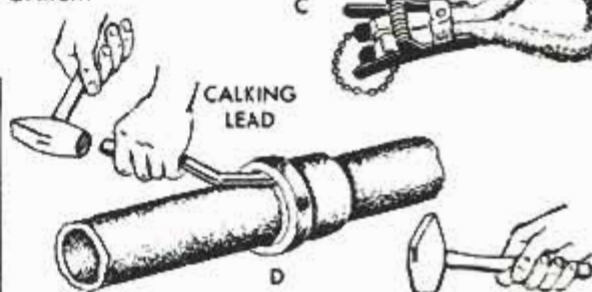
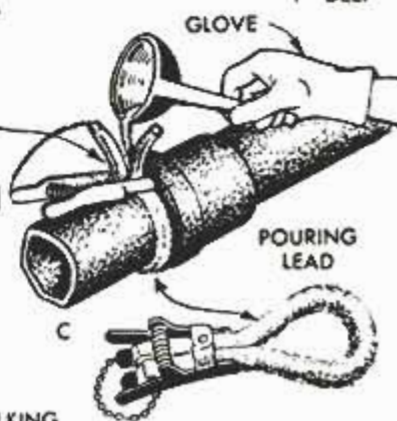
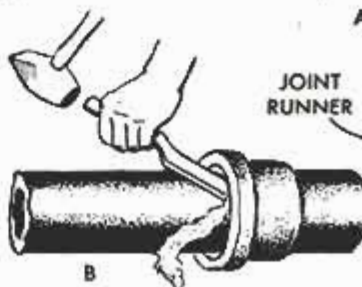
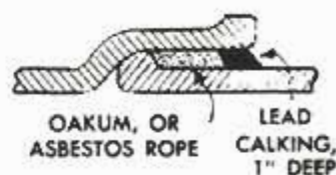
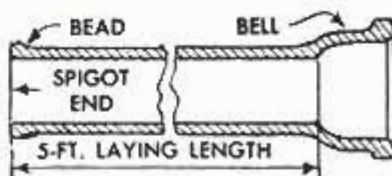
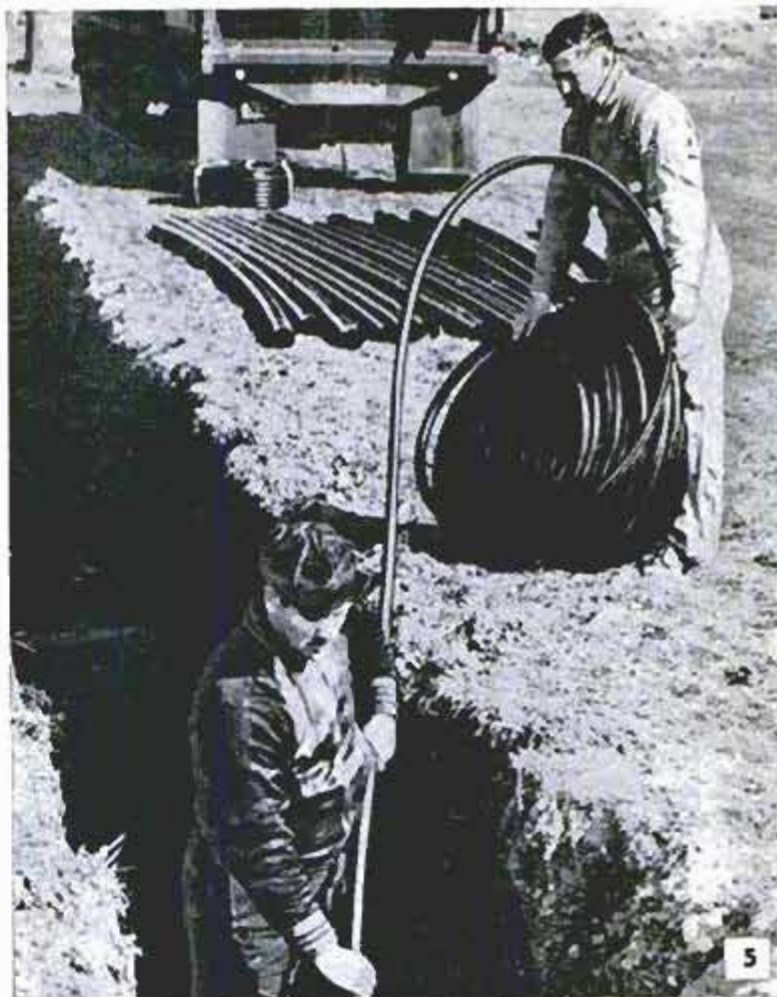



8

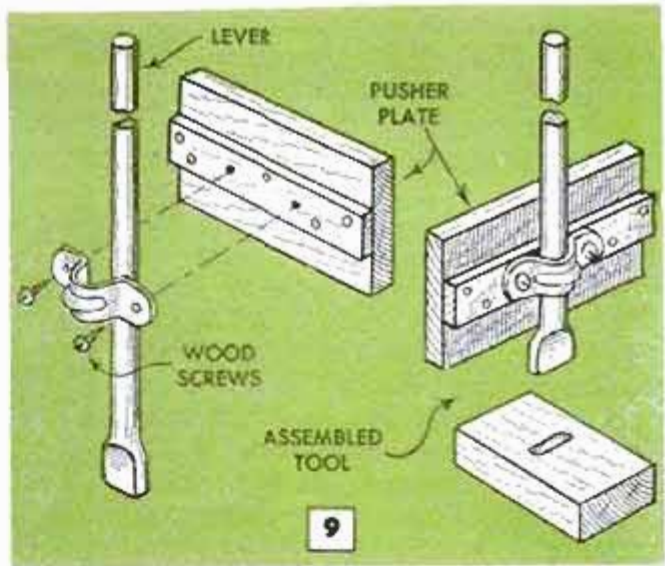

10



11

for house drains to sewer or septic tank.

Drainage fittings are recessed at the threaded portion so that the inside surface of the pipe will be flush with the inside surface of the fittings, which prevents solids from accumulating at a joint. Detail B, Fig. 6, shows the difference between regular and drainage fittings in this respect. Another important difference is that the latter has one or more slightly pitched outlets, as shown in detail C, to match the usual $\frac{1}{4}$ -in.-per-foot pitch of horizontal drainage pipes.

Plastic Pipe

For many applications plastic pipe has specific advantages. Its weight is $\frac{1}{8}$ to $\frac{1}{3}$ that of ordinary pipe of corresponding

size. It is rot and corrosion proof, and can be cut easily with a knife or saw. The material has been found highly satisfactory for jet wells and other cold-water installations. Most brands of plastic pipe should not be installed where the pipe is subjected to excessive heat. Some are vulnerable to rodent attack where exposed.

Available in nominal inside diameters from $\frac{1}{2}$ to 6 in., plastic pipe comes in rigid, semirigid and flexible form. The latter is used in trenches as shown in Fig. 5, and comes in 100 and 400-ft. lengths. Freezing water will not damage it. Rigid pipe is obtainable in 20-ft. lengths and is used for well casings, septic-tank lines, field drainage and irrigation lines.

Fittings for plastic pipe permit any type of connection, which may be of the insert type held securely with clamps, or a fitting which is attached to the pipe with cement. Threaded and compression fittings may also be used in some cases. Threaded joints are practical for low pressure or gravity lines but are not recommended for vertical runs. When threading plastic pipe, a mandrel should be inserted for support, and plain or soapy water applied as a cutting solution. Strap wrenches are used to assemble threaded plastic pipe. No joint-sealing compound is required.

Bell-and-Spigot Soil Pipe

Made of cast iron and coated with coal-tar pitch for protection, bell-and-spigot soil pipe (Fig. 7) comes in 5-ft. lengths. The 3 to 6-in. diameters (inside) are used generally. Lengths with a bell at each end also are furnished for economy when two short lengths are required.

When assembling this type of soil pipe the bell end of each length should face "upstream." Joining ends should be clean and dry, and in perfect alignment. The latter is checked by means of a taut cord held parallel to the axis of the pipe. Wrong

alignment will make it difficult to form a tight joint. To seal a joint, first tamp oakum, hemp or asbestos rope tightly and uniformly into the joint with a yarning iron and hammer as shown in Fig. 7-B. The packing should come to about 1 in. from the rim of the bell so that enough space is left for the lead, which is poured next.

For horizontal pipe a joint runner, as shown in Fig. 7-C, is needed to retain molten lead in the joint. Use calking lead only, obtainable in 3 to 5-lb. cakes. Melt it in a plumber's firepot and pour with a ladle when the lead is heated to a cherry-red color. Fill the entire joint at one pouring if possible. Since lead shrinks slightly upon cooling, it must be tamped with a calking iron, as in Fig. 7-D, to make it fit snugly.

Soil pipe can be cut with a cold chisel as shown in Fig. 7-E. After marking, score the pipe lightly, moving the chisel forward for overlapping cuts. Then set the pipe on wooden blocks or on a sandbag and deepen the score with increasingly heavier blows, until the pipe can be severed with a few sharp blows.

Fittings for cast-iron soil pipe have ends like the pipe and are joined similarly. The angle of a fitting is usually designated as a "bend," a $\frac{1}{4}$ bend being $\frac{1}{4}$ of 360 deg.

Asbestos-Cement Pipe

Asbestos-cement pipe also is used for outside drainage lines. The long lengths of the hard, strong pipe permit laying a line with fewer joints. The type used for house-to-sewer connections comes in 5 and 10-ft. lengths and has machined ends which take couplings of the same material. Durable rubber rings between pipe ends and couplings make slightly flexible and rotproof joints. Figs. 10 and 11 show a joint before and after assembling. Pipe and couplings are forced together with a simple tool detailed in Fig. 9. When short lengths are needed the pipe is cut with a handsaw. A variety of fittings are available. Machined ends are made with a special cutting tool.

Vitrified-Clay Pipe

Vitrified-clay pipe, Figs. 12 and 13, is durable, comparatively low in cost and easy to install. It is available in straight and curved lengths, with numerous fittings. One end of each length or fitting is bell-shaped to fit over the end of the adjoining member.

While good joints can be made with mortar applied over a packing of oakum or jute, poor workmanship usually is responsible for entrance of roots. Once inside the pipe, the roots expand and often break it. To avoid this difficulty, clean the joints of dirt and grease so that the mortar will adhere properly. Then bring the pipe



12

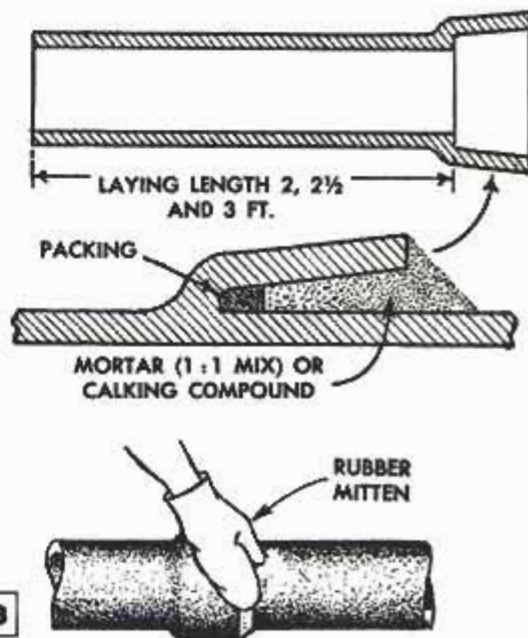

13

lengths together snugly and seal the crack with a shallow layer of packing tamped down lightly. Follow with a layer of fairly stiff mortar consisting of equal parts of clean, sharp sand and portland cement. The surplus on the outside can be rounded off, using a rubber mitten as shown in Fig. 13. After the mortar has set, cover with sand to avoid too rapid drying, which would prevent it from attaining its maximum strength.

Each length of pipe should rest on compact earth for most of its length, with clearance under the joints only. The pipe



should not be moved after mortar joints have been formed.

Asphalt-Base Joint-Sealing Compound

Asphalt-base joint-sealing compounds that provide tight yet slightly flexible joints generally are preferred to mortar where trouble is experienced from root penetration. Most of these compounds are poured hot into the joints over a base seal of oakum. A compound should be used at the temperature recommended by the manufacturer, since overheating makes it brittle and underheating allows the compound to harden before a joint can be completely filled.

To facilitate the work, several lengths of pipe can be joined into a long unit by stacking them in a rack as shown in Fig. 12, and assembling the units in the trench after the compound has hardened.

Bituminized-Fiber Pipe

In addition to its use for outside drainage lines as shown in Fig. 14, bituminized-fiber pipe can be used for downspouts, conductor pipes for irrigation, and also for gravity-type water-supply lines on farms and ranches. It is lightweight, noncorroding and semiflexible. Available in 5 and 8-ft. lengths, the pipe has tapered, machined ends which join couplings that are tapered internally as shown in Figs. 16 and 17.

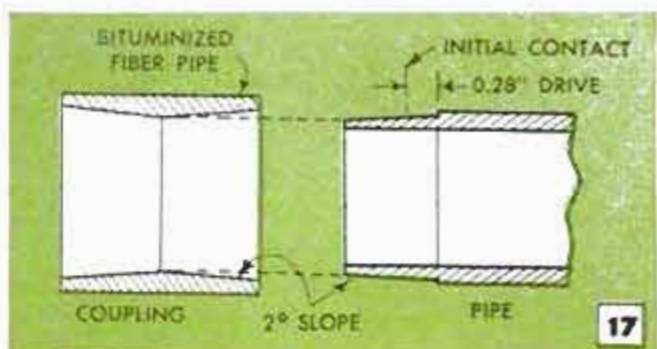

Driven together with a block and hammer, Fig. 15, the joints are so tight that tree roots cannot enter. Bends and fittings of numerous types are available, and connections can be made to threaded or bell-and-spigot-type soil pipe by means of adapters. Joints to the latter are sealed with flexible-joint compounds or lead wool. An ordinary handsaw is used to cut the pipe. A special cutter is used to taper ends cut in this manner, although the ends also can be tightly sealed with a special coupling.

Installing Pipe

Water pipes should be installed so that they can be drained completely. Insulation should be used on pipes that are subject to freezing. All pipes must be adequately supported, but not so rigidly that they will be under strain when temperature changes cause them to expand or contract. Horizontal steel pipe should be supported by straps at intervals of not less than 12 ft., cast-iron soil pipe at intervals not over 5 ft. and as near the joints as possible. Risers should be held by collars or yokes which should be spaced not over 1½ stories for threaded pipe and not over 1 story for soil pipe. Drainage pipe requires a pitch or slope of ¼ in. per foot, so that the liquid inside will flow easily. Underground pipe should be laid on compact earth that will not settle. ★ ★ ★

Lengthening Chain-Hoist Life

One means of lengthening the useful life of a chain hoist is to remove the lower, movable sheave and fit it in the free loop of the chain. Since the action of the hoist now is reversed, wear also will be in the opposite direction on chain and sprockets.

Covers on Bench-Vise Jaws Protect Tubing

Wood or fiber covers fitted over the jaws of a bench vise will permit holding polished or chrome-plated pipe and tubing without damage. Two L-shaped sheet-brass flanges first are cut and bent to fit over the jaws of the vise. The vertical edges then are drilled and both flanges are screwed to a block of hardwood or fiber. Several holes, to accommodate various sizes of tubing, are drilled along the center line of the block which now is cut in half. The width of the saw kerf permits the two halves to grip the tubing when the vise jaws are

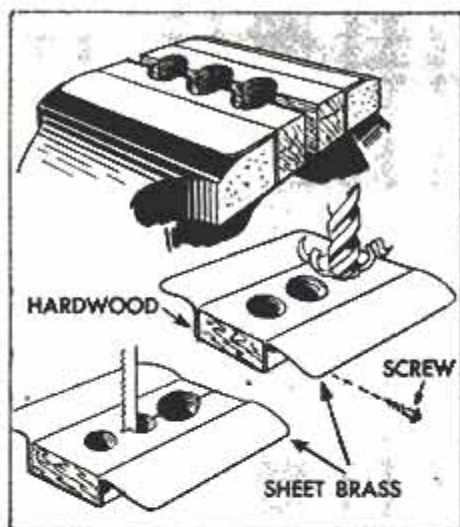

closed. Use of heavy material for the block will increase the holding power of the block, for a better grip on tubing in it.

Special Cotter-Pin Extractor For Use in Restricted Space

If your work frequently requires the removal of cotter pins in places where it is difficult to use the more common types of extractors, try this one. With it you can reach into restricted places and extract a pin merely by turning a long hex nut. The tool consists of a body cut from $\frac{5}{8}$ -in. steel plate to a rough pistol shape. A hole is drilled for the extractor rod which is a length of $\frac{5}{16}$ -in. drill rod, threaded for half its length. A flat is ground on the top of the threaded portion and a hook is formed in the opposite end of the rod. A setscrew

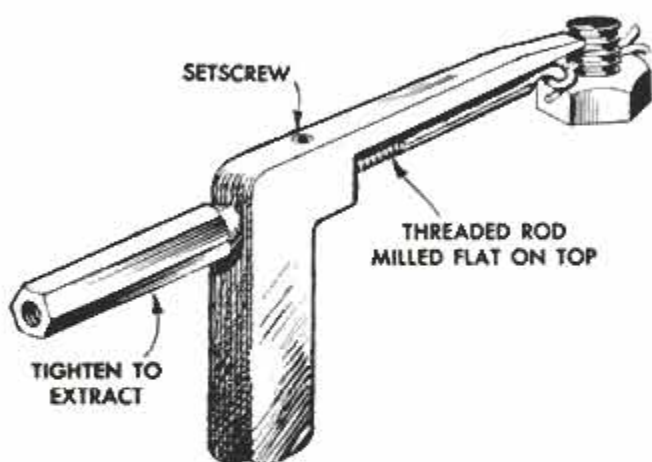

turned into a tapped hole on top of the extractor body bears against the flat on the extractor rod and prevents the latter from turning when the hex nut is tightened on it. The hex nut is a length of hexagonal steel bar, drilled and tapped to turn on the drill rod. When a cotter pin proves stubborn a wrench can be used on the nut to provide more power.

C. H. Willey, Penacook, N. H.

Warped Doors Straightened With Turnbuckle and Rods

Warped doors on his poultry houses are kept in proper alignment by one poultryman by utilizing heavy turnbuckle braces of the type used to correct sagging screen doors. The brace is located on the convex side of the warp. It may be necessary to tighten the turnbuckle at intervals of two or three days, until the door is straight.

Charles L. Stratton, Hollis, N. H.

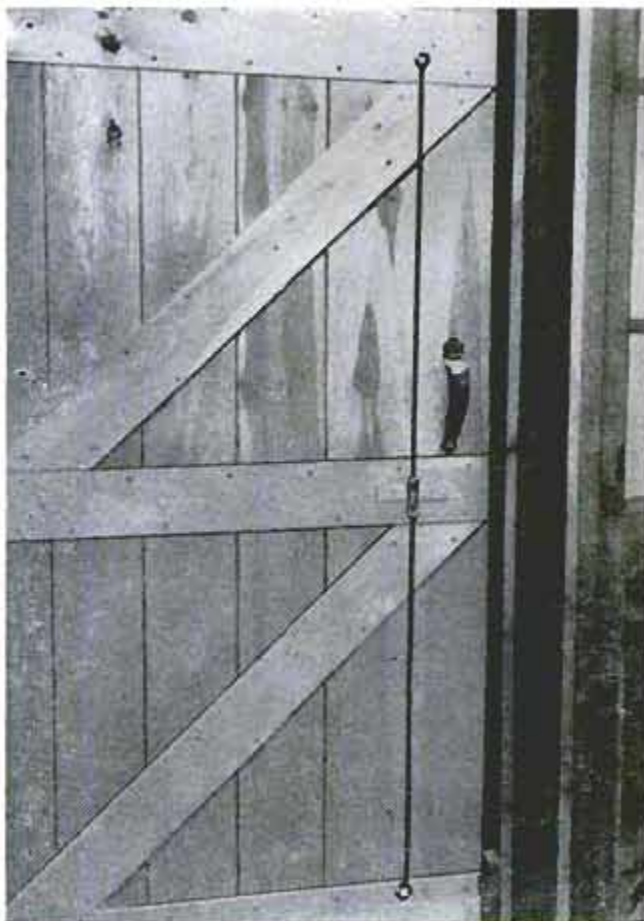

Bushel Basket Used as "Persuader" to Drive Hog up Truck Ramp



A bushel basket was used by one livestock buyer as an aid in driving several hogs up a ramp into a truck. The buyer held the basket over the head of one hog, which caused the animal instinctively to back away and up the ramp. When the other hogs heard the first in the truck, they lost their reluctance to being driven in.

Sanding Renews Wiper Blades

To get better service and prolong the life of your auto windshield-wiper blades, give them a thorough cleaning with soap and water and remove oxidized rubber and hardened foreign material with an abrasive. After the cleaned blade is dry, rub its wiping edge across a sheet of fine sandpaper with a light, lengthwise movement until a continuous line of fresh rubber is exposed along the entire edge.

E. Carranza, Lodi, N. J.

Portable Concrete Platform Towed Behind Tractor

A portable platform of this type will have many uses on the average farm. It is ideal to prevent mudholes under temporary watering tanks, and is very handy as a portable feeding platform for hogs fed in the field. The reinforced concrete platform is 3 in. thick, 6 ft. wide and 8 ft. long. Steel rods cast in the concrete extend from opposite sides of the platform and are bent to form loops. A chain passed through the loops permits the platform to be towed by a tractor. Heavy objects are easy to load, because the loading surface is less than 3 in. off the ground, eliminating the need for a loading platform or a ramp.



Farrowing-Pen "Entry Hall" Provided by Inside Doors

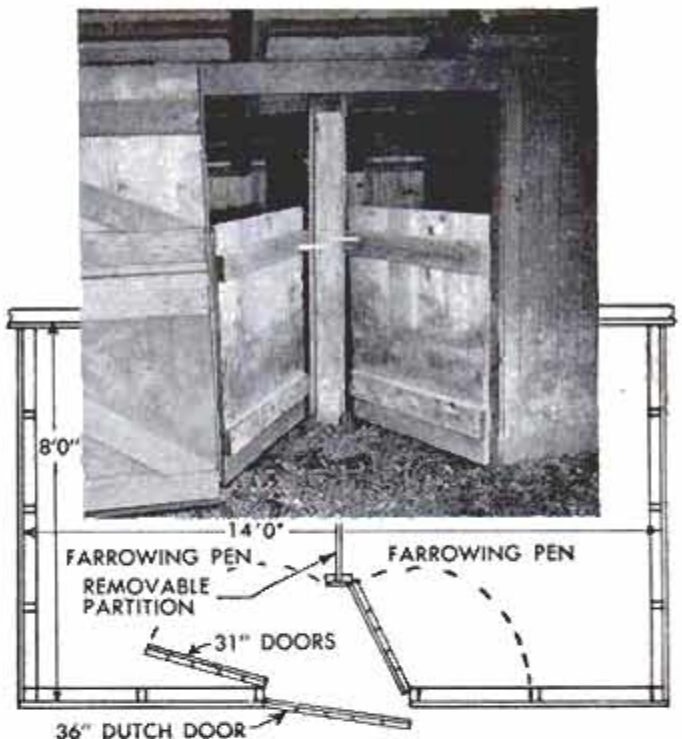

The removable partition in this farrowing pen is located so that two doors hinged to the pen wall on either side of the outside door divide the pen in half and leave a triangular-shaped area just inside the main door. The farmer can stand inside the shelter of the pen while observing the sows and pigs. A Dutch door is used for the outside entrance, so the upper half can be opened for light and ventilation when the partition is removed and the pen is used for pigs being readied for market.

George Laycock, Batavia, Ohio.

SHOPPING FOR TOOLS

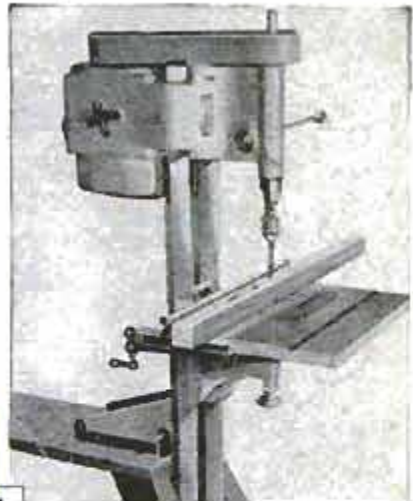
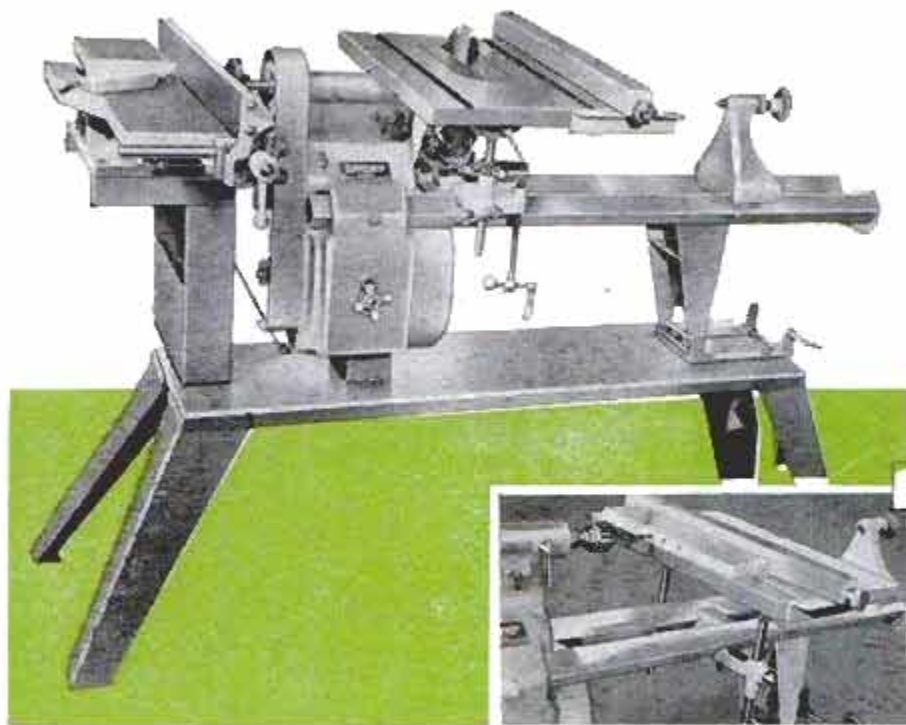

1. COMBINATION SHOP POWER TOOL is a lathe, drill press and bench grinder, and can be equipped with jointer-planer and table-saw accessories, all mounted on a 24-in. bench. The 30-in. lathe includes a spur center, tool rest, quill-action tailstock and steel spindle. Table saw is mounted on the lathe bed

and is fitted with an 8-in. blade which attaches to the spindle. The lathe converts to a drill press when a geared chuck is fitted to the spindle and the saw table is positioned on the bed as a unit. The jointer-planer accessory permits bevel, square taper and rabbet operations. All castings are aluminum

Power Tools, Inc., Beloit, Wis.

2. ROTARY INDEX MILLING TABLE incorporates rotary feed, two cross slides and a tilting feature which enables an operator to set the table at any angle from 0 to 90 deg. in a vertical plane. The dial is calibrated in 3-min. intervals, and the cross-feed dials are accurately graduated in thousandths

Chicago Tool and Engineering Co., 8383 South Chicago Ave., Chicago 17

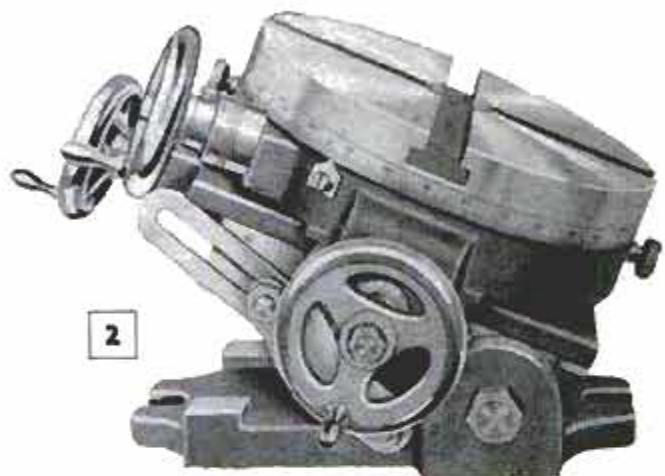

3. PORTABLE POWER-SAW-BLADE ADAPTER permits flush cuts and cutting close to studding, rafters, etc. It is available with an attached guard and a 7 1/4-in. blade, which is riveted to a cadmium-plated hub. The diamond-shaped hole in the hub is broached for absolute accuracy in fitting it on the arbor

Barnes Blade Co., 16249 Colorado Ave., Paramount, Calif.

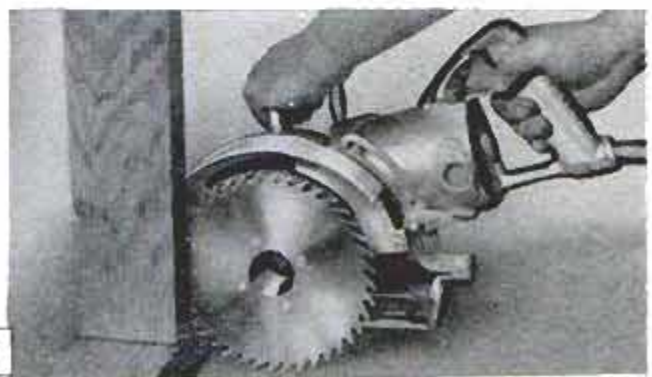
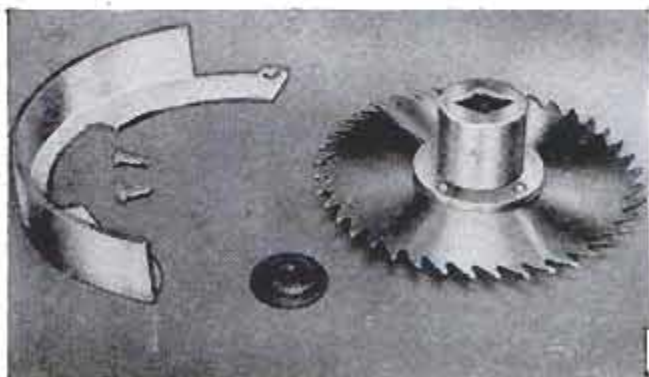



4. CHALK-LINE REEL features a flush rewind handle, a positive-action mechanical brake, and a combination hook-and-ring securing device. It is also designed to be used as a plumb bob, and is supplied with a 50 or 100-ft. line. Made of lightweight die-cast aluminum, the case is leakproof and shaped like a plumb bob. The refill cap is removed for refilling with chalk by a quarter turn to the left

Evans Rule Co., 400-416 Trumbull St., Elizabeth, N. J.

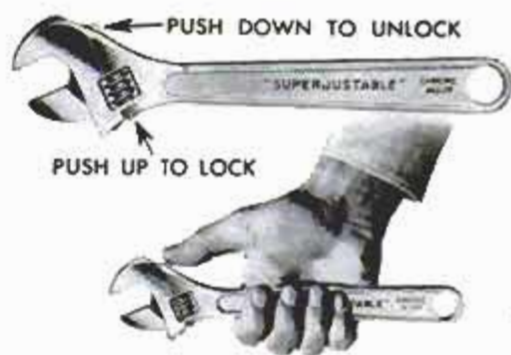

5. LOCKING ADJUSTABLE WRENCH offers rapid adjustment and a positive lock in a desired position without clumsy or unsightly obstructions or protrusions. The locking device eliminates a tendency toward loss of adjustment caused by involuntary rotation of the adjustment knurl on the movable jaw. Fumbling with the knurl to hold an adjustment is eliminated. A flick of the thumb or finger locks or unlocks the adjustment in any position. The wrench is now available in 6, 8, 10 and 12-in. sizes

J. H. Williams & Co., 400 Vulcan St., Buffalo 7, N. Y.

6. PRY BAR for metal-repair work on auto and truck-door panels, quarter panels, trunk lids and rocker panels enables a metal worker to pry out dented metal in areas that are inaccessible to ordinary tools. A flexible guide bar positioned over the pry-bar member permits the operator to locate an area that requires prying immediately, without unnecessary stretching of the metal by repeated bending. The pry bar is made of square stock, which prevents the metal from tearing as readily

Air Peck Distributors, N. 1619 Madison St., Spokane 17, Wash.

7. CARBIDE TOOL GRINDER removes metal from carbide and shank of tool being ground by an electrical process, with an average voltage between wheel and work of 1.5 volts. No physical contact need occur between the cast-iron grinding wheel (electrode) and the tool. Metal particles are removed from the tool by an electrical discharge crossing a gap between an electrode and the tool, which is maintained by a semisolid dielectric film. A roughing or finishing cut may be had by turning the selector

Firth Sterling Inc., 3113 Forbes St., Pittsburgh 30, Pa.

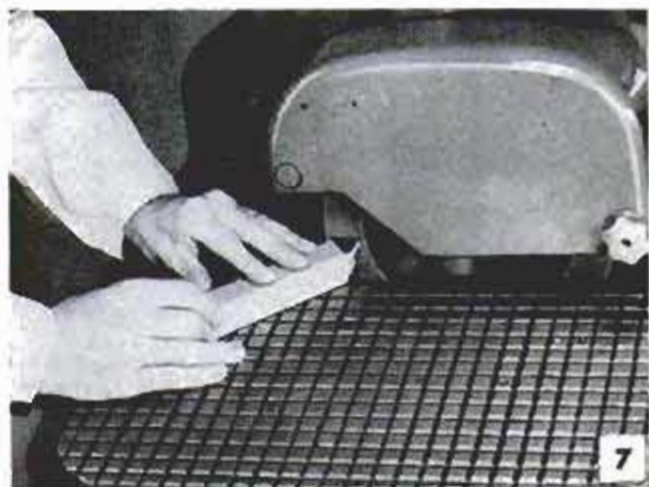

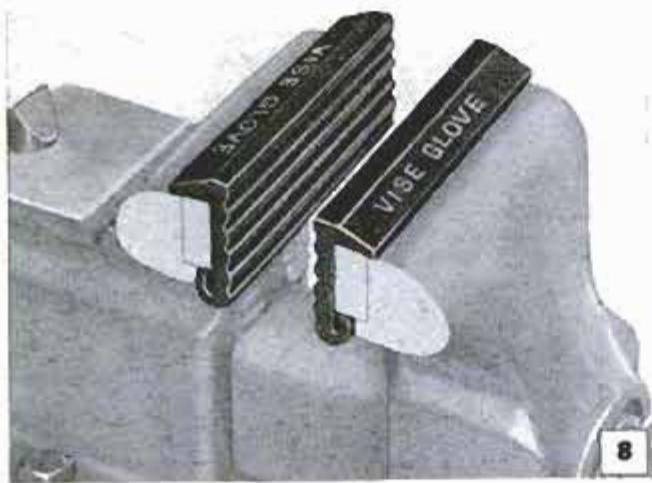

8. RIBBED RUBBER CAPS for vise jaws are new item intended as low-cost substitute for usual brass jaw covers. It is claimed that wood, glass and plastic can be held firmly in vise jaws and rubber caps will not mar materials as would brass. Called "Vise Gloves," the caps snap into place over vise jaws and are held by elasticity of rubber. Vise Gloves are available to fit all sizes of vise jaws, beginning with 3 in.

S. J. Williams, Inc., 4448 Soo Line Lane,
Schiller Park, Ill.

9. PRECISION-MACHINED PARTS are cleaned of foreign matter by "washing machine" that employs ultrasonic energy. Sound waves are passed through tub in which parts are submerged in solution of water and detergent or other cleaning fluid. Sound waves "cold boil" solution so millions of tiny bubbles literally blast material from metal. Cabinet contains ultrasonic generator and other necessary electronic circuits

Pioneer-Central Div. of Bendix Aviation Corp.,
Davenport, Iowa.

10. PAINTBRUSH HOLDER is screwed to ferrule of brush in matter of moments. Brush then can be hung on side of paint pot or can so bristles do not touch, thus aiding in keeping brush in proper shape. Ideal for brushes stored in solvent, since it is simple matter to remove one brush without disturbing others. Holder does not in any way interfere with use of brush in normal manner. Fits any size or shape of paintbrush

Marsh Safety Equipment Co., North Andover, Mass.

11. HIGH-TEMPERATURE CONTROL SWITCH for kilns is available in two models. One model is wired through relay so all electric current to kiln is shut off when temperature reaches desired point. Other model can be hooked to light, buzzer or other warning device to indicate when temperature is reached. Unit is then shut off manually. Switch is actuated by shrinkage of pyrometric cone held horizontally on probe

Edward G. Pierson Co., 2326 East River Rd., Grand Island, N. Y.

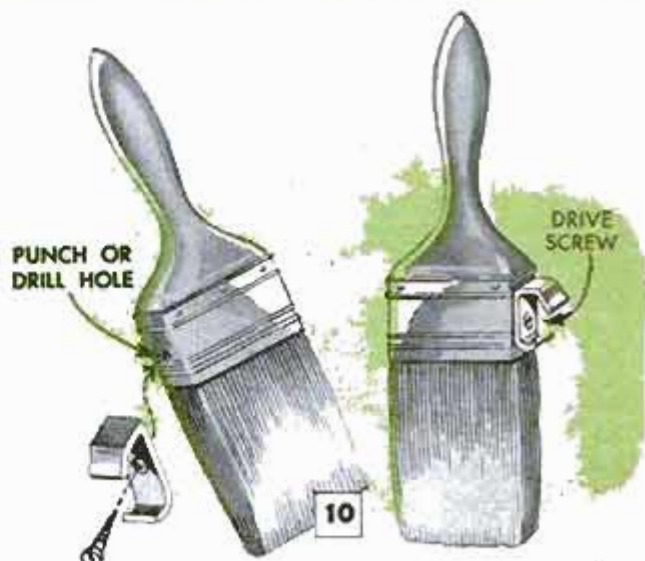

12. GLASS CUTTER for the home workshop has adjustable guide so glass can be cut on line exactly parallel to edge of piece being cut. Guide permits "self measuring" action when cutting narrow strips of glass. Heat-treated, high-carbon cutting wheel works equally as well on window or plate glass

Arrow Products Co., Box 52, Dayton, Ohio.

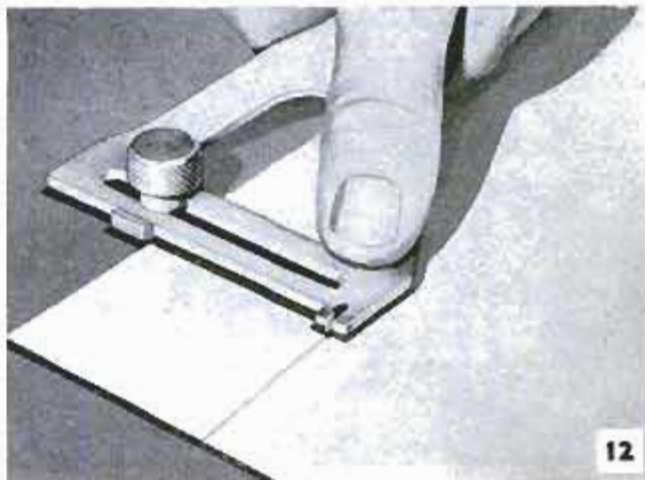



On the MARKET

WALLPAPER CLEANER (left) removes oil-base stains caused by greasy foods, hair, hands, etc., without damage to the paper. Apply the cleaner, which is in paste form, on a stain and allow it to dry into a powder before brushing it off. If one application fails to remove stain, repeat the process
Inwood Products, 216 E. 125 St., New York City 35

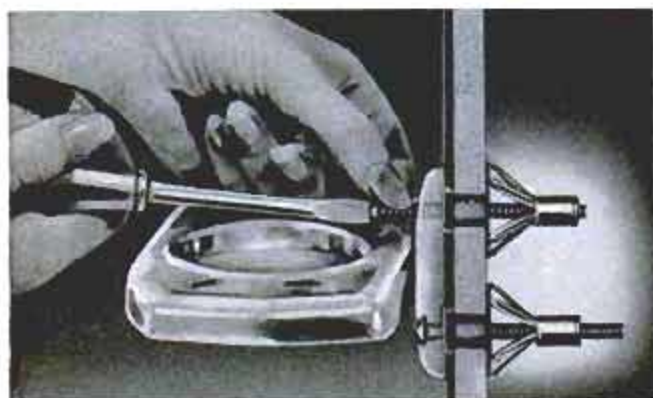

WALL-SCREW ANCHOR makes it possible to secure a bathroom fixture to a hollow wall. The metal anchor is designed to expand against the inside surface of a wall and hold a fixture in place on screws
Rocket Devices Corp., 142 Liberty St., New York City



LUBRICANT for wooden objects, such as drawers and doors, waterproofs wood and lubricates sliding surfaces. The liquid also can be used to remove grime, and is guaranteed safe on hands and furniture
Slide-Free Co., Orangeburg, N. Y.

NATURAL-WOOD-finishing material gives doors, paneled walls, wood trim and furniture a soft, lasting sheen without expensive hand-rubbing and waxing. Three coats can be applied in one day
William Zinsser & Co., 516 W. 59 St., New York City 19

PLASTIC-RESIN PAINT applied to cement, brick and other masonry interiors hardens to a porcelain-like finish which is waterproof, resists heat and staining and washes clean with soap and water
American Metaseal Corp., 607 65 St., West New York, N.J.

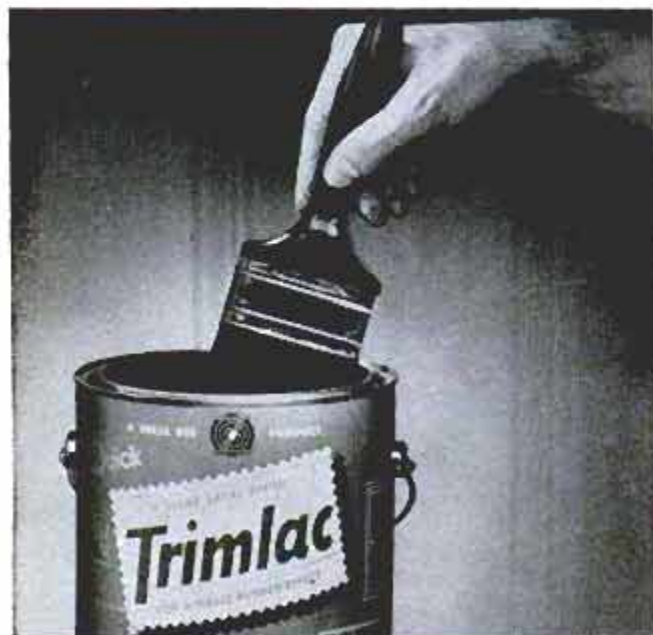

WHAT'S NEW IN ELECTRONICS

Personal Telephone Amplifier

for those who use telephones in noisy locations and for the hard of hearing. The ingeniously designed phone aid can quickly and easily be attached to any style of telephone. The amplifier, which consists of three transistor stages and reproducing unit, requires no warm-up time and is said to have a gain of approximately 49 decibels. A volume control permits adjustment of the output to any desired level. While the unit shuts itself off when removed from the phone, a separate off switch eliminates battery drain if it is to remain attached to the phone.

THIS NEW 3-ounce telephone amplifier, powered by dime-sized batteries, is now available



"Registered" Music

Here is a novel method for distributing music throughout the entire house that is adaptable to any home having a warm-air furnace or central air conditioning. The system can be easily installed without special tools. A specially designed steel case housing a waterproof, fungus and heat-resistant speaker and volume control is attached to the plenum chamber or "dome" of the furnace. The ends of a 20-ft. cord are connected with alligator clips to the speaker of the music system. The sound is carried throughout the house by means of the heating or cooling ducts.

All-Purpose Radio

An unusually styled radio, this unit features the utmost in versatility. Consisting of separate sections, the receiver is equally useful as a portable, mobile or home radio. The main unit contains a 4-tube superhet circuit including a 3½-in. speaker. Individually housed power supplies for various types of operation are quickly attachable to the main unit.

Universal mounting brackets permit separate mounting, if desired. A station selector switch mounted on the radio section permits instant reception from any of three pretuned stations.

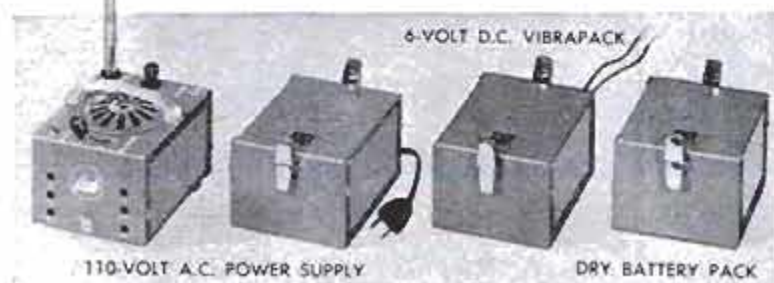

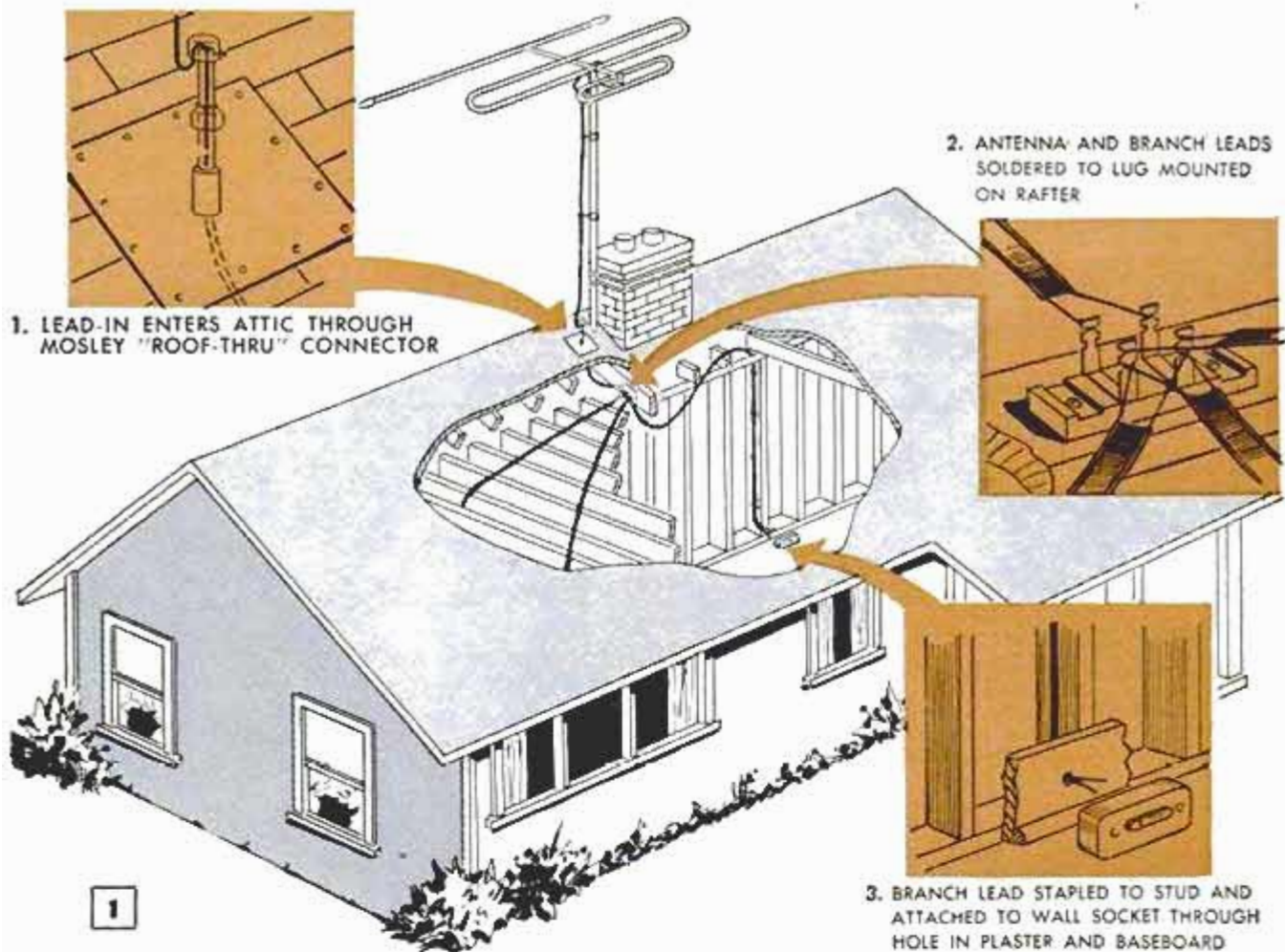

Versatile Installation "Unhitches" TV Receiver

IN MOST HOMES where outdoor antennas are needed for satisfactory TV reception, viewing is restricted to a single room of the house because the antenna lead-in is not long enough to permit movement of the set to another location. This,

however, need not be so. With some careful planning, and just a little effort, you can install your antenna system so that your receiver has all the versatility of a plug-in-type telephone. What's more, by following these installation suggestions, re-

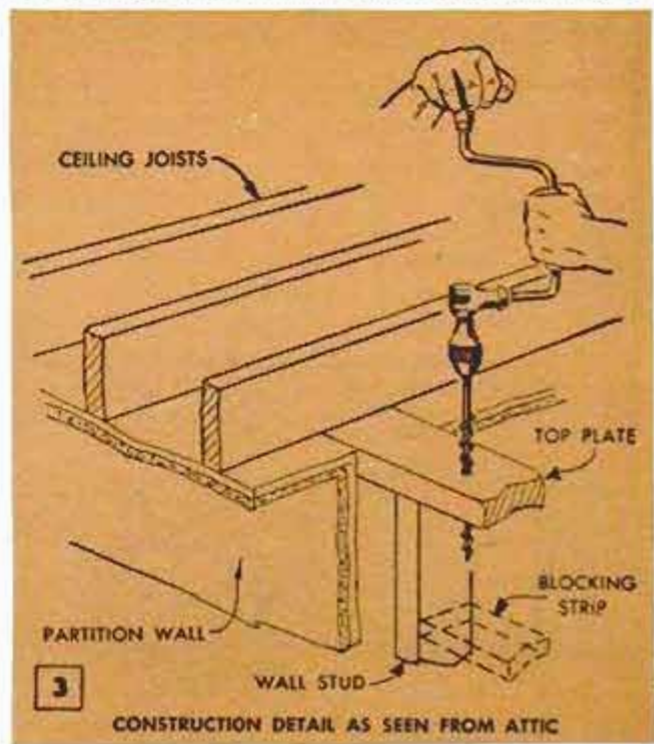
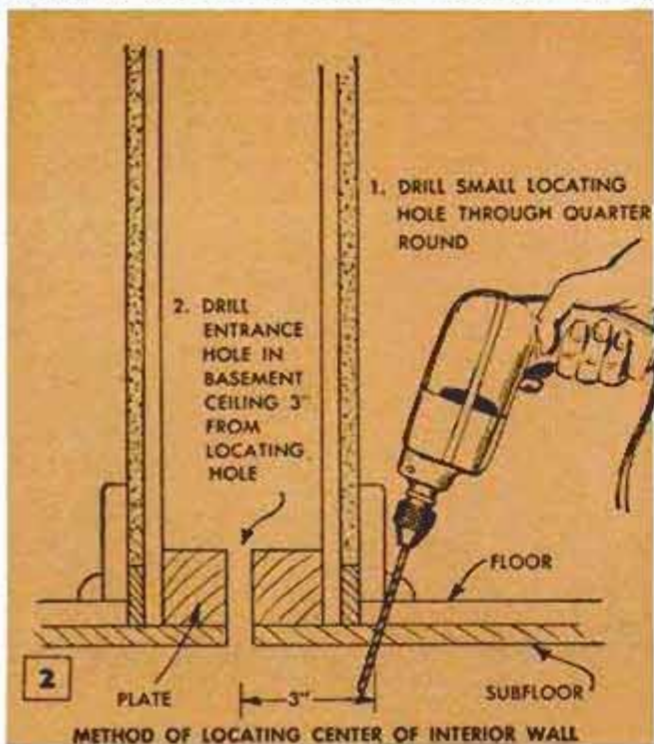

ception is usually improved, and lead-in deterioration is greatly reduced.

The whole idea consists of running a number of lead-in lines through the walls of various rooms in which you may want to watch your set. These lines are terminated at the baseboard with special sockets so that a short lead from the set to any socket will make a direct antenna connection.

The installation is most conveniently done during the initial construction of the home. It takes only a few simple tools and an elementary knowledge of home construction, however, to adapt the method to existing homes.

Fig. 1 shows the principles involved in installing the antenna system during the construction of a home. The main lead-in from the antenna is brought into the attic by means of a "Roof-Thru" insulator, and connected to a convenient tie point. From there, individual leads run between the various wall studs to the locations where the sockets are to be installed. Small holes drilled through the baseboards permit the leads to be attached to the sockets.

For existing homes, the installation is somewhat more involved but not necessarily difficult. If you do not wish to bring the lead-in through the roof, you can make the entrance through an attic window, or through a basement or crawl-space opening. Since the main junction can be made in either the attic or the basement, the best location is determined by the construction of the house and by your own preference.

The most difficult part of an attic junction is locating the exact points where the leads must be dropped through the wall.

This involves careful measurements from two sides of the house, so that the lead will drop between the two specific studs where the socket is to be located. Since the studs are usually placed 16 in. apart, the measurements need not be absolutely accurate. However, it is easier to fish the lead through a small hole in the baseboard if it is dropped close to the hole.

Fig. 3 shows a cutaway sketch of a typical uninsulated attic. The top plates of the various walls are visible between the ceiling joists. It is merely necessary to measure to the point of a particular wall where the hole must be drilled. Once this is done, the weighted lead can be dropped, and pulled through a corresponding hole in the baseboard with a bent wire clothes hanger.

Some homes are constructed with blocking strips running parallel to the floor between the wall studs, as shown by the dotted lines in Fig. 3. In such cases, the attic junction is impractical, and the antenna lead should be brought into the basement or crawl space and up through the wall. Locating the center of a particular inside wall is easily done by following the procedure shown in Fig. 2. A small hole is drilled through the quarter round and floor at the point where the socket is to be installed, and a wire is pushed through to mark its location. A $\frac{3}{8}$ -in. hole is then drilled up through the floor and wall plate at a point 3 in. from the protruding wire. This permits the lead to be pushed up through the center of the wall, and fished through a corresponding baseboard hole.

The installations described above are

(Continued to page 276)

Mosley lead-in accessories: A. Terminal connector; B. Socket; C. Line splicer; D. Plug; E. Wall socket; F. Two-set coupler; G. Plug and socket; H. Co-ax-to-flat line splicer; I. Socket; J. "Wall-Thru" connector

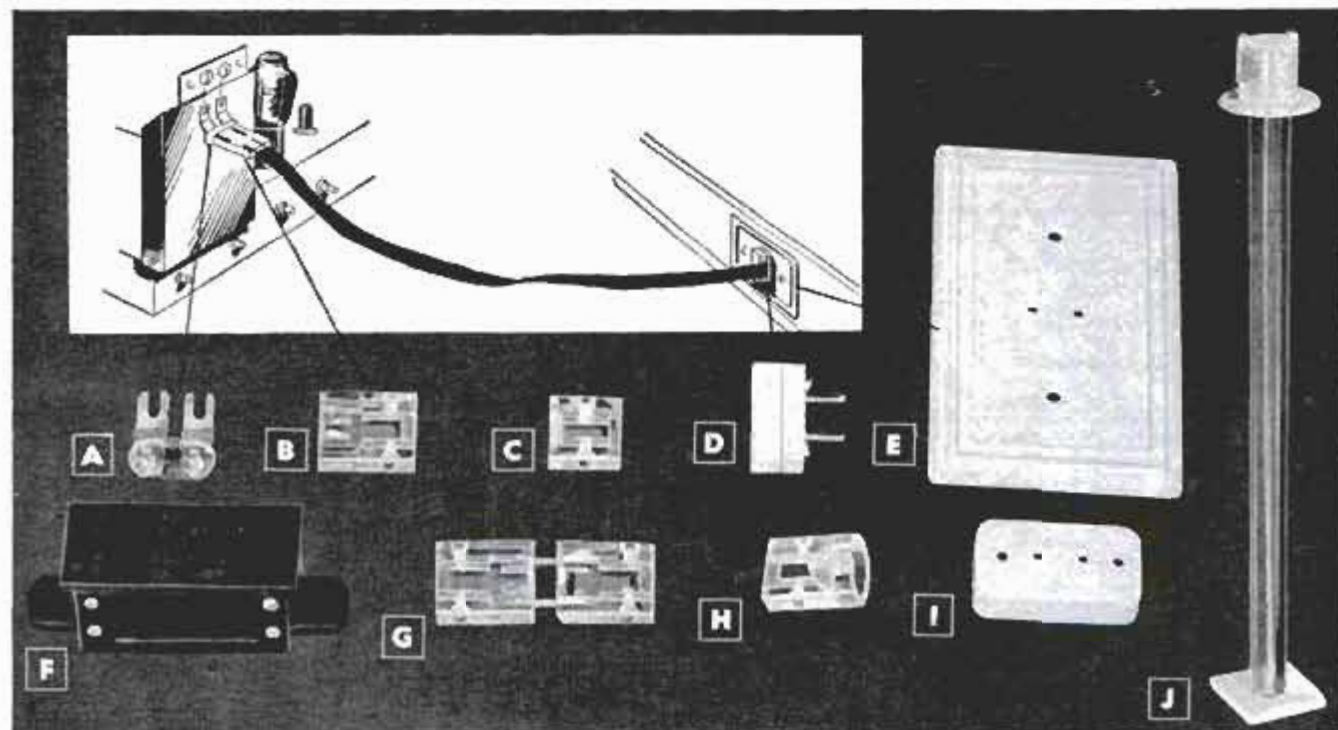

Recipe-Box Continuity Checker

Finds Open Filaments



WITH AN ever-increasing number of television sets, as well as most ordinary radios, using series-connected tube filaments, more troubles due to burned-out filaments will be encountered. When a single filament opens up, all other tubes of a series-connected filament string will go out simultaneously. Locating the defective one usually requires the services of a repairman.

With this handy little tester, even the inexperienced can quickly locate any tube with a burned-out filament. To do so, merely insert the line cord of the tester into any wall receptacle and plug the suspected tube into the proper test socket. If the tester bulb lights, the tube is good. If not, the tube must be replaced.

The checker will test all tubes used in modern radio and TV sets, including picture tubes, for open filaments. Picture tubes are tested by removing the socket from the end of the tube and connecting the test leads across pins 1 and 12 of the tube. If the tester bulb lights, the filament is good and the trouble is in the picture-tube socket, or elsewhere in the set.

In addition to testing tube filaments, this unit can be used for checking fuses and pilot lamps, transmission lines from folded dipoles, power cords of electrical appliances and other items where a short or open-circuit indication is required. For such purposes, the test leads are connected across unit or circuit to be tested.

The little model was built into a recipe

box purchased at the dime store for 29c. However, any metal, wood or plastic container will serve the purpose. Neither the size or material of the container, nor the placement of parts, will affect the performance of the unit, so long as the simple wiring diagram is carefully followed.

The neon bulb is mounted by being pressed into a rubber grommet. A solder lug is "sweated" to the tip of the bulb, and the lead from resistor R4 as well as one line-cord lead is soldered to the other end of the lug. The wire from pin 7 of the octal socket is soldered to the side of the bulb. A bulb socket may be used, if desired, to prevent damage to the bulb from overheating.

A push-button switch is provided for testing those tubes whose internal wiring would cause a "good" indication even if the filament were defective. The following tubes are included in this list: 6AQ5, 6BF5, 12AQ5, 35B5, 50B5. For these tubes the switch should be depressed and the bulb should light in both switch positions. It is suggested that a typed list of these tubes be pasted near the switch for a quick and handy reference.

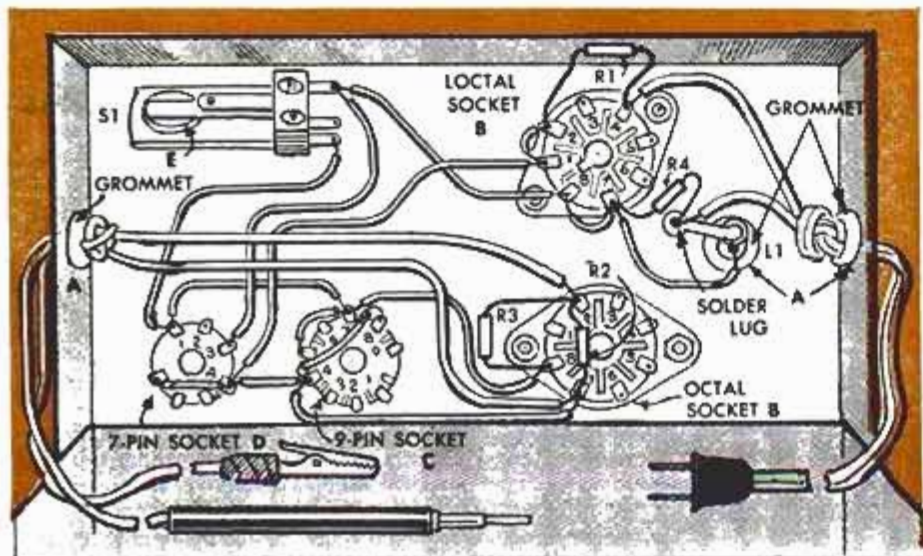

LIST OF MATERIALS

- R1—470 ohms
- R2, R3—270,000 ohms
- R4—330,000 ohms
- S1—S.p.d.t. switch, Switchcraft 1003
- L1—Neon bulb, NE-51
- Sockets—(1 each) octal, loctal, 7-pin, 9-pin. Rubber grommets for 1/2-in. holes, (3 reqd.). Line cord, test leads, recipe box, screws, nuts, wire and resin-core solder. Chassis hole sizes: A—1/2", B—1/8", C—3/4", D—5/8", E—3/8".



Tubeless Tires *can't** be safely repaired

*
*...unless your tire
repairman has proper
equipment and materials*

Many car owners have had "sad" experiences with tubeless tire repairs. This has been true because the repairman did not recognize that you cannot use old methods and materials for tubeless tire

repairing. It just can't be done that way. Remember, it's the tire that has to hold air now . . . not the tube and this means that new methods and materials had to be developed.

For SURE, SAFE Tubeless Tire Repairing

look for the

BOWES *Tubeless Tire
Repair Expert*



As the largest manufacturers of tire repair materials in the world it follows that Bowes would start, long before the actual announcement of tubeless tires, on exhaustive research and tests.

Today, the Service Station or Tire Dealer equipped with Bowes Tubeless Tire repair materials, equipment and "Know How" offers you the sure safe results of these several years of research and exhaustive highway testing.

Leading Tubeless Tire Manufacturers use and approve Bowes Tubeless Tire repair equipment and materials.

For those who
want the finest

the fabulous Evinrude

Lark

America's Finest
Outboard Motor



One glance tells you . . . something wonderfully new and exciting has come to outboard boating. *The Lark is here* . . . with its sparkling million-dollar look . . . commanding power encased in spectacular beauty. One glance tells you that it's finer than need be—we planned it that way—and for you the payoff is bountiful! The Lark's crisply modern styling lends distinction to the smartest run-

about . . . gives a gay lift to *any* boat. Its performance is as you'd expect . . . just a bit out of this world! 30 eager horsepower, trigger-fast take-off, blazing top speed. Your crew is pampered with a ride that's pure luxury—noise-free, vibrationless—the sailing-smooth ride of Whispering Power. Truly a motor for those who seek the finest . . . and the price is the pleasant surprise of all!



SEE YOUR EVINRUDE DEALER. Look for his name under "Outboard Motors" in the yellow pages of your phone book. He will gladly show you the complete line of nine Evinrude models for 1956. Three brilliant "Thirties," two with electric starting. New electric starting Fastwin. New Sportwin, 10 HP, and Fisherman, 5.5 HP. Revolutionary new Eas-A-Matic starting on five models. *Catalog Free!* Write for big, full-color catalog of the complete Evinrude line. EVINRUDE MOTORS, 4186 No. 27th Street,



Evinrude

Pioneers in quiet Outboard Motors



A Division of Outboard, Marine & Manufacturing Company
In Canada: Manufactured by Evinrude Motors, Peterborough

GRAVELY

More
for your
Money!



GRAVELY MAKES TOUGH JOBS EASY!

Gravely does jobs other tractors won't . . . because Gravely has that *extra* power you need for the tougher mowing, gardening, field and farm jobs. Does a better job, even on *steep slopes!*

You get *more* when you get Gravely. All-gear drive, power reverse, simple operation. More traction from easy-handled, *balanced* weight.

- ALL-GEAR DRIVE
- POWER REVERSE
- Power Attachments Securely Mounted by Only 4 Bolts

NEW FOR 1956

An optional ELECTRIC STARTER . . . push-button power! A new STEERING SULKY for finger-tip handling of your Gravely . . . a small dozer blade . . . and tractor improvements for MORE value . . . new cooling system, chrome rings, engine improvements for *more* power . . . see the improved Gravely!

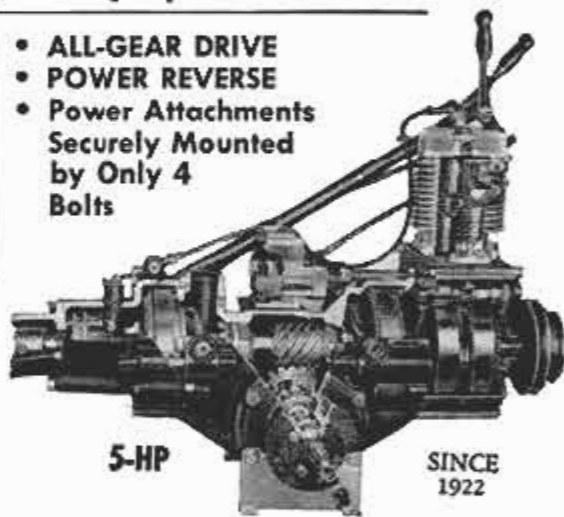

PLUS . . . 23 JOB-RIGHT TOOLS!

Your choice of 23 tools for a versatile tractor that saves time, work and worry *all year long*. Tools to do every mowing, gardening, field and farm job.

Send coupon today for "Power vs. Drudgery", the big booklet that shows how Gravely equipment solves your upkeep and gardening problems . . . *faster, easier, better!* (EASY PAY PLAN, TOO!)

GRAVELY TRACTORS, INC.
BOX 263 DUNBAR, W. VA.

Please send me "Power vs. Drudgery" Booklet and dealer's name.

NAME _____

ADDRESS _____

CITY _____ STATE _____



CULTIVATE



MOW WEEDS



SAW
TIMBER,
FIREWOOD



MOW
LAWNS



BLOW
SNOW



MOW
LAWNS, WEEDS,
MULCH
LEAVES



HAUL

Every AC Fuel Pump is precision-made like a *fine watch*

Here's the INSIDE story

1. Accurate control of spring tension and temper insures maintenance of pre-determined operation limits to secure efficiency and long life.

2. Patented multiple-layer, specially processed cloth diaphragms endure millions of flexing actions, are resistant to all chemicals found in fuels, and operate effectively at extremely high and low temperatures.

3. Uniform pull rod hardness at the linkage slots prevents uneven wear that would impair efficiency.

4. High, controlled pin hardness at this point of constant contact makes possibility of wear a negligible factor.

5. Specially hardened rocker arm pads centering on camshaft eccentric are engineered to durability standards necessary for this constant moving contact.

6. Rocker arm and link contact surfaces are precision-ground and hardened for long life.

7. Hot oil vapors are kept from contact with the diaphragm by protective seals.

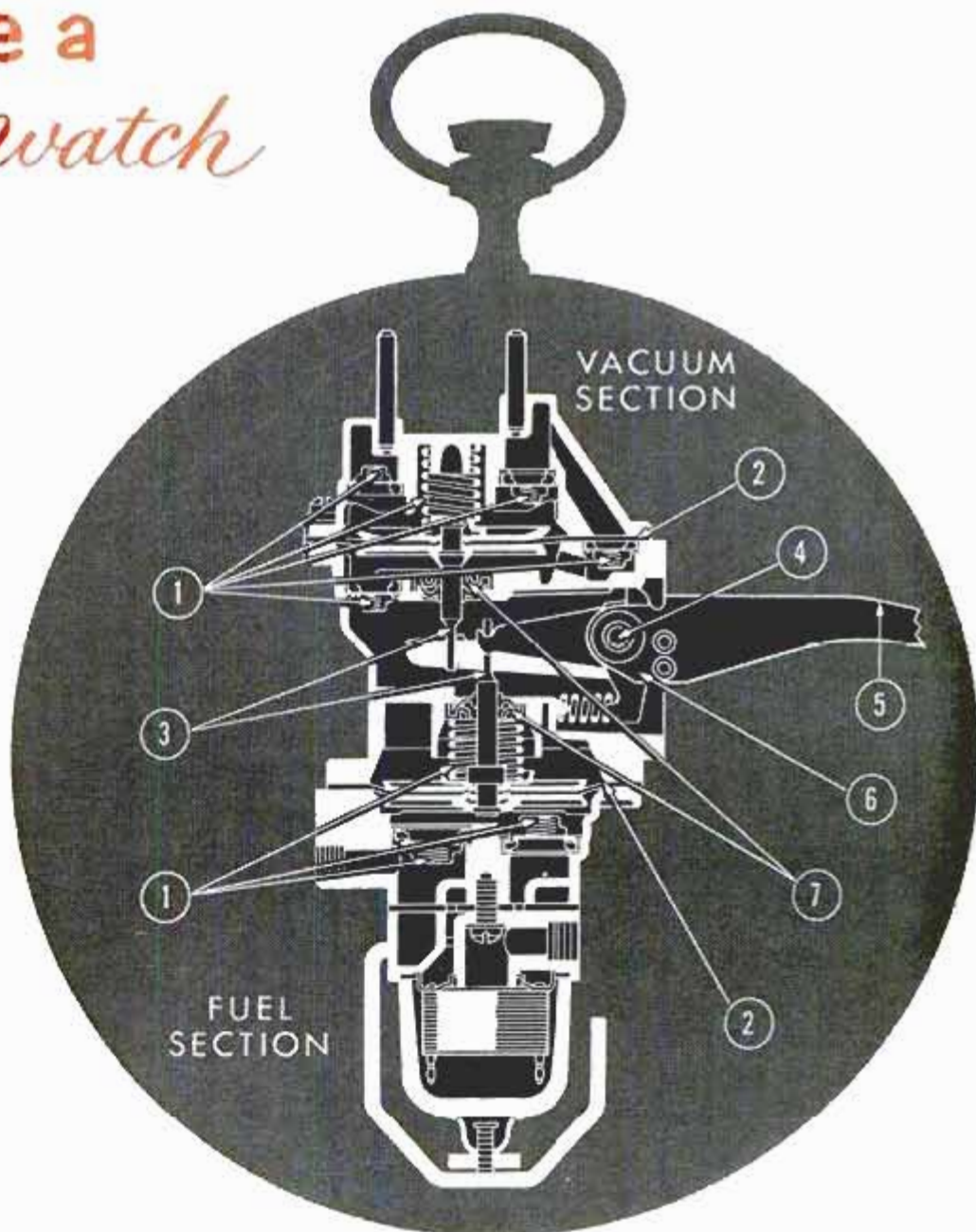

Two jobs superbly done — fuel delivered, wiper action boosted!



In the diagram cutaway above you see an AC Combination Fuel and Vacuum Booster Pump. Not only does this fine mechanism *pump* gasoline and *control* gasoline flow to the carburetor; it also assists in building up *extra* vacuum power to assure smooth windshield wiper operation. When the manifold vacuum drops off during acceleration, this AC Vacuum Booster Pump cuts in and helps keep wiper action strong and steady so you can see safely. Should you ever need fuel pump service or replacement, be sure to call on an AC dealer.

AC SPARK PLUG  THE ELECTRONICS DIVISION OF GENERAL MOTORS

Now...
a versatile B-C powered flashholder
you can carry in your pocket!

New Kodalite Super-M Flashholder

With a Kodalite Super-M Flashholder you can be truly ready to take flash pictures *any time, anywhere*. It's small enough, as is, to fit into your pocket. And when you're really pinched for space, you can slip off the 3-inch reflector, unscrew the bracket . . . and tuck the whole unit into a corner of your gadget bag. The Super-M accepts No. 8, 5, or 25 bulbs as well as low-cost M-2 bulbs—and is battery-condenser powered* to provide top flash dependability. A universal mounting bracket and interchangeable, flash-post connector tips (ASA and Continental-type) enable the Super-M to fit most any shutter-synchronized camera.

You'll like the Super-M's handling ease, too . . . the push-button bulb release, the sliding scale flash-calculator on the back, the natural-handle grip that assures steadiness. Smartly styled in your choice of brown or black, the Super-M is the most versatile miniature flash holder Kodak has ever built. Visit your dealer and see it soon. Only \$9.95 (battery extra).

***This is why we recommend B-C Flash . . .**

As you know, the batteries in a regular flash holder grow weak with usage. When this happens, a flashbulb is often slow to fire—or fails to fire at all. Result: you miss the picture.

With B-C (battery-condenser) powered flash, you needn't worry about "slow-fires" or misfires from a weak battery. A small photo-flash battery (a 15-volt battery in the Kodalite Super-M Flashholder) feeds current into a condenser which stores up energy

until needed. When the camera shutter is tripped, the condenser releases a bulb-firing surge of energy many times stronger than that produced by the usual 1.5-volt flashlight battery.

One of the nicest things about B-C is that besides prolonging the battery life, it also gives you positive, full-force voltage for hundreds of shots. Even when the battery begins to weaken, you get full voltage every time the shutter is tripped . . . Be certain with B-C!





KODAK PONY 135 CAMERA



KODAK PONY 828 CAMERA



KODAK SIGNET 35 CAMERA



KODAK BANTAM RF CAMERA



KODAK RETINA IIIc CAMERA



KODAK RETINA IIc CAMERA



KODAK CHEVRON CAMERA



KODAK TOURIST II CAMERAS

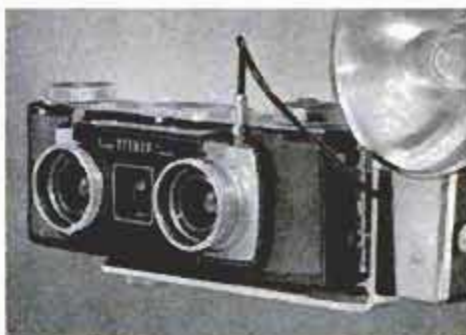

KODAK STEREO CAMERA

The Kodalite Super-M Flashholder fits all the flash-synchronized cameras on this page—and many others

ASA Bayonet Connector

Kodak Bantam RF Camera. Kodak Chevron. Kodak Flash Bantam. Kodak Pony. Kodak Signet 35. Kodak Stereo. Kodak Tourist. Kodak Medalist. Kodak Reflex. Polaroid Model 95. DeJur Reflex. Ricohflex. Stereo Graphic. Condor I. Mamiyaflex. Tower Reflex. Videon.

European Bayonet Connector

Kodak Retina IIIc, IIc, Ib, IIa. Retinette f/4.5 and f/3.5. Ansco Super Speedex, Speedex, Viking,

Karomat, Regent, Super Regent, Memar, Super Memar. Voigtlander Perkeo, Bessa, Prominent. Vito II, Vitessa Jr., Vito B. Zeiss Ikonta, Super Ikonta, Nettar, IkoFlex Ia, IIa, Contaflex I, II, Contina Ia, IIa, Ikonta 35. Konica. Minolta. TDC Stereo Colorist. Bower X. Bower 35. Dacora. Belfoca. Edinex. Edixa. Bolsey Explorer. Paxette. Super Dollina. Weltax. Welti. DeJur D1. Iloca Quick B. Futura S. Diax. Alpa 4, 5, 7. Minolta A. Nikon S-2. Baldix, Baldax. Baldalux. Baldina. Super Baldina. Baldi-

nette. Realist A—35mm. Realist B—35mm. Lordomat. Lordax Jr. Lordax I. Photrix B. Condor II. Solida. Rolfix. Iloca Stereo. Photrix Stereo. Wirgin Stereo. Edixa Stereo.

ASA Bayonet Connector and Kodak Clip-On Connector

Graflex 22. Realist St 41. Realist St 42. Revere. Wollensak. Argus C4. Graphic 35. TDC Colorist.

Price is list and includes Federal Tax.

Eastman Kodak Company, Rochester 4, N. Y.



"TWIN INSULATE" your attic...it's easy

Make your whole home up
to 15° cooler this summer!
Cut your fuel bills up to
25% next winter!



You've dreamed about insulating your attic... talked about doing it... known so well how much warmer it would make your home in winter... how much cheaper to heat... how much cooler and more "sleepable" in summer.

But perhaps you *didn't* know that you now can TWINSULATE your whole attic in just a few hours this very week end... with Gold Bond TWINSULATION®.

TWIN ACTION... Gold Bond TWINSULATION gives you heat-blocking, fireproof rock wool plus a heat-reflecting covering of silvery aluminum all around it. You get a unique twin insulating action that cuts your fuel bills up to 25% and makes your house ever so much more livable all year!

See your Gold Bond dealer now. He'll show you samples, give you all the simple directions you need and supply a handy stapler for easy application.

NATIONAL GYPSUM COMPANY—Buffalo 2, N. Y.

Send for booklet that tells all about Gold Bond TWINSULATION... what it does for your home, how it cuts fuel bills.



NATIONAL GYPSUM COMPANY
Dept. PM26, Buffalo 2, N. Y.

I enclose 10¢ for "Home Insulation" booklet.

Name _____

Address _____

City _____ Zone _____ County _____ State _____

Clinic for Homemakers



As a service to our readers in solving the hundreds of problems pertaining to a home—inside or out—the editors of *Popular Mechanics* invite you to present your problems to The Clinic Editor for help and advice. Address your questions to The Clinic Editor, *Popular Mechanics Magazine*, 200 East Ontario Street, Chicago 11, Ill.



Termites?

Q—Last fall, as I finished painting the cornices of my small home, I noticed what appeared to me to be large black ants coming from holes in the ends of several rafters, which are of the exposed type, that is, the cornices are not boxed in. A neighbor assures me that these insects are not termites and that they do comparatively little damage. But is he right?—R.N., Mo.

A—If we can judge correctly from your description you are host to a colony of carpenter ants. Your neighbor is not entirely correct in saying that they do comparatively little damage. Carpenter ants tunnel into wood, in your case the rafter ends, usually for the purpose of sheltering larvae. They do not consume the wood as food, as do termites. However, over a period of time carpenter ants may extend and enlarge the tunnels sufficiently to weaken wooden frame members infested. Usually it is possible to destroy a colony by forcing a solution containing an insecticide into the openings leading to the tunnels. Or it may be possible to reach the tunnel, or tunnels, by drilling small holes into the rafter along its length in the attic. A small amount of creosote poured into the tunnels through these holes should effectively eliminate the ant colony. Plug all holes with dowels, including those leading to the tunnels at the ends of the rafters.



Renewing Reed Furniture

Q—I have three old pieces of furniture of natural reed which have been painted several coats. I would like to refinish these pieces in the natural color with clear varnish. I applied a liquid varnish remover and although it removed most of the paint, enough remained to discolor the reed. What should I do?—C. F., N. Y.

A—We're rather doubtful about the complete success of this project. However, there is one procedure that perhaps is worth trying. Remove as much of the old paint as possible with a varnish remover, brushing the reed thoroughly with a scrubbing

(Continued to page 274)

Texaco Tips On Car Care

How to prevent door locks from sticking

Occasionally, door locks on your car may tend to freeze up or stick, be difficult to open. Here's a simple way to keep them "easy to open." Squeeze powdered graphite in a tube directly into the keyholes. Also, in very cold weather, condensation inside lock may cause freezing—try heating your key lightly by match-flame, insert in lock and repeat if necessary to "soften" up jammed tumblers. Do not force key.

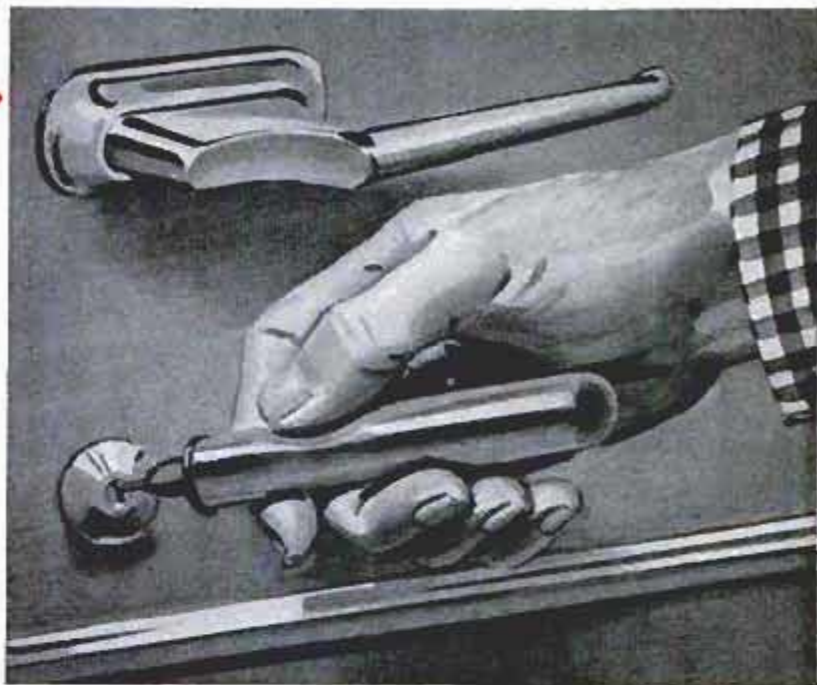

How to assure top engine power

On the road, you want the very best from your engine. Be sure to get it with *Advanced Custom-Made Havoline*—the motor oil that out-performs all others, regardless of price! Tested against the toughest motor oil competition on the market, *Havoline* proved its superiority. *Havoline-lubricated* engines delivered full power, used less gasoline and oil, stayed far cleaner. For top power and protection, change now to *Havoline*. See your Texaco Dealer, the best friend your car has ever had.



THE
TEXAS
COMPANY

TEXACO DEALERS IN ALL 48 STATES

Texaco Products are also distributed in Canada and in Latin America

TUNE IN: TEXACO STAR THEATER starring JIMMY DURANTE, on TV Saturday nights, NBC.
Metropolitan Opera radio broadcasts Saturday afternoons, ABC. See newspaper for time and station.

(Continued from page 272)

brush while the paint is still soft from the action of the remover. This will get most of it off. Then rent a paint sprayer from your local paint dealer and use it to apply lacquer thinner in a fine mist coat. As a rule, the thinner will wash away the remaining traces of paint and leave the wood in its original color. *Caution:* Lacquer thinner, or reducer, is a fast-acting solvent, highly flammable and especially hazardous when applied as a spray. Remove the furniture from the proximity of buildings or other flammable material and take every other precaution against fire. Avoid inhaling the fumes from the reducer while it is in a container, or the fine spray from the gun while the sprayer is in operation.

Asphalt Driveway

Q—I have an asphalt-surfaced driveway from the curb to my garage at the back of the house. Each time I walk across the driveway I track loose material from it into the house. This is difficult, if not impossible, to remove from the kitchen floor. I'm told that I should have it resurfaced with cement. Won't this coating crack up in time?

—F. G., Iowa.

A—It will. About the only practical remedy in your case is to wait until the asphalt surface is softened by the sun on a hot summer day. Then sweep it thoroughly with a broom to remove dust and fine gravel. Spread washed white sand in a thin coating over the asphalt and roll it in with a weighted lawn roller. After one rolling which covers the entire surface of the driveway, brush lightly with the broom and roll again. In order to cover the surface effectively with embedded sand particles it may be necessary to spread a second coat of sand and repeat the rolling procedure. Another method that is said to be fairly successful is to dust the surface (when softened by the sun's heat) with portland cement and roll as described.

Plastered Concrete-Block Wall Shows Cracks

Q—I built an addition to my home of concrete blocks and applied a cement plaster to the exterior of the walls. Now the plaster has cracked along the joints, the cracks following the joints both vertically and horizontally. The widest cracks are not more than 1/8 in., but they are very unsightly. Is there some way to repair the defect?

—R. Y., Calif.

A—We assume the plastering was done immediately after the walls were laid up. Apparently the structure has settled appreciably and this raises the question of how much more settling is likely to take place before the building stabilizes at some point. It is possible that you can conceal the cracks with a thin wash of cement and water applied with a brush. Some use a half-and-half mixture of cement and clean, sharp sand mixed with water to an easy brushing consistency. Wet the wall before applying the coating.

Window to Shadowbox

Q—I have a small upstairs window in my home which I would like to close off and convert to a shadowbox, rather than remove it entirely. The sill is about 40 in. from the floor. How can I close it off and make an attractive shadowbox with shelves?

—D. F., N. Y.

A—Perhaps it would be a good idea to cover the outside of the window with shutters, although this is not at all essential. Inside, fit a piece of plywood into the opening and attach to the lower sash frame, using screws or small nails. Coat the plywood with a sealer and paint in a dark color. Fit shelves in whatever arrangement is desired and paint these white. After the paint is dry fasten the shelves in place. Paint the window trim white to match the shelves.

WOLLEY SEGAP



NO, NO, MORTIMER! You've spelled it backwards. Not **WOLLEY SEGAP**... It's **'YELLOW PAGES'**. You know... when you're looking for something... you find it fast in the **'YELLOW PAGES'** of your Telephone Book.

Find It Fast
In The
'Yellow Pages'



Ads with this symbol
make your shopping easier

NOW! Apply Three Finishing Coats a Day!

Wonderful Satinlac® dries so quickly, you're ready for the next coat in 3 or 4 hours. Thus, 3 coats a day is a reality! But time-saving isn't Satinlac's only advantage . . . not by a long shot!



It gives you the most beautiful natural finish you've ever seen. A handsome satiny effect which not only wears well but is easy to maintain. This Wizard with Wood works like magic with hard or soft woods! Never darkens or turns yellow.

New Adhesive with 1001 Uses Discovered!

It's the most revolutionary adhesive in years! It bonds instantly, permanently, on contact . . . without clamps, presses or nails! It's Weldwood® Contact Cement! Bonds any combination of wood, glass, leather, paper, cloth, rubber and metal (including do-it-yourself aluminum). Makes it easy . . . even for amateurs . . . to apply Micarta or other plastic surfacing materials to table tops, kitchen counters, etc. Enables you to put up plywood paneling without nails! A real Wizard around home, shop or garage.



Get Weldwood Glues and Finishes at Hardware, Paint and Lumber Dealers!

You can always get Weldwood Glues, as well as Firzite® and Satinlac, at your local hardware, paint or lumber dealers. Weldwood Products come in a variety of convenient sizes, suited

to your individual needs. Weldwood Contact Cement comes in 25¢, 35¢ and 60¢ and larger sizes. Weldwood Presto-Set* Glue comes in 25¢, 45¢ and larger sizes. Weldwood Plastic Resin Glue comes in 15¢, 35¢, 65¢ and larger sizes. Firzite and Satinlac are available in pints, quarts, gallons and 5 gallon cans. Keep a supply of these Wizards with Wood on hand in your shop — you'll use them all the time.

First Ready-to-Use Glue worthy of the Weldwood Name!

We experimented for years to find a white glue worthy of Weldwood's reputation. Now we have it—Weldwood's new Presto-Set Glue. It's ready to use! Sets fast! Bonds like magic! Bonds wood to wood, wood to cloth, cloth to paper, upholstery fabrics to wood, etc. Saves you time, too, because you can often machine jobs just 30 minutes after using Presto-Set! Now available in handy "squeeze" bottle.



Best Undercoater for Plywood Stain Jobs . . . Clear Firzite!



Yes, there is a way to tame unsightly wild fir plywood grain! There is a way to make it take on the appearance of costlier woods. Start with a coat of Clear Firzite on stain jobs. This Wizard with Wood soaks into the pores and subdues the wavy grain; practically eliminates grain raise and surface checking. To produce oak, walnut and mahogany stains, simply add colors-in-oil.

Weldwood Plastic Resin Glue is "Old Reliable" of Professionals!

Professional cabinetmakers, men whose reputations are at stake on every job, call Weldwood Plastic Resin Glue, "Old Reliable" . . . and with good reason. It makes glued joints stronger than the wood itself. The joints actually grow stronger with age. It's highly water-resistant, too! More and more hobbyists have discovered that when the job has to be right . . . it's best to rely on the "Old Reliable" . . . Weldwood Plastic Resin Glue.



Best Undercoater for Paint Jobs . . . White Firzite!

Hobbyists use White Firzite to solve 2 distinct problems. They use it as an undercoater on fir plywood paint jobs, to seal the pores; help prevent grain raise and checking. And they use it to get a "woody" blond or pickled or wiped effect so popular today. White Firzite can easily be tinted with colors-in-oil to obtain any light pastel tone you want.



*Trade Mark

UNITED STATES PLYWOOD CORPORATION

Box 525, New York 46, N. Y.

Send me leaflets on:

- Weldwood Plastic Resin Glue Satinlac
 Weldwood Presto-Set Glue Firzite
 Weldwood Contact Cement

NAME _____

ADDRESS _____

CITY _____ ZONE _____ STATE _____

Earn More!

get into **BIG PAY**
ARC WELDING

It's EASY to do arc welding!



It costs little to own one of these big capacity Hobart welders.

NEW "Husky-Boy"

200 Amp. air-cooled gas engine arc welder WELDS ANYWHERE!

Equip your lightweight truck with Hobart "Husky Boy." It's a real money maker on emergency repair jobs. Use it in or out of the shop. Ready on a moment's notice to go to work for you.

BUILD YOUR OWN with Hobart's "generator only" Simply connect it to a good used auto engine. Make your own portable welder and get in on the extra profits of arc welding.

AC POWER OR AC WELDER. An excellent dual purpose combination. Welds or runs tools, lights, motors independent of power lines. Can be belted or coupled direct to your own gas engine.

TRANSFORMER TYPE AC WELDER. A real welder for production and repair work in shops that have only single phase power available.

300 AMP ELECTRIC MOTOR DRIVEN portable welder for average welding requirements. Perfect for production, maintenance, repair, tool room work and all general shop welding.

Investigate These Big Money Makers Today! Mail coupon for complete details.

HOBART BROTHERS CO., BOX M-26, Troy, Ohio, Phone 21223 "One of the world's largest builders of arc welding equipment"



Hobart School of Arc Welding

Learn profitable arc welding at the non-profit Hobart Trade School. Skilled instructors, G. I. approved Low cost

CLIP THIS COUPON and MAIL!



Build Your Own



AC Power—AC Welding



AC Transformer



300 Amp Electric Drive

MODERN ARC WELDING LESSONS. 200 pages, fully illustrated, \$1.00



HOBART BROTHERS CO., BOX M-26, Troy, Ohio

Without obligation, send complete information on the items checked below.

Husky Boy Build Your Own AC Welding—AC Power AC Transformer Type 300 Amp. Electric Drive Hobart Trade School Modern Arc Welding Lessons, \$1.00

FREE!

Welder's Vest Pocket Guide

NAME _____

ADDRESS _____

CITY _____

STATE _____

Versatile Antenna Installation "Unhitches" TV Receiver

(Continued from page 263)

suitable only if a single TV set is to be used in various locations. If two or more sets are to be connected at the same time, a television set coupler should be employed to prevent an impedance mismatch and interaction between the sets.



Typical television set coupler for distributing the signal from one antenna to as many as four sets

The use of such a coupler does not change the installation procedure. The only difference is the replacement of the tie point shown in Fig. 1 with the set coupler. All leads are then attached to the coupler, which provides the proper isolation.

When a television signal is to be distributed between a number of sets, the signal strength at the antenna must be relatively high. In metropolitan areas, an ordinary antenna can usually supply more than one receiver with adequate signals. In fringe areas, however, special high-gain antennas and, in some cases, signal boosters may be needed to assure a satisfactory signal.

To provide proper protection against lightning, a lightning arrester should be installed at the point where the lead-in is brought into the house. Numerous types of arresters with various mounting brackets are commercially available. Some can be fastened directly to the antenna mast, while others may be mounted against the side of the building. Each arrester is supplied with installation instructions. Your selection can be governed by the mounting method which meets your needs. ★ ★ ★

Men with mechanical skills: measure yourself against this yardstick



Mechanics Creed



Upon my honor I swear that I shall hold in sacred trust the rights and privileges conferred upon me as a certified mechanic. Knowing full well that the safety and lives of others are dependent upon my skill and judgment, I shall never knowingly subject others to risks which I would not be willing to assume for myself, or for those dear to me.

In discharging this trust, I pledge myself never to undertake work or approve work which I believe to be beyond the limits of my knowledge; nor shall I allow any superior to persuade me to approve aircraft or equipment as airworthy against my better judgment; nor shall I permit my judgment to be influenced by money or other personal gain; nor shall I pass as airworthy aircraft or equipment about which I am in doubt, either as a result of direct inspection or uncertainty regarding the ability of others who have worked on it to accomplish their work satisfactorily.

I realize the grave responsibility which is mine as a certified mechanic, to exercise my judgment on the airworthiness of aircraft and equipment. I, therefore, pledge unyielding adherence to these precepts for the advancement of aviation and for the dignity of my vocation.

This challenging creed has made the U. S. Air Force the finest technical service in the world. If you are a man who feels a deep sense of satisfaction from the knowledge of a job well done, the U. S. Air Force offers you a rewarding and exciting life. Skills you acquire in the Air Force will help you choose and succeed in your future career.

**YOU GO PLACES FASTER ON THE
ALL VOLUNTEER TEAM**

THE U. S. AIR FORCE

Paste Coupon on Postcard and mail to

M-45-PM

Airman Recruiting Information Branch
Box 2202
Wright-Patterson AFB, Ohio

Please send more information on my opportunities for enlisting in the U. S. Air Force. I am between the ages of 17-34 and reside in U. S. A. or possessions.

Name _____

Address _____ Age _____

City _____ Zone _____ State _____

**"I bought a
HARLEY-DAVIDSON
HUMMER**

**... now I beat
the traffic
instead of
joining it!"**



A machine shop foreman in Chicago, Ill., reports, "When the shop whistle blows, I hop on my Harley-Davidson and head for home. Where cars are stacked up waiting for lights, I scoot between lanes ahead of traffic . . . leave the rush-hour jams far behind. You'd be amazed at the time and worry I save with my Hummer. What's more," he says, "I get up to 100 miles per gallon . . . have practically no parking problem. And I've found that the total cost of a Hummer is actually far less than a year's depreciation on an automobile."

**Only \$17.00*
per month to own!**

Why not see your Harley-Davidson dealer this weekend for a trial spin. Or, write now for literature to Dept. P, HARLEY-DAVIDSON MOTOR CO., Milwaukee 1, Wis.

*After minimum down payment. Small monthly installments include fire, theft and collision insurance; local taxes; freight and carrying charges.

**New low prices
EXCISE TAX NOW OFF**

First Aid for an Ailing Bridge

(Continued from page 130)

Bridge. They support a solid stream of autos, trucks, trains (live load) besides the roadways (dead load). All this weight is hooked to the cables by steel "suspenders" that hang straight down from the main cables. These smaller cables, about as thick as your arm, are long near the towers, but become shorter as they descend the cables on both sides of the tower. It would take 100 tons of pressure on every square inch of the wire in a Manhattan Bridge suspender to break it.

Suspenders Slip

The Manhattan Bridge has an embarrassing problem of slipping suspenders. Usually, slippage occurs near the tower, where the cable incline is steepest. When a suspender slips, it ceases to hold up its part of the roadway and the suspender next to it has to take on more load, which may cause the second suspender to slip, too. Engineers can measure the amount of stress on each suspender and tell how much work it is doing. A suspected suspender clamp gets a ring of white paint at its high rim so engineers can measure the amount of slippage. The fault usually rests with the clamps. There would be no slippage if the clamps held fast.

The Manhattan Bridge boasts two levels of roadways. The lower level has three lanes for trucks and cars, flanked on each side by a pair of tracks for BMT trains. The upper roadway has four lanes for pleasure autos, two on each side of the bridge, directly over the tracks.

Trusses Gird Bridge

A system of trusses provides a rigid framework for the two levels. The bottom chord of the truss is connected to the steel network under the lower roadway, and the top chord helps support the upper roadway. A suspender is fastened to the juncture of truss and the steel network. Trusses run the length of the bridge. They distribute the live load and prevent too much bending or turning at any one point.

The truss also acts as middleman between suspenders. When one suspender loosens its hold on a truss, the truss passes the change in stress to the neighboring suspender.

Life under the BMT trains is not an easy one for the Manhattan Bridge, so every one of its steel sinews is needed. No other suspension bridge carries such a burden. In the average 24-hour period in 1952, the Manhattan Bridge carried 78,591 autos,

(Continued to page 280)

This ALADDIN Readi-Cut House



delivered to you

\$1985

Slightly Higher West of Missouri River

BUILD IT YOURSELF and SAVE!

All Aladdin Houses come to you with lumber cut to EXACT size and each piece plainly marked. You get easy-to-understand drawings and instructions so you can't go wrong. It's fun to build, and you SAVE up to 50% on the cost. Aladdin has

YOU SAVE UP TO 30% ON

Your ALADDIN comes to you ready to nail together—you don't waste time measuring and cutting each piece of lumber. All that has been done by precision machines at our mill. That's why it fits together perfectly—why it takes less time and labor to build. Even if you hire a carpenter to help, his time is not spent in measuring and cutting. Aladdin's Readi-Cut System eliminates waste. No short ends are left over that cost you money. No wonder thousands of people WITHOUT any carpentry experience have built their own Aladdin Homes and saved thousands of dollars.

WORLD'S LARGEST MANUFACTURER OF READI-CUT HOMES



WHAT YOU GET WHEN YOU BUY AN ALADDIN HOUSE

- ALL THE LUMBER accurately cut to fit, marked and numbered ready to erect practically without use of a saw.
- SIDING
- MILLWORK
- FLOORING
- WINDOWS
- DOORS
- TRIM
- COMPLETE DRAWINGS & INSTRUCTIONS
- MOULDINGS
- HARDWARE
- PAINT
- GLASS
- NAILS
- ROOFING

been manufacturing readi-cut houses for 50 YEARS. Only the finest materials are used and all lumber is guaranteed THOROUGHLY DRY. 120 plans to choose from in 5 to 8 room modern styles.

IMMEDIATE DELIVERY

LABOR—18% ON WASTE!



BUY DIRECT from the Manufacturer
SAVE Agents' & Dealers' Profits

WHAT READI-CUT MEANS!

The tedious work of measuring, sawing, mitering, and fitting has been done in our mill, assuring you of a perfect fit of all parts. Aladdin Houses are designed to meet the most exacting building standards. Our expert designers and engineers never offer a home to the public until every construction detail is carefully checked. Aladdin Homes are modern in design and plan arrangements. Write for your catalog today. 120 PLANS TO CHOOSE FROM

ALADDIN HOUSES ARE NOT PREFABRICATED



EXCITING NEW HOME DESIGNS FOR 1956!

SEND 25¢

for Beautiful, New,
Full Color
72 Page Catalog

MAIL THIS
COUPON TO
**THE ALADDIN
COMPANY**
BAY CITY, MICH.

Name _____

Street _____

City _____ State _____

EM-18

**no other plier
does so many jobs
SO WELL**

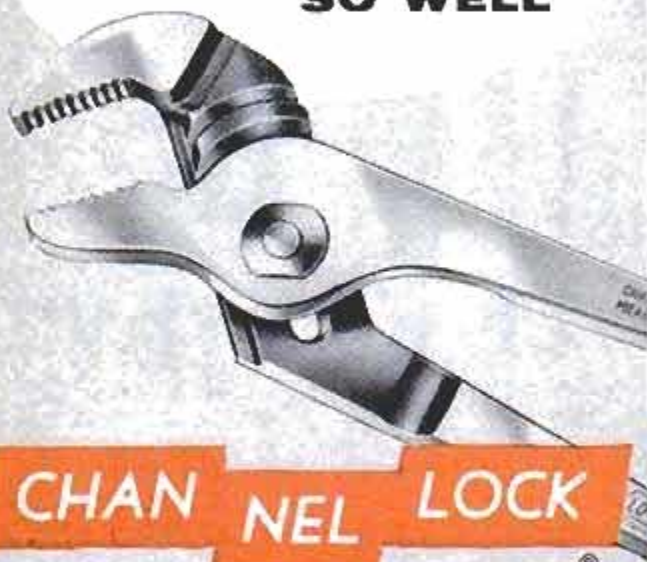

CHAN NEL LOCK

No. 420

GRIPS LIKE A PIPE WRENCH

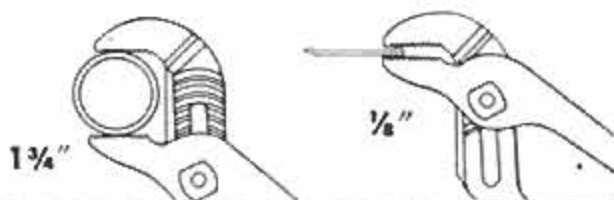

Help yourself to a Channellock No. 420 . . . the handiest plier of them all. With this handy plier, you can grip anything from a cotter pin to a 1 1/4" hex nut. And what gripping power! Just like a pipe wrench. What's more, Channellock is streamlined . . . easy to use in hard-to-get-at places. This all 'round usefulness is the reason why Channellock is the favorite plier of craftsmen everywhere. It'll be your favorite, too . . . for the same reason. Ask your hardware man for a Channellock No. 420.

BE SURE IT'S A GENUINE CHANNELLOCK



CHAMPION DEPARTMENT TOOL CO. MEADVILLE, PA.

17,772 trucks, 163 buses. And almost 200,000 people were along for the ride. Every year it carries more vehicles than the Triborough Bridge, 50 percent more than the George Washington Bridge, and as many as Holland and Lincoln Tunnels combined.

In that same 24-hour period, 892 BMT trains (6177 cars) carried almost twice as many people. Together, vehicles and trains transported the population of New Orleans, Buffalo or Minneapolis.

One-Sided Traffic

Today, 92 percent of the BMT trains going over the bridge use the two easterly tracks. The other eight percent use the westerly tracks. Some of those trains are whoppers, too—made up of Triplex cars (three units permanently coupled together) and weighing 211,042 pounds. Four Triplex units are as heavy as a standard train of eight 67-foot cars.

Transit Authority tests have shown that 300 passengers can be squeezed into one car. (Everybody who travels the BMT knows that he's been squeezed harder.) A single jam-packed train, as one would be during rush hour, throws a weight of 550 tons on the bridge.

Is that too much? No. The maximum theoretical loading of the bridge is more than nine tons for every lineal foot. This means that the big bridge could safely carry four continuous lines of trains packed with passengers, stretched from one end of the bridge to the other; trucks and autos, bumper to bumper, clear across, and the promenade packed with people.

But a subway train doesn't do it any good today. Every time one rumbles across the heavy side, it puts the pinch on the steel network under the roadways. The steel girders that run the width of the bridge every 20 feet, and play an important part in holding up the roadways, twist and groan under the load.

It's a Problem

What can be done for the Manhattan Bridge? City engineers can't run the same number of trains over both sides because the unequal routing of trains was built in with the tracks. Trains feeding over the "light side" run around a loop in lower Manhattan and return to Brooklyn through a tunnel. Those on the "heavy side" stream back and forth over a separate main line feeding midtown Manhattan.

How about reducing the number of trains using the bridge? Little can be done here. The only other route is the tunnel. On a rush morning, it is already handling its maximum of one train every two minutes.

(Continued to page 282)

ELECTRIC MOTORS—KITS—SPEED REDUCERS PERFORM MANY TASKS

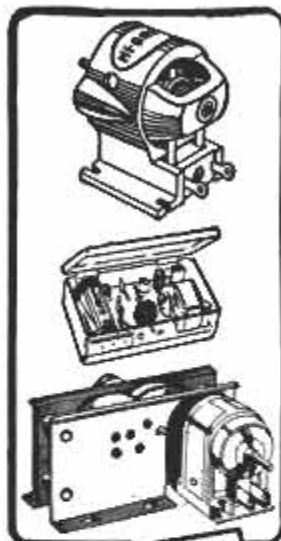

Hobby items—industrial models—research devices—recording equipment—model train accessories—toys—barbecue spits—sporting goods items—all these and many similar mechanical items can be actuated by Wilson's battery-operated motors and power accessories listed below. MAIL YOUR ORDER TODAY.

- *No. 7-100 Hi-Drive Motor, 1½-3V \$2.00
- *No. 8-100 Same for 3-6V \$2.50
- No. 3-100 Tiny Atom Motor, 1½-3V \$2.00
- For higher voltages \$2.50
- No. 96 Steel frame motor with gear, pinions, pulley, worm \$4.00
- *No. 3113 Tiny Atom motor assembly kit with many acc. \$3.00
- No. 1300 Small accessories kit \$1.00
- No. 3700 Large accessories kit \$3.00
- No. 4000 DeLuxe accessories kit with motor \$5.00
- No. 700 Super-Power kit with motor, speed reducer, all accessories \$10.00
- No. 88 Kit of 8 pulleys—2 belts \$2.00
- *No. 3000 Vari-speed gear unit \$4.00
- *Item illustrated. Ask for FREE Cat.

All Wilson's motors have Permanent Alnico Magnets.



Remit with order and we pay postage in U.S.A. No C.O.D. Add 3% Sales Tax for delivery in Ohio. Write Dept. PM.

For quick delivery see your local dealer — or order direct

WILSON'S OF CLEVELAND

425 Lakeside Ave., N.W. • Cleveland 13, Ohio



Print Your Own

Cards, Stationery, Advertising, labels, circulars, photo and movie titles, church work, tags, etc. Save money. Sold direct from factory only. Raised printing like engraving, too. **Print for Others, Good Profit.** Have a home print shop. Easy rules supplied. Pays for itself in a short time. Write for free catalog of outfits and all details.

KELSEY PRESSES, N-37 MERIDEN, CONN.

Guaranteed Auto Parts at Western Auto

FIND HIDDEN RICHES!

NOW—find buried treasure, gold, silver, and metal objects, with sensational 3½-lb. locator—GOLDAK'S "FIND-IT" ... only \$49.50 complete with earphones, batteries, instructions.



Manufacturers of metal detection devices since 1933

Write for FREE literature full line metal, mineral locators; geiger and scintillation counters.

GOLDAK CO. 1542 W. Glenoaks Blvd., Glendale, Calif.

SAY YOU SAW IT IN POPULAR MECHANICS

6-ft. only
\$149

Insist on
Evans
TAPES "KING-SIZE"
At your hardware store



EXCLUSIVE! Belt clip for handy carrying. Also available in 8, 10, 12-ft. lengths with free plastic utility case.

1699

NOW AUTOMATIC POWER LUBRICATION FOR YOUR CAR

WITH THE NEW

Multi-Luber



If you own a late model Ford or Chevrolet, this is for you. With a mere press of a button on your dash, all chassis points are high pressure lubricated in seconds ... guarantees that smooth "Just Lubricated" ride every day ... provides wonderful, time-saving convenience ... adds years of economical car operation. The Multi-Luber has been exhaustively tested and is available on current models of one of the largest car manufacturers.

Buy it installed from your car dealer, garage, or service station—or install it yourself. Kit includes complete instructions for quick and easy installation.

IN KITS
AS LOW AS
\$46⁹⁵
PLUS
INSTALLATION



LINCOLN ENGINEERING COMPANY, St. Louis 20, Mo.

Please send me your illustrated leaflet describing MULTI-LUBER, and the name and address of my nearest Multi-Luber Dealer.

NAME.....

STREET.....

CITY..... STATE.....

(Please print or typewrite)

The answer is to move the tracks to the middle of the bridge so that all four cables will carry the load and strengthen the bridge where it needs strengthening. The job is worth doing because it would cost \$100,000,000 to build a new Manhattan Bridge today.

This has been the thinking of New York's Department of Public Works for some time. Now it has gained support from D. B. Steinman, an expert on suspension bridges, who was commissioned by the city to study the problem. Steinman is the man who cast the Brooklyn Bridge in its new role that began May 3, 1954: A six-lane roadway free of heavy traffic. The view from the new promenade is the same old magnificent one. The job took four years and \$7,000,000.

Revamping Begins

In his Manhattan Bridge assignment, Steinman analyzed all the asymmetrical loadings and deflections, and prepared preliminary plans to revamp the old warrior. The cost: \$30,000,000.

To date, the city has not put its final okay on the Steinman report. But already some preliminary reconstruction is under way. The Division of Bridges is busy hitching up the Manhattan's slipped suspenders. The old clamps that have grown tired of holding the suspenders to the cables are being loos-

ened, the suspenders are being pushed back into place, and new high-tension clamps of great gripping power are being put on. These clamps may play a large role in easing the bridge's strain even before the tracks are moved. With all the suspenders committed to holding up the roadways, the latter will take less of a beating. This job will take 12 to 18 months.

Operation Track Switch

Then, when the money becomes available, Operation Track Switch will begin. Truck traffic will be taken off the center roadways and diverted to the Williamsburg Bridge. The roadways will be reconstructed and railroad tracks put in. There will not be enough room for four tracks so they may be double-decked. Trains will continue to use the present tracks while new ones are installed.

The transition from old tracks to new ones will be made overnight. Trucks will use the space the old tracks had occupied. When the job is finished—about 2½ years after it is started—the Manhattan Bridge will be as good as new. ★ ★ ★

☐ An antibiotic chemical obtained from a common variety of mushroom has given encouraging results in treatment of typhoid-fever patients in a Calcutta hospital.

Why Edgeworth Smokes Coolest (8 to 10 DEGREES COOLER)



A. BITS AND FLAKES
burn hot and fast, bite the tongue.



B. FINE CUT SHREDS
all right for cigarettes—
not so good for pipes.



C. ONLY EDGEWORTH
gives you slow burning,
cool smoking "chunks."



ONLY EDGEWORTH IS "READY-RUBBED"

No other tobacco manufacturer can duplicate the Edgeworth cut—because it's actually "ready-rubbed" by an exclusive process. See in the picture what a difference this makes. Edgeworth is made of cool smoking white burley, and packed fresh in this heat-sealed wrap-around pouch. This is why Edgeworth smokes 8 to 10 degrees cooler by actual test.



AMERICA'S FINEST PIPE TOBACCO—LARUS & BROTHER COMPANY, INC., RICHMOND, VIRGINIA

EARN EXTRA MONEY the IDEAL way!

SHARPEN POWER OR HAND MOWERS LIKE AN EXPERT!

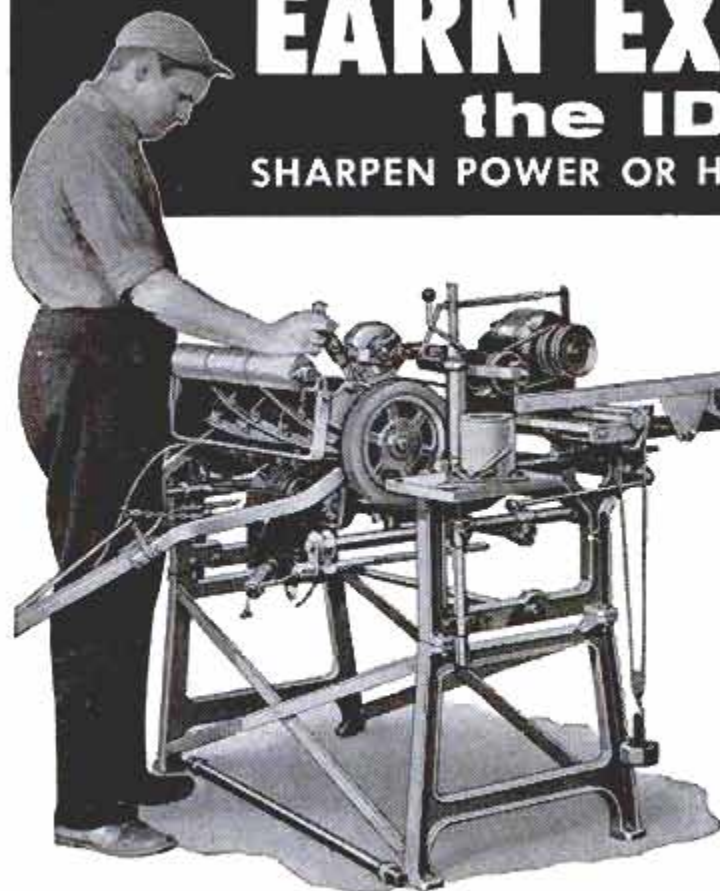

NO EXPERIENCE NEEDED

You can sharpen your first lawnmower expertly on an Ideal Sharpener. Just put the mower in your Ideal—no need to take it apart—and you'll have a perfect cutting mower in minutes.

CASH-IN ON THE POWER MOWER BOOM

Start a profitable business full-time, or in your spare time at home. Hundreds of power and hand mowers are in use in your area. It's a real opportunity. Be ready for spring and summer business . . . get your Ideal Lawnmower Sharpener now!

Write for FREE catalog to:

The FATE-ROOT-HEATH CO.

Dept. PM-2, Plymouth, Ohio

IDEAL LAWNMOWER SHARPENERS, THE QUALITY LEADER FOR 52 YEARS!



NEW PENN YAN BOAT CATALOG

44 PAGES
OVER
100
MODELS

FREE! Get yours today. Many models illustrated in color. Cartops*, Trailboats, other outboards, canoes, rowboats described fully. Catalog features amazing new no-soak, work-free, all-wood *Stripites*. Penn Yan Boats, Inc., 34th St., Penn Yan, N. Y.

**10 TIMES FASTER
THAN RAKE AND HOE!**

**RO-HO
GARDENER**

Grow better crops, have more fun, save gardening work! 40 rotating hoe points, scuffle knife, and 5 cultivator teeth kill weeds, mulch soil, make extra-fine seed beds. "Every tooth in every blade digs the soil like a spade." Easy as mowing a lawn, RO-HO GARDENER works as you walk.

Write for FREE Folder
ROWE MFG. CO.

1651 Adams St., Galesburg, Ill.

FEBRUARY 1956



WEEDS
HOES
MULCHES
CULTIVATES

Red Devil WOOD SCRAPERS



High carbon steel replaceable blades. Hardwood enamelled handles designed for easy holding. Scrapers clean in seconds. A model for every job (blade widths of 2½", 1½" and 1") priced to suit your budget.



FREE

#10 How to Prepare Surfaces for Finishing. Illustrated instructions on preparing masonry, wood and metal surfaces for painting.

Red Devil Tools. Dept. 141
130 Coit Street, Irvington, N. J.

Please send FREE copy of "HOW TO PREPARE SUBFACES FOR FINISHING."

NAME _____
ADDRESS _____
CITY _____ ZONE _____ STATE _____

1615

an all



DELTA . . . world's most complete power tool line
53 machines . . . 246 models . . . over 1300 accessories

ROCKWELL-BUILT

new

DELTA

10" tilting arbor bench saw

Now you can get big 10" saw capacity and performance—for little more than the price of an 8" saw! One look will convince you that it's the finest bench saw ever built for home workshops—that it's the biggest dollar-for-dollar value you've ever seen! Look at what you get:

BIG CAPACITY—You can handle practically any job because it lets you cut stock up to 3½" thick, rip to the center of a 48" panel.

REAL ECONOMY—You get all the features and advantages of a big saw at a price that will really surprise you. And its solid construction assures minimum maintenance.

PRECISION—You get all the power and precision you need to do fast, accurate cutting on every job.

SAFETY—Completely shielded drive mechanism provides maximum safety, prevents damage to saw. A new push button switch prevents accidental starting, provides fast emergency stopping.

See this great new Delta 10" Bench Saw—try it yourself—compare it! Get all the facts, and make up your own mind! Your Delta Dealer is listed under "TOOLS" in the classified pages of your phone book. Send the coupon for catalog details—today!



DELTA QUALITY POWER TOOLS

Another Product by **Rockwell**



*Send The Coupon
For All The Facts!*

**DELTA QUALITY
COSTS NO MORE**

Delta Power Tool Division, Rockwell Manufacturing Co.
502B N. Lexington Avenue, Pittsburgh 8, Pa.

- Please send name of my nearest Delta Dealer.
 Please send Delta Industrial Catalog on new Delta 10" Tilting Arbor Bench Saw.

Name _____

Address _____

We'll Plant a Village On the South Pole

(Continued from page 123)

Sea and Knox Coast areas. In certain phases of this operation, and particularly the airlift required to set up the South Pole station, the United States Air Force will provide important assistance. The Air Force also gives auxiliary support to Task Force 43 in carrying out the American and exploratory programs.

The other part of the expedition—the IGY operational phase—will involve a body of some 70 scientists, all outstanding experts in their fields. They will have at their disposal the most modern instruments and equipment and they will be supported by a substantial technical staff, both Navy and civilian. The logistics for this operation, from the initial establishment of bases to the final removal of scientific personnel, will be the responsibility of the task force. But the direction of the scientific-IGY phase of the expedition will be in the hands of the United States National Committee for the IGY, which was created for this purpose by the National Academy of Sciences. The chairman of this committee is the celebrated physicist Dr. Joseph Kaplan; and the chairman of the Special Antarctic Com-

mittee is my old friend and expedition colleague Dr. Laurence Gould.

Unexplored Areas

In many respects, Antarctica will be one of the most exciting and important phases of the entire IGY program. Much will be added to what has already been learned; and much of value will be learned for the first time. This amazing part of the world is not, like the arctic, a monster raft of ice floating 10,000 feet above the ocean floor. It is a continent of solid land with barren mountain peaks jutting through a glacial icecap that is two miles thick in some places. This land mass appears to encompass 6,000,000 square miles. The entire areas of the United States and Europe, planted on it, would not touch its vast ice-covered perimeters. The great continent is the last large corner of the world containing huge "white areas" in its map, signifying that these areas have never yet been seen by human eyes.

The occasional glimpses of geological formations in Antarctica's hazardous terrain have only hinted at the great wealth that may lie beneath this mass of ice and snow—recently estimated by a slide-rule wizard to amount to six septillion (6,000,000,000,000,000,000,000,000,000) tons. On the wind-lacerated side of a jagged peak in the

(Continued to page 288)

IT SMELLS GRAND



SNIFF IT! YOU'LL SAY "THAT'S FOR ME!"

IT PACKS RIGHT



CUT TO PACK IDEALLY!

IT SMOKES SWEET



JOY YOU'VE DREAMED OF — YOU'LL AGREE!

IT CAN'T BITE!

SIR WALTER RALEIGH'S BLEND OF CHOICE KENTUCKY BURLEYS IS EXTRA-AGED TO GUARD AGAINST TONGUE BITE.

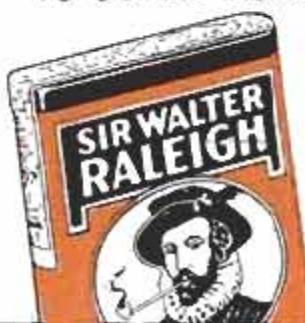

FREE!

24-PAGE BOOKLET ON PIPE CARE. JUST WRITE TO: SIR WALTER RALEIGH DEPT. G6, LOUISVILLE, KY.

deft-finish it yourself

IT'S SO EASY



Dries in 30 Minutes

DEFT WOOD FINISH FOR ALL INTERIOR WOOD SURFACES

Clear, semi-gloss bar top finish. Deft seals, primes, finishes. Nothing else to use. Will not darken. No thinning, no brush marks. Get a professional finish every time. Use on paneling, floors, cabinets, furniture, etc. Insist on Deft, wherever paints are sold. Or write for free booklet. D-M. DESMOND BROS., 1826 W. 54th St., Los Angeles 62, Calif.



Auxiliary Accelerator...

LEFT FOOT PEDAL

Step on the gas with either foot with equal ease. Drive relaxed.

Guaranteed for the life of the car— which originally installed on. FITS ALL CARS.

PRICE \$6.95
Delivered to You

ORDER FROM
R. V. LEHNER, Ness City, Kansas

ONLY \$495
Fiberglass boat included
FREE FOLDER

18 FT CRUISER

BOAT KITS
12 Models as low as \$39.95 (freight included). Fiberglass boat covering kits, marine supplies, etc. Free folders.

TAFT MARINE WOODCRAFT
DEPT. PM-2 636-39th Ave. N.E., Minneapolis 21, Minn.

SENSATIONAL NEW HIGH SPEED DRILL MASTER

NOW turns the ordinary shop drill into HIGH SPEED DRILL PRESS at a big saving. When DRILLMASTER is used on a 5,000 rpm drill press its top speed will be 30,000 rpm. Does the work of expensive high speed drill presses on brass, aluminum, plastic and cast iron where high speed drilling is necessary. Available for work of any size runs. Fits any 1/2" chuck, holding drills from 5/32 to #80. Shafts are heat treated and ground. Ball bearings and oil impregnated bearings and gear train are housed in cast aluminum. Precision made throughout. **\$62.50** Fob. Chgo. Wt. 2 1/2 lbs. MAIL ORDER TODAY only. **ON C.O.D. ORDERS WE REQUIRE A 10% DEPOSIT.** DIRZIUS MACHINE SHOP "K", 1423-25 So. 52nd Ave., Cicero 50, Ill.

PAGE Garden Tractors

1956 line now ready - low prices!

Ruggedly built riding and walking models, 2 to 6 HP. All gear drive with reverse, no belts or chains. Plow, till, harrow, disc, spray, remove snow, do dozens of other farm and home chores. Also handy new "Bantam" one-wheel model.

Fully Guaranteed
LOW PRICES, EASY TERMS

NEW "PAGE-BOY" TILLER
Ask for Details!

PAGE 1904 S. 81st ST. MILWAUKEE, WIS.

Free Catalog Shows over 60 attachments!



HUNTING URANIUM

for pleasure or profit...

Before You Buy A
GEIGER COUNTER
check these 10 features
RCA HAS THEM ALL!

- ✓ Full vision, easy-to-read meter
- ✓ All-weather metal case—easy to decontaminate
- ✓ Rugged, durable construction
- ✓ Compact, lightweight
- ✓ As easy to use as a portable radio
- ✓ Uses popular portable-radio batteries—readily available
- ✓ Low-drain circuits for long battery life
- ✓ 3 counting ranges
- ✓ Handy meter zero-reset button
- ✓ Factory-authorized service



*User Prices (Optional)

6 models . . . from \$119.50 to \$750*

Supplied complete with batteries, instructions, carrying strap, radioactive test sample, AEC booklet—"PROSPECTING WITH A COUNTER."

Write to Section B-63-MM, Commercial Engineering, RCA, Harrison, N.J., for literature and dealer's name



RADIATION DETECTION EQUIPMENT

Radio Corporation of America • Harrison, N. J.

The New Model 70 UTILITY TESTER FOR REPAIRING ALL ELECTRICAL APPLIANCES MOTORS • AUTOMOBILES • TV TUBES

As an electrical trouble shooter the Model 70:

- Measures A.C. and D.C. Voltages, A.C. and D.C. Current, Resistances, Leakage, etc.
- Will measure current consumption while the appliance under test is in operation.
- Incorporates a sensitive direct-reading resistance range which will measure all resistances commonly used in electrical appliances, motors, etc.
- Leakage detecting circuit will indicate continuity from zero ohms to 5 megohms (5,000,000 ohms).
- Will test toasters, irons, broilers, Heating Pads, Clocks, Fans, Vacuum Cleaners, Refrigerators, Lamps, Fluorescents, Fans, Switches, Thermostats, etc.
- Will test all TV tubes for open filaments, inter-element shorts, burned out tubes, etc.



As an Automotive Tester the Model 70 will test:

- Both 6 Volt and 12 Volt Storage Batteries • Generators • Starters • Distributors • Ignition Coils • Regulators • Relays • Circuit Breakers • Cigarette Lighters • Stop Lights • Condensers • Directional Signal Systems • All Lamps and Bulbs • Fuses • Heating Systems • Horns • Also will locate poor grounds, breaks in wiring, poor connections, etc.

Handsome round-cornered molded bakelite case, 3 1/2" x 5 1/2" x 2 1/4". Complete with all test leads. Also included is a 64 page book giving detailed instructions for testing all electrical appliances, automotive equipment, TV tubes, etc. Only **\$15.85**

SHIPPED ON APPROVAL
NO MONEY WITH ORDER - NO C.O.D.

Try it for 10 days before you buy. If completely satisfied then send \$3.95 and pay balance at rate of \$4.00 per month for 3 months — No Interest or Finance Charges Added! If not completely satisfied, return to us, no explanation necessary.

MOSS ELECTRONIC DIST. CO., Inc.
Dept. D-203, 3849 Tenth Ave., N.Y. 34, N.Y.

Phase rush 1 Model 70. I agree to pay \$3.95 within 10 days after receipt and \$4.00 per month thereafter.

Name _____
Address _____
City _____ Zone _____ State _____



A DITCH-WITCH TRENCHER*

COSTS ONLY \$795 FOB FACTORY

DIGS TRENCHES

as low as **1¢**
a foot



* Model DW DITCH-WITCH digs a 4½" trench any desired depth to 30". Equipped with 6" width bucket line for slight additional cost. Both lines are interchangeable.

SAVE LABOR . . . TIME and MONEY

by cutting trenches 12 to 15 times faster, 8 to 10 times cheaper than hand labor with 1/5 the investment of heavier, more cumbersome equipment. Exclusive, patented features mean speed, economy, performance.

NOTE THESE OUTSTANDING FEATURES:

- VERTICAL BUCKET LINE cuts smooth, even trenches — no "end ramps" — hand finish work practically eliminated.
- BUCKET and TOOTH DESIGN guarantees self-cleaning buckets in all soils. Tool-steel teeth are replaceable.
- REVERSIBLE SPOILS CHUTE permits spoils deposit on either side of trench.
- SIMPLE OPERATION requires no special skill. Rugged construction throughout.
- LIGHT WEIGHT (only 700 lbs.) The small pneumatic tires leave no deep tracks.

PERFECT FOR DIGGING:

Service line trenches through yards and across fine lawns . . . distribution systems for cities, golf courses, estates . . . drainage lines for nurseries, hot houses . . . cable trench for signal lights, street lights, airports . . . foundations for houses, small buildings, grain bins. These are only a few of many jobs DITCH-WITCH performs every day for enthusiastic owners everywhere.

Ditch-Witch often pays its entire investment on the first job!

MAIL THIS COUPON . . . TODAY!

The CHARLES MACHINE WORKS
620 Birch St., Perry, Oklahoma
Please send us illustrated details on DITCH-WITCH Trenchers, especially the model best suited for our needs.

COMPANY.....

ADDRESS.....

CITY.....ZONE.....STATE.....

NAME.....TITLE.....

We require trenches for.....

Queen Maud Range, less than 200 miles from the Pole, I have seen a great, black vein of coal. Evidence of valuable mineral deposits has also been brought back by other explorers.

Nature's Own Freezer

The incredible antarctic cold averages at least 40 degrees colder than the arctic. I have watched the wavering ink line on a thermograph in a snow-buried, fume-ridden shack slump through to the minus 83 degree mark, and I know that up on the two-mile-high plateau of central Antarctica, where no man has yet wintered, it may well skid to a shuddering minus 100 degrees in the long polar night. That kind of temperature may one day be put to use. Here, in nature's own freezer, an international stock pile of surplus perishable food might easily be stored and preserved indefinitely—and drawn against when needed by disaster or famine-stricken countries.

The preservative effect of antarctic cold has been demonstrated in more than one old camp, where foodstuffs left as long as 40 years ago were found as fresh and edible as the day they were stored. No bacteria and little oxidation can work in the sterile cold of Antarctica. On my last expedition one of my crews found a camp that had been abandoned 37 years before. Unpainted boards gleamed white and unweathered; nails showed no rust. A dog, outside, was whole in every pore and hair, but rigid in the frozen death that had immobilized him nearly four decades earlier.

With its fleet of powerful 35-ton "snowshoe" tractors, so light on their "feet" that they exert less pressure on a square inch of snow than a man on skis; its 19 airplanes, 16 electric generating stations, Weasels, wanigans, cargo carriers and "luxurious," roomy, insulated buildings—with all of these technical improvements and, with science represented in unprecedented strength, Operation Deepfreeze must inevitably produce historic results. It has all the advantages that recent cold-weather experimentation and the experience of many hard-fought polar expeditions, six under my command, have been able to give it.

When we first used tractors in 1933, the radiators froze and burst, metal parts snapped in the intense, structure-changing cold, and the machines coughed, sputtered and died several times in an hour, each "death" resulting in up to two hours of "road" repairs and in frostbitten appendages and torn flesh. Yet my old trail-mates, recalling earlier days of 1000-mile dog-sled runs, called it "limousine" exploring. The

(Continued to page 290)

How TO SAVE 30% to 40% WHEN YOU BUILD A HOME



3 bedrooms — \$5378



3 bedrooms — \$5898



2 bedrooms — \$4610



2 bedrooms — \$3952

BUILD A READY-CUT "LIBERTY" HOME!

You can save several thousand dollars by building a Liberty Home! Buy direct from our mill at our low, freight-paid price.

HERE'S WHAT WE FURNISH

- DOORS
- WINDOWS
- SIDING
- MILLWORK
- LUMBER CUT-TO-FIT
- FLOORING
- ROOFING
- MOULDING
- HARDWARE
- TRIM
- PAINT
- GLASS
- NAILS
- PLANS & BUILDING INSTRUCTIONS

Big savings in labor. All materials priced at rock-bottom. No wonder our customers write us that we saved them 30% to 40%. Easy terms—monthly payments. Architecturally approved construction. (Not prefabricated).

What "Liberty" Owners Say! Saved \$4,000 to \$6,000

"Compared to a local contractor's price to build a home equal to my 'Liberty', I will be saving \$4,000 to \$6,000; so you can see why I have such enthusiasm for Liberty Homes."

VERY EASY to Build

Every step in the building of a Liberty Home is figured out for you, so that all you have to do is follow the drawings and instructions that we furnish you.

Send for Catalogue

Pictures wonderful homes in colors at money-saving prices. Designs to suit everyone. Send 25¢ for catalogue today.



LEWIS MANUFACTURING CO.

1262 Lafayette Ave.

Bay City, Mich.

BUILD FINE GRANDFATHER CLOCK NOW
The simple sensible Red-i-Kut way as thousands have — **SAVE HALF. SHOP TESTED PLANS "SPIRIT OF THE CENTURY"**. Narrow waist 83" tall or stately straight side **"SPIRIT OF AMERICA."** EASY-to-FOLLOW photopack PLANS tell all—plus BROCHURE of heavy brass weight Westminster, tube chime, movements, gorgeous dials, 3/4" solid mahogany case kits. Send \$1.00 today—Both plans \$1.50 NOW.
KUEMPFL CHIME CLOCK CO., #7 Kuempfl Bldg., Minneapolis 16, Minn.

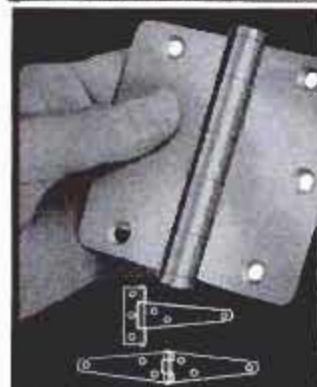

best hardware . . .
for hard wear
GRIFFIN
HINGES

at your hardware or
building supply store
GRIFFIN MFG. CO., ERIE, PA.

Insist on Evans TAPES POCKET SIZE

At Your Hardware Store

6, 8, 10, 12-ft.
lengths

from **98¢**

with FREE
plastic utility
case.



Self-adjusting sliding
hook starts you at
zero for accurate inside
or outside measuring.

Make \$500 an Hour CASH PROFIT THE DAY YOU START!



START YOUR OWN BUSINESS AT HOME... SHARPEN HOUSEHOLD, GARDEN AND SHOP TOOLS IN SPARE TIME

Now you can turn spare time into Big Cash Profits with new Belsaw Sharp-All. Sharpen knives, scissors, shears, snips, ice skates, mower blades, hedge trimmers, grass whips, axes, chisels, screw drivers, scrapers and saws... just about any household, garden and shop tool. Your own CASH business with no inventory. No calls to make. No experience needed.

Learn how easily you can start your own spare time business. Amazing low cost easy-payment plan. Send postcard for FREE BOOK.

BELSAW SHARP-ALL CO
716 Field Bldg. Kansas City 11, Missouri



FAST—Old Town Lapstrake Boat

SMOOTH lines of this lapstrake outboard boat help you start in a hurry—and get there fast! She's roomy, too, with wide cross seats having folding backs. Has one seat at stern, tool drawer and gas tank rack. Handles easily, with deep bow to fight stormy waves! Built of handsome woods for strength and service. Upkeep is easy.

FREE CATALOG shows just the model you need. Write for one today! Also rowboats, sailing dinghies, sailboats, canoes.

OLD TOWN BOATS

Old Town Canoe Co., 342 Middle St., Old Town, Maine
PLEASE SEND ME FREE CATALOG

Name _____

Address _____

City _____ State _____

tractors had cabs. The fact is that it was fancy for its day.

Against the tapestry of time, every expedition I led was the best-equipped, most modern and progressive that existing knowledge, material and equipment could make it. Some things worked, some didn't. Some were redesigned so they would work. Nearly every polar expedition that has ever gone out has helped the next one to beat back the incredible barriers of cold, darkness and hazard a little further, thus enabling men to penetrate deeper and snatch a few more fiercely guarded secrets from the frozen polar areas.

First Expedition to Antarctica

In 1928-30 I led my first expedition to Antarctica and we built the first United States base—Little America—on the great continent. The ski-equipped Ford Tri-Motor planes we used were the finest of their day, and our first operational experiment with ski-type landing gear proved a phenomenal success. Hauled five miles across the Ross Shelf from ship to Little America by a team of 100 huskies, the knockdown planes were assembled on the ice. They provided skyhooks from which we mapped with aerial cameras more antarctic territory than all previous expeditions together had been able to chart. On Nov. 28, 1929, one of those skyhooks airlifted a group of us over the South Pole on the first such flight ever made.

When my second antarctic expedition took off in 1933 we had an autogyro with us and a huge Curtis Condor. Our old Tri-Motors had wintered over for five years, but were still operable. On that expedition we learned a lot more about planes in the antarctic. The 'gyro crashed due to snow accumulation in the tail assembly. We did more pioneering with skis, and used floats successfully to explore large sea areas. During the winter of '33-'34 we set up an inland base 123 miles south of Little America to make the first interior weather observations and study the aurora australis. To this advance base we were able to freight by tractor-drawn sled and by plane enough supplies for one man, no more. So I manned the frigid outpost alone through the crackling antarctic winter in a tiny shack submerged to the roof in snow. With 800 feet of ancient ice beneath me and the vastness of the polar night above, I holed in for six months of meteorological observation. I had hoped to enjoy myself by reading and by examining my philosophy in this atmosphere of total solitude. Instead, my heater and generator-exhaust fumes backed up and poisoned me with carbon

(Continued to page 292)

It's **QUICKER...Works SLICKER** with

WISE-GRIP

Does More Jobs Easier Than Any Other Tool Made!

No. 10W,10
\$2.60

Made By PETERSEN MFG. CO., Dept. M-2, DeWitt, Nebr.

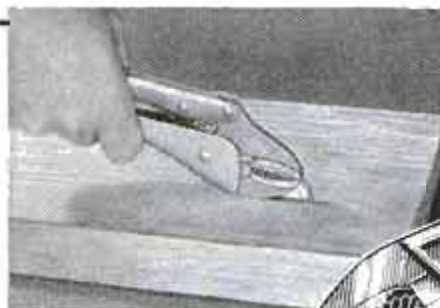

Pull headless nails! If they're imbedded, drive jaws into wood, then lock on. Use wood as fulcrum.



A squeeze of the hand locks jaws onto work with ton-pressure! Quickly adjusts for use as All-Purpose Wrench, Super-Pliers, Clamp, Wire Cutter, 7" and 10" cutter optional. \$1.85 to \$2.60 at your dealer.

Makes EVERY JOB EASIER



Hinges S-Q-U-E-A-K?

America's most popular remedy is 3-IN-ONE Oil. Penetrates and frees stiff hinges and locks. Gives lasting lubrication and rust protection. Leaves no gummy deposit.

"3-IN-ONE" OIL



ELECTRIC WELDER

AC or DC
110 Volts

The "Little Marvel" all-metal welder, 5-year written guarantee. Welds 1/8" metal or money back. Repairs tanks, tools, fenders, machine parts, etc. Complete with everything—rods, unit, eye shield, directions. \$6.95

plus 50c postage. Flame torch accessory for soldering, cutting, brazing \$3.95 complete with carbons, brass rods, flux. \$2.00 Deposit on C.O.D. 75 ampere 1/4 inch Transformer Welder \$21.95 F.O.B.

ESSAY MFG. CO., Dept. 51, Quincy 69, Mass.

\$6.95
Complete

MACHINE TOOL RECONDITIONING

& THE ART OF HAND SCRAPING (2nd printing)

—USEFUL FOR DESIGN, SHOP & INSPECTION WORK—
SEND FOR FOLDER DESCRIBING ILLUSTRATED BOOK
MACHINE TOOL PUBLICATIONS, 382 Holly Ave., St. Paul 2, Minn.

SAY YOU SAW IT IN POPULAR MECHANICS

HERE'S HOW AMAZING

MOTALOY WORKS

RESTORES LOST
POWER AND
COMPRESSION
HERE

SAVES
FUEL
HERE

FILLS
SCORED
CYLINDER
WALLS
HERE

STOPS
PISTON
SLAP
HERE

STOPS OIL
LEAKING
PAST RINGS
HERE



IMPROVES VALVE
ACTION HERE



MOTALOY ring and valve job replates parts while you drive!

Easy! Just drop MOTALOY tabs in fuel tank. Motaloy's scientific metalplating action takes place while you drive, eliminating expensive and old methods of replacing worn pistons, rings and valves. Simple! No equipment to buy. Increases gas mileage! Will last for 200,000 miles. Money-back guarantee!

MOTALOY

REG. U.S. PAT. OFF.

the only product of its kind in all the world!

ONLY

\$6
POST PAID

ORDER MOTALOY NOW For Your Car

Motaloy Manufacturing Corp., Dept. M F-1
South Texas Bldg., San Antonio, Texas

() Enclosed is \$6 cash, check or money order. Please send me one package of Motaloy, postage paid.

NAME _____

ADDRESS _____

CITY _____ STATE _____

For Free Literature only, check here ()

DO IT YOURSELF

It's Easy With...

Soldering's really a "cinch" ... when you use time-tested, reliable KESTER ... available everywhere.

FREE! "Soldering Simplified" ... 16-page how-to-solder booklet. At your dealer or write direct.

KESTER SOLDER COMPANY

4251 Wrightwood Avenue Chicago 39, Illinois



More cutting power
for 1/4" electric drills

Irwin Speedbor "88"

most revolutionary bit in years

Irwin's Exclusive Hollow Ground Point and spade-type cutters bore faster, deeper, cleaner with less power. Try the Speedbor "88" in your small 1/4" electric drill or drill press and see. Get smooth, effortless cutting action in hard or soft woods, plaster, plywood, plastics — even hardrock maple! Forged in one piece from solid bar of high carbon steel, hardened full length to stay sharp. And remember . . . the hollow

ground point is exclusive with Irwin's Speedbor "88". Buy individual sizes or sets from your independent hardware dealer.

No. 886-R plastic roll set of 6, sizes 3/8" to 1", only \$4.50

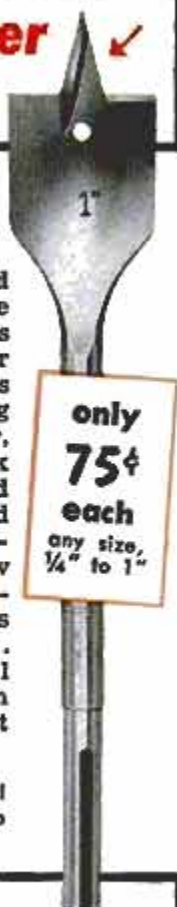

IRWIN • the original solid center auger bit
Wilmington, Ohio • screw drivers • screw driver bits

FROM ALL OVER THE WORLD...

news you want to hear with a



hallicrafters Model S-38D—Only \$49.95

It's a fascinating, exciting hobby to listen in on the whole wide world by short wave with Hallicrafters S-38D radio. With this exceptional receiver you enjoy not only standard broadcasts . . . but can choose from the 3 international short wave bands. You, too, will praise the performance of Hallicrafters S-38D radio . . . the choice of countless governments as well as radio experts the world over. Hear the S-38D at your nearest Electronic Parts Distributor today—\$49.95 . . . or write

hallicrafters

CHICAGO 24, ILLINOIS

monoxide. Temperatures dropped to 60 to 80 degrees below zero, for weeks on end, the transmitter generator went haywire—and I very nearly lost my life before the tractor party arrived to take me out in the cold dawn of an antarctic spring.

Back to Antarctica Again

In 1940 we were back again, this time under the aegis of the United States Antarctic Service which President Roosevelt had established and asked me to command. The expedition, shadowed by war clouds and hampered by a troublesome fleet of worn-out aircraft, was shortlived due to World War II. Even so, we built Little America II and made good use of the planes to obtain the first delineation of the Antarctic Coast in the Pacific quadrant.

Then came "High-Jump" in 1946—an expedition organized by the Navy, to which I was appointed officer in charge, with Admiral Cruzen as Task Force Commander. By now we were rolling. With 13 ships carrying 4200 men, four helicopters to help icebreakers scout passage, and 19 planes, we formed far and away the most formidable sortee ever made against the Antarctic Continent. Six of our R4D aircraft, equipped with new ski-wheel landing gear, roared off the deck of the aircraft carrier *Philippine Sea* to land on the ice barrier at Little America. Gone were the five-mile mushes with 100 dogs straining and tugging while everyone massaged his burning frost-bites. A seaplane tender filled in many missing outlines of the coast. We were still learning.

More information and knowledge resulted from the Lincoln Ellsworth trans-Atlantic flight, and from two expeditions which took place over 1947-48 under the respective leadership of Comdr. G. L. Ketchum and Capt. Finn Ronne.

Antarctic Airlift

With all this experience behind it, Operation Deepfreeze will be in a position to attempt the first antarctic airlift of materials and supplies for bases. Many of its specially equipped planes will fly in from New Zealand, marking the first such flight in history. A major airlift operation will be undertaken by the United States Air Force to establish the challenging South Pole base. By 1957 military air-commuting service may be established between Antarctica and the outside world. No more, we hope, will an expedition be cut off for months from all but radio contact.

I have stressed the advancements in aircraft for polar exploration because it is so dramatic in its vast strides. But Deepfreeze

(Continued to page 294)

THE ORIGINAL PACKAGED BOAT KITS

Made ONLY by *Custom-Craft*
Top Performance,
Design, Styling!
Over 70 Models
8 to 21 ft

World's largest line! Over 200
Boats: Kits, Formed-Hulls, Semi
& Custom-finished! All types: Prams
-Cruisers! Easy to build! Flying stern,
Tredonic bottom, Bulkhead construction!
Send 25¢ for KIT CATALOG
52 pages; Includes Victory Series, hardware, paint
accessories, Fiberglass! Send \$1.00 for Catalog Plus
"Boating Handbook". DEALERS-AGENTS INQUIRE

BOAT PLANS & PATTERNS Frame-Pac Kits

World's largest selection; over 200 plans, full-
size patterns, frame-pac kits! Designed strictly
for amateurs! All types: prams, kayaks, racers,
runabouts, catamarans, houseboats, cruisers -
Inboard-outboard 6-40' wood-plywood-steel!
Send 25¢ for PLAN CATALOG
Catalog PLUS "Boatbuilding Handbook" \$1.00
DEPT. A CUSTOM-CRAFT - BUFFALO 7, N. Y.

MONEY for MEN ALL FREE

THE PLASTEX Industry needs manufacturers on small
scale and for big production of Lamp and Clock
Stands, Art Goods and Novelties in Plastex and Marble
imitation. Experience unnecessary. The material makes
regular 10c store sellers. Rubber moulds furnished for
speed production. Small investment brings good re-
turns. We are now placing big Chain Store Orders with
manufacturers. Ambitious men have chance for real
prosperity. Our Free booklet will interest and benefit you.
PLASTEX INDUSTRIES, Dept. A
3400 Third Ave. New York 56, N. Y.

AGENTS - SELL

Buy tools, photo equipment, sport-
ing goods, jewelry and thousand
other nationally advertised prod-
ucts at big discounts. Big profits
selling to others. Postcard brings
free plan.

**TOOLS! GUNS!
CAMERAS!**

Get up to
40% off

AMERICAN BUYERS SERVICE HERTEL STATION, DEPT. 15
BUFFALO 16, NEW YORK

Powerful *Black & Decker*® Orbital Sander

44 Sander gives satin-smooth finish on toughest
jobs—sands right up to obstructions—sands with,
across or against grain For info. write: The Black
& Decker Mfg. Co., Dept. M-25, Towson 4, Md.

ONLY
\$52.50

Find HIDDEN TREASURES

GOLD, SILVER, PRECIOUS METALS with the Famous Model
27 Metal Detector. Lightweight, ultra-sensitive, low
cost. None finer. Also GEIGER COUNTERS for uranium
and the VIOLITE for tungsten. INFORMATION FREE

THE *Detectron* CORP.
5528 Vineland Ave., No. Hollywood, Calif.

GENUINE ALNICO MAGNETS

UP TO 350 lb. PULL
AMAZING, PERMANENT, NON-ELECTRIC, HIGHLY PRACTICAL.
Have pull as high as 66 times their own weight.
MYSTIFYING, PERPETUAL POWER WITHOUT ELECTRICITY!
Test metals. Conduct interesting experiments. Hundreds of uses—
Retrieve valuable steel items such as guns, tackle from deep water;
tools from tanks & drains. Our customers include big industries and
home hobbyists. Every magnet **GUARANTEED** to please.

No. M-800	Has pull of 350 lbs. on flat steel block	\$34.50
No. M-725	Has pull of 225 lbs. on flat steel block	\$16.50
No. M-625	Has pull of 125 lbs. on flat steel block	\$9.50
No. M-575	Has pull of 75 lbs. on flat steel block	\$6.50
No. M-500	Has pull of 50 lbs. on flat steel block	\$4.50
No. M-101	U-shaped Magnet. Has pull of 6 1/2 lbs.	2 for \$1.50
No. M-47	Hot Pad Magnets. 10 for \$1.00	50 for \$1.50
No. M-35	Hobbyist assortment of 8 small magnets	\$4.87

Send M.O. or check. We pay postage. Sorry no C.O.D.'s.
MIAMI MAGNET COMPANY, 3240 N.W. 27th Ave., Miami 42, Fla.

NEW IDEAS FOR DECORATING



- COFFEE TABLES
- PICTURE FRAMES
- LAMP SHADES
- WASTE BASKETS
- ETC., ETC.

Create them yourself
with New Flexible

Weldwood® Wood-Trim®

Add a distinctive, luxury look
to scores of familiar household
objects—with Weldwood Wood-
Trim. It's real wood veneer in
easy-to-use rolls! Applies in
minutes, with any good wood
glue like Weldwood Contact
Cement or Presto-Set® Glue.
No clamps, nails, hot iron, etc.
So pliable... shapes to cover any
shape or surface.

Edges plywood too!
Great for covering exposed
edges and giving a "pro" finish
to plywood tables, desks,
cabinets, etc.

8 ft. rolls 1" wide, 79¢ each.
Oak, African Mahogany,
Walnut, Birch, Korina, Fir.

At hardware, paint and lumber dealers
or write for free leaflet. Dept. PM 2-BWT

UNITED STATES PLYWOOD CORP., BOX 525, N. Y. 46

DO MORE PLANING JOBS WITH LOW COST BELSAW

Exclusive MONEY-MAKING features:

- Full 12 1/4 in. x 6 in. capacity
- Power feeds at 24 ft. a minute. (Easily adjusted for lower feed rate)
- Machined cast iron bed; adjustable rolls, total bed length 42 in.
- Provides for Grinding Knives in the Cutterhead.
- Attachments for Jointing, Rabbeting, Tongue, Groove, Matching.

Belsaw Multi-Duty Planer for cabinet shops, builders, lumber
yards, woodworking plants and spare time work
shops... Now you can convert low cost rough and
random size lumber into high priced cabinet
finished stock... Easy to make flooring and popular
patterns. Belsaw quickly returns cost with savings
on raw material... profits on finished stock.

Send Today for **FREE literature on Belsaw,**
the **LOW COST, high speed production planer.**

BELSAW MACHINERY CO

2056 Field Bldg • Kansas City 11, Missouri

LOW DOWN
PAYMENT
EASY
TERMS

is a story of advancement on every front in polar exploration—all of which points to the gruelling trial and error of the past. The job we have to do this year and next could never have been achieved with the tools we had in 1933-34—good as they were for their time.

The tractor fleet is a phenomenon. Each has an ether-aided electric starting system which is expected to operate full steam when the polar wind is whistling across temperatures of 65 degrees below zero. Insulated cabs will really make it "limousine" exploring, for their independent heating systems will keep them warm even if the big diesel engines die. Their huge tracks return on wooden guides instead of idler-rollers to reduce the possibility of jamming with ice and snow. These are the engines that, under the guiding hands of a 100-man Seabee battalion, will help to create antarctic bases more elaborate and foolproof than any built before. "Cat" trains loaded with materials will head out to all sites from the Ross Shelf and McMurdo Sound barrier.

The big 20 by 48-foot buildings, in which each man will have 100 square feet to himself, are a far cry from the days in 1928 when eight men shared a 10 by 10-foot shack. The new houses, prefabricated in four by eight-foot panels, will be erected

with flat roofs flush at snow level, interconnected by tunnels and accessible via ramps to outdoors. Their metal linings provide vapor seal and radiation. Sitting on girders with timber footings, they will not sink. A 15-man crew can erect a shell complete in about six hours, even under antarctic conditions. Most of the parts go together with clips instead of nails. Antarctic carpenters can't hold nails in their mouths. In subzero weather, metal freezes fast to flesh.

Runways Made of Ice

A huge diesel compacter will pound the snow of McMurdo Sound barrier into a compact mass, so that an airstrip can be made by flooding the site with sea water, and allowing it to freeze in 3-inch layers, until it has reached 10 inches of thickness. Runways thus made can be used to land even heavy, four-engined, wheeled aircraft.

Toughest project of all will be the 15-man South Pole base. Dr. Paul Siple, senior scientist of the expedition, who has been with me on every antarctic trip I've made, will be in charge of bringing about this crowning achievement. A man of determination and great capability, even he cannot commit himself on our chances of success. Some 700 miles south of Little America, the Pole

(Continued to page 296)

FUN-WORK YARD TRACTOR

WHEEL-HORSE RIDE-AWAY



Designed to turn work into FUN! ... do a dozen back-breaking jobs in a jiffy. Yard-size tractor with 5 forward speeds and 1 reverse. 2½ hp (or 3½ hp) engine mounted on heavy channel steel chassis. Mow a 5-foot swath at 5 mph ... plow snow ... cultivate ... pull any of 22 attaching tools for yard and garden. Write for complete details, and name of nearest dealer.

SENSATIONALLY \$299.50
PRICED AT

WHEEL-HORSE PRODUCTS COMPANY

2643-K Dixieway North

South Bend, Indiana

send for
FREE
tool catalog

SNAP-ON TOOLS CORPORATION
8062-B 28th Avenue, Kenosha, Wis.

Send me free catalog.

OCCUPATION
NAME
ADDRESS
CITY ZONE STATE



A big, fact-packed catalog full of pictures and tool information ... yours for the asking.

- Snap-on tools help you handle repair jobs faster, easier, better.
- Snap-on tools LAST ... pay for themselves over and over.
- Used and endorsed by America's top-earning mechanics in all fields.
- Start building your Snap-on set with basic units ... add other tools any time.

Snap-on Tools
THE CHOICE OF BETTER MECHANICS

24-Page Illustrated DO-IT-YOURSELF PROJECTS BOOK

Describes attic finishing, built-in cabinets, add-a-room, recreation room, kitchen remodeling, summer cottage and farm projects. Helpful information on how to get started, planning, cost estimating, materials purchasing, proper procedures, nail charts, moulding designs, etc. Send 25c and also receive 52-PAGE POWER TOOL CATALOG.

BOICE-CRANE CO., 943 Central - Toledo 6, Ohio



MAGNETS

ASSORTED MAGNETS with big list of handy uses ... 5 for \$1
POWERFUL POCKET MAGNET ideal for testing metals ... \$1
RETRIEVING MAGNET pulls tools, etc., from tank or lake ... \$4
HOT PAD MAGNETS to insert in your own hot pads ... 8 for \$1
BULLETIN BOARD MAGNETS to "pin-up" memos, etc. ... 8 for \$1
EXPLORE, LEARN—Electricity, Magnetism, Electro-Magnets. Complete kit and instructions with 22 experiments and models ... \$3.98
FREE CATALOG. 100% satisfaction guaranteed. ... POSTPAID
PARK MAGNETS, 262, 1557 GREENBAY RD., HIGHLAND PARK, ILL.

Shaky
table?



Build up short leg with *New Plastic Wood*. Makes a permanent fix that won't chip, crack or peel. And *New Improved Plastic Wood* has a finer grain — minimum shrinkage!



NEW "PLASTIC WOOD"

Handles like putty—hardens into wood.



Loosens Rusted Bolts
nuts, screws, "frozen" parts!

LIQUID WRENCH

AT HARDWARE STORES, GARAGES
SERVICE STATIONS EVERYWHERE

For information write manufacturer
Radiator Specialty Co., Charlotte, N. C.



G E A R S

In Stock - Immediate Delivery
Gears, speed reducers, sprockets, thrust bearings, flexible couplings, pulleys, etc. A complete line is carried in our Chicago stock. Can also quote on special gears of any kind. Send in your blueprints and inquiries.

Send for Complete Catalog No. 10
CHICAGO GEAR WORKS
440-50 N. Oakley Blvd., CHICAGO 12, ILL.

ALADDINIZE IN 1 HOUR

CLEANS AND WAXES in one easy operation. Aladdin, a guaranteed Auto Paste Wax, makes a luster that LASTS for MONTHS. 8 oz. net weight. \$1.98 postpaid.

ALADDIN PRODUCTS CO., P.O. Box 691, Salinas, Calif.



EXPLORE FOR TREASURE!

Find wealth lost or buried for centuries! Battle relics, antiques, gold and silver coins, bullion, jewelry, treasure chests and other valuables can be yours with M-SCOPE Treasure-Metal Locators. Used worldwide for Treasure Hunting. **GUARANTEED**. Time Payment. Free literature. **FISHER RESEARCH LAB., INC.**, Dept. 1-D, Palo Alto, Calif.

KING MIDGET

World's
Lowest
Priced
Car!



Lower priced, improved performance. Drive it for 75c per week. Also **KING MIDGET JUNIOR**, finely engineered, less than one-third cost of any comparable car, one-twelfth cost of large cars. Agents wanted. **IT WILL PAY YOU TO GET THE FACTS.** Send 25c for literature and agents proposition on both cars, or \$1 (refunded first order) for this plus actual assembly book and service manual.

MIDGET MOTORS MFG. CO., Athens 1, Ohio

free

GET THE WORLD'S LEADING
TV & RADIO PARTS AND
EQUIPMENT CATALOG

**ALLIED'S 1956
ELECTRONIC SUPPLY GUIDE**

**324
VALUE-
PACKED
PAGES**



Save on
Everything
in
Electronics

**WORLD'S
LARGEST
STOCKS**

Everything for Experimenters,
Builders, Amateurs, Servicemen,
Engineers and Hi-Fi Experts

Send for ALLIED'S big 324-page Catalog, offering the world's largest selection of latest top-quality electronic equipment at lowest, money-saving prices. Features High Fidelity systems and components; recorders and phono equipment; TV tubes, antennas and accessories; Amateur station equipment; P.A. systems; test instruments; latest build-your-own kits; industrial electronic supplies—plus thousands of parts, tubes, transistors, tools and books. Get *everything, get more* for your money—send today for your **FREE 1956 ALLIED Catalog!**



ALLIED RADIO

**ALLIED RADIO CORP., Dept. 5-BB-6
100 N. Western Ave., Chicago 80, Ill.**

Rush **FREE 1956 ALLIED 324-Page Catalog**

Name _____

Address _____

City _____ Zone _____ State _____

Send for
**FREE
CATALOG**



**BETTER PERFORMANCE
IN ALL KINDS OF WEATHER**

Whether it is 100 in the shade or 30 below zero, your car will start quicker and run better with a Bendix* Electric Fuel Pump. It's easy to install and costs less per mile of operation than any electric fuel pump on the market. Sold by independent garages and service stations.

*REG. U. S. PAT. OFF.



FREE! A descriptive folder is yours for the asking. Write today.

Bendix

ELECTRIC FUEL PUMP

Grand Prix Winner

ECLIPSE MACHINE DIVISION, BENDIX AVIATION CORP.
ELMIRA, N. Y.

Extra-hardened at points of extreme wear. Last longer.



Are Your Pliers Worn Out?

Take a good look at your pliers and adjustable wrenches. Are they worn, nicked and burred?

If so, there's small satisfaction in using them. Jobs are harder and slower. Hobbies are less fun.

But fine, drop forged UTICA® pliers and adjustable wrenches are a pleasure to use—because they make the job easier, quicker, better.

Your dealer has them or can get them for you.



DROP FORGE & TOOL CORP.

Utica 4, N. Y.

itself is located on a continental plateau 10,000 feet high. Even the powerful heated tractors could never make it alone—much less with sled trains to drag behind them over the difficult mountain ranges. Temperatures up there almost surely stagger to 100 degrees below zero in the antarctic winter, and are well below zero, with brutal winds, in summer. The unknown terrain, with crags and crevasses in the ancient glacial ice, may well be past coping with. So, the 18th Air Force, if conditions permit, will fly in and airdrop 15 men and 350 tons of material and equipment from planes. It will require 100 cargo flights to do the job—which will make the South Pole run almost as routine as the trans-Atlantic run was not so many years ago. Each plane will carry five tons of payload. The two biggest airdropped items will be a "Cat" and an electric generator.

As a result of our undertaking, a vast, new fund of scientific knowledge will be opened to the world. No matter what happens, the great Antarctic Continent, with its many potentialities for the future of mankind, will be opened up at last. By 1958 it will have a population of more than 2000 people. In early November, President Eisenhower issued a directive calling for the establishment of a new United States Antarctic Program and designating me officer in charge. Under this program, Deep-freeze will be only the beginning of an organized permanent program of United States antarctic activity.

Every American has a stake in the bottom of the world. To me, it is cause for deep gratification that our government has now recognized the importance of Antarctica to the future, and that it has taken this essential step in affirming the continuity of our national interest. ★ ★ ★

Sun, Oxygen and Water Ruin Car Finish

Dr. Roger L. Saur of General Motors' research laboratory has pinned down the three things which combine to ruin the lacquer finishes on cars—sunlight, oxygen and water vapor. It isn't the heat but the ultraviolet rays in sunlight which do damage, activating the breaking up of the lacquer by affecting the nitrate part of the cellulose nitrate found in lacquer. A chain of chemicals develops and, when the car is washed or it rains, these chemicals are sloughed off along with tiny colored particles in the paint, leaving a rougher surface behind. Larger white particles are thus exposed, and the result in time is a characteristic whitening, or "chalking" effect.

SMALL INVESTMENT PUTS YOU IN GOOD PAYING BUSINESS OF YOUR OWN

ROGERS MANUFACTURING CO.
Dept. M-26, Lindsey, Ohio

Gentlemen: Please rush complete details about
the big-profit possibilities of the Universal
Lawn Mower Grinder. **FREE**

Name _____

Address _____

State _____

City _____

SHARPENING LAWN MOWERS IN SPARE OR FULL TIME . . . AT GOOD PROFIT.

Thousands are successfully earning good money with the Universal plan of a spare or full time business in their garage or basement. Previous experience not necessary. Age no handicap. C.H.R. of Ohio made \$3,688.20 working part time, in one season. The new Universal is the only grinder in the world that enables you to grind both the bed knife and reel blades . . . **IN A SINGLE SET-UP**

. . . without removing them from the mower. Just put the mower in the grinder, follow a few simple instructions and you can do an expert job sharpening hand or power mowers without removing engine, handle, or roller. **SEND COUPON** today for success plan of this low investment big pay business of your own.

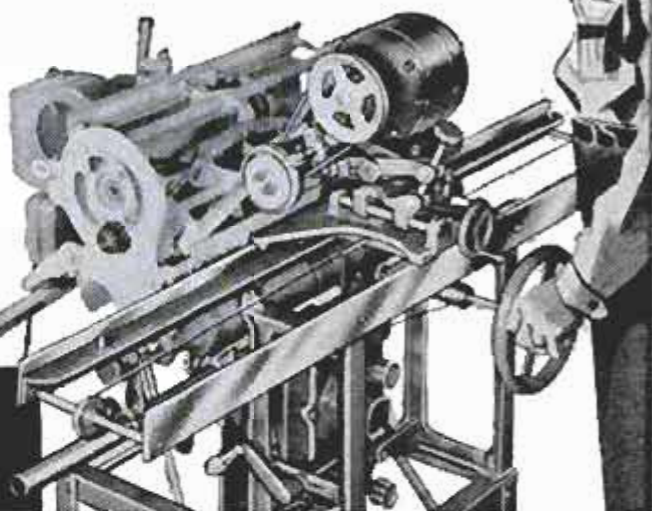

ROGERS MANUFACTURING CO.
LINDSEY, OHIO

SPRINGFIELD TILLER

Big 3 h.p. Springfield SPRINGTIL model. Tines guaranteed for life. Non-winding. Easy to control. 7 1/2" to 21 1/2" tilling widths. Converts to roller, aerating tool, edger, and furrower.



SEND FOR FREE 1956 CATALOG

Quick Mfg. Inc., 3257 E. Main St.,
Springfield, Ohio

COMPLETE SOLDERING KIT only \$7.95



Includes: Weller Soldering Gun, over 100 watts; supply of famous Kester Solder; Weller Soldering Aid; and Wire Brush. For hobbies and homecraft. Write for catalog.

WELLER ELECTRIC CORPORATION
816 Packer St., Easton, Pa.

Get This NEW Catalog of WOOD AND WOODWORKING MATERIALS



World's Largest Selection
of Finest Domestic and Imported
Woods . . . Mouldings, Hardware, Tools.
—ALL AT LOW MONEY SAVING PRICES!

Your complete wood buying guide and project book. Craftsman is your best, most complete source of finest kiln-dried domestic and rare imported woods, beautiful woodinlays, colorful bandings, matched plywoods, embossed mouldings, carved ornaments, newest woodworking tools, "hard to find" cabinet hardware and fittings. . . more than 1,500 items! Packed with newest scroll saw patterns, project ideas & money making plans. Enclose 25c (refunded with first order) to help pay mailing, handling cost. Write now! **Craftsman Wood Service Co., Dept. A-2 2729 S. Mary Street - Chicago 8, Ill.**

128 PAGES
Many in
full color

packed with rare,
fancy & imported
woods . . . veneers,
plywoods, patterns,
tools, ornaments,
hardware
. . . everything for
the woodworker.

**MAIL COUPON
NOW!**

CRAFTSMAN SERVICE CO., Dept. A-2.
2729 S. Mary St., Chicago 8, Ill.

Enclosed find 25c. Rush me new *Woodworkers' Catalog Handbook*.

NAME _____

ADDRESS _____

CITY _____ ZONE _____ STATE _____

POWERFUL!

Man, here's
light! 1/4-mile beam —
15,000 beam candle
power. Compact, easy to
carry, built to last! Uses two 6-volt
batteries. See your dealer. **\$6.50**

DELTA ELECTRIC CO., Marion, Ind.

less bolts.



Delta POWER-KING ELECTRIC LANTERN

ROX Protects Against Water Leakage

Guaranteed Not to Chip, Blister or Peel

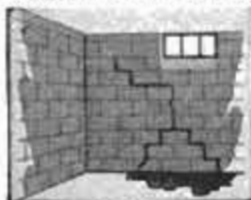

Before



After

Transforms dingy, wet basements into beautiful, usable recreation areas . . . protects against severe water leakage.

PROOF! "5 Feet of Water In Basement Until We Used ROX"

"Our basement was so bad that we would have to pump out 4 to 5 feet of water. It was considered by contractors and builders as the worst basement in this area. After trying dozens of preparations, we tried Rox Masonry Paint. We followed the simple directions and the results have been amazing. For the first time in 13 years, the basement is usable."—Midland Furniture Co., Midland, Michigan.

PROOF! ROX Painted Exterior Still Good After Several Years

"After using several masonry paints on the walls of our block buildings, we found that within six months to a year the paints would blister and peel. A number of painters and paint experts all suggested Rox Masonry Paint because it was guaranteed not to blister or peel. Our buildings were painted with Rox several years ago and are still in perfect condition."—W. D. Andrews, V. P., Hazel Park Racing Assoc., Hazel Park, Mich.

Insist on Rox Masonry Paint in the blue and white can. Easy to use. Requires only water for mixing. No primer necessary. Odorless. In gleaming white and popular colors at authorized Rox dealers in U. S. and Canada. Write for free literature and name of your nearest Rox dealer. Rox Products Co., Department M2, Detroit 27, Michigan



© ROX PRODUCTS CO.

Sports Cars of the World

(Continued from page 169)

"Virile good looks and fun to drive because of fabulous steering and stability."—Cedar Rapids, Iowa.

"Uncomfortable, impractical, expensive, but lots of fun."—Lowell, Mass.

"Must cause hot feet, cold ears and a tired behind."—Omaha, Neb.

"An impractical, two-place, four-wheel luxury that is a lot of fun."—Delray Beach, Fla.

"A car that rides hard, burns your face and neck, takes you back to high-school days and lets you forget business completely."—Muncie, Ind.

"Mechanical excellence encased in the elegance of functional beauty."—USS Iowa.

"A car you can safely play with."—Dayton, Ohio.

"A very maneuverable, fast, sleek automobile, for which it is next to impossible to secure parts or service."—New Orleans, La.

"A car that can be maneuvered with the greatest amount of real security under highway or racing conditions without alterations for either."—Indianapolis, Ind.

"An automobile in which the driver sits closer to the rear axle than to the front axle."—Winston-Salem, N. C.

"An unreliable, uncomfortable toy; a testing ground for many good and some asinine automotive developments; a mobile hobby."—Scranton, Pa.

"A car which can be driven over the road to a race, can compete in the race and with luck return home under its own power."—Peterborough, N. H.

Probably the real definitions, though, are the simplest, like the following:

"A car that has its own personality and is a joy to drive."—U.S. Navy.

"A car that is fun to drive."—Gowanda, N. Y.

"To me a sports car is that automobile which puts the pleasure back in pleasure driving."—Harrison, N. J. ★ ★ ★

Freezing Water Protects Food

Freezing water is used by the Air Force to protect foods from freezing while being flown to subzero areas. The food, usually fresh fruits or vegetables, is placed in a cardboard box wrapped with waterproof material. This box is placed in a slightly larger box that is filled with water. At minus 65 degrees Fahrenheit it takes six hours for the water to freeze. Until then, the food inside remains at 32 degrees, slightly above its freezing point.

House a hobby handsomely in space-saving built-ins!

This useful and decorative group of Western Pine* shelves and cabinets houses Hi-Fi equipment, records and books. Build one around *your* hobby, whether it's music, motion pictures, collection of pewter or ivories—even an aquarium of tropical fish!

Clean-cutting, smooth surfaced and economical Western Pine woods are a joy to use in any workshop project. They are carefully selected and well seasoned, take all finishes without grain raising. See them at your local lumber dealer.

FREE—“INSTALLING AND COLORING YOUR WALLS OF WESTERN PINES.” Also, “FRIENDLY HOME IDEAS IN WESTERN PINE,” new booklet of building and remodeling ideas—88 pictures! Write to WESTERN PINE ASSOCIATION, Dept. 501-N, Yeon Building, Portland 4, Oregon.



the **Western Pines**

- * IDAHO WHITE PINE
- * PONDEROSA PINE
- * SUGAR PINE



TODAY'S WESTERN PINE TREE FARMING GUARANTEES LUMBER TOMORROW



CUT RADIO CHASSIS HOLES IN 1-1/2 MINUTES OR LESS

Quickly make accurate round, square, key, or "D" openings . . . in metal, bakelite or hard rubber . . . with GREENLEE Radio Chassis Punches. Simply turn with a wrench. Many sizes. Write for details. Greenlee Tool Co., 2102 Columbia Avenue, Rockford, Illinois.



make your own Gems 29⁵⁰ F.O.B.

The Gem Maker comes complete with all necessary equipment, including a super-charged diamond blade for sawing, and all wheels for grinding, shaping and polishing; also complete instructions. The complete equipment as shown, less motor and belt, for only \$29.50, f.o.b., Burlington, Wisconsin. Write today for information and literature.

B & I MANUFACTURING CO.
Dept. 5 Burlington, Wis.

CUT PERFECT GROOVES WITH *Warren* WASHERS ON YOUR SAW BLADE!

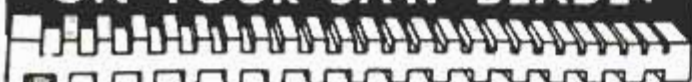

NOT ONE—NOT TWELVE—BUT 40 DIFFERENT CUTS

Engineered to cut clean, accurate, parallel grooves—just dial the desired width—40 micromatic adjustments—leave on saw for straight cuts. **GUARANTEED.** At your dealers or order direct. Arbor sizes 1/2", 3/8", 3/4", 1". Send for free booklet

WARREN WASHERS COMPANY
Dept. 22, Box 98, North End Station, Detroit, Michigan

Shark Brand Swedish Chisels



MAKE YOUR JOB EASIER

You'll do neater, more accurate woodworking with SHARK BRAND SWEDISH CHARCOAL STEEL paring chisels . . . hold their sharpness 3 times longer than ordinary chisels.

Write for new folder Dept. PM

Sandvik SAW & TOOL

DIVISION OF SANDVIK STEEL, INC.

1702 NEVINS RD., FAIR LAWN, N. J.





No gripping job too rugged! Increases pressure 10 times from handle to jaw. Four jaw adjustments to 1 1/4"... Chrome plated. Every P&C tool guaranteed—"the BEST tool money can buy". Ask your dealer for the P&C Compound Plier!



**THE P & C COMPOUND PLIER
GIVES YOUR GRIP THE
STRENGTH OF 10!**



Buy your P&C Tools from this Self-Service Display in tool stores. Send 10c TODAY for P&C's big catalog. All the dope on over 500 tools.

**P & C HAND FORGED
TOOL COMPANY**
Dept. H1 • Box 5926
Portland 22, Oregon



Model Railroad in a Chicken House

(Continued from page 139)

He gathered up a few broken auto pistons and a couple of carburetors, together with some used fuel pumps and melted these items down. He cast his locomotive-wheel blanks out of the aluminum, using steel molds, and then trued them up in a home-made lathe.

He drew the temper from some wrist pins and turned his car-wheel rims and flanges from them. He poured his wheels and axles in one piece right into these rims which were enclosed in the molds.

The brass and steel dies and jigs were all made on the lathe or were carved, using a drill press, a hand power tool and finally a deal of hand scraping and filing. For the pressure to force the metal into the "corners," Gail used the weight of the metal in the sprue column and, in the case of the wheels, he rigged up a centrifugal jig. He cautions anyone trying this method to be sure to have a good heavy guard around the outfit.

Cars From Cans

The cars are made from large cans and some sections of tinned-iron furnace pipe. The boiler front of one locomotive and the front end of the diesel were cast in one chunk of aluminum and then sawed and filed into shape.

The power is transmitted by a three and four-rail system. There is a skilfully camouflaged series of humps along one side of the track. This supplies power to a separate shoe that works the solenoid-activated chuffing and smoke mechanism mounted in the engine boiler.

The power-supply rails are between the tracks and are of heavy copper wire stretched until straight as a string. Those on the outdoor portion of the track are under permanent spring tension so that they "give and take" with the wide variations in temperature.

A rebuilt rectifier is used to supply the 27-volt series-wound, war-surplus aircraft motors, used for traction. The separate light circuit is used for reversing by activating a polarized relay.

The motors are husky brutes and are mounted in the heavily lead-weighted tenders whose multiple wheels supply the necessary traction. It takes about all the strength in an average man's hooked finger to start one of these long trains rolling. This makes for a realistic slow start and eliminates the "jack rabbit" take-off many models have. The cars are weighted so that they give off a "solid" sound when running over the rails and joints. ★ ★ ★

now get **BLONDE
WOOD EFFECTS**
on **DARK** woodwork and furniture
without removing old paint or stain!

- goes right over old paint or finish!
- three easy steps!
- four colors

Bring old, dark woodwork, furniture and cabinetry up to date—get popular Blonde Wood effects—with O'Brien's Lite-Chrome. This amazing new product goes right over old finishes. No messy removing! No tedious sanding! Three simple steps. Apply Base Coat over old finish... a thin coat of Color Grain... Clear Coat that dries to a rich, satiny finish. Four colors—Satinwood, White Elm, Silver Birch, Honey Maple. Send only \$2.00 for enough Lite-Chrome for average chest.



NEW

The O'Brien Corp., Dept. PM-2, South Bend, Ind.
Enclosed is \$2.00 (cash, check or money order—no C.O.D.'s.)
for 1/2 pt. of Lite-Chrome Base Coat, 1/4 pt. of Color Grain
and 1/4 pt. of Finish Coat. Specify desired color.

Name _____

Address _____

It Becomes Something Special to Her Because You Built It Yourself



Convert SKIL to a tilting arbor table saw with optional SKIL table. \$39.95

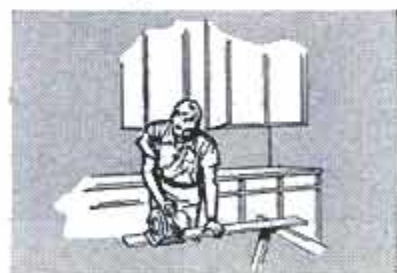

Make cabinets, cupboards, closets, an easy weekend project with SKIL Saw!



Extra rooms, extra storage space are easy to build with SKIL Saw!

There's a real thrill in finishing those big jobs you've dreamed of doing. There's an extra satisfaction that comes with the family's pride in your ability. Many projects you could never handle before are *easy* with SKIL Saw to help you!

This speedy, powerful 6" SKIL Saw has all the features professional builders demand for peak performance and efficiency. So simple and safe to operate, a boy can handle it. You'll do all kinds of home workshop jobs—from simple furniture-making to construction of a garage or porch!

What's more, this SKIL Saw is priced so low you can own it easily! Have your hardware dealer, appliance dealer or department store show you this outstanding SKIL Saw value today!

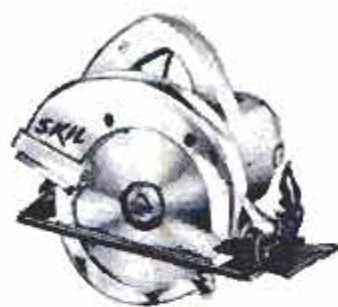

Model 526

Only

\$49.95

Cuts through plywood, sheeting, siding, even stone and metals! Lightweight and easy to handle. Built-in bevel and depth adjustment for accurate cutting. Automatic blade guard and trigger-type switch for safety. Powerful motor; sturdy die-cast aluminum housing.

Send for Valuable Chart. Shows You How to Build Kitchen Cabinets! Only 10¢!

SKIL

BUILDERS TOOLS

Made only by SKIL Corporation formerly SKILSAW, Inc.
5033 Elston Avenue, Chicago 30, Illinois
3601 Dundas Street West, Toronto 9, Ontario
Factory Branches in ALL Leading Cities

SKIL Corporation, Dept. PM-26
5033 Elston Avenue, Chicago 30, Illinois

I enclose 10¢. Please send me SKIL Chart 105, a step-by-step guide that tells how to modernize my kitchen by making built-in cabinets.

Name _____

Street _____

City _____ Zone _____ State _____

WATCHDOGS ON YOUR GAS LINE...

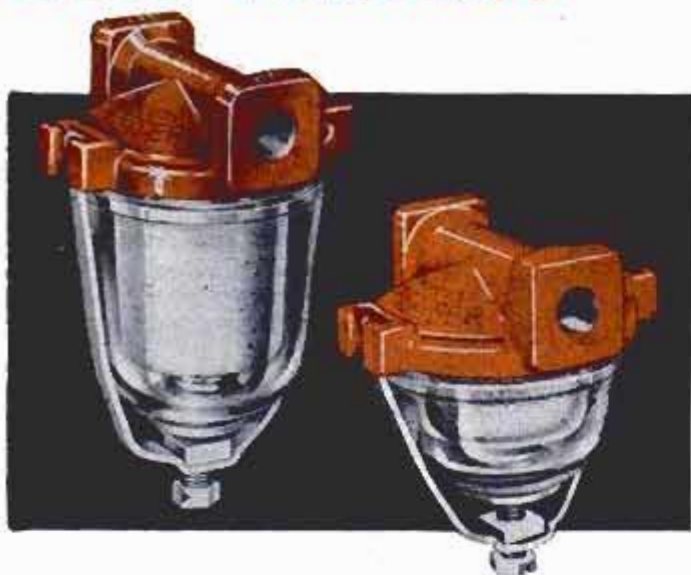

CARTER



CERAMIC FUEL FILTERS

Do you really need a filter for today's highly refined fuels? Remember this: as your car draws gasoline out of the tank, air must be drawn in to replace it. This dirty, dusty road air may eventually clog your carburetor, affecting operation and economy.

When your car is equipped with a genuine CARTER filter every drop of gasoline passes through the microscopically-small pores of a specially designed ceramic filtering element. CARTER filters can be equipped with a Magnatrap*, a powerful permanent magnet that traps small particles of iron oxide which are a frequent cause of carburetor flooding.

See the CARTER dealer in your neighborhood... or ask your mechanic.

*T. M. Reg.



CARTER CARBURETOR CORPORATION

St. Louis 7, Missouri

Division of ACF INDUSTRIES, INCORPORATED

How to Win Stock-Car Races

(Continued from page 191)

over the front springs by welding steel bars to them. We beef up each front-spindle support arm by adding a U-bolt to it. Rear springs get extra leaves. We think of little things, too. For instance, we keep the gasoline tank from shaking loose by wrapping an additional metal strap around it. (We lost one race when our car hit a fuel tank that had dropped from a competitor's car, sending us into the fence.)

On the front wheels we use Chrysler's regular taxicab spindles plus heavier bearings of our own choice. We mount double shock absorbers on all four wheels.

Wheels are beefed up by welding two wheels together to make them twice as strong. We use extra-wide rims to increase tire life. Wheels are attached to the drums with special wheel bolts two sizes larger than the regular cap screws.

Steering is modified. We use Chrysler's power-steering Pitman arm, which is longer, and Plymouth steering arms, which are shorter, to give quick steering for quick-manuevering on the tracks. Conventional steering ratios are too slow for racing.

All these changes involve running gear, not the engine. We do almost nothing to the engine except put it in peak tune. We do use special air filters on the carburetors. We machine our own aluminum sediment bowls to replace the glass ones in the fuel-line filters (we lost one race when the glass bowl cracked.) We beef up throttle linkage to resist the rough treatment of heavy-footed drivers who keep trying to kick a hole in the floor.

These points I mentioned are a minimum. Others do much more. For example, Chevrolet uses mostly Oldsmobile parts in its running gear, Corvette parts in its engine. Ford uses Lincoln parts such as spindles and "A" frames, and had even gone so far as to authorize the use of the biggest Mercury interceptor police engine in its race cars. This stopped about the time that Chrysler threatened to put the Chrysler C300 engine in a Plymouth!

As an outboard-motor manufacturer, we are forbidden to take part directly or indirectly in outboard-motor racing. So we turned to automobiles. (Incidentally, in my opinion, the best thing that could happen to stock-car racing would be the adoption of a similar rule to keep out car manufacturers. This would help eliminate the present confusion as to what is and what is not stock. A manufacturer competing with his customers is unfair, if not unwise. It's poor public relations. Give it back to the drivers

(Continued to page 304)

Why wish and wait?
... We'll ship this beautiful home complete
YOU ERECT IT YOURSELF
... at amazing savings!



THE HAWTHORNE A compact, livable floor plan. Every foot of space put to good use. No wasted building dollars—more closet space than many larger homes. House above shown with carport and planter.

Only \$2775 (Without Basement)
 Most complete House "Package" anywhere. Precut and panelized—ready for easy "Build-it-Yourself" Erection. Prices subject to change without notice. Freight paid in 11 Midwestern States.

Are you among the many who wish they could have a fine, attractive home of their own? Then wait no longer because you can afford the beautiful Pagemaster "Hawthorne" right now!

Perhaps you'd like to change the floor plan. Then you help plan your new home just the way you want it. When it arrives, you erect it yourself in just days and put the \$\$s you save in construction costs right in your own pocket. All exterior walls are panelized, all openings accurately cut in. Windows and doors are hung in frames and weather-stripped as complete units, ready for you to insert in prepared openings. Pre-manufactured roof trusses come in two sections—just nail them together. No other build-it-yourself home saves you so much construction time or helps you avoid costly on-the-job mistakes. Unmatched in value, unequalled in low cost, all Pagemaster-quality-built Homes are eligible for VA and FHA financing.

Send 50¢ for our full-color catalog with many exciting new homes to choose from



Pagemaster
HOMES

200 PIERCE STREET, SHAKOPEE, MINN.

"EXCLUSIVE NORTHWEST PRODUCER" of — "THE PM PRECUT HOUSE" — "PANELIZED FOR EASY ERECTION"

NEW! AUTOMOTIVE CATALOG

Giant 1956 Edition! Everything for car, truck, custom-styled car, hot rod ... at **LOWEST PRICES!** Save up to 50% on all parts, accessories! Only complete automotive buying guide...60,000 items...164 pages! Thousands of hard-to-find parts; equipment, parts for 1920 to 1956 models; **Molly-wood accessories** never before offered; **hi-speed parts**. Send your name and address and 25¢ (refundable with first \$5.00 order) to:

J.C. Whitney & Co., 1917 Archer, Dept. P-2, Chicago 16, Ill.



\$500 in 4 months spare time

is what I made with the **FOLEY**

LAWN MOWER SHARPENER

... and I can sharpen all power mowers. No one can go wrong with the Foley machine."—V. J. Patterson wrote us. Get in this profitable business where you take in CASH right from the start. 99¢ of every dollar you take in is YOUR profit! The Foley Lawn Mower Sharpener handles all makes of hand and power mowers.—up to 3 or 4 per hour. Hand mowers run \$1.50 to \$3.00—power mowers \$5.00 to \$8.00. **FREE PLAN** shows how to start—no experience needed. Foley prices are low—easy payments available. Get set now for big profits this Spring and Summer. Send coupon today—no salesman will call.

"In my home town of 5,000 I paid for the Foley 4 or 5 times over the first season. I also put a \$1035 oil furnace in my new home."—B. Mathews.

"We sharpened nearly 1000 mowers our first season and gained a reputation for the best work."—J. W. Kemper

Send for **FREE BOOK "HOW TO SHARPEN POWER MOWERS"**



FOLEY MFG. CO., 207-6 Foley Bldg., Minneapolis 18, Minn. Send **FREE BOOK "How to Sharpen Power Mowers,"** and **FREE PLAN** on lawn mower business.

Name _____
 Address _____

MODERN

LAWN MOWER SHARPENER

COMPARE BEFORE YOU BUY



Write for free booklet 10E

Oil remains in engine while sharpening. Bed knife sharpened in same centers—no attachments needed.

Start your own business—**increase your income**

Sharpens any mower in ten to twenty minutes. Handles complete assembly of all reel types including 36 in. power mowers. Handle, wheels, roller, and engine are not removed.

\$26300

MODERN MFG. CO.

F.O.B. PASADENA

160 N. FAIR OAKS, PASADENA, CALIF.



Even the sound a Disston saw blade makes as it cuts is something special.

That's because Disston craftsmen build special quality into every blade at every step—from the fine Disston-made steel to the finished product.

There's so much extra satisfaction in using good tools, remember to ask your hardware dealer to show you Disston

- Circular saw blades and dado heads
- Band saws
- Hand saws
- Chisels and gouges

● GET THIS FREE TOOL MANUAL!

Henry DISSTON DIVISION

H. K. PORTER COMPANY, INC.
211 Tecony, Phila. 35, Pa.
In Canada: 2-20 Fraser Ave., Toronto 3, Ont.

Please send me, free, illustrated 68-page booklet. It tells how to choose, use and care for tools.



Name.....

Address.....

City.....Zone.....State.....

and their sportsman sponsors. It looks as though NASCAR is moving in that direction with its recent ruling that the racing group will establish its own specifications.)

At the start of the '55 season, our Chrysler C300s did not do well. They were fast enough. They usually took the lead and led for much of the race, but then they were apt to slow down or quit. We discovered why: Dirt was ruining our engines.

After the first Langhorne race, the air filters on our cars were completely loaded with dirt. The engines were just about to quit when, fortunately for us, the race was stopped because of a heavy rain.

At Winston-Salem, our two cars conked out almost simultaneously—so close together that an official accused us of willfully pulling out of the race, an infraction of the rules.

But we had not pulled out. The cars had just quit. We opened up the engines and there was no oil left in them. Just a cupful of stuff that looked and felt like lapping compound. The engines had no compression. The oil and dirt formed a grinding compound that wore out the rings. All the oil had pumped past the rings; the main bearings were shot and so were the rods.

Our 300s were susceptible to dirt. Their two four-barrel carburetors have eight holes to carry the abrasive stuff into the engine. Being a high-performance engine, it breathes faster and deeper, taking in more dirt per lap than other engines. Dirt was killing the 300's chances.

Back we went to our laboratory to get ourselves off the hook. We found that for racing, the conventional oil-bath air filter is inadequate. It actually collects dirt and dumps it in big gulps into the carburetor. At full throttle we would suck oil and dirt right out of the filters themselves. We'd be better off with no filter.

But you have to have filters in dirt-track racing. So we drew on our experience in building portable chain saws for the government during the war. We knew that dry paper filters had worked there under dusty conditions. So we tried paper.

We improvised a filter from the sawed-off bottom of a garbage can. We built one inside an aluminum saucepan. We were on the right track as our hurried tests showed. Finally, with the help of Purolator parts, we came up with the simple, but amazingly efficient dry paper filter that all racers use today.

It shows no power loss on the dynamometer, yet it keeps out all dirt particles over two microns in diameter. Dirt under two microns seems to do little or no damage.

With the dirt problem licked, the 300s

(Continued to page 306)

NEW! Make your own hi-fi speaker cabinet with Weldwood!



Model KD1
The Patrician IV



Model KD4
The Regency



Model KD7
The Baronet



Model KD2
The Georgian



Model KD5
The Empire



Model KD3
The Centurion



Model KD6
The Aristocrat

7 Electro-Voice models for single- or multiple-speaker high-fidelity units—kits start at \$24; Do-It-Yourself books including plans, \$1.00 (except Patrician and Georgian, \$1.50; Baronet, 75¢).

Here's why the new plans and kits by Electro-Voice, Inc., specify beautiful Weldwood plywood as ideal material for speaker enclosures.

Nothing equals wood for fine sound reproduction. Weldwood plywood preserves the precise sound characteristics that Electro-Voice has designed into your cabinet. For Weldwood resists warping, swelling and shape changes—distortions that may ruin hi-fi sound. And Weldwood's beauty matches the beautiful music you'll enjoy.

Weldwood® Plywood

A Product of

UNITED STATES PLYWOOD CORPORATION

In Canada: Weldwood Plywood, Ltd.

WELDWOOD—The Best Known Name in Plywood

Electro-Voice kits come in 7 different models. Kits contain everything you need—Weldwood plywood, framing and finishing materials, and step-by-step, easy-to-follow directions. If you wish, you may buy only the instructions—then buy Weldwood plywood at your own lumber dealer's.

Mail the coupon today for more information

United States Plywood Corporation PM 2-56
55 West 44th St., New York 36, N. Y.

RUSH ME free literature on hi-fi speaker enclosures I can build with Electro-Voice kits or plans, and Weldwood plywood.

NAME.....

ADDRESS.....

CITY.....STATE.....

I CAN SAVE YOU 94%!



Send for NEW 1956 Illustrated BOOK of BIG WAR SURPLUS BARGAINS for mechanics, farmers, gadgeteers & outdoorsmen. Unbelievably LOW PRICES.



P-1 GENERATORS

200-250 Amp. 24 Volt DC. 4500 RPM. Makes dandy Arc Welder. Cost Gov't. \$396. Used like NEW—SPECIAL, at \$12.88. Gov't. Overhauled \$19.80. NEW \$24.75. FOB York. GUARANTEED! Diagrams & Instructions included FREE! Cat. with 1,000's BIG BARGAINS FREE!

K. ORT, Dept. 2PM, York, Pa.

WAR SURPLUS BARGAIN BOOK FREE!

SAVE MONEY on SURPLUS PARTS for MILITARY TYPE TRUCKS & JEEPS

4 & 6 wheel drive. FREE catalog to Jeep owners. State make truck or Jeep. (New Jeep Tops, steel or canvas all models). AMERICAN AUTO PARTS CO., Inc., 1830 Locust, Kansas City, Mo.

Say You Saw It in Popular Mechanics

Remove Paint the EASY way

Don't waste time with weak removers. Use safe, powerful Wonder-Paste—largest selling remover. Makes paint, enamel, varnish come off easily. Won't run on upright surfaces.

At paint and hardware stores.

Write for helpful Wonder-Paste leaflet

Wilson-Imperial Co., 119 Chestnut St., Newark 5, N. J.

WONDER-PASTE 5 MILLION CANS SOLD



Cushman PACEMAKER

ACE of ACES in LOW-COST transportation

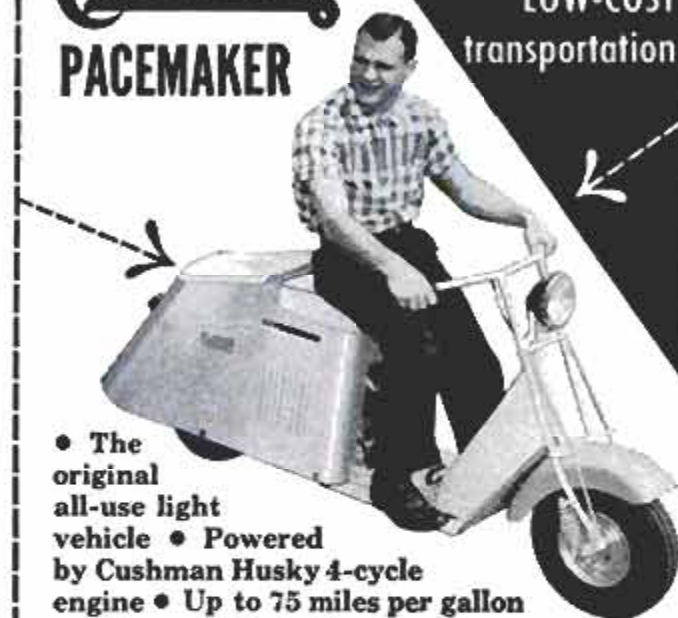

- The original all-use light vehicle
- Powered by Cushman Husky 4-cycle engine
- Up to 75 miles per gallon
- ... 3/4c per mile total operating cost.

Ask your dealer for a FREE demonstration or write for illustrated literature. Dealer inquiries invited.

933 No. 21st
Lincoln, Nebraska

CUSHMAN MOTOR WORKS, Incorporated



Even
without
this
famous
guarantee

Genuine

RIDGID

would still be

the World's Most Popular Pipe Wrench



Millions of users know it
out-performs,
out-lasts all others!

It's the "RIDGID" name that guarantees you everything you want in a pipe wrench—instant bite on the pipe or conduit, instant let-go—it can't lock because of patented hookjaw suspension . . . handy pipe scale, easy-spin adjusting nut, comfort-grip I-beam handle . . . and every one factory-tested before shipment! For your work, for your home, it's most for your money—buy it at your Hardware Store!



The Ridge Tool Company, Elyria, Ohio, U.S.A.

began to win races. Things looked good. Then at Raleigh, N. C., Herb Thomas beat us. He was driving the same Buick we had been outrunning all season. Something was changed, we knew. He finished the race without a tire stop. We were leading until we had to change tires and we never caught him again.

The next day at Milwaukee, we were beaten by Marshall Teague in a Chevrolet that went all the way on one set of tires—this same type of tire, again.

As we were given to understand, Thomas and Teague were running on special experimental tires given to General Motors and Ford by Firestone for test purposes. Somehow these tires got onto the two cars that beat us. As you can imagine, the tires caused many heated discussions. A pit stop for tires can mean the difference between winning or losing a race. This new tire meant that the races could be won or lost by the tire company.

We had been doing lots of work with tires. The 300 is hard on rubber, being the heaviest and fastest car on the track. You just can't get oversize tires for it. Largest racing tires made were 8:00 x 15. Smaller cars use the same tires we do (8:00 x 15) and, being lighter, go farther between changes. Sometimes these smaller cars win on the time they save in tire changes.

Our first move had been to install wide-base wheels. We have long been aware of the advantages of wide-base rims. Our distributor in New York had gone into the wheel business during the tire shortage of World War II. They proved to me that wide-rim wheels increase tire life sharply on cars, trucks and buses. (Watch for wide-base wheels on '57 cars and trucks!)

The wide-base rim allows the tire to hold more air. And more air means it runs cooler. Wide rims also increase load capacity and stability on turns. We now use 9½-inch rims, about optimum for our tires.

We also developed a tire-curing system. Every tire is broken in for 1000 miles on our station wagons before it goes on a race car. We never trust a new tire for high-speed driving.

We also inflate our tires with a dry gas—we use nitrogen. The humidity in air can increase pressure to 90 pounds when it becomes steam during the race. So we empty our tires before each race and refill them with dry nitrogen.

We thought we had the tire problem in hand when along came this fabulous new Firestone racing tire, the 170 Super Sports, that made it possible for Thomas and Teague to beat us twice in a row.

We and others put so much pressure on
(Continued to page 308)

New! Just \$99⁵⁰!

World's only orbital-action bayonet saw!

Now—the first *real* improvement since portable jig saws were invented! It's Porter-Cable's revolutionary new Model 148—designed around a wholly new principle, *guaranteed to outperform any other portable jig saw at any price.*

Orbital action makes the difference. Blade teeth are in contact *only* on the cutting stroke—*back away* on the relief stroke. Harmful "drag" is completely gone—and performance reaches a new high.

By actual test, the Model 148 cuts up to 4 times faster than the best conventional up-and-down saws. It has a full 2" capacity in wood— $\frac{3}{4}$ " in aluminum, $\frac{1}{4}$ " in steel. Its cool, comfortable grip and perfect balance make easy work of any job. Get the whole amazing story from your Porter-Cable dealer—or write today for full information and name of your nearest Dealer.



Exclusive
Orbital
Action!

Blade moves ahead on upward cutting stroke—moves back $\frac{3}{64}$ " on downward relief stroke. No harmful "drag"—blades run cooler, last far longer—cutting speeds increase up to 4 times!

Porter-Cable

Quality Electric Tools

PORTER-CABLE MACHINE COMPANY

6142 N. Salina Street, Syracuse 8, N. Y.

**belt sanders • finishing sanders
saws • drills • routers • planes**

In Canada, write Porter-Cable, Ltd., Box 5019,
London, Ont. Canadian prices slightly higher.

Here's the window you want...



It's Truscon's Double-Hung Steel Window that will never stick or rattle. That's because steel will never rot, warp, swell or shrink. You buy these Truscon Series 138 Windows from your dealer ready to install. All hardware is factory-attached. Stainless steel weather stripping is built in. There are types and sizes for every home style—with storms and screens available, too.

HERE'S HOW TO INSTALL IT



Free book shows how to install Truscon Steel Window in frame, brick veneer, masonry and concrete block construction. Clear pictures and complete step-by-step explanation are easy to follow—with helpful tips on professional methods. Send coupon below.

**TRUSCON STEEL DIVISION
REPUBLIC STEEL
YOUNGSTOWN 1, OHIO**



**TRUSCON STEEL DIVISION,
REPUBLIC STEEL**

1126 Albert Street • Youngstown 1, Ohio
Please rush free book showing how to install
Truscon® Double-Hung Steel Windows, Series 138.

Name

Address

City Zone State

K-9693

race headquarters and the tire company about these special tires that Firestone went into accelerated production on its experimental molds. Just before Darlington, Firestone officials received a phone call every two minutes and all but went into hiding! Finally, we were able to get tires and we continued to win races, finishing the season well out in front of both circuits.

Obviously, there is more to winning races than setting-up the cars. There are also the pit crews and the drivers—we have the best of these. The transportation of crews, cars and parts, fuels, vapor lock and rainouts also add woes.

Our pit crews are new at the game with no previous race experience. But they have a great pride in our products, whether race cars or outboard motors. A favorite lunch-time diversion at the shop is practicing pit stops. The boys can complete a scheduled pit stop (gas, oil and four tires) in 48 seconds. That takes practice.

We have a 12-man team for three cars, the usual number we take to a race. Each car has its own truck to haul it around. The driver buys both the race car and the truck on a time-payment plan out of his winnings. We do all the set-up work and pay all racing expenses. The drivers get the prize money.

Some week ends we are in three races: Friday night, Saturday night and Sunday afternoon. They may be hundreds of miles apart. The crews drive at night and get the cars in shape for the next race the following morning. This hectic life continues for most of the year. There are about 45 races in the Grand National Circuit of NASCAR. To win the championship, you have to be in most of them.

Tim Flock was in 39 races, winning 18 for an average of .462. His nearest rival averaged only .236. In AAA we took 10 firsts out of a possible 13 with Mundy, Bettenhausen and Nelson driving for an average of .770.

That's a record we're proud of. We have never had a car disqualified. We never hurt a driver; in fact, we never turned over.

Here are some quick rules on how to win a stock-car championship:

1. Pick the best "horse" or chassis, a top driver and a hard-working pit crew.
2. Learn to be a good loser. Perpetual "bellyachers" get nowhere in the game.
3. Don't let name calling disturb you. Stock-car fans are rabid individuals.
4. Be a good winner. Don't let your drivers or crews lose their humility.
5. Respect your competitors. No one has all the answers.
6. Be willing to go for days without sleep to keep your cars in top condition. ★ ★ ★

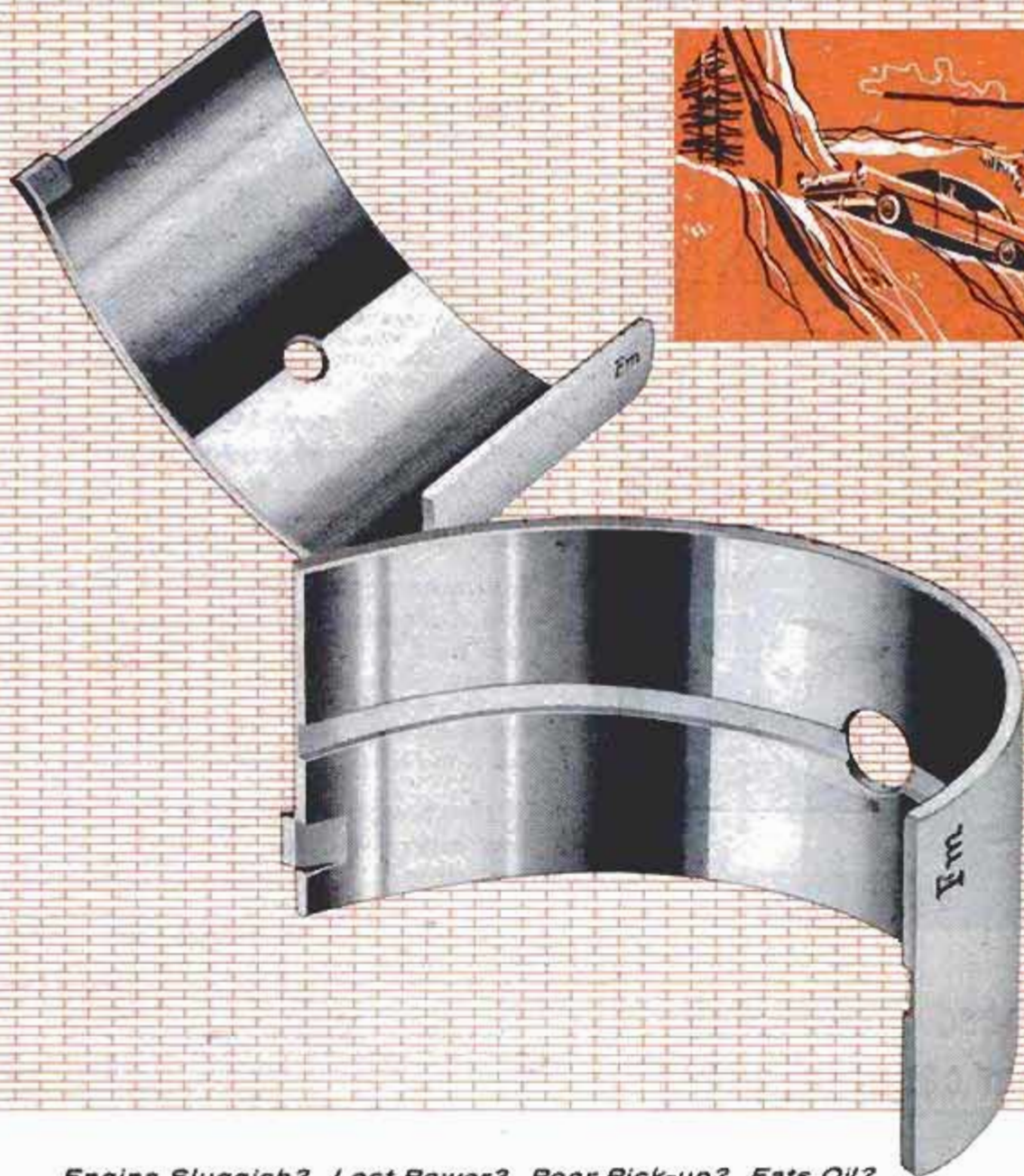

Engine Sluggish? Lost Power? Poor Pick-up? Eats Oil?

Smooth Engine Power calls for Quality Bearings . . .

FEDERAL-MOGUL QUALITY!

Engine performance starts at the connecting rod and crankshaft bearings. These are the vital points where gasoline explosive force is converted to turning power. Bearings take the impact, carry the load of variable driving conditions. They meter oil and control the flow of lubrication for cylinder walls and rings. Replacing with Federal-Mogul QUALITY bearings restores lively traffic response, smooth power on highways and hills, gas and oil economy, freedom from power-stealing oil pumping!

FEDERAL-MOGUL SERVICE
FEDERAL-MOGUL-BOWER BEARINGS, INC.

Ask your
mechanic!



RESEARCH • DESIGN • METALLURGY • PRECISION MANUFACTURING • SERVICE



Years-ahead Quaker State keeps your car at full power



Super-refined from Pure Pennsylvania Grade Crude Oil, world's finest. Famous for performance, protection, economy! Try it!

QUAKER STATE OIL REFINING CORP., OIL CITY, PA.
Member Pennsylvania Grade Crude Oil Association

Why Do People Buy the Cars They Do?

(Continued from page 195)

When the Boss owns a Mercury:

Employees buying Chevrolet.....	12.5%
♦ Employees buying Ford.....	25.0%
Employees buying Plymouth.....	12.5%

When the Boss owns a De Soto:

Employees buying Chevrolet.....	14.8%
Employees buying Ford.....	14.8%
♦ Employees buying Plymouth.....	25.9%

These percentages make it obvious that the brand of car the Boss owns has an important influence on the brand an employee selects.

✓ How does the new 1955 car compare with the car they traded in size?

New car is larger.....	47.1%
Smaller.....	17.6%
Same size.....	35.3%

✓ How many could get along with a car of a different size from the one they now own?

Present car is right size.....	66.1%
Could use little smaller car.....	20.3%
Could use a lot smaller car.....	11.8%
Could use a larger car.....	2.7%

✓ Of those who could use a smaller car, how many will buy a smaller model next time?

Will buy a smaller car.....	17.7%
Will not buy a smaller car.....	82.3%

People seem to have a prejudice against a smaller car. Even those who admit they could get along with a smaller car are, as a group, not willing to buy one. When asked for a reason why they would not buy a smaller car more than half (51.9%) replied that they just like a large car. Another 22.0% said the smaller car is not as comfortable or as safe as the large car.

✓ How many persons normally ride in the car with the driver?

Drive alone most of the time.....	43.9%
With one other person most of the time.....	38.2%
With several others most of the time.....	19.2%

Even though most of the owners admit they do not need a large car most of the time, they bought and seem anxious to continue to buy large cars.

✓ If they had unlimited money to spend, how many would buy the same make they now own?

Income under \$5000 a year.....	24.1% would
Income \$5000 to \$10,000.....	22.6% would
Income over \$10,000 a year.....	35.8% would

Both extremes, the low-income group and the high-income group, seem to be more satisfied with their cars than the middle-income owners (although statistically the difference is small). Perhaps this may have some relationship to the added emphasis on "keeping ahead of the Joneses" that is felt in the middle-income brackets.

(Continued to page 312)



Professional, big-tool precision
at small-tool cost!

...in the new Yates-American Saw-Jointer-Sander Combination

Standing behind your choice of Yates-American is the experienced craftsmanship of a company that, for more than 73 years, has specialized in designing and building precision machinery for professional woodworkers.

You get instant change-over

and many other features that give you more for your money

See your Yates-American dealer



Yates-American BELLOIT, WISCONSIN

Chicago, Ill. • High Point, N. C. • Memphis, Tenn. • Portland, Ore.
Manufacturer of woodworking machinery since 1883

A tool with a touch of tomorrow
\$274.50
complete with 1/4-hp. totally enclosed, dust-proof motor that runs everything
(Less saw guard and table extension)

Send coupon for free bulletin—and name and address of your dealer

----- Tear out coupon and mail today! -----

YATES-AMERICAN PT-3
Dept. B, 781 North Fourth St., Beloit, Wisconsin

Send free bulletin on Yates-American Saw-Jointer-Sander Combination.
 Send name and address of my Yates-American dealer.

Name.....
Address.....
City..... Zone..... State.....

Insist on
Evans
TAPES

50 ft.-100 ft. long
At your hardware store
For building and gardening measuring.

from **\$4.98**

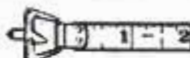

each with FREE plastic utility case and

SPECIAL HOOK-RING ATTACHMENT FOR EASY ONE-MAN MEASURING

EVANS RULE CO., Elizabeth, N. J. 3050

KEEP ALL SAWS SHARP

SUPER SAW FILER NO. 6

IT'S NEW! with Automatic DEPTH CONTROL ROLLERS

Automatically controls **DEPTH—ANGLE—PITCH**

Perfect bevel and angle maintained, and fool-proof depth control for all Rip, Cross-cut, and Handsaws. Precision made and calibrated for instant setting at desired angle. Can be used in any vise or clamp. Complete with file, only... **\$6.50 ppd.**

SAVE TIME AND \$\$\$

JOINT & SHARPEN CIRCULAR SAWS

Sensational new Super Filer No. 11 joints and sharpens both hand and circular saws 6" to 10" with all teeth the correct height, depth, pitch and bevel. Easy to use—when file hits hardened steel roller, teeth are finished. Saw runs true and smooth with no side pull. Complete with special 8" file **\$9.95 ppd.** "TRU-CIRCLE" saw set automatically sets teeth at 10° or more **\$2.95.**



SHARP SAWS CUT TRUER



SEND FOR FREE CATALOG

Guaranteed
A. D. McBURNEY, 5908 Hollywood Blvd., Hollywood 28, Cal., Dept. A-26

FEBRUARY 1956

BOLENS 2 in 1 POWER-PAK COMBINATION Tiller & Mower



Why buy two
when one
will do?



This compact unit with big 2 1/2 h.p. Clinton 4-cycle engine attaches in seconds without tools to a powerful 12 to 18 inch Rotary Tiller or to an 18 inch side-trimmer Rotary Mower with an efficient side discharge—everything you need for a beautiful garden and lawn.

See POWER-PAK at your Bolens dealer today!

MAIL COUPON for DETAILS

BOLENS PRODUCTS DIVISION
Food Machinery & Chemical Corp.
265-E Park Street, South
Port Washington, Wisconsin

Please send me full information re Bolens Power-Pak combination unit.

NAME.....

ADDRESS.....

CITY..... STATE.....



This fireplace
 circulates heat, will not smoke,
 damper seals air-tight!

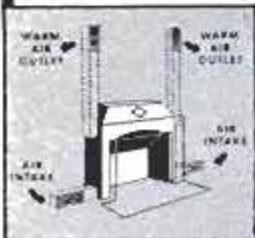

Here is the only fireplace especially designed for modern homes. It is the new Heatilator fireplace that gives you all 3 of these features . . .

Circulates Warm Air. Cool air from the floor level is warmed in the double walled firebox — then circulates gently to every corner of the room and even to adjoining rooms.

Will Not Smoke. A scientifically designed steel form, the Heatilator unit does away with guess-work and rule-of-thumb construction methods. It adds little to cost of finished fireplace.

Damper Seals Air-Tight. The new Pressure-Seal Damper seals the chimney throat air-tight when the fireplace is not in use. No house heat escapes up the chimney to add dollars to fuel bills. No chimney downdrafts can cause cold drafts in the room. And in the air-conditioned home, it prevents the loss of expensive summer cooling as well as winter warmth.

The Fireplace for Every Purpose. Ideal for homes, basement rooms, camps or cabins. Be sure you get the genuine. Look for the name Heatilator on the damper handle and dome. Sold by building material dealers. Mail coupon for free booklet.



HEATILATOR® FIREPLACE



Heatilator Inc.
 442 E. Brighton Ave.
 Syracuse 5, N. Y.

Send free booklet on new 3-Star Heatilator Fireplace.

Name

Street

City Zone State

✓ If they had unlimited money to spend, what make would they buy?

Under \$5000 a year:

Cadillac	35.6%
Oldsmobile	11.9%
Lincoln	9.9%
Chrysler	7.6%

\$5000 to \$10,000 a year:

Cadillac	39.5%
Lincoln	12.6%
Chrysler	9.3%
Oldsmobile	7.4%

Over \$10,000 a year:

Cadillac	41.2%
Chrysler	14.9%
Oldsmobile	9.6%
Lincoln	5.4%

In all income brackets, there is no doubt that Cadillac has a firm grip on the prestige market. It is a grip that gets stronger as the income bracket goes up. Another interesting point is the way Chrysler moves up from 4th in the low-income group to 2nd in the high-income group.

✓ When buying their new 1955 car how many bought the same make as the one traded in?

Bought same make	47.4%
Different make	52.6%

✓ When buying their 1955 car how many bought in the same "family" as the one they traded in?

Same "family"	67.2%
Different "family"	32.8%

There seems to be considerable shifting of brand-ownership with fewer than half the owners staying with the same make. But more than two thirds remained in the same family (General Motors, American Motors, etc.).

✓ How many owners say they feel loyal toward one particular make?

Feel loyal toward a make	47.5%
Do not	52.5%

✓ How many owners would look first at a different make from their present car if going out to buy a new car tomorrow?

Would look at same make	48.2%
Different make	51.6%

✓ Of those who would look at a different make, what is the most important factor in their choice of a new car?

Styling	20.3%
Engineering	10.1%
Cost of operation	8.5%
Price	6.1%

Once again it seems that styling or exterior appearance is the most important influence in the choice of a new car. Far down on the list come speed and performance with a combined total of only 3.0%. ★ ★ ★

Look! Router At Work



Those of you who have never used a router need only see one at work to be fascinated . . . need only try one to want it for your own shop.

The router shown here, cutting a decorative edge, is Stanley's No. H15. Its $\frac{1}{4}$ hp Stanley-built motor powers a wide variety of bits at a smooth cutting 27,000 rpm. For heavier duty we recommend the $\frac{1}{2}$ hp Stanley H45 Router.

Look Again! It's A Shaper

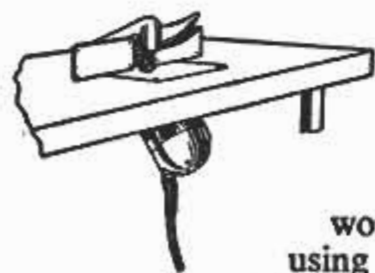

Now it's a shaper! The Stanley Router converts to a useful shaper when mounted on your work bench as above, using the special shaper adapter kit. Same router motor powers shaper. With H15 Router use Kit H127 . . . Kit H26 if you have H45.

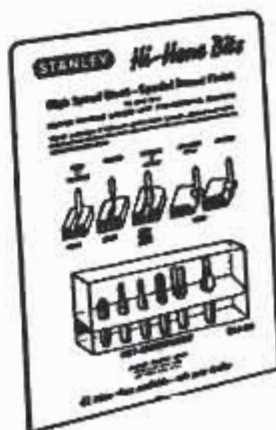

You'll want a variety of bits for your router. This H27 Assortment of "Hi-Hone" bits gives you 6 of the most popular. Your dealer has a full selection of Stanley bits and cutters for router and shaper. Start with the H27 pack and add as you need.

Stanley Routers are on display at your favorite hardware store or building supply dealer's. Ask for a demonstration. For further details send for Catalog 400. Write Stanley Electric Tools, 622 Myrtle St., New Britain, Connecticut.



STANLEY

FREE PLAN

Tells How to Start
Your Own Business

FILING SAWS



Saws come
from 20 and
30 miles

Files Thousands of Saws
in Spare Time

"I rented a two-car garage and have all the work I can do. Some days I start 6:30 in the morning. I get work 20 and 30 miles from my place of business."
—Charles H. Smith

"I have done 4 or 5 thousand saws in my spare time in the 4½ years since I got the outfit, and they are all coming back with repeat orders."
—Len Grego.

FOLEY FILED SAWS BRING NEW CUSTOMERS

Here is a steady repeat CASH business that pays up to \$3 to \$5 an hour, and you can start in your own basement or garage in your spare time. Every saw you sharpen with the machine accuracy of the Foley Saw Filer is an ad that brings more customers. S. M. Hollingshead wrote to us: "I am doing very well with my Foley Filer, and I am glad I invested in your machinery. It is very satisfactory and works very well in the small community in which I live."

You can file all hand saws, also band and crosscut circular saws on the Foley Saw Filer. The adjustments are simple—there is no eyestrain—and you can start right away to turn out perfect cutting saws. "The first saw I sharpened with my Foley Saw Filer came out 100%. I think it is a marvel of perfection,"—writes Clarence E. Parsons.

"**MONEY MAKING FACTS**" explains how you can get business from hardware stores, home owners, farmers, carpenters, schools, mills, factories, etc. Just think—with a modest investment, no overhead, no stock of goods to carry, you can start right in on a cash business that will help pay the rent, buy groceries, or a new car. Get the facts—send coupon today for this practical, money making plan. No salesman will call.



Send for **FREE BOOK**

FOLEY MFG. CO., 216-6 Foley Bldg.,
Minneapolis 18, Minn.

Send me free book "MONEY MAKING FACTS"

Name _____

Address _____

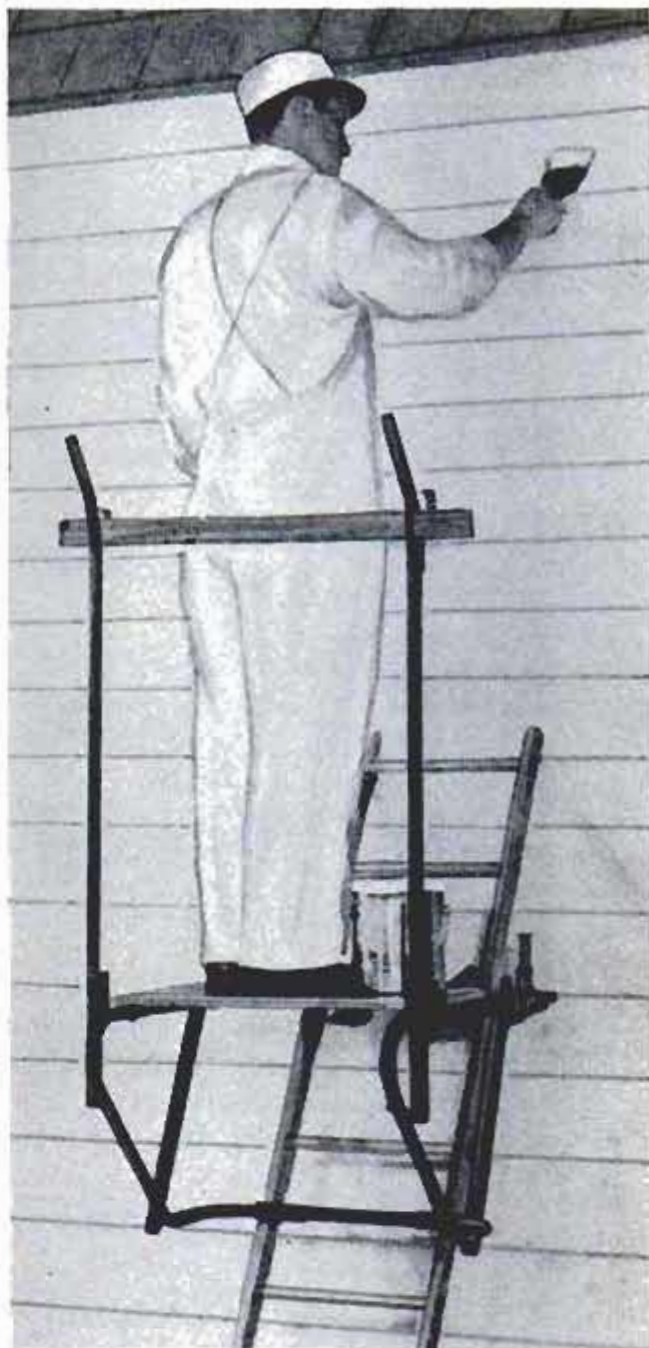

Ladder Scaffold

Amateur painters can work rapidly while standing on a portable platform that mounts near the top of any ladder. The sturdy platform, made of lightweight aluminum, grips the side rails of the ladder with nonslip clamps. A guard rail prevents accidental falls. By combining two platforms and two ladders, a large scaffold is quickly formed.

Floating Roof for Fuel Tanks

Installation of floating steel roofs on conventional fuel-storage tanks is helping to cut huge evaporation wastage. Last year, oil companies lost 63,000,000 gallons of fuel through evaporation from fixed-roof tanks. The floating roof, which rises and falls with the fuel, gives it no chance to vaporize and seep out.

IF YOU WANT BETTER PICKUP AND POWER plus big gas savings...please read this ad!

**Amazing new gasoline pressure regulator,
pulsation dampener, lifetime fuel filter,
carburetor protector employs entirely new automotive
engineering principles, gives results never
before possible in new or old cars!**



Are you one of the hundreds of thousands of motorists troubled with rough idling, dying, vapor lock, jerky acceleration, difficult starting, traffic stalling, carburetor wear, poor gas mileage, excessive gasoline odors in the car?

Then you'll want to read this ad very carefully.

Whether your car is factory new or years old, Mileage Minder positively promises quick help.

Yes, Mileage Minder was developed to meet the urgent need for a continuous, clean, non-pulsating supply of fuel at the carburetor... to lick the serious fuel waste and performance problems of later model high-speed engines fed by present wasteful, pulsating types of fuel pumps.



1. Stops Flooding, Saves Gas—*Pressure Regulator*... maintains uniform fuel pressures, prevents flooding and gas waste and assures maximum economy and performance at high or low speeds.

2. Prevents Carburetor Wear, Improves Performance—*Pulsation Dampener*... and carburetor protector. When raw, unregulated gasoline pulsates violently into the carburetor, the needle is constantly hammered. Wear quickly results and gas is wasted, particularly in modern high-speed engines. Mileage Minder positively and continuously delivers smooth-flowing fuel economically to the carburetor at any speed.

3. Traps All Dirt and Metal Particles—*Perma-Life Fuel Filter*... the micro-porous sintered bronze filter disc removes ALL dirt, never needs replacement, and always assures clean, pure fuel. Tiny metallic particles dislodged from factory welded gas tanks, and other new parts, are trapped—they can't clog jets, can't jam carburetor needles—flooding, stalls and gas waste at high speeds are eliminated. A very important point!

4. Ends Vapor Lock... Vapor dome employs new principle to trap vapor-locking gasses.

5. Beautify your engine... Mileage Minder is a picture of proud polished-chrome engineering skill.

If you'd like a quick and positive power increase... and if you'd like to stop gas waste, flooding, stalling, vapor lock, carburetor wear...if you'd like to do all of these things for your new or old car, then fill out the no-risk coupon on this page, right now while this magazine is in your hand.

You'll find Mileage Minder simple and easy to install in a matter of minutes, with end wrench or pliers. Easy-to-follow instructions. Mileage Minder is fool proof for a lifetime of car service. No adjustments or worn out parts.

Remember, satisfaction is absolutely guaranteed, with no strings attached. If you aren't absolutely amazed and pleased, just return Mileage Minder and your money and postage will be promptly refunded, without question.

MR. DEALER AND WHOLESALE—Mileage Minder will quickly and easily solve many of your common tune-up and maintenance problems, such as flooding, poor gas mileage on both new and older model cars. Only one number to stock—for all popular cars including 1956 models. Free convincing displays. Write now!

MILEAGE MINDER

HERE'S HOW MILEAGE MINDER IS ABLE TO ABSOLUTELY GUARANTEE MORE POWER, BETTER PERFORMANCE, GREATER GAS MILEAGE:

- From fuel pump—gasoline surges in raw, unregulated hammering pulsations!

Within amazing new Mileage Minder, four steps take place:

- A.** Lifetime micro-porous filter removes all sludge-making dirt and metal particles small as .001".
- B.** Patented spring loaded neoprene diaphragm tames hammer-like pulsations, regulates fuel to even, full flow.
- C.** Vapor-locking gasses are harmlessly trapped in vapor dome.
- D.** A steady, clean, economical flow of gasoline is delivered to the carburetor.

©1956

What Engineers Say: "Mileage Minder has been thoroughly tested, and has gained my unqualified approval. It does everything claimed for it and more." **Edmund D. Carlson, A.E.E. Engineer**



MAIL NO-RISK COUPON TODAY!

PASER MFG. CO.
535 Turk Street, San Francisco 2, California
Please send Mileage Minder postpaid, with satisfaction guaranteed.
I enclose cash _____ check _____ money order _____ for \$4.95.
(Special, quick action offer includes postage)

Name _____
Address _____
CITY _____ STATE _____
Make, year, model of car _____

Coleman "OUTING PALS"

Add Hours of Fun
to Every Outing!

You'll have more fun, enjoy new comfort outdoors with Coleman Outing Pals. See them at your dealers.

New Coleman Portable Cooler

Keeps foods, beverages freezer fresh. Low "K-factor" (heat-transfer) holds the cold longer. Lid catch lifts easily, locks automatically. Inside corners rounded, stay clean, odor-free.



Coleman Folding Camp Stove



Lights instantly. Hot, homelike meals anywhere... in a jiffy! Burns low-cost Coleman Fuel or unleaded gasoline. Folds up, carries like small suitcase.

Coleman Carrying Case-Camp Table

Roomy, all-steel carrying case holds 4 folding stools, cooking utensils, food, hunting and fishing gear. Unfolds into strong, rigid picnic table, 28-in. square. Keeps food away from damp ground, insects, litter!



Coleman Floodlight Lantern



Brilliantly floodlights 100-ft. area. Safe, stormproof. Lights instantly. Gives 8 to 10 hours service on single filling. Burns inexpensive Coleman Fuel or unleaded gasoline. Coleman REFLECTOR converts it to a powerful spotlight.

Try new Coleman FUEL. Specially blended, clean burning. Has rust inhibitor. Won't gum up.



FREE

New Outdoor Book. Many useful tips for your hunting, fishing and vacation trips.

FILL OUT COUPON!

THE COLEMAN COMPANY, INC.
Dept. 11-PM, Wichita 1, Kansas

Please send me free copy of the new Coleman Book "More Fun on Every Outing."

Name.....

Address.....

City..... State.....



Plastic Flying Model Of Douglas Skyraider

With only scissors and cement, youngsters can assemble a flying scale model of the Douglas F4D-1 Skyraider, a foot and a half long yet weighing only three ounces. The model is launched with rubber bands, and flies and glides like its prototype. It is molded of high-impact styrene and shows fine detail, even down to the rivetheads. Half sections are quickly cut from the formed sheets and cemented together; then exterior parts are cut out and cemented on.



APPROXIMATELY

* 22

DIFFERENT BRANDS OF SANDERS TO CHOOSE FROM

15 14 13 12 11 10 9 8 7 6 5 4 3 2 1

WHICH IS THE BEST SANDER FOR YOU...?

Professionals claim it's the sanding pad motion that counts in surface removal. Today's army of over 22 sanders use 1 of 4 different "motions"! Which motion will do that sanding job *best* in your home away from advertising claims and salesmen? We say exclusive Syncro MULTI-MOTION will *BECAUSE*—most wood grain being naturally crooked and irregular—only Syncro "Multi-Motion" sanding pad action can sand *with* such grain and completely *finish* the *whole* surface! See for yourself—accept our sporting offer shown below—and get your *next* home sanding job done *without* having to buy *any* sander!

* Maybe More Any Day!

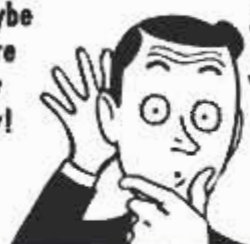

"Mine is Best!"
"No—My Sander is Better!"
"Don't Believe Their Claims!"
"Ours Sands Perfectly!"
"X-Sander is Cheaper and Better!"

RENT—TRY THIS SANDER ON YOUR OWN JOB... RETURN FOR PROMPT RENT FEE REFUND... OR BUY IF IT SATISFIES YOU!



SEND NO MONEY

DO THIS: (1) Send coupon, your tool dealer name, address—we'll ship No. 900 Sander, Sanding Handbook, Sandpapers to you. (2) Pay postman \$20 (10 days rental fee). COD fee, postage charge, on arrival. (3) Use sander 10 days, return it prepaid—we'll refund your \$20 promptly. (4) To buy it, pay dealer (named on coupon) balance of \$19.95. Send us *receipt of purchase* from dealer, we'll ship you \$3 worth of sandpapers as our Gift!

Free

OF EXTRA COST

In addition to the Free Sandpaper included with your Rental 900 Sander, if you buy sander after trying on this offer—send us receipt of purchase from dealer, we'll ship you \$3 worth of sandpaper FREE.

DEALERS WRITE!

Dealers write on letterhead for complete Rental Sander details... for entirely different store-operated "Rent or Buy" Plan that can increase sander sales 60% at Full Dealer Profits!

"900" SANDER FACTS

Outlasts and outsands others. Jump-Free. Easiest of all to use. Exclusive Multi-Motion sanding pad action. Heavy-duty. Guaranteed against burn-out during rental use and ownership. Full 6 months Warranty. Retail Price only \$39.95.

SYNCRO POWER UNITS
GUARANTEED
AGAINST BURN-OUT DURING
YOUR OWNERSHIP OR
REPLACED FREE!

OFFER ENDS JULY 1, 1956

TO: SYNCRO CORPORATION
Dept. 1-26, Oxford, Michigan, U.S.A.

Send me Syncro #900 Sander COD on 10 Day Rent Fee Refunded Offer. Within 10 days after Rental Period I may either (1) return Sander prepaid to factory only (Syncro Corporation, Oxford, Mich.) for prompt \$20 refund! Or (2) I may pay dealer direct (named below) balance of \$19.95 and I will own Sander. Offer ends July 1, 1956.

Name of Hardware Store or Tool Dealer: _____

ADDRESS _____

MY NAME _____

ST. & NO. _____

CITY _____ ZONE _____ STATE _____

(Offer Good Only In Continental U.S.A.)

Just Mail This



© SYNCRO CORP. 1956

SYNCRO

SAWS AND SANDERS

SYNCRO CORPORATION, Dept. 1-26, Oxford, Michigan, U. S. A.

KLEINS

mean a better job

201-NE
Side Cutting
Plier



301
Long Nose
Plier

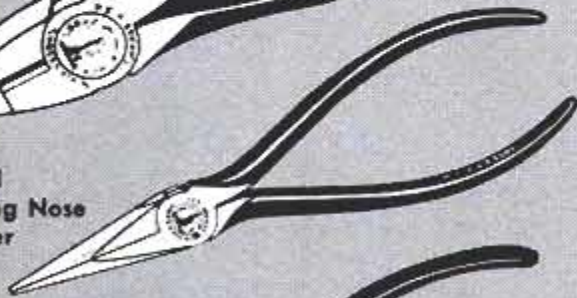

202
Oblique Cutting
Plier

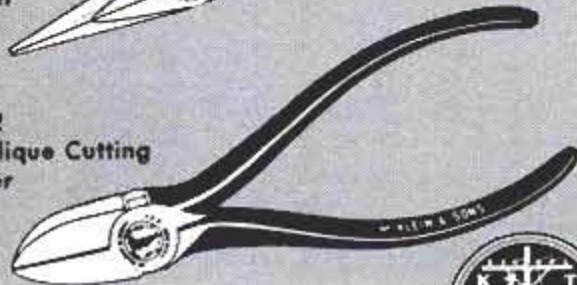

Here are three pliers that will help you do a better job—three tools that should be in every workman's kit.

Klein pliers are recognized by electricians, linemen and good workmen everywhere as the standard of comparison by which other pliers are judged.

The work you do is only as good as the tools you use. Be sure the tools on your bench or in your kit include genuine Kleins, famous for quality "since 1857."



Your hardware store has Kleins in stock or can get them for you quickly. Look for this new display board. It shows the most popular items in the Klein line.

Seattle Police Patrol an Underwater Beat

(Continued from page 155)

most startling sight he has ever encountered under water. And Francis, mind you, grapples with octopuses in his off-duty hours, for sport and food. But staring at him now was a hairy face with long horns.

Then, within his mask, Francis chuckled. He was looking at a dead cow.

Minutes later he had the blown safe. Cash and checks were gone, but some important papers were still intact.

And Christmas can even loom up for a police-frogman in midsummer. Officer Yerabek, who ordinarily walks a beat in the Belltown district, got a call in the heat of the afternoon to dive for the body of a four-year-old boy who had drowned off the Salmon Bay Terminal.

When Yerabek went down he first found himself crawling along sunken logs. Then he drifted into a forest of evergreens. This was an experience that had not come even to Alive in Wonderland—walking through a forest beneath the water. But when Yerabek grasped a tree it moved. Then he knew. A Christmas-tree merchant had used the bay for dumping his surplus stock.

Just about everything ever found by charwomen cleaning up in a theater has been discovered by the police-frogmen while on diving jobs. One thing that puzzles them, however, is the odd places they have found lost golf balls such as off the West Waterway Bridge.

A 23-year-old man had turned Fagin in the "Oliver Twist" manner, and trained teen-agers as purse snatchers. When caught, a teen-ager talked. The looted purses were habitually tossed off the bridge by the gang's master-mind. Officer Faires went down into the water and retrieved the purse evidence—plus golf balls. Seattle, he figures, has some long-distance drivers.

Among other odd and incidental recoveries was the *Laura Lee*, a 29-foot cruiser which sank in Lake Washington in 1942 when, in a storm, she was blown against the Floating Bridge. The battered *Laura Lee* was not exactly a rich find, but Faires is hoping for better luck.

Chief Lawrence has offered the services of the Underwater Search and Recovery Unit to other police departments in the area, and that means the frogmen are likely to get assignments in a great many different waters. On the wall in his home, Faires has tacked up a coastal chart showing the more than 450 places where ships have been sunk. Under water, he is continually

(Continued to page 320)

Mathias **KLEIN** & Sons
Established 1857 Chicago, Ill., U.S.A.
7200 McCORMICK ROAD • CHICAGO 45, ILLINOIS



Mainstays of the Hertz rental fleet. Front row (left to right)—Buick, Ford, Chevrolet. Back row—Cadillac, Oldsmobile, Plymouth

Why does Hertz — world's largest rental fleet — use Champion Spark Plugs?

Operating 15,500 cars and 15,000 trucks, Hertz wants the most power and the most miles per gallon . . . so Hertz uses full-firing Champions!

You can bet that Hertz—world's largest rental fleet—knows all there is to know about spark plug performance and value!

In countries all around the globe—Hertz has put spark plugs through the world's toughest road test. And the fact that Hertz uses 5-rib Champions speaks for itself!

Whatever car you drive—Chevrolet, Ford, Plymouth or any of the

higher-priced makes—take a tip from Hertz . . . use 5-rib Champion Spark Plugs. When you install new Champions, you can immediately feel the difference in your car's response. You'll get quicker starts, faster acceleration . . . and more miles per gallon!

When you need spark plugs, don't settle for anything but the best. Get precision-made 5-rib Champions!

CHAMPION

LOOK FOR THE 5 RIBS



LUBRIPLATE

THE MODERN LUBRICANT



LUBRIPLATE Car Lubrication is different . . . it's better. **LUBRIPLATE** Lubricants make your car run better, last longer. Protect your car investment, cut your repair bills and parts replacements to an absolute minimum. If you want the very best for your car insist on **LUBRIPLATE** Lubrication.

LOOK FOR THIS SIGN!

It's Your Guarantee of the Finest in Car Lubrication. Consult your car dealer.



LUBRIPLATE H.D.S. MOTOR OIL—A heavy duty superior oil with high film strength. Fully detergent, keeps your engine clean, gives your car more power, faster starts, better fuel economy. *The oil that requires no additives.*

LUBRIPLATE IN TUBES

Packed in handy tubes. Excellent for lubrication of car door hinges, locks, hoods, fishing reels, guns, outboard motors and everything around the house. Available at sporting goods and hardware stores, marine dealers and all automotive outlets.



LUBRIPLATE DIVISION, Fiske Brothers Refining Company, Newark 5, N. J., Toledo 5, Ohio

on the lookout for those sunken ships.

Ask the three police-frogmen what their off-duty hobbies are, and you get one answer: Swimming and diving. Each began swimming before school age.

"My brothers took me out to Pier 91, gave me a pair of water wings and said, 'Swim,'" recalled Yerabek. "I started dog-paddling like mad."

Now he is an instructor in the police-school swimming and first-aid classes. So, too, is Faires, who used to be on the University of Washington swimming team. To augment his police salary—and keep in practice—Faires does commercial diving in his spare time.

For Francis, the police diving is more of the same that he had in a nine-year Navy stretch. During World War II, he served in the South Pacific with an underwater demolition outfit, and helped blow up a Grade-A Japanese sea wall to expedite an invasion. Besides wrestling octopuses in Puget Sound water now, Francis spear-fishes cod down where ordinary fishermen don't go. He tucks about 2000 pounds of fish in the freezer each year.

All three frogmen are sold on regular police work, but they can't get too much of the underwater stuff. Once a year, however, when Seattle holds its Seafair, the frogmen get full-time water duty. They are on the alert in Harbor Patrol boats or on docks to dive for anybody who goes overboard—especially during the Gold Cup speedboat trials and races. And usually somebody does—more often than not a small-fry spectator.

Faires had a particularly pleasant rescue job when one of the Seafair princesses was water skiing and, in a spill, hit her face on a ski. Semiconscious, she floundered in the water, and Faires dove. He swam back to the dock with her and shoved her onto it. The spectators were so startled by the scene, no one offered to help. So Faires climbed on the dock, picked up the girl, carried her to shore and gave her first aid. It was a one-man frogman show with a beautiful girl as the "prop."

But Faires says he got the biggest boot out of Seafair duty in retrieving a cannon. At the Corinthian Yacht Club an 18-inch cannon has long been used to start the sailboat races. Only this time the starter became overenthusiastic with his powder-pouring. The cannon went off—into the water. Faires dove down 36 feet, and quickly recovered it.

The frogmen will go deeper if they have to—more than 100 feet down. And the Seattle Underwater Search and Recovery Unit, one of the newest police organizations in the nation, will go far. ★ ★ ★

THERE'S A NEW YOU IN THIS PICTURE!

• **SHOPSMITH** gives you new skill!

You're bound to do better woodworking with SHOPSMITH. Its Speed-Dial automatically gives you correct tool speeds. Its built-in jigs give positive accuracy. Its changeability gives you exactly the right tool for any sawing, sanding, drilling or lathe job.

• **SHOPSMITH** gives you new satisfaction!

You'll have the satisfaction of seeing jobs through to completion with the one tool that can take you step by step—from the first saw cut to the finished sanding.

• **SHOPSMITH** gives you new versatility!

You'll be equipped for any job—from building toys and play-yard equipment to remodeling or adding complete rooms—at savings of 20-60% (more than enough to pay for SHOPSMITH).

• **SHOPSMITH** gives you new pride!

You'll be proud owner of the finest, most modern home workshop tool—a masterpiece of functional machine design (compare it with modern industrial tools). Its polished, precision parts are held to tolerances as close as .0002".

Now you can own **SHOPSMITH** for as little as \$3 per week on Magna's Tool-Time Plan

See the new SHOPSMITH® Mark 5 demonstrated at leading hardware or department stores or any Montgomery Ward store. See how it converts in less than 30 seconds from a 9" circular saw to a 12" disc sander, 34" lathe, 16" drill press or horizontal drill.

Power Mount makes it easy to add Magna's new 18" jigsaw or 4" jointer. See the Speed-Dial you simply dial to select the right speed for the job. SHOPSMITH comes ready to plug in, with built-in ¾-hp. motor, bench, chrome rustproofing — \$289.50



3 FREE BOOKS

1. "Project Digest," 36 project-packed pages.
2. "What to Look for When You Buy Power Tools," valuable shop guide.
3. Illustrated 20-page SHOPSMITH catalog.



MAGNA POWER TOOL CORPORATION

Dept. 317-B, at factory nearest you:
Box 2808, Fort Wayne, Ind., OR Menlo Park, Calif.

I'm interested! Please rush me the three free books and name of my nearest dealer.

Name _____
Address _____
City _____ State _____

(Continued from page 118)



WORLD'S TOUGHEST HAMMER

Now you can get a heavy-duty 20-oz. ripper in the famous ROCKET model. It's a brute-strength tool—the most rugged hammer ever made. The tubular steel shaft won't bend or break. The head, locked to the shaft, can't loosen. It's the perfect hammer for electricians, plumbers and for all heavy-duty work—crating, flooring, framing, concrete forms, etc.

The nonslip cushion grip absorbs shock. This is the sweetest feeling hammer you ever swung. See all the ROCKETS—and True Temper's fine wood-handled hammers, too. True Temper Corp., Cleveland 15, Ohio.



TRUE TEMPER.

Finest quality in Hammers, hatchets, axes • Garden, lawn and farm tools • Shovels • Shears • Fishing tackle • Golf-club shafts

10,500-pound-thrust engines and other equipment that will be installed on Comet 4, the new airliner now being designed. Comet 4 is intended to carry 58 passengers a distance of 2870 miles against a continuous headwind of 50 miles per hour with normal fuel reserves. It will be able to fly from London to New York in 9½ hours, including one fuel stop. It could fly from San Francisco to New York in 5 hours and 18 minutes.

De Havilland, manufacturer of the Comet 4, reports that no fewer than 3000 fatigue tests have been conducted on specimen assemblies during the designing of the new jet. These tests, combined with information and techniques gathered from earlier Comet models, indicate that the Comet 4 will have a fatigue life of 60 years—roughly six times the minimum flight life required of the aircraft.

With all these new aircraft, Mr. Average Air Traveler will soon be traveling faster than ever before and probably he won't have to pay a bonus for speed. Douglas engineers who worked out the economics of the DC-8 figure that on a seat-mile basis, operating costs of the DC-8 will actually be less than with some of our present transports. Mr. Average Air Traveler may find that he can go from New York to Chicago in less than two hours for the same price that he now pays for a much longer ride.

In the race to cut their schedules and supply faster and more comfortable service for their patrons, the airlines and the aircraft manufacturers are not waiting for the new designs to roll off the assembly lines. Many of the airliners flying today are being tested with new equipment to bring about these timetable revisions as soon as possible. For example, the Convair 340, a workhorse on short and medium-length hauls, is being tested with turboprops replacing the present Pratt and Whitney R-2800 piston engines. Preliminary research is being done for the Air Force, but if the conversion performs as expected, the airlines which use the Convair will be anxious to adapt their own equipment.

The rapid progress of the aviation industry is due to a large extent to keen competition. The airline company offering the fastest schedules and the newest equipment draws the larger share of the passenger and freight traffic. And the aircraft manufacturer who provides the airlines with the best equipment for their purposes gets the biggest share of the orders.

(Continued to page 324)



Hay-Bale Dump Truck Sets Its Load Down Quickly

Hay bales carried on a specially modified truck are stacked on the ground minutes after the truck backs up to the site. The bed is tilted like a dump truck's to a vertical position by a hydraulic cylinder. Two heavy steel-plate forks extend upward from the rear of the bed to prevent the bales from falling during the tilting operation.

When the bales come to rest on a framework of four-by-fours, the two steel forks are freed of their weight and the truck drives away. During unloading operations, metal legs on the ends of the frame beams drop down to rest on the ground. Bales can be loaded on the truck by reversing the procedure.

Here's that new **MAGNA** JOINTER

This big Magna Jointer has all the built-in precision and features that you'd expect from the makers of SHOPSMITH®

*Exclusive *Twin-tube Mount* for bench, *Magna Power Stand*, or SHOPSMITH. Gives you *Instan-Tension*.

- ① Longest table of any 4" Jointer—28"
- ② Largest and most rigid fence—21 3/4" x 3"
- ③ Greatest depth of rabbet—3/8"+
- ④ Single knob fence control—3 auto-stops
- ⑤ Safety-taper, Micro-Adjustable Knives

Only \$49.95. Ask your dealer about Magna-Tool-Time Plan. See the new Magna Jointer demonstrated at leading hardware and department stores or any Montgomery Ward store. For free literature write Department 319-B, Magna Power Tool Corporation, Box 2808, Fort Wayne, Indiana, or Menlo Park, California.

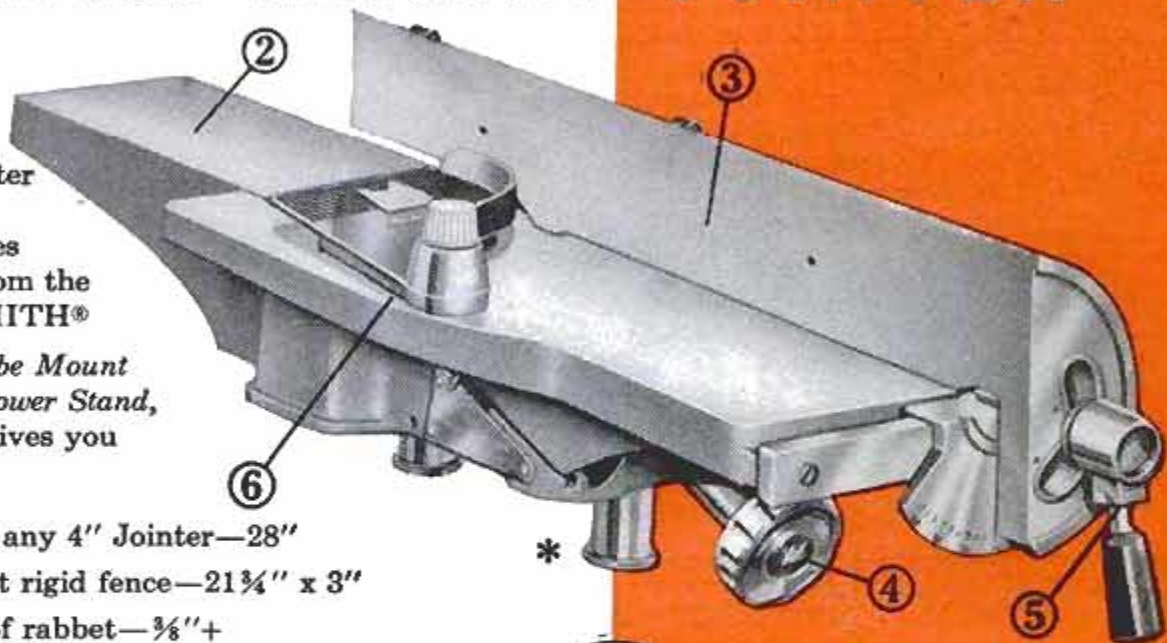

MAGNA

POWER TOOL
CORPORATION

Manufacturers of
SHOPSMITH

Add this BOY'S ROOM in your waste attic space!

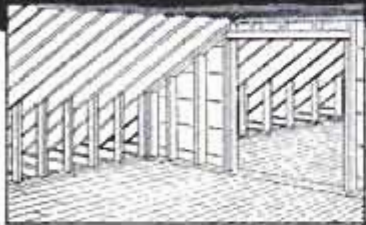

Start this week end... with Gold Bond Building Products



It's easy to build your boy his own room right in your attic—with Gold Bond Add-A Room products. With framing in place, just staple up new, fireproof TWINSULATION . . . it keeps his room warm and cozy in winter, up to 15° cooler in summer. Next, nail up rugged Gold Bond Gypsum Wallboard for smooth, fireproof walls and ceilings. And, for a beautiful finish, roll on your favorite shade of Gold Bond Velvet paint. It dries in minutes and it's washable!



NATIONAL GYPSUM COMPANY
Buffalo 2, N. Y.

MAIL COUPON TODAY

NATIONAL GYPSUM COMPANY
Dept. PM26, Buffalo 2, N. Y.

Please send me my Gold Bond Add-A-Room Instruction Packet. Enclosed is 10¢ to cover mailing.

Name _____

Address _____

City _____ Zone _____ State _____

This fierce competition forces aircraft manufacturers to look far into the future. They are already planning planes for 10 and 15 years from now. In the Lockheed engineering department today is a concept of a future airliner that would blast from Chicago to Los Angeles in 1 hour and 23 minutes. It would have a block speed exceeding 1200 miles per hour.

No one knows when Lockheed will build an airliner like that, but you can be sure of one thing. Mr. Average Air Traveler will become impatient after a few flights. "When are we going to chop this time down to one hour flat?" he'll be demanding of the airline companies. ★★★

Instrument Counts a Million Objects per Second

With a new instrument, scientists can count up to a million objects of varying shapes and sizes within one second. The instrument, developed by Du Mont Laboratories, may be used to count blood cells, nuts and bolts, stars on astronomical photos, impurities in raw materials and other objects. The objects are placed within the unit's "counting house" compartment and are lighted by a cathode-ray tube, which has on its screen a pattern of light composed of 1000 individual lines. The tube scans the objects line by line, and the light reflected from them falls on a photocell, which generates an electrical signal corresponding to the light falling upon it. The signal is fed to a memory system and a computer, which determine how many objects there are in the "counting house."



QUIT "FUELING" AROUND.



Perfect partners in power! Rochester Carburetors are engineered for the newest high-compression engines.

No sense in playing "gas-ing" games! All fuels are fine—every one of today's high-octane gasolines delivers high-power, high-economy performance! But Rochester Carburetors are designed to really deliver the goods—to give you more performance, longer mileage between gas stops. So hop to it—specify Rochester when you're ready for a carburetor. Original equipment for Cadillac, Buick, Oldsmobile, Pontiac and Chevrolet cars.

CARBURETORS BY ROCHESTER

ROCHESTER
PRODUCTS
DIVISION OF
GENERAL MOTORS
CORPORATION
ROCHESTER N. Y.



How FORD'S new steering wheel soaks up impact



The statistics: 40% of all driver-injuries in accidents are caused by the driver striking the steering wheel assembly!

The problem: to develop a new kind of steering wheel that would have a high degree of energy dissipation upon impact . . . protect the driver from the steering post in the event of an accident.

The solution: Ford's exclusive new deep-center Lifeguard steering wheel!

Ford's new Lifeguard wheel, standard on every '56 Ford model, is connected to the shorter steering post by three *equally spaced* spokes. Exhaustive tests show (see opposite page) that in case of impact, the spokes of this exclusive new Lifeguard wheel will bend away from the driver and at the same time, "soak up" force of impact. The driver, with his weight distributed over the rim of the wheel, is thus cushioned from striking the rigid steering post violently in an accident.

FORD Division of

POPULAR MECHANICS

After more than two years of testing and research, Ford comes up with an exclusive new contribution to driver safety!

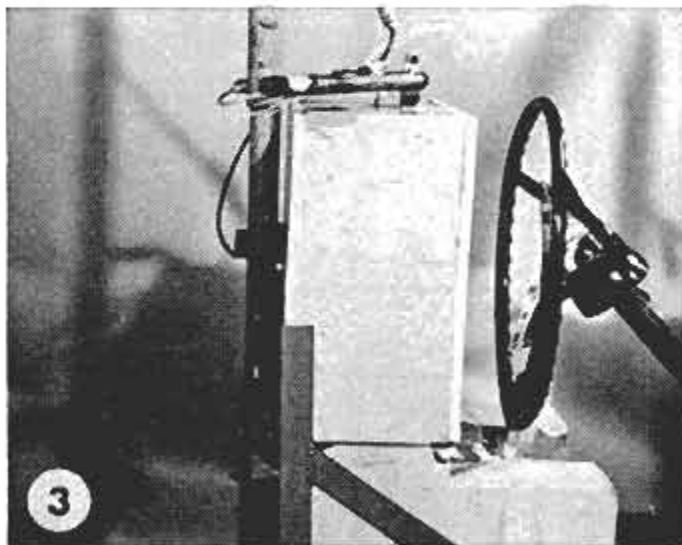
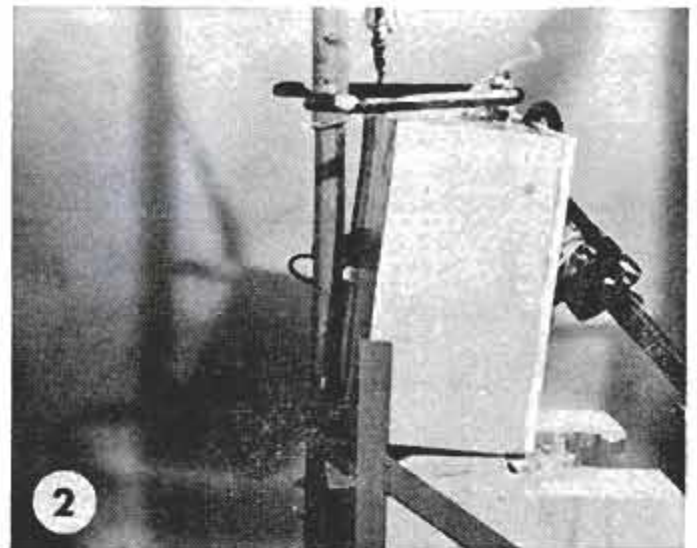
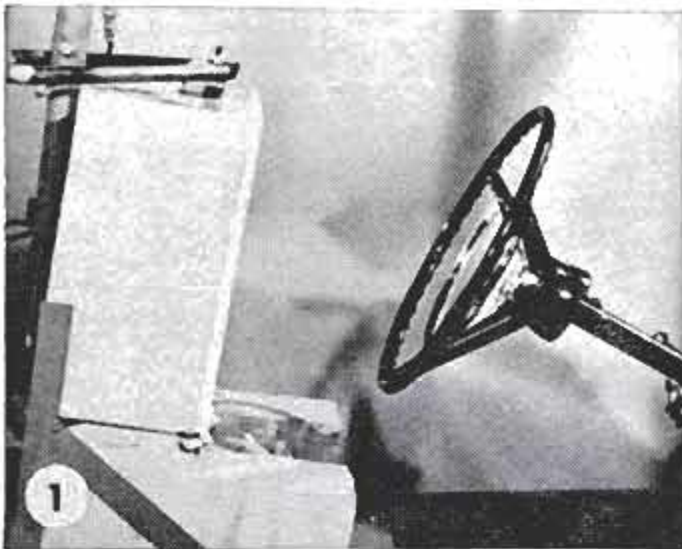

1. Test equipment for impacting steering wheels is shown in illustration No. 1. A mass equal to the weight of the driver is dropped onto the wheel—in this case, Ford's exclusive Lifeguard deep-center design.

2. As block strikes deep-center Ford wheel, spokes yield under impact, absorbing energy as they do so. The force is dissipated before the block reaches steering post.

3. Note in illustration No. 3 the rim has not collapsed but rather the spokes have yielded following the *controlled* direction pattern that helps protect the driver from injury.

FORD MOTOR COMPANY

IN YOUR CAR RADIATOR...

GUARANTEED TO STOP RUST!

**WATER STAYS
CRYSTAL CLEAR
FOR OVER
ONE YEAR**

Just one can of
MAC'S NO. 13 re-
moves rust and scale
... prevents costly
repairs. Get MAC'S
NO. 13 today.



**AT SERVICE
STATIONS EVERYWHERE**

MAC'S SUPER GLOSS CO., INC.
Los Angeles 42, California

New HEAVY DUTY Tape Rule

makes measurement
easier and faster

$\frac{3}{4}$ "
R



WHITE CLAD SUPER MEZURALL

CHECK THESE "SUPER" FEATURES—16-inch centers indicated. Wide $\frac{3}{4}$ " steel line is flexible, yet extends farther unsupported. Long lasting snow-white line has bold, jet black figures. Top edge graduated feet and inches, bottom edge consecutive inches. Long, wide adjustable end hook permits accurate measurement, hooks securely. Feather-weight Magic Metal case is light yet very strong. Packed in beautiful, two-color re-usable plastic box with hinged cover and snap fastener.

A Perfect Gift

for Craftsmen

BUY **LUFKIN**

334
TAPES • RULES • PRECISION TOOLS
AT YOUR HARDWARE OR TOOL STORE

THE LUFKIN RULE CO., Saginaw, Mich.

Parade of '56 Cars

(Continued from page 170)

This is the year, too, of the power pack to increase what engineers call maneuverability. It is also the year of the accentuation of the wedge shape which will lead to 1957's radically different rear fenders.

This is the year that Chevrolet offers 205 horsepower, Ford offers 202 horsepower and Plymouth 200 horsepower. Only five

SpecRating PRICE CLASSES

A. Low-price class (\$1795 to \$2231)

Rambler
Chevrolet
Ford
Plymouth
Studebaker, except the Classic

B. Low-medium price class (\$2229 to \$2760)

Dodge
Pontiac
Nash, except V8 models
Mercury, except Montclair
Buick Special
Hudson, except V8 models
Oldsmobile 88, Super 88
De Soto Firedome
Studebaker President Classic

C. High-medium price class (\$2731 to \$3444)

Nash Ambassador V8
Mercury Montclair
Buick Century, Super
Oldsmobile 98
De Soto Fireflite
Clipper
Chrysler Windsor
Hudson Hornet V8

D. High-price class (\$3458 to \$9507)

Buick Roadmaster
Chrysler New Yorker
Lincoln
Packard
Cadillac
Imperial
Continental

E. Sports-type class (\$1982 to \$6501)

Caribbean
Corvette
Thunderbird
Eldorado
Chrysler 300B
Studebaker Hawks

years ago, Packard and Cadillac alone offered as much as 160 horsepower. Now Packard advertises 310 horsepower and Cadillac's Eldorado has 305 horsepower.

Obviously, the manufacturers are catering to the motorist's passion for primacy at the stop lights. A significant drawback has been the declining economy of a tankful of gas. Higher horsepower has meant lower

(Continued to page 330)

Do *more jobs better* with a **THOR** home SpeedShop

ONLY
\$49⁹⁵



Only SpeedWay offers you a complete home workshop powered by a professional precision-engineered universal electric motor at such a rock-bottom price.

You can do a thousand-and-one jobs around your home or work-

shop. This 201-JTD SpeedShop will pay for itself in a few months. And you'll have satisfaction backed by SpeedWay's 40 years of volume production of quality electric tools.

Look! All this for only \$49⁹⁵

- ① Power saw table attachment
- ② Power drill press attachment
- ③ Power hand saw attachment
- ④ One 201-J 1/4" SpeedDrill
- ⑤ Geared, key-operated Jacob's chuck
- ⑥ Horizontal bench mounting stand
- ⑦ Combination steel wall box & carrying case

SpeedWay Manufacturing Co., Cicero, Ill. A division of Thor Power Tool Co., Aurora, Ill.

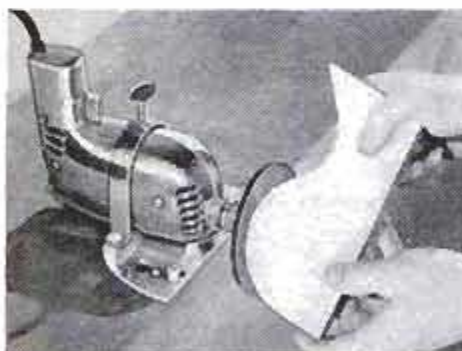

SANDING. All purpose sander. Finish furniture or use for fancy edge sanding. Equipped with ten 4" sanding discs.



DRILLING. There's power aplenty in this motor to drill 1/4" in steel, 1/2" in hardwood. Kit is equipped with 7 drill bits, 1/4" to 1/2".



POLISHING. 4 1/2" wool bonnet fits over rubber backer—shines anything. 3" buffing cloth, 3" wire brush for paint removal included.

TOOL OF 1001 USES!

"The Pocket-Size Machine Shop"

- GRINDS • CARVES • SHARPENS
- ROUTS • DRILLS • ENGRAVES

*Fastest, Most Powerful
Tool in Its Class*

You'll never run out of uses for the famous DREMEL Moto-Tool. Proved in hundreds of industrial plants, it works in metal, plastics and wood. It weighs only 13 oz., handles as easily as a pencil—yet it's so powerful and fast it's truly the "pocket-size machine shop!" Use it in your workshop—or to build a creative all-family hobby. Choose from two models and two complete kits!



27,000
R. P. M.

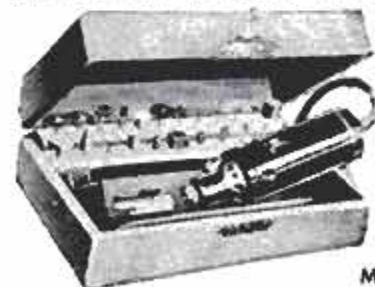

MOTO-TOOL NO. 1
For small bench work.
(6 oz. in weight.) With
1 emery wheel.....**\$10.85**

KIT NO. 1
Model 1 Moto-Tool plus 34
accessories. In steel case.....**\$19.50**

MOTO-TOOL NO. 2
More performance and features
for the money than any other
grinder! With emery wheel point.....**\$17.85**

KIT NO. 2
Includes Model 2 Moto-Tool and
23 accessories (high-speed steel
cutters, grinding wheels, pol-
ishers) in steel case.....**\$25.95**

FAMOUS DREMEL MOTO-SAW A TOOL ENJOYED BY ALL AGES!



CUTS SCROLLS LIKE MAGIC—SANDS AS IT SAWS

BLADE
FACES
4 WAYS

SAFE!
AS A
HANDSAW

**JUST
GUIDE IT!**

Only
\$6.85
with 3-1/2" blade

**Cuts 3/4" wood, plastics, light metal, tile, etc.!
No finer tool for beginning woodworkers!**

There's unbelievable capacity packed into this low-cost, electric wonder worker! Cuts scrolls smoothly—no sanding needed. Ideal for making toys, knickknacks, valances, shelves—a host of decorative and useful projects for the home. Best of all, the DREMEL Moto-Saw is priced so low you need no longer be content with hand coping saws. Start your family on a Moto-Saw hobby now!

SEE YOUR DEALER. If he cannot supply, order direct on 5-day trial, money-back guarantee. Remit in full for postpaid shipment. Or send \$2 now, pay postman balance plus COD fee.

DREMEL MFG. CO., Dept. 116-B, Racine, Wis.

miles per gallon. And gasoline prices have gone up in many states due to increased road taxes.

In the vital-statistics department, this year marks the end of Kaiser passenger cars and leaves Willys with only Jeeps and commercial vehicles. It hails the birth of the Continental Mark II and the resultant challenge by the Cadillac Eldorado Brougham. Also in the prestige area are the Chrysler Imperial and the Packard Caribbean.

American Motors is gearing its production and sales to the new Rambler which boasts a four-door hardtop and a four-door hardtop station wagon.

Throughout the industry the so-called hardtop models accounted for almost one out of four cars sold in 1955. With further emphasis on the four-door models this year, manufacturers expect this pillarless body style to supplant the conventional four-door sedan in two years.

Tabulations still are being made on Ford's new safety features and engineers believe it is still too early to determine the true demand. Door locks and safety steering wheels are standard on the 1956 Fords, but dashboard padding, seat belts and other items are optional. It is this optional material that should reflect the demand created by Ford's first annual safety conference.

Studebaker, with a major change in its basic models, is counting on the change to return it to a sales volume that will boost its share of the market. The aim is to sell at least 200,000 Studebakers and half as many Packard-Clippers. The new Hawk line of sports-type cars may give lots of competition to the Thunderbird and the Corvette.

Automatic transmissions, down in price, are expected to be ordered on more cars this year than they were even in the record production year of 1955. But car makers admit that power assists like power seats and power windows are not keeping pace with the demands for such practical aids as power steering and brakes.

General Motors, with a showcase filled with its own power packages plus a wide variety of station wagons, hardtops, engines and transmissions, has no intention of letting any business slip away to the competition. The 1956 Motorama suggests that its 1957 cars, some features of which are highlighted in this year's dream cars (see page 186), will continue the kind of consumer appeal that keeps it out in front in a most competitive market.

And after Ford introduces the new line of cars it will bring out in 1957 (still known as the Edsel and designed to fit pricewise between the Lincoln and Mercury), you can expect competition to get even rougher than it will be in 1956. ★ ★ ★

SHOP BY MAIL AND
SAVE
at **GROBAN'S**

SURPLUS & NEW MANUFACTURE
FOR HOME, FARM AND FACTORY **EQUIPMENT**

ALL
ITEMS
Unconditionally
GUARANTEED!

**RUGGED!! 20 TON MASSIVE!!
CAPACITY
HYDRAULIC CYLINDER**

- ALL STEEL CONSTRUCTION
 - 7 1/4" BORE—15" STROKE
 - DOUBLE ACTION
- 
- ITEM #1715
• 41,300 LBS. PRESSURE WITH 1000 P.S.I. PUMP OUTPUT.
- UP TO 70,000 LBS.—CAPACITY ON INTERMITTENT SERVICE.
 - SOLID STEEL 2 1/2" PISTON ROD
 - 1" PORTS
 - OVERALL DIAMETER—10 1/2"
 - DISTANCE BETWEEN CENTERS—28 1/4" CLOSED—43 1/4" OPEN.

IDEAL FOR:
• HYDRAULIC PRESSES • DUMP TRUCK HOISTS • TD-18, TD-24 INTERNATIONAL HARVESTER DOZERS AND GRADERS • LEVELING RAMPS • INDUSTRIAL MACHINERY • ROAD MACHINERY • FARM MACHINERY • HYDRAULIC TAIL GATES

Replacement cost—\$260.00.
Shipping Wt.—15 lbs.
SPECIAL PRICE **80.00**
F.O.B. Chicago.

**GROBAN FOUR-WAY
OPEN CENTER HYDRAULIC
CONTROL VALVE**

ITEM #126 — Four-way open center control valve, with built-in adjustable relief valve factory set at 1000 P.S.I. Spring loaded neutral position. For use with one double acting cylinder. In neutral position cylinder is locked and pump unloaded. Can be used as single unit or mounted in series. Has 3/4" pipe thread inlet and outlet, 1/2" pipe thread cylinder ports. Finger grip handle. Ship. wt. 10 1/2 lbs. AN OUTSTANDING BUY!



F.O.B. Chicago **21.50**

**MULTI PURPOSE
HYDRAULIC PUMP
OR MOTOR**

ITEM #55 Silent, high efficiency. Helical Gear Type Ball Bearings. Hydraulic Pump or Motor, Rated 8 Gal. Per Min. At 1500 R.P.M.—Delivers 1000 P. S. I. Using 6 H.P. — Reversible Rotation — 3/4" Pipe Thread Inlet and Outlet Ports—3/4" Drain Port—3/4" shaft with keyway and flat for either direct or pulley drive. Dimensions—5 3/8" high, 7 1/4" long, 5 1/4" wide. Shipping weight 18 lbs.



F.O.B. Chicago **45.50**

ORDER DIRECT FROM AD
SATISFACTION GUARANTEED
Send Payment Or
Purchase Order Today

**FACTORY-TO-YOU-VALUE
PORTABLE ELECTRIC
LIGHT PLANTS**



POWER TO OPERATE:
• Electric Saw, Electric Drills, Pipe Bender.
• Refrigerator, Deep Freezer, Incubator.
• Water Pump, Radio, Lights, Air-conditioner.

BRAND NEW 1956 ITEM #1008

COMPACT — FITS IN THE TRUNK OF YOUR CAR
1000 WATTS OUTPUT, continuous duty, 115 Volts A.C. 60 cycles, 9 amps. Powered by husky, easy starting Clinton engine. Engine and generator operate at 3600 R.P.M. for maximum efficiency at minimum weight. Both units are mounted on steel base, with heavy sheet metal belt guard. Generator is self regulating, and is equipped with outlet box containing fuse and 2 A.C. convenience receptacles. Cost only 5c an hour to operate. Dimensions: Length 20 1/2", Width 12", Height 16". Shipping wt. 100 lbs. F.O.B. Chicago.....

700 WATT-GENERATOR SET—same as above, slightly smaller—with Briggs-Stratton Engine—Model 708—F.O.B. Chicago..... **129.50**

149.50

**Brand New! 5-TON BLACKHAWK
HYDRAULIC LIFT KIT**

Now Only **38.95** Complete

The Complete Kit
For — • Dumping farm wagons • Adjusting depth of plow • Hydraulic presses • Hydraulic jacks • Snow plows.

KIT CONSISTS OF:

- 1—Brand new Blackhawk Model P-151—Hydraulic hand pump with built-in oil tank and release valve. Rated from 1200 P.S.I.—to 3400 P.S.I. 20" handle. Dim. 8" x 6" x 6"
- Item #82..... **22.50**
- 1—6 Ft. length double wire braid rubber covered hydraulic hose—tested to 20,000 lbs.
- Item #2784..... **3.95**
- 1—Hydraulic cylinder—2" bore, 6" stroke, husky 1" solid steel shaft, will lift 10,000 lbs., using pump pressure. Standard clevis mounting. May be used for double action service.
- Item #41C1C..... **12.50**
- 2—Qts. non-foaming hydraulic fluid..... **1.00**
- All necessary hydraulic fittings.
- Total ship. wt.—40 lbs.

COMPLETE KIT PRICE **38.95**
ALL OF ABOVE INCLUDED F.O.B. Chicago



Brand New — U. S. Navy Cost \$146.00

**OBERDORFER Self-Priming
BRONZE PUMPS**

For: — • Water Pumping • Sprinkling • Insecticide Spraying • Sump Pump • Fuel Transfer — Rated Speed — 500 to 2000 R.P.M.—Perfect for P.T.O., Direct or Belt Drive. Output —63 Gal. Per Min., 150 P.S.I.—use 1/2 to 6 H.P.—1 1/4" Pipe Thread Ports, 2 Grease Cups included. 1" Solid Bronze Shaft—Shipping Wt. 38 Lbs. Save



Item No. 324 118.50 F.O.B. Chicago..... **27.50**

FREE WINTER CATALOG
1956 EDITION, 56 PAGES, chock-full of unsurpassed War Surplus Equipment Bargains for farm, factory, workshop. Write letter today. To place phone orders—Call WEster 9-3793

GROBAN SUPPLY CO. Dept **PM-2**
1139 S. WABASH AVE., CHICAGO 5, ILL.

**A. C. ELECTRIC
GENERATOR**

7 1/2 K.W. (7500 WATTS) single phase, 110/220 volt output, 3 wire system, 2 bearing construction. 5 groove 8" V belt pulley included. Self-excited. Foot mounted. Drive generator from tractor or stand by engine. Ample power for 6 room house. Dimensions: 34" x 11 1/2". Shipping Wt. 420 lbs.



ITEM #Q-75-D **295.00**
F.O.B. Chicago.....

Complete control box for these generators includes A.C. rheostat, automatic voltage regulator, field rheostat, and voltmeter, already wired and ready to connect to generator. List price \$167.00. Our Price **56.45**

**BRAND NEW 1 H.P.
12 Volt Electric Motor**

• For electric wheel chairs (Pop. Mech. design—Mar.-1953)
• For electric golf carts
• For self-propelled scooters, children's midge-cars.



ITEM #308
Rated 1 H.P.—100 amps., 5000 R.P.M., 12 volts, D.C.—This double shaft motor of ball-bearing construction may be run on 6 volts for lower horsepower requirements.—Standard 3/8" shafts, nut and bolt electrical terminals, flange mounting.—Dimensions: 9" x 4 1/2" x 4 1/2". Ship. wt. 19 lbs. A real value at..... **12.50** F.O.B. Chicago

**BELT DRIVEN
A. C. GENERATORS**

Ideal for powering electric tools, oil burner, refrigerator, lights, or other appliances requiring up to 700 watts of power. 700 WATTS, 115 Volts, 60 cycles A.C. 3600 R.P.M. Compact, self-regulating generator with V Belt pulley and double outlet receptacle. Rotation counterclockwise. May be driven by tractor or auxiliary gasoline engine. Requires 2 HP minimum. Dimensions: 10" long x 8" high x 6" wide. Shipping wt. 27 lbs.



ITEM #700
F.O.B. Chicago..... **59.50**

Model 1010 — 1000 WATTS
Same as above. **79.50**
F.O.B. Chicago.....

MINIATURE BLOWERS

Use for small dryers, ventilators, drafts, heat boosters.



Squirrel cage blower Mfg. by WESTINGHOUSE. Intake 1 1/2" Dia., outlet 1 1/2" x 1/2". Rated 6700 R.P.M., 115 Volts A.C., 400 cycles. May be operated on 60 cycle current at reduced voltage. Overall size 4" X 3 1/2" X 4". Price Postpaid..... **5.95**

Make Precise Drawings FAST! Easy! With the *Handee Dandee* PROTRACTOR and TEMPLATES CLEAR PLASTIC 30" x 12"

Sensational NEW Drawing Instrument contains the BASIC MECHANICAL features of equipment costing 10 TIMES MORE! **START TODAY • MAKE FINE ACCURATE DRAWINGS • EASY • MORE PROFESSIONAL ORDER NOW! DEALERS INQUIRE!** Address

LOOK AT THESE FEATURES!
• ADJUSTABLE PROTRACTOR — SQUARE
• ANGULAR T SQUARE — 1/4 inch SCALE
• FULL 12 INCH RULER • TEMPLATES
• FRACTIONS and DECIMAL EQUIVALENTS
• PORTABLE — USE ON THE BOARD • OFFICE • AT HOME!

Order Yours **TODAY** **\$3.95** SEND CASH — CHECK or MONEY ORDER
HANDEE DANDEE PRODUCTS, INC. — 3019 PICO BLVD. SANTA MONICA 2, CALIF.



At Last!

The NEW RECLAIMO

A Wm. Schwalge Product

ELECTRICALLY HEATED
(Automatic Control)

Oil RE-REFINING Filter



FOR CARS—TRUCKS—TRACTORS

It's HERE! After many years in development—NEW Electrically Heated RECLAIMO—fully tested and GUARANTEED—the most efficient motor oil filter available. Filters and RE-REFINES OIL as you drive (by utilizing electric heat). Keeps oil at peak lubricating quality at all times. Proves beyond question U.S. Bureau of Standards (Bul. 86) statement "Oil Does Not Wear Out Mechanically."

New RECLAIMO

Eliminates All Needless Oil Changes!

REMOVES SOLIDS by filtration—REMOVES WATER by evaporation—PREVENTS excess fuel dilution—PREVENTS acid and sludge formation—MAINTAINS stable viscosity.

NEW FEATURES: #1. Electrically heated from generator. #2. Thermostatic control prevents overheating. #3. Dual Flow permits oil by-pass when filter is clogged. #4. New non-corrosive steel body; built to last a lifetime. #5. Adjustable hinged mounting bracket, simplifies installation or transfer to other equipment.



Write at once for illustrated folder and **SIX MONTHS NO-RISK TRIAL OFFER.** Latest edition "Oil Facts", now in preparation, will be sent FREE later.

Reclaimo Co.

4251 Touhy Ave., Dept. M-26, Chicago 30, Ill.



WM. SCHWALGE
Inventor of "RECLAIMO."
Author of the famous booklet "Oil Facts."
Pioneer in oil reclamation since 1910.
MEMBER:
Chicago Academy of Sciences.
Microscopic Society of Ill.
Chicago Automobile Trade Ass'n.

DISCONTINUED Model. RECLAIMO OWNERS and DEALERS—Turn in your old cast aluminum, manifold-heated Reclaimo (new or used) for "trade-in" allowance on the new model. Details on request.

You MIGHT get along without a TELEPHONE



but your family deserves the

finest water system

Your best "buy" in a water system is the *best* you can buy! See your Goulds Dealer . . . pick your pump from the big Goulds line—including Balanced-Flow, the amazing NO TANK pump that costs *less* to buy—*less* to install. See him soon—or mail coupon today . . .



Be sure you get a **GOULDS** water system

GOULDS PUMPS, Inc., Dept. PM-256, Seneca Falls, N.Y.

Please send 20-page pump booklet telling how to select the correct water system. Also send name of nearest distributor.

Name

Address

Own your own motorcycle business

Profitable! Interesting!

Here's a chance to get in on the ground floor of a satisfying, profitable business as your own boss. Sell and service famous, nationally-advertised Harley-Davidson motorcycles for police, pleasure and commercial use. Recent advancements in our organization have made several select dealerships available for the right men.

If you have a youthful outlook and mechanical aptitude . . . enjoy selling and working with young people—you may be the man we want.

Interested? Then, drop us a line and tell us about yourself . . . your motorcycle background . . . the amount of money you can invest. Your letter will get prompt attention.

Write Department PM-2

HARLEY-DAVIDSON MOTOR CO.
MILWAUKEE 1, WISCONSIN

ELECTROPLATE IT YOURSELF!



HOW using NEW plating kit. It's easy to electroplate any object with the same LUSTER and DURABILITY as done by the most expensive equip. Complete kit and instructions on plating metal and non-metal objects, with Nickel, Chrome, Copper, Gold, etc. ONLY \$5.95. SEND NO MONEY—everything sent C.O.D. plus postage. OR send \$5.95 now and receive it postpaid. Money back in 7 days if not satisfied.

EASY INSTRUCTIONS

TOOLS

CHROME WORK

BABY SHOES

M. Z. SALES CO., Dept. G-4, 113 W. 42nd St., New York 36, N. Y.

ZWEYGARDT PIPE MITER



Pat. applied for

Cut any angle on 1 1/2" to 1 1/2" pipe, angles, flats or squares. Clamps in vise or can be slipped on pipe at job. Carbon steel guide posts—Length 12"; Weight 4 lbs.

\$695 postpaid

MONEY BACK GUARANTEE

GOODSELL MFG. CO.
214 N. Quincy, St. Francis, Kan.

Insist on

Evans TAPES KING-SIZE

At your hardware store



6-ft. \$149 only

3/4" wide blade stands up straight for one-man upright measurement.

Also available in 8, 10, 12-ft. lengths with free plastic utility case.

EVANS RULE CO., Elizabeth, N. J. 3000

The JIG SAW Designed for EVERY MEMBER of the FAMILY!



Now you can build an exciting and profitable all-family hobby with one tool. The new **HEAVY-DUTY Moto-Jig Saw** makes furniture, toys, cabinets—1001 projects. And it's great fun to use! So simple, women and children master it fast. Takes any length stock. For an eye-popping experience try it soon. Start your year-round jig saw hobby—share in the fun with the whole family!

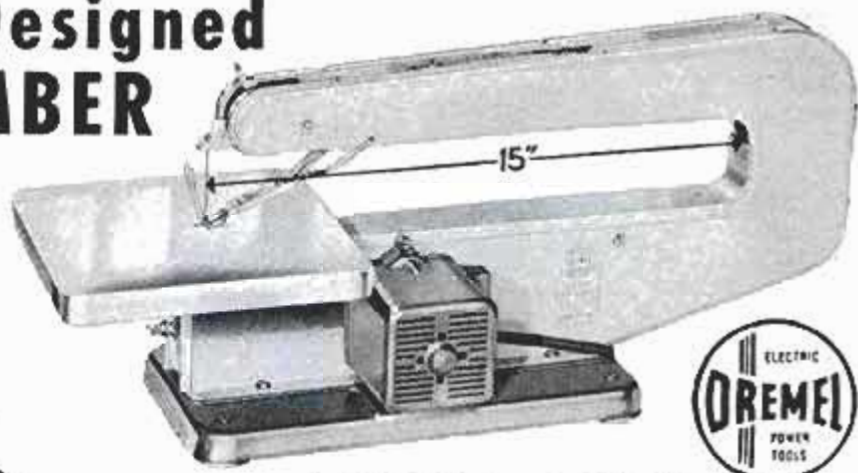

Model 8 (8" throat) **\$23.50**
Model 15 (15" throat) **\$29.95**

Portable! Weighs only 12 lbs. Sets up anywhere! Makes any table a home workshop!
Powerful! Real **ROTARY MOTOR** cuts $1\frac{3}{4}$ " wood, metals, plastics! Tremendous capacity!
Safe! Foolproof blade guard protects against injury. Ideal for women and children!

SEE YOUR DEALER. If he cannot supply order on 5-day trial, money-back guarantee. Remit in full and we will ship postpaid. Or send \$2 now, pay postman balance plus COD fee.

WRITE FOR FREE CATALOG

DREMEL MFG. CO., Dept. 116-B, Racine, Wis.

BUILD ARC WELDER

DUNBAR'S Build-Your-Own PLANS show you how to build either a 200 or 300 amp. DC Welder. Our 1956 Catalog lists 4-low-priced easy-to-assemble Welder-Kits; also 1500 other items—generators, hydraulics, motors, winches, etc. Send 10c today for Complete PLANS, we'll include Catalog FREE.
DUNBAR MFG. CO., INC., 6606 Sylvan Road, Houston 23, Texas



SHAW PLOW, CULTIVATE, MOW, RAKE
BULLDOZE, SNOWPLOW
SAWWOOD

TRACTORS

Just steer it with power turn. Several walking & riding models up to 14 H.P. Low price! Write for FREE literature.

SHAW Manufacturing Co.
4502 Front St., Galesburg, Kansas
668-GN. 4th St., Columbus, Ohio



Say You Saw It in Popular Mechanics

An Outstanding METAL HAND PUNCH

with unusual performance

Needed by every Mechanic in every Shop

No. 5 Jr. HAND PUNCH

CAPACITY— $1/4$ " THRU 16 Ga. Mild Steel. $3/32$ " THROAT
 $1/8$ " — $5/32$ " — $3/16$ " — DEPTH
 $7/32$ " — $1/4$ " — $9/32$ " — 2 inches

Punches and Dies Furnished.

ORDER YOURS TODAY!

Write for FREE Catalog on other tools.

Weights $2\frac{3}{4}$ lbs.

only **\$10.25**

Postpaid in U.S.A.

WHITNEY METAL TOOL CO., Dept. PM-2, Rockford, Ill.

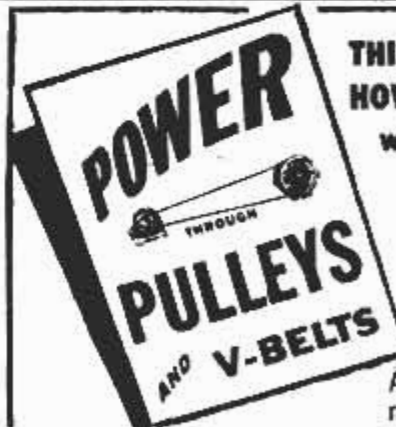

THIS BOOK TELLS YOU HOW TO MAKE THINGS with PULLEYS and V-BELTS

- HOME APPLIANCES
- POWER TOOLS
- MOTORIZED TOYS

"MAKE IT YOURSELF" CONTEST

A \$50 prize every month—duplicate prize for your dealer. A grand \$100 prize every six (6) months. Get the details from your dealer or write direct.

You can make many useful things with pulleys and v-belts, a few gadgets and a spare motor or engine. Order your book today and start a useful project.

Win yourself a \$50 Savings Bond and make a useful tool or toy.

SEE YOUR DEALER OR SEND THIS COUPON TODAY

CONGRESS DRIVES DIVISION TANN CORPORATION
3750 E. Outer Drive, Detroit 34, Mich.

Gentlemen:

Enclosed is 25c—please send me the book "POWER THROUGH PULLEYS and V-BELTS"—also contest entry form.

Name _____

Address _____

City _____

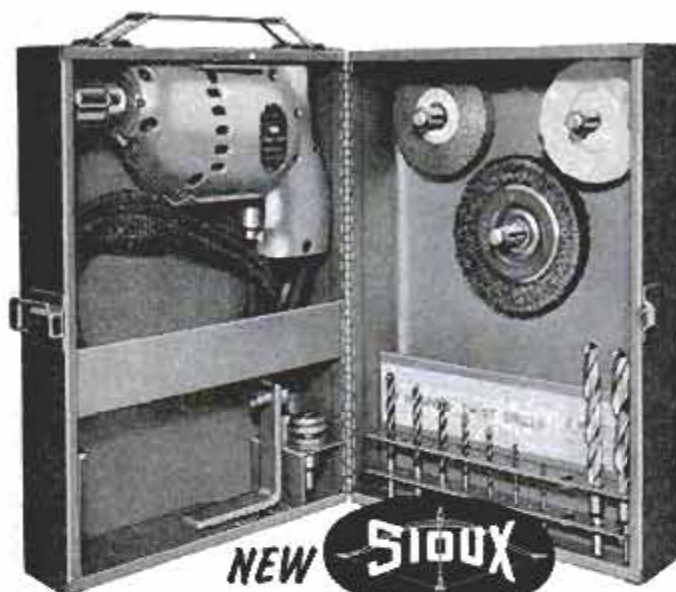

NEW SIOUX

1/4" DRILL KIT

Here's the powerful SIOUX 1/4" electric drill with accessories for sanding, drilling, grinding, sharpening, wire brushing, polishing, cleaning, etc., all in a handsome, fitted metal case that hangs on the wall or goes to the job... \$41.75 Complete Drill only \$24.95



WRITE TODAY FOR MORE INFORMATION



ALBERTSON & CO., INC., SIOUX CITY, IOWA, U.S.A.

**SAVE UP TO \$20!
8" TILT ARBOR SAW
SOLD ONLY DIRECT FROM
FACTORY TO YOU!**



**ONLY \$29.95
Less Guard**

FAMOUS AMERICAN IRONCLAD GUARANTEE - Try any Plana Centric power tool for 10 days. If you are dissatisfied, return for full and complete refund - no questions asked. Guarantee offered on more than 3 1/2 million power tools, and never violated.

Save big money. Buy this fine 8 inch Tilt Arbor Power Saw direct from manufacturer. All cast iron and steel construction. Will last a lifetime; shipping weight 30 lbs. Cross-cuts, rips, bevels, mitres, dadoes, cuts compound angles. Massive cast mitre gauge. Heavy steel base fastens to any workbench. Uses any standard 1/4 to 1/2 H.P. motor. INCLUDED at no extra charge: 8" Simonds Combination Blade that sells for \$4.95. Buy direct and save almost \$20. Send check, M.O., or sent C.O.D.

LOOK AT ALL THESE SPECIAL FEATURES

- Heavy, long lasting cast iron and steel construction
 - Precision ground cast iron table with mitre gauge slots on both sides of blade for operating convenience
 - Famous patented tilt arbor construction. Blade tilts 0° to 50°; table is always level
 - Automatic depth of cut control from 0" to 2 3/4"; blade locks in any setting
 - Single hand wheel control. Tilts blade and locks at chosen angle
 - Saw insert quickly removable for dadoing
 - Motor rides on patented ball bearing roller drive
 - Self-aligning patented cam action rip fence is always straight. Locks rigidly against table surface.
- FREE CATALOG**-Write for big bargains in home power tools.

All power tools sent express collect

**AMERICAN MACHINE & TOOL CO.
ROYERSFORD 1, PA.**

D.C. ARC WELDER

AT A.C. TRANSFORMER WELDER PRICE

\$350.00 VALUE

ONLY

Fully Guaranteed

\$85.00
f.o.b.



200 Amps. Belt Driven

Model #LG-200 Can't be Matched!

Pays for itself immediately!

For field and shop use! Ideal for machinery break-downs in field. Operates at 3000 RPM off any tractor, jeep, truck or 5 HP electric motor

any engine of 10 HP or more (old auto engine is excellent). Welds anything from Tractor frames to Sheet metal. Make your own special equipment for Farm, Shop or Factory. Does 1,001 jobs! **WELDS, CUTS, BRAZES** steel, cast iron, galvanized, bronze, aluminum, tool steels and stainless steels. Straight or reverse polarity. Welds 1/32" to 1/2" plate, cuts 3/8" plate. Uses 1/16 to 3/16" rods.

COMPARE FEATURES: Brand New! Compact. Reactor-type series winding for EVEN ARC. Rheostat for pin-point heat control. Large brushes for extra long life. Oversize ball bearings. Air cooled by internal fan. Complete with 2-groove V pulley. Direct current makes arc striking and welding easier. Output is 30 to 200 amps.

ACCESSORIES AT A BUY! Two 15-ft. cables. Ground Clamp. 300 amp. electrode holder. Ass't. electrodes. Helmet.

Simplified instructions. **COMPLETE OUTFIT \$98.50 f.o.b.** (shpg. wt. 85 lbs.), only.

FULLY GUARANTEED! You can't go wrong. Send for our

LIMITED OFFER! 10-DAY FREE TRIAL! ORDER FROM AD

Use it for 10 days. Be 100% satisfied or money back!

FREE... CATALOG of Motors, Electrical BUYS!

ROBERTS ELECTRIC CO., Dept. PM-362, 849 W. Grand, Chicago 22, Ill.

help
your
**HEART
FUND**



help
**YOUR
heart**

MAKE A "Stradivarius"

VIOLIN

BOOK
AND
PLANS
ALL
YOU
NEED



- For Pleasure
- For Profit
- For Your Own Use

**You Can Do It at Little Cost!
It's Easy! It's Fun!**

Here is the "tops" of all home crafts projects. Make a violin—a replica of a famous "Strad"—the original of which sold for \$80,000.00. Joe Reid who has made hundreds of fine violins makes the job so easy—so inexpensive—in his new book "You Can Make a 'Stradivarius' Violin." You don't need any tools. Reid shows you how to make all the tools you need from old table knives, worn out files, sheet metal, etc. Eight full-size plans, 16x23 inches, folded into the book give you every detail in actual size.

Violins Bring High Prices

Make a violin and you probably will never want to sell it. But good tone modern violins bring terrific prices, yet the materials cost comparatively little. With Reid's plans and step-by-step instructions you can make such a violin for yourself! 15 chapters guide you in selection of wood, fashioning the body, back, sides, mold, lining, neck, scroll, purfling. Other chapters cover varnishing, finishing, stringing. Others show how to make tools and clamps at little or no cost.

Order Book Today.

Money Back if Not Satisfied.

Make your own violin for pleasure or profit. Get book and plans now. Clip this ad and mail with check, money order or cash for only \$3.50 or we will ship C.O.D. Money back in 7 days if not satisfied.

FULL SCALE PLANS INCLUDED

Working plans, drawn to full scale, are included in a special pocket inside the book where they may be withdrawn for quick and easy reference.



**Complete Instructions
8 Actual Size Plans
How to Make the
Tools You Need
Where to Get the
Materials**

You trace or work direct from actual size plans. No measurements to translate or confuse you. You see the entire violin in the plans. You read the how-to-do-it instructions in the book.

\$3.50 Cloth Bound

POPULAR MECHANICS PRESS

Dept. 30
200 E. Ontario St., Chicago

GIGANTIC
SAVE-TO-70%

MAIL SALE

WAR SURPLUS
EXCESS INVENTORY
BANKRUPT STOCK

ARMY POWER PLANTS

Marvelous buys in new condition Govt. surplus plants and generators. We pay freight!



- 1000-w, 115-v, 60-c, \$149.50
- 2000-w, 115-v, 60-c, \$289.50
- 3000-w, 115-v, 60-c, \$349.50
- 7500-w, 115-v, 60-c, \$590.00
- 3000-w, DC generator \$58.75

Send for free bulletin

AUTOMATIC REMOTE CONTROL SWITCHES



Amazing electro-magnetic switch with dial. Any circuit from 1 to 100 can be selected simply by dialing the number. Will work up to 20 miles. Used. excellent.

Fine intercoms, phone systems, experimental, etc. New

Cost Over \$200.00. Sale. Prepaid, \$13.71

MOTOR DRIVEN WINCH



A 4-star special! Rugged electric motor-driven winch ideal for contractor, builder, farmer, boat docks, etc.

Motor is 115-v, 60-c. G.E. squirrel cage induction type. Reversible. runs winch in either direction. Load capacity 1000 lbs. Drum capacity 100' of 1/4" cable. Cost Govt. over \$495. SALE, Prepaid (less cable) \$69.50

GOV'T. STEEL TOWER



Excellent for TV, amateur radio antennas, advertising signs. 30-ft. tall.

Copper-bearing steel, hot-dip galvanized. Has ladder for climbing and servicing antenna, etc.

Units can be combined to 150' ht. Face width 12". Complete with guy cables, hardware, anchors, etc. In 3 crates. Wt. 250 lbs. Cost Govt. over \$150. SALE, FOB our warehouse Vanceburg, Ky. \$31.95



HYDRAULIC BARGAINS

- Pump, 1000 lbs., 12 g.p.m., 400 r.p.m. \$45.50
- Cylinder, 3" bore, 24" stroke, 7000 lb. lift \$39.90
- Cylinder, 2" bore, 10" stroke, 3141 lb. lift. Sale \$16.50
- Control Valve, For single or double acting cylinders. Sale \$17.98
- Pressure Gauges, 1000 lb., 1500 lb., 2000 lb. \$3.49

6-Volt HYDRAULIC PUMP

Complete hydraulic system. 6-v DC motor operates from truck battery. Drives 2,500 lb. per sq. in. pump. Has control valve, etc. Use for dump trucks, snow plows, jacks, lifts, special machinery, etc. Leading make, F.O.B. Wt. 48 lbs. 1st \$121.50. SALE \$45.50

CONTRACTOR-ARCHITECT LEVEL

Excellent highly accurate professional instrument made by leading manufacturer. Ideal for setting foundations, grading, farm contouring, surveying, etc. Powerful erecting optical telescope, built-in graduated degree scale, sensitive spirit bubble, etc. Furnished complete with 8 1/2-ft. 3-sec. rod, fine tripod and polished wood carrying case. Our 4-star buy! Prepaid to you \$42.95



IRRIGATION PUMP

2 1/2" size, 16,500 gph. Brand new Navy bronze ball bearing hi-capacity centrifugal. Wonderful small farm and truck irrigation, many industrial uses. Capacity to 280 gpm. Pressure to 65". Speed 2100-2700. Clock-wise rotation. Complete with 8" pulley. Wt. 40 lbs. Size 10"x11"x9". Inlet 2 1/2", outlet 2". Note—2 of these units driven by single engine will deliver almost 600 gpm or 33,000 gph. Natl. Adv. list \$98 each. SALE, Prepaid \$44.37

AIR POWERED TREE TRIMMER

Simply press button. Powerful air cylinder cuts limbs to 3/8" or better. Operates from any small home air compressor. Works on 40-70 lbs. air. 10". Reg. list, \$69.50. SALE, \$15.37 Ppd.

SPECIAL OF THE MONTH!



GOLF CAR BATTERY MOTOR
Govt. Surplus
1300 available
Powerful, brand new, gear reduction, slow-speed battery motor. Runs on ordinary 6, 12 or 24-volt storage battery. 200 to 400 R. P. M.



Build your own
Self-propelled golf car
Warehouse carts
Store lift trucks
Electric boat winch
Boy's midjet auto
Garage door opener
Motorized invalid's wheel chair



Many other private and industrial applications. Unit consists of powerful direct-current, heavy duty, finest



Timken roller bearing motor with built-in precision 18 to 1 gear reduction. Output shaft is 1" diameter. Speed is easily controlled. Exceptionally high torque. Will pull two men in cart at speeds up to seven miles per hour. This expensive unit was designed for a high torque aviation application. It is exceptionally powerful and will last for years. Very efficient. Draws minimum current and batteries require minimum charging. Buy promptly. This is already one of our most popular items. Instructions furnished. Wt. 22 lbs. Gov't. cost over \$200.00. Special F.O.B. Lincoln \$13.48

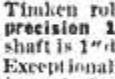

Pinpoint accuracy. Unit consists of powerful direct-current, heavy duty, finest Timken roller bearing motor with built-in precision 18 to 1 gear reduction. Output shaft is 1" diameter. Speed is easily controlled. Exceptionally high torque. Will pull two men in cart at speeds up to seven miles per hour. This expensive unit was designed for a high torque aviation application. It is exceptionally powerful and will last for years. Very efficient. Draws minimum current and batteries require minimum charging. Buy promptly. This is already one of our most popular items. Instructions furnished. Wt. 22 lbs. Gov't. cost over \$200.00. Special F.O.B. Lincoln \$13.48

AIR COMPRESSORS — TANKS, Etc.

Save to 70% on air fittings, tanks, compressors, etc. See our catalog.
• Piston Air Compressor, 150 lb. \$18.91
• Air Corp 300-lb. Pressure Tank \$6.79
• Auto Pressure Switch for Motor \$4.95
• Professional Paint Spray Gun \$9.95
• DeLuxe Air Kit complete \$45.49



SPECIALS FROM PREVIOUS ADS

AC-DC Power Rectifiers (F.O.B.) \$15.61
Army Power Heater (oil) \$190.00 \$49.50
Antenna Rotator—110 volt (8-475.00) \$49.49
Electric Drills—110 volt (1 1/2" 8-12.00) \$29.95
Dual Amplifier (8205.00) \$13.51
Campers Power Plant—28 volt (8-125.00) \$69.50
We pay transportation to you except where stated "F.O.B." Write for large FREE Catalog.

BURDEN SALES COMPANY
804 "D" St., LINCOLN, NEBR.

Guide to
HOME REPAIRS

Pays for Itself 100 Times Over

Beat the high cost of home upkeep. Save hundreds of dollars every year on carpentry, electrical, painting, plumbing and other jobs around the house with Popular Mechanics GUIDE TO HOME REPAIRS. Simplified how-to-do-it instruction and 646 pictures make all jobs, inside and out, easy. Covers construction, remodeling, modernizing, repairing that you can do yourself at small cost. 192 page cloth bound book only \$2.50 postpaid. Order today under our money back guarantee.

POPULAR MECHANICS PRESS, Dept. PM16
200 EAST ONTARIO STREET CHICAGO 11, ILLINOIS

SAY YOU SAW IT IN POPULAR MECHANICS

USE HANDY-STANDY ANY PLACE ANY TIME

- Adjustable in height
- Knocks down for easy storage
- Lightweight — Portable
- Pair supports over 1000 lbs.

Handy-Standys let you have a table in the basement, for ironing or carrying, a serving table for many purposes, a temporary typing stand, drawing board or check bed table.

Just mount a board on HANDY-STANDYS, and you quickly have a table, bench or workboard WHEN AND WHERE YOU NEED IT! When you're finished, HANDY-STANDYS are quickly disassembled and can be stored flat or hung against a wall. HANDY-STANDYS weigh only 9 1/2 lbs. each, and are furnished with one set of extensions for 24" or 30" height. Order HANDY-STANDYS today — shipped postpaid \$13.50 per pair.

Use HANDY-STANDYS for long picnic tables, in workshops for layout, cutting or fitting table, as adjustable workboard for interior painting, plastering, paperhanging or exterior work around the house.

TOP QUALITY

Built of the finest materials, Gerstner Chests are acknowledged top quality everywhere. Free catalog.

GERSTNER TOOL CHESTS
456 Columbia St., Dayton 7, Ohio

TOP SPEED BETTER SKIING or FUN

MICHIGAN AQUA-JET propellers win twice as often in the "National Stock Outboard Championship" as all other wheels, custom-built included. Inexpensive stock propellers, requiring no alteration of lower unit, each specifically engineered for motor used (5 HP and larger). Write for FREE 1956 catalog — the Outboarders' Bible. Shows how to get better performance from specific motor-boat-load combinations for racing, skiing, cruising, pleasure — also fine line of boat fittings. Michigan Wheel Co., Dept. P-2, Grand Rapids 3, Mich.

TUBE AND METAL FORMING CORP.
940 NORTH 20th STREET • COLUMBUS 19, OHIO

WAR SURPLUS AND OTHER BARGAINS **SAVE UP TO 90%**

ARC WELDER KIT \$24.95—build your own

Complete make-up package consisting of 1 Aircraft DC Generator, Electric Auto-Lite, 200-250 Amps, 24 Volt, RPM from 2600 up, 1 Rheostat, 1 Giant Toggle Switch, 1 Ammeter, 1 Shunt, 0 to 240 Amps, 1 Voltmeter, 0 to 30 Volts, 1 Electrode Holder, Wiring diagram chart showing conversion of Aircraft Generator to Arc Welder. Shpg. Wt. under 100 lbs. Approx. GOVT. COST \$475. Buy of a lifetime. Like new, perfect. \$24.95.

D.C. Generator—same as above, if purchased separately: \$12.50.

HIGH SPEED HAND TAPS

10 assorted, precision-ground thread. National Mfr. Like NEW. From 3/16" up. Approx. GOVT. COST \$25. Now \$2.50.

LONG-FLUTE, HIGH SPEED DRILLS

12 assorted sizes. Up to 1/2". Like NEW. Approx. GOVT. COST \$23. Now \$2.25.

SPECIAL ON \$4770 NAVY AUXILIARY POWER UNITS AIR COOLED

Ideal for your shop, camp, cottage, farm, trailer, home, boat or mine. Makes a terrific welder for any size job. Also excellent for auxiliary power in pumping wells, operating saws, or wherever power is needed. 300-1A Lawrence, 24V, 2 Cylinder opposed 4-cycle 10 1/2 H.P. comes complete with various generators which can be attached to standard stud mounting. Shpg. wt. cases 350 lbs. Like new. Type 2 CM73-B9-140 amps., 24V—\$125. Type P1, 200 amps., 24V—\$137.50. AC-DC NEAS (DC side 24V, 200 amps., AC side 10.5 amps., 1200 watts), 800-cycle 2400 RPM—\$142.50.

NEW PUMP AND MOTOR

Pump has 1" connections, built-in relief valve, adjustable up to 1500 lbs. Max capacity 6 GPM, 1 1/2 H.P., 24-volt motor, 4000 RPM. Can be used on 12 or 36 volts. Govt. cost approx. \$350—our price—NEW—\$9.95.

MICROSWITCH

Normally open or closed... dual purpose. For automatic contacting, light, sound, model train systems, chimes, etc. Approx. Govt. cost \$15. NEW, 3 for \$2 ppd USA.

NEW IMPROVED MAUSER-TYPE VERNIER CALIPERS

Quick, handy, accurate, 6" vernier Calipers. Glass hardened, lapped measuring surfaces. Fine engraved scales—1/1000" and 1/128" for inside, outside & depth measurements. Friction thumb release. Larger capacity. 2 gib adjustments. Reg. \$25. Now only \$7.95. Leather case \$1 extra.

MICROMETERS Chrome plated, precision engineered, carefully tooled to give long life. All new 0-1" cap. \$2.25 ea., 1-2" cap. \$3.50.

REVERSIBLE RACHET WRENCH

For diesels, ships, farm machinery, trucks, bridges, oil fields, all heavy equipment. Terrific leverage. 4" Lowell, safety steel, sockets for 2 3/8", 2 9/16" & 3 1/8" hexagon nuts. Navy surplus. Approx. GOVT. COST \$215 a set. Wt. 50 lbs. NEW! Now \$10.95 per set.

PRECISION GROUND SQUARES

Production engineer's Squares. Accuracy guaranteed. Mfd. by Wright & Moore, Sheffield, Eng. Square blades hardened & tempered. Individually packed in wood box. Brand NEW. Fraction of original cost. 2"—\$3.25, 3"—\$2.50, 4"—\$3.75, 5"—\$3, 6"—\$3.25, 8"—\$6.50, 12"—\$8.25.

JACKSON ELECTRODE HOLDER

Model A-4. Fully insulated, 300 Amps. Replaceable jaws. Will handle up to 1/4" electrodes. NEW! Boxed. Approx. GOVT. COST \$15. Now just \$4.50.

NEW! 1956 CATALOG Largest ever... just out... new low prices. Send 25c for your copy today. Prices F.O.B. Culver City unless otherwise stated. Check, cash or money order. 25% deposit for C.O.D.

AIRBORNE SALES CO., INC. DEPT. PM256
8501 Stellar Drive, Culver City, Calif.

WIN
This Riding
TRACTOR
FREE

ESHELMAN TRACTORS LOW AS \$99

MAKES • PLANS • CULTIVATES • SOWS
DOES • HARROWS • SOWS • FLOW • BELLS
SPRAYS • MOWS • MOWS • CUTS • TILLS

Enter this exciting contest now and you may win this deluxe Eshelman Riding Tractor FREE. Write for entry blank and free Literature TODAY.

ESHELMAN, Dept. R-52
109 Light St., Balto. 2, Md.

Shipping Points: BALTIMORE • CHICAGO • RENO • 1 to 8 H. P.



Amazing Tyler
SPYRAL BLADE

A MUST for every Workshop!

SAWS ANY MATERIAL
metal, wood, plastics etc.

... IN ANY DIRECTION
up or down, right or left, even in circles!

Does what no other Blade can Do
Fits Standard Coping Saw or Hacksaw Frames
NO special adaptors needed! • World's safest saw blade.

You'll find hundreds of uses for Tyler Spyril Blades. There's nothing like them! The first important improvement in blades since the invention of the saw. Fun to use... cuts so fast and easy: no chipping or tearing—leaves clean smooth edge.

At your Hardware dealer or send **\$1.00** for package of 12 Spyril Coping Saw Blades or 3 Spyril Hacksaw Blades.

TYLER MANUFACTURING COMPANY
1005 W. Arbor Vitae Ave., Inglewood, Calif.



FREE OIL FILTER REPLACEMENTS

No more Filter Elements to buy! Get the ZENICK Permanent Porous Bronze Filter Element for only \$3.95! Full Flow \$7.95. For all cars & light trucks. Also, Vaporizer that saves 3 miles per gal. \$3.00. State car make when ordering. Money Back Guarantee. Dealer Inquiries Invited.

ZENICK PRODUCTS CORP. Dept. 2
Box 2461, Los Angeles 54, California



HELPFUL BOOKS

Send post card asking for **FREE** catalog

Popular Mechanics Press, 200 E. Ontario, Dept. 601, Chicago 11

OWN A... FORD?

FIX IT YOURSELF!

Popular Mechanics Magazine has published an Owners Manual covering all 1941 to 1952 models of Ford cars... So accurate mechanics use it... so simple a woman can understand it.

Save money on your Ford car repairs. Prevent trouble. Enjoy care-free driving. Increase trade-in value. Avoid major repairs by fixing minor troubles before they get serious. Get sparkling performance at all times. Has 272 pages, more than 350 photos, diagrams, tables, charts, breakdown drawings, plus clear, non-technical directions that make all repairs simple as A B C. Written by Ed Packer with the assistance of the Ford Motor Company. Shows you how to diagnose all Ford troubles by feel, sound, sight, smell and performance. Simple trouble shooting. Permanent repairs. Emergency repairs. Plus, "How to get value from garages."



MONEY BACK IF IT DOESN'T SAVE MORE THAN IT COSTS!

One minor repair will save the cost ten times over. Read it. Then you decide. If you don't see that you'll save more than the cost, send it back for refund. **SEND NO MONEY.** Send postcard. Ask for the Ford Manual. Postman will deliver C.O.D. for \$3.50 plus postage. Or, save postage by sending \$3.50 with order. Send today. Save its cost on your next repair.

POPULAR MECHANICS PRESS
200 E. Ontario, Dept. 90, Chicago 11, Illinois

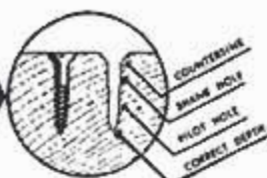
STANLEY*Screw-Mate.***4** JOBS
AT ONCE
EASY!

Every screw you drive in a Screw-Mated hole has maximum holding power and fits exactly... does a real, professional job!

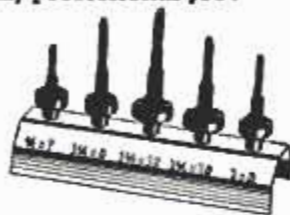

GET A SET FOR
YOUR WORKBENCH

Screw-Mate Set
No. 1525B

Stanley Screw-Mate is at your hardware store in 22 sizes @ 75¢ each... 2 large sizes @ \$1.25 each. If your dealer can't supply you, order this handy holder with 5 most popular sizes — 3/4" x #7, 1" x #8, 1 1/4" x #8, 1 1/4" x #10, 1 1/2" x #12. Ask for No. 1525B and enclose check or money order for \$3.69. Send to Stanley Tools, 2602 Elm St., New Britain, Conn. We'll pay return postage.

ARE YOU SURE YOU NEED A DEEP
WELL WATER SYSTEM?



See Why
**BURKS
PUMPS**
LIFT FARTHER

DECATUR PUMP CO., 61A ELK ST., DECATUR, ILL.

CRESCENT TOOLS

Give Wings to Work

ASK YOUR
HARDWARE
DEALER

Say You Saw It in Popular Mechanics

Get Our Big Manual of
WOOD & "HARD-TO-GET" ITEMS

For home craftsmen, wood workers, industrial art departments, furniture repair men, hobbyists, cabinet makers, etc. Send only 50¢ today for your copy.

A few of the items we sell: Inlays, fancy cabinet wood, lumber, Ebony, Holly, Dimension cut lumber, lignum vitae, Carving Blocks, Turning Squares, 120 kinds of veneers. Abrasive papers, archery woods, bill-board clamps, binswings, bed fasteners, blueprints, Chair braces, brass chair, brass forming, Craftsmen books, candlestick holders, candlestick sockets, card table hardware, casters, Chair cane, ceramic tiles, clamp nails, crib hardware, Dowels and dowel pins, dowel centers, drawer rollers, felt, Flok finishes, foam rubber, furniture clamps, complete professional finishing materials, Folding tablelegs, hand tools, furniture pulls, modern and period, chest and ornamental hardware, all types of hinges and locks, small box hardware, Inlaid picture kits, inlaid card table tops, leather working tools, Micarta, revolving Lazy Susans, musical movements, moulded wood carvings, Metalcraft material, Moto Sander, nut bowl hardware, Picture frame moldings, Pre Cut Wood Pix, perforated steel panels, pilaster standards, plastics and plexiglass, internal carving bits, plastic polishing compounds, Electric routers, sanders, foot rheostats, hand drills, sprayers, revolving fixtures for television tables, chairs, etc. Fibre rush, screw hole buttons, spiral saw blades, sliding door track, sharpening stones, home owners specialties, 109 woods, ski woods, platform rocker springs, Table leaf supports, tack rags, thermometer cards, turned furniture legs, typewriter fixtures, Complete upholstery supplies, Veneer presses, wood burning pens, wood working instructions, black and copper wrought iron hardware, zigger wire.

Send fifty cents today (refunded on 1st order) for your copy of the Country's leading Catalog, "Constantine Manual for Craftsmen" to:

ALBERT CONSTANTINE & SON, Inc.

Dept. PM-26, 2050 Eastchester Road, New York 61, N. Y.

BASEMENT
LIKE A
DUNGEON?

make it brighter and drier with

DURA-DRI

CEMENT COATING

Do it yourself! Just apply this heavy-bodied protective coating with a brush right over any porous masonry. **TEXOLITE*** DURA-DRI controls water penetration; decorates in any one of four beautiful colors.

DURA-STOP Compound fills holes and cracks through which water flows under pressure. Use this quick-setting hydraulic cement when necessary before applying DURA-DRI—for a complete water control system. For further information see your U.S.G. dealer, or write Dept. PM-1, 300 W. Adams St., Chicago 6. *T.M. Reg. U.S. Pat. Off.



UNITED STATES GYPSUM
The Greatest Name in Building



BUILD YOUR OWN POWER TOOLS - GIL-BILT WITH

Exclusive GIL-BILT Build-It-Yourself Features

- No machining—build easily with hand tools only
- No blueprint reading—step-by-step pictorial plans, full scale patterns, actual photographs
- Sturdy wood, aluminum and steel construction
- Capacity and performance of commercial saws selling from \$60 to \$250.
- Proved performance. Nationally advertised and sold for 8 years. Satisfied customers around the world.

GIL-BILT 10-in. TILT/ARBOR SAW

PARTS KITS
PLANS only \$1.00 EACH POSTPAID



- 27x28 in. table, 13 1/2 in. capacity in front of blade
- 10 in. blade cuts 3 1/4 in. deep, tilts full 45 degrees
- Floor model 34" high, table always stays level
- New Departure ball bearing arbor, 3/4" precision shaft turned down for 5/8" bore blades, alum. housing, shipped ready to run
- Jackscrew and 4 1/2 in. dia. handwheel lowers and raises blade
- Cast-aluminum miter gauge and self-aligning rip fence guide
- GIL-BILT Metal Parts Kit includes Plans, ball bearing arbor, miter gauge and bar, rip fence guide, dado insert, lock knobs, jackscrew mechanism and handwheel, and all other metal parts (less blade).....\$22.95
- Same Kit with 10" Combination Blade \$25.90
- Same Kit with 8" Combination Blade \$24.90

GIL-BILT 12-INCH BAND SAW

- Cuts to center of 24 inch circle
- Handles stock up to 6 inches thick
- 18x18 inch table tilts 45 degrees
- Lower wheel and drive pulley runs on sealed New Departure Ball Bearings. Upper wheel runs on two 3/4" bore Oilite Bronze bearings
- Upper wheel tension and tilt mechanism of cast aluminum, completely assembled
- Upper and lower blade guides. Each has ball thrust bearings, self-lub bronze jaws
- Rigid cast aluminum wheels fully machined ready-to-install. Heavy rubber tires
- Uses standard 78 inch blades up to 3/8 in. wide
- Fully enclosed mechanism for utmost safety
- GIL-BILT Metal Parts Kit includes Plans, rubber tires, aluminum wheels, 1/4 in. blade, ball bearing spindle, tilt mechanism, blade guides, table tilt segments and all other metal parts.....\$23.95



ALSO AVAILABLE Plans & Parts Kits for 18-in. Band Saw, Belt Sander, Spindle Shaper, 8-in. Tilt/Arbor Saw

Return Kits in 10 days for refund if not satisfied. For shipments up to 600 miles, add 5%; over 600 add 10%

Amount in excess of actual postage will be refunded

Order Kit now, or order Plans at \$1.00 each and Kit later less cost of plans. Write for FREE Catalog. Dept. 80-B, Lambert Field, St. Louis 21, Missouri

GILLIOM POWER TOOLS

FRENCH PLIERS Rockwell Tested

Made to U. S. Govt. specifications. Meets Rockwell hardness test. Mirror-polished heads, blued handles, hand-boned cutting edges. Unconditionally guaranteed.

LINEMEN'S PLIERS

- 7"\$1.19
- 8"\$1.29

LONG NOSE with CUTTER PLIERS

- 5 1/2"89c
- 6 1/2"99c
- 8"\$1.19

DIAGONAL SIDE CUTTER PLIERS

- 5"\$1.09
- 6"\$1.19

(Add 10c to each plier for postage and handling.)

SOLID BRASS POCKET SLIDE CALIPERS

One of the handiest and most accurate instruments made. Of highly polished brass, lacquered for durability. 3-inch capacity for precision inside and outside reading. Graduated in thirty-seconds and sixty-fourths of an inch. Individually packed..... \$2 ppd.

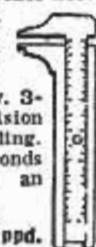

CHROME VANADIUM 29 Pc. DRILL SET

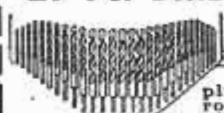

Specially made for speed drilling. In sturdy plastic tool roll. Finest alloy steel drills hardened and precision ground to the sharpest, longest lasting cutting edge obtainable; will easily and cleanly bite through hardwoods, plastics, aluminum, iron and the toughest steels. Unconditionally guaranteed for thousands of drillings. Full jobber length. Sizes by 64th from 1/16 to 1/2". NOW \$6.49 ppd. Also available with Turned Down Shanks to fit all 1/4" drills. In individual pocket roll.... \$8.95 ppd.

60 Pc. Set Wire Gauge CHROME VANADIUM DRILLS



Top quality high test Chrome Vanadium Drills designed for speed drilling through toughest steels, woods, plastic, iron and aluminum. Precision ground, long-lasting cutting edges. Guaranteed to give years of satisfaction. A full 60 pc. set nos. 1 through 60. A \$14.95 value —NOW ONLY \$5.35 plus 25c pp. & hdg. Same set above available with Huot Index container—Only \$6.35 plus 25c pp. & hdg.

PAY RAISING—EXTRA MONEY BOOKS

Use these books to prepare for a better job—bigger pay—to start a profitable spare time or full time business of your own, improve your home, or start a hobby. Popular Mechanics specializes in supplying outstanding self-help books on many subjects. Send for our FREE catalog.

- Outdoor Sports Manual Hunters, Fishermen, Trappers, Campers, Archers, Boatmen, here is your book!...\$2.00
- Diving, Cutting and Welding in Underwater Salvage Operations Only book of its kind...\$2.00
- Picture Framing Modern methods for making and painting picture frames. Fully illustrated...\$2.75
- Household Mechanics The "fix-it" book to top all "fix-it" books. Covers electric appliances, painting, carpentry, etc.....\$3.50
- Turn Scrap Into Money Convert old auto generators into motors, welders, etc.....\$1.00
- Popular Mechanics Farm Manual Packed with practical ideas and usable information that can easily be worth hundreds of dollars to every farm family and to homeowners everywhere. Send for free descriptive folder giving complete contents or buy the book for.....\$3.00
- Carpentry.....\$2.50
- Your Home and How to Build It Yourself Step-by-step construction of this famous POPULAR MECHANICS house. Wonderfully illustrated.....\$3.00
- Motorist's Handbook Popular Mechanics stores again. A 160 page guide to happier driving.....\$2.00
- What to Make for Children Junior tough on toys? Build him playthings that will last.....\$2.00
- LeJay Manual of Homemade Electric Equipment How to construct 100 items that are scarce and valuable.....\$1.50
- Ice Cream for Small Plants Some technical formulas for ice cream, ices and frozen desserts on a commercial scale.....\$2.50
- How to Write Better Business Letters Shows the best ways for good business letter writing.....\$2.25
- Portrait Painting Now you can become a portrait painter so simply that you won't believe it yourself. Easy and fun with this book.....\$3.00
- Leather Arts Book Everything explained for making leather products and items.....\$3.00
- Course in Wood Turning Step-by-step instructions and pictures included with this simple method.....\$3.75
- New Essentials of Upholstery Make that furniture in the living room look new again.....\$3.25
- Rustic Construction Complete details for building all forms of rustic furniture.....\$2.50
- Anyone Can Paint With this book you can prove it yourself.....\$2.95
- Hooked Rugs for Fun and Profit Make extra money this easy way.....\$1.00
- Official Gun Book.....\$1.50
- How to Make Animated Cartoons This is really fun.....\$1.00
- How to Succeed with Bees Complete instructions on the care and raising of bees for profit.....\$1.00
- Rules and Practice for Adjusting Watches Save on repair bills this easy way.....\$3.50
- Plain and Fancy Brickwork Learn all there is to know about this interesting business.....\$2.60
- Magic, by Hoyam Complete set of stage illusions presented by one of the most famous performers in the business.....\$5.00
- Soap Carving New treatment of a fascinating hobby.....\$1.00
- Planning the Little House.....\$2.75
- Radio Operating Questions and Answers.....\$3.50
- The Book of the Pigeon.....\$3.00
- The Runabout Boat Book All about Runabouts.....\$3.50
- The Veterinary Adviser.....\$1.50
- Pencil Broadside All drawings are in black and white.....\$4.00
- Bob Becker's Dog Digest Learn how to take care of your dog.....\$1.50
- Gun Digest Latest listings and pictures of gunnery.....\$2.00
- Fishing Tackle.....\$1.50
- Carpentry and Joinery Work Complete instructions on this trade.....\$4.75
- The Home Mechanics Outdoor Handbook Take care of things around the home.....\$5.95
- Plastic Arts Craft A fast growing hobby.....\$3.25
- Popular Tools and Materials Shows how to use and gain from the tools and materials most used in construction of all kinds.....\$1.50
- Gregg shorthand Manual Increase your earning ability by learning the famous Gregg system.....\$1.50
- Diesel Engine and Diesel Electric Power Complete book on construction, care, adjustment.....\$3.00
- Troubleshooter's Handbook An expert guide to diagnosing all electrical and engine troubles.....\$5.00
- Handicrafts and Hobbies Over 30 how-to-it hobbies for fun or profit.....\$2.98
- How to Build Fences and Gates Many beautiful designs with complete building instructions.....\$1.50
- How to Build Your Fireplace Excellent designs to suit every period and taste.....\$1.50
- Power Span, Wrought, and Cast A complete how-to-do-it approach to a beautiful and useful craft.....\$4.00
- Science of Watch Repairing Simplified The most technical watch repairs become simple with this clearly written book.....\$3.00
- Fascinating Pen Flourishing Delight your friends with expert ornamental writing.....\$1.00
- Weaving You Can Do Takes up the important "little" questions involved in fine hand weaving, describes many new methods.....\$2.75
- Bookbinding Made Easy Manual of clear instructions, descriptions of equipment, finishing processes.....\$2.50
- 100 Ways to Save Money Buying Your Car A handy book to have to save yourself time, money, and worry when buying a new or used car.....\$1.25
- Touch Typing in Ten Lessons A short, complete course in the fundamentals of professional touch typing.....\$1.00
- Engineer's Sketch Book A valuable study of mechanical and structural composition with nearly 3000 designs and drawings.....\$3.00
- 2000 Designs for the Craftsman An idea and reference book for artist, craftsman, hobbyist, and designer.....\$2.00

MAIL THIS COUPON TODAY

Check the books you want, write your name and address below, and mail this advertisement with money order or check. Outside U. S. A. include 15% additional for shipping charges.

Books selected will be mailed promptly on our "money back if you're not entirely satisfied" guarantee.

Name.....

Address.....

City.....State.....

Mail to POPULAR MECHANICS PRESS
DEPT. 700—200 EAST ONTARIO ST., CHICAGO 11, ILL.

SEND CHECK OR MONEY ORDER. IF C.O.D. FEE EXTRA. MONEY BACK GUARANTEE
SCOTT-MITCHELL HOUSE, Inc.
DEPT. M-146 611 BROADWAY N. Y. 12, N. Y.

READY CUT HOMES

\$2150 AND UP DIRECT FROM MILL

YOU SAVE the items which help make today's building cost expensive: high labor cost, contractor's profit and overhead, insurance, architect's fees. Cut-to-Fit eliminates usual lumber and material waste, also costly mistakes. Anyone can assemble. Simple, easy-to-follow plans furnished and each part numbered. Complete with all lumber, roofing, nails, glass, hardware, paint, doors, windows. Freight paid. Low-cost building plans sold separately if desired. 57 Homes and Floor Plans.

5 EASY PAY PLANS
COLOR CATALOG

Send *Starting Homes*
25c



INTERNATIONAL MILL & TIMBER CO.
Dept. PM-26 Bay City, Mich.

WELD **BRAZE**
SOLDER **CUT**



4WAY
ONLY
\$14.75
f.o.b. factory

WELDER
Complete with
Twin Carbon Arc
Torch and ac-
cessories... to
handle all metal-
craft work.

Acclaimed by thousands of Homeowners, Mechanics and Hobbyists as the welder of 1001 uses. Easily operated from properly wired 110 volt AC or DC line. The ideal gift with a life-long use... Order today on 10 day money back guarantee.

FOUR-WAY WELDER CO., Dept. F2-B
1810 S. Federal St. • Chicago 16, Ill.

Say You Saw It in Popular Mechanics

BUY DIRECT..SAVE!

Big Discounts on
**TILLERS - TRACTORS
MOWERS**



8 1/2 H.P.
Riding Tractor \$488.00



20" rotary
mower

12"
tiller

- Complete line of 2-wheel and 4-wheel tractors and implements.
- Clean cutting rotary power mowers handle all grass and weeds.
- Spade, hoe and rake in one operation with 12" or 8" tiller. Assemble-it-yourself Kit only \$59.00 less engine.

Write for complete catalog.
RED-E GARDEN TRACTORS
RICHFIELD 9, WISCONSIN



\$5000
PER
DAY

AND
MORE

SERRATING
AND SHARPENING
TABLE KNIVES

SAW-KEEN PORTABLE, ELECTRIC,
EASY - TO - OPERATE

Be your own boss, work anywhere, full or part time. Every restaurant, hotel, drive-in, etc., repeat customers. Serrated (saw-edged) table and steak knives in great demand. \$98.50 investment returns first week. Guaranteed. Write today for proven daily profit plan.
CUTTER-CRAFT 58-B SOUTH RAYMOND
PASADENA 1, CALIF.

Mammoth
1956 Wholesale
Tool Catalog

TOOL CATALOG



YOUR NAME



The opportunity now awaits you to own and operate your own business on a part time or full time basis in the lucrative field of HARDWARE, HAND TOOLS, FANS, POWER TOOLS, MOTORS, PAINTS, etc., or BUY TOOLS FOR YOUR INDUSTRIAL OR INSTITUTIONAL USES.



Buy Nationally Advertised Tools for Resale or Industrial or Institutional Use

NO INVESTMENT REQUIRED. BUY AS YOU NEED IT. A MILLION DOLLAR INVENTORY AT YOUR FINGER TIPS.

Discount
UP
TO **50%**

\$1.00 refund on first purchase or refund if you are not 100% satisfied.



Every one needs tools. Meet the demands of the growing "Do-it Yourself" markets. Sell direct from the jumbo buying guide—your cost is known only to you.

JUST FILL OUT
COUPON

ENCLOSE \$1.00 FOR DEALER'S CARD & 1956 MAMMOTH TOOL CATALOG.

SILVO HARDWARE COMPANY

Dept. PM-2, 108 Market St., Philadelphia 6, Pa.

I am enclosing \$1.00. Rush me your dealer's card and big Catalog Today. If I am not completely satisfied with your plan, I understand that I can return the Dealer's Card and Catalog for refund, and if I decide to order, my \$1.00 will be deductible from my first order.

NAME

ADDRESS

CITY ZONE STATE

"ARCO JIG-SAW"

WITH EXCLUSIVE NEW
CIRCLE-
CUTTER
& RIP
GAGE!



Another "ARCO" FIRST! "Arco Jig-Saw" (guaranteed to fit any 1/4" drill) with Adjustable Circle-Cutter & Rip Gage saves hours of work—assures professional-looking results everytime—whether cutting circles, curved patterns, or straight cutting. Cuts perfect circles any size up to 20" diameter; rips accurate widths any size up to 10" wide. Has same capacity and cutting speed as \$55 jig saws. Does work of Jig, Keyhole, Coping, Rip, Crosscut, Band & Hack-saw! Built-in "Air-Jet" blows away sawdust. Cuts intricate patterns—however large—in plywood, plastics, metals—even cuts 2x4's! Starts inside holes. Includes blade. Converts to Table Model with



RIPPING WITH GAGE

ONLY \$9.95

No. 401 "ARCO STAND" Sturdy Casting & Clamp..... \$2.75
SOLD AT BETTER HDWE. STORES EVERYWHERE. If not available, order direct with handy coupon on our MONEY BACK GUARANTEE.

Arrow Metal Products Co., Dept. PM-2, 140 West Broadway, N.Y. 13, N.Y.

MAIL THIS COUPON TODAY!

Please send on Unconditional 10-Day Money Back Guarantee:

- No. 550 "Arco Jig-Saw" incl. 1 Blade..... \$9.95
 No. 401 "Arco Stand"..... \$2.75
 6 Extra Jig Saw Blades..... \$1.95

Name.....

Address.....

City..... Zone..... State.....

Check, M.O. Ship ppd. C.O.D. plus post.

Arrow Metal Products Co., Dept. PM-2, 140 West Broadway, N.Y. 13, N.Y.

Say You Saw It in Popular Mechanics

Protect your home against
power interruptions
with an...

ONAN Emergency ELECTRIC PLANT

Provides dependable stand-by electricity for heating system, pumps, freezer, lights, appliances. Keeps home safe, livable. Automatic start and stop. Find out how little it costs!

Write for Folder!

D. W. ONAN & SONS, INC.
3632 University Ave. S. E. • Minneapolis 14, Minnesota

A SIZE FOR EVERY NEED
500 to 50,000 watts.
Compact, quiet-running.
Gasoline-powered.
Priced from \$255.00

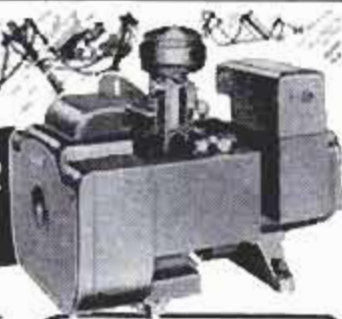

Build a MOLDED PLYWOOD RUNABOUT With This Complete Kit...



by America's largest maker
of molded plywood hulls

Save 75% construction time. Molded plywood hull has strength of steel of same weight... assured precision fit... no complex forms to erect... no framing... no planking. Pre-cut all mahogany parts mean factory built appearance inside and out.



Cruiser semi-kits also available.

See your dealer or write
for information to

U. S. MOLDED SHAPES, INC.

651 Market St. S.W.

Grand Rapids 2, Michigan

SMALL! POWERFUL!

ECONOMY TRACTOR

Thousands in Use Write for complete details.
Engineering Products Co.
915-K-2 Niagara Ct.
Waukesha, Wisconsin

Unequaled value! Low price! America's finest tractor. Ruggedly built. Easy to operate. 790 lbs. Borg-Warner clutch, trans. and diff 140 to 1 reduction. 40% more drawbar pull than ordinary tractors 8-1/4 H. P. engine. 20 quick change implements. HOOD, FENDERS.

SPARE-TIME MONEYMAKING OPPORTUNITIES READ OUR CLASSIFIED ADS

HUNDREDS OF BARGAINS

AMAZING OFFERS

ONE-MAN SAWMILL LOW \$50.00 DOWN

Take BELSAW Portable Sawmill right to the trees—turn out valuable lumber for home and farm—sell to local yards—make up to \$50 a day custom sawing for neighbors. BELSAW lasts a lifetime. No crew needed. Power with tractor or auto engine. Beginners get excellent results. Send today for FREE BOOK.

BELSAW MACHINERY CO.
P. O. Box 3456 Field Bldg. Kansas City 11, Missouri

FREE BOOK

NEW "WIZARD" TOOL DRILL GRINDING GUIDE

MAKE OLD DRILLS LIKE NEW...

For respointing dull and broken twist drills up to 1/2" in diameter. One piece cast Aluminum. Simple. Anyone can use it. Order yours today. \$1.00 post-paid.

BRASS CASTING CO. \$1.00
P. O. Box 3056 Memphis 9, Tenn.



Build Your Own Walks,
Driveway, Outdoor
Fireplace, Steps, Etc.

What to Make With CONCRETE



The terrific high costs of even little concrete jobs are mostly for labor. Get Popular Mechanics WHAT TO MAKE WITH CONCRETE and save all the labor costs while making your home or farm ship-shape. You can lay foundations, sidewalks and driveways; build steps, outdoor fireplaces, sandboxes, tennis courts, garden and swimming pools and other installations at very little cost. Book shows all—tells all—how to make the right mixture, plan, apply and gives 50 professional short cuts. Hundreds of pictures. Only \$2.00 postpaid. Order today. Money back if not pleased.

POPULAR MECHANICS
PRESS

Dept. PM17, 200 E. Ontario
Chicago 11, Ill.



Be Your Own Boss in the Profitable Excavating Business!

Custom Operators of Sherman Power Diggers Earn Up to \$1,000 and More Per Month

Wherever you live, you'll find plenty of profitable work the whole year 'round for this versatile outfit . . . not just a "trencher" but an all-purpose excavating machine! Custom operators everywhere are making big money with Sherman Power Diggers. One bought a farm with just 3 years' profits! Work for builders, contractors, utilities, and municipalities on such jobs as • SEPTIC TANKS and DRAINFIELDS • SEWER LINES • FUEL TANK INSTALLATIONS • FOUNDATIONS and FOOTINGS • GAS and WATER LINES • FIELD TILLING and many others. The Sherman Power Digger travels quickly from job to job, digs at a fraction of the cost of manual labor. It's simple to operate, easy to maintain, built to last.

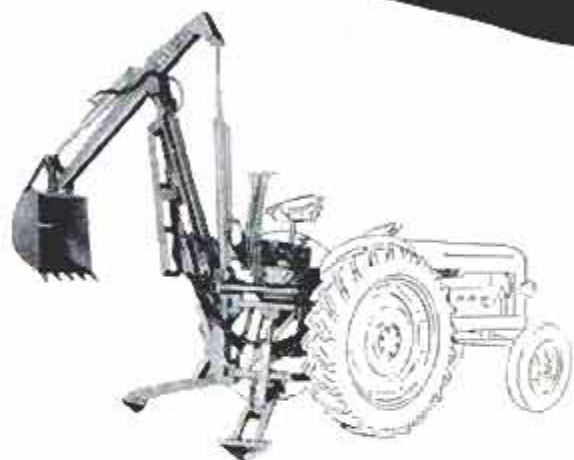

Send now for complete information about the easy-to-get jobs for your Sherman Power Digger. Let us tell you —without obligation—how you can go into business for yourself with an investment of less than \$5000.

SHERMAN PRODUCTS, Inc.

Dept. 1736 Royal Oak, Michigan

Exclusive Double-Bearing HEAVY-DUTY PUMPS

IRRIGATE • DRAIN • CIRCULATE • SPRAY
Up to 7,500 GPH. 3,000 GPH from 25' well. Use 1/4 to 1 HP motor. 1 1/4" inlet; 1" outlet. Stainless shaft. TYPE X-2 oilless bronze bearings. Won't rust. \$10.95
TYPE XB—Ball bearing model. \$12.95
Postpaid if cash with order. (West of Miss. add 5¢)



MONEY BACK GUARANTEE
Centrifugal and Gear Pumps in All Sizes
LABAWCO PUMPS, Belle Mead 2, N. J.



#53
RAZOR SAW
BLADE SET
\$1.75
X-ACTO, INC.
48-45 Van Dam St.
Long Island City, N. Y.
Send 25c for 28-page Catalog

Automatic Saw Set...

MAKE EXTRA PROFITS!

Set 400 teeth per minute on hand or band saws, 4 to 16 point, with the BeMaCo Automatic Saw Set. Fast, accurate, true hammer-anvil action sets teeth uniformly, eliminates tooth breakage. Used profitably by saw shops and manufacturers everywhere. Every machine positively guaranteed! Write for details—today!



Saw
Machine
Division
20-C

BEAVER MFG. CO.
800 ISIS AVENUE • INGLEWOOD, CALIF.

SAVE! \$ SAVE!

Automatically!



CONVERT YOUR DRILL PRESS NOW

Easy to install.
Eliminates Fatigue.
Safety engineer's dream
Increase production 300%.
Accurate to $\pm .002$
Does not hamper manual operation.
Converts hobbies to profitable enterprises.

- Boxed complete
- Installation instructions
- Satisfaction guaranteed
- Now ONLY \$325.00

Write today!

GENERAL PACIFIC CORP.

8740 W. Washington Blvd.
Culver City • California

Openings for
Dealers &
Mfr's Repts.

GENERAL Multi-Speed DRILL FEED

NOW! INSTANT SOLDER GUN and COMPLETE "DO-IT-YOURSELF" KIT



FOR HUNDREDS OF RADIO, TV AND HOMECRAFT JOBS

SOLDER GUN ONLY — MODEL G14 \$7.95

BEST KIT VALUE! MODEL G14K \$8.95

Includes:

- ✓ 150-Watt Instant Solder Gun Model G14
- ✓ Cutting Tip for plastic tile, old putty, toys, etc.
- ✓ Smoothing Tip for furniture scratches, sealing, etc.
- ✓ Famous Kester TV-Radio Resin Core Solder
- ✓ Sandpaper for cleaning parts

"You'll like the way it HANDLES!"

COMBINES ALL THE ADVANTAGES OF THE SOLDER GUN AND THE CONVENTIONAL SOLDERING IRON. No waiting — press trigger and solder at once. Ideal tool for shop or home use. Takes only half the space of transformer guns in tool boxes.

120 Volts AC-DC 1/4" Tip (also available 1/8" Tip)

COMPARE THESE FEATURES WITH ORDINARY SOLDER GUNS!

- POWER PACKED—150 Watts
- NO HEAVY TRANSFORMER — weighs only 8 oz.
- STURDY LIFETIME TIP — no soft fragile wire
- HEAT RIGHT IN TIP — new unique element design
- LONGER, THINNER REACH — EFFECTIVE SPOTLIGHT

HEXACON ELECTRIC COMPANY
162 WEST CLAY AVENUE, ROSELLE PARK, NEW JERSEY

Serving Craftsmen for a Quarter of a Century

Also Eshelman Adult 2 Pass. SPORT & GOLF Cars 1/5 the Price of most other Cars. 70 Miles Per Gal. Free Catalog.

ESHELMAN TRACTORS LOW AS \$99

For Better Lawns and Gardens investigate Eshelman Riding Rotary Mowers, Tillers, Tractors. Advertised in GOOD HOUSEKEEPING and leading magazines. Amazing Savings. Free Literature Write: ESHELMAN CO., Dept. M-52, 109 Light St. Balto. 2, Md.

Shipping Points: BALTIMORE - CHICAGO - RENO

TURBINES — NOW AVAILABLE FOR CIVILIAN USE

KITS FROM — \$59.50

FEATURES:

- ONE PRIMARY MOVING PART
- NO AUXILIARY COOLING
- USES LOW COST FUEL
- LIGHT WEIGHT SMALL VOLUME
- SELF CONTAINED GEARBOX
- .685 SQ. FT. FRONTAL AREA
- CORROSION RESISTANT CONST.

Having applied mass production techniques with sound engineering we have developed a series of low cost gas turbines. This type unit is applicable to automotive, aircraft, marine, and industrial usage. It is the engine of the future as well as the present. Its ultramodern design will remain current for years to come.

Send \$1.00 for catalogue containing prices, photographs, technical data, etc., or send \$3.00 for catalogue plus a bound set of assembly and detailed blueprints. Catalogue or blueprint fee refunded on first order.

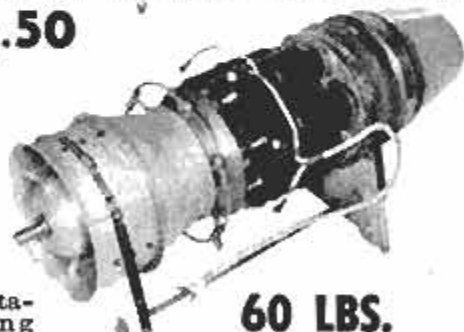

60 LBS.

TRECO PRODUCTS, DEPT. 20, 1364 WOODLAND HILLS DR., ATLANTA 5, GEORGIA

AMAZING BARGAINS—SAVE TO 100%

75 MOUNTED WHEELS AND MINIATURE CUTTERS

Regular \$11.00 Value. Only **\$4.50** Post Paid

For cutting and grinding on wood, metal or plastic. Includes 26 mtd. wheels and points on 3/32" shanks; 24 miniature cutters on 3/32" shanks; 25 short shank min. cutters. Will fit all electric drills and hand grinders.

FLEXIBLE SHAFT \$9.50 Value \$4.95

Fits all electric drills & hand power tools. 35 3/4" long. Oilite bearings. Core of specially wound, high carbon steel wire in flexible steel casing. Will accommodate tool shafts up to 1/4" dia. For lathes, electric drills, etc.

10 Hi-Speed Steel & Carbon Drills \$1.00 Post-paid

5 Woodworkers Drills \$2.95 From 1/4" to 3/8" on 1/4" shank.

5 Hi-speed steel Drills \$1.95 1/4" to 1/2" Diameter.

SCHUPACK SUPPLY CO. 7331 Cottage Grove, Dept. Send ckk. or m.o. P.M.-9, Chicago 19, Ill. No C.O.D.'s
NEW ILLUSTRATED CATALOG. 10c

Amazing New TRU-FIRE SPARK PLUG

SPECIAL OFFER! Order by Mail Reg. 1.50 **1.25** EACH

Specify Make and Year of Car. Cash, Check or Money Order—Post Paid

FIRES IN OIL! TWIN ELECTRODES! New Life to Your Car! Delay Costly Motor Job! Guaranteed to Fire when Other Plugs Fail— or Money Back!

LEONARD SPARK PLUG CO. 148 Summit St., Newark 3, N. J.



STOP LEAKS

Tight seals for automotive gaskets—fix leaks (liquid or gas) around the house.

FORM-A-GASKET No. 1, No. 2 or No. 3

At your garage or service station

More than 50 Chemical Products for Better Automotive Maintenance

How to Build Your Own GARAGE



Save as Much as 50% of Usual Construction Costs

Get Popular Mechanics' brand new book *How to Build Your Own Garage* by Wayne Leckey, Assistant Shop Notes Editor, and find out how you can build your own garage at savings of 50% of usual cost. Leckey tells in famous step-by-step instructions and shows in big, clear photos, drawings and diagrams how to perform every building operation from laying the concrete to installing the final trim. There are 25 designs. Brick, frame, and concrete block fully covered. Send \$3.50 for your copy. 7-day money back guarantee.

POPULAR MECHANICS PRESS, 200 E. Ontario, Chicago 11, Ill.



new!**BULLDOG
Screw Type
Top Crank
JACK**

- Fits Any Tongue
- Makes Hitching and Parking One-Man Job
- Adaptable to Channel, Angle or Wood Tongues Up to 4" Thick
- Solid Steel Threaded Shaft With 6" Steel Wheel

With its interchangeable mounting bracket, it is easy to install and move from one piece of equipment to another... handle folds, Model 52-F illustrated \$18.50 F.O.B. Wausau... prompt delivery.

\$18.50

Also full line of trailer axle assemblies and trailer couplers. Write today for FREE Catalog 13-K.



**HAMMERBLOW
TOOL COMPANY**
WAUSAU • WISCONSIN

SHEET METAL BRAKES

Forms angles, locks, pans, etc. New eccentric clamps. All steel construction. Size 15" — 16 gauge steel, \$23.50; 36" — 22 ga. \$35.50; 48" — 24 ga. \$52.00. Stand \$8.00.

16 ga. Metal Bender 48" size, \$42.00
3/8" x 12" Angle Former \$15.50
14 ga. 6" Compound lever shear \$29.00

SEND FOR FREE CATALOG

VYKE MFG. CO., 4158-P Jason St., Denver 11, Colo.



Say You Saw It in
POPULAR MECHANICS

SPECIAL FOR FEB. ONLY**WOOD UTILITY CHEST . . .**

- tool kit
- photographic equipment
- tube caddy
- gadget box
- toy chest
- hobby material



Sturdy, all purpose case 20 1/4" x 9 1/2" x 7 1/4". 2 locks and clasp. No nails, all countersunk screws. Approx. shipping weight 11 lbs. Reg. \$14.46. **\$1.95**

FREE Tube and Parts CATALOG. Over 400 Tube Types! Write Dept. PM-2
RAD-TEL TUBE CO., 115 Coit St., Irvington 11, N. J.

PLEASE INCLUDE POSTAGE WITH REMITTANCE

**EASY
TO
INSTALL**

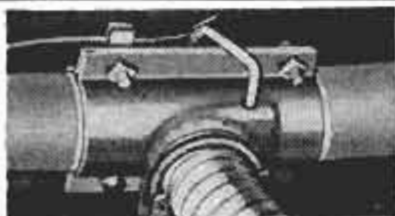

**FITS
ALL
CARS**

Get the original . . .

HURRICANE CUT-OUT

Costs no more than imitation. More sold than all other makes combined.

ST. LOUIS PRODUCTS CO.
2755 Walton Road St. Louis 14, Mo.

**PRICE
\$4.95**
postpaid

LOOK! All New - All Precision - All Deluxe
SUPERSHOP MODEL X

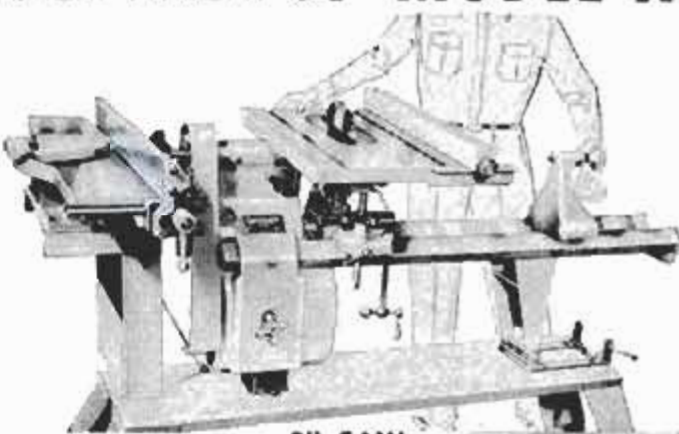
**8" SAW**

**WE PAY ALL
FREIGHT FOR
YOUR FREE
HOME TRIAL**

**ONLY
\$139.50
EASY
PAY
PLAN**



Vert. Drill Press



Hor. Drill Press



8" Sander



30" Lathe



5" Grinder

Never before have you seen so much deluxe, precision-built power tool workshop at any price! Designed for the man who wants the best. Massive cast and precision-machined headstock, self-centering inverted "V" bedways (like precision metal lathes), exclusive non-friction speed changer, extra-large cast and precision-ground saw table. 100% ball bearing, lifetime-lubricated. You save by ordering direct from factory. You are invited to test Supershop Model X in your home FREE. Mail coupon or postcard for FREE brochures, photos, details, specifications, accessory list — and amazing freight prepaid FREE HOME TRIAL PLAN. All free.

**MAIL COUPON OR
POSTCARD TODAY**

POWER TOOLS, INC. 180 Yates Avenue
Beloit, Wisconsin

NAME _____

ADDRESS _____

CITY _____ STATE _____

For Her...

THE FINEST KITCHEN VENTILATING SYSTEM

Easily built into your present kitchen or your new home

TRADE-WIND KITCHEN VENTILATOR



The Trade-Wind Super Clipper is the only equipment that gives you complete kitchen ventilation. Powerful dual blowers installed in the cabinet over the range have 2 inlets, both equipped with washable filters. One inlet under the hood eliminates all cooking heat, grease and odors. A second one at the ceiling discharges heat and keeps the entire house clean. 4 other top quality models available. Easy to install in your new or existing home.

MAIL COUPON FOR COMPLETE INFORMATION

TRADE-WIND MOTORFANS, INC.
7755 Paramount Blvd., Dept. PM, Rivera, Calif.
Please send information on Trade-Wind Ventilators.

Name _____

Address _____

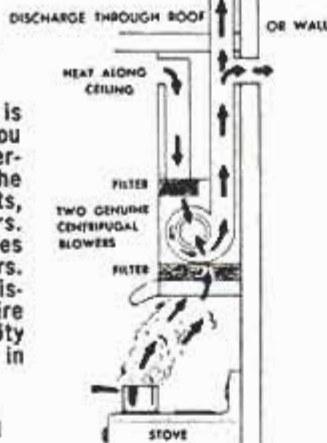

NEW Easy-to-Use SOLDER



Solders metals instantly ... just apply Swif and heat

Swif is real 50/50 Tin-Lead solder with flux in paste form that makes all kinds of soldered connections permanently—and fast. No separate flux needed. Just apply Swif by squeezing the tube and heat with torch or iron—on small jobs even a match will do the job perfectly. Each tube holds enough solder for hundreds of jobs. Swif has been used by professional plumbers for years. At hardware stores, hobby shops, plumbing dealers, auto stores. 59c.

SEND FOR FREE LITERATURE

HERCULES CHEMICAL CO., INC.
332 Canal St., New York 13, N.Y.



BARRON Drill Press TOOLS



FOR WORKSHOP AND INDUSTRIAL USES...

Over 40 precision built woodworking tools and accessories... Hi-Speed Router Bits—Rotary Surface Sanders & Drum Sanders—Safety Shaper Cutters—Dovetail Cutters—Large Auxiliary Metal Tables—All Metal Shaper Fences—Spindle Adapters—Handy Bench Vises. Many other items indispensable for accurate, useful, versatile workshop use. Every tool sold on complete satisfaction or your money back. See your Barron Dealer. Ask for special folder—"24 Extra Uses for Your Drill Press."

ROTARY PLANER

- Planes • Rabbits
- Tenons • Panels
- Routs • Bevels

Only \$8.50 COMPLETE

BARRON TOOL CO. INC.
302 Architects Bldg., Detroit 1, Mich.

FREE Workshop Guide & Catalog



IMPERIAL RAPID BRUSH CLEANER

For HARD-CAKED brushes

Acts instantly—no long soaking. At paint and hardware stores.

Wilson-Imperial Co., 119 Chestnut St., Newark 5, N.J.



BRONZE FOUNDRY

Schools and Home Workshops

Make your own castings of aluminum, copper, bronze, silver. Foundry sets are available in three sizes including 2400 Deg. F. blast Furnaces. \$22.50; \$29.50; and \$42.00. f.o.b. Marysville, Kans. Free Circular.

KANSAS CITY SPECIALTIES CO. P. O. Box 6022, Dept. P-2 MARYSVILLE, KANS.

FREE AMAZING NEW BOOK "HOW TO ANSWER ADS"



Never before have you seen anything like this. Tells you in simple language the correct way to answer ads. Gets you quicker replies—better results, and greater satisfaction. Will save you time and money and it's ABSOLUTELY FREE. No obligation whatever. Every reader of advertising should have this booklet. Send a postcard for your copy NOW. F. W. JOHNSON, Popular Mechanics Magazine, Room 600-A, 204 East Ontario Street, Chicago 11, Ill.

PRI ROAD TO RICHES

You can be the next uranium millionaire! Government guarantees huge bonus! PRI instruments from \$29.95. See your local dealer today! FREE CATALOG! Write PRI, 4223 PM W. Jefferson Los Angeles 16, California



ALL CAR OWNERS MICRO-MATIC PROPORTIONATOR

FASTER SMOOTHER ACCELERATION
THIS EASILY INSTALLED PROVED DEVICE GIVES THAT ADDED ACCELERATION ESSENTIAL IN STARTING, PASSING OR AN EMERGENCY. BY PROPORTIONATING SPARK TO REVS. • LUGGING & PINGING VANISH

Only \$4.95 Postpaid-No C.O.D.

MOTIVE DEVICES
5585 N. Lagoon Ave.
Portland 11, Oregon

U.S. ARMY FIELD PHONE

A private phone or intercom system. Ideal for use on target range, farms, mountains, forest or any place where portable two-way communication is desired. This is the famous EE-8 field phone used to success by the Signal Corps. Gives clear reception up to 15 miles. Uses two standard batteries. Set consists of a ringing generator, one phone, all contained in the original handy carrying case. Several of these phones can be used on one line. Records checked out. Price per ea. phone. **1495**

Price for a SYSTEM - two sets... **2950**

RADIO ANTENNA REEL

For tuning beam antenna. Powered by 1/8 HP. 24V. GE motor, engaged to gear reduction only when electrical contact is made. Operated in either direction. Ideal for auxiliary power take-off, 150 RPM at take-off. Used for opening & closing doors etc. A tremendous value. **NEW 675**

5 DRAWER FASTNER KIT

A typical Palley Bargain. Buy! Here's a 5 drawer steel cabinet jammed full of fabric fasteners, rivets, etc. Included are metal grommets, twist fasteners, snap fasteners, speedy rivets, etc. Also included is a hand Press complete with punches and dies for installation. You will look a long time to beat this. **2895**

VICKERS HYDRAULIC TRANSMISSION

Self-contained, constant torque at all speeds with variable volume, reversible piston pump which supplies piston hydraulic motor. Has 2 H.P. Automatic pressure dash pot for smooth control. Power output RPM - 0 to 1/3 input RPM in both directions. Input RPM 1800 continuous, 4000 intermittent. Ideal for Lathes, Duplicator setup on Mills, Conveyors, Small Cars, Drives, etc. **4950**

4" SPLINE SHAFTS for input and power take-off on above. Pair **\$2.50**
INPUT & TAKE-OFF PLATE ASSEM. To adapt Trans. to pulley drive. Has 1/2" keyway shaft. High Speed bearings. **2000 SET**

NEW ELECTRIC LINEAR ACTUATOR

Has a 5-1/4" stroke. Delivers an 800 pound thrust and will stand a 1750 lb. static load. Motor operates on 24 volt DC current at 11-1/2 amps - turns at 7500 RPM with 1/6 HP. The overall length, eye-to-eye is 13 inches. **995**

12 SWISS PATTERNED P.C. NEEDLE FILES

Made of finest quality and specially hardened file steel. Designed for very precise work. Ideal for Technicians, Model Makers, Repairmen, etc. Set of 12 ass't shapes. A \$5 Value. **279**

PHILLIPINE MAHOAGANY PLYWOOD BUY FROM IMPORTER

SAVE 50% FREE SAMPLE ON REQUEST SELECT QUALITY

All orders shipped by Special Truck for lowest rates. No order accepted for less than 100 lbs. (min. number of sheets)
3MM (1/8") x 3FT. x 6 FT. **179** \$500 VALUE PER SHEET MINIMUM ORDER 8 SHEETS.
1/4" x 4 FT. x 8 FT. **449** 950 VAL. PER SHEET MIN. ORDER 4 SHEETS

QUALITY WOOD LEGS WITH BRASS TIPS BUILD OR RESTYLE YOUR FURNITURE

Beautifully turned, fully seasoned hardwood legs. Smoothly sanded and complete with brushed Brass tip and sturdy steel mounting plate. Available Finished or Unfinished - Finished units come in Blonde, Silver Fox, Mahogany or Charcoal Black. Please Specify type. Price per set of 4 with Brass tip.

SIZE	FINISHED	UNFINISHED	SIZE	FINISHED	UNFINISHED
4"	\$2.65	\$2.15	14"	\$4.40	\$3.95
6"	3.00	2.65	16"	4.75	4.40
8"	3.55	3.00	18"	5.35	4.75
12"	3.95	3.55	20"	6.25	5.35

3400 RPM 1/2 HP POWER SAW RIPS - CROSSCUTS CUTS A FINISHED 2x4 LIKE A KNIFE THROUGH BUTTER

COMPARES TO SAWS SELLING UP TO \$49.50 **1998** Complete with 5-1/2" Blade
A rugged, professional type, adjustable saw. Will cut any angle from 0 to 45°. Has an adjustable (0 to 6") rip fence. Safety-trigger switch on handle. Full 1/2 HP Universal AC-DC, 110-120 Volt, 60 cycle motor. Weighs only 6 1/2 lbs. Thousands already sold. Your satisfaction guaranteed.

PALLEY 100-200-300 POWER MICROSCOPE

Ideal for the Home Lab, Student, Amateur Scientist, etc. Study insects, plant life, plant tissue, etc. Has fine ground and polished lenses. Precision ALL-METAL construction - this is NOT A TOY! The triple, revolving objective lens turret will allow you to select 100X - 200X or 300 power magnification. Has right or left hand rack & pinion adjustment for smooth, precise movement. Body inclines 90°. Adjustable plane sub-stage mirror. Complete in sturdy, dove-tailed hardwood case. **Only 895** A \$1600 VALUE

NEW 18" HYDROPLANE

The sleek, single-step hull is made of special hardwood. Hull sections are pre-formed and shaped making construction fast and easy. All parts including metal framed, plastic windshield are furnished. Hull is designed to use miniature, electric outboard motor (described below). Complete kit **495 LESS MOTOR**

ELECTRIC OUTBOARD MOTOR

Runs on two flashlight cells. Enough power for boats up to 18". Has tilt-swivel mount. Propeller diameter 1". Ready to go! **269**

ARMY CANTEEN CUP & BELT

Genuine U.S. Army equipment. The one quart canteen and aluminum cup fit into the insulated canvas cover. Cover hooks onto the web type pistol belt, which has metal grommets for hooking on other gear. **259**

HEAVY FLEECE LINED LEATHER JACKET

Genuine leather with a zipper front. Lined with extra thick fleece. High collar. Adjust. waist. Wool inner cuffs. 2 large pockets. **2295** SIZES: 38-42-48

ARMY MACKINAW

Heavy duty Army duck. Full wool inner liner. Has two large pockets and full belt. Adjustable cuffs. Excellent for winter. Size 36 Only **ONLY 795**

AIR CORPS SEXTANT

Can be used for any navigational purpose. Contains many valuable optics, lenses, prisms, gears, drives, spring motor, bubble level, etc. Can be used as is. Comes with sturdy plastic bag. **1795**

SEXTANT TYPE STADIMETER

An optical instrument for measuring the exact distance between two points. Originally used by the Navy. Complete set includes Stadimeter miniature telescope and complete instructions for use. Comes beautiful, polished hardwood case. A Bargain at **1795**

GENUINE AN6530 ARMY AVIATORS GOGGLES

Have precision ground, interchangeable lenses. Choice of 3 colors - Clear, Amber or Green. Frames are rubber covered with a soft, chamolix lining and built-in, non-fogging lens ventilators. Adjustable nose bar. An elastic headband. WINDPROOF - DUSTPROOF! Genuine Air Corps Surplus. **NEW 249** Give lens color choice. **EXTRA LENSES - color above. 100**

ARMY OFFICER LENSATIC COMPASS

An all-purpose precision instrument for the Boy Scout, Hunter, Hiker, Surveyor, etc. Used for map orientation, taking an azimuth reading or as a guide on unfamiliar terrain. Has a 300° rotating bezel ring marked in 3 degree notches for fine computation. Cover has built-in "peep" sight and hairline guide for sighting on distant objects or landmarks. **595 VALUE**

SELSYN TRANSMITTER MOTOR

A Synchronous AC motor. The most accurate type of electric motor made. Will operate without speed variation for indefinite time. Ideal for precision work. 115 volt - 60 cycle. **ONLY 1495** SUPPLY LIMITED

NEW 133 PIECE POWER TOOL ACCESSORY SET

The complete accessory set for any small job. Can be used with any electric drill or grinder. Contains 133 pieces including grind, polish, cut-off & buffing wheels, sanding discs, steel cutters, mandrels, burnisher, mounted stones and knife edge rubber wheels. A very handy set for the model builder or hobbyist. Worth many times our price. **198**

PRESSURE TANKS

G1 Type Stainless Steel. Shatterproof and rustless. Has reinforcing ribs and is pressure tested up to 400 PSI. Has high safety factor. 1/4" pipe ports. Ideal for use in air supply in underwater fishing, painting, spraying, etc. Also as body or for water supply. Size: 12 1/2" x 24". Stainless Steel. **1295**
Corrosion Resistant Steel TANK - 395 No. D-2. 500 cu. in. capacity. **395**

Palley's

2263 E. VERNON AVE., DEPT. PM-2 Los Angeles 58, California

Order From This Ad Pay by M.O. or check P.O. accepted from DAB items. A deposit with C.O.D.'s All Prices FOB Los Angeles

ONLY 795

WILLIAMS LOCKING ADJUSTABLE

MAKES ALL OTHER ADJUSTABLE WRENCHES OLD FASHIONED

NO EXTRA COST



Now, you can have the mechanics favorite wrench. Locks instantly. One hand adjustment. No obstruction. No fumbling. Drop-forged and heat-treated alloy steel, chrome plated. Popularly priced at most leading hardware stores:

6" @ \$2.08; 8" @ \$2.45
10" @ \$3.10; 12" @ \$4.50

Made by famous industrial tool specialists.



J. H. WILLIAMS & CO.

417 VULCAN STREET • BUFFALO 7, N. Y.

CUT THE BOLT YOU NEED TO ANY LENGTH

HEAT AND BEND TO ANY SHAPE

24" and 36" lengths

7 SIZES

1/4" 5/16" 3/8" 7/16"
1/2" 5/8" 3/4"

REDI-BOLT

THREADED STEEL RODS

Ask Your Hardware Dealer or Write

REDI-BOLT, Inc., 5330 Indianapolis Blvd., E. Chicago, Ind.

Professional Mechanics' TOOL CHEST

FOR YOUR HOME WORKSHOP



This may be the lowest cost full-sized chest in America! 4 sliding drawers in blue-gray rugged steel cabinet. 26" x 12 1/2" x 12 1/4". Free bulletin describes this and 12 other models!

\$24⁷⁵ F.O.B. ST. PAUL

HUOT MANUFACTURING CO.

555 No. Wheeler St., St. Paul 4, Minn.



HARDWOODS

PRICES BELOW PER 100 BOARD FEET AIR DRIED & ROUGH

WALNUT 1" inch No. 1 common \$30.00
CHERRY 1" First And Second \$25.00
OAK (Red or White) 1" FAS \$30.00
AROMATIC RED CEDAR 1" Grade No. 1 \$30.00

Orders of less than 100 bd. ft. price is 10% higher per bd. ft. Write for prices on other kinds and grades of Hardwoods. Air Dried or Green. Surfaced or Rough. FOB Fayetteville. Any reasonable lengths, widths, thickness.

JIM BELCHER Route #1 Fayetteville, Ark.
"SATISFACTION GUARANTEED"

Also Eshelman TRACTORS. Riding ROTARY MOWERS. ROTARY TILLERS at amazing savings. Write for Free Literature

ESHELMAN GOLF CAR

GASOLINE ENGINE

70 MILES PER GAL. GAS UP TO 20 MILES PER HR.

1/3 the cost of most other cars. Ideal for golfers, industrial plants, farms, etc. Also Child's 2 pass. Cars. Free Literature Write ESHELMAN CO., Dept. MC-52, 109 Light St., Balto. 2, Md.



Shipping Points: BALTIMORE - CHICAGO - BENO

YIPEE - A SAWHORSE IN A Jiffy

Jiffy Brackets and 2x4s are all you need. Set up and knocked down in a jiffy—no nails, screws, or bolts required. Easy to move or store. Sold by hardware and building supply stores everywhere, or order direct.

GRAND HAVEN STAMPED PRODUCTS CO., Grand Haven, Mich.

POWER HACKSAW \$58.50

LESS MOTOR F.O.B. Benton Harbor

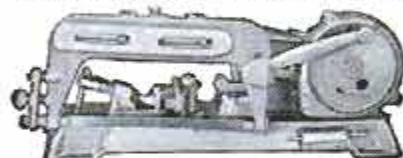

Send for full details and name of nearest dealer.

Rugged cast iron construction. Wt. 56 lbs.. bronze bearings. Draw cut. Auto. return lift. Auto. shut-off. Vise swivels 45°. Cap. 4"x4".

Dept. PM-26
EXCEL MACHINE TOOLS BENTON HARBOR, MICHIGAN

MASTER THE EASY ART OF SURE-DIRECTION DRIVING

DRIVE BY HULL AUTO COMPASS

Be sure it's a Hull—for famous fine instrument accuracy, LASTING dependability. Used by hundreds of thousands. At better dealers everywhere. Write for free literature.

Beaconlite 16" STEERING 14"

HULL MFG. CO., P.O. Box 246, D-2, WARREN, OHIO

MORE ACCURACY • VERSATILITY • DEPENDABILITY FOR YOUR MONEY

SOUTH BEND gives you quality that counts — quality that pays off in better and faster metal working by means of more accuracy, versatility and dependability.

Compare the South Bend 7" Shaper and Pedestal Grinder with any others on this basis. You'll find that their quality actually gives you more value on a dollar-for-dollar basis. The best way to prove this is in your own plant. Let our distributor show you how both of these efficient machine tools can best be used in your production, toolroom or maintenance work. Time payment terms available.

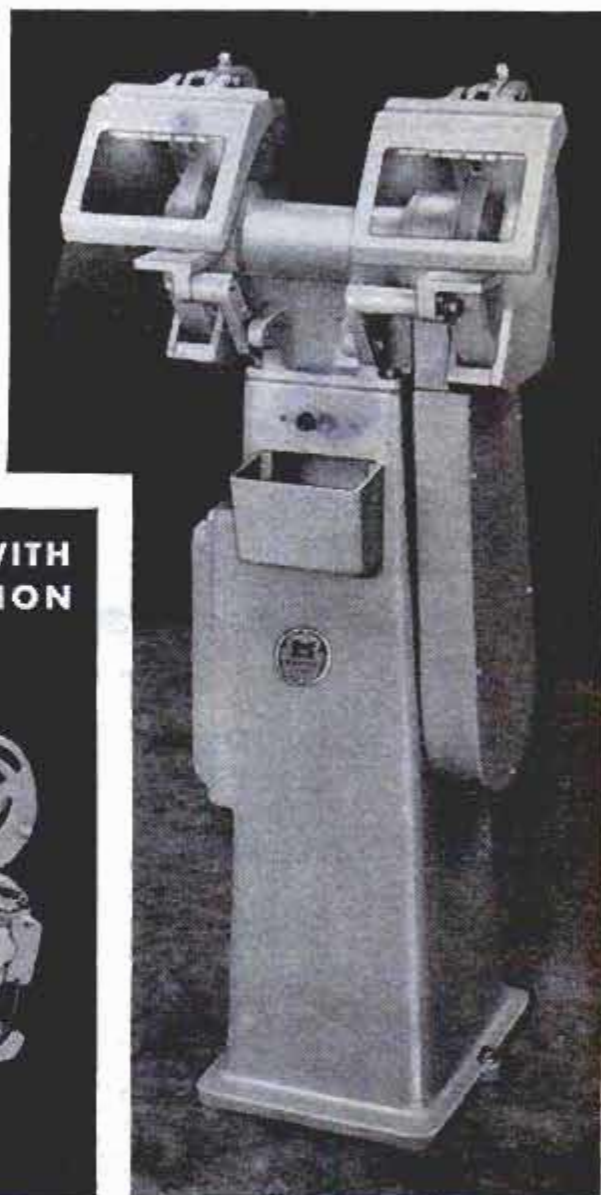

8" Pedestal Grinder—\$257

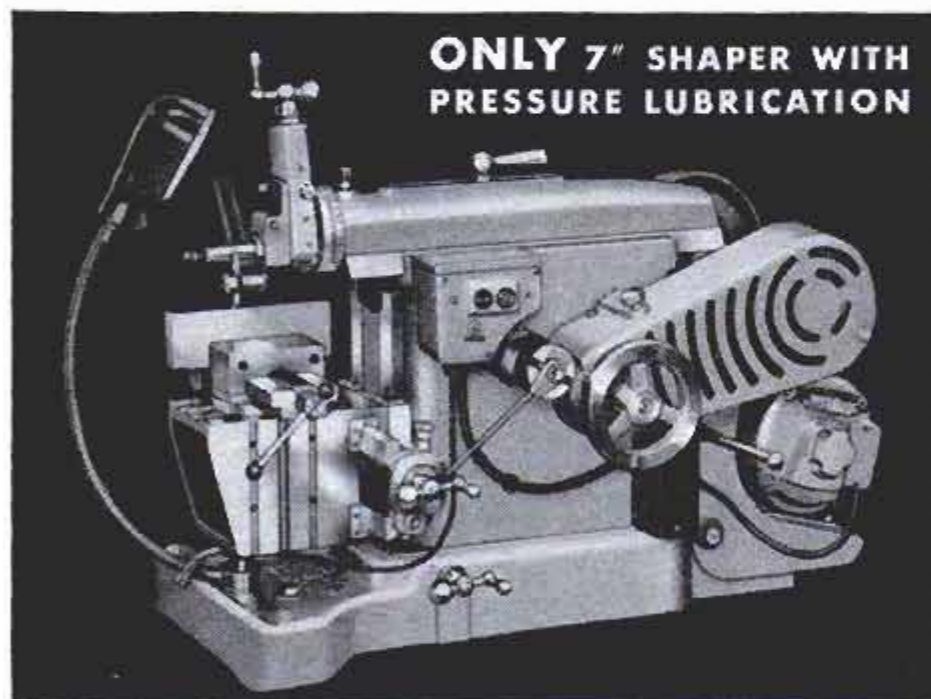







**ONLY 7" SHAPER WITH
PRESSURE LUBRICATION**

7" Precision Bench Shaper — \$551

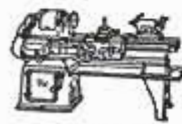
(Prices f.o.b. factory, less motors)



PLEASE SEND INFORMATION CHECKED:

- | | | | | | | |
|---|---|---|--|---|---|---|
|  |  |  |  |  |  |  |
| <input type="checkbox"/> 9" and 10" BENCH LATHES | <input type="checkbox"/> 10" to 16-24" FLOOR LATHES | <input type="checkbox"/> DRILL PRESSES | <input type="checkbox"/> 1/2" & 1" Collet TURRET LATHES | <input type="checkbox"/> TOOL GRINDERS | <input type="checkbox"/> 7" BENCH SHAPERS | <input type="checkbox"/> MILLING MACHINES |

Name _____ Street _____
City _____ State _____

Building Better Tools Since 1906 • SOUTH BEND LATHE • South Bend 22, Indiana

Learn how homeowners everywhere
save money by installing their own

MATICO TILE FLOORING



*MATICO's New Improved
Install-It-Yourself System
Makes It Easy!*



1—Mark straight lines through the center of the room in both directions, using a chalk and line.

2—With a notched trowel, spread adhesive evenly over floor and allow to "set."



3—Press tiles into position. You can walk on MATICO as soon as floor is in place.



Yes, you can enjoy colorful, durable MATICO Asphalt Tile Flooring in your home at amazing low cost by installing MATICO yourself. You can't buy a more economical type of luxury flooring than MATICO. It lasts for years . . . is easy to keep sparkling clean and comes in 29 striking decorator colors that can't wear off because colors and marbleization go clear through the tile.

It's a cinch to install, too, with MATICO's tested install-it-yourself instruction booklet . . . tile calculator . . . and special tool kit. Why, you can finish a room in just a few hours.

Why put up with a dingy, worn-out floor when it costs so little to install a MATICO tile floor yourself.

See your classified telephone directory for the name of your MATICO dealer.



MASTIC TILE CORPORATION OF AMERICA
Houston, Tex. • Joliet, Ill. • Long Beach, Calif. • Newburgh, N.Y.

Manufacturers of:
Confetti • Aristoflex • Parquetry • Maticork • Asphalt Tile
• Rubber Tile • Vinyl Tile • Cork Tile • Plastic Wall Tile

MASTIC TILE CORPORATION OF AMERICA
Dep't. M2-1, P.O. Box 986, Newburgh, N. Y.
Please send me MATICO's money-saving install-it-yourself instruction kit and complete color chart.

Name

Address

City..... Zone..... State.....

IT'S A PSYCHOLOGICAL FACT: **PLEASURE HELPS YOUR DISPOSITION**



R. J. Reynolds Tob. Co.,
Winston-Salem, N. C.

How's your disposition today?

EVER FEEL LIKE SQUAWKING? It's only human to be irked by little annoyances. But — it's a psychological fact that pleasure helps your disposition! If you smoke, don't forget: there's *more pure pleasure in Camels!*

For **more**
pure pleasure... have a
Camel

"I've tried 'em all — once a Camel smoker, always a Camel smoker!"

Tyrone Power



TODAY MORE PEOPLE SMOKE CAMELS and get more pure pleasure from Camels than from any other cigarette! Fact is, no other cigarette is so *rich-tasting*, yet so *mild* as Camel! If you want the most possible pleasure, remember this: pleasure helps your disposition. For *more* pure pleasure — have a Camel!

No other cigarette is so rich-tasting, yet so mild!