

JANUARY 1956

35 CENTS

POPULAR MECHANICS

MAGAZINE

WRITTEN BY YOU CAN UNDERSTAND IT

REG. TRADE MARK, GREAT BRITAIN, NO. 40528

REG. U.S. PAT. OFF.

Hot-Line Men
—Page 158

Here's the New
RAMBLER

Why All These Hurricanes?

For the Craftsman

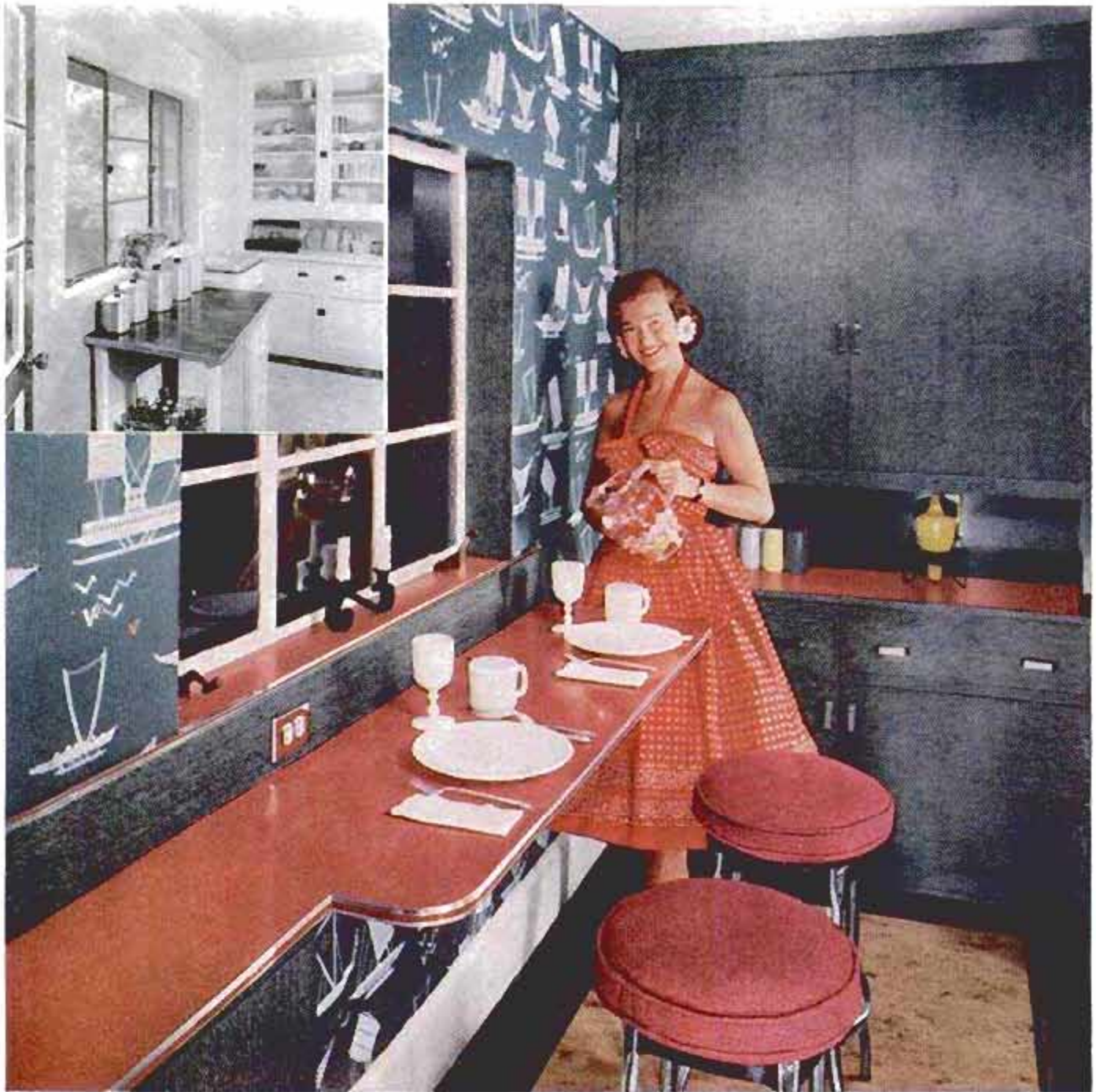

Look what an amateur did with \$49 worth of **FORMICA**[®]

If you can use simple hand tools, you can resurface worn-out tops or put waste space to work with genuine Formica. You just cut Formica sheets to size with a carpenter's saw and apply it with Contact Bond Cement and a kitchen rolling pin.

From the 70 Formica colors and wood grains this homecraftsman selected Black Oak and Red Linen.



Look in your classified phone book under "plastic" for your nearest Formica dealer. Send today for free illustrated instruction folder together with actual samples of Formica. Write . . .

FORMICA
4596 Spring Grove Ave.
Cincinnati 32, Ohio

In Canada: Arnold Bonfield & Co. Ltd., Oakville, Ontario

DEMAND THIS CERTIFICATION

This mark certifies genuine
REMOVE WITH SOAP AND WATER

Seeing is believing. If this wash-off identification is not on the sheet, it's not FORMICA.



Champion Spark Plugs are ribbed like power line insulators to give you faster starting!

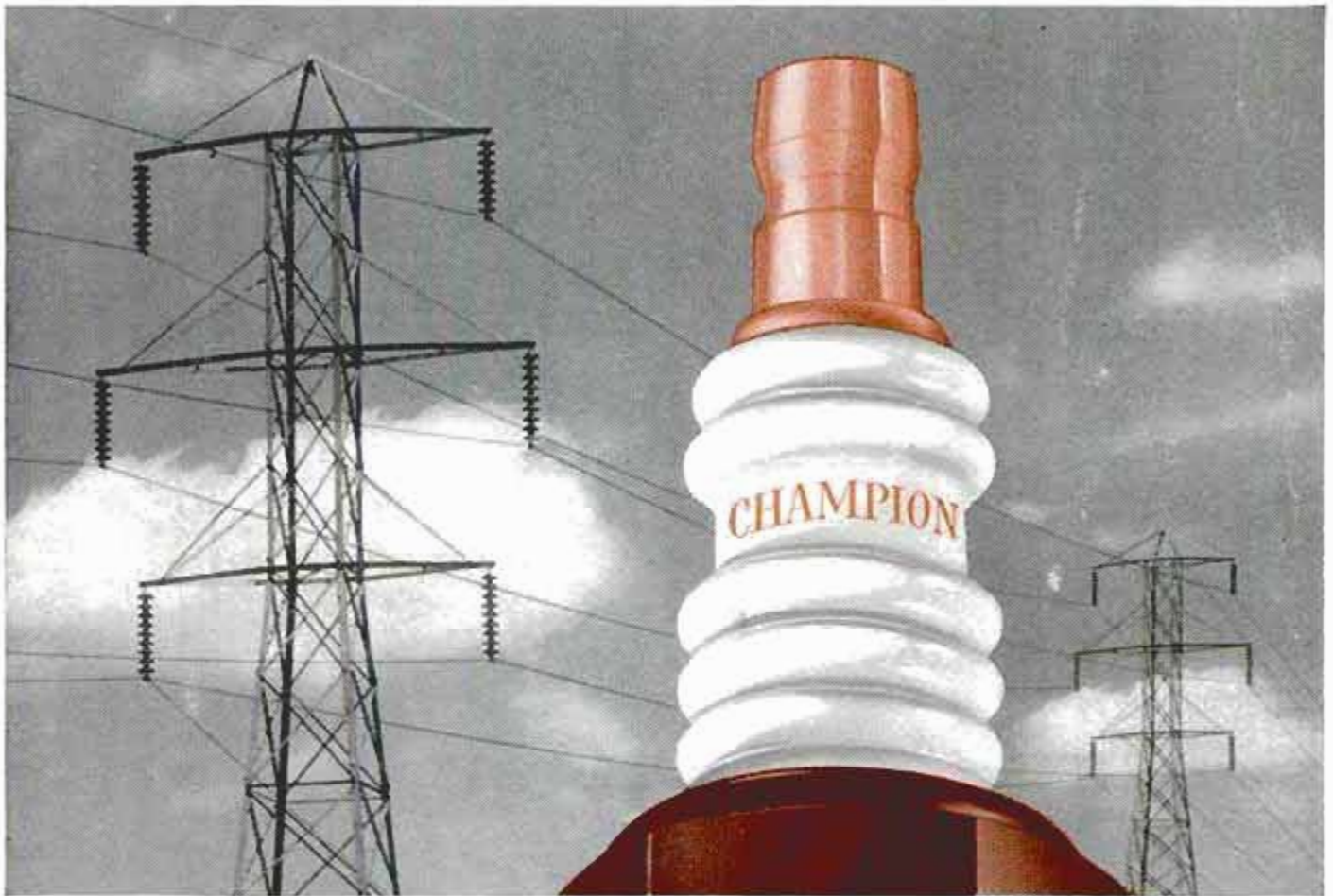

**Don't be pushed around this
winter—get a new set of full-
firing 5-rib Champions NOW**

You can see at a glance one of the big differences between Champion Spark Plugs and all others.

It's the exclusive 5-rib construction which protects you against power losses in your engine.

Like the multi-ribbed insulators you see every day on high-tension power lines, these 5 ribs increase the insulator length by as much as 20% over straight line insulators.

This construction permits higher voltages to be put through the spark plug to the firing end—where it belongs—before “flashover” occurs. “Flashover” simply means an external shorting of the plug which causes hard starting, misfiring, wasted gasoline and crankcase dilution, to say nothing of excessive drain on your battery.

Only Champions have the 5-rib construction—an identifying feature to remember when you need new spark plugs.

CHAMPION SPARK PLUG COMPANY, TOLEDO 1, OHIO

Where voices are powered by the sun

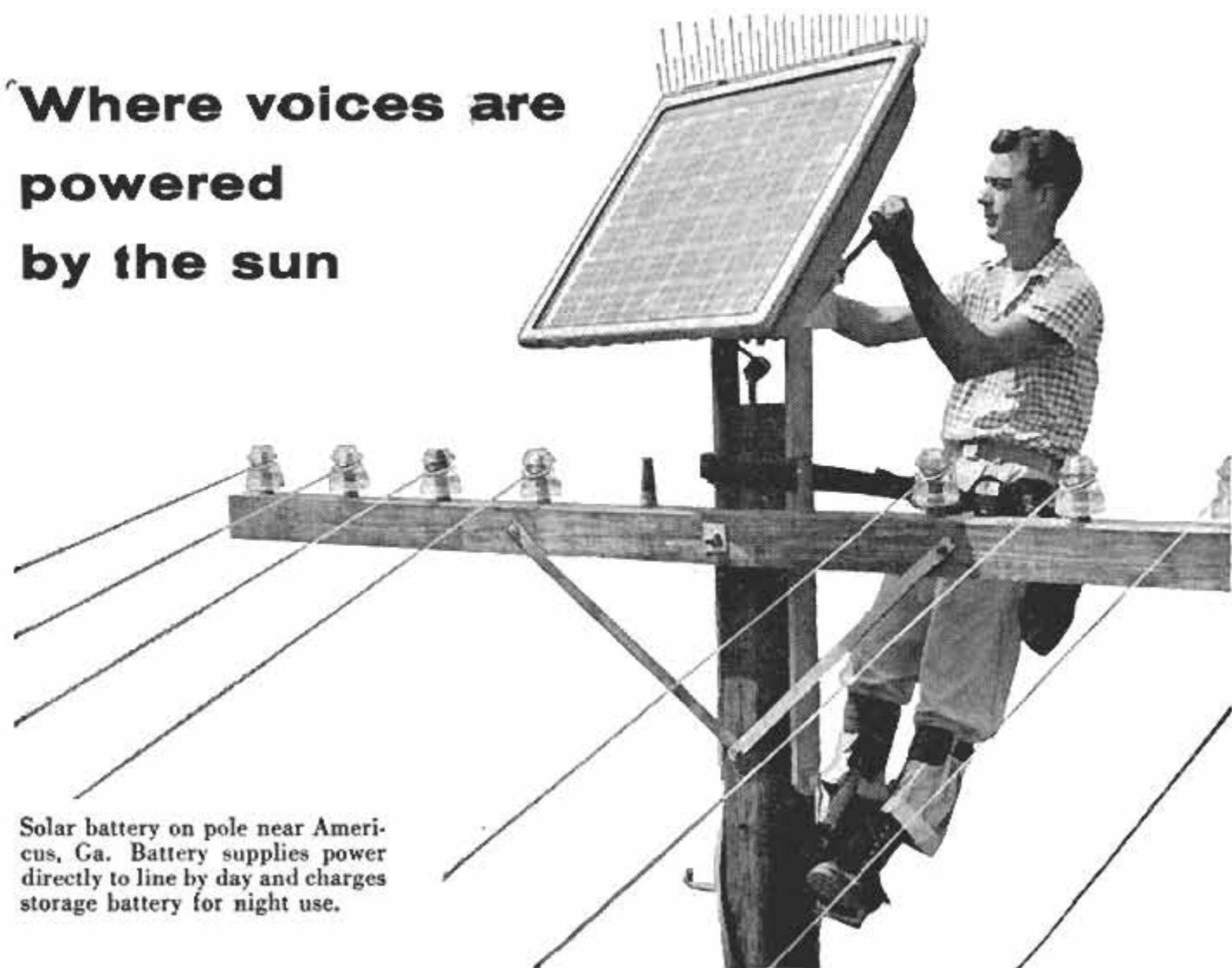

Solar battery on pole near Americus, Ga. Battery supplies power directly to line by day and charges storage battery for night use.

A new kind of telephone system developed by Bell Telephone Laboratories for rural areas is being operated experimentally by electric current derived from sunlight. Electric current is generated as sunlight falls on the Bell Solar Battery, which a lineman is seen adjusting.

The exciting achievement is made possible by two Laboratories inventions—the solar battery and the transistor. The new system uses transistors to the complete exclusion of electron tubes. Transistors require little power and this power can be easily supplied by the solar battery.

Compact and economical, the system can carry several voices simultaneously without interference. It has proved its ruggedness by standing up to heat, cold, rain and lightning.



In sending and receiving terminals, transistors are used as oscillators, amplifiers and regulators, and for signaling.

It promises more and improved telephone service for rural areas and it typifies the Laboratories' continuing efforts to make American telephony ever better.

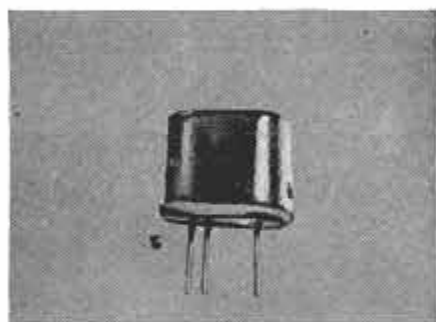

One of the transistors (actual size) used in the new system. The project called for new ideas, equipment, tools and methods.

BELL TELEPHONE LABORATORIES



Improving America's telephone service provides careers for creative men in scientific and technical fields.

Popular Mechanics Magazine

Registered in U. S. Patent Office and Canada

H. H. WINDSOR, Founder

H. H. WINDSOR, JR., Editor and Publisher



Next Month

IF YOU ARE INTERESTED in automobiles (and it's a rare bird indeed who isn't) you'll be happy with the February issue of *Popular Mechanics*. It contains our annual automobile section, 49 pages of interesting facts and photographs about the nation's most exciting business. The section provides a roundup of all the '56 cars, including specifications, prices, production figures, all in one package. But that's not all. Leading off the 49 pages is a full-color portfolio of fine paintings of 10 outstanding sports cars. Among them are (quite naturally) the well-known Jaguar XK140, above, and the lesser-known (in this country, at least) Lancia Spyder, below, plus eight more beauties, each posed on a world-famed race course



Information not listed on articles in the index, starting on page 92, frequently is listed in the WHERE-TO-FIND-IT LIST, which is available to readers without charge. A copy may be obtained by writing to the Bureau of Information, *Popular Mechanics*, 200 E. Ontario, Chicago 11, Ill.

Published monthly by Popular Mechanics Company, 200 E. Ontario St., Chicago 11, Ill. H. H. Windsor, Jr., president; Wm. Harrison Felridge, exec. vice-pres.; D. F. Windsor, vice-president and secretary-treasurer; H. H. Windsor III, vice-president; W. T. Windsor, vice-president; Clover L. Perkins, advertising manager; Alan M. Deyoe, circulation manager. Single copy in the United States and Canada, 35 cents; subscription rates in the United States and possessions, Canada, Philippines and countries of the Pan-American Postal Union, 1 year \$3.50; 2 years \$6.00; 3 years \$8.00. To all other countries add \$1.00 a year over United States prices for overseas postage. If you plan to move, notify us at least 30 days in advance so you will not miss an issue. Give both your old and new addresses. Entered as Second Class Matter, September 15, 1903, at the Post Office at Chicago, Illinois, under Act of March 3, 1879. Entered as Second Class Matter at Post Office Dept., Canada. Registered as Second Class Matter at the Post Office at Mexico, D. F., Mexico, June 20, 1950. Copyright 1955 by Popular Mechanics Company. Copyright under International Copyright Union. Copyright in France. All rights reserved under Pan-American Copyright Union. Printed in the United States of America.

Volume 105

JANUARY 1956

Number 1

Address all communications to: 200 E. Ontario St., Chicago 11, Ill.

Managing Editor.....	Roderick M. Grant
Assistant Managing Editor.....	Wayne Whittaker
Shop Notes and Crafts Editor.....	James R. Ward
Radio-Television, Electronics Editor.....	Lothar Stern
Associate Editor.....	Clifford B. Hicks
Associate Editor, Automotive.....	Arthur R. Railton
Associate Editor, Shop Notes and Crafts.....	Wayne C. Leckey
Assistant Editor, Shop Notes.....	W. Clyde Lamme
Assistant Editor, Crafts.....	Jay W. Hedden
Assistant Editor, Makeup.....	John C. Dalen
Automotive Correspondent.....	Leo Donovan
Art Director.....	Frank Beatty
Assistant Editors—Leonard F. Hilts, Elliott H. McCleary, Emily Mullaney, Earl F. Wobek	
Eastern Editor.....	Richard F. Dempewolff
Empire State Bldg., Room 2906, New York City 1	
Western Editor.....	Thomas E. Stimson, Jr.
Suite 1010, 3460 Wilshire Blvd., Los Angeles 5, Calif.	
London Manager.....	Douglas W. Wedderspoon
Eagle House, Jermyn St., London S. W. 1, England	
Director, Bureau of Information.....	Allan Carpenter
200 E. Ontario St., Chicago 11	

Advertising Offices
 Chicago: 200 E. Ontario St., Whitehall 4-0100; New York: Empire State Bldg., 350 Fifth Ave., Longacre 5-7580; Detroit: General Motors Bldg., TRinity 5-8711; Cleveland: Hanna Bldg., 1422 Euclid Ave., PRospect 1-0456; Los Angeles: Tishman Bldg., 3460 Wilshire, DUmkirk 2-8458; San Francisco: Russ Bldg., 235 Montgomery St., YUKon 2-0823.

In This Issue . . .

Ben Franklin—Trail Blazer for Inventors	- - - - -	99
They Graduate Underwater	- - - - -	109
The All-New Rambler	- - - - -	116
Traffic Tunnels Under Greenland's Icecap	- - - - -	118
Detroit Listening Post	- - - - -	122
Winter Is the Best Time for Fishing	- - - - -	124
We're Running Out of Air Space	- - - - -	131
Owners Report on the Mercedes-Benz 300SL	- - - - -	140
Stay Alive in the Great Outdoors	- - - - -	152
Hot-Line Men Never Trust to Luck	- - - - -	158
What's New for Your Home	- - - - -	164
\$2,000,000 Fish Bowl	- - - - -	168
Keeping Up With the Atom	- - - - -	177
Radio, TV and Electronics	- - - - -	179

For the Craftsman.

Lazy-Susan Bookcase-Lamp	- - - - -	183
One-Evening Projects	- - - - -	187
Shots in the Dark	- - - - -	192
Solving Home Problems	- - - - -	196
Patterncraft—Shoeshine Boxes	- - - - -	200
Homemade Organs—Part II	- - - - -	206
Service Your Own Carburetor	- - - - -	216
Portable One-Motor Workshop	- - - - -	221
How to Use Metal Tubing	- - - - -	229
Shopping for Tools	- - - - -	236
Clinic for Homemakers	- - - - -	242

See pages 92, 94 and 96

for other items and manufacturers of available products

Engineer's Report:
1956 CHEVROLET

Behind Chevrolet's record-shattering Pikes Peak climb are important engineering changes

by **ED COLE**, *Chevrolet Chief Engineer*

Since Chevrolet's record-breaking run up Pikes Peak, people have asked me just what we've done to this new Chevrolet to make it the mountain-climbing champ.

Well, to begin with, our job was to produce a car that would out-perform last year's Chevy which, you'll recall, was the leading winner on the stock car tracks. That was a big order.

Our men started by making refinements in the "Super Turbo-Fire V8" engine. They raised the compression ratio to 9.25 to 1. Horsepower was boosted to 205. You can imagine what these changes did for performance!

Next we went to work on the "Blue-Flame" 6. The compression ratio went up to 8 to 1. Horsepower was increased to 140. The final result of these and other improvements is the most powerful, sweetest running 6 we've ever had in a Chevrolet passenger car!

Drivers who like a full-flow oil filter will be pleased to hear that we've made provision for one on our V8 engines. And *all* engines—both 6- and 8-cylinder—are now equipped with Hydraulic-Valve lifters. This eliminates the need for periodic valve adjustments.

Drop by and drive this record-breaking new Chevrolet at your Chevrolet dealer's. . . . Chevrolet Division of General Motors, Detroit 2, Michigan.

Chevrolet

1956 Chevrolet setting new record for Pikes Peak climb

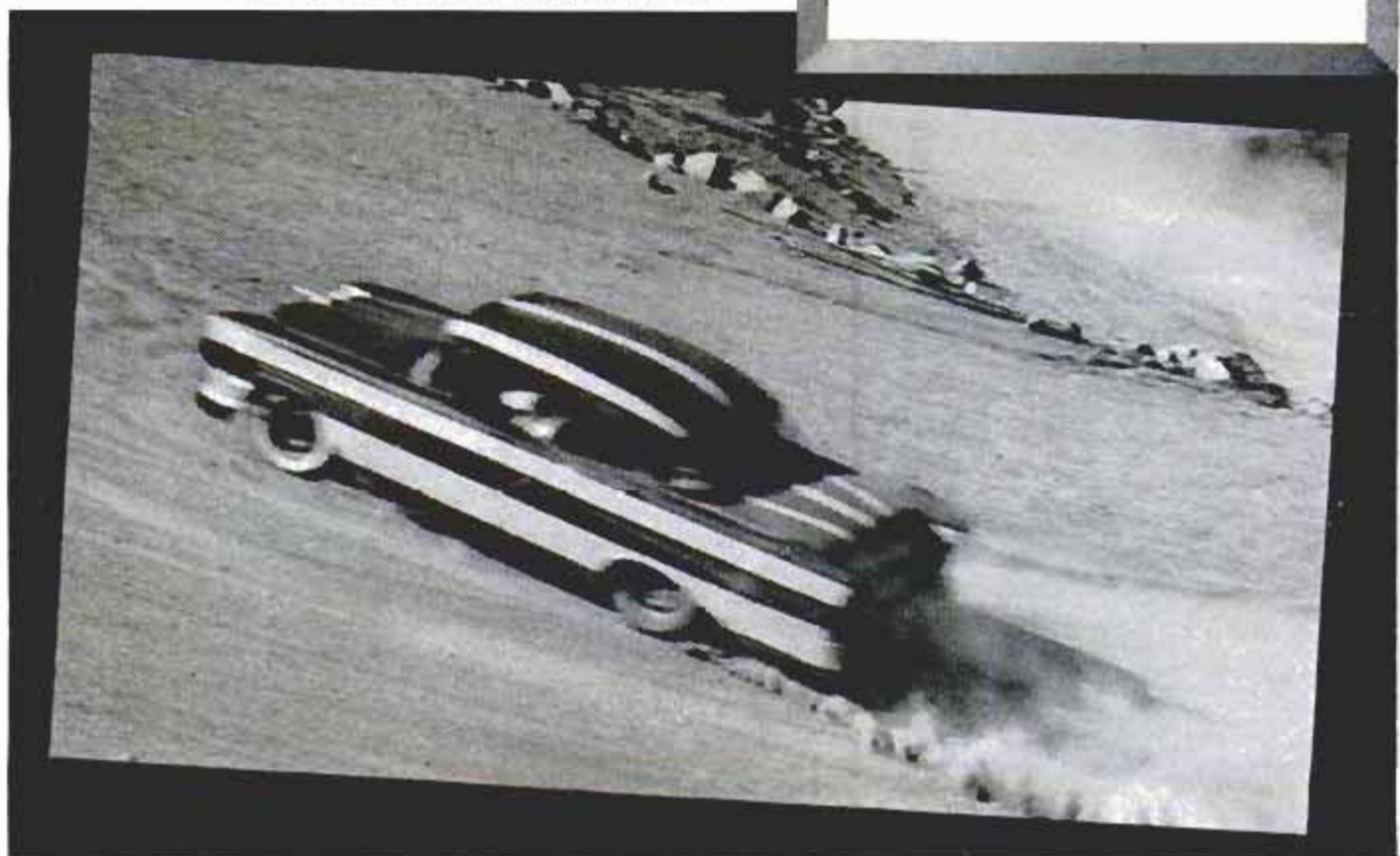

Now!
Porter-Cable quality
in this all new
finishing sander

only \$39⁵⁰

Here's the great new finishing sander that's got *everyone* talking—with a price tag *anyone* can afford!

It's Porter-Cable's Model 145—and it's a honey! Use it for coarse, medium, and fine finishing on wood, metal, plastics, glass, and many other materials—do hundreds of sanding jobs faster and easier! Orbital motion lets you sand with, against, or across the grain, with never a gouge or ripple. Husky Universal motor has all the speed and power you'll ever need—lightweight, *balanced* design prevents fatigue.

Best of all, this rugged new Sander is built to Porter-Cable's uncompromising *quality standards*—which means long life, trouble-free service, *value* far beyond its price. See and try it soon!

MODEL 145—ONLY \$39.50 COMPLETE
Precision ball and bronze bearings throughout. Standard 9 x 11 sandpaper size provides 4 abrasive sheets for the 145. Quick-change paper clamps, sturdy die-cast aluminum housing. Weight, 5½ lbs.

Porter-Cable

Quality Electric Tools



SEE YOUR DEALER—OR MAIL COUPON TODAY!

PORTER-CABLE MACHINE CO.
6141 N. Salina St., Syracuse 8, N. Y.

Yes, send me a complete catalog sheet on the
Model _____ of
my **This one**

Name _____

Address _____

City _____



TAN2-Y6C-JKA9

In Canada, write to Porter-Cable, Ltd., Box 5019,
London, Ontario. Canadian prices slightly higher.

saws • belt sanders • finishing sanders • drills • routers • planes

GIVE YOUR WORK MORE DRIVE!

with PROTO

"Bet'r Grip" Screwdrivers



Only in PROTO plastic-handle screwdrivers do you get handles shaped to fit your hand. They have a large palm diameter, smaller diameter for little finger, dome top, thumb and forefinger thrust grooves, deep flutes and smooth lines. Distinctive, too, are PROTO's popular wood-handle screwdrivers, noted for their power-grip handle and steel cap. For screwdrivers that give you more drive, see your PROTO dealer. Send 10¢ for catalog of entire line to

PLOMB TOOL COMPANY
2255G Santa Fe Ave., Los Angeles 54, Calif.



EVERY TYPE AND SIZE YOU NEED!

Long, short or special types—you'll find them all among the great many models made by PROTO.



© REG. U.S. PAT. OFF.

5583



Eastern Factory, Jamestown, N.Y. • Canadian Factory, London, Ont.

ACROSS THE DESK



In the busy moments before his departure for the Antarctic, Adm. Richard E. Byrd took time to write a report for *Popular Mechanics* on this greatest assault on the South Polar area. The veteran explorer, who heads the gigantic undertaking as director of U.S. Navy Task Force 43, is now en route to the bottom of the world. His article will appear in the February issue. Don't miss it!

Pedal Pusher on Hampton Roads

Milton Morrison is a machinist with Newport News Shipbuilding and Drydock Company. Like the postman who went walking on his holiday, Morrison has built a boat. His company has turned out such



ocean-going leviathans as the *SS United States* and the *USS Forrestal*. Morrison's craft is not so big, but it creates quite a sensation when he pedals it on Hampton Roads like a jet-propelled waterbug. Using some ideas gleaned from the pages of *Popular Mechanics*, Morrison mounted a bicycle frame on a pair of eight-foot wooden pontoons; its pedals turn a pair of paddle wheels located astern between the floats. Veteran shipbuilders shook their heads when he decided to mount a wafer-thin rudder at the bow, controlled by conventional bicycle handle bars. But it works. On the shakedown cruise the trim little craft, named *Octopus*, crossed up its builder and proceeded to perform with more speed in reverse than forward. Morrison promptly beached the vessel in his workshop "dry dock" for further consultation with his cobuilder, Don Maglieri. They altered the paddle wheels slightly, giving

(Continued to page 8)

LAW TRAINING *for* BUSINESS

[in spare time at home]

Earn LL.B. Degree

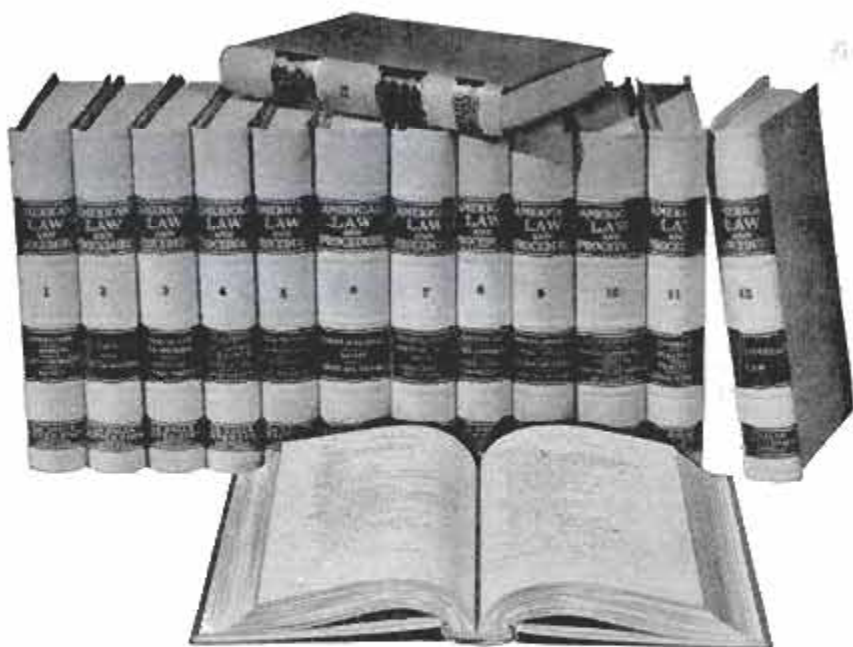

Thousands of men and women who never intend to practice are studying Law in spare time at home—not for a legal career but as an aid to business advancement.

Law today is involved in almost every major business decision. In many lines of work it is almost indispensable—credits and collections, accounting, traffic and transportation, employee relations, real estate, insurance, finance, taxation, etc. For all types of work, Law training develops keen, clear, quick, correct, and decisive thinking.

You can study LaSalle's American Law and Procedure right in the privacy of your own home—progressing as rapidly as your time and ability permit. LaSalle has, for nearly 50 years, helped more than 1,350,000 ambitious people get ahead in the business world. Thousands of letters in our files from grateful students and businessmen who have achieved greater success speak of—better jobs, more money and the satisfaction it brings, prestige and leadership.

A MOST UNUSUAL LAW LIBRARY

This training includes the fourteen-volume LaSalle Law library—AMERICAN LAW AND PROCEDURE, which is the basis of all the instruction service. This library has been compiled by leaders in the field of Law. It covers the whole basic field of Law in an orderly and simple manner that is easy to learn and understand. Collateral reading and printed lectures on legal problems which are furnished at regular intervals throughout the training, supplement the text. Law instructors personally supervise your program from the first assignment to the LL.B. degree or diploma. Under the LaSalle method you deal with legal problems—you learn by

doing—actually solving legal problems—not just memorizing rules.

WRITE TODAY FOR TWO FREE BOOKS

You are determined to get ahead—to prepare for greater future possibilities—and to earn more money. Send the coupon below and find out how to qualify yourself for the many openings available to the Law-trained man. In our FREE books, "Law Training for Leadership" and "Evidence," you will find answers to all your questions about the study of Law and the LaSalle method.

No investment is likely to pay higher returns than an investment in yourself, by enrolling in the American Law and Procedure training. Send coupon today for full information—no obligation, of course.

LaSalle Extension University A Correspondence Institution

Dept. 164L, 417 S. Dearborn St., Chicago 5, Ill.

Gentlemen: Please send me your two free booklets, "Law Training for Leadership" and "Evidence," which tell how I may study Law at home and qualify for the LL. B. degree.



Name.....Age.....

Street.....

City.....Zone.....State.....

TO INTRODUCE YOU TO THE MIRACLE OF
TRUE HIGH FIDELITY RECORDINGS

10 Major Works

BACH

Tocatta and Fugue in D Minor
Alexander Schreiner at the Organ of
the Tabernacle, Salt Lake City

CHOPIN

Fantasia-Impromptu, Opus 66
Robert Goldsand, Pianist

BEETHOVEN

Piano Sonata No. 24 in F Sharp, Opus 78
Grant Johansen, Pianist

MUSSORGSKY

Night on Bald Mountain
Netherlands Philharmonic Orch., Walter Goehr, Conducting

VIVALDI

Concerto in C for Two Trumpets and Orchestra
H. Severson and F. Haasdoerfer, Trumpeters,
Netherlands Philharmonic Orch., Otto Ackermann, Cond.

MOZART

Symphony No. 26 in E Flat, K. 184
Netherlands Philharmonic Orch., Otto Ackermann, Cond.

BRAHMS

The Academic Festival
Utrecht Symphony, Paul Hupperts, Conducting

BERLIOZ

The Roman Carnival
Netherlands Philharmonic, Walter Goehr, Cond.

WAGNER

Die Meistersinger, Prelude, Act 1
Zurich Fuedale Orch., Ackermann, Cond.

DUKAS

Sorcerer's Apprentice
Utrecht Symphony, Hupperts, Cond.

COMPLETE TO THE LAST NOTE!

Yes, all works complete on two
EXTRA-Long Playing High Fi-
delity Discs.

Take
all 10
for just
one dollar

try them **FREE**

Don't pay a penny until
AFTER you've heard them
on approval.

NO STRINGS ATTACHED!

All the advantages of Trial
Membership—but no obligations.

TAKE THESE 10 great master-
pieces for a free 5-day home
trial, and if you decide to keep
them pay only \$1.00 for all ten.

Why We Make This
Amazing Offer

We want you to hear for yourself
the exciting quality and value of
our recordings. Performed by in-
ternationally renowned artists and
orchestras. Reproduced with a
tone fidelity encompassing the
entire range of human hearing

Internationally Acclaimed
"The recording is of such
perfection it seems to
bring the artist into your
living room." — *Glorious
Sounds, Amsterdam, Hol-
land.*
"Uncommonly fine, even
for these days of technical
advancement." — *Los An-
geles Examiner, Calif.*

... 50 to 15,000 cycles. Custom pressed on noise-free vinylite.

MEMBERSHIP PRIVILEGES

As a Trial Member you are under no obligation to buy any
record from us ever. Future selections will be described to you
in advance. You may audition any of these free of charge
and you don't have to keep those you try. Pay only for those
you keep at the Member's low price of just \$1.65 per 33½ rpm
disc, containing about 40 minutes of music. A saving of 40%
off usual retail price. Mail coupon now—without money—and
get all 10 masterpieces for just \$1.00.

The Musical Masterpiece Society Dept. 70-1
43 West 61st Street, New York 23, N. Y.

Send me 10 masterpieces for free home trial. En-
roll me as a Trial Member. After 5 days I will
return discs or send only \$1 plus few cents ship-
ping as payment in full. Privileges: No purchase
obligation ever. Monthly advance notice of releases.
5 day free trial on any discs. I may reject records
before or after release; may cancel membership at
any time. For future l.p. disc I keep I'll pay only
\$1.65 each, plus shipping. Saving 40% off usual
retail price.

LIMIT: Only one sample package per customer.

Name

Address

City Zone State

Canada: 105 Bond Street, Toronto 2, Ont.

Long Playing

(Continued from page 6)

them more power from their chain drive, added a wood covering over the stern of the pontoons to keep the backwash from kicking up too much over the framework, and hoped for the best. The result was gratifying. It performed as a pedal boat should.

Howard L. Goshorn,
Norwalk, Va.

To the Editor:

This is a short note to thank you for sending me a copy of your November issue containing my IGY article, and to congratulate you on the excellent way in which it is illustrated. The illustrations are pertinent and well presented. Someone may write to say, what is the fact, that mountains often seem to repel rather than to attract the plumb bob. The raised body of the mountains does indeed pull the plumb line toward it, but the mountain has deep roots that project down into the denser layers beneath, just as the greater part of an iceberg is under water; and so there is a tendency for this deficiency of density at deeper levels to cause the plumb line to tilt away from the mountain. This can be your answer if anyone does so write. Of course, for illustration without more than a few words of comment, it is natural to illustrate the matter as you have done it.

Dr. Sydney Chapman,
International Chairman for the
International Geophysical Year

☆☆☆



S/Sgt. James B. Gilmer, of Miami University, Oxford, Ohio, an instructor in aeronautics, drove a King Midget from Atlantic City, N. J., to San Francisco in a driving time of 4 days, 11 hours and 21 minutes. Sergeant Gilmer spent \$26.35 for all gasoline, oil and greasing on the trip,

(Continued to page 10)

How long since your last raise?

Sure, you've had a "cost of living increase." But what about the *big* pay boost?—the kind the boss asks you not to talk about and the kind that starts you thinking about a new car, a better home, luxuries for your family!

If you've had one of these in the past six months, stop reading right here. If not, it's time to start doing something about it.

Look around you. The men who are advancing are the trained men. They've learned special skills that bring them higher pay. It's the men without training who get what's left.

What are you going to do about it? Just wait and hope for the jackpot to pay off? If you really want the *big money*, you can start by getting the necessary training at home in your spare time.



International Correspondence Schools offer you a course in 256 success-proved subjects. You get the practical plus the bedrock facts and theory. You earn while you learn. Students often report their first *big* pay increases right after enrolling.

Read carefully the list of subjects in the coupon below. Pick out the field of study that interests you most—the one with the greatest future for you. Then mark and mail the coupon and *find out* what I. C. S. can do for you. All it costs is a stamp or a postcard. Why not do it right away—it may be the most important step you've ever taken!

wide choice of courses

I. C. S. offers a total of 256 different courses—256 roads to advancement. Among them is the one you want. You'll find the lessons modern, simple, easy to understand. Each one you study takes you farther along the road to knowledge and success.

machine operator to shop foreman

"When I enrolled for my I. C. S. course in Carpentry and Millwork, I was a machine operator. Today, eleven months later, I am a shop foreman. As a consequence my salary has been increased 73.3%."



Why Home Study?

When you learn the I. C. S. way, your time is your own. Arrange your schedule to suit yourself. No tiresome traveling to and from school. No classes missed because of other engagements. Home study through I. C. S. has proved out for millions of ambitious men and women. You, too, can use it to get ahead!

For Real Job Security—Get an I. C. S. Diploma!

I. C. S., Scranton 9, Penna.

Member, National Home Study Council

INTERNATIONAL CORRESPONDENCE SCHOOLS

ICS

BOX 64626A, SCRANTON 9, PENNA.

(Partial list of 256 courses)

Without cost or obligation, send me "HOW TO SUCCEED" and the opportunity booklet about the field BEFORE which I have marked X (plus sample lesson):

<p>ARCHITECTURE and BUILDING CONSTRUCTION</p> <p><input type="checkbox"/> Air Conditioning—Refrig.</p> <p><input type="checkbox"/> Architecture</p> <p><input type="checkbox"/> Architectural Interior</p> <p><input type="checkbox"/> Building Contractor</p> <p><input type="checkbox"/> Building Maintenance</p> <p><input type="checkbox"/> Carpenter and Mill Work</p> <p><input type="checkbox"/> Estimating</p> <p><input type="checkbox"/> Heating</p> <p><input type="checkbox"/> Painting Contractor</p> <p><input type="checkbox"/> Plumbing</p> <p><input type="checkbox"/> Reading Arch. Blueprints</p> <p>ART</p> <p><input type="checkbox"/> Cartooning</p> <p><input type="checkbox"/> Commercial Art</p> <p><input type="checkbox"/> Fashion Illustrating</p> <p><input type="checkbox"/> Magazine Illustrating</p> <p><input type="checkbox"/> Show Card and Sign Lettering</p> <p><input type="checkbox"/> Sketching and Painting</p> <p>AUTOMOTIVE</p> <p><input type="checkbox"/> Auto Body Rebuilding</p> <p><input type="checkbox"/> Auto Elec. Technician</p> <p><input type="checkbox"/> Auto-Engine Tune Up</p> <p><input type="checkbox"/> Automobile</p>	<p>AVIATION</p> <p><input type="checkbox"/> Aeronautical Engineering Jr.</p> <p><input type="checkbox"/> Aircraft & Engine Mechanic.</p> <p>BUSINESS</p> <p><input type="checkbox"/> Advertising</p> <p><input type="checkbox"/> Bookkeeping and Accounting</p> <p><input type="checkbox"/> Business Administration</p> <p><input type="checkbox"/> Business Correspondence</p> <p><input type="checkbox"/> Public Accounting</p> <p><input type="checkbox"/> Creative Salesmanship</p> <p><input type="checkbox"/> Federal Tax</p> <p><input type="checkbox"/> Letter-writing Improvement</p> <p><input type="checkbox"/> Office Management</p> <p><input type="checkbox"/> Professional Secretary</p> <p><input type="checkbox"/> Retail Business Management</p> <p><input type="checkbox"/> Sales Management</p> <p><input type="checkbox"/> Stenographic-Secretarial</p> <p><input type="checkbox"/> Traffic Management</p> <p>CHEMISTRY</p> <p><input type="checkbox"/> Analytical Chemistry</p> <p><input type="checkbox"/> Chemical Engineering</p> <p><input type="checkbox"/> Chem. Lab. Technician</p> <p><input type="checkbox"/> General Chemistry</p> <p><input type="checkbox"/> Natural Gas Prod. & Trans.</p> <p><input type="checkbox"/> Petroleum Engineering</p> <p><input type="checkbox"/> Plastics</p> <p><input type="checkbox"/> Pulp and Paper Making</p>	<p>CIVIL, STRUCTURAL ENGINEERING</p> <p><input type="checkbox"/> Civil Engineering</p> <p><input type="checkbox"/> Construction Engineering</p> <p><input type="checkbox"/> Highway Engineering</p> <p><input type="checkbox"/> Reading Struct. Blueprints</p> <p><input type="checkbox"/> Sanitary Engineering</p> <p><input type="checkbox"/> Structural Engineering</p> <p><input type="checkbox"/> Surveying and Mapping</p> <p>DRAFTING</p> <p><input type="checkbox"/> Aircraft Drafting</p> <p><input type="checkbox"/> Architectural Drafting</p> <p><input type="checkbox"/> Electrical Drafting</p> <p><input type="checkbox"/> Mechanical Drafting</p> <p><input type="checkbox"/> Mine Surveying and Mapping</p> <p><input type="checkbox"/> Plumbing Drawing and Estimating</p> <p><input type="checkbox"/> Structural Drafting</p> <p>ELECTRICAL</p> <p><input type="checkbox"/> Electrical Engineering</p> <p><input type="checkbox"/> Electrical Maintenance</p> <p><input type="checkbox"/> Electrician <input type="checkbox"/> Contracting</p> <p><input type="checkbox"/> Linemen</p> <p>HIGH SCHOOL</p> <p><input type="checkbox"/> Commercial <input type="checkbox"/> Good English</p> <p><input type="checkbox"/> High School Subjects</p> <p><input type="checkbox"/> Mathematics</p>	<p>LEADERSHIP</p> <p><input type="checkbox"/> Foremanship</p> <p><input type="checkbox"/> Industrial Supervision</p> <p><input type="checkbox"/> Leadership and Organization</p> <p><input type="checkbox"/> Personnel-Labor Relations</p> <p>MECHANICAL AND SHOP</p> <p><input type="checkbox"/> Gas—Electric Welding</p> <p><input type="checkbox"/> Heat Treatment <input type="checkbox"/> Metallurgy</p> <p><input type="checkbox"/> Industrial Engineering</p> <p><input type="checkbox"/> Industrial Instrumentation</p> <p><input type="checkbox"/> Industrial Supervision</p> <p><input type="checkbox"/> Internal Combustion Engines</p> <p><input type="checkbox"/> Machine Design-Drafting</p> <p><input type="checkbox"/> Machine Shop Inspection</p> <p><input type="checkbox"/> Machine Shop Practice</p> <p><input type="checkbox"/> Mechanical Engineering</p> <p><input type="checkbox"/> Quality Control</p> <p><input type="checkbox"/> Reading Shop Blueprints</p> <p><input type="checkbox"/> Refrigeration</p> <p><input type="checkbox"/> Sheet Metal Worker</p> <p><input type="checkbox"/> Tool Design <input type="checkbox"/> Toolmaking</p> <p>RADIO, TELEVISION</p> <p><input type="checkbox"/> Industrial Electronics</p> <p><input type="checkbox"/> Practical Radio TV Eng'ng</p> <p><input type="checkbox"/> Radio and TV Servicing</p> <p><input type="checkbox"/> Radio Operating</p>	<p><input type="checkbox"/> Television Technician</p> <p>RAILROAD</p> <p><input type="checkbox"/> Air Brakes <input type="checkbox"/> Car Inspector</p> <p><input type="checkbox"/> Diesel Locomotive</p> <p><input type="checkbox"/> Locomotive Engineer</p> <p><input type="checkbox"/> Section Foreman</p> <p>STEAM AND DIESEL POWER</p> <p><input type="checkbox"/> Combustion Engineering</p> <p><input type="checkbox"/> Diesel—Elec. <input type="checkbox"/> Diesel Eng's</p> <p><input type="checkbox"/> Electric Light and Power</p> <p><input type="checkbox"/> Stationary Fireman</p> <p><input type="checkbox"/> Stationary Steam Engineering</p> <p>TEXTILE</p> <p><input type="checkbox"/> Carding and Spinning</p> <p><input type="checkbox"/> Cotton, Rayon, Woolen Mfg.</p> <p><input type="checkbox"/> Finishing and Dyeing</p> <p><input type="checkbox"/> Loom Fix'tg <input type="checkbox"/> Textile Des'ing</p> <p><input type="checkbox"/> Textile Eng'g <input type="checkbox"/> Throwing</p> <p><input type="checkbox"/> Winding and Weaving</p> <p>MISCELLANEOUS</p> <p><input type="checkbox"/> Domestic Refrigeration</p> <p><input type="checkbox"/> Marine Engineering</p> <p><input type="checkbox"/> Ocean Navigation</p> <p><input type="checkbox"/> Professional Engineering</p> <p><input type="checkbox"/> Short Story Writing</p> <p><input type="checkbox"/> Telephony</p>
---	---	--	--	--

Name _____ Age _____ Home Address _____

City _____ Zone _____ State _____ Working Hours _____ A.M. to P.M. _____

Occupation _____

Canadian residents send coupon to International Correspondence Schools, Canadian, Ltd., Montreal, Canada. . . . Special tuition rates to members of the U. S. Armed Forces.



START AS HIGH AS \$4,525.00 A YEAR!

Prepare NOW for 1956 Examinations
Veterans Get Preference

City Mail Carriers — Post Office Clerks

Clerks and Carriers now get \$3,466.00 the first year of regular employment and automatically increase \$106 a year to \$4,314.00. Open to Men—Women 18 and up. Clerks and Carriers can be promoted to other postal positions paying as high as \$8,943.00.

Railway Postal Clerks

Railway Postal Clerks get \$3,785.00 the first year of regular employment, being paid on the first and fifteenth of each month. (\$157.70 each pay day.) Their pay is automatically increased yearly to \$4,314.00. Advance may be had to District Transportation Manager at \$7,476.00 a year. Men only, 18 and up.

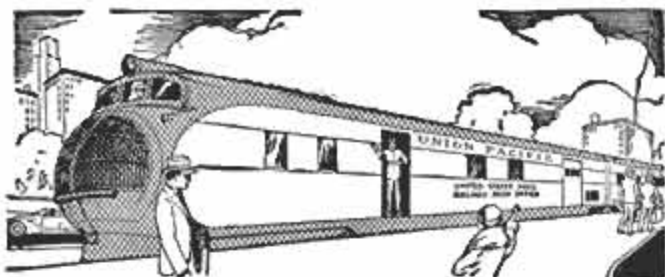

3 Days On — 3 Days Off — Full Pay

Railway Postal Clerks on long runs usually work 3 days and have 3 days off duty or in the same proportion. During this off duty their pay continues just as though they were working. They travel on a pass when on business. When they grow old, they are retired with a pension.

Many Other Positions

Many other positions are obtainable. Rural Carriers—Stenographers—Typists—Patrol Inspectors—Meat Inspectors—etc. Those wishing these positions should qualify at once.

Get Free List of Positions

Fill out the following coupon. Tear it off and mail it today—NOW at once.

Although the Institute is not government controlled, this can result in your getting a big paid government job.

FRANKLIN INSTITUTE, Dept. L-93, Rochester 4, N. Y.

Rush to me, without charge, copy of 361-page book describing salaries, hours, work, etc., and partial list of U. S. Civil Service big pay jobs. Tell me how to prepare for one of these tests.

Name _____

Street _____

City _____ Age _____

Use This Coupon Before You Mistake It. Write or Print Plainly.

(Continued from page 8)

and in setting this record he was forced to drive almost 600 miles per day following Route 40.

The King Midget is a one-cylinder, 8½-horsepower, air cooled, two-passenger roadster, with two-speed automatic transmission and reverse, and is manufactured in Athens, Ohio, by the Midget Motors Corporation. The cars get from 60 to 65 miles per gallon of gasoline and have a top speed of about 50 miles per hour.

To the Editor:

I wish to acknowledge tear sheets from the November issue of *Popular Mechanics* on the article by Francis Dickie entitled "On the Trail of the Whooping Crane." We appreciate receiving this article. It came at a time when interest is high with the last of the migrants leaving Canada for Aransas, Tex., and when requests are coming in from students requesting material on the whooping crane for various school projects. I have referred this article to several and feel the photographs, charts, etc., are well worth having.

The whooping-crane population is at a dangerous low and every article to attract public attention and enlist their services is all to the good. The three whooping cranes appearing on the first page of the article were photographed here two years ago by Fred Lahrman of the museum staff. This I think is one of the best, if not the best photograph ever taken of whooping cranes in their migration. They are naturally more difficult to approach when in migration than on the winter or summer nesting grounds.

Frankly I wondered why the story of the whooping crane appeared in *Popular Mechanics* and then I realized the fact that the magazine is read by so many people. I think it was a clever idea to have such an article in this well-liked magazine. Thank you again and with all good wishes.

Fred G. Bard, Director,
Saskatchewan Museum
of Natural History,
Regina, Saskatchewan

☆☆☆

You can't depend on it for a satisfying meal, but the glue on the back of United States postage stamps is somewhat nutritious and even palatable. It's made of a mixture of corn and cassava.

☆☆☆

A British government laboratory has found that silver and copper articles can be kept from tarnishing by laying them on paper impregnated with a solution of chlorophyll, which absorbs hydrogen sulphide in the air.

For Good Pay, Interesting Work, Security

Learn Electric Appliance Repair

AT HOME IN SPARE TIME

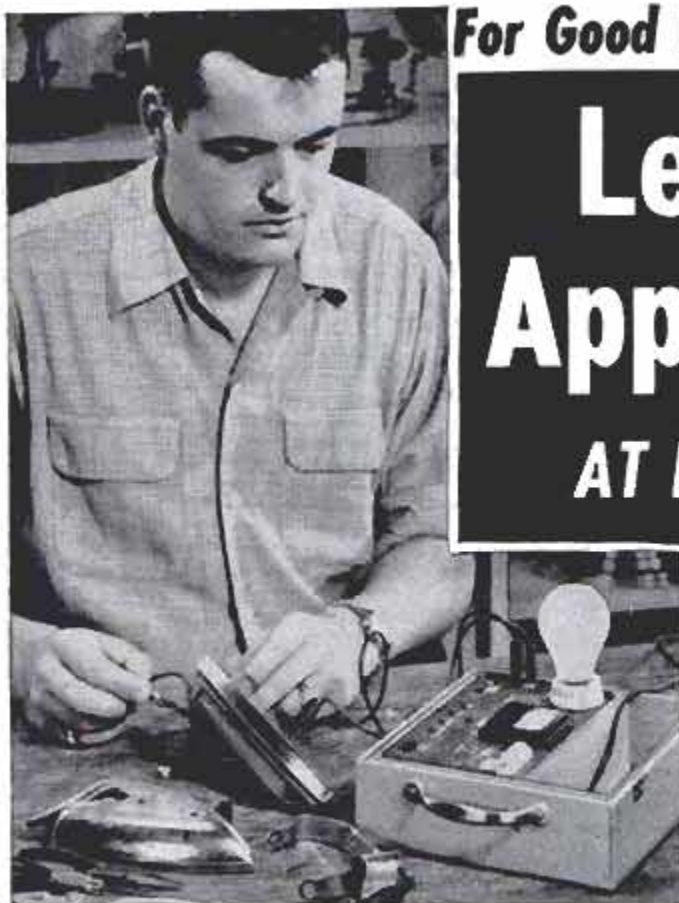

Build a better future. Get into a field where there is important work and the security that comes from knowing a good trade. The electrical appliance repair business offers OPPORTUNITY FOR YOU. Every wired home today has an average of 8 electrical appliances. Up to 10 million new appliances are sold every year. Owners pay well to keep them in repair and enjoy the convenience they provide. That means there's a fast growing need for trained men.

Opportunities Increasing For Men Who Know This Profitable Trade

You may want to be your own boss so you can enjoy the profits of your business. Or you may want to qualify for the better job of Service Manager or Supervisor in an Appliance Servicenter. Or perhaps you want to supplement your income doing electrical appliance repairs in your spare time. Opportunity in this growing field is great. Send for free book and see what the Electrical Appliance field offers you!

Pick up \$3, \$4, \$5 an Hour in Spare Time Starting Soon

Start soon to fix electric toasters, clocks, fans, vacuum cleaners, etc. for neighbors and friends. Spare time work done in your basement, garage, or spare room can earn you \$3 to \$5 an hour. See how easy it is to increase your earning power—how you can pay for this training many times over with spare time earnings.

Learn and Earn With This Appliance Tester You Get

This course includes the parts to build this sturdy portable appliance tester that helps you find electrical defects quickly and easily. You use it to learn and do actual electrical and appliance repair jobs. This multi-use tester helps you start making money soon after your training starts.

Train Now for Greater Security Low Price—Easy Terms

Today's automatic electrical appliances need expert servicing. The man who knows a good trade like appliance repair has a secure future. Put your spare time to good use. Invest \$2.50 down and \$5.00 a month in a better future. Write Electrical Appliance Training, National Radio Institute, Dept. AA6, Washington 9, D. C.



ACT NOW! Get Free Book And Sample Lesson

Actual lesson proves our method is clear, practical. Book gives facts about Electric Appliance opportunities and details of our training. Act now to make your future more secure.

MAIL COUPON TODAY

NATIONAL RADIO INSTITUTE

Dept. AA6, Washington 9, D. C.

Please send me Electrical Appliance Training Lesson and Book Free. (No salesman will call.)

Name _____ Age _____

Address _____

City _____ Zone _____ State _____

APPROVED MEMBER NATIONAL HOME STUDY COUNCIL

VALUES TO \$5
YOUR
CHOICE
ANY
ARTICLE **99c**
ANY 4 FOR 2.99

IMPORTER'S SACRIFICE SALE

VALUES TO \$5
YOUR
CHOICE
ANY
ARTICLE **99c**
ANY 4 FOR 2.99



TINY!

German Binoculars

The ISOLAN Binocular fits in the palm of your hand but it gives clear, sharp, magnified viewing. Optical lenses are precision made. Wonderful for theatre and watching sports. Reg. 1.98. Made in West Germany.

No. 8 99c

MUST RAISE \$250,000

We placed orders for over \$250,000 with various European manufacturers and the bulk of the shipments are arriving within the next few weeks. We have to pay cash on arrival and as a result we're sacrificing the items listed below in order to get the ready cash. **YOU GET THE BENEFIT!** Some of the items have sold for up to \$5.00. Buy 4 for only 2.99. Send the handy coupon below and take advantage of these once-in-a-lifetime bargains before it's too late!

REG. 1.98



NOW 99c

POCKET MICROSCOPE GIVES 2,500 TIMES AREA MAGNIFICATION!

Measures but 2 1/4 inches—but this microscope from West Germany gives **GIANT POWER & PERFORMANCE!** Metal design—optically ground precision lenses. Gives 2,500 times area magnification! Clear, sharp images—see Nature's wonders, examine liquids, textiles, insects, cells, stains, tissue, etc. 2 special slides given. Simple eyepiece focusing. No. 12 99c

REG. 1.98



GET 30 BETTER SHAVES FROM ONE BLADE!

HONIKRON—new marvel of German ingenuity—gives you **30 OR MORE SHAVES FROM A SINGLE BLADE!** Hones & conditions old & new double-edge blades to an unbelievable sharpness. Does it in a few seconds—just whisk the plunger back & forth a few times and you have a factory sharp blade!

No. 3 99c

**A
E
R
O
M
A
T**



washes
cars
like magic!

The AEROMAT fountain spray attaches to your garden hose—washes your car in minutes. 3-foot telescope handle. Special built-in suds chamber. Detergent supplied. Soft, silky Durostyrene brush head. Sold for up to \$5—**NOW 99c.** Order by No. 444.

3-color POLICE FLASHLIGHT throws red, white & green beam!

1/2
PRICE!

Reg. 1.98

The famous 3-Color Police Flashlight can now be yours! Police & fire departments have been ordering 'em by the carload—N.Y. City policemen alone have ordered thousands! Pushbuttons give you red, green or white beam instantly. Hi-Glo reflector increases beam intensity—visible miles away! Great for highway emergencies. Formerly sold for as much as \$5.00. **ALL-METAL DESIGN.**

No. 75 99c

10 - IN - 1

All-Purpose
OPTICAL
GLASS



REG. 1.98

IMAGINE! 10 separate optical instruments in **ONE** compact unit—magnifying glass, reading glass, telescope, compass, binoculars, mirror, solar watch, campfire lighter, magnifying mirror and textile tester. Folds into small space—carry it in your pocket. One of the most amazing gadgets in years! Imported from West Germany. No. 93 only 99c

4-STAR SPECIALS

- ☆ 10-IN-1 Army Officer's Knife — 99c — No. 880
- ☆ \$2.98 Walking Doll — 99c — No. 540
- ☆ Imported Power Telescope—99c—No. 160
- ☆ \$3.98 Black Forest Hunting Knife—99c—No. 80-C
- ☆ \$1.98 Famous Spectoscopes—TWO PAIR 99c—No. 90
- ☆ Regular \$4.95 Trans-Kleer Storm Window Kit — 1.99 — No. 47
(ENOUGH TO MAKE 10 WINDOWS)

SPECIAL COUPON FOR THIS SALE ONLY!

THORESEN'S, Dept. 6-A

352 Fourth Ave., New York 10, N. Y.

Please rush me the items listed below on 5-day free home trial. I must be absolutely satisfied with the merchandise or I will return it in 5 days for full refund. Payment enclosed. Send prepaid. Send C.O.D. I'll pay charges. (NOTE: C.O.D.'s sent **ONLY** on orders for 2.99 or more.)

LIST ITEM NUMBERS HERE

NAME _____

ADDRESS _____

CITY _____ STATE _____

INVENTORS

Learn how to protect your invention. The U. S. Patent Laws provide that any new and useful art, machine, article of manufacture, or composition of matter, or any new and useful improvement thereof, may be patented if the act of invention is involved. Therefore, every inventor with a valuable invention should take advantage of the Patent Laws and proceed for patent protection in order to safeguard his rights.

A patent gives the inventor the exclusive right to prevent others from making, using, or selling the invention claimed in the patent for a period of seventeen years.

The Patent Laws were enacted for the benefit of the inventor to give him protection for the features of his invention which are patentable. These features must be properly and concisely set forth and claimed in a formal application for patent, in order to comply with the requirements of the Patent Laws. For that reason, unless the inventor is familiar with patent matters, he should engage a competent registered patent attorney or agent to represent him. We are registered to practice before the U. S. Patent Office and are prepared to serve you in the handling of your patent matters.

A specially prepared booklet entitled "Patent Guide for the Inventor", containing detailed information with respect to patent protection and procedure, together with a "Record of Invention" form will be promptly forwarded to you without obligation upon request.

CLARENCE A. O'BRIEN & HARVEY JACOBSON

Registered Patent Attorneys

61-A DISTRICT NATIONAL BUILDING

WASHINGTON 5, D. C.

YOU can find over 100 PRACTICAL USES and have LOTS OF FUN with

5 in 1 Miracle Projector

Electric Enlarger and Copy Maker

Magnify & Project

Stamps, coins, postage, clippings, maps, science specimens, plans, etc. Examine magnified details. Project on paper and obtain copies, large or small. Easier reading for weak eyes.

Magnifying Reader for Small Detail & Print



Amazingly Useful Invention

Home Fun—Schools—Salesmen—Clubs—Artists—Teachers—Shops—Sign Makers—Doctors—Classroom—Scientists—Students—Money Maker—Photographers—Experiments—Lab workers—Printers—Painters—Etc., etc.

HIGH FIDELITY, TRUE VIEW, FULL COLOR

Learn to Draw & Sketch Signs, Cartoons, Pictures Easily

Posters, Lettering, Comics, Objects



Project sketches, pictures, objects, etc. on drawing paper, sketch over with pen, pencil, colors, etc. Easy to make any kind of cartoons, drawings, signs, etc. either large or small. Make cartoons from pictures. Easy to do; no skill, no practice.

Copy Any Picture or Object

Project a n d focus in large or small. Make enlargements of plans or drawings. You'll be surprised how many practical and entertaining uses you can make. Advertising posters, cartoon sketches of friends, etc., etc.

Natural Moving Pictures

Projecting Microscope Gives Live Show

Put ants, insects, flies & other bugs or animated objects under glass & let them walk around. See them in action greatly enlarged & d magnified MOVING on screen. Amazing, real-life scientific motion pictures. Like having a projecting microscope.



Make Photo Enlargements and Copies Without Negatives!

Use Any Photo or Picture

Direct positive photo enlargements and prints without negatives using Eastman direct positive paper. Use any black & white or color picture, colored transparency, etc. Easy to do; excellent results. No complicated dark room equipment. Makes correct copy (same as original), large or small. Also useful for making copies of important papers, plans, documents, stamps, sketches, maps, etc., etc. EASY, FUN, USEFUL, PROFITABLE.

Picture Enlarger and Projector

Project 3-Dimension Pictures



Put on your own show by projecting 3-D pictures, photos, post cards, photos, comics, clippings, etc. on wall or screen. Fine for school, clubs, talks, home shows, telling about your trip, salesmen, etc. Full color, correct projection, entirely readable & correct. Special device enables you to project real 3-dimension or stereoscopic pictures. Startling, life-like.

Make Money—Machine Pays for Itself

Many ways to make money. Make photo enlargements, photo copies, give shows, make sketches and drawings and advertising signs, etc. Easy to do—the machine does the work.

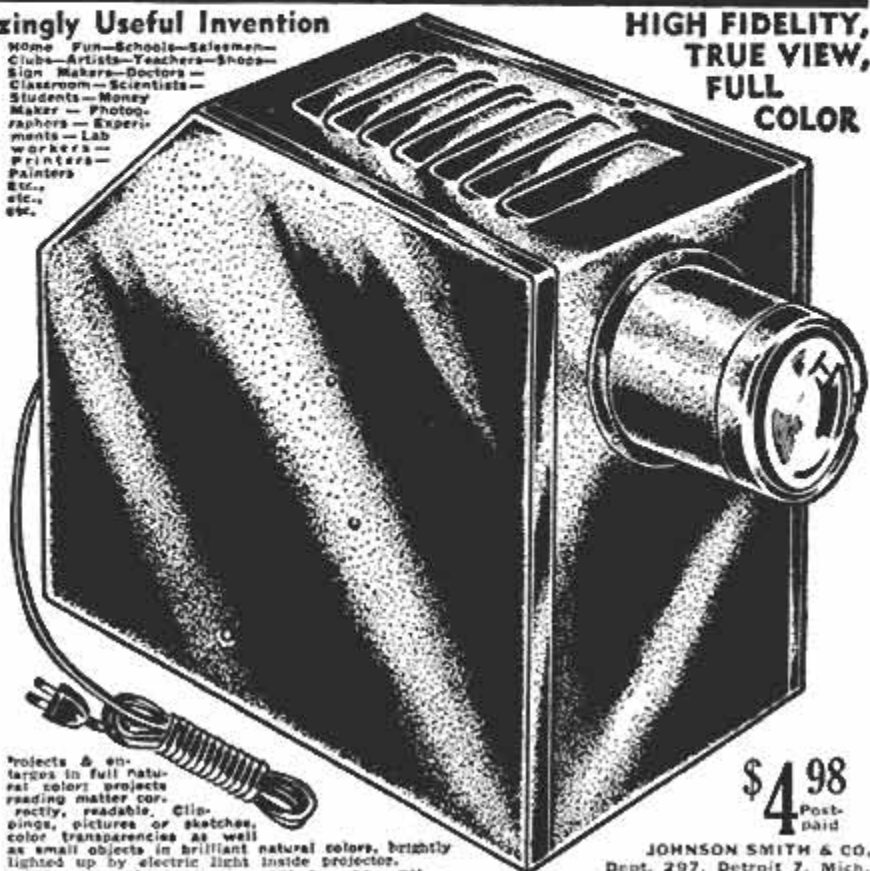

\$4.98 Postpaid

JOHNSON SMITH & CO., Dept. 297, Detroit 7, Mich.

Projects & enlarges in full natural color; projects reading matter correctly, readable. Clippings, pictures or sketches, color transparencies as well as small objects in brilliant natural colors, brightly lighted up by electric light inside projector.

Different Show Every Night; No Films

to Buy; No More Expense; Sports, Girl Beauties, Comics, Etc. Four favorite or COMIC PICTURES from papers & magazines. Enlarge action pictures. Project snapshots of your girl, family trip. Project and read comic strips to kids. Large pictures projected in full color. Educational, Scientific; Real Life Action! Live ants, flies, bugs and small animals can be projected on screen; watch them in real life action, fighting, eating, playing. Great for amateur scientist experimenter and camera fan.

Make Signs, Sketches, Posters, Cartoons, Lettering, Etc. Quick! Easy! In Black & White or Full Color; From Clippings or Copy; Large or Small. Make sketch of cartoon of friends. Posters and signs for clubs, stores, dances. Easy to make, large or small. Project picture or rough sketch right on blank drawing paper. Using pen, pencil or colors, sketch OVER PROJECTED PICTURE. Project photos and make funny, life-like cartoons or sketches. Amazing & practical. So a good artist, even though you never did it before! Lettering and signs easy to do.

Magnifies Stamps, Specimens, Objects for Close Examination; Reader for Weak Eyes ABOUT 50 AREAS. Make photo enlargements direct from object! Enlarges small type, maps, etc., projecting it for easy reading.

Photo Enlarger; Makes Photo Prints, Photo Copies, Etc.—No Negatives. Uses Eastman direct positive paper. Correct true-image photos, large or small, from any photo; or even from color prints & color transparencies. Photo enlargements, copies, etc., done cheaply, quickly, easily. 8x10-in. enlargement costs 12c; roll up to \$1.00. NO NEGATIVES. Made by projecting picture on direct positive printing paper. Duplicate copies of blueprints, diagrams, papers; large or small.

3-Dimension Stereoscopic Pictures. Its special process you can project 3-dimensional pictures and see in startling, life-like realism. So real you expect to reach out and touch them! Project beautiful girl pictures, travel scenes, etc.

No Skill—No Experience—Fun All Year Round. Low-priced instrument that quickly pays for itself. No experience and no skill to operate. Just plug into any 110-volt AC-DC standard home socket. Years of entertainment and practical uses for every member of the family. Lasts indefinitely; nothing to wear out, so only cost is low price of MIRACLE PROJECTOR. Schools, shops, offices, artists, etc., all find many uses for it. Project almost anywhere—even on table. No screen necessary—any blank wall or white paper will do. Wonderful for classroom, clubs and salesmen.

Electric, Optically Ground Double Lens, Enameled Steel Construction. Complete except for lamp bulb; use any household 60 to 100 watt lamp bulb. Steel construction, handsomely enameled in brilliant colors. Easy carrying. 7 1/2-in. high, 10-in. long. Optically ground and polished lenses; slide focusing so you can PROJECT FROM VARIOUS DISTANCES to make picture large or small. Takes pictures up to 3 1/4 x 4-inches. With Illustrated instruction booklet, views, etc. **\$4.98** (2 for \$9.45; 3 for \$13.95). COMPLETE, CASH PRICE ONLY. . . . EACH

What Users Say: Artist & Signmaker: "Valuable aid; enables anyone to do all kinds of art work without training." Photographer: "Many uses; money maker and money saver." Teacher & Lecturer: "Makes talks ten times more interesting; Teaches faster, more fun." Collector: "Magnifies & illuminates specimens for easy study."

Rush This Coupon Today!

Johnson Smith Co., Dept. 297, Detroit 7, Mich.

(Since 1914 America's Leading Novelty House)

Rush . . . Projectors Each \$4.98 Postpaid
Enclosed is \$ Special: 2 for \$9.45
3 for \$13.95

Name

Address

(Sorry, No C.O.D.'s at This Cash Price)

THESE MEN ARE GETTING PRACTICAL TRAINING IN **ELECTRICITY**

—ELECTRONICS

On Real:

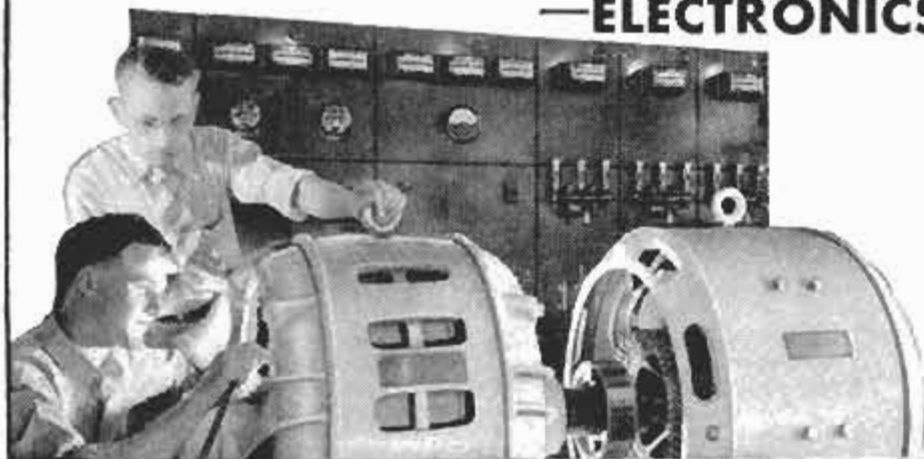

**A.C. and D.C. MOTORS
GENERATORS
SWITCHBOARDS
CONTROLLERS
WIRING JOBS
APPLIANCES
ELECTRONIC UNITS**

(Shown at left—Instructor explaining operation and testing of a large Motor Generator in our A.C. Department.)

AND **TELEVISION-RADIO**

On Real:

**TELEVISION SETS
RADIO RECEIVERS
F.M.
(Frequency Modulation)
ELECTRONICS
RECORD CHANGERS
AUTO RADIOS
PUBLIC ADDRESS Systems**
(Right — Instructor helping students check the wiring and trace circuits of television receivers.)

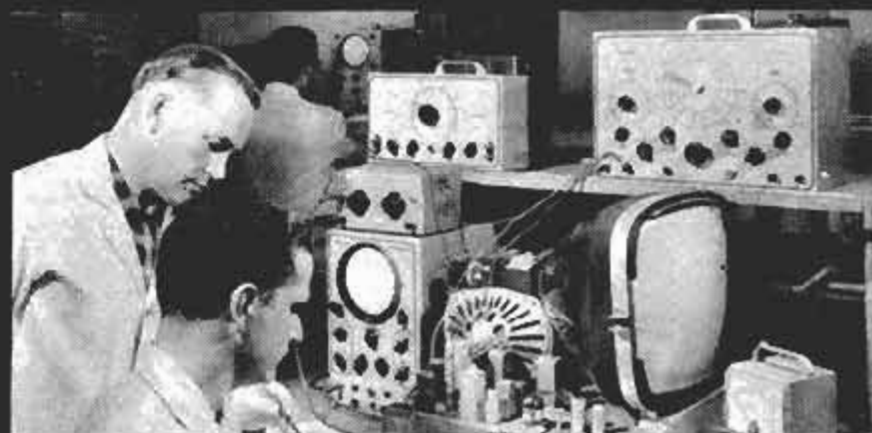

Train in the great **SHOPS** of **COYNE**

Largest, Oldest, Best Equipped School Of Its Kind In The U. S.

Whether 17 or up to 45 years of age, prepare for your future now. Don't be satisfied with a "No Future" job. Train the Coyne way for a better job in a field that offers a world of opportunities in the years ahead.

FINANCE PLAN Enroll now, pay most of tuition later. Part-time employment service while training. If needed.

WE TRAIN YOU IN CHICAGO. At Coyne you learn on real, full-size equipment. Trained instructors show you how, then you do practical jobs yourself. No previous experience or advanced education needed.

CLIP COUPON NOW for big new illustrated Coyne book "Guide to Careers in ELECTRICITY and TELEVISION-RADIO". No obligation; no salesman will call. Get vital facts now!



*Mail Coupon for
Big Free Book*

**APPROVED
FOR
VETERANS**

**B. W. COOKE, President
COYNE ELECTRICAL SCHOOL**

500 S. Paulina St., Chicago 12, Ill. Dept. 16-72H
Send **BIG FREE** book and details of your training offer. This does not obligate me and no salesman will call. I am interested in:

ELECTRICITY TELEVISION-RADIO

NAME.....

ADDRESS.....

CITY.....STATE.....

B. W. COOKE, Pres. **COYNE** FOUNDED 1899
ELECTRICAL SCHOOL

A TECHNICAL TRADE INSTITUTE OPERATED NOT FOR PROFIT
500 S. PAULINA STREET, CHICAGO, Dept. 16-72H
ELECTRICITY ★ RADIO ★ TELEVISION ★ REFRIGERATION ★ ELECTRONICS

My NEW Easy Method Trains You At Home

for a Good-Pay Job and Security IN AIR CONDITIONING AND REFRIGERATION

**MAIL COUPON
FOR 2 NEW
FREE BOOKS**



R. C. Anderson, President of Commercial Trades Institute, has devoted his entire adult life to training thousands of men for success in the technical world.



YOUR OPPORTUNITIES FOR SUCCESS ARE BEST IN AMERICA'S FAST-GROWING INDUSTRY

Over 150 million air conditioning and refrigeration units are in use today—and millions more are in production. *The industry is growing so fast that there's a big shortage of trained mechanics who can make installations and repairs.* Air conditioning and refrigeration men are well paid, they work steady, and their futures are secure. *You can break into this big, uncrowded field.* You can do it by learning air conditioning and refrigeration *at home in spare time.* To find out how easy it is, just mail coupon below. I'll send you two books which give astounding job and training facts.

You Get Shop Practice with 23 Big Kits I Send

Only CTI sends you 23 big kits of air conditioning and refrigeration equipment. You get practical service and repair experience at home, the kind of experience that trains and qualifies you for the big-paying field jobs. In the photo above, you see a student assembling a condensing unit with kits I send. The final result is a complete, heavy duty, commercial type, 1/4 hp air conditioning and refrigeration high side. CTI kits help you run many tests. You will overhaul, repair and assemble motor and twin-cylinder compressor. With this unit you do 10 complete service and trouble-shooting jobs. During your training, you build and keep an air conditioner, refrigerator, freezer or milk cooler. Here is a proven, exciting way to get solid experience with your training. You start at the top, not near the bottom, when you graduate. Mail coupon below for full description of kits.

Earn Money Spare Time As You Train

My training will help you begin earning extra money in spare time soon after you enroll. Many students earn from \$10 to \$20 a week repairing refrigerators and air conditioners in their communities. Many have gone right into business upon graduating because of the satisfied customers they gained while doing spare time work. The "On-the-Job" Training that you get with CTI kits gives you practical experience which makes it easy for you to do outside service work.

Mail Coupon for Facts on Your Future

Make up your mind right now to get the better things out of life. Mail coupon below, which will bring you my brand new book, "Success in Air Conditioning and Refrigeration," and also, a free sample lesson. Learn how I train you . . . how big your opportunities are . . . and what my graduates are earning. — R. C. ANDERSON, PRESIDENT, COMMERCIAL TRADES INSTITUTE, CHICAGO 26, ILL.

CTI Trains You for Hundreds of Jobs in this Big-Pay Field . . .

I TRAIN MEN TO MAKE GOOD IN LIFE



"When I came home from the army, there was no work. Thanks to CTI training, I am now employed full time at good wages. I got 3 raises and a bonus. Have my own home." — DANIEL STEVENS, SPRINGFIELD, O.

"Without the practical and theoretical training I received through CTI, I never could have started a business of my own. I have a small shop. Am financially independent." — K. SELLMAN, GUTHRIE CENTER, IA.

"Am very glad I learned through CTI. I am now an able refrigeration technician. Am earning good wages, find my work interesting. I recommend CTI to any ambitious man." — A. W. HEINRICH, KEWANEE, ILL.



"I find the lessons very interesting and easy. Since my fifth lesson I have been working on refrigerators. I rebuild old ones and sell at a nice profit. Am planning a full time shop." — W. O. WARD, MICH.

"Your course proved to be very valuable to me. As a result of your training, my partner and I run our own repair shop. He is also a CTI graduate. We also employ a former CTI student as our outside repair technician." — J. J. GIERTUGA, CHICAGO.

"My training thru CTI has changed my life. It has changed it from working for bare necessities to my owning a business." — J. J. RISA, E. CHICAGO, IND.



Last year, 2 million air conditioners were installed in homes. Experts say that 6 million will be sold in 3 years more. Plenty of job opportunities in the home field! And many new jobs are opening in the institutional, industrial and transportation fields, too! Office buildings, factories, hospitals, motels and stores are installing units by the thousands. Experts say that 4 million cars will have air conditioning within three years. You can see, there's opportunity for high pay and advancement everywhere, often right in your own back yard. Let CTI help you get set for success.

REFRIGERATION MAKES JOBS

Over 42 million refrigerators in American homes! Over 3 million sold last year — 4 million per year in the future! Over 1 million food freezers are sold annually, too. All this adds up to job opportunities. When you consider the millions of groceries, meat markets, truck lines, transport systems and beverage industries that depend heavily on refrigeration, you get some idea of the big need for skilled technicians who must install, repair and service. Yes, refrigeration is big, uncrowded!



BOTH BOOKS FREE!

Mr. R. C. Anderson, President
Commercial Trades Institute
1400 Greenleaf Ave.
Chicago 26, Ill. Dept. R-200

Mail me Sample Lesson and 32-page book,
"Success in Air Conditioning and Refrigeration."
Both FREE.

Name _____ Age _____

Address _____

City _____ Zone _____ State _____

Member: National Home Study Council



IT'S EASY TO START IN BUSINESS—BE YOUR OWN BOSS

Want to be independent? You, too, can start your own business with a small investment—and grow big, as so many CTI men have done.

MAIL TODAY



Your success is as near as the corner mail box

INVENTORS

If you believe that you have an invention, you should find out how to protect it. The first step is to have a search made of the prior pertinent U. S. patents. If a report on this search indicates that the invention appears patentable you can apply for a patent, and the specifications and claims should be prepared.

The firm of McMorrow, Berman & Davidson, with offices in Washington, D. C., is qualified to take the necessary steps for you. We can make a preliminary search on your invention, advise you whether we think it can be patented, and prepare your application for patent.

Unless you are fully familiar with the U. S. Patent Laws, we recommend that you engage the services of a Registered Patent Attorney to protect your interests. The patent laws are *your* laws. A patent gives you the right to prevent others from making, using or selling the invention claimed in your patent for a period of 17 years.

Use these patent laws for your protection. Investigate whether your invention can be patented. If you have what you believe to be an invention, we suggest that you have this firm make a search for you:

Send for a copy of our Patent Booklet entitled "How To Protect Your Invention," containing information about patent protection and patent procedure. Along with this we will also send you an "Invention Record" form, for your use in writing down and sketching details of your invention. We will mail them promptly. No obligation. They are yours for the asking.

McMORROW, BERMAN & DAVIDSON

Registered Patent Attorneys

PATENTS • COPYRIGHTS • PATENTS

135-R VICTOR BUILDING, WASHINGTON 1, D. C.

Inventors

If you consider your invention valuable, take these necessary preliminary steps promptly to protect it by applying for a United States patent.

Sketch and describe your invention. (For convenience in starting action on your invention, use "Evidence of Invention" form offered below.)

Sign, date and have this invention disclosure witnessed by two people capable of understanding your invention.

Have us make a preliminary search among U. S. patents already granted for similar types of invention. We then prepare a report for you on the probable patentability of your invention and recommend your further course of action.

This firm is registered to practice before the U. S. Patent Office. We are available to assist you in the preparation and prosecution of your application for patent.

We shall be glad to send you promptly and without obligation, an instructive booklet—"Patent Protection for Inventors"—and our convenient "Evidence of Invention" form.

VICTOR J. EVANS & Co. *Merlin M. Evans*
REGISTERED PATENT ATTORNEYS
1230-A MERLIN BUILDING, WASHINGTON, D. C.



INSURED TIRE SERVICE
POPULAR BRANDS

FREE INSURANCE POLICY given with each used tire sold. We guarantee the amount of service you pay for.

NOWHERE CAN SUCH QUALITY BE FOUND AT SUCH LOW PRICE!

SPECIAL!
Deduct 10% on orders for Two or More used tires

YOU CAN'T LOSE!!

GOODYEAR SUBURBANITE TYPE SNOW TIRES

New Tire Guarantee—Factory Rebuilt
BEST WINTER TRACTION OF ALL!

670x15	\$9.95	710x15	650x16	\$10.90
600x16		760x15	650x15	

Super Quality — Rugged Performance — 15 Months Insured Service

600x16	\$3.65	670x15	\$3.95	700x16	\$4.45	760x16	\$4.75
650x15	3.85	670x16	4.05	710x15	4.35	820x15	4.95
650x16	4.25	700x15	3.95	760x15	4.45	550x17	4.65

Supreme Quality — Nothing Finer — 30 Months Insured Service

600x16	\$5.25	475x15	\$5.45	700x15	\$10.45	700x20	\$12.50
600x16	6.75	640x15	4.95	750x16	15.95	750x20	15.50
650x16	5.75	670x15	5.35	700x17	11.95	750x20	17.50
650x16	7.25	710x15	5.45	750x17	16.45	825x20	21.50
700x16	6.35	760x15	5.95	750x15	10.95	900x20	19.95
750x16	8.45	800x15	6.35	30x5	11.25	1000x20	20.45
550x18	4.95	820x15	6.35	600x20	10.95	1100x20	21.25
550x17	4.75	550x15	5.35	650x20	11.75	1000x22	21.95
650x15	8.25	670x16	5.15	32x6-8	11.95	1100x22	22.75
700x15	5.35	700x16	6.10	25x6-10	12.75	1100x24	25.95

Whitewalls \$1.00 extra.

MIDLAND
TIRE SALES

Speedy shipments on Mail Orders, F.O.B. Chicago. Insurance policy sent with each order. Deduct 10% on orders for 3 or more used tires. Send CHECK or MONEY ORDER.—No COD's.

3701 S. Normal, Dept. PM-42, Chicago 9, Ill.

A "GOOD HAND" HELPS YOU SUCCEED!

LEARN TO WRITE WELL

Your Name

beautifully written, plus special pen-point for shaded writing.

Only 10c

OUR 53rd YEAR

Handwriting quickly improves with our easy-to-understand picture lessons! Put your spare time to good use; send today for FREE BOOKLET. "How to Become a Good Penman," or check volumes wanted below at \$1 each: Business Writing Artistic Writing Card Writing Bird & Design Flourishing Engraving Alphabets. COMPLETE SET \$4.50. Ask for price list of penman's supplies.

TAMBLYN SCHOOL of PENMANSHIP
S.A. Zitter, Pres., 442 Ridge Bldg., Kansas City, Mo., USA

Make BIG MONEY!

RAISE CHINCHILLA RABBITS!

Cash Markets Supplied for Your Production
FREE - Illustrated Booklet - WRITE TODAY!
ROCK HILL RANCH, SELLERSVILLE 36, PA.

World's Largest Breeder of Chinchilla Rabbits

FALSE TEETH

KLUTCH holds them tighter

KLUTCH forms a comfort cushion: holds dental plates so much firmer and snugger that one can eat and talk with greater comfort and security; in many cases almost as well as with natural teeth. Klutch lessens the constant fear of a dropping, rocking, chafing plate. 35c and 60c at druggists . . . If your druggist hasn't it, don't waste money on substitutes, but send us 10c and we will mail you a generous trial box.

KLUTCH CO. Box 693-A ELMIRA, N. Y.

BIG PROFITS!

OVER \$45.00 PER HOUR

● NEW ● FASCINATING ● YEAR 'ROUND
● BUSINESS AT HOME



The AMERICAN PLASTIC PRESS laminates or "permanizes" social security cards, photos, driver's permits, records, etc. with unbelievable speed. Follow our FREE mail order plan and build a sound lifetime business. No soliciting or hard work . . . terrific demand. Each mail brings ready cash . . . exciting new orders. No faster machine on market . . . easy to operate.

Dept. C-1
Write today for FREE literature & sample work.
AMERICAN MACHINE MFG. CO.
P.O. BOX 1246, SAVANNAH, GEORGIA

Work with and keep all of this practical, commercial type equipment

"YOU LEARN BY DOING! THAT'S WHY D.T.I. GETS REAL RESULTS!"

21 INCH

Build and keep D.T.I.'s NEW 2 Unit TV Set—ideal for custom installation. (D.T.I. also offers home training without the TV set.)

Television, Radio, Electronics, has created thousands of good jobs; jobs with money, respect, position; jobs you may choose among—if you only had training. DeVRY Training is modern, thorough, practical—followed by a real Employment Service. Thousands have stepped into good pay—why not you? No need to leave home; no need to quit your present job; no special preliminary training required. Fill out coupon below and get the full story. Men 17 to 55 preferred.

Patents applied for

Amazingly effective NEW home training in
TELEVISION RADIO ELECTRONICS

NEW STYRENE ELECTRO-LAB SPEEDS LEARNING

Simply place a pictorial diagram under transparent Styrene base. Follow the diagram. Wiring is tremendously simplified. Work a total of over 300 learn-by-doing projects—a wonderful way to get practical experience.

*Trade-mark

One of America's Foremost Television Training Centers



You build and keep a quality Oscilloscope—almost a necessity for Television servicing. Helps you earn while you learn. You also build and keep a Vacuum Tube Voltmeter—a highly versatile test unit you can use when you are ready to make real money! IF PREFERRED, you may get all your preparation in D.T.I.'s Chicago training laboratories—among the finest. (See building pictured below.)

Valuable information for men subject to military service.

YOUR OWN HOME MOVIES

Movies are a remarkable feature of the D.T.I. System. You use a movie projector and many reels of films. Run off each film as often and as slowly as you want. A wonderful aid to help make important points crystal-clear. Get the full story! Send in that coupon.

MEMBER OF NATIONAL HOME STUDY COUNCIL

Mail Coupon Today

DEVRY TECHNICAL INSTITUTE

4141 Belmont Ave., Chicago 41, Ill. Dept. PM-1-M

I would like complete facts including "89 Ways to EARN MONEY in Television-Radio-Electronics."

Name _____ Age _____

(PLEASE PRINT)

Street _____ Apt. _____

City _____ Zone _____ State _____

2 _____ D.T.I.'s training is available in Canada.

89 WAYS TO EARN MONEY IN TELEVISION RADIO ELECTRONICS

DEVRY TECHNICAL INSTITUTE

FORMERLY

DEFOREST'S TRAINING, INC.

CHICAGO 41, ILLINOIS

TRY CORTINA'S SHORT-CUT TO



MORE MONEY



NEW CAREER



CULTURAL ENJOYMENT



TRAVEL FUN

MAIL COUPON FOR

FREE RECORD

START SPEAKING SPANISH OR FRENCH



ALMOST OVERNIGHT!

MAIL coupon for double-sided, non-breakable record and sample lesson. BOTH FREE! Listen as native instructor speaks to you on record. Let your eyes follow words in sample lesson at same time. Before you realize it, you'll be "chatting" easily in your new language—with a perfect accent!

Now's the time to learn a new language. It gives you such an advantage in business, social life. And here's the easiest way to learn—by listening! You gain a perfect accent (that's all you hear!). You don't learn grammar the "hard way"; you pick it up in CONVERSATION.

MAIL COUPON NOW

There are no "strings" to this offer. But it may end soon. Hurry! Rush coupon with 25c to help cover cost of special packing, shipping. We'll also send FREE book describing full Cortina course. No obligation.

Also:
GERMAN
ITALIAN
RUSSIAN
JAPANESE
BRAZILIAN

CORTINA ACADEMY

(Originators of Phonograph Method)

Dept. 641, 136 W. 52nd Street, New York 19, N. Y.

MAIL AT ONCE FOR *Free* RECORD

CORTINA ACADEMY, Dept. 641, (Est. 1882)
136 W. 52nd Street, New York 19, N. Y.

Please send me a FREE sample record and lesson in (check one)
 SPANISH FRENCH RUSSIAN GERMAN
 ITALIAN JAPANESE BRAZILIAN

and information about full Cortina course. Enclosed is 25c (stamp or coin) to help cover the cost of special packaging, shipping.

Name _____

Address _____

City _____

Zone _____

State _____

MIRACLE TOMATO

Yields **2** BUSHELLS To a Vine



Now—You can grow the world's most amazing Tomato right in your own garden and get from 2 to 3 bushels of delicious, ripe tomatoes from every vine.

BURGESS CLIMBING TRIP-L-CROP

TOMATO grows 16 to 20 feet high. Huge, meaty, solid fruit, wonderful flavor. Some weigh as much as 2 pounds each. Unsurpassed for canning and slicing. Blight free—drought and disease-resistant. Grows in any garden. Outyields all other varieties.

TRIAL PACKET **10c**
Postpaid. Order Today
3 Packets for 25c

Write for FREE complete Catalog listing many unusual Seeds, Plants and Bulbs.

BURGESS SEED & PLANT CO.
117 B. Galesburg, Mich.

SHINE WITHOUT 'POLISH'



Cars Gleam Like Mirror

MEN! WOMEN! So easy a child can do it! Amazing "Dry" Polisher puts mirror-like shine on car WITHOUT 'POLISH'. No messy pastes, liquids, sprays. Simply glide over car. PRESTO! Leaves hard, lustrous, long-lasting protective Wax Coating. Take orders! Earn money!

SAMPLES FOR TRIAL

Sample offer sent immediately to all who send name at once. Just a postcard will do. SEND NO MONEY—just your name.

KRISTEE CO., Dept. 608 Akron 8, Ohio

LEARN WATCH REPAIRING

AT HOME Modern, original instruction. Prepare for a position or start in business after completing our course. Write Today!
WISCONSIN SCHOOL OF WATCH REPAIRING
2908 N. 44th St. Dept. M Milwaukee 10, Wis.

LEARN PLASTICS



COMPLETE LOW COST SHOP METHOD HOME TRAINING NOW AVAILABLE

Get in on Big Money opportunities in Plastic molding, casting, forming, carving, etc. Earn as you learn with Interstate's professionally prepared course. All plastic materials furnished.

WRITE FOR FREE BOOKLET

INTERSTATE TRAINING SERVICE
DEPT. C-3, PORTLAND 13, OREGON



LEFAX

TECHNICAL DATA BOOKS

POCKET SIZE • LOOSE LEAF

Printed on loose leaf, 6 hole, 6 1/4" x 3 3/4" bond paper, each book contains about 140 pages of technical data, condensed, accurate, essential, for engineer, technical worker, student, business man

Architecture	Surveying	Mech'l Drawing	Metallurgy
Home Heating	Surveying Tables	Machine Design	Hydraulics
Illumination	Highway Eng'g.	Machinist's Data	Radio
Electrician's Data	General Math	Mech. of Materials	Television & FM
Builder's Data	Math Tables	Pwr. Trans. Mach.	Electricity, AC
Lumber Data	Physics	Thermo. Tbls. & Charts	Electricity, DC
Air Conditioning	Trig-Log Tables	Phys. & Thermo. Data	AC Motors & Gen'lrs.
Building Constr.	Gen'l Chemistry	Metals	Transformers, Relays & Motors
Reinf. Concrete	Chemical Tables		
Piping Data	Analytic Chem.		

Write for FREE catalogs (2000 listings). See how helpful LEFAX can be to you. Send \$1.25 book, or \$5 for any five books to

LEFAX PUBLISHERS, Dept. PM-1, PHILADELPHIA 7, PA.



L. C. Lane, B.S., M.A.
President, Radio-Television
Training Association.
Executive Director, Pierce
School of Radio & Television.

VETERANS!

NON-VETERANS!

MY FREE LESSON

MAY CHANGE YOUR ENTIRE LIFE

THREE COURSES TO TRAIN YOU FOR THE JOB YOU WANT

RADIO-FM-TELEVISION TECHNICIAN COURSE — No previous experience necessary. You learn by practicing with the professional equipment I send you. Many of my graduates now have good paying technician jobs with such firms as RCA, NBC-TV, Dumont TV and numerous other TV Studios and plants.

FM-TV TECHNICIAN COURSE — Previous training or experience in radio required. You can save months of time if you have previous Armed Forces or civilian radio experience! Train at home with kits of parts, plus equipment to build **BIG SCREEN TV RECEIVER**. **ALL FURNISHED AT NO EXTRA COST!**

EXTRA TRAINING IN NEW YORK CITY AT NO ADDITIONAL COST — After you finish your home study training in either of these two courses, you get two weeks, 50 hours, of intensive Laboratory work on modern electronic equipment at our associate school in New York City, Pierce School of Radio & Television. **THIS EXTRA TRAINING IS YOURS AT NO EXTRA COST WHATSOEVER.** My courses are complete without this extra training, but it gives you added opportunity for review and practice.

TV CAMERAMAN AND STUDIO TECHNICIAN COURSE — Advanced training for men with radio or TV training or experience. I train you at home for an exciting high pay job as the man behind the TV camera.

VETERANS

My school fully approved to train Veterans under New Korean G. I. Bill. Don't lose your school benefits by waiting too long. Write discharge date on coupon.

EARN WHILE YOU LEARN — Almost from the very start you can earn extra money while learning by repairing Radio-TV sets for friends and neighbors. Many of my students earn up to \$25 a week . . . pay for their entire training from spare time earnings . . . start their own profitable service business.

FCC COACHING COURSE — Important for **BETTER PAY JOBS** requiring FCC License. You get this training **AT NO EXTRA COST.** Top TV jobs go to FCC-licensed technicians.

With the equipment I send you as part of your course you build and keep an Electromagnetic TV RECEIVER designed and engineered to take any size picture tube up to 21-inch, (10-inch tube furnished. Slight extra cost for larger sizes.) . . . also a Super-Het Radio Receiver, AF-RF Signal Generator, Combination Voltmeter-Ammeter-Ohmmeter, C-W Telephone Transmitter, Public Address System, AC-DC Power Supply. Everything supplied, including all tubes. My practical, easy-to-understand lessons have brought success to hundreds of men. You, too, can train for a better-paying job or set up a business of your own if you act NOW!

ENOUGH EQUIPMENT TO SET UP YOUR OWN HOME LABORATORY

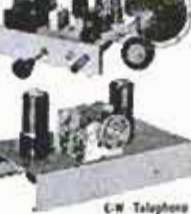

Combination Voltmeter Ammeter-Ohmmeter

Super-Het Radio Receiver

AF-RF Signal Generator

C-W Telephone Transmitter



Just by clipping the coupon below and sending it to me today, you can open up a whole new future for yourself in America's fastest-growing field — **Radio-Television-Electronics.**

The very day I receive your coupon I will send to you Free a Sample Lesson and my New 36-page Book showing you "How to Make Money in Television, Radio, Electronics" by **STUDYING AT HOME IN YOUR SPARE TIME.**

At absolutely no cost or obligation you can see for yourself how you can begin now to prepare yourself for a better-paying career as a TV repairman, studio technician, cameraman or any one of the many promising jobs in the field that is bringing success and security to hundreds of men — many of them with no more than grammar school education and **no experience whatsoever.**

If you think I was exaggerating when I said, "My Free Lesson May Change Your Entire Life," just see what some of my graduates say about my training —

"RTTA training gave me the skill and know-how to do the work I love best and enjoy better things in life."
Harold Gimlen
Flint, Michigan

"If it had not been for you, your instructors and the school, I never would have had this opportunity."
J. A. Irwin
Radio-TV Repairman
Coburg, Ont., Canada

"I know I would not have achieved this progress if it weren't for the help and guidance from RTTA."
Edward Breault
Chief Radar Operator
National Guard
Central Falls, R.I.

These letters and many more like them are in my files. The TV Boom that brought good opportunities to these RTTA graduates is still on with no sign of letting up. Don't let opportunity pass you by. Write today for your Sample Lesson, new 36-page book, TV Job Opportunities List, and 48-state list of future TV stations — **ALL FREE!**

MAIL THIS COUPON TODAY!

Mr. Leonard C. Lane, President
RADIO-TELEVISION TRAINING ASSOCIATION
Dept. M-1C, 52 East 19th Street, New York 3, N. Y.

Dear Mr. Lane: Send me your NEW FREE BOOK, FREE SAMPLE LESSON, and FREE aids that will show me how I can make TOP MONEY IN TELEVISION. I understand I am under no obligation.

(PLEASE PRINT PLAINLY)

Name _____ Age _____

Address _____

City _____ Zone _____ State _____

I AM INTERESTED IN:

- Radio-FM-TV Technician Course
- FM-TV Technician Course
- TV Cameraman & Studio Technician Course

VETERANS!

Write discharge date

Radio Television Training Association

52 EAST 19th STREET • NEW YORK 3, N. Y.

Licensed by the State of New York • Approved for Veteran Training

NO OBLIGATION!

JANUARY 1956

SELL NOTHING

YET MAKE OVER \$132 WEEKLY!

You actually sell nothing, so it won't make any difference whether you are a crackerjack salesman or just a beginner! Don't even step out of your home unless you want to! Yet, you can earn as much as \$132 weekly and more! Sounds fantastic? All right, listen: Would you like to offer women a complete set of solid stainless steel ever-bright tableware free of money cost? Do you think there is one woman in this wide world who wouldn't be interested?

Solid stainless steel tableware is all the rage today. Every woman has heard about it and knows about it. It is as beautiful as Sterling yet will never rust, stain, tarnish or corrode. It never needs polishing and makes old fashioned silver polishing a thing of the past. Its beauty changes eating to dining. Plain soap and water will keep it everlastingly bright.

Plenty of fine stainless steel tableware is being sold today at \$50 and \$100 a set but even though this is much less than Sterling, many cannot afford the price. Topval's entry into this field, has, overnight, changed all that. It has removed the high price obstacle and created a market of fifty million families.

You can mail out the free set offer (using sales letters and circulars furnished by us) or can go to women personally and say:

"I want to give you this beautiful set, guaranteed 50 years, without a penny of cost! Just show this booklet which I will leave with you to a few friends and in no time at all, I know you will have two friends eager to get a set for themselves. In return for only TWO orders, I will give you your own set free! There is no obligation on your part. Nothing for you to pay or sign. I'll be glad to call back in a few days and am sure you will have two orders so I can give you your own set free."

That's all there is to it. You can place out a dozen or more booklets a day and have others working for you or can mail out the offer and get business without stepping out of your home! When you get the orders, whether in person or by mail, you keep your big profit, mail us your confidential wholesale cost and we will deliver prepaid for you!

If a woman sells two 30-piece Career sets at on'y \$19.95 each, she will give or mail you \$39.90 for the two sets sold. **YOU KEEP \$22.05 FOR YOUR PROFIT**, mail us only \$17.85 and we will deliver THREE sets prepaid, to include the gift set! Just ONE transaction a day will give you over \$132 weekly profit!

There has never been anything like this before. Actually, this is only ONE of the many ways you can make money. Catalogue, money-making plans, confidential distributors' wholesale prices, etc., yours absolutely free. Regardless of age or experience, if you want to make money, rush coupon below or just mail postcard with your name and address. Writing TODAY may be the most important thing you ever did.

TOPVAL CORP., Lindenhurst 52, N. Y.

TOPVAL CORPORATION, Lindenhurst 52, N. Y.

I'm willing to be shown. With no obligation on my part, send me catalogue, money-making plans and full details of your amazing offer.

Name _____

Address _____



Instead of a job . . . train for a Career



Industrial growth . . . automation . . . technical advances create career opportunities for engineers, accountants, management experts. Share rewards awaiting college-trained men. Important firms visit campus regularly to employ Tri-State College graduates. Start any quarter in this world-famed college. *Approved for veterans.*

Bach. of Science degree in 27 months

in Mechanical, Civil, Electrical, Chemical, Aeronautical, Radio (TV-Electronics) Engineering. In 26 Months a B.S. in Business Administration (General Business, Accounting, Motor Transport Management majors). Capable students may accelerate. 36-weeks course in Drafting. *Intensive program: technical fundamentals stressed; comprehensive courses with more professional class hours. Small classes; personalized instruction. For earnest, mature students whose time and budget requires accelerated courses and modest costs. Preparatory courses. Beautiful campus in friendly college town. Well-equipped, new and modernized buildings and laboratories. Enter March, June, Sept., Jan. Write Jean McCarthy, Director of Admissions, Int "Your Career in Engineering and Commerce."*



TRI-STATE COLLEGE

416 College Avenue Angola, Indiana



MAGIC TRICKS

IT'S FUN TO DO MAGIC

Be popular! Amaze—mystify—entertain! For 30 years Douglas has satisfied customers all over the world. Now, you can enjoy this fascinating hobby. Only 10c brings our Catalog 500 Tricks, containing brand new tricks for pocket, parlor, stage. Join in the fun—send 10c today!

Douglas Magician, Dept. A, Dallas, Texas



MECHANICAL DENTISTRY

A profession offering unlimited opportunities. Most modern and complete course embracing every branch from Plate to Porcelain Work, which prepares you to work for Dentists or start your own business. Individual instruction—practical training in day or night school. No books—no classes. Catalog upon request.

McCARRIE SCHOOL OF MECHANICAL DENTISTRY
207 N. Broad Street Dept. 49 Philadelphia 7, Penna.

FREE! Big Illustrated Do-It-Yourself

METALCRAFT CATALOG

Make Aluminum, Copper and Foil Items
J. C. LARSON CO., 820 South Tripp Avenue
Department 5327A, Chicago 24, Illinois



REAL ESTATE BE A BROKER

PAYS BIG! SEND FOR FREE, BIG, ILLUSTRATED CATALOG NOW! Graduates report making substantial incomes. Start and run your own business quickly. Men, women of all ages, learn easily. Course covers Sales, Property Management, Appraising, Loans, Mortgages, and related subjects. **STUDY AT HOME** or in classrooms in leading cities. Diploma awarded. Write TODAY for free book! No obligation.

Approved for World War II and Korean Veterans
WEAVER SCHOOL OF REAL ESTATE (Est. 1936)
2020R Grand Avenue Kansas City, Mo.



Step up in "ELEVATORS" and others will look UP to you. The moment you slip on these height increasing shoes you add almost 2 inches to your height. The shoes look no different, but you'll see an amazing difference in your appearance. Be sure, be smart, be taller!



For FREE Booklet and Dealer's name write to:
STONE-TARLOW CO., INC., DEPT. PM 1-56, BROCKTON 68, MASS.

START YOUR OWN BUSINESS!

ELECTRICAL APPLIANCE REPAIRING

**SECURITY — INDEPENDENCE
WORK SHORT HOURS**

IN YOUR OWN KITCHEN, BASEMENT, OR GARAGE

EARN WHILE YOU LEARN!

There are millions of electrical equipment units in daily use . . . in factories, homes, office buildings and on farms. Skilled electrical technicians are needed to keep this equipment in good running condition. Learn at home in spare time.

You can now **BE TRAINED** to fill this **BIG NEED** . . . a need that grows day by day because of new electrical inventions for home and factory.

If you are mechanically inclined, can hold and use tools, we can give you the training and time-saving kits that will enable you to . . . **Command More Money at Work . . . A Better Paying Job Elsewhere . . . Or A Business Of Your Own!**

You don't need elaborate fixtures or expensive equipment to be a successful repairman. Work as many hours as you wish. The Electrical Appliance Technician is his own boss!

\$5.00 - \$6.00 HOUR

often charged for making ordinary repairs. We show you how to repair refrigerators, vacuum cleaners, washing machines, motors, etc., etc.

AGE IS NO BARRIER

Nor is a minor physical handicap. Work is light, pleasant and **PROFITABLE.**

The **ELECTRONIC KIT**, a multi-purpose trouble detector, and other valuable Shop Method Training is sent to you! All instruction material is written in simple, easy-to-understand language, chock full of hundreds of detailed photos and drawings. Used by servicemen the country over.

We show you how to quickly locate the trouble, how to fix it and what to charge. **ALSO**, how to solicit business and keep business coming to you.

Get Full Facts on how you can get this training at home in your spare time and pay for it out of your earnings while learning!

FREE BOOK

On America's fastest growing industry

CHRISTY TRADES SCHOOL, Dept. D-5003, 4804 N. Kedzie, Chicago 25

**CHRISTY TRADES SCHOOL, Dept. D-5003
4804 N. Kedzie Ave., Chicago 25, Ill.**

Gentlemen:
Please rush me your **FREE ILLUSTRATED BOOK** about Electrical Appliance Servicing, facts on your Electronic Kit and Special form for paying later from earnings while learning.

NAME _____ Age _____
ADDRESS _____
CITY _____ Zone _____ State _____

Only had your course a few short weeks and have already made \$800.00. Going to quit my job paying \$250.00 straight salary to operate my own business.—J. D. S., St. Louis, Mo.
I work day times at the shipyard and after 4:00 P. M. I operate from my cellar and garage. I average \$10.00 to \$15.00 clear every day.—Walter Hanby, Brockton, Mass.



SEND COUPON TODAY

WORKING KIT FURNISHED



NEW INVENTION **REPLATES** by **ELECTROPLATING** RESTORES HOME, AUTO METALS **CHROME-SILVER-GOLD!**

NEW BRILLIANCE WITH SAME PROCESS AS PROFESSIONAL PLATERS
SILVER-CHROME-GOLD, ETC.



REPLATED, Quickly, Easily Now—with an amazing new invention, **APPL-I-COTER**, you plate hundreds of items, using the mild, safe current of 2 flashlight batteries in its handle. **ALL YOU DO** is simply hold disk on applicator to metal, dip brush into solution—and plate as you brush. It's Easy, Quick, Genuine plating.



RESTORES METALS LIKE NEW Replaces Silver, Chrome, Nickel, Steel, Gold and Brass—all worn Spots, Stains, "Blisters." Silverware, Trays, Teapots, Rims of Holloware and other items can look like new again with this exclusive Electroplating process. Restore all your valuable Gold jewelry with amazing **APPL-I-COTER**. The plating you apply becomes an indestructible part of the metal itself!

QUICKLY BUILDS-UP A THICK NEW PLATING WITH EACH APPLICATION.



COMPLETE PLATING KITS:
MET-L-COTE: For Chrome & other white metals... **\$3.95**
SILV-R-COTE: For Silver-plating with pure Silver... **\$3.95**
GOLD-COTE: Gold Plate with 24 K. Gold... **\$6.25**
Copper **\$3.95**; Rhodium **\$7.95**
ALL 5 METALS... \$19.95
(You Save \$6.10)



BRILLIANT AUTO TRIM — You'll be mighty proud of the Dazzling new finish on your car's bumpers and trim after replating with **MET-L-COTE**... and remember, each time you electroplate worn areas you build up a lasting layer of coating that tremendously lengthens the life of original trim.

MET-L-COTE is constantly used in leading hospitals, and in doctors and dentists offices to Replate surgical instruments—Also in hotels and restaurants to RESTORE cutlery.

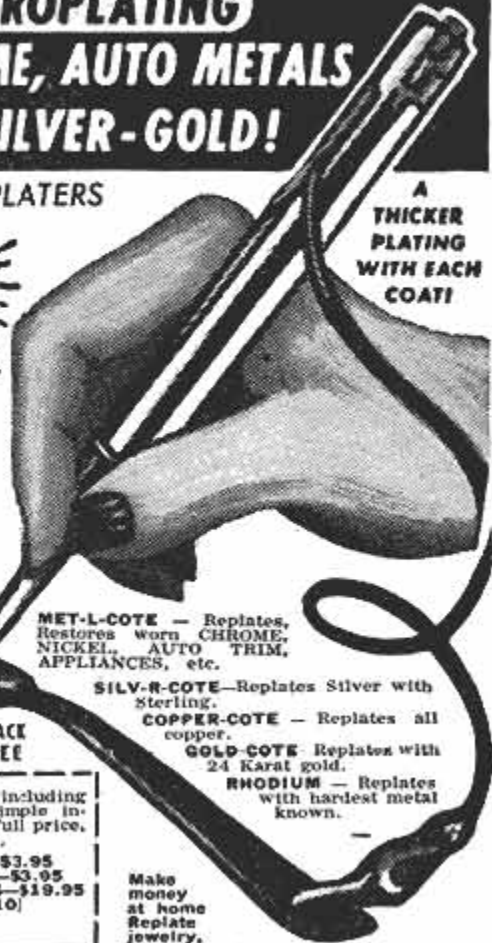

A THICKER PLATING WITH EACH COAT!

MET-L-COTE — Replaces, Restores worn **CHROME, NICKEL, AUTO TRIM, APPLIANCES,** etc.

SILV-R-COTE—Replates Silver with Sterling.

COPPER-COTE — Replates all copper.

GOLD-COTE—Replates with 24 Karat gold.

RHODIUM — Replates with hardest metal known.

Make money at home Replate jewelry, silver, chrome. Earn up to \$10 per hour.

EMPIRE MERCHANDISING CO.
Dept. J-22
28 E. First St., Mt. Vernon, N.Y.

MONEY-BACK GUARANTEE

Please rush the Complete Plating Kits including Solution, New Pocket Applicator & full simple instructions I have checked below. I enclose full price, sent postpaid, or send C.O.D. plus postage.

- MET-L-COTE—\$3.95**
- GOLD-COTE—\$6.25**
- RHODIUM—\$7.95**
- SILV-R-COTE—\$3.95**
- COPPER-COTE—\$3.95**
- ALL 5 METALS—\$19.95** (Save \$6.10)

NAME _____
ADDRESS _____
CITY _____ STATE _____

RESTORE YOUR TREASURES—MAKE THEM VALUABLE AGAIN

Empire Mds. Co., 28 E. First St., Mt. Vernon, N.Y.

See the Greatest Show on Earth with this **GIANT ASTRONOMICAL TELESCOPE**

\$15.00
FULL PRICE



Delivered ready for use. Has 45X, 75X and 100 power individually mounted eyepieces with brass focusing tube plus sun projector lens for observing sun spots and solar storms. Steel telescope tube 50 in. long. Rigid 6 ft. tripod adjustable to any height. Steel forked mounting with closely machined aluminum tripod head assembly assures extra fine adjustments. This professional type instrument provides full power with clear vision at all times. See the moons of Jupiter, our own moon, planets, milky way, double stars, star clusters, etc. All for only \$15.00 F.O.B. Mattituck. Sent express. COD orders require \$5.00 deposit. Satisfaction guaranteed. 200X and 400X eyepieces available at \$2.00 ea.

SUFFOLK SCIENCE SERVICE
Dept. TD-1
MATTITUCK, N. Y.

MONEY in **DONUTS**

Make new greaseless donuts. Start in kitchen. No smoke. Sell stores. **HALF PROFIT.** Cash daily. **Free recipes.** No obligation. Write! **MARTIN RAY CO., 3605 SO. 15th AVENUE, MINNEAPOLIS 7, MINN.**

"How to Make Money with Simple Cartoons"



A book everyone who likes to draw should have. It is free; no obligation. Simply address

FREE BOOK

CARTOONISTS' EXCHANGE
Dept. 91D Pleasant Hill, Ohio



This Sealed Book **LOANED To You**

THOUSANDS EVERYWHERE ACCLAIM THIS **New Psychology Of Life!**

Have you unrealized hopes? Are the better things of life always just beyond your reach?

Times have changed—but have you? Adopt a new psychology of life and **MASTER YOUR PROBLEMS.** It takes no greater mental effort to *achieve results* when you know how.

Let the Rosicrucians show you how, by the use of simple laws, you can apply the powers of your mind to bring about startling changes in your life. If you are sincere in your desire, write for the free Sealed Book. It will point out how you may obtain this most helpful information. Address: Scribe Q.K.B.

The Rosicrucians (AMORC)
SAN JOSE CALIFORNIA



**Get more money!
More security! More out of life!**



**Learn
TELEVISION
• RADIO •
ELECTRONICS**

Get the best!

Get National Schools' SHOP-METHOD HOME TRAINING!

Start now! Why wait around for that raise or promotion that may never come? Get started *now* in high-paying TV-Radio-Electronics! National Schools' SHOP METHOD Home Training prepares you for success in a top-salary job or in your own business. You learn *all three*... Television, Radio, Electronics... in one complete course. Our Shop-Tested lessons and manuals help you master all phases in shortest possible time! Send coupon, find out today!

WHY NATIONAL SCHOOLS LEADS THE FIELD

Located in the "Television Center" of the world, our staff is in close touch with latest developments and opportunities. We give you personalized job placement assistance. We also give you confidential help with both technical and personal problems relating to your training. We show you how to make Part Time Earnings as you progress. Whether you live 30 miles away, or 3,000, you will always be pleased with our prompt, friendly service!

DRAFT AGE? Our home training helps you achieve specialized ratings and higher pay grades if you go in service.

We send you this precision-tested Multitester! Plus parts to build Oscillators, Receivers, Signal Generator, Continuity Checker, Combination Short Wave and Standard

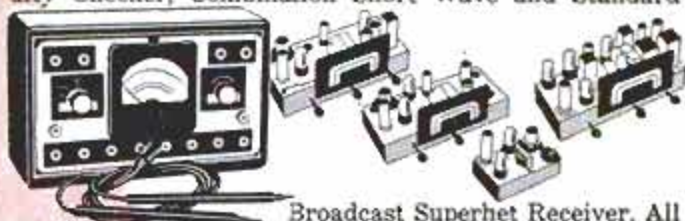

Broadcast Superhet Receiver. All this equipment is part of your National Schools course. **NO EXTRA CHARGES!** Send coupon for free books!

NATIONAL SCHOOLS, world-famous technical trade school. Now in our 50th year!



NATIONAL SCHOOLS

TECHNICAL TRADE TRAINING SINCE 1905

LOS ANGELES 37, California - CHICAGO: 323 West Polk St.

IN CANADA: 811 West Hastings Street, Vancouver, B. C.

• APPROVED FOR G. I. TRAINING

• BOTH HOME STUDY AND RESIDENT COURSES OFFERED

30 MILLION TV SETS

need regular repair! Color TV means more sets than ever before. NOW is the golden opportunity to cash in on this multi-billion-dollar industry Or "write your own ticket" in broadcasting, manufacturing, and other specialized phases!

**YOUR AGE
IS NO
OBSTACLE!**

**Send for
FREE LESSON!**

FREE BOOK & SAMPLE LESSON
will convince you!
SEND COUPON TODAY!



MAIL NOW TO OFFICE NEAREST YOU!

(mail in envelope or paste on postal card)

NATIONAL SCHOOLS, Dept. RB-16

4000 SOUTH FIGUEROA STREET
LOS ANGELES 37, CALIFORNIA

OR 323 WEST POLK STREET
CHICAGO 7, ILLINOIS

Please rush **FREE BOOK**, "My Future in Radio-Television-Electronics," and **FREE LESSON** at once. I understand there is no obligation, and no salesman will call.

NAME _____ BIRTHDAY _____ 19 _____

ADDRESS _____

CITY _____ ZONE _____ STATE _____

Check if interested **ONLY** in Resident Training at Los Angeles.

VETERANS: Give date of discharge _____

**"TOOK IN \$217
FIRST 10 DAYS"**

Some make more, some less...

**We help you to start Your
Own All-Year Business**

Make Big Money! With our easily operated, highly efficient wall washer, Charles Stelle took in \$217 gross in first ten days. E. L. Goss took in more than \$10,000 in one year. E. C. Taber wrote, "I made \$400 gross in two weeks."



And no wonder... this machine washes walls 6 times faster and better than by hand.

Your Money-making Opportunity. We want more men to go into this profitable business for themselves and enjoy independence—freedom from bosses, layoffs. Customers everywhere—homes, offices, schools, churches, hotels, etc. How much you earn depends largely on you. What you take in is mostly profit. No need to rent shop or office; operate business from home. Can start spare time until your full time is available.

Lose no time. Get all facts without obligation

FREE BOOK! MAIL COUPON TODAY!

• **VON SCHRADER MFG. CO.**
• 110 "W" Pl., Racine, Wisconsin
• Send at once (no obligation) your FREE booklet containing information about your WALL WASHING MACHINE and how I can start my own permanent, profitable business.

Name _____
Address _____
City _____ Zone _____ State _____

**Secrets of VENTRILOQUISM
Now Revealed!**

Easy to learn in 60 to 90 days with our Home Study Course. **RESULTS GUARANTEED.** Make Money! Be Popular! Have Fun! Big Opportunity! Radio, Television, Stage Appearances! For FREE information regarding price and terms WRITE. You must state your age. Dummy Catalog 25c.
FRED MAHER SCHOOL OF VENTRILOQUISM
Box 36, Studio PM-1 Kensington Station
Detroit 24, Michigan

TELEPHONES



Desk Stand Style
Slightly used but in excellent condition
Many Valuable Uses
Inter-House Phones House to Barn, etc.
Loud Speakers Microphones
Educational Purposes, Toys, etc.
Come complete, ready to use with wiring diagrams included.
Two complete for only \$5.00 **\$2.75** Postpaid in U.S.A.
TELEPHONE LAMP KIT—with illustrated instructions for making Desk Telephone Lamp including all parts (harp, nipples, push switch, cord, plug, etc.)
... \$6.50 Ppd. (Shade is not included).

MICROPHONE, Dept. X-3402, 1760 W. Lunt Ave., Chicago 26, Ill.

**Shrinks Hemorrhoids
New Way Without Surgery**

Science Finds Healing Substance That Relieves Pain—Shrinks Hemorrhoids

For the first time science has found a new healing substance with the astonishing ability to shrink hemorrhoids and to relieve pain—without surgery.

In case after case, while gently relieving pain, actual reduction (shrinkage) took place.

Most amazing of all—results were so thorough that sufferers made astonishing statements like "Piles have ceased to be a problem!"

The secret is a new healing substance (Bio-Dyne*)—discovery of a world-famous research institute.

This substance is now available in suppository or ointment form under the name Preparation H.* Ask for it at all drug counters—money back guarantee. *Reg. U. S. Pat. Off.

FOR BIG MEN ONLY!



SEND FOR FREE CATALOG

SIZES 10 to 16 WIDTHS AAA to EEE

We SPECIALIZE in large sizes only—size 10 to 16; widths AAA to EEE. Low Cuts; Wing Tips; Hand-Sewn Moccasins; Cordovans; Dress Oxfords; Work Shoes; Sox; Slippers; Rubbers. Enjoy the finest in fit, comfort, style at amazingly low cost. Mail only. Write TODAY for FREE Style Book!

KING-SIZE, INC.
674 BROCKTON, MASS.

Learn ACCOUNTING
Business Administration
Bookkeeping, secretarial and allied subjects at home in your spare time or attend nationally approved resident school. Write for FREE Success Book giving complete details on courses, plans, rates and employment opportunities. G.I. approved. Write Dept. A.

Hills BUSINESS UNIVERSITY AND EXTENSION SCHOOL
619 W. MAIN ST. OKLAHOMA CITY 2, OKLAHOMA

Learn SHELLCRAFT

Wonderful, New, Easy—Up to 500% Profits! Make Shell Lamps, Shell Jewelry and Novelties. Sell for BIG PROFITS! Markets everywhere. Hand-in-Action PLAN designed for you... to learn and earn as you succeed in Shellcraft.
FREE Genuine Sea Shells, full color pictures, and Hand-in-Action Plan Folder. Write:
NATIONAL SHELLCRAFT SCHOOL
639-26th ST. S., ST. PETERSBURG, FLA.

RUPTURED

BE FREE FROM TRUSS SLAVERY
NOW there is a new modern Non-Surgical treatment that permanently corrects rupture. These Non-Surgical treatments are so certain, that a Lifetime Certificate of Assurance is given. Write today for our New FREE Book that gives facts that may save you painful and expensive surgery, and tells how non-surgically you may again work, live, play and love and enjoy life in the manner you desire. There is no obligation.
Excelsior Hernia Clinic Dept. 8305 Excelsior Springs, Mo.

Learn PHOTOGRAPHY at Home

Splendid opportunities. Prepare in spare time. Practical basic training. Long-established school. Send for free book. "Opportunities in Photography." No obligation.
AMERICAN SCHOOL OF PHOTOGRAPHY, 835 Diversy Pkwy., Dept. 1351, Chicago 14, Ill.

BUILD A BUSINESS OF YOUR OWN

Supervised Home Study Training

The American Technical Society offers a step-by-step method of training men to become experts in the field of Building, Estimating, and Contracting. Learn Blueprint Reading, Carpentry, Masonry, House Planning, Remodeling, Mathematics. Learn how to estimate for the Building Trades. Seventy-four step-by-step training lessons complete with up-to-date text books to train you as a Building, Estimating and Contracting expert.



Become a Builder, Estimator & Contractor

EARN WHILE YOU LEARN

Train to become a Builder, Estimator and Contractor in your spare time at home. The American Technical Society's supervised home study methods enable you to earn while you learn. Get the technical knowledge you need to bring you greater earnings and an eventual business of your own.

We Furnish All Training Materials

You get complete training assignments in such subjects as Structural Details, Specifications, Sheet Metal, Heating, Insulation, Excavation, Foundations, Woods, Windows, Styles of Roofs, Interior Wall Coverings, Stair Construction, Wind Resistant Construction, Selection and Application of Mortars, Theory, Kinds, Design and Building of Driveways, Floors, Steps and Sidewalks. Kinds and selection of Columns, Steel, Lally, Concrete, Brick, Fireplace Constructions, Design, Estimating, Septic Tank Systems, Styling a House, Remodeling. Complete materials include 9 text books, 8 lesson booklets, 8 study guides with instructions for the study and preparation of the examinations, 61 sets of self-checking quizzes, 4 supplementary information sheets, 74 examinations to be submitted for corrections and grading by your supervisory instructor who helps you in your training program.

Is Your Future Worth a 3c Stamp?

A three cent stamp will bring you your first set of training assignments in Building, Estimating and Contracting for your examination without cost and without obligation. If, after examination, you are not convinced about the value of this training and do not believe it can help you raise your income by thousands of dollars, return the assignments within ten days and it will cost you nothing! However, if you are convinced you can build a business of your own and boost your earning power, and you do not return the first training assignment within ten days, you authorize us to ship the second set of training assignments C.O.D. for a registration fee of only \$10.00 and the balance of 8 sets of training assignments, one each succeeding month, C.O.D. for \$25.00 per month until the total cost of \$210.00 has been paid. You may stop any set of training assignments by simply notifying us 10 days in advance of any shipment due. Upon this notification, no further shipments will be made and the balance of training costs will be cancelled.

Application For

Budget Plan of Training

For: BUILDING, ESTIMATING & CONTRACTING

If you are interested in greater advancement and independent financial security, plan today to expand your knowledge in the Building field. The American Technical Society will start you on the road to success by providing you with the kind of home study training you need to learn the technical aspects of Building, Estimating and Contracting.

Here Is What You Get

COUNSELOR SERVICE: Instruction in studying, also the advantage of consultation with the Instructors on all problems within the scope of the Text Material.

TESTS: Examining and grading Tests in order to qualify you for our Diploma in Building, Estimating and Contracting.

DIPLOMA: A Diploma to be awarded as soon as you have completed this Training.

STUDY MATERIAL: (1.) All textbooks and study material and examinations for completion of the course are to be supplied to you by the American Technical Society. This material is to be sent periodically to insure steady progress in your training. (2.) Twelve Human Relations Chats on the Art of Getting Along with Others. (One mailed monthly.)

MAIL THIS APPLICATION TODAY

I have read your offer and would like you to send me, without cost or obligation, your first set of training assignments in Building, Estimating & Contracting. If I do not return same within 10 days you may ship the second set of training assignments C.O.D. for a registration fee of \$10.00 and I will pay for the balance of my training on terms as stipulated in this January issue of Popular Mechanics magazine.

Signature _____

Address _____

City _____ State _____

MAIL TO:

American Technical Society, Dept. PM-16

850 E. 58th Street

Chicago 37, Illinois



WHAT DO YOU KNOW ABOUT THIS PEA-SIZE TUBE?



This new ceramic vacuum tube is revolutionizing the electronics world. It does twice the work of ordinary vacuum tubes. It is newer than the recently developed transistor—its possibilities even more exciting.

A current issue of **POPULAR ELECTRONICS** tells how this tube is made, how it improves performance, saves space and money, what it will mean to your future.

Whether you're a beginner or an old hand with a schematic... a hobbyist or a ham... experimenter or student... **HI-FI** fan or radio control builder... every issue of **POPULAR ELECTRONICS** will open the door for you to the fabulous, fascinating world of electronics. For example, if you had been reading **POPULAR ELECTRONICS** during the past year you would know...

- What's coming in HI-FI
- About cordless lamps and magnetic stoves
- About electronic farming beneath the sea
- How to qualify for a ham license
- How to build a Geiger Counter
- How to install a P.A. system

Yes, **POPULAR ELECTRONICS** will show you how to do a thousand and one things that will make life more fun for you and your family. Every issue will tell you in simple, practical language, about today's electronic miracles—discoveries that are opening up rich opportunities for men who know—and keep knowing.

NOW SAVE \$1.62

WITH EXTRA BONUS OFFER!

ACT NOW and take advantage of this special introductory offer... 16 idea-packed monthly issues of **POPULAR ELECTRONICS** for only \$2.88... actually less than the \$3 you'd ordinarily pay for a one year (12 issue) subscription.

EXTRA BONUS OFFER! Send payment with your order and we'll add 2 extra issues... giving you 18 issues in all... a whopping \$4.50 value for just \$2.88! Use the coupon below to start **POPULAR ELECTRONICS**—with all its fun and profits—coming to you each month.



POPULAR ELECTRONICS, Dept. 1016
366 Madison Ave., New York 17, N. Y.

Please send me **POPULAR ELECTRONICS** for 16 months for only \$2.88.

Payment enclosed.* Bill me.
* 2 extra issues free.

Name

Address

City Zone State

OUR IRON-CLAD GUARANTEE: If at any time, for any reason, you feel **POPULAR ELECTRONICS** hasn't delivered on every claim, you get your money back on the unused portion of your subscription.

ZIFF-DAVIS PUBLISHING COMPANY
Publishers of Radio & Television News - Popular Photography - Flying

LINGUAPHONE

MAKES IT EASY TO LISTEN and LEARN to

Speak

SPANISH [New World or European] **FRENCH**
GERMAN • **ITALIAN** • **RUSSIAN**
MODERN GREEK — Any of 34 languages available

for **10 DAY FREE TRIAL**

With **LINGUAPHONE**—The World's Standard Conversational Method—You Start to **SPEAK** another language tomorrow—or **IT COSTS YOU NOTHING!**

For just 20 Minutes a Day you listen to Linguaphone's life-like recordings. You learn another language **AT HOME** the same, easy natural way you learned to speak English before you went to school. Only **LINGUAPHONE** brings 8 to 12 of the world's best native language teachers into your home. You hear these men and women speak about everyday matters in their native tongue. **YOU understand—YOU SPEAK.** It's like living in another country.

That's why Linguaphone is used 'round the world by educators, governments and business firms. Over a million home-study students. Stop Wishing—Start Talking. **SEND FOR FREE BOOK and Details of FREE TRIAL.** No obligation. **LINGUAPHONE INSTITUTE, T-143-016** Rock Plaza, New York 20.



WORLD'S LOWEST PRICED
ADDING MACHINE

IDEAL FOR BUSINESS AND PERSONAL USE—GUARANTEED ACCURATE. Not a toy. Operates with only a finger flick. Adds, subtracts, multiplies, divides. Counts up to one billion. Pays for itself over and over. **Ideal Gift—for Business, Income Tax and School use. MONEY BACK GUARANTEE.** Send name and address. Pay postman only \$2.95 plus postage. (Send full cash if outside U.S.) Beautiful rich-looking Leatherette Case included at no extra cost. Money back in 10 days if not delighted. **AGENTS WANTED.**

CALCULATOR MACHINE CO., (Mfrs.)
Box 44 Dept. J-56 Glenview, Illinois

FREE — Amazing Book on RHEUMATISM, ARTHRITIS

If you suffer the aches, pains and discomforts of Rheumatism, as manifested in **ARTHRITIS, NEURITIS, SCIATICA** or **LUMBAGO**, send today for the **FREE** Book. It reveals important facts about why drugs and medicine give only temporary relief without removing cause. Explains fully a proven, specialized system of treatment that may save you years of distress. No obligation. Write for this **FREE** Book today!

BALL CLINIC, Dept. 756, Excelsior Springs, Mo.

Send for **FREE** 112 page
Illustrated Catalog of Farm, Home,
and Workshop Bargains.

Write to **WELLWORTH TRADING COMPANY**
Dept. F-1

1832 S. WABASH AVE.

CHICAGO 16, ILL.

Say You Saw It in Popular Mechanics



EXTRA MONEY
Selling **EXCLUSIVE**
PARAGON Cushion Shoes

Even If Now Employed

Enjoy your own lifetime, independent shoe business without investment. Steady repeats. To \$4.00 pair advance commissions. Big bonus. Make \$50 and more a week in full or spare time. 144 latest smart styles. Magic cushion. Easy to start. Write for **FREE OUTFIT** today!

No. 574
Lo-Line
2 Eyelet
Crushed
Grain

PARAGON SHOE COMPANY
79 Sudbury St., Dept. 20, Boston 18, Mass.

POPULAR MECHANICS

MAKE BIG MONEY

Plasticasting!

MAKE JEWELRY, NOVELTIES, STATUES, ETC.

WE BUY THOUSANDS OF PLASTICAST ITEMS ANNUALLY

We always need Gemcraft stones made from PLASTICASTINGS for our regular customers. We guarantee to buy your output too when made from PLASTICAST materials.

START YOUR OWN BUSINESS

Make beautiful and useful things out of LIQUID PLASTIC, LIQUID MARBLE, LIQUID IVORY, LIQUID GLASS, LIQUID GEMSTONE, LIQUID PORCELAIN, CERAMICS, ETC., without tools or machinery! Anyone can do PLASTICASTING! It's as easy as pouring water out of a glass!

BUILD PLASTIC MODELS

OF YOUR OWN AND OTHERS' INVENTIONS

It's easy when you know PLASTICASTING. It's also easy and highly profitable to make novelties, jewelry, gifts, artware, toys, tools, dies, gadgets, ceramic articles, etc. A million useful things! Use PLASTICASTING for mounting specimens for laboratories, institutions, doctors, dentists, etc. Use your early earnings to become a full time Hobby Shop Dealer.

We can supply you with everything you need—MATERIALS and INSTRUCTIONS. Send only 25c for big 98 page catalog of casting materials, molds and accessories and we will include free our remarkable book "The Wonders of Liquid Plastics." Send 25c today for the giant sized catalog of PLASTICASTING materials and supplies.

You will be on your way to owning a big profit-making business of your own.

PLASTICAST CO., Dept. PC-402
6612 N. Clark St., Chicago 26, Ill.

I am enclosing 25c for PLASTICASTING Catalog 19 and include FREE of extra cost "THE WONDERS OF LIQUID PLASTICS."

Name _____

Address _____

City _____ Zone _____ State _____

FREE

"The Wonders
of Liquid
Plastics"

A fascinating book that will open your eyes to the marvels of liquid plastics. Shows how easy it is and the wonders you can accomplish.

PLASTICAST CO., Dept. PC-402

6612 N. CLARK ST.

CHICAGO 26, ILL.

BECOME AN Electrical Engineer



- Major in Electronics or Power
- Earn B. S. Degree in 36 Months

Over 50% of the nation's industrial leaders began their careers with engineering training. Prepare now for a rewarding future as an Electrical Engineer or Engineering Technician. Enroll at the Milwaukee School of Engineering.

Plan Your Career—Eight Courses Give You Wide Range of Study

ENGINEERING COURSES

Electrical Engineering-Bachelor of Science Degree
Save a valuable year through optional year 'round study.
Electronics major36 months
Power major36 months

TECHNICIAN COURSES

Electro Technician12 months
Electronic Technician12 months
Radio Technician12 months
Radio and Television Technician18 months

SERVICE COURSES

Electrical Service6 months
Radio and Television Service12 months

MECHANICAL TECHNOLOGY

COURSES — Also available, Service and Technician courses 6 to 18 months — Heating, Refrigeration, Welding, Air Conditioning and Mechanical — B.S. Degree in Mechanical Engineering with a major in Design, Metal Fabrication, or Plant Engineering. Also, general 3-month preparatory course.

Terms open January, April, July, September
Prior Military, Practical or Academic training evaluated for advanced credit. Faculty of specialists. 50,000 former students. Annual enrollment from 48 states and 23 overseas countries. 52nd year. Non-profit. Residence courses only. Send handy coupon today. MS-11A



MILWAUKEE

SCHOOL OF ENGINEERING

MILWAUKEE SCHOOL OF ENGINEERING

Dept. PM-156, 1025 Milwaukee St., Milwaukee, Wis.

Send free illustrated career booklets Electrical Technology Mechanical Technology Radio-Television.

I am interested in..... (name of course)

Name.....Age.....

Address.....

City.....Zone.....State.....

If veteran, indicate date of discharge.....

HEARING BAD?

If so, you will be happy to know how we have improved the hearing and relieved those miserable head noises, caused by ear-tarrh of the head, for thousands of people (many past 70) who have used our simple Elmo Palliative Home Treatment in the past 16 years. This may be the answer to your prayer. **NOTHING TO WEAR.** Here are **SOME** of the symptoms that may likely be causing your catarrhal deafness and head noises: Head feels stopped up from mucus. Dropping of mucus in throat. Hawking and spitting. Mucus in nose or throat every day. Hearing worse with a cold. Hear — but don't understand words. Hear better on clear days. Worse on rainy days. Head noises like crickets, bells, whistles, clicking, escaping steam or many other sounds. If your condition is caused by catarrh of the head, you, too, may likely enjoy such wonderful relief as many others have reported. **WRITE TODAY FOR PROOF AND 30 DAY TRIAL OFFER.**



THE ELMO COMPANY
DEPT. 6PM1 DAVENPORT, IOWA

IT'S EASY...

MAKE MONEY IN PHOTOGRAPHY

If you are over 17—good pay and fascinating work await you in photography! Start making money quickly in sparetime—step into your own studio or exciting career job. **LEARN BY DOING** method trains you at home! Write TODAY for FREE catalog. Also Resident Training. 46th Year. Approved for Vets.

NEW YORK INSTITUTE OF PHOTOGRAPHY
Dept. 49, 10 West 33 Street, New York 1, New York
46th YEAR

BUILD LUGGAGE AT HOME WE SELL YOUR PRODUCTS!

ONLY NEW HOME MONEY-MAKING PLAN IN YEARS!

Make Luggage and cases for traveling, photographers, musicians, salesmen, electronics, tools, portables, 1001 other items. Also repair Luggage. No special equipment needed. **BIG PROFITS.** We supply complete instructions, materials—everything. Write for free details and Business Plan. **ABARSI CASE-CRAFT, Dept. G-1, 805 W. Sunset Blvd., Los Angeles 12, Calif.**

BECOME AN EXPERT IN

TRAFFIC

Traffic men earn \$4,000 to \$10,000 and up. Thousands of firms need experts on rates, traffic regulations. We train you thoroughly in spare time at home for executive traffic jobs. Personal training under traffic authorities. Placement counsel and help. Write for free 48-page book "Traffic Management—the Fast Growing Profession."

LASALLE Extension University, 417 So. Dearborn St.
A Correspondence Institution Dept. 164T Chicago 5, Ill.

Make Big Money At Home

BEFORE



AFTER

INVISIBLE REWEAVING

PAYS UP TO \$10.00 IN AN HOUR!

Here's your chance for spare-time earnings at home! Be the **INVISIBLE REWEAVER** in your own community. Make cuts, burns, moth holes, tears in dresses, suits, all fabrics **DISAPPEAR!** Do it at home—in spare time. Demand from tailors, cleaners, dept. stores, laundries, individuals. Profits up to \$10 for 1 hour's work reported! Write for details. **FABRICON CO., 8342 S. Prairie Ave., Dept. 321, Chicago 19, Ill.**

Tune Up, Pep Up, Fix Up ANY CAR!

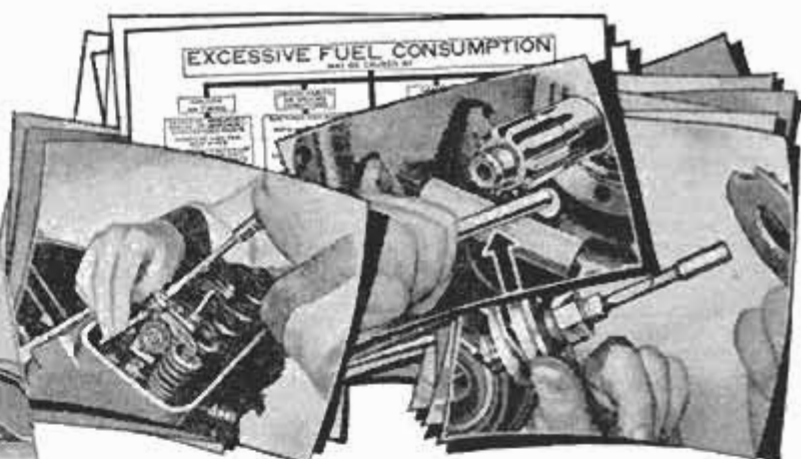

Giant New Edition!
Almost 900 big pages!
Weighs 4 3/4 lbs!

YOU WON'T "MISS" WITH HOW-TO-FIX-IT DATA LIKE THIS TO GUIDE YOU!

Handle practically any job on any car like an expert . . . even if you've never repaired a car before!

Using this giant, 4 3/4 pound Chilton "ALL CARS" Auto Repair Manual is like having the 19 Chilton service experts who prepared it standing beside you.

First, they show you how to locate troubles in a jiffy. Then they show you just what to do and exactly how to do it to make needed repairs. Almost 3,000 specially-taken pictures help make almost every move crystal clear.

FIX ANY MAKE, MODEL OR PART

Chilton covers every model of the leading 22 car makes from 1940 to the present . . . *practically every car on the road today.*

From simple tune-ups to complete engine overhauls; from complicated transmissions to overdrives; from

ignition systems to timers and all the rest, it is a complete, accurate and fully authentic service guide. Tells what work-saving shortcuts to take . . . what adjustments to make . . . what mistakes to avoid . . . even what standard tools to use!

NOT A "STUDY" BOOK JUST LOOK UP THE JOB YOU WANT TO DO!

This big Chilton Manual is chock full of how-to-fix-it data on specific jobs . . . NOT a lot of general theory. It's a real "work" book to be used right on the job. Just look up the car make, model and part you want to repair or adjust. Follow the Manual's easy instructions and presto! the work is done faster, better, easier than you may have thought possible.

Contains almost 900 big pages; 58 Troubleshooting Charts; 353 Quick

Check Data Tables and literally thousands of parts and repair specifications. Price only \$6.95 on easy terms. More than pays for itself in time saved THE FIRST TIME YOU USE IT.

Practice 10 full days at our risk! You be the judge! Send 10-day Free Examination coupon today.



You'll find this giant Chilton Car Repair Manual in practically every car repair shop...

It's widely used in Army-Navy training...

And it's tops for beginners . . . because it makes everything so amazingly clear!

Covers every model from 1940 through 1956:

- BUICK • KAISER
- CADILLAC • LINCOLN
- CHEVROLET • MERCURY
- CHRYSLER • NASH
- CONTINENTAL • OLDSMOBILE
- DE SOTO • PACKARD
- DODGE • PLYMOUTH
- FORD • PONTIAC
- FRAZIER • RAMBLER
- HENRY J. • STUDEBAKER
- HUDSON • WILLYS

The Original Book of its kind . . . and still the best! Published each year for 27 years by Chilton . . . world's largest automotive publishers.

MAKES EVERY JOB EASY TO UNDERSTAND!

Read what these users say:



"With my Chilton 'All Cars' Manual, I finished a job in an hour that another fellow had worked on all day!"
GENE ARNOLD, Iowa

"Chilton makes every job easy to understand. You don't need a lot of previous training!"
OTTO MORGENSTERN, Maryland



Chilton Books are sold by leading book stores.

PRACTICE 10 DAYS FREE!

THE CHILTON CO., Dept. PM-16
5605 Chestnut St., Philadelphia 39, Pa.

Send me the big CHILTON "ALL CARS" REPAIR MANUAL (Price \$6.95) for 10-day FREE EXAMINATION. If I like Manual, I will then promptly remit \$1.95 (plus 45¢ postage and handling); then send \$2.50 each month for two months. Otherwise I will return manual postpaid in 10 days and owe you nothing. **SAVE!** Send \$6.95 with order and we pay postage-handling. Same 10-day return privilege.

Name

Address

City, Zone, State

(OUTSIDE U.S.A.—Price \$8.95 cash with order. 10-day return privilege with money refunded.)

FREE! ELIZABETH II EMPIRE STAMPS



Rush coupon below *at once!* We'll send you one of the most exciting offers ever made! Think of it! . . . from the far corners of the British Empire — Falkland Islands, Ceylon, Seychelles, South Africa, Tristan da Cunha, to name just a few — this generous collection of hard-to-get (mint and used) Elizabeth II stamps, Coronation and others. They're *all genuine, all different!* Also a FREE copy of our helpful illustrated "Stamp Collector's Guide"! PLUS! in handsome color, a reproduction and story of the World's Rarest Stamp! Other valuable offers included for your free inspection. Don't delay — this rare offer may be withdrawn soon! If coupon has been clipped, send direct to: GARCELON STAMP CO., Dept. JPME, Calais, Maine.

GARCELON STAMP CO., Dept. JPME, Calais, Maine.

Rush FREE Empire Stamps and other offers.
(PLEASE PRINT)

NAME _____

ADDRESS _____

CITY _____ ZONE _____ STATE _____



...TURN CONCRETE INTO GOLD!



MAKE UP TO \$75 A DAY IN YOUR OWN BUSINESS

If you want to have your own business — to start a business on your own — here's your big opportunity! New high speed, low cost General block machine produces up to 1,000 concrete blocks a day. Sell all you make to builders, supply houses, and others for homes, factories, buildings, garages. Cash in on the building boom! You can make profits of 100% to 150% — up to \$75 a day! General block machine equipped with 1/2 h.p. electric motor — or can be supplied with gasoline engine — works anywhere, in little space, indoors or out. Operates from ordinary house light socket. Simple, foolproof 3 step operation — so easy a child can do it. Makes superior 3 core blocks any size from 4" to 12". Also makes chimney, ash, corner and other types. Blocks meet any building code anywhere in the country. Materials — sand, water, cement, available anywhere. Simple illustrated operating instructions and mixing formulae for cement and cinder blocks supplied with each machine. Write for FREE folder with full information.

MOTOR DRIVEN

R.L.T. of New York City reports: "MY GENERAL BLOCK MACHINE PAID FOR ITSELF IN FIRST 2 WEEKS!"

Hundreds now in use the world over! Write for FREE details today!

EXTRA

book gives floor plans for 6 sensational concrete block bungalows. Tells how to lay blocks, lay out building lines, mix concrete, build steps, porch and concrete floors all at great savings. Written by experts. Can save many times the cost of the machine! Get it now! No strings attached. Send \$7.

BOOK SENT FREE IF YOU BUY MACHINE.
\$1 REFUNDED IF YOU BUY LATER.

GENERAL ENGINES CO.

DEPT. M-16, ROUTE 130, THOROFARE, N. J.



SHORTHAND IN 6 WEEKS

Write 120 words per minute
Age no obstacle—LOWEST COST

Famous SPEEDWRITING shorthand. No symbols; no machines; uses ABC's. Easiest to learn and use. Fast preparation for a better position. Nationally used in leading offices and Civil Service. 120 words per minute—50% FASTER than Civil Service requirements. Over 300,000 taught by mail or through classroom instruction. The very low cost will surprise you. Typing available. 33rd Year. Schools in over 400 cities in U.S., Canada, Cuba, and Hawaii.

WRITE FOR FREE BOOKLET TO: SCHOOL OF

Speedwriting

Dept. 1501-6, 55 W. 42 St., N.Y. 36

LOOK!

A MILLION THRILLS!



High Power
BINOCULARS

33 Models: \$9.95 to \$125

Free! Catalog & Book
"How to Select Binoculars"

BUSHNELL Binoculars
Dept. M21 43 E. Green
Pasadena, Calif.

FREE
TRIAL
PLAN

LEARN METALCRAFT

and JEWELRY MAKING

Low Cost Home Training Now Available



Make money. Learn profitable skills and arts of decorative metal and jewelry crafts. Course is complete. Professionally prepared. Easy to master. Special tools and materials furnished.

Write for
Free Booklet

INTERSTATE TRAINING SERVICE
DEPT. K-3 PORTLAND 13, OREGON

The finest of Gifts...

ENCYCLOPAEDIA BRITANNICA



SEND FOR THIS **FREE!**

Make money. Know how to break and train horses. Write today for this book FREE, together with special offer of a course in Animal Breeding. If you are interested in Galting and Riding the saddle horse, check here () Do it today—now.

BEERY SCHOOL OF HORSEMANSHIP
Dept. 1101 Pleasant Hill, Ohio



Blast off with **DUAL**
vacuum AIR HORNS!

ONLY
\$9.95
*POSTPAID
Money-back Guarantee

Compare with
\$25 to \$100
Air Horns

The voice of authority and commanding warning for safer highway driving. One BLAST and those "Road Hogs" really move over. Installed under the hood or on the front fender. Beautiful lacquer finish. Operates from intake manifold. No tank needed. Only \$9.95 complete with cylinder head bracket, steering column lever, hose, fitting, etc. Send check or money order today. We pay postage. \$1.00 deposit required on all C.O.D. orders.

THE PROTECTORED CO.
Dept. 801, 2750 N.E. 19th Street, Fort Lauderdale, Fla.

Now Many Wear FALSE TEETH With More Comfort

FASTEETH, a pleasant alkaline (non-acid) powder, holds false teeth more firmly. To eat and talk in more comfort, just sprinkle a little FASTEETH on your plates. No gummy, gooey, pasty taste or feeling. Checks "plate odor" (denture breath). Get FASTEETH at any drug counter.

We'll train & establish you in Your Own Business ... even if now employed

We are enlarging this 26-year-old world-wide chain of Duraclean dealerships. Many excellent locations are still available in the U.S.A., Canada, and other countries. If you are reliable and diligent, this is an opportunity to increase your income... and have the freedom, financial independence, and prestige of YOUR OWN business.

These are full time dealerships... but you can start

in spare time and have a profitable, lifetime business when your present job ends. A Duraclean dealer will train and assist you. He'll reveal his successful, proven methods and sales plans. He'll work with you.

Alert dealers can average \$5 hourly gross profit on service they render plus \$3 on EACH service-man at National Price Guide charges. This business is easy to learn... quickly established.

World-wide Service

FREE Booklet tells how!



Fabrics dry in a few hours. Rug pile again stands erect and even. Brilliant colors revive. Furnishings become clean, fresh and enlivened.

You Become an Expert in cleaning and protecting Rugs and Upholstery

DURACLEAN cleans by absorption. It eliminates scrubbing... soaking... shrinkage. Aerated foam, created by electric Foamovator, restores natural lubrication in rugs and upholstery. Dirt, grease and many unsightly spots vanish. Fabrics and floor coverings are cleaned with a new consideration for their life and beauty.

This modern process avoids strong soaps and machine scrubbing, eliminating unnecessary wear and breaking of fibers. Fabric life is increased.

DURACLEANING is done in the home. Customers like this convenience.

DURAPROOF is another year 'round service rendered in the home, office or institution — without removing furnishings. It protects upholstery, rugs, furs, clothing and auto interiors against damage by moths and carpet beetles. U. S. Government says "Moths are present in practically every household... No section of country seems free from such infestations." **DURAPROOF** kills moths and carpet beetles... it makes materials non-estable to both. **DURAPROOF** is backed by an International 6-Year Warranty.



Easy to Learn • No Overhead Expense

Permanent, Growing Market

Service is rendered in homes, offices, hotels, theaters, institutions and to revive used-car upholstery for auto dealers. There is need for these services in almost every building. Duraclean dealers operate from their home, an office or shop, as they prefer. It's easy to learn... we quickly train you. Rendering service yourself, at first, prepares you to train and supervise service men.

Repeat and Voluntary Orders

Demonstrations win new customers. **DURACLEAN** Dealers find **REPEAT** and **VOLUNTARY** orders a major source of income. Customers, enthused with results, tell friends and neighbors. Furniture and department stores and others turn over rug and upholstery cleaning and mothproofing to **DURACLEAN** Dealers. We show you 27 ways to get new customers.

We Help YOU Grow

Our **MUTUAL COOPERATION** program gives you many unique and continuous advantages: National Advertising in Life, McCall's, House & Garden, Maclean's (Canada) and a dozen others. Copyright and trademark protection. Certificate approves equipment and materials. Products Insurance. Six-year Warranty. Pocket Demonstrators. Sales Book. Advertising Folders & Cards. Tested Ads. Ad Cuts & Mats. Store Display Cards. Radio & TV Musical Commercials. Home Show Booth Display. Publicity Program gets FREE local newspaper stories. Prizes. Laboratory research and development. Duragram bulletins. Resale Service. Annual Conventions. Behind all this is a 26 YEAR OLD headquarters interested in YOUR personal success. If you want to become the owner of a **DURACLEAN** Service business, you should inquire now. TODAY, while territory is still available.

What Dealers Say

- W. Lookbill: We've had 20 years of pleasant dealings. I'm 65 but am setting my sights for 20 more years.
- Earl Davis: Our sales increased \$17,660 this year over last.
- P. D. Freidinger: 70% of our business is repeat.
- A. Ullman: Every demonstration has been a sale.
- Ellsworth: Your advertising certainly has paid dividends.
- M. Lassanske: My original investment was returned in about two months. I am not sorry in any way that I started my business 'on a shoe string.'
- R. Kimbrough: Finished First White House of Confederacy and am to Duraclean the Governor's Mansion.
- A. Wilson: Working alone this month, I grossed \$1,299.10.
- L. Johnson: Each customer leads to 3 or 4 more.
- T. Komari: We have 1,000,000 yen contract Duracleaning for U. S. Army in Japan.

EASY TERMS

A moderate payment establishes your own business—pay balance from sales. We furnish electric machines, folders, store cards, introduction slips, sales book, demonstrators and enough material to return your **TOTAL** investment.

"OWN a Business" Coupon

DURACLEAN CO., 6-161 Duraclean Bldg., Deerfield, Illinois

Without obligation to me, send booklet and letter giving full details. Tell me how I may OWN a growing business of my own built upon satisfied customers.

Name _____

Address _____

City _____ State _____

FREE Booklet

Our first letter and illustrated booklet will explain everything — the two modern, urgently needed services, waiting market, how business grows, your large profit, easy terms and PROTECTED territory. Clip and mail coupon today! Get all the facts... no obligation.

Duraclean Co. 6-161 Duraclean Bldg., DEERFIELD, ILLINOIS



**NOW
COYNE**
TRAINS YOU
IN SPARE TIME
AT HOME

TELEVISION RADIO-ELECTRONICS

Only from famous COYNE do you get this modern up-to-the-minute TV Home Training, Easy to follow, Step-by-Step instructions—fully illustrated with 2150 photos and diagrams. Not an old Radio Course with Television tacked on. Personal guidance by Coyne Staff. So practical you can quickly **EARN MONEY IN A TV-RADIO SALES AND SERVICE BUSINESS**—part time or full time. Not only **FINEST TRAINING** but **COSTS MUCH LESS**—pay only for training—no costly extras.

SEND COUPON FOR FREE BOOK
SEND COUPON BELOW for Free Book and full details including **EASY PAYMENT PLAN, NO COST OR OBLIGATION—NO SALESMAN WILL CALL.**



B.W. COOKE
President

COYNE
ELECTRICAL SCHOOL FOUNDED 1899

A TECHNICAL TRADE INSTITUTE OPERATED NOT FOR PROFIT
500 S. Paulina Dept. 16-HT2 Chicago 12, Illinois

B.W. COOKE, President
COYNE ELECTRICAL SCHOOL
500 So. Paulina St., Chicago 12, Ill., Dept. 16-HT2
Send **FREE** Book and details of your Television-Radio-Electronics Home Training offer.

Name

Address

City State

Learn to MOUNT Birds and Animals



To All Men & Boys!
Here is FUN and PROFIT!

Send Coupon for Free Book

Tells all about **Taxidermy**, and how you can learn at home to mount life-like **Birds, Animals, Game-Heads, Fish**. Save your valuable trophies. Decorate your home and den. Learn valuable **Chrome Tanning** for business and sole leather buckskin and fine furs. Mount **Common** specimens, squirrels, rabbits, owls, even frogs. Into marvelous craft-work groups, both useful, humorous. Wild game not necessary. **Marvelous hobby. Fascinating.**

BIG PROFITS Turn your spare time to cash. Have a sideline profitable business. Mount game trophies for sportmen; sell your own mounts; save money and **Make Money** with expert tanning. Learn by mail from old reliable school with 400,000 graduates. **Investigate Now.** Send coupon or letter or post card **Right Now** for this marvelous **FREE BOOK**. There is no cost or obligation. Please state your **AGE**.

FREE BOOK

Northwestern School of Taxidermy,
2501 Elwood Bldg., Omaha, Neb.

Gentlemen:—Please send me your **FREE** 48-page booklet explaining Taxidermy. Please print plainly and state **age**. Use postal card if more convenient.

Name Age

Address



INVENTORS

PROTECT YOUR INVENTION BY A U. S. PATENT. SEND FOR FREE "INVENTION RECORD" FORM AND "PATENT INFORMATION EVERY INVENTOR SHOULD HAVE".

CARL MILLER
REGISTERED PATENT ATTORNEY
WOOLWORTH BLDG., 35th FLOOR, 16A
NEW YORK CITY

INVENTORS

Whether an invention is patentable can be substantially determined by a search of the U. S. Patent records. Without obligation, write for information explaining the steps you should take to secure a patent.

JOHN N. RANDOLPH
Registered Patent Attorney
201 Columbian Building, Washington 1, D. C.



PATENTS

C. A. SNOW & CO.

REGISTERED PATENT ATTORNEYS
WRITE FOR INFORMATION TO
428 SNOW BUILDING, WASHINGTON 1, D. C.



INVENTORS

Send for **PATENT INFORMATION** **REGISTERED PATENT ATTORNEY**
book and INVENTOR'S RECORD **ASSOCIATE EXAMINER**
without obligation U. S. PAT. OFF. 1922-1929
GUSTAVE MILLER Patent Attorney & Advisor
16-PM WARNER BUILDING U. S. NAVY DEPT. 1930-1947
WASHINGTON 4, D. C. **PATENT LAWYER**

GET THE HABIT OF READING
OUR CLASSIFIED ADS.
Wonderful Opportunities Amazing Bargains

INVENTIONS WANTED

If you want to market, or sell, your invention for cash or royalties, Write for our Free Booklet. Send no drawings. We also welcome hearing from firms, or private capital, wishing to review inventions in any field. We will be glad to send notice of our clients' inventions.

GLOBAL MARKETING SERVICE
2420 77th Ave. Dept. PD Oakland 5, Calif.

INVENTORS

I shall be pleased to furnish you, upon request, with full information relative to patent procedure—without any obligation on your part.

PATRICK D. BEAVERS
Registered Patent Attorney
934 Columbian Building Washington 1, D. C.

New PROFIT-PROVEN* Home-Business!

"I make \$400.00 a week!"



*Proves
Mr. J. T. Anderson,
Inglewood, Calif.

(Notarized statement on file in our
office and open to inspection.)



MAKE BIG MONEY, TOO—printing without a printing press! Learn the secrets of this new MIRACLE PRINTING METHOD . . . build a Big-Pay Business, SPARE or FULL-TIME, right in your own home. Never before has there been such a golden opportunity to turn pennies into dollars in profit! — to build a successful, prosperous future easily, quickly, and enjoyably—AT HOME!

WHAT IS SCREEN PRINT? It's a new, fascinating technique—so amazingly simple and economical it may soon revolutionize the printing industry! Imagine—after only a few short days, you may print many beautiful professional jobs for LESS THAN IT WOULD COST ON A \$5000 PRINTING PRESS!

SCREEN PRINTING IS FUN . . . EASY! If you like to work with your hands and make beautiful things, you'll find no Home Business that provides greater enjoyment, relaxation, and PROFIT. You'll enjoy every moment . . . creating beautiful printed material that may sell for really BIG MONEY!

NO EXPERIENCE OR COSTLY EQUIPMENT NEEDED! Few home businesses offer such BIG PROFITS for so little time, money, or training! You don't need art ability, expensive equipment, or previous experience! You start at home with little or NO OVERHEAD. Yet you can print—almost immediately—on PAPER, GLASS, LEATHER, CLOTH—ANYTHING! Work with all colors, even the vibrant new FLUORESCENT "Glow Colors" that are in such big demand in advertising circles! It's amazing—but true!

START SPARE TIME—ON A "SHOESTRING"! Use your spare time to earn up to \$12.50 per hour, right from the start. Earn 2 INCOMES INSTEAD OF ONE. Print in your garage, basement, spare room—anywhere! Screen Printing requires little space—won't interfere with your household set-up. Later, when you see the TREMENDOUS PROFITS to be made, you may wish to make Screen Printing your full-time occupation. Become your own boss—make BIG MONEY! Others are doing it—why can't you?



HELP FILL THE HUGE, GROWING DEMAND! Businesses in every city, every community have learned—almost "overnight"—of the amazing quality and economy of MIRACLE Screen Printing! You save them up to 50% on many jobs—yet you make up to 100% profit! When the word gets around people come to you—no selling necessary! Because this sensational printing discovery is so new, many Screen Printers sell exclusively by mail!

WE SUPPLY EVERYTHING YOU NEED! Every secret, enough materials to start making money almost immediately can be yours! Never before has such a wonderful "profitability" been offered to anyone desiring to start a profitable spare or full-time business of his own! We guide you every step of the way with our Personal Counseling Service & Home Business Plan . . . explain how we have helped others, and how we can help you, too! All the CONFIDENTIAL, money-making facts are yours if you MAIL COUPON today—while there's still time for you to get in on the ground floor!

and READ what others
are saying about
Screen Print

"My first attempt at Screen
Printing netted me \$40.00."
J.R., Canada

Copy, 1955



"I would not take \$1,000 for it right
now. Just what I have been searching
the world over for."—Mr. R.T., Florida

"Wonderful new method...made \$80.00
first week...swamped with orders."
R.T., Florida

"Screen Printing is nothing
less than fascinating"
S.M.D., Mass.

PRINT WITHOUT A
PRINTING PRESS!
OR ANY SPECIAL EQUIPMENT



Print Beautiful CLOTH,
FABRICS, GLASS JARS,
NOVELTIES, etc., at home!

MIRACLE Screen Print lets you print on all surfaces, all materials—a big advantage over regular print shops. You provide a service offered only by Screen Printers — may have the entire field to yourself!



PRINT expensive
Posters, Banners,
Labels, Signs, at home!

Realtors, Political Candidates, business firms, many are discovering that Screen Printing is the best answer to their needs. Be the first in your area to fill the huge demand!



PRINT Colorful
ADVERTISING
DISPLAYS at home!

Stores, markets, gas stations, theaters—all businesses need eye-catching displays. Ordinary printers simply can't compete, price-wise, with Screen Printers, on many jobs!

Free!

COMPLETE
REVEALING DETAILS,
Authentic Samples, Proven
Big-Money Opportunity Plan,
Large Illustrated "How To" Booklet.



Learn the Secrets—RUSH COUPON TODAY!

SCREEN PRINT CO., Dept. 21
15127 S. Broadway, Los Angeles 61, Calif.

Gentlemen: Please mail me Free Revealing Details, samples, Opportunity Plan, etc.—All this is sent absolutely Free and sent to me by return mail. I am under no obligation now or ever.

Name _____

Address _____

City _____ Zone _____ State _____

Screen Print Co., 15127 S. BROADWAY, LOS ANGELES 61, CALIF.

DIESEL MECHANICS IN DEMAND



Learn to earn big pay in DIESEL in our large, modern equipped Chicago school and shop. No previous experience or training necessary. We help you find living quarters and part time job while in school. Complete, practical courses taught in the following trades, under the supervision of experienced, expert technicians.

APPROVED FOR CIVILIANS OR GI'S

— CHOOSE YOUR TRADE —

CHECK HERE	WEEKS
<input type="checkbox"/> DIESEL MECHANICS	20
<input type="checkbox"/> AUTO MECHANICS	20
<input type="checkbox"/> BODY & FENDER	16 1/2
<input type="checkbox"/> GAS-ARC WELDING	4-12
<input type="checkbox"/> REFRIGERATION	13 1/2
<input type="checkbox"/> AIR CONDITIONING	8 1/2
<input type="checkbox"/> MACHINIST TRADE	30
<input type="checkbox"/> ADVANCED MACHINIST (includes tool & die)	32 1/2
<input type="checkbox"/> PIANO TUNING & REPAIR	36

CHOOSE YOUR ENGINEERING COURSE

These courses are intended as terminal education for men who wish to enter the Diesel-Automotive and Refrigeration-Air Conditioning fields as technicians. These courses are designed to prepare men for supervisory positions. Students with a high school education, or equivalent, will be accepted.

<input type="checkbox"/> DIESEL AUTOMOTIVE ENGINEERING	2 years
<input type="checkbox"/> REFRIGERATION & AIR COND. ENGINEERING	18 months

FREE EMPLOYMENT HELP

Start your career with Greer by checking your interest above and mail coupon for complete information at no obligation.

NAME _____ AGE _____
 STREET _____
 TOWN _____ ZONE _____ STATE _____

Established 1902 — Over 50,000 Graduates.
 53 years of continuous trade school experience to guide your training.

GREER SHOP TRAINING
 Box A, 2236 S. Michigan Ave.
 Chicago 16, Illinois



OUR GUARANTEE GIVES FULL REPLACEMENT PROTECTION. ONLY LOWER QUALITY TIRES NEED HEAVY GUARANTEES WITH PROMISES & CONDITIONS.

22 YEARS AT THIS ADDRESS AN ESTABLISHED POLICY OF CAREFUL SELECTION ASSURES YOU MANY HAPPY MILES. BE WISE — TRY ONE — YOU'LL BUY MORE! WE WELCOME COMPETITION. NO ONE CAN TOUCH OUR QUALITY & PRICE! White Walls \$1.00 Ex. 50 Years of Combined family experience in High Quality tires.

PARTIALLY USED TIRES — AND OTHERS



FREE If you buy 2 or more Passenger 4-ply tires, WE GIVE ONE tire FREE, on each order, on request. Does not include W.W. or Truck Tires. Free Tube with Mail Order.

Specialists in Truck Tires—Selected for Toughest Jobs—Tops in Value

36 MOS. WRITTEN GUARANTEE WITH EVERY TIRE	
600-16 \$5.52 (475-19)	54.82 700-15 \$7.52
600-16 (1) 5.92 (640-15)	4.22 750-16 (8) 8.72
650-16 5.72 (670-15)	5.52 700-17 8.82
650-16 (1) 6.62 (710-15)	5.52 750-17 10.32
700-16 6.02 (780-15)	5.82 825-15 12.92
750-16 (1) 7.52 (800-15)	5.92 600-20 9.82
550-18 4.52 (820-15)	5.92 650-20 9.82
550-17 3.72 (670-16)	5.32 32x6 (8) 12.02
650-15 5.52 (760-16)	7.02 32x6 (10) 13.92
700-15 4.92 (700-16)	7.32 750-15 10.72

"EXTRA SPECIAL" SOME NEAR NEW all size 4-ply pass. FREE TIRE with 2 or more of these also.—W.W. \$1.00 \$7.62 Extra Factory Tested Tube given—GIANT TIRE SALE. EA.

SNOW TIRES \$8.02 EA. ORDER ANY 4 PLY PASSENGER SIZE BLACK WALL

Thousands of tires shipped all over the U.S.A. All tires shipped F.O.B. Phila. Send Check or M.O. with this ad. Dept. 2. No C.O.D. **STANDARD 834 N. Broad St., Philadelphia 30, Pa.**

GIANT BALLOONS 49c



They're really BIG—surplus U.S. Govt. (new overage). Neoprene weather, target balloons. GREAT FUN in the backyard; at parties, picnics, dances, fairs. TERRIFIC for high school and college PROMS. They attract BIG CROWDS to business openings, civic events, conventions, exhibitions, trade shows. ORDER TODAY! Great for gift. Approx. inflated sizes:

18 in. dia., 3 for 70c
 3 ft. dia., 49c—5 ft. dia., 99c
 10 ft. dia., \$1.59

Postage paid on prepaid orders. Calif. residents please add sales tax.

VOLUME SALES CO., War Assets Division
 Dept. PM-156 3930 Sunset Blvd. Los Angeles 29, Calif.

AGENTS START BUYING SERVICE AT HOME

GET BIG NAME MERCHANDISE

for your clients up to 40% less than reg. price. Operate sparetime. Sales easy as you can give sizeable discounts, still make fat comm. Postcard brings free plan.

AMERICAN BUYERS SERVICE
 HERTEL STATION, DEPT. R, BUFFALO 16, NEW YORK

GET UP TO 40% OFF

Watch Repairing Pays Big Money Learn at home



Watch repairers in great demand. Train step-by-step in 10 easy lessons. We furnish all tools and 15 jewel watch and practice movement. Turn spare time into cash. A licensed school. Low cost. Send for FREE book today.

ILLINOIS SCHOOL OF WATCH REPAIRING
 2870 Elston Ave., Dept. PM16, Chicago 18, Ill.

POWERFUL MIDGET TV ANTENNA



Amazing Television Invention!

Fits into Palm of Your Hand AS CLEAR A PICTURE AS WITH 535 ANTENNAS!

Installed in seconds! Hidden From View! This Powerful Midget outperforms far costlier antennas. Weighs only few ozs. Works on all frequencies. Sensational value, \$1.

MONEY BACK GUARANTEE
 Junk that old unsightly weak-pulling TV Antenna for this handy, newest Evans All Frequency TV Antenna. See the difference immediately. So low-priced you can't afford to be without this 'Midget Wonder.' Mechanism fully concealed. Perfect for apts. where outdoor antennas are prohibited.

Clip This Ad and Mail with Only \$1 plus Dime for Postage We'll ship postpaid to your door. If not delighted with improved TV reception, return in 10 days for full refund. Order for yourself and friends today while this BARGAIN OFFER remains in effect.

EVANS RADIO CO., Dept. 8-B, 650 Asbury, Evanston, Ill.

5 reasons why ACCOUNTANCY



offers you

MORE MONEY and SUCCESS

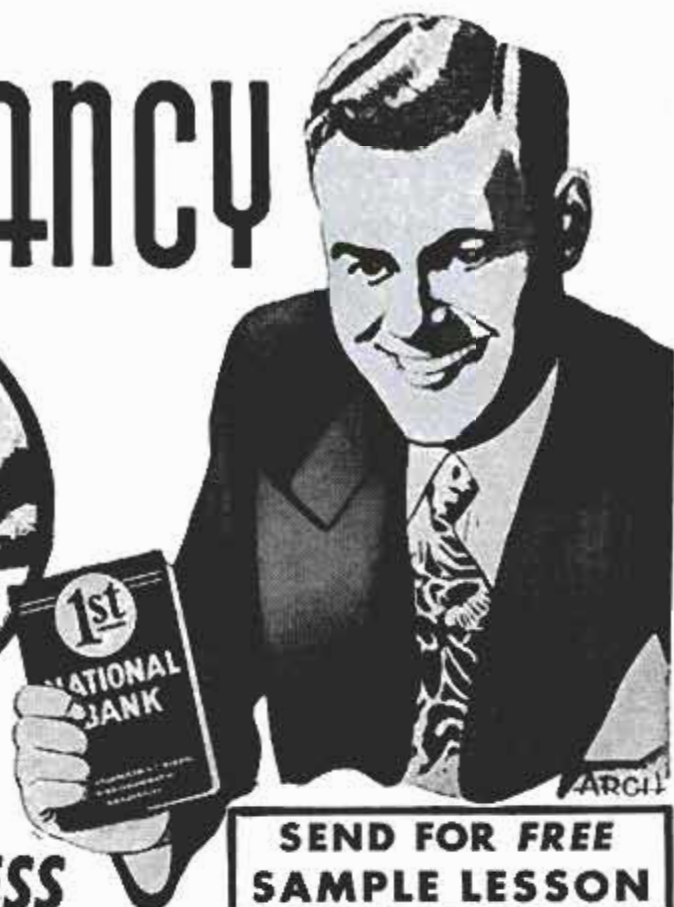

**SEND FOR FREE
SAMPLE LESSON**

REASON #1. If you were an expert accountant right now, chances are you would find yourself among the highest-paid of all professional men and women. Even back in "depression years," accountants earned more than many men in other major professions.

REASON #2. The demand for accountants is great—everywhere. All businesses must have trained accountants to cope with ever-growing requirements. It's a profession offering wide opportunity—always—to the man who knows.

REASON #3. You can fit into any business, anywhere in the country—because accounting principles are universal. Think what this means in terms of security and independence!

REASON #4. Accountancy is open to all. Any man or woman of good intelligence, who enjoys figure work and is willing to follow LaSalle's systematic "problem method" plan, can rapidly qualify for a highly profitable, enjoyable

**LASALLE EXTENSION
UNIVERSITY**
A Correspondence Institution
417 S. Dearborn St., Chicago 5



lifetime career . . . and he doesn't have to finish his training before beginning to "cash in."

REASON #5. Without losing a day from your present work, you can prepare in spare hours at home, at low cost, under LaSalle's step-by-step "Problem Method" of "learning by doing." This famous plan accounts for LaSalle's remarkable record of having trained over 4,200 of all Certified Public Accountants and of having put many thousands of others into high-paying careers.

Send today for Free Sample Lesson and "Accountancy, the Profession That Pays." Learn about the several great fields of opportunity . . . and LaSalle's time-tested plan for helping men and women to rapid advancement, higher income, greater prestige and professional standing. The coupon below will bring this information to you—without cost or obligation.

MAIL THE COUPON NOW

LaSalle Extension University
A Correspondence Institution

Dept. 164-H, 417 S. Dearborn St., Chicago 5, Ill.

Please send me, free of all cost or obligation, your Free Sample Lesson and 48-page illustrated book "Accountancy, the Profession That Pays."

Name Age

Address

City, Zone, State

1 I SHOW YOU HOW TO
MAKE MONEY AT ONCE

2 **START YOUR OWN BUSINESS**

IN 2 WEEKS—
AT HOME
IN SPARE TIME



**PLATE
Baby Shoes
IN
BRONZE
AND
COLORED
PEARL**

**MILLIONS OF
NEW PROSPECTS
EVERY YEAR**

Now is the time to cash in on this big-paying, easy-to-operate, year-round business and you need no experience. **MATERIALS COST YOU ONLY 50c—YOU GET \$6.00!** With many actual "show-how" illustrations and step-by-step instructions, **YOU** can start earning money at once in one week. Working only a few hours you can make more money than many people make working an entire week.

IMMEDIATE RESULTS

- Big Income
- Huge Demand
- Sales Plan
- Future Security
- Your Own Business

We will send you full details absolutely free.

FREE!
MONEY
MAKING
PLAN

Full Details
Without
Obligation

**MAIL COUPON
TODAY!**

KIKTAVI COMPANY, Dept. PM-561
11029 S. Vermont, Los Angeles 44, Calif.

KIKTAVI COMPANY, Dept. PM-561
11029 S. Vermont, Los Angeles 44, Calif.

Send me **FREE** details of your **MONEY MAKING PLAN**, without obligation.

NAME _____

STREET _____

CITY _____ ZONE _____ STATE _____

If Ruptured

For lasting relief your rupture must
BE HELD BACK DAY and NIGHT.

Consult Your Doctor.

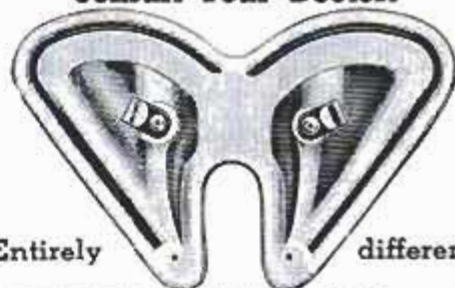

Entirely different

SOFT, FLEXIBLE, and fits neat as a glove. The famous Miller saves you **TIME, MONEY, DISAPPOINTMENT.**

Write for my **FREE** booklet today.

FRED B. MILLER Manufacturer
Dept. PM-A, Hagerstown, Maryland

GROW HERBS FOR US!

AT HOME— IN YOUR SPARE TIME



**FREE
SEEDS**
Write!

Help fill our huge demand—used in expensive medicines. Easy to grow indoors or out—multiply rapidly. Year around Profitability! You grow 'em—we buy 'em! We supply everything you need. Free rare seeds and revealing plan is yours free for the asking. Be one of the first to profit—rush name and address to: **NATIONAL HERB EXCHANGE**, Dept. A-1, Box 304, Gardena, Calif.

BIG MONEY FOR YOU
IN FLORIDA REAL ESTATE



Learn how to **BUY, SELL, TRADE, INVEST, MANAGE**. Brand NEW course in Real Estate for Ambitious YOU. More opportunities than ever before if you are prepared when you come to Florida. Free sunshine—free fishing—free healthful climate. Send postal for free details on this easy-to-read home study "FLORIDA REAL ESTATE" course. **T. EWIG**, 5120 Fifth Ave. S., St. Petersburg, Florida.

CABINET MAKING



LOW COST HOME TRAINING COURSE FOR BEGINNERS & ADVANCED CRAFTSMEN

Make money. Learn skills and secrets of fine woodworking and tool use. Professionally prepared shop method training tells and shows how. Covers everything. Easy to master.

Write for
Free Booklet

INTERSTATE TRAINING SERVICE
DEPT. F3, PORTLAND 13, OREGON

**Operate a Successful
Dry Cleaning Business**
LEARN AT HOME!

If you want to get into a fine-paying business of your own, this may be the opportunity you've been seeking. Now you can learn **at home** to operate a successful Dry Cleaning business... or to qualify as a highly paid skilled worker.

Write for FREE Literature

Don't let lack of experience or education hold you back. These lessons are simple and **easy to understand**. You study in **SPARE TIME** and may enroll on our convenient time-payment plan. Remember, dry cleaning is a **necessity**. If you want to go into a fast-growing, profitable year-around business...

WRITE TODAY... send your name and address for **FREE** information about this new, **LOW-COST COURSE**.

IMPERIAL SCHOOL OF DRY CLEANING
1700 Touhy Ave., Dept. M, Chicago 26, Illinois



**... A
BUSINESS
OF YOUR
OWN**

BARGAINS

IS THE ONLY BIG TABLOID PUBLICATION in
Existence That Tells You WHERE & HOW
—EVERY MONTH—



- To Buy Bankrupt, Closeout, Surplus Bargains!
- To Buy Items at Wholesale! ● At Below Wholesale!
- To Buy Many New & Unusual Items!
- To Obtain Information on Rare Money Making Offers!

TOYS, BOOKS, JEWELRY, GREETING CARDS,
COSMETICS, HOUSEHOLD MERCHANDISE,
APPLIANCES, INDUSTRIAL MATERIALS,
MACHINERY, TOOLS, ETC.

Often as Low as 10c-25c on the Retail Dollar!!

ONE issue of this Sensational NEW publication can save you MORE MONEY than the cost of the entire subscription! You can BUY BETTER, CHEAPER, NEWER THINGS EVERY MONTH OF THE YEAR! Today, when your dollar buys so little, you absolutely need every single issue of BARGAINS in order to get the MOST FROM EVERY PENNY YOU SPEND. Each issue carries HUNDREDS of bargain offers . . . many times SO EXTRAORDINARY that it's hard to believe that they're GENUINE! Buying at WHOLESALE, BANKRUPT, SURPLUS, CLOSEOUT PRICES can save you from 40c to 80c or more on every dollar you spend! THIS MAY BE HARD TO BELIEVE, BUT IT IS THE TRUTH!

YOU Can make FANTASTIC PROFITS Buying Up Bargain Merchandise CHEAP and Selling It CHEAP

Thousands of Agents, Salesmen, Dealers are subscribers to "BARGAINS." They want to know where to buy BEST in order to sell at low prices for BIG PROFITS. NO REASON why you CAN'T DO THE SAME! Special articles in BARGAINS give you valuable tips on HOW to sell these bargains for BIG PROFITS. And you know, EVERYBODY is looking for bargains these days . . . in fact, this is the only kind of merchandise that is being sold in tremendous volume. Ask any big businessman!

Unique "Subscribers Shopping Service" Enables You to Buy Big Name Merchandise at TREMENDOUS SAVINGS

You won't find this feature in ANY OTHER MAGAZINE. ONLY "BARGAINS" has it. For subscribers ONLY, each month it negotiates bargain offers in famous merchandise at LOW WHOLESALE PRICES and then offers them to subscribers AT NO PROFIT! Enables you to buy in small lots—singly or in quantity at the same prices (sometimes even lower) than dealers are paying! This SINGLE FEATURE OF BARGAINS IS WORTH THE LOW SUBSCRIPTION PRICE A DOZEN TIMES OVER. Yet, it's only ONE feature among many to be found! Yes. Just one!

"Bargains" is the ONLY Publication of Its Kind in Existence!

Search your newspaper high and low. You won't find another publication like it! BARGAINS is available by subscription ONLY. Read the glowing letters by subscribers who received their first copies and WERE AMAZED by this sensational publication! You will be, too!

SAVE Up to \$1,000 — EARN Up to \$3,000

We honestly believe that it's possible to SAVE up to \$1,000— and EARN up to \$3,000 within a year by reading "BARGAINS" EVERY MONTH! WHY NOT PROVE THIS FOR YOURSELF!

Your subscription will automatically include the BIG 1956 CHRISTMAS SPECIAL ISSUE . . . jam full of terrific, eye opening holiday BARGAINS! JUST \$2.00—17c per month gives you 12 great money saving issues of BARGAINS!

\$2.00 Per Year — 12 Big Issues

(Regular price, \$3.00 per Year)

Special Limited Time Offer to Get 10,000 New Subscribers!

Your Money Back IN FULL if the First Issue Doesn't Please You!

LET'S FACE IT . . . Claims, promises are easily made on paper. You may or may not believe all we say here. BUT can you go wrong in subscribing to "Bargains" on this iron-clad MONEY BACK GUARANTEE . . . Your money back IN FULL if the first issue that you receive doesn't please you! Can any offer be more POSITIVE, more FAIR than this POWERFUL guarantee?

TOWER PRESS, INC., P.O. Box 591-DV, Lynn, Mass.

Here's a FEW Samples of the Bargains Usually Found in "BARGAINS"!

- PENCILS, 57 1/2c per Gross!
- 25c Rudolph the Reindeer Brooches, 2c each!
- Plastic Toy GUNS, 2c each!
- \$1 Mufflers, Scarfs, 12 1/2c each!
- Double edge razor blades, \$1.50 per 1000!
- LADIES APRONS, 6 1/4c each!
- \$2.50 WALLETS, 30c each!
- \$1 val. BILLFOLDS, 15c each!
- \$1 Kiddies handbags, 3c each!
- CIGARETTE HOLDERS, 1c each!
- BUTTONS, 144 for 25c!
- NEW Phono records, 78 & 45 r.p.m. 7c each!
- 69c Insect Repellent, 5c each!
- New 20" T.V. Pic. tubes, \$21.95 each!
- Famous brand \$18.75 perfume, \$1 each!
- 49c Xmas window decorations, 10c per set!
- \$1-\$3 Hard cover books, 20c each!
- \$200.00 Surplus typewriters, \$23.00 each!
- 50c Everyday greeting cards, 7c per box!
- \$1.95 Men's Silk Ties, 12 1/2c each!
- \$1 val. personal cloth name tapes, 40c for 72!
- 39c Under arm deodorant, 2c jar!
- \$1 Automatic card shufflers, 9c each!
- NEW HAIRNETS, 1/2c each!
- \$15.00 Electric Percolators, \$5.00 each!
- \$1.75 Rudolph Reindeer kiddies toiletry sets, 35c each!
- \$5.50 Lucite Hairbrushes, 65c each!
- New Bobby Pins, 70c per 700 pins!
- \$10 Men's Toiletry Sets, 60c each!
- Calendar Wrist Watches, \$5 each!
- Christmas Socks, 25c per 1000!
- \$2.98 Horserace game records, 30c each!

● PLUS HUNDREDS OF OTHER SENSATIONAL BUYS!

(Above list merely illustrates type of bargains usually found in this paper. Lists naturally change from month to month.) Pro rate prices based on quantity buys.

DON'T Take Our Word For it—Here's What Subscribers Say About "BARGAINS"!

" . . . Received my 1st issue and may I say IT IS A GREAT MAGAZINE."—M. C., Ark.

" . . . I am very pleased with BARGAINS. I have never seen anything like it."—Mrs. D. M., Maine.

" . . . Just received my 1st copy of "Bargains" and believe me, it is all that you claimed it to be."—T. A., N. Y.

" . . . I was the recipient of my 1st copy a few days ago. I am completely satisfied with the periodical. I also wish to express my appreciation to you for having made the magazine available to me. I shall be pleased to continue my subscription as long as the magazine is available."—W. S., Wash.

Every One OF THESE LETTERS ARE IN OUR FILES & WERE NOT SOLICITED IN ANY WAY OR MANNER!

—“Tear out Coupon. Mail NOW—at once!”—

Tower Press, Inc., P.O. Box 591-DV, Lynn, Mass.
O.K. Here's my \$2.00 for 1 year subscription. Rush me 1st copy!

Name _____

Address _____

City _____ State _____

Remember! Your Money Back IN FULL if the 1st issue you receive doesn't please you!

IMPORT PAYS BIG!

B. L. MELLINGER
Exporter-Importer

NEW WORLD TRADE BOOM OFFERS BIG PROFIT OPPORTUNITY to ambitious Men and Women everywhere. I'll show you how you may Import Thousands of desirable products at low foreign prices for buyers in your locality at high U.S. Prices—how you can operate a world-wide mail-order Import-Export business from home whether you live in a big city, or small town.

B. L. Mellinger

HERE'S PROOF!

As startling first-hand proof I will send you an actual import from overseas, **AT MY COST**—something to see and use. Just mail me 25¢ in coin and I will rush you this Imported Melson Automatic cigarette lighter—made to retail in the U.S. at \$2. This magnificent import will convince you of the tremendous profits being made in World Trade.

START AT ONCE WITHOUT CAPITAL or previous experience. Fantastic profits are possible. My training also includes shipment to you of many sample imports from 'round the world.

GRASP THIS OPPORTUNITY TODAY! Send for your Melson Automatic cigarette lighter now and I will include full details that show you how to learn my Big Profit secrets of Import-Export—complete instructions that will put you on the road to a Profitable business of your own. Opportunity to travel abroad for profit and pleasure. I'll also show you how you can save many dollars on your own purchases of Clothes, Tools, Gems, Antiques, Watches, Cameras, China, Silks, Toys, etc. You can have the complete details FREE without ordering the lighter if you wish, but I would like to send you the Melson lighter as an actual demonstration of Import Values. Either way, mail coupon Now. Airmail reaches me overnight.

The Mellinger Co., Dept. F-251, 1717 Westwood, Los Angeles, 24, Calif.

HERE'S MORE PROOF!

"We operate a profitable World Trade Business from our home... Thanks to MELLINGER."

Mr. and Mrs. Beke, N.Y.

MAIL COUPON NOW!

The Mellinger Co., Dept. F-251
1717 Westwood, Los Angeles 24, Calif.

Mr. Mellinger: Show me the big profits to be made through World Trade. I enclose 25¢ in coin. Send me one Melson Cigarette Lighter and your plan that shows me how to learn the secrets of World Trade. (No lighter without a coupon. Only one to a person.)
 Just send your FREE World Trade Plan.

Name _____ Age _____
Street _____
Town _____ Zone _____ State _____

Are you a SQUARE PEG in a ROUND HOLE?

If you're unhappy with your job, disgusted with your future and bored with your spare time—don't despair. You've got plenty of company. Surveys show that NINE out of TEN people are in the same fix. But NOW you can do something about it. Modern psychological testing can show you the way to work you're best suited for. It can reveal your basic aptitudes, abilities and personality traits. And once you KNOW these vital facts about yourself, you can do something about changing your present and future. Do simple "yes" and "no" answer tests at home. Mail them to the Institute. You receive a comprehensive, confidential 43-page report by mail that may show you the way to a better, bigger-paying job . . . to a happier future for yourself and your family. Psychological testing by mail is quick, easy, confidential and costs but a fraction of what similar in-person testing costs. Write today for complete details FREE in a plain envelope. Psychologic Testing Institute, 201 N. Wells St., Dept. 650, Chicago, Ill.

\$1300 BUILDS INCOME DUPLEX



Build your own 24'x36' concrete block duplex, complete for \$1300. Slab floor, steel windows, wall furnaces, rock wool insulated, no block cutting necessary. Each side contains 11'x17' living room and kitchenette, 10'x11' bedroom, 6'x9' bath, and four closets. Genuine blueprint, scale 1/4"=1', step by step instructions, and material cost list \$1.00 ppd. Money back guarantee. \$2850 Deluxe Duplex, brick veneer construction, gable roof. Two sheets blueprints and Mat. List \$3.00. \$1150 Block Garage Apartment, 22'x24' Liv. Room, Kit., bath and two bedrooms. Double garage below. Plan \$1.00.

BAILEY BUILDERS, 915 Pyramid Bldg., Little Rock, Ark.

STAMP COLLECTORS

314 STAMPS 25¢



Big imported collection of 314 all different foreign stamps including Monaco, Jules Verne Science-Fiction Set showing balloon & elephant, steamer & Atlantic Platform, giant tank, Argentina Flying Horse, Bolivian Revolution set, National Anthem, Italy AMG set PLUS hundreds of fascinating stamps of the world. This collection, cataloging over \$7.00, is yours for only 25¢ to introduce our bargain approvals. BONUS: 48 Page Stamp Dictionary included free.

Stampex Co., Dept. HM, P.O. Box 47, White Plains, N. Y.

Super Powerful All Channel TV RECEPTION IN ALL DIRECTIONS

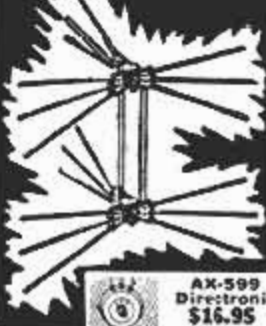

Rocket DIRECTRONIC MOTORLESS TV ANTENNA
360° Electronically Switched Beam
• No Motors • No Ghosts
• No Roof • No Flick of Orientation • Switch Clears Picture Instantly
• No Electric Power

In the city or in an ultra-fringe area, the Directronic will outperform ordinary antennas. Only the Motorless 360° Directronic TV Antenna offers "around the compass" reception WITHOUT Rotors. Clarity of picture will amaze, it's so bright, so sharply defined. AX-599 "Service-man's Array" contains Hi-Pac molded insulator of extremely high tensile strength, 18 hi-tensile aluminum alloy elements, 1 set of connecting stubs (3), Universal U-Clamps for masts to 1 1/2". Directronic Beam Selector, 75 feet of Tri-X Cable, 25% deposit on C.O.D. orders, please. Money Back Guarantee.

NATIONAL ELECTRONICS OF CLEVELAND
6608 EUCLID AVE. Dept. P-1 CLEVELAND 3, OHIO

ARE YOU TOO OLD TO LEARN?

not at all, scientists say

New tests show that: your ability to think increases with age; your powers of deduction are greater; your judgment is better.

In the I. C. S. files are thousands of cases of men and women of every age. Their successes, their promotions, their raises prove that men and women past school age can learn!

I.C.S. GIVES YOU EXPERT GUIDANCE FREE! Do you have the feeling you're "stuck" in your job? Your trained I. C. S. counselor will appraise your abilities, help you plan for the future.

IT'S NEVER TOO LATE TO GET STARTED! You study with I. C. S. at home, in your spare time. There's no interference with business or social activity. Famous I. C. S. texts make learning easy. Don't delay. Pick your field from the coupon below. And mail it today!



3 FREE BOOKS

36-page, pocket-size guide to advancement, a gold mine of tips on "How to Succeed." Big catalog outlining opportunities in your field of interest. Also sample lesson (Mathematics).

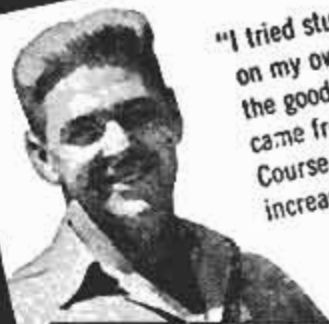

"I tried studying my work on my own, but I never got the good out of it that came from my I. C. S. Course. My salary has been increased 73.3%!"

E.L.B.
Ohio

"I am president of a small corporation. A year ago I enrolled with I. C. S. as the most practical means available to me to learn what I needed."

W.J.A.
Michigan



"It's been so long since I went to school, I've forgotten much. But now that I'm taking an I. C. S. Course, I have confidence in my ability again."

H.A.R.
New Jersey



Actual statements.
Posed by models.

For Real Job Security—Get an I. C. S. Diploma! I. C. S., Scranton 9, Penna. Member, National Home Study Council

INTERNATIONAL CORRESPONDENCE SCHOOLS

BOX 99626A, SCRANTON 9, PENNA.

(Partial list of 277 courses)

- Without cost or obligation, send me "HOW TO SUCCEED" and the opportunity booklet about the field BEFORE which I have marked X (plus sample lesson):
- | | | | | |
|--|--|--|---|--|
| <p>ARCHITECTURE and BUILDING CONSTRUCTION</p> <ul style="list-style-type: none"> <input type="checkbox"/> Air Conditioning—Refrig. <input type="checkbox"/> Architecture <input type="checkbox"/> Architectural Interior <input type="checkbox"/> Building Contractor <input type="checkbox"/> Building Maintenance <input type="checkbox"/> Carpenter and Mill Work <input type="checkbox"/> Estimating <input type="checkbox"/> Heating <input type="checkbox"/> Painting Contractor <input type="checkbox"/> Plumbing <input type="checkbox"/> Reading Arch. Blueprints <p>ART</p> <ul style="list-style-type: none"> <input type="checkbox"/> Cartooning <input type="checkbox"/> Commercial Art <input type="checkbox"/> Fashion Illustrating <input type="checkbox"/> Magazine Illustrating <input type="checkbox"/> Show Card and Sign Lettering <input type="checkbox"/> Sketching and Painting <p>AUTOMOTIVE</p> <ul style="list-style-type: none"> <input type="checkbox"/> Auto Body Rebuilding <input type="checkbox"/> Auto Elec. Technician <input type="checkbox"/> Auto-Engine Tune Up <input type="checkbox"/> Automobile | <p>AVIATION</p> <ul style="list-style-type: none"> <input type="checkbox"/> Aeronautical Engineering Jr <input type="checkbox"/> Aircraft & Engine Mechanic <p>BUSINESS</p> <ul style="list-style-type: none"> <input type="checkbox"/> Advertising <input type="checkbox"/> Bookkeeping and Accounting <input type="checkbox"/> Business Administration <input type="checkbox"/> Business Correspondence <input type="checkbox"/> Public Accounting <input type="checkbox"/> Creative Salesmanship <input type="checkbox"/> Federal Tax <input type="checkbox"/> Letter-writing Improvement <input type="checkbox"/> Office Management <input type="checkbox"/> Professional Secretary <input type="checkbox"/> Retail Business Management <input type="checkbox"/> Sales Management <input type="checkbox"/> Stenographic-Secretarial <input type="checkbox"/> Traffic Management <p>CHEMISTRY</p> <ul style="list-style-type: none"> <input type="checkbox"/> Analytical Chemistry <input type="checkbox"/> Chemical Engineering <input type="checkbox"/> Chem. Lab. Technician <input type="checkbox"/> General Chemistry <input type="checkbox"/> Natural Gas Prod. & Trans. <input type="checkbox"/> Petroleum Engineering <input type="checkbox"/> Plastics <input type="checkbox"/> Pulp and Paper Making | <p>CIVIL, STRUCTURAL ENGINEERING</p> <ul style="list-style-type: none"> <input type="checkbox"/> Civil Engineering <input type="checkbox"/> Construction Engineering <input type="checkbox"/> Highway Engineering <input type="checkbox"/> Reading Struct. Blueprints <input type="checkbox"/> Sanitary Engineering <input type="checkbox"/> Structural Engineering <input type="checkbox"/> Surveying and Mapping <p>DRAFTING</p> <ul style="list-style-type: none"> <input type="checkbox"/> Aircraft Drafting <input type="checkbox"/> Architectural Drafting <input type="checkbox"/> Electrical Drafting <input type="checkbox"/> Mechanical Drafting <input type="checkbox"/> Mine Surveying and Mapping <input type="checkbox"/> Plumbing Drawing and Estimating <input type="checkbox"/> Structural Drafting <p>ELECTRICAL</p> <ul style="list-style-type: none"> <input type="checkbox"/> Electrical Engineering <input type="checkbox"/> Electrical Maintenance <input type="checkbox"/> Electrician <input type="checkbox"/> Contracting <input type="checkbox"/> Lineman <p>HIGH SCHOOL</p> <ul style="list-style-type: none"> <input type="checkbox"/> Commercial <input type="checkbox"/> Good English <input type="checkbox"/> High School Subjects <input type="checkbox"/> Mathematics | <p>LEADERSHIP</p> <ul style="list-style-type: none"> <input type="checkbox"/> Foremanship <input type="checkbox"/> Industrial Supervision <input type="checkbox"/> Leadership and Organization <input type="checkbox"/> Personnel-Labor Relations <p>MECHANICAL AND SHOP</p> <ul style="list-style-type: none"> <input type="checkbox"/> Gas—Electric Welding <input type="checkbox"/> Heat Treatment <input type="checkbox"/> Metallurgy <input type="checkbox"/> Industrial Engineering <input type="checkbox"/> Industrial Instrumentation <input type="checkbox"/> Industrial Supervision <input type="checkbox"/> Internal Combustion Engines <input type="checkbox"/> Machine Design-Drafting <input type="checkbox"/> Machine Shop Inspection <input type="checkbox"/> Machine Shop Practice <input type="checkbox"/> Mechanical Engineering <input type="checkbox"/> Quality Control <input type="checkbox"/> Reading Shop Blueprints <input type="checkbox"/> Refrigeration <input type="checkbox"/> Sheet Metal Worker <input type="checkbox"/> Tool Design <input type="checkbox"/> Toolmaking <p>RADIO, TELEVISION</p> <ul style="list-style-type: none"> <input type="checkbox"/> Industrial Electronics <input type="checkbox"/> Practical Radio TV Eng'ng <input type="checkbox"/> Radio and TV Servicing <input type="checkbox"/> Radio Operating | <ul style="list-style-type: none"> <input type="checkbox"/> Television Technician <p>RAILROAD</p> <ul style="list-style-type: none"> <input type="checkbox"/> Air Brakes <input type="checkbox"/> Car Inspector <input type="checkbox"/> Diesel Locomotive <input type="checkbox"/> Locomotive Engineer <input type="checkbox"/> Section Foreman <p>STEAM AND DIESEL POWER</p> <ul style="list-style-type: none"> <input type="checkbox"/> Combustion Engineering <input type="checkbox"/> Diesel—Elec. <input type="checkbox"/> Diesel Eng's <input type="checkbox"/> Electric Light and Power <input type="checkbox"/> Stationary Fireman <input type="checkbox"/> Stationary Steam Engineering <p>TEXTILE</p> <ul style="list-style-type: none"> <input type="checkbox"/> Carding and Spinning <input type="checkbox"/> Cotton, Rayon, Woolen Mfg. <input type="checkbox"/> Finishing and Dyeing <input type="checkbox"/> Loom Fix'g <input type="checkbox"/> Textile Des'ing <input type="checkbox"/> Textile Eng'g <input type="checkbox"/> Throwing <input type="checkbox"/> Warping and Weaving <p>MISCELLANEOUS</p> <ul style="list-style-type: none"> <input type="checkbox"/> Domestic Refrigeration <input type="checkbox"/> Marine Engineering <input type="checkbox"/> Ocean Navigation <input type="checkbox"/> Professional Engineering <input type="checkbox"/> Short Story Writing <input type="checkbox"/> Telephony |
|--|--|--|---|--|

Name _____ Age _____ Home Address _____

City _____ Zone _____ State _____ Working Hours _____ A.M. to P.M. _____

Occupation _____

Canadian residents send coupon to International Correspondence Schools, Canadian, Ltd., Montreal, Canada. . . . Special tuition rates to members of the U. S. Armed Forces.

DRAFTSMEN



**CASH BIG
PAY CHECKS!**

**Train Now for
more success,
greater security**

**LEARN AT HOME IN SPARE TIME
(or at college in Chicago)**

Check the want ads in any newspaper—SEE the big-pay opportunities open to you as a draftsman. What's more, you can learn this well-paid, prestige profession at home—quickly, easily! No special talent needed. Get complete, step-by-step Chicago Tech lessons in the mail, spend a few pleasant hours studying each week. In a short time you'll be a well-trained draftsman, ready to take your pick of many good jobs. Act now!



Free Information—Mail Coupon Today!

Get FREE TRIAL LESSON plus information about C.T.C. practical training. Learn what successful Chicago Tech graduates say about high pay and opportunities in drafting. No charge, or obligation.

CHICAGO TECHNICAL COLLEGE

A-254 Tech Bldg., 2000 So. Michigan Ave.
Chicago 16, Illinois

Mail me FREE lesson with facts about big opportunities in DRAFTING.

Name _____ Age _____

Address _____

City _____ Zone _____ State _____



OWN YOUR OWN BUSINESS

Free folder tells how!
Build and operate this
profitable roadside stand—
seasonal or year 'round.
Mail coupon now.



RICHARDSON CORPORATION
Dept. PM-1, P.O. Box 790, Rochester 3, N. Y.

Please send me FREE folder on your tested,
franchised refreshment stand.

Name _____

Address _____

Place _____

B6



You Can Be a Manufacturer of BRIKRETE

"The World's Most Modern
Masonry" is produced in a
chain of independently
owned local plants. That's
why such low prices go

along with such high quality without
sacrifice of manufacturing profits. Local
materials and local labor cut freight and distribution.
Brikrete brings a super-masonry down to price levels of
frame. Gives owners incentive to buy.

Brikrete has design, size, and color in keeping with the
modes of today. Self-contained insulation values—12" long
—8" or 4" thick—range of 14 colors. Suited to every kind
of construction—residential, commercial, industrial.

Many territories are open for additional local plants.
Franchise protection. Equipment available on easy terms,
or basic machine can be leased to responsible operators.
Write today for interesting Brikrete Book No. 2.

Brikrete Associates, Inc.
402 W. 25th Street
Holland, Mich.



*The World's
Most Modern Masonry*

IN CANADA: DUNN MASONRY MACHINERY LIMITED
800 Dundas Highway, Cooksville, Ont.

TASOPE PHOTO-ENGRAVING PLANTS



Material Cost
Of This Cut 34c
Selling Price
\$1.00 And Up

Establish your own profitable PHOTO-EN-
GRAVING business. Make cuts for newspapers,
printers, and advertisers. Make etched name
plates, plaques etc. Instructions furnished, no
experience necessary. Sold direct from factory
since 1931. First five hundred cuts sold locally
or by mail will pay for plant and pay you well
for your time. Write for FREE catalog.

TASOPE, DEPT. PM-1, AURORA, MO.

New, Fast FOOT EXERCISER \$3.95 postpaid

Scientific Foot Exerciser, of vinyl. Ends foot discomfort!
strengthens weak ankles! stimulates circulation!
Recommended by leading physicians, chiropractors.
DR. GROSSMAN, 203 West 69 St., Box 87, N. Y. 23, N. Y.
Send cash, check or money order. No C.O.D., please.



WHEELS WHEELS WHEELS

7" Disc Wheel 3/4" Tire 3/4" sleeve	45c ea.
8" Disc Wheel 1 1/4" Tire 1/2" sleeve	70c ea.
7" Disc Wheel 1" Tire 1/2" ball bearing	80c ea.
8" Disc Wheel 1 1/4" Tire 1/2" ball bearing	\$1.00 ea.
6" Disc Wheel 1.50 semi-pneum. Tire 1/2" S.B.	\$1.35 ea.
8" Disc Wheel 2" semi-pneum. T. 1/2" S.B.	\$1.50 ea.
10" Disc Wheel 1.75 semi-pneum. T. 1/2" S.B.	\$1.50 ea.
10" Disc Wheel 2.75 semi-pneum. Tire 3/4" S.B.	\$3.50 ea.
12" Disc Wheel 1.75 semi-pneum. T. 1/2" S.B.	\$1.88 ea.

Above wheel prices includes hub cap. Plus Postage, C.O.D.'s accepted.
AXLES—Sizes 7/16 in., 1/2 in., 3/4 in.—Cut to size—End holes drilled.

UNITED WHEEL STAMPING CO.
12131 S. PEORIA STREET PM-1 CHICAGO 43, ILLINOIS

REPAIR ANY WATCH



... Swiss or American

No previous experience needed to learn
modern watch repair. An enjoyable hob-
by or profitable career. Unique Sweazey
System starts you making repairs right
away. Develops your skill step by step.
Teaches you modern shop methods . . .
professional short cuts . . . mistakes to
avoid. Learn by personal attendance or
spare time home study. Individual
training. Start any time. Free sample
lesson. No obligation. Write today!

CHICAGO SCHOOL OF WATCHMAKING
2330 N. Milwaukee, Dept. 116, Chicago 47, Illinois
Founded 1908 • Approved for veterans

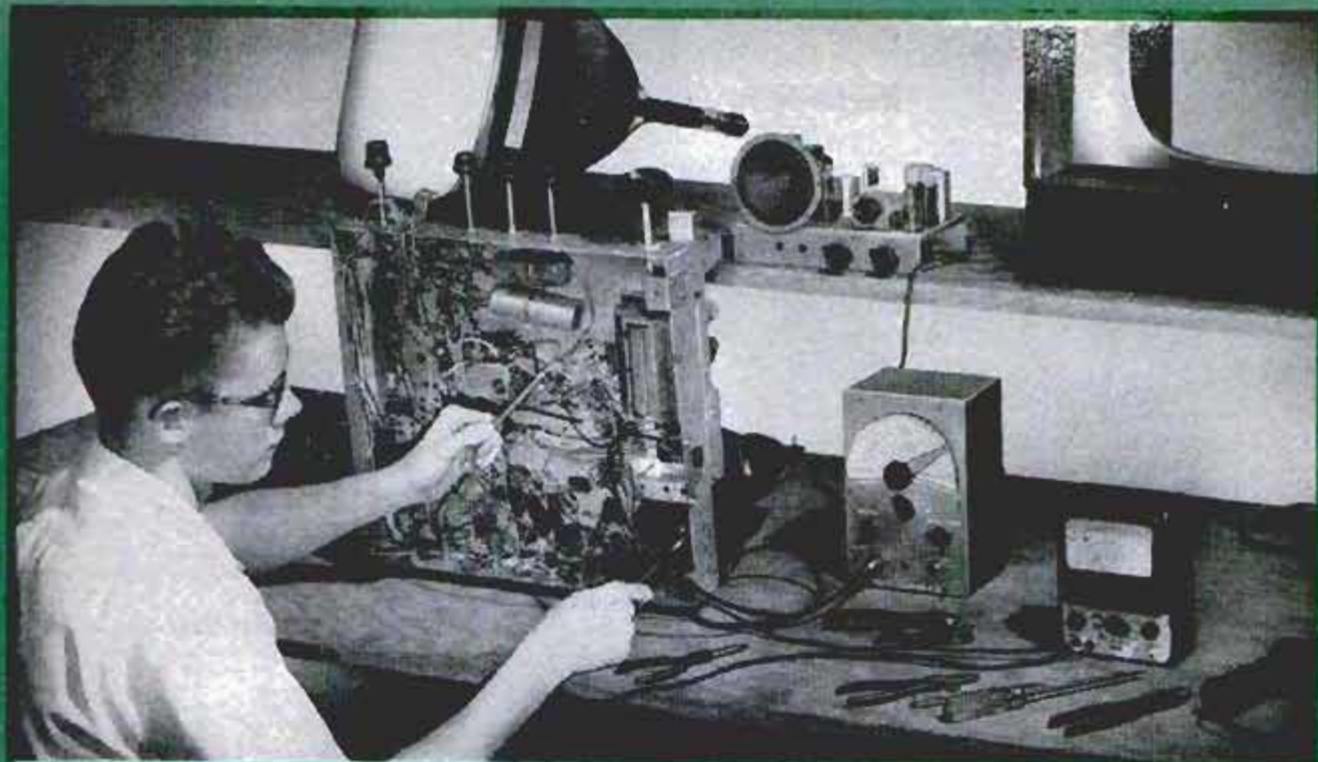

NOW...RCA trains you at home to be an expert technician in

RADIO TV ELECTRONICS • TV SERVICING • COLOR TV SERVICING

NOW THREE HOME STUDY COURSES . . . prepared by instructors of RCA Institutes in cooperation with technicians, engineers, and training specialists of RCA. Clearly written . . . easy to understand . . . the same high caliber instruction as given in resident classrooms of RCA INSTITUTES.

● **COURSE I—RADIO-TELEVISION ELECTRONICS**—starts you from the ground up to a solid working knowledge of electronics. Without any previous experience, you get a thorough training in radio theory and servicing techniques for AM, FM, home and car radios . . . plus an introduction to the fundamental theory and practices of television.

● **COURSE II—TELEVISION SERVICING**—prepares you to advance from radio into the expanding field of television servicing as a well-trained service technician. If you have completed Course I or are now working in the field of radio or TV, Course II will show you the many special techniques of trouble-shooting, aligning, checking, and repairing modern black and white TV sets.

NEW TV KIT AVAILABLE WITH COURSE II—there is no better way to learn than by *doing* and RCA Institutes has developed a large-screen TV KIT available to home study students to build while taking Course II. It has the most modern up-to-date circuitry, actually enabling you to apply at home all the latest servicing techniques.

● **COURSE III—COLOR TELEVISION SERVICING**—covers all phases of color servicing techniques. It is a practical, down-to-earth course in color theory as well as how-to-do-it servicing procedure. A natural move "up" from Course II or for those now employed in TV.

SINCE 1909, RCA INSTITUTES has trained thousands for successful careers in electronics. Many gradu-

ates have established their own paying business. Now this opportunity is available to you at home.

"PAY-AS-YOU-LEARN" PLAN . . . you pay for one study group at a time, as you progress through the course. Tuition costs are amazingly low. For full details, mail coupon.

A SERVICE OF RADIO CORPORATION OF AMERICA—RCA INSTITUTES is licensed by the N. Y. State Education Department . . . recommended by radio and television service organizations.

**SEND FOR
FREE
CATALOG
NOW**



RCA Institutes, Inc., Home Study PM-16
350 West Fourth Street, N. Y. 14, N. Y.

Without obligation, send me FREE CATALOG on Home Study Courses in Radio, Television and Color TV. No salesman will call.

Name _____ Please Print

Address _____

City _____ Zone _____ State _____



RCA INSTITUTES, INC.

A SERVICE OF RADIO CORPORATION OF AMERICA
350 WEST FOURTH STREET, NEW YORK 14, N. Y.

ELECTRIC BRAIN KIT

Can you think faster than this Machine?

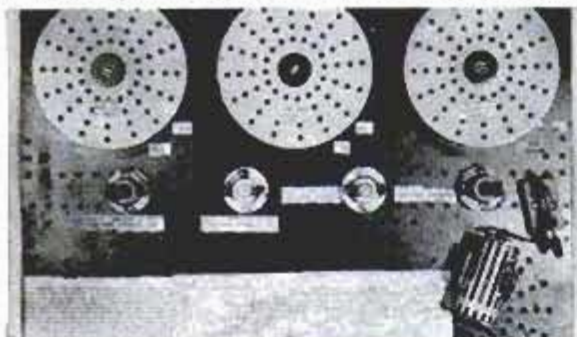

Control Panel of GENIAC set up to do a problem in check valve research.

Be careful before you answer. GENIAC the first electrical brain construction kit is equipped to play tic-tac-toe, cipher and encipher codes, convert from binary to decimal, reason (in syllogisms) as well as add, subtract, multiply and divide. Specific problems in a variety of fields — actuarial, policy claim settlement, physics, etc., can be set up and solved with the components. Connections are solderless and are completely explained with templates in the manual. This covers 33 circuits and shows how new ones can be designed.

You will find building and using GENIACS a wonderful experience; one kit user wrote us: "this kit has opened up a new world of thinking to me." You actually see how computing, problem solving, and game play (Tic-tac-toe, nim, etc.) can be analyzed with Boolean Algebra and the algebraic solutions transformed directly into circuit diagrams. You create from over 400 specially designed and manufactured components a machine that solves problems faster than you can express them.

Schools and colleges, teachers of science or math, engineering, philosophy or psychology will find these excellent demonstrators of circuitry, solutions in symbolic logic, theory of numbers, cybernetics, and automation.

Note: Teachers take advantage of our 10% discount to educational institutions and for group purchases.

SEND for your GENIAC kit now. Only \$19.95 with over four hundred components and parts, fully illustrated manual and wiring diagrams. We guarantee that if you do not want to keep GENIAC after one week you can return it for full refund plus shipping costs.

MAIL THIS COUPON

SCIENCE KITS, Dept. PM-13, Oliver Garfield Co.
126 Lexington Ave., N. Y. 16, N. Y.

Please send me:

- 1 GENIAC Electric Brain Construction Kit and Manual,
\$19.95 (East of Mississippi)
\$20.95 (Elsewhere in United States)
\$21.95 (Outside the United States)

Returnable in seven days for full refund if not satisfied. I enclose \$..... in full payment. My name and address are attached.

ENGINEERING DEGREE IN 27 MONTHS

Big Demand for Graduates

Aeronautical, Chemical, Civil, Electrical, Mechanical and Electronic Engineering (inc. Radio and TV)

Hundreds of young men are earning B. S. ENGINEERING DEGREES annually in this recognized institution — year around operation. New terms start quarterly. Many students earn a major part of their college expenses in this large industrial center.

Low tuition. Competent instruction. Thorough, intense practical program. Modern, well-equipped laboratories including new physics laboratory and modern wind tunnel. Individualized instruction emphasized.

Government approved for G.I.'s. Engineering preparatory courses. Students from 48 states and 21 foreign countries. Enter March, June, September and December. Send coupon for free catalog and full information. Enroll now.

INDIANA TECHNICAL COLLEGE

516 E. Washington Boulevard, Fort Wayne 2, Indiana

Please send me free information on B.S. Engineering Degree in 27 months as checked.

- Aeronautical, Chemical, Civil, Electrical,
 Mechanical, Electronics

Name _____

Address _____

Free! VALUABLE U.S.A!



Scarce genuine postage stamp as illustrated, picturing first U.S.A. (issued in 1847!); PLUS big collection of 30 all-different United States; 19th century, valuable \$5 stamp, etc... PLUS packet beautiful Commemoratives including '93 Columbian, Boy Scouts, Wild West, and many others. EXTRA! Big illustrated U. S. catalog; 64-page Collectors' Guide—and other attractive offers for your consideration. Send 10c for mailing costs. Act NOW!

H. E. HARRIS & CO.

314 Transit Bldg., Boston 17



I Made \$14,839 in 1 Year SERVICING RADIATORS!

Rex Ryan (Iowa) and hundreds of others earn \$8,000-\$20,000 a year servicing auto-truck-tractor radiators the inland way. Inland, largest radiator servicing equipment mfg., offers the complete package — equipment, merchandising, "Pays-for-itself" financing, and Free training school for customers.

WRITE for FREE Radiator Servicing Folder.

INLAND MFG. COMPANY

Dept. PM-1
1108 Jackson St., Omaha 8, Nebr.

BE A LANDSCAPE CONTRACTOR

Make \$20 to \$60 a day. Millions of new and old homes, estates, etc., need modern landscaping. Contracting is full time job for those who want to start own business. Start with smaller projects, and work into larger jobs. We show you how. Easy-to-follow Home Study Course. Hundreds of successful graduates. Write for FREE Book.

NATIONAL LANDSCAPE INSTITUTE

310 S. Robertson Blvd. Dept. M-16 Los Angeles 48, Calif.

SAY YOU SAW IT IN POPULAR MECHANICS

Write Like This

YOUR penmanship can be improved in 3 hours or corrected to your satisfaction in 10 hours' practice with my DEFINITE HAND CONTROLS. New way!

WRITE OZMENT BOX 665 34-P, ST. LOUIS, MISSOURI

Complete OUTLINE FREE!

LEARN LOCKSMITHING

Learn this fascinating, profitable trade from experts in your spare time at home! Age or physical handicap no disadvantage. Year around, steady income. Full or part time. Practical, illustrated lessons. You can make money even while learning! All materials and special tools supplied without extra charge.

INSTITUTE OF LOCKSMITHING, Dept. P-74
15 PARK AVENUE RUTHERFORD, N. J.
Lic. by N.J. State Board of Education
Approved for Veterans

send for FREE BOOKLET



BE A CLAIM INVESTIGATOR



INVESTIGATE ACCIDENTS! Many earning \$750 to \$1000 a month. Thousands of insurance companies, airlines, steamship lines and Government Offices need Claim Investigators. Also big opportunities for your own spare time business. We train you at home. National Placement Service FREE of extra charge. Bill King writes: "Your course has paid off for me with large earnings. You can quote me—your Adjuster Training Course is worth many times the cost." Write TODAY for FREE book.

UNIVERSAL SCHOOLS

University Park, Dept. PM-1, Box 8202, Dallas 5, Texas

FROM THOUSANDS OF ACTUAL LETTERS IN OUR FILES ...

Amazing Proof That Anyone Can Play Music!



No Teacher or Special "Talent" Needed — We Show You How to Sit Right Down and START PLAYING REAL MUSIC at Once

IT'S not what we say about our wonderful easy way to learn music that really counts. It's what our 900,000 STUDENTS say. And THEY send us thousands of enthusiastic comments like those reprinted here — saying it's what they've always dreamed of! A quick, easy way of learning to play any musical instrument. WITHOUT suffering through dull "theories" first. WITHOUT practicing boring scales and exercises. WITHOUT spending time and money on a private teacher.

You just sit right down with the piano, guitar, accordion—or any instrument you're interested in—and actually begin to play. Simple songs at first. Then more advanced compositions. Soon you'll amaze your friends by playing almost anything they request!

Even Children "Catch on" At Once
No "trick" methods. You play real sheet music. Big, clear pictures and simple directions make every step simple as A-B-C. So

12-Year-Old Surprises Her Friends

"I am twelve years old. Thanks to your Course, I was able to play for the department in our church. All my friends were certainly surprised when they discovered I could play!" — *Patsy Jeffrey, Sweetwater, Texas.*

"Opened Door to Popularity"

"I was able to play pieces in a short time. Family and friends certainly surprised. Course opened door to popularity." — *Peter H. Kozyra, P. O. Brokenhead, Manitoba.* (Picture on other side of page)

Now Invited Out Lots

"It's been fun. Hasn't cost anywhere near as much as private teacher. Now invited to affairs, dances. Auditioned for 'Barn Dance Jamboree.'" — *Howard Hopkins, E. Syracuse, N. Y.* (Picture on other side of page)

clear, even children "catch on" right away. Whole family can learn for price of one. Costs only a few cents a lesson, including sheet music.

MAIL COUPON FOR FREE BOOK

The whole fascinating story of this revolutionary new way to learn music is told in a 36-page illustrated book. You may have a copy FREE simply by mailing coupon. No obligation; no salesman will call on you. **U. S. SCHOOL OF MUSIC, Studio 301, Port Washington, N. Y.** (Special Reduced Prices on instruments to our students.) Now in Our 58th Successful Year.



Our Former Student
LAWRENCE WELK

Now Has Regular Full Hour TV Show Weekly — with his Own Orchestral



Telecasts his famous "Champagne Music" from Hollywood Over ABC-TV Every Saturday Night

MR. WELK says: "I got my start in music with a U. S. School of Music course. How easy it is to learn to read notes and play an instrument this 'teach yourself' way! In fact this school did so much for me that I've enrolled my two daughters. I highly recommend your school. My best wishes for your continued success."

Lawrence Welk,
Hollywood, Calif.



U. S. SCHOOL OF MUSIC, Studio 301, Port Washington, N. Y.

I am interested in learning to play, particularly the instrument checked below. Please send me your free illustrated book. NO SALESMAN IS TO CALL ON ME.

- | | | |
|--|--|---|
| <input type="checkbox"/> Piano | <input type="checkbox"/> Pipe, Hammond, Reed Organ | <input type="checkbox"/> Piccolo |
| <input type="checkbox"/> Guitar | <input type="checkbox"/> Tenor Banjo | <input type="checkbox"/> Modern Elementary |
| <input type="checkbox"/> Hawaiian Guitar | <input type="checkbox"/> Ukulele | <input type="checkbox"/> Harmony |
| <input type="checkbox"/> Violin | <input type="checkbox"/> Clarinet | <input type="checkbox"/> Mandolin |
| <input type="checkbox"/> Piano Accordion | <input type="checkbox"/> Trombone | <input type="checkbox"/> Practical Finger Control |
| <input type="checkbox"/> Saxophone | <input type="checkbox"/> Flute | |
| <input type="checkbox"/> Trumpet, Cornet | | |

Do you have the instrument? _____

Mr. _____
 Mrs. _____
 Miss _____ (Please Print Carefully)
 Address _____
 City _____ State _____
 (Insert Zone Number, If Any)
NOTE: If you are under 18 years of age parent must sign coupon.



IF YOU "EAT, SLEEP AND LIVE" CARS...

TURN YOUR HOBBY INTO A CAREER!

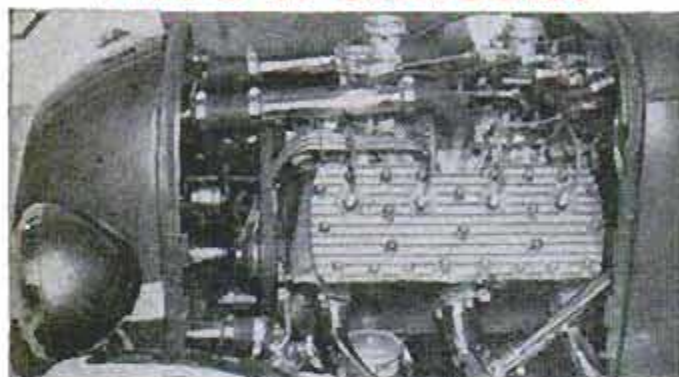

Get America's Big-time, Big-future

AUTO MECHANICS & DIESEL COURSE

at home in your spare time!

Los Angeles' National Schools, America's automotive Technical Trade School since 1905, now brings its famous resident Shops and Faculty direct to you at home—to prepare you to earn more money, with job security, in today's fast-moving, opportunity-filled Auto Mechanics Industry! Get your home training from the "Car Capital of The World"—America's most auto-minded city, center of Hot Rod and Sports Car activity! Mail coupon right now!

"SHOP-METHOD" HOME TRAINING!

YOU MASTER ALL PHASES, INCLUDING DIESEL! All lessons fully illustrated. Latest equipment covered.



THIS SET OF LIFETIME TOOLS IS YOURS! Also all-metal tool box. Part of your course, yours to keep. **EARN WHILE YOU LEARN!** We show you how to start Spare Time Earnings soon after enrollment.

ATTENTION MEN OF DRAFT AGE. Learn how you can achieve higher rating and pay. Mail coupon at once! APPROVED FOR G. I. TRAINING. Both Home Study & Resident Courses. Free help with technical and personal problems—Job Placement Service.



Send for **FREE FACT-BOOK AND SAMPLE LESSON!**

NOW! 2 offices to serve you faster! Mail coupon today to one nearest you!

NATIONAL SCHOOLS

Technical Trade Training Since 1905

LOS ANGELES 37, CALIFORNIA

IN CANADA: 811 West Hastings Street, Vancouver, B. C.

MAIL NOW TO OFFICE NEAREST YOU!

(mail in envelope or paste on postal card)

NATIONAL SCHOOLS, Dept. DB-16

4000 S. FIGUEROA STREET OR 323 WEST POLK STREET
LOS ANGELES 37, CALIF. CHICAGO 7, ILLINOIS

Send **FREE** Auto-Mechanics Book and Sample Lesson. No obligation, no salesman will call.

NAME _____ BIRTHDAY _____ 19 _____

ADDRESS _____

CITY _____ ZONE _____ STATE _____

Check if interested ONLY in Resident School Training at Los Angeles. VETERANS: Give Date of Discharge _____

We're sorry...

that we have not had the production to supply all the demand for Life-Time 50,000 Mile Spark Plugs. New equipment and greatly accelerated production enable us now to make immediate delivery. If you have ordered and your check has been returned, please place your order again. Life-Time Spark Plug Sets may be ordered from this advertisement. We will postpay at regular retail price. Specify make, model and year of car. Set of 6, \$7.14; set of 8, \$9.52.

DISTRIBUTORSHIPS

Some additional distributorships are now available. If you have already written us regarding your area, please contact us again. If you have not written before, please send us an outline of your previous business experience and qualifications.

CONTINENTAL MANUFACTURING CORP.
Washington Blvd. at Motor Ave. Culver City 24, California



NEW BENJAMIN SUPER CO₂ GAS CARBINE - \$16.50

HI-LO (2 Stage) Jet Power
Cal. .177 or .22

RIFLED
Shoots
Pellets
& Darts



New Benjamin .177 or
.22 CO₂ ROCKET GAS
Pistol with HI-LO JET
POWER..... \$13.00

IDEAL FOR
TARGET & SMALL GAME
SAFE - ECONOMICAL - ACCURATE
CONVENIENT - PRACTICAL - NON TOXIC
EASY TO OPERATE - NO PUMPING - NO FLINCHING.
Get 40 SHOTS from each 10¢ STANDARD SIZE CO₂
(Soda) CARTRIDGE. Up to 3/4" penetration.
Ask your DEALER for DEMONSTRATION.

BENJAMIN AIR RIFLE CO.
896 MARION ST., ST. LOUIS 4, MO., U.S.A.

FREE
Folder

LAW

Men and women **STUDY AT HOME** for Business Success and **LARGER PERSONAL EARNINGS**, 44 years expert instruction—over 114,000 students enrolled. LL.B. Degree awarded. All text material furnished. Easy payment plan. Send for **FREE BOOK**—"Law and Executive Guidance"—NOW!

AMERICAN EXTENSION SCHOOL OF LAW

Dept. H-7, 201 N. Wells St., Chicago 6, Illinois

WHOLESALE Electric Guitars - Parts - Build Your Own
Solid-body Spanish, amplifiers, double-necks, single-necks, triple-necks, 4-necks, solid-body mandolin, electric violin, pickup mikes, non-electric instruments, etc. 1956 Models wholesale. **FREE CATALOG.** Free home study course with instruments. Parts & plans available to build your own.
CARVIN CO., Box 287, PM-1, Covina, Calif.

Finish HIGH SCHOOL AT HOME

Complete 4 Yrs. in 12 Months

Learn More! Earn More! Enter professional or technical schools. Advance Socially. Live a Mapper, Fuller Life. Individual Courses or complete schedule. **WRITE FOR SCHOOL BULLETIN.**

ACADEMY FOR ADULTS

30 W. Washington, Dept. PM-16, Chicago, Ill.

make it with **60¢** worth of sand & cement
SELL IT FOR \$2000

every home a prospect for these patented "LIFETIME"

CONCRETE INCINERATORS

Make big profits manufacturing rust proof, fire proof, almost indestructible concrete incinerators in your own backyard or garage . . . full or part time. Sell to home-owners, hardware, department and garden supply stores. Phila. manufacturer doing big volume with Sears, Roebuck; large department stores. Easy to follow instructions and all needed equipment supplied. Exclusive protected franchise—No competition! Territories going fast. Write immediately for full details.
Dept. PM16, T. C. TOR, 2113 Bellevue St., Phila. 40, Pa.





**Yours for the asking—
No charge—no obligation**

"How to Become a Mail Order Millionaire"

Read how Gilbert on a "peanut" investment built up to \$350.00 A DAY. Learn how Zimmerman started a mail order business on a buck private's pay and spiraled \$16.80 into a big yearly income. See how a Chicago clerk quit a \$75.00 job and now makes \$22,000 a year in his own Mail Order business. Read how a southern boy made a fortune selling war-surplus parachutes which he bought as he went along. All Free! Send name on coupon for a copy of this fascinating reprint of "How to Become a Mail Order Millionaire" from Mechanix Illustrated plus details on the L.W. Mail Order Survey.

Start on a SHOESTRING!

The real-life stories of success in Mail Order read like fairy tales. If I had not personally known these people their stories would be hard to believe. Yet they are not only true, but they represent just a few of the hundreds of "little operators" who have been swept into big money by Mail Order.

GAINES. I personally guided his start when he invented an automatic pants presser. He started with one little ad in one magazine. Four years later he retired — with enough real estate to keep him in cash income the rest of his life.

YAN MARK. I worked with him for six years. I met him when he was a wagon man for a tea and coffee house, knocking on doors. He went into Mail Order on nothing—made money from the start—ended up six years later with savings of \$50,000 and an income of \$50,000.00 a year for life without further work.

DUGGAN. A few years ago he was a truck driver. Started fooling with Mail Order in a spare room in his spare time. Last year he said, "I don't know how much I'm worth—after you get the first million you quit keeping track."

MRS. NIXON. Started a small Mail Order business at home—just to keep occupied. It looked good and she came to me for advice. I showed her how to expand. In two years the business got so big her husband resigned his job to help manage it.

FOXMAN. Foxman worked as a hack writer at \$70 a week. He had idle time in the evenings—ran an ad offering something he didn't have—got so many orders he had to find a source of supply. He made \$18,000 the first year. He gives me credit for "showing the way."

JORGENSON. Consulted me about a specialty product. On my advice he ran one ad to "test" its saleability. That ad brought sales of \$50,000. In his first year he did a business of nearly a half million dollars. His original investment was less than a thousand.

These things I have seen. These people I have helped to the realization of their dreams — these and hundreds of others. My own fortune was made in Mail Order. And now my secrets can be yours.

L. W.

Have you ever thought of running a profitable little sideline right from your home? Has it occurred to you that you are just as capable as anyone else of making money on a product or service that can be sold by mail? Have you ever looked into the Mail Order business as it's run (on tiny investments) by innumerable small operators?

Forget about Sears and Ward's! Read about the "little fellows" . . . clerks, teachers, vets, mechanics, salesmen and others . . . who are packing Mail Order items in bedrooms, spare rooms, attics, garages, cellars . . . dumping them in the Post Office . . . and quietly banking the fistful of Money Orders, cash and checks delivered to them daily by the mailman.

An annual business of almost a billion dollars is done by "little fellows" who advertise and sell just one item! The Department of Commerce of the United States says, "A number of the most successful obtain incomes as high as \$40,000 to \$50,000.00."

It's an incredible story . . . a story of a business that's wide-open for newcomers . . . with opportunities for income far-and-away greater than you can ordinarily hope to attain by holding down a job. And in Mail Order you can stay as small as you wish—run your deal as a \$50 or \$75 weekly sideline—or consider jacking it up into really big figures as a full time operation.

Glance at the examples at left. These true stories are far from unusual. Multiply them by the hundreds and you begin to get an idea of what can be done . . . what is being done . . . in the phenomenal Mail Order field.

Yet, if you were to jump blindly into Mail Order your chances would be slim. A peculiar brand of "know-how" is vital in this little-known, little-understood business. This is fortunate for you. If any Tom, Dick, or Harry would "click" in Mail Order, the field would have been overloaded years ago.

But now you have the opportunity to learn the authentic secrets of successful Mail Order operation. They are revealed for the first time, step by step, in an extraordinary new Survey . . . the L.W. Confidential Mail Order Letters.

This Survey is not a course—not a book—not a group of lessons. It is a simple guide that anyone can follow. It shows you how to pick the right product for Mail Order. It shows you exactly how to start a profitable business fast, with cash or Money Orders in the envelopes you receive. It shows how to buy your product out of the very money you get in the mail, so you don't have to tie up cash in large supplies of your product. It gives you actual examples of ads and letters, analyzed to show how and why they make money. It demonstrates the months to start, the time to expand, the best way to get prospects' names. It reveals from A to Z the confidential facts that have made fortunes for Mail Order operators who use them.

Mail the coupon today, or simply send your name and address on a postcard. No salesman will call. We will mail, postage prepaid, a Free copy of "How to Become a Mail Order Millionaire" and along with it will give you complete facts about the L.W. Mail Order Survey. Read the facts. Then decide whether you would like to spend spare time or full time in a profitable, fascinating Mail Order enterprise. If you think you would like to follow the footsteps of hundreds of others who are now making good money in this way, you can get your L.W. Survey and begin at once.

Please don't decide to write us "a little later." Send your name now, before you forget. This one little act might be the first step to a future of independence and wealth.

**The L.W. MAIL ORDER SURVEY, Dept. 11
805 LARRABEE ST., LOS ANGELES 46, CALIF.**

**The L.W. MAIL ORDER SURVEY, Dept. 11
805 LARRABEE ST., Los Angeles 46, Calif.**

Mail me a free copy of "How to Become a Mail Order Millionaire" and details about the L.W. SURVEY. It is understood there is no charge at any time, and that I am not under the slightest obligation. After reading, I will decide whether I want to use the L.W. Confidential Letters to help me start a Mail Order business at home.

NAME _____
ADDRESS _____
CITY _____ Zone _____ STATE _____

BUY DIRECT and
SAVE UP TO 1/2
on ITALIAN ACCORDIONS
EASY TERMS



Act NOW!

Accordions of famous makes and breath-taking beauty now can be yours! Mail coupon for FREE Color Catalog and amazing Wholesale Prices.

5 DAYS FREE TRIAL
MONEY BACK GUARANTEE
MAIL COUPON NOW

TRY BEFORE YOU BUY

World's largest selection direct from Importer to you! 30 models to choose from. **SATISFACTION GUARANTEED** or your money back. Trade-ins accepted. Terms as low as \$10 monthly. Write today!

Big Color Catalog FREE!

Send me Free Color Catalog—full details.

Name _____

Address _____

City _____ State _____

ACCORDION MANUFACTURERS & WHOLESALE OUTLET

2003 West Chicago Ave., Dept. R-16, Chicago 22, Ill.

MAKE TREMENDOUS PROFITS

Have fun! Earn Big Money! Cast plaster figurines, bookends, plaques, novelties at home in your spare time with X.L. rubber molds! **NO EXPERIENCE NEEDED!** Models and rubber for 3 molds, only \$1.50 ppd. Send 25c (refunded with order) for 40 page catalog now!

PLASTIC ARTS STUDIO 3403 SO. MADISON, DEPT. PM2 MUNCIE, INDIANA

LEARN TV in KC

UNIVERSAL TV FAMOUS FOR 24 YEARS
1,000's OF SUCCESSFUL GRADS COAST TO COAST



Easy, quick, fascinating. Learn **TELEVISION** in 36 short weeks of enjoyable companionship in shop training. Wonderful job opportunities. Graduates have choice of many jobs or can establish their own TV repair shop. **YOU CAN START EARNING AS MUCH AS \$150 PER WEEK.** No limit as time goes on. U.T.S. is an old established school (TV exclusive for 24 years) staffed by expert instructors, headed by one of America's first TV broadcasters. Costs so little to prepare yourself for life. No previous experience needed. Fully approved for Korean Veterans. Also fully approved course in color TV (1st in US). Send coupon now for **FREE** book on TV Electronic opportunities.

WRITE FOR FREE CATALOG

FILL OUT COUPON
UNIVERSAL TV SCHOOL
 1220M Admiral Boulevard, Kansas City, Missouri

PLEASE SEND ME INFORMATION FREE

Name _____ Age _____

Address _____

City _____ State _____

Check here if Korean Veteran

"YOU ARE UNDER ARREST!"

There's a Thrill in Bringing a Crook to Justice Through Scientific



CRIME DETECTION!

We have taught thousands this exciting, profitable, pleasant profession. Let us teach you, too, in your own home. Learn Finger Printing, Fire Arms Identification, Police Photography and Criminal Investigation thoroughly, quickly and at small cost.

Be A FINGER PRINT Expert

Over 800 of All American Bureaus of Identification employ students or graduates of I. A. S. You, too, can fit yourself to fill a responsible crime detection job with good pay and steady employment. But don't delay—get the details now. Let us show you how easily and completely we can prepare you for this fascinating work, during spare time, in your own home. Write today stating age.

INSTITUTE OF APPLIED SCIENCE

(A Correspondence School Since 1918)

1920 Sunnyside Ave., Dept. 1351, Chicago 40, Ill.

FREE!!!
 Send for Thrilling "BLUE BOOK OF CRIME"

SHEET METAL BRAKES

Forms angles, locks, pans, etc. New eccentric clamps. All steel construction. Size 15"—18 gauge steel. \$31.50; 36"—22 ga. \$43.50; 48"—24 ga. \$60.00. 14 ga. open end Shear. 6" blades. Compound lever. \$29.00. Angle Shear. 3 adj. gauges, 7"—16 ga. \$16.50.



ORDER DIRECT OR SEND FOR CATALOG

VYKE MFG. CO., 4158-P Jason St., Denver 11, Colo.



Grow authentic, **LIVE** dwarf trees! Fascinating hobby! Fabulous profit!

GROW MINIATURE TREES

SEND FOR FREE SEED & INFORMATION!

MINIATURE NURSERY CLUB
 Dept. JJ-1, P.O. Box 8794, Los Angeles 8, Calif.



DRAINS cellars, cisterns, wash tubs; **\$6.95**
IRRIGATES - CIRCULATES - SPRAYS

Type P Pump has 1,001 uses. Up to 3000 GPH; 450 GPH 80' high; or 1800 GPH from 25' well. Use 1/6 to 3/4 HP motor. Coupling included free. 1" inlet; 3/4" outlet. Stainless shaft. Won't rust or clog! Postpaid if cash with order. (West of Miss. add 50c)

MONEY BACK GUARANTEE
 Centrifugal and Gear Pumps in All Sizes
LABAWCO PUMPS, Belle Meade 7A, N. J.

WANTED FOR CASH
ELECTRONIC TUBES

TRANSMITTING - SPECIAL PURPOSE - RECEIVING -
 Any Quantity from one to thousands. Immediate response to all offers.

JACK KAY, 129 5th Ave., N. Y. C. 3, N. Y.

LAW FREE BOOK **THE LAW TRAINED MAN**

Write today for a **FREE** copy of illustrated law book, "THE LAW TRAINED MAN," which shows how to earn the professional Bachelor of Laws (LL.B.) degree through home study of the famous Blackstone Law Course. All necessary books and lessons provided. Moderate cost; convenient monthly terms. Write for **FREE** law training book today.

Blackstone School of Law, 225 N. Michigan Ave.

Founded 1890

Dept. 51 Chicago 1, Ill.

Learn BAKING At Home

Baking is one of America's high industries in wages. Nearly **DEPRESSION-PROOF**. Thorough basic home course lays sound foundation. If you have aptitude, write for **FREE** Booklet, "Opportunities in Commercial Baking."

NATIONAL BAKING SCHOOL
 835 Diversey Parkway Dept. 1351 Chicago 14, Ill.



HOW TO REPAIR

Electric Appliances

ASK TO SEE IT!



SAVE TIME, TROUBLE, MONEY WITH AUDELS BIG 800 PAGE HOME APPLIANCE SERVICE GUIDE

THIS HANDY, PRACTICAL "How to Do It" Book for Electric & Gas Home Appliance Servicemen, Mechanics & Users Covers the Basic Principles, Servicing, Trouble Shooting & Repairs of Home Appliances. 500 ILLUSTRATIONS 1001 FACTS!

Sent on 7 Days Approval

Step up your own skill with the facts and figures of your trade. Audels Mechanics Guides contain Practical Inside Trade Information in a handy form. Fully illustrated and Easy to Understand. Highly Endorsed. Check the book you want for 7 DAYS FREE EXAMINATION. Send No Money. Nothing to pay postman.

Tells How to Locate Troubles, How to Take Appliances Apart, How to Make Repairs, How to Assemble and Connect. Easy to read and understand. Gives up-to-date testing methods, clear concise wiring diagrams, photos and complete data on each appliance.

INFORMATION IN A HANDY FORM ANSWERS YOUR QUESTIONS

34 INTERESTING CHAPTERS—Read this partial list of subjects on which practical information is fully given for ready reference

- Electric Garbage Disposers
- Household Refrigeration
- Electric Drainage Pumps
- Circuit Fundamentals
- Measurement of Electricity
- Fundamental Electricity
- Gas Fired Water Heaters
- Gas Fired Space Heaters
- Bottled Gas Appliances
- Electric Casseroles, Roasters & Broilers
- Electric Food Mixers
- Electric Pressing Irons
- Electric Waffle Bakers
- Gas Fired Furnaces
- Appliance Testing Instruments
- Fractional Horsepower Motors
- Electric Fans and Blowers
- Electric Vacuum Cleaners
- Electric Washing Machines
- Electric Clothes Dryers
- Electric Coffee Makers
- Electric Space Heaters
- Automatic Electric Water Heaters
- Electric Dishwashers
- Window Type Air Conditioners
- Gas Ranges
- Electric Ranges
- Electric Ironers
- Electric Toasters
- Home Wiring
- Oil Burners
- Shop Technique
- Servicing

O. K. SAY READERS

"It is a gold mine of information for the shop."

"I have Audels Home Appliance Service Guide... It is the finest book of its kind I have ever seen!"



CUT HERE MAIL ORDER

AUDEL, Publishers, 49 W. 23 St., NEW YORK 10, N. Y.
Please send me for FREE EXAMINATION books marked (x) below. If I decide to keep them I agree to mail \$1 in 7 Days on each book or set ordered and further mail \$1 monthly on each book or set until I have paid price, otherwise I will return them.

- HOME APPLIANCE SERVICE GUIDE, 800 Pages \$4
- AUTOMOBILE MECHANICS GUIDE, 1664 Pages. 4
- TRUCK & TRACTOR GUIDE, 1299 Pages . . . 4
- DIESEL ENGINE MANUAL, 575 Pages . . . 2
- MACHINISTS HANDY BOOK, 1650 Pages . . . 4
- WELDERS GUIDE, 400 Pages . . . 1
- BLUE PRINT READING, 416 Pages . . . 2
- MATHEMATICS & CALCULATIONS, 700 Pages. 2
- SHEET METAL PATTERN LAYOUTS, 1100 Pages 4
- SHEET METAL WORKERS HANDY BOOK, 388 Pgs. 1
- MECHANICAL DRAWING GUIDE, 160 Pages . . . 1
- MECHANICAL DRAWING & DESIGN, 480 Pages 2
- AIRCRAFT WORKER, 240 Pages . . . 1
- TELEVISION SERVICE MANUAL, 434 Pages . . . 2
- RADDMANS GUIDE, 1040 Pages . . . 4
- ELECTRONIC DEVICES, 216 Pages . . . 2
- ELECTRIC MOTOR GUIDE, 1000 Pages . . . 4
- WIRING DIAGRAMS (Light & Power), 272 Pgs. 1
- ELECTRICIANS EXAMINATIONS, 250 Pages. . . 1
- ELECTRIC POWER CALCULATIONS, 425 Pages. 2
- HANDY BOOK OF ELECTRICITY, 1440 Pages. . 4
- ELECTRIC DICTIONARY, 9000 Terms . . . 2
- ELECTRIC LIBRARY, 7000 Pages (12 Book Set) 18
- SHIPFITTERS HANDY BOOK, 250 Pages . . . 1
- REFRIGERATION & Air Conditioning, 1280 Pgs. 4
- MILLWRIGHTS & MECHANICS GUIDE, 1200 Pgs. 4
- POWER PLANT ENGINEERS GUIDE, 1500 Pages 4
- ENGINEERS & FIREMANS EXAMS, 525 Pages. 1
- PUMPS, Hydraulics & Air Compressors, 1658 Pgs. 4
- OPERATING ENGINEERS LIBRARY (3 Books) . 9
- MECHANICAL DICTIONARY, 950 Pages . . . 4
- GARDENERS & GROWERS GUIDES (4 Book Set) 6
- CARPENTERS & BUILDERS GUIDES (4 Book Set) 6
- PLUMBERS & Steamfitters Guides (4 Book Set) 6
- MASONS AND BUILDERS GUIDES (4 Book Set) 6
- PAINTERS & DECORATORS MANUAL, 450 Pgs. 2
- HOUSE HEATING GUIDE, 1000 Pages 4
- OIL BURNER GUIDE, 384 Pages 1

Name.....
Address.....
Occupation.....
Employed by.....

\$4 COMPLETE PAY \$1 A MONTH ONLY

7 DAYS' FREE TRIAL TO GET THIS ASSISTANCE FOR YOURSELF SIMPLY FILL IN AND MAIL COUPON TODAY.

AUDEL, Publishers, 49 W. 23 St., New York 10, N. Y.

The **BIG DEMAND** is for *Engineering* Technicians!



- Electronics
- Television
- Radio

**HIGH PAY
CAREERS
Await Central-
Trained Men**

Nationally recognized, accredited Central training is designed to help you qualify for the higher-paying, advanced career position of *Electronic Engineering Technician*—in the shortest possible time. Central's "Progressive Plan" is so arranged that each phase of training you complete, qualifies you for a better-pay position.

Central offers 3 proven training plans to fit the requirements of ambitious young men: (1) Home Study, (2) Combination Home Study-Resident and (3) Full Resident Course—*complete* Electronics-TV-Radio training leading to Associate of Science Degree. Through our nationwide placement service, thousands of Central graduates have entered almost every technical phase of the electronic industries.

Don't limit yourself! Get the facts on Central's *complete* training. Preliminary training need not interfere with present job. For **FREE** brochure and full information—fill in below and mail this ad today.

Central offers courses Approved for Veterans

CENTRAL TECHNICAL INSTITUTE
Dept. 5-16, 1644 Wyandotte, Kansas City, Mo.

Name.....
Address.....County.....
City.....State.....

not everyone does as well, but E. O. Lockin, who started a business of his own, reports...

for 12 months I've averaged
**\$800 PER MONTH
INCOME** —
most of it clear profit for me!

● Many men have discovered how to be independent, to be free of bosses and layoffs. L. A. Eagles grossed more than \$200 his first week. Others report gross up to \$12,000 per year. How much you make depends largely on *you*. You need no special skill, no large investment.

No shop necessary. Our **ELECTRIC RUG WASHER** cleans rugs, carpets right on floor... helps to show their natural color, beauty. So efficient and safe, used by largest hotels and railroads.

You take no risk. Machines fully guaranteed. Write for full information including how to make big profits in **YOUR OWN business.**



MAIL COUPON TODAY FOR FREE BOOK

VON SCHRADER MFG. CO., 110 "R" Pl, Racine, Wis.

Without obligation, send your **FREE** booklet containing information about your **ELECTRIC RUG WASHER** and how I can start *my own* permanent, profitable business.

Name.....
Address.....
City.....Zone.....State.....

Build it Yourself!



Spinet, two-manual and three-manual electronic organs. Save hundreds of dollars with our easy-to-assemble kits. Designed to sound and look like a pipe organ.

Send \$1.00 for "Organ Builders Manual." Full plans for home, church and concert models. Includes parts catalog.



ELECTRONIC ORGAN ARTS Dept. 1
4878 Eagle Rock Blvd. • Los Angeles 41, Calif.

AMAZING NEW TINY RADIO

Really Works—Small as a Pack of Cigarettes!



GETS LOCAL RADIO STATIONS WITH CLEAR BELL-LIKE TONE—NO STATIC OR INTERFERENCE! NEEDS NO TUBES, BATTERIES OR COMPLICATED HOOKUPS! NO AC PLUG INS! Nothing to wear out. Thousands of users—many report years of service. Uses new crystal diode and HI-Q coil. **SELF-CONTAINED SPEAKER PHONE.** Just the tiny radio to take with you ANYWHERE YOU GO—ON TRIPS, VISITING, ETC.—for real fun and enjoyment—ANYTIME. Merely hook to anything that can act as antenna for local reception. Free DX antenna kit included. **SEND ONLY \$1.00** (bill, ck., mo.) and pay postman \$4.99 C.O.D. postage or send \$5.99 for p.p. delivery. **COMPLETE READY TO LISTEN.** MIDWAY CO., Dept. PPM-1, Kearney, Nebr.



FREE! This Beautiful BIG Illustrated LEATHERCRAFT CATALOG

Make Leather Billfolds, Belts, Purses, Etc.
J. C. LARSON CO., 820 South Tripp Avenue
Department 5527, Chicago 24, Illinois

Do You Make These Mistakes in English?

MANY persons say "between you and I"—use "who" for "whom"—don't know whether to use one or two "e's" or "m's" or "r's." Every time you speak or write you show what you are. A command of effective English brings you added advantages, better opportunities.

You can improve your English through Sherwin Cody's 100% self-correcting invention. If you are ever embarrassed by mistakes in grammar, spelling, punctuation, or pronunciation, write for **FREE** book "How You Can Master Good English in 15 Minutes a Day." No obligation. **SHERWIN CODY COURSE IN ENGLISH, 561 Central Drive, Port Washington, N. Y.**



**WAR
SURPLUS
BARGAINS**

**\$500,000.00 INVENTORY
for QUICK LIQUIDATION**

Surplus items—hundreds of them for home, shop, factory, farm and outdoor use. New items, used items, reconditioned items—all at tremendous savings—all priced for quick sale.

Page After Page of Values

This big catalog shows page after page of amazing money saving values. Write for your copy today. Send 10c to cover postage, mailing, etc. Write today! **SEND TODAY FOR YOUR COPY**

STARK'S 212 W. Madison St.
Dept. PM-1
CHICAGO 6, ILL.

10c

FOR REPAIRING RADIO AND TV

The New Model 670-A

SUPER METER

A COMBINATION
VOLT-OHM MILLIAMMETER
PLUS CAPACITY REACTANCE
INDUCTANCE AND DECIBEL
MEASUREMENTS



ADDED FEATURE:

Built in ISOLATION TRANSFORMER reduces possibility of burning out meter through misuse.

SPECIFICATIONS:

D.C. VOLTS: 0 to 7.5/15/75/150/750/1,500/7,500 Volts
A.C. VOLTS: 0 to 15/30/150/300/1,500/3,000 Volts
OUTPUT VOLTS: 0 to 15/30/150/300/1,500/3,000 Volts
D.C. CURRENT: 0 to 1.5/15/150 Ma. 0 to 1.5/15 Amperes
RESISTANCE: 0 to 1,000/100,000 Ohms 0 to 10 Megohms
CAPACITY: .001 to 1 Mfd. 1 to 50 Mfd. (Good-Bad scale for checking quality of electrolytic condensers.)
REACTANCE: 50 to 2,500 Ohms 2,500 Ohms to 2.5 Megohms
INDUCTANCE: .15 to 7 Henries 7 to 7,000 Henries
DECIBELS: -6 to +18 +14 to +38 +34 to +58

The Model 670-A comes housed, in a rugged crackle-finished steel cabinet complete with test leads and operating instructions.

28⁴⁰

The new streamlined model TC-55

TUBE TESTER

QUICKLY AND EFFICIENTLY TESTS RADIO AND TV TUBES INCLUDING: SEVEN PIN MINIATURES; EIGHT PIN SUBMINARS, OCTALS AND LOCTALS; NINE PIN NOVALS

YOU CAN'T INSERT A TUBE IN THE WRONG SOCKET.

It is impossible to insert the tube in the wrong socket when using the new Model TC-55. Separate sockets are used, one for each type of tube base. If the tube fits in the socket it can be tested.

"FREE-POINT" ELEMENT SWITCHING SYSTEM.

The Model TC-55 incorporates a newly designed element selector switch system which reduces the possibility of obsolescence to an

absolute minimum. Any pin may be used as a filament pin and the voltage applied between that pin and any other pin, or even the "top-cap."

CHECKS FOR SHORTS AND LEAKAGES BETWEEN ALL ELEMENTS. The Model TC-55 provides a super sensitive method of checking for shorts and leakages up to 5 Megohms between any and all of the terminals.

ELEMENTAL SWITCHES ARE NUMBERED IN STRICT ACCORDANCE WITH R.M.A. SPECIFICATION.

One of the most important improvements, we believe, is the fact that the 4 position fast-action snap switches are all numbered in exact accordance with the standard R.M.A. numbering system. Thus, if the element terminating in pin No. 7 of a tube is under test, button No. 7 is used for that test.

The Model TC-55 comes complete with operating instructions and charts. Use it on the bench—use it for field calls. A streamlined carrying case, included at no extra charge, accommodates the tester and book of instructions.

26⁹⁵

FOR REPAIRING ALL ELECTRICAL APPLIANCES MOTORS AND AUTOMOBILES

The New Model 70 UTILITY TESTER

As an electrical trouble shooter
the Model-70:

- Measures A.C. and D.C. Voltages, A.C. and D.C. Current, Resistances, Leakage, etc.
- Will measure current consumption while the appliance under test is in operation.
- Incorporates a sensitive direct-reading resistance range which will measure all resistances commonly used in electrical appliances, motors, etc.
- Leakage detecting circuit will indicate continuity from zero ohms to 5 megohms (5,000,000 ohms).
- Will test Toasters, Irons, Broilers, Heating Pads, Clocks, Fans, Vacuum Cleaners, Refrigerators, Lamps, Fluorescents, Fans, Switches, Thermostats, etc.

As an Automotive Tester
the Model 70 will test:

- Both 6 Volt and 12 Volt Storage Batteries
- Generators
- Starters
- Distributors
- Ignition Coils
- Regulators
- Relays
- Circuit Breakers
- Cigarette Lighters
- Stop Lights
- Condensers
- Directional Signal Systems
- All Lamps and Bulbs
- Fuses
- Heating Systems
- Horns
- Also will locate poor grounds, breaks in wiring, poor connections, etc.



Handsome round-cornered molded bakelite case, 3 1/4" x 5 1/2" x 2 1/4". Complete with all test leads. Also included is a 64 page book giving detailed instructions for testing all electrical appliances, automotive equipment, etc.

15⁸⁵

SHIPPED ON APPROVAL NO MONEY WITH ORDER — NO C. O. D.

Try any of the above instruments for 10 days before you buy. If completely satisfied then send down payment and pay balance as indicated on coupon. **No Interest or Finance Charges Added!** If not completely satisfied return unit to us, no explanation necessary.

MOSS ELECTRONIC DISTRIBUTING CO., INC.
Dept. D-196, 3849 Tenth Ave., N. Y. 34, N. Y.

Please send me the units checked. I agree to pay down payment within 10 days and to pay the monthly balance as shown. It is understood there will be no finance, interest or any other charges, provided I send my monthly payments when due. It is further understood that should I fail to make payment when due, the full unpaid balance shall become immediately due and payable.

Model 70 . . . Total \$16.85
\$3.85 within 10 days. Balance \$4.00 monthly for 3 months.

Model 670-A. Total \$28.40
\$7.40 within 10 days. Balance \$9.50 monthly for 6 months.

Model TC-55. Total \$26.95
\$6.95 within 10 days. Balance \$5.00 monthly for 4 months.

Name

Address

City Zone .. State

DRAFTING *pays* BIG MONEY!



Draftsmen earn more, enjoy pleasanter working conditions. Get into DRAFTING and Blue-Printing, the starting point of all production. Trained Draftsmen are needed everywhere. Machines can never replace the draftsman.

LEARN AT HOME IN SPARE TIME

Revolutionary new method teaches you quickly the hows and whys of Mechanical, Structural, Machine, Architectural, etc. Drafting. You are sent professional drafting instruments, drafting equipment, portable drafting table, etc., at no extra cost. You learn by making actual drawings.

BIG MONEY...ADVANCEMENT OPPORTUNITIES offered trained draftsmen. Drafting is light, pleasant work, paying big salaries. Is a stepping stone to top managerial jobs. The draftsman plans the World of Tomorrow. That is why drafting is such interesting work.

OWN YOUR OWN DRAFTING FIRM

The investment requirement is small, the earning possibilities great. Many draftsmen eventually branch out into manufacturing the products they created. Learn of the opportunities in Drafting.

MAIL THIS COUPON TODAY!

CHRISTY TRADES SCHOOL, Dept. DB-2903
4804 N. Kedzie Ave., Chicago 25

Mail at once your big FREE book on Drafting and Blue-Printing. Tell me how your Home Training and Professional Drafting Instruments, Portable Drafting Table, Drafting Equipment, etc. can be had on a **PAY AS YOU LEARN** plan.

NAME _____ Age _____
ADDRESS _____ CITY _____ STATE _____

"I'M MAKING MORE THAN \$1000 a Month Haven't Touched Bottom Yet!"



—reports Charles Kama, Texas, one of many who are "cleaning up" with orders for PRESTO, Science's New Midget Miracle Fire Extinguisher. So can YOU!



Science's New Midget Miracle "PRESTO"

AMAZING new kind of fire extinguisher. Tiny "Presto" (about size of a flashlight!) does job of bulky extinguishers that cost 4 times as much, are 8 times as heavy. Ends fires fast as 2 seconds. Fits in palm of hand. Never corrodes.

Guaranteed 20 years! Over 2 million sold!
Sells for Only \$3.98

Show it to civil defense workers, owners of homes, cars, boats, farms, etc. and to stores for re-sale—make good income. H. J. Kerr reports \$20 a day. Wm. Wydallis, \$15.20 an hour. Write for FREE Sales Kit. No obligation.

(If you want a regular Presto to use as a demonstrator, send \$2.50. Money back if you wish.)

MERLITE INDUSTRIES, Dept. 15-E, Presto Div.,
114 East 32nd St., New York 16, N.Y. IN CAN-
ADA: Mopa Co., Ltd., 371 Dowd St., Montreal
1, P. Q.

NEW! PERSONAL RADIO

LISTEN WHILE YOU WALK, RIDE, WORK!



Slips in any pocket—Wt. only 7 ozs. Size 2 3/4" x 4 3/4" x 1 1/2". Beautiful Black Gold plastic case. NO HOOKUPS—NO WIRES—NO PLUG-INS! Self contained with 150 hour life flashlight battery. (Available anywhere) and BUILT-IN ANTENNA!

GUARANTEED RECEPTION OF RADIO STATIONS TO 50 miles—up to 1500 miles for powerful stations! Has new Patented Super-regenerative Diode tube and transformer audio stages for sharp selectivity and sensitivity! Easy to use top controls (while walking).

Almost invisible plastic foam personal earplug lets you alone listen while you walk, visit, work, ride or sleep—anytime—anywhere. Money Back guarantee—1 year service guarantee.

SEND ONLY \$5.00 (Ck. Mo) and pay postman \$14.95 plus postage on delivery or send \$19.95 for postpaid delivery. Get YOUR Tintone REAL pocket radio now and be ready to listen to Civil Defense alarms, news, music, sports, etc. on a moment's notice. Not an unworkable incomplete kit or playing! Shipped complete with batteries—Ready to listen! Available only from **WESTERN RADIO Dept. APM-1 Kearney, Nebraska**

STUDY INDUSTRIAL DESIGN

You can train at Art Center School in California with practicing-professionals for upper-level jobs in INDUSTRIAL DESIGN. Recent graduates have been added to the staff at General Motors, Chrysler, Raymond Loewy, Henry Dreyfus, etc. Majors in transportation, general product design, structures, community development, furniture design, packaging, display, 4-year degree courses. Learn to combine imaginative design with technical proficiency, coordinate utility and beauty. Stimulating environment. Field trips. Advantages of mild Southern California climate and nearby holiday spots. Coed. Placement service. Established 25 years. New terms Feb., June, Sept. Write for catalog.

ART CENTER SCHOOL, Edward M. Adams, Director
5353 WEST THIRD STREET, LOS ANGELES 5, CALIFORNIA

How to "Grow EXTRA \$\$\$ At Home"

Start your own spare or full-time business. Get this helpful 48-page illustrated book, "Grow Extra Dollars at Home!" Tells *what* to grow, *when* to grow it, *how* to SELL it. This easy-to-understand book doesn't entertain. Instead it tells you *How To MAKE MONEY*. Proven tips on materials, growing conditions, seasonal favorites, pricing, selecting your own trade name, customer contact, how to sell to single stores or chains. No other book like it. Send only \$1.00 to

HORTO CORP. P.O. Box 188 Salem 23, Mass.

PRINTS POST CARDS

Learn how both large and small businesses are boosting sales with new advertising machine. Write today for FREE illustrated BOOK of unique advertising plans, money-making ideas for your business. **Cardmaster, 1920 Sunnyside, Dept. 121, Chicago 40, Ill.**



250 POWER



Complete Telescope Lens Kit **only \$3.49** postpaid

Conquer Space, Explore the Universe, Planets, Moon Craters, New Stars, etc. Complete Lens Kit consists of 80 inch focal length ground and polished objective lens, eyepiece lenses for 50 POWER, 100 POWER, 150 POWER, 200 POWER, 250 POWER, and all necessary lens fittings. Easy to make from simple step by step instructions. (Tripod and mount not included.) Money back guarantee.

BUSSE SALES CO., Hartford 1, Conn., Dept. PM 41

FREE

NEW LAFAYETTE

132 PAGE ELECTRONIC CATALOG

Packed with the largest selection of electronic equipment at **LOWEST MONEY SAVING PRICES** the finest in radio, Hi-Fi, TV, P.A. Systems, antenna accessories, Microscope, Binoculars, Telescopes, ham supplies. Check full of supplies. **SEND FOR YOUR FREE COPY TODAY.**

IMPORTED BINOCULARS

All have coated lenses — clamped in prism — light weight all metal bodies. Complete with case and straps.

F-182	— 6x.15	I.F.	NET 10.75
F-105	— 8x.30	I.F.	NET 17.95
F-115	— 7x.35	I.F.	NET 17.95
F-183	— 7x.35	C.F.	NET 20.95
F-103	— 7x.50	I.F.	NET 21.50
F-116	— 7x.50	C.F.	NET 24.95
F-117	— 10x.35	C.F.	NET 23.95
F-104	— 12x.50	I.F.	NET 27.95
F-118	— 16x.50	C.F.	NET 31.50
F-185	— 20x.50	C.F.	NET 37.50

Add 10% Fed. Tax to Prices

MONEY BACK GUARANTEE

LAFAYETTE RADIO Dept. LA 100 - 6th Avenue,
New York 13, N. Y.

ENCLOSE POSTAGE WITH ORDER

TRAIN FOR GOOD PAY IN A FIELD THAT ISN'T CROWDED!



NOW! you can
LEARN ELECTRIC MOTOR REPAIR
 ... A good-paying, modern profession



OPPORTUNITIES EVERYWHERE!

Don't drift into a rut! Don't train for something that everybody and his brother are studying! Consider the facts. . . . The average small home has at least 11 electric motors! Big homes have many more—in phonographs, recorders, oil burners, refrigerators, washers, fans, clocks, mixers, cleaners, air conditioners, etc., etc. Millions more in office, industrial, mining, and transit equipment. Be the well-paid expert who can keep them working!

... for only **\$6**

FOR THE COMPLETE TRAINING

COVERS EVERY MOTOR TYPE IN COMMON USE

Every day, more and more electric motors and motor control systems are being used BOTH in industry and in home appliances. The expert who can install and keep them working properly is a valuable man in this Electrical Age. The pay is surprisingly good. The field is tremendous—and growing rapidly. Trained men find opportunities everywhere for full or part time work. **ELECTRIC MOTOR REPAIR**, the big 560-page training course book teaches you the work step by step—quickly and easily—at home in spare time. There is no other book like it. Ideal for beginners or for actual bench use in busy shops. Over 100,000 copies already in use in leading vocational schools, shops, and for home study.

FREE STUDY GUIDE

A unique Study Guide booklet of 500 practical motor study questions—priced and sold separately at 25c—is yours FREE with your request to examine **ELECTRIC MOTOR REPAIR** book. Makes learning easier—speeds up the work! See coupon.



SHOWS YOU HOW . . . Every Step of the Way!

Based on what you can learn quickly at home from **ELECTRIC MOTOR REPAIR** you can train for prompt profitable installation, servicing, repairing and complete rewinding of practically any motor in use today.

You learn fast! You learn right! Every subject is clearly explained by text AND ALSO by more than 900 illustrations and diagrams. You not only read what to do—you SEE how it is done. Quick reference guides tell you how to handle specific jobs. When a certain motor comes in for repairs, just look it up. **ELECTRIC MOTOR REPAIR** tells you what to do—and exactly how to do it.

ELECTRIC MOTOR REPAIR is designed for use right at the service bench. Unique Duo-Spiral Binding divides the book into

two sections so that both text and related diagrams can be viewed together. An instructor standing by your side could hardly do better! **ELECTRIC MOTOR REPAIR** covers the entire field—from alternating- and direct-current motors and generators, etc. to mechanical and electrical and electronic control systems. Right down the line, it explains trouble diagnosing, repair, rewinding and maintenance in a way you can easily understand.

LEARN FAST . . . no lessons to wait for! EARN WHILE YOU LEARN

Practice by repairing motors for friends, neighbors or nearby business houses. Earn while you learn this profitable, fast-growing business!

If sold as a course and sent to you in lesson form, you'd regard **ELECTRIC MOTOR REPAIR** as a bargain at 10 times the price! Instead, you get it all at once—for only \$6. You learn fast . . . and right. Here are just a few of the motor types that are fully covered:

- Split-Phase Motors
- Capacitor Motors
- Repulsion-type Motors
- Polyphase Motors
- Alternating-Current Motor Controls
- Direct-Current Armature Winding
- Direct-Current Motors
- Direct-Current Motor Controls
- Universal, Shaded-pole, and Fan Motors
- D-C-Generators, Synchronous Motors and Generators
- Electronic Motor Controls . . .



Send No Money! PRACTICE 10 DAYS FREE!

Dept. PM-16, RINEHART & COMPANY, Inc., 232 Madison Ave., New York 16, N. Y.

Send me the 560-page **ELECTRIC MOTOR REPAIR** home-training book:

- \$6.00 enclosed in full payment; or
- Send C.O.D. for \$6.00 plus postal charges; or
- Send on 10-day Free Examination and I will then remit \$6.00 plus small postage and handling charge, or return book postpaid in 10 days.

On cash and C.O.D. orders, book may be returned in 10 days if unsatisfactory and your \$6.00 will be refunded.

Name _____
 Address _____
 City, Zone, State _____
 (Outside U.S.A. \$6.50 each only—same return privilege)

Rinehart Books are sold by leading book stores

free

ALLIED'S SPECIAL 100-PAGE HI-FI CATALOG

Send for it



This 100-page book is your guide to an easy understanding of Hi-Fi. Shows you how to own the best for less. Offers the world's largest selection of Hi-Fi systems and components. Write for this invaluable catalog today—it's FREE.

ALLIED RADIO America's Hi-Fi Center

ALLIED RADIO CORP., Dept. A-16
100 N. Western Ave., Chicago 80, Ill.

Send FREE High Fidelity Catalog.

Name _____

Address _____

City _____ Zone _____ State _____

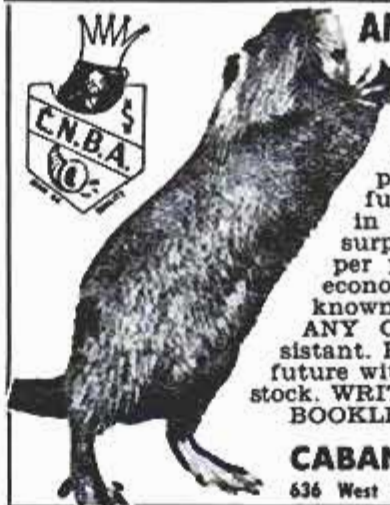

AMERICA'S NEWEST OPPORTUNITY

New fur-bearing animal now being bred in U. S. Offers huge profits to breeders. This fur is next to Mink NOW in price and will soon surpass it. 15 to 20 young per year. Most easily and economically raised animal known. 1 1/2¢ per day to feed. ANY CLIMATE, disease resistant. Build yourself a sound future with this fine, registered stock. WRITE TODAY FOR FREE BOOKLET.

CABANA NUTRIA, INC.
636 West Lemon Ave., Arcadia, Calif.

POSTCARD PRINTER

\$10⁹⁵

Complete



Prints fast, easy on postcards, cartons, envelopes, etc. at a cost of only a few cents per 1,000. 30-day trial offer, Money-Back Guarantee. Send check or money order or write for additional information.

JACOBI ADVERTISING
208 S. LaSalle St., Chicago 4

PORTABLE CAR COVER

Heavy Vinyl Plastic
(formerly \$8.95)

Protect Against RAIN
• SUN • DUST. \$6.95

Long-lasting plastic, folds compactly, off and on in a jiffy, sturdy elastic binding gives extra security. State make, model and year—buy direct from mfr. Send \$6.95 plus 35¢ postage or sent C.O.D. BEA SALES, Dept. G-50, 125 E. 46th St., New York 17



Say You Saw It in POPULAR MECHANICS

★ Red ★ Yellow ★ Pink

CARNATIONS



HENRY FIELD

(Each color in separate packet)
"Thousands of our finest customers came to us through this carnation offer."

SPECIAL JUST **10¢** **FOR 3 FULL-SIZE PACKETS** P.P.B.

Fragrant as perfume—hardy as zinnias—bloom all summer. Our carnation offer brings you a whole summer of colorful blooms—a flower that always thrills with its beauty and fragrance. Hardy, grow anywhere, bloom all summer—and you'll love the delicate pinks and yellows—the bold reds. All yours for just a dime—to win you as another friend for Henry Field's. Why not send this ad in today?

"Bloom in your garden like those in the greenhouse...yellow, pink, red. Gorgeous blooms right up 'till frost."

HENRY FIELD Seed & Nursery Co.
7152 Oak St., Shenandoah, Iowa

Please send me those 3 packets of carnation seed. My dime is enclosed. I'd like your new catalog, too.

Name _____

St. or Rt. _____

P.O. _____ State _____

"For Over 60 Years!"



TURN RIGHT

Get on the Road to a Better Job-Brighter Future with **RIGHT** Training —then You Can Really GO!

AMERICAN SCHOOL, Dept. G145, Drexel at 58th, Chicago 37, Ill.

Without obligation, please send FREE and postpaid, full particulars about the subject checked below.

- | | | |
|--|---|---|
| <input type="checkbox"/> Accounting | <input type="checkbox"/> Diesel Technician | <input type="checkbox"/> Metalworking Courses |
| <input type="checkbox"/> Apprenticeship Courses | <input type="checkbox"/> Drafting—Building Trades | <input type="checkbox"/> Plumbing—Practical |
| <input type="checkbox"/> Architecture & Building | <input type="checkbox"/> Drafting—Machine Trades | <input type="checkbox"/> Private Secretary |
| <input type="checkbox"/> Automotive Technician | <input type="checkbox"/> Electrical Engineering | <input type="checkbox"/> Retail Merchandising |
| <input type="checkbox"/> Better Foremanship | <input type="checkbox"/> Electricity—Practical | <input type="checkbox"/> Salesmanship—Outside |
| <input type="checkbox"/> Bookkeeping | <input type="checkbox"/> Electronics—Industrial | <input type="checkbox"/> Sheet Metal Work |
| <input type="checkbox"/> Business Management | <input type="checkbox"/> HIGH SCHOOL COURSES | <input type="checkbox"/> Tool Making |
| <input type="checkbox"/> Civil Engineering | <input type="checkbox"/> Mechanical Engineering | |
| <input type="checkbox"/> Contracting | <input type="checkbox"/> Mechanical Technology | |

NAME _____ OCCUPATION _____
HOME ADDRESS _____ AGE _____
CITY _____ STATE _____

START NOW by checking, filling in and mailing this coupon.
You'll get full information — No cost, No obligation!

• Today, make the BIG decision of your life. Choose the career you want and take the first easy step toward your goal. Learn how you can get the training that can put you in the bigger pay class and give you security in the years ahead. Find out how, in spare time at home, you can qualify for work you prefer, and higher pay. Or if you are already in the work you like, find out how you can win quicker promotion and a larger income.

Backed by 59 Years of Training Know-How

Since 1897 American School has helped many thousands of ambitious people toward success by providing specialized training for

commercial and technical advancement. Its study program for *you* has been prepared by experts in the subject you select and the school will give you guidance every step of the way. In time you might otherwise waste and at a cost you can afford you can prepare at home and really GO on the right road.

Don't Delay YOUR Start

Give serious thought to the list of training courses listed above. Pick the opportunity that interests you, check it and add your name and address. (Check more than one if you are undecided which appeals most.) Then clip and mail the coupon. Full information will be supplied without cost or obligation.

PRACTICAL, EFFECTIVE HOME STUDY TRAINING SINCE 1897

AMERICAN SCHOOL, Dept. G145, Drexel at 58th, Chicago 37, Ill.

Canadian Residents: Write to American School, 1610 Sherbrooke St. West, Montreal

THE SOONER YOU START, THE SOONER YOUR GOAL CAN BE REACHED



I HELPED T.E.H. MAKE \$14 A DAY WHILE STILL LEARNING!

T. E. H.—West Virginia. "By the time I finished half your course, I was making \$14.00 per day. I have made enough on the side to more than pay for the course."

H. T. ARMSTRONG

Learn

ELECTRIC APPLIANCE REPAIR & SERVICE

WE TEACH:

- How to Repair
- Washing Machines
- Vacuum Cleaners
- Electric Ranges
- Lamps, Motors, Irons, etc.,
- REFRIGERATION and House Wiring At Home In Your Spare Time!

For a man handy with tools, and happiest when working with his hands, OPPORTUNITY is Wide Open Today in this great and growing field. Everyone is a customer for the man trained to service electric appliances.

Open Your Own Shop

Our practical HOME COURSE teaches you this business from A to Z—preparing you to take a well paid job or open your own shop. You can actually start in your basement or garage with the tools we send you . . . before finishing.

We Include An **ELECTRICAL APPLIANCE TESTER**
A Big Kit of Tools at NO EXTRA COST

MAIL THIS COUPON for FREE BOOK

H. T. ARMSTRONG
PACIFIC TRAINING SCHOOLS Dept. P-561
11029 S. Vermont, Los Angeles 44

Dear Sirs: Please send me, without obligation, your free booklet and complete details.

Name _____

Address _____

City _____ Zone _____ State _____

High School at Home

MANY FINISH IN 2 YEARS

No classes. No time wasted going to and from school. Progress as fast as your time and abilities permit. Standard H. S. texts supplied. Thousands enroll each year in this 59-year-old school. Send for FREE descriptive booklet.

AMERICAN SCHOOL, Dept. H145
Drexel at 58th St., Chicago 37, Ill.

Without obligation, please send FREE descriptive booklet.

Name _____

Address _____

Canadian Residents: Complete Canadian Course Available. Write American School, 1610 Sherbrooke St., West, Montreal.



RADIO MAN SAYS NEW AMAZING

STAY-A-WAKE TABS SAVED MY JOB!

YOU TOO CAN PREVENT SLEEPINESS! FEEL ALERT AND ALIVE! Introductory Offer! 35 **STAY-A-WAKE TABS ONLY \$1.00**

Yes, "Stay-A-Wake" tabs have saved many a worker from loss of job due to sleepiness. Whenever you must "carry on" and be "on your toes" even though sleepy, tired, or under strain, here's the quick and easy way to revive and feel refreshed and energetic. Let Stay-A-Wake tabs come to your rescue. Used by thousands of car, truck and bus drivers, entertainers, students, research workers, business people, housewives. Just swallow a Stay-A-Wake tab and this new scientific discovery chases away that sluggish, sleepy feeling, gives you a lift without a letdown. Perfected by a leading research laboratory, Stay-A-Wake tabs are harmless, safe, not habit forming. Ask your doctor. Helps spark you to alertness at work, when slating, entertaining, for late driving or whenever needed. Handy to carry in purse, pocket, or glove compartment. Ready for "Pop-Up" use. Send \$1 for 35 Stay-A-Wake tabs. Or save money. Enclose \$2 cash, check or money order for free trial package of 100 Stay-A-Wake tabs. Sent prepaid in plain wrapper. No risk. Money back guarantee offer. Try a few Stay-A-Wake Tabs. If not delighted, return balance in 10 days for full refund.

HOPKINS LABORATORIES, Dept. PM-12 225 W. MONUMENT ST. BALTIMORE 1, MD.



MASTER MIND!

Learn Short-Cut Mathematics

Juggle figures, do baffling number tricks. Make people gasp at your marvelous lightning-quick mind. Multiply 4 figures by 4 figures without using old-fashioned multiplication! Big cloth-bound volume; fully illustrated course.

Sharpen up Your Brain Power

Includes worked out problems, answers, etc. Sensational bargain, only \$2.95, postpaid or C.O.D. plus postage. Satisfaction guaranteed or refund. Order this amazing "Short-Cut Mathematics" today!

NELSON-HALL CO., 210 S. Clinton St. DEPT. 2AU-2 CHICAGO 6, ILL.

\$2.95 Complete

SAVE MONEY ON U S GOV'T SURPLUS

Buy surplus direct from US Government. These are samples of the savings that can be made. Life boat \$12.00. Grinder \$4.69. Shaper \$15. Dump truck \$76.77. Tractor \$75.00. Typewriter \$7.51. Freezer \$50. Spray painter \$15.25. Motor \$4. Hunting, fishing, camping, sporting Equip, jeep, boat, tools. Hundreds others may be purchased at tremendous savings through our Bulletin "Surplus Sales." Price \$1.00.

The Abacus Press, Box 169DDD, Dept. 4, East Hfd. 8, Conn.



LEARN TO

BECOME A GAME WARDEN

or GOVT. HUNTER. Join FORESTRY, FISHERY, or WILDLIFE Services. Excellent opportunities! Good pay (\$2500 to \$10,800 a year). Pleasant Work, Prestige, Real Security, Healthful Working Conditions, and Retirement Income can all be yours. Help fill the demand in your area. Make your love of the outdoors become your business.

Learn at home in spare time—it's Easy! Fun! Fascinating!

FREE! (if over 17 years old.) Complete, illustrated booklet that gives you complete facts. **SUPPLY LIMITED—send your name and address now—TODAY!**

HOME STUDY EDUCATORS, Dept. R-1
1036 S. La Brea Los Angeles 19, Calif.



EXPORT-IMPORT

Unlimited opportunities. Earn big money from home. No experience or capital necessary. Write **UNIVERSAL SERVICES, Dept. 44, Clayton 5, Missouri**

LEARN

DRAFTING



After completing your course my salary increased to \$820 per month, G.T.W.

Veteran Approved

You Get This Professional Set of Instruments at no Extra Cost



IT'S EASY — AT HOME IN YOUR SPARE TIME

Or At The Institute in Cleveland

There's a growing, desperate need for draftsmen—the key men in all industry. CEI can quickly give YOU the necessary skill. Bigger income, jobs, and opportunities are yours with a CEI diploma. Thousands have succeeded. So can you. CEI guarantees to train you until you qualify. Write today!



Home of C.E.I. "ENGINEERING DRAFTING EXCLUSIVELY"

CLEVELAND ENGINEERING INSTITUTE
Extension Division PM-1-F
6300 Euclid, Cleveland 3, Ohio

Please rush your valuable Success Book showing how drafting can increase my pay check.

Aeronautical Mechanical

NAME..... AGE.....

ADDRESS

CITY..... STATE.....

CLEVELAND ENGINEERING INSTITUTE

PERFECT LETTERING

Quick-Easy-Inexpensive with
STENSO Lettering Guides

DO IT YOURSELF



Easy as writing your name, with STENSO Lettering Guides of sturdy treated stencil board. Use over and over for perfect lettering.



GOthic

No. 210 . . 1/2" - 3/4" - 1" - 1 1/4" - 1 3/4" letters & numbers.. \$1.50

ROMAN

No. 211 . . 1/2" - 3/4" - 1" - 1 1/4" - 2" letters & numbers.. \$1.50

Old English

No. 212 . . 1" - 1 1/4" - 2 1/4" letters & numbers \$1.50

LARGE SIZE STENSO LETTERING GUIDES

#93—3" letters, numbers \$1.00
#94—4" letters, numbers 1.75
#95—5" letters, numbers 2.50

#96—6" letters, numbers \$3.25
#98—8" letters only 4.00
#99—8" numbers only . . . 1.75

At stores selling school supplies, stationery, art materials, hobbies, or order from

STENSO LETTERING CO. Dept. 256

Industrial Bldg., Baltimore 2, Md. No C.O.D.'s, Please!

NO TANKS USED
NEW SIMPLIFIED METHOD
SUCCESS IN THE
ELECTROPLATING
BUSINESS



ELECTROPLATE

ANY OBJECT IN HOME, SHOP, GARAGE OR STABLE
YOUR OWN WELL PAYING ELECTROPLATING BUSINESS

NOW, using NEW plating kit.

It's easy to electroplate any object. Complete kit and instructions on plating metal and non-metal objects, with nickel, copper, chrome, gold, etc., plus full data on obtaining all the business you desire and make **BIG MONEY** full or spare time. **ONLY \$5.95 SEND NO MONEY**—everything sent C.O.D. plus postage—OR

send \$5.95 now and receive it postpaid. Money back in 7 days if not satisfied. **M. Z. SALES CO., Dept. PM-22, 113 W. 42 St., New York 36, N. Y.**

FROGMEN - SKINDIVERS

Membership is now open in the only non-profit international association dedicated solely to the proper and safe advancement of the exciting new sport of skin diving. Each member receives a large colorful jacket patch, distinctive large decal for window or car, membership card and FREE periodic newsletters containing diving news; treasure hunting, salvage, and spearfishing information and many other items. Membership \$1.00.

MAIL TODAY TO

INTERNATIONAL SKINDIVERS ASSN.
PO BOX 347 LOWELL, MASS.

SEWS LEATHER AND TOUGH TEXTILES LIKE A MACHINE

With **SPEEDY STITCHER** Automatic Sewing Awl, anyone can quickly and skillfully sew or repair anything made of **LEATHER, CANVAS, NYLON, PLASTIC**, or other heavy materials. Sews firm, even lock-stitches like a machine. Gets into hard-to-reach places. Specially made for heavy duty sewing on **LUGGAGE, FOOTWEAR, RUGS, AWNINGS, SADDLES, SADDLERY, UPHOLSTERY, OVERALLS, AUTO-TOPS, SPORTS GEAR**, and other tough sewing jobs. Here's the handiest tool you'll ever own. Will save you many times its small cost. Comes ready for instant use . . . complete with bobbin of waxed thread and 3 different types of diamond-pointed needles. Easy-to-follow directions will make you an expert in minutes. Extra needles and waxed-thread always available. Save money, send \$1.98 for post-paid delivery. If C.O.D., \$1.98 plus postage. **MONEY BACK GUARANTEE.**

SPORTSMAN'S POST
366 Madison Ave., Dept. A-342, New York 17



ONLY **1.98**

SAVE 1 GALLON IN 10!



Quickly Pays for Itself

with the new Econ-o-Miser Fuel Pressure Regulator

Here's a remarkable development that will be standard equipment on all new cars within the next 5 years: the amazing new Econ-O-Miser that eliminates gas waste, saves up to 25% on gas consumption!

The precision-built Econ-O-Miser incorporates a large and sensitive diaphragm which causes an absolutely even fuel flow under all conditions, permits the ideal fuel-air mixture for top carburetor efficiency.

GIVES FASTER STARTS AND SMOOTHER IDLING

The Econ-O-Miser is guaranteed to give you smoother, faster acceleration. It eliminates excessive pressure on the carburetor, takes out "surge," prevents stalling, vapor lock, and flooding. You can easily install the Econ-O-Miser yourself.

TRY THE ECON-O-MISER AT OUR RISK!

If it doesn't pay for itself in gasoline savings in the first 5,000 miles of driving, return it for a full refund of your purchase price!

Some car-owners report mileage gains of 20% to 25%. Think of the money saved - \$40 or \$50 every few months! Why not keep this money in your own pocket by installing an Econ-O-Miser right away? **USE THE COUPON NOW**



Carburetor works at maximum efficiency at 2 lbs. pressure. Without pressure regulator, fuel pump at high speeds can develop pressures up to 40 lbs., forcing gasoline through carburetor and causing fuel waste, loading up, flooding, stalling.

What the ECON-O-MISER Does for You:

- 1 Smooths out fuel pump pulsations — eliminates surge.
- 2 Eliminates excessive pressure and loading of carburetor.
- 3 Prevents annoying vapor lock.
- 4 Gives you smoother idling and faster starts.
- 5 Prevents flooding and stalling due to excessive pressure.
- 6 Saves gasoline — up to 25%!
- 7 Reduces carbon formation — helps keep engine clean.
- 8 Saves frequent carburetor adjustment.
- 9 Reduces fire hazard.
- 10 Automatically adjusts for any altitude.

DEALER AND DISTRIBUTOR OPPORTUNITY

A complete dealer-distributor network is now being set up. If you are interested in an exclusive protected territory, write, wire or phone today.

CARPARTS CORPORATION
12381 Wilshire Blvd., Los Angeles 25, Calif.

Only \$6.95

FOR ALL MAKES AND MODELS OF CARS AND TRUCKS

CARPARTS CORPORATION, Dept. PM-16
12381 Wilshire Blvd., Los Angeles 25, Calif.

Here is my check or money order. Please rush me Econ-O-Misers @ \$6.95 each, shipping charges prepaid, on money-back guarantee of satisfaction.

NAME _____
ADDRESS _____

BIG PAY JOBS

for men who qualify in

DIESEL



TRAIN NOW FOR A DIESEL FUTURE. Steady, high-pay jobs await men qualified in Diesel, Tractor, and Heavy Equipment. Are you qualified for job and advancement opportunities in this fast-growing field? You can qualify!

COMPLETE DIESEL COURSE NOW AVAILABLE. If you are ambitious and want to get ahead in this big money field, you'll want to know about the complete Diesel home training course now offered by Interstate Training Service. Covers all phases of operation, repair, service. Easy to master in spare time. No interference with present job. Up-to-the-minute. Regularly revised to cover new developments. We invite comparison of material offered. Advisory placement service for our students.



YOU OWE IT TO YOURSELF to investigate Interstate Training Service Diesel Training. Thousands agree it has helped them to better jobs...better pay. It can do the same for you!

WRITE FOR FREE INFORMATION TODAY

INTERSTATE TRAINING SERVICE, Portland 13, Ore.
Please see that I receive FREE 24-page book, "Getting Ahead in Diesel." (A-3)

NAME _____ AGE _____
ADDRESS _____
CITY _____ ZONE _____ STATE _____

WARN HUBS for 4-WHEEL DRIVES



Make 2 Vehicles Out of 1!

Over 75,000 satisfied users! Warn Hubs disengage front power train for 2-wheel drive use—stop drag, gear whine, front end shimmy; save gas, gears, tires. Use your 4-wheel drive for any purpose, any time, with Warn Automatic or Locking Hubs. Models for all makes of 4 W. Ds. to 1½ tons at dealers, or write:



WARN MFG. CO., Riverton Box 6064A1, Seattle 88, Wn.

**AUTOMATIC
FREE-WHEELING
2-WHEEL DRIVE
OR HIGH SPEED
4-WHEEL DRIVE
AS YOU SHIFT!**

JEEP OWNERS

STA. WAGONS • JEEPSTERS • PICK-UPS!

Take full advantage of 4-wheel drive by installing a Ford V-8 engine—MORE POWER—means less shifting, better traction at lower speeds, greater safety, plenty of power in high. All this is now possible by using our F-3 adaptor plate. Conversion Kit \$43.25 incl. FED. TAX. Please indicate year of engine you will use and whether 2 or 4 wheel drive. Write for free details or send check or M.O. for prepaid delivery. Order now for early shipment.

HOOSIER MACHINE PRODUCTS CO.

312 S.E. 6th St. Pendleton, Oregon

AUTO GOOD PAY FOR YOU IN MECHANICS

Why settle for less when you can learn Auto Mechanics—America's No. 1 trade! It offers you better jobs, higher pay, lifetime security. Earn up to \$125 a week and more. Train at home the easy, practical CTI way. Get valuable tools and a Tune-Up Kit. Write for new, FREE BOOK.

COMMERCIAL TRADES INSTITUTE Dept. A-160
1400 Greenleaf Avenue • Chicago 26, Ill.



Homeowner's DO-IT-YOURSELF IDEA BOOK

**only 75¢ at
YOUR FAVORITE
NEWSSTAND**

Popular Mechanics Press has come out with a new type of book. Now you can have, in one volume, information on every kind of job and project around the home. Learn how to upholster with foam rubber... use prefinished paneling... lay flagstone walks. Fix wobbly chairs and faded carpets. Sharpen scissors, remove paint, modernize old doors. 160 pages long—over 900 subject listings in the handy index. Ask your dealer for a copy today.



Genuine Western 4-Ply Hand Plaited Leather

Train Animals, Pets! Self Defense! Do Tricks! Loud Noise Like Bang of a Shot Gun!

PLAITED LEATHER BIG BULL WHIP

Exports knock ashes off cigaret, gun out of hand, yank people off feet, etc. Used by trainers, ranchmen, etc. Grip lightly (pressure is on loop), then crack or coil; snake out or back; overhand, underhand, side-arm. Neat's oil finished for pliability & long life. "Cracker" or tongue on end. Solid grip handle with loop.

6-ft. Whip \$1.98; 8-ft. Whip \$2.69.

JOHNSON SMITH & CO., Dept. 297, Detroit 7, Michigan

POWERFUL ELECTRIC GENERATOR

Cost Over \$20.00 New; While They Last, \$3.95

Generates Up To 75 Volts. Use to generate electricity, to ring bells, light up lights, as a medical battery, deliver terrific electric shock as joke, many electrical experiments, classroom uses, etc. Cost over \$20 new. Used but excellent operating condition. Hand crank or gear wheel drive. Made by leading electrical companies. Each has 3 or 4 five-inch 1-lb. bar magnets (alone worth more than total cost), generating armature, wire leads, gear crank, ready for use. Originally used in crank phones. Complete unit weighs over 5 lbs. Each Postpaid \$3.95 (Over 1000 miles from Detroit, send \$4.95, otherwise shipped express charges collect). Telephone Mike \$1.75. Mail order to Johnson Smith Company, Dept. 297, Detroit 7, Mich.



The Catalog Featured on Cover of "Mad" Comics!

**New
1956 Issue**

Catalog of 3,100 Novelties, Gadgets, Jokes & Tricks

Send 10c for amazing catalog of novelties, joke articles, funmakers, tricks, gadgets, live animals, scientific supplies, hobbies, planes & boats, unusual seeds, time-savers, cameras, optical goods, projectors, movies, lucky jewelry, religious goods, disguises, masks, musical instruments, stamps, coins, puzzles, fortune tellers, radios, auto & bike accessories, telescopes, magnifiers, compasses, banks, smokers' items, artist supplies, printing sets, engines, motors, shockers, knives, billfolds, guns, rifles, sports, books, games, plants, pennants, emblems, etc. Send name, address and 10c to:

JOHNSON SMITH & CO.
Dept. 297 Detroit 7, Mich.

Here's 10c. Rush me New Catalog!

Johnson Smith & Co., Dept. 297, Detroit 7, Mich.

Name _____

Address _____

Check the Kind of Body YOU Want! RIGHT IN THE COUPON BELOW

...and I'll Prove How EASILY You Can Have It!



Valuable Trophy Given Away
Be the envy of friends! Win this strikingly handsome "Atlas Champions" trophy, over 14 ft. high! All copies eligible.

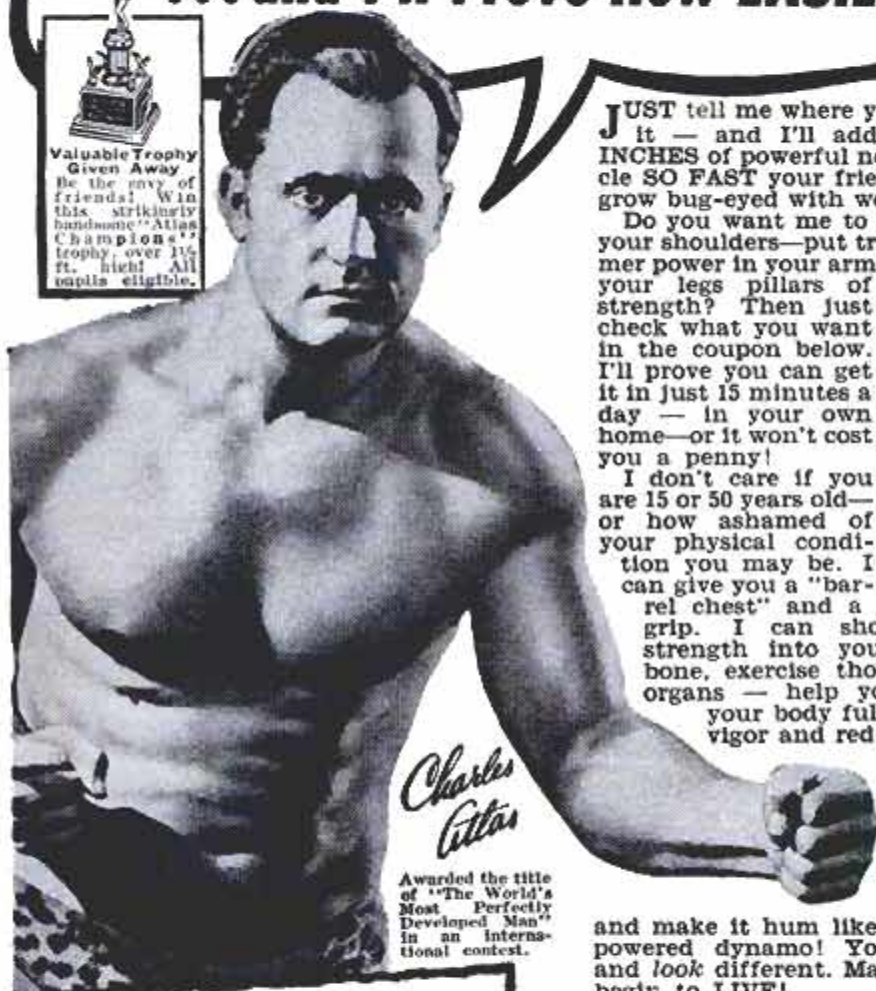

Charles Atlas

Awarded the title of "The World's Most Perfectly Developed Man" in an international contest.

JUST tell me where you want it — and I'll add **SOLID INCHES** of powerful new muscle **SO FAST** your friends will grow bug-eyed with wonder!

Do you want me to broaden your shoulders—put trip-hammer power in your arms—make your legs pillars of strength? Then just check what you want in the coupon below. I'll prove you can get it in just 15 minutes a day — in your own home—or it won't cost you a penny!

I don't care if you are 15 or 50 years old—or how ashamed of your physical condition you may be. I can give you a "barrel chest" and a vise-like grip. I can shoot new strength into your backbone, exercise those inner organs — help you cram your body full of pep, vigor and red-blooded vitality! I'll wake up that sleeping energy of yours

and make it hum like a high-powered dynamo! You'll feel and look different. Man, you'll begin to LIVE!

ling I was at 17 to my present superman physique! Thousands of fellows are becoming marvelous physical specimens — my way. I give you no gadgets or contraptions to fool with. When you develop your strength through "Dynamic Tension" you can laugh at artificial muscle-makers. You simply utilize the dormant muscle-power in your own God-given body—watch it increase and multiply double-quick into real solid LIVE MUSCLE.

My method — "Dynamic Tension" is so easy! Spend only 15 minutes a day in your own home. From the very start you'll be using my method of "Dynamic Tension" almost unconsciously every minute of the day—walking, bending over, etc.—to BUILD THE MUSCLE and VITALITY you want. And you'll be using the method which many great athletes use for keeping in condition — prize fighters, wrestlers, baseball and football players, etc.

ARE YOU

Skinny. Weak and run down?
Always tired?
Nervous?
Lacking in confidence?
Constipated?
Suffering from bad breath?
Fat and flabby?
Do you want to lose or gain weight?
WHAT TO DO ABOUT IT is told in my FREE BOOK

FREE Illustrated 32-Page Book. Just Mail the Coupon.

SEND NOW for my famous book, "Everlasting Health and Strength." (Over 3½ MILLION fellows have sent for it already.) 32 pages, packed with photographs and valuable advice. Shows what "Dynamic Tension" has done for others, answers many vital questions.

This book is a real prize for any fellow who wants a better build. Yet I'll send you a copy absolutely FREE. Rush coupon to me personally: Charles Atlas, Dept. 81, 115 East 23rd St., New York 10, N. Y.



Here's The Kind of Results I Give:

"I gained 11 lbs. and 4¼ inches on my chest, 3 inches on my arms. I am never constipated."
—Henry Neven, Canada

"I gained 34 lbs. and increased my chest 6 inches."
—Stanley Lynn, Calif.

"What a difference! Have put 3½ inches on my chest (normal) and 2½ inches expanded."
—F. S., New York

"Gained 29 pounds. When I started your

course I weighed only 141. Now I weigh 170."
—Y. K., New York

"The benefits are wonderful. The first week my arm increased one inch, my chest two inches."
—E. M., Conn.

"You changed me from a weakling to a real he-man. My chest has gone up 6 inches. I am a solid mass of muscle. Friends and doctors have noticed a great change in me."
—J. W., Montana

WHAT'S MY SECRET?

"DYNAMIC TENSION"! That's the ticket! The identical natural method that I myself developed to change my body from the scrawny skinny chested weak-

CHARLES ATLAS, DEPT. 81
115 East 23rd St., New York 10, N. Y.

Dear Charles Atlas: Here's the kind of Body I Want:

(Check as many as you like)

- More Weight—Solid—In The Right Places
- Broader Chest and Shoulders
- More Powerful Arms and Grip
- Slimmer Waist and Hips
- More Powerful Leg Muscles
- Better Sleep, More Energy

Send me absolutely FREE a copy of your famous book "Everlasting Health and Strength"—32 pages, crammed with photographs, answers to vital health questions and valuable advice. I understand this book is mine to keep and sending for it does not obligate me in any way.

NAME.....AGE.....
(please print or write plainly)

ADDRESS.....

CITY.....STATE.....

RUSH COUPON FOR FREE BOOK

HOW TO GROW ORCHIDS IN YOUR HOME

NO GREENHOUSE NEEDED YEAR 'ROUND - ANY CLIMATE - MAINE TO CALIFORNIA

Most enjoyable hobby I know. People drove 100 miles to see this plant... 10 flowers, 8 1/2 inches across!

THOMAS MURST—Utah



Home Growers Coast to Coast Benefit from the Schirmers' Help

FILL YOUR HOME WITH ORCHIDS... EVERY MONTH OF THE YEAR.

Successful family of home growers now reveal their secrets for your pleasure and profit. Learn the exciting facts about raising beautiful Orchids at home... how to grow dozens of varieties in every rainbow color... have Orchids in full bloom every month of the year! Many grow without soil, getting food from the air. No Greenhouse Needed. Start on table or window ledge. THRILLING HOBBY—EXCITING HOME BUSINESS. delight of watching gorgeous Orchids burst into bloom right in your own living room! The big lavender corsage Orchids you see in every flower shop—also many others in all sizes and colors. Orchids for your own enjoyment, for gifts or to sell at good profits.

FINE PROFITS—ANY LOCATION—RETAIL—WHOLESALE—MAIL ORDER. Learn how to market your Orchids for profit, no matter where you live—small town, big city, or on a farm. Millions sold by mail order, year 'round. Tropical Flowerland's "Quick-Profit Plan" helps you get started at once, without investment in stock. No overhead.



My Orchids are doing fine. I sell many blooms and haven't really started to try yet. I owe my success to the Schirmers.

MRS. FRANK HARWOOD—Oregon



LOUIS and GLADYS SCHIRMER SUCCESSFUL HOME-GROWERS SAY: "We'll Show You How We Raised Orchid Plants Worth a Fortune—Starting At Home in Spare Time."

FUN FOR ALL THE FAMILY. It's great fun to grow Orchids. And the whole family can help—from teen-agers up. Mr. Schirmer himself is over 60—was nearly 50 when he and Mrs. Schirmer first started to grow Orchids for profit. LEARN HOW ORCHIDS MULTIPLY. Learn how one plant may become many, each as valuable as the first! Flower production and plant stock should both increase steadily—year after year—and so should your profits!

COMPLETE INSTRUCTIONS and Blooming-Size Orchid Plant Sent for You to Examine at Home without Risk!

Airmail coupon today for amazing offer of Complete Home Course and a real blooming-size Orchid plant for you to examine at home without risk! Nearly 300 large-size pages, filled with "show-how" drawings and

photos—many in full color. Shows you how to grow 30 different kinds of Orchids at home, and market them for extra income—spare or full time. Send no money—fill out and send in the coupon. Airmail is quickest.

TROPICAL FLOWERLAND, Dept. 311, 4422 Wilshire, Los Angeles 5, Calif.

FREE—AIRMAIL THIS COUPON NOW!



Name _____ Street _____ Town _____ Zone _____ State _____



I have standing orders for future issues and divisions of this plant. I shall always be grateful to the Schirmers.

MRS. ROBERT E. LEE—Ohio

Los Angeles 5, Calif.

Paint STRIPES with New "PAINT PEN"!

Straight, Curved or Parallel Lines

Use like a fountain pen with any color paint to stripe furniture, bikes, autos, model planes, toys, linoleum, wall board. Beautiful clean, crisp results every time. Can't clog or smear. Also use with glue, tempera, textile paint or ceramic under glaze. Paints on wood, glass, plastic, metals, fabrics and paper. Tool complete with tip for 1/16" stripe only \$1.25 postpaid. Other complete tools with following tips, 1/64", 1/32", 3/64", 5/64", 3/32", 1/4"—\$1.75 each. Extra tips 90¢ each. Entire kit with tool and 7 tips—\$5. A 1/4" tip only \$1.20 each. C.O.D.'s postage collect.

New! "DOUBLE-STRIPE" 5 Way Combination Model only \$3.25

Double Stripes—one wide and one narrow or two wide or two narrow at the same time.

FREE Send postcard for complete information—or ORDER TODAY.



\$1.25

DEALERS: Master Paint Stripping Tool in display cartons of 1 doz. FAST, PROFITABLE SALES. Write for new discounts.

HOME CRAFTSMEN! New Paint Stripping Tool gives "professional" results every time, simple, easy to use. Send \$1.25 now.

MANUFACTURERS: Write today for information about industrial models and production stripping tools.

WENDELL MFG. CO., Dept. 313 4234 Lincoln Ave., Chicago 18, Ill.



Cuba's famous stamps of 1946, showing actual train wreck scene! Complete set of 3, a dramatic display for your collection, only 10¢. Handsome, exciting stamps to look over, too, without charge or obligation. WINTHROP STAMP CO., Dept. P-1, GROTON, CONN.

\$2.95 OR 2 FOR \$5.00! Genuine Telephone Company Upright Telephones, tested and guaranteed with 50 ft. of wire and inter-communication instructions. Complete line of telephones, dial, magneto, etc. Write for free list. All shipments F.O.B. Simpson, Pa. 50% deposit required on all C.O.D. orders. TELEPHONE ENGINEERING CO., Dept. 1856, Simpson, Pa.

60 POWER TELESCOPE \$3.98

VARIABLE EYEPIECE 20X-40X-60X — BRASS BOUND NEW! Three telescopes in one. 3 different magnifications. 20 power for ultra-bright images with 40 and 60 power for extra long range. Guaranteed to bring distant objects, people, sports events, ships, moon, stars, etc. 60 times as close.

Most powerful for any where near the moon. ey. 5 sections. Close to 1 ft. long. Contains 4 ground and polished lenses. Also used as a powerful compound microscope. Directions included. Mass production enables us to offer this instrument at amazing price of \$3.98 complete. Money back guarantee. We pay postage. Get yours now. CRITERION CO., 331 Church St., Hartford, Conn., Dept. PMB 30

MEN WANTED Earn \$100 Per Week and up

Master a trade with a future—learn Auto-Diesel mechanics in our shops. You learn with tools on real equipment. Earn while you learn. Many of our graduates earn \$100 per week and up. No previous experience necessary. Day and night courses. Approved for veterans. Write for free bulletin.

NASHVILLE AUTO-DIESEL COLLEGE 226 7th Ave., N., Dept. 75 Nashville 3, Tenn.

Say You Saw It in Popular Mechanics

COMPLETE NEW FALSE IN 24 PLATE HOURS FROM YOUR OLD \$15.95 NOW LOW AS . . .

New process transforms old, broken or loose plates into new lightweight plastic plates. NO IMPRESSION NEEDED. Let us help you enjoy life again. You will marvel at this revolutionary new method. Using your own old plates, we will remake them completely in only 24 hours. Missing teeth are carefully matched and replaced. Work is done on an absolute MONEY BACK GUARANTEE. SEND NO MONEY—just rush your name and address for full FREE DETAILS. If your teeth are loose, we'll tell you how to tighten them before duplication. Act now. Tru-Grip Dental Labs., 7th Fl., 127 N. Dearborn, Dept. 81, Chicago 2, Ill.

FIX TV AND RADIO SETS RIGHT AWAY

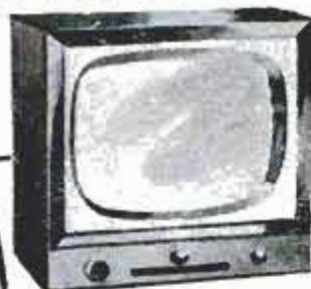

—even if you never fixed a lamp or doorbell before!

McGraw-Hill's Amazing New Low-Cost Instruction Manual Skips Hard-to-Understand "Theories" and "Formulas." Tells How-to-do-it in PLAIN ENGLISH!



WHY hasn't somebody done this **BEFORE**? That's what you'll exclaim the minute you see this amazing new one-volume instruction manual in TV and radio repair.

For here at last an **EXPERT** tells you in **PLAIN ENGLISH** how to fix almost **ANY** radio or television set. (And he even tells you where you can go to have the extra-tough jobs done **FOR** you . . . at reduced professional rates.) Right from the very first chapters you can start doing simple repairs . . . and before you're **HALF** way through the manual, you can fix **HALF** the television and radio sets that you encounter. In just a few weeks you can start fixing your own and friends' sets . . . get a service shop job . . . even start your own money-making business at home.



Save Money on Your Own Set

Save \$50 to \$100 a year just in installing, repairing, and servicing your own TV set. Book tells which controls to adjust or tubes to replace if picture is entirely dark — blurred — split — distorted — off center — tilted — wiggles and weaves — too pale — too black — jitters — snow effects — drifts — etc., etc.

The author, Associate Editor of *Electronics Magazine*, spent four years making this manual practical and easy-to-understand — even for a beginner.

Here's everything you need to know about *where* and *how* to buy tubes and parts, where and how to get an official circuit diagram for any receiver; how to use basic tools; how to test tubes **WITHOUT** a tube tester; how to use 58 common TV controls; how to "diagnose" and "cure" common radio and TV troubles; how to fix loudspeakers, phono pickups; how to install antennas; and much, more more.

SEND NO MONEY

Examine this book for 10 days **FREE**. Try it out on your own or a neighbor's set. See how simple it makes nearly every repair job. Make it pay for itself in 10 days or don't keep it! Mail coupon to: **McGraw-Hill Book Co., Inc., Dept. PM-1, 327 West 41st St., New York 36, N. Y.**

Why It's So EASY to Understand

No complicated formulas, algebra, laboratory experiments. You deal *only* with the parts that go wrong in sets—how to recognize the trouble—and what to do about it. "Easy as A-B-C" directions and 700 clear photos, diagrams, and drawings show you exactly **WHAT** and **HOW** to fix, step-by-step.

Tells HOW To "Cash In" ON THE BIG DEMAND FOR RADIO-TV REPAIRMEN

Over 25 million TV sets . . . over 100 million radios! Make nice extra money just fixing sets for friends and neighbors in your spare time . . . or start your own full-time repair business. Book tells exactly how to get started; which tubes to stock; how to make a service call. Actually start fixing sets and making money before you're half-way through book.



Same FREE Offer on "Repairing Record Changers" Manual

Gives ABC'S OF ALL repair jobs on EVERY record changer model — from simple needle troubles to most complex breakdowns. Step-by-step directions, pictures and diagrams make every adjustment, replacement, or repair clear and easy. Cov-

ers portables, HI-FI units, tape recorders. Includes everything you need to know to **SAVE** money on your own repairs or start a profitable business. Check proper box in coupon for **FREE TRIAL!**



TELEVISION AND RADIO REPAIRING

TRY IT FREE ON YOUR OWN SET FOR 10 DAYS

PARTIAL CONTENTS

How to Remove and Replace Tubes
 • Testing Tubes without a Tester
 • Using a Tube Tester
 • Power-Supply Troubles
 • How to Test and Replace Resistors, Controls, Switches, Condensers, Coils, Transformers
 • Loudspeakers
 • Phono Pickups and Needles
 • Antennas . . . MUCH MORE.

"Written as simply and clearly as possible. A natural for the beginner."
 —Radio & TV News

"Prepared for people who know absolutely nothing about radio or use of tools."
 —Radio Electronics

FREE 10-DAY TRIAL COUPON

McGraw-Hill Book Co., Dept. PM-1
 327 West 41st St., New York 36, N. Y.

Please send me, for 10 Days' **FREE EXAMINATION**, the book(s) checked below. If not delighted, I may return book(s), pay nothing.

"Television and Radio Repairing." If I keep it, I will send only \$1.95 plus few cents delivery; then 3 monthly installments of \$2.00 each.

"Repairing Record Changers." If I keep it, I will send only \$1.95 plus few cents delivery; then 3 monthly installments of \$2.00 each.

Name _____ (PLEASE PRINT CLEARLY)

Address _____ PM-1

City _____ Zone _____ State _____

SAVE MONEY. Check here if enclosing full payment WITH coupon (\$7.95 for TV Repair Book; \$5.95 for Record Changer Repair Book). Then WE will pay postage. Same 10-day return privilege. (Offer good only in U.S.A.)

MANUFACTURE THIS BEAUTIFUL CONCRETE OUTDOOR FIREPLACE

Right In Your Own Backyard

\$4.00 Worth of Sand & Cement produces this Attractive Fireplace.

Sells on Sight from \$60. to \$80. Easy to start your own Profitable Business.

The General Fireplace Molds and Process are the most amazing and foolproof ever invented. Simple to operate. Two men can produce five fireplaces a day.

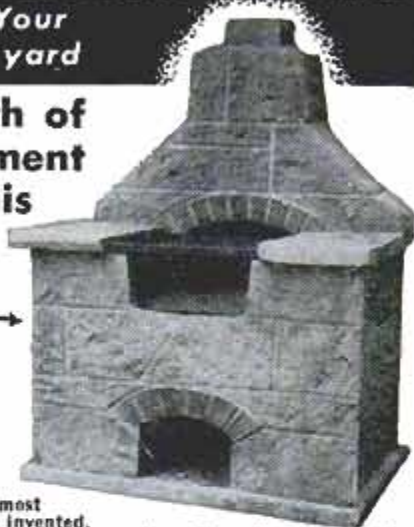

BIG DEMAND!!

Sell all you produce to Department Stores, Homeowners, Parks, Nurseries and Picnic Groves. Fireplaces sell on sight. No experience necessary. We supply full operating instructions and equipment plus the know-how that spells BIG PROFITS. This is an outstanding opportunity for men of vision and small capital to get into a busy rich paying field. Don't delay, be the only exclusive manufacturer in your own home town. Mail coupon at once for full details as to how you can reserve your territory. Molds sold only on exclusive franchise.

GENERAL ENGINES CO., Inc., Dept. MF-16
ROUTE 130, THOROFARE, N. J.

Mr. Tor of Philadelphia writes: Sold 250 in first 4 months. Selling to Sears Roebuck, Jahn Wanamaker, and Gimbel Bros. in Philadelphia area.

Name
Address
City Zone
State

HIGH WAGES!

Are being paid to Operators of Bulldozers, Draglines, Back Hoes, Earthmovers and Motor Graders. Contractors want our graduates. Learn these skills NOW

National School of Heavy Equipment Operation
P.O. Box 8243-D-5, Charlotte, N. C.

Please send me your School Catalog FREE

Name
Street Address
City State



GENUINE TOLEDO BLADES

Includes original hand

made steel scabbard as shown

Cavalry Sabres. They are just over three feet long overall. Blades are engraved with the Royal Spanish crown with "Toledo," major Spanish arms center and for over 1000 years the world's leading sword-making city. All are used, guaranteed in good condition. Our European agent informs us that these sabres are about 1875 vintage. They were imported directly by us.

For C.O.D. send \$3 deposit. Send check, cash or money order. Calif. residents only send 3% state tax.

ANTIQUE ROYAL SPANISH CAVALRY SABRES \$995
ppd.

The Swordsman

104 Army Bldg.

1165 E. COLORADO BLVD., PARADISE 1, CALIF.

Auto Service Men . . . STEP UP YOUR PAY!



New Sun School Makes it Easy!

Be an EXPERT in Scientific Engine Tune-Up and Service!

Sun-trained experts in the use of electronic engine test equipment are in demand now! They MAKE MORE MONEY because they know how to use the "tools" which can quickly and profitably keep today's complex engines tuned up to their full power and economy levels!

You Can Provide This Service and Increase Your Earnings—*it's easy the Sun way!*

Sun Electric Corporation, Chicago—world's largest

Costs are LOW . . . plan NOW to increase your skill and position in the industry! Send for complete information . . . FREE Brochure!

DRAW ANY PERSON IN ONE MINUTE

Anyone Can Draw With This Amazing New Invention—Instantly! The "Magic Art Reproducer"

NO LESSONS! NO TALENT!

You Can Draw Your Family, Friends, Anything From REAL LIFE—Like An Artist Even if You CAN'T DRAW A Straight Line!



Also Excellent for Every Other Type of Drawing!

• Human Figures • Outdoor Scenes, landscapes, buildings • Still life, vases, bowls of fruit, lamps, furniture, all objects • Copy photos, other pictures, portraits, etc. • Copy blueprints, designs, decorations, etc., for woodwork, machine, for needlework, crocheting, knitting • Copy all cartoons.

Complete for only \$1.98

Yes, anyone from 5 to 80 can draw or sketch or paint anything now . . . the very first time you use the "Magic Art Reproducer" like a professional artist—no matter how "hopeless" you think you are! Anything you want to draw is automatically seen on any sheet of paper instantly! Then easily and quickly follow the lines of the "picture image" with your pencil . . . and you have an accurate original drawing that anyone would think an artist had done. Also makes drawing larger or smaller as you wish. Anyone can use it on any desk, table, board, etc.—indoors or outdoors! No other lessons or practice or talent needed!

Have fun! Be popular! Everyone will ask you to draw them. You'll be in demand! After a short time, you may find you can draw well without the "Magic Art Reproducer" because you have developed a "knack" and feeling artists have—which may lead to a good paying art career.

FREE with order

A.B.C. Guidance of Figure Drawing
This valuable illustrated guide contains simple guidance on drawing human figures. Includes techniques, shading, proportions, etc., to use with your "Magic Art Reproducer" for added touches to your drawings.

SEND NO MONEY! Free 10-Day Trial!

Just send name and address. Pay postman on delivery \$1.98 plus postage. Or send only \$1.98 with order and we pay postage. 10 Day Trial must satisfy or money will be refunded.

NORTON PRODUCTS, Dept. 5801W, 298 Broadway, N.Y. C.

FREE! 60 APPROVED EXERCISES, 68 PHOTOS with FAMOUS DAN LURIE



LOW DIRECT PRICE

BARBELLS

50 lb. set \$ 8.48 • 100 lb. set \$13.98

150 lb. set \$20.48 • 200 lb. set \$25.98

SEND FOR FREE CATALOG

Order by mail—50% with order Balance COD. Extra WTS. 13¢ lb. FOB Plant.

DAN LURIE BARBELL CO.

52M1 Bristol St., Dept. 559A, Brooklyn 12, N.Y.

SEE DAN ON T V "BIG TOP" SHOW

Prepare for a Good Paying Job — Or Your Own Business

Learn PRACTICAL RADIO-TV
with 25 BIG KITS

of equipment I send you while
you train with me . . . for valuable
shop bench experience . . .

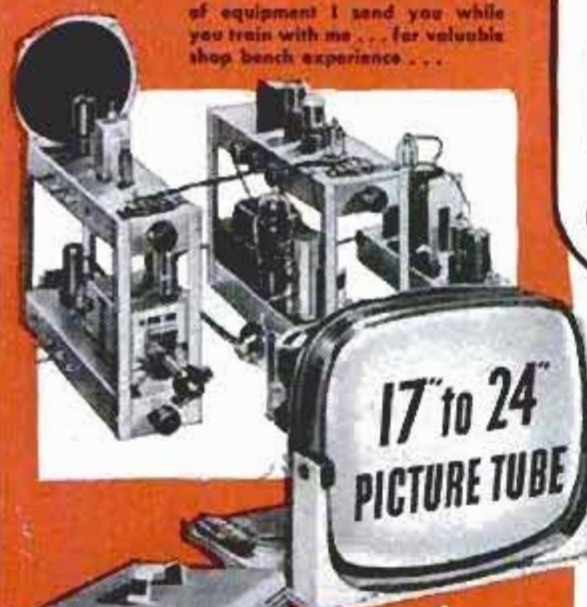

17" to 24"
PICTURE TUBE

The new Sprayberry Training
Television receiver,
built and tested in sections.

I now offer this fine modern
oscilloscope.

You build this powerful 2
Band superhet radio re-
ceiver.

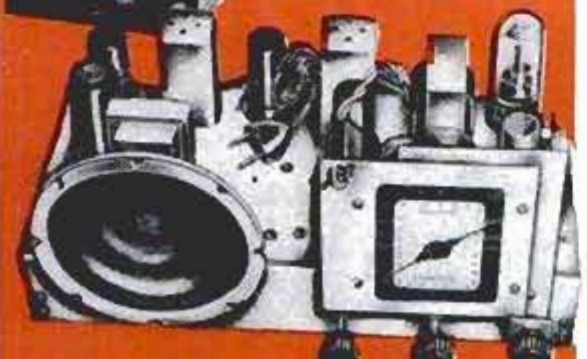

You build the new
Sprayberry Tester . . . 18-range
Volt-Ohm-Milliammeter readings.

In addition to modern lesson training, I also give you
plenty of home practice on actual Radio-Television
equipment . . . you will build and use the units shown
here plus many more. All this equipment is yours to
keep . . . keep everything you need to set up your shop.

"I Will Train You at Home in
RADIO-TELEVISION
on Liberal No Obligation Plan!"

New Equipment! New Lessons! Enlarged
Course! The true facts are yours in my
big new catalog . . . YOURS FREE . . .
JUST MAIL COUPON!



Frank L. Sprayberry
President, Sprayberry
Academy of Radio

I can train and prepare you in as little as
10 months to step into the big opportunity
Radio-Television service field. Train *without*
signing a binding contract . . . without obli-
gating yourself to pay any regular monthly
amounts. You train entirely at home in spare
hours . . . you train as fast or as slowly as
you wish. You'll have your choice of THREE SPRAYBERRY TRAINING
PLANS . . . planned for both beginners as well as the more experienced
man. Get the true facts about the finest most modern Radio-Training avail-
able today . . . just mail the coupon for my big new 56 page fact-filled
catalog plus sample lesson—both FREE.

Train the Practical Way—with Actual Radio-Television Equipment

My students do better because I train both the mind and the hands. Sprayberry
Training is offered in 25 individual training units, each includes a practice giving
kit of parts and equipment . . . all yours to keep. You will gain priceless practical
experience building the specially engineered Sprayberry Television Training Re-
ceiver, Two-Band Radio Set, Signal Generator, Audio Tester and the new Spray-
berry 18 range Multi-Tester, plus other test units. You will have a complete set
of Radio-TV test equipment to start your own shop. My lessons are regularly
revised and every important new development is covered. My students are com-
pletely trained Radio-Television Service Technicians.

**NEWEST
DEVELOPMENTS**

Your training
covers U H F, Color
Television, F M,
Oscilloscope
Servicing, High
Fidelity Sound
and Transistors.

**See for Yourself . . . Make Your Own Decision
. . . Mail Coupon Today!**

The coupon below brings you my big new catalog plus
an actual sample Sprayberry Lesson. I invite you to read
the facts . . . to see that I actually illustrate every item
I include in my training. With the facts in your hands,
you will be able to decide. *No salesman will call on you.*
The coupon places you under no obligation. Mail it now,
today, and get ready for your place in Radio-Television.

SPRAYBERRY ACADEMY OF RADIO
111 North Canal Street, Dept. 10-G, Chicago 6, Illinois

Mail This Coupon For Free Facts and Sample Lesson



SPRAYBERRY ACADEMY OF RADIO
Dept. 10-G, 111 N. Canal St., Chicago 6, Ill.

Please rush all information on your ALL-NEW Radio-Television
Training Plan. I understand this does not obligate me
and that no salesman will call upon me. Include New Cata-
log and Sample Lesson FREE.

Name _____ Age _____
Address _____
City _____ Zone _____ State _____

THIS TRAINING PAYS OFF FAST!

NO EXPERIENCE NEEDED
This **NEW PRACTICAL**
DELEHANTY PLAN entails
NO RISK, NO OBLIGATION
Money Back Guarantee

EARN EXTRA MONEY in SPARE TIME in a few weeks! And GOOD FULL TIME JOBS at HIGH PAY... or a PROFITABLE BUSINESS of YOUR OWN in matter of months!

Learn **TELEVISION RADIO & ELECTRONICS**
AT HOME
We furnish ALL Your EQUIPMENT without Extra Charge!

YOU GET FULL-SIZE
21" TV SET & TUBE
at No Extra Charge!

YOUR PRACTICAL SHOP WORK STARTS WITH VERY FIRST LESSON FIRST KIT OF TOOLS SENT IMMEDIATELY!

Now you can learn money-making skills right from the start! Soon your training will be paying for itself... and more! Entirely NEW, COMPLETE, UP-TO-THE-MINUTE practical shop course includes Color TV, UHF, Printed Circuits, Transistors, etc.

ESTAB. NEARLY 50 YRS. — HALF A MILLION GRADUATES
Study at your own pace. Send for each unit as you need it and pay only when you order. All units SAME LOW PRICE! We send you 15 Big Kits to build and keep 21" TV Set complete with 21" Tube, Super-Hel. Radio, Multimeter, etc. We supply attractive sturdy 3-ring binders for your lessons which become valuable permanent reference library. NO EXTRA CHARGES FOR ANYTHING!

YOU DON'T RISK A PENNY — YOU SIGN NO CONTRACT!

Send TODAY for FREE Illustrated Booklet

DELEHANTY INSTITUTE of TELEVISION

APPROVED BY EDUCATION DEPT. OF N. Y. STATE

115 EAST 15th STREET, NEW YORK 3, N. Y.

NAME _____
ADDRESS _____
CITY, ZONE & STATE _____ PM156

"HOW I DOUBLED MY INCOME In Less Than A Year, As A CUSTOM UPHOLSTERER"



Alvin Ledarkramer, Former Low Salaried Auto Mechanic — Now Earning Big Pay

"When I enrolled for UTS training I was an auto mechanic earning a meager salary. While learning I earned good spare-time money. After graduation, I got a job in upholstery with better pay than ever before. Now, less than one year later, I've doubled my income. Soon, I'll get into my own business. The future looks bright, thanks to UTS."

WHAT DO YOU WANT? Your Own Profitable Business—A Steady Job—Substantial Sparetime Earnings—A More Secure Future? They're all waiting for YOU in the Big-Opportunity Field of Custom Furniture Upholstery.

The big nationwide housing boom has created a great demand for trained upholsterers. Prepare for this well-paid trade—easily, quickly. You can earn as you learn to make good money all year 'round at home, in your own shop, or in a well-paid job. The practical N. Y. State-approved UTS Course teaches you professional custom furniture upholstery, reupholstery, slip-covers, furniture finishing, window cornice, cushion, and drapery making. Course includes—FREE—ALL tools, complete frames and materials.

FREE ILLUSTRATED BOOK WITH SAMPLE LESSON!

Our FREE book, "YOUR NEW WAY TO A SUCCESSFUL CAREER" with Sample Lesson shows you how. WRITE TODAY! Training in N. Y. School also available. Upholstery Trades School, Dept. EA-305, 721 B'way, N. Y. 3

MATERIALS FREE WITH COURSE YOU MAKE

SLIPPER CHAIR

CLUB CHAIR

OTTOMAN

PLUS SLIP COVERS
Yours to keep or sell

MAIL COUPON TODAY

APPROVED FOR VETERANS

UPHOLSTERY TRADES SCHOOL, Dept. EA-305
721 Broadway, New York 3, N. Y.

Please send me FREE book with FREE Sample Lesson. No obligation—no salesman will call.
 Home Study In N.Y. School Training

Name _____
Address _____

City _____ Zone _____ State _____
— Check if Korean Veteran

Treasure Chest OF 513 PRIZED STAMPS



Yours
For Only
35¢

including stamps from
**PIRATE STRONGHOLDS
ALL OVER THE WORLD!**

YOU'LL BE "RICH" IN STAMPS when you receive this "Treasure Chest" of 513 valuable stamps from all over the world: Bahamas, Barbados, Haiti, Trinidad, Madagascar—all the fabled haunts of such PIRATES, as Blackbeard, Captain Kidd, Henry Morgan, etc. All different! What treasures will YOU discover? Total stamp-catalog value guaranteed to be AT LEAST \$10. But YOU pay only 35¢!

YOU ALSO GET a free copy of "How to Collect Stamps" if you order NOW. Other interesting offers included for your inspection. Mail this ad with name and address, clearly printed, and only 35¢ to: LITTLETON STAMP CO., Dept. PM-1, Littleton, N. H.

earn as **TAX EXPERT**
\$15
HOURLY
Our students earn as much as \$3,000 in 3 short months preparing income tax returns in spare time. Also operate lucrative year-round Business Tax Service. Dignified home-office business. Experience unnecessary. We train you to help you start. State approved home training program. Write today for free prospectus.
UNION INSTITUTE, 68 Hudson, Hoboken 20F, N. J.

"Building Beautifiers" Can Earn High Incomes

Colorcrete, a cementitious plastic, gives lifetime beauty and protection to drab, dirty masonry — concrete, stucco, etc. — on all kinds of buildings. Tough, tenacious, enduring. Easily cleaned. Helps to daylight dark interiors. Choice of gleaming white or 30 colors. Applied under pneumatic pressure to form an inseparable bond.



More Colorcreters are needed to supply the ever-increasing demand. Low investment appeals to men of limited capital. Work is easy, fascinating, highly profitable. Broad opportunity to develop a lifetime business. No special ability or experience needed because we supply full instructions and sales co-operation. Colorcrete machine is simple to operate, easy to move around. Write today for Opportunity Book.

Colorcrete Industries, Inc. **COLORCRETE**
570 Ottawa Av., Holland, Mich.

IN CANADA: DUNN MASONRY MACHINERY LIMITED
1020 Dundas Highway, Cooksville, Ont.

MAKE UP TO \$10 AN HOUR AT HOME WITH 50¢ WORTH OF MICRO-FLUFF

HIGH COST OF LIVING GETTING YOU DOWN

Want to add an extra \$100 or more to your regular monthly pay check in a few **SPARE TIME** hours of pleasant occupation **AT HOME**? That's just the position I was in a few years ago when I ran across an Old-World formula for applying short cotton fibers to practically any surface, in such a manner that it looked and felt just like costly velvet or velour.

THIS PROCESS AMAZED ME

I spent several years experimenting until I developed what I now call the **FLOK-KRAFT MICRO-FLUFF** method. This **NEW METHOD** is far removed from the Old-World way of applying these short fibers. Also it permits the use of tiny fibers of **RAYON** and other modern materials in **MANY COLORS** in addition to cotton.

NO OVERHEAD—NO EXPENSIVE EQUIPMENT

Start in your basement, garage, attic, service porch, or even on a card table in your bedroom. With an hour's practice you can apply a few pennies worth of **FLOK-KRAFT MICRO FLUFF** to a yard or two of butcher paper, and make it look like \$15-a-yard velvet for window displays in the finest jewelry, gift, or department stores, etc. Takes only a few minutes and practically no effort.

MICRO-FLUFF IS BEAUTIFUL AND LONG WEARING

Truly the most amazing material you ever saw, **MICRO-FLUFF** comes in every color of the rainbow, is long lasting, has the **TOUCH** appeal of luxurious velvet or suede, and goes on practically any surface—paper, metal, wood, glass, plastic, plaster, rubber, even sponge-rubber. It is wonderful to line silverware or hosiery drawers, cover and line jewelry boxes, decorate lamps and lamp shades, finish the inside of auto trunks or glove compartments (to protect luggage and accessories from scratching) re-cover women's party shoes, phonograph turntables, etc. Apply to toys, figurines, wall plaques, signs, store displays and a thousand-and-one other items, new or old. **FLOK-KRAFT MICRO-FLUFF** makes old objects beautiful and salable — increases value of many new products by 500%.

Read What Others Say . . .

"Received the outfit and everyone that saw it is very enthused. I only had it about thirty minutes and got an order for a \$100 job."

Mr. C. H., Maryland

"Got \$52.50 for those 7 trunk interiors for about 4 hours work. \$7.50 per trunk."

J. O., Mo.

"... I have received my order and believe me, I'm very pleased and happy as as I've made myself MORE than the cost of my supplies already, and I've still got more jobs to do."

Cpl. G. W., S. Carolina

"... pleased with your course and I'm being swamped with work to do."

W. F., Penn.



BIG-PROFIT ORDERS COME FROM NEIGHBORS, GIFT SHOPS, STORES—ALSO MAIL-ORDER

Every household has one or more items that can be saved from discard by a **FLOK-KRAFT** job. Decorate store display cases and windows (jewelers love this) and also supply them with fast-selling **FLOK-KRAFTED** gift items and other merchandise. Manufacturers are prospects for contracts to apply **FLOK-KRAFT** to furniture, instrument cases, luggage, and hundreds of other products. Every neighborhood needs a **FLOK-KRAFTER**. **HELP US FILL A HUGE DEMAND.**

Since succeeding beyond my wildest dreams in my own **FLOK-KRAFT** business, I have concentrated on helping ambitious men get started in the same way to build a successful future, free of time clocks and nagging bosses. My plan is designed to help you start at home in spare time, and build gradually toward a full-time business with employees working for you. And you can start **RIGHT NOW**. **DON'T SEND ME ANY MONEY**, just your name and address on a postcard, and I'll rush you a **FREE SAMPLE OF FLOK-KRAFT MICRO-FLUFF**, the **FLOK-KRAFT PLAN** and full **FREE** details. I'll also arrange to send you the complete **FLOK-KRAFT MICRO-FLUFF** outfit to try out right in your home, before you agree to buy anything at all. The outfit includes detailed instructions with hundreds of show-how photographs and drawings that make everything simple, right from the start. Also included is our specially designed, high-velocity Applicator and a generous supply of **FLOK-KRAFT MICRO-FLUFF**—everything you need to get going right away. You owe it to yourself to investigate. Rush me your name and address today by Airmail, and I'll show you how to start making money at once!

NELS IRWIN, Coast Industries, Dept. 21,
Los Angeles 61, California

SEND NO MONEY—MAIL COUPON NOW!

Nels Irwin—COAST INDUSTRIES, Dept. 21.
Los Angeles 61, California

Please rush me **FREE** sample, details, etc. I understand that everything you send is free and that I'll be under no obligation now or ever.

NAME _____

STREET _____

CITY _____ STATE _____



MEN! TRAIN NOW FOR A BIG PAY FUTURE IN **DIESEL** & SCIENTIFIC MOTOR TUNE-UP



- Diesel Construction
- Diesel Engine Repairman
- Diesel Operator
- Industrial Maintenance
- Auto Engine Rebuilding
- Bus & Truck Maintenance



Be a Trained Diesel Man

Go places with DIESEL! Farms, factories and power plants, trains, ships, trucks, busses all use DIESEL POWER... all need DIESEL-trained men! You can start your DIESEL training at home, in spare time, with tested, proved U E I training. Course includes practical work on Diesel engines under skilled instructors. You learn the operation, maintenance, servicing of all types of Diesel engines. PLUS Scientific Motor Tune-up. **ACT NOW!** If you have mechanical ability, you'll like Diesel! High School diploma not necessary. Write now for FREE book, "EARNING POWER IN DIESEL." Act Today!

MAIL NOW FOR FREE BOOK!

UTILITIES ENGINEERING INSTITUTE, Dept. DC-52
2521 Sheffield Ave., Chicago 14, Ill. (Founded 1907)
O.K.! Rush, without obligation, FREE Book on DIESEL.

NAME _____

ADDRESS _____

CITY _____ ZONE _____ STATE _____

Check here for information if under 17.

RADIO Engineering. All phases radio & electronics theory & practice; television; FM; broadcasting; servicing; aviation, marine & police radio. Prepare for good pay; 18-month course. Graduates in demand by major companies. Enter Jan., March, June, Sept. Regular campus life. Write for catalog. VALPARAISO TECHNICAL INSTITUTE, Dept. D, Valparaiso, Ind.

CHEMISTRY



BIG LABORATORY GIVEN FREE!

Are you looking for a **WONDERFUL FUTURE** that can start at home right now? The **NATIONAL SCHOOL OF CHEMISTRY** offers a fascinating correspondence course in **PRACTICAL CHEMISTRY** which will give you a wonderful education that can be used almost immediately to increase your income and your position in life, with prospects of a **GLORIOUS FUTURE!** The course is very **THOROUGH**, yet specially prepared to be easy to all regardless of lack of previous training. Very little theory... this is a **PRACTICAL** course with **HUNDREDS** of fascinating **EXPERIMENTS** and valuable **FORMULAS!** Students learn, almost from the start, how to make chemicals and chemical products of commercial value, how to convert wastes into money, etc. **THERE IS A GOLD MINE IN CHEMISTRY!** Why not share in it? We will open your eyes to **GOLDEN OPPORTUNITIES** you've never dreamt of; for this is a **GOLDEN AGE** for those who possess special **KNOWLEDGE!** An extensive laboratory of chemicals and equipment is included with the course at no extra cost! Just send 25¢ for your first lesson and the **CHEMICAL KIT!** full details will be included. If you send \$1.00 we will send first 3 lessons and supplies, including "How To Make 100 New Chemicals!" Absolutely no obligation! **START YOUR NEW CAREER TODAY!**

FREE! URANIUM TESTER (ideal for field trips and **CHEMICAL PUZZLE** (worth \$2.50) both **FREE** with dollar outfit!

NATIONAL SCHOOL OF CHEMISTRY
POST OFFICE BOX 606-A • REDWOOD CITY, CALIFORNIA

LOCKSMITHING & Key Making

PRACTICAL UP-TO-DATE COURSE—ONLY \$4.95
Easy-to-learn modern information for self-instruction. How to work on locks, de-code, make master-keys, repair, install, service, etc. For every handyman, home owner, carpenter, mechanic, service station operator, fix-it shop, hardware dealer, gunsmith, 53 plain illustrated lessons. **FULL PRICE ONLY \$4.95. SEND NO MONEY.** Just pay postman plus C.O.D. postage. Or send \$4.95 with order, we'll ship postpaid. Satisfaction guaranteed or refund. **NELSON-HALL CO., 210 S. Clinton St., Dept. AU-2, Chicago 6, Ill.**

SAY YOU SAW IT IN POPULAR MECHANICS

FAMILY SAFE, PARTIALLY USED TIRES. CHECK MY GOLDEN RULE GUARANTEE!
"THE BLATT NAME famous in tires for 40 years." Only BLATT offers a "FREE REPLACEMENT" guarantee! Any other guarantee is USELESS where you must pay for the months service you've received. I replace **FREE** instantly ANY defective tire within 36 mos. **FOOLISH TO PAY MORE—DANGEROUS TO PAY LESS!**

CHOOSE YOUR FAVORITE BRAND GOOD YEAR FIRESTONE

These are not Recaps—not cheap grade tires. We are selling thousands in our retail store at higher prices! America's most respected "Free Replacement"

36 MONTH GUARANTEE & A FREE TUBE WITH EACH TIRE	600-16 \$5.53	670-15 \$5.43	700-20 \$9.83	600-16 (6) \$5.93
	650-16 5.83	710-15 5.43	750-20 11.83	650-16 (6) 6.83
	700-16 8.03	760-15 5.73	825-20 17.93	700-16 (6) 7.33
	640-15 4.83	800-15 5.83	900-20 17.93	700-15 (6) 7.83
	700-15 \$4.93	820-15 \$5.83	1000-20 \$17.93	700-17 \$8.83
	600-20 9.03	850-20 9.83	1100-20 17.93	750-16 7.53
	WHITEWALLS \$1.00 Extra	1000-22 19.93	750-17 9.93	

Send Ck. or M.O. & this ad for instant shipment. FOB Phila. I personally select your tires—as if my future depended on it. Thousands of tires shipped the world over. Road that top line again.

● If you buy 2 or more TIRES you get an extra tire FREE! **FREE TUBE!**

Give a Tire FREE FOR XMAS. This pictured tire ash tray FREE given with 2 or more tires!

SPECIAL TIRES RELEASED BY CO. ADJUSTERS!
If a tire fails in 36 months, I charge you nothing. \$7.53
Just slightly used. Any car size. World's top tire value (Whitewalls \$1 extra). Free tube with each tire!

MILITARY MUD-GRIP TIRES
AA Guar. 20 Mos. AAA 38 Mos. Months
900-16 \$9.53 900-16 \$13.93
750-20 12.93 750-20 17.33

BLATT 6th & Spring Garden Sts. Philadelphia, Pa.

EARN BIG MONEY!

GROW "LIVING" MIDGET TREES!

AT HOME — SPARE TIME — NO EXPERIENCE NEEDED!
It's new! Amazing! At last, the secret of growing miniature (MING) trees can be yours. FULL GROWN, dwarf trees—only a few inches high. Beautiful miniature fir, orange, oak, Chinese elm, peach, pine, cypress—any kind! ALL BLOOM and even BEAR FRUIT. All perfect healthy specimens—but miniature in size! Make costly home decorations and expensive centerpieces. (SOLD FOR OVER \$1,500 EACH.) Big demand. Costs only pennies—takes only minutes per week. IT'S EASY! Fun! A new fascinating hobby—a new fabulous \$\$\$ business. Send for free secret plan details and real seed.

HELP US FILL HUGE DEMAND
These trees are being demanded by STORES · CLUBS · HOTELS · FLORISTS · HOUSEWIVES · INTERIOR DECORATORS · COLLECTORS · HOBBYISTS—Big Money Opportunity for you.

HOW TO LEARN GROWING SECRETS BOTH FREE SEED

MAIL TODAY FOR FREE SEED AND PLAN!

NATIONAL NURSERY GARDENS, Dept. M-1
8463 South Van Ness, Inglewood 4, California
Rush me **FREE PLAN** and **SEED** IMMEDIATELY!

Name _____
Address _____ Zone _____
City _____ State _____

Make up to \$18⁰⁰ PER HOUR!



with this NEW

PLASTIC SANDWICH MACHINE!

Amazing earnings are possible with this remarkable PLASTIC SANDWICH MACHINE.

Make PLASTIC SANDWICHES that cost you less than 10c each, take only 2 to 3 minutes of your time, yet sell for 50c to \$1.00 each! That's 600% to 1200% PROFIT!

"Plastic Sandwiches" are thin sheets of plastic fused (laminated) around social security cards, photographs, driver's licences, letters, membership cards, etc. Anything you want to save permanently.

We want to introduce our Plastic Sandwich Machines from coast to coast as quickly as possible. We supply the finest quality, quicker, surer working plastic sheets at rock bottom prices.

Send today for FREE sample and illustrated literature about Plastic Sandwich Machines from \$35.00 up.

PLASTIC SANDWICH MACHINE CO.

6612 N. Clark St., Dept. LM-501 Chicago 26.

FREE SAMPLE SENT

PLASTIC SANDWICH MACHINE CO., Dept. LM-501
6612 N. Clark St., Chicago 26

Please send me FREE sample and illustrated literature. No obligation.

Name _____ Age _____

Address _____

City _____ Zone _____ State _____

THIS TANK HOLDS

4,538 TROPICAL FISH
WORTH \$2,456⁶⁵!

EARN BIG PROFITS In Your Spare Time!

If you have a little space in a SPARE ROOM, PORCH, BASEMENT, GARAGE ... ANYWHERE. Investigate this "chance of a lifetime" opportunity of breeding rare tropical fish for profit. The tropical fish "BOOM" IS JUST BEGINNING and here's your opportunity to cash in on it now. Experts estimate \$780 MILLION DOLLARS will be spent on tropical fish within next ten years. Investigate now—Rush coupon below.

WOW!

—AND YOU BREED THEM IN YOUR SPARE TIME—IN YOUR HOME

YES BOB I BREED THEM IN MY BACK PORCH. THEY ALMOST SELL THEMSELVES, TOO. BELIEVE ME THE "BOOM" HAS STARTED

DID IT COST YOU MUCH TO START?

NO—ONLY A FEW DOLLARS, A LITTLE SPACE AND MY SPARE TIME AND THE LITTLE KNOWN BREEDING SECRETS ARE ALL YOU NEED TO START. IF YOU'RE INTERESTED—LEARN THE FACTS TODAY!—THE "BIG BOOM" HAS STARTED SO CASH IN ON IT **NOW!**

Join others that are saying: "Business prospects amazing." J. K., Ga. "Dealers want all I can breed." J. P., Ore. "Pays off large dividends." R. D., N. Y., etc.

IT'S EASY! Once you know the SECRETS you may breed exotic ANGEL FISH; Zebra striped DANIO; beautiful GOURAMI; majestic FIGHTING FISH; the mysterious weather predictors—and BRILLIANTLY BEAUTIFUL rare tropicals of every kind. Sell for up to \$35.00 pr. *Amazing Profits!*

SOME TROPICAL FISH LAY TO 600 EGGS AT A TIME. That's why tropical fish breeding is so profitable. Nature multiplies your \$\$.

This advertisement is an URGENT APPEAL OPPORTUNITY Orders backlogged in many areas. RUSH coupon NOW!

TROPICAL FISH BREEDERS OF AMERICA, Dept. D-1 15121 S. Broadway Los Angeles 61, Cal.

1 and 2 FREE! (BOTH)

MAIL THIS COUPON BELOW TODAY!

"How to Learn Breeding Secrets" Booklet, VUER-PROJECTOR KIT with COLOR slides (\$4.95 value) Yours FREE for writing for FACTS.

Tropical Fish Breeders of America, Dept. D-1 15121 S. Broadway, Los Angeles 61, Calif. Please Rush FREE COLORFUL BOOKLET and amazing VUER-PROJECTOR KIT details to me. Both Free! Sending for these does not obligate me in any way

Name _____ Age _____

Address _____

City _____ Zone _____ State _____

Start a profitable manufacturing business in spare time

with your own home as your headquarters

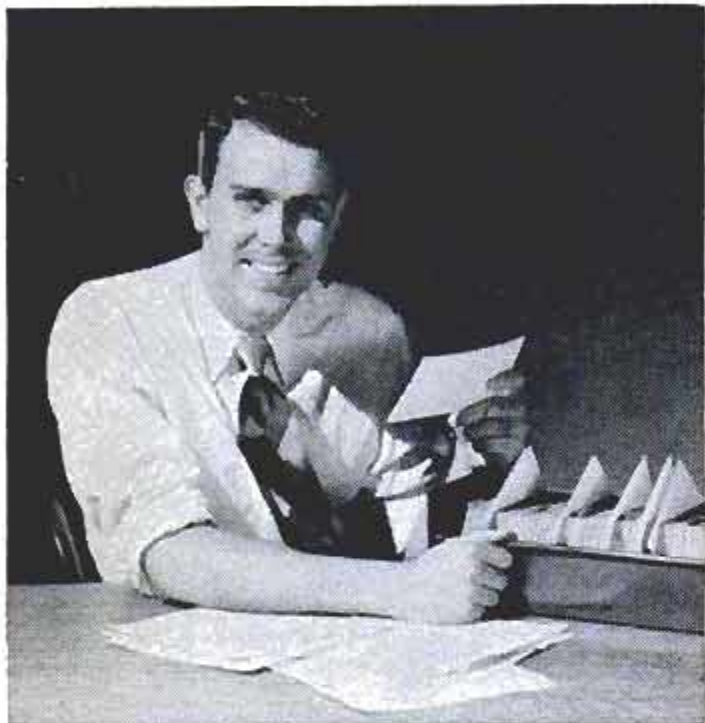

RIGHT at this moment there is a tremendous demand for new business enterprises in a branch of the plastics industry. Fortunately, this is a type of manufacturing business that does not require heavy or expensive machinery, rented space for storage, production or sales. A portable hand machine does the work wherever electric current is available, and the working area can be in almost any part of your home.

The opportunity that is open to you today, is to meet this growing demand in a new industry by establishing yourself as the manufacturing agent in your own trading area. Several hundred of our machines are already in use in both large and small communities. Some are even being operated successfully by women whose family duties make it necessary for them to be at home during the day, but whose family income is not enough to meet rising expenses. Most are being operated by men. Many started in spare time just to pick up an extra five or ten dollars for an evening's work. They found the work so profitable that some have now given up former jobs to devote full time to a business of their own.

One of our manufacturers gets all of his business by mail. Orders and money come to him in envelopes and he sends his products out the same way. Another delivers his entire output to stores in the vicinity. An-

other does a wholesale business supplying other manufacturers who do the selling. Still another works with advertisers in the manufacture of plastic advertising novelties and specialties.

The operation of the machine is simple and easy for anyone to learn. It does not require any knowledge of chemistry, mechanics, or electricity. And what some say is best of all, a manufacturing business like this enables a person to make good money without any house to house canvassing. The machine turns out from \$5.00 to \$15.00 worth of work per hour and it can be operated for as short or long a time as you wish.

We have prepared a simple step by step instruction manual that not only tells how to operate the machine, but also tells how to get the business coming in at a profitable clip right from the start. We will lend a copy of this book to any serious minded man or woman with the

understanding that a copy will be given them free if and when they purchase a machine—or the copy we lend can be returned if you decide not to go into the business. Reading it will not cost you anything.

If you are interested in a nice little home business that can bring in an extra \$60 or more for ten or twelve hours work in spare time, send your name. All information on the book and machine will be sent free, postage prepaid and no salesman will call to bother you. You read about it in the privacy of your own home without outside pressure and then decide whether you'd like to take the next step. Address your envelope to me in person. Send me the coupon below. Or, if you prefer send your name on a post card and ask for "Free information on starting a manufacturing business at home." Either way, send your name today and find out about this wonderful new fast growing money-making business.

RAYMOND E. BRANDELL

1512 Jarvis Ave., Dept. L-101, Chicago 26, Ill.

Raymond E. Brandell, 1512 Jarvis Ave., Dept. L-101, Chicago 26, Ill.

Dear Mr. Brandell: Please send information showing how I can start a profitable manufacturing business in my home in spare time. All the information you send will be mailed to me free of charge and no salesman is to call on me. I am not under any obligation to go ahead with the business and there is no charge for this information now or any other time.

Name _____

Address _____

City _____ Zone _____ State _____

WORLD'S
BEST
WANT-AD
MEDIUM

CLASSIFIED ADVERTISEMENTS



Advertisements in this section \$1.25 per word, each insertion, minimum 10 words, payable in advance.

To be inserted under proper classification, copy must be in our office the 20th of the second month preceding date of issue

F. W. Johnson, Manager, Classified Advertising
Popular Mechanics Magazine, 200 East Ontario Street, Chicago 11, Illinois

YOU'LL PROFIT

By reading and answering the classified ads in this section. Hundreds of opportunities for you to make and save money

AUTOMOBILES, MIDGET CARS

GLASS Fiber auto body construction simplified. 100 photographs. Leading "how" book among all established professionals and sharp amateurs. Eminently qualified author, all new, complete, latest techniques. Boat building. \$3 postpaid. Post Books, Box 897A, Arcadia, California.

CAR OWNERS—Save hundreds of dollars. Unique "Know Your Car" home study course teaches trouble shooting and how to make repairs. Anyone can learn. Free booklet. Roberts Technical & Trade Schools, Dept. Y-2, 211 W. 61st St., New York, N. Y.

HUNDREDS Of automobile catalogs—American, antique, foreign; dealer books, glossy photographs, shop manuals; free motor magazines. Offered by non-profit club. Write immediately; get on free mailing list. Auto Maniacs, Stockbridge, Mich.

1956 PONTIACS By mail. Buy 1 or 20. Save 26%! Write for factory net prices. Pontiac Fleet Sales, Box 45144M, Airport Station, Los Angeles.

BUILD Midget auto. Complete drawings, pictures and list of parts \$1.00. Lee's Midget Autos, Box 82, Avila, California.

ANTIQUA Automobile color slides. 2x2. Illustrated catalog free. Universal, Box 779A, Beverly Hills, Calif.

BOYS' Power-driven auto. Build your own. Plans 25 cents. Sypher Co., Sta. F., Toledo, Ohio.

AUTO SUPPLIES AND EQUIPMENT

JIFFY Snug-fit plastic car cover. Fits and protects all make cars parked outdoors. Electric welded seams, elastic hem adjustable under head and tail lights. \$21.95. General Car Cover Sales, 1422 Kerlerec St., New Orleans 16, La.

BUY Wholesale nationally advertised auto supply, thousands other products at big discount. Free "Wholesale Plan." American Buyers, Hertel Station, Buffalo 16-G, N. Y.

FOR Your life membership "on approval" send only your name, address: Gane Economy Club, San Gabriel, California.

JULY Starting in January for your car, when you use our electric motor heater. No installation. Details free. Thomas, Lakeside 1, Arizona.

SIMONIZE, Polish, quickly, efficiently. No messy rags. Patent pending. 50c. Miracle Mitt, Box 276, New York City 18.

STARVED For air? Poor mileage, loss of power result. Make two-minute test. Free information. Aqua-Jets Company, Florence, Ky.

LACHAPPELLE'S Patented treatment. Puts metal bearings on the cylinder walls for the pistons to slide on. Dan Ferns, Box 71827-B, Los Angeles 1, Calif. In Canada, Master, Box 216, Welland, Ont.

MOTORIST—Protect your engine, insert magnetic disc in your oil filter \$1.50. Art & George Co., 5170 No. Hollywood Avenue, Milwaukee 17, Wisconsin.

MOTORIST, Save gasoline vacuumating overrich mixtures. For free particulars, how you install on your car for introducing write, Vacuumatic, Dept. 840, Wauwatosa, Wis. Salesmen wanted.

GM71-110 Discarded injector parts wanted. Bonus on HV. Buescher, 7120 Carnegie, Cleveland 3, Ohio.

GIANT Size, softer than real chamois for automobiles, homes. Send \$2.00 for 3. Renraw Sales, 19 Irvington Pl., Trenton, N. J.

SAFETY Belts. Color maroon, \$8.95. Free gift with each belt, value \$6.95. Free brochure. Dealers inquiries invited. Home Supply Service, Kiel, Wisconsin.

CRANKSHAFT Grinder, hand operated. Makes bearings fit without taking engine apart. \$3.75. Literature. L. D. McGee, 719 Cascade St., Wenatchee, Wash.

BRAND New first quality tires. Tractor, truck, aircraft, passenger. Wholesale prices. Also all size army surplus used tires at tremendous savings. Duddy's, 152 No. Beacon Street, Boston, Mass.

GENUINE Motor treatment, Lachapelle's, (patented). Only \$3.00 delivered. Increases compression, power. Saves gas, oil, repairs. Money-back guarantee. You can't lose. Free circular. Write Joe Dillon, Authorized Warehouse and Agents Distributor, Box 32316, Bridgeport, Ohio. Exclusive agencies open.

JEOP Owners—V8 power. Read Jeep Owners ad, page 60.

SENSATIONAL Free trial offer! Gale Hall Mile-O-Meters (original models), advertised at \$9.75, our price only \$2.98! Compression testers, formerly \$8.50, only \$2.98! Limited supply—order today—money-back guarantee! (Add 40c postage each.) New England Surplus Sales, Dept. PM1-6, Newburyport, Mass.

FREE, illustrated, descriptive information "The Truth About Water Injection." Injector, Box 526, Burbank, California.

STOP Car rattles forever. New \$2 kit with simple tool. (Money back if not o.k.) Concourse, 4003 Dyre Ave., New York 66, N. Y.

CARPENTS, Patio roofs. Partitions, build them yourself with beautiful Fiberglass "planks." Details free. Concourse, 4003 Dyre, New York 66, N. Y.

LATEST Custom accessories. Items not in stores. New low prices. Continental tire kits, push-button doors, trunks, etc. New illustrated catalog, biggest ever, 25c. Eastern Auto, 3319-A South Grand, Los Angeles 7, California.

AUTO Accessory and parts catalog. 1956 edition—All new! 164 pages. Save up to 50%—Over 50,000 items, including Hollywood accessories, hi-speed equipment, re-built engines, all parts and accessories for all cars and trucks; Hard-to-get parts! Send 25c (refundable). J. C. Whitney, 1919-PM Archer, Chicago 16, Illinois.

CAR Burning oil? Losing compression? Try Clifford's Compression Seal. Tube, \$2 postpaid. Clifford's Engineering, 452 Claim, Aurora, Illinois.

ELECTROPLATE Auto parts, novelties, mirrors. Easy, inexpensive home processes. Free booklet. Tyco Metals, Box 13231-BG, Houston 19, Texas.

FREE Discount catalog—Speed, power, custom equipment. Almquist Engineering, Milford 7P, Pennsylvania.

NEW And used parts at savings. Complete guaranteed parts service for all models cars and trucks, 1924 and later. Largest in the West. Army parts specialists. No catalog, write for quotations. Fast mail order service. Pioneer Auto and Truck Parts Co., 734 W. 13th Avenue, Denver, Colorado.

AUTO TRAILERS

TRAILER Parts catalog. Largest in mid-west. Send 25c. Refundable. Hanna Trailer Supply, 615 West Layton, Milwaukee, Wis., Dept. M.P.

TRAILER Manual. Over 200 pages. 250 pictures. Tells how to: buy, tow, travel, build live-in, repair. \$1.98. Trail-R-Club of America, Dept. PM111, Box 1376, Beverly Hills, Calif.

TRAILER Manual construction plans \$1.00. Booklet 25c. Craftsmann Books, Box 1153, Milwaukee 1, Wis.

EXCEPTIONAL Expanding eight foot trailer. Accommodates family of five. Build yourself. Literature 10c. Framar Company, Wilmington, Mass.

BUILD Your own trailer! Plans for all kinds illustrated catalog 10c. Jim Dandy, 125-N, Wausau, Wisconsin.

MOTORCYCLES, BICYCLES, MOTORSCOOTERS AND SUPPLIES

WHIZZER Motorbike engine \$5; midget car \$25; Micromidget racer \$65; Briggs Wagonmobile \$19; Doodlebug motorscooter \$15; (mailorder only). Send 25c (35c for first class mailing) for directory-catalogue Number 69, listing these and hundreds of other bargains. Midget Motors Directory, Athens, Ohio.

MOTORSCOOTER Parts—Send 50 cents for price list, refunded first order. Give year and model. MotorScooter Parts Co., Box 721, Indianapolis 1, Ind.

SERVICYLE \$20.00; Whizzer motorbike \$25.00; Cushman motorscooter \$25.00; midget auto \$25.00. Rush 25c (35c first class mail) for new catalog #958 listing many other amazing bargains in motors, midget cars, motorscooters, motorbikes, construction plans. Associated, Box 534, Toledo, Ohio.

MOTORCYCLES And supplies. Complete service. Free Bulletins. 813 Ohio Ave., Wichita Falls, Texas.

RECONDITIONED Motorcycles and motors. Chromium accessories. Complete stock Indian parts. Expert rebuilding. Fast service. Indian Motorcycle Sales, Kansas City 27, Missouri.

HARLEY-Davidsons — America's finest used bargains! We pay shipping on motorcycles. Genuine new, used parts, accessories for current and obsolete models. Send 25c for bulletin, catalog. Knuth's (factory dealer), 1753 Muskego, Milwaukee, Wis.

AVIATION

SIX Giant airplane photographs 14 x 17 reproduced in full color. Decorate your den, etc., with color prints of war planes in action. Complete set of six assorted only \$1.00 postpaid. Jarvis Bros., Box 126-A, Bostonia, California.

AIRLINE Steward-purser. Fly 85 hours monthly. Starting salary \$235 up. G.I. approved. Free catalog. Air-Purser School, Room A, 1030 Nicollet Ave., Minneapolis, Minnesota.

PROPELLERS Specially designed for airboats and snow sleighs by the world's oldest manufacturer of aircraft propellers. Free literature. Flottorp Mfg. Co., G. R. Airport, Grand Rapids 8, Mich.

BUILD A fast, safe airboat or snow sleigh from your 65-200 h.p. aircraft engine. Propellers, plans, supplies. Satisfaction guaranteed. 48 page catalog 25c. Banks-Maxwell Co., Box 3301E, Ft. Worth 5, Texas.

LIGHTPLANE Manual construction plans \$2.00. Circular 25c. Craftsmann Books, Box 1153, Milwaukee 1, Wis.

LIGHTPLANE Plans, information, \$4.75 postpaid. Brochure, dime. W. Fike, Box 683-P, Anchorage, Alaska.

PROPELLERS, Plans, supplies for airboats, snow sleighs. Catalog 10c. Gano Propellers, Box 3284-A, Ft. Worth, Texas.

BATTERIES, GENERATORS

EDISON Nickel storage batteries. Any voltage, any amperage. Unconditionally guaranteed. Power plants, generators, motors. Literature. Hawley Smith Co., Croton Falls 1, N. Y.

ELECTRICAL SUPPLIES

TELEPHONE Transmitter. Hand set type. Suitable for inter-house phones, speakers or any communication purpose. Delivered two for \$1.00. No. c.o.d.'s. Telephones, Dept. C-325, 1760 Lunt, Chicago 26.

NEW 1956 Lamp parts catalog showing everything you need to make and repair most types of lamps. Everything at lowest wholesale prices. Send only 25c today for both catalog and wholesale price list. Gearon Co., Dept. 503-B1, 27 S. Desplaines, Chicago 6, Ill.

LAMPS — 25c Brings bargain catalog showing all parts for repairing, building. Contains instructions for electrifying vases, oil lamps, etc. Gyro Lamps, 5402P Clark, Chicago 40.

LAMP And electrical parts—Wholesale. Thousands of items for building, repairing, and converting lamps. Illustrated catalog 25c. Brown Lamp Co., Box 501, Wellston Sta., St. Louis 12, Mo.

ELECTRIC Pencil: Engraves all metals \$1.50. Beyer Mfg., 10511-H Springfield, Chicago 43.

WELDING, SOLDERING, PLATING

NEW And different oxy-acetylene outfit welds, cuts, heats, brazes, with interchangeable tips. No attachments needed. Light, portable. Complete outfit, full instructions, only \$76.50. Special money-saving plan for oxygen and acetylene supply. Write for free literature today: Dept. M, Linde Air Products Company, 30 East 42nd Street, New York 17, N. Y.

"BUILD-UR-OWN" a.c. welder and a.c. power plant with a good used engine and low cost Hobart generator. Welds anywhere and supplies 5KW stand-by power for any emergency. Write Hobartweld, Box M-163, Troy, Ohio.

BUILD 300-Ampere welder using aircraft generator. Plan 10c, including big catalog welder parts, kits, and other electrical items. Dunbar Mfg., 6600 Sylvan, Houston 23, Texas.

A.C. Welders, 4 sizes. Lowest prices. Free literature. Holgeron's Serv., Canton, Kan.

WELDERS, 110/220, \$39.50. Morris, 1070 Inner Drive, Schenectady 3, New York.

ACETYLENE Welding outfits, new \$49.00; used \$29.00; arcwelders \$56.50. Eagle Welding, Dept. PM, 5085 Broadway, Chicago 40, Ill.

ELECTROPLATING Equipment, anodes and solutions for all types of plating. Instructions. Assemble your own plater and save. Free catalog. Ramyr, Dept. E-4, 1624 East First Street, Los Angeles 33, California.

MACHINERY, TOOLS, SUPPLIES

6" VERNIER Callipers, measuring outside, inside, depth, famous German brand, hardened, double vernier 1/1000" and 1/128". Money-back guarantee. \$8.75 (check, money order). Stephani, P.O. B. 398, N. Tonawanda, N. Y.

RADIUS: And ball turning tool post turns thousands of different size concave, convex radii 0" to 4". No special tools to grind. Box 476, Wellston 12, Mo.

BIG Factory catalog! Buy direct—Save middleman's profits; hundreds of labor saving tools and equipment; tremendous savings. Send 10c. Master Mechanic Mfg., Dept. CL-105, Burlington, Wis.

YARD-Man lawnmower reel grinder. Henry Kohl, Furnace, Kingston, N. Y.

HARDWARE, Tools, drills, taps, dies brass, steel, drill rod. Free catalog. Terek, 6304 Patterson, Chicago 34.

\$33.45 POSTPAID For accurate model engineer's lathe, English manufacture catalog. Science Now Co., Catskill, New York.

NEW Portable vise and drill. 45' off. Free details. American Kaylac Co., 3217 Ketcham, Saginaw, Michigan.

AIR Compressor. Build yourself. Circular 10c. Little Machines, Hamilton, Michigan.

NEW Ratchet screwdriver. Different interchangeable blades. Free circular. Wiltron Co., Box 765, North Hollywood, Calif.

MILLING Machine: Models for every purpose. Home workshop, tool and die shops, plastic plants, etc. Amazing low price. Literature free. Southern Machine Tool Co., Conyers 1, Georgia.

McCULLOCH Chain saw parts. Special prices on Oregon chain for all makes of saws. Free price lists. Barnett Equipment, So. Glens Falls, N. Y.

MAGNETIC Tool — Pencil type. New, amazing, powerful. Picks up small parts. Hundreds of uses. Ideal for mechanics, radio-television repairmen and hobbyists. 69c post paid. Empire Magnetics, Inc., 107 E. Clinton Street, Maumee, Ohio.

SURVEYING INSTRUMENTS

GUARANTEED Factory rebuilt transits and levels, sale or rent, with purchase option. We will repair, trade or buy old instruments. Write for list M-61. Warren-Knight Co. (Manufacturers of Surveying Instruments), 136 N. 12th St., Philadelphia 7, Penna.

ENGINES, MOTORS, DYNAMOS

REBUILT 1½ To 3 h.p. engines \$17.00 to \$37.00. Parts also. Cauffiel Motors, Temperance, Mich.

1½ HORSEPOWER Motors. Used, good, \$5.00 each. f.o.b. Plant Machinery Corp., Richmond & Norris Sts., Philadelphia 25, Penna.

A.C. Generators, 750 watt, \$42.50; 1500 watt, \$67.50; motors, ½ horse, \$15.00; 1 horse, \$25.00; 2 horse, \$65.00. Butler, 1885 Milwaukee, Chicago.

WINDING Data, 225 motors, single and three phase, \$1.00. Data Company, Box 7631, Kansas City 28, Mo.

REWIND Motors yourself. Complete instructions \$1.00. Lewis Mfg., Howell, Michigan.

PARTS For Briggs Stratton, Clinton, Lauson power products, Wisconsin Continental engines. Weeden Company, Wakefield, R. I.

BOATS, OUTBOARD MOTORS

BUY Wholesale nationally advertised outboards, thousands other products at big discount. Free "Wholesale Plan." American Buyers', Hertel Station, Buffalo 16-H, N. Y.

BOAT Supply catalog and big list used inboard and outboard motors. Send 25c. Masters, 212 W. Chicago Ave., Chicago 10.

FULL Size, cut-to-shape boat patterns, blueprints, 7½-38 feet. New 1956 illustrated "Build a Boat" catalog of 50 naval architect-designed cruisers, runabouts, sloops, skiffs, outboard boats, sailing, racing, houseboats, 50c. Small boat hardware catalog, \$1.50. Bigger, better 1956 "How to Build Boats" book, \$2.50. Cleveland Boat Blueprint Co., Dept. A-66, Box 1651, Cleveland 4, Ohio.

BOAT Plans, patterns, frame kits. Modern inboard and outboards 11'-22' for amateur builders. State requirements or send 40c for complete catalog. Glen Designs, Box 568, Compton, Calif.

DECORATIVE Ship's wheel 25" mahogany. Circular free. Concourse, 4003 Dyre, New York 56, N. Y.

WHOLESALE! Sea legs boat kits, factory prices from \$31.98. Savings to 25%. Pre-assembled frames, pre-cut parts, illustrated instructions. Penney Woodcraft Industries, Dept. C-47, Defiance, Ohio.

FREE Instructions. Boat docks. Built, installed out of water. Dock Products Company, 3422 26th Avenue South, Minneapolis, Minnesota.

FREE Catalog! Boat kits, trailers, fiberglass, marine hardware. Luger Industries, Dept. M, 4452 Nicollet, Minneapolis, Minn.

MARINE Conversion. Willys to Cadillac, engines, kits and parts. Catalogue and conversion hints free. Barr Marine, 2706 Castor Avenue, Philadelphia 34, Penna.

BARGAINS In kit boats, marine hardware, fiberglass and accessories. Catalog 35c. Marine Associates, Box 6188-MJ, Long Beach 11, California.

BUILD A fast, safe airboat or snow sleigh from your 65-200 h.p. aircraft engine. Propellers, plans, supplies. Satisfaction guaranteed. 48 page catalog 25c. Banks-Maxwell Co., Box 3301F, Ft. Worth 5, Texas.

JOHNSON Outboard specialists. Used parts for all models at substantial savings. Prompt quotations. Specify model serial. Crandall-Hicks, 910 Commonwealth, Boston, Mass.

"GLASBOTE" Plastic and glass cloth for boat covering. Complete information and material price list free. Buchanan Plastics, 1728 Hamilton Road, Okemos, Michigan.

PLYWOOD Boat plans, 21 for \$1.00. Catalog boat building plans 25c. The Rudder, 15 Murray Street, New York 7.

CONVERT Fords and Jeeps to 100% marine engines with Osco's world famous Convo-Kits. Deluxe catalogue 25c (coin). Oscomotors, 3627B Lawrence, Philadelphia 40, Penna.

FIBERGLAS Permanent boat waterproofing. Lowest wholesale prices. Guaranteed materials. Easy application. Full instructions. Complete kits, \$12.60 up. Free literature. Ajax Plastics, Dept. PM, P.O. Box 1323, Fort Worth, Texas.

NEW, Used, rebuilt marine motors. Marine conversions, fittings. Free catalog. Stokes Marine Supply, Dept. 24, Coldwater, Michigan.

MARINE Conversions for Ford and Jeep engines. Catalog 25c. Lehman Manufacturing Company, 972D Broad Street, Newark 2, New Jersey.

BOAT Plans. Welded steel, wood, plywood. Inboards, cruisers, sail. Free literature. Please specify size-type. John B. Clark, N.A., Box 51, Bay Village, Ohio.

ATHLETIC EQUIPMENT, BOAT BUILDING COURSES

OUTSTANDING Physical development! All you need is a rope! Oriental secret discovered! Strength, health, gain, reduce. Free details. Ropercise, 4834 Art St., Room 102, San Diego 15, California.

100 TRICK Knockouts for self-defense \$1.—1c each. Priest, Box 251, Evanston 1, Illinois.

FREE Catalogue, 10c for postage appreciated. Dr. Thompson, 919 Fourth, Manhattan 30, Kansas.

BARBELLS, Exercise equipment, Courses. Free booklet. Good Barbell Co., Reading, Penna.

MUSCLE Development while sitting in any car or chair. Amazingly new simple method shown in illustrated copyrighted booklet. Money back guarantee. \$3.00 to I.M.T., Box 206 Northwest Branch, Miami 47, Florida.

SPORTING GOODS, GUNS, FISHING TACKLE, ARCHERY, TRAPPING

FLY Makers! 1956 free catalogue. D. H. Thompson. 335 Walnut Avenue, Elgin, Ill.

TENTS (Direct from manufacturer), camping equipment. World's largest selection. Send 15c for 100 page 1956 tent and camping equipment catalogue-handbook. Morsan Tents, 10-21R 50th Avenue, Long Island City 1, New York.

OLD Guns. Current prices. Free catalog. Pioneer Books, Harriman, Tennessee.

BUY Wholesale nationally advertised sporting goods, thousands other products at big discount. Free "Wholesale Plan." American Buyers', Hertel Station, Buffalo 16-I, N. Y.

LEARN Gun repairing at home. Profitable business. Details 10c. Modern Gun Repair School, Box 430-P, Marshfield, Wis.

FISHERMEN Catch your limit every time. Our free 1956 catalog tells you how. Hergert Company, Box 345, Wilkes-Barre, Penna.

FREE Fishing catalog—132 pages. Over 3000 hard to find fishing specialties. Netcraft Company, Dept. PM1, Toledo 13, Ohio.

LEARN Fly tying. Beginners kit, \$3.50. Free details. F. Cuillo, 521 Hemlock Street, Brooklyn 8, New York.

4-6-8 GROOVE Rifle barrels. Write for list. Diefenbach, Barrelmaker, Grawn, Michigan.

NEW Springfield walnut rifle stocks, army issue, inletted, modified pistol grip. Worth \$25.00, cash price \$3.50 postpaid. Barco Trading Co., Atlanta 18, Georgia.

FREE. Fishing catalog. Luremaking tools, beads, spinners, sinker molds, bargain spinning outfits. FinnySports (MP), Toledo 6, Ohio.

BANG'S Gun stock/finish. Synthetic resin type. Beautiful permanent finish. Free literature. Dealers wanted. 4 oz. bottle \$1.00 pp. Alameda Supply, Box 434, Albuquerque, N. M.

ARCHER'S Free new illustrated catalog. Pride Archery Company, R.F.D. #1, Danbury, Connecticut.

FINEST Imported German monofilament line. 2-18 lb. Half price. Write Dept. P. Woodlors Products, Bradley Beach, N. J.

JEOP Owners—V8 power. Read Jeep Owners ad, page 60.

180 PROFUSELY illustrated pages antique pistols, swords, daggers, armor, etc. 50c. Robert Abels, M860 Lexington Ave., New York 21.

MOLDS—For making fishermen's sinkers. Free illustrated booklet. Reading Instrument Co., Box 78, Reading, Penna.

5000 BARGAINS. Firearms, binoculars, war relics. Catalog 50c. Smith Firearms, Runnemeade, N. J.

JAP Rifle altering to 30-06, \$6.00. Japshells, \$3.75. Catalog 5c. T. F. Shop, West Branch 11, Mich.

"SHOCKING" Expose! Catfish caught with telephone apparatus! Complete details, \$1.00. Pop, Box 6122, Houston 6, Texas.

BINOCULARS, TELESCOPES, MICROSCOPES, MAGNIFIERS

REFLECTOR Telescope kits \$6.25 (3") to \$175. (12"). Mirrors, cells, focusing mounts, tripods, eye-systems. Anything, everything in telescopes. Free illustrated catalog. Also ready to use telescopes from \$26 to \$176. Inquiries to Esco Products, Dept. PM, 1428 Willow Ave., Hoboken, N. J. Sales showroom, 156 Church St., New York City.

BINOCULARS, Telescopes, microscopes. Terrific values, \$3.98 up. Request free money saving catalog. Criterion, Dept. P37, Hartford, Conn.

REFLECTING Telescopes. 60X, completely assembled \$29.75. Guaranteed observatory clearness. Free information. Skyscope, 475 Fifth Avenue, New York 17.

WAR Surplus bargains! Millions of lenses, instruments, telescopes, binoculars, components and complete line of astronomical telescope items. World's greatest optical market place! Send only \$1.00 for beginner's 10-lens kit and big instruction booklet Stock 2-CH. Write for Catalog CH, free! Edmund Scientific Corp., Barrington, New Jersey.

DYNASCOPE—Sensational new reflector telescope. Send for details. Criterion Co., Dept. DP16, Hartford, Conn.

6 THUMBS On each hand? Even you can assemble our telescope kits from our easy instructions. Enjoy the heavens with a high precision telescope assembled in less than an hour. You'll like our complete line of telescopes, microscopes and accessories, biological stains, etc. Send for free catalog T of finest quality and newest design astronomical kits or free Catalog M of microscopes. Optical Engineering Co., 164-19 Northern Boulevard, Dept. PM, Flushing, New York.

SAVE 25%! America's largest selection. Free 56 page 1956 binocular catalog. \$3.95 to \$250.00! United, 9043 S. Western, A-9808, Chicago 20. Dealers wanted.

BUILD Your own reflector telescope. Complete kit: mirrors, eyepieces, tripod, all other accessories. Request free illustrated literature. Criterion Manufacturing, Dept. KPM 13, Hartford, Conn.

400 POWER Telescope easily made. Kit includes focusing tube, erector, five finished lenses and instructions—\$3.75. Giant astronomical telescope complete with tripod \$15.00. Free information. Suffolk Science, Mattituck 3, N. Y.

IMPORTERS' Amazing prices, precision binoculars, 22 models. Free trial. Folder, "Binocular Selecting," catalog free. Dealers wanted. Prentiss Importers, Mercury Bldg., West Los Angeles 25, Calif.

SPECIALISTS! Used microscopes and accessories. Unusual slides. Supplies. Catalog free. Research Scientific Supplies, 60 Wall St., New York City 5.

PETS—DOGS, BIRDS, RABBITS, HAMSTERS, ETC.

ENCYCLOPEDIA Of canaries and other cage birds (including budgies) with questions and answers, \$2.75, plus 25c postage. Audubon Publishing Company, 3449 North Western, Dept. P.M., Chicago, Ill.

RAISE Rabbits successfully by knowing facts. 48 page illustrated book describing 25 breeds. Housing, feeding, breeding, marketing, etc. Plus bulletin. 25 cents. American Rabbit Association, 36 Arba Building, Pittsburgh, Penna.

HAMSTERS—Golden: young, \$3.00 pair; fully developed, \$4.00 pair. Adirondack Hamstery, Prospect 130, New York.

1000 BRED Mink—Booklet plans 20c. Wettlaufer, Gravel Road, Webster, N. Y.

HUNTERS' Raccoon Mountain and Short Creek kennels now combined. Large number of coonhounds, foxhounds, rabbit-hounds, beaglehounds, bird-dogs, puppies. Free literature and pictures. Trial, Dures Thomas, Owner, Box 464, Boaz, Alabama.

RACCOONS, Minks—Bred females. Baby skunks. Catalog 25c. Shady Fur Farm, Springfield, Minnesota.

RAISE Nutria; Mynahs, monkeys. Herb Miller, 513 Kent, Lubbock, Texas.

EXTRA Money raising Angora. New Zealand rabbits. Write Martin's Rabbitry, Morganfield, Ky.

BEAUTIFUL Pure white pedigreed police puppies. Ansonia Kennels, Mose, N. Dak.

CHINCHILLAS. Profit plus pleasure. Registered. Graded. Delivered personally. Stewart Chinchilla Ranch, Washingtonville, N. Y.

ANGORAS. Chinchillas. World's most profitable rabbits! Catalog free. Grinsteads, Edwardsville, Illinois.

STANDARD Rabbit Journal. Milton 3, Penna. Year \$1.00. Sample dime. Beginners manual 25c.

GROW Mushrooms. Cellar, shed, and outdoors. Spare, full time, year round. We pay \$3.50 lb. We paid Babbitt \$4.165.00 in few weeks. Free book. Washington Mushroom Ind., Dept. 171, 2954 Admiral Way Seattle, Washington.

MINK Raising information free. Complete. Lake Superior Mink Farm, Superior, Eel, Wisconsin.

MAKE Big money! Raise Chinchilla rabbits. Cash markets supplied. Write today! Rockhill Ranch, Sellersville 15, Penna.

SPORTSMEN: World's largest kennel offers 500 Pointers, Setters, Straight Cooners, Combination Hounds, Rabbit and Squirrel Dogs, Beagles, Fox and Wolf Hounds. Trial. Prices reasonable. Catalogue free. Smokey Mountain Kennels, Cleveland, Tennessee.

CHINCHILLAS—Beautiful young pairs \$75.00 per pair! Free details. Consolidated Chinchillas of America, Ashboro, N. C.

CHINCHILLAS—Registered sturdy stock. Wholesale. One or one hundred pairs—\$75.00 pair. Slater Chinchillas, 1535 Ruhland Ave., Manhattan Beach, California.

CHINCHILLAS. Registered. Unbelievable prices. Far-West Chinchilla, 1446A Jones, San Francisco 9, California.

CAGE-Bird Magazine (budgies, canaries, etc.) one year, \$3.00. American Cage-Bird Magazine, 3449 N. Western Avenue, Dept. P.M., Chicago 18, Illinois.

RAISE Money-making Angora, New Zealand rabbits. Particulars free. White's Rabbitry, Jackson, Mich.

MAKE Money raising chinchillas, mink, pigeons, rabbits, cavies for us. Free catalogue. Keeney Brothers, New Freedom 2, Penna.

HAMSTERS—Goldens \$2.95 pair. Free literature. Jer-Fre's Hamstery, Muskegon Heights, Michigan.

"PR" German shepherd police pups. Good hunting, watch and cattle dogs. Send 25c for pictures. H. Schumacher, Ottertail, Minn.

PLANTS, SEEDS, NURSERY AND GARDEN SUPPLIES

TREES And shrubs. Raise your own from seed for shade, windbreak, snow fence, ornament, erosion control, etc. For free planting guide, pricelist, write Woodlot Seed Co., Norway 9, Michigan.

MIDWINTER 1c Sale nursery stock. Spring delivery. Hurry: Bayer Gardens, Route #1, Neenah, Wisconsin.

WORLD'S Greatest cash crop. Free information. Write Ginseng Gardens, Asheville, N. C.

FARMS, FARM LANDS, REAL ESTATE

STROUT Catalog—Mailed free! Farms, homes, businesses, 36 states, coast-to-coast, 2,914 bargains described. World's largest; 55 years service. Strout Realty, 7-MP So. Dearborn St., Chicago 3, Ill.

CANADIAN Tax sale lands for three dollars an acre and up. Small monthly payments. Farms, timber, hunting and fishing camps, minerals. Limited number of properties. Write at once for free catalogue. Tax Sale Service, Room 105, 120 Bloor St., West, Toronto 5, Canada.

HOMESITES \$15 Monthly—California's finest garden section. Morro Bay's scenic shores. Wonderful fishing, boating. Fertile soil, softest water, temperate climate, congenial community. Free literature. Richard Otto, Department M, San Luis Obispo, California.

FLORIDA Winter Garden farms and homesites. Beautifully wooded. Near booming Panama City pleasure resort. World's finest beaches. Many lovely lakes. Finest fishing, hunting. Sportsman's paradise. 10-acre berry, fruit, poultry farms. Money-making tung groves. Lowest prices—Easy terms. Booklet free, Wendell Wood, Fountain, Florida.

RETIREMENT Homes, like rent, nothing down. Information. Perrys, Brier Hill, Penna.

INEXPENSIVE Property? Manual tells where eastern and southern states. \$1. Loft Services, 175 5th Ave., New York City 10.

CALIFORNIA Farm and ranch lands. \$15 to \$35 per acre on easy terms. 100% oil and uranium rights. Free catalog. Pacific Tax Sales, 1621-A Cahuenga, Hollywood 28, California.

FLORIDA. Nice homesites, \$245 at \$10 monthly. Folder free. Howard Vernor, DeLand, Florida.

FLORIDA Lakefront homesites near Ocala forest. Excellent fishing-hunting. \$10.00 monthly without interest. Complete price \$195-\$995. Literature. Grace Parker, Paisley, Florida.

FLORIDA Waterfront homesites on famous Saint John's river, \$50.00 front foot. Also inland lakefront five miles from river \$195.00-\$995.00. Specify which literature. Easy monthly payments. Pine Lakes, Eustis, Florida.

SAVE, Buy direct from government, land, homes, islands, farms, etc. Listings \$1.00. Abacus, Box 169D, Dept. M, East Hartford 8, Conn.

OZARKS, Fruit, grazing, retirement. \$6.00 acre, \$5.00 monthly. Descriptions free. Write Armstrongs, Shook, Missouri.

POULTRY, FARM SUPPLIES

POULTRY Farmers—Broiler growers—Turkey raisers read the new American Poultry Journal for latest ideas and greater profits. 12 months, 50c. Special offer, 4 years \$1.00. American Poultry Journal, 182 North Wabash, Chicago.

PROFITABLE OCCUPATIONS

ANNOUNCING Home study course in commercial baking. Practical basic training. Good field for those with aptitude. Free booklet. "Opportunities in the Baking Industry." National Baking School, 835 Diversey Pkwy., Dept. 3431, Chicago 14.

WELDING Pays big money. Learn easily at best equipped school in country. Non-profit school with low cost training. G.I. approved. Write Hobart Trade School, Box M-162, Troy, Ohio.

"HOW To Make Money With Simple Cartoons"—A book everyone who likes to draw should have. It is free; no obligation. Simply address Cartoonists' Exchange, Dept. 91CP, Pleasant Hill, Ohio.

MEN Wanted. Build luggage and cases at home. We sell your products, supply instructions, materials, everything. No special equipment needed. Free details. Cascraft, 805-G Sunset, Los Angeles 12.

1200 OPENINGS Monthly. Inside, outside, skilled, unskilled. Current list \$1.95. Garlock's, #3 Campbell Block, Honolulu.

BUY Wholesale thousands nationally advertised products at big discount. Free "Wholesale Plan." American Buyers', Hertel Station, Buffalo 16-B, N. Y.

\$10,800 PROFITS! Your own mailorder business! No risk! Success plan free! Treasury, 709 Webster, New Rochelle L-32, N. Y.

ALASKA Jobs—Up to \$1500 monthly. 1956 business directory and government map—\$1.00. Includes military and civilian construction, mining, aircraft, lumber, fur-farming, homestead and highway facts. Hot list of firms hiring! Line up your spring job now! Bayer, Box 424-PM, Hollywood 28, Calif.

FOREIGN Jobs—Latin America, Alaska, Canada, up to \$1500 monthly. Up-to-date 1956 foreign service directory gives complete information; hot list of firms hiring for military and civilian construction, aircraft, oil, exporters-importers, mining, \$1.00. How-when-where to apply. 9th successful year! Global Reports, Box 883-S, Hollywood 28, Calif.

JOBS Galore, opportunities. San Francisco Sunday classified airmailed \$1.00. Ellsworth, Box 6P, San Mateo, Calif.

MUSHROOMS Grown boxes. Manureless process. Spawn \$1.00. Gordons, 553 William, Winnipeg, Manitoba.

TYPISTS—Profitable home business. Complete copyrighted information, 50c. Gaunt, 827-A Irving, Chicago 13.

JOB Guidance. What job are you suited for? Send for free questionnaire. National Guidance Service, Bainbridge Road, Elizabethtown, Penna.

HOUSTON, Texas, current help wanted listings airmailed \$1. Housing 25c extra. Dempsey, 2818 Hardy, Houston 9, Texas.

CONFIDENTIAL Reports on best paying jobs with travel, adventure, promotions. Construction, aviation, shipping, laborers, clerical, trades, supervisory, factory, unusual opportunities, all types of work. Skilled and unskilled. Foreign and state-side openings for men and women. Only \$2.00, including year registration-advisory service. Reports airmailed same day order received. Guaranteed best service available or double your money back. Research Services, Suite 207-PMA, Brown Building, St. Louis 5, Missouri.

FREE Folio "\$5,000-\$45,000; Unlimited Vacations." No merchandise, equipment. Unknown! Work home, sparetime! Haylings, Carlsbad, Calif.

INSPIRATIONAL Money making method. Distributor, 1305 West 46th, Los Angeles 37, California.

BOOM-Town hub of the booming new South. Huge Atlanta Sunday classified airmailed Saturday, \$1.00. With data book \$1.25. Benny's, Box 3001, Atlanta 17, Georgia.

FREE Book "505 Odd, Successful Businesses." Work home. Pacific, Oceanside, Calif.

SUNSHINE! Columns Florida jobs air mailed for \$1.00. Evans, Box 4325, Fort Lauderdale, Florida.

CHINCHILLA Breeding for beginners. Read this important booklet about first steps at lowest cost. Expertly written, factual, not sales gimmick. Start lucrative future. True picture, \$1 ppd. Hollert, Dept. PM, 38-14 218 St., Bayside, N. Y.

\$18.75 NATIONALLY Advertised Ecstasy perfume. Closeout price 60c. Sample \$1.00. Details free. Essef, 73-14K 175, Flushing 66, New York.

ATTENTION Construction, aviation, oilmen! Trades, laborers, truck drivers, clerical, engineers, many others. Who to contact for highest paying jobs! To \$1500.00 monthly. Latest copyrighted reports, 52 countries—St. Lawrence project, Spain, Alaska, Latin America, Europe, Pacific. Year registration-advisory service. Application forms. Unconditional money-back guarantee. \$2.00. Airmailed \$2.25. (C.O.D.'s \$2.49.) International Reporter, St. Louis 1-PB, Missouri.

\$1300.00 MONTHLY For truck drivers, \$1400.00 monthly for carpenters, electricians, plumbers, mechanics, \$1200.00 for clerks and laborers. Full information and complete foreign listings, with current information on Spain, Korea, Australia, Alaska and Canada. \$1.00. Current information on stateside projects, \$1.00. Dept. 3-A. Opportunities Unlimited, 1110 Commerce Bldg., St. Paul, Minn.

MUSHROOM Growing simplified. Spawn (seed), instructions, \$1.00 ppd. Prepared trays, grow when watered. 6 for \$6.00 (Express charges collect). Literature free. Luxur, 641 S. 19th, Newark 3, N. J.

MAGAZINE Subscriptions—Largest commissions, bonus. Qualified Agency, 451AA Kingston, Brooklyn 25, N. Y.

ALASKA Police jobs open. Information \$1.00. Write now. ABCo, Box 282, Juneau, Alaska.

CONSTRUCTION. Money, travel, opportunity. U.S., Canada, Europe, Asia. All trades. Dependable. Send \$1 now for detailed listing. Ralph Baxter, P.O. Box 4032, San Francisco 1, Calif.

TAKE Advantage of prosperity and exciting job vacancies. Send for new book describing detailed techniques for landing a better job. Two dollars, c.o.d. including free packet of successful job letters. Money-back guarantee. National Publications, Washington 7, D. C.

JOBS To \$1500 monthly. All trades. South America, The Islands, U.S. Fare paid. Application forms. Free information. Write Dept. 760, National, 1020 Broad, Newark, N. J.

BUY Wholesale 550,000 products. Literature free. Carter, Box 6011-D, Chicago.

SECRET Investigation. Experience unnecessary. Investigators particulars free. George Wagner, 125M West 86th, New York 24.

UP To \$50.00 weekly, spare time, home mail-order. Details free. Yeager, 2328-P Carmona, Los Angeles 16, Calif.

RAISE Pheasants on \$100 week plan. Little capital and space can make you independent. Free details. Great Central System, Columbus 1, Kansas.

GROW Mushrooms. Cellar, shed, and outdoors. Spare, full time, year round. We pay \$3.50 lb. We paid Babbitt \$4,165 in few weeks. Free book. Washington Mushroom Ind., Dept. 99, 2954 Admiral Way, Seattle, Wash.

MAKE New greaseless doughnuts in kitchen. Sell stores. Free recipes. Michael Ray, 3605 South 15th Ave., Minneapolis 7, Minnesota.

BE The Popular Mechanics representative in your neighborhood and earn big profits in your spare time. Write Popular Mechanics Magazine, Room 408M, 200 E. Ontario St., Chicago, Ill.

MONEY In saw and lawnmower sharpening sparetime at home. Repeat cash business. Experience unnecessary. No selling. Free booklet explains. Vernon Foley Company, Columbia Heights, Minnesota.

FORTUNE Possible raising fishworms and crickets. Free literature. Carter Wormery, Plains, Georgia.

\$200 WEEKLY Cleaning Venetian blinds. Free book. Burt, 2434A, Wichita 13, Kans.

WHOLESALE Catalog! 30-80% discounts! Appliances, musical instruments, typewriters, phonographs, watches, jewelry, recorders, housewares, etc. Consolidated Distributors, 21-14 Lafayette, Paterson 15, New Jersey.

AUCTIONEERING—Home study course. Diploma granted. Auction School, Ft. Smith, Ark.

MAILING Postcards offering fast-selling merchandise is profitable. Everything furnished. Send 3c stamp for details. The Wm. F. Liska Co., 102 Birchwood Ave., Cranford, N. J.

EVERYBODY Likes candy. Learn to make professionally home. Our 45th year. Ragsdale Candies, D6, East Orange, New Jersey.

BOOKS, PERIODICALS, PICTURES, POSTCARDS

BRITISH Books—All subjects. Catalog 10c. Wants solicited. Transbooks, Box 22-PM, Brooklyn 26, N. Y.

BOOKS Found! No obligation. Williams, 165-3rd St., Hoboken, N. J.

BOOKS, Government surplus. Bargain prices. Free catalog listing 50 other free catalogs. Instructional, educational, vocational subjects. Millions of volumes, new and used. Books bought. Est. 1902. Long's College Book Co., Dept. PM, Columbus 1, Ohio.

SHIPS Photographs, lists 10c. Scorzafava, 1648 59th St., Brooklyn 4, N. Y.

TAINTER'S Book Shop, Temple, N. H. Books on everything! Try our search service.

USED Fiction, religion, etc. \$1.00 brings three. Books of Yesterday, 820 Moore Ave., Williamsport, Penna.

"WHY Make a Will?" Bulletin 10D free. Willform, Box 33, Ferndale 20, Mich.

BACK Dated magazines and out-of-print books. Send wants. Joseph Di Stefano, 1200 Decatur St., Brooklyn 7, N. Y.

BOOK Catalog. 1000 interesting titles. Send 10c. Books Publishing Co., Amityville 3, N. Y.

SPARETIME Profits taking subscriptions all magazines. Wholesale catalog free. Cassell Publishers, Westfield, New Jersey.

NATIONAL Geographic Magazines, 1888-1952. Periodical Service, Box 465-PM, Wilmington, Delaware.

BOOKS Found! Any author, old or new. Rush titles wanted; no obligation. International Bookfinders, Box 3003-PM, Beverly Hills, California.

BOOKFINDERS! All subjects. Send wants! Jaher Book Service, 183 Hazelwood Drive, Westbury, N. Y.

"SCIENCE Milestones." Records march of science starting 400 years before Christ, right up to date. Amazing facts revealed. 312 pages packed with startling information that will thrill you. A real history of science. \$5.00. Literature free. Popular Mechanics Press, 200-5M East Ontario St., Chicago 11, Ill.

GAMES, TOYS, NOVELTIES

50 METAL And plastic assorted toys, attractively packaged. 50c. Deluxe, 3405-B, Southern, Baltimore 14, Md.

MAGIC TRICKS, PUZZLES, JOKER NOVELTIES

LEARN Ventriloquism, easiest method. Details free. Smith, 801 Bigelow, Peoria, Ill.

3100 NOVELTIES, Jokes, tricks, gadgets, funmakers, hobbies. Big catalog 10c. Johnson-Smith, D-252, Detroit 7.

BE A magician! Large professional catalog of latest tricks, 35c. Ireland, C-109 North Dearborn, Chicago 2, Illinois.

GO Ventriloquist, all secrets told. Make money, surprise friends. Send 35c for information. Free \$1.00 catalogue of dummies, dialogues, etc. Limited supply. Gough, R. 3, Hartford City, Ind.

SMOKEBOMBS 25c, 7 For \$1.00. Terrific! 4463-PM Greene, Philadelphia 44.

500 MAGIC Tricks, games, puzzles, jokes, novelties, ventriloquism, moneymaking secrets, fortune telling, experiments, palmistry, talismans, \$1.00. Ken's, 1704 Norris, Austin, Texas.

EARN Money as a magician; fine hobby. Large professional catalog \$1.25. Holden's, 120 Boylston Street, Boston, Mass.

VENTRILLO. Professional voice-throwing instrument and catalog 25c. Box 971-PM, Philadelphia 5.

BEST Magic. Joker's novelties. Lower prices. Catalog 10c. Top Hat, Evanston 12, Ill.

DOLLAR Magic set free with catalog 25c. 4462-PM Germantown, Philadelphia.

FREE Trick and professional catalog of 600 tricks, \$1.00. Terry's Magic Studio, 1921-66th Street, Brooklyn 4, New York.

SENSATIONAL Magician's wand 25c. Vanishes handkerchief! Catalog included. Box 1352-PM, Philadelphia 5.

500 TRICKS, Douglas famous catalog, 10c. Fastest magic service for 30 years. Douglas Magicland, Dept. 1, Dallas, Texas.

LEARN Ventriloquism. Details without obligations. Harry Harmon, Box 33, Mint Spring, Va.

PROFESSIONAL Catalog, 175 pages, 25c. Williams, 900 Plymouth, Ellwood City, Penna.

WOODEN Nickels. Magic catalog, free trick, 10c. Fun'n Magic, Box 1375, San Antonio, Texas.

FREE Deck trick cards with catalog 50c. 1746-PM Market, Philadelphia 3.

COINS, TOKENS, CURRENCY

OLD Money wanted. Will pay fifty dollars for nickel of 1913 with Liberty head (no buffalo). We pay cash premiums for all rare coins. Send 4c for large coin folder. May mean much profit to you. Numismatic Co., Dept. 20, Fort Worth, Texas.

AMERICAN Coins! Stamps! Extensively! Sullivan, 127-FF East Fourth, St. Paul 1, Minnesota.

LARGEST Coin magazine (160 pages) 30c. Scrapbook, 7320-J Milwaukee, Chicago 31.

BEAUTIFUL New set—Laos \$1.50; Tahiti \$1.00; Lundy Island \$1.65; Siam \$1.25. Giant bargain catalogue 35c; guidebook \$1.75. Bebee's, 4514 North 30th, Omaha 11, Nebraska.

16 PAGE Illustrated U.S. coin list 10c. Stoney, 192 Washington, Boston 8, Mass.

SCARCE Uncirculated 1955S dimes \$6.50 roll. Jack Turner, Box 1406, Prescott, Ariz.

40 DIFFERENT Coins \$1.00. 100 different bills, \$1.00. Oddehon, Box 482, St. Louis, Mo.

\$3,000.00 FOR 1913 Liberty head nickel. Dimes 1894-S, 1895-O, 1916-D. Quarters 1827, 1896-S, 1901-S, 1913-S, 1923-S. We pay \$5.00 to \$1,500.00. Certain dates—Lincoln cents, \$60.00. Indianheads, \$60.00. Large cents, \$500.00. Eagle cents, \$200.00. 2c pieces, \$45.00. 3c pieces, \$60.00. Half-dimes, \$500.00. Shield nickels, \$100.00. Old dimes, \$300.00. 1875 Canadian quarter, \$50.00. Hundreds of others worth \$5.00-\$500.00. Wanted—Half dollars, dollars, gold coins, paper money, etc. Know their true value. Our large illustrated guarantee buying-selling catalogue, giving complete all coin information—Send \$1.00. Purchase catalogue before sending coins. Catalogue money refundable. Worthycoin Corporation, Leaders Numismatic Quotations, K-112-C, Boston 8, Massachusetts.

GET Profit and pleasure in collecting old coins. Send 10c for 56-page illustrated coin catalog. You'll be delighted with it. Send for it now. B. Max Mehl, 370 Mehl Building, Fort Worth, Texas. Largest rare coin establishment in U.S. Established 56 years.

FOREIGN Coins, 10 diff., 25c. Foreign bills, 20 diff., 25c. Indian cents 10 diff., 50c. Lists. Oliver Arnold, Macon, Mo.

BARGAIN Lists, Indianhead cent before 1900, 10c. Economy Sales, 157 Dean, Mansfield, Mass.

TWENTY Different Indian cents \$1.00. Sayers, 1000 East Unaka, Johnson City, Tennessee.

6-IN-1 Special: Magnifying glass; check list; 25 coin envelopes; giant 60 page bargain catalog; ten different Indian pennies; Mexican ten-peso; All six, \$1.00 postpaid. Ben's Coin Shop, 31 North Clark, Chicago 2, Illinois.

U. S. Large cent, 2c piece and bargain list, only \$1. Delmaco, Box 1123, Wilmington, Del.

FREE! Foreign coin, banknote and coin collectors illustrated catalog to approval service applicants. Send 3c postage. Tatham Coinco, Springfield 30, Mass.

MORGAN Dollars; 1878, 1887, 1890, 1891, 1897 S mint unc. \$2.00 ea. Illustrated catalogue, 25c. Shultz, Salt Lake 10, Utah.

101 DIFFERENT Foreign bills—\$1.00 postpaid. Dwight Musser, Dunbar, West Virginia.

COIN Collector's greatest magazine, huge pages, big illustrations, 10c. Lawrence Brothers, Anamosa, Iowa.

SAN Francisco mint closed! Made only cents and dimes in 1955. In short supply and great demand. One each, brilliant uncirculated, for 25c. Free coin lists with order. Bryson Stamp & Coin Company, 612 White, Toledo 5, Ohio.

STAMP COLLECTING

100 YEAR Old United States stamps are sent on approval together with all commemoratives, airmails, etc. Also all foreign, Roosevelt, etc. Send 10c for 50 different U. S. and approvals. Globus Stamp Co., 268-4th Ave., New York 10, N. Y. Dept. 213.

OLD Stamps wanted. I will pay \$100.00 each for 1924 1c green Franklin stamps, rotary perforated eleven (up to \$1,000.00 each unused). Send 10c for large illustrated folders showing amazing prices paid for old stamps and coins. Scheuermann, (PM-61), 50 Berkshire, Rockville Centre, New York.

WOW! 135 All different Germany 10c. Zeppelins, semi-postals, airmails, high values. Big bargain lists and approvals included. Jamestown Stamp, Dept. A1PMC, Jamestown, N. Y.

"TOPICAL Stamps." Big new book. How to collect, mount, writeup. Lavishly illustrated. Only 25c. American Topical Association, 1602-M West Wells, Milwaukee 3, Wisconsin.

100 DIFFERENT U.S.—50c. Approvals. Utechs, 1143D North Keeler, Chicago 51.

AUSTRALIA—Fifty different exciting commemoratives, animals, kings, queens. This valuable Australian collection only 10c with approvals. Viking, Great Neck 8, N. Y.

1000 BEAUTIFUL Mounted stamps for you to look over. Pick and choose at 1c and 5c each! Wolverine Stamp Service, Dept. A25, Fruitport, Mich.

U.S. Stamps—Top philatelic investment at discount prices. Giant illustrated catalogue. Only 10c. Raymax, 37-VZ Maiden Lane, New York City 38.

SOMETHING New—Something different. Try our books of 1,000 different stamps. Mostly 1c and 2c all catalogued for your convenience. Big discounts. Modern Stamp Co., Dept. A-3, Ferrysburg, Mich.

50 DIFFERENT Bulgaria 10c! Approvals. Ensign Stamp Company, Dept. M, Berdan Avenue, Paterson 2, New Jersey.

FIRST U.N. set. Among world's prettiest. Only 10c. Approvals. Welles, Box 1246-R, New York City 8.

LOOKING For bargains? Try our 1c and 2c quality approvals in books of 1,000. Also U.S. Clark Stamp Co., Dept. A-46, Muskegon Heights, Mich.

GREAT Value, 6 mint Monaco triangles, 10c. Approvals. Bruce Stamp Company, 64-46D 214th St., Bayside 64, New York.

FREE! Giant catalog offering thousands of bargains. Sent with beautiful approvals. Jamestown Stamp Co., Dept. E1PMC, Jamestown, N. Y.

1000 DIFFERENT Worldwide plus 100 different U. S. \$1.00. Approvals. C. Casto, 1233 West Virginia, Dunbar, W. Va.

50 DIFFERENT A-Z countries 3c. Abyssinia-Zanzibar. To approval applicants. Avalon Stamp Co., Dept. M, Springfield, Mass.

CANADA—Newfoundland collection including early issues, commemoratives, pictorials and high values. Plus set of fascinating triangle stamps. Plus set of unused British Colonies. Plus large stamp book. All four offers free. Send 10c to cover postage. Empire Stamp Corp., Dept. PM, Toronto, Canada.

DEALERS, Wholesale list. Postage 3c. Frank, 5031 Queensberry, Baltimore 15, Maryland.

FREE! World's 10 ugliest! Weird colors, valuable cut design. Send 3c postage today! Norrisco, Milwaukee 7, Wis.

SUPERIOR Worldwide mission mixture. Amazing variety! Half pound only \$1.50. Baye Nielsen, 4545B Harvard, Montreal 28, Canada.

50 SPAIN 3c. Approvals. Walter Kotowski, 19265 Eureka, Detroit 34, Mich.

FIRST Complete German airport set, 10 cents. Approvals. Boger, P.O. Box 152, North Wales, Penna.

FREE U.S. stamps, 1943 occupied nations flag, airmails, commemoratives included, collection of 25 different U.S., plus \$5.00 stamp. Everything for 10c mailing charge. Approvals. Willett Stamps, 141-A, E. Main St., Mount Kisco, N. Y.

FOREIGN Approvals for all collectors. Connelly, Box 106, Shelby, Ohio.

100 DIFFERENT China 10c with approvals. Tru-Value, Box 2098, Santa Ana 3, California.

\$12.00 CAT. At \$1.00 only—Denmark T.B. sanatorium seal D. Greens #81. \$3.00 in a fine mint block of four. Singles at 30c. Free stamp and seal pricelist plus "The Founder of the Christmas Seal" on card to customers. Joint orders \$5.00 postpaid. Under \$5.00 extra 15c return postage required. Mint stamps. Write: Vendelskov, Rolighedsvej 22, Copenhagen V, Denmark.

FINE Foreign stamps on approval. Laddy, Kresge Bldg., Minneapolis 2, Minnesota.

100 DIFFERENT United States, 25c. Approvals. Hunichen, Box 786, Edgewood, Maryland.

UNHINGED U. S. mint approvals. Dale Dronso, 3647A Plankinton, Cudahy, Wis.

30,000 STAMPS Disposal sale: Grabbag 40c. Big bargain lot \$1. Extra special bette: stamps \$2. Giant assortment \$5. Literature free. Persil, 436 N. Y. Ave., Brooklyn 25, N. Y.

OLYMPIC Set, 1000 hinges only 10c. Approvals. Buckey, 208 Ludlow Bldg., Dayton 2, Ohio.

SCARCE Afghanistan, Comore, Greenland, Manchukuo, Singapore, 10c with unusual approvals. Baye Nielsen, 4545B Harvard, Montreal 28, Canada.

RUSSIA—25 Exciting gems 5c, approvals. Belmont Stamp, Washington 15, D. C.

FREE: Souvenir sheet requesting 2c attractive hi-value pictorials. E. M. Remler, Mount Dora, Florida.

1500 MIXED Foreign stamps \$1.00. No approvals. Aaron, 789 Valencia, San Francisco 10.

NO Approvals—305 Foreign stamps from 25 countries \$1. Bonder, Ellenville, N. Y.

GIANT Stamp zoo free! Snakes, leopards, rhinoceros, zabu, koalabear and other fierce jungle beasts. Approvals. Send 10c for handling. Free stamp magazine. Lincoln Stamp Co., St. Catharines 51B, Ontario.

500 FINE Mixed U.S. stamps 15c. Wright, 201 Mealey, Hagerstown, Maryland.

EXCELLENT Approvals at 1/2 catalogue. Tobysco, Box 255, Gloversville, N. Y.

SPECIAL High value commems, topicals, eighteen percent catalog mint set bonus \$1.00 packets. Limited, Rich, Box 109, Velasco, Texas.

ROOSEVELTS. Set giant F.D.R. death stamps from Uruguay. Free with approvals. Itasca Stamps, P.O. 758, Itasca, Illinois.

FAMOUS Americans! 10 American beauties 10c. 7 other commemoratives included. Approvals. White, 516-A Avenue L, Brooklyn 30, New York.

FREE \$1.00 Mint Hongkong! Bargain approvals! Mayer, Box 208C, Forest Hills 75, N. Y.

100 DIFFERENT Austria 10c. Approvals. Aronson, 91 Marion, Brookline 46, Mass.

100 BRITISH Colonies 10. Approvals. Neal, 5950 Tower, Riverside, Calif.

FREE Packet of attractive, colorful pictorials with approvals. Anarden, 4749-14th Ave. So., Minneapolis 17, Minnesota.

BRITISH Colonies only. \$5 catalogue, special \$1. Mostly pictorials over 10c, mint, used. Hudson's, Box 556, Pinedale, Calif.

LIMITED! First 100 sending \$1.00 receive 11 rare 1873-90 U. S. classics worth double, approvals. Kuehl, 3125 East K, Tacoma 4, Washington.

FREE: Obsolete U. S. occupation set with most interesting approvals. Airmails, colonials, pictorials, commemoratives. Selling out. Riedell, Greensburg, Pennsylvania.

12,000 PENNY Approvals waiting for you. Many from exotic countries, pictorials, airmails, new issues. Tilbury, Box 862, Newark 1, N. J.

20 DIFFERENT U. S. commemoratives, 25 regular issues, hinges, perforation gauge and our illustrated U. S. catalogue 20c. Scioto Stamps, Box 547, Portsmouth, Ohio.

UNUSUAL Japanese UPU souvenir sheet, plus mint German airmail and semi-postal collection only 10c. Worldwide pictorial approvals included. Firland Stamp Co., Box 493, Seattle 11, Washington.

STAMP Collecting outfit, includes packet worldwide stamps, package hinges, watermark detector, millimeter gauge. Everything, 10c with approvals. Lorain Brown, Marion 1, Michigan.

SPECIAL! Large pictorial approvals with world, British-French Colonies, Americas in neat album order! Honest values, 110 different British Colonies 10c with approvals. Darling's, Ridgway 2, Penna.

MINT Queen Elizabeth pictorial sets (Caymans, Barbados, Tristan, Dominica, Grenada, Leewards)—21 bicolors 25c. Approvals, Gannon Stamps, Box 931, Canton 1, Ohio.

MIXTURES: 300 Canada \$1.00, contains wildlife, commemoratives, even "G's." 250 U.S.A. \$1.00, commemoratives, airmails, high values, 250 Australia \$1.00. Free \$1.00 totem with \$3.00 order. Willing Weir, 7416 Gilbert, Philadelphia 38, Penna.

72 PAGE Illustrated U. S. catalog free. Stone's, 192 Washington, Boston 8, Mass.

100 CHINA 10c, Approvals, gifts. Coast, P.O. 2187H, Santa Ana, California.

101 WORLDWIDE 10c, With approvals. Box 815, San Francisco 1, Calif.

FOREIGN Approvals, Reasonably priced. Arlo Bones, 128 S.E. 24th, Portland 15, Oregon.

FREE Triangle set with approvals, EAC, 8400 Main, Clarence, N. Y.

QUALITY Approvals, no junk. Comco Stamps, Box 56, Brooklyn 29, N. Y.

FREE Worldwide selection accompanies approvals! Erv's, 802 North Central, Marshfield, Wisconsin.

ZEPPELIN Set free with approvals. (Postage appreciated.) Variety Stamps, 57-Z Circuit, Newton Highlands 61, Mass.

NETHERLANDS—100 Different pictorials (cataloging \$5.00), \$1.00 with approvals. Royal Stamp Company, Tamaqua, Penna.

5 UNUSUAL Mint sets, includes Abyssinia, Azerbaijan, Albania, Slovenia, Liberia. Only 25c with approvals. Montalto, New Church, Virginia.

UNITED States airmails, 25 different including 80c Hawaii, \$1.00. William Wolf, 6942 Paxton, Chicago 48, Ill.

200 U.S. Plus 10 foreign sets, 10c. Approvals. Farmer, 6919 Camrose, Los Angeles 28.

FREE United States illustrated catalog. Bailey, 45 Bromfield, Boston, Mass.

SELL Your surplus good grade stamps. Write, describing fully what you have. Vanroy Shirk, Lebanon, Pennsylvania.

FREE! Surprise packet with approvals. Pioneer, Box 414M, Pasadena, California.

U. S. Price list free. Send 3c postage. Sale, Box 128, Highland Springs, Va.

ASTONISHING Gift—40 diff. with superior approvals. Sparta, Box 1082, Rochester 3, N. Y.

CIPEX Souvenir sheet plus 25 different U.S., 10c. Approvals accompany. Village Stamps, 90-39P 214 St., Queens Village 28, N. Y.

1000 DIFFERENT 50c. Approvals. Ouellette, Box 66, Flint, Fall River, Mass.

100 FOREIGN, 20 U. S. commemoratives, 10c. Approvals. Weckerling, Box 442V, La Feria, Texas.

GIANT Approvals, thousands different, 1c and 2c each. Wahl's Stamp Exchange, 7008P Farragut, Chicago 31, Ill.

FIVE Nicaragua new pictorials mint 5c with approvals. Gobie Approvals, 931 Emwell, Ferndale 20, Mich.

25 DIFFERENT Luxembourg, 10 cents. Approvals. Waha Company, 178 No. 17th St., East Orange, N. J.

90,000 BEAUTIFUL U.S. grab-bags, 25c and 50c each. Elroy, 105 North Tenth, Northwood, Iowa.

100 DIFFERENT U.S. commemoratives, 100 different world. Both for \$1.00. Mike Filipas, 7128 So. Carpenter, Chicago 21, Illinois.

FAMOUS Americans—21 different only 20c to new approval applicants. Kitchel, Box 2355-M, Phoenix, Arizona.

WORLDWIDE Packet! 5c with approvals. Acme, Box 534, Winston-Salem, N. C.

U.S. Air mails only, 32 diff. fine used, special \$1.00. Hudson's, Box 4015, Fresno 44, Calif.

800 MIXED U. S. old, new, 25c. Lists. Weatherby, Fort Myers, Fla.

STAMP Cleaning service. No creasing or staining. Licensed and bonded, 75 cents per 100. Minimum order 75 cents, money order only. Lobell and Son, Route 3, Denham Springs, La.

EVERYTHING 20c To approval applicants. Government reproduction (cipex), 15 different commemoratives, obsolete dollar presidential, surprise packet, large illustrated catalog. Standard, 10840 Woodview, Parma Hts. 30, Ohio.

GREATEST Premium! World-wide collection! Over 1000 different stamps from Aden, Nigeria, Corea, Macao, other exotic lands. Includes triangles, airmails, sport, animal, ship, map stamps. Catalog value over \$25.00. This exciting collection given to approval customers. Request approvals, details, today. Odd Stamps Co., Dept. A3, Box 31, Redondo Beach, Calif.

BEAUTIFUL Collection of Italian stamps. Pictorial history of famous men, emperors, kings, scenic views, historical events, airmail, special delivery. High value, 100 different, 10c with approvals. DeRespinis, G.P.O. Box 771E, New York 1, N. Y.

FREE Complete set of famous Americans, flags, parks and presidentials to approval buyers. Send 5c for 15 of the above stamps plus full particulars. Triboro Stamp Company, 145 Nassau Street, Dept. 101, New York 38, N. Y.

TEN Triangles and over 50 others 10c with approvals. Bennett, Candor 3, N. Y.

FREE—Scarce Allenstein! Tru-val-u approvals. Brunning, Donaldson St., Ruthersford, N. J.

FREE U.S. plate block list. Simstaco, Box 63, Mattapan 26, Mass.

BRITISH Colonial approvals, £ values free. Tanglewood, 5401 Clarkston, Tacoma 46, Wash.

SEND 500 Different good duplicates plus 25c. No damaged. Receive 500 different. Better sent, better received. Bitzer, Dabel Station 178, Dayton 10, Ohio.

U.S. Mint commemoratives, 13 different, 25c. Free price list. Brooks, 2352A East 23rd Street, Brooklyn 29, New York.

UNBEATABLE! Ten superb complete mint sets mailed with United Nations stamps only 10c. Approvals, Sunlite, Box 1259-W, New York City 17.

FEATURING Low priced approvals. Stamps from 1/4c upwards. Keigwin, Box 933B, Daytona, Florida.

"TRAIN Wreck" stamps (complete set, Cuba, showing locomotive and cars wrecked on steep embankment), only 10c. Approvals. Winthrop Stamps, Dept. M1, Groton, Conn.

FIFTEEN Different triangles and 53 different other stamps. Everything only 20c with approvals. Nevin Otis, San Andreas, California.

FAROUK, 27 Different Egypt, only 10c with approvals. Excello, Box 489, Red Bank, New Jersey.

30 DIFFERENT Commemoratives, 1893 up, 10c. U. S. approvals. K. & B., Box 5, Brooklyn 14, N. Y.

ISRAEL—25 Different 25c. Value \$1.00. Limited supply. Approvals accompany. Stamps, Box 2562, San Antonio 6, Texas.

U.S. Mint 797 SPA sheet, 10c to U.S. approval applicants. M. Haycock, 153M 74th St., Brooklyn 9, N. Y.

200 DIFFERENT Including Macau, Rhodesia, Mauritius, 10c to approval applicants. Eviden, Box 128, Valley Stream 50, New York.

MYSTERY Lot \$3.75, worth \$7.50. Included mail sale catalogue. Robbern, Shirley, N. Y.

FREE Sample stamp newspaper, information on collecting, special lists, Approvals, Littleton Stamp Co., Littleton A1, N. H.

PHILIPPINES—30 Different 10c. Approvals. Moffat's, 740 Milton, Rock Hill 17, South Carolina.

FREE Samples of revolutionary new stamp selection method praised by collectors, with approvals. Major Company, 604 West Dartmouth, Kansas City 13A, Mo.

FREE Beautiful German pictorials, approvals. Eagle, 6918 Roosevelt, Philadelphia 49, Penna.

1000 DIFFERENT Worldwide stamps \$1.00. Universal, P.O. Box 6, Kenosha, Wisconsin.

WANTED—Stamp collections. Accumulations. Murray Gold, 62-95P Saunders, Rego Park 74, N. Y.

CORONATIONS, Triangles, sports, animals, free with approvals. Exotic, Box 482-M, Coral Gables 34, Florida.

BE Smart—Stop paying high retail prices. Approvals at wholesale. Write for details. Bargain Stamps, Redlands, Calif.

BRITISH Colonial collection—Hivalves, commemoratives. Free to approval buyers. Pleasure Stamps, 1865P—52nd, Brooklyn 4, New York.

DIFFERENT, 500, 50c; 1000, \$1.25; 2000, \$3.00; 5000, \$11.00. Clearing approvals wholesale. K. S. Holmes, London, Canada.

REVOLUTIONARY New stamp selection method praised by collectors. Send for details with approvals. Major, 432 West 70th Terrace, Kansas City 13A, Missouri.

VARIETY! 55 Singles, 5 sets, souvenir sheet 25c with approvals. Philatelie Den, R.D. #1, Towanda, Penna.

20 MINT Blocks \$1.00. Heckl, 1207 Northland, Buffalo 15, N. Y.

FREE! Catalog! About stamps. Illustrated. Free! The Stampmart, Hartford 1, Connecticut.

FREE Lists general foreign sets, singles and packets. No approvals. Snooks, Box 1715, St. Louis 2, Mo.

WONDERFUL Offer. 7 complete mint sets only 10c with approvals. Reich (M26), 1033 Lawrence, Chicago 40.

FREE U.S. Illustrated bargain catalogue. Rothberg's, Box 60, Boston 1, Mass.

1000 DIFFERENT 95c. John Hourigan, 1500 Archer Road, New York 62, New York.

FREE United States price list. Mark Hanna, 335 Fifth Ave., Pittsburgh 22, Penna.

FREE! Flower triangles, others. Approvals. Delton Page, Box 201X, East Paterson, New Jersey.

50 DIFFERENT Argentine 10c. Approvals. Reuter, 611 W. 40th Pl., Los Angeles 37.

100 DIFFERENT Spain 25c. Penny approvals included. Reed, Box 980, Chicago 90, Ill.

OLD Scarce U.S. seconds on approvals. Slight imperfections, lowest prices. Hernefield, Clintonhill Sta., Newark 8, N. J.

THOUSANDS Of exciting stamps, all different, yours for 1c, 2c each. Fill your album for pennies! Big collection sent for free examination. Cole, 43-A Rinewalt, Buffalo 21, N. Y.

100 JAPAN 10c. All different, with approvals. Gould's Stamps, Box 631, San Francisco 1, California.

50 DIFFERENT United States 5c with bargain approvals, lists. Bookman, Box 8245-M, Madeira Beach, Fla.

U. S. Classics. Over 50 yrs. old. 15 selected old-timers. Missing in biggest collections. All 15 at less than 1c each. 10c with approvals. Jaro, Box 246-T, New York City 8.

AMAZING Offer! 200 United States stamps—including commemoratives, airmails, high denominations to \$1.00. Only 10c to approval applicants! Illustrated bargain lists free. Mystic Stamp Co., Dept. 80, Camden, New York.

FREE Sample! Interesting, illustrated, informative! National Stamp News, Anderson, South Carolina.

50,000 STAMP Grabbags 25c each. Anderson, Box 1, Reading, Penna.

300 DIFF. World wide 25c. plus surprise packet. Packet list free. Econopackets, Box 168, Riverside 9, Calif.

WORLD'S Largest stamp (7½ x 14 inches). A real curiosity! Retail for \$60. only 3c to approval applicants. Tatham Stamp Co., Springfield 30, Mass.

WEIRD Diamond shape coffee stamp! Lovely flower triangle! First American big commemorative, Greenland, idol dancer, etc. Free with approvals. Capital Stamp Co., Little Rock 2, Ark.

100 OLD United States between 1861 and 1935, \$1.00. Roush Stamps, 51 Chestnut, Mansfield, Ohio.

SELL Stamps to our readers. Your ad in this space will be read by thousands of stamp buyers. I'll prove that to you. Write now for Folder "S." F. W. Johnson, Classified Advertising Manager, Popular Mechanics, 200 E. Ontario St., Chicago 11, Ill.

TWO \$5.00 U. S. stamps plus 20 different, 10c with U. S. approvals. Irwin Stamp Co., Box 1105, Brooklyn 30, N. Y.

ECONOMICAL ½c-1c-2c-Approvals. 22,000 varieties available. Dresel, Box 270-n, New York 25, N. Y.

225 STAMPS For only 10c! This mammoth value includes airmails, pictorials; stamps from strange countries cataloging up to 25c each! Also approvals. Mystic Stamp Company, Camden 80, New York.

FAMOUS Men, jungle scenes, zoo, United States commemoratives, 100 others. Ten cents with request for thrifty approvals. Casner Stamps, 247-A Riverside, El Paso, Texas.

30,000 DIFFERENT Collector's stamps from all parts of the world for less than 1½c each! Send \$12.50 for each book of 1,000 stamps as often as you want. J. Huppert, 1970 E. 18th St., Brooklyn 29, N. Y.

14,000 DIFFERENT—Yours on our streamlined systematic club plan for only 50c weekly. Big shipment every two weeks. Details free. Sjoquist, Box 217, Valley Stream 75, New York.

MINT Commemoratives at face! Send 25c for surprise packet of all different, mint U. S. commemoratives. Mint U. S. approvals too. Western, Box 1689P, Salinas, California.

UNITED States commemorative price list free. James Cunningham, 101 Terrace, Hasbrouck Heights, N. J.

295 DIFFERENT Plus mint set 25c with approvals. Suburban, 24 Dogwood Drive, Baltimore 20, Maryland.

VIETNAM Dragon stamp, seldom seen, sensational! Also Congo jungle gods; airmails; triangle; unusual collection free with approvals. Send dime, mailing. Lock, 2216 Third, Montgomery 6, Alabama.

UNITED States approvals. Select copies, used—mint. Kingsbury, Fairfax, Vermont.

200 DIFFERENT 10c. Bargain approvals. Ideal, Box 210, Brooklyn 11, N. Y.

\$20,250 PROFIT Selling stamps by mail. How we did it book; send only \$2.00. Free details. Fahsing, Atascadero, California.

CORONATIONS, 10 Different only 10c with approvals. Seminole Stamps, Box 1138-P, Coral Gables 34, Florida.

FREE! Benelux lands, 25 different. Approvals. McLendon, 1830 West Fifth, Montgomery, Alabama.

ANTIQUES, RELICS, INDIAN GOODS, CURIOS

FREE! Indian relic catalog. Nirscher's, 111 South 31st, Belleville, Illinois.

4 PERFECT Arrowheads \$1.00. George Smith, 841 N. Tacoma, Indianapolis, Ind.

4 SELECTED Arrowheads \$1.00. List 5c. H. Talburt, Calico Rock, Ark.

4 FINE Indian arrowheads \$1.00. Stone tomahawk \$2.15. List free. Arrowhead, Box 5283, Indianapolis, Indiana.

GESUNDHEIT! Illinois. Selling 580 historical firearms, 30,000 prehistoric, stoneage Indian relics, collectors cartridges, Confederate money, coins, Revolutionary, Civil, Indian wars flintlocks, muskets, swords, bayonets, bullet molds, powder flasks, blunderbusses, pepperboxes, Kentucky rifles, Winchester, buffalo-stagecoach carbines, frontiers, Derringers, duelling pistols, matchlocks, arrowheads, tomahawks, bannerstones, spearheads, spearheads, steer, deer, buffalo horns, mounted pheasants, owls, quail, squirrels, deerheads, Agates, fossils, mineral specimens, lapidary supplies, Daguerrotypes, gold dollars, bo-wood, blo-horns, violin wood. Send 35c for profusely illustrated catalog. Heike, Thruphies, Weno-na, Illinois.

PRECIOUS STONES, MINERALS

URANIUM In petrified wood (autunite) good test specimen \$1.00 postpaid. T. Skookos, Box 151, Kanab, Utah.

BEAUTIFUL Marine catseyes \$1.00 pair. Gemco, Eisner Ave., Sheboygan, Wis.

TEN N. Mex. minerals \$1.50, six fluorescent \$1.00, five crystallized minerals \$1.00, fool's gold 25c. Free literature. Minerals, Winston, New Mexico.

GENUINE Cut diamonds \$5.00 each, 1/20 carat. Gamco, Sistersville, W. Va.

PROFITABLE Fun with gems, minerals, rocks, jewelry. How-to magazine tells how. Four month trial \$1.00. Guaranteed. Gems and Minerals, Dept. A13, Palmdale, Calif.

HANDBOOKS For rockhounds. Free list. Minpub, P.O. Box 3114, Station "A", Spokane 17, Washington.

GEMSTONES, Mineral specimens. Every variety. Lowest prices. Free booklet. Plummer's, 4720 Point Loma Ave., San Diego 7, Calif.

GEMCUTTING—Silvercraft illustrated magazine. Tells how to cut gems, make jewelry. 150 ads illustrating equipment, gems for collectors, cutters. Free literature. Lapidary Journal, Del Mar 2, Calif.

SAPPHIRE, Topaz, tourmaline, garnet, peridot, Five uncut gem specimens, \$1.00. Ten polished gems, baroque shaped, \$1.00. Free big bargain list jewelry, gems, profitable, easy "do it yourself" projects. O'Brien's, 1116M Wilcox, Hollywood 38, Calif.

HOBBIES AND COLLECTIONS

INTEREST Your son in birds as a hobby. Send him The Aviculturist's Gazette. Pictorial monthly, \$3.00 year. 1328-P Allen Park, Salt Lake City, Utah.

NAZI Insignia, 12 different, \$1.00. Medals, armbands, flags, daggers. Illustrated lists. Medcrafts, 1923 34th St. S.W., Calgary 2, Canada.

MATCH-Box radio. Make it yourself. Plans \$1.00. Rida-Craft, 28 Cassius, New Haven 11, Conn.

8-80! THRILL To your own musical "hit" tunes! Popular! Copyrighted formula \$1. Attractive sketchbook free! Griscom, Berkshire V, Sandy Hook, Conn.

GROW Giant crystals! Free booklet. Crystocraft, Box 35, College Station, Texas.

TWENTY Different naval cancellations \$1.00. Milling, 919 Newport, Chicago, Ill.

UNUSED Matchbook covers, 100 different \$1.00. 36 page catalog 25c. Matchcover album \$3.00. Charles Edelman, 1311C East 84, Cleveland 3, Ohio.

INVENTING Can be an interesting and profitable hobby. Write for complete particulars. Institute of American Inventors, Dept. 40-E 631-E St., N.W. Washington 4, D. C.

65 ASSORTED Army patches, insignias, ribbons \$1. Surprise included. Lhgco, 19 East 16th St., New York City 3.

GENUINE Nazi medal \$1.00; 37 different American emblems \$1.00. Catalog 10c. Insignia Club, 550-B Fifth Avenue, New York.

EXCITING New book, "How to Collect Stamps, Coins, Paper Money." Packed with amazing facts; information worth dollars. Fully illustrated, 160 pages. 75c. Popular Mechanics Press, 200-ST E. Ontario St., Chicago 11, Ill.

CAMERAS, PHOTO SUPPLIES

CAMERA Repairmen greatly needed! You can learn manufacturers' service methods at home, in your spare time! Free, big illustrated book tells how! Write today. National Camera Repair School, Dept. PM5, Englewood, Colorado.

PHOTOGRAPHY For pleasure or profit. Learn at home. Practical basic training. Long established school. Free booklet. American School of Photography, 835 Diversey Parkway, Dept. 3441, Chicago 14.

UNDERWATER Camera case for Argus C-3, plastic construction. Guaranteed, \$39.95. Seahawk Products, Dept. A, Box 1157, Coral Gables, Fla.

BUY Wholesale nationally advertised cameras, photo supplies, thousands other products at big discount. Free "Wholesale Plan." American Buyers, Hertel Station, Buffalo 16-E, N. Y.

FREE! Free! Free! Central Camera Co., photographic headquarters since 1899, saves you money on all photographic equipment. Send for Central Camera Co.'s free photographic bargain list today! Central Camera Co., Dept. 13-B, 230 S. Wabash, Chicago 4, Ill.

SHREWD Buyers use our camera and projector comparison charts (still and movie). Complete set \$1.00. Consultants, Box 554-M, Rancho, Los Angeles 64.

UNDERWATER Photography pays off, brochure tells how. Send 3c stamp. Seahawk Products, Box 1157, Coral Gables, Fla.

SUNBEAM "120" Flash camera, film, bulbs, batteries, gadget-bag photo book. \$15.95 complete. \$1.00 down, \$1.00 weekly. Osgoods, 1320-J Prospect, New York City 59.

REAR Projection guide and 24x36 screen, unmounted, \$2.00 postpaid, discontinued size, dark, high contrast for slides, movies, titles. Klearcite, 1432 Orleans, Chicago 10, Illinois.

POWERFUL Telephoto lenses and mounting instructions for your camera, \$2.00 postpaid. Lensman Jamer, Manorville, N. Y.

NEW Argus automatic projector \$48.90. Terrific discounts photo equipment, appliances, typewriters. Free catalog. Mallers Mart, Box 135-A4, New Rochelle, N. Y.

YOUR 35MM. camera can bring you hundreds of dollars in spare time. Almost every family and business is a prospect for amazing new low cost method of color enlargements. Send 10c for samples and surprising facts. Write Polypix Co., Dept. PM-1A, 723 S. Wells, Chicago 7, Ill.

CAMERA Owners, proven money making plans without studios. Photo markets included. \$1.00. Satisfaction guaranteed. Details free. Scott's, Juniata, Nebr.

BASS Says: Quality cameras since 1910. When in Chicago visit the camera cross roads of the world, or write us for your favorite equipment, new or used. Satisfaction guaranteed. Bass Camera Co., Dept. AG, 179 W. Madison St., Chicago 2, Ill.

20 TO 50% Discount everything photographic, giftware. Free catalogue. Dart, 3812E Atlantic Avenue, Brooklyn 24, N. Y.

PHOTO FINISHING

6 OR 8 Picture roll 35c. 12 or 16 picture roll 55c. Each roll developed and printed in handy pocket wallet. Send coin with roll. No c.o.d.s. Mailing containers sent free. DeLuxe Film Service, Box 1268-A, Shreveport, Louisiana.

CUSTOM Finishing—50 years in business. 8 exposure roll jumbo 39c, 12 exp. jumbo 59c. Reprints jumbo 4c. Mel-Jo, P.O. Box F, Hillside, N. J.

FROM Rolls or negatives. Jumbos 4c. Regulars 3c. This ad and \$1.00 for 30 jumbos or 8-5x7. Guaranteed. Square Deal Photos, Hutchinson, Kansas.

EKTACHROME—Ansochrome—35mm. processed-mounted, \$1.00. 120-620 B & W custom developed—printed, \$1.00. Professional quality. National Color Corp., Box 55, Northside Station, Atlanta 5, Ga.

8-HOUR Service on deluxe jumbo prints. 8-exposure roll developed and 8 jumbo prints 40c, 12 exposure 55c, 16 exposure 70c; 35mm. 20 exposure 75c, 36 exposure \$1.25. Jumbo deckledge reprints 4c each. Contact prints made if specified. Bay Photo Service, P.O. Box 210, Oakland, California.

SPECIAL Introductory offer. 8 jumbos 25c, 12-35c. Western Photo, PM16, Box 298, San Francisco 1, Calif.

FAST First class return free, plus careful processing. Oversize in album 8, 49c; 12, 59c; 16, 69c; 20, \$1. Any portrait copied at sensible prices. Postcard brings free mailer. Delco Film Lab, Box 362R, Upper Darby, Penna.

20 WALLET Prints only \$1.00 from negative or print. One laminated in plastic free. Same day service. Pearson Photo, Laurens, South Carolina.

COMPARE Our film developing at one-half price. Extra large prints, 40 cents per eight-exposure roll, any size. Vermont Prints, Box 151 P, Rutland, Vt.

NEW Photography technique—Get multiple views of subject with one shot using own equipment. Instruction booklet \$2.00. Box 271 A, Mill Valley, Calif.

ENLARGEMENTS! Eight 5x7's or five 8x10's, \$1.00. Wilart Enlargers, Box 967, Little Rock, Ark.

HIGH Quality finishing—Rapid service. 8 exp., 35c; 12, 50c; 16, 75c; 20, \$1.00. Camera, Box 280, West Chester, Penna.

QUALITY Kodak finishing. 8 exposure roll 35c; 12 exposure 50c; 16 exposure 60c. Reprints 4c. Fast service. Guaranteed quality. 40 years continuous operation. Be a satisfied customer. We do color. Send for mailers. Mail Order Photo Service, Box 297, Watertown, Wisconsin.

FREE Beautiful superpak ring binder album with order 8 jumbos only 35c. Quality guaranteed. Prompt service. Free mailers. Free particulars complete superior finishing service. Grand Fotos, GPOB 1410, New York 1.

TOP Quality. Fast service. 8 jumbos 35c in beautiful ring binder album. 16 contacts 40c. Reprints—Jumbos 4c; contacts 3c. Satisfaction guaranteed. Free mailers and circulars. Fast-X-Photo, Box A, Jersey City, New Jersey.

8-12 EXPOSURE Rolls 35c, jumbo prints. Free 5x7 enlargement with each roll developed. Guaranteed work, one day service. Lincoln Studios, Dept. K, Box 13, Lincoln, Nebraska.

MOTION PICTURES AND SOUND EQUIPMENT

"ENTIRE Life Story of Christ." 8mm., 16mm., sound and silent, purchase or rent. State projector. Hemenway Film, 424 Little Building, Boston 16, Mass.

8-16MM. Silent-sound films. Latest subjects. Free catalogue, (sample film 10c). Garden Film, 690 Howard Ave., Brooklyn, N. Y.

5,000 8-16MM. Movie films. Free catalogues. International, Greenvale, N. Y.

SAMPLE—Color slide or movie 10c. Eddings, R-3, Corning, N. Y.

16 MM. Sound, lowest rentals, features, \$2.75. Sales, exchanges. Movies, Box 65, Old Hickory, Tennessee.

MOVIES Equipment. All sizes. Bought, sold, exchanged, rented. Catalogue dime. Red, 1797 Seaman Neck, Seaford, N. Y.

ALL Kinds 16mm sound films. Rent, sale. Roshon, 335 Fifth, Pittsburgh 22, Penna.

FREE! Blackhawk's big sale catalog new and used 16mm., 8mm. films; 2"x2" color slides; used 16mm. sound projectors. Biggest stock in U.S.A. Blackhawk Films, 1200 Eastin, Davenport, Iowa.

TAPE Recorders, tapes, accessories. Unusual values. Dressner, Box 66M, Peter Stuyvesant Station, New York City 9.

MOVIE Camera film: 8mm. roll \$1.50, 16mm. 100' \$3.00. Free processing. Better Films, 742 New Lots, Brooklyn, N. Y.

SAVE 50%! Guaranteed-fresh color, b.&w. movie film! 8mm., 16mm. Free catalog! Eso-R, 47th Holly, Kansas City 12, Missouri.

MUSIC AND MUSICAL INSTRUMENTS

ACCORDIONS—Direct from importer. Save 50% and more! Free trial. Lifetime guarantee. Trades accepted. Free catalog. Write Accordion Outlet, Dept. 16-R, 2003 Chicago, Chicago 22, Ill.

POEMS Wanted for musical setting. Send poems. Immediate consideration. Five Star Music Masters, 630 Beacon Bldg., Boston, Mass.

SWISS Musical movements (best) \$2.50. Spielman, 131 West 42nd, New York 36.

ORGAN? Piano? Choral technique? Consult. Griscom, Berkshire V. Sandy Hook, Conn.

BEAUTIFUL Music! Build electric organ, easily secured parts under \$100 or rebuild your old reed organ into electrically pumped, amplified instrument. Complete illustrated instructions, \$1.50. Gallo-way, Box 211, Beaufort, S. C.

PHONOGRAPH Records cheap. Catalogue. Paramount, MC-313 East Market, Wilkes-Barre, Penna.

POPULAR Songs. How to write and sell them. Write for free booklet Successful Songwriting. Gateway Songs, Box 2470, Hollywood 28, Calif.

SONGWRITERS: Melodies composed, \$5.00. John Corley, 906 E. Main, Brenham, Texas.

POEMS, Songs wanted! Free examination. Bengol Music, 93 Jefferson, Chelsea 50, Massachusetts.

10 BOOKLETS, 591 Pages! "Musical Terms" "Harmony" "Orchestra" "Piano" "Jazz" "Sound" "Music" "Rhythmic" "Writing" "Poetry." All \$1.00. Separately 10c each. (Specify title.) List free. Franks, 3121 South Racine, Chicago 8.

PROFESSIONAL Songwriting tips can open doors—\$2. Pritchett Publications, Box 2908-A, Hollywood 28, Calif.

UNIQUE Musical door attachment. See page 164. "What's New for the Home."

AFFILIATED Songwriters. Mutual co-operation. Collaboration. Publishing. Recording. Latest record and information, \$1.00. Web, 149 W. 48, New York City 36.

SONGWRITERS: Recording company wants new songs. Royalty basis. National sales, promotion if selected. No charge for melodies. Send material. Music Makers, Dept. E-17, Box 2507, Hollywood, Calif.

PLAY Piano the first day! Copyrighted secret. Details free. Miracle Method, Box 5203P, Phoenix, Arizona.

WHOLESALE Catalog! 30-80% discounts! Appliances, musical instruments, typewriters, phonographs, watches, jewelry, recorders, housewares, etc. Consolidated Distributors, 21-80 Lafayette, Paterson, New Jersey.

SWISS Musical movements, \$1.90. Helax, 218 West 72nd Street, New York 23.

POEMS Needed for new songs. Send poems for free examination, details. Immediate consideration. Songcrafters, 2724 Arcade Station, Nashville, Tenn.

1955 ACCORDIONS—Wholesale. Free catalog. American Accordion Center, PM-3, 5329 Belmont, Chicago.

SONGWRITERS! Send poems, songs. Music Service, 243 West 72nd St., PM, New York City 23.

FREE Records of your song. Your words, my melody. Free information. Johnny Mack's Melody Mart, 1094 West 39th Street, Dept. A, Los Angeles 37.

ACCORDIONS, Wholesale to everyone. Save up to 60%. All national known brands. Free catalogue. Del Principe, 29 South Cicero, Chicago 44.

POEMS Wanted for new songs. Send poems. Immediate consideration. Crown Music Company, 1476 Broadway, New York City 36.

WANTED! Poems for musical settings. Write Songwriters' Service, Clifton, N. J.

WRITE Songs. Big money and reputation. Write for information. J. Gordon Pub. Co., 4700 South California Avenue, Chicago.

VIOLINMAKERS. Repairers. Fine tone wood, and all violin supplies. Send for free wholesale price list. International Sales, 414-MPM E. Baltimore St., Baltimore 2, Maryland.

SONGPOEMS And lyrics wanted. Mail to: TinPan Alley, Inc., 1650 Broadway, New York 19, N. Y.

SONGWRITERS—Success, fame, fortune if talented. Songs revised, composed, published, promoted by largest firm. Free appraisal. Since 1943. Postcard to Nordyke Publishing Co., 6000 Sunset Blvd., Hollywood 28, PM, Calif.

SONGS—Poems wanted. Good opportunity. Tunemiths, 1609 Vista Del Mar, Dept. U, Hollywood, Calif.

RADIO, TELEVISION AND ELECTRONICS

FREE 324 Page 1956 Television, Radio, Hi-Fi, Electronics catalog! World's largest stocks, lowest prices. Everything for experimenters, builders, amateurs, servicemen. Latest build-your-own kits, Hi-Fi, phonos, recorders, P. A., TV accessories. Thousands of parts, tubes, test instruments, tools and books. Write for free copy! Allied Radio Corp., 100 N. Western Ave., Dept. 34-A-6, Chicago 80, Ill.

ATTENTION TV servicemen! 3,000 set selection used television sets. Tremendous values from trade-in stock of large retailer. Open daily and Sunday. Abner Rand, 3500 W. Grand Avenue, Chicago, Illinois.

RECORDERS, Tapes, radios, phonographs! Wholesale! Catalog. Towers, Box 155, Philadelphia 5.

FREE Television and radio troubleshooting manuals and descriptive literature upon request. Build 16 radio circuits, using printed circuitry as well as professional punched metal chassis. "Edu-Kit" includes all radio parts, tubes, instructions, tester, soldering iron, quizzes, free consultation service—Only \$19.95 complete. Progressive Edu-Kits Inc., Room 36B, 497 Union Ave., Brooklyn 11, N. Y.

MAKE Simple, tubeless, batteryless, distance-getting radio. Genuine Melomite crystal, detector, illustrated instructions, 50c postpaid. Allen, 427-PM5, Clinton, Missouri.

AMAZING! Midget radio transmitter will broadcast up to 75 feet through any radio without wires connecting. Complete with batteries only \$10.95. National Sales Company, Box 865, Charleston, W. Va.

TV Trade-in sets, Philco, Emerson, G.E., Admiral, Motorola, Tele-King, others. List available, 10"—\$17, 12"—to 17"—\$20 up. Washtek Service Co., 956 Southern Blvd., Bronx, N. Y.

NEW! Radio-television tube base pin locator, computer type, \$1.00 postpaid. Distributors wanted. Electronics, Box 827, Sparks, Nevada.

BUILD Amazing transistor personal radio. Illustrated instructions, 50c. Cook, 4003 Roosevelt, Midland, Texas.

SAVE! Repair your own T.V. So easy with marvelous new index, it's fun. Now only \$2.00. Pasqua's Television, Geneva, New York.

GET Greatly improved all-round TV reception with the remarkable AMT-X3 Tenna-Matcher. This device will eliminate or minimize snow, ghosts and other annoying interference and also appreciably increase signal strength. Government laboratory reports 30% improvement. For all TV sets—VHF and UHF. Easily attached to antenna terminal on back of set. Price, only \$3.00. Satisfaction or money refunded. Order direct from manufacturer. Remotrol Mfg. Co., 439 Kanuga Street, Hendersonville, N. C.

CRYSTAL Radio builders. Free information. Hulet, 305 Hope, Lakewood, N. J.

NEW Germanium diode, variable condenser crystal radio kit \$2.95. Phone \$1.75. Free catalogue. Clearco Crystal Co., Box 1857, Milwaukee 1, Wisconsin.

MAKE Simple powerful distance-getting crystal radio. Works anywhere. Illustrated booklet 25c. Money back guarantee. Jay Francis, Box 5963, Cleveland, Ohio.

BUSINESS OPPORTUNITIES

YOU'LL Be amazed at the tremendous profit possibilities in selling the finest quality Bibles available anywhere! Many men make \$30,000 yearly and more! Get my free proven Bible sales course plus catalog of many Morocco grain, genuine leather covered Bibles and related items. Joseph W. Cain, Wholesaler, Box 5065-S, San Antonio 1, Texas.

BOWES "Seal Fast" automotive supply distributorships available in a few states. Investment in truck and inventory, but no store required. Opportunity to join successful national distributing organization established over 35 years. For information write Bowes "Seal Fast" Corporation, Indianapolis 7, Indiana.

BE Successful in TV and show business. Free details. Omnibus, 30B Ingraham, Newark, N. J.

SELL U.S. stamps. Good profits. No stock required. Circulars for your use supplied free. Raymax, 37-RZ Maiden Lane, New York City 38.

MAKE Money growing miniature trees on your window sill. Free seed and plan. National Nursery, Dept. PP, Inglewood 4, Calif.

WORK From home in spare time. Start profitable magazine renewal service. We show you how; furnish everything free. No experience needed. Write McGregor Magazine Agency, Dept. 500-B, Mt. Morris, Illinois.

START A buying service, buy wholesale thousands nationally advertised products. Make big profits selling at sizable discounts. Postcard brings details. American Buyers, Hertel Station, Buffalo 16-C, New York.

IMPORT-Export opportunity, profitable, world-wide, mail-order business from home, without capital; or travel abroad. Established world trader ships instructions for no-risk examination. Experience unnecessary. Free details. Mellinger F701, Los Angeles 24.

ADVERTISING Book matches—Cash in on big demand; sell union label matches. Cuts for all businesses and political parties. Free powerhouse selling kit, low prices, protection guaranteed on repeat orders. Cash commissions. Superior Match Co., Dept. MX-156, 7530 Greenwood, Chicago.

BUY Wholesale — \$75,000 merchandise. Catalog 25c. Worldwide, Box 12-El, New York City 60.

THRIVING Home mailorder business. Details free. Progress, Box 545, Laguna Beach, Calif.

NEW Plastic mending tape. Just press on! Repairs clothing instantly. Lightning seller. Samples sent on trial. Kristee 116, Akron, Ohio.

EASY inexpensive complete course. Learn ventriloquy. Details free. Omnibus, 30A Ingraham, Newark 8, N. J.

MEN Wanted—Build luggage and cases at home. We sell your products—supply instructions, materials, everything. No special equipment needed. Free details. Cascraft, 805-G Sunset, Los Angeles 12.

MAKE Perfumes, other products—Sell mailorder. International, 6347 Farnell PM-1, Chicago 21, Illinois.

WANT To make big money at home? \$5 profit in an hour possible with invisible reweaving. Make tears, holes disappear from clothing, fabrics. Steady year-round demand from cleaners, laundries, homes. Details free. Fabricon, 8334-S Prairie, Chicago 19, Illinois.

BUSINESS Papers and magazines keep you posted. Late single copies. 5,166 publications—211 fields, yours included. Current list free. Commercial Engraving Publishing Company, 34C North Ritter, Indianapolis 19, Indiana.

WHOLESALE Catalogue! Appliances, cameras, watches! Cam Company, 6806PM 20th Ave., Brooklyn 4, N. Y.

TIME Payment businesses coin money. If sincere, honest, can operate on others' money. Protected key territories. Start part time or full. Write National Acceptance Exchange Company, Marysville, Calif.

IMPRINTS For mail dealers: samples, dime. Sell advertising by mail; details, dime. Volchok, 1098 Gerard, New York City 52.

YOUR Own business. Others work for you. Your profits pyramid. It's amazing. Free details. Clark, Box 2004, Cheyenne, Wyoming.

WANTED: Home producers, to be subcontractors. Cast plastic products for manufacturers in our clearing house service. Thousands of easily-made items required. Cash in at home, without previous experience. Plastic Service Associates, Dept. 1-PM, East Boston 28, Massachusetts.

NATURAL Molding rubber, extra thick. Free sample. W. Wooley, 115-A Donald, Peoria, Illinois.

500% PROFIT. Bronzing baby shoes. Simplified, machineless process. \$1.00. Beachcraft, 115 Springfield St., Lawrence, Mass.

MAIL Sale Advertiser Magazine. Mail order plans and "how to" enterprises. Copy 10c. Year \$1.00. Ernest L. Gentry, 2623 Pollard Lane, Mobile 5, Alabama.

MAKE \$7 Per hour and up! Donald Wicks made \$48 in a few hours. You can too! Write for free book and amazing product sample. Theodore-Wilson Products Co., 3523 Government Way, Seattle 99, Wash.

2000 SIGN Slogans, clock sign \$1.00. ABC, 2227 Southpark, Buffalo 20, N. Y.

MONEY In saw and lawnmower sharpening sparetime at home. Free book. Virgil Foley Company, Columbia Heights, Minnesota.

MAILORDER Merchandise! Fast seller! Free samples! Houstex, 3026 East Holcombe, Houston, Texas.

LEARN Reweaving! Free details. Harris Reweavers, Box 7112, New Orleans 19, Louisiana.

TO \$100.00 Weekly. Your own sparetime business. Operate from your home. Plans \$2.00. Jul's Workshop, Box 1448, Lemon Grove, California.

THOUSAND Dollar making tips! Literature free. Publisher, Cutler, Reading, Penna.

PUT Success in your mailorder business. Write Carlstrom, Box 1293-M, Miami 8, Fla.

HOW To make money with hobbies. \$1.00. ABC, 2227 Southpark, Buffalo 20, N. Y.

INTERESTED Mail order? Read mail trade magazines. Copies several different 25c. Palm, Box 1221-A, Baton Rouge, La.

PRINT Advertising posters, personalized greetings, many others by photographic screen process. Send dime for particulars. Remle, Box 1092, Glendale, California.

EARN \$2 Hourly, making and selling sandals! Youngs, 1308-PM, South First, Arcadia, California.

HOME Earnings for you; compile names; big fees; steady income. New manual tells how; write today. Fortier, 63-A Hill, Buffalo 14, N. Y.

BE A landscape contractor. Make \$20 to \$60 a day. Start with smaller projects and work into larger jobs. We show you how. Easy-to-follow home study course. Write for free book. National Landscape Institute, Dept. M-16-C, 310 S. Robertson Blvd., Los Angeles 48.

SELL Cigarette lighters. Retail for \$1.00. Look and perform like 55.00 models. Carded. Sell to stores, gas stations, etc. Free wholesale price list and literature. Refundable. Sample \$1.00 postpaid. Senak Sales, Bevidere, N. J.

IMPORTING Without capital. Become successful U.S.A. resident agent for leading overseas manufacturers. High income, home operated, no risk. Complete arrangements furnished including U.S.A. distribution assistance. Impex, 1974-A Comstock, Los Angeles 25.

BOOKKEEPING-Tax record distributorship. Sell merchants, farmers, accountants. Substantial profits. Handytax, 5632-C Lankershim Blvd., North Hollywood, Calif.

START A doll hospital at home. Big profits. No expensive equipment. Illustrated secrets never before revealed, everything you need to start. Free details. Hollywood Doll House, 6617 Hollywood Blvd., Hollywood 28, California.

SELL Scotchlite reflective signs for \$10,000 or more per year. \$10 for sales kit, refundable. Prestoflex Corporation, Mason City, Iowa.

EXCLUSIVE Distributor franchise, America's finest ball point pen. Writeaway Pen Company, Box 7, St. Louis 14, Missouri.

POPCORN And potato chip equipment. Eakins, Box 933-A6, Springfield, Ohio.

WANT Money? Catalog! "48 profitable opportunities." Rush 35c! Ridsen, 3468 Cass, Detroit 1, Michigan.

FREE Folio "\$5,000-\$45,000, Unlimited Vacations." No merchandise, equipment. Unknown! Work home, sparetime! Haylings, Carlsbad, Calif.

OPERATE Profitable mail order business. Write—National Specialties, 5334 Pedley, Riverside, Calif.

MONEYMAKING Mailorder business plan, free! Write, George Lenhoff, Lincoln 8, Nebraska.

MONEY In your mail everyday! Free details. Baillard's, 425 East Catherine, Louisville 3, Ky.

FREE! Complete mailorder business! Terrific profits! No investment! Vitamins, 2908PM Beverly, Los Angeles 57.

\$250 WEEK Cleaning venetian blinds. Patented machinery. Free literature. Robinson, 7213B, Indianapolis 1, Indiana.

MAKE Money sharpening shears. Details free. W. Zell, Summitville, PM2, Indiana.

MAKE Tough, attractive building plastic, easily, 88 1/2% waste, 101 uses, 800% profit. Exclusive district. Bays Laboratory, Oklahoma City 9.

BUY Wholesale thousands products. Free literature. Triple J Industries, 132 Berkshire, Bridgeport 8, Conn.

ARE You mechanically inclined? Amazing home business pays wonderful profits. Free book tells all. Belsaw, 756 Field Bldg., Kansas City 11, Mo.

LEARN Sewing machine "big money" repair. Machines, supplies wholesale. Write Taylor Service, Box 2126, San Bernardino, Calif.

CASH For sawdust (seventy methods). Tin-cans (thirty methods). Newspapers (eighteen methods). Instructions 50c each. All three \$1.00. Charles Company, 12-DXY, Norwood, Ohio.

TUNE Pianos spare time. Learn quickly. Inexpensive home course. Write Stafford, 708 Rawlings, Carbondale, Ill.

VENDING Machines, pens, nuts, perfume. Details, samples. American, Box 162, W. Englewood, New Jersey.

SELL Wholesale, stores, agents. Join national cooperative. Start part time. Be self employed. Send \$10. Refunded if you decline proposition. A'Neals, Co., 4427 Park Blvd., San Diego 16, Calif.

FORTUNE. Fame, freedom, fun. All possible through highly practical moneymaking plan. Operates anywhere. Work for yourself and love it. Information free. Holland, 166-C1 Crescent Place, Ithaca, New York.

PRINT Without a printing press! Amazing new method! Print colorful signs, banners, cards, posters, glasswear; anything at home. Big profits. Moneymaking opportunity! We supply everything. Beautiful sample, home-business plan free! Write Screen-Print Company, PM-1, Los Angeles 61, California.

TO \$100.00 Weekly. Sparetime, home operated mailorder business. Successful beginner's plan. Everything supplied. Lynn, 10426-M National, Los Angeles 34.

"FROG Raising!" Season just starting. Get this year's eggs. New book tells how. Folder 10c. Broel-A, Box 506, New Orleans 1, Louisiana.

WHOLESALE Buyers' service! Buy nationally advertised merchandise wholesale. Sell way below retail. Fabulous profits. Write Wholesale Buyers, Box 22-PA, St. Louis 3, Missouri.

EXPORT, Import! Unlimited opportunities. Free literature. Write Universal Services, Clayton 5-PA, Missouri.

"THE Truth About Mail-Selling." Book by counselors and specialists, with one year consultation certificate. Satisfaction guarantee. \$2.00. J. G. Smith, 163-11 25 Dr., Flushing 58, N. Y.

\$50.00 WEEKLY Spare time possible, home mail order. Details free! McKenzie, 8463-P LeRoy, San Gabriel, Calif.

POLITICAL Greeting cards. Republicans and Democrats buy like wildfire. Sample and wholesale prices, 25c. Tasker, 105 East Custis Avenue, Alexandria, Virginia.

ELABORATELY Illustrated brochure. 1000 moneymaking plans 25c. Box 521, Waterloo, Iowa.

GROW Expensive herbs for us! Big profits home-business of your own. Year around profitability! We supply everything necessary! Send for free rare seeds and revealing plan. National Herb Exchange, Dept. A, Gardena, Calif.

IMPOSSIBLE? Perpetual motion! Lifetime powered from outer space! Scientific radiometer, Prestosphere, \$1.00 postpaid, \$8.00 dozen, fifty \$32.50, hundred \$60.00. Salesmen write. Presto Enterprises, Muskogee, Oklahoma.

OWN A mail-order envelope business. Sell envelopes, spare time! Tremendous demand. Big profits! No investment. Omaha Envelope Service, Dept. 6, 4721 California, Omaha 3, Nebraska.

WORK From home or office on the newest sales craze to hit America. Details 25c. Lifetime Mail Service, Dept. P 12, 1007 Elizabeth Avenue, Elizabeth, New Jersey.

BUY Wholesale! 100,000 name brand products! Save 66 2/3%! Big profits selling others spare time! Free catalogs! National Buyers Service, Box 426EE, Oakland, Calif.

\$70 WEEKLY—Home, spare time. Simplified mail bookkeeping. Immediate income, easy! Auditax, 34757A, Los Angeles 34.

131 SUCCESSFUL Money making plans. Details free. Capitol Specialties, Box 413A, Springfield, Illinois.

GET 500,000 Items wholesale. Business directory 50c. Hatt Sales Company, Box 357, Calais, Maine.

CAPITAL Easily obtained. Unlimited sources of money. For your immediate use. Millions now available. Any purpose. How and where, information free. Act quickly! Write today! Advance, Box 1377-B, Miami 8, Florida.

23 WAYS For home mail business with lifetime repeat income. Free details. Hardy, Box 546, Cantonment, Florida.

UP To 95% discount with investigated list of 30 lowest priced brand wholesale catalogs in the world. Rush \$2.00. B. Ruman Investigating Co., 573 Sheridan, Niles, Ohio.

\$1,000 MONTHLY, Home, mailorder, free advertising method. Revealing information. Seidel, 6000-AM Sunset, Los Angeles 28.

IF You don't love your job, write for fascinating data on sponsored home businesses. Free. Roland, P.O. Box 281, Bridgeport, Conn.

POSTAL Brings mailorder gold mine. Durotex Products, 672 Stuyvesant, Trenton 8, N. J.

NEED Cash capital? For "know-how and where" write: Business Service, 304 Bank Bldg., Cole Camp, Mo.

YOU'LL Be amazed at the tremendous profit possibilities in selling the finest quality Bibles available anywhere! Many men make \$30,000 yearly and more! Get my free proven Bible sales course plus catalog of many Morocco grain genuine leather covered Bibles and related items. Joseph W. Cain, Wholesaler, Box 5065, PM, San Antonio 1, Texas.

EARN Up to \$2000.00 monthly with spare or full time route of automatic 3 in 1 hot drink merchandisers using Maxwell House coffee, Bakers chocolate, Tenderleaf tea, in your community. We train you. \$190.00 starts you. Write Superior, 4555-BB East Warren, Denver, Colorado.

6 BUSINESS Plans plus the formula of success, all for \$3.00 or for details write McConaghy, 3806 Nile, San Diego 4, Calif.

AMBITIOUS? We establish you in your own business, supply catalogues, circulars, etc., ship orders under your name, paid or c.o.d., show you exactly what to do. Household items needed in every home. Sell direct, by mail or through agents. Catalogue, plans, details absolutely free. Write Topval Corp., Lindenhurst 918, N. Y.

AMAZING Home business. Build tubular glass fishing rods. Everything furnished. Wonderful profit. Free details. Rodman, Box 41, Wauwatosa, Wis.

REBUILD Batteries; repair dolls; make rubber stamps; silk screen printing. Catalogue "60 Ideas" free. Universal, Box 1076-A, Peoria, Ill.

"MAILORDER Laws and Regulations." Discusses federal, state, local licenses, taxes, legal requirements governing mail-order businesses. Play safe. Order today. Only \$1.00. Tasker, 105 East Custis Avenue, Alexandria, Virginia.

"HOW To Profitably Operate a Mail Order Business." Free literature. Lawrence J. Archer, Rt. #1, Navarre, Ohio.

PROFITABLE Home collection office. Experience unnecessary. Details, Hyatt, 411 West Walnut, Kalamazoo 42, Mich.

MAKE-Sell polishes, cleaners, anything. Formula catalog free. Kemixer, Park Ridge, Ill.

EARN Money at home! Homemaker Magazine tells how. Sample 25c. Sizemore, 20-H East Delaware, Chicago 11.

LEARN Modern sign painting—Commercial lettering. Anyone can be successful. Earn \$40-\$160 per week, spare time! Sign Instruction, Box 187A, No. Chicago, Ill.

MAKE Money helping others out of debt, stop garnishments, save jobs, re-establish credit. Details. Borum 57, 411 W. Walnut, Kalamazoo 42, Michigan.

\$19,000 SALES In two months. Sensational mailorder method. Actually works. Details free. Cartier, Box 261, Gainesville, Georgia.

\$200 WEEKLY Cleaning Venetian blinds. Free book. Buritt, 2434A, Wichita 13, Kansas.

\$16.00 PER Pound hand spinning Angora wool at home. Angora House, PM, Springfield, Illinois.

WHOLESALE Catalog! 30-80% discounts! Appliances, musical instruments, typewriters, phonographs, watches, jewelry, recorders, housewares, etc. Consolidated Distributors, 21-11 Lafayette, Paterson 15, New Jersey.

BOOKKEEPERS. Keep books, small firms spare time. Manual latest technique by C.P.A., \$3.00. Modern Business, Box 406, Youngstown 1, Ohio.

PLASTERCRAFT Molds, liquid rubber, plasters, flocks, candle supplies. Catalog and manual free. Blue Rapids Supply, Blue Rapids, Kansas.

WHAT'S New in mailorder? Let "Mail-order World," published monthly, keep you informed. Sample, 25c. Wayte, 1233 Elden, Los Angeles 6, Calif.

DOLLARS: Baby record books. Kitty Kat shoes. My Baby albums, eleven thousand new prospects daily. Sold by mail, use our literature. No-Co-Ro, Oakland 6, Calif.

WANT Up to \$100.00 weekly deposited in your mail box? Details free! Smith, 2708-P Ladera, San Bernardino, Calif.

ELECTROPLATE Auto parts, novelties, mirrors, baby shoes. Easy, inexpensive home processes. Free booklet. Tyco Metals, Box 13231-MM, Houston 19, Texas.

LEARN Sewing machine repair. How to make big money at home sparetime. New machines. Everything supplied. Write Taylor Service, Box 2126, San Bernardino, California.

BREED Rare tropical fish at home. Earn big money! Learn secrets! Help fill huge demand. Amazing opportunity! Free plan. Tropical Fish Breeders, Los Angeles 61, Calif.

BE Appointed state notary public now. Write, Stationers, Helotes, Texas.

HOW And where to obtain capital. Particulars free. Star Service, Wapakoneta, Ohio.

WE Love our mailman—He leaves over \$1000.00 monthly in our rural mailbox. My college professor husband drafted a scientific home mailorder method. We bought a Texas ranch, live as we always wanted. Now we sell the Ranch Mailorder Method. Operates anywhere. Inquire: Eveningshade Ranch, Helotes, Texas.

MEN—Income from local information. No selling. Neherco, LaVerne, California.

COPUBLISH Mail Sale Advertiser, leading mail order paper. Details, latest copy, dime. Vanroy Shirk, Lebanon, Penna.

GROW Mushrooms. Cellar, shed, and outdoors. Spare, full time, year round. We pay \$3.50 lb. We paid Babbitt \$4,165.00 in few weeks. Free book. Washington Mushroom Ind., Dept. 172, 2954 Admiral Way, Seattle, Washington.

OPERATE Profitable mail order business. Write Walter Service, 4159-A East 112th, Cleveland 5, Ohio.

COLORGLAZED Concrete pottery made without molds. Patented method. Cemetery products, novelties, tiles. Basement leak-sealing. Money-making projects. Booklet, details free. Men only. National Potteries Company, Grand Rapids, Minnesota.

MINK Raising information free. Complete. Lake Superior Mink Farm. Superior, EE1, Wisconsin.

FREE Book "505 Odd, Successful Businesses." Work home. Expect something odd! Pacific, Oceanside, Calif.

BRONZE Baby shoes. Instructions, equipment and mountings for genuine electroplated process. Free catalog. Hollywood Bronze Supply, Dept. B-3, 1624 East First Street, Los Angeles 33, Calif.

YOUR Own name brand business. No investment; no inventory. Part time or full time. Sell famous brands of appliances, housewares, silverware, radios, vacuum cleaners, lamps, tools, clocks, watches, jewelry, etc., etc., over 1000 items. Join thousands of successful independent dealers. Send for free catalog and dealer price list. H. B. Davis Corp., Dept. W. 145 W. 15 St., New York City.

LIQUID Rubber. Make flexible molds. Free sample. Chaney, 1130 E. 16th St., Jacksonville 6, Fla.

GOOD Paying business silvering mirrors, plating articles in the shop and home by late method. No tanks or shop required. Free booklet. Gunmetal Co., Ave. H, Decatur, Illinois.

GROW Orchids at home—Profitable, fascinating. Year 'round, Maine to California. No greenhouse. Gorgeous cattleyas, cymbidiums, etc. Successful home grower shows you how. Full details free. Flowerland, 4622 Wilshire, Los Angeles 5.

FIX Typewriters. Inexpensive home course teaches factory secrets. Free booklet. Write, Typewriter, Tarentum 1, Penna.

BIG Profits raising fishworms and crickets. Free literature. Carter Farms, Plains, Georgia.

\$25 DAILY Profits sharpening farm discs without dismantling or moving. No experience necessary. Free plan explains. B. T. Foley Company, Columbia Heights, Minn.

METALIZE Baby shoes, jewelry, gifts. Free catalog. Publisher, Box 73136, Los Angeles 3.

NEWEST Spare, full-time home business, \$5 to \$10 hour possible. Paint with suede—The finish with touch and eye-appeal. Beautify auto dashboards, signs, radios, toys, figurines, lamps—1001 others. Complete, step-by-step instructions sent for no-risk examination. Free details. Coast, Los Angeles 61.

IMPORT-Export mailorder opportunities! Details. Warner, Box 6, Fort Scott, Kansas.

MAKE New greaseless doughnuts in kitchen. Sell stores. Half profit. Free recipes. M. Ray, 3605 South 15th, Minneapolis 7.

VENDING Machines—Every description. New or used. Lowest prices. Mack Postal, 2952 Milwaukee, Chicago 18.

BUILD A home business sharpening saws. Wonderful profits. You'll get orders galore. No experience needed. Everything furnished. Complete details absolutely free. Max Mfg. Co., Dept. A, 138 Stockton Ave., San Jose 26, Calif.

WORK At home. Make money. Amazing opportunities. Free details. Coleman, Box 821, Newark 2, N. J.

"23 WAYS To build a home mail business." Free details. Penn General Distributors, Monessen, Penna.

HIGHEST Commissions all magazines. Free catalogue, supplies, prizes, exclusive extras. Subscription Service Co., Box 2070, Birmingham, Alabama.

EXPORT Business made easy! You can do it! Substantial income from home. No merchandise buying. Complete business setup service—Not only instruction. Hermes, 152 West 42, New York City 36.

HUGE Sparetime home profits. It's easy! Details free! Stommel, Box 104, Detroit 31, Michigan.

A Monthly repeat business which you can operate in your own community. For free details write Grusak, Dept. A-101, P.O. Box 494, McKeesport, Penna.

SELL From your own large wholesale catalog. Rush name! C-S, Box 9091, Kansas City 18, Missouri.

\$20,250 PROFIT Selling stamps by mail. How we did it book; send only \$2.00. Free details. Fahsing, Atascadero, California.

LET Others sell for you. Earn steady from home. Operate successful direct selling company. Complete setup arrangements furnished, from idea to success. Harold, 69-A Bennett, New York City 33.

\$46 FROM Square foot plywood; jigsaw necessary. Details free. Woodart, Bridgewater, Mass.

HAVE Home business! Get \$10.00 orders by mail. Keep \$8.00. Everything furnished. National, Box 88-W, Dorchester 22, Mass.

CAST Figurines! Novelties! Make production molds! New copyrighted course! Quick method! Illustrated! Only 25c! Castcraft Studios, 508-P Marion St., Brooklyn 33, N. Y.

FLORIDA Opportunities! Hundreds of jobs, businesses, farms, groves, homes. Free details! Florida Opportunity Journal, Vero Beach 14, Florida.

MONEYMAKING OPPORTUNITIES

MEN And women wanted to start home business in spare time with little table-top rubber stamp machine. Easy to earn up to \$9.80 an hour without previous experience. Full particulars free by mail. Send postcard to Roberts, 1512 Jarvis, Room 71, Chicago 26, Ill.

OPERATE Cafe, diner. Start with minor investment. Guides reveal every step. Information free. Restaurant School, MO11, Fremont, Ohio.

INVEST In your own business manufacturing our patented fibre glass tops for pickup trucks. We teach you and make molds, and patterns. Write Glas Laminates, Inc., Box 298, Costa Mesa, Calif.

START A buying service, buy wholesale thousands nationally advertised products. Make big profits selling at sizable discounts. Postcard brings details. American Buyers, Hertel Station, Buffalo 16-D, New York.

TELEVISION Advertising without investment! Commission basis! 93 stations! Guaranteed "how" instructions, \$2.95. Jakiela, 2644-Pal North Western, Chicago 47.

START Money-making plastic laminating business at home in spare time. Material that costs 11c brings back \$2.58. No canvassing or selling but mail orders bring in \$20 a day. Write for full particulars free. Rush name on postcard to Warner, Room 71, 1512 Jarvis, Chicago 26, Ill.

MAKE Money at home as renewal headquarters for all magazines. Big profits now. Liberal commissions. Supplies furnished. Experience unnecessary. Write for free catalog. McGregor Magazine Agency, Dept. 500-C, Mount Morris, Ill.

AMAZING Book! 1,000 money making tips. \$2. Curtiss, 6711 Sunset, Hollywood 28, Calif.

MAKE Money writing short paragraphs! No tedious study. I tell you what to write, where and how to sell; and supply list of editors buying from beginners. Many small checks add up quickly. Write to sell, right away. Send for free facts. Benson Barrett, 1751 Morse, Dept. C-27-N, Chicago 26.

"WINNING Contests for Profit and Pleasure" reveals how to become a successful prize winner. Free details if you write today. Edko Enterprises, P.O. Box 409, New Britain 2, Conn.

START Big-pay business at home in spare time. No experience needed to operate little table-top machine for bronzing baby shoes. Make \$5.46 profit on every pair. Full particulars free. Send postcard to Mason, 1512 Jarvis, Room 71, Chicago 26, Ill.

EARTHWORMS—Amazing reproduction makes you money. Breeders, supplies, spawn, new "senior kit" information plus newly published booklet and facts. Send 25c. Multiple Enterprises, P.M.-72, Kalkaska, Mich.

BIG Profits—Greeting card business full or part time year round, learn successful secrets, operate from home. Get facts today. J. A. Myers, 201 E. Lee Str., Pharr, Texas.

FASCINATING Hobby or lifetime income making gewgaws in your home. We furnish materials. Hanco, Box 97B, Lombard, Ill.

FREE! Money-making opportunities. Big interesting mail. Al-Don Sales, Box 414, Woodstown, New Jersey.

"MONEY Getter's Bulletin." sample 25c. Donovan, 791 Greenbelt, Levittown, N. Y.

MAKE \$7 Per hour and up! Donald Wicks made \$48 in a few hours. You can too! Write for free book and amazing product sample. Theodore-Wilson Products Co., 3522 Government Way, Seattle 99, Wash.

\$20.00 RETURNS \$400.00 Repeats. \$1.00 for samples. Refundable. Ezee, Bayport 7, Mich.

PRESERVE Live flowers for years. Fascinating and profitable hobby. Details free. Mountainside, Springwater 1, New York.

EARN Money evenings copying and duplicating comic cartoons for advertisers. Adservice, Argyle 1, Wisconsin.

MONEY In hobbies and specialty farming. Copy 25c. Joy Industries, 1547 S. Cloverdale, Los Angeles 19, Calif.

\$1,000 MONTHLY Possible, raising earthworms! Backyard, garage, basement. Complete illustrated booklet explains raising, feeding, packing, marketing. 25c postpaid! Ozark Worm Farm-J, Willow Springs, Missouri.

PRINTING. Office supplies wholesale. Save 50%. Royal, Box 368-A, Cleveland 27, Ohio.

SEWING Machine profits — \$1.00. C. Smith, 843 East 95, Cleveland 8, Ohio.

FREE "\$5,000-\$45,000; Unlimited Vacations." Work home! No merchandise, equipment! Haylings, Carlsbad, Calif.

MAKE Millions with thrilling outdoor hobby. Others have. Complete information \$2.00. Holland, 166-B1 Crescent Place, Ithaca, N. Y.

GET Big mails galore: Latest money-making offers, opportunities, catalogues, magazines, samples, etc., by listing your name in our directory. One issue 10c; 3 issues 25c. Results guaranteed. Heritage Mailing Service, Box 145, Planetarium Sta., New York 24, N. Y.

TO \$100.00 Weekly. Sparetime, home operated mailorder business. Successful beginner's plan. Everything supplied. Lynn, 10420-M National, Los Angeles 34.

USE Proven home mail order plans. Details free! Owen, 2057-P Newport Ave., Costa Mesa, Calif.

GAMBLE Postal for golden opportunity. Vinsco, 159 Abernethy, Trenton 8, N. J.

LEARN Technical metaphysics and insure your future. Easy, inexpensive correspondence course. Simplest method known. Diploma. Write: Premier College of Technical Metaphysics, 2532 McKenzie St., Vancouver 8, B. C., Canada.

BUY Wholesale! Save 66%! Appliances, furniture, jewelry, toys, sporting goods, tools. Free catalog. National Buyers Service, Box 426EB, Oakland, Calif.

SYSTEM Plus secrets plus spare time equals money in mail order. Free details! Buck, Granada Buildings, Los Angeles 57, Calif.

\$5.00 HOURLY Possible, spare time home mail order. Details free! Dempsey, Box 42237p, Los Angeles, Calif.

WANT To go in business for yourself without capital? We show you how. Start part time your own home. Postcard brings details absolutely free. Topval Corp., Lindenhurst 820, N. Y.

DON'T Let the millionaire outsmart you. Enjoy Florida sunshine, bathing, fishing. Live longer. Be boss. 25 ways to make extra cash to thousands. Send \$1.00. Sun Associates, Wildwood, Fla.

MONEY In saw and lawn mower sharpening sparetime at home. Repeat cash business. Experience unnecessary. No selling. Free booklet explains. V. Foley Company, Columbia Heights, Minnesota.

\$200 WEEKLY Cleaning Venetian blinds. Free book. Burt, 2434A, Wichita 13, Kans.

MAKE Spare time money preparing and mailing sales literature. Adams Surveys, 3513-AT Sunset Blvd., Los Angeles 26, Calif.

PRIZE Contests provide fabulous and confidential home income opportunities! Here's how and where to win your share! Send stamp! National Contest Bulletin, Box 2685, Miami 16, Florida.

MAKE Money with camera. Professional secrets \$1.00. Brewer—Photographer, 5880 Hollywood, Hollywood 28, Calif.

EARN \$50.00 Daily making mats, shoes and mud guards from old tires. S and S Patents Inc., 1307 North Clark St., Chicago 10, Ill.

BUILD Sales by recruiting productive distributors selling direct or to retail outlets. Secure most concentrated circulation through classified columns of Salesman's Opportunity. Write for facts. Gilbert, Salesman's Opportunity, Room 1700, 850 N. Dearborn, Chicago 40.

SPARETIME Profits taking subscriptions all magazines. Wholesale catalog free. Casell Publishers, Westfield, New Jersey.

GENERAL Contest Bulletin. Issued monthly. Sample, 25c. 1609½ East 5th, Duluth, Minn.

GROW Mushrooms. Cellar, shed, and outdoors. Spare, full time, year round. We pay \$3.50 lb. We paid Babbitt \$4,165.00 in few weeks. Free book. Washington Mushroom Ind., Dept. 173, 2954 Admiral Way, Seattle, Washington.

FREE Book "505 Odd, Successful Businesses." Work home. Expect something odd! Pacific, Oceanside, Calif.

READ Progressive Mailtrade, the magazine that tells how to make money by mail. Dime brings sample and special offer. Progressive Mailtrade, Box 357, Sheboygan, Wisconsin.

ATTENTION: Typewriter owners. Make handsome profits. Write today. Groves Company, 682, Hastings 8, Nebraska.

SCHOOL Seniors—Sell classmates America's most beautiful graduation name cards. Largest selection. Highest commission. Outsell all others. Free sample kit. Printcraft, Dept. M, 1509 Maple Street, Scranton 5, Penna.

VENDING Machines—No selling. Operate a route of coin machines and earn amazing profits. 32-page catalog free. Parkway Machine Corporation, Dept. 15, 715 Ensor St., Baltimore 2, Md.

SELL Titania gems; far more brilliant than diamonds. Catalog free. Diamonite, 2420-M 77th, Oakland 5, California.

"47 WAYS How to Make Money in Florida." \$1.00. Lorelei Publications, 3142 Coral Way, Miami 45, Florida.

UP To \$200.00 monthly! Spare time home mail order! Details free! Stauch, 948 No. Wayne, Wayne, Mich.

FREE Details. Money-making offers, sparetime work, earning plans. Nelson Sales, Elkhorn 9, Nebraska.

PARKING Trouble? \$10,000 per year possible. Park five cars in place of one. Preliminary plans \$1.00. Detailed plans (exp.) prices upon request. Troupe Trice, Gilbertown, Ala.

FORMULAS, PLANS, ETC.

FORMULAS, 100 Fine perfumes, cosmetics, \$2.00. Brockway, 1145 High, Topeka 1, Kansas.

LARGE Formula catalog free. Anything analyzed \$35.00. Western Chemical, Salem, Oregon.

FORMULAS; All kinds, latest, best. Literature free. Kemixal, Park Ridge, Ill.

REAL Manufacturing formulas. Lists free. Cummings, Chemist, Gordon Ave., Syracuse 4, N. Y.

PRODUCT Analysis, manufacturing formulas, processes developed. Moderate fees. Plastics, Box 1574, Boston 4, Mass.

PLASTICS

PLASTICS Home-craft course for men and women. Tells and shows how to make hundreds of fast selling plastics products. All plastics and materials for 23 projects included in course. No special tools needed. Course pays for itself. Write for free booklet. Interstate Training Service, Dept. D-3, Portland 13, Oregon.

NEW Liquid casting plastic, clear, colors. Embed real flowers, insects, photos, coins. Saw, drill, carve. Send 25c for handbook, "How to Cast with Liquid Plastic," and proved success plan showing how to make money at home. Castolite, Dept. A-101, Woodstock, Ill.

CARDS, Photos, etc. Sealed in plastic. Wallet size 50c. Sample free. Laminating, Box 61, San Antonio 11, Texas.

"U-Mix-It" liquid vinyl experimental kit, 20c. Technicraft, 1156 Commonwealth, Boston 34, Mass.

PLEXIGLAS, Lucite. Square foot cost 1/16", \$1.15; 1/8", \$1.52; 3/16", \$1.86; 1/4", \$2.21; 3/8", \$3.28; 1/2", \$4.38. Colors add 10%. Send 15% for postage. Aristocrat Plastics, 23-25 Sussex Avenue, Newark, N. J.

PLASTIC Items manufactured to your specifications, also, representatives wanted. Kesich Manufacturing, Pitman 1, New Jersey.

PLEXIGLAS. All colors, cut to size. Edins Service, Abilene, Texas.

SIMPLIFIED Casting course. Make low cost permanent molds for casting plastic. Complete course, sample mold, sample casting \$2.00. Namber-Lite, Box 883, Redwood City, California.

PLEXIGLAS Transparent sheets 1/4", \$1.10 square foot cut to size. Ultra Plastics Mfg., Pitman 22, N. J.

PLEXIGLAS. Lucite sq. ft. (12"x12") cost 1/16", \$1.12; 1/8", \$1.34; 3/16", \$1.68; 1/4", \$2.00. Minimum order \$3.00. Add 10% for postage. Ailmac Plastics, 600 Broadway, New York 12, N. Y.

PLEXIGLAS. Fiberglass, polyester, acetate. Unique wholesale-retail catalog, 15c. Gem-O-Lite, Box 686M, North Hollywood, California.

LAMINATING Supplies. Free price list. Solomonson, 46 Cornhill, Boston 8, Mass.

PLEXIGLAS. Cut to size. Clear. Any thickness. Colors. Rods. Tubing. McClarin Plastics, P.O. Box 168H, Hanover, Penna.

FREE Brochure. Casting, coating, adhesive plastics. Dunn, Box 5537, Chicago 80, Ill.

CHEMISTRY

HOME Laboratory and apparatus kits, laboratory supplies. Catalog 25c. John H. Winn, 124A West 23rd St., New York, N. Y. Established 1931.

CHEMICAL Glassware catalog, 25c. Used supplies. Laboratory Sales, Box 161-A, Brighton, Mass.

SPECTROSCOPE For quick chemical analysis \$3.00. Kutting Sons, Los Altos, Calif.

MAGIC Patented indicator—green to purple—reversible—dropper bottle 120 tests 25c coin—Carlson Chemical, Box 616, Washington 4, D. C.

BEGINNER'S Chemistry. Modern. Fascinating. All ages. Sample lesson 25c. Future Chemists of America, McKees Rocks, Penna.

AMAZING New book of science. Experiments, formulas and catalogue of laboratory supplies. Only 25c. National Scientific Co., Dept. PM-1, 2204 W. North Ave., Chicago 47, Illinois.

LABORATORY Apparatus, chemicals, microscopes, complete chemistry sets, minerals, uranium ore. 10c brings catalog. Porter Chemical Co., Hagerstown 4, Md.

ILLUSTRATED Catalog: Chemistry, mineralogy, biology 20c. Tracey Laboratories, Evanston, Illinois.

CHEMICALS And apparatus for industrial, analytical, and private laboratories. Catalog 25c. Dept. M-50, Biological Supply Co., 1176 Mt. Hope Ave., Rochester 20, N. Y.

BOOKLETS: 60 pages each! "Beginners Chemistry," "Chemistry," "Einstein's Relativity," "Physics," "Atomic Theory," "Electron Theory," "Scientific Oddities," "Light," "Sound," "Heat," "Electricity," "Radio," "Astronomy," "Useful Tables," "Geometry," "Mathematical Oddities," "Scientific Terms." (Order by titles.) 10c each. Franks, 3121 South Racine, Chicago 8.

AGENTS WANTED

MONEY In minutes! Even beginners scoop up big earnings with Elmira—the greeting line so beautiful, it sells by itself! Friends, neighbors—even perfect strangers want to see and buy from Elmira's exciting array of all-occasion greeting cards, personalized stationery, napkins and gift wraps. Look no further—Elmira gives you everything to make your extra-money dream come true! Send today for free samples, catalog, assortments on approval. Request Elmira's fund-raising plan for churches and clubs! Elmira Greeting Card Co., Dept. 159, Elmira, N. Y.

EXCLUSIVE Sales plan. New profitable field. Immediate, permanent, growing income. Full, spare time. \$1.00 brings samples, details. Cerco Products, Salem, Connecticut.

SELL New automatic floor waxer. Trigger on handle. Retail \$2.95. Your profit 125%. Write Smith, Inc., Greenfield 15, Mass.

LOOK! \$50, \$75, \$100 Extra money! Show friends new type tall parchment, photochrome, humorous greeting cards. Unusual all occasion, Easter assortments, home and gift novelties. Profits to 100%. Bonus. Write today for feature boxes on approval, free samples personal stationery. New England Art Publishers, North Abington 133-K, Mass.

NEW Costume jewelry item. Latest fad-fast seller. 300% profit. Free details. Packard (M), 550 Fifth, New York City.

ZODIAC Lucky coins—Sell on the spot to prospects everywhere! 100% profit. Complete information and sample \$1.00. Give your birthdate. Zodiac Co., 1053BD Lawrence, Chicago.

MAKE \$7 Per hour and up! Donald Wicks made \$48 in a few hours. You can too! Write for free book and amazing product sample. Theodore-Wilson Products Co., 3522 Government Way, Seattle 99, Wash.

\$3.65 PROFIT On \$3.95 sale. yet saves customer \$50. Noted specialist says "Only outstanding deal seen in 18 years." Maxson, Falls Church 17, Virginia.

IF You want to earn money fast, I'll send you free sample stocking of newest stretch DuPont nylons to sell at only \$1 a pair. American Mills, Dept. 479, Indianapolis 7, Ind.

RUN A spare-time greeting card and gift shop at home. Show friends samples of our new 1956 all-occasion greeting cards and gifts. Take their orders and earn up to 100% profit. No experience necessary. Costs nothing to try. Write today for samples on approval. Regal Greetings, Dept. 59, Ferndale, Michigan.

GOLDMINE Of 600 money makers. Copy free. Specialty Salesman Magazine, Desk 5-B, 307 N. Michigan, Chicago 1.

MAKE Money at home as renewal headquarters for all magazines. Liberal commissions. No experience-capital needed. Supplies furnished. Write for free catalog. McGrouer Magazine Agency, Dept. 500-A, Mount Morris, Illinois.

BIG Money in valentines! Easy to earn with 4 different valentine packs. Best sellers for every occasion all year—Mother's, Father's Day, Easter, birthday, all-occasion assortments, gifts, stationery. Over 100% profit on bargain specials. Samples on approval. Midwest, 1113 Washington, Dept. 699-H, St. Louis 1, Mo.

MAKE \$60.00 Easily showing newest tall-occasion greeting cards. Religious, deluxe, 21 for \$1, notes, comic, photo cards—all tall 150 fastest sellers. Biggest profits. Samples on approval. \$1.25 prompt action gift. Cardinal, 1402 State, Cincinnati 14.

CALENDARS. Advertising novelties, matches. All styles, including religious, varnished, 12 sheet, girls. Hundreds of advertising novelties, book matches, etc. Fleming Calendar Co., Sales Division, 6539 Cottage Grove, Chicago 37, Ill.

BIBLES. Make up to \$100 a week. Selling outstanding Reference Bible. Latonia Pilgrim Hour, Box 31, Latonia, Ky.

MAKE Extra money with newest fast selling "Slim" and "Photochrome" greeting card assortments. \$1.00, \$1.25 all occasion, birthday, valentine, Easter boxes. Stationery, gift wrappings, gifts, gadgets. Experience unnecessary. Amazing profits. Bonus plan. Write today for samples on approval, free gift offer, catalog. Hedekamp, 361 Broadway, Dept. PM-39, New York City.

AGENTS-Salesmen: Sell beautiful hand-colored plastic enlargements and sensational new personalized photo compacts, rings, bracelets, lockets, etc. Experience unnecessary. 40% advance commissions. We deliver, collect. Wonderful sideline. Better full time. Free sample outfit. Novel Portrait Co., 3343 North Ave., Chicago, Ill.

YOUR Own wholesale business with no investment. Free catalog. Jay Norris Co., 487-X Broadway, New York City.

FREE! Sunshine's petite everyday assortment—Special introductory offer to big profits available selling exclusive everyday cards, imprinted stationery, gift wraps, deluxe 21 card assortment, etc. Free catalog. Send postcard today for sample kit on approval. Sunshine Art Studios, Inc., Dept. PM-1, Springfield 1, Mass.; Pasadena 1, California. (East of Rockies address Springfield).

HOME Motorized massage. Big money! Mary Mac, 1012 Powhattan, Dallas 2, Tex.

\$1,000.00 A Month for making dramatic 3-second demonstration of amazing lightweight Presto fire extinguisher. New chemical used by airforce snuffs out fires instantly. Only \$3.98. Terrific commissions. Millions want it. Free kit. Merlite, 114 E. 32nd, Dept. 50-E, New York City 16.

BUY Wholesale thousands nationally advertised products at big discount. Free "Wholesale Plan." American Buyers, Hertel Station, Buffalo 16-A, N. Y.

FOG-Stop windshield cloth. Instantly removes blurry mist, frost, sleet, snow. Stops windshield fogging. Samples sent on trial. Kristee 80, Akron, Ohio.

PROFITS To 150% selling finest everyday greeting cards. New 21 for \$1 tall cards, unusual gifts, 129 fast-sellers. Valuable gift bonuses. Assortments on approval, stationery samples free. \$1 gift free for promptness! Creative Cards, 4401 Cermak, Dept. 525-C, Chicago 23.

START Your own business on credit. Your own boss. 1135 of our dealers sold \$5,000 to \$30,000 in 1954. We supply stocks, equipment on credit. 200 home necessities. Sales experience unnecessary. Pleasant profitable business backed by world-wide industry. Write Rawleigh's, Dept. A-U-PPM, Freeport, Ill.

BUY Wholesale, 25,000 items, catalog 25c. Matthews, 1472-B4 Broadway, New York City 36.

STRANGE Dry window cleaner. Sells like wild. Replaces messy rags, liquids. Simply glide over glass. Samples sent on trial. Kristee 81, Akron, Ohio.

BEAUTIFUL Feather pictures. 200% profit! Free sample. Apartado 9036, Mexico 1, D. F.

THIS Ad worth money to you! Make big profits spare time or full time. Sell over 600 unusual gifts, gadgets, greeting cards, stationery, toys, jewelry to friends and neighbors. No big investment. Samples on approval. Write for big free catalog and tested money-making plan for organizations or individuals. North Star, Dept. 361, 251 E. 5th St., St. Paul 1, Minn.

MAKE Money introducing world's cutest children's dresses. Big selection, adorable styles. Low prices. Complete display free. Rush name. Harford, Dept. R-2341, Cincinnati 25, Ohio.

EASY Handwork makes fast-selling articles. Sample free. Sunmade Company, Brockton 64, Massachusetts.

UP To 85% discounts on name brands! Giant 100 page catalog. BTS Products, Box 217, Oakland 54, N. J.

MAKE Your spare time profit time! Over 600 beautiful, unusual gifts, greeting cards, household gadgets, toys, jewelry, baby items, and gift wraps you can sell to friends, neighbors, relatives. Write at once for big, bright free catalog just off the press. Samples on approval. Hurry—Get details on sensational money-makers! Greetings Unlimited, 36A Park Square, St. Paul 1, Minnesota.

EXCITING New auto novelty. Dealers buy thousands. Amazing profits. No competition. Literature free. Kenway Products, 757 North Milwaukee St., Milwaukee, Wis.

60% PROFIT On cosmetics—Famous nationally advertised Hollywood cosmetics pays 60%! Make \$25 day up! Hire others. For free samples, details, write Studio Girl, Glendale, Calif., Dept. 1261F.

POSTAL Brings opportunity of lifetime. Write. Durotex Products, Trenton 8, N. J.

RICH Profits. Easy sales. Men or women. Free literature. Hazel's, Box 135, Stratford, N. J.

BIG Profits selling post card storyettes of the great west. Pebra Mailings, P.O. Box 5422, Tucson 10, Arizona.

BUY Wholesale 550,000 products. Literature free. Carter, Box 6011-B, Chicago.

BIGGER Profits, better service, best brands with investigated list of 30 lowest priced name brand wholesale catalogs in the world. Rush \$2.00. Ruman Investigating Co., 573 Sheridan, Niles, Ohio.

YOUR Own business—Used suits \$1.50, overcoats 65c, mackinaws 35c, shoes 12½c, ladies coats 30c, dresses 15c. Enormous profits. Catalog free. Nathan Portnoy Associates, 605-AA West 12th Place, Chicago 7.

NEW Way to make money! Sell nothing. Don't even step out of your home unless you want to! Let others do the work. Experience unnecessary. We show you how. No money for stock. We ship your orders, paid or c.o.d. Catalogue, money-making plans, etc., free. Write Topval Corp., Lindenhurst 41, N. Y.

PRINTING! Highest quality. Big profits. Free wholesale pricelist, supplies, details. Napco, 3337-A Bath Avenue, Brooklyn 14.

MAKE \$100 Up weekly—Demonstrate, take orders. Sensational new product. Prospects everywhere, part-full time. Campbell Company, Rochelle 53, Illinois.

SCHOOL Seniors—Be popular with classmates. Have spending money galore. Details free. Craftcards, Box 235-L, Pittsburgh 19, Pennsylvania.

\$200 WEEKLY Cleaning Venetian blinds. Free book. Burt, 2434A, Wichita 13, Kans.

GOLD Or silver letters, numbers. Windows, doors, trucks, 1" to 6". 500% profits. Free samples. Atlas-T, 544 West 79th, Chicago 20.

PRINTING. Advertising salesmen—Excellent moneymaking sideline selling decalcomania name plates, small quantities. Automobile initials, sign letters. Free samples. Ralco, XL, Boston 19, Mass.

MAKE Extra money. Sell front door name plates to friends, neighbors. Retail \$1.98; you make \$1.00! Free selling kit. Modern Engraving Co., P.O. Box 194, Boston 14, Mass.

\$1.00 PROFIT Selling \$2.95 photo enlargement deal. Allen Studio, Riegler Bldg., Little Rock, Ark.

AGENTS—300% Profit selling genuine gold window letters; stores and offices. Free samples. Metallic Sign Letter Co., 431-D North Clark, Chicago.

CALIFORNIA Sweet smelling beads. Sensational sellers. Particulars free. Mission, 2328 FR, W. Pico, Los Angeles 6, Calif.

BE In your own business. Buy wholesale. Big profits. Get free nationally famous name brand mdse. Catalog. Dept. PM, Normandy Distributing Corp., 133 Fifth Ave., New York City, N. Y.

USED And new watches \$2 up. Free list. Southern Watches, Gray, Georgia.

YOUR Ad in this space will get some good agents for you. Yes, I'll prove it. Write for Folder "A" right now. F. W. Johnson, Classified Advertising Manager, Popular Mechanics Magazine, 200 E. Ontario St., Chicago 11, Ill.

BUY IT WHOLESALE

APPLIANCES, Housewares, watches, jewelry, giftwares. Wholesale catalogue \$1.00 deposit, refundable. Laconia, P.O. Box 6014, Bridgeport 6, Conn.

BUY Wholesale for yourself, sell wholesale to friends, co-workers! All standard brands. Appliances, housewares, refrigerators, washers, dryers, ranges, TV sets, gifts, watches. Over 2,000 items in our own six floor building. Write for free details. Five Star Sales, 601 Randolph, Chicago 6, Illinois.

WHOLESALE—2 Catalogs for \$1.00 (refundable). Finest name brands. Latonia Pilgrim Hour, Box 31, Latonia, Ky.

BUY Wholesale! Name brand major appliances, housewares, etc. 30-50% discount. Catalog 10c, refundable. Marpat Distributors, Box 1485, J-PMCS, Milwaukee, Wis.

NAME Brands, 30-80%, catalog \$1 (refundable). Plotte, Box 5103B, New Orleans (15).

WHOLESALE Catalog! Appliances, cameras, watches. Postcard: Selbyco, Decatur 252, Illinois.

BUY Wholesale! Nationally known brands. Catalog \$1.00. D'Auria, Box 355-M, Jackson, Michigan.

1956 "PORTABLE Showroom." Save to 50% on watches, radios, appliances. Rush 50c (refundable). Edward Clemens, 318 W. Bridge St., Morrisville, Penna.

YOUR Cost as little as 25c on dollar! Household items needed in every home. Sell direct, by mail or to agents. Catalogue, confidential distributors' wholesale prices and money-making plans absolutely free. Rush postcard to Topval Corp., Lindenhurst 524, N. Y.

WHOLESALE Catalog! 30-80% discounts! Appliances, musical instruments, typewriters, phonographs, watches, jewelry, recorders, housewares, etc. Consolidated Distributors, 21-29 Lafayette, Paterson, New Jersey.

THOUSANDS Nationally advertised brand name products. Discounts to 80%. Meder, 550-PM Fifth Avenue, New York City 36.

POGO Sticks. Will carry 150 lbs. guaranteed! \$4.50 postpaid. U. S. Industries, 803-A Macy Street, Los Angeles 12, Calif.

SALESMEN—DISTRIBUTORS

SELL Grease that won't melt. Moly products also included in complete line of heavy duty lubricants. Our leading salesmen now earning over \$12,000 in a year. Write E. J. Baker, Dept. 6-A, P.O. Box 676, Dayton, Ohio.

\$1,000.00 A Month for making dramatic 3-second demonstration of amazing lightweight Presto fire extinguisher. New chemical used by airforce snuffs out fires instantly. Only \$3.98. Terrific commissions. Millions want it. Free kit. Merlite, 114 E. 32nd, Dept. 50-E, New York City 16.

CASH in on tremendous demand for new cheap maniac and burglar alarm for homes, stores, banks, gasoline filling stations and other property. Nothing like it. Everybody wants it. Make up to \$50.00 a day. Unique sample offer. Northwest Electric Co., 502-A Main, Mitchell, S. Dak.

MONEY-Making opportunity! Take big profit orders for world famous patented varieties fruit trees. Also flowering shrubs, roses, vines. Big sales outfit free. Stark Bro's, Desk 30116, Louisiana, Missouri.

GET New shirt outfit free. Make \$90.00 weekly on 5 average orders a day. Famous quality made-to-measure dress and sport shirts at \$3.95 up sell fast to all men. No experience needed. Full or part time. Write: Packard Shirt Co., Dept. 262, Terre Haute, Ind.

BUY Wholesale thousands nationally advertised products at big discount. Free "Wholesale Plan." American Buyers, Hertel Station, Buffalo 16-J, N. Y.

ADVERTISING Book matches—Cash in on big demand; sell union label matches. Cuts for all businesses and political parties. Free powerhouse selling kit, low prices, protection guaranteed on repeat orders. Cash commissions. Superior Match Co., Dept. M-156, 7530 Greenwood, Chicago.

AD Matches! Sell amazing designs—10, 20, 30, 40 and 240-light book matches. Bigger spot cash commissions; every business a prospect. Low prices for high quality. Repeats. Start without experience; men, women; full, part time. Buy nothing! Sales kit furnished. Match Corp., Dept. PM-73, Chicago 32, Illinois.

BONANZA For salesmen! Sell work uniforms embroidered to advertise. Complete selection of colors, styles, fabrics, including miracle orlon, acrilan, dnyel. Prospects everywhere—Factories, garages, institutions, all businesses! Profits unlimited! Sales-making outfit free. Write Topps, Rochester 611, Indiana.

DISTRIBUTORS—Salesmen. Sensational profits. "Steam-Cloud" immersion electric water heaters. Freight prepaid. Write for prices. Real Products Co., 900-3 Mile Rd. N.E., Grand Rapids 5, Michigan.

BRAND New product. Needed by millions. 250% profit. Information free. Vita-Cell Corporation, 929 Sheridan, Saginaw, Michigan.

FREE Sample. Auto compass. Magnetic. Sensation. Smith Agency-PM, Excelsior Springs, Missouri.

SELL Calendars. You make big money daily. Giant line. Every business buys. Also business printing, book matches, advertising specialties. Big sales outfit free. Write, Arrow Press, 515-A Fourth Ave. So., Minneapolis, Minn.

WILL You wear new suits and topcoats without one penny cost and agree to show them to friends? You can make up to \$30.00 in a day even in spare time, without canvassing. Stone-Field, 532 South Throop St., Dept. L-926, Chicago 7, Illinois.

\$50,000.00 IN 5 Years. Man wanted—Join our top salesmen averaging over \$10,000.00 year. Many beginners \$400 to \$1,000 month. No investment. Earnings in advance. (If you live in Canada write President, Dept. PM, 25 Industrial St., Leaside, Ontario.) In U.S., President, Dept. PM, P.O. Box 711, Fort Worth 1, Texas.

ANYONE Can sell famous Hoover uniforms for beauty shops, waitresses, nurses, doctors, others. All popular miracle fabrics—Nylon, dacron, orlon. Exclusive styles, top quality. Big cash income now, real future. Equipment free. Hoover, Dept. A-100, New York 11, N. Y.

BIG Money! Taking orders, religious articles. 1956 catalog. Write Pette Company, 1554-A West 11 Street, Brooklyn 4, N. Y.

BIG Money! Buy wholesale, sell retail. Dresses, children's wear, family apparel. Lowest factory prices. No stock to carry. No samples to buy. Big sales kit with actual fabrics free. C. E. Israel, Dept. R-2703, Cincinnati 25, Ohio.

NEW Jobs open in selling! Send name, address for five free issues of Opportunity Magazine's money-making guide, listing hundreds of companies who'll pay you well, full or part-time. No experience needed. Opportunity, 850 N. Dearborn, Dept. 17, Chicago 40, Ill.

DISTRIBUTORS—Large profits. Terrific repeat orders. Unique Italian brooms, details free. Write P.M. Peacock, 915 Bryant, San Francisco, California.

BUSINESS Kit free! Postcard puts you in business! Complete line. 160 shoe styles. Also jackets. New discoveries pay big commissions. No investment. Send for free kit. Mason Shoe, Cl, Chippewa Falls, Wis.

EDUCATIONAL AND INSTRUCTION

COMPLETE Your high school at home in spare time with 59-year-old school. Texts furnished. No classes. Diploma. Information booklet free. American School, Dept. X145, Drexel at 58th, Chicago 37, Illinois.

HIGH School—No classes. Study at home. Spare time. Diploma awarded. Write for free catalog HF-60. Wayne School, 2527 Sheffield, Chicago 14, Ill.

INDUSTRY Needs draftsmen. We help you qualify. Free information. Industrial Training, 1704-A Frederick, Fort Worth 7, Texas.

WELDING Training pays at Hobart Welding School, Box M-161, Troy, Ohio. VA contract. Best equipment. Catalog free.

APPLY For jobs by letter. Short folio shows how. Free trial offer. Telesis Company, Room 706, 507 Fifth Avenue, New York 17, New York.

IT'S Fun learning a language by Linguaphone world's standard conversational method. At home, quickly, easily learn to speak French, Spanish, German, Japanese, Russian, Modern Greek. Your choice of 34 languages. It's like living in another country. Complete recorded courses on free trial. Send for free book and details. No obligation. Try, don't buy! Linguaphone Institute, T-83-016 Rock Plaza, New York City 20.

BLUEPRINT Reading—Train at home. Learn to read blueprints with confidence in 10 easy lessons. Write today Belton School, 1059-D North Lawndale, Chicago 51.

STUDY For Doctor's degree of psychology, metaphysics and divinity. Correspondence courses only. College of Divine Metaphysics, Dept. P-M, 2811 North Illinois, Indianapolis 8, Indiana.

HELP Yourself! Solve personal problems by self-mastery. Free information. The Leavitt Science, Clinton 5, Illinois.

LEARN Mineralogy at home. Diploma course. Fortunes now being made in uranium and other minerals. Free catalog. Mineral Science Institute, Desk 2, 159 East Ontario, Chicago 11.

WANT Strong, masculine voice? Send for free booklet. Perfect Voice Institute, 210 South Clinton, Studio 2AU-2, Chicago 6.

HIGH School diploma at home. Licensed teachers—Approved materials. Southern States Academy, Box 144-MX, Station E, Atlanta, Georgia.

USED Correspondence courses and educational books bought, sold, rented. Free catalog. Educational Exchange, Menlo, Georgia.

LEARN Real estate—High profits, life time career. Up to date, complete training course. Low cost, money-back guarantee. Free literature. Seavy Realty Institute, 13348-b Bessemer St., Van Nuys, Calif.

SPANISH Quickly! Recordings, textbook. Special, \$6.95. Speed-O-Way, Box 32-161, Los Angeles 32, California.

ENGINEERING, Home study. Midwest Engineering School, 10923 Hillcrest, Hickman Mills, Missouri.

INVESTIGATE Accidents—Many earn \$750 to \$1000 monthly. Thousands of insurance companies, airlines, and steamship lines need claim investigators. We train you at home spare time. Placement counsel and help. Free book—Now! Universal Schools, Dept. 101, Box 8202, Dallas 5, Texas.

BECOME A counsellor in personality engineering. A lucrative profession for those who qualify. Field is growing, uncrowded. Work is interesting, fulfilling. Write, enclose recent snapshot. More information in book, "Formula for Genius," \$1.00 (refundable). Kimball Foundation of Human Engineering, St. Louis (Brentwood) 17, Mo.

BE Somebody! Get somewhere! Request free positive thought motivation plan. Easy, quick results. Write Applied Christian Psychology, Inc., Box 1924-B, Louisville 1, Ky.

BECOME A doctor of psychology or metaphysics. Learn secret of contentment, happiness. Win degree of Ps.D. or MsD. Correspondence only. Free book. College of Universal Truth, 23-C East Jackson Blvd., Chicago 4, Ill.

PIANO Tuning pays. Learn this profitable profession at home easily with patented Tonometer and mechanical aids. No knowledge music necessary. Diploma granted. Write for booklet, Niles Bryant School, 3731 Stockton Blvd., Dept. P, Sacramento 20, California.

BOATING, Learn home. Seamanship, piloting. Cruise scientifically. Compensate your own compass. Write for particulars. Fairway School, Box 811, Old Greenwich, Conn.

COACHING Until appointed—U. S. Civil Service tests! Many jobs open. Start high as \$350.00 monthly. Quality now! Experience often unnecessary. Get free 36-page illustrated book showing salaries, requirements, sample tests. Write: Franklin Institute, Dept. M-24, Rochester, N. Y.

MEN Wanted 21 to 65 to become real estate salesmen. Complete course of 12 lessons, only \$10. Earn big money. Our 25th year in business. W. Evans, 1407 N. 12th St., Reading, Penna.

BECOME A real estate broker or salesman. Complete home study course. Free information. Kansas City Realty School, Box 6808PM, Kansas City, Missouri.

AUCTIONEERING! Be an auctioneer. Earn big money. Term soon. Free catalog. Kansas City Auction School, Box 6808PM, Kansas City, Missouri.

A Pleasing dynamic singing and speaking voice can be yours! Use self-training Canfield Voco-Records. Thrilling details! 2018-A—5th Avenue South, Minneapolis 4, Minnesota.

MIDLAND Linotype School. Charles City, Iowa. Civilian and Veteran Courses. Free placement. Established 1909.

CLERGYMEN'S, Laymen's courses. Free bulletin! Midwestern Bible School, 517 Merchants Bank Building, Indianapolis.

MEDICAL Laboratory technicians in big demand by hospitals and physicians. We train you at home. Free catalog. Century College, Desk 3, 960 Montana St., Chicago 14.

COLLEGE Degrees—Independent study. Keep employed. Brentwood College, Box 19-721, Los Angeles 19.

PIANO Tuning pays. Big money in spare time. Learn at home in 30 days. No musical knowledge necessary. Phonograph, records, tools and instructions furnished. Free catalog. Capital Tuning School, 16 Southwest Second, Fort Lauderdale, Fla.

I want to send you proof of the wonderful pulling power of Popular Mechanics classified pages. What's your proposition? Write me today. Include literature if possible. F. W. Johnson, Manager Classified Advertising, Popular Mechanics Magazine, 300 E. Ontario St., Chicago 11, Ill.

BE A real estate broker. Study at home. Write for free book today. OI approved. Weaver School of Real Estate, 2018P Grand, Kansas City, Missouri.

INVESTIGATOR Training. Phillips Secret Service System, 1917-B North Kenneth, Chicago 39.

SECRET Investigation. Experience unnecessary. Investigators particulars free. George Wagner, M125 West 86th, New York 24.

GROW Mushrooms. Cellar, shed, and outdoors. Spare, full time, year round. We pay \$3.50 lb. We paid Babbitt \$4,165.00 in few weeks. Free book. Washington Mushroom Ind., Dept. 174, 2954 Admiral Way, Seattle, Washington.

EARN While you learn. Auto and diesel mechanics master this top paying trade. Many graduates earn \$100 a week and up. Approved for Korean veterans. For free information write Dept. No. 256, Nashville Auto-Diesel College, Nashville 3, Tenn.

BOOKKEEPERS! Increase your earnings! Operate your own simplified "Dollar-A-Week" bookkeeping and tax service. Full or spare time. Details free. No obligation. Ellis, Box 200, Cedar Grove, North Carolina.

USED Correspondence courses and books sold and rented. Money back guarantee. Catalog free. (Courses bought.) Lee Mountain, Pisgah, Alabama.

PIANO Tuning pays. Learn this profitable profession at home easily with patented Tonometer and mechanical aids. No knowledge music necessary. Diploma granted. Write for booklet. Niles Bryant School, 3731 Stockton Blvd., Dept. P, Sacramento 20, California.

WANT A diesel job? New opportunities to increase income. Higher pay. More money. We can help you qualify. Tools. Shop method home training. Write today! Diesel, Tractor, Heavy Equipment Division, Interstate Training Service, Dept. B-3, Portland 13, Oregon.

UNIVERSITY Degrees by residence, correspondence. Golden State University, Box 2883, Hollywood, Calif.

PHYSICAL Therapy and massage. We train you at home. Earn big profits from your own private practice or work with hospitals and doctors. Free catalogue. National Institute, Desk 4, 159 E. Ontario, Chicago, Ill.

OPPORTUNITY To earn \$15,000.00 or more annually. Business of your own. No selling nor merchandise to buy. Over 5000 persons operating these exclusive offices. Free booklet, Franklin Credit, Roanoke 7, Virginia.

OFFICE Automation: Prepare for the future with the only home study course instructing "Application of Electronic Computers to Business Clerical Operations." Free information. Business Electronics, Computer Dept., Box 3330 Rincon Annex, San Francisco, California.

PLAYS, STORIES, MANUSCRIPTS

BOOK And publication printers. Lowest cost. Catalog free! Adams Printery, 30 West Washington, Chicago 2, Illinois.

WANTED: Book manuscripts, all subjects considered. Greenwich Book Pub., Atten. Mr. Zealand, 489 Fifth Ave., New York City.

NO Luck finding a book publisher? Write for free Booklet PM. Vantage Press, 120 W. 31, New York.

SPECIAL SERVICES

DOES Anyone in the United States owe you money? Send names, amount, and addresses. Dan Hughes Claim Forwarding Agency, 6327 South Aberdeen Street, Chicago, Illinois.

INFORMATION, Research, service, scientific consulting. Reasonable rates. Murray, 1651 18 Street, Santa Monica, Calif.

RENO—Fun center of the universe! Nevada, fastest growing state! Address: Information Unlimited, Box 1121, Reno, Nevada, enclosing 25c silver.

INFORMATION On any subject, \$1. Certified research! J. F. Griffith, Wynnewood, Pennsylvania.

INFORMATION On anything. Ferguson Research Specialists, 116-14 141 St., South Ozone Park 36, N. Y.

ARTISTS' SUPPLIES

IF Interested in artist frames, canvas, canvas boards, Red Sable brushes, etc., be sure to get our money saving price lists before buying. International Sales Co., 414-APM E. Baltimore St., Baltimore 2, Md.

CARTOONING, COMMERCIAL ART, SHOWCARD & SIGN PAINTING, TATTOOING

PAINT With fire. Glowing black light colors. Different as day from night because you literally paint with light! Water colors, oils, chalks, crayons—Blak-Ray lamps. Free—write today for dealer's idea packet. Black Light Corporation of America, San Gabriel M, Calif.

"HOW To Make Money With Simple Cartoons"—A book everyone who likes to draw should have. It is free; no obligation. Simply address Cartoonists' Exchange, Dept. 91C, Pleasant Hill, Ohio.

YOU Can entertain with chalk talks. Catalog 10c. Balda The Cartoonist, Oshkosh, Wis.

LEARN Cartooning from famous cartoonists! Details free! Famous Names School, 2776 California Ct., Lincoln 10, Nebraska.

BASIC Art training course. New plan. Pay only as you progress. Free talent test, write: Student Art Club, Kennebunkport, Maine.

FREE Cartooning lesson. No obligation. Dahlborg, Box 101 PM, Brockton 69, Mass.

PAINT Signs—Master die cut, outline letter patterns. Complete assortment 1½" to 12" high, prepaid \$2.00. Eyerly, 583, Newton, Iowa.

9 ALPHABET, 3 Numeral pattern sets and raised wood letter catalog, \$1.00. Sign Letter Distributors, P.O. Box 101, Mineola, N. Y.

CARTOONISTS: Amateur, professional. Prepare for animation with Max Fleischer's plan. Write Vera Coleman, Lincoln Building, New York, N. Y.

TATTOOING Supplies, licensed course, illustrated brochures 25c. Zeiss, 728 Lesley, Rockford, Illinois.

ADVERTISING AGENCIES, LETTER WRITERS, FOR ADVERTISERS

FREE Copies! Advertiser's Newspaper, Bernzott, 299 E. 162 St., New York City.

HUNDREDS Radio stations advertising, selling your product on commission. No money down. Approved. List \$2.00. Radio-test, P.O. Box 4024C Normandy Branch, Miami Beach, Fla.

ADVERTISING Ratebook leading newspapers, magazines, 10c. Chicago Advertising Agency, Chicago 4.

FREE! 1956 Advertisers Rate and Data Directory, 52 pages! E. H. Brown Advertising Agency, 20 N. Wacker, Chicago 6.

ADVERTISING Literature designed to sell your product. Complete service, beautiful workmanship, reasonable cost. Details ten cents. Humbert Advertising, 3516 Felton, Marion, Indiana.

ADVERTISE: 24 Words, 100 Canadian newspapers \$5.50. Lists free. Advertising Bureau, 10511-C Springfield, Chicago 43.

MAILING Lists, most any classification, 1000 names \$5.00. 1000 your circulars mailed with ours \$4.00. 5000 your circulars printed and mailed \$12.95. Write Dixie Mailers, King, North Carolina.

ADS Placed in out of town newspapers and magazines. Low rates. Catalogue free. Ideas that pay. Baker Advertising Agency, Successors Ankrum Agency, 189 W. Madison, Chicago 2.

RUBBER STAMPS AND OFFICE SUPPLIES

3 LINE Stamp. Self-inking pocket stamp only dollar. Ajay, 1462A Junction Ave., Detroit 9, Mich.

THREE Lines \$1.00. Free stamp pad. Barber, 596 Girard, Marion, Ohio.

3 LINES \$1.00. Price list. Carlton, 3007 Wharton, Philadelphia 46, Penna.

RUBBER Stamps by professional craftsmen. 3 lines \$1.00. Price list. South Coast Press, 654 East Base Line, San Bernardino, Calif.

3 LINES, \$1.00. Fast service. Catalogue. Joanson, 443 MacDonough, Brooklyn 33, N. Y.

FREE Style list stock stamps. Criterion, Box 2326, Denver 25, Colo.

LINE 25c; 2-45c! 3-65c. Stamp Works, Auburn, Nebraska.

TYPEWRITERS, DUPLICATORS, OFFICE DEVICES

RECONDITIONED Typewriters, duplicating, printing devices, \$25.00 up. Supplies, Appliances, DixieGraph, King, N. C.

NEW Portable typewriters sold wholesale to salesmen \$54.50. Typewriter Specialists, 5541 S. Ashland Ave., Chicago 36, Ill.

SMITH-Corona typewriter \$39.50. Other bargains. Typewriter Exchange, Bedford, Penna.

PRINTING, MULTIGRAPHING, MIMEOGRAPHING, GUMMED LABELS

SPECIAL Offer 1,000 letterheads, 1,000 envelopes plus 5 large executive-type memo pads with your imprint up to 4 lines—All for \$10. Write to: Ad-Press Service, Dept. PM, Box 694, Anderson, Indiana.

OFFSET Printing \$6.50—1000, 8½x11 16 lb. National Letter, 1463 Broadway, New York City 36.

PRINTING Specials, list 10c. Selco Products, Department PM-156, Danvers, Massachusetts.

1000 BUSINESS Cards \$2.50. 100 letterheads \$1.00. Taylor, 5103 Forty-third Ave., Hyattsville, Maryland.

LETTERHEADS, Envelopes, statements, etc. Samples on request. Rogers Printing Service, 3663 Independence Rd., Cleveland 5, Ohio.

WE Put drawings, lettering, advertising on mimeograph stencils. Rus' copy and \$5.00 to Illustration Stencil Service, 3019 A North Haskell Ave., Dallas, Texas.

20% DISCOUNT Thermographed letterheads, envelopes. Distinctive raised printing finest papers. Free samples, price list. Crane Co., 144 Eighth, Passaic 1, N. J.

1000 EMBOSSED Business cards, \$2.95. 23 kinds available. Samples. Jaynar, Box 723B, Oak Lawn, Illinois.

ENVELOPES Only, 110 for \$1.00. Box 122, Camp Hill, Penna.

100 LETTERHEADS (8 1/2 x 11) \$1.00 Postpaid. Envelopes same. Premier Press, Box 483, Syracuse 1, N. Y.

INEXPENSIVE, Colorful printing. Convincing samples free. Hughes Service, Shillington, Penna.

100 LETTERHEADS (8 1/2 x 11) Printed carefully, \$1.00, postpaid. Envelopes same. Race Printers, Hudson, New York.

"HOW To Buy and Use Printing"—Free booklet tells how to cut costs, choose paper, type, etc. Samples and prices included. R-K Press, 825 Powder Mill Lane, Philadelphia 31, Penna.

100 8 1/2 x 11 HAMMERMILL Letterheads and 100 envelopes postpaid \$1.98. H. Hudson, Centredale, R. I.

DISTINCTIVE Business cards. Free catalog. Harmon Bean, 137 Shorewood Hills, Malvern, Arkansas.

COLOR Mimeographing and offset printing reasonable. Prices and samples. Joy, 1547 S. Cloverdale, Los Angeles 19.

QUALITY Printers—Small publications, circulars. Foty Printers, 16721 Prospect, Wayzata, Minnesota.

250 BOND Letterheads or billheads, \$2.00. Moyer, B-241, Milton, Penna.

BOOST Prestige and business! Super quality simulated engraved business cards \$3.90 per 1000 one color, \$4.45 two colors. Free samples. Estimates. Printing and advertising salesmen. Printer Lee, Box P-307, Sturgis, Michigan.

LABELS! What sort? Samples free. Fred Hoffman, 2471 Yeager St., Port Huron, Mich.

LETTERHEADS, Business forms, circulars, 1000—\$4.95. Samples. D'Yarmett, 65 Dakota, Columbus 22, Ohio.

MIMEOGRAPHING—Reasonable. Any copy. Mallers Service, Box 606-B, Chicago 90, Ill.

QUALITY Printing since 1929. Free samples. Spender & Son, Millington, Mich.

1000—2 COLOR Embossed cards, \$3.95. 250 letterheads and #10 envelopes, \$4.95. Free catalog airmailed. Redoprint, Ojai, Calif.

1000 EMBOSSED Business cards \$2.95. Decco Service, Box 5825, St. Louis 21.

QUALITY Printing at small town prices. Samples. Quotations. Mercury Press, Box 69M, Marengo, Iowa.

100 LETTERHEADS (8 1/2 x 11) Printed neatly \$1.00 postpaid. Envelopes same. Blue or black ink. Stark Press, Capitola, Calif.

OFFSET, Letterpress, mimeographing. Economical prices, samples. Litho-Press, Madison, Tenn.

1000 EMBOSSED Business cards, one color \$3.95; two color \$4.50. Samples free. L. Watson, Box 162, St. Charles, Illinois.

MIMEOGRAPHING—Letters, pricelists, formulas, instructions. Lowest prices. Lem's Letter Shop, 5710 Stanton, Detroit 8.

500 3 1/2 x 2 1/4 FOUR Line gummed stickers 50c. Red border \$1.00. Moritz Printery, Saginaw, Mich.

ADS Running under this heading sell printing. Ask me for proof. I'll gladly send you amazing facts. Ask for Folder "P." F. W. Johnson, 200 E. Ontario St., Chicago 11, Ill.

10,000 ATTRACTIVE Circulars \$10.00 up. Labels, stickers. Samples. Fame, 291 Ellis, San Francisco 2, Calif.

INFORMATION, Free samples offset printing. Harold Osterhoudt, Poughkeepsie 2, N. Y.

500 PRINTED Gummed name and address labels, \$1.00. No c.o.d.'s. Print clearly. Addison, 1840-A Addison, Chicago 13.

100 8 1/2 x 11 LETTERHEADS \$1.00 postpaid. #8 1/2 envelopes same. Other printing. Federal, Box 678A, Washington, D. C.

PRINTING OUTFITS AND SUPPLIES

MAKE Your own self-molding rubber stamps and printing cuts. Plexirubber, Argyle 1, Wisconsin.

HOBBY Printers—Join non-profit American Amateur Press Association, 822 South Orleans, Tampa 6, Florida. Hobby papers exchanged.

PRESSES, Type cabinets, supplies. List for stamp. Lincoln Press Company, 220-A Hartwell, Fall River, Mass.

PRESSES, Supplies, paper. Catalog 10c. Custom, Box 211-P, Springfield, Missouri.

DO Your own printing. Save money. Simple rules. We supply everything. Print for others; good profit. Raised printing like engraving too. Have home shop. Details free. Kelsey Presses, V-11, Meriden, Connecticut.

PATENT ATTORNEYS

INVENTORS, If you believe you have an invention, you should find out how to protect it. The firm of McMorow, Berman & Davidson with offices in Washington, D. C., is qualified to take the necessary steps for you. Send for copy of our patent booklet "How to Protect Your Invention." We will also send you an "Invention Record" form. No obligation. They are yours for the asking. McMorow, Berman & Davidson, Registered Patent Attorneys, 134-R Victor Building, Washington 1, D. C.

INVENTORS: Learn how to protect your invention. Unless the inventor is familiar with patent matters, he should engage a competent registered patent attorney or agent to represent him. We are registered to practice before the U.S. patent office and prepared to serve you in handling your patent matters. "Patent Guide for the Inventor" containing detailed information concerning patent protection and procedure with "Record of Invention" form will be forwarded to you upon request—without obligation. Clarence A. O'Brien & Harvey Jacobson, Registered Patent Attorneys, 61B-A District National Building, Washington, D. C.

INVENTORS—Take these preliminary steps toward patent protection. Sketch and describe your invention. Sign, date and have this disclosure witnessed by two people who understand your invention. Have us make a preliminary search among U.S. patents already granted for similar types of invention. We report on the probable patentability of your invention and recommend your further course of action. Write for our instructive booklet, "Patent Protection for Inventors" and convenient "Evidence of Invention" disclosure form. Victor J. Evans & Co., 231-A Merlin Building, Washington 6, D. C.

PATENTS—Irving L. McCathran, 315 McLachlen Bldg., Washington 1, D. C. Registered Patent Attorney.

INVENTION Record form free and "Patent Information Every Inventor Should Have." Carl Miller, Registered Patent Attorney, Woolworth Building, New York.

REGISTERED Patent attorney offers services. Sanders, 6430 Evans, Chicago 37, Illinois.

C. A. Snow & Co.—M437, Snow Building, Washington 1, D. C. Registered Patent Attorneys. Write for information.

INVENTORS: When you are satisfied that you have invented something of value write me, without obligation, for information as to what steps you should take to secure a patent. Write Patrick D. Beavers, Registered Patent Atty., 935 Columbian Bldg., Washington 1, D. C.

PATENTS. "Proof of Invention" free. E. E. Vrooman, Registered Patent Attorney, 507 McKim Building, Washington 5, D. C.

"INVENTOR'S Guide" and "Record of Invention" free on request. Frank P. Ledermann, Registered Patent Attorney, 154 Nassau Street, New York City.

INVENTORS: Without obligation, write for information explaining the steps you should take to secure a patent. John Randolph, Registered Patent Attorney, 203 Columbian Bldg., Washington 1, D. C.

FOR INVENTORS

INVENTORS—This firm is registered to practice before the United States Patent Office and available to assist you in the preparation and prosecution of your patent application. "Patent Protection for Inventors" booklet containing detailed information and steps to take toward patent protection sent promptly upon request. No obligation. Victor J. Evans & Co., 232-A Merlin Building, Washington 6, D. C.

INVENTORS: If you have an invention for sale, patented or unpatented, write Institute of American Inventors, Dept. 40A, 631-E St. N.W., Washington 4, D. C.

INVENTORS: Learn how to protect your invention. Unless the inventor is familiar with patent matters, he should engage a competent registered patent attorney or agent to represent him. We are registered to practice before the U. S. patent office and prepared to serve you in handling your patent matters. "Patent Guide for the Inventor" containing detailed information concerning patent protection and procedure with "Record of Invention" form will be forwarded to you upon request—without obligation. Clarence A. O'Brien & Harvey Jacobson, Registered Patent Attorneys, 61A-A District National Building, Washington, D. C.

INVENTORS—If you believe you have an invention, you should find out how to protect it. The firm of McMorow, Berman & Davidson with offices in Washington, D. C., is qualified to take the necessary steps for you. Send for copy of our patent booklet "How to Protect Your Invention." We will also send you an "Invention Record" form. No obligation. They are yours for the asking. McMorow, Berman & Davidson, Registered Patent Attorneys, 134-P Victor Building, Washington 1, D. C.

INVENTORS: Our invention promotional service is guaranteed. Write for free copy of plan and guarantee. Kessler Corporation, F111, Fremont, Ohio.

PATENT Searches \$6.00. 48-hour airmail service. Invention protection forms free. Write Patent Engineering Service, 711 14th Street, N.W., Washington 5, D. C.

INVENTORS: Profit from copyrighted "One Inventor's Experience" or money back. Send \$1.00. R. E. McLean, 5703 South Benton, Kansas City 30, Missouri.

GERMAN Books. Free price list. International, 25 McMaster, Toronto, Canada.

PATENT Searches, including copies of nearest patents, \$6.00. Reports airmailed within 48 hours. More than 100 registered patent attorneys use my service. For free invention protection forms, write Miss Ann Hastings, P.O. Box 176, Washington 4, D. C.

INVENTORS—Send for free patent information book and inventor's record. Registered Patent Attorney, Associate Examiner, Patent Office 1922-29, Patent Attorney & Advisor, Navy Department 1930-47. Gustave Miller, 16A Warner Building, Washington 4, D. C.

PATENT Searches \$6.00. 48-hour service. Free invention protection forms. Write Raymond L. Smith, Patent Searcher, 622 Sheraton Building, Washington 5, D. C.

SAVE Money on your patent application. Patents for any country. Free details. International, 25 McMaster, Toronto, Can.

"INVENTOR'S Guide" and "Record of Invention" free on request. Frank P. Ledermann, 154 Nassau Street, New York 38, N. Y.

INVENTION Record form free and "Patent Information Every Inventor Should Have." Carl Miller, Registered Patent Attorney, Woolworth Building, New York.

SEARCHES—Put your patent searches in the hands of a registered patent attorney or agent, as he qualifies to give a worthwhile patentability report. Record of invention form upon request and information on patent protection. Patrick D. Beavers, Registered Patent Attorney, 936 Columbian Bldg., Washington 1, D. C.

INVENTORS: Information on patent procedure furnished on request, without obligation. John Randolph, Registered Patent Attorney, 202 Columbian Building, Washington 1, D. C.

INVENTIONS WANTED

WE Are interested in new products. If your idea, invention, or patent appeals to us we will finance it, giving you full protection. No advance fee charged. Only letters of interest answered. Send details today. National Research & Development Corp., Dept. M, 11 West 42 Street, New York City.

NO Prepayments. Patented inventions marketed, 10% of profits. Jerry Peters, Box 9238, Rosslyn Station, Arlington 9, Virginia.

INVENTIONS And patents promoted. A-1 service for inventors for many years. Write Adam Fisher Co., 5418 Idaho, St. Louis, Mo.

UNEQUALLED Promotion service for patented or unpatented inventions. Particulars, forms, invention recording, advice, etc., free. Superior, 338-344 North Rodeo, Beverly Hills, Calif.

INVENTIONS Wanted. Patented or patent pending. 25 years experience promoting inventions. National Service Bureau, 3120 Meramec, St. Louis 18, Mo.

INVENTIONS Wanted. Patented; unpatented. Tremendous manufacturers lists. Global Marketing Service, 2420 77th, Oakland 5, California.

INVENTORS: Hundreds of manufacturers have requested our assistance in locating marketable new products. Complete information free. Institute of American Inventors, Dept. 40-D, 631-E St. N.W., Washington 4, D. C.

INVENTORS. Don't sell your invention patented or unpatented until you receive our offer. Write Cowgill, Box 298, Marion, Ohio.

CASH Buyers for ideas and inventions. Write National Inventors Institute, 457 Munsey Building, Washington 4, D. C., or 4900 Euclid Ave., Cleveland 3, Ohio.

INVENTIONS Wanted now by my manufacturer-clients. Patented, unpatented. Send for free form "S." Adams, Patent Broker, 80 Wall Street, Financial District, New York City.

PATENTS FOR SALE

NO. 2,641,048. Cutting tool. Improved tool bit for metal working lathe and shaper. Features easy resharpening. Vreeland, 4105 N.E. 58th, Portland 13, Oregon.

HANDY Golf ball carrier. A. Lefebvre, P.O. Box 212, Outremont, Montreal 8, Canada.

INVENTORS: Test the commercial value of your patented or unpatented inventions, quickly and inexpensively. Write for free information. Institute of American Inventors, Dept. 40-B, 631-E St., N.W., Washington 4, D. C.

MANUFACTURING

SHEET Metal items wanted to manufacture by production shop. Send us your ideas and we will develop them. H. Flanner, 2509 N. Reese St., Philadelphia 33, Penna.

WHITE Metal castings from your metal pattern. Low mold cost. Selley, 744 Clay, Winter Park 13, Fla.

WIRE Forming stamping tools, dies. Send your print, part or sketch. B. L. Tool & Die, 413-26th St. Union City, N. J.

DESIGNING. Manufacturing Machinery, parts, models. Engineer, 2136 East Monmouth, Philadelphia 34, Penna.

MODELS—Small lot manufacturing. Metals, plastics, etc. Milburn, Burlington, Kentucky.

MODELS, MODEL SUPPLIES

NEW Truescale ship model kits cut building time to one-quarter—More detail than ever with castings and pre-cut pieces. Mahogany hulls and baseboards, brass mounting pegs, new simplified plans, parts keyed and numbered, genuine wood blocks and deadeyes. (No plastics.) Send 10c for brand new catalog 22 ships, 4 guns. All collectors' items. Marine Models, Dept. 594, Halesite, Long Island.

1955 CAR Models, 1/25 scale, all metal, chrome trim. Send for catalog! Cars and Hobbies, Dept. PM-10, 2333 Haddon, Chicago.

WORKING Steam models—Tractors, locos, marine, stationary engines, boilers, fittings, materials, castings, prints. 1956 catalog-manual \$1.00. Tiny Power, Corvallis, Oregon.

RAILROADERS Get 1956 catalog-reference manual. O gauge scale, tinplate 50c. HO 50c. Terminal Hobby, 247 Erie, Milwaukee 2, Wis.

MODEL Railroads, O and HO cast metal items. Over 850 illustrations. Catalog only 10c. Selley, Winter Park 15, Fla.

SHIP Models. Most complete line in New England. Kits, fittings, plans, books, tools, engines, motors. Illustrated catalog 25c. James Bliss & Co., Inc., Dept. SM, 342 Atlantic Ave., Boston 10, Mass.

BALSA Wood and model aircraft. 40-page catalog 10c. Sig Co., Montezuma, Iowa.

SHIP Models and yacht supplies. Complete, large 68 page catalogue 50c. Bill Wild's, 510 East 11 St., New York City 9.

SHIP And yacht model fittings; blueprints. Send 35c for illustrated catalog listing hundreds of items. A. J. Fisher, 1002-1 Etowah Ave., Royal Oak, Mich.

POWER Models. Unusual steam, gasoline and traction engines, fittings, metals. Anniversary catalog 50c. Chas. Cole, Ventura, Calif.

LIONEL American Flyer trains repaired by factory mechanics. Fast mail service and satisfaction guaranteed. 20 to 40% electric trains and accessories. Catalog free. Mack Bros., 2041 Chicago Ave., Chicago 22.

HOME CRAFTSMEN

FREE Catalog. 1560 patterns and designs. Craftplans, 1321-A South Michigan, Chicago 5.

PLASTICS Home-craft course for men and women. Tells and shows how to make hundreds of fast selling plastics products. All plastics and materials for 23 projects included in course. No special tools needed. Course pays for itself. Write for free booklet. Interstate Training Service, Dept. D-3, Portland 13, Oregon.

101 FULL Size patterns. Smart, new, gifts, novelties, lawn figures, shelves, action windmills, alphabets. Plus "Make Money Jig Sawing." Only \$1.00. Mastercraft 15M, 7041 Olcott, Chicago 31, Illinois.

LEATHERCRAFT. Metal enameling, beadcraft, shellcraft, metal tooling, textile painting, many other crafts. Free big illustrated catalog. Kit Kraft, Dept. 231, Studio City 1, California.

JIGSAW Patterns! Large variety especially for boys, \$1.00. Pauls Plans, 4633 North 18th, Milwaukee 9, Wis.

LEATHERCRAFT. Send 10c for new 60-page catalog of tools, supplies, kits, including metalcrafts, enameling, ceramics, all other crafts. Complete stock. Reasonable. Since 1910. Sax Bros., Dept. PM1, 1111 N. 3rd, Milwaukee, Wis.

WOODWORKING Course for home craftsmen. Twenty-two manuals. Over 1000 pages. 75 training projects. Only complete home training program available today. Carefully written, profusely illustrated. Covers everything from wood selection to final finishing. Complete instruction in care and use of all hand and power tools. Prepared by expert manual training instructors. Write for free booklet. Interstate Training Service, Dept. G-3, Portland 13, Oregon.

LEATHERCRAFT Quality supplies at lowest prices. Send 10c (refundable) for most complete catalog containing 16 other crafts. Russo Handicrafts, Box 29-P-1, Los Angeles 12, California.

16 NEW Lawn chairs, 22 picnic tables, benches, trellises, etc. All 38 plans with necessary full size patterns, \$1.00. Mastercraft 13M, 7041 Olcott, Chicago 31, Ill.

BUY Wholesale nationally advertised power, hand tools, thousands other products at big discounts. Free "Wholesale Plan." American Buyers', Hertel Station, Buffalo 16-F, N. Y.

129 NEW Full-size jigsaw patterns. Artist-drawn. \$1. Craftplans, 1321-A South Michigan, Chicago 5.

WROUGHT Iron legs, make your own furniture. Plans, literature 25c. Hibbard's 624 Celey, Hampton, Va.

89 FULL Size jig saw patterns of beautiful shelves, ornaments, toys, novelties. Plus "How, Where to Sell." Only \$1.00. Mastercraft 14M, 7041 Olcott, Chicago 31, Illinois.

WIRECRAFT. Do it yourself. Smart wrought iron wall decorations from coat hangers and tin cans. Use solder or liquid solder. No fancy bending tools required. Six complete plans instructions, \$1. Wirecraft, 19605 N.W. 5th Ave., North Miami, Florida.

REDWOOD Burl. Myrtle burl. Make bowls, ornaments, novelties. Artwood, Santa Rosa, Calif.

MATCHED Jigsaw-painting patterns. Motifs, alphabets combine for nameplates, pins, plaques, decorations, other sure-sellers. Book \$1.00. Heaver, Grand Marais, Minn.

RARE Tropical hardwoods, 20 lbs. assorted rosewood, gonzala alives, teakwood, rosewood predominating. Suitable for bag clasps, miniature furniture, inlay, and always included pieces for larger articles. \$3.00 plus postage your zone. No c.o.d.'s. Salisbury Artisans, 11 Washnee St., Salisbury, Conn.

BLACK Walnut slices. Make belts, bracelets, earrings, etc. Sample kit \$1.00. Circular free. Matzdorf, Eureka Springs, Ark.

HAMBURGER Pattie press. Make it yourself. Drawings 35c. Art & George Co., 5170 No. Hollywood Avenue, Milwaukee 17, Wisconsin.

METALCRAFT. Big illustrated catalog free. Aluminum, copper, and enameling supplies. J. C. Larson Co., 820 S. Tripp, Dept. 5875, Chicago 24.

JIGSAW. Bandsaw owners, let your machine bring extra profits. Free details. Nu-Art, Box 2235, Boston, Mass.

I want to send you proof of the wonderful pulling power of Popular Mechanics classified pages. What's your proposition? Write me today. Include literature if possible. F. W. Johnson, Manager Classified Advertising, Popular Mechanics Magazine, 200 E. Ontario St., Chicago 11, Ill.

FREE Handicraft supply and project catalog. American Handicrafts, Box 1479-EQ, Fort Worth, Texas.

DIRECT Light on your work. Amazing adjustable magnetic base lighting unit. Sticks tight to iron surface. Illustrated circular free. Cullen Manufacturing Company, Racine, Wis.

VIOLINMAKERS, Amateurs, professionals. Fine toned, seasoned European wood. Materials, tools, patterns, instructions. Catalogue 10c. Premier Violin Supplies Division PVM, 430 South Broadway, Los Angeles 13, California.

LAMP Size cypress knee with nipple installed. \$2.00. Cy Products, Dept. 2-0, Lafayette, La.

ALL Crafts, supplies. Large free catalog. National Handicraft, 199 William Street, New York City 38.

FREE "Do-it-yourself" leathercraft catalog. Tandy Leather Company, Box 791-M13, Fort Worth, Texas.

FREE Information. Money-making full size patterns. Professional designs. Furniture, gift shop items. Write Jigsawers, 117 Worth, New York 13.

EXTRA Money from home workshop. Instructions \$1.00. Warren, 5A Woodbury Terrace, Woodbury, N. J.

KNOCKDOWN Cedar chests. Lumber and veneers. Free price list. Giles & Kendall Company, Huntsville, Ala.

STYLECRAFT Sure fire hits. "Pre-traced" leather kits. Handbags, billfolds, filigree belts, over fifty other projects. Patterns on leather. Why trace? Just carve, assemble and lace. Large assortment "precarved" kits also available. Send 25c for catalog, free folder. Refunded first order. Apache Leather Company, 2804 E. Washington St., Phoenix, Arizona.

KNOCKDOWN Cedar chests and lumber. Free price list. Bedford Lumber Company, Shelbyville, Tennessee.

18 FULL-Size patterns. Save money with easy-to-use, professionally designed full-size patterns. Make money selling beautiful, useful furniture. Make modern step and cocktail tables; metal lamps; pupola; 12-foot outdoor. All patterns test-built; sold with money-back guarantee. Get your free list of these convenient, economical patterns today. Popular Mechanics Press, 200-HH E. Ontario Street, Chicago 11, Illinois.

DO IT YOURSELF

PLANS How to build your outdoor fireplace. Illustrated step-by-step. 10c. Hancock Iron Works, Box 13-146, Pontiac, Mich.

DO It yourself. Save money on electrical appliance repair jobs. Build your own appliance tester. Send \$1.00 for diagram and instructions to Walt's, 601 Leslie, Woodriver, Ill.

FREE Unfinished figurine. Valencia Art, 1606 Grand Ave., Santa Barbara, Calif.

PRICE Of haircuts got you down? Double the life of yours with Saffrim! Convert your double edge razor into haircutter. Shaves hairlines, trims barber smooth. Guaranteed. \$1.00. How can you lose? Saffrim, Escondido Calif.

BUILD Inexpensive concrete blockmaker. Motor, hand. Make 500 blocks daily. Write, C. Lee, Mountain View, Oklahoma.

MONEY Spare time. Sharpen lawnmowers, \$10-\$20 hour. Build your own machine. Plans \$3.75. Box 5017, Los Angeles 55, Calif.

CLOCK Movements — Gorgeous dials, plans, kits. See ad page 245.

POWER Lawnmower out of your old hand mower. Plans \$1.00. Box 5017, Los Angeles 55, Calif.

DO It yourself. What? Repair TV, build furniture, make barbecue, plumbing repairs, build boats, do house wiring, remodel home, lay tile, modernize kitchen, repair home, and scores of other things you can do yourself. Books covering each subject, only 25c. Send for descriptive list. It's free. Popular Mechanics Press, 200-LB East Ontario St., Chicago 11, Ill.

"HOW To Appraise Diamonds." Informative, complete. \$2 postpaid. Appraisers, Box 374 GK, Staten Island 8, N. Y.

BUILD Four wheel drive, hydraulic steered tractor. Plans and details, \$1.00. Hunter's Products, P.O. Box 31, Garrett, Ind.

GEIGER Counter and metal detector kits. Inexpensive, educational. Free literature. Electronic Applications, 5024 Lee Highway, Arlington 7, Va.

"DO It Yourself Encyclopedia." 12 giant volumes (3,000 pages) packed with thousands of ideas, plans, gadgets and projects you can do yourself. How to weld, paint, repair most anything. How to make boats, deepfreeze, draperies, jigsaw projects and just scores of other items. How to do electric wiring, plumbing, room building. How to modernize kitchens, bathrooms. Greatest, most complete fix-it library ever offered. Written so you can understand it. You'll be thrilled when you see what these 12 big volumes contain. It's simply sensational. You must really see them to fully appreciate this exciting fix-it library. You'll fall in love with them just as soon as you open the first volume. I'll send you a descriptive circular that will open your eyes to the greatest, most complete and beautifully illustrated "Fix-it" library you ever laid your eyes on. Send a postal right now. Popular Mechanics Press, 200-DY East Ontario St., Chicago 11, Illinois.

WATCHES, OLD GOLD, JEWELRY

HIGHEST Cash for old gold, broken jewelry, gold teeth, watches, diamonds, silverware, spectacles, platinum. Free information. Satisfaction guaranteed. Rose Refiners, Heyworth Bldg., Chicago 2.

RHINESTONES, Jewelry settings, copper enameling, hobby kits. Illustrated catalog 10c. J & M Novelties, Dept. CA-3, Griffith, Indiana.

WATCHMAKERS' Tools, materials, supplies, watches. Catalog. Gales, Box 1000, Chicago 90, Illinois.

FREE Sample pair of earrings with catalog 25c. Exclusive line of make your own costume jewelry. Barry's, 213 Ardsley Ct., Newark 2, N. J.

RHINESTONES. Send \$2.25 for five gross, value \$5.00, free bargain list. Catalog. Ebert, Box P183, East Orange, New Jersey.

WATCH And clock repairing books. Free information. North American, Dept. 18A, 2320 N. Milwaukee, Chicago 47, Illinois.

WATCHMAKERS' — Jewelers' supplies, instructions. Catalog 20c. Bengale Company, Culver City, California.

COSTUME Jewelry supplies. Catalog and samples. 35c. Largest line in America. Milady-Fair Co., G.P.O. Box 1328, New York City 1.

USED And new watches \$2 up. Free list. Southern Watches, Gray, Georgia.

10 SWISS Watches \$18.00. Catalog 10c. Berkowitz, 1150 Castlehill, New York 62.

TOBACCO, SMOKERS' SUPPLIES

CLEAR Havana rejects of a nationally advertised cigar. \$3.50 for 50. Guaranteed. Tobacconist, 220 N. Clark, Chicago 1, Ill.

INTRODUCTORY Offer: pipe smoking. 3 pounds \$2.00 postpaid. Star Farms, Ralston, Tennessee.

CUSTOM Pipes. Pipe-making supplies. Tools. Instructions. Walter Miller, Germantown, Ohio.

PIPE Smokers! Cigar smokers! Free illustrated catalog offers fabulous savings on choice imported and domestic pipes, cigars, tobaccos, supplies. Write Wally Frank, Dept. 25, 150 Nassau Street, New York 38, N. Y.

PIPE Smokers! Broken stems replaced. Utter Pipe Factory, Olean, New York.

RAZORS, BLADES, SHARPENING

D.E. blades, none better. Fit Gillette razor. 100, \$1.00. Send dollar to: P.O. Box 452, Wilkes-Barre, Penna.

FOR THE HOME

OPEN Jars, bottles with ease. New jar wrench \$1.00, postpaid. Satisfaction guaranteed. C. G. Roy, 49 Park Street, Medfield, Massachusetts.

RID-O-Snow. Write for folder. Kaess, 45 Chester Ave., Irvington 11, N. J.

PAINTED Portrait. Memorial. Lifelike. Canvases, \$12.75-\$27.75! Easy payments. Total refund guaranteed. Free approvals! Write: Dorstudio, Ojai, Calif.

FOAM Rubber furniture cushions. Factory seconds. 50% discount. Free catalog. Perma-Foam, 429C Central Ave., East Orange, New Jersey.

OF INTEREST TO WOMEN

EMBROIDERED Stamped linens. Buy direct from manufacturer and save. Send for free catalog. Dept. 949, Merrilee, 18 West 19th Street, New York 11, N. Y.

TREASURES From India. Silk and Zari scarfs. Other items. Box 5051, Beacon Hill Station, San Antonio 1, Texas.

"8 MISTAKES Parents Make." Every parent should have this new book about child training. It is free; no obligation. Simply address Parents Association, Dept. 671, Pleasant Hill, Ohio.

PROFITABLE Home business. Make fast-seller chenille monkey trees, dolls, flowers. Terrific holiday demand. Information free. Velva, Bohemia 16, N. Y.

EARN Beautiful stainless steel tableware set. Few hours work. Write for information. E. W. Smith, 102 Post Ave., New York 34, N. Y.

WANT To make big money at home? \$5 profit in an hour possible with invisible reweaving. Make tears, holes disappear from clothing, fabrics, Steady year-round demand from cleaners, laundries, homes. Details free. Fabricon, 8332 S. Prairie, Chicago 19, Illinois.

FREE! 14-Piece waterless cookware set. For details, write: Natseger, 3566-A Diamond Ave., Oakland 2, Calif.

"SHOULD Husband Make a Will?" Free pamphlet. Willform, Box 33, Ferndale 20, Mich.

SELL Fine fabrics. Get yours wholesale. Box 863, Norwalk, Conn.

DRESSES 24c; Shoes 39c; men's suits \$4.95; trousers \$1.20. Better used clothing. Free catalog. Transworld, 164-S Christopher, Brooklyn 12, N. Y.

BIG Profits making candles. Rush name. Raymond Schenck, Butler, Penna.

GOOD Money in weaving. Weave rugs at home for neighbors on \$69.50 Union Loom. Thousands doing it. Booklet free. Union Looms, 153 Post St., Boonville, N. Y.

GROW Mushrooms. Cellar, shed, and outdoors. Spare, full time, year round. We pay \$3.50 lb. We paid Babbitt \$4,165.00 in few weeks. Free book. Washington Mushroom Ind., Dept. 176, 2954 Admiral Way, Seattle, Washington.

FLASHLIGHT. The ideal gift. Every sportsman needs this handsome Ray-O-Vac flashlight with built-in electric cigarette lighter. Absolutely fireproof, stormproof, explosionproof. Has positive action lock-type selective switch. \$5.00 each postpaid. 5 for \$20.00. Stannhill Industries, Plain, Wisconsin.

FOR SALE—MISCELLANEOUS

HEARING Aid batteries, wholesale. Free list. Habs, Box 51, York, Penna.

OLD Wall telephones. Working order, oak cabinets, hand crank for ringing. \$5.00 each f.o.b. Telephone Co., Turtle Lake, Wis.

WANTED—MISCELLANEOUS

WANTED \$2.00 To \$5.00 mail order items. Lilart Co., Box 965, Scottsdale, Arizona.

SCRAP Mercury (quicksilver) containers supplied — Tantalum, bismuth, tungsten. Metallurgical Products Company. Established 1909, 35th and Moore Sts., Philadelphia 45, Penna.

QUICKSILVER, Sterling, silver solders, precious metals. Wholesale Terminal, Norwood, Massachusetts.

HIGHEST Prices for gold, silver, platinum, diamonds, watches, gold teeth. Satisfaction assured. Goods returned if offer unsatisfactory. United Smelting Works (Old Reliable), 6-B East Monroe, Chicago 3.

PERSONAL

BORROW By mail from Postal Finance Co. Employed men and women can easily obtain \$50 to \$600 fast, entirely by mail. Repay in small monthly payments. Friends, relatives, employer, tradespeople will not know you are applying for loan. Advise occupation, amount wanted. Postal Finance Co., 200 Keeline Bldg., Dept. 7A, Omaha, Nebraska.

BORROWING By mail. Loans \$100 to \$500 to employed men and women. Easy, quick. Completely confidential. No endorsers. Repay in convenient monthly payments. Details free in plain envelope. Give occupation. State Finance Co., 323 Securities Bldg., Dept. P-227, Omaha 2, Nebraska.

BORDER Bulletin! Co-publish this little magazine for \$1 per month! Your thirty word advertisement free! Sample, details 5c! Border Bulletin, 910 Marion, Pharr 2, Texas.

FEET Hurt? Wonderful new callous arch cushion, foam and plastic covered, \$1.75 pair. Bunion shield, foam sponge, washable, hooks over toe \$3.00 pair. R. Grossman, 203 West 69 Street, Box 97, New York 23, N. Y.

BUY Vitamins direct. Amazing savings. Catalog free. Motosko, White Bear, Minn.

LOS Angeles, Hollywood or San Diego complete daily classified section. Help wanted, houses, etc., rent or sale. \$1.00 each air mailed. Clark, 3761 Boundary, San Diego 4, California.

LETTERS Remailed \$1. Swan, 39 Clarence Street, Devonport, Auckland, New Zealand.

NEW York City help wanted ads \$1.00. Remails 25c. James, P.O. Box 512, New York 1, N. Y.

LOS Angeles: Letters reairmailed 25c. Received-forwarded \$3.00 per month. Confidential handling for legitimate personal and business operations. Reliable. Prompt. International Courier Service, Box 6480-FM, Metropolitan Station, Los Angeles 55, California.

PROFIT! Prestige! Fun! Pool your friends with an authentic looking newspaper clipping about your fabulous past or future. You compose item. Details 25c (coin). Monroe, Box 365-A, Bellflower, Calif.

BE Somebody! Get somewhere! Request free positive thought motivation plan. Easy, quick results. Write Applied Christian Psychology, Inc., Box 1924-C, Louisville 1, Ky.

MIAMI. Complete classified airmailed \$1.00. Letters remailed 25c. Lewellyn, Box 69, South Miami, Florida.

REMAILS 25c. Sunday classifieds \$1.00. Jordan, 1120 Chenevert, Houston, Texas.

TRAVELERS. Any state souvenir decal, 20c. Box Seventeen, Nyack, N. Y.

CANADA Offers unlimited opportunities. Classifieds, three Toronto newspapers airmailed \$1.00. Canada Classified Service, 11 Edgemore Drive, Toronto 18, Canada.

LEARN Mind reading! Easy method! Details free! Knowledge, 1101-E, Warren, Bucyrus, Ohio.

ANNOUNCING Our new psychological test that reveals your true vocational aptitude. If you long for real inner contentment, self-confidence, and better, adequate income, send today for free full facts to Employment Counselors, Suite 507-AA, Professional Building, Baltimore 1, Md.

"HOW Can I find out?" You can! Information confidentially developed. Any matter, person, problem. Worldwide. Officially licensed. Established 1922. William Herman, 170 Broadway, New York City.

MEXICAN Law. General Practice Attorney. Apartado 79, Juárez, Chih., México.

LETTERS Remailed 25c. Personal forwarding address. Monthly rates. Hicks Service, Box 1547, Washington 13, D. C.

GLOBAL Viewcard selection, worldwide remailing. Travelpost, Box 198, Nogales, Arizona.

BOOMING Los Angeles employment ads \$1.00. Hollywood remails 20c. Dunlap, 11250 Playa St., Culver City, Calif.

REMAILING, Forwarding 25c each. Ace Service, Box 186, Tampa 1, Fla.

LIKE Pull mail boxes? Interesting offers galore, 25c. Traylor's Enterprises, La Feria, Texas.

ALASKA'S Capital exclusive business directory, \$1.00. Air remail 30c. ABCo, Box 282, Juneau, Alaska.

EXCITING New book, "How to Collect Stamps, Coins, Paper Money." Packed with amazing facts; information worth dollars. Fully illustrated, 160 pages. 75c. Popular Mechanics Press, 200-ST E. Ontario St., Chicago 11, Ill.

REMAILING SERVICE

LETTERS Forwarding 25c. 5 postcards \$1.00. Remailed free. Box 4138, Sarasota, Florida.

LETTERS Remailed, New York, 25c. Gross, W.M.L., Rockaway, N. J.

ROMANTIC Hawaii remails 50c. Reair-mails \$1.00. Barrow, 45 Johnson Circle, Honolulu 18, Hawaii.

MAIL Received, forwarded. \$3 month. Hedgpeh, Box 830, Alhambra 23, Calif.

LETTERS Remailed 25c. Phoenix, Arizona. Lilart Co., Scottsdale, Arizona, Box 965.

LETTER Remailing, receiving-forwarding address for rent. McLaughlin, 800 Stewart, Columbus 6, Ohio.

MAINE Remails 25c. "Vacationland" postcards 8 for \$1.00. Santore, P.O. Box 3232, Portland, Maine.

CHICAGO Sunday classified \$1.00. Remails 25c. Business Cards, Box 3073M1, Chicago 54.

REMAILS 25c. Sunday classified \$1.00. Robert Beisheim, Box 7353, Philadelphia 1, Penna.

REMAILS 25c; Classified airmailed \$1. Olson, Box 1041, Ketchikan, Alaska.

REMAILING — 25c. Cards 5c. Royal Service, Box 3201-M, Denver 18, Colo.

FLORIDA Remailing letters 25c, classified \$1.00. Pronto, Box 118, Miami Beach 39.

LETTERS Remailed, 10c. Ten scenic postcards, \$1.00; free stamps, remailing. Scenic Postals, Box 1128, Chattanooga, Tenn.

AUSTRALIA, Air-remail with beautiful postals \$1; with boomerang \$3. Mitro, Box 1915 GPO, Sydney, Australia.

LETTERS Remailed 25c. Hackney, 216 Poplar Street, Sanford, North Carolina.

LETTERS Remailed from New York City 25c. 10 postcards \$1.25. Remailed free. S. H. Brown, 178-39 Leslie Rd., St. Albans, Long Island 34, N. Y.

TREASURE FINDERS

FIND Buried treasure, gold and silver, with Goldak's sensational 3 1/2 lb. "find-it" locator, only \$49.50. Write for free literature on complete line of mineral, metal locators; Geiger and scintillation counters. Goldak, 1541 W. Glenoaks Blvd., Glendale, Calif.

GEIGER Counters, metal detectors, ultra-violet mineralights, from \$29.50 up. Write for free catalogs. The Radiac Co., Inc., 489 Fifth Ave., Dept. 13-PM, New York 17, N. Y.

URANIUM, Where, how, prospectors' handbook. Continental, Box 5017, Los Angeles 55, Calif.

JEEP Owners — V8 power. Read Jeep Owners ad, page 60.

NEW! Uranium detector kit, \$8.49. Free catalog. CMG, Box 611-PM, Laramie, Wyoming.

GEIGER Kit \$15.95. Send \$5, balance c.o.d. Amerlabs, 471 Clifton Ave., Newark 4, New Jersey.

TREASURE, Metal, mineral locators M-scope type. Latest electronic design \$75.00 up. Geiger counters, scintillators, mineralights for uranium prospecting \$35.00 up. Fully guaranteed. Monthly payment plan available. Books "How to Be a Successful Uranium Prospector," "For Fun and Profit." Literature free upon request. Fisher Research Laboratory, Inc., Palo Alto, Calif.

URANIUM, Gold, silver treasure. New, power-packed, highly sensitive metal detectors, Geiger counters and mineralights, kits and assembled models from \$12.50. Lightest weight, guaranteed, free literature. Electronic Applications, 5024 Lee Highway, Arlington 7, Va.

GOLD, Silver, metal detectors. Geiger counters for uranium. Mineralights. Sensational new fully guaranteed models. None finer. Information free. Detectron Corp., 5528 Vineland Ave., North Hollywood, California.

URANIUM! Informative booklet gives known and potential locations. Government map included free, \$1.00. Map and tips 20c. Uranium Research, Box 1555, College Station, Texas.

GEIGER Counters and kits. Sensational values. Free literature. Roberts Mfg. Co., Cleburne, Texas.

MISCELLANEOUS

ENTERTAIN With new French toy. These French acrobats will mystify both young and old with their lifelike antics. Easy to operate. Children will love them. Only \$1.00 postpaid. Research Novelities Company, 346 Bryant St., Palo Alto, Calif.

FREE Booklet "Septic Aide — How It Works for You." Tells how to keep your septic tank trouble-free and save you money. Best Products, Box 893-P, Norfolk 1, Virginia.

NEW Invention projects life-size pictures with any flashlite. Lowlie, Dept. PM, 4145 Broadway, Chicago 13, Ill.

COMMUNICATIONS 1 Cor. 15. Whitcomb, 308 Sycamore, Newport News, Va.

FOR Beautiful engraved name plate send \$1.00 and name. Mail-N-Post, Wapping, Conn.

BUY Wholesale thousands nationally advertised products at big discount. Free "Wholesale Plan." American Buyers, Hertel Station, Buffalo 16-K, N. Y.

TIE Exchange — Yours and 50c. Joe Boyd, 1437 Reiser, Indianapolis.

BEAUTIFUL Foreign magazines. Single copies. Illustrated brochure 25c. Contacts, Box 4563-PM, Sarasota, Florida.

SELL! Buy! Trade! Anything. In "Trading Post Magazine." Details free! Thorne's, 525 Dewey, Jackson 40, Michigan.

SENSATIONAL Offer! Exciting, miniature tree growing secrets; new, catch-all fishing formula; money-saving, "Home Dental Care" booklet. Rush \$1.00 for all. Revealer, 1749 Grand Concourse, New York City 53.

SENSATIONAL Waterless hand cleaner. 2 pound can 89c. 4 pound \$1.69. Sunway, Box 811, St. Louis, Mo.

CESSPOOL, Septic tank troubles? Use "Septi-Magic." Complete treatment. Save pumping, digging, stop odor. Non-toxic. Simply flush down toilet. \$3.98 lb. postpaid. Details free. Agents wanted. Manufactured and guaranteed by Cerco Products Co., Salem, Connecticut.

HAIRCUT As you like it. Booklet 25c. Mastrolia, 32-20CH 89th Street, Jackson Heights 69, New York.

HOUSE Plan booklet — 30 modern designs of available plans. \$1.00. Melman Homes, Box 62, Mt. Pleasant, Penna.

FREE. Complete illustrated catalog. Leathercraft kits, supplies. J. C. Larson Co., 820 S. Tripp, Dept. 5550, Chicago 24.

WALLET Photos, cards sealed in protective transparent plastic—50c. Plastic Press, Box 13, St. Louis 14, Missouri.

PIPE Smokers — Enjoy fine imported, aromatic, domestic tobacco, reasonably priced. Facts free. Pete Moberly, Box 804, Owensboro, Kentucky.

SUPER Memory overnight! Success guaranteed! Bijou, Box 1727-M, Hollywood 28, California.

BE Somebody! Get somewhere! Request free positive thought motivation plan. Easy, quick results. Write Applied Christian Psychology, Inc., Box 1924-D, Louisville 1, Ky.

HOME Mailorder beginner's manual, sources, methods, opportunities, 25c. Carnahan Brothers, 9610 Acacia, Fontana, Calif.

BUY Wholesale. Everything! Thousands items! Free catalogs! Econ-O-Mart, 8 Perry, Whippany 2, New Jersey.

FREE. Get our offers. Durr & Durr, 6521-N Pine Point, Tinley Park, Ill.

PANNING Gold lesson—Free mail-order catalog, mining supplies, mineral books. Old Prospector, Box 729D1, Lodi, Calif.

SEALED In plastic. Photos, social security cards (4 1/2 x 2 1/2). 25c. Stamped, addressed envelope. 817 No. Rampart, Los Angeles 26, Calif.

70 BIBLE Lessons, 25c. Bulletin, Box 87, Cathedral Station, New York 25.

300 INTERESTING Mails guaranteed. 35c. Postal Associate, 1514 West Eleventh, Brooklyn 4, New York.

BUY Wholesale 550,000 products. Literature free. Carter, Box 6011-H, Chicago.

STUPENDOUS Mental power. Adults. (Details 10c.) Delmar Wisdom, 846 Sunnyside, Chicago 40.

YOUR Name wanted. We'll send 1000 publishers, mailers, wholesalers your name, on our list one year 25c. Dixie Mailers, King, N. C.

HEAT Your home or business for almost nothing. Amazing method, thousands satisfied. Valuable information free. A. Enault, R.F.D. #1, White River Junction, Vermont.

CLOGGED Drains, cesspools and septic tanks cleaned by new powerful chemical. Sursolvent removes grease, soap, tree roots, etc., without expensive digging and electric rodding machines. No pumping necessary. Mix with water and pour down drain. Free details. Electric Drain Cleaning Co., Boston 34, Mass.

HOW To paint. Do it yourself. Illustrated instructive book. 25c. Catalog free. Popular Mechanics Press, 200-HP E. Ontario St., Chicago 11, Ill.

RECEIVE Magazines, samples, catalogues. Mails from everywhere. Offers, hundreds. Get listed 25c. Rorick, Box 86, Cincinnati 26, Ohio.

GROW Mushrooms. Cellar, shed, and outdoors. Spare, full time, year round. We pay \$3.50 lb. We paid Babbitt \$4,165.00 in few weeks. Free book. Washington Mushroom Ind., Dept. 175, 2954 Admiral Way, Seattle, Washington.

300 BIG Mails guaranteed. Samples, plans, offers, propositions, 12 months listing, \$1.00 refundable. Wright Publications, 2270 Hubbard, Memphis 8, Tenn.

WHOLESALE Catalog! 30-80% discounts! Appliances, musical instruments, typewriters, phonographs, watches, jewelry, recorders, housewares, etc. Consolidated Distributors, 21-13 Lafayette, Paterson 15, New Jersey.

WANT More business? Here's an amazing opportunity to increase your sales. Talk to thousands of interested readers of "Mechanics Popular." Our Spanish Edition covers the Latin American countries like a blanket. They're real mailorder buyers. Classified rate 75c per word. Try an ad in our next issue. Classified Advertising Department, Popular Mechanics Magazine, 200 East Ontario Street, Chicago 11, Ill.

HOMES Now built of earth and cement. Know-how \$2.00. Agents wanted. Sam House, P.O. Box 727-A, Indianapolis 6, Ind.

FREE: Exciting catalog packed with books covering most everything. Think of it—From cover to cover you will find described and illustrated hundreds of books telling how to fix and how to build almost anything. How to remodel your home; do your own decorating, plumbing, electrical work. Simplified books covering concrete work, carpentry, painting, furniture making and refinishing. How to build your own boat, home workshop tools. Best books on photography, welding, hobbies, homecraft. How to make a home freezer. Send for your free copy now. Popular Mechanics Press, 200-BC East Ontario St., Chicago 11, Ill.

New Rubber Stamp Business Pays Beginners ^{UP} ^{TO} \$9.20 an hr.

**Start at home in spare
time with this little
table top machine**

The multi-million dollar Rubber Stamp Business—once controlled by a few big companies—is now being taken over by small home operators—one in each community throughout the U.S. Men and women who have this inexpensive machine can turn out huge quantities of Rubber Stamps with special wording that buyers once were forced to order from big cities. Material costing only 27c makes a stamp that sells for \$1.80. The machine that does the work is simple and easy to operate and it turns out as many as six Rubber Stamps at a time each with different wording such as names, addresses, notices, stock numbers, prices and other "copy" needed by offices, factories and individuals. Working full capacity, it can earn as much as \$9.20 an hour for the operator! Now you can get into the big-pay business yourself, with your own home as headquarters. You don't need any experience. We supply everything, including complete instructions and eight ways to get business coming in fast. Start making up to \$9.20 an hour from the very beginning. Cash in on the profitable Rubber Stamp Business in your community right away.

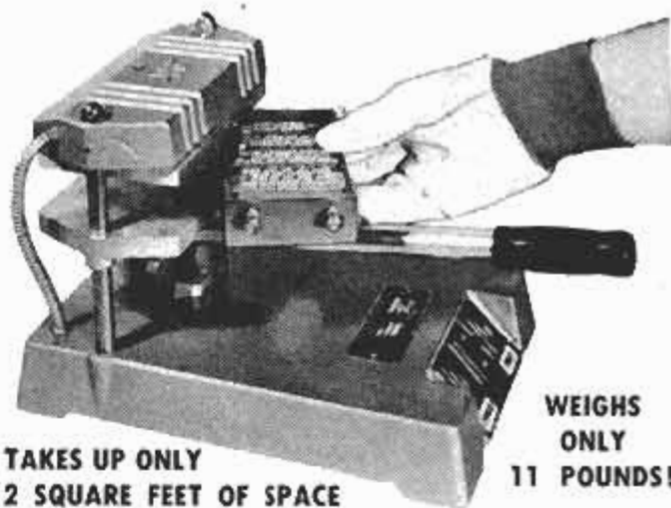

**TAKES UP ONLY
2 SQUARE FEET OF SPACE**

**WEIGHS
ONLY
11 POUNDS!**

Read the complete and fascinating Rubber Stamp story in a big 110-page Book recently published by the Warner Electric Company. The book is profusely illustrated with more than 100 pictures and photographs. And you can read it for a full two weeks without risking a penny of your own money.

Here's what the new WARNER PLAN Tells You about Making Money with RUBBER STAMPS

CHAPTERS

1. HOW TO have fun now and at the same time provide for a secure and prosperous future.
2. HOW TO check the advantages of operating a Rubber Stamp Business in your own community.
3. HOW TO acquire a general knowledge of the business based on a brief history of the Rubber Stamp.
4. HOW TO visualize the scope of the Rubber Stamp market.
5. HOW TO make a Rubber Stamp (general outline).
6. HOW TO assess the value of Warner Equipment.
7. HOW TO get acquainted with the "Tools of your Trade."
8. HOW TO make a Rubber Stamp (Specific procedure).
9. HOW TO mount a vulcanized Rubber Stamp.
10. HOW TO make "Special" Rubber Stamps.
11. HOW TO cut plastic Matrix Board for the chase.
12. HOW TO get the right price for the Rubber Stamps you make.
13. HOW TO price your complete Rubber Stamp Line.
14. HOW TO figure costs so you will be sure of a substantial profit on all the work you turn out.
15. HOW TO set up your workshop.
16. HOW TO get the most out of Warner's "Eight Tested Sources for Getting Business."
17. HOW TO operate at peak efficiency when YOU ARE YOUR OWN BOSS.
18. HOW TO get started on a cash outlay so small that you can get back your entire investment inside of two weeks.

NEW WARNER SUCCESS PLAN

**Tells How to Build — Step by Step — to
big profits and Personal Independence
READ THIS PLAN FOR 2 WEEKS
ENTIRELY AT MY RISK.**



**110 Pages
More Than 100
Pictures**

**Now Ready to Mail
Tell Me Where To
Send Your Copy**

USE COUPON

In this amazing Plan you will find exact and detailed instructions for starting a Home Business in spare time—without giving up your present job and without risking the loss of a single pay check. The Warner Plan shows you—with pictures, photographs and drawings—just how to make Rubber Stamps just as good as those turned out by the big companies. It shows how to get orders without canvassing or house-to-house selling. It shows you how to expand, how to get others to work for you and how to be SURE of at least twice your present job for a life of personal independence.

But don't make any decision now. Read the Plan first—entirely at my risk. Then—after you have made a careful investigation—after you have talked things over with your family—only then do you decide what you want to do.

The thing to do now is to get full details which I will send you FREE. No salesman will call to urge you to buy anything. Mail coupon today—or just send me a postcard—and I will see that complete information goes out to you by return mail—postage paid.

RUBBER STAMP DIVISION

1512 Jarvis Ave., Dept. R-21, Chicago 26, Illinois

**RUBBER STAMP DIVISION
1512 Jarvis Avenue, Dept. R-21
Chicago 26, Illinois**

**SEND NO
MONEY**

Please rush full particulars about the little machine that can get me started in the profitable Rubber Stamp Business at home in spare time. Everything you send me is FREE. No salesman will call.

Name _____

Address _____

City _____ Zone _____ State _____

HOW MANY FEATHERS ON AN EAGLE?

Add up the figures and find out. Most anybody can add, but can you add correctly? The reason people like number puzzles is because they are fascinating. Fun right in your own home, and CASH REWARDS for the WINNERS.



\$6360.00 IN CASH PRIZES (NOW ON DEPOSIT)

FIRST PRIZE \$1500 plus \$500 Bonus for Promptness (see rule 2)

Second Prize	\$1000.00	9th to 13th Prize, each . . .	\$100.00
Third Prize	\$500.00	14th to 18th Prize, each . . .	\$50.00
Fourth Prize	\$350.00	19th to 44th Prize, each . . .	\$25.00
5th to 8th Prize, each	\$200.00	45th to 75th Prize, each . . .	\$10.00

— HERE ARE THE RULES —

1. This is entirely a contest of numbers, strictly a Game of Skill. Add together the numbers that make up the drawing of the Eagle and get the SUM TOTAL of the figures. The picture is made up of single digits: 2, 3, 4, 5, 7, 8 and 9. There are no sixes, no ones, no zeros. There are no double numbers like "23," etc. Just add 2 plus 3 plus 5, etc., and get the TOTAL. There are no tricks to this puzzle, just a problem in addition. It is not so easy but if you are careful you may get it exactly right. Only persons sending a \$5.00 contribution to our Scholarships Program are eligible for these Cash Prizes. No additional donation will be required at any time during the contest. Checks and Money Orders should be made payable to 'SCHOLARSHIPS, INC.' Send cash if you prefer. Write us for additional puzzle sheets if you need them.

2. If you send your contributions before the date printed on the entry blank you will qualify for the \$500 Promptness Bonus, making the total First Prize \$2000.00. The Promptness Bonus will be added to the first prize only.

3. You should check and recheck your solution carefully before mailing. Once it has been sent it may not be changed or withdrawn. A contestant may submit an additional entry in this contest with an improved score provided each such entry is accompanied by the required \$5.00 contribution. We will acknowledge receipt of your entry and contribution promptly. Read the rules carefully. Please do not write for additional infor-

mation concerning this contest since information that is not available to all other contestants cannot be given.

4. This contest is confined to persons within the continental limits of the United States. Persons directly connected with Scholarships, Inc. and members of their immediate families are ineligible. Due to the uncertainty of mail address entries are not recommended from persons in the Armed Forces. Entries will not be accepted from persons in Alaska, Canada, Hawaiian Islands and other locations outside of the United States proper.

5. Entries will be accepted from January 1 to April 10, 1956. Entries postmarked April 10 will be accepted.

6. In case of ties on this Eagle Puzzle the winners will be decided by a tiebreaker number puzzle consisting of drawing a path across a chart of numbers to arrive at a high total. The contestant's position in the winning list will be determined by the best scores submitted; the best answer will receive First Prize, the second best answer will receive Second Prize, etc. In case of ties on the tiebreaker puzzle, prizes will be reserved for the positions of tied contestants and their final order of finish determined by additional tiebreaker puzzles until a definite winner for each prize is chosen. Seven days will be allowed for working the first tiebreaker puzzle and three days for each subsequent tiebreaker. If ties remain after seven tiebreaker puzzles, duplicate prizes will be paid.

See rules and coupon on next page. —>

PRIZE CONTEST continued

7. It is permissible for any contestant to receive help from their relatives or friends but **ONLY ONE SOLUTION** may be submitted to the tie-breaker puzzle by any group working together, and any solution known to have been submitted in violation of this rule will be rejected.

8. A complete report of this contest including the names of all winners will be mailed to every contestant just as soon as the winners have been decided. The sponsors of this contest reserve the right to decide any questions that may arise during the contest and persons who enter agree to accept these decisions as final.

C. L. KITTLE, Manager

Here is a contest soon over and soon paid off. The rules are simple and complete. It's entirely a contest of numbers, strictly a game of skill. We print the winning answer with the name and address of the winner, in fact we print the names and scores of all of the winners. A pencil is the only tool required and you start on an equal basis with everyone else. No pictures to identify, no statements to write.

If you have never taken part in a number puzzle contest why not give it a try. Give yourself a fair chance to succeed. This may be the hobby you have been looking for. Operated by a non-profit corporation required by its charter to devote receipts in excess of prizes, advertising and legitimate operating expenses to charitable purposes.



Miss Nancy McAllister is one of 24 nurses in training at nearby hospitals under our Scholarships and writes "My ambition to become a nurse is soon to be a reality and I am very proud and happy. My most sincere thanks to those who have helped make this possible."

Mail to **SCHOLARSHIPS, INC.,**
Box 241, Lawrenceburg, Ind.

There are.....feathers on the Eagle.

Please type your name and address if possible. If not print by hand.

Name.....

Address.....

City.....

Zone..... State.....

Donations mailed before February 7, 1956 qualify for Promptness Bonus.

Do You Like art?

DRAW FOR MONEY!

Our Simple Method Proves You Can Learn to Draw at Home in Spare Time

YOU can learn Commercial Art, Designing, Illustrating, Cartooning, etc. . . . right at home, in spare time. No previous art training necessary. Soon be your own boss — work at home, pick your own working hours. Or earn big money as staff artist for advertising agency, newspaper, magazine, dept. store, etc. Or make Art a profitable hobby. Earn while you learn. 22-piece art outfit given with your first lesson **AT NO EXTRA CHARGE.** (School est. 1914.)

FREE BOOK, "ART FOR PLEASURE AND PROFIT." Describes our methods. Lists opportunities. Tells what our students say. No obligation. So mail coupon at once.

Washington School of Art
Studio 141, Port Washington, N. Y.

Send me—**FREE**—your valuable illustrated Book, "Art for Pleasure and Profit." No obligation. No salesman will call.

Name.....Age.....

(PLEASE PRINT PLAINLY)

Street.....

City.....Zone.....State.....



CHOOSE YOUR NEW HOME FROM HUNDREDS of Garlinghouse HOME PLANS SHOWN IN THESE 5 LATEST PLAN BOOKS

- These beautiful books contain hundreds of colored drawings, photos, floor plans and descriptions—making it easy and economical to select your new home. All sizes and styles are shown. Complete working plans, specifications, lumber and mill lists available for each design at Low Cost—enabling you to get bids quickly—or to figure doing part or all the work yourself. The moderate price of these plans is your best investment when building since you know in advance what you are getting, thus avoiding misunderstandings. 24 hour service on plans with a money-back guarantee if unused plans are returned in five days.
- **"RANCH & SUBURBAN"**
125 plans most practical for town and country. Many in color50c
 - **"CHOICE SELECTED HOMES"**
82 designs (12 are split-levels) 2 and 3 bedrooms. 32 in color. . .50c
 - **"NEW SMALL HOMES"**
Over 80 new plans. Sizes 650 to 1175 sq. ft. floor space, 1, 2 and 3 bedrooms. 32 in color. . . .50c
 - **"NEW BRICK HOMES"**
64 genuine beauties, brick exteriors. Varied styles and sizes. 50c
 - **"PLANS FOR NEW HOMES"**
84 very desirable homes in wide variety of styles and sizes. 32 in full color.50c
- All 5 above books for \$2.00

ORDER YOUR BOOKS TODAY
All Books Mailed **POSTPAID**. No C.O.D.'s Please
Our Plan Service used by Builders and Lumber Dealers for over 45 years—America's Pioneer Home Plan Service.

L. F. GARLINGHOUSE CO., INC., Box PM-25 TOPEKA KANSAS

free!

1956 ALLIED



ELECTRONIC SUPPLY CATALOG

**324
value-packed
pages**

**Save on Everything
in TV and Radio
Parts & Equipment**

**Everything for Experimenters,
Builders, Amateurs, Servicemen,
Engineers & Hi-Fi Specialists**

Send for ALLIED's big 324-page value-packed guide to *everything* in TV, Radio and Electronics! Select from the world's largest stocks of High Fidelity systems and components; recorders and phono equipment; TV tubes, antennas and accessories; Amateur station equipment and supplies; P.A. systems; test instruments; latest build-your-own kits; industrial electronic supplies—plus *everything* in electronic parts, tubes, transistors, tools and books. Save on everything in Electronics—send today for your **FREE 1956 ALLIED Catalog.**

**Everything in Electronics
From One Reliable Source**

send for it

**FREE
CATALOG**

ALLIED RADIO

ALLIED RADIO CORP., Dept. 5-A-6
100 N. Western Ave., Chicago 80, Ill.

Rush FREE 1956 ALLIED 324-Page Catalog

Name _____

Address _____

City _____ Zone _____ State _____

WHERE-TO-BUY-IT INDEX

Source of supply appears after items commercially available

AUTOMOTIVE

Cost-cutting trailer	114
Power parker	123
Small car still king on European highways	130
Lift tilts car to any angle (Bleiber Iron Works, 411 Page Mill Rd., Palo Alto, Calif.)	157
Guide points on automobile headlights make alignment easy job	173

AVIATION

Autopilot for helicopters (Sperry Gyroscope Co., Great Neck, N. Y.)	113
British plane has inflated wing	114
Navy jet seaplane's speed equal to land-based bomber	115
Sailplane in kit for glider fans (Schweitzer Aircraft Corp., Country Airport, Elmira, N. Y.)	150
French "drive aboard" airliner	176
Whirlybirds are getting bigger	178

BOATS AND BOATING

Roll-on, roll-off ship speeds cargo handling (Sun Shipbuilding & Dry Dock Co., Chester, Pa.)	115
Swiveling deck on Scottish ferry ends need for gangplank	150
Iron bulb smooths flow of water from ship's propeller (W. K. Maier, 15 Whitehall St., New York City 4)	151
Side-mounted motor gives canoe speed of 10 miles per hour	167
Plastic float for boat (Kay-Sea-Kraft Boat Co., 1706 Euclid Ave., Cleveland, Ohio)	258

MISCELLANEOUS

Paint sample in plastic bag lets you try before you buy	105
Toll calculator on turnpike weighs vehicles (International Business Machines Corp., 590 Madison Ave., New York City 22)	105
Water sports take to the air (Bensen Aircraft Corp., Raleigh, N. C.)	108
Apron for filling-station hose prevents untidy gasoline drips (Kerr's Gas Apron, 117 S. Main St., Muncie, Ind.)	113
Hand-cranked wheel chair (John A. Padjen, Evanston, Wyo.)	139
German monorail transports concrete in cars at 100 yards per minute	145
Tiny record player in toys makes them talk back	145
Car Bingo keeps travelers entertained (A. Trader Publishing Co., 815 Arthington St., Chicago)	146
Robot drives toy tractor away from obstructions (Saunders-Swadar Toy Co., Aurora Ill.)	146
Midget autos check freight cars	147
Lawn rake with rubber teeth won't spear leaves or toes (Kay Products Ind., 1389 Sloane Ave., Lakewood 7, Ohio)	147
Giant push-button press straightens 20-inch slab (Clearing Machine Corp., 6499 W. 65th St., Chicago 38)	151
Speedy coal digger	151
Plant fish in Salton Sea	157
Lychee—fruit with a future	166
"Stone" facing on wall fastened with nails (Enco Cement Prod., Inc., Shamokin Sudbury Highway, Paxinos, Pa.)	167
Stop light for blind	167
New home movie equipment (Eastman Kodak Co., Rochester 4, N. Y.)	172
Anchoring compound (New England Carbide Tool Co., Inc., 60 Brookline St., Cambridge 39, Mass.)	173
Portable box seat for football coaches (Bil-Jax Inc., Archbold, Ohio)	173
Musician's practice cabinet (Acousti-Practice Co., Box 2248, Cleveland 9, Ohio)	175
Dial on adding machine speeds multiplication (Alma Office Machine Corp., New York City 16)	272

SCIENCE

Flame burns without air	113
Dried pond weed beats alfalfa meal in fattening swine	123
Instruments on mountaintop catch cosmic dust and static	139

(Continued to page 94)

DIESEL - AUTO MECHANICS DESPERATELY NEEDED

Big Pay... Good Future

NEVER IN HISTORY has there been such a tremendous demand for Diesel and Gasoline Mechanics. Authorities report a shortage of 150,000 auto mechanics. Virtually all heavy power equipment such as stationary power plants, farm tractors, boats, trucks, buses, earth moving and construction equipment is rapidly converting to Diesel Power, creating the greatest demand in history for Diesel Mechanics.

YOUR SUCCESS IN THIS FIELD depends upon the reputation of the school you attend and the quality of training you receive. It is only natural you will want and should have the very best in training. We urge you to send for our big free booklet, which is almost like visiting with us.

THIS BOOKLET clearly emphasizes the advantages of THE WORLD FAMOUS BAILEY METHOD of "LEARN-BY-DOING" on the most modern equipment...

TAKES YOU ON A STEP BY

STEP CAMERA TOUR through our spacious modern shops, where you see BAILEY students in action.

IT EXPLAINS WHY IT IS NECESSARY TO KNOW BOTH DIESEL AND GASOLINE MECHANICS, in order to get the **BIG PAY JOBS** and advance rapidly in these fields!

IT POINTS OUT HOW OUR BAILEY METHOD permits you to learn both Diesel and Gasoline Mechanics for the price of one... in the amount of time ordinarily required to learn just one of these subjects... and finally it explains completely how you are provided with part time employment and housing during your training period and the success we are having in the placement of Bailey Graduates with America's leading companies.

WE ARE CONFIDENT after reading the material we send you... you will agree we offer the finest training in the country.



Students learning trouble shooting on Motor Analyzer.

Students learning Diesel operation.

MAIL TODAY!

Please mail immediately this free booklet without obligation.

FREE BOOKLET



Name _____

Address _____

City _____ State _____

Approved for Veteran and Non-Veteran

BAILEY TECHNICAL SCHOOLS

1634 S. Grand St. Louis 4, Mo.

RUPTURE



RELIEF...OR YOUR MONEY BACK
Write now for free booklet and pictures of rupture care. You can be helped...work steady, with low cost, easy to wear Web Truss, thousands satisfied.

WEB TRUSS CO. Dept. M-1, Hagerstown, Maryland



GIANT FREE CATALOG of OPTICAL BARGAINS

ASTRONOMICAL TELESCOPE HEADQUARTERS

Complete Line of Astronomical Telescope Parts and Assembled Telescopes. Also huge selection of lenses, prisms, war surplus optical instruments, parts and accessories. Telescopes, microscopes, binoculars, etc. America's No. 1 source of supply for Telescope Makers. **SEND ONLY \$1.00** for beginner's 10-lens kit and big instruction booklet Stock 2-H. Ask for FREE catalog H.

EDMUND SCIENTIFIC CORP., Barrington, N.J., U.S.A.

LEARN MEAT CUTTING AT NATIONAL

Pay After Graduation



The steady dependable trade of Meat Cutting taught easily in 8 short weeks. **YOU LEARN BY DOING** under actual meat market conditions in big modern school at Toledo.

For beginners or men with experience. Get a profitable store of your own. Remember. **PEOPLE MUST EAT!** Big pay jobs. Free employment help. Thousands of successful graduates.

Buying, cutting, percentage, pricing, advertising, selling, etc. A complete retail meat education. National School established 33 years. Get National training NOW. Pay your tuition in easy weekly payments

after you graduate. Send coupon for FREE 52 page school catalog — TODAY, G.I. approved.

National School of Meat Cutting, Inc., Dept. 50-Z, Toledo 4, Ohio

Send me your FREE school catalog on National Training at Toledo in Meat Cutting, Meat Merchandising and Self Service Meats. No obligation. No salesman will call.

Name _____ Age _____

Address _____

City _____ State _____

Approved for training Korean Veterans

I'll Set You Up In a
**MONEY-MAKING
 BUSINESS** You Can
 Run From Home!

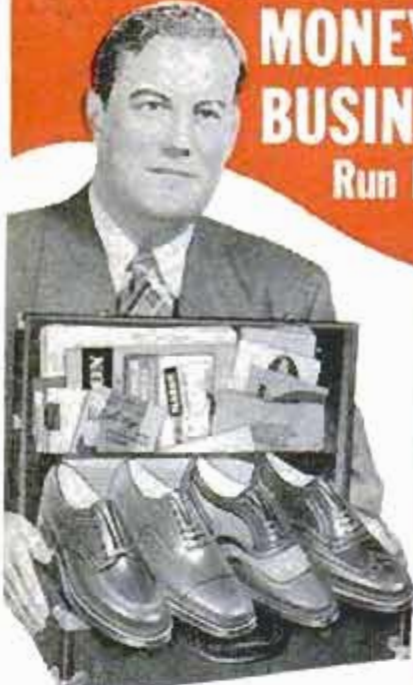

**EVERYTHING
 FURNISHED
 FREE!**

• • •
**TOP MEN MAKE
 \$5 - \$10
 AN HOUR!**

• • •
**YOU NEVER
 INVEST
 ONE CENT!**

**I'll Show You How to Make
 BIG MONEY The First Hour!**

Get into a high-paying business without spending a cent! I'll rush you, absolutely FREE, a powerful Starting Business Outfit. It contains EVERYTHING you need to make exciting cash profits from the first hour!

As the Mason Shoe Counselor in your town, you can start taking easy orders the minute your Outfit arrives. You need no experience. I'll show you how to add as much as **\$217 EXTRA Income a month for just 2 orders a day...** how to take orders from friends, relatives, neighbors, folks where you work.

EVERYONE wants comfortable shoes. Mason Air-Cushion shoes are backed by Good Housekeeping Seal, have been accepted for advertising by the American Medical Association. Some topnotch men have taken up to 20 orders their first day, earning up to \$10 an hour!

MASON SHOES ARE NOT SOLD IN STORES! Folks **must** buy from you and **keep** buying from you! You feature 160 dress, sport, work shoe styles for men, women . . . with such EXTRA features as Air Cushion Innersoles, Steel Shanks, work soles of Neoprene, Cork, Cushion Neoprene Crepe, Safety Shoes.

You'll run the best "shoe store" business in town, because you actually "carry" a greater selection than a store. You draw on our stock of over 200,000 pairs in sizes 2½ to 15, widths AAAA to EEEE. No need to substitute . . . folks get the style, size, width they order. No wonder you can expect fast profits!

Rush Coupon for Your FREE Outfit!

Start now! We will rush absolutely **FREE EVERYTHING** you need to start making Big Money from the very first hour! Send your coupon TODAY!

**MASON SHOE MFG. CO., Dept. MA954
 CHIPPEWA FALLS, WISCONSIN**

Send for FREE Outfit!

Mr. Ned Mason, Dept. MA954
 Mason Shoe Mfg. Co., Chippewa Falls, Wis.
 Please set me up in a MONEY-MAKING BUSINESS I can run from home. Rush FREE and postpaid my Starting Business Outfit with EVERYTHING I need to start making extra cash from the first hour!

Name.....
 Address.....
 Town..... State.....

(Continued from page 92)

Moving sidewalks carry pedestrians around turns, up hills (Hewitt-Robins, Inc., Stamford, Conn.; Otis Elevator Co., Harrison, N. J.).....146
 Radio towers crank up to the sky (Alpar Mfg. Corp., 2910 Spring St., Redwood City, Calif.).....149
 Long-range loudspeaker works like human speech system....163
 2000 m.p.h. rocket.....163
 Radiation may save ancient buildings from further beetle damage172
 Tooth freezing264

WHAT'S NEW FOR YOUR HOME

Lift-up electric range.....164
 Clothes rod has built-in rollers.....164
 Rolling vacuum cleaner.....164
 Music box attached to door greets guests.....164
 Adjustable door bumper fits hinge pin.....165
 Arc-shaped dial on new top-loading washing machine.....165
 Ironing board folds for compact storage.....165
 Extra hand in the laundry provided by metal fingers.....165

Radio-Television, Electronics

Tattle tapes179
 Wire your home for sound.....180

Craftsman and Shop Notes Index

FARM AND FARMING

Angle iron set in concrete guides farm-building doors.....186
 Horseshoe serves as latch for trap door in barn loft.....191
 Mousetraps in coffee cans no hazard to poultry.....204
 Wire guard on feed grinder removes foreign objects.....210
 Offset drawbar for combine reduces towing width.....227
 Car-axle housing forms prop to support combine tongue.....228
 Watering trough for cattle.....233

HOUSE AND HOME

Magnet holds papers to door of metal kitchen cabinet.....185
 Bolted or welded assemblies used for window-well gratings...190
 Small window greenhouse utilizes storm sash.....191
 Solving Home Problems—
 Corrugated cardboard an ideal "jig" for restringing beads...196
 Small knitting needle through cork provides an adjustable gauge196
 Egg slicer used for slicing beets.....196
 Installing door locks.....196
 Supply of tacks handy when working on stepladder.....197
 Cuffs made from paper cups protect long-sleeved garment...197
 Earrings clipped to bobby pin easily found in jewelry box...197
 Drawer stops197
 Crushing medicinal tablets by using two spoons.....197
 Installing recessed fixtures in bathroom wall.....198
 Wooden-utensil holder199
 Kitchen cabinet redesigned for living-room use.....204
 Old-time pull-cord arrangement actuates doorbell push button.211
 Now on the Market—
 New bonding agent permanently bonds concrete.....238
 "Bubble off" action of paint remover.....238
 Shelf support made of Homeboard Hooks.....238
 Easy-to-use pipe hanger.....238
 Flex-O-Fix squeezed from a tube dries into tough, elastic rubber238

HOUSEHOLD HINTS

Broom clip is handy holder for garden-hose nozzle.....198
 Baby oil removes paint from tender skin without irritating...204
 "Snow" shellacked to evergreens.....204
 Spring-type clothespin provides quick-acting towel rack.....204
 Sleeve on lamp-cord covering prevents it from unravelling...209

MISCELLANEOUS

Broken lines penciled quickly with modified straightedge....184
 Rubber band around toy auto protects furniture.....184
 Dark newspaper picture used for emergency tracing paper....195

(Continued to page 96)

Free! 105 UNITED NATIONS plus 87 FOREIGN FLAG STAMPS



Get this spectacular collection of 105 genuine, all-different stamps from far-away U.N. countries in Africa, the exotic Orient, South Seas, etc. **PLUS** gorgeous flag stamps of 87 foreign countries! Other exciting offers, free booklet "How to Recognize Rare Stamps." Enclose 10c for mailing expenses...**SEND TODAY!**

KENMORE STAMPS, MILFORD N-649, N.H.



TRAIN Your VOICE!

RESULTS GUARANTEED

STRENGTHEN your voice this tested, scientific way. Yes—you may now be able to develop the **POWER** of your speaking and singing voice in the privacy of your own room. Self-training lessons, mostly silent; no music required. Write **TODAY** for Eugene Feuchtinger's great booklet "How to Strengthen Your Voice." It's absolutely **FREE!** You must state your age. Booklet mailed in plain wrapper. No salesman will call. Send your name and age **RIGHT NOW!**

Perfect Voice Institute, 210 S. Clinton St., Studio AU-2, Chicago 6, Ill.

REAL ESTATE A BROKER

PAYS BIG! SEND FOR FREE, BIG, ILLUSTRATED CATALOG NOW! Graduates report making substantial incomes. Start and run your own business quickly. Men, women of all ages, learn easily. Course covers Sales, Property Management, Appraising, Loans, Mortgages, and related subjects. **STUDY AT HOME** or in classrooms in leading cities. Diploma awarded. Write **TODAY** for free book! No obligation. Approved for World War II and Korean Veterans.

WEAVER SCHOOL OF REAL ESTATE (Est. 1936)
2022B GRAND AVENUE KANSAS CITY, MO.



SAY YOU SAW IT IN POPULAR MECHANICS

PREPARE FOR THE BEST JOBS

IN INDUSTRY

**TRAIN
at HOME**
IN YOUR SPARE TIME
or at
ALLIED INSTITUTE
in Chicago

- MECH. ENGINEER
- DRAFTSMAN
- TOOL DESIGNER
- TOOL ENGINEER
- TOOL & DIE MAKER
- MASTER MACHINIST

NO RECESSION FOR ALLIED TRAINED MEN

MORE JOBS THAN GRADUATES Shortages of Draftsmen, Designers, Tool Engineers, Machinists, Tool & Die Makers are so widespread that you can pick a highly paid key job and look forward to Achievement and Security.

You can begin your training in Short Courses and continue progressively to a Bachelor Degree in 26 months.

Allied is approved by Industry, Dept. of Education, Office of Public Instruction, State of Illinois, U.S. Veterans Admin., U.S. Dept. of Justice. Accredited: C.S.A.

SEND FOR
FREE
BOOKS

ALLIED SCHOOL of MECHANICAL TRADES
1338-42 South Michigan Ave. Dept. PM-1 Chicago 5, Illinois

SEND ME WITHOUT OBLIGATION INFO. ON YOUR COURSES:

HOME STUDY RESIDENT VETERAN NON VETERAN

NAME _____

ADDRESS _____ AGE _____

CITY _____ STATE _____

Before Starting Any Business...

learn these revealing profitable secrets!

If you know a trade or occupation — why not go into business for yourself? Why not make the profits others are now making? Let National Business Consultants show you how.

IT'S EASY TO START A NEW BUSINESS

It's easier than you think—once you learn the simple ABC's of building a new business of your own. National Business Consultants has shown over 5000 others how to be successful—let us show **YOU** too. We guide you every step of the way with sound, proved, simple business practices. Send for our free book today.



FREE BOOKLET!

Proves it's easier than you think to build a business for yourself. Send for it.

EXPAND YOUR OWN BUSINESS

Learn our tested, profit-making methods for business success. If you already own a business, let N. B. C. guide you too. You'll be amazed.

SEND FOR FREE BOOKLET TODAY!

"How to Start a Business" is jam-packed with revealing information. In easy-to-understand language it explains how to start and make any kind of business profitable. Free for the asking! Sent to you in confidential plain envelope. Just write:

© 1956

National Business Consultants
Office P-1, Los Angeles 61, Calif.
Gentlemen:
Rush me Free Booklet without obligation. No salesman will call.

Name _____
Address _____
City _____ Zone _____ State _____

OFFICE P-1, LOS ANGELES 61, CALIFORNIA

I'll Send You This Handsome SAMPLE CASE—FREE!



**Make up to
\$30.00 in a Day!**

**Your Own
Tailored Suits
Without 1¢ Cost**

If you want to make more money, spare time or full time, rush the coupon below today for this big, valuable tailoring Sample Case packed with 150 beautiful, big-value suit and overcoat samples. Just show the samples and last-minute styles to friends, fellow-workers, others. Take their orders for fine made-to-measure clothes—and pocket **BIG CASH PROFITS** in advance. No experience, no tailoring knowledge needed—and no money needed, ever. **WE SUPPLY EVERYTHING FREE**... sample case, sample suitings, equipment, complete instructions. Start making money first day!

Use Spare Evenings... Weekends... Make Money... Get Suits!

It's easy to make money taking orders in just spare time—lunch-time, evenings, weekends. When men see the fine fit, quality and value of our suits—**THEY ORDER!** So we make it easy for you to get your own personal suits and overcoats without paying even one penny. Don't wait! Rush coupon with your name, address, and age for **FREE** Sample Case.

PIONEER TAILORING COMPANY
Dept. L-1116, Congress & Throop Sts., Chicago 7, Ill.

PIONEER TAILORING CO., Dept. L-1116
Congress & Throop Sts., Chicago 7, Ill.
Please rush **ABSOLUTELY FREE** the valuable Sample Case with suit fabrics and style display. Include instructions, money-making plans and details for getting my own suits without paying one cent.

Name _____ Age _____
Address _____
City _____ State _____

BE RUGGED!

COMMAND RESPECT

You can pack crashing power in your fists and build a body that men respect and women admire. You can win new popularity when Champions help you...and never be lonely or "second best"!



JOE LOUIS

YOUR PLANNED CONDITIONING PROGRAM

ONLY \$1.00

FAMOUS EXPERTS LEAD WAY



VOGI BERRA

10 Champions have combined to give you a "sure fire" method to build a better body. They promise you action FAST! In just 10 days, you'll see new muscles... feel better... be more aggressive. In just 10 days, your mirror will show new positive proof. That's the promise of 10 World Champions.



PAUL GIEL

JUST 15 MINUTES A DAY

Secrets of sport conditioning revealed by Joe Louis, Whitey Lockman, Kid Gavilan and Ezzard Charles. Easy instructions that are fun to follow. You need no gym, no equipment... just 15 minutes a day makes you a new man.



WILLIE PEP

TAKE ON THE CHAMPS

These famous athletes offer you their medically approved Conditioning Course. They guarantee that with their special Exercises you'll measure new muscle and gain new confidence - for only \$1 - or your money back. Take on the Champs and see for yourself.



Extra! You'll also receive exciting material from the Champions' Manly Art of Self Defense—an amazing Home Course.

FREE—Joe Louis' 24 page "Fight Secrets," free, if you act at once.

The National Sports Council, Dept. P-16
33 West 46th St., New York 36, N. Y.

Enclosed \$1 for the Planned Conditioning Course of the Champions. I must see results in 10 days or my money is refunded immediately. Fight Secrets is free.

NAME _____
ADDRESS _____
CITY _____ STATE _____

MAIL COUPON TODAY

(Continued from page 94)

Folding chairs stacked upright kept from sliding with hose.....	198
"Chain reaction" torch lights fire on windy day.....	202
Nontipping dog feeder made from coffee can.....	202
Wastebasket with slot in side hooks on screw in wall.....	202
Hands "washed" without water by using shaving cream.....	205
Magnifying-lens holder clamps to temple of eyeglasses.....	205
Oil can fitted with bobby pin made "clogproof".....	210
Pencil sharpener points crayons.....	210
Handy pocket for eraser taped to side of typewriter.....	211
Areas in water color painting washed out with foam rubber.....	214
Toothbrush container utilized as miniature pencil box.....	214
Bird-feeding station has roof of corrugated glass fiber.....	215
Turkish towel speeds processing of matte prints in drier.....	219
Detecting "thumping" car wheel.....	234

PHOTOGRAPHY

Cellophane diffuses scratches on negatives when enlarging.....	219
Masking easel for small prints.....	219
Photoflash extension cord converted by 3-way cube tap.....	219
Plastic-embedded labels identify photo chemicals.....	219
Camera tripod accessory tray made from can lid.....	220
Darkroom thermometer holders.....	220
Dial thermometer in tank drain checks print-washing water.....	220
Mirror is retouching stand.....	220

TOOLS

Quick-acting wrench made by grinding flat on screw.....	186
C-clamp helps align butt joint.....	191
Screwdriver fitted with adapter for installing screw eyes.....	215
This accurate angle plate is shop-made from flat-steel stock.....	227
Drill-press vise modified to hold cylindrical pieces of work.....	235
Shopping for Tools—	
Air-operated nail-pulling device.....	236
Curved-line stamp holder.....	236
Nail-puller attachment for claw hammer.....	236
Jointer safety hold-down.....	236
Jigsaw attachment for 1/4-in. drill.....	237
Open-end roller ratchet wrench.....	237
Quick-acting clamp for sawhorse.....	237
Inexpensive new drill chuck.....	237
Self-attaching wooden pads for clamp jaws.....	237

WORKSHOP HINTS

Ladder rails "skidproofed".....	185
Whatnot cabinet made from window shutters.....	185
Disassembly of wood forms is easy with lath strips under nails.....	186
One-piece metal chimney hood requires no fastening bolts.....	186
Outlining designs on wood with shellac and stain.....	191
Accurate helices on cylinders marked with masking tape.....	195
Tools held at convenient level when working from stepladder.....	195
Blotter predetermines paint color.....	198
Horseshoes serve as handles to carry cement blocks.....	198
Length of metal tubing fills holes with putty.....	205
Small-parts boxes kept in order when tagged by numbered nails.....	210
Vinegar used to prime galvanized-metal surfaces for painting.....	210
Cigar-box jig simplifies job of soldering small grilles.....	214
Dowel secures roofing-paper roll safely on hoist rope.....	214
Leakproof lighter-fluid can used as small-size oiler.....	220
Hose centers tap-wrench handle.....	227
V-block for drilling round stock assembled from tubing.....	228
Screw holds firmly in end grain when flat is filed on threads.....	228
Quick alignment of lathe centers.....	228
Blowtorch efficiency increased by adding bulb pump.....	228
Prevent loss of marking pencil by taping magnet to end.....	233
Removable bench-top turntable aids in model and radio work.....	233
Welded drawbar hitchpins made in farm workshop.....	233
Collet stop positions lathe work for facing cut.....	234
Carton corner guides drill for hand-held brace and bit.....	234
Wire solder easy to handle in coil-spring shape.....	235
Die started squarely on rod by using lathe tailstock.....	235

IMPORTANT NOTICE—It is the intention of this magazine to provide its readers with information regarding the latest developments in the mechanical arts. We take no responsibility as to whether the disclosures contained in our articles are covered by patents and advise readers to investigate this subject before making, using, or selling any of the products, machines, or processes described in order to avoid possible liability for patent infringements.

Learn All About Cars!

Auto Mechanics — Automatic Transmissions
Acetylene and Arc Welding
Body and Fender Repair

Day-Night School 30 Years in the Same Location

WOLVERINE SCHOOL OF TRADES

Approved Under the G.I. Bill of Rights by the State Board of Education

WOLVERINE SCHOOL OF TRADES, Dept. PM
1400 West Fort St., Detroit 16, Mich.

Name _____
Address _____
City _____ State _____

**ENGINEERING
DEGREE IN
27 MONTHS**

INDIANA TECHNICAL COLLEGE

B. S. DEGREE. Aeronautical, Chemical, Civil, Electrical, Mechanical and Electronic Engineering (inc. Radio and TV), Drafting. One-year, G.I. Government approved. Low rate. Earn board. Large industrial center. Students from 48 states, 21 countries. Demand for graduates. Enter March, June, September, December. Write today for catalog. 1616 E. Washington Boulevard, Fort Wayne 2, Indiana.



LEARN MODERN WATCH AND CLOCK REPAIRING Complete Course—Only \$5.95

At home, spare time. Good field now security and contentment in future. Start part-time business and **EARN** while you learn. Horology is precision instrument work... a great and growing field, sensational opportunities. Easy self-instruction course. Full price, only \$5.95. **SEND NO MONEY.** Just pay postman, plus C.O.D. postage. Or send \$5.95 with order, we'll ship postpaid. Satisfaction guaranteed or refund. **NELSON-HALL CO., 210 S. Clinton St., Dept. 3AU-2, Chicago 6, Ill.**

Free! AIRMAIL COLLECTION



Get this spectacular collection of all-different, genuine Airmails from strange, far-away countries in Asia, Africa, Europe, the exotic Orient! World's largest airmail, scarce \$27 stamp, old Zeppelin, many many others. A truly remarkable collection containing stamps worth up to 40c each at catalog prices! **EXTRA:** new illustrated booklet "Men Against the Sky." **PLUS** Bargain Catalog and other unusual offers. Send 10c for mailing costs. Supplies limited — mail coupon today!

JAMESTOWN STAMP CO. Dept. F1PM JAMESTOWN, N. Y.



RUSH my Free Airmail Collection and other offers. I enclose 10c for mailing costs.

Name _____
Street _____
City _____ State _____

"We're looking for people who like to draw"

by **Albert Dorne**

Famous Illustrator



If you like to draw — America's 12 Most Famous Artists are looking for you. We want to test your art talent!

Too many people miss a wonderful career in art — simply because they don't think they have talent. But my colleagues and I have helped thousands of people get started. Like these —

Three years ago Don Smith knew nothing about art — even doubted he had talent. Today he is an illustrator with a big New Orleans advertising agency — and has a future as big as he wants to make it.

Don Golemba of Detroit stepped up from railroad worker to the styling department of a major automobile company. Now he helps design new car models.

Pipe-fitter to Artist

John Busketta was a pipe-fitter's helper with a gas company — until he did something about his urge to draw. Now he's an artist in the advertising department of the same company. At a big increase in pay!

A cowboy from Miles City, Mont., studied art with us. Now he paints portraits and sells them for \$250 each. And gets all the business he can handle.

Free Art Talent Test

How about you? Wouldn't you like to find out if you have the talent for a fascinating money-making art career (part time or full time)? We'll be glad to send you our remarkably revealing 8-page talent test. Thousands of people formerly paid \$1 for this test. But we'll send it to you *free* — if you sincerely like to draw. No obligation. Mail coupon below.

America's 12 Most Famous Artists

Norman Rockwell
Jon Whitcomb
Al Parker
Steven Dohanos
Harold Von Schmidt
Peter Helck
Fred Ludwicks
Ben Stahl
Robert Fawcett
Austin Briggs
Doug Kingman
Albert Dorne

FAMOUS ARTISTS SCHOOLS

Studio 6-A, Westport, Conn.

Send me, with no obligation, the Famous Artists Talent Test.

Mr. _____ Age _____
Mrs. _____
Miss _____ (please print)
Address _____
City, Zone, State _____

AC
 engineers
 developed the
SPARK PLUG
INSULATOR
 with
HI-TENSION
 insulation
 features

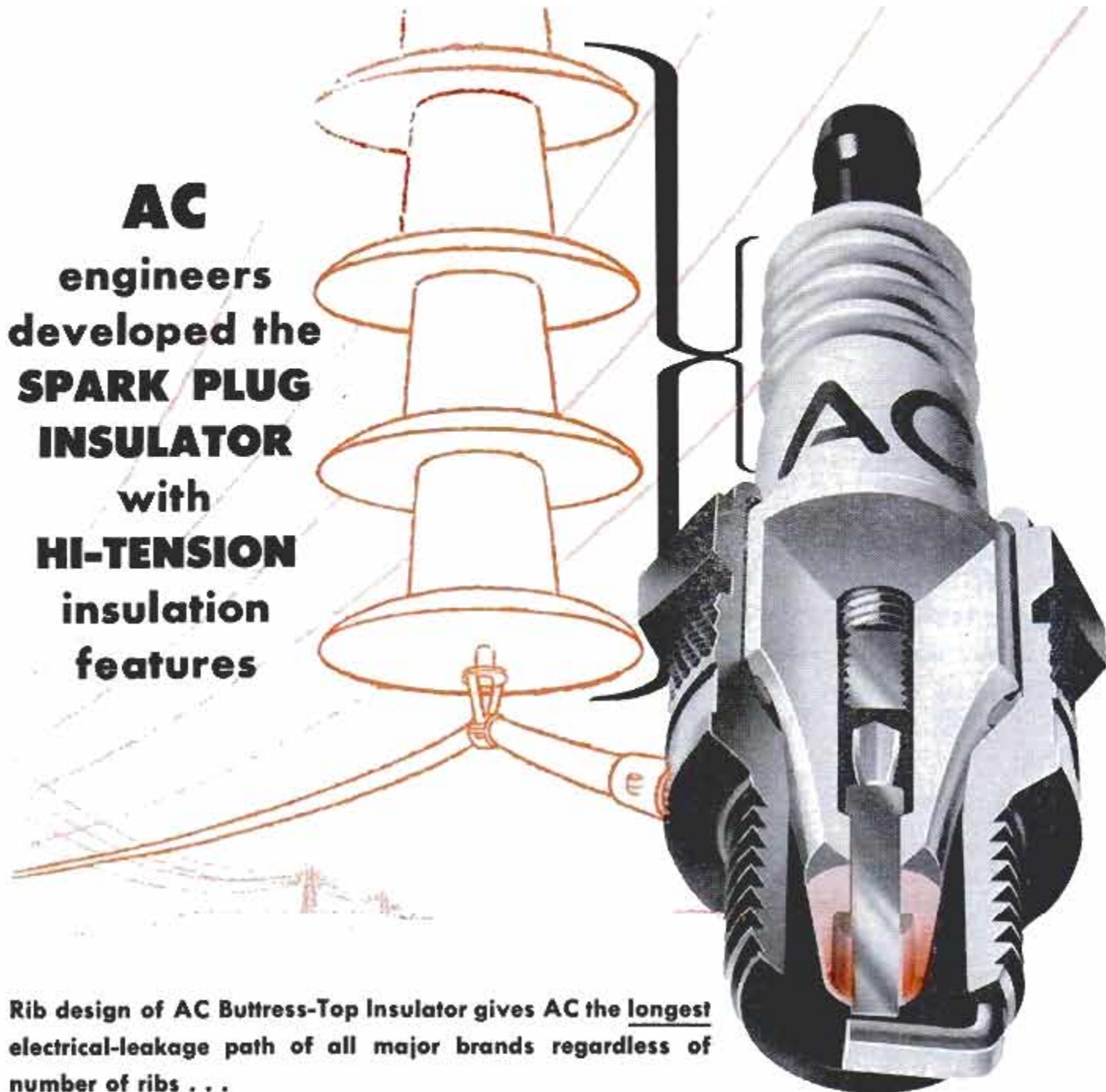

Rib design of AC Buttress-Top Insulator gives AC the longest electrical-leakage path of all major brands regardless of number of ribs . . .

THIS MEANS that you are more completely protected from "flash-over" that can cause power-wasting misfiring. "Flash-over" can occur when insulator tops get coated with dirt or moisture. The AC rib design has an umbrella effect in preventing dirt or moisture accumulation. AC's rib contour also lengthens the path the "flash-over" must take. These factors practically end "flash-over."

plus CONDUCTASEAL, an exclusive AC center-wire-to-insulator seal formed from metal and ceramic materials *fused* in the assembly process. This seal prevents power-robbing "blow-by" yet acts as a splendid conductor for top ignition performance.

plus HOT TIP, another AC exclusive feature! The AC insulator tip is long, and deeply recessed to heat fast, burn away carbon and oil residues that would soon foul ordinary plugs. Put in AC HOT TIP Spark Plugs, and enjoy the full performance that was built into your engine.



AC SPARK PLUG  THE ELECTRONICS DIVISION of GENERAL MOTORS



POPULAR JANUARY 1956
MECHANICS

WRITTEN SO YOU CAN UNDERSTAND IT
VOL. 105 NO. 1

January 17, 1956, is the 250th birthday of a great American. Here's a look across 2½ centuries at some of the curiously modern inventions of a curious and modern man,

BEN FRANKLIN— TRAIL BLAZER FOR INVENTORS

By Paul Lee

IN THE FRANKLIN INSTITUTE at Philadelphia stands a remarkably impressive statue of Benjamin Franklin.

Actor Charles Laughton recently stood before the statue to address a capacity audience in the surrounding hall. The hushed crowd was startled by his first motion, though it seemed natural and even inevitable. He turned to the statue and addressed it first, "Mr. Franklin, Sir—" as though the man were still alive.

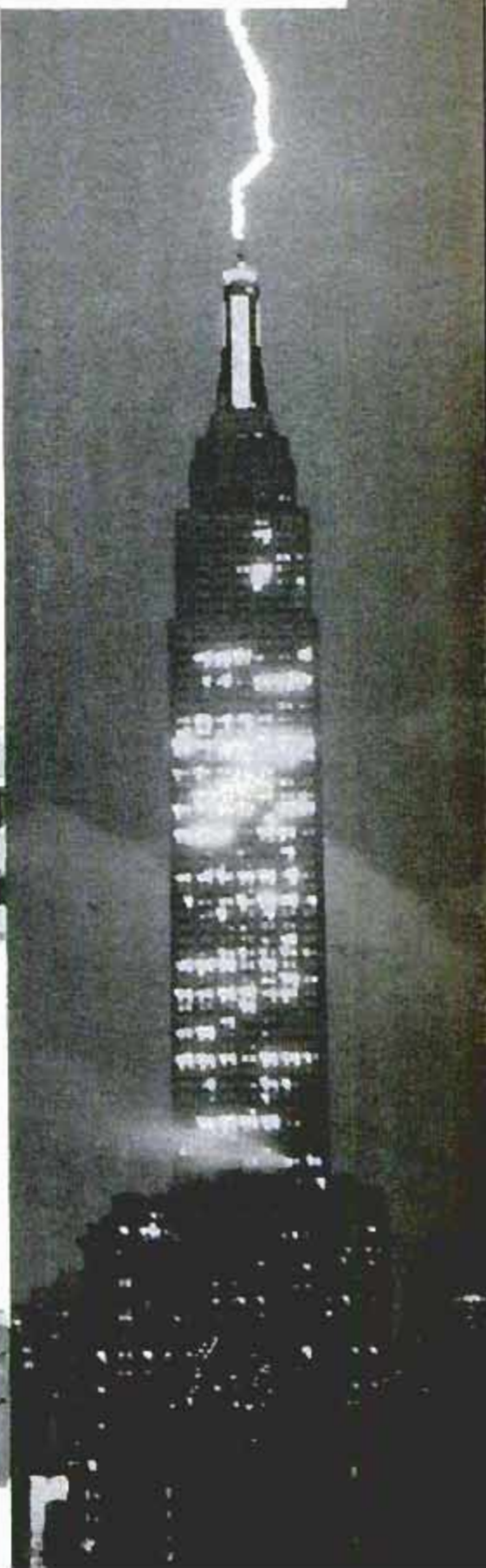

REMARKS
Upon the Navigation from
NEWFOUNDLAND to NEW-YORK,
In order to avoid the
GULPH STREAM

On one hand, and on the other the SHOALS that lie to the
Southward of Nantucket and of St George's Banks.

AFTER you have passed the Banks of Newfoundland in about the 44th degree of latitude, you will meet with nothing, till you draw near the Isle of Sables, which we commonly pass in latitude 43. Southward of this isle, the current is found to extend itself as far North as 41° 20' or 30', then it turns toward the E.S.E. or SE ¼ E.

Having passed the Isle of Sables, shape your course for the St. George's Banks, so as to pass them in about latitude 40°, because the current southward of those banks reaches as far North as 39°. The shoals of those banks lie in 41° 35'.

After having passed St. George's Banks, you must, to clear Nantucket, form your course so as to pass between the latitudes 38° 30' and 40° 45'.

The most southern part of the shoals of Nantucket lie in about 40° 45'. The northern part of the current directly to the south of Nantucket is felt in about latitude 38° 30'.

By observing these directions and keeping between the stream and the shoals, the passage from the Banks of Newfoundland to New-York, Delaware, or Virginia, may be considerably shortened; for so you will have the advantage of the eddy current, which moves contrary to the Gulph Stream. Whereas if to avoid the shoals you keep too far to the southward, and get into that stream, you will be retarded by it at the rate of 60 or 70 miles a day.

The Nantucket whale-men being extremely well acquainted with the Gulph Stream, its course, strength and extent, by their constant practice of whaling on the edges of it, from their island quite down to the Bahamas, this draft of that stream was obtained from one of them, Capt Folger, and caused to be engraved on the old chart in London, for the benefit of navigators, by

B. FRANKLIN.

Note, The Nantucket captains who are acquainted with this stream, make their voyages from England to Boston in as short a time generally as others take in going from Boston to England, viz. from 20 to 30 days.

A stranger may know when he is in the Gulph Stream, by the warmth of the water, which is much greater than that of the water on each side of it. If then he is bound to the westward, he should cross the stream to get out of it as soon as possible.

B.F.



Courtesy Bausch & Lomb

Letter from Franklin describes invention of bifocals

January 17, 1956, is Benjamin Franklin's 250th birthday. Throughout the world great societies will meet to honor the man.

Many historians have pointed out that we owe even more to Franklin, the inventor and scientist, than we do to Franklin the statesman. Just one of his inventions—bifocal glasses—has had a profound and

Franklin's research to locate Gulf Stream resulted in chart and first scientific paper on this subject

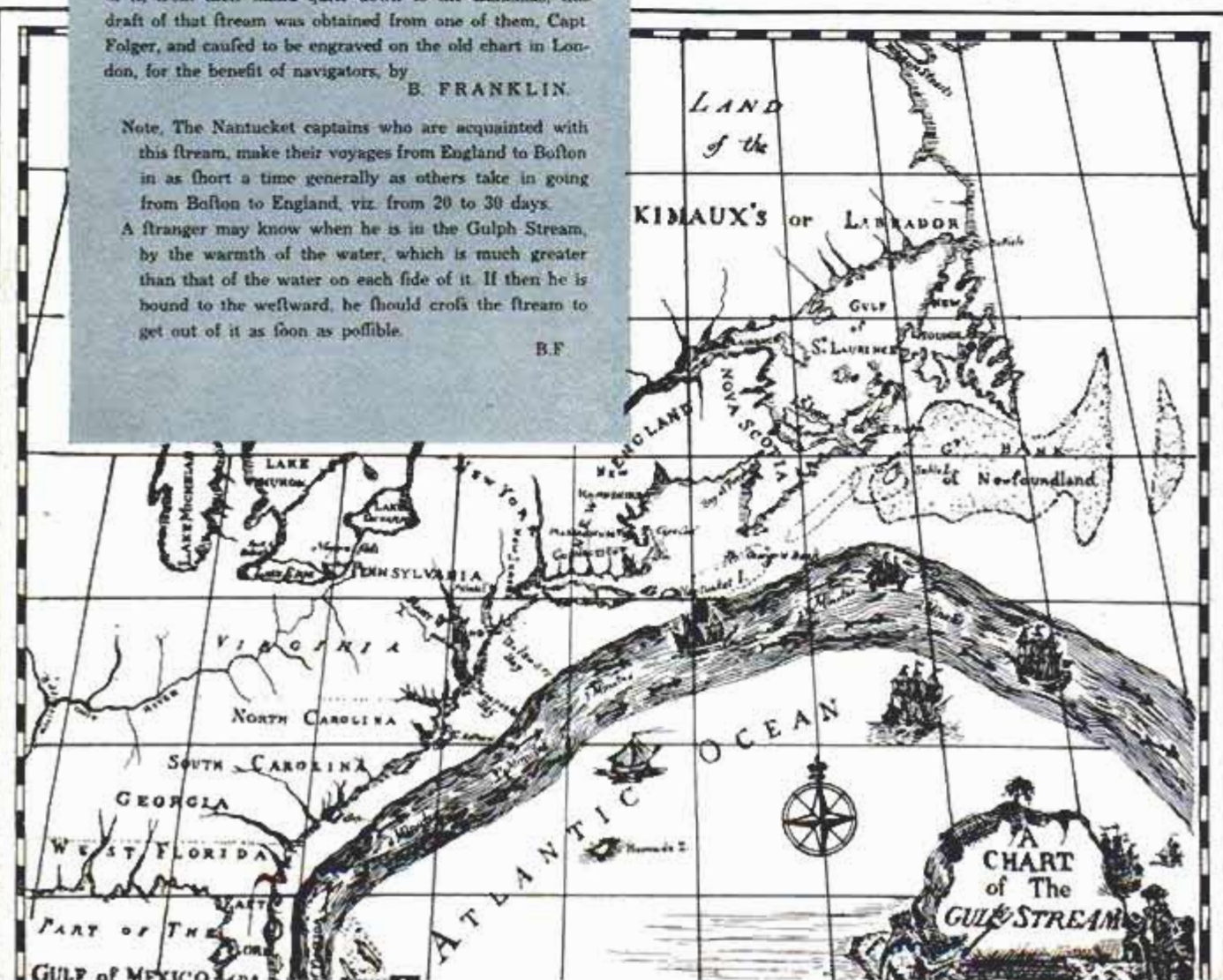

personal effect on the lives of millions.

So it is our privilege, Mr. Franklin, Sir, on this, your 250th birthday, to look back across the years to your inventions and scientific studies. Much of your work is still alive after more than two centuries. A few of your developments have become profoundly important to the modern world.

Dangerous Kite Experiment

Every schoolboy knows of Franklin's dramatic proof that electricity and lightning are identical. It was a dangerous experiment; others throughout history have been killed attempting it. Franklin himself was aware of the danger. The precautions he took are not nearly as well known as the experiment itself. Though the legend has grown up that he used wire in flying the kite, he used twine. To the twine he fastened a key, and to the key he tied a piece of silk ribbon, knowing that silk would not conduct "electrical fire." He held the kite by the ribbon and stood inside a shed to keep himself dry while flying it.

In a letter describing how to perform the

experiment he said, "As soon as any of the thunder clouds come over the kite, the pointed wire [on the kite] will draw electric fire from them, and the kite, with all the twine, will be electrified, and the loose filaments of the twine will stand out every way, and be attracted by an approaching finger. And when the rain has wet the kite and twine, so that it can conduct the electric fire freely, you will find it stream out plentifully from the key on the approach of your knuckle."

Through his lightning experiments he developed the lightning rod, an invention that, more than any of his other activities, made him famous throughout the world even while he was living. Today's big lightning arresters and insulators are direct descendants of his pointed iron rod.

Not nearly as well known are his other significant electrical experiments. He was the first to theorize that "electrical fluid" is a single form of energy existing in two states, which he called *positive* and *negative*. This theory provided one of the keys to unlock electrical research for generations. Franklin discovered electric repulsion and was the first scientist to identify the aurora as an electric phenomenon. He

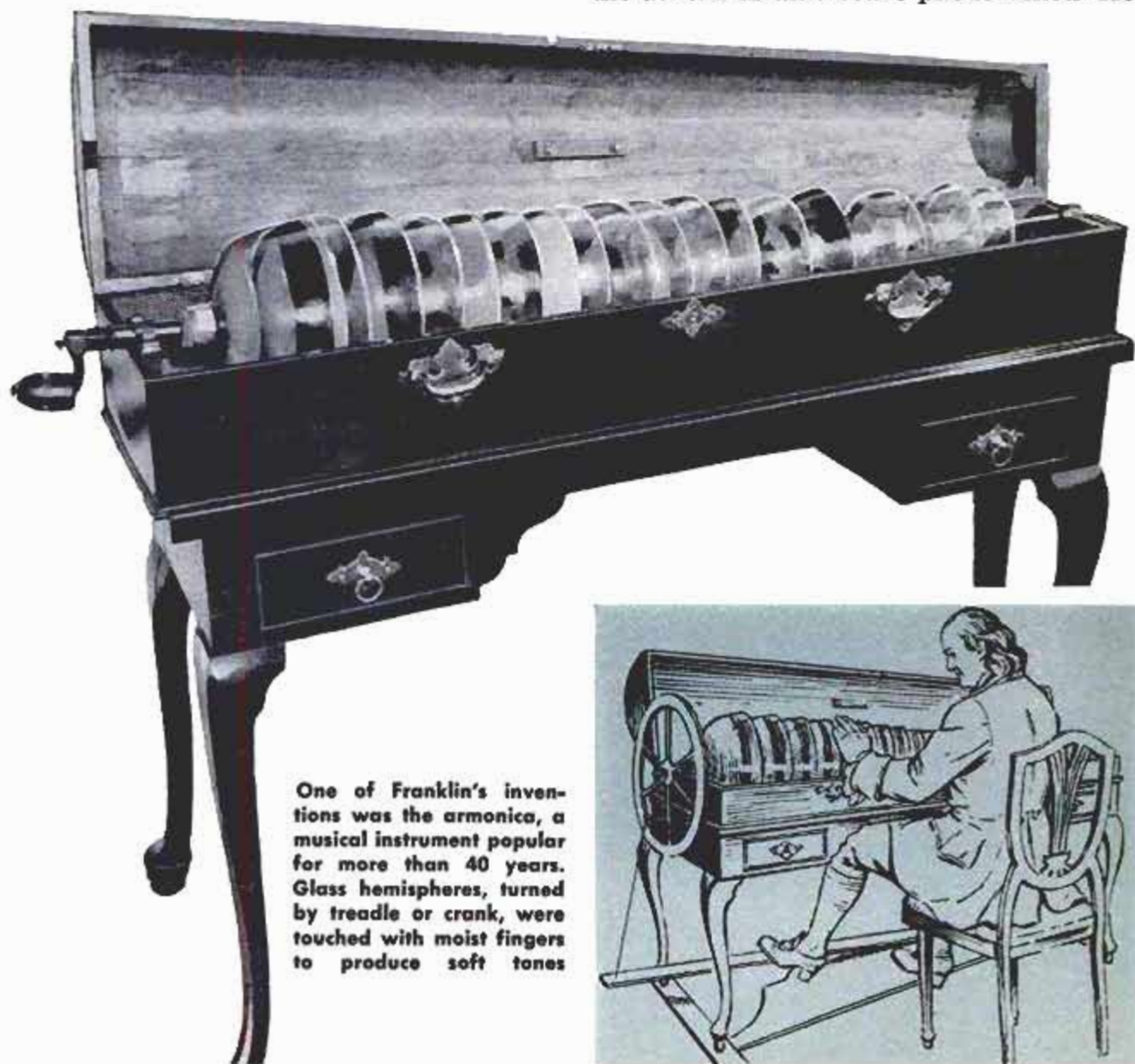

One of Franklin's inventions was the armonica, a musical instrument popular for more than 40 years. Glass hemispheres, turned by treadle or crank, were touched with moist fingers to produce soft tones

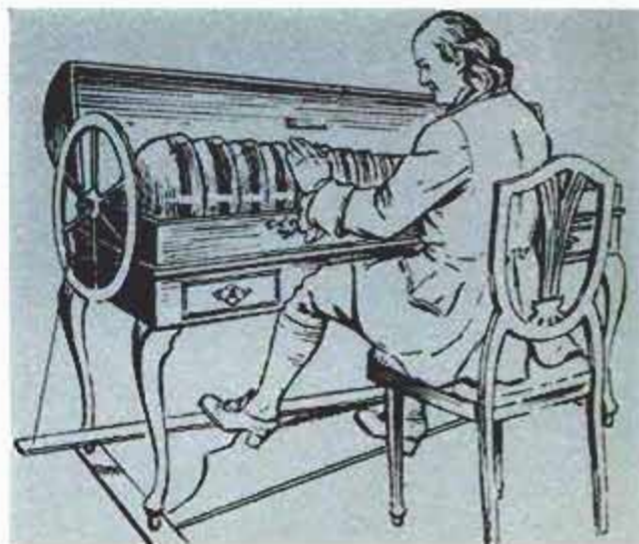

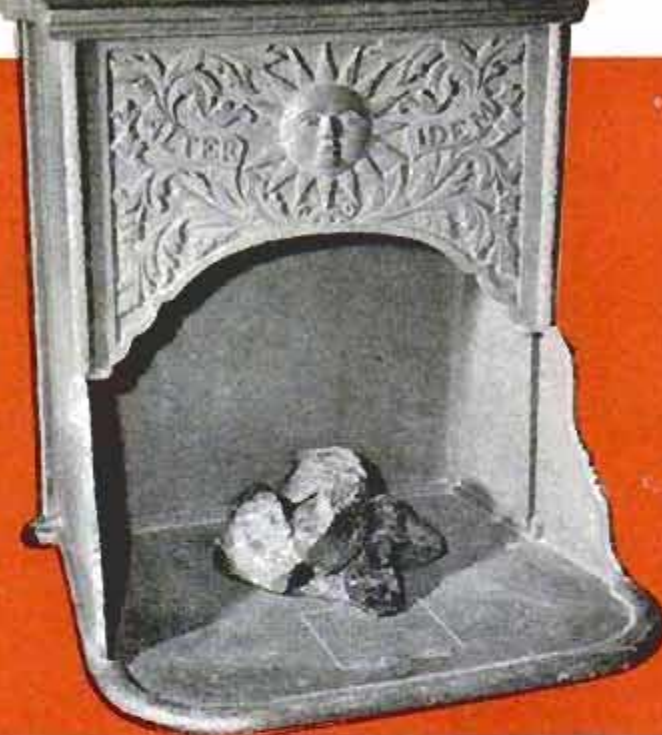

SMOKE AND HOT GASES RISE, THEN ARE FORCED DOWN BACK OF FIREPLACE BEFORE THEY RISE THROUGH CHIMNEY. MEANWHILE THEY HEAT FRESH AIR IN AIR CHAMBER.

FRESH AIR MOVES UP THROUGH AIR CHAMBER IN CENTER OF FIREPLACE, IS WARMED AND THEN VENTED OUT THROUGH SIDE PLATES INTO THE ROOM.



Franklin stove trapped gases and smoke, used them to warm fresh air. Principle is used in modern fireplaces



He developed a mechanical arm to reach books on high library shelves. Grocers use similar arm today

Best known for his kite experiment, Franklin made more significant studies in his electrical laboratory

Drawing from The Bettman Archive



was also the first man to suggest the use of electricity in the treatment of paralysis, arthritis and certain diseases. His book, *Experiments and Observations on Electricity*, became a reference book throughout the world, and he introduced many expressions that have become everyday terms in the field of electricity: *Armature, charge, condenser, conductor, discharge, electrical shock, electrician* and *nonconductor*. His work was a significant stepping stone in electrical — and subsequently electronic — research.

Study of Gulf Stream

His curiously curious mind found something to question at every turn. For years the Nantucket whaling captains had known of the existence of the moving "river" of water in the Atlantic which we call the Gulf Stream. On his trips to and from Europe Franklin spent part of each day taking the temperature of the water, until finally he pinned down the Gulf Stream with sufficient precision to present a scientific report on its existence and course. Today his research lives in such modern symbols of exact knowledge as isobars and isotherms.

One of his weather observations became the cornerstone of the modern science of meteorology. He observed and reported that northeast storms originate in the southwest, that local winds reverse directions as a storm passes over a given area, and that the course of storms can be plotted.

Franklin was never too busy to satisfy his curiosity. One day in 1755 he was out riding with friends when he noticed a small whirlwind forming in the dust of the road. The others stood by and watched, one of

(Continued to page 268)



Designer-builder Ray Maker acts as engineer in his junior-sized monorail railroad in Santa Clara, Calif.

Midget Monorail

PATTERNED after the famous "Hanging Railroad" at Wuppertal, Germany, a midget monorail races around a 240-foot track in Santa Clara, Calif., where it is used as a gate attraction for an outdoor theater. Small theatergoers love to get there early

for a ride in the train, designed and built by Ray Maker. Transportation experts, wondering if a monorail could solve their problems, have traveled to Santa Clara. Maker's railroad is the only working example of a monorail outside of Germany.

To guard against accidents, the monorail passengers are protected by heavy wire mesh during the ride

Drive wheels are hard rubber coated for traction. Power is from air-cooled engine with chain drive

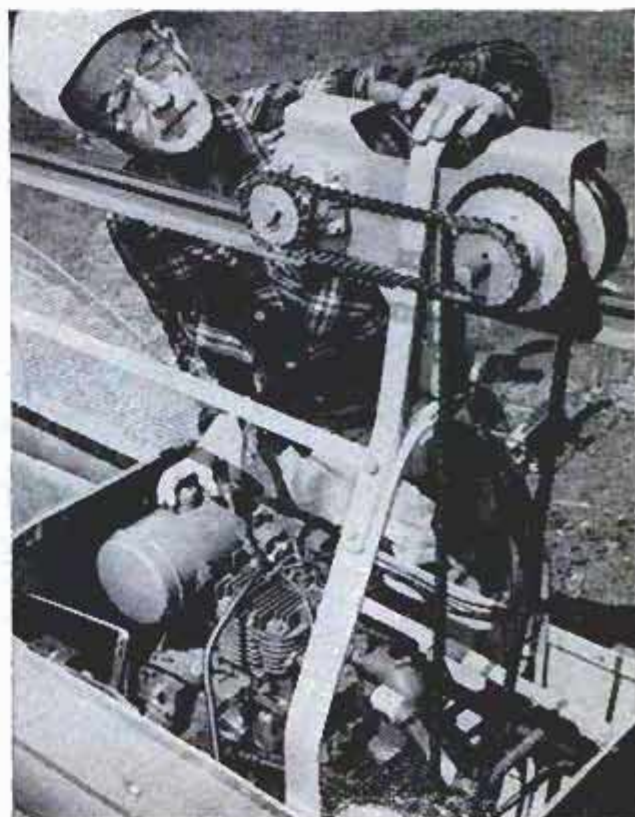

Air-Dropped Robot Broadcasts Weather

A ROBOT WEATHERMAN that drops from an airplane and then scrambles to its feet will help the Navy pitch camp at the South Pole.

Once on its pins, the robot will stand still and broadcast wind and weather conditions every six hours in slow, easy-to-copy Morse. Its signal carries 800 miles. Its batteries are good for 60 days.

It is called the "Grasshopper" from the ungainly kicking of its six legs as it scrambles from the ground. And its compressed-air mechanism gives out a loud chirping sound as the process begins.

At the South Pole, where Navy planes will put down men and tons of supplies next winter, the Grasshopper will tell waiting transport planes hundreds of miles away when the weather is right for a polar flight.

A timing mechanism as simple as an electric toaster's unleashes air at 1500 pounds' pressure to work the legs, push out a wind vane and run up a 25-foot fish-pole antenna. Power is supplied by a 12-volt nickel-cadmium battery. The electrolyte is lye sufficiently concentrated to remain liquid at 40 degrees below zero Fahrenheit.

Air-dropped, the robot, top left, lies like a little dud bomb. But timer within is ticking. With cricket-like chirp, robot kicks out in all directions. Fins fly off. Legs flailing, robot gets two feet into position. Sturdily upright, it pops out wind gauge and starts to sprout 25-foot antenna. Weight of the unit is 150 pounds. Only two of them have been made

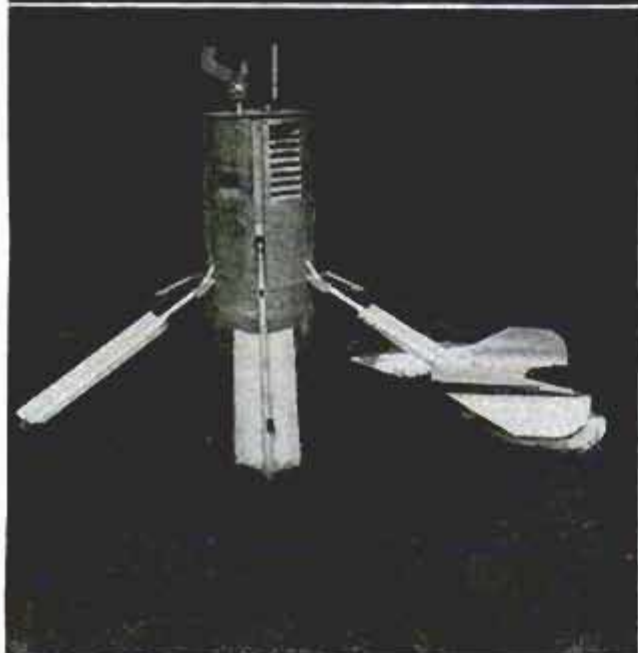
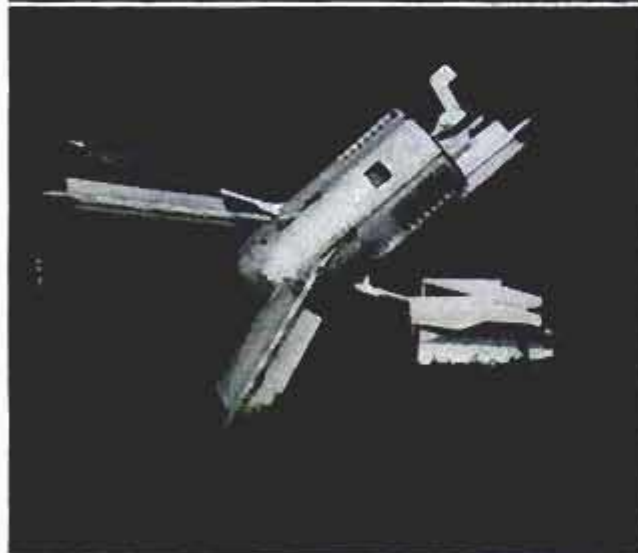
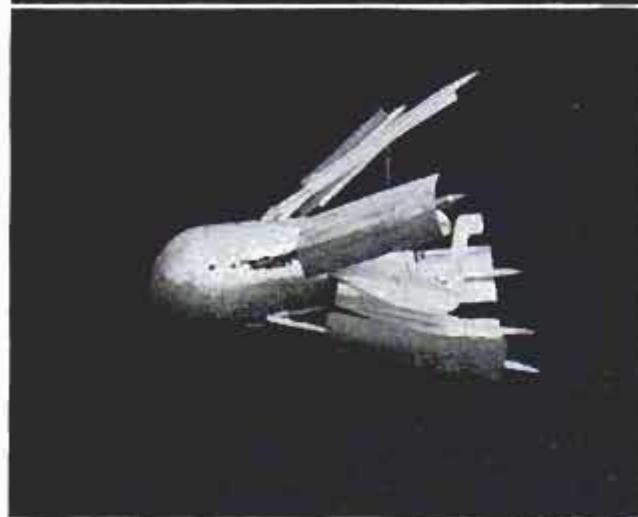

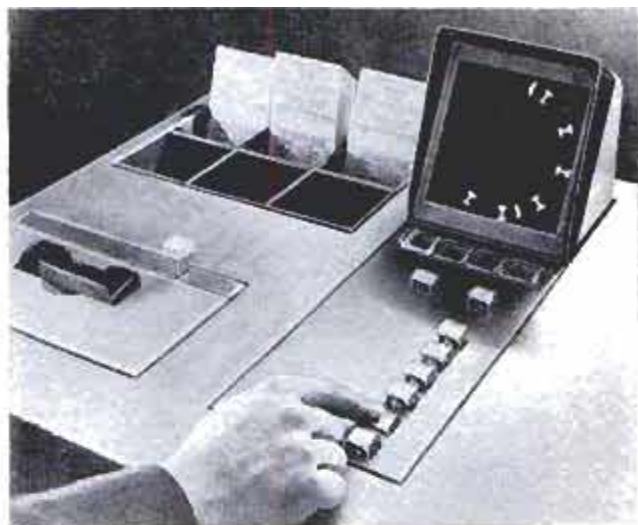

Toll Calculator on Turnpike Weighs Moving Vehicles

On the new Ohio Turnpike, toll charges are calculated automatically through a combination of photoelectric cells, built-in weighing treadles and electronic calculators. Toll rates vary according to the weight of the vehicle and the number of axles.

When a vehicle approaches the new toll booth, it crosses a weighing treadle built into the pavement, which weighs each axle separately. Meanwhile, photoelectric cells count the number of axles. The vehicle need not stop until it comes to the toll booth, where the attendant has already inserted a fare card into the recorder. He

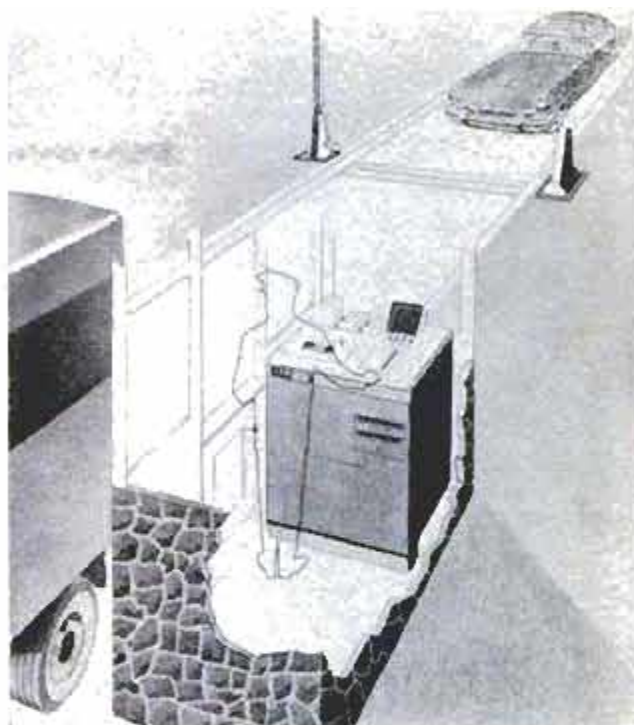

presses a button corresponding to the number of axles, and the necessary information is recorded on the fare card. This card is presented at the other end of the turnpike. The equipment permits the processing of vehicles even when they are moving bumper to bumper.

The new 241-mile expressway connects the western terminus of the Pennsylvania Turnpike with the Indiana state line. Toll for passenger cars on the route is \$3.00.

Paint Sample in Plastic Bag Lets You Try Before You Buy

Now you can take home a sample of paint, brush it on a wall and see how it looks dry—before you buy. "Wet sampling," under test by Sears Roebuck, makes foolproof the process of color selection or matching. You are given half-ounce

samples of paint, packaged in polyethylene and cellophane bags, instead of a color card. You squeeze the contents of a package into a jar lid and apply a swatch to the walls or woodwork. When it is dry you can judge the results before you buy the paint.



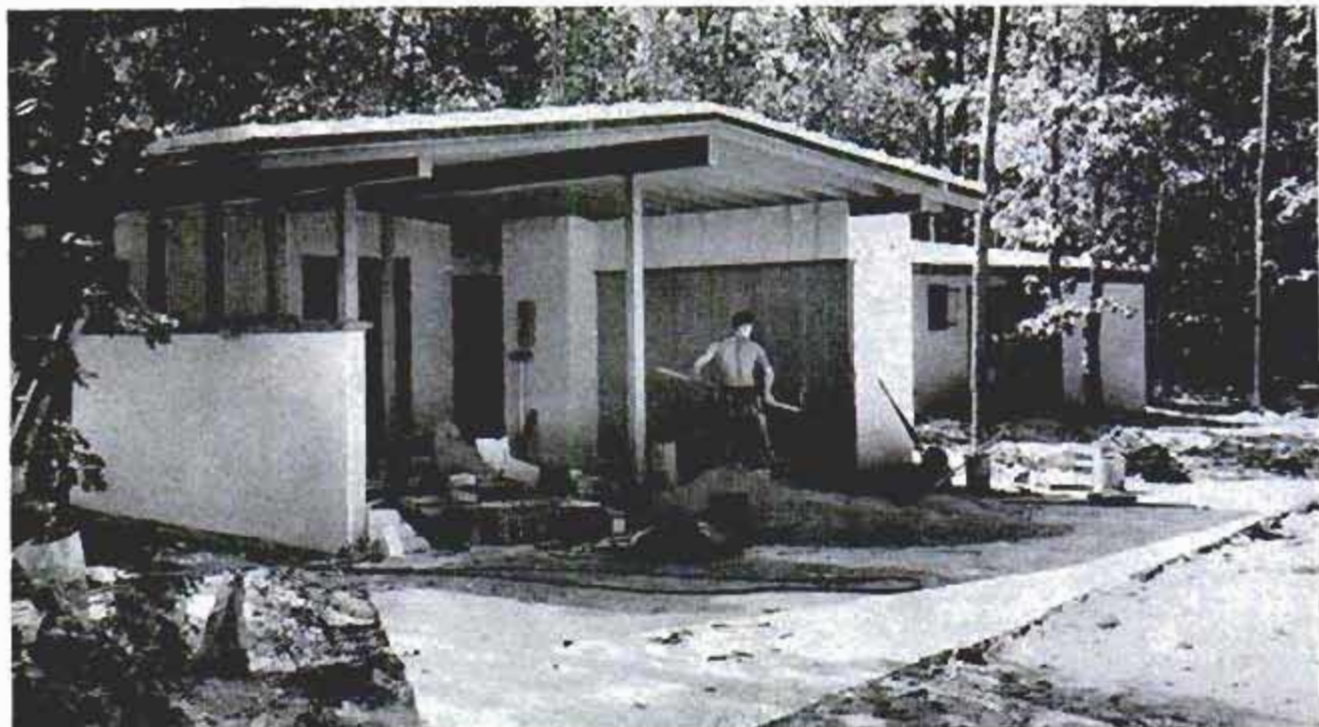

Nearly completed, plastic-foam house will look conventional from outside with its stucco-cement coating

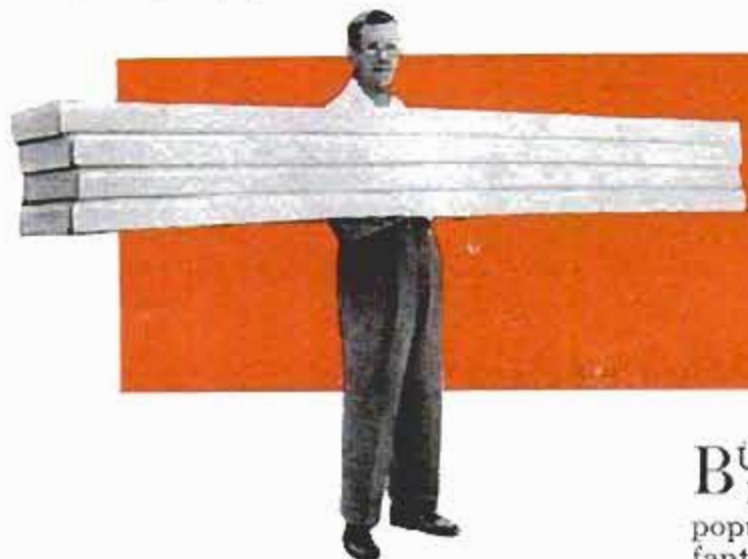

HOUSE OF FOAM

Builder Emerson holds 108 board feet that weigh only 20 pounds. Below, insides of the Styrofoam walls are covered with plaster one inch thick



BUILDING A HOUSE of Styrofoam—the lightweight, white, foamlike plastic so popular for Christmas decorations—sounds fantastic. But a man down in Houston, Tex., did just that after tests showed the plastic board could be treated to serve as load-bearing members of a house.

The builder, Dean Emerson, built his house walls of Styrofoam boards nine feet long, twelve inches wide and three inches thick. The boards were laid horizontally on the three-inch sides and pegged together with treated wood skewers. Wires were strung from ceiling to floor to compact the boards. Then they were coated with one inch of cement stucco on the outside and one inch of plaster on the inside, resulting in a five-inch-thick wall with built-in insulation. (Styrofoam's biggest use in the past has been as an insulator for the cooler-freezer field.)

The roof of Emerson's house is a conventional four-ply built-up job with Styrofoam shingles 9 feet long and 18 inches wide, overlapped and coated with $\frac{1}{4}$ inch of concrete. In one room of the house,

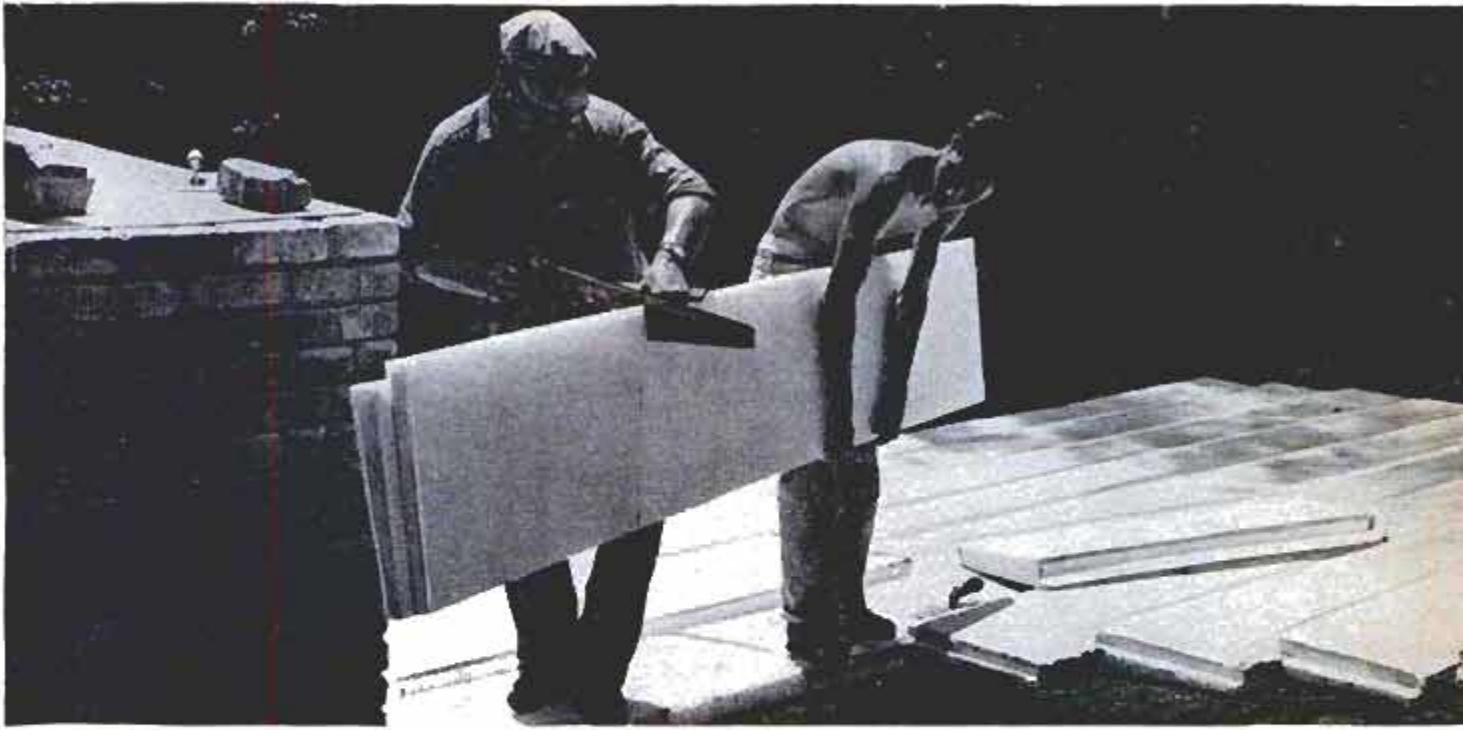

Huge Styrofoam shingles are easy to handle, are lightweight and can be sawed with ease or cut with knife

Styrofoam is also used as flooring covered with marble tiles. The plastic acts as an insulator to keep the marble at room temperature. Emerson reports his house is so well insulated that he can save about 50 percent in air conditioning and heating. As for strength, he says the house will withstand a 200-mile-per-hour wind.

The ranch-type house, which has four bedrooms and three baths, cost \$30,000. Emerson figures it would have cost at least

\$5000 more using conventional materials. The cost of the wall was 85 cents per square foot compared with an insulated brick-veneer wall at \$1.25. The walls are resistant to water, bugs and mold.

The Dow Chemical Company, manufacturers of Styrofoam, were not sponsors of this project but they have watched it with a friendly eye looking into the future. If the lightweight plastic proves practical, a new building material has been found. ★ ★ ★

Cement is sprayed on walls at 70-pound pressure to form natural bond. Wires help hold boards together

Workmen fit top board of Styrofoam into place as the last step before side wall is wired and sprayed

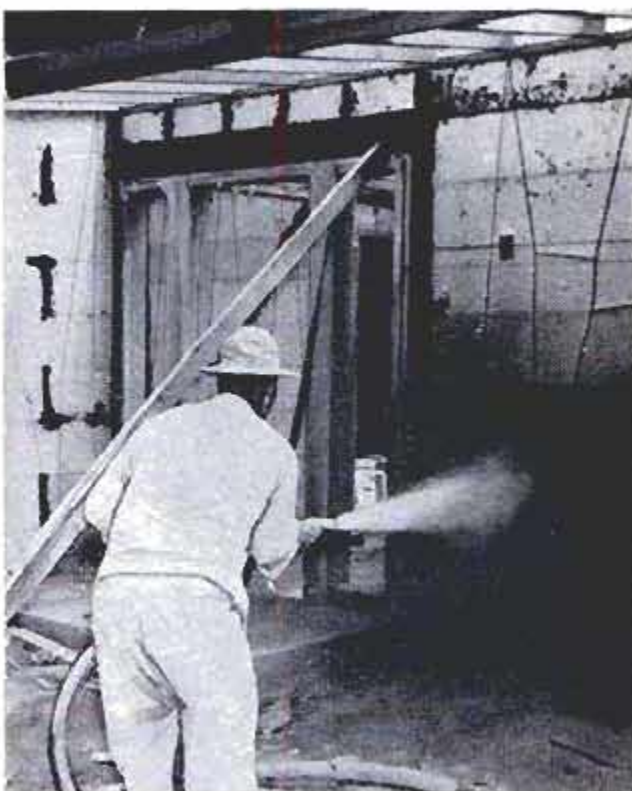



Photographed at Cypress Gardens, Fla.



Water Sports Take to the Air



FROM WATER SKIING it is only a small step to the newest of water sports, hydrogliding. Equipment needed for hydrogliding is a new motorless helicopter with pontoons which is towed by a boat. Requiring only 10 horsepower to tow, the craft flies along at 20 knots and can be controlled while in the air. In addition to being used in a new sport, the little helicopter is expected to have commercial use for spotting schools of fish, and military use as a submarine spotter and radar-antenna carrier. It is being marketed in both ready-to-fly and kit form. Another version is equipped with wheels instead of pontoons.



Most important lesson learned at this Florida school for skin divers — don't panic!

THEY GRADUATE UNDER WATER

By Brett Barton

THE VICTIM of the drowning had purchased an underwater breathing device by mail. With the lung strapped to his body he had dived down to one of the beautiful coral reefs off the Florida coast. When eventually his body returned to the surface he was dead.

Reading the pitiful details in the newspapers, outraged citizens demanded that such "tricky" devices be outlawed from future use.

"These gadgets are far too dangerous for the average person," was the way one incensed observer put it. "This case is a good example. The man was healthy and strong. He'd taken the precaution of buying the best equipment available. His outfit even boasted an additional, self-inflating 'rescue pack' safety feature. He'd done everything he could."

"Not quite," countered husky Ed Townsend, a 260-pound Florida amateur skin diver and enthusiastic advocate of the exciting sport. "He obviously got panic-stricken down there and hadn't trained himself to handle such a situation."

To prove his point the 40-year-old former Coast Guard skipper donned the dead man's complete outfit—even using the same mouth-piece—and, while others watched tensely, descended to the disaster reef. The equipment gave no trouble whatever.

Discussing the incident later with Henri Henri, a Hollywood, Fla., ocean-front-hotel



Townsend shows one of his prettier students how to don the diving lung properly. Below, he fills breathing apparatus with water, then demonstrates how to clear it within seconds



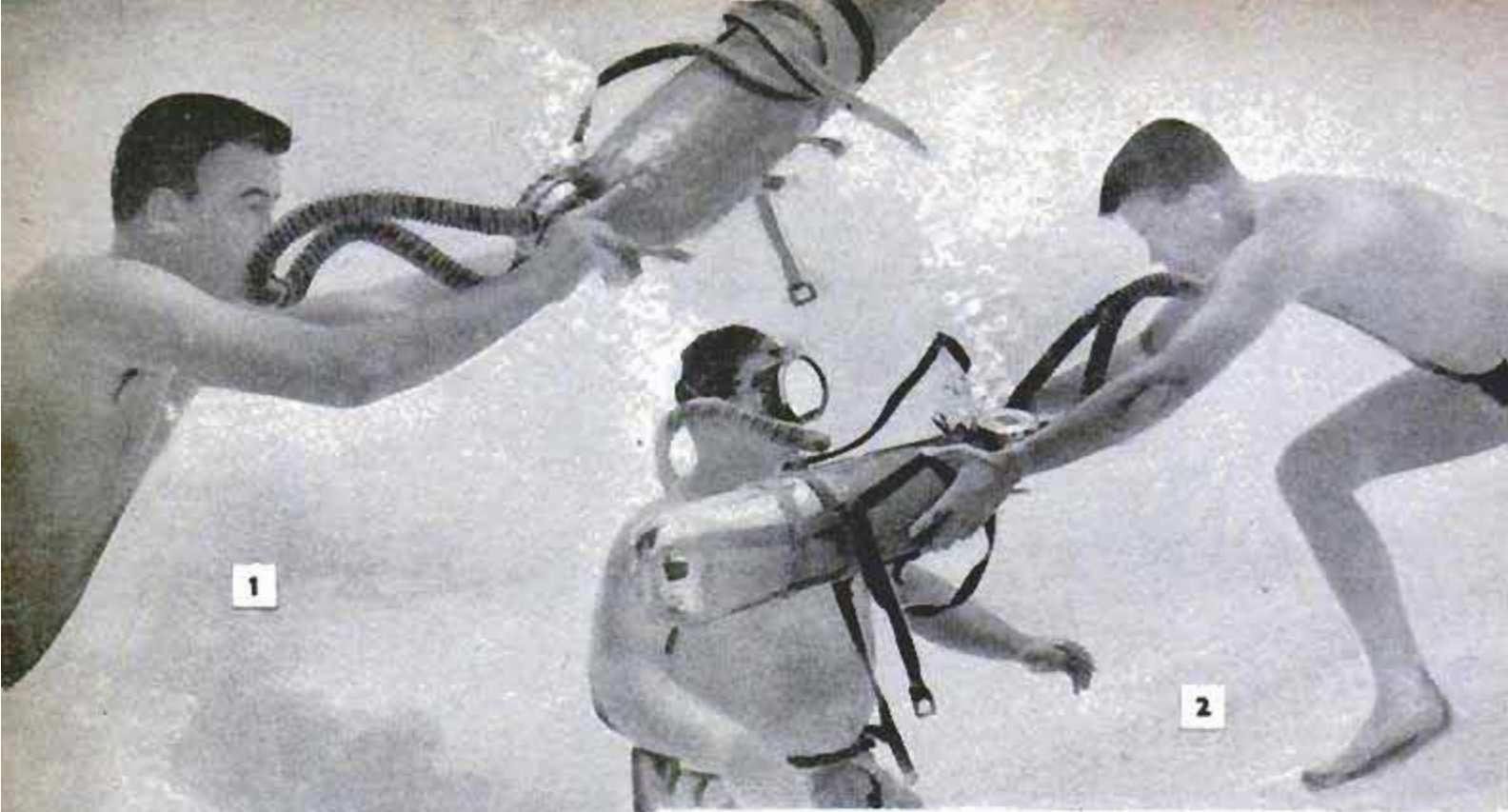

1

2

operator and fellow diving enthusiast, Townsend told his friend: "There is an urgent need today for a diving school in this country. Thousands of people are buying these lungs and trying to use them with no experience whatever."

The hotel man, a native of France who had witnessed in the Mediterranean a half century before the first recorded demonstration of such diving, immediately offered Townsend the use of his large swimming pool. Thus was launched three years ago Aqua Divers, Inc., what is believed to be the first such school in this country, perhaps in the world.

Since that time over 3800 enthusiastic persons

Learning to fight underwater panic: 1. Student tilts tank, blows water from clogged breathing tube; 2. Instructor watches as he opens valve from air tank; 3. Breathing again, he swings tank to his back; 4. He fastens air tank with the body strap



3



4

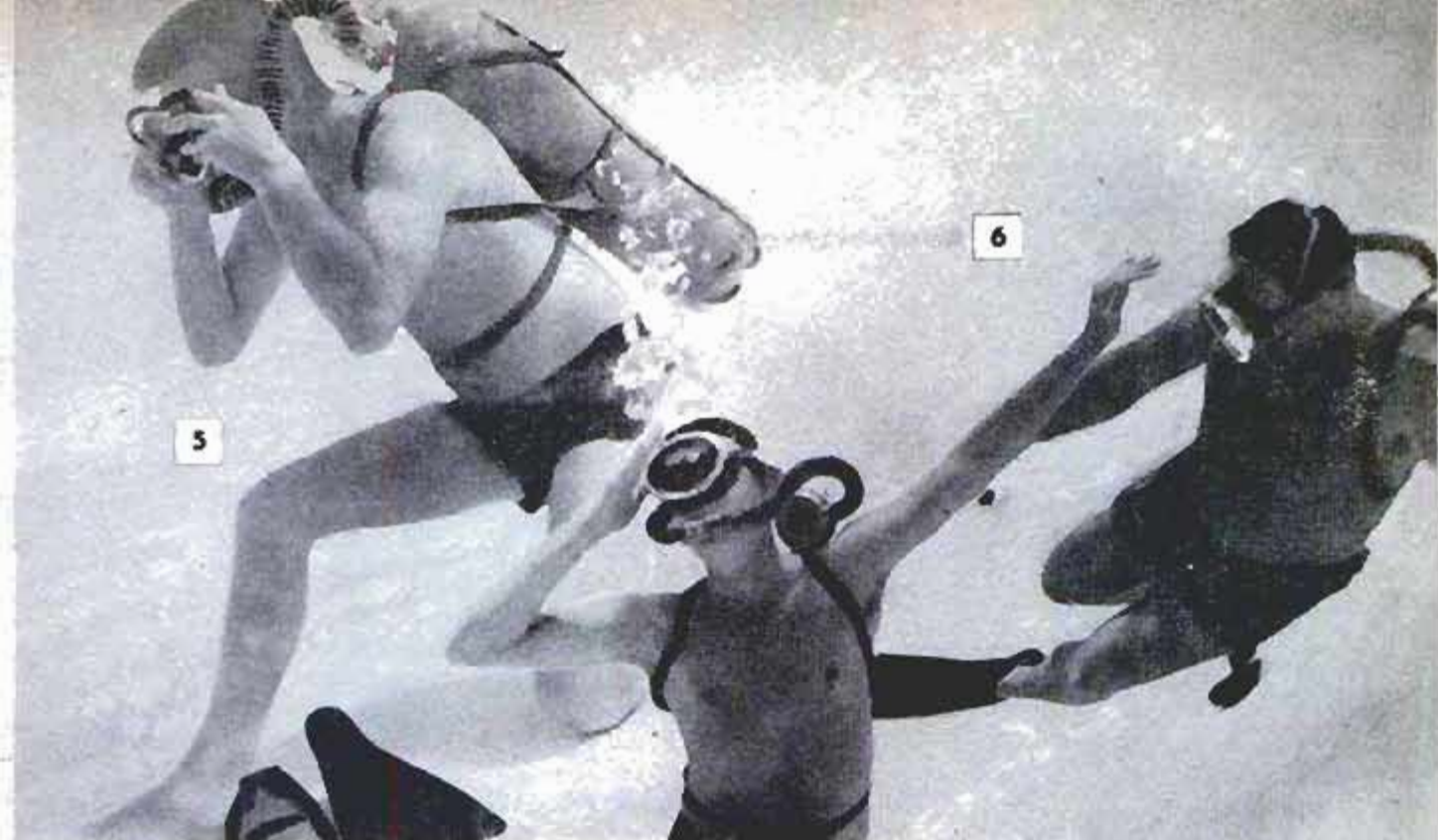

have been graduated; the oldest, Townsend's 67-year-old mother; the youngest, a six-year-old girl.

"And those graduates are 90 percent more advanced than many other divers who have been going down for years," says Townsend proudly. "For example, you'll find very few self-taught divers, indeed, who can deliberately remove their compressed-air outfits in the depths, letting them fill with water, then put them back on again without surfacing—and without drowning in the process."

The course, which costs \$25, consists of a complete two-hour pool "check out," after which you are ready to go ocean-reef diving. Sometimes, too,

5. Student next puts on his water-filled face mask; 6. As he starts rolling his body he snorts through nose to blow water out lower edge of mask; 7. Last step is to put on the swim fins; 8. Away he goes, breathing normally once again





Instructor loops free end of belt back through the buckle. Quick jerk then permits diver to shed equipment in an emergency. Below, Townsend shows student how to roll body to his left while submerged to clear clogged breathing system



Townsend will take his students, a dozen at a time, on week-end sailboat cruises to the nearby Bahamas (56 miles away) for supplementary diving instruction over the colorful reefs and wrecks awaiting there.

First step of the course acquaints the student with the lung and what it does for him in the water. There are at least a half dozen reputable manufacturers of such equipment, says Townsend. However, he warns against the use of lungs that have been manufactured primarily for emergency use in escaping from flooded coal mines and similar disasters.

"Some of those converted mine-safety devices will kill you!" he says bitterly. "They'll corrode and freeze up when used in salt water. To play safe, buy only recognized gear that is nationally advertised."

Fins Increase Speed

Next, you are shown how to put on rubber swim fins and glass face mask. The fins increase your underwater speed from about $\frac{1}{2}$ to $2\frac{1}{2}$ or $3\frac{1}{2}$ miles per hour.

The face mask improves your vision considerably while submerged (75 feet under favorable conditions). Townsend reminds you not to breathe through the nose, as this will cause the face mask to fog. Should you forget and do so, he demonstrates how saliva, rubbed briskly over the glass to break the oil surface there, will permit you to see clearly once more.

After you have become accustomed to the strange feeling of wearing a mask and fins, and after you've grown used to breathing via the mouth only, you are ready for the "controlled breathing" stage. That is, as you practice surface diving you are directed to remain submerged for intervals of 15 to 20 seconds until you no longer feel uncomfortable under water.

The portly Townsend now shows you how to put on the diving apparatus. The single tank, which holds clean, compressed air, is harnessed securely upon your back with chest and stomach straps. Both these straps, like the strap of the weighted belt which next goes about your waist, have their ends looped back through the

(Continued to page 282)



Autopilot relieves helicopter pilot for navigation and other duties. Light pattern in photo below at right shows stick movement in 15 seconds of flight



Autopilot for Helicopters

Using tiny transistors and miniature-circuit techniques, engineers have produced the first automatic pilot for use on helicopters. Four years of intensive development and flight testing were required to perfect the device, which will be available for installation during 1956. Set on manual, the autopilot will save the pilot hundreds of motions on every flight. Set on automatic, it will fly the plane as the pilot sets the controls. Variations on the basic control system will be available for large and small craft, and for civilian as well as military types of operation. As a safety feature, the system continues to operate in the event of engine failure, using only a small amount of power from the aircraft's storage battery.

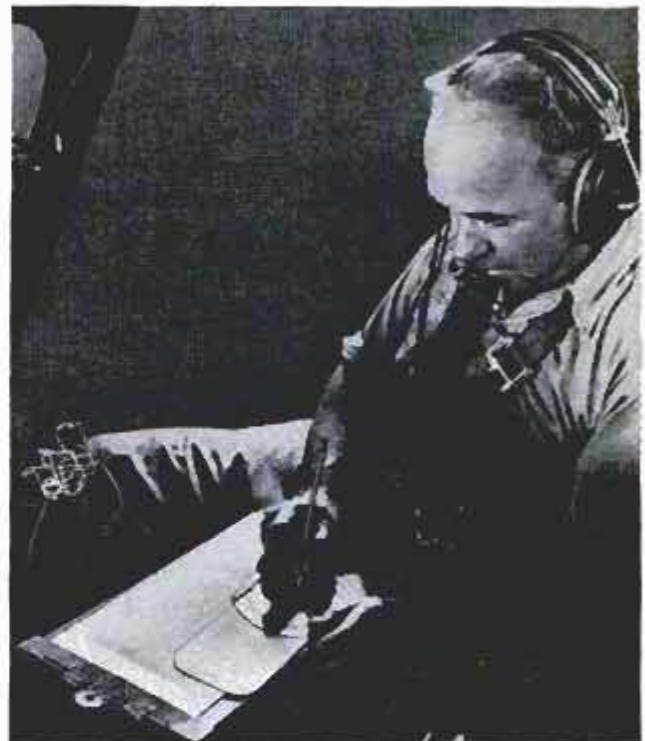

Apron for Filling-Station Hose Prevents Untidy Gasoline Drips



Latest touch of refinement at filling stations is a bib for the gasoline hose. It prevents waste gasoline from dripping down the side of the rear fender. Three permanent magnets sewn into the top edge of the cloth hold it against the side of the car so that there is no need for any form of attachment. When not in use, the bib can be snapped to the side of the gasoline pump.

Flame Burns Without Air

Flame without air has been produced at Cambridge University. Orange-red and shaped like a flat disk, it occurred when methyl-nitrate vapor was burned in a large glass tube. The new flame was where no air could reach it, well below the main flame burning at the mouth of the tube. When the main flame was blown out, the new flame continued to burn as before.

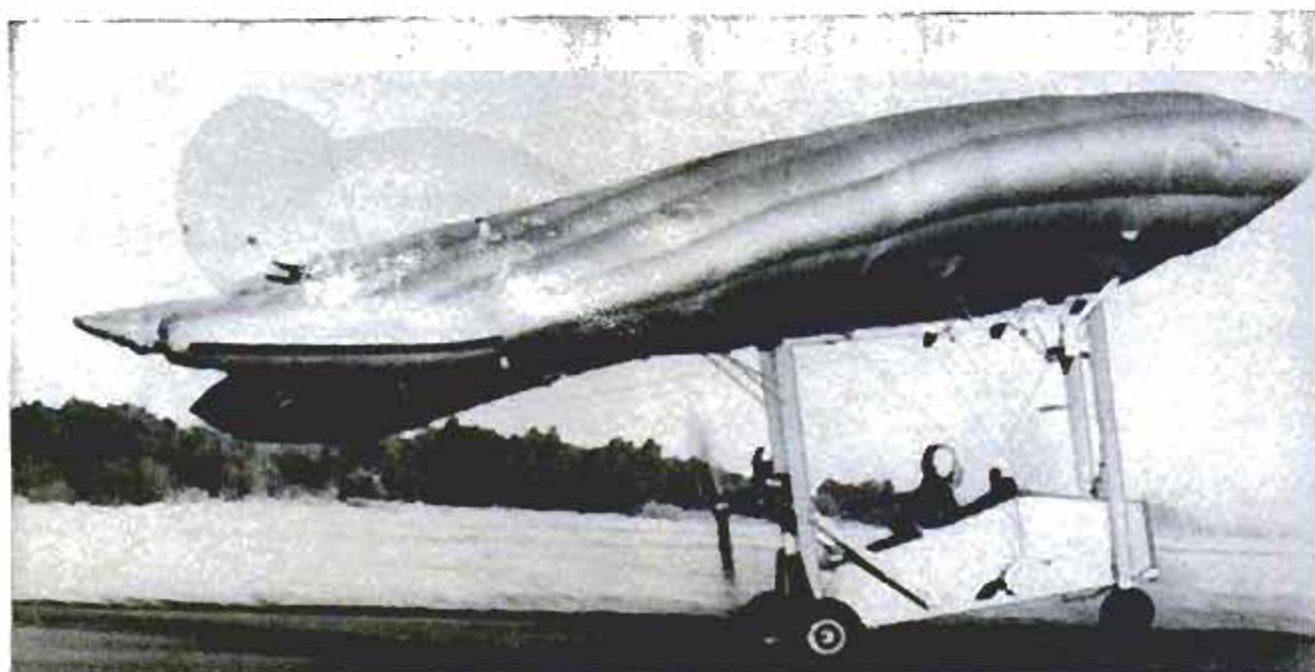
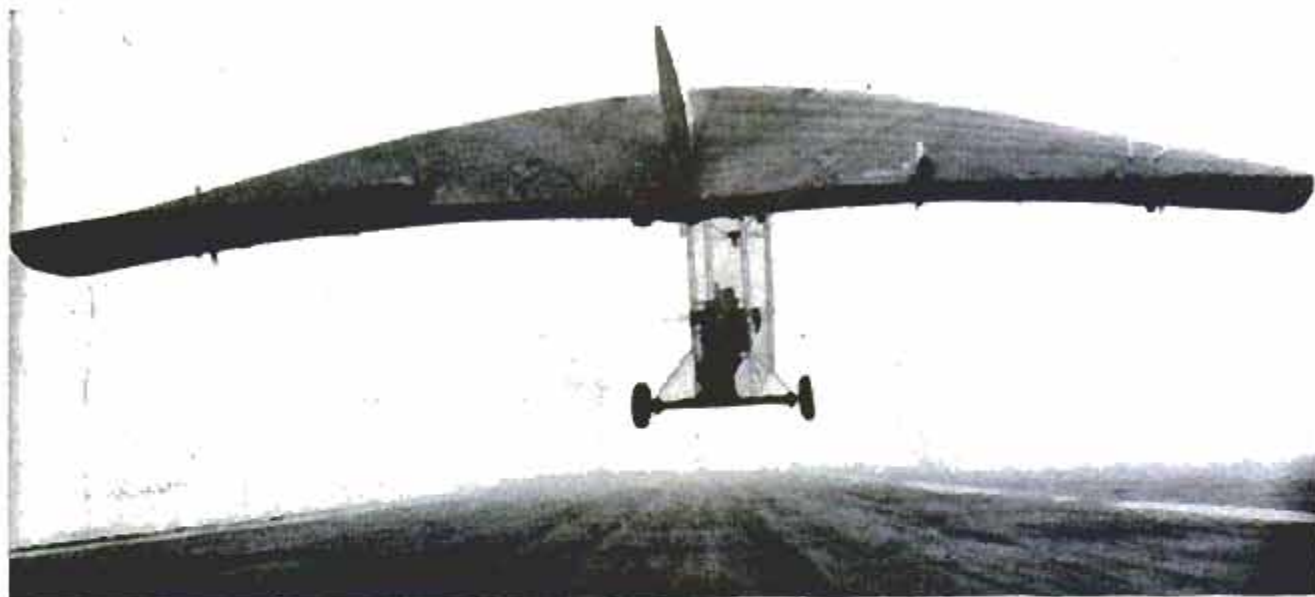

British Plane Has Inflated Wing

Looking like a flying machine held over from the early days of aviation, a new British utility plane features a collapsible wing which is inflated with a tire pump just before flight. The British Ministry of

Supply has placed an order for a number of these planes, described as easy and inexpensive to produce. A 65-horsepower engine gives the plane, a two-seater with a 40-foot wingspread, a range of 100 miles.



Cost-Cutting Trailer

By eliminating expensive materials and streamlining, James B. Moore of Alliance, Ohio, built a comfortable trailer for \$250. The trailer is 6 feet high, 6½ feet wide and 10 feet long. The chassis is five-inch channel iron, mounted on the springs and wheel assembly from a 1938 Plymouth. Two by fours are bolted across the chassis to support the plywood floor. The framing is covered with plywood and fiberboard.

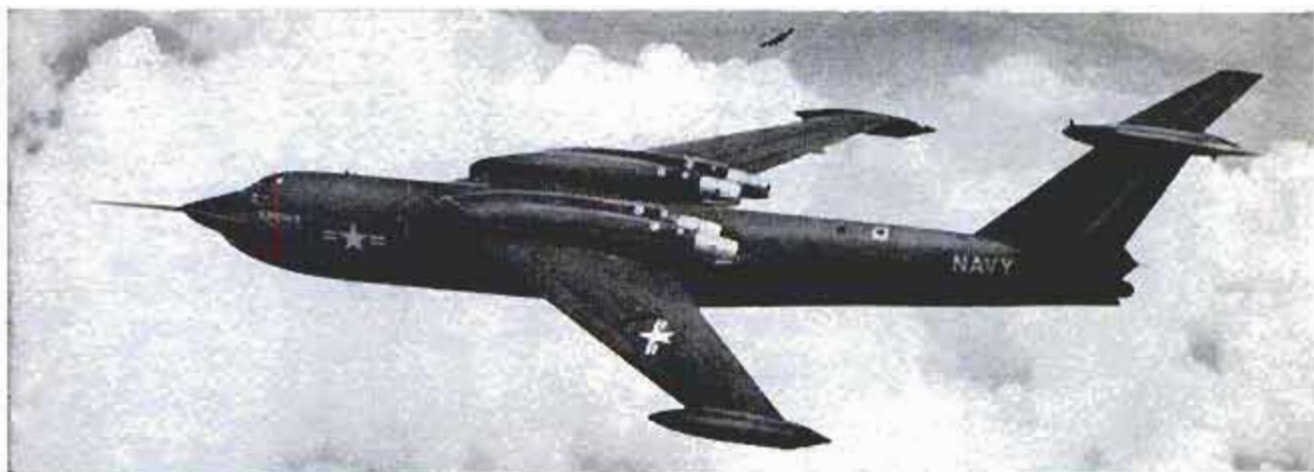

Navy Jet Seaplane's Speed Equal to Land-Based Bomber

Martin's SeaMaster, the XP6M-1, the world's first multijet seaplane is now being flight tested, and shows promise as a 600-mile-per-hour mine-laying and photo-reconnaissance plane. The SeaMaster is a radical departure in seaplane design, fea-

turing swept-down wings with plastic floats built into the tips. Power is supplied by four Allison J-71 turbojet engines with take-off afterburners. The plane is the first to fit into the Navy's new concept of mobile seaplane striking forces.

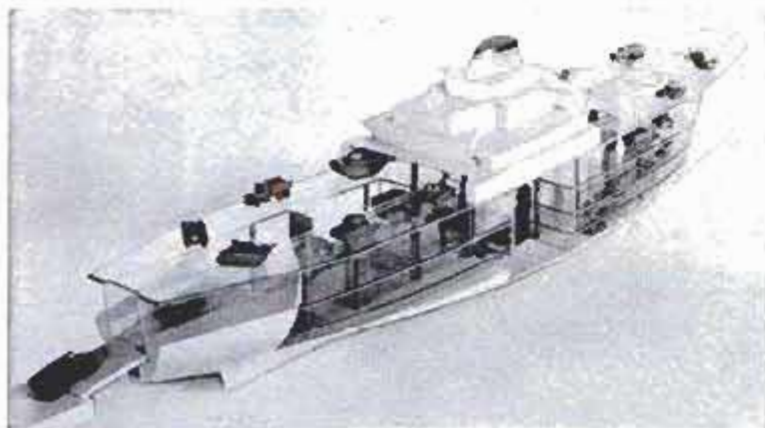

Glass model of new cargo ship shows how cars and military vehicles will be able to drive aboard, go between decks on ramps



Roll-On, Roll-Off Ship Speeds Cargo Handling

Now being built for launching late in 1956 is a new type of cargo ship designed to cut loading and unloading time from 2½ days to only four to six hours. Trucks drive right into the ship through one of five ramps, one in the stern and two in each side, to unload their cargoes. In some cases trucks and trailers will be parked on the ship for unloading at the port of destination. Designated as a T-AK 269 vehicle cargo ship, it will displace 14,084 tons, be 499 feet long, 78 feet wide, and make a speed of 18 knots. It is being built for the Navy's Military Sea Transportation Service. Seven similar vessels are planned by the Pan Atlantic Steamship Corp.



All Ramblers for '56 have four doors, like this four-door hardtop

Rambler Has Everything New—Even a Hardtop Wagon

NO BABY ANYMORE, the Rambler has grown up and taken its place as a full-size car. It is not only bigger, but it's all new in body and engine.

A first in the industry is the new four-door-hardtop station wagon that Rambler has announced. This body has the room of the regular four-door station wagon plus the styling and visibility of the four-door hardtop sedan with its pillarless construction.

If you want proof of the fact that the 1956 Rambler is a grown-up automobile, look at this comparison with the original model that came out in 1950:

The first Rambler, a two-door convertible sedan that is no longer produced, had a 100-inch wheelbase, an over-all length of 176 inches, a weight of 2500 pounds. In contrast, the 1956 Rambler has a 108-inch wheelbase, an over-all length of 191 inches, a weight of 2830 pounds.

It is still the smallest car produced in the United States. However, it has leg-room, headroom and hiproom that come within an eyelash of matching figures of the top-selling cars in the low-price field.

Headroom on the 1956 Rambler is 36 inches, a half inch greater than the average of the other three low-price cars. Yet over-all height of the Rambler is 58 inch-



Above is the newest idea in body styling for 1956: a station wagon with four-door hardtop styling. It has no center posts between the doors. Below, the regular four-door wagon, known as the Cross Country



es, almost three inches under the average. Leg-room is 43 inches, one inch less than the average. Hiproom is 59.8 inches, also one inch less than the average.

Rambler's styling has a fresh look. It is distinctively different, as they say. Most noticeable feature is the "rollbar" design of the back roof support which provides an opportunity for two-toning.

Headlights are mounted inboard in the grille, but set fairly wide nevertheless. Viewed from the front, fenders are slender and have parking lights in their leading edges. The grille consists of widely spaced vertical and horizontal bars. All wheels are uncovered for the first time in Rambler history. The original Rambler was fully skirted. Its front skirts drastically curtailed maneuverability. This year, there is no such handicap and the car is very nimble.

The six-cylinder engine is of overhead-valve design for the first time and develops 120 horsepower, up 30 from last year, providing lively performance. Displacement is still the thrifty 195.6 cubic inches that means many miles per gallon. Power brakes are standard on Custom models, optional on others. Power steering is optional on all models. ★ ★ ★



Featured on the Rambler station wagons is a crank-down rear window. It provides excellent ventilation and eliminates the transom-type top half of the door. The crank handle is outside and has a lock in it. You get an idea of the lowness of the new body here. Over-all, it is 58 inches high

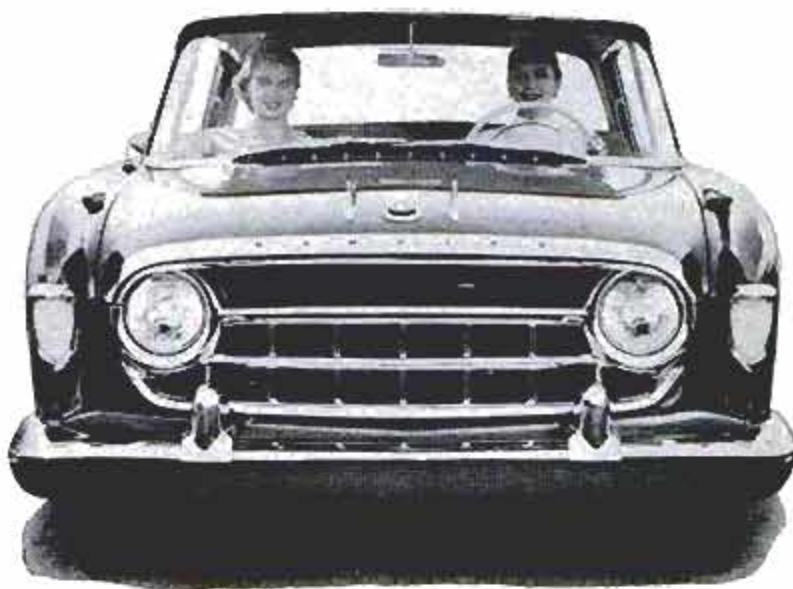

From the front, the Rambler has a light, thin-roofed look. The roof panel is shallow and flat. There is 30-percent additional glass area

Style features include inboard headlights, above, and the "rollbar" design of the back roof support, below

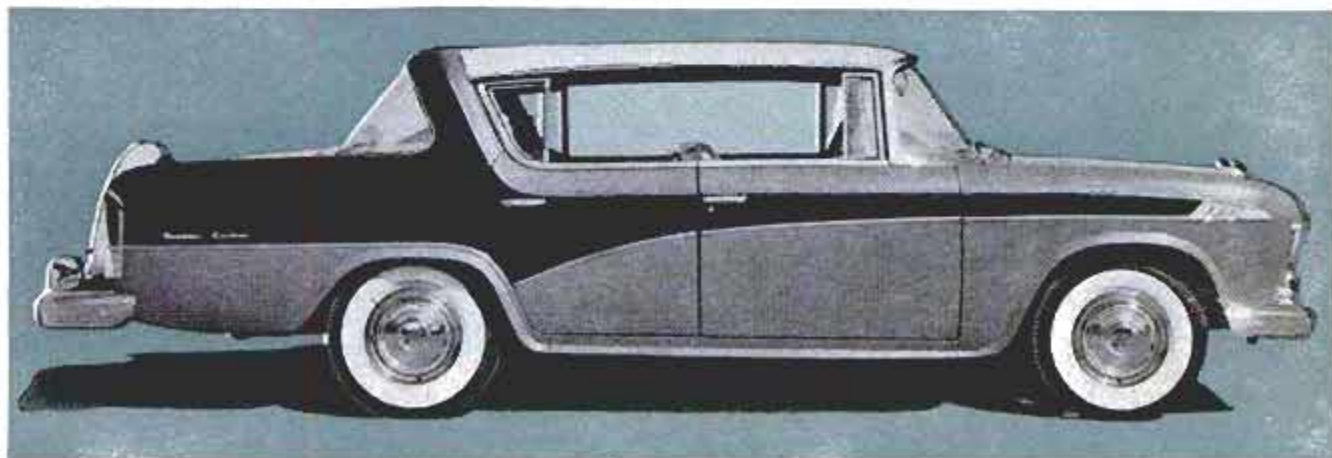

Traffic Tunnels Under Greenland's Icecap To Supply Our Arctic Outposts

By Elliott H. McCleary

A RMY ENGINEERS are making transportation history with tunnels gouged through the crust of the Greenland icecap—tunnels that could in event of military necessity be snowy subways linking the outposts of our Arctic frontier.

Their tool is a crawling snow eater with a massive bite. Its speed alone would never win a race, even in such forsaken country.

But as it slowly churns through the snowy frosting of the mile-thick ice sheet, its cylindrical digger whirling, its twin chutes spewing snow 20 feet into the air, it leaves a trench eight feet wide and three to five feet deep.

Three more passes with the snow eater, and the trench is 12 feet deep. Men place curved plywood forms on top of it and the forms are covered with snow.

Artist's conception shows the type of under-snow defenses which might be built far inland on top of icecap. Below, snow diggers gouge out a trench that is covered with removable forms and overlaid with layer of snow. Above and right, supply trains shunted from main railroad tunnel unload materials in under-snow storage rooms. Planes roll out of under-snow hangars to packed-snow landing field. Radar station, living quarters are also subsurface

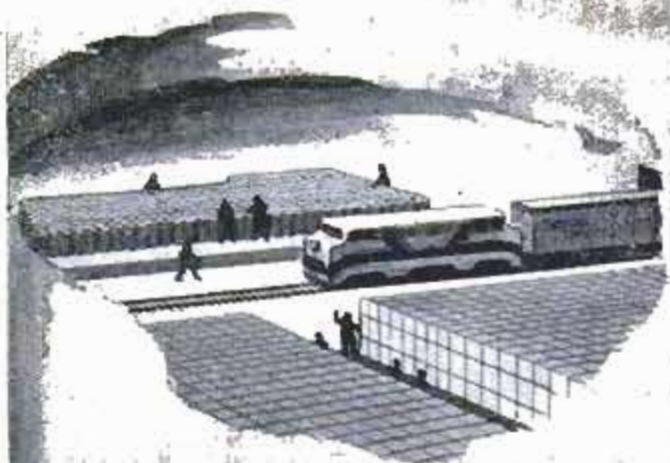

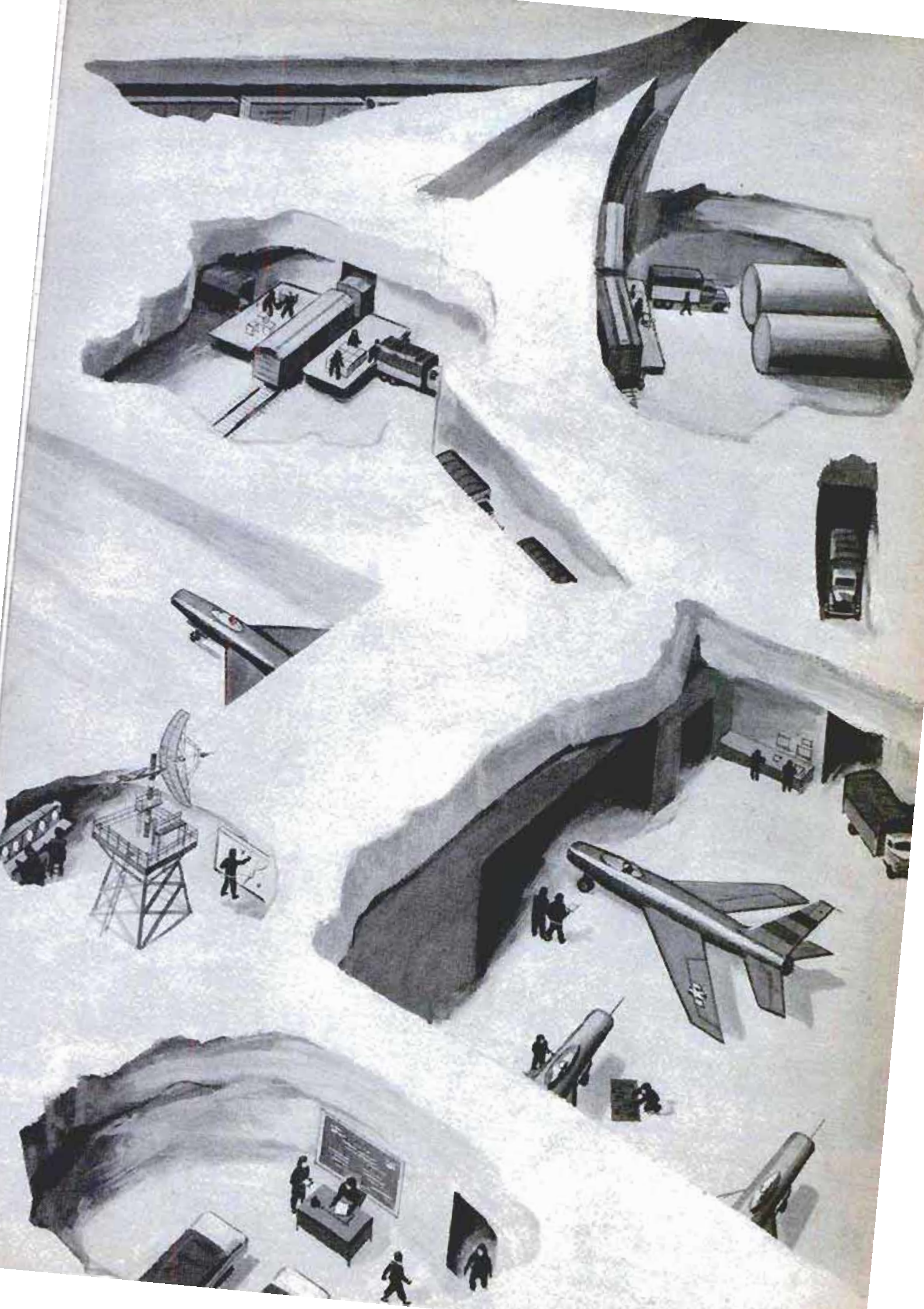



Snow digger is type used to clear mountain passes. Painted swirls on hubs warn when rotor is in motion



Digger cuts a trench eight feet wide and three to five feet deep at each pass, blows snow out the top



Experimental tunnel dug in ice at edge of icecap is four feet wide. It was dug by hand with picks

The snow freezes to a granitelike consistency. The forms are removed, and you have a tunnel through the icecap.

What can you do with such a tunnel? The Army Engineers, who flew the massive snowplow from its native Switzerland last summer to dig experimental tunnels in the icecap 200 miles east of Thule, are cautious in their predictions.

But this is what you *could* do: Run a diesel railroad train, trucks, Jeeps and other rolling equipment through the tunnel; carry troops, jet fuel and supplies to bases of Air Force planes guarding the approaches to the North American continent.

"There are many things possible with such a tunnel when you know some of the advantages," says Robert Philippe, one of the chief engineers on the project. "It can provide a system of transport away from the chill and wind. Cold is never bad by itself. A man can stand 80 below zero in still, calm weather for quite a while. But let a 40-mile-per-hour wind blow at 20 above, and he's dead in no time. The tunnel, by the way, maintains a constant temperature of five degrees below zero winter and summer."

Gen. S. D. Sturgis, head of the Army Engineer Corps, states that the tunnel "would provide a permanent road, away from wind and cold and is cheap to build. We think it would cost about \$2000 a mile, much less than a conventional gravel road."

Wouldn't a tunnel of any length take years to build? On the contrary, say members of the Greenland expedition who refuse to be quoted. Four such machines, one behind the other, could excavate a trench at least 12 feet deep and 3 miles long every 24-hour period. With enough equipment, a tunnel stretching the width of Greenland, 600 miles, could be built in a summer.

Men following behind the diggers would place the curved plywood forms over the top of the tunnel, and another snow digger would follow alongside the trench, throwing snow on top of the forms. In a few days the tunnel roof would be hard, and crews could remove the forms and use them in tunnel work ahead.

Later, railroad tracks for a diesel train could be laid in the tunnel. Air drops and "snow trains"—long lines of sleds drawn by crawler tractors—are at present the only means of supplying points on the icecap. Sled trains are slow. The tracks left in the snow cause huge drifts on the wind-swept wastes of the icecap, a lasting mark which can be seen by searching aircraft.



Removable arched plywood forms are set in place over trench, two feet down. Snow will be blown on top



Mechanical snow blower follows alongside the trench after forms have been laid, covering them with snow

Right now, a two-man team, bundled in parkas and thick arctic clothing to shield them from temperatures which dip to minus 80 degrees Fahrenheit, is atop the ice sheet, investigating the tunnels which were dug last summer. Their report will guide the Engineers in their work and hopes for the future.

"If our expectations prove out," says Dr. Henri Bader, father of the snow-tunnel idea and chief scientist on the expedition, "the tunnels will last for years. The roof will never cave in. As more snow falls on the surface of the icecap, the tunnel top is covered with an ever-thicker load of snow. Thus, each year, the tunnel is farther below the surface. At the same time, the snow on each side of the tunnel becomes compacted. The walls of the tunnel are pushed in four inches each year, on each side, by the force of this compaction. Every so often, a machine will have to go through the tunnel to trim off the sides."

Various types of tunnel roofing were tried during the 1955 expedition, but snow was found to be the most practical, because of its economy. One method involved the use of squirrel-wire netting anchored on each side of the tunnel by stakes. Over it was placed a thin sheet of plastic, and the snow went on top of that. Another method used V-shaped wooden forms, another, blocks of snow that were cut out and placed over the tunnel.

The trench tunnels are practical over almost the entire surface of the Greenland icecap. Only on the edges of the icecap must other means be employed.

The Greenland icecap covers all but a thin margin along the coast, and reaches a depth of 9000 feet at some inland points. It is formed by snowfall of two to nine feet per year, and the top layer is just snow. But as more snow falls, the snow beneath it is compacted. The deeper you go,

(Continued to page 280)

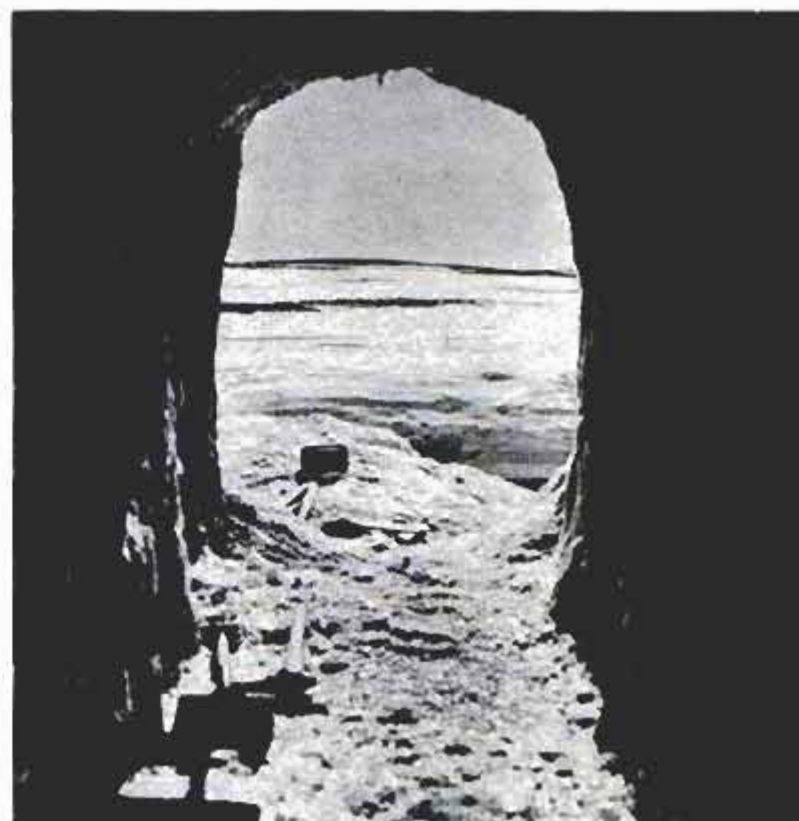

Experimental ice tunnel is too small for vehicles. Larger one might be built with continuous-mining machine. Below, a conventional earth compactor tamps snow on top of icecap to construct a landing field



Detroit Listening Post



By Leo Donovan

AND STILL THEY COME. This month it is the 1956 Rambler, next there will be the 1956 Chrysler 300B and the 1956 Corvette. After that the season is over and we can start worrying about 1957.

Just about the time you are reading this, American Motors will start building its own V8 engines at Kenosha, Wis. Both the Hudson and Nash cars have been using Packard V8 engines and transmissions. Beginning in January, they will be available with their own V8s, in addition. The new engine will be smaller than the Packard, of course. (After all, Packard's is the biggest in the business.) And the new AM engine will come in a variety of sizes, including one small enough for the Rambler. With the new V8 engine, the Rambler should be a bomb—it's plenty peppy right now with its six.

What horsepower will the Chrysler 300B have? Informed guesses put it at around 335, up 35 from 1955. The car has run away with the stock-car racing championships in both AAA and NASCAR. What it will do in the 1956 season is hard to predict. At least one major manufacturer is going after the title with all its resources, another is after it only a little less strenuously.

Chrysler will have a surprise package to offer, according to rumor. A new transmission is expected to be announced with the 300B.

You can bet Dodge will be winning races shortly. It is planning to announce (if it hasn't by this time) a special speedster known as the "500." You'll see it on the NASCAR tracks this winter. And it should do mighty well.

What About 1957?

Next year is the year for another "complete" change. That means new body shells in most cars, new engines in many cars. But they are not properly called revolutionary changes, engineers insist. Not until the gas turbine is offered should the word "revolutionary" be used, say the slide-rule boys.

But GM will have a gas turbine in one of its passenger cars in the Motorama in New York this month. Of course, GM had two V6 engines with fuel injection last year at the Motorama and as yet there is no sign of them on the production line.

GM's turbine is ready for the highway. It could power the family car except that the rare metal used in the blades puts it out of reach pricewise. Until metal costs can be cut—and drastically—the turbine will power show cars only. It is mounted in a four-passenger body unlike the old Firebird that was shaped more like a jet plane.

So the V8 will be around for some time. There is a lot more efficiency that engineers can wring out of both the V8 and the automatic transmission before they switch to the turbine.

There is still talk of fuel injection by 1957 (see the Owners Report on the 300SL, page 140, for a first-hand story on fuel injection). That could mean the end for carburetors. But don't expect it tomorrow.

The new Lincoln, which appeared well ahead of the industry cycle, will have to offer something hot in 1957 to stay in the news and it could be the first to make fuel injection optional. It's just a guess, of course.

Strong supporters of the fuel-injection system, strangely enough, are the stylists and sales forces. With injection, the hood line could be lowered considerably. And stylists like that.

Packard's torsion-bar system has forced the rest of the industry to take a fresh look at suspensions. In the bus field, General Motors pioneered the bellows type of air suspension. Now the industry conversation includes speculation that Buick may pioneer a passenger-car version of the rubber-air suspension in its 1957 models.

There's no doubt that 1957 cars will be lower, drastically lower. This will mean that you will find them more awkward to enter and leave, but once in the car, you will feel safer because of the lower center of gravity. Additional lowering increases the big hump in the front floor board caused by the transmission. Both GM and Chrysler are rumored to be experimenting with transmissions mounted on the rear axle. Such a move would also improve weight distribution, front and rear.

Will there be radar-controlled brakes in 1957? Most engineers are skeptical. If offered, the brakes would have to be a very high-price option and there are still problems to be solved, engineers say. They are possible, but not likely for 1957.

More likely is the introduction of faster-stopping brakes—by Chevrolet, according to the rumor department.



Automobile equipped with the power-parking unit drives head first into a parallel-parking place

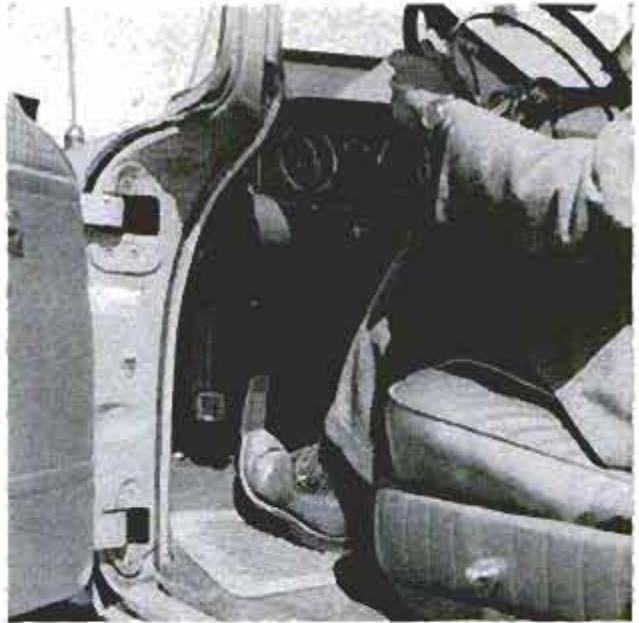

Depressing a foot pedal hydraulically lowers pair of parking wheels attached to rear-axle housing

Power Parker

Fellow motorists gape when C. P. Farr of Toronto parks his car. Farr pulls head first into a parking spot, whereupon the rear of the car rises and coasts over to a

Parking wheels lower, lifting car. Spinning right rear car wheel turns parking wheel to move car over

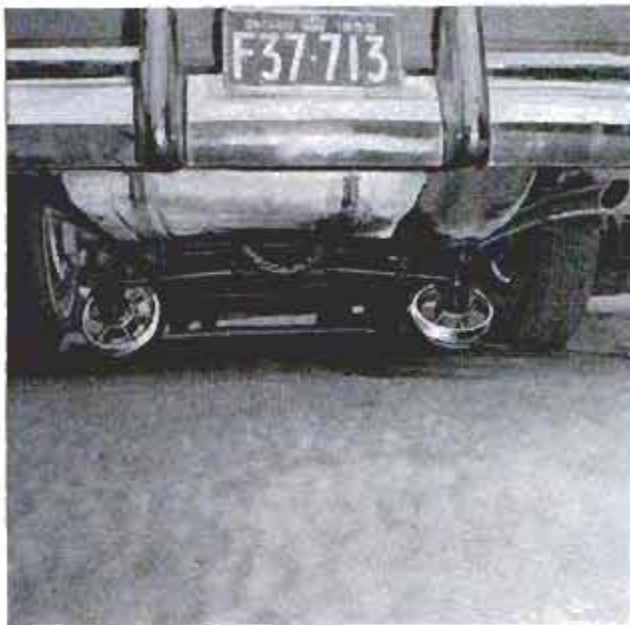

snug fit against the curb. Depressing a foot pedal diverts fluid from the power-steering unit to a cylinder that lowers a pair of wheels under the rear of the car. One of the oddly shaped wheels, resting against a car wheel, turns as the wheel is spun, moving the car over. The unit is homemade.

Parking unit can also be used when changing tires. No jack is needed, since unit lifts car from ground



Dried Pond Weed Beats Alfalfa Meal in Fattening Swine

Pigs fed a common pond weed, *Elodea canadensis*, gain better than those fed alfalfa meal. That's the report of scientists at Kansas State College. The mosslike weed yields 12 to 14 tons green weight to the pond acre and replaces itself in three months. Dehydrated for use, *Elodea* be-

comes a dark, alfalfalike meal with a faint fishy smell. In the Kansas State experiments, it was substituted for alfalfa meal as part of a balanced ration for 16 weanling pigs. The pigs gained 1.75 pounds per day with the new ration as compared to 1.57 pounds per day with the old.

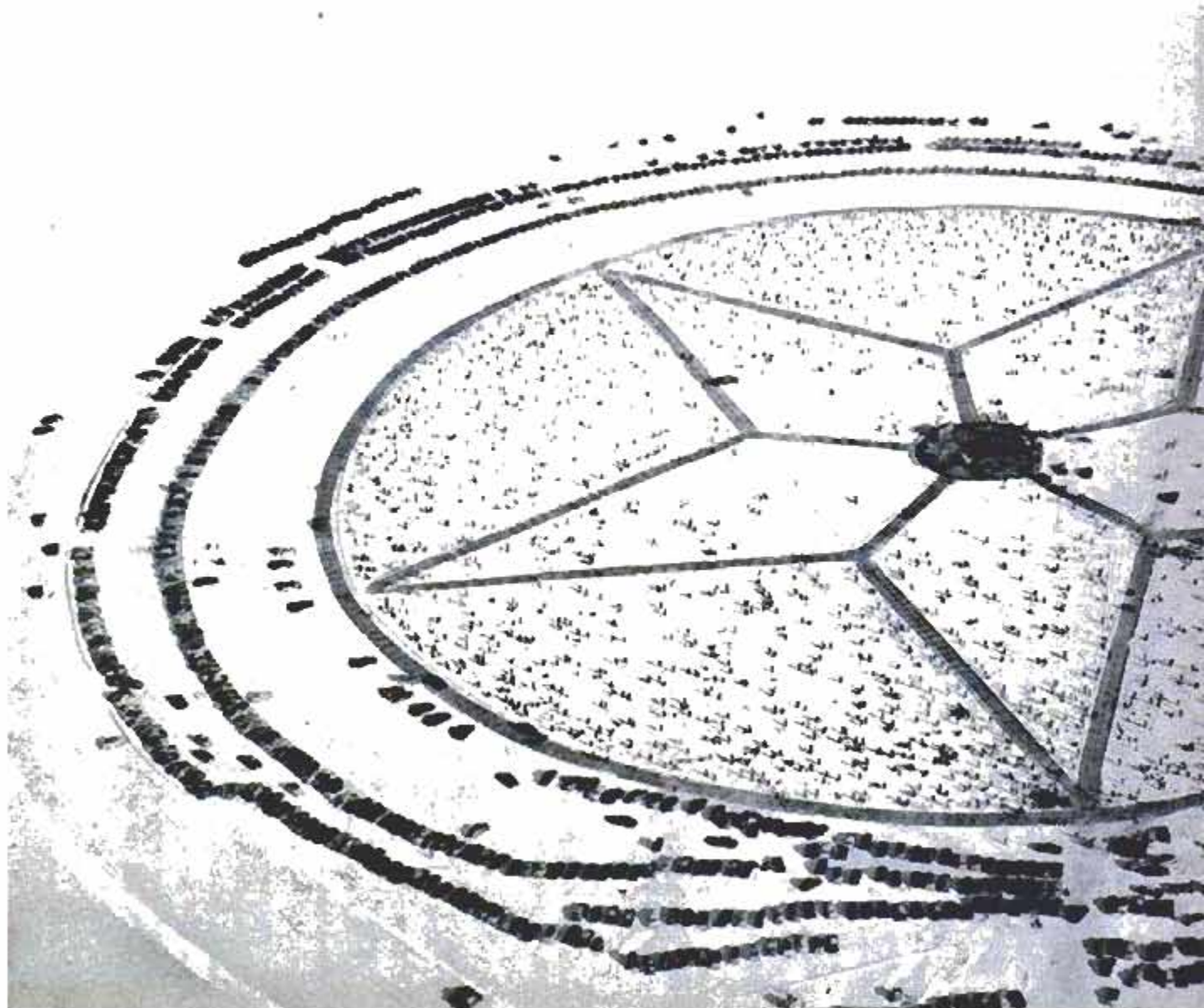

About 8000 anglers participated in 1955 contest at White Bear Lake near St. Paul. They chopped holes in a circular area 500 yards in diameter. Roads were laid out in star pattern with cars parked outside the circle

Winter is the Best Time

By Joe Hennessy

Sports Editor, St. Paul Pioneer Press

FISH BITE BETTER in winter. That is the most important reason for the tremendous boom in ice fishing, particularly in Minnesota and western Wisconsin. The number of participants has quadrupled since World War II.

There are other factors only a shade less important:

- The development of warm footwear, after military experience in the Aleutian Islands and later in Korea, is a major one. The hardy devotees of ice fishing always had plenty of heavy clothing, but even the thrill of a good many strikes can't overcome the discomfort of cold feet.

- The ice-fishing contest, a sort of picnic on ice complete with prizes, still less than 10 years old, was another.

- Then there was a change in thinking by fish biologists on the matter of restrictions. Today the two most sought after winter species, crappies and sunfish, are open the year 'round with bag limits large enough to satisfy the most hungry of anglers.

In a game where luck supposedly plays a great part, the experts now have scientific proof that fish do bite better in winter than in summer.

Dr. John B. Moyle, Minnesota fisheries-



Walter Wettschreck photo



Real prize for the winter fisherman is a good-sized northern pike, hauled up through two feet of ice



for Fishing

research supervisor, conducted an exhaustive survey in cooperation with the federal authorities and came up with the following conclusion:

On a man-hour basis on 12 selected lakes scattered over the state, summer anglers caught 2.43 fish per trip and winter anglers brought through the ice 3.24 fish per trip.

Doctor Moyle estimated about one fourth of all those who held Minnesota fishing licenses in 1955 fished in the winter as well as the summer.

On another phase of winter fishing—spearing—done from a darkened shack,

Right center, one trick is to attach matches to willow pole. Weaving matchbook indicates interested fish. Right, tools of pan-fisherman's sport are insulated minnow bucket, chisel, spiked pole and ice scoop



Lakes near Twin Cities draw heavy load of winter anglers. Some have shacks, some pull equipment on sleds

there was an exact count. Gordon B. Wallen, assistant game and fish director, noted that spearing permits jumped from 22,528 in 1948 to 62,784 in 1954, the last full year for which records are available.

This is a more specialized form—and a highly controversial one. The spearers generally are seeking only northern pike, and the largest northern pike at that. According to fish biologists, the northern, a voracious feeder on the smaller pan fish, is necessary to keep lakes in balance. Without the big fish, the smaller ones have a tendency to propagate themselves to the point of overpopulation, resulting in stunted, underfed fish.

Plenty of Fish

Moyle said he believes it virtually impossible for fishermen, using hook and line and observing even the generous 25-fish limit, to "fish out" the pan fish.

The fish are there in great numbers. Getting them is the ice angler's problem and he is solving that in comfort today.

Basically the equipment is simple and inexpensive. During the midwinter months when ice is two feet thick on the northern lakes, anglers use either snow tires or chains and drive within a few feet of the fishing hole.

The few old-time blacksmiths left in Minnesota can't keep up with the demand for ice chisels. That's the first and most important piece of equipment. They are forged from car springs or other tempered steel and have shafts made of water pipe, frequently loaded with lead for greater heft. Most chisels run about five feet long. Even veteran ice choppers take a good five minutes to punch an 8-inch-diameter hole through ice varying from 6 inches to 30 inches thick.

An old-fashioned soup ladle, with a handle some 30 inches long, now is a standard item in all bait and tackle stores in

the north. With this the angler scoops out the chopped ice.

The line usually is strung along a 40-inch pole with a spiked end which is set in the ice. Leaders, a large hook for crappies, a very small one for sunfish, and bait complete the equipment.

If the angler is after crappies—and they made up 80.5 percent of the winter catch, according to Doctor Moyle's survey—he will put on a minnow. Some hook them just under the dorsal fin, others string them through the mouth as in summer trolling and some hook them through the tail.

Fish in Shallow Water

Desired depths vary among the ice fraternity. Most fishing is done in less than 25 feet of water, about a foot off the bottom.

By this time the angler probably has brought up a nail keg or apple box for a seat, lighted the pipe or cigarette and left the rest to the fish.

The more ambitious will be digging second holes, for most of the states in the northern Great Lakes area now have liberalized the rules to permit use of two lines. Some old-timers insist that a single line is best, for it demands constant attention.

The slightest movement on the bobber indicates fish in the neighborhood. Pan fish seem to nibble at the bait during the winter months rather than strike hard as in the summer.

Not that pan fish are the only lure to the cold-nosed of the winter-fishing breed. Walleyed pike and northern pike, which are protected for a part of the winter months, also take the bait.

Those who want to settle down for a winter of fishing in comfort have spent the fall building fishing shacks. Some shacks have runners and are towed by car to the fishing spot.



Biggest chore is cutting hole through the ice. Old-timers still use the double-bitted lumberman's ax

The spearers use a completely darkened house; the anglers use one with a window. Under a change in the Minnesota law, both must be specially licensed this year. Formerly only the "dark" house required such a license.

Comforts in Fishing Shacks

On Mille Lacs, a 100-square-mile expanse in central Minnesota and a much favored walleye lake, some fishermen even installed bunks last winter. All are equipped with stoves, and the coffee pot seldom cools.

Near Wadena, Minn., one enterprising angler even rigged up a television aerial. Many shacks are equipped with portable radios.

Such conveniences still are scoffed at by the more serious fisherman who is too busy watching his line or spearing hole. The latter is a hole at least 18 inches square chopped over comparatively shallow water.

Once the spearer's eyes are adjusted to the darkness, he has a clear picture of the lake bottom and any fish that passes beneath the hole. He usually is after a trophy-size northern pike of 15 pounds or upward.

Even for an angler, it requires patience, and many a day he will trudge home with nothing. According to Moyle's survey, the spearer averaged 0.25 fish per hour to the angler's 1.06 per hour.

But by far the greatest number of fishermen, without shacks, are standing against the winter wind. Military-surplus houses in the Twin Cities are thronged every winter by anglers in search of airmen's flight boots and the type of insulated rubber boots used in Korea.

Flight clothing, padded pants and coats are also in demand. Some prefer loose,



Colburn Machine & Tool photo

Enterprising anglers use power-driven posthole auger to drill hole through two-foot ice in six seconds



Drill designed for ice fishermen works like carpenter's brace. Below, heavy chisel is favorite tool



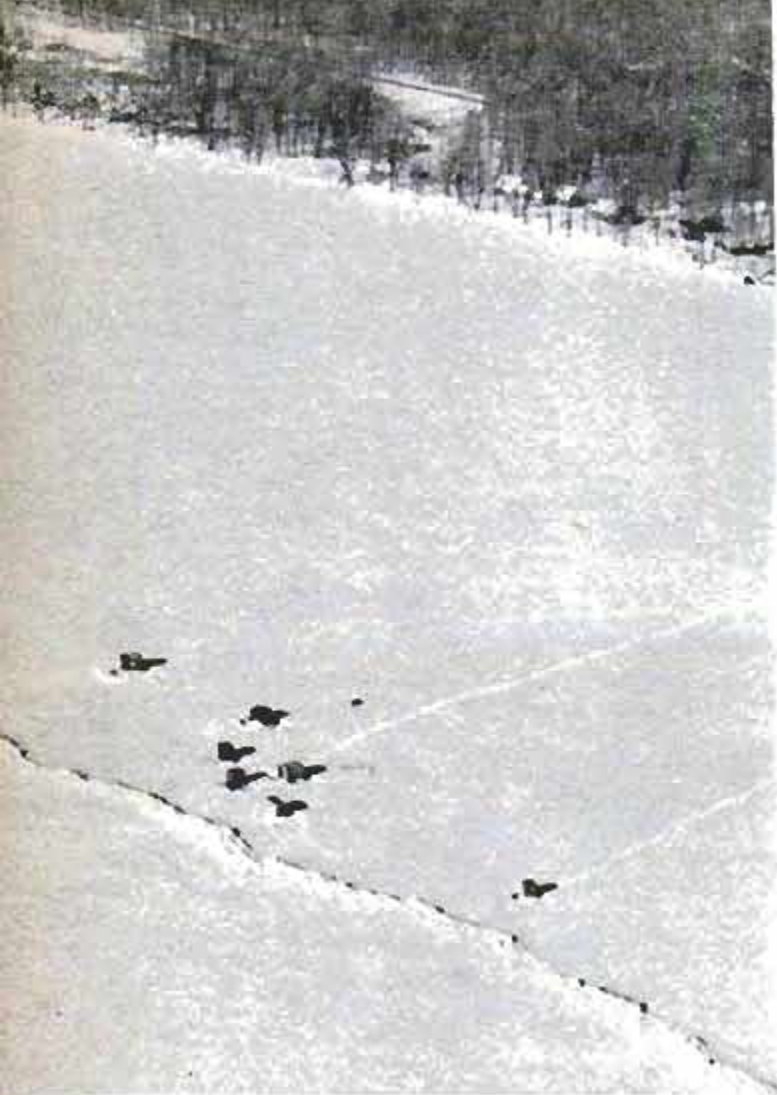

Nine-foot ice barrier bars fishermen from middle of Mille Lacs. Below, fishing from ice floes in the spring is an exciting but very dangerous sport



heavy mitts that can be dropped in a split second when the fishing bobber goes into action. Sporting-goods stores also now are offering more dressy, thermal-type, lightweight outfits.

Gaining popularity are Finnish socks of pounded felt. The newcomer who ventures out in ordinary footwear or leather hunting boots is in a hurry to get home.

Miniature Sailfish

It is common to see hundreds of properly attired anglers standing around their fishing holes with the temperature 15 degrees below zero. On such days the fish are super-quick frozen and, if a high wind comes along, the smaller ones will sail off across the slick ice.

Emil Berglund of St. Paul had a black Labrador pretty well trained along those lines, much to Emil's embarrassment. Fishing at Farm Island Lake near Aitkin, the dog retrieved a full limit of crappies from other unbemused anglers before Emil had completed chopping a hole.

First question asked by visitors from the southern areas is about the safety of the ice. There have been accidents, but they are rare and invariably have happened early or very late in the season, or on the large lakes or rivers where currents keep areas open or with only a thin shell of ice.

Most fishermen leave their car doors slightly ajar if there is the slightest possibility of danger. It is advisable to follow regular roadways over the ice. Some of these are as heavily traveled as city streets at the peak of the season.

During the 1955 St. Paul Winter Carnival, visiting members of the Cavaliers Club from San Antonio, Tex., were driven onto White Bear Lake for the annual fishing derby in three 20,000-pound city transit-system buses.

Since the road to the fishing grounds had been sanded, many of the Texans thought they were over a solid cement highway until they peered into some of the adjoining fish holes, cut over 20 feet of water but through 27-inch ice.

It was the fishing derby that brought the sport to the attention of those in the rest of the nation. Last year more than 400 fishing derbies were staged in Minnesota and western Wisconsin.

Elaborate Prizes

The contest is a family and town outing rolled into one, and usually with elaborate prizes. Last year Forest Lake sportsmen offered a trip to Mexico for two. Boats, motors and fishing equipment are the usual prizes.

The writer will have to shoulder some

(Continued to page 266)

**Buick
Cadillac
Chevrolet
Chrysler
Clipper
Continental
Corvette
De Soto
Dodge
Ford
Hudson
Imperial
Lincoln
Mercury
Metropolitan
Nash
Oldsmobile
Packard
Plymouth
Pontiac
Rambler
Studebaker
Thunderbird**

Read the **WHOLE STORY
on the '56 Cars in**

February

**IT'S P M'S FAMED
ANNUAL SECTION ON**

Cars

**49 pages about automobiles
INCLUDING**

- All the 1956 models,
complete specifications, prices
- Full-color portraits of the
world's sports cars
- Why do people buy the cars they do?
—another PM survey
- The truth about stock-car racing
as told by a champion
- Power-tune your engine
- Get more miles per gallon,
a how-to-do-it feature

ON THE NEWSSTANDS JANUARY 26



Small Car Still King On European Highways

Sleek three-wheeled convertible hits 65, gets 55 miles per gallon. Twin-cylinder two-stroke engine drives the single rear wheel by roller chain. Folding fabric top holds side curtains. The English "Powerdrive" has an \$885 price tag

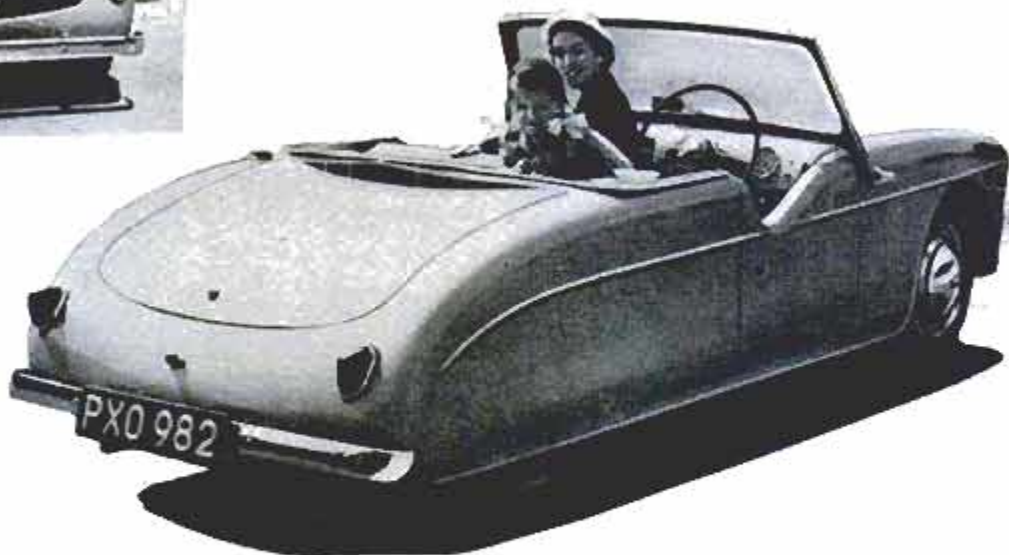

WHILE AMERICA keeps producing bigger and heavier cars, Europe continues to turn out midgets that are easier to handle, easier on the gas and less trouble to park. They'll win no horsepower race, but that doesn't seem to bother their owners a bit.



← Family motorcycle has a three-seater sidecar that hooks onto the cycle. It is complete with sun roof, hinged windshield, glass side windows, twin windshield wipers and comfortable seats like an auto's

Baby four-wheeler from France weighs only 530 pounds, gets 80 miles per gallon and has a top speed of 35 miles per hour. It carries two people with luggage. Full hand controls for disabled are optional





We're Running Out of Airspace

By Clifford B. Hicks

FOR A THREE-DAY period in September 1945—called “Black Friday” by the traffic controllers, who will never forget it—there was literally an air-traffic jam in the skies above New York City. Planes were stacked up in every holding pattern around the city, with more roaring in from every direction.

At one point for nearly an hour Civil Aeronautics Administration controllers were not accepting any flight plans whatever. Planes were backed up halfway across the country. In Chicago and Miami,

disgruntled passengers looked at clear skies and grumbled about the delay, while in New York the tense traffic controllers were sweating out the exacting job of guiding onto cleared runways all those planes that were droning through the murk overhead.

Thanks to the expert work of the controllers, every plane landed safely and every passenger waiting on the ground got into the air. The worst air-traffic jam in history finally was unsnarled without violation of a single safety rule.

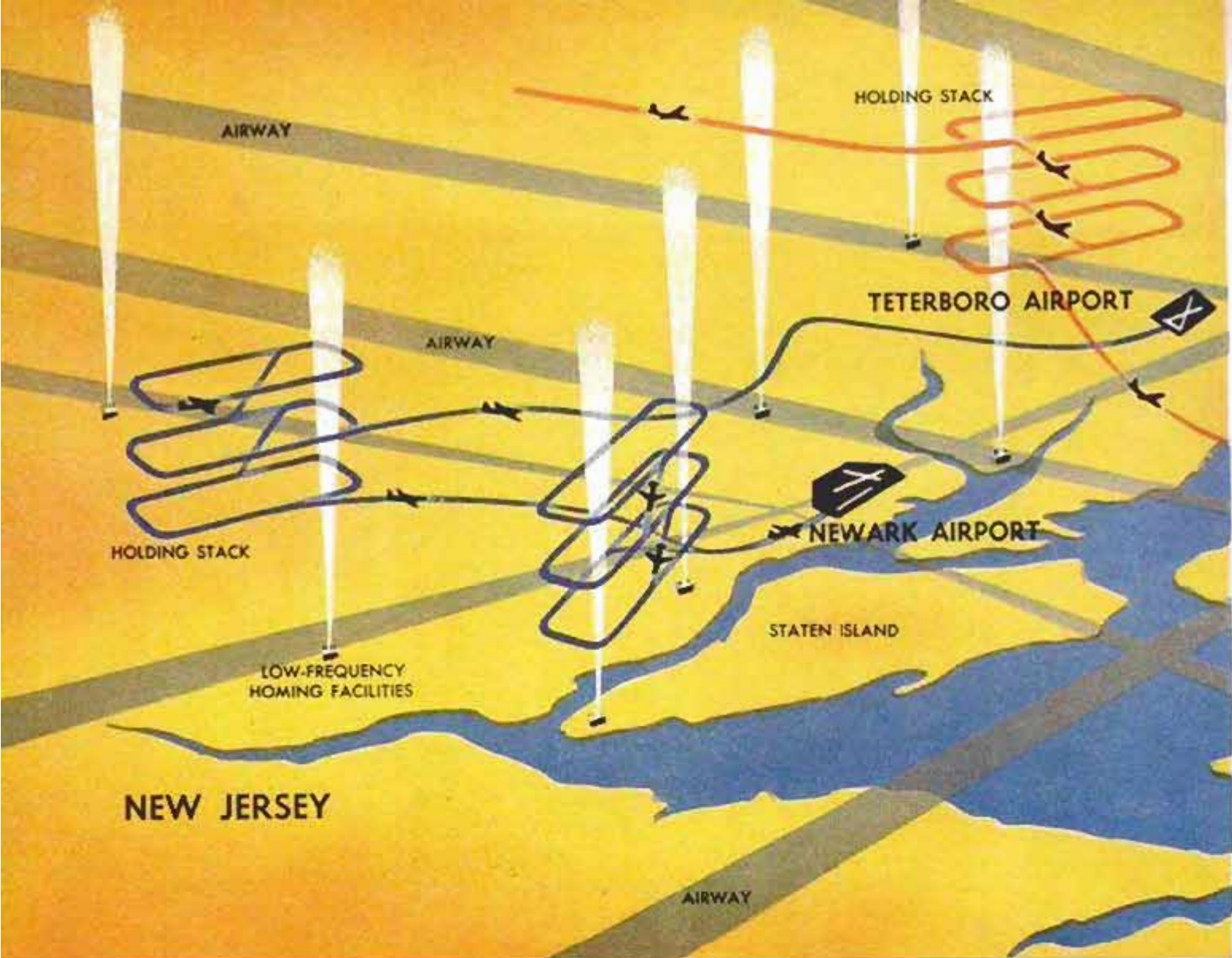

Long-range radar at terminal cities (below) puts much of the East Coast area under continual surveillance

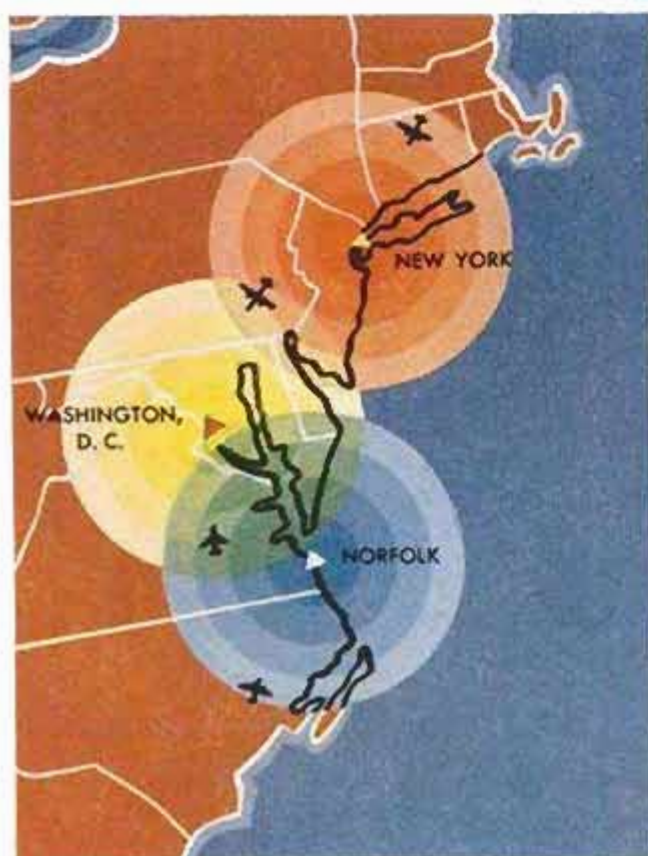

Studies of Black Friday never pinned down the precise reasons for the sudden glut of air traffic. But these studies, along with others made by the CAA, proved one thing: *in some areas of the country we're rapidly running out of airspace.*

Airspace is a nonrenewable asset. On the ground, you can build more highways and rail lines to solve traffic jams. But overhead there's a definite, limited amount of airspace. When it's gone, there is no more.

Surveying the magnificent bowl of blue sky, man tends to think his airspace is endless. Actually it's carved into a good many imaginary chunks—so many that in some areas there's nothing left to carve.

When you take a plane flight you fly along an airway, an aerial highway 10 miles wide. These highways are laid out by the CAA to provide the most direct route between airports while skirting any hazards to safe flying or safety on the ground. During instrument-flying weather, regulations require that all aircraft flying on the same airway be separated by at least 1000 feet in altitude, or by 10 minutes' flying time if two or more planes are at the same altitude. Thus a single plane oc-

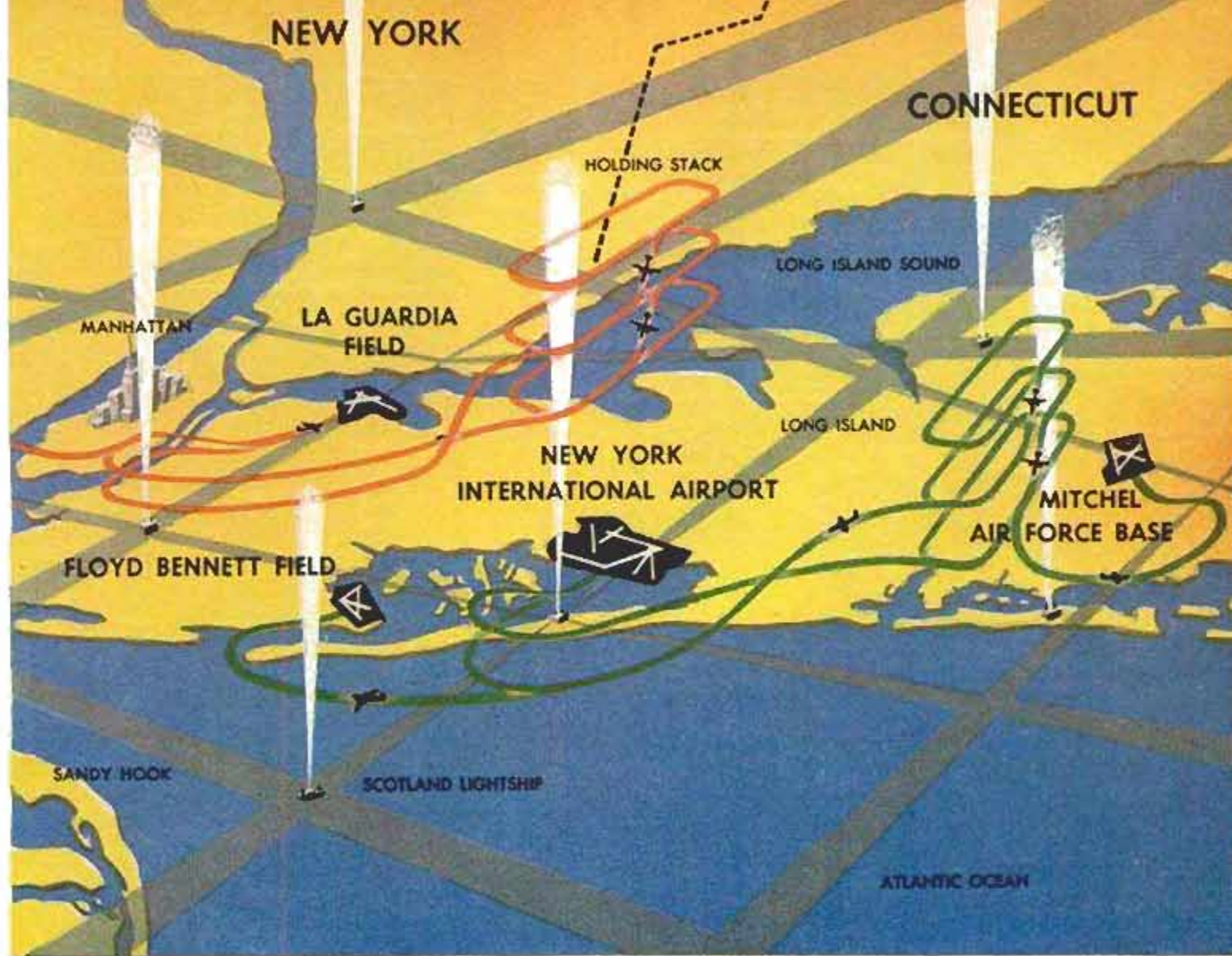

Several airports and high traffic level cause air-traffic jams above New York. Changes now being made will produce the pattern diagrammed above. Gray

lines represent the airways and white vertical lines are the holding fixes. In some cases, holding stacks will serve more than one metropolitan-area airport

cupies a tremendous chunk of airspace measuring at least 1000 feet high, 10 miles wide and some 40 to 60 miles long.

Multiply this by the number of planes in the air. Traffic on scheduled air routes of the United States today is nearly three times what it was when World War II ended. During 1954, control towers handled 17,261,461 plane movements, or almost 2000 every hour, day and night.

Today there are about 140,000 miles of airways. The airspace problem is not critical on most of these airways. But by their very nature, the airways converge upon metropolitan areas. Around these cities the air, except for scattered prohibited areas, is literally all airway. It is here that the airspace has been used up.

Take an example. At the Chicago Municipal Airport the daily traffic peak occurs between 5:00 and 6:00 p.m., when there is a plane landing or taking off every 20 seconds. Other trouble spots are Washington, D.C., Norfolk, Miami, Los Angeles, San Francisco and Seattle, with ominous hints of traffic jams showing up at Detroit,

Dallas, Pittsburgh, Cleveland and St. Louis.

The obvious answer—to add more airports—is probably the worst possible answer because it simply compounds the confusion. New York has the most critical airspace problem in the country, and here within 20 miles of La Guardia there are three major airports and four others capable of handling instrument approaches.

To see the problem clearly, watch what happens as you approach New York high in the air. Your flight is bound for New York International (Idlewild), one of the three major airports serving the city. As you enter the metropolitan area under instrument-flight conditions, the traffic controller must guide you unerringly through the web of New York traffic. Planes—some four of them per minute—may be taking off or coming into the various airports from every point of the compass. Your plane must bypass or pierce all the traffic around Newark Airport and much of the traffic around La Guardia to reach Idlewild. Since the weather is bad, planes are stacked up throughout the area,

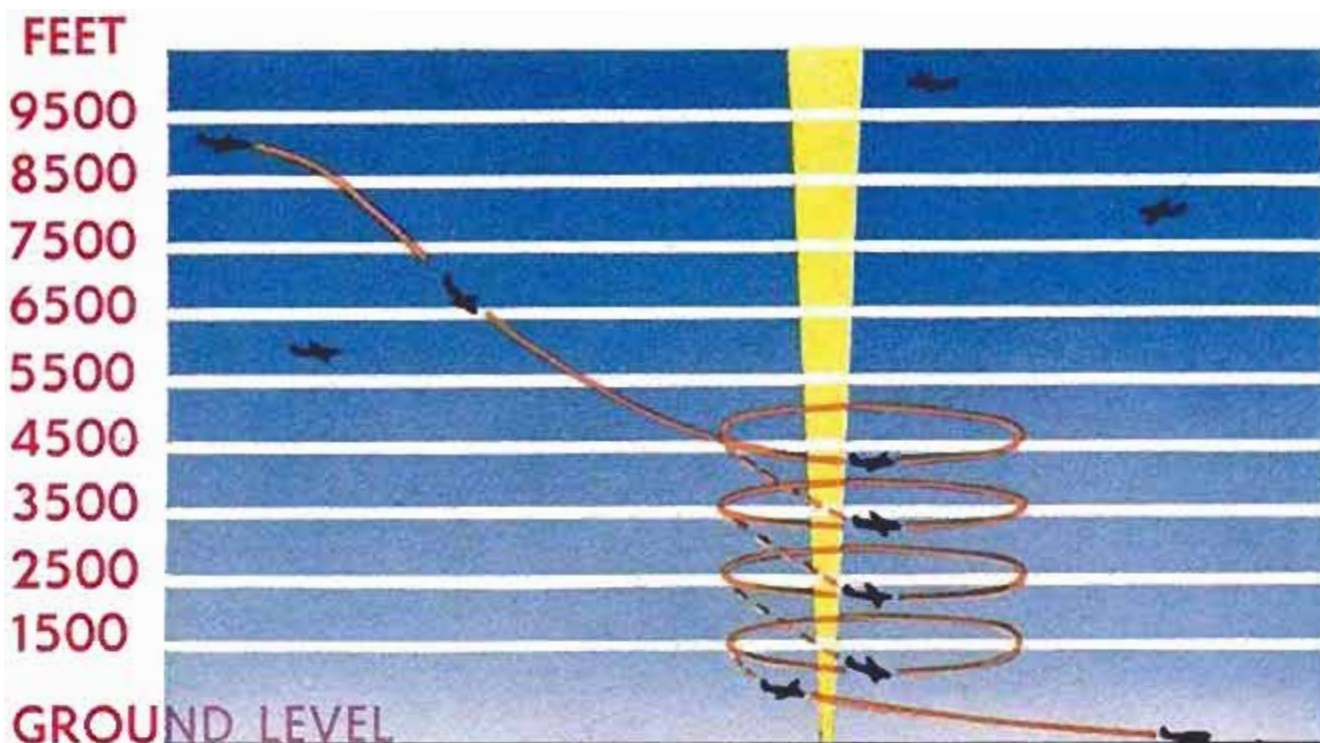

Each holding stack is looped around a radio beacon. Incoming plane enters top of the stack and works its way down. Controller's big problem is to feed planes through stack and onto runways with minimum delay

and your controller directs you to one of the two holding patterns for Idlewild. This is simply a long oval where planes are stacked up like cards in a deck awaiting their turn to land.

Holding patterns are divided vertically into layers of 1000 feet. Planes are handled on a first-come, first-served basis; you enter the top of the deck and work your way down. Eventually, when you reach the bottom and the tower man gives you permission to make your approach, you pass through the "gate" (the final wave-off point if anything is wrong) and land. It takes the average plane two minutes to descend from one level to another so, un-

til recent improvements, one landing every two minutes was the maximum possible rate. CAA controllers shuffle you through this deck of planes with an expert hand. Your safety is their primary consideration. Indeed flying today, despite the traffic jams in some areas, is safer than it has been throughout its history.

But the slightest hitch can cause an aerial misdeal. For example, a Boeing 377 Stratocruiser once dropped an engine on its way into Chicago. The tower controller had to hold 42 inbound airplanes simultaneously until the cripple landed. This held up traffic for 25 minutes and compounded the problem of getting the planes down.

"We know that air-space and traffic-control problems are serious and must be solved if we are to have sound aviation," says F. B. Lee, Administrator of Civil Aeronautics. "We have no doubt they can be solved."

More Holding Patterns

What are the solutions? More holding patterns? To make room for them, you sometimes have to establish them farther from the field, thereby increasing the time necessary for the bottom plane in this stack to reach the gate and land.

Intricate network of airways controlled by high-frequency radio blankets map of East. About as many low-frequency airways (not shown) also cover area. Traffic jams occur in air above focal-point cities





In experimental setup, radarscope is projected on glass table. Controllers move markers as the blips move

The CAA is using a high level of imagination to come up with some of the answers. Men, women and some ingenious instruments are hard at work on the airspace problem at the CAA's Technical Development and Evaluation Center at Indianapolis, Ind.

Each airspace problem is unique, and no pat formula applies to all of them. That's why a complex research tool developed at Indianapolis is so valuable. It's called the dynamic air-traffic control simulator and it combines radar, television, optical projectors, calculators and aircraft instruments. With this tool, researchers can duplicate the traffic conditions around any airport in the country, right down to the exact speed of every approaching plane.

The simulator is installed in a big room at the Center. Some 18 women (wives of CAA workers) are seated at one end behind aircraft-instrument panels. Each woman serves as a pilot and has been taught to "fly" her plane in response to orders given her by radio or according to instructions on a written script. Across the room from these "cockpits" is located a large screen which is overlaid with an airways map of

the metropolitan area that is under study.

When an experiment begins, the women start flying their planes into the area, duplicating the approach courses at the real airport. As each "pilot" flies into the area, a projector in front of her, synchronized with her instruments, casts a pinpoint of light onto the screen. This spot represents

Experimental computer may help guide pilot through maze of airways. Tiny plane moves across map to show him where he is
Sperry Gyroscope Co. photo

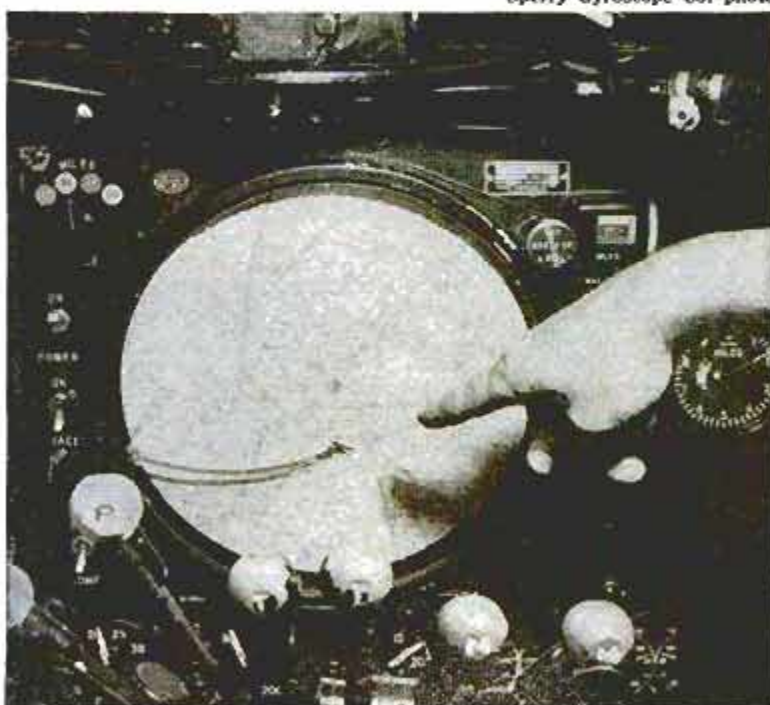

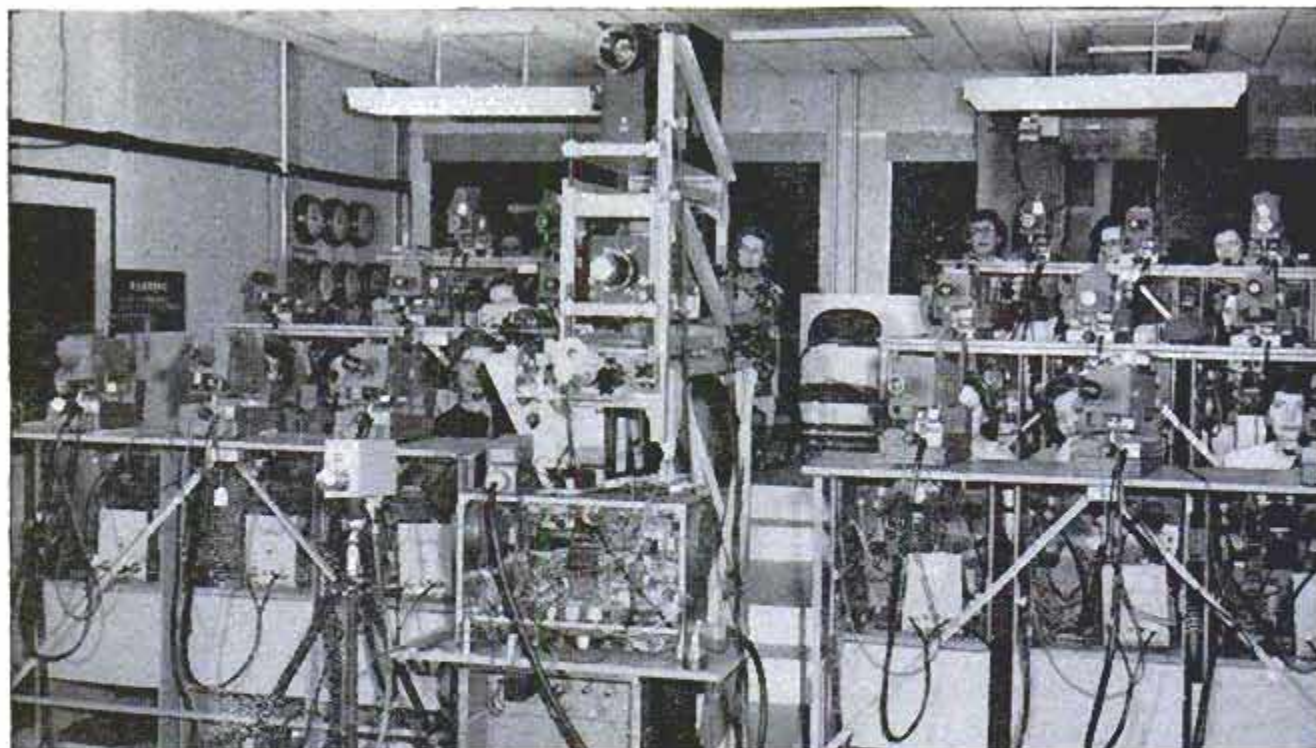

Complex instrument shown above and in diagram below can simulate air traffic anywhere in the world. "Pilots" sit behind instrument flight panels and guide dots of light representing planes across airways map

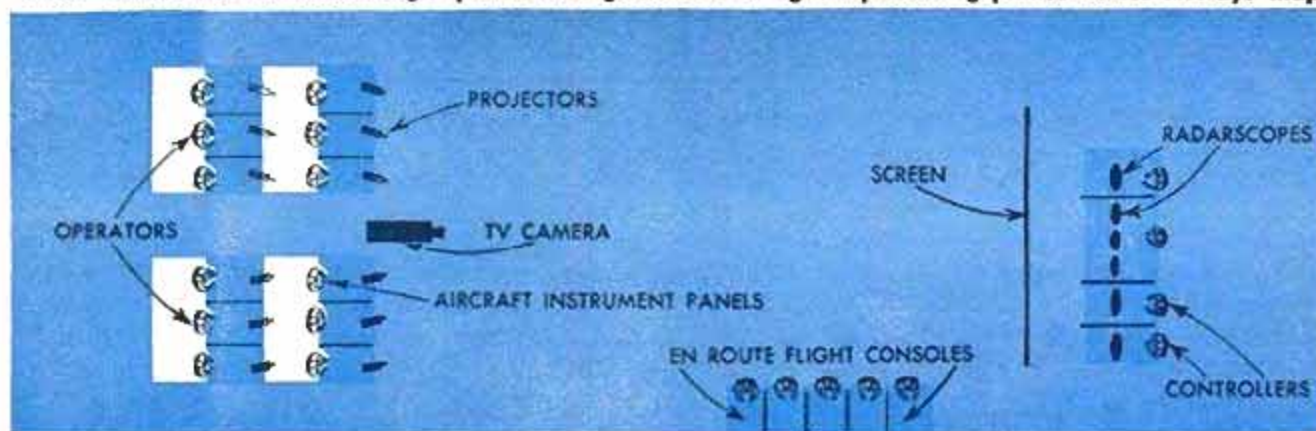

Controllers behind the screen must unscramble the traffic and guide each plane in for a safe landing at airport



her plane as it nears the airport.

A camera televises this screen with its moving spots of light, and projects the picture onto a radar screen. CAA controllers, seated in front of the radar screen, must handle the planes safely and land them with the least possible delay. They radio instructions to the pilots, who respond exactly as regular commercial pilots. As each woman "lands" her plane, she starts piloting another into the area. For experimental purposes the area can be so saturated with planes that the system actually breaks down. (In actual practice, of course, this never happens.)

With the simulator, the controllers can try any alterations in the terminal area. They can change the course of the airways, move holding patterns or increase their numbers, decrease the distance between the bottom of the stack and the "gate," even experiment with changes in safety regulations, all without endangering the life of a single pilot or plane passenger. The simulator is made to order to solve the complicated problem of the New York area, or the unique problem at Washington, D.C., where elements of three different airfields are located within a mile of each other.

The simulator was used with excellent success in solving the traffic jam at Norfolk, where there are five different fields, military and civil, within a few miles of each other. Long experimentation with the simulator brought about a solution whereby the bulk of the traffic flows along a single course and individual planes peel off into "feeding troughs" leading to their terminal airports.

One-Way Airways

One development that has come out of the simulator is one-way airways. In many situations these prove just as efficient as one-way highways. With all traffic moving in one direction there's no need to assign specific altitude levels for two different directions, nor is there a problem of high closing speeds. With planes at their designated altitudes, conflicts can occur only when one plane overtakes another. One-way airways have led naturally to the development of aerial intersections, much like the clover-leaves of superhighways, with intricate but efficient traffic patterns for high-speed turnoffs.

Other studies show that minor changes in runways can pay off with a great in-

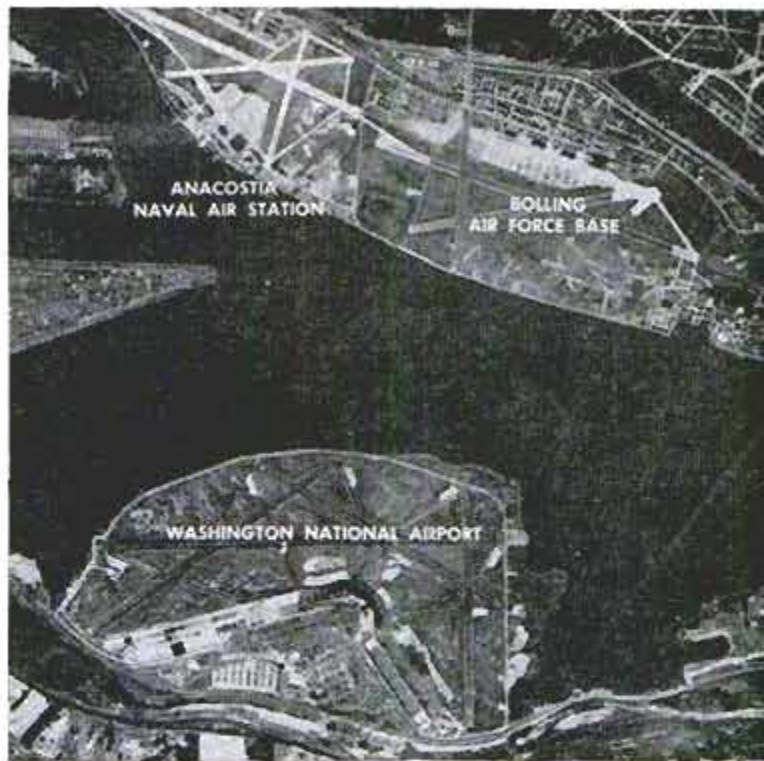

Jams have occurred at Washington where the National Airport and two service airports are located within a mile of each other

crease in an airport's traffic-handling capacity. On the average it takes a plane about 70 seconds from the time it passes the wave-off point until it lands, brakes to five miles per hour and makes a right-angle turn off the runway. Research at Indianapolis shows that a plane can safely negotiate a gradual turn off the runway at a speed of up to 30 miles per hour. If such a high-speed turnoff is available, the runway can be cleared in about 40 seconds, at which time a skillful controller will have the succeeding plane passing through the wave-off point.

Simulation studies of the New York problem have resulted in some concrete action. An Instrument Landing System has been in use on one runway at Idlewild for years. Now another is being installed. This is the first time two ILS systems have served the same airport. In addition, holding patterns have been changed, so that in most cases two different holding fixes serve each airport, giving the controller much greater flexibility in bringing in planes.

Long-Range Radar

But the biggest aid for solving the traffic jam is long-range radar. Until recently, airports had only short-range radar (about 30 miles) which was used by the tower controller as a visual check on the planes landing or waiting to land. By the time a plane was picked up, it already was approaching and virtually in the holding pattern, so radar served as a valuable safety

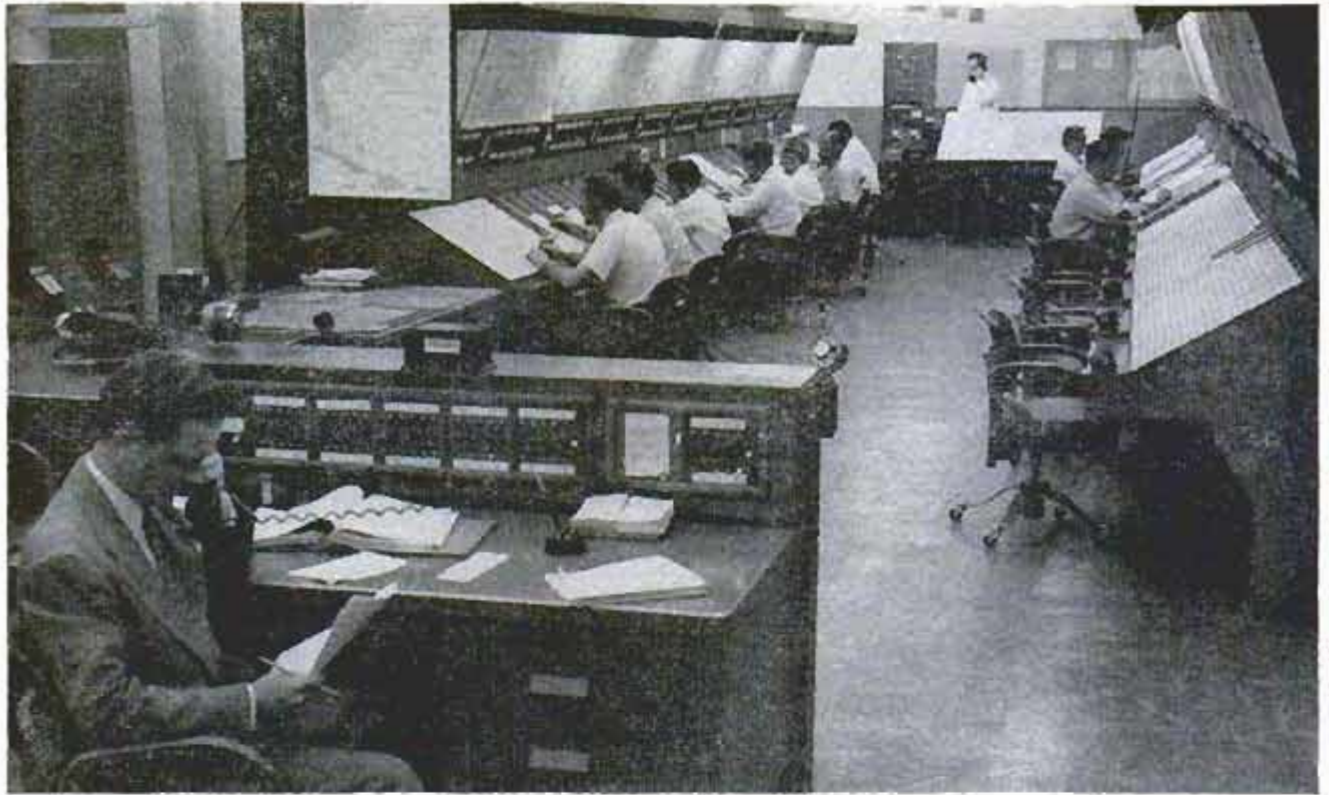

Men in traffic-control center know precise location of each plane, preserve a chunk of airspace around it

check but little else. Now a big new radar has been installed at Washington and another, on loan from the Air Force, now is being operated at New York by CAA personnel. Still another long-ranger already is in operation at Norfolk. This means that a plane can fly from Norfolk to Boston and be under radar surveillance virtually the entire distance.

To the controllers this is an incalculable help. When a blip appears on the scope, controllers know precisely where the plane is at any moment, and can follow it from far out. A plane under such radar surveillance can legally—and safely—approach within five miles of another plane at the same altitude. This permits control-

lers to bring planes into the metropolitan area much faster. They can route planes from some distance away toward one of two different holding patterns. If there are no conflicts, they can order a pilot to start his descent a long way from the airport. Often a plane at 11,000 feet is denied a normal letdown because another plane is cruising along at 9000 feet less than 10 minutes behind. The first plane is required to hold over a fix. With radar, such situations can be avoided, as the controller can actually watch both planes and warn the pilots if they approach too close for safety.

In order to make any airport function effectively during heavy traffic, planes must pass through the gate with the regularity of clockwork. There can be no big gaps. With radar, controllers can spot such impending gaps and route an incoming plane directly to the field, filling the gap without forcing the "holding" planes to wait any longer than would otherwise be necessary.

Radar will be even more important with the coming of jet transports. Jets, with their enormous fuel consumption at low altitudes, will not be able to fly a holding pattern for very long. Radar

(Continued to page 250)

Experimental instrument would aid controllers by eliminating handwriting on slips. It presents all information about planes in numbers on board

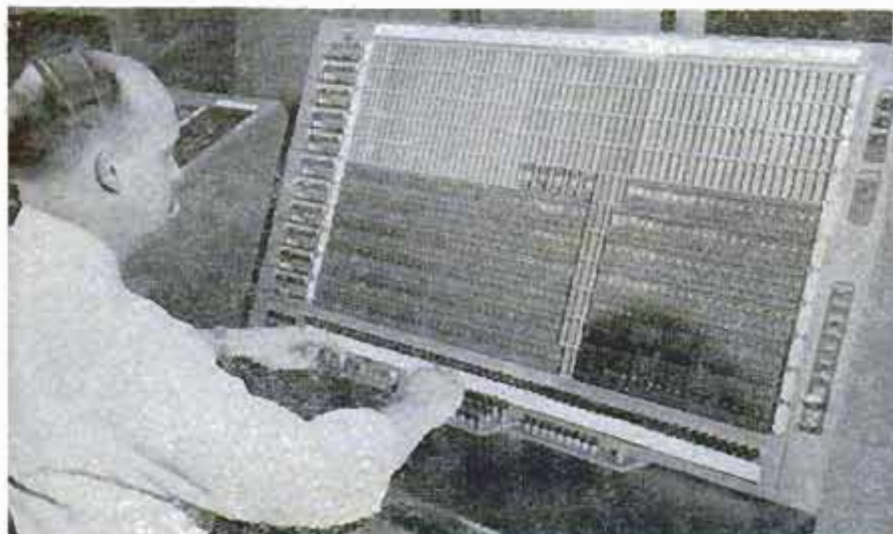

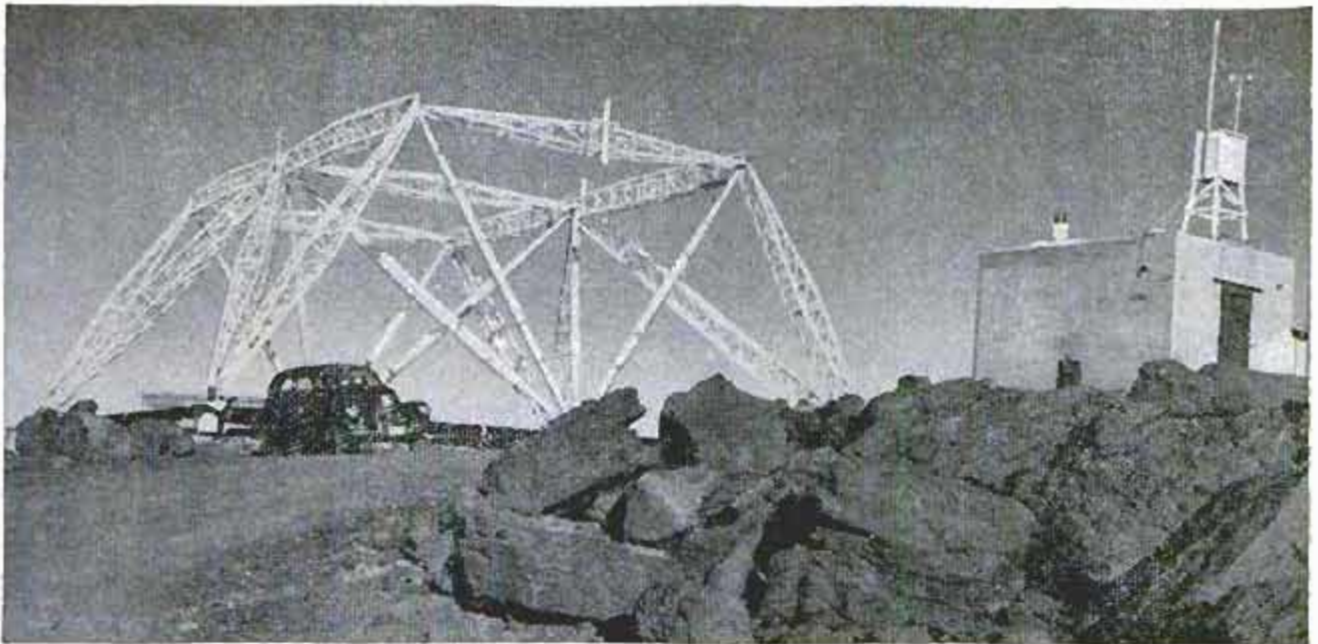

Rotating framework supports antenna which catches radiowaves that emanate from distant constellations

Instruments on Mountaintop Catch Cosmic Dust and Static

Strange effects from outer space are measured by two instruments resting on the peak of 12,000-foot Mount Haleakala on the island of Maui, Hawaii. One, a radiotelescope, has a huge framework which supports an antenna. The other instrument is no bigger than a sawhorse and catches meteoritic dust.

The radiotelescope, which rotates on a 360-degree track, catches the radiowaves emanating from distant constellations. By studying the differences in direct rays and those reflected off the surface of the ocean, radioastronomer Grote Reber hopes he will be able to pinpoint the exact origins of the "cosmic static."

The dust-collecting instrument includes a vacuum cleaner which draws air through a jet to deposit particles on a gelatin-coated film. The particles are analyzed to see if they originated from meteorites. Then they are put through experiments to determine whether meteoritic dust particles can serve as the nuclei of raindrops. Physicist Sean Twomey hopes to prove by the experiments

Dust-collecting device catches meteoritic particles



that heavy rainfall during the month of January is caused when the earth's orbit takes it through an area thick with meteors that disintegrate and fall into the earth's atmosphere as dust.



Hand-Cranked Wheel Chair

Rotating a hand crank propels a new wheel chair built for outdoor and indoor use. A lever on one arm assures positive steering. The chair is said to "float" over railroad crossings, climb four-inch curbs, go through mud or deep snow and spurt across an intersection at a speed of 10 miles per hour. It turns in its own length. The comfortable chair has foam-rubber cushions, coil springs, ball-bearing construction and a differential.

OWNERS REPORT on the MERCEDES-BENZ 300SL

Best-Liked Features:

"A more-than-wonderful experience to own and drive. A quiet machine that becomes an antelope when you want speed."

Investment banker

"I drive eight miles on a curving, crowned street twice a day and it's more fun than 18 holes of golf."

Sales manager

"What impresses me most is the way it sits down at really high speeds as though on railroad tracks."

Photographer

"Point by point, the finest piece of automotive engineering in all the world -- bar none."

Chemist

"The ultimate for high-speed cross-country driving when too much luggage does not have to be carried."

Rancher

Complaints:

"I would like roll-up windows."

Manufacturer

"Brakes are treacherous in wet weather."

Executive

"A little noisy in the indirect gears."

Cafe owner

"Being tall, I have trouble getting in and out."

Businessman



CLYMER TESTS the 300SL

By Floyd Clymer

OUR MERCEDES-BENZ 300SL had 15,500 miles on the speedometer at the start of the test. A California aviation executive, Wendell Fletcher, offered the loan of his car and we accepted.

The six-cylinder fuel-injection engine develops 240 horsepower. Displacement is 182.8 cubic inches, about half the size of a Cadillac, Chrysler or Lincoln engine.

The fuel-injection unit is designed and

manufactured by the German Bosch firm which has had long experience with fuel injectors, both in the diesel and gasoline field. (German fighter planes in World War II were equipped with Bosch gasoline injectors.) The fuel is intermittently injected directly into the combustion chambers. Because of fuel injection, carburetion flat spots are eliminated and pickup is

(Continued to page 258)

One of the sleekest cars in the world, the 300SL stands only 51 inches high. It has a dignified and unpretentious look, but it's loaded with performance

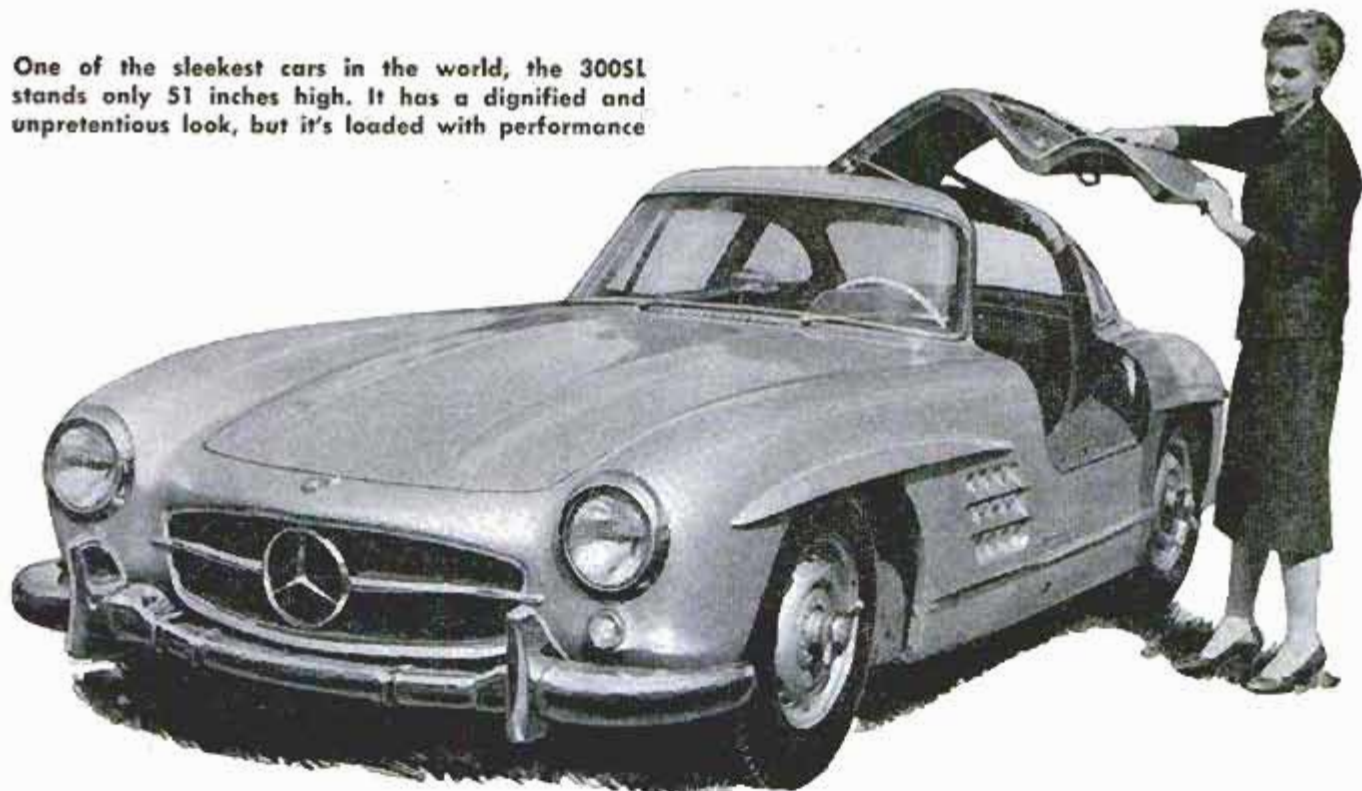

By 300SL Owners

WHAT IS NEXT in engine design? Many experts say it is fuel injection—they claim the carburetor is inefficient and inadequate for today's high-performance engines. Others argue that fuel injection is too temperamental, too sensitive and too expensive for the family car.

To find out how fuel injection performs in day-by-day operation we surveyed owners of the Mercedes-Benz 300SL, a \$7500

sports car with a fuel-injection six-cylinder engine. These owners are experienced with fuel injection. They use it in all kinds of weather, under all conditions. They know its good points and its bad points. We asked them to tell us.

The owners are enthusiastic about the advantages of fuel injection. Almost all of them say it's practical and should be on every car. Only six percent do not believe

Doors swing up from a high sill that increases structural rigidity, but makes entry and exit a bit awkward

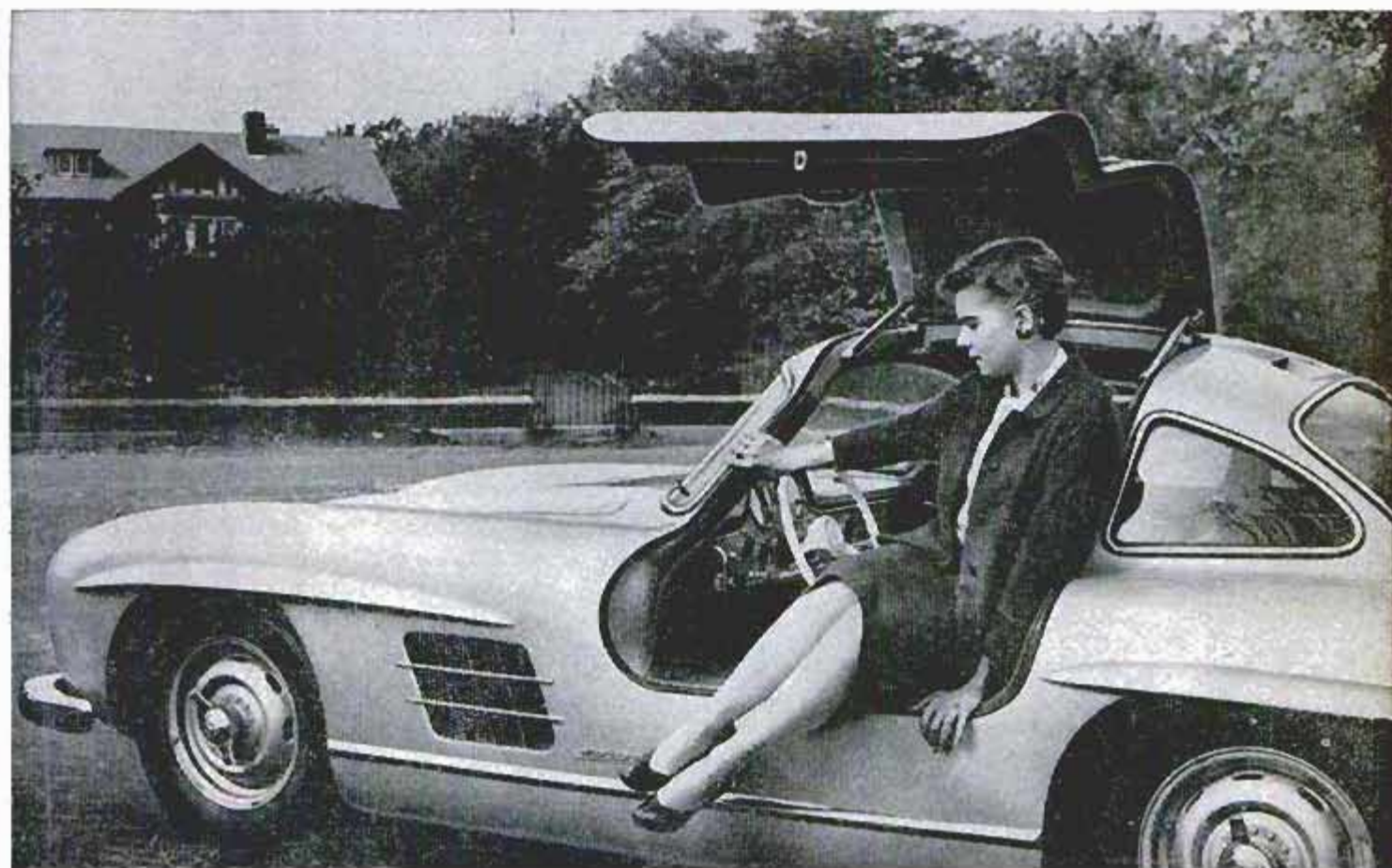



You can see why the doors are called gull wings. They open and close easily due to counterbalancing. Windows don't roll up and down, but are clamped into position from outside car

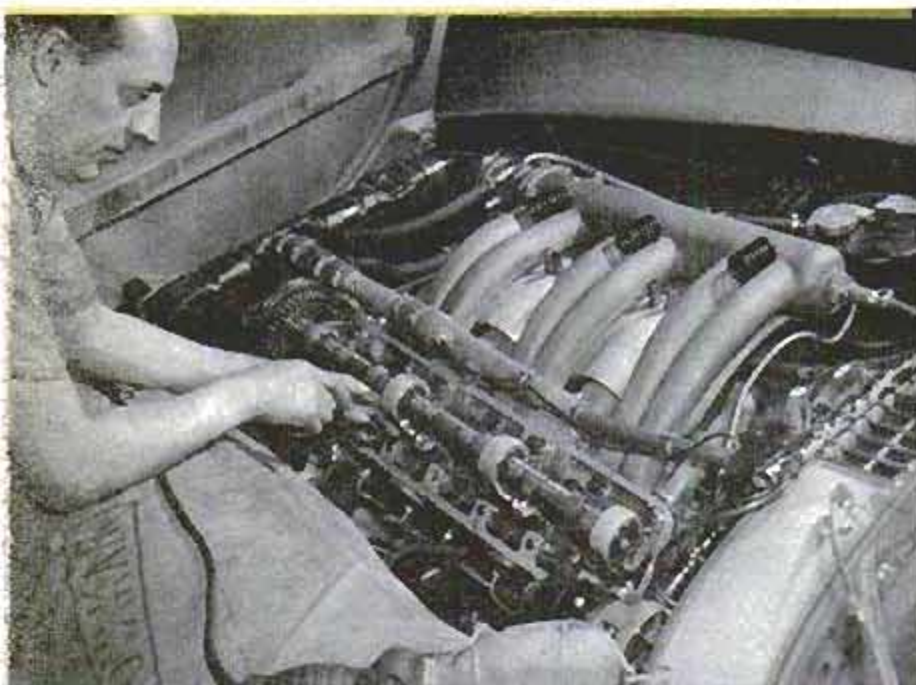

Mechanic works on overhead camshaft. "Plumbing" is part of injection system. Engine tilts to fit under low hood. Below, gas tank and tire fill trunk; hammer is for removing wheels

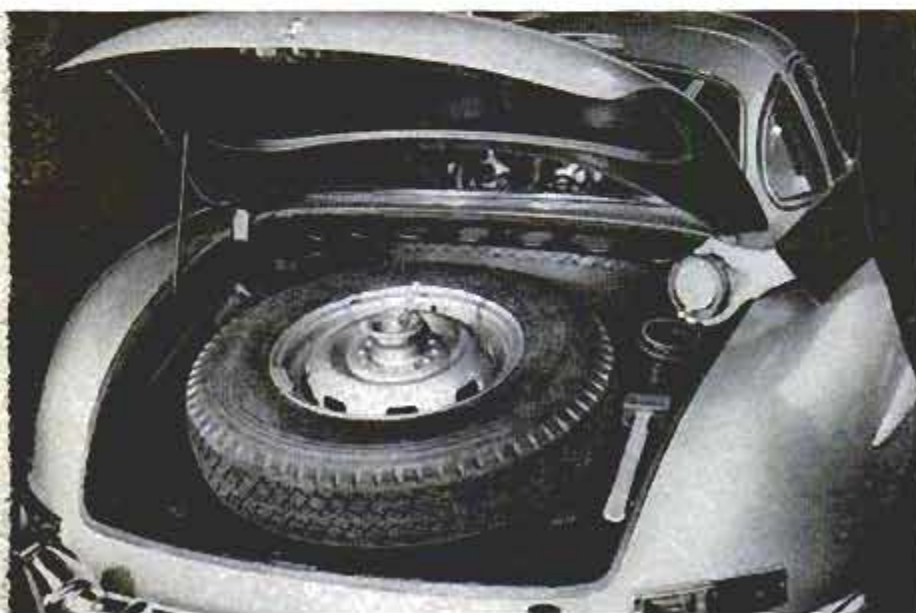

it is perfected enough for use on the family car at this time. But an enthusiastic 89 percent are convinced it's the best fuel system for any car, sports or family. The remaining 5 percent are undecided.

Why is fuel injection so good? Here are some of the reasons given by the owners:

Why Fuel Injection?

"Better mileage, more power, better acceleration with no flat spots. In every way fuel injection is superior to carburetion."—California car dealer (not a Mercedes-Benz dealer, incidentally).

"Excellent economy of operation. I believe that it is definitely the coming thing in this industry."—California oilman.

"Troublefree. I would like it on all my automobiles."—New Jersey manufacturer.

"Not as much tuning trouble as with carburetors. Much quicker starting in cold weather."—California owner.

"Great flexibility. Very low specific consumption. Superior to carburetors in every way except serviceability."—Pennsylvania construction man.

"Sure it's practical. I use the car every day to drive 40 miles. Have had no trouble with fuel injection."—California executive.

"Provides wonderful performance from a small engine."—Nevada businessman.

By the way, the displacement of the 300SL engine is only 182.8 cubic inches. It is smaller than the engine in any standard car built in this country—smaller than the Rambler Six, for example. Yet it develops 240 horsepower and the car will go 150 miles per hour!

What are the reasons given by owners who say fuel injection is not practical?

"Fuel filters must be cleaned too frequently."—Illinois owner.

"Temperamental. Requires nursing. Excellent in the hands of good driver."—Wisconsin attorney.

"Too few know how to repair the pump."—New Jersey retail merchant.

Some owners say the system is practical, but too expensive for the family sedan.

"Cost is main deterrent to widespread use of fuel injection."—Connecticut manufacturer.

Results of PM Poll of Mercedes-Benz 300SL Owners

Fuel-injection system

Have had some trouble.... 12%
Have had no trouble..... 88%

Fuel injection for family cars?

Yes, is practical..... 89%
No, is not practical..... 6%
Do not know..... 5%

Easy to drive in traffic?

Yes, is easy..... 84%
No, is difficult..... 7%
No answer..... 9%

Riding quality

Excellent..... 73%
Average..... 18%
Poor..... 4%
No answer..... 5%

Is entrance too awkward?

Yes, too awkward..... 25%
No, not too awkward..... 71%
No answer..... 4%

Would buy another?

Yes..... 89%
Might..... 5%
No..... 6%

OVER-ALL RATING

Excellent 99 %
Average 1 %
Poor 0 %

Have owned another sports car?

Yes..... 83%
No..... 17%

What was previous sports car?

Jaguar..... 40%
Porsche..... 17%
Aston Martin..... 10%
Mercedes-Benz 300..... 6%

Best-Liked Features

Performance..... 60%
Handling..... 35%
Roadability..... 22%
Comfort..... 20%

Quality construction..... 17%
Styling..... 17%
Quiet..... 9%
Brakes..... 9%

Most-Frequent Complaints

Difficult to enter..... 13%
Window design..... 9%
Dealer service..... 7%
Brakes when wet..... 7%
Noisy gears..... 6%
No trunk space..... 6%
Noisy tires..... 5%
Steering-wheel position..... 5%
Leaks..... 5%
Ventilation in rain..... 5%

No complaints at all..... 17%

What Should Be Changed?

Needs no changes..... 35%
Adjustable steering wheel... 11%
Improve doors..... 6%
Offer convertible top..... 5%
Dash light too bright..... 4%

"It can never be mass-produced."—California food processor.

Some of the owners have had trouble with the fuel-injection system, although in all cases the trouble was corrected. Here are troubles mentioned: pressure leaks, broken nozzle spring, broken pump, clogged nozzle and improper adjustments.

Fuel injection seems to provide fuel economy. Many of the owners report averages of around 20 miles per gallon on trips and it is a safe bet that they drive at high speeds most of the time. In city driving they report averages of about 16 miles per

gallon. See the Economy Test results shown on this page, below left.

What About the Rest of the Car?

There is more to the Mercedes-Benz 300SL than fuel injection, though, and we asked the owners to tell us what they think about this machine. Their answers are phenomenal. Almost unanimously, they described the car as excellent over-all. Only one owner in the sample failed to give it an excellent rating and he described it as average. No owners called it poor. This is the best recommendation any car has received in our five years of Owners Reports.

The single owner who described it as less than excellent had this to say about the car:

"Styling is smart. It has good getaway. Suspension is wonderful on slippery roads. Have had trouble with door locks. Oil sprays over the engine. Difficulty with wheel alignment. Brakes dangerous when a little wet. I have trouble keeping warm in winter. Many small things seem to give trouble."—New Jersey owner.

How Wonderful Can a Car Be?

It is difficult to know where to start quoting when the replies are so enthusiastic. For example, here are a few comments from owners:

"The car is fantastic!"—Arizona owner.

"I keep my 300SL very carefully, mechanically and appearance-wise. I spend some hours wiping the engine clean of even the slightest fleck of dust. I enjoy this. I enjoy the whole car. It is a revelation to own such a quiet piece of machinery which can become such an antelope when you want speed."—New York banker.

TEST DATA

Acceleration Tests

MERCEDES-BENZ 300SL

Equipped With 3.25:1 Rear-Axle Ratio

¼ mile from zero 15.2 seconds
½ mile from zero 24.8 seconds
0 to 30 m.p.h. (1st gear only) 3.7 seconds
0 to 60 m.p.h. (1st and 2nd gears) 9.1 seconds
Top speed (by speedometer) 150 m.p.h.

Actual top speed about 137 m.p.h.

Clymer's Economy Test

MERCEDES-BENZ 300SL

Miles per Gallon

At constant 30 m.p.h. - (in 3rd gear) - 22.8 m.p.g.
At constant 50 m.p.h. - 22.4 m.p.g.
At constant 60 m.p.h. - 20.3 m.p.g.
At constant 75 m.p.h. - 16.9 m.p.g.

Mileage - Cross Country

Los Angeles to Rosamond Dry Lake in Mojave Desert (via Angeles Crest winding mountain highway) 18.9 m.p.g.
Rosamond to Yuma, Ariz., via Salton Sea (246 ft. below sea level) 21.6 m.p.g.
Yuma to Los Angeles via Needles, Calif., and Lake Arrowhead 20.3 m.p.g.

Not to be confused with the 300SL, the Mercedes-Benz 190SL has a four-cylinder, overhead-camshaft engine of only 115.7 cubic inches. It does not have fuel injection, instead has two Solex carburetors. It has a top speed of about 100 miles per hour, a 0-to-60 time of about 13 seconds. Very rigid and rattlefree, it is a fine, carefully built, high-speed touring car with roll-up windows, easy-to-operate top. It costs about \$4000.



"I drive on a curving, crowned street twice a day and it's more fun than 18 holes of golf or high-school football was. And I am 47 years of age."—California owner.

"No one but an owner can conceive what a truly fine car the 300SL really is. The finest piece of automotive engineering in all the world—bar none."—Florida chemist.

Complaints

However, there are some complaints. The owners are enthusiastic, but not blind to the car's faults.

The most frequently mentioned complaint involves the gull-type doors that swing upward from roof-mounted hinges. The car is too awkward to enter and leave, say 25 percent of the owners.

"Turret doors are unnecessarily extreme and certainly poorly designed for women."—New York advertising executive.

"Getting in and out is awkward, but who cares in a sports car?"—California canner.

"A little difficult getting in and out, but once you are in and on your way you find yourself happy once again."—California investment banker.

"If you have trouble getting in, you have no business driving the car."—Wisconsin engineer.

Finally on the door subject is this comment from a woman owner: "It is not awkward. After a half hour's practice with tight skirt I find it practical, although owner should be athletic."—California owner.

Second on the complaint list was the absence of roll-down windows. Because of the door construction, there is no room for window-crank linkage. The windows are removable, but you have to be outside the car to do it.

"Windows assemble from the outside. This is inconvenient during rainstorms. They will eventually have to operate from inside."—Michigan engineer.

"Lack of a convenient and accessible place to keep the windows when removed."—Ohio real-estate man.

"Don't like window arrangement. However, there seems to be no alternative due to the frame. It's still better than side curtains."—California disk jockey.

Third most frequent complaint was the poor dealer service. There were 7 percent of the owners making this complaint.

"Mercedes people seem more interested in tuning cars for racing and the resultant publicity than in repairing cars already sold. Cars will be out of service at least

(Continued to page 262)



Tiny Record Player in Toys Makes Them Talk Back

Telephones, Teddy bears and other toys now are talking back to the small fry. A miniature record player built into the toys is said to talk louder than the normal human speaking voice. The record is played by turning a crank. Up to 25 seconds of sound can be recorded. The record is still loud after more than 6700 plays.

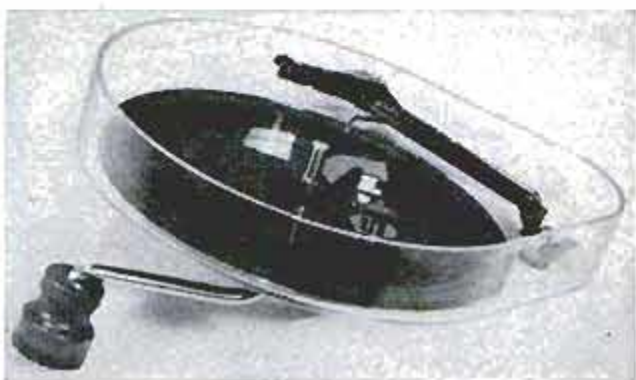

German Monorail Transports Concrete in Cars at 100 Yards per Minute

In Germany, little cars riding monorails are used to transport concrete from the mixer to the construction site. The rail can be laid, taken up or moved to a new site quickly. The little car, powered by a three-horsepower gasoline engine, moves along

the rail at 100 yards per minute and requires no driver. It carries 10 cubic feet of concrete, and a trailer can be attached to increase the load. The car can also be powered by an electric motor or even by a small diesel engine.



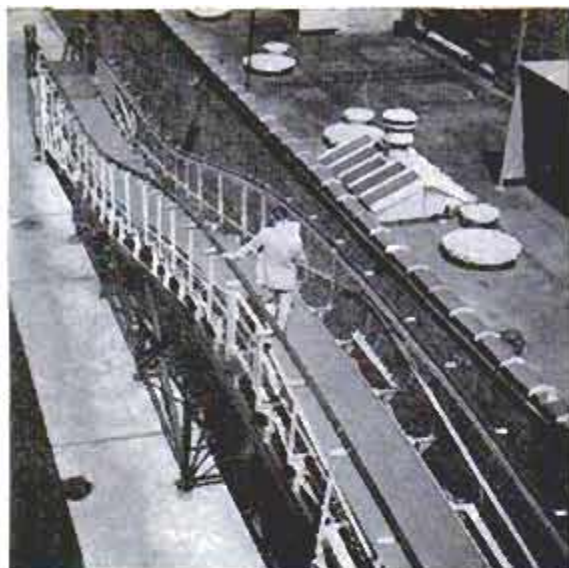

Moving Sidewalks Carry Pedestrians Around Turns, Up Hills

Moving sidewalks that travel at normal walking speed have been unveiled by two companies. One, built by Hewitt-Robins, Incorporated, consists of a rubber carpet mounted on a train of steel pallets that run on steel track. Electric motors drive a chain which engages dogs on the underside of each pallet. The conveyor takes

curves, loops or moderate grades in stride. Three will be installed at a new air terminal in Dallas. The second moving sidewalk, built by Otis Elevator Company, has an endless series of articulated, cleated treads, traveling on a wheel and track system, with ball-bearing "wheels." The conveyor can climb grades as steep as 14 degrees.



Robot Drives Toy Tractor Away From Obstructions

No obstruction can overcome "Marvelous Mike," a robot that operates a toy tractor. When the tractor strikes an obstruction, the robot quickly shifts gears, operates clutch pedals and backs away from the obstruction. Then it rumbles off on a new tangent. The robot's arms and legs move realistically as he operates the controls of the tractor. "Mike" and his tractor won't stop until the youngster turns off the switch. The toy is powered by a 4½-volt motor operated by three flashlight batteries in a box behind the robot.

Car Bingo Keeps Travelers Entertained ➤

Bingo has appeared in a new form for breaking the monotony of long auto trips. Included in the new game are eight plastic-coated cards with pictures of typical sights along the road. Players mark off the squares with crayons. At the end of the game, the crayon marks can be wiped off with paper tissues. The set includes four different bingo games using automobiles, traffic signs, billboards and trademarks.



Midget Autos Check Freight Cars

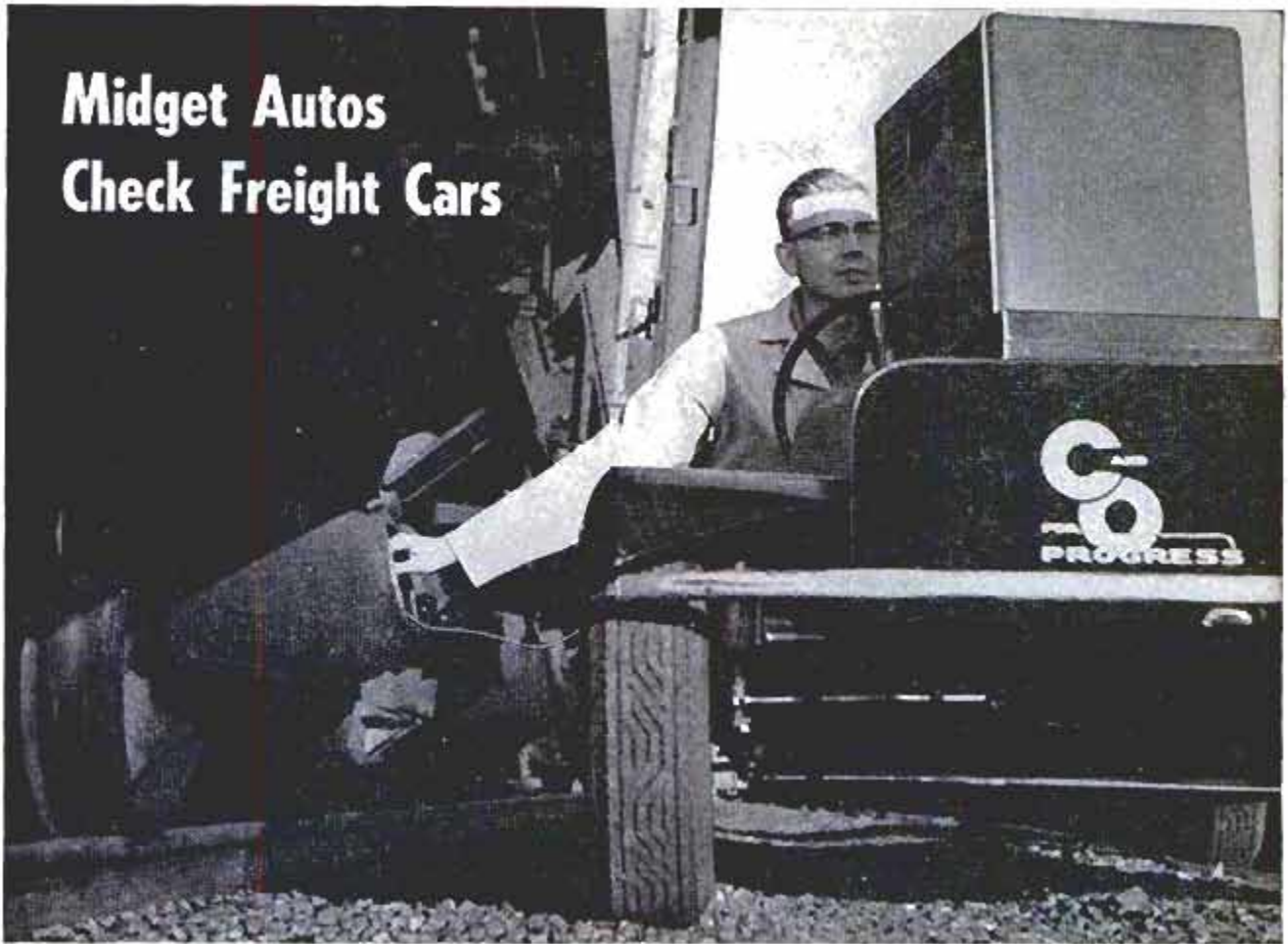

Inspecting railway axles and wheels was a tedious job until the Chesapeake and Ohio started using midget cars. The little autos roll right down the ties with the driver at just the right level to check the wheels. Built into the cars are flaw-detecting reflectoscopes which project ultrasonic waves. The waves bounce back if they strike a flaw in the wheel or axle, and show up on an oscilloscope mounted directly in front of the driver. The system eliminates the need for disassembly of the trucks during inspection.



Lawn Rake With Rubber Teeth Won't Spear Leaves or Toes



Flexible rubber teeth on a contour-hugging rake comb up leaves and cuttings but do not dig out the grass or damage roots. Because the rake does not spear the leaves, no unclogging of the teeth is necessary. If the rake is left on the lawn and someone steps on it, the rubber teeth simply flatten. There is no injury to the foot and the handle does not fly up. The rake is made in 8, 12, 16, 20, 24 and 32-inch widths.

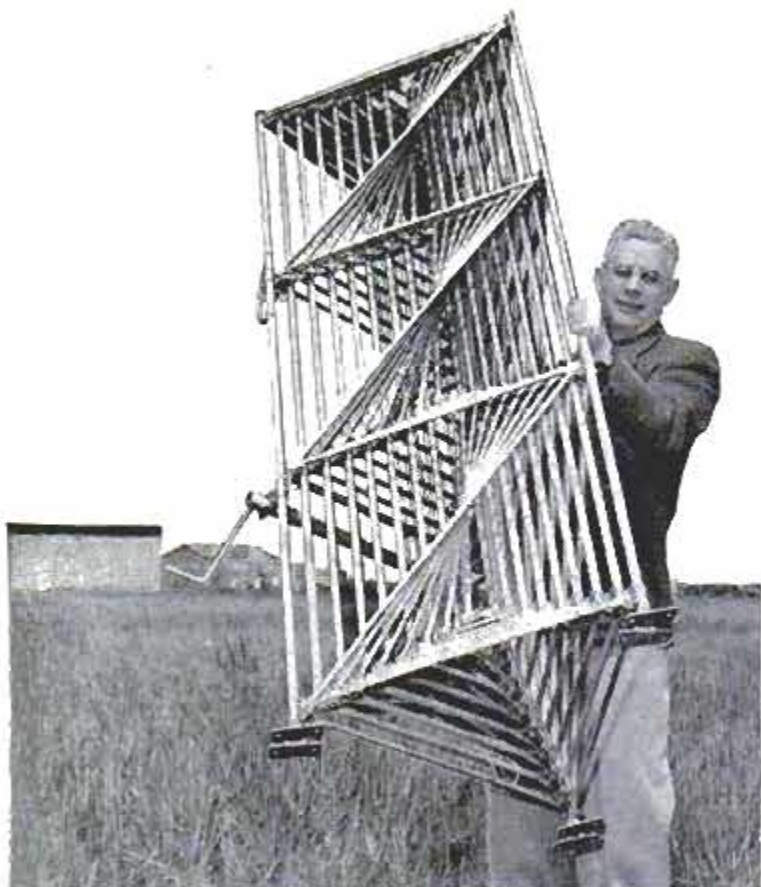
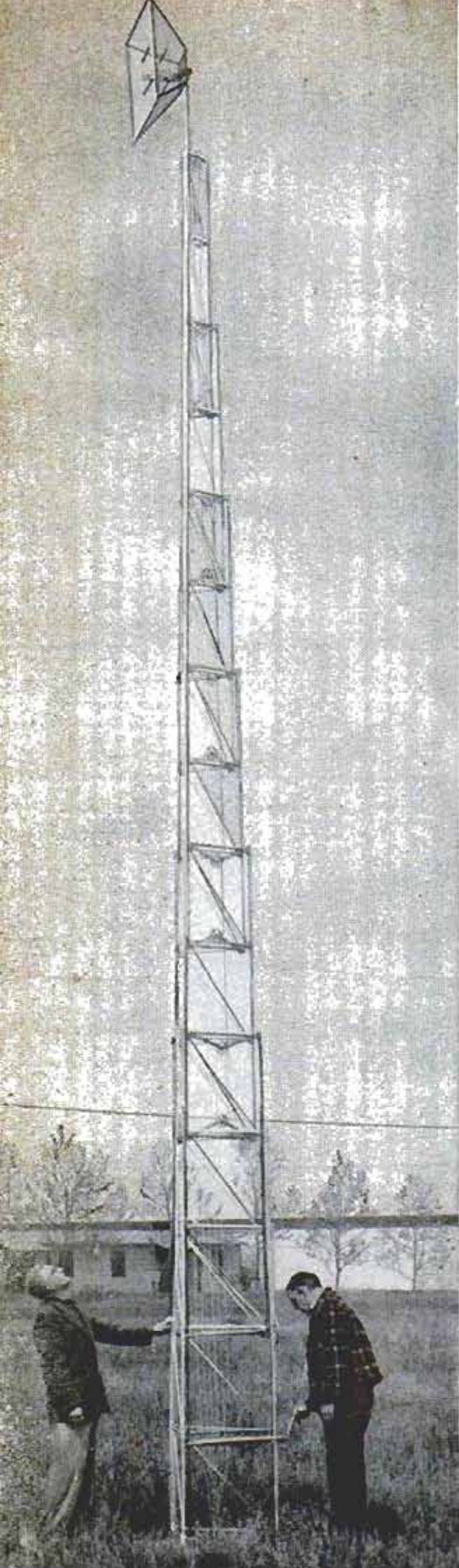

Fifty-pound nested tower, cranked up at left to 40 feet in five minutes, is held by inventor-manufacturer C. R. Parmenter

Tower on the way up. Operator of crank holds the nylon cords that operate locking levers that anchor each section of tower

Photos on this page by Alpar Manufacturing Co.

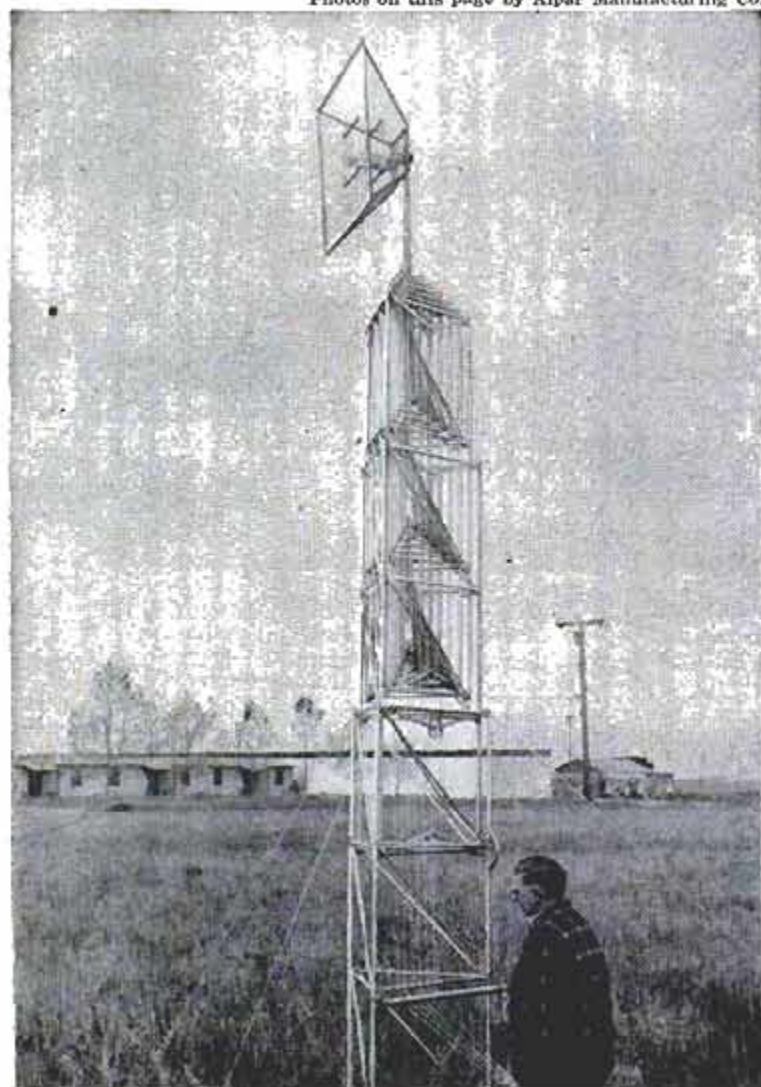

Radio Towers Crank Up To the Sky

RADIO AMATEURS and Civil Defense officials can carry a nested 40-foot radio tower in their station wagon or on top of a car, then crank it up to full height when they wish. The collapsible aluminum tower weighs 50 pounds and can be extended for use in five minutes. An ingenious system of cord-operated levers locks or unlocks each section of the tower as it is raised or lowered.

The towers are engineered to withstand 100-mile-per-hour winds when properly guyed and can be lowered at once when higher winds are expected. Among other purposes, they are used for temporary lighting stands and for public-address systems. One railroad company mounts a collapsed tower on a rail car, then erects the tower at various points along its right of way to check the signal reception of the division's radio transmitter.

Another kind of aluminum crank-up tower, 60 to over 100 feet tall, is assembled on the ground and then erected by one man in less than an hour with the aid of a short boom or spar pole. ★ ★ ★

Hundred-foot aluminum tower used by Stanford Research Institute in Arctic research is assembled on ground, then cranked into vertical position. Here, icing problems bar nested type of tower

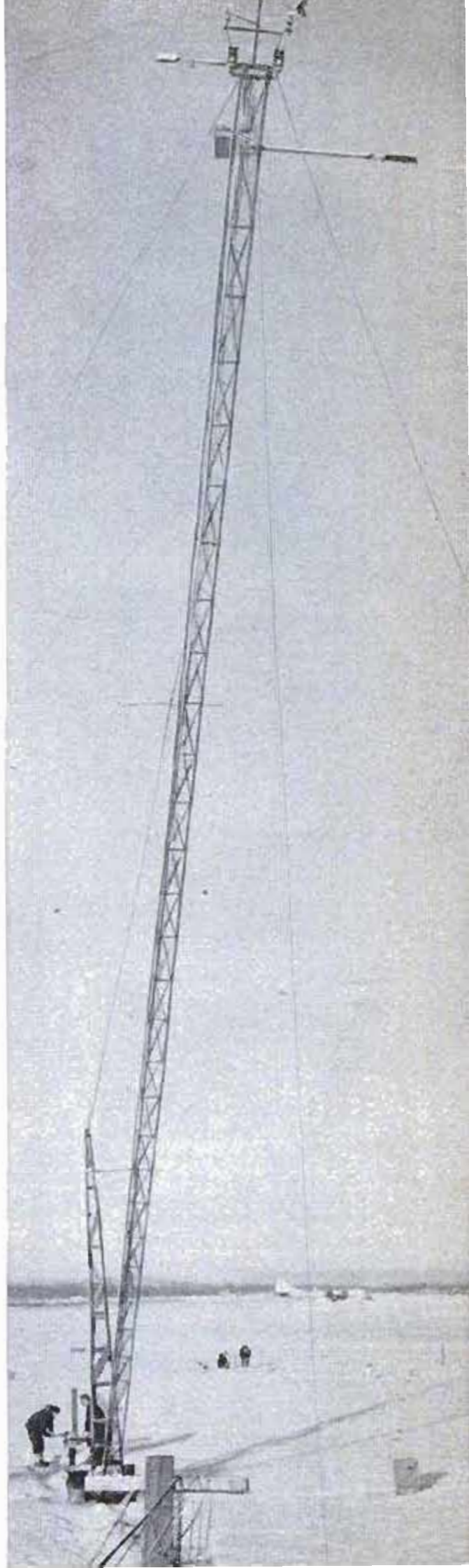
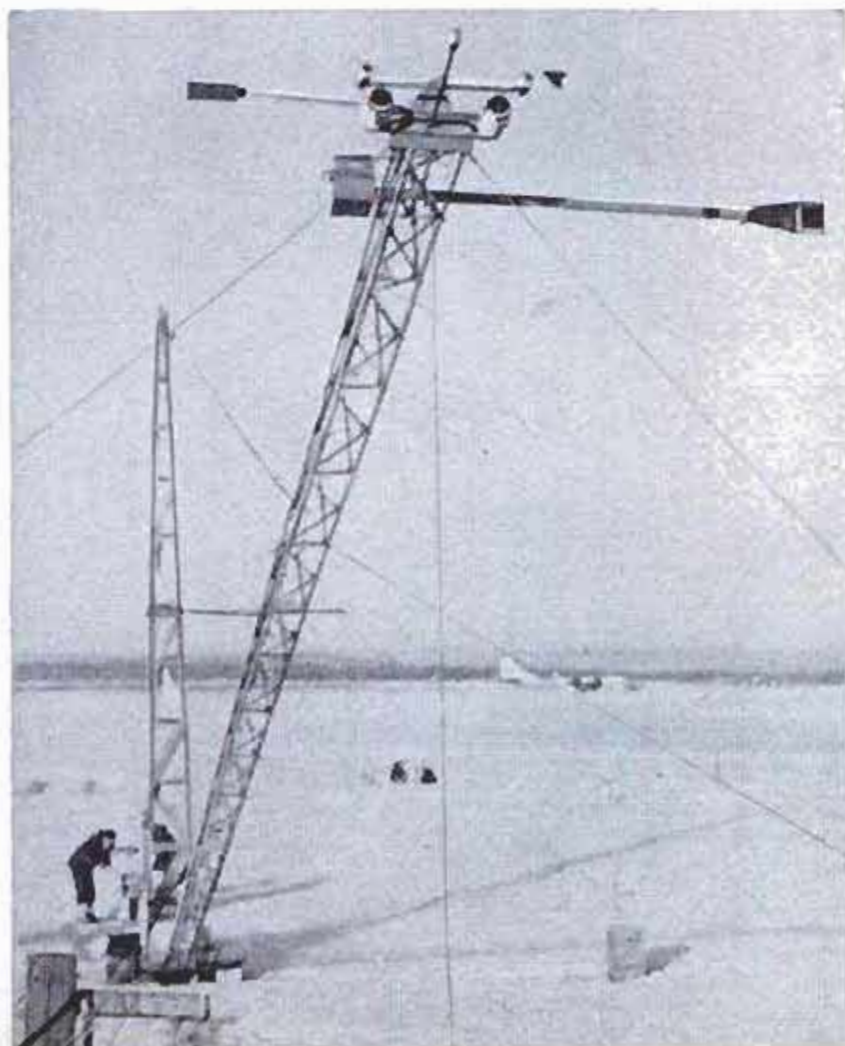



British Railways photo

Swiveling Deck on Scottish Ferry Ends Need for Gangplank

Cars and trucks are carried between the Scottish mainland and the island of Skye on a ferry boat with a swiveling deck. The boat, the *Portree*, edges up to a wharf, the

deck swivels around and vehicles are loaded or unloaded without the use of a ramp. The unique vessel is owned and operated by British Railways.

Sailplane in Kit For Glider Fans

Designed primarily for gliding clubs and home aircraft-building enthusiasts, a high-performance sailplane in kit form is being marketed by Schweitzer Aircraft Corp., internationally known glider manufacturer. The metal sailplane, called the SGS 1-26, has a wingspan of 40 feet, a length of 21 feet 3 inches and a maximum gross weight of 575 pounds. It has been granted a Civil Aeronautics Administration approved-type certificate. Performance has been proved by a prototype that flew more than 150 miles.

During 5000 miles of driving, an oil filter will remove a pound or more of dirt and sludge from the oil in a car, according to GM engineers.

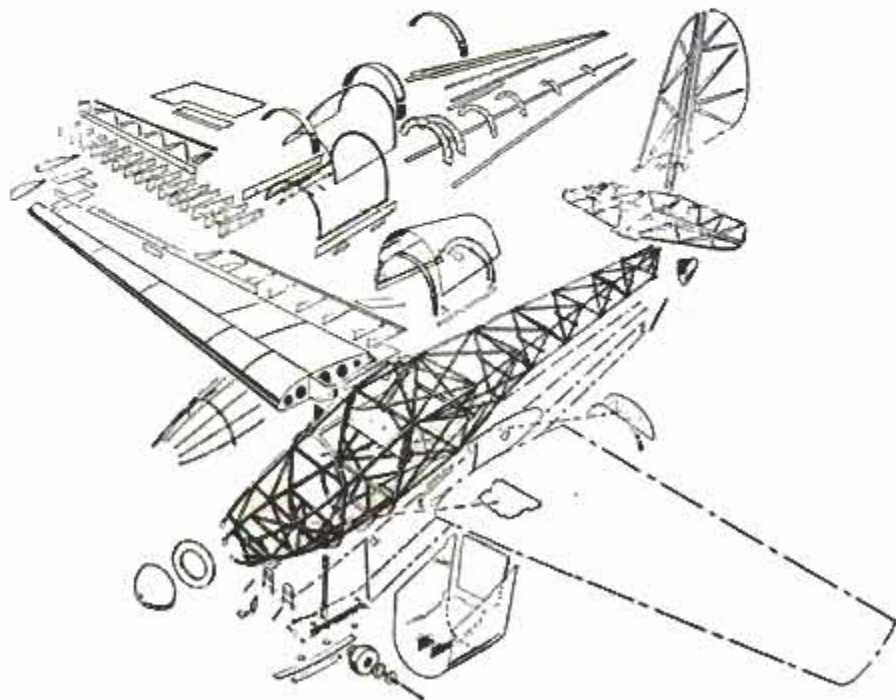
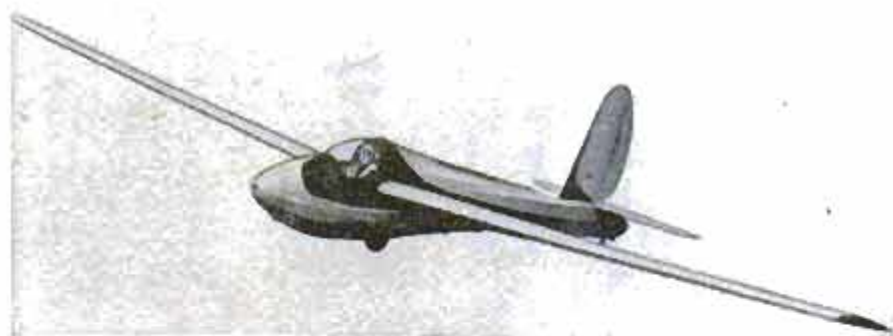

Giant Push-Button Press Straightens 20-Inch Slab

Steel plate nearly two feet thick is straightened by a giant push-button press installed at Coatesville, Pa. A cylindrical pressing head moves from right to left a total of 13 feet to iron out the steel, which is used as armor plate for Navy ships. Two motorized cars on either side of the press can shift a slab 50 inches wide and 14 feet long forward and backward so that its entire area can be pressed. The two-story-high press can straighten steel plate 20 inches thick to within $\frac{1}{2}$ -inch tolerance. It is electrically controlled by one man from a control panel and derives its pressure from a hydraulic system.

Car on each side shifts slab back and forth.
The two-story press weighs 1,500,000 pounds

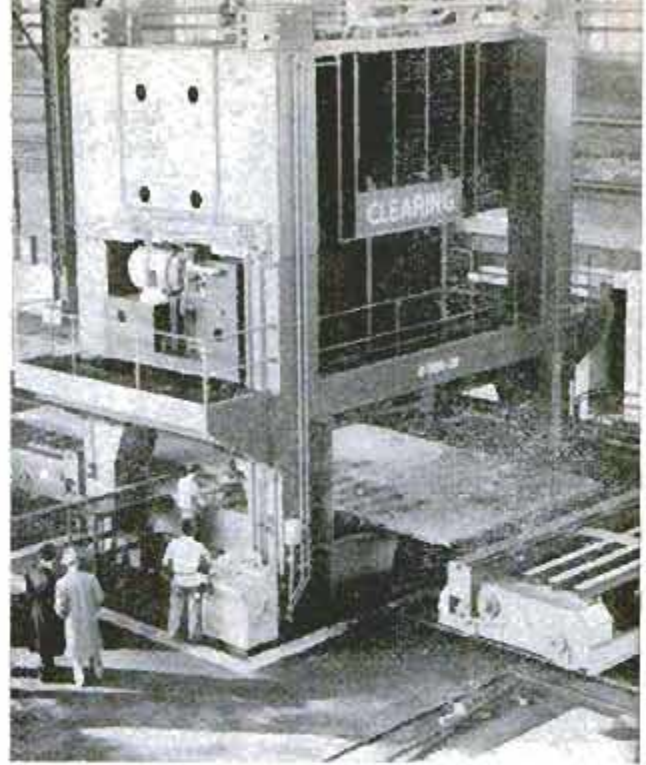

Speedy Coal Digger

Up to eight tons of coal per minute pour from the conveyor of a machine that removes the full face of the coal seam in one operation. Two boring arms spiked with breaker bits revolve at the front of the machine to cut double overlapping circles and break out the coal between. At the same time, two trim chains fitted with tungsten-carbide-tipped bits slice out the top and bottom segments.

Iron Bulb Smooths Flow of Water from Ship's Propeller

Welded to the rudder immediately astern of the propeller, an iron bulb has been found to increase the speed and efficiency of maritime vessels of all kinds. The de-

vice, known as the "Costa Propulsion Bulb," smooths the flow of water around both propeller and rudder, tending to eliminate cavitation, or empty space.

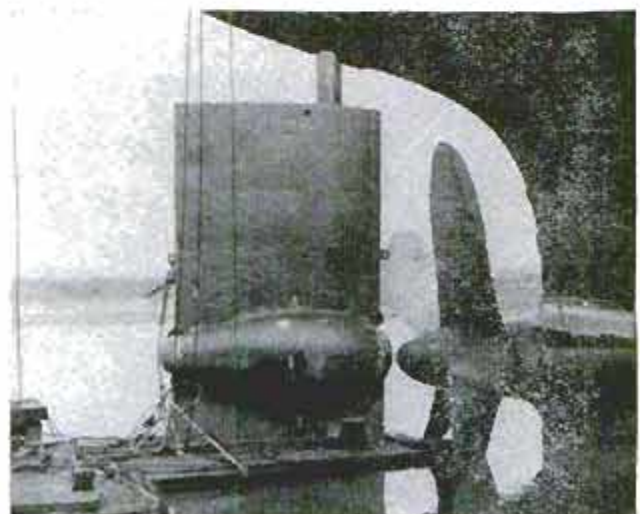
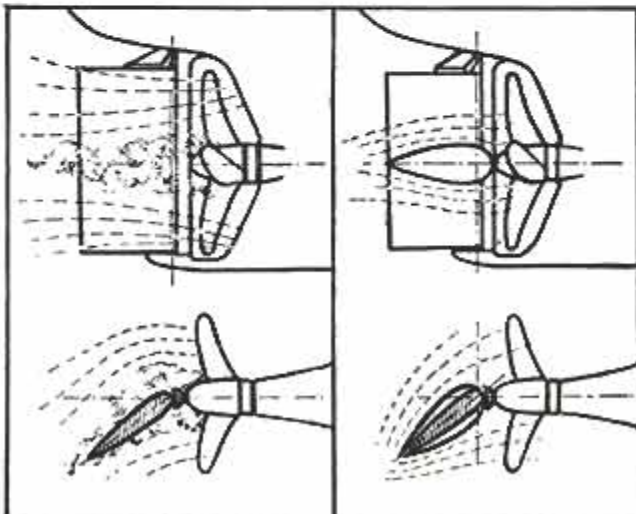

Notes: Western Round-trip
8421 Melrose Ave., L.A. 48, Calif.

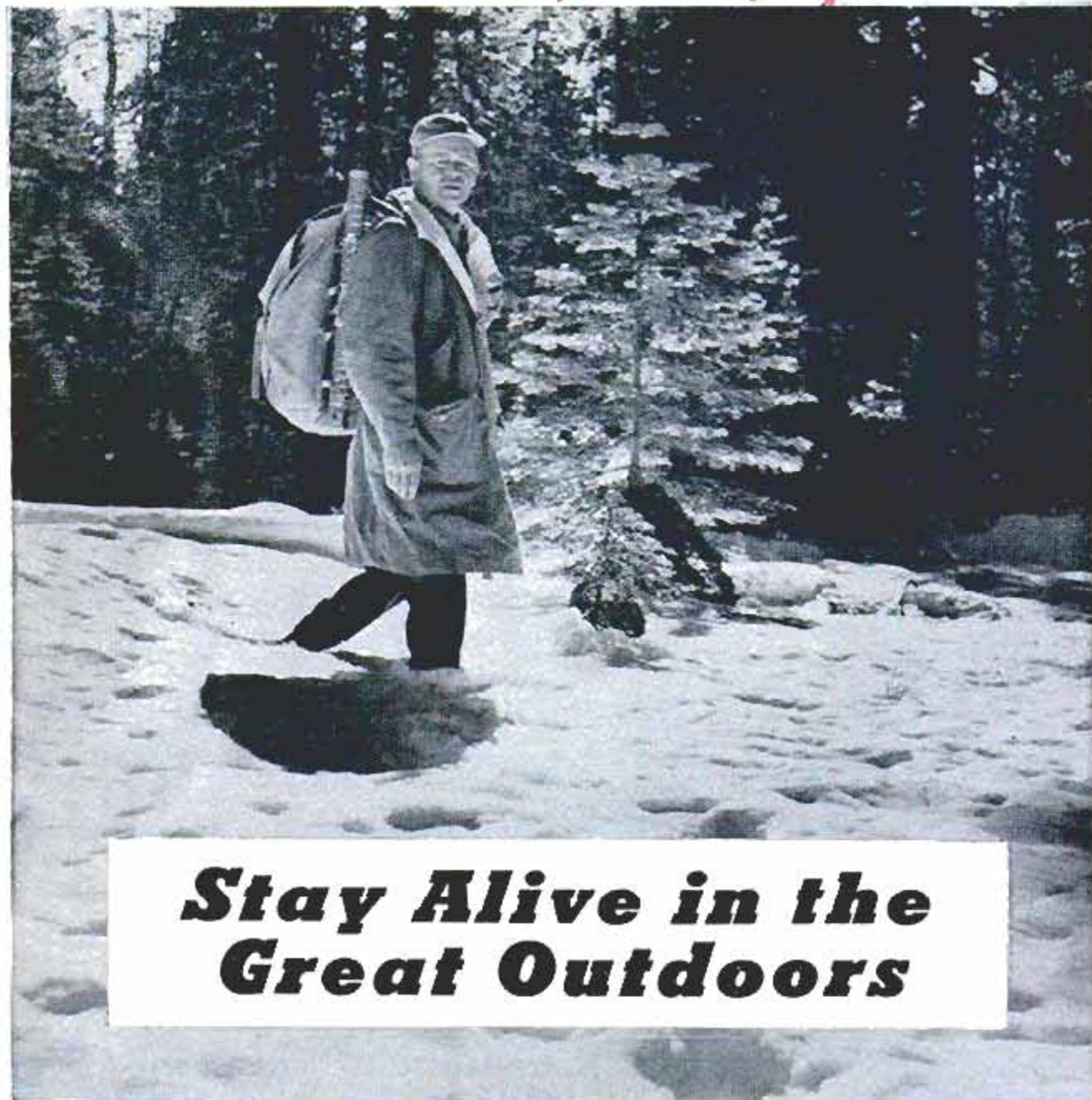

Stay Alive in the Great Outdoors

When lost in the snow, backtrack your own trail or glance behind to make sure you're going straight

By James Joseph

ABOUT 12,000,000 vacationers—perhaps you among them—camped in national parks and forests during 1955. Another 8,500,000 camped in other woods. Never had more Americans been recreation-minded.

Statisticians were jubilant. Somewhat less elated were our sparse-country guardians—the forest rangers.

To them, 1955 was a season of brazen tomfoolery, of nitwit misadventure and blundering.

Rangers spent sleepless nights fighting fires which carelessness had started. They snatched hundreds of would-be Edmund Hillarys from precipices. They splinted umpteen legs and broken backs. They carried out the weak and weary. They parachuted from helicopters in their never-

ending search for the lost and the strayed.

"Kinda pathetic," a district ranger concluded, "the way people get themselves into jams." He swept a hand toward a gnarled crag. We'll pull a dozen hikers out of that granite mantrap before summer's end. And 'long about November, with the first snows, we'll be going up there with ski litters after more."

Nationwide the plot's the same. Only the names are different. More and more vacationers are succumbing to the beauties—and dangers—of America's great outdoors.

Why? Because too many week-end woodsmen venture into primitive areas outfitted with every camping essential save one: common sense.

One western camper built a fire in vege-



Survival may depend on your feet. Keep your boots well oiled to make them as waterproof as possible

table rather than mineral soils—and died in his own conflagration. He kindled it in a wide, open space. Trouble was he didn't recognize the reddish-brown, dry-as-parchment soil for what it was: duff. Duff is gray-to-reddish humus, the product of mold, decayed logs and forest litter. It's as volatile as naphtha. During the night his fire literally went underground, ignited nearby brush and trapped him. Had he camped on mineral soil—heavier, flintlike decomposed rock—he'd have been safe.

Another camper soloed a canyon wall. From the river it had looked easy. Half-



Dip a batch of matches in barely melted paraffin. In wet weather, scrape off coating for a dry match

way up, his ascent was blocked by a giant boulder. He tried backtracking. Suddenly, like a small boy caught in the fork of an apple tree, he discovered that it's far easier getting up than down. Rangers worked 24 hours extricating him.

Rescuers explain that seldom do even the most experienced woodsmen go it alone. They use the buddy system. And before scaling anything much higher than a stepladder, they survey the terrain, plotting their escape before they start.

Recently a veteran packer was crossing a narrow log bridge when he spotted a man

Here's a ranger's full winter field kit, except for skis. With this gear a ranger has spent days on long snow surveys, traveling fast, warm and light

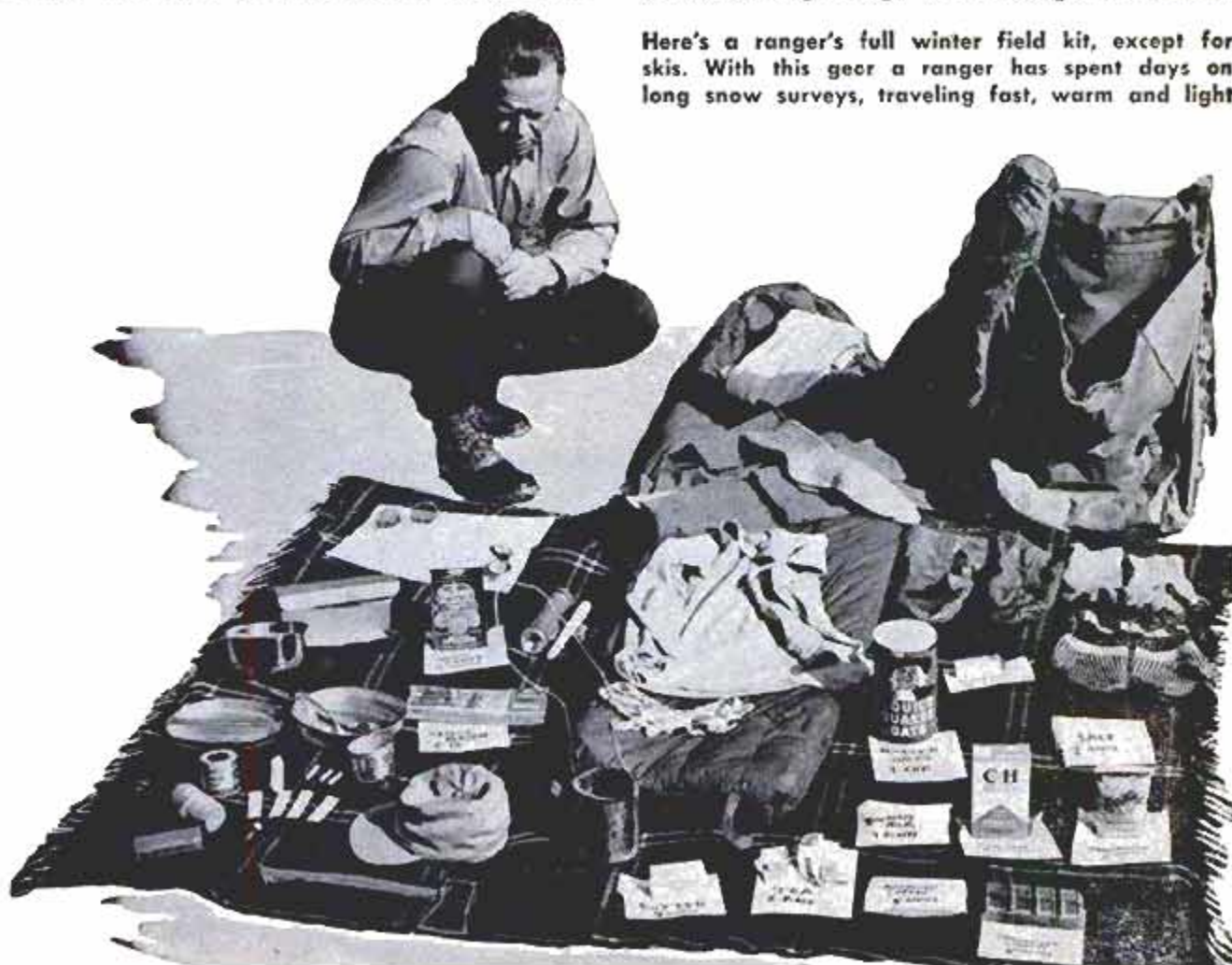



If you find green grass along a dry stream bed, you probably can find water just beneath the surface



Ranger scoops up hatful of water from a "well" he dug. Some streams go underground during summer



Dust-dry, gray-to-reddish vegetable soils are dangerous. They can spread a campfire underground



Mineral soils are heavier than vegetable soils, feel rough and flinty. Build fires only on these soils

stumbling along the stream bed, 100 feet below. Puzzled, he hailed the pedestrian. No reply. He tried again. Remembering that a man was reported lost, he tethered his string of mules and clambered into the ravine.

When the packer finally caught his prey he asked, "Didn't you hear me yellin'?"

The camper wheeled around, gaped and collapsed in the woodsman's arms.

"Thank God," he whispered, "you found me!"

Since losing his way three days before, the camper had stumbled downstream. His whole being throbbled with but one purpose: Follow the stream.

Single-mindedly he'd pushed on, looking neither left nor right (nor overhead), so intent was his frenzied drive for survival. Yet during his bruising trek, he'd walked

blindly under four bridges, skirted a traveled highway, passed a couple of camping areas and missed a score of well-marked trails.

The packer fingered a map. "Feller," he said, "it's a good 25 miles to a downstream town. You'd never have made it."

When you realize you're lost (perhaps hours after becoming disoriented), stop. Sit down. Think. It's exhaustion born of panic, not starvation, that kills.

One hiker, lost and thirsty, stopped, sprawled atop a boulder edging the dry bed of a high-country stream, and tried to figure some way out of his plight. As he lay there he heard water trickling. He listened. The sound came from the dry stream bed. He investigated, began digging among the loose pebbles. Less than a foot below the surface he struck water.

The stream, like most in high country, especially during midsummer, was flowing beneath its wet-weather bed. Refreshed, the camper regained his wits and made camp by nightfall.

If you're lost in winter, you can often back-trail, following your own path to safety. In summer it may be tougher. If you're not too far from camp, stay put. Try to get the attention of a forest lookout tower by flashing a mirror or bright-metal object, a tin can for example. A smoky fire from green branches may bring help. Failing this, you may have no choice but to start downstream. Walk only by daylight, never at night. Senses dulled by the stream's gurglings, you might blunder over a waterfall in the darkness.

Ridges are likewise highways to safety. It's a good idea, particularly in dense, snow-covered forests, to pick out a distant tree or landmark and walk toward it. Walking tree to tree is better than kidding yourself into believing you're endowed with a God-given sense of direction.

Above all, stay alert. Except in our most primitive areas, you're bound to cross a power line (and its maintenance trail), a road or fence long before finding that downstream village.

Rangers are forever analyzing the human animal in panic. The picture is far from flattering.

"Panic," concludes one forester, "is an evil sculptor. It molds men into twisted caricatures."

Comments another, "When we're tracking a guy, we throw the book away. We

bypass the places we'd reasonably expect to find him. We begin by searching the most unlikely. And usually that's where he is."

A few years ago a party wandered off a snowbound Yosemite trail. Although it hadn't snowed for three days, the party tossed common sense into the nearest snowdrift and pushed ahead with the frenzied hysteria of the lost. Searchers caught up with them 18 hours later. How? Merely by following their well-plowed trail.

Commented one rescuer sourly, "You people were blazing a path wide enough for a bulldozer."

For the first time the hikers glanced behind them and discovered their own trodden trail. No one had thought of back-tracking to safety!

Anselmo Lewis, district ranger of California's Mount Baldy area, has seen panic at close quarters. Yet even Lewis can't explain the "case of the shell-shocked hunter."

"Reads like fiction," Lewis admits, "but it's fact."

The ranger and his crew tracked a hunter, lost for three days near Mount Baldy. They found him by following a trail littered with unfired rifle shells.

"I kept firing," the exhausted man insisted, "but nobody heard me."

Actually, he hadn't fired a shot. Instead, he'd been ejecting one shell after another.

How could shock so numb a man's senses?

"Beats me," declares ranger Lewis, "but it does. That incident proves it."

In the summer of 1952, a young husband

Caught out alone in the winter woods? You can sleep comfortably regardless of the snow on a bough bed





One Oregon hunter, caught in a snowstorm, kept himself warm—and alive—by walking around a tree all night. Below, instead of eating raw snow, which saps vitality, warm to body temperature. Add salt or cube of concentrated soup if possible



and wife hired a guide, loaded their pack animals and headed for Colorado's high country. Theirs was billed as the vacation to end all vacations. Unfortunately, it lived up to its billing.

Two blistering days later they camped on an emerald lake nestled between twin peaks at 10,000 feet. Hubby donned trunks and, heedless of the guide's warning, dived into the shattering cold water. He died moments later—victim of a heart attack.

Even in midsummer, only the surface two or three feet of a mountain lake are warm. Beneath lurks snow-cold water (veteran campers use lakes as summertime iceboxes, submerging food in watertight containers). Fatigue plus high altitude plus the water's shocking chill can be fatal.

Those pondsized high-country lakes are deceiving in another way, too. You may be rated an endurance swimmer in low country, but at 10,000 feet you'll be lucky to swim 200 yards before exhaustion or cramps set in.

Although thousands blunder into trouble, many others keep their wits and survive. Consider the Oregon hunter caught out alone after dark in an early fall snowstorm. He saved himself simply by walking methodically around a tree all night. The exercise, carefully paced to avoid fatigue, kept his blood circulating and prevented frostbite. Each circling packed the snow deeper. Within a few hours he'd tramped a shallow shelter. Next morning, warmed by the sun, he made his way safely to town.

"That guy," appraises Yosemite's assistant chief ranger, Duane D. Jacobs, "had snow sense!" Jacobs should know. He has spent several thousand miles of his life on skis and snowshoes.

Seven members of Phillips Exeter Academy's mountaineering club used snow sense when caught in a thunderous avalanche on Maine's mile-high Mount Katahdin. They were swept a thousand feet down the mountain, yet they lived. They saved themselves by backstroking, like swimmers, as the snow swept over and around them. Backstroking thrust them to the slide's crest, preventing

(Continued to page 252)

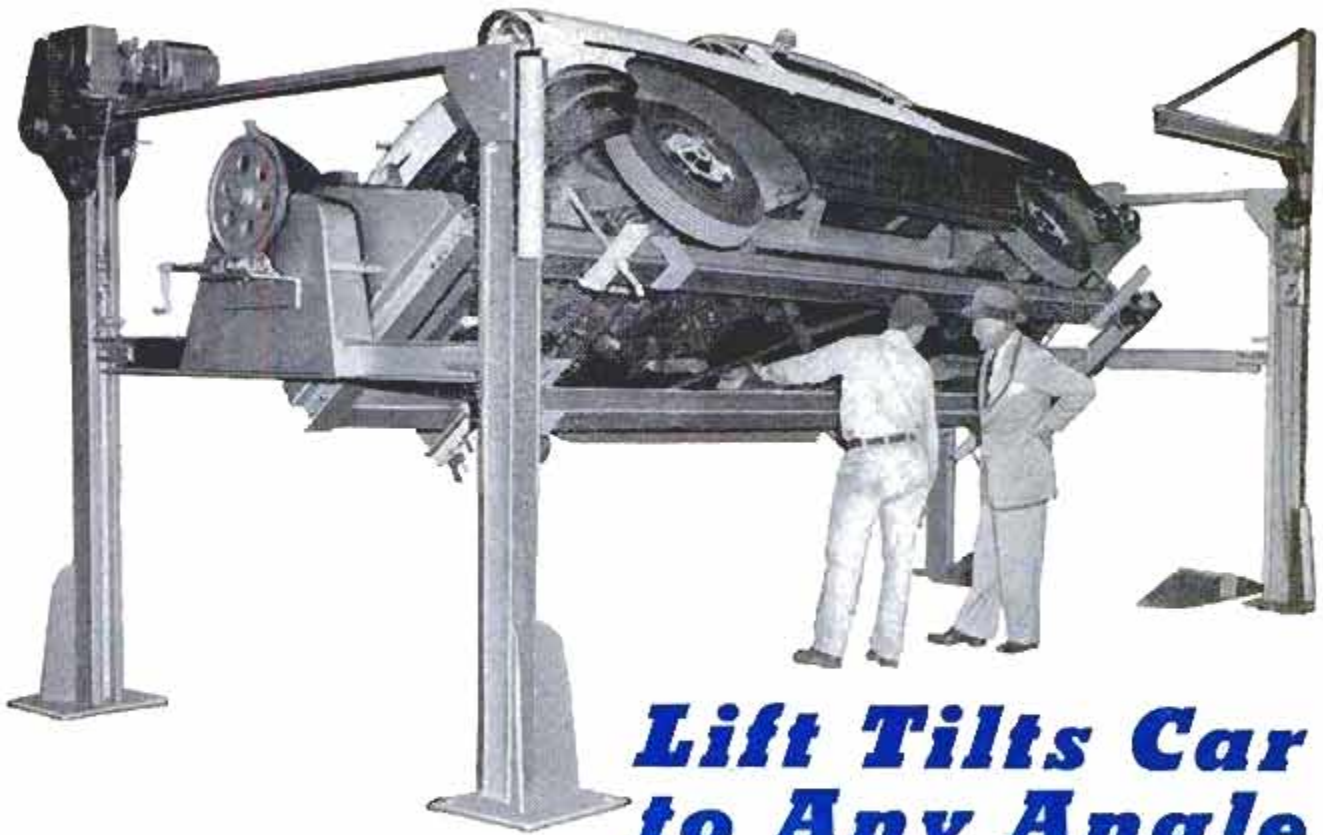

Lift Tilts Car to Any Angle

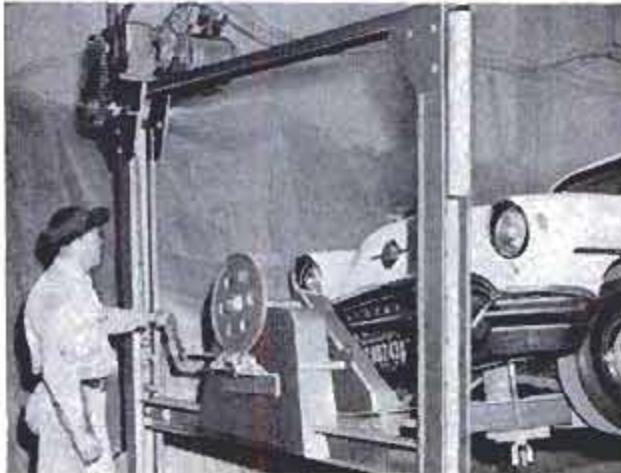

Mechanic turns a hand crank to tilt the automobile. Little effort is needed because car is balanced

Automobiles can be tilted to any angle for convenient repair work by a machine that resembles a barbecue rotisserie. A car is driven onto a pair of ramps and large clamping devices are attached to the frame. It is raised to a convenient height by hy-

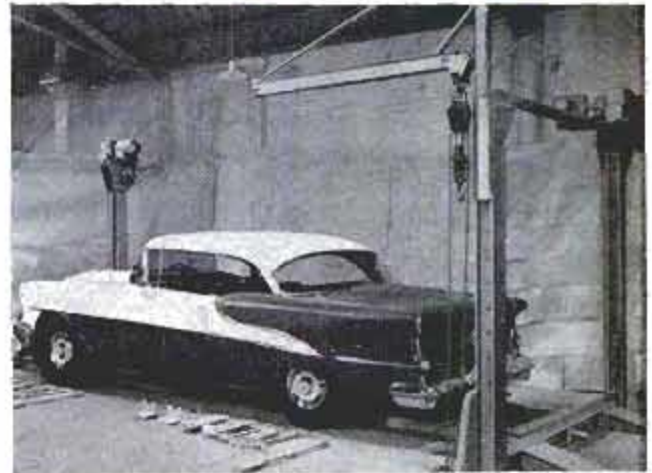

Clamps beside car on ramp are fastened to frame of automobile, hold it firmly during tilting operation

draulic lift, and a hand crank is turned to tilt the car as much as 90 degrees. Because the vehicle is balanced on the center of the device, little effort is necessary to tilt it by hand. The car can be tilted either right or left to avoid gasoline or oil spillage.

Plant Fish in Salton Sea

Pan-sized Gulf croaker fish and large, gamy corbinas planted in the Salton Sea have multiplied rapidly and promise to make the California desert lake a top sport-fishing area. Dr. Boyd Walker of U.C.L.A., director of the program, has been investigating the possibility that the vast, salty body of water will support a large fish population. The corbinas were planted two years ago, the croakers in 1950-1951.

Army Diesel Locomotive

Generators and electric motors are dispensed with in a diesel locomotive built for the Army. The engine transmits power directly to the drive wheels through a mechanical-hydraulic transmission similar to an automotive torque converter. The 48-ton experimental locomotive uses a minimum of critical materials and does not require the skills needed to maintain a conventional diesel-electric locomotive.



Lineman leans 'way over to slide rubber "snake" over wire. Voltage here is 4000 volts phase-to-phase

The Hot-Line Men Never Trust to Luck

By Richard W. Emery

BEN FRANKLIN ran a kite string up into a cloud and took a thunderstorm's pulse. Electricity tingled under his fingers. Modern linemen know about Ben's efforts, but they also know that within the same year two centuries ago, a Russian scientist tried the same kite-flying experiment and got himself electrocuted.

Ben was lucky, that was all. With high voltages, you never trust to luck.

"In this game," the linemen say, "there's no second chance."

From one side of the United States to the other, high-voltage lines bring elec-

trical power from generators to substations and from substations to homes and factories.

The hardy souls who keep watch over those lines are called linemen. There are no weak knees in their fraternity. Atop poles or steel towers when the wind whistles and high-voltage whispers behind their heads, they live close to death and are unafraid.

Their job puts them into a world of their own with a vocabulary all its own. They speak of "splashovers" and relays, "pig-tail sticks," "burndowns," "rubber snakes"

and "220 KV." And in their world of high voltages the ordinary ground rules of safety don't reach far enough: They live by an exacting safety code all their own.

They work without horseplay. They never dare each other to try something foolhardy. They go by the book rules because each one of those rules had to be learned the hard way, back in the beginning of hot-line work. They keep electricity flowing and most of them live to a ripe old age.

"The more hazardous the job, the fewer accidents we have. Our accidents are mostly on something routine where the man didn't have his mind on the job." That's from the safety engineer of the Southern California Edison Company, which has an outstanding safety record.

Power companies learned long ago that they could spare their linemen many a hazardous job under emergency conditions by training some of their linemen to be patrolmen and detectives.

Patrolmen patrol the lines. They travel by truck, by helicopter, or afoot where the going's toughest. They look for "anything unusual"—anything from a broken insulator to a bullet's nick in a wire, or a dead bird, or unexplained tire tracks, or a piece of steel missing from a tower. "Anything unusual" may be the only clue to threatened or existing trouble.

Linemen turn detectives when they are sent out to investigate a line failure. By "failure" they mean any drop of power on the line, even though the drop was only a split second long.

Lineman in bucket at top of extension tower washes insulators with spray from high-pressure water gun

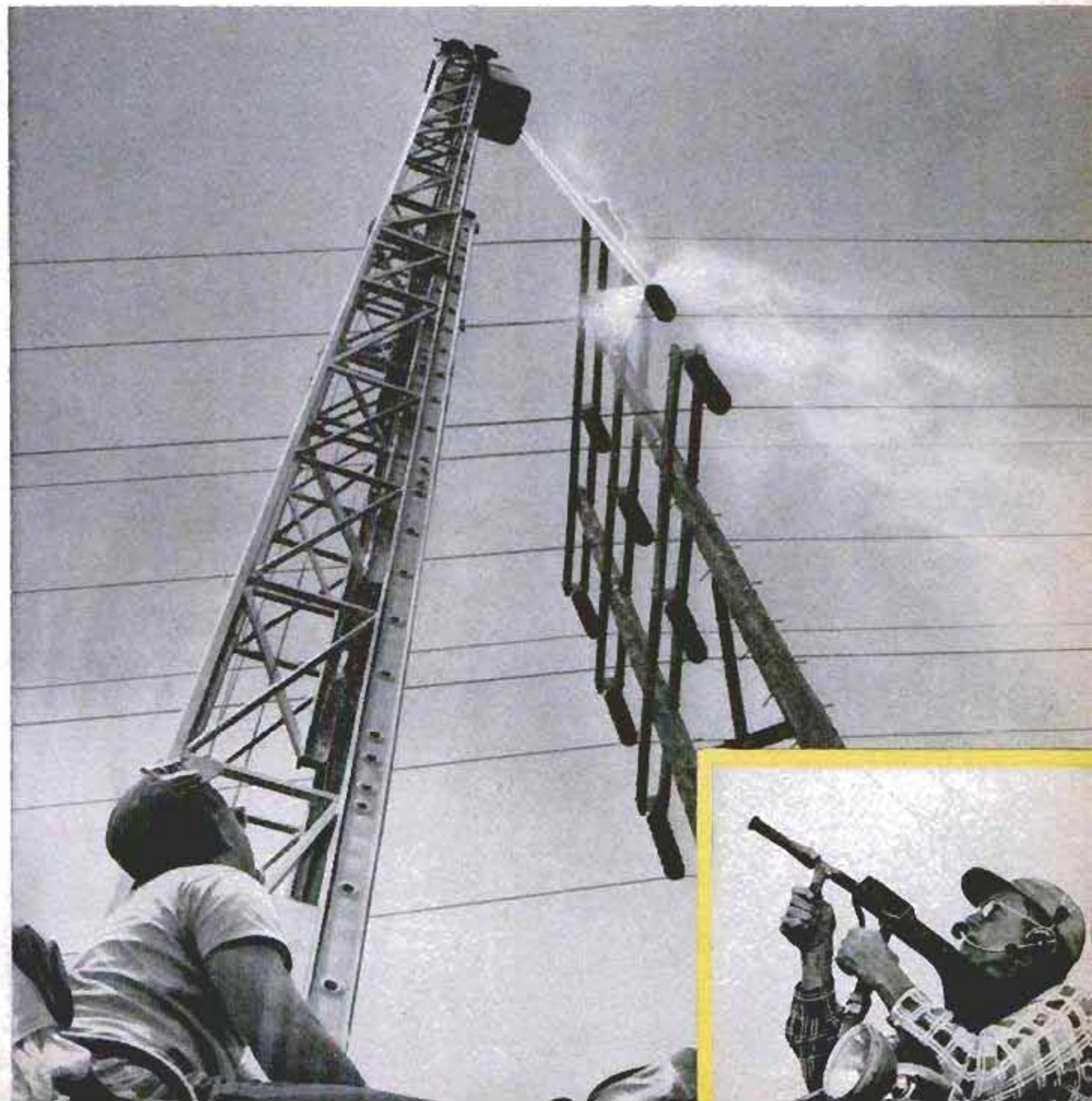



Rubber hood is placed over an insulator to protect workers on power line. Rubber "snake" covers wire

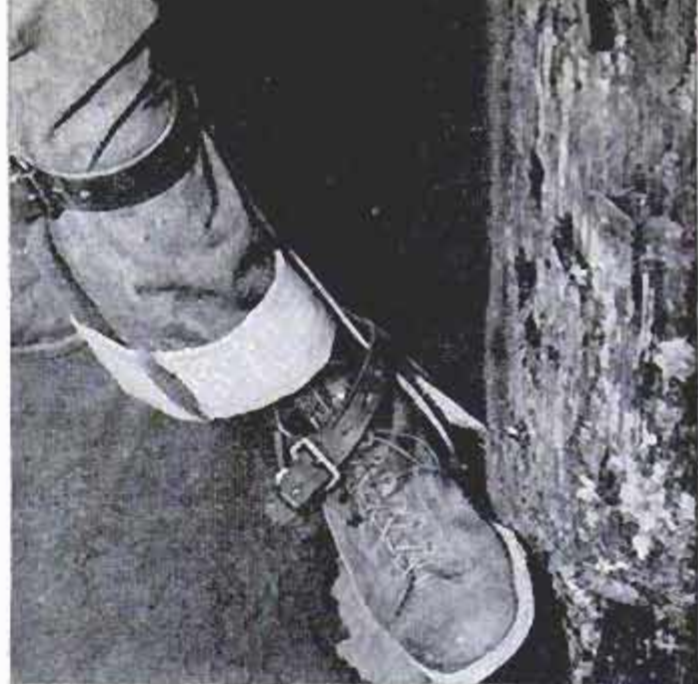

Gaffs — spikes on lineman's climbers — are kept sharp by filing. When badly worn, they are replaced



For work on a line carrying up to 7500 volts the lineman wears rubber gloves inside leather gloves. "Hot stick" is used to place fuse in top clip of holder. Other end of stick shoves it into bottom clip



Rubber glove gets its daily roll test. A pinhole could be deadly. Below, this hot stick is lineman's socket wrench, used for clamping together two cables. Sticks are rotated to grip clamp, join nut and bolt

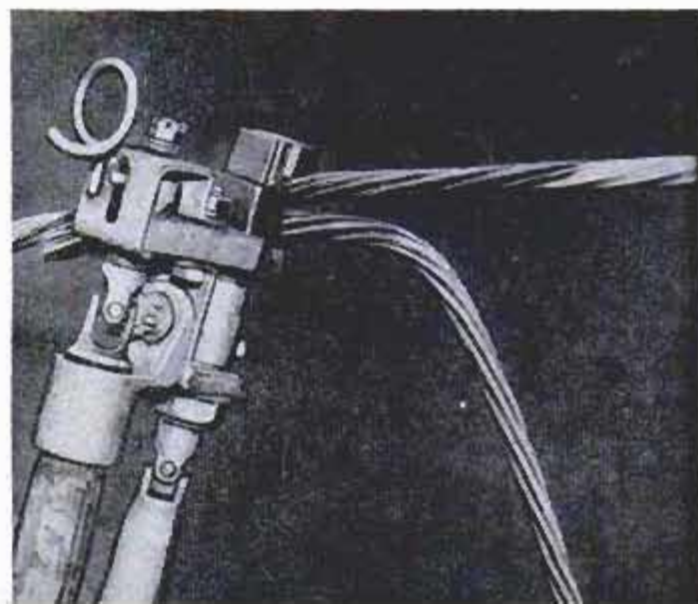
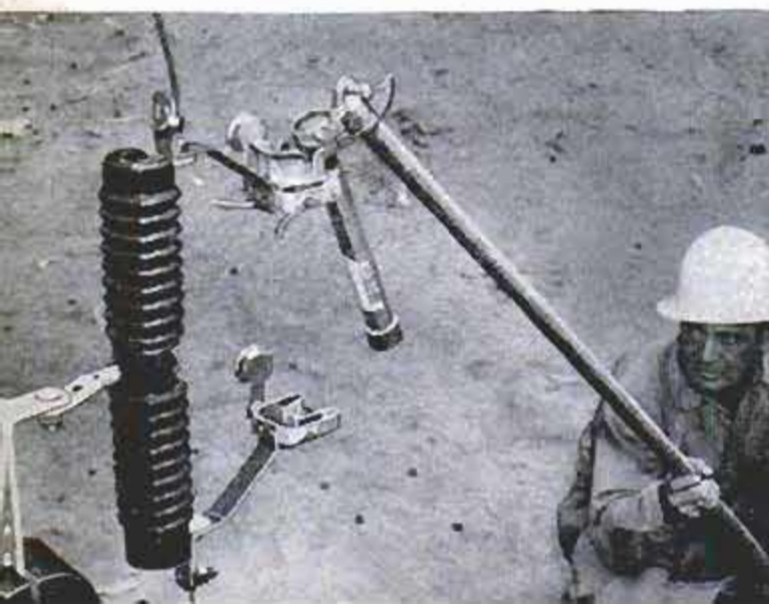



"Pigtail sticks" are used for holding, raising or moving hot 11,000-volt and 16,000-volt power lines



Hot-stick cutters can nip off heavy wire. Extremely heavy wire is usually sawed with hot-stick hacksaw

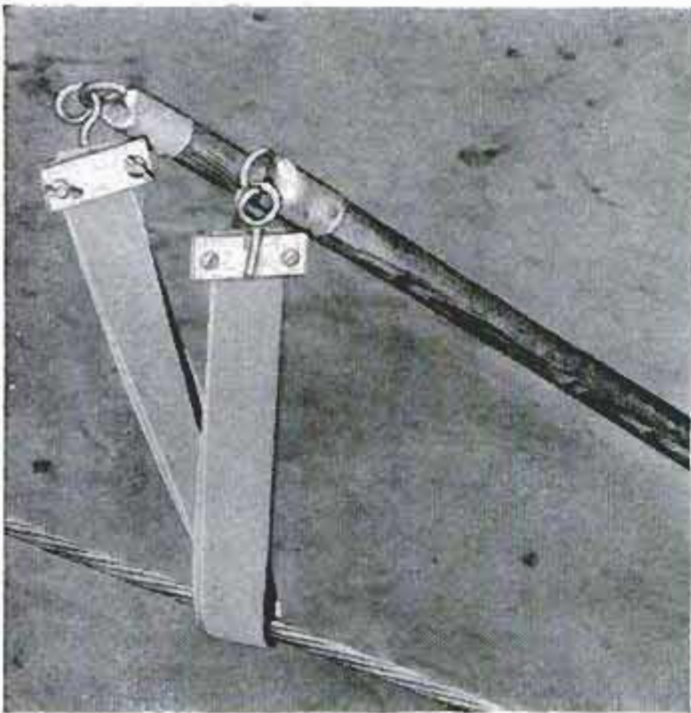

At point where connection is to be made, corrosion is polished off with abrasive cloth hung from sticks

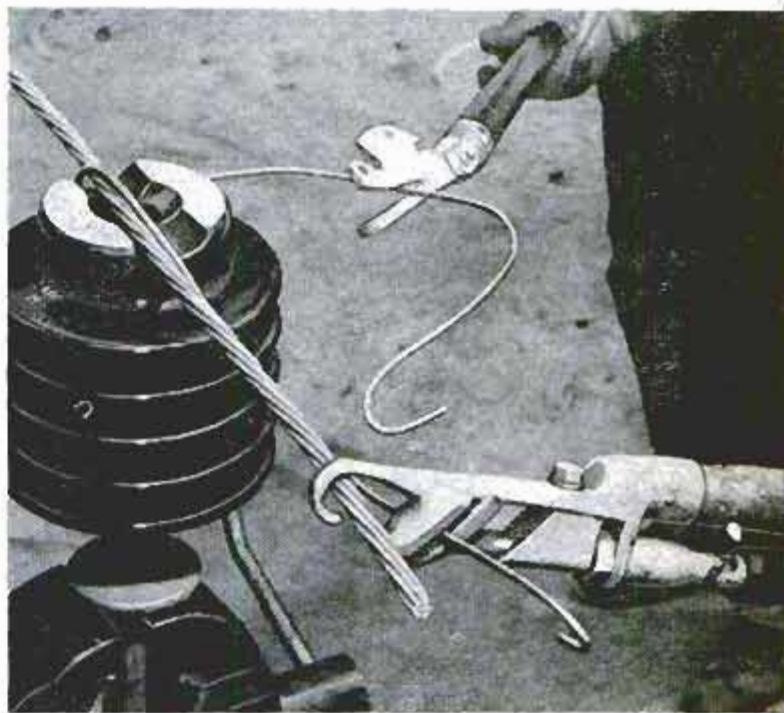

One "mechanical hand" holds tie wire against cable while another wraps wire around cable and insulator

"Line failure *must* be run down! Something relayed that circuit. Find out what it was."

So the linemen-detectives start looking. Whatever happened may have burned a nick in the line; that makes a weak spot. The next time a storm or accident puts a surge on the line, it may "burn down" at that weak spot. They hunt for it and, when they find it, hours or days later, hot-line men repair the damage.

A very little thing can cause a very large disturbance when high voltage is involved. A bird's nest can cause no end of trouble. Some birds like to use fine wire as nesting material; they drop it across high-voltage lines and the fire flies! Trees, bullets and kites cause trouble. In Rosemead,

Calif., a whirlwind picked up an umbrella from a fruit stand and spun it into a maze of wires, setting off an electrical barrage that shook the town.

In dry seasons, the insulators on high-voltage lines pick up a coat of dust. To prevent splashover of current on the dirty insulators, with resulting pole fires and possible line failure, to say nothing of television interference nearby, linemen "hot wash" the insulators. The cleaning job once was done by mechanical means, by linemen who had to climb up into the poles. A nozzle was invented which breaks up water into spray, under 900-pound-per-square-inch pressure; and with water tested for high resistance the nozzle safely sprays insulators even of 220,000-volt lines.

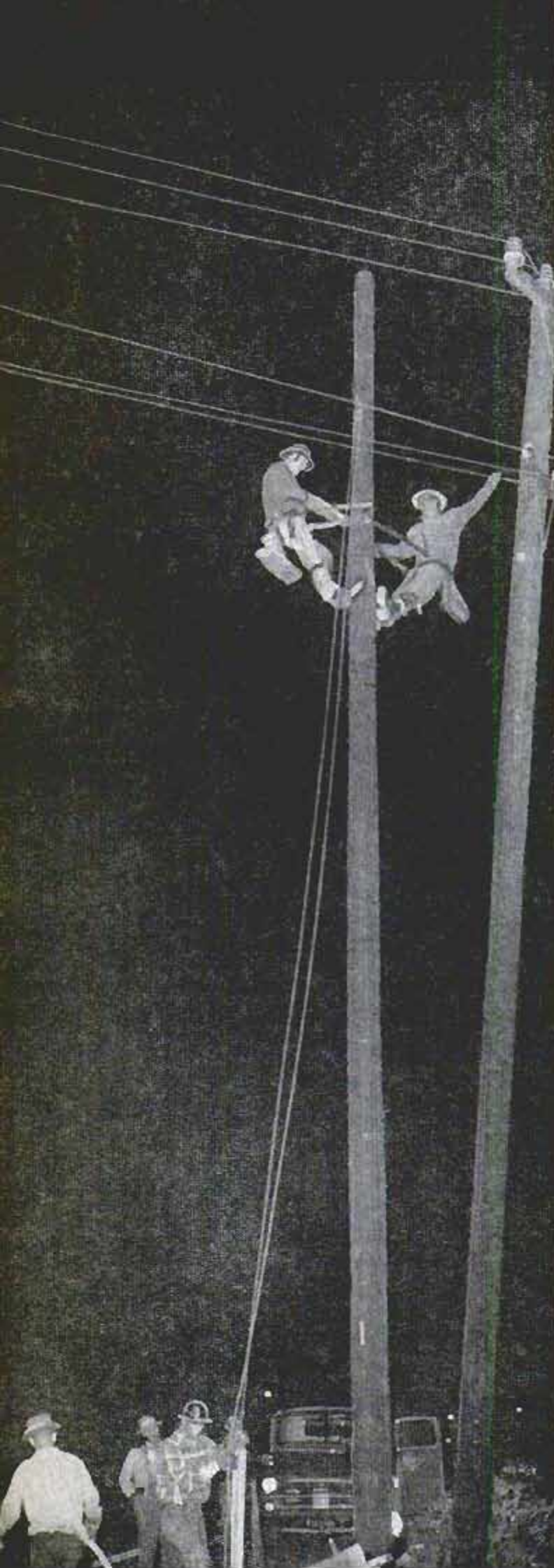

Linemen, above and left, take on job of transferring hot lines from pole snapped off at base to new pole

Good communications reduce the lineman's hazard and speed up installation and repair jobs. On the Southern California Edison Company's thousands of miles of high-voltage lines, line crews keep in two-way contact with a central dispatcher by radio or by metallic or beamed microwave telephone.

Most of the distribution lines, which carry power from substations to consumers, are on high poles; but in some city districts the lines must go underground. If a lineman feels uneasy about high work, he is transferred to underground work, and vice versa.

"If he's scared, he's got no business being there; let him try something else. To work safely he must not be afraid."

It is a tremendous problem to kill a line while hundreds or thousands of consumers

(Continued to page 246)

With crossarm installed on new pole, the linemen place rubber snakes on one of the 4000-volt lines





New Bell X-2 will be carried to flight altitude in bay of B-50 bomber which has been redesigned for the job

Bell Aircraft's rocket-powered, supersonic X-2, the first plane designed to probe the so-called "heat barrier," will make its first powered flight this year at Edwards Air Force Base, Calif. The X-2 will be used as a flying research laboratory to investigate heat and speed problems beyond the speed of sound. It is expected to fly beyond 2000 miles per hour. To withstand the heat pro-

2000 M.P.H. ROCKET

duced by such high speeds, the wings and fuselage are made of stainless steel and K-monel metal. In an emergency, explosive charges detach the entire cabin from the rest of the plane and a ribbon-type parachute carries the capsule to lower altitudes, where the pilot uses a normal parachute. Heavily tinted windshield protects the pilot from serious sunburn.

Long-Range Loudspeaker Works Like Human Speech System

Little SAM, a loudspeaker developed at the Stanford Research Institute, can shout so loudly he is heard two miles away. A bigger brother now being built has a range of four miles. SAM (Stanford Airstream Modulator) is the mechanical equivalent of human speech organs and consists of a compressor (the lungs), a quick-acting valve (the vocal cords) and an acoustic horn (the mouth).

Quick surges of high-pressure air create the powerful sound waves which dwarf those created by the vibrating diaphragm of the conventional speaker. SAM, which has long-range clarity and cannot be jammed, may be used to issue battle commands, Civil Defense instructions, and psychological messages to enemy troops. To test SAM quietly, scientists placed it in a muffler lined with glass fiber and surrounded by 12 tons of sand.

Diagram shows human equivalents of SAM's parts. Scientist by acoustic horns holds mechanical vocal cords

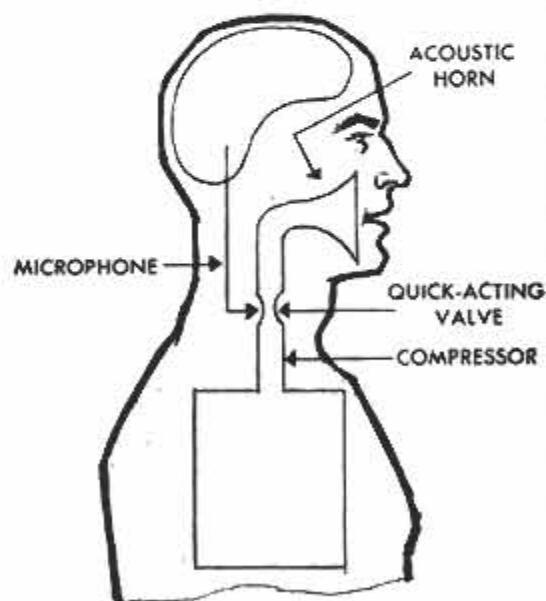



WHAT'S NEW FOR Your Home

LIFT-UP ELECTRIC RANGE, left, permits housewife to clean inside as well as out. Drip pan catches any boil-over from the burners. Similar gas range is available. Both can be built into the counter top

Chambless Ranges, 2464 N. Meridian St., Indianapolis, Ind.

CLOTHES ROD, left center, has built-in rollers that prevent crushing of clothing. Any kind of hanger can be inserted in the eye of the roller. Four wheels carry the roller smoothly along the rod, preventing clothes being jammed against each other

Hobi, 15 W. 57th St., New York City 19

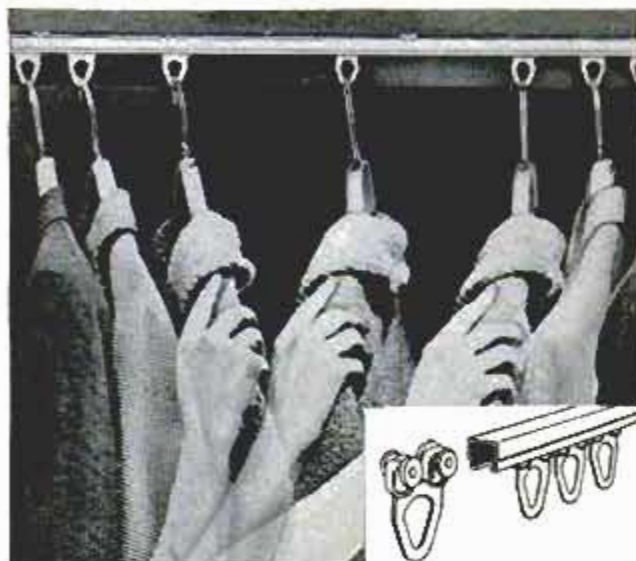

ROLLING VACUUM CLEANER, below left, has two 12-inch wheels that permit it to be towed easily across the room or up and down steps. Cleaning wand, when inserted in a special receptacle, becomes a steering handle when the cleaner is moved. Reversible head is used to clean floors as well as rugs

General Electric Co., Small Appliance Div., Bridgeport 2, Conn.

MUSIC BOX attached to door, below, greets guests with a tune as soon as the door is opened. As the door closes, the box automatically is rewound. Cord can be released and music box used only when desired. You can choose from a large selection of tunes

Walters Modern Hobby Shop, 207 French Road, Utica 4, N.Y.

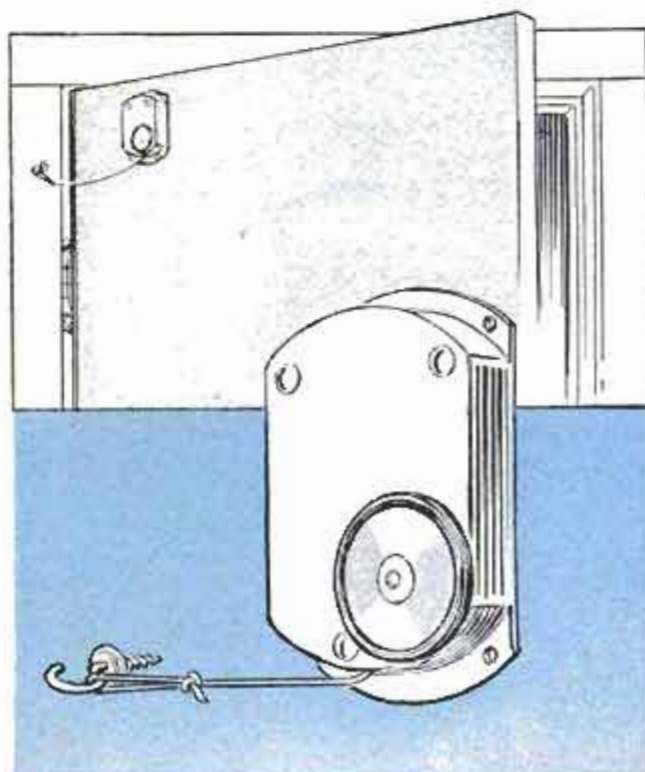

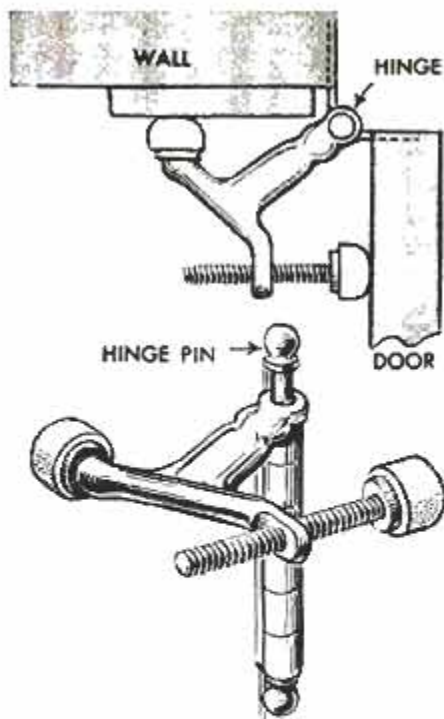

ADJUSTABLE DOOR BUMPER fits the hinge pin instead of being fastened to the floor or wall. No drilling is required, and there's no problem of cleaning the floor around the bumper. Screw-type adjustment permits you to regulate the travel distance of the door. The bumper can be installed on either the top or bottom hinge. It is available in several finishes

Harry L. Gordon, Derby, Conn.



ARC-SHAPED DIAL on a new top-loading washing machine tells at a glance which phase of the washing cycle is in operation. Indicator slides across the dial from start to finish. The housewife can move it in either direction to skip, repeat, lengthen or shorten any part of the cycle. Washer has two cycles, one for regular loads, other for synthetic fabrics

Kelvinator Division, American Motors Corp., Detroit 32, Mich.

IRONING BOARD FOLDS for compact storage. It also is equipped with a drawer which slides under the board and can be used to store the electric iron, pad and cover. The board measures 36 inches long unfolded, 18 inches collapsed. Designed for college students, vacationers and trailerites, the ironing board can be used on top of a table or a dresser

Port-O-Board Mfg. Co., 617 Winston, Dallas 8, Tex.

EXTRA HAND in the laundry is provided by metal fingers which hold large sheets and blankets for folding. A corner of the sheet is slipped between the fingers and a lever pressed down, squeezing the fingers together. Flipping up the lever releases the sheet. The little mechanical hand is made of rustproof spring steel and is screwed to the wall

Kay Craft, Nashotah, Wis.





Lychees, which grow in clusters, have a rough outer skin which is peeled away to reveal the firm, juicy pulp

Lychee—Fruit With a Future

FLORIDA NOW IS PROVIDING a new taste treat—the Chinese lychee. It's a fruit, about the size of a large strawberry, harvested from a subtropical tree. Dried, the fruit becomes the lychee nut, a favorite of the Chinese. In this country the lychee is being marketed quick-frozen and eaten as a fresh delicacy. The outer skin of the ripe

Twigs and leaves are snipped off by hand before the fruit is packed for quick-freezing and marketing

fruit varies in color from bright red to purplish red and is peeled away to expose the pulp, which is white, juicy and firm. Most people find the taste difficult to describe, though it has been compared to the taste of fine grapes. A lychee tree doesn't begin to produce for three to five years, but then has a producing life of 100 years.

Lychee is a small, subtropical tree that continues to produce its tasty fruit for 100 years or more





Side-Mounted Motor Gives Canoe Speed of 10 Miles per Hour

You can mount an 18-pound English motor on the side of a conventional or folding canoe and cruise at speeds up to 10 miles per hour. The one-cylinder, two-stroke motor develops 1.3 horsepower and mounts a .6-gallon gasoline tank that supplies fuel for nearly 10 hours' running

time. The unit has a six-inch propeller, a 39-inch propeller shaft, a mounting bar and bracket, and a tilting device for raising the propeller out of the water for starting. The boat is steered by rudder. The depth of the propeller is variable to suit different canoes and loads.

"Stone" Facing on Wall Fastened With Nails

Weighing considerably less than stone but with greater strength, a "stone" finish made of plastic and cement can be attached to any kind of wall. It is held to the wall with galvanized clips and nails. After the stones are fastened, mortar is filled into the joints to conceal the nails and clips and to give a natural-stone appearance to the building. According to the manufacturer, the stone will not decay or burn and is resistant to termites. Made under high heat and pressure from portland cement, mineralized fibers, metallic hardeners and glass fiber, the stone never requires painting.



Stop Light for Blind

Blind pedestrians in Louisville, Ky., can cross the road between two institutions for the blind with the aid of a special traffic signal. Pedestrians halt traffic by pushing control buttons located at the intersection. The light changes to red, a buzzer sounds and traffic is halted for 15 seconds.



Seaquarium sprawls across a 55-acre tract on Virginia Key, reached by Rickenbacker Causeway from Miami

\$2,000,000 Fish Bowl

STAID Miami fishermen, who supposedly have grown accustomed to seeing the very latest in fishing tackle, were startled recently at the sight of a speeding porpoise being chased by a fast boat. From the bow of the craft a man hurled a strange harpoonlike device.

The "harpoon," consisting of a pair of

By **George X. Sand**

shiny semicircular Monel-metal arms, landed full upon the back of the fleeing quarry. Instantly the spring-triggered arms closed firmly yet carefully about the body of the porpoise. Then, with almost human instinct, the metal harness dropped away, leaving in its place a stout length of rope which now slid backward to fasten itself

Catching a spotted ray by its spiracles, Capt. William B. Gray, director of specimens and collecting, helps former Yale coach Herman Hickman boat fish. Rays frequent shallow bays, often hooked by rod and reel





Homeward bound, specimen collectors have managed to capture a loggerhead turtle for the Seaquarium

in a secure noose about the thrashing porpoise's tail.

An air barrel was secured to the end of the rope. The captive then was released until it became exhausted from towing the floating drag. Later it was carefully hoisted aboard and wrapped inside a special rubber blanket before being placed in a tank of water containing "knockout drops." The blanket prevents the porpoise, tarpon or sailfish from injuring itself against the walls of the small tank until the anesthetic can take effect.

This corsetlike fish harpoon is but one

Here's housekeeping at aquarium. Diver operates undersea vacuum cleaner which picks up marine growth

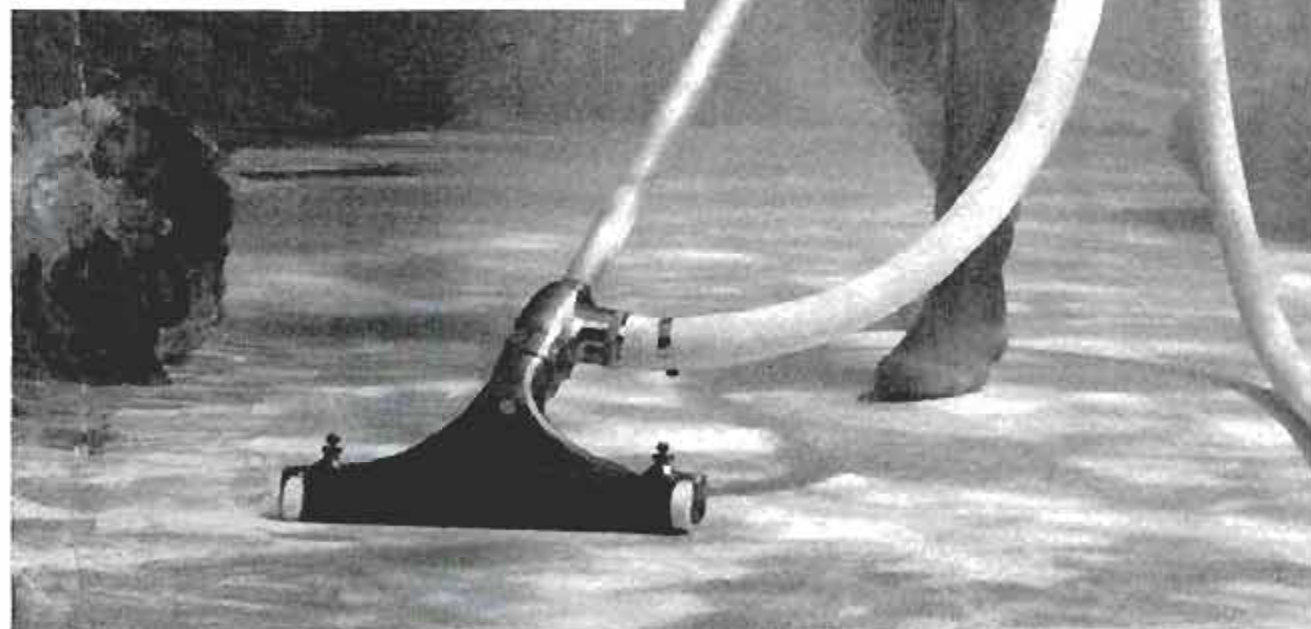



In their eagerness to get at their dinner, big turtles sometimes attack divers who carry the food below

of several radically new mechanical features that make Miami's sparkling new Seaquarium the most up-to-date installation of its type in the world.

For example, the \$2,300,000 salt-water fish-viewing plant, recently opened to the public on a 55-acre tract at the southern tip of Virginia Key, boasts two circular steel viewing tanks of the very latest type. Each tank is three stories high and had to be installed so that it "floated" free of the surrounding buildings before the manufacturer would guarantee his unusual product against leakage. To accomplish this the huge steel shells—one 80 feet across by 240 feet in circumference (565,000-gallon capacity) and the other 50 by 150 feet (285,000 gallons)—rest upon massive concrete foundations that are in turn supported by pilings driven to bedrock. "Paraplastic," a recently developed chewing-gum-like substance acts as a flexible cushion between the tanks and the cement structures.

Tanks Have Concrete Lining

The interiors of the tanks were sprayed with concrete, which varies from two to six inches in depth. The walls were then brushed with a special paint which has a chlorinated-rubber base that is resistant to both bacteria that flourishes in the water and the acid from fish slime.

Seaquarium design engineers guarded against salt-water corrosion and leakage by prohibiting use of steel, copper, zinc or

other exposed metal surfaces. Instead, plastic pipe and glass fiber are used extensively throughout the big plant.

Both main tanks have viewing ports or "show windows of the deep" at two platform levels, thereby offering to as many as

New porpoise is laid out on "operating table" and treated with potassium permanganate for rope burns



a thousand onlookers at one time a clear view of hundreds of different fish of all sizes, shapes and colors. The background is a tropic sea-bottom setting that includes a sunken Spanish galleon. The viewing windows are made of two sheets of $\frac{3}{8}$ -inch plate glass and, to preclude the possibility of condensation forming from temperature changes, a moisture-absorbent material was inserted between the glass plates.

On the opposite side of the broad circular corridor that surrounds the biggest tank are 26 additional smaller tanks (600 gallons each), constructed of laminated glass fiber. Many weird and amusing children of the sea are housed in these smaller aquariums, including brilliant jewelfish, the frogfish that lures its prey with a tiny fishing pole on its head, the light-reflective neon gobies, high hats, four-eyes and abudefdufs.

Built-in Lights

These exhibits also offer for the first time built-in lighting effects for the convenience of visitors to the Seaquarium who wish to photograph the strikingly beautiful marine specimens. To encourage photographers, particularly amateurs who heretofore have never

(Continued to page 256)



Craig Phillips, marine biologist and curator, patiently builds an authentic sea-floor setting before water and fish are admitted

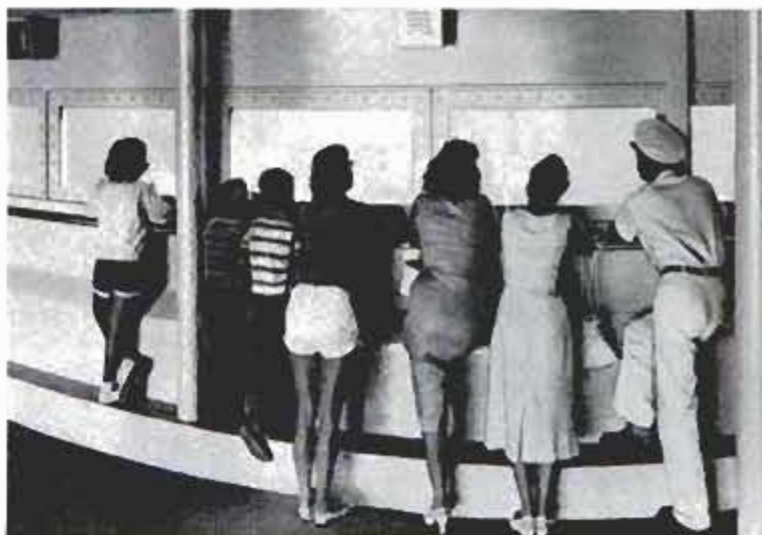

Windows give visitors a fish-eye view of the three-story main tank. Inside is a sea-bottom setting including a sunken ship

Trainer Adolph Frohn gives new porpoise a 500,000-unit shot of antibiotic to guard against infection





Comparatively inexpensive, this turret camera permits quick use of wide-angle and telescopic lenses

Shutter on projector below transmits 60 percent more light than old types, fills screen five feet wide



Radiation May Save Ancient Buildings From Further Beetle Damage

For centuries the deathwatch beetle has been eating away the timbers of Westminster Abbey, St. Paul's Cathedral and other famous structures. Now the pest may be controlled by atomic energy. Experi-



Photos from Eastman Kodak Company

More compact than most 8-millimeter cameras, this one weighs a pound and a half, has an f:1.9 lens

New Home Movie Equipment

DIRECTORS AND PRODUCERS, home-grown 8-millimeter type, can count on new equipment recently introduced to help them get better home motion pictures with less trouble and at less cost. Cameras have made great progress since 1900, when George Eastman produced a camera for \$1 which was designed to be so simple even a child could operate it. But Eastman's basic idea of low cost and simple operation is being applied to the new movie equipment. For example, one of the new 8-millimeter cameras sells for well under \$100 and yet has a turret with a standard f:1.9 lens and converters to supplement it for wide-angle and telephoto use as well. Another, a bit more expensive, is a magazine-loading camera with a finder of the zoom type, parallax-allowance indicators and a focal-plane marker for accurate focusing—and yet weighs only a pound and a half. And, in spite of all the extras on the camera, it is simple to operate. Projectors are improving, too, and this newest one for 8-millimeter film will project pictures to fill a screen up to five feet wide. A new-design shutter transmits 60 percent more light than older types.

ments at the British Forest Products Laboratory indicate that low doses of radiation make the eggs of the deathwatch beetle infertile. Until now there has been no method of destroying the pest.



Guide Points on Automobile Headlights Make Alignment Easy

Headlight aligning is swift and simple in a system where three guide points cast into the lamp lens are matched with points on an inexpensive aiming device. A service-station attendant can install and correctly aim a set of the lamps in eight minutes, in broad daylight and in a space only as large

as the automobile. The lamps are standard on 1956 General Motors cars and trucks. Ordinarily, lamps are aimed by using a screen or expensive equipment. Today, it is reported, over half of all cars on the road have headlights that are not correctly aimed or adjusted.

Portable Box Seat For Football Coaches

During football games, a coach can get a better look at what his team is doing from a box seat atop a 14-foot movable tower. Made of tubular steel, the tower can be erected in a few minutes. The platform at the top is 5 by 7 feet, allowing room for the coach and several assistants, and is surrounded by a guard rail. The tower is equipped with locking-type rubber wheels and, when used during practice sessions, can be rolled about the field as needed.

Anchoring Compound

Weight-bearing nails and screws can be anchored in plaster, tile and other masonry with a new compound.



A rough hole is bored with a drill or jumper. The material is moistened, rolled into a plug and tamped into the hole. The nail or screw is then inserted in the fibrous plug, which needs no drying time.





AFRICAN IMAGES FROM AN OHIO BACK YARD

By Walter E. Burton

Parsons puts the finishing touches on his version of Ahasuerus, Biblical king. Head was carved from elm

GROTESQUE DEVIL DANCERS and pierced-nose Ubangis frozen in wooden carvings glare from the walls of a quiet Midwestern home. They are typical primitive art. But their birthplace was not the Congo; their creator has never speared a lion or brewed a voodoo potion.

C. O. Parsons, in fact, has never been far from his Akron, Ohio, home. Without ever studying primitive sculpture, without reference to books or museum displays, he has carved over 100 statuettes and heads remarkably like the work of a loin-clothed savage. Seven years of spare time went into their making.

Branching totem pole and Indian, right, are children's favorites. Below, Biblical queen and king, pierced-nose Ubangis are among larger carvings

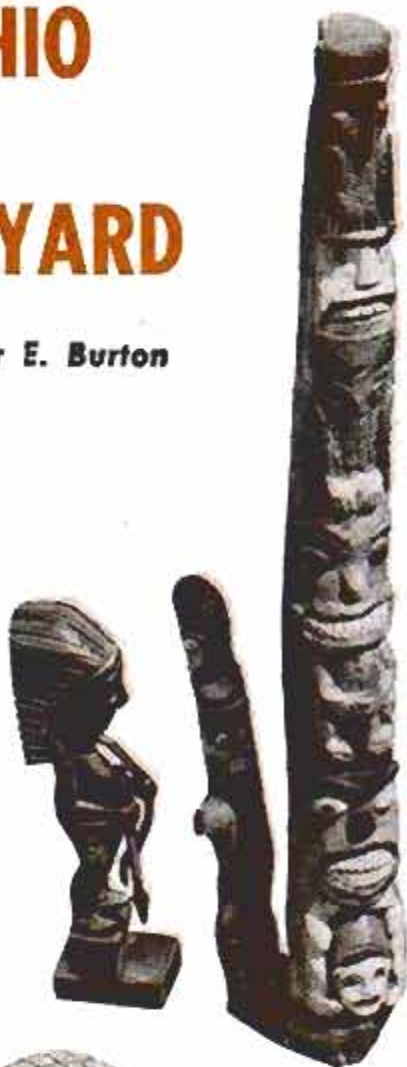



Small figures, respectively, show Egyptian and Puritan influences. Large ones are female devil, five-eyed mate

Parsons, seated under a tree in his back yard, simply unhitches his imagination as he applies a keen pocketknife to a rough block of wood. With chisels, he roughs out the general form and makes heavy undercuts. A jigsaw removes waste wood and a power-driven cloth buffing

wheel works up the final finish. The dark figures are stained with black ink before the buffing. Knife cuts remain, and sometimes the grain of the wood dictates the shape of the carving. Parsons says he doesn't want his figures to have a machine-made appearance. ★ ★ ★

Musician's Practice Cabinet

That trombone or trumpet player next door can be silenced for good—by legitimate means. Just give him a new practicing cabinet that muffles all but 10 to 20 percent of his music. The cabinet, lined with sound-absorbing material, is built in different shapes to house the bell of various musical instruments. Some models, like those for the clarinet, also allow room for the player's hands and arms inside the enclosure. A feature of the cabinet is that impure sounds are not so effectively absorbed, allowing the musician to spot tone imperfections that would normally be masked by other notes.

☞ Insects preserved in amber for 60,000,000 years have been discovered in Alaska.



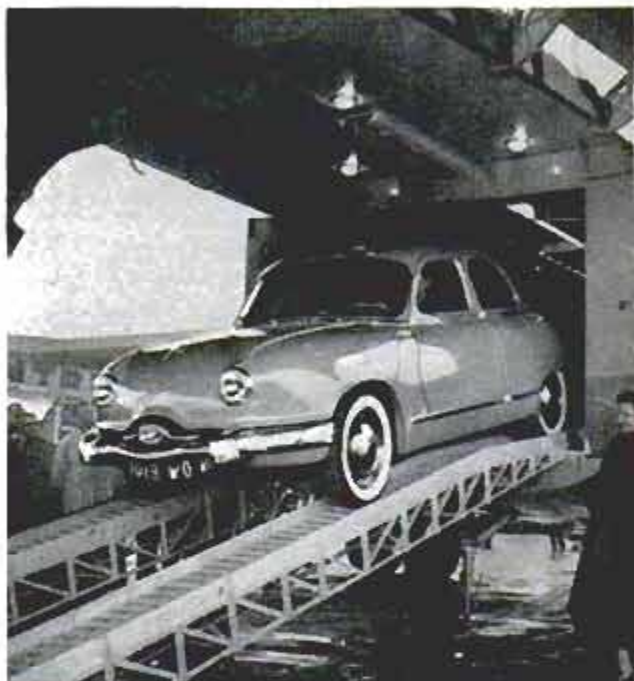

Automobile being driven out of Breguet's big cargo hold. Payload of giant air freighter is 10½ tons



Unique construction of fuselage permits entire lower rear section to open for access to cargo hold

French "Drive Aboard" Airliner

AIR FRANCE is now flying a double-decked passenger-cargo plane with a unique hatch and ramp in the tail which permits automobiles to be driven aboard. The entire lower rear section of the fuselage opens to give access to the main hold, and an inclined ramp facilitates loading of cars and other heavy cargo. The cargo hold is in the lower deck, which may also

be used as a passenger cabin when freight is not being carried. It can accommodate 48 tourist passengers. The upper deck is fitted out to carry 59 tourist and 48 first-class passengers. Designed and manufactured by Louis Breguet, one of France's aviation pioneers, and called the Breguet after him, the plane has a wingspread even larger than that of the Super Constellation.

Capable of carrying 155 passengers when not hauling cargo, the Breguet cruises at 230 miles per hour



KEEPING UP WITH THE ATOM

A NEW ATOMIC PARTICLE, called the "antiproton," has been discovered by a team of radiation experts (right) using University of California's multibillion-volt bevatron. The new particle increases the prospects of releasing, in controlled fashion, vastly greater energy from the atom than is now possible by the fusion process. All natural elements, except hydrogen, are made up of protons, neutrons and electrons, the protons being needed to hold the neutrons and electrons together. The antiproton, as a negative proton, would cancel out the binding force of the proton and, with nothing to hold them, the neutrons and electrons would fly apart. Thus, the antiproton is a disintegrator of the basic building block of all matter. It cannot, however, be used as an instrument, such as a gun or a bomb, for destroying matter.

☆☆☆

Radioisotope by-products are finding more and more uses. One of the newest is to cut down by irradiation the annual loss of \$300,000,000 caused by insect infestation of grain, flour and other cereal products. Radioisotope by-products from atomic reactors can supply a low-cost source of radiation for this purpose, according to

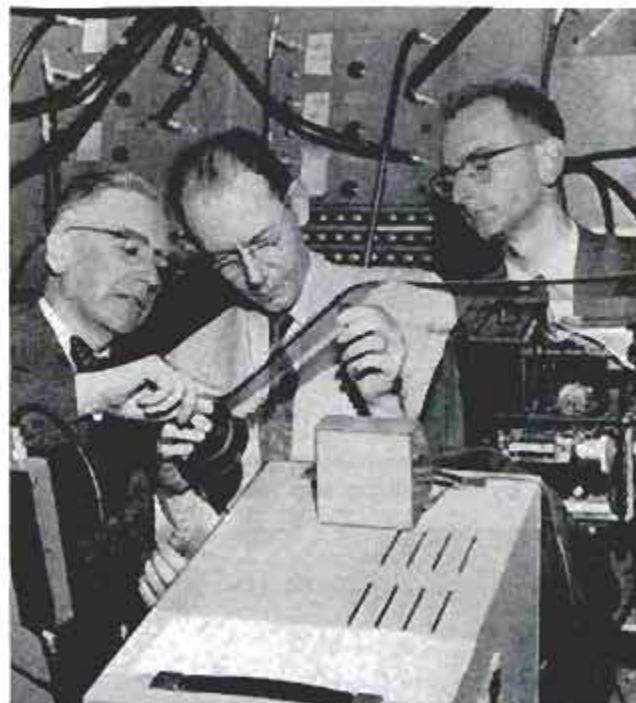

L. E. Brownell, supervisor of Fission Products Laboratory of the University of Michigan. Taste panels have approved the flavor and baking characteristics of bread, biscuits and cakes prepared from irradiated flour. Facilities designed to treat 27 tons per hour operate for less than \$6 per ton.

☆☆☆

Ergot, extracts of which are valuable as muscle-contracting drugs, has been produced in a radioactive form in sealed greenhouses at the Argonne National Laboratory. Since none of the extracts of ergot can be synthesized in the laboratory, the first use of the radioactive material will be laboratory analysis and separation to detect concentrations of alkaloids which are beyond the reach of chemical assay methods. The "tagged" ergot can be used to make a survey for unknown or previously unidentified alkaloids in the ergot, and tracer studies of the action of the alkaloids on the nervous and muscular systems of the body now become possible.

To produce the radioactive ergot, Canadian spring rye was fed radioactive carbon dioxide during its growing period (see left). When the plants flowered they were injected with a fungus and later developed a spurlike growth at the site of the injection. Ergot is extracted from this growth and, since the rye was radioactive, the ergot extracted from the fungus growth will be radioactive also.



WHIRLYBIRDS ARE GETTING BIGGER



World's largest tandem-rotor helicopter is the Piasecki YH-16A. Each rotor is 82 feet in diameter and each is driven by an Allison shaft-turbine engine of 1800 horsepower. It can carry 40 fully equipped troops



Developed as an assault transport for the Marines and comparable in size to a DC-3, the Sikorsky XHR25-1 carries 26 troops at 150 miles per hour



Sikorsky H-34A is the Army version of the Navy's HSS-1. The tail folds for stowing on a carrier, and the Army retained this feature for economy reasons

Below is another photo of the H-34A. It carries a crew of two and 20 troops. Used for evacuation and cargo hauling, it is powered by a 1425-horsepower engine. The S-58, a civilian version, is planned for the future





Tattle Tapes

By
Celia
Webster

YOUR TAPE-RECORDING MACHINE can mix very well with daily routines if you will practice a bit of ingenuity.

Like Mrs. B., a Detroit housewife who put her recorder to task by making a tape of her children's favorite bedtime stories: When the Bs had their night out, the baby sitter turned on the recorder and the familiar voice read to the children just as Mother did every night.

When the Bs took their vacation, tapes were made before they left. On these they imposed stories the children had not heard, and a few gentle reminders and instructions. This little trick on tape helped to bring parents and children closer together each time the machine was turned on.

Another mother, Mrs. A., despaired at the scrapping and constant bickering of her two youngsters. One day, in the midst of a quarrel, she turned on her tape recorder, unknown to them. The tape, when played back to the children, caused them to realize how silly their quarrel had sounded. Now, when they have disagreements and tempers begin to flare, the mention of the recorder calms their voices and many times solves the argument.

The tape-recording machine is useful as a means of secret self-improvement.

In the case of Mr. J., his Rotary speech might not have been so well arranged without it. In preparing the speech, his

recorder was his severest critic. His editing and rearranging otherwise would not have been possible.

One Illinois housewife was recently chosen chairman of the local garden club. She suffered the pangs of fright when she was singled out to speak to a group. She enrolled in a public-speaking course, and all of her "homework" was recorded on her machine. By hearing herself in the playback, she was able to improve her voice quality, and soon her fright disappeared.

In a group of Cleveland churches, parishioners have formed small groups which meet weekly to discuss various religious problems. Since their minister is not present, they often reach an impasse which needs explanation. Many discussions are recorded and are later heard by the minister who can weave the explanations into his sermons.

In our home, the recording machine is an unlimited source of entertainment. One of the most fascinating diversions for our children is to record their assorted songs, jokes and a sales pitch or two. One particular tape has been set aside for this purpose, and the children use it only when we are close by.

These are but a few of the practical ways a recorder can be used in the home. The mixture of moppets and tape can make for a more enjoyable existence.

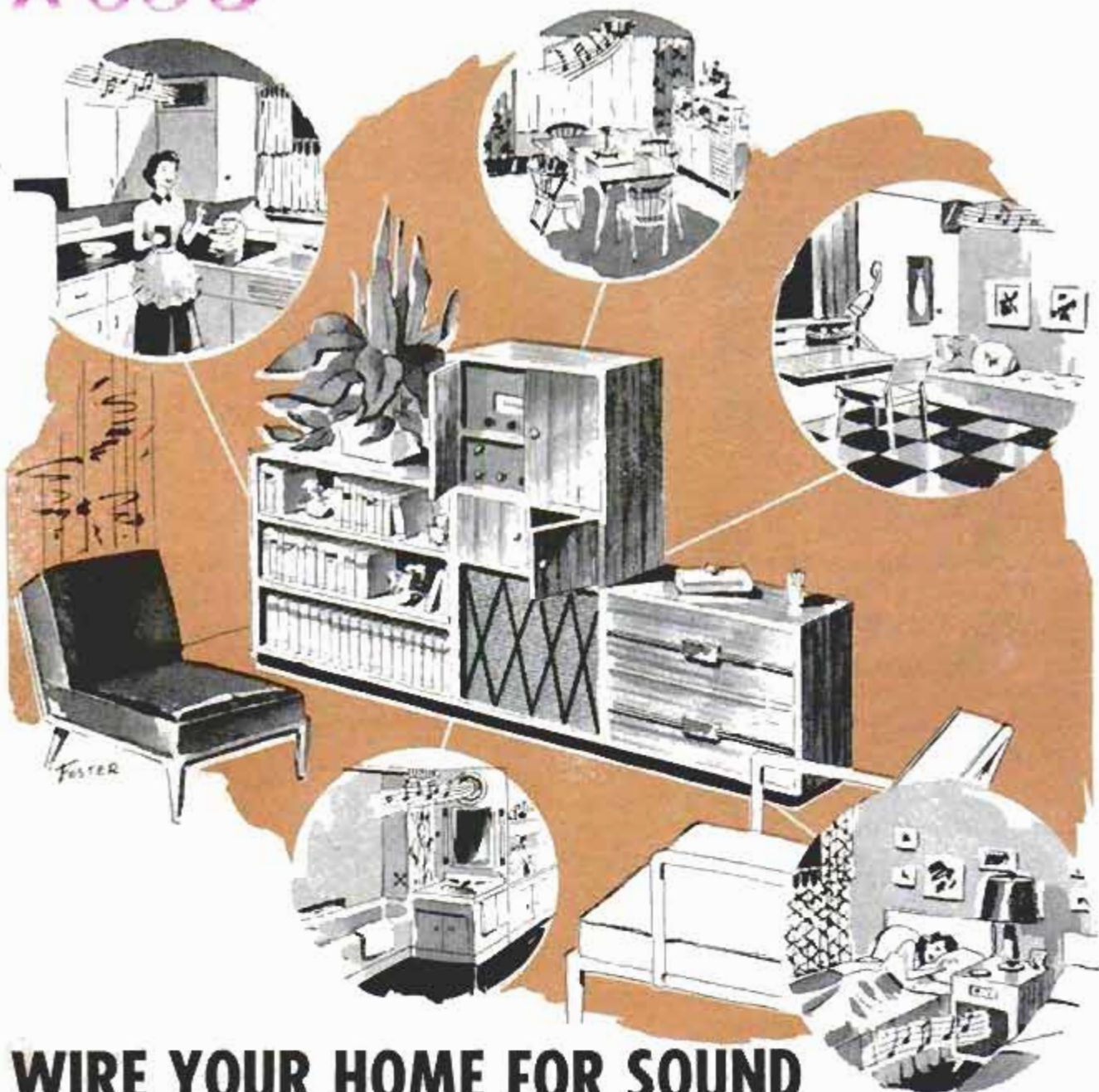

WIRE YOUR HOME FOR SOUND

By Dr. Richard C. Hitchcock

YOUR RADIO or phonograph can follow you to any room of your home without moving from its central location. Yes, through the simple installation of a series of extension speakers you can shave to the latest news, dine to the accompaniment of pleasant dinner music or raid the icebox without missing a single word of that championship fight.

To distribute the output of your music system to various points it is merely necessary to determine the maximum number of speakers that can be driven by the system and the manner of connecting these so that maximum output and fidelity can be obtained. In making the connections, it is essential that a proper match between the audio amplifier and the speakers, regardless of their number, be maintained. This can be done by carefully selecting

speakers with proper voice-coil impedances to provide the required total impedance.

The diagrams of Fig. 1 show various ways of connecting speakers in series, parallel, or series-parallel. The accompanying table, when matched with the indicated diagram, will tell you the required voice-coil impedance of each speaker to obtain any particular impedance match. For example, if three speakers are to provide a total of 4 ohms' impedance, the connections of diagram 1c or 1d can be used. The former requires two 16-ohm and one 8-ohm speaker, while the latter requires two 4-ohm and one 8-ohm speaker.

It is often desirable to distribute the total amplifier power unequally between the various speakers. By choosing the correct diagram and speaker impedances, it may be possible to channel most of the available

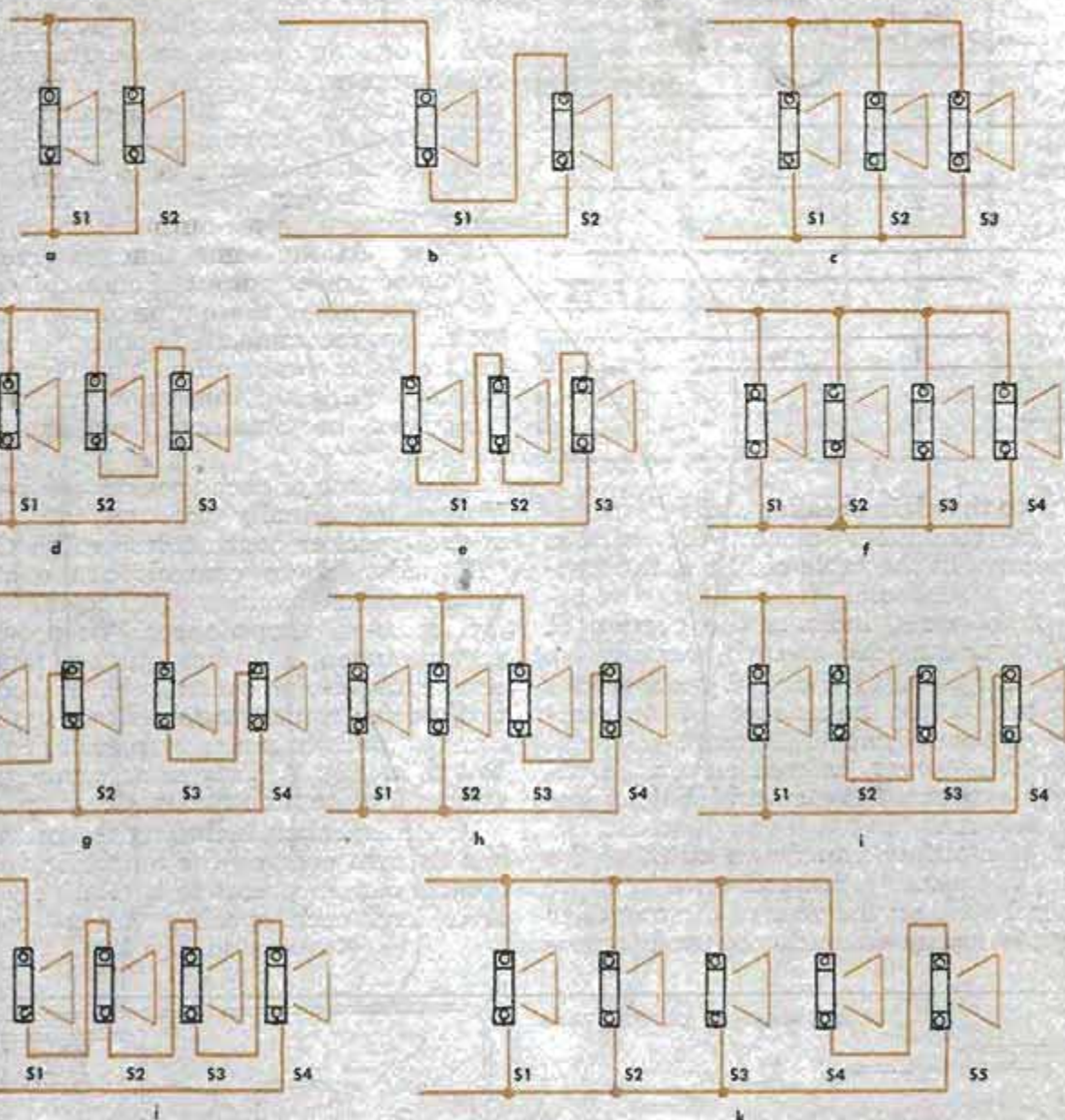

Amplifier Output Impedance	Desired No. of Speakers	Diagram	Voice Coil Impedances and Power Distribution (fractions indicate amount of total power per speaker)				
			S1	S2	S3	S4	S5
4	2	a	8 (1/2)	8 (1/2)			
		c	16 (1/4)	16 (1/4)	8 (1/2)		
	3	d	8 (1/2)	4 (1/4)	4 (1/4)		
		f	16 (1/4)	16 (1/4)	16 (1/4)	16 (1/4)	
	4	g	4 (1/4)	4 (1/4)	4 (1/4)	4 (1/4)	
		h	16 (1/4)	16 (1/4)	4 (1/4)	4 (1/4)	
		h	8 (1/2)	16 (1/4)	8 (1/2)	8 (1/2)	
	5	k	16 (1/4)	16 (1/4)	16 (1/4)	8 (1/2)	8 (1/2)
n		8 (1/2)	8 (1/2)	8 (1/2)	8 (1/2)	8 (1/2)	
8	2	a	16 (1/2)	16 (1/2)			
		b	4 (1/2)	4 (1/2)			
	3	d	16 (1/2)	8 (1/4)	8 (1/4)		
		g	8 (1/4)	8 (1/4)	8 (1/4)	8 (1/4)	
	4	i	16 (1/2)	8 (1/4)	4 (1/8)	4 (1/8)	
		m	16 (1/2)	4 (1/8)	4 (1/8)	4 (1/8)	4 (1/8)
5	n	16 (1/2)	16 (1/8)	16 (1/8)	16 (1/8)	16 (1/8)	
16	2	b	8 (1/2)	8 (1/2)			
	3	e	8 (1/2)	4 (1/4)	4 (1/4)		
	4	i	4 (1/4)	4 (1/4)	4 (1/4)	4 (1/4)	

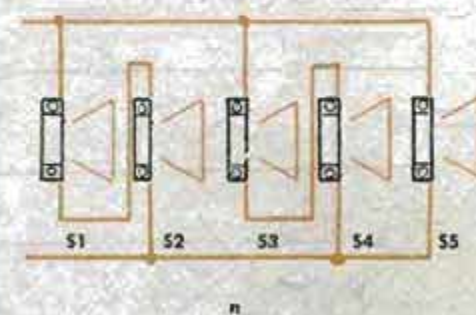
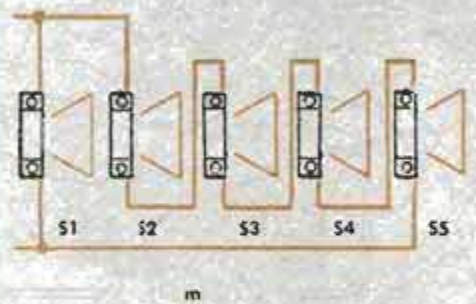

1

Output Tube Types	No. of Output Tubes	Estimated Power Output In Watts	Maximum No. of Speakers Suggested
2A3	1	3.5	3
	2	10-15	5
6AQ5 6K6 6F6 12AQ5	1	3-4.5	3
	2	10	5
6L6	1	6-10	4
	2	15-50	5 or more
6V6	1	3-5.5	3
	2	10-14	5
50C5 50L6 50B5	1	2	2

power to the main speaker while distributing the remainder among the various extensions. In the table of Fig. 1, the fractions in parentheses, following the voice-coil impedances, indicate the portion of total power supplied to each speaker.

Most single-unit radios and phonographs have an output impedance of approximately 4 ohms. Some of the more-powerful consoles, however, as well as most high-fidelity systems, have several output impedances, including 4, 8 and 16 ohms. In cases of multiple impedance outputs, the values are usually marked on a plug or terminal strip on the rear of the amplifier chassis, and any value can be used to pro-

vide a proper match between the amplifier and speaker systems.

Almost any radio or phonograph is capable of driving at least one extra speaker. Many of them can supply five or more with better-than-normal listening volume. It all depends on the amount of power which the amplifier can deliver.

The table, Fig. 2, lists several of the most common power-output tubes in present use. At the same time, it gives the estimated power output of an amplifier using one or two of these tubes, as well as the maximum recommended number of speakers for each combination. The power-output capabilities of tubes not listed in the table can be obtained from any tube manual.

The volume of each speaker can be controlled individually through the use of special speaker controls known as "L" or "T" pads. These controls are available with resistance values equal to the standard voice-coil impedances. To provide a proper match, a 4-ohm speaker must be used with a 4-ohm control, etc. The correct method for connecting speakers with "L" and "T" pads in series or parallel is illustrated in Fig. 3. This same arrangement applies if more than two speakers are used.

If each speaker, including the main one, has its own control, the amplifier volume control can be preset to a relatively high level, and each speaker volume can be

(Continued to page 254)

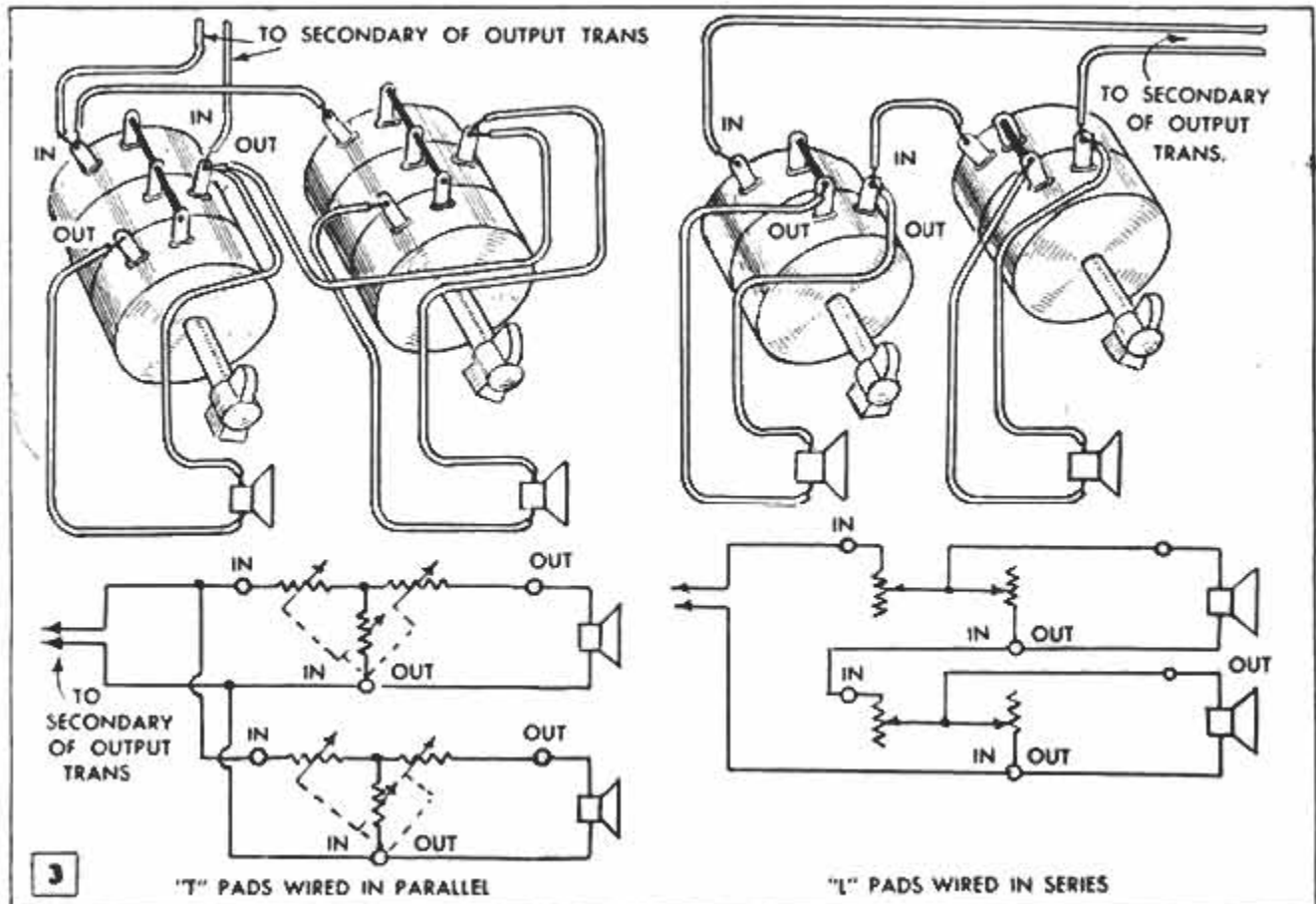

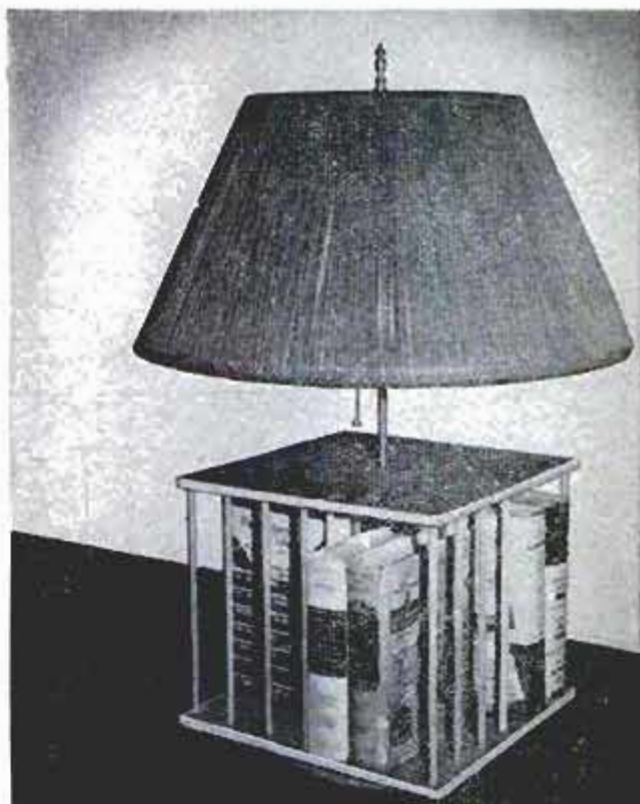
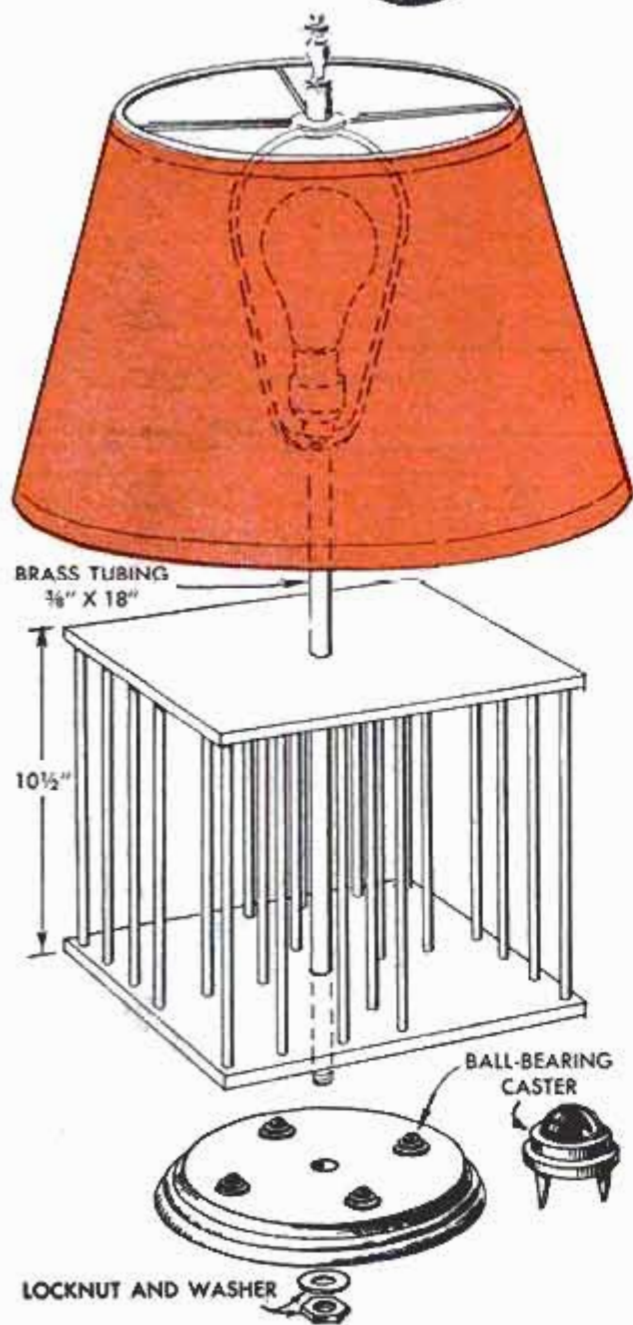

LAZY-SUSAN BOOKCASE- LAMP

By Elmer W. Ferris

THIS BOOKCASE-LAMP combines two necessities for relaxed reading, a light and a generous supply of books. Twelve or more books will fit in the bookcase and it rotates at the touch of a finger so any book can be reached without leaving your chair.

Although the details show the lamp base to be a turned disk, a square base made with hand tools would do as well. In either case, 1-in. stock should be used, preferably hardwood. A circular base should be at least 8 1/2 in. in diameter, and a square base should measure 8 1/2 in. on a side. While the round base is turned with a hollow on the underside, the square base would require

counterboring the center hole to receive the locknut and washer which fit on the lower end of the 3/8-in. brass tubing of the lamp column. Bearings on which the bookcase "floats" as it rotates on the lamp column consist of four ball-type casters, spaced equidistant on a 6-in.-dia. circle scribed in the center of the upper surface of the lamp base.

The lamp column is an 18-in. length of 3/8-in. brass electrical tubing, threaded on the upper end to receive a lamp harp and socket. Thread the lower end far enough to permit using a nut and washer against both upper and lower surfaces of the lamp base. It is not necessary to counterbore the

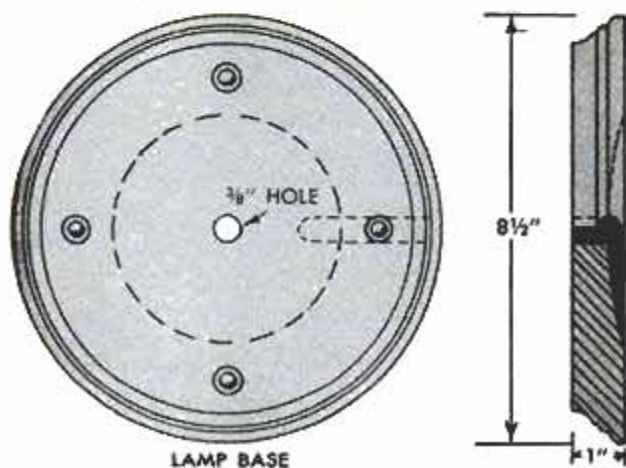
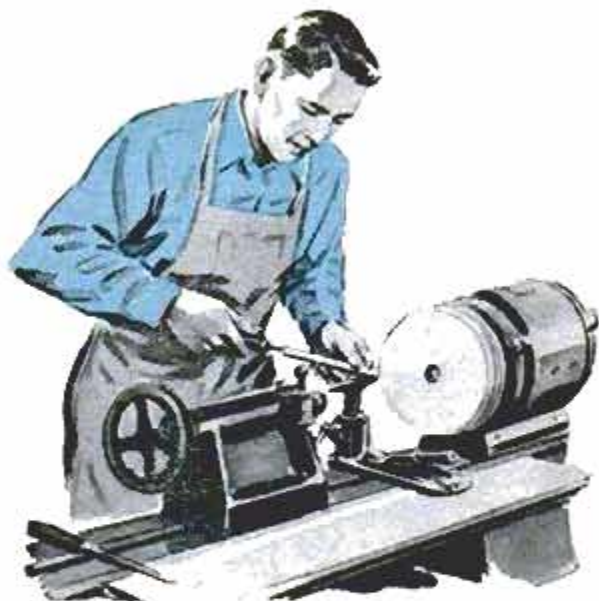

LAMP BASE

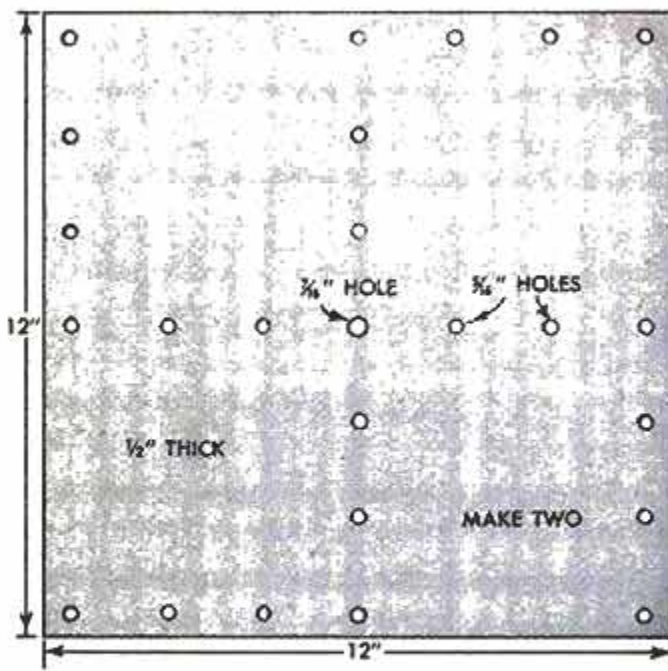

upper surface of the base for the nut and washer, since the casters provide ample clearance.

Two 12-in. squares of $\frac{1}{2}$ -in. plywood drilled with a pattern of $\frac{3}{16}$ -in. blind holes $\frac{1}{4}$ in. deep are used for the top and bottom of the bookcase. Taper the ends of 10-in. lengths of $\frac{3}{16}$ -in. dowel to aid assembly, wipe with glue and insert in the holes in top and bottom. A sheet of thin aluminum tacked to the underside of the bookcase will provide a bearing surface against which the casters will turn more easily.

Broken Lines Penciled Quickly With Modified Straightedge

Securely attached to a drawing pencil, a pencil pocket clip that is adjusted to ride on raised portions of a straightedge will enable you to produce uniformly spaced dots, dashes and other types of broken lines used in drafting. Sunken portions of the straightedge may be shallow notches cut with a gouge, or routed as in the upper

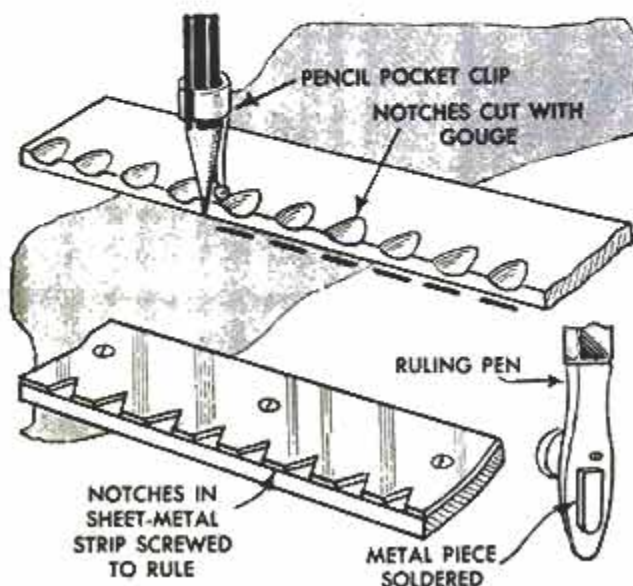

detail. Another way to provide alternate high and low spots is to notch a piece of sheet metal and screw it to the straightedge as shown in the lower detail. A third method is to drive small roundheaded brads or thumbtacks into the straightedge. A ruling pen can be used in the same manner by soldering a small block of metal to one leg. Round the lower corners of the metal block and space it above the pen-point tip according to the thickness of the straightedge.

Rubber Band Around Toy Auto Protects Furniture

A heavy rubber band stretched around a child's small auto or truck will act as a bumper to prevent dents and scratches on furniture legs, baseboards and other household objects. Bands cut from inner tubes can be used for larger mobile toys.

Mrs. Michael Fey, New York City.

☛ Metal and wooden kitchen trays last longer when a coat of thinned white shellac is applied to the top surface.

Whatnot Cabinet Made From Window Shutters

Three wooden window shutters were hinged together to form the back and sides of this cleverly designed corner whatnot cabinet. Legs for the cabinet are provided by cutting the lower shutter sections in half horizontally and removing the paneling so only the vertical rails remain. Three of the six shelves in the cabinet are cut from plate glass and three from $\frac{3}{8}$ -in. plywood. Strips of molding on the inner surface of the cabinet back support the rear edges of the glass shelves and L-hooks support the front edges. The plywood shelves are drilled to receive the vertical projection of three L-hooks, one in the center at the back and one at each front corner. The latter arrangement helps to hold the cabinet together. For a more finished appearance, the same type of molding used to support the glass shelves is nailed to the front edges of the sides.

Otto Merker, Chicago.

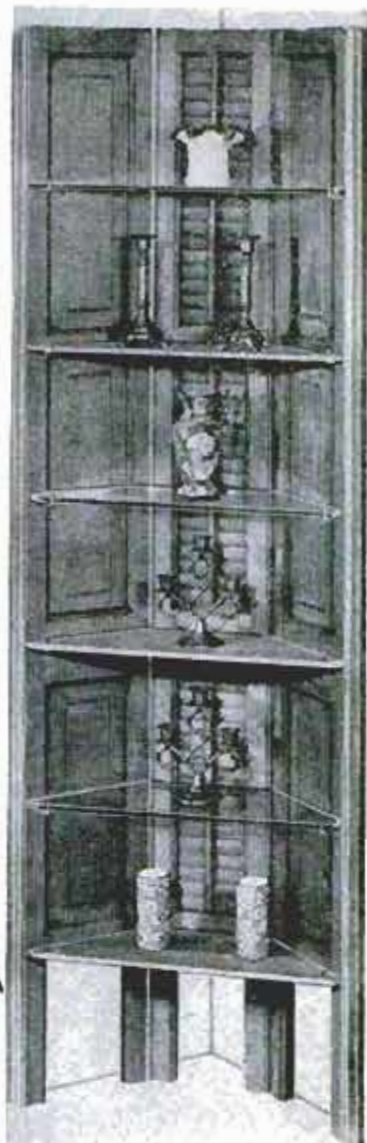
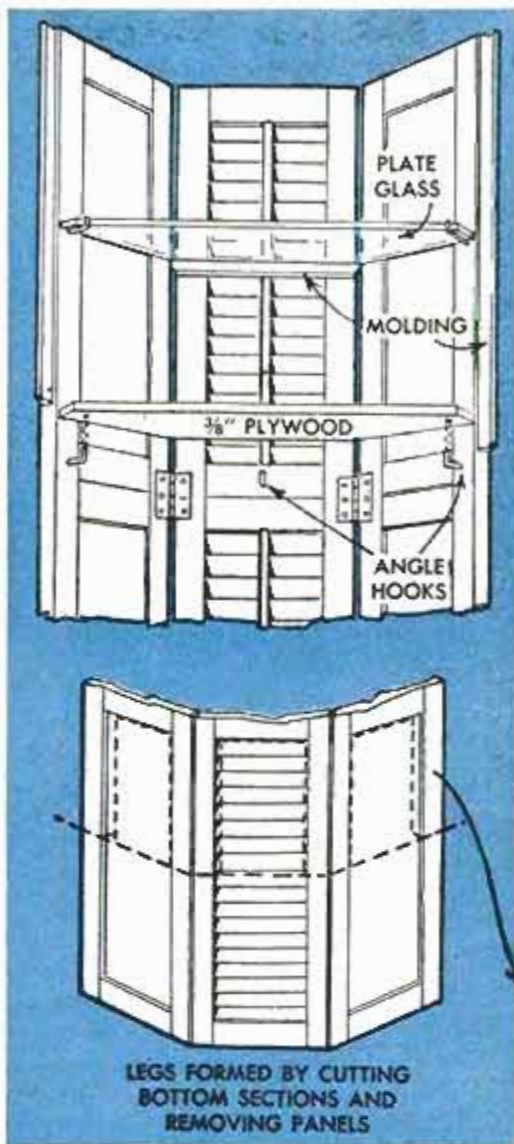

Magnet Holds Papers to Door of Metal Kitchen Cabinet

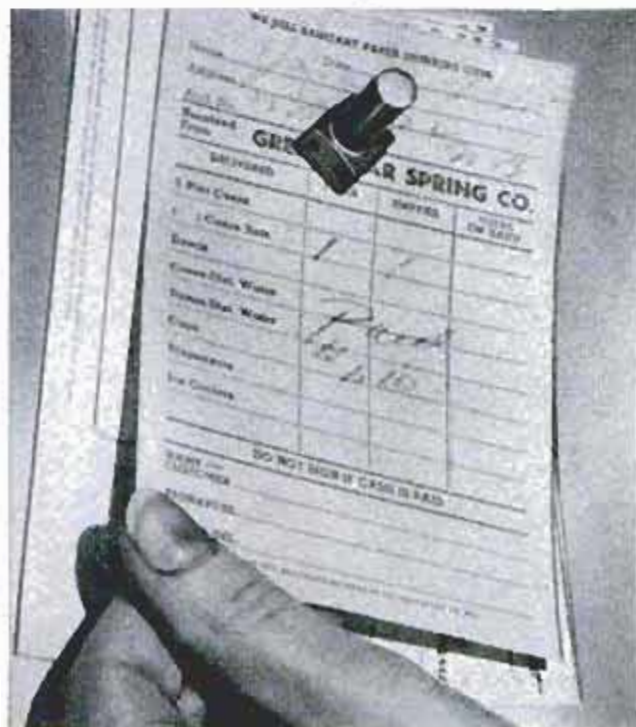

Metal kitchen-cabinet doors serve double duty as handy bulletin boards when small magnets are used to "pin" recipes, notes and bills to them. To use this method just hold papers against the metal surface and place a magnet on top of them.

Ladder Rails "Skidproofed"

To prevent a ladder from slipping when it is used on a smooth surface, attach old rubber heels to the lower ends of the rails. Use nails or screws with fairly large heads so the rubber heel is firmly held, but countersink the heads to prevent them from contacting any surface on which the ladder is placed.—Ted Fenn, Chicago.



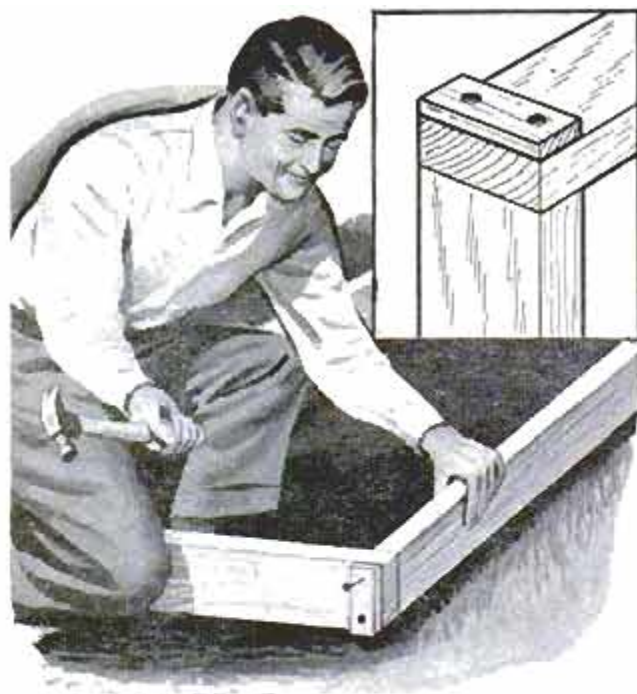

Disassembly of Wood Forms Is Easy With Lath Strips Under Nails

For temporary frames and small construction, such as concrete forms, scaffolding, barricades and animal pens, the lumber is salvaged in good condition at a later date if a piece of lath is used under the nailheads as indicated. Members of the frame are held securely yet the thin lath can be split easily to leave the nailheads projecting enough to get under them with the claws of a hammer.

One-Piece Metal Chimney Hood Requires No Fastening Bolts

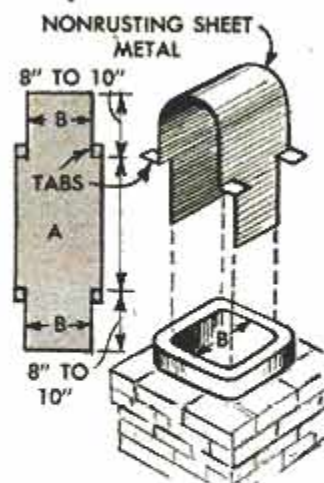

Cut and bent from a single piece of heavy-gauge sheet metal, this chimney hood will fit either square or rectangular flues. Two fins, which extend down 8 to 10 in., are cut to fit snugly inside the flue, being slightly wider than dimension B. The length of the curved portion, A, is determined by multiplying dimension B by 3.1416 and dividing the result by 2. The curve is bent so tension is provided to keep the fins forced against the sides of the flue. When the fins are forced into place inside the flue, the hood is held firmly on the chimney, but it can be quickly and easily removed by pressing the fins inward and pulling upward.

Quick-Acting Wrench Made By Grinding Flat on Screw

By grinding off a portion of the adjustment screw of an ordinary car or monkey wrench, it can be made quick-acting. When the flat side of the adjustment screw is turned toward the threads, the wrench jaws can be pushed together quickly over the work. Then the adjustment screw is turned to mesh

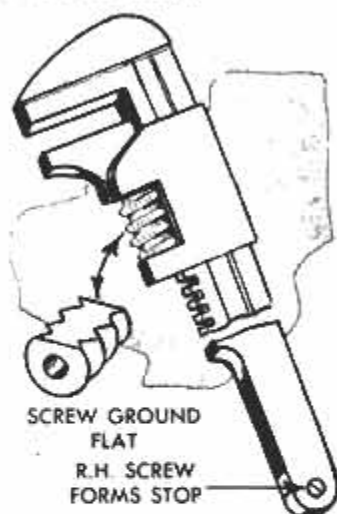

with its threads for final tightening. To prevent the movable jaw from slipping off the bottom of the handle, a small screw is driven into a tapped hole in the handle.

Angle Iron Set in Concrete Guides Farm-Building Doors

Sliding doors are held tightly against farm buildings and align perfectly when two lengths of heavy angle iron are set in concrete at a doorway to form a channel guide for the bottom of the door as shown. The metal channel also is effective for keeping rodents from entering the building by crawling under the door, a factor which would make the channels valuable for any building used as a granary.

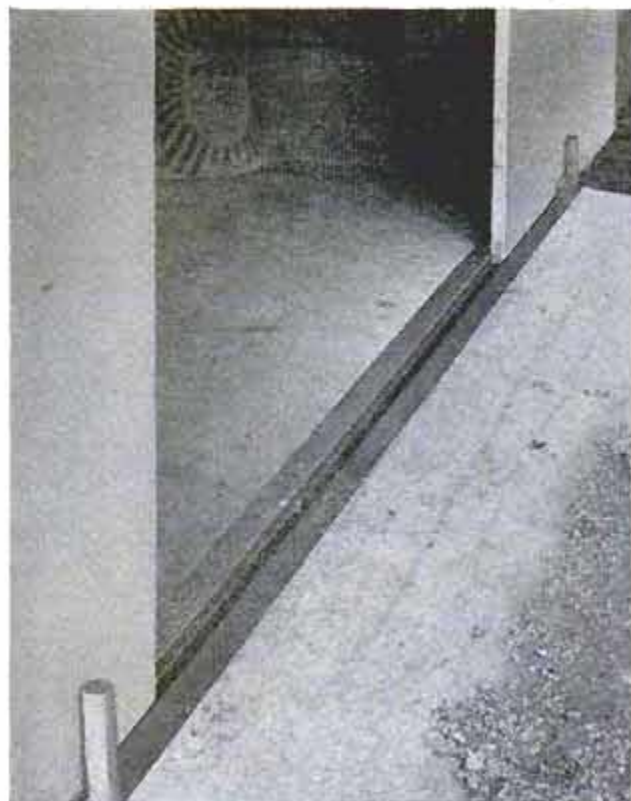



ONE-EVENING PROJECTS

ANY ONE OF THESE eight projects affords the craftsman a full evening of relaxation in the workshop. Most of the work can be done with the jigsaw, or with a coping saw if you don't have power tools. Several of the projects have been purposely designed to utilize small pieces of wood of contrasting color and attractive graining, such as the four pieces used in assembling the book ends pictured at the right. The humidor-pipe rack and the cigarette server can be made from contrasting woods or of a single variety of wood as desired.

Each unit of the book ends consists of two pieces, one of walnut and one of maple or ash, cut in the manner indicated in the detail and face-glued with the horizontal

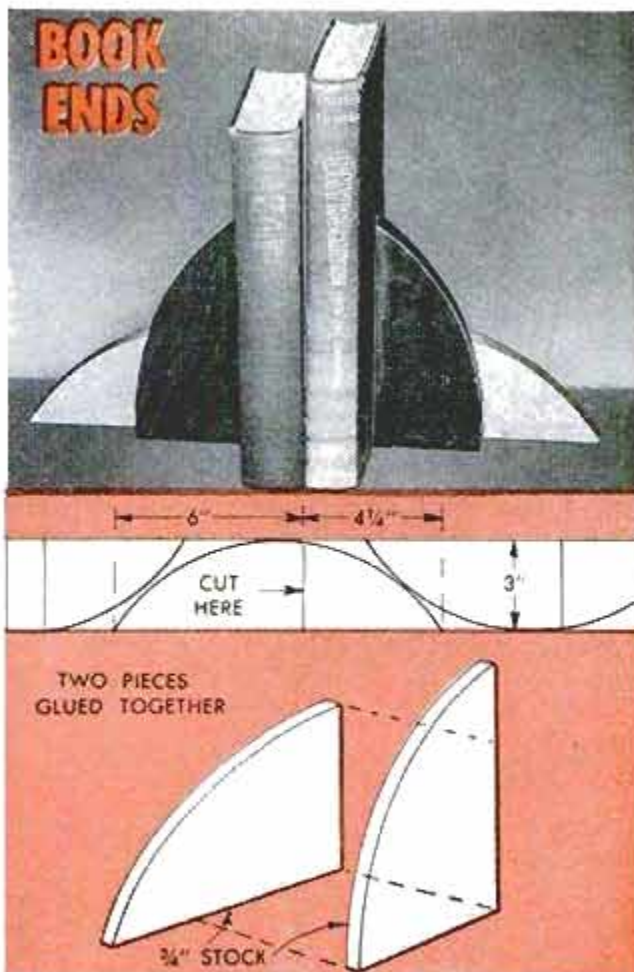

Above, book ends pictured are not only attractive and useful, they can be made with a coping saw and several pieces of sandpaper. Just cut four pieces, two from dark wood and two from light wood, glue together and you have the pair. Below, construction of the lamp is clearly shown in details and pictures

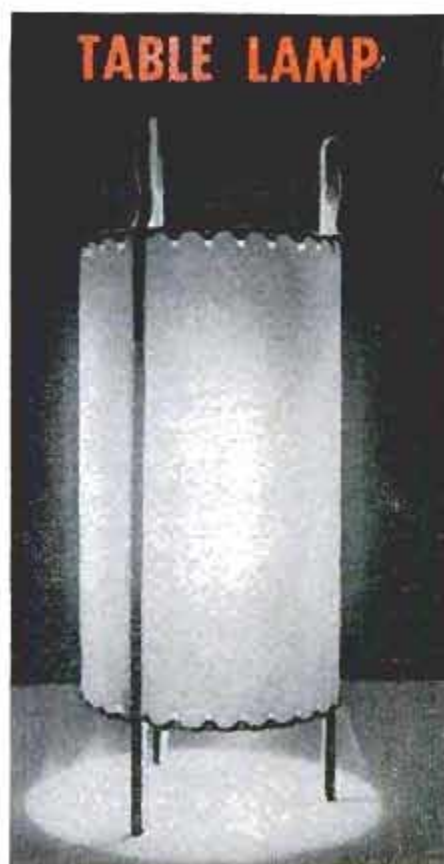

JANUARY 1956

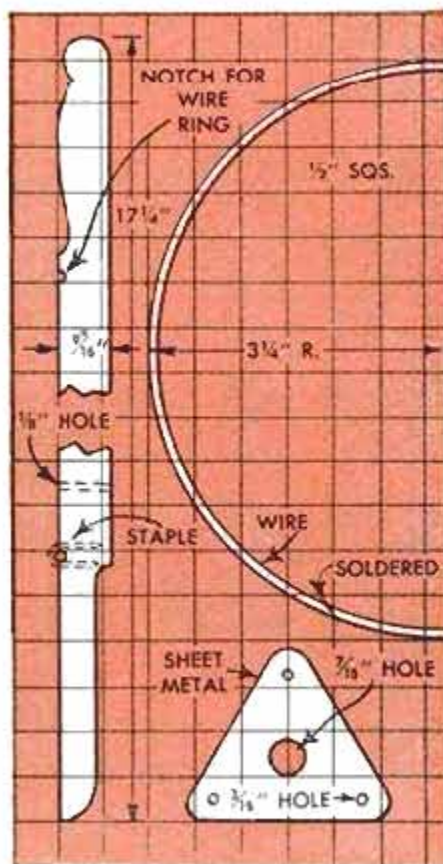

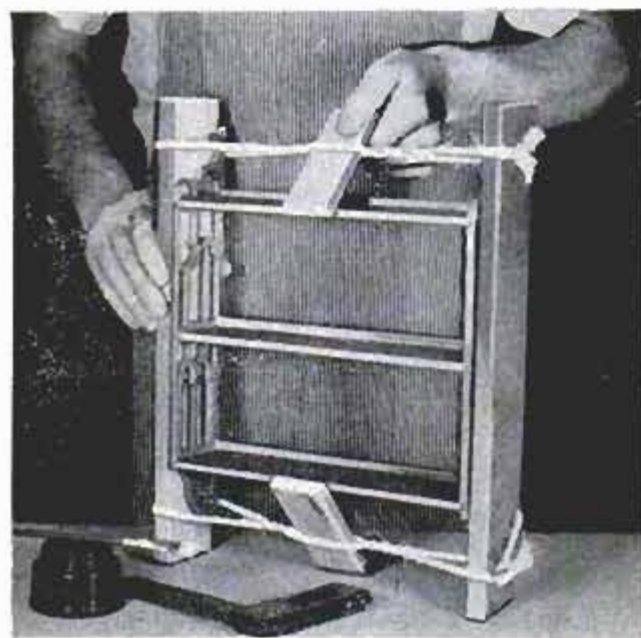
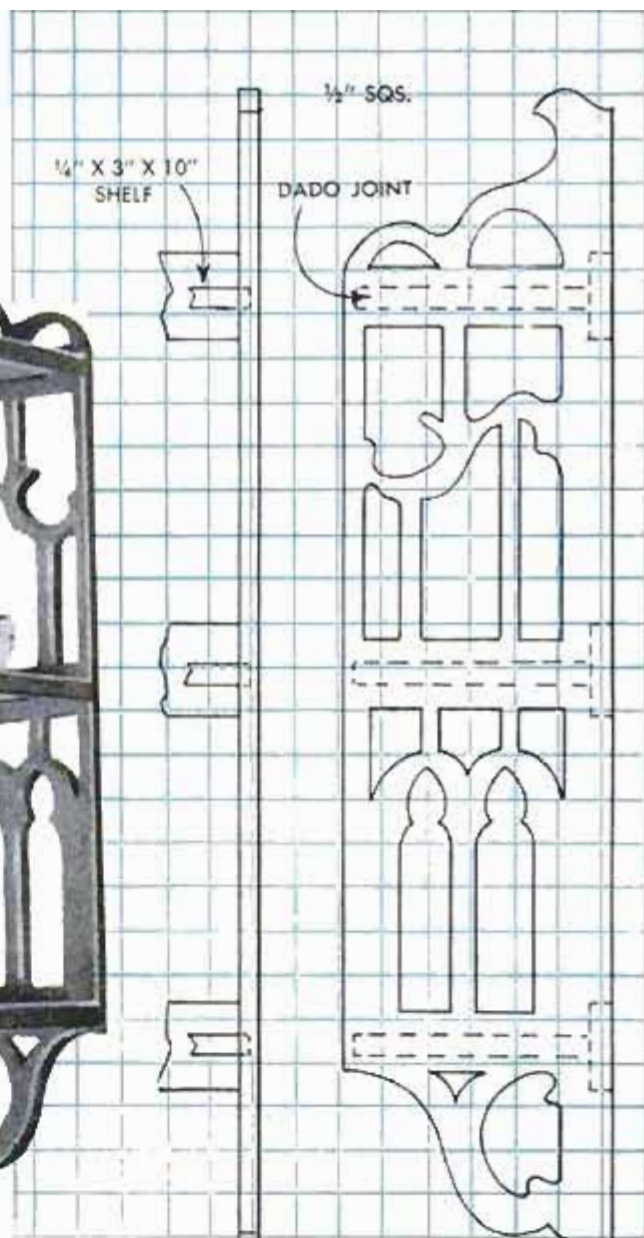
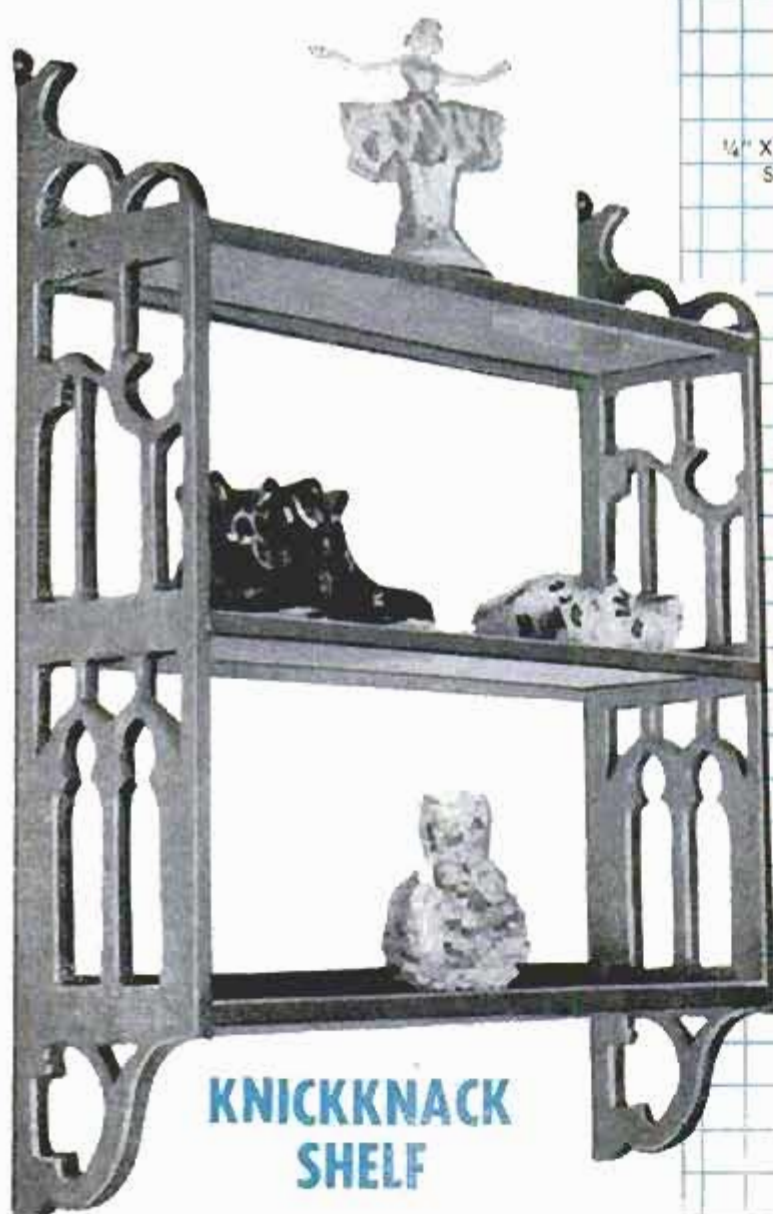

End panels of knickknack shelf are cut by stack-sawing, resulting in two identical parts. Lower photo shows method of assembling with improvised clamp

and vertical edges flush. After sanding smooth, finish with pale varnish or water-white lacquer and polish with very fine steel wool.

With the materials at hand you can have the table lamp ready for service in the recreation room or TV room in an hour or so. Note the scroll cuts at the ends of the three strips which form legs and frame of the lamp, also the round-bottom notches which take the wire rings. The ends of the wires which form the rings are filed at an angle and soldered. Be sure that both rings are the same diameter before soldering. Join the rings to the uprights with small staples, as indicated in the detail. Then fit the "spider" which supports the lamp socket and you're ready to install the parchment shade. Finishing the exposed ends of the wooden uprights is necessary only if the wood is to be stained or painted to match other furnishings. Otherwise leave the wood unfinished.

Collectors of miniatures have found that an attractive and orderly display of a col-

TOOTHBRUSH HOLDER



You can put any face you like on this toothbrush holder. Cut to pattern from $\frac{1}{4}$ -in. plywood, paint face in flesh tone, add eyes, nose, mouth, ears in black. Hair is dark orange color. Two L-hooks hold brushes

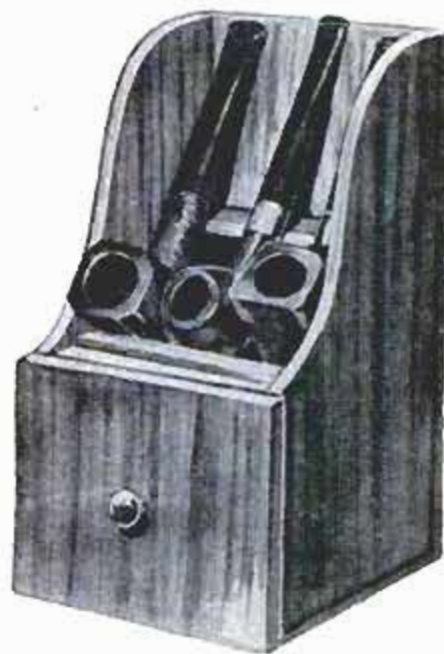

lection adds much to the pleasure of ownership. For this purpose the knickknack-shelf unit pictured is much more effective than a cabinet. Scrolled endpieces are stacked, fastened with brads and the pattern layout made on the top piece. Then saw through both pieces in one operation on the jigsaw and you have two identical parts. Ordinarily, the dados are cut before jigsawing.

In making the toothbrush holder, humidor-pipe rack and cigarette server, most of the parts are jigsawed to the patterns which are laid out on thin stock. Cut edges



CIGARETTE SERVER

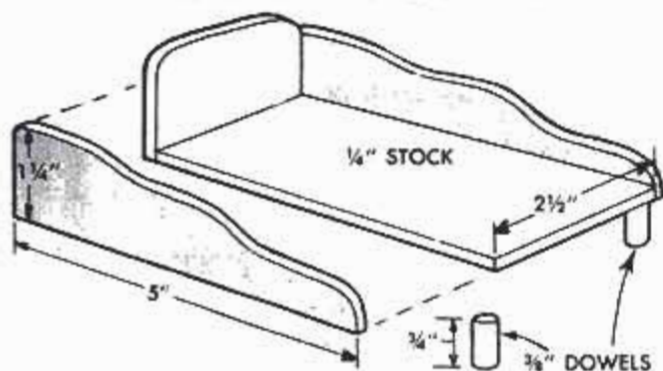

HUMIDOR-PIPE RACK

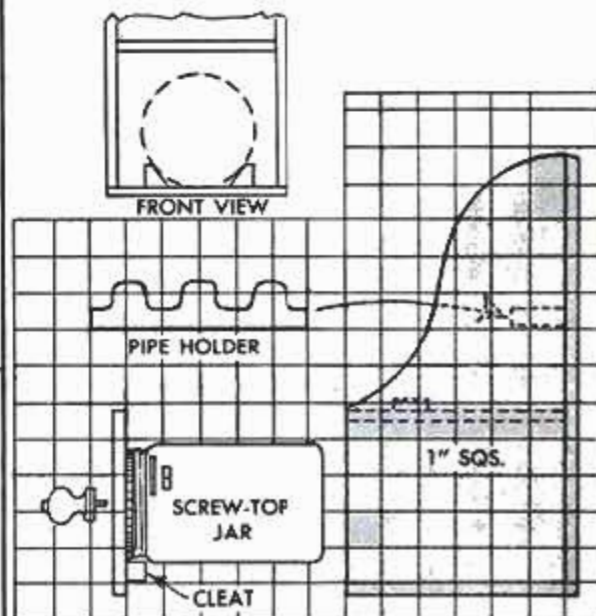

Pipe rack and cigarette server should be made from choice cabinet woods and finished in the natural color to bring out the grain. Note novel tobacco humidor made from a screw-top glass jar attached to the inside face of "drawer" front. Rack-humidor unit, also cigarette server and book ends are especially adapted to mass production in a small workshop and should be of interest to craftsmen desiring to turn out items for sale at a profit. Stack-sawing and jig assembly of parts reduce costs per unit

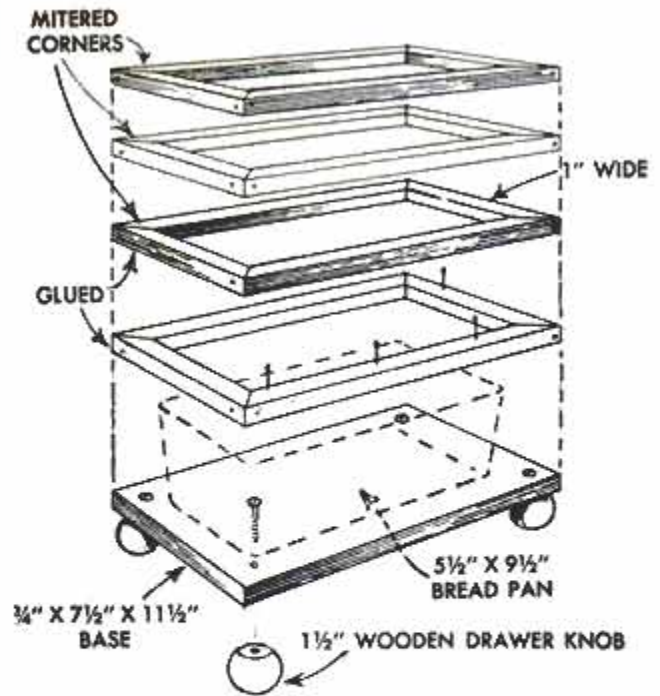
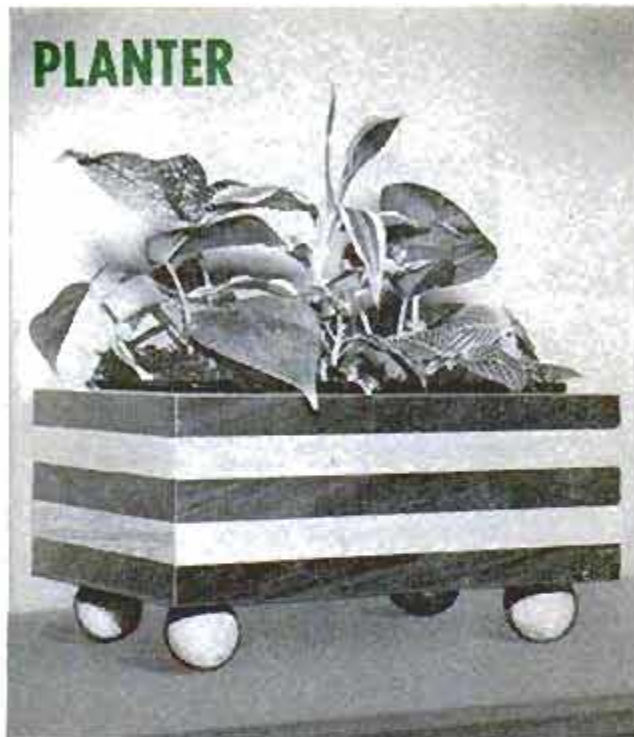

Attractive and unusual appearance of this planter results from use of two contrasting woods. Base and two frames are dark wood, two other frames are light. Waterproof liner in planter is bread pan

should be finished by sanding to remove saw marks. Use $\frac{1}{4}$ -in. plywood for the painted toothbrush holder and choice pieces of solid stock for the pipe rack and cigarette server. Sand thoroughly and finish in the natural color of the wood with pale varnish or water-white lacquer.

The planter consists of four frames made

with mitered corners, two frames cut from a dark-colored wood such as walnut and two from a light, contrasting wood such as maple. The frames are stacked as pictured and then glued to a base piece. Sand after assembly and finish in the natural color of the wood to obtain the most pleasing contrast. ★ ★ ★

Bolted or Welded Assemblies Used for Window-Well Gratings

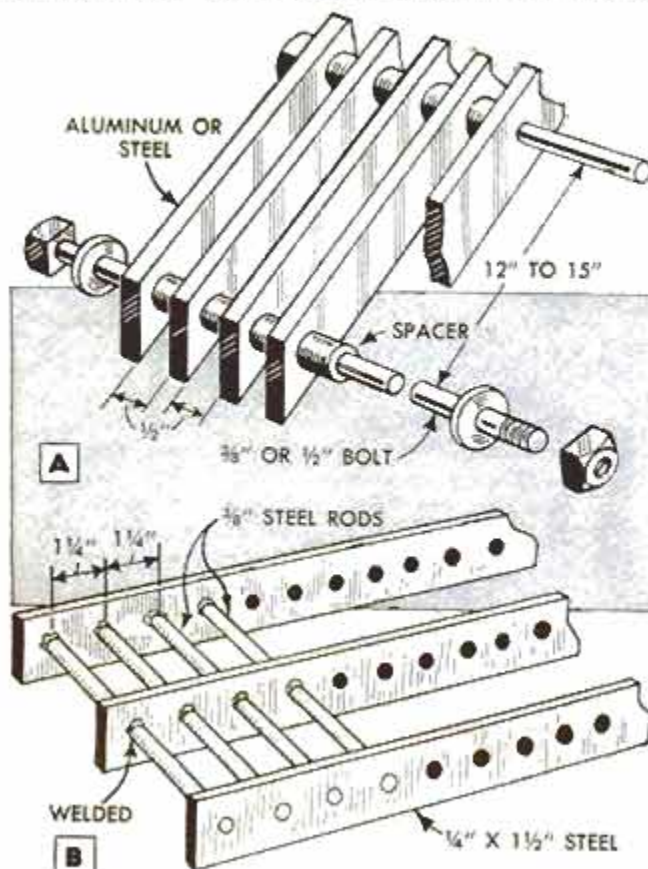

Metal gratings, which should be fitted across open window wells to prevent possible injury by persons falling into them, can be made with either a welded or bolted assembly. Detail A in the drawing illustrates a grating assembled from flats, rods, spacers and nuts. The flats can be either steel or aluminum. Aluminum is preferred for a grating that will be removed and replaced often, such as over a coal-bin window. The flats are drilled to receive $\frac{3}{8}$ or $\frac{1}{2}$ -in. bolts or steel rounds, long enough to span the window well. Spacers, which can be short lengths of pipe or large nuts, are fitted between the flats that are assembled on the bolts. Detail B shows a grating made from steel flats drilled to receive $\frac{3}{8}$ -in. steel rods. The rods are welded to the flats. With either type, if the window well is not recessed to receive a grating, hang the grating from the well edges with hooks.

When the cap or stopper is lost from a bottle or other container, an airtight cover can be made by fitting a child's balloon over the top.

Horseshoe Serves as Latch For Trap Door in Barn Loft

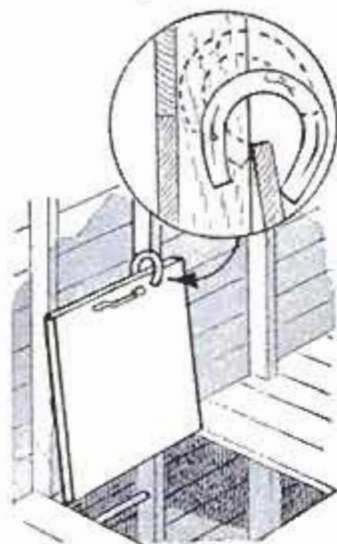

One farmer uses a discarded horseshoe as an automatic latch on the trap door to his barn loft to prevent accidental dropping of the door when opened from below. The shoe is attached to one of the barn studs so that when the trap door is opened against it, the shoe pivots to engage the edge of the door securely.

The weight of the shoe is sufficient to hold an average-sized door. For heavier doors, the shoe should be tightened against the stud so that it does not pivot as easily, or the door should be held with a hook.

C-Clamp Helps Align Butt Joint

When fastening simple butt joints together, it isn't easy to hold them in proper alignment while drilling pilot holes or during assembly. To minimize this trouble hold the joint with a C-clamp as shown. Bits of scrap wood under the clamp members prevent pressure marks as well as keeping the parts in alignment.

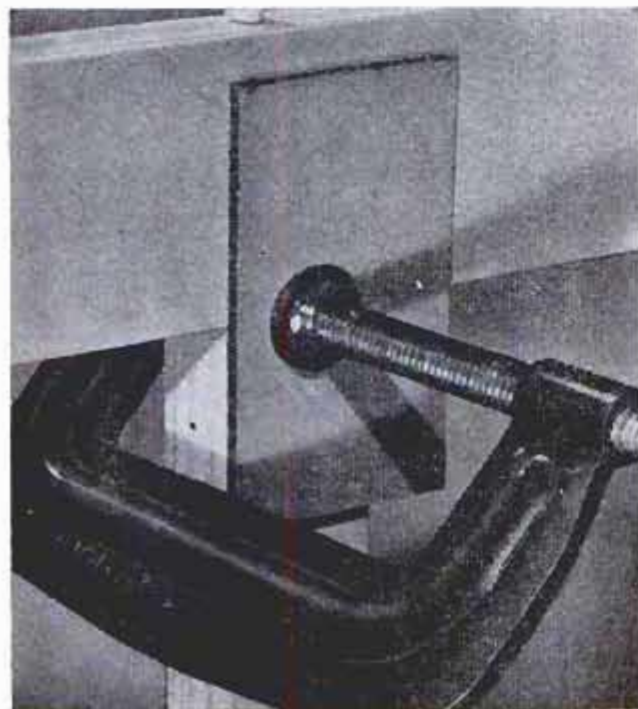

Resin will not "bleed" through when finishing knotty pine if the knots are sealed with one or two coats of white shellac.



Small Window Greenhouse Utilizes Storm Sash

A window greenhouse which utilizes the present storm sash can be built in a couple of hours and at a nominal cost. First, the storm sash should be hung on hook-and-eye hangers at the top. The bottom of the sash is extended and a platform of 1-in. stock is fitted between it and the window sill as shown. Hooks hold the platform against the sill to prevent entry from the outside. Two triangular-shaped pieces of $\frac{3}{4}$ -in. exterior plywood form the sides of the greenhouse. Glue and wood screws are used throughout the assembly. Weather stripping is nailed to the window frame so it covers the opening between the top of the storm sash and the frame.

Outlining Designs on Wood With Shellac and Stain

For an interesting decoration in natural wood, outline a selected design on the finished surface of a square of wood and cover the scribed design with thinned shellac.



When the shellac is dry, the surrounding area of the wood can be stained in a color of your choice, leaving a design which will hold its natural-wood appearance.

Ted Otsu, Vancouver 4, B. C., Can.

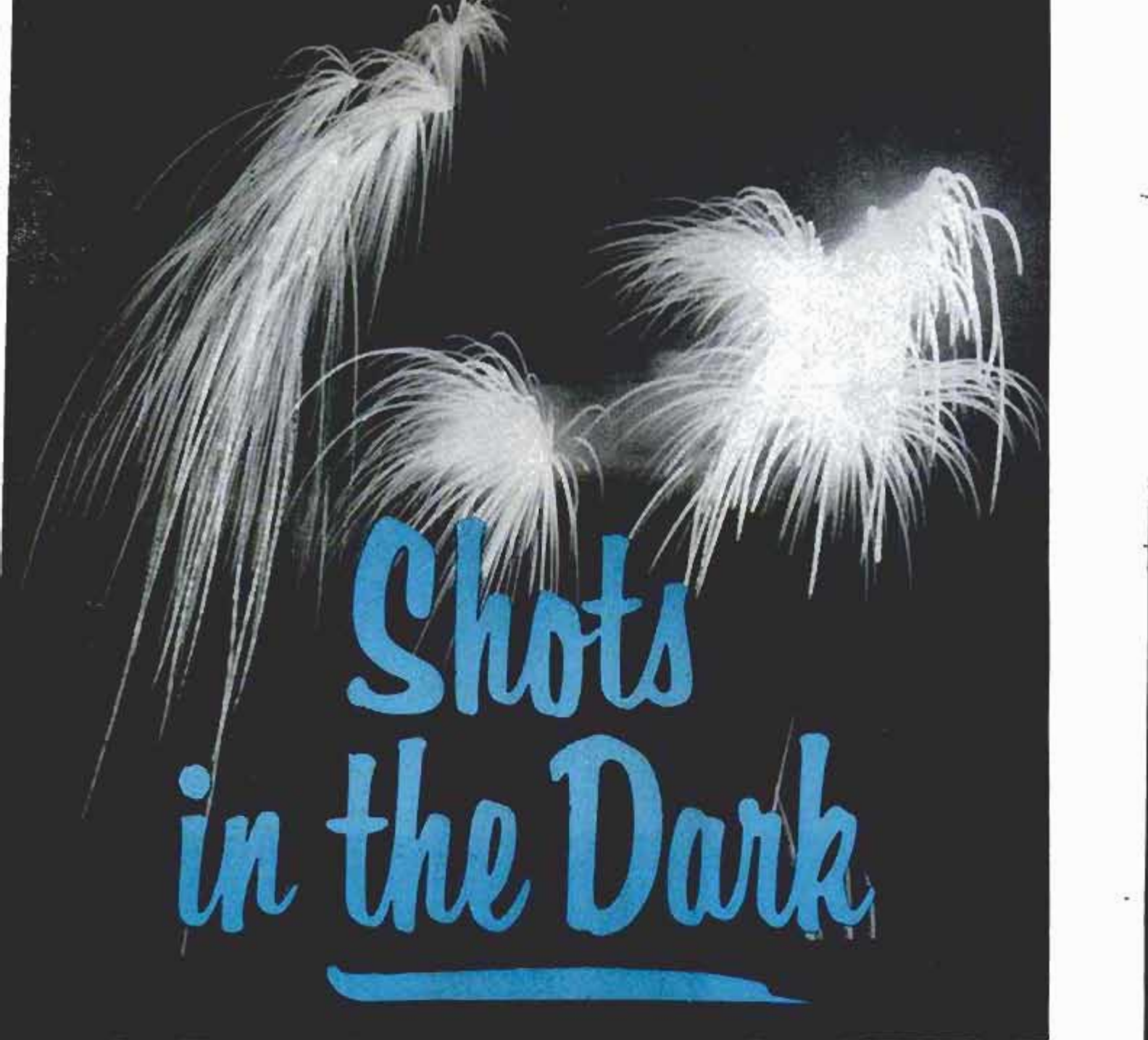

Shots in the Dark

By Shep Shepherd

Architectural subjects, lighted only from within, or, as in this case, by exterior floodlights as well, are ideal subjects for the alert nighttime photographer



Startling fireworks photos are fun to make. This one is three different shots superimposed on one negative

AMATEUR PHOTOGRAPHERS who cannot find interesting subjects during the day in their locality may make the mistake of putting away their cameras at nightfall. A city or countryside has an entirely different appearance by night and offers numerous challenges to a photographer seeking unusual and striking effects.

Night photography does not require expensive equipment. Even a box camera can be used with good results. The primary requisite is a rigid tripod, or lacking that, any solid support that will hold the camera steady. Lighted buildings and other structures often have stairways, low walls or ornamental projections that will provide suitable rests.

After-dark pictures require a medium-speed panchromatic film, such as Kodak

Plus X. If color film is used, it should be indoor type, since all pictures will be taken with artificial light.

Because of the unusual lighting conditions encountered in nighttime photography, the use of an exposure meter is not recommended. Instead, use a colored neon light as a gauge, increasing or decreasing exposure time and lens aperture for lights which are brighter or dimmer than the neon. A colored neon light requires an 8-sec. exposure with an $f:11$ lens-aperture setting. Cameras with no diaphragm adjustments are usually compromised at a setting of $f:8$. Since $f:8$ admits twice as much light as $f:11$, reduce exposure time by half.

When photographing night subjects with an exposure of 8 sec. or more, do not worry about people walking between the camera and the subject. They will not register on the film unless they stop in the field of view of the lens. However, any light moving into the picture will register. Therefore, when

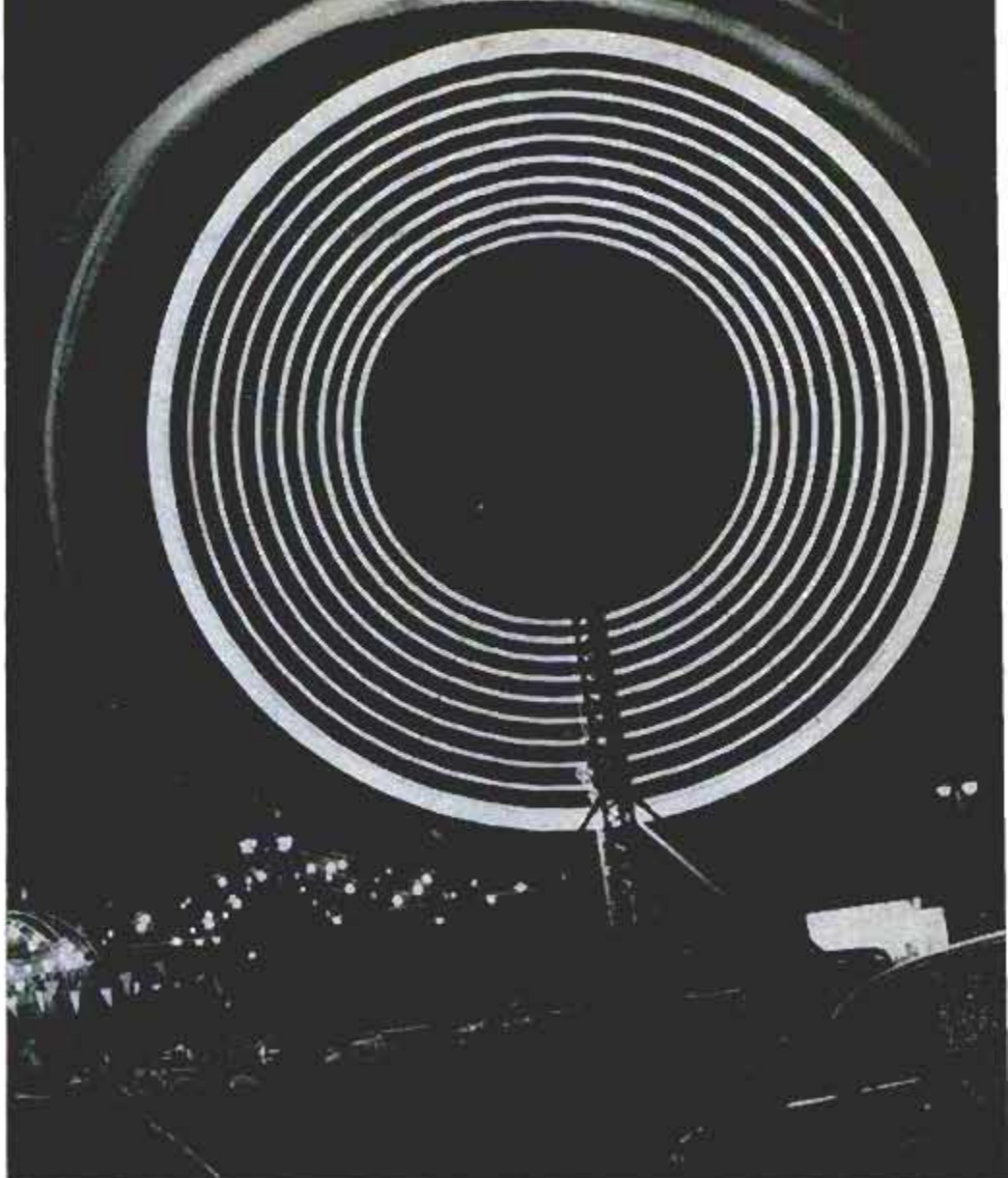

Ferris wheel in motion forms unusual light pattern. Eight seconds at $f:11$ was used on medium-speed film. Scene was tilted in printing for effect

Lights reflected on water result in eye-catching shots, such as this building "supported" on light columns





To make this shot, 16 exposures of approximately 1 second were required. Camera shutter was kept open, but covered, until fountain sprayed upward

photographing an object in surroundings where cars may pass between it and the camera, simply close the shutter before the car lights appear in the field of view, and open it after they have passed. Count the time the shutter actually is open to compute exposure time. A camera equipped with a safety lock to prevent double exposures does not permit opening and closing the shutter, so keep the latter open and hold your hand or some object in front of the lens to keep out the unwanted light. The same method can be used to photograph signs that are illuminated for a few seconds at a time, then darkened; for fountains which spray intermittently, or for any objects that are lighted or in action only part of the time.

Because only that portion of the film receiving light is exposed, it is possible in night photography to place several images on one negative by locating each succeeding image on a different portion of the film. The shot of the exploding fireworks

Auto headlights on busy highway intersection should be shot from elevated position for complete pattern



at the beginning of this article is an example of this technique.

Moving lights make excellent nighttime shots, since they register as paths of light. Lights on amusement-park rides, lights on airplanes landing or taking off, and auto headlights at a busy intersection make interesting patterns. In the latter situation, if one road is more heavily traveled than the other, it may be necessary to block the lens against lights on that road for a while, and open the lens only for the lights on the less busy road. The result will be a more balanced pattern.

Fireworks are the most intriguing of all night subjects, especially those spectacular displays put on for a community. No tripod is used for these shots, since the camera must follow the paths of the soaring rockets to the point where they explode. Keep the shutter open but covered with one hand. As soon as the ground lights are out of the camera view as the rocket is tracked upward, uncover the lens and hold the camera as steady as possible while the explosion flares and dies out. Fireworks are ideal for nighttime color shots. Use indoor film with an aperture of $f:5.6$.

When developing films of nighttime shots, agitate the developing solution frequently to insure good contrast. Printing most night pictures requires a 2-min. development time in standard developer.

The scope of pictures taken at night is limited only by the need for a light source in the darkness. You may soon find that the pictures which please you most, and cause the most reaction, are those taken after sundown. ★ ★ ★

Accurate Helices on Cylinders Marked With Masking Tape

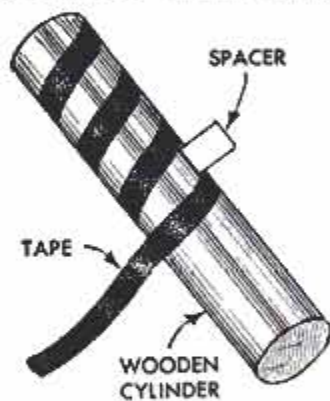

When making helical candlesticks, lamp bases or other objects, or for merely marking off a helix on a cylinder for decorative purposes, you will find masking or other detachable tape handy. It can be pulled off and readjusted to suit.

After making one complete turn of the tape around a cylinder at the desired pitch, measure the distance between the tape strips and cut a cardboard spacer to equal the distance. Use the spacer for making subsequent turns. After the helix is completely taped off, score along the edge of the tape with a knife or scroll saw.

Tools Held at Convenient Level When Working From Stepladder

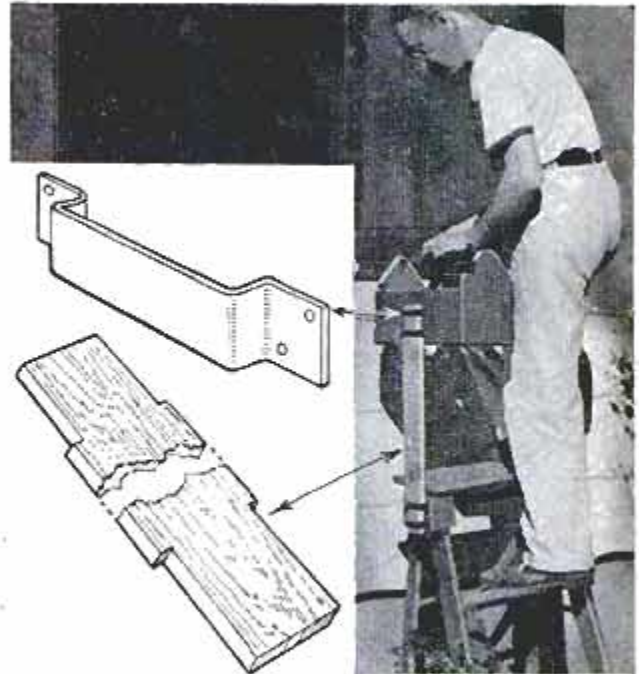

A toolbox can be held at a convenient height while working on a stepladder by means of sheet-metal brackets bent to the shape shown in the illustration. Two brackets are fastened to the side of the toolbox, and two are secured to the ladder. The wooden extension arm, notched at each end to fit into the brackets, is inserted to support the toolbox. The extension arm should fit snugly into the brackets to hold the toolbox steady.

Dark Newspaper Picture Used For Emergency Tracing Paper

When you wish to make a tracing of a sketch or drawing and carbon paper is not available select a dark halftone picture from a recent newspaper and use it as a carbon. Although the result will not be quite as dark as if regular tracing carbon had been used, it will be legible.

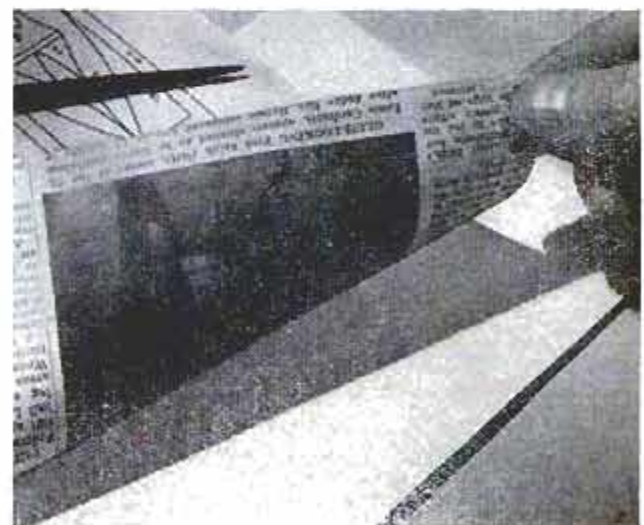

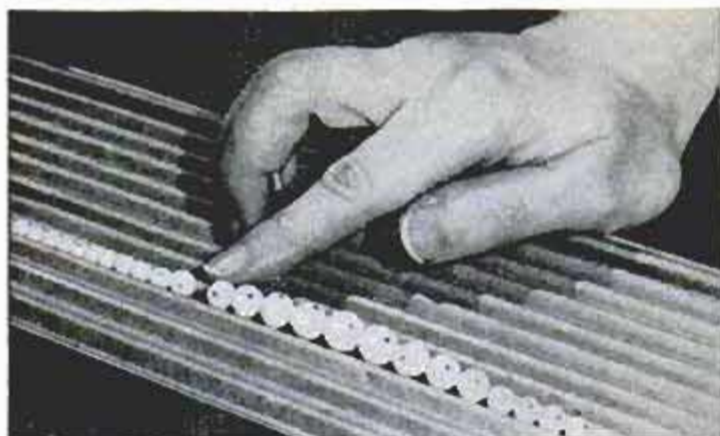

CORRUGATED CARDBOARD MAKES AN IDEAL "JIG" for restringing beads. Beads are aligned in correct order in one corrugation groove for stringing the necklace by picking up the beads individually on the end of a needle. Jig is useful for stringing necklaces with beads of graduated sizes

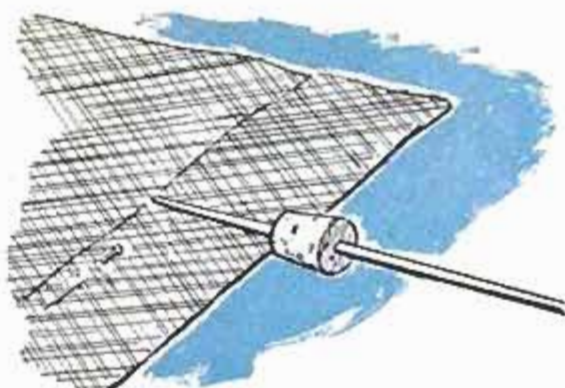

INSTEAD OF USING NOTCHED PIECES of cardboard to serve as gauges when turning hems on garments, force a small knitting needle through a cork to provide an adjustable gauge. Cork slides easily, yet stays put

Solving

HOME PROBLEMS

IF YOU LIKE PICKLED-BEET SLICES in a salad, but don't prepare them often because of the task of cutting into uniform slices, try using an ordinary egg slicer. Simply place the beet in the hollow of the slicer as you would a hard-boiled egg and cut in the same manner. If a beet is too large for the slicer, cut it in half with a knife before slicing it

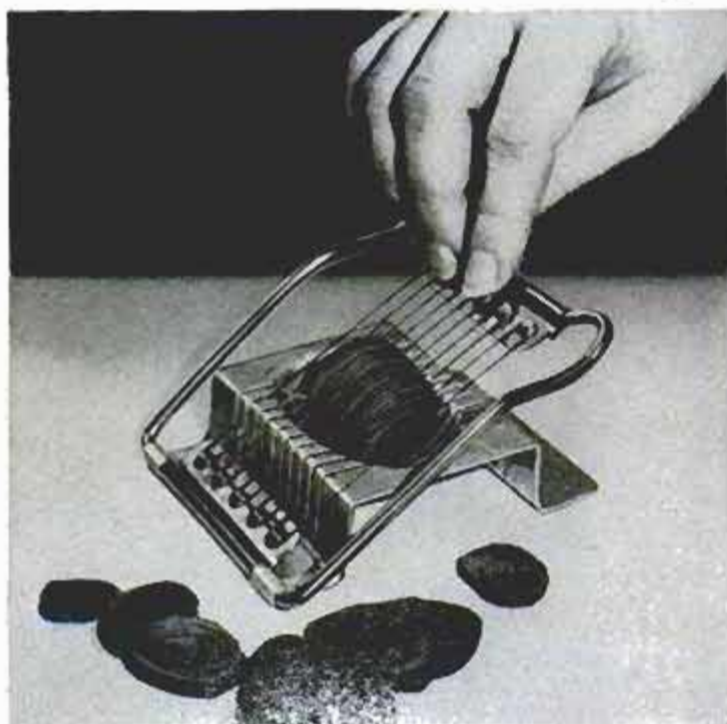

WHEN INSTALLING DOOR LOCKS of the type having a turnpiece, or handle, for bolting from the inside, insert the square shank so that the handle is in the vertical position when the door is unbolted. Position of handle then serves as an indicator, also a reminder

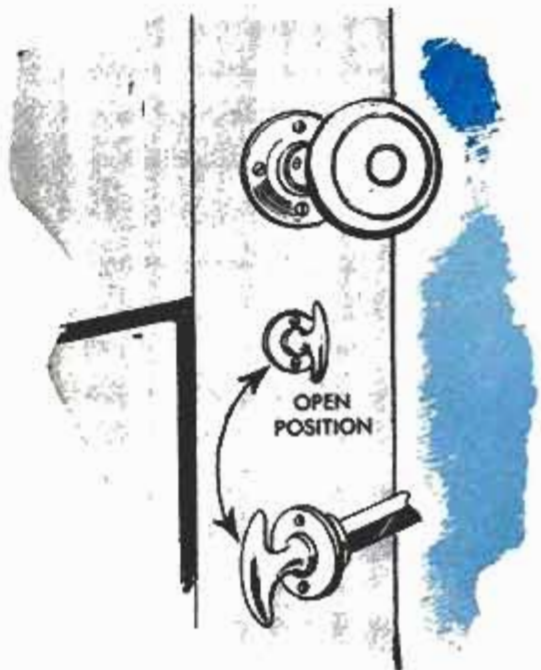

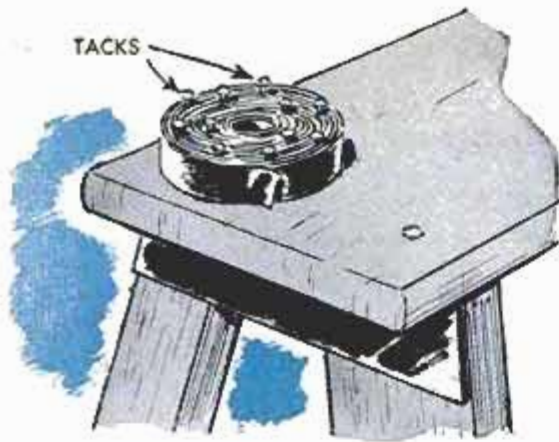

KEEP A SUPPLY OF TACKS HANDY when working on a stepladder by simply inserting the points of the tacks into the side of a roll of friction tape. The roll of tape itself will not slide easily because of its sticky surface

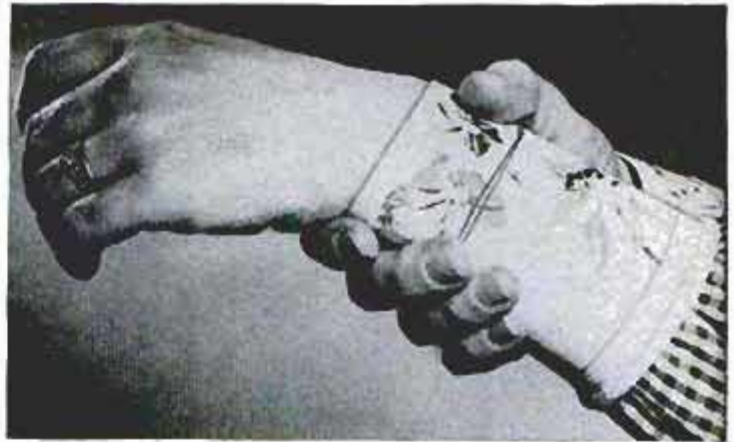

IF YOU HAVE SOME AFTER-THEATER OR PARTY COOKING to do while dressed in a long-sleeved garment, protect the sleeves by wearing a pair of neat cuffs made from paper cups. Remove the cup bottoms, slit the cups lengthwise and slide them over your wrists. Hold in place with rubber bands

NO TIME WILL BE WASTED LOOKING through a jewelry box or drawer for an elusive earring to complete the pair you want to wear if each pair is clipped to a bobby pin when put away. Cuff links, shirt studs and other jewelry worn in sets also can be "filed" this way



DRAWER STOPS cut from tempered hardboard and pivoted on screws driven into the inside of chest, cabinet or desk will prevent pulling drawers all the way out accidentally. Swinging the stops up permits removing drawers

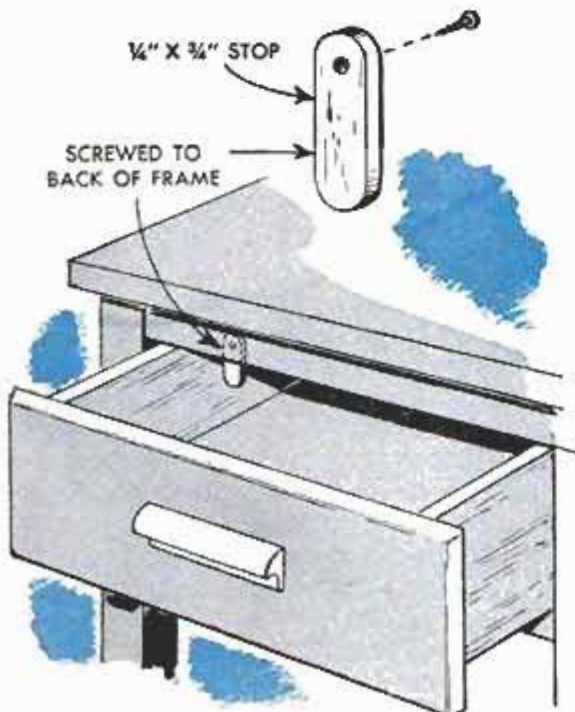

CRUSHING AN ASPIRIN OR OTHER MEDICINAL TABLET to powder, so it can be dissolved in water and taken by a person who has difficulty swallowing tablets, can be done neatly by using two spoons. The tablet is placed in the bowl of one spoon and crushed by the bowl of the other





Horseshoes Serve as Handles To Carry Cement Blocks

Handling or carrying rough cement blocks is easier when a horseshoe is used as a handle. The horseshoe handle will provide a more comfortable grip if a short length of rubber hose is slit open at one side and slipped over one side. A large-size shoe, with its wide clearance between the open ends, will serve this purpose better than a small one.

Blotter Predetermines Paint Color

The color of a rubber-base paint when thoroughly dried can be determined by applying a smooth coating of the paint to a clean, white blotter. The blotter absorbs the liquid vehicle of the paint in a few minutes, leaving only the dry pigment on the surface, which shows the color the paint will be when dry.

Broom Clip Is Handy Holder For Garden-Hose Nozzle

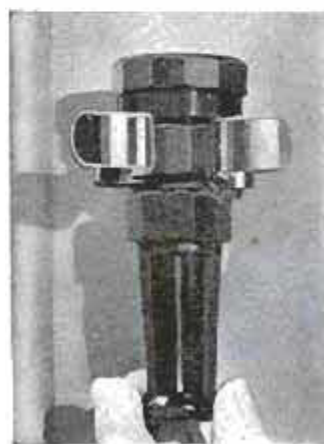

A broom clip fastened in a convenient location on the house provides an excellent holder for the garden-hose nozzle when it is removed from the hose. Located at shoulder height the nozzle will be located above the reach of curious youngsters.

Folding Chairs Stacked Upright Kept From Sliding With Hose

When folded and stacked in rows, metal folding chairs of the type shown have a tendency to slide on slippery floors and the whole row collapses. To prevent this, slit a length of rubber hose and fit it over the horizontal "foot" of one chair. Place this chair at the end of a stacked row. Its "skidproof" foot will keep the chair from sliding, and it in turn will hold the other chairs in place.

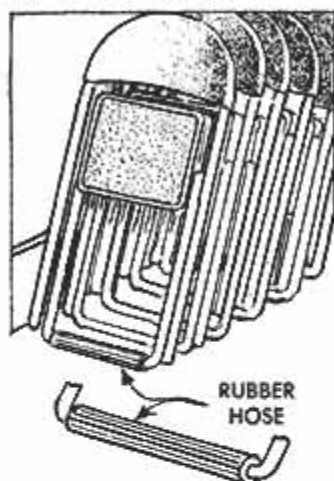

Installing Recessed Fixtures In Bathroom Wall

Installing recessed bathroom fixtures, such as a soap dish over a tub, is not as difficult a job as it might seem. Locate an area of the wall that is between the studs and cut a hole about $\frac{1}{8}$ in. larger than the recessed portion of the fixture. Stuff excelsior tightly into the wall to form a bedding

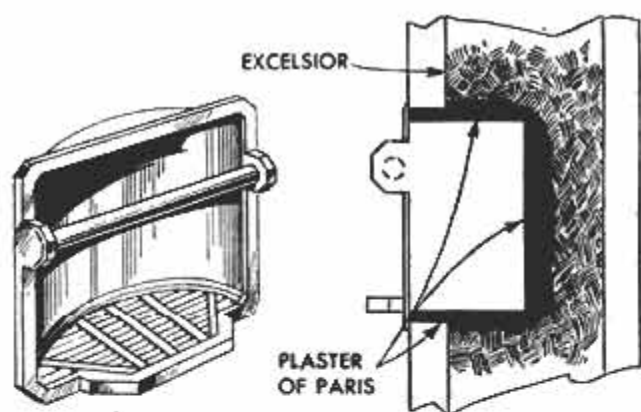

above, below and on both sides of the hole. Cover the excelsior liberally with plaster of paris, then fill the hole about half full of plaster so it will be forced around the fixture when the latter is pressed into place. Work quickly because the plaster sets in a short time. Recessed fixtures that do not have flanges or ribs to anchor in the plaster have lugs between which wire is strung so that it is embedded in the plaster. Press the fixture into the hole and hold it firmly until the plaster sets. Clean off excess plaster around the edges with a putty knife and damp cloth. To prevent water from seeping behind the fixture, calk its edges with one of the special calking compounds made for use in bathrooms.

Wooden-Utensil Holder

By Hi Sibley

LOOKING FOR SOMETHING unusual to add a quaint touch to your kitchen? This decorative and practical wooden-utensil holder will accommodate purchased utensils or items made by using the squared patterns below. The cutting board, which slides down behind the rolling pin when the holder is hung on the wall on two L-hooks is cut from softwood, as is the rest of the holder. Close-grained hardwood, such as maple, should be used for the utensils. The pattern on the faces of the meat-tenderizing hammer is made by first cutting V-grooves in one direction, then cutting similar grooves at right angles to those cut first.

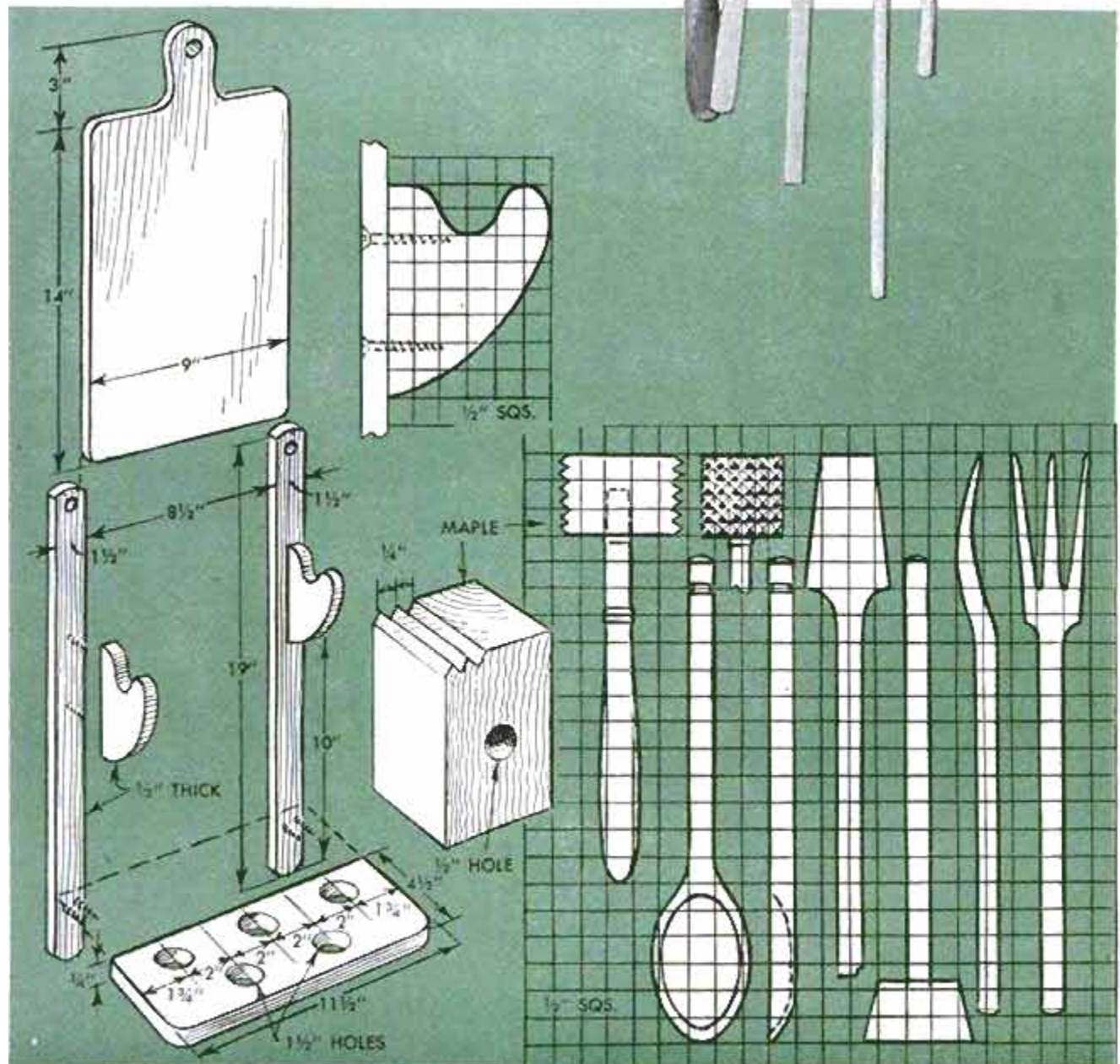
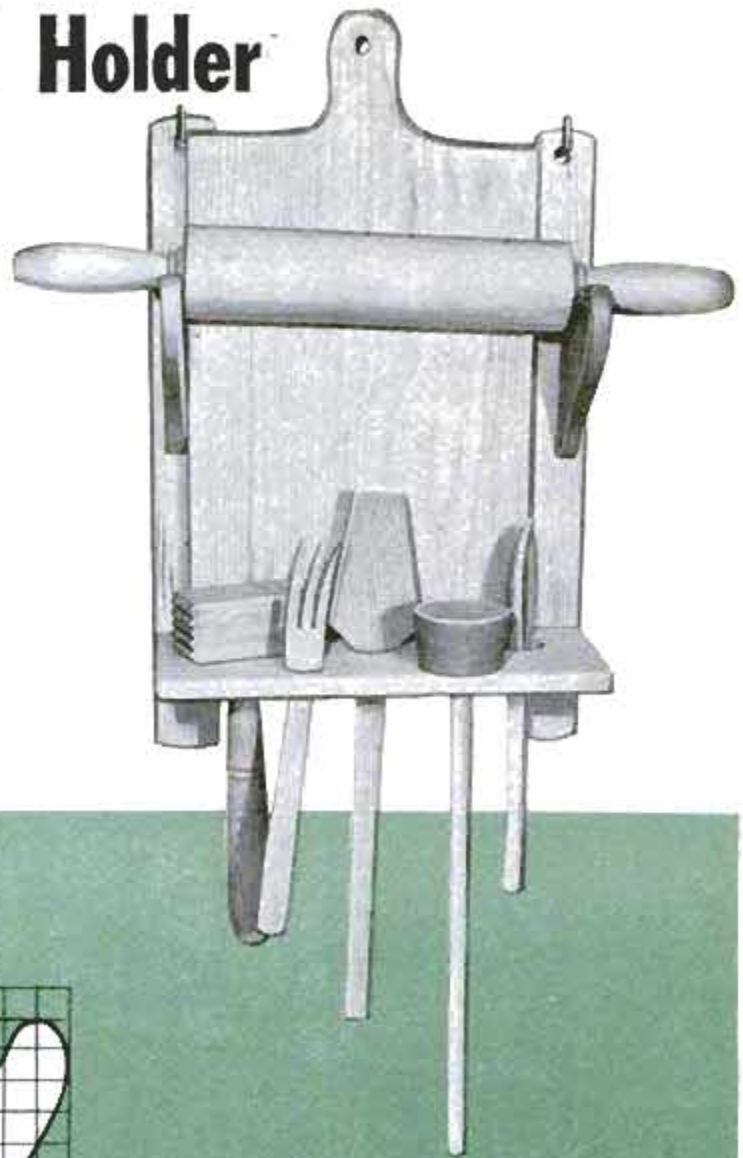

PATTERNCRAFT

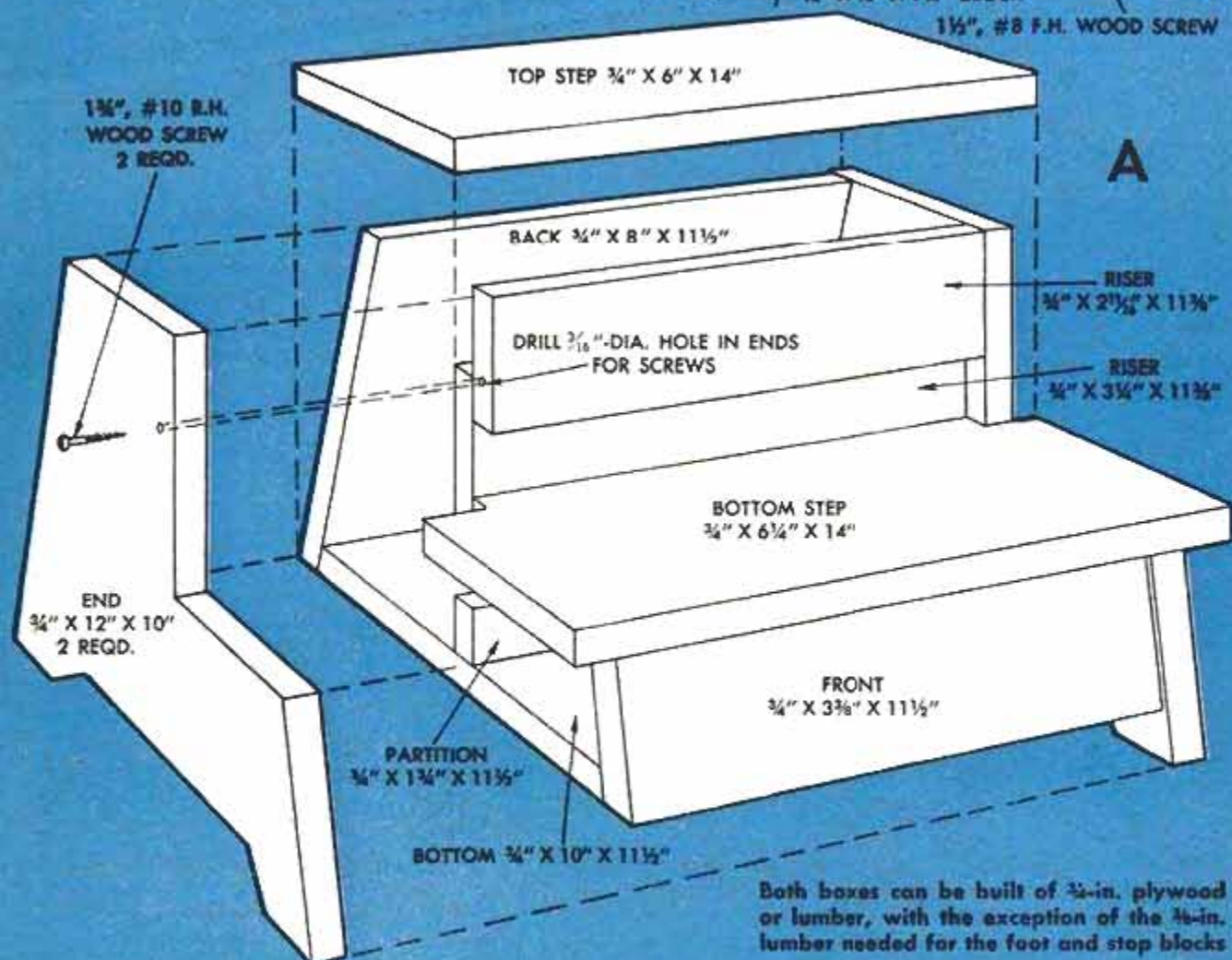
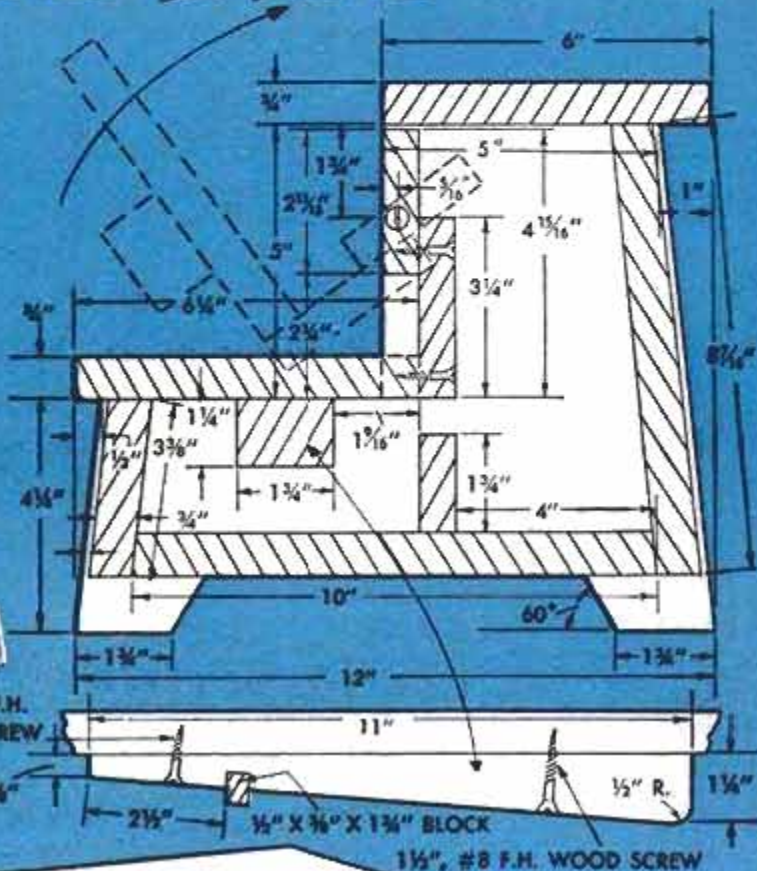

Both boxes can be built of 3/4-in. plywood or lumber, with the exception of the 1/2-in. lumber needed for the foot and stop blocks

W.M. 57

SHOE-SHINE BOXES

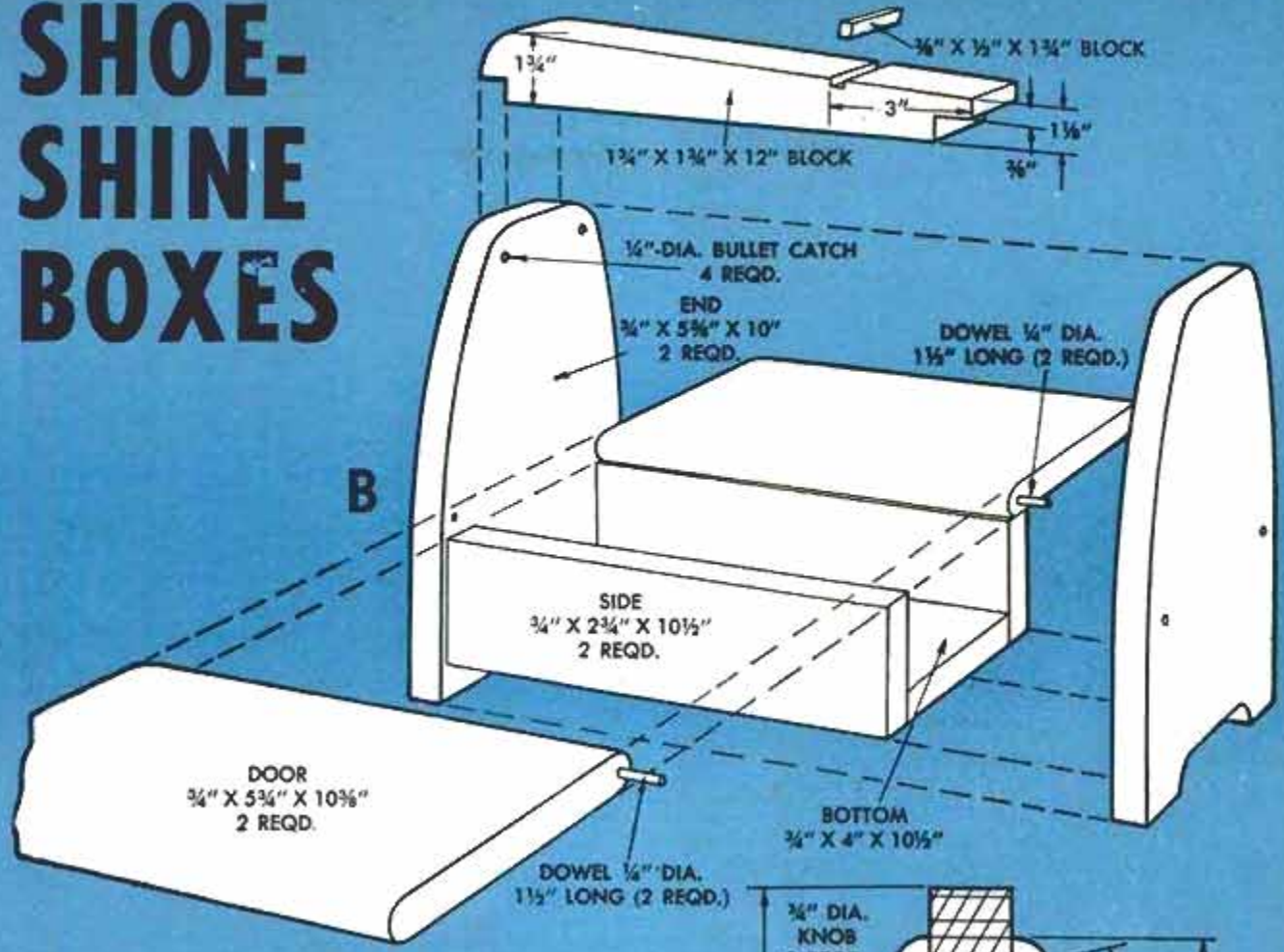

MATERIAL LIST

Box A

Lumber or plywood

- 1 pc.— $\frac{3}{4}$ " x 6" x 14"—Top step
- 1 pc.— $\frac{3}{4}$ " x $6\frac{1}{4}$ " x 14"—Bottom step
- 2 pcs.— $\frac{3}{4}$ " x 12" x 10"—Ends
- 1 pc.— $\frac{3}{4}$ " x $8\text{-}7/16$ " x $11\frac{1}{2}$ "—Back
- 1 pc.— $\frac{3}{4}$ " x $3\frac{3}{8}$ " x $11\frac{1}{2}$ "—Front
- 1 pc.— $\frac{3}{4}$ " x $2\text{-}11/16$ " x $11\frac{3}{8}$ "—Riser
- 1 pc.— $\frac{3}{8}$ " x $3\frac{3}{4}$ " x $11\frac{3}{8}$ "—Riser
- 1 pc.— $\frac{3}{4}$ " x $1\frac{3}{4}$ " x $11\frac{1}{2}$ "—Partition
- 1 pc.— $\frac{3}{4}$ " x 10" x $11\frac{1}{2}$ "—Bottom

Lumber

- 1 pc.— $1\frac{3}{4}$ " x $1\frac{3}{4}$ " x 11"—Foot block
- 1 pc.— $\frac{3}{8}$ " x $\frac{1}{2}$ " x $1\frac{3}{4}$ "—Stop block

Box B

Lumber or plywood

- 2 pcs.— $\frac{3}{4}$ " x $5\frac{5}{8}$ " x 10"—Ends
- 2 pcs.— $\frac{3}{4}$ " x $2\frac{3}{4}$ " x $10\frac{1}{2}$ "—Sides
- 2 pcs.— $\frac{3}{4}$ " x $5\frac{3}{4}$ " x $10\frac{3}{8}$ "—Doors
- 1 pc.— $\frac{3}{4}$ " x 4" x $10\frac{1}{2}$ "—Bottom

Lumber

- 1 pc.— $1\frac{3}{4}$ " x $1\frac{3}{4}$ " x 12"—Foot block
- 1 pc.— $\frac{3}{8}$ " x $\frac{1}{2}$ " x $1\frac{3}{4}$ "—Stop block
- 4 pcs.— $\frac{1}{4}$ " dia. x $1\frac{1}{2}$ " Dowels
- 2 pcs.— $\frac{3}{4}$ "-dia. Knobs

FULL-SIZE PATTERNS

If following magazine details is difficult for you, make the shoeshine boxes the easy way—use a full-size pattern with complete directions. Send 50 cents for Plan No. 124 to Patterncraft, Popular Mechanics Press, 200 East Ontario Street, Chicago 11, Ill.

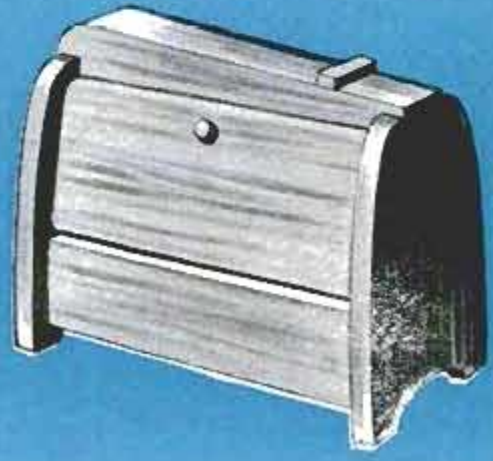
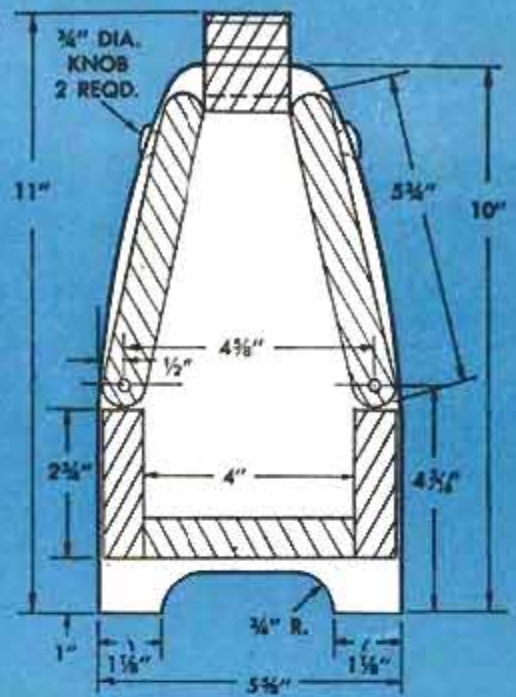

Wastebasket With Slot in Side Hooks on Screw in Wall

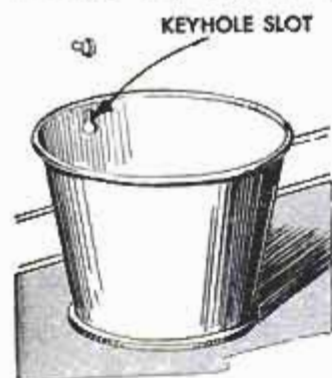

The school or shop wastebasket will not be overturned if a keyhole slot is cut in one side of the container to engage the head of a wood screw driven into a wall or other stationary object. The screw should be

located at the same height as the narrow part of the slot in the basket, so that the container rests squarely on the floor.

Nontipping Dog Feeder Made From Coffee Can



To keep a dog from overturning or carrying away his feeding dish, use a coffee can staked to the ground with a wire loop as a feeder. Fit a length of wire through holes punched opposite each other near the lower edge of the can. Bend the projecting ends of the wire down and force them into the ground as indicated.

"Chain Reaction" Torch Lights Fire On Windy Day



When a strong wind or a draft makes lighting a fire difficult, a number of book matches and a loosely rolled newspaper can be used to make a torch that will keep reigniting itself. The matches are fitted into slits cut or torn in the

outside surface of the rolled newspaper as shown. Stagger the matches so the starting flash from each match ignites the next one after a slight delay.

Leonard W. Mitchell, Marion, Ky.

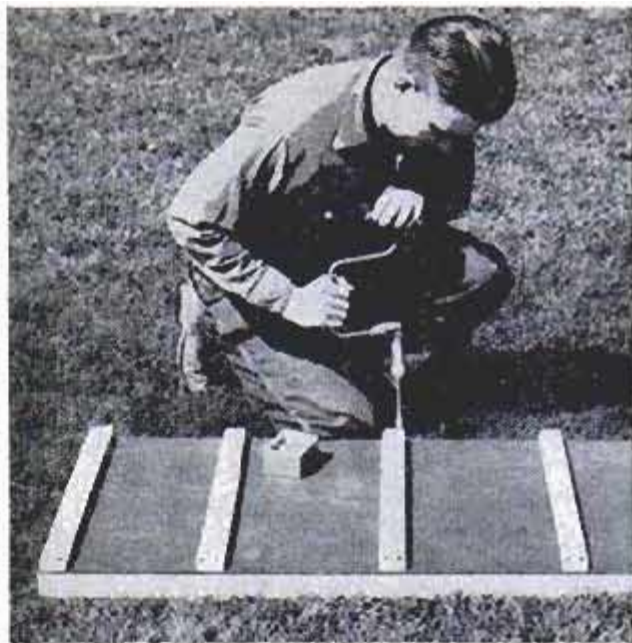

The tempered-hardboard slide surface is reinforced with 1 x 2-in. crosspieces spaced one foot apart

COMBINATION

IF YOU HAVE youngsters between two and eight years of age, here is a combination slide and exerciser which will bring them hours of healthful fun. It dismantles into three easily handled sections so it can be moved indoors and set up in the basement playroom during the winter months. The whole unit is made of standard lumberyard material, consisting mainly of 1 x 2s and 2 x 4s, with hardboard being used for the bottom of the slide. All wooden parts should be protected with a coat of paint followed with two coats of spar varnish. Varnishing and waxing the hardboard will give a slick surface. ★ ★ ★

To provide maximum strength and avoid splitting of the members, pilot holes should be made for screws

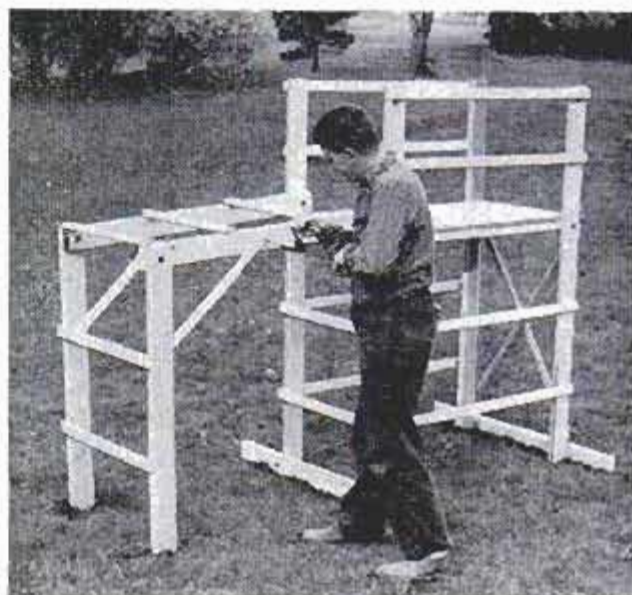

WIM '57



A summer-winter unit — comes apart in sections for setting up indoors when basement space permits

SLIDE AND EXERCISER

By Bob Brown

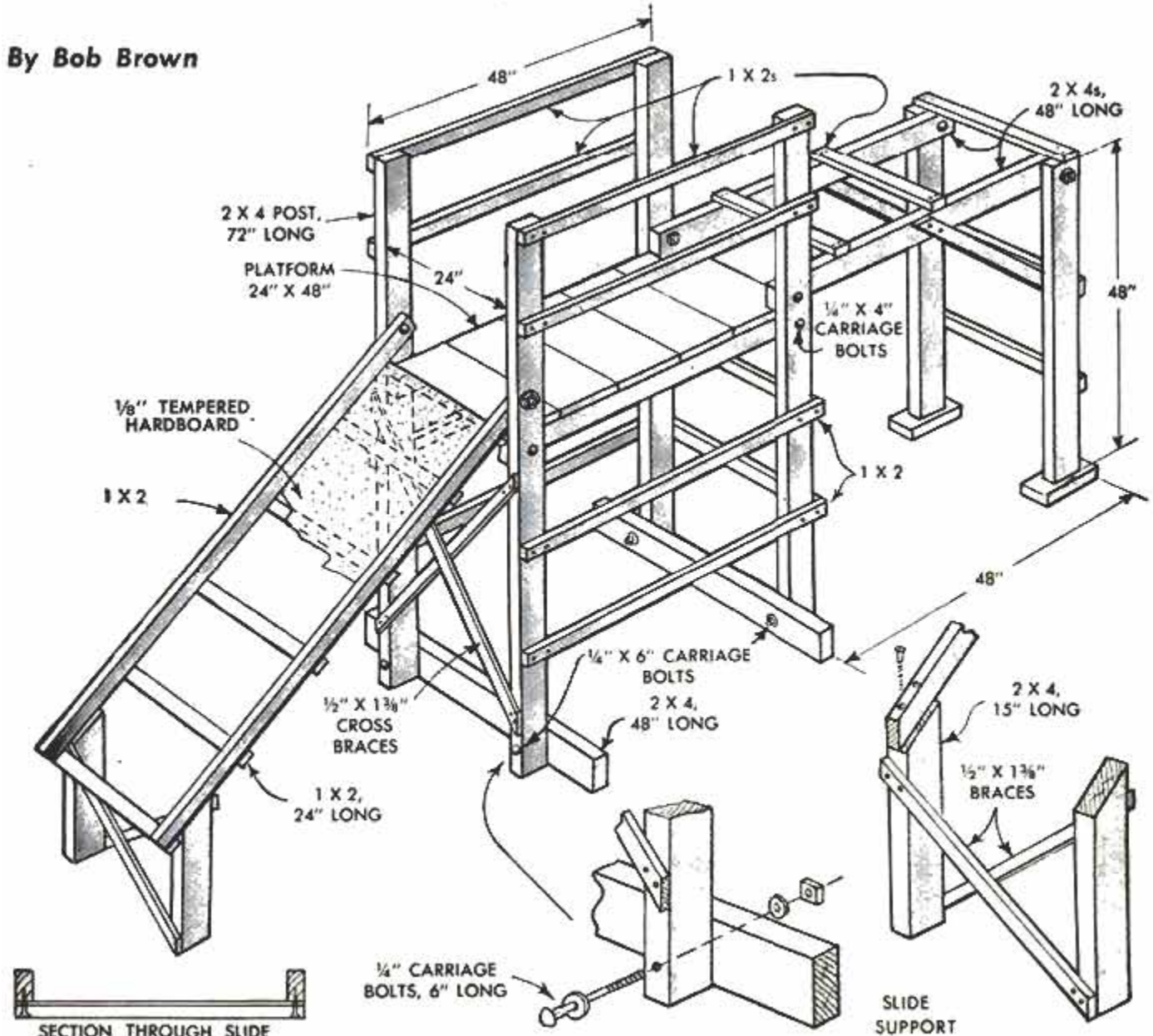

Baby Oil Removes Paint From Tender Skin Without Irritating



If the skin on your hands burns and becomes roughened when you remove spattered paint from it with thinner or other solvents, use a cloth saturated with baby oil. Used to remove paint from the face also, the oil has no adverse effects upon the eyes as conventional solvents do.

Mousetraps in Coffee Cans No Hazard to Poultry

If mousetraps set in a poultry house or chick brooder are placed in coffee cans, they remain effective but present no hazard to the poultry. Cut a hole in the side of each can large enough to admit a mouse, set the trap inside and replace the can cover. A correspondingly larger container could be used in the same manner for a rattrap.



"Snow" Shellacked to Evergreens

A snow effect is given to evergreens for indoor decoration by brushing them with a coat of thinned white shellac and then quickly sprinkling on packaged "snow." The "snow" is held firmly in place when the shellac dries.

Spring-Type Clothespin Provides Quick-Acting Towel Rack

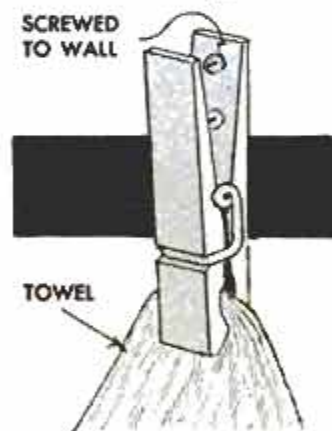

An ideal holder for hand towels and dish towels consists of a spring-type clothespin screwed to a wall or cabinet. Pressing the free leg of the clothespin releases the towel or permits inserting it. To fasten the clothespin to the wall, disassemble

it, drill one leg and screw it to the wall. Reassemble the pin on the wall. To permit easy cleaning and to prevent soiling the wood, paint or varnish the clothespin before reassembling it.

Kitchen Cabinet Redesigned For Living-Room Use

A discarded steel kitchen cabinet was converted into a piece of attractive living-room furniture by refinishing it and mounting it on a base fitted with legs. The base is simply a wooden frame built to fit snugly under the bottom of the cabinet. Short legs of the type shown are used for coffee tables, and can be purchased at lumberyards.

Lynda Carpenter, Santa Monica, Calif.



Magnifying-Lens Holder Clamps to Temple of Eyeglasses

Hobbyists, collectors and photographers who wear glasses will find this magnifying-lens holder handy. It clips to one temple of the glasses and swings away from the eye when not in use. The holder is made from a 35-mm. film container and a lens that will fit snugly inside its cap. First, cut a hole in the cap slightly smaller than the lens and then bend a $\frac{1}{8}$ -in. lip around the top edge of the container to form a seat for the lens which is held in place by the cap. Next, cut off the bottom half of the container, saving only the upper half. Then drill this for a $\frac{1}{4}$ x $1\frac{1}{4}$ -in. screw, inserting the latter from the inner side. Then slide a sleeve of small tubing over the screw, followed by a nut to hold the assembly. Follow this with an arm of heavy sheet metal and a second nut. The arm is bolted to one side of a small paper clamp, which

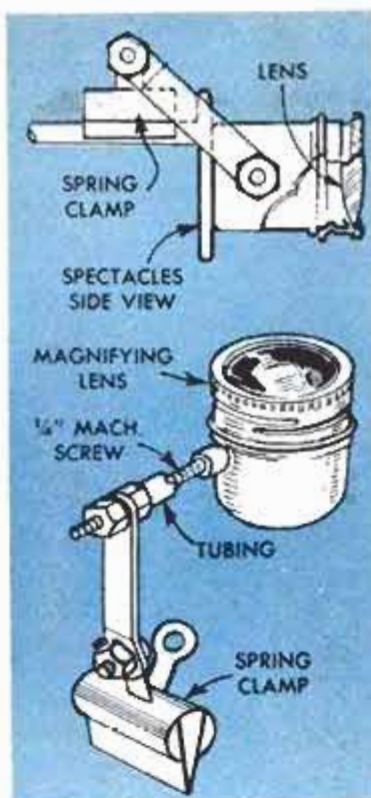

fastens the holder to the glasses. A person who does not ordinarily wear glasses also can use the holder by clamping it to the temple of a pair of sunglasses from which the lenses have been removed.

Length of Metal Tubing Fills Holes With Putty

This handy tool holds an ample supply of putty for use in filling nail holes before painting a house or other smaller projects. It is easily made of a 2-in. length of $\frac{3}{8}$ -in. i.d. metal tubing fitted

with a $\frac{3}{8}$ -in.-dia. wood-dowel plunger that is slightly longer. With a load of soft putty in the tube, press the open end over a nail hole, depress the plunger a short distance and then slide the tube over the work. The result is a smooth, even job in which the hole is packed with putty for a considerable distance.

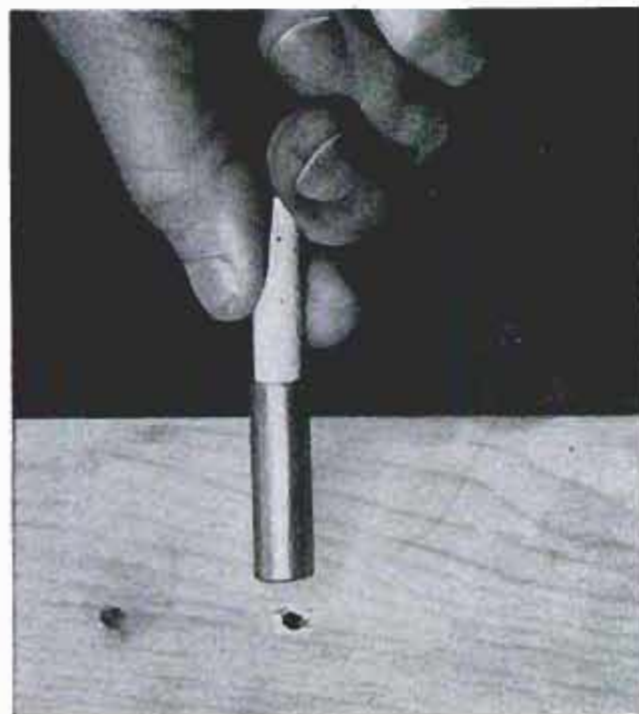

Hands "Washed" Without Water By Using Shaving Cream

Washing your hands after changing a tire on the highway is no problem when a tube of brushless shaving cream is carried in the glove compartment. A quantity of the cream is rubbed between the palms, worked over the hands, then wiped off with a cloth. Hands are clean enough to prevent soiling clothes, upholstery or steering wheel until there is a chance to use soap and water.



WTM '57

Homemade Organs

By Allan Carpenter

PART II

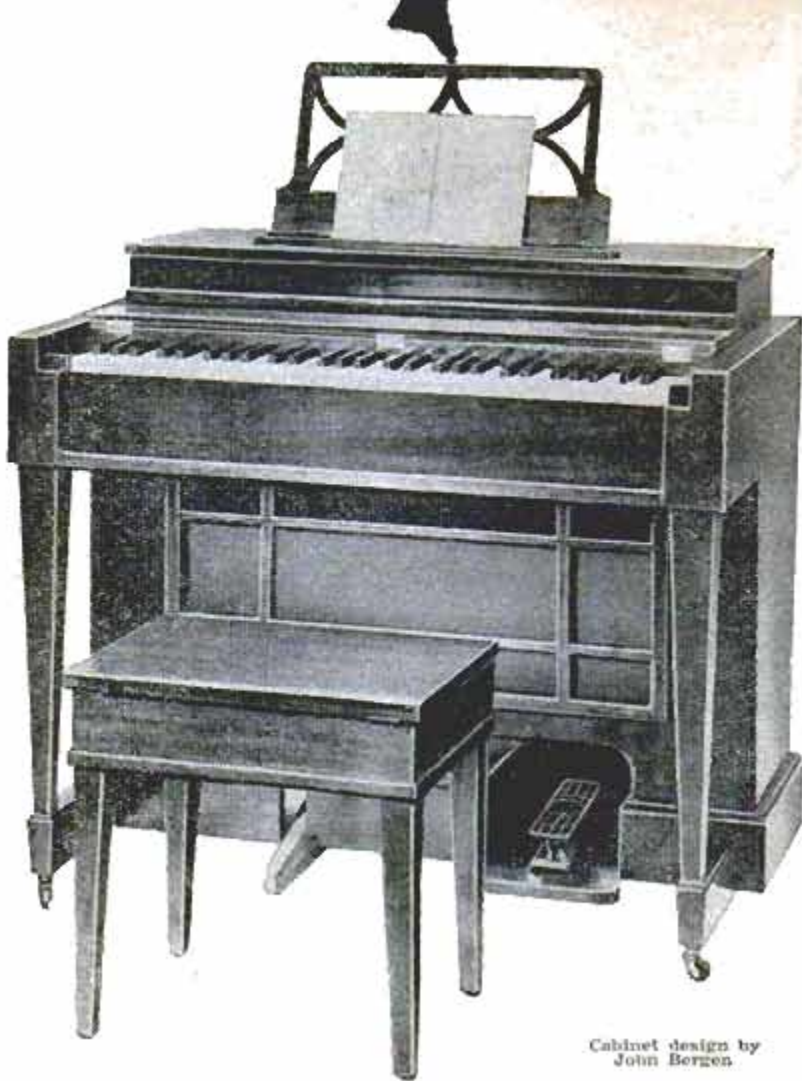

Cabinet design by
John Borzen

EQUALLY AS HANDSOME a piece of furniture as the accordion-organ presented last month, this somewhat larger one is designed to house musical works that are sold as a kit which anyone can install. The keyboard section and the double set of reeds come ready-mounted as a single unit to simplify installation to the point of merely screwing the keyboard to the mounting board of the cabinet. The photo below pictures the parts that comprise the kit.

The drawings on the facing and following page detail construction of the cabinet. The original organ shown above was made

from mahogany-faced plywood and solid stock where specified. The bench detailed on page 208 can be used with either organ. The cabinet consists of four sections, all being joined together permanently with cleats and screws, except the top section which is left removable.

Action of the air supply for this organ is by suction rather than by a blower. Air is pulled through the reeds by a large motor-driven disk which is furnished with the kit. The reed chamber is connected to a distribution box by flexible air hoses. The distribution box is positioned to make light contact against

the rotating disk. The amount of pressure against the disk is important. If the box bears too tightly it will slow down the disk, reducing the air supply to the point that the reeds will not vibrate. If the distribution box bears too lightly against the disk, inadequate suction will result. Therefore, the post to which the distribution box is fastened should not be permanently fixed until final adjustment is made. Motor and blower noises are deadened by lining the area around them with U-200 Tufflex, a soundproofing material.

Volume is controlled by the right foot pedal. The pedal is connected to a hinged

Here's basic kit of necessary parts, including full 61-note reed keyboard. Costs about \$170. Amplifier-speaker kit is available also to operate organ electronically and produce wider range of tone and volume

Photo courtesy Bell and Campbell Industries

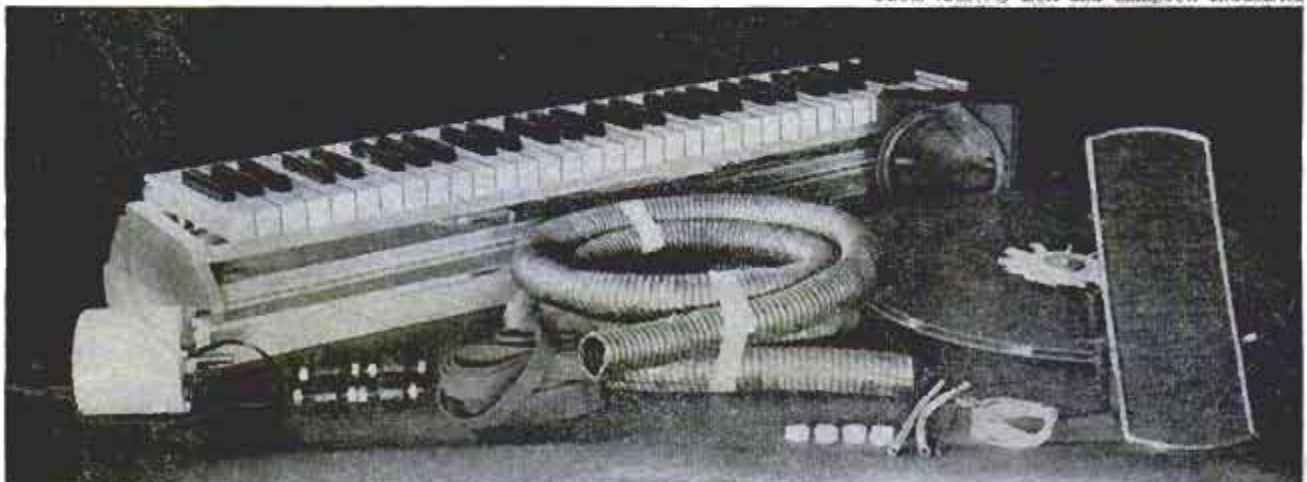

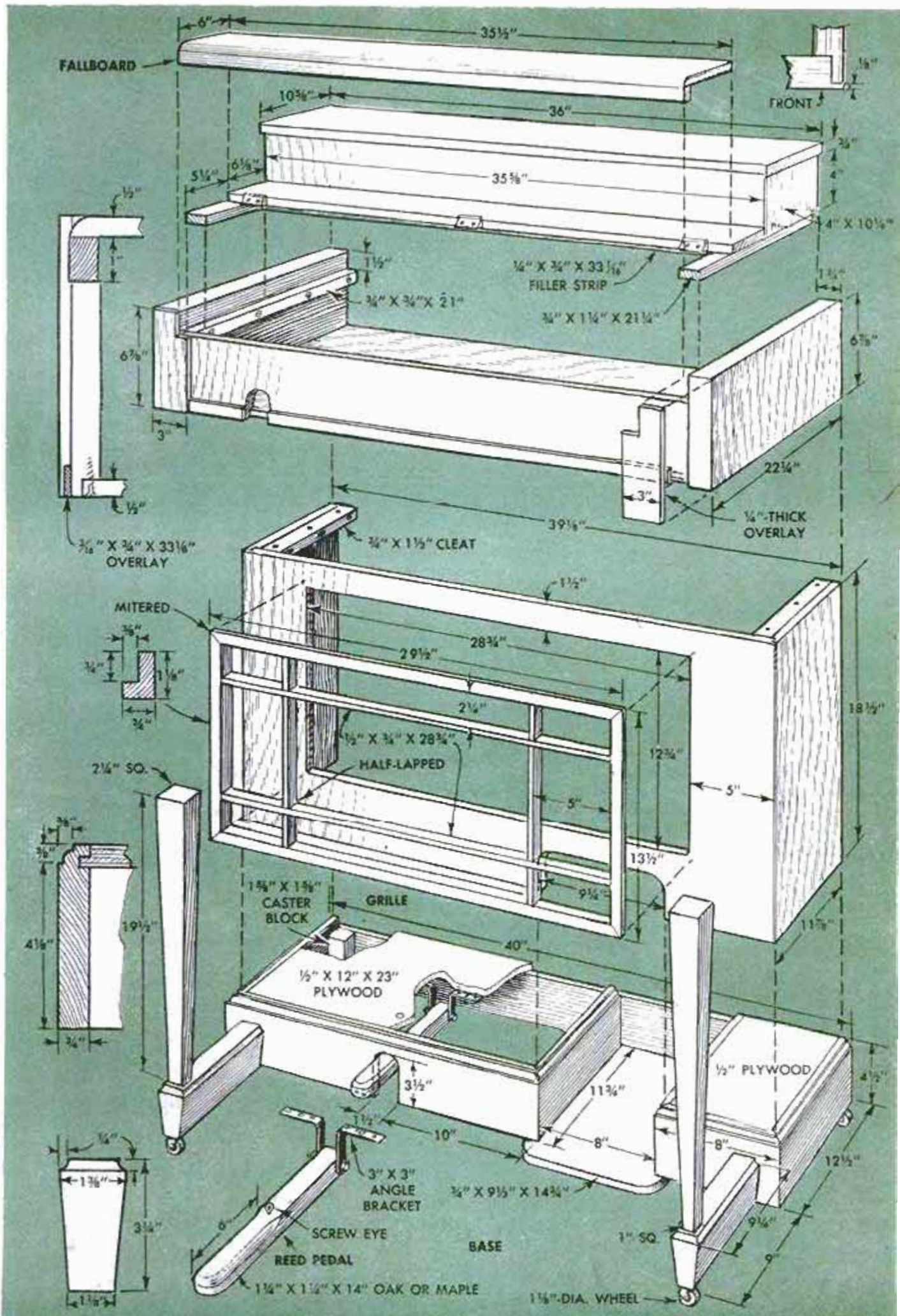

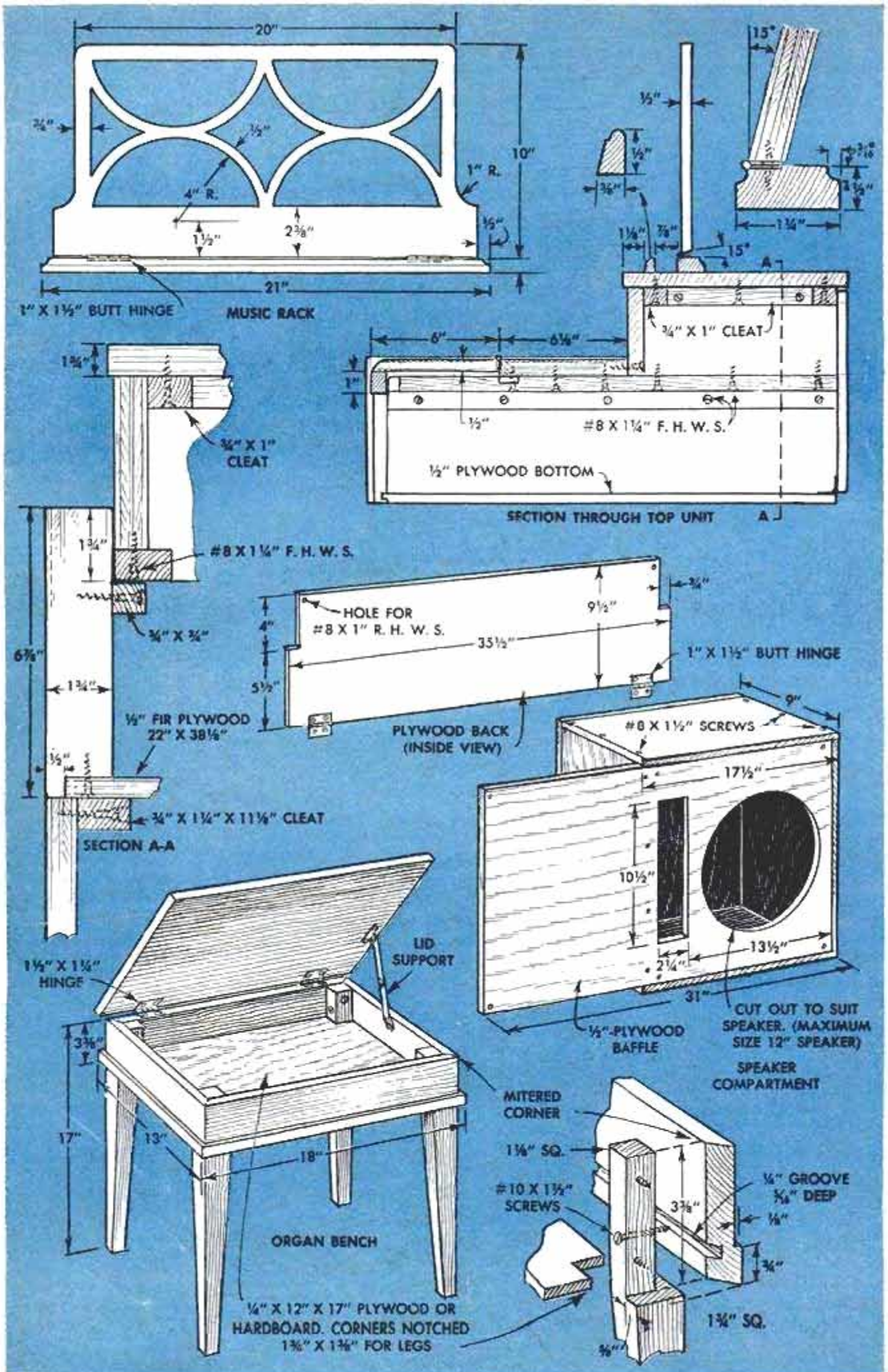

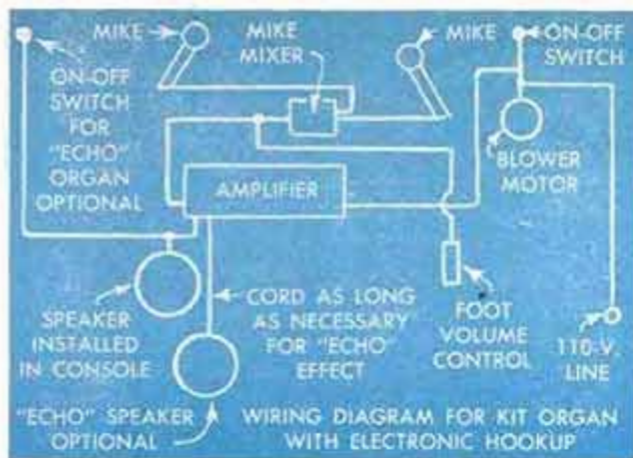

In the wiring diagram above note especially the position of the on-off switches and the echo speaker

leaf, or door, which covers an opening just back of the reeds. This is called a "swell." When the pedal is depressed, opening the swell, the volume is increased proportionally. An even closer control of volume, especially when playing softly, is obtained by soundproofing the keyboard. This can be done by removing the keyboard assembly and fitting strips of soundproofing material into the bottom of the keyboard compartment. This must be done with care as no soundproofing should touch the keys or any other part of the mechanism when the unit is reassembled.

Greater volume and a different tone character are obtained by means of a second swell, which, when opened, activates the second complete set of reeds. This swell is controlled by the left foot pedal. The assembly is covered in the instructions that come with the kit.

Although the organ pictured used electronic amplification to obtain variation in tone and volume, the basic organ can be built as detailed and described and the amplifying system added later.

In the electronic system volume depends largely on the size of the amplifier used, but in any case electronic amplification gives much greater brilliance and range of tone and a closer control of volume. In addition, the effect of an echo organ is made possible by the use of an extra matching speaker. A complete hi-fi system can be had by connecting an AM-FM

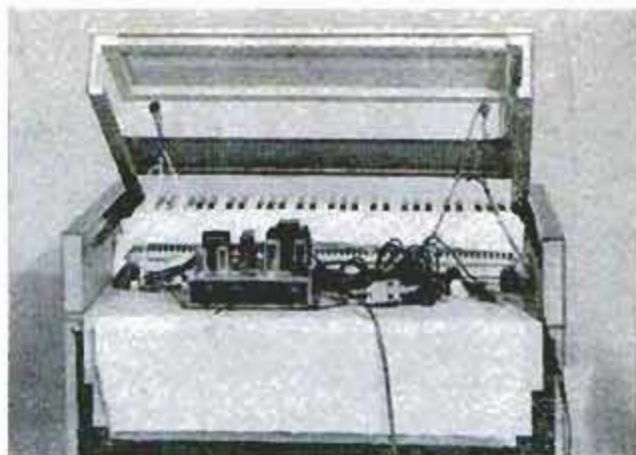

Rear view of cabinet showing top compartment with electronic units being assembled for testing purposes

tuner and record player. The original organ was so equipped.

Electronic equipment required consists of amplifier and two crystal-type non-directional microphones, also a microphone mixer, a volume-control pedal and speaker. The wiring diagram for the complete electronic hookup is shown above. Experimentation is necessary to determine the proper placement of the microphones. Moving them about while playing various notes will indicate positions in which the mikes will pick up all notes of the scale without distortion. In order to dampen out any mechanical sounds that may bounce into the mikes from the top of the cabinet, cover exposed areas (except over the reeds) with soundproofing material cut into strips that fit snugly.

When the echo-organ effect is desired, the matching speaker is connected to the amplifier with a long cord and placed in an adjoining room or in the back of the auditorium when entertainment is to be provided for a public gathering. If you plan to use the echo speaker more or less regularly, install an on-off switch to control the first speaker which is mounted in the organ console. Then it is possible to utilize both speakers for interesting musical effects, or the echo speaker individually. In most cases with electronic amplification it will be necessary to remove the swell back of the reeds so the mikes can pick up the sound. ★ ★ ★

Sleeve on Lamp-Cord Covering Prevents It From Unravelling

Braided fabric used on some lamp cords will be less likely to unravel if rubber "ferrules" are used where the fabric is cut for connecting electric plugs. The ferrules are short pieces of rubber tubing of a size to fit tightly on the cord. Stretching the ferrules with long-nose pliers as indicated will facilitate slipping them in place.



Vinegar Used to Prime Galvanized-Metal Surfaces for Painting



Rain gutters and garbage cans are galvanized as a protection against corrosion, but this same surface will not permit a good bond for paint when it is new. Vinegar brushed on the galvanized objects will give them better bonding surfaces for painting. Paint can be applied when the vinegar has dried.

Small-Parts Boxes Kept in Order When Tagged By Numbered Nails

Small-parts boxes in the home or farm workshop get shuffled around as they are used so that a box is seldom found in the same place twice. Numbered nails, of the type used on screens and storm windows, solve the problem easily and inexpensively. Use one of the nails on each box, numbered consecutively, and it is an easy matter to return the boxes to the same position each time they are removed.



Pencil Sharpener Points Crayons

A pocket pencil sharpener is ideal for pointing crayons used to mark things in your shop or shipping room. The sharpener also strips the paper shell off the crayon neatly, eliminating the fingernail-breaking chore of peeling it off by hand.

Oil Can Fitted With Bobby Pin Made "Clogproof"



An oil can used to apply fluid poison to dandelions can be kept free-flowing when a bobby pin is inserted in the spout with the looped end projecting, as shown. The exposed head of the pin may be pressed into the center of the weed at ground level and the fluid injected with little danger of clogging.

Should the spout become blocked, removal of the pin will quickly clear the passage and it can be inserted again with little loss of time. To assure a snug fit in the spout, it may be necessary to spread the pin.

Wire Guard on Feed Grinder Removes Foreign Objects

Farmers who spout grain directly from bins into a feed grinder run the risk of having foreign objects enter the mill and damage it. Such damage is avoided when a wire guard installed over the feed hopper of the grinder prevents metal objects, such as the pliers shown, from entering the machine. The guard is made from a refrigerator shelf with 2-in. metal sides welded in place and a flat-iron leg welded on one end. No bolts are used to hold it in place, making it easy to remove when grinding hay or ear corn.

Ken Hadenfeldt, Storm Lake, Iowa.



Old-Time Pull-Cord Arrangement Actuates Doorbell Push Button

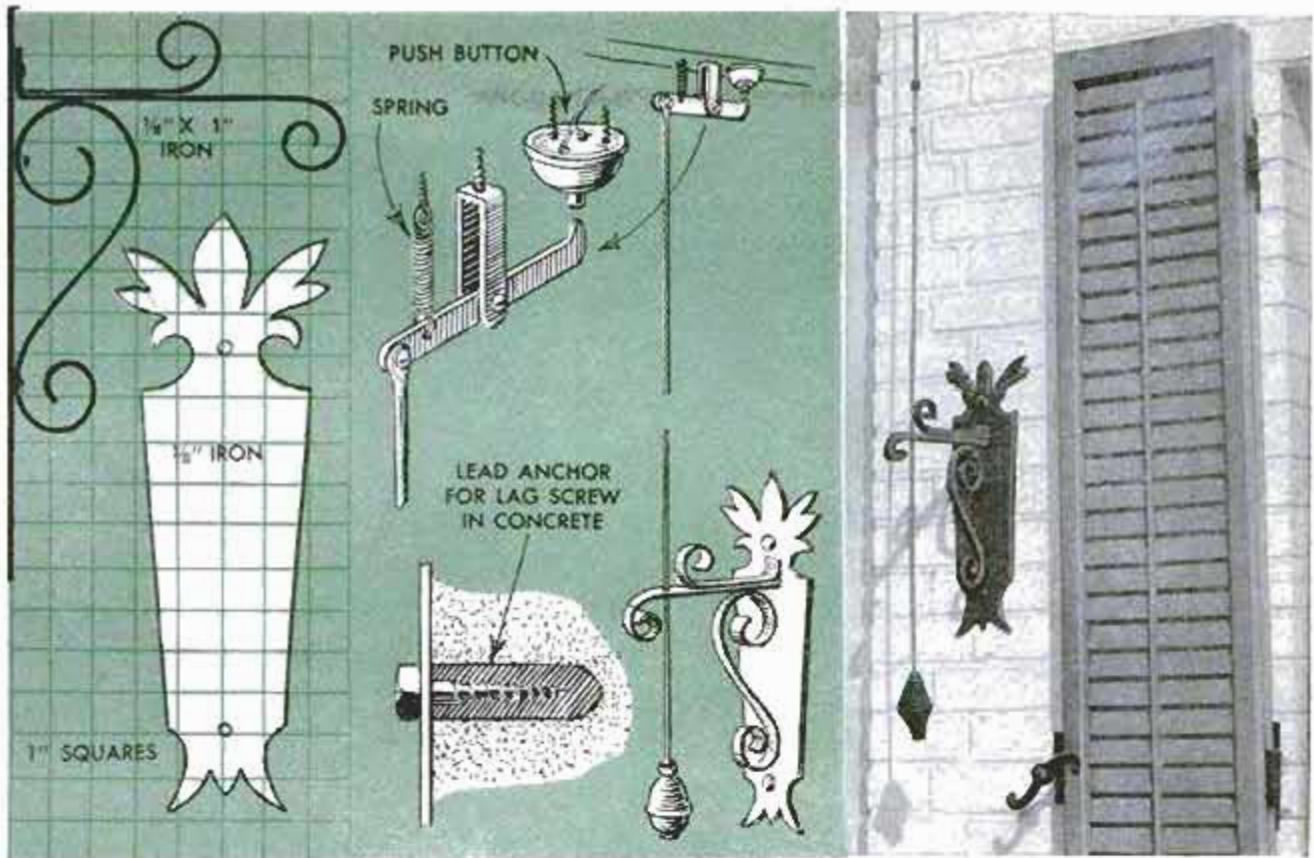

If you want to add a touch of character to the front entrance of your home, install this pull-type arrangement for ringing the doorbell. Its antique appearance simulates the old-time pulls once used to actuate mechanically operated doorbells.

First, the doorbell push button is relocated at some point above the door. If there is an overhang above the door, the button can be screwed to the soffit as indicated. A U-shaped flat-steel bracket also is screwed to the soffit and located so that one end of an arm pivoted in the bracket will depress the button. The opposite end of the arm is drilled to receive a screw or rivet on which the upper end of the pull cord is pivoted. A coil spring pulls the arm away from the push button when the pull cord is released.

When there is no means of locating the push button in a horizontal position, the pivoted arm can be made L-shaped and

pivoted in the U-shaped bracket which then is located above the vertically mounted button. The pull cord would be pivoted to the end of the short leg of the L-shaped arm, which then would be located in the same relative position to the long portion of the arm, but also would be horizontal.

When using either method of mounting, the lower end of the pull cord—it can be light chain, heavy cord or a small-diameter rod—passes through a hole drilled in the horizontal arm of an ornamental, wall-mounted bracket. The wall plate of the bracket can be cut to the shape indicated on the squared pattern or made in any design preferred. Lengths of $\frac{1}{8}$ x 1-in. wrought-iron or steel flats are bent as indicated to form the ornamental brace and projecting arm through which the pull cord passes. The knob on the end of the pull can be a wood turning or any suitable ornamental knob.

Handy Pocket for Eraser Taped to Side of Typewriter



Your typewriter eraser will always be at hand if it is kept in a pocket taped to the typewriter. The pocket is made by folding a strip of light cardboard and then stapling it across each end.

☐ A metal fork inserted under buttons permits ironing under them and keeps the iron from touching plastic buttons that might be affected by the heat.

CLEANING HINTS



Below, paintbrush makes quick work of dusting window mullions where a cloth would be awkward

Above, to aid "spot cleaning," rub stains on table linens with bar soap before placing in washer



IN HOUSECLEANING, as in other jobs, once the basic techniques have been learned there are dozens of short cuts and aids that can be adopted to save time and lessen the work required. Some of these include using soft paintbrushes for special dusting, wrapping wrists with cloth to prevent water running down arms when washing walls, and sewing a pad into a heavy-duty apron so that it automatically falls into place under knees when scrubbing floors or doing other work that requires kneeling.

As a housewife gains in experience, she tries some ideas that she discards, others that she accepts. However, even the experts will agree on one thing: The first rule in fast, efficient housecleaning is system. Get a good supply of cleaning cloths, stain removers, bleaches, brushes, detergents, etc., and place them all in a handy box or basket that can be carried. ★ ★ ★

To clean upholstery: Dissolve $\frac{1}{2}$ cup soap flakes in boiling water, whip cooled mixture until stiff. Apply in small area. When dry, remove with spatula and wipe with damp cloth. Brush nap when nearly dry

To clean woolen rugs: Make a paste of equal parts of corn meal and cleaning fluid, apply briskly with a cloth. Shake rug and hang to dry. Brush when dry

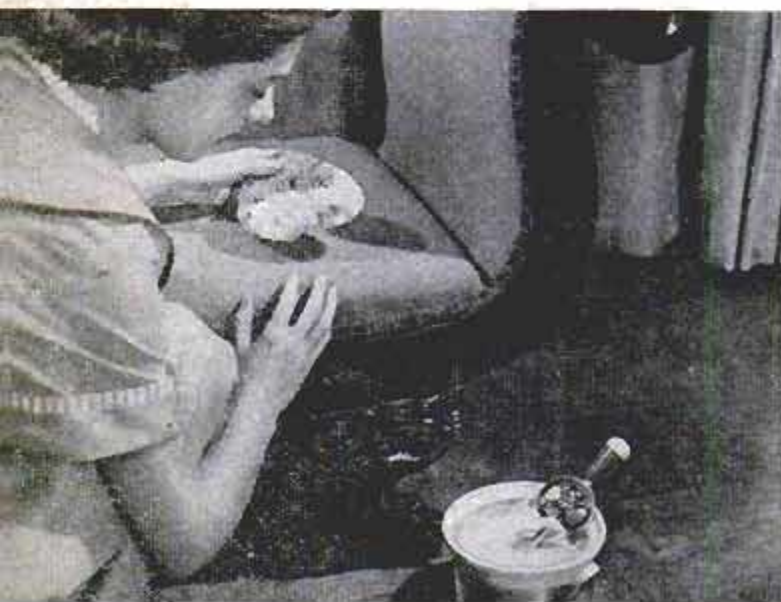

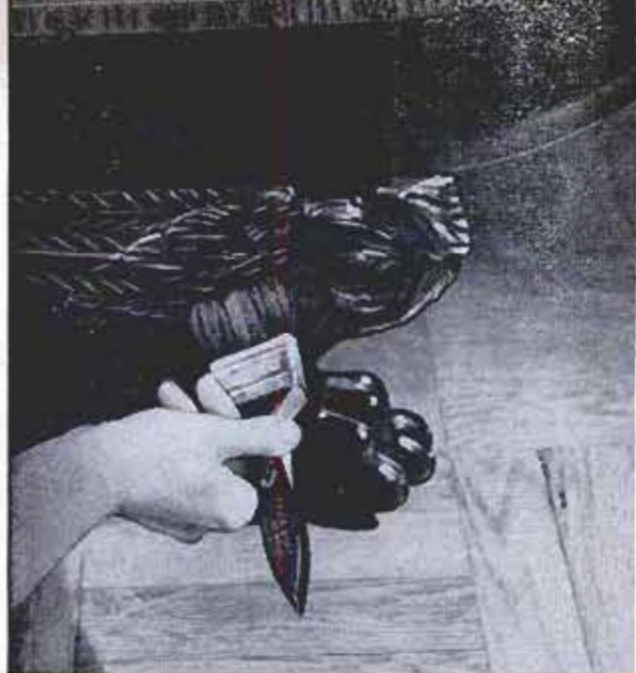

Dusting intricately carved furniture or valuable china figurines is another job for a paintbrush



Don't discard paper shopping bags. Save them for rough work, such as scraping grease from range



Above, cleaning refuse can is easier if it is coated with plastic spray. Below, left, if soot falls on rug, sprinkle with salt, sweep up without stains. Below, center, spin mop between palms to untangle it



Above, remove oxidation from copper-bottomed pans by scouring with a mixture of salt and vinegar. Below, right, to clean small items, such as ties, place in jar with cleaning fluid, cap and shake vigorously

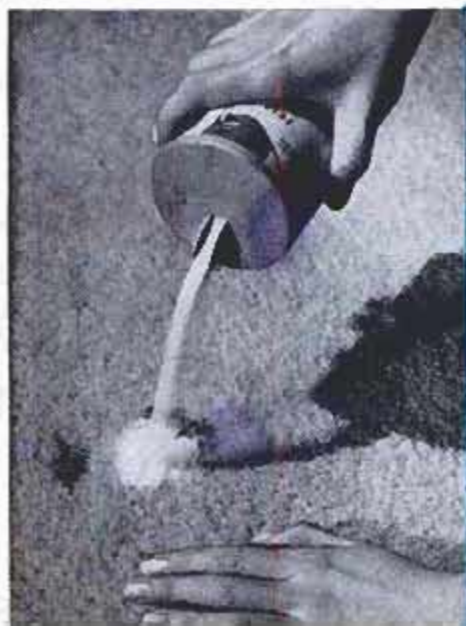



Areas in Water Color Painting Washed Out With Foam Rubber

A small cube of foam rubber is ideal for washing out selected areas in a water color painting, especially when the surface of the paper or illustration board is rough. The texture is not smoothed out by this operation as it is in dry erasing. Sharp-edged areas can be washed out by masking the surrounding surface with masking tape.

Walter L. White, Indianapolis, Ind.

Cigar-Box Jig Simplifies Job Of Soldering Small Grilles

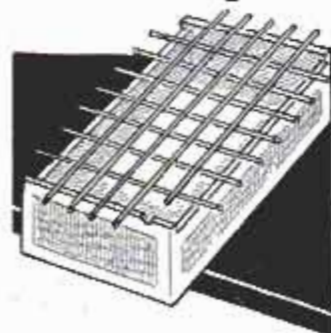

Assembling a wire grille is simplified by using a jig made from a cigar box to hold the wires in place. Correctly spaced slots are sawed in the top edges of the ends and sides of the box to receive the wires. The slots in the sides are slightly deeper to permit the longer wires to rest on top of the shorter ones.

The slots in the sides are slightly deeper to permit the longer wires to rest on top of the shorter ones.

If you want to build a desk...

be sure to see the unusual one that will appear in the February issue of *Popular Mechanics*. It features a well in the top which can be used as a planter or a filing drawer, and its plain, straight lines make it easy to duplicate with only a few tools. The top and legs are cut from a stock flush door; the rest from hardwood plywood

Dowel Secures Roofing-Paper Roll Safely on Hoist Rope

When attaching a hoist rope to a roll of asphalt roofing paper a dowel or a short length of broomstick tied to one end of the rope will provide an easy and safe means of securing the roll to the rope. The stick, when dropped through the core of the roll,

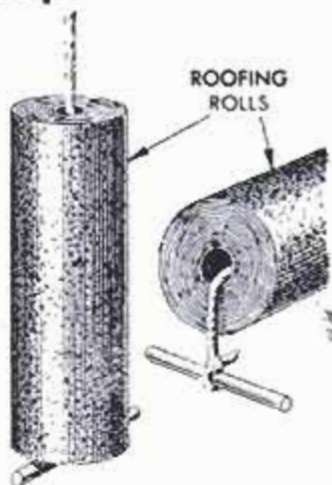

will rest horizontally to support it safely and will also hold the roll in a vertical position so that there is much less danger of it striking and damaging the wall or windows of the building. This method eliminates the problem of having to pass the rope through the core of a roll and securing it with a safe knot each time a roll is hauled to the roof.

Toothbrush Container Utilized As Miniature Pencil Box

Carrying pencils in luggage or pockets often results in damaged and marked clothing, along with broken pencil points. To avoid these problems, utilize a plastic toothbrush container as a miniature pencil box. Generally, three or four pencils can be carried in the container.



Bird-Feeding Station Has Roof of Corrugated Glass Fiber

This bird-feeding station provides free access both to the birds and to the owner when he restocks it. The base of the feeder is a 10 x 14-in. piece of $\frac{3}{4}$ -in. plywood onto which is nailed the $\frac{1}{8}$ -in. hardboard floor. The floor measures 12 x 22 in. Roof supports are 10-in. lengths of $\frac{3}{4}$ x $1\frac{1}{4}$ -in. stock. Triangular-shaped pieces of $\frac{3}{4}$ -in. material, measuring 15 in. across the base and 5 in. high at apex, are used to support the roof. A 12 x 24-in. sheet of corrugated glass fiber is used for the roof. Aluminum nails

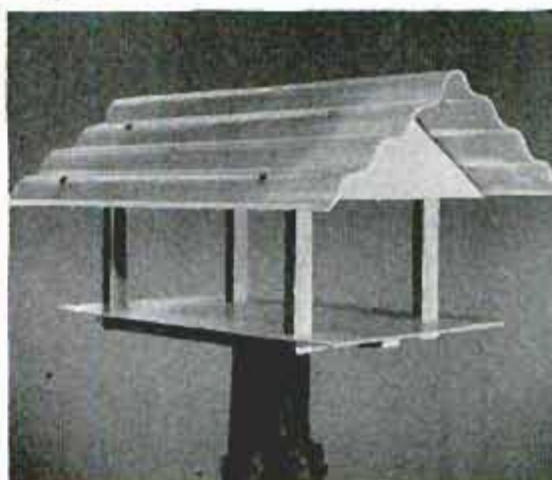
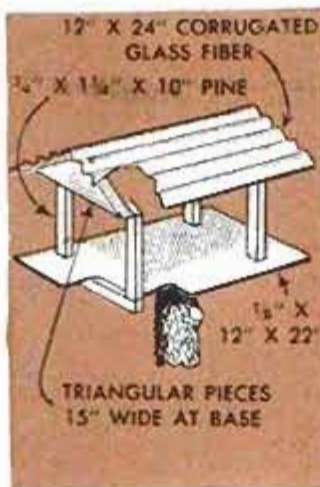

and screws are used to avoid the problem of rust. Protect the wood with several coats of exterior-type paint or varnish.

Screwdriver Fitted With Adapter For Installing Screw Eyes



Slipped over the tip of a screwdriver blade, a holder for driving screw eyes permits doing the job more quickly and easily. The holder is a length of steel tubing flattened and driven onto the end of the driver blade, the lower end being notched to fit over the screw eye as shown. Unless the screw eyes are very small, always drill pilot holes to assure easier driving.

Build This House Yourself!

Save 65% Easily!

Two bedrooms, a spacious living room, bath, carport, compact dining room and kitchen all in a space 24 x 46 feet. You can build the Precut House in three stages, using any of numerous floor plans—all of which are designed to provide maximum comfort with minimum cost. Think of it! You can build that house you've always wanted. You can make a livable shell for only \$1800. The second stage will give you a summer home with all conveniences for only \$2800. When you add the third stage, you have a luxury home for year 'round living, in any climate, for only \$3800!



Livable Shell—\$1800; Summer Home—\$2800; Luxury Home—\$3800; Simplified How-To-Do-It Instructions—Hundreds of Pictures—Working Blueprint Plans!

You can build the house with the book alone. The plans make it easier. The book gives lists of materials required, all measurements and dimensions, suggestions for financing and tells in words and shows in pictures every detail of construction. Richard Dempewolf, author of the "Precut House" book, built the house in 1650 man hours for \$3731.23—complete!

Features of Expensive Homes are included: built-in furniture, unusual amount of closet space, adaptability to various interior arrangements, and materials designed especially for amateur builders. The book is \$2.50 and a complete set of 10 blueprints \$12.50 (a duplicate set is \$5.00). You can place a C.O.D. order or mail your remittance in full.

Order book and plans from

POPULAR MECHANICS BOOKSHOP

208 E. Ontario St.

Chicago 11, Ill.

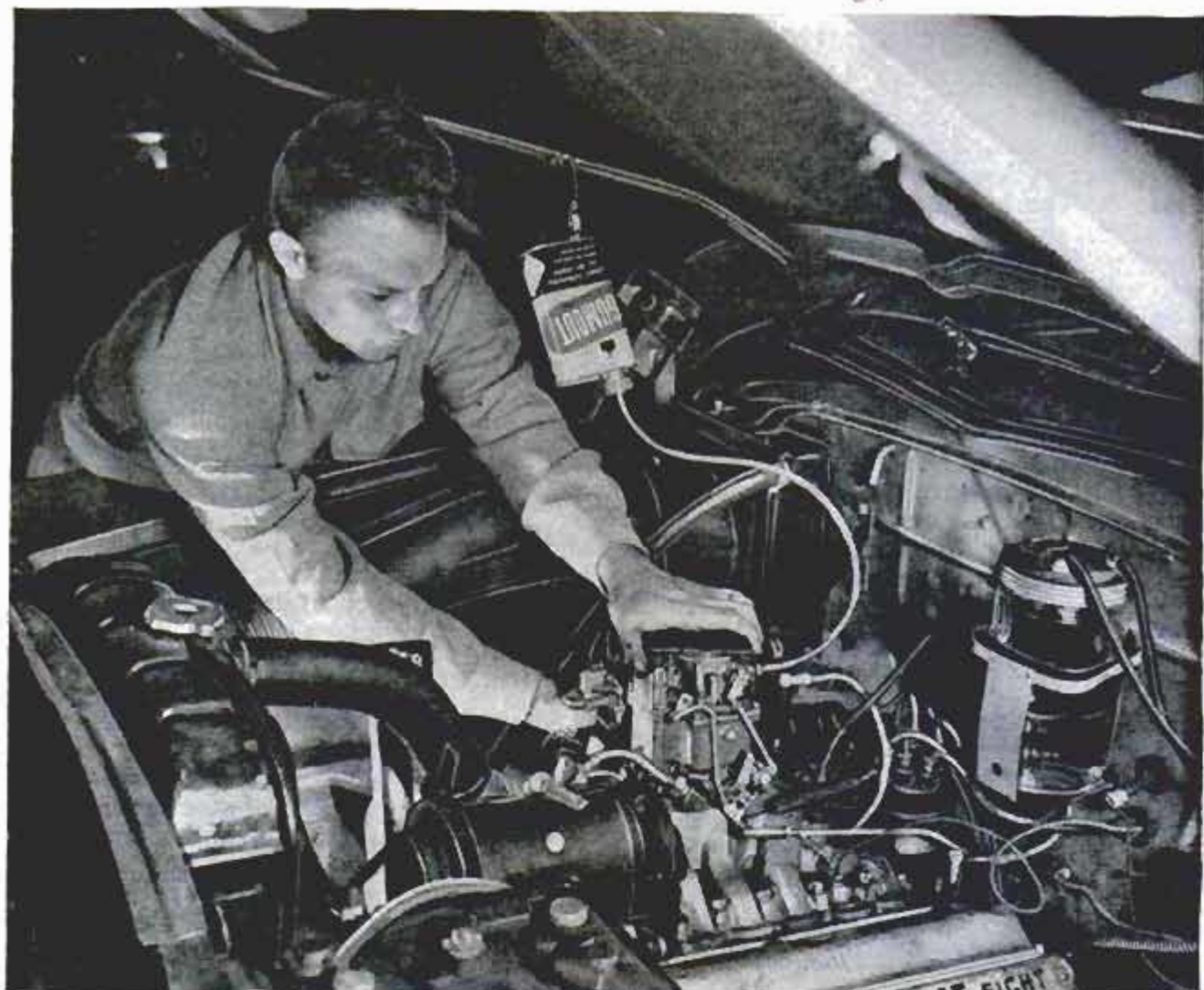

SERVICE YOUR OWN CARBURETOR

By Ed Packer

THERE IS NO MILEAGE chart to tell you precisely when the carburetor in your car should be cleaned and serviced. You have to judge largely by driving conditions and engine performance. If most of your driving is on dusty country roads, or if you make short runs with frequent starts and stops, the carburetor will need to be serviced more often than it would normally under conditions more nearly average. **But even though your driving is mostly on paved highways and city streets and even though the air cleaner is serviced regularly, the carburetor will gradually accumulate dirt and gum.**

Where there is no mechanical defect to be corrected, a thorough cleaning of the carburetor with a special solvent usually does the trick. Fuel residues, due to heating of the gasoline, form a gummy adhesive that builds up gradually in the tiny passages of the unit. "Inhaled" dust-particles

cling to this coating just as they would to tacky varnish. As the coating builds it restricts the openings, affecting the adjustments necessary for quick starting, fast acceleration and good fuel economy.

Little or no gumming takes place when the engine is running as the carburetor is cooled by gasoline drawn from the fuel tank and also by the blast of air from the fan. This keeps the temperature of the fuel in the carburetor much below the boiling point. But the moment the engine is shut off, the fan ceases cooling and fresh gasoline no longer circulates through the carburetor, absorbing heat. **The latent heat in the engine immediately gathers under the hood and moves upward around the carburetor as it is dissipated.** Gasoline left in the carburetor float chamber is "cooked," in some cases actually is boiled. The residue from the cooked gasoline forms the gum or "varnish" which collects inside the

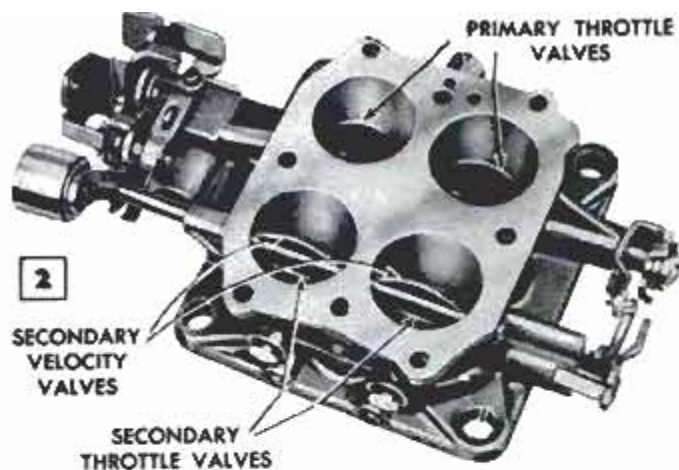
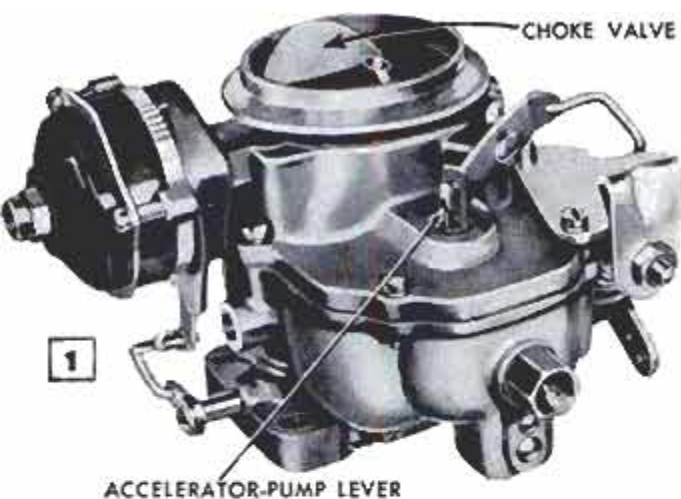

Choke valve is held in the closed position by the automatic-choke mechanism when the engine is cold. When the engine is started it opens automatically

Throttle valves in a four-barrel carburetor control engine speed by regulating amount of fuel. Velocity valves open automatically for top performance

carburetor. Since nozzles and jets in carburetors are calibrated in thousandths of an inch, it does not take much gum, or dirt and gum, to reduce jet sizes or even plug them completely.

One method of cleaning a carburetor without removing it from the engine is illustrated on the preceding page. A can of gum solvent mixed with gasoline is suspended above the carburetor and connected to it, while the regular fuel-supply line is plugged. The engine is started and the 50-50 mixture of gasoline and solvent is run through the carburetor. The engine is operated at high and low speeds, allowed to idle and even run with the choke closed so that a rich mixture of solvent and fuel is forced through all jets, nozzles and passages in the carburetor, removing the gum. Gum deposits in the float chamber also are dissolved and burned by the engine. After the carburetor has been cleaned in this manner, always service the air cleaner. Wash both inside and outside with gasoline, then rinse the copper mesh of the dry type with a suitable solvent, blow out with compressed air and reoil according to specifications. On the oil-bath cleaner, clean out old oil with solvent and replace with new. Use

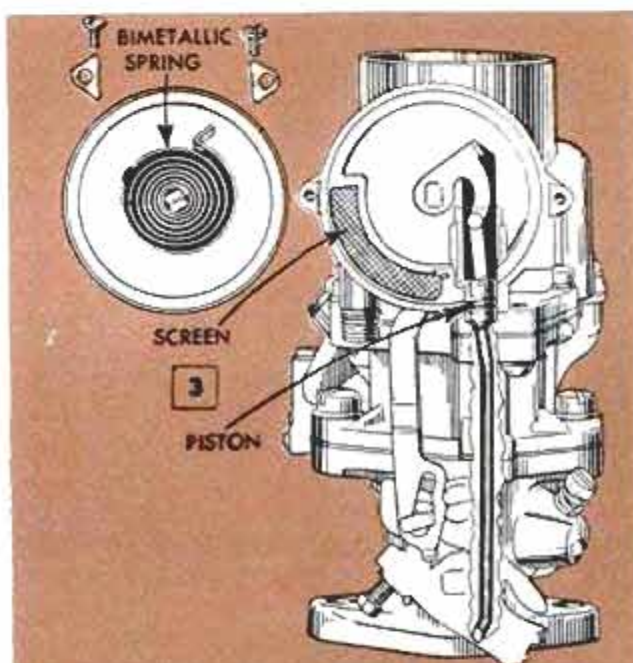

Above, engine heat reaches the choke mechanism through the screen in the housing. Below, cover, or cap, on the choke-mechanism housing can be rotated to adjust the setting

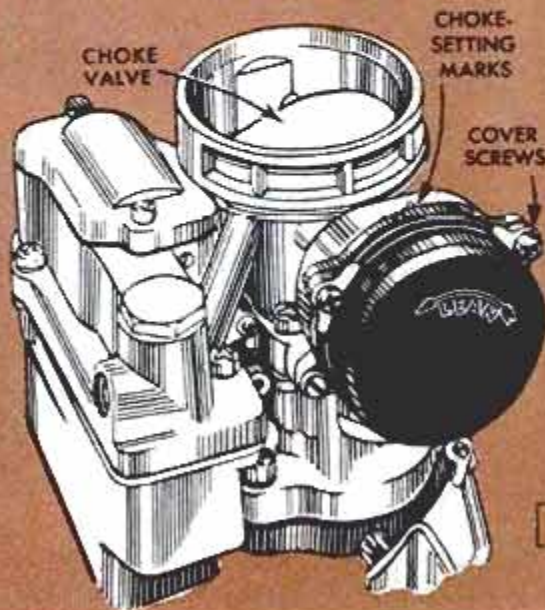
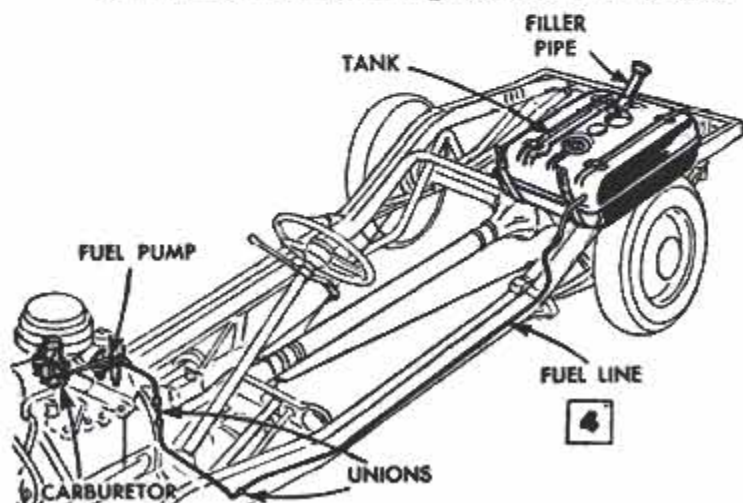

a slightly heavier grade oil than recommended and a smaller quantity. Excess oil often runs down into the carburetor and clogs air bleeds.

Late types of carburetors and a typical fuel system are shown in Figs. 1 to 5 inclusive. Many late-model cars are equipped with four-barrel carburetors like that shown in Fig. 2. **Parts subject to the greatest wear in both the single and multiple-barrel types are the check valves, metering rods, metering-rod jets, float valves and seats, accelerating-pump plungers and the linkages which operate these parts, Figs. 6 and 7.** Manufacturers now supply repair kits consisting of replacements for all common wear parts, including the necessary gaskets which must be replaced when the carburetor is removed from the engine. The kit includes step-by-step instructions for the make of carburetor being serviced.

As parts of the carburetor wear, the float level tends to rise. Wear points are the pivot, needle and needle seat. Slight wear at these points causes the float to rise higher in order to control the flow of fuel into the bowl. A variation in the float level can materially affect engine performance and fuel economy. Whenever the carburetor is disassembled for any reason, the float level should always be checked with a gauge of the type recommended by the manufacturer.

Before disassembling a carburetor which appears to be affecting engine performance, make sure that you have eliminated all other possible causes of engine trouble which give the same or similar symptoms.

When disassembling becomes necessary, use the right tools for the job. Some units require the use of special jet wrenches to avoid damaging the unit beyond repair. On some types special screwdrivers are necessary. In some cases it is possible to grind a screwdriver blade to fit inside the threaded jet seats, but as a rule the special tools designed for the purpose should be used. Be especially careful to avoid bending such parts as metering rods, and pump linkages, both when disassembling and reassembling. Take special pains to keep all parts in order when removing and replacing.

When reassembling a carburetor, be sure that the choke valve works freely. In nearly all late-model carburetors the valve is actuated by a bimetallic spring mounted on a cap which can be rotated right or left to change the setting, or tension, Figs. 3 and 5. When the engine is cold, the spring holds the choke valve fully closed. As the engine warms, heat rising through the heater tube and the screen into the spring housing gradually opens the valve through thermostatic action of the spring. **Be sure that the heater tube and the screen are thoroughly cleaned and that the connecting linkage and the shaft on which the choke valve is mounted are free of carbon and dirt which may cause the parts to bind.** The air or vacuum-operated piston that controls the choke effect, or degree, according to the load and speed of the engine is an important part of the mechanism, Fig. 3. It must operate freely and should be replaced if it shows excessive wear or looseness at any point. ★ ★ ★

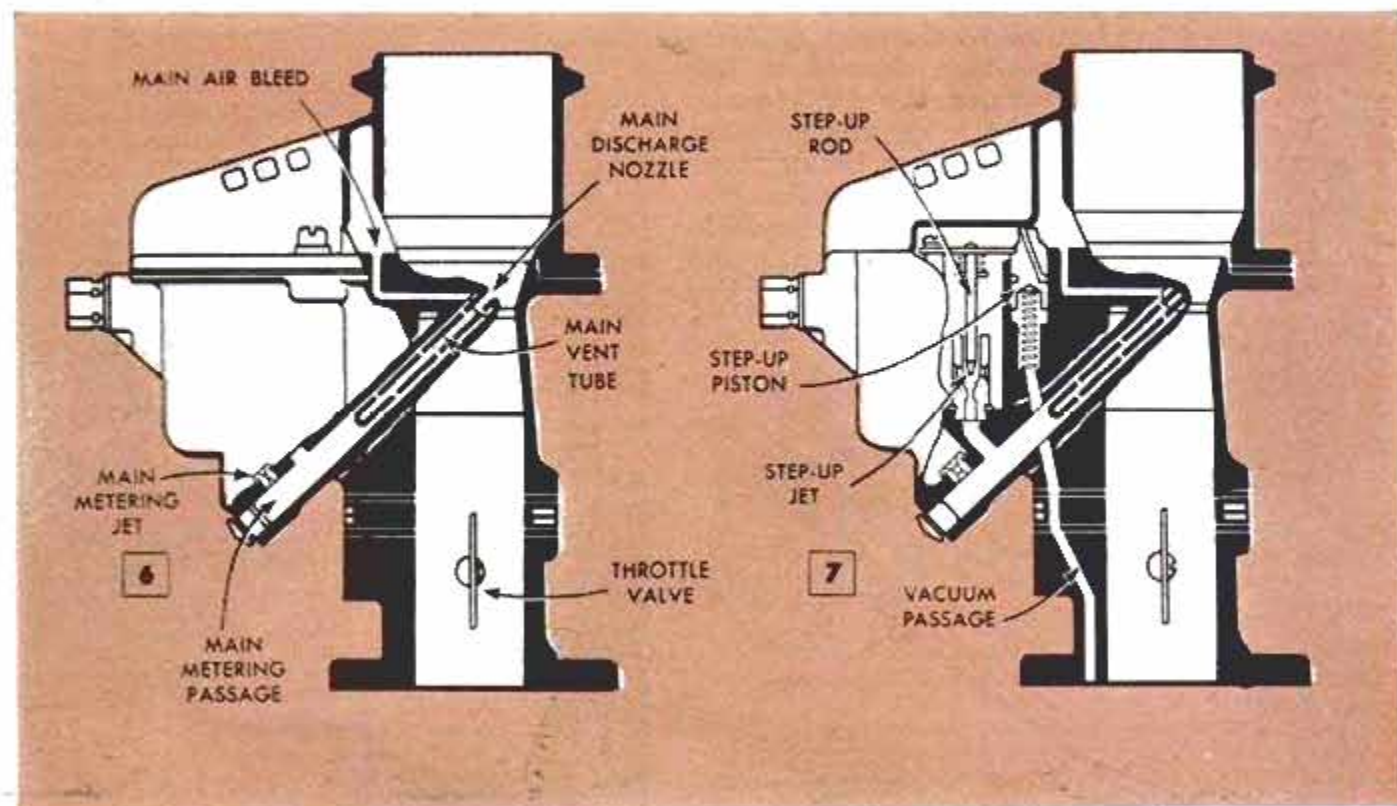

Turkish Towel Speeds Processing of Matte Prints in Drier

A Turkish towel spread over the metal surface of a print drier will speed up drying matte prints by absorbing moisture from the heated prints. Allow the prints to dry just until moisture no longer is apparent when a hand is placed on the canvas cover of the drier. The slightly moist prints then are removed from the drier and air-dried to minimize curling.

Eugene M. Hanson, Los Angeles, Calif.

Plastic-Embedded Labels Identify Photo Chemicals



One photographer has found a way of identifying photo-chemical bottles with labels that do not become wet, stained or otherwise illegible. Labels cut from the cans of dry chemicals are embedded in liquid plastic of the type

that sets hard. A hole is drilled in the hardened plastic and a length of corrosion-resistant wire is used to fasten the plastic-covered labels around the necks of the bottles.—Terrell Nichols, Bowie, Tex.

Photoflash Extension Cord Converted by 3-Way Cube Tap

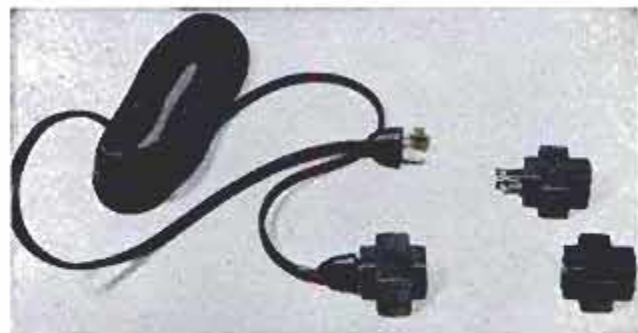

A modified 3-way cube tap is standard equipment for one photographer who has frequent need for a long extension cord. The tap is fitted on one end of a photoflash extension cord that has male plugs on both ends, so that one plug is converted to a female connection. Cut off the blades on the male side of the tap to modify it, push the remaining portions of the blades back into the tap and cover them with tape. A line tap, which is similar to a 3-way cube, except that it has no male blades and is wired directly to the line, can be used in the same manner.

Robert C. Florian, Chicago.



Cellophane Diffuses Scratches On Negatives When Enlarging

When enlarging a picture from a negative that is scratched, a piece of crumpled, clear cellophane moved quickly back and forth between the lens and the enlarging paper will diffuse the regular lines caused by the scratches. It is necessary to hold the cellophane near the lens to avoid inadvertent dodging and burning.

Masking Easel for Small Prints

A discarded film pack is practically a ready-made enlarging easel for small-sized prints. To make the easel, file the top edges of the pack until they are thin and can be broken off. To use, simply press down the film-pack pressure plate and insert the paper, which then will be held flat and print with an even white border.

D. J. Murphy, Springfield, Mass.



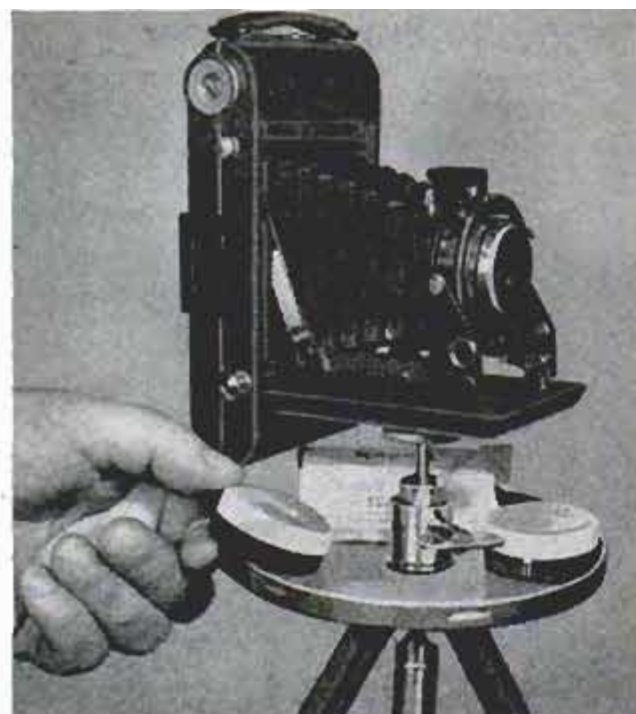

Camera Tripod Accessory Tray Made From Can Lid

Adding a tray to the top of a camera tripod will provide a convenient place to lay extra lens filters, spools of film and accessories. The tray is a metal can lid of large diameter with a hole punched through the center. Keep the flange up and fit the lid over the tripod screw before adding the tilting top and camera.

Darkroom Thermometer Holders

Discarded roll-film spools make excellent holders for darkroom thermometers and glass or plastic stirring rods. Cut off one flange of each spool and drill a small hole in the remaining flange. Bend the drilled portion of the flange at right angles and screw the holder to a wall or cabinet.

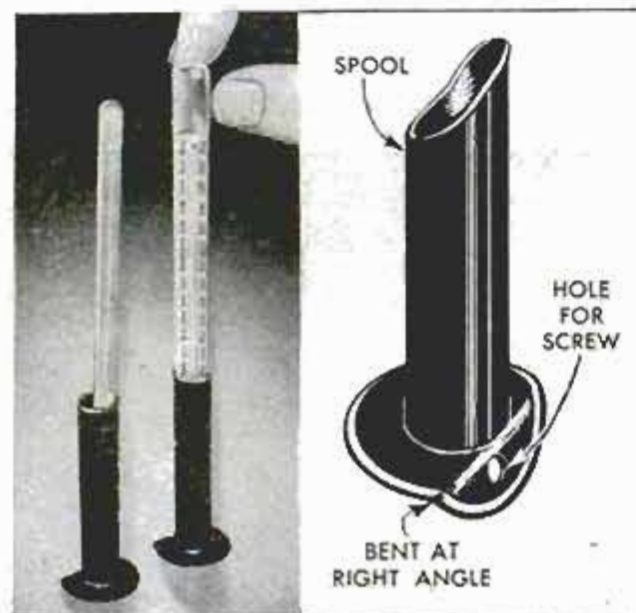

Dial Thermometer in Tank Drain Checks Print-Washing Water

A constant check of faucet-water temperature during the time required to wash photo prints is possible if a dial thermometer is installed in the drain of the washing tank. An occasional glance at the dial will indicate any change in water temperature.

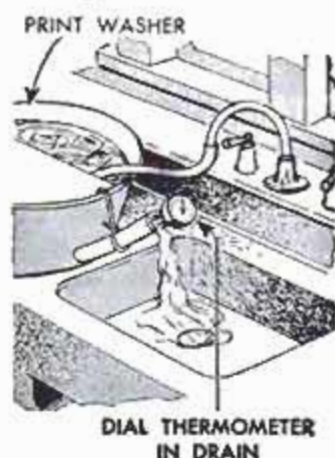

Mirror Is Retouching Stand

You do not need a special retouching stand for working on negatives 4 x 5 in. and smaller, if a small mirror with a wire stand, such as a shaving mirror, is available. Place the mirror flat on a table and rest a sheet of glass against the wire stand as shown. Turn the mirror so light from a window or lamp is reflected through the negative on the sheet of glass. A strip of cellophane tape attached to the table and the bottom edge of the glass will hold it in place. A second strip could be used to hold the glass to the wire stand.

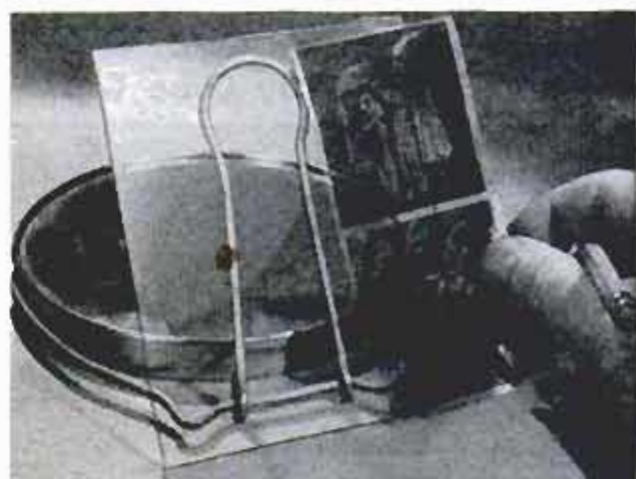

Leakproof Lighter-Fluid Can Used as Small-Size Oiler

When one home craftsman needed a small, leakproof oil can, he used a lighter-fluid can of the type that has a pivot top. The plastic top, which seals when pivoted to either side, was carefully removed and the can filled with oil. With the top replaced, the can is ready for service. Should oil leak between the plastic top and the can, a small amount of nonhardening gasket compound will effect a good seal.

Emmett Vowell, Washington, D. C.

Shop Notes

Portable One-Motor Workshop

By Tom Riley

Few power tools can match a high-speed router in variety of applications in the home workshop



A ROUTER does just about everything—even performs some jobs ordinarily carried out on the jigsaw, circular saw and shaper. Cut edges of grooves, rabbets, moldings and beads run with a router are as smooth as surfaces painstakingly sanded with a fine abrasive. Spindles of nearly all hand-held routers, such as the one pictured above, rotate at no-load speeds of 18,000 r.p.m., or even higher. This extremely high speed of the cutters, direct-driven from the spindle, gives factory-perfect work.

The Basic Unit

Routers designed for hand operation usually consist of a special high-speed motor mounted vertically in a base which has a provision for adjusting the motor up or down to vary the depth of cut. The motor can be locked securely at any point. The base usually comes with a circular bottom plate, or shoe, handles on opposite sides and is drilled and tapped for attachment of various types of template guides. An accessory edge guide, Figs. 4 and 5, also is supplied. Its purpose is to provide an accurate means of guiding the router parallel with the edge of the stock when cutting an inlay groove as in the photo above. It will work against a straight or curved edge. The motor can be removed from the base and used as the power source in other types of work. As a rule the motor spindle is fitted with a 1/4-in. collet chuck in which adapters accommodate smaller-shank bits.

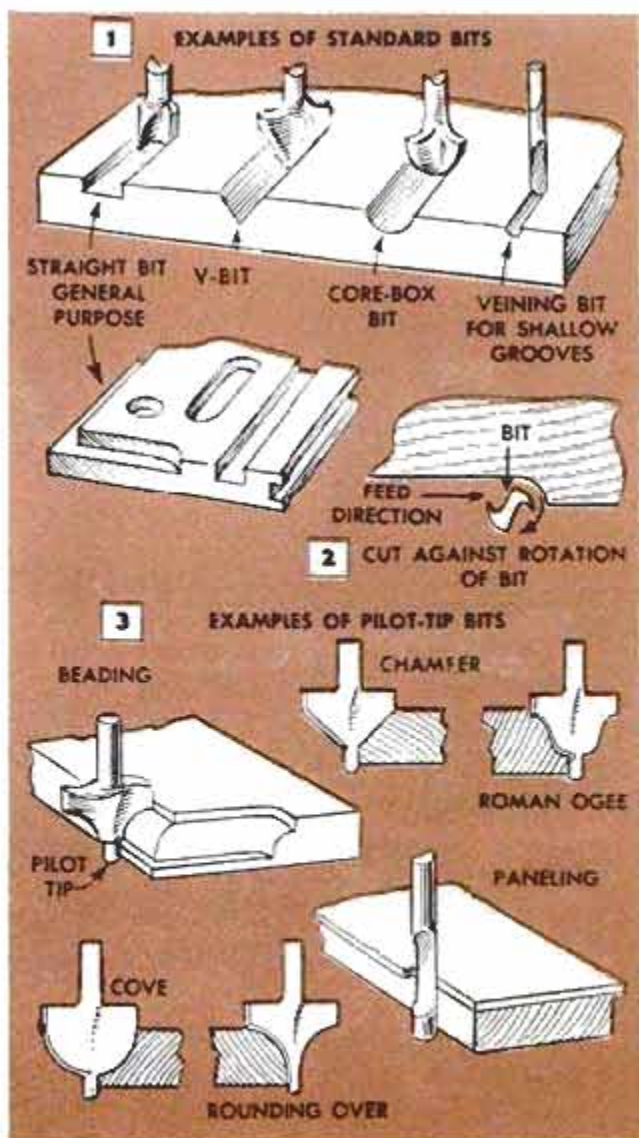



Standard Router Bits

These are designed to cut straight, vee and round-bottom grooves of various widths on the face of flat stock, Fig. 1. Although not ordinarily done, the conventional bits can be used to cut grooves in the edge of the stock as in the left-hand detail, Fig. 2. However, the tool is somewhat more difficult to control due to the narrow bearing surface. All bits are designed to cut against the direction of rotation, Fig. 2.



Pilot-Tipped Molding Cutters

Six types of pilot-tipped cutters are shown in Fig. 3. Five of these are two-winged cutters having two cutting edges like the vee and core-box bits in Fig. 1. Pilot-tipped cutters do not require a guide. The pilot tip riding on the uncut portion of the stock guides the bit and fixes the depth of cut from the edge of the stock. The paneling bit, Fig. 3, is made especially for trimming veneer flush with the edge of the core, also for trimming hard plastic facings in sink tops and table tops. Bits designed for this purpose usually are made from tungsten carbide. A special edge guide is improvised as in Fig. 25.

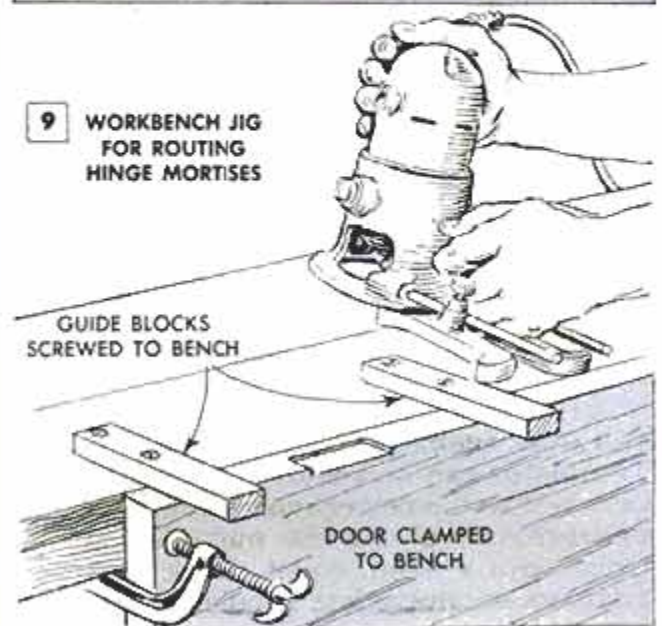
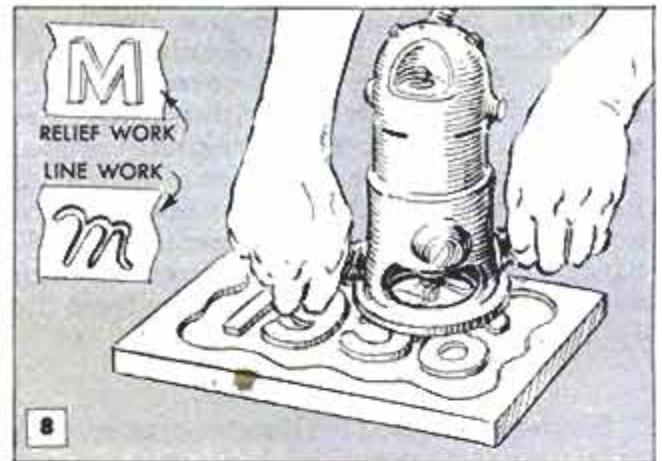
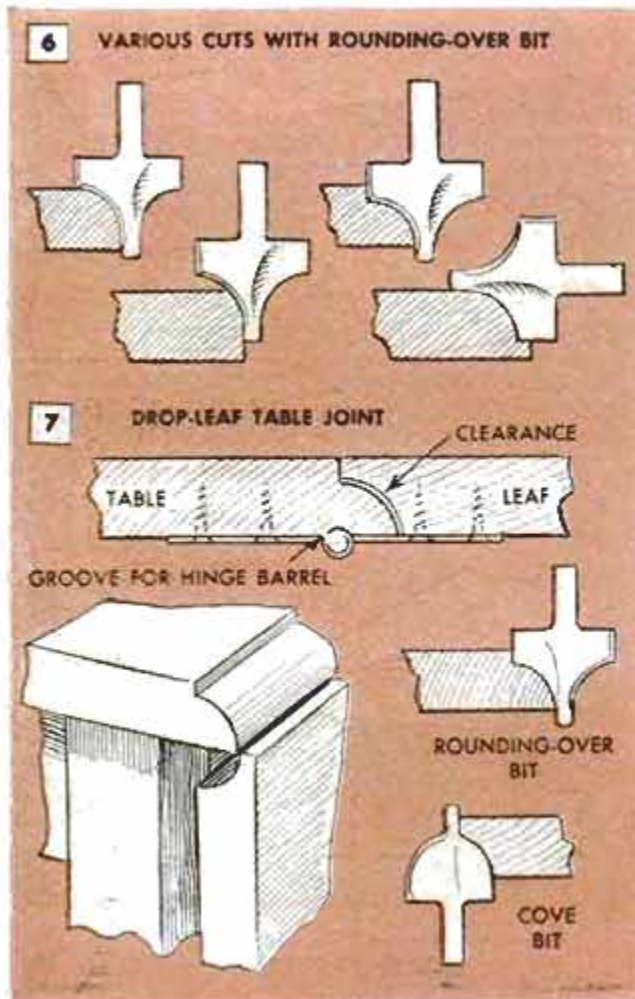



In certain types of work it is necessary to use bits not having a pilot tip. When working on the edge of the stock the regular adjustable edge guide is sometimes fitted with an auxiliary wooden strip as in Figs. 4 and 5. The strip generally is cut out, or round-bottom notched, to permit chip clearance as in Fig. 5. A guide strip of this type is necessary when making certain cuts shown in Figs. 6 and 7.

Freehand Routing

Extreme high speed of the bits and cutters makes it easy to control the tool when it is necessary to work freehand as in Fig. 8. The trick is to make successive shallow cuts, not more than $\frac{1}{8}$ in. deep, until you reach the required depth. For curved relief such as that shown in Fig. 8, follow the penciled pattern lines with a $\frac{1}{16}$ or $\frac{1}{8}$ -in. straight router bit, outline the border and remove the background waste with a bit of larger diameter. This procedure works well with signs, cartoons and curved-line drawings, but straight-line designs, block lettering and long, sweeping curves should be done with a guiding template cut from plywood. When working this type of design, either freehand or with a template, it helps to wax the router base to aid free movement.

Freehand Shaping

Most shallow cuts with pilot-tipped shaping cutters can be run in one pass. Deeper moldings which require the full capacity of the cutter should be run in two or more passes, starting with a shallow cut first and then lowering the router to increase the depth of cut until the molded shape is of the desired size and form. Before running a shaping cut with a pilot-tipped cutter be sure that the edge of the stock is smooth and true, as any irregularity will be reproduced in the molding cut.

Using an Edge Guide

Edge guides supplied with hand routers usually will adjust to permit cutting at least 6 in. from the edge of the stock. This

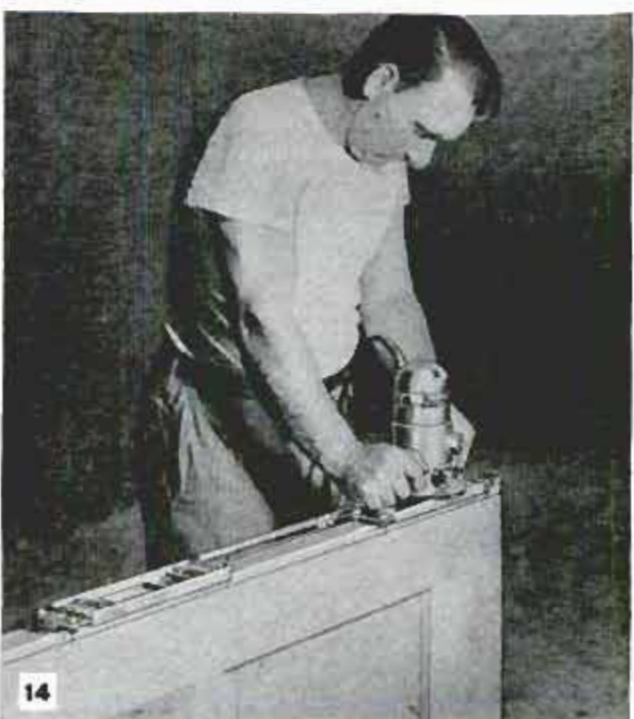
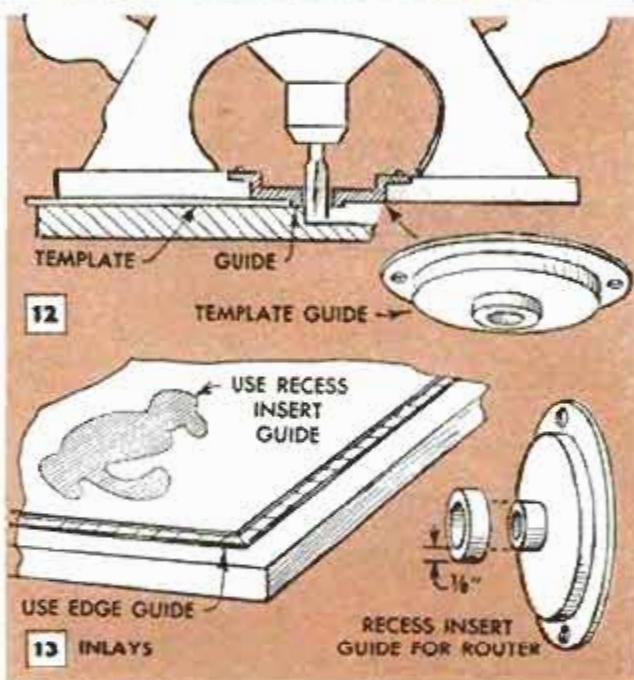
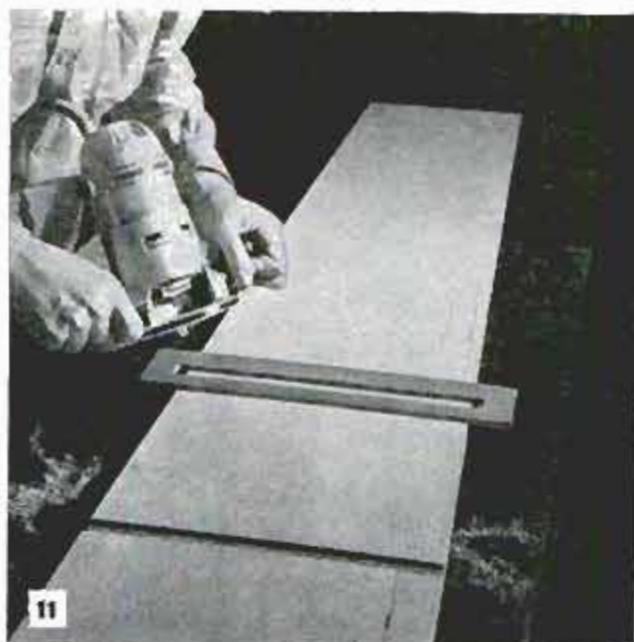



15

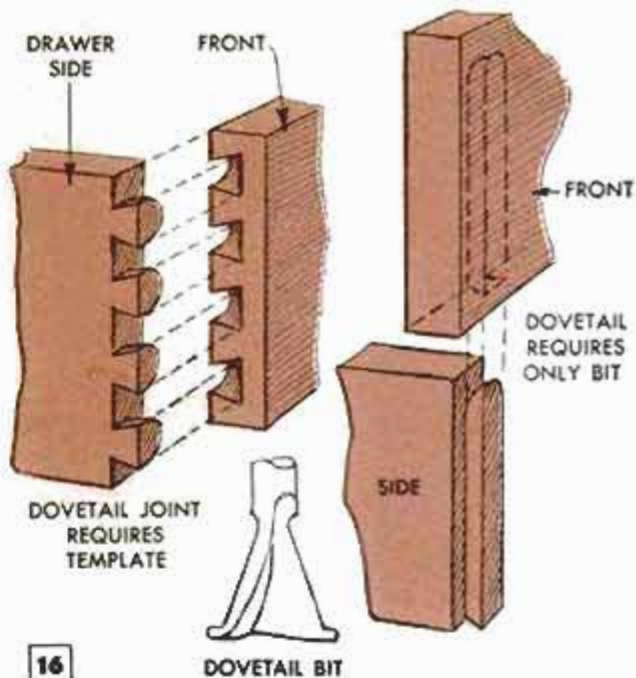

16

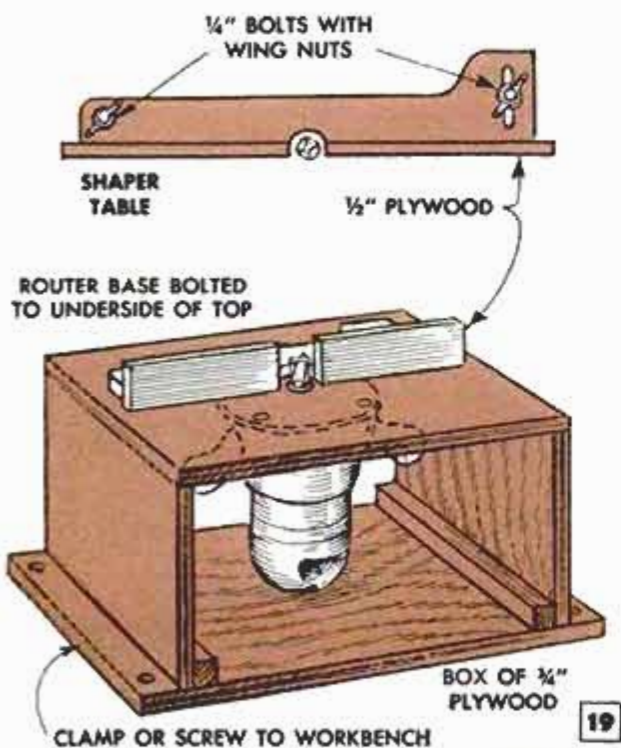

19



17



18

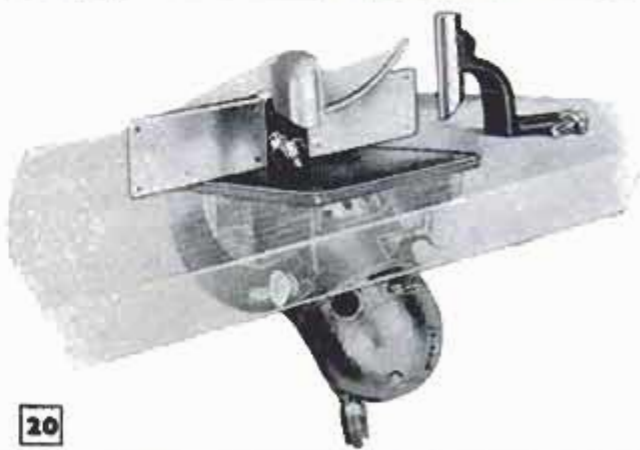

20

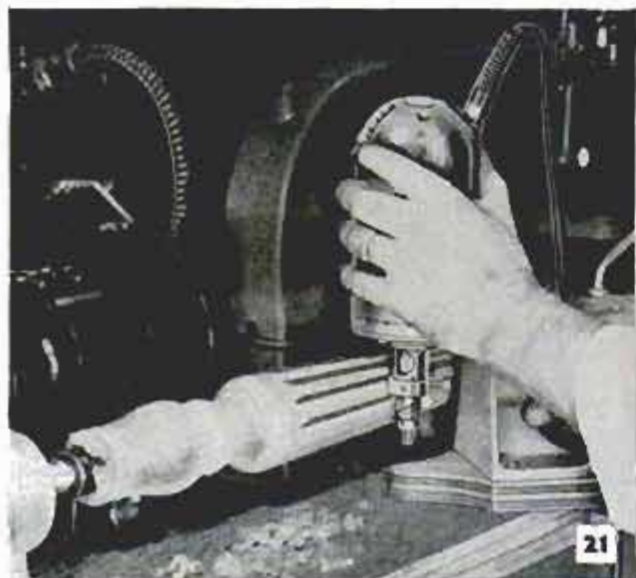

21

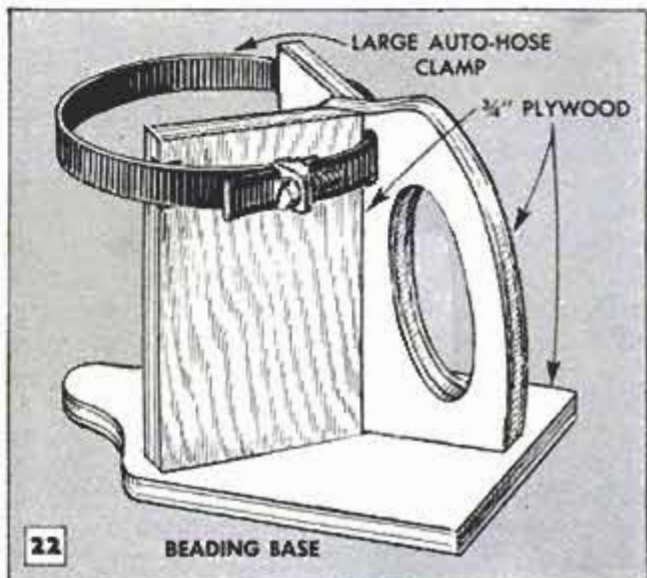

22

covers the practical range of veining and also grooving for inlaying and certain types of marquetry and two-tone veneering, Figs. 12 and 13. When it is necessary to work beyond 6 in. from the edge of the stock, the base of the router can be guided by a strip clamped to the stock, Fig. 24, or by a template, Fig. 10. Grooves across the grain are cut with a special template as in Fig. 11. If you wish to make a dado, which is a stopped groove generally made across the grain, use the same template, locating and clamping it to stop the groove as desired. Use a template guide, Fig. 12, for best results. An example of this type of work is cutting dados to house the ends of non-adjustable bookcase shelves. By reversing the regular edge guide you can cut grooves near the edge of stock which has been cut to a fairly short radius. As an example, note the work being done in the photo above Fig. 1. A simple setup for routing door-hinge mortises is shown in Fig. 9. The door is clamped to the edge of the bench and the router fitted with the regular edge guide. Stop blocks screwed or clamped to the bench top limit the lengthwise travel of the router. A professional-type template jig for the same purpose is pictured in Fig. 14.

Template Routing

Intricate designs cut in relief, circular cuts and pierced work require a template for best results. When a template is used, the router base must be fitted with a template guide, Figs. 12 and 13. The guide fits in the position shown in Fig. 12 and has a projecting sleeve which bears against the edge of the template. Templates for this type of work should be jigsawed from $\frac{1}{8}$ or $\frac{1}{4}$ -in. plywood and the cut edges sanded smooth. For working with the type of template guide shown in Fig. 12 the plywood templates can be quite intricate in design with curves of short radius. Cutting through the stock, or piercing, as it is sometimes called, gives results similar to intricate jigsawed patterns with the added advantage that the edges of the work do not require sanding. Keep in mind that the template must be oversize. The amount it is over is determined by the size of the



23



24

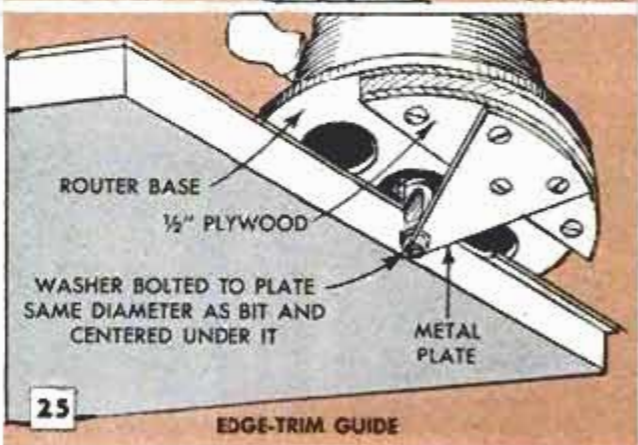

25

EDGE-TRIM GUIDE



26

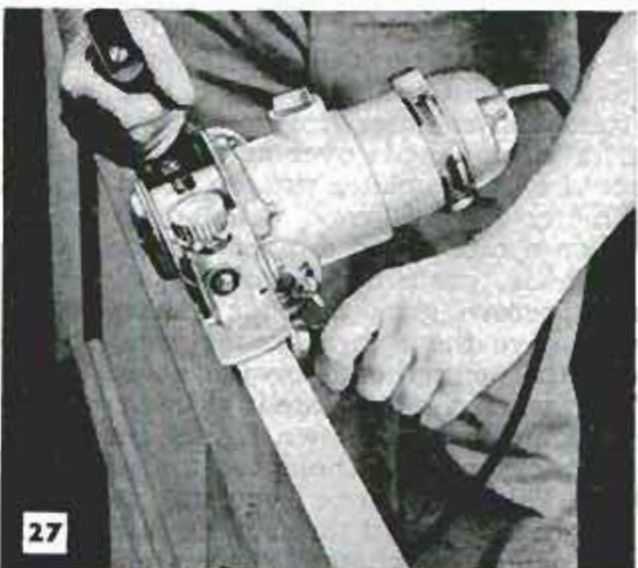

27

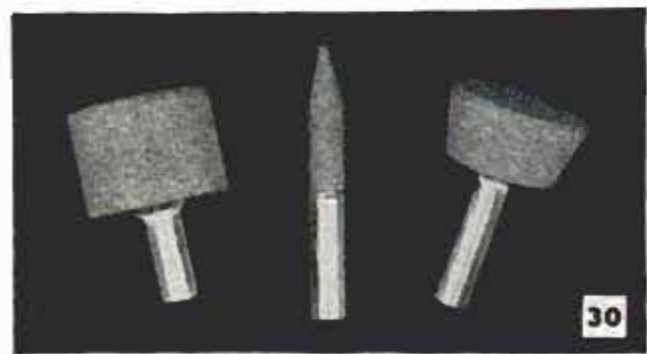
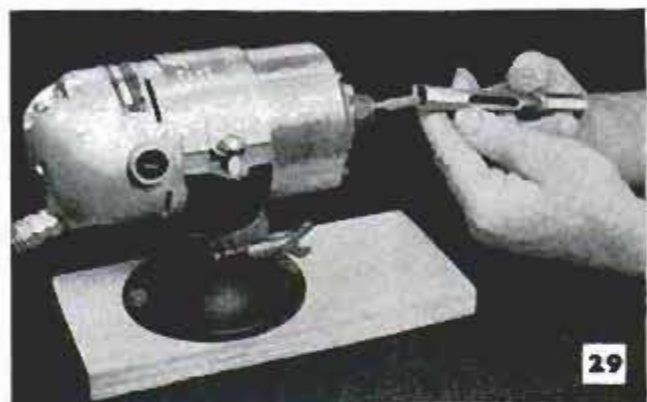
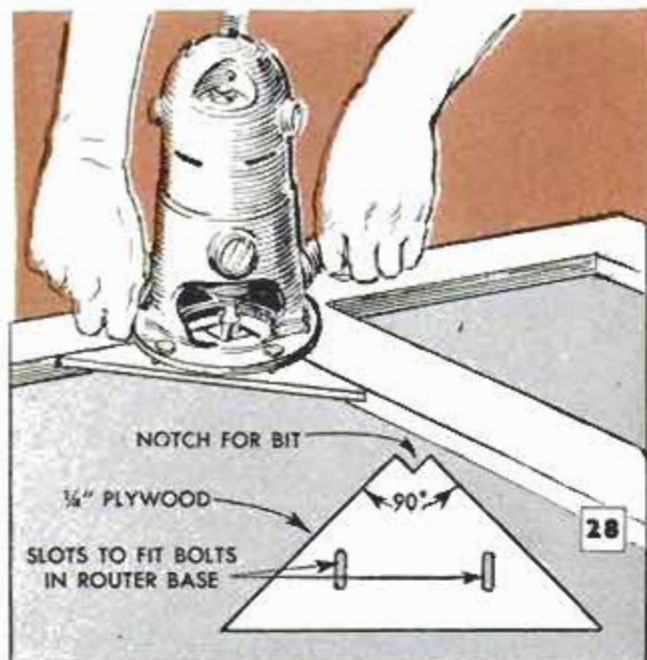

template guide being used, usually half the diameter of the guide less half the diameter of the bit, but be sure to take careful measurements as otherwise you may end up with work that is over or under the size required. Templates usually are attached directly to the work with small brads. When a number of duplicate parts are to be made, craftsmen often select several small screws, grind the ends to sharp points and drive them through the template so that the pointed ends project about $\frac{1}{16}$ in. Then when the template is placed over the work and pressed down tightly the sharp points of the screws hold it securely in position. This also is done frequently when the pattern is to be cut through the stock, as in end panels of whatnot shelves and chair

splats, a type of work ordinarily done with the jigsaw.

Dovetailing, Beading and Shaping

Figs. 15 to 22 inclusive picture the basic router adapted to special operations by means of accessories. The dovetail jig turns out a complete joint, Fig. 16, the dovetail sockets and matching pins being cut in one pass of the router equipped with a dovetail bit, Figs. 16 and 17. Single dovetails also can be cut as in the right-hand detail, Fig. 16. For an occasional job of straight shaping you can improvise a shaper table as in Fig. 19, mounting the router below the table and using the accessory shaper spindle, Fig. 18. For a wider range of shaping operations, use the inexpensive accessory in Fig. 20. This unit provides for angle adjustment of the motor as indicated and is designed for installation in a bench or table top.

Certain types of period-furniture reproductions require beading on the turnings. Fig. 21 pictures a typical operation with a router accessory. A special beading collar, fitted with an eccentric ring for adjusting the depth of cut, is attached directly to the router motor. The router itself is clamped in a subbase which provides a vertical adjustment. The work is mounted in the lathe as shown and the indexing head is used to space the beading cuts. An improvised beading base, suitable for occasional jobs, is detailed in Fig. 22.

Grinding, Carving and Planing

Certain light grinding operations can be carried out freehand, or with the router motor mounted in a stationary stand as in Fig. 29, using wheels of the type pictured in Figs. 26 and 30. Some carving can be done as in Fig. 23, using burr-type cutters, or rotary files. Use only grinding wheels and cutters recommended by the manufacturer. An edge-planing attachment utilizing the router motor is pictured in use in Fig. 27. A similar attachment is available for weather-stripping window sash. An improvised paneling guide, Fig. 28, makes it easy to rout out molding on the stiles and rails of a door so that you can remove a plywood panel and replace with a pane of glass or a mirror. ★ ★ ★

Aluminum Lettering for Trucks

When applying aluminum lettering on trucks or other objects, use aluminum paste mixed with spar varnish thinned with turpentine. The mixture will cover well and outlive more difficult "dust" jobs. Be sure decals are removed and the surface is clean before applying the new lettering.

Edward M. Mayover, Bradenton, Fla.

This Accurate Angle Plate Is Shop-Made From Flat-Steel Stock

An angle plate for holding light irregularly shaped pieces of work on a lathe faceplate can be made from cold-rolled steel flats. Three $\frac{5}{16}$ -in.-wide slots are milled in the upright which bolts to the faceplate. The base is $\frac{1}{2}$ -in. stock, while the two side brackets are $\frac{1}{8}$ -in. stock. A rabbet is milled on two edges to receive the side brackets. Holes are drilled and tapped for assembly to the base as shown. Two $\frac{1}{4}$ -in. holes are drilled and tapped in the face to attach work pieces of various shapes. When using the angle plate it is necessary to add a weight near one edge of the lathe faceplate as a counterbalance.

C. W. Woodson, Chicago.

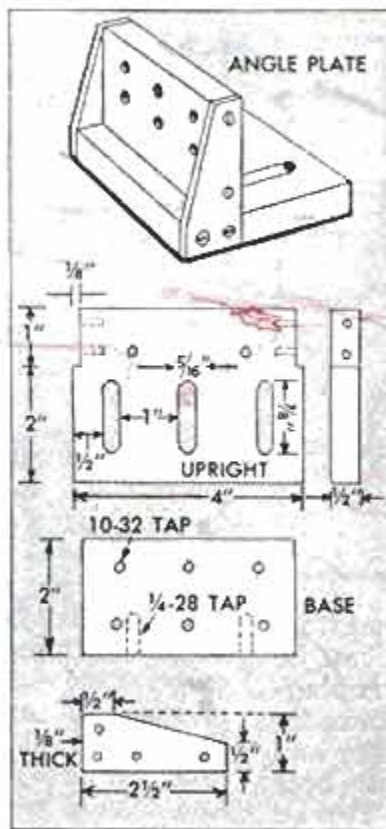

Offset Drawbar for Combine Reduces Towing Width

This auxiliary offset drawbar permits towing a combine directly behind a tractor so it will pass through narrow gates and farm lanes without difficulty. The drawbar is a 7-ft. length of 5 x 5-in. oak. A tractor hitch is provided on one end of the drawbar and a length of steel channel is bolted to the opposite end while a projecting flat of steel is bolted inside the flanges of the channel. The drawbar is fastened to

the combine by a clevis pin passed through a hole in the overhanging end of the flat and into holes in a clevis clamped to the combine drawbar. The offset between the combine and auxiliary drawbar is maintained by two braces which are lengths of steel flat drilled at 2-in. intervals for bolts. The holes allow adjustment to permit centering or any degree of offset of the combine behind the tractor.

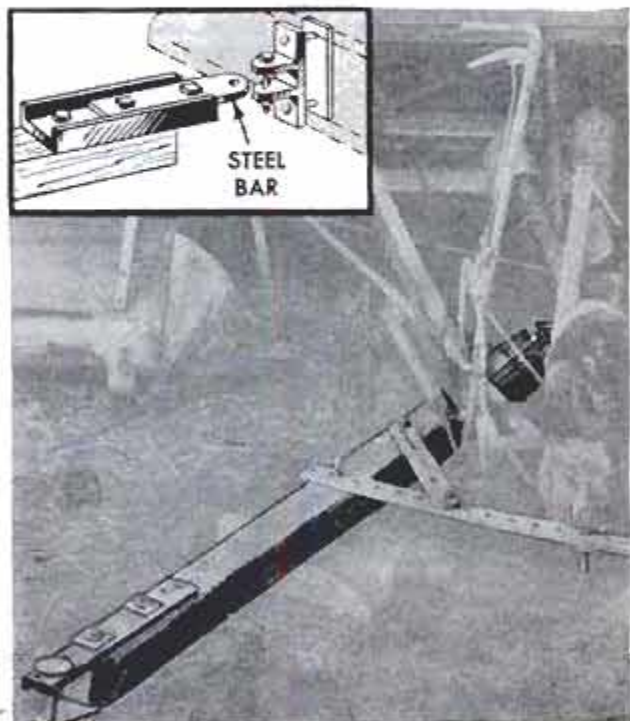

Hose Centers Tap-Wrench Handle

To avoid breaking taps when using a T-handle tap wrench, secure the handle with two short lengths of small-diameter rubber hose, as shown, so it will not slide to one side. Breakage is usually due to the handle slipping off center, which permits application of too much pressure to one side of the tap, causing it to bind and break. The tight-fitting hose will keep the rod in the center of the wrench and will also provide a grip-type handle to grasp.



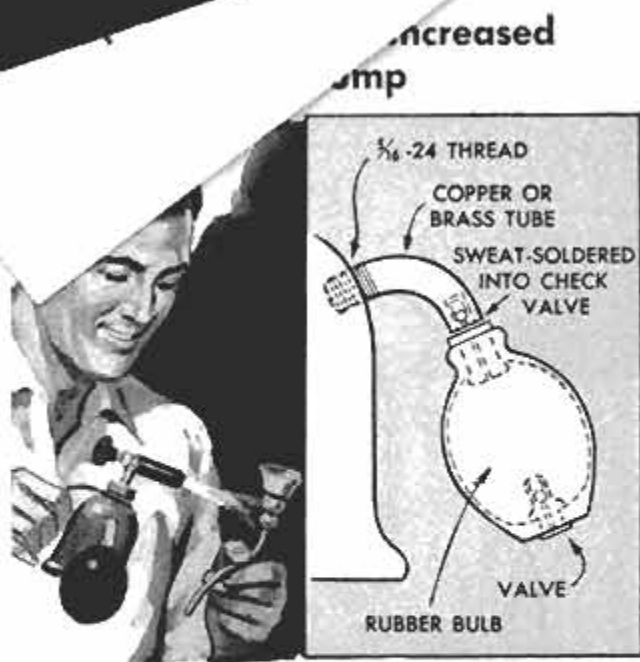

The heat output of small self-generating-type gasoline and alcohol torches can be increased by fitting them with a rubber-bulb pump. By pumping slight pressure into the tank, the flame becomes longer and more pointed, as well as hotter. Drill a hole near the top of the tank and tap it. Thread one end of a length of brass or copper tubing to fit this hole, then bend it L-shape. Solder the unthreaded end of the tubing into the pump check valve and screw the threaded end into the tank. It is best to also solder the tank connection. When doing so, fill the tank about two thirds full of water to prevent ignition of any remaining fumes.

Screw Holds Firmly in End Grain When Flat Is Filed on Threads

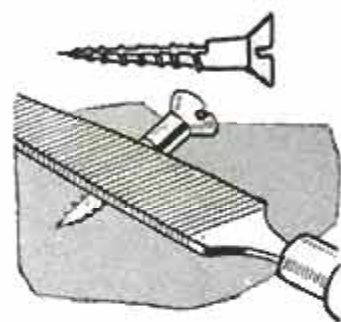

A wood screw will hold more securely when driven into the end grain of lumber or into the edge of a piece of plywood if a flat has been filed on threaded portion of the screw. Instead of forcing the wood fibers apart as does a regular screw, the modified screw will tear its way into the wood, thus anchoring itself.

Quick Alignment of Lathe Centers

When a shaft being turned in a lathe shows a taper due to the tailstock being out of alignment, use a dial indicator to eliminate guesswork when realigning the tailstock. First, determine the amount of misalignment. Then clamp the dial indicator in the toolholder on the lathe carriage

and move the carriage so the indicator contacts the tailstock quill. Move the tailstock exactly one half the amount of taper and it will be in accurate alignment. Vertical alignment of centers would, of course, require shimming under the tailstock.

Frank LaSaracina, New York City.

V-Block for Drilling Round Stock Assembled From Tubing

An accurate V-block to hold round stock for drilling can be assembled quickly from two short lengths of metal tubing or from two smooth-surface pipe nipples. Holes are drilled diametrically across the lengths of tubing



near each end to take the long bolts which hold the assembly together. For accuracy and ease of handling, both sections of tubing should be of the same diameter.

Car-Axle Housing Forms Prop To Support Combine Tongue

If a combine tongue is held on a heavy-duty support it requires no lifting and can be hitched to a tractor by one man. The support is a section cut to the required height from the differential-axle housing of a car. Sideways stability of the support is assured by the large diameter of the differential housing resting on the ground.

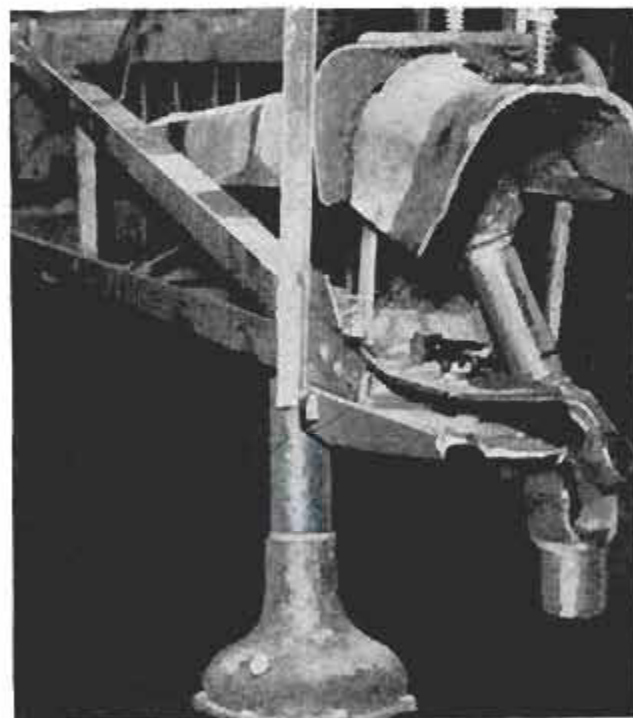

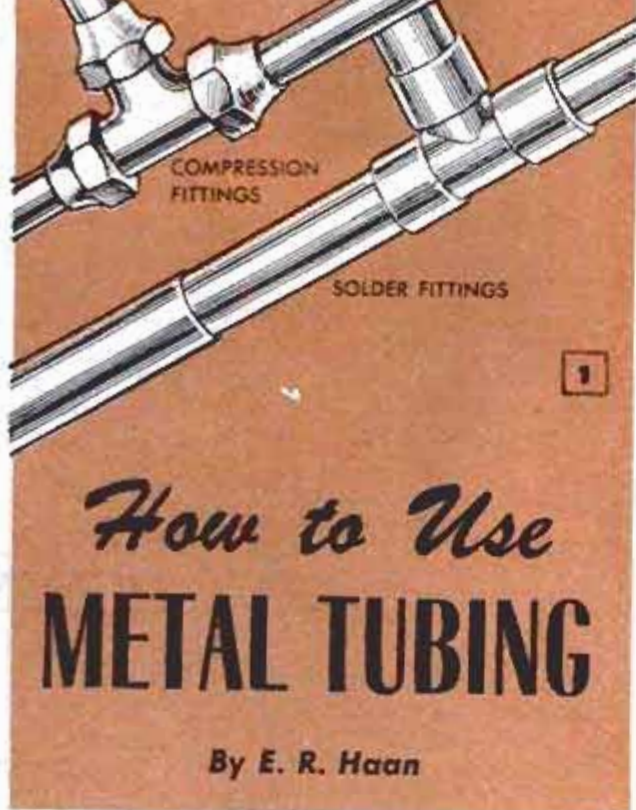

How to Use METAL TUBING

By E. R. Haan

WHEN REPLACING WATER LINES, extending old ones or adding new ones in your home, the job may be simplified by using soft copper or aluminum tubing. It can be run around corners, over or under obstructions and "snaked" through partitions with ease. Besides being rustproof, soft tubing expands if water freezes in it and therefore can resist several successive freezings before rupturing.

Available in 60 and 100-ft. coils, tubing eliminates many pipe-cutting and threading operations and requires fewer fittings than does rigid pipe when used in continuous runs. The tubing generally used ranges from $\frac{1}{4}$ to 2 in. in diameter, and comes in hard as well as soft varieties. The former is made in straight lengths, while the latter is obtainable in coils.

Two assembly methods: There are two methods of tubing assembly which differ in the kinds of fittings used, as shown in Fig. 1. Compression fittings are used with soft tubing, and solder fittings with both soft and hard tubing. The fittings include practically all the kinds used in regular pipe work plus adapters that connect tubing to threaded pipe. Copper, tinned-steel and brass tubing can be soldered readily. Aluminum tubing is assembled with compression fittings.

Straightening coiled tubing: To straighten coiled tubing, set the coil on edge on a flat surface and unroll it slowly while holding the straightened portion down as in Fig. 2.

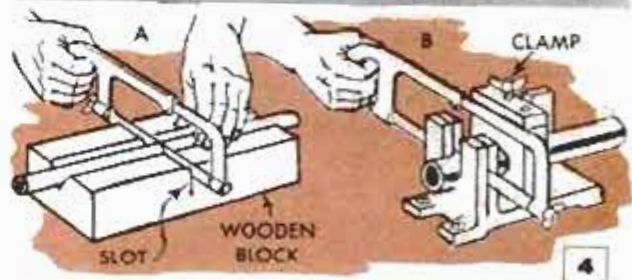
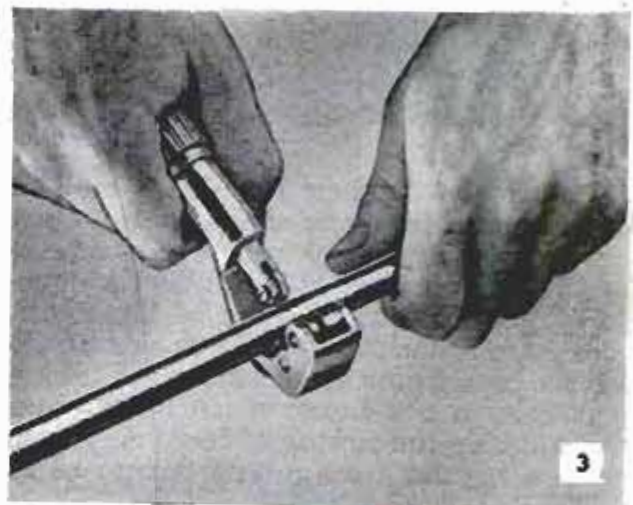

JIGS FOR SAWING TUBING WITH HACKSAW



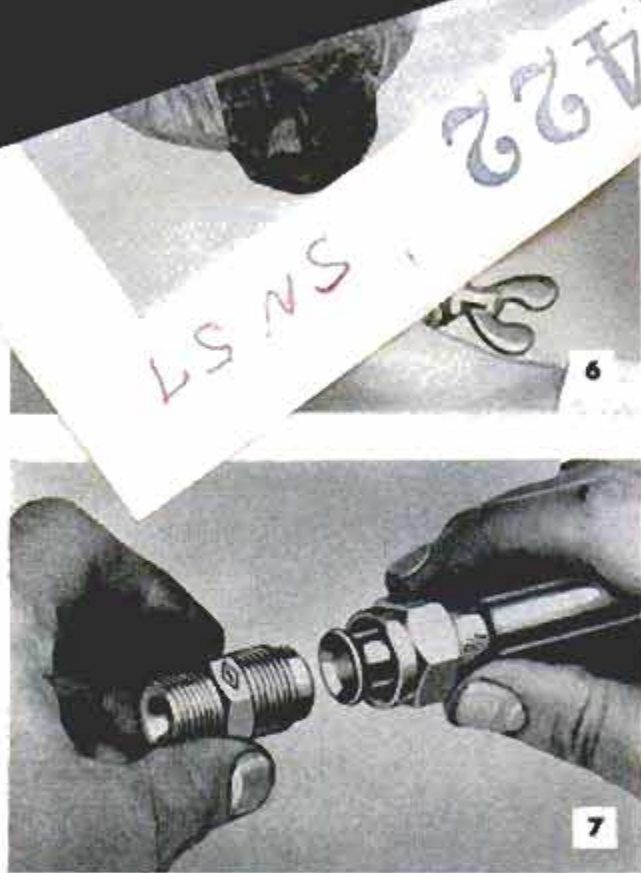

How to cut tubing: For either method of assembly, the ends of the tubing must be cut off absolutely square. Cutting is best done by means of a regular tube cutter, Fig. 3. Cutting also can be done with a fine-tooth hacksaw—32 teeth per in. To assure square cuts when sawing the tubing it is held in a V-block which has a cross slot to guide the saw as in detail A, Fig. 4, or in a regular tube-cutting fixture as in detail B.

A cutter forms a burr on the inside of the tube and it is necessary to remove it by reaming lightly as in Fig. 5. Hacksawing produces burrs on both inside and outside. To remove them, use a reamer on the inside and a file on the outside. When reaming or filing, always hold the open end of the tubing downward so that the chips fall away from, rather than into, the tube.

Compression fittings: Fig. 8 shows three types of compression fittings. The kind shown in detail A requires flaring the ends of the tubing. Those shown in details B and C require merely pushing the tube into a fitting, then tightening the latter. This compresses a wedge-shaped ferrule or sleeve firmly on the tubing wall.

Flaring the ends of tubing: Flaring is done with a special tool as shown in Fig. 6. After slipping the compression nut of the fitting over the tubing, insert it in the block of the flaring tool so the end will pro-

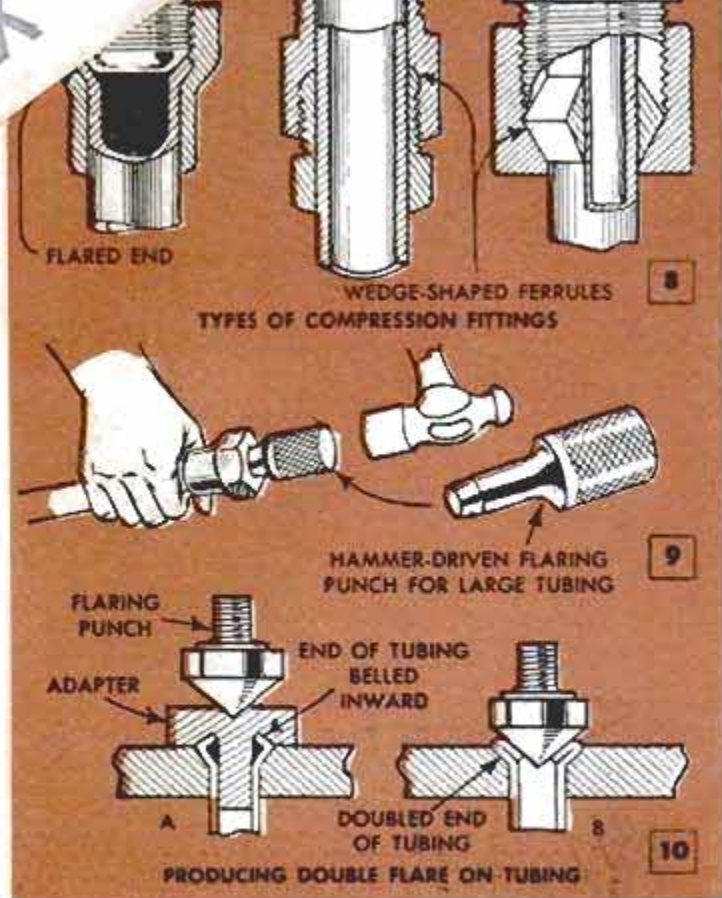

ject from $\frac{1}{16}$ to $\frac{1}{8}$ in. above the block. Tighten the block to grip the tubing securely, then screw down the threaded punch. Most flaring tools accommodate tubing from $\frac{1}{4}$ to $\frac{5}{8}$ in. in diameter, but larger ones are available. Also, for large tubing, a hammer-driven flaring punch of proper size often is used, as shown in Fig. 9.

Double flaring, Fig. 10, is recommended for steel tubing, which is especially likely to crack when only a single flaring is used. Double flaring also is advised for copper and aluminum tubing when extra-strong joints are desired, or where they must be frequently disconnected and reconnected. The inside bend is made by using an adapter on the flare block as in detail A, Fig. 10, after which the flaring proceeds as in detail B. A little oil on the end of a flaring tool reduces friction and helps to prevent scoring the metal. Avoid using excessive pressure when flaring tubing, since pressure hardens it and makes it more likely to crack from strain or vibration. After flaring, assemble the fitting as in Fig. 7.

Solder fittings: With solder fittings you merely insert the tubing in a fitting and sweat-solder the two together. If there is any distortion caused by soldering heat, the tubing must be shaped to perfect roundness by means of a sizing tool, Fig. 17. The surfaces to be soldered together (the outside of the tubing and the inside

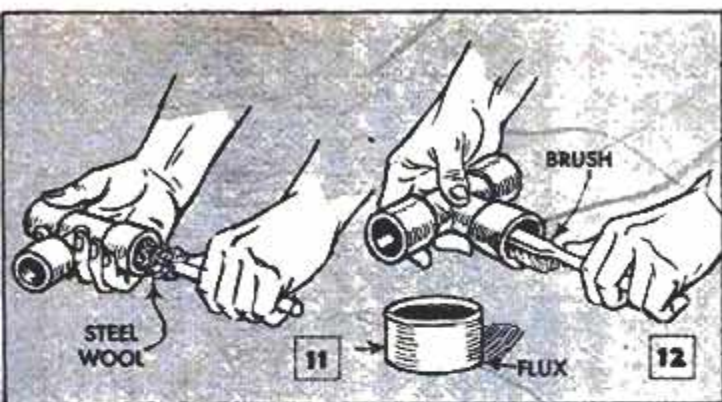

of the fitting) must be cleaned thoroughly with fine steel wool or emery cloth, rubbing the metal as in Fig. 11 until it is bright. Wipe the tubing clean, then apply a thin film of soldering flux, Fig. 12. Push the tubing into the fitting as far as it will go, then rotate it a few times to assure even distribution of the flux.

Preheating and soldering: Preheating the joint comes next, using any suitable kind of torch. Play the flame over the fitting, not concentrating it too long at any one point. As most torches produce a flame that has a temperature considerably higher than the melting point of copper (1900 deg. F.), care must be taken to prevent burning a hole.

While heating, touch the end of a piece of wire solder to the edge of the fitting occasionally—outside the flame—to check for correct soldering temperature. This is reached when the solder liquefies immediately when touched to the fitting. Do not heat the metal above this temperature.

Next, feed the solder along the edge of the fitting, Fig. 13, while keeping the fitting hot. The solder is drawn between the contacting surfaces by capillary attraction no matter at what angle the fitting is held. Generally, the correct amount of $\frac{1}{8}$ -in. wire solder to use per joint is a length equal to the diameter of the tubing.

Avoid getting solder all over the work. You can wipe off excess solder while it is still liquid with a moistened cloth but do not remove the bead from the chamfered ends of the fitting. Avoid movement of the tube or fitting until after the solder has "set" or hardened, since any disturbance before this time weakens the joint. To protect wood or other combustible material in the vicinity of the flame when soldering a joint, use a sheet of asbestos board or asbestos paper.

Whenever soldering tubing into a fitting which has other outlets already soldered into it, prevent the latter from melting loose by wrapping wet cloths around the joints to be protected as in Fig. 14.

Solder to use: Ordinary "soft" solder is

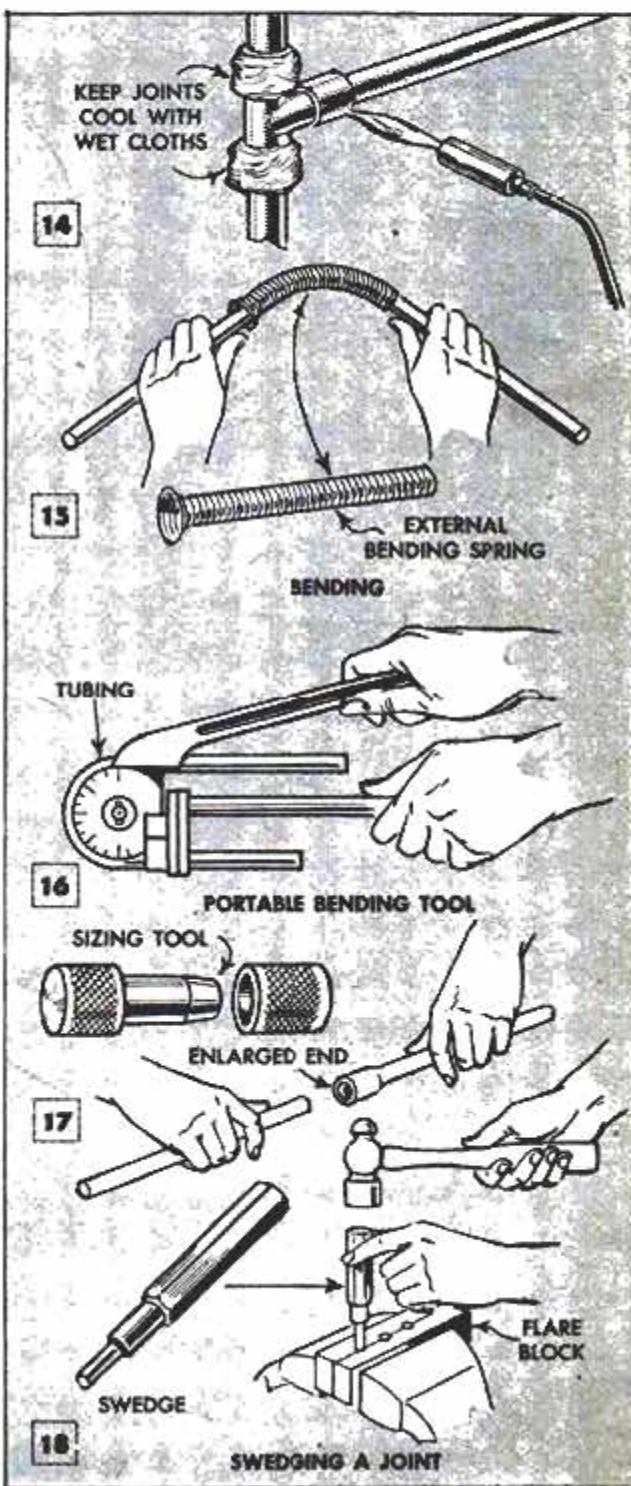
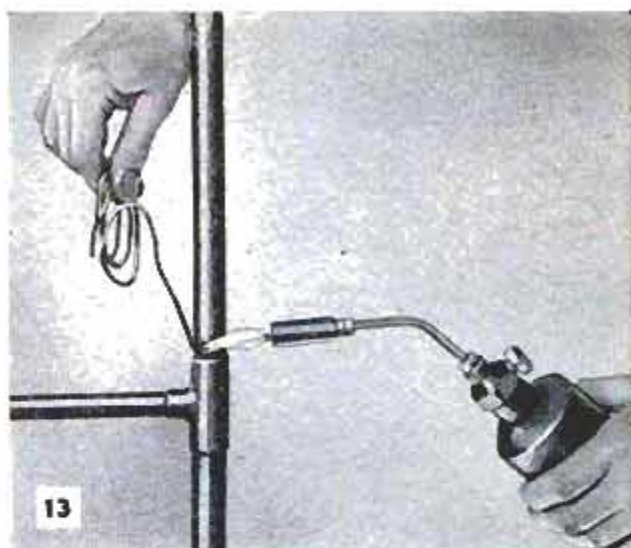

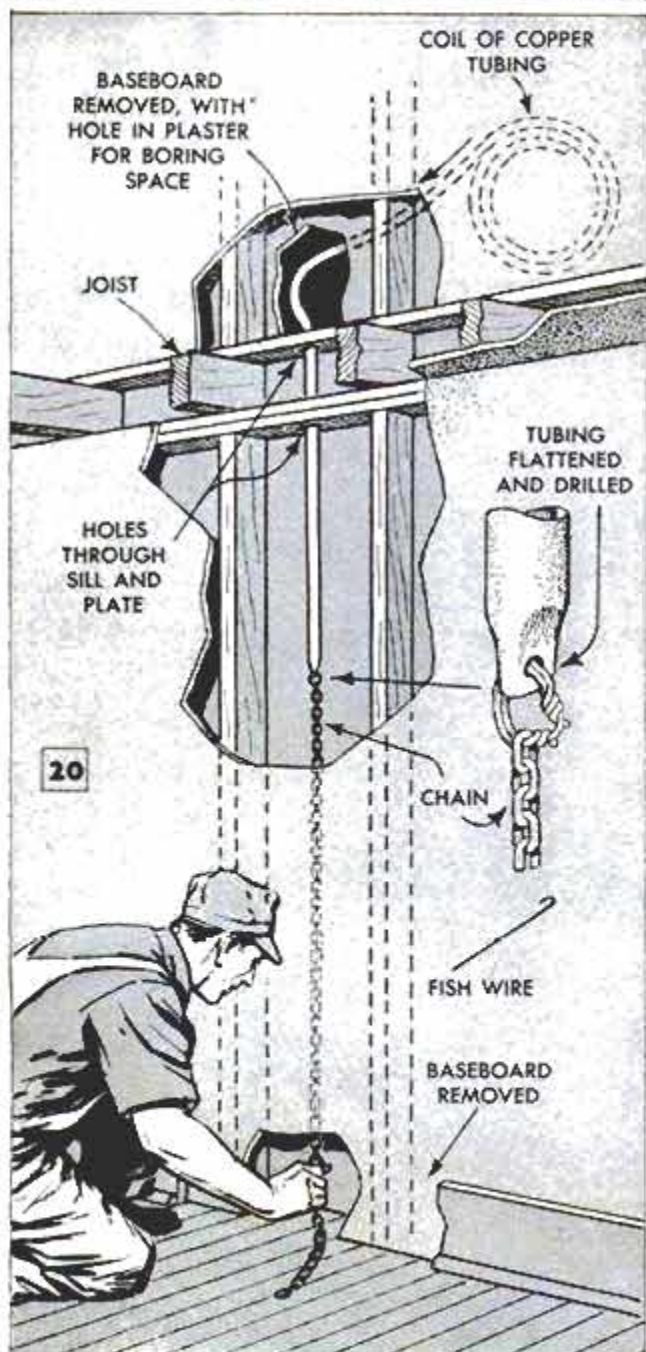

satisfactory where joints are not subjected to much strain or vibration and are never heated to temperatures above 250 deg. F. For producing stronger joints, use "hard" or brazing solder which flows at temperatures of 1300 and 1400 deg. F.

How to bend tubing: You can bend soft copper tubing by hand as in Fig. 15, using spring-steel bending coils. Bending coils come in various sizes, for either inside or outside application. For accurate, small-radii bends, use a bending fixture, Fig. 16.

When copper tubing is bent or otherwise worked, it becomes hard and brittle. Therefore, before rebending copper tubing, anneal it by heating to a dull cherry-red color, then quench it in water. Aluminum is annealed in the same manner.

Swaged joints: Lengths of tubing can be spliced together by swedging, thus eliminating the need for a coupling. A swedging tool of the proper size, Fig. 18, increases the diameter of tubing a short distance from its end so it can be fitted over the end of another length. The joint is finished and soldered in the manner already described.

"Snaking" tubing through partitions: Copper tubing usually can be snaked through partitions as shown in Figs. 19 and 20. Two workers are required for this job. Holes are bored through the top and sole plates of the partition, a length of chain is lowered from the upper to the lower opening and it is pulled through the lower opening by means of a piece of wire with a hook bent in the end. This arrangement permits the worker below to pull the tubing through the partition by pulling on the chain while the worker above feeds the tubing into the partition. If any cross-pieces or fire stops are encountered, it is necessary to open the wall at this point and notch the obstruction.

Horizontal lengths of tubing must be supported adequately with suitable hangers to prevent sagging at any point. The hard variety of tubing generally is used for long horizontal lengths.

Buried copper tubing: Copper tubing buried underground should never be run through cinder fill, especially where the ground is wet. The sulphur in the cinders attacks copper. Where such a condition exists, damage to the tubing can be prevented by wrapping it with canvas liberally coated with an asphalt compound such as roofing cement or roofing paint. The covered pipe then is surrounded for a distance of 1 ft. with a layer of sand mixed with lime or broken plaster in equal proportions. Compression fittings are preferred for underground work and should be tack-soldered for added security against loosening. ★ ★ ★

Removable Bench-Top Turntable Aids in Model and Radio Work

A bench-top turntable will prove invaluable when working on radios or any job that requires frequent rotating. It consists of a disk of $\frac{3}{4}$ -in. plywood with a floor flange screwed to the center of one side. A short pipe nipple is screwed into the flange and fits inside a second nipple set flush in a hole in the bench top. Two small holes are drilled in the wall of the second nipple to take finishing nails which are driven into the bench top.

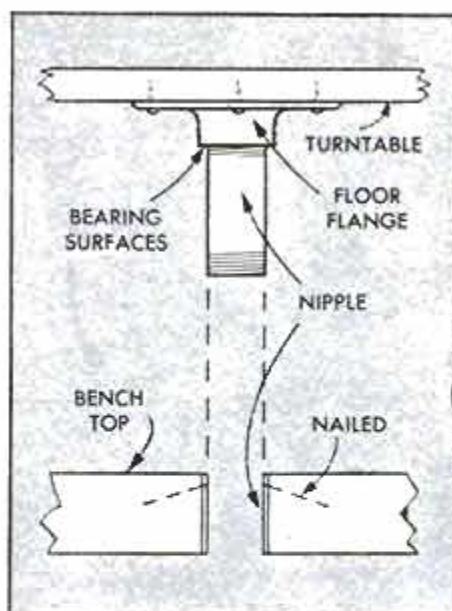

Prevent Loss of Marking Pencil By Taping Magnet to End



A marking pencil, used when working with a circular saw or other power tool, will not readily become lost if a magnet is taped near its upper end. The pencil then can be "hung" at any convenient point on the steel table or frame of the power tool. Should the pencil be dropped, the weight of the magnet will cause it to fall eraser-end first, thus protecting the point.

Welded Drawbar Hitchpins Made In Farm Workshop

Watering Trough for Cattle

One farmer made this sturdy watering trough for his cattle by cutting a large steel oil drum in half lengthwise with a cutting torch. After the rough edges were ground smooth, a piece of steel plate was welded at each of the four corners to provide a means of bolting on the wooden legs as shown. The legs can be made from lengths of 2 x 6-in. oak as shown, or steel angles or flats.

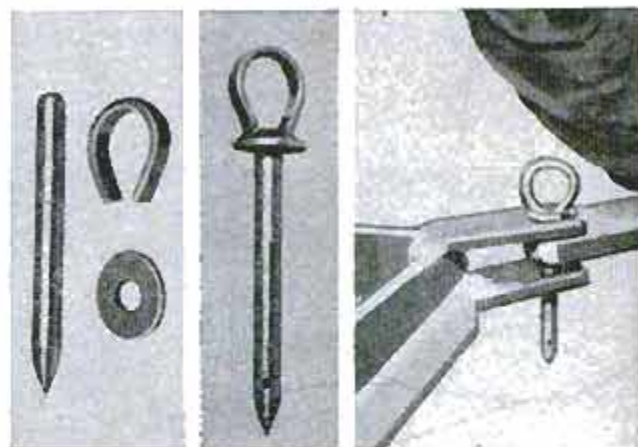

Inexpensive drawbar pins that can be designed to fit a particular implement hitch require only a length of $\frac{5}{8}$ or $\frac{3}{4}$ -in. steel rod, some steel washers of the same diameters and a length of $\frac{3}{16}$ x $\frac{1}{2}$ -in. steel flat. The rod is cut to the desired length and ground to a taper on one end. A washer then is welded to the opposite end and a U-shaped length of the steel flat is welded to the washer. An additional safety precaution can be provided by drilling a hole near the end of the pin for a cotter key.

Collet Stop Locates Lathe Work for Facing Cut

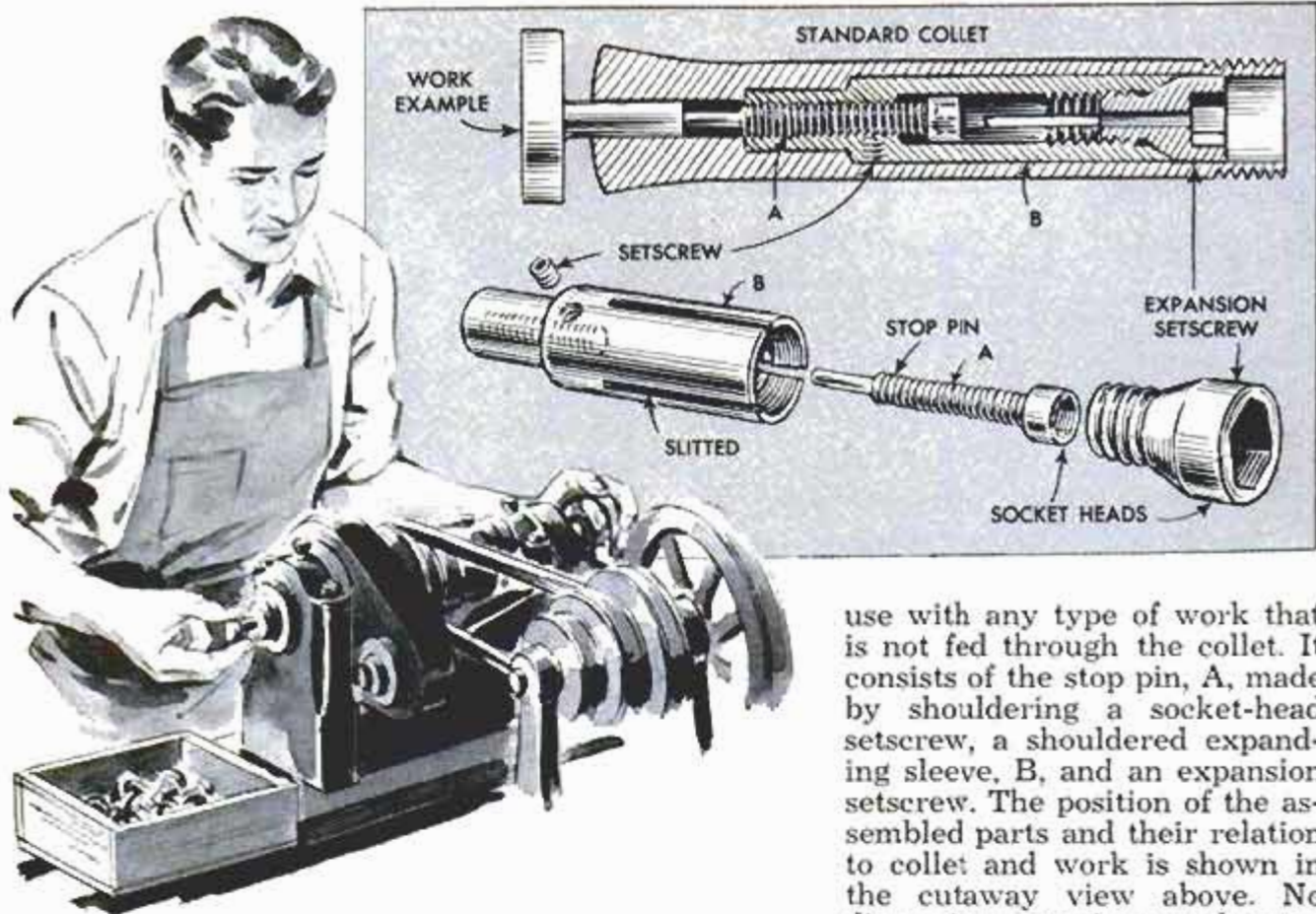

Repeat facing or cutting off work gripped in a collet chuck requires a positive stop in order to hold the length of each part within the limits usually specified. The adjustable stop detailed is designed to fit inside a standard collet and is suitable for

use with any type of work that is not fed through the collet. It consists of the stop pin, A, made by shouldering a socket-head setscrew, a shouldered expanding sleeve, B, and an expansion setscrew. The position of the assembled parts and their relation to collet and work is shown in the cutaway view above. No dimensions are given as the stop must be made to fit the collet.

The shouldered end of the stop pin should be ground and hardened. Machine the sleeve, B, to a light press fit. Then only a slight turn of the expansion screw will lock it in place at any point desired.

Taft A. Buaz, New Bedford, Mass.

Carton Corner Guides Drill For Hand-Held Brace and Bit

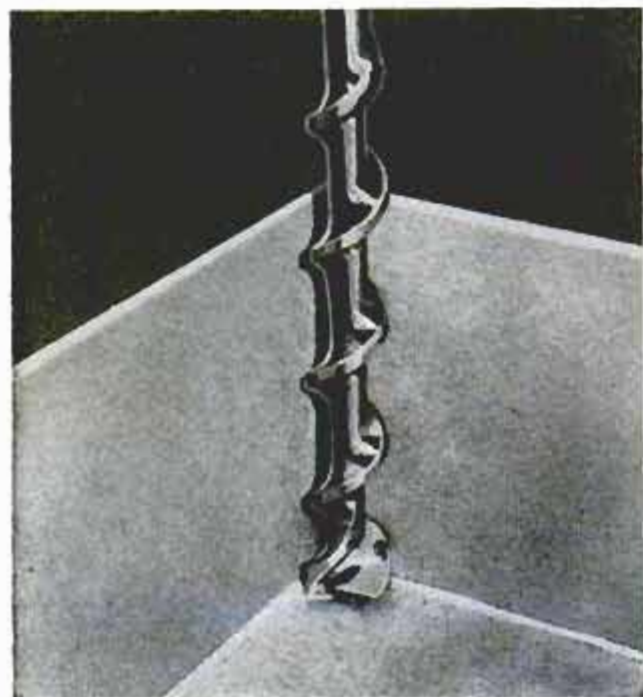

It is not easy to drill a perpendicular hole with a hand-held brace and bit. But it's a simple trick if you use the inside corner of a cardboard carton as a bit guide. Place the bit in the corner of the carton so it touches adjacent sides and force the spur point through the bottom. Then spot the drill point over the hole to be drilled.

Detecting "Thumping" Car Wheel

Determining which one of the tires on an automobile is causing a "thumping" can be done in the following manner: Inflate three of the tires to 45 lb. pressure and drive at the speed which results in a thumping noise. If no thump is evident, inflate the fourth tire to 45 lb. and reduce one of the others to normal pressure. Repeat this until a tire with normal pressure causes a thump. This is the tire that is causing the trouble.

Drill-Press Vise Modified to Hold Cylindrical Pieces of Work

The smooth-faced jaws of a drill-press vise must be modified to provide a positive grip if the vise is to be used extensively for holding cylindrical pieces of work. To modify the vise for holding work vertically, clamp the vise on a piece of light cardboard and drill three holes of different diameters vertically down through the jaws as shown in the upper detail. When the cardboard shim is removed, the jaws will tighten firmly on objects of the same diameter as the holes. Modifying a vise to hold cylindrical objects horizontally, such as when drilling cotter-key holes in small-diameter axles, requires drilling a hole horizontally through the

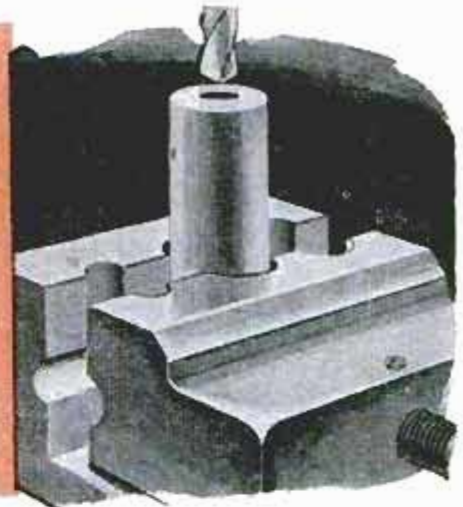
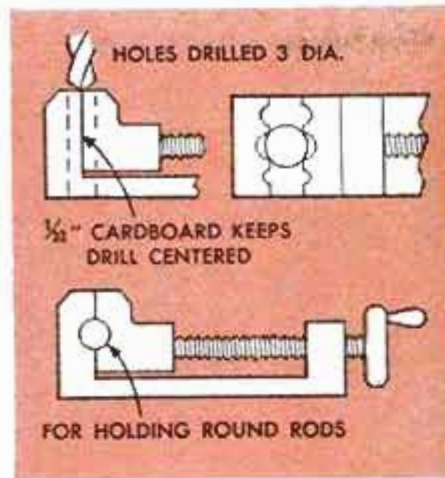

closed vise jaws. The cardboard shim is used again between the jaws while they are being drilled. Hole sizes should be determined on the basis of minimum and maximum diameters of stock most frequently used.—Carl S. Bates, Chicago.

Die Started Squarely on Rod By Using Lathe Tailstock

The difficulty of starting a thread die squarely on a shaft or rod held in a vise can be avoided by using a lathe. Chuck the rod in the headstock, fit the die on the end and force the tailstock quill against it. Keep the tailstock snugly against the die while the rod is turned into it to hold the die square with the end of the rod. Operate the lathe at its lowest speed, or by hand. It may be necessary to substitute a length of pipe for one handle of the die so it can rest on the carriage or some other point clear of the lathe ways.

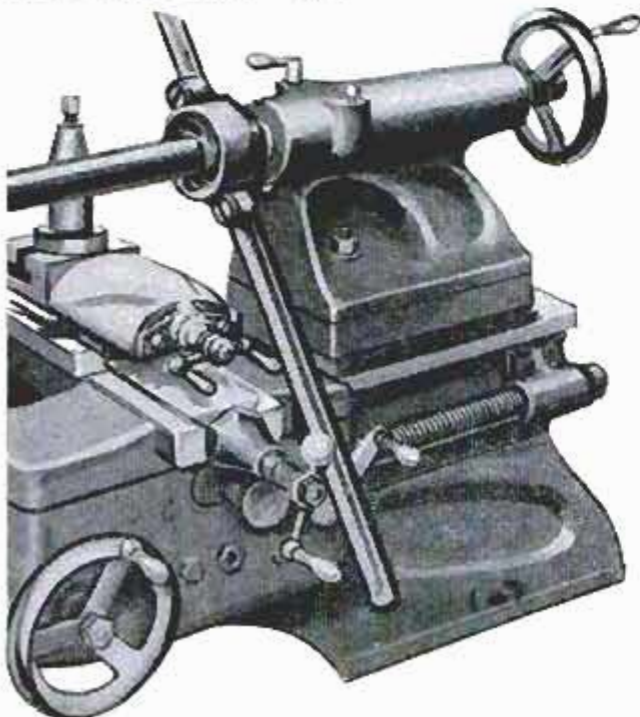

Wire Solder Easy to Handle In Coil-Spring Shape

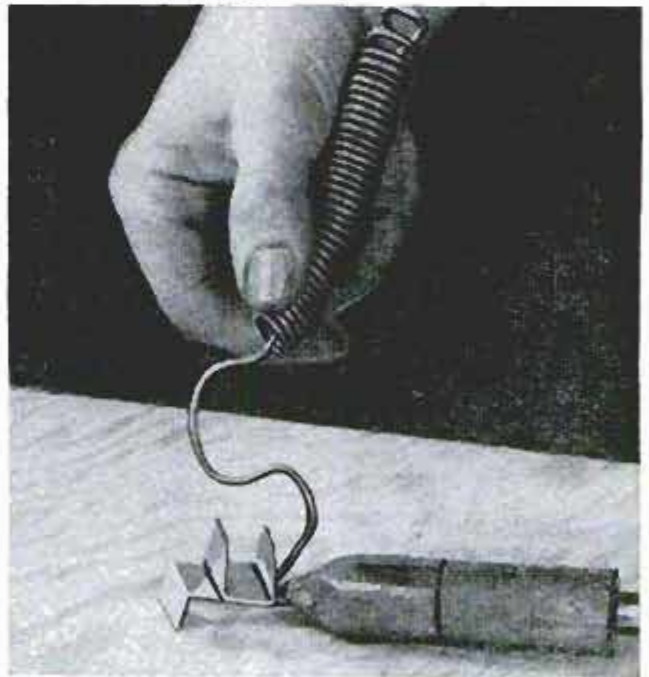

Instead of wrapping wire solder into a cumbersome loop from which it must be used wind it on a small dowel or pencil so it will assume the shape of a coil spring and be easy to grip. Push one end of the solder through the coil until it extends beyond the opposite end a distance convenient for soldering. As the solder is used, more is pulled out, which reduces the length of the coil.

☐ A clear finish on wood is obtained by applying a coat of thinned white shellac followed by sanding and a wax polish.

SHOPPING FOR TOOLS

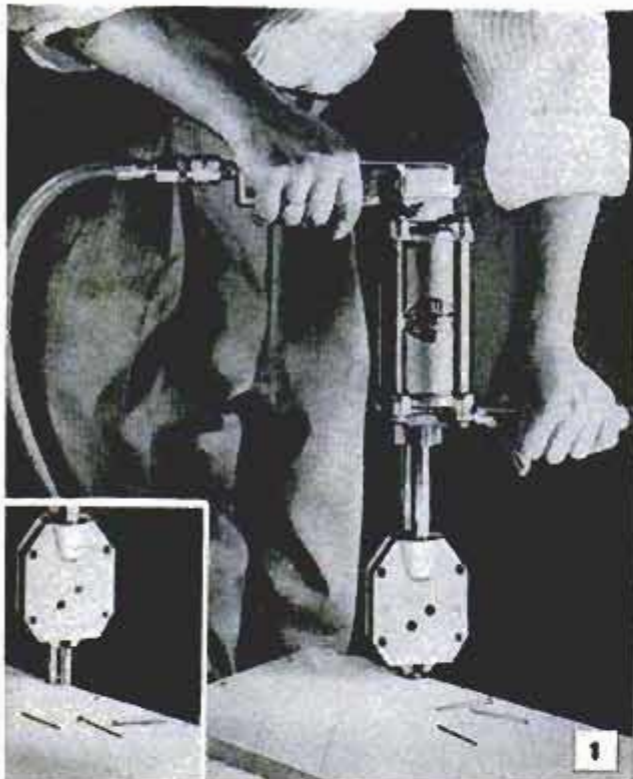

1. AIR-OPERATED NAIL-PULLING DEVICE pulls nails without bending them. Because of straight, powerful pull, lumber is not split when nail is removed. Since neither nails nor lumber are damaged, both can be reused, resulting in a considerable saving in material. Manufacturer claims puller does not grip nail-head, but grips nail itself, so even head is unmarked. Also states that the puller can be used to open boxes containing delicate instruments without damaging the contents. Puller operates on 75 to 100 lb. air pressure. Several sizes are made, covering various sizes of nails; 6 to 10d, 10 to 20d and 10 to 30d
W. D. Allen Manufacturing Co., 506 W. Lake St., Chicago 6.

2. CURVED-LINE STAMP HOLDER simplifies stamping on ends of round bars, shafts and tubular sections. Unit is supplied with or without gauge that enables operator to position holder so all parts are marked in same place. For tubular parts, radius of type circle can be changed within limited range. Special feature is type-retaining device. When slide is opened, retaining bar drops out of slots so type can be changed. When slide is closed, wedge arrangement lifts retaining bar into type slots, locking type
M. E. Cunningham Co., 1025 Chateau St., Pittsburgh 33, Pa.

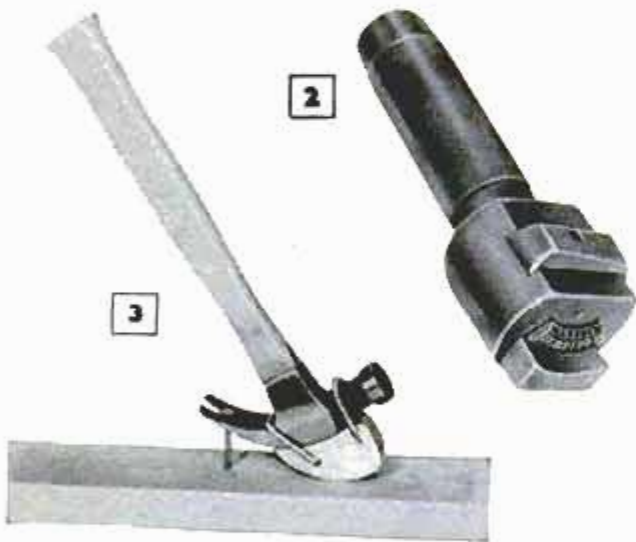

3. NAIL-PULLER ATTACHMENT FOR CLAW HAMMER fits over hammer head to add leverage. Permits pulling most nails without bending them. Curved surface of fulcrum block provides an infinite number of adjustments in distance between hammer claws and nailhead. Puller consists of three parts: Wire bail that slips over claws, coil spring that hooks over hammer head and "nonmarring" fulcrum block
Johnson Products Co., 1670 N. Jackson St., Milwaukee 2, Wis.

4. JOINTER SAFETY HOLD-DOWN consists of two adjustable-tension, C-shaped springs suspended from a pivoted bracket. When doing edge work, hold-down swings out of way as in right-hand photo. Left-hand photo shows how device holds stock so hands need not approach blade. Rough finish, chatter and kickback are eliminated it is claimed. Even thin stock can be planed in perfect safety; work is pushed into one end, pulled out other, with no need for push stick. Plastic window is available to cover open side of hold-down to protect operator's face
R. E. Peterson, Co., Turlock, Calif.

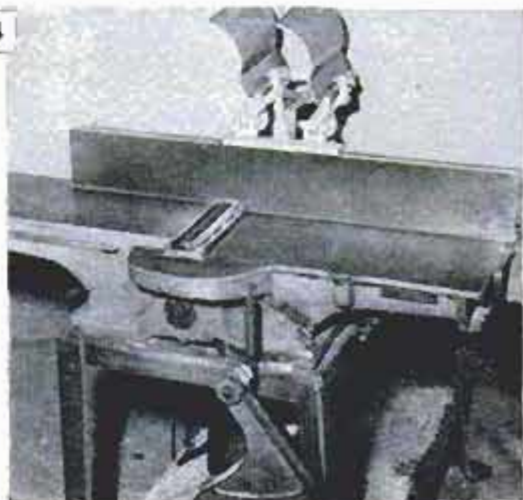
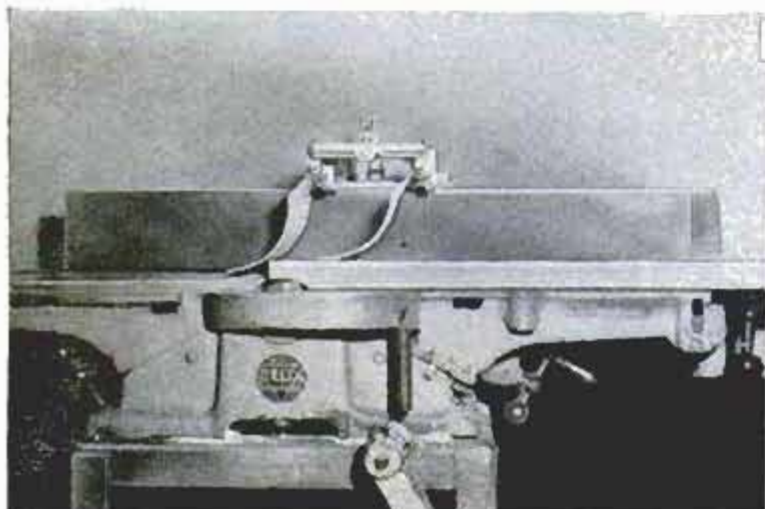

5. JIGSAW ATTACHMENT FOR 1/4-IN. DRILL has flexible-shaft drive inside hollow spindle which permits close coupling of drill and attachment, yet allows for drill-chuck "run-out." Vibration is reduced by using two pistons in unit, arranged so they reciprocate in opposite directions. One piston drives saw blade, other is air pump. Leather cup on air piston assures generous supply of air. Unit has T-bar which permits clamping it in vise so it can be used as stationary saber saw
Babcock Mfg. Co., 6253 Claremont Ave., Oakland 18, Calif.

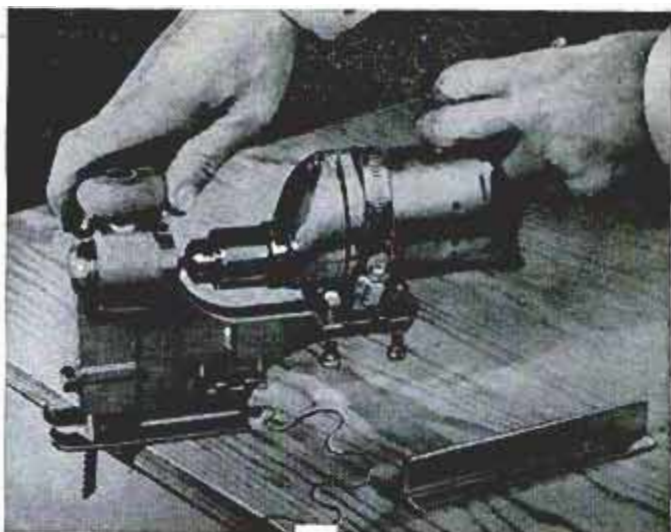

6. OPEN-END ROLLER RATCHET WRENCH will fit over badly burred or heavily plated nuts, due to spring expansion allowed behind precision-made steel rollers in wrench jaw. It is stated that jaw will not mar chrome-plated fittings. Wrench can be used on all tube fittings, soft aluminum, brass or plastic nuts and bolts, turnbuckles and connectors or wherever an open-end wrench is required with quick-ratcheting action. Ratcheting arc permits wrench to be used in tight locations
TKF Company, Fisher Building, Detroit 2, Mich.



7. INEXPENSIVE NEW DRILL CHUCK fits standard hand drills, power drills and lathes. Chuck is ideal for working on radios, model building, jewelry making or any hobby or operation that requires accurate drilling of very small holes. Drill bits from size No. 61 to No. 80 can be accommodated. Selling for about 50 cents, chuck pays for itself in savings of drill-bit breakage
X-Acto, Inc., 48-41 Van Dam St., Long Island City 1, N. Y.



8. QUICK-ACTING CLAMP FOR SAWHORSE holds most stock sizes of lumber for planing and sawing operations. Versatile clamp combines functions of bench vise, square, saw gauge and miter box. Screws directly to top or end of any sawhorse. Units are sold on a ten-day-trial basis
W. I. Stearns Co., Arlington, Vt.



9. SELF-ATTACHING WOODEN PADS for clamp jaws utilize small permanent magnets to provide that "extra hand" that often is needed when attempting to insert wooden non-marring pads between clamp jaws and work. Pads come in 2 sizes, 1 3/4 x 1 3/4 x 3 in. and 1 1/2 x 1 x 3/8 in.
Hildebrandt and Co., 414 Southern Building, Washington 5, D. C.

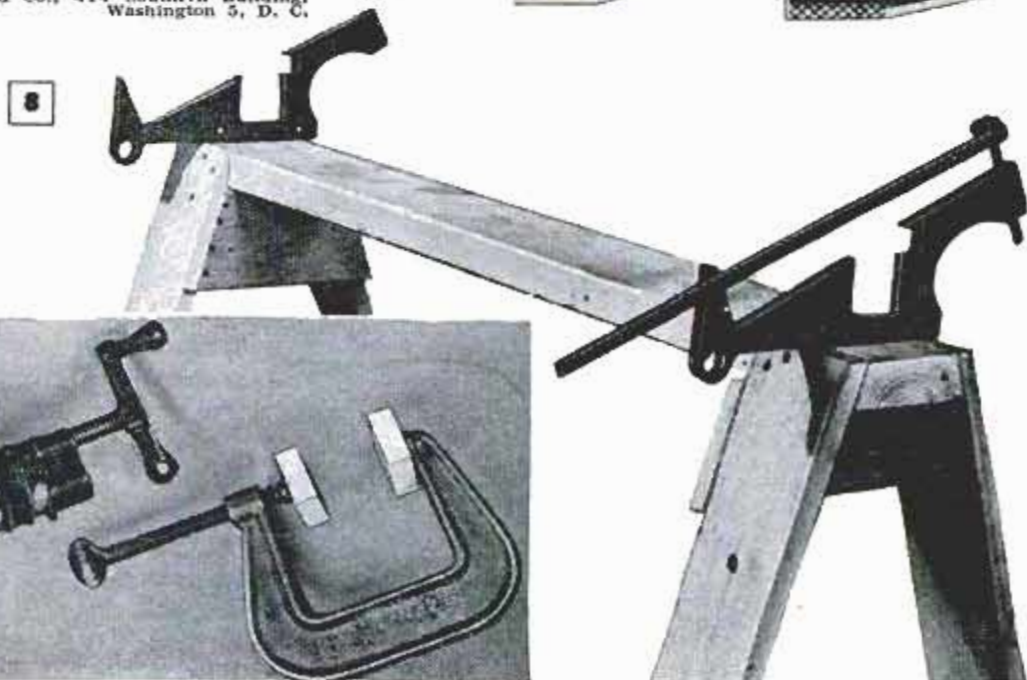



NEW BONDING AGENT called Kwik-Weld permanently bonds concrete, tile or plaster to almost any surface. Product can be brushed or sprayed. Eliminates acid-etching or chipping concrete

Chemical Products Co., Inc., Aberdeen, Md.

NOW ON THE MARKET

FOR THE
DO-IT-YOURSELF HOMEOWNER



"BUBBLE OFF" ACTION of Zip-Strip paint remover can raise dozen coats of paint in one application. Leaves wood ready for repainting. Safe to use; won't ignite

Star Bronze Co., P.O. Box 568, Alliance, Ohio

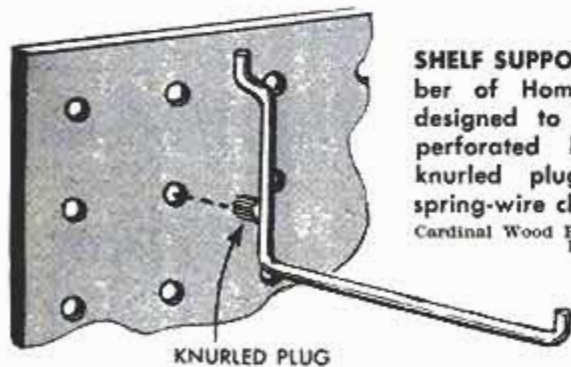

SHELF SUPPORT, one of a number of Homeboard Hooks, is designed to anchor rigidly to perforated hardboard by a knurled plug. Eliminates the spring-wire clips ordinarily used

Cardinal Wood Products, 9229 N. East Prairie Rd., Skokie, Ill.

EASY-TO-USE PIPE HANGER, Fix-O-Strip, is locked by passing end through perforation and twisting with pliers. Also may be bolted. Excellent for banding and repairing wire or link fences

Jaysen Strips Co., 157 Adelpi St., Brooklyn 5, N.Y.

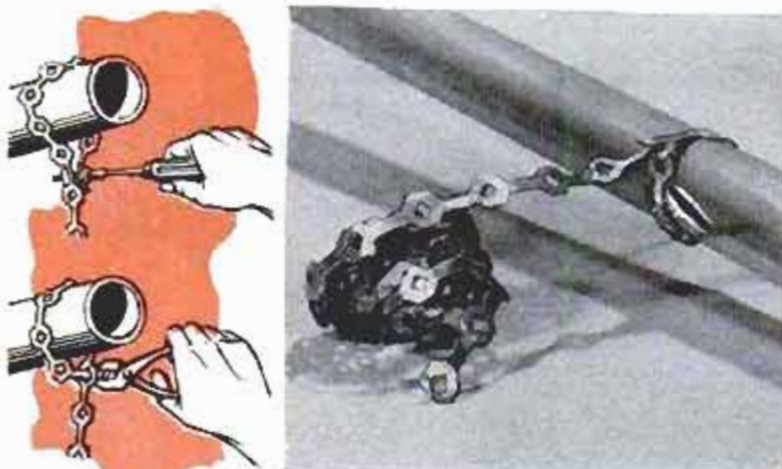

SQUEEZED FROM A TUBE, Flex-O-Fix dries into a tough, elastic rubber. Mends and waterproofs fiber, leather or rubber. Retreads small tires and insulates wiring. Stops car rattles, seals windows

Pyroil Company, Inc., LaCrosse, Wis.



ANNOUNCES

THE WORLD'S FINEST
STEERING SYSTEM

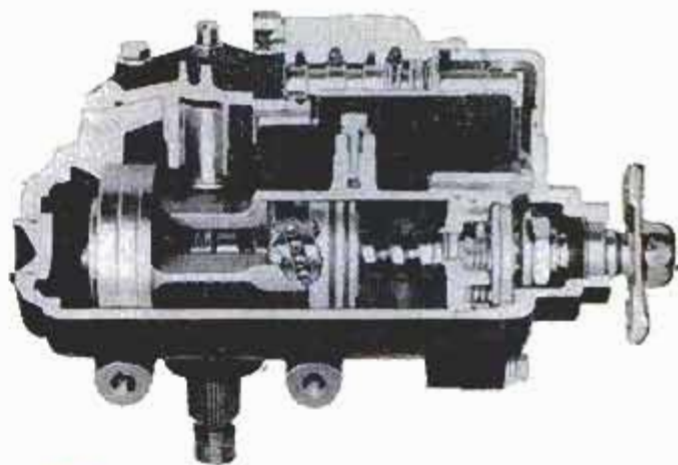

new
Safety
POWER STEERING
by **Saginaw**

WITH **3** MAJOR IMPROVEMENTS FOR 1956 !



1 TWICE-AS-EASY PARKING. Revolutionary new valve design cuts maximum manual effort in half. It never exceeds 5 lbs.

2 GREATER ROAD STABILITY. New system helps hold car "on course"—assures even more secure "road feel" than ever.

3 RELAXING NEW RESPONSE. Lower-ratio wheel responds more effortlessly—reduces mental and physical fatigue.

NEW "FROM THE GROUND UP"

A completely redesigned, simplified In-Line system with only 49 parts and basic improvements in steering geometry beginning right at the front wheels. Every part has been specifically engineered for power steering.

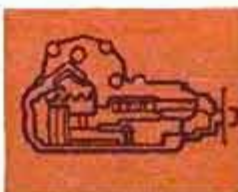

AUTOMATICALLY HELPS HOLD CAR "ON COURSE"—Precision pre-load built into ball-nut-and-worm assembly helps keep wheels centered straight ahead.



AUTOMATICALLY LIMITS MANUAL EFFORT WHILE PARKING. New reaction-limiting valve cuts in whenever turning resistance reaches predetermined point; increases power assistance to lower manual effort.

**MAIL COUPON TODAY
FOR FREE BOOKLET!**



Saginaw Steering Gear Div.
General Motors Corporation
Saginaw, Michigan (Dept. 36B)

Please send free facts booklet on your NEW Safety Power Steering System

NAME _____
ADDRESS _____
CITY _____ ZONE _____ STATE _____



REGULAR VIEW



WIDE-ANGLE VIEW



TELEPHOTO VIEW

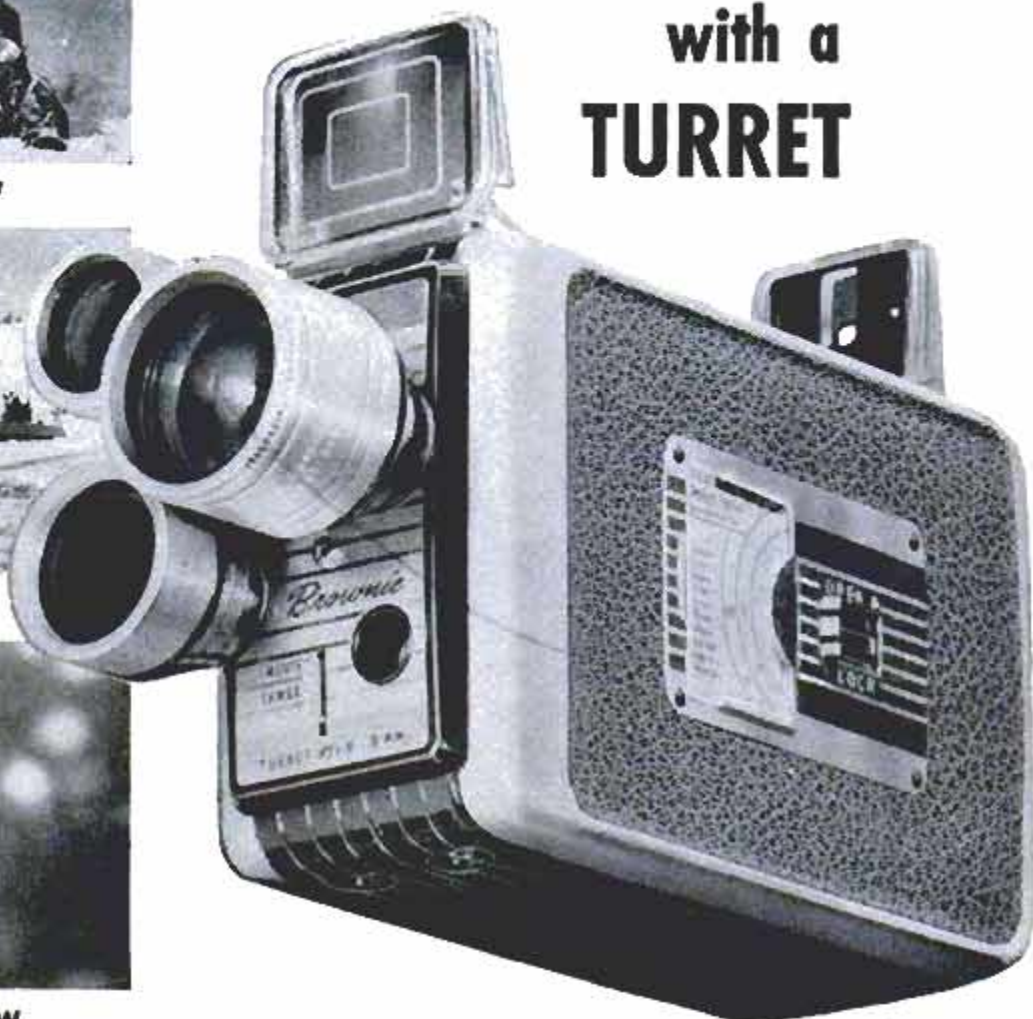

NEW! BROWNIE with a TURRET

Brownie Movie Camera, Turret $f/1.9$... Only \$79⁵⁰

Imagine! 3-lens range at a 1-lens price!

Now you can enjoy the thrill of having a whole turret-full of lens power at your command—backed by true “Brownie” ease and economy. Just sight through the finder and note the color of the rectangle that frames the view you like best (regular, wide-angle, or telephoto). Then simply click the turret around until the color-coded lens of your choice is in shooting position. No individual exposure adjustments to make—the setting for the regular lens is automatically

“right” for wide-angle and telephoto conversion lenses, too. This is a camera you must see for yourself to fully appreciate.

Here are a few of its special features

- A complete 8mm turret camera for the price many amateurs have paid for *one* auxiliary lens.
- No focusing—never before the versatility of a 3-lens turret camera that’s so easy to use!
- All 3 lenses shoot as fast as $f/1.9$.

Cine-Kodak Medallion 8 Camera

No bigger'n a minute, the Cine-Kodak Medallion 8 Camera has the look, feel, and "purr" of a finely built watch. Takes but 3 seconds to load it with a magazine of film; little more to switch from indoor to outdoor color. Fast $f/1.9$ Ektanon Lens focuses down to 12 inches for close-ups, is directly interchangeable with all "D-thread" type lenses. Optical finder adjusts to show fields of lenses from $6\frac{1}{2}$ mm to 38mm. Speeds of 16 to 48 frames per second, plus single-frame. Continuous run lock; ready-set footage counter. It's an easy-to-use little gem—yet the Medallion 8 Camera comes packed with the kind of features every serious movie maker wants. **\$144.50**



NEW Biggest little 8mm magazine camera ever!

NEW Brighter, big-screen 8mm movies!

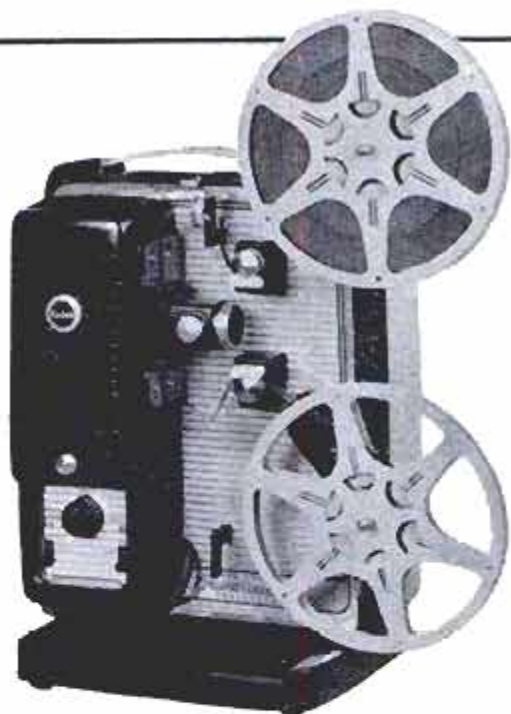

Cine-Kodak Showtime 8 Projector

Years ahead in design—a Cine-Kodak Showtime 8 Projector will actually give you sparkling, big-screen color movies up to 5 feet wide—or larger. Threading, focusing, framing, and tilting are unusually simple . . . positive. A lighted switch panel gives you finger-tip control of "still-picture" projection, comic reverse action, fast rewind. Reel arms accept 400-foot capacity reels for a full half-hour show. Fast $f/1.6$ Lumenized lens . . . a new shutter and pull-down system transmits 60% more light for extra-big, extra-bright pictures. Truly the surest-operating 8mm projector Kodak has ever produced. Complete with built-in case. **\$115**

Ask your dealer about small down payment and easy terms

Prices are list, include Federal Tax, and are subject to change without notice

Eastman Kodak Company, Rochester 4, N. Y.

Kodak
TRADE-MARK

Care and Feeding of Engines



BY
S. P. CORP

BRAKE SQUEAL

To silence squealing brakes, remove the brake drum and inspect the brake shoe to remedy the cause of vibration which produces the squeal.

1. Move shoe toward brake backing plate, noting clearance of guide, which should hold shoe square. If cam pin is too long, throwing shoe out of alignment, file pin until shoe moves in line with center of wheel cylinder. Check guide to see that it is not forcing shoe away from backing plate. Lubricate guides with a thin coating of Lubri-Plate. 2. Check for a bent brake shoe by laying web of shoe on a flat surface plate. It should contact plate for full length of shoe. 3. When assembling, make sure brake shoe fits anchor pin snugly. If there is clearance, replace shoe.



VALVE SPRINGS

Valve reconditioning should always include these important checks on valve springs: Compare with a new spring for length, discarding any which are more than $\frac{1}{8}$ " shorter than new spring. They have lost tension. Check squareness of spring ends. A distorted spring will cause trouble. Look for cracks, checks or pitting, discarding springs which show such damage. Rusty springs should be cleaned. Check under load for correct spring height. A load of 80# should compress spring to $1\frac{1}{2}$ " in height. Get manufacturer's specifications from car dealer. Place right end up. If coils are closer together at one end than the other, install with tight coils toward head of valve, otherwise spring will break in operation. Replace all springs if they have been used a long time.



RIGHT WRONG

from car dealer. Place right end up. If coils are closer together at one end than the other, install with tight coils toward head of valve, otherwise spring will break in operation. Replace all springs if they have been used a long time.

THIS FREE MANUAL IS FOR YOU!



To get this free illustrated manual of car care, just send your request on a postal card. You'll find dozens of detailed instructions on how to make repairs and adjustments. And when you re-ring, insist on Sealed Power KromeX Ring Sets—for fast break-in, more power, greater oil economy, and longer life. Your dealer has them or can get them for you. Sealed Power, Dept. G-1, Muskegon, Michigan.

Sealed Power

PISTON RINGS

Clinic for Homemakers



As a service to our readers in solving the hundreds of problems pertaining to a home—inside or out—the editors of *Popular Mechanics* invite you to present your problems to The Clinic Editor for help and advice. Address your questions to The Clinic Editor, *Popular Mechanics Magazine*, 200 East Ontario Street, Chicago 11, Ill.

Paint Cracks



Q—When we redecorated the whole interior of our house about a year ago, I painted the interior woodwork, doors and sash frames the same color as the wall in several rooms. The old finish seemed fairly good so I applied two finish coats of the new paint. Now, the new paint has peeled back to the old finish on the doors. What could cause this?—A. L., Mass.

A—It's difficult to say with certainty. You do not say whether the old finish is paint, varnish or shellac, or whether you cleaned the surface thoroughly before applying the new finish. We would suspect that the trouble is due to the presence of fingermarks, wax or oil, any one of which could prevent the new finish from bonding properly to the old. Wherever the failure to bond occurs, peeling of the new paint film will result. Moisture is not likely to be the cause, inasmuch as the old finish is not affected. About the only sure remedy is removal of the defective paint, followed by a thorough cleaning of the surface with a solvent. To make doubly sure, it may be wise to remove the old finish back to the bare wood. This is easily and quickly done with a paint remover: Then wash the surface with a solvent, sand smooth and apply an undercoater of the type recommended for use under interior paints. Follow with one coat of interior finish in the color desired and allow this to dry thoroughly. Then go over the surface lightly with fine sandpaper and apply the finish coat.

Rotted Supports



Q—The 4 x 6 wooden supports under the center beam in my home are beginning to show signs of rot at the lower ends. They will have to be replaced soon. The beam is in two pieces, the ends meeting on a post at the center. The length is 30 ft. and there are three posts. Can I replace the posts myself?—W. D., Ore.

A—One possibility is replacing the original wooden bearing posts with adjustable steel posts which will be available through your local building-materials dealer. However, it may be best to replace

(Continued to page 244)

MEN WITH MECHANICAL SKILLS:



CAN YOU MEET THIS CHALLENGE?



Mechanics Creed

Upon my honor I swear that I shall hold in sacred trust the rights and privileges conferred upon me as a certified mechanic. Knowing full well that the safety and lives of others are dependent upon my skill and judgment, I shall never knowingly subject others to risks which I would not be willing to assume for myself, or for those dear to me.

In discharging this trust, I pledge myself never to undertake work or approve work which I believe to be beyond the limits of my knowledge; nor shall I allow any superior to persuade me to approve aircraft or equipment as airworthy against my better judgment; nor shall I permit my judgment to be influenced by money or other personal gain; nor shall I pass as airworthy aircraft or equipment about which I am in doubt, either as a result of direct inspection or uncertainty regarding the ability of others who have worked on it to accomplish their work satisfactorily.

I realize the grave responsibility which is mine as a certified mechanic to exercise my judgment on the airworthiness of aircraft and equipment. I, therefore, pledge unyielding adherence to these precepts for the advancement of aviation and for the dignity of my vocation.

If you are a man who takes real pride in a job well done, the Air Force offers you a challenging and rewarding career. The safety of our country, and the lives of its defenders, depend on your accuracy and devotion to duty. Act today and put your skills to work tomorrow—in the U. S. Air Force.

GO PLACES FASTER ON
THE ALL VOLUNTEER
TEAM

THE U. S. AIR FORCE

PASTE COUPON ON POSTCARD

And Mail To

M-40-PM

Airman Recruiting Information Branch
Box 2202
Wright-Patterson AFB, Ohio

Please send more information on my opportunities for enlisting in the U. S. Air Force. I am between the ages of 17-34 and reside in U.S.A. or possessions.

Name _____

Address _____ Age _____

City _____ Zone _____ State _____

Now! Do jobs you never tried before!

NEW! WELDWOOD® CONTACT CEMENT

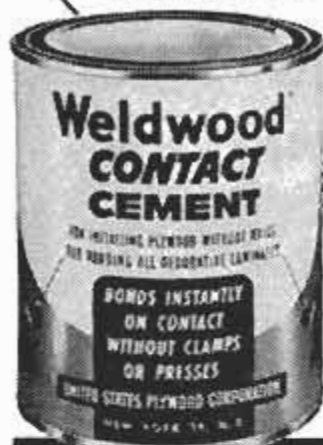

MAKES "IMPOSSIBLE" JOBS EASY!



BONDS INSTANTLY ON CONTACT WITHOUT CLAMPS, PRESSES, NAILS!

1001 USES FOR HOME, HOBBY, GARAGE!

THINGS YOU CAN DO!

APPLY MICARTA or other plastic surfacing materials, without clamps or presses!

PUT UP PLYWOOD paneling without nails!

STAIR TREADS—put down stair treads made of any material.
WEATHER STRIPPING—apply it to doors or windows of home or car.

PROTECT WITH FELT—apply felt bases to lamps, vases, etc.; make felt-backed protective covers for dining tables etc.

LEATHER—apply leather to any surface: desk tops, tables.

HOBBY WORK—model building; leather crafts; metal working; wood working.

ALUMINUM—make place or counter mats; cover anything with aluminum.

CLOTH & PAPER—apply cloth of any kind (canvas, upholstery material etc.) to wood, composition board or metal. Fasten paper to paper or anything else.

THINGS YOU CAN MEND!

Restore loose wood veneers, even in places where clamps can't hold—because no clamps are needed.

Repair rainwear, beach bags, rubberized cases, furniture covers, etc.

Repair or replace weather stripping of home or car.

Repair or replace articles made of Novoply, Masonite, Weldwood Hardboard, Tekwood.

Reline or recover luggage; mend belts, bags, book bindings, etc.

Repair anything made of paper, cardboard, fabric and Fiberglas®

Repair convertible auto tops, torn seat covers or upholstery.

In tubes, bottles, cans, 25¢, 35¢, 60¢ and larger sizes at hardware, paint and lumber dealers and variety stores. Mail coupon for leaflet.

United States Plywood Corporation

55 W. 44th St., N. Y. 36

PM 1-6

Please send me information on Weldwood Contact Cement.

Name _____

Address _____

City _____ Zone _____ State _____

(Continued from page 242)

with wooden posts of the same size as the originals. We are assuming that you have a concrete floor in the basement. We also are assuming that the lower ends of the present posts rest on concrete footings which are below the level of the floor. It will be necessary to support the ends of the beam, or girder, adequately before the center post is removed. This can be done with two jackscrews and 4 x 4 extensions long enough to reach from the jackscrew pads to the underside of the beam. One full turn on the screws should raise the beam sufficiently to release the post. The new center post should be fitted with a bolster, 4 x 6 or 6 x 6-in. sectional size and 18 to 24 in. long. Soak the lower end of the post overnight in a creosote solution, cut to length, place in position and lower the beam onto it. Proceed in the same manner in replacing the other posts. In some cases builders would advise breaking up the floor and replacing the footings also, especially if the tops are below the floor level. In this case forms should be placed and the new footings poured with the tops above the floor level. If the floor is damp for long periods of time, this extra step may be advisable.



Protecting Bulbs

Q—A year ago last fall we planted bulbs in a small, round bed following the planting instructions in all details, but only a few plants came up in the spring, less than half the number of bulbs we planted. We covered the bed with a leaf mulch while the weather was still quite warm. A neighbor says this was the cause of failure, that the bulbs will rot if the bed is mulched immediately after planting. Is this correct?—W. N., Iowa

A—We doubt that the mulch alone is the cause of the trouble. In many locations, early mulching of bulb plantings prevents freezing of the ground and encourages field mice to take up winter residence. The mulch provides shelter and the bulbs—especially tulips and crocuses—are an unfailing source of food. The ideal time to mulch bulb plantings is after the ground is frozen to a depth of about 2 in. The mulch will prevent thawing during mild winter days and the frozen ground effectively prevents mice from digging down to the bulbs. However, in some locations, especially in warmer climates, mice may cause trouble even though the bed is not mulched. To protect beds under these conditions, gardeners place strips of ½-in.-mesh hardware cloth in a trench dug entirely around the bed. The top of the bed is covered with the same material, the edge overlapping that of the vertical strip.

Repairing Wooden Gutters

Q—The wooden gutters on my home are cracked badly in several places. I was told to fill the cracks with paste white lead, which I did about six months ago. Now I notice that the cracks have opened again and the gutters leak almost as badly as before. They must either be replaced or repaired this coming spring. I would like to repair them if this is possible. Is there a satisfactory repair and if so, how do I go about it?—F. H., Ala.

A—Of course, we would ordinarily recommend that you replace the wooden gutters, either with copper units or new ones of wood. However, if you wish to carry out a repair, as you say, there is one fairly effective procedure that can be expected to add from 1 to 3 years of useful life to the present gutters. First clean thoroughly and apply two coats of outside oil-base paint. Thicken the second coat to a heavy-cream consistency with paste white lead and before the second coat sets place strips of medium-weight canvas over the paint and press into close contact. After the paint dries (about 2 weeks) apply a third coat. Treat the full length of the gutters in this manner, not just the sections that are cracked.

Make Gardening Easy

with the amazing new

Ariens Jr.

ROTARY TILLER... ONLY \$139.50

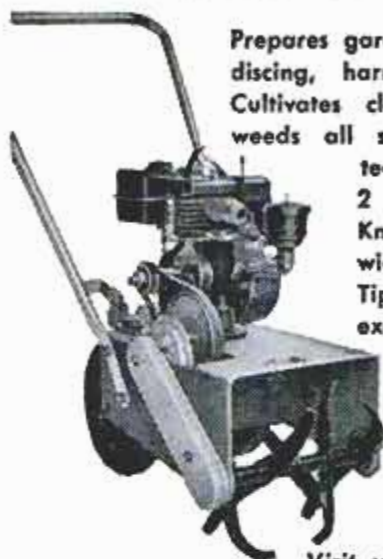

Prepares garden without plowing, discing, harrowing or spading! Cultivates close to plants, kills weeds all season long without tedious hoeing by hand! 2 h.p. engine. "Paring Knife" tines. Tills 12" wide, up to 6" deep. Tip-toe clutch and other exclusive features which make Ariens Jr. unequalled for construction, looks, performance and price! See it soon!

Visit your dealer or write:

ARIENS COMPANY • 159 Calumet St. • Brillion, Wis.

BUILD FINE GRANDFATHER CLOCK NOW



The simple sensible Red-i-Kut way as thousands have — SAVE HALF. SHOP TESTED PLANS "SPIRIT OF THE CENTURY" Narrow waist 83" tall or stately straight side "SPIRIT OF AMERICA." EASY-TO-FOLLOW photopack plans tell all—plus BROCHURE of heavy brass weight Westminster, tube chime, movements, gorgeous dials, 3/4" solid mahogany case kits. Send \$1.00 today—Both plans \$1.50 NOW. KUMPEL CHIME CLOCK CO., # 7 Kuempel Bldg., Minneapolis 16, Minn.



The fine car at half the fine-car price

FORD!

PIPE SMOKERS!



Get this guaranteed
OLDE LONDON PIPE

and 2 full-size pouches of
HOLIDAY Pipe Mixture

The Olde London Pipe is imported briar, has hard rubber bit, carbonized bowl. If your dealer can't supply you, write **OLDE LONDON, Larus & Brother Co., Inc., Richmond, Va.** Offer good only in U. S. A.

Only \$1.00

YOU'LL EARN BIG MONEY

with
HOBART
"Simplified"

ARC WELDING



AC Welding and DC Power

Double your earnings doing repair and construction work, away from power lines. "Build Your Own" gives you AC welding—plus electric power for operating tools, lights, etc. Use a gasoline engine, or hook to drive shaft with V belt.

Welds Anywhere! Air Cooled Portable Engine Drive

With the "Husky Boy" 200 amp. arc welder you can do profitable general shop and outside repair work; emergency service on pickup trucks—all on a low investment. It's compact and lightweight—easy to transport. For extra convenience when used inside, wheels and handles easily bolt to the unit, and are available at slight extra cost.



300 Amp. Electric Portable Arc Welder

Superior performance with true economy should make this welder your choice for 9 out of 10 welding jobs. Remote Control • 1000 Welding Heat Gradations • Oversize 4 Pole Exciter • Siracco Type Cooling Fan • Vibrationless Steel Shaft • Polarity Control are Hobart features that assure faster, better, low cost welds.



The Hobart Welding School

America's most modern. Every type of training. Equipment latest and best.



You'll like Hobart Electrodes

Hobart's complete line, precision made and rigidly inspected, solves every welding problem.

Hobart Brothers Co., Box M-16, Troy, O.
"One of the world's largest builders of arc welders"

HOBART BROTHERS CO., BOX M-16, TROY, O.

Send complete details on items checked.

Electric Drive Gas Drive Generator Only Air Cooled Gas Drive Hobart Trade School Electrodes Accessories

NAME _____

ADDRESS _____

CITY _____

STATE _____

FREE!



Check here for your vest pocket welding guide

FINEST WOOD LATHE in Atlas HISTORY

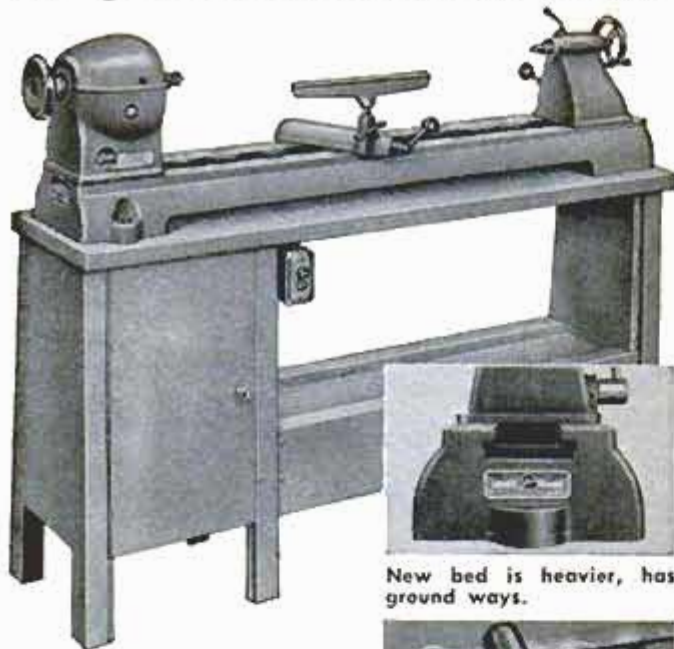

New bed is heavier, has ground ways.



One movement of lever loosens tool support for instant positioning, or anchors it to bed.



Headstock spindle is turned from a solid bar of tough, fine-grained steel, accurately ground. Sealed-for-life ball bearings take all radial and thrust loads and are pre-loaded at factory to eliminate spindle play. Top is hinged to make belt changing easy.

NEW FUNCTIONAL CABINET STAND

The new ATLAS 12" is a heavy-duty lathe built for professional workmanship and efficiency in the complete range of turning operations . . . inboard and outboard . . . light or heavy. Has new massive bed with ground ways, 60-hole indexing mechanism, 4 speeds, Lever-controlled bed locks, Sealed-for-life ball bearings.

And what a stand . . . a completely new cabinet design . . . a massive foundation for accurate work, with $\frac{1}{8}$ " steel plate construction, thick wood top, enclosed V-belt drive. Your shop isn't complete without this fine lathe. Write for literature.



20 PRACTICAL WOODWORKING PLANS

Distinctive projects for everyone — letter rack, knife holder, bar stool, cocktail table, table lamp, etc. 32 pages. Size 8½" x 11". Price 50c (65c outside U.S.A.)

ATLAS PRESS CO.

1-24 N. Pitcher St., Kalamazoo, Mich.

Please send catalog showing wood lathe. Enclosed is \$_____ for 20-Pfan Book.

Name _____

Address _____

City _____ State _____

The Hot-Line Men Never Trust to Luck

(Continued from page 162)

are depending on its current. So the power industry has developed methods of working safely with lines energized anywhere from household voltages of 110 volts up to transmission-line voltages of 220,000 or more.

To work on a line carrying up to 7500 volts the lineman wears rubber gloves inside leather gloves. He covers all nearby lines with rubber "snakes" and rubber blankets. He wears a hat with a brim. He keeps his sleeves rolled down. He wears no watch chains or metal wrist bands. He never works alone; he works with a partner whose job is to watch him. Before the two linemen climb to their working position high on a pole, they take part in a "tailboard conference" at the truck. There, the job is discussed and hazards are talked over, and the entire plan of action is worked out by a foreman. When work starts, the working member of the team tells his watching partner what he intends to do before doing it. The chance for error is minimized; there is no haste. This work must be done surely, safely, one step at a time, no matter how noisy the wind or how wet the rain.

To work on lines energized above 7500 volts the lineman uses tools called "hot sticks." They are special-purpose tools ranging all the way from hacksaw to socket wrench, with six-foot handles of dry, clean wood. A good hot-stick man can work as nimbly with those long-handled tools as Grandma can work with a pair of knitting needles. High on a pole where electrical corona makes his hair stand on end, he deftly cleans, twists, cuts or bolts together the deadly high-voltage wires. He may be 100 or 200 or even 400 feet above the ground; he knows what he's doing and he's not afraid.

"You work in constant alertness. You keep your thoughts always on the job, on what you're doing, on what's to be done. You keep a leg pressed tight to the pole, or tower, to ground out the static charge that keeps building up in your body from induction. Wearing thin pants helps a lot; heavy cloth where you touch the pole insulates you more and lets the static build up more, and you keep waiting for it to let go into the pole. You keep listening and watching."

That's not from an amateur at hot-line work; that's a 25-year man talking, an expert, an instructor in "hot stick" operations. He still climbs up there where "220

(Continued to page 248)

How TO SAVE 30% to 40% WHEN YOU BUILD A HOME



3 bedrooms — \$5378



3 bedrooms — \$5898



2 bedrooms — \$4610



2 bedrooms — \$3952

BUILD A READY-CUT "LIBERTY" HOME!

You can save several thousand dollars by building a Liberty Home! Buy direct from our mill at our low, freight-paid price.

HERE'S WHAT WE FURNISH

- DOORS
- WINDOWS
- SIDING
- MILLWORK
- LUMBER CUT-TO-FIT
- FLOORING
- ROOFING
- MOULDING
- HARDWARE
- TRIM
- PAINT
- GLASS
- NAILS
- PLANS & BUILDING INSTRUCTIONS

Big savings in labor. All materials priced at rock-bottom. No wonder our customers write us that we saved them 30% to 40%. Easy terms—monthly payments. Architecturally approved construction. (Not prefabricated).

What "Liberty" Owners Say! Saved \$4,000 to \$6,000

"Compared to a local contractor's price to build a home equal to my 'Liberty', I will be saving \$4,000 to \$6,000; so you can see why I have such enthusiasm for Liberty Homes."

VERY EASY to Build

Every step in the building of a Liberty Home is figured out for you, so that all you have to do is follow the drawings and instructions that we furnish you.

Send for Catalogue

Pictures wonderful homes in colors at money-saving prices. Designs to suit everyone. Send 25c for catalogue today.

BIG BOOK
of
House Plans
in Colors
25¢

LEWIS MANUFACTURING CO.

1261 Lafayette Ave.

Bay City, Mich.

ENJOY TRAVELING WITH AMERICA'S FINEST AUTO COMPASSES



TRAVELITE \$5.95
(ILLUMINATED)

GUIDEWAY \$4.95
(NON-ILLUMINATED)

ONLY COMPASS
APPROVED BY
AUTO MAKERS

DINSMORE

Shows you the right way — the short cuts. Always accurate and dependable anywhere. Fits all cars. Send for free folder — "Pants, Knives and Compasses" and name of nearest dealer.

DINSMORE INSTRUMENT CO. 1802-21 Kelso Street Flint 1, Mich.

FIND URANIUM!!!

Prospecting made easy with Goldak's new U-238C triple-action geiger counter! Also famous line of metal locators, from \$49.50

Send 25c for radioactive uranium sample!

FREE DETAILS. Dealer Inquiries Welcome.

GOLDAK COMPANY 1542 W. Glenoaks Blvd., Glendale, Calif.



Insist on
Evans
TAPES
KING-SIZE
At your
hardware
store



6-ft. \$1.49
only

3/4" wide
blade stands
up straight
for one-man
upright
measurement.



Also available in 8, 10,
12-ft. lengths with
free plastic utility case.

*No Sanding!
No Finishing!*



Lay it
right over
your old floor

Bruce PREFINISHED Oak Floors

BLOCK, STRIP OR RANCH PLANK — Now it's easy and economical to give your home the new beauty of modern oak floors... with all the glamour of nationally-famous Bruce Prefinished Hardwood! In only a few hours, your living room, bedroom, dining room—or that unfinished room upstairs—will glow with a style as modern as tomorrow. You can choose Block, Strip or Ranch Plank design.

It's EASY! These floors are completely finished—even waxed—at the factory. Just cover old floor or smooth subflooring with felt paper and nail down this highest quality oak (or install in mastic over concrete). No sanding or finishing... no mess or smell. Ready for use as soon as it's laid... and your home will have the rich style and beauty chosen by leading decorators.

It's ECONOMICAL! A new Bruce Hardwood Floor will cost you less than a good rug or carpet... and will last the life of your home. The famed Bruce "Scratch Test" proves this durable finish doesn't scratch, chip or mar. Ask your lumber dealer for an estimate. Mail coupon below for colorful literature.

MAIL FOR FREE LITERATURE

E. L. Bruce Co., Box 397-E, Memphis 1, Tenn.

Send me complete, free information on prefinished Bruce Hardwood Floors.

Name.....

Address.....

City..... State.....



Bruce Hardwood Floors

Product world's largest hardwood flooring maker

KV" could fry an elephant like a hot dog, and he's not afraid.

Regularly, as part of their work, linemen study in safety classes. They study and they drill in rescue work and first aid. They tackle their lessons wholeheartedly; their instructor has no laggards in his class. Among them, safety is no fuddy-duddy word out of a dog-eared handbook. It's a word that spells out life itself.

The hot-line men know this slogan well: "No job is so urgent or no service so important that it prevents us from taking the time to do our work safely!" ★ ★ ★



Civilians Get Combat Camera

Civilians can now obtain a 70-millimeter high-speed combat camera developed for the Army. Complete with a basic four-inch lens, assorted accessories, a telephoto lens and a 90-degree wide-angle lens, it sells for \$3320. The camera weighs five pounds, far less than a standard press camera, yet is suitable for press and other professional use. With one winding of a spring motor, you can prepare the camera to take as many as 10 pictures in six seconds. The film is loaded in cassettes, and produces 50 negatives 2¼ by 2¾ inches on one strip of film. A built-in slicing knife chops off exposed film for processing after any number of pictures have been taken. A pistol grip keeps the camera steady. The camera has a synchronized shutter with nine speeds from 1/600 second to one second. The three lenses are rapidly interchangeable, and as each lens is inserted, the view finder and range finder are automatically coupled in proper adjustment.

KING SIZE ALUMINUM BOATS



by **WAGEMAKER**

Big and roomy, tough and sturdy, that's the Wagemaker All-Aluminum line. Models from 12' to 18'. Styrofoam flotation, self-bailing valves. Also Ply-Lap, molded plywood, strip boats, and fiberglass models. See these boats at all major boat shows. Free catalog on request.

WAGEMAKER COMPANY

Dept. 54 Grand Rapids, Michigan



The Modern **PLASTIC** for lasting Home Repairs

PERMANENTLY mends cracks or holes in wood, tile, stone or plaster. Sticks and stays put—Does not chip, shrink or fall out. Easy to use. Economical. Mold it, chisel it, polish or paint it. The big 4-lb. can is obtainable from your lumber, paint or hardware dealer at \$1.25; or will be shipped direct postpaid (in U. S.) for \$1.50. Complete satisfaction guaranteed or your money refunded.

DONALD DURHAM CO.
Box 804-T Des Moines, Iowa

MONEY FOR MEN ALL DATA FREE

THE PLASTEX Industry needs manufacturers on small scale and for big production of Lamp and Clock Stands, Art Goods and Novelties in Plastex and Marble imitation. Experience unnecessary. 3/8" material makes regular 10¢ store sellers. Rubber molds furnished for speed production. Small investment brings good returns. We are now placing big Chain Store Orders with manufacturers. Ambitious men have chance for real prosperity. Our Free booklet will interest and benefit you.

PLASTEX INDUSTRIES, Dept. A
3400 Third Ave. New York 56, N. Y.

Protect your home against power interruptions with an...

ONAN Emergency ELECTRIC PLANT

Provides dependable stand-by electricity for heating system, pumps, freezer, lights, appliances. Keeps home safe, livable. Automatic start and stop. Find out how little it costs!

Write for Folder!

D. W. ONAN & SONS, INC.
3319 University Ave. S. E. Minneapolis 14, Minnesota

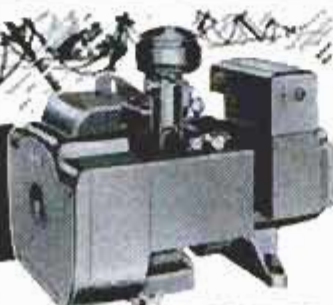

A SIZE FOR EVERY NEED
400 to 75,000 watts. Compact, quiet-running. easy to install. Gasoline engine powered.

free

GET THE WORLD'S LEADING TV & RADIO PARTS AND EQUIPMENT CATALOG

ALLIED'S 1956 ELECTRONIC SUPPLY GUIDE

324 VALUE-PACKED PAGES

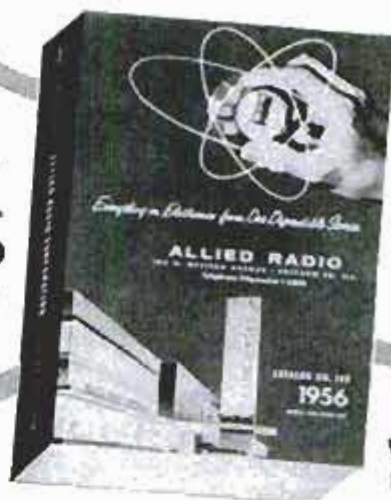

Save on Everything in Electronics

WORLD'S LARGEST STOCKS

Everything for Experimenters, Builders, Amateurs, Servicemen, Engineers and Hi-Fi Experts

Send for ALLIED's big 324-page Catalog, offering the world's largest selection of latest top-quality electronic equipment at lowest, money-saving prices. Features High Fidelity systems and components; recorders and phono equipment; TV tubes, antennas and accessories; Amateur station equipment; P.A. systems; test instruments; latest build-your-own kits; industrial electronic supplies—plus thousands of parts, tubes, transistors, tools and books. Get everything, get more for your money—send today for your FREE 1956 ALLIED Catalog!



ALLIED RADIO

Send for FREE CATALOG

ALLIED RADIO CORP., Dept. 5-AA-6
100 N. Western Ave., Chicago 80, Ill.

Rush FREE 1956 ALLIED 324-Page Catalog

Name _____

Address _____

City _____ Zone _____ State _____

We're Running Out of Airspace

(Continued from page 138)

permits the controller to take over positive control of the plane from some distance, save a place for it in the landing parade, and slip it directly into this niche.

Transponder Answers Radar Call

Another instrument that may prove valuable in the future is the transponder. The radio band now is so crowded that radio and radar beams are interfering with each other. At long range, a ghostly blip may appear on a scope that may—or may not—be a scheduled plane. At Indianapolis, six DC-3s of Lake Central Airlines have been equipped with transponders. These are small metal boxes housing special radio equipment. A faint radar beam from 200 miles away will trigger the transponder, which automatically sends out a strong beam in return. This not only produces a bright, strong blip on the scope, but the equipment can be so rigged that it will send out a coded message so the plane identifies itself. The transponder, if installed in all commercial planes, will greatly extend the range and usefulness of radar. No longer will a tower man have to ask a pilot to make a 90-degree turn so he can identify the plane on the scope.

Strong, long-range radar will also prevent the kind of traffic pile-up that occurred in Chicago not so long ago, when a small private plane became lost on instrument flight somewhere near the city. Neither the airport radar nor the radar at the Glenview Naval Air Station could find the lost pilot. All flights into the city were held up for one hour and 45 minutes until the plane finally was located and guided in. During that time this one small private plane forced some 80 scheduled airline flights from all over the country either to land immediately or to proceed to holding fixes.

Air traffic has become so heavy and planes so large that some thought is being given to ways that the pilot himself can spot imminent collisions. An experimental periscope, installed in a DC-3 at Indianapolis, enables the pilot to see the air all around him, eliminating his present blind spots. Electronics firms may produce an aircraft-proximity warning indicator.

Computer May Be Answer

Perhaps the inevitable answer to the airspace problem is a computer that will take much of the personal element out of juggling planes for a landing. Such a unit, called Volscan, already has been built and is reported to be under test by the Air

Force. As soon as a plane turns up on the edge of the radar scope, its blip is connected electronically to the computer. The computer surveys a scope full of blips and figures quickly and constantly the course that the planes must fly to bring them safely to the airport at a rate of two per minute. All the dovetailing is done by calculating an indirect route for each plane, so its entry into the gate will be on time.

Experiments also are underway at Indianapolis to solve the controllers' biggest headache. For years controllers have kept track of each plane in flight on a flight-data strip. This slip contains a description of the plane, its destination, altitude, the time that it passes certain fixes and any other pertinent information. By expert reading and juggling of these strips, controllers are able to spot conflicts in advance and give the necessary orders to each pilot to keep the precious block of airspace around his plane.

To solve this problem, research workers at Indianapolis have come up with some ingenious electromechanical display boards that present instantly in numerical fashion all the data on any flight. They also are working on horizontal map-type display boards. On such pictorial displays, each plane is identified by a small "shrimp boat" (so named for its pointed shape). The point of the boat indicates the direction the plane is moving. A slip of paper on the boat gives all the vital information on the flight. As the plane checks in at various points on its course, the boat is moved with it. A somewhat similar system has been tried with a radar projector. The picture of the scope is thrown onto a large horizontal glass disk, and the shrimp boats are moved along as the radar blip moves. These systems give the controller a two-dimensional image of the traffic. He adds the third dimension mentally.

Color Radar?

And even this problem may be taken care of if another new development is adopted. Officials at the Center hope to test color radar within a few months. This equipment, when used with transponders, would present a great deal of visual information about planes approaching a metropolitan area. For example, the traffic controller in the New York area could tell at a glance (by the colors) the altitude of each plane in the area and its terminal airport.

All this research adds up, not only to safe air travel in the future, but better means of utilizing one of our most precious of modern resources, the crowded space above our heads. ★ ★ ★

"I entered the Army my way!"

PVT. GEORGE L. LaMONTAGNE, Jr.
Worcester, Massachusetts
Graduate, St. Peter's High School

"I CHOSE MY TRAINING BEFORE ENLISTMENT — SO CAN YOU!"

"Yes, I picked my *own* technical training in the Army—a 33-week radar repair course. I couldn't ask for a better way to begin my electronics career! Best of all, it was guaranteed *before* I enlisted—reserved and waiting for me. And am I learning a lot! The course is packed with practical training that will put me at least a year ahead of other guys. You can get a head start on *your* career, too—by seeing your Army recruiter. I'm sure glad *I* did."

Over 100 courses available! You'll find the right career training for *you* at an Army technical school. There are over 100 courses to choose from—aviation, photography, medicine, communications — practically anything you want. And the course you *pick* is the course you *get!* You receive a written guarantee that a place in class is reserved for you—all *before* enlistment!

Act Now! If you have a high school diploma or its equivalent, or if you are a high school senior, you can reserve your Army schooling right *now!*

Get CHOICE, not chance, in the ARMY!

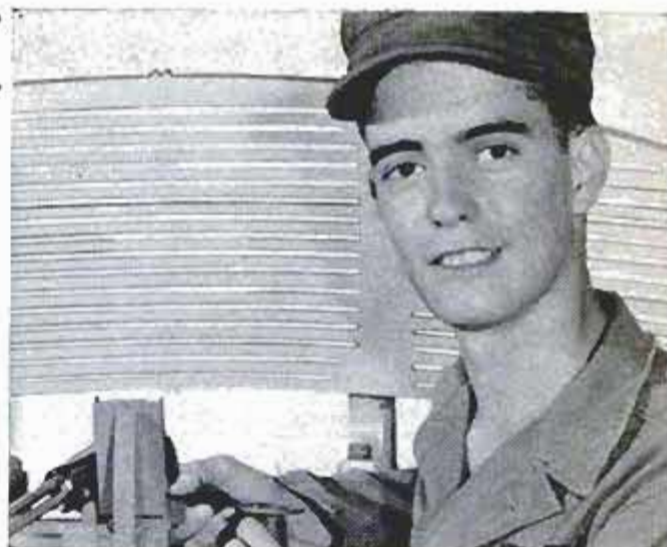

FOR FULL DETAILS,
MAIL THIS COUPON TODAY! 

THE ADJUTANT GENERAL PM 56-2
Department of the Army, Washington 25, D. C.
Attn: AGSN

Please send me the Army booklet describing special opportunities for high school graduates.

MR.

ADDRESS.....

CITY.....STATE.....DATE OF GRAD.....

SMALL! POWERFUL!



ECONOMY TRACTOR

Unequaled value! Low price! America's finest tractor. Ruggedly built. Easy to operate. 790 lbs. Borg-Warner clutch, trans. and diff 140 to 1 reduction. 40% more drawbar pull than ordinary tractors 8-1/4 H. P. engine. 20 quick change implements. HOOD, FENDERS.

Thousands In Use Write for complete details.

Engineering Products Co.
915-K-1 Niagara Ct.
Waukesha, Wisconsin

MAGNETS

ASSORTED MAGNETS with big list of handy uses..... 5 for \$1
POWERFUL POCKET MAGNET ideal for testing metals..... \$1
RETRIEVING MAGNET pulls tools, etc., from tank or lake..... \$4
HOT PAD MAGNETS to insert in your own hot pads..... 8 for \$1
BULLETIN BOARD MAGNETS to "pin-up" memos, etc..... 8 for \$1
EXPLORE, LEARN—Electricity, Magnetism, Electro-Magnets. Complete kit and instructions with 22 experiments and models..... \$3.98
FREE CATALOG. 100% satisfaction guaranteed..... POSTPAID
PARK MAGNETS, 261, 1557 GREENBAY RD., HIGHLAND PARK, ILL.

KING MIDGET

World's Lowest Priced Car!



Lower priced, improved performance. Drive it for 75c per week. Also KING MIDGET JUNIOR, finely engineered, less than one-third cost of any comparable car, one twelfth cost of large cars. Agents wanted. IT WILL PAY YOU TO GET THE FACTS. Send 25c for literature and agents proposition on both cars, or \$1 (refunded first order) for this plus actual assembly book and service manual.

MIDGET MOTORS MFG. CO., Athens 1, Ohio

Get This NEW Catalog of **WOOD AND WOODWORKING MATERIALS**



NEW CATALOG No. 22
WOOD and Woodworking Materials
Price 25c

CRAFTSMAN WOOD SERVICE COMPANY, CHICAGO 8, ILLINOIS

World's Largest Selection of Finest Domestic and Imported Woods... Mouldings, Hardware, Tools. — ALL AT LOW MONEY SAVING PRICES!

Your complete wood buying guide and project book. Craftsman is your best, most complete source of finest kiln-dried domestic and rare imported woods, beautiful wood inlays, colorful bandings, matched plywoods, embossed mouldings, carved ornaments, newest woodworking tools, "hard to find" cabinet hardware and fittings... more than 1,500 items! Packed with newest scroll saw patterns, project ideas & money making plans. Enclose 25c (refunded with first order) to help pay mailing, handling cost. Write now! Craftsman Wood Service Co., Dept. A-1 2729 S. Mary Street - Chicago 8, Ill.

128 PAGES
Many in full color
packed with rare, fancy & imported woods... veneers, plywoods, patterns, tools, ornaments, hardware... everything for the woodworker.
MAIL COUPON NOW!

CRAFTSMAN SERVICE CO., Dept. A-1,
2729 S. Mary St., Chicago 8, Ill.

Enclosed find 25c. Rush me new Woodworkers' Catalog Handbook.

NAME.....

ADDRESS.....

CITY.....ZONE.....STATE.....

Stay Alive in the Great Outdoors

(Continued from page 156)

burial and almost certain death beneath those tons of snow.

Every winter dozens of skiers collide with trees while downhill at better than 30 miles per hour. Results are messy—and sometimes fatal. The same applies to the guy afoot who decides to run downhill. It looks easy, and it is—until you try applying the brakes.

Running downhill throws your normal center of gravity off kilter. To regain it, you instinctively run faster. The greater your speed, the more off balance you become until you're out of control and heading for trouble.

"Make yourself into a triped, rather than a biped," advises ranger Lewis, "especially in steep, rocky country. Work down a slope with one hand on the ground. Slower? Sure. But also safer."

It's natural for hikers to play follow the leader. Sticking close to the pack builds confidence. There's no denying the going's easier, following a well-worn trail. Yet it can be a dangerous practice. A rock dislodged a few hundred feet above you builds up terrific speed. Even a small stone can become a deadly missile when hurtling 40 miles per hour and better. So, whether climbing or descending, spread out, each member of the party working parallel and on approximately the same level.

Rock falls are one reason—but only one—why many rangers have discarded their time-honored Stetsons in favor of hard hats, fabricated from plastic or aluminum. Hard hats, universally used on the fire lines, are versatile. They protect against falling rocks. They're cool. With the chin straps as handles, they're easily converted to half-gallon buckets, and have been mustered into "hat brigades" to douse small, stubborn fires. In emergencies they substitute for shovels. Moreover aluminum's visibility from aloft can very well be a lifesaver.

Uncontrolled fire is always dangerous. It's doubly so for the camper. The "don'ts" have often been recited: Don't fire logs or snags, don't kindle campfires in vegetable soils, don't strike any fire before you've cleared 10 to 20 feet all around and cut heavy, overhead growth.

Forest Service firefighters will long remember July 20, 1953—the Grindstone Canyon disaster, when 14 tough, fire-wise volunteers died in Mendocino National Forest. The fire they thought controlled suddenly jumped the breaks. Seconds later, goaded by a stiff wind, it roared up a canyon where line watchers camped. Some

threw themselves up sheer canyon walls. Others tried to outrun the explosive fingers of flame. If those 14 could speak, they'd likely tell campers that nothing moves faster through dry timber than fire. A fire in Las Padres National Forest was clocked at 35 miles per hour. Another burned at better than 43 miles per hour. By comparison, a man fighting through heavy brush is lucky to make 150 feet in five minutes.

"It's 100 to 1 against you winning the sprint," says ranger Leslie Cammack who, with his wife, lives at 5700 feet near Crystal Lake in Angeles National Forest.

Yet Cammack and a dozen fire fighters once beat the odds. As the fire swept toward them, they hurriedly built a backfire, pressed wet bandannas over their faces, and reached the safety of their self-set burn a jump ahead of the main blaze. But notice, they ran for a "burn," not away from the fire.

Campers have cheated fiery death by holing up in low-lying caves (below, not above the fire), by wading a stream's center and occasionally by hacking a firebreak, walling themselves from danger.

Hikers get themselves into enough jams, but fishermen go them one better. Ranger Cammack tells of an angler who was following a trail high off a stream. Instead of keeping his eyes on the trail, he was scouting rainbows—the finny variety. Suddenly the trail turned. The fisherman didn't. He plunged 75 feet into the ravine, wrenching his back. He lay there 30 hours before rangers got him out.

Spring and fall are seasons of rock slides, almost as dangerous as wintertime avalanches. A false step, dislodging a single rock, can bring down a ton of mountain.

Three hikers once headed for high country. Foolishly, they ascended a 45-degree slope, taking no heed of its barrenness nor of its gouged profile, indicative of previous slides. Nearing the crest, the leader stubbed a rock. Moments later a slide roared down upon his companions. One man jumped clear. The third wasn't as lucky. The slide caught him and carried him 300 feet, shattering both ankles.

Rangers effected a rescue with ropes, crampons and some sound advice. Any denuded slope greater than 45 degrees is slide-prone. Wind erosion can trigger an avalanche; so can a sudden temperature change. Even lizards have been blamed for starting slides. The rangers' creed: Stay off slide areas. If you must venture up, skirt the slide, working its vegetated edges.

Take the experts' word for it. An ounce of common sense equals 10 pounds of grub when it comes to staying alive—and having fun—in America's great outdoors. ★ ★ ★

GRAVELY makes tough Jobs EASY!



Perfect seedbed in one operation with Rotary Plow! — only one of 23 sturdy year-round tools. . . . Powerful 5-HP Gravelly Tractor does every lawn, garden, field job easier, better! All-gear Drive, Power Reverse. New improved Starter optional.

EASY PAY PLAN



Write today for FREE 24-page "Power vs Drudgery" Booklet.

GRAVELLY TRACTORS, INC.
BOX 163 DUNBAR, W. VA.

FIELD-TESTED SINCE 1922

AGENTS — SELL TOOLS! GUNS! CAMERAS!

Buy tools, photo equipment, sporting goods, jewelry and thousand other nationally advertised products at big discounts. Big profits selling to others. Postcard brings free plan.



AMERICAN BUYERS SERVICE HERTEL STATION, DEPT. 15
BUFFALO 16, NEW YORK

Guaranteed Auto Parts at Western Auto

Print Your Own

Cards, stationery, circulars, tags, labels, photo and movie titles, advertising, etc. Save money. Print for Others. Good Profit! Easy rules sent. Raised Printing like Engraving, too. Sold direct from factory only. Write for free catalog of outfits and all details. **KELSEY PRESSES, M-37, Meriden, Conn.**

NEW "WIZARD" TOOL DRILL GRINDING GUIDE

MAKE OLD DRILLS LIKE NEW...

For repointing dull and broken twist drills up to 1/2" in diameter. One piece cast Aluminum. Simple. Anyone can use it. Order yours to-day. \$1.00 post-paid.

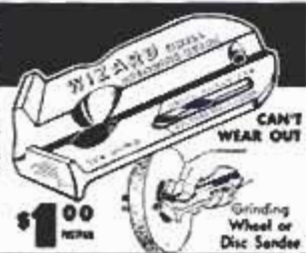

BRASS CASTING CO.
P. O. Box 3056 Memphis 9, Tenn.

\$1.00

CUT PERFECT GROOVES WITH Warren WASHERS ON YOUR SAW BLADE!

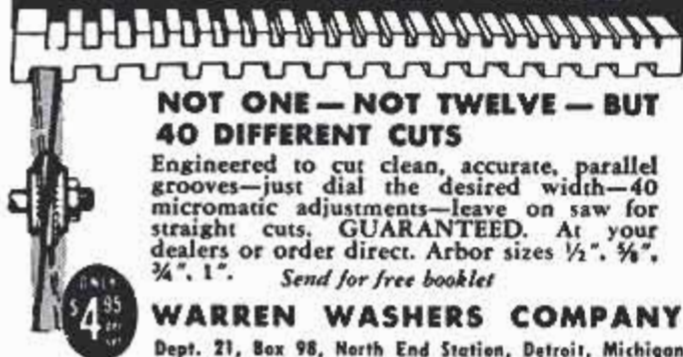

NOT ONE — NOT TWELVE — BUT 40 DIFFERENT CUTS

Engineered to cut clean, accurate, parallel grooves—just dial the desired width—40 micrometric adjustments—leave on saw for straight cuts. **GUARANTEED.** At your dealers or order direct. Arbor sizes 1/2", 3/8", 3/4", 1". Send for free booklet

WARREN WASHERS COMPANY
Dept. 21, Box 98, North End Station, Detroit, Michigan

ONLY \$4.95



AMAZING NEW "ARCO-SAW" CUTS ANY GROOVE!

WHIZZES THRU 2x4's!

Not even a \$100 Portable Saw has a dado cutter! "ARCO-SAW" (fits any 1/4" drill) with new "Dado-Arbor" adjusts easily to cut any size groove up to 1/2" wide x 1" deep in **ONE CUT!** Graduated **Depth-Bevel-Rip Gages** adjust for depth of cut up to 1 3/4", angle cuts to 45°. "Dado-Arbor" swivels sawblade to cut large grooves cleanly and accurately and is easily removed to use the saw for straight ripping, crosscutting or angle cuts. Right angle steel gear drive and safety-yoke permit **ONE HAND** operation. Includes quick-cutting **5" Safcut Blade**. **\$12.95**

BLADES—5" Rip, Crosscut, or Combination. **\$1.75**

"ARCO JIG-SAW"

WITH EXCLUSIVE NEW **CIRCLE-CUTTER & RIP GAGE!**



Another "ARCO" FIRST! "Arco Jig-Saw" (guaranteed to fit any 1/4" drill) with **Adjustable Circle-Cutter & Rip Gage** saves hours of work—assures professional-looking results everytime—whether cutting circles, curved patterns, or straight cutting. Cuts perfect circles any size up to 20" diameter; rips accurate widths any size up to 10" wide. Has same capacity and cutting speed as \$55 jig saws. Does work of Jig, Keyhole, Coping, Rip, Crosscut, Band & Hack-saw! Built-in "Air-Jet" blows away sawdust. Cuts intricate patterns—however large—in plywood, plastics, metals—even cuts 2x4's! Starts inside holes. Includes blade. Converts to **Table Model** with



RIPPING WITH GAGE

\$8.95 No. 500 without gages.
\$9.95 No. 550 with gages.

No. 401 "ARCO STAND" Sturdy Casting & Clamp. **\$2.75**
6 Extra Assorted Blades for wood, plastics, metals. **\$1.95**
SOLD AT BETTER HOME STORES EVERYWHERE. If not available, order direct and try these amazing tools on our **UNCONDITIONAL 10-DAY MONEY BACK GUARANTEE.** Send check or M.O. (ppd.) C.O.D.'s—plus post. Write for **FREE CATALOG** of other "Arco" Tools.

ARROW METAL PRODUCTS CO.
Dept. PM-1, 140 WEST BROADWAY, NEW YORK 13, N. Y.

Wire Your Home for Sound

(Continued from page 182)

individually adjusted to the desired level. Each control may be located at some distance from its associated speaker.

If each speaker has its own control, the amplifier must be correctly adjusted if maximum undistorted power output is to be obtained. To do this, set the volume control of the main speaker to maximum and adjust the radio or amplifier volume control to the highest level possible before distortion sets in. The amplifier control can then be left in that position, and all further volume adjustments should be made with the individual speaker controls.

If the amplifier control is on the same shaft with the on-off switch, the maximum position of this control can be marked on the panel so that it can be reset to that particular point whenever the system is turned on.

Extension-speaker cabinets and baffle plates are available in a great variety of styles, some of which are illustrated in Fig. 4. These are suitable for any type of installation, including wall baffles, ceiling fixtures, separate enclosures, etc. Of course, extension speakers may also be built into existing cabinets, closets, or especially built enclosures to fit in with any type of room decor.

If you are building a new home, plans can easily be made to install the necessary speaker wiring in the walls, along with the electrical wiring. In existing homes, it may be simpler to run the connecting wires along the baseboards, behind quarter rounds or under carpeting. Since these wires carry only low voltages, no safety hazard exists, regardless of the type of installation.

Ordinary 2-wire lamp cord may be used to interconnect the extension speakers. The individual conductors should be No.

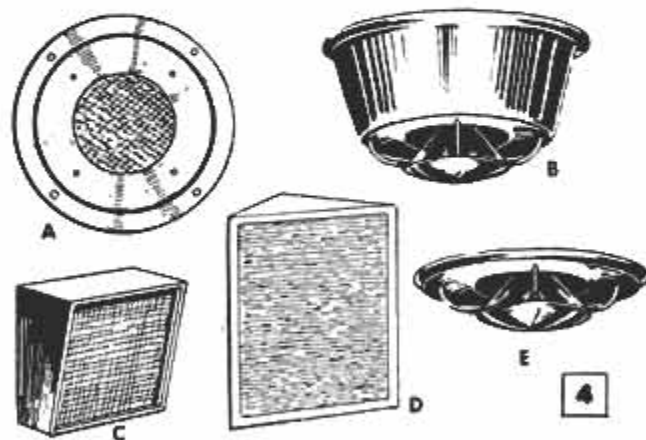

Some commercially available baffles for extension speakers: A. Flush-mounting wall type; B. Surface-mounting ceiling type; C. Sloping-front wall mount; D. Corner baffle; E. Flush-mounting ceiling baffle

18 wire, or heavier, to prevent excessive losses in lines more than 30 ft. in length.

Loudspeakers are available in sizes that range from 3 to 15 in. in diameter. The larger units are able to handle more power and will provide better sound quality. Usually, a 5 or 8-in. speaker is adequate for extension-speaker use.

Speaker prices vary even more widely than their sizes. A 12-in. unit, such as found in some radio or TV sets can be purchased for less than \$10.00, while a hi-fi speaker of similar size may cost more than \$100.00. Low-cost replacement-type speakers will provide equal or better performance than speakers usually furnished with ordinary radios. However, if you have a hi-fi system and wish to provide high-fidelity reproduction throughout the house, more-expensive speakers should be used.

Hi-fi speakers usually have voice-coil impedances of 8 or 16 ohms, while replacement types are normally furnished with 3.2-ohm voice coils. However, there is at least one manufacturer, the Quam-Nichols Co., that will supply the inexpensive speakers with any desired voice-coil impedance. These special speakers are available on special order from most large radio-parts distributors.

Helpful Hints

1. If two or more speakers are to be installed in one room, they must be properly phased in order to prevent dead spots. To do this, wire the speakers together in the proper manner and connect the input leads across a 1½-volt flashlight cell. When this voltage is applied, both speaker cones should move in the same direction, either in or out. If they do not, reverse the connections to one of the speakers.

2. When proper matching is possible with either series or parallel wiring, the parallel connection is preferred. In a series connection, if one voice coil should open up, all speakers would be silenced, thus making troubleshooting more difficult. In a parallel connection only the defective speaker would be silenced.

3. If you live very close, within a hundred yards or so, to a powerful radio or TV transmitter, shielding of the speaker leads may be necessary to prevent pickup of the station. The shield should be grounded.

4. In some installations, flat TV lead-in used as speaker cable may be easier to hide under carpets, behind quarter rounds, and baseboards, than ordinary lamp cord or other round cable. ★ ★ ★

☐ The first large truck tires made of a new manmade rubber which synthetically duplicates natural tree rubber are reported to be giving satisfactory road service.

MODERN**LAWN MOWER SHARPENER****COMPARE
BEFORE YOU BUY**Write for
free
booklet
10¢**Start your own
business—increase
your income**Sharpens any mower in
ten to twenty minutes.
Handles complete assem-
bly of all reel types in-
cluding 36 in. power
mowers. Handle, wheels,
roller, and engine are
not removed.Oil remains in engine
while sharpening. Bed
knife sharpened in same
centers — no attachments
needed.**\$26300****MODERN MFG. CO.**

F.O.B. PASADENA

160 N. FAIR OAKS, PASADENA, CALIF.

**Easy to make your own
BOWS—ARROWS—EQUIPMENT**Illustrated Hand-Book 84 pgs. 75¢, tells
you how! Large Colored Catalog 5¢—
Send for it!Ask your dealer for "Stemmler's
Archery" (Oldest Mfr. in U.S.A.)**L. E. STEMMLER CO.**

Manorville (Box 1) L. I., N. Y.

DITCH-WITCH TRENCHERPortable DITCH-WITCH digs 4 1/2"
or 6" clean, even ditches to 36"
depth in all types of soil. Four
rugged models. Complete unit —
self-propelled. **OUTDIGS 8 MEN**
Write for Illustrated LiteratureThe **CHARLES MACHINE WORKS**
620 B Street Perry, Okla.**Find URANIUM!!**GEIGER COUNTERS for uranium detection. All
models and sizes — from low-cost, portable
to super-sensitive airborne units. Prices start at
\$37.50. Also TREASURE DETECTORS and
MINERALITES. • **FREE INFORMATION** •**Detectron** CORP.
5528 Vineland, North Hollywood, Calif.**send for
FREE
tool catalog****SNAP-ON TOOLS CORPORATION**
8062-A 28th Avenue, Kenosha, Wis.

Send me free catalog.

OCCUPATION

NAME

ADDRESS

CITYZONESTATE

**FLOOR LEVELING JACKS**Do a professional job yourself
on uneven floors and sagging
floors. Just set jack on cement
block or bricks and adjust nut.
Price \$1.85 F.O.B. Write for folder
or order from ad.**Ray Haupt Machine Shop**
Earlsville, Oklahoma**NEW for 1956 . . . 16 Models****GET 1956 CATALOG
NOW . . . FREE!****STARCRAFT BOAT COMPANY**
Dept. Q-1 Goshen, Indiana

STARLITE ALUMINUM BOATS BY

STARCRAFT**FISHING or FUN there's a Starcraft for everyone!**A big, fact-packed catalog full
of pictures and tool informa-
tion . . . yours for the asking.

- Snap-on tools help you handle repair jobs faster, easier, better.
- Snap-on tools LAST . . . pay for themselves over and over.
- Used and endorsed by America's top-earning mechanics in all fields.
- Start building your Snap-on set with basic units . . . add other tools any time.

Snap-on Tools
THE CHOICE OF BETTER MECHANICS

\$2,000,000 Fish Bowl

(Continued from page 171)

made underwater shots in color, an information plaque beside each of the lighted aquariums tells what speed and exposure to use for various films. Floor markings indicate the distance to the subject, and at the flip of a switch powerful photoflood lights, balanced for both color and black-and-white pictures, make possible perfect exposures without a flash gun.

The Seaquarium boasts another first in that provision has also been made for nighttime operation. With the coming of darkness every corner of the spacious grounds is flooded with carefully controlled light, whether it be the fish tanks, the 2500-car parking lot, the special 750-foot circular viewing channel, the large crustacean pools or the amphitheater where the porpoises perform. Since the Seaquarium accommodates as many as 10,000 visitors daily, an emergency generating system is necessary. With such large crowds, panic might result if the regular service should falter or fail altogether.

Channel for Large Fish

The large viewing channel, 24 feet wide by 8 feet deep, consists of a circular concrete structure that surrounds a picturesque coral island. The island is reached from the perimeter by a series of connecting moats or scanning bridges. Here are kept in captivity such large ocean specimens as sharks, barracuda and rays that are brought directly into the channel via an entrance lock that connects it with the nearby bay and ocean. Past experience has proved this to provide an ideal method for handling large fish; that is, not removing them from the water at all. A shark, for example, has a large liver that remains in safe equilibrium only so long as the fish is submerged; the liver can be harmfully ruptured should the captive be lifted from the surface.

Provision has been made to control the flow of water from 2 to 10 miles per hour in this well-aerated 750-foot millrace. Here may be kept for the first time in captivity such specimens as sailfish, marlin and other deep-water gamesters. Heretofore such species, because they are very swift swimmers and easily excited, have killed themselves by striking the walls, rocks and similar obstructions in conventional confinement tanks. Such obstacles will not exist here and the excitable captives will follow the curving sides of the channel instead and take their exercise against the controlled current.

Westward from the viewing channel is a

65-foot kidney-shaped pool where spectators may have front-row seats in an outdoor theater that features Adolf Frohn, world-famous animal trainer, as he puts his porpoises and trained sea lions through their jumping, balancing, bell-ringing, flag-raising and similar acts.

On the Biscayne Bay side of the Seaquarium island are two interlinking crustacean or tidal pools, low ponds surrounded by native jungle areas that have been landscaped with plants, flowers and vines from all over the Caribbean area. Here one encounters giant clams, lobsters, starfish, trunkfish and tree-climbing robber crabs, many of which have never before been exhibited in their natural habitats.

Two additional pools are kept stocked to capacity with every type of sporting and food fish to be found in Florida waters. Here every child who visits the Seaquarium can catch some of these fish and take them home at no extra charge. Fishing equipment is provided gratis. There's a "no adults" rule here.

Water Is Filtered, Cooled

A complex filter plant insures the fish of water that surpasses in purity requirements even the most-elaborate human swimming pools. Each day the aquarium water is given tests for alkalinity, salinity, turbidity, bacteria count and chemical analysis. In addition, the water is "medicated" to insure that the various finny inhabitants enjoy robust health. One need for such medication is to compensate the fish for loss of protective skin slime as a result of handling and confinement, which can be fatal to the fish.

To avoid danger from a too-high bacteria count in this tropic latitude it became necessary to install a \$265,000 refrigeration plant to cool the water and maintain it at a constant 72 degrees by cooling coils about the intake and filter piping systems.

Located but 15 minutes from downtown Miami via the Rickenbacker Causeway, the costly Seaquarium project was financed by a group of well-known sportsmen. They hope that the aquarium will in time become the property of the taxpayers in the area. Curator Craig Phillips, marine biologist and artist who helped design the Seaquarium, explains that the main object of the huge installation is to encourage the public, particularly students, to become directly acquainted with the myriad fish and other marine specimens that are found throughout the world's waters. Scientifically accurate painted seascapes and the careful use of concealed lighting inside the

(Continued to page 258)

TENSE NERVOUS HEADACHES

call for

STRONGER Yet SAFER ANACIN

Won't Upset The Stomach

Anacin® not only gives stronger, faster relief from pain of headache, but is also safer. Won't upset the stomach and has no bad effects. You see, Anacin is like a doctor's prescription. That is, Anacin contains not just one but a combination of medically proven, active ingredients. Scientific research has proved no single drug can give such strong yet such safe relief as Anacin. Buy Anacin Tablets today!

FREE BOAT KIT CATALOG

8' to 14' Models from \$39.95 incl. freight

- Assemble your own boat
- No experience necessary
- Save 1/2 to 2/3 factory prices



12 ft. Runabout Pictured.

Write: **LUGER INDUSTRIES**, DEPT. B, 4452 NICOLET AVE, MINNEAPOLIS 9, MINN.

NEW! Giant AUTOMOTIVE CATALOG

1956 Edition! Everything for car, truck, custom-styled car, hot rod... at **LOWEST PRICES!** Save up to 50% on all parts, accessories! Only complete automotive buying guide... 60,000 items... 164 pages! Thousands of **hard-to-find parts**; equipment, parts for 1920 to 1956 models; **Holly-wood accessories** never before offered; **hi-speed parts**. Send your name and address and 25c (refundable with first \$5.00 order) to:

J.C. Whitney & Co., 1917 Archer, Dept. P-1, Chicago 16, Ill.



make your own Gems 29.50 F.O.B.

The Gem Maker comes complete with all necessary equipment, including a super-charged diamond blade for sawing, and all wheels for grinding, shaping and polishing; also complete instructions. The complete equipment as shown, less motor and belt, for only \$29.50, f.o.b., Burlington, Wisconsin. Write today for information and literature.

B & I MANUFACTURING CO.
Dept. S Burlington, Wis.



Say You Saw It in Popular Mechanics



INSULATE Right With ZONOLITE®

Says **DANNY KAYE**, star of "THE COURT JESTER" Paramount comedy hit in VistaVision... color by Technicolor

You don't even have to be "handy" to insulate your own home in 4 miraculously short hours with Zonolite vermiculite insulating fill. Pour it, level it, *leave it!* Start saving immediately on fuel bills—Zonolite often pays for itself in two or three seasons. Rotproof, rodent-proof, 100% fireproof. Guaranteed to outlast life of your home. Send coupon today.

DO IT YOURSELF in one afternoon... save up to 40% on fuel bills

Mail This Coupon Today

ZONOLITE COMPANY,
Dept. PM16, 135 S. LaSalle St.
Chicago 3, Illinois

Please rush me how-to-do-it free booklet HI-47 "Safety, Comfort, Savings in Your Home."

Name _____
Address _____
City _____
Zone _____ State _____

as low as

\$67.60

insulates an average attic

NOW ON SALE WHEREVER LUMBER AND BUILDING MATERIALS ARE SOLD

Now! Cover plywood edges with real wood



New Flexible Weldwood® Wood-Trim®

Avoid unsightly edges in building any plywood project—tables, desks, cabinets, etc. Give them a "pro" finish with Weldwood Wood-Trim. So flexible you can beautify any edge—straight, curved, angled. In handy rolls, Wood-Trim is a cinch to apply. No clamps, nails, hot iron, etc. Just use Weldwood Contact Cement or Presto-Set® Glue.

Countless Decorating Uses!

Trim lamp shades with Wood-Trim! Decorate picture frames! Smarten coffee tables, clocks, waste baskets, etc. There's no end to the wonderful ways you can put Wood-Trim to work.

8 ft. rolls 1" wide, 79¢ each.
Oak, African Mahogany, Walnut, Birch, Fir, Korina.



*Trade Mark

UNITED STATES PLYWOOD CORPORATION, N. Y. 36, N. Y.

A NEW YEAR



This year and every year is a New Year of satisfaction when you use a Gerstner Chest. Free catalog.

GERSTNER TOOL CHESTS
456 COLUMBIA ST., DAYTON 7, OHIO

aquariums give the illusion of looking into the distance along the floors of such distant oceans.

Specimens Are Wanted

Specimens are gathered by whatever means prove best suited for the particular quarry involved. Teams of fishermen range throughout the Florida Keys, the nearby Bahama Islands and elsewhere. Often hooks are used, but they are three times normal size to prevent them from being swallowed, thereby injuring the fish internally. Charterboat captains and spearfishermen are encouraged to bring back live specimens for purchase by the Seaquarium.

A tremendous amount of food, both in the live and dead state, must be kept on hand at all times. A 60,000-pound capacity "icebox" provides storage for perishable delicacies, maintaining these at a temperature of five degrees above zero. Many of the fish are vegetarians and eat Irish and sweet potatoes, onions and cabbage.

Curator Phillips recalls with a wry smile that some imported California sea lions snubbed the choice Florida butterfish offered them at mealtime. "They had to have herrings, no less," he says. "And the herrings, in turn, could not weigh more than a half pound each!" ★ ★ ★

Plastic Float for Boat

Boats are made more buoyant by aluminum-covered foam plastic that can be installed under the seats, in the bow and along the sides of a boat like a liner. Odorless and lightweight, it does not absorb water and will not rot or mold. A chunk four feet long, five inches deep and ten inches high, according to the manufacturer, will support four 175-pound men.



Clymer Tests the 300SL

(Continued from page 140)

always certain, even from very low speeds in fourth gear.

To check this unit I wanted both low and high-altitude tests. At Salton Sea I was 246 feet below sea level and near Lake Arrowhead at El Cajon Pass in the San Bernardino Mountains, the altitude was 4301 feet above sea level. The injector system worked equally well within these altitude ranges.

The engine is mounted in the chassis at an angle (the cylinders are placed in about the same position as one bank of a conventional V8) to permit the use of a lower hood. The body is actually only 51 inches high.

The handling qualities of the car at high speeds, over rough roads and around corners are terrific. There is but little exhaust or wind noise at high speeds and little body rumble. Acceleration is extremely fast and there is a feeling of safety in the car even at high speeds. The car I used was not specially prepared for the test yet it proved to be very fast. The speedometer needle hit 150 miles per hour on speed runs.

The SL is a car that must be really driven to enjoy its unique qualities. By that I mean it is necessary to do considerable gear-shifting to keep engine speed up to the most efficient point for top performance. In many ways, driving it can be compared to the thrill of riding a powerful scrambles-model motorcycle because of its lively performance and quick response to steering.

The test car had a rear-axle ratio of 3.25:1, the highest of the optional gear ratios, the others being 3.42:1, 3.64:1, 3.89:1 and 4.11:1. The 3.64 axle is stock and the most popular for ordinary use. With the 3.25 axle, Mercedes claims 161-mile-per-hour speed and, with proper tuning and road conditions, it is undoubtedly possible. It does 100 easily at 5200 revolutions per minute in third gear. In fourth gear it loafs at 110. The car's top speed almost seems limited only by highway and traffic conditions and not by mechanical factors.

The fuel consumption is surprisingly low, considering the high-performance engine. Oil consumption was approximately 300 miles per quart. There is an oil radiator to keep temperature down in hot weather—an excellent feature.

The car steers hard, due to the fast steering ratio (two wheel turns from lock to lock). This is desirable for high-speed driving and cornering. Double-acting dampers are used on all wheels and the steering gear

(Continued to page 260)

**BUILD
IT
YOURSELF**



MODEL BR-2

\$1750 (Less Cabinet)
SHPG. WT. 10 LBS.

Heathkit
**BROADCAST BAND
RECEIVER KIT**

Have you ever experienced the thrill of building your own radio? Invest a few of your dollars—a few hours of your time, and build a truly worthwhile broadcast band receiver. Transformer operation eliminates potential shock hazard characteristic of "economy" AC-DC sets. Operates as radio, phono, amplifier, or tuner. Fine tone quality, excellent sensitivity. Simplified Construction Manual outlines basic theory of radio principles. Actually a radio course in itself. Price includes tubes—speaker—chassis, etc. Every part you need! Order your Heathkit Radio Kit today.

OTHER "BUILD IT YOURSELF" Heathkits

- | | |
|-------------------------|----------------------|
| Oscilloscope | Hi-Fi Preamplifier |
| Vacuum Tube Voltmeter | Battery Eliminator |
| Signal Generator | Signal Tracer |
| Amateur Transmitter | Tube Checker |
| Communications Receiver | (and over 50 others) |
| Multimeter | |
| Handitester | |
| Hi-Fi Amplifier | |

**WRITE FOR
FREE CATALOG**



HEATH COMPANY
A Subsidiary of Daystrom, Inc.
BENTON HARBOR 17, MICH.

STOP SAGGING REARS!



with
LOW-COST

AIR LIFT PNEUMATIC SPRING BOOSTERS

Car got that "middle age spread" look? Even new cars need help for overloads of luggage, equipment or extra passengers. AIR LIFTS fit between leaf springs and frame — inflate with air to support overloads up to 1000 lbs! Perfect for vacation trips, and so easy to install. See your dealer or write for his name.

Most Models
\$20



FREE! . . . tip-packed literature on Air Lift remedies for sagging rears. Write Dept. 41.



AIR LIFT COMPANY,
LANSING, MICHIGAN

**MACHINE TOOL RECONDITIONING
& THE ART OF HAND SCRAPING (2nd printing)**
—USEFUL FOR DESIGN, SHOP & INSPECTION WORK—
SEND FOR FOLDER DESCRIBING ILLUSTRATED BOOK
MACHINE TOOL PUBLICATIONS, 382 Kelly Ave., St. Paul 2, Minn.

ONE-MAN SAWMILL LOW \$50.00 AS... DOWN

Take BELSAW Portable Sawmill right to the trees—turn out valuable lumber for home and farm—sell to local yards—make up to \$50 a day custom sawing for neighbors. BELSAW lasts a lifetime. No crew needed. Power with tractor or auto engine. Beginners get excellent results. Send today for **FREE BOOK**.
BELSAW MACHINERY CO
P.O. 3456 Field Bldg. Kansas City 11, Missouri

Say You Saw It in Popular Mechanics

**DRILL • SAW • REAM • CUT
ALL WITH ONE BIT!**
BEAVER Hi-Speed Saw DRILL BIT

**ONLY \$2.45 each
3 for \$7.00
POSTPAID**

Beaver's new improved high speed side cutting drill bit can be used on any electric drill, drill press, lathe or milling machine. Made from the finest American high speed steel. 3 1/2" long. 2" side cutting section. 1/4" diameter. Designed to cut steel, wood, plastic, aluminum, etc. A versatile time-saving tool for EVERYONE. Money back guarantee! Three types available: All-Purpose, Wood and Heavy Metal—specify type desired. Buy them from your dealer today! Or send cash, check or money order NOW.
SET OF 3 MAKES AN IDEAL GIFT.
Dealer inquiries invited.

BEAVER DRILL & TOOL COMPANY
3008B McGee Trafficway Kansas City 8, Missouri

Red Devil



**PUTTY KNIVES
WALL SCRAPERS
SPACHTLING
KNIVES**

Top-quality professionally-styled at prices to suit your pocket-book. High carbon, tempered steel blades—imported hardwood or tenite handles.

FREE How to Fix Broken Windows. Illustrated instructions on cutting and replacing window panes.

Red Devil Tools, Dept. 140
130 Coit Street, Irvington, N. J.

Please send **FREE** copy of "HOW TO FIX BROKEN WINDOWS."

NAME _____
ADDRESS _____
CITY _____ ZONE _____ STATE _____

has a hydraulic shock damper. The car corners as though it were mounted on steel rails except when over-sliding. Even in a four-wheel slide the car retains its maneuverability and the driver has a feeling of unusually good control. There is very little roll and no softness when cornering. Rear suspension uses coil springs with swinging half axles. Front suspension is by independent coil springs with wishbones. There is a front antiroll bar. Of course, a feature that is vital to the road-holding qualities is the low center of gravity.

Brakes are hydraulically operated with a vacuum servo assist for easy pedal operation. The drums are aluminum with cast-iron liners and radial vanes to assist in heat dissipation. The brake shoes are aluminum and self-adjusting. This car has the excellent brakes that are necessary with such high performance. I found them very efficient, with little evidence of fading at any speed or under any conditions. The hand brake is on the left side of the driver's seat and is applied by an upward pull. There is a wing nut for adjustments that become necessary because of lining wear.

Doors are hinged at the top and open upward. Entry and exit are inconvenient, especially for a woman. But, after all, the 300SL is supposed to be a competition car and this feature does not bother the sports-car enthusiast—in fact, many like it. The steering wheel folds down to permit easier entry. The doors are counterbalanced, lift up and pull down easily once unlatched. Door handles fold into the body and thumb pushing is required to flip out the recessed lever, which is then pulled to open the door. A double hand movement is necessary to accomplish this—it is not a good arrangement.

The seating position is extremely comfortable and the vision is good. The low, sloping hood gives fine vision directly forward. The driver and passenger have the feeling of sitting in an airplane cockpit, rather than in an automobile, as the instrument panel is loaded with instruments and knobs of every kind. Well-located directly in front of the driver are the 180-mile-per-hour speedometer and tachometer, which the sports-car enthusiast uses to advantage, especially in competition. To the driver's left is an ignition-control button to advance or retard timing to match fuel octaves, a fuel gauge for the 32-gallon gas tank located under the rear deck and an oil-pressure gauge.

Also on the dash are a water-temperature gauge, oil-temperature gauge, clock, a button to control a rear-mounted fuel pump, which is sometimes used at high speed and is also used to place the 2.3-gal-

lon gas reserve in operation. There are two horn buttons, one in the center of the steering wheel and one at the right for the use of the passenger, cigarette lighter, excellent two-speed windshield wipers, heater and levers to control the inside ventilation on either side. The ventilating system is designed for draft-free ventilation. A slot above the rear window exhausts stale air as you drive. Fresh air comes in through the port ducts. The passenger can smoke in the car with all windows closed and the driver won't be bothered as the smoke is exhausted through the rear slot. While the ventilating system is suitable when the car is moving, it is almost a bake oven in hot weather. The door windows can be entirely removed if desired. There are hinged glass wings at the door fronts.

Mounted on top of the instrument panel is a removable ash tray. The rear-view mirror has considerable vibration and the glass was somewhat distorted. Directly above the mirror is a dome light which turns on when a covering shield is opened—a nice arrangement. The turn-indicator lever is on the right (wrong side to suit Americans). It is mounted on the steering column below the wheel and is not self-canceling. It must be pushed back to non-flashing position after cornering.

Foot pedals are small and the throttle pedal could be higher or the brake pedal lower for more-convenient operation. Only light pedal pressure is required for brake operation. The clutch is rough, rugged and has extremely heavy springs, necessary for the power that the engine develops and the abuse that the car usually gets. As a result, pedal pressure is heavy—so heavy in fact, that constant operation in traffic is tiring. It should have additional power-assist for easier operation.

The four-speed transmission is synchromesh and there is no clashing of gears when changing. The transmission is of excellent construction designed for abuse and quick shifting, but in first, second and third speeds the gears are noisy. These noises are annoying to the novice but, again, the sports-car enthusiast thinks nothing of them. There is a slight hum when cruising in fourth gear but with it is a feeling that only the sports-car fan enjoys. It is a feeling of mastery of a car that has power, speed, strength and durability.

The bumpers, as on most foreign cars, are narrow and do not afford enough protection for parking. Quite often when foreign cars are bumped or pushed when parking, the massive bumpers used on American cars are apt to slide above the small bumpers and do damage to the body. ★ ★ ★

DO MORE PLANING JOBS WITH LOW COST BELSAW

Exclusive **MONEY-MAKING** features:



- Full 12 1/4 in. x 6 in. capacity
- Power feeds at 24 ft. a minute. (Easily adjusted for lower feed rate)
- Machined cast iron bed; adjustable rolls, total bed length 42 in.
- Provides for Grinding Knives in the Cutterhead.
- Attachments for Jointing, Rabbeting, Tongue, Groove, Matching.

Belsaw Multi-Duty Planer for cabinet shops, builders, lumber yards, woodworking plants and spare time work shops... Now you can convert low cost rough and random size lumber into high priced cabinet finished stock... Easy to make flooring and popular patterns. Belsaw quickly returns cost with savings on raw material... profits on finished stock.

Send Today for **FREE** literature on Belsaw, the **LOW COST**, high speed production planer.

BELSAW MACHINERY CO

2056 Field Bldg • Kansas City 11, Missouri

**LOW DOWN
PAYMENT
EASY
TERMS**

24-Page Illustrated DO-IT-YOURSELF PROJECTS BOOK

Describes attic finishing, built-in cabinets, add-a-room, recreation room, kitchen remodeling, summer cottage and farm projects. Helpful information on how to get started, planning, cost estimating, materials purchasing, proper procedures, nail charts, moulding designs, etc. Send 25c and also receive 52-PAGE POWER TOOL CATALOG.

BOICE-CRANE CO., 943 Central - Toledo 6, Ohio



GEARS

In Stock - Immediate Delivery

Gears, speed reducers, sprockets, thrust bearings, flexible couplings, pulleys, etc. A complete line is carried in our Chicago stock. Can also quote on special gears of any kind. Send in your blueprints and inquiries.

Send for **Complete Catalog No. 10**

CHICAGO GEAR WORKS
440-50 N. Oakley Blvd., CHICAGO 12, ILL.

VARIABLE SPEED HYDRAULIC POWER TRANSMISSION



It has Infinite Speeds 0 to 550, Reverse, Automatic Overload Protection; Adjustable Torque up to 180 inch pounds, 5/8" input and Output Shafts. It will handle 1/2 to 1 1/2 H.P. Motor. Case measures 7 1/2" long, 7" high, 6 1/2" wide. **VALUE OVER \$300.** Shipping Wt. **\$54.50**
25% On C.O.D. Orders only
we require a 10% Deposit. Fab. Chicago

DIRZIUS MACHINE SHOP "J" 1423-25 So. 52nd Ave., Cicero 50, Ill.

Say You Saw It in Popular Mechanics

INTERNATIONAL DRILL-SAW



NEW LOW PRICE

REAM • CUT

DRILL, SAW, REAM... metal, pipe, wood, plastic, Transite, etc. Use with electric drill, slow drill press, lathe, milling machine. Drills own starting hole, upper part of bit is used to cut, saw, ream circles, ovals, squares, scrolls. Easy to use. Ideal for carpenters, mechanics, electricians, plumbers, hobbyists, etc. Abrasive resistant, high speed steel. Flutes ground from solid. Withstands severe continuous use without breaking. Resharpens free. Takes place of up to \$50.00 in tools. 1" diameter, 2" cutting sections, total length 3 1/2". Three types—All purpose, Wood, Heavy Metal. Specify type needed. Set of three \$8.50. Details on request. Shipped same day. Money-back guarantee. Dealer inquiries invited. Order Now. Send Cash, Check or Money Order to

\$2.95
POST PAID
3 for \$8.50

INTERNATIONAL TWIST DRILL CORP. 418 Wyandotte, Rm. 640
Kansas City 4, Mo.

NOW AN OIL THAT
**ACTUALLY CUTS ENGINE
WEAR.. REDUCES REPAIR
BILLS.. GIVES YOU MORE
MILES PER GALLON!**
LUBRI-LOY
THE MIRACLE CONCENTRATED OIL



ADD ONE QUART in your crankcase now... (and with each oil change)

At service stations, garages and new car dealers

The Miracle Concentrated Oil. Lubri-Loy is not an "ordinary" oil. It contains a remarkable blend of ingredients that make your motor sing with new power. It's guaranteed to give you a quieter, better running engine and more miles per gallon of gas...or your money back!

LESS GAS.. MORE GO
THE LUBRI-LOY COMPANY,
6319 Wilson Avenue, Saint Louis 10, Mo.

QUALITY UNSURPASSED—
PERFORMANCE UNEQUALLED

Yet Cost No More Than
Ordinary Screwdrivers?

HOLD-E-ZEE
The Original **AUTOMATIC GRIP**
SCREWDRIVERS

Much Wanted
Special Features

EXCLUSIVE
LOK-BLOK

Makes Blade
Twist & Impact
Proof

AT ALL
LEADING
DEALERS

UPSON BROS., INC., ROCHESTER 14, N.Y.

Owners Report on the Mercedes-Benz 300SL

(Continued from page 144)

two weeks awaiting mechanic from Mercedes to repair fuel-injection system, as it is out of service today."—Nevada surgeon.

Other less-common complaints are described in the following quotations, listed in order of frequency of mention:

"Race venting of the brakes provides a hazard on wet days as the car is often without brakes and requires maximum downshifting for stopping. It is also difficult to stop the car when the engine stalls."—California owner.

"Gearbox is noisy compared to the very pleasant quiet engine."—New York owner.

"Excessive noise when rear-axle differential starts to work."—California owner.

"Naturally I don't care for the method of getting in, the way the windows operate and the high-pitched sing of the racing tires. But I realize these are essential to the outstanding performance of the car."—Illinois retired banker.

"Both doors leak in the rain."—New York banker.

"Poor ventilation in summer in the rain. Windows are either full in or full out. All windows leak."—Wisconsin executive.

"Windows are awkward at toll gates."—New York financial man.

"Inconvenient to get out and open trunk lid at each fuel stop."—California owner. (Note: The gasoline tank is located inside the trunk, which has to be opened for access to the filler pipe. However, the tank holds 34 gallons and, at 20 miles per gallon, requires a refill only every 680 miles.)

"Rear bumper unsatisfactory. It is made of two pieces, is too weak and much too near the body."—California owner.

"Turn signals not self-canceling. Dash

Dashboard of the 300SL is businesslike. The hinged steering wheel makes it easier to get into the seat



lights have no dimming rheostat. Steers like a truck."—Pennsylvania contractor.

Probably the most backhanded compliment handed out by a 300SL owner is this one from a Nevada doctor:

"My complaint is that there are too many people who want to inspect the car. I am pestered with questions. Whenever it is parked, people gather around."

Best-Liked Features

Outstanding performance is the best-liked feature of the 300SL, say the owners.

"I have driven up to 130 miles per hour, but have not yet tried for top speed."—Ohio manufacturer.

SPECIFICATIONS

ENGINE

Type	6-cylinder, single overhead camshaft
Bore and stroke	3.346 x 3.465 inches
Displacement	182.8
Compression ratio	8.55:1
Horsepower	240 at 6100
Maximum engine speed	6400 r.p.m.

GENERAL

Steering-wheel turns (lock to lock)	2 turns
Turning circle	38 feet
Brakes	Hydraulic with vacuum booster
Curb weight	2849 pounds
With load as tested	3200 pounds
Weight distribution	
front	52%
rear	48%
Wheelbase	94.48 inches
Suspension	
front	Independent, with coil springs and wishbones
rear	Independent, coil springs and swinging half axles
Ground clearance	5.1 inches
Width	70.5 inches
Height (unloaded)	51.2 inches
Length	178.0 inches

CAPACITIES

Gasoline tank	34 gallons
Water capacity	16.5 quarts
Oil	Including oil tank: 4 gallons

"No other car is as docile in traffic or as strong at the top end. In Nevada there is ample room to let it out. I have averaged 108 miles per hour for 4 hours."—Nevada restaurant owner.

"It will go as slow as 12 miles per hour in high and is still accelerating at 135 miles per hour."—Pennsylvania executive.

"I have challenged the field to this race: Follow me from Thompson raceway to Springfield, Mass., in heavy traffic on a hot day. Park and then load cars with groceries, luggage. Drive back with long waits in traffic. Then, without adding oil, water or fuel, race for 30 laps. Nobody accepts this challenge because no other car could do it. The 300SL is the only dual-purpose

(Continued to page 264)

SHOP BY MAIL AND
SAVE
at GROBAN'S

SURPLUS & NEW MANUFACTURE
FOR HOME, FARM AND FACTORY EQUIPMENT

ALL
ITEMS
Unconditionally
GUARANTEED!

SAVE \$30.30 ON THIS PESCO

HYDRAULIC CONTROL VALVE

ITEM #371V



FOR SAFE POSITIVE CONTROL OF HYDRAULIC CYLINDERS AND MOTORS

— BUILT-IN RELIEF VALVE — factory set at 1200 P.S.I. — FOUR-WAY VALVE — to operate one double acting cylinder — OPEN CENTER — with valve in neutral, cylinder is locked in position and pump is unloaded. — SPRING RETURN TO NEUTRAL — FULLY BALANCED PLUNGER — EASILY STACKED INTO 2, 3, or 4 valve combinations for multiple cylinder operation. — 8 gpm. per min. capacity, at 1500 P.S.I. — 3/4" pipe ports — CONNECT PUSH RODS TO HANDLE FOR REMOTE CONTROL — EASY MOUNTING. — LIST PRICE — \$46.80. — YOU SAVE \$30.30. — DIMENSIONS — 1 1/2" x 4 1/2" x 2 1/2" — SHIP. WT. 6 lbs. F.O.B. Chicago. **16.50**

PESCO GEAR TYPE

HYDRAULIC PUMP

Compact — Powerful — Reliable



ITEM #180 — Especially designed for belt drive from fan belt, power take-off, drive pulley, electric motor or small gas engine. Equally suitable for direct coupling.

Pedestal type mounting with two bolt holes for 3/4" hold-down bolts. Standard 1/2" pipe thread inlet and outlet ports. Delivers 4.5 GPM at 1000 PSI at 2800 RPM with 4 HP. Hardened steel gears turn in dense oilite bronze bearings. Rotation — clockwise facing shaft. Guaranteed trouble-free service. Ship. wt. 6 lbs. F.O.B. Chicago. **22.50**

DOUBLE ACTION HYDRAULIC CYLINDERS

ITEM #31C — 3 1/2" bore, 1 1/2" stroke. Alloy steel cylinder wall. Micro-Honed and all steel 1 1/2" diameter piston rod. 19 1/2" overall length closed. Clevis mounting at base and shaft. Will lift 625 lbs. with 1000 PSI Pump Pressure. Uses 3/4" tubing fittings. (Fittings to pipe thread; two 3/8" MPT @ 35c.) A \$102.00



value, shipping weight 11 lbs. FOB Chicago. **25.00**

ITEM #16C — 1 1/2" bore, 20" stroke. Will lift 1760 lbs. with 1000 lbs. pump pressure. Great for hay loaders, etc. 1 1/2" stainless steel piston rod. Postpaid. **16.95**

ITEM No. 33C — 1 1/2" bore, 4 1/2" stroke, alloy steel barrel, aluminum alloy ends, clevis mounting at both ends, lifting capacity 1760 lbs. in approximately 1/2 second using 1000 P.S.I., overall length closed 15 1/2", has 2 — 1/4" pipe thread ports. Postpaid. **8.95**

ORDER DIRECT FROM AD SATISFACTION GUARANTEED
Send Payment Or Purchase Order Today
For Phone Orders call Webster 8-3793

FREE! — NEW CATALOG
1956 EDITION, 52 PAGES, chock-full of unsurpassed War Surplus Equipment Bargains for farm, home, factory, workshop. Write letter today.

FACTORY-TO-YOU-VALUE
PORTABLE ELECTRIC LIGHT PLANTS



BRAND NEW 1956

ITEM #1008

POWER TO OPERATE:
• Electric Saw, Electric Drills, Pipe Bender.
• Refrigerator, Deep Freezer, Incubator.
• Water Pump, Radio, Lights, Air-conditioner.

COMPACT — FITS IN THE TRUNK OF YOUR CAR
1000 WATTS OUTPUT, continuous duty. 115 Volts A.C. 60 cycles, 9 amps. Powered by husky, easy starting Clinton engine. Engine and generator operate at 3600 R.P.M. for maximum efficiency at minimum weight. Both units are mounted on steel base, with heavy sheet metal belt guard. Generator is self regulating, and is equipped with outlet box containing fuse and 2 A.C. convenience receptacles. Cost only 5c an hour to operate. Dimensions: Length 20 1/2", Width 12", Height 16". Shipping wt. 100 lbs. F.O.B. Chicago. **149.50**

700 WATT-GENERATOR SET — same as above, slightly smaller — with Briggs-Stratton Engine — Model 708 — F.O.B. Chicago. **129.50**

GROBAN **HYDRAULIC SPEED REDUCER**



CONTROL HANDLE
REVERSE ROTATION
FILLER PLUG
INPUT SHAFT
CONTROL LOCK

with FINGERTIP CONTROL

USE FOR: • Reamer Drives • Midget Cars • Feed Mills • Canning Machines • Conveyors • Lathes • Milling Machines • Motor Boats • Cream Separators • Garden Tractors • Pumps.

Variable output speeds from 0 to input speed available by moving control handle. Locking handle maintains setting. Use input power of 1/4 to 1 1/2 H.P. Shafts 5/8" diam. Input rotation counter-clockwise facing shaft. Input speed 750 R.P.M. 7 1/4" x 7 1/2" x 1 1/2". Govt acquisition cost \$428.00. Ship. wt. 31 lbs. Complete with 2 qts. of oil and full instructions. F.O.B. Chicago. **54.50**

U. S. NAVY ALL BRONZE CENTRIFUGAL PUMP

These all bronze Centrifugal Pumps are ideal for use as marine bilge pumps, circulating pumps, fire protection or irrigation, car-washing, watering, basement sump pumping, lawn sprinkling. Will pump water, oil, brine, gasoline, DDT and sulphur compounds. Equipped with 6" adjustable "V" pulley, 2" dia. inlet and outlet, 180 GPM capacity. Inlet and outlet take hose with 2 1/4" inside diameter. Dimensions 11" x 8" x 11".

Total head-feet	Speed	H.P.	GPM
25	3600 RPM	3	180
35	3000 RPM	1 1/2	90
20	2400 RPM	1 1/4	75

Back plate may be rotated for most convenient inlet position. Shipping weight 31 lbs. Govt. cost \$29.50. \$6.00. F.O.B. Chicago. **29.50**



ITEM #384

TORQUE AMPLIFIER

An ideal unit for close control torque boosting of rotating device requiring instant start, stop, and reversing. A small amount of power applied to the input shaft is reproduced at the output shaft with greatly multiplied torque. Speed and direction of the output shaft vary directly with speed and direction of the input. The Torque Amplifier is powered by a 1/40 H.P. three phase, 115 volt, 60 cycle motor. The motor may be run on 115 volt single phase merely by adding a starting capacitor. Power is transmitted from the motor through reduction gears, and is controlled by two carbon disc clutches. The gearbox is totally enclosed in an aluminum case. Dimensions: 12" H, 5 3/4" W, 7 1/2" D. Weight 23 Lbs. Ship. Wt. 30 Lbs. **12.95** F.O.B. Chicago.

ITEM #209

SELF-PRIMING ROTARY PUMP

Item #104A — A fine pump for gasoline, fuel oil, water, kerosene. For fuel transfer, sump pumping, for draining basements. Capacity, 400 gallons per hour. 3/4" pipe thread inlet and outlet. Has built-in, adjustable relief valve, set at 30 P.S.I. Adjustable to 100 P.S.I. Rotation in either direction; use 1/4 Hp. motor; 1/2" standard shaft, ball-bearing supported. Dimensions: 5 1/2" x 3 1/2" x 10". Shipping weight 8 lbs. A \$55.00 VALU. F.O.B. Chicago. **16.50**



BRAND NEW 1 H.P. 12 Volt Electric Motor

• For electric wheel chairs (Pop. Mech. design—Mar.—1953)
• For electric golf carts
• For self-propelled scooters, children's mid-cool cars.

Rated 1 H.P., — 100 amps, 5600 R.P.M., 12 volts, D.C. — This double shaft motor of ball-bearing construction may be run on 6 volts for lower horsepower requirements. — Standard 3/4" shafts, nut and bolt electrical terminals. Flange mounting — Dimensions: 8" x 4 1/2" x 4 1/2". Ship. wt. 19 lbs. A real value at..... **12.50** F.O.B. Chicago



BELT DRIVEN A. C. GENERATORS

Ideal for powering electric tools, oil burner, refrigerator, lights, or other appliances requiring up to 700 watts of power. 700 WATTS. 115 Volts, 60 cycles A.C. 3600 R.P.M. Compact, self-regulating generator with V Belt pulley and double outlet receptacle. Rotation counterclockwise. May be driven by tractor or auxiliary gasoline engine. Requires 2 HP minimum. Dimensions: 10" long x 8" high x 6" wide. Shipping wt. 27 lbs. F.O.B. Chicago. **59.50**



Model 1010 — 1000 WATTS (Same as above) F.O.B. Chicago. **79.50**

SELF-PRIMING HAND FLUID PUMP WITH STRAINER

ITEM #129 — Type D-2 — May be used as a boat bailing pump, sump pump, barrel pump, fuel transfer pump, for water, oil, gasoline, insecticides, etc. Bronze and aluminum construction, 3/4 in. pipe thread ports. Fine general utility hand pump. Capacity — 300 Gal. per hr. Ship. wt. 6 lbs. F.O.B. Chicago. **11.95**



OVERLOAD SPRINGS
\$9.95 Per Pair Postpaid
2,000 lb. Size \$11.95
For cars and trucks. Front and rear. Gives 2,000 lbs. extra capacity for all 1/2, 3/4, and 1 ton trucks, 500 or 1,000 lbs. extra for all cars. Easily installed. Guaranteed. State make, model. Dealers wanted. BRINKMAN MFG. CO. 2315 CLAY, DEPT. 15-J, TOPEKA, KAN.

ONE POWER TOOL for DOZENS of JOBS

IDEAL "DO-IT-YOURSELF" AID
The FOREDOM FLEXIBLE SHAFT MACHINE, saves money, provides unending fun. Professionally used over 30 years. Pencil-size handpiece reaches tight spots, keeps work in view for superior results.
USES: Grind, polish, drill, mill, saw, cut, clean, carve, rout, sand, etch, engrave, etc. Free Catalog 34 shows machines & over 140 accessories.
FOREDOM ELECTRIC CO. Dept. H34A, 27 Park Pl., N.Y. 7, N.Y.



sports car in the world today."—Connecticut owner.

The car's wonderful handling characteristics are second on the list of best-liked features.

"I like best the driving pleasure."—Arizona retired owner.

"I drive a lot and enjoy taking my hobby with me."—Connecticut executive.

"Drives fine. Haven't enjoyed a car as much since I owned a Cord in 1932."—Michigan manufacturer.

Roadability is the third-best-liked feature, say the owners.

"Pickup is really incredible, but what impresses me most is the way it sits down as though on railroad tracks at high speed."—New York photographer.

"Drove 400 miles through 5 inches of snow. It went through as easily as a truck. I was worried because of low clearance, but could drive off road into deep snow and back out with no trouble. Drove on ice and sleet for 300 miles. Could slide with no worries. It has a good solid feel."—Michigan owner.

Fourth on the list is comfort. Next is the pleasure of high-speed touring.

"Riding qualities are as good if not better than any American production car. Ride in one for more than 10 straight hours and see. It is really terrific."—New York executive.

"The ultimate in high-speed cross-country driving where too much baggage does not have to be carried."—Colorado rancher.

"Extremely comfortable in driving on long trips. Noise level at high speeds is at very minimum. Mileage is excellent—17 miles per gallon at 110 miles per hour."—Nevada investment banker.

"Have just returned from a 5000-mile trip with my wife through the West. Whenever the opportunity arose we would cruise at more than 80 miles per hour. One hour's run through Nevada we averaged 101.5 miles per hour. At all times we felt that we were not being reckless or careless as we have four small children. The sense of security in all types of driving is incomparable."—California oilman.

Here are the other best-liked features, listed in order of frequency of mention:

"Styling will look modern for years to come."—Nevada dairy processor.

"Brakes are best feature. Give feeling of absolute control."—California owner.

"This car is strictly for people who like to drive. For them, it surpasses anything that I have ever seen or driven."—Illinois executive.

"Extremely well made. The acme of German know-how."—Ohio physician.

"Simplified and functional design makes

it easy to work on. Every item on the car has some function."—California aeronautical engineer.

What Changes?

As you have no doubt noticed, the 300SL owners are a happy group. But they do have just a few changes to suggest. Here they are in order:

"Should have adjustable steering column. Wheel is too far away from driver."—Illinois retired owner.

"Improve method of getting in and out."—Nevada owner.

"Make another model with a folding cloth top."—Virginia quarry owner.

"For those who don't race, a 20-gallon gas tank would be better. Say 10 gallons in each rear fender so you could have some space in the trunk for luggage."—Missouri owner.

"Put gas-filler pipe outside to eliminate occasional gasoline fumes in passenger compartment."—New York owner.

"Add a glove compartment."—New Jersey manufacturer.

"I have no complaints about the car but would like a better and clearer instruction book for people who love, understand and like to care for their cars themselves. This car is, in my opinion, out of this world."—Pennsylvania car enthusiast.

"Add Zeus fasteners to belly pans."—California mechanic.

"Better headlights. Present lights are inadequate for high-speed driving."—Tennessee executive.

"Install a small jump seat for the kids as on the XK140 Jag."—Nevada doctor.

There you have it. That is what the owners think about one of the world's outstanding automobiles. To find out what Floyd Clymer thinks about the car read the test report that begins on page 140. ★ ★ ★

Tooth Freezing

Dentists using an experimental device developed in France are actually freezing mouth tissue to prevent pain during drilling. Increasingly colder air is directed at the mouth tissue until a temperature of 33.8 degrees Fahrenheit is reached and the area is anesthetized. The method may be used in cases where the dental patient cannot tolerate the conventional local anesthetics. When 100 persons were given the mouth-freezing treatment at the Naval Dental School, Bethesda, Md., 94 reported little or no discomfort from having cavities filled. The other six who reported pain had cavities mainly involving wisdom teeth, which are not easily accessible.

Dry-Always ready Fast-Always steady

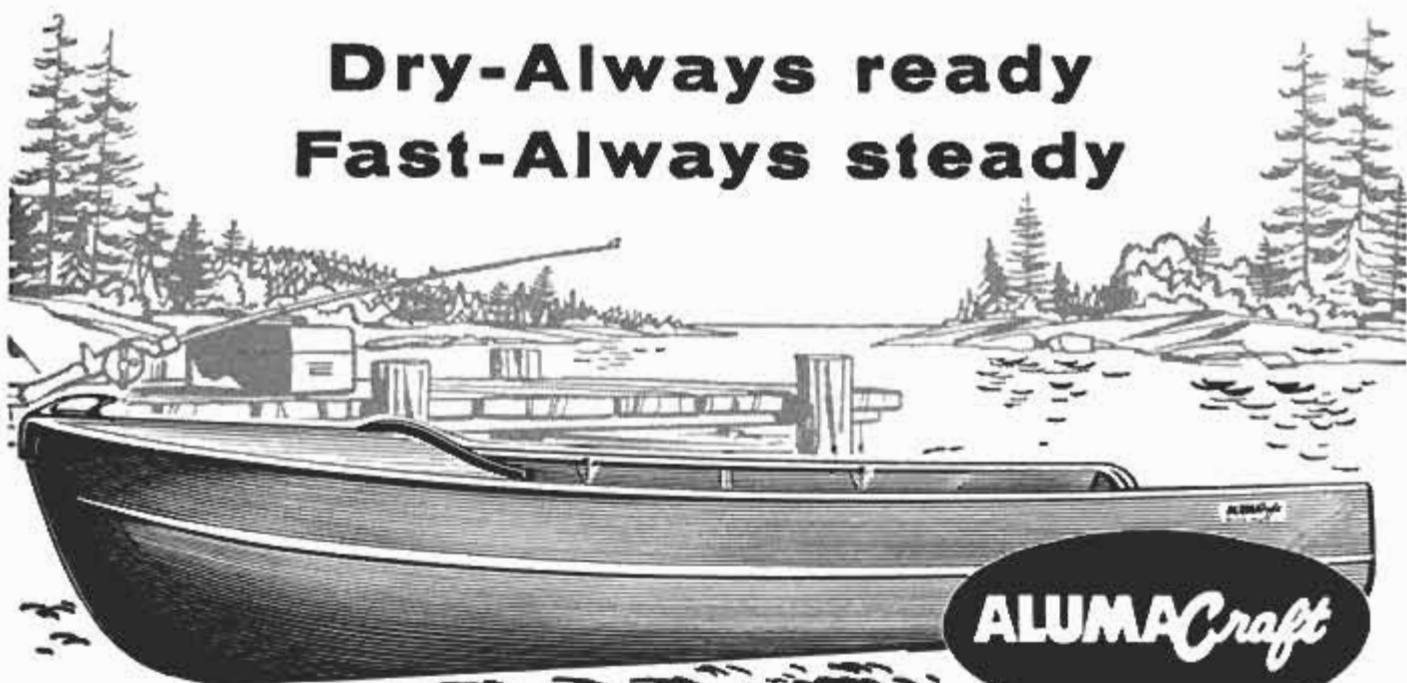

ALUMACraft

Genuine Erich Swenson designs assure easy planing... top speeds... smooth performance... stable ride. Fine Aluma Craft construction assures extra strength... positive flotation... long life. Always ready... no work... no painting. Never soaks up water... never dries out and leaks. Easy to own on easy terms. Select from 18 models, the right boat or canoe for your use.



See your dealer or send for beautiful, full color catalog.

ALUMA CRAFT BOAT COMPANY

2625 27th Avenue South, Minneapolis, Minnesota

RIDE WHILE YOU MOW



Take it easy with the **SPRINGFIELD RIDING LAWN TRACTOR**. Cut on slopes. Forward and reverse. Mows weeds or grass. Snow blade, roller, cart, leaf pulverizer, aerator attachments available. **FREE CATALOG.**

Quick Manufacturing Inc.
3257 E. Main St., Springfield, Ohio



ROAD TO RICHES

You can be the next uranium millionaire! Government guarantees huge bonus! PRI Instruments from \$29.95. See your local dealer today! **FREE CATALOG!** Write PRI, 4223 PM W. Jefferson Los Angeles 16, California



Insist on **Evans** TAPES
POCKET SIZE
At Your Hardware Store

6, 8, 10, 12-ft.
lengths

from **98¢**

with **FREE**
plastic utility
case.



Self-adjusting sliding hook starts you at zero for accurate inside or outside measuring.

RENT-A-SANDER On New "RENT FEE REFUNDED" PLAN

FOR YOUR NEXT HOME JOB!



Syncro offers you a new easy, attractive way to get your next sanding job done right without buying a sander—with privilege of returning it for full Rental Fee Refund! **DO THIS:** (1) **SEND NO MONEY**—send coupon, tool dealer name, address—we'll ship No. 900 Sander, Sanding Handbook, sandpapers to you. (2) Pay postman \$20 (10 days rental fee), COD fee, postage charge, on arrival. (3) Use sander 10 days, return it prepaid—we'll refund your \$20 promptly. (4) To buy it, pay dealer (named on coupon) balance of \$19.95. Send us receipt of purchase from dealer, we'll ship you \$3 worth of sandpapers as our Gift!

WHY THIS LIBERAL OFFER?

Because we want you to try America's finest heavy-duty portable! Outsands others. Jump-free. Exclusive Multi-Motion. Costs only \$39.95. You don't risk a cent of your 10 day Rental Fee! (Normal dealer rent \$2.00 per day.) Dealers write! **OFFER EXPIRES JULY 1, 1956.**



Don't buy trouble—buy

SYNCR

SEND NO MONEY—JUST COUPON!

SANDERS

SYNCR CORPORATION, Dept. 1-16, Oxford, Michigan

Send Syncro #900 Sander COD on 10 Day Rental Offer. I will pay postman \$20 plus COD Fee, few cents postage—on delivery. I may return Sander prepaid to factory only within 10 days after Rental Period for prompt refund! OR I may pay dealer direct (named below) balance of \$19.95 and I will own sander.

HARDWARE STORE NAME: _____

ADDRESS: _____

MY NAME: _____

ST. & NO. _____

CITY _____

ZONE STATE _____

(Offer Good Only In Continental U.S.A.)

SAY YOU SAW IT IN POPULAR MECHANICS

Winter is the Best Time for Fishing

(Continued from page 128)

blame—or credit—for fishing derbies. Back in 1947 Perry Dotson, former St. Paul newspaperman and general overseer and publicist for the winter carnival, was casting about for an idea that would have mass-participation appeal. The big parade was fine, but after that the events were specialized. He wanted something that anyone from 8 to 80 could join.

"Why not an ice-fishing contest," we asked.

"That's fine," said Dotson, "and you're now the chairman."

Some of the more conservative leaders of the carnival either laughed the idea off as a joke or took a dim view. Their greatest fear, and mine too, was the safety of the event when it became apparent that there would be not just a few hundred out on a Sunday morning, but thousands.

The district Army Engineers' office in St. Paul had some tables showing the safety of ice. As little as two inches would support a man. Sixteen inches would support a heavy vehicle. But what of hundreds of vehicles, or thousands? That never had been done, although old-timers in the north logging country had hauled sleds weighing tons across the ice.

With the aid of veteran game warden John Salvator and Harold Leich and others of the White Bear Rod and Gun Club, the event was whipped together.

It was amazingly successful and aerial photos of the ice pattern were printed in almost every newspaper in the nation and in many foreign countries. Letters from incredulous readers are still arriving. The ice-fishing contest gave the winter carnival its greatest piece of national publicity.

No Serious Accidents

Fishing contests are commonplace today. Fortunately there have been no serious accidents at any of them, and with reasonable precautions there should be none in the future.

There is only one drawback. With hundreds of hurrying anglers chopping holes in the ice—some even use truck-mounted posthole augers—fishing results at such affairs generally have not been as good as individual efforts elsewhere.

Moyle and his men also made a study of that phase of ice fishing. His reaction to the study: "If I were a fish, I think I'd try to get away from all that noise too."

But the boom in winter fishing apparently has not yet seen its peak. When their feet are warm and the fish are biting, few anglers can stay away. ★ ★ ★

IT SMELLS GRAND



WANT AROMA WITH "LIFT"? MAN, HERE'S HOW

IT PACKS RIGHT



AND IT PACKS SO NEAT IT RATES A BOW

IT SMOKES SWEET



IT'S THE PIPE-BLEND CHAMP YOU MUST ALLOW

IT CAN'T BITE!

SIR WALTER RALEIGH'S BLEND OF CHOICE KENTUCKY BURLEYS IS EXTRA-AGED TO GUARD AGAINST TONGUE BITE.

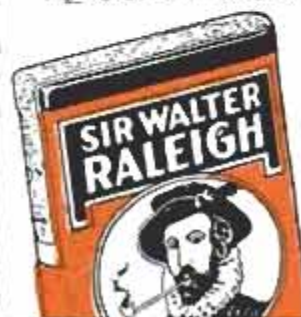

FREE!

24-PAGE BOOKLET ON PIPE CARE. JUST WRITE TO: SIR WALTER RALEIGH DEPT. G6, LOUISVILLE, KY.

AMMUNITION



Reload a whole carton for the cost of a few rounds of factory ammunition. Shotgun shells, rifle and pistol cartridges can be reloaded safely and easily with an inexpensive set of famous IDEAL Reloading Tools. 164 page IDEAL Reloaders Handbook ... \$1.00, post-paid. Free folder on request.

THE LYMAN GUN SIGHT CORP.
MIDDLEFIELD, CONN.

NEW, IMPROVED CALCULATOR FOR WOODWORKERS only 25c



Instantly gives information on lumber, nails, concrete mixes, painting materials, etc. Convenient, simple to read. Just set dial for nail specifications, to convert linear to board feet, find bit sizes for screws, compare characteristics of woods. 6" diameter heavily varnished cardboard. Send 25c, no stamps, please to Greenlee Tool Co., 2101 Columbia Avenue, Rockford, Illinois.

HARDWOODS

PRICES BELOW PER 100 BOARD FEET AIR DRIED & ROUGH

WALNUT 1" inch No. 1 common	\$30.00
CHERRY 1" First And Second	\$35.00
OAK (Red or White) 1" FAS	\$30.00
AROMATIC RED CEDAR 1" Grade No. 1	\$30.00

Orders of less than 100 bd. ft. price is 10% higher per bd. ft. Write for prices on other kinds and grades of Hardwoods. Air Dried or Green, Surfaced or Rough, FOB Fayetteville. Any reasonable lengths, widths, thickness.

JIM BELCHER Route #1 Fayetteville, Ark.
"SATISFACTION GUARANTEED"

BOAT KITS

ONLY \$495
Fiberglass
FREE FOLDER



14 FT. CRUISER

TAFT MARINE WOODCRAFT
DEPT. PM-1 636-39th Ave. N.E., Minneapolis 21, Minn.

12 Models as low as \$39.95 (freight included). Fiberglass boat covering kits, marine supplies, etc. Free folders.

MONEY in '314'

make \$3 to \$5 an hour
in SPARE TIME

Start your own sharpening business in your basement or garage with this new low-cost Foley "314" Grinder. Make up to \$3 or \$5 an hour in spare time. Sharpens circular saws, dado heads, rotary power lawn mower blades, ice skates, scissors, sharp edged tools. Also does sanding, buffing, polishing. Easy to operate—no experience needed. Send postcard today for free literature. No salesman will call—we sell only by mail.

FOLEY MFG. CO.
173-6 Foley Bldg., Minneapolis 18, Minn.

with New
FOLEY GRINDER

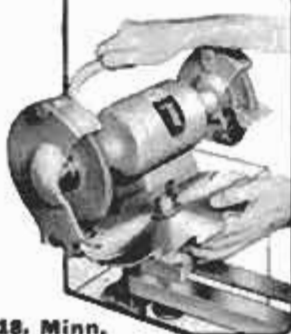

Make \$100 to \$500
for a Single Picture



Magazines, calendars and many newspapers are buying more color photographs than ever before. You can get in on this big money by taking the kind of pictures they want and use.

Best equipment for commercial color photography is the Graphic 45 with Strobflash ... it produces big 4x5 inch transparencies which offer the sharpness and detail sought by picture editors.

PACEMAKER GRAPHIC 45

For best reproduction results editors and art directors prefer the type of 4x5 color transparencies produced by the Pacemaker Graphic. In addition to being easier to process, you have the advantage of choosing from several different kinds of sheet color film. And the many built-in features of the Graphic 45 will help you get a greater variety of pictures.

STROBOFLASH

The NEW Strobflash IV with exclusive 4-way power selector permits regulated flash output of 50, 100, 150 and 200 watt-seconds. Light intensity is ample for color but can be reduced for fast black and white films or extreme close-ups without wasting power. Faster recycling time between flashes. Operates at less than 2c per flash.

TIME PAYMENTS

Ask your dealer about trading in your present camera as a down payment and monthly budget plan. For price list and catalog write: Dept. PM-16, Graflex, Inc., Rochester 8, N. Y.

GRAFLEX®
Price-Winning Camera

Daisy Gun Book

Ready for Boys and Dad's



DERINGER PERCUSSION POCKET PISTOL

... only 4" long. One of many famous guns shown in Gunbook

See historic rifles, pistols pictured in gun section of Daisy's new 128-page pocket-size Gunbook! A gun collector authority wrote each gun story. Also contains western lore, ranch-cowboy cartoons, jokes, comic strips plus latest Daisy Air Rifle Catalog. All only 25c including FREE ARROWHEAD CHARM. HURRY! Send Coupon.

Announcing the New No. 98

DAISY EAGLE

With 2X Bulls Eye Scope Mounted

Our Finest Since 1888

New "98" Eagle with 2-Power Scope mounted looks like expensive hunting rifles: ramp-type front sight; oval stock and long forepiece both resembling "natural mesquite" color on custom-made rifles! Heavy top grain leather sling. This new 37-inch 850-shot repeater comes with Scope mounted. Lens Caps. Scope Book. BB Load- \$12.95 er. BBs—only . . .

No. 98

2X SCOPE

has ADJUSTABLE CROSS HAIRS

Arrowhead Charm FREE with Book!



NEW "303" DAISY SCOPE FITS ANY OLD OR NEW DAISY BB GUN!

Features: new-type 4 lens system; 2X (2-power) magnification; cross-hairs adjustable for windage, elevation; detachable. Adjustable universal mount. Length: 11". With Lens Caps. \$3.98 Scope Book — only . . .

HOW TO GET YOURS:

At Your Dealers. If he hasn't it, send \$12.95 for No. 98 Eagle with Scope Mounted; enclose \$3.98 plus 52c postage-handling (\$4.50 total) for No. 303 Scope only. We will ship postpaid.

START A JUNIOR BB GUN CLUB!

16-Page Brochure tells how any junior, adult or group can start a club—based on the Junior 15-foot (range) spring-type air rifle marksmanship program of National Rifle Association. Only 10c.

DAISY MANUFACTURING COMPANY

DEPT. 1816, PLYMOUTH, MICHIGAN, U.S.A.

25c enclosed. Send Gunbook, Charm, Catalog postpaid.
 10c enclosed. Send Junior BB Club Brochure postpaid.

NAME _____

ST. & No. _____

CITY _____

STATE _____

Ben Franklin— Trail Blazer for Inventors

(Continued from page 102)

them later reported, but Franklin rode along by its side to observe it closely. He chased it for three quarters of a mile, even trying to beat it down with his whip.

Poor Richard seemed obsessed with poor fireplaces. His letters and notes are filled with observations on smoking chimneys and unhealthy drafts. Eventually this interest led him to the invention of the Franklin stove (Pennsylvania fireplace). The stove, as built to his specifications, was made of iron. It could be free-standing within the room (connected, of course, with the chimney) or slipped into an existing fireplace. What made it so unique? The back wall actually was a false wall, with a chamber between it and the true back wall. Hot smoke and gases from the fire were trapped at the top of the fireplace and forced through a passage down behind the chamber. Fresh air, introduced into the chamber, absorbed much of the heat and this warm air was vented into the room, while the smoke passed up the chimney. Today, in countless modern homes, we are using prefabricated fireplace units that operate on the same principle.

Ben Franklin was the first man, as far as is known, to experiment with the conductivity of heat by color. His experiment was classically simple. He cut small squares of cloth, ranging from black and white through all the colors of the spectrum. These he laid out on a sunny snowbank, starting with black at one end and getting progressively lighter to white. The black piece soon melted the snow and sank out of sight, the white piece remained on the surface, and the other pieces sank varying degrees depending upon their colors.

Scientific Farmer

As an agronomist, Franklin brought to this country new crops such as turnips, Swiss barley and Scotch kale that have become important to the modern dinner table. In turn he sent several nut-bearing trees, pippin apples and various grasses to Europe. He introduced to the Colonies the idea of applying mineral fertilizers to fields. He urged the adoption of plaster of paris (gypsum) as a fertilizer. To impress Pennsylvania farmers he used gypsum to write in huge letters on a field "This has been plastered." The next rain washed out the letters, but they soon reappeared in brilliant green grass compared with the brownish grass of the rest of the field. He was the first American to recommend that the

(Continued to page 270)

Be Your Own Boss in the Profitable Excavating Business!

CUSTOM OPERATORS OF SHERMAN POWER DIGGERS EARN UP TO \$1,000 AND MORE PER MONTH!

Wherever you live, you'll find plenty of profitable work the whole year 'round for this versatile outfit . . . not just a "trencher" but an all-purpose excavating machine! Custom operators everywhere are making big money with Sherman Power Diggers. One bought a farm with just 3 years' profits! Work for builders, contractors, utilities, and municipalities on such jobs as • SEPTIC TANKS and DRAINFIELDS • SEWER LINES • FUEL TANK INSTALLATIONS • FOUNDATIONS and FOOTINGS • GAS and WATER LINES • FIELD TILING and many others. The Sherman Power Digger travels quickly from job to job, digs at a fraction of the cost of manual labor. It's simple to operate, easy to maintain, built to last . . . and, complete with tractor, actually costs less than many new cars! Send now for complete information about the easy-to-get jobs for your Sherman Power Digger. No obligation.

SHERMAN PRODUCTS, Inc.
Dept. 1720 Royal Oak, Michigan



Send Now for **FREE LITERATURE!**

SHERMAN PRODUCTS, Inc.
Dept. 1720 Royal Oak, Michigan

Please send me complete information on the Sherman Power Digger

NAME _____

ADDRESS _____

CITY _____ STATE _____



Treasure and Mineral
LOCATORS
GEIGER-COUNTERS
Superior performance, lowest price, monthly payment plan. **FREE LITERATURE**
FISHER RESEARCH LABORATORY, Inc.
PALO ALTO CALIF.

Accurate Easy LEVELING
for FOOTINGS FLOORS etc.
Accuracy and dependability of expensive instruments—simple, fast, durable. A professional builders' level.
LEVEL EASY
\$795
WRITE FOR **FREE** DETAILS ON MODERN LIQUID LEVELING
HYDROLEVEL Suite 915, 407 S. Dearborn, Chicago 5



FISHERMEN
SEND FOR
FREE
CATALOGUE
TODAY!
FULLY ILLUSTRATED
FULLY DESCRIPTIVE
ALL PRICES LISTED

**Make Your Own SINKERS!
JIGS! SOUIDS! CASTING
AND SPINNING LURES!**

It's fun, It's easy with Sweet's
ALUMINUM MOLDS
Molds for fresh and salt water fishermen. Handed and hinged for easy, fast operation. Over 100 types, 500 sizes. Write for free catalogue.
AS LOW AS
\$2.95
PER MOLD

SWEET'S MOLDS
Tonawanda 16, N. Y.



the flashing new 1956
CUSHMAN EAGLE
America's BEST transportation BUY



• 7 major improvements for smooth riding, smart appearance • Powered by Cushman Husky 4-cycle engine • Up to 75 miles per gallon . . . 3/4c per mile total operating cost

Ask your dealer for a **FREE** demonstration or write for illustrated literature. Dealer inquiries invited.

932 No. 21st
Lincoln, Nebraska

CUSHMAN MOTOR WORKS, Incorporated



KLEAN-STRIP Remover makes any refinishing job easier

- Breaks bond between any finish and surface
- One application removes many coats
- Fast-acting, non-messy, easy to use
- Leaves surface smooth, dry, ready to refinish
- Needs no neutralizing or afterwash
- Buy Klean-Strip where you buy paint

NON-INFLAMMABLE KLEAN-STRIP PAINT REMOVER

The Klean-Strip Co., Inc.
2340 S. Lauderdale, Memphis 6, Tenn.



Glide LIKE AN INDIAN GUIDE

Down the twisting streams, across the ruffled lakes, your Old Town Canoe is your dependable friend for fishing and hunting. Sturdy and strong for long trips, yet light and easy to carry. Perfectly balanced. An Old Town is designed like a birchbark, but built for many years

of adventure and sport. Easy to own.

FREE CATALOG shows all kinds of canoes and outboards, sailboats, dinghies, rowboats.

OLD TOWN CANOES

Old Town Canoe Co., 341 Middle St., Old Town, Maine

PLEASE SEND ME FREE CATALOG

Name _____

Address _____

City _____

State _____

agricultural subjects be taught in colleges.

Though he was not a physician, patients and even doctors sought his advice. He developed an instrument for showing the circulation of the blood, invented a flexible catheter and suggested experiments to determine the cause of lead poisoning. He pinned down the dangers of infection from impure water. He made a great many observations on the contagious nature of colds and influenza, observations that became important when other scientists tackled the problem.

Millions of persons have cursed their first bifocals, then grown to prize them. Here is Franklin's own account of his simple but valuable invention: "I formerly had two pairs of spectacles, which I shifted occasionally. Finding this change troublesome . . . I had the glasses cut and half of each kind associated in the same circle. By this means, as I wear my spectacles constantly, I have only to move my eyes up or down, as I want to see distinctly far or near, the proper glasses being always ready."

Popular Musical Instrument

One of his inventions which failed the test of time was his musical instrument, the armonica. He mounted 37 hemispherical glasses of varying sizes on a spindle, and used a treadle to turn the spindle. The musician rubbed the edges of the moving glasses with damp fingers, producing "sweet, ethereal" tones. The instrument enjoyed great popularity for more than 40 years, and both Mozart and Beethoven composed music especially for the armonica.

Walk into almost any grocery store and you'll see one of Franklin's minor inventions. An avid reader, he needed a tool for reaching books on the highest shelves. His long mechanical hand survives today in the tool grocers use to reach cereal and soap chips on the top shelves. Franklin also designed a library chair with an underframe that folded down to convert the chair into a short stepladder. Today we use the same idea in stools that convert into kitchen ladders.

Franklin lived during the days of the first balloon ascensions, and suggested the use of aerial reconnaissance and airborne troops. After witnessing balloon ascensions he observed that aircraft might "possibly give a new turn to human affairs. Convincing sovereigns of the folly of wars may perhaps be one effect of it, since it will be impracticable for the most potent of them to guard his dominions. Five thousand balloons, capable of raising two men each, could not cost more than five ships of the line; and where is the prince who can

(Continued to page 272)

POWER
THROUGH
PULLEYS
AND V-BELTS

IDEAS PAY OFF

ORDER this AMAZING BOOK TODAY!

★ **FIRST BOOK OF ITS KIND . . .**

ENTER THIS *Easy Money* CONTEST

Yes we pay you to make something useful and practical for yourself. Devise a useful apparatus or product using a Congress V-Belt drive—submit a photo of it and you qualify for the \$50 Savings Bond to be awarded each month starting January 1956.

Each 6 winners during 1956 will be eligible for a bonus prize of a \$100 Savings Bond. Duplicate prizes will be awarded the dealer who certifies the contestant's entry form.

Make something useful and make money, too. There's an entry form in every book, so get started now.

This book is packed with information every mechanic should know about pulleys, v-belts, drives, bearings and includes easily understood formulae and technical data. Illustrations show a wide variety of useful products using v-belt drives. It's full of "do-it-yourself" ideas.

MAIL THIS COUPON TODAY!

CONGRESS DRIVES DIVISION, TANN CORP.
3750 E. Outer Drive, Detroit 34, Mich.

Gentlemen:

Enclosed is 25c—please send me the book "POWER Through PULLEYS and V-BELTS"—also contest entry form.

Name _____

Address _____

City _____

CONGRESS

Since 1914



ELECTRIC WELDER

AC or DC
110 Volts

The "Little Marvel" all-metal welder, 5-year written guarantee. Welds 1/8" metal or money back. Repairs tanks, tools, fenders, machine parts, etc. Complete with everything—rods, unit, eye shield, directions. \$6.95

plus 50c postage. Flame torch accessory for soldering, cutting, brazing \$3.95 complete with carbons, brass rods, flux. \$2.00 Deposit on C.O.D. 75 ampere 1/4 inch Transformer Welder \$21.95 F.O.B.

ESSAY MFG. CO., Dept. 51, Quincy 69, Mass.

\$6.95
Complete

Exclusive Double-Bearing HEAVY-DUTY PUMPS

IRRIGATE • DRAIN • CIRCULATE • SPRAY
Up to 7,500 GPH. 3,000 GPH from 25' well. Use 1/4 to 1 HP motor. 1 1/4" inlet; 1" outlet. Stainless shaft. TYPE X-2 oilless bronze bearings. **\$10.95**

Won't rust. TYPE XB—Ball bearing model. **\$12.95**
Postpaid if cash with order. (West of Miss. add 50c)

MONEY BACK GUARANTEE
Centrifugal and Gear Pumps in All Sizes
LABAWCO PUMPS, Belle Mead 2A, N. J.



LOWEST COST PER MILE

Here is the electric fuel pump that will give you greater power and faster acceleration. The Bendix* Electric Fuel Pump has better performance with less operating cost per mile. Sold by independent garages and service stations.

*REG. U. S. PAT. OFF.

FREE: A complete descriptive folder is yours for the asking. Write us today.



Bendix

ELECTRIC FUEL PUMP

Grand Prix Winner

ECLIPSE MACHINE DIVISION, BENDIX AVIATION CORP.
ELMIRA, N. Y.

PAGE TILLERS

New 1956 "Page-Boy"

Makes tough jobs easy!
3 Models—1 1/2-2-3 1/2 HP.
Tiller, mower, snow blow attachments easily shifted. Safe and easy to operate. Rugged steel frame, adjustable rubber tired wheels. So handy around the home or farm!

FREE CATALOG—Complete tractor line with all attachments

★ FULLY
GUARANTEED
★ LOW PRICED
★ EASY TERMS



PAGE 1904 South 81st Street
Milwaukee, Wisconsin

Tills.
Cuts Grass.
Blows Snow!

New HASTINGS WEAR REDUCER

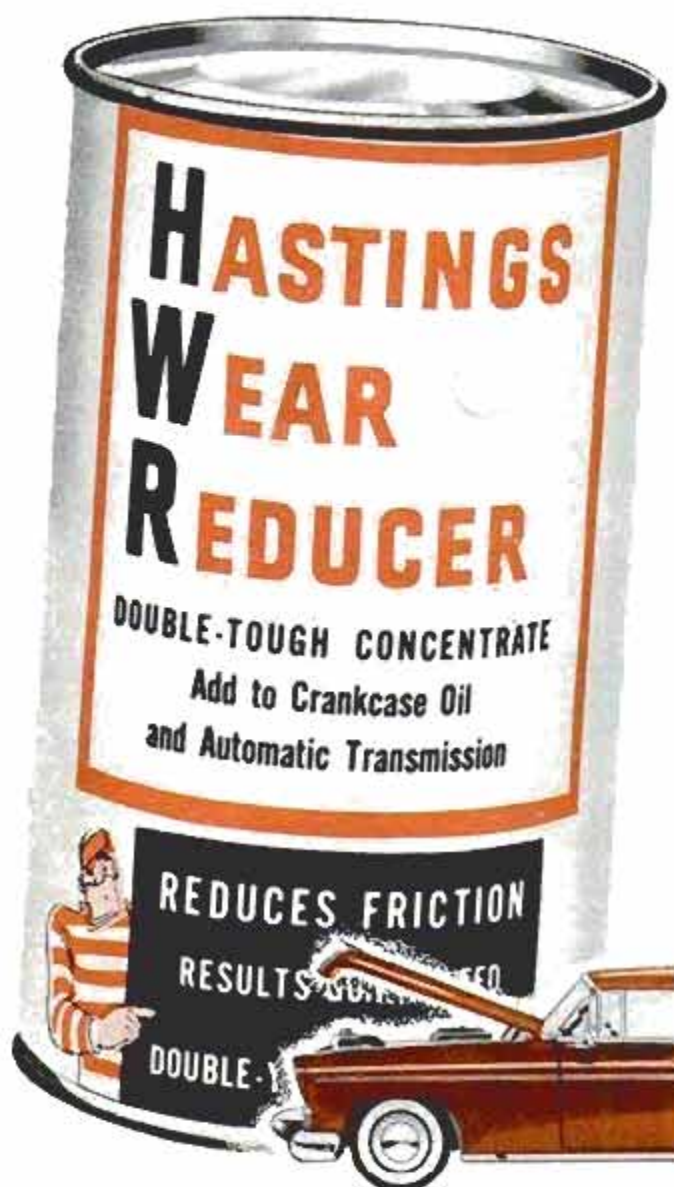

**Guaranteed to do all 3
or Double-Your-Money-Back!**

- Make your engine smoother, quieter!
- Stop hydraulic valve lifter noise!
- Smooth out your automatic transmission!

ADD A PINT TO ANY MOTOR OIL—H-W-R works with any brand or type preferred, including heavy duty and detergent oils.

WORKS IN ANY FULLY AUTOMATIC TRANSMISSION Add a pint to the transmission fluid to stop jar and jerk.

HASTINGS MANUFACTURING CO. • HASTINGS, MICH.
Wear Reducer, Casite, Piston Rings, Oil Filters, Spark Plugs

afford so to cover his country with troops for its defence as that 10,000 men descending from the clouds might not in many places do an infinite deal of mischief before a force could be brought together to repel them?"

Scientific Predictions

Back in 1780 Franklin regretted that he had been born so soon. So, in a way, do we. But he saw our world, at least in its hazy outlines, when he wrote, "The rapid progress true science now makes occasions my regretting sometimes that I was born so soon. It is impossible to imagine the height to which may be carried, in a thousand years, the power of man over matter. We may perhaps learn to deprive large masses of their gravity . . . for the sake of easy transport. Agriculture may diminish its labour and double its produce; all diseases may by sure means be prevented or cured, not excepting even that of old age. . . . O that moral science were in a fair way of improvement, that men could cease to be wolves to one another, and that human beings would at length learn what they now improperly call humanity."

Mr. Franklin, Sir, we salute you on your 250th birthday. ★ ★ ★

Dial on Adding Machine Speeds Multiplication

With a telephone-type dial on its keyboard, an electric adding machine multiplies either positive or negative numbers quickly when the numbers are dialed. A signal shows whether the multiplied number is positive or negative when it is printed. The machine also has a decimal-point selector and prints the decimal in its proper place to figure discounts, taxes and to multiply fractions.



TORO

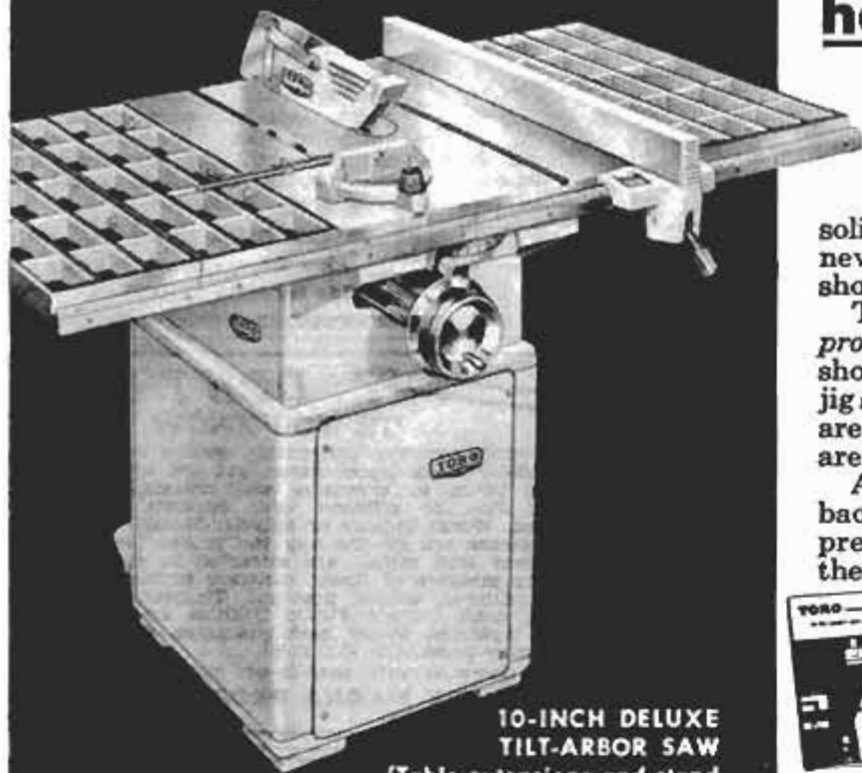

**10-INCH DELUXE
TILT-ARBOR SAW**
(Table extensions and stand
optional. 8-inch models available.)

Now! Professional quality in home power tools!

What a pleasure to work with — the new Toro power tools! Mirror-polished working surfaces make handling easy. Every operation is done accurately. And every finished piece fits tightly, solidly, to give you the kind of results you never thought possible with home workshop power tools.

The reason is simple. Toro has built *professional* quality into its home workshop table saws, drill press, jointer-planers, jig saw, band saw and belt sander. Castings are heavier. Finishing is finer. Tolerances are closer.

And no wonder! Toro power tools are backed by 40 years' experience in building precision power equipment — including the world's most complete line of power



mowers. See the new Toro power tools at your dealer's soon, and write Toro, Dept. PM-16, Minneapolis 6, Minn., for your copy of the deluxe full-color catalog.

TORO MANUFACTURING CORP.
MINNEAPOLIS 6, MINNESOTA

New "PULL-GEAR" SPEED-REDUCING PULLEY



**Provides Correct Speed and
Power to Drill Up to 1 3/8"**
with 1/2 H.P. Motor

Amazing new internally geared speed reducer doubles drill press capacity. Greater power, greater efficiency, greater productivity.

Provides the correct speed and power for larger drilling, reaming, tapping and boring on light presses. Easily installed in five minutes. Adaptable to all type machines. Spindle speed range approx. 45 to 3000 RPM. Made in 3 motor shaft sizes: 1/2" — 5/8" — 3/4". Write for literature.

Make \$500 an Hour CASH PROFIT THE DAY YOU START!



**START YOUR OWN BUSINESS AT HOME... SHARPEN
HOUSEHOLD, GARDEN AND SHOP TOOLS IN SPARE TIME**

Now you can turn spare time into Big Cash Profits with new Belsaw Sharp-All. Sharpen knives, scissors, shears, snips, ice skates, mower blades, hedge trimmers, grass whips, axes, chisels, screw drivers, scrapers and saws... just about any household, garden and shop tool. Your own CASH business with no inventory. No calls to make. No experience needed.

Learn how easily you can start your own spare time business. Amazing low cost easy-payment plan. Send postcard for FREE BOOK.

BELSAW SHARP-ALL CO
716 Field Bldg. Kansas City 11, Missouri



WRITE
FOR
LITERATURE

THE PULL-GEAR CO.
25427 Mound Road
Center Line, Mich.

CUT-TO-FIT HOMES CUT BUILDING COSTS

CHOICE OF 57 DESIGNS

ORDER NOW

SAVE UP TO 1/3

Build your own home and save the builders' profit—plus savings in lumber and labor with Sterling Ready-Cut-Homes. Anyone can assemble with simple, easy to follow plans furnished. Every house complete with all lumber, roofing, nails, glass, hardware, paint, doors and windows marked ready to erect. Freight paid. Complete building plans ready for filing at low cost. Sold separately if desired. Write today!

PRICED FROM \$2150 up

Five Easy Payment Plans

Send 25c for NEW COLOR CATALOG



INTERNATIONAL MILL AND TIMBER CO.
DEPT. PM 16 BAY CITY, MICHIGAN

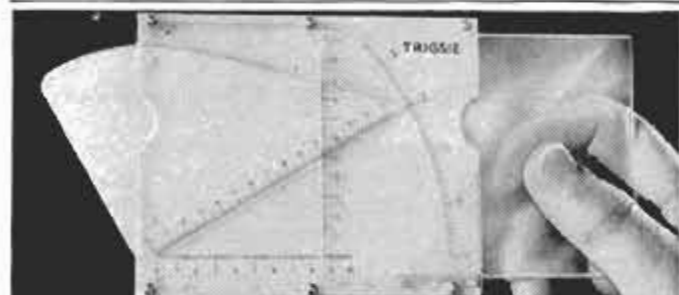

INSTANT DIRECT READING of UNKNOWN SIDES and ANGLES

in right triangles. Simple, quick—just set "TRIGSIE" Trigonometer* on known data. No fuss with formulas and lengthy figuring. Accurate for practical purposes. Useful for designers, draftsmen, estimators, machinists, carpenters and most trades. Engineers quickly rough-check computations. A quality instrument, precision-made of dimensionally stable plastic. Translucent for easy reading against light. Pocket size, 4 1/2 x 3 5/8 in. MONEY-BACK GUARANTEE of Satisfaction. Send no money. You pay postman only \$4.85 plus postage and C.O.D. *Patent pending. Order from: YANORA PRODUCTS, Dept. P-1, P. O. Box 8485, Kansas City 14, Mo.

DON'T DIG 'TIL YOU KNOW WHERE

The most amazing instrument you've ever seen! MAGNA-PROBE traces water, gas and sewer lines. Saves hours of expensive and unnecessary digging. Just as efficient over concrete as bare ground. Works indoors or outside. MAGNA-PROBE will amaze you by the way the probes (each of a different type metal) are attracted to each other in the presence of linear moisture sources in pipe lines. Simple, unique, practical. Thousands of satisfied users include Public Utilities and Government Agencies. Money back guarantee. Send Check or money order. (No C.O.D.'s)

ONLY \$2.98

Post-paid

Complete with easy-to-use instructions.

THE MAGNA PROBE CO.

6022 Mayfield Road

Cleveland 24, Ohio

SPARE-TIME MONEYMAKING OPPORTUNITIES

READ OUR CLASSIFIED ADS

HUNDREDS OF BARGAINS

AMAZING OFFERS

BE PRECISE

Say

STANLEY

IT'S A GOOD RULE

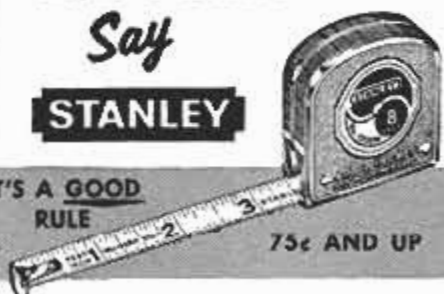

75c AND UP

96 inches of easy-to-read accuracy in an easy-to-pocket 2 inch case.

Model 1208W — only \$1.19 at your favorite hardware dealer. See his display of Stanley Rules — each in a useful plastic box with magnifying lens. Select the rule that you need from 6 ft. to 12 ft.



Write Stanley Tools, 621 Elm St., New Britain, Conn., for free booklet on measuring tools and how to use them.

STANLEY

PLEASE SEND ME



for the time checked.

I am enclosing . . .

1 year \$3.50

2 years \$6.00

name _____

address _____

city _____

zone _____

state _____

Hand this order to your newsdealer or send it to

POPULAR MECHANICS
200 East Ontario St. Chicago 11, Ill.

Plan now for a summer of boating fun!

Chart your course by the Weldwood tag when you buy or build a boat

The Weldwood tag tells you the boat is made with superior Weldwood Waterproof Plywood. That means: **Maintenance will be low, resale value high.** Weldwood helps keep your boat tight and dry for years. You need fewer haul-outs, get top return when you sell.

Weldwood's strength saves weight in your boat's construction. It can replace thicker planks or other materials. **Perfect for weekend boats** that must stand up to repeated wetting and drying as they're hauled to and from the water. Weldwood Waterproof Plywood won't ever split, shrink or warp!

Less caulking, easier repairs. Big Weldwood panels cover large areas with fewer seams. And it's easy to bend them to simple curves or to work Weldwood with ordinary tools.

Guaranteed not to delaminate. The plies in Weldwood Waterproof Plywood are bonded with a special phenolic-formaldehyde adhesive that can never dissolve. This bond is unaffected by fresh or salt water.

Be sure of the materials in any boat you buy or build... look for the Weldwood name on boats and kits.



WELDWOOD—
The Best Known Name in Plywood



Weldwood® WATERPROOF PLYWOOD

A product of UNITED STATES PLYWOOD CORPORATION, New York 36, N. Y.



STOP Radio and TV Noises with NEW, IMPROVED FILTER PLUG

BALANCED CIRCUIT eliminates power line interference from household appliances, fluorescent lights, motors, oil burners, autos, etc. Simple to use. Don't despair if you've tried other filters without success. THIS ONE works! 5 day trial period. Money back guarantee. (No C.O.D.'s please.) We pay postage.

\$1.50 DELUXE MODEL
SCOPE MFG. CO. Dept. PM-3, Box 23
Knickerbocker Sta., NYC 2, N. Y.

x-acto

KNIVES • TOOLS
HANDICRAFT KITS



NO. 77
VIZI-DOME
WOODCARVING
SET \$3.60

X-ACTO, INC.
48-45 Van Dam St.
Long Island City, N. Y.

Send 25c for 28-page Catalog



GENUINE ALNICO MAGNETS

UP TO 350 LB. PULL

AMAZING, PERMANENT, NON-ELECTRIC, HIGHLY PRACTICAL.

Have pull as high as 66 times their own weight.

MYSTIFYING, PERPETUAL POWER WITHOUT ELECTRICITY!

Test metals. Conduct interesting experiments. Hundreds of uses—

Retrieve valuable steel items such as guns, tackle from deep water;

tools from tanks & drains. Our customers include big industries and

home hobbyists. Every magnet GUARANTEED to please.

No. M-800 Has pull of 350 lbs. on flat steel block \$34.50

No. M-725 Has pull of 225 lbs. on flat steel block \$16.50

No. M-625 Has pull of 125 lbs. on flat steel block \$9.50

No. M-575 Has pull of 75 lbs. on flat steel block \$6.50

No. M-500 Has pull of 50 lbs. on flat steel block \$4.50

No. M-101 U-shaped Magnet. Has pull of 61½ lbs. 2 for \$1.50

No. M-47 Hot Pad Magnets. 10 for \$1.00 \$4.87

No. M-35 Hobbyist assortment of 8 small magnets \$1.50

Send M.O. or check. We pay postage. Sorry no C.O.D.'s.

MIAMI MAGNET COMPANY, 3240 N.W. 27th Ave., Miami 42, Fla.

Made \$2,600 LAST SEASON



with
**FOLEY
LAWN MOWER
SHARPENER**

99c Profit On Each Dollar!

It costs less than 1c per mower for electricity and material. The Foley sharpens all blades and cutter bar together just like lawn mower manufacturers do it. Start in spare time in basement or garage. The Foley handles up to 3 or 4 mowers per hour—prices run \$1.50 to \$3.00 for hand mowers—\$5.00 to \$8.00 for power mowers.

FREE — VALUABLE ILLUSTRATED BOOK shows how to sharpen all leading makes of power mowers. Foley prices are low—easy payment plan lets you pay for machine with profits. **FREE PLAN** tells how to start. Send coupon today—no salesman will call.

"Last year we sharpened and repaired about 1000 lawn mowers for a net profit of \$2,600," says E. G. "In 1939 I bought a Foley Lawn Mower Sharpener," writes W.T.J., "the best investment I ever made. I have made a good living for my wife and myself and have put money in the bank besides."



SEND FOR FREE BOOK

FOLEY MFG. CO., 107-6 Foley Bldg., Minneapolis 18, Minn.
Send FREE BOOK and FREE PLAN on Foley Lawn Mower Sharpening business.

Name _____
Address _____

It's QUICKER... Works SLICKER with

WISE-GRIP



A SAFE way to hold work under power tools! The work CAN'T slip.

Does More Jobs Easier Than Any Other Tool Made!



No. 10W, 10" \$2.60

A squeeze of the hand locks jaws onto work with ton-pressure! Quickly adjusts for use as All-Purpose Wrench, Super-Pliers, Clamp, Wire Cutter. 7" and 10" cutter optional. \$1.85 to \$2.60 at your dealer.

Made By PETERSEN MFG. CO., Dept. M-1, DeWitt, Nebr.



\$50.00 PER DAY AND MORE

SAW-KEEN SERRATING AND SHARPENING TABLE KNIVES

Be your own boss, work anywhere, full or part time. Every restaurant, hotel, drive-in, etc., repeat customers. Serrated (saw-edged) table and steak knives in great demand. \$98.50 investment returns first week. Guaranteed. Write today for proven daily profit plan.

CUTTER-CRAFT 58-Z SOUTH RAYMOND PASADENA 1, CALIF.

"FEATHER-LIGHT" LEVEL MAGNIFIES!

NEW EMPIRE ACRA-LITE NO. 1521

ONE THIRD LIGHTER than aluminum, ACRA-LITE Magnesium levels handle like a breeze! Easier to read, too, with "Full-Vue" magnifying vial cover plates. You'll want yours now! Order from your dealer, or direct.

EMPIRE LEVEL MFG. CO. 10930 W. Potter Rd., Dept. PM, Milwaukee 13, Wis.

EMPIRE ACRA-LITE Level No. 1521, 24", Only \$6.70
28", \$7.60, 48", \$13.50

41 SURPLUS TWIST \$2 | only 75c each for the
DRILLS | **Finest Quality Imported PRECISION PLIERS**

Less Than 5c Each! **GENUINE, HI-GRADE, CARBON TOOL STEEL, BRAND NEW**

FOR HAND OR ELECTRIC DRILLS: Hobbyists! Homeowners! Carpenters! A lost your last chance to get 41 brand-new Carbon tool-steel twist drills for less than 5c each! Usually sells for much more. You get about 5 each of all most-used sizes from needle-sized 1/16" up to and including 1/4". Tempered cutting edges easily bite through steel, aluminum, iron, wood, or plastic. Each drill hardened and designed to give 1800 drillings. Limited supply going fast!

FOR JEWELERS, OPTICAL WORKERS, HOBBYISTS, CRAFTSMEN OF ALL KINDS! These superb German instruments are of drop-forged, heat-treated high quality tool steel, fabricated to most exacting specifications. All over ground and polished to smooth hard surfaces. Smooth working joints with just the right tension. Jaws meet perfectly to safely and securely hold even the most delicate objects in the hard-to-reach corners and angles. Each plier is 4" long and a veritable gem of precision and strength.

• Flat Nose
• Combination
• Diagonal Cutter
• Round Nose
• Snipe

75c each, all 5 for **\$3.50** ppd.

Set of 6 PRECISION SCREWDRIVERS

Perfect for jewelers, watchmakers, hobbyists, etc. **SIX DIFFERENT SIZES:** No. 3, No. 4, No. 5, No. 6, No. 8, No. 10. Knurled body grip assures easy handling. Finest steel and craftsmanship. A hard-to-beat value from Switzerland. **\$1.25** Ppd.

FLEXIBLE SHAFT SCREWDRIVER

For hard-to-get-at places. 8" long. Unbreakable, shockproof, non-inflammable amber handle. Hardened and tempered blade electrolytic plated for longer life. Works perfectly at any angle. **59c** Ppd.

Send check or Money Order. C.O.D., plus postage. Money Back Guarantee.

SCOTT-MITCHELL HOUSE, INC.
Dept. M-129 611 Broadway, New York 12, N. Y.

Make your own conversion

AIRCRAFT STARTERS

Makes an excellent winch for loading hay, wagon unloaders, pulling stumps, stretching fence or moving heavy objects—1001 uses at home, farm or factory. Operates on 6 to 32 volts or manually. Has built-in reduction gear (300 to 1) and clutch. High torque, low speed. Made by Bendix at many times this price. F.O.B. York (wght. 12 lbs.) **\$14.89**

KARL ORT, Dept. PM155, York, Pa.

THE RIGHT DIRECTION IS ALWAYS A SNAP FOR YOU AND YOUR

HULL AUTO COMPASS

THE FAMOUS QUALITY NAME IN AUTO COMPASSES

Now also in New Car Colors

At your dealers. Write for literature.

Hull Mfg. Co., P. O. Box 246-D1, Warren, Ohio

Beaconlite
ILLUMINATED 1/4" 55
STREAMLINE 5
RED-ILLUMINATED 1/4" 55

Say You Saw It in Popular Mechanics

BOAT KITS 28 MODELS—8 to 19 ft. \$39 up—FREE FREIGHT

SAVE 2/3!
Easy-to-build MAHOGANY DECKS & FRAMES
SEND 10c for CATALOG
Includes Hardware—Trailers—Fiberglass

Boat Plans—Patterns—Frame Kits

Build over 50 modern boats from large scale plans, available with FULL-SIZE patterns, new PRE-FAB frame kits! All types: prams to cruisers, 6 to 25 ft. Best buy for Amateurs! SEND 10c for CATALOG.

Craig Craft
Tonawanda, N. Y.

Now — for the first time —
Instant Change-over
with the right combination of the 3 most-used woodworking machines

— in new Yates-American
Saw-Jointer-Sander Combination



NO BELTS
TO CHANGE



NO PARTS
TO REMOVE



JUST TURN A HANDLE
TO CHANGE FROM ONE
TOOL TO THE OTHER.

With these additional basic features:

- Patented feather-touch fence
- Power take-off adds operations
- Totally enclosed base
- More working capacity in each tool

Inherent design assures maximum safety



Yates-American

BELOIT, WISCONSIN

CHICAGO, ILL. • HIGH POINT, N. C. • MEMPHIS, TENN. • PORTLAND, ORE.

Manufacturer of woodworking machinery since 1883

A tool with a
touch of tomorrow

\$274.50

complete with 1/2-hp. totally
enclosed, dust-proof motor
that runs everything
(Saw, jointer and
sander accessories)

Eye it!
Try it!
Buy it!

See your
Yates-American dealer

Send coupon for his name and ad-
dress — and free bulletin.

Tear Out Coupon and Mail Today!

YATES-AMERICAN

Dept. A, 781 North Fourth Street, Beloit, Wisconsin

Send me information I have checked below:

- Name and address of my Yates-American dealer
- Free bulletin on Yates-American Saw-Jointer-Sander Combination

Name.....

Address.....

City..... Zone..... State.....

**SAVE MONEY on SURPLUS PARTS for
MILITARY TYPE TRUCKS & JEEPS**

4 & 6 wheel drive. FREE catalog to Jeep owners. State make truck or Jeep. (New Jeep Tops, steel or canvas all models). **AMERICAN AUTO PARTS CO., Inc.**, 1830 Locust, Kansas City, Mo.

SAY YOU SAW IT IN POPULAR MECHANICS

KEEP ALL SAWS SHARP



SO EASY: With this new filing jig and jointer anyone can now sharpen any handsaw (like new) When file hits hardened steel rollers teeth are finished and EXACTLY SAME HEIGHT. All teeth cut and saw runs true and smooth. Jig and instructions \$2.95 postpaid. Free literature.

SAVE TIME AND \$\$\$ JOINT & SHARPEN CIRCULAR SAWS

Sensational new Super Filer No. 11 joints and sharpens both hand and circular saws 6" to 10" with all teeth the correct height, depth, pitch and bevel. Easy to use—when file hits hardened steel roller, teeth are finished. Saw runs true and smooth with no side pull. Complete with special 8" file \$9.95 p.p.d. "TRU-CIRCLE" saw set automatically sets teeth at 10° or more \$2.95.

SUPER SAW FILER NO. 6
Automatically controls

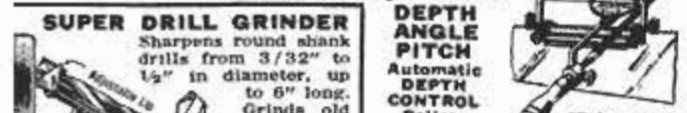

DEPTH ANGLE PITCH
Automatic DEPTH CONTROL Rollers
IT'S NEW!
Perfect bevel and angle maintained, and fool-proof depth control for all Rip, Crosscut and Handsaws. Precision made and calibrated for instant setting at desired angle. Can be used in any vise or clamp. Complete with file, only \$6.50 p.p.d. SEND FOR FREE CATALOG

A. D. McBURNEY, 5908 Hollywood Blvd., Hollywood 28, Cal., Dept. A-16

**ANSWERS TO
100 BUILDING QUESTIONS**

Send for the Homasote Handbook (64 pages)!

It took 20 years to write this "know-how, show-how" book!

Here, in simple, clear-cut language, the owner who proposes to do it himself — and the owner who proposes to use a professional builder — will find the answers to the values he might seek in interior walls, ceilings, sub-flooring, exterior sheathing, exterior finish, roof-decking, etc. He will be shown the do's and don'ts in each operation. For any part of a house — or the whole house — he will know that he has sound investment values and comfortable living. Elaborately indexed to enable you to find the answers to your questions. Mail the coupon today.



MAKE IT AT HOME—WITH HOMASOTE

HOMASOTE COMPANY
Department A-5, Trenton 3, N. J.

Please send me the Homasote Handbook.
I enclose 10¢ to cover handling costs.

NAME.....

ADDRESS.....

CITY..... ZONE..... STATE.....

BUILD YOUR OWN POWER TOOLS - WITH GIL-BILT

Exclusive GIL-BILT Build-It-Yourself Features

- No machining—build easily with hand tools only
- No blueprint reading—step-by-step pictorial plans, full scale patterns, actual photographs
- Sturdy wood, aluminum and steel construction
- Capacity and performance of commercial saws selling from \$60 to \$250.
- Proved performance. Nationally advertised and sold for 8 years. Satisfied customers around the world.

GIL-BILT 10-in. TILT/ARBOR SAW



- 27x28 in. table, 13 1/2 in. capacity in front of blade
- 10 in. blade cuts 3 1/4 in. deep, tilts full 45 degrees
- Floor model 34" high, table always stays level
- New Departure ball bearing arbor, 3/4" precision shaft turned down for 5/8" bore blades, alum. housing, shipped ready to run
- Jackscrew and 4 1/2 in. dia. handwheel lowers and raises blade
- Cast-aluminum miter gauge and self-aligning rip fence guide

GIL-BILT Metal Parts Kit includes Plans, ball bearing arbor, miter gauge and bar, rip fence guide, dado insert, lock knobs, jackscrew mechanism and handwheel, and all other metal parts (less blade) \$22.95
Same Kit with 10" Combination Blade \$25.90
Same Kit with 8" Combination Blade \$24.90

GIL-BILT 12-INCH BAND SAW

- Cuts to center of 24 inch circle
- Handlex stock up to 6 inches thick
- 18x18 inch table tilts 45 degrees
- Lower wheel and drive pulley runs on sealed New Departure Ball Bearings; Upper wheel runs on two 5/8" bore Oilite Bronze bearings
- Upper wheel tension and tilt mechanism of cast aluminum, completely assembled
- Upper and lower blade guides. Each has ball thrust bearings, self-lub bronze jaws
- Rigid cast aluminum wheels fully machined ready-to-install. Heavy rubber tires
- Uses standard 78 inch blades up to 3/4 in. wide
- Fully enclosed mechanism for utmost safety



GIL-BILT Metal Parts Kit includes Plans, rubber tires, aluminum wheels, 3/4 in. blade, ball bearing spindle, tilt mechanism, blade guides, table tilt segments and all other metal parts \$23.95
Return Kits in 10 days for refund if not satisfied.
For shipments up to 600 miles, add 5%; over 600 add 10%.

Amount in excess of actual postage will be refunded

Order Kit now, or order Plans at \$1.00 each and Kit later less cost of plans. Write for FREE Catalog. Dept. 80-A, Lambert Field St. Louis 21, Missouri

ALSO AVAILABLE Plans & Parts Kits for 12-in. Band Saw, Belt Sander, Spindle Shaper, 8-in. Tilt/Arbor Saw

GILLIOM POWER TOOLS

MARLITE-IT-YOURSELF

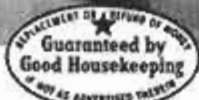

a few days ago,
this was a dingy basement!

... but economical Marlite Plank and Block made the beautiful difference. This easy-to-handle paneling makes week-end projects out of week-long jobs. The exclusive tongue and groove joint simplifies installation; conceals all fastening. And Marlite's melamine plastic finish never needs painting. Dirt wipes off with a damp cloth.

Your building materials dealer will show you Marlite in "Companion Colors," distinctive wood and marble patterns. Ask him for free remodeling folder, or write Marsh Wall Products, Inc., Dept. 142, Dover, Ohio.

Marlite

plastic-finished
WALL and CEILING PANELING

A product of Masonite® research

ELECTRIC STARTER FOR SMALL GASOLINE ENGINES



Briggs & Stratton, Wisconsin, Cushman, Clinton and similar air cooled engines. Also for Johnson & Evinrude outboard motors.

Perfect for Garden Tractors, Lawn Mowers, Tractors, Golf Carts, and any small engine with pull-cord or crank starting. DYNA-START electric starter is powered by a 6-volt auto battery and is installed in a few minutes by an average mechanic without altering engine. DYNA-START has been thoroughly tested and approved for use by leading engine manufacturers.

Why Crank?
Push a Button to Start!

For complete information on applying DYNA-START to your starting problem, Write!

LAUSEN SPECIALTY CO.

1010 N. GRAND • GAINESVILLE, TEXAS

Mfrs. Inquiries Invited

STEP UP PERFORMANCE OF YOUR OUTBOARD



WRITE FOR OUTBOARDERS' BIBLE—our 1956 catalog. It's FREE. Contains much valuable information on how to get MORE SPEED, or more thrust for WATER SKIING from motors of 7 1/2 to 50 HP; better performance and load carrying capacity from any motor old or new. Easily understood recommendations enable you to choose a propeller virtually custom-built for your motor-boat-load combination—much more rugged and damage resistant than the original. Write NOW. Michigan Wheel Co., Dept. P-1, Grand Rapids 3, Mich.



BRONZE FOUNDRY

Schools and Home Workshops

Make your own castings of aluminum, copper, bronze, silver. Foundry sets are available in three sizes including 2400 Deg. F. blast Furnaces. \$22.50; \$29.50; and \$42.00. f.o.b. Marysville, Kans. Free Circular.

KANSAS CITY SPECIALTIES CO. P. O. Box 6022, Dept. P-1 MARYSVILLE, KANS.

POWER HACKSAW \$58.50

LESS MOTOR
F.O.B. Benton Harbor



Send for full details and name of nearest dealer.

EXCEL MACHINE TOOLS BENTON HARBOR, MICHIGAN Dept. PM-16

HOME CRAFTSMEN!

NEW SURFACE CLAMP

Fastens to Wood or Metal — Assures Better Work — Easier



All-purpose clamp, fastens to any desired point on either wood or metal surface. Swings to any angle, slides on or off in seconds, leaves no obstruction. Holds ANY flat work, or portable tools, securely. Assures home craftsman, or shop, better work, easier. Order a pair. Guaranteed. 3" size \$3 each, postpaid. 2 for \$5.00.

HENRY E. CASTON

788 YALE ST. AKRON 11, OHIO

Now You Can Upholster Any Piece of Furniture!

Upholster—Restyle Any Piece of Furniture Yourself

John Bergen, custom furniture designer, tells and shows you how to transform old out-of-date furniture into brand new smart-looking comfortable furniture in his new book **ALL ABOUT UPHOLSTERING**.

No Experience Needed

Bergen tells you every step to follow in amazingly clear easy-to-understand step-by-step instructions and then shows you how in hundreds of big, clear drawings and photos. You read and see how to strip the old frame, install new webbing and springs, apply burlap, install stuffing and padding, fit the muslin cover and the final fabric and install trim.

Use New Materials—Methods

Now you can have furniture upholstered with foam rubber, sagless springs and other new materials that add so much to comfort and durability and are so costly when included in new furniture.

Save 50% of Usual Cost

Don't pay a small fortune for new furniture when you can make your old furniture better than new! Why pay high prices to have someone else upholster and restyle your old furniture when you can do it yourself for cost of materials alone? It's easy and it's fun.

Special Chapter on Slipcovers

Learn how to make custom-made slipcovers with professional look and fit. Find out how you can realize tremendous savings by investing a few spare-time hours and the cost of a few yards of fabrics.

7-Day Money Back Guarantee

Send for your copy of **ALL ABOUT UPHOLSTERING** today. Read and use it for 7 days. If it isn't entirely satisfactory return it for a full refund.



USE THIS HANDY ORDER COUPON

POPULAR MECHANICS PRESS, Dept. AAU
200 E. Ontario St., Chicago 11, Illinois

Gentlemen:

Please send my copy of **ALL ABOUT UPHOLSTERING**. Enclosed is my remittance of \$3.50. If I am not completely satisfied with the book I will return it for a full refund after 7 days.

Name _____

Address _____

City _____ Zone _____ State _____

Mammoth 1956 Wholesale Tool Catalog

TOOL CATALOG



YOUR NAME



The opportunity now awaits you to own and operate your own business on a part time or full time basis in the lucrative field of **HARDWARE, HAND TOOLS, FANS, POWER TOOLS, MOTORS, PAINTS, etc., or BUY TOOLS FOR YOUR INDUSTRIAL OR INSTITUTIONAL USES.**



Buy Nationally Advertised Tools for Resale or Industrial or Institutional Use

NO INVESTMENT REQUIRED. BUY AS YOU NEED IT. A MILLION DOLLAR INVENTORY AT YOUR FINGER TIPS.

Discount UP TO **50%**

\$1.00 refund on first purchase or refund if you are not 100% satisfied.



Every one needs tools. Meet the demands of the growing "Do-it Yourself" markets. Sell direct from the jumbo buying guide—your cost is known only to you.

JUST FILL OUT COUPON

ENCLOSE \$1.00 FOR DEALER'S CARD & 1956 MAMMOTH TOOL CATALOG.

SILVO HARDWARE COMPANY

Dept. PM-1, 108 Market St., Philadelphia 6, Pa.

I am enclosing \$1.00. Rush me your dealer's card and big Catalog Today. If I am not completely satisfied with your plan, I understand that I can return the Dealer's Card and Catalog for refund, and if I decide to order, my \$1.00 will be deductible from my first order.

NAME _____

ADDRESS _____

CITY _____ ZONE _____ STATE _____

Make \$20 to
\$30 a Week

**EXTRA
MONEY**



MACHINE SAW FILING PAYS UP to \$3 or \$5 an HOUR

• Turn your spare time into CASH—sharpening saws with a Foley Automatic Saw Filer pays up to \$3 or \$5 an hour. You will find you can make \$20 to \$30 a week in your spare time as a starter.

You can work in your basement or garage—no experience necessary. "The first saw I sharpened with my Foley Filer came out 100%"—writes Clarence E. Parsons. No canvassing—"I advertised in our local paper and got in 93 saws"—says M. L. Thompson. The Foley is the only machine with which you can file all hand saws, also band saws and cross-cut circular saws.

SEND FOR FREE BOOK "MONEY MAKING FACTS"

Shows how you can get business from home owners, farmers, carpenters, schools, factories, etc. With a small investment, no overhead, no stock of goods to carry, you can get right into a cash business,—and possibly later on develop into a full-time repair shop. Send coupon today for Free Book. No salesman will call.

"Each saw I filed got me 6 more and business has been picking up that way since a year ago. If it keeps up I will have to buy another Foley Saw Filer."
William C. Baldwin

"I have done 4 or 5 thousand saws in my spare time in the 4 1/2 years since I got the outfit, and they are all coming back." Len Crego

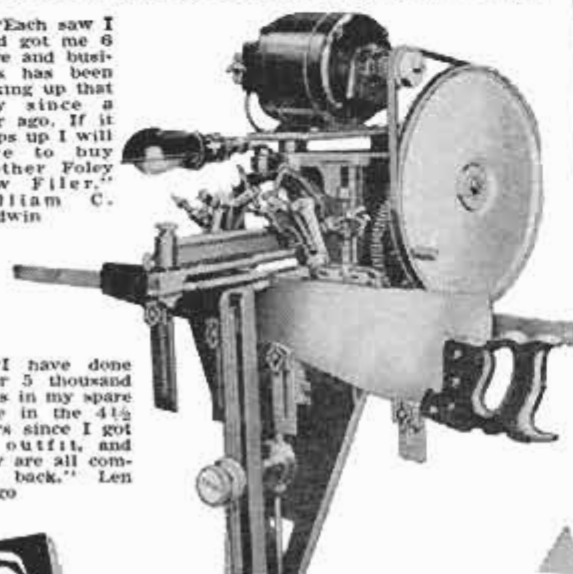

Send Coupon for **FREE BOOK**

FOLEY MFG. CO., 116-6 Foley Bldg.
Minneapolis 18, Minnesota

Send **FREE BOOK**—
"Money Making Facts"

Name _____

Address _____

Traffic Tunnels Under Greenland's Icecap

(Continued from page 121)

the denser is the snow, until at about 150 feet it turns to ice. But ice is plastic, will flow and, under the terrific pressure of the icy mass above, pushes out at the edges of the icecap in the form of glacial streams and icebergs. As far as is known, the altitude of the icecap remains the same. The amount of ice pushed out around the edges of the icecap equals the precipitation which falls on the surface.

The icecap starts only a few miles from the coast. It is only 12 miles from the giant U. S. Air Force base at Thule, which rests on permanently frozen ground. Icy cliffs only 100 feet high mark the edges of the icecap. The farther inland you go, the deeper is the icecap. At the point where the experimental tunnels were dug, it is 7000 feet thick.

Although the inland portion of the icecap has a snow covering, the coastal rim is solid ice, and is subject to melting and deformation. Dangerous crevasses and abrupt drop-offs mark this rim.

Here, along the icy coastal rim of the icecap, the trench tunnels made of and with snow cannot be used. Instead, the expedition tunneled through the ice with hand picks. The work went fast, for the ice at this point is cold and brittle.

A tunnel connecting Thule with other points on the island would have to start several miles inland from the edge of the icecap. A dirt road built on top of a natural ice ramp leading onto the icecap would extend for three to five miles. At other points an ice tunnel might lead directly from the edge of the icecap to its top.

An ice tunnel (not to be confused with a snow tunnel) 10 to 20 miles long would be dug, possibly by machine. From this point, the snow tunnel would be employed.

"The possibilities of tunneling don't stop with transportation," says Doctor Bader. "We could hollow out huge underground rooms in the ice only a few miles from Thule. Huge caches of supplies could be stored there, safe from anything but a direct hit by an atom bomb. The rooms, supported by conventional wooden beams, could be any size desired. Inside the ice room a building would be placed. With this room-inside-a-room arrangement, heating and insulation would not be a problem.

"Naturally, the same kind of hidden depot could be built in the snow at any point where we might wish to build a snow-field runway or store vital supplies. And each year, Nature would place another protective covering over our heads." ★ ★ ★



CRESTOLOY WRENCHES

**Unmatched in
QUALITY
PERFORMANCE
REPUTATION**

Forged from Crescent's own CRESTOLOY Steel, these fine wrenches are 200% stronger and 30% thinner than conventional adjustable wrenches. They are hardened by a selective induction process which guarantees longer life through a combination of surface hardness and interior toughness. Chrome plate finish.



8 SIZES IN SINGLE AND DOUBLE END TYPES

Number	Size	Capacity
AC14	4"	1/2"
AC16	6"	3/4"
AC18	8"	15/16"
AC110	10"	1-1/8"
AC112	12"	1-5/16"
AC115	15"	1-11/16"
AC118	18"	2-1/16"
AC124	24"	2-7/16"
BC146	same as 4"	6" and 8" above
BC168	" " 6"	" " " "
BC1810	" " 8"	" " 10" "
BC11012	" " 10"	" " 12" "

CRESCENT and CRESTOLOY TOOLS

are sold by hardware dealers and industrial distributors everywhere. Look for the bright yellow Crescent display panels and select from one of the world's greatest assortments of quality hand tools.



CRESCENT TOOLS

Give Wings to Work

*Sign of the Artisan
Symbol of Excellence*

®

Crescent is our trade-mark, registered in the United States and abroad, for wrenches and other tools. Sold by leading distributors and retailers everywhere and made only by
CRESCENT TOOL COMPANY, JAMESTOWN, NEW YORK

**"GET IN WHERE BIG ONES LURK
WITH
Bait Casting
Tackle!"**

says W. E. Johnson
of Duluth, Minn.



FIRST WITH BAIT CASTERS!

Shakespeare
DIRECT DRIVE REELS
WITH
LQT* NYLON GEARS

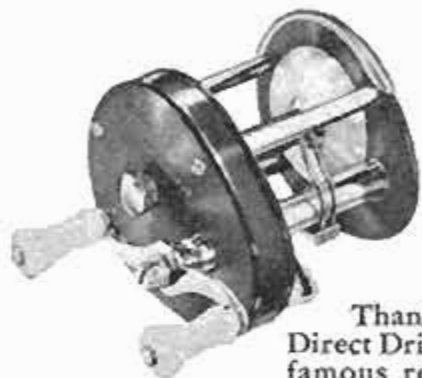

No. 1926
Feather-light,
sporty, in green
anodized aluminum.
Tough and rugged
for all fresh-water
use... **\$12.00**



No. 19245
Chrome-plated brass,
for light salt water
and heavy-duty fresh
water use. With star
drag crank. Priced at
only **\$13.50**

Thanks to the amazing
Direct Drive principle, these
famous reels out-cast and
out-last ordinary reels! Only
two LQT* nylon gears... and
a rugged one-piece shaft
with *two* bearings... give
Shakespeare DIRECT DRIVE
reels the smooth, quiet per-
formance, and dependability
that make them *preferred!*

*LIGHTER, QUIETER, TOUGH-
ER nylon gears are lighter
than metal, quiet as a cat on
a carpet... and *hundreds of
thousands* in use prove they
outwear metal gears! Try one
soon—at your dealer's.

Free! NEW 1956 "TIPS and TACKLE" BOOK-PAK
WITH POCKET FISHING CALENDAR

Catch more fish! These 4 new books show
ways to fish, where to find 'em, tackle for:

SPINNING • BAIT CASTING
FLY FISHING • SALT WATER



SHAKESPEARE COMPANY
Dept. PM-1, Kalamazoo, Michigan.

Please send, FREE, new 1956 "TIPS and TACKLE"
booklets and Joe Godfrey pocket fishing calendar.

Name _____

Address _____

City _____ Zone _____ State _____

They Graduate Underwater

(Continued from page 112)

buckles. This provides a "quick release" feature whereby with a single jerk both the heavy lung and belt can be released, permitting the diver to surface quickly.

The belt contains thick, coin-shaped lead weights of one pound each. They provide "neutral buoyancy" for the diver. The average male requires five pounds, the female four, to provide neutral buoyancy.

All this time you have kept your face mask in position, breathing through your mouth, so that now—as the instructor fits your mouthpiece into position—you "go on" compressed air for the first time.

"Breathe in firmly, causing a slight suction in the hose," he tells you. You feel the dehydrated air coming as you demand it from the regulator. It is tasteless.

Fill Mouthpiece With Water

You have been standing waist-deep in the pool, and now Townsend orders you to remove the mouthpiece and deliberately fill it with water at the surface. "This is exactly what happens should you suddenly sneeze or hiccup or otherwise lose your mouthpiece while swimming underwater," he says. "If you are down deep, that means you will not have time to make it back to the surface. You *must* be able to clear that mouthpiece and exhaust hose of water—and fast!"

Demonstrating with his own flooded equipment, he now shows you how to drop your left shoulder, tilting your body—and hence the regulator assembly at your back—in that direction. "Since the stale air normally goes out the left-hand tube to the exhaust valve, which is located on the left side of your regulator, you are now making sure that the clogging water follows the same path," Townsend explains. "Then, rolling even farther—so that you are almost over onto your back—you make sure this water has settled into the lowest part of the regulator. You use the remaining air in your body to blow it out, like this..." As he blows sharply into the mouthpiece the unwanted water can be seen emerging through the regulator's flapper valve, thereby clearing once more the lung's vital breathing circuit.

"Now go sit on the bottom and do it several times," Ed Townsend tells them.

Rid Masks of Water

Before the students are turned loose to roam the pool depths, Townsend also teaches them how to rid their face masks of water without surfacing. Such masks

(Continued to page 284)

As little as \$53* (full price!) buys a 1956 CHRIS-CRAFT Boat Kit!



SPORTS UTILITIES **\$53 to \$255**

Enjoy new fun and adventure, save up to 50% with a 1956 Chris-Craft Boat Kit! Choose from such top performers as the *8-ft. pram (kit \$53); the sporty 12-ft. Vagabond (kit \$133); the trim 14-ft. Dolphin (kit \$158); the rakish 14-ft. Caribbean (shown at left; kit \$192); or the rugged 15-ft. Marlin (kit \$255).

SPORTS RUNABOUTS **\$167 to \$349**



Finest designs and materials go into our new Boat Kits; they're *easy* and *fun* to put together! See the sleek, five-passenger 14-ft. Bonito with smart center deck (kit \$167); the sensational 14-ft. Barracuda (kit \$229); or the superb 16-ft. Custom Runabout (shown at right) with its roomy cockpit (kit \$349).

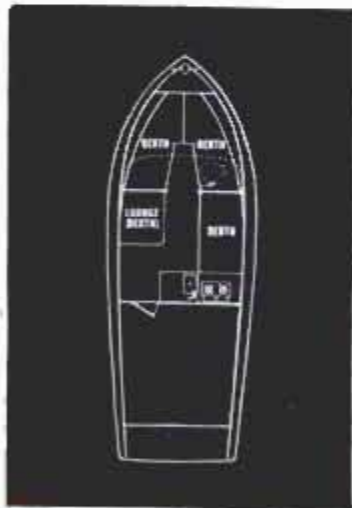

CRUISERS **\$352 to \$910⁵⁰**
Outboard or Inboard

BUY NOW! SEE YOUR CHRIS-CRAFT BOAT KIT DEALER OR MAIL COUPON, TODAY!

CHRIS-CRAFT CORPORATION, BOAT KIT DIVISION, ALGONAC, MICHIGAN

Gentlemen: Please send me more information about 1956 Chris-Craft Boat Kits.

NAME _____

ADDRESS _____

CITY _____ ZONE _____ STATE _____

For weekend or vacation cruising, there are low-cost cruisers: the 16-ft. Outboard Two-Sleeper Express (kit \$352), and both inboard and outboard models in the beautiful 22-ft. Four-Sleeper Express Cruiser shown above (hull and cabin kit only \$910.50; cabin interior kit \$83; fly-bridge windshield kit \$62.50).

Prices f.o.b. factory, subject to change without notice.

LIMITED **Darra James** POWER TOOLS OFFER

NEW Westinghouse MOTOR 1/2 PRICE

WITH THE PURCHASE OF ANY
DARRA-JAMES QUALITY POWER TOOL

Now! Start, or add to, your home workshop at a price so low you may never be able to duplicate it again! Choose from Darra-James 25 professional quality table saws, drill presses, band saws, jig saws, jointers, sanders, lathes, etc. Get a brand-new matching Westinghouse Motor for 1/2 price! Shop and compare!

EXAMPLE #1



8" Tilting Arbor
Saw (Model 28) **\$38.95**
1/3 HP Capacitor
motor **38.20**
Regular price **\$77.15**

NOW! BOTH ONLY \$57.85
(EXTENSIONS EXTRA)

EXAMPLE #2

12" Drill Press (Model
350B) **\$56.50**
1/3 HP Westinghouse
motor **26.95**
Regular price **\$83.45**

NOW! BOTH ONLY \$69.95



CLIP AND MAIL TODAY!

TOOLKRAFT CORP. DEPT. P-16
PLAINFIELD STREET, SPRINGFIELD, MASS.

- Please send me your free catalog, with information and coupon needed to take advantage of your 1/2 price motor offer, and name of nearest dealer.
- Please contact my favorite dealer. He is

NAME _____

CITY _____

- Please send me your Power Tool Handbook. I enclose 10c to cover handling and postage.

NAME _____

STREET _____

CITY _____

may suddenly leak, and he feels the resultant loss of vision is the first step toward uncontrollable panic—and death.

"Once more, tilt your body sharply to the left," he explains. "Then, using the right hand to hold the right side of the face mask close against your cheek, blow out sharply through the nose and into the mask. The air so compressed in the mask will force the water past the seal on the lower, or left edge."

The ocean-diving portion of the school comprises a trip by cruiser to reefs off Hollywood and Fort Lauderdale, Fla. The boat is anchored in 40 or 50 feet of water and, under the watchful care of three instructors (one of whom dives with you), you are permitted to go overboard.

To avoid possible injury from the 40 pounds of equipment on your back (it could knock you out by striking the head), you are shown how to jump in feet first or to sit on the gunwale and tumble over backward. The latter method prevents sudden contact from dislodging your mask.

You are cautioned always to swim up-current. "That way a student in trouble can surface and let himself drift back to the boat," explains Townsend. "Should he be permitted to swim in the opposite direction, the current speed plus his own speed would have him a mile away within 15 minutes."

Emergency Signal

The emergency signal is an upraised hand at the surface. It is given only in the event of a cramp, if the pupil is running out of air or in a similar emergency.

As you descend the sloping anchor line you experience an exhilarating feeling of newfound freedom and excitement that will very likely remain as long as you live. Below you awaits a vague, shimmering world of gold and jade. You are surprised at the loud croaking clatter made by a family of crayfish as they emerge partially from their cavern to inspect you. Perhaps you hear the grunt of a big grouper or count the slow, booming revolutions of a freighter's screw half a dozen miles away.

Cost of a good quality outfit, says Townsend, will range from \$135 to \$185. Face mask and fins will add about \$15. Charge for having one of the compressed-air tanks refilled is \$1.50. This quantity of air enables an experienced diver to operate at a 30-foot depth for about 90 minutes.

"Remember that it is exceedingly simple to put on one of these devices and dive down," Ed concludes. "And it is equally simple to get into trouble. Unless you are prepared beforehand to combat it, panic can hit you, boom—just like that!" ★ ★ ★

Do it yourself with

REYNOLDS DO-IT-YOURSELF ALUMINUM

There's *double* enjoyment when you make anything for your home with Reynolds *Do-It-Yourself* Aluminum... the reward of accomplishment, plus the pride of owning beautiful, useful furnishings you *thought* you couldn't afford. Hard to make? Not at all. One easy step... then another... and your lamp or buffet, primitive or wall sconce is complete, and ready for a *lifetime* of service, thanks to aluminum.

Oh yes you can

Reynolds Plans and Easi-Bild* Patterns are easy to follow. Ask your dealer for plans and patterns or write for illustrated catalog.



REYNOLDS METALS COMPANY

2494 South Third Street • Louisville 1, Kentucky

*T.M. Easi-Bild Pattern Co. • Available in Canada



BUILD YOUR OWN MIDGET ROADSTER \$25 BUILDS BODY & FRAME

BUILD A PONY ROADSTER or Pick-Up in few spare hours. Uses 2 hp engine, 450 lb. loads, 70 m.p.gal., plenty of speed. Designed for **VERY LOW-COST** assembly from **PARTS BOUGHT IN YOUR NEIGHBORHOOD**. Use home tools. Great for kids, sturdy utility car. **COMPLETE** step-by-step plans, 17 large-size pages, 30 "show-how" photos. Body templates, complete material and parts list. **ONLY \$1.95 POST-PAID**. Satisfied or money back.

PONY PLANS, 7641-T TEXHOMA AVE., NORTHRIDGE, CALIF.

WHY TAKE LESS THAN THE BEST?

INSIST ON EAGLE FOLDING RULES

COIL SPRING JOINTS

GUARANTEED AGAINST JOINT FAILURE FOREVER

EAGLE RULE MFG. CORP. N.Y. 59, N.Y.

THE ORIGINAL PACKAGED BOAT KITS Made ONLY by *Custom-Craft*

Top Performance, Design, Styling! Over 70 Models 8 to 21 ft

World's largest line! Over 200 Boats: Kits, Formed-Hulls, Semi & Custom-finished! All types: Prows - Cruisers! Easy to build! Flying stern, Tredonic bottom, Bulkhead construction!

Send 25¢ for KIT CATALOG

32 pages! Includes Victory Series, hardware, paint accessories, Fiberglas! Send \$1.00 for Catalog Plus "Boating Handbook". DEALERS-AGENTS INQUIRE

BOAT PLANS & PATTERNS Frame-Pac Kits World's largest selection: over 200 plans, full-size patterns, frame-pac kits! Designed strictly for amateurs! All types: prows, kayaks, racers, runabouts, catamarans, houseboats, cruisers - inboard-outboard 6-40' wood-plywood-steel!

Send 25¢ for PLAN CATALOG Catalog PLUS "Boatbuilding Handbook" \$1.00

DEPT. A CUSTOM-CRAFT - BUFFALO 7, N.Y.

BIG PROFIT IN YOUR OWN BUSINESS

The GRINDRITE Lawnmower Sharpening Machine can be used right in your own garage. WE HAVE A PROVEN PLAN FOR MAKING MONEY. Every home and many businesses have lawnmowers and most need sharpening right now! \$2.50 or more per sharpening is yours in 10 to 20 minutes. GRINDRITE is your key to success and security. Don't delay. **BE YOUR OWN BOSS** Work on your own schedule—the profit is all yours. Your investment returned in a few days.

GRINDRITE LAWNMOWER SHARPENING MACHINE

Complete, ready and simple to operate. Anyone can do a precision sharpening job by following simple instructions.

THE FASTEST, EASIEST-TO-USE SHARPENING MACHINE AVAILABLE

WELDED STEEL CONSTRUCTION—SIMPLIFIED CONTROL—QUICK PRECISION SHARPENING.

\$285.00 Complete with 110v motor. Freight paid in U. S. **GRINDRITE** Dept. P-1, 9841 Alpaca EL MONTE, CALIF.

"HIDDEN VALUES" MAKE A *Mall* DRILL YOUR BEST BUY



These exclusive MALL "hidden" construction features make any MALL tool your best buy for years of trouble-free performance. MALL manufactures a complete line of power tools and attachments for every need... for the home shop, farm and industrial use. And MALL direct-to-dealer distribution assures lowest economy prices for high quality power tools.



MALL TOOL CO. PORTABLE POWER TOOLS • GASOLINE • ELECTRIC • AIR
7805 South Chicago Avenue, Chicago 19, Illinois
Send me all the facts about MALL Drills.
Name _____
Address _____
HU-199

LIMITED SUPPLY! BRAND NEW, BALL-BEARING SINGLE PHASE ELECTRIC MOTORS FAMOUS BRAND! SAVE WAY OVER HALF!



Powerful Capacitor and Repulsion-Induction MOTORS with heavy starting torques to handle EVERY heavy-duty job. NEW, ball bearing models that mount IN ANY POSITION, 115-230 Volts, 60 cycle, single phase. Standard mounting and shaft size. Perfect for: refrigeration, saws, machine tools, blowers, grain elevators, wood-working tools, pumps and farm equipment. Fully guaranteed. Save dollars! ORDER DIRECT FROM THIS AD TODAY!

3/4-HP, (Reg. \$49.80) 1750 RPM, Ball Bearing...only \$29.85 fob
1 1/2-HP, (Reg. \$107.42) 3450 RPM, Ball Bearing only \$52.25 fob
2-HP, (Reg. \$150.15) 1750 RPM, Ball Bearing...only \$93.45 fob
3-HP, (Reg. \$190.00) 1750 RPM, Ball Bearing...only \$114.85 fob
FREE CATALOG OF MOTORS and WAR SURPLUS

ROBERTS ELECTRIC CO., Dept. PM-356, 849 W. Grand, Chicago 22, Ill.

SAY YOU SAW IT IN
POPULAR MECHANICS

MAKE UP TO \$25 DAY sharpening Discs with New Machine

Now you can quickly sharpen farm discs in a farmer's own yard or shop. New portable Foley Disc Sharpener jacks up harrow, rotates discs as it grinds them—takes only 1 or 2 minutes per blade. Saves farmers time and trouble—no dismantling or hauling to town—and you can make up to \$25 a day. Foley equipment easily carried in car trunk.

FREE PLAN— shows how to start in spare time CASH business. No experience needed—no salesman will call on you. Write today.

C. H. FOLEY CO.
COLUMBIA HEIGHTS, MINN.



Enjoy Modern Living • Make Your Home Worth More With This Popular Mechanics Book . . .



759 PICTURES
Above: How to lay a new roof over the old.
Right: New walls over the tired old walls. A few of the 83 modern kitchen ideas.
Below: Modern ceilings for old basements.

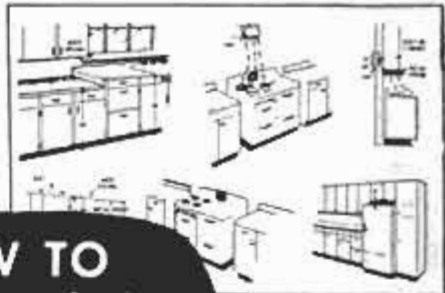

HOW TO Remodel Your Home

With Data on New Materials and Products Available to Home Owners

Here are hundreds of ways you can make a modern home out of an old house, make the house worth more and save money while doing it. If you own an old house or intend to buy one, get "How to Remodel Your Home" by E. R. Haan, formerly technical editor for Popular Mechanics. You can do the modernizing yourself or have it done for this vital book contains 547 methods and 759 illustrations covering complete modernization, adding rooms and living space, installing new kitchens and baths, adding closets, wardrobes, rumpus rooms. Complete face-lifting jobs for the outside and morale building jobs for the inside. Learn the joys and conveniences of modern living with this vital book prepared especially for the home owner. Mail coupon for your copy today.

Money Back if You Want It.

Get the book now. Check it for information that will help you improve your home for appearance, convenience and value. If not fully pleased return the book in 7 days and Popular Mechanics will refund every penny you have paid.



Big Book.
Same Size as
This Magazine.

What to Do! How to Do It! How to Cut Costs and Save

In this book—17 big helpful sections. They are:

- From old to new—Your modern kitchen
- Better bathrooms
- Basement rumpus rooms
- Curing wet basements
- Attic space and dormers
- Adding rooms to the outside—Porches and breezeways
- Utilizing idle space—New look for outside walls
- Modern interior walls—Heat-loss and humidity controls
- Roof framing and covering—Windows that modernize
- Entrances and doors
- Variety in floors
- Wiring, plumbing heating. In all—547 money-saving articles you can use.

Use Coupon to Get Remodeling Book

POPULAR MECHANICS PRESS, 200 E. Ontario St., Chicago 11

Send at once "How to Remodel Your Home," postpaid for \$2.95. I understand I may return the book in 7 days for full refund.

Remittance for \$2.95 enclosed. Send book postpaid.
 Send COD. I will pay postman.

Name _____

Address _____

City _____ State _____

FUEL HARDY!

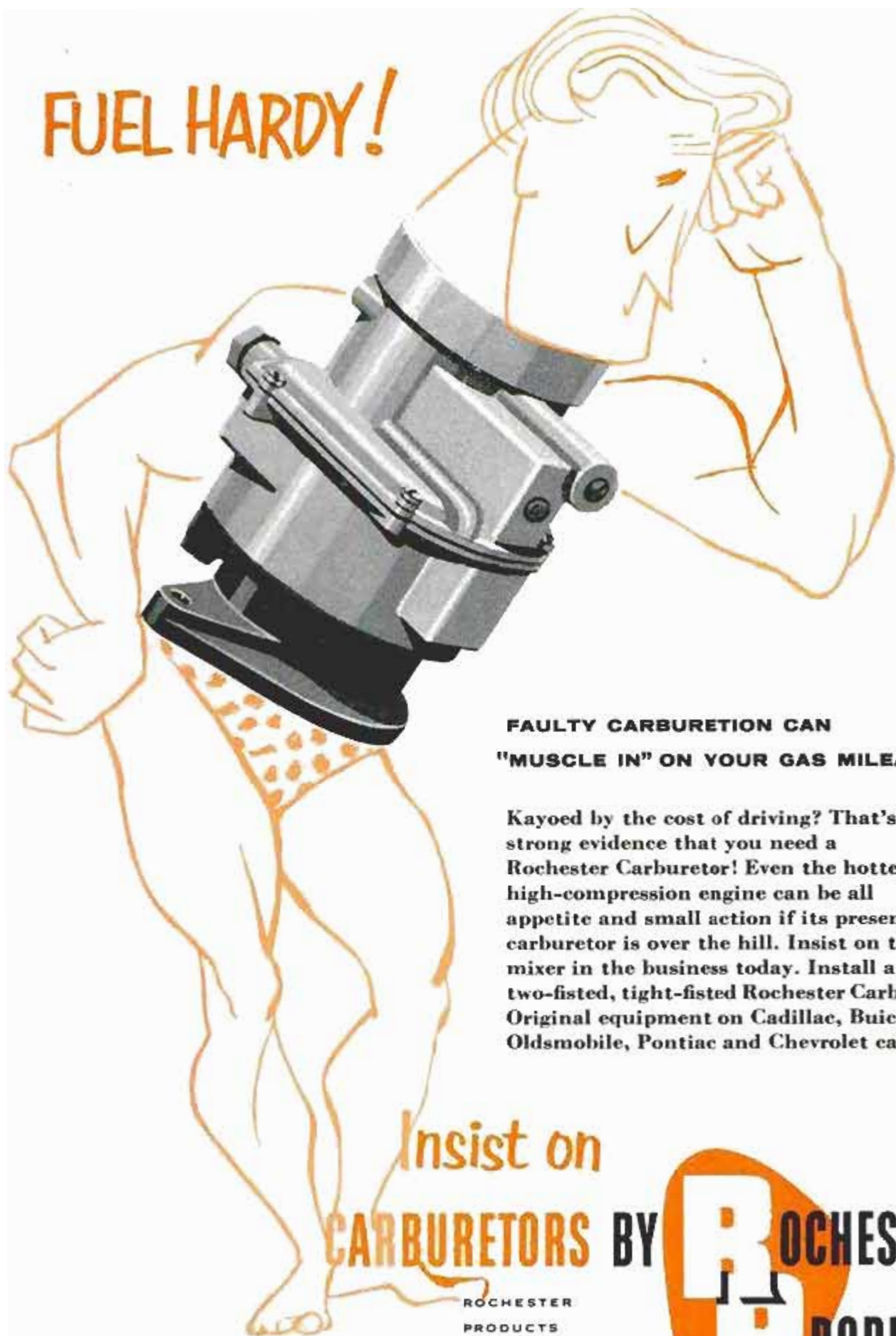

**FAULTY CARBURETION CAN
"MUSCLE IN" ON YOUR GAS MILEAGE!**

Kayoed by the cost of driving? That's strong evidence that you need a Rochester Carburetor! Even the hottest high-compression engine can be all appetite and small action if its present carburetor is over the hill. Insist on the best mixer in the business today. Install a two-fisted, tight-fisted Rochester Carburetor. Original equipment on Cadillac, Buick, Oldsmobile, Pontiac and Chevrolet cars.

**Insist on
CARBURETORS BY ROCHESTER**

ROCHESTER
PRODUCTS
DIVISION OF
GENERAL MOTORS
CORPORATION
ROCHESTER N.Y.





FREE
WRITE FOR COMPLETE DETAILS AND EASY PAY PLAN

NOW! HOME CRAFTSMEN CAN OWN THIS PROFESSIONAL ARC WELDER

EASY TERMS ONLY \$98.50 F. O. B.



Guaranteed 12 MONTHS IN CONTINUOUS OPERATION

Now you can own a Trindl full 125 amp Industrial Welder at a price far less than smaller machines. With a Trindl 125A you can weld metals up to 1/2 inch thick. Operates off either 110 or 220 volt line, properly wired. 16 heat stages from 20 to 125 amps. Make and repair anything of metal around the home, garage, farm or shop, like a professional. No previous experience or training needed. Full "do-it-yourself" instructions with each machine. Complete only \$98.50 f.o.b. factory, or write for details. Trindl manufactures a complete line of heavy duty welding machines. Dealer inquiries invited.



TRINDL PRODUCTS Ltd., Dept. T2-A
1807 So. Clark St., Chicago 16, Ill.

NEW Govt. Release!
Original Cost \$444.00



HOMELITE "Carryable" GENERATING PLANT

1500 WATT 60 CYCLE, \$189.00
Single Phase, A.C.

Carrying handles for easy portability. Fits easily in car trunk

Fully Guaranteed

Save Hundreds of \$\$\$

PAYS FOR ITSELF! Saves time, labor and money. Provides on-the-spot power for CONSTRUCTION, etc. where none is available or expensive to run in. LARGE ENOUGH for Floodlights; Saws; Pumps; and many more labor-saving, heavy-duty machines. Ideal as a stand-by emergency power plant to duplicate house current. Plenty of power for lights, refrigerator, deep freezer, oil burner, radio, etc. Specifications below CAN'T BE MATCHED anywhere at this price!

GENERATOR 1500-1700 Watts, 115 Volts, 60 cycle, single phase, A.C. Overload capacity well above its rated output. Excellent automatic voltage regulation plus Field Rheostat for even closer adjustment. Built-in Shock-mounted Volt Meter. Oversize brushes.

ENGINE Famous Homelite single cylinder engine. Air cooled; two cycle. Easy rope start. Dust and rain-proof ignition system. Built-in automatic governor. Foolproof pressure vapor lubrication system. Adjustable jet-type carburetor.

This Precision power plant has ball and needle bearings throughout and costs only 8c an hour to operate. Satisfaction Guaranteed.

SUPPLY LIMITED! IMMEDIATE DELIVERY! ORDER FROM AD
FREE Catalog of Compressors, Motors and Welders
ROBERTS ELECTRIC CO., Dept. PM-358, 849 W. Grand, Chicago 22, Ill.

"PRACTICAL FINISHING METHODS"

NEW DELTA hard bound book covers over 25 step-by-step schedules on how to obtain the most popular wood, metal finishes—only \$1.00. Write for FREE folder on many other Delta books: Delta Power Tool Div., Rockwell Mfg. Co., 502A N. Lexington Ave., Pgh. 8, Pa.

SAY YOU SAW IT IN POPULAR MECHANICS



YOU'LL FIND 1,001 USES FOR IT!

THE FAMOUS TEE-NEE MARINE WINCH

Wherever there's pulling or hoisting to be done, Tee-Nee's famous winch, developed for the marine industry, is always ready to do the job effortlessly, smoothly. Exceptionally powerful, holds any load up to 1,000 pounds. Scoffs at time, work and weather. Spool cast one-piece from special tough alloy, turns on full length bearing.

TEE-NEE TRAILER CO.
217 E. Indianola Ave., Youngstown, Ohio
Gentlemen: Rush _____ winch (s) to address below, for which find enclosed (cash) (check) (money order) in amount of \$ _____
Name _____
Street Address _____
City _____ State _____

Heavy gauge steel frame and detachable handle with plastic grip. Gear ratio 3 1/2 to 1. Self-locking ratchet lever may be turned to free-feed-out position. Comes with 35 feet of 3/8" rope and "S" hook. Only \$11.95 Postpaid

TEE-NEE TRAILER CO. 217 E. Indianola Ave. YOUNGSTOWN, OHIO
In Canada: Canasco Products Ltd., 1 Parnell Ave., Toronto

How to Build Your Own GARAGE



Save as Much as 50% of Usual Construction Costs

Get Popular Mechanics' brand new book **How to Build Your Own Garage** by Wayne Leckey, Assistant Shop Notes Editor, and find out how you can build your own garage at savings of 50% of usual cost. Leckey tells in famous step-by-step instructions and shows in big, clear photos, drawings and diagrams how to perform every building operation from laying the concrete to installing the final trim. There are 25 designs. Brick, frame, and concrete block fully covered. Send \$3.50 for your copy. 7-day money back guarantee.

POPULAR MECHANICS PRESS, 200 E. Ontario, Chicago 11, Ill.

SPARE-TIME MONEymAKING OPPORTUNITIES
READ OUR CLASSIFIED ADS
HUNDREDS OF BARGAINS AMAZING OFFERS

YES! SEND



directly to my door every month

I am enclosing
 \$3.50 for 1 year
 \$8.00 for 3 years

name _____
address _____
city _____ zone _____ state _____ A-16

Hand this order to your newsdealer or send it to
POPULAR MECHANICS
200 East Ontario St. Chicago 11, Ill.

SMALL INVESTMENT PUTS YOU IN GOOD PAYING BUSINESS OF YOUR OWN

ROGERS MANUFACTURING CO.
Dept. M-16, Lindsey, Ohio

Gentlemen: Please rush complete details about
the big-profit possibilities of the Universal
Lawn Mower Grinder. **FREE**

Name _____
Address _____ State _____
City _____

SHARPENING LAWN MOWERS IN SPARE OR FULL TIME . . . AT GOOD PROFIT.

Thousands are successfully earning good money with the Universal plan of a spare or full time business in their garage or basement. Previous experience not necessary. Age no handicap. C.H.R. of Ohio made \$3,688.20 working part time, in one season. The new Universal is the only grinder in the world that enables you to grind both the bed knife and reel blades . . . **IN A SINGLE SET-UP**

. . . without removing them from the mower. Just put the mower in the grinder, follow a few simple instructions and you can do an expert job sharpening hand or power mowers without removing engine, handle, or roller. **SEND COUPON** today for success plan of this low investment big pay business of your own.

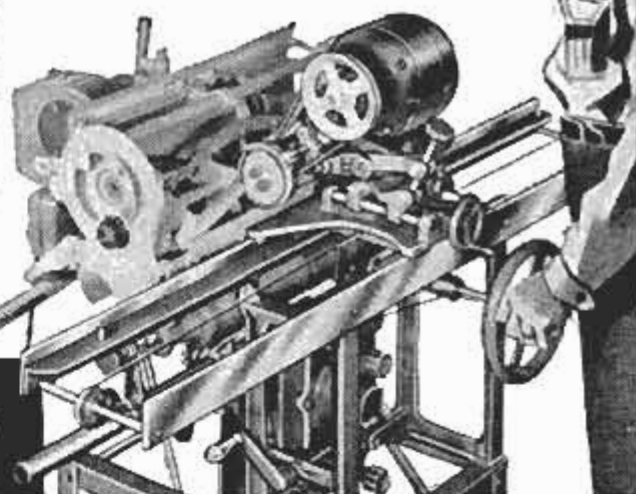

ROGERS MANUFACTURING CO.
LINDSEY, OHIO

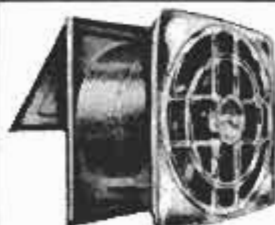

ATTENTION HOME OWNERS!
NO EXCUSE NOW FOR NOT
HAVING A KITCHEN FAN!

Complete unit. Polished grill. Automatic fan goes on when door opens! **\$15.95**

Postpaid
Don't let price fool you,
this is the latest new model!

Pennsylvania Wholesale Distributors
104 N. 6th Street, Philadelphia 6, Pa.

HOW TO BUY WHOLESALE

Start a buying service. No experience or capital necessary. Buy Nationally Advertised Merchandise Wholesale. Sell to others at fabulous profits. Rush postcard to: **WHOLESALE BUYERS' SERVICE**, Box 22, Dept. 21, St. Louis 3, Missouri

Say You Saw It in Popular Mechanics

Insist on *Evans* TAPES
"The Mathematical Genius"
At Your Hardware Store

6-ft.
pocket tape
only **98c**



Available, too, in 8, 10, 12-ft. lengths.
Each with **FREE** plastic utility case.

Automatically
figures for you in
feet and inches or
total inches.



Also in 6, 8, 10, 12-ft. King-Size Tapes.

**AMERICA'S
LARGEST STOCKS
of JEEP PARTS**

**LOWEST PRICES!
SATISFACTION
GUARANTEED!**

The King of Jeeps

FREE JEEP CATALOG - WRITE FOR IT TODAY!

BRAND NEW CAPSTAN WINCHES

NEW LOW PRICES

6000 lb. capacity. Accurately machined gears provide for smooth efficient operation. Suitable for both front or rear mounting. May be used on jeeps or trucks. All units are brand new and fully guaranteed.

EACH

\$25.00



FRONT AXLE SHAFTS
Army or Civilian
LONG **\$40.65** SHORT **\$34.48**

JEEP WHEEL
New - 16 in. Drop Center
Army or civilian **\$6.50** EA.



The "K" Free Wheeling **FLANGE**
Saves Gas Stops Growl
Simple-Easy Conversion
FROM 4 TO 2 WHEELS
\$19.95 Per Set
Complete With Ball Bearings

The **JEEP KING**
ALL STEEL CAB



HALF CAB **\$125.00**
FULL CAB **\$185.00**

F.O.B. Ohio

SPECIAL SERVICE TO GARAGES AND SERVICE STATIONS

Thousands of other Jeep parts and accessories available. **SHOP BY MAIL**-Order Direct From This Today. **TERMS:** Net cash with order. Open account to rated firms only. C.O.D. shipments should have 25% deposit with order. Minimum order \$1.50. Inquiries invited from dealers, exporters and quantity buyers.

BERG TRUCK & PARTS CO., INC.

1608 S. WABASH AVE., DEPT. 16, CHICAGO 16, ILLINOIS

WATER AT LOWER COST!

WITH A

General Motors
DELCO
Wellmaster Jr.
Water Pump

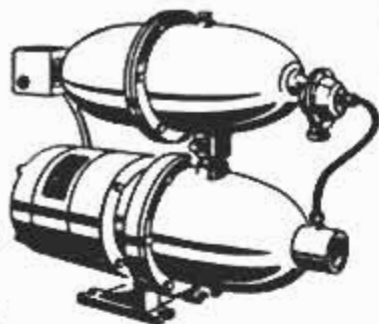

ONLY
\$89.95
f.o.b. Rochester

Suggested List Price
Model S3372 as illustrated

Now, a Delco Jet unmatched for Price and Quality . . . in the 1/3 H.P. class! This Delco Jet offers the simplicity of only ONE moving part . . . plus, self-adjusting capacity, greater compactness . . . greater durability. Here is a shallow well pump to bring water at a low, low cost. Built and backed by General Motors . . . your assurance of years of trouble-free service. Other sizes available.

FREE! Water Systems Demonstration and Survey of Your Problem.

Write Today! DELCO APPLIANCE DIVISION
GENERAL MOTORS CORPORATION
Dept. PM, Rochester 1, N. Y.

YOU BUILD EICO KITS

in one evening. SAVE 50% & LEARN

Easy Instructions | Vacuum Tube Voltmeter
38 Instruments | KIT \$25.95 Wired \$39.95

Write now for FREE Catalog . . . PM-1



Electronic Instrument Co., Inc. • 84 Withers St. • Brooklyn 11, N. Y.



I WILL SAVE YOU UP TO 90%

Send for my NEW 1956 Illustrated BIG BARGAIN BOOK OF WAR SURPLUS for mechanics, farmers, gadgeteers, outdoorsmen. My prices are unbelievably low.

WAR SURPLUS BARGAIN FREE!

P-1 GENERATORS

200-250 Amp, 24 Volt DC, 4500 RPM. Makes dandy Arc Welder. Cost \$398. Used like NEW—SPECIAL \$12.88. Gov't. Overhauled \$19.80. NEW \$24.75. FOB York. Diagram Free! GUARANTEED! Cal.—1000's BIG BARGAINS FREE!

KART ORT, Dept. 1PM, York, Pa.



WELD **BRAZE**
SOLDER **CUT**



4WAY
ONLY
\$14.75
f.o.b. factory

WELDER
Complete with
Twin Carbon Arc
Torch and accessories . . . to
handle all metal-craft work.

Acclaimed by thousands of Homeowners, Mechanics and Hobbyists as the welder of 1001 uses. Easily operated from properly wired 110 volt AC or DC line. The ideal gift with a life-long use. . . Order today on 10 day money back guarantee.

FOUR-WAY WELDER CO., Dept. F2-A
1810 S. Federal St. • Chicago 16, Ill.

A Business of Your Own without Investment!



Start a dignified, big-paying Work Uniform business in your community. There's big money just for taking orders for work uniforms embroidered to advertise. Customers are everywhere—garages, service stations, factories, institutions. You represent the finest, largest selection of styles, embroidery, fabrics—including amazing "wash and wear" Orion, Dacron, Dynel, etc. Sales come easy. Profits are big. Repeat business insures future. **AND YOU DON'T INVEST A PENNY TO GET STARTED.**

EVERYTHING YOU NEED SENT FREE!

Write for exciting, full-color SALES DISPLAY that shows styles, actual fabric samples (including miracle Orion, Dacron, etc.) It doesn't cost you a cent . . . yet it can put you into a steady, big pay business for life. Write today.

TOPPS, Dept. 531, Rochester, Ind.

FREE CATALOG STEEL

STEEL • BRASS • ALUMINUM and ALLOYS
ANGLES, CHANNELS, TEES, "I"'S, FLATS, ROUNDS, SQUARES, & SNAFTING, ALSO BEARINGS, GEARS, PULLEYS, SPROCKETS, ROLLER & WELDED LINK CHAIN, BOLTS FROM 1/8" TO 2" DIA. PIPE FROM 2 1/2" TO 24" DIA., STEEL CABLE. GET YOUR FREE CATALOG NOW!

EVERY DIMENSION ANY QUANTITY **AVCO • 879 Broadway, Cleveland 15, O.**

FREE AMAZING NEW BOOK "HOW TO ANSWER ADS"



Never before have you seen anything like this. Tells you in simple language the correct way to answer ads. Gets you quicker replies—better results, and greater satisfaction. Will save you time and money and it's **ABSOLUTELY FREE**. No obligation whatever. Every reader of advertising should have this booklet. Send a postcard for your copy NOW. F. W. Johnson, Popular Mechanics Magazine, Room 600-A, 204 East Ontario Street, Chicago 11, Illinois.

200 ONE-EVENING PROJECTS

Start and Finish Any One of These Projects in One Evening!

The editors of Popular Mechanics have assembled 200 projects, any one of which you can start and complete in a single evening. In a few hours' time, using only simple hand tools, you can build a coffee table, magazine rack, end table or scores of other useful projects. There are projects for the entire family. Best of all, any one may be built in just a few hours. No special skills are needed. Even if you have never built anything before, you can build the 200 projects in this big new book!

Step-by-Step Instructions, Show-How Photos, Drawings

First you read how to do it in famous Popular Mechanics step-by-step instructions and then actual photos, drawings and diagrams show you how it is done.

Each Project Costs Just 1c

Just imagine! Each project costs you only 1c. Where else today can you get so much for so little? Fill out and mail the coupon now. Pull money-back guarantee, of course.



POPULAR MECHANICS PRESS, Dept. EP-1
200 E. Ontario St., Chicago 11, Ill.

Gentlemen: Remittance for \$2.00 enclosed. Rush postpaid my copy of 200 ONE-EVENING PROJECTS. Unless it is entirely satisfactory I may return it in seven days for a full refund.

NAME _____

ADDRESS _____

CITY _____ ZONE _____ STATE _____

Send C.O.D. (U.S.A. only). Postage extra.

AMAZING BARGAINS—SAVE TO 100%
75 MOUNTED WHEELS AND MINIATURE CUTTERS



Regular \$11.00
 Value, Only
\$4.50
 Post Paid

For cutting and grinding on wood, metal or plastic. Includes 26 mtd. wheels and points on 3/32" shanks; 24 miniature cutters on 3/32" shanks; 25 short shank min. cutters. Will fit all electric drills and hand grinders.

FLEXIBLE SHAFT \$9.50 Value **\$4.95**
 Post paid



Fits all electric drills & hand power tools. 35 1/4" long. Oilite bearings. Core of specially wound, high carbon steel wire in flexible steel casing. Will accommodate tool shafts up to 1/4" dia. For lathes, electric drills, etc.

10 Hi-Speed Steel & Carbon Drills \$100
 Post-paid

5 Woodworkers Drills \$2.95
 From 1/4" to 5/8" on 1/4" shank.
 5 Hi-speed steel Drills \$1.95
 1/4" to 1/2" Diameter.

SCHUPACK SUPPLY CO. 7331 Cottage Grove, Dept. PM-8
 Chicago 19, Ill.
 NEW ILLUSTRATED CATALOG, 10c

NOW—SHOPSMITH®
 for as little as **\$3 per week**

Start enjoying SHOPSMITH now for only \$29 down, \$3 weekly. Start saving now! Savings on projects and home repairs can more than equal weekly payments. See your hardware dealer or Montgomery Ward store. Write for 2 big, free, illustrated books.
 SHOPSMITH, Dept. 318-B, Menlo Park, Cal., Waynedale, Ft. Wayne, Ind.

ALSO Adult Eshelman 2 Pass. SPORT & GOLF CARS LOWEST PRICE 70 Miles Per Gal. Free Catalog.

ESHELMAN CAR SNOW PLOW
 CLEARS ROADS & DRIVEWAYS



Bolts on to car or truck in 3 minutes without tools. Clears snow 16" deep and 72" wide. Lightweight and sturdy. Order now, or write for free catalog.

ESHELMAN, Dept. SP-21
 109 Light St., Baltimore 2, Md.
SHIPPING POINTS:
 Baltimore, Chicago, Reno

ALADDINIZE IN 1 HOUR



CLEANS AND WAXES in one easy operation. Aladdin, a guaranteed Auto Paste Wax, makes a luster that LASTS for MONTHS. 8 oz. net weight. \$1.98 postpaid.
ALADDIN PRODUCTS CO., P.O. Box 691, Solinas, Calif.

DYNAMITE POCKET RADIO \$3.95



Satisfied users report up to 1500 mile range with this electron tube complete KIT. Originally sold at \$5.99, production costs slashed! Assembles easily in one hour, with simple directions. Batteries and all parts fit in case. (Batteries \$1.00. Radioheadphone \$1.45. SUPER QUALITY American made hearing aid earset \$3.98, guaranteed \$7.00 value. (FACTORY WIRED \$7.95 SET ONLY). C.O.D.'s accepted with \$1.00 deposit.
PRECISION ELECTRONICS, Dept. M6, Cupertino, California

Get the facts on **Mobile Living**

Get **TRAILER TOPICS MAGAZINE**



When you subscribe to Trailer Topics Magazine, you get the latest information on Mobilehomes... Equipment... Accessories... Trailer Trips... Trailer Parks and many other interesting monthly features at only—\$3.00 for 2 years.

6-Month Trial Subscription \$1

TRAILER TOPICS MAGAZINE (Room 1570)
 28 East Jackson Blvd., Chicago 4, Illinois

help yourself to the handiest plier ever designed



CHANNEL LOCK

No. 420

GRIPS LIKE A PIPE WRENCH



No other plier does so many jobs so well as a Channellock No. 420. Grips anything from a small cotter pin to a 1 3/4" hex nut. And what a grip! Just like a pipe wrench. What's more, Channellocks are streamlined... easy to use in hard-to-get-at places. Ask your hardware man for a Channellock plier. You'll soon agree with thousands of other craftsmen... Channellock is the handiest plier of them all.

BE SURE IT'S A GENUINE CHANNELLOCK



CHAMPION DEARMENT TOOL CO. MEADVILLE, PA.

Build it Yourself! Furniture • Furnishings • Work Benches • Children's Toys • Shelves • Boat • Cupola • Weathervane • With

**Popular
Mechanics
NEW**

FULL SIZE PATTERNS

**Authentic Designs by Professional Designer
Trace Patterns on Wood and Follow Simple Guides
Every Step Made Easy for Building at Home**

Now, save money and turn out professional-looking jobs in your own home. Everything you need to know for building handsome furniture, a 12-foot outboard, toys for the children and many other items is contained in these patterns. Trace the patterns on the lumber, saw, smooth the edges and assemble—it's as easy as that. Every nail, screw, dowel and bolt is clearly located for you on the pattern. You can't make a mistake.



Modern Step Table

No. 103. Designed to be a companion piece for No. 104, described in the listing below, this table is 28 x 18 inches, upper step 24 inches high. Complete in one pattern. **50 cents**



Personal Work Bench

No. 108. This compact, sturdy work bench has sliding doors and a drawer. Top is 44 x 20 inches, 35 inches high. Lots of work space in small area. Two patterns in set. . . . **\$1.00**



**CRUSETTE
12 Foot Utility Outboard**

No. 101. Build this runabout at amazing savings with ordinary hand tools. Length 12 feet, beam 4½ feet. Complete material list and instructions included. Four patterns. . . . **\$2.00**



Trundle Beds

No. 102. These space-saving beds are safer for young people. 90 x 45½ inches. Top bed 40 inches, lower bed 23 inches high. Springs included. Three patterns in set. . . . **\$1.50**

11 OTHER PATTERNS AVAILABLE

In addition to the 4 full-size patterns illustrated, there are 11 others in stock. If you've been looking for some good projects for your shop, you'll want more than one of them. These patterns have become so popular that the supply may soon be exhausted. It is not surprising that Popular Mechanics readers have responded enthusiastically to the original announcement of these patterns—just think of it, you can't go wrong! Every pattern has been proven for design and correct fit of parts—is guaranteed to please you! So act now, while all patterns are still available.

No. 104. **Modern Cocktail Table.** Matches No. 103 above. 40 x 19 inches, 15½ inches high. Plank top and metal grill inserts in sides. One pattern. . . . **50 cents**
No. 105. **Toys for the Children.** "Giraffe Drawing Board" and "Bucking Bronco" riding toy. Pattern includes painting suggestions. One pattern. . . . **50 cents**
No. 106. **Juvenile Chest Robe.** Has hanging storage space, two drawers and shelf. 30 inches wide, 16 inches deep, 39 inches high. Two patterns in set. . . . **\$1.00**
No. 107. **Cupola and Weathervane.** 24 x 24 inches, 34 inches high, plus height of vane, which is made of metal or tempered hardboard. One pattern. . . . **50 cents**
No. 109. **Valances and Trims.** Twelve designs included. Merely trace patterns on the wood, saw and assemble. Finishing suggestions given. One pattern. . . . **50 cents**
No. 115. **Corner Table.** A new pattern to be used with the step and cocktail tables (Nos. 103 and 104) or alone. 29½ x 29½ inches, 18 inches high, plus an 8 inch diagonal step. One pattern. . . . **50 cents**

No. 110. **Decorative Wall Shelves.** Modern shelf with metal trim is 28 x 16 x 8 inches. Traditional shelf is 29½ x 16 x 8 inches. One pattern. . . . **50 cents**
No. 111. **TV Chair.** Seat 22 inches deep, 24 inches wide. Overall, 27½ x 32½ inches, 26½ inches high. Sagless springs and foam rubber. Two patterns in set. **\$1.00**
No. 112. **Modern Tub Chair.** Seat 22 inches deep, 24 inches wide. Overall, 28 x 27 x 27 inches. Sagless type springs and foam rubber. Two patterns in set. . . . **\$1.00**
No. 113. **Sofa Bed.** 78¾ x 29¾ inches, 33 inches high, with removable bolster. Uses 4½ inch standard foam rubber or other mattress. Two patterns in set. **\$1.00**
No. 114. **Love Seat.** Uses sagless type springs with foam rubber padding. 48 inches between arms, 21 inches deep. Overall, 55½ x 29 inches. Two patterns in set. . . . **\$1.00**

Order Blank for Popular Mechanics Patterns

Popular Mechanics Press • 200 E. Ontario St. • Chicago 11

Send postpaid Popular Mechanics Full Size Patterns as indicated below. Remittance for \$_____ enclosed. I understand that any pattern which does not please me may be returned within 7 days for full refund.

Gentlemen: Please send me Full Size Patterns numbers:
101 102 103 104 105 106 107 108 109 110 111 112 113 114 115
(circle numbers desired)

Name _____

Address _____

City _____ State _____

WAR SURPLUS AND OTHER BARGAINS SAVE UP TO 90%



P1 GENERATORS

Electric Auto-late, 200 Amps, 24 Volts, 4400 RPM. Dandy arc welder. Wt. 53 lbs. Approx. GOVT cost \$450. Like NEW. \$11.50 incl. easy diagram.

SENSATIONAL GENERATOR BUY!!

Famous Navy NEA-5 Generator. Combination AC-DC Type, AC voltage—115 V. DC voltage—24 V. 200 Amp. 2 complete generators in 1... 2 separate fields and 2 separate armatures on same shaft yet no larger than regular aircraft generator. Ideal for home, farm and shop lighting plants by hooking wires to AC side. DC side can be used for welding and operating war surplus low voltage hobby motors and equipment. Weight 54 lbs. Approx. GOVT. COST \$350. NEW \$27.50. Used, perfect, \$18.00.

SPECIAL CARBON PILE TYPE VOLTAGE REGULATOR TO GO WITH ABOVE GENERATOR. Incl. mounting base and completely enclosed in steel-mesh box. Helps maintain constant current and prevents pulsation. Ideal for installation with above generator for lighting plant. Wt. 5 lbs. Complete NEW, Approx. GOVT. COST \$90. Now only \$7.95.

BUY'EM BOTH SAVE \$5.45! Generator & Regulator together \$30

RI GENERATORS

RI Jack & Heintz. Rated 300 Amps, 30 Volts. Approx. GOVT. COST \$450. Perfect, like new. Wt. 60 lbs. \$23.50.

NEW PUMP AND MOTOR

Pump has 1" connections, built-in relief valve, adjustable up to 1500 lbs. Max capacity 6 GPM. 1 1/2 H.P., 24-volt motor, 4000 RPM. Can be used on 12 or 36 volts. Govt. cost approx. \$350—our price—NEW—\$9.95.



HOMELITE PORTABLE POWER PLANT

Buy power for pennies. Ideal for welding, battery charging, emergency lights for cabins, camps, trailers, aircraft or wherever power needed. Easy rope pull starting. Fully equipped, ready to start. 2000 W. 32 V. 5 HP. Complete, nothing else to buy. Like new, tested. Shock mounted. De Luxe type. Net wt. 115 lbs., gross wt. cased 200 lbs. Approx. GOVT. COST \$700. While they last—\$59.95.



PIONEER MAGNETIC COMPASS

For boats, trucks, cars. By Pioneer Instrument Co., Div. of Bendix, No. 1829-2A. Contains screw-type heeling compensator, removable drawer-type compensator, screw-type horizontal compensator and spider-type compensator. All devices for elimination of errors caused by effects of magnetism. Has constant deviation corrector and course setter. Rotable dial engraved with compass card graduations. Complete with book of instructions, light and mounting screws and shock mounts. Shpg. Wt. 10 lbs. Approx. GOVT cost \$400. NEW. \$13.95.



MICROMETER DEPTH GAUGE

With 3 rods to measure all depths from 0 to 3 inches by thousandths. Hardened tool steel lead screw has full 1 inch run. Base is 2 1/2" long, hardened ground and hand lapped. Accuracy guaranteed. Mfd. by Millers Falls Co. GOVT COST approx. \$30. NEW—\$10.95 ppd. USA. In velvet case.



MICROMETERS Chrome plated, precision engineered, carefully tooling to give long life. All new 0-1" cap. \$2.25 ea., 1-2" cap. \$3.50.



NEW IMPROVED MODEL MAUSER-TYPE PRECISION 1/1000" VERNIER CALIPERS

Quick, handy, accurate. 6" Vernier Calipers. Glass hardened, lapped measuring surfaces. Fine engraved scales—1/1000" and 1/128" for inside, outside & depth measurements. Friction thumb release. Larger capacity. 2 gib adjustments. Reg. \$25. Now only \$7.95. Leather case \$1 extra.



MAMMOTH CATALOG

Biggest ever... new low prices... Send 25c for your copy today. Prices F.O.B. Culver City unless otherwise stated. Check, money order or cash. 25% deposit for C.O.D.

AIRBORNE SALES CO., INC. DEPT. PM156
8501 Stellar Drive, Culver City, Calif.

Say You Saw It in Popular Mechanics



PLOW, CULTIVATE, MOW, RAKE BULLDOZE, SNOWPLOW SAW WOOD

TRACTORS

Just steer it with power turn. Several walking & riding models up to 14 H.P. Low price! Write for FREE literature.

SHAW Manufacturing Co.
4501 Front St., Galesburg, Kansas
668-G.N. 4th St., Columbus, Ohio



FORD Owners SAVE MONEY



Learn How to Make Your Ford Run Better... Last Longer... and Save Hundreds of Dollars!

Get this book, written especially for you, without one penny of risk and get more out of your car. Mail coupon for **MANUAL FOR FORD OWNERS** today. When the book comes, skip through the pages and see how your investment in one of America's most popular automobiles can be even a better investment than you thought. If you don't agree, send the book back and you'll get your money back.

A Popular Mechanics Book Written Just for You

Not a re-hash of service manuals. A complete new Popular Mechanics book written for the Ford owner by an outstanding automotive authority with the full cooperation of Ford engineers and service directors. It will save you money on repairs and service; make your Ford last longer; give you safe, economical and trouble-free motoring. And this is true whether you take your Ford to a regular service station or service it at home.

Prevents Trouble. Cuts Down on Repair Bills

Nothing like this manual anywhere. It covers all phases of operation, service and maintenance. It has entire chapters on the individual parts of your Ford—battery, ignition, starter, generator, regulator, lighting, fuel system, engine, lubrication, gasoline qualities, cooling systems, transmission, differential, rear axle, brakes, wheel alignment, tire care, body maintenance, trouble shooting on the road, etc. It covers your Ford, new and older models, step by step—bumper to bumper—showing you how parts operate; what can go wrong; how repairs and adjustments should be made and how to avoid all types of trouble.

Money Back if Not Satisfied

Mail the coupon today. Send only \$3.50 or you can pay postman. Money back guarantee protects you.

Official, Authoritative, Practical Information

Written by C. E. Packer, formerly service school instructor and auto show lecturer for automobile manufacturers, Member Society of Automotive Engineers, Special Services Editor of Automobile Digest, contributor to leading magazines, author of some of the biggest selling books on Automotive subjects.

Entire Chapters on Fordomatic and Overdrive



304 Pages. Hundreds of How-To-Do-It Illustrations and Diagrams

The entire book follows Popular Mechanics famous easy-to-read and easy-to-understand style. While primarily intended for the Ford owner, to help him get more out of his car at lower cost, it can be worth its weight in gold to the auto mechanic and service station operator who works, not only on Fords, but on all other makes as well, to which the information in the book can be easily applied.

Order on this Coupon

POPULAR MECHANICS PRESS, Dept. MF-2
200 E. Ontario St., Chicago 11, Ill.

Send Manual for Ford Owners at once. If not satisfactory I will return it within 7 days and you will refund full purchase price.

Remittance for \$3.50 enclosed. Send C.O.D.

Name _____

Address _____

City _____ State _____

The SANDER Designed for EVERY MEMBER of the FAMILY!

IT SANDS—Flawlessly!
IT POLISHES—Perfectly!
IT MASSAGES—Soothingly!

and it features

- STRAIGHT-LINE ACTION -

Set yourself for a new high in excitement when you get your first look at the new DREMEL Model B Moto-Sander! Here's versatility and performance that will make the whole family itch to put it to work. It delivers 14,400 sanding, or polishing, or massaging strokes per minute. Straight-line action guarantees flawless finishes, free of orbital or rotary scratches and swirls.

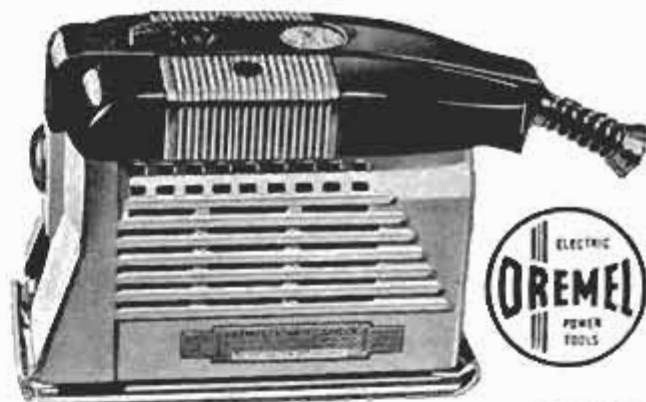

Model B Sander-Polisher-Massager \$14.85

Here's power-to-spare for finish sanding, polishing, a host of jobs in every home! Thousands of American families find the DREMEL Sander the most useful and used appliance they own. A single trial will prove why. See and try the DREMEL today!

WRITE FOR FREE CATALOG!

SEE YOUR DEALER. If he cannot supply, order direct on 5-day trial, money-back guarantee. Remit in full for post-paid shipment. Or send \$2 now, pay postman balance plus COD fee.

DREMEL MFG. CO., Dept. 116-A, Racine, Wisconsin



Model 2000 Sander, with steel case, 21 sq. in. sanding pad, **\$24.50**

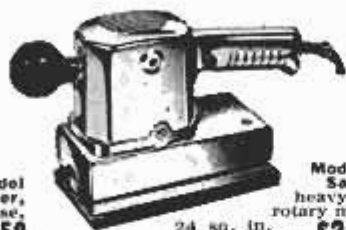

Model 53 Sander, heavy-duty rotary motor, 24 sq. in. sanding pad, **\$34.85**

DEPEND ON DREMEL FOR NEW IDEAS IN POWER TOOLS!

HELPFUL BOOKS

Send post card asking for **FREE** catalog

Popular Mechanics Press, 200 E. Ontario, Dept. 601, Chicago 11

What Every Farmer Should Know About Taking Care of Farm Animals



The Most Popular Veterinary Guide Ever Printed

This practical and helpful **VETERINARY GUIDE FOR FARMERS** prepares the farmer to perform many routine veterinary tasks—provides quick information that can often save the life of an animal—prevents disease in herds—saves money on the farm in a hundred different ways.

Written in plain understandable language. It covers symptoms, causes of disease and prevention, and treatment of cattle, swine, sheep, horses and poultry and warns when to call in the professional veterinarian. Names, terms and phrases made clear in a separate section. Over 100,000 copies of this book are in use on American farms. 275 pages. Fully illustrated. Only \$3.95. Order today under money-back guarantee.

POPULAR MECHANICS PRESS, Dept. PM13
200 E. Ontario St. Chicago 11, Ill.

CARBURETOR SAVES GAS VACUATING OVERRICH MIXTURES



Car owners who are getting poor gas mileage, and wasting money due to overrich mixtures, will be pleased to learn how to save gas. Easily installed Vacu-matic invention is **Automatic** and operates on the supercharge principle. For cars, trucks, tractors.

SALESMEN WANTED! Big Profits! FOR FREE PARTICULARS, HOW YOU CAN GET ONE ON YOUR OWN CAR FOR INTRODUCING, just send your name and address on a post card to—

VACU-MATIC CARBURETOR, Dept. 838, Wauwatosa, Wis.

FREE TV & RADIO SERVICING MANUALS



and Descriptive Literature on "Edu-Kit"—You Build 16 PRINTED CIRCUIT and METAL CHASSIS RADIO CIRCUITS at Home with the New Deluxe, 1956 PROGRESSIVE RADIO "EDU-KIT"

ONLY \$19.95 COMPLETE

All parts, chassis, instructions, Soldering Iron, Tester included. 30 Day Unconditional Money-Back Guarantee.

Gentlemen: Please Rush me **FREE** Descriptive Literature concerning "Edu-Kit." Also send me **FREE** TV & Radio Servicing Manuals. No obligation.

Name _____
Address _____

PROGRESSIVE "EDU-KITS" INC., Room 540-C, Progressive Bldg., 497 Union Ave., Brooklyn 11, N. Y.

GENUINE U.S. SIGNAL CORPS TELEPHONES AND COMMUNICATION WIRE!

INDUSTRY—RANCHES—BUSINESS . . . SAVE TIME, STEPS, MONEY . . . WITH YOUR OWN DIRECT LINE INTER-TELEPHONE SYSTEM.



Join the thousands of our customers who are now saving money with these easy to install phone systems. Just string wire, connect from 2 to 8 phones and ring and talk up to 20 miles. Battery powered. Perfect performance.

New Kellogg Magneto telephones. Sturdy, trouble-free. \$22.50 ea. per pair \$42.50. EES Army Field phones—factory reconditioned. Like new—per pair \$39.50.

OTHER PHONES AVAILABLE
C-433 latest field phone \$29.50 pair.
EE-91 all metal field phone \$29.50 pair.
Desk phone and magneto ringer box \$29.50 pair.
New sound powered hand-sets \$27.50 pair.

ALL WEATHER—ALL PURPOSE WIRE on original factory reels. For communications—blasting and intercom. Hundreds of other uses. W110B 18 ga. 2-conductor insulated copper-steel conductors.

New—Perfect, Select Grade 1/2 mile reels... \$15.00
1 mile reels... \$27.50
WD12/TT—new 2-cond. field wire. Polyethylene plastic, 1/2 mi. reels... \$20.95
Grade 1, Unused, like new 1/2 mile reels... \$10.00
1 mile reels... \$17.50
Insulators—Porcelain. Box of 75... \$3.95

Send ck. or m.o. . . no c.o.d.'s . . . all prices f.o.b. Sacramento, California. Buyers add 3% tax. Other wire and phones not listed. **LORIS SALES, P.O. Box 1896-B12, Sacramento, Calif.**

Get the Practical Help You Need With These

POPULAR MECHANICS BOOKS

Use Them to
Save Time and Money
Make Extra Money
Enjoy Hobbies and Pastimes
Build Your Own Home
Improve Farm Income
Get the Most Out of Your Home Workshop
Enjoy Better Living



You may examine any books that interest you. Full purchase price refunded on books returned in 7 days. Order by number in coupon below. All books are cloth bound and fully illustrated with photos, drawings, plans and working diagrams. Some in colors. Only Popular Mechanics with 53 years of publishing experience and tremendous facilities can give you such practical and helpful how-to-do-it books so moderately priced. Order today. Prompt shipment and guaranteed delivery. Order by number in coupon below

HOME SHOP

SIXTY POWER TOOLS AND HOW TO BUILD THEM (1) How to turn scrap and discarded materials into power tools at little cost.\$2.50

POWER TOOLS AND HOW TO USE THEM (2) Expert advice on selection and use of power tools for the home shop\$2.50



PLANNING YOUR HOME WORKSHOP (3) The six basic power tools, floor plans, layouts, etc.\$2.50

PORTABLE POWER TOOLS (4) Practical information on the selection, care and use of portable power tools...\$2.00

WELDING, BRAZING AND SOLDERING (5) All the tricks and know-how of good soldering, welding, etc.\$1.75



HOMES - BUILDING

YOUR HOME AND HOW TO BUILD IT YOURSELF (6) Hundreds of amateur builders have built this six room house themselves\$3.00

CONCRETE BLOCK HOUSE (7) Built in many communities for less than \$4500. ..\$2.00

RANCH HOUSE BOOK (Build it Yourself) (8) Exciting new ranch type home with five or six rooms you can build yourself.\$3.50

PRECUT HOUSE BOOK (9) Smart, modern home featured in the March, 1955, issue...\$2.50

GUIDE TO HOME REPAIRS (10) Money and time saving information for home owners. \$2.50

HOW TO BUILD YOUR OWN GARAGE (11) Popular Mechanics own collection of designs, plans and building information for amateur builders.\$3.50

HOME PLUMBING GUIDE (12) Approved methods, materials and how-to-do-it instructions.\$3.50

LAWNS AND GARDENS (13) How to grow the best lawns and gardens in any neighborhood. \$2.50

HOW TO PAINT WITH BRUSH AND SPRAY (14) Includes interior and exterior painting, walls, woodwork and furniture finishing.\$2.50

AUTO BOOKS

AUTO OWNERS MANUALS By C. E. Packer. Cover all models from 1940 to 1953.
MANUAL FOR PLYMOUTH OWNERS. (15) ...\$3.50
MANUAL FOR CHEVROLET OWNERS. (16) ...\$3.50
MANUAL FOR FORD OWNERS. (17) ...\$3.50

AUTO REPAIR MANUAL (18)

How to avert auto troubles, make repairs on all makes, models, years.\$2.50

POPULAR MECHANICS AUTO ALBUM (19) Most fascinating of all auto books. From the first cars to the cars of tomorrow.\$3.00

SAVE WITH THESE

TELEVISION MANUAL (20) New and timely money-saving complete repair guide for the TV set owner\$3.00

RADIO, TV AND ELECTRONICS HANDBOOK (21) Ideal book for the student, beginner and experimenter.\$2.50

ALL ABOUT UPHOLSTERY (22) How to do all types of upholstery and save 50% of the cost.\$3.50

ELECTRICAL FIX-IT BOOK (23) How to repair and service all types of electrical appliances. \$2.00

WHAT TO MAKE

WHAT TO MAKE AND HOW TO MAKE IT Volumes 1 to 12. Average 175 projects to volume. Each. Give volume number with prefix (WM)\$1.75

12 Volume set (24) There are over 3,000 projects in this 12 volume set. Complete instructions for each. \$18.00

1956 Volume, (25)\$2.50
1955 Volume, (26)\$2.00

WHAT TO MAKE FOR CHILDREN (27) 175 projects—things to make from discarded and inexpensive materials. ..\$2.00

100 BEST WOODWORKING PROJECTS (28) Cream-of-the-crop projects. Selected by Popular Mechanics editors for their popularity.\$2.00

100 BEAUTIFUL PIECES OF FURNITURE YOU CAN MAKE (29) Real furniture projects for the craftsman with few tools.\$3.00

23 BOATS YOU CAN BUILD (30) Build a boat for pleasure or profit — row boat, sail boat, power craft.\$2.00

YOU CAN MAKE A STRADIVARIUS VIOLIN (31) Full set of actual size plans in pocket in the cover.\$3.50

WHAT TO MAKE WITH CONCRETE (32) Covers walks, walls, pools, fireplaces and ornamental garden pottery. \$2.00

OUTDOORS - SPORTS

OUTDOOR SPORTS MANUAL (33) 200 helpful articles for hunters, fishermen, trappers, etc. Hundreds of ideas on fishing tackle, guns, traps, boats, motors, etc.\$2.00

FAMILY BOOK OF GAMES AND SPORTS (34) Treasury of over 500 outdoor and indoor games of all kinds for children and adults\$2.95

GUIDE TO GOOD HUNTING AND TRAPPING (35) How, where and when to hunt all game animals. Special section on birds, guns and hunting dogs. \$3.00

FOR GIFTS - FOR BETTER LIVING

HOW TO BUILD AND ENJOY YOUR OWN OUTDOOR KITCHEN (39) How to build and use outdoor living facilities.\$2.00

FOOD FOR HOME USE (40) How to produce and conserve food from farms and home gardens.\$3.00

FIFTY YEARS OF POPULAR MECHANICS (41) The fascinating story of invention, scientific discoveries and mechanical developments from the pages of



Popular Mechanics during its first 50 years. ..\$5.00

ALBUM OF AVIATION (42) A history of famous flights and flyers commemorating the anniversary of 50 years of powered flight. Hundreds of thrilling photographs and drawings.\$3.00

PICTORIAL HISTORY OF AMERICAN TRANSPORTATION (43) Fascinating gift book featuring 50 years of an America on the move...\$5.00

FOR CHILDREN

MR. WIZARD'S SCIENCE SECRETS (44) By TV's famous Don Herbert. Collection of safe, simple experiments children can make at home...\$2.95

BOY MECHANIC (45) New edition with all new material. Hundreds of things a boy can easily make at home...\$2.95

BOY SCIENTIST (46) Perfect introduction to wonders of science for young people, ages 10-16\$3.95

FOR FARMERS

HOG PROFITS FOR FARMERS (47) A "must" book for every hog producer.\$3.00

FARM MANUAL (48) A book every farm home should have. More than 150,000 sold to date.\$3.00

VETERINARY GUIDE FOR FARMERS (49) Enables farmers to perform most veterinary tasks. ..\$3.95



USE THIS MONEY BACK ORDER COUPON

POPULAR MECHANICS PRESS, 200 E. Ontario St., Chicago 11, Ill.

Send Popular Mechanics books as indicated by numbers.

Number					
Number					

Remittance for \$_____ enclosed. Send postpaid.
 Send C.O.D. I will pay postman for books and delivery.

I understand I may return book within 7 days and you will refund the full purchase price. (Attach extra sheet to coupon if more space is needed.)

Name _____

Address _____

City _____ Zone _____ State _____

Get Our Big Manual of WOOD & "HARD-TO-GET" ITEMS

For home craftsmen, wood workers, industrial art departments, furniture repair men, hobbyists, cabinet makers, etc. Send only 50c today for your copy.

A few of the items we sell: Inlays, fancy cabinet wood, lumber, Ebony, Holly, Dimension cut lumber, lignum vitae, Carving Blocks, Turning Squares, 120 kinds of veneers, Abrasive papers, archery woods, bill-board clamps, binswings, bed fasteners, blueprints, Chair braces, brass chain, brass fencing, Craftsman books, candlestick holders, candlestick sockets, card table hardware, castors, Chair cane, ceramic tiles, clamp nails, crib hardware, Dowels and dowel pins, dowel centers, drawer rollers, felt, Flok finishes, foam rubber, furniture clamps, complete professional finishing materials, Folding tablelegs, hand tools, furniture pulls, modern and period, chest and ornamental hardware, all types of hinges and locks, small box hardware, Inlaid picture kits, inlaid card table tops, leather working tools, Micarta, revolving Lazy Susans, musical movements, moulded wood carvings, Metalcraft material, Moto Sander, nut bowl hardware, Picture frame moldings, Pre Cut Wood Pix, perforated steel panels, plaster standards, plastics and plexiglass, internal carving bits, plastic polishing compounds, Electric routers, sanders, foot rheostats, hand drills, sprayers, revolving fixtures for television tables, chairs, etc. Fibre rush, screw hole buttons, spiral saw blades, sliding door track, sharpening stones, home owners specialties, 109 woods, ski woods, platform rocker springs, Table leaf supports, tack rags, thermometer cards, turned furniture legs, typewriter fixtures, Complete upholstery supplies, Veneer presses, wood burning pens, wood working instructions, black and copper wrought iron hardware, zigzag wire.

Send fifty cents today (refunded on 1st order) for your copy of the Country's leading Catalog, "Constantine Manual for Craftsmen" to:

ALBERT CONSTANTINE & SON, Inc.

Dept. PM-16, 2050 Eastchester Road, New York 61, N. Y.

<p>ALSO ADULT Eshelman 2 Pass. SPORT & GOLF CARS LOWEST PRICE 70 Miles Per Gal. Free Catalog.</p>	<p>ESHELMAN MAKES WINTER JOBS EASIER Women can operate it. 1 to 8 H.P. Shipping Points: BALTIMORE, CHICAGO, RENO Free Catalog Write: ESHELMAN CO., Dept. R-51 109 Light St., Baltimore 2, Md.</p>
---	--

GET THE HABIT OF READING OUR CLASSIFIED ADS.

Wonderful Opportunities Amazing Bargains

BUILD D.C. WELDER!

WE SHOW YOU HOW to build this powerful welder without rewinding. Uses most any surplus aircraft generator. Produces 75-350 amps. Easy to build. **PLANS 35c** includes NEW booklet "HOW TO WELD," and **FREE WAR SURPLUS AND ELECTRICAL CATALOG.**

LEJAY MFG. CO., 1247 Le Jay Bldg., Minneapolis 8, Minn.

**Save 50%! Assemble Your Own
DIVING LUNG**
FREE BOOK SHOWS HOW

We furnish the parts and instructions. Complete outfits \$49.95 and \$59.95. Write for our descriptive literature today!

UNDERWATER SPORTS, INC.
Dept. 1, 302 W. Adams
O'Fallon, Ill., P.O. Box 65

Need an extra \$1,000, \$2,000, or more? Make it with an IDEAL LAWNMOWER SHARPENER

There are thousands of lawnmowers in your locality; Average \$1,000 profit per 250 mowers with customer satisfaction and repeat business assured. Provide this essential service with an Ideal[®] Lawnmower Sharpener, the only machine that grinds the reel to "fit" the bed knife. Compare by any standard. The Ideal, backed by 53 years of experience, costs no more. Write today for complete, free catalog.

THE FATE-ROOT-HEATH COMPANY
Dept. PM-1 Plymouth, Ohio

LOOK! All New - All Precision - All Deluxe SUPERSHOP MODEL X

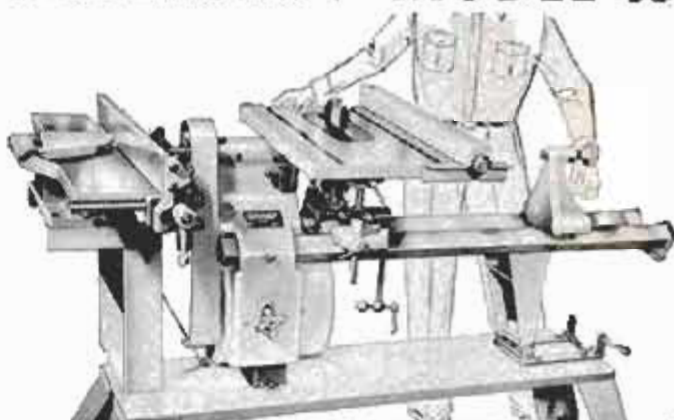

8" SAW

**WE PAY ALL
FREIGHT FOR
YOUR FREE
HOME TRIAL**

**ONLY
\$139.50
EASY
PAY
PLAN**



Vert. Drill Press



Hor. Drill Press



8" Sander



30" Lathe



5" Grinder

Never before have you seen so much deluxe, precision-built power tool workshop at any price! Designed for the man who wants the best. Massive cast and precision-machined headstock, self-centering inverted "V" bedways (like precision metal lathes), exclusive non-friction speed changer, extra-large cast and precision-ground saw table. 100% ball bearing, lifetime-lubricated. You save by ordering direct from factory. You are invited to test Supershop Model X in your home FREE. Mail coupon or postcard for FREE brochures, photos, details, specifications, accessory list — and amazing freight prepaid FREE HOME TRIAL PLAN. All free.

**MAIL COUPON OR
POSTCARD TODAY**

POWER TOOLS, INC. 179 Yates Avenue
Beloit, Wisconsin

NAME _____
ADDRESS _____
CITY _____ STATE _____

WHAT...

3398



...DO YOU KNOW ABOUT HAND SAWS?

QUALITY STEEL...

Good saw steel should be hard enough to hold its cutting edge and yet malleable enough to be flexible. Only saw manufacturers who operate their own mines and steel mills can give you the uniform controlled steel consistency necessary in every saw blade. Sandvik Swedish Charcoal Steel Hand Saws feature this high quality hand saw steel. This is only one of Sandvik's many exclusive advantages. Before you buy any hand saw, ask your dealer to show you a Sandvik.



Write today for the new 16 page booklet... "Things You Should Know About Hand Saws" It's free - Dept. PM.



Sandvik SAW & TOOL

Division of Sandvik Steel, Inc.

1702 NEVINS ROAD, FAIR LAWN, N. J.

AUTOMATIC

MAKES NEW PROFITS

Cuts new teeth in 30 seconds - only size to 16 points. Old teeth fall off as they. Easy to operate. A perfect job.

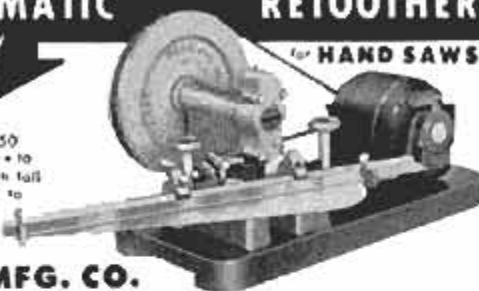

BURR MFG. CO.

8933-R VENICE BLVD. LOS ANGELES 34, CALIFORNIA

BARRON Drill Press TOOLS



ROTARY PLANER

Planes • Rabbits
Tenons • Panels
Routs • Bevels

Only \$8.50 COMPLETE

FOR WORKSHOP AND INDUSTRIAL USES...

Over 40 precision built woodworking tools and accessories... Hi-Speed Router Bits—Rotary Surface Sanders & Drum Sanders—Safety Shaper Cutters—Dovetail Cutters—Large Auxiliary Metal Tables—All Metal Shaper Fences—Spindle Adapters—Handy Bench Vises. Many other items indispensable for accurate, useful, versatile workshop use. Every tool sold on complete satisfaction or your money back. See your Barron Dealer. Ask for special folder—"24 Extra Uses for Your Drill Press."

FREE Workshop Guide & Catalog

BARRON TOOL CO. INC.
302 Architects Bldg., Detroit 1, Mich.

DO IT YOURSELF

It's Easy With ...



Soldering's really a "cinch" ... when you use time-tested, reliable KESTER ... available everywhere.

FREE! "Soldering Simplified" ... 16-page how-to-solder booklet. At your dealer or write direct.

KESTER SOLDER COMPANY
4251 Wrightwood Avenue Chicago 39, Illinois

ALL CAR OWNERS

MICRO-NATIC PROPORTIONATOR

FASTER SMOOTHER ACCELERATION

THIS EASILY INSTALLED PROVED DEVICE GIVES THAT ADDED ACCELERATION ESSENTIAL IN STARTING, PASSING OR AN EMERGENCY. BY PROPORTIONATING SPARK TO KEYS. • LUGGING & PINNING VANISH

Only \$4.95
Postpaid-No C.O.D.

MOTIVE DEVICES
5585 N. Lagoon Ave.
Portland 11, Oregon



Loosens Rusted Bolts nuts, screws, "frozen" parts!

LIQUID WRENCH

AT HARDWARE STORES, GARAGES SERVICE STATIONS EVERYWHERE

For information write manufacturer
Radiator Specialty Co., Charlotte, N. C.

Handy Mail Order List

Little Library of Useful INFORMATION

5 for \$1.00
12 for \$2.00
25¢ Each

Here at amazingly low cost is the practical help and information you have always wanted. Articles in previous issues of Popular Mechanics have been classified according to subject and are now available in these handy reprint booklets.

- How to Use Measuring Tools—Micrometers, Calipers, etc.—106.
- Power Driven Saws—74.
- Drill Presses, Grinders, etc.—79.
- Wood, Metal-Turning Lathes—81.
- Filing Machine, Hack Saw, Cutoff Wheel, Shaper—82.
- Lathe Tools You Can Make—101.
- Workbenches—Tool Cabinets—47.
- Spray Painting—94.
- From Pattern to Casting—91.
- Tool and Saw Sharpening—92.
- Sharpening Drills, Wood Bits—90.
- Successful Wood Turning—32.
- How to Read Blueprints—71.
- Metal Turning Lathe Kinks—99.
- Operating a Metal Lathe—100.
- Heat Treating, Hardening—102.
- Working With Glass—103.
- Servicing Electric Motors—75.
- Electromagnets & Solenoids—44.
- Transformer Construction—41.
- The Boy Electrician—43.
- Soldering and Brazing—17.
- Arc and Spot Welders—5.
- Electroplating With Nickel, Chromium, Cadmium, etc.—86.
- Plating Leather, Wood, etc.—87.
- Lower Your Fuel Costs—31.
- Curing Leaky Basements—45.
- Fitting Home Game Room—55.
- Indoor & Outdoor Fireplaces—88.
- Backyard Gardening—39.
- Lawn and Garden Novelties—72.
- Trellises, Pergolas, Fences—76.
- Lawn and Garden Furniture—77.
- Playground Equipment—73.
- How to Use Your Drill Press—125.
- Making Serving Trays—53.
- Knots and Ropework—105.
- Sanders—80.
- House-Wiring—89.
- Hanging Wallpaper—38.
- Built-in Fixtures—78.
- Bird Houses—7.
- Magazine Racks—49.
- Clock Cases—50.
- Book Ends—52.
- Small Tables—54.
- Smoking Stands—56.
- Decks—58.
- Book Cases—59.
- Action Toys—86.
- High Flying Kites—67.
- Telescopes—20.
- Metal Craft—28.
- Small Looms—37.

- Working With Plastics—61.
- Simple Home Improvements—104.
- Ridding Home of Insect Pests—107.
- Children's Room Furniture—51.
- Jigsawed Novelties—57.
- Doll House & Doll Furniture—60.
- 25 Shelves You Can Make—64.
- Novelties Turned on Lathes—62.
- Inlay Pictures—Veneering—63.
- Wood, Soap Carving—65.
- Windmills & Weather-vanes—68.
- Lamps from Wood, Metal—69.
- Rustic Furniture—18.
- Wood Finishing—40.
- How to Fix Electrical Appliances—111.
- Painting Your House—117.
- Build Your Own Relays—123.
- Rowboats, Small Dinghy—83.
- Small Sail Boats—84.
- Two Outboard Runabouts—85.
- Build Your Own Kayak—30.
- Build Class-E Ice Yacht—22.
- Auto Kinks, Shortcuts—10.
- Lawn and Garden Equipment—124.
- Motor-Driven Midget Cars—34.
- Stop Auto Electric Troubles—95.
- Photo Printers and Dryers—25.
- Photo Darkroom Equipment—96.
- Trick and Table Top Photos—97.
- Home Movie Equipment—118.
- Poultry Houses—108.
- Guns and Decoys—109.
- Re-Silvering Mirrors—70.
- Chemical Experiments—93.
- Log Cabins, Tourist Houses—14.
- Using Basic Tools—120.
- Farm and Garden Tractors—8.
- Building Extra Attic Rooms—23.
- Attractive Basement Rooms—24.
- Gem Cutting—42.
- Photo Enlargers—1.
- Photo Kinks—98.
- Cleaning Formulas—11.
- Taxidermy—9.
- Photo Lighting—119.
- Training Dogs—35.
- Small Furnaces—36.

Check Titles Wanted, Clip, Mail with Remittance to
POPULAR MECHANICS PRESS, Dept. 23, 200 E. Ontario, Chicago 11



THE
BASIC
SHOP TOOL

9" x 3' Model C Bench Lathe \$235 f.o.b. factory. Time payment terms available.

9" SOUTH BEND LATHE

This South Bend 9" Precision Lathe is the basic tool for your shop. It enables you to perform accurately the same full range of operations done on South Bend Lathes in industry. Also, operations ordinarily performed on other machine tools are made possible through the use of efficient attachments. You get more for your money in a South Bend 9" Lathe.

Write for catalog — see local distributor — look under "Machine Tools" in your classified telephone directory.

NEW 14" DRILL PRESS—a ruggedly built tool unsurpassed for accuracy and dependability.

Write for catalog.



SOUTH BEND LATHE WORKS

Building Better Tools Since 1906

455 EAST MADISON STREET, SOUTH BEND 22, INDIANA

A Few of the Many
Operations You Can Perform



TURNING



BORING



THREADING

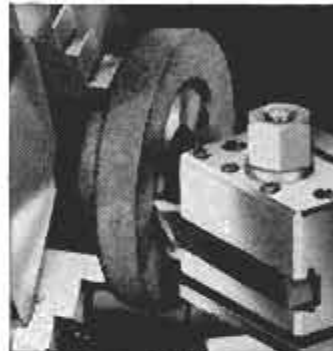

FACING



MILLING



GRINDING



TAPER TURNING



WOOD TURNING

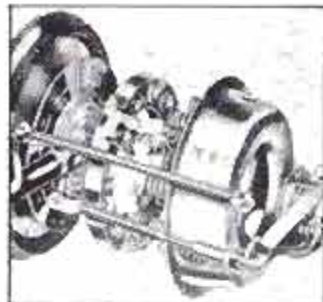

2900 photos and diagrams, plus crystal-clear directions, make every operation easy as A-B-C.

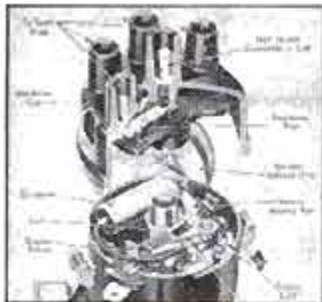

Diagrams, tables and text take the "mystery" out of all ignition systems.



You get illustrated repair procedures for all types of carburetors.

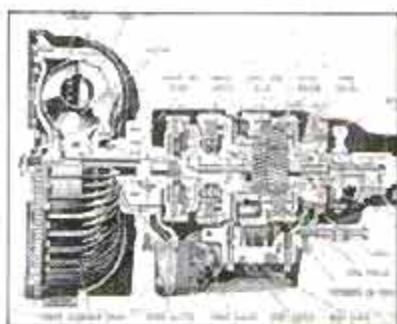

ALL AUTOMATIC TRANSMISSIONS are fully covered in special big section. (NOTE: All pictures shown here are greatly reduced in size. Actually, this giant book is almost a foot high!)

Here's the EASY Step-by-Step Way to FIX ANY CAR IN A JIFFY!

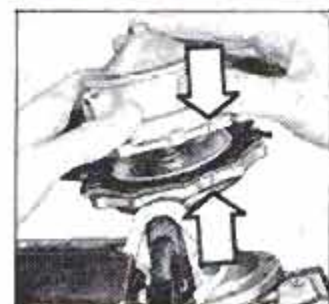

Fuel pumps can cause trouble. Pictures show exactly how to take them apart, fix them.

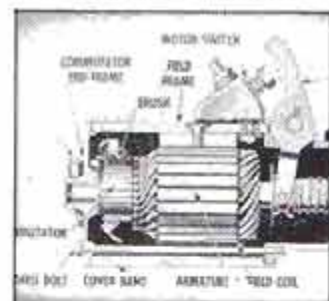

No guesswork. Clear pictures show how to fix starting motor, generator, brakes, chokes, etc.

Just 2 of the Many Letters of Praise

Does Every Job. "My MOTOR Manual is a wonderful help. It has a position to do every job." — S. L. Sharpless, Los Angeles, Calif.

Amazed Self and Friends. "I amazed myself and my friends, too. Now do jobs that stumped me before." — Michael Dolterky, Newark, N. J.

Now—Whether You're a Beginner or Expert Mechanic—You Can "Lick" Any Repair Job On Any Car Built From 1940 Thru 1955

NOW you can tackle any repair job, and do it quickly, easily, right—the first time! MOTOR'S BRAND-NEW AUTO REPAIR MANUAL shows you how—with crystal-clear pictures and step-by-step directions you can easily follow.

No guesswork. This giant guide tells you where to start; what tools to use. Leads you easily and quickly through the entire operation. Covers everything from a simple carburetor adjustment to a complete overhaul.

Everything You Need to Know

BIG, NEW REVISED Edition has MORE REPAIR INFORMATION THAN EVER! OVER 1,000 giant pages, 2,900 "This-Is-How" pictures—clear drawings, diagrams, cut-away photos—make every step EASY. 291 "Quick Check" charts—more than 23,436 essential repair specifications. Over 225,000 service and repair facts. Instructions and pictures so COMPLETE, so CLEAR — you CAN'T go wrong!

Even a green beginner can do a good job. If you're a top mechanic, you'll be amazed at the time-saving procedures.

The "Meat" of Over 160 Official Shop Manuals

The editors have put together the "Know-How" from over 160 Official Shop Manuals; "boiled it down" into one handy indexed book.

Includes ALL Automatic Transmissions. Covers new Carburetors, Engines (including new Chevrolet, Nash, Packard, Hudson, Plymouth V-8s), Chokes, Fuel Pumps, Oil Filters, Starting Motors, Generators, Distributors, Clutches, Universals, Axles,

Brakes, Power Steering, Shock Absorbers, etc.

Factory Specifications and Adjustment Tables, Tune-up Charts, Tables of Measurements and Clearances, Overhauling and Replacement, Facts — AND MUCH MORE.

Used by Armed Forces, hundreds of thousands of auto service men! YOU'LL want to try it, too — on the following UNCONDITIONAL GUARANTEE:

Try Book for a Week FREE

SEND NO MONEY. Pay nothing to postman. Test book in your own garage or shop. It's GUARANTEED to pay for itself in 7 days. If it doesn't just return the book, and owe nothing. Rush coupon for your free-trial copy of this great money-saving Manual. MOTOR Book Dept., Desk 1A, 250 West 55th St., New York 19, N. Y.

USED BY U.S. ARMY NAVY MARINES

BRAND-NEW EDITION!

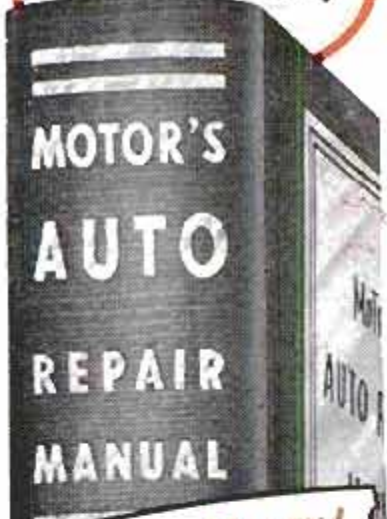

SEND NO MONEY! TRY BOOK FOR A WEEK FREE!

MAIL COUPON NOW FOR 7-DAY FREE TRIAL

MOTOR Book Dept., Desk 1A, 250 West 55th Street, New York 19, N. Y.

Rush to me at once: (Check box opposite book you want.)

MOTOR'S New AUTO REPAIR MANUAL. If okay, I'll remit just \$2.00 in seven days, then \$2.00 monthly for two months and a final payment of \$5c (plus 35c delivery charges) one month after that. Otherwise, I'll return the book postpaid in seven days. (Foreign price: Remit \$9.00 cash with order.)

MOTOR'S New TRUCK REPAIR MANUAL. (Described at left.) If okay I will remit \$2.00 in seven days, and \$2.00 monthly for three months, plus 35c delivery charge with final payment. Otherwise, I will return book promptly. (Foreign price: Remit \$10.00 cash with order.)

Print Name.....Age.....

Print Address.....

City & Zone No.....State.....

SAVE 35c delivery charge by enclosing WITH COUPON check or money order for full payment of \$8.95 for Auto Repair Manual for \$8.00 for Truck Manual.) Same 7-day return-for-refund privilege applies.

COVERS 737 MODELS — ALL THESE MAKES

- | | | |
|-----------|---------|------------|
| Buick | Ford | Nash |
| Cadillac | Frazier | Oldsmobile |
| Chevrolet | Henry J | Packard |
| Chrysler | Hudson | Plymouth |
| Crosley | Kaiser | Pontiac |
| De Soto | Lincoln | Studebaker |
| Dodge | Mercury | Willlys |

2,000,000 COPIES SOLD!

Some FREE 7-Day Offer on MOTOR'S NEW TRUCK REPAIR MANUAL

Covers EVERY job on EVERY popular make gasoline truck made from 1946 thru 1955—including GM and Cummins Diesels. Over 300,000 facts. Check proper box in coupon for free trial.



**NOW...TRY
YOUR HAND**

with these 2 NEW
WELLER TOOLS

**POWER SANDER
and Polisher**

Here's power and performance that exceeds any sander in its price class. 25 square inches of sanding area • Straight-line action—no bucking; sands and polishes with the grain; goes all the way into corners • Less than 3" high—fits into tight places • Practically impossible to stall • Takes the irk out of work for only \$14.95



**COMPLETE
SOLDERING SET**

Here's everything you need for scores of home repair and hobby jobs. Kit contains: 100 watt Soldering Gun with instant heat, dual spotlights, and low-cost replaceable tip features; supply of famous Kester Solder; Soldering Brush for cleaning connections; Soldering Aid for opening old joints, twisting wire, etc. . . . all in a sturdy cardboard case for only \$7.95.



Ask Your Hardware Dealer
For A Demonstration,
Or Write Direct For
Catalog Bulletins.

Weller

**ELECTRIC
CORP.**

808 Packer Street
Easton, Penna.