

WHAT OWNERS SAY OF THE THUNDERBIRD

POPULAR MECHANICS MAGAZINE

WRITTEN SO YOU CAN UNDERSTAND IT

DECEMBER 1955

35 CENTS

*New Profession in the Sky—
Jetography—page 81*

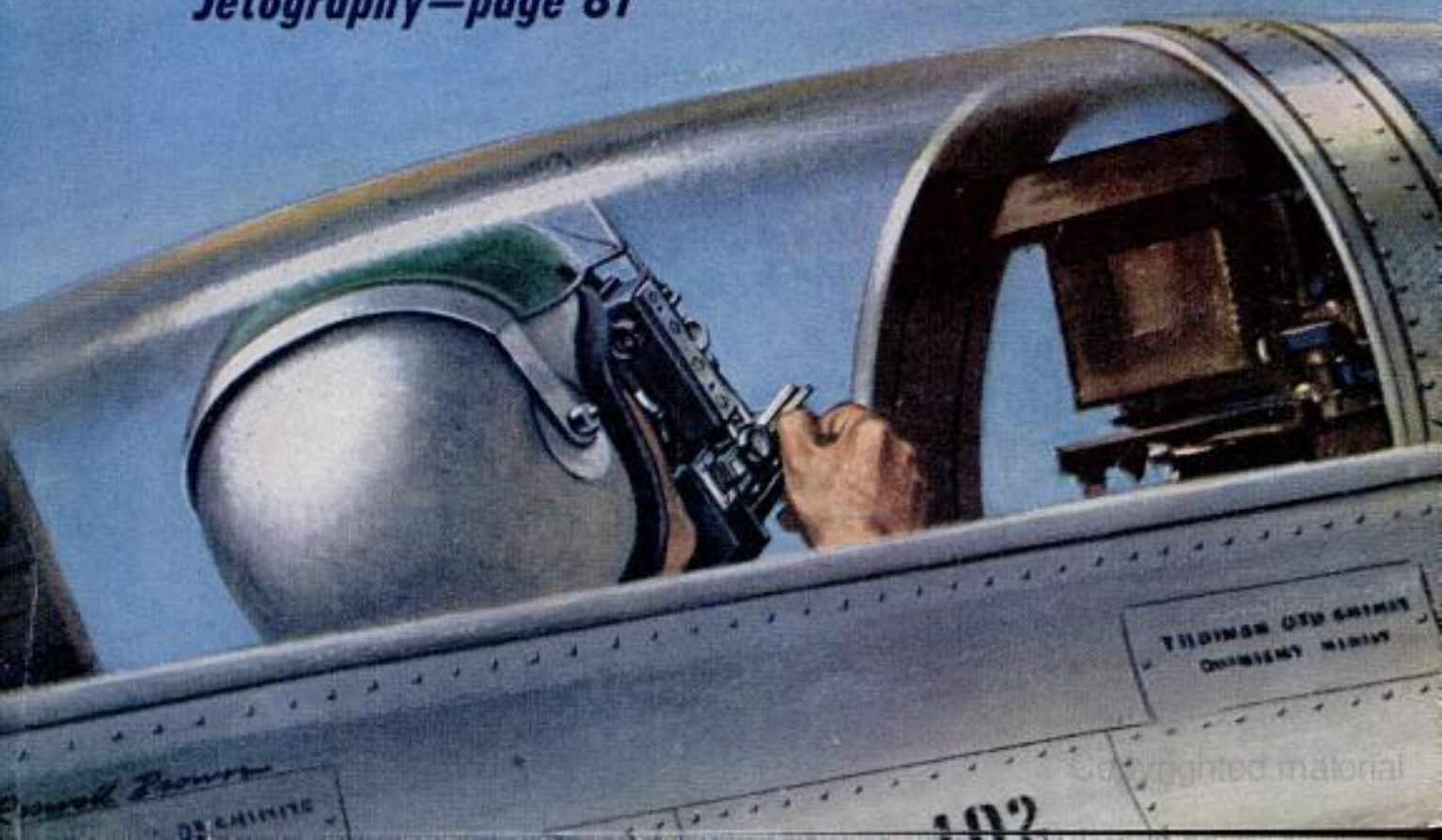

THUNDERBOLT CHINIC
CHINIC THUNDER

102

Copyrighted material

No wonder it's called
"Miracle Vinyl-Flooring"!



MATICO ARISTOFLEX

RESISTS GREASE, ACID, ALKALI AND GRIME!

You'll call it "miracle flooring," too, when you see for yourself how rugged, durable MATICO Aristoflex shrugs off household acid, alkali and grease... stays new and sparkling looking with easy damp moppings. Biggest miracle of all is the price! Produced especially to meet the needs of homeowners everywhere, MATICO

Aristoflex is low in cost... gives you more for your money. And you can install economical Aristoflex in every room in your home... from basement to attic. See Aristoflex in 13 rich, clear colors at your MATICO dealer soon. You'll find him listed in your classified telephone directory.



4036

MASTIC TILE CORPORATION OF AMERICA

Houston, Tex. • Joliet, Ill. • Long Beach, Calif. • Newburgh, N. Y.

Manufacturers of: Confetti • Aristoflex • Parquetry • Maticork
Asphalt Tile • Rubber Tile • Vinyl Tile • Cork Tile • Plastic Wall Tile

INSTALL IT YOURSELF AND SAVE!



It's easy! Just mark a straight line through the center of your room in both directions, using a chalk and line. Be careful not to cover up your guide lines.



With a notched trowel, spread adhesive over one-half of your room at a time. Leave only a thin coat of adhesive on the floor.



After adhesive becomes tacky, snap the tiles into place. Do not slide tiles or adhesive will push up between the tiles.



Here's the best part! Show your wife your handiwork. (Don't tell her what a cinch it is with MATICO's easy-to-follow instructions).

It's The Talk of the Test Drivers!

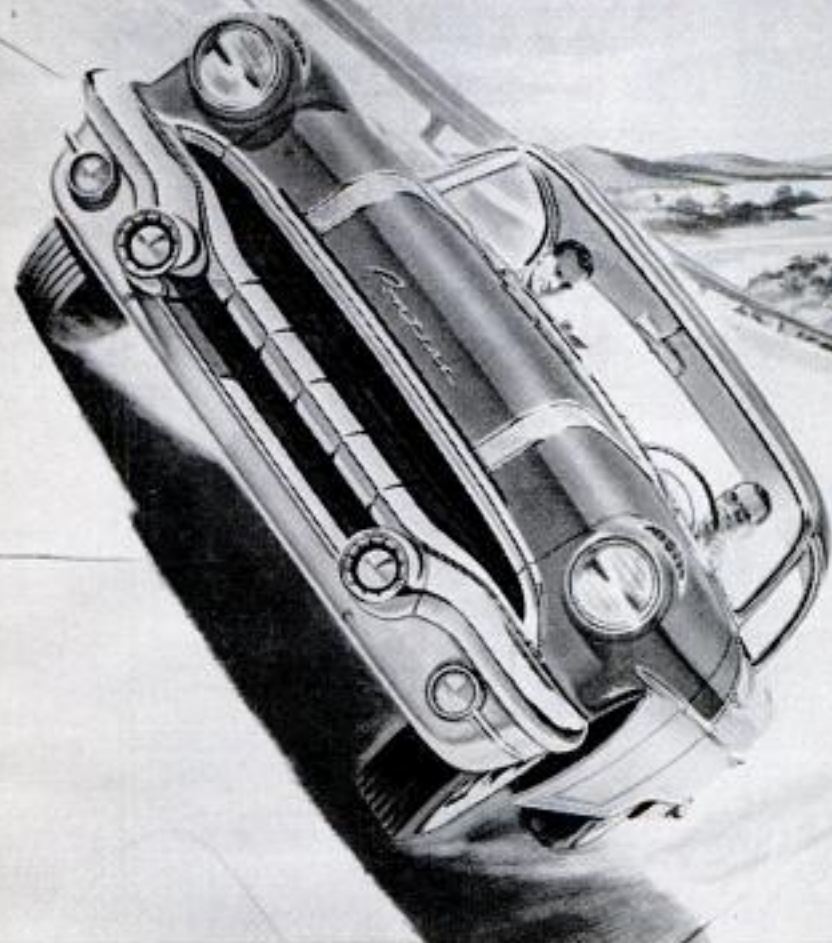

THE FABULOUS '56 PONTIAC WITH A BIG AND VITAL GENERAL MOTORS "AUTOMOTIVE FIRST"

Believe us—it isn't easy to impress a test driver!

But they're cheering Pontiac in a big way.

What's set them buzzing is that big and vital General Motors "First" combining:

Pontiac's new big-bore Strato-Streak V-8 with the terrific thrust of 227 horsepower.

General Motors' new Strato-Flight Hydra-Matic that gentles this mighty "go" to smoothness beyond belief.*

You don't need a test track to prove that here is the lift of a lifetime.

Traffic tells you. Here's "stop-and-go" response as fast as thought itself. A hill helps. High or low, it's left behind without a sign of effort. And passing definitely pins it down.

Gun it and instant, flashing power sweeps you swiftly by the loitering car ahead. No drag, no lag—just safe and certain "go"!

There's plenty more to charm you. The safety of big new brakes, a steady ride, advanced controls. Glamorous new beauty.

But, above all, it's that fabulous new "go" that gets you!

Drive a Pontiac today for a glorious double thrill. There'll be pride in your heart, a torrent at your toe-tip. What more could anyone want?

**An extra cost option*

PONTIAC MOTOR DIVISION OF GENERAL MOTORS CORPORATION

DECEMBER 1955

'56 PONTIAC

This One



Y10U-RHU-477C

If you drive one of these cars . . . BUICK, CADILLAC, CHEVROLET, CHRYSLER, DODGE, FORD, HUDSON, MERCURY, NASH, OLDSMOBILE, PLYMOUTH, PONTIAC, STUDEBAKER, here's a sure-fire way to get all the horsepower and performance you paid for!

DOMESTIC SERVICE Check the class of service desired; otherwise this message will be sent as a full rate telegram.		<h1 style="margin: 0;">WESTERN UNION</h1> <small>1234 15-07</small> W. P. MARSHALL, PRESIDENT	INTERNATIONAL SERVICE Check the class of service desired; otherwise this message will be sent at the full rate.	
FULL RATE TELEGRAM DAY LETTER NIGHT LETTER	\$ \$ (TS)		FULL RATE LETTER TELEGRAM SHIP RADIOGRAM	
NO. WDS.-CL. OF SVC.	FD. OR COLL.	CASH NO.	CHARGE TO THE ACCOUNT OF	
			TIME FILED	

Send the following message, subject to the terms on back thereof, which are hereby agreed to

**CHAMPION SPARK PLUG COMPANY
TOLEDO, OHIO**

FOR THE SECOND STRAIGHT YEAR OUR OFFICIAL RECORDS SHOW THAT EVERY SINGLE CAR PARTICIPATING IN THE ANNUAL SOUTHERN 500 STOCK CAR RACE SANCTIONED BY NASCAR WAS EQUIPPED WITH CHAMPION SPARK PLUGS PURCHASED AT THE TRACK. LAST YEAR THE ENTIRE FIELD OF 52 RAN ON CHAMPIONS. THIS YEAR 69 OUT OF 69 USED CHAMPIONS WITH 13 DIFFERENT MAKES OF CARS COMPETING. THE FIELD WAS MADE UP OF FORD, CHEVROLET, MERCURY, PONTIAC, OLDSMOBILE, BUICK, CADILLAC, PLYMOUTH, DODGE, CHRYSLER, NASH, STUDEBAKER AND HUDSON. THIS IS ABOUT AS FINE PROOF AS YOU WOULD WANT THAT YOUR SLOGAN "BETTER BY FAR FOR EVERY CAR" IS 100 PER CENT RIGHT.

BOB COLVIN, PRESIDENT, DARLINGTON RACEWAY

Why settle for claims when it's *results* you want from spark plugs! Claims didn't count at Darlington when all stock cars in the classic Southern "500"—cars exactly like yours—were tuned to razor-sharp perfection by the nation's best mechanics.

Only *results* pay off—so full-firing, 5-rib Champions were installed in every car which did not already have them for extra horsepower and performance.

Give *your* car a chance to show what it can do. You're paying for top performance. Get it with Champions!

CHAMPION SPARK PLUG COMPANY, TOLEDO 1, OHIO



Any car is better with 5-rib Champion Spark Plugs!

Popular Mechanics Magazine

Registered in U. S. Patent Office and Canada

H. H. WINDSOR, Founder

H. H. WINDSOR, JR., Editor and Publisher



Next Month

ONE OF OUR most valuable natural resources, oddly enough, is the wide blue yonder—the “empty” space above our heads. For a generation, prophets have been sounding solemn warnings that someday we’ll run out of airspace. Now it has happened. Skyway traffic jams are occurring above metropolitan areas. So far the airways themselves have not become too crowded. But soupy weather can turn a terminal point into a nightmare of stacked-up planes, while down on the ground still other planes are waiting to take off. Unlike some of our other natural resources, we can’t “grow” more airspace. What’s to be done about this critical problem? The CAA is coming up with some remarkable instruments to find unique solutions. The men above are working with a new type of radar display which tabs and tracks every aircraft above a busy city. Some possible solutions are described in a feature next month, “We’re Running out of Airspace”

Information not listed on articles in the index, starting on page 74, frequently is listed in the WHERE-TO-FIND-IT LIST, which is available to readers without charge. A copy may be obtained by writing to the Bureau of Information, Popular Mechanics, 200 E. Ontario, Chicago 11, Ill.

Published monthly by Popular Mechanics Company, 200 E. Ontario St., Chicago 11, Ill. H. H. Windsor, Jr., president; Wm. Harrison Petridge, exec. vice-pres.; D. F. Windsor, vice-president and secretary-treasurer; H. H. Windsor III, vice-president; W. T. Windsor, vice-president; Clover L. Perkins, advertising manager; Alan M. Deyoe, circulation manager. Single copy in the United States and Canada, 35 cents; subscription rates in the United States and possessions, Canada, Philippines and countries of the Pan-American Postal Union, 1 year \$3.50; 2 years, \$6.00; 3 years, \$8.00. To all other countries add \$1.00 a year over United States prices for overseas postage. If you plan to move, notify us at least 30 days in advance so you will not miss an issue. Give both your old and new addresses. Entered as Second Class Matter, September 15, 1903, at the Post Office at Chicago, Illinois, under Act of March 3, 1879. Entered as Second Class Matter at Post Office Dept., Canada. Registered as Second Class Matter at the Post Office at Mexico, D. F., Mexico, June 20, 1950. Copyright 1955 by Popular Mechanics Company. Copyright under International Copyright Union. Copyright in France. All rights reserved under Pan-American Copyright Union. Printed in the United States of America.

Volume 104 DECEMBER 1955 Number 6

Address all communications to: 200 E. Ontario St., Chicago 11, Ill.

Managing Editor.....Roderick M. Grant
Assistant Managing Editor.....Wayne Whittaker
Shop Notes and Crafts Editor.....James R. Ward
Radio-Television, Electronics Editor.....Lothar Stern
Associate Editor.....Clifford B. Hicks
Associate Editor, Automotive.....Arthur R. Railton
Associate Editor, Shop Notes and Crafts.....Wayne C. Leckey
Assistant Editor, Shop Notes.....W. Clyde Lammy
Assistant Editor, Makeup.....John C. Dalen
Automotive Correspondent.....Leo Donovan
Art Director.....Frank Beatty
Assistant Editors—Leonard F. Hiltz, Jay W. Hedden, Elliott H. McCleary,
Emily Mullaney, Earl F. Wabeck
Eastern Editor.....Richard F. Dempewolff
Empire State Bldg., Room 2906, New York City 1
Western Editor.....Thomas E. Stimson, Jr.
Suite 1010, 3460 Wilshire Blvd., Los Angeles 5, Calif.
London Manager.....Douglas W. Wedderspoon
Eagle House, Jermyn St., London S. W. 1, England
Director, Bureau of Information.....Allan Carpenter
200 E. Ontario St., Chicago 11

Advertising Offices

Chicago: 200 E. Ontario St., Whitehall 4-0100; New York: Empire State Bldg., 350 Fifth Ave., Longacre 5-7580; Detroit: General Motors Bldg., TRinity 5-8711; Cleveland: Hanna Bldg., 1422 Euclid Ave., PROspect 1-0456; Los Angeles: Tishman Bldg., 3460 Wilshire, DUmkirk 2-8458; San Francisco: Russ Bldg., 235 Montgomery St., YUKon 2-0823.

In This Issue . . .

Jetography	81
The Parade of New Cars	88
Detroit Listening Post	99
Owners Report on the '56 Thunderbird	102
Gigantic Dam in the Alps	108
Across Four Continents on Two Cylinders	113
Keeping Up With the Atom	121
What Kind of Camera for You?	126
What's New for Your Home?	132
Miami Has an Electric Nervous System	144
He Made a Business of Camping Out	150
Look What They Do to Your Dinner	158
Radio, TV and Electronics	165

For the Craftsman . . .

Cover It With Stick-on Plastic	169
New Uses for Mailing Tubes	177
Solving Home Problems	184
Patterncraft—Children's Dinette Set	188
Homemade Organs—Part I	191
Trundle Beds Feature Storage Headboards	197
Give Your Battery a Break	202
Midget Telescopes	211
Silver-Soldering Bandsaw Blades	219
Shopping for Tools	222
Clinic for Homemakers	228

See pages 74, 76 and 78

for other items and manufacturers of available products

"Old Timer" Shows Young Pipe Smoker Reason EDGEWORTH SMOKES COOLEST

Compare the Cuts of Pipe Tobacco

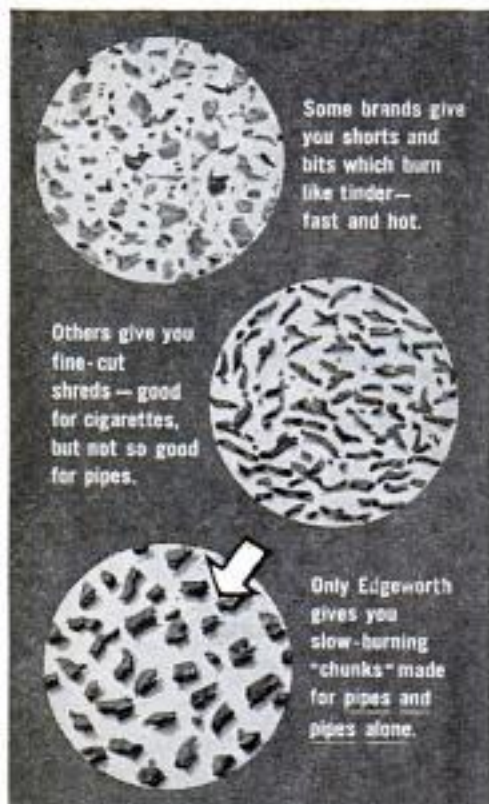

AT YOUR DEALER'S



Shows Meaning of "Ready-Rubbed"

Old time smokers knew the secret of cool, even burning. They carefully "hand-rubbed" their tobacco into chunks of just the right size. Now Edgeworth does all this

before the tobacco is packaged. An exclusive process "ready-rubs" Edgeworth into chunks that pack right for a cool smoke without a touch of tongue bite.

Made Right...Cut Right and Packed Right!

Your true tobacco expert will tell you that white burleys are the world's coolest smoking tobaccos. Edgeworth is a blend of white burleys only—aged for years. It leaves our plant with just the right moisture content for a cool, no-

bite smoke and reaches you in the same condition because only Edgeworth has the Seal-Pak pouch. Air-and-water tight, it promises you fresher tobacco than any other type of pocket pack. No bulky corners in your pocket, either.

FOR A MILD MIXTURE TRY HOLIDAY

A "custom" blend of five tobaccos selected for mildness and aroma. The only mixture in the Seal-Pak pouch.



Get this guaranteed "Olde London" Pipe and two full-size pouches of Edgeworth tobacco for only \$1.00. The pipe is fine, hand-rubbed imported briar . . . with genuine hard rubber bit . . . carbonized bowl for cooler smoking. If your dealer is unable to supply you, use this handy order blank.

Name _____

Address _____

City _____ State _____

Mail with \$1.00 to "Olde London," Larus & Brother Company, Inc., Richmond, Va.
Offer Good Only in U. S. A. **PM-12**

Edgeworth

AMERICA'S FINEST PIPE TOBACCO FOR OVER HALF A CENTURY

POPULAR MECHANICS

Copyrighted material



**MECHANICAL
SKILLS
CAN GET
YOU
AHEAD
IN THE
U. S.
AIR FORCE**

Here's why —

If you're interested in mechanics, join the U. S. Air Force. As an Airman you may develop your technical ability and learn a skill that will pay well...and win you extra stripes. Such interesting career fields as Aircraft and Engine Maintenance, Rocket Propulsion and Intricate Equipment Maintenance are open to you, if you qualify. Don't delay—see your local Air Force Recruiter or mail the coupon, *today*.



AIRMAN INFORMATION BRANCH
Box 2202, Wright-Patterson AFB
Ohio

M-19-PM-2

Please send me more information on my opportunities as an Airman in the U. S. Air Force.

Name _____

Address _____

City _____ Zone _____ State _____

**YOU GO
PLACES
FASTER
IN THE
U. S. AIR FORCE**



**IF YOU "EAT, SLEEP
AND LIVE" CARS...
TURN YOUR HOBBY
INTO A CAREER!**

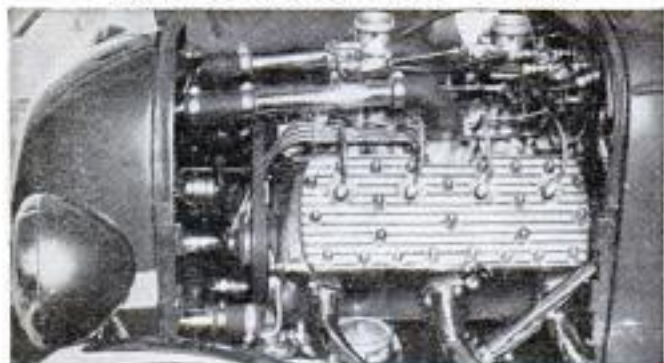

Get America's Big-time, Big-future

**AUTO MECHANICS
& DIESEL COURSE** at home in your spare time!

Los Angeles' National Schools, America's automotive Technical Trade School since 1905, now brings its famous resident Shops and Faculty direct to you at home—to prepare you to earn more money, with job security, in today's fast-moving, opportunity-filled Auto Mechanics Industry! Get your home training from the "Car Capital of The World"—America's most auto-minded city, center of Hot Rod and Sports Car activity! Mail coupon right now!

"SHOP-METHOD" HOME TRAINING!

YOU MASTER ALL PHASES, INCLUDING DIESEL! All lessons fully illustrated. Latest equipment covered.



THIS SET OF LIFETIME TOOLS IS YOURS! Also all-metal tool box. Part of your course, yours to keep.

EARN WHILE YOU LEARN! We show you how to start Spare Time Earnings soon after enrollment.

ATTENTION MEN OF DRAFT AGE. Learn how you can achieve higher rating and pay. Mail coupon at once!

APPROVED FOR G. I. TRAINING. Both Home Study & Resident Courses. Free help with technical and personal problems—Job Placement Service.



**Send for FREE FACT-BOOK
AND SAMPLE LESSON!**

**NOW! 2 offices to serve you faster!
Mail coupon today to one nearest you!**

NATIONAL SCHOOLS

Technical Trade Training Since 1905

LOS ANGELES 37, CALIFORNIA

IN CANADA: 811 West Hastings Street, Vancouver, B. C.

MAIL NOW TO OFFICE NEAREST YOU!

(mail in envelope or paste on postal card)

NATIONAL SCHOOLS, Dept. DB-125

4000 S. FIGUEROA STREET
LOS ANGELES 37, CALIF.

OR 323 WEST POLK STREET
CHICAGO 7, ILLINOIS

Send **FREE** Auto-Mechanics Book and Sample Lesson.
No obligation, no salesman will call.

NAME _____ BIRTHDAY _____ 19__

ADDRESS _____

CITY _____ ZONE _____ STATE _____

Check if interested ONLY in Resident School Training at Los Angeles.
VETERANS: Give Date of Discharge _____

**ACROSS THE
DESK**



Now We Speak German, Too

Another foreign-language edition has joined the *Popular Mechanics* family. Printed in German for distribution in West Germany, Austria and Switzerland, the first issue of *Populare Mechanik* is meeting enthusiastic reception with its initial printing of 130,000 copies.

For many years *Popular Mechanics* has



had worldwide readership with subscribers on every continent. In 1946 a French edition, *Mecanique Populaire*, started our foreign-language family, circulating through much of continental Europe and French Canada. The Spanish edition followed a year later. A Danish edition began publication at Copenhagen in 1949 and in 1950 a Swedish edition was launched. Now it's *Popular Mechanics* in Germany.

All foreign editions are essentially translations of the original American magazine. Each has made a successful niche for itself in the country of its particular language, and *Populare Mechanik* is expected to find great popularity in German-speaking Europe. The economy of West

(Continued to page 8)

This **FREE SAMPLE LESSON** will prove you can become an expert **BOOKKEEPER... ACCOUNTANT** OR **C.P.A.**



This well-paid
LaSalle-trained
Accountant's
success could
be yours.

FREE SAMPLE LESSON

We offer you this free sample lesson so that you can prove to yourself that you CAN master Accountancy—quickly, thoroughly—in spare time at home.

You will see exactly how LaSalle's famous "Problem Method" works . . . how you are led step-by-step through actual accounting work—learning by doing and not by study of theory alone. First you tackle easy problems, then more difficult ones—until soon you master them all. And at every step you have the close personal guidance of LaSalle's large staff of C.P.A. instructors.

HIGHER ACCOUNTANCY

By the LaSalle Problem Method..

• Practical Accounting

Assignment 1

THE BALANCE SHEET



QUESTION from the "Journal of Accountancy," the authoritative organ of the professional accountants of the United States:

"The accounting profession is probably the best paid in the world. It does not require a high degree of intelligence or special training. It is not known to be."

"There is need for accountants. There is ample opportunity for advancement. There is no prospect that the supply will overtake the demand, with the result of even the payment of it."

LaSalle Extension University
A Correspondence Institution
CHICAGO

THIS SAME LESSON HAS STARTED HUNDREDS OF THOUSANDS toward well-paid accounting careers—in business, government, and as C.P.A.'s. Even without previous knowledge, progress is rapid—earning power climbs fast. This sample lesson shows why.

IF you have been envying the high incomes and good jobs enjoyed by thousands of men and women Accountants today . . . incomes ranging from \$4,000 to \$10,000 and more per year . . . why not launch such a career for yourself?

Do you doubt that you can?

Then let us send you—without cost or obligation—the same Lesson Number One with which LaSalle has started several hundred thousand

men and women toward successful accounting careers. We want you to see for yourself how this remarkable method, originated by LaSalle, makes Accountancy simple, interesting, practical, and certain . . . how it leads you step-by-step to a complete mastery of Accounting—and on up to the coveted degree of Certified Public Accountant if you so aspire.

It doesn't matter whether you've had previous bookkeeping experience, or whether you don't know a debit from a credit. Whether you wish to qualify as an expert bookkeeper, advanced accountant, cost accountant, auditor, government accountant, income tax specialist, or public accountant . . . you'll find in LaSalle's Problem Method the exact plan to prepare you rapidly and inexpensively—in spare hours at home—without losing a day from your present job.

So right now, today . . . if you are an adult, employed, and earnestly ambitious for rapid advancement in this highest-paying of all professions . . . send your name and address on the coupon below. We'll send the free sample lesson—plus our 48-page book outlining today's career opportunities and how you can qualify for them. A coupon like this has started many thousands toward greater success. It can do the same for you. Mail it today!

Clip Coupon . . . Mail TODAY!

LaSalle Extension University . . . A Correspondence Institution
Dept. 1264H, 417 S. Dearborn Street, Chicago 5, Illinois

YES, I want to see how LaSalle's "Problem Method" works . . . how I can qualify for high-pay Accountancy positions. Send Free Sample Lesson—also your 48-page book, "Accountancy, the Profession That Pays" . . . all without cost or obligation.

Name Age

Street Address

City, Zone & State

Present Position



**Nearly 10%
of all C.P.A.'s
in the U.S. have
been trained by the
LaSalle Problem
Method**

GOOD-PAY JOBS IN 5 BIG FIELDS

If you were an expert accountant right now, chances are you would find yourself among the highest-paid of all professional men and women. Surveys show that accountants earn more than those in other major professions.

There are five big fields of opportunity open to Accountancy-trained men and women . . . opportunities that are wide open and highly inviting, offering maximum income and job security in good times or bad. And under LaSalle's "Problem Method" you can start earning while still learning—either in spare-time or full-time employment . . . or in business for yourself with no capital required.

Get the latest information by sending for our 48-page book, "Accountancy, the Profession That Pays" . . . plus free sample lesson. The coupon at right will bring both to you without cost or obligation. LaSalle Extension, 417 S. Dearborn St., Chicago 5, Ill.

(Continued from page 6)

Germany is booming and its people are actively improving their standard of living after the lean war years. They are interested in the scientific achievements reported in *Popular Mechanics* and in learning new ways to improve their homes and perform their shop work.

Populare Mechanik is printed at Strasbourg and distributed from Offenburg, Germany.

To the Editor:

I was surprised to see my plaster-cast cutter shown on page 154 of the September number, and more surprised to learn that it was developed in Europe. As you can see from the enclosed patent No. 1,967,888, I invented this device in 1934. The General Electric X-Ray Corporation built and sold these cast cutters for many years. The patent has now expired and evidently some manufacturer in Europe has started making them.

W. K. Kearsley,
611 S. Grandview St.,
Mount Dora, Fla.

EDITOR'S NOTE: Mr. Kearsley, one of General Electric Company's most famous inventors, was the subject of a feature article in our January 1952 issue entitled "The Tinker With Million-Dollar Ideas."

Now in his early 70s, he is living in retirement at Mount Dora.

To the Editor:

Last year I designed the "House You Asked For" which you featured in the October 1955 issue. I thought you might like to know that since the magazine came out we have received exactly 6569 letters about the house. We have sold several hundred sets of plans from coast to coast



and even in foreign countries. Inquiries are still coming in and we expect the number to exceed 7000 before the end of the year. This certainly speaks volumes for the pulling power of your excellent magazine in the housing field.

Rudolph A. Matern,
90-04 161st St.,
Jamaica 32, N. Y.

(Continued to page 10)

A great gift... a smart buy too!

... the new 1956

HARLEY-DAVIDSON

HUMMER

Here's practical, economical and handy transportation. The Hummer costs less than \$17.00 per month to buy*. What's more, you get up to 100 miles per gallon. Yes, it's the easy way to travel to work or play... avoid the high costs of depreciation and operation.

Also, the Hummer makes a wonderful gift for your teen-age son. It's easy to operate... helps him get many part-time jobs.

Want the complete story? See your nearest Harley-Davidson dealer or write for free literature. HARLEY-DAVIDSON MOTOR Co., Dept. PM, Milwaukee 1, Wisconsin.

As little as \$17.00 per mo.... up to 100 miles per gal.

*After minimum down payment; includes fire, theft and collision insurance, local taxes, freight, carrying charges.



NEW LOW PRICES
Excise tax now off

I saw my job failure in my family's eyes

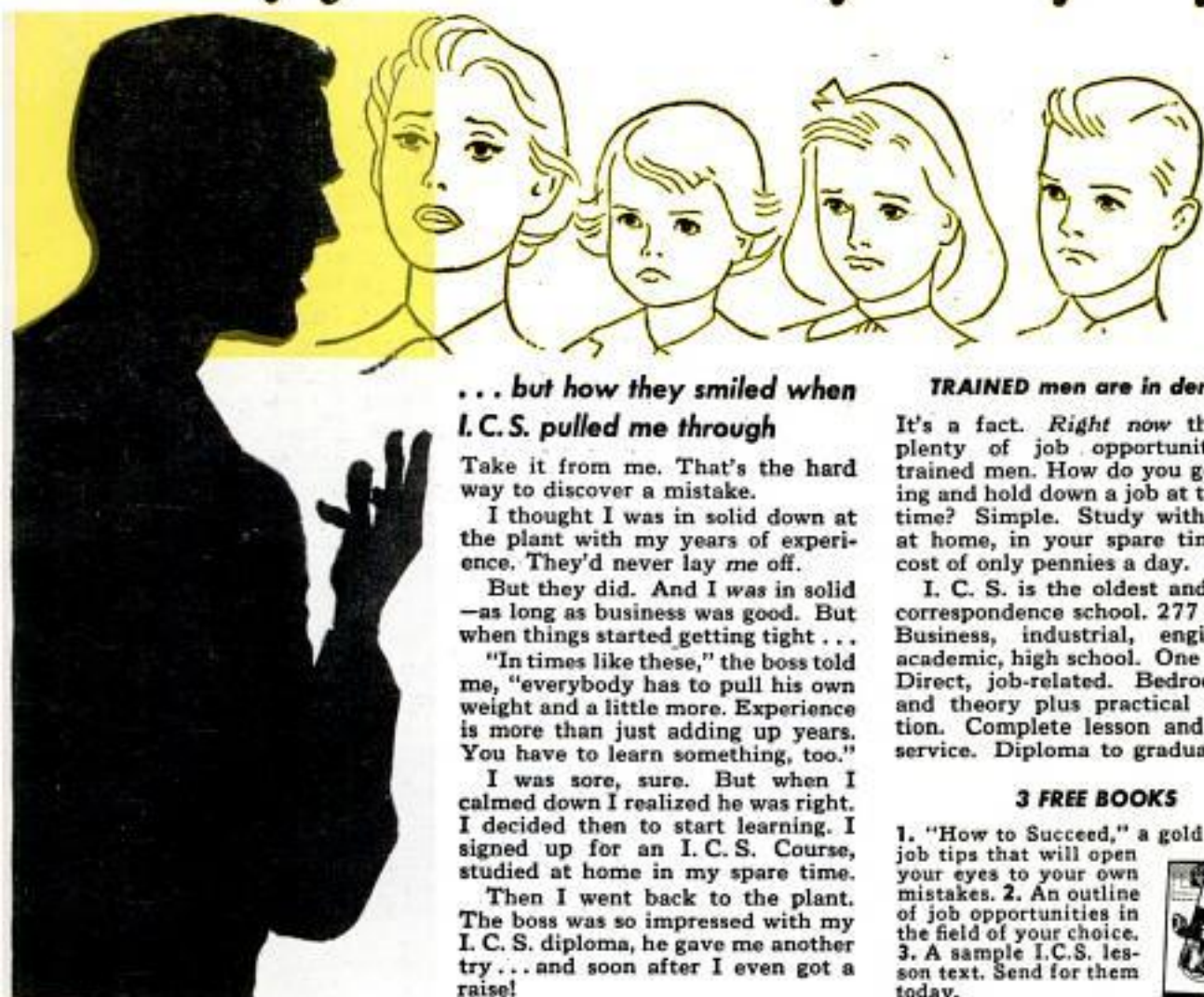

... but how they smiled when I. C. S. pulled me through

Take it from me. That's the hard way to discover a mistake.

I thought I was in solid down at the plant with my years of experience. They'd never lay me off.

But they did. And I was in solid—as long as business was good. But when things started getting tight...

"In times like these," the boss told me, "everybody has to pull his own weight and a little more. Experience is more than just adding up years. You have to learn something, too."

I was sore, sure. But when I calmed down I realized he was right. I decided then to start learning. I signed up for an I. C. S. Course, studied at home in my spare time.

Then I went back to the plant. The boss was so impressed with my I. C. S. diploma, he gave me another try... and soon after I even got a raise!

TRAINED men are in demand

It's a fact. Right now there are plenty of job opportunities for trained men. How do you get training and hold down a job at the same time? Simple. Study with I. C. S. at home, in your spare time, at a cost of only pennies a day.

I. C. S. is the oldest and largest correspondence school. 277 courses. Business, industrial, engineering, academic, high school. One for you. Direct, job-related. Bedrock facts and theory plus practical application. Complete lesson and answer service. Diploma to graduates.

3 FREE BOOKS

1. "How to Succeed," a gold mine of job tips that will open your eyes to your own mistakes. 2. An outline of job opportunities in the field of your choice. 3. A sample I. C. S. lesson text. Send for them today.



For Real Job Security—Get an I. C. S. Diploma! I. C. S., Scranton 9, Penna. Member, National Home Study Council

INTERNATIONAL CORRESPONDENCE SCHOOLS



BOX 22299M, SCRANTON 9, PENNA.

(Partial list of 277 courses)

Without cost or obligation, send me "HOW TO SUCCEED" and the opportunity booklet about the field BEFORE which I have marked X (plus sample lesson):

- | | | | | |
|--|---|---|--|--|
| <p>ARCHITECTURE and BUILDING CONSTRUCTION</p> <ul style="list-style-type: none"> <input type="checkbox"/> Air Conditioning—Refrig. <input type="checkbox"/> Architecture <input type="checkbox"/> Architectural Interior <input type="checkbox"/> Building Contractor <input type="checkbox"/> Building Maintenance <input type="checkbox"/> Carpenter and Mill Work <input type="checkbox"/> Estimating <input type="checkbox"/> Heating <input type="checkbox"/> Painting Contractor <input type="checkbox"/> Plumbing <input type="checkbox"/> Reading Arch. Blueprints <p>ART</p> <ul style="list-style-type: none"> <input type="checkbox"/> Cartooning <input type="checkbox"/> Commercial Art <input type="checkbox"/> Fashion Illustrating <input type="checkbox"/> Magazine Illustrating <input type="checkbox"/> Show Card and Sign Lettering <input type="checkbox"/> Sketching and Painting <p>AUTOMOTIVE</p> <ul style="list-style-type: none"> <input type="checkbox"/> Auto Body Rebuilding <input type="checkbox"/> Auto Elec. Technician <input type="checkbox"/> Auto-Engine Tune Up <input type="checkbox"/> Automobile | <p>AVIATION</p> <ul style="list-style-type: none"> <input type="checkbox"/> Aeronautical Engineering Jr. <input type="checkbox"/> Aircraft & Engine Mechanic <p>BUSINESS</p> <ul style="list-style-type: none"> <input type="checkbox"/> Advertising <input type="checkbox"/> Bookkeeping and Accounting <input type="checkbox"/> Business Administration <input type="checkbox"/> Business Correspondence <input type="checkbox"/> Public Accounting <input type="checkbox"/> Creative Salesmanship <input type="checkbox"/> Federal Tax <input type="checkbox"/> Letter-writing Improvement <input type="checkbox"/> Office Management <input type="checkbox"/> Professional Secretary <input type="checkbox"/> Retail Business Management <input type="checkbox"/> Sales Management <input type="checkbox"/> Stenographic-Secretarial <input type="checkbox"/> Traffic Management <p>CHEMISTRY</p> <ul style="list-style-type: none"> <input type="checkbox"/> Analytical Chemistry <input type="checkbox"/> Chemical Engineering <input type="checkbox"/> Chem. Lab. Technician <input type="checkbox"/> General Chemistry <input type="checkbox"/> Natural Gas Prod. & Trans. <input type="checkbox"/> Petroleum Engineering <input type="checkbox"/> Plastics <input type="checkbox"/> Pulp and Paper Making | <p>CIVIL, STRUCTURAL ENGINEERING</p> <ul style="list-style-type: none"> <input type="checkbox"/> Civil Engineering <input type="checkbox"/> Construction Engineering <input type="checkbox"/> Highway Engineering <input type="checkbox"/> Reading Struct. Blueprints <input type="checkbox"/> Sanitary Engineering <input type="checkbox"/> Structural Engineering <input type="checkbox"/> Surveying and Mapping <p>DRAFTING</p> <ul style="list-style-type: none"> <input type="checkbox"/> Aircraft Drafting <input type="checkbox"/> Architectural Drafting <input type="checkbox"/> Electrical Drafting <input type="checkbox"/> Mechanical Drafting <input type="checkbox"/> Mine Surveying and Mapping <input type="checkbox"/> Plumbing Drawing and Estimating <input type="checkbox"/> Structural Drafting <p>ELECTRICAL</p> <ul style="list-style-type: none"> <input type="checkbox"/> Electrical Engineering <input type="checkbox"/> Electrical Maintenance <input type="checkbox"/> Electricians <input type="checkbox"/> Contracting <input type="checkbox"/> Lineman <p>HIGH SCHOOL</p> <ul style="list-style-type: none"> <input type="checkbox"/> Commercial <input type="checkbox"/> Good English <input type="checkbox"/> High School Subjects <input type="checkbox"/> Mathematics | <p>LEADERSHIP</p> <ul style="list-style-type: none"> <input type="checkbox"/> Foremanship <input type="checkbox"/> Industrial Supervision <input type="checkbox"/> Leadership and Organization <input type="checkbox"/> Personnel-Labor Relations <p>MECHANICAL AND SHOP</p> <ul style="list-style-type: none"> <input type="checkbox"/> Gas—Electric Welding <input type="checkbox"/> Heat Treatment <input type="checkbox"/> Metallurgy <input type="checkbox"/> Industrial Engineering <input type="checkbox"/> Industrial Instrumentation <input type="checkbox"/> Industrial Supervision <input type="checkbox"/> Internal Combustion Engines <input type="checkbox"/> Machine Design-Drafting <input type="checkbox"/> Machine Shop Inspection <input type="checkbox"/> Machine Shop Practice <input type="checkbox"/> Mechanical Engineering <input type="checkbox"/> Quality Control <input type="checkbox"/> Reading Shop Blueprints <input type="checkbox"/> Refrigeration <input type="checkbox"/> Sheet Metal Worker <input type="checkbox"/> Tool Design <input type="checkbox"/> Toolmaking <p>RADIO, TELEVISION</p> <ul style="list-style-type: none"> <input type="checkbox"/> Industrial Electronics <input type="checkbox"/> Practical Radio TV Eng'ing <input type="checkbox"/> Radio and TV Servicing <input type="checkbox"/> Radio Operating | <ul style="list-style-type: none"> <input type="checkbox"/> Television Technician <p>RAILROAD</p> <ul style="list-style-type: none"> <input type="checkbox"/> Air Brakes <input type="checkbox"/> Car Inspector <input type="checkbox"/> Diesel Locomotive <input type="checkbox"/> Locomotive Engineer <input type="checkbox"/> Section Foreman <p>STEAM AND DIESEL POWER</p> <ul style="list-style-type: none"> <input type="checkbox"/> Combustion Engineering <input type="checkbox"/> Diesel—Elec. <input type="checkbox"/> Diesel Eng's <input type="checkbox"/> Electric Light and Power <input type="checkbox"/> Stationary Fireman <input type="checkbox"/> Stationary Steam Engineering <p>TEXTILE</p> <ul style="list-style-type: none"> <input type="checkbox"/> Carding and Spinning <input type="checkbox"/> Cotton, Rayon, Woolen Mfg. <input type="checkbox"/> Finishing and Dyeing <input type="checkbox"/> Loom Fix'g <input type="checkbox"/> Textile Des'ing <input type="checkbox"/> Textile Eng'g <input type="checkbox"/> Throwing <input type="checkbox"/> Warping and Weaving <p>MISCELLANEOUS</p> <ul style="list-style-type: none"> <input type="checkbox"/> Domestic Refrigeration <input type="checkbox"/> Marine Engineering <input type="checkbox"/> Ocean Navigation <input type="checkbox"/> Professional Engineering <input type="checkbox"/> Short Story Writing <input type="checkbox"/> Telephony |
|--|---|---|--|--|

Name _____ Age _____ Home Address _____

City _____ Zone _____ State _____ Working Hours _____ A.M. to P.M. _____

Occupation _____

Canadian residents send coupon to International Correspondence Schools, Canadian, Ltd., Montreal, Canada. . . . Special tuition rates to members of the U. S. Armed Forces.

HOW TO ELIMINATE STALLING



LAZY PICK-UP



*clean your carburetor
with **GUMOUT***

If your car's running sick—stalling, with lazy pick-up—chances are it's suffering from a dirty carburetor. Gum and dirt are choking off the vital fuel and air supply.

But—there's no need to tear down the carburetor!

GUMOUT cleans out your carburetor while you drive. Just add GUMOUT to your gas tank every two or three months. You'll keep your carburetor sparkling clean the year 'round. There's nothing like it!

GUMOUT is sold by service stations and auto supply stores everywhere.
GUMOUT DIVISION, Pennsylvania Refining Co.
2671 Lisbon Road, Cleveland 4, Ohio



SEND FOR FREE 46-page "CARBURETOR HANDBOOK." Gives you all the answers. Good to have.

GUMOUT, due to its amazing solvent action, has many additional uses around the home and workshop. If you'd like to know about them, ask for Technical Bulletin 103-G when writing for your free Carburetor Handbook.

(Continued from page 8)

To the Editor:

I read with great interest your article on electric heating in the October issue of *Popular Mechanics Magazine*. I think you did a splendid job of covering the situation.

You might be interested to know that in Cowlitz County of which Longview, Wash., is the principal city and only 45 miles northwest of Vancouver, over 80 percent of our new homes are installing electric heat while about 500 homeowners annually are converting from solid fuels to electric heat. In our service area, we have approximately 18,000 residential customers of which nearly 4000 are using electric heat.

Lacy M. Peoples,
Commercial Manager,
Public Utility District No. 1,
Cowlitz County, Wash.

To the Editor:

In the August 1955 issue there is a description of a lawn mower that has been converted to electric power. The enclosed picture is of my mower which I converted

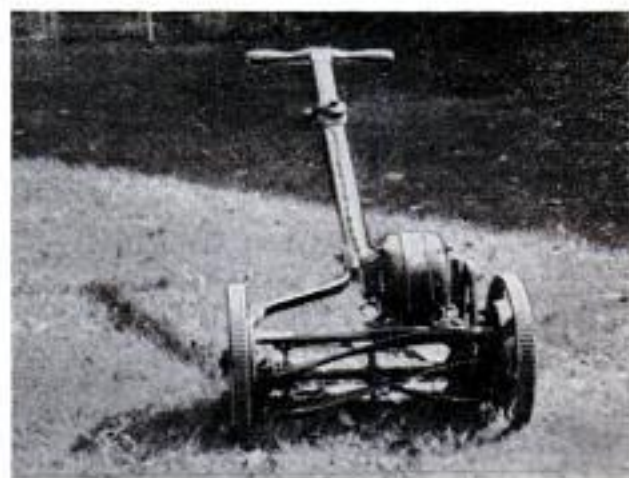

to electric power 30 years ago and which has been in use continuously ever since.

E. L. Dreher,
Claremont, Calif.

To the Editor:

Your article about the bus train (PM, Sept. 1955) I'll say is phenomenal, and I am not a railroader.

Judging from what I have heard in traveling, and my own personal outlook, from Norfolk, Va., to Philadelphia, Pa., this is a change millions of bus riders not only are looking for but will welcome.

Wilfrid S. Hudon, RM3 USN,
USS *Holder* DDE 819,
c/o FPO New York City

☞ More than 100,000 automobiles are ferried across the English Channel each year.

You Practice **SERVICING** with Kits I Send You



Nothing takes the place of PRACTICAL EXPERIENCE. That's why NRI training is based on LEARNING BY DOING. You use parts I send to build many circuits common to Radio and Television. With my Servicing Course you build the modern Radio shown at left. You build a Multitester and use it to help make \$10, \$15 a week fixing sets in spare time while training. All equipment is yours to keep. Coupon below will bring book of important facts. It shows other equipment you build.

You Practice **BROADCASTING** with Kits I Send You



As part of my Communications Course I send you parts to build low-power Broadcasting Transmitter at left. Use it to get practical experience. You put this station "on the air" . . . perform procedures demanded of broadcasting station operators. An FCC Commercial Operator's License can be your ticket to a bright future. My Communications Course trains you to get your license. Mail coupon. Book shows other equipment you build for practical experience.

I Will Train You at Home in Spare Time to be a **RADIO-TELEVISION** Technician



TELEVISION

Making Jobs, Prosperity

25 million homes have Television sets now. Thousands more sold every week. Trained men needed to make, install, service TV sets. About 200 television stations on the air. Hundreds more being built. Good job opportunities here for qualified technicians, operators, etc.



J. E. SMITH, President
National Radio Institute
Washington, D. C.
Our 40th Year

America's Fast Growing Industry Offers You Good Pay, Success

Training PLUS opportunity is the PERFECT COMBINATION for job security, advancement. When times are good, the trained man makes the BETTER PAY, gets PROMOTED. When jobs are scarce, the trained man enjoys GREATER SECURITY. NRI training can help assure you and your family more of the better things of life. Radio is bigger than ever with over 3,000 broadcasting stations and more than 115 MILLION sets in use, and Television is moving ahead fast.

N.R.I. Training Leads to Good Jobs Like These

I TRAINED THESE MEN

"I have progressed very rapidly. My present position is Studio Supervisor with KEDD Television, Wichita."—Elmer Frewaldt, 3026 Stadium, Wichita, Kans.

"Fix sets part time in my shop. Made about \$500 first three months of the year. Could have more but this is about all I can handle."—Frank Borer, Lorain, Ohio.

"I've come a long way in Radio and Television since graduating. Have my own business on Main Street."—Joe Travers, Asbury Park, New Jersey.

"I didn't know a thing about Radio. Now have a good job as Studio Engineer at KMMJ."—Bill Delsell, Central City, Nebraska.



BROADCASTING: Chief Technician, Chief Operator, Power Monitor, Recording Operator, Remote Control Operator. **SERVICING:** Home and Auto Radios, Television Receivers, FM Radios, P.A. Systems. **IN RADIO PLANTS:** Design Assistant, Technician, Tester, Serviceman, Service Manager. **SHIP AND HARBOR RADIO:** Chief Operator, Radio-Telephone Operator. **GOVERNMENT RADIO:** Operator in Army, Navy, Marine Corps, Forestry Service Dispatcher, Airways Radio Operator. **AVIATION RADIO:** Transmitter Technician, Receiver Technician, Airport Transmitter Operator. **TELEVISION:** Pick-up Operator, Television Technician, Remote Control Operator.

Act now to get more of the good things of life. I send actual lesson to prove NRI home training is practical, thorough. My 64-page book "How to be a Success in Radio-Television" shows what my graduates are doing and earning. It gives important facts about your opportunities in Radio-Television. Take NRI training for as little as \$5 a month. Many graduates make more than the total cost of my training in two weeks. Mail coupon now to: J. E. SMITH, President, Dept. 5NA, National Radio Institute, Washington 9, D. C. Our 40th year.

Start Soon to Make \$10, \$15 a Week Extra Fixing Sets

My training is practical, complete; is backed by 40 years of success training men at home. My well-illustrated lessons give you basic principles you need and my skillfully developed kits of parts "bring to life" things you learn from the lessons. I start sending you special booklets the day you enroll, that show you how to fix sets. Multitester you build with my parts helps you discover and correct set troubles, helps you make money fixing neighbors' sets in spare time while training. Many make \$10, \$15 a week extra this way.

Mail Coupon — Find Out What Radio-Television Offer You

Act now to get more of the good things of life. I send actual lesson to prove NRI home training is practical, thorough. My 64-page book "How to be a Success in Radio-Television" shows what my graduates are doing and earning. It gives important facts about your opportunities in Radio-Television. Take NRI training for as little as \$5 a month. Many graduates make more than the total cost of my training in two weeks. Mail coupon now to: J. E. SMITH, President, Dept. 5NA, National Radio Institute, Washington 9, D. C. Our 40th year.

AVAILABLE to all qualified VETERANS UNDER G.I. BILLS

Good for Both—FREE

MR. J. E. SMITH, President, Dept. 5NA
National Radio Institute, Washington 9, D. C.
Mail me Sample Lesson and 64-page Book, FREE.
(No salesman will call. Please write plainly.)

Name.....Age.....
Address.....
City.....Zone.....State.....

VETS write in date of discharge



Mail Today—Tested Way to Better Pay

49¹/₂¢

STORM WINDOW

protects your family . . . all winter . . .

**No Nails • No Hooks
No Tools • No Screws
10.8 Sq. ft. Window
only 49¹/₂¢!
JUST PRESS ON—
that's all!**



Now . . . Storm Windows need not cost up to \$14.00. A world famous industrial firm developed this light weight flexible product that seals out wintry blasts for as low as 49¹/₂ cents a window! Imagine—for pennies you can insulate 'most ANY room in your home! This storm window is as transparent as glass yet can't peel, chip, shatter or rattle! Weighs less than 1/10 of the lightest glass windows developed—yet it has the tensile strength of over a TON per square inch! Crystal-clear, yet flexible like rubber! Not affected by snow, sleet, rain or dampness—because it's 100% waterproof. Won't crack at even 53 degrees BELOW FREEZING. Use and re-use YEAR AFTER YEAR for winter comfort and protection.



Lift Border for Airing

INSTALL IN 5 MINUTES

No nails, hooks, screws or tools. Just cut to fit window (any shape) then press on special Adheso Border. That's all! No hard work, no broken glass. Simple! Easy—a child can do it. Cleans easily with damp cloth, too! At winter's end, fold away like cloth for next year.

Over 2,000,000 Sold

No wonder so many home owners, hospitals, churches use this tried and true product—over 2,000,000 sold last year! A 36" x 43 1/2" TRANS-KLEER kit—108 sq. feet, enough for 10 windows of 10.8 sq. feet—complete with Adheso Border is \$4.95, just 49¹/₂¢ a window! 10 glass windows would cost \$79 to \$160—you save a terrific sum on purchase and on fuel savings! Play safe—order NOW on trial. The factory can produce only so much—no more. Act fast, mail coupon now. Enjoy new comfort, feel the difference—even test with thermometer. Then, if not convinced, your \$4.95 comes back! Only 2,500,000 can be made this year—and demand is going up! Avoid disappointment! RUSH COUPON TODAY!

THORESEN'S, Dept. 6-N-47

352 Fourth Avenue, New York 10, N. Y.

RUSH _____ Kits Trans-Kleer measuring 108 sq. ft. (10 windows averaging 10.8 sq. ft. each), with Adheso Border on 7 day trial—money back guarantee.

- Payment Enclosed. Send Prepaid.
 Send C.O.D. plus postage.

CHECK AMOUNT DESIRED

- 1 KIT (108 sq. ft.) for 10 windows—4.95
 2 KITS (216 sq. ft.) for 20 windows—8.95

Name _____

Address _____

City _____

State _____

(Canadian: save tariff—order direct from Thoresen Ltd., 55 St. James St. W. Dept. US-47, Montreal 1, P. Q.)

You can have a career instead of a job

Industrial growth . . . automation . . . technical advances create tremendous opportunities for engineers, accountants, management experts. Share the rewards awaiting college-trained men in engineering and commerce. Important concerns visit campus regularly to employ Tri-State College graduates. Start any quarter in this world-famed college. Approved for veterans.

Bach. of Science degree in 27 months

In Mechanical, Civil, Electrical, Chemical, Aeronautical, Radio (TV-Electronics), Administrative Engineering; Business Administration and Accounting. 36-weeks course in Drafting; Intensive program: technical fundamentals stressed; comprehensive courses with more professional class hours.

Small classes; personalized instruction. For earnest, mature students whose time and budget requires accelerated courses and modest costs. Preparatory courses. Beautiful campus in friendly college town. Well-equipped, new and modernized buildings and labs. Enter Jan., March, June, Sept. Write Jean McCarthy, Director of Admissions, for "Your Career in Engineering or Commerce".



TRI-STATE COLLEGE

4125 College Avenue

Angola, Indiana

\$14,839 in 1 Year SERVICING RADIATORS

—REX RYAN, Bloomfield, Iowa

Hundreds earning \$8,000-\$20,000 a year servicing auto-truck-tractor radiators! New Inland equipment makes work easy, insures finest professional workmanship. "Pays-for-itself" financing available. \$100 training course included free by world's largest radiator servicing equipment manufacturer.

WRITE for free folder "Want a business of your own?"

INLAND MFG. COMPANY Dept. PM-12
1108 Jackson St., Omaha 8, Nebr.



OWN WORLD'S FINEST CRYSTAL RADIO

Complete Kit Only **\$9.95** Money Back Guarantee

Plays anywhere. Needs no batteries or electric current. Excellent performance guaranteed. Germanium crystal diode can get stations over 500 miles away. Head phones, aerial kit included. Nothing else to buy. Assembled in minutes. Popular 5"x4 1/2"x6 3/4" personal size. Send \$2.00 deposit now, we'll mail C.O.D. plus postage. Satisfaction guaranteed.

IDEAL FOR CHRISTMAS GIFTS!

JAEGER & CO.

P.O. BOX W246 SKOKIE, ILL.

BECOME AN EXPERT IN

TRAFFIC

Traffic men earn \$4,000 to \$10,000 and up. Thousands of firms need experts on rates, tariffs, regulations. We train you thoroughly in spare time at home for executive traffic jobs. Personal training under traffic authorities. Placement counsel and help. Write for free 48-page book "Traffic Management—the Fast Growing Profession."

LASALLE Extension University, 417 So. Dearborn St.
A Correspondence Institution Dept. 1264T Chicago 5, Ill.

SHORTHAND IN 6 WEEKS

Write 120 words per minute
Age no obstacle—LOWEST COST

Famous SPEEDWRITING shorthand. No symbols; no machines; uses ABC's. Easiest to learn and use. Fast preparation for a better position. Nationally used in leading offices and Civil Service. 120 words per minute—50% FASTER than Civil Service requirements. Over 300,000 taught by mail or through classroom instruction. The very low cost will surprise you. Typing available. 33rd Year. Schools in over 400 cities in U.S., Canada, Cuba, and Hawaii.

WRITE FOR FREE BOOKLET TO SCHOOL OF

Speedwriting
Dept. 1512-5, 55 W. 42 St., N.Y. 36



INVENTORS

Learn how to protect your invention. The U. S. Patent Laws provide that any new and useful art, machine, article of manufacture, or composition of matter, or any new and useful improvement thereof, may be patented if the act of invention is involved. Therefore, every inventor with a valuable invention should take advantage of the Patent Laws and proceed for patent protection in order to safeguard his rights.

A patent gives the inventor the exclusive right to prevent others from making, using, or selling the invention claimed in the patent for a period of seventeen years.

The Patent Laws were enacted for the benefit of the inventor to give him protection for the features of his invention which are patentable. These features must be properly and concisely set forth and claimed in a formal application for patent, in order to comply with the requirements of the Patent Laws. For that reason, unless the inventor is familiar with patent matters, he should engage a competent registered patent attorney or agent to represent him. We are registered to practice before the U. S. Patent Office and are prepared to serve you in the handling of your patent matters.

A specially prepared booklet entitled "Patent Guide for the Inventor", containing detailed information with respect to patent protection and procedure, together with a "Record of Invention" form will be promptly forwarded to you without obligation upon request.

CLARENCE A. O'BRIEN & HARVEY JACOBSON

Registered Patent Attorneys

51-M DISTRICT NATIONAL BUILDING

WASHINGTON 5, D. C.

WHAT ALL AUTO MECHANICS WANT TO KNOW

1664 PAGES



This Big Practical Book gives full information with working diagrams covering the principles, construction, ignition, service and repair of modern cars, trucks and buses.

Diesel Engines, Hydrumatic & Fluid Drives Fully Explained.

A complete Guide of 1664 pages, with over 1500 illustrations showing inside views of working parts, with instructions for service jobs.

IT PAYS TO KNOW

How to fit pistons—How to locate engine knocks, How to fit connecting rod bearings—How to service main bearings—How to recondition valves—How to time valves—How to adjust fan belts—How to adjust carburetors and chokes, How to rebuild a clutch—How to service automatic transmissions—How to service brakes—How to adjust steering gear—How to cope with ignition troubles—How to service distributors—How to time ignition—How to "tune up" an engine.



to rebuild a clutch—How to service automatic transmissions—How to service brakes—How to adjust steering gear—How to cope with ignition troubles—How to service distributors—How to time ignition—How to "tune up" an engine.

\$4 COMPLETE • PAY \$1 A MO. TO GET THIS ASSISTANCE FOR YOURSELF SIMPLY FILL IN AND MAIL COUPON TODAY.

Step up your own skill with the facts and figures of your trade. Audels Mechanics Guides contain Practical Inside Trade Information in a Handy Form, Fully illustrated and Easy to Understand, Highly Endorsed. Check the book you want for 7 DAYS FREE EXAMINATION. Send No Money, Nothing to pay postman.

MAIL ORDER



Check NOW!

You Can Look Over Any Guide In Your Own Home — Start the Easy Payments If Satisfied

MAIL THIS TODAY

AUDEL, Publishers, 49 W. 23 St., NEW YORK 10, N. Y.

Please send me postpaid for FREE EXAMINATION books marked (X) below. If I decide to keep them I agree to mail \$1 in 7 Days on each book or set ordered and further mail \$1 monthly on each book or set until I have paid price, otherwise I will return them.

- AUTOMOBILE MECHANICS GUIDE, 1664 Pages. \$4
- TRUCK & TRACTOR GUIDE, 1299 Pages. 4
- DIESEL ENGINE MANUAL, 575 Pages. 2
- MACHINISTS HANDY BOOK, 1650 Pages. 4
- WELDERS GUIDE, 400 Pages. 1
- BLUE PRINT READING, 416 Pages. 2
- MATHEMATICS & CALCULATIONS, 700 Pages. 2
- SHEET METAL PATTERN LAYOUTS, 1100 Pages. 4
- SHEET METAL WORKERS HANDY BOOK, 388 Pgs. 1
- MECHANICAL DRAWING GUIDE, 160 Pages. 1
- MECHANICAL DRAWING & DESIGN, 480 Pages. 2
- AIRCRAFT WORKER, 240 Pages. 2
- TELEVISION SERVICE MANUAL, 434 Pages. 2
- RADIODIAGNOSIS GUIDE, 1040 Pages. 4
- ELECTRONIC DEVICES, 216 Pages. 2
- ELECTRIC MOTOR GUIDE, 1000 Pages. 4
- WIRING DIAGRAMS (Light & Power), 272 Pgs. 1
- ELECTRICIANS EXAMINATIONS, 250 Pages. 1
- ELECTRIC POWER CALCULATIONS, 425 Pages. 2
- HANDY BOOK OF ELECTRICITY, 1440 Pages. 4
- ELECTRIC DICTIONARY, 9000 Terms. 2
- ELECTRIC LIBRARY, 7000 Pages (12 Book Set) 18
- SHIPFITTERS HANDY BOOK, 250 Pages. 1
- REFRIGERATION & Air Conditioning, 1280 Pgs. 4
- MILLWRIGHTS & MECHANICS GUIDE, 1200 Pgs. 4
- POWER PLANT ENGINEERS GUIDE, 1500 Pages. 4
- ENGINEERS & FIREMANS EXAMS, 525 Pages. 1
- PUMPS, Hydraulics & Air Compressors, 1658 Pgs. 4
- OPERATING ENGINEERS LIBRARY (3 Books). 9
- MECHANICAL DICTIONARY, 950 Pages. 4
- GARDENERS & GROWERS GUIDES (4 Book Set) 6
- CARPENTERS & BUILDERS GUIDES (4 Book Set) 6
- PLUMBERS & Steamfitters Guides (4 Book Set) 6
- MASONS AND BUILDERS GUIDES (4 Book Set) 6
- PAINTERS & DECORATORS MANUAL, 450 Pgs. 2
- HOUSE HEATING GUIDE, 1000 Pages. 4
- OIL BURNER GUIDE, 384 Pages. 1
- HOME APPLIANCE SERVICE GUIDE, 800 Pages. 4

Name _____
 Address _____
 Occupation _____
 Employed by _____ P12

FREE

A NEW HOME INDUSTRY

GEARS **FISHING LURES** **JEWELRY GEMS** **HANDLES KNIVES - DIALS** **STATUES FIGURINES**

OPPORTUNITIES UNLIMITED

Let us show you how extremely easy and PROFITABLE it is to make beautiful and useful things out of LIQUID PLASTIC, LIQUID MARBLE, LIQUID IVORY, LIQUID GLASS, CERAMICS, ETC. . . as easy as pouring water out of a glass! Make novelties, jewelry, gifts, artware, toys, tools, dies, gaggets, ceramics . . . a million useful things! We supply everything—MATERIALS and INSTRUCTIONS! —Send only 25c for big 64 page catalog of casting materials, molds and accessories and we will include free of extra cost a remarkable book, "THE WONDERS OF LIQUID PLASTICS" . . . that will open your eyes to wonders you never dreamed of! Send 25c today—this may be the lucky coin that will start the most fascinating and profitable phase of your life!

PLASTICAST COMPANY
 6612 N. CLARK ST. DEPT. PC-202 CHICAGO 26, ILLINOIS

SEND FOR THIS FREE!

HOW TO BREAK and TRAIN HORSES

Make money. Know how to break and train horses. Write today for this book FREE, together with special offer of a course in Animal Breeding. If you are interested in Gaiting and Riding the saddle horse, check here () Do it today—now.

BEERY SCHOOL OF HORSEMANSHIP
 Dept. 11012 Pleasant Hill, Ohio

REAL ESTATE

BE A BROKER

PAYS BIG! SEND FOR FREE, BIG, ILLUSTRATED CATALOG NOW! Graduates report making substantial incomes. Start and run your own business quickly. Men, women of all ages learn easily. Course covers Sales, Property Management, Appraising, Loans, Mortgages, and related subjects. **STUDY AT HOME** or in classrooms in leading cities. Diploma awarded. Write TODAY for free book! No obligation. Approved for World War II and Korean Veterans

WEAVER SCHOOL OF REAL ESTATE (Est. 1936)
 2020R Grand Avenue Kansas City, Mo.

FREE BOOK TELLS NOW

STAMP COLLECTORS

308 DIFFERENT STAMPS 25¢

including scarce Trieste collection; United Nations Issue, Olympics, Latest wild animal set—in gorgeous multi-color showing the Lynx, Bear, Chamols, Deer, etc. Stamps from riot-torn Trieste are becoming very scarce. These are only part of the big collection of 308 all different foreign stamps Cataloging \$7.00 that you get for only 25c to introduce our approvals.

IDEAL STAMP CO., Dept. 3A, P. O. Box 64
 West Farms Station, New York 60, N. Y.

URANIUM PROSPECTORS!

A MUST FOR

The **Radioactive CALTRON Standard**

A convenient, pocket-size radioactive source for testing and standardizing operation of geiger counters and scintillometers.

MODEL X-1 (Regular) Only \$1.00 **Check Equipment Regularly** **MODEL X-2.5 (Professional) Only \$2.50**

100 millimicrogram radium source encased in plastic disc—shows if any counter is working. Instructions included

100% SAFE—1000's In Use! No C. O. D. Send Check or M. O.

CALTRON LABS
 P. O. Box 88 • Dept. PM-12 Overland Park, Kansas

Duplex calibrated plastic encased radium source—mr/hr ratings stamped in. High level reading on back face, low level on back.

ORDER YOURS TODAY! **MAKES A FINE GIFT!**

GET A JET BOOST TO BIG-PAY PROMOTIONS WITH AN I.C.S. DIPLOMA!



Here's how you can turn "normal advancement" into a sudden, tremendous spurt that will put you years ahead in your job!

Most men are content to rise slowly, letting seniority and experience carry them to bigger, better jobs. A few, however, have what it takes to skyrocket upward, passing older, more experienced men along the way.

You can be one of the few. If you have ambition and determination, ICS can supply the rest—modern training, especially developed for "accelerated advancement" in business and industry. In a single three-month period, 1973 ICS students reported pay increases and promotions!

"My ICS training is paying off

with an extra \$120 a month—and more to come," writes J.R.T., Crane, Texas.

New, exciting opportunities!

If you want to move up *fast*—get higher pay, do more interesting work, leave money worries far behind—take advantage of today's new, exciting opportunities—NOW!

The aircraft industry, for example, is suddenly booming with new billions in defense orders. Color television, microwave transmission, industrial electronics are wide-open fields. Trained men are in demand in industry after industry!

A few cents a day, the ICS way!

For only a few cents a day, you can prepare yourself for advancement. 277 ICS courses to choose from. Direct, job-related. Personalized, expert instruction. Lesson and answer service. Diploma to graduates.

You study at home. No conflict with business or social life. You set your own pace—progressing as rapidly as your abilities permit.

3 FREE BOOKS

Free ICS career kit consisting of: (1) "How to Succeed," a 36-page gold mine of valuable success tips; (2) Career Catalog outlining new opportunities in your field of interest; (3) sample ICS lesson (Mathematics) demonstrating the famous ICS method.

For Real Job Security—Get an I. C. S. Diploma! I. C. S., Scranton 9, Penna. Member, National Home Study Council

INTERNATIONAL CORRESPONDENCE SCHOOLS

BOX 07299M, SCRANTON 9, PENNA.

(Partial list of 277 courses)

Without cost or obligation, send me "HOW TO SUCCEED" and the opportunity booklet about the field BEFORE which I have marked X (plus sample lesson):

<p>ARCHITECTURE and BUILDING CONSTRUCTION</p> <p><input type="checkbox"/> Air Conditioning—Ratrig.</p> <p><input type="checkbox"/> Architecture</p> <p><input type="checkbox"/> Architectural Interior</p> <p><input type="checkbox"/> Building Contractor</p> <p><input type="checkbox"/> Building Maintenance</p> <p><input type="checkbox"/> Carpenter and Mill Work</p> <p><input type="checkbox"/> Estimating</p> <p><input type="checkbox"/> Heating</p> <p><input type="checkbox"/> Painting Contractor</p> <p><input type="checkbox"/> Plumbing</p> <p><input type="checkbox"/> Reading Arch. Blueprints</p> <p>ART</p> <p><input type="checkbox"/> Cartooning</p> <p><input type="checkbox"/> Commercial Art</p> <p><input type="checkbox"/> Fashion Illustrating</p> <p><input type="checkbox"/> Magazine Illustrating</p> <p><input type="checkbox"/> Show Card and Sign Lettering</p> <p><input type="checkbox"/> Sketching and Painting</p> <p>AUTOMOTIVE</p> <p><input type="checkbox"/> Auto Body Rebuilding</p> <p><input type="checkbox"/> Auto Elec. Technician</p> <p><input type="checkbox"/> Auto-Engine Tune Up</p> <p><input type="checkbox"/> Automobile</p>	<p>AVIATION</p> <p><input type="checkbox"/> Aeronautical Engineering Jr.</p> <p><input type="checkbox"/> Aircraft & Engine Mechanic</p> <p>BUSINESS</p> <p><input type="checkbox"/> Advertising</p> <p><input type="checkbox"/> Bookkeeping and Accounting</p> <p><input type="checkbox"/> Business Administration</p> <p><input type="checkbox"/> Business Correspondence</p> <p><input type="checkbox"/> Public Accounting</p> <p><input type="checkbox"/> Creative Salesmanship</p> <p><input type="checkbox"/> Federal Tax</p> <p><input type="checkbox"/> Letter-writing Improvement</p> <p><input type="checkbox"/> Office Management</p> <p><input type="checkbox"/> Professional Secretary</p> <p><input type="checkbox"/> Retail Business Management</p> <p><input type="checkbox"/> Sales Management</p> <p><input type="checkbox"/> Stenographic-Secretarial</p> <p><input type="checkbox"/> Traffic Management</p> <p>CHEMISTRY</p> <p><input type="checkbox"/> Analytical Chemistry</p> <p><input type="checkbox"/> Chemical Engineering</p> <p><input type="checkbox"/> Chem. Lab. Technician</p> <p><input type="checkbox"/> General Chemistry</p> <p><input type="checkbox"/> Natural Gas Prod. & Trans.</p> <p><input type="checkbox"/> Petroleum Engineering</p> <p><input type="checkbox"/> Plastics</p> <p><input type="checkbox"/> Pulp and Paper Making</p>	<p>CIVIL, STRUCTURAL ENGINEERING</p> <p><input type="checkbox"/> Civil Engineering</p> <p><input type="checkbox"/> Construction Engineering</p> <p><input type="checkbox"/> Highway Engineering</p> <p><input type="checkbox"/> Reading Struct. Blueprints</p> <p><input type="checkbox"/> Sanitary Engineering</p> <p><input type="checkbox"/> Structural Engineering</p> <p><input type="checkbox"/> Surveying and Mapping</p> <p>DRAFTING</p> <p><input type="checkbox"/> Aircraft Drafting</p> <p><input type="checkbox"/> Architectural Drafting</p> <p><input type="checkbox"/> Electrical Drafting</p> <p><input type="checkbox"/> Mechanical Drafting</p> <p><input type="checkbox"/> Mine Surveying and Mapping</p> <p><input type="checkbox"/> Plumbing Drawing and Estimating</p> <p><input type="checkbox"/> Structural Drafting</p> <p>ELECTRICAL</p> <p><input type="checkbox"/> Electrical Engineering</p> <p><input type="checkbox"/> Electrical Maintenance</p> <p><input type="checkbox"/> Electrician <input type="checkbox"/> Contracting</p> <p><input type="checkbox"/> Lineman</p> <p>HIGH SCHOOL</p> <p><input type="checkbox"/> Commercial <input type="checkbox"/> Good English</p> <p><input type="checkbox"/> High School Subjects</p> <p><input type="checkbox"/> Mathematics</p>	<p>LEADERSHIP</p> <p><input type="checkbox"/> Foremanship</p> <p><input type="checkbox"/> Industrial Supervision</p> <p><input type="checkbox"/> Leadership and Organization</p> <p><input type="checkbox"/> Personnel-Labor Relations</p> <p>MECHANICAL AND SHOP</p> <p><input type="checkbox"/> Gas—Electric Welding</p> <p><input type="checkbox"/> Heat Treatment <input type="checkbox"/> Metallurgy</p> <p><input type="checkbox"/> Industrial Engineering</p> <p><input type="checkbox"/> Industrial Instrumentation</p> <p><input type="checkbox"/> Industrial Supervision</p> <p><input type="checkbox"/> Internal Combustion Engines</p> <p><input type="checkbox"/> Machine Design-Drafting</p> <p><input type="checkbox"/> Machine Shop Inspection</p> <p><input type="checkbox"/> Machine Shop Practice</p> <p><input type="checkbox"/> Mechanical Engineering</p> <p><input type="checkbox"/> Quality Control</p> <p><input type="checkbox"/> Reading Shop Blueprints</p> <p><input type="checkbox"/> Refrigeration</p> <p><input type="checkbox"/> Sheet Metal Worker</p> <p><input type="checkbox"/> Tool Design <input type="checkbox"/> Toolmaking</p> <p>RADIO, TELEVISION</p> <p><input type="checkbox"/> Industrial Electronics</p> <p><input type="checkbox"/> Practical Radio TV Eng'ng</p> <p><input type="checkbox"/> Radio and TV Servicing</p> <p><input type="checkbox"/> Radio Operating</p>	<p><input type="checkbox"/> Television Technician</p> <p>RAILROAD</p> <p><input type="checkbox"/> Air Brakes <input type="checkbox"/> Car Inspector</p> <p><input type="checkbox"/> Diesel Locomotive</p> <p><input type="checkbox"/> Locomotive Engineer</p> <p><input type="checkbox"/> Section Foreman</p> <p>STEAM AND DIESEL POWER</p> <p><input type="checkbox"/> Combustion Engineering</p> <p><input type="checkbox"/> Diesel—Elec. <input type="checkbox"/> Diesel Eng'g</p> <p><input type="checkbox"/> Electric Light and Power</p> <p><input type="checkbox"/> Stationary Fireman</p> <p><input type="checkbox"/> Stationary Steam Engineering</p> <p>TEXTILE</p> <p><input type="checkbox"/> Carding and Spinning</p> <p><input type="checkbox"/> Cotton, Rayon, Woolen Mfg.</p> <p><input type="checkbox"/> Finishing and Dyeing</p> <p><input type="checkbox"/> Loom Fix'g <input type="checkbox"/> Textile Des'ing</p> <p><input type="checkbox"/> Textile Eng'g <input type="checkbox"/> Throwing</p> <p><input type="checkbox"/> Waring and Weaving</p> <p>MISCELLANEOUS</p> <p><input type="checkbox"/> Domestic Refrigeration</p> <p><input type="checkbox"/> Marine Engineering</p> <p><input type="checkbox"/> Ocean Navigation</p> <p><input type="checkbox"/> Professional Engineering</p> <p><input type="checkbox"/> Short Story Writing</p> <p><input type="checkbox"/> Telephony</p>
---	--	--	--	--

Name _____ Age _____ Home Address _____

City _____ Zone _____ State _____ Working Hours _____ A.M. to P.M. _____

Occupation _____

Canadian residents send coupon to International Correspondence Schools, Canadian, Ltd., Montreal, Canada. . . . Special tuition rates to members of the U. S. Armed Forces.



**Want better pay,
steady work and
a way to make
extra money?**

Learn at Home IN YOUR SPARE TIME to Fix Electrical Appliances

To build a better future, get into a field where there's much important work and the security that comes from knowing a good trade. Servicing electrical appliances offers that OPPORTUNITY. Every wired home has an average of 8 electrical appliances. Up to 10 million new appliances are sold every year and owners pay well to keep them in repair. That's making a fast-growing need for trained men.

Start Soon to Earn \$3, \$4, \$5 an Hour Extra in Your Spare Time

Start soon to fix electric toasters, clocks, fans, vacuum cleaners and other appliances for neighbors and friends. Work in your basement, garage or spare room. Pick up \$3 to \$5 an Hour extra that way. It's easy to increase your earning power—to pay for this training many times over with your spare time earnings.

Learn and Earn with Multi-Use Tester Built with Parts We Send

This course includes the parts to build a portable, sturdy Appliance Tester that helps you locate electrical defects quickly and easily. You use it to learn and do actual electrical appliance repair jobs. If you want better pay learn this good

trade. No need to give up your present job. You can train at home in your spare time for only \$2.50 down and \$5.00 a month. A small price to pay for increased earnings, a more secure future. Paste coupon below on a 2c postal or mail in envelope for free book and sample lesson. Address National Radio Institute, Dept. AN5, Washington 9, D. C.

**2c TO MAIL THIS
COUPON MAY START
YOU TO SUCCESS
LESSON AND BOOK
FREE**



**NATIONAL RADIO INSTITUTE
Dept. AN5, Washington 9, D. C.**

Please send me Electric Appliance Training lesson and book free.
(No salesman will call.)

Name _____ Age _____

Address _____

City _____ Zone _____ State _____

APPROVED MEMBER NATIONAL HOME STUDY COUNCIL

INVENTORS

If you believe that you have an invention, you should find out how to protect it. The first step is to have a search made of the prior pertinent U. S. patents. If a report on this search indicates that the invention appears patentable you can apply for a patent, and the specifications and claims should be prepared.

The firm of McMorrow, Berman & Davidson, with offices in Washington, D. C., is qualified to take the necessary steps for you. We can make a preliminary search on your invention, advise you whether we think it can be patented, and prepare your application for patent.

Unless you are fully familiar with the U. S. Patent Laws, we recommend that you engage the services of a Registered Patent Attorney to protect your interests. The patent laws are *your* laws. A patent gives you the right to prevent others from making, using or selling the invention claimed in your patent for a period of 17 years.

Use these patent laws for your protection. Investigate whether your invention can be patented. If you have what you believe to be an invention, we suggest that you have this firm make a search for you.

Send for a copy of our Patent Booklet entitled "How To Protect Your Invention," containing information about patent protection and patent procedure. Along with this we will also send you an "Invention Record" form, for your use in writing down and sketching details of your invention. We will mail them promptly. No obligation. They are yours for the asking.

McMORROW, BERMAN & DAVIDSON

Registered Patent Attorneys

PATENTS • COPYRIGHTS • PATENTS

135-P VICTOR BUILDING, WASHINGTON 1, D. C.

WHAT SECRET POWER DID THIS MAN POSSESS?



BENJAMIN FRANKLIN
(A Rosicrucian)

WHY was this man great? How does anyone—man or woman—achieve greatness? Is it not by mastery of the powers within ourselves? Know the mysterious world within you! Attune yourself to the wisdom of the ages! Grasp the inner power of your mind! Learn the secrets of a full and peaceful life!

Benjamin Franklin—like many other learned and great men and women—was a Rosicrucian. The Rosicrucians (NOT a religious organization) first came to America in 1694. Today, headquarters of the Rosicrucians send over seven million pieces of mail annually to all parts of the world. Write for YOUR FREE COPY of "The Mastery of Life"—TODAY. No obligation. No salesmen. A non-profit organization. Address: Scribe P.S.A.

THIS BOOK FREE!



The ROSICRUCIANS

SAN JOSE • (AMORC) • CALIFORNIA

SEND THIS COUPON

Scribe P.S.A.
The ROSICRUCIANS (AMORC)
San Jose, California
Please send me the free book, *The Mastery of Life*, which explains how I may learn to use my faculties and powers of mind.

Name _____

Address _____

City _____



INSURED TIRE SERVICE
POPULAR BRANDS

FREE INSURANCE POLICY given with each used tire sold. We guarantee the amount of service you pay for.

NOWHERE CAN SUCH QUALITY BE FOUND AT SUCH LOW PRICE!

SPECIAL!
Deduct 10% on orders for two or more used tires

YOU CAN'T LOSE!!

GOODYEAR SUBURBANITE TYPE SNOW TIRES
New Tire Guarantee—Factory Rebuilt
BEST WINTER TRACTION OF ALL!

670x15	\$9.95	710x15	650x16	\$10.90
600x16		760x15	650x15	

Super Quality — Rugged Performance — 15 Months Insured Service			
600x16	53.85	670x15	53.95
650x15	3.85	670x16	4.05
650x16	4.25	700x15	3.95
700x16			
53.95		700x16	
54.45		700x16	
4.35		820x15	
4.48		850x17	
4.68			

Supreme Quality — Nothing Finer — 30 Months Insured Service			
600x16	55.25	475x19	55.45
600x16(6)	6.75	640x15	4.95
650x16	5.75	670x15	5.35
650x16(6)	7.25	710x15	5.45
700x16	6.35	760x15	5.95
750x16(6)	8.45	800x15	6.35
550x18	4.95	820x15	6.35
550x17	4.75	850x15	5.35
650x15	5.25	670x16	5.15
700x15	5.35	700x16(6)	10.25
		32x6(10)	
		12.75	
		1100x24	
		25.95	

Whitewalls \$1.00 extra.

MIDLAND TIRE SALES Speedy shipments on Mail Orders. F.O.B. Chicago. Insurance policy sent with each order. Deduct 10% on orders for 2 or more used tires. Send CHECK or MONEY ORDER. —No COD's.

3701 S. Normal, Dept. PM-41, Chicago 9, Ill.

EARN EXTRA MONEY GROWING MIDGET TREES!

AT HOME • SPARE TIME • FOR FUN AND PROFITS!



It's New! Amazing! FULL GROWN living dwarf trees—only 12 INCHES HIGH! Elm, orange, oak, cypress—any kind! All BLOOM and even BEAR FRUIT! Perfect, healthy specimens, but miniature! Make costly home decorations and beautiful expensive centerpieces (sold for over \$1,500 each). It's Fast! A new fascinating artistic HOBBY — a new \$55555 HOME BUSINESS! Real seed and occasional new growing plan details. BOTH ABSOLUTELY FREE!

FREE! GENUINE SEED AND PLAN

NATIONAL NURSERY GARDENS, Dept. M-12
8662 SOUTH VAN NESS, INGLEWOOD 4, CALIFORNIA

STAMMER?

Get your copy of the new 18th edition of my book, "Stammering, Its Cause and Correction," which describes the Bogue Unit Method for scientific correction of stammering and stuttering. Ask, also, for free SPEECH CHART! 54th year. Benjamin N. Bogue, Dept. 553, Circle Tower, Indianapolis 4, Indiana.

GET THIS FREE SOON!

CABINET MAKING

LOW COST HOME TRAINING COURSE FOR BEGINNERS & ADVANCED CRAFTSMEN

Make money. Learn skills and secrets of fine woodworking and tool use. Professionally prepared shop method training tells and shows how. Covers everything. Easy to master.

INTERSTATE TRAINING SERVICE

Write for Free Booklet DEPT. F3, PORTLAND 13, OREGON

NEW! Leader Gun Sight

Guaranteed Accurate



PRICE \$1.10

POSTPAID

NO GUESSING!

NEW SIGHT FIGURES LEAD AUTOMATICALLY!

Here's a simple way to improve your marksmanship IMMEDIATELY! Use Frank Chapek's sensational success story, proved-in-the-field Leader Sight. Fits all shotguns, single or double barrel, over and under models (except .410 ga.) . . . also poly choke guns and compensator barrels. Made of molded latex rubber; no scratching, marring; no screws, bolts, tools needed. Attach in seconds! HURRY ORDER TODAY! Only \$1.10 postpaid. (Sorry, no c.o.d.'s). Satisfaction or money back!

CHAPEK'S LEADER SIGHT CO. SHERIDAN, WYOMING

P.O. BOX 866-P

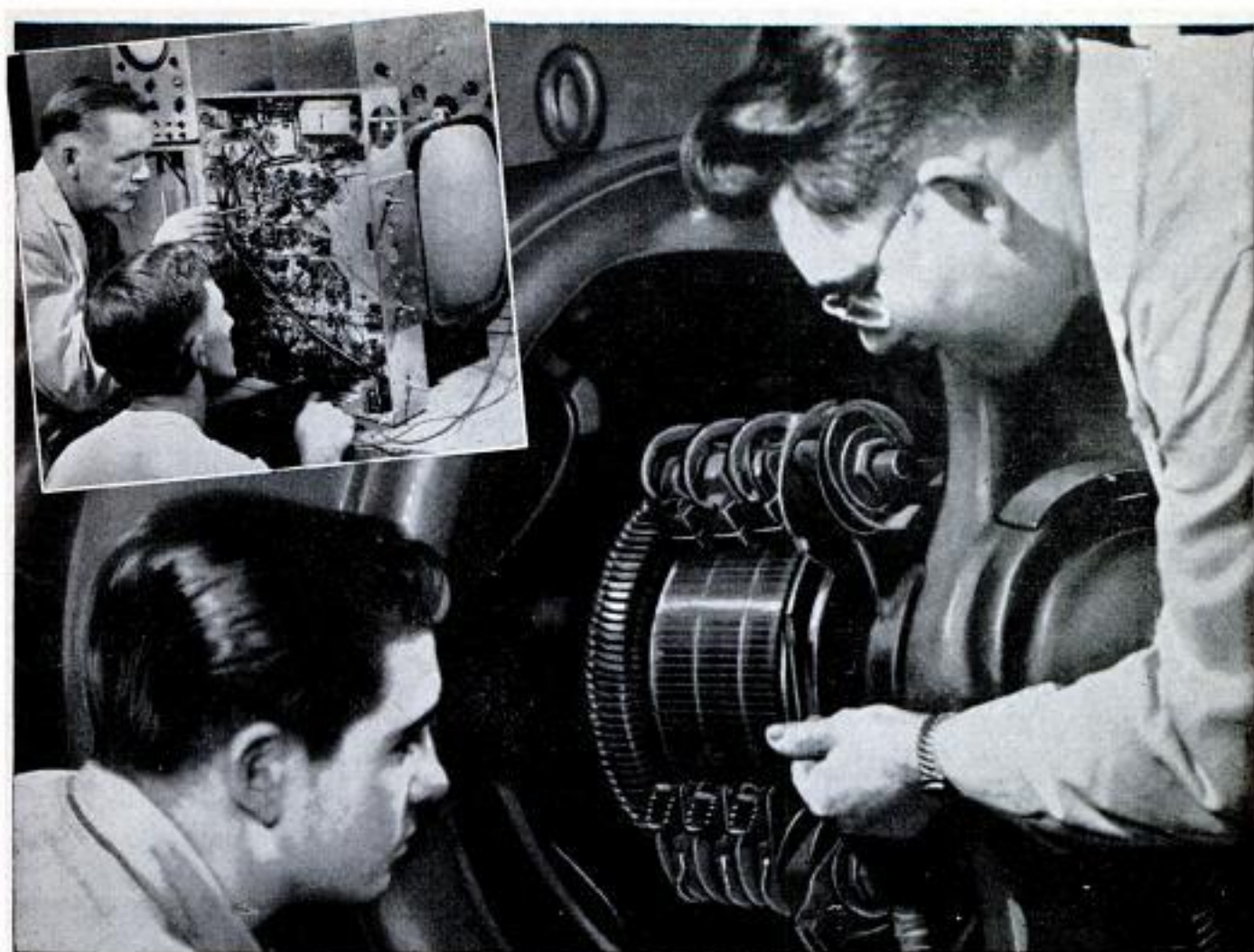

TRAIN FOR A FUTURE IN

Electricity or Television-Radio

**IN GREAT SHOPS OF COYNE—
Largest, Oldest, Best Equipped
School Of Its Kind In The U. S.**

Prepare quickly at Coyne for a career with a future!

Whether 17 or up to 45 years of age, prepare for your future now. Don't be satisfied with a "No Future" job. Train the Coyne way for a better job in a field that offers a world of opportunities in the years ahead.

WE TRAIN YOU IN CHICAGO

Learn the easier, practical way at Coyne, on real, full size equipment. No advanced education or previous experience needed. You learn *better* the Coyne way.

Train in the shops of Coyne—where thousands of successful men have trained for over 56 years—*Coyne is the largest, oldest, best equipped school of its kind*—established in Chicago in 1899.

FINANCE PLAN Enroll now. You may pay most of tuition later. We have a *special plan for men of draft age*.

CLIP COUPON NOW for big new illustrated Coyne book. No obligation; *no salesman will call*. Get vital facts now!

B. W. COOKE, Pres. **COYNE** FOUNDED 1899

ELECTRICAL SCHOOL

A TECHNICAL TRADE INSTITUTE OPERATED NOT FOR PROFIT

500 S. PAULINA ST., CHICAGO, Dept. 95-72H

ELECTRICITY ★ RADIO ★ TELEVISION ★ REFRIGERATION ★ ELECTRONICS

**APPROVED
FOR
VETERANS**

Mail Coupon
Today for
**BIG FREE
BOOK**

"Guide to Careers
in ELECTRICITY and
TELEVISION-RADIO"



B. W. COOKE, President
COYNE ELECTRICAL SCHOOL
500 S. Paulina St., Chicago 12, Ill., Dept. 95-72H

Send BIG FREE book and details of your training offer. This does not obligate me and no salesman will call. I am interested in:

ELECTRICITY TELEVISION-RADIO

Name.....

Address.....

City..... State.....

AMERICAN MACHINE & TOOL COMPANY MODEL CHANGEOVER SALE SAVE \$800 ON THIS TILT ARBOR SAW

All year a great buy at regular price of \$24.95—this 8-inch Plana Centric Tilt Arbor Power Saw is a spectacular bargain at \$16.95 during model changeover period. This big saving is made possible by our patented construction, our manufacturing facilities, and our distribution methods. Top-quality saw features the original Plana Centric Patented Ball-Bearing Floating Drive, Patented Plana Centric Cradle Suspension, and Plana Centric Patented Rip Fence that locks front and rear against the table surface. Every part in this fine saw is manufactured in our own factories. All cast iron and steel construction. Crosscuts, rips, bevels, mitres, dados, cuts compound angles. Massive cast mitre gauge. Heavy steel base fastens to any workbench. Uses any standard $\frac{1}{4}$ or $\frac{1}{2}$ h.p. motor. INCLUDED: 8" Simonds Combination Blade at no extra charge. (SELLS EVERYWHERE FOR \$4.50). We start soon on 1956 models. During model changeover you can have this fine 1955 at a saving of \$8.00. Send check, M. O. or sent C. O. D.

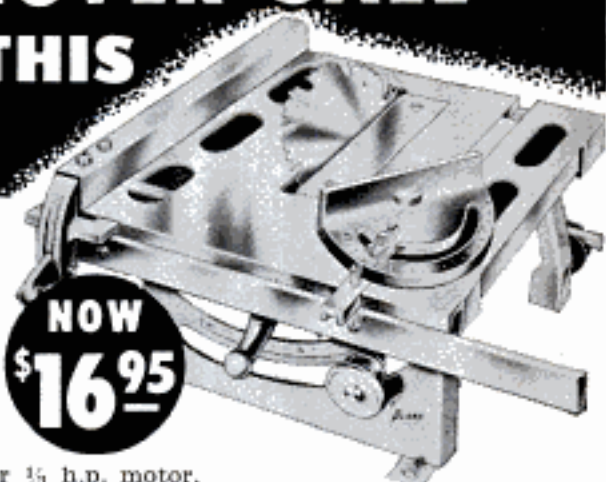

**NOW
\$16.95**

LOOK AT ALL THESE SPECIAL FEATURES:

- Blade tilts, table stays level. Blade adjusts to any angle up to 50°.
- Single Hand Wheel Control. Tilts and tightens blade with a twist of the wrist. Blade rises and lowers; cuts from 0° to 2 1/4".
- Precision-ground cast iron table. Perfect flatness resists nicking and wear.
- Self-aligning rip fence. Adjustable to lie parallel to blade or give clearance either way.
- Patented Motor Mount takes any standard 1/4 or 1/2 h.p. motor. Motor rides on ball bearing rollers. Keeps belt tight, transmits full power.
- Heavy long-lasting, all-metal construction. Built for a lifetime. Shipping weight 25 lbs.

**WRITE FOR FREE CATALOG
BIG BARGAINS IN HOME
WORKSHOP POWER TOOLS**

ALL POWER TOOLS SENT EXPRESS COLLECT

**AMERICAN MACHINE & TOOL COMPANY
ROYERSFORD 19, PA.**

FAMOUS AMERICAN IRONCLAD GUARANTEE

Try any Plana Centric power tool for ten days. If, for any reason, you are dissatisfied, return the merchandise for full and complete refund—no questions asked. This famous guarantee has been offered on sales of more than 3 1/2 million power tools, and it has never been violated.

Plant operators!
Stationary engineers!
EARN MORE



Solve plant troubles FASTER with expert help!

"Keeping the wheels turning" is important work today in your plant—in any plant—and pays big money to the experts. Build your skill in operating and maintaining plant power equipment. Get the facts and methods you need, to qualify for top jobs and pay in this field, from this Library.

PLANT Operators' and Stationary Engineers' Library

5 vols., 2411 pp., 1723 illus., EASY TERMS Here's help you'll use regularly to check operating procedures, reduce maintenance and repair work, improve performance. Gives every step in running equipment safely, efficiently—testing, inspection, repair, overhaul, increasing production and power output, etc. Special volume makes plain mathematics for plant men.

LIBRARY INCLUDES:
Kristol & Annett's Pumps,
Spring's Boiler
Operator's
Guide, Siskind's
Electrical Ma-
chines, Skrotzki
& Vopat's Steam
& Gas Turbines,
and Palmer &
Bibb's Practical
Mathematics.

USE THIS LIBRARY 10 DAYS FREE

McGraw-Hill, Att: H. Bubrow, Dept. PM-12, 327 W. 41 St., N.Y. 36
Send me the Plant Operators' and Engineers' Library for 10 days FREE trial. If satisfactory, I will send \$4.75 in 10 days, then \$4.00 a month until special price of \$24.75 is paid. (A savings of \$5.00 under the regular price.) Otherwise I will return books postpaid.

Name _____
Address _____
City _____ Zone _____ State _____
Company _____ Position _____

SAVE MONEY. We pay delivery costs if you enclose first payment. Same return privilege.

Offer good only in U. S.

PM-12

Secrets of VENTRILOQUISM Now Revealed!



Easy to learn in 60 to 90 days with our Home Study Course. **RESULTS GUARANTEED.** Make Money! Be Popular! Have Fun! Big Opportunity! Radio, Television, Stage Appearances! For FREE information regarding price and terms WRITE. You must state your age. Dummy Catalog 25c.
FRED MAHER SCHOOL OF VENTRILOQUISM
Box 36, Studio PM-12, Kensington Station
Detroit 24, Michigan

Finish HIGH SCHOOL AT HOME

Complete 4 Yrs. in 12 Months

Learn More! Earn More! Enter professional or technical schools. Advance Socially. Live a Happier, Fuller Life. Individual Courses or complete schedule. **WRITE FOR SCHOOL BULLETIN.**

ACADEMY FOR ADULTS

30 W. Washington, Dept. PM-125, Chicago, Ill.

Learn ACCOUNTING Business Administration

Bookkeeping, secretarial and allied subjects at home in your spare time or attend nationally approved resident school. Write for FREE Success Book giving complete details on courses, plans, rates and employment opportunities. G.I. approved. Write Dept. A.

**Hills BUSINESS UNIVERSITY AND
EXTENSION SCHOOL**
619 W. MAIN ST. OKLAHOMA CITY 2, OKLAHOMA

250 POWER



Complete Telescope Lens Kit **only \$3.49** postpaid

Conquer Space, Explore the Universe, Planets, Moon Craters, New Stars, etc. Complete Lens Kit consists of 80 inch focal length ground and polished objective lens, eyepiece lenses for 50 POWER, 100 POWER, 150 POWER, 200 POWER, 250 POWER, and all necessary lens fittings. Easy to make from simple step by step instructions. (Tripod and mount not included.) Money back guarantee.

BUSSE SALES CO., Hartford 1, Conn., Dept. PM 40

Work over
300 projects
with your
wonderful HOME
LABORATORY

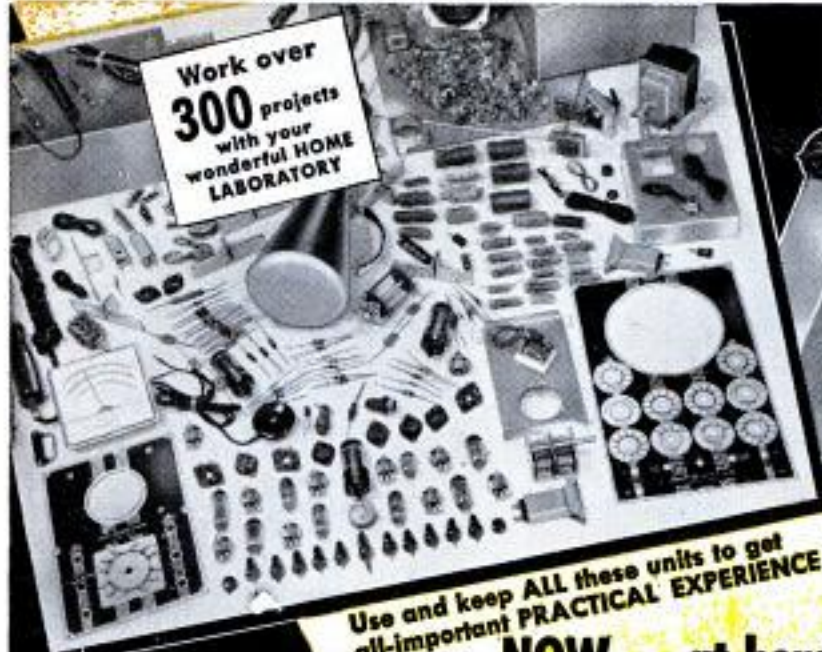

21 INCH
Build and keep D.T.I.'s NEW
2 Unit TV Set—ideal for cus-
tom installation. (D.T.I. also
offers home training with-
out the TV set.)

Use and keep ALL these units to get
all-important PRACTICAL EXPERIENCE

MEMBER OF NATIONAL
HOME STUDY COUNCIL

NOW... at home... get D.T.I.'s
amazingly effective **NEW** training in
TELEVISION

RADIO-ELECTRONICS! Nothing else like it for providing real LABORATORY-
TYPE training at home. Get the kind of thorough, practical experience YOU NEED
for the kind of progress YOU WANT in today's tremendous field of Television,
Radio and Electronics. Qualify yourself for real money... interesting work...
a wonderfully promising future. And when you finish, D.T.I.'s active Employment
Service HELPS YOU GET STARTED! Or open your own profitable Television-Radio
Service Business.

THOUSANDS OF SUCCESSFUL GRADUATES

WHY has D.T.I. become one of the largest training organizations
of its kind? Because it provides EVERY MAJOR HOME TRAINING
AID to help make the subject EASIER to learn... EASIER to re-
member—the kind of training so helpful for REAL PROGRESS.
Students get thorough, up-to-date, practical training that TAKES
ADVANTAGE of new and improved training developments.
Study the ADVANTAGES shown on this page. Think what they
can mean to YOU... to YOUR FUTURE! Or come to D.T.I.'s
big Training Laboratories in Chicago. MAIL COUPON TODAY
for complete facts—including valuable publication, "89 Ways
to Earn Money in Television-Radio-Electronics." Also, valuable
information for men subject to MILITARY SERVICE.

"One of America's Foremost Television Training Centers"

DeVRY
Technical Institute
CHICAGO 41, ILLINOIS
Formerly DeFOREST'S TRAINING, INC.

MAIL COUPON TODAY

DeVRY TECHNICAL INSTITUTE
4141 Belmont Ave., Chicago 41, Ill., Dept. PM-12-L

I would like complete facts including "89 Ways
to Earn Money in Television-Radio-Electronics."

Name _____ Age _____
(PLEASE PRINT)
Street _____ Apt. _____
City _____ Zone _____ State _____
1 D.T.I.'s training is available in Canada.



NEW!

Build and keep
D. T. I.'s new
VACUUM TUBE
VOLTMETER...
one of the most
useful of all test
instruments.



5 INCH
"SCOPE"



ABOVE: Also build
and keep this quality
Oscilloscope—almost
a "must" for Televi-
sion servicing.

**Exclusive
HOME
MOVIES**

help you grasp
important points
**FASTER...
EASIER...
BETTER.**
A tremendous
advantage!



Remarkable **NEW Styrene
ELECTRO-LAB***

Insert pictorial diagram on transparent styrene base. (See insert.) Mount parts to follow pattern—using handy "snap in" fasteners. Eliminates wiring errors. Tops for speedy circuit changes... for providing maximum circuit experience in minimum time. Build and operate scores of interesting projects—such as the electronic circuit shown below.

*Trademark



PATENTS APPLIED FOR



Some make more, some less; T. THORN reports:

\$690 gross in single
MONTH
IN MY OWN BUSINESS!

**Start
YOUR OWN
Business!**



• Here's YOUR chance to start a money-making, year-'round business of your own and make the success you've dreamed about. R. O. Donnley took in \$40 in seven hours. O. W. Ware landed a \$750 hotel job. R. Traynor grossed over \$450.00 in five days. Homes, hotels, offices, clubs, offer you big profit possibilities. Auto upholstery also.

NO SHOP OR OFFICE NECESSARY. You clean furniture on customers' premises. No hauling. No high rents. Supplies inexpensive; operate from your home. What you take in is mostly profit.

• If you want to be your own boss—free from layoffs, strikes and bosses, we will help you to start and succeed. Don't delay... read the facts, then decide for yourself.

MAIL COUPON TODAY FOR FREE BOOK

VON SCHRADER MFG. CO.
W10 "D" Pl., Racine, Wisconsin

Without obligation rush your **FREE** booklet about how I can start my own permanent, profitable electric Upholstery Cleaning business.

Name _____

Address _____

City _____ Zone _____ State _____

IT'S EASY...
MAKE MONEY IN PHOTOGRAPHY
If you are over 17—good pay and fascinating work await you in photography! Start making money quickly in sparetime—step into your own studio or exciting career job. **LEARN BY DOING** method trains you at home! Write **TODAY** for **FREE** catalog. Also Resident Training. 46th Year. Approved for Vets.
NEW YORK INSTITUTE OF PHOTOGRAPHY
Dept. 49, 10 West 33 Street, New York 1, New York
46th YEAR

GIANT BALLOONS 49c



They're really **BIG**—surplus U.S. Govt. (new average) Neoprene weather, target balloons. **GREAT FUN** in the backyard: at parties, picnics, dances, fairs. **TELEVIC** for high school and college **PROMS**. They attract **BIG CROWDS** to business openings, civic events, conventions, exhibitions, trade shows. **ORDER TODAY!** Great for Xmas. Approx. inflated sizes:

- 18 in. dia., 3 for 70c
- 3 ft. dia., 49c—5 ft. dia., 99c
- 10 ft. dia., \$1.59

Postage paid on prepaid orders. Calif. residents please add sales tax.

VOLUME SALES CO., War Assets Division

Dept. PM-1255 3930 Sunset Blvd. Los Angeles 29, Calif.

**KEEP YOUR CAR
BATTERY
FULLY CHARGED
AT HOME!**



With a **NORKO CHARGER**, you charge your battery at home—overnight—without disconnecting cables or removing battery from car. And you get better service—much longer life—from a battery kept fully charged.

Priced as low
as **\$14.95**

A dependable **NORKO CHARGER** is the handiest automotive device you'll ever own. Quickly pays for itself. Operates from 110-volt home power. Compact, lightweight; sets on floor or shelf or hangs from wall. Models for 6 and 12-volt batteries. Sold by most auto stores.

If your dealer can't supply, send for **FREE** catalog. Many thousands of wise motorists own **NORKO CHARGERS**. Get yours now.

SCHAUER MANUFACTURING CORP.

4532 Alpine Ave.

Cincinnati 36, Ohio

A "GOOD HAND" HELPS YOU SUCCEED!
LEARN TO WRITE WELL
Your Name
Handwriting quickly improves with our easy-to-understand picture lessons! Put your spare time to good use; send today for **FREE** BOOKLET, "How to Become a Good Penman," or check volumes wanted below at \$1 each: Business Writing Artistic Writing Card Writing Bird & Design Flourishing Engraving Alphabets. **COMPLETE SET \$4.50.** Ask for price list of penman's supplies.
OUR 53rd YEAR
Only 10¢ writing.
TAMBLYN SCHOOL of PENMANSHIP
S.A. Ziller, Pres., 442 Ridge Bldg., Kansas City, Mo., USA

LAW FREE BOOK **THE LAW TRAINED MAN**

Write today for a **FREE** copy of illustrated law book, "THE LAW TRAINED MAN," which shows how to earn the professional Bachelor of Laws (LL.B.) degree through home study of the famous Blackstone Law Course. All necessary books and lessons provided. Moderate cost; convenient monthly terms. Write for **FREE** law training book today.

Blackstone School of Law, 225 N. Michigan Ave.
Founded 1890 Dept. 59 Chicago 1, Ill.

**BUILD LUGGAGE AT HOME
WE SELL YOUR PRODUCTS!**

ONLY NEW HOME MONEY-MAKING PLAN IN YEARS!
Make Luggage and cases for traveling, photographers, musicians, salesmen, electronics, tools, portables, 1001 other items. Also repair Luggage. No special equipment needed. **BIG** Profits. We supply complete instructions, materials—everything. Write for free details and Business Plan. **ABARSI CASE-CRAFT, Dept. G-12, 805 W. Sunset Blvd., Los Angeles 12, Calif.**

you may think you're TALL enough... but what does she think?

No doubt in YOUR mind, or HERS when you wear "ELEVATORS". These amazing height-increasing shoes make you almost 2 inches taller instantly, smartly, confidentially. She'll look UP to you. Be sure, be smart, be taller; change to "ELEVATORS".



For **FREE** Booklet and Dealer's name write to:

STONE-TARLOW CO., INC., DEPT. PM12-55, BROCKTON 68, MASS.



Get more money!
More security! More out of life!



Learn TELEVISION • RADIO • ELECTRONICS

Get the best!

Get National Schools' SHOP-METHOD HOME TRAINING!

Start now! Why wait around for that raise or promotion that may never come? Get started now in high-paying TV-Radio-Electronics! National Schools' SHOP METHOD Home Training prepares you for success in a top-salary job or in your own business. You learn *all three*... Television, Radio, Electronics...in one complete course. Our Shop-Tested lessons and manuals help you master all phases in shortest possible time! Send coupon, find out today!

WHY NATIONAL SCHOOLS LEADS THE FIELD

Located in the "Television Center" of the world, our staff is in close touch with latest developments and opportunities. We give you personalized job placement assistance. We also give you confidential help with both technical and personal problems relating to your training. We show you how to make Part Time Earnings as you progress. Whether you live 30 miles away, or 3,000, you will always be pleased with our prompt, friendly service!

DRAFT AGE? Our home training helps you achieve specialized ratings and higher pay grades if you go in service.

30 MILLION TV SETS

need regular repair! Color TV means more sets than ever before. NOW is the golden opportunity to cash in on this multi-billion-dollar industry. Or "write your own ticket" in broadcasting, manufacturing, and other specialized phases!

**YOUR AGE
IS NO
OBSTACLE!**

Send for
FREE LESSON!
FREE BOOK & SAMPLE LESSON
will convince you!
SEND COUPON TODAY!



We send you this precision-tested Multitester! Plus parts to build Oscillators, Receivers, Signal Generator, Continuity Checker, Combination Short Wave and Standard



Broadcast Superhet Receiver. All this equipment is part of your National Schools course. **NO EXTRA CHARGES!** Send coupon for free books!

NATIONAL SCHOOLS, world-famous technical trade school. Now entering our 50th year!



NATIONAL SCHOOLS TECHNICAL TRADE TRAINING SINCE 1905

LOS ANGELES 37, CALIFORNIA

In Canada: 811 W. Hastings St., Vancouver, B. C.

• APPROVED FOR G. I. TRAINING

• BOTH HOME STUDY AND RESIDENT COURSES OFFERED

MAIL NOW TO OFFICE NEAREST YOU!

(mail in envelope or paste on postal card)

NATIONAL SCHOOLS, DEPT. RB-125

4000 SOUTH FIGUEROA STREET
LOS ANGELES 37, CALIFORNIA OR 323 WEST POLK STREET
CHICAGO 7, ILLINOIS

Please rush **FREE BOOK**, "My Future in Radio-Television-Electronics," and **FREE LESSON** at once. I understand there is no obligation, and no salesman will call.

NAME _____ BIRTHDAY _____ 19__

ADDRESS _____

CITY _____ ZONE _____ STATE _____

Check if interested **ONLY** in Resident Training at Los Angeles.

VETERANS: Give date of discharge _____

LEARN ELECTRIC APPLIANCE REPAIR IN JUST A FEW WEEKS OF TRAINING AT HOME



Start YOUR OWN BUSINESS

Repair electrical appliances for friends and neighbors. Service electrical equipment in factories, stores, hospitals, etc. Work full or part time! There is a potential market of 50,000,000 customers.

NEW SHOP METHOD HOME TRAINING

Permits you to learn this big money making business at home in your spare time by having you work with your hands testing and repairing.

ing. CTS sends you their famous Electronic Trouble Detector, Special Service Kits, together with illustrated Lesson Manuals showing how to easily locate the trouble, quickly repair it, what to charge and how to keep new customers coming to you.

EARN WHILE YOU LEARN

Pay us later with your EARNINGS WHILE LEARNING. Start in the corner of your basement or garage. Earn on the basis of \$5.00 to \$6.00 and more per hour! It's a common practice among repair technicians.

CHRISTY TRADES SCHOOL

4804 N. KEDZIE AVE.

DEPT. D-4903

CHICAGO 25

RUSH NAME FOR

FREE BOOK

and Special

Pay Later Form



... TURN CONCRETE INTO GOLD!

MAKE UP TO \$75 A DAY IN YOUR OWN BUSINESS

If you want to have your own business - to start a business on your own - here's your big opportunity! New high speed, low cost General block machine produces up to 1,000 concrete blocks a day. Sell all you make to builders, supply houses, and others for homes, factories, buildings, garages. Cash in on the building boom! You can make profits of 100% to 150% - up to \$75. a day! General block machine equipped with 1/2 h.p. electric motor - or can be supplied with gasoline engine - works anywhere, in little space, indoors or out. Operates from ordinary house light socket. Simple, foolproof 3 step operation - so easy a child can do it. Makes superior 3 core blocks any size from 4" to 12". Also makes chimney, ash, corner and other types. Blocks meet any building code anywhere in the country. Materials - sand, water, cement, available anywhere. Simple illustrated operating instructions and mixing formulae for cement and cinder blocks supplied with each machine. Write for FREE folder with full information.

MOTOR DRIVEN

R. L. T. of New York City reports: "MY GENERAL BLOCK MACHINE PAID FOR ITSELF IN FIRST 2 WEEKS!"

Hundreds now in use the world over! Write for FREE details today!

EXTRA

Book gives floor plans for 6 sensational concrete block bungalows. Tells how to lay blocks, lay out building lines, mix concrete, build steps, porch and concrete floors all at great savings. Written by experts. Can save many times the cost of the machine! Get it now! No strings attached. Send \$1.

BOOK SENT FREE IF YOU BUY MACHINE.
\$1 REFUNDED IF YOU BUY LATER.

GENERAL ENGINES CO.

DEPT. M-125, ROUTE 130, THOROFARE, N. J.



SHEET METAL BRAKES

Forms angles, locks, pans, etc. New eccentric clamps. All steel construction. Size 15" - 16 gauge steel, \$23.50; 36" - 22 ga., \$35.50. 48" - 24 ga. \$52.00. Floor Stand, \$8.



SHEARS FOOT SQUARING, 30"-24 ga., \$115.00
HAND SQUARING, 36"-24 ga., \$80.00
ANGLE SHEAR, 3 Adj. Ga. 7"-18 ga. \$16.50

ORDER DIRECT OR SEND FOR CATALOG

VYKE MFG. CO., 4152 Jason St., Denver 11, Colo.

Say You Saw It in Popular Mechanics

If Ruptured

For lasting relief your rupture must BE HELD BACK DAY and NIGHT.

Consult Your Doctor.



Entirely

different

SOFT, FLEXIBLE, and fits neat as a glove. The famous Miller saves you TIME, MONEY, DISAPPOINTMENT.

Write for my FREE booklet today.

FRED B. MILLER Manufacturer
Dept. PM-A, Hagerstown, Maryland

Tune Up, Pep Up, Fix Up ANY CAR!



Here's How!

NOW! Even beginners can handle practically ANY job on ANY make, model or part!

TUNE UP, PEP UP, *fix up* ANY automobile . . . even if you've never repaired a car before!

Handle practically any job "slick as a whistle."

A tune up? New rings? Ignition or carburetor troubles? Brake or clutch problems? A valve job? Something wrong with power steering or one of those tricky new automatic transmissions?

Just look up the job you want to do!

This giant, 4 $\frac{3}{4}$ pound CHILTON REPAIR MANUAL tells what to do. Then it shows you step by step just how to do it. No guess work. No lost time. You handle auto repairs easier, faster and better than you may have dreamed.

There's a "secret" to easy auto service and this giant manual is it!

YOU WON'T MISS

with how-to-fix-it data like this to guide you!

Chilton covers practically every part of every car on the road today. Gives complete service details on every model of the leading 20 car makes from June 1940 to the present. Over 600 models in all!

Tells how to locate troubles. Shows what work-saving shortcuts to take . . . what adjustments to make . . . what parts to use . . . what mistakes to avoid . . . *even what tools to use.*

"Minor" details, often so puzzling to beginners, are fully explained.

From beginning to end, it's an honest-to-goodness HOW-TO-FIX-IT guide. NOT a "study" book. You use it right at the bench when you've got a car to fix!

Use the CHILTON MANUAL 10 days . . . FREE. If it's not all you expect . . . and more . . . return it postpaid AND DON'T OWE US A PENNY! Send coupon today to: Chilton Co., Dept. PM-125, 56th & Chestnut Sts., Philadelphia 39, Pa.

GIANT NEW ENLARGED EDITION

BY CHILTON, WORLD'S LARGEST AUTOMOTIVE PUBLISHERS

- 904 Big Pages
- Weighs 4 $\frac{3}{4}$ pounds
- Almost 3,000 clear pictures.
- 58 Troubleshooting Charts
- 353 Quick Check Data Tables
- Thousands upon thousands of parts and service specifications

Covers Every Model of These 20 Makes Since 1940:

BUICK	FRAZER	OLDSMOBILE
CADILLAC	HENRY J.	PACKARD
CHEVROLET	HUDSON	PLYMOUTH
CHRYSLER	KAISER	PONTIAC
DE SOTO	LINCOLN	STUDEBAKER
DODGE	MERCURY	WILLYS
FORD	NASH	



Read What These Users Say!

EASY! "The Chilton how-to-do-it pictures are worth the entire price of the Manual!"

MELVIN WADE, Penna.
(CHILTON BOOKS ARE SOLD BY LEADING BOOK STORES)

FAST! "Thanks to my Chilton Manual, I did a job in an hour another mechanic had worked on all day!"

GENE ARNOLD, Iowa

PRACTICE 10 DAYS FREE!

THE CHILTON CO., Dept. PM-125
5605 Chestnut St., Philadelphia 39, Pa.

Send me the big 904-page CHILTON "ALL CARS" REPAIR MANUAL (Price \$6.95) for 10-day FREE EXAMINATION. If I like Manual, I will then promptly remit \$1.95 (plus 45¢ postage and handling); then send \$2.50 each month for two months. Otherwise I will return manual postpaid in 10 days and owe you nothing.

SAVE! Send \$6.95 with order and we pay postage-handling charge. Same return privilege.

Name

Address

City, Zone, State

(OUTSIDE U.S.A.—Price \$8.95 cash with order. 10-day return privilege with money refunded.)

EARN BIG PAY

Industry needs skilled mechanics. GREER, leader for more than 50 years in the Trade School field, can train you quickly—You "learn by doing," using the finest equipment, under the supervision of expert technicians.

APPROVED FOR CIVILIANS OR GI'S

— CHOOSE YOUR TRADE —

CHECK HERE	WEEKS
<input type="checkbox"/> DIESEL MECHANICS	20
<input type="checkbox"/> AUTO MECHANICS	20
<input type="checkbox"/> BODY & FENDER	16½
<input type="checkbox"/> GAS-ARC WELDING	4-12
<input type="checkbox"/> REFRIGERATION	13½
<input type="checkbox"/> AIR CONDITIONING	8½
<input type="checkbox"/> MACHINIST TRADE	30
<input type="checkbox"/> ADVANCED MACHINIST (includes tool & die)	32½
<input type="checkbox"/> PIANO TUNING & REPAIR	36

CHOOSE YOUR ENGINEERING COURSE

These courses are intended as terminal education for men who wish to enter the Diesel-Automotive and Refrigeration-Air Conditioning fields as technicians. These courses are designed to prepare men for supervisory positions. Students with a high school education, or equivalent, will be accepted.

<input type="checkbox"/> DIESEL AUTOMOTIVE ENGINEERING	2 years
<input type="checkbox"/> REFRIGERATION & AIR COND. ENGINEERING	18 months

HOME STUDY COURSES

Learn at Home — Approved for Civilians & G.I.s. Write for detailed information on Courses in

- PLASTICS
- REFRIGERATION & AIR-CONDITIONING
- DIESEL ENGINES

FREE EMPLOYMENT HELP

Start your career with Greer by checking your interest above and mail coupon for complete information at no obligation.

NAME _____ AGE _____

STREET _____

TOWN _____ ZONE _____ STATE _____

Established 1902 — Over 50,000 Graduates.
53 years of continuous trade school experience to guide your training.

GREER SHOP TRAINING

Box L, 2236 S. Michigan Ave.
Chicago 16, Illinois



McNess WANTS MEN

TO RUN McNESS FARM HOME STORES

Wonderful Work for Man with Car

Use your car as McNess Farm Home Store. Call on same homes month after month. Every farm family becomes your friend. Farmers depend on McNess Farm Home Stores for countless necessities—save orders for you—buy everything they can because McNess quality is tops, values are best, and every product is guaranteed. Premiums, special offers, new products help you make good money from start.

WE SUPPLY CAPITAL

You supply car. We'll supply capital and sales know-how. You start making money first day. There's no finer, more enjoyable work anywhere. Big profits, permanent, no boss, no age limit. No sales experience necessary. This can easily be the biggest money maker you've ever had. Write today for free McNess Dealer Book. No obligation. (16)

THE McNESS CO., 251 Clark St., Freeport, Ill.



Use Your CAR to Raise Your PAY

TELEPHONES



Desk Stand Style

Slightly used but in excellent condition

Many Valuable Uses

Inter-House Phones House to Barn, etc.
Loud Speakers Microphones
Educational Purposes, Toys, etc.

Come complete, ready to use with wiring diagrams included. Two complete for only \$5.00. **\$2.75** Postpaid in U.S.A.
TELEPHONE LAMP KIT—with illustrated instructions for making Desk Telephone Lamp including all parts (hard, nipples, push switch, cord, plug, etc.) ... \$6.50 Ppd. (Shade is not included).

MICROPHONE, Dept. X-3302, 1760 W. Lunt Ave., Chicago 26, Ill.

How to Make Money with Simple Cartoons

A book everyone who likes to draw should have. It is free; no obligation. Simply address **FREE BOOK**

CARTOONISTS' EXCHANGE
Dept. 912D Pleasant Hill, Ohio

SCIENTIFIC CRIME DETECTION



IT'S EASY TO LEARN

Let us teach you in your own home. Learn Finger Printing, Firearms Identification, Police Photography, Criminal Investigation Methods thoroughly, quickly, at small cost. Over 800 of all U. S. Bureau of Identification employ I. A. S. students or graduates. Write today, stating age.

INSTITUTE OF APPLIED SCIENCE, 1920 Sunnyside Ave., Dept. 1359
LA Correspondence School Since 1916 Chicago 40, Ill.

See the Greatest Show on Earth with this GIANT ASTRONOMICAL TELESCOPE

\$15.00
FULL PRICE



Delivered ready for use. Has 45X, 75X and 100 power individually mounted eyepieces with brass focusing tube plus sun projector lens for observing sun spots and solar storms. Steel telescope tube 50 in. long. Rigid 6 ft. tripod adjustable to any height. Steel forked mounting with closely machined aluminum tripod head assembly assures extra fine adjustments. This professional type instrument provides full power with clear vision at all times. See the moons of Jupiter, our own moon, planets, milky way, double stars, star clusters, etc. All for only \$15.00 FOB Mattituck. Sent express. COD orders require \$5.00 deposit. Satisfaction guaranteed. 200X and 400X eyepieces available at \$2.00 ea.

SUFFOLK SCIENCE SERVICE
Dept. ATD-12 MATTITUCK, N. Y.



NOW...RCA trains you at home to be an expert technician in

RADIO TV ELECTRONICS • TV SERVICING • COLOR TV SERVICING

NOW THREE HOME STUDY COURSES

... prepared by instructors of RCA Institutes in cooperation with technicians, engineers, and training specialists of RCA. Clearly written... easy to understand... the same high caliber instruction as given in resident classrooms of RCA INSTITUTES.

● COURSE I—RADIO-TELEVISION ELECTRONICS

—starts you from the ground up to a solid working knowledge of electronics. Without any previous experience, you get a thorough training in radio theory and servicing techniques for AM, FM, home and car radios... plus an introduction to the fundamental theory and practices of television.

● COURSE II—TELEVISION SERVICING

—prepares you to advance from radio into the expanding field of television servicing as a well-trained service technician. If you have completed Course I or are now working in the field of radio or TV, Course II will show you the many special techniques of trouble-shooting, aligning, checking, and repairing modern black and white TV sets.

NEW TV KIT AVAILABLE WITH

COURSE II—there is no better way to learn than by *doing* and RCA Institutes has developed a large-screen TV KIT available to home study students to build while taking Course II. It has the most modern up-to-date circuitry, actually enabling you to apply at home all the latest servicing techniques.

● COURSE III—COLOR TELEVISION SERVICING

—covers all phases of color servicing techniques. It is a practical, down-to-earth course in color theory as well as how-to-do-it servicing procedure. A natural move "up" from Course II or for those now employed in TV.

SINCE 1909, RCA INSTITUTES has trained thousands for successful careers in electronics. Many gradu-

ates have established their own paying business. Now this opportunity is available to you at home.

"PAY-AS-YOU-LEARN" PLAN

... you pay for one study group at a time, as you progress through the course. Tuition costs are amazingly low. For full details, mail coupon.

A SERVICE OF RADIO CORPORATION OF AMERICA—RCA INSTITUTES is licensed by the N. Y. State Education Department... recommended by radio and television service organizations.

**SEND FOR
FREE
CATALOG
NOW**



RCA Institutes, Inc., Home Study PM-125
350 West Fourth Street, N. Y. 14, N. Y.
Without obligation, send me FREE CATALOG on Home Study Courses in Radio, Television and Color TV. No salesman will call.

Name _____

Please Print

Address _____

City _____ Zone _____ State _____



RCA INSTITUTES, INC.

A SERVICE OF RADIO CORPORATION of AMERICA
350 WEST FOURTH STREET, NEW YORK 14, N. Y.

DRAFTSMEN



**CASH BIG
PAY CHECKS!**

**Train Now for
more success,
greater security**

**LEARN AT HOME IN SPARE TIME
(or at college in Chicago)**

Check the want ads in any newspaper—SEE the big-pay opportunities open to you as a draftsman. What's more, you can learn this well-paid, prestige profession at home—quickly, easily! No special talent needed. Get complete, step-by-step Chicago Tech lessons in the mail, spend a few pleasant hours studying each week. In a short time you'll be a well-trained draftsman, ready to take your pick of many good jobs. Act now!



Free Information—Mail Coupon Today!

Get FREE TRIAL LESSON plus information about C.T.C. practical training. Learn what successful Chicago Tech graduates say about high pay and opportunities in drafting. No charge, or obligation.

CHICAGO TECHNICAL COLLEGE

6-253 Tech Bldg., 2000 So. Michigan Ave.
Chicago 16, Illinois

Mail me FREE lesson with facts about big opportunities in DRAFTING.

Name _____ Age _____

Address _____

City _____ Zone _____ State _____



**GIVE THE GIFT OF
LANGUAGE**

IT'S FUN TO LEARN

by **LINGUAPHONE**

The World's Standard Conversational Method

**FRENCH • SPANISH • GERMAN • JAPANESE
RUSSIAN • ITALIAN • MODERN GREEK**

Any of 34 languages available

A Linguaphone Language Set is a lasting gift—an invaluable asset in business, travel, school, armed services and social life. With LINGUAPHONE'S life-like recordings, you LISTEN and LEARN another language the same easy, natural way you learned your own. AT HOME you hear 8 to 12 of the world's best native language teachers, both men and women, make everyday conversation. You Understand—YOU SPEAK! It's like living in another country. Over a million home-study students of all ages. There's nothing like "The Gift of Language." Mail coupon TODAY for FREE Book, "Passport to a New World of Opportunity."

LINGUAPHONE INSTITUTE,
143-125 Radio City, New York 20, N. Y.

Please send me your FREE Book, LANGUAGE INTEREST.

NAME _____

ADDRESS _____

CITY _____ ZONE _____ STATE _____

REPAIR ANY WATCH



... Swiss or American

No previous experience needed to learn modern watch repair. An enjoyable hobby or profitable career. Unique Sweazey System starts you making repairs right away. Develops your skill step by step. Teaches you modern shop methods... professional short cuts... mistakes to avoid. Learn by personal attendance or spare time home study. Individual training. Start any time. Free sample lesson. No obligation. Write today!

CHICAGO SCHOOL OF WATCHMAKING

2330 N. Milwaukee, Dept. 1125, Chicago 47, Illinois
Founded 1908 • Approved for veterans

TASOPE PHOTO-ENGRAVING PLANTS



Material Cost
Of This Cut 3/4¢
Selling Price
\$1.00 And Up

Establish your own profitable PHOTO-ENGRAVING business. Make cuts for newspapers, printers, and advertisers. Make etched name plates, plaques etc. Instructions furnished, no experience necessary. Sold direct from factory since 1931. First five hundred cuts sold locally or by mail will pay for plant and pay you well for your time. Write for FREE catalog.

TASOPE, DEPT. PM-12, AURORA, MO.

LEARN LOCKSMITHING

Learn this fascinating, profitable trade from experts in your spare time at home! Age or physical handicap no disadvantage. Year around, steady income. Full or part time. Practical, illustrated lessons. You can make money even while learning! All materials and special tools supplied without extra charge. **INSTITUTE OF LOCKSMITHING, Dept. P-73**
15 PARK AVENUE RUTHERFORD, N. J.
Lic. by N.J. State Board of Education
Approved for Veterans

send
for
**FREE
BOOKLET**

Learn SHELLCRAFT

Wonderful, New, Easy—Up to 500% Profits! Make Shell Lamps, Shell Jewelry and Novelties. Sell for BIG PROFITS! Markets everywhere. Hand-in-Action PLAN designed for you... to learn and earn as you succeed in Shellcraft.

FREE Genuine Sea Shells, full color pictures, and Hand-in-Action Plan Folder. Write.

NATIONAL SHELLCRAFT SCHOOL
637-26th ST. S., ST. PETERSBURG, FLA.



**25
Yulecards
\$1.00**
plus
35¢ postage



Personal Photo Christmas Cards, including envelopes, from your own negative.

FREE SAMPLE ... send snapshot negative for free sample Deluxe Yulecard. Include 6¢ stamps for handling.

Negative returned with sample. No obligation. Satisfaction guaranteed. Write today **YULECARDS**,

Dept. 34, Quincy 69, Mass.

*Div. Mail-N-Save *T.M. Reg.

Free Book on Arthritis and Rheumatism

HOW TO AVOID CRIPPLING DEFORMITIES

Explains why drugs and medicines give only temporary relief and fail to remove the causes; tells all about a specialized non-surgical, non-medical treatment which has proven successful for the past 36 years. Write for this 44-page FREE BOOK today.

Ball Clinic Dept. 756 Excelsior Springs, Mo.

Learn BAKING At Home

Baking is one of America's high industries in wages. Nearly DEPRESSION-PROOF. Thorough basic home course lays sound foundation. If you have aptitude, write for FREE Booklet, "Opportunities in Commercial Baking."

NATIONAL BAKING SCHOOL
835 Diversey Parkway Dept. 1359 Chicago 14.



VETERANS . . . NON-VETERANS

You can be a TELEVISION TECHNICIAN



I'LL TRAIN YOU AT HOME IN
YOUR SPARE TIME FOR
BETTER-PAYING JOBS IN THE
DYNAMIC RADIO-
TELEVISION-ELECTRONICS
FIELD.

Not since the beginning of the Industrial Revolution in the 18th Century has any industry developed as fast as the wide open Radio-Television-Electronics field. And there's no end in sight . . . FM — UHF — HIGH FIDELITY — COLOR TELEVISION — RADAR — LORAN — all magic words holding out the promise of good-paying jobs with a secure future . . . for qualified men.

NOW, while opportunities for trained men are still increasing, is the time to prepare yourself to advance with the ever-expanding, Radio-Television-Electronics field. You can become a well-paid TELEVISION TECHNICIAN by letting me start your training now!

L. C. Lane, B.S., M.A.
President, Radio-Television
Training Association, Executive
Director, Pierce School
of Radio & Television.



VETERANS

My School fully approved to train Veterans under new Korean G. I. Bill. Don't lose your school benefits by waiting too long. Write discharge date on coupon.

EARN WHILE YOU LEARN. Almost from the very start you can earn extra money while learning by repairing radio-TV sets for friends and neighbors. Many of my students earn up to \$25 a week . . . pay for their entire training from spare time earnings . . . start their own profitable service business.

FCC COACHING COURSE. Important for BETTER PAY JOBS requiring FCC license. You get this training AT HOME and AT NO EXTRA COST. Top jobs go to FCC-licensed technicians.

RADIO-FM-TELEVISION TRAINING

My Radio-FM-Television Technician Course is especially prepared for men with no previous experience or training. I have trained hundreds of men for successful careers in radio-television-electronics. Many of them had only a grammar school education and no previous experience whatsoever in the field.

EXPERT FM-TV TECHNICIAN TRAINING

My FM-TV Technician Course lets you take full advantage of your previous experience — either civilian or Armed Forces. YOU CAN SAVE MONTHS OF TIME . . . complete your training by getting a thorough background in Frequency Modulation and Television Theory and PRACTICE. You "Learn by Doing", working with parts and equipment I send you. YOU BUILD AND KEEP A TV RECEIVER.

EXTRA TRAINING IN NEW YORK CITY AT NO ADDITIONAL COST

You get two weeks, 50 hours, of intensive laboratory work on modern electronic equipment at our associate school in New York City — Pierce School of Radio & Television. I give you this AT NO EXTRA COST whatsoever, after you finish your home study training in the Radio-FM-TV Technician Course or the FM-TV Technician Course. Your home study course is complete without this two-week laboratory session, but it is one of the many Extras available to you from RTTA.

YOU GET ALL THIS EQUIPMENT



As part of your training I give you the equipment you need to set up your own home laboratory and prepare for a BETTER-PAY TV JOB. You build and keep an Electromagnetic TV RECEIVER designed and engineered to take any size picture tube up to 21-inch, (10-inch tube furnished. Slight extra cost for larger sizes.) . . . also a Super-Het Radio Receiver, AF-RF Signal Generator, Combination Voltmeter-Ammeter-Ohmmeter, C-W Telephone Transmitter, Public Address System, AC-DC Power supply. Everything supplied, including all tubes.

**MAIL THIS COUPON TODAY!
NO SALESMAN WILL CALL**

Mr. Leonard C. Lane, President
RADIO-TELEVISION TRAINING ASSOCIATION
Dept. M-12 C, 52 East 19th Street, New York 3, N. Y.

Dear Mr. Lane: Mail me your NEW FREE BOOK, FREE SAMPLE LESSON, and FREE club that will show me how I can make BIG MONEY IN TELEVISION. I understand I am under no obligation and no salesman will call.

(PLEASE PRINT PLAINLY)

Name _____ Age _____

Address _____

City _____ Zone _____ State _____

I AM INTERESTED IN:
 Radio-FM-TV Technician Course
 FM-TV Technician Course
 TV Consumer & Studio Technician Course

VETERANS!
Write discharge date

Radio Television Training Association

52 EAST 19th STREET • NEW YORK 3, N. Y.

Licensed by the State of New York • Approved for Veteran Training

HOW TO FIX ANY PART OF ANY CAR

QUICKLY--EASILY--RIGHT!

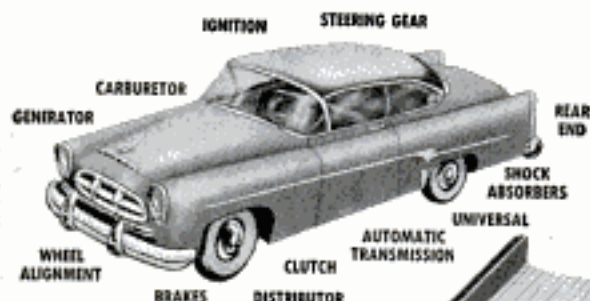

FREE 7-DAY TRIAL

Whether you're a beginner or an expert mechanic—now you can "breeze through" any "fix-it" job from simple carburetor adjustment to complete overhaul. Just look up job in index of MOTOR'S Brand-New Auto Repair Manual. Follow simple step-by-step directions, clear pictures, Presto—the job is done!

No guesswork! MOTOR'S MANUAL takes you from "scratch"—shows WHERE to start, WHAT tools to use. Covers EVERY job on EVERY car built from 1910 thru 1955!

Everything You Need to Know "Boiled Down" from 160 Official Shop Manuals

BIG NEW, REVISED, ENLARGED, Edition contains the "meat" from over 160 OFFICIAL shop manuals—simplified for YOU, 23,436 essential repair specifications on 137 chassis models. Over 1,000 big pages. More than 2,000 "this-is-how" pictures, 225,000 service and repair facts. Leads beginners every step of the way. Time-saving factory repair procedures for experts. Instructions and pictures so clear you CAN'T go wrong. Used by U. S. Army and Navy.

Try Book FREE 7 Days

SEND NO MONEY! Pay postman nothing.

Make Manual show you what it's got. Unless you agree this is the greatest time and work saver you've ever seen—return book in 7 days and pay nothing. Mail coupon today to: MOTOR—Book Dept., Desk 112, 350 W. 55th St., New York 19, N. Y.

MOTOR'S AUTO REPAIR MANUAL

Covers 737 Models All These Makes

- Buick Hudson
- Cadillac Kaiser
- Chevrolet Lincoln
- Chrysler Mercury
- Crosley Nash
- De Soto Oldsmobile
- Dodge Packard
- Ford Plymouth
- Frazer Pontiac
- Henry J Studebaker
- Willys

2,000,000 Copies Sold!

Same FREE Offer On MOTOR'S New Truck Repair Manual

Covers EVERY job on EVERY popular make gasoline and Diesel truck made from 1946 thru 1955. FREE 7-Day Trial. Check proper box in coupon.



FULLY GUARANTEED TIRES COST LESS!

Nationally famous FIRESTONE, GOOD-RICH, U. S. ROYAL, GOODYEAR, and other makes. Every tire selected and inspected for your safety.

BUY WITH CONFIDENCE FROM PYRAMID TIRE

WHITE WALL TIRES \$1 EXTRA

HIGH GRADE TIRES GUARANTEED 12 MONTHS

600x16	4.14	700x16	5.14	32x6(8)	8.84	825x20	14.24
650x16	4.54	670x15	4.74	32x6(10)	10.84	900x20	13.34
650x16	4.34	650x20	7.84	750x20(8)	8.54	1000x20	14.14
700x16	4.64	700x20	8.94	750x20(10)	9.94	1100x20	16.14

AAA PREMIUM GRADE GUARANTEED 18 MONTHS

550x16	5.48	700x15	5.98	760x15	5.98	750x20(10)	14.98
600x16	5.28	700x16	6.78	550x17	5.48	825x20	15.68
600x16(1)	6.58	700x16(1)	7.98	600x20	9.78	900x20	18.98
640x16	5.88	750x16(1)	8.98	650x20	10.88	1000x20	19.98
650x16	5.78	800x15	6.88	700x20	12.88	1000x22	21.98
650x16(1)	6.98	820x15	7.48	32x6(8)	10.48	1100x20	20.98
650x16	5.98	710x15	6.09	32x6(10)	12.48	1100x22	21.98
670x16	6.18	550x18	5.98	750x20	12.98	1100x24	23.98

MILITARY SPECIAL AA Guaranteed 12 Months—

900x16	10.98	1000x20	19.98
750x20	10.98	1100x20	21.98

AAA GUARANTEED 18 MONTHS

900x16	14.98	750x20	16.48
--------	-------	--------	-------

Largest stock of used tires in the East. Thousands of satisfied customers. Write for Free Catalogue. MONEY ORDER OR CHECK WITH ORDER. NO C.O.D.'s

PYRAMID TIRE CO.
1333-35 North 9th St.
Dept. M., Phila. 22, Pa.

LOOK!



A MILLION THRILLS!

High Power **BINOCULARS**
33 Models: \$9.95 to \$125

Free Catalog & Book "How to Select Binoculars"

FREE TRIAL PLAN

BUSHNELL Binoculars
Dept. M12 43 E. Green
Pasadena, Calif.

DRAINS collars, cisterns, wash tubs, **\$6.95**
IRRIGATES - CIRCULATES - SPRAYS



Type P Pump has 1,001 uses. Up to 3000 GPH; 450 GPH 80" high; or 1800 GPH from 25" well. Use 1/8" to 3/4" HP motor. Couplings included free. 1" inlet 1/2" outlet. Stainless shaft. Won't rust or clog! Postpaid if cash with order. (West of Miss. add 50c)

MONEY BACK GUARANTEE
Centrifugal and Gear Pumps in All Sizes
LABAWCO PUMPS, Belle Meade 7A, N. J.

LAW Men and women **STUDY AT HOME** for Business Success and **LARGER PERSONAL EARNINGS**, 44 years expert instruction—over 114,000 students enrolled. LL.B. Degree awarded. All text material furnished. Easy payment plan. Send for **FREE BOOK**—"Law and Executive Guidance"—NOW!

AMERICAN EXTENSION SCHOOL OF LAW
Dept. H-6, 664 N. Michigan Ave., Chicago 11, Illinois

SAY YOU SAW IT IN POPULAR MECHANICS

Outdoor Fun for the Whole Family



ORDER BY MAIL ONLY \$2 Postpaid

THE AUSTRALIAN MYSTERY STICK

No special skill required. Flight tested—guaranteed returns. Beautiful lacquer finish in your choice of Red, Green or Natural. Fun for sportsmen from 12 to 60. A collector's items for game room or den. Mailed direct with story and instructions.

Carved by **COL. JOHN M. GERRISH**
4105-M S.W. Parkview Ave., Portland 1, Ore.

MAIL COUPON NOW FOR 7-DAY FREE TRIAL

MOTOR BOOK DEPT.
Desk 112, 250 W. 55th St., New York 19, N. Y.

Rush to me at once (check box opposite book you want):
 MOTOR'S New AUTO REPAIR MANUAL. If O.K., I will remit \$2 in 7 days, \$2 monthly for 2 months and a final payment of \$50 (plus 50c delivery charges) one month after that. Otherwise I will return the book postpaid in 7 days. (Foreign price, remit \$9 cash with order.)
 MOTOR'S New TRUCK REPAIR MANUAL. If O.K., I will remit \$2 in 7 days, and \$2 monthly for 2 months, plus 50c delivery charges with final payment. Otherwise I will return book postpaid in 7 days. (Foreign price, remit \$30 cash with order.)

Print Name..... Age.....
 Address.....
 City..... State.....
 Check box and save 35c delivery charge by enclosing WITH coupon entire payment of \$6.35 for Auto Repair Manual (or \$8 for Truck Repair Manual.) Same return-refund privilege.

THIS TANK HOLDS

**4,538 TROPICAL FISH
WORTH \$2,456⁶⁵!**



FANTASTIC NEW HOME-BUSINESS OPPORTUNITY!

"I predict a new home industry will be the breeding of Tropical Fish. I predict the Breeding of Tropical Fish will be the Nation's No. 1 pet shop favorite." (This is what the renowned Mr. Criswell predicts on his National T. V. Program—[he's right too].)

WOW!

—AND YOU BREED THEM IN YOUR SPARE TIME — IN YOUR HOME

YES BOB, I BREED THEM IN MY BACK PORCH. THEY ALMOST SELL THEMSELVES, TOO. BELIEVE ME THE "BOOM" HAS STARTED

FANTASTIC! BUT WHAT "BOOM"?

THE TROPICAL FISH "BOOM." EVERYBODY WANTS THEM—I CAN'T BREED ENOUGH TO FILL MY ORDERS

HOW ABOUT BIG COMPANIES. MUST GIVE YOU REAL COMPETITION?

NOPE. NEARLY ALL TROPICAL FISH ARE BRED BY SMALL SPARE TIME HOME-BREEDERS LIKE ME. WE KEEP VALUABLE BREEDING SECRETS TO OURSELVES

DID IT COST YOU MUCH TO START?

NO—ONLY A FEW DOLLARS, A LITTLE SPACE AND MY SPARE TIME AND THE LITTLE KNOWN BREEDING SECRETS ARE ALL YOU NEED TO START. IF YOU'RE INTERESTED—LEARN THE FACTS TODAY!—THE "BIG BOOM" HAS STARTED SO CASH IN ON IT NOW!

EARN BIG PROFITS In Your Spare Time

(Breed thousands in your own home)

If you have a little space in a SPARE ROOM, PORCH, BASEMENT, GARAGE... ANYWHERE. Investigate this "chance-of-a-lifetime" opportunity of breeding rare tropical fish for profit. The tropical fish "BOOM" IS JUST BEGINNING and here's your opportunity to cash in on it now. It is estimated that the staggering sum of \$780 MILLION DOLLARS will be spent on tropical fish within the next 10 years. Investigate now—Rush coupon below.

BREED FASCINATING VARIETIES

IT'S EASY! Once you know the "breeding secrets" you may breed EXOTIC RADIANT "Angle Fish," Beautiful "Gourami" that are 12 different colors; Majestic "Fighting Fish" that actually CHANGE COLORS before your eyes and will FIGHT UNTIL DEATH, "Danio" that are ZEBRA STRIPED; TRANSPARENT FISH, "Mysterious Weather Fish that PREDICT THE WEATHER"—BRILLI-

ANTLY BEAUTIFUL rare tropicals of all kinds. SOME SELL FOR \$100.00 pr. but most sell for \$2 to \$20 pr. Amazing Profits!

● WE SUPPLY EVERYTHING YOU NEED to start if you ACT NOW because

WE NEED NEW BREEDERS NOW!

This advertisement is an URGENT APPEAL OPPORTUNITY! Please rush coupon today!

SOME TROPICAL FISH LAY 300 TO 600 EGGS AT A TIME. That's why tropical fish breeding is so profitable. Nature multiplies your profits for you.

ANGLE FISH Majestically Beautiful. Female lays about 400 eggs at a time.

JEWEL FISH with eggs. Beautifully colored and valuable. Female lays 100 to 300 eggs. Retail for \$4 pr.

KISSING FISH—Kiss each other on sight. Female lays over 200 eggs at a time. Retail for about \$5.50 pr.

JOIN WITH OTHERS THAT ARE ALREADY SAYING: "Business Prospects Tremendous" J. K. Ga. "Earned \$125.00 first week" T. S. Calif. "Dealers want all I can breed" J. P. Fla. "Over \$4000.00 and how" T. V. Me. "Pays off large dividends." R. D., New York, etc.

1 and 2 FREE! (BOTH)

MAIL THIS COUPON BELOW TODAY!

Colorful "How to Learn Breeding Secrets" BOOKLET with FULL COLOR prints of fabulous rare tropical fish. REVEALING INFORMATION, CONFIDENTIAL DETAILS.

Amazing VUER-PROJECTOR KIT Details Complete with FULL COLOR slides (\$4.95 value—yours free for investigating). Handsome, precision-viewing instrument. Shows gorgeous tropical fish come to life before your eyes.

Tropical Fish Breeders of America, Dept. D12
15121 S. Broadway, Los Angeles 61, California
Please Rush FREE COLORFUL BOOKLET and amazing VUER-PROJECTOR KIT details to me. Both Free! Sending for these does not obligate me in any way.

Name _____ Age _____
Address _____
City _____ Zone _____ State _____

Tropical Fish Breeders of America, Dept. D12,

15121 S. Broadway, Los Angeles 61, Calif.

Inventors

Take these necessary preliminary steps promptly to protect your invention by applying for a United States patent—

Sketch and describe your invention. Sign, date and have this disclosure witnessed by two people who understand your invention. Have us make a preliminary search among U. S. patents already granted for similar types of invention. We then report to you on the probable patentability of your invention and recommend your further course of action.

Write for our instructive booklet, "Patent Protection for Inventors" and our convenient "Evidence of Invention" disclosure form. No obligation.

VICTOR J. EVANS & Co. *Merlin M. Evans*
REGISTERED PATENT ATTORNEY

130-P MERLIN BUILDING, WASHINGTON 6, D. C.

"My selling time actually shows me a profit of
\$20 TO \$25 AN HOUR
with Science's New Midget Miracle, the
PRESTO Fire Extinguisher

says M. R. Stanley of Montana. Many others "cleaning up"—so can YOU!

THIS is an amazing new kind of fire extinguisher. Tiny "Presto" (about the size of a flashlight) does job of bulky extinguishers that cost 4 times as much, and are 8 times as heavy. Ends fires fast as 2 seconds. Fits in palm of hand. Never corrodes. Guaranteed for 20 years! Sells for only \$3.98! Over two million already sold!

Show it to civil defense workers, owners of homes, cars, boats, farms, etc., and to stores for re-sale. Make good income. C. S. Mellous made \$175 in just first 5 days. C. Kama, \$1,000 a month. Write for FREE Sales Kit. No obligation.

(If you want a regular Presto to use as a demonstrator, send \$2.50. Money back if you wish.)

MERLITE INDUSTRIES, Dept. 15-C, Presto Div., 114 East 32nd St., New York 16, N. Y.

(In Canada: Mopa Co., Ltd., 371 Dowd St., Montreal 1, P. Q.)



Science's New Midget Miracle—**"PRESTO"**



M. R. STANLEY

LOOK! UNUSUAL XMAS GIFT!



Makes a Car
BELLOW
like a Bull

THE *New Kattle Kaller*

AUTO HORN

Completely different novelty horn. Sounds just like a lonesome bull. Imitates any cattle sound. Actually used by ranchers to call cattle. Makes low gentle tone, or roars full blast. Variable tone control located on steering column.

If your dealer can't supply you, order direct and send us his name.

Send check, M. O., C. O. D.
Money back if not satisfied.

KATTLE KALLER DIV., 1954 So. 20th St., Omaha, Nebraska



- REALLY GETS ATTENTION!
- EASILY INSTALLED UNDER HOOD
- FITS ANY CAR OR TRUCK

Special Introductory Offer
ONLY \$10.95 Post Paid
(\$2 below reg. list)

STOPS FOGGY WINDSHIELDS NEW Chemical Mitt



Amazing Discovery! Autoists will love new FOG-STOP Windshield Cleaner. Simply glide over windshield chemically-treated Mitt—at once glass sparkles crystal clear. Hurry mist, frost, sleet, snow disappear like magic. Stops fogging. *Sells like wild!*

SAMPLES FOR AGENTS Sample offer sent immediately to all who send name at once. Hurry. Postcard will do. **SEND NO MONEY—just your name.** KRISTEE CO., Dept. 687, AKRON 8, OHIO

MAKE CERAMICS IN YOUR KITCHEN

Make lovely vases, bowls, lamps, trays. No special skill or equipment needed. New Della Robbia Kit contains Miracle Clay, tools, brushes, 10 glaze colors, illus. instruction book. Clay bakes hard and durable in kitchen oven. Try kit 7 days. Only \$5.95 postpaid. If not delighted return for full refund. Or send \$1 for illustrated instruction book credited on purchases. **SCULPTURE HOUSE, Dept. A1012, 304 West 42nd Street, New York 36, N. Y.**



MAGIC TRICKS

IT'S FUN TO DO MAGIC

Be popular! Amaze—mystify—entertain! For 30 years Douglas has satisfied customers all over the world. Now, you can enjoy this fascinating hobby. Only 10c brings our Catalog 500 Tricks, containing brand new tricks for pocket, parlor, stage. Join in the fun—send 10c today!

Douglas Magicland, Dept. A, Dallas, Texas

Opportunity for the holder of a production-item patent!

A large manufacturing plant equipped with precision machinery will finance and manufacture, on royalty basis, patented production items.

If you have such a patent, and are interested, write:

**PRODUCTION PATENT DEPT.
3300 W. Temple St., Los Angeles 26, Calif.**

**Design, build, operate
hundreds of all-steel
action models with Gilbert**

ERECTOR®



Build this
giant ferris wheel
with ERECTOR No. 8½



ERECTOR No. 6½—The Electric Engine Set. More than 325 real steel parts come packed in this big steel chest. Powerful motor runs in forward and reverse, has Magic-Twist coupling that sends power from the motor to the model in bends, twists and loops. Make a Windmill, Lift Bridge, Pump, Airplane Beacon and hundreds of other wonderful action models. Only..... **\$14.95***

*Slightly higher Denver and West



You'll build this high-flying airplane ride with ERECTOR No. 6½

This Christmas Have Fun with Erector—The World's Greatest Toy—Manufactured by A. C. Gilbert, makers of American Flyer Trains, Chemistry Sets, Microscope Sets, and Tool Chests.

Construct hundreds of wonderful working models! It's easy and so much fun with Erector! Each set has loads of parts... rugged steel girders, heavy plates, precision-made gears, wheels and pinions. Design and build your own inventions, or use the "How to Make 'Em" book with your set. You'll create models that operate by remote control, run forward and reverse, glow with real electric lights! Erector is the original and *best build-it-yourself* set!

See exciting action Erector models now on display at your dealer's! They're fascinating to watch. Take Dad along. He'll love 'em, too. Pick the set you want for Christmas. Erector Sets start as low as \$2.00.*

**Write for Your Free
Gilbert Toy Catalog Today!**

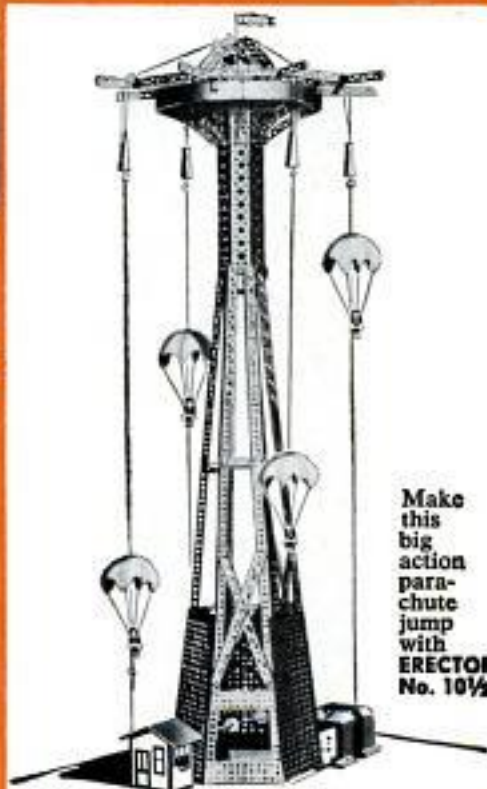

Make
this
big
action
para-
chute
jump
with
ERECTOR
No. 10½

**Gilbert Hall of Science, Dept. E7
Erector Square, New Haven 6, Conn.**

Please send your 4-color folder that illustrates and tells all about ERECTOR, Gilbert Chemistry and Microscope Sets, Tool Chests and other scientific toys.

Name _____

Address _____

City _____

Zone _____

State _____

Become an
Electrical Engineer



**Major in Electronics or Power
BS Degree in 36 months**

Prepare now for a career as an electrical engineer or engineering technician—and take advantage of the many opportunities in these expanding fields.

You can save a year by optional year 'round study. At MSOE previous military, academic, or practical training may be evaluated for advanced credit.

**Enter Radio and Television
— courses 12 to 18 months**

You can be a radio technician in 12 months. In an additional 6-months you can become a radio-television technician with Associate in Applied Science degree. Color television instruction is included in this program.

These technician courses may form the first third of the program leading to a degree in Electrical Engineering. Twenty-one subjects in electronics, electronic engineering and electronic design are included in these courses.

Courses also offered: radio-television service (12 mos.); electrical service (6 mos.); general preparatory (3 mos.).

Terms — January, April, July, Sept.

Faculty of specialists. 50,000 former students — annual enrollment from 48 states, 23 foreign countries. Non-profit institution. 52nd year. Courses approved for veterans. Residence courses only.

MS-68



**MILWAUKEE
SCHOOL OF ENGINEERING**

MILWAUKEE SCHOOL OF ENGINEERING
Dept. PM-1255, 1025 N. Milwaukee Street
Milwaukee 1, Wisconsin

Send FREE illustrated booklets
 Career in Electrical Engineering,
 Career in Radio-Television.

I am interested in.....
(name of course)

Name.....Age.....

Address.....

City.....Zone.....State.....

..... If veteran, indicate date of discharge.....

Learn to **MOUNT
Birds and
Animals**



**FUN-FASCINATION
PROFITS — IN SPARE TIME**

Learn **TAXIDERMY** at home **BY MAIL**. Save your hunting trophies, decorate your home and den, have a grand **HOBBY**. This old reliable school (with 250,000 students) will teach you at home to mount **BIRDS, ANIMALS, FISH, GAME-HEADS**—and to **TAN** hides and furs by wonderful **KROME-TAN** system, also **NOVELTY TAXIDERMY**, using common specimens—no wild game needed.

FREE BOOK 100 beautiful pictures. Tell how **YOU** can learn Taxidermy easily, quickly, at home. Tells how to **EARN FINE PROFITS** in spare time. Rush letter or postal for this strange marvelous **FREE BOOK**. Write **NOW—TODAY**. State **AGE**.

N. W. School of Taxidermy • DEPT. 2512 Omaha, Neb.

MOTHER: Send for this!

8 Mistakes Parents make

Every parent should have this new book about child training. It is free; no obligation. Simply address

FREE BOOK PARENTS ASSOCIATION

Dept. 6712-D, Pleasant Hill, Ohio



Covers all ages

The finest of Gifts...

ENCYCLOPAEDIA BRITANNICA



**Easy to make your own
BOWS—ARROWS—EQUIPMENT**

Illustrated Hand-Book 84 pgs. 75c, tells you how! Large Colored Catalog 5c—Send for it!

Ask your dealer for "Stemmler's Archery" (Oldest Mfr. in U.S.A.)

L. E. STEMMLER CO.

Manorville (Box 1) L. I., N. Y.

**Shrinks Hemorrhoids
New Way Without Surgery**

Science Finds Healing Substance That Relieves Pain—Shrinks Hemorrhoids

For the first time science has found a new healing substance with the astonishing ability to shrink hemorrhoids and to relieve pain — without surgery.

In case after case, while gently relieving pain, actual reduction (shrinkage) took place.

Most amazing of all — results were so thorough that sufferers made astonishing statements like "Piles have ceased to be a problem!"

The secret is a new healing substance (Bio-Dyne*) — discovery of a world-famous research institute.

This substance is now available in suppository or ointment form under the name **Preparation H.*** Ask for it at all drug counters — money back guarantee. *Reg. U. S. Pat. Off.

**Now... YOU Can Own and Play a
New, Improved 1956 Italian**

ACCORDION

Buy Direct—Save UP TO 50%



FREE HOME STUDY TRAINING COURSE!

Let your accordion open a new world of pleasure and popularity—Own yours for pennies a day on amazing NO RISK PLAN

Why envy any longer others who seem to have "all the fun" playing the accordion at home, at parties and everywhere happy people gather? Now you can own and play your own hand crafted, richly toned Italian Accordion. You'll be amazed how easily you can learn and how little you pay.

Under our new NO RISK PLAN we ship the accordion of your choice to you on 5 DAYS FREE HOME TRIAL. We include an easy, student-proved Home Study Training Course FREE, plus many other valuable "extras". We are America's leading direct factory importer of the finest Italian accordion makes...and because of our huge volume and unusual buying advantages we SAVE YOU UP TO 50% AND MORE OFF REGULAR PRICES. You pay only a small down payment and small monthly payments that amount to only a few pennies a day. Trade-ins accepted with top allowances.

It Pays to Deal Direct with America's Top Accordion Firm

We are accordion specialists... this is the only thing we sell. Our skilled buyers travel regularly to Italy, the one country that produces the very finest quality accordions. We hand select the truly outstanding instruments for shipment to America. Each accordion is carefully checked and tested before it goes to you... and we ship on an UNCONDITIONAL GUARANTEE OF SATISFACTION OR MONEY BACK.

Each accordion carries a life-time guarantee of performance. Mail coupon below for the exciting facts about owning an accordion, plus beautiful Color Catalog showing dozens of newest models and low wholesale prices. No obligation. Write today.

**New 1956 Models Now Available—
Rush Coupon for Exciting Details
and Special Direct Import Prices**

5 DAYS FREE TRIAL

PLUS ALL THESE AVAILABLE EXTRAS

- ✓ Easy Terms with Low Down Payment
- ✓ Money Back Guarantee of Satisfaction
- ✓ More Than 30 Distinctive Models in Wide Variety of Exciting Color Combinations
- ✓ Latest Models with Most Up-to-Date Playing Features
- ✓ Save Money Dealing Direct... No Middleman to Pay
- ✓ Trade-ins Accepted at Top Prices
- ✓ Lifetime Guarantee on Your Accordion
- ✓ Expert Personal Help in Choosing Your Accordion If Desired

FREE!

**Color Catalog
and Wholesale
Prices**

Complete Home Study Course FREE!

The accordion is easy to play, especially if you have any musical training at all. However, with each instrument we include a Complete Home Study Course. The training is easy to follow and you will probably be playing simple tunes within a half hour. The course should help you become an excellent player in a very short time.

"Received our accordion today, we are pleased with such a wonderful instrument. I have talked to my neighbor who taught accordion for 20 years and he praised this accordion highly as a wonderful instrument."
Theodore M. Swiateck,
Denver, Colorado

"My accordion arrived yesterday and am thrilled and happy over the beautiful instrument and pleased with the tone it gives. It is all that you said it was and more."
Mrs. Fred Richter,
Clear Lake, Wisc.

**ACCORDION MANUFACTURERS
AND WHOLESALERS OUTLET**

2003 W. Chicago Ave., Dept. R-125, Chicago 22, Illinois

Mail Coupon Today! No Obligation

**ACCORDION MANUFACTURERS AND WHOLESALERS OUTLET
2003 W. Chicago Ave., Dept. R-125, Chicago 22, Ill.**

Please rush Color Catalog of newest Italian Accordions and low wholesale prices.

Name _____

Address _____

City _____ Zone _____ State _____

HOBBIES FOR Profit



MAKE BIG MONEY!

Make beautiful and UNUSUAL items for both home and industry. Things which cost you but pennies and which net you big cash prices. Previous training, experience or special education is not needed. Start in your spare time at home. Soon you can have a big flourishing business of your own!

HAVE FUN!

Working with your hands creating hundreds of useful and lovely things. Turn spare hours into big cash dollars.

WE SHOW YOU HOW!

to make exquisite jewelry, ceramics without a kiln, toys, dolls, puppets, tools, planters, embedded Plastics, Metal Enamelling, etc. Learn Jewelry Making, Wirecraft, Photocraft, Woodcraft, Metalcraft, Leathercraft, Model Making, Bait Making, Gemcraft, Plastic Laminating, Lampcraft, Feathercraft, Basket Weaving, etc.

Over 1000 Golden Opportunities! Send 25c for giant-sized catalog giving full facts on all of these hobbies.



HOBBIES-FOR-PROFIT

6612 N. Clark Street, Dept. HP-203, Chicago 26, Illinois

TRAINED MEN NEEDED

BIG PAY—GOOD FUTURE

- TELEVISION ELECTRONICS
 DIESEL AUTO

WHY WORK FOR LOW PAY or risk being out of a job??? Usually the properly trained man has a steady job... through good times or bad. Even back during DEPRESSION there was a big demand for Bailey Trained men.

In only 5½ to 6 months we can train YOU to enter one of the big pay fields!

No previous experience or special education necessary. With our method of training you do not spend years pouring over books, figures, charts and graphs. You learn by rebuilding, repairing, testing and operating the most modern equipment, under the guidance of experienced, courteous and friendly instructors. This method of training gives you the experience and confidence required to step right into the big pay jobs without spending years as a mechanic's helper.

It's EASIER and COSTS LESS than you may think to get this residence shop training... we help you find part-time jobs while in school—full-time jobs after graduation. Check subject above in which you are interested and mail for complete information.

BAILEY Technical SCHOOLS

Veteran Approved

1634 S. Grand St. Louis 4, Mo.

NAME.....AGE.....
STREET.....
TOWN.....ZONE.....STATE.....

INVENTORS

PROTECT YOUR INVENTION BY A U. S. PATENT. SEND FOR FREE "INVENTION RECORD" FORM AND "PATENT INFORMATION EVERY INVENTOR SHOULD HAVE".

CARL MILLER
REGISTERED PATENT ATTORNEY
WOOLWORTH BLDG., 35th FLOOR, 125A
NEW YORK CITY

INVENTORS

Whether an invention is patentable can be substantially determined by a search of the U. S. Patent records. Without obligation, write for information explaining the steps you should take to secure a patent.

JOHN N. RANDOLPH
Registered Patent Attorney
201 Columbian Building, Washington 1, D. C.

PATENTS

C. A. SNOW & CO.

REGISTERED PATENT ATTORNEYS
WRITE FOR INFORMATION TO
428 SNOW BUILDING, WASHINGTON 1, D. C.

INVENTORS

Send for PATENT INFORMATION Book and INVENTOR'S RECORD without obligation
GUSTAVE MILLER
125-PM WARNER BUILDING WASHINGTON 4, D.C.

REGISTERED PATENT ATTORNEY
ASSOCIATE EXAMINER
U.S. PAT. OFF. 1922-1929
Patent Attorney & Advisor
U. S. NAVY DEPT. 1930-1947
PATENT LAWYER

HELPFUL BOOKS

Send post card asking for FREE catalog
Popular Mechanics Press, 200 E. Ontario, Dept. 601, Chicago 11

INVENTIONS WANTED

If you want to market, or sell, your invention for cash or royalties, Write for our Free Booklet. Send no drawings. We also welcome hearing from firms, or private capital, wishing to review inventions in any field. We will be glad to send notice of our clients' inventions.

GLOBAL MARKETING SERVICE
2420 77th Ave. Dept. PD Oakland 5, Calif.

INVENTORS

I shall be pleased to furnish you, upon request, with full information relative to patent procedure—without any obligation on your part.

PATRICK D. BEAVERS
Registered Patent Attorney
934 Columbian Building Washington 1, D. C.

Make SURE, SAFE INSULATED ELECTRICAL CONNECTIONS

The New SUPER *CHAMP* Hand Tool

The ONE Tool for ALL Wire Sizes used in Home Wiring, Appliances, Automobiles.

DOES ALL THESE THINGS BESIDES

CRIMPS Solderless Terminals and Connectors without solder or tape for safe connections.

CUTS Wire, making clean, sharp cut through Insulation and Conductor.

STRIPS Wire sizes #22-#10. Gauges assure proper length for sure, safe crimp.

SHEARS Bolts and screws without damaging threads — no filing or hack sawing.



comes with
PRE-INSULATED



FREE with Each TOOL

ORDER DIRECT — USE COUPON

Satisfaction guaranteed or money back. Send check or money order for \$3.95. (Ohio residents add 12c sales tax.)

T. W. Berger, Inc.
National Distributor Consumers and Dealers
AIRCRAFT-MARINE PRODUCTS, Inc.
1315-D American Bldg., Cincinnati 2, Ohio

Only
\$3.95
Post Paid

T. W. Berger, Inc.
National Distributor Champ Tool
1315-D American Bldg., Cincinnati 2, Ohio
Send me post paid the new super Champ Hand Tool. I am enclosing \$3.95. (Ohio residents add 12c sales tax.)

check money order

NAME

ADDRESS

CITY.....ZONE.....STATE.....



Leo Kerber, Shakopee, Minn. "Awhile ago I tried for one of these scholarships. I didn't think my sketch could win, but it did! I've learned a lot from the art course—and have already sold quite a bit of my work."



DRAW THIS GIRL'S HEAD

5 inches high. Use pencil only. All drawings must be received by Jan. 31, 1956. None returned. Winner notified. Amateurs only. Our students not eligible.

DRAW ME!

TRY FOR A FREE 2-YEAR
ART SCHOLARSHIP WORTH \$335⁰⁰

Prize: Two years of free training for career in advertising art or illustrating—plus a series of art textbooks and a professional drawing outfit! Scholarship is offered by a famous homestudy art school—world's largest. Many of its graduates are earning real money, today, in the art field.

You're trained by professional artists. You get individual coaching, guidance. Mail your drawing today!

ART INSTRUCTION, INC.
STUDIO 12135—500 S. 4th Street
Minneapolis 15, Minnesota

Please enter my attached drawing in your January contest.

—(PLEASE PRINT)—

Name.....AGE.....

Address.....City.....

Zone.....County.....State.....

Occupation.....Phone.....

12135



**YOU
can
acquire**

**LAW NIGHTS AT HOME!
L. L. B. DEGREE**

LaSalle's famous Law Library—used as reference in many Law libraries and Law offices—has enabled thousands to master Law surprisingly fast, in spare hours at home, for business and professional advancement.

These 14 remarkable volumes, compiled by leading professors and lawyers, cover the whole basic field of Law in condensed, orderly, simplified manner.

You advance rapidly with this great library, plus special lectures furnished. We guide you step-by-step with personalized Problem Method of instruction . . . you learn by doing—handling legal problems—not by memorizing rules.

Send for two FREE 48-page booklets, "Law Training for Leadership," and "Evidence," answering questions about Law and its value to you, and telling how LaSalle Law graduates are winning rapid advancement in business and public life. Mail coupon below. No obligation.

**LA SALLE EXTENSION UNIVERSITY
A Correspondence Institution**

417 S. Dearborn St. Dept. 1264L Chicago 5, ILL.

Send me your two FREE booklets described above, without obligation.

Name.....Age.....

Street.....

City, Zone & State.....

ENGINEERING

**DEGREE IN
27 MONTHS**

**Big Demand
for Graduates**

Aeronautical, Chemical, Civil, Electrical, Mechanical and Electronic Engineering (inc. Radio and TV)

Hundreds of young men are earning B. S. ENGINEERING DEGREES annually in this recognized institution — year around operation. New terms start quarterly. Many students earn a major part of their college expenses in this large industrial center.

Low tuition. Competent instruction. Thorough, intense practical program. Modern, well-equipped laboratories including new physics laboratory and modern wind tunnel. Individualized instruction emphasized.

Government approved for O.I.'s. Engineering preparatory courses. Students from 48 states and 21 foreign countries. Enter December, March, June and September. Send coupon for free catalog and full information. Enroll now.

INDIANA TECHNICAL COLLEGE

5125 E. Washington Boulevard, Fort Wayne 2, Indiana

Please send me free information on B.S. Engineering Degree in 27 months as checked.

- Aeronautical, Chemical, Civil, Electrical,
- Mechanical, Electronics

Name.....

Address.....

we're sorry...

that we have not had the production to supply all the demand for Life-Time 50,000 Mile Spark Plugs. New equipment and greatly accelerated production enable us now to make immediate delivery. If you have ordered and your check has been returned, please place your order again. Life-Time Spark Plug Sets may be ordered from this advertisement. We will postpay at regular retail price. Specify make, model and year of car. Set of 6, \$7.14; set of 8, \$9.52.

DISTRIBUTORSHIPS

Some additional distributorships are now available. If you have already written us regarding your area, please contact us again. If you have not written before, please send us an outline of your previous business experience and qualifications.

CONTINENTAL MANUFACTURING CORP.

Washington Blvd. at Motor Ave.

Culver City 115, California



**FREE CATALOG
of TV KITS**

LEARN TV the practical way--

Assemble a TRANSVISION TV KIT in easy stages. Pay as you wire—only \$15 for Starting Package #1. Learn while building a superb 17" to 27" screen TV Set with latest features. Ideal for Fringe Areas, adaptable to UHF. Easy — no instruments or technical knowledge required. Free Catalog describes 8 great TRANSVISION TV KITS.

Write today to Educational Dept. at—

TRANSVISION, INC., Dept. PM, NEW ROCHELLE, N. Y.



LEARN METALCRAFT

and JEWELRY MAKING

Low Cost Home Training Now Available

Make money. Learn profitable skills and arts of decorative metal and jewelry crafts. Course is complete. Professionally prepared. Easy to master. Special tools and materials furnished.

Write for
Free Booklet

INTERSTATE TRAINING SERVICE

DEPT. K-3 PORTLAND 13, OREGON

YES! SEND

**directly
to my door
every month**

I am enclosing
 \$3.50 for 1 year
 \$8.00 for 3 years

name.....

address.....

city..... zone..... state.....
A-125

Hand this order to your newsdealer or send it to
POPULAR MECHANICS
 200 East Ontario St. Chicago 11, Ill.

Make up to \$18⁰⁰ PER HOUR!



with this NEW

PLASTIC SANDWICH MACHINE!

Amazing earnings are possible with this remarkable PLASTIC SANDWICH MACHINE.

Make PLASTIC SANDWICHES that cost you less than 10c each, take only 2 to 3 minutes of your time, yet sell for 50c to \$1.00 each! That's 600% to 1200% PROFIT!

"Plastic Sandwiches" are thin sheets of plastic fused (laminated) around social security cards, photographs, driver's licences, letters, membership cards, etc. Anything you want to save permanently.

We want to introduce our Plastic Sandwich Machines from coast to coast as quickly as possible. We supply the finest quality, quicker, surer working plastic sheets at rock bottom prices.

Send today for FREE sample and illustrated literature about Plastic Sandwich Machines from \$35.00 up.

PLASTIC SANDWICH MACHINE CO.

6612 N. Clark St., Dept. LM-401
Chicago 26.

**FREE
SAMPLE
SENT**

PLASTIC SANDWICH MACHINE CO., Dept. LM-401
6612 N. Clark St., Chicago 26.

Please send me FREE sample and illustrated literature. No obligation.

Name _____ Age _____

Address _____

City _____ Zone _____ State _____

earn as TAX EXPERT

**\$15
HOUR**

Our students earn as much as \$3,000 in 3 short months preparing income tax returns in spare time. Also operate lucrative year-round Business Tax Service. Dignified home-office business. Experience unnecessary. We train you; help you start. State approved home training program. Write today for free prospectus.

UNION INSTITUTE, 68 Hudson, Hoboken 20E, N. J.

SAY YOU SAW IT IN
POPULAR MECHANICS

NEW BENJAMIN SUPER CO₂ GAS CARBINE - \$16.50

HI-LO (2 Stage) Jet Power
Cal. .177 or .22

RIFLED
Shoots
Pellets
& Darts



IDEAL FOR

TARGET & SMALL GAME

SAFE - ECONOMICAL - ACCURATE

CONVENIENT - PRACTICAL - NON TOXIC

EASY TO OPERATE - NO PUMPING - NO FLINCHING.

Get 40 SHOTS from each 10r STANDARD SIZE CO₂

(Soda) CARTRIDGE. Up to 1/4" penetration.

Ask your DEALER for DEMONSTRATION.

BENJAMIN AIR RIFLE CO.

896 MARION ST., ST. LOUIS 4, MO., U.S.A.

**FREE
Folder**

LEARN MEAT CUTTING AT NATIONAL

Pay After Graduation



The steady dependable trade of Meat Cutting taught easily in 8 short weeks. YOU LEARN BY DOING under actual meat market conditions in big modern school at Toledo.

For beginners or men with experience. Get a profitable store of your own. Remember, PEOPLE MUST EAT! Big pay jobs. Free employment help. Thousands of successful graduates.

Buying, cutting, percentage, pricing, advertising, selling, etc. A complete retail meat education. National School established over 30 years. Get National training NOW. Pay your tuition in easy weekly payments

after you graduate. Send coupon for FREE 52 page school catalog - TODAY. G.I. approved.

National School of Meat Cutting, Inc., Dept. 50-Y, Toledo 4, Ohio

Send me your FREE school catalog on National Training at Toledo in Meat Cutting, Meat Merchandising and Self Service Meats. No obligation. No salesman will call.

Name _____ Age _____

Address _____

City _____ State _____

Approved for training Korean Veterans

1 I SHOW YOU HOW TO
MAKE MONEY AT ONCE
 2 START YOUR OWN BUSINESS
 IN 2 WEEKS— AT HOME IN SPARE TIME



PLATE BABY SHOES IN REAL BRONZE & COLORED PEARL

IF YOU ACT NOW, I will show you how to start earning extra money immediately—in spare time or full time. I WILL SHOW YOU HOW to start your own profitable business with my complete course and easy-to-understand illustrated instructions. Contains trade secrets of ALL processes and all my TESTED and PROVED METHODS of operating a successful business. Absolutely NO PREVIOUS EXPERIENCE needed. Send coupon today for FREE details of my MONEY MAKING PLAN for you and be convinced.

KIKTAVI CO., DEPT. PM-5512
 11029 S. Vermont, Los Angeles 44

FREE!
 MONEY MAKING PLAN
 Full Details Without Obligation
 MAIL COUPON TODAY!

KIKTAVI CO., Dept. PM-5512
 11029 S. Vermont, Los Angeles 44, Calif.
 Send me FREE details of your MONEY MAKING PLAN, without obligation.

NAME _____
 STREET _____
 CITY _____ ZONE _____ STATE _____

FREE 1956 CATALOG

WORLD RADIO LABORATORIES
 "The World's Largest Distributor of Amateur Radio Equipment"

Jam packed with bargains — everything in Radio, TV, and Hi Fi — for Handyman, Ham, Experimenter or Serviceman!

- Pay Only 10% Down
- Easy Terms
- Liberal Trade-Ins
- Save Over 50% on Recond. Equipment
- Over 800 Guaranteed Reconditioned Items



WORLD RADIO LABORATORIES
 3415 W. Broadway — Council Bluffs, Iowa
 Leo I. Meyerson PERSONALIZED SERVICE

MAIL HANDY COUPON

WORLD RADIO LABORATORIES, INC. PM-12
 3415 W. Broadway — Council Bluffs, Iowa

Free 1956 Catalog Recond. Eq't. List
 3'x4' U. S. Radio Map 25c

NAME _____
 ADDRESS _____
 CITY _____ STATE _____

OUR GUARANTEE GIVES FULL REPLACEMENT PROTECTION. ONLY LOWER QUALITY TIRES NEED HEAVY GUARANTEES WITH PROMISES & CONDITIONS.

22 YEARS AT THIS ADDRESS AN ESTABLISHED POLICY OF CAREFUL SELECTION ASSURES YOU, MANY HAPPY MILES. BE WISE — TRY ONE — YOU'LL BUY MORE! WE WELCOME COMPETITION. NO ONE CAN TOUCH OUR QUALITY & PRICE! White Walls \$1.00 Ex. 50 Years of Combined family experience in High Quality tires.

PARTIALLY USED TIRES — AND OTHERS

FREE If you buy 2 or more Passenger 4-ply tires, WE GIVE ONE tire FREE, on each order, on request. Does not include W.W. or Truck Tires. Free Tube with Mail Order.

Specialists in Truck Tires—Selected for Toughest Jobs—Tops in Value

36 SIZES. WRITTEN GUARANTEE WITH EVERY TIRE		36 SIZES. WRITTEN GUARANTEE WITH EVERY TIRE	
600-16	\$5.52	475-16	\$4.82
600-16 (0)	5.92	640-15	4.22
650-16	5.72	670-15	5.52
650-16 (0)	6.02	710-15	5.82
700-16	6.02	760-15	5.82
750-16 (0)	7.52	800-15	5.92
550-18	4.82	820-15	5.92
550-17	3.72	670-16	5.32
650-18	5.52	760-16	7.02
700-15	4.92	700-16 (0)	7.32
700-15 (0)	5.72	750-15 (0)	5.72
700-20	5.92	750-20 (0)	5.92
750-20 (0)	6.72	825-20	10.32
800-20	12.02	900-20	17.92
1000-20	17.92	1100-20	19.92
1200-20	23.02	1300-20	25.02
1400-20	28.02	1500-20	30.02
1600-20	33.02	1700-20	35.02
1800-20	38.02	1900-20	40.02
2000-20	43.02	2100-20	45.02
2200-20	48.02	2300-20	50.02
2400-20	53.02	2500-20	55.02
2600-20	58.02	2700-20	60.02
2800-20	63.02	2900-20	65.02
3000-20	68.02	3100-20	70.02
3200-20	73.02	3300-20	75.02
3400-20	78.02	3500-20	80.02
3600-20	83.02	3700-20	85.02
3800-20	88.02	3900-20	90.02
4000-20	93.02	4100-20	95.02
4200-20	98.02	4300-20	100.02
4400-20	103.02	4500-20	105.02
4600-20	108.02	4700-20	110.02
4800-20	113.02	4900-20	115.02
5000-20	118.02	5100-20	120.02
5200-20	123.02	5300-20	125.02
5400-20	128.02	5500-20	130.02
5600-20	133.02	5700-20	135.02
5800-20	138.02	5900-20	140.02
6000-20	143.02	6100-20	145.02
6200-20	148.02	6300-20	150.02
6400-20	153.02	6500-20	155.02
6600-20	158.02	6700-20	160.02
6800-20	163.02	6900-20	165.02
7000-20	168.02	7100-20	170.02
7200-20	173.02	7300-20	175.02
7400-20	178.02	7500-20	180.02
7600-20	183.02	7700-20	185.02
7800-20	188.02	7900-20	190.02
8000-20	193.02	8100-20	195.02
8200-20	198.02	8300-20	200.02
8400-20	203.02	8500-20	205.02
8600-20	208.02	8700-20	210.02
8800-20	213.02	8900-20	215.02
9000-20	218.02	9100-20	220.02
9200-20	223.02	9300-20	225.02
9400-20	228.02	9500-20	230.02
9600-20	233.02	9700-20	235.02
9800-20	238.02	9900-20	240.02
10000-20	243.02		

"EXTRA SPECIAL" SOME NEAR NEW all size 4-ply pass. FREE TIRE with 2 or more of these also.—W.W. \$1.00 Extra Factory Tested Tube given—GIANT TIRE SALE. \$7.62 EA.

SNOW TIRES \$7.72 ORDER ANY 4 PLY PASSENGER SIZE BLACK WALL

FACTORY RETREAD SNOW TIRES AND OTHERS 28 MO. GUAR.

Thousands of tires shipped all over the U.S.A. All tires shipped F.O.B. Phila. Send Check or M.O. with this ad. Dept. 2, No C.O.D. STANDARD 834 N. Broad St., Philadelphia 30, Pa.

EARN WHILE YOU LEARN

UPHOLSTERY BE YOUR OWN BOSS

Practical low-cost LEARN-BY-DOING Course, complete with tools, materials, frames, trains you quickly AT HOME in spare time. Start making money in Upholstery almost at once! Big FREE illustrated book and free sample lesson shows you how—gives full facts about business, job opportunities for men and women. Write TODAY! Also Resident Training. G.I. Approved.

UPHOLSTERY TRADES SCHOOL
 Dept. DX-309 721 Broadway, New York 3.

Write Like This

YOUR penmanship can be improved in 3 hours or corrected to your satisfaction in 10 hours' practice with my DEFINITE HAND CONTROLS. New way!

WRITE OZMENT BOX 665 34-P, ST. LOUIS, MISSOURI

Complete OUTLINE FREE!

Print Your Own

Cards, Stationery, Advertising, labels, circulars, photo and movie titles, church work, tags, etc. Save money. Sold direct from factory only. Raised printing like engraving, too. Print for Others, Good Profit. Have a home print shop. Easy rules supplied. Pays for itself in a short time. Write for free catalog of outfits and all details.

KELSEY PRESSES
 KELSEY PRESSES, N-37 MERIDEN, CONN.

ARRO-PING

Guided-flight accuracy—bullet-like power for target and small game! Quiet—fun in rumpus room or patio, on porches, in areas closed to firearms! Safe to carry in car. Economical—use arrows over and over!

Improved model \$1.25 postpaid with 5 arrows. Extra arrows, 10 for 75c 20 for \$1.25 post.

ARRO-PING CO.
 P.O. Box 779-H, Colorado Springs 12, Colo.

Say You Saw It in Popular Mechanics

RUPTURED

BE FREE FROM TRUSS SLAVERY

NOW there is a new modern Non-Surgical treatment that permanently corrects rupture. These Non-Surgical treatments are so certain, that a Lifetime Certificate of Assurance is given. Write today for our New FREE Book that gives facts that may save you painful and expensive surgery, and tells how non-surgically you may again work, live, play and love and enjoy life in the manner you desire. There is no obligation. Excelsior Hernia Clinic Dept. 8305 Excelsior Springs, Mo.

Tired of the same old job?

Sure you are. Anybody gets tired of standing still. But don't get the idea that just quitting your present job and going somewhere else will get you out of the rut.

The trouble may be inside yourself. You're burning up energy *worrying* about getting ahead instead of actually getting ahead. You want to make more money, be respected. All right, you *can!*

Look around you. The men who are getting ahead are *trained* men. They've learned special skills that bring higher pay. The men *without* training stick in the same old job.

What are you going to do?

Ask yourself one question—Do I really want to succeed? If the answer is yes, you can succeed. All you need is training. And you can get that *at home*, in your spare time, for pennies a day.

International Correspondence Schools offer you a course in practically any field you choose, giving you the practical side *plus* the bed-rock facts and theory. Earn while you learn.



Machine operator to shop foreman

And success can come in just a few months. Here's what one student reports: "When I enrolled for my I.C.S. course in Carpentry and Millwork, I was a machine operator. Today, eleven months later, I am a shop foreman. As a consequence, my salary has been increased 73.3%."

I.C.S. has the course for you

There are a total of 277 I. C. S. courses. The lessons are modern,

simple, easy to understand. Each course takes you further up the road of knowledge to success.

The most important step in your life

Pick out the field of study that interests you most. That's the one with the greatest future for you—whether it's in your present field or not. Then mark and mail the coupon and find out what I. C. S. can do for you. It costs one stamp. *But it can be the most important step in your life.*

3 FREE BOOKS Pocket-size career guide, "How to Succeed." Also catalog outlining opportunities in field that interests you. Free sample lesson (Math).

I. C. S., Scranton 9, Penna.

INTERNATIONAL CORRESPONDENCE SCHOOLS



BOX 48299M, SCRANTON 9, PENNA.

Without cost or obligation, send me "HOW TO SUCCEED" and the opportunity booklet about the field BEFORE which I have marked X (plus sample lesson):

- | | | | | |
|--|---|--|---|---|
| <p>ARCHITECTURE and BUILDING CONSTRUCTION</p> <ul style="list-style-type: none"> <input type="checkbox"/> Air Conditioning—Refrig. <input type="checkbox"/> Architecture <input type="checkbox"/> Architectural Interior <input type="checkbox"/> Building Contractor <input type="checkbox"/> Building Maintenance <input type="checkbox"/> Carpenter and Mill Work <input type="checkbox"/> Estimating <input type="checkbox"/> Heating <input type="checkbox"/> Painting Contractor <input type="checkbox"/> Plumbing <input type="checkbox"/> Reading Arch. Blueprints <p>ART</p> <ul style="list-style-type: none"> <input type="checkbox"/> Cartooning <input type="checkbox"/> Commercial Art <input type="checkbox"/> Fashion Illustrating <input type="checkbox"/> Magazine Illustrating <input type="checkbox"/> Show Card and Sign Lettering <input type="checkbox"/> Sketching and Painting <p>AUTOMOTIVE</p> <ul style="list-style-type: none"> <input type="checkbox"/> Auto Body Rebuilding <input type="checkbox"/> Auto Elec. Technician <input type="checkbox"/> Auto-Engine Tune Up <input type="checkbox"/> Automobile | <p>AVIATION</p> <ul style="list-style-type: none"> <input type="checkbox"/> Aeronautical Engineering Jr. <input type="checkbox"/> Aircraft & Engine Mechanic <p>BUSINESS</p> <ul style="list-style-type: none"> <input type="checkbox"/> Advertising <input type="checkbox"/> Bookkeeping and Accounting <input type="checkbox"/> Business Administration <input type="checkbox"/> Business Correspondence <input type="checkbox"/> Public Accounting <input type="checkbox"/> Creative Salesmanship <input type="checkbox"/> Federal Tax <input type="checkbox"/> Letter-writing Improvement <input type="checkbox"/> Office Management <input type="checkbox"/> Professional Secretary <input type="checkbox"/> Retail Business Management <input type="checkbox"/> Sales Management <input type="checkbox"/> Stenographic-Secretarial <input type="checkbox"/> Traffic Management <p>CHEMISTRY</p> <ul style="list-style-type: none"> <input type="checkbox"/> Analytical Chemistry <input type="checkbox"/> Chemical Engineering <input type="checkbox"/> Chem. Lab. Technician <input type="checkbox"/> General Chemistry <input type="checkbox"/> Natural Gas Prod. & Trans. <input type="checkbox"/> Petroleum Engineering <input type="checkbox"/> Plastics <input type="checkbox"/> Pulp and Paper Making | <p>CIVIL, STRUCTURAL ENGINEERING</p> <ul style="list-style-type: none"> <input type="checkbox"/> Civil Engineering <input type="checkbox"/> Construction Engineering <input type="checkbox"/> Highway Engineering <input type="checkbox"/> Reading Struct. Blueprints <input type="checkbox"/> Sanitary Engineering <input type="checkbox"/> Structural Engineering <input type="checkbox"/> Surveying and Mapping <p>DRAFTING</p> <ul style="list-style-type: none"> <input type="checkbox"/> Aircraft Drafting <input type="checkbox"/> Architectural Drafting <input type="checkbox"/> Electrical Drafting <input type="checkbox"/> Mechanical Drafting <input type="checkbox"/> Mine Surveying and Mapping <input type="checkbox"/> Plumbing Drawing and Estimating <input type="checkbox"/> Structural Drafting <p>ELECTRICAL</p> <ul style="list-style-type: none"> <input type="checkbox"/> Electrical Engineering <input type="checkbox"/> Electrical Maintenance <input type="checkbox"/> Electrician <input type="checkbox"/> Contracting <input type="checkbox"/> Lineman <p>HIGH SCHOOL</p> <ul style="list-style-type: none"> <input type="checkbox"/> Commercial <input type="checkbox"/> Good English <input type="checkbox"/> High School Subjects <input type="checkbox"/> Mathematics | <p>LEADERSHIP</p> <ul style="list-style-type: none"> <input type="checkbox"/> Foremanship <input type="checkbox"/> Industrial Supervision <input type="checkbox"/> Leadership and Organization <input type="checkbox"/> Personnel-Labor Relations <p>MECHANICAL AND SHOP</p> <ul style="list-style-type: none"> <input type="checkbox"/> Gas—Electric Welding <input type="checkbox"/> Heat Treatment <input type="checkbox"/> Metallurgy <input type="checkbox"/> Industrial Engineering <input type="checkbox"/> Industrial Instrumentation <input type="checkbox"/> Industrial Supervision <input type="checkbox"/> Internal Combustion Engines <input type="checkbox"/> Machine Design-Drafting <input type="checkbox"/> Machine Shop Inspection <input type="checkbox"/> Machine Shop Practice <input type="checkbox"/> Mechanical Engineering <input type="checkbox"/> Quality Control <input type="checkbox"/> Reading Shop Blueprints <input type="checkbox"/> Refrigeration <input type="checkbox"/> Sheet Metal Worker <input type="checkbox"/> Tool Design <input type="checkbox"/> Toolmaking <p>RADIO, TELEVISION</p> <ul style="list-style-type: none"> <input type="checkbox"/> Industrial Electronics <input type="checkbox"/> Practical Radio TV Eng'ng <input type="checkbox"/> Radio and TV Servicing <input type="checkbox"/> Radio Operating | <ul style="list-style-type: none"> <input type="checkbox"/> Television Technician <p>RAILROAD</p> <ul style="list-style-type: none"> <input type="checkbox"/> Air Brakes <input type="checkbox"/> Car Inspector <input type="checkbox"/> Diesel Locomotive <input type="checkbox"/> Locomotive Engineer <input type="checkbox"/> Section Foreman <p>STEAM AND DIESEL POWER</p> <ul style="list-style-type: none"> <input type="checkbox"/> Combustion Engineering <input type="checkbox"/> Diesel—Elec. <input type="checkbox"/> Diesel Eng's <input type="checkbox"/> Electric Light and Power <input type="checkbox"/> Stationary Fireman <input type="checkbox"/> Stationary Steam Engineering <p>TEXTILE</p> <ul style="list-style-type: none"> <input type="checkbox"/> Carding and Spinning <input type="checkbox"/> Cotton, Rayon, Woolen Mfg. <input type="checkbox"/> Finishing and Dyeing <input type="checkbox"/> Loom Fix't'g <input type="checkbox"/> Textile Des'ing <input type="checkbox"/> Textile Eng'ng <input type="checkbox"/> Throwing <input type="checkbox"/> Warping and Weaving <p>MISCELLANEOUS</p> <ul style="list-style-type: none"> <input type="checkbox"/> Domestic Refrigeration <input type="checkbox"/> Marine Engineering <input type="checkbox"/> Ocean Navigation <input type="checkbox"/> Professional Engineering <input type="checkbox"/> Short Story Writing <input type="checkbox"/> Telephony |
|--|---|--|---|---|

Name _____ Age _____ Home Address _____
 City _____ Zone _____ State _____ Working Hours _____ A.M. to P.M. _____
 Occupation _____

Canadian residents send coupon to International Correspondence Schools, Canadian, Ltd., Montreal, Canada. . . . Special tuition rates to members of the U. S. Armed Forces.

So Easy to Install Yourself!

GENUINE

CONTINENTAL KITS

at HALF of car dealer prices!



Complete Quality Kits Direct from California...

Here's authentic continental styling for your car—at lowest prices ever! Genuine, quality kits like these are selling elsewhere for twice as much—and more. Not "falsies"...all parts included: splash pan, bumper extension brackets, all-metal tire cover, tire carrier assembly—everything but the emblem. Prime coated.

SPECIFY choice of solid drum or open face plate—also make, year, model, tire size and if tubeless.

FORD 49-56	\$48.50	MERC. 1955-56	\$56.50
CHEV. 53-55		BUICK 1955	
PLY. 1955		PONT. 53-55 OLDS. 54-55	

CHROME TIRE RING, \$10 EXTRA.

UNCONDITIONALLY GUARANTEED to be exactly as advertised.

Order Now—Direct From

25% deposit required.
FOB Los Angeles.
Postage COD.
Calif. residents add
3% sales tax.



I'll Send You This Handsome SAMPLE CASE—FREE!



Make up to **\$30⁰⁰** in a Day!

Your Own Tailored Suits Without 1¢ Cost

If you want to make more money, spare time or full time, rush the coupon below today for this big, valuable tailoring Sample Case packed with 150 beautiful, big-value suit and overcoat samples. Just show the samples and last-minute styles to friends, fellow-workers, others. Take their orders for fine made-to-measure clothes—and pocket **BIG CASH PROFITS** in advance. No experience, no tailoring knowledge needed—and no money needed, ever. **WE SUPPLY EVERYTHING FREE**... sample case, sample suitings, equipment, complete instructions. Start making money first day!

Use Spare Evenings... Weekends... Make Money... Get Suits!

It's easy to make money taking orders in just spare time—lunch-time, evenings, weekends. When men see the fine fit, quality and value of our suits—**THEY ORDER!** So we make it easy for you to get your own personal suits and overcoats without paying even one penny. Don't wait! Rush coupon with your name, address, and age for **FREE** Sample Case.

STONE-FIELD CORP., Dept. K-816
532 SOUTH THROOP STREET, CHICAGO 7, ILLINOIS

STONE-FIELD CORP., Dept. K-816
532 S. Throop St., Chicago 7, Ill.

Please rush **ABSOLUTELY FREE** the valuable Sample Case with suit fabrics and style display. Include instructions, money-making plans and details for getting my own suits without paying one cent.

Name.....Age.....
Address.....
City.....State.....

How to Turn JUNK into GOLD

Learn at home in one evening



No selling. Pay friends and neighbors good prices for old rings, watches, chains and bridges. U. S. Gov't pays you \$35 an ounce for the gold this junk contains.

THERE'S gold to be picked up on any street in any town any day of the year if you know my secrets. I teach you how to find it, how to buy it, what to pay for it, how to test and how to ship to Uncle Sam for cash. I supply you with testing outfit and weighing scale. Takes only one evening to learn at home. Next day you are ready to fill your pockets with gold at junk prices. I'll teach you the secrets by which I made \$20,000 a year. No charge for facts. Send name on postcard—no money. **Leslie Patton, 335 W. Madison Street, Dept. 912, Chicago 6, Illinois.**



WORLD'S LOWEST PRICED ADDING MACHINE

Best Pocket Size FREE TRIAL **\$2.95**
TOTAL COST SEND NO MONEY
only \$2.95 plus postage. (Send full cash if outside U.S.) Beautiful rich-looking Leatherette Case included at no extra cost. Money back in 10 days if not delighted. AGENTS WANTED.

CALCULATOR MACHINE CO., (Mfgs.)
Box 84 Dept. D-55 Glenview, Illinois

LEARN PLASTICS



COMPLETE LOW COST SHOP METHOD HOME TRAINING NOW AVAILABLE

Get in on Big Money opportunities in Plastic molding, casting, forming, carving, etc. Earn as you learn with Interstate's professionally prepared course. All plastic materials furnished.

WRITE FOR FREE BOOKLET

INTERSTATE TRAINING SERVICE
DEPT. C-3, PORTLAND 13, OREGON

WHEELS WHEELS WHEELS

7" Disc Wheel 3/4" Tire 3/4" sleeve	45c ea.
8" Disc Wheel 1 1/4" Tire 1 1/4" sleeve	70c ea.
7" Disc Wheel 1" Tire 1 1/2" ball bearing	80c ea.
8" Disc Wheel 1 1/4" Tire 1 1/2" ball bearing	\$1.00 ea.
6" Disc Wheel 1.50 semi-pneum. Tire 1/2" S.B.	\$1.35 ea.
8" Disc Wheel 2" semi-pneum. T. 1/2" S.B.	\$1.50 ea.
10" Disc Wheel 1.75 semi-pneum. T. 1/2" S.B.	\$1.80 ea.
10" Disc Wheel 2.75 semi-pneum. Tire 3/4" S.B.	\$3.50 ea.
12" Disc Wheel 1.75 semi-pneum. T. 1/2" S.B.	\$1.85 ea.

Above wheel prices includes hub cap. Plus Postage, C.O.D.'s accepted. AXLES—Sizes 5/16 in., 3/8 in., 1/2 in.—Cut to size—End holes drilled.

UNITED WHEEL STAMPING CO.
12131 S. PEORIA STREET PM-12 CHICAGO 43, ILLINOIS

Save Hundreds of Dollars Yearly With Guide to Home Repairs



CARPENTRY

Home Repairs, Modernizing Jobs Made Easy for Home Owners

Beat the high cost of home upkeep. Stop staggering labor costs. Save hundreds of dollars every year on carpentry, electrical, painting, plumbing and other jobs around the house with **POPULAR MECHANICS GUIDE TO HOME REPAIRS**. Simplified how-to-do-it instructions and 646 pictures make all jobs, inside and out, easy. Covers construction, remodeling, modernizing, repairing that you can do yourself at small cost. Repair leaky faucets for pennies; save \$10 to \$15 on new electrical outlets; save hundreds of dollars on new floors, porch repairs, tuck pointing, gutter replacements and other improvements. 192 page cloth bound book only \$2.50 postpaid. Get **GUIDE TO HOME REPAIRS** today under our money back guarantee.



ELECTRICAL WORK



INSULATION



PLUMBING

POPULAR MECHANICS PRESS, Dept. PM1, 200 E. Ontario St., Chicago 11

POPULAR MECHANICS

Copyrighted material

AMAZING NEW **LAWN** MACHINE DOES THE WORK OF TEN MEN!

Establishes and Maintains Thick Green Turf AUTOMATICALLY! Now ANYONE Can Make Big Money Offering COMPLETE Lawn Care at Prices Home Owners Can't Resist. No Gardening Experience Necessary!

THIS IS IT—the ideal one-man business you've always dreamed of! Can be started on just a few hundred dollars capital, yet can repay you a handsome five-figure annual profit. (Or with larger capital you can invest in a number of machines, hire operators, launch a business capable of grossing hundreds of thousands a year.) Requires no high-pressure selling or hard physical labor.

Beginning *this Spring*, you can offer home owners in your area **COMPLETE** lawn service for the entire season—mowing, mulching, fertilizing, weed and crabgrass control, rolling, aerating, etc.—for no more than they now often pay for their lawn supplies alone. Think of it! While the home owner lounges in his deck chair or snoozes in his hammock, a beautiful thick green turf is established and maintained on his lawn **AUTOMATICALLY!**

Services Acre of Lawns Per Man-Hour

The revolutionary new scientific development which makes this possible is **LAWN-SCAPER**, the new miracle machine that does *all ten basic lawn jobs at the same time*. Simply by driving it around the lawn, you can do **EVERYTHING** a beautiful lawn needs—at the almost unbelievable rate of an acre of lawns per hour! Using the very latest scientific principles of lawn feeding and care, the **LAWN-SCAPER** can establish and maintain a velvety green "golf course lawn" with only 5 service calls per year. You can care for more than 300 average-size lawns a year—at an average seasonal profit of \$50 or more per lawn! And you'll have your winter months free

to work at another job . . . or to vacation in Florida!

No special lawn or garden experience needed. No "high pressure selling." Many home owners today spend much more than your complete service costs on lawn materials alone—and *still* don't get good results. A \$23.96 "Front Lawn Special," your full price for all-season care (5 service calls), will bring you more eager customers than you can handle.

A \$500 down payment puts you in business. Profits from first year of operation can pay entire cost of machine and supplies ten times over.

Rush Coupon for Details

But it's important to act **NOW** if you want to "get in on the ground floor" of this multi-million dollar boom. This is the kind of opportunity that occurs only once or twice in a decade. So rush coupon now for full details or to get the information even faster, wire Joseph Coopersmith, President, at address below.

FULLY PATENTED—no other machine in America like it.



- A** **MOWS.** Fan-like suction of whirling blades, shielded from driver, lifts low-lying grasses for cutting.
- B** **MULCHES.** Any larger particles of grass and leaves are re-cut into fine mixture. Makes valuable plant food.
- C** **RE-SEEDS.** One of machine's 4 drums can carry enough seed to re-seed 50,000 square feet of lawn.
- D** **FERTILIZES.** Another drum is filled with tiny free-flowing pellets of instantly soluble fertilizer. Spreading mechanism assures uniform distribution.

- E** **KILLS WEEDS, CRAB-GRASS.** Drums also dispense latest weed and crabgrass killer. All 4 drums can flow at once.
- F** **CONTROLS GRUBS, MOSQUITOES, INSECTS.** Latest insecticides, mixed in with fertilizer, assure beautiful lawn, no more mosquito bites.
- G** **AERATES.** Spiked roller aerates without lifting turf. Can be raised or lowered as desired.
- H** **ROLLS.** Back roller levels turf, mashes chemical pellets into close contact with moist earth and grass.

**RUSH This Coupon to:
LAWN-SCAPE CORP. OF AMERICA
Dept. 36, 11 West 42nd St., New York 36, N. Y.**

RUSH me complete details on your new **LAWN-SCAPER.**

Name _____
Address _____
City _____ State _____



Try YOUR Voice! Talk! Sing! Play! It's Fun! Over 100 Practical Uses!

Broadcast Thru ANY Radio!

Test & improve your voice, playing, thrill & fool friends. Do acts, surprise programs, imitate Crosby or Hope, announce games & events, be disc jockey, etc. Practice broadcasting, be popular. Educational, over 100 practical uses. Users say: "Not of fun—many other uses too!" "Bargain—does the work of \$50 unit."

- New do YOU Sound?
- Public Address Amplifier
- Intercommunication System
- Jokes, Party Fun, Home Entertainment
- Secret Detectaphone, Overhear Others
- Announce People and Events

Use with 1, 2 or more radios for powerful public address system, music amplifier, etc. Use to overhear private conversations, baby or burglar alarm. Used by show barkers. Talk as you walk! Improve personality! Speak better! Sing & Play better! Learn techniques worth many dollars. Do "fake" broadcasts. "Call all cars!" Used for home, school games, office, shop, etc., etc. Wonderful for announcing games, events, etc. Saves you time & money! Even make money renting it out for games, parties, dinners, speeches.

New Micro-Vox Wireless Microphone

Use It Anywhere! Broadcast to Car & Portable Radios Too!

- No Wiring! No Connections! Do Not Touch Radio—Works Normally

Self-contained 1-tube portable transmitter. Broadcasts to any radio within 75 feet. Even from car to car! High fidelity, professional tone. Adjustable volume. Adjustable frequency transmitter. Walnut plastic housing, 6-in. high. Operates indoors or outdoors. TWO MODELS. Portable, self-contained battery model (with batteries) each \$9.95. (2 for \$18.95). Electric Plug-in Model, operates on standard 110 volt AC-DC house current, each \$12.95 (2 for \$24.95).

Send to: JOHNSON SMITH & CO.

Dept. 293

Detroit 7, Michigan



100X Area Magnifying Projector

— Enlarges Pictures, Printing, & Objects! — Full Color!

NEW! Electric Magna-Vue Optical Instrument projects & enlarges clippings, pictures, sketches, objects in full natural color, correctly & readable. Project on wall, screen or table. **MAGNIFIES 100 AREAS.** Enlarges any material up to 3 1/2 x 4 in. to 32 x 40 in. For home, school, class, business, shop use. Also make signs, sketches easy from any copy. Enamelled steel, 10x7 1/2 in. high. Quality "F" focusing lens. Operates on standard 110 volt current. Money back guarantee. Price Postpaid..... **\$4.98**

JOHNSON SMITH CO., Dept. 293, Detroit 7, Mich.

500 Treasured "Pirate" STAMPS

Get this big, all-different "Treasure Chest" of 500 prized stamps from Pirate strongholds. Total catalog value over \$10. 13 extra special stamps FREE if you act quickly. Approvals. Send only 35c to LITTLETON STAMP CO., Dept. PM-12, Littleton, New Hampshire. **FOR ONLY 35c**

Catalog of 3000 Novelties 10c



Send 10c for amazing catalog of novelties, live animals, scientific supplies, hobbies, funmakers, planes & boats, looms, magic tricks, joke articles, unusual seeds, gadgets, get timesavers, cameras, optical goods, projectors, movies, lucky jewelry, religious novelties, disguises, musical instruments, stamps, coins, puzzles, fortune tellers, radios, auto & bike accessories, telescopes, magnifiers, compasses, banks, smokers' gadgets, artists' supplies, printing sets, eye glasses, motors, shockers, knives, billfolds, guns, rifles, sports, books, games, plants, etc. Send 10c (3 for 25c—get for friends!). **JOHNSON SMITH & CO. Dept. 293 Detroit 7, Michigan**

MEN WANTED

Earn \$100 Per Week and up

AUTO DIESEL MECHANICS

Master a trade with a future—learn Auto-Diesel mechanics in our shops. You learn with tools on real equipment. Earn while you learn. Many of our graduates earn \$100 per week and up. No previous experience necessary. Day and night courses. Approved for veterans. Write for free bulletin.

NASHVILLE AUTO-DIESEL COLLEGE
226 7th Ave., N., Dept. 75 Nashville 3, Tenn.

HOW TO REPAIR Electric Appliances



"This HANDY, Practical" How to Do It" book for Electric & Gas Home Appliance Servicemen, Mechanics & Users covers Principles, Servicing & Repairs. Tells How to Locate Troubles, How to take Appliances Apart, How to Make Repairs, How to Assemble and Connect. Gives up to date testing methods, wiring diagrams and complete data on each appliance.

SAVE TIME, TROUBLE, MONEY WITH AUDELS BIG 800 PAGE HOME APPLIANCE SERVICE GUIDE

- Toasters—Pressing Irons—Waffle Bakers—Casseroles—Roasters—Broilers—Coffee Makers—Space Heaters—Water Heaters—Ranges—Home Wiring—Shop Work—Appliance Testing—Fundamental Electricity—Fractional H.P. Motors—Food Mixers—Fans & Blowers—Vacuum Cleaners—Washing Machines—Clothes Dryers—Ironers—Dishwashers—Garbage Disposers—Refrigeration—Window Air Conditioners—Oil Burners—Drainage Pumps—Gas Ranges, Furnaces & Water Heaters—Bottled Gas Appliances.

A SHOP COMPANION THAT ANSWERS YOUR QUESTIONS. Easy to read and understand—over 800 pages fully illustrated—with 500 photos and diagrams—1001 Facts. A ready reference.

\$4 COMPLETE • PAY \$1 A MONTH TO GET THIS SERVICE INFORMATION FOR YOURSELF—FILL IN AND MAIL 7 DAY TRIAL COUPON TODAY.

AUDEL, Publishers, 49 W. 23rd St., New York 10, N. Y. Mail AUDELS HOME APPLIANCE SERVICE GUIDE (\$4) for free examination. If O.K. I will send you \$1 in 7 days; then remit \$1 monthly until \$4 is paid. Otherwise, I will return book promptly.

Name _____
Address _____
Occupation _____
Employed by _____

SEND ME

every month so I am sure to see each new issue. Here's

\$3.50 for 1 year
 \$8.00 for 3 years

name _____
address _____
city _____ zone _____ state _____ B-125

Hand this order to your newsdealer or send it to

POPULAR MECHANICS
200 East Ontario St. Chicago 11, Ill.

THE MASONIC CASUALTY COMPANY

OFFERS

ACCIDENT — HEALTH — HOSPITALIZATION INSURANCE AT COST

- Non Cancellable
- Benefits Not Prorated
- No Medical Examination
- No Paid Agents
- Coverage On or Off the Job

FIRST 3 MONTHS PROTECTION FOR MEMBERSHIP FEE \$2.00
FOR MASONS ONLY under 56 yrs. of age
WRITE AT ONCE

THE MASONIC CASUALTY COMPANY
80 BOYLSTON STREET, Dept. P. BOSTON 16, MASS.
NO AGENT WILL CALL

The WATCH FOR ACTIVE MEN

17 JEWELS WATERPROOF

Anti-Magnetic

Here's one of the greatest watch values ever offered. Rugged and good looking, this 17 Jewel precision timepiece is shock-proof and rust-proof, and has sweep-second hand, radium dial, unbreakable main spring. Smart steel expansion band with luxurious lizard insert. Complete with handsomely lined leatherette case. Guaranteed for one year.

Send check or M.O. Money back in 10 days if not thoroughly delighted.

BELDNER WATCH CO. Dept. P. 1568 E. 7th St., Brooklyn 30, N.Y.



Reg. \$49 Value
\$19.95 incl. Fed. Tax

Become a Doctor of PSYCHOLOGY

Win the degree of Ps.D. Learn the secret of contentment, happiness. Solve mental worries. Experience the revelation of truth. Correspondence only. Individual help. Write for FREE book. **COLLEGE OF UNIVERSAL TRUTH, 5038-B Broadway, Chicago.**

\$2.95 OR 2 FOR \$5.00!

Genuine Telephone Company Upright Telephones, tested and guaranteed with 50 ft. of wire and inter-communication instructions. Complete line of telephones, dial, magnets, etc. Write for free list. All shipments F.O.B. Simpson, Pa.

TELEPHONE ENGINEERING CO. Dept. 1285 Simpson, Pa.

ELECTROPLATE IT YOURSELF!

NOW using NEW plating kit, it's easy to electroplate any object with the same LUSTER and DURABILITY as done by the most expensive equip. Complete kit and instructions on plating metal and non-metal objects, with Nickel, Chrome, Copper, Gold, etc. ONLY \$2.95. SEND NO MONEY—everything sent C.O.D. plus postage.

OR send \$5.00 now and receive it postpaid. Money back in 7 days if not satisfied.

M. Z. SALES CO., Dept. G-3, 115 W. 42nd St., New York 36, N. Y.



WAR SURPLUS BARGAINS

\$500,000.00 INVENTORY FOR QUICK LIQUIDATION

Surplus items—hundreds of tons for home, shop, factory, farm and outdoor use. New items, used items, reconditioned items—all at tremendous savings—all priced for quick sale.

Page After Page of Values

This big catalog shows page after page of amazing money saving values. Write for your copy today. Send 10c to cover postage, mailing, etc. Write today! SEND TODAY FOR YOUR COPY

10c

STARK'S 212 W. Madison St. Dept. PM-12 CHICAGO 6, ILL.

I WILL TRAIN YOU FOR RADIO-TELEVISION

ON MY EXCLUSIVE NO-OBLIGATION NO-RISK TRAINING PLAN



Frank L. Sprayberry, President

Let me prove to you . . . without cost or obligation . . . that I can prepare you to be a Radio-Television Serviceman in 10 Months or Less

Let the true facts speak for themselves! That's why I want you to have my big new catalog and an actual sample lesson of Sprayberry Training . . . both FREE! Read, then make up your own mind! Train on my exclusive NO OBLIGATION PLAN . . . which means you DO NOT sign any kind of time payment contract. You pay for and accept your training as fast or as slowly as you wish. Prepare now for big paying jobs in Radio-TV or your own business. I will help you earn while you learn . . . in spare hours at home.



Get Practical Experience with 25 Kits of Radio-TV Parts

Practical experience counts most. In addition to modern lessons, you train with actual parts and equipment. Build the famous Sprayberry Training Television Set, Multi-Range Tester, 2-Band Radio, other Test Equipment—all yours to keep. Get latest training

on Color TV, Transistors, Hi-Fi and UHF Conversions . . . included to make your training more valuable.

You owe it to yourself to get all the facts . . . Mail coupon for catalog and sample lesson—FREE

See for yourself . . . in actual pictures and descriptions . . . why Sprayberry Radio-Television Training offers more. Backed by almost 25 years of training experience. Three training plans to suit your exact needs. Rush coupon today for big new catalog and sample lesson. No obligation; no salesman will call.

TWO BIG FREE BOOKS

SPRAYBERRY ACADEMY OF RADIO

Dept. 10-F, 111 N. Canal St., Chicago 6, Ill.

Mail Coupon Today!

NEW TO MANY MEN IN Radio Television TRAINING PLAN

SPRAYBERRY ACADEMY OF RADIO Dept. 10 F, 111 N. Canal St., Chicago 6, Ill. Sample Lesson

Mail for FREE Facts and Sample Lesson

Please rush catalog on your ALL-NEW Radio-Television Training Plans. I understand this does not obligate me and that no salesman will call. Include Sample Lesson FREE.

Name _____ Age _____

Address _____

City _____ Zone _____ State _____

THIS TRAINING PAYS OFF FAST!

NO EXPERIENCE NEEDED
This **NEW PRACTICAL**
DELEHANTY PLAN entails
NO RISK, NO OBLIGATION
Money Back Guarantee

EARN EXTRA MONEY in SPARE TIME in a few weeks! And GOOD FULL TIME JOBS of HIGH PAY... or a PROFITABLE BUSINESS of YOUR OWN in matter of months!

Learn **TELEVISION** RADIO & ELECTRONICS
AT HOME We Furnish ALL Your EQUIPMENT without Extra Charge!

YOU GET FULL-SIZE
21" TV SET & TUBE
at No Extra Charge!

YOUR PRACTICAL SHOP WORK STARTS WITH VERY FIRST LESSON FIRST KIT OF TOOLS SENT IMMEDIATELY!

Now you can learn money-making skills right from the start! Soon your training will be paying for itself... and more! Entirely NEW, COMPLETE, UP-TO-THE-MINUTE course includes Color TV, UHF, Printed Circuits, Transistors, etc.

ESTAB. NEARLY 50 YRS. — HALF A MILLION GRADUATES Study at your own pace. Send for each unit as you need it and pay only when you order. All units SAME LOW PRICE! You build and keep 21" TV Set complete with 21" Tube, Super-Het. Radio, Multimeter, etc. We supply attractive loose-leaf binders for your lessons which become valuable permanent reference library. NO EXTRA CHARGES FOR ANYTHING!

YOU DON'T RISK A PENNY — YOU SIGN NO CONTRACT!

Send TODAY for FREE Illustrated Booklet

DELEHANTY INSTITUTE of TELEVISION
APPROVED BY EDUCATION DEPT. OF N. Y. STATE
115 EAST 15th STREET, NEW YORK 3, N. Y.

NAME _____

ADDRESS _____

CITY, ZONE & STATE _____

PM125

WORK MORE AT EASE IN

Anvil Brand



and

Tom Long



Don't you get more joy out of any job when you're dressed in easy comfort?

It's the best of reasons for working in Anvil Brand tough utility clothes and Tom Long durable casual wear.

Here are two brands expressly built for active men, in separate or matching shirts and pants, dungarees, coveralls and hobby styles; tough materials assuring longest wear.

You have a treat coming when you outfit in Anvil or Tom Long. At leading stores.

ANVIL BRAND FACTORIES HIGH POINT, N. C.

POWERFUL — REVERSIBLE ELECTRIC MOTOR

Hundreds of Uses:

- BOATS
- PLANES
- CARS
- CRANES
- CAROUSELS
- CONSTRUCTION SETS
- and many, many more



ALL 3 FOR
MOTOR, GEAR BOX AND POWER-PACK \$2.98

A REAL electric motor — yet it measures only 1 1/2" x 1 1/2" x 1 1/2". Turns up to 6000 RPMs—and it's instantly reversible with the power-pack. Remote control operation! Direct drive and belt-drive arrangements. Enclose check or money order for \$2.98 and we'll pay the postage. If not completely satisfied after 10 days, your money will be cheerfully refunded.

B & C CO., Box 183, Hempstead, N. Y.

Send for **FREE** 112 page Illustrated Catalog of Farm, Home, and Workshop Bargains.

Write to **WELLWORTH TRADING COMPANY**
Dept. E-12

1832 S. WABASH AVE.

CHICAGO 16, ILL.

NOW! Practical Home Course in AUTOMATIC TRANSMISSION

FREE loan of automatic transmissions while you learn at home! Demand for specialists is terrific! Real big money in this field. Learn from experts in spare time. Easy to understand, illustrated lessons plus **FREE** use of Hydramatic, Dynaflo and Fordomatic transmissions. You can start making money. Send for **FREE BOOKLET**.

LINCOLN TECHNICAL INSTITUTE
Dept. PM-4, 472 Market St. Newark 5, N. J.

MAKE TREMENDOUS PROFITS

Have fun! Earn Big Money! Cast plaster figurines, bookends, plaques, novelties at home in your spare time with X.L. rubber molds! **NO EXPERIENCE NEEDED!** Models and rubber for 3 molds, only \$1.50 ppd. Send 25c (refunded with order) for 40 page catalog now!

PLASTIC ARTS STUDIO 3403 SO. MADISON, DEPT. PM2
MUNCIE, INDIANA

Say You Saw It in Popular Mechanics

JEEP OWNERS

STA. WAGONS • JEEPSTERS • PICK-UPS!

Take full advantage of 4-wheel drive by installing a Ford V-8 engine — **MORE POWER**—means less shifting, better traction at lower speeds, greater safety, plenty of power in high. All this is now possible by using our F-J adaptor plate, Conversion Kit \$43.25 incl. **FED. TAX**. Please indicate year of engine you will use and whether 2 or 4 wheel drive. Write for free details or send check or M.O. for prepaid delivery. Order now for early shipment.

HOOSIER MACHINE PRODUCTS CO.
312 S.E. 6th St. Pendleton, Oregon

WARN HUBS AUTOMATICALLY FREE-WHEEL 4-W.D.s. IN 2-WHEEL DRIVE



Free-wheeling 2-wheel drive stops front end drag! Cuts front end repairs 50% or more, saves gas, tires; gives amazing pep, performance, handling ease to 4 W.D.s! Warn Automatics engage or disengage front power train as you shift into 4-wheel drive, or out for fast, economical free-wheeling 2-wheel drive use. Automatics only also permit high speed driving in 4-wheel drive. Warn Automatic and Locking models for Willys factory approved, sold only by Willys dealers worldwide. Over 70,000 sets in use around the world. Models for other 4 W. Ds. at dealers or write:

RUGGED DESIGN PROVEN IN USE
WARN MFG. CO., Riverton Box 6064-A7, Seattle 88, Wash.

POPULAR MECHANICS

Copyrighted material

HERE'S THE MOST POWERFUL ASTRONO-SCOPE WE EVER SOLD UNDER \$10

FREE TRIPOD!
FREE ASTRONOMY BOOK!
FREE MOUNT! ALL IN 1 BOX
Try to Beat This for \$10, \$15, \$25



*Reg. U. S. Pat. Office

YOU GET

- 1—75 Power Telescope
- 2—Aluminum Tripod
- 3—Universal Mount
- 4—108 Page Book
"Discover the Stars"

ALL FOR ONLY

\$9.95
COMPLETE
POST PAID

A fabulous saving . . . but it's our way of making friends! Yes, here's a rare opportunity to get a genuine Astrono-scope — Criterion's exclusive, powerful 20X, 40X, 75X telescope! It's 3 feet long, is finished in brass, has 4 precision lenses that bring the moon, stars, birds, planets, planes, ships, targets, people — all distant objects — 75 times closer, 75 times clearer and gives you 5,625 times area magnification, the instant you focus it! The Astrono-scope is versatile — can be used as powerful compound microscope. Folds to fit glove compartment of car, brief case, purse, etc. Special introductory price, only \$9.95 . . . and you get FREE all-aluminum tripod with non-skid rubber tips . . . FREE universal mount for steady viewing from any angle . . . FREE 108-page book "Discover the Stars" — not a booklet, but

real book! What a value! Supply limited . . . act now! All four beautifully boxed. Money back in full if not 100% enthused! Hurry, send check or money order. We pay shipping charges.

Remember Only We Have The Amazing,
Powerful 75 Power Astrono-scope That Brings The
**MOON, STARS, BIRDS, JET PLANES, SHIPS,
SCENERY, TARGETS, PEOPLE, ANIMALS
EVERYTHING 75 TIMES BIGGER!**
MAGNIFIES AREA 5,625 TIMES!

DON'T BE FOOLED by small power telescopes. For example: 12 power telescopes give you only 144 times area magnification. Our 75 Power Astrono-scope Gives You 5,625 Times Area Magnification.

Remember, It's The Power That Counts!

CRITERION MFG. CO.

331 Church-St., Dept. PMP-2
Hartford, Conn.

OUTLAWED HITLER JUGEND DAGGER... \$5.95

PPD.

Identical to pre-1930 official ceremonial dagger of Hitler's Youth (Jugend) Corps. Assembled post World War II, now illegal in Germany. The legendary Hitler Jugend carried this knife when the desperate Nazi government threw thousands of these fanatic youths into the battle of Berlin, 1945. 9 1/2" overall with a fine steel blade. Checkered black grip has Nazi swastika (black on silver) on red and white diamond, the German Jugend insignia. A small lot found by our agent, was imported by us from Europe. Sheaths are black steel and leather. A rare collector's find, an excellent hunting knife. Send check, cash or money order. No C.O.D.'s. Add 80c per knife for U.S. A.P.O. or P.P.O. air mail. Calif. residents add 3% state tax.



COMPLETE
WITH SHEATH

The
Swordsman

91 Army Bldg., 1165 E. Colorado St. Pasadena 1, Calif.

Want to Pass a CIVIL SERVICE TEST?

AS HIGH AS \$3,678.00 FIRST YEAR

RAILWAY POSTAL CLERKS

Veterans Get Special Preference



Many other U. S. Civil Service Jobs. City and Rural Carriers — Post-office Clerks — Meat Inspectors — Accountants — Stenographers — Typists — etc. Prepare now for next Examinations.

FRANKLIN INSTITUTE
Dept. K-93, Rochester 4, N. Y.

(Not Government Controlled)

Elrs: Rush to me, without charge, copy of 36-page book, describing salaries, hours, work, etc., and partial list of U. S. Civil Service big pay jobs. Tell me how to prepare for one of these tests.

Name _____
Street _____
City _____ Vet? _____

\$5 hourly profit in . . .

Your OWN Business

. . . Even if NOW Employed

We'll personally train and help you get established . . . starting full or part time.

If reliable and diligent, you can become financially independent in a growing lifetime business of your own. Alert dealers can average \$5 hourly gross profit on service they render plus \$3 on EACH serviceman. Nationally Advertiser services rendered IN homes, offices, clubs, institutions, etc.

DURACLEAN (illustrated above) cleans by absorption. Eliminates scrubbing . . . soaking . . . shrinkage. Dirt, grease and many unsightly spots vanish as if by magic. Wool fibers come to life . . . matted pile rises . . . colors revive. Upholstery and floor coverings last longer. **DURAPROOF** (not illustrated) is another year 'round service. Kills moths and carpet beetles. Makes material resistant to both. Protects furnishings, clothing, and auto interiors. Only such service backed by international money-back, 6-year warranty.

Easy to learn. A Duraclean dealer will train you right in your town. He'll reveal his successful methods and sales plan. He'll work with you. Our entire program of continuous help will impress you. Your service dealership becomes part of a world-wide organization built upon repeat orders and recommendations from satisfied customers. You have the freedom, prestige and profits of YOUR OWN business.

- No Overhead Expense
- No Shop Necessary
- No Experience Needed
- You Learn Quickly, Easily
- Nationally Advertised
- World-wide Services

Operate from your own home, a shop or office as you prefer. We furnish enough materials to return your TOTAL INVESTMENT. We help finance reliable men. Start part or full time. Write TODAY for FREE booklet and full details while territory is available.

DURACLEAN CO., 5-16D Duraclean Bldg., Deerfield, Illinois



Write For FREE Booklet

Our 25th year

NEW! PERSONAL POCKET RADIO

LISTEN WHILE YOU WALK, RIDE, WORK!



Slips in any pocket—Wt. only 9 ozs. Size 2 3/4" x 4 3/4" x 1 1/4". Beautiful Black Gold plastic case. NO HOOKUPS — NO WIRES — NO PLUG-INS! Self contained with 100 hour life flashlight batteries. (Available anywhere) and BUILT-IN ANTENNA!

GUARANTEED RECEPTION OF RADIO STATIONS TO 50 miles—up to 1500 miles for powerful stations! Has new Patented Super-regenerative Diode tube and transformer audio stages for sharp selectivity and sensitivity! Easy to use top controls (while walking). Almost invisible plastic foam personal carrying lets you alone listen while you walk, visit, work, ride or sleep—anytime—anywhere. Money Back guarantee—1 year service guarantee.

SEND ONLY \$5.00 (ck. Mo) and pay postman \$14.95 plus postage on delivery or send \$19.95 for postpaid delivery. Get YOUR Tinytone REAL pocket radio now and be ready to listen to Civil Defense alarms, news, music, sports, etc. on a moment's notice. Not a Kit or plaything! Shipped complete with batteries—Ready to listen!—Order now—today.

WESTERN RADIO Dept. APM-12 Kearney, Nebraska

LOCKSMITHING & Key Making



PRACTICAL UP-TO-DATE COURSE—ONLY \$4.95

Easy-to-learn modern information for self-instruction. How to work on locks, de-code, make master-keys, repair, install, service, etc. For every handyman, home owner, carpenter, mechanic, service station operator, fix-it shop, hardware dealer, gunsmith, 53 plain illustrated lessons. FULL PRICE ONLY \$4.95 SEND NO MONEY. Just pay postman plus C.O.D. postage. Or send \$4.95 with order. We'll ship postpaid. Satisfaction guaranteed or refund.

NELSON-HALL CO., 210 S. Clinton St., Dept. MV-2, Chicago 6, Ill.

AGENTS START BUYING SERVICE AT HOME

GET BIG NAME MERCHANDISE

for your clients up to 40% less than reg. price. Operate sparetime. Sales easy as you can give sizeable discounts, still make fat comm. Postcard brings free plan.

AMERICAN BUYERS SERVICE

HERTEL STATION, DEPT. R, BUFFALO 16, NEW YORK

GET UP TO 40% OFF

200 ONE-EVENING PROJECTS

Start and Finish Any One of These Projects in One Evening!

The editors of Popular Mechanics have assembled 200 projects, any one of which you can start and complete in a single evening. In a few hours' time, using only simple hand tools, you can build a coffee table, magazine rack, end table or scores of other useful projects. There are projects for the entire family. Best of all, any one may be built in just a few hours. No special skills are needed. Even if you have never built anything before, you can build the 200 projects in this big new book!

Step-by-Step Instructions, Show-How Photos, Drawings

First you read how to do it in famous Popular Mechanics step-by-step instructions and then actual photos, drawings and diagrams show you how it is done.

Each Project Costs Just 1c
Just imagine! Each project costs you only 1c. Where else today can you get so much for so little? Fill out and mail the coupon now. Full money-back guarantee, of course.



POPULAR MECHANICS PRESS, Dept. EP-1
200 E. Ontario St., Chicago 11, Ill.

Gentlemen: Remittance for \$2.00 enclosed. Rush postpaid my copy of 200 ONE-EVENING PROJECTS. Unless it is entirely satisfactory I may return it in seven days for a full refund.

NAME _____
ADDRESS _____
CITY _____ ZONE _____ STATE _____
 Send C.O.D. (U.S.A. only). Postage extra.

PREPARE FOR THE BEST JOBS

IN INDUSTRY

TRAIN at HOME

IN YOUR SPARE TIME

or at

ALLIED INSTITUTE in Chicago

- MECH. ENGINEER
- DRAFTSMAN
- TOOL DESIGNER
- TOOL ENGINEER
- TOOL & DIE MAKER
- MASTER MACHINIST

NO RECESSION FOR ALLIED TRAINED MEN

MORE JOBS THAN GRADUATES Shortages of Draftsmen, Designers, Tool Engineers, Machinists, Tool & Die Makers are so widespread that you can pick a highly paid key job and look forward to Achievement and Security.

You can begin your training in Short Courses and continue progressively to a Bachelor Degree in 26 months.

Allied is approved by Industry, Dept. of Education, Office of Public Instruction, State of Illinois, U.S. Veterans Admin., U. S. Dept. of Justice, Accredited: C. S. A.

SEND FOR FREE BOOKS

ALLIED SCHOOL of MECHANICAL TRADES
1338-42 South Michigan Ave. Dept. PM-12 Chicago 5, Illinois

SEND ME WITHOUT OBLIGATION INFO. ON YOUR COURSES:

HOME STUDY RESIDENT VETERAN NON VETERAN

NAME _____

ADDRESS _____

CITY _____ STATE _____

New PROFIT-PROVEN* Home-Business!

"I make \$400⁰⁰ a week!"



*Proves MR. J. T. ANDERSON, Inglewood, Calif.
(Notorized statement on file in our office and open to inspection)

Big Money?—sure it is—because Huge Profits are waiting to be "tapped" with this **MIRACLE NEW PRINTING METHOD**. Now, you may share the exciting secrets and build a big-paying **FULL OR SPARE TIME** Screen Printing Business right in **YOUR OWN HOME**. Yes, we'll teach you, too, how to turn pennies into dollars in this newest, most sensational printing method ever invented. **WHAT IS SCREEN-PRINT?** It's an exciting new printing technique—amazingly simple and fascinating. (It may soon revolutionize the entire printing industry) **NO EXPENSIVE EQUIPMENT**, no printing press, no "cuts," no art ability, no experience is necessary—yet you can print beautiful professional jobs on **PAPER, GLASS, LEATHER, CLOTH—ANYTHING!** You print in all colors—even new "glowing" **FLUORESCENT**

SCREEN PRINT CO.
Dept. 2C
15127 S. Broadway, Los Angeles 61, Calif.
Gentlemen: Please mail me Free Revealing Details, samples, Opportunity Plan, etc.—All this is sent absolutely Free and sent to me by return mail. I am under no obligation now or ever.

NAME _____
ADDRESS _____
CITY _____ ZONE _____ STATE _____



free!
Complete REVEALING DETAILS, Authentic SAMPLES, Proven Big-Money OPPORTUNITY PLAN, "HOW-TO" BOOKLET. Learn the secrets. Rush this coupon TODAY!



READ WHAT OTHERS ARE SAYING—Investigate! "Would not take \$1000.00 for secret...just what I have been searching the world over for," C.S., Nev.; "Making 75% of living expenses already in spare time," E.L., Ontario; "Made \$80 first week—terrific opportunity"—W.S., Iowa.

Mail Coupon and Learn Secrets Tool

COLORS. It's amazing—but true! **EARN PROFITS IMMEDIATELY—IN YOUR OWN HOME!** Start in your garage, basement, kitchen, spare room—anywhere! It's much easier than you think. Then expand as this new printing industry grows. **300% PROFIT** on some jobs—earn up to **\$12.50 per hr.** **HELP FILL THE HUGE GROWING DEMAND.** No selling because every business in your area needs Screen-Printing. You can save them up to 50% on printing, too. **WE SUPPLY EVERYTHING YOU NEED.** Never before has such a profit opportunity been offered to anyone wishing to start a full-time or spare-time "business of his own." Don't Hesitate! All the **CONFIDENTIAL FACTS** are yours if you **MAIL COUPON TODAY**—before it's too late.



Print colorful ADVERTISING DISPLAYS, SIGNS, BANNERS, POSTERS, LABELS, WALLPAPER, NOVELTIES, INSTRUMENTS, ETC. ET

SAVE MONEY ON U S GOV'T SURPLUS

Buy surplus direct from US Government. These are samples of the savings that can be made. Life boat \$12.00. Grinder \$4.69. Shaper \$15. Dump truck \$76.77. Tractor \$75.00. Typewriter \$7.51. Freezer \$50. Spray painter \$15.25. Motor \$4. Hunting, fishing, camping, sporting Equip, jeep, boat, tools. Hundreds others may be purchased at tremendous savings through our Bulletin "Surplus Sales." Price \$1.00. The Abacus Press, Box 169DDD, Dept. 4, East Hfd. 8, Conn.

IS YOUR LIFE WORTH \$8.95?

This amount may well save your life when used to purchase a top-quality auto Safety Belt at our low, direct factory-to-you price. Belt is 2" wide Nylon webbing, has a chrome-plated, quick-release type buckle... includes all necessary hardware for quick-easy installation. Available in 9 beautiful colors: Black, Gray, Green, Blue, Maroon, Flame, White, Yellow and Brown. Satisfaction guaranteed! Order yours today.

DEALER INQUIRIES INVITED.
LLOYD AWNING COMPANY 806 SPENCER ST. AURORA, ILLINOIS

Don't Throw Old Radios Away!



Let Ghirardi's 744-page **RADIO TROUBLESHOOTERS' HANDBOOK** show you how to fix old radios good as new! Gives easy troubleshooting and service instructions for old sets which dealers often say should be thrown away because repair details are no longer available. Covers specific troubles—NOT general theory. Eliminates useless testing. Covers 4,800 different models made between 1922 and 1942: Airline, Arvin, Atwater Kent, Belmont, Brunswick, Clarion, Crosley, Emerson, Fada, G-E, Majestic, Motorola, Philco, Pilot, RCA, Silvertone, Stromberg, Zenith... and almost 200 more! The only guide of its kind. Over 50,000 copies in use. Weighs 2 1/2 lbs. Price only \$8.95. Try it 10 days at our risk!

Dept. PM-125, RINEHART & CO., Inc.
232 Madison Ave., New York 16, N. Y.

Send TROUBLESHOOTERS HANDBOOK C.O.D. I will pay post-man \$6.50 plus postal charges.
 I enclose check or money order. You pay postage. Money will be refunded if I return book in 10 days.

Name _____
Address _____

PREPARE FOR BETTER JOB, BIGGER PAY IN SPARE TIME AT HOME

Today, choose the job you want—and prepare for it in time you might otherwise waste. Or if you are already in the work you like best, start training now for quicker promotion and increased pay. During more than 50 years **AMERICAN SCHOOL** has helped ambitious people to reach higher goals. Check subject that interests you and mail coupon for full information.

AMERICAN SCHOOL, Dept. G945, Drexel at 58th, Chicago 37, Ill.
Without obligation, please send FREE and postpaid, full particulars about the subject checked below.

- | | | |
|--|---|---|
| <input type="checkbox"/> Accounting | <input type="checkbox"/> Diesel Technician | <input type="checkbox"/> Mechanical Engineering |
| <input type="checkbox"/> Apprenticeship Courses | <input type="checkbox"/> Drafting—Building | <input type="checkbox"/> Plastics Engineering |
| <input type="checkbox"/> Architecture & Building | <input type="checkbox"/> Drafting—Machine | <input type="checkbox"/> Plumbing—Practical |
| <input type="checkbox"/> Automotive Technician | <input type="checkbox"/> Electrical Engineering | <input type="checkbox"/> Private Secretary |
| <input type="checkbox"/> Better Foremanship | <input type="checkbox"/> Electricity—Practical | <input type="checkbox"/> Retail Merchandising |
| <input type="checkbox"/> Bookkeeping | <input type="checkbox"/> Electronics—Industrial | <input type="checkbox"/> Salesmanship—Outside |
| <input type="checkbox"/> Business Management | <input type="checkbox"/> High School Courses | <input type="checkbox"/> Sheet Metal Work |
| <input type="checkbox"/> Civil Engineering | <input type="checkbox"/> Machine Shop Operations | <input type="checkbox"/> Tool Making |
| <input type="checkbox"/> Contracting | <input type="checkbox"/> Mathematics & Slide Rule | |

NAME _____ OCCUPATION _____ AGE _____
HOME ADDRESS _____ STATE _____
CITY _____

Canadian Residents: Write American School, 1610 Sherbrooke St. West, Montreal

MAIL COUPON NOW



The World's Most Modern Masonry

Opportunities Open for Local Manufacturing

From local plants dotting the country has come the Brikcrete used to erect many thousands of buildings—homes, apartments, motels, stores, shopping centers—practically every type of residential, commercial and industrial construction. Why?

Because Brikcrete has more quality features than any other fine masonry—design, size, light weight, insulation properties, range of 14 colors. And a price competitive to lumber! It's an outstanding business opportunity.

High Income Potentials

Freight and distribution costs are by-passed in the manufacture of Brikcrete. By using local aggregates and local labor it's a "direct to user" business. Production economies enable low prices to consumers and generous profit margins to manufacturers.

More plants are needed to operate in protected territories under franchise privileges. Basic machine available on lease or purchase. Write for Brikcrete Book No. 2.

Brikcrete Associates, Inc.

402 West 25th Street
Holland, Mich.

BRIKCRETE

IN CANADA: DUNN MASONRY MACHINERY LIMITED
800 Dundas Highway, Cooksville, Ont.

MAKE A "Stradivarius" VIOLIN

—For Pleasure
—For Profit
—For Your Own Use

BOOK AND PLANS ALL YOU NEED



You Can Do It at Little Cost!
It's Easy! It's Fun!

Here is the "top" of all home crafts projects. Make a violin—a replica of a famous "Strad"—the original of which sold for \$80,000.00. Joe Reid who has made hundreds of fine violins makes the job so easy—so inexpensive—in his new book "You Can Make a 'Stradivarius' Violin." You don't need any tools. Reid shows you how to make all the tools you need from old table knives, worn out files, sheet metal, etc. Eight full-size plans, 16x21 inches, folded into the book give you every detail in actual size.

Violins Bring High Prices

Make a violin and you probably will never want to sell it. But good tone modern violins bring terrific prices, yet the materials cost comparatively little. With Reid's plans and step-by-step instructions you can make such a violin for yourself. 15 chapters guide you in selection of wood, fashioning the belly, back, sides, mold, lining, neck, scroll, purfling. Other chapters cover varnishing, finishing, stringing. Others show how to make tools and clamps at little or no cost.

Order Book Today.
Money Back if Not Satisfied.

Make your own violin for pleasure or profit. Get book and plans now. Clip this ad and mail with check, money order or cash for only \$3.50 or we will ship C.O.D. Money back in 7 days if not satisfied.

FULL SCALE PLANS INCLUDED

Working plans, drawn to full scale, are included in a special pocket inside the book where they may be withdrawn for quick and easy reference.



Complete Instructions
8 Actual Size Plans
How to Make the Tools You Need
Where to Get the Materials

You trace or work direct from actual size plans. No measurements to translate or confuse you. You see the entire violin in the plans. You read the how-to-do-it instructions in the book.

\$3.50 Cloth Bound

Dept. 30

200 E. Ontario St., Chicago

POPULAR MECHANICS PRESS

LEARN WATCH REPAIRING

AT HOME Modern, original instruction. Prepare for a position or start in business after completing our course. Write Today!

WISCONSIN SCHOOL OF WATCH REPAIRING
2908 N. 44th St. Dept. M Milwaukee 10, Wis.

FREE BOAT KIT CATALOG

8' to 14' Models from \$39.95 incl. freight

- Assemble your own boat
- No experience necessary
- Save 1/2 to 2/3 "factory built" prices



Write: Marine Hardware, Fiberglass, & Trailers
DEPT. B 6432 NICOLET AVE. MINNEAPOLIS 9, MINN.

Save 50%! Assemble Your Own DIVING LUNG

FREE BOOK SHOWS HOW

We furnish the parts and instructions. Complete outfits \$49.95 and \$59.95. Write for our descriptive literature and off-season specials today!

UNDERWATER SPORTS, INC.
Dept. H, 302 W. Adams
O'Fallon, Ill., P.O. Box 65



Family safe, partially used tires. Check my Golden Rule Guarantee! "THE BLATT NAME famous in tires for 40 years." Only BLATT offers a "FREE REPLACEMENT" guarantee! Any other guarantee is USELESS! where you must pay for the months service you've received. 1 replace FREE instantly ANY defective tire within 36 mos. FOOLISH TO PAY MORE—DANGEROUS TO PAY LESS!

CHOOSE YOUR FAVORITE BRAND GOOD YEAR Firestone U. S. Goodrich, Lee & others.

These are not Recaps—not cheap grade tires. We are selling thousands in our retail store at higher prices! America's most respected "Free Replacement"

36 MONTH GUARANTEE & FREE TUBE WITH EACH TIRE

600-16	\$5.53	670-15	\$5.43	700-20	\$9.83	600-16 (G)	\$5.93
650-16	5.63	710-15	5.43	750-20	11.83	650-16 (G)	6.63
700-16	6.03	760-15	5.73	825-20	17.93	700-16 (G)	7.33
640-15	4.83	800-15	5.83	900-20	17.93	700-15 (G)	7.83
700-15	\$4.53	820-15	\$5.83	1000-20	\$17.93	700-17	\$8.83
600-20	9.03	850-20	9.83	1100-20	17.93	750-16	7.53
WHITEWALLS \$1.00 Extra		1000-22	19.93	750-17	9.53	750-17	9.53

Special! Tires released by CO. ADJUSTERS! If a tire fails in 36 months, I charge you nothing. Just slightly used. Any car size. World's top tire value (Whitewalls \$1 extra). Free tube with each tire! \$7.53

GOODYEAR SUBURBANITE type & other. Factory retreads & partially used. 36 mos. guar. & free tube. \$7.27 SNOW-TIRES

Send Ck. or M.O. & this ad for instant shipment. FOB Phila. I personally select your tires—as if my future depended on it. Thousands of tires shipped the world over! Read that top line again.

RADIO CONTROL YOUR MODEL PLANES BOATS CARS

"CUSTOM MIDGET" RADIO \$9.98
LICENSE FREE BAND
OPERATES SAME AS \$20.00 SETS. INCLUDES LONG RANGE TRANSMITTER RADIO, RECEIVER RADIO AND CONTROL ACTUATOR ALL 3 EASY ASSEMBLY WITH OUR PARTS AND PLANS \$9.98. PLANS ALONE \$1.



DETAILED INFORMATION & RADIO CATALOGUE 25c
SPECIAL "SUPPLY SOURCE DIRECTORY" & \$7.00 SUPPLY COUPON... \$1.00
BOOK "RADIO CONTROL OF MODEL AIRCRAFT" CONTAINS 14 PLANS \$3.98
RADIO CONTROL GARAGE DOOR DETAILS..... \$1.00

RADIOMODELS BOX 36 DEPT. PM BALTIMORE 6, MARYLAND

SAY YOU SAW IT IN POPULAR MECHANICS

Become A --- BUILDING CONTRACTOR!

MAIL COUPON for FREE BROCHURE

Simplified home study training program. Learn every phase of building, estimating, contracting. Fortunes are made in this line of work every year. Use spare hours—no interference with present work. Diploma awarded. Low tuition rates.



AMERICAN TECHNICAL SOCIETY
Dept. PM-12, 850 E. 58th Street, Chicago 37, Ill.

Please send me your FREE Brochure and full details of your building, estimating and contracting training program.

Name _____
Address _____
City _____ State _____

FAMILY SAFE, PARTIALLY USED TIRES. CHECK MY GOLDEN RULE GUARANTEE! "THE BLATT NAME famous in tires for 40 years." Only BLATT offers a "FREE REPLACEMENT" guarantee! Any other guarantee is USELESS! where you must pay for the months service you've received. 1 replace FREE instantly ANY defective tire within 36 mos. FOOLISH TO PAY MORE—DANGEROUS TO PAY LESS!

CHOOSE YOUR FAVORITE BRAND GOOD YEAR Firestone U. S. Goodrich, Lee & others.

These are not Recaps—not cheap grade tires. We are selling thousands in our retail store at higher prices! America's most respected "Free Replacement"

36 MONTH GUARANTEE & FREE TUBE WITH EACH TIRE

600-16	\$5.53	670-15	\$5.43	700-20	\$9.83	600-16 (G)	\$5.93
650-16	5.63	710-15	5.43	750-20	11.83	650-16 (G)	6.63
700-16	6.03	760-15	5.73	825-20	17.93	700-16 (G)	7.33
640-15	4.83	800-15	5.83	900-20	17.93	700-15 (G)	7.83
700-15	\$4.53	820-15	\$5.83	1000-20	\$17.93	700-17	\$8.83
600-20	9.03	850-20	9.83	1100-20	17.93	750-16	7.53
WHITEWALLS \$1.00 Extra		1000-22	19.93	750-17	9.53	750-17	9.53

MARVIN BLATT 6th & Spring Garden Sts. Philadelphia, Pa.

MILITARY SUB-DRIP TIRES
AA Guar. 20 Mos. AAA 38 Months
900-16 \$9.53 900-16 \$13.93
750-20 12.93 750-20 17.33

150% to 300% PROFIT!

MAKE JEWELRY AT HOME!



America's latest sensational fad—**ENAMELLED JEWELRY!** Enamel copper, steel and silver in 3 to 4 minutes time. Make hundreds of dollars worth of earrings, cuff links, brooches, lapel pins, tie clasps, etc., in your own kitchen! No previous experience needed. **VITRO-NAMEL OUTFIT** includes improved, faster heating, larger capacity kiln with many patented features; 6 powdered enamels, tongs, asbestos pad, 12 jewelry findings, assortment of 10 heavy copper blanks, solder, sand paper, polishing material, oil filter, screens, electric cord, instruction manual, **SILVERPLATING COMPOUND**. Everything you need to begin making jewelry at once. Rush order today or send **\$9.75** for free illustrated book.

VITRO-NAMEL CO.

6612 N. Clark St., Dept. VE-103, Chicago 26

MAKE EXTRA MONEY



Start Your Own Business

Sell tools part time, full time. Save money for your industrial and institutional use. **A MILLION DOLLAR INVENTORY AT YOUR FINGERTIPS.**

Buy **NATIONALLY ADVERTISED** hand tools, hardware, fans, motors, power tools, paints, etc., **NO INVESTMENT REQUIRED.** Buy as you need it. Up to 50% **DEALERS DISCOUNT.**

Send \$1 Deposit for Dealers Card and mammoth dealers catalog. \$1 refunded on first purchase or returned if you are not 100% satisfied. **SILVO HARDWARE CO., Dept. PM-12, 108 Market St., Phila. 6, Pa.**

MASTER MIND!



Learn Short-Cut Mathematics

Juggle figures. Do baffling number tricks. Make people gasp at your marvelous lightning-quick mind. Multiply 4 figures by 4 figures without using old-fashioned multiplication! Big cloth-bound volume; fully illustrated course.

Sharpen up Your Brain Power

Includes worked out problems, answers, etc. Sensational bargain, only \$2.95, postpaid or COD plus postage. Satisfaction guaranteed or refund. Order this amazing "Short-Cut Mathematics" today!

NELSON-HALL CO., 210 S. Clinton St., CHICAGO 6, ILL. \$2.95 Complete

ENGINEERING DEGREE IN 27 MONTHS

INDIANA TECHNICAL COLLEGE

B. S. DEGREE, Aeronautical, Chemical, Civil, Electrical, Mechanical and Electronic Engineering (inc. Radio and TV), Drafting, One-Year, G.I. Government approved. Low rate. Earn board. Large industrial center. Students from 48 states, 21 countries. Demand for graduates. Enter—December, March, June, September. Write today for catalog. 1612 E. Washington Boulevard, Fort Wayne 2, Indiana.

MAKE UP TO \$5 AN HOUR WITH

EASISHARP



Big profits in your spare time sharpening scissors. We show you how to start making money immediately. This is your chance now to have your own business and a steady income. Sharpen a pair of scissors in less than two minutes. A child can operate it. Weighs only 10 lbs. Every home, barber, tailor, dressmaker—everybody uses scissors and all need sharpening two to four times a year. Don't let some one else beat you to this opportunity. Write immediately to

SERR-EDGE MACHINE CO., 9731 Lorain Ave., Cleveland, Ohio

Only

Silver Lifetime

gives you 6-year guaranteed service at an economy price!



The Battery You've Been Waiting for at a Price You Can Afford!

Only **\$24.95** for all 6-volt cars
\$27.95 for all 12-volt cars

Made with Silver, the **SILVER LIFETIME BATTERY** incorporates the most advanced developments of the American and European battery industries. Mass production equipment and methods make possible its modest cost. Your purchase of a **SILVER LIFETIME BATTERY** need be your only battery purchase for six years or more! You will enjoy faster starting, brighter lights and better operation of all your car's electrical equipment. Most important, you will discover the satisfaction of real battery dependability, avoid embarrassing battery failure.

GOOD FOR 400,000 STARTS... In laboratory tests, the **SILVER LIFETIME BATTERY** made 400,492 "starts" and each time bounced back with no sign of weakening—equivalent to starting your car 39 times a day for 36 years! In one minute or less after you run it down, this battery will start your car with a surge of regained power. The **SILVER LIFETIME BATTERY** is the finest battery made for emergencies.

FORGET ABOUT ADDING WATER FOR A YEAR OR MORE... Heavy duty plates, special plastic separators, extra large electrolyte reservoir, and new-type vent caps combine to make the **SILVER LIFETIME** the most trouble-free battery made!

GIVES BETTER SERVICE DURING ITS ENTIRE LIFE... The **SILVER LIFETIME BATTERY** produces up to 1990 amps of instant power release. It spins your motor 16% faster than ordinary batteries... gives you brighter lights and better operation of all electrical equipment. Has a remark-

able 600 watt capacity and exceeds S.A.E. requirements for overcharge tests by 100%. Is not affected by overcharge.

COOLEST OPERATING BATTERY EVER BUILT! Heat causes plates to dry out, harden and buckle, insulators to "short!" The **SILVER LIFETIME**'s extra fluid capacity, special plastic separators and heavy duty plates, keep damaging heat to a minimum... add greatly to its long life.

SILVERLYTE BATTERY SOLUTION... Exclusive formula contains silver (plus other ingredients). Natural electroplating action forms a coating of silver on the grids, increasing conductivity and ability to develop electrical charge quickly.

THE SILVER LIFETIME BATTERY SAVES UP TO 370. The average lead-acid battery costs you about \$20.00, lasts less than 1½ years (about \$14.00 per year). The **SILVER LIFETIME** costs you \$24.95 and is guaranteed to last six full years!

SILVER LIFETIME BATTERY CORP.

9937 Culver Boulevard, Culver City, California • Cable Address: SILVERLIFE

DISTRIBUTORS WANTED!

Exclusive protected sales territories now being awarded. Silver Lifetime Batteries are available also for industrial, marine, truck, tractor and bus use. Inquiries invited.

SILVER LIFETIME BATTERY CORP., Dept. PM 125
9937 Culver Blvd., Culver City, Calif.
Ship Silver Lifetime Battery with 6-year guarantee:
 6 volt automotive battery (\$24.95 including tax)
 12 volt automotive battery (\$27.95 including tax)

for _____
Make & Model, Year of Car
Cash, check, or money order enclosed. Silver Lifetime pays all delivery costs to your door.
NAME _____
ADDRESS _____
CITY _____
STATE _____



I HELPED T.E.H. MAKE \$14 A DAY WHILE STILL LEARNING!

T. E. H.—West Virginia. "By the time I finished half year course, I was making \$14.00 per day. I have made enough on the side to more than pay for the course."

H. T. ARMSTRONG

Learn **ELECTRIC APPLIANCE REPAIR & SERVICE**

WE TEACH:

How to Repair
Washing Machines
Vacuum Cleaners
Electric Ranges
Lamps, Motors,
Irons, etc.,

REFRIGERATION
and
House Wiring
At Home
In Your
Spare Time!

For a man handy with tools, and happiest when working with his hands, OPPORTUNITY is Wide Open Today in this great and growing field. Everyone is a customer for the man trained to service electric appliances.

Open Your Own Shop

Our practical Home Course teaches you this business from A to Z—preparing you to take a well paid job or open your own shop. You can actually start in your basement or garage with the tools we send you . . . before finishing.

We Include An **ELECTRICAL APPLIANCE TESTER**
A Big Kit of Tools at NO EXTRA COST

MAIL THIS COUPON for FREE BOOK

H. T. ARMSTRONG
PACIFIC TRAINING SCHOOLS Dept. P-5512
11029 S. Vermont, Los Angeles 44

Dear Sirs: Please send me, without obligation, your free booklet and complete details.

Name _____
Address _____
City _____ Zone _____ State _____

HOW TO GROW ORCHIDS IN YOUR OWN HOME!

NO GREENHOUSE NEEDED
- ANY CLIMATE - MAINE
TO CALIFORNIA . . .
YEAR 'ROUND!

BIG PROFITS SPARE OR FULL TIME

Fill your home with gorgeous Orchids. Huge purple Cattleyas, exquisite Cymbidiums - dozens of others! Many grow without soil, getting food from the air. White Orchids, yellows, greens, every rainbow color. No equipment needed. Start on table or window ledge.

SUCCESSFUL HOME GROWER SHOWS YOU HOW! Complete instructions show you step-by-step how he and his wife started with a few plants and developed a big-profit home-business-grew an Orchid collection now worth a fortune. Learn how orchids multiply, how one plant may become many, each as valuable as the first. No big investment or overhead. Takes but a few minutes a week.

Big-profit orders for plants and flowers come from individuals, florists, hotels, clubs, etc. Year 'round gift. Millions sold by Mail-Order.

COMPLETE INSTRUCTIONS AND BLOOMING-SIZE ORCHID PLANT SENT FOR YOU TO EXAMINE AT HOME WITHOUT RISK. Secrets of the experts in simple language, jam-packed with "show-how" drawings, magnificent full-color pictures of Orchids. **Send No Money!** Write NOW for your FREE FACTS that show you how to learn to grow Orchids at home. Airmail is quicker.

Orchids have rewarded me richly - thanks to Tropical Flowerland.
S. V. SMART - Orlando

TROPICAL FLOWERLAND, Dept. 31C
4622 Wilshire Blvd., Los Angeles 5, Calif.

NOW AVAILABLE for HOME USE



THE ORIGINAL CARVER LAMINATING PRESS

Now, do your own plastic laminating: identification and membership cards; badges; photos; clippings; documents; nameplates; charts; diagrams; religious pieces, etc. Moisture-proof, tamper-proof, long-wearing protection. Exclusive, patented 2-opening design for fast, simultaneous heating and cooling; accurate, adjustable, time, temperature and pressure controls. Uses regular electric outlet. **NOT A TOY** - but easily operated, commercially proven - same as used by U. S. Army, Navy, Air Force, Coast Guard, Dept. of Justice, State Dept., industrial firms and institutions. Laminates over 1200 wallet size pieces a day! 2 sizes up to 9" x 12". Send for facts.

FRED S. CARVER INC.
HYDRAULIC EQUIPMENT
SUMMIT, NEW JERSEY

Try it FREE for 10 DAYS!

INCREASE "GAS" MILEAGE!

Amazing Results! 25% gas savings reported with this phenomenal New Gas Needle. Patented. Install yourself with simple twist-of-the-wrist. Fits all cars! 1/2 million users already! Some report "no improvement" so try before you buy - send no money! - pay postman nothing! If unused at increased mileage send only \$1.50 per needle (8 cyl. cars use 2) otherwise return the "title stinker" - you owe nothing. Rush make-year, No. cyl. of car. Free Trial Supply Limited!
ECONOMY AUTOMOTIVE INDUSTRIES
Dept. A-12, 1036 S. LaBrea, Los Angeles 10, Calif.

AUTO MECHANICS... Learn SUPER-TUNE

Join 1000's of Sun-Trained Men Now Enjoying Increased PROFITS... PRESTIGE... ENGINE KNOWLEDGE!

***ELECTRONIC TUNE-UP TESTING** Course now offered at Sun's Modern Training Center, Chicago. Complete in 4 weekly units: *Test Equipment Operation; Automotive Electricity; Modern Tune-Up Procedure; Service Merchandising* - take any or all, **COST IS LOW!** Write to: Sun Electric Corp., Dept. PM 2, Harlem & Avondale, Chicago 31, Ill.

CASH by MAIL from Big-Profit Imports

Let me show you how I get up to 1,163 cash-in-advance orders in a day for imports shipped direct from abroad. **ALL BY MAIL ORDER.** Think! Your own business from home. I show you how to find imports for a "song". How to export too. No investment in merchandise, Big profit opportunity. **FREE** details. Write today! Mellinger, Importer, Dept. E-25C, 1717 Westwood Blvd., Los Angeles 24, California



FIELD JACKETS

A Super-value, fine poplin Navy (War Surplus) **FIELD JACKET** can be yours for only \$3.88. Quality features: full zipper-front, 100% blanket-lined, water repellent, adjustable hip straps. Ideal for Farmers, Luncheoners, Truck Drivers, Sportsmen. Brand new - every jacket guaranteed perfect condition. Sizes 34 to 40. State size and send for Free check or M.O. Supply limited. Hurry. Surplus Catalog

\$3.88 ONLY Post-paid

MARKO SURPLUS, Dept. PM-12, 540 S. State St., Chicago 5, Illinois

How to Build Your Own GARAGE



Save as Much as 50% of Usual Construction Costs

Get Popular Mechanics' brand new book **How to Build Your Own Garage** by Wayne Leckey, Assistant Shop Notes Editor, and find out how you can build your own garage at savings of 50% of usual cost. Leckey tells in famous step-by-step instructions and shows in big, clear photos, drawings and diagrams how to perform every building operation from laying the concrete to installing the final trim. There are 25 designs. Brick, frame, and concrete block fully covered. Send \$3.50 for your copy. 7-day money back guarantee.

POPULAR MECHANICS PRESS, 200 E. Ontario, Chicago 11, Ill.

NEW FLYING SENSATION THE HELI-FLYER



ONLY
\$1.98

GET YOURS
TODAY BY
MAILING
COUPON

You control HELI-FLYER as it soars to any height by the rotation of an 8 blade rotor 3 ft. in dia.

Scientifically Engineered By
MARSHALL MFG. CO.
6359 GRANT AVE.
MERCHANTVILLE, N. J.

- Flies like a Helicopter
- Variable Pitch Rotors
- All Parts Replaceable
- Gyroscopic Stability

Please send _____ HELI-FLYERS @ \$1.98 Ea.

NAME _____ Check Money Order Enclosed

ADDRESS _____

CITY _____ STATE _____

SEND CHECK OR MONEY ORDER. NO COD'S. SATISFACTION GUARANTEED

PORTABLE CAR COVER

Protect Against
RAIN • SUN • DUST
\$695 formerly
\$8.95



Don't risk damage to your car finish when this low-cost car cover protects against weather elements. Long-lasting durable plastic folds compactly, off and on in a jiffy, sturdy elastic binding gives extra security. State make, model and year—buy direct from mfg. Send \$6.95 plus 35c postage, or sent C.O.D. Extra Heavy Plastic Gauge \$8.95 + 45c postage—formerly \$10.95
BEA SALES, Dept. G-35, 125 E. 46, New York 17, N. Y.

TRAIN Your VOICE!

RESULTS GUARANTEED
STRENGTHEN your voice this tested, scientific way. Yes—you may now be able to develop the POWER of your speaking and singing voice in the privacy of your own room. Self-instructing lessons, mostly silent; no music required. Write TODAY for Eugene Feuchtinger's great booklet "How to Strengthen Your Voice." It's absolutely FREE! You must state your age. Booklet mailed in plain wrapper. No salesman will call. Send your name and age RIGHT NOW! Perfect Voice Institute, 210 S. Clinton St., Studio MV-2, Chicago 6, Ill.

WHOLESALE Electric Guitars - Parts - Build Your Own

Solid-body Spanish, amplifiers, double-necks, single-necks, triple-necks, 4-necks, solid-body mandolin, electric violin, pickup milks, non-electric instruments, etc. 1954 Models wholesale. FREE CATALOG. Free home study course with instruments. Parts & plans available to build your own.
CARVIN CO., Box 287, PM-12, Covina, Calif.

NOW! Test Your Own TV AND RADIO TUBES

with new Omni-Tester. Save the cost of one TV service call and Omni-Tester pays for itself. Easy to operate—no technical knowledge required. Absolutely safe. Use 110 volts AC or DC. Complete with test cords and instructions. Guaranteed. No C.O.D. Please. ONLY **\$3.98**
OMNI-ELECTRONICS CORP. 911 W. 53rd ST., DEPT. 11, CHICAGO 9, ILL.

Attention Hobbyists

World's Great TINY MOTOR Value
New **MIGHTY MOTOR**
Heavy Duty

It's tiny—but powerful. Weighs 2 oz. This long life MIGHTY MOTOR has hundreds of uses for hobbyists. Runs on 2 flashlight batteries. Fine for toy motor boats, airplanes, Erector sets, Bar BQ Spitters, Electric items, etc.

Not an import. American made. Motor alone sells for \$2.50 everywhere. When limited supply is gone... that's all. Better hurry. Motor, plus gear, reduction gear with shaft, battery holders and reversible switch. A \$3.65 value, sent postpaid for only **\$1.00**
(6 COMPLETE SETS FOR ONLY \$5.00)
PLEASE SEND CASH, CHK. OR M.O. . . . NO C.O.D.'S
BERG SALES CO. 202 E. TRUMAN RD. KANSAS CITY 6, MO.

You Can Play



ANY INSTRUMENT
... even if you don't know
a single note of music now!

IMAGINE! Even if you never dreamed you could play... you can soon surprise your friends with your musical ability. No special talent or previous training needed. Spend just a few minutes a day—and only a few cents per lesson. Teach yourself to play piano, guitar, accordion, whatever instrument you choose. Make amazingly rapid progress because you start right out playing real pieces by note. No boring exercises. Over 900,000 people have chosen this easy home method.

SEND FOR FREE BOOK

Mail coupon for 36-page illustrated FREE BOOK. No obligation; no salesman will call on you. **U. S. SCHOOL OF MUSIC, Studio A3012, Port Washington, N. Y. (58th SUCCESSFUL YEAR)**



U. S. SCHOOL OF MUSIC
Studio A3012, Port Washington, N. Y.

Please send me valuable illustrated Free Book. No obligation. I'm interested in playing (name instrument) _____
 I do I do NOT—have instrument now.

Name _____ (please print)
Address _____

Here's the Kind of MEN I Build!



CHARLES ATLAS

Will You Let Me PROVE I Can Make YOU a New Man?

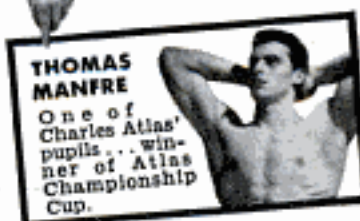

THOMAS MANFRE
One of Charles Atlas' pupils... winner of Atlas Championship Cup.

I don't care how old or young you are, or how ashamed of your present physical condition you may be. Just give me 15 minutes a day, and I'll start giving you RESULTS that you can SEE, FEEL, and MEASURE with a tape! I can broaden your shoulders, strengthen your back, develop your whole muscular system INSIDE and OUTSIDE! I can add inches to your chest... give you a vise-like grip... make your legs powerful... help cram your body so full of strength, red-blooded vitality.

ity your friends will be amazed! WRITE FOR FREE BOOK. 32 pages about how "Dynamic Tension" changed me from 97-lb. wanking into "World's Most Perfectly Developed Man"—and what I'll prove it can do for YOU. **CHARLES ATLAS, Dept. R-2, 115 E. 23rd Street, New York 10, N. Y.**



CHARLES ATLAS, Dept. R-2, 115 East 23rd St., New York 10, N. Y.
Send me—absolutely FREE—a copy of your famous book, "Everlasting Health and Strength"—32 pages, crammed with photos and valuable advice. No obligation. (Please print).
Name _____ Age _____
Address _____
City _____ State _____

**SUCCESS STORY...
MAN AND WIFE TEAM
MAKE \$10,000 A YEAR!
FROM A SPARE-TIME START**



"The Flok-Kraft Plan showed us the way from a spare time start to a full time business of our own with profits to \$20,000 a year."
Grace Hoyer - Grob House



Covers Plaster, Fabric, Wood, Metal, Plastic, Rubber—any surface!

READ what others say about FLOK-KRAFT

"Received the Flok-Kraft outfit and everyone that saw it is very enthused. I only had it about thirty minutes and got an order for a \$100 job."
C. N., Maryland

"pleased with your Course and I'm being swamped with work to do."
W. F., Pa.

"I want to take a moment to thank you for the wonderful service. Several jobs and customers are well pleased."
C. A. F., Mass.

"Many thanks for your fine course. Pleased with ease in which Flok-Kraft is applied. Have orders on hand and expect more."
S. C. W., Md.

"Received your outfit... delighted! Made sample glasses, everyone who sees them wants a set. Good future in Flok-Kraft."
H. J. B., Penn.

NOW, PROFESSIONAL SECRETS CAN BE YOURS...
George & Grace Hoyer are not in the "Genius" class but regular folks just like you and I—They have learned the FLOK-KRAFT Secrets and have a successful Big Profit business all their own. Why don't you join the Hoyers. Help us fill Huge Demand for FLOK-KRAFT in all parts of the country.

PROFITS ARE BIG—DEMAND IS HUGE...
Big Profits wait to be tapped in tremendous new field. There's a Huge Demand in every community for this New Miracle Finish that makes new products worth much more—makes old things beautiful & saleable. Big-Profit orders come from Manufacturers, Gift Shops, Dept. Stores, Hardware & Variety stores, Neighbors, Friends. FLOK-KRAFT can be applied to any surface whether brand new or old and worn. Gives a velvety, luxurious surface to instrument cases, bookery and silverware drawers, radios, lamps, toys, signs, store displays, store fixtures, wearing apparel, purses, auto dash boards, trunks, glove compartments—a thousand and one items to be seen on every hand easily and quickly beautified, enriched and increased in value with FLOK-KRAFT.

YOU CAN LEARN IN A FEW DAYS... Make to \$5.00—Yes, even \$10.00 and more per hour. Fully detailed and illustrated FLOK-KRAFT instructions—complete and easy to understand—every point explained—shows you how to start right away on the road to big money, full or spare time.

WE FURNISH EVERYTHING YOU NEED TO START...
You also get complete FLOK-KRAFT kit of materials and special equipment that enables you to start at once. Add to your income from your regular job or begin to build a successful business of your own and do it all right in a corner of your basement, garage, service porch, kitchen or living room. Here is that "golden" opportunity you have been looking for to build a business of your own starting spare time—remember, your own business is protection against lay-offs or enforced retirement.

YOURS TO EXAMINE WITHOUT RISK...
Grasp this lifetime opportunity today. I'll send you the complete FLOK-KRAFT outfit and instructions—everything you need to start—to examine leisurely right in your own home without risk. You owe it to yourself to investigate. Fill out and mail the coupon below for free FLOK-KRAFT Plan, and full details that show you how to learn to be a FLOK-KRAFT expert. It's all FREE and Postpaid. Airmail is quicker.

COAST INDUSTRIES, Dept. 2-C
Los Angeles 61, Calif.

**SEND NO MONEY!
JUST YOUR
NAME AND
ADDRESS**

COAST INDUSTRIES, Dept. 2-C, Los Angeles 61, Calif.
Gentlemen: Please rush me FREE Plan and everything I need to be a FLOK-KRAFT Expert. I understand that it is free and Postpaid. I am under no obligation whatever.



**FREE!
Complete
PLAN!
Full
Details**

NAME _____ STREET _____ CITY _____ STATE _____

**TRAIN AT HOME
LEARN UNDERWATER
Skin & Lung Diving**



Only Home Training Course of its kind. Train for enjoying this great sport in safety or for good paying job opportunities. Home training program written by outstanding authority, E. R. Cross, Master Diver. Write asking for information about the Dive-master Home Training Program.

DIVEMASTER
U. A. S. Corporation, Dept. PM-12,
5637 West 63rd Place, Chicago 38, Ill.



**LEARN MODERN WATCH
AND CLOCK REPAIRING**
Complete Course—Only \$5.95

At home, spare time. Good field now... Start security and contentment in future. Start part-time business and EARN while you learn. Horology is precision instrument work... a great and growing field, sensational opportunities. Easy self-instruction course. Full price, only \$5.95. SEND NO MONEY. Just pay postman, plus C.O.D. postage. Or send \$5.95 with order, we'll ship postpaid. Satisfaction guaranteed or refund. NELSON-HALL CO., 210 S. Clinton St., Dept. 3MV-2, Chicago 6, Ill.

**AUTO
MECHANICS**

**FAST, NEW WAY TO LEARN—
TOOLS AND TUNE-UP KIT SENT**

Thousands of top-pay jobs must be filled. Earn up to \$125 a week and more. Or, start in business. CTI Shop-Proved Home Training is practical. You get valuable tools and a Tune-Up Kit. Earn spare time dollars while learning. Write for FREE BOOK today.

COMMERCIAL TRADES INSTITUTE, Dept. A-122
1400 Greenleaf Ave. Chicago 26, Illinois

RADIO

Engineering. All phases radio & electronics theory & practice; television; FM; broadcasting; servicing; aviation, marine & police radio. Prepare for good pay; 18-month course. Graduates in demand by major companies. Enter Jan., March, June, Sept. Regular campus life. Write for catalog. VALPARAISO TECHNICAL INSTITUTE, Dept. D, Valparaiso, Ind.

LEARN REAL ESTATE

The Easy Listening Way. Complete Real Estate Course on records. LEE INST. H 231 Wash. St. Brookline, Mass.

**FREE! 60 APPROVED EXERCISES, 68 PHOTOS
with FAMOUS DAN LURIE
BARBELLS**



LOW DIRECT PRICE
50 lb. set \$ 8.48 • 100 lb. set \$13.98
150 lb. set \$20.48 • 200 lb. set \$25.98
SEND FOR FREE CATALOG
Order by mail—50% with order Balance C.O.D. Extra WTS. 13c lb. FOB Plant.
DAN LURIE BARBELL CO.
52M12 Bristol St., Dept. 559M, Brooklyn 12, N.Y.
SEE DAN ON T V "BIG TOP" SHOW

**FREE AMAZING NEW BOOK
"HOW TO ANSWER ADS"**

Never before have you seen anything like this. Tells you in simple language the correct way to answer ads. Gets you quicker replies—better results, and greater satisfaction. Will save you time and money and it's ABSOLUTELY FREE. No obligation whatever. Every reader of advertising should have this booklet. Send a postcard for your copy NOW. F. W. JOHNSON, Popular Mechanics Magazine, Room 600-A, 204 East Ontario Street, Chicago 11, Ill.

BUILD HELICOPTER GLIDER

The famous new GYRO-GLIDER, world's simplest and safest aircraft, is now available to amateur builders in plans and kits. Send \$1.00 now for three-view drawings with specifications and ask about kits and detailed building and flying instructions.
BENSEN AIRCRAFT CORP., Dept. PM-12
P.O. Box 2621 Raleigh, N. C.



ONLY \$1 Name _____ Address _____
Greatest Thrill in Flying! City _____ State _____

WORLD'S
BEST
WANT-AD
MEDIUM

CLASSIFIED ADVERTISEMENTS



Advertisements in this section \$1.00 per word, each insertion, minimum 10 words, payable in advance.

To be inserted under proper classification, copy must be in our office the

20th of the second month preceding date of issue

F. W. Johnson, Manager, Classified Advertising

Popular Mechanics Magazine, 200 East Ontario Street, Chicago 11, Illinois

YOU'LL PROFIT

By reading and answering the classified ads in this section. Hundreds of opportunities for you to make and save money

AUTOMOBILES, MIDGET CARS

FOREIGN Car Scrapbook. 224 pages, 400 illustrations, early British, German, French, Italian cars. Historical, educational, humorous. Enthusiasts', collectors' delight. \$2.00 postpaid. Catalog free. Floyd Clymer, Dept. 12-PM, 1268 S. Alvarado, Los Angeles, Calif.

GLASFIBER Auto Body Construction Simplified. The recognized reference book among amateurs, professionals. Clear, complete treatment, latest techniques. 100 process photographs. Boat building also covered. All new—Satisfaction guaranteed. \$3 postpaid. Post, Box 807, Arcadia 3, California.

CHILDREN'S 2 Passenger electric driven automobiles. Worth \$200.00. Special offer \$49.00 for complete kit. Includes everything (less battery). Dealers wanted. Send 25 cents for details. Frankford Products Mfg. Co., 3331 Frankford Ave., Philadelphia 34, Penna.

BUILD Midget auto. Complete drawings, pictures and list of parts \$1.00. Lee's Midget Autos, Box 82, Avila, California.

ANTIQUÉ Automobile color slides. 2x2. Illustrated catalog free. Universal, Box 779A, Beverly Hills, Calif.

CLYMER'S Latest antique car catalog. Just published. All 1912 U.S. automobiles illustrated with specifications. \$2.50. Catalog all 1927 automobiles, specifications. \$2.50 postpaid. Book catalog free. Floyd Clymer, Dept. 12-PM, 1268 S. Alvarado, Los Angeles, Calif.

HUNDREDS Of automobile catalogs—American, antique, foreign; dealer books, glossy photographs, shop manuals; free motor magazines. Offered by non-profit club. Write immediately; get on free mailing list. Auto Maniacs, Stockbridge, Mich.

HENRY'S Wonderful Model T. Floyd Clymer's latest, largest, finest book published by McGraw-Hill. Large 220 page, beautifully bound gift book, 500 illustrations, all models shown, unusual Model T data never published before, including experimental models, jokes, songs, poems, parts, accessories and listing all model numbers. Every T enthusiast, past or present owner, historian and collector will treasure this new book just off press. \$5.95 postpaid. Floyd Clymer, Dept. 12-PM, 1268 S. Alvarado, Los Angeles, Calif.

ANTIQUÉ Automobile Handbook. 224 pages, 400 illustrations. Complete information repairing all automobiles of 1920s and earlier. \$2.50 postpaid. Floyd Clymer, Dept. 12-PM, 1268 S. Alvarado, Los Angeles, Calif.

BOYS' Power-driven auto. Build your own. Plans 25 cents. Sypher Co., Sta. F., Toledo, Ohio.

CLYMER'S Scrapbook of Early Advertising. 1880 to 1920. Famous products of yesteryear, illustrated in text, pictures, early "corny" advertisements. Educational, historical, comical. 224 pages. Real collectors' item. Just published. \$2.00 postpaid. Floyd Clymer, Dept. 12-PM, 1268 S. Alvarado, Los Angeles, Calif.

FIBERGLAS Car Book. How to build one, by expert author. \$2.00 postpaid. Floyd Clymer, Dept. 12-PM, 1268 S. Alvarado, Los Angeles, Calif.

FORD Owner's Complete Handbook. Newly revised, just published. Covers all Ford V-8s, 1932 to latest 1955 Six and V-8 models, also Fordomatic. Finest book for Ford owners or mechanics ever published. Written for average owner in non-technical language. 224 pages, 350 illustrations. \$2.00 postpaid. Floyd Clymer, Dept. 12-PM, 1268 S. Alvarado, Los Angeles, Calif.

CLYMER'S Catalog All 1955 Automobiles \$1.50 1955 Mobilgas AAA Economy Run Book gives every detail. 150 photos, \$1.50. How to Build a Fiberglass Body Car \$2.00. World's Famous Aircraft Book \$1.50. 1955 Indianapolis Race Yearbook \$1.50. All postpaid. Catalog free. Floyd Clymer, Dept. 12-PM, 1268 S. Alvarado, Los Angeles, Calif.

CHEVROLET Owner's Complete Handbook. Newly revised, just published. Full information all Chevrolet six models, 1929 to date, including latest 1955 V-8s. Also includes Powerglide. Finest book for Chevrolet mechanics and owners ever published. Written for average owner, non-technical language. 224 pages, 325 illustrations. \$2.00 postpaid. Floyd Clymer, Dept. 12-PM, 1268 S. Alvarado, Los Angeles, Calif.

AUTO SUPPLIES AND EQUIPMENT

USE Lachapelle's patented treatment. For a better motor for \$3.00. Write, Ferns, Box 71827-B, Los Angeles 1, Calif. In Canada, Master, Box 216, Welland, Ont.

ENGINE Books. Free list covers speed tuning, cam secrets, competition engine building, etc. Frank Morgan, Marysville, California.

VACUUM Rebuilt windshield motors \$2.50 postpaid. Send your motor to National Rebuilding, Mt. Pleasant, Penna., R. D. #1.

BUY Wholesale nationally advertised auto supply, thousands other products at big discount. Free "Wholesale Plan." American Buyers, Hertel Station, Buffalo 16-G1, N. Y.

FREE. Illustrated, descriptive information "The Truth About Water Injection." Injector, Box 526, Burbank, California.

RADIO Reception booster—Universal for all auto radios. Improves reception in weak signal areas. Send \$2.00. Winnick Stores, Inc., 68 Main St., White Plains, N. Y.

STOP Car rattles forever. New \$2 kit with simple tool. (Money back if not o.k.) Concourse, 4003 Dyre Ave., New York 66, N. Y.

SPARK Plugs. Champion, AC, Autolite. Guaranteed 10,000 miles. Send \$3.00 box of ten. Free auto parts discount card. West Co., 4259 Gardena, Riverside, Calif.

JEEP Owners—V8 power. Read Jeep Owners ad, page 46.

AUTO Safety belts; lustrous nylon webbing, CAA approved buckle, complete hardware, \$6.95. Literature. The Safety Belt Company, Box 1142, Poughkeepsie, N. Y.

YOU Can buy first grade automobile tires 10% below dealers cost. Hoagland Hardware, Hoagland, Indiana.

KEEP Antifreeze antiacid permanently. Condeco pH Positive stops acid formation. Use antifreeze year after year. Guaranteed. \$1 ppd. Contemporary Development Corp., 444 N. High St., Columbus, Ohio.

CARPORTS, Patio roofs, Partitions, build them yourself with beautiful Fiberglass "planks." Details free. Concourse, 4003 Dyre, New York 66, N. Y.

AMAZING Discovery. Saves gas, oil, repairs. Increases compression, power. Lachapelle's (patented) Motor Treatment. Only \$3.00 delivered. Money back guarantee. You can't lose. Free circular. Write Joe Dillon, Authorized Warehouse and Agents Distributor, Box 32315, Bridgeport, Ohio. Exclusive agencies open.

AUTO Safety belts. \$10.95 value, now \$6.50. Blue or gray. Money-back guarantee. Safety, 114 W. Hubbard, Chicago 10, Illinois.

ONLY \$5.00! Just drop new Solatone anti-carbon electronic cell in fuel tank and save on tune-up and gasoline. Money back guarantee. Prepaid. Order to: Hydrocarbon Manufacturers, 2808 McKinney, Dallas, Texas.

BLINDED By rear window glare? Does following car headlights bother? Get our reflective "lights" sign for the rear window. Price only 98c postpaid. Fabricated Metal Products Co., Exeter, New Hampshire.

DE Luxe foot horn switch. Patented accelerator design. Self-cleaning contact points. Beautiful chrome finish. Wiring provided. Easily installed. Introductory \$1.00. Rite-o-way Products, 17886 Hull, Detroit 3, Michigan.

BUY Wholesale 550,000 products. Literature free. Carter, Box 6011-AS, Chicago.

SAFETY Belts. Easy to open and adjust. \$8.95 each. Free gift with each belt, value \$4.95. Free brochure. Home Supply Service, Kiel, Wis.

SENSATIONAL GE-Subzero automobile engine heater starts coldest cars, trucks, tractors immediately. Special \$3.95 (regularly \$8.95). Order for yourself, sell others locally and mailorder. Huge profits. Terrific quantity discounts. Act now! Wisniewski Inc., Milwaukee 7, Wisconsin.

GM71-110 Discarded injector. Parts wanted. Bonus on HV. Buescher, 7120 Carnegie, Cleveland 3, Ohio.

LATEST Custom accessories. Items not in stores. New low prices. Continental tire kits, push-button doors, trunks, etc. New illustrated catalog, biggest ever, 25c. Eastern Auto, 3319-A South Grand, Los Angeles 7, California.

MOTORIST—Keep foreign matters out of your engine. Insert magnetic disk \$1.50. Art & George Co., 5170 No. Hollywood Avenue, Milwaukee 17, Wisconsin.

PROPELLERS Specially designed for airboats and snow sleighs by the world's oldest manufacturer of aircraft propellers. Free literature. Flottorp Mfg. Co., G. R. Airport, Grand Rapids 8, Mich.

PROPELLERS, Plans, supplies for airboats, snow sleighs. Catalog 10c. Gano Propellers, Box 3284-A, Ft. Worth, Texas.

BUILD A fast, safe airboat or snow sleigh from your 65-200 h.p. aircraft engine. Propellers, plans, supplies. Satisfaction guaranteed. 48 page catalog 25c. Banks-Maxwell Co., Box 3301E, Ft. Worth 5, Texas.

AUTO Accessory and parts catalog. 1956 edition—All new! 164 pages. Save up to 50%—Over 50,000 items, including Hollywood accessories, hi-speed equipment, rebuilt engines, all parts and accessories for all cars and trucks; Hard-to-get parts! Send 25c (refundable). J. C. Whitney, 1919-PM Archer, Chicago 16, Illinois.

CAR Burning oil? Losing compression? Try Clifford's Compression Seal. Tube, \$2 postpaid. Clifford's Engineering, 452 Claim, Aurora, Illinois.

ELECTROPLATE Auto parts, novelties, mirrors. Easy, inexpensive home processes. Free booklet. Tyco Metals, Box 13231-BG, Houston 19, Texas.

FORD T parts? Try best source old car parts anywhere. Wisneski, Milwaukee 7, Wis.

FREE Discount catalog—Speed, power, custom equipment. Almquist Engineering, Milford 7P, Pennsylvania.

NEW And used parts at savings. Complete guaranteed parts service for all models cars and trucks, 1924 and later. Largest in the West. Army parts specialists. No catalog; write for quotations. Fast mail order service. Pioneer Auto and Truck Parts Co., 734 W. 13th Avenue, Denver, Colorado.

AUTO TRAILERS

"SHORT-Short" family trailer. Simple assembly. Plans \$1.75. Welch Workshop, 645 Rochdale Circle, Lombard, Illinois.

TRAILER Building manual illustrated \$1.00. Booklet 25c. Craftsman Books, Box 1153, Milwaukee 1, Wis.

EXCEPTIONAL Expanding eight foot trailer. Accommodates family of five. Build yourself. Literature 10c. Pramcar Company, Wilmington, Mass.

BUILD Your own trailer! Plans for all kinds. Illustrated catalog 10c. Jim Dandy, 125-M, Wausau, Wisconsin.

MOTORCYCLES, BICYCLES, MOTORSCOOTERS AND SUPPLIES

VINCENT Motorcycle Owner's Handbook. Just published. 224 pages, excellent illustrations. Full non-technical details servicing all model Vincent motorcycles. \$2.00 postpaid. Triumph or Ariel Owner's Handbook, excellent owner service information \$1.50 each. Modern Motorcycle Mechanics, largest best book covers all makes motorcycles \$5.00. Clymer's Cycle Magazine, all about motorcycles, new models, racing technical information, road tests. Every motorcyclist needs this informative, interesting, educational monthly magazine. Only \$3.50 per year. Sample copy 35c. Floyd Clymer, Dept. 12-PM, 1268 S. Alvarado, Los Angeles, Calif.

MOTORCYCLES And supplies. Complete service. Free Bulletins. 813 Ohio Street, Wichita Falls, Texas.

NSU And BMW motorcycles, 2 to 35 h.p., singles and twins, chaindrive and shaft-drive. Butler & Smith, P.O.B. 45, New York 24, N. Y.

BICYCLE Owner's Complete Handbook. Full information repairing all bicycles. Written for the average owner. Well illustrated. \$1.00 postpaid. Floyd Clymer, Dept. 12-PM, 1268 S. Alvarado, Los Angeles, Calif.

RECONDITIONED Motorcycles and motors. Chromium accessories. Complete stock Indian parts. Expert rebuilding. Fast service. Indian Motorcycle Sales, Kansas City 27, Missouri.

MOTORBIKE Engine \$7.50. Cushman motorscooter \$30, midget car, less engine \$16, engine \$5 up. (Mailorder only.) Send 25c (35c for first class mail) for new directory-catalogue Number 68, listing the above and hundreds of other bargains in new and used midget cars, motorscooters, home builders parts, plans, etc. Midget Motors Directory, Athens, Ohio.

HARLEY-Davidsons—America's finest used bargains! We pay shipping on motorcycles. Genuine new, used parts, accessories for current and obsolete models. Send 25c for bulletin, catalog. Knuth's (factory dealer), 1753 Muskego, Milwaukee, Wis.

AVIATION

CYCLIC Propulsion, latest jet propulsion system for boats and low velocity vehicles. Details \$1.00. Decker Engine Works, Plasterco, Virginia.

AVIATION Surplus bargain catalogue. One dime. Box 22F1, Thomasville, Penna.

HELICOPTERS—1 And 3 man. Aviation marvels. Construct own. Instructions \$3.50, \$6.00 respectively. Mayberry Aircraft, Box 343, St. Clair Shores, Michigan.

SIX Giant airplane photographs 14 x 17 reproduced in full color. Decorate your den, etc., with color prints of war planes in action. Complete set of six assorted only \$1.00 postpaid. Jarvis Bros., Box 126, Bostonia, California.

LIGHTPLANE Building manual \$2.00. Circulars 25c. Craftsman Books, Box 1153, Milwaukee, Wis.

BATTERIES, GENERATORS

EDISON Nickel storage batteries. Any voltage, any amperage. Unconditionally guaranteed. Power plants, generators, motors. Literature. Hawley Smith Co., Croton Falls 1, N. Y.

ELECTRICAL SUPPLIES

LAMPS—25c Brings bargain catalog showing all parts for repairing, building. Contains instructions for electrifying vases, oil lamps, etc. Gyro Lamps, 5402P Clark, Chicago 40.

ELECTRIC Pencil: Engraves all metals \$1.50. Beyer Mfg., 10511-H Springfield, Chicago 43.

NEW 1955 Lamp parts catalog showing everything you need to make and repair most types of lamps. Everything at lowest wholesale prices. Send only 25c today for both catalog and wholesale price list. Gearon Co., Dept. 503-B12, 27 S. Desplaines, Chicago 6, Ill.

LAMP And electrical parts—Wholesale. Hundreds of items for manufacturing, repairing, and retailing. Illustrated catalogue 25c. Brown Lamp Co., Box 501, Wellston Sta., St. Louis, Mo.

WELDING, SOLDERING, PLATING

A.C. Welders, 4 sizes. Lowest prices. Free literature. Holgeron's Serv., Canton, Kan.

GUARANTEE Your white metal welding. Successful procedure \$2.00. Kittell, 1305 S. Western, Tecumseh, Mich.

ACETYLENE Welding outfits, new \$49.00; used \$29.00; arcwelders \$56.50. Eagle Welding, Dept. PM, 5085 Broadway, Chicago 40, Ill.

ELECTROPLATING Equipment, anodes and solutions for all types of plating. Instructions. Assemble your own plater and save. Free catalog. Ramyr, Dept. E-4, 1624 East First Street, Los Angeles 33, California.

NEW, Portable oxy-acetylene outfit welds sheet, light plate; cuts heavy steel; heats, brazes. Just change tips. Complete, with instructions, only \$76.50. Special money-saving plan for oxygen and acetylene supply. Write today for free literature. Dept. M, Linde Air Products Company, 30 East 42nd Street, New York 17, N. Y.

WELDERS, 110/220, \$39.50. Morris, 1070 Inner Drive, Schenectady 3, New York.

BUILD-UR-OWN a.c. welder and a.c. power plant with a good used engine and low cost Hobart generator. Welds anywhere and supplied 5kw stand-by power for any emergency. Write Hobartweld, Box M-1253, Troy, Ohio.

MACHINERY, TOOLS, SUPPLIES

McCULLOCH Chain saw parts. Special prices on Oregon chain for all makes of saws. Free price lists. Barnett Equipment, So. Glens Falls, N. Y.

ALLEN Two ton power bench type punch press. \$97.50. Circular. Allen, Dept. PMB, Clinton, Missouri.

MILLING Machine: New, complete \$149.50. Southern Machine Tool Co., Conyers 1, Georgia.

SHEBEL Saw filer files all saws. Circular. A. P. Shebel, 730 So. 2nd St., Milwaukee 4, Wis.

BIG Factory catalog! Buy direct—Save middleman's profits; hundreds of labor saving tools and equipment; tremendous savings. Send 10c. Master Mechanic Mfg., Dept. CL-99, Burlington, Wis.

FREE Lists—Screws, nuts, bolts, washers assortments for home and shop. Coe, 19 Monroe Drive, Williamsville, N. Y.

MAGNETIC Tool—Pencil type. New, amazing, powerful. Picks up small parts. Hundreds of uses. Ideal for mechanics, radio-television repairmen and hobbyists. 69c post paid. Empire Magnetics, Inc., 107 E. Clinton Street, Maumee, Ohio.

ENGINES, MOTORS, DYNAMOS

WINDING Data, 225 motors, single and three phase. \$1.00. Data Company, Box 7631, Kansas City 28, Mo.

REWIND Motors yourself. Complete instructions \$1.00. Lewis Mfg., Howell, Michigan.

PARTS For Briggs Stratton, Clinton, Lauson power products, Wisconsin Continental engines. Weeden Company, Wakefield, R. I.

NEW Motors 50% off retail price. Unused, in original containers. G.E. and Diehl. Capacitor start, drip proof, 110-220v., 1750 rpm. 1/4 hp. (usual retail \$42.50), \$21.25. 1/2 hp. (usual retail \$55.10), \$27.55. F.o.b. Portland. While quantity lasts. Burrowes, 70 Free Street, Portland, Maine.

ELECTRICAL Repair men, motor winding and testing catalog free. Motor Industries, Quincy, Illinois.

NEW Gasoline engines. Bargain catalogue 10c. Loren, Box 436, Danville, Illinois.

BOATS, OUTBOARD MOTORS

FULL Size, cut-to-shape boat patterns, blueprints, 7 1/2-38 feet. New 1955 illustrated "Build a Boat" catalog of 50 naval architect-designed cruisers, runabouts, sloops, skiffs, outboard boats, sailing, racing, houseboats, 50c. Small boat hardware catalog, \$1.50. Bigger, better 1955 "How to Build Boats" book, \$2.50. Cleveland Boat Blueprint Co., Dept. A-66, Box 1651, Cleveland 4, Ohio.

BUILD A fast, safe airboat or snow sleigh from your 65-200 h.p. aircraft engine. Propellers, plans, supplies. Satisfaction guaranteed. 48 page catalog 25c. Banks-Maxwell Co., Box 3301F, Ft. Worth 5, Texas.

JOHNSON Outboard specialists. Used parts for all models at substantial savings. Prompt quotations. Specify model serial. Crandall-Hicks, 910 Commonwealth, Boston, Mass.

"GLASBOTE" Plastic and glass cloth for boat covering. Complete information and material price list free. Buchanan Plastics, 1728 Hamilton Road, Okemos, Michigan.

BOAT Plans, patterns, frame kits. Modern inboards and outboards, 11'-22' for amateur builders. State requirements or send 40c for complete catalog. Glen Designs, Box 568, Compton, Calif.

PLYWOOD Boat plans, 21 for \$1.00. Catalog boat building plans 25c. The Rudder, 15 Murray Street, New York 7.

CONVERT Fords and Jeeps to 100% marine engines with Osco's world famous Convo-Kits. Deluxe catalogue 25c (coin). Oscomotors, 3627B Lawrence, Philadelphia 40, Penna.

FIBERGLAS Permanent boat water-proofing. Lowest wholesale prices. Guaranteed materials. Easy application. Full instructions. Complete kits, \$12.60 up. Free literature. Ajax Plastics, Dept. PM, P.O. Box 1323, Fort Worth, Texas.

NEW, Used, rebuilt marine motors. Marine conversions, fittings. Free catalog. Stokes Marine Supply, Dept. 24, Coldwater, Michigan.

MARINE Conversions for Ford and Jeep engines. Catalog 25c. Lehman Manufacturing Company, 972D Broad Street, Newark 2, New Jersey.

FREE Catalog! Boat kits, trailers, fiberglass, marine hardware. Luger Industries, Dept. M, 4452 Nicollet, Minneapolis, Minn.

90 PLANS, Patterns, frame, boat, trailer, conversion kits, hardware. Catalog 50c, refundable. Marinecraft, Box 161-M, Brighton, Mass.

BUY Wholesale nationally advertised outdoors, thousands other products at big discount. Free "Wholesale Plan." American Buyers', Hertel Station, Buffalo 16-H1, N. Y.

BOAT Plans. Welded steel, wood, plywood. Inboards, cruisers, sail. Free literature. Please specify size-type, John B. Clark, N.A., Box 31, Bay Village, Ohio.

BARGAINS In small boat hardware and Fiberglass. Catalog 35c. Marine Associates, Box 6188-MD, Long Beach 11, California.

WHOLESALE! Sea legs boat kits, factory prices from \$31.98. Savings to 25%. Pre-assembled frames, pre-cut parts, illustrated instructions. Penney Woodcraft Industries, Dept. C-45, Defiance, Ohio.

ATHLETIC EQUIPMENT, BODY BUILDING COURSES

MEN'S Athletic supporters, form-fitting pouch, S.M.L. \$1.00. Poly Shop, Box 3203, Ft. Worth 5, Texas.

100 TRICK Knockouts for self-defense. \$1.00, 1c each. Priest, Box 251, Evanston 1, Illinois.

FREE Catalogue, 10c for postage appreciated. Dr. Thompson, 919 Fourth, Manhattan 30, Kansas.

STRENGTH, Health, Gain or reduce. Any age. Easy! "All you need is a rope!" Sensational new discovery! Free details. Ropercise, 4834 Art St., Room 101, San Diego 15, Calif.

BARBELLS, Exercise equipment. Courses. Free booklet, Good Barbell Co., Reading, Penna.

BUILD Powerful arms, chest, shoulders! 22 exercises, \$1. Ponsad, Box 601-B, 1100 Market, Wilmington 99, Del.

BEGINNER'S Muscle building course 25c. Leonard Austin, the Iowa Strongman, De Soto, Iowa.

MUSCLE Development while sitting in any car or chair. Amazingly new simple method shown in illustrated copyrighted booklet. Money back guarantee. \$3.00 to I.M.T., Box 206 Northwest Branch, Miami 47, Florida.

JUDO! Deadly Japanese techniques. Illustrated booklet only \$1.00. Argyle, Box 27, Bellingham, Wash.

SPORTING GOODS, GUNS, FISHING TACKLE, ARCHERY, TRAPPING

GOVERNMENT Surplus ammunition—45/70 caliber \$6.50 per hundred; 30 carbine, 30/06 government \$5.95 hundred. Also ammunition, Italian, German, Jap revolvers, rifles. Free list. Hudson, P-52 Warren Street, New York City 7.

180 PROFUSELY Illustrated pages antique pistols, swords, daggers, armor, etc. 50c. Robert Abels, M360 Lexington Ave., New York 21.

TENTS, Camping equipment. Send 10c for new 1955 100 page tent, camping equipment catalogue-handbook. Morsan, 10-21R 50th Avenue, Long Island City 1, N. Y.

MOLDS—For making fishermen's sinkers. Free illustrated booklet. Reading Instrument Co., Box 78, Reading, Penna.

BUY Wholesale! Guns, fishing, sporting goods. Save 66%! Free catalogs. National Buyers Service, Box 426EC, Oakland, California.

5000 BARGAINS, Firearms, binoculars, war relics. Catalog 50c. Smith Firearms, Runnecede, N. J.

MOLDS For fisherman's sinkers, jigs, squids, casting and spinning lures. Free catalog. Sweet's Molds, Tonawanda 1, New York.

JAP Rifle altering to 30-06, \$6.00. Japshells, \$3.75. Catalog 3c. T. P. Shop, West Branch 11, Mich.

FREE Fishing catalog—132 pages. Over 3000 hard to find fishing specialties. Netcraft Company, Dept. PM12, Toledo 13, Ohio.

FREE Gun catalog. We buy, sell, trade, repair. Let us know your wants. Barlow, 3365 S. Howell, Milwaukee 7, Wisconsin.

SWIMMERS! Send \$3.95 for imported French mask. Catalog of skin divers' equipment and books 25c. Aquafun PM, Davenport, Iowa.

BUY Wholesale nationally advertised sporting goods, thousands other products at big discount. Free "Wholesale Plan." American Buyers', Hertel Station, Buffalo 16-H1, N. Y.

"SHOCKING" Expose! Catfish caught with telephone apparatus! Complete details, \$1.00. Pop, Box 6123, Houston 6, Texas.

100,000 GUNS, Accessories! Winchesters, Colt's, Kentuckies. Antique, modern gun bargains. Time payments. Super catalog 50c. Agramonte's, Yonkers 2G, N. Y.

MANY Modern, antique guns. List 10c coin. Ed Howe, 52 Main, Coopers Mills, Maine.

JEEP Owners—V8 power. Read Jeep Owners ad, page 46.

TAXIDERMY

YOUR Deerskins tanned and custom made into beautiful dress gloves, moccasins, handbags, coats and vests. Deal direct. Catalogue on request. J. R. Styres, Little Falls 1, N. Y.

BINOCULARS, TELESCOPES, MICROSCOPES, MAGNIFIERS

LOWEST Prices, all sizes, binoculars, telescopes, microscopes. Also repaired. Free catalogue, Joe's Binocular Sales, 4627 Second Blvd., Detroit 1, Michigan.

TELESCOPES, Microscopes, binoculars, past quarter century. Comprehensive scientific instrument catalog \$1.00. None free. Dollar deductible from orders. Harry Ross, 70 West Broadway, New York 7, N. Y.

6 THUMBS On each hand? Even you can assemble our telescope kits from our easy instructions. Enjoy the heavens with a high precision telescope assembled in less than an hour. You'll like our complete line of telescopes, microscopes and accessories, biological stains, etc. Send for free catalog T of finest quality and newest design astronomical kits or free Catalog M of microscopes. Optical Engineering Co., 184-19 Northern Boulevard, Dept. PM, Flushing, New York.

UNITED Binoculars. Ideal Christmas gifts. \$3.95 to \$250.00. Free 56 page binocular-telescope catalog. United, 9043 S. Western, A-8608, Chicago 20. Dealers wanted.

400 POWER Telescope easily made. Kit includes focusing tube, erector, five finished lenses and instructions—\$3.75. Giant astronomical telescope complete with tripod \$15.00. Free information. Suffolk Science, Mattituck 3, N. Y.

IMPORTERS' Amazing prices, precision binoculars, 22 models. Free trial. Folder, "Binocular Selecting," catalog free. Dealers wanted. Prentiss Importers, Mercury Bldg., West Los Angeles 25, Calif.

BINOCULARS, Telescopes, microscopes, terrific values \$3.98 up. Request free money saving catalog. Criterion, Dept. P 36, Hartford, Conn.

WAR Surplus bargains! Millions of lenses, instruments, telescopes, binoculars, components and complete line of astronomical telescope items. World's greatest optical market place! Send only \$1.00 for beginner's 10-lens kit and big instruction booklet Stock 2-CH. Write for Catalog CH, free! Edmund Scientific Corp., Barrington, New Jersey.

BUILD Your own reflector telescope complete kit: Mirrors, eyepieces, tripod, all other accessories. Request free illustrated literature. Criterion Manufacturing, Dept. KPM 12, Hartford, Conn.

I Can save you money on binoculars, microscopes and barometers. Send for free information about 7-power binoculars at \$29.95, triple turret electric microscopes at \$10.95 and finest German barometers at \$7.50. Joseph Sales Co., Room 507B, 1740 East 12th St., Cleveland 14, Ohio.

PRECISION Lens list and microscope circular. General Science, Box 8423, Minneapolis 16, Minn.

DYNASCOPE—Sensational new reflector telescope. Send for details. Criterion Co., Dept. DP 15, Hartford, Conn.

REFLECTOR Telescope kits \$4.25 (3") to \$175. (12"). Mirrors, cells, focusing mounts, tripods, eye-systems. Anything, everything in telescopes. Free illustrated catalog. Also ready to use telescopes from \$26 to \$176. Inquiries to Esco Products, Dept. PM-12, 1428 Willow Ave., Hoboken, N. J. Sales showroom, 166 Church St., New York City.

SPECIALISTS! Used microscopes and accessories. Unusual slides. Supplies. Catalog free. Research Scientific Supplies, 60 Wall St., New York City 5.

PETS—DOGS, BIRDS, RABBITS, HAMSTERS, ETC.

STANDARD Rabbit Journal, Milton 3, Penna. Year \$1.00. Sample dime. Beginners manual 25c.

GROW Mushrooms. Cellar, shed, and outdoors. Spare, full time, year round. We pay \$3.50 lb. We paid Babbitt \$4,165.00 in few weeks. Free book. Washington Mushroom Ind., Dept. 171, 2954 Admiral Way, Seattle, Washington.

TREATISE On breeding canaries for profit. Only \$1.00. Free copy of bird magazine included. Audubon Publishing Company, 3449 N. Western Ave., Dept. P.M., Chicago 18, Illinois.

MINK Raising information free. Complete. Lake Superior Mink Farm, Superior, Eel, Wisconsin.

MAKE Big money! Raise Chinchilla rabbits. Cash markets supplied. Write today! Rockhill Ranch, Sellersville 15, Penna.

SPORTSMEN! World's largest kennel offers 500 Pointers, Setters, Straight Cooners, Combination Hounds, Rabbit and Squirrel Dogs, Beagles, Fox and Wolf Hounds, Trial. Prices reasonable. Catalogue free. Smokey Mountain Kennels, Cleveland, Tennessee.

CHINCHILLAS (No rabbit). Registered. Guaranteed. Easily raised. Profitable. Big future. Terms. Hibner Chinchillas, Ithaca, Michigan.

CHINCHILLAS—Beautiful young pairs \$75.00 per pair! Free details. Consolidated Chinchillas of America, Asheboro, N. C.

CONVERT Cheap foods into money-making mink. Complete information free. Voight Farms; Lomira 2, Wisconsin, or Atlanta 2, Texas.

RAISE Mink: Free booklet, pen plans, inside secrets, feed, care. Mink are money makers. Investigate today. Lawrence Morgard, Brigham City 12, Utah.

CHINCHILLAS—Registered sturdy stock. Wholesale. One or one hundred pairs—\$75.00 pair. Slater Chinchillas, 1535 Ruhlman Ave., Manhattan Beach, California.

CHINCHILLAS, Registered. Unbelievable prices. Far-West Chinchilla, 1446A Jones, San Francisco 9, California.

RABBIT Raising facts complete in 48 page illustrated book, by world's largest rabbit association, 10 cents. Address American, 36 Arba Building, Pittsburgh 17, Pennsylvania.

CAGE-BIRD Magazine (budgies, canaries, etc.) one year, \$3.00. American Cage-Bird Magazine, 3449 N. Western Avenue, Dept. P.M., Chicago 18, Illinois.

HUNTERS! Raccoon Mountain and Short Creek Kennels now combined. Large number of coonhounds, foxhounds, rabbit-hounds, beaglehounds, bird-dogs, puppies. Free literature and pictures. Trial, Dures Thomas, Owner, Box 464, Boaz, Alabama.

RAISE Money-making Angora, New Zealand rabbits, Particulars free. White's Rabbitry, Jackson, Mich.

DESCENTED Skunks, monkeys, reptiles, etc. Illustrated catalogue 25c. Trails End, St. Stephen, S. C.

BEAUTIFUL Pure white pedigreed police puppies. Ansonia Kennels, Mose, N. Dak.

MAKE Money raising chinchillas, mink, pigeons, rabbits, cavies for us. Free catalog. Keeney Brothers, New Freedom 2, Penna.

HAMSTERS—Goldens \$2.95 pair. Free literature. Jer-Fre's Hamstery, Muskegon Heights, Michigan.

HAMSTERS—Golden: young, \$3.00 pair; fully developed, \$4.00 pair. Adirondack Hamstery, Prospect 124, New York.

DEWORMING Powder for dogs, cats or goats. Wright's the best. It's non-toxic. Guaranteed to satisfy. 4 oz. can, dog: \$2.00; 4 oz. can, cat: \$2.50; 4 oz. can, goat: \$2.50. Postpaid. Free valuable booklet with purchase. Wright Laboratory, Box 23, Ramona, California.

"PR" German shepherd police pups. Good hunting, watch and cattle dogs. Send 25c for pictures. H. Schumacher, Ottertail, Minn.

PLANTS, SEEDS, NURSERY AND GARDEN SUPPLIES

TREES And shrubs. Raise your own from seed for shade, windbreak, snow fence, ornament, erosion control, etc. For free planting guide, price list, write Woodlot Seed Company, Norway 9, Michigan.

WORLD'S Greatest cash crop. Free information. Write Ginseng Gardens, Asheville, N. C.

FARMS, FARM LANDS, REAL ESTATE

HOMESITES \$400 - Convenient payments. California's finest garden section. On Morro Bay's scenic shores. Wonderful fishing, boating, bathing. Fertile soil, softest water, temperate climate, congenial community. Free literature. Richard Otto, Department M, San Luis Obispo, Calif.

FLORIDA - Beautiful retirement homesites near gulf coast. Excellent hunting, fishing in 9 fresh and salt water rivers. 11 bays and gulf. \$250 at \$10 monthly. Free literature. V. M. Mathews, Box 1406, Asheville, N. C.

FLORIDA. Nice homesites, \$245 at \$10 monthly. Folder free. Howard Vernor, DeLand, Florida.

STROUT Catalog - Mailed free! Farms, homes, businesses, 36 states, coast-to-coast, 2,914 bargains described. World's largest; 55 years service. Strout Realty, 7-MF So. Dearborn St., Chicago 3, Ill.

FLORIDA Lakefront homesites near Ocala forest. Excellent fishing-hunting. \$10.00 monthly without interest. Complete price \$195-\$995. Literature, Grace Parker, Paisley, Florida.

FLORIDA Waterfront homesites on famous Saint John's river, \$50.00 front foot. Also inland lakefront five miles from river \$195.00-\$995.00. Specify which literature. Easy monthly payments. Pine Lakes, Eustis, Florida.

SAVE. Buy direct from government, land, homes, islands, farms, etc. Listings \$1.00. Abacus, Box 169D, Dept. M, East Hartford 8, Conn.

ROADSIDE Home, garage, nothing down. List free. Perrys, Brier Hill, Penna.

FLORIDA - Several five acre tracts. Grand climate and location. Near Gulf Mexico for fishing, boating, bathing. Priced at \$985.00, \$20.00 down, \$20.00 month. Information write G. B. Potterfield, Owner, Union Building, Dept. X, Charleston, W. Va.

CALIFORNIA Farm and ranch lands. \$15 to \$35 per acre. 10 to 640 acre parcels. Easy terms. Free catalog. Pacific Tax Sales, 1621-A Cahuenga, Hollywood 28, California.

MOZARKS. Fruit, grazing, retirement. \$8.00 acre, \$5.00 monthly. Descriptions free. Write Armstrongs, Snook, Missouri.

POULTRY, FARM SUPPLIES

POULTRY Farmers - Broiler growers - Turkey raisers read the new American Poultry Journal for latest ideas and greater profits. 12 months, 50c. Special offer, 4 years \$1.00. American Poultry Journal, 182 North Wabash, Chicago.

PROFITABLE OCCUPATIONS

OVERSEAS, Latin American, Alaska, Canada employment. Originator 1933 "Foreign Service Directory" up-to-minute report on military and civilian construction; oil companies; aviation; transportation; steamship; mining; government job info. How-when-where to apply. Listing firms hiring. \$1.00. Global Reports, Box 883-P, Hollywood 28, Calif.

RAISE Pheasants on \$100 week plan. Little capital and space can make you independent. Free details. Great Central System, Columbus 1, Kansas.

FREE Folio "Up to \$45,000; Unlimited Vacations." No merchandise, equipment. Unknown! Work home, sparetime! Haylings, Carlsbad, Calif.

GROW Mushrooms. Cellar, shed, and outdoors. Spare, full time, year round. We pay \$3.50 lb. We paid Babbitt \$4,165 in few weeks. Free book. Washington Mushroom Ind., Dept. 99, 2954 Admiral Way, Seattle, Wash.

FREE Book "505 Odd, Successful Businesses." Work home. Expect something odd! Pacific, Oceanside, Calif.

MAKE New greaseless doughnuts in kitchen. Sell stores. Free recipes. Michael Ray, 9605 South 15th Ave., Minneapolis 7, Minnesota.

BE The Popular Mechanics representative in your neighborhood and earn big profits in your spare time. Write Popular Mechanics Magazine, Room 408M, 200 E. Ontario St., Chicago, Ill.

MONEY In saw and lawnmower sharpening sparetime at home. Repeat cash business. Experience unnecessary. No selling. Free booklet explains. Vernon Foley Company, Columbia Heights, Minnesota.

FORTUNE Possible raising fishworms and crickets. Free literature. Carter Wormery, Plains, Georgia.

\$200 WEEKLY Cleaning Venetian blinds. Free book. Burt, 2434A, Wichita 13, Kans.

WHOLESALE Catalog! 30-80% discounts! Appliances, musical instruments, typewriters, phonographs, watches, jewelry, recorders, housewares, etc. Consolidated Distributors, 21-14 Lafayette, Paterson 15, New Jersey.

MUSHROOM Spawn plus complete instructions various processes. \$1.00. Luxur, 641 S. 19th, Newark 3, N. J.

AUCTIONEERING - Home study course. Diploma granted. Auction School, Pt. Smith, Ark.

ANNOUNCING Home study course in commercial baking. Practical basic training. Good field for those with aptitude. Free booklet. "Opportunities in the Baking Industry." National Baking School, 835 Diversey Pkwy., Dept. 3439, Chicago 14.

WELDING Pays big money. Learn easily at best equipped school in country. Non-profit school with low cost training. G.I. approved. Write Hobart Trade School, Box M-1252, Troy, Ohio.

BUY Wholesale thousands nationally advertised products at big discount. Free "Wholesale Plan." American Buyers', Hertel Station, Buffalo 16-B1, N. Y.

JOB Opportunities Miami area \$1.00. Box 814, Int. Airport, Miami, Florida.

INDUSTRY Moving here! Why shouldn't you? Perfect climate. Columns of Florida Jobs. Airmailed for \$1.00. Box 4325, Fort Lauderdale, Florida.

JOBS To \$1500 monthly. All trades. So. America The Islands, U.S. Fare paid. Application forms. Free information. Write Dept. 76G, National, 1020 Broad, Newark, N. J.

BUY Wholesale 550,000 products. Literature free. Carter, Box 6011-BB, Chicago.

MAGAZINE Subscriptions - Highest commissions, bonus. Qualified Agencies, 451DB Kingston, Brooklyn 25, N. Y.

RAISE Earthworms. Illustrated instructions 25c. Birchall, Box 6065-U, Orlando, Florida.

MAKE \$5 Per hour and up net after taxes. Donald Wicks made \$48.00 in a few hours. You can too! Write for free book and sample of product. Theodore Wilson Products Co., P. O. Box 922, Dept. 11, Seattle, Wash.

MAILING Postcards offering fast-selling merchandise is profitable. Everything furnished. Send 3c stamp for details. The Wm. F. Liska Co., 102 Birchwood Ave., Cranford, N. J.

MEN Wanted - Build luggage and cases at home. We sell your products, supply complete instructions, materials, everything. No special equipment needed. Free details. Cascraft, 805-J Sunset, Los Angeles 12, Cal.

WORK, Live in southern California. Many good pay jobs in Los Angeles area. Pages of job ads mailed \$1.00. P.O. Box 422, Elmonte, Calif.

EVERYBODY Likes candy. Learn to make professionally home. Our 45th year. Ragsdale Candies, D6, East Orange, New Jersey.

ATTENTION Construction, aviation, oilmen! Trades, laborers, truck drivers, clerical, engineers, many others. Who to contact for highest paying jobs! To \$1500.00 monthly. Latest copyrighted reports. 52 countries - St. Lawrence project, Spain, Alaska, Latin America, Europe, Pacific. Year registration-advisory service. Application forms. Unconditional money-back guarantee. \$2.00. Airmailed \$2.25. (C.O.D.'s \$2.49.) International Reporter, St. Louis 1-PA, Missouri.

\$1300 MONTHLY For truck drivers, \$1400.00 monthly for carpenters, electricians, plumbers, mechanics, \$1200.00 for clerks and laborers. Full information and complete foreign listings, with current information on Spain, Korea, Australia, Alaska and Canada, \$1.00. Current information on state side projects, \$1.00. Dept. 3L, Opportunities Unlimited, 1110 Commerce Bldg., St. Paul, Minn.

CONFIDENTIAL Reports on best paying jobs with travel, adventure and top pay. Construction, aviation, shipping, laborers, clerical, trades, unusual opportunities, all types of work. Foreign and U.S. Only \$3.00, including year advisory service. (\$2.25 airmail.) Guaranteed best service of this type available or double your money back. Research Services, Box 2904-PMC, St. Louis 17, Missouri.

BOOKS, PERIODICALS, PICTURES, POSTCARDS

YOUR Little girl will love "Jumprope" and "Hopscotch." Both booklets 50c. Porpoise Bookshop, 308 Clement, San Francisco 18.

SUBSCRIPTIONS Accepted for all magazines. Scott Magazine Agency, 7905 Birchdale, Chicago 35, Illinois.

SPARETIME Profits taking subscriptions all magazines. Wholesale catalog free. Cassell Publishers, Westfield, New Jersey.

NATIONAL Geographic Magazines, 1888-1952. Periodical Service, Box 463-PM, Wilmington, Delaware.

BOOKS Found! Any author, old or new. Rush titles wanted; no obligation. International Bookfinders, Box 3003-PM, Beverly Hills, California.

BOOKFINDERS! All subjects. Send wants! Jaheer Book Service, 183 Hazelwood Drive, Westbury, N. Y.

"SCIENCE Milestones." Records march of science starting 400 years before Christ, right up to date. Amazing facts revealed. 312 pages packed with startling information that will thrill you. A real history of science. \$5.00. Literature free. Popular Mechanics Press, 300-3M East Ontario St., Chicago 11, Ill.

USED Books, homestudy courses. Bought-sold. Hutchison, 4167 Hemphall, Fort Worth 15, Texas.

TEN Scenic postcards, \$1.00. Free stamps, remaining. Scenic Postals, Box 1128, Chattanooga, Tenn.

MEDICAL Books, all subjects. Special offer to laymen. Reduced prices. Write for free list. Milbon Medical Book Co., 6643 Newgard, Chicago 26, Ill.

BOOKHUNTERS! All subjects. Send wants! College Book Service, 52 W. Kingsbridge Rd., New York 68, N. Y.

BOOK Catalog, 1000 interesting titles. Send 10c. Books Publishing Co., Amityville 3, N. Y.

WILL Find books wanted, old, rare, new. Occidental Bookfinders, Box 387, La Jolla, California. Selling \$1 each; How to Avoid Financial Tangles; How Invest Wisely.

GAMES, TOYS, NOVELTIES

100 METAL And plastic assorted toys, attractively packaged, \$1.00. Deluxe, 3405-A, Southern Ave., Baltimore 14, Md.

60 PLASTIC Toys \$1.00. Trains, trolleys, sedans, trailers, hammers, saws, rifles, etc. Hirsch, 3438 Corlear Ave., New York 63, N. Y.

"PLEASE Clean my windshield." New copyrighted gas cap and vent window decals remind station attendants who often neglect. 50c pair. Jay-D-Cal, 682 Cecil, Louisville 11, Kentucky.

LARGE Box of 25 beautiful assorted toys. Will fill many Christmas stockings. \$8.00 value only \$2.00. Toyland, 5139 N. Clark, Chicago 40.

MAGIC TRICKS, PUZZLES, JOKER NOVELTIES

MAGIC Trial lessons free. Write today! Magic School, Sparta 9, Michigan.

EARN Money as a magician; fine hobby. Large professional catalog \$1.25. Holden's, 120 Boylston Street, Boston, Mass.

VENTRILLO. Professional voice-throwing instrument and catalog 25c. Box 871-PM, Philadelphia 5.

BEST Magic. Joker's novelties. Lower prices. Catalog 10c. Top Hat, Evanston 12, Ill.

DOLLAR Magic set free with catalog 25c. 4462-PM Germantown, Philadelphia.

3100 NOVELTIES, Tricks, jokes, gadgets, funmakers, hobbies. Catalog 10c. Johnson-Smith, D101, Detroit 7.

SENSATIONAL Magician's wand 25c. Vanishes handkerchief! Catalog included. Box 1352-PM, Philadelphia 5.

500 TRICKS, Douglas famous catalog. 10c. Fastest magic service for 30 years. Douglas Magicland, Dept. 1, Dallas, Texas.

LEARN Magic. 32 easy lessons, 25c. W. Nation, Pleasanton, Kansas.

LEARN Ventriloquism. Details without obligations. Harry Harmon, Box 33, Mint Spring, Va.

KEYS For reading all factory marked cards. Astonishing card tricks. Details 10c. Babe Ross, Dilliner, Penna.

FREE Trick and professional catalog of 600 tricks, \$1.00. Terry's Magic Studio, 1921-65th Street, Brooklyn 4, New York.

TRICKS—Magic. Big catalog 10c. Jasper Joke Shop, 804 South Wesley, Oak Park, Illinois.

WOODEN Nickels. Magic catalog, free trick. 10c. Fun'n Magic, Box 1373, San Antonio, Texas.

FREE Deck trick cards with catalog 50c. 1748-PM Market, Philadelphia 3.

BE A ventriloquist. Make money, have fun, delight your friends. All secrets told. Send 35c for information and big catalogue of dummies, dialogues, monologues, etc. Gough, R.R. 3, Hartford City, Ind.

LEARN Ventriloquism. 3c stamp brings particulars. Smith, 801 Bigelow, Peoria 5, Ill.

PROFESSIONAL Catalog. 175 pages, 25c. Williams, 900 Plymouth, Ellwood City, Penna.

COINS, TOKENS, CURRENCY

TWENTY Different Indian cents \$1.00. Sayers, 1000 East Unaka, Johnson City, Tennessee.

FIFTY 2x2 Coin envelopes, six page bargain lists, 10c. Economy Sales, 157 Dean, Mansfield, Mass.

6-IN-1 Special: Magnifying glass; check list; 25 coin envelopes; giant 60 page bargain catalog; ten different Indian pennies; Mexican ten-peso; All six, \$1.00 postpaid. Ben's Coin Shop, 31 North Clark, Chicago 2, Illinois.

U. S. Large cent, 2c piece and bargain list, only \$1. Delmaco, Box 1123, Wilmington, Del.

FREE! Foreign coin, banknote and coin collectors illustrated catalog to approval service applicants. Send 3c postage. Tatham Coinco, Springfield 30, Mass.

MORGAN Dollars: 1878, 1897, 1890, 1891, 1897 8 mint unc. \$3.00 ea. Illustrated catalogue, 25c. Shultz, Salt Lake 10, Utah.

GET Profit and pleasure in collecting old coins. Send 10c for 56-page illustrated coin catalog. You'll be delighted with it. Send for it now. B. Max Mehl, 370 Mehl Building, Fort Worth, Texas. Largest rare coin establishment in U. S. Established 55 years.

COIN Collector's Magazine. Over 1000 pages per year. Sample copy 30c; \$3.00 per year. Hewitt, T320-J Milwaukee, Chicago 31.

INDIAN Cent with bargain lists 10c. Hutchinson, 3463 "I" Street, Philadelphia 34, Penna.

101 DIFFERENT Foreign bills — \$1.00 postpaid. Dwight Musser, Dunbar, West Virginia.

BEAUTIFUL New sets — Tahiti \$1.00; Lundy Island \$1.65; Siam \$1.25; MacArthur \$2.95; 1955 proofs \$3.00; Giant bargain catalogue 35c; guidebook \$1.75. Bebee's, 4514 North 30th, Omaha 11, Nebraska.

\$3,000.00 FOR 1913 Liberty head nickel. Dimes 1894-S, 1895-O, 1916-D. Quarters 1827, 1896-S, 1901-S, 1913-S, 1923-S, we pay \$5.00 to \$1,500.00. Certain dates—Lincoln cents, \$60.00. Indianheads, \$60.00. Large cents, \$500.00. Eagle cents, \$200.00. 2c pieces, \$45.00. 3c pieces, \$60.00. Half-dimes, \$500.00. Shield nickels, \$100.00. Old dimes, \$300.00. 1875 Canadian quarter, \$50.00. Hundreds of others worth \$5.00-\$500.00. Wanted—Half dollars, dollars, gold coins, paper money, etc. Know their true value. Our large illustrated guarantee buying-selling catalogue, giving complete all coin information. Send \$1.00. Purchase catalogue before sending coins. Catalogue money refundable. Worthycoin Corporation, Leaders Numismatic Quotations (K-140-C), Boston 8, Massachusetts.

OLD Money wanted. Will pay \$100.00 for 1894 dime, 8 mint, \$50.00 for 1913 Liberty head nickel (not buffalo). Big premiums paid for all rare coins. Send 4c for large coin folder. May mean much profit to you. Numismatic Co., Dept. 20, Fort Worth, Texas.

LIQUIDATION. Old style English trapezoid, 25c each. Five different dates \$1.00. 8203 Ashworth, Seattle, Washington.

35 DIFFERENT Foreign coins, \$1.00. Claud Denney, 3406 S. Harwood, Dallas 15, Texas.

COIN Collector's greatest magazine, huge pages, big illustrations, 10c. Lawrence Brothers, Anamosa, Iowa.

1956 U.S. Coin catalogue 10c. Stoney, 192 Washington, Boston 8, Mass.

40 DIFFERENT Selected coins \$1.00. Oddehon, Box 482, St. Louis, Mo.

SAN Francisco mint closed! Made only cents and dimes in 1955. In short supply and great demand. One each, brilliant uncirculated, for 25c. Free coin lists with order. Bryson Stamp & Coin Company, 612 White, Toledo 5, Ohio.

STAMP COLLECTING

U. S. Price list. Over 400 illustrations. 25c refundable first order. Alvin Gould, Carew Tower, Cincinnati 2, Ohio.

CORONATIONS, Triangles, sports, animals, free with approvals. Exotic, Box 482-M, Coral Gables 34, Florida.

BE Smart—Stop paying high retail prices. Approvals at wholesale. Write for details. Bargain Stamps, Redlands, Calif.

BRITISH Colonial collection—Hivalues, commemoratives. Free to approval buyers. Pleasure Stamps, 1865P—52nd, Brooklyn 4, New York.

DIFFERENT, 500, 50c; 1000, \$1.25; 2000, \$3.00; 5000, \$11.00. Clearing approvals wholesale. K. S. Holmes, London, Canada.

U.S. Mint plate blocks, 17c each! Regularly 20c. Your choice #934-57, #981-1005, #1022-29. Free list. Brooks, 2352D East 23rd Street, Brooklyn 29, New York.

VARIETY! 55 Singles, 5 sets, souvenir sheet 25c with approvals. Philatelic Den, R.D. #1, Towanda, Penna.

FREE, Turkish pictorials, request approvals. Eagle, 6916 Roosevelt, Philadelphia 49, Penna.

20 MINT Blocks \$1.00. Heckl, 1207 Northland, Buffalo 15, N. Y.

GERMAN Peace dove set free. Approvals. George Richie, 1539 Sixth, Alameda, Calif.

FREE! Catalog! About stamps. Illustrated. Free! The Stampmart, Hartford 1, Connecticut.

FREE Lists general foreign sets, singles and packets. No approvals. Snooks, Box 1715, St. Louis 2, Mo.

WONDERFUL Offer. 7 complete mint sets only 10c with approvals. Reich (M26), 1033 Lawrence, Chicago 40.

LUXEMBOURG 25 Different 5c. Approvals. Neal, 5950 Tower, Riverside, Calif.

1000 DIFFERENT 95c. John Hourigan, 1500 Archer Road, New York 62, New York.

U.S. Mint 797 SPA sheet, 10c to U.S. approval applicants. D. Kelly, 153M 74th St., Brooklyn 9, N. Y.

FREE! U. S. price catalogue (illustrated). New-Way Stamp Co., Lawrence, Mass.

FREE U.S. Illustrated bargain catalogue. Rothberg's, Box 60, Boston 1, Mass.

NUDE, Pioneer, animals packet—10c with approvals! Atlas, Eisenhower, Racine, Wisconsin.

FREE United States price list. Mark Hanna, 335 Fifth Ave., Pittsburgh 22, Penna.

FREE! Flower triangles, others. Approvals. Delton Page, Box 201X, East Paterson, New Jersey.

STAMPS Wanted. Mint and used, collections, accumulations. Good grades only. Buy outright if bargain. What have you? Write, give details. Vanroy Shirk, Lebanon, Penna.

50 DIFFERENT Argentine 10c. Approvals. Reuter, 611 W. 40th Pl., Los Angeles 37.

100 DIFFERENT Spain 25c. Penny approvals included. Reed, Box 980, Chicago 90, Ill.

OLD Scarce U.S. seconds on approvals. Slight imperfections, lowest prices. Herfield, Clintonhill Sta., Newark 8, N. J.

THOUSANDS Of exciting stamps, all different, yours for 1c, 2c each. Fill your album for pennies! Big collection sent for free examination. Cole, 43-A Rinewalt, Buffalo 21, N. Y.

100 JAPAN 10c. All different, with approvals. Gould's Stamps, Box 631, San Francisco 1, California.

50 DIFFERENT United States 5c with bargain approvals, lists. Bookman, Box 8245-M, Madeira Beach, Fla.

U. S. Classics. Over 50 yrs. old. 15 selected old-timers. Missing in biggest collections. All 15 at less than 1c each. 10c with approvals. Jaro, Box 246-T, New York City 8.

SPEND Pennies! Not dollars! Thousands of fascinating stamps to choose from our 1c and 2c approvals. No premiums. Just honest value. Pat F. Knowles, Box 2247, Van Nuys, Calif.

AMAZING Offer! 200 United States stamps—including commemoratives, airmails, high denominations to \$1.00. Only 10c to approval applicants! Illustrated bargain lists free. Mystic Stamp Co., Dept. 80, Camden, New York.

FREE Sample! Interesting, illustrated, informative! National Stamp News, Anderson, South Carolina.

SELL Stamps to our readers. Your ad in this space will be read by thousands of stamp buyers. I'll prove that to you. Write now for Folder "S." F. W. Johnson, Classified Advertising Manager, Popular Mechanics, 200 E. Ontario St., Chicago 11, Ill.

50,000 STAMP Grabbags 25c each. Anderson, Box 1, Reading, Penna.

300 DIFF. World wide 25c, plus surprise packet. Packet list free. Econopackets, Box 168, Riverside 9, Calif.

WORLD'S Largest stamp (7 1/2 x 14 inches). A real curiosity! Retail for 50c, only 3c to approval applicants. Tatham Stamp Co., Springfield 30, Mass.

WEIRD Diamond shape coffee stamp! Lovely flower triangle! First American big commemorative, Greenland, Idol dancer, etc. Free with approvals. Capital Stamp Co., Little Rock 2, Ark.

100 OLD United States between 1861 and 1935, \$1.00. Roush Stamps, 51 Chestnut, Mansfield, Ohio.

TWO \$5.00 U. S. stamps plus 30 different, 10c with U. S. approvals. Irwin Stamp Co., Box 1105, Brooklyn 30, N. Y.

ECONOMICAL 1/2c-1c-2c-Approvals, 22,000 varieties available. Dresel, Box 270-n, New York 25, N. Y.

225 STAMPS For only 10c! This mammoth value includes airmails, pictorials; stamps from strange countries cataloging up to 25c each! Also approvals. Mystic Stamp Company, Camden 80, New York.

FAMOUS Men, jungle scenes, zoo, United States commemoratives, 100 others. Ten cents with request for thrifty approvals. Casner Stamps, 247-A Riverside, El Paso, Texas.

30,000 DIFFERENT Collector's stamps from all parts of the world for less than 1 1/2c each! Send \$12.50 for each book of 1,000 stamps as often as you want. J. Huppert, 1970 E. 18th St., Brooklyn 29, N. Y.

14,000 DIFFERENT — Yours on our streamlined systematic club plan for only 50c weekly. Big shipment every two weeks. Details free. Sjoquist, Box 217, Valley Stream 75, New York.

GIANT Approvals. Thousands different at 1 and 2c each. Wahl's Stamp Exchange, 7008P Farragut, Chicago 31, Ill.

MINT Commemoratives at face! Send 25c for surprise packet of all different, mint U.S. commemoratives. Mint U.S. approvals too. Western, Box 1689P, Salinas, California.

50 DIFFERENT Foreign and 25 different Canada 10 cents with requests for approvals. Somerville, 2369 Orchard, Niagara Falls 1, Canada.

EXCITING Approvals. Send for trial selection. You will be surprised and pleased. Murray, 4146 Warwick, Kansas City 11, Mo.

77 DIFFERENT U.S.—25c. Approvals. Utechs, 1143D North Keeler, Chicago 51.

UNITED States stamps! Coins! Discounts! Unistate, 730-F North Lexington, St. Paul 4, Minn.

FIRST U.N. set. Among world's prettiest. Only 10c. Approvals. Welles, Box 1246-R, New York City 8.

312 MIXED U.S. only 10c to "Gold Nugget Approval" applicants! Nothing like them. Kessel's, Box 6116, Tucson, Arizona.

FINE Approvals. Fast, personal service. What countries do you prefer? I'll send their stamps. Skinner, 438 Locust, Long Beach 12, California.

FREE—1,000 Different stamps to approval applicants becoming customers. Enclose 6c postage. Sobel, 4353 N. Drake, Chicago 18.

FREE: Mint British Colonies from Brunel, Papua, New Guinea, Caymans, Gilbert Ellice, Seychelles, Sarawak, Grenada. Free with approvals. Viking, Great Neck 8, N. Y.

\$5.00 PER Book. 1000 different world wide. Will refund 1/2 cent per stamp returned. W/S Stamps, 5752 W. Washington, Indianapolis 21, Ind.

80c U.S. Air 35c; Canada \$1; totem 30c. Willing Weir, 7416 Gilbert, Philadelphia 38, Penna.

100 DIFFERENT Pictorials and airmails. \$2.00. Guaranteed no junk. Souvenir sheet free with approval requests. E. M. Remley, Mount Dora, Florida.

SUPERIOR Worldwide mission mixture. Amazing variety! Half pound only \$1.50. Baye Nielsen, 4545B Harvard, Montreal 28, Canada.

UNITED States commemorative price list free. James Cunningham, 101 Terrace, Hasbrouck Heights, N. J.

LARGEST U.S. commemorative collection ever offered. Worldwide surprise packet 10c. Approvals. Geber, 900 Sweetzer, Los Angeles 48.

PICTORIAL Packet from Antigua, Barbados, British Guiana, British Honduras, Burma, Curacao, Leewards, Rhodesia, Trinidad, Tobago, and many other hard to get countries. Bi-colors, topicals. Tremendous value. Each stamp a beauty. 10c with inexpensive, attractive approvals. Wolverine Stamps, Dept. A-27, Fruitport, Michigan.

GIANTIC Collection free. Includes triangles, early United States, animals, commemoratives, British Colonies, high value pictorials, etc. Complete collection plus big illustrated magazine all free. Send 5c for postage. Gray Stamp Company, Dept. PM, Toronto, Canada.

GREATEST Premium! World-wide collection! Over 1000 different stamps from Aden, Nigeria, Coren, Macao, other exotic lands. Includes triangles, airmails, sport, animal, ship, map stamps. Catalog value over \$25.00. This exciting collection given to approval customers. Request approvals, details, today. Odd Stamps Co., Dept. A2, Box 31, Redondo Beach, Calif.

THOUSANDS Of stamps for your collection at 1c and 2c. See our big books of attractive approvals. Everything catalogued. Large discounts. Modern Stamp Co., Dept. A-2, Ferrysburg, Mich.

HOW Many of your album pages would a few stamps complete? Want to fill them? Try our approval books of 1000 at 1c and 2c. Values will amaze you. Also U.S. Roseland Stamp Co., Dept. A-36, Spring Lake, Mich.

FREE! Fascinating, valuable special lists, collector's supplies, U.S. and foreign stamps, mixtures, packets, sets, singles, coins and paper money. Approvals. Littleton Stamp Co., Littleton MI, N. H.

FREE Complete set of famous Americans, flags, parks and presidentials to approval buyers. Send 5c for 15 of the above stamps plus full particulars. Triboro Stamp Company, 145 Nassau Street, Dept. 112, New York 38, N. Y.

513 DIFFERENT Worldwide from Haiti, Sudan, Libya, etc., cataloguing over \$10 only 35c. Approvals. Littleton Stamp Company, Littleton Q1, New Hampshire.

200 COUNTRIES, Packet \$2. Approvals. Richard, 1032 W. 6th, Davenport, Iowa.

APPROVALS—U.S. and foreign. Poland a specialty. Chas. Alexander, 7380 Jericho Rd., Rockford 4, Michigan.

PENNY Approvals, Stamp Packets, Box 8102, Southwest Sta., Washington, D. C.

295 DIFFERENT Plus mint set 25c with approvals. Suburban, 24 Dogwood Drive, Baltimore 20, Maryland.

21 DIFFERENT B.W.I. plus six N.Z. healths. 25c. Approvals. Banks, 6635 16th Ave., Kenosha, Wis.

200 DIFFERENT, Including Roosevelt triangle. 10c to approval applicants. M. Avalon Stamp Company, Springfield, Mass.

300 DIFFERENT Given free with approvals. Particulars. Windsor Stamps, 8634 Cornell Ave., Chicago 17.

50 SAN Marino 10c with approvals. J. Moyle, Twain Harte, California.

100 DIFFERENT World 10c. Free set. Bellet, Mapledale, Hazel Park, Mich.

100 DIFFERENT British Empire, no Great Britain, 10c. Approvals. Hudson's, Box 4015, Fresno 44, Calif.

100 DIFFERENT U.S. commemoratives, 100 different world. Both for \$1.00. Mike Filippas, 7128 So. Carpenter, Chicago 21, Illinois.

FREE 107 British Colony stamps! Yes! All different from Britain's far flung colonial empire. Catalogue value over \$2.25. Free stamp magazine. Approvals. Send dime for handling. Act today. Niagara Stamp Co., St. Catharines 71, Ontario.

LUXEMBOURG, 25 Different 10 cents, approvals. Waha Stamps, 178 No. 17th St., East Orange, N. J.

FABULOUS Collection—Large U.S. commemoratives. Only 10c. Approvals. Raymax, 39-Z Maiden Lane, New York City 38.

NO Approvals. 305 stamps from 25 countries \$1. Bonders, Ellenville, N. Y.

DIFFERENT, Canada: 100, 48c; 150, \$1.45; 200, \$2.95; 250, \$6.95. Newfoundland: 40, \$1.00; 50, \$1.85; 75, \$4.10. Richard Timm, 368 Gloucester, Ottawa 4, Can.

1000 MIXED United States. Guarantee over 140 different \$1.10. Quaintance, Box 178F, Upper Sandusky, Ohio.

BELGIUM'S Foolish virgin, complete. 15c. Approvals. Alamo, Box 1090, Houston 1, Texas.

5 UNUSUAL Mint sets, includes Albania, Azerbaijan, Istria, Berlin bears. Only 25c with approvals. Montalto, New Church, Virginia.

FREE 60 Good foreign with approvals. Alpaugh Stamps, Highbridge, N. J.

135 DIFFERENT U.S. commemoratives \$1.00. Request approvals. Harold Holub, 18 East 198 Street, New York 68, N. Y.

30 DIFFERENT Commemoratives 1893 up 10c. U.S. approvals. K & B, Box 5, Brooklyn 14, N. Y.

BRITISH Empire, 200 different 75c. 100 Israel \$6.00, 5000 worldwide \$9.50. Roborn, Shirley, N. Y.

FREE, U.S. price list. Over 400 wonderful illustrations. Alvin Gould, Carew Tower, Cincinnati 2, Ohio.

AIRMAILS! 25 Different Latin Americans—10c with approvals. Riedel, Greensburg, Penna.

CANADA, Queens, wildlife, commemoratives, 9 var. 10c with attractive approvals. Rheasme, 6591 11th Ave., Montreal 36, Canada.

GOING Out of business! One dollar lot includes mixtures, packets, wholesale, sheets. Norge Company, Ho-Ho-Kus, N. J.

TERRIFIC! Value packed pictorial approvals with world, British-French Colonies, Americas in neat album order! 110 different British Colonies 10c with approvals. Darling's, Ridgway 1, Penna.

NORWAY 50 Diff. 10c. Approvals. Wakefield's, Box 22, Alhambra, Calif.

U.S. Commemoratives. 100 mixed 25c. Ray Worth, 321 So. Cicero, Chicago 44.

VIETNAM Dragon stamp, seldom seen, sensational! Also Congo jungle gods; airmails; triangle; unusual collection free with approvals. Send dime, mailing. Lock, 2216 Third, Montgomery 6, Alabama.

WILL Send you 20,000 collection, 1/2c to 3c. Many free. Cut Rate, Blue Springs 8, Missouri.

SANTA Claus bicolored stamp, plus worldwide packet, free to approval buyers. Conquistador, 2627P Troy Road, Schenectady 9, N. Y.

U.S. Mint plate number blocks topical collections. Five different state capitols only \$1.00 with approvals. Wm. Kuehl, 3125 East K, Tacoma 4, Washington.

CROATIA 100 Different \$1.00, San Marino 100 different \$1.00, Paraguay 100 different \$1.00. Gandey Company, Shore Acres, New Jersey.

FREE Bicolor triangles! Picturesque approvals. Gernert, 4235-I Alton, Louisville 7, Kentucky.

HAWAII 5 Different 20c with U. S. approvals. Stamp Shop, 719 Pierce, Sioux City, Iowa.

CIPEX Souvenir sheet plus 25 different U. S., 10c. Approvals accompany. Village Stamps, 90-39P 214 St., Queens Village 28, N. Y.

UNITED States approvals. Select copies, used—mint. Kingsbury, Fairfax, Vermont.

100 FOREIGN, 20 U.S. commemoratives, 10c. Approvals. Weckerling, Box 442T, La Feria, Texas.

FREE—15c Stamps. Pick your approvals. Novelty Approvals, 1127 Manor Ave., Box 72, New York City.

U. S. Plate block list free. Simstaco, Box 63, Mattapan 26, Mass.

200 DIFFERENT 10c. Bargain approvals. Ideal, Box 210, Brooklyn 11, N. Y.

TEN Triangles and over 50 different, 10c with approvals. Bennett, Candor 3, N. Y.

FREE: List 60 oddest postmarks. Frost, 4214 Downing, Tampa 3, Florida.

5 FOREIGN—5 U. S. stamps 10c. Free stamps with approval. Cardinal Stamp Co., 3039 S. Union Ave., Chicago 16, Ill.

FREE 1956 U.S. illustrated catalogue. Stone's, 192 Washington, Boston 8, Mass.

ATTRACTIVELY Priced approvals for advanced collectors. Ref. required. Econopacks, Box 168, Riverside 9, Calif.

SPORTS Sets, new issues and other popular sets sent on approval. Bailey Stamps, Box 892, Peoria, Ill.

\$20.250 PROFIT Selling stamps by mail. How we did it book; send only \$2.00. Free details. Fahsing, Atascadero, California.

UNITED States commemorative collection containing 33 different—10c approvals. White, 516-A Avenue L, Brooklyn 30, New York.

MONACO, Nudes (5) 10c. Approvals. Royal Stamp Company, Tamaqua, Penna.

50 STAMPS Free with Lagniappe approvals. Guyton, Box 1275, Monroe, La.

4 LATEST Vatican—50c. Free description. Thomas, 4339 Coldwater, North Hollywood, California.

COILS U.S. 20 different 25c. William Wolf, 6942 Paxton, Chicago 49, Ill.

ASTONISHING Gift; 40 U.S. with superior approvals. Send 5c for postage. Sparta, Box 1082, Rochester 3, N. Y.

1000 DIFFERENT \$1.00 With approvals. Jacobsen, 4395-C Broadway, New York 40, N. Y.

FREE Samples of revolutionary new stamp selection method praised by collectors, with approvals. Major Company, 604 West Dartmouth, Kansas City 13, Missouri.

REVOLUTIONARY New stamp selection method praised by collectors. Send for details with approvals. Major, 432 West 70th Terrace, Kansas City 13, Missouri.

CORONATIONS, 10 Different only 10c with approvals. Seminole Stamps, Box 1138-P, Coral Gables 34, Florida.

100 DIFFERENT France 10c. Approvals. Aronson, 91 Marion, Brookline 46, Mass.

2MSL Lifts stamps from envelopes perfectly—Two minutes. Lasts almost indefinitely \$1.00. Nicholson Corporation, 3400 Cabuena, Los Angeles 28, California.

SPECIAL! 50 Different U.S. commemoratives plus 10 different foreign sets, 25c. Approvals. Farmer Stamps, 6919 Camrose, Los Angeles 28.

FREE! Giant catalog offering thousands of bargains. Sent with beautiful approvals. Jamestown Stamp Co., Dept. E12PMC, Jamestown, N. Y.

FREE Gifts! Fabulous prizes! Astounding offers! Adventure Studio, Buckland, Connecticut.

FREE! Benelux lands, 25 different. Approvals. McLendon, 1830 West Fifth, Montgomery, Alabama.

50 DIFFERENT U. S. commemoratives 25c. Durham, 1021 North Granger, Saginaw, Michigan.

UNITED States. Fine mint airmails. #C7, #C8, #C9, #10. Only \$1.00. Approvals accompany. Whiton Paine, Westport 11, Connecticut.

WOW! 135 All different Germany 10c. Zeppelins, semi-postals, airmails, high values. Big bargain lists and approvals included. Jamestown Stamp, Dept. A12PMC, Jamestown, N. Y.

DOLLAR! 125 Different Africans. Correspondence invited. Morris, Highway, Fishhook, South Africa.

ANTIQUES, RELICS, INDIAN GOODS, CURIOS

4 SELECTED Arrowheads \$1.00. List 5c. H. Talburt, Calico Rock, Ark.

4 FINE Indian arrowheads \$1.00. Stone tomahawk \$2.15. List free. Arrowhead, Box 5283, Indianapolis, Indiana.

CHRISTMAS Special. Indian museum \$3.00. Six arrowheads \$1.00. Palmer, 435 Washington Road, McKeesport, Penna.

20 FINE Arrowheads \$3.50. Chalmer Lynch, 2163 Morgan, Evansville 11, Ind.

4 TINY Ancient bird arrowheads \$2.00. List free. Lear's, Glenwood, Arkansas.

GESUNDHEIT! Illinois. Selling 580 historical firearms, 30,000 prehistoric, stoneage Indian relics, collectors cartridges, Confederate money, coins, Revolutionary, Civil, Indian wars flintlocks, muskatoons, swords, bayonets, bullet molds, powder flasks, blunderbusses, pepperboxes, Kentucky rifles, Winchesters, buffalo-stagecoach carbines, frontiers, Derringers, duelling pistols, matchlocks, arrowheads, tomahawks, bannerstones, gempoints, spearheads, steer, deer, buffalo horns, mounted pheasants, owls, quail, squirrels, deerheads, Agates, fossils, mineral specimens, lapidary supplies, Daguerrotypes, gold dollars, bo-wood, bio-horns, violin wood. Send 35c for profusely illustrated catalog. Heike, Gardebrille, Wena-na, Illinois.

PRECIOUS STONES, MINERALS

HANDBOOKS For rockhounds. Free list. Minpub, P.O. Box 3114, Station "A", Spokane 17, Washington.

TEN N. Mex. minerals \$1.50, six fluorescent \$1.00, five crystallized minerals \$1.00, fool's gold 25c, mistletoe 50c, \$1.00, \$1.50. Minerals, Winston, N. Mex.

GEMSTONES. Mineral specimens. Every variety. Lowest prices. Free booklet. Plummer's, 4720 Point Loma Ave., San Diego 7, Calif.

GEMCUTTING — Silvercraft illustrated magazine. Tells how to cut gems, make jewelry. 150 ads illustrating equipment, gems for collectors, cutters. Free literature. Lapidary Journal, Del Mar 2, Calif.

SAPPHIRE. Topaz, tourmaline, garnet, peridot. Five uncut gem specimens, \$1.00. Ten polished gems, baroque shaped, \$1.00. Free big bargain list jewelry, gems, profitable, easy "do it yourself" projects. O'Brien's, 1116M Wilcox, Hollywood 38, Calif.

FIND Tungsten, mercury, uranium with Mineralight. Free brochure. Write Dept. PMS, Ultra-Violet Products, South Pasadena, California.

PROFITABLE Fun with gems, minerals, rocks, jewelry. How-to magazine tells how. Four month trial \$1.00. Guaranteed. Gems and Minerals, Dept. A10, Palmdale, Calif.

TWENTY-Four identified gem stones and specimens in display box, \$2.00 prepaid. JH Desert Jewelry, Rt. 4, Box 403, Yucaipa, California.

BEAUTIFUL Marine catseyes \$1.00 pair. Gemco, Elsner Ave., Sheboygan, Wis.

TOPAZ. Bargain packet 25c. D&E Products, Pleasant Grove, Utah.

COLLECTION Colorado gems, including gold-ore \$1.00. Bader's, 839 E. Las Animas, Colorado Springs, Colorado.

EARTH Science, the Rockhounds' national magazine. Subscription \$2.00, sample 25c. Box 1357, Chicago 90.

HOBBIES AND COLLECTIONS

UNUSED Matchbook covers, 100 different \$1.00. 35 page catalog 25c. Match-cover album \$3.00. Charles Edelman, 1311C East 84, Cleveland 3, Ohio.

NAZI Medals, ribbons, armbands, flags, daggers. Big introductory packet \$1.00. Illustrated lists. Medcrafts, 1923 24th St. S.W., Calgary 2, Canada.

INVENTING Can be an interesting and profitable hobby. Write for complete particulars. Institute of American Inventors, Dept. 40-E 631-E St., N.W. Washington 4, D. C.

65 ASSORTED Army patches, insignias, ribbons \$1. Surprise included. Lhgco, 19 East 16th St., New York City 3.

STATE Souvenir decals, collectors item. 20c. Box Seventeen, Nyack, N. Y.

GENUINE Nazi medal \$1.00; 37 different American emblems \$1.00. Catalog 10c. Insignia Club, 550-B Fifth Avenue, New York.

MILITARY Miniatures, insignia catalog. 25c; miniature flag catalog and sample, \$1.00. Griffin and Gray, B-1 72-05 67th Street, Glendale 27, N. Y.

50 ARMY Insignia \$1.00. Insignia Mart, 703A Broadway, New York 3, N. Y.

WANTED — Cigarette, tobacco cards. Write Charles Bray, East Bangor, Penna.

ORIGINAL Luggage stickers from exclusive hotels abroad. 15 different \$1.00. Very decorative in your bar, rumpus room, den; on lampshades, waste baskets and screens. Continental Novelty Co., P.O. Box 181, New York 21, N. Y.

GROW Giant crystals! Instructions \$1.00. Crystcraft, Box 35, College Station, Texas.

CAMERAS, PHOTO SUPPLIES

CAMERA Owners, proven money making plans without studios. Photo markets included. \$1.00. Satisfaction guaranteed. Details free. Scott's, Juniata, Nebr.

BASS Says: Quality cameras since 1910. When in Chicago visit the camera cross roads of the world, or write us for your favorite equipment, new or used. Satisfaction guaranteed. Bass Camera Co., Dept. AG, 179 W. Madison St., Chicago 2, Ill.

20 TO 50% Discount everything photographic, giftware. Free catalogue. Dart, 3812E Atlantic Avenue, Brooklyn 24, N. Y.

PHOTOGRAPHY For pleasure or profit. Learn at home. Practical basic training. Long established school. Free booklet. American School of Photography, 835 Diversey Parkway, Dept. 3431, Chicago 14.

BUY Wholesale nationally advertised cameras, photo supplies, thousands other products at big discount. Free "Wholesale Plan." American Buyers, Hertel Station, Buffalo 16-E1, N. Y.

NEW Argus automatic projector \$48.90. Schick custom shaver \$14.95 (regularly \$28.50). Terrific discounts, photo equipment, appliances. Free catalog. Mailers Mart, Box 135-A3, New Rochelle, New York.

SEND 25c Complete photo book catalog. Deductible first order. Amphotos, 33 West 60, New York City 23.

ELECTRIC Tray rocker, accommodates three 8x10 trays, \$11.95 prepaid. Marra, 1337 Kenilworth, Cleveland 7, Ohio.

FREE! Free! Free! Central Camera Co., photographic headquarters since 1899, saves you money on all photographic equipment. Send for Central Camera Co.'s free photographic bargain list today! Central Camera Co., Dept. 12-B, 230 S. Wabash, Chicago 4, Ill.

PHOTO FINISHING

ENLARGEMENTS! Eight 5x7's or five 8x10's, \$1.00. Wilart Enlargers, Box 967, Little Rock, Ark.

HIGH Quality finishing—Rapid service. 8 exp., 35c; 12, 50c; 16, 75c; 20, \$1.00. Camera, Box 280, West Chester, Penna.

TWO Beautiful enlargements from each picture on roll—8 exposures 55c, 12 exposures 75c. Cut Rate Photos, Dept. B-4, Janesville, Wisconsin.

6 OR 8 Picture roll 35c. 12 or 16 picture roll 55c. Each roll developed and printed in handy album pack. Send coin with roll. No c.o.d.'s. Mailing containers sent free. Deluxe Film Service, Box 1268-A, Shreveport, Louisiana.

TWO Beautiful prints from each picture on roll. 8 exposure 40c; 12 exposures 50c. Thirty four years of satisfied customers. Quick Service, Lens Photos, Dept. J-4, Janesville, Wis.

QUALITY Kodak finishing. 8 exposure roll 35c; 12 exposure 50c; 16 exposure 60c. Reprints 4c. Fast service. Guaranteed quality. 40 years continuous operation. Be a satisfied customer. We do color. Send for mailers. Mail Order Photo Service, Box 297, Watertown, Wisconsin.

FREE Beautiful superpak ring binder album with order 8 jumbos only 35c. Quality guaranteed. Prompt service. Free mailers. Free particulars complete superior finishing service. Grand Fotos, GPOB 1410, New York 1.

20 WALLETS Prints only \$1.00 from negative or print. One laminated in plastic free. Send ad. Pearson Photo, Laurens, South Carolina.

NOW! Give everyone that favorite picture of baby, yourself, with convenient wallet photos. Send us any photo or negative with \$1.00 now for 20 photos, or \$2.00 for 50 photos, postpaid. Original returned unharmed. Mail Today Co., Altoona 16, Penna.

TOP Quality. Fast service. 8 Jumbos 35c in beautiful ring binder album. 16 contacts 40c. Reprints—Jumbos 4c; contacts 3c. Satisfaction guaranteed. Free mailers and circulars. Past-X-Photo, Box A, Jersey City, New Jersey.

LOOK! 8x10 "Warmtone" enlargement in beautiful easel back frame \$1.50. Send negatives do not send prints. Star Photo, Box 16, Andover, Mass.

ROLLS Of 8 exposure jumbo 35c, 12 exp. 50c, 20 exp. 35 mm 80c, jumbo reprints 4c, confidential. Free mailers. Send films to: Nu-Tone Photo, Box 917, Cheyenne, Wyo.

PHOTO Xmas cards, 20 for \$1.10. Techni-Photo, Dept. PM, Lorain, Ohio.

SPECIAL Introductory offer. 8 jumbos 25c, 12—35c. Western Photo, PM125, Box 288, San Francisco 1, Calif.

ONE Day service. 35mm. Microdol developing. 20 exposure jumbo prints \$1.00; 36 exposure \$1.49; 8 exposure 35c; 12 exposure 50c; reprints 4c. Special. 100 photo Xmas cards \$5.00. Foto Craft, Box 3146, Washington, D. C.

8-12 EXPOSURE Rolls 39c, jumbo prints. Free 5x7 enlargement with each roll developed. Guaranteed work, one day service. Lincoln Studios, Dept. K, Box 13, Lincoln, Nebraska.

EKTACHROME — Anscochrome processing. Roll \$1.00. National Color Corporation, Box 55 Northside, Atlanta 5, Georgia.

MOTION PICTURES AND SOUND EQUIPMENT

GUARANTEED Savings! All brands movie equipment! Listings. Fotosales, Box 3908A, Kansas City 11, Missouri.

ALL Kinds 16mm sound films. Rent, sale. Roshon, 335 Fifth, Pittsburgh 23, Penna.

FREE! Blackhawk's big sale catalog new and used 16mm., 8mm. films; 2"x2" color slides; used 16mm. sound projectors. Biggest stock in U.S.A. Blackhawk Films, 1200 Eastin, Davenport, Iowa.

TAPE Recorders, tapes, accessories. Unusual values. Dressner, Box 66M, Peter Stuyvesant Station, New York City 9.

5,000 8-16MM. Silent-sound films. International, 2120 Strauss, Brooklyn 12.

8-16MM. Silent-sound films. Latest subjects. Free catalogue, sample film 10c. Garden Film, 690 Howard Ave., Brooklyn, N. Y.

MOVIE Camera film: 8mm. roll \$1.50, 16mm. 100' \$3.00. Free processing. Better Films, 742 New Lots, Brooklyn, N. Y.

SAVE 50%! Guaranteed-fresh color, b.&w. movie film! 8mm., 16mm. Free catalog! ESO-R, 47th Holly, Kansas City 12, Missouri.

FREE Sample kit. Make movie titles in color. A-to-Z Movie Accessories, Flatiron Building, New York City 10.

SEND For big bargain bulletin. 16mm. sound and silent films. Gaines, Box 114-PM, Skokie, Illinois.

TAPE Recorders, tapes; wholesale prices. Carstan, 215 E. 88, New York City 28.

8 OR 16MM. films \$2.98 each. List 10c. Specify sound or silent. Corey, 556-PM Aldine, Chicago 13.

FREE Catalog—8-16 mm film now available. Best Rite Sales Co., PO Box 357, Times Square Station, New York 36, N. Y.

TAPE Recorders wholesale! Free bargain catalog! Towers, Box 135, Philadelphia 5.

BEAUTIFUL Color slides and movies. Sample 10c. Eddings, Corning R-3, N. Y.

MUSIC AND MUSICAL INSTRUMENTS

PLAY Piano the first day! Copyrighted secret. Details free. Miracle Method, Box 5202P, Phoenix, Arizona.

WHOLESALE Catalog! 30-80% discounts! Appliances, musical instruments, typewriters, phonographs, watches, jewelry, recorders, housewares, etc. Consolidated Distributors, 21-80 Lafayette, Paterson, New Jersey.

SWISS Musical movements, \$1.90. Helax, 218 West 72nd Street, New York 23.

POEMS Needed for new songs. Send poems for free examination, details. Immediate consideration. Songcrafters, 2724 Arcade Station, Nashville, Tenn.

1955 ACCORDIONS—Wholesale. Free catalog. American Accordion Center, PM-3, 3239 Belmont, Chicago.

SONGWRITERS! Send poems, songs. Music Service, 243 West 72nd St., PM, New York City 23.

FREE Records of your song. Your words, my melody. Free information. Johnny Mack's Melody Mart, 1094 West 39th Street, Dept. A, Los Angeles 37.

ACCORDIONS. Wholesale to everyone. Save up to 60%. All national known brands. Free catalogue. Del Principe, 29 South Cicero, Chicago 44.

POEMS Wanted for new songs. Send poems. Immediate consideration. Crown Music Company, 1476 Broadway, New York City 36.

SONGWRITERS! Protect your ideas! Hold all songs, poems! Write for safe correct procedure first! Song Service, Dept. P, 333 W. 56th St., New York 19, N. Y.

WANTED! Poems for musical settings. Write Songwriters' Service, Clifton, N. J.

WRITE Songs. Big money and reputation. Write for information, J. Gordon Pub. Co., 4700 South California Avenue, Chicago.

RETIRED Church organist composes beautiful music to sacred words. Hymn complete \$3.00. Reginald Belcher, Terrace Place, Morristown, New Jersey.

VIOLINMAKERS, Repairers. Fine tone wood, and all violin supplies. Send for free wholesale price list. International Sales, 414-MPM E. Baltimore St., Baltimore 2, Maryland.

ACCORDIONS—Direct from importer. Save 50% and more! Free trial. Lifetime guarantee. Trades accepted. Free catalog. Write Accordion Outlet, Dept. 115-R, 2003 Chicago, Chicago 22, Ill.

SWISS Musical movements (best) \$2.50. Special tunes to order. Spielman, 131 West 42nd, New York City 36.

PROBLEMS? Organ? Piano? Choral technique? Consult. Griscom (DA), Berkshire V. Sandy Hook, Conn.

POEMS Wanted for musical setting by America's largest songwriting organization. Immediate consideration. Five Star Music Masters, 630 Beacon Building, Boston.

POEMS, Songs wanted! Free examination. Bengol Music, 93 Jefferson, Chelsea 50, Massachusetts.

SONGWRITERS: Large recording company wants new songs. Royalty basis. National sales, promotion if selected. No charge for melodies. Send songs, song poems, Music Makers, Dept. E-18, Box 2307, Hollywood, California.

STANDARD Brand musical instruments and supplies up to 50% off. Free catalog. Musicians Service, Box 711, Wilkes-Barre, Penna.

PIANO—Play at once! Swing, jazz. Dial A Chord \$3.75. Play boogie \$1.00. O. Nelson, 1651 E. 93 St., Cleveland 6, Ohio.

SONGPOEMS And lyrics wanted. Mail to: TinPan Alley, Inc., 1650 Broadway, New York 19, N. Y.

SONGWRITERS—Success, fame, fortune if talented. Songs revised, composed, published, promoted by largest firm. Free appraisal. Since 1943. Postcard to Nordyke Publishing Co., 6000 Sunset Blvd., Hollywood 28, PM, Calif.

PHONOGRAPH Records cheap. Catalogue. Paramount, MC-313 East Market, Wilkes-Barre, Penna.

SWISS Musical movements \$2. Any Christmas song. Rare old music box recordings. Free literature. Walters Hobby Shop, 307-B French, Utica 4, New York.

SONGS—Poems wanted. Good opportunity. Tunesmiths, 1609 Vista Del Mar, Dept. U, Hollywood, Calif.

WORLD'S Leading producer of authentic folk music on records. Write for free catalogue to: Folkways Records, 117 West 46 St., New York City.

RADIO, TELEVISION AND ELECTRONICS

CRYSTAL Radio builders. Free information. Hulet, 305 Hope, Lakewood, N. J.

NEW! Printed circuit television antenna, smaller than a transistor. Only \$1.98 postpaid. Ekeradio, 646 North Fair Oaks, Pasadena, Calif.

BUILD Cigarette case radios. Four plans, \$1.00. Cook, 4003-M Roosevelt, Midland, Texas.

MONEY In radio, T.V., appliance repair. Make your own tester. Most parts from old radio. Complete information \$1.00. R. Manning, P.O. Box 2216, Kansas City, Mo.

NEW Germanium diode, variable condenser crystal radio kit \$2.95. Phone \$1.75. Free catalogue. Clearco Crystal Co., Box 1857, Milwaukee 1, Wisconsin.

MAKE Simple powerful distance-getting crystal radio. Works anywhere. Illustrated booklet 25c. Money back guarantee. Jay Francis, Box 5963, Cleveland, Ohio.

MAKE Simple, tubeless, batteryless, distance-getting radio. Genuine Melomite crystal, detector, illustrated instructions. 50c postpaid. Allen, 427-PM3, Clinton, Missouri.

TV Trade-in sets. Philco, Emerson, G.E., Admiral, Motorola, Tele-King, others. List available. 10"—\$17, 12"—\$20 up. Washtek Service Co., 1501 Boston Rd., Bronx, N. Y. DA 3-9261.

NEW TV catalog free. Loaded with bargains. Finest new TV antennas, converters, motors, boosters, parts, instruments, hundreds of quality accessories. Get your catalog now. National Electronics, Dept. P-12, 6608 Euclid, Cleveland 3, Ohio.

FREE Television and radio troubleshooting manuals and descriptive literature upon request. Build 15 radio circuits. "Edu-Kit" includes all parts, instructions, tester, soldering iron—Only \$19.95 complete. Progressive "Edu-Kits" Inc., Room 36B, 497 Union Ave., Brooklyn 11, N. Y.

REPAIR Your own TV. Instructions compiled exclusively for your set. Simple as replacing light bulb. Send set name, chassis, model number, \$2.00. LS Engineering Company, Box 4113-PM-12, North Hollywood, Calif.

FREE 324 Page 1956 Television, Radio, Hi-Fi, Electronics catalog! World's largest stocks, lowest prices. Everything for experimenters, builders, amateurs, servicemen. Latest build-your-own kits. Hi-Fi, phonos, recorders, P. A., TV accessories. Thousands of parts, tubes, test instruments, tools and books. Write for free copy! Allied Radio Corp., 100 N. Western Ave., Dept. 34-M-5, Chicago 80, Ill.

TOY TV antennas. Replace rabbit ears. \$1.00. Sound House, 2516 Highland, Cincinnati 19, Ohio.

ALL Channel figure 8 aerials. Light weight. Attic installation. Install yourself. Manufactured by Fred E. Smith, 119 N. Leroy, Fenton, Michigan. Telephone MA-96342.

GUARANTEED Simplified TV trouble shooter automatically pinpoints faulty tubes. \$1.00. Stern, Box 42-B, Hillside, New Jersey.

COLOR Television! Black-white television owners enjoy beautiful 3 color screens. Easily attached. Instructions, details free. Zingo Electronics, Johnstown 74, New York.

15 TESTED One-tube circuits 25c, including "Radiobuilder" magazine, catalog. Laboratories, 328-C Fuller, Redwood City, California.

BUSINESS OPPORTUNITIES

AMAZING Home business. Build tubular glass fishing rods. Everything furnished. Wonderful profit. Free details. Rodman, Box 41, Wauwatosa, Wis.

MONEY In saw and lawnmower sharpening spare time at home. Repeat cash business. Experience unnecessary. No selling. Free booklet explains. Victor Foley Company, Columbia Heights, Minnesota.

REBUILD Batteries; repair dolls; make rubber stamps; silk screen printing. Catalogue "60 Ideas" free. Universal, Box 1076-A, Peoria, Ill.

NATURAL Molding rubber, extra thick. Free sample. Flock, W. Wooley, 115-A Donald, Peoria, Ill.

"MAILORDER Laws and Regulations." Discusses federal, state, local licenses, taxes, legal requirements governing mail-order businesses. Play safe. Order today. Only \$1.00. Tasker, 105 East Custis Avenue, Alexandria, Virginia.

OPERATE Mailorder folio business. Write Ballard's, 425 East Catherine, Louisville 3, Ky.

BUY Wholesale, thousands products. Free literature. Triple J Industries, 132 Berkshire, Bridgeport 8, Conn.

"HOW To Profitably Operate a Mail Order Business." Free literature. Lawrence J. Archer, Rt. #1, Navarre, Ohio.

YOUR Opportunity. "How to build your own mail order business." For beginners, mail dealers. 25c booklet. Satisfaction guaranteed. J. G. Smith, 163-11 25 Dr., Flushing 58, N. Y.

EARN Up to \$2000.00 monthly with spare or full time route of automatic 3 in 1 Hot Drink Merchandisers using Maxwell House coffee, Bakers chocolate, Tenderleaf tea, in your community. We train you. \$1190.00 starts you. Write Superior, 4555-BH East Warren, Denver, Colorado.

PROFITABLE Home collection office. Experience unnecessary. Details. Hyatt, 411 West Walnut, Kalamazoo 42, Mich.

MAKE Sell polishes, cleaners, anything. Formula catalog free. Kemixer, Park Ridge, Ill.

\$70 WEEKLY—Home, spare time. Simplified mail bookkeeping. Immediate income, easy! Auditax, 34757AW, Los Angeles 34.

EARN Money at home! Homemaker Magazine tells how. Sample 25c. Sizemore, 20-H East Delaware, Chicago 11.

HOME Opportunities, sample literature, details 25c. Gentgen Publications, Oconomowoc, Wis.

LEARN Modern sign painting—Commercial lettering. Anyone can be successful. Earn \$40-\$160 per week, spare time! Sign Instruction, Box 187A, No. Chicago, Ill.

MAKE Money helping others out of debt, stop garnishments, save jobs, re-establish credit. Details. Borum 87, 411 W. Walnut, Kalamazoo 42, Michigan.

WHOLESALE. Thousands items. Supply source directory, 10c. Idealer, Park Ridge, Ill.

\$19,000 SALES in two months. Sensational mailorder method. Actually works. Details free. Cartier, Box 261, Gainesville, Georgia.

RAISE Nutria for profit. Inquire Edwin Calvert, 2 Haynes Ave., St. Catharines, Ontario.

\$200 WEEKLY Cleaning Venetian blinds. Free book. Burt, 2434A, Wichita 13, Kansas.

\$16.00 PER Pound hand spinning Angora wool at home. Angora House, PM, Springfield, Illinois.

"FROG Raising!" Get ready now for next spawn. New book tells how. Folder 10c. Broel-A, Box 366, New Orleans 1, Louisiana.

WHOLESALE Catalog! 30-80% discounts! Appliances, musical instruments, typewriters, phonographs, watches, jewelry, recorders, housewares, etc. Consolidated Distributors, 21-11 Lafayette, Paterson 15, New Jersey.

BOOKKEEPERS. Keep books, small firms spare time. Manual latest technique by C.P.A., \$3.00. Modern Business, Box 406, Youngstown 1, Ohio.

TO \$50.00 Weekly. Sparetime, home operated mailorder business. Successful beginner's plan. Everything supplied. Lynn, 10420-M National, Los Angeles 34.

PLASTERCRAFT Molds. Liquid rubber, plasters, floccs, candle supplies. Catalog and manual free. Blue Rapids Supply, Blue Rapids, Kansas.

BUY Wholesale. 800,000 items. Write Info-Center, 216 West Jackson Blvd., Chicago, Ill.

PINEST Formulas for making world's fastest sellers. Literature free! Miller, Chemist, 1517-R, Tampa, Florida.

BUY Wholesale! 100,000 name brand products! Save 68%!! Big profits selling others spare time! Free catalogs! National Buyers Service, Box 426EE, Oakland, Calif.

\$3.75 HOURLY Minimum. evenings. Preparing tax returns—Simplified! Auditax, 34757AT, Los Angeles 34.

WHAT'S New in mailorder? Let "Mail-order World," published monthly, keep you informed. Sample, 25c. Wayte, 1233 Elden, Los Angeles 6, Calif.

DOLLARS! Baby record books, Kitty Kat shoes, My Baby albums, eleven thousand new prospects daily. Sold by mail, use our literature. No-Co-Ro, Oakland 6, Calif.

WANT Up to \$100.00 weekly deposited in your mail box? Details free! Smith, 2708-P Ladera, San Bernardino, Calif.

ELECTROPLATE Auto parts, novelties, mirrors, baby shoes. Easy, inexpensive home processes. Free booklet, Tyco Metals, Box 1331-MM, Houston 19, Texas.

LEARN Sewing machine repair. How to make big money at home sparetime. New machines. Everything supplied. Write Taylor Service, Box 2126, San Bernardino, California.

IMPORT-Export opportunity, profitable, world-wide, mail-order business from home, without capital; or travel abroad. Established world trader ships instructions for no-risk examination. Experience unnecessary. Free details, Mellinger E701, Los Angeles 24.

BREED Rare tropical fish at home. Earn big money! Learn secrets! Help fill huge demand. Amazing opportunity! Free plan. Tropical Fish Breeders, Los Angeles 61, Calif.

BE Appointed state notary public now. Write, Stationers, Helotes, Texas.

HOW And where to obtain capital. Particulars free. Star Service, Wapakoneta, Ohio.

FREE Folio "Up to \$45,000; Unlimited Vacations." No merchandise, equipment. Unknown! Work home, sparetime! Haylins, Carlsbad, Calif.

WE Love our mailman—He leaves over \$1000.00 monthly in our rural mailbox. My college professor husband drafted a scientific home mailorder method. We bought a Texas ranch, live as we always wanted. Now we sell the Ranch Mailorder Method. Operates anywhere. Inquire: Eveningshade Ranch, Helotes, Texas.

RESILVERING Mirrors, formula 50c; two-way lookout mirrors. (No one sees you). 50c; coppered mirrors, 50c. All \$1.00. Nelko-Mir Box 3462-J, Chicago 54.

POPCORN And potato chip equipment. Eakins, Box 933-A5, Springfield, Ohio.

MEN—Income from local information. No selling. Neherco, LaVerne, California.

COPUBLISH Mail Sale Advertiser, leading mail order paper. Details, latest copy, dime. Vanroy Shirk, Lebanon, Penna.

GROW Mushrooms. Cellar, shed, and outdoors. Spare, full time, year round. We pay \$3.50 lb. We paid Babbitt \$4,165.00 in few weeks. Free book. Washington Mushroom Ind., Dept. 172, 2954 Admiral Way, Seattle, Washington.

\$25 WEEKLY Working two hours daily at home. Lycke, Box 3471-A, Cleveland 12, Ohio.

OPERATE Profitable mail order business. Write Walter Service, 4159-A East 112th, Cleveland 5, Ohio.

COLORGLAZED Concrete pottery made without molds. Patented method. Cemetery products, novelties, tiles. Basement leak-sealing. Money-making projects. Booklet, details free. Men only. National Potteries Company, Grand Rapids, Minnesota.

MINK Raising information free. Complete. Lake Superior Mink Farm, Superior, EE1, Wisconsin.

FREE Book "505 Odd, Successful Businesses." Work home. Expect something odd! Pacific, Oceanside, Calif.

BRONZE Baby shoes. Instructions, equipment and mountings for genuine electroplated process. Free catalog. Hollywood Bronze Supply, Dept. B-3, 1624 East First Street, Los Angeles 33, Calif.

YOUR Own name brand business. No investment; no inventory. Part time or full time. Sell famous brands of appliances, housewares, silverware, radios, vacuum cleaners, lamps, tools, clocks, watches, jewelry, etc., etc., over 1000 items. Join thousands of successful independent dealers. Send for free catalog and dealer price list. H. B. Davis Corp., Dept. W, 145 W. 15 St., New York City.

LIQUID Rubber. Make flexible molds. Free sample. Chaney, 1130 E. 16th St., Jacksonville 6, Fla.

GOOD Paying business silvering mirrors, plating articles in the shop and home by late method. No tanks or shop required. Free booklet. Gunmetal Co., Ave. H, Decatur, Illinois.

GROW Orchids at home—Profitable, fascinating. Year 'round, Maine to California. No greenhouse. Gorgeous cattleyas, cymbidiums, etc. Successful home grower shows you how. Full details free. Flowerland, 4622 Wilshire, Los Angeles 5.

FIX Typewriters. Inexpensive home course teaches factory secrets. Free booklet. Write, Typewriter, Tarentum 1, Penna.

WANT To make big money at home? \$5 profit in an hour possible with invisible reweaving. Make tears, holes disappear from clothing, fabrics. Steady year-round demand from cleaners, laundries, homes. Details free. Fabricon, 8334-S Prairie, Chicago 19, Ill.

BIG Profits raising fishworms and crickets. Free literature. Carter Farms, Plains, Georgia.

FLEXIBLE Rubber molds for plaster and Marbleite figurines. Sample and large illustrated catalog 25c, refunded on first order. K-C Novelties, Dept. 205, Southampton, Mass.

\$25 DAILY Profits sharpening farm discs without dismantling or moving. No experience necessary. Free plan explains. B. T. Foley Company, Columbia Heights, Minn.

METALIZE Baby shoes, jewelry, gifts. Free catalog. Publisher, Box 73136, Los Angeles 3.

WHOLESALE Catalogue! Appliances, cameras, watches! Cam Company, 6806PM 20th Ave., Brooklyn 4, N. Y.

GROW Expensive herbs for us! Big profits home-business of your own. Year around profitability! We supply everything necessary! Send for free rare seeds and revealing plan. National Herb Exchange, Dept. A, Gardena, Calif.

SAWDUST. Turn it into cash. Forty-nine methods. Instructions \$1.00. Sawdust Laboratories, Box 155, Islington, Ontario, Canada.

NEWEST Spare, full-time home business. \$5 to \$10 hour possible. Paint with suede—The finish with touch and eye-appeal. Beautify auto dashboards, signs, radios, toys, figurines, lamps—1001 others. Complete, step-by-step instructions sent for no-risk examination. Free details. Coast, Los Angeles 61.

IMPORT-Export mailorder opportunities! Details. Warner, Box 6, Fort Scott, Kansas.

WE'VE Got a highly unusual deal for you on a new line of fire extinguishers. This is a new company, but you'll recognize the men behind it, who have had more than 20 years' experience in this field, when you write us, and it might pay you well to airmail us today. The Fire King Company, Inc., Dept. 12, Littleton, Colo.

MAKE New greaseless doughnuts in kitchen. Sell stores. Half profit. Free recipes. M. Ray, 3605 South 15th, Minneapolis 7.

VENDING Machines—Every description, New or used. Lowest prices. Mack Postel, 2952 Milwaukee, Chicago 18.

BUILD A home business sharpening saws. Wonderful profits. You'll get orders galore. No experience needed. Everything furnished. Complete details absolutely free. Max Mfg. Co., Dept. A, 138 Stockton Ave., San Jose 26, Calif.

ADVERTISING Book matches—Cash in on big demand; sell union label matches. Cuts for all businesses and political parties. Free powerhouse selling kit, low prices, protection guaranteed on repeat orders. Cash commissions. Superior Match Co., Dept. MX-1255, 7530 Greenwood, Chicago.

BECOME Tax consultant. Our students earn to \$3,000 in 3-month season, part-time. We train you—help you start. State approved. Union Institute, 68 Hudson, Hoboken 2E, New Jersey.

OPERATE Profitable magazine subscription service. Earn big Christmas profits. New telephone plan. Handle renewals for all magazines. No experience or investment. Rush name. McGregor Agency, Dept. 500-B, Mt. Morris, Illinois.

START A buying service, buy wholesale thousands nationally advertised products. Make big profits selling at sizable discounts. Postcard brings details. American Buyers, Hertel Station, Buffalo 16-C1, New York.

OPERATE Profitable mailorder business. Details free! Wilber, R2, Rhinebeck, N.Y.

WORK At home. Make money. Amazing opportunities. Free details. Coleman, Box 821, Newark 2, N. J.

"23 WAYS To build a home mail business." Free details. Penn General Distributors, Monessen, Penna.

\$1,000 MONTHLY Possible in collection agency business. Free details. Write Cole Associates, Syracuse 2, N. Y.

NEW Plastic mending tape. Just press on! Repairs clothing immediately. Lightning seller. Samples sent on trial. Kristee 115, Akron, Ohio.

HOME Earnings for you; compile names; big fees; steady income. New manual tells how; write today. Fortier, 63-A125 Hill, Buffalo 14, N. Y.

LEARN Sewing machine repair. Money secrets. Purdy's, 207-M, Weatherford, Texas.

BUY Wholesale—\$75,000 merchandise. Catalog 25c. Worldwide, Box 12-E12, New York City 60.

WANTED: Home producers, to be subcontractors. Cast plastic products for manufacturers in our clearing house service. Thousands of easily-made items required. Cash in at home, without previous experience. Plastic Service Associates, Dept. 12-PM, East Boston 28, Massachusetts.

HIGHEST Commissions all magazines. Free catalogue, supplies, prizes, exclusive extras. Subscription Service Co., Box 2070, Birmingham, Alabama.

FREE Catalog. Boxed jewelry sets for Christmas. New England, 124 Empire, Providence, R. I.

NEW Mail order opportunities. Free details! Central Sales, Robbins, N. C.

FREE! Complete mailorder business! Terrific profits! No investment! VitaMins, 2908PM Beverly, Los Angeles 57.

ONE Million articles wholesale. Source directory \$1.00. Satisfaction guaranteed. Johnson, 3262-Z Medina, Fort Worth 19.

MAKE Perfumes, other products—Sell mailorder. International, 6347 Parnell PM-12, Chicago 21, Illinois.

MAKE \$5 Per hour and up net after taxes. Donald Wicks made \$48.00 in a few hours. You can too! Write for free book and sample of product. Theodore Wilson Products Co., P.O. Box 922, Dept. 12, Seattle, Wash.

PRINT Without a printing press! Amazing new method! Print colorful signs, banners, cards, posters, glassware; anything at home. Big profits. Moneymaking opportunity! We supply everything. Beautiful sample home-business plan free! Write Screen-Print Company, PM-12, Los Angeles 61, California.

CONCRETE Specialty manufacturing. New adjustable forms. 25 fast selling home needs. Illustrated instructions \$1.00. Guaranteed. Vyke Co., 4150 Jason, Denver, Colo.

BUSINESS Papers and magazines keep you posted. Late single copies, 5,166 publications—211 fields. Current list free. Commercial Engraving Publishing Company, 34C North Ritter, Indianapolis 19, Indiana.

EXPORT Business made easy! You can do it! Substantial income from home. No merchandise buying. Complete business setup service—Not only instruction. Hermes, 132 West 42, New York City 36.

YOU'LL Be amazed at the tremendous profit possibilities in selling the finest quality Bibles available anywhere! Many men make \$30,000 yearly and more! Get my free proven Bible sales course plus catalog of many Morocco grain, genuine leather covered Bibles and related items. Joseph W. Cain, Wholesaler, Box 5065-R, San Antonio 1, Texas.

MAKE Jewelry, gifts, novelties, from seashells, gems, plastics. Wholesale price-list, details, 10c. Giftcrafts, Box 4550-G, Coral Gables, Florida.

INVESTIGATORS Wanted, Work furnished. Credit Correspondent Service, 517-M New York Bldg., St. Paul 1, Minn.

LET Others sell for you. Earn steady from home. Operate successful direct selling company. Complete setup arrangements furnished, from idea to success. Harold, 69-A Bennett, New York City 33.

EARN \$2.00 Hourly, making and selling sandals! Youngs, 1308-PM, South First, Arcadia, California.

HUGE Sparetime home profits. It's easy! Details free! Stommel, Box 104, Detroit 21, Michigan.

TV Remote control \$7.95. Just patented. Free trial. Unbelievable opportunity. Information, D'Erweg Co., Tarzana, Calif.

MEN Wanted—Build luggage and cases at home. We sell your products, supply complete instructions, materials, everything. No special equipment needed. Free details. Cascraft, 805-G24 Sunset, Los Angeles 12, Calif.

NEW Idea. Use your vacuum cleaner to make extra money. Customers everywhere. No cleaning. Full details \$1.00. R. Petersen, Box 78-E, Alpine, Calif.

USED And new watches \$2 up. Free list. Southern Watches, Gray, Georgia.

\$1,000 MONTHLY. Home, mailorder, free advertising method. Revealing information. Seidel, 6000-AL Sunset, Los Angeles 28.

UNPAINTED Novelties, shelves, doll furniture, etc. Henry Kiewiet, Kalamazoo 84, Michigan.

HUGE Profits bronzing and pearlcoating baby shoes. Free instructions. Box 521, Waterloo, Iowa.

A Monthly repeat business which you can operate in your own community. For free details write Grasak, Dept. A-101, P.O. Box 494, McKeesport, Penna.

HURRY—Don't miss this chance, over 1000 ideas to make money. Free circular. Hooser Vendors, PM, 3117 Broadway, Indianapolis, Ind.

OPERATE Shopping center from your living room. Get investigated list of 30 lowest priced name brand wholesale catalogs in the world for \$2.00. B. Ruman Investigating Co., 573 Sheridan, Niles, Ohio.

200 NAMES. Addresses newly engaged girls—\$1.00, 1,000, \$3.00. Sotter, Box 422, Huntington Park, Calif.

HOW You too can succeed in the mail order business. Free details. Albert D'Agostino, 144-17-A 29th Rd., Flushing 54, N. Y.

HOW And where to obtain money. Many ways to use your time to make big money. How I started with \$38 and built assets over half million dollars. Complete information postpaid \$2.00. Money-back guarantee. Particulars free. Business Consultants, 5853 N.E. 2nd Avenue, Dept. "C," Miami 37, Florida.

OPERATE "Escalator" mailorder system, selling our products or any products. Most revolutionary mailorder system known. Postcard: Selbyco, Decatur 163, Illinois.

\$500 MONTHLY For life! Your own mail-telephone collection service for businessmen, doctors. Easy, profitable everywhere! Write: Financial, B-740-P12, Chicago 90.

SELL "Political greeting cards." Republicans and Democrats buy like wildfire. Wonderful mailorder item. 25c brings samples and wholesale prices. Neil H. Tasker, 105 East Custis, Alexandria, Virginia.

INCORPORATE Your business in Delaware. Do business anywhere. Quickest. Cheapest. Write Faulstich, 684 N. Sangamon St., Chicago 22.

NOW You can own a business. How? Find out by rushing a postcard to Paul Ribnikkar, 203 Ribnikkar Bldg., Kramer-Boron, Calif.

SELL From your own large wholesale catalog. Rush name! C-S, Box 9091, Kansas City 18, Missouri.

\$20,250 PROFIT Selling stamps by mail. How we did it book; send only \$2.00. Free details. Fahsing, Atascadero, California.

CAPITAL Easily obtained. Any purpose. Unlimited sources. How and where. Information free. Advance, Miami 8A, Fla.

\$46 FROM Square foot plywood; jigsaw necessary. Details free. Woodart, Bridgewater, Mass.

MAKE Extra money between now and Christmas. Sell subscriptions to all popular magazines. Liberal commissions. For supplies write DeSales Magazine Service, 60 East 42nd St., New York 17, N. Y.

GIANT 100 Page catalog! Wholesale prices! BTS Products, Box 217, Oakland 3, N. J.

WHOLESALE Buyers, salesmen, dealers! New 1958 Blue Book gives you names of over 3000 jobbers-manufacturers who will supply anything—everything. Send postal for literature. Associated Wholesalers Service, 1016-D, Starr, Burlington, Iowa.

SAVE Money on your patent application. Patents for any country. Free details. International, 25 McMaster, Toronto, Can.

HAVE Home business! Get \$10.00 orders by mail. Keep \$8.00. Everything furnished. National, Box 33-W, Dorchester 22, Mass.

\$26,500 SALES in two weeks! Amazing radio-mail order method. Free details. Broadcast Service, 1412-PD Great Northern Building, Chicago 4, Illinois.

HOME Mailorder course \$2. Free details. Spera, Box 596, Toronto 1, Canada.

OPERATE Profitable mail order business. Splendid opportunity. Write Blair Company, Perkinaton, Mississippi.

BEGINNER'S Ready made mail order set up, 25c. Albert Daufeldt, Atalissa, Iowa.

FIRST Time offered. Exclusive distributor franchise, finest quality pens. Write-away Pen Co., Box 7, St. Louis 14, Mo.

CAST Figurines! Novelties! Make production molds! New copyrighted course! Quick method! Illustrated! Only 25c! Castcraft Studios, 508-P Marion St., Brooklyn 33, N. Y.

SAWDUST. Turn it into cash. Seventy methods. Instructions 50c. Charles Company, 12-DXE, Norwood, Ohio.

SPROUT Flowering vegetables in artistic glass containers. Huge demand as planter decoration pieces. New, big profit home business. Beautiful. Easy. No investment. Free plan! Interior Publishers, 2112 Countryman Lane, La Canada 2, Calif.

START Profitable home and/or mail business without capital. Domestic-foreign trade sources plus large wholesale name-brand catalog free. Inquire Quay Enterprises, 645 Robinwood West, Detroit 3, Michigan.

AMBITIOUS? We establish you in your own business, supply catalogues, circulars, etc., ship orders under your name, paid or c.o.d., show you exactly what to do. Household items needed in every home. Sell direct, by mail, or through agents. Catalogue, plans, details absolutely free. Write Topval Corp., Lindenhurst 918, N. Y.

BECOME A game warden, professional hunter! Join forestry, park, fishery services. Good pay! Opportunities open! Free revealing "Select-Job Chart," details, job-getting secrets. Write Home Study Institute 1036-RDR, Los Angeles 19, California.

EXCLUSIVE Distributors. Amazing cedar lining powder! Add water, applied like paint. Makes cedar closets, chests! Terrific "do-it-yourself" seller stores, supermarkets, building supply, homes, builders. Samples, details sent. Cedarco, 90-A Summit Ave., Brookline, Mass.

PROTECT Your business! 15 ways dishonest employees operate. Report 25c. Zana, Box 1185, Newburgh, N. Y.

SAVE Thousands of dollars building your own home. Substantial discounts and know-how. Sell our bank, G.I. (refundable), P.H.A. approved homes in your area. Send \$10.00 for sales kit and four beautiful illustrated catalogs with floor plans. 1½ story, basementless, 2 bedroom, 3 bedroom. Catalogs \$1.00 separately. Do It Yourself Homes Co., Box 748, Lewistown, Penna.

CASH Profits selling from our catalogs. Write Kenroe, Yorktown, Ind.

SENSATIONAL New, profitable home career now revealed. At long last, you too can learn the amazing techniques of the portrait studios. Don't lose out, get your share of these steady, life long dependable profits. (Some portraits sell for more than \$100.00.) Be your own boss in this uncrowded field. Complete kit \$3.00 or valuable information free. John G. Marshall Co., Dept. PM-12, 167 N. 9th St., Brooklyn, New York.

FLORIDA Opportunities! Hundreds of jobs, businesses, farms, groves, homes. Free details! Florida Opportunity Journal, Vero Beach 14, Florida.

NEWSPAPERS. Turn them into cash. Eighteen methods. Instructions 50c. Charles Company, 12-DXF, Norwood, Ohio.

MONEYMAKING OPPORTUNITIES

AMAZING Matched jigsaw-painting patterns bring independence. Sure-selling combinations galore. Complete \$1.00; details 10c. Hoover, Grand Marais, Minn.

EARN Big money. Manufacture better mousetrap. Disposability assures recorders. \$1.00 brings complete plans. Dispos-O-Mouser, Box 2693, Dept. PM125, Sacramento, California.

START A buying service, buy wholesale thousands nationally advertised products. Make big profits selling at sizable discounts. Postcard brings details. American Buyers, Hertel Station, Buffalo 16-D1, New York.

EXPORT. Career. Profitable hobby. Wade, 8/119 Hamilton Terrace, London N.W. 8, England.

START Your own moneymaking mail order business! Write—R. Pickett, Mt. Airy, Maryland.

MONEY In saw and lawn mower sharpening sparetime at home. Repeat cash business. Experience unnecessary. No selling. Free booklet explains. V. Foley Company, Columbia Heights, Minnesota.

HOME Money making opportunity. Quentin Trent Publishing Company, 10216 Kercheval, Detroit 14, Michigan.

LEARN Technical Metaphysics and insure your future. Easy, inexpensive correspondence course. Simplest method known. Diploma. Write: Premier College of Technical Metaphysics, 2532 McKenzie St., Vancouver 8, B. C., Canada.

PRINTING And office supplies wholesale. 20,000 items. Literature free. Royal, Box 368-A, Cleveland 27, Ohio.

\$9.00 RETURNS \$160.00. Repeats. 25c coin for sample. Ezee, Bayport 7, Mich.

CLOSEOUT 50,000 GE subzero automobile engine heaters. Listed \$8.95, sample \$3.95. Terrific quantity discounts. Illustrated literature and mailorder plans \$1.00 (refundable first order). Wisnieski, Milwaukee 7, Wisconsin.

\$200 WEEKLY Cleaning Venetian blinds. Free book. Burt, 2434A, Wichita 13, Kans.

SELL Helbros watches-jewelry. 70% discount. Wholesale catalog 25c. Dorinda, Box 77, Huntington Station, New York City.

MAKE Spare time money preparing and mailing sales literature. Adams Surveys, 3513-AT Sunset Blvd., Los Angeles 26, Calif.

SCHEMER Magazine. Canfield 1, Ohio. Mailorder and business plans. Year \$2.00, sample 25c.

PRIZE Contests provide fabulous and confidential home income opportunities! Here's how and where to win your share! Send stamp! National Contest Bulletin, Box 2685, Miami 16, Florida.

MAKE Money with camera. Professional secrets \$1.00. Brewer—Photographer, 5880 Hollywood, Hollywood 28, Calif.

EARN \$50.00 Daily making mats, shoes and mud guards from old tires. S and S Patents Inc., 1307 North Clark St., Chicago 10, Ill.

BUILD Sales by recruiting productive distributors selling direct or to retail outlets. Secure most concentrated circulation through classified columns of Salesman's Opportunity. Write for facts. Gilbert, Salesman's Opportunity, Room 1700, 850 N. Dearborn, Chicago 40.

FREE Folio "Up to \$45,000; Unlimited Vacations." No merchandise, equipment. Unknown! Work home, sparetime! Haylings, Carlsbad, Calif.

SPARETIME Profits taking subscriptions all magazines. Wholesale catalog free. Cassell Publishers, Westfield, New Jersey.

GENERAL Contest Bulletin. Issued monthly. Sample, 25c. 1609 1/2 East 5th, Duluth, Minn.

GROW Mushrooms. Cellar, shed, and outdoors. Spare, full time, year round. We pay \$3.50 lb. We paid Babbitt \$4,165.00 in few weeks. Free book. Washington Mushroom Ind., Dept. 173, 2954 Admiral Way, Seattle, Washington.

50,000 ARTICLES Wholesale. Source directory, dime. Nelko, Box 3462-DR, Chicago 54.

FREE Book "505 Odd, Successful Business." Work home. Expect something odd! Pacific, Oceanside, Calif.

READ Progressive Mailtrade, the magazine that tells how to make money by mail. Dime brings sample and special offer. Progressive Mailtrade, Box 337, Sheboygan, Wisconsin.

ATTENTION: Typewriter owners. Make handsome profits. Write today. Groves Company, 682, Hastings 8, Nebraska.

START A profitable subscription business in spare time! We need men and women (young or old) as representatives for all leading national magazines. Liberal commissions paid for new and renewal subscriptions. Start earning money in this pleasant work at once! Clip this ad and send with your name and address to: Agency Bureau, Dept. PM, Hearst Magazines, 250 West 35th St., New York 19, N. Y.

SCHOOL Seniors—Sell classmates America's most beautiful graduation name cards. Largest selection. Highest commission. Outsell all others. Free sample kit. Printcraft, Dept. M, 1509 Maple Street, Scranton 5, Penna.

BUY Wholesale! Save 66%! Appliances, furniture, jewelry, toys, sporting goods, tools. Free catalogs. National Buyers Service, Box 428EB, Oakland, California.

TO \$50.00 Weekly. Sparetime, home operated mailorder business. Successful beginner's plan. Everything supplied. Lynn, 10420-M National, Los Angeles 34.

VENDING Machines—No selling. Operate a route of coin machines and earn amazing profits. 32-page catalog free. Parkway Machine Corporation, Dept. 15, 715 Ensor St., Baltimore 2, Md.

OVER \$200,000.00 In cash prizes offered this month. They are yours for the taking. Free details. Robert Spence, Dept. P, 7252 Central Ave., St. Petersburg 7, Fla.

MINIATURE Bird houses. Wonderful for groups. Sample postpaid 50c. Bird Houses, Mountain Lake, Minnesota.

START Mailorder business! Amazing booklet, "Build Your Own Mailorder Business," shows how! 25c. Lee M. Dahm, 383 Box Avenue, Buffalo 11, N. Y.

METAL Castings, art, machine parts. Write Box 124, Lynwood, California.

CIGARETTES—Facts free. How to roll them for 8c a pack. Pete Moberly, Box 795, Owensboro, Kentucky.

\$1,000 MONTHLY Possible raising earthworms! Backyard, garage, basement. Complete illustrated booklet explains raising, feeding, packing, marketing. 25c postpaid! Ozark Worm Farm-J, Willow Springs, Missouri.

1956 IMPORT-Export directory, \$1.00. Comstock, 1702 Roberson, Springfield, Missouri.

SAVE Buying nationally advertised merchandise. Catalog 50c. D'Auria, Box 355-PM, Jackson, Michigan.

MAKE \$5 Per hour and up net after taxes. Donald Wicks made \$43.00 in a few hours. You can too! Write for free book and sample of products. Theodore Wilson Products Co., P.O. Box 922, Dept. 14, Seattle, Wash.

LEARN Research as a profession. No previous training. Send 10c to cover cost of literature. Ray Putt, 1640 Dyre St., Philadelphia 24, Penna.

SELL Titania gems; far more brilliant than diamonds. Catalog free. Diamonite, 2420-M 77th, Oakland 5, California.

MANUFACTURERS! Complete manufacturing, selling instructions, guidance. Unique! Free booklet! Jarry, 268-BD, New York City 5.

HOME Mailorder beginner's manual, sources, methods, opportunities, 25c. Carnahan Brothers, 9610 Acacia, Fontana, Calif.

"47 WAYS How to Make Money in Florida." \$1.00. Lorelei Publications, 3142 Coral Way, Miami 15, Florida.

"HOW To Invent Successfully," Free details. Burger, 11592 Gateway, Los Angeles 64.

EARN Money evenings copying and duplicating comic cartoons for advertisers. Adservice, Argyle 1, Wisconsin.

IMPORT Direct from Japan low-cost fast-selling merchandise for highest profits. Sell mailorder, wholesale, retail. Airmail \$1 for confidential export price list and simple home-business plan. Francis Justice Company, Akasaka Postoffice, Box 7-A, Tokyo, Japan.

UP To \$200.00 monthly! Spare time home mail order! Details free! Stauch, 948 No. Wayne, Wayne, Mich.

FREE Details. Moneymaking offers, sparetime work, earning plans. Nelson Sales, Elkhorn 9, Nebraska.

PARKING Trouble? \$10,000 per year possible. Park five cars in place of one. Preliminary plans \$1.00. Detailed plans (exp.) prices upon request. Troupe Trice, Gilbertown, Ala.

INCREASE Your income, without any investment. Wholesale Merchandisers, 200 Allen Str., New York.

WANT To go in business for yourself without capital? We show you how. Start part time your own home. Postcard brings details absolutely free. Topval Corp., Lindenhurst 820, N. Y.

FORMULAS, PLANS, ETC.

100 COSMETIC Formulas, latest developments, huge profits, \$2.00. Brockway, 1145 High, Topeka 1, Kansas.

LARGE Formula catalog free. Anything analyzed \$35.00. Western Chemical, Salem, Oregon.

FORMULAS; All kinds, latest, best. Literature free. Kemikal, Park Ridge, Ill.

REAL Manufacturing formulas. Lists free. Cummings, Chemist, Gordon Ave., Syracuse 4, N. Y.

PRODUCT Analysis, manufacturing formulas, processes developed. Moderate fees. Plastics, Box 1574, Boston 4, Mass.

MODERN Formulas for today's fastest selling big-profit products. Literature free! Miller, Chemist, 1517-N, Tampa, Florida.

PLASTICS

PLEXIGLAS, Fiberglass, polyester, acetate. Unique wholesale-retail catalog. 15c. Gem-O-Lite, Box 686M, North Hollywood, California.

LAMINATING Supplies. Free price list. Solomon, 46 Cornhill, Boston 8, Mass.

PLEXIGLAS. Cut to size. Clear. Any thickness. Colors. Rods, Tubing. McClarin Plastics, P.O. Box 168H, Hanover, Penna.

NEW Liquid casting plastic, clear, colors. Embed real flowers, insects, photos, coins. Saw, drill, carve. Send 25c for handbook. "How to Cast with Liquid Plastic," and proved success plan showing how to make money at home. Castolite, Dept. P101, Woodstock, Ill.

PLASTICS Home-craft course for men and women. Tells and shows how to make hundreds of fast selling plastics products. All plastics and materials for 23 projects included in course. No special tools needed. Course pays for itself. Write for free booklet. Interstate Training Service, Dept. D-3-N, Portland 13, Oregon.

PLASTIC Laminators. Here is your opportunity to greatly increase your profits. An item that is bought every day, summer and winter, by folks in all walks of life. Send for free sample. No obligations. Theo. R. Pautz, 135 Ross Street, Williamsport, Penna.

FREE Brochure. Casting, coating, adhesive plastics. Dunn, Box 5537, Chicago 80, Ill.

PLEXIGLAS, Lucite. Square foot cost 1/16", \$1.15; 1/8", \$1.52; 3/16", \$1.86; 1/4", \$2.21; 3/8", \$3.28; 1/2", \$4.36. Colors add 10%. Send 15% for postage. Aristocrat Plastics, 23-25 Sussex Avenue, Newark, N. J.

CHEMISTRY

LABORATORY Apparatus, chemicals, microscopes, complete chemistry sets, minerals, uranium ore. 10c brings catalog. Porter Chemical Co., Hagerstown 4, Md.

CHEMICALS, Supplies. Catalog 25c. Laboratory Sales, Box 161-A, Brighton, Massachusetts.

ILLUSTRATED Catalog: Chemistry, mineralogy, biology 20c. Tracey Laboratories, Evanston, Illinois.

CHEMICALS And apparatus for industrial, analytical, and private laboratories. Catalog 25c. Dept. M-50, Biological Supply Co., 1176 Mt. Hope Ave., Rochester 20, N. Y.

BOOKLETS; 60 pages each! "Beginners Chemistry," "Chemistry," "Einstein's Relativity," "Physics," "Atomic Theory," "Electron Theory," "Scientific Oddities," "Light," "Sound," "Heat," "Electricity," "Radio," "Astronomy," "Useful Tables," "Geometry," "Mathematical Oddities," "Scientific Terms." (Order by titles.) 10c each. Franks, 3121 South Racine, Chicago 8.

CHEMISTRY For beginners, all ages, everywhere. Fascinating, systematic. First lesson 25c. Plastics information, formulas, trade secrets. Parkway Laboratory, McKees Rocks, Penna.

NEW Idea chemical and apparatus outfits for home experimenting. Photo-scales, microscopes, chemicals, biologicals, and laboratory supplies in small quantities. Catalog 25c. Established 1931. John H. Winn, 124A West 23rd St., New York, N. Y.

FREE! Uranium detector and chemical puzzle (worth \$2.50) with first five lessons of diploma course on practical chemistry! Big package of chemicals, filtering equipment, charts, etc. Only \$1.00. National School of Chemistry, P.O. Box 606-G, Redwood City, Calif.

AGENTS WANTED

PRINTING! Highest quality. Big profits. Free wholesale pricelist, supplies, details. Napco, 2337-A Bath Avenue, Brooklyn 14.

AGENTS Make big profits on stainless steel tableware. Bargain deals. Low wholesale prices. Rush name for catalog and amazing details. House of Cards, 208 S. Lamar, Amarillo, Texas.

MAKE \$100 Up weekly—Demonstrate, take orders. Sensational new product. Prospects everywhere, part-full time. Campbell Company, Rochelle 53, Illinois.

SCHOOL Seniors—Be popular with classmates. Have spending money galore. Details free. Craftcards, Box 235-L, Pittsburgh 19, Pennsylvania.

\$200 WEEKLY Cleaning Venetian blinds. Free book. Burt, 2434A, Wichita 13, Kan.

AMAZING \$1.00 Retailer! Used by men, women, children! Tremendous market! Free details. Edmunds, 3009 Weaver, Baltimore 14, Md.

YOUR Own business—Used suits \$1.50, overcoats 85c, mackinaws 35c, shoes 12 1/2c, ladies coats 30c, dresses 15c. Enormous profits. Catalog free. Nathan Portnoy Associates, 605 West 12th Place, Chicago 7.

NEW Line portable electric power tools. National manufacturer sponsoring Perry Como's fall program. Send for free catalog. Glasser Products, 369 Kingston Avenue, Brooklyn, N. Y.

IMPORTING Without capital. Become successful U.S.A. resident agent for leading overseas manufacturers. High income, home operated, no risk. Complete arrangements furnished including U.S.A. distribution assistance. Impex, 1974-A Comstock, Los Angeles 25.

PROFIT With your own wholesale, name brand catalog. Appliances, watches, jewelry, gifts, tools. Imprint your name on cover. Full or part-time sales. Details free. Robel Sales, Dept. P.M., 487 Broadway, New York 13, N. Y.

GOLD Or silver letters, numbers. Windows, doors, trucks, 1" to 6", 500% profits. Free samples. Atlas-T, 544 West 79th, Chicago 20.

FREE Color catalog of religious jewelry. 100% profit. Virgin Mary heart necklace, sample \$1.00 (value \$2.50). Money back guarantee. Stephen-New York Inc., 1947 Broadway, New York 23.

PRINTING. Advertising salesmen—Excellent moneymaking sideline selling decalcomania name plates, small quantities. Automobile initials, sign letters. Free samples. Balco, XL, Boston 19, Mass.

MAKE Extra money. Sell front door name plates to friends, neighbors. Retail \$1.98; you make \$1.00! Free selling kit. Modern Engraving Co., P.O. Box 194, Boston 14, Mass.

\$1.00 PROFIT Selling \$2.95 photo enlargement deal. Allen Studio, Riegler Bldg., Little Rock, Ark.

AGENTS—300% Profit selling genuine gold window letters; stores and offices. Free samples. Metallic Sign Letter Co., 431-D North Clark, Chicago.

YOUR Ad in this space will get some good agents for you. Yes, I'll prove it. Write for Folder "A" right now. F. W. Johnson, Classified Advertising Manager, Popular Mechanics Magazine, 200 E. Ontario St., Chicago 11, Ill.

CALIFORNIA Sweet smelling beads. Sensational sellers. Particulars free. Mission, 2328 FR, W. Pico, Los Angeles 6, Calif.

FOG-STOP Windshield cloth. Instantly removes blurry mist, frost, sleet, snow. Stops windshield fogging. Samples sent on trial. Kristee, 79, Akron, Ohio.

START Your own business on credit. Your own boss. 1135 of our dealers sold \$5000 to \$30,000 in 1954. We supply stocks, equipment on credit. 200 home necessities. Sales experience unnecessary. Pleasant profitable business backed by world-wide industry. Write Rawleigh's, Dept. L-U-PPM, Freeport, Ill.

BUY Wholesale thousands nationally advertised products at big discount. Free "Wholesale Plan." American Buyers, Hertel Station, Buffalo 16-A1, N. Y.

DEFINITELY Different. Unique feather-weight metal dangle earrings. Gold-plated, non-tarnishable. Ideal gift. Resell 100% profit. \$12.75 assorted dozen. Sample \$2.00 boxed. Herbert Diamond, Box 64, Riverside Station, Miami, Florida.

CLEANS Windows without mess. Strange dry cleaning cloth. Replaces liquids. Windows gleam. Samples sent on trial. Kristee 78, Akron, Ohio.

GO Into business for yourself. Sell nationally popular name brand items of jewelry, watches, appliances, housewares, toys, gifts, premiums, prizes. No inventory, no investment. Send for free big new catalog now. Halen, Inc., 125 Fifth Ave., Dept. P.M., New York City, N. Y.

BIGGEST Distributor profits! Hire agents, salesmen! Amazing new wonder car polish with magic Dow Corning silicones. Steady, repeat seller. Rush name for free details, no-risk sample offer. United, 1035 East 10th Street, Brooklyn 30, N. Y.

IMPORT From Japan! Directory 1200 names leading export firms. \$3.00 prepaid. Hoffman Box 662, Passaic, New Jersey.

AGENTS Wanted: Make much money selling famous "Sweet Georgia Brown" beauty products. Hair pomade, face creams, face powder, perfumes. Write for free sample offer. Valmor, 2451 AQ Michigan, Chicago 16, Illinois.

BE Your own boss! No investment—No inventory. Big real profit-making wholesale catalog free! Dept. PM, Jay Norris, 487-X Broadway, New York City, N. Y.

BEAUTIFUL Feather pictures 200% profit! Free sample. Apartado 9036, Mexico 1, D. F.

BUY Wholesale 550,000 products. Literature free. Carter, Box 6011-M, Chicago.

\$300 WEEKLY—Sell new chain saws \$99.50 up. Catalogue 25c. M-G Saws, Coatesville, Penna.

BUY Wholesale, 25,000 items, catalog 25c. Matthews, 1472-B3 Broadway, New York City 36.

BIG Money in valentines! Easy to earn with 4 different valentine packs. Best sellers for every occasion all year—Mother's, Father's Day, Easter, birthday, all-occasion assortments, gifts, stationery. Over 100% profit on bargain specials. Samples on approval. Midwest, 1113 Washington, Dept. 699-G, St. Louis 1, Mo.

MAKE \$5 Per hour and up net after taxes. Donald Wicks made \$48.00 in a few hours. You can too! Write for free book and sample of product. Theodore Wilson Products Co., P.O. Box 922, Dept. 13, Seattle, Wash.

\$4.85 PROFIT On \$4.85 sale, yet saves customer \$50. Noted specialist says "Only outstanding deal seen in 18 years." Maxson, Falls Church 17, Virginia.

GOOD Profits selling Mexican feather pictures. Free sample. Apartado 7118, Mexico City.

BE in your own business. Buy wholesale. Big profits. Get free nationally famous name brand mdse. Catalog. Dept. PM, Normandy Distributing Corp., 133 Fifth Ave., New York City, N. Y.

USED And new watches \$2 up. Free list. Southern Watches, Gray, Georgia.

UNUSUAL Mail order plan pays \$100.00 per car commission. No investment required. Take orders only. My agents may order their own cars less commission. Brand new 1956 automobiles equipped with windshield washers, turn indicators, outside rear-view mirror, tuxedo paint, oil filter, undercoating, federal taxes. Prices start at: Nash, \$1873; Ford, \$1733.09; Plymouth, \$1730.25; Chevrolet, \$1795.65; Studebaker, \$1858.98; Dodge, \$2095.99; Pontiac, \$2107.74; Mercury, \$2222; Buick, \$2341.19; Oldsmobile, \$2415.17. Other equipment additional. Also Lincoln, De Soto, Chrysler, Packard, Hudson, etc. Down payment layaway plan pays 4% interest on layaway payments until delivery. Send \$1.00 for complete details. Harry A. Harwoods, Box 4, 20038 Renfrew, Detroit 21, Michigan.

NAMEPLATES, Desk signs. For homes and business. Free samples. Whitney Signs, West Springfield, Mass.

\$15.20 AN Hour is what W. F. Wydallis reports he earns with amazing Presto fire extinguisher. Sells itself. No experience needed. Free sales kit. Merlite, 114 E. 32nd St., Dept. 50-C, New York City 18.

GOOD Pay to introduce cosmetics in your territory. Write Box 282, Columbus, Nebr.

EASY Handwork makes fast-selling articles. Sample free. Sunmade Company, Brockton 64, Massachusetts.

AMAZING Home business. Stamp social security plates. Free details. General Products, 188-PM State, Albany 10, N. Y.

NEW Way to make money! Sell nothing. Don't even step out of your home unless you want to! Let others do the work. Experience unnecessary. We show you how. No money for stock. We ship your orders, paid or c.o.d. Catalogue, money-making plans, etc., free. Write Topval Corp., Lindenhurst 41, N. Y.

BUY IT WHOLESALE

BARGAINS, Joblots, closeouts. 2000 items. Tremendous savings, clothing, toys, gifts, jewelry, television, etc. 25c brings wholesale catalog. \$1.00 merchandise certificate included free. Reliable Jobbing, 311-B North Desplains, Chicago.

BUY Surplus wholesale. Catalogue 25c (refundable). Box 22F8, Thomasville, Penna.

THOUSANDS Nationally advertised brand name products. Discounts to 80%. Meder, 550-PM Fifth Avenue, New York City 36.

WHOLESALE Catalog! 30-80% discounts! Appliances, musical instruments, typewriters, phonographs, watches, jewelry, recorders, housewares, etc. Consolidated Distributors, 21-20 Lafayette, Paterson, New Jersey.

BUY Wholesale! Save 66%! Appliances, furniture, jewelry, toys, sporting goods, tools. Free catalog. National Buyers Service, Box 428EB, Oakland, California.

POGO Sticks. Will carry 150 lbs. guaranteed! \$4.50 postpaid. U. S. Industries, 603-A Macy Street, Los Angeles 12, Calif.

BUY Wholesale! Nationally known brands. Catalog 50c. D'Auria, Box 355-M, Jackson, Michigan.

WATCHES, Diamonds, appliances, tools. Big discounts. Catalog \$1.00—Refundable. Hill Products, Sellersville, Penna.

CLOSEOUT, Imitation diamond rings, wholesale priced at \$3.00 dozen. Money back guarantee. Brockman, 1440 Meridene Dr., Baltimore 12, Maryland.

BUY Smarter. Live better. Have more! Economy unlimited. Smart buyer's service. Information. Derweg, Tarzana, Calif.

1956 WHOLESALE Catalog. Radios, appliances, watches, tools. Rush 50 cents to Edward Clemens, 318 West Bridge St., Morrisville, Penna. (Refundable.)

NAME Brands wholesale! Park Sales, 51 Elizabeth Ave., E. Paterson, New Jersey.

THOUSANDS Articles wholesale! Catalog \$1.00 refundable. Evanich, Stamford (Catskill), N. Y.

FREE Lists. 640,000 items wholesale. P. Cottage Industries, Omaha 12, Nebr.

GIANT 6-Color general wholesale catalog. Postcard: Selbyco, Decatur 263, Ill.

YOUR Cost as little as 25c on dollar! Household items needed in every home. Sell direct, by mail or to agents. Catalogue, confidential distributors' wholesale prices and money-making plans absolutely free. Rush postcard to Topval Corp., Lindenhurst 524, N. Y.

BUY Wholesale for yourself, family, friends. Save, make hundreds annually. Geiger counters, firearms, typewriters, diamonds, watches, appliances, etc. Kennedy Enterprises, 848 East 96th, Seattle, Washington.

SALESMEN—DISTRIBUTORS

WILL You wear new suits and topcoats without one penny cost and agree to show them to friends? You can make up to \$30.00 in a day even in spare time, without canvassing. Progress Tailoring Co., 500 South Throop St., Dept. L-326, Chicago 7, Illinois.

SELL Name brand safety belts. 50% commission. Free details. Home Supply Service, Kiel, Wis.

FABULOUS Profits. Imported hand made unique straw feather pictures. Samples 25c. Refund first order. Economy Manufacturers, 5622½ Lankershim, North Hollywood, California.

\$15.20 AN Hour is what W. F. Wydallis reports he earns with amazing Presto fire extinguisher. Sells itself. No experience needed. Free sales kit. Merlite, 114 E. 32nd St., Dept. 50-C, New York 18.

SPARE Or full time top earnings selling America's largest low-priced line business printing and advertising specialties to every retail store and business. Big advance commissions. Complete order-winning sales kit free. National Press, North Chicago 1, Illinois.

SALESMEN Calling on any trade using grinding wheels can make money selling our patented dresser. Write for proposition. Thompson Manufacturing Co., Erie, Penna.

SIX Ways to sell alphabet checkers. Krume, 240 W. Eight, Dallas 8, Texas.

NEW Jobs open in selling! Send name, address for five free issues of Opportunity Magazine's money-making guide, listing hundreds of companies who'll pay you well, full or part-time. No experience needed. Opportunity, 850 N. Dearborn, Dept. 17, Chicago 49, Ill.

GOLDMINE Of 600 money-makers. Copy free. Specialty Salesman Magazine, Desk 5, 307 N. Michigan, Chicago 1.

DISTRIBUTORS—Large profits. Terrific repeat orders. Unique Italian brooms, details free. Write P.M. Peacock, 915 Bryant, San Francisco, California.

SELL Calendars. You make big money daily. Giant line. Every business buys. Also business printing, book matches, advertising specialties. Big sales outfit free. Write, Arrow Press, 515-V Fourth Ave. So., Minneapolis, Minn.

ADVERTISING Book matches—Cash in on big demand; sell union label matches. Cuts for all businesses and political parties. Free powerhouse selling kit, low prices, protection guaranteed on repeat orders. Cash commissions. Superior Match Co., Dept. M-1255, 7530 Greenwood, Chicago.

MONEY-Making opportunity! Take big profit orders for world famous patented varieties fruit trees. Also flowering shrubs, roses, vines. Big sales outfit free. Stark Bro's, Desk 30166, Louisiana, Missouri.

BUY Wholesale thousands nationally advertised products at big discount. Free "Wholesale Plan." American Buyers, Hertel Station, Buffalo 16-J1, N. Y.

MAKE \$100 Weekly spare time selling terrific booklet to employers. Teaches professional salesmanship without ploughing through books. Money back guarantee. Mail \$1 for booklet, refundable with first quantity price order. Post Publications, 2 Depot Plaza, (D), White Plains, N. Y.

DISTRIBUTORS—New method. Religious items. K.P.R., 1305 West 46th Street, Los Angeles 37, California.

BIG Money-making opportunity. Exclusive line work uniforms. Jackets, pants, shirts, coveralls. Advertising embroidered. Every business prospect. Outfit free. Master Div., 573 Water, Ligonier, Ind.

AD Matches! Sell amazing designs—10, 20, 30, 40 and 240-light book matches. Bigger spot cash commissions; every business a prospect. Low prices for high quality. Repeats. Start without experience; men, women; full, part time. Buy nothing! Sales kit furnished. Match Corp., Dept. PM-72, Chicago 32, Illinois.

100% PROFIT. Fast money for you! Take orders for Sweet Georgia Brown cosmetics. Colored people buy it quick. Free sample. Write Valmor, 2451-AL Michigan, Chicago 16.

VENDING Machines and merchandise, unbelievable prices. McDonald Distr'., Box 6095, Dallas, Texas.

EDUCATIONAL AND INSTRUCTION

TUNE Pianos spare time. Learn quickly. Inexpensive home course. Write Stafford, 708 Rawlings, Carbondale, Illinois.

MEN Wanted 21 to 65 to become real estate salesmen. Complete course of 12 lessons, only \$10. Earn big money. Our 25th year in business. W. Evans, 1407 N. 12th St., Reading, Penna.

USED Correspondence courses and educational books bought, sold, rented. Free catalog. Educational Exchange, Menlo, Georgia.

BECOME A real estate broker or salesman. Complete home study course. Free information. Kansas City Realty School, Box 6808PM, Kansas City, Missouri.

AUCTIONEERING! Be an auctioneer. Earn big money. Term soon. Free catalog. Kansas City Auction School, Box 6808PM, Kansas City, Missouri.

A Pleasing dynamic singing and speaking voice can be yours! Use self-training Canfield Voco-Records. Thrilling details! 2018-A—5th Avenue South, Minneapolis 4, Minnesota.

MIDLAND Linotype School. Charles City, Iowa. Civilian and Veteran Courses. Free placement. Established 1909.

CLERGYMEN'S, Laymen's courses. Free bulletin! Midwestern Bible School, 517 Merchants Bank Building, Indianapolis.

MEDICAL Laboratory technicians in big demand by hospitals and physicians. We train you at home. Free catalog. Century College, Desk 3, 960 Montana St., Chicago 14.

ENGINEERING Without college. You can become a licensed professional engineer, qualified for thousands of engineering jobs without college education. Write Newton, 5910 South Bend Drive, Fort Wayne, Indiana.

COLLEGE Degrees—Independent study. Keep employed. Brentwood College, Box 19-721, Los Angeles 19.

ENGINEERING Degrees earned through home-study. American College of Engineering, Box 27724 (B), Hollywood 27, Calif.

PIANO Tuning pays. Big money in spare time. Learn at home in 30 days. No musical knowledge necessary. Phonograph, records, tools and instructions furnished. Free catalog. Capital Tuning School, 16 Southwest Second, Fort Lauderdale, Fla.

I Want to send you proof of the wonderful pulling power of Popular Mechanics classified pages. What's your proposition? Write me today. Include literature if possible. F. W. Johnson, Manager Classified Advertising, Popular Mechanics Magazine, 200 E. Ontario St., Chicago 11, Ill.

BE A real estate broker. Study at home. Write for free book today. GI approved. Weaver School of Real Estate, 3018P Grand, Kansas City, Missouri.

INVESTIGATOR Training. Phillips Secret Service System, 1917-B North Kenneth, Chicago 39.

HIGH School diploma at home. Licensed teachers—Approved materials. Southern States Academy, Box 144-MX, Station E, Atlanta, Georgia.

SECRET Investigation. Experience unnecessary. Investigators particulars free. George Wagner, M125 West 88th, New York 24.

GROW Mushrooms. Cellar, shed, and outdoors. Spare, full time, year round. We pay \$3.50 lb. We paid Babbitt \$4,165.00 in few weeks. Free book. Washington Mushroom Ind., Dept. 174, 2954 Admiral Way, Seattle, Washington.

EARN While you learn. Auto and diesel mechanics master this top paying trade. Many graduates earn \$100 a week and up. Approved for Korean veterans. For free information write Dept. No. 256, Nashville Auto-Diesel College, Nashville 3, Tenn.

BOOKKEEPERS! Increase your earnings! Operate your own simplified "Dollars-A-Week" bookkeeping and tax service. Full or spare time. Details free. No obligation. Ellis, Box 200, Cedar Grove, North Carolina.

USED Correspondence courses and books sold and rented. Money back guarantee. Catalog free. (Courses bought.) Lee Mountain, Pisgah, Alabama.

PIANO Tuning pays. Learn this profitable profession at home easily with patented Tunometer and mechanical aids. No knowledge music necessary. Diploma granted. Write for booklet. Niles Bryant School, 3731 Stockton Blvd., Dept. P, Sacramento 20, California.

STUDY For doctor's degree of psychology, metaphysics and divinity. Correspondence courses only. College of Divine Metaphysics, Dept. P-M, 2811 North Illinois, Indianapolis 8, Indiana.

WANT A diesel job? New opportunities to increase income. Higher pay. More money. We can help you qualify. Tools. Shop method home training. Write today! Diesel, Tractor, Heavy Equipment Division, Interstate Training Service, Dept. B-3, Portland 13, Oregon.

PHYSICAL Therapy and massage. We train you at home. Earn big profits from your own private practice or work with hospitals and doctors. Free catalogue. National Institute, Desk 4, 159 E. Ontario, Chicago, Ill.

IT'S Fun learning by Linguaphone's world standard conversational method. At home, quickly, easily master French, Spanish, German, Japanese, Russian, Modern Greek—34 languages available. Save time, work, money. Send for free book. Linguaphone Institute, 83-125 Radio City, New York 20.

HOW To write and sell advertising. Van Buskirk System, 825 East Harrison, Danville, Illinois.

OPPORTUNITY To earn \$15,000.00 or more annually. Business of your own. No selling nor merchandise to buy. Over 5000 persons operating these exclusive offices. Free booklet. Franklin Credit, Roanoke 7, Virginia.

UNIVERSITY Degrees by residence, correspondence. Golden State University, Box 2882, Hollywood, Calif.

BOOKS, Government surplus. Bargain prices. Free catalog listing 50 other free catalogs. Instructional, educational, vocational subjects. Millions of volumes, new and used. Books bought. Est. 1902. Long's College Book Co., Dept. PM, Columbus 1, Ohio.

COMPLETE Your high school at home in spare time with 58-year-old school. Texts furnished. No classes. Diploma. Information booklet free. American School, Dept. X945, Drexel at 58th, Chicago 37, Ill.

HIGH School—No classes. Study at home. Spare time. Diploma awarded. Write for free catalog HF-59. Wayne School, 2527 Sheffield, Chicago 14, Ill.

WANTED: Men to learn how to write sales letters, circulars, etc. Writers get \$25.00 to \$100.00 per letter, or salaries of \$3,000.00 to \$10,000.00 per year. Earn while learning. Write: Henry Stewart, Inc., 210 Ellicott Street, Buffalo, New York.

INVESTIGATE Accidents—Many earn \$750 to \$1000 monthly. Thousands of insurance companies, airlines, and steamship lines need claim investigators. We train you at home spare time. Placement counsel and help. Free book—Now! Universal Schools, Dept. 112, Box 8202, Dallas 5, Texas.

WELDING Training pays at Hobart Welding School, Box M-1251, Troy, Ohio, VA contract. Best equipment. Catalog free.

GET Paid for learning a trade. Company training programs, toolmaking, drafting, welding, etc. Complete listing only \$2.00. Surveys, Box 181, Glastonbury, Conn.

APPLY For jobs by letter. Short folio shows how. Free trial offer. Telesis Company, Room 706, 507 Fifth Avenue, New York 17, N. Y.

CAR Owners—Save hundreds of dollars. Unique "Know Your Car" home study course teaches trouble shooting and how to make repairs. Anyone can learn. Free booklet. Roberts Technical & Trade Schools, 211 W. 81st St., New York, N. Y.

OFFICE Automation: Prepare for the future with the only home study course instructing "Application of Electronic Computers to Business Clerical Operations." Free information. Business Electronics, Computer Dept., Box 3330 Rincon Annex, San Francisco, California.

WILLARD Drafting School, home study, 101 South Second, Wilmington, N. C.

BLUEPRINT Reading—Train at home. Learn to read blueprints with confidence in 10 easy lessons. Write today Belton School, 1059-B North Lawndale, Chicago 51.

CORRESPONDENCE Courses, educational books bought, sold, rented. Catalog free. Willard Bayles, 211 Essex, Hackensack, New Jersey.

ENGINEERING, Home study. Midwest Engineering School, 10923 Hillcrest, Hickman Mills, Missouri.

U.S. Civil Service tests! Training until appointed. Men-women, 18-55. Start high as \$350.00 month. Many jobs open. Qualify now! Get free 36-page illustrated book showing salaries, requirements, sample tests. Write: Franklin Institute, Dept. L-24, Rochester, N. Y.

BECOME A doctor. Belong to most esteemed profession in society. Full information, schools, requisites, shortcuts, etc. Save time, money, errors. Start right. Mail \$1.00 now for complete guided details. Professional Development, Box 1277, Sherman Oaks, California.

PLAYS, STORIES, MANUSCRIPTS

STORIES, Books, plays wanted for movies. Farlow Company, 720 S. Michigan Ave., Chicago, Ill.

WANTED: Book manuscripts, all subjects considered. Greenwich Book Pub., Attn. Mr. Zealand, 489 Fifth Ave., New York City.

NO Luck finding a book publisher? Write for free Booklet PM. Vantage Press, 120 W. 31, New York.

SPECIAL SERVICES

INFORMATION On most any subject. Prompt. Reasonable. Let us know your wants. Reliable Information Service, Box 173B, South Lansing, Michigan.

JAPAN Information. Nippon Annal, 920 3rd Ave., 739, Seattle, Washington.

INFORMATION On any subject, \$1. Certified research! J. F. Griffith, Wynnewood, Pennsylvania.

INFORMATION On anything. Ferguson Research Specialists, 116-14 141 St., South Ozone Park 36, N. Y.

ARTISTS' SUPPLIES

IF Interested in artist frames, canvas, canvas boards, Red Sable brushes, etc., be sure to get our money saving price lists before buying. International Sales Co., 414-APM E. Baltimore St., Baltimore 2, Md.

CARTOONING, COMMERCIAL ART, SHOWCARD & SIGN PAINTING, TATTOOING

LEARN Cartooning from famous cartoonists! Details free! Famous Names School, 2776 California Ct., Lincoln 10, Nebraska.

"HOW To Make Money With Simple Cartoons"—A book everyone who likes to draw should have. It is free; no obligation. Simply address Cartoonists' Exchange, Dept. 912C, Pleasant Hill, Ohio.

9 ALPHABET, 3 Numeral pattern sets and raised wood letter catalog. \$1.00. Sign Letter Distributors, P.O. Box 101, Mineola, N. Y.

CARTOONISTS: Amateur, professional. Prepare for animation with Max Fleischer's plan. Write Vera Coleman, Lincoln Building, New York, N. Y.

LEARN Sign painting at home. Test lesson free. Ben Kerns, Box 812-PM, Greenville, S. C.

BASIC Training for beginners. Free talent test. Student Art Club, Kennebunkport, Maine.

PAINT Signs with master patterns. Set 1 1/4" to 12" high, with supplies, \$2.00; sample 3c. Eyerly, B-583, Newton, Iowa.

AMATEUR Artists, cartoonists! Turn your art ability into money. Hamilton, Box 4-PML, Astoria 5, N. Y.

TATTOOING Supplies, licensed course, illustrated brochures 25c. Zeiss, 728 Lesley, Rockford, Illinois.

ADVERTISING AGENCIES, LETTER WRITERS, FOR ADVERTISERS

ADVERTISE: 24 Words, 100 Canadian newspapers \$5.50. Lists free. Advertising Bureau, 10511-C Springfield, Chicago 43.

MAILING Lists, most any classification. 1000 names \$5.00, 1000 your circulars mailed with ours \$4.00. 5000 your circulars printed and mailed \$12.95. Write Dixie Mailers, King, North Carolina.

ADS Placed in out of town newspapers and magazines. Low rates. Catalogue free. Ideas that pay. Baker Advertising Agency, Successors Ankrum Agency, 189 W. Madison, Chicago 2.

ADVERTISE — 24 Words, 20 big newspapers, \$30.00. Newspaper, magazine, rate-book free. Chicago Advertising Agency, Chicago 4.

25 WORDS Published 50,000 mailorder circulars \$5. Lee Press, Little Rock, Ark.

6000 OPPORTUNITY Seekers! \$7.00—1000; 75c—100. Maxwell, 2938 Oak, Bettendorf, Iowa.

RUBBER STAMPS AND OFFICE SUPPLIES

RUBBER Stamps by professional craftsmen. 3 lines \$1.00. Price list. South Coast Press, 654 East Base Line, San Bernardino, Calif.

3 LINES, \$1.00. Past service. Catalogue. Johnson, 443 MacDonough, Brooklyn 33, N. Y.

FREE Style list stock stamps. Criterion, Box 2326, Denver 25, Colo.

LINE 25c; 2-45c; 3-65c. Stamp Works, Auburn, Nebraska.

NICE Gift. 3 line self-inking pocket stamp, \$1.00. Ajay, 1462 Junction Ave., Detroit 9, Mich.

TYPEWRITERS, DUPLICATORS, OFFICE DEVICES

RECONDITIONED Typewriters, duplicating, printing devices. \$25.00 up. Supplies. Appliances. DixieGraph, King, N. C.

NEW Portable typewriters sold wholesale to salesmen \$34.50. Typewriter Specialists, 5541 S. Ashland Ave., Chicago 38, Ill.

SMITH-Corona typewriter \$39.50. Other bargains. Typewriter Exchange, Bedford, Penna.

PRINTING, MULTIGRAPHING, MIMEOGRAPHING, GUMMED LABELS

1000 EMBOSSED Business cards \$2.95. Decco Service, Box 5825, St. Louis 21.

QUALITY Printing at small town prices. Samples. Quotations. Mercury Press, Box 69M, Marengo, Iowa.

100 LETTERHEADS (8 1/2 x 11) Printed neatly \$1.00 postpaid. Envelopes same. Blue or black ink. Stark Press, Capitola, Calif.

OFFSET, Letterpress, mimeographing. Economical prices, samples. Litho-Press, Madison, Tenn.

OFFSET Printing \$6.50-1000, 8 1/2 x 11, 16 lb. National Letter, 1463 Broadway, New York City 35.

1000 EMBOSSED Business cards, one color \$3.95; two color \$4.50. Samples free. L. Watson, Box 162, St. Charles, Illinois.

QUALITY Printing. Booklets, publications, catalogs, stationery. Free catalog. Adams Printers, 30 West Washington, Chicago 2, Ill.

MIMEOGRAPHING—Letters, pricelists, formulas, instructions. Lowest prices. Lem's Letter Shop, 5710 Stanton, Detroit 8.

500 3/4 x 2 1/4 FOUR Line gummed stickers 50c. Red border \$1.00. Moritz Printery, Saginaw, Mich.

100 LETTERHEADS, \$1.00, #6 3/4 Envelopes same, two colors, \$1.50. Broadbrook, Botsford, Conn.

SENSIBLY Priced business printing. Special! 250 8 1/2 x 11 bond letterheads, 250 #10 heavyweight envelopes, \$5.95. Postpaid, guaranteed. Free samples, quotations. Sparks Company, Box 4096, Austin, Texas.

ADS Running under this heading sell printing. Ask me for proof. I'll gladly send you amazing facts. Ask for Folder "P." F. W. Johnson, 200 E. Ontario St., Chicago 11, Ill.

FINE Printing, illustrated catalog free. Century, 425 Arlington, Kalamazoo 50, Michigan.

\$1.00, 100 LETTERHEADS Or envelopes, carefully printed, postpaid. Artcraft Press, Ligonier, Ind.

1,000 POSTCARDS, With your photo, Kromekote stock, \$10.25. Leon Otteson, Box 852, Alliance, Ohio.

10,000 ATTRACTIVE Circulars \$10.00 up. Labels, stickers, Samples. Fame, 291 Ellis, San Francisco 2, Calif.

SAVE! Postcard brings details. Samples. Business card specialists. Durr & Durr, 6521-M Pine Point, Tinley Park, Ill.

INFORMATION, Free samples offset printing. Harold Osterhoudt, Poughkeepsie 2, N. Y.

500 PRINTED Gummed name and address labels, \$1.00. No c.o.d.'s. Print clearly. Addison, 1840-A Addison, Chicago 13.

1000 EMBOSSED Business cards, \$2.95 postpaid. Samples. Jaynar, Box 723B, Oak Lawn, Illinois.

PARTICULAR Printing—Promptly. Reasonable. Styles, samples, estimates. Airmailed. Maldorprint, Ojai, California.

FREE Catalog business, personal printing. D & M Press, Sebastopol, Calif.

100 8 1/2 x 11 LETTERHEADS \$1.00 postpaid. #6 3/4 envelopes same. Other printing. Federal, Box 678A, Washington, D. C.

PRINTING OUTFITS AND SUPPLIES

PRESSES, Type cabinets, supplies. List for stamp. Lincoln Press Company, 230-L Hartwell, Fall River, Mass.

PRESSES, \$5.50. Printers bargain list. Sc. R. Cundiff, Bluford, Illinois.

MAKE Your own self-molding rubber stamps and printing cuts. Plexirubber, Argyle 1, Wisconsin.

PRESSES, Supplies, paper. Catalog 10c. Custom, Box 211-P, Springfield, Missouri.

DO Your own printing. Save money. Simple rules. We supply everything. Print for others; good profit. Raised printing like engraving too. Have home shop. Details free. Kelsey Presses, V-11, Meriden, Connecticut.

PATENT ATTORNEYS

INVENTORS — Take these preliminary steps toward patent protection. Sketch and describe your invention. Sign, date and have this disclosure witnessed by two people who understand your invention. Have us make a preliminary search among U.S. patents already granted for similar types of invention. We report on the probable patentability of your invention and recommend your further course of action. Write for our instructive booklet, "Patent Protection for Inventors" and convenient "Evidence of Invention" disclosure form. Victor J. Evans & Co., 131-P Merlin Building, Washington 6, D. C.

PATENTS — Irving L. McCathran, 315 McLachlen Bldg., Washington 1, D. C. Registered Patent Attorney.

INVENTION Record form free and "Patent Information Every Inventor Should Have." Carl Miller, Registered Patent Attorney, Woolworth Building, New York.

REGISTERED Patent attorney offers services. Sanders, 6430 Evans, Chicago 37, Illinois.

INVENTORS—If you believe you have an invention, you should find out how to protect it. The firm of McMorrow, Berman & Davidson with offices in Washington, D. C., is qualified to take the necessary steps for you. Send for copy of our patent booklet "How to Protect Your Invention." We will also send you an "Invention Record" form. No obligation. They are yours for the asking. McMorrow, Berman & Davidson, Registered Patent Attorneys, 134-M Victor Building, Washington 1, D. C.

C. A. Snow & Co.—M427, Snow Building, Washington 1, D. C. Registered Patent Attorneys. Write for information.

INVENTORS: Learn how to protect your invention. Unless the inventor is familiar with patent matters, he should engage a competent registered patent attorney or agent to represent him. We are registered to practice before the U.S. patent office and prepared to serve you in handling your patent matters. "Patent Guide for the Inventor" containing detailed information concerning patent protection and procedure with "Record of Invention" form will be forwarded to you upon request—without obligation. Clarence A. O'Brien & Harvey Jacobson, Registered Patent Attorneys, 518-E District National Building, Washington, D. C.

INVENTORS: When you are satisfied that you have invented something of value write me, without obligation, for information as to what steps you should take to secure a patent. Write Patrick D. Beavers, Registered Patent Atty., 935 Columbian Bldg., Washington 1, D. C.

PATENTS, "Proof of Invention" free. E. E. Vrooman, Registered Patent Attorney, 507 McKim Building, Washington 5, D. C.

"INVENTOR'S Guide" and "Record of Invention" free on request. Frank P. Ledermann, Registered Patent Attorney, 154 Nassau Street, New York City.

INVENTORS: Without obligation, write for information explaining the steps you should take to secure a patent. John Randolph, Registered Patent Attorney, 203 Columbian Bldg., Washington 1, D. C.

FOR INVENTORS

INVENTORS—Send for free patent information book and inventor's record. Registered Patent Attorney, Associate Examiner, Patent Office 1923-29, Patent Attorney & Advisor, Navy Department 1930-47. Gustave Miller, 125A Warner Building, Washington 4, D. C.

PATENT Searches, including copies of nearest patents, \$5.00. Reports airmailed within 48 hours. More than 100 registered patent attorneys use my service. For free invention protection forms, write Miss Ann Hastings, P.O. Box 176, Washington 4, D. C.

INVENTORS: If you have an invention for sale, patented or unpatented, write Institute of American Inventors, Dept. 40A, 631-E St. N.W., Washington 4, D. C.

"INVENTOR'S Guide" and "Record of Invention" free on request. Frank P. Ledermann, 154 Nassau Street, New York 38, N. Y.

INVENTION Record form free and "Patent Information Every Inventor Should Have." Carl Miller, Registered Patent Attorney, Woolworth Building, New York.

PATENT Searches \$5.00. 48-hour airmail service. Invention protection forms free. Write Patent Engineering Service, 711 14th Street, N.W., Washington 5, D. C.

SEARCHES—Put your patent searches in the hands of a registered patent attorney or agent, as he qualifies to give a worthwhile patentability report. Record of invention form upon request and information on patent protection. Patrick D. Beavers, Registered Patent Attorney, 936 Columbian Bldg., Washington 1, D. C.

INVENTORS: Information on patent procedure furnished on request, without obligation. John Randolph, Registered Patent Attorney, 203 Columbian Building, Washington 1, D. C.

PATENT Searches \$5.00. 48-hour service. Free invention protection forms. Write Raymond L. Smith, Patent Searcher, 623 Sherman Building, Washington 5, D. C.

MAKE Money on your invention with help of illustrated description. Free information. Uncle Tom Publications, Box 5008, Detroit 35, Mich.

INVENTORS: Learn how to protect your invention. Unless the inventor is familiar with patent matters, he should engage a competent registered patent attorney or agent to represent him. We are registered to practice before the U.S. patent office and prepared to serve you in handling your patent matters. "Patent Guide for the Inventor" containing detailed information concerning patent protection and procedure with "Record of Invention" form will be forwarded to you upon request—without obligation. Clarence A. O'Brien & Harvey Jacobson, Registered Patent Attorneys, 51A-K District National Building, Washington, D. C.

INVENTORS—If you believe you have an invention, you should find out how to protect it. The firm of Mc Morrow, Berman & Davidson with offices in Washington, D. C., is qualified to take the necessary steps for you. Send for copy of our patent booklet "How to Protect Your Invention." We will also send you an "Invention Record" form. No obligation. They are yours for the asking. Mc Morrow, Berman & Davidson, Registered Patent Attorneys, 134-L Victor Building, Washington 1, D. C.

INVENTORS—This firm is registered to practice before the United States Patent Office and available to assist you in the preparation and prosecution of your patent application. "Patent Protection for Inventors" booklet containing detailed information and steps to take toward patent protection sent promptly upon request. No obligation. Victor J. Evans & Co., 132-P Merlin Building, Washington 6, D. C.

INVENTORS: Protect your invention yourself. Get free help from U. S. patent office. Sell it yourself. Free information. Dynavolt Company, 3310 Huntington, Newport News, Virginia.

INVENTORS, Confidential arrangements, sale or royalty, brochure 10c. Zana, Box 1183, Newburgh, N. Y.

INVENTIONS WANTED

INVENTIONS Wanted. Patented; unpatented. Tremendous manufacturers lists. Global Marketing Service, 2420 77th, Oakland 5, California.

HIGHEST Cash, royalties paid for unpatented ideas, patents. "Inventors Guide." Tells how. Send \$2.00. We have large list of investors, manufacturers. Inventors Creative Service, 354-M South Spring, Los Angeles 13, Calif.

INVENTORS: Hundreds of manufacturers have requested our assistance in locating marketable new products. Complete information free. Institute of American Inventors, Dept. 40-D, 631-E St. N.W., Washington 4, D. C.

INVENTIONS Promoted. Patented or unpatented. A-1 service for inventors since 1911. Write Adam Fisher Co., 5418 Idaho, St. Louis, Mo.

INVENTIONS Wanted. Patented or patent pending. 24 years experience promoting inventions. National Service Bureau, 3120 Meramec, St. Louis 18, Mo.

INVENTORS, Don't sell your invention patented or unpatented until you receive our offer. Write Cowgill, Box 298, Marion, Ohio.

CASH Buyers for ideas and inventions. Write National Inventors Institute, 457 Munsey Building, Washington 4, D. C., or 4900 Euclid Ave., Cleveland 3, Ohio.

INVENTIONS Promoted. Patented; unpatented. Outstanding manufacturer lists. Unequaled service; particulars upon request. Superior, 338-344 North Rodeo, Beverly Hills, Calif.

INVENTIONS Wanted now by my manufacturer-clients. Patented, unpatented. Send for free form "S." Adams, Patent Broker, 80 Wall Street, Financial District, New York City.

NO Advance fee. Patented inventions marketed for 10% of profits. Jerry Peters, 1710 N. 16th, Arlington, Virginia.

PATENTS FOR SALE

UNIQUE Hand skewer. Patent 2,706,446. Lockett, 1429 N. Clark, Chicago.

INVENTORS: Test the commercial value of your patented or unpatented inventions, quickly and inexpensively. Write for free information. Institute of American Inventors, Dept. 40-B, 631-E St., N.W., Washington 4, D. C.

2,659,176 IS A universal fishing plug featuring a unique way of controlling the depth and attracting fish. Harvey Wenger, Sabetha, Kansas.

MANUFACTURING

DESIGNING, Manufacturing. Machinery, inventions, models. Henry, Engineer, 2136 E. Monmouth, Philadelphia 34, Penna.

MANUFACTURERS! Businessmen! Complete instructions: Choosing, manufacturing, selling products—financing, managing enterprises successfully. Unique! Free booklet! Jarry, 268-BO, New York City 5.

WHITE Metal castings from your metal pattern. Low mold cost. Selley, 744 Clay, Winter Park 9, Fla.

MODELS—Small lot manufacturing. Metals, plastics, etc. Milburn, Burlington, Kentucky.

SMALL Lot manufacturing, models, designing, electrical, mechanical, electronic devices. Brownell Electronic Engineering, Marshall, Michigan.

MODELS, MODEL SUPPLIES

GEARS And model supplies for the inventors. Send 10c for catalog. Pierce Model Works, Tinley Park, Illinois.

BALSA Wood and model aircraft. 40-page catalog 10c. Sig Co., Montezuma, Iowa.

SHIP Models and yacht supplies. Complete, large 68 page catalogue 50c. Bill Wild's, 510 East 11 St., New York City 9.

SHIP And other scale models. Most complete line in New England. Kits, fittings, plans, books, tools, engines, motors. Illustrated catalog 25c. James Bliss & Co., Inc., Dept. SM, 342 Atlantic Ave., Boston 10, Mass.

MODEL Train, hobby catalog free. Shannon's, 505 Franklin, Nutley 10, N. J.

SHIP And yacht model fittings; blueprints. Send 35c for illustrated catalog listing hundreds of items. A. J. Fisher, 1002-1 Etowah Ave., Royal Oak, Mich.

POWER Models. Unusual steam, gasoline and traction engines, fittings, metals. Anniversary catalog 50c. Chas. Cole, Ventura, Calif.

LIONEL American Flyer trains repaired by factory mechanics. Fast mail service and satisfaction guaranteed. 20 to 40% electric trains and accessories. Catalog free. Mack Bros., 2041 Chicago Ave., Chicago 22.

LIVE Steam castings and supplies. Catalog 25c. Yankee Shop, Box 275, Danvers, Mass.

FAMOUS Old time $\frac{3}{4}$ " scale airplane kits. Big variety. Catalog 10c. Cleveland Model, 4511M21 Lorain, Cleveland 2, Ohio.

MODEL Railroads. O and HO, over 850 cast metal items, illustrated, catalog only 10c. Selley, 744 Clay, Winter Park 11, Fla.

HOME CRAFTSMEN

BIG Santa, sleigh, and reindeer for lawn or roof. Complete patterns and all instructions. Only \$1.00. Craftmaster, 2977 N. Shepard, Milwaukee, Wisconsin.

15 BEAUTIFUL Unique full size doll cradle patterns \$1.00. Dept. A, Ravilla Service, R1, Belle Center, Ohio.

BUY Wholesale 550,000 products. Literature free. Carter, Box 6011-DD, Chicago.

ALL Crafts, supplies. Large free catalog. National Handicraft, 199 William Street, New York City 38.

GIVE Wrought iron legs for Xmas. Sample set \$3.98 prepaid. Literature free. Hibbard's, 624 Celey, Hampton, Va.

KNOCKDOWN Cedar chests. Lumber and veneers. Free price list. Giles & Kendall Company, Huntsville, Ala.

FREE Handicraft supply and project catalog. American Handicraft Co., Box 1479-DQ, Fort Worth, Texas.

FREE "Do-it-yourself" leathercraft catalog. Tandy Leather Company, Box 791-P11, Fort Worth, Texas.

JIGSAW, Bandsaw owners, extra profits, fun. Free details. Dept. A, Nu-Art, Box 2235, Boston.

KNOCKDOWN Cedar chests and lumber. Free price list. Bedford Lumber Company, Shelbyville, Tennessee.

STYLECRAFT Sure fire hits. "Pre-traced" leather kits. Handbags, billfolds, fillgree belts, over fifty other projects. Patterns on leather. Why trace? Just carve, assemble and lace. Large assortment "precarved" kits also available. Send 25c for catalog, free folder. Refunded first order. Apache Leather Company, 2804 E. Washington St., Phoenix, Arizona.

VIOLINMAKERS. Amateurs, professionals, fine tone European wood. Complete materials, tools, instructions, patterns. Illustrated catalogue, 10c. Premier Violin Supplies, Division MVP, 430 South Broadway, Los Angeles 13, California.

FREE! Metalcraft catalog. Enameling supplies, copper and aluminum. J. C. Larson Co., 820 S. Tripp, Dept. 5775, Chicago 24.

LEATHERCRAFT. Send 10c for new 60-page catalog of tools, supplies, kits, including metalcrafts, enameling, ceramics, all other crafts. Complete stock. Reasonable. Since 1910. Sax Bros., Dept. PM12, 1111 N. 3rd, Milwaukee, Wis.

\$9 FULL Size jig saw patterns of beautiful shelves, ornaments, toys, novelties. Plus "How, Where to Sell." Only \$1.00. Mastercraft 124M, 7041 Olcott, Chicago 31, Illinois.

LEATHERCRAFT, Metal enameling, beadcraft, shellcraft, metal tooling, textile painting, many other crafts. Free big illustrated catalog. Kit Kraft, Dept. 2212, Studio City 1, California.

WOODWORKING Course for home craftsmen. Twenty-two manuals. Over 1000 pages. 75 training projects. Only complete home training program available today. Carefully written, profusely illustrated. Covers everything from wood selection to final finishing. Complete instruction in care and use of all hand and power tools. Prepared by expert manual training instructors. Write for free booklet. Interstate Training Service, Dept. G-3-N, Portland 13, Oregon.

I Want to send you proof of the wonderful pulling power of Popular Mechanics classified pages. What's your proposition? Write me today. Include literature if possible. P. W. Johnson, Manager Classified Advertising, Popular Mechanics Magazine, 200 E. Ontario St., Chicago 11, Ill.

SPICE Cabinets, knocked down. Reproductions. Mortises machined. Just assemble and finish. 4 drawer \$2.75. 8 drawer \$4.95. Horizontal or vertical. Crafters, Oostburg, Wisconsin.

LEATHERCRAFTERS: Everything you need. Free catalog. Art Leather, 411 Joseph Ave., Rochester 5, N. Y.

LAMP Size cypress knee with nipple installed \$2.00. Cy Products, Dept. 2-N, Lafayette, La.

PLASTICS Home-craft course for men and women. Tells and shows how to make hundreds of fast selling plastics products. All plastics and materials for 23 projects included in course. No special tools needed. Course pays for itself. Write for free booklet. Interstate Training Service, Dept. D-3-N, Portland 13, Oregon.

BUY Wholesale nationally advertised power, hand tools, thousands other products at big discounts. Free "Wholesale Plan." American Buyers', Hertel Station, Buffalo 16-F1, N. Y.

WIRECRAFT—Ideal gift for hobbyists. Do it yourself—Smart wrought iron wall decorations from coat hangers and tin cans. Use solder or liquid solder. No fancy bending tools required. Six complete plans, instructions \$1. Wirecraft, Box 408M, North Miami Beach, Fla.

FREE! Large complete leathercraft catalog. J. C. Larson Co., 820 S. Tripp, Dept. 5750, Chicago 24.

101 FULL Size patterns. Smart, new, gifts, novelties, lawn figures, shelves, action windmills, alphabets. Plus "Make Money Jig Sawing." Only \$1.00. Mastercraft 125M, 7041 Olcott, Chicago 31, Ill.

18 FULL-Size patterns. Save money with easy-to-use, professionally designed full-size patterns. Make money selling beautiful, useful furniture. Make modern step and cocktail tables; metal lamps; cupola; 12-foot outboard. All patterns test-built; sold with money-back guarantee. Get your free list of these convenient, economical patterns today. Popular Mechanics Press, 200-HH E. Ontario Street, Chicago 11, Illinois.

DO IT YOURSELF

MAGIC "Velcoat" sprays fur or velvet finish on any article. Multiplies value. Refinishes shoes, bags, toys, pictures, like new. 6-color kit \$4.95. Single color \$1.00. Literature free. Velcoat, Box 5172-MD, Tulsa 16, Okla.

BEAUTIFUL All aluminum weather vanes. Make them with simple tools, our kits. Free folder. Wild Wind, 24 East Euclid, Spokane 21, Washington.

AWNINGS, Ventilated, aluminum, wood frame. Materials \$3.50. Plans \$1.00. Coolshade Awnings, 125 Broad, Pawtucket, Rhode Island.

HAMBURGER Pattie press. Make it yourself. Drawings 35c. Art & George Co., 5170 No. Hollywood Avenue, Milwaukee 17, Wisconsin.

PLANS For piddlers, \$1.00 each. 1. Emergency light plant, 300 watts, 110 volts, a.c. Made from rebuilt car generator and lawn mower engine. 2. Drill water well by hand. Rotary method. Use same pump and pipe for both drilling and producing. Very cheap and fast. 3. Push-button controls on your overhead garage door, using simple hand tools and parts usually found around the home workshop. Bennett, 2461 Lucas Drive, Beaumont, Texas.

GEIGER Counter and metal detector kits. Inexpensive, educational. Free literature. Electronic Applications, 5024 Lee Highway, Arlington 7, Va.

CLOCK Movements—Gorgeous dials, plans, kits. See ad page 247.

"DO It Yourself Encyclopedia." 12 giant volumes (3,000 pages) packed with thousands of ideas, plans, gadgets and projects you can do yourself. How to weld, paint, repair most anything. How to make boats, deepfreeze, draperies, jigsaw projects and just scores of other items. How to do electric wiring, plumbing, room building. How to modernize kitchens, bathrooms. Greatest, most complete fix-it library ever offered. Written so you can understand it. You'll be thrilled when you see what these 12 big volumes contain. It's simply sensational. You must really see them to fully appreciate this exciting fix-it library. You'll fall in love with them just as soon as you open the first volume. I'll send you a descriptive circular that will open your eyes to the greatest, most complete and beautifully illustrated "Fix-it" library you ever laid your eyes on. Send a postal right now. Popular Mechanics Press, 200-DY East Ontario St., Chicago 11, Illinois.

JEWELRY Crafter's supplies—Wholesale. Literature 20c. Cosmopolitan, Box 178, New York 8, N. Y.

BEAUTIFUL Contemporary do-it-yourself furniture plans. Free literature. McAleer Hardwood Products, Box 645, Bensenville, Ill.

FURNITURE. Build it with our wrought iron legs, wood legs, or metal frames! Free catalog. Phillips Furniture, East Peoria 8, Illinois.

DO It yourself. What? Repair TV, build furniture, make barbecue, plumbing repairs, build boats, do house wiring, remodel home, lay tile, modernize kitchen, repair home, and scores of other things you can do yourself. Books covering each subject, only 25c. Send for descriptive list. It's free. Popular Mechanics Press, 200-LB East Ontario St., Chicago 11, Ill.

WATCHES, OLD GOLD, JEWELRY

RHINESTONES, Jewelry settings, copper enameling, hobby kits. Illustrated catalog 10c. J & M Novelties, Dept. CP-3, Griffith, Indiana.

FREE Sample pair of earrings with catalog 25c. Exclusive line of make your own costume jewelry. Barry's, 213 Ardsley Ct., Newark 2, N. Y.

BANKRUPT Auction goods; Klondike, novelty jewelry findings assorted, beads, pearls, jewels, 5 pound lots \$7.50; sample \$2.00 pound. Merchandise, 19A East 16th St., New York City 3.

GOLD Nugget tie tack \$4.95 postpaid. The Trading Post, Box 624PM, Ketchikan, Alaska.

MAKE Costume jewelry for fun and profit. Catalog 25c. Bergen Arts, Hackensack 8, N. J.

WATCHMAKERS'—Jewelers' supplies, instructions. Catalog 20c. Bengale Company, Culver City, California.

COSTUME Jewelry supplies. Catalog and samples. 35c. Largest line in America. Milady-Fair Co., G.P.O. Box 1328, New York City 1.

GOLD, Silver, platinum, diamonds wanted. Cash immediately, highest prices, appraisals made. Wilmo's, 2547 102nd St., Toledo 11, Ohio.

JEWELRY Hobbyists: Plated settings, imported rhinestones, flat backs. Free catalog. Sextons, 418 Potomac, Buffalo 13, N. Y.

NEW 1958 Jewelry finding and copper enameling catalog 25c. Bergen Arts, Hackensack 9, N. J.

RHINESTONES. Send \$2.25 for five gross. Value \$5.00, free bargain list. Catalog. Ebert, Box P183, East Orange, New Jersey.

USED And new watches \$2 up. Free list. Southern Watches, Gray, Georgia.

BEAUTIFUL Gold-engraved sterling silver buckle sets. Only \$5.00 postpaid. Cedar Grove, 1604—13th, Ashland, Kentucky.

WATCH And clock repairing books. Free information. North American, Dept. 15-M, 2320 N. Milwaukee, Chicago 47, Illinois.

10 SWISS Watches \$18.00. Catalog 10c. Berkowitz, 1150 Castlehill, New York 62.

DISTINGUISHED, Gentlemen's ladies' colored meshed watch bands. Similar \$12.95 we sell \$2.25. State watch case silver or gold. Send m.o., check or cash. Ben-Rom Co., Dept. WB-5, 337 Clinton St., New Britain, Conn.

WATCHES, Clocks, jewelry and appliances at discount prices. Large illustrated catalog 40c refunded on first purchase. San's Jewelry, 3428 N. Octavia, Chicago 34, Ill.

SENSATIONAL New rickrack and gimp jewelry. Illustrated instructions and catalog. 10c. Folsom's, 11 Oakland St., Medford 55, Mass.

TOBACCO, SMOKERS' SUPPLIES

PIPE Smokers! Use a pipe holster for convenience. Wear with belt or suspenders. Genuine leather. Guaranteed. \$1.00. Special prices to dealers. Cardinal Products Company, P.O. Box 24, Lansdowne, Penna.

PIPE Smokers! Cigar smokers! Free illustrated catalog offers fabulous savings on choice imported and domestic pipes, cigars, tobaccos, supplies. Write Wally Frank, Dept. 25, 150 Nassau Street, New York 38, N. Y.

CUSTOM Pipes. Pipe-making supplies. Tools. Instructions. Walter Miller, Germantown, Ohio.

PIPE Smokers! Broken stems replaced. Utter Pipe Factory, Olean, New York.

CIGARS! 3/30c, 15c and 2/25c clear Havana seconds, \$1.75 for 25 in sealed vacuum container. Satisfaction guaranteed. Other bargains. Tobacconist, Inc., 220 N. Clark, Chicago 1, Ill.

RAZORS, BLADES, SHARPENING

20 GERMAN Razor blades for \$1.00. Box 8107, Philadelphia 1, Penna.

SIX Ball point pens free with 100 guaranteed D.E. blades—\$1.00. Nucleus Trading, 2440 Amsterdam Ave., New York City 33.

125 "DON Juan" double edge blades \$1.00, thousand \$6.00. Guaranteed. Johnson, 805 Wells, St. Paul 1, Minn.

200 DOUBLE Edge blades \$1.50. Money-back guarantee. Randolph Co., Box 3406, Detroit 3, Mich.

100 DOUBLE Edge blades 70c. Hornsby, Box 122, Washington 4, D. C.

FOR THE HOME

FOAM Rubber furniture cushions. Factory seconds. 50% discount. Free catalog. Perma-Foam, 429C Central Ave., East Orange, New Jersey.

FAMILY'S Portraits. Always wanted. Now affordable! Free illustrations. Studarts, Ojai, California.

QUICK—Secure safety door lock, palm size—\$1. Other handy gadgets and household cleaning supplies. Write your needs. Also hobbyists' supplies. Dept. SDL—P.O. Box 86, Richmond Hill 18, N. Y.

OXFORD Tie and belt rack. It's unique. Holds 22 ties and 10 belts in only 4" space. Gold plated. Only \$2.00 each. Refunded if not pleased. James Products, 1625 South 50th Avenue, Cicero, Ill.

OF INTEREST TO WOMEN

COLGATE'S Laistre-Creme shampoo, 4 lbs. \$4.85 postpaid. Geller, 2089 Matthews, New York 62, New York.

GOOD Money in weaving. Weave rugs at home for neighbors on \$69.50 Union Loom. Thousands doing it. Booklet free. Union Looms, 153 Post St., Boonville, N. Y.

PROFITABLE Home business. Make fast-seller chenille monkey trees, dolls, flowers. Terrific holiday demand. Information free. Velva, Bohemia 16, N. Y.

GROW Mushrooms. Cellar, shed, and outdoors. Spare, full time, year round. We pay \$3.50 lb. We paid Babbitt \$4,165.00 in few weeks. Free book. Washington Mushroom Ind., Dept. 176, 2954 Admiral Way, Seattle, Washington.

WANT To make big money at home? \$5 profit in an hour possible with invisible reweaving. Make tears, holes disappear from clothing, fabrics. Steady year-round demand from cleaners, laundries, homes. Details free. Fabricon, 8332-S Prairie, Chicago 19, Ill.

"MULTIFLEX" Pie crust lifter for lifting the most delicate rolled out pie crust. Aluminum. \$1.00 postpaid. Makes an ideal gift. H. M. Kellogg, Box 155, Stratford, Connecticut.

UNUSUAL And attractive imported gifts. Free catalog. Itradco, Columbian Bldg., Washington 1, D. C.

FREE—25 Fascinating gift catalogs. Several thousand intriguing items! Unique Distributors, 303 Meluchen Avenue, Woodbridge, New Jersey.

"8 MISTAKES Parents Make." Every parent should have this new book about child training. It is free; no obligation. Simply address Parents Association, Dept. 6712C, Pleasant Hill, Ohio.

LOOK Ten years younger in ten weeks. Easy home course. Free information. Whitney, Rt. 3, Box 3415A, Wenatchee, Wash.

FLASHLIGHT. The ideal gift. Every sportsman needs this handsome Ray-O-Vac flashlight with built-in electric cigarette lighter. Absolutely fireproof, stormproof, explosionproof. Has positive action lock-type selective switch. \$5.00 each postpaid. \$ for \$20.00. Stannhill Industries, Plain, Wisconsin.

FOR SALE—MISCELLANEOUS

VERMONT Maple syrup, pints \$1.50 postpaid. Maple cream and sugar for holiday gifts. Butternuts, black walnuts, hickory nuts. List, Marshall Maples, Poulney 5, Vt.

HEARING Aid batteries, wholesale. Free list. Habs, Box 51, York, Penna.

OLD Wall telephones. Working order, oak cabinets, hand crank for ringing. \$5.00 each f.o.b. Telephone Co., Turtle Lake, Wis.

WANTED—MISCELLANEOUS

SCRAP Mercury (quicksilver) containers supplied—Tantalum, bismuth, tungsten. Metallurgical Products Company, Established 1909, 35th and Moore Sts., Philadelphia 45, Penna.

WANTED, Mail order product. Sells, 10 Cranbrook, Tonawanda, N. Y.

QUICKSILVER, Sterling, silver solders, precious metals. Wholesale Terminal, Norwood, Massachusetts.

PERSONAL

FABULOUS Houston Sunday classifieds \$1.00. Remains 25c. Mailing lists 1 1/2 name. Jordan, 1120 Chenevert, Houston, Texas.

FLORIDA—Orlando, classifieds \$1.00. Remains 25c. Box 7571, Orlando, Fla.

"HOW Can I find out?" You can! Information confidentially developed. Any matter, person, problem. Worldwide. Officially licensed. Established 1923. William Herman, 170 Broadway, New York City.

LETTERS Remailed 25c. Personal forwarding address. Monthly rates. Hicks Service, Box 1347, Washington 13, D. C.

PROFIT! Prestige! Publish a magazine under your own name! Only \$3.25 per month! Sample, details 5c! Filmer, 910 Marion, Pharr 22, Texas.

MEXICAN Law. General Practice Attorney. Apartado 79, Juárez, Chih., México.

LETTER, Package, telegram remailing, receiving-forwarding address for rent \$2.00. McLaughlin, 800 Stewart, Columbus 6, Ohio.

CHICAGO Is booming. Classified help wanted ads airmailed \$1.00, remails 25c. Scott, 7905 Birchdale, Chicago 33, Illinois.

BORROW By mail from Postal Finance Co. Employed men and women can easily obtain \$50 to \$800 fast, entirely by mail. Repay in small monthly payments. Friends, relatives, employer, tradespeople will not know you are applying for loan. Advise occupation, amount wanted. Postal Finance Co., 300 Keeline Bldg., Dept. 72, Omaha, Nebraska.

GLOBAL Viewcard selection, worldwide remailing, Travelpost, Box 198, Nogales, Arizona.

BOOMING Los Angeles employment ads \$1.00. Hollywood remails 20c. Dunlap, 11250 Playa St., Culver City, Calif.

ADDRESSING-Mailing service. Write or call collect. M. Pavini, 80 Snow Street, Fitchburg, Massachusetts, Tel. 3-9012.

PROVE You've been here! Sourdough certificates. Ideal for framing, \$1.00 each. Write: Sourdough, PO Box 1755, Anchorage, Alaska.

REMAILING, Forwarding 25c each. Ace Service, Box 186, Tampa 1, Fla.

LETTERS Retailed 25c. Message typewritten upon post card 50c. Souvenirs mailed \$1.00. Confidential address \$5.00 yearly. Back seat driver's license 25c. Hertzoga, Box 972, Santa Barbara, Calif.

LOS Angeles: Letters retailed 25c. Received-forwarded \$3.00 month. Confidential handling for legitimate personal and business operations. Reliable. Prompt. International Service, Box 6480-PM, Metropolitan Station, Los Angeles 35, California.

LETTERS Retailed 25c. 5 postcards: Bathing, scenic, fishing, \$1.00. Sarasota Remail, Box 4138, Sarasota, Florida.

LIKE Full mail boxes? Interesting offers galore, 25c. Traylor's Enterprises, La Feria, Texas.

CHICAGO Classified \$1.00, remails 25c. Ruden, Box 3073, Chicago 54.

REMAILS - Tampa, St. Petersburg, Clearwater, 25c. Sunday classified, all three, \$1.00. Florida Research 4, Box 215, Clearwater, Florida.

MIAMI, Complete classified airmailed \$1.00. Letters retailed 25c. Lewellyn, Box 69, So. Miami, Florida.

YOUR Last will and testament. Do it yourself; spare your heirs hardship and delay. Short form \$1.00, long form \$2.00. Approved and recognized. Legal Forms Co., Box 862, Hollywood 28, California.

BILLION Dollar construction boom continues in Los Angeles County. Jobs, opportunities, galore. Highest wages. New homes, cars, no down payments. Big Sunday classifieds \$1.00. Los Angeles remails 25c. Monroe, Box 365-A, Bellflower, Calif.

ALASKA'S Capital exclusive business directory, \$1.00. Air remail 30c. ABCo, Box 282, Juneau, Alaska.

REMAILING SERVICE

LETTERS Mailed Miami 25c, airmail 50c. Box 614, Int. Airport, Miami, Florida.

LETTERS Retailed 25c each. Stamp your letter forwarding address. Elsa's Mail Service, 5375 N. 58 St., Milwaukee, Wis.

AUTO Capitol remails 25c, classified \$1.00. Anderson Viking Sales, Box 5604, Detroit 38, Michigan.

LETTERS Mailed from Matamoros or Reynosa, Mexico, 25c each. Tip o' Texas Traders, P.O. Drawer 831, Harlingen, Tex.

FLORIDA Retailed letters 25c. Classified \$1.00. Pronto, Box 118, Miami Beach 39.

REMAILS 25c-Classified \$1.00. Reairmail \$1.00. Sharkey, Box 151, 22nd Street Station, Saint Petersburg, Florida.

LETTERS Retailed from New York City 25c, 10 postcards \$1.25. Retailed free. S. H. Brown, 178-39 Leslie Rd., St. Albans, Long Island 34, N. Y.

TREASURE FINDERS

LEARN Mineralogy at home, Diploma course. Fortunes now being made in uranium and other minerals. Free catalog. Mineral Science Institute, Desk 2, 159 East Ontario, Chicago 11.

TREASURE, Metal, mineral locators M-scope type. Latest electronic design \$75.00 up. Geiger counters, scintillators, mineralights for uranium prospecting \$35.00 up. Fully guaranteed. Monthly payment plan available. Books "How to Be a Successful Uranium Prospector," "For Fun and Profit." Literature free upon request. Fisher Research Laboratory, Inc., Palo Alto, Calif.

URANIUM, Gold, silver treasure. New, power-packed, highly sensitive metal detectors, Geiger counters and mineralights, kits and assembled models from \$12.50. Lightest weight, guaranteed, free literature. Electronic Applications, 5024 Lee Highway, Arlington 7, Va.

AMAZING Triple-action Geiger counter U-238C, combines audio, neon flasher, meter. Guaranteed best available. Also metal detectors and scintillation counters from \$49.50. For radioactive uranium sample send 25c to Goldak Company, 1541 W. Glenoaks Blvd., Glendale, California.

GOLD, Silver, metal detectors. Geiger counters for uranium. Mineralights. Sensational new fully guaranteed models. None finer. Information free. Detectron Corp., 5528 Vineland Ave., North Hollywood, California.

FIND Gold, silver, other valuable minerals with a CMC metal detector. Also uranium detectors. New models, fully guaranteed. Catalogs free. CMC Corporation, 5457-a Cleon Ave., North Hollywood, Calif.

GEIGER Counters, metal detectors, ultra-violet mineralights, from \$29.50 up. Write for free catalogs. The Radiac Co., Inc., 489 Fifth Ave., Dept. 12-PM, New York 17, N. Y.

URANIUM! Informative booklet gives known and potential locations. Government map included free. \$1.00. Map and tips 20c. Uranium Research, Box 1555, College Station, Texas.

"HOT Rock" Geiger counter kit. Only \$15.95 complete. Send \$5. balance c.o.d. Catalogue. American Laboratories, 471 Clifton Ave., Newark 4, N. J.

GEIGER Counters and kits. Sensational values. Free literature. Roberts Mfg. Co., Cleburne, Texas.

JEEP Owners—V8 power. Read Jeep Owners ad, page 48.

MISCELLANEOUS

STUPENDOUS Mental power. Adults. (Details 10c.) Delmar Wisdom, 846 Sunnyside, Chicago 40.

70 BIBLE Lessons, 25c. Bulletin, Box 87, Cathedral Station, New York 25.

BE Somebody! Do things! Get somewhere with our simplified self-training plan of positive thought motivation and constructive action mastery. Eye-opening information free. Write today. Applied Christian Psychology, Inc., Box 1924-T, Louisville 1, Kentucky.

YOUR Name wanted. We'll send 1000 publishers, mailers, wholesalers your name, on our list one year 25c. Dixie Mailers, King, N. C.

FORESTRY, Game warden, park, fish hatchery, patrol and wildlife conservation jobs pay well. Prepare now. Write Delmar Institute, N5, Whittier, Calif.

HEAT Your home or business for almost nothing. Amazing method, thousands satisfied. Valuable information free. A. Enault, R.F.D. #1, White River Junction, Vermont.

CLOGGED Drains, cesspools and septic tanks cleaned by new powerful chemical. Sursolvent removes grease, soap, tree roots, etc., without expensive digging and electric rodding machines. No pumping necessary. Mix with water and pour down drain. Free details. Electric Drain Cleaning Co., Boston 34, Mass.

HOW To paint. Do it yourself. Illustrated instructive book. 25c. Catalog free. Popular Mechanics Press, 200-HP E. Ontario St., Chicago 11, Ill.

RECEIVE Magazines, samples, catalogues. Mails from everywhere. Offers, hundreds. Get listed 25c. Rorick, Box 86, Cincinnati 26, Ohio.

GROW Mushrooms. Cellar, shed, and outdoors. Spare, full time, year round. We pay \$3.50 lb. We paid Habbitt \$4,165.00 in few weeks. Free book. Washington Mushroom Ind., Dept. 175, 2954 Admiral Way, Seattle, Washington.

300 BIG Mails guaranteed. Samples, plans, offers, propositions, 12 months listing. \$1.00 refundable. Wright Publications, 2270 Hubbard, Memphis 8, Tenn.

IMPORTED German razor blades. Famous name. 50 blades \$2. I am nearly blind. Frank Mason, 780 Broadway, Newark, N. J.

WHOLESALE Catalog! 30-80% discounts! Appliances, musical instruments, typewriters, phonographs, watches, jewelry, recorders, housewares, etc. Consolidated Distributors, 21-13 Lafayette, Paterson 15, New Jersey.

GADGET Catalog, 32 pages, over 200 gadgets 10c. Dime refunded. P. Saunders, 1319 W. 20th St., Los Angeles 7, Calif.

RAYON Flock users save! Order direct. All colors, \$2.50 pound. Baker's, 27 West Kearsarge, Chincoteague, Virginia.

BUY Wholesale thousands nationally advertised products at big discount. Free "Wholesale Plan." American Buyers, Hertel Station, Buffalo 16-K1, N. Y.

CHECK Protector. Ideal Christmas gift. \$1.00 postpaid. Hix Novelty Works, 15328 East Valley Blvd., Puente, California.

WANT More business? Here's an amazing opportunity to increase your sales. Talk to thousands of interested readers of "Mechanica Popular." Our Spanish Edition covers the Latin American countries like a blanket. They're real mailorder buyers. Classified rate 75c per word. Try an ad in our next issue. Classified Advertising Department, Popular Mechanics Magazine, 200 East Ontario Street, Chicago 11, Ill.

BEAUTIFUL Charcoal portrait done from your photo, \$10. Unusual gift for loved ones. John Walencik, 15703 Kennicott, Harvey, Illinois.

NATURE'S Original Xmas tree decoration. Natural color. While they last. 25c each. Five large \$1.00. 8203 Ashworth, Seattle, Washington.

YOUR Name, two initials, hand branded western style on plaque 5"x12" \$2.50. Scott Plax, Rt. 2, Box 286, San Antonio, Texas.

HOMES Now built of earth and cement. Know-how \$2.00. Agents wanted. Sam House, P.O. Box 727-A, Indianapolis 6, Ind.

REVOLUTIONARY New health product. Amazing result producing sales plan. Thousand dollars monthly after first month is common. Not sold in stores. Details. Hartmann, Southold, N. Y.

BUY Wholesale 550,000 products. Literature free. Carter, Box 6011-MC, Chicago.

PINE Cones for beautiful holiday decorations. Ten large \$1.00. Penny's Products, Box 702, Eaton, Colorado.

IN My name. John 14, 15 and 16. Whitcomb, 308 Sycamore, Newport News.

OUTDOOR Cookware with legs, bales, folding handles. California Jack, 172 Garfield, Pomona, Calif.

SATELLITES, Space travel! New knowledge! Send dime for particulars. Palomar Institute of Astrognation, Mt. Wilson, Calif.

FREE: Exciting catalog packed with books covering most everything. Think of it—From cover to cover you will find described and illustrated hundreds of books telling how to fix and how to build almost anything. How to remodel your home; do your own decorating, plumbing, electrical work. Simplified books covering concrete work, carpentry, painting, furniture making and refinishing. How to build your own boat, home workshop tools. Best books on photography, welding, hobbies, homecraft. How to make a home freezer. Send for your free copy now. Popular Mechanics Press, 200-BC East Ontario St., Chicago 11, Ill.

BUY Wholesale! Appliances, homewares, furniture, jewelry, watches, cameras, everything! Free catalogs. Free details. Econ-O-Mart, 8 Perry, Whippany 2, New Jersey.

GERMAN Address lists. Anything manufactured 25c. Burke Associates, Manchester, Mass.

REAL OPERATING SUBMARINE



SUBMERGES . . . SURFACES . . . UNDER ITS OWN POWER

Of course you recognize it! It's the famed U.S.S. NAUTILUS . . . an accurately detailed, authentic scale model (fully half-a-yard long) of the world's first atomic submarine. This exciting sub model actually speeds along the water surface . . . submerges to periscope depth . . . then automatically resurfaces. Easy to assemble! Kit includes power unit and all prefabricated parts. A cinch to assemble! Only some lead ballast needed (available at any hardware store).

ONLY
\$198

Guaranteed to Work or Your Money Back

AT YOUR DEALERS OR ORDER-BY-MAIL

Nautilus Dept. PM125, Scientific Model Airplane Co.
115P Monroe St., Newark 5, New Jersey

Please rush my U.S.S. NAUTILUS postpaid. I enclose \$2.00 to save postage. If sub does not work I can return in 10 days for full refund.

NAME _____

ADDRESS _____

CITY _____

STATE _____

HIGH WAGES!

Are being paid to Operators of Bulldozers, Draglines, Back Hoes, Earthmovers and Motor Graders. Contractors want our graduates. Learn these skills NOW

National School of Heavy Equipment Operation
P.O. Box 8243-D-4, Charlotte, N. C.

Please send me your School Catalog FREE

Name _____

Street Address _____

City _____ State _____

WELDING may aid your SUCCESS

Are and Acetylene; welding metallurgy; Heliarc, etc. This is home, spare-time training for men who appreciate the importance of welding and want to advance in the art, get promotion, enlarge own shop, etc. Send for FREE BOOK. Utilities Engineering, 2523 Sheffield, Dept. WC-11, Chicago 14

T4



BIG PROFIT making Concrete Drain Tile

Millions of dollars' worth of drain tile are used every year for farm drainage, building construction, reclamation projects, highways, and other purposes. And the big swing is to concrete tile because it's better and costs less. Sales potentials are BIG.

Concrete drain tile is locally manufactured of local materials, for direct selling to local users or contractors. Useless costs—freight, distribution, breakage—are eliminated. While worth more than clay tile, concrete tile can sell for less and still earn a handsome profit.

Tile made on the Champion Machine are strong and uniform. Truly round. All sizes up to 12" diameter. Easy to make because the Champion is simple to operate.

Get The Champion Facts

Write for the Champion book. Tells about concrete drain tile as an outstanding manufacturing opportunity. Describes the machine and outlines liberal payment terms.

W. E. DUNN MFG. CO.
522 W. 24th Street, Holland, Mich.



IN CANADA: DUNN MASONRY MACHINERY LIMITED
970 Dundas Highway, Cooksville, Ont.

FORD Owners SAVE MONEY



Learn How to Make Your Ford Run Better . . . Last Longer . . . and Save Hundreds of Dollars!

Get this book, written especially for you, without one penny of risk and get more out of your car. Mail coupon for MANUAL FOR FORD OWNERS today. When the book comes, skip through the pages and see how your investment in one of America's most popular automobiles can be even a better investment than you thought. If you don't agree, send the book back and you'll get your money back.

A Popular Mechanics Book Written Just for You

Not a re-hash of service manuals. A complete new Popular Mechanics book written for the Ford owner by an outstanding automotive authority with the full cooperation of Ford engineers and service directors. It will save you money on repairs and service; make your Ford last longer; give you safe, economical and trouble-free motoring. And this is true whether you take your Ford to a regular service station or service it at home.

Prevents Trouble. Cuts Down on Repair Bills

Nothing like this manual anywhere. It covers all phases of operation, service and maintenance. It has entire chapters on the individual parts of your Ford—battery, ignition, starter, generator, regulator, lighting, fuel system, engine, lubrication, gasoline qualities, cooling systems, transmission, differential, rear axle, brakes, wheel alignment, tire care, body maintenance, trouble shooting on the road, etc. It covers your Ford, new and older models, step by step—bumper to bumper—showing you how parts operate; what can go wrong; how repairs and adjustments should be made and how to avoid all types of trouble.

Money Back if Not Satisfied

Mail the coupon today. Send only \$3.50 or you can pay postman. Money back guarantee protects you.

Official, Authoritative, Practical Information

Written by C. E. Packer, former service school instructor and auto show lecturer for automobile manufacturers, Member Society of Automotive Engineers, Special Services Editor of Automobile Digest, contributor to leading magazines, author of some of the biggest selling books on Automotive subjects.

Entire Chapters on Fordomatic and Overdrive

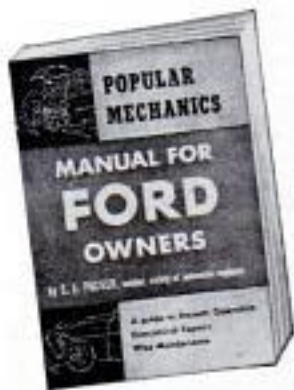

304 Pages. Hundreds of How-To-Do-It Illustrations and Diagrams

The entire book follows Popular Mechanics famous easy-to-read and easy-to-understand style. While primarily intended for the Ford owner, to help him get more out of his car at lower cost, it can be worth its weight in gold to the auto mechanic and service station operator who works, not only on Fords, but on all other makes as well, to which the information in the book can be easily applied.

Order on this Coupon

POPULAR MECHANICS PRESS, Dept. MF-2
200 E. Ontario St., Chicago 11, Ill.

Send Manual for Ford Owners at once. If not satisfactory I will return it within 7 days and you will refund full purchase price.

Remittance for \$3.50 enclosed. Send C.O.D.

Name _____

Address _____

City _____

State _____

Get info.. PLASTIC LAMINATING AT HOME!



THIS MAN . . . is taking out of the machine a Plastic Sealing Job — ordered by mail — only 11¢ in material cost brings back \$2.58 in cash by mail. Capacity of machine: **\$25.00 profit per hour of operation.**

Get **ORDERS** and **CASH** from your mailman—do work in **SPARE TIME** at home—or expand into **FULL TIME** business. Send coupon for **Free facts** about the newest and most fascinating of all home operated businesses. For the first time a simplified machine brings the fabulous profits of **Plastic Sealing and Plastic Laminating** within the reach of the small operator. Anyone can learn to operate the machine with a few minutes practice—then with our **Magic Mail Plan** can get mail orders pouring in daily with cash in every envelope. **No canvassing—no selling.** We even

Make \$20 to \$30 a Day by.. MAGIC MAIL PLAN!

supply the circulars you mail to bring back cash and orders. Don't waste a minute. Rush your name. We'll send you **FREE** and postpaid, pictures, prices, details, and all the facts you need to start. Mail coupon or send name on postcard. No charge. Warner Electric Co., 1512 Jarvis Av., Dept. L-10-P, Chicago 26, Ill.

Make Thousands of Beautiful Art Creations
COSTUME JEWELRY • CIGARETTE BOXES
TRAYS • CANDLESTICKS • COASTERS
LAMP BASES • BOOK ENDS...ALL IN
SPARKLING COLORED PLASTIC



WARNER ELECTRIC CO., 1512 Jarvis Av. Dept. L-10-P, Chicago 26, Ill.
 At no cost to me, please rush complete details postage prepaid. I am under no obligation.

Name.....
 Address.....
 City.....Zone.....State.....

REAL ESTATE BE A BROKER

PAYS BIG! SEND FOR FREE, BIG, ILLUSTRATED CATALOG NOW! Graduates report making substantial incomes. Start and run your own business quickly. Men, women of all ages, learn easily. Course covers Sales, Property Management, Appraising, Loans, Mortgages, and related subjects. **STUDY AT HOME** or in classrooms in leading cities. Diploma awarded. Write **TODAY** for free book! No obligation. Approved for World War II and Korean Veterans

FREE BOOK TELLS NOW

WEAVER SCHOOL OF REAL ESTATE (Est. 1936)
 2022B GRAND AVENUE KANSAS CITY, MO.

High School at Home

MANY FINISH IN 2 YEARS

No classes. No time wasted going to and from school. Progress as fast as your time and abilities permit. Standard H. S. texts supplied. Thousands enroll each year in this 58-year-old school. Send for **FREE** descriptive booklet.

AMERICAN SCHOOL, Dept. H945
 Drexel at 58th St., Chicago 37, Ill.

Without obligation, please send **FREE** descriptive booklet.

Name.....
 Address.....
 Canadian Residents: Complete Canadian Course Available. Write American School, 1610 Sherbrooke St., West, Montreal.

MAKE BIG PAY OR OWN A BUSINESS Learn AIR CONDITIONING AND REFRIGERATION

Play safe—choose your future in Air Conditioning, a billion-dollar industry that's growing every day. New **CTI Shop-Method** plan teaches installation and repair at home. You get **23** practical training kits—motor, compressor, gauges, controls, refrigeration hi-side, tools, supplies. You build an air conditioner, freezer, refrigerator or milk cooler. Write today for **FREE BOOK**.

COMMERCIAL TRADES INSTITUTE, Dept. R-126
 1400 Greenleaf Ave. Chicago 26, Illinois

100 BEST Woodworking Projects

SELECTED FOR YOU BY POPULAR MECHANICS EDITORS Enjoy the fun—the pride—of making things. Get **100 BEST WOODWORKING PROJECTS**, complete with simplified instruction, plans, diagrams and more than 400 how-to-do-it pictures. Make all kinds of furniture, baby carriages, clocks, lamps, book shelves, fireplaces and other useful articles at little or no cost. Send only \$2.00 with name and address. Money back if not pleased.

POPULAR MECHANICS PRESS, Dept. PM6, 200 E. Ontario St., Chicago 11

SAY YOU SAW IT IN POPULAR MECHANICS



Homeowner's DO-IT-YOURSELF IDEA BOOK

Popular Mechanics Press has come out with a new type of book. Now you can have, in one volume, information on every kind of job and project around the home. Learn how to upholster with foam rubber . . . use prefinished paneling . . . lay flagstone walks. Fix wobbly chairs and faded carpets. Sharpen scissors, remove paint, modernize old doors. 160 pages long—over 900 subject listings in the handy index. Ask your dealer for a copy today.

only 75¢ at YOUR FAVORITE NEWSSTAND

DECEMBER 1955



MINIATURE CLOCK FROM SWITZERLAND is the ideal Xmas or birthday gift. 5 1/2" tall, this precision timepiece sports spring-wound brass works and carved hardwood front. Shiny brass pendulum and fittings. Send \$3.95 regis. Air Mail or Int. M. O. Allow 2 weeks shipping time. H. Châ, Dept. PM-1, Seestr. 6, Lucerne, Switzerland

new product digest

Illustrated monthly magazine of new products field features exclusive valuable information for inventors, patent attorneys, and manufacturers about new products. 12 issues—\$10.

Send \$1.00 for this month's issue to

New Product Digest, Dept. A 29
 P. O. Box 2052, Austin, Texas

Name.....
 Address.....
 City.....State.....

Paint STRIPES with New "PAINT PEN"!

Straight, Curved or Parallel Lines

Use like a fountain pen with any color paint to stripe furniture, bikes, autos, model planes, toys, linoleum, wall board. Beautiful clear, crisp results every time. Can't clog or smear. Also use with glue, tempera, textile paint or ceramic under glaze. Paints on wood, glass, plastic, metals, fabrics and paper. Tool complete with tip for 1/16" stripe only \$1.25 post-paid. Other complete tools with following tips, 1/64", 1/32", 5/64", 3/32", 3/16" — \$1.75 each. Extra tips 90c each. Entire kit with tool and 7 tips — \$5. A 3/4" tip only \$1.25 each. C.O.D.'s postage collect.

New! "DOUBLE-STRIP" 5 Way Combination Model only \$3.25

Double Stripes — one wide and one narrow or two wide or two narrow at the same time.

FREE Send postcard for complete information — or ORDER TODAY.

\$1.25

DEALERS: Master Paint Stripping Tool in display cartons of 1 doz. FAST, PROFITABLE SALES. Write for new discounts.

HOME CRAFTSMEN! New Paint Stripping Tool gives "professional" results every time, simple, easy to use. Send \$1.25 now.

MANUFACTURERS: Write today for information about industrial models and production stripping tools.

WENDELL MFG. CO., Dept. 312
4234 Lincoln Ave., Chicago 18, Ill.

HELPFUL BOOKS

Send post card asking for FREE catalog

Popular Mechanics Press, 200 E. Ontario, Dept. 601, Chicago 11

ELECTRIC BRAIN KIT

Can you think faster than this Machine?

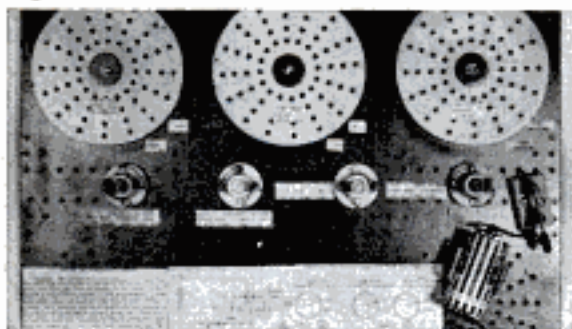

Control Panel of GENIAC set up to do a problem in check valve research.

Be careful before you answer. GENIAC the first electrical brain construction kit is equipped to play tic-tac-toe, cipher and encipher codes, convert from binary to decimal, reason (in syllogisms) as well as add, subtract, multiply and divide. Specific problems in a variety of fields — actuarial, policy claim settlement, physics, etc., can be set up and solved with the components. Connections are solderless and are completely explained with templates in the manual. This covers 33 circuits and shows how new ones can be designed.

You will find building and using GENIACs a wonderful experience; one kit user wrote us: "this kit has opened up a new world of thinking to me." You actually see how computing, problem solving, and game play (Tic-tac-toe, nlm, etc.) can be analyzed with Boolean Algebra and the algebraic solutions transformed directly into circuit diagrams. You create from over 400 specially designed and manufactured components a machine that solves problems faster than you can express them.

Schools and colleges, teachers of science or math, engineering, philosophy or psychology will find these excellent demonstrators of circuitry, solutions in symbolic logic, theory of numbers, cybernetics, and automation.

Note: Teachers take advantage of our 10% discount to educational institutions and for group purchases.

SEND for your GENIAC kit now. Only \$19.95 with over four hundred components and parts, fully illustrated manual and wiring diagrams. We guarantee that if you do not want to keep GENIAC after one week you can return it for full refund plus shipping costs.

MAIL THIS COUPON

SCIENCE KITS, Dept. PM-12, Oliver Garfield Co.
126 Lexington Ave., N. Y. 16, N. Y.

Please send me:

- 1 GENIAC Electric Brain Construction Kit and Manual, \$19.95 (East of Mississippi)
- \$20.95 (Elsewhere in United States)
- \$21.95 (Outside the United States)

Returnable in seven days for full refund if not satisfied. I enclose \$..... in full payment. My name and address are attached.

WHERE-TO-BUY-IT INDEX

Source of supply appears after items commercially available

AUTOMOTIVE

Detroit Listening Post.....	99
25-ton French tractor carries 100-ton payload.....	101
Volkswagen gets a sport-coupe model.....	106
Now that the clutch pedal is extinct, is the brake pedal next? (Hemphill, Inc., Automatic Brake Div., Gowanda, N. Y.).....	123
Cabin scooter built for two.....	136
Truck cab elevates to uncover engine.....	136
Self-loader makes truck triple-threat unit (Lodal, Inc., Norway, Mich.).....	163

AVIATION

Plane swallows truck.....	107
Anticollision light for aircraft.....	112
Assembly-line operation speeds jets into air.....	122
"Pogo" lands in 50-foot area.....	123
Conductor's "baton" guides airliner pilots.....	137
Signal suit for Navy officers guides planes to carrier.....	156

BOATS

German trailer is a boat, too.....	122
Off-center radar picture tube gives added forward vision (General Electric, Syracuse, N. Y.).....	123
Here comes the <i>Lil' Belle</i>	135
Giant propeller shipped by barge (Baldwin-Lima-Hamilton Corp., Philadelphia, Pa.).....	136

HOUSE AND HOME

What's New for Your Home—	
Disposable broiler pan of heavy aluminum foil.....	132
Window screens mounted under tension.....	132
Fence kit contains precut pieces.....	132
Automatic fire extinguisher for home.....	133
Vertical Venetian blinds.....	133
Timer for home use.....	133
New doorknobs can be snapped into place.....	133
Liquid cloth repairs rips in rubber, plastic or leather.....	133
Plastic film forms vapor barrier for home construction (Visking Corp., Plastics Div., Terre Haute, Ind.).....	138
Week-end cottage (Leisure House, 802 Montgomery St., San Francisco 5, Calif.).....	140
Porcelain-on-aluminum tile (Vikon Tile Corp., Washington, N. J.).....	262

MISCELLANEOUS

Mobile compressor and spray gun requires no lubrication (Bell and Gossett Co., Morton Grove, Ill.).....	98
Magnetic light bulbs leap into sockets (Marvel Lamp Co., Hoboken, N. J.).....	98
Nursery cars on Swedish railroads.....	101
Auto raft does 12 miles per hour on water.....	107
Danes begin mining operations 140 miles north of Arctic Circle.....	107
Train rolls through maze of wires on suspended track.....	134
Magnifying machine lets near-blind read (American Foundation for the Blind, 15 W. 16th St., New York City).....	136
Pocket battleship <i>Graf Spee</i> sails again—in model form.....	138
Light bulbs in disguise.....	139
Hospital on wheels treats ailing pets throughout city.....	142
Celery factory.....	143
Plastics with a charge have "magical" effects.....	149
Tiny big show.....	153
Fighting the Battle of Yorktown.....	154
Meter on telephone shows call charge.....	156
As the twig is bent.....	164
Peanut husks pave roads.....	250
Miniature dry battery.....	272

SCIENCE

Radiation detector buzzes alarm.....	78
Rocket-eye view from 100 miles up.....	101

(Continued to page 76)

FABULOUS

SPRINGFIELD

RIFLE

FIND! \$59⁹⁵

BACK FROM BRITAIN! This may be the last sizeable quantity of the famous U.S. Springfield Model 1903, CALIBER 30/06, ever located for public sale. We believe these guns were shipped over early in WW II. They are **GUARANTEED EXCELLENT.**



In other words they are in beautiful shape! This is the most accurate and dependable military rifle ever made and an all-time favorite hunting weapon without alteration. It is the late model high-number weapon also used with scope as a sniper rifle by marine troops on Guadalcanal and in Korea. A powerful and accurate rifle at extreme ranges. Softnose hunting ammunition (30/06) sold everywhere. Orders filled on as-received basis. For better priority use air mail stamp. Send check, cash or money order for \$59.95 per gun. For C.O.D. send \$10 deposit. All shipments F.O.B. Pasadena. Calif. resid. only add 3% state tax.

GOLDEN STATE ARMS CORP. 89 Armory Bldg., 1165 E. Colorado Street, Pasadena 1, Calif.



Popular Mechanics Book for Pleasure or Profit

23 BOATS You Can Build

Build the boat you have always wanted. Build it for fun or to sell at a profit. Get Popular Mechanics 23 BOATS YOU CAN BUILD — row boats, canoes, sail boats, power boats and other craft including a 25 foot cabin cruiser. Book includes more than 500 photos, plans, diagrams and working drawings, plus step by step instruction that anyone can follow. Only simple tools needed. Material list of lumber, hardware, fittings, etc., included. Order today under money-back guarantee. Only \$2.00 postpaid.

POPULAR MECHANICS PRESS, Dept. PM3, 200 E. Ontario St., Chicago 11

SAY YOU SAW IT IN
POPULAR MECHANICS

Build This Beautiful Corner Table

Full-Size Pattern Now Available

To make this attractive table, you merely trace the design on wood, saw, smooth the edges and assemble. It's so easy it takes all the guesswork out of furniture building. Designed as a companion piece for the step and cocktail tables detailed in Full-Size Patterns Nos. 103 and 104, this table can be used alone or with any grouping of contemporary furniture.



Other Patterns In This Series

There are 14 other full-size patterns in stock. These include a 12-foot boat, a work bench and toys for the children. For details, send coupon.

Guaranteed to Please

Designed by John Bergen, noted furniture designer, this table will be a handsome addition to your home. If, however, you are not thoroughly pleased with the pattern, you may return it within 7 days for a full refund. The price is only 50c.

Order on this Handy Coupon

POPULAR MECHANICS PRESS, 200 E. Ontario St., Chicago 11

Please send postpaid the Full-Size Corner Table Pattern. If not satisfied, I will return it within 7 days for a full refund of the purchase price.

- Send the Corner Table Pattern (I enclose 50c)
- Send information on other full-size patterns

Name _____

Address _____

City _____ State _____

Learn All About Cars!

Auto Mechanics — Automatic Transmissions
Acetylene and Arc Welding
Body and Fender Repair

Day-Night School 30 Years in the Same Location

WOLVERINE SCHOOL OF TRADES

Approved Under the G.I. Bill of Rights by the State Board of Education

WOLVERINE SCHOOL OF TRADES, Dept. PM
1400 West Fort St., Detroit 16, Mich.

Name _____

Address _____

City _____ State _____

Do you work all day with

COLD FEET?

NOW,

at last, a new, modern, low priced electric foot warmer that will keep you healthy, happy and comfortable



Check stand cashiers, secretaries, assembly line workers, housewives, office workers, theatre cashiers, machine operators, telephone operators, and many others throughout the country are now singing the praises of the Electro Mat. There is no further need to work all day with cold feet. Many colds, causing absenteeism and irritability, can be directly traced to cold feet. **Safe and Economical**

Size 14" x 21"
light-weight,
portable

Consumes less power than a 75 watt light bulb. Mail your check or money order today for **ONLY**

\$7.95

PREPAID

PETERSON RUBBER MAT CO.
5508 N. Halifax Arcadia, California

Please send me ___ Electro Mats at \$7.95 each
IMPORTANT SAVING:
If 6 or more ordered, price is only \$6.95 each.
 C.O.D. Enclose \$1.00 deposit with order.
 Prepaid

Name _____
Address _____
City _____ State _____

PLEASE PRINT CLEARLY

New positions now open:

TOOLING MEN: JOIN

the long-range production
and development program at
Lockheed in California

Forty-six major projects are in progress at Lockheed. Thirteen aircraft are already on assembly lines. It's the biggest production and development program in Lockheed's history — and it's expanding rapidly.

It has created new positions for:

TOOLING MEN

Tool Designers — *with at least three years' major jig aircraft experience*

Tool Planners — *with at least four years' aircraft tool planning experience*

Jig and Fixture Builders — *with aircraft major jig experience*

Tool and Die Makers • Plaster Pattern Makers • Template Makers

MACHINISTS

Duplicating and Profiling Machinists • General Machinists • Horizontal Boring Mill Machinists • Jig Borer Machinists • Milling Machine Machinists • Shaper Machinists • Turret Lathe Machinists

To qualify you need at least three years' journeyman experience in your field.

Lockheed offers Tooling Men:

Top pay • A wide range of extra employe benefits including an outstanding pension plan, free insurance, paid vacations and sick leave with pay • Liberal Travel and moving allowances.

Use coupon below to request job application blank and illustrated brochure describing life and work at Lockheed in California.

TOOLING MEN PROGRAM

Mr. E. W. Des Lauriers, Dept. M-T 12
Lockheed Aircraft Corporation
Burbank, California

Please send me a job application blank and brochure.

NAME _____

YOUR FIELD OF WORK _____

NUMBER OF YEARS' JOURNEYMAN EXPERIENCE _____

STREET ADDRESS _____

CITY AND STATE _____

(Continued from page 74)

Keeping up with the atom.....	121
Shell radios data.....	122
Radio "eyes" peer into space.....	124
Baby A-bombs	157
Birth of new stars seen by scientists.....	242

Radio-Television, Electronics

How to select your hi-fi system.....	165
Wake up to music.....	168

Craftsman and Shop Notes Index

AUTOMOTIVE

Tape on doorframe switch shuts off dome light.....	181
Gaskets for automobile lamps.....	190
Generator efficiency restored by washing out excess oil.....	218

FARM AND FARMING

Jack-equipped trailer backed to unhitch from tractor.....	210
Reel for barbed-wire fencing.....	210
Horse-drawn planter modified for use with tractor.....	218

HOUSEHOLD HINTS

Pressurized rubber force cup clears clogged drains.....	171
Christmas-tree-light sockets used as curtain pulls.....	172
Masking-tape adhesive dissolved to permit easier removal.....	172
Convenient light-bulb storage provided by hardwood panel.....	176
Simple Christmas-tree stand made from siding strips.....	181
Moist sponge prepares wood for smoother staining job.....	186
Warped records straightened.....	190
Painting to simulate flagstones renews worn linoleum.....	195

HOUSE AND HOME

Concrete-filled flowerpots hold driveway markers.....	176
Outdoor Christmas-tree stand made from implement wheel.....	176
Boot and mitten rack teaches children neatness.....	180
System simplifies painting double-hung window sash.....	180
Storm sash or window screens held by concealed pins.....	181
Hamper-work table.....	182
Solving Home Problems—	
Flat-ended punch drives nails through plaster boards.....	184
Tool made from ice pick used to remove pickles.....	184
Empty food tins with screwed-on handle easier to hold.....	184
Novel candleholder from gelatin mold.....	184
Small nicks and chips hidden by using wax crayons.....	185
Save soap powder by dispensing from syrup container.....	185
How to remove stains and rings from table top.....	185
Cardboard shield prevents marring of wall.....	185

MISCELLANEOUS

Dyed pine cones and bottle caps make miniature trees.....	172
Magnifying glass on tweezers aids splinter removal.....	172
Two-piece portable unit holds cord and cutter.....	180
Matches under lantern base always ready for use.....	181
Metallic letters printed with rubber stamp.....	181
Forms inside concrete pottery disassembled for removal.....	183
Indicator shows trump suit in card game.....	183
Bowl cover on bicycle seat protects it against rain.....	190
Rubber ball anchors cushion on car seat.....	195
"Convertible" camera tripod provides outdoor typewriter stand	201
Short lengths of garden hose are electric-fence insulators.....	208

PHOTOGRAPHY

Sash weight hung on tripod stabilizes camera.....	186
L-shaped bracket on camera permits using bounce-flash.....	205

(Continued to page 78)

IMPORTANT NOTICE—It is the intention of this magazine to provide its readers with information regarding the latest developments in the mechanical arts. We take no responsibility as to whether the disclosures contained in our articles are covered by patents and advise readers to investigate this subject before making, using, or selling any of the products, machines, or processes described in order to avoid possible liability for patent infringements.



\$35,000 REWARD FOR URANIUM

Here's your chance to "cash in!" Over \$2,500,000 in Government Bonuses have been paid for URANIUM discoveries in the past 2 years. Currently \$150,000 a month is paid to people just like you.

Precision Geiger Counters and Scintillators are the finest instruments made for URANIUM prospecting. These highly sensitive instruments are compact, lightweight and ruggedly built for field use. Prices start at \$29.95.

CONTACT YOUR NEAREST DEALER or write direct to factory for FREE 12-PAGE CATALOG, describing URANIUM and Metal detectors.



PRECISION RADIATION INSTRUMENTS, INC.
4223PM W. Jefferson, Los Angeles 16, California
WORLD'S LARGEST MANUFACTURER OF PORTABLE RADIATION INSTRUMENTS

Old Wall Telephones

WORKING ORDER

OAK CABINETS
HAND CRANK FOR RINGING

\$5.00 EACH F.O.B.

TELEPHONE CO., Turtle Lake, Wis.



**PLEASE
SEND ME**



for the
time checked.
I am enclosing . . .

- 1 year \$3.50
 2 years \$6.00

name _____

address _____

city _____ zone _____ state _____ C-125

Hand this order to your newsdealer or send it to
POPULAR MECHANICS
200 East Ontario St. Chicago 11, Ill.



200 WATT SECONDS!

STROBOFLASH III



That's the amount of energy at your command in the Stroboblast III, shown in use here on a Pacemaker Graphic. Here is the finest portable electronic flash unit on the market! It has a flash duration of 1/500 second, a recharging time of six seconds (you can hardly change bulbs that fast!) and a guide number on fast pan of 450! If you don't need that much light, try the Stroboblast I or II . . . both have less output and are adequate for most photographers. Use them on the Pacemaker Graphic, the Graphic 35 or any camera with "X" synchronized shutter and you'll enjoy perfect, low-cost lighting for black and white or color! Write for free folder. Dept. PM-125, Graflex, Inc., Rochester 8, N. Y.

GRAFLEX® Price-Winning Control

SAY YOU SAW IT IN POPULAR MECHANICS

FREE TV & RADIO SERVICING MANUALS
and Descriptive Literature on "Edu-Kit"—You Build 16 PRINTED CIRCUIT and METAL CHASSIS RADIO CIRCUITS at Home with the New Deluxe 1956 PROGRESSIVE RADIO "EDU-KIT"

ONLY \$19.95 COMPLETE

All parts, chassis, instructions, Soldering Iron, Tester included. 90 Day Unconditional Money-Back Guarantee.

Gentlemen: Please Rush me FREE Descriptive Literature concerning "Edu-Kit." Also send me FREE TV & Radio Servicing Manuals. No obligation.
Name _____
Address _____

PROGRESSIVE "EDU-KITS" INC., Room 540-B, Progressive Bldg., 497 Union Ave., Brooklyn 11, N. Y.



Be a Trained Diesel Man

Go places with DIESEL! Farms, factories and power plants, trains, ships, trucks, buses all use DIESEL POWER. . . all need DIESEL-trained men! You can start your DIESEL training at home, in spare time, with tested, proved U E I training. Course includes practical work on Diesel engines under skilled instructors. You learn the operation, maintenance, servicing of all types of Diesel engines. PLUS Scientific Motor Tune-Up.

ACT NOW! If you have mechanical ability, you'll like Diesel! High School diploma not necessary. Mail coupon for FREE book "EARNING POWER IN DIESEL."

UTILITIES ENGINEERING INSTITUTE
2521 Sheffield, Dept. DC-51, Chicago 14
DIESEL DIVISION

O.K.! Rush Free Book and Full Facts.

Name _____ Age _____
Address _____
City _____ Zone _____ State _____
 Check here for information if under 18.



- Industrial Maintenance
- Bus & Truck Maintenance
- Diesel Construction
- Diesel Engine Repairman
- Diesel Operator

SAVE ON XMAS GIFTS

BUY FROM IMPORTER

A COMPLETE CAMP KIT!

Special 12 Pc. SPORTSMAN'S KNIFE

1295 VALUE
Only 4.95 WITH CASE



Eliminates 12 Items from Pack or Tool Kit

IDEAL GIFT FOR FATHER, SON OR FRIEND...

Here is the Perfect Combination Knife-Tool for every Outdoor Sportsman, Hunter, Camper, Fisherman, Boy Scout, Ranger, Rancher, etc. Think of it! 11, Fine quality Steel Tools, precision made to fold easily into the heavy bone covered body. In one neat, compact unit you have (1) a regular knife, (2) a fork, (3) a spoon, (4) a draw-knife, (5) a bone-saw and fish-scaler, (6) scissors, (7) a can and bottle opener, (8) a cork-screw, (9) awl punch, (10) a screwdriver and (11) a metal file. All this PLUS a genuine leather, belt holster.



BUILD-IT YOURSELF BOAT KIT WITH INBOARD MOTOR
3.95

12 inch ELECTRIC BOAT KIT with ELECTRIC MOTOR & SPOTLIGHT

Here is a genuine electric motor driven speedboat that will make many a young sailor happier this Xmas. The hardwood hull and deck are already completed (excepting paint) and is ready for final assembly. Included in this complete kit is an electric motor, flexible coupling, drive shaft with propeller, adjustable rudder, windshield, electric spotlight and other accessories and hardware. Can be finished and ready for launching in one hour. Motor and spotlight operate on 2 standard flashlight batteries.



MINIATURE OUTBOARD MOTOR

Specially designed for use on model boats. Has swivel bracket with thumb screws for mounting. Runs forward or reverse. Operates on standard flashlight batteries. Overall lgth. 5". Weight 6 ozs.



AMAZING - NEWLY DESIGNED 60 TO 450X MICROSCOPE

FEATURING 60, 120, 150, 180, 300 AND 450 POWER MAGNIFICATION

NEWLY DEVELOPED - Self-Contained SUB-STAGE LIGHT ELIMINATES NEED FOR EXTERNAL LIGHT SOURCE

Take advantage of our tremendous foreign purchase. Ideal for use by Amateur Scientist, Student, in Home Laboratory for study of insects, plant life, etc.

CHECK THESE FEATURES

- 1-Triple, revolving turret with 10X, 20X, 30X precision ground & polished lenses.
- 2-Two interchangeable eyepieces, 6X and 15X with precision ground and polished lenses.
- 3-SIX MAGNIFICATIONS for all purposes - 40X, 120X, 150X, 180X, 300X and 450X.
- 4-NEW! Self-stage with SELF-CONTAINED LIGHT. No external light source needed.
- 5-Large sub-stage mirror for use with external light source.
- 6-All Metal Body - inclines through 90 degrees.
- 7-Special Hardwood Case and 3 glass slides.

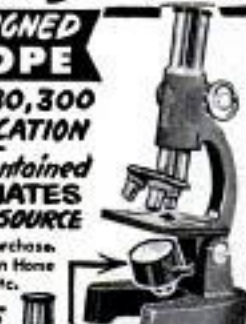

FREE with MICROSCOPE - 8 Pc. DISSECTING SET with hardwood case. Has Scalpel, Scissors, Tweezers, etc.

Only 12.95 INCLUDING DISSECT SET

SATISFACTION GUARANTEED OR MONEY BACK
ORDER TODAY for Xmas Delivery - Pay by Money Order or Check.
1/2 deposit with C.O.D.'s. All prices F.O.B. Los Angeles.
Palley SUPPLY CO. 2263 E. VERNON AVE., DEPT. PM-12 LOS ANGELES 58, CALIF.

(Continued from page 76)

- Improvised extension tube permits camera close-ups.....205
- Fused switch box wired as multiple outlet for photo flood-lamps205
- Drawer converted to "light box" for checking film slides...206
- Tape marks photo thermometer at solution temperature...206
- Sponge-rubber padding in case minimizes camera damage....206
- "Teeter totter" darkroom shelf conserves counter space....206

TOOLS

- Drill stand screwed to T-block can be clamped in vise.....186
- "Rubber mallet" improvised from shop hammer.....186
- Dual-purpose chuck mount.....207
- Taper turning lathe center made from drill shank.....208
- Saw filer208
- Ball-turning attachment for lathe utilizes drill-press vise...217
- Screwdriver removes bolts.....218
- Shopping for Tools—
- Drill sharpener for bits up to 1/4 inch.....222
- Gradient-level attachment fitted on any level.....222
- Miter box takes standard hacksaw.....222
- Pipe wrench has ratchet handle.....222
- Slide square made of dural for lifetime use.....222
- Circle-cutting attachment for portable electric ligsaws...223
- Expansion sleeves permit using nails.....223
- Interlocking connectors use wedges.....223
- Lightweight portable router for home workshop.....223
- Low-cost metal-turning lathe is all steel.....223

WORKSHOP HINTS

- Installing solid-rubber tires.....172
- Hammered-copper snack trays.....173
- L-book driven into yardstick assures accurate measuring...176
- Roller used to apply glue evenly on large surface.....176
- Wood strips on exposed edges give plywood finished look...180
- Oil prepares new paintbrush.....183
- Wire solder binds tape measure.....183
- Wire ball added to paint pail.....186
- Paint kept thoroughly stirred by using two containers.....190
- Removing broken hammer handle.....190
- Handy jig for power sanding a uniform bevel.....195
- Clothespin holds drill chuck key.....208
- Dull countersink sharpened with grinding compound.....210
- Improvised C-clamp extensions increase useful capacity...210
- Machinery crankcase filled through extension funnel....217
- Micrometer and calipers used to measure blind recess....217
- Guide clamped to tubing assures square saw cuts.....218

Radiation Detector Buzzes Alarm To Warn of Danger

Bzzzzzz! A new radiation detector sounds a buzzer to warn the wearer before he becomes exposed to too much radiation. The alarm is designed for use in emergencies by firemen, policemen and others directly involved in Civil Defense. It fastens to the wearer's belt. Only six inches long, it weighs less than half a pound.



Biggest elevators in the world, each twice the size of a suburban lot, are the four 166-ton units on the USS *Forrestal*, which transfer 35-ton jet fighters from hangar deck to flight deck in seconds.

The Most Fascinating Book About the Automobile Ever Printed!

Popular
Mechanics

AUTO ALBUM

The Motor Car in Picture
and Story from
1769 to 1952



You'll Find...

the Answers... the Fascinating Stories . . . in the AUTO ALBUM

Who built the first horseless carriage?

Who obtained the first U.S. patent on an automobile?

Where did the name "automobile" come from?

Are you familiar with the workings of the Stanley Steamer . . . the "electrics" . . . the famous Ford Model T?

Do you know when the first Indianapolis race was won . . . by whom . . . at what speed?

Do you know the story of Henry Ford, Barney Oldfield, Ransom Olds, Walter Chrysler, W. C. Durant and other automotive giants?



Cloth
Binding

166 Illustrations Including 94 Old-Time Cars — 22 Auto Ads of By-Gone Days!

Here is a book you can't help enjoying and wanting, whether or not you have, or ever will own an automobile. It is the fascinating, thrilling and informative story of the horseless carriage from the first gasoline-propelled buggy to a forecast of the atomic car of the future.

Popular Mechanics AUTO ALBUM by Throm and Crenshaw presents America's first cars and the pioneering men who made them; the scrambled start and the development of the fabulous auto industry; the story of automobile racing; the growth of the Nation's highways. It is a book that just had to be published.

To Read . . . to Enjoy . . . to Remember!

More than one-half of the book is pictures, most of them action pictures, from photos of old-time cars in operation. Other pictures show race cars from 1911 to 1951; early auto advertising, picturing 32 cars priced from \$375 to \$6000; tri-cycle autos, wind wagons, auto cycles and other automotive oddities. A roll call of horseless carriages is included — the names of more than 2000 cars made in the United States.

Gift Book of the Year

Get the fascinating AUTO ALBUM for yourself today. Send it as a gift to friends and business associates. Order on coupon below. Money refunded if you are not entirely pleased.

Use Coupon to Get AUTO ALBUM

POPULAR MECHANICS PRESS, 200 E. Ontario, Chicago 11

Send at once postpaid — copies of Popular Mechanics AUTO ALBUM at \$3.00 each. Remittance enclosed. Send COD. I will pay postman plus charges. I understand books are returnable in 7 days for full refund if I am not pleased.

Name _____

Address _____

City _____ Zone _____ State _____

free!

1956

ALLIED

ELECTRONIC
SUPPLY
CATALOG

324
value-packed
pages

Save on Everything
in TV and Radio
Parts & Equipment



Everything for Experimenters,
Builders, Amateurs, Servicemen,
Engineers & Hi-Fi Specialists

Send for ALLIED's big 324-page value-packed guide to *everything* in TV, Radio and Electronics! Select from the world's largest stocks of High Fidelity systems and components; recorders and phono equipment; TV tubes, antennas and accessories; Amateur station equipment and supplies; P.A. systems; test instruments; latest build-your-own kits; industrial electronic supplies — plus *everything* in electronic parts, tubes, transistors, tools and books. Save on everything in Electronics — send today for your FREE 1956 ALLIED Catalog.

Everything in Electronics
From One Reliable Source

send for it

FREE
CATALOG

ALLIED RADIO

ALLIED RADIO CORP., Dept. 5-M-5
100 N. Western Ave., Chicago 80, Ill.

Rush FREE 1956 ALLIED 324-Page Catalog

Name _____

Address _____

City _____ Zone _____ State _____

**SOMETHING
DIFFERENT FOR
CHRISTMAS?**

*These Gifts
will please
the whole
Family!*



FLEXBAC® PAD KIT

Flexible foam rubber pad follows curves and contours... gives faster disc sanding. \$7.00* complete.



"HANDY-SANDY" DISCS

Designed for use with FLEXBAC® PAD KIT. Approx. 35¢* per envelope of 5, depending on grit size.



NO. 66 SHARPENER

Puts keenest edges on kitchen knives. Handy in size, has a colorful handle. Lasts for years. 64¢* each.



**NIAGARA® BRAND
GRINDING WHEELS**

A size for every home workshop grinder—all at economy prices. The popular 6" wheel, 1/2" thick, costs only \$1.55*



"HANDY-SANDY" ASSORTMENTS

Flint Paper, Emery Cloth and Garnet Waterproof Paper in convenient packages. 20 sheets per pack, approx. 20¢*



"RED-I-RUB" RUBBER SANDING BLOCK

Flexible soft rubber block... perfect for hand sanding of contours and flats. Grips sandpaper firmly. Only 59¢* each



"SAND SCREEN"

Sands on both sides... lasts 15 times longer. Approx. 29¢* a sheet—depending on grit size.



NO. 109 COMBINATION STONE

Coarse abrasive on one side—fine on the other. Perfect for sharpening all steel cutting tools. \$2.05*



NO. 76 SHARPENER

Designed for putting keen edges on carving knives. Fast-cutting, long-lasting, with protective hand guard. 96¢*



NO. 57 FILE

Outlasts and out-cuts metal files. Puts sharper edges on scythes, sickles and garden tools. \$1.60*



"HANDY-SANDY" SANDING BLOCK.

A durable hard-rubber block for sanding wood or metal. Sandpaper wraps around, fits in slots. \$1.29*



HOOK STONE

The fisherman's delight... made exclusively for sharpening fish hooks. Includes leather case. 96¢*

P.S. TO MEN:

Tear this page out, circle the items you want, then leave it where your wife can spot it!

*Suggested retail prices. You may find slight variations in your neighborhood.

YOUR HARDWARE STORE or Building Supply Dealer is headquarters for these practical work-saving Christmas gifts and other top-quality home-workshop products by

CARBORUNDUM

REGISTERED TRADE MARK

10-555

Convair's supersonic all-weather interceptor, the F-102A, has the new "wasp-waist" design and redesigned canopy

AT 40,000 feet and near the speed of sound, you're gulping oxygen, struggling against a Herculean G-force that slams you into the seat, as heavy-armed and sweating you try to focus your camera—a camera which weighed a mere 10 pounds groundside, but now weighs 30.

There, off to starboard and headed straight at you on collision course, hurtles a jet fighter. You've planned it this way, of course—briefed and plotted every move and turn. But things can go wrong. Sweat trickles down your back. Your legs are rubbery, but somehow, fighting that strangling G-force, you work out of your seat.

You've got but a split-second in which to aim your camera, focus and fire.

Now! You trigger the shutter, then brace as your pilot wings under and up to avoid a mid-air collision. After that comes the prayer—that you got that head-on photo the engineers need for wing evaluation, or perhaps to enliven a magazine's cover.

You're a "jetographer," a practitioner of the sonic age's most nerve-shattering brand of photography.

"You never really get used to it," says Roy Wolford, for fifteen years Northrop Aircraft's chief photographer and one of the nation's few "old hand" jetographers. "Old hands" are rare because jetography

There's no time for thrills when you're shooting jets at f.11, at the speed of sound. Meet the men of a brand-new profession—

JETOGRAPHY

By James Joseph

Jetographers, like Northrop's Val Hawes, can shoot only above and 45 degrees ahead and behind from jet



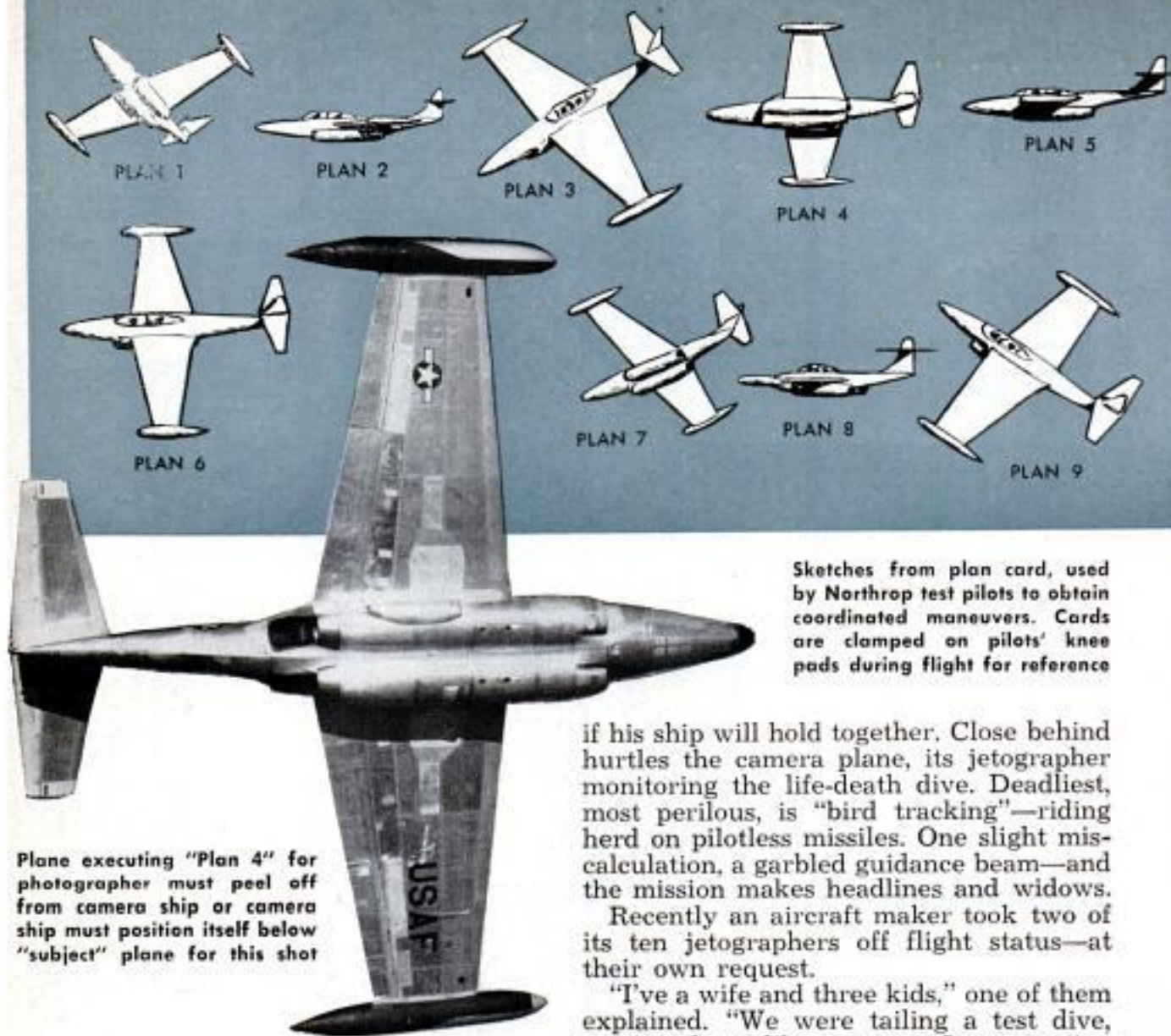

Plane executing "Plan 4" for photographer must peel off from camera ship or camera ship must position itself below "subject" plane for this shot

Sketches from plan card, used by Northrop test pilots to obtain coordinated maneuvers. Cards are clamped on pilots' knee pads during flight for reference

is a newborn art of the sonic era. Nationwide there are probably 100 qualified jetographers. Most of them shoot for such major plane builders as North American, Boeing, Douglas, Northrop and Lockheed.

Jetographers are a special breed with a special mission. Their job: to photograph at perilously close range and at screeching speeds the test flights of every jet craft and missile. Occasionally a jetographer works on assignment from public relations, snaps a magazine cover. More routinely he's attached to his company's flight-test and engineering staff.

What of a missile screaming airborne from its test launcher? Tracking alongside is a camera plane, its jetographer filming the launching sequence, his lens focused on the "bird's" fins and control tabs. What's the pattern of fuel jettisoned from a fighter's wing tanks? To find out, engineers assign a cameraman to monitor the drop—to work within 50 feet of the subject plane, both jets throttling just under the speed of sound. More nerve-jangling are "structural integrity" flights—where a test pilot full-throttles from 45,000 feet to find out

if his ship will hold together. Close behind hurtles the camera plane, its jetographer monitoring the life-death dive. Deadliest, most perilous, is "bird tracking"—riding herd on pilotless missiles. One slight miscalculation, a garbled guidance beam—and the mission makes headlines and widows.

Recently an aircraft maker took two of its ten jetographers off flight status—at their own request.

"I've a wife and three kids," one of them explained. "We were tailing a test dive, coming down like a comet. I was getting the thing on film. The test jet pulled out fine. My ship didn't. Something jammed

Propeller-driven planes are seldom used nowadays, but here Northrop's Sam Orr shoots from A-26 dome



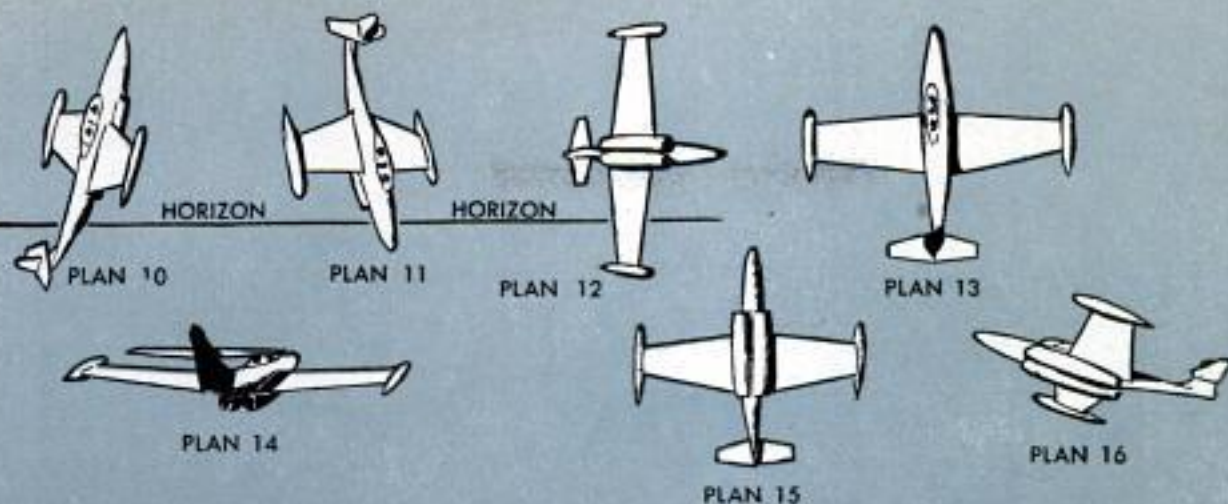

... or maybe it was the G-force that did it. Ground wasn't 1000 feet below as we wrenched free from that jet stream and leveled. That's when I checked in my pressure suit and Fairchild K-20."

As for Northrop's Roy Wolford, he voices no objection when a staffer asks for safer, saner duty. "If a man's had enough, that's OK... and no questions asked." Then he grows emphatic. "We're not glamour boys or daredevils. We think of ourselves as technicians—as essential researchers in the development and advancement of modern aircraft."

Wolford himself came close to being the nation's first jetographer casualty. It happened on Oct. 21, 1947.

Roy was aloft, crouching in the forward gunner's seat of a prop-powered Black Widow F-61. Up front sat the pilot. Ahead of them—and just letting down for a landing at California's Muroc Air Force Base—

churned the YB-49, Northrop's 8-jet flying wing. Roy and his pilot had tracked out of Hawthorne, Calif., filming that YB-49 flight. Like any first flight—especially a jet's—it was tricky. Anything could happen.

Suddenly a voice cut through the radio's static.

"Your right engine's afire!"

The warning came from an F-80, one of the mission's half dozen escorts. Roy looked starboard, saw the pall of smoke billowing from the F-61's twin-boom tail. The booms were already aflame, the fabric sloughing off, the rudder nearly burned through. A fuel line had ruptured, pouring lethal stuff into the red-hot outlet of the starboard engine's supercharger.

Roy shoved \$3000 worth of cameras off his lap (he'd been shooting movies for a newsreel pool and color for Northrop's engineering department). Fighting to get free of that fiery coffin, he didn't worry

Jetographer Sam Orr's once-in-a-lifetime picture of a Scorpion F-89D firing barrage of 104 air-to-air rockets





Lockheed's Erik Miller snapped Air Force "Acrojets" in formation. Camera ship must roll over for this shot

Preflight conference between Northrop test pilot Dale Johnson and jetographer Jim Wilkinson to plan shots





Formation photos are among the most difficult to get. Jetographer must trip shutter at the precise moment

about cameras or footage. The pilot went over the starboard; Roy out the port. Hanging from the shrouds, Roy watched as the Black Widow flipped belly up, spasmed and dived groundward. The cameras spilled from the cockpit, landed hard but safe, their film intact. But some hare-brained good Samaritan found them, used all that irreplaceable first-flight film to fence off the crash area.

Today, Roy admits, a jetographer would find it all but impossible to bail out of a similar tight spot. In huddled briefings, jet-borne cameramen have just about decided that, for them at least, there'll be no escape next time a photo plane runs afoul of bad luck. Why? Because shooting from a jet, there's no way to get rid of those heavy cameras. You can't toss them over-side, not at near-sonic speeds. Most cockpits are too cramped to stow them. So they lie on your lap. And that's the danger, for it takes both hands to trigger a jet's ejector seat. One flip and the canopy is jettisoned. Now, with both hands, you actuate the escape mechanism. Sshhh! you slam out of the cockpit. But the cameras, being lighter, accelerate faster. There's nothing to prevent battery case, cameras and photo meters from shredding your face with a lethal uppercut, and your hands are too busy to fend them off.

"Sure," a jetographer shrugs, "you'd get out alive—but after those cameras clobbered you, you'd need a new face."

Bundled into flight gear and loaded down with cameras, Northrop's Paul Wheeler is ready for a flight



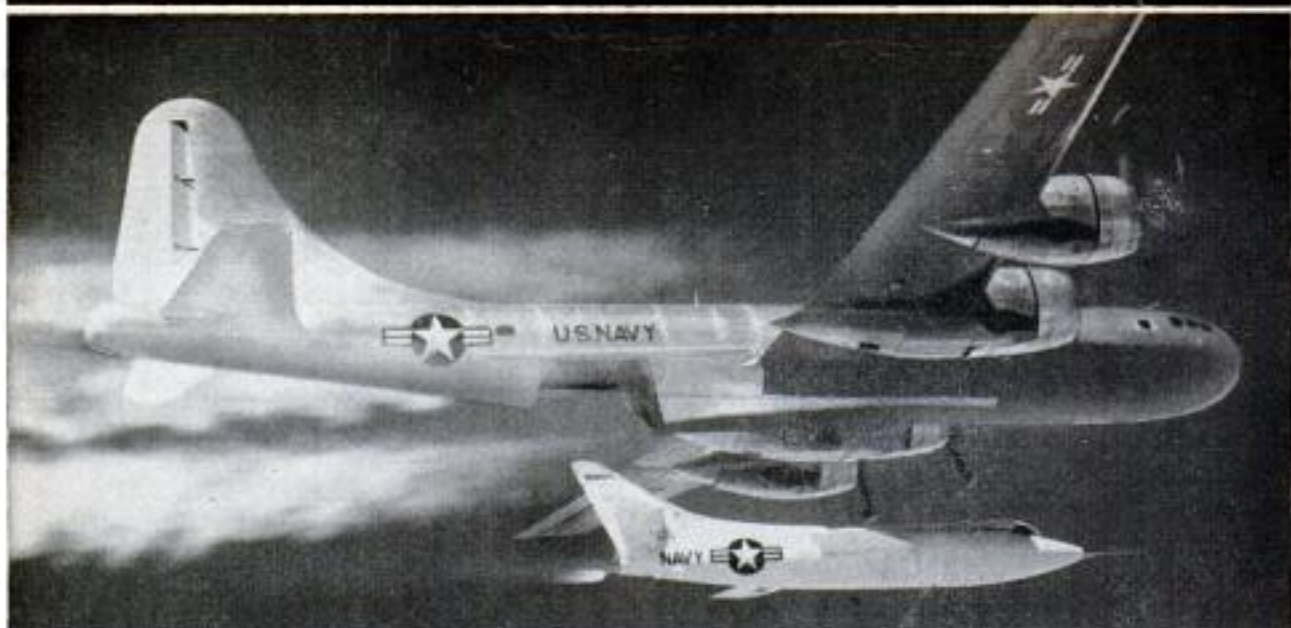

Walt Tufts held his breath at 37,000 feet so he could take off his oxygen mask to make sure of this shot



F-89D Scorpion executes a "Plan 5" position so the photographer can shoot rockets firing from wing pod

One of the few "old hands" in the jetography business, Roy L. Wolford, Northrop's chief photographer



No one's yet proved or disproved this suspicion, but aerodynamics predict it.

Why, then, do the nation's few score jetographers run the risk? The \$125-\$200 weekly they earn doesn't explain it. Neither does the occasional \$50 a day bonus which the best of them command for extra-hazardous duty.

"Gets in your blood," a jetographer explains, "It's the trickiest, most rewarding kind of photography. It's an art—snapping a jet cavorting at the speed of sound—and the art's growing right along with the jet age."

The problems are many. In the slow-going days of prop flight, a cameraman could open a hatch, lean overboard and snap. Today he's sealed in, pressurized, air conditioned and breathing oxygen from ground all the way to 45,000, even 60,000 feet. As the camera plane wings-over and climbs, G-forces build, multiplying the photographer's weight and the weight of his camera and gear. At 2 Gs, a 10-pound camera weighs 20 pounds; at 5 Gs it weighs 50 pounds. The same increases apply to the jetographer's head, to his fingers and legs. Just raising a camera from his lap becomes a feat of strength. Focusing—as grueling as weight-lifting. Then, too,

(Continued to page 256)

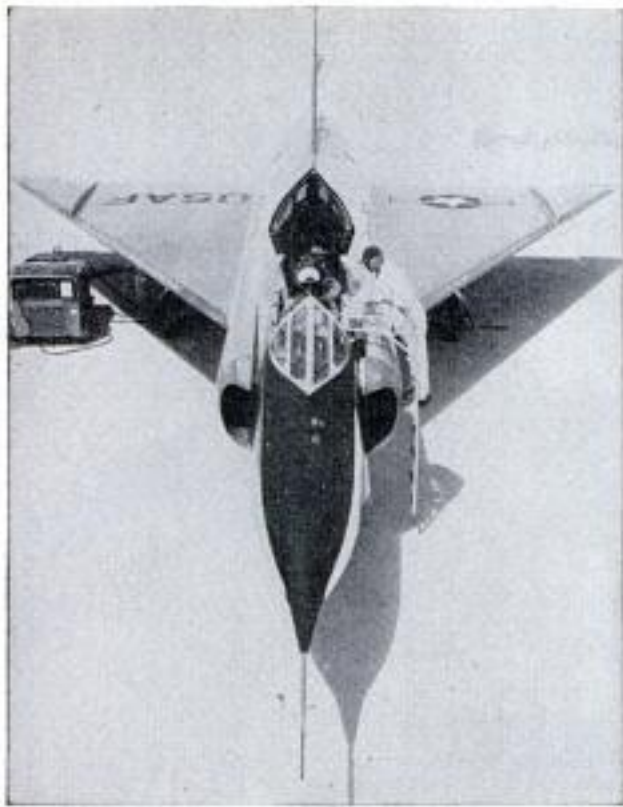

Supersonic Jets Get New Shape to Increase Speed

Supersonic jets now rolling off the assembly lines have lost their straight, slim lines and developed some effective curves because of a newly discovered principle of aircraft design. Hailed as "one of the most significant military scientific breakthroughs since the atomic bomb," the new principle will increase the speed of aircraft by 25 percent or more as they go through and beyond the sonic barrier. The inventor, Richard T. Whitcomb, scientist at the National Advisory Committee for Aeronautics' Langley Laboratory at Hampton,

Va., has labeled the principle "the area rule." In simple terms, an application of the area rule results in a pinching in of the fuselage at the point where the wings join it, producing a wasp-waisted body. This design eliminates some shock waves, and their resulting drag, permitting a smoother, faster passage of the plane through the air. The first two planes to appear with the new look are the Grumman F9F-9 (called the F11F-1 in the new version) and the Convair YF-102. It is also to be used on the Navy's Chance-Vought F8U-1.

"The Thing"—Bad News for Enemy Tanks

Called "The Thing," a new fast-firing armored vehicle has been adopted by the Marine Corps for its amphibious forces. It is mainly an antitank vehicle and mounts

six 106-mm. recoilless rifles along with four .50-caliber spotting rifles which are used to establish the range for the larger weapons. The vehicle has light armor.

Nemesis of enemy tanks bristles with armament. Note the .50-caliber spotting rifles used to find range





Rear, a Super four-door hardtop; right, a Roadmaster (chrome bands on trunk identify it); left, a Special

'56 BUICK

Buick offers a new idea in "age-labeling" of cars by stamping model year "1956" on the grille medallion



ALL BUICKS now have the same engine—the 322-cubic-inch V8. Horsepower, however, is different: 220 on the Special, 255 on the Century, Super and Roadmaster. The additional 35 horsepower on the more expensive Buicks result from higher compression ratio (9.5:1 compared to 8.9:1 on the Special) and more carburetion (four barrels compared to two barrels on the Special).

Styling changes are minor: Wider front grille; full wheel cutouts on all models, not just on two-door models as in 1955; rear fenders are longer with less chrome showing around the taillights.

Performance in the lower speed ranges has been improved by adding a second stator to the Dynaflow transmission. This, plus the bigger engine, is said to give the 1956 Special the same performance from 0 to 30 as the 1955 Century.

Brakes have new linings, grooved along their full length to relieve the high-pressure zone in the center of the shoe and also to aid cooling. Brake area on the Special is increased.

Steering ratio is 17.5:1 with power steering, which is considerably faster than previously. The rear axle, including the differential, is completely redesigned.



Called a sport sedan by Chevrolet, this Bel Air four-door hardtop has no center pillar to obstruct vision



Luxury member of the station-wagon line, the two-door Nomad combines utility and beauty in one vehicle

'56 CHEVROLET

WITH A NEW grille and spearlike two-tone paint treatment, the 1956 Chevrolet is instantly recognized from any angle. Big news is the four-door hardtop model. Except for the front end, most of the styling changes have been in the handling of trim and interiors. The grille has been drawn forward into a shallow V and made wider to give the front end a lower look.

Four engine choices are available: The familiar overhead-valve Six with 140 horsepower this year; a 162-horsepower V8 for hand-shift models; a 170-horsepower V8 for Powerglide; and a Super Turbo-Fire V8 of 205 horsepower as an optional power pack with four-barrel carburetor, dual exhausts, 9.25:1 compression.

New this year for Chevrolet is a nine-passenger station wagon, the third seat of which is removable for hauling cargo.

Also new are the following: High-lift camshaft on the two most powerful V8 engines; a full-flow oil filter for reduced engine wear; directional signals standard on all models.

Major change in Chevrolet styling is in its front grille. It is wider and has been made more pointed





All new this year is the front-end styling of the Hudson. Shown here is the 1956 Hornet V8 four-door sedan

'56 HUDSON

Hudson has a new grille that makes it instantly recognizable as it comes down the highway. The grille, a broad mesh design, features a bold "V" in its center, a styling motif that is repeated in Hudson's side treatment as well as in its interiors.

A narrow band of gold color that runs horizontally along the rear fender makes three-tone cars actually four-tone and two-tone cars three-tone.

All 1956 Hudsons use the 12-volt electrical system. Three basic engines are available and, in addition, two optional

six-cylinder engines. Horsepower is up in all of them.

The Hornet V8 engine develops 220 horsepower with a compression ratio of 9.55:1 and a 352-cubic-inch displacement.

The Hornet Six develops 165 horsepower with a 7.5:1 compression ratio. An optional twin-carburetor kit increases the power to 175 horsepower.

The Wasp Six develops 120 horsepower and can be obtained with twin carburetion which boosts output to 130 horsepower.

A redesigned dashboard features a horizontal thermometer-type speedometer. A crash pad of foam plastic covers the top of the dash. Reclining seats that make up into beds are optional.

Continental tire adds 10 inches to the length of the hardtop. Narrow panel on rear fender is gold colored





Speed-line styling along the side panel of the Ambassador hardtop is new for 1956. This is the V8 model

'56 NASH

Nash has four horsepower ratings for 1956, ranging from 130 to 220. Included in the engine list is the new Statesman overhead-valve Six, which is said to have the highest ratio of horsepower to displacement of any six in the United States.

Principal style element of the Nash continues to be its inboard front headlights—a treatment that was adopted from the Nash-Healey sports car. For 1956, the parking lights, mounted in the fenders where the headlights are on other cars, have been enlarged and placed inside a

Rear fenders of the Nash have been raised and the taillights have been made larger and distinctive

miniature grille to give the leading edge of the fender a diagonal appearance.

The rear fenders have been restyled and raised almost three inches. The taillights are greatly enlarged.

Other changes for 1956 include: Adoption of the 12-volt electrical system; rear-view mirror is enlarged; front brakes on the Statesman are wider; parking-brake handle is now on the left side of the steering column; Ambassador wheels have been widened and tire size increased.

Nash continues its all-welded, no-bolt body construction which, their engineers claim, offers superior energy-absorbing characteristics in collisions.

You can always spot a Nash by its inboard headlights. Parking lights in fender have been enlarged





Four-door hardtop of the Oldsmobile Super "88" features a new pattern of slash two-toning along the side

'56 OLDSMOBILE

Oldsmobile, which pioneered the slash-type two-toning so common today, has two variations of it this year. The two-toning of the "98" series is distinctively different from that of the "88" models.

Principal styling change is the grille which is now a wide, slender oval of utmost simplicity. Rear-fender styling is new.

Oldsmobile offers the improved Hydra-Matic with the jerkless shifts that result from the addition of a second fluid cou-

pling, actually a dump-and-fill clutch. Mechanics can set the ignition points without removing the distributor cap this year, thanks to a small access door in the side of the cap. The parking brake is now operated by the left foot and a Park position is incorporated in Hydra-Matic for the first time.

Horsepower on the Super "88" and "98" models is 240, compression on all Oldsmobiles is now 9.25:1. The engine on the "88" model develops 230 horsepower.

Grille is adapted from the styling of the Delta dream car. Parking lights are in outer ends of the bumper





Fenders, hood and trunk have been raised on the President V8, now the largest car in the low-price field

'56 STUDEBAKER

New sheet metal plus a sportster that will go 120 miles per hour give Studebaker lots to talk about in 1956.

Sedan models have hoods and trunks squared up to make them appear much larger. All Studebakers are now in the low-price field. The Champion 6 has 101 horsepower, the Commander V8 has 170 horsepower, the President V8 has 190.

The Hawk sportsters come with horsepowers of 190, 210, and 275. The 275-horsepower Golden Hawk has tailfins and the performance of a racing machine.



Hawk's trunk lid has a promising styling trick: The decorative texturing of a previously ignored area

Studebaker's "bomb" is the Golden Hawk. It weighs only 3375 pounds, has 275 horsepower, will go 120

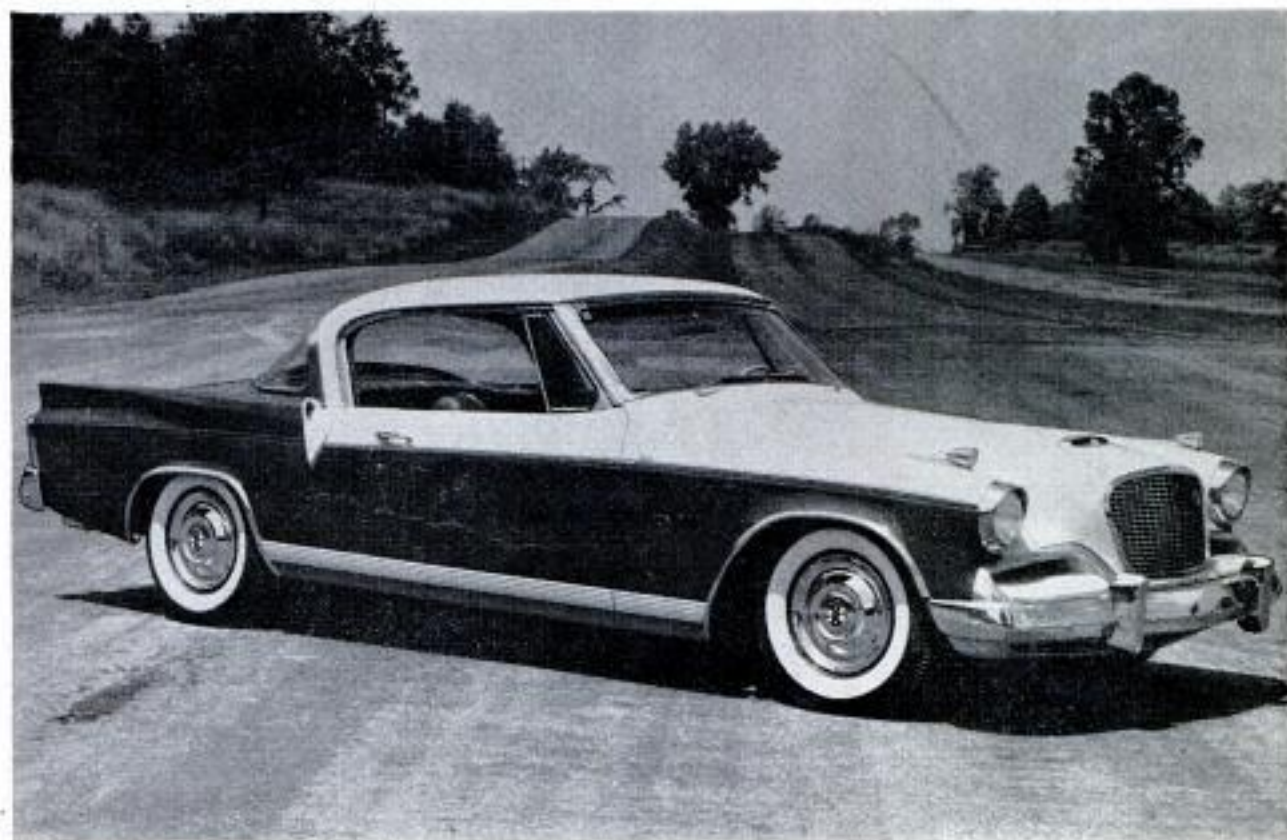



Officials in diesel railcar at left send verbal orders which are relayed to controls in robot train at right

Train Speeds Along Rails Without Crew

WITHOUT CREW or passengers, a radio-controlled electric train hummed along the rails at a speed of almost 75 miles per hour in a test run. The robot train made the run

on one section of the main line of the French National Railroads between Paris and Le Mans. Radio was used to release the brakes, control the supply of current to the traction motors and apply the brakes at the end of the run. A diesel railcar running on a parallel track carried railway officials, who sent verbal orders by radio to control the train. At a radio-control station, these orders were retransmitted as special radio signals to control mechanisms on the train. Three weeks previously the locomotive's sister engine set a world-record rail speed of 205.6 miles per hour.

The New York, New Haven and Hartford Railroad has also announced experiments in which officials control the train from a truck on an adjoining highway.

← Test run of crewless train was made between two towns on main line of French National Railroads

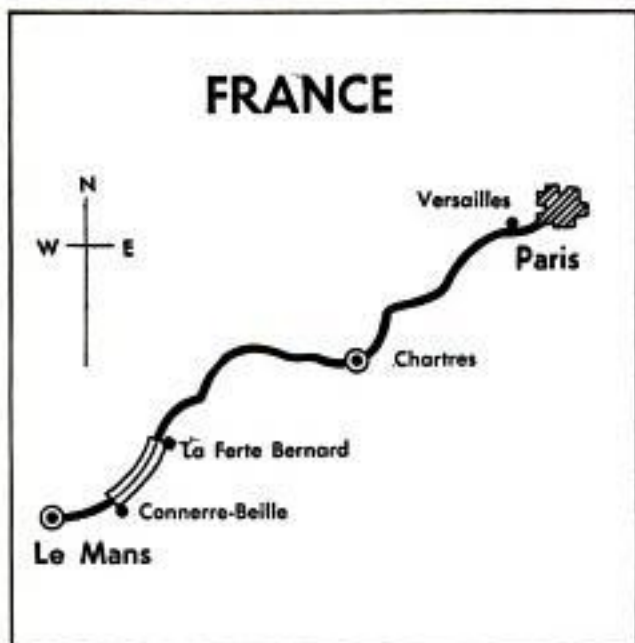

Verbal orders were relayed from the control station as special radio signals to robot train

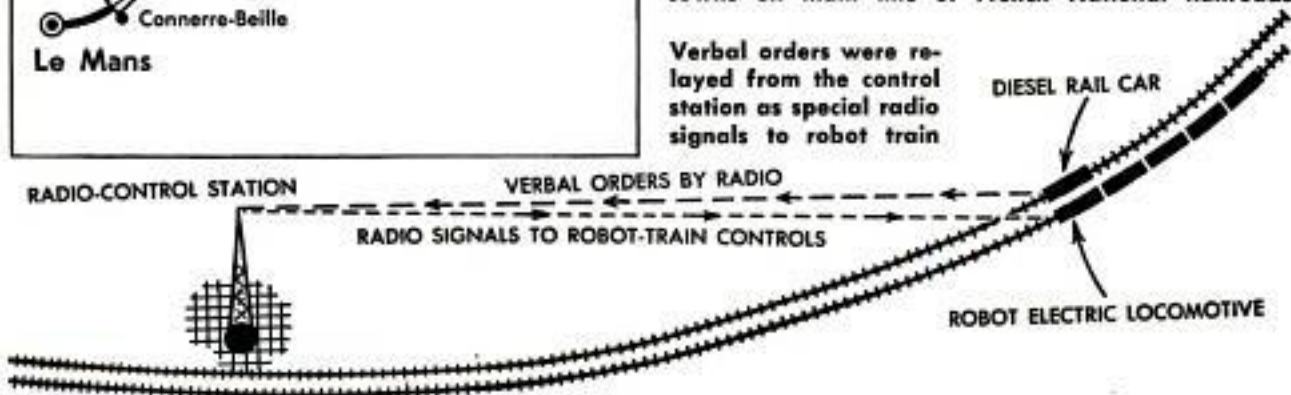

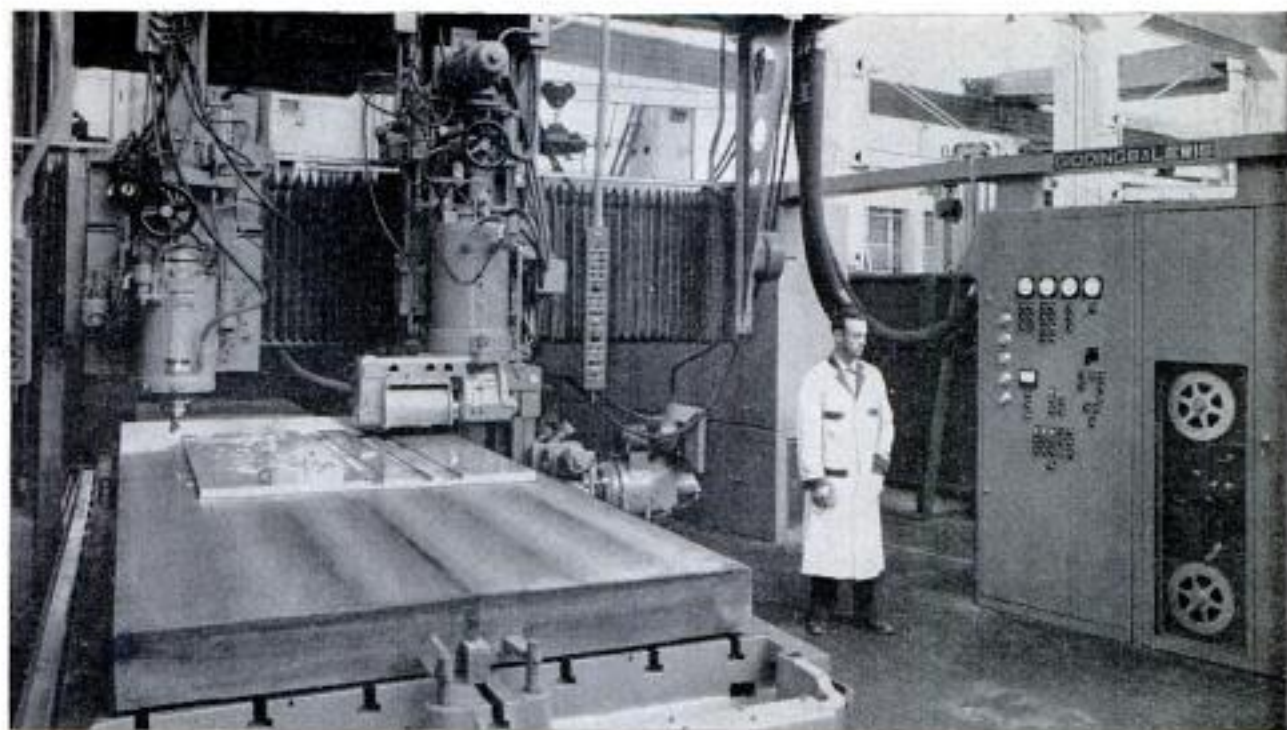

Tape Recording Guides Milling Machine

Guided by orders stored on magnetic tape, a new milling machine makes all the intricate cuts necessary to turn out wing and skin panels for jet planes. An engineer converts the plans for a panel into decimal numbers, which then are perforated into a paper tape. The paper tape then is run through a computer, which coordinates the information into precise time-and-motion orders to the machine. It also records these orders on magnetic tape. The magnetic

tape is used to control all functions of the machine. One advantage of the system is that the magnetic tape can be prepared thousands of miles from the machine tool if necessary. No templates are required and no sample must be cut in order to make the tape recording. Such recordings can be stored indefinitely, then brought out for use whenever they are needed to produce more parts of the same type, an important factor in production for national defense.

Kite-Borne Water Skier Soars High Above Waves

Water skiing wasn't exciting enough for Tony Baird of Everett, Wash., until he built a kite that now enables him to soar high above the waves. As his brother Gordon tows him in a speeding motorboat, Tony grasps a bar attached to the huge kite and is soon aloft. When the boat slows down, he drifts back down and lands like a seaplane—but on only one ski. With the kite, he has achieved an altitude of 100 feet, which he believes is a world's record.

Name Elements 99 and 100

Two great scientists who died within the last year, Albert Einstein and Enrico Fermi, have been honored by the naming of elements 99 einsteinium and 100 fermium. The symbol for einsteinium is plain E, that for fermium, Fm. Now all discovered elements are named, since 101 was previously named mendelevium after the Russian, D. Mendeleev, who announced the periodic system of the elements in 1869.

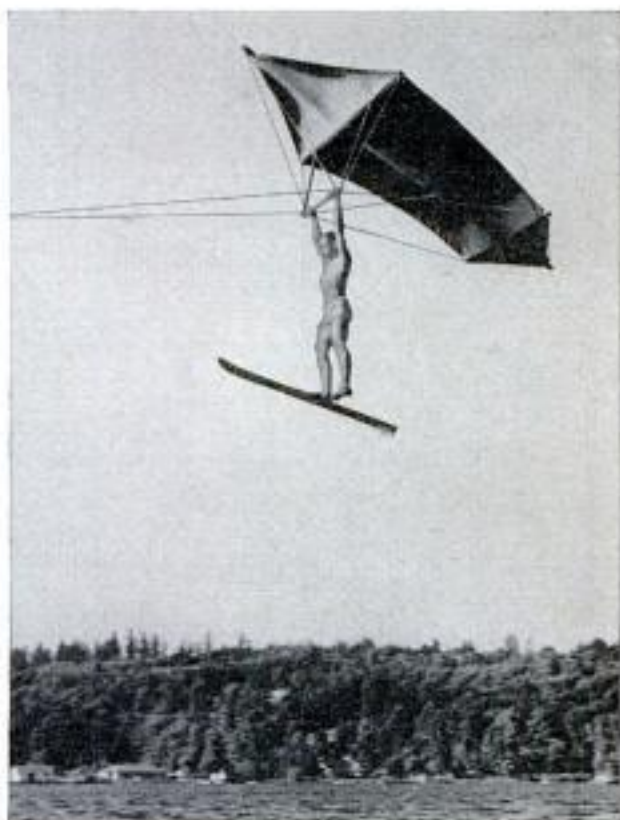

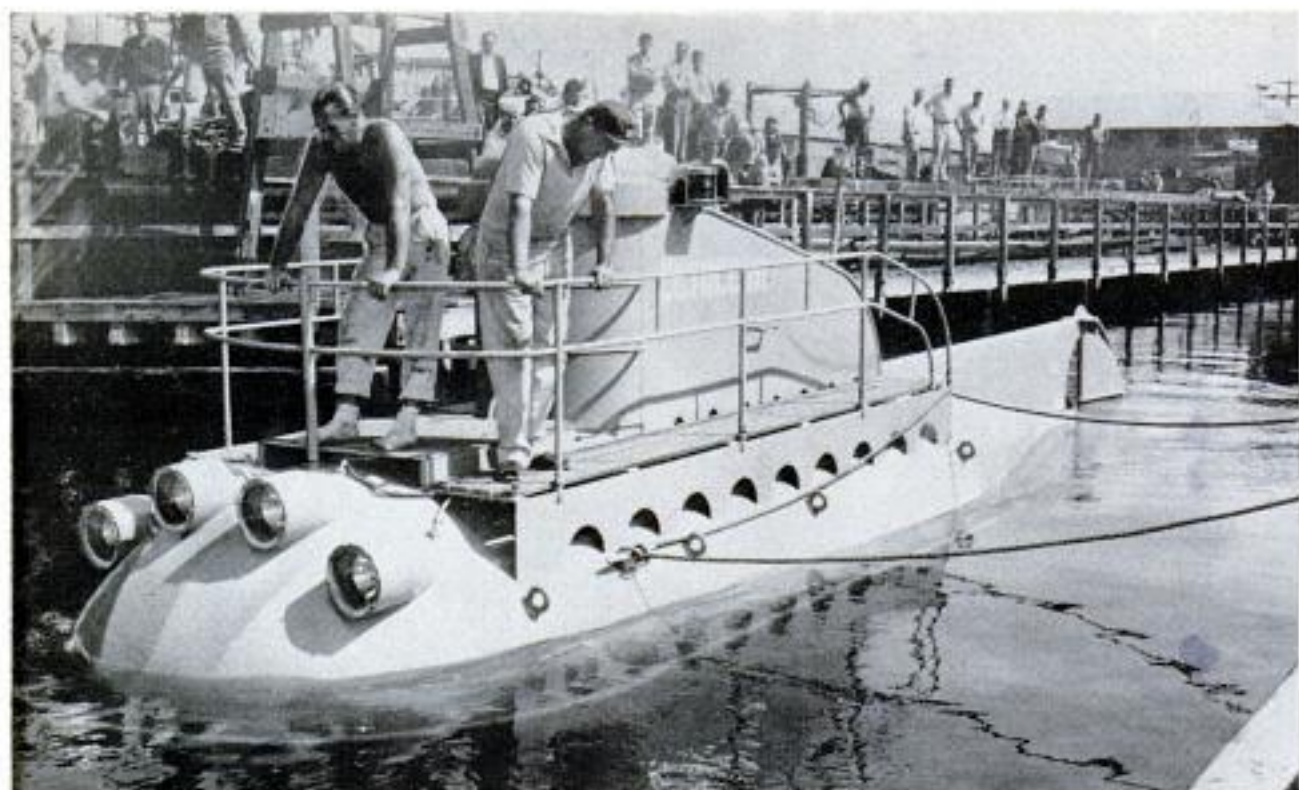

Little submarine carries a crew of five or six, has powerful lights for deep-sea motion-picture photography

Stubby Sub Cruises One Mile Deep

DEEP-SEA MONSTERS not yet seen by man will be sought in the *Cetacean*, a 50-ton submarine that can cruise a mile or more below the surface.

The craft has an underwater range of 35 miles and can lie for days on the ocean bottom, resting on two fat "legs" in which seven tons of storage batteries are carried.

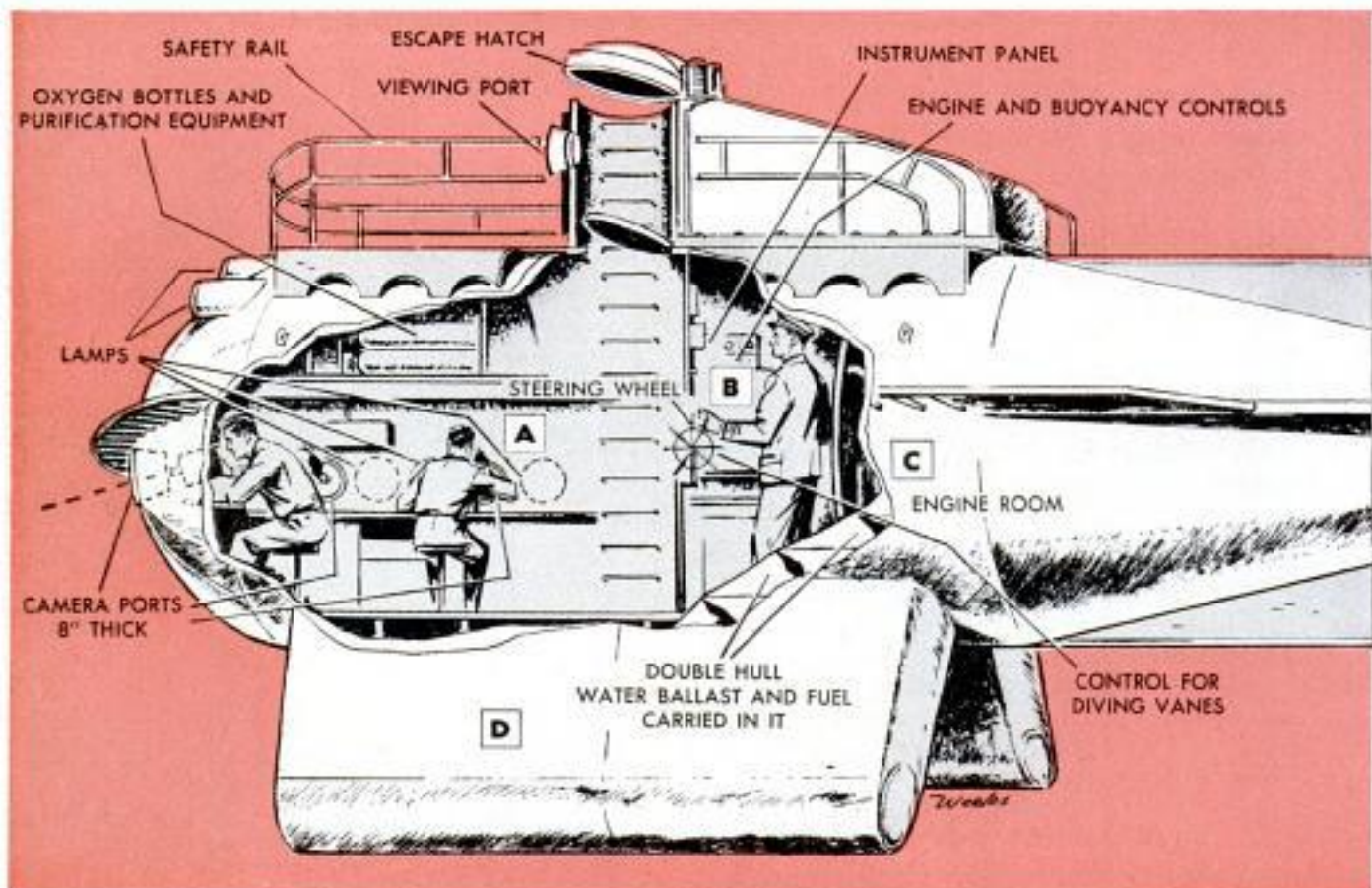



Craft enters water for trim trials. Fat "legs" support it on ocean floor and carry storage batteries

In an emergency the double pressure hull could withstand the squeeze that would be encountered at a depth of five miles. Space between the two hulls is used to carry 2000 gallons of fuel for the 150-horsepower diesel engine which drives the craft on the



Inventor Martine checks propeller. Behind and above him are diving vanes and rudder that maneuver sub

surface, as well as water ballast for controlling buoyancy during dives and ascents.

As a result of its relatively short length of 41 feet the *Cetacean* can be maneuvered with aircraft-type control surfaces—a rudder and elevators located aft of the propeller. It is designed to make nine knots on the surface, seven knots submerged.

The new submersible is fitted with powerful underwater floodlamps to provide illumination for exploring at great depths and for making wide-screen color motion pictures of interesting objects that are sighted. Edmund Martine, inventor, says that bait in the form of a slaughtered animal may be towed astern to attract deep-zone predators. Counting the photo staff, the crew consists of five or six men. The craft is fitted for other types of deep-sea research in addition to photography.

Martine, inventor and builder of large diving bells that are used on both coasts, made use of his long experience with submersibles in devising watertight fittings and other necessary gear to withstand the pressures that will be encountered at great depths. It is said that his craft is the world's first self-propelled submarine designed from the keel up for underwater research and exploration. Now undergoing diving trials on the West Coast, the *Cetacean* may soon be stationed in the Bahamas. ★ ★ ★

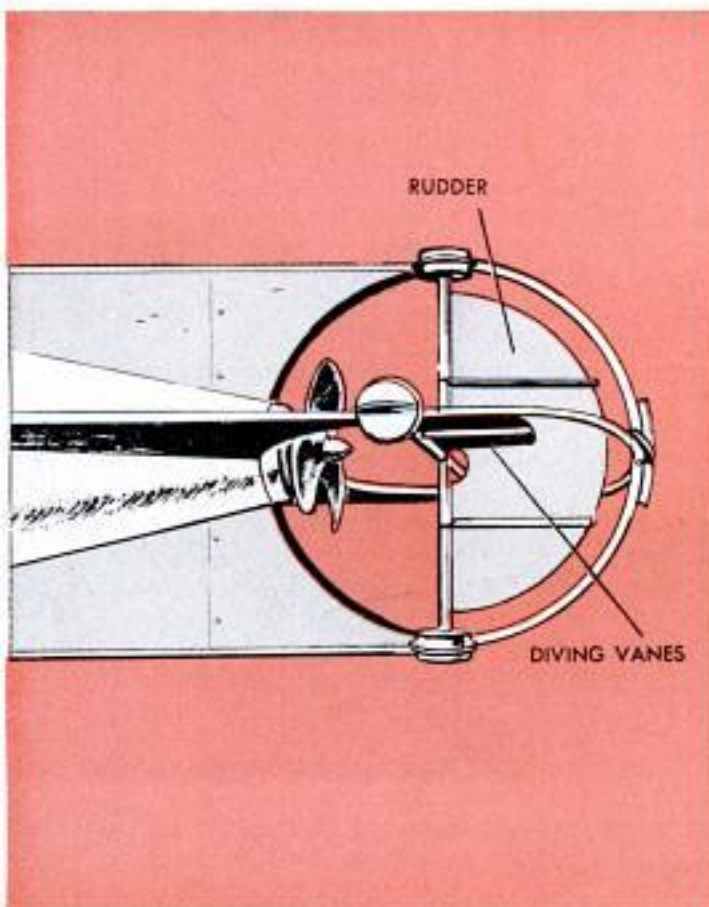

Cutaway shows interior of sub. Compartment A is for cameramen; B shows control compartment; C holds electric and diesel engines; batteries are in "legs" D



Because of its oilless construction, the compressor delivers clean, dry air without need of separator



Normally thought of as part of a paint-spraying outfit, a compressor can do many jobs around the home

Mobile Compressor and Spray Gun Requires No Lubrication

Suitable for the home craftsman, a new compressor is now being marketed which rolls on wheels for ease of handling. Driven by an electric motor, the unit uses graphite or carbon piston rings instead of conventional steel rings, which eliminate the necessity for lubricating cylinder walls. A complete line of accessories enabling the

compressor to do dozens of different jobs, such as paint spraying, insecticide spraying, inflating of tires and beach toys and even the operating of air tools in the home workshop, is available. Because of the oilless feature, no filters are needed to get clean, dry air at the spray nozzle. Spray guns used are the external mixing type.



Magnetic Light Bulbs Leap Into Sockets

Five turns are required to fit an ordinary light bulb into its socket, and five more turns are required to remove it. But now a new bulb with a magnetic base that virtually jumps into place has been developed to eliminate all this twisting. The socket contains a permanent magnet, and the base of the bulb is a metal plate which is attracted to it. No current is needed to energize the magnet. The bulb is expected to be useful in maintenance of large buildings, where a number of bulbs must be changed each day. For example, the Pentagon, the world's largest office building, is illuminated by 68,000 fixtures, and 1200 of these bulbs must be replaced each day. Manpower savings also could be effected in maintaining theater marquees.

☐ Last year American farmers applied 23,000,000 tons of fertilizer to their fields, a tonnage just about equal to the total tonnage of vehicles produced by the automotive industry for the past two years.

THIS IS A STRANGE business. Studebaker brought out its low, "European styled" cars in 1953 with concave, sculptured sides. On its 1956 models the sculpturing is gone, according to rumor, as the car has been "Americanized" again.

Then (and this is more rumor) along comes Chevrolet with its 1956 Corvette (out in January) and it has sculptured sides! Of course, the treatment isn't the same as Studebaker's, but the story does illustrate that this is a strange business.

Incidentally, the 1956 Corvette is to be a hot one, stories say. Dig out an old picture of the Biscayne (Chevrolet's 1955 dream car) and you'll get a clue to its over-all styling. It will have windows that roll up and a removable hardtop.

With it, Chevrolet hopes to deflate some of the Thunderbird's amazing sales: 16,155 sold in 1955. The Ford division plans to sell 20,000 in 1956. Chevrolet plans to get some of that business.

Metal Sculpturing

Any talk of metal sculpturing must include reference to the 1956 Studebaker (shown in this issue on page 93). Look at the way the metal is formed around the wheel openings. Then look at the sculptured treatment of the trunk lid on the Hawk. You will see more of this in the years to come.

The Studebaker idea on the trunk lid opens a whole new area for stylists to work in. Trunk lids of tomorrow's cars may be as distinctive as grilles are today. You'll be able to spot the make from the rear as quickly as from the front—and not by tail-lights alone as you do today.

Tomorrow's cars may also have textured roofs. They will be low enough so you'll be looking down on them. That means the roof must have character—and metal sculpturing is the way to do it cheaply and effectively.

Dealers' Nameplates

At least one company is putting on a campaign to get dealers to stop plastering advertisements on the back end of every car they sell.

Stylists work hours over the precise shape of a trunk latch, or the exact script of the car's trademark. Then the dealer bolts on an entirely different and often clashing chrome sign giving his name and address. Some even apply colored transfers that list everything about the dealer except his credit rating.

Stylists object. And with reason. After all, the most continuously viewed portion of a car is the back end. The front grille whizzes past in a split second. You look

Detroit Listening Post



By Leo Donovan

at the rear end for minutes as you follow another car in traffic.

Station Wagons

All companies are awakening to the fast-growing station-wagon field. With almost 20 percent of the country living in the suburbs, and most of that 20 percent involved in planting, remodeling and other chores that require hauling things, the market is expected to grow rather than shrink. (Incidentally, there are some engineers in the industry who think that the standard sedan of tomorrow will have four separate bucket seats and the six-passenger car will be a station-wagon type with three rows of two seats each.)

Many companies (especially the lower-price lines) have put station wagons in a separate series, distinct from the sedans.

The station wagon has been the big factor in the sales increase at American Motors. The Rambler Crosscountry wagon accounted for half the Rambler sales in 1955. So American Motors spends lots of time thinking about the wagon market.

For 1956, the Rambler wagon boasts a full six-foot length of interior space behind the front seat (with the rear seat folded into the floor, that is). The new wagon also has a rear window that cranks down into the tailgate, doing away with the upper transomlike half of the rear door.

Rambler announced a new body style in advance of the rest of its line: A four-door hardtop-type station wagon without posts between the doors. It will not be available until January, about a month after the rest of the Rambler line is in the showrooms. The reason for the premature announcement is that President George Romney of American Motors heard that another company was going to bring out the same kind of body style before his "surprise package" could be unveiled. Wanting to be first, Romney authorized the advance release. Nobody would say what the other company was, but it could be Chevrolet or Pontiac—you may know by the time you read this.

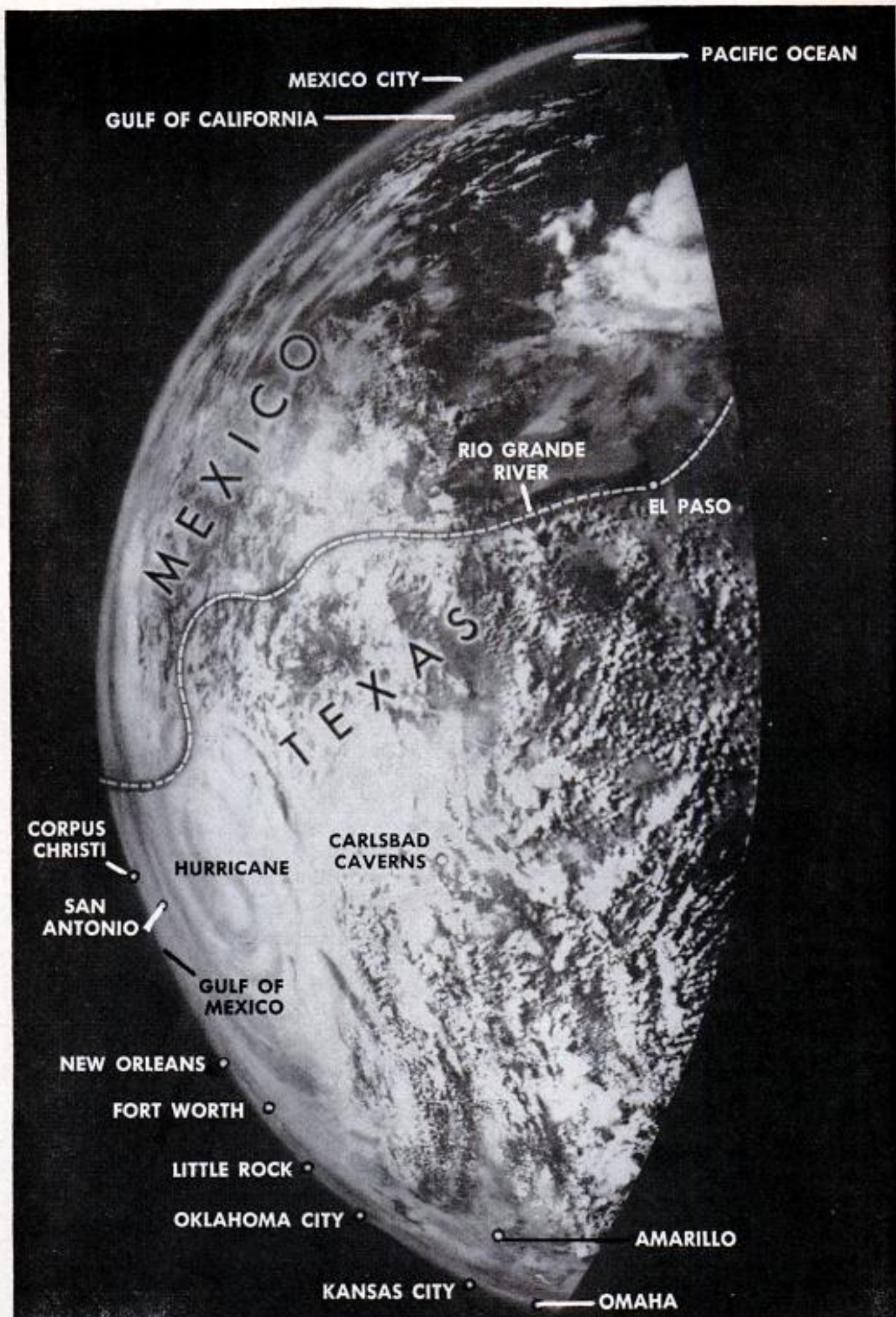

MEXICO CITY —
GULF OF CALIFORNIA —

PACIFIC OCEAN

MEXICO

TEXAS

RIO GRANDE RIVER

EL PASO

CORPUS CHRISTI

HURRICANE

CARLSBAD CAVERNS

SAN ANTONIO

GULF OF MEXICO

NEW ORLEANS

FORT WORTH

LITTLE ROCK

OKLAHOMA CITY

KANSAS CITY

AMARILLO

OMAHA

Rocket-Eye View From 100 Miles Up

◊ PEERING DOWN on the earth from 100 miles out in space, a camera in an Aerobee rocket glanced over 1,225,000 square miles of the earth's surface, and brought back a record of what it saw. Then scientists at the Naval Research Laboratory in Washington, D. C., sat down to piece together a giant jigsaw puzzle, consisting of 310 prints from the 16-millimeter colored motion-picture film taken from the rocket. When the puzzle was finished, they had a composite photograph covering the largest area of the earth ever photographed from one spot at one time. The horizon in the photo extends about 2800 miles, from Omaha, Neb., to the lower Gulf of California, in Mexico. The whole state of Texas and parts of nine others appear in the photo. Also in the picture, is a hurricane, the first ever to have its whole picture taken. It was centered over Del Rio, Tex., and measured about 1000 miles in diameter. Strangely enough, on this date, October 5, 1954, the surface winds in this area were easterly and of normal velocity, in spite of the high-powered storm sitting overhead. The Aerobee, a two-stage rocket 22 feet long and 15 inches in diameter, was fired from the White Sands Proving Grounds, Las Cruces, N. Mex. Since 1948, this rocket has been used by the Naval Research Laboratory in its upper-atmosphere research program. ★ ★ ★



Nursery Cars on Swedish Railroads

Babies are about the same the world over, but the practical-minded Swedes are apparently the first to try solving the problems of mothers who take their babies on train trips. Swedish railways provide separate cars for mothers traveling with small children. Compartments in the cars are fitted with racks, similar to luggage racks, which are actually beds for babies. The racks can be shut off with curtains if desired. The compartments also contain lavatories and diaper-changing tables. A mother pays her regular fare; there's no charge for any child under two. The mothers are enthusiastic—and so are all the other passengers!

25-Ton French Tractor Carries 100-Ton Payload

Recently tested by the French army at the Camp de Satory proving grounds, the Berliet T-12 semitrailer tractor is a gasoline-powered behemoth with a 12-cylinder 450-horsepower engine. The tractor weighs 25 tons and can carry a useful load of 100 tons on high-speed, long-distance hauls. Power from the engine is transmitted through special differentials to eight of the wheels. It is designed to operate under moderately difficult field conditions.



OWNERS REPORT:

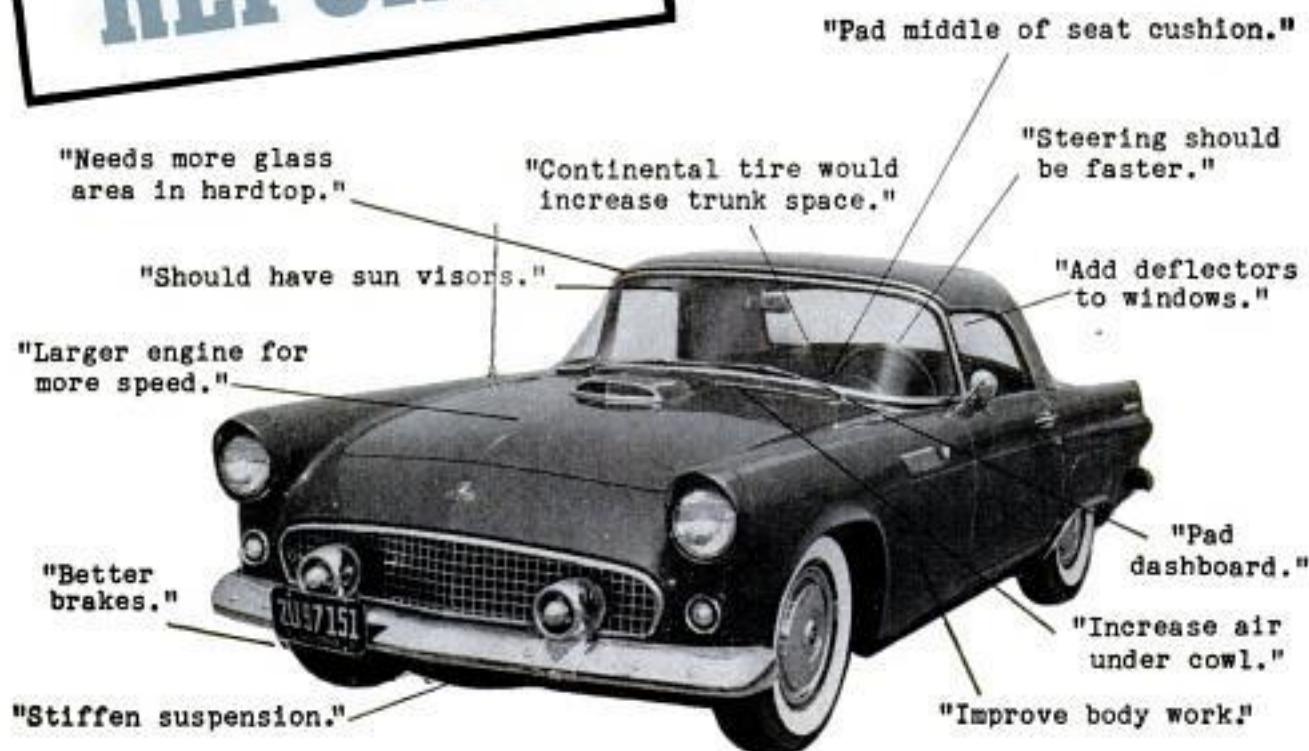

Owners of the 1955 Thunderbird say they want these changes made in their cars

And these are the changes Ford made for 1956:

'55 Thunderbird Owners Like Performance And the '56 T-Bird Will Provide Even More

By Thunderbird Owners

DO AUTOMOBILE companies react to the complaints of owners? If our Thunderbird Owners' Report is any indication, they certainly do. Ford reacted—but quick!

We asked 1000 owners of the 1955 Thunderbird about their cars and tabulated the complaints. We compared this list with the changes made in the 1956 Bird. The similarity is amazing as you will see. This evidence proves the accuracy of the Owners-Report technique of reporting on automobiles.

Here are the complaints of the 1955 owners and the action taken by Ford to eliminate them in 1956:

"Poor visibilty with top on. Blind spot

over left shoulder. Should have more glass area in hardtop."—California manager.

In the 1956 Thunderbird, the plastic hardtop is available with two portholes that eliminate the blind spot the California owner complains about. The soft top also has more rear-window area in the new Bird.

"I have been disappointed in the top speed of 110 miles per hour. Car should have a larger engine for more speed."—Illinois chemist.

Ford has put a 225-horsepower engine in its Fordomatic-equipped 1956 Thunderbird. The displacement is 312 cubic inches compared to 292 cubic inches of the 1955 car.

"Continental tire kit should be standard on car to give more luggage space."—California housewife.

This has been done in 1956. Luggage space has also been increased by changing the position of the dust shield behind the seat. Now the Thunderbird trunk will hold enough suitcases for a long trip plus a set of golf clubs.

"There are three of us in the family and the hard part in the middle of the seat is uncomfortable."—Indiana distillery owner.

By redesigning the cushion, Ford has softened the center portion of the seat that is directly over the driveshaft. The seat has also been made level so it is more comfortable for three persons.

"Would like wind deflectors on doors to keep wind out."—Missouri merchant.

This change has been made in the 1956 Thunderbird. Small wings have been added outside the regular window.

"Increase air intake under the cowl."—Pennsylvania attorney.

On each side of the 1956 Thunderbird

there is a push-out vent that scoops plenty of air into the passenger compartment. Especially on automatic transmission models, the 1955 Thunderbird was very hot inside with the hardtop in position.

"Convertible rear window should have a zipper so it could be opened."—West Virginia sales-promotion man.

The new Thunderbird has a zip-out rear window in its soft top.

"Soft top should be a one-man job. It takes at least two now. It is impossible to get the top behind the seat unless you have 30 minutes to do it. It takes 13 operations to get it down and behind the seat so we just leave it resting on the body."—New York businessman.

Ford has not made the top automatic, despite the pleas of many owners, but the operation has been improved. Ford says one man can operate it without too much trouble now. This has been done by the addition of a link in the main support on each side.

"Develop a practical sun visor for the

ADDED PORTHOLES TO HARDTOP

SUN VISORS ARE INSTALLED

PADDED DASHBOARD IS OPTIONAL

1956 Thunderbird

BACK WINDOW OF CONVERTIBLE ZIPS OPEN CONVERTIBLE TOP CAN BE PUT UP BY ONE MAN

WINDOWS HAVE SMALL VENT PANES

CENTER PORTION OF SEAT IS NOW PADDED

INSTALLED A BIGGER ENGINE

CHANGED TRUNK TO INCREASE LUGGAGE ROOM

SCOOPS ON SIDES COOL PASSENGER COMPARTMENT

CONTINENTAL TIRE IS STANDARD

SPECIFICATIONS—1956 THUNDERBIRD

Wheelbase	102 inches
Over-all length	185 inches
Over-all width	70.2 inches
Over-all height	52 inches
Over-all steering ratio	23.0:1

ENGINE

Fordomatic models	
Bore and stroke	3.80 x 3.44
Displacement	312 cubic inches
Compression	9.0:1
Horsepower	225 at 4600
Torque	324 at 2600

Overdrive models	
Bore and stroke	3.80 x 3.44
Displacement	312 cubic inches
Compression	8.4:1
Horsepower	215 at 4600
Torque	317 at 2600

Handshift models	
Bore and stroke	3.75 x 3.30
Displacement	292 cubic inches
Compression	8.4:1
Horsepower	202 at 4600
Torque	289 at 2600

front windshield."—California engineer.

Interior sun visors have been added to the top of the windshield. In fact, these were added as a running change during the 1955 season.

"Two rear clamps for the hardtop are too hard to operate."—Wisconsin butcher.

The clamps are changed for easier operation but it is still an awkward arrangement at best.

"As long as they made the dashboard appear padded, why didn't they pad it?"—Utah moulder helper.

Buyers can get the padded dashboard as an extra-cost option in 1956. It is part of the safety package.

"Safety belts should be standard."—Indiana technician.

For 1956, the Thunderbird has seat belts as an extra-cost option, also part of the safety package.

Best-Liked Features

But there is more to the Thunderbird story than complaints and changes. The 1955 owners had many wonderful things

to say about their "personal cars." All the following good points are retained on the 1956 models.

The feature mentioned most frequently is the power or performance of the car. Sixty-one percent of the owners listed that characteristic.

"I like the acceleration best. I get a buzz each time I tromp on the gas."—Texas electrician.

"Car runs good. Have never been passed when I didn't want to be and have been tried by everything from a Cadillac on down."—Colorado fireman.

"I have made about 22 round trips between Las Vegas and my home in California averaging about 100 miles per hour. I have never been as comfortable at high speed in any other car. The Thunderbird is a good road car."—California electronics executive.

Second on the best-liked list is handling. There were 46 percent of the owners who mentioned this.

"Ease of handling. So easy to handle in traffic as well as on the road. Easy to park.

Thunderbird for 1956 retains its removable plastic roof. It takes two men to put it on or take it off. Optional this year are windows in the quarter panels. The locking clamps are improved on the 1956 models



Ford sold 16,155 Thunderbirds for 1955. Owners in the 36 states shown in color took part in our poll

Percentages from PM Poll of Thunderbird Owners

OVER-ALL RATING OF THE THUNDERBIRD

Excellent	70%	Fair	4%
Good	25%	Poor	1%

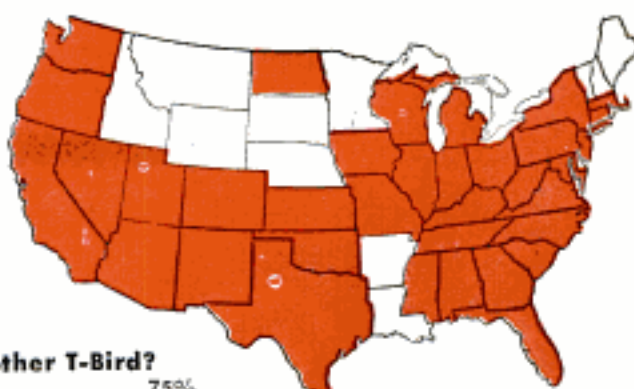

Dealer service

Excellent	36%
Good	26%
Fair	21%
Poor	17%

Owned other sports car?

Have owned	22%
Have not	78%

What was other car?

Jaguar	10%
MG	9%
Other	3%

Own another car now?

Yes	71%
No	29%

What is the other car?

Ford	22%
Mercury or Lincoln	12%
Other make	37%

Would buy another T-Bird?

Yes	75%
Might	19%
No	6%

What should be changed?

Soft-top design	20%
Brakes	12%
Suspension	9%
Interior ventilation	8%
Seat design	8%
Dash gauges	7%
Trunk space	6%
More horsepower	6%
Needs no changes at all	18%

MOST-FREQUENT COMPLAINTS

Soft-top operation	29%
Door fit	18%
Window operation	15%

Poor body work	15%
Rattles	13%
Interior ventilation	11%
Windshield distortion	9%
Brakes inadequate	8%
Hard-top operation	7%
No complaints at all	15%

BEST-LIKED FEATURES

Power, performance	61%
Handling	46%
Styling	45%
Comfort	20%
Roadability	19%
Compact size	8%
Distinctiveness	3%

I think I will never return to a big car."—California attorney.

"I like the way it handles. No car I have ever had has given me this feeling."—Oregon truck driver.

"A fine personal car for the whole family. Easy to drive for anyone. Especially good for women drivers. But does not compare with the Jaguar or Mercedes 300SL I own for driving at speed with safety."—Massachusetts owner.

Right behind handling came styling in the list of best-liked features with 45 percent praising it.

"The styling sold me. No ugly grille or chrome ornamentation. No juke-box look. Also I'm tired of driving a six-passenger bus when I am usually alone or have only one passenger."—Indiana attorney.

"Beautiful styling. Has sports-car look

with the continental flavor."—Michigan technician.

"Styling has dignity and respectability plus speed and acceleration. Doesn't resemble a crazy teen-ager's dream."—Maryland retired research scientist.

Other Best-Liked Features

After these three best-liked features come comfort, roadability and compact size, in that order.

"Comfortable on long trips. Two tops make it a real all-weather car."—Texas student.

"I have driven it for a straight 30 hours and found it very comfortable."—Florida Air Force pilot.

"I like its roadability—the way it handles on the mountain roads we have here."

(Continued to page 266)

ROAD-TEST DATA

At press time, no production model of the 1956 Thunderbird was available for road-test purposes. *Popular Mechanics* does not road-test engineering prototypes of any car because such prototypes are not necessarily typical of the cars the public is able to buy. Floyd Clymer did road-test the 1955 Thunderbird and here are the results:

¼ mile from zero	- - - - -	14.7 seconds
½ mile from zero	- - - - -	25.9 seconds
0 to 30 miles per hour	- - - - -	4.1 seconds
0 to 60 miles per hour	- - - - -	11.7 seconds
Top speed	- - - - -	112 miles per hour
Over-all gasoline economy	- - - - -	18.2 miles per gallon

Road-test data on a production version of the 1956 Thunderbird will be published as soon as possible.



Completely streamlined, the low, sleek body is designed and built by one of Italy's most famous body shops

Volkswagen Gets a Sport-Coupe Model

LOW AND STREAMLINED, a two-passenger sport coupe is available on a Volkswagen chassis. The car, called the Karmann-Ghia-Coupe, has standard VW chassis components with only those minor modifications made necessary by the drastic streamlining. Designed to seat two persons comfortably on adjustable bucket seats, the car does have two additional jump seats in the rear suitable for children or for adults on short trips only. Normally the area behind the front seats is used for

luggage. The engine is the standard four-cylinder air-cooled power plant that has made the VW famous for reliability and economy. It is in the rear, of course, and puts out 36 horsepower. Price of the car is about \$2400.

SPECIFICATIONS

Wheelbase	94.5 inches
Over-all length	163 inches
Over-all width	64.2 inches
Over-all height	52.2 inches
Weight	1782 pounds
Top speed	72 miles per hour
Average fuel consumption	32 miles per gallon

In the rear is the VW air-cooled four-cylinder engine. The battery is mounted in the engine compartment

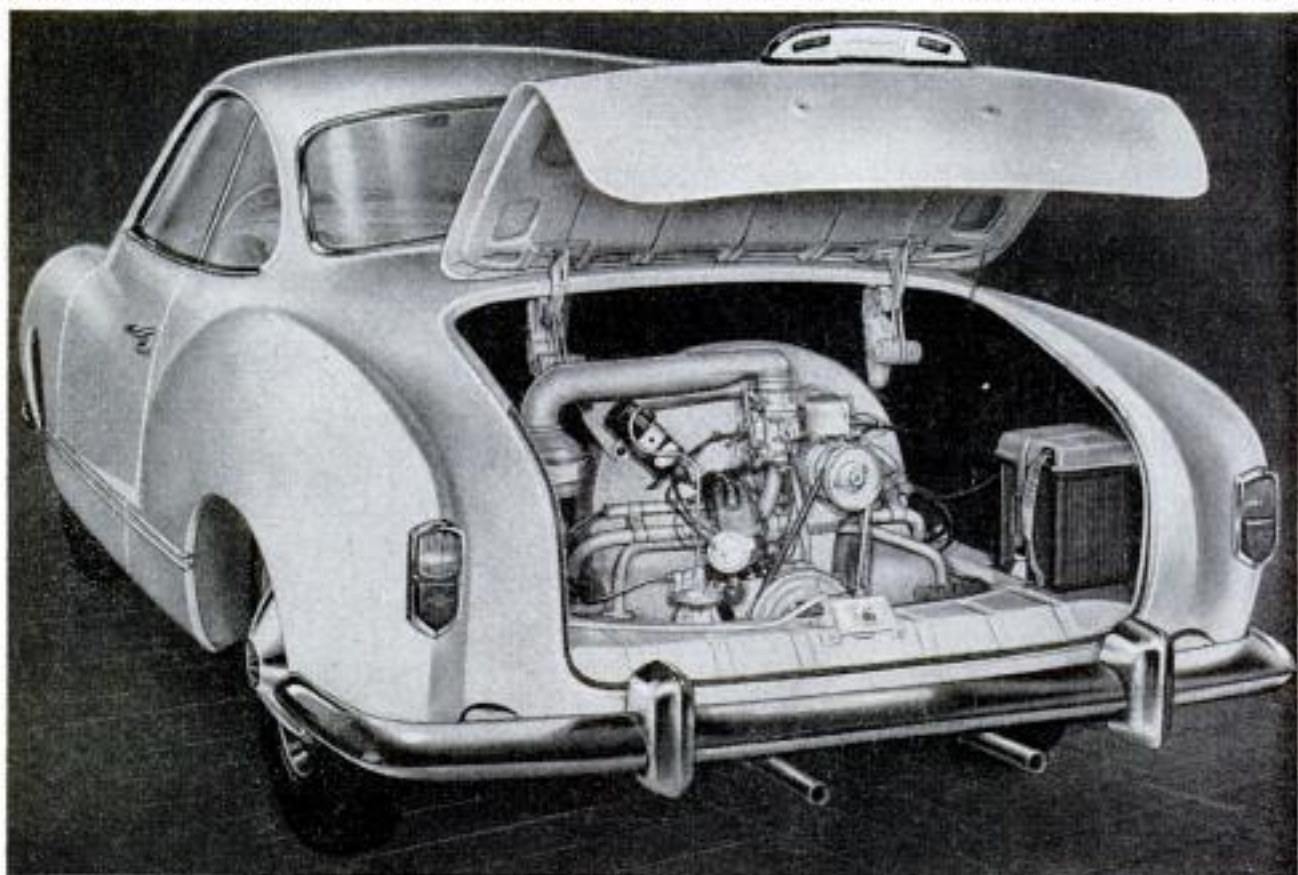



"Auto Raft" Does 12 Miles Per Hour on Water

Using two Army rubber bridge pontoons, Dr. Sverre Quisling of Madison, Wis., has constructed an "autoraft" which he hopes might be useful in time of war. The raft is the result of experiments to find an easy method for military vehicles to cross water bodies. The raft consists of three steel beams between the pontoons, on which

the car is placed. Ordinary tire chains, to which U-shaped irons filled with wood blocks have been welded, give the back wheels of the car the effect of paddle wheels. A rudder, connected by cables to the front-wheels, steers the craft. Doctor Quisling claims a speed of 12 miles per hour and feels it may have civilian uses.

Danes Begin Mining Operations 140 Miles North of Arctic Circle

Lead and zinc will soon be mined at a point 140 miles north of the Arctic Circle in East Greenland, where the average temperature is 16 degrees and snow 15 feet deep is common. A Danish firm has built a town, Mesters Vig, near the mine,

and expects to begin production next spring. Rooms will be blasted out of the side of the mountain to be mined, and separation machinery installed. Water for the separation process will be pumped to the mine through electrically heated pipes.



Plane Swallows Truck

It may look impossible, but an Air Force tank truck laden with jet fuel can actually be driven into the hold of a C-130 cargo plane and be taken aloft. The method speeds loading and unloading of fuel. After landing, the truck finishes its trip by road.



Outline of new dam is shown on picture taken of dam site before work began. Dam will be 2300 feet across top

GIGANTIC DAM IN THE ALPS WILL TAKE 18 YEARS TO BUILD

By G. H. Davis

HIGH in the stony mountains of the Swiss Alps, thousands of men toil day and night during the summer months to build a gigantic dam to supply hydroelectric power for Switzerland. Scores of miles of tunnels are being bored through the rock to supply the dam with glacial water.

The 922-foot dam will rise to a point 7750 feet above sea level, which means that it will be at a higher altitude than any large dam in Europe. When finished, it will give Switzerland enough electric power to make her independent of surrounding nations. Surplus electricity will be sold to France, which now must make up Switzerland's power deficiency during droughts.

G. H. Davis, noted English artist, was commissioned by *Popular Mechanics* to visit the site of Switzerland's unique high-altitude dam project and bring back a report. Here is his eyewitness account, in words and pictures.

Designed in 1947, the dam was begun in 1950 and is due for completion in 1968, after \$224,000,000 are expended. Over 7,550,000 cubic yards of concrete will have been poured into the completed dam, which will hold back a reservoir of 520,000,000 cubic yards of water.

Three power stations will be supplied with water by the system. The Fionnay station is being constructed beside a compensating basin a short distance from the new dam. An underground tunnel will carry water from the Fionnay reservoir through the mountains to the Rhone-Dixence power station on the River Rhone. Another tunnel will carry water from the dam to the Chandoline power station, which is

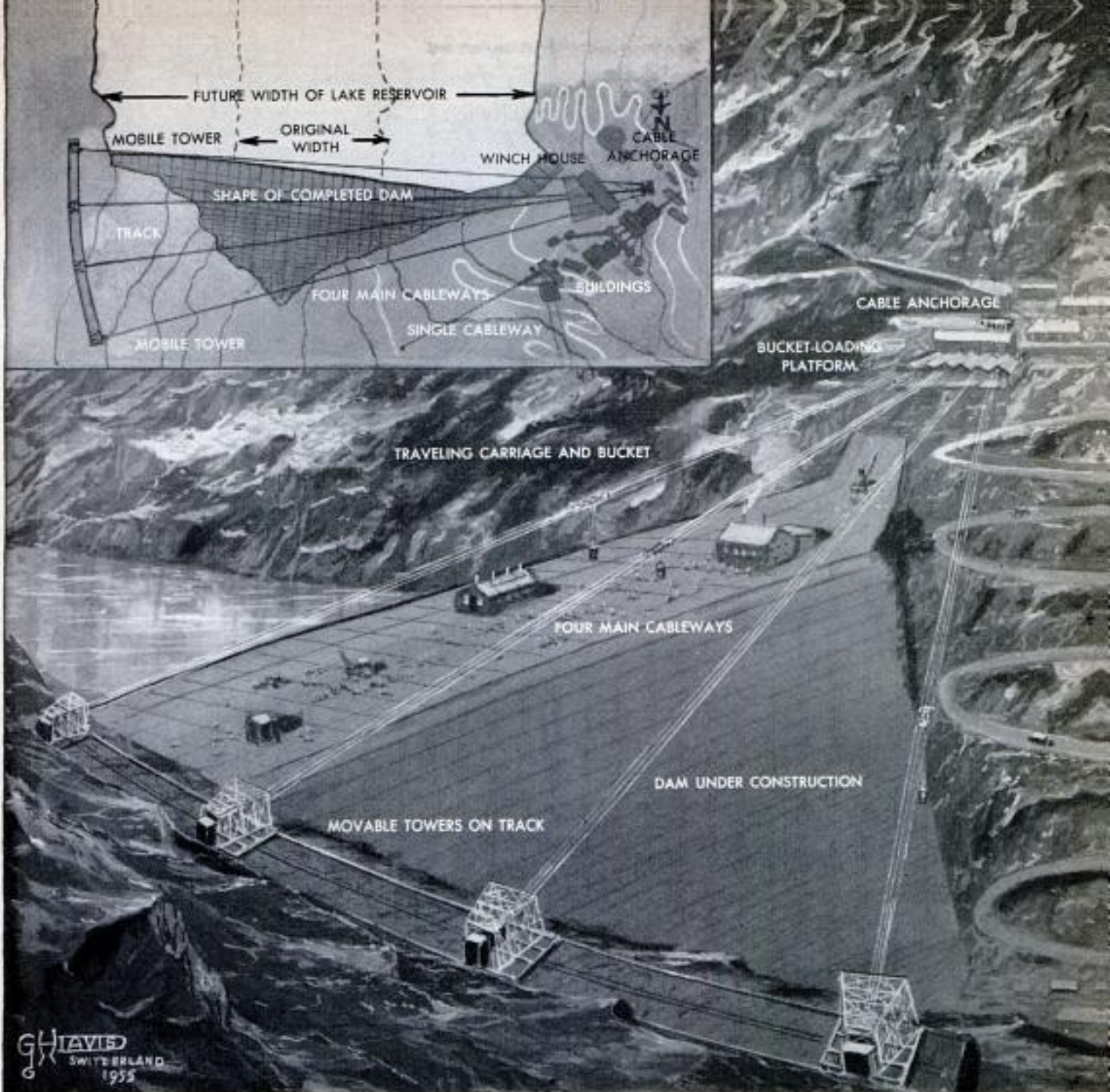

Materials and equipment for dam are carried by cableways anchored to mobile towers on a curving track

Concrete plant built on mountainside will furnish a total of 7,550,000 cubic yards of concrete to build dam

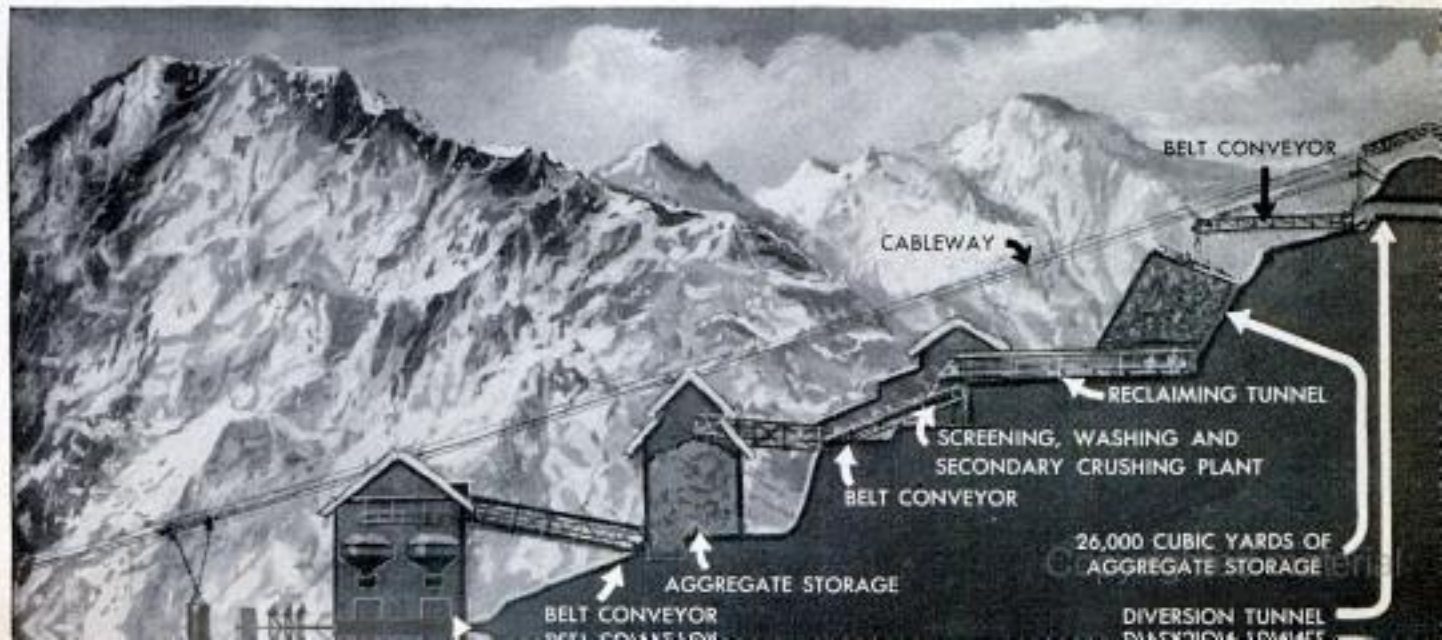

also located on the banks of the distant River Rhone.

Approximately 20 large and small glaciers will be tapped to supply the dam with water. During spring, summer and autumn, water from the melted surface of the glaciers will spill into the tunnels and rush in torrents through them to the reservoir.

Total length of the water tunnels will be 103 miles. The force of gravity will carry the water most of the way, but at certain points electric pumps will boost it over humps in the subterranean tunnels. The tunnels vary in size, but average 12 feet in diameter.

Last summer, approximately 2000 men working in two shifts (a day shift of 11 hours and a night shift of 10 hours) toiled on the dam. In the winter, six to eight feet of snow covers the area, but work goes on in the tunnels.

Gigantic tools, including much American equipment, have been brought up to the dam site on twisting supply roads cut into the side of the mountain. A small town has

Dam will be almost as tall as the Eiffel Tower. It will be 72 feet thick at top, 721 feet thick at base

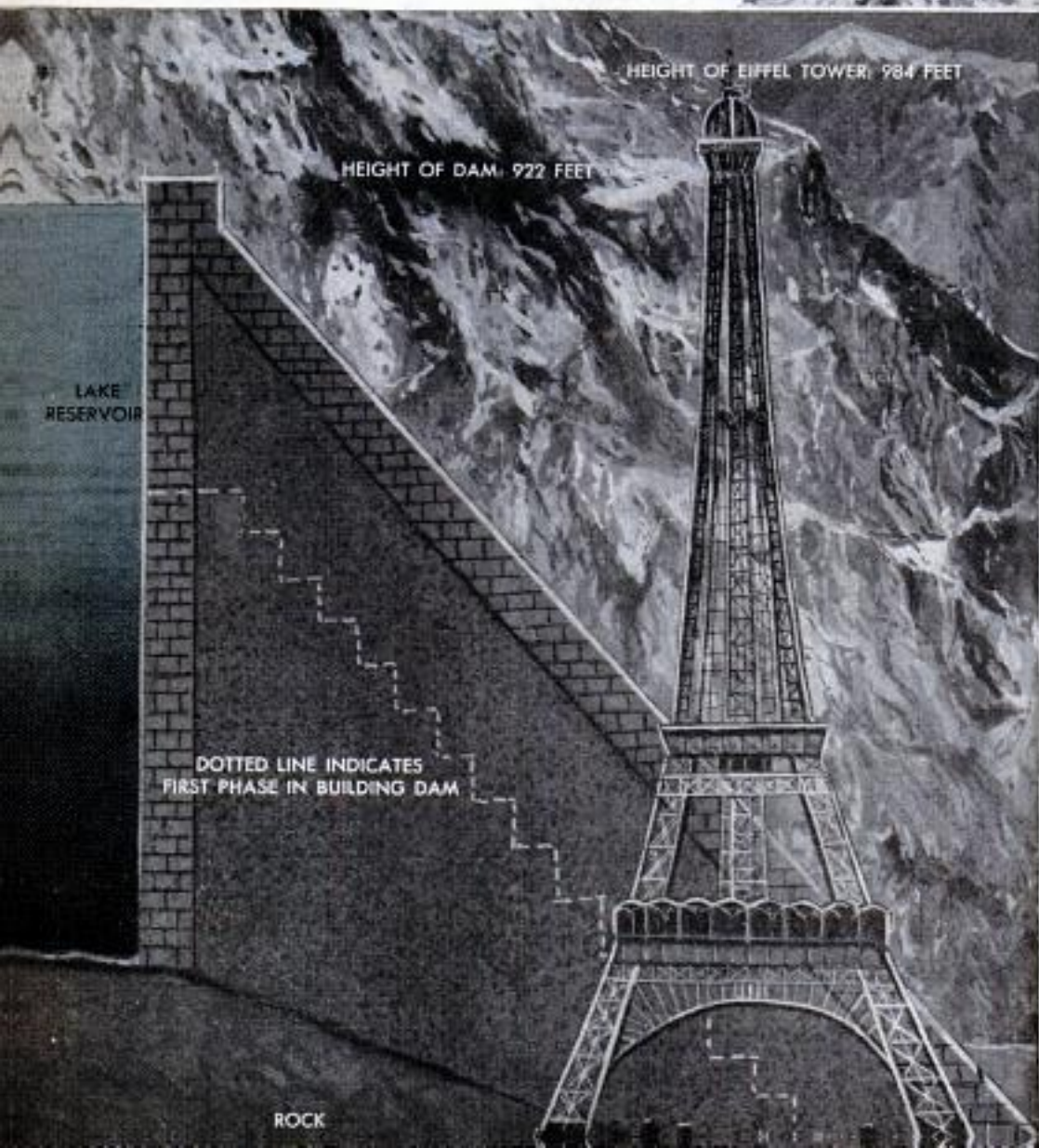



With assists from pumping stations, water from melting glaciers will flow through tunnels to dam reservoir

been built on the side of the mountain to house the construction workers.

Concrete for the dam is produced by a special plant constructed for the purpose. All the screen washing and secondary crushing of gravel is performed in the plant. Sheds protect the machinery and the conveyor belts that carry the material on its way. The finished concrete is loaded onto cable cars that swing out over the dam and

dump their loads into the forms below. Huge equipment, including giant bulldozers, can be carried by the cableways and lowered into position on the working area below. Each of the cableways, stretching the width of the chasm, spans a distance of 2900 feet. The carriages that move on the cables have a traveling speed of 17 feet per second.

On the opposite side of the valley from



Thousands of tons of material must be brought up the side of the mountain from valley on this twisting road

the concrete plant and equipment sheds are the unique traveling anchorages of the four main cableways. Four great lattice-steel towers on multiple-wheel trucks support the ends of the cables. The towers rest on a curving track that enables them to move from side to side. With this arrangement, the cables can be moved to cover any point of the dam, and materials and gear can be lowered to desired points in the working area.

The huge power house at Fionnay is being cut out of the solid rock of the mountain so that its front will project slightly over the sheer face of the mountainside.

Its spacious generator room houses six

generators. Controls and transformers are housed in other rooms, and an administration headquarters, auxiliary service installations, living quarters and workshops are housed in adjacent buildings.

The water falls through the outfall tunnels from the dam in three stages. Having passed through the gates in the dam, it passes controlling valves and pressure regulators and surge tanks before reaching the power station. There it drives the water turbines which generate the power. When finished, the gigantic dam will provide power to increase greatly the productive energy of small but extremely industrialized Switzerland. ★ ★ ★

Anticollision Light for Aircraft

Called a "relative-danger light," a new running light for airliners indicates the plane's course to approaching planes. It was developed by an airline pilot. The light actually consists of three lights in one unit. The front light flashes forward three times a second. The middle light flashes to the sides once a second and the

back light flashes astern once every three seconds. The pilot of an approaching plane can determine the position and course by the duration of the flash he sees. Instead of the conventional red light, the new navigational aid uses a blue-white xenon light, known to photographers as a stroboscopic light, which has great fog penetration.



This is southern Chile, in the Region of Lakes. Behind us, Osorno volcano dominates Lake Todos los Santos

Across **FOUR CONTINENTS** *on two cylinders*

*Reprinted "PM
Highlights"*

By Jacques Cornet

As told to Richard F. Dempewolf

SPUTTERING NOISILY, our battle-scarred, heroic beetle of a Citroen wheezed and shuddered over the cobbled square of Notre Dame de Paris and ground to a halt at the curb. A welcoming committee of one excited, gesticulating gendarme promptly greeted us with a ticket for parking in a restricted zone. But who cared? This was home—home after 367 days and 32,292 rugged miles of driving, the likes of which would put a bulldozer to the supreme test.

It was impossible now to believe. Our little 1100-lb., 9-horsepower vehicle, popping along on two cylinders, had teetered on dizzy mountain burro trails that had

Henri Lochon, left, and I smile happily after our return to Paris in May 1954. We had traveled a total of 32,292 miles on four continents in 367 days



DECEMBER 1955

Copyrighted 113aterial



The roads in Colombia were little better than wide mud beds. We were stuck several times a day, and usually had to dismantle the car before pulling it out

never seen a tire. Stripped to little more than chassis and body frame, it had jounced over rock outcrops to cross a roadless Andean peak 17,000 feet in the Bolivian sky. It had put-putted faithfully across the trackless, desolate wastes of Patagonia to the southernmost tip of the Americas. Tired engine throbbing with heat, it had carried us 1000 miles over the burning Sahara Desert, where a compass showed the route. In fact, thinking back, it seems a remarkable number of those 32,292 miles were roadless. Life was a nightmare of plunging through swamps and creek beds, swishing through sand on beaches at low tide to circumvent impassable mountains, bounding cross-country with only the stars for road signs — and heaven knew what obstacles ahead.

Naturally, all this was something more than just a carefree summer motor tour. For four years, my friend Henri Lochon had nursed a burning desire to drive a car down the Pan American Highway—from





The landscape of the Atacama Desert in Chile makes one think he is driving on the moon. Here we fix a flat

Mexico clear to Tierra del Fuego, last point of land at the foot of South America. He talked about it ceaselessly on the holiday motor trips we took around Europe—to the Austrian Alps for skiing, Cannes for spear fishing, to Italy, Spain and Corsica just for sight-seeing. Motoring was a hobby we enjoyed and shared together at every opportunity. I agreed that South America was a fine idea, but my desire was to tour North America.

"Why not do both?" Henri said one day. "Pool our money, buy a new car and plan a year's expedition across all of the Americas. We could make a tour probably no car has ever covered."

The more we thought about it, the more exciting it seemed. Why not? We were healthy and young (he 29, I 27). We pored over maps. We would go by ship to Quebec, drive down through Canada to New York and Washington, head west across the United States via Chicago and Salt Lake City to San Francisco. From there

it would really begin—down to Los Angeles, then to El Paso to pick up the Pan American and drive effortlessly (we thought) through Central and South America to the bottom of the world. Then, up the east coast to Rio and sail home. What a tour!

The next months were a maelstrom of planning and preparation, much of it undertaken by Henri, since this was his "baby." Because of its small size, light weight, and the fact it can be easily dismantled to go almost anywhere, the Citroën seemed like a good car for our journey. It has a simple two-cylinder air-cooled engine and a rugged four-speed transmission. It holds four passengers. With Henri and me in front, the entire rear could be used for our gear, food, and reserve water and fuel. Another unique feature is that the doors and side panels of this little car are removable simply by slipping them out of slots. For driving through mud, or up precipitous slopes, such a reduction in weight

Left, the only gas station for 1000 miles in Patagonia. Right, sometimes we had to pave our own roads





In Nicaragua we discovered that mulepower was better than horsepower for pulling a car out of heavy mud

can mean the difference between going someplace or turning around in defeat. This feature was to save our expedition many times before we were through. The car was standard except for one modification in the suspension system. The wheels were mounted on movable arms, tied together by a system of spring rods similar to torsion bars. With the rear of the car weighted, rocking motion was thus controlled, resulting in a firm, flat ride and plenty of clearance.

We shopped for lightweight equipment, necessities only—nylon jackets and trousers, canvas shoes, light rubber sleeping bags and air mattresses, a small nylon tent, aluminum utensils, watertight aluminum cases for cameras, aluminum tanks to hold fuel and water. A tiny box held powdered milk, coffee, wheat and chocolate tablets, vitamin pills and some canned foods. With those few things and the two of us, the Citroën was bulging.

At 3 p.m. on May 8, 1953, our compact expedition roared bravely out of the plaza in front of Notre Dame, while dozens of friends cheered and waved us off. It was a year and two days before we saw them again. In no time, we were weaving through jumbled traffic in the waterfront streets of Le Havre. We watched from the pier as a deck crane lifted our car in a sling and lowered her through a yawning hatch into the hold of the British ship *Scythia*. We didn't see it again until the *Scythia* sailed up the St. Lawrence River and deposited us at Quebec. From that ancient walled city, on May 20, 1953, our great adventure on wheels really began.

The first leg, on good Canadian and United States roads, whizzed by without mishap. Our two-cylinder bug "sang" up the St. Lawrence valley, through Montreal, Niagara Falls, New York and Washington. Along the way we began to hear rumors that we might not have clear sailing through Central and South America. And, at Pan American Union headquarters in Washington, the rumors were confirmed. "There is no Pan American highway linking the Americas," the man told us.

Good blacktop highway spears through Mexico, we learned—but at the Guatemalan border the road would peter out to muddy cart ruts, cattle trails and a jagged mountain wilderness for an impassable 25 miles. After that, we might make it along poorly graded one-way paths hanging on mountainsides to Guatemala City, and over fair roads in El Salvador. But in Costa Rica a good highway that soars to a pass 11,000 feet high, from which one would see both oceans, suddenly dead-ends against a mountain and doesn't pick up again until 150 miles later in Panama.

"Worst of all," said our informer, "is a 250-mile gap in the steaming tropical rain forest of Darien, south of Panama, where hostile Indians inhabit jungles and swamps that make the Everglades look like a duck marsh. This part has never even been surveyed for roadway. In southern Ecuador another nonexistent section separates Riobamba and Macara, and your car will have to be carried by plane or train."

What about all those rugged fellows we'd heard about who drove jeeps and "house trucks" from Alaska to Argentina and



The Citroën was not designed to be amphibious but it proved to be just that. This is a river in Ecuador

wrote articles? Our friend grinned. "No one has driven from Alaska to Argentina—or will in our lifetime, probably."

Most car drivers, we discovered, resorted to ships around the Darien jungle—like Leonidas Borges de Oliveira who claimed to have driven a Model-T Ford from Rio to New York. Borges and two friends built 116 bridges and three rafts during their nine-year trip across the Mato Grosso. At each bridge, the Model-T was dismantled, carried across, and rebuilt on the other side!

With this gruesome news, we headed for the West Coast via Detroit, Chicago and Salt Lake City, determined to try our luck anyway.

Through San Francisco, Los Angeles and El Paso we purred along as planned. The sunlit landscapes of Mexico whirled past in a panoramic kaleidoscope of towering mountains and fields, huts and mansions. Colorful Indians and drab peasants trudged the roadside, leading dejected little burros buried under prodigious loads. We ducked and dodged mad-cap Mexico City taxi drivers whose least concern is another car or a pedestrian. Still we zoomed southward with a problem—through Puebla, Mitla and Oaxaca, where we stopped long enough to see the magnificent Zapotec temples that had

been destroyed by the Spanish conquistadores, and to tighten up our steed, check her tires, fuel and engine performance for what lay ahead.

At Tehuantepec we ran out of hard-surface highway, and never saw any again until Oran, 20,000 miles later.

Now the fun began. Guatemalan border mountains loomed ahead. The road narrowed to a rutted, rocky ox path that rapidly dwindled to a foot trail through towering forests. A normal car could never have squeezed between the trunks of virgin jungle giants that crowded our Citroën. The first river was easily forded. Then came another—deeper. We pushed the Citroën across. Then another and another. Jungle closed in until we had to alternate

The date is Christmas Eve, 1953, and we have just disembarked from this landing craft of the Chilean marines after crossing Strait of Magellan





In emergencies, we had to improvise. When the jack broke in the Atacama Desert we replaced it with stones

walking in front of the car with machete to clear a path, signaling the way to the driver. Advancing a few feet at a time we came to the edge of a rushing stream, and drove confidently into it. Almost instantly, the wet motor died. For hours we battled with rope, tackle and jacks, inching our dismantled car to the opposite shore while the glittering eyes of ugly five-foot iguanas peered at us from the foliage. Once across, lianas tangled around us. The car sank in soft earth. No amount of chopping or hauling would free it. Steaming heat descended like a fog, and the mosquitoes went to work on us. We were stuck. This was it. Henri threw up his hands. "Back to the Mexican National Railroad," he announced. "We aren't the first."

That night was spent in the jungle. Without emergency food and equipment it might have been worse. Next day, we stripped the car and pulled it by hand line some 10 miles to the tracks. Then another trip to pack in the rest of our gear. We waved down the first freight and piled aboard for the half-day train ride around the mountains into Guatemala.

Except for incredible 45-degree slopes that worked our little two-cylinder engine to fiery heat, requiring many cooling-off stops, the mountainous road to Guatemala City from the railhead was fairly good. It curled through spectacular canyons, past lush coffee plantations, Mayan ruins and the fabulous palace of Antigua where Spaniards once ruled all of Central America. After ignition and tire repairs at Guate-

mala City, we headed south again, good as new. And for hundreds of miles through El Salvador and Nicaragua, everything was great. We began to scoff at the dark tales we'd heard.

Then we saw the terrifying, jagged peaks that separate Nicaragua from Costa Rica. What's more, the rainy season was in full swing. As we progressed, the road became a sewer of mud—three feet deep in spots. We bogged down a dozen times, finally unloaded, jacked up the Citroen and put on chains while a knot of wet, bedraggled Indians gathered to watch and shake their heads. Not a man, they told us, had been down this road in four months. We must be crazy. For a while the chains helped. Then, thigh-deep in muck, we pushed, hauled and rocked from one mudhole to the next, advancing a few feet at a time. Wheels churned against nothing, the engine overheated, the heat was sickening. Finally, the little car thumped into a huge hole and gave up. It took six mules and as many drivers to pull us out of there—and we decided to take to the sea. We thumped and ground our way to the coast where we boarded a ship for the Panamanian border. From there to Panama City, the road was good. And when we learned on arrival that a French ship was about to depart for Buenaventura, Colombia, we gave up all thought of attempting the Darien jungle and just drove aboard.

Once cleared by customs, we lost no time getting out of Buenaventura. Though pitted and washed out, the road was passable. But



A water and oil break at the northern end of the Atacama Desert. South of here the vegetation disappeared

the creaking, rotten wooden bridges gave us many a qualm. Outside Cali, on the way to Bogota at night, one of these ancient contraptions finally did come apart under us. With a thundering crash the floor gave way and we crashed nose-first into the river bank, exploding both front tires, denting the wheels and snapping the axle. We had barely hauled the car up to the roadside when we heard shots and galloping horses from a nearby hill. Someone had heard us. We'd been warned not to travel at night. Guerillas lurking in these hills shot at anyone. Though famed for their remarkable inaccuracy with guns, stray shots had been known to graze people now and then. We doused the lights and waited. The first horseman shot past us, thundered right



Crossing the Rio Blanco at the equator, we had to disassemble car and reassemble it on the other bank

The mosaic pavements of Rio de Janeiro, Brazil, look wonderful after the thousands of miles of wilderness

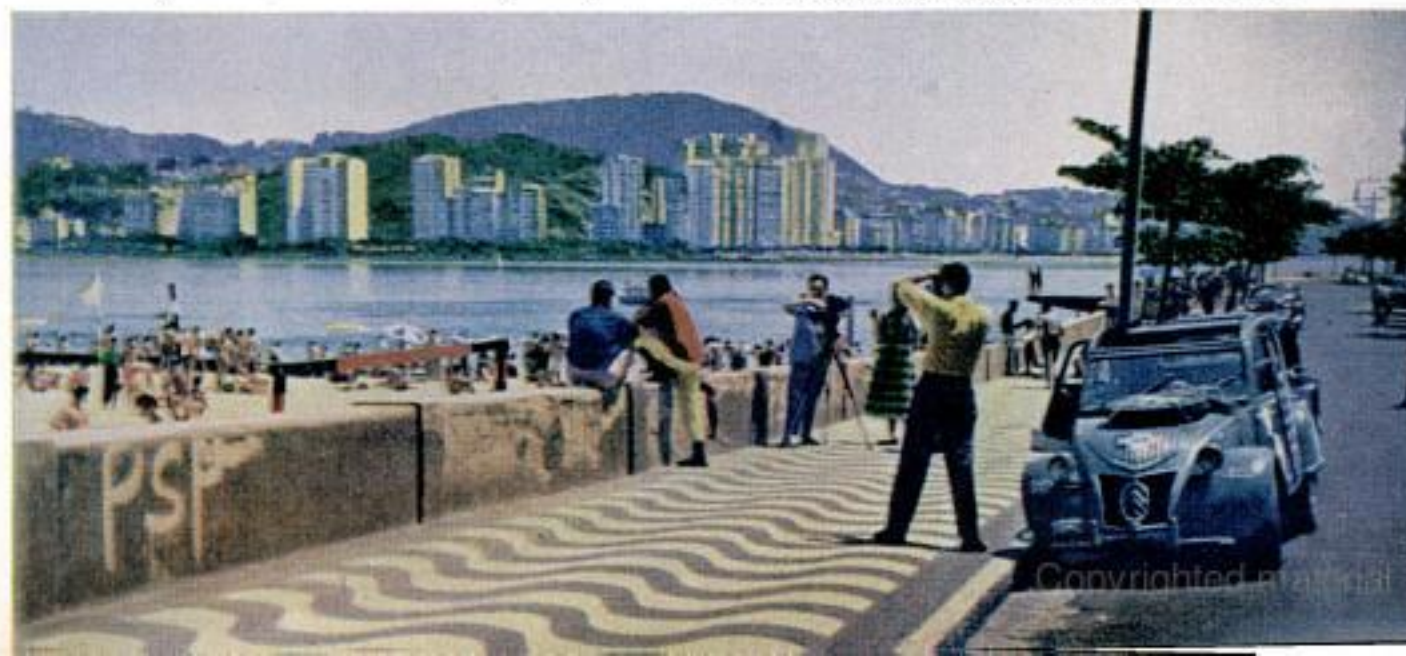

Copyrighted material



In Bolivia, the little 9-horsepower Citroen was stripped down for an altitude run. After a hazardous ride we reached a record-breaking 17,000 feet (5420 meters), certified by the Automobile Club of Bolivia



Above, Indian women living near Lake Titicaca in Bolivia wear melon hats as they do a festival dance. Below, nothing ever looked as good as Paris, the Champs Elysees and the Arc de Triomphe on our return



through the hole in the bridge, bashed himself against the far embankment and lay groaning. Those following reined in just in time to avoid the same fate, and rushed to his assistance with much chattering. The confusion played into our hands. Henri flipped the ignition, hit the starter and the faithful little car revved up in fine shape. Flat tires, bent wheels, broken axle and all, she went shuddering down the road at a great clip. Those horsemen never knew what took off from there.

We limped into Bogota next morning and cabled a friend in Paris to send new axle, tires and parts by air. They arrived in two days. We waited six more while the damage was repaired by an Indian "mechanic" who could not understand us, nor we him. This may be why he installed the axle upside down—who knows? The error came to light 5000 miles later when, grinding over a pass in the Chilean Andes, the upside-down axle, unable to stand the unusual stress imposed on it, snapped in two and left our front wheels knock-kneed.

Until that happened, there were other things to prevent lethargy. The Citroen bounded unhappily along the poorly graded mountain roads through Ecuador—frequently bottoming out on rocks jutting from the high-crowned, deeply rutted trails. By the time we hit the interminable straightaway to Lima, on the Peruvian coast, seven breaks in the chassis were held together precariously with baling wire. Every place we stopped, curious natives gathered to stare at the muddy, wobbly little car and its haggard occupants. Tropical

(Continued to page 236)

KEEPING UP WITH THE ATOM

LARGEST atomic power plant contracted for in the U. S. is the \$45,000,000 installation General Electric will build for Commonwealth Edison Company of Chicago. A scale model (right) of the dual-cycle boiling reactor plant, which will generate 180,000 kilowatts, was shown at the Geneva atomic conference and later taken to Chicago for public exhibition. Individual earphones connected with the model bring a description of the project to the listener in English, French, Spanish and Russian. The reactor will be built at the junction of the Kankakee and Des Plaines rivers, southwest of Chicago, with completion planned for 1960.



☆ ☆ ☆

To detect the minutest variations in thickness of aluminum, steel, plastic and other materials, Pratt & Whitney has devised a beta-ray gauge (below). Not only does the gauge sense changes in thickness or weight of the material as it comes from the rolling mill, but it makes a record at the same time, accurate within a few micro-inches. Radiation is within safe limits.

☆ ☆ ☆

Because radioactive phosphorus seems to accumulate more in cancerous tissue

than noncancerous, injections of the substance under the skin are proposed by a Japanese scientist for the diagnosis of cancer of the stomach. He reported that his method proved close to 100 percent correct in diagnoses.

☆ ☆ ☆

To produce a light that will burn without fail in storm or battle, independent of electric lines or batteries, the Navy is experimenting with phosphors which glow like luminous watch dials under bombardment of radioactive strontium 90. A lamp has been developed which emits light ten times as strong as bright moonlight.

☆ ☆ ☆

The United States Army is experimenting with radiation to prevent formation of mildew in shoes.

☆ ☆ ☆

Both Russian and American scientists are using carbon 14, the radioactive form of carbon, in botanical experiments seeking to pry loose the secret of photosynthesis.

☆ ☆ ☆

Venezuela plans a nuclear-research center at the Institute of Neurology and Brain Disease Study at the capital, Caracas.

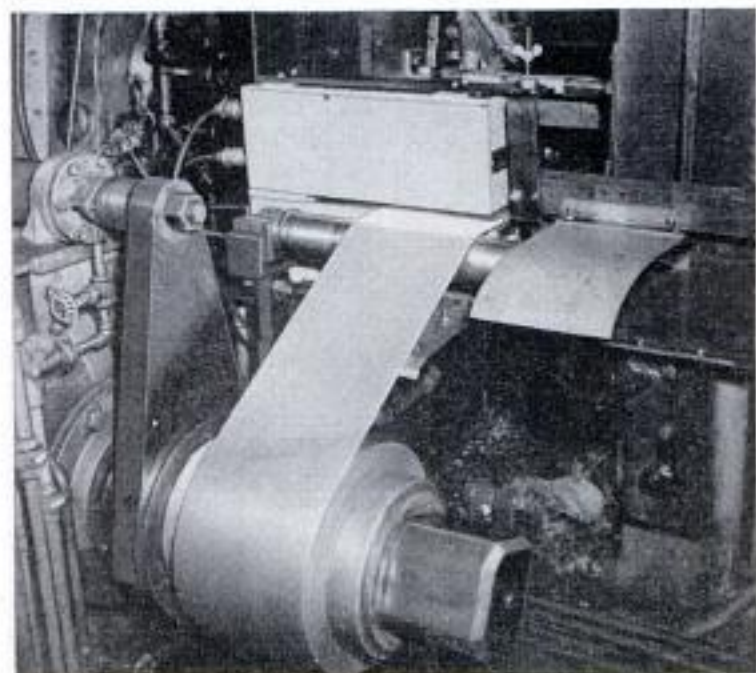

Assembly-Line Operation Speeds Jets Into Air



Jet planes are readied for their first flights more quickly by a modification of the automobile assembly line. The planes are placed on dollies that run on rails under open-shed roofs. At specified inter-

vals, a tractor pulls the whole line of dollies ahead one station to move the planes sideways for the next step in their final pre-flight check. When the planes reach the end of the line, they are ready to be flown.

German Trailer Is a Boat, Too

Hook a new German trailer on the back of your car and you have the ingredients for a sportsman's vacation. The multipurpose trailer has a canvas top with plastic windows and screening. It sleeps two persons. After serving as sleeping quarters, the trailer becomes a boat in the morning. It even has an air-cooled outboard motor on the back end (which probably should be called the stern) so you don't have to row. Over-all, it measures four by seven feet.

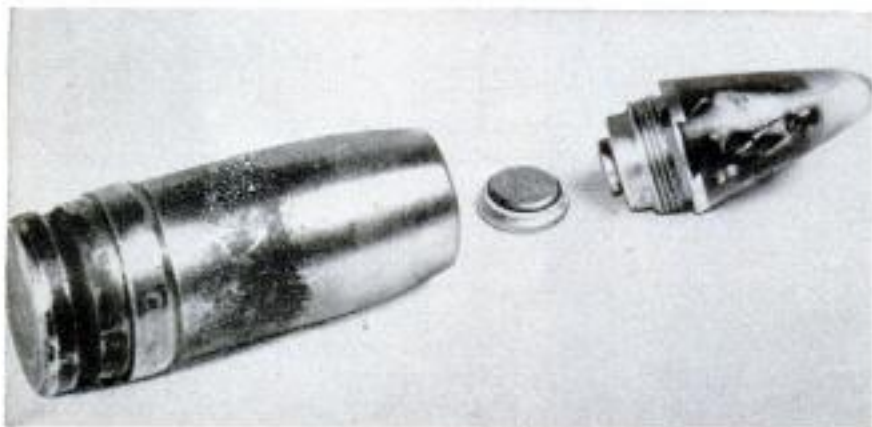

Shell Radios Data

Equipped with a miniature radio transmitter, a 20-mm. shell broadcasts information during its flight. The transmitter is sealed in the shell's plastic nose. It is powered by a mercury battery about the size of a dime. The transmitter broadcasts information on the shell's spin rate.

"Pogo" Lands In 50-Foot Area

Turboprop powered and capable of more than 500 miles per hour in level flight, the Convair XFY-1 "Pogo" uses only a 50-foot square of the big 8100-foot runway at Lindbergh Field (see arrow), San Diego, Calif., as an operating base. Like an elevator, it takes off straight up and lands straight down, settling gently onto four caster-like wheels set into the wing tips.



Off-Center Radar Picture Tube Gives Added Forward Vision

Ships can "see" 50 miles ahead and 30 miles behind with a special radar cathode-ray tube. General Electric, which developed it, calls it the "far-sighted, near-sighted radar indicator tube." Engineers built the first tube by taking a standard 17-inch TV picture tube and installing a different phosphor screen and electron gun. Then they bent the glass neck of the tube five degrees so that the electron gun would give an off-center indication on the screen. The tube, used on Navy cargo vessels, gives added forward vision without the addition of a larger tube and a more expensive radar set.

Lopsided radar picture tube was made that way to give 50-mile forward view, only 30-mile rear view. The former range was 40-mile radius

Now That the Clutch Pedal Is Extinct, Is the Brake Pedal Next?

Single-pedal control of the automobile is possible with an automatic braking system that operates from the accelerator pedal.

A metering control valve mounted inside the engine compartment applies the brakes, using manifold vacuum for power. An inch is added to the accelerator travel on the upper end of its movement. This extra inch provides a braking zone (the first three-quarter inch of travel) and a coasting zone (the next one-quarter inch). When the

driver releases the pedal all the way, the brakes are automatically applied. He can release it part way to let the car roll.

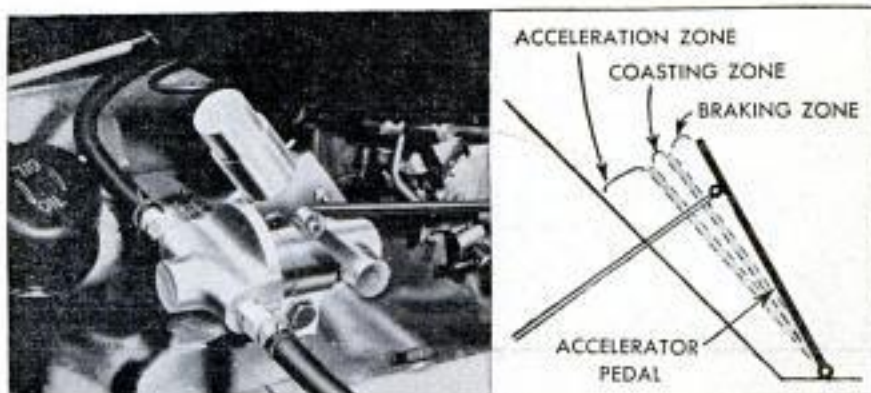

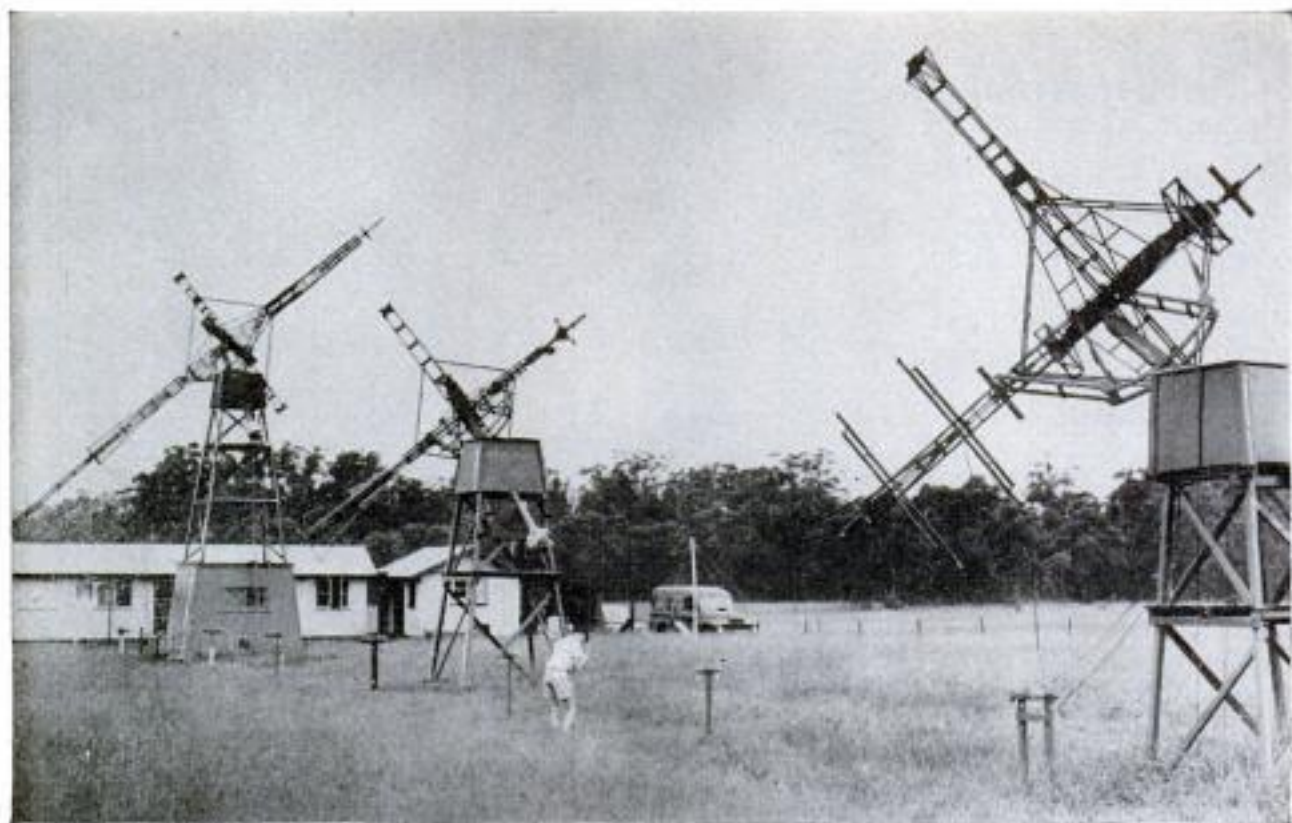

Rhombic aerials rotate to follow the sun and pick up bursts of intense radio waves that are emitted by it

RADIO "EYES" PEER INTO SPACE

WITH STRANGE-LOOKING instruments that catch radio waves from the stars, Australian scientists are probing the mysteries of the universe. So far they have identified 100 "radio stars"—highly localized sources of cosmic static.

Several of the instruments are used to study the radio waves that originate on the sun's surface. A "quiet" sun emits a

constant radio signal indicative of its temperature. But when great columns of fire shoot from its surface, the radio waves change and the earth experiences radio fadeouts and magnetic storms.

Near Sydney, three separate rhombic aerials rotate to follow the sun from sunrise to sunset. They are connected to radio receivers that tune rapidly from 40 to 240

Radio telescope is designed for studying distribution of neutral hydrogen in space. It is 36 feet across

Antennas arranged in a right angle beside reservoir pinpoint areas on sun where radio waves originate

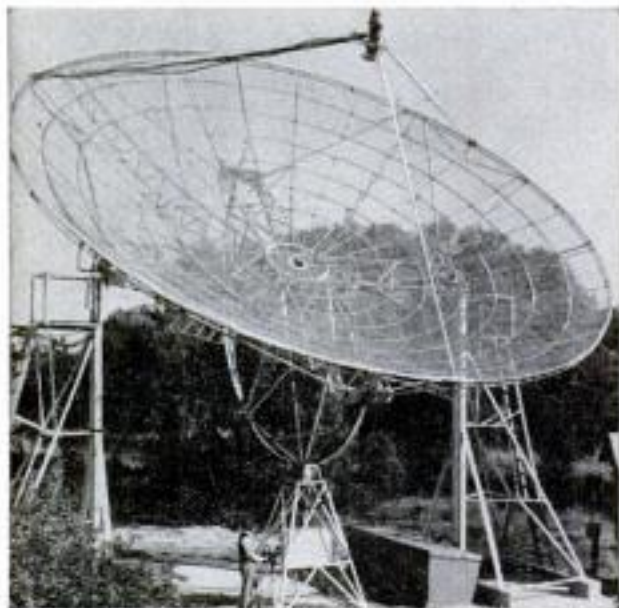



Radio telescope on cliff near entrance to Sydney Harbor is mounted in bowl hollowed out of the ground

megacycles each second, and record when and on what wavelength any of these transitory disturbances occur.

Another installation consists of 48 parabolic "dish" antennas arranged in two rows at right angles to each other. Operating in a very narrow range, the system can pinpoint any existing active radio areas on the sun.

The distribution of neutral hydrogen in space is investigated with a small radio telescope that has a bowl antenna 36 feet in diameter. Hydrogen gas is audible on its receiver as a steady humming note.

A larger radio telescope in use is 80 feet in diameter and is mounted in a bowl hollowed out of the ground on a cliff near the entrance to Sydney Harbor.

Australia's biggest radio telescope, however, is the "Southern Cross," named for its shape. Each of the 1500-foot arms of the cross contains hundreds of receiving elements which pick up the minute static of far-distant radio stars.

Eventually this equipment will be augmented by a giant saucer-shaped aerial 250 feet in diameter that will rotate between two towers 200 feet from the ground. This will allow the telescope to scan any section of sky. ★ ★ ★

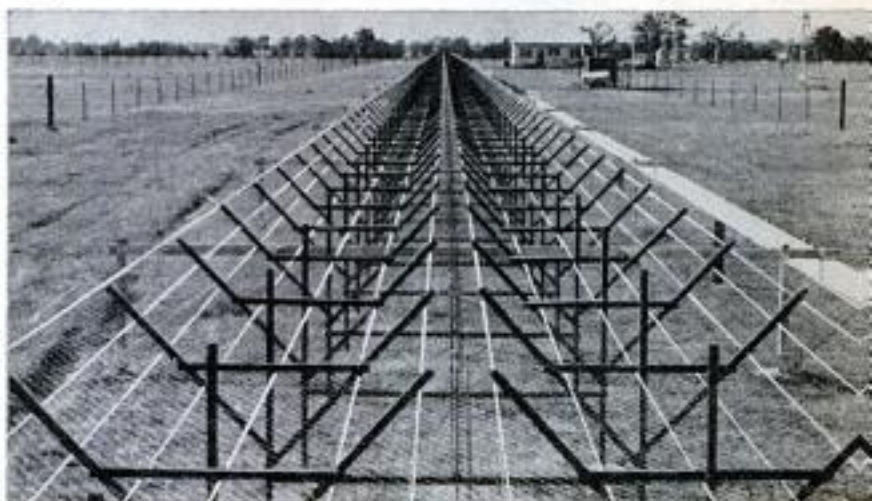

Receiving elements of "Southern Cross" radio telescope run parallel to its length. Wire netting is strung beneath them

Arms of Southern Cross, Australia's largest radio telescope, are each 1500 feet long. Operating frequency is 85 megacycles



What Kind of Camera for You?



BOX

The Kodak Duaflex IV, a reflex with a 75-mm fixed-focus lens, uses 620 roll film with 12 2¼ by 2¼ exposures. Flash is synchronized. There is double-exposure prevention. Speeds are instant and bulb

SHOPPING FOR A CAMERA? Even the seasoned amateur may be perplexed by the wide range of types, makes and prices. What are the features of the box type, roll, reflex, miniature, subminiature, press or stereo? Which will best serve your needs? The pages that follow are intended to help you choose. There are many other cameras of the same types available at wide price ranges; those shown here are typical.



Another fixed-focus reflex type is the Anscoflex II. It uses 620 roll film, has built-in flash synchronization and a double-meniscus lens. A sliding front panel protects the lens when not in use. Built in are a yellow filter and a close-up lens which fall into place at turn of dial



Simplest of the Kodak Brownies is the Holiday, a midget box camera that takes eight exposures, 1½ by 2½, on a roll of 127 film. It has Kodet f:15 lens in a shutter with a speed of about 1/50 second. The extra-large view finder is at eye level and of the optical type. It has a body release and neck strap. The flash attachment is optional, uses midget bulbs

BOX CAMERAS are the easiest to operate and the most inexpensive. (These range in price from \$2.95 to \$15.95.) You just aim and click the shutter. If the light is good, or if you have a flash attachment, you'll get an excellent snapshot. But you can't take fast action or close-ups. The simple, fixed-focus lens prohibits big, sharp enlargements. Box cameras have one speed (about 1/25 second) plus time exposure.

Most conventional in appearance, the Zeiss Tenger box camera is the only one which has more than one focusing zone. There are three self-changing supplementary lenses. It takes eight exposures, 2¼ by 3¼, on 120 roll film, has a Goerz Frontar f:9 lens, three apertures, waist-level view finders, built-in synchronization for flash, 1/30 second and time release



The Argus 75 has a reflex-type view finder with a folding metal hood, takes 12 2¼ by 2¼ exposures on 620 roll film, has a fixed-focus f:13 lens with instant and time settings, a body release, built-in synchronization and double-exposure-prevention device





Speeds from 1 to 1/500 are possible with the Super Ikonta A, which takes 16 exposures, $2\frac{1}{4}$ by $2\frac{1}{4}$, on 120 roll film. It has a coated 75-mm Zeiss Tessar f:3.5 lens in shutter, an eye-level finder, coupled range finder, depth-of-field guide, automatic shutter lock, body release



ROLL

The Kodak Chevron shoots at 1 to 1/800 second. It takes 12 exposures, $2\frac{1}{4}$ by $2\frac{1}{4}$, on 620 roll film, has a 78-mm. Kodak Synchro-Rapid 800 shutter, a depth-of-field scale, built-in synchronization for FM and electronic flash, coupled range finder, minimum focusing distance of $3\frac{1}{2}$ feet, lever-operated film stop and counter, parallax correction, eye-level view finder

A coupled range finder and view finder in one window comprise a feature of the Super Ikonta III. The folding camera takes 12 exposures, $2\frac{1}{4}$ by $2\frac{1}{4}$, on 120 roll film. A Synchro Compur shutter (MX) gives speeds of 1 to 1/500 second. You can also set the camera for bulb release. Accessories include close-up lenses, filters, lens shade, camera case

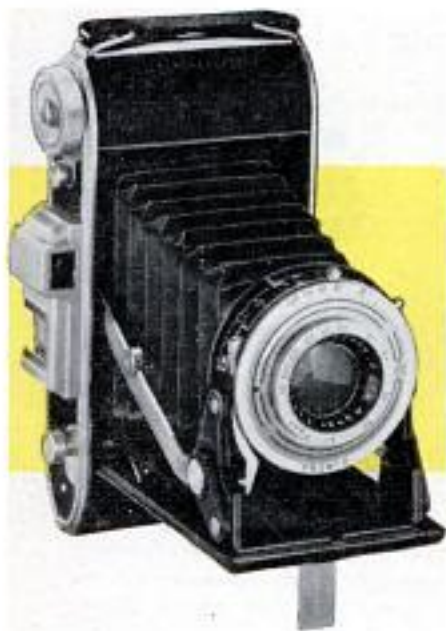

Eight exposures, $2\frac{1}{4}$ by $3\frac{1}{4}$, are shot on a roll of 120 film by the Ansco Viking f:4.5. It has a coated f:4.5 Agfa Agnar lens, Pronto shutter, speeds 1/25 to 1/200 and bulb, eye-level view finder, built-in synchronization, built-in timer, manual focusing and a swing-out film spool



MOST ROLL CAMERAS, nonreflex, nonminiature, are distinguished by a collapsible bellows. A few have a screw-out lens mount instead. A general-duty camera, the roll has plenty of versatility and takes a lot of punishment. The wide price range starts just above the box cameras. The most expensive have the refinements and advantages of the very best cameras. These five range from \$45 to \$199.

Automatic loading and a lens-coupled range finder are features of the Ansco Super Speedex, which takes 12 $2\frac{1}{4}$ by $2\frac{1}{4}$ exposures on a roll of 120 film. Its Synchro-Compur shutter gives speeds of 1 to 1/500 second and bulb release, and it is fitted with an Agfa Solinar f:3.5 four-element lens. The camera has automatic film transport and a rim-set shutter and lens diaphragm





35 MM.

You focus the Graphic 35 by the push of a button. The camera takes up to 36 exposures and has a 50-mm. Graflex f:3.5 lens. Its Prontor SV5 shutter has a speed range from 1 to 1/300 second, in addition to a bulb release. Its minimum focusing distance is three feet, and it has built-in synchronization for electronic flash, F and M-delay lamps. The camera has coupled range finder, eye-level view finder, push-button body release

THE 35-MILLIMETER miniature camera is compact, easy to carry, ideal for casual, candid shots and the favorite for color photography. A color transparency for a viewer or projector costs about 10 cents less than the next larger size. With 20 or

36 shots on a roll, you get more shots per dollar in black-and-white photography, too. Of course, this can be a disadvantage if you take only one or two shots at a time. Another disadvantage of the small film size is that enlarging the small negative emphasizes its faults. Your exposure must be precise. The more expensive 35s have the highest speeds and greatest versatility of any camera, and can be fitted with long-focus and wide-angle lenses. Some have focal-plane shutters. Prices range upward from \$30. These are \$84.50 to \$261.



A rapid-feeding lever with automatic shutter-cocking device and exposure counter is a feature of the Ansco Karamat, which is cartridge loaded and takes up to 36 exposures. It has a coated 50-mm. Schneider Xenar f:2 lens, and also a depth of field scale, Synchro-Compur shutter with speeds from 1 to 1/500, time and bulb release, coupled range finder, helical focusing



A chief feature of the Kodak Retina IIc is the two-section 50-mm. f:2.8 lens, the front half of which can be replaced with telephoto or wide-angle components. The camera has a coupled range finder combined with a projected-frame view finder, a Synchro-Compur shutter, 1 to 1/500, a self timer, rapid film-advance lever and automatic shutter setting

Automatic shutter cocking and a double-exposure and skip-frame prevention device are featured on the Argus C-4. It takes up to 36 exposures on cartridge film, has a 50-mm. coated anastigmatic lens, behind-the-lens shutter, 1/10 to 1/300 second, a combined range-view finder of the superimposed-image type, exposure counter, focusing from three feet

The metal focal-plane shutter of the Contax IIa has speeds from 1 to 1/1250. A self-timer gives 3, 6, 9 and 12-second delay. The camera takes up to 36 exposures on cartridge or spool film, has a bayonet-type lens mount, a film-type indicator, automatic film transport, exposure counter, coupled range finder, depth-of-focus guide, full synchronization





A 35-mm. single-lens reflex, the Automatic Exakta VX takes up to 36 1 by 1½ exposures and has a focal-plane shutter and built-in flash synchronization, fully automatic diaphragm, eye-level view finder, coupled split-image range finder and f:1.9 lens. Many variations of camera and lens are available



Twin-lens reflex Rolleicord V uses 120 roll film, has adjustable back for 2¼ by 2¼ and 35 mm., f:3.5 lens, Synchro Compur shutter, 1 to 1/500, parallax compensation, self timer, sports finder, depth of field scale, light-value scale with coupling device and bayonet mounts

REFLEX

The Rolleiflex Automatic takes 12 exposures, 2¼ by 2¼, on 120 roll film; has an f:3.5 lens; shutter speed from 1 to 1/500; light-value scale; shutter and self timer coupled to rapid film transport; waist, eye-level focusing magnifiers



Automatic shutter cocking is a feature of the Ikoflex IIa, which takes 12 exposures, 2¼ by 2¼, on 120 roll film. The lens is a 75-mm. coated Zeiss Tessar f:3.5. The camera has a Synchro Compur shutter, speeds from 1 to 1/500, an extra-bright reflex finder of combined magnifier and Fresnel grating and a focusing magnifier. Lens shades, slip-on lenses are available



REFLEX CAMERAS are of two distinct types: single lens and twin lens. With both, you see the picture in actual negative size as you focus. In the twin-lens reflex, the top lens provides the image you see in the hooded ground glass at the top of the camera and the bottom lens takes the picture. The single-lens reflex reflects an image from the camera lens itself. Some single-lens reflexes contain an eye-level viewer. With either camera, focusing is easy; the lens is moved back and forth until the image is in focus on the glass. No range finder is needed. The single-lens reflexes are compact and have interchangeable lenses. These five cameras range from \$126 to \$398.70.

Another single-lens reflex is the Contaflex I, which is loaded by 35-mm. cartridge. It has a 45-mm. Zeiss Tessar f:2.8 lens in Synchro Compur shutter, which gives it speeds of 1 to 1/500 second, in addition to a bulb release. The camera has a self timer, built-in MX synchronization, ground-glass and split-field range finder, automatic preset lens diaphragm, shutter cocking and eye-level focusing, picture counter, flash connections, double-exposure prevention





The Linhof Super Technika 4 by 5 press camera features a rising, falling, tilting, swinging, shifting front and a tilting, swinging, revolving back. An adapter handles 2¼ by 2¼ roll film. Extra lenses, like the multifocus view finder shown, are optional. The built-in multifocus range finder can be coupled to as many different lenses as desired. The Universal back with Kodak Ektalite Field lens takes all standard 4 by 5 holders, Polaroid back, enlarging attachments, etc. Track is triple extension. Leather bellows extends 17 inches

PRESS

THE PRESS CAMERA is the choice of most newsmen because it is rugged, dependable, suitable for action shots or portraits, and uses cut film so you can take a picture and develop it immediately. It is also expensive (these range from \$239 with lens to \$330 without lens). Each negative must be loaded separately, unless you use film packs. Although bulky, it is very versatile.

THE ONE-MINUTE CAMERA which develops its own pictures is luring professionals as well as amateurs. New films give sharp, permanent prints; \$70 and \$90.



Interchangeable lens boards are featured in the Pacemaker Crown Graphic. It takes 4 by 5 sheet and film pack. Adapter handles roll film. It has built-in synchronization, and double-extension bellows



Most popular press camera is the Pacemaker Speed Graphic, which has a focal-plane shutter. Other features are same as Crown's: range finder coupled to various lenses, Ektalite lens

POLAROID

In only one minute the Land 95A Polaroid Speedliner develops its own pictures, on a special 3¼ by 4½ eight-exposure roll. It has a coupled lens-shutter setting; a single dial selects the lens and shutter combination. There is built-in synchronization for regular and electronic flash, scale focusing, a combination view finder



Another one-minute camera, the Polaroid Highlander is similar to the Speedliner, but takes 2¼ by 3½ exposures on its eight-exposure roll. It has a self-erecting front, front-element focusing and a coupled lens-shutter setting. An optional flashing unit has a built-in flash guide, exposure counter





The Stereo Realist ST41 takes up to 29 stereo pairs per loading of standard 35-mm. cartridges. It uses f:3.5 David White anastigmatic lenses, has speeds from 1 to 1/150, focusing scale, coupled, split-image range finder and flash

STEREO CAMERAS enable you to capture people and places in three dimensions. You can obtain special projectors for screen showings, but inexpensive viewers are most popular. Most of the twin-unit cameras are simple to operate, do not have expensive lenses, delicate adjustments or many shutter speeds. But the pictures are sharp. One film load produces 20 to 30 color slides. These four cameras range from \$80 to \$160.



STEREO

No focusing is needed with the Graflex Stereo Graphic. One of the f:4 lenses focuses on foreground, the other on background. Viewer sees sharp picture. Camera has one speed, 1/50, automatic shutter cocking and takes 20 slides on a roll of 35-mm. film



Stereo pairs from 335 and 135 film are produced by the Kodak Stereo, which has f:3.5 lenses, four speeds, 1/25 to 1/200, automatic shutter cocking and flash



Stereo Vivid takes up to 29 22 by 24-mm. stereo frames per loading, has f:3.5 lenses, speeds 1/10 to 1/100, flash synchronization, many other features

SUBMINIATURE CAMERAS, small enough to be concealed in your fist, range from Lilliputian box cameras to high-precision instruments that have all the features of normal-size cameras. The Minox, at \$140, is one of these. Quality enlargements to album size are possible with the best cameras, and film cost is very low. A "fun" camera, the subminiature is ideal for candid shots.

Small as a cigarette lighter, 3/8 by 1 by 3 inches, the Minox III S takes sharp 8 by 11-mm. pictures, at speeds of 1/2 to 1/1000, plus time and button-release shots. The camera has built-in flash synchronization, coated 15-mm. f:3.5 lens. Features include automatic simultaneous shutter winding and film transport, exposure counter, two built-in filters, orange and green, direct view finder with automatic parallax correction, focus from eight inches to infinity and a Lammelar shutter in front of the lens. One roll takes 50 exposures



SUBMINIATURE



WHAT'S NEW FOR Your Home

DISPOSABLE BROILER pan of heavy aluminum foil, aimed at eliminating messy chore of cleaning greasy broilers, can accommodate three to four-pound steak without bending. It fits any oven, rotisserie or grill

Manhattan Products Company,
331 Madison Ave., New York City 17

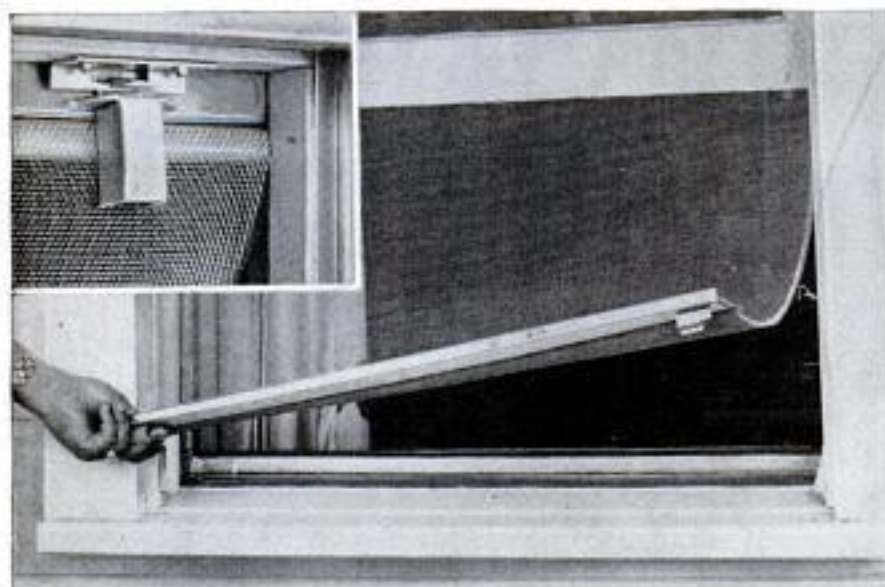

WINDOW SCREENS which are mounted under tension fit windows without sagging or losing shape. They are held tight by two coil springs in the top and are easy to open at the bottom for window cleaning

Springtite Screen Mfg. Co.,
1617 Jonesboro Road, S.W.,
Atlanta, Ga.

FENCE KIT containing pre-cut pieces for an eight-foot length of decorative fence is now sold in lumber yards. Sections can be arranged in many ways around yard or patio. Height of each section is 4½ feet

Weyerhaeuser Sales Co., St. Paul, Minn.





AUTOMATIC FIRE EXTINGUISHER for home releases chemical that fights fire in three phases. On first contact, it produces a flash fog; as it heats, a more penetrating fog is sent out; and finally, a small amount of the chemical remains to produce further fog should a reignition of the fire occur. The fog produced is nontoxic carbon dioxide

Red Comet, Inc., Littleton, Colo.

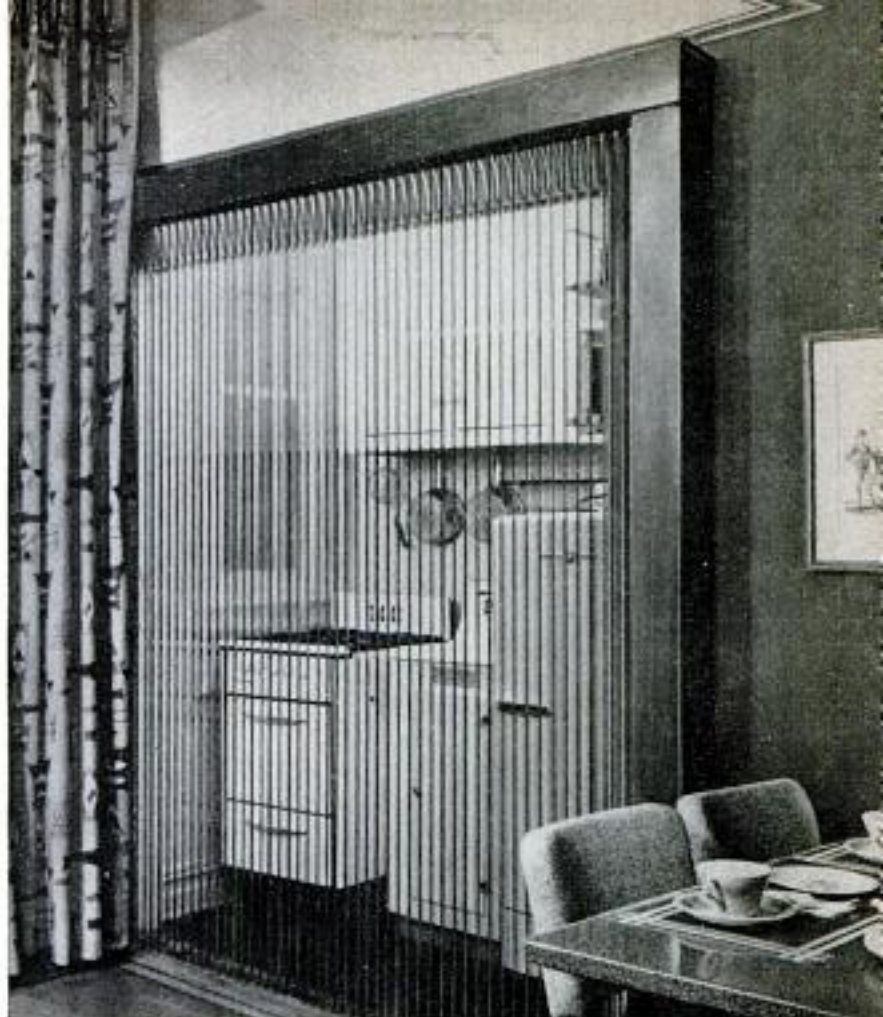

VERTICAL VENETIAN BLINDS can be used as draw draperies or as room dividers. Made of aluminum, they come in 15 colors

Hunter Douglas Corp., 150 Broadway, New York City



TIMER FOR HOME USE has two speeds, showing elapsed time in either minutes or seconds. Handy for timing phone calls, home permanents, baking, cooking

M. H. Rhodes, Inc., 30 Bartholomew Ave., Hartford 6, Conn.



NEW DOORKNOBS to replace old or loose ones can be snapped into place. A built-in spring holds the knob securely

Murphy Machine Products Co., 14320 E. Jefferson Ave., Detroit 15, Mich.

RIPS IN CLOTH, rubber, plastic or leather can be repaired in moments with an easily applied liquid cloth

Downs and Co., 816 University Place, Evanston, Ill.



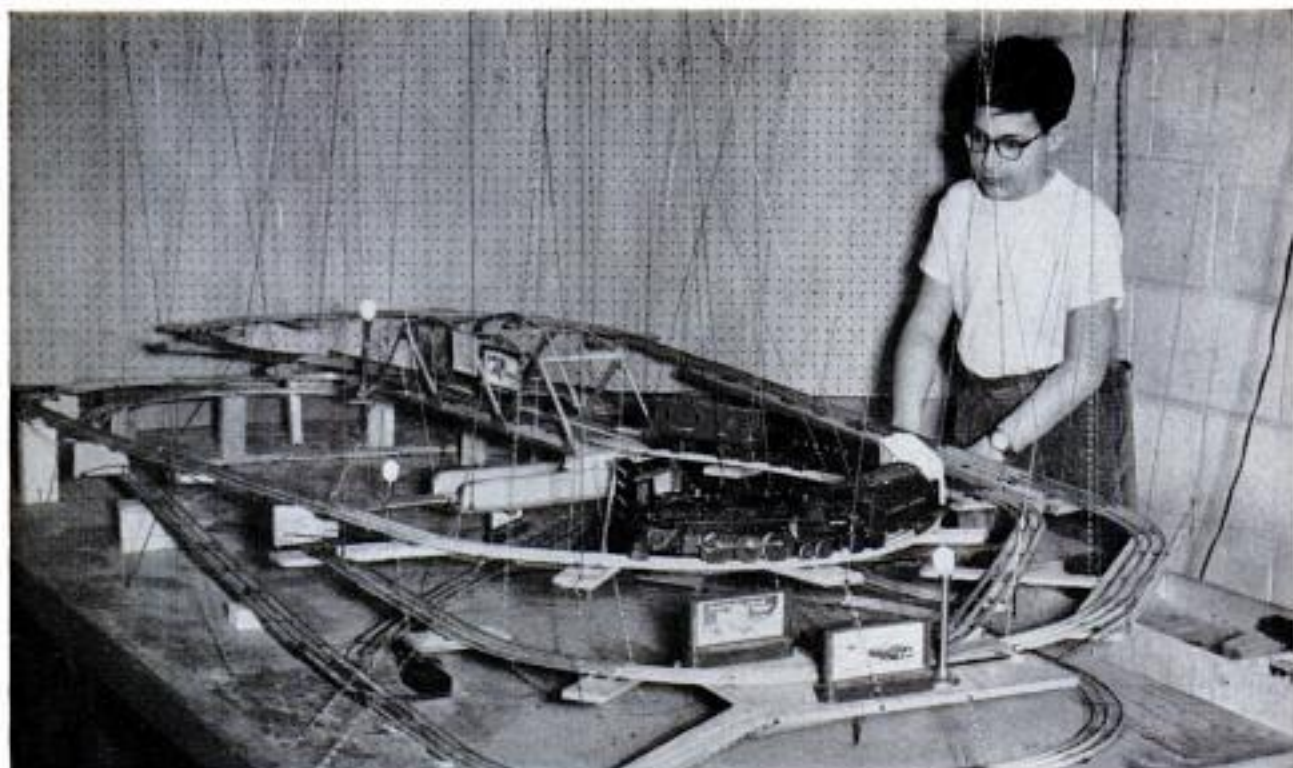

Train highballs through the maze of wires as it moves from one of the three track levels to another

Train Rolls Through Maze of Wires on Suspended Track

SOMETHING DIFFERENT—that was the goal of Philip Karr and his son David, of Milwaukee, Wis., when they decided to build a model-railroad layout. They achieved it by suspending the rails from the ceiling joists on wires. Now they have a multilevel layout that can easily be

changed by lengthening or shortening the wires. Chains anchored to a table under the layout prevent any side sway of the tracks. The layout contains 84 feet of track, supported by plywood strips at the joints. From a distance the track appears to be floating in mid-air.

All the joints of the track are supported with strips of plywood. Chains anchored to table prevent sway

Wires fastened to the overhead joists support the track sections. Layout contains 84 feet of track





Richly decorated in the style of the old-time river boats, *Lil' Belle* plies her own 125 by 500-foot lake

HERE COMES THE *LIL' BELLE*

By Leland Elam
and Leo Rosenhouse

"STEAMBOAT!"

You almost can hear that familiar old river cry out of the Mississippi's past as *Lil' Belle* chugs up to her miniature pier in the Peralta Playground, Oakland, Calif. *Lil' Belle* is a small edition of an old stern-wheeler, carefully constructed to bring back memories of the old-time Southern pleasure boats. She makes numerous daily trips on her own lake, carrying 30 happy small fry comfortably in her cabin. From

The gangplank is a part of the rail above the pilot, hinged for lowering to embark passengers

bow to churning stern wheel, she measures 23 feet, and is eight feet wide at the beam. In order to make the turns in the tiny lake, *Lil' Belle* was equipped with four rudders, and as a safety feature the hull was designed with six watertight compartments. The whole ship is gaily decorated in the ornate style of the old river boats, giving her a picturesque appearance as she splashes along. But the gayest touch of all is the laughter and chatter of her riders.

A 14-horsepower gasoline engine drives the stern wheel, which is 46 inches in diameter, 68 inches wide

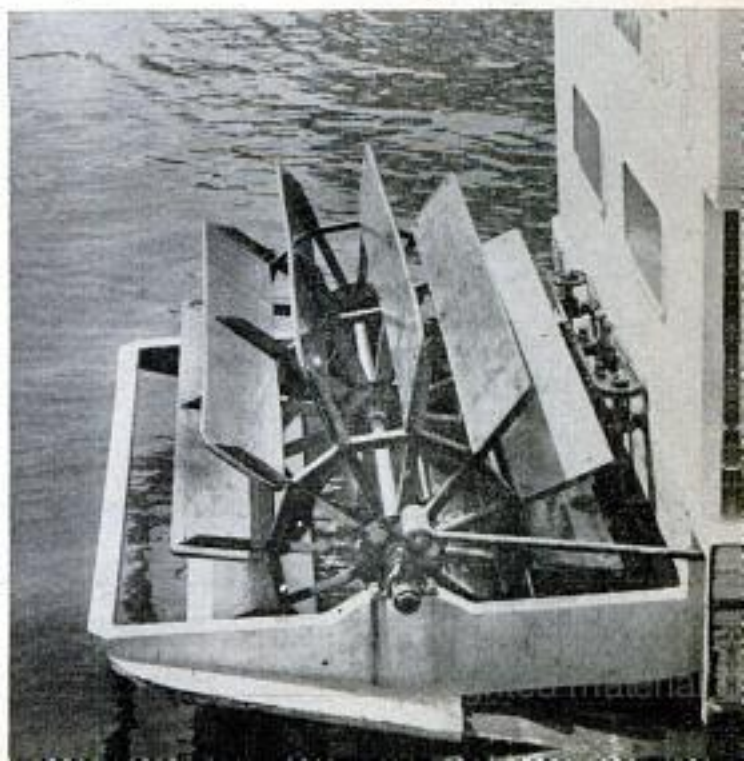
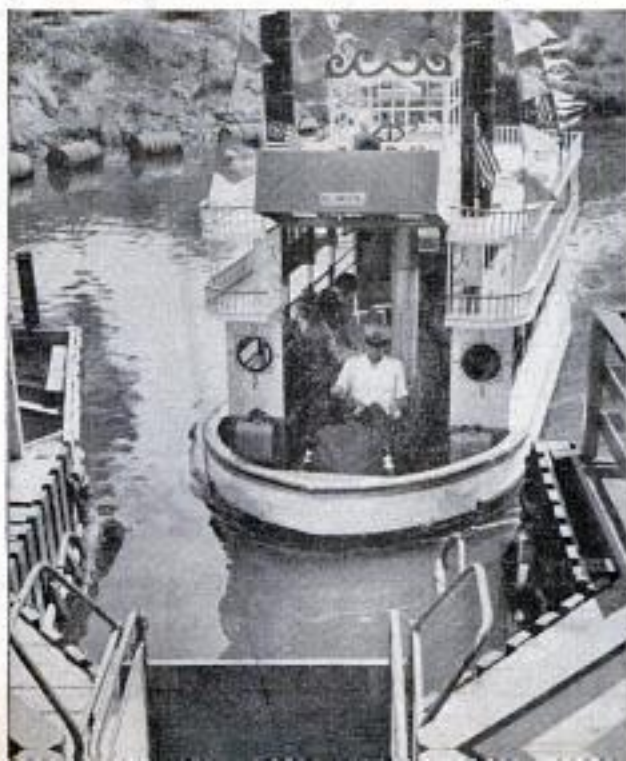



Cabin Scooter Built for Two

Europe continues to come up with new and fresh designs for the small basic car. A fully enclosed three-wheel scooter with a top speed of about 60 miles per hour seats two persons side by side behind a single front door. There's ample room for children or luggage in the rear. A canvas roof is rolled back in good weather. The car is expected to sell for less than \$1000. It has a four-stroke, 175-cycle engine.

Magnifying Machine Lets Near-Blind Read

Persons nearly blind can read a book with the aid of a magnifying machine known as the Megascope. The instrument magnifies print as much as 25 times. One woman with only a tiny fraction of light perception was able to see what print looked like for the first time.

Open book is laid upside down on top of enlarger, which projects two lines of type at a time on screen

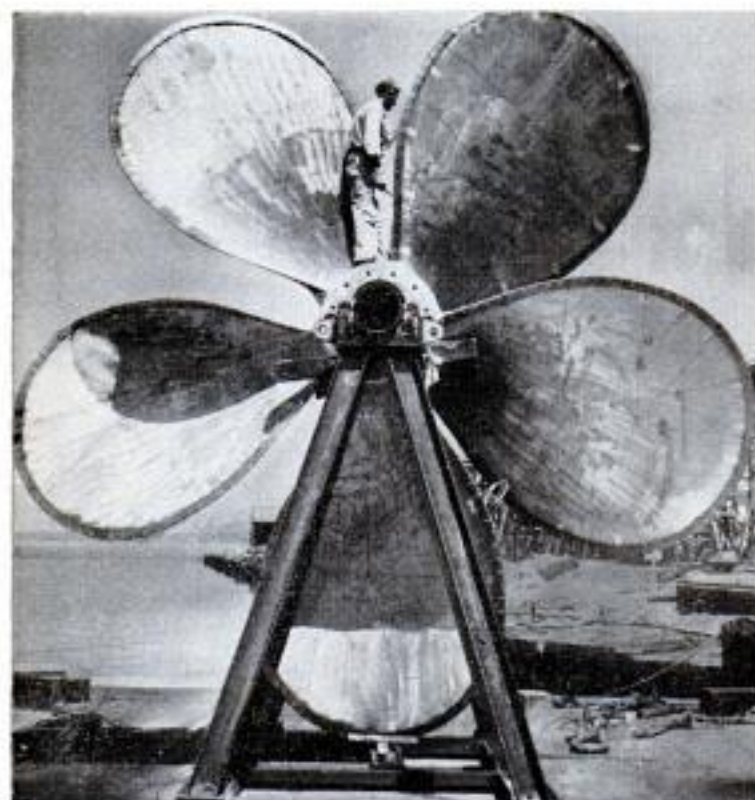

Giant Propeller Shipped by Barge

No truck nor train could carry a giant propeller made for the *USS Forrestal*, so it was shipped by barge. Four of the 35-ton propellers were slowly transported from Philadelphia to Newport News. Each is about 21 feet in diameter and is made of cast manganese bronze. Four more of the variable-pitch, five-bladed propellers have been completed and will serve as spares for the *Forrestal*. Power for driving the propellers is supplied by a 200,000-horsepower electrical propulsion plant, big enough to supply electricity to a city of 1,500,000.

☐ Radiocarbon dating of charcoal found at what is believed to be an early camp site indicates Indians were on the North American continent 22,500 years ago.



"Straight ahead"

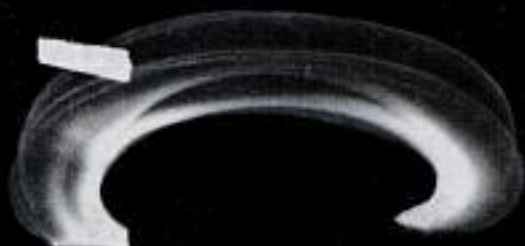

"Turn to your left"



"Slow down"

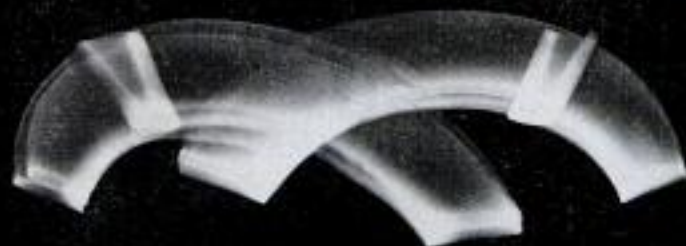

"Stop"

"All clear—marshalling finished"



CONDUCTOR'S 'BATON' Guides Airliner Pilots

Bringing a mammoth airliner to rest in the chocks is a delicate job, entrusted at many airports to the "plane marshal." For, though free and maneuverable in the air, airliners are awkward and cumbersome on the ground and require help. These pictures, taken in Amsterdam, Netherlands, show the international signals used by plane marshals as they wield their batons, acting as eyes for the pilots while the big airliners slowly wheel in

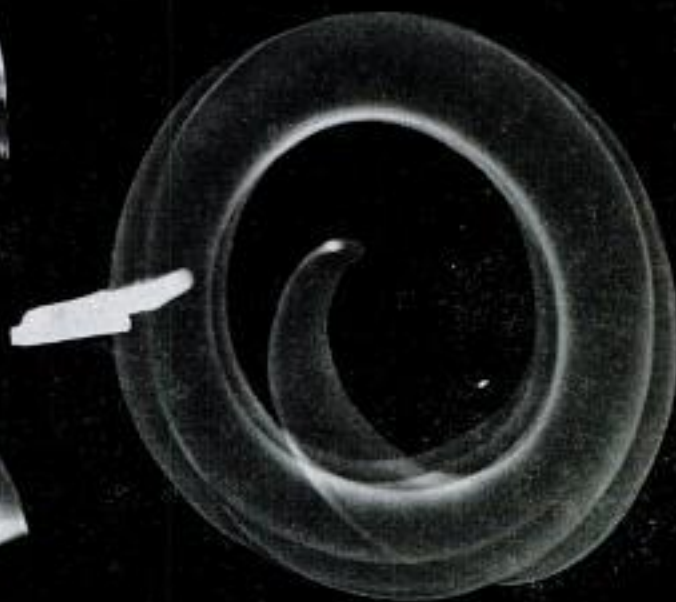

"Start engines"

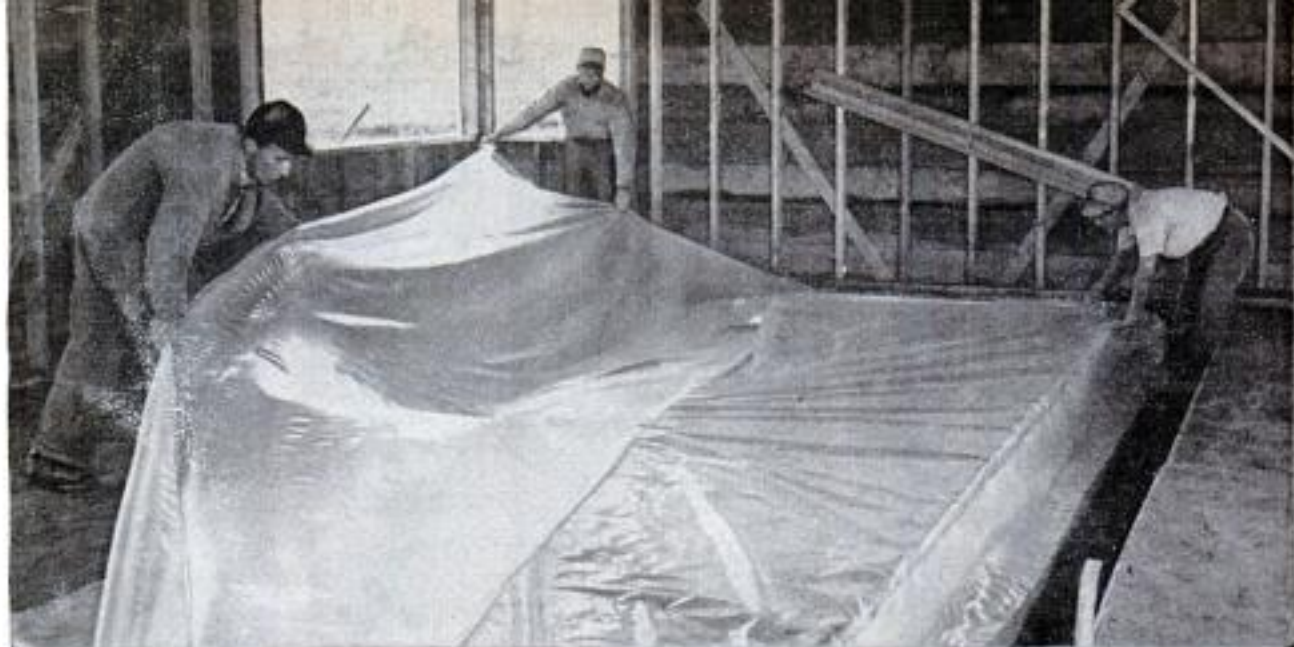

Plastic Film Forms Vapor Barrier for Home Construction

Tough, thin plastic sheeting is now being used in home building to provide an almost impenetrable vapor barrier. The seamless, chemically inert film is expected to last at least as long as the rest of the house. It can be used on the warm side of exterior walls, over subflooring, underneath concrete slabs or laid on the bottom of a crawl space. When used with concrete slabs, it

takes the place of gravel or stone. A layer of sand is sufficient. Used over subflooring, it stops the passage of moisture, dust and cold air. The plastic, which is made in thicknesses varying from .002 inch to .020 inch, is easy to handle, extremely lightweight and nonflammable. The thin material remains flexible in either tropic or arctic temperatures.

Pocket Battleship Graf Spee Sails Again—in Model Form

Eight feet long and weighing 30 pounds, a scale model of the *Graf Spee*, famous German pocket battleship, has been constructed by 17-year-old Gunther Lobell of Holstein, Germany. The model has a radio-

control system and is designed for operation on ponds and small lakes. The original *Graf Spee* was sunk off Montevideo, Uruguay, in a battle with British warships, early in World War II.

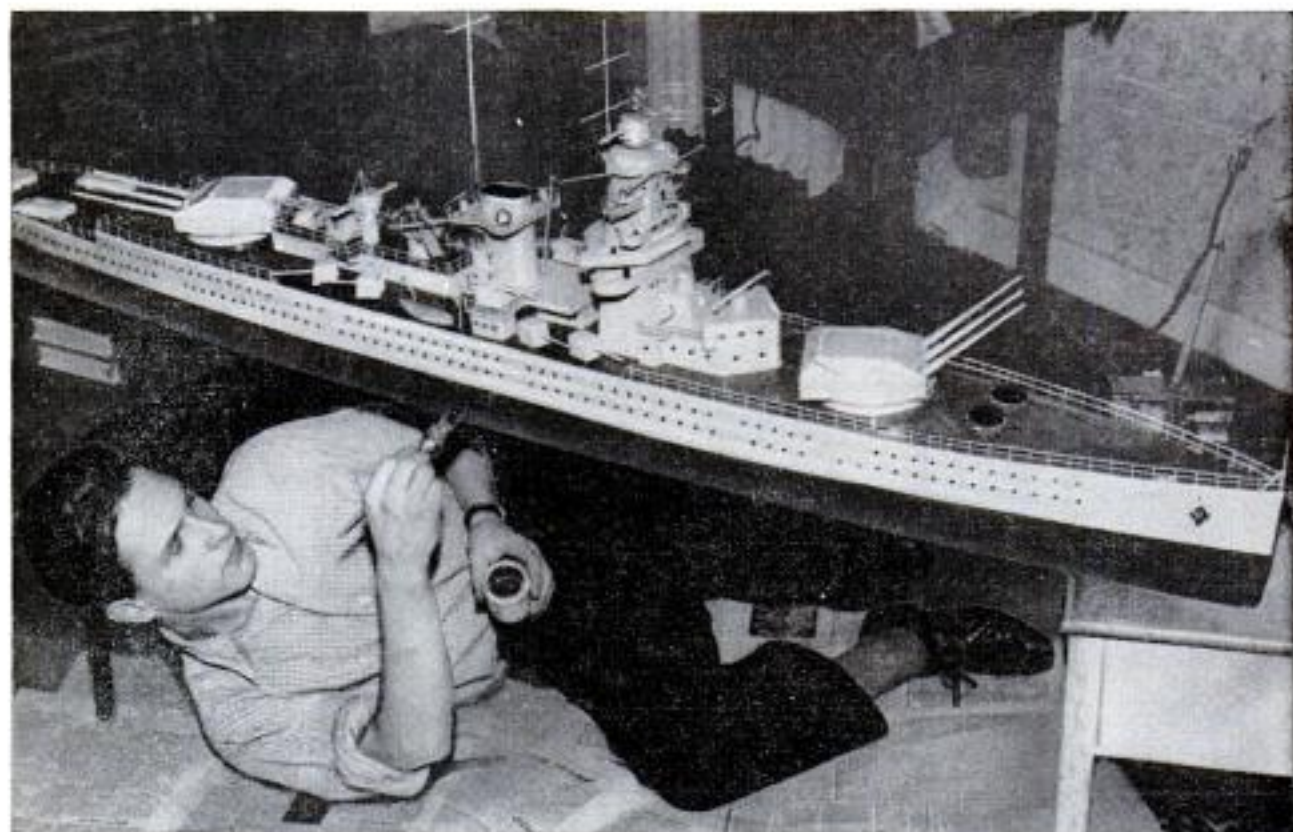

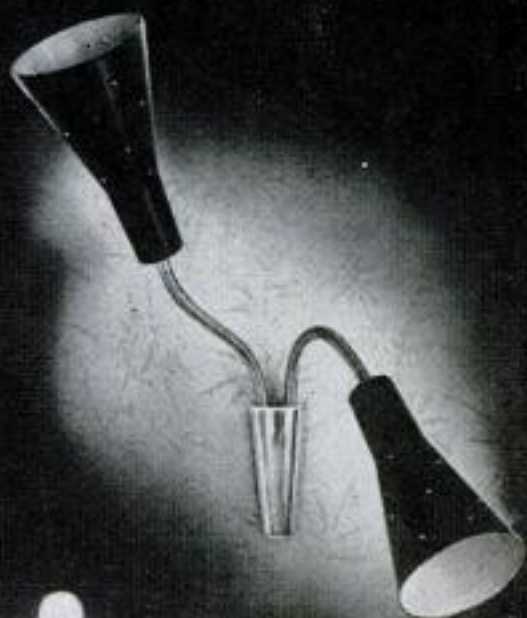

Light Bulbs in Disguise

SINCE THE FIRST electric light bulb shaped like a candle flame, designers have taxed their imaginations for new ways of dressing up or disguising light sources. They're still at it, as is proved by these recent German creations. The lamps range from a classic 617-pound chandelier of 125 candles to a bouquet of glowing tulips branching from a flowerpot.





Week-End Cottage

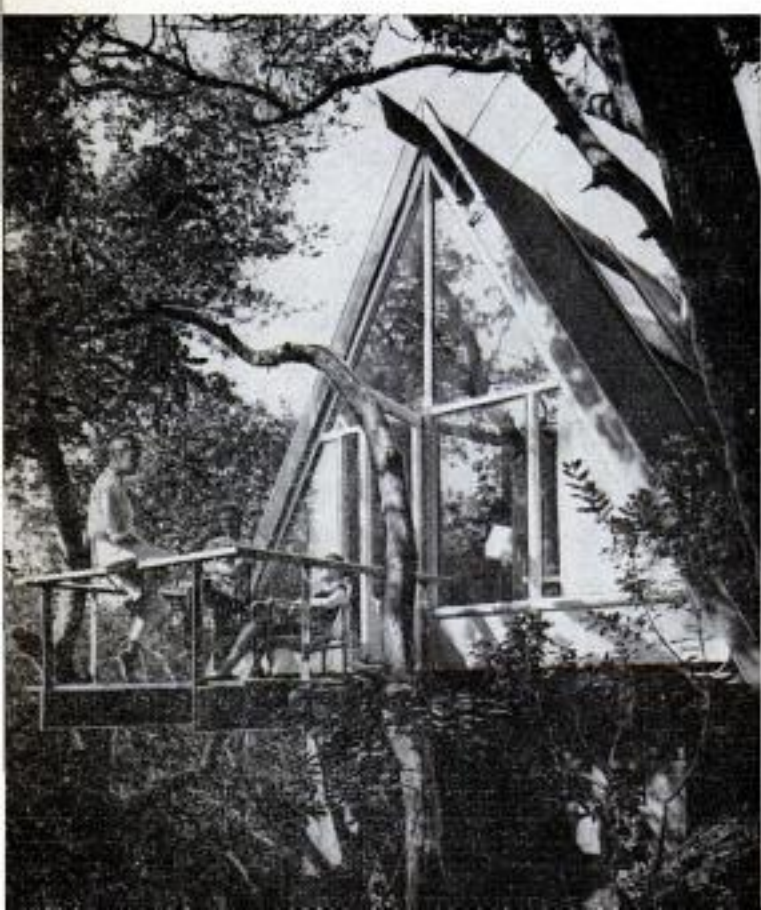

TWO SAN FRANCISCO architects, John Campbell and Worley Wong, designed a Leisure House that you can build yourself in four or five days. It is precut and is shipped in kit form. The basic unit provides a living-sleeping room, kitchen, bath and sun deck with over-all dimensions 16 feet by 18 feet. This sells for \$1150. Additional four-foot sections are available to increase the size. These sell for \$148 each. The house shown on these pages includes the basic unit and two four-foot sections for the bedroom. Plumbing, glass, paint and wiring for this house cost an additional \$1000. Triangular trusses eliminate cross bracing and simplify construction. Girders are nailed on foundation piers, joists are set over the girders and flooring nailed down. Rafters are bolted to the ridgepole. The house is adaptable for flat or hillside lots. ★ ★ ★

San Francisco owner of this Leisure House added a porch at rear. House was built on a hillside with a foundation of concrete posts for sturdy support



Bedroom was added to rear of basic precut house with two four-foot sections. Dimensions are eight by thirteen feet. Interior walls provide privacy but do not reach peak of roof. House has "tree house" effect

Double beds in living room afford additional sleeping space. This room is 10 by 17 feet with the glass end overlooking the sun deck. Glass panels on sides of the roof have bamboo shades for controlling the light





Mobile animal clinic, which cost \$84,000, tours New York City giving aid to injured and ailing pets of all kinds

Hospital on Wheels Treats Ailing Pets Throughout City

EMERGENCY CALLS to New York's Speyer Hospital for Animals bring a real ambulance to help ailing pets. The "Petmobile" actually is an animal hospital on wheels. Built at a cost of \$84,000, it is equipped for minor animal surgery. The vehicle contains an X-ray machine, Polar-

oid developer, fluoroscope, sterilizer, refrigerator, medical cabinets, surgical instruments, water tank and sink. A veterinarian who travels with the Petmobile gives instructions to thousands of children each year on the care of their pets. There is no charge for instruction or minor treatment.

Injured dogs, taken aboard the mobile hospital, are X-rayed, given treatment and operated on if necessary



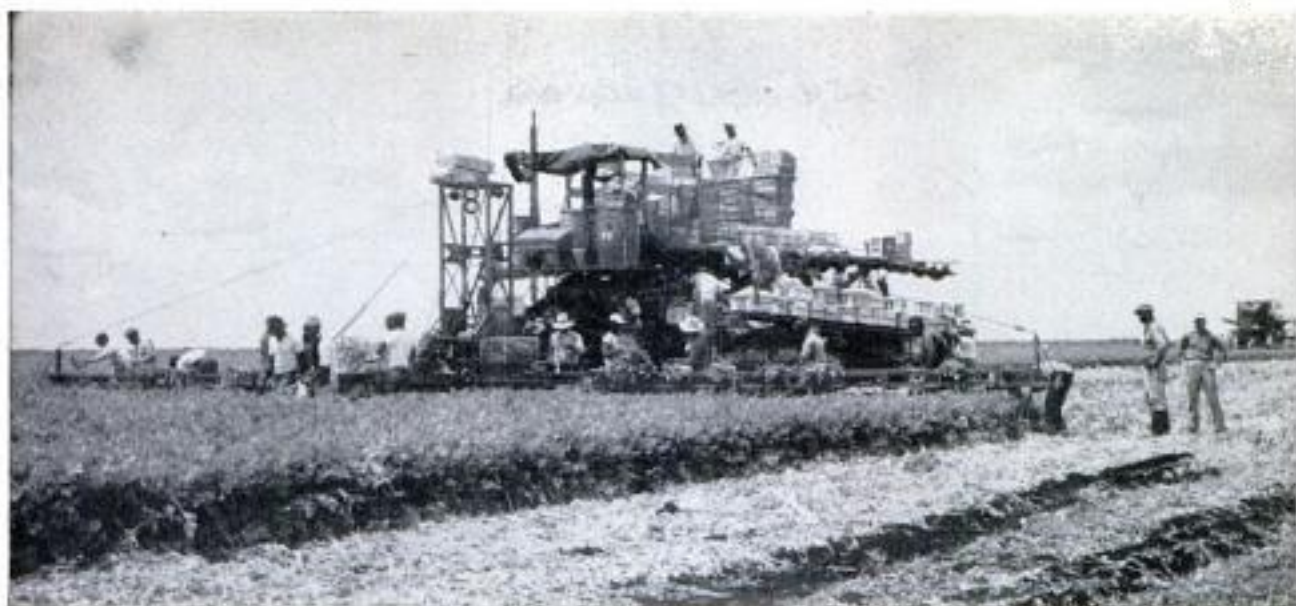

It takes a 60-man crew of cutters and packers to keep up with the harvester as it crawls across the field

Celery Factory

JUST ABOUT EVERYTHING is mechanized on the big Duda Farms, Oviedo, Fla. Eighteen vegetable-harvesting machines manage to harvest and pack 80 freight-car loads of celery each day. The machines, which cost \$18,000 apiece, can travel 40 miles per hour on the highway or crawl along at 1200 feet in 10 hours in the field. Wings unfold to cover the rows of celery. The crew cuts the celery and throws it on moving belts. Carried into the heart of the machine, the celery is automatically washed with water from the machine's 1000-gallon tanks and is crated for shipment. The harvester weighs from 10 to 12 tons.



Celery, carried into the machine by conveyor belts, is automatically washed by water spray from tanks inside the machine

Truck loader lifts a finished crate, ready for the market, from machine's delivery platform. Below, radio keeps the field bosses of big farming operation in touch with headquarters





Converted city bus, which carries own generator, could be Miami communications headquarters in emergency

CAPTAIN Verner Smith pushed the attitude lever and nosed the blimp down closer to the water. Now it was within 50 feet of choppy Biscayne Bay off Miami, Fla., so close that the trailing landing lines of the huge powered balloon almost touched the water. A loudspeaker in the cabin

blared: "This is Miami Communications, Vern. What's happening?"

The sun-browned pilot pulled a control and the blimp nosed up again. "He's still struggling. Trying to hold onto his boat. Get the patrol boat here—fast."

The loudspeaker talked again. "The po-

Miami Has an Electric

Telephones and radios mounted in air-conditioned bus are each on a different circuit. There is also a Teletype





Nervous System

By
Elliott H. McCleary

Radio-equipped blimp serves as link in communications network. It can direct rescues, relay radio messages

lice boat radios that he's coming over. Stay directly overhead. He'll sight on you."

"Check."

Guided by the blimp, a patrol boat of the Miami Police Department scudded to the rescue scene.

Blimps and even horses mount two-way radios in Miami, a city with an electronic nervous system that is as complete as the latest in modern science can make it. The Magic City was first in the nation with a unified system to handle all city communications—fire calls, police intercom, hurricane warnings, Civil Defense and the routine business of running a metropolis.

Miami's head start is largely due to cheerful, energetic Ben Demby, a radio-electronics enthusiast who keeps his Miami Communications Department equipped with the latest advances in technology.

He's been so successful that, as one observer remarked, "Miami offers a preview of what the average city may expect in 10 or 20 years."

At every stop-light intersection in Miami you'll find an emergency telephone that allows you to summon fire trucks or an ambulance in jig time. The system, suggested by Ben Demby to Bell Telephone and installed first in Miami, is duplicated in only 10 other American towns.

Demby's Communications Department, together with Detroit and the FBI, was the first to employ Speedphoto machines to flash pictures, fingerprints and information about dangerous criminals across the country.

Ben Demby, against the advice of FCC experts, was first to employ high-frequency radio in everyday use. Today, the six-foot



Robert Cotter, engineering aide, sights mobile TV camera. It is used for police work, sports coverage

antennas that are the mark of the old 30-megacycle radios are slowly disappearing from squad cars all over the nation. In their place appear thin little wands no longer than a man's hand—the antennas of high-frequency radios that give better, surer reception.

Fire-department communications subcenter has phone switchboard, radio microphones, Teletype, tape recorders

In the nerve center of the Miami Communications Department, a two-story stucco building beside Biscayne Bay, the blare of a police loudspeaker mingles with the sound of Teletypes and card-sorting machines. The crackle of an acetylene torch and the whir of a drill float in from the adjacent electronic shop. An attractive red-haired girl dispatcher in a soundproof glass booth tries to keep calm as excited squad-car police give a running account of a shooting and the chase for the gunman.

Next to her, in a similar booth, a soft-spoken girl dispatcher directs a squad car to a child who has just been hurt.

Banks of files along one wall hold cards with information on the 300,000 cars registered in Dade County. And spotted through all the files are thousands of pink cards—reports on all the stolen cars in the United States.

An electronic card sorter that speeds through cards at the rate of 700 per minute starts a check on used cars newly registered. Moments later a card is flung out of the machine. It's a duplicate of a pink card placed in the sorter—a 1955 blue Cadillac convertible stolen in southern Georgia and sold to a dealer in Miami.

"With this latest equipment," says Demby, "we can often catch a hit-run driver before he's able to remove the blood and dent from his fender—even when we know only the last three digits of his license. In an hour, given those few digits and a description of the car, we can narrow the list down to a handful of suspects."





Each card racked before radio dispatcher of squad cars represents a radio call. Sergeant, right, in police headquarters receives a complaint and writes message for squad car. Message goes via moving belt to radio dispatcher behind window, who contacts car



Just a few steps away from the Speedphoto darkroom is a mobile TV unit. Weighing only a few pounds, the compact camera with its tripod can be carried in one hand, set up anywhere, and linked to a "watching station."

Another valuable crime-fighting tool in the center is the Speedphoto machine—an instrument that links Miami with 25 other major cities and the FBI. In Detroit, a 17-year-old boy ran amuck, killed his mother and sister, then headed south. He landed in Miami and was picked up by Miami police on a minor charge. Although the police had no inkling of his Detroit crime, they put his picture on the wire as a matter of routine. The boy was identified by Detroit police and he was booked on suspicion of murder within the hour. If police had depended upon air mail, the boy would have been released before it became possible to identify him.

Police receive a "hot" telephone tip that a bank robber wanted for murder is headed for Miami. It's believed he'll stay at a certain hotel near the business district. Communications men hide the TV camera behind the hotel desk and string a coaxial cable to a room above where detectives gather around an ordinary television receiver.

Two nights later, the murderer checks in. The detectives alert headquarters by walkie-talkie, a call goes out to a cruising squad car and police nab the criminal as he

Emergency telephone, here used to report bus wreck, was installed as part of a system to report fires

Driver of fire truck checks in with headquarters, using two-way radio that is standard on all trucks





Teletypes line wall of Communications Center. Slave units of these machines are installed in police, fire stations of Miami and suburbs



Portable radio transmitter built by Communications technicians is used at Miami-sponsored golf tournaments, parades and other special events. Speedphoto unit in Communications Center sends and receives photos, information, fingerprints of dangerous wanted criminals



opens the door of his room.

But the mobile TV camera is not just a police tool. Each year it's set up on the grounds of the city golf course to give sports reporters in the clubhouse a stroke-by-stroke account of the Miami Open Tournament. A wide-angle shot of the golfer and the turf ahead turns into a close-up as the Zoomar lens goes into action and catches the almost-spent ball bouncing on the green. The camera is used as effectively for traffic checks and the relay of election returns.

Fire Phones

Of all the features of the Communications Department, Demby is perhaps proudest of the emergency telephones installed at all traffic-light intersections.

The moment you pick up the receiver of one of them a light flashes on the fire-department board and you're talking to the fire dispatcher. If you're reporting a fire, he gets the exact address and nature of the blaze from you, looks up at a chart of the city, and engages a plug that sets one, two or a fleet of trucks rolling to the scene in 30 seconds.

The telephone system, inaugurated by Miami in 1952, replaces the familiar red fire box still used in all but ten American cities. According to Demby, the old system took three minutes longer to alert the nearest fire station—enough time for a minor fire to turn into a major one.

Miami mounts two-way radios on all rolling pieces of fire equipment. Once at the scene of the blaze, fire-department officers direct operations not by shouted commands but by radio. Smoke-eaters rescuing fire victims inside the blazing building carry walkie-talkies to get instructions or summon more help to squelch flames or cut through a wall.

The Network Begins

The city's complete communications network began in
(Continued to page 246)

Plastics With a Charge Have 'Magical' Effects

IT MAY BE that in the future your umbrella will consist of nothing more than a small plastic knob on the end of a stick, if the research being done by Jacque Fresco in his small Los Angeles laboratory is successful. Fresco has been doing some odd stunts with electrified plastic disks and high-voltage electricity. To demonstrate, he turns on a small stream of water from a laboratory faucet, then one at a time, holds various plastic disks near the stream. Depending on its electrical charge, the disk may pull the water toward it, or push it away. The electric umbrella would consist of a plastic knob charged to repel water. Held overhead, it would keep you dry.

Fresco believes, too, that he has found new ways of preventing icing on aircraft wings and new ways to maneuver aircraft. Under another stream of water, he places a model of an aircraft wing, and then turns on a high-voltage source that is connected to the wing. The stream of water is immediately pushed away from contact with the wing. This is his de-icer, which prevents ice by keeping all moisture off the wing.

In another experiment, Fresco connects the high-voltage source to electrodes that protrude from the tips of a small wing. When the current is turned on, the wing dips to the left or the right, depending on which way the electrodes are bent. Fresco suggests that a high-voltage control system weighing much less than present mechanical control systems may be developed for aircraft in the future. He thinks, in fact, that after further development, electrical forces will be used not only to maneuver aircraft and keep them free of ice, but also to decrease the density of air on the leading edge. This would reduce drag as well as aerodynamic heating, an important block in the design of supersonic aircraft.

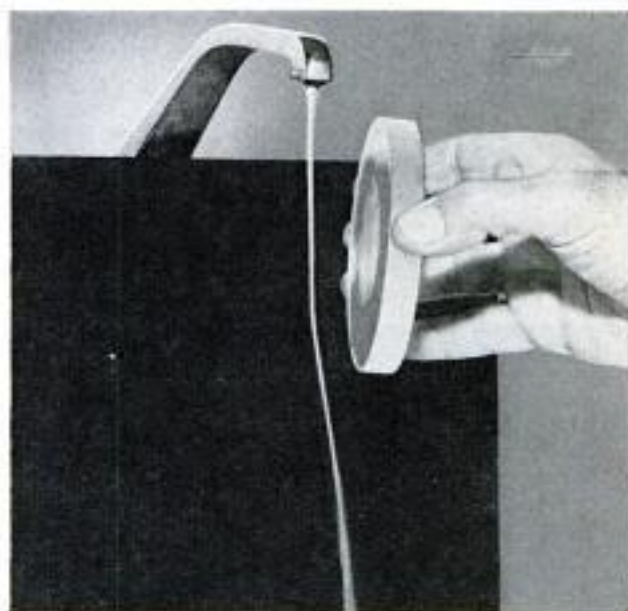

Charged plastic disk, above, attracts or repels water, depending on polarity of the charge. Below, the same principle applied to the leading edge of an airplane wing would keep it dry and prevent icing





He Made a Business of Camping Out

McOmber, above, loads sleeping bags on trailer before trip. Below, he shows how to mark trail in mine tunnel to aid return

By Hugh Manessier

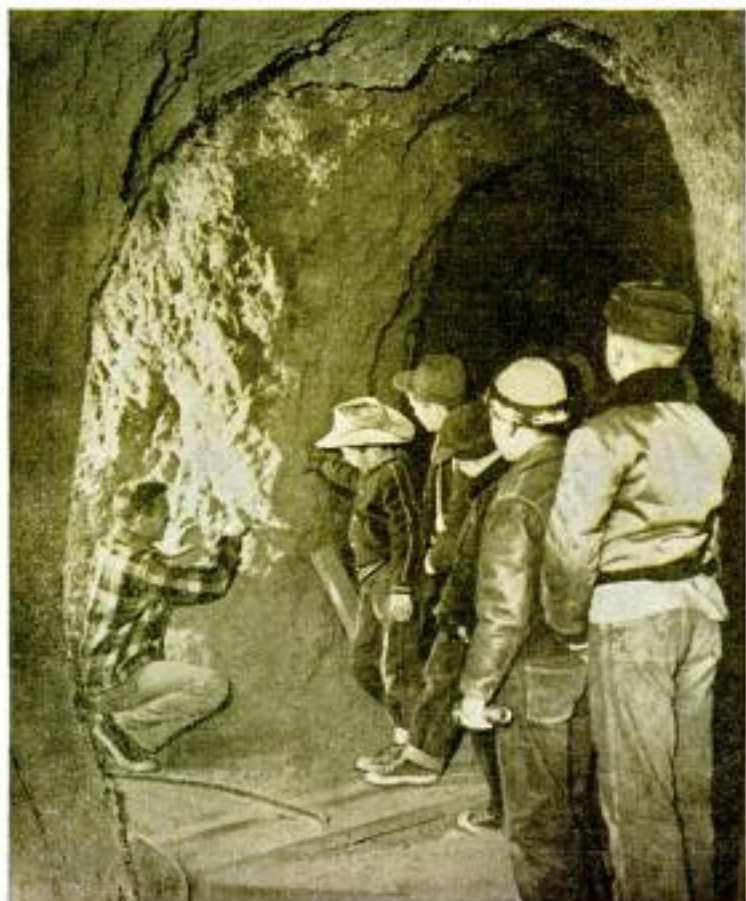

EVENING SHADOWS were deepening at Yosemite National Park as a station wagon loaded with young boys pulled into a camp site. In minutes an even dozen had piled out, picked up their sleeping bags from their camping trailer, and unrolled them in a circle on the ground.

A startled tourist walked over to the young man busily unloading luggage from the trailer. "That's some family you've got there," he said. "I admire the way you keep them under control."

"My name's Darrel McOmber," the newcomer replied, "but that's not my family—it's my business."

During the two years that Journeys for Juniors has been in existence, McOmber has enthusiastically explained his unique business to hundreds of interested parents and travelers. His program involves taking youngsters between the ages of 6 and 11 on exciting, educational trips to a variety of attractions. The trips fill the gap between the time youngsters first display an interest

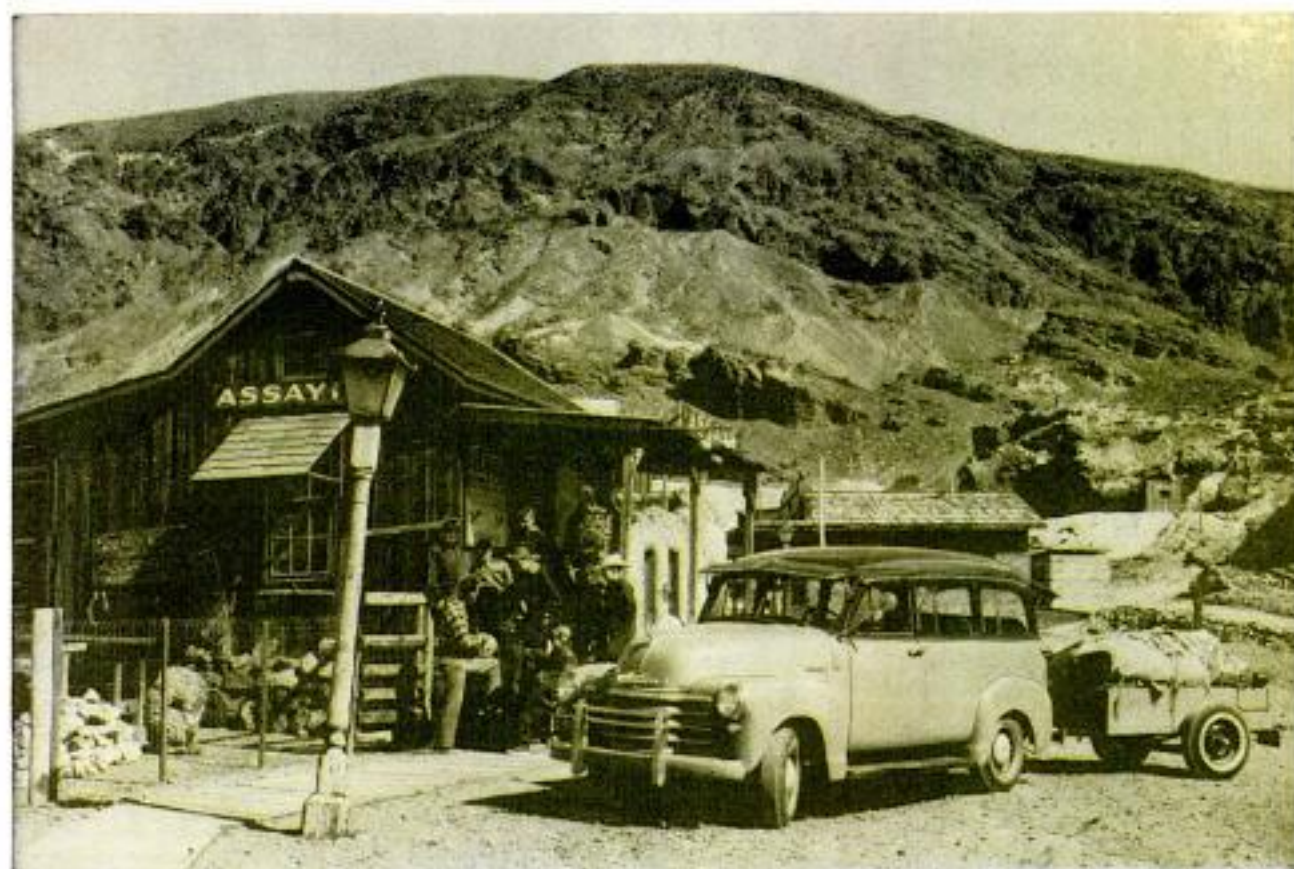

Stop at assay office in restored ghost town of Calico yields information about ore samples and prospecting

in nature until they are ready for established programs in scouting. His rates are low but, although his business is a spare-time venture, he grossed nearly \$3400 in 1954 and more in 1955.

His initial trips were to nearby deserts, beaches, national parks and monuments. Later he added winter trips to the mountains where some of the youngsters build their first snow men, others ski, and all learn basic survival skills. Trips to various museums and selected factories came later as a result of the children's intense interest in science and industry.

McOmer's current rates are \$5.00 for day trips and about \$8.00 per day for camping trips. His most ambitious trip, added this year, is a 17-day journey exploring half a dozen western national parks. The kids bring their sack lunches for day trips but McOmer provides virtually everything on camping trips. Youngsters furnish only their sleeping bags and personal gear.

The fees are modest when the expenses of gasoline, food and insurance are considered, but a camping trip with 11 youngsters will gross \$88 per day and net up to \$40 per day. Day trips bring in less, but also cost less. Against

this net must be charged the time at home for making phone calls, planning trips, packing and unpacking, and other extra work.

Although recreation and adventure are important ingredients of McOmer's trips,

Boy shows companion a horned toad he has found and learned to identify. Trips increase youngsters' knowledge of nature





In Joshua Tree National Monument, McOmber stops station wagon to explain peculiarities of the desert plant

he never misses an opportunity to stress safety, education and common sense. New youngsters receive their instruction in survival skills at the earliest opportunity. Actual practice in finding directions, food and water in the desert give them life-saving information they'll never forget.

McOmber feels that character development is as important as recreation and education, so he has established minor duties like gathering wood and washing pans that provide training in responsibility. It's

usually more trouble to supervise such work than to do it yourself, but McOmber feels it's worth it.

On most trips McOmber takes a teen-age helper who gets an expense-free vacation in return for his supervisory assistance. Mrs. McOmber frequently accompanies the tours, helps to supervise the all-girl trips and prepares hot meals.

The outings offer many advantages over the conventional summer camp, believes

(Continued to page 234)

McOmber thumbs book to identify ore sample boys have found. Their interest in such details amazes him





TINY BIG SHOW

OPERATING out of Sherman, Tex., is one of the most complete miniature carnivals in the world. Travis T. Womack, owner, manager and only employee of the show, began building it 28 years ago to entertain his small son. Since then, by renting the show to business firms for advertising purposes, he has put three sons through college. The midway of the show is 10 feet long, and a crowd of 150 spectators (dolls on two moving belts) strolls along it. Offered for their entertainment are all the shows and rides usually found at a carnival, including dancing girls, a freak show and a mirror maze. Miniature hot dogs are sold at the concession stand, and a boy sells cotton candy at another booth. At the weight-guessing booth, the scale jumps every time the customer sits down. Every exhibit in the show is animated and two quarter-horse motors supply power to the shafts, belts, chains and gears which provide this motion.

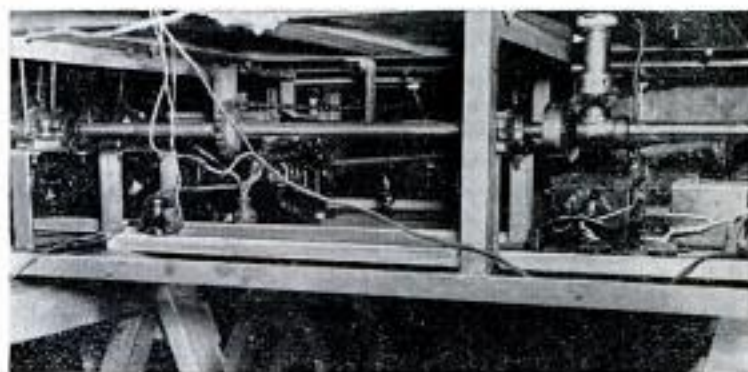

Fighting the Battle of Yorktown Again



Battle of Yorktown relived on the shores of Lake Matoaka, near Williamsburg, Va. Setting provides realism

By **Walter E. Burton**

THEATERS USUALLY are not called upon to solve problems in navigation or armament, since these most often are matters for admirals and generals to deal with. But the outdoor Matoaka Lake Amphitheater, on the southwest edge of Williamsburg, Va., has had to face problems involving boats and guns, and the theater's technicians have had to use a considerable

Divers clear old tree stumps from lake bottom so that cables drawing ship across lake won't foul up



amount of mechanical ingenuity to solve them.

There, the historical drama, *The Common Glory*, has been playing to audiences totaling over 600,000 persons in eight seasons. The stage is at the water's edge on the sloping eastern shore of the lake. This shore also is the edge of the campus of the College of William and Mary. The theater

Miniature of "French frigate" closes in to bombard British troops. The ship's sails are painted screen wire



was built in 1947 as an educational project and had the backing of the State of Virginia. It is now self-supporting.

The Common Glory is a historical drama centering largely around the activities of Thomas Jefferson. One of the highlights is a noisy, fire-studded scene depicting the Battle of Yorktown in 1781. The battle opens when a cannon fires toward the audience. Then a French frigate, its guns blazing, moves across the lake which, in the spotlighted darkness and with the night as a backdrop, has become actually a part of the stage. The frigate, though not life-size, looks startlingly real. A tape recording of battle noises — gunfire, ricocheting bullets, and all — is played over the loud-speaker system.

Behind the frigate and the cannon is some additional drama not a part of the main plot. The theater staff constructed the frigate from a retired Navy lifeboat,

adding the necessary scenery and equipment to make it look like a miniature 18th-century man-of-war. The sails were designed to function just the opposite of those on a regular boat. They were made of hardware cloth covered with window screening, so the wind will blow through them without too much resistance.

When the theater first opened, part of the frigate's "crew" included two divers. In the 1¼-minute frigate scene, the boat moves majestically across the lake, firing its 32 guns. The technical staff devised an ingenious plan for propelling the craft. At first, a gasoline-driven winch on shore pulled the boat across the water by means of a cable. The lake, being artificial, contained many old tree stumps and the divers had to be kept on hand to free the cable every time it snagged on a stump. Eventually a system consisting of a submerged

(Continued to page 232)

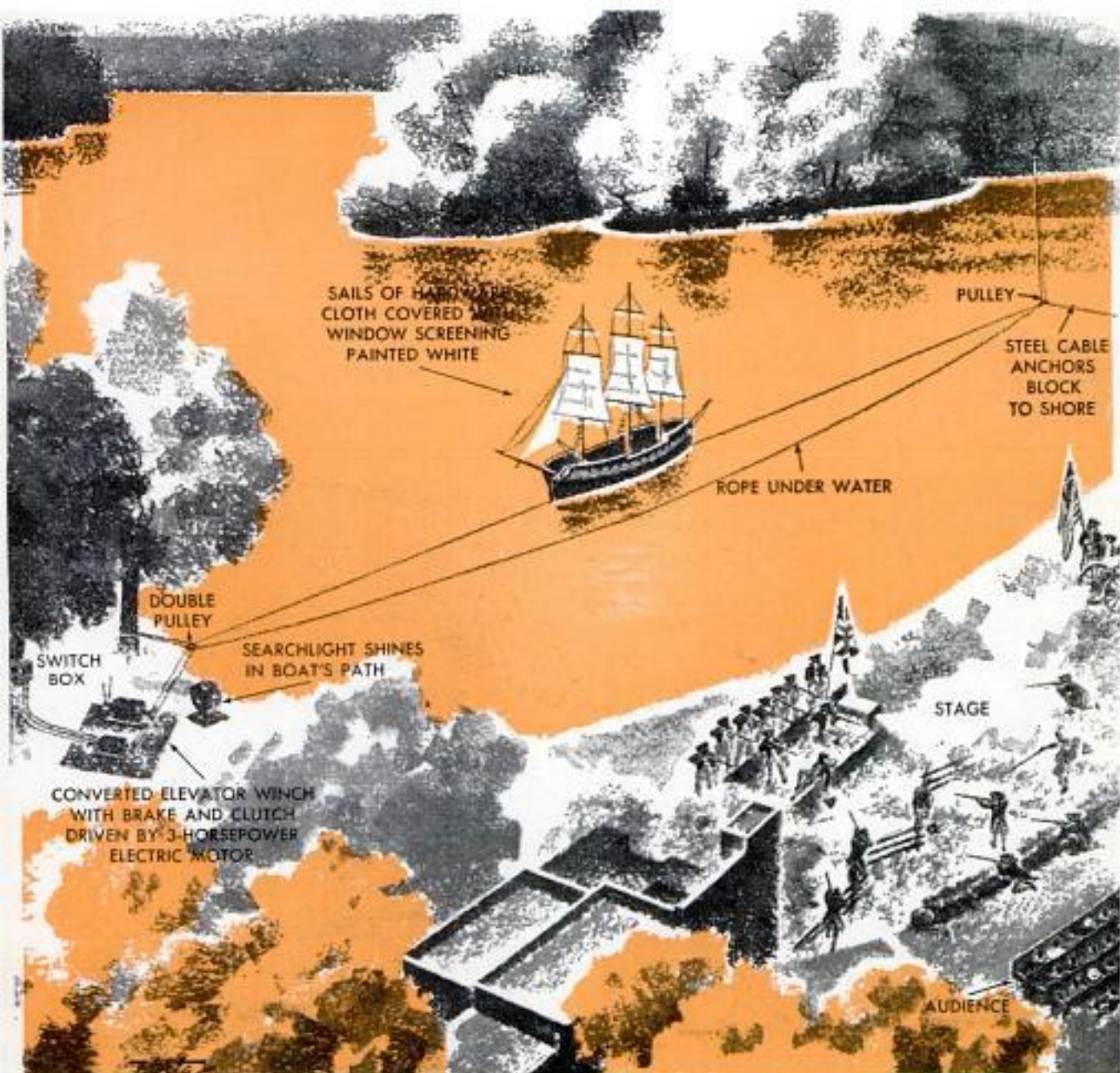

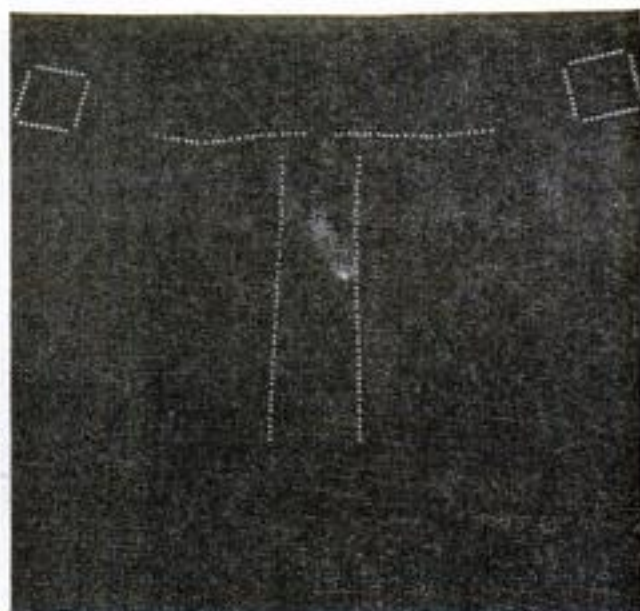
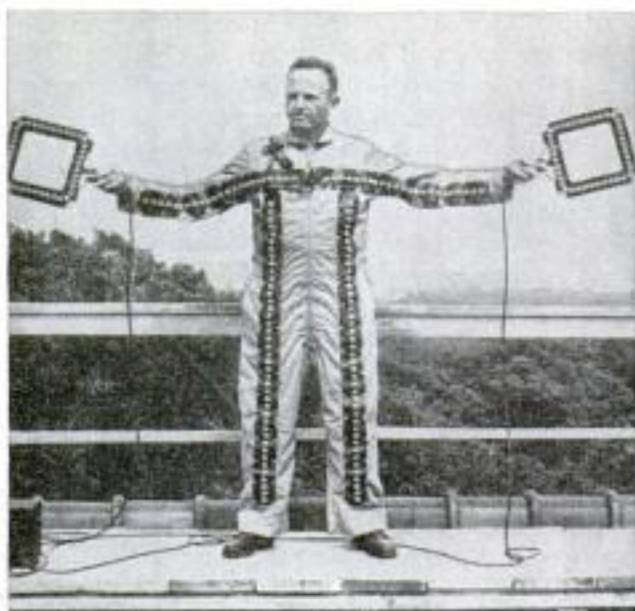

Signal Suit for Navy Officers Guides Planes to Carrier

Illuminated by dozens of tiny lamps, a suit and paddle set developed by the Navy for landing officers promises new safety in night aircraft-carrier operations. The

illuminated stripes on the suit and paddles are visible to pilots on the darkest nights. The lights replace fluorescent strips illuminated from the deck.

Meter on Telephone Shows Call Charge

For a small extra charge, telephone subscribers in West Germany may rent a phone with a built-in charge meter. The purpose of the meter is to give the user a running account of the cost of his calls and thereby remind him to cut off his conversation before running up too big a bill. It operates on alternating current. Impulses vary with the distance, so appropriate charges are recorded according to the distance involved. The charge visible to the subscriber is automatically recorded in a central office. The meters are used only with dial phones.

Truck Cab Elevates To Uncover Engine

Without disconnections of any kind, the cab of the 1955 Mack truck is lifted straight up to uncover the engine for maintenance. A hand pump or optional hydraulic power elevates the cab, which locks securely in the top position. With the cab up, the mechanic can reach all parts of the engine without having to move around axle and wheels. Because it does not tilt forward as it lifts, the new design requires no additional floor space.

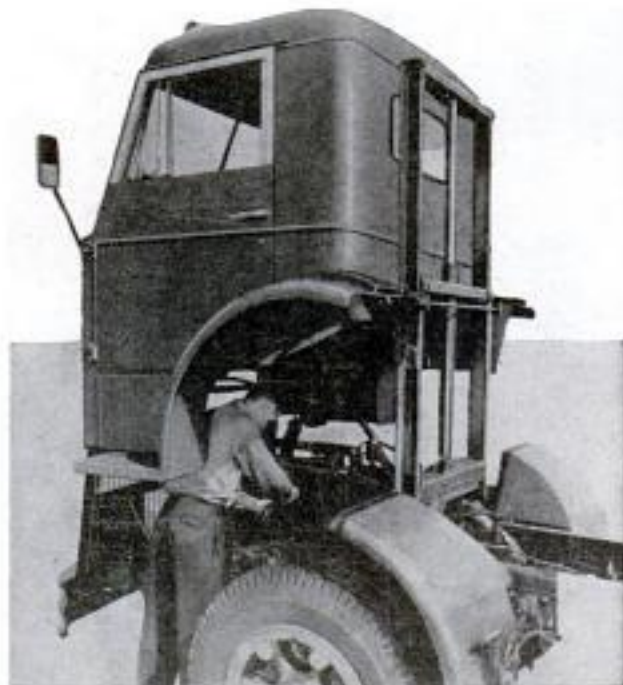



Baby A-Bombs

TROOPS TRAINING at Camp McCoy, Wis., no longer have to imagine atomic explosions during their field problems, for Capt. Loren J. Blazer has devised a simulated A-bomb for them. The bomb explodes with an earth-shaking roar, has a fire ball, the mushroom shape, and even a weird cloud effect that rises 3000 feet in the air. Two 55-gallon drums, with tops and bottoms cut off, are sunk into a pit to form a "cannon." Then three capsules of TNT wrapped in white phosphorus warheads are lowered into the drums. Powdered high explosives are poured over them, and the "brew" is topped off with 50 gallons of gasoline. Eighteen pounds of demolition charges provide the noise and shock wave, while the main charge sends a boiling fire ball up, followed by the rockets which cause the mushroom cloud.



Ordnance experts, below left, wire three capsules of TNT and rocket warheads together. Below right, electric firing device behind protective bunker 300 yards from blast site triggers simulated atom bomb



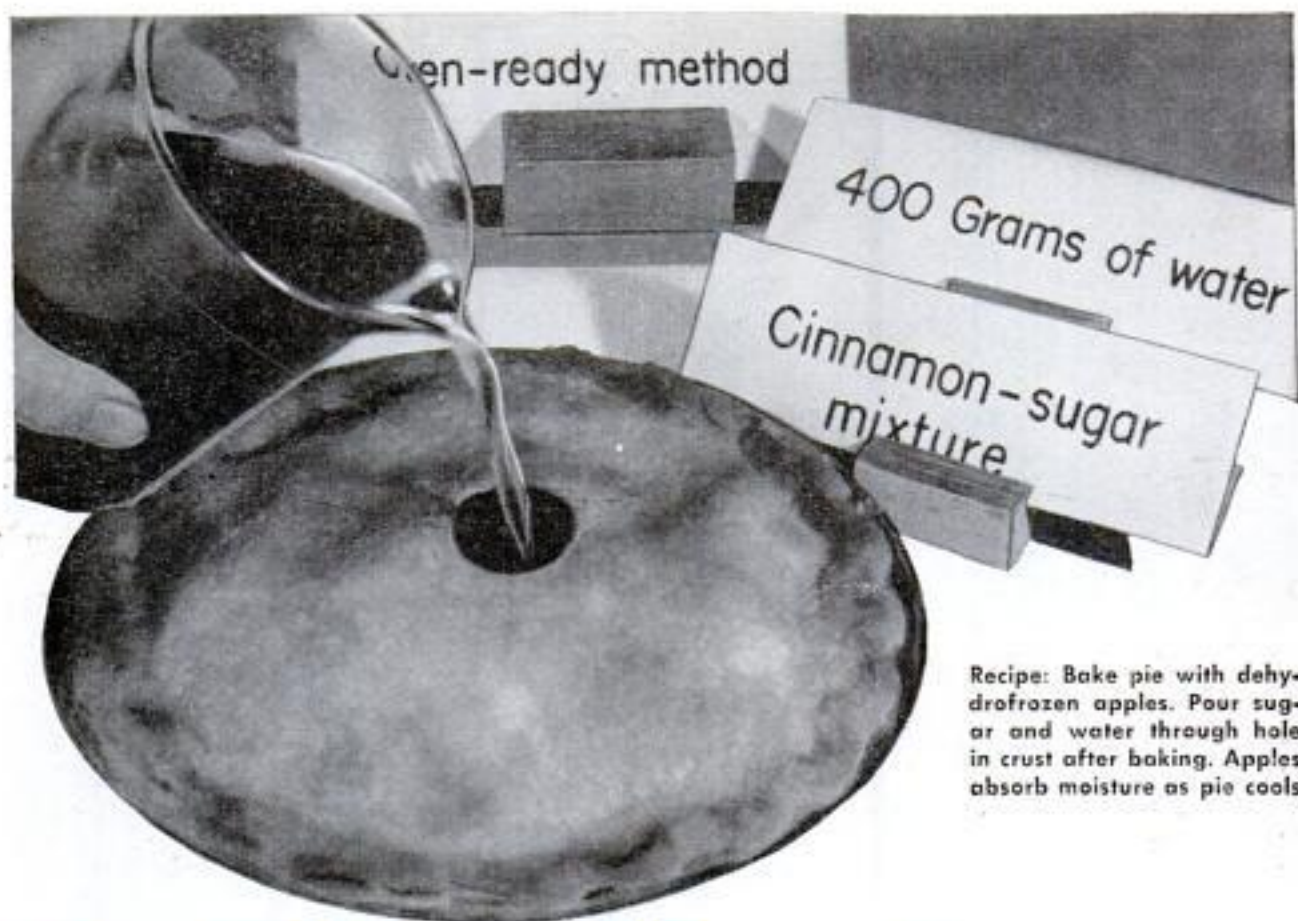

Recipe: Bake pie with dehydrofrozen apples. Pour sugar and water through hole in crust after baking. Apples absorb moisture as pie cools

The Things They Do to Your Dinner!

Rotary drier removes sufficient moisture from apples to reduce their weight by 50 percent. Food then is frozen for shipment

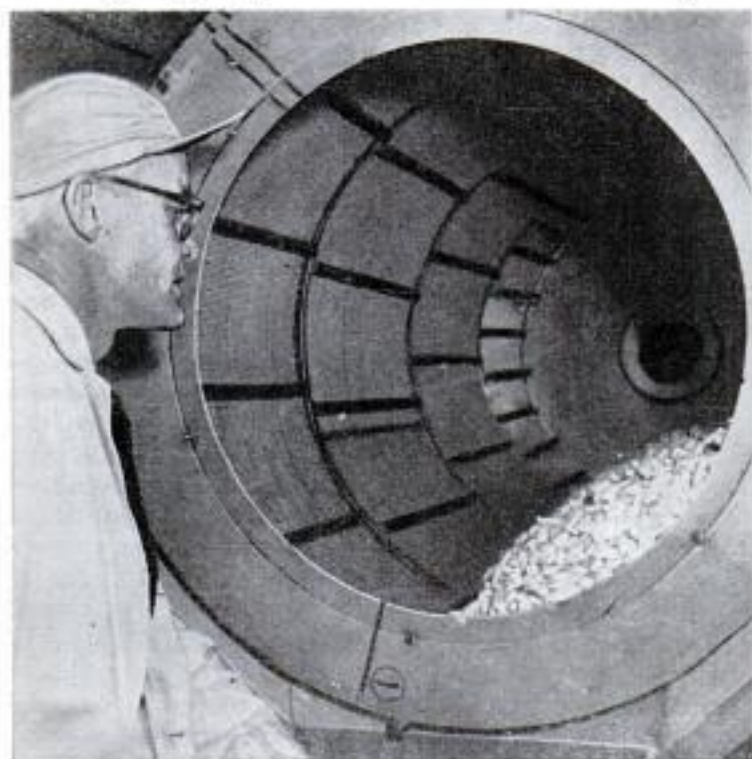

By Ronald M. Deutsch

NOT TOO MANY years ago, Great Aunt Martha scoffed at the notion you could get a palatable vegetable out of a tin can. And when she saw her first freezer, she wouldn't believe her eyes. But the nation's food laboratories are hinting that she hasn't seen anything yet.

Indications are that in a few years, if Great Aunt Martha is still around, she may watch a meal prepared from the following: A two-year-old steak stored on an open shelf in a plastic bag; a tiny packet of powder that turns into a pitcher of fresh-tasting fruit juice; two little boxes about as big as king-size cigarette packages, taken from the freezer to become vegetables for four; and for dessert, "fresh" uncooked fruit out of a can.

Each of these items is a proven reality today, and there are several more such eye openers in the

food scientists' larder right now.

Two of the most important discoveries have come from the Department of Agriculture's huge laboratory at Albany, Calif. Reflecting on the high cost of frozen packing and storage, and on the fact that nearly all fruits and vegetables are at least two thirds water, Dr. Louis B. Howard wondered if there weren't some way to combine the advantages of dehydrating with those of quick freezing.

Out of this thinking grew an important advance in food technology—dehydrofreezing.

DF, as the trade calls it, removes up to 80 percent of the water from a fruit or vegetable. The residue is quick frozen. The result? A package of frozen food a third the size of the original, with a saving of at least two thirds in the costs of packing, shipping and storage. Not enough water is removed to damage flavor or texture (as in dehydration) but enough is taken out so few ice crystals form in freezing. And it's the ice crystals that break down texture and flavor in freezing.

The DF foods thaw dry with no dripping, and pop back into size, shape and flavor when cooked in water. An ordinary refrigerator freezing compartment that holds 25 pounds of frozen food will hold 75 pounds of DF fruits and vegetables.

DF foods, including pimentos for cheese and apples for pie, are already being sold commercially to bakers, institutions and manufacturers. Some time in the future they may hit the retail market and may be a few cents cheaper than quick-frozen products. The grocer can store far more in the same space.

The military services are extremely interested in DF, as they are in any method which enables them to get fresh-tasting foods to fighting men at sea and abroad. For this reason, too, the Army is fostering another of the Albany laboratory's discoveries.

Any man who's ever dined on an

Here's difference in bulk that must be shipped. Same quantity of apples is shown dehydrofrozen (left), canned (center) and before processing on the platter at right



Enough food for four hungry adults! Water will turn this dry food into soup, potatoes, celery, spinach, steak, peaches, milk





Dehydrated meat gets a try in the laboratory. By adding exactly the right amount of water, technician converts it to juicy steak

Army C ration will tell you what a big morale booster it would be to have a quart of fruit juice in a field pack. This has now been made possible by William F. Talburt and his brother food researchers, who have succeeded in drying several different kinds of fruit and vegetable juices.

Talburt starts with the fresh concentrate that is produced by the frozen-juice packers, but instead of quick freezing this, he places it in a vacuum chamber and dries it quickly in a method called "fluff" drying. The juice concentrate becomes a dry, puffy mass of crystals, easily broken into a coarse powder. When you mix a small envelope of the powder with a quart of cold water, you get a fruit juice as fine as any frozen juice you've tasted.

A pilot plant to produce the powder has been started in Florida, backed by the Army. Experts predict that savings in shipping weight, packing and storage costs may make the powder a formidable competitor to frozen juice. The inventors of the process also see it as a means of getting fresh fruit juice to many parts of Europe and Asia where refrigeration is

Radiation will prevent potatoes from sprouting. Doses of varying intensity produce different effects

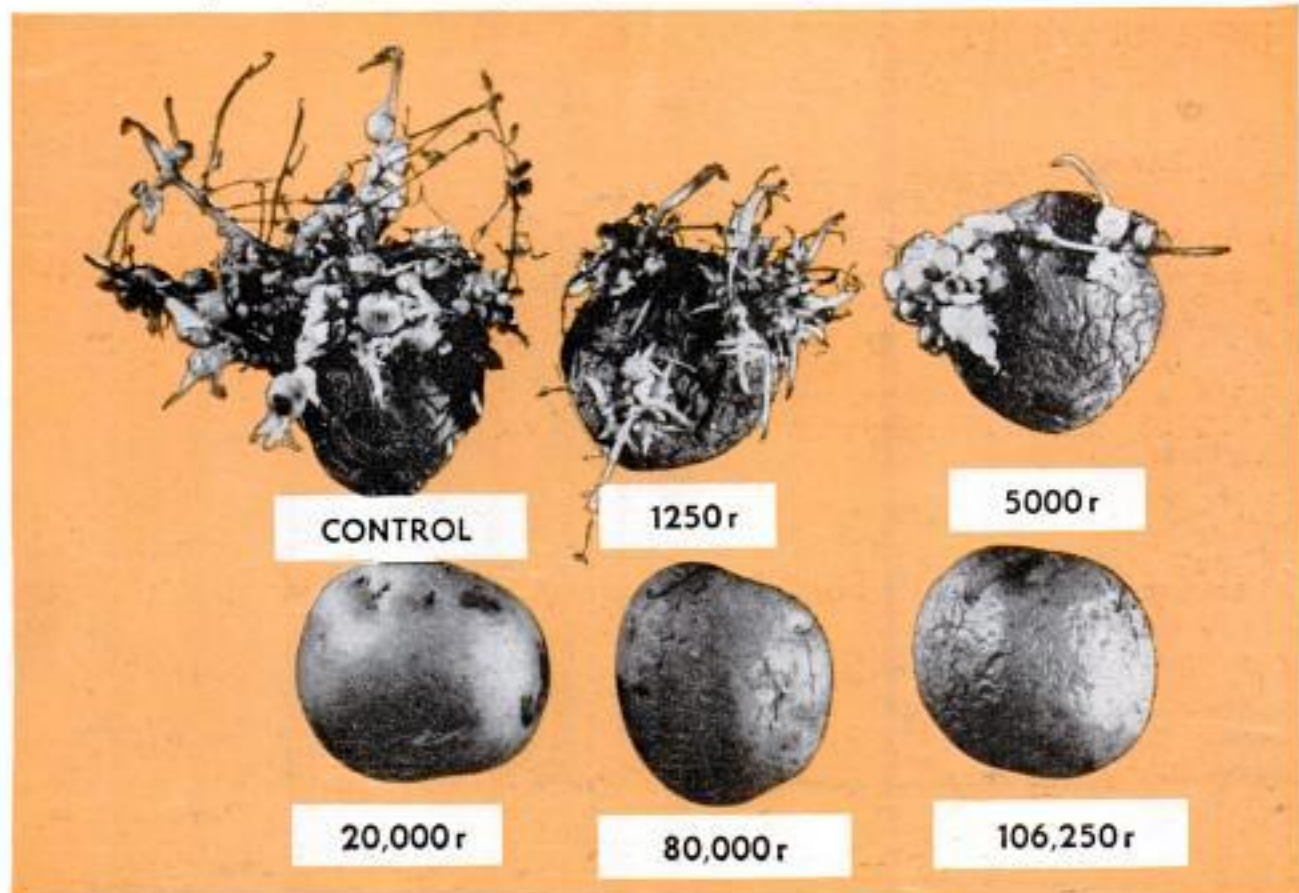

rare. The juice powder is being sampled in long-range submarines and went with the party that climbed K2.

It isn't really surprising that the juice powder can be kept on open shelves for years, but visitors to a laboratory at the University of California's Davis campus are startled to see shelves of unrefrigerated steaks, roasts and chops, of veal, lamb, poultry and fish. They are even more startled when they learn that these items have been there for more than two years and are still pleasantly edible.

This is another pet project of the military, known as freeze drying. Aloys Tappel, an assistant professor of food technology at the school, developed the process, in which frozen meats are subjected to a high vacuum which removes almost all the water without damaging the meat. They then are stored at room temperature. When rehydrated (by soaking in water for a few minutes before cooking) the meat is tender and flavorful.

The beauty of freeze drying is that meat can be stored without refrigeration. No bulky cans are needed, the meat needn't be cooked first and shipping weight and space are vastly reduced. The processed food is simply enclosed in a plastic foil-laminated bag. Not only is this a blessing for the serviceman and the sportsman; it may well find its way into the supermarkets in the not-far-distant future.



Powder in can at left becomes orange juice in jar at right. Small container holds drying agent in can

Meanwhile another new development is the shipment of frozen foods without refrigeration. This method, initiated by Libby, McNeill and Libby, uses a "superchill" to bring the temperature of frozen foods down to minus 150 degrees. The food is shipped in a big aluminum container which has insulation six inches thick. The containers are easily loaded aboard ship or boxcar, and the food inside stays at below-zero temperatures for more than a month without additional refrigeration.

The key to much of this food research is the simple fact that all foods deteriorate

Look what's happened to the good old drumstick! Three dehydrofrozen chicken legs weigh less than two ounces





Tomato juice is concentrated into a semisolid inside a vacuum evaporator. Concentrate is spread on trays for further drying

Million-volt electron-beam generator bombards food to kill bacteria. Such research is promising but still experimental

General Electric photo

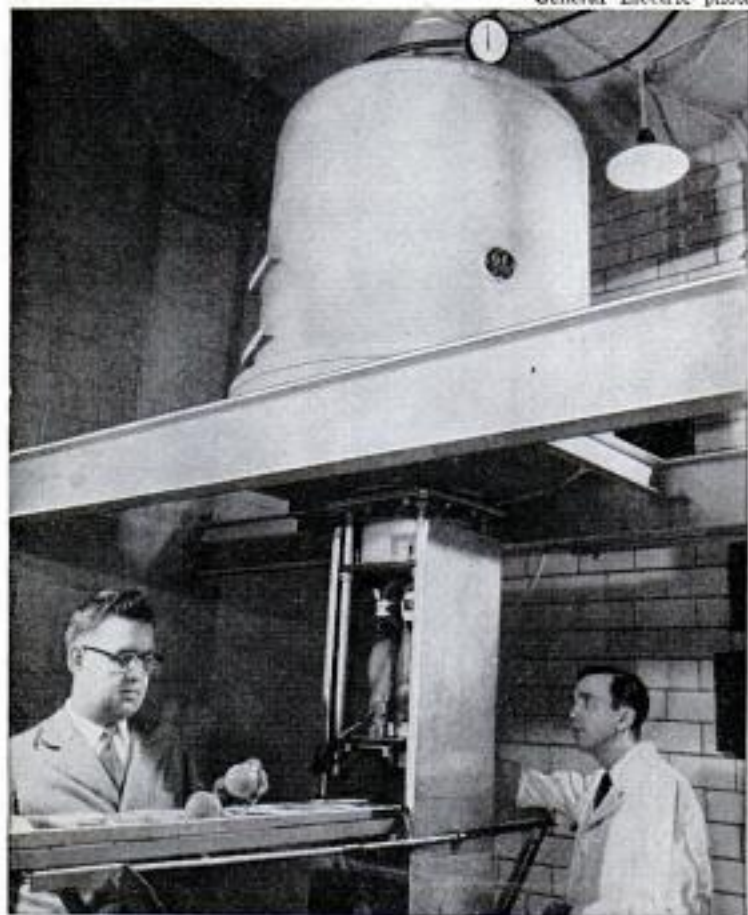

rapidly because of the bacteria they contain, which tend to make the food unfit or even poisonous to eat. Until recently there have been two prime ways to beat the bacteria: chill them into inactivity, or heat and kill them.

But it isn't always practical to keep food cold, and cooking food (as in canning) can spoil the delicate fresh flavor and texture. Even DF and freeze drying injure these qualities to some extent. So scientists have been intrigued by the possibility of killing the bacteria without affecting the food.

Three important means of doing this job have been tried successfully in the past few years. Food technologists believe that within the next decade at least one will be represented in the markets.

Food Shot With Rays

The best known of these ideas is radiation sterilization, the firing of deadly gamma rays at the food. In this process fresh foods are placed in cans or jars which are irradiated by a kind of atomic gun. The rays pass through the container walls and kill the bacteria. Since the containers are sealed, no new bacteria can get to the food.

Though radiation sterilization is now being studied at several laboratories, three big problems remain. One of these is the high cost of atomic radiation, no mean consideration in the highly competitive food business. The second problem is safety and shielding. And the third is that irradiation sometimes affects flavor.

Another way to do this same job has gained prominence of late, and it may well prevent the radiation process from ever becoming big business. The process is ultrasonic radiation.

These radiations are the extremely high-frequency sound waves, many times higher than those which can be heard, which are being used for everything from dental drills to metal inspection. Used properly, these high-speed sound waves can destroy bacteria just as effectively as gamma rays.

The ultrasonic-wave producers are much cheaper than atomic-radiation equipment and a good deal safer. Just like gamma waves, the ultrasonic vibrations will go

(Continued to page 244)



Sprinkler holds down dust as street-sweeper attachment picks up dirt in bin. Broom is 72 inches long



When the street-sweeper bin, with 1/2-yard capacity, is full, it is emptied into the dump box of truck

Self-Loader Makes Truck Triple-Threat Unit

NOSING UP to a pile of sand or gravel, a dump truck equipped with a new hydraulic self-loader can fill itself in minutes while the driver sits in the cab. Designed to make an ordinary dump truck a triple-threat work unit, the self-loader has a number of attachments to increase its usefulness. Among these are a snowplow that can be raised or lowered hydraulically, a forward-tilting bucket that makes it possible for one truck to load another, and a street sweeper that gathers the dirt into its bin and then empties the bin into the dump box of the truck.



Combination of sideboard assembly and special refuse lip on bucket solves refuse-collection problems





Wooden forms keep two willow saplings growing in a spiral. Below, geometric pattern was formed when two sycamores were grafted together. Living armchair, right, was built by grafting four trees together

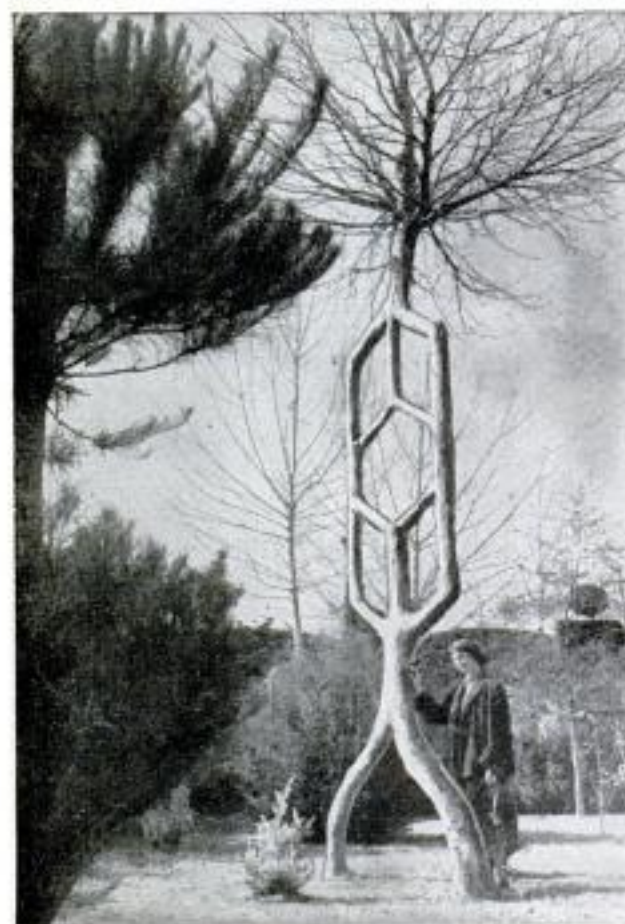

As the Twig Is Bent . . .

RETIRED FARMER A. N. Erlandson isn't content to let Nature take her course. In his "tree circus" near Santa Cruz, Calif., are about 50 weird formations of trees that he has produced by grafting and shaping.

One of his masterpieces is a living armchair made from four balm of Gilead trees, a species of poplar. Erlandson planted the trees five years ago and has been shaping them ever since through intricate grafting and interlacing. The chair, which will support the weight of an adult, provides its own shade in summer when the leaves are on the branches.

Another formation consists of two sycamores grafted together to form a geometric pattern. The two trunks were arched together, trained into the pattern, and then allowed to continue their normal growth at the top.

A double spiral of weeping willows was started two years ago. As the willow shoots grew, Erlandson kept them spiraling with wooden forms. These will be removed in two years when the trees, now 10 feet high, are permanently shaped. Wooden, steel and wire guides are used to train the members of the tree circus, which Erlandson started as a hobby 30 years ago. Today the collection is a tourist attraction.



RADIO



ELECTRONICS



Courtesy Allied Radio Corp.

Typical hi-fi demonstration room. Switch panel, right, permits comparison of many component combinations

HOW TO SELECT YOUR HI-FI SYSTEM

ADVANCES IN THE ART of electronics have made it possible to reproduce music with all the splendor and realism of the original presentation. This realism, called high fidelity, is now within the reach of most music lovers.

It is no longer necessary to buy a commercially assembled system with its fancy cabinet and expensive price tag. Today, you can choose from dozens of attractively styled components to assemble a hi-fi system which will meet your own personal requirements.

You need not be an electronic engineer to select the system best suited for your needs. A little advance planning, followed by an actual listening test will enable anyone to get the most enjoyment for every dollar spent.

A basic hi-fi system consists of a record changer, an amplifier and a speaker system. To this can be added, perhaps at a later date, a radio and television tuner and a tape recorder. Each part must be carefully selected because the final quality of reproduction depends not so much on the price of the over-all system as it does on

THE BASIC SYSTEM



AMPLIFIER



PICKUP CARTRIDGE



RECORD CHANGER



SPEAKER AND ENCLOSURE

ADD-ON COMPONENTS



RADIO TUNER



TV TUNER



TAPE RECORDER

a careful balance of components within a given price range.



COST ?

Components for a complete basic hi-fi system can be purchased from less than \$150 to more than \$1000. In spite of this wide price difference, it is comforting to know that even an expert will, under certain conditions, be hard-pressed to differentiate between the most expensive system and a carefully balanced, moderately priced one. As a start, therefore, you should determine how much of your total budget must be allotted to the individual parts. The following chart is designed to guide you in this determination.

TOTAL COST OF BASIC SYSTEM	Select Turntable and Cartridge Priced at About	Select Amplifier Priced at About	Select Speaker and Enclosure Priced at About
\$150	\$35- 50	\$45- 60	\$40- 70
200	45- 60	60- 75	65- 95
300	60- 80	75-125	95-165
500	90-120	100-220	130-310

Once you have an idea of how much you should spend for each item, you can study a catalogue to determine what components are available in your range. Catalogues are available free of charge from a number of reliable radio-parts distributors. These catalogues illustrate and accurately describe the various units. The information to follow will enable you to evaluate the technical data and select the components in your price range which meet the conditions for high fidelity.

Wherever possible, the tentative selection of parts from the catalogue should be followed up by a listening test in one of the high-fidelity showrooms located in many cities. If this is not practical, you can make your final selection directly from the catalogue with complete confidence and order the components by mail.



THE RECORD CHANGER

Modern high-fidelity changers are equipped with magnetic or ceramic pick-up cartridges, or have separate plug-in heads for any type of cartridge. The record changer itself should have a heavy duty, four-pole motor which reduces objectionable speed variations and hum to a minimum. For convenience it should be

able to play records at speeds of 33-1/3, 45 and 78 r.p.m. Most high-fidelity changers meet these qualifications.

Until recently, magnetic cartridges have been accepted as the finest available for hi-fi use. Today, however, some manufacturers have produced ceramic units which are claimed to have all the advantages with none of the disadvantages of the magnetic types. Ceramic cartridges have a high-voltage output and require no preamplification or equalization. With magnetic units these features must be included in the amplifier.

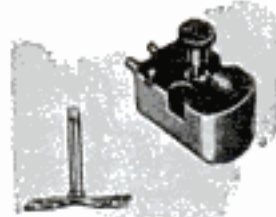

THE CARTRIDGE AND STYLUS

Tentative selection of cartridges from the catalogue should be based on the published data regarding their frequency response and inherent distortion. These characteristics will be explained later in some detail. For the present, any cartridge with a flat frequency response from 30 to 15,000 c.p.s. and a distortion figure of less than 3 percent merits hi-fi status.

Styli, or needles, for high-fidelity cartridges are available with sapphire or diamond tips. Either will outlast the osmium stylus generally supplied with ordinary phonographs, as shown by the illustration below.



Comparison of wearing qualities of different styli

While sapphire styli will give excellent performance for a reasonable length of time, the extra investment for diamond tips, particularly for long playing records, is highly worthwhile.



AMPLIFIERS

In selecting the amplifier, three important electrical characteristics must be considered. These are power output, frequency response and distortion. Let's consider these requirements individually.



POWER

achieve that illusive phenomenon called "presence," the amplifier must be able to provide considerable power.

The average power required for the normal living room, even when the volume is high, probably does not exceed $\frac{1}{2}$ watt. The amplifier, however, must be capable of furnishing far more than that. If the weakest passages of a record are reproduced with about $\frac{1}{2}$ watt, the loudest passages may well reach 10 or 20 times that proportion. If the amplifier cannot reproduce these faithfully, the results can be very disturbing.

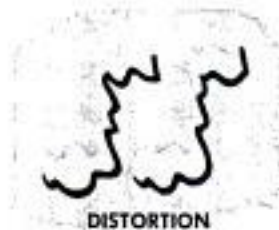

DISTORTION

it is difficult to distinguish between the tones of the various instruments. In addition, distortion can actually introduce new tones which are not related to the original ones, so that the over-all results are unpleasant.

To become audible to the human ear, distortion must reach a certain minimum level. It is generally conceded that even a critical listener cannot detect distortion below three percent of the total output.



FREQUENCY RESPONSE

The frequency response of the human ear is approximately 20 to 17,000 cycles per second. This means that our eardrums are sensitive to pressure variations occurring at any rate within the above limits. In order to meet high fidelity standards, an electronic component must be able to reproduce all of these frequencies with equal intensity. If it does not, we will not hear the various sounds in their true perspective. A wide and flat frequency response, therefore, is a prime requisite of true high fidelity.

In your catalogue you will find amplifiers with distortion figures of less than 1 percent and a flat response from a very few

The output power of the amplifier determines the volume which can be obtained from the speaker. Since hi-fi music must be played loudly in order to

cycles to more than 100,000 c.p.s. Such units, however, are relatively expensive, and the improvement in quality is not commensurate with the increase in cost. In general, an amplifier with a response within 1 db. (a unit of measure of sound intensity) from 20 to 20,000 c.p.s. with less than 3 percent distortion, will provide excellent results.

As to power output, 10 watts is sufficient for average installations with 20 watts being needed for large or heavily draped rooms. For multiple-speaker installations or halls and auditoriums, a power output of 30 or more watts may be required.

In addition to the usual volume control, the amplifier should have separate bass and treble tone controls to permit compensation for personal preference and room acoustics. Furthermore, the unit should incorporate extra input jacks so that other components may be added later. A front panel selector switch is another important requirement.

If a radio tuner is purchased at the same time, all of the above-mentioned controls and inputs may be incorporated in the tuner. In this case, a basic amplifier, one without any controls, may be employed, at considerable saving in cost.

If a magnetic phono cartridge will be used, an equalized preamplifier must be included in the tuner or amplifier. For ceramic cartridges, this feature is not needed.



SPEAKERS AND ENCLOSURES

The speaker and its enclosure usually represent the weakest link in any music system. It is here that an increase in cost will bring the greatest improvement in quality. For this reason, several units in varying price ranges should be selected for later auditioning. If you are ordering your system from a catalogue, the following explanations will help you in making your final selection.

Hi-fi speakers are available in sizes ranging from 8 to 15 inches in diameter. The larger the speaker, the larger its enclosure must be in order to obtain best results. This consideration becomes important when the system must be installed in a small room.

The least costly of the hi-fi speakers have large cones and heavy magnets (in

(Continued to page 252)

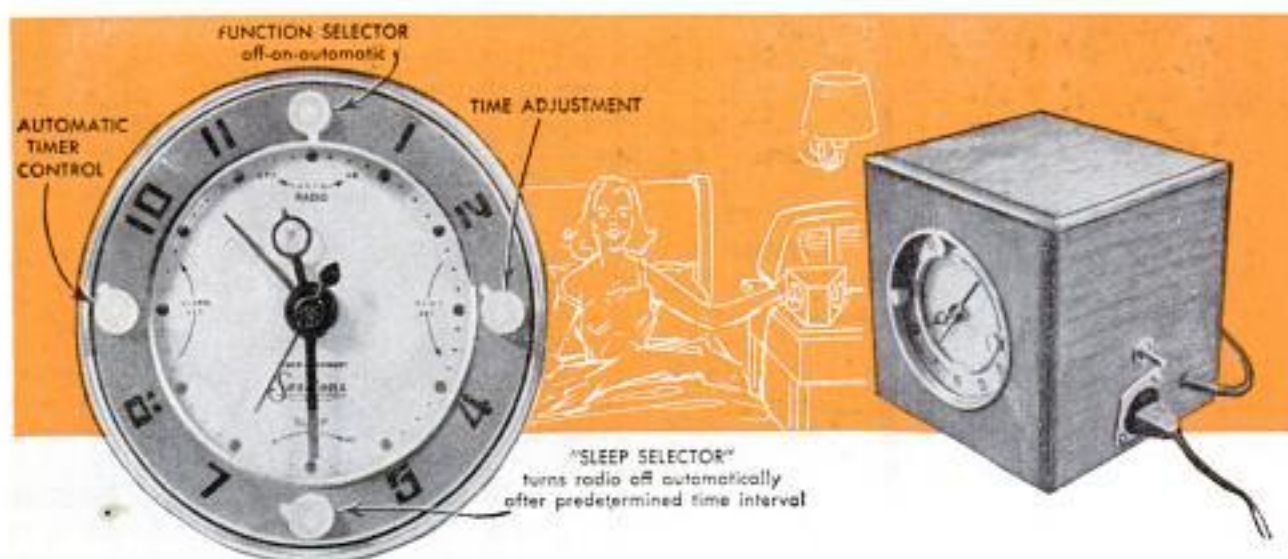

WAKE UP TO MUSIC

By Dr. Richard C. Hitchcock

THIS EASY-TO-BUILD clock timer, when used in conjunction with your radio, will start your day on a happy note by replacing the jangle of the alarm clock with music from your local radio station. This model, which uses two timer clocks, was especially designed for twin-bed rooms. It permits both parties to see the time simultaneously, and it can be used to turn on the radio at two different times merely by flipping the clock selector switch on the cabinet.

The illustrations below show necessary wiring and the cabinet construction details. Naturally, if a single clock will serve your purpose, the second one can be omitted and the selector switch will not be needed. The width of the cabinet can be reduced accordingly.

Construction should begin with the assembly of parts of the cabinet, except part 6, using a good wood glue and headless brads. After the glue has dried, sand

the cabinet smooth and stain or varnish, as desired. Finish side 6 and mount the selector switch and a.c. receptacle as shown. Then, insert the line cord through the panel and wire the circuit as below left. Install the clocks in the cabinet, below right, and attach part 6 to the rest of the cabinet with short wood screws.

To operate, plug timer line cord into wall receptacle and radio cord into timer receptacle. Leave radio switch always in the on position and use the clock controls for the various on-off functions.

LIST OF MATERIALS (See below)

Item	Description	Size
1	Clock mounting face	6"x6"x $\frac{3}{8}$ " 2 reqd.
2	Cabinet front panel	5 $\frac{3}{4}$ "x5 $\frac{1}{4}$ "x $\frac{3}{8}$ "
3	Cabinet top panel	6"x5 $\frac{1}{4}$ "x $\frac{3}{8}$ "
4	Cleats (to hold item 6)	5 $\frac{3}{4}$ "x $\frac{3}{8}$ "x $\frac{3}{8}$ " 2 reqd.
5	Strips of felt material	
6	Cabinet side panel	5 $\frac{3}{4}$ "x5 $\frac{1}{4}$ "x $\frac{3}{8}$ "
7	S.p.d.t. toggle switch, use Hart and Hegeman 21350-BP for radios, and 80618 for appliances drawing more than 3 amperes.	
8	A.c. outlet, Amphenol 61-MIP-61P	
9	Timer clocks, Sessions TF-582, 2 reqd.	

Line cord, wood screws, wood glue, headless brads, etc.

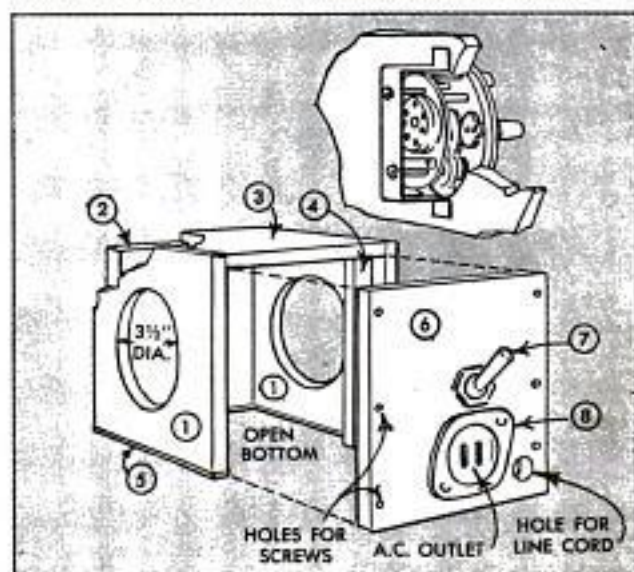
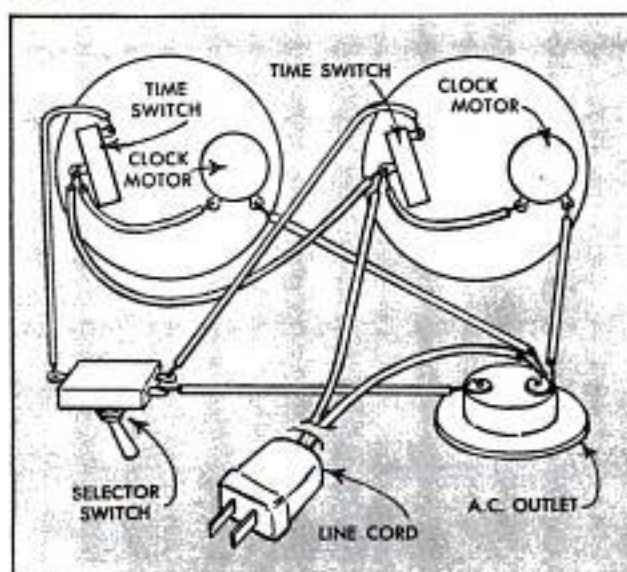

the **POPULAR MECHANICS** CRAFTSMAN

COVER IT WITH **STICK-ON PLASTIC**

By Theodosia Carpenter

Makes many common household items take on a brand-new look. Adhesive backing lets it stick securely yet permits it to be peeled off like masking tape. Wipes clean with cloth

YOU'VE PROBABLY used masking tape and know how easily it can be peeled off. That's the way a waterproof decorative stick-on plastic works, except that a paper backing must be peeled off to expose the adhesive coating. The peeling feature makes the material exceedingly easy to apply—if you make an error in positioning it the first time, simply peel it off and start over. Or, if you wish to change to a new color scheme, just pull it off and begin anew. It can be applied to any smooth surface, adds a durable skin-thin layer of plastic and comes in rolls 18 in. wide. It can be obtained in peppermint stripes, gay kitchen and nursery prints, solid colors, wood grains and marble patterns.

Adhesive characteristic of Con-Tact makes it a suitable finishing material for many craft and household objects because of its ability to bond permanently to any smooth surface to which it is applied

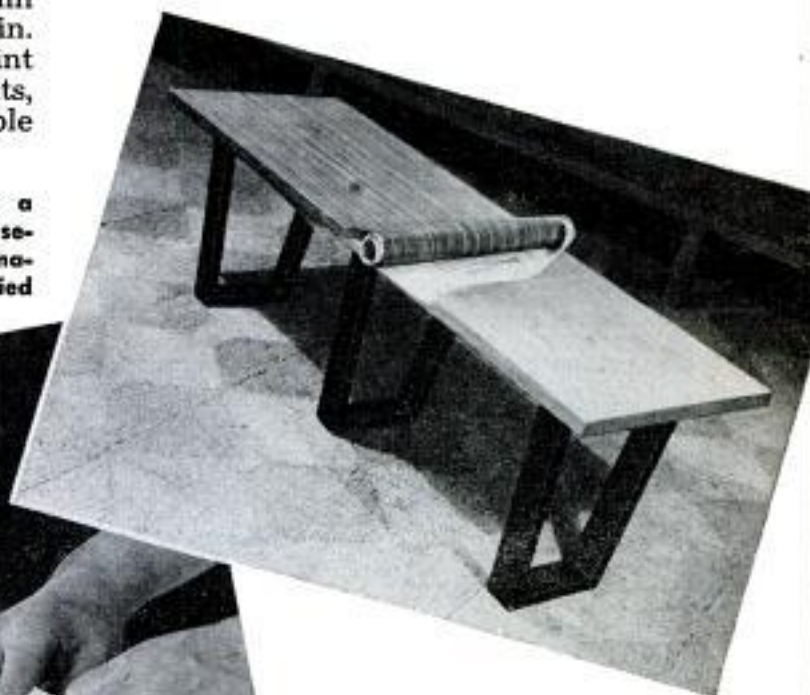

When applying the plastic to a kitchen work area or marred table top, first fill deep scratches and gouges with wood filler and sand smooth



A candy-striped "bib" of stick-on plastic waterproofs and decorates the splash area of this washbowl. Note matching mirror frame in plastic

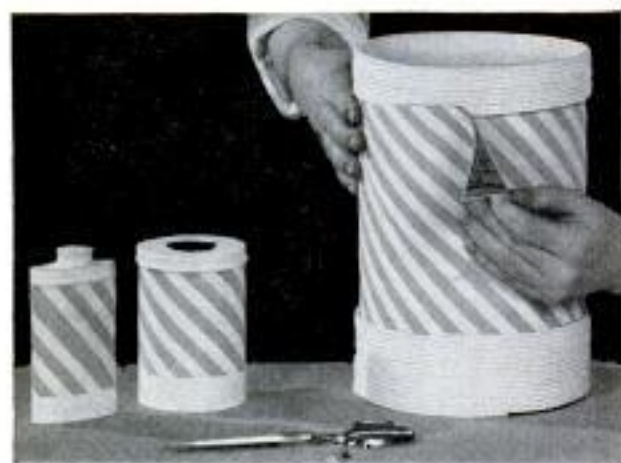

Plastic covering makes companion pieces of this wastebasket, talcum can and cleanser can. Below, no water, paste or tools are needed. Cut in the desired shape, remove backing and apply



Printed designs are easy to cut from stick-on plastic and used like decals. Cut out before removing backing

One of several brands on the market is Con-Tact which is shown being applied in the photos. In the craft field, stick-on plastic can be used to transform many common articles into attractive pieces. A plain potato-chip can, for example, can be converted to an elegant bathroom wastebasket by covering it in a spiral pattern. The top and bottom are wound with white plastic clothesline glued in place. Matching pieces are a talcum-powder can and a scouring-powder can holder.

Stick-on plastic is excellent for covering books and magazines. In the time normally required to make a paper jacket, a book can be given a sturdy, permanent binding. The spine is covered first with a piece that extends well over the book covers. Matching or harmonizing pieces are cut about

Weathered and damaged sills take on new beauty when covered with wood-grained waterproof plastic





The numerous colors and patterns offered in the material afford a good covering for picture frames

$\frac{1}{2}$ in. larger than the covers and stuck in place. Next the corners are mitered and the edges folded over. An appropriate pattern is used for end papers. If the book is coming apart, the end paper should extend both across the inside of the cover and the facing page.

Magazines are given a hard binding in much the same way. The front cover is cut off and a piece of cardboard of the same size substituted, while another is added on top of the back cover. After the binding has been attached, the magazine cover is pasted on the front.

Plastic coverings for kitchen tables are inexpensive and good looking. Working surfaces in the kitchen may be restored to a new appearance with the durable material. Its adhesive characteristic makes it especially useful for covering shelves and window sills.



This marble pattern lends a distinctive note to the dressing table and gives it added serviceability

Because it is waterproof, the product offers a wide variety of uses in the bathroom, as a splash covering around the washbasin or as a colorful frame on the wall around the medicine cabinet. The imitation wood grains are excellent for "paneled" dens or playrooms, while the patterned pieces make lasting washable wall coverings for bathroom and kitchen. ★★★

Pressurized Rubber Force Cup Clears Clogged Drains

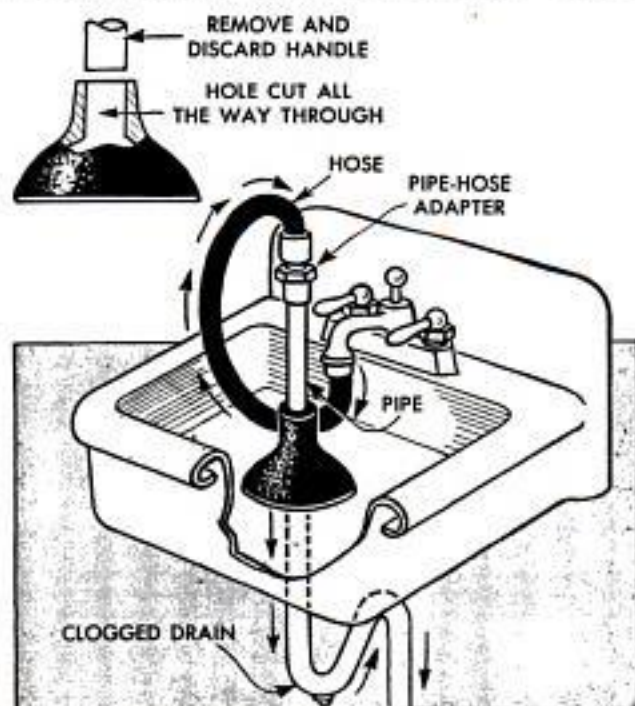

A rubber force cup, modified to direct water pressure into a clogged drain, will clear the drain when a regular force cup will not. To modify the cup, first remove the wooden handle and drill through the blind hole from which the handle is removed. Replace the handle with a 24-in. length of $\frac{3}{4}$ -in. pipe threaded at both ends. Hold the cup on the pipe with a hose clamp. Screw a garden-hose adapter to the upper end of the pipe and attach a garden hose connected to a hot-water faucet. Use only a small amount of water pressure and apply it intermittently. Lift the cup to release the pressure after a few moments, then drop it down over the drain again and turn on more pressure. The cup can be used in the regular way by replacing the garden-hose adapter with a pipe cap.

☐ White shellac will serve as a wood filler in the absence of other suitable materials when applied in one or two coats.

Magnifying Glass on Tweezers Aids Splinter Removal



Removing a splinter from your hand is easier if a small magnifying glass is mounted on one leg of the tweezers. Make a sheet-metal clamp as shown for fastening the glass to the tweezers. Either sheet-metal screws or machine screws will hold the clamp in place. Tilt the glass until the tip of the tweezers is in focus before tightening the clamp screws.

Masking-Tape Adhesive Dissolved To Permit Easier Removal



To prevent chipping fresh paint when masking tape is removed after painting, dissolve the tape adhesive with lighter fluid. Apply fluid to the gummed side of the tape as it is slowly pulled from the surface.

Christmas-Tree-Light Sockets Used as Curtain Pulls

Plastic sockets from an old string of Christmas tree lights can be used to make good curtain and Venetian-blind pulls. First cut the wire to remove the socket from the string, then pull both the wire and the metal insert from inside the socket.

Now slip the curtain cord through the hole in the socket and tie a knot in the cord.
R. M. Woodbury, Natick, Mass.

Dyed Pine Cones and Bottle Caps Make Miniature Trees

Realistic miniature trees for use in model landscaping can be made quickly by coloring pine cones. The cones are dried, then sprayed with green dye. Bases to hold the "trees" upright are made by driving nails through the bottle caps and forcing the cones onto the nails. Sprinkling boric-acid crystals or other suitable material on the cones will provide a snow effect.



Installing Solid-Rubber Tires

Replacing solid-rubber tires on baby carriages and children's wheeled toys is no problem when this simple wire-stretching tool is used. It consists of a frame bent from flat steel and a crank bent from metal rod. Two holes are drilled through the crank and two through the bottom of the frame so the wire can be threaded as indicated. To operate the tool, strip the tire back until about 6 in. of wire are bared at each end, making sure the remaining length of tire is about $\frac{1}{4}$ to $\frac{3}{8}$ in. longer than the circumference of the wheel. Next, thread the wire ends through the frame and crank holes and turn the crank until the wire is under tension but is not taut. Give the frame one half turn and cut the wires near the twist. Fold the ends down and force them into the tire. Then with a hammer tap the tire on both sides of the joint until the ends are forced together.

Carl S. Bates, Chicago.

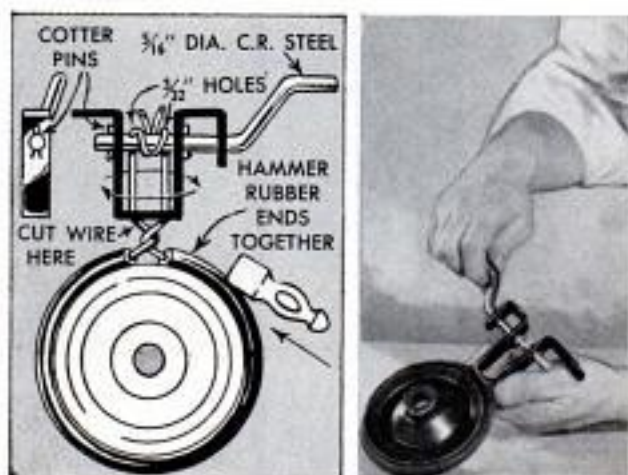

HAMMERED-COPPER SNACK TRAYS

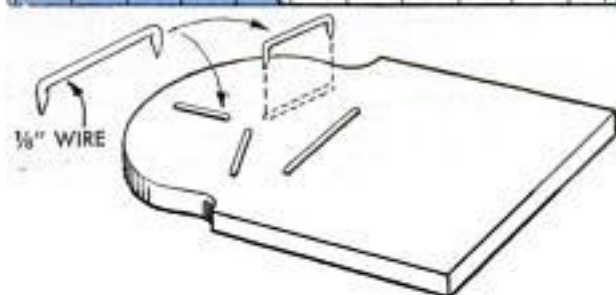
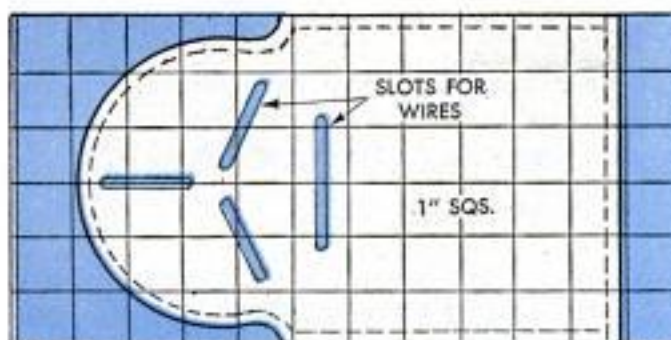

Above, trays are just the right size for holding coffee cup and sandwich when watching special TV program. Ridges pressed into tray provide three-point rest for cup to prevent it from heating tray

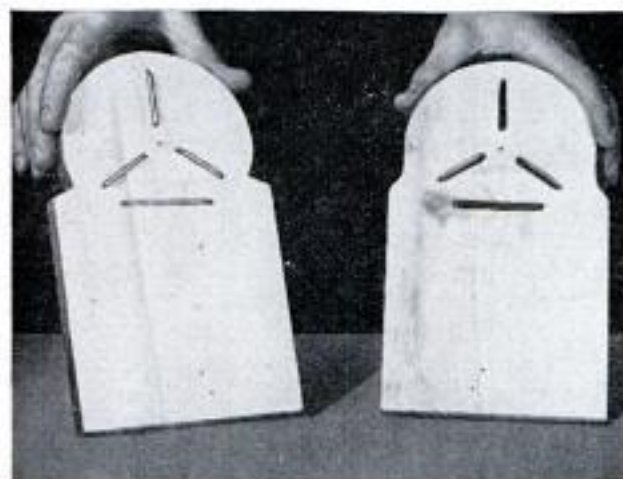

Jig for shaping trays consists of two pieces cut from 1-in. stock, one having slots, the other wire staples

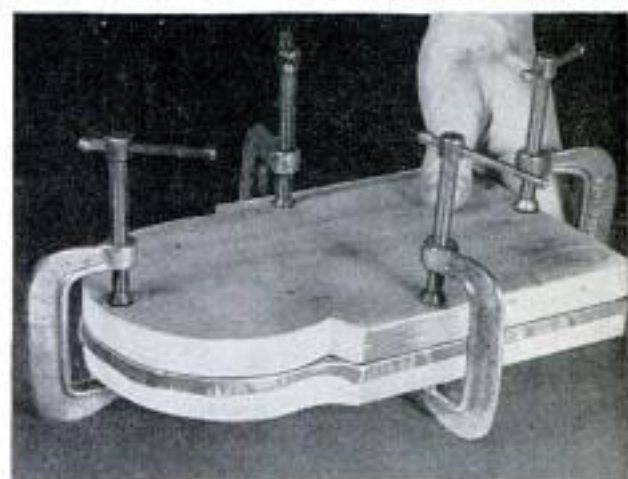

Final step in shaping trays is to clamp them between jig halves and bend down projecting edges of metal

THESE HAMMERED-COPPER snack trays are strikingly attractive when buffed to a high polish, and are just the right size for holding a cup of coffee and a sandwich or piece of cake when a special program keeps you at the television set. Best of all, using a simple two-piece wooden jig, the trays can be mass-produced, thus offering an opportunity for Christmas gifts, or salable items for spare-time projects.

Roofing copper is the material used to make the trays. Although this type of sheet copper actually is heavier than necessary, it is generally available in most localities. Also, it comes in a 12-in. width that can be cut economically to make trays which require a 6 x 12-in. sheet. If a lighter-gauge sheet copper is available, it can be used, since peening the metal hardens it so that it will be rigid enough.

To make the jig for shaping the trays, transfer the pattern shown at the upper

left onto 1-in. squares—the dotted lines show the dimensions of the jig, the solid lines show the outline of the sheet-metal pattern—and cut two identical pieces from 1-in. stock. In one piece, cut four slots as indicated on the pattern. In the other piece drive four "staples" to align with the slots in the first piece. The staples are lengths of $\frac{1}{8}$ -in. wire, sharpened on the ends and bent to a U-shape.

Cut a piece of copper according to the pattern, peen it well, then place it between the jig halves and hammer on the slotted end of the jig so the wires force the copper into the slots to form ridges in the tray. Next, clamp the copper sheet between the jig halves and hammer over the $\frac{1}{4}$ in. of metal that projects all around, thus forming the tray edge.

Remove the tray from the jig, smooth the edges, then polish the whole tray with steel wool and coat with clear lacquer.

Hydraulic Wheel-Chair Support

Anyone confined to a wheel chair will find use for this support, whether in the home or in business, as it permits the occupant to raise, lower, or turn the chair to any angle

By Clinton R. Hull

SPECIFICALLY DESIGNED to hold the wheel chair of a handicapped filing clerk who uses a two-shelf, circular desk in his work, this swivel support is mounted on the hydraulically controlled column of an old barber chair. The latter not only permits a swivel action, but its hydraulic mechanism allows the wheel chair to be raised by its occupant to any height within the

Chair occupant controls support height by a few strokes on lever of hydraulic unit in column



limits of the barber-chair column—in this case to permit the occupant to work from either level of the desk. It also positions the chair at a height most convenient for using a typewriter which is fitted on a swivel bracket mounted on the end support of the circular-desk shelf.

Construction of the swivel support starts with the removal of the seat of the barber chair. Usually four bolts are used to hold the chair to the column. The wheel-chair support is designed to be mounted by using the same four bolt holes. A sheet-metal disk is cut to fit over the opening in the upper end of the barber-chair column.

The main frames of the wheel-chair support are lengths of $\frac{1}{4}$ x 2-in. flat steel, bent to inverted U-shapes as indicated in the drawing, so they straddle the top of the barber-chair column. Lengths of the frames are determined by the height of the column when it is at its lowest position. "Tracks" for the wheel chair are $\frac{1}{4}$ x 2 x 2-in. steel angles welded to the lower ends of the frames. These tracks should be positioned so they are about $\frac{1}{4}$ in. above the barber-chair base when the column is at its lowest position.

Track spacing on the original support was $18\frac{3}{4}$ in. between the vertical flanges. However, since wheel chairs vary in size and construction, this dimension should be checked on a particular wheel chair. The vertical flanges help align the wheels of the chair when rolling it onto the tracks and prevent the wheels from slipping off sideways. The vertical flanges of the angles are cut at a point $23\frac{1}{4}$ in. from the back ends, then are heated and bent flat to provide supports for the sheet-steel platform which is bolted across the forward ends of the tracks. The ends of the tracks also are bent down $1\frac{1}{2}$ in. at a point 4 in. from the front ends.

Wedge-shaped wooden blocks are bolted to the lower surfaces of the front ends of the tracks. These blocks should just touch the floor and hold the tracks level when the wheel-chair support is at its lowest position. To determine the latter position, place both wheel chair and its occupant on the completed support and release the hydraulic valve so the column

Hydraulically raised and lowered support positions chair so occupant can work at upper or lower desk level or at typewriter

settles to its lowest point. Otherwise, the column, which has been lightened by removal of the barber chair, might not settle to its true low point.

After the tracks have been spaced properly, they are held in place by a $\frac{1}{4}$ x 1-in. flat bar welded horizontally at the rear, and by one or two diagonal braces welded to the upper ends of the U-shaped frames and to the tracks in front of the column as shown in detail at right.

The circular desk for which the wheel-chair support was designed is made of several circular segments cut from $\frac{3}{4}$ -in. plywood. The segments of the lower shelf have an inner radius of 24 in. and an outer radius of 44 in., resulting in a top 20 in. wide. Radii of the upper shelf are 27 and 44 in., resulting in a 16-in. width. The desk is supported on vertical legs spaced along the outer edge of the lower shelf. Angle-steel braces are fitted diagonally between the lower ends of these legs and the inner edge of the lower shelf. This arrangement provides clearance for the wheel chair as it swivels. Sheets of hardboard are fastened to the outer edge of the lower shelf and extend to the floor.

The typewriter support is a welded angle-steel frame, braced and welded to a section of $1\frac{3}{4}$ -in. pipe which is split and rewelded so it will slip over a $1\frac{1}{2}$ -in. pipe, that size being used for the spacers between the upper and lower shelves of the circular desk. ★ ★ ★

Chair support at lowest position permits chair to be rolled onto it, where occupant can adjust it to any height or direction

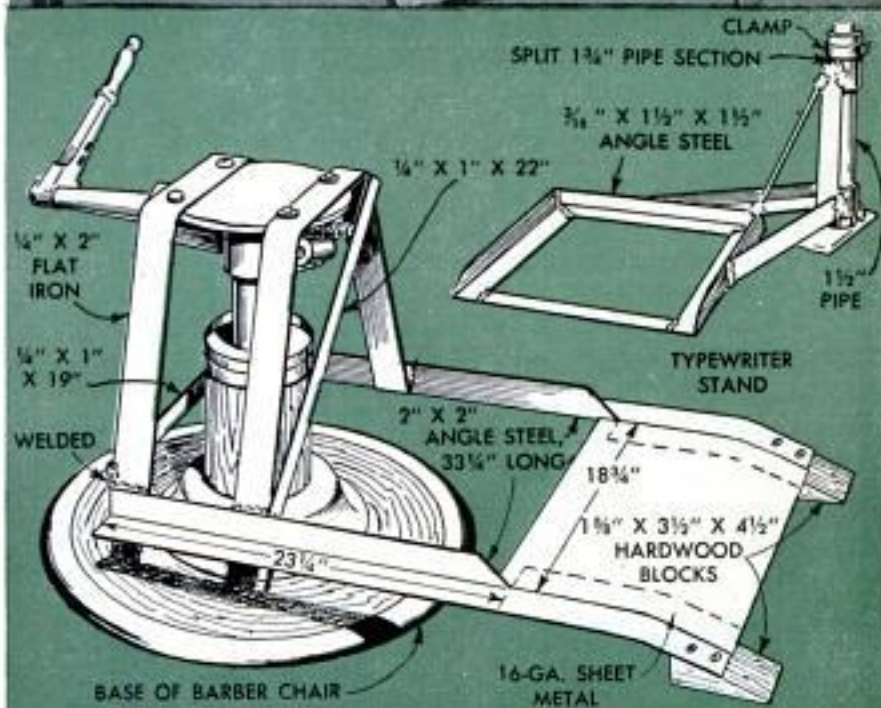

Convenient Light-Bulb Storage Provided by Hardboard Panel



There is no need to wonder about the light-bulb supply, when a single glance at this storage panel will tell how many unused bulbs remain. The panel is a 12-in. square of hardboard in which 16 equally spaced 1-in. holes are drilled to receive the bulb bases. Cut two empty thread spools in half and use the halves as spacers under the four corners of the panel when it is screwed to the wall. The holder also can be used to hold burned-out bulbs by marking the ends of the bulbs with a grease pencil. Masonite Corp.

Concrete-Filled Flowerpots Hold Driveway Markers



Attractive bases for supporting patio lamps and portable driveway markers consist of large flowerpots filled with concrete. Pour each pot full of a fairly stiff mixture of concrete and invert it on a board. Force the standard of the lamp or

marker through the hole in the bottom of the pot and down into the concrete. Brace the standard in a vertical position and let it stand until the concrete hardens.

Roller Used to Apply Glue Evenly on Large Surfaces

Glue can be applied more quickly and evenly to large areas, such as when cement-

ing counter-top material to plywood, if a roller is used rather than a brush or other type applicator. A print roller of the type used in a photo darkroom would be ideal, or one could be improvised by fitting a length of fairly large-diameter dowel with a Y-shaped handle bent from flat steel.

Outdoor Christmas-Tree Stand Made From Implement Wheel

A stand for an outdoor Christmas tree can be made by modifying an implement wheel. The rim of the wheel is cut off and the spokes are heated close to the hub and bent down. The ends of the spokes should be ground to points so the stand can be driven into the ground. If a tree with a small-diameter trunk is to be used, drill and tap two or three holes in the hub to receive bolts that can be tightened against the tree trunk to lock it in place.



L-Hook Driven Into Yardstick Assures Accurate Measuring

A small L-hook can be used on the end of a yardstick to serve the same purpose as a hook on the end of a steel measuring tape. To prevent the wood from splitting when driving the hook, drill a pilot hole. The outer portion of the hole then is counter-bored to receive the nonthreaded body of the hook, thus permitting it to be drawn tightly against the end of the yardstick.

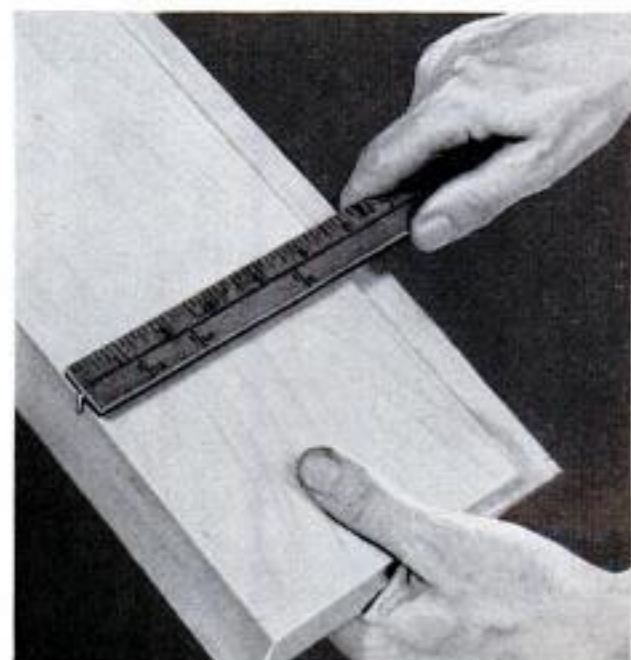



Shallow top section of mailing-tube candle is filled with melted wax a little of which is allowed to trickle down the sides. Then wick is burned just long enough to blacken it. Photo at right shows base, see detail C

New Uses for MAILING TUBES

By Walter E. Burton

DUE TO THEIR sturdy construction, smooth finish and ease of handling, cardboard mailing tubes find many practical and novel uses around the home. The photos on these pages show several applications of mailing-tube construction—from a Christmas candle to an archery quiver.

There are various ways of cutting mailing tubes so the cut end will be square. The simplest is to draw a line around the tube and cut along the line with a razor blade. For multiple cutting of short sections, the tube may be rotated against a knife which is raised above a table or bench top by means of a wooden block. The knife is clamped in place. The circular saw and

Cylindrical box made from tubing sections holds jewelry or stores camera lens. Tubing may be covered with soft leather or cloth. Cardboard disks form lid

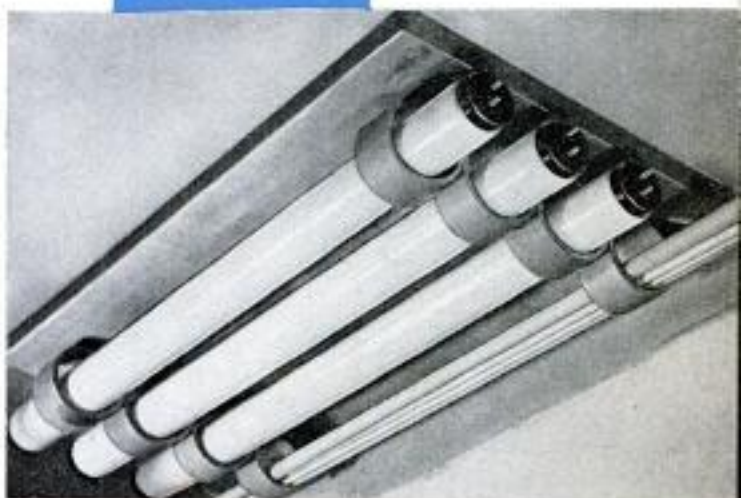

Mailing tubes can be used for storage in several ways. Under-shelf rack, above, is shown in detail E. Below, tubular storage rack holds maps, plans or papers. Tubes are glued to plywood and to each other





Storage drawer utilizes tube sections which are dipped in shellac or glue size and then glued together



Honeycomb compartments made of tubing are ideal for storing rolls of 35-mm. film, buttons or small parts

Camera-lens shade is made as in detail B, below. If inner ring is too small, pad with felt to fit snugly

Mailing tubes form decorative columns at end of hanging shelf. Corner tube conceals steel rod, detail D

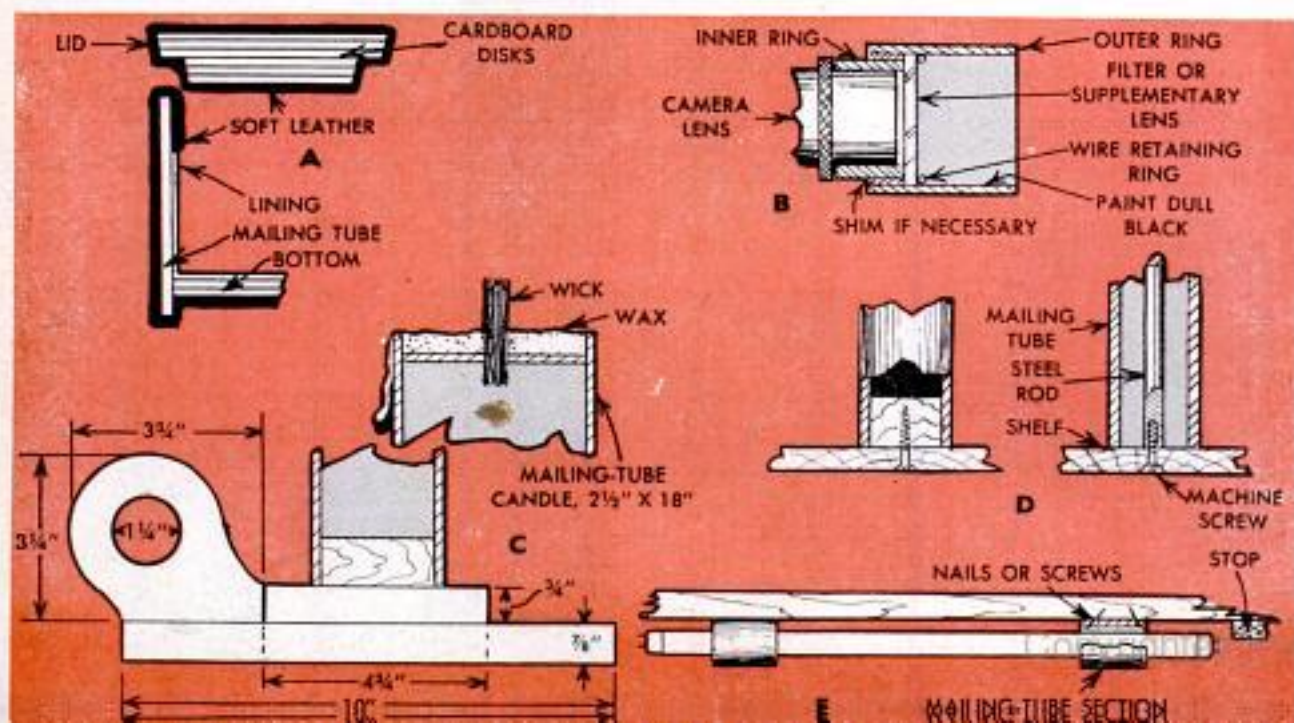
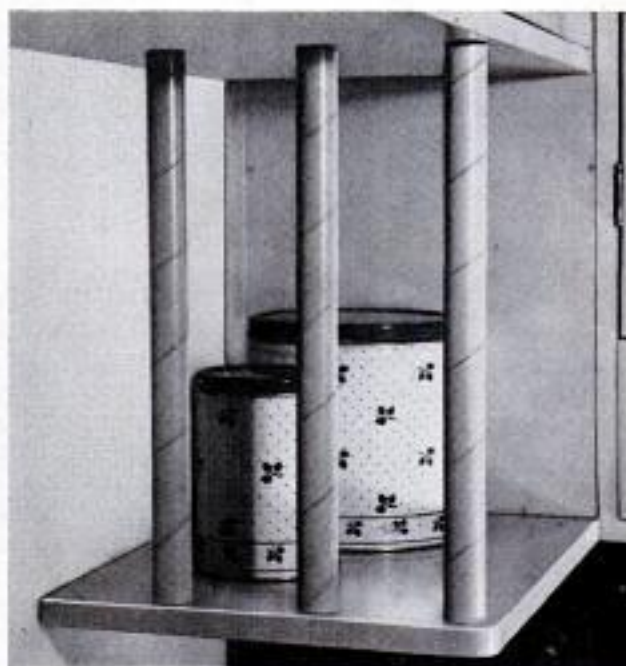
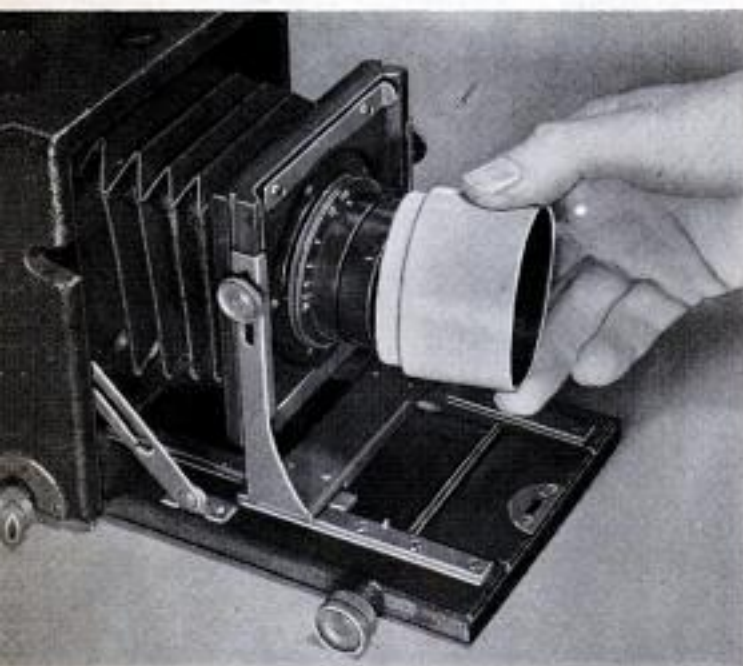

lathe also can be used to cut heavier tubes, the lathe setup being ideal for cutting thin rings.

For appearance, the tubes may be covered with wallpaper, plastic fabric, leather or cloth. Or they may be painted. Before painting, however, seal the cardboard with glue size or shellac and follow sealing with a light sanding.

Surprising strength is obtained by nesting together tubes of different diameters. This was done in the case of the jewelry or lens box, detail A. Lid and bottom of the box were made of cardboard disks cemented together. The camera-lens shade, detail B, consists of two mailing-tube rings glued together. The rings may be shimmed with thin cardboard to make them fit snugly.

Both the candle, detail C, and the decorative shelf columns, detail D, show how the tubes can be supported vertically by gluing the ends over dowel plugs. Detail E illustrates how tube sections may be toenailed to shelves or joists to form racks for extra fluorescent bulbs or lengths of molding. ★ ★ ★

Archery quiver, pictured below, is made from mailing tube as detailed at right. Metal cap is improvised from film container or can lid by cutting tabs in center and bending downward

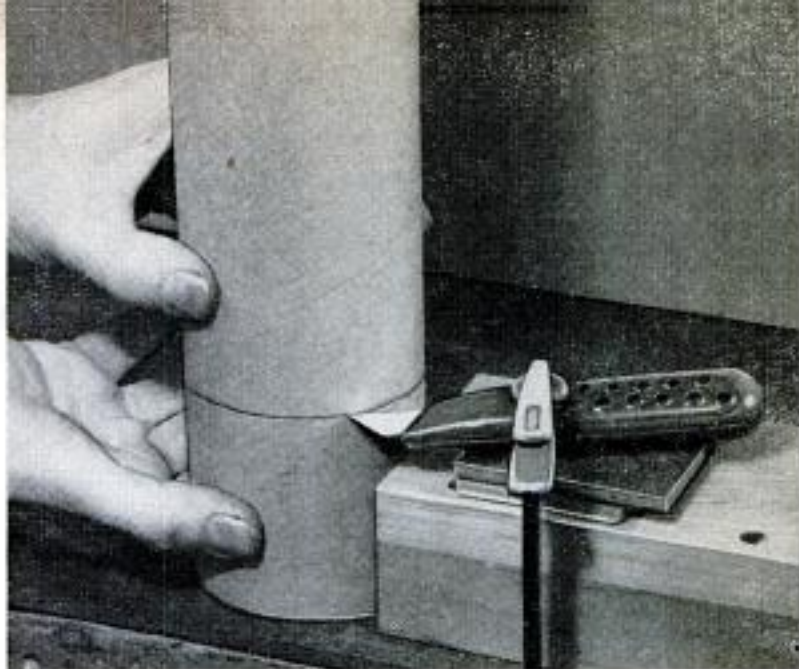

Mailing-tube cutter is made by blocking sharp knife to proper height and clamping to table or bench top

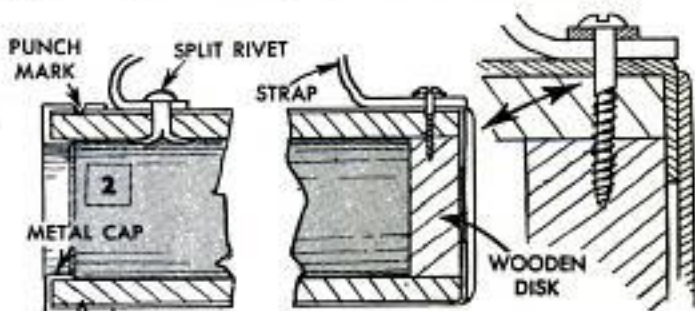

Sides of archery quiver may be covered with cloth-backed plastic fabric which is cemented in place

Vise anvil and hammer are used to rivet carrying strap to quiver. Note punch marks in metal cap

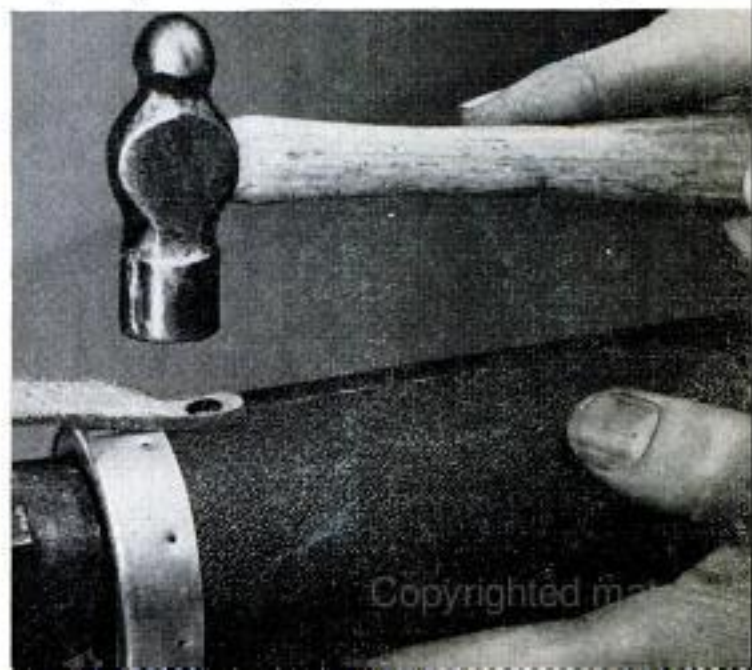

Boot and Mitten Rack Teaches Children Neatness



Placed in a convenient spot in the house, this rack will teach children to keep their mittens and overshoes in one location, as well as prevent them from tracking mud and water through the house. Dimensions of the rack will vary with the number and size of the children. Dowels fitted in the cross-piece of the rack upright accommodate wet mittens, the slatted ramp below holding rubbers and overshoes. A metal pan under the rack catches dripping water. With slight modifications the rack could also be used for hanging snow suits and coats.

Two-Piece Portable Unit Holds Cord and Cutter

Whenever he has a number of packages to wrap, one man clamps this portable cord supply and cutter to a worktable or counter top. The cord spool rotates on a dowel slipped through holes in the side-pieces of the lower bracket. Cord from the spool is threaded through a drilled cork forced into a hole in a projection of the bracket crosspiece. The cutter is a razor blade held between two U-shaped pieces of plywood. The assembly is screwed to a plywood base for clamping.

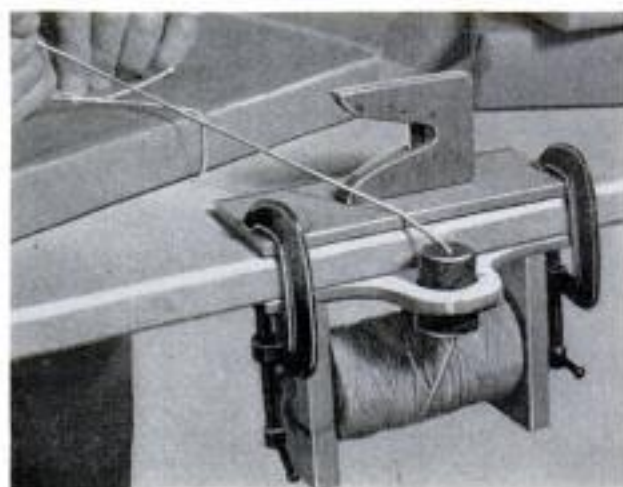

System Simplifies Painting Double-Hung Window Sash

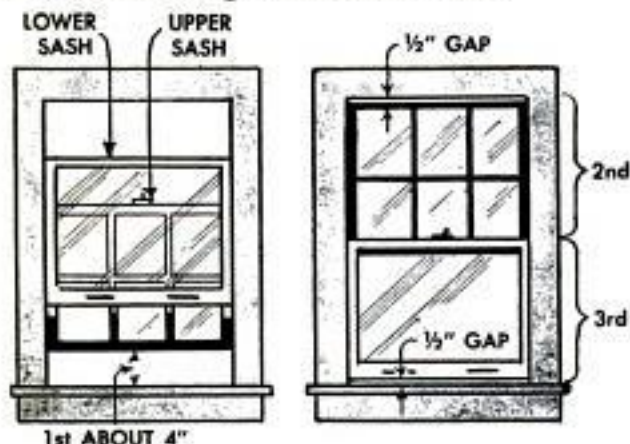

When painting either side of double-hung window sash, position the two sections so that about 4 in. of the top sash can be painted first as shown. Then close the window, leaving a gap of an inch at the top and bottom to keep paint away from

the top of the frame and sill, and finish painting the top sash. To avoid missing any of the crossbars on windows of multiple panes it is best to follow a set pattern of painting all the vertical bars first, following with the horizontal ones. Naturally all loose paint should be removed and loose putty replaced before repainting.

Wood Strips on Exposed Edges Give Plywood Finished Look

Strips of wood glued and nailed to the exposed edges of plywood panels used in cabinets and other projects improve the appearance of the work and conceal blemishes and holes in the core. Screen molding is ideal for this purpose because it approximates the thickness of $\frac{3}{4}$ -in. plywood and can be purchased already sanded.

Storm Sash or Window Screens Held by Concealed Pins

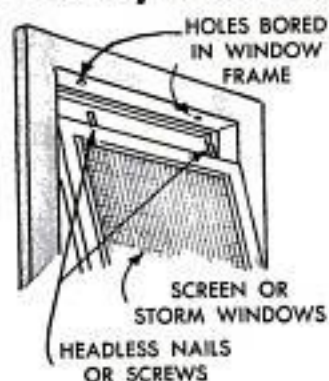

Screens and storm sash can be held securely in window frames without the need of hooks or turn buttons by driving two headless nails or screws into the top edges to fit registering holes in the top of the window frames. Brass

pins or $\frac{3}{16}$ -in. dowels may be used instead, and have the advantage of being rustproof. Ordinary hooks and eyes located near the lower edge of each stile will keep the screens or storm sash closed tightly at the bottom.

Matches Under Lantern Base Always Ready for Use



There is no need to hunt for matches to light a camping lantern when a book of them is taped under the base of the lantern. In most instances the rim of the lantern base will prevent the matches from contacting the ground and becoming damp. If

the lantern is to be used in an especially damp location, wrap the matches in aluminum foil or plastic sheeting before taping them in place.

Tape on Doorframe Switch Shuts Off Dome Light

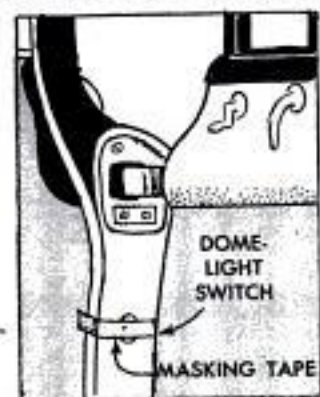

When it is necessary to work on the interior of a car for a long period of time, one mechanic keeps the dome light turned off by pressing a strip of masking tape over the automatic switch on the doorframe. The tape keeps the switch depressed,

but does not interfere with the opening and closing of the door, should that be necessary during the repair work.



Simple Christmas-Tree Stand Made From Siding Strips

Four lengths of leftover siding were used by one homeowner to build a simple Christmas-tree stand. The stand is made in an I-shape, the vertical bar consisting of two parallel strips spaced to accommodate the tree trunk. Wood blocks nailed between the strips support the tree in a vertical position.—Frank Zagar, Cleveland, Ohio.

Metallic Letters Printed With Rubber Stamp

You can print names in gold or silver on book covers and luggage with a rubber stamp by using varnish as ink and metallic powder for color. A small amount of varnish is applied to a pad consisting of four sheets of cleansing tissue placed on a piece of glass or hardboard. After lightly inking the rubber stamp from the pad, carefully stamp the name on the object to be identified, then dust the wet varnish with a metallic powder of the type used to color metallic paints. Blow off the excess powder and allow the varnish to dry overnight before the object is handled.



HAMPER- WORK TABLE

By Jack Wall



Hamper located in kitchen saves steps and provides extra counter space needed in many small kitchens

COMBINING a counter top with large storage space for soiled clothes, this hamper was designed to utilize scarce floor space to best advantage and provide needed counter space in the kitchen as well as jumbo storage for laundry.

Start construction with the base which is 3 in. high and topped with $\frac{3}{4}$ -in. material. The side frames are 1 x 2s joined with corrugated fasteners and waterproof glue, the spreaders, front and back, being nailed to them. Sides and front of the cabinet are $\frac{1}{8}$ -in. perforated hardboard, and the lid, which is hinged to a 4-in. strip across the top at the rear, is $\frac{3}{4}$ -in. fir plywood. Hinges can be mortised flush with the lid to provide an unobstructed counter. Notice the front is set at an angle to get maximum work area with minimum floor space.

Finish is a matter of choice. Cover the top with a material to match the present counter top in your kitchen. The body of the hamper may be finished to match the base cabinets. Hardboard should be given a coat of primer before painting. Follow the primer coat with at least two coats of paint. If you desire to finish the counter top in natural wood, hardwood-faced plywood should be used.

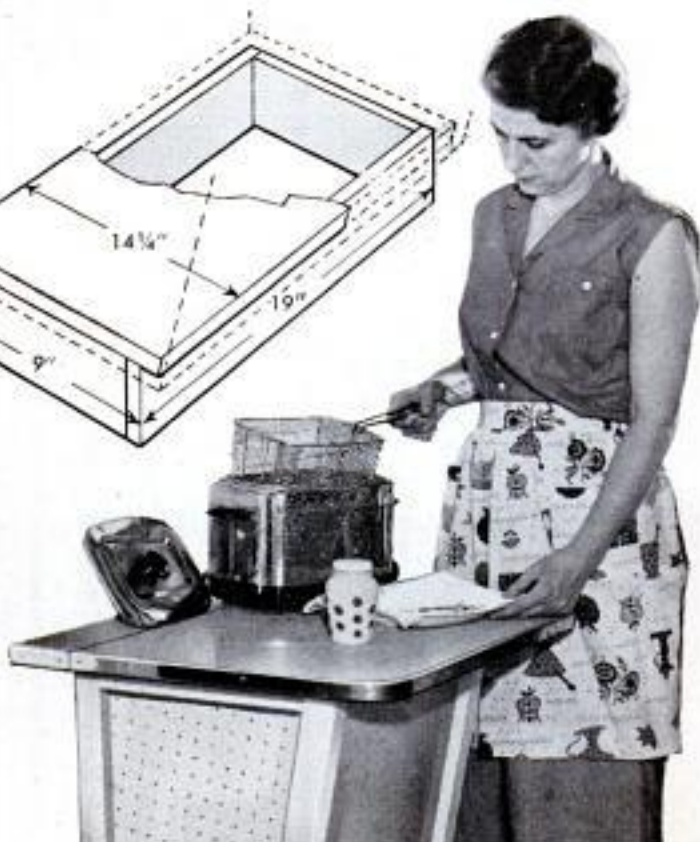
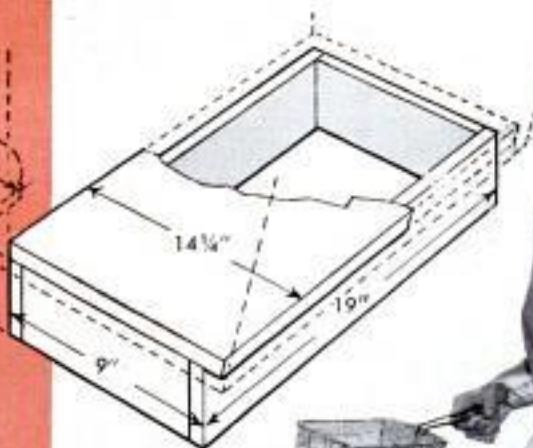
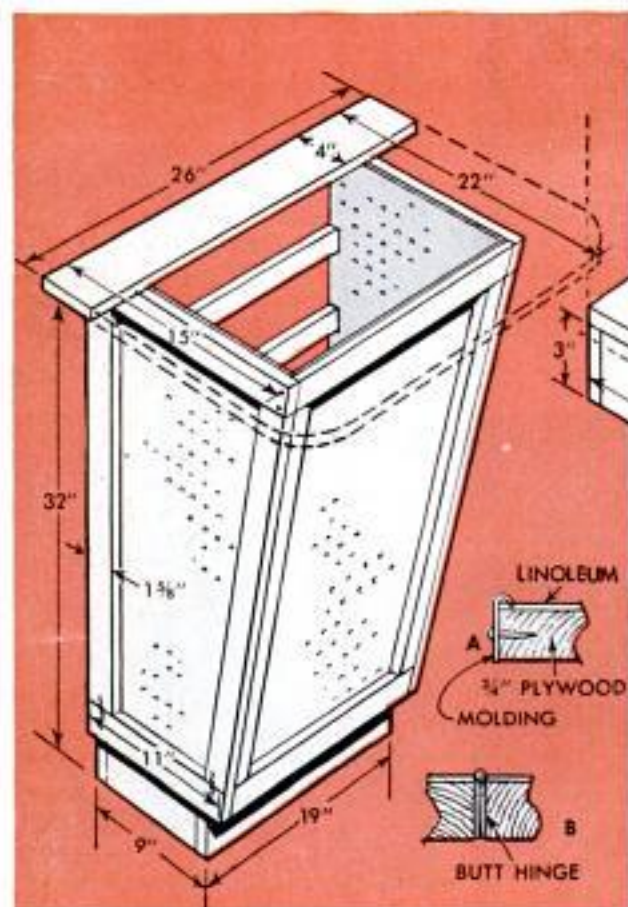

Indicator Shows Trump Suit in Card Game

There will be fewer arguments about which is the trump suit in a card game when this attractive trump indicator is used. Material for making it can be plastic or hardboard. The four card suits are painted on both sides of a 3½-in. disk cut from ½-in. stock. It rotates inside a housing consisting of two 4-in. disks of ½-in. material fitted over a ¾-in. circular spacer block. Viewing windows are provided by cutting V-notches in the housing disks. The three center-drilled disks are assembled with a small nut and bolt so there is a slight drag on the rotating disk to assure that it remains in

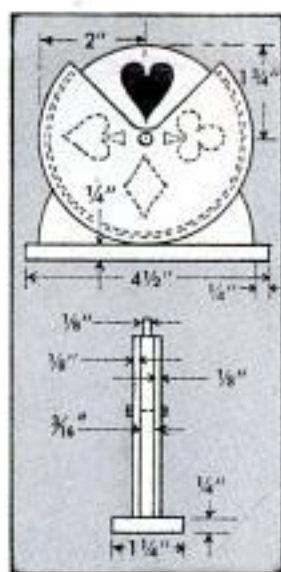

position when set. Dimensions of the block used for the indicator base are ¼ x 1¼ x 4½ in.—E. M. Blackman, Lancashire, England.

Forms Inside Concrete Pottery Disassembled for Removal

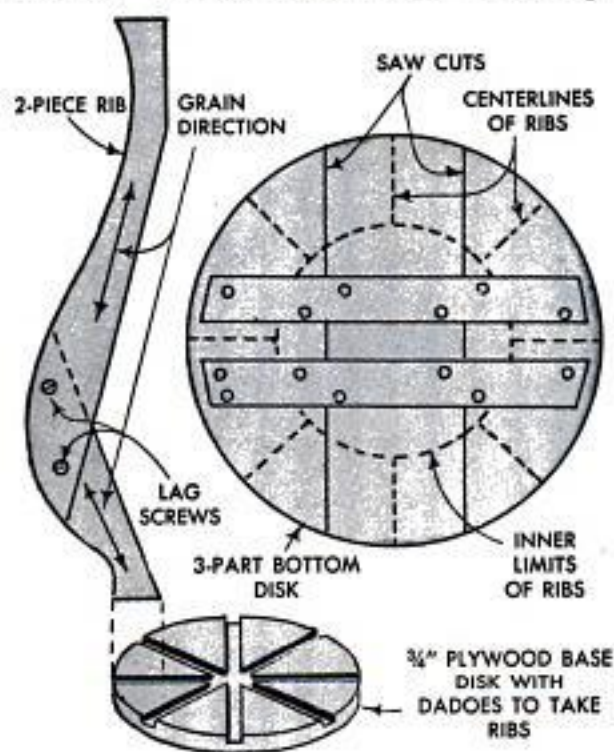

When casting large concrete vases and urns, it is advantageous to use collapsible forms that can be removed through small-diameter necks. Cut the form ribs from 1-in. stock, keeping the grain lengthwise to the ribs. The rib ends fit into dados cut diametrically across disks of ¾-in. exterior-type plywood. Blocks nailed in the dados keep the ribs from being pressed inward by the concrete. When the bottom disk of the form is larger in diameter than the neck clearance, the disk is sawed

into halves or thirds. Cleats, screwed or doweled to the sections for easy removal, hold the disk sections together. The upper disk of the form is the same diameter as the neck. Two-piece ribs are required for some forms, being held together with two lag screws at each joint. Wire mesh or metal lath is wired over the form to anchor the concrete to it.

Wire Solder Binds Tape Measure

A tape measure will not become tangled and knotted when stored in a drawer if a length of wire solder is permanently attached to one end and used to bind the tape when it is put away. The solder will also serve to weight the end of the tape when vertical measurements are made with it, stretching the tape to its full length to make the measurements more accurate.



Oil Prepares New Paintbrush

The bristles of a paintbrush will remain flexible and easy to clean after each use if the brush is soaked in linseed oil briefly when it is new. The oil prevents hardening of paint on the bristles.

Solving HOME PROBLEMS



INSTEAD OF PULLING NAILS when removing plasterboard, drive nails through with a flat-ended punch. Board is only slightly damaged and can be reused. Patch holes after reinstalling

REMOVING THAT FIRST PICKLE from tightly packed jar is easy when a tool made from an ice pick is used. Tool is made by heating pick about 1 in. from point and bending it at right angles



EMPTY FOOD TINS can be adapted to a number of uses more readily if they are fitted with a handle for easier holding. Simply screw a drawer pull or cabinet handle to the tin



MAKE A NOVEL CANDLEHOLDER by punching hole in the bottom of a gelatin mold, inserting a candle stub and weighting mold with plaster. When plaster is set, remove candle and shellac mold for easy cleaning

SMALL CHIPS AND NICKS in painted surface can be hidden by using wax crayons. The crayons, which come in an almost endless variety of colors, can be selected to match any paint color. Rub a crayon lightly over the marred area, both to fill and color the damaged spots in the paint

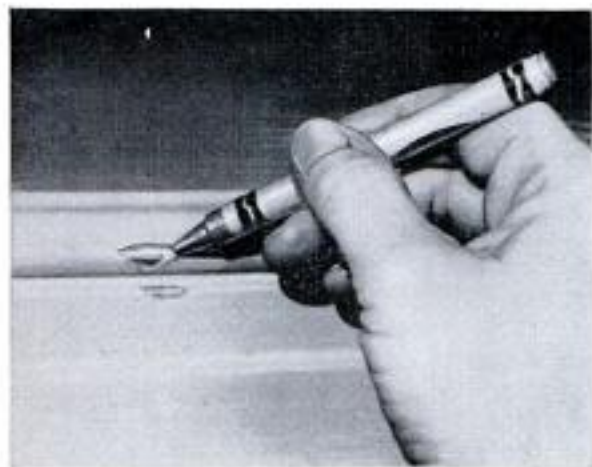

SAVE ON SOAP POWDER or detergent by dispensing from a sliding-lid syrup container. Glass sides of container permit keeping an accurate check of the amount of powder used, while sliding lid seals out dust and dirt



STAINS AND RINGS left on finish of a table top by drinking glasses can be removed by using a fine abrasive consisting of oil mixed with cigarette or cigar ashes. Dip an oil-moistened cloth in the ashes and gently rub away the stains

WHEN USING A HAMMER close to a wall, as when driving staples into woodwork to hold a lamp cord, avoid marring the paint or wallpaper by using a cardboard shield. The shield also prevents damage to the plaster, should the hammer slip

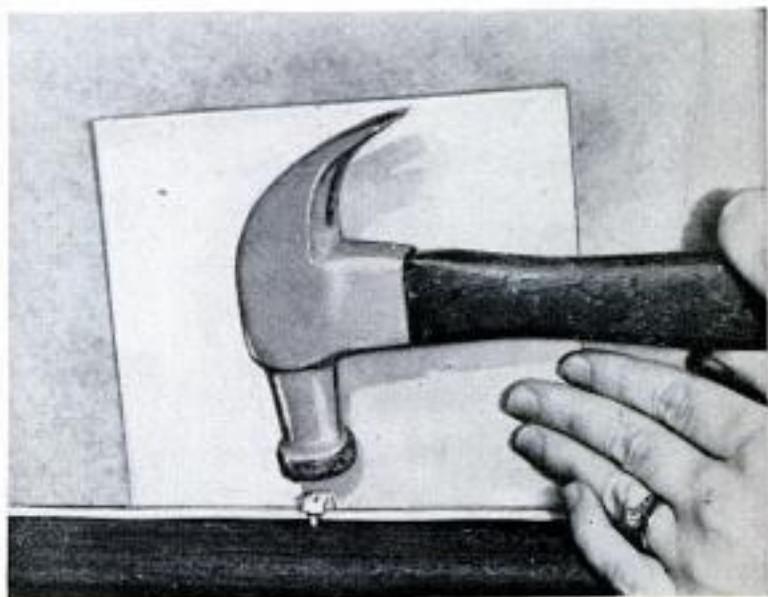

Sash Weight Hung on Tripod Stabilizes Camera



Blurred pictures, resulting when the tripod of a small movie camera vibrated in the wind, were eliminated by one amateur movie maker who suspended a window-sash weight under the tripod to act as a vibration dampener. The weight is hung on a cord looped around the tripod thumb-screw so it can be removed quickly.

Wire Bail Added to Paint Pail



It is a lot easier to carry a paint can if you fit it with a wire bail, which now seldom is furnished on gallon cans and never on smaller-sized containers. Bend the bail from a length of coat-hanger wire, twist a loop in each end

and attach it to the can with sheet-metal screws. To start the screws, simply punch small holes in the can with an awl.

Moist Sponge Prepares Wood For Smoother Staining Job

One method of preventing a wood surface from becoming "fuzzy" after the application of a water-type stain is to pre-moisten the sanded wood surface with a damp sponge. Allow the surface to dry

thoroughly, then sand lightly to remove any wood fibers raised by the water. When the water stain now is applied there will be few, if any, raised fibers.

"Rubber Mallet" Improvised From Shop Hammer

A serviceable "rubber mallet" can be improvised from any shop hammer by wrapping the head with rubber tape. Fold several layers across the face of the head, then tape them firmly in place. If a tool with a larger face is required, a wooden mallet can be modified in the same manner.

Frank A. Javor, North Bergen, N. J.



Drill Stand Screwed to T-Block Can Be Clamped in Vise

The problem of where to clamp the U-shaped metal stand, into which a 1/4-in. drill motor is snapped when it is used as a stationary tool, is solved by first screwing the stand to a T-shaped wooden block. The vertical bar of the T-block then can be clamped in any vise. It may be necessary to notch the block to clear the vise screw.

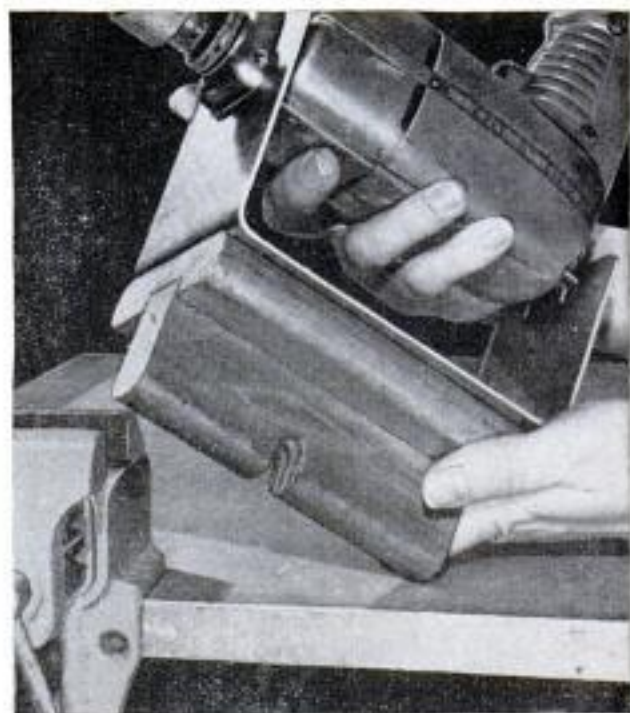

After painting walls or woodwork, fill an old nail-polish bottle with some of the leftover paint. Later this can be used to touch up nicks and scratches.

UTENSIL CABINET Has Roll-Top Door

FITTED WITH A DOOR that works like a roll-top desk, this little utensil cabinet will add a novel touch to a wall of your kitchen and provide a handy place to keep kitchen cutlery at your finger tips. A study of the drawing below will show you how the cabinet is put together and how a track is formed for the roll-up door.

Temporarily nail the sidepieces together for sawing. In this way they can be cut out simultaneously so that they will match. Note that the upper ends are cut down from $\frac{3}{4}$ in. thick to $\frac{1}{2}$ in. thick. A piece of $\frac{1}{8}$ -in. hardboard provides the back panel which fits in grooves cut in the sidepieces and upper spreader. To assure smooth operation of the door, it is important that both sidepieces be grooved identically and assembled squarely with the spreaders.

The curved sections at both top and bottom of the cabinet are covered with strips of screen molding. The same type of molding is used to make the sliding door. It is best to check the grooves in the cabinet side panels before assembly to be sure that they are wide enough to permit free movement of the door. The latter should be long enough to extend around the curved portion of the guide when in the closed position.

The handle which is fastened near the lower edge of the door keeps the door from sliding too far into the guide when opened. A coat of paint and, finally, an application of wax to the guides complete the cabinet.



By J. W. Rocke



Butt the door slats against a straightedge and square them before joining with strips of cloth tape

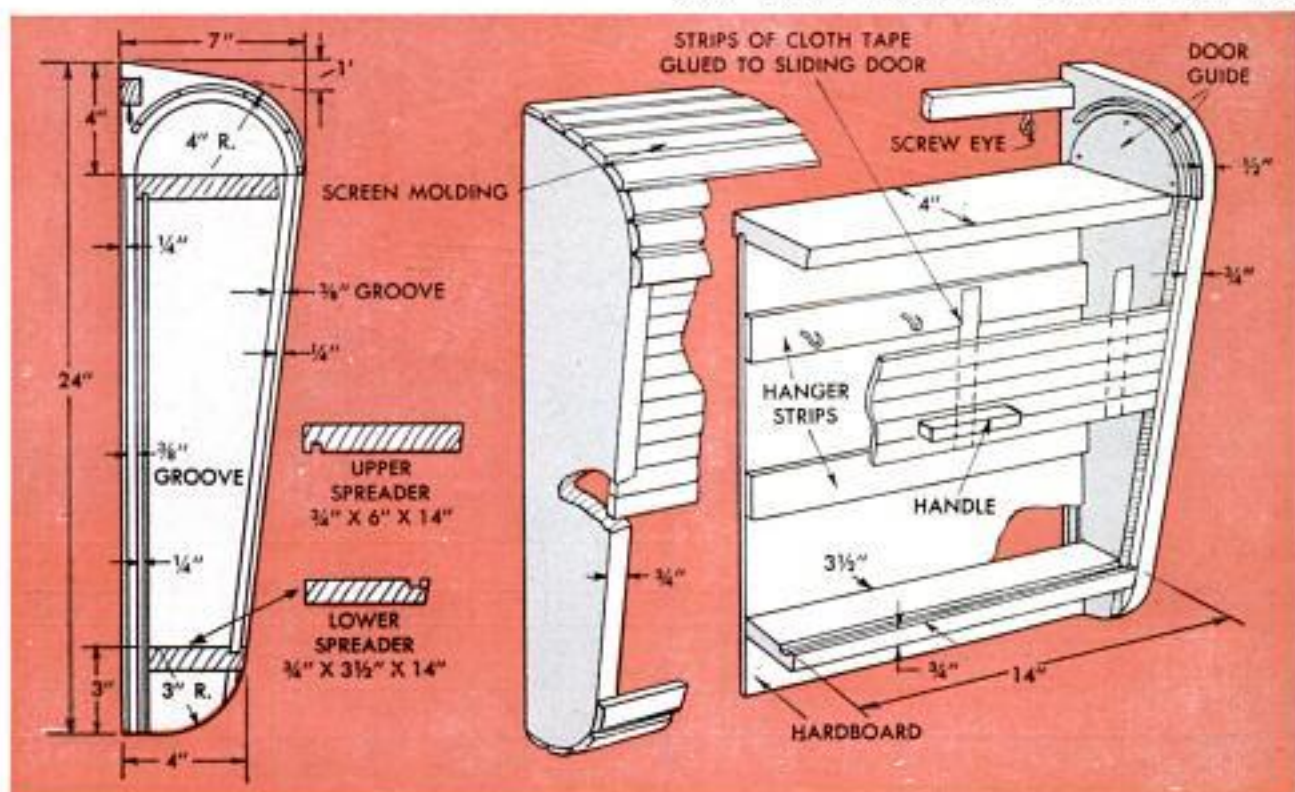

PATTERNCRAFT

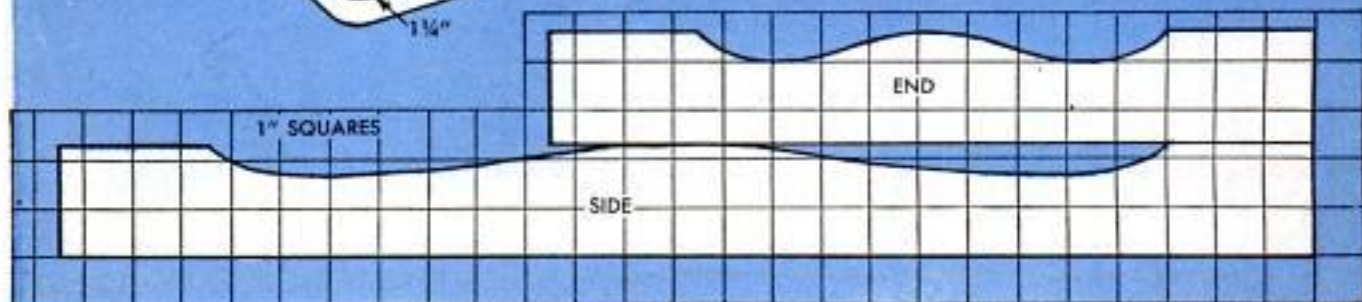
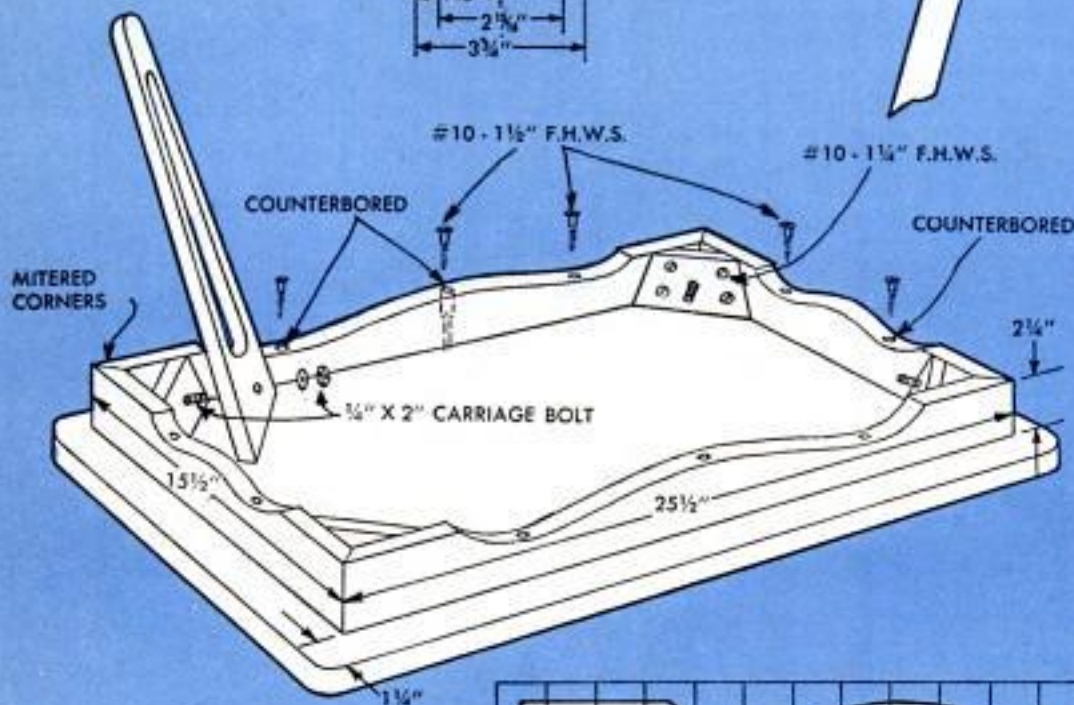
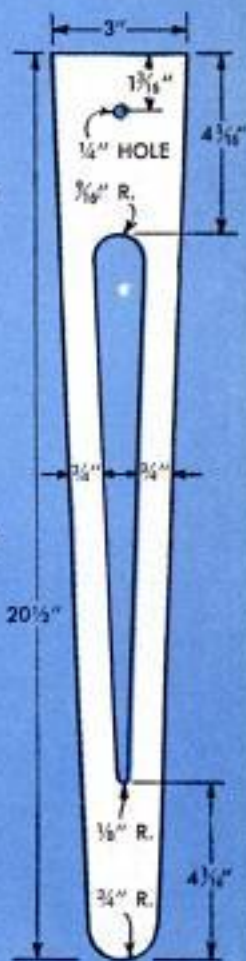
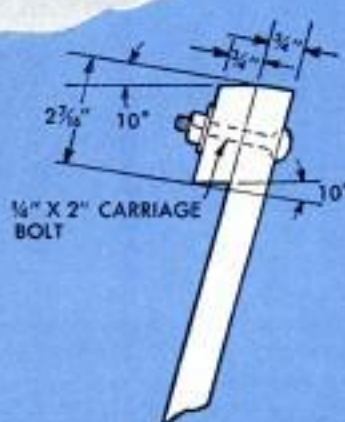
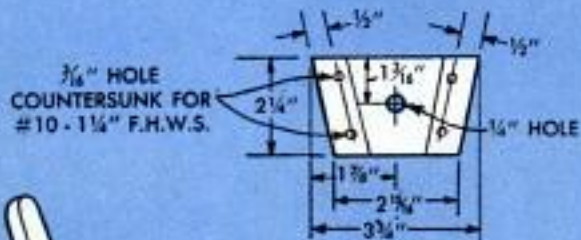

Children's Dinette Set

Always appealing to little girls and boys, a pint-sized dinette set means tea parties in style as well as a fine place for drawing and playing games. The table top may be a 20 x 28-in. piece of $\frac{3}{4}$ -in. plywood or the sink-cutout blank from a plastic-laminated counter top. Rails and legs are made of $\frac{3}{4}$ -in. lumber and assembled as in the details. If ordinary $\frac{3}{4}$ -in. plywood is used for the table top, it may be covered easily with plastic laminate. Make as many chairs as you like, using the patterns shown below. The back and seat are of $\frac{3}{4}$ -in. plywood, with legs, rails and arms of $\frac{3}{4}$ -in. lumber. When assembling both chairs and table, apply glue to all joints before fastening them together with wood screws. Then simply bolt the legs to the corner blocks. The exposed surfaces of the wood can be enameled or stained and varnished.

FULL-SIZE PATTERNS

Laying out, or drawing to size, the parts for a project, like this, where you have a number of scrolled edges, is greatly simplified by using a full-size pattern. To obtain your pattern of the children's dinette set, send 50 cents to Popular Mechanics Press, 200 E. Ontario St., Chicago 11. Be sure to ask for plan No. 123

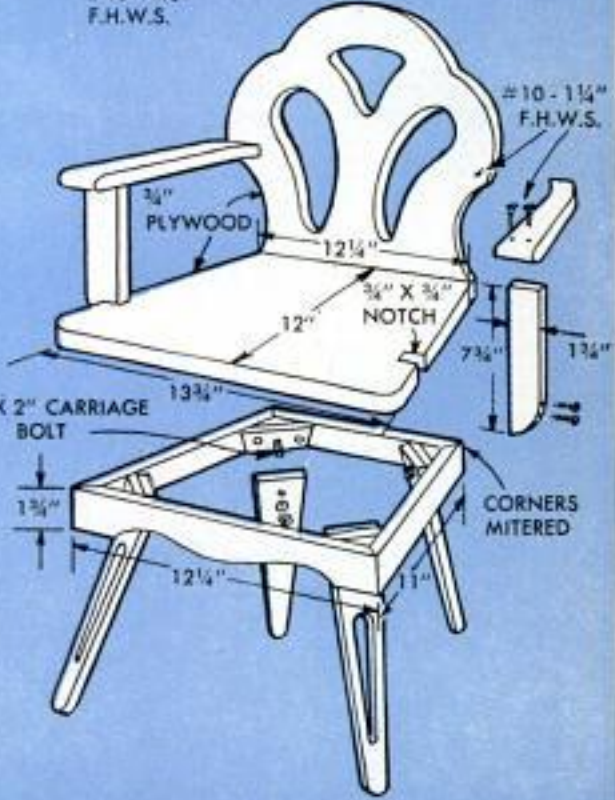
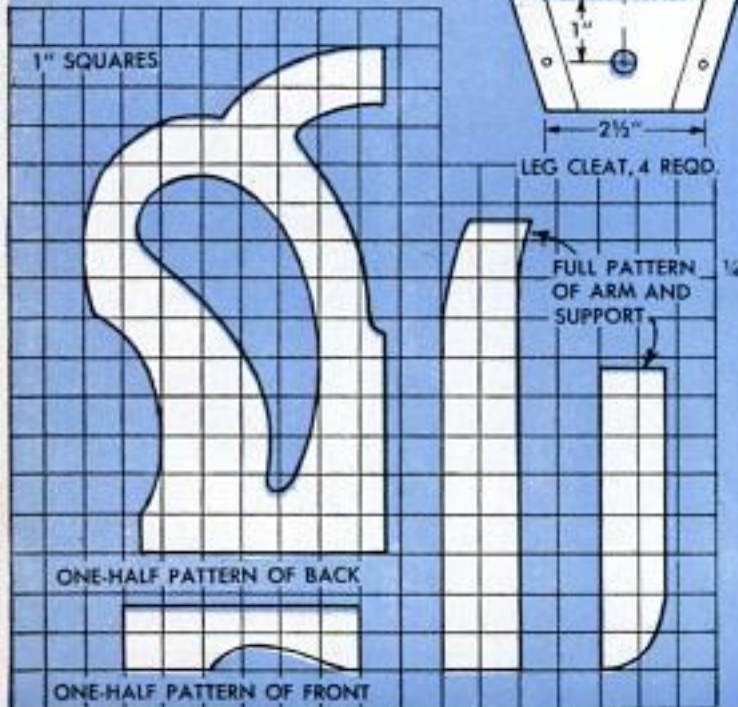
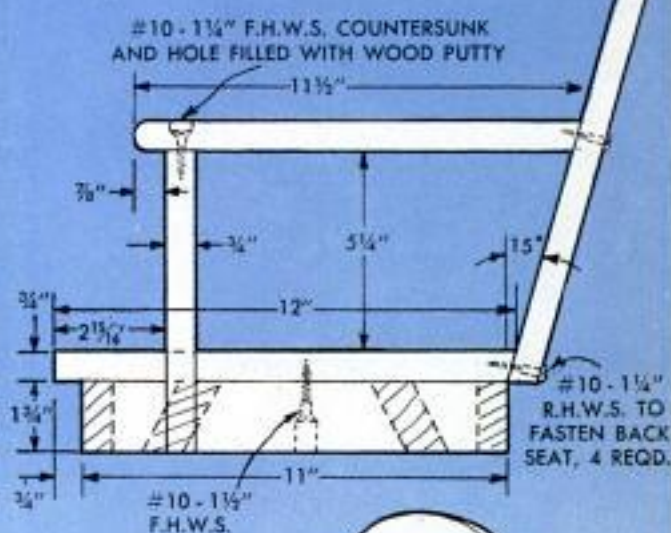
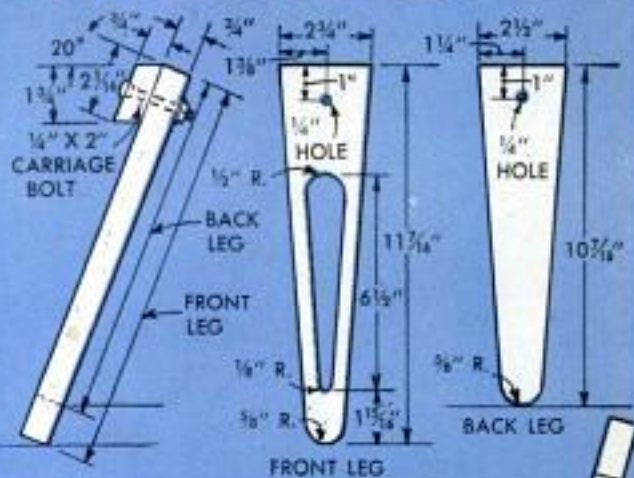

Bowl Cover on Bicycle Seat Protects it Against Rain



Where a bicycle is kept outdoors and unprotected against rain, it is a simple matter to keep the seat dry by covering it with a plastic bowl cover. When not in use, the cover can be carried in a pocket.

Warped Records Straightened



Place a 1-lb. weight on the plate and leave the record under pressure until the water has cooled to room temperature.

Stanley Clark, East Bradenton, Fla.

Paint Kept Thoroughly Stirred By Using Two Containers

Using two containers will solve the problem of keeping paint well mixed when its pigment is a metallic powder such as aluminum, which has a tendency to settle rapidly. Mix the paint thoroughly in a large container, then pour a small portion into a smaller container into which the

brush will be dipped for applying the paint. The action of dipping the brush and touching the bottom will keep the metallic pigment well agitated. Stir the paint each time in the large container before refilling the smaller one.

Removing Broken Hammer Handle

The next time it is necessary to replace the handle of a hammer, hatchet or ax, cut off the old handle just behind the head and drive out the remaining piece of wood with a pin punch. Clamp the head in a vise as shown and drive the punch into the wood at the cutoff end. Locate the punch so that the steel wedges will be driven out first, after which the wood will be loosened and can be driven out in fragments. This method of removing the wood is much easier than attempting to remove the entire piece with a large punch or burning out the wood which will ruin a carefully tempered hammer head.

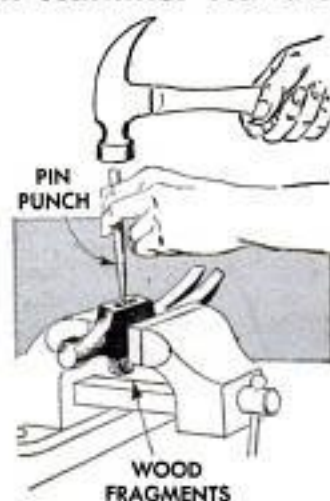

Gaskets for Automobile Lamps

Effective gaskets for automobile lamps other than headlights are made easily from light cord, such as window-sash cord. Fit the cord in the rim of the lamp and cut it slightly long so the ends must be forced together. Remove the cord and staple the ends together in the manner shown. A light coating of rubber cement on the cord will assure an even more watertight gasket.



To remove a bulge in wallpaper, slit the bulge and insert paste under it, then press the paper until the paste holds.

WTM 57

Homemade Organs

PART I

Cost and space are the factors that keep many individuals as well as small churches and Sunday schools from enjoying the ownership of an organ. Here are two fine instruments—one made from an accordion and the other from a reed-organ kit



By Allan Carpenter

Cabinet designs by John Bergen

THE SMALLER of the two organs, pictured below, consists of an accordion and blower installed in a specially designed cabinet. Construction of this organ is detailed on these pages. The larger organ, shown above, is made from a do-it-yourself kit which includes everything necessary for a 61-note reed organ except the cabinet. Cabinet and kit installation will be detailed next month in Part II.

Musical quality of the accordion organ depends entirely on the quality of the accordion. However, a mere \$35 purchased a fine used instrument for the original organ. Condition of the bellows is not important, as it will not be used.

Photo at right shows small size and pleasing design of accordion organ. Note how both keyboard and chord buttons are within easy reach. Bench will be detailed in Part II next month



Copyrighted material

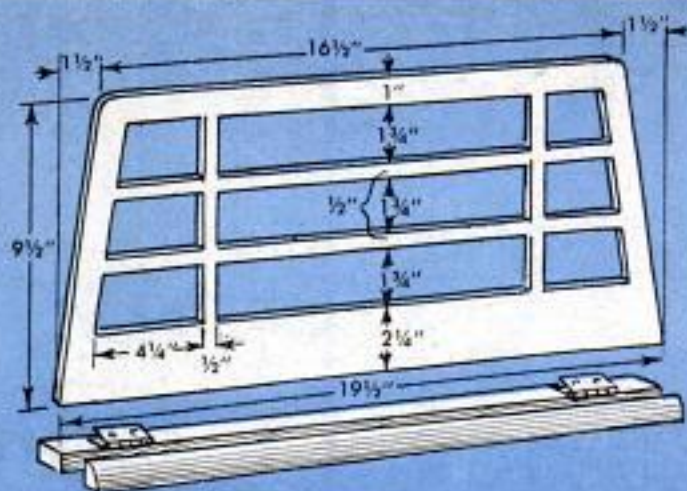

MUSIC RACK

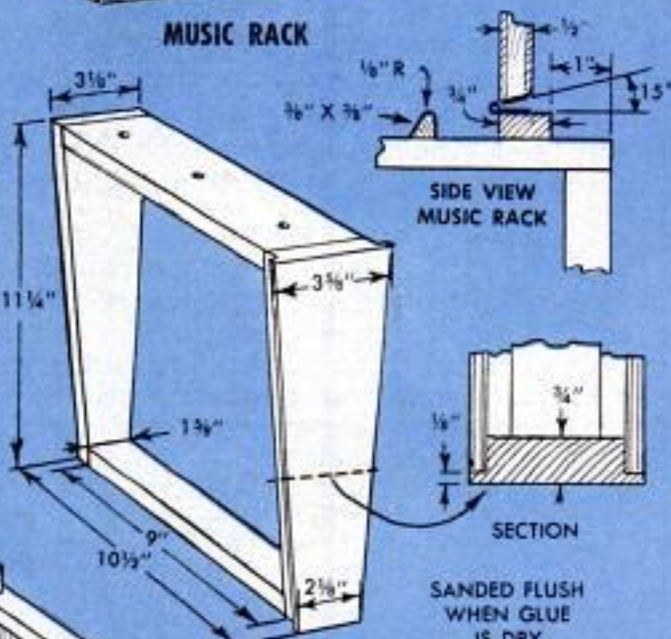

PEDESTAL FRAME

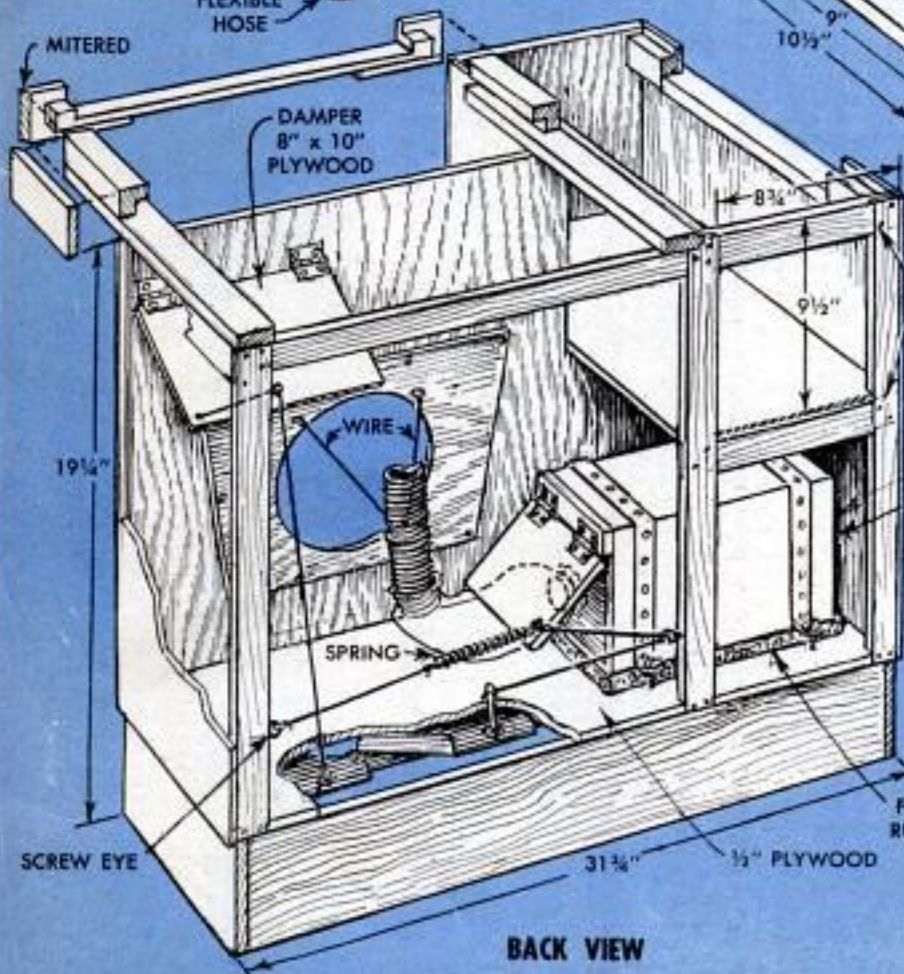
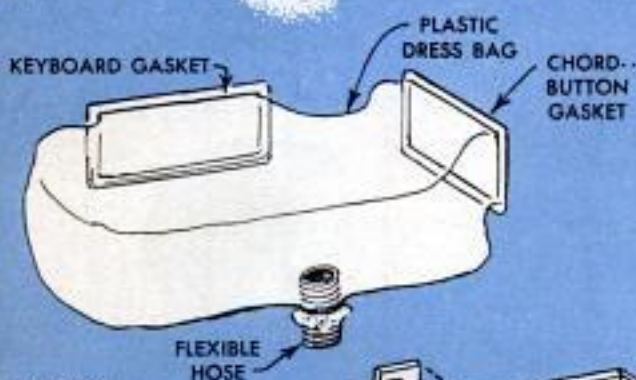

BACK VIEW

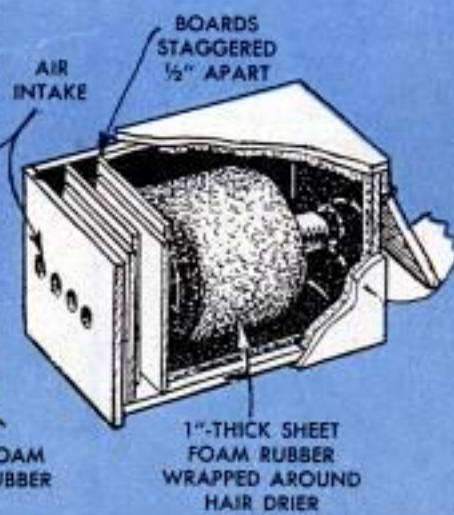



Rear view of accordion organ with back panel removed shows air bag and hose connection to blower

The cabinet is built from $\frac{1}{2}$ -in. hard-wood-faced plywood according to the details shown on the preceding pages. Fir plywood may be used for the unexposed shelves and the baffle board. Note that the 7 x 10 x 23-in. top section is made separately and then fastened to the main cabinet and over the keyboard mechanism. The keyboard of the accordion slips in a groove on each side of the cabinet as in detail A. The base is of cabinet wood as detailed and the frames are of 1 x 2 lumber. Certain slight

changes may be necessary, depending on the type of accordion used, such as cutting out portions of the upper cabinet of the front keyboard rail to accommodate the accordion switches.

The opening on the left-hand side of the cabinet is made just large enough to expose the chord-button portion, allowing it to be played without restriction.

An inexpensive hair drier which can be operated on "cold" provides adequate air supply for the organ. This is enclosed in a soundproof housing, as shown just to the right of the back-view detail. The air reservoir is a plastic dress-storage bag which is cut out for the keyboard and chord-button gaskets and to permit attaching a flexible hose. The latter, a car-radiator hose, is taped to the bag and held in place with stiff wire. A plastic tube, made from a small refrigerator bag, connects the radiator hose to the drier, and a piece of hardboard hinged to the drier housing can be closed to stop the flow of air through the connecting tube. This controls sound volume. Note in the details how this is connected to the left-foot pedal.

Another hardboard panel is hinged to the inside of the cabinet front so it can be raised by the right-foot pedal to press against the full air bag. This provides the sudden loud sound which is called a *sforzando*, or accent. An electronic amplifying system will be described in Part II, which also will detail the kit organ.

(Continued next month)

Accordion organ pictured below differs from instrument detailed in the respect that a small organ keyboard is used and the keys linked to the chord buttons, photo A, and accordion keyboard, photo B, with stiff wire



Designed and built by A. J. Schneider, Chicago

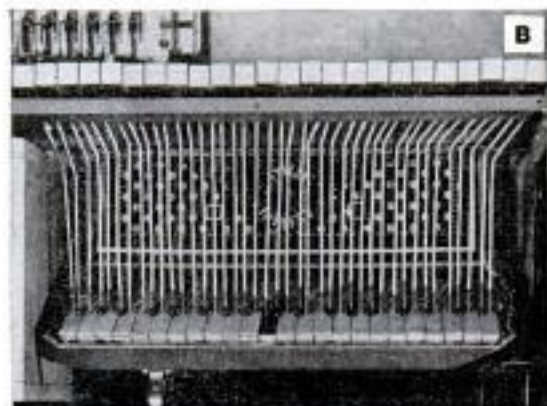

Handy Jig for Power Sanding a Uniform Bevel

This handy jig clamped to the fence of a sander equipped with a suitable table makes it easy to sand a uniform bevel on a wooden part parallel with a finished straight or convex surface. Made of wood, the parts of the jig are easily cut and assembled in an hour. The triangular piece at the lower left of the jig serves as a guide and stop for the work. The fence, with the jig and work attached, is moved at intervals to feed the work gradually toward the sanding surface. Depth of cut and width of the bevel are determined by the position of the

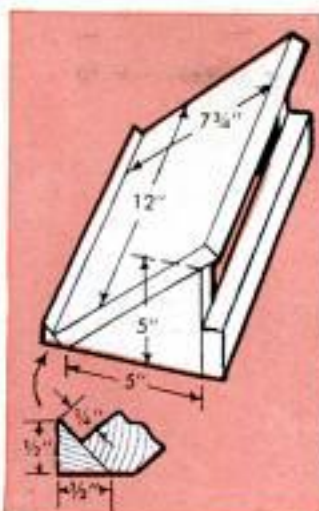

jig in relation to the face of the sanding disk or the sanding belt.

Howard E. Good, Waterville, Ohio.

Painting to Simulate Flagstones Renews Worn Linoleum

A badly worn linoleum floor can be given new life by painting it to simulate flagstones. Clean the linoleum thoroughly to remove any grease or oil, then paint it a



solid color. After the paint is dry, sketch in the flagstones with pencil and paint over the pencil lines with a narrow brush to simulate earth or mortar. An alternate method, which helps utilize paint leftovers, is to paint the various "stones" different colors, leaving about $\frac{1}{4}$ in. between them. Outline the stones with a $\frac{1}{2}$ -in. strip of white paint.

Rubber Ball Anchors Cushion On Car Seat

When an extra cushion is used in the driver's seat of an automobile, it may be held in place by an anchor made from a sponge-rubber ball. The ball is attached to one edge of the cushion with heavy twine and then forced down between the back and the seat cushions as shown. It will wedge into place sufficiently to hold the cushion and yet will not be difficult to remove when desired. The easiest way to attach the twine to the ball is to cut a hole through the ball, putting the twine through it and tying a large knot in the end.



The Portable Router . . .

is one of the most versatile power tools available to the home craftsman. It is excellent for everything from shaping and grooving to grinding and drilling. Learn just what this amazing little tool can do and how to use it by reading the story on routers next month

When light bulbs are removed from outdoor sockets, replace the bulbs with burned-out fuse plugs to protect the sockets against rain and weather.

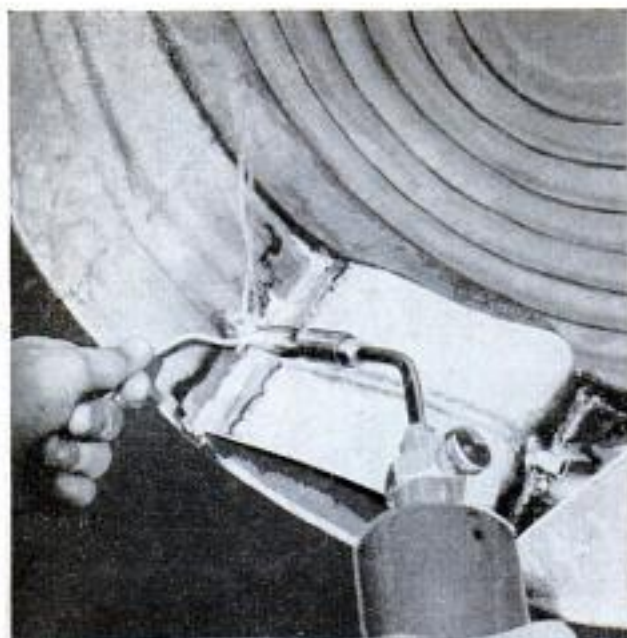

Start with a galvanized pan—a service-station drain pan is just right—and drill holes in side for outlet fitting and inlet tube. Cut and bend sheet-metal outlet baffle and solder to pan as above

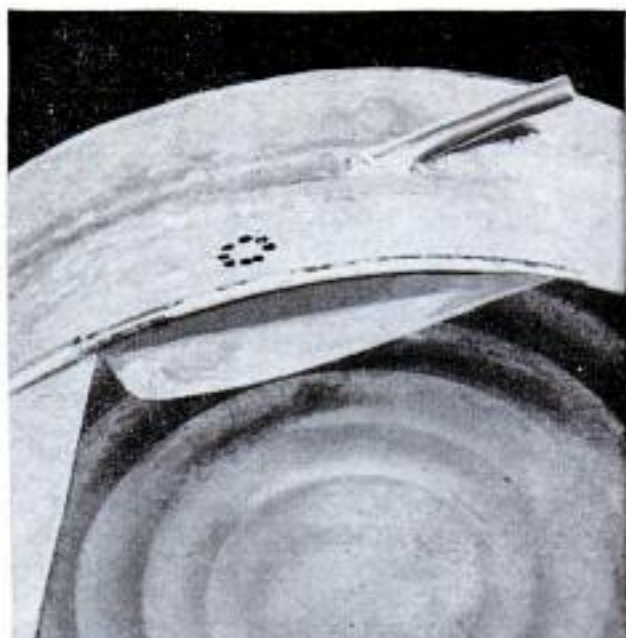

Insert copper inlet tube through holes in side of pan and baffle and remove zinc from galvanized surfaces with muriatic acid before soldering. Drill and punch out hole near pan rim for outlet fitting



Outlet fitting is standard garden-hose connection having pipe threads on opposite end. This permits fastening fitting to pan side with double nuts, using rubber washers to prevent leakage around fitting

YOU CAN MAKE THIS PRINT WASHER

FOR \$3

By Jack Wall

After soldering, clean pan thoroughly and spray with "industrial chrome" finish or aluminum paint. Then waterproof with plastic spray. Print washer may be connected to faucet with portable shower-spray hose

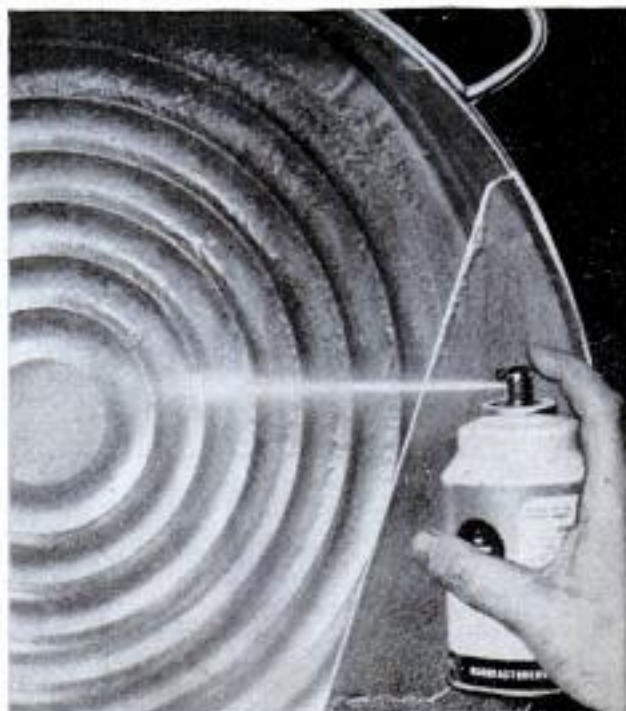
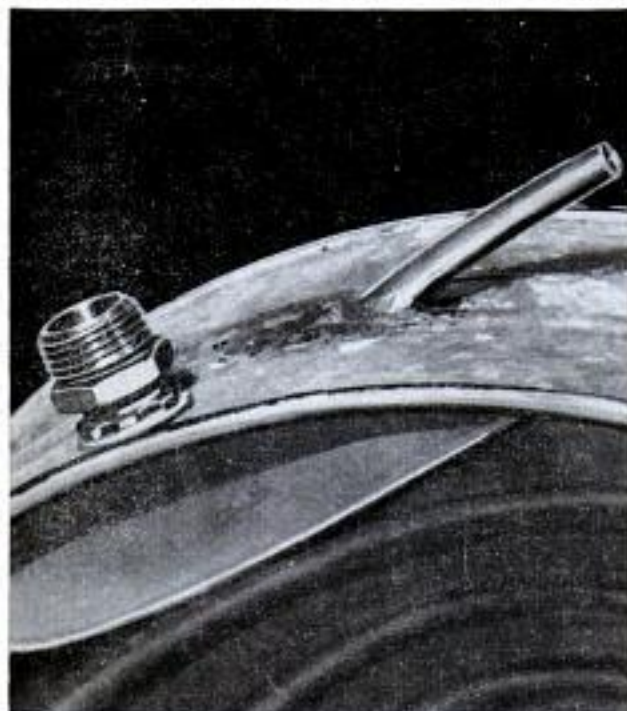

WTM '57

TRUNDLE BEDS

FEATURE STORAGE HEADBOARDS

Designed by John Bergen



IDEAL FOR A SMALL ROOM in a home cramped for space, these trundle beds stack one above the other when not in use. Storage headboards take extra blankets and bed linens as well as provide a hiding place for the "valuables."

Start construction with the frames, the parts of which can be stock thicknesses and widths. The legs for the upper bed are $2\frac{1}{2}$ -in. squares and those for the lower bed are $1\frac{3}{4}$ -in. squares. All legs can be tapered

with a hand plane. Note that the legs on the high bed are set in the corners of the frame and bolted to the side rails and screwed to the headboards and footboards, while those on the lower bed are set in from the headboards and footboards and screwed to the side rails only. Note, also, that the latter boards on the low bed are tenoned into the rails and fitted with glue blocks, the headboard on this bed being built up as the storage unit. The unit on

Lower bed is on casters so it can be moved out into room at night, and back under upper bed during day

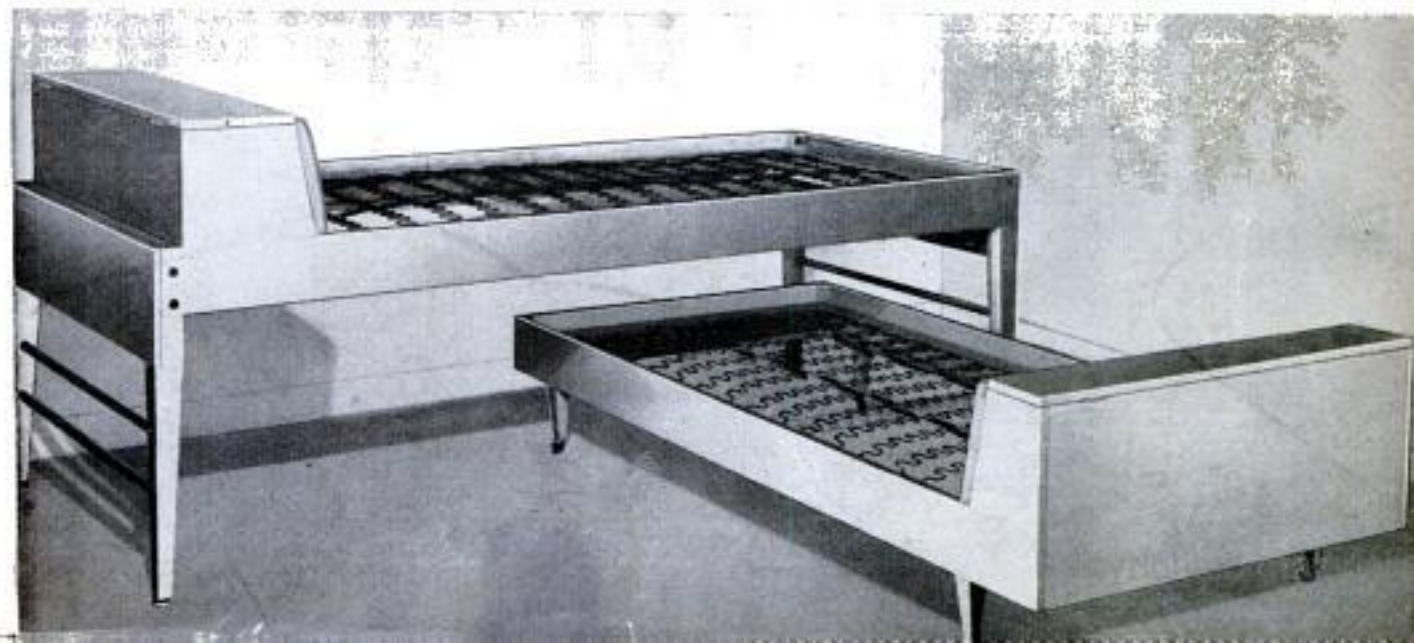



Sagless-type springs are fastened to frame of yellow pine 2 x 4s butt-joined and doweled together

the high bed is assembled separately to fit between the side rails. If power tools are not available for cutting the tenons on the headboard pieces, they may be made with a special plane, or by sawing across the width of the board at a distance from the end equal to the desired length of the tenon. Make the cut halfway through the board and remove the waste stock with a wood chisel to form the tenon. Grooves are made with two saw cuts on the same side of the board, removing the waste stock between them with a chisel. Solid stock is used for all parts except the storage units which may be made of hardwood-faced plywood, preferably the cored type. Fronts of the storage units are framed to take an upholstered panel of $\frac{1}{2}$ -in. plywood, which is screwed in place. Upholstering material,

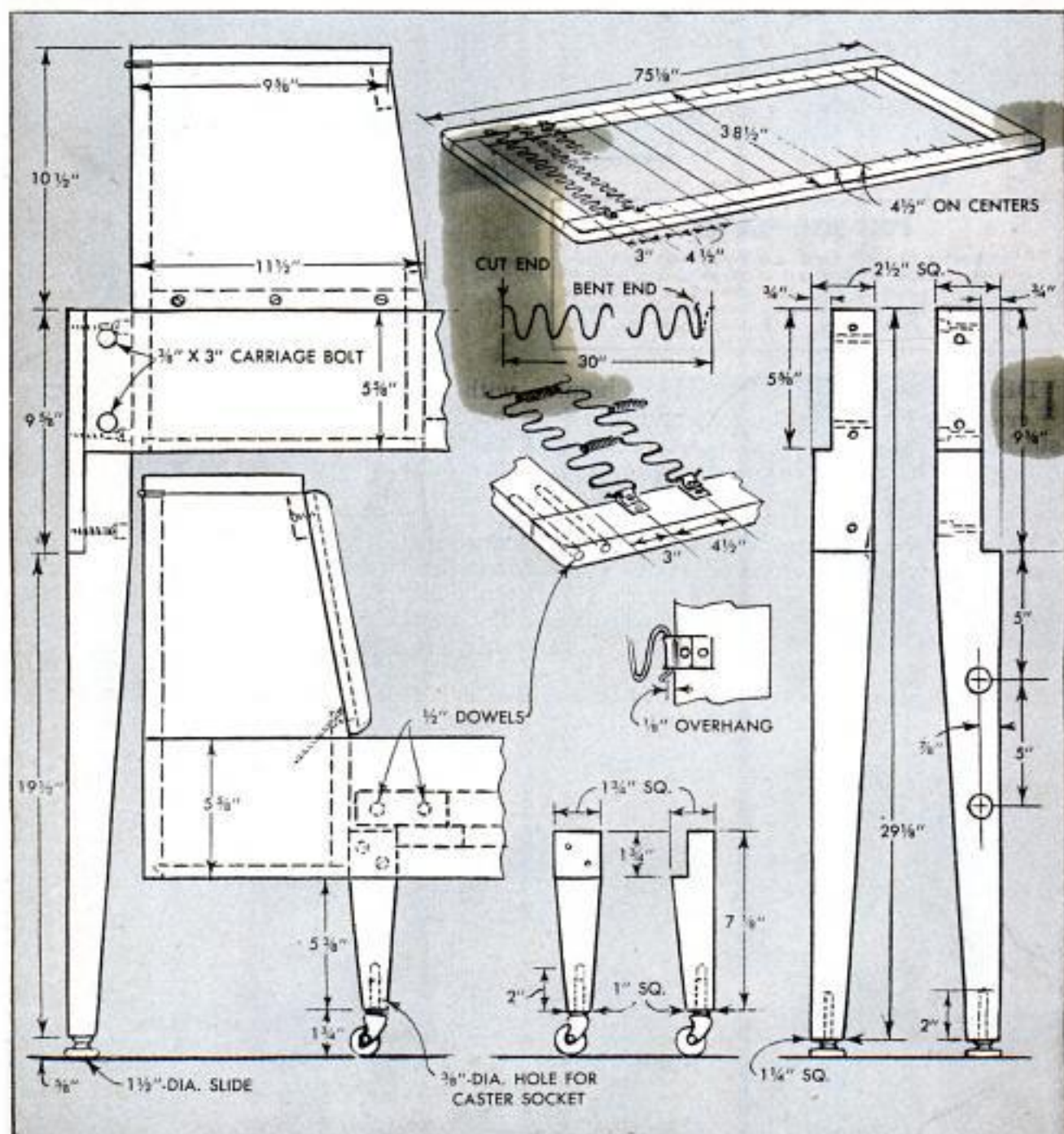

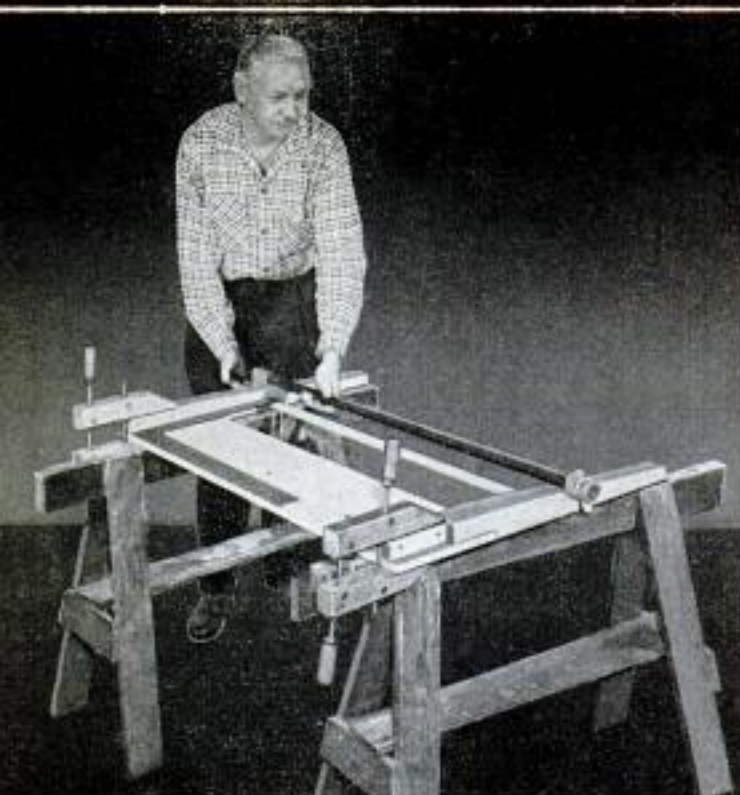

Head and foot boards of upper bed are glued and screwed to legs. Dowel stretchers are glued in holes in the legs and side rails are bolted to legs. Note legs are cut away to take boards flush with surface

placed over foam-rubber padding, may be any material desired.

Since the spring unit is a frame of 2 x 4s butt-joined and doweled, only three slats are necessary. These are screwed to cleats to keep them in place and also to prevent spreading of the rails. Springs are of the sagless type spaced 4½ in. on centers, starting 3 in. from one end. Spring stock is available in most department stores and from some mail-order houses. Special clips for attaching the springs are required. Be sure all spring pieces are the same length and install them as indicated in the photo on page 198. Notice that they bow upward about 3 in. at the center of the frame.

Large casters are used on the low bed as it stores under the upper one, but pads may be used on the latter as indicated to assure it staying in place.

Finishing depends on the type of wood used. If a light finish is desired, oak, maple or birch should be used. Walnut or mahogany is best for a dark finish. ★ ★ ★



Storage units are faced with upholstered panel of ½-in. plywood which is screwed in place on the unit



Foam rubber 1 in. thick is ideal for padding under the covering material, which may be any type desired

Note in these four photos how the upholstering material is folded over all edges of the panel . . .

then tacked to the back side of the panel. Corners are folded over and tacked also to produce neat job

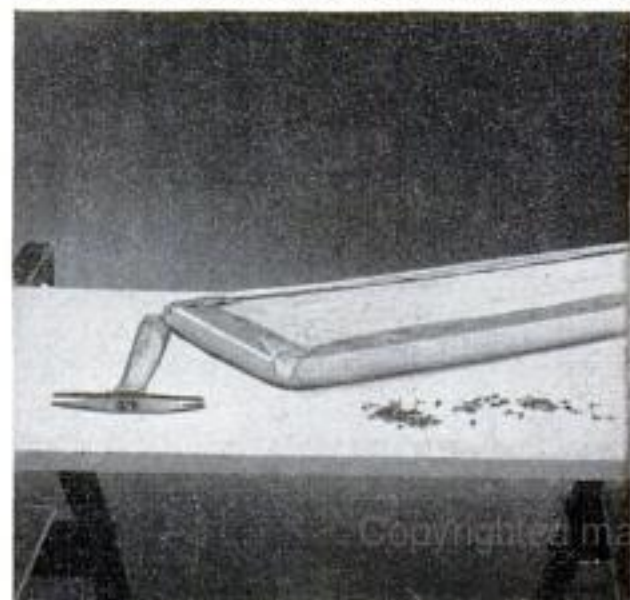
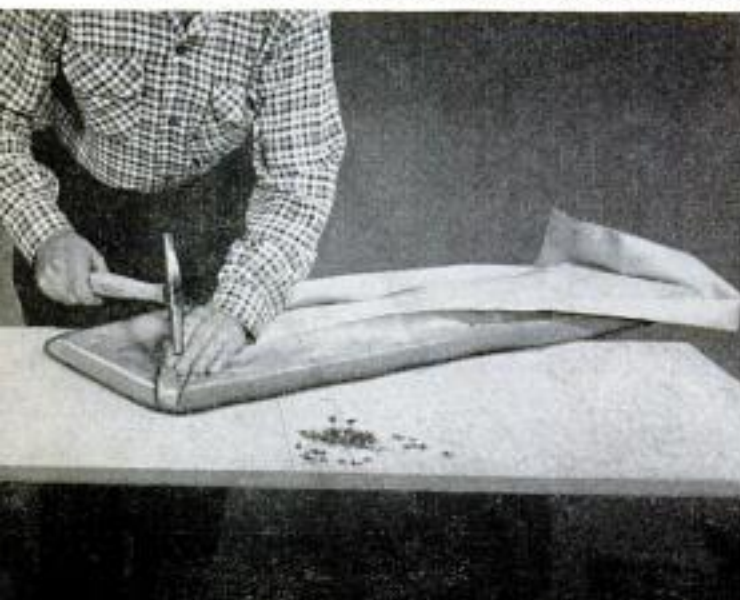

"Convertible" Camera Tripod Provides Outdoor Typewriter Stand

A few modifications on a wooden camera tripod permit it to be used as an outdoor stand for a portable typewriter or quickly reconverted for use with a camera. To assure rigidity when it is used with a typewriter, hooks screwed into two of the legs are fitted into a screw eye driven into the third leg as shown in the upper detail. Stability on uneven ground is assured by replacing the rubber-tipped leg extensions with sharpened wooden stakes. A flatheaded machine screw is countersunk in each stake and allowed to project far enough to fit through the slots in the tripod legs. A washer and thumb nut are used to hold the stakes to the legs.



The lower half of the portable-typewriter case also must be modified by drilling a hole in the center of the bottom and reinforcing it with a steel washer screwed to the inside surface. The typewriter is

mounted by removing the tripod screw and replacing it with a bolt passed through the hole in the typewriter case. A wing nut also is used on the bolt to permit quick attachment and removal of the typewriter.

Popular Mechanics Bookshop



Remodel Your Home

Now is the time to plan home-remodeling for next spring. *How to Remodel Your Home* gives you 160 pages of remodeling know-how. Whether your home is old or brand new—whether you want to add a porch, modernize a kitchen, add new closets, build a basement playroom, convert attic space into living quarters or any one of 101 projects, you'll find complete step-by-step instructions. \$3.50



Build Your Own Furniture

Here's a profitable way to spend cold winter evenings! Build beautiful furniture for every room of your home at really worth-while savings. Select from 100 pieces. Choose complete suites or occasional pieces. You'll find step-by-step directions together with photographs and diagrams. Send for *100 Beautiful Pieces of Furniture You Can Build* today. \$3.00



Take Care of Your Home

If you have some last-minute home repairs, this is the book you'll need. *Guide to Home Repairs* can easily save you as much as \$100 a year. You can easily correct leaky faucets, sticking doors, squeaking floors, leaking gutters and hundreds of other annoying and expensive household defects simply by following the easy-to-use instructions in the book. \$2.50

All books available from Popular Mechanics Book Dept., 208 E. Ontario St., Chicago 11, Ill.

SN 58



Check the Battery Regularly and Avoid Scenes Like This One

GIVE YOUR BATTERY A BREAK

By Ed. Packer

FEW PARTS OF A CAR give so much for so little as does the storage battery. Just give it a "drink" at regular intervals, "feed" it the required current and it will perform for years. Unlike some other parts of a car, it is not a loud-mouth. If neglected, it never howls, growls, grinds or squeaks for attention. It just slowly weakens and

Hammering the cable terminal on the battery post may break it from the plates inside the battery



dies. Thirst has sulphated its plates, or an overly enthusiastic generator has warped them, or its life blood has spilled through a crack in the case.

Adding Water

The liquid in a battery called electrolyte consists of water and sulphuric acid. Water

Tightening the terminal bolts with the wrong type wrench may crack sealing material and cause leak

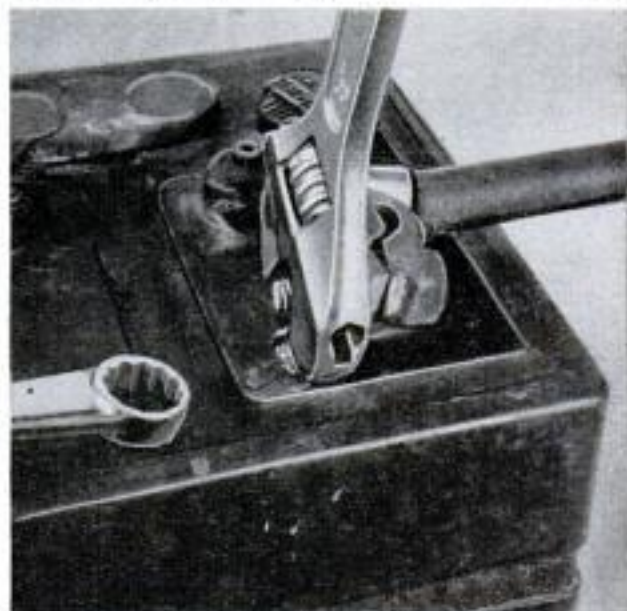

is lost by evaporation and must be replaced at intervals. Frequency of water addition depends on evaporation, charging rate and reserve space above the plates. Some batteries have so much reserve space they require addition of water only at long intervals, possibly three times a year.

Use distilled water or water that is demineralized, and add it carefully with a special syringe to avoid spilling. Water spilled on top of the battery may combine with dirt and acid spray to produce a current-conducting material that can slowly discharge the battery.

One post is grounded and all other posts are "hot" relative to the ground. Consequently, electricity will flow from the hot posts or terminals to the ground if there is dirt, acid and water on top of the battery case. If the car is out of use for a few days or weeks, the cells will discharge in proportion to the shorting effect of the dirt.

After adding water, wipe off the top of the battery with a cloth moistened with soda water. It is important, too, to avoid overfilling a battery. When it warms up under charging, the liquid expands and may overflow the battery if it is filled above the mark indicated by the manufacturer. If acid gets on electrical parts, such as the coil or spark plugs, it may make starting difficult or impossible.

Clean Terminals Let Current Flow

The same cleaning care given to the top of the battery should be extended to the terminals. If corroded, they should be dipped into strong soda water to neutralize the acid, after which any corrosion should be scraped off and the terminals again

This happens when battery is used with electrolyte too low. Plates slowly disintegrate and warp and separators dry out. Regular checking of electrolyte level will help avoid this type of trouble



DECEMBER 1955



You can use any type of container to add water, but don't. Use a syringe and keep battery clean

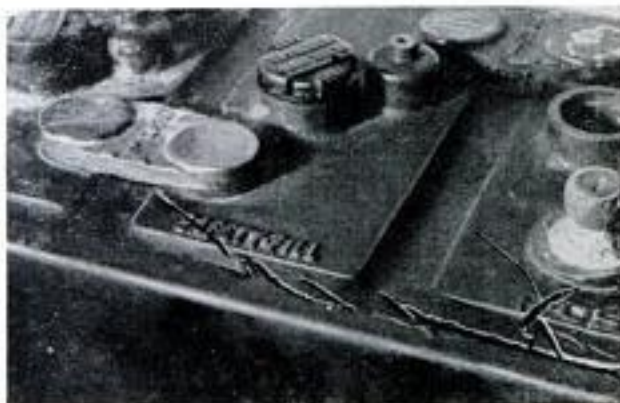

Above, pulling hold-down nuts too tight cracked top of battery which will let electrolyte leak out. Below, disconnect grounded terminal first to remove battery; connect it last when installing battery

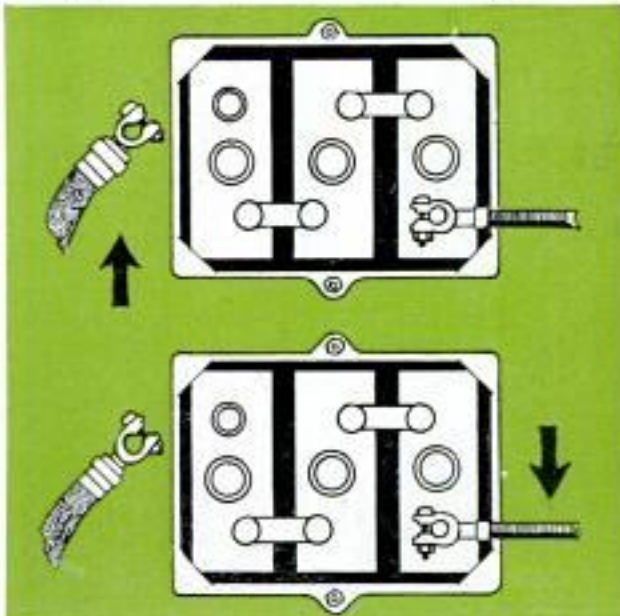

GRAVITY TABLE

Percent of Charge	Type of Battery		
	Regular	High-level	Tropical
100	1.280	1.260	1.225
75	1.230	1.220	1.180
50	1.180	1.170	1.135
25	1.130	1.120	1.090
0	1.080	1.070	1.045

soaked in soda water. Follow cleaning with a coating of nonmetallic grease or corrosion-preventing compound. Never hammer terminals on their posts since this might break the post off the plates inside the battery.

If the battery cable is corroded, it should be replaced. Corrosion frequently weakens the cable wires or even severs them, which reduces the current-carrying capacity of the cable with the result that starter action may be sluggish.

If it is necessary to remove the battery from the car, note whether the positive or negative post is grounded and then remove the grounded cable first. This will avoid accidental short circuits which are especially serious with 12-volt batteries. When installing a battery, reverse this procedure. The hold-down nuts that keep the battery in its cradle should be pulled up snugly but not extremely tight as this might crack the case.

After installing the battery, check it to see that the connections are made cor-

Active material from plates accumulates in bottom of case and will "short" plates if it touches them

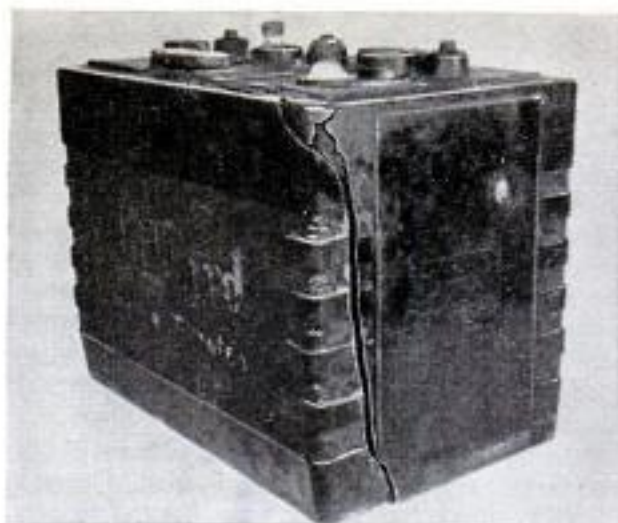

A low charge and a cold snap teamed up to ruin this battery by freezing it and cracking the case

rectly. Turning on the lights should show a discharge reading on the ammeter. If the reading shows charge, reverse the connections by turning the battery around.

Charging Rate

If the regulator is adjusted correctly and the generator is in good condition, a fully charged battery will receive a low rate of charge. Immediately after using the starter, the rate may go fairly high, but within minutes it should drop to a lower reading, possibly 3 to 5 amps.

A discharged battery or one that is used in a partially discharged condition may freeze in cold weather. A battery that tests around 1.150 will freeze at 5 deg. F. A half-charged battery, specific gravity of 1.210, is safe to 19 deg. below zero, while a fully charged one will be safe to 65 deg. below zero.

Testing Specific Gravity

Since the electrolyte in a battery consists of water and acid, the specific-gravity test with a hydrometer is a good way of determining the battery condition provided acid has not been lost. Acid weighs 1.835 times as much as water, which has a specific gravity of 1.000. In a fully charged battery, the gravity reading should be 1.280 to 1.300. Some manufacturers, however, have reduced the gravity of a fully charged battery to 1.260 or even less. Therefore, it is well to know the desired gravity of your battery in order to get an accurate check.

All cells should test within 25 points in specific gravity. A greater variation may indicate trouble. It is possible that active material has been shaken from the plates while in a partially discharged condition. If active material is lost from the plates, the gravity of the battery cannot be brought up fully. ★ ★ ★

Fused Switch Box Wired as Multiple Outlet for Photo Floodlamps

A handy device used by commercial and industrial photographers is a multiple-plug-in unit which supplies electric current simultaneously to a number of photo floodlights. A comparable unit, adequate for the average home photographer, can be made from a regular fused switch box. Six knockout blanks are removed from the box and the holes fitted with insulating grommets. Five heavy-duty shockproof sockets are wired to the box as indicated. The sixth hole is used for the line cord. As a safety precaution, check the size of the fuse used in the

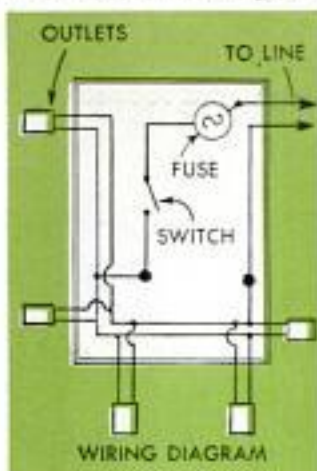

circuit into which the line cord is plugged, then use a fuse of the same, or lesser, capacity in the switch box. The switch-box fuse then will blow before the circuit fuse.

Improvised Extension Tube Permits Camera Close-Ups



Discovering he had forgotten an extension tube for his 35-mm. camera, one photographer on a field trip improvised an extension from a cardboard mailing tube and two scraps of wood. First, the original lens was removed and the supplementary lens held in front of the camera so it was roughly in focus when sighting through the ground glass of the camera. The distance from camera to lens was measured, the mailing tube cut to match and the tube taped to the camera. A hole was bored in a piece of lumber to match the mailing-tube diameter and the wood then was cut in half lengthwise. Two bolts through the

edges of the halves clamp them around the mailing tube. A piece of plywood next was fitted across the back of the camera. Two long bolts hold plywood and lumber piece together, clamping camera, lens and extension tube as a unit. A piece of felt protects the camera back, and black plastic tape is used to make all joints light-tight.

L-Shaped Bracket on Camera Permits Using Bounce Flash

Replacing the straight flash-gun bracket on his camera with an L-shaped aluminum bar permits one camera enthusiast to use the gun for bounce flash. Holes are drilled near each end of the bar to accommodate gun and camera, then a portion of the bar at one end is bent at right angles. The flash reflector now can be used facing straight ahead or in any position in a vertical plane.

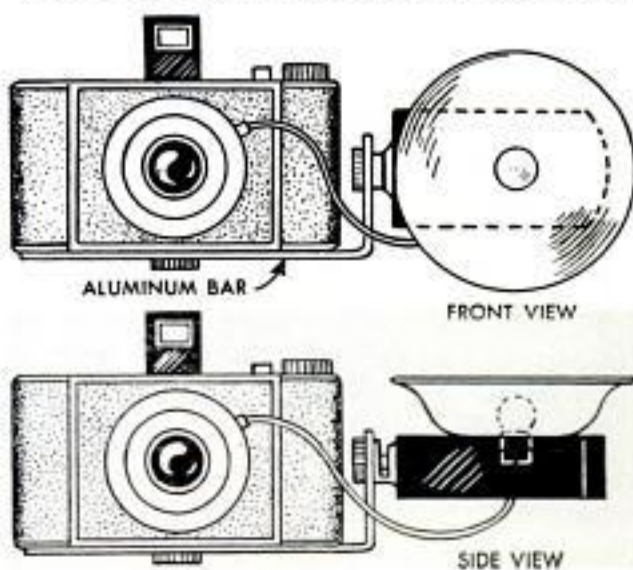

Sponge-Rubber Padding in Case Minimizes Camera Damage



A camera that is carried in the trunk of an automobile will suffer less vibration damage if it is kept in a carrying case fitted with a padded bottom. The padding consists of several pieces of thick sponge rubber. For further insurance against camera damage, fit straps or brackets in the car trunk to hold the bag securely, yet permit its easy removal.

Virginia Hanson, Los Angeles, Calif.

"Teeter Totter" Darkroom Shelf Conserves Counter Space

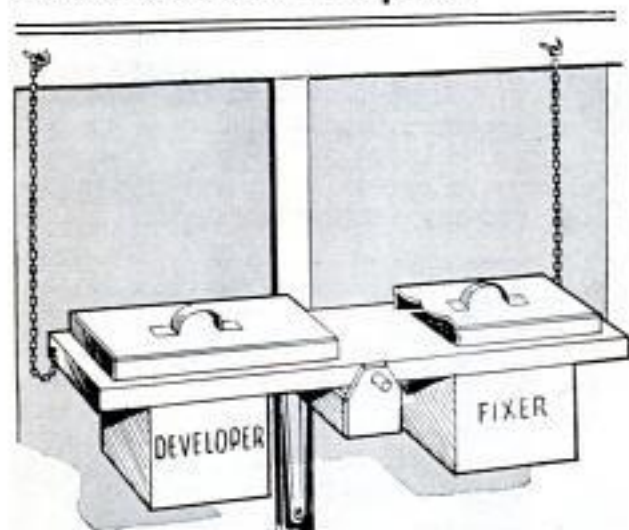

If counter space is at a premium in a darkroom, suspend the film-developing tanks in openings cut in a shelf pivoted above the sink as shown. The shelf is a piece of $\frac{3}{4}$ -in. plywood with a length of steel rod screwed to the lower surface at the center to provide a pivot rod. The latter pivots in two flat-steel brackets located at the ends of a wooden block which is

screwed to a metal shelf bracket. Agitating the developing solutions is accomplished by rocking the shelf. Lengths of light chain screwed to the ends of the shelf and looped over hooks driven into the wall prevent the shelf from being tipped down too far.

Drawer Converted to "Light Box" For Checking Film Slides

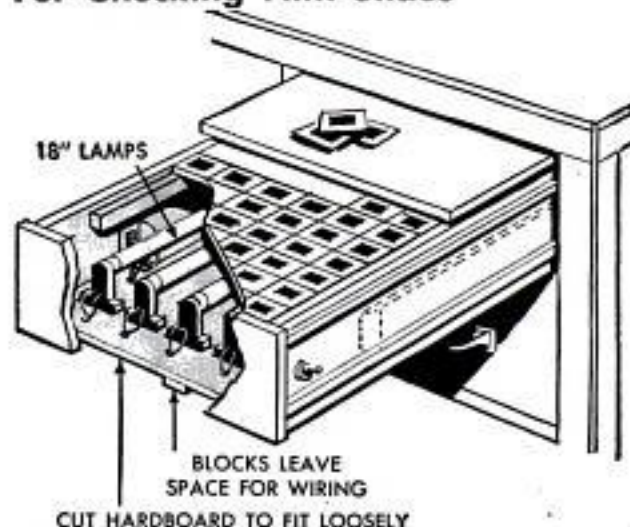

When the task of examining negatives and arranging slides for proper sequence of showing are combined with other duties in a desk job, converting a desk drawer to a "light box" will simplify the film work. Fluorescent lamps are used in the drawer to minimize the heat problem. Starters and transformers for the lamps also are installed inside the drawer. The "opal" or translucent glass cover of the drawer rests on wooden cleats screwed to the inside. A toggle switch fitted on the front or side of the drawer controls the lights.

Tape Marks Photo Thermometer At Solution Temperature

Since the temperature of photographic solutions is critical for good developing, it is important that a thermometer be marked for quick and accurate reading. A bit of colored cellulose tape stuck to the thermometer to serve as a pointer provides a legible, waterproof marker. Do not cover the graduation marks with the tape.



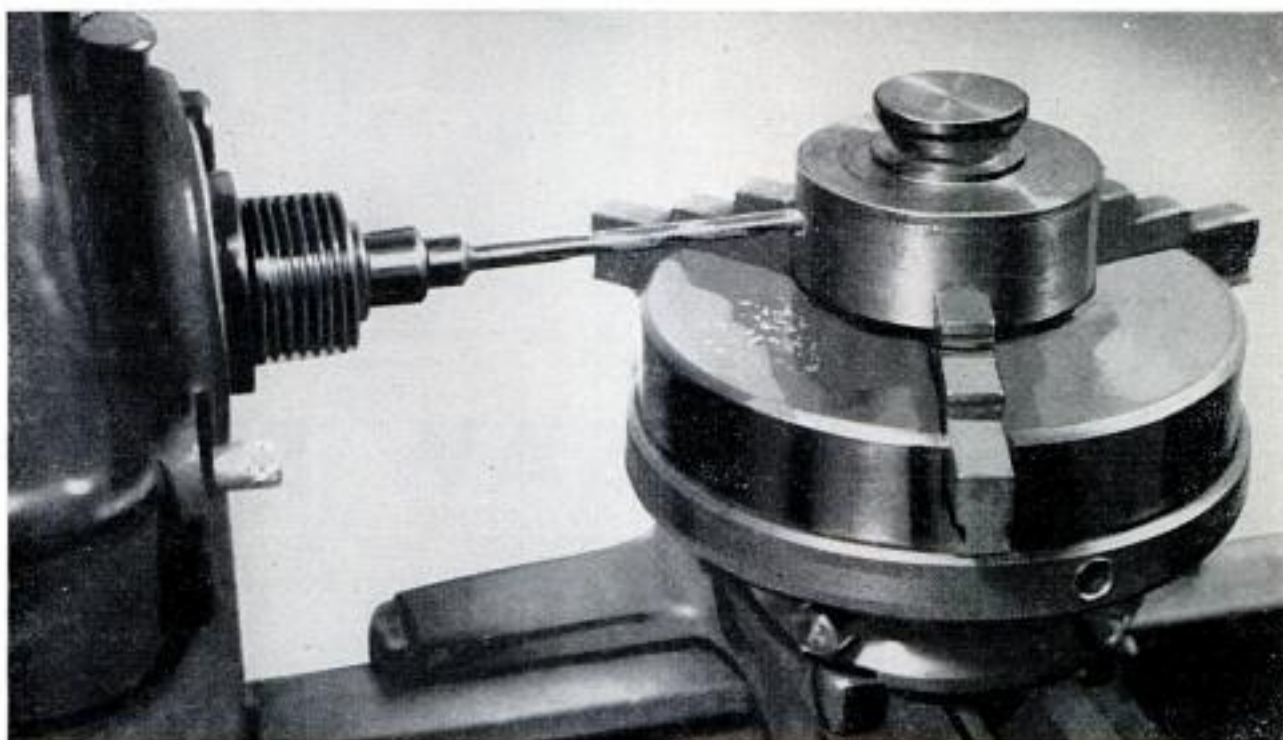

Chuck mount used to hold universal three-jaw chuck on lathe cross slide for precision drilling operation

DUAL-PURPOSE CHUCK MOUNT

By R. Glen Nye

ONE OF THE MOST USEFUL milling accessories for a metal-cutting lathe is a chuck mount, which not only greatly increases the utility of the lathe but can even replace the milling attachment in a number of machining operations. The chuck mount's primary use is in holding round stock which is otherwise difficult to clamp. It also provides for exact angular positioning of the work about an exactly known center, permitting milling and jig-boring in circular as well as rectangular coordinates. When mounted on the cross slide as shown above, the same types of work are accomplished about a different axis. Between the two positions almost any conceivable setup can be made.

Gray iron or cold rolled or mild steel are satisfactory materials for the chuck mount. If the largest stock available is undersized in diameter, studs may be added to bring the angle indicator marks flush with the protractor scale. Socket-head setscrews are preferable for position locking.

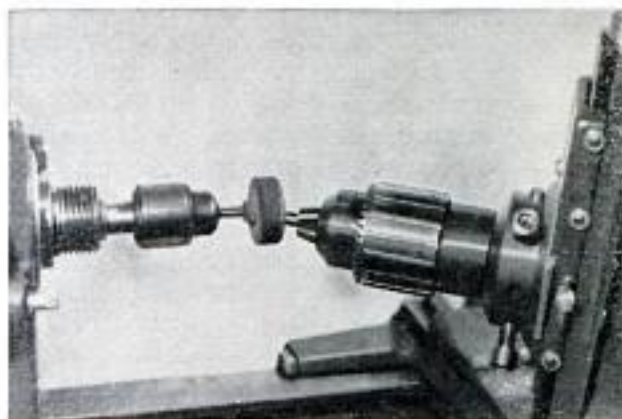

Chuck-mount setup on milling attachment. Spindle on chuck mount takes threaded sleeve on geared drill chuck. Pictured is angular grinding small part

Holes located between the setscrews permit insertion of a positioning lever made from a length of drill rod.

On the lathes shown in the illustrations on this page, the vise, which is part of the milling attachment, also fits the post on the lathe cross slide that mounts the compound rest. Therefore a single chuck mount will accommodate any of the lathe chucks on either the milling attachment or the lathe cross slide. Owners of milling heads often overlook the fact that the milling-head vise also fits the cross-feed and that a drill-press vise clamped in it can do many difficult jobs.

SN 57

Taper Turning Lathe Center Made From Drill Shank

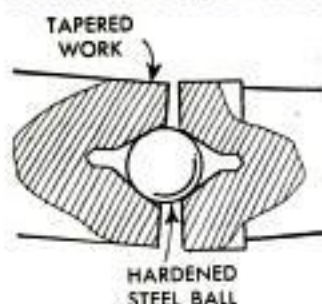

Turning tapers between centers, using the set-over tailstock method, can be readily accomplished with the simple tailstock center shown in the detail. It is made

from the tapered shank of a discarded twist drill with a large center hole drilled in the big end and a hardened steel ball inserted for the work to rest on. This will support the off-center work evenly and allow it to rotate true, without danger of burning or scoring the regular lathe center point when steep tapers are turned, which would throw the ordinary center point badly out of alignment.

Clothespin Holds Drill Chuck Key



Loss of an electric-drill chuck key can be prevented and the key kept within easy reach if it is attached to the cord with a

spring-type clothespin. The clothespin can be taped to the cord at a point close to the handle, or it may be fastened to the drill housing with a short length of wire. The clothespin will be held firmly in place if the fastening material is applied at both ends of the lower member. The jaws of the clothespin hold the key securely until it is needed.

Short Lengths of Garden Hose Are Electric-Fence Insulators

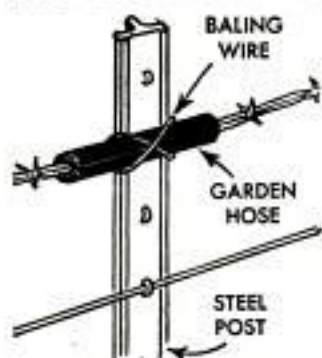

When steel posts are used for electric-fence installations, 6-in. lengths of discarded garden hose can be used for insulators as substitutes for the conventional porcelain ones. The lengths of hose

should be split along one side, slipped over the barbed wire and fastened with baling wire which is wrapped around the post and the hose. These insulators are easily removed and reused when it becomes necessary to move the fence.

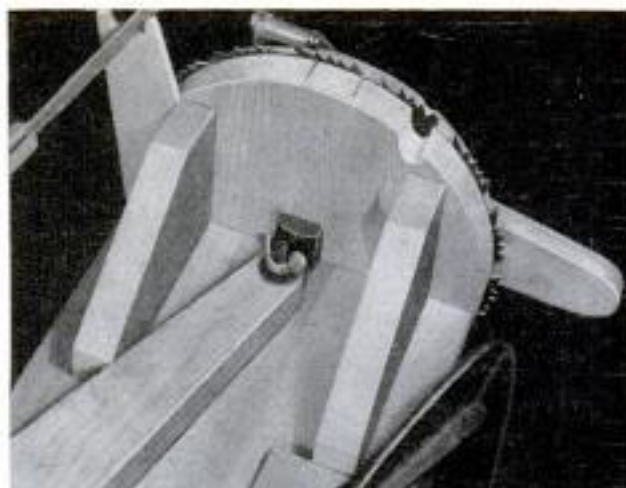

Rear view shows purpose of file rest, index marks and notch in vise for filing gullet of raker teeth

SAW FILER

HOLDING THE FILE at the proper angle is no problem with this circular-saw filing jig for it guides the file for you. Once the file guide is adjusted to suit the teeth of the blade at hand, you simply push the file forward, lifting it on the back stroke. The jig will accommodate 8-in. rip and crosscut blades as well as the combination type. A roller guide is provided for filing the raker teeth of the latter. The details below and on the opposite page show how the jig is made, and the photo above shows how the swinging arm of the file guide is locked in position with a wing nut. In use, the file is held in the slotted end of a dowel and the blade is clamped between the disks of the vise. As each tooth is filed, the locking handle is loosened and the blade is advanced to bring the third tooth in line with an index mark on the top of the vise. ★ ★ ★

H. R. Heydorf, Beaverton, Ore.

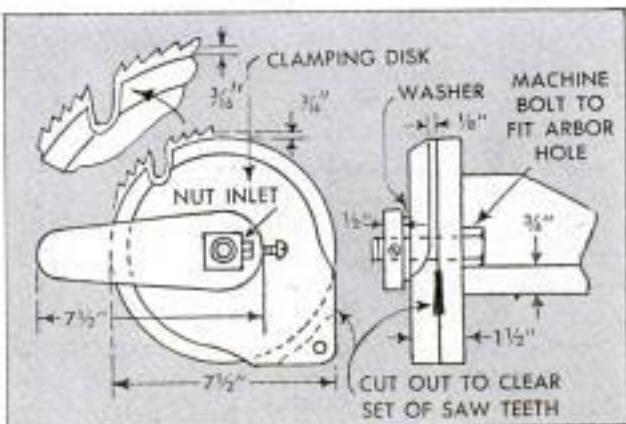
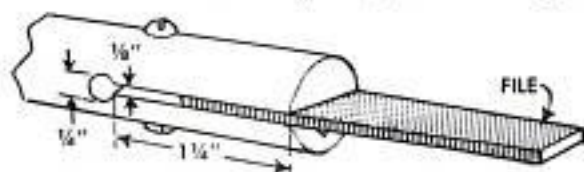

Jack-Equipped Trailer Backed To Unhitch From Tractor

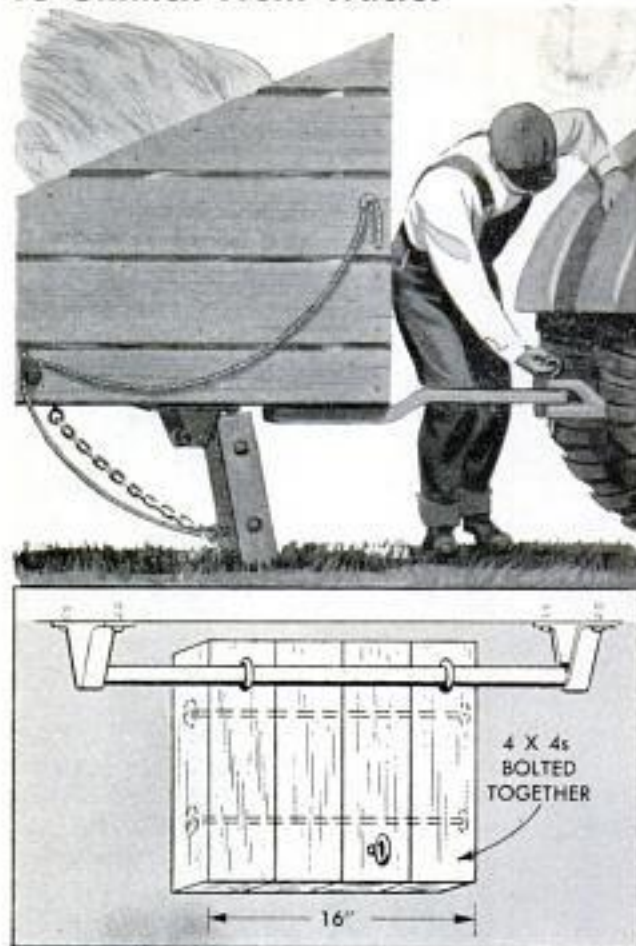

Equipped with a simple jack, consisting of four 4 x 4s bolted together, a 2-wheeled trailer on one farm can be quickly hitched or unhitched from the tractor. The 4 x 4s are suspended on a shaft which passes through two eyebolts in the jack assembly. The shaft is attached solidly to the underframe of the trailer. Backing the trailer lifts it up on the jack, the forward motion of which is limited by a length of chain. Towing the trailer forward releases the jack, which then is pulled up by means of a rope passed through a pulley.

L. D. Johnson, Leslieville, Alberta, Can.

Improved C-Clamp Extensions Increase Useful Capacity

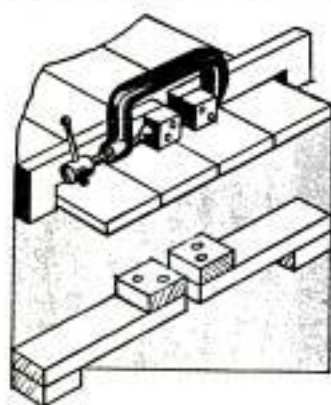

When bar clamps are not available for a particular job, improvised wooden extensions often will permit using C-clamps as substitutes. The extensions, which require only a few minutes to assemble, can be made in either of the two

ways detailed. The upper detail shows one type which consists of L-shaped wooden hooks. Blocks are nailed to the sides of the straight ends to provide pads for the C-clamps. The second type of extension, shown in the lower detail, is made from straight pieces of stock with blocks nailed on the opposite sides at the ends.

Dull Countersink Sharpened With Grinding Compound

Sharpening the dulled edges of a countersink can be done with a "hone" improvised from a block of mild steel and valve-grinding compound. A hole is drilled in the steel with the countersink, after which valve-grinding compound is applied to the sides of the hole. Then the countersink, which is chucked in a drill press, is brought down into the hole and turned by hand in a counter-clockwise direction. It is raised from time to time and the grinding compound redistributed.

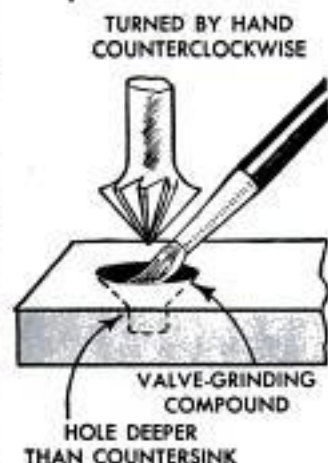

Reel for Barbed-Wire Fencing

Any barbed-wire fence which must be moved frequently can be relocated quickly by using this two-wheeled reel. It is made by cutting the axle of a hayrake to a convenient length and fitting it with a welded-steel angle spool, frame and drawbar. The reel is pushed to pick up the wire; the handwheel welded to the end of the axle permits backing the axle against the ratchets to take up slack. When the wire is unrolled the reel is pulled and the ratchets provide a light tension.

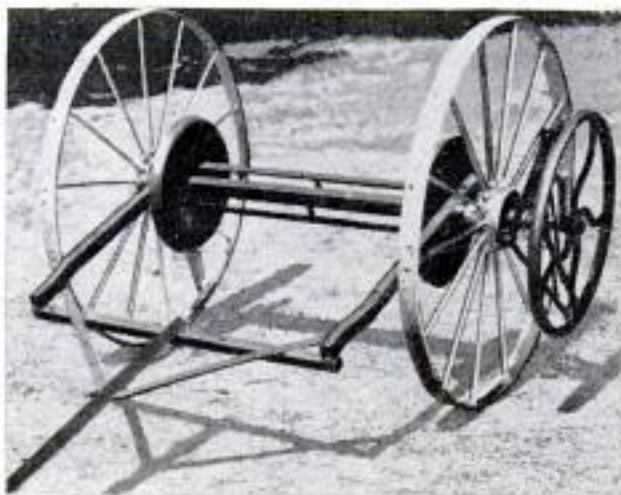

MIDGET TELESCOPES



STANDARD 6 X 30



No. 1-5X



No. 2-4X



No. 3-5X



No. 4-5 1/2 X

1

By Sam Brown

YACHTSMEN, football fans, birders and hunters used to conventional binoculars can well appreciate the lightness in weight, the optical brilliance and resolving power of a workshop-made instrument no larger than a pack of cigarettes. The midget monoculars, or "telescopes," pictured in Fig. 1, illustrations 1 to 4 inclusive, are prismatics of top optical quality assembled from eyepieces, objective lenses and prisms obtainable from dealers in military surplus. Note the comparison in size with the standard monocular in Fig. 1, also the comparison with standard 7 x 50 binoculars in Fig. 5. The eyepiece mounts, prism cells, cover plates and certain other parts can be made of wood, aluminum and black or colored plastic.

The 5X (5-power) midget, No. 1 in Fig. 1, has the greatest light-gathering power, which makes it especially useful when good illumination is required under poor lighting conditions. The unit is fitted with standard 6x30 binocular prisms and has an eyepiece giving sufficient relief to be used without removing eyeglasses. The prism cell is bandsawed from hardwood, the various steps in the construction being shown in Figs. 2 to 8 inclusive. Use the full-size centering pattern in laying out all the parts shown in the exploded view, Fig. 7. The seat for the objective lens is cut in the lathe, the setup being made as in the detail, Fig. 3, after boring the block according to the pattern layout, Fig. 2. Then the block is bandsawed to outside contour as in Fig. 4. In the initial operation both the front and back cell blocks must be squared on two adjacent sides so that the center lines can be transferred accurately. The hole for the eyepiece should be bored in the lathe as in Fig. 10. It's a good idea to check the layout, Fig. 14, on all pieces by setting up the parts

In the photo above the four midget scopes are compared in size with a standard 6 x 30 monocular. All four are pocket scopes of high optical quality



2

First operation on the prism cell after layout. Layout is made carefully to assure correct hole register



3

Above, turning the objective-lens seat in the prism cell. Note that work is mounted on a plug chuck for boring. Below, after boring operations are completed, cell block is bandsawed to outside contour

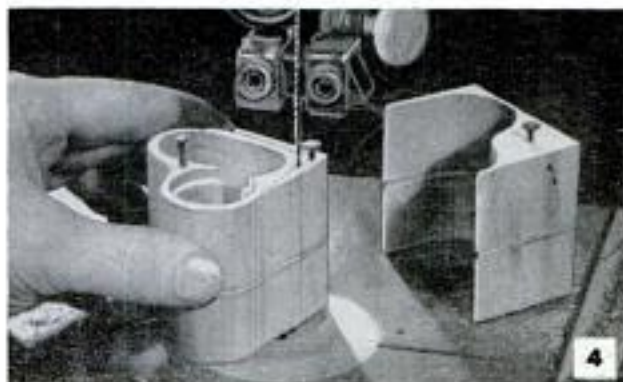

4



OBJECTIVE 25-mm. DIA.—95-mm. F.L.
PRISMS 13/16" FACE, PORRO-ABBE
EYEPIECE TWO, 18 x 38-mm. ACH.
 E.F.L.=19 mm.

POWER 5X
FIELD 122 YDS. AT 1000 YDS.
LIGHT 21 (85%)
EYE RELIEF 3/4"

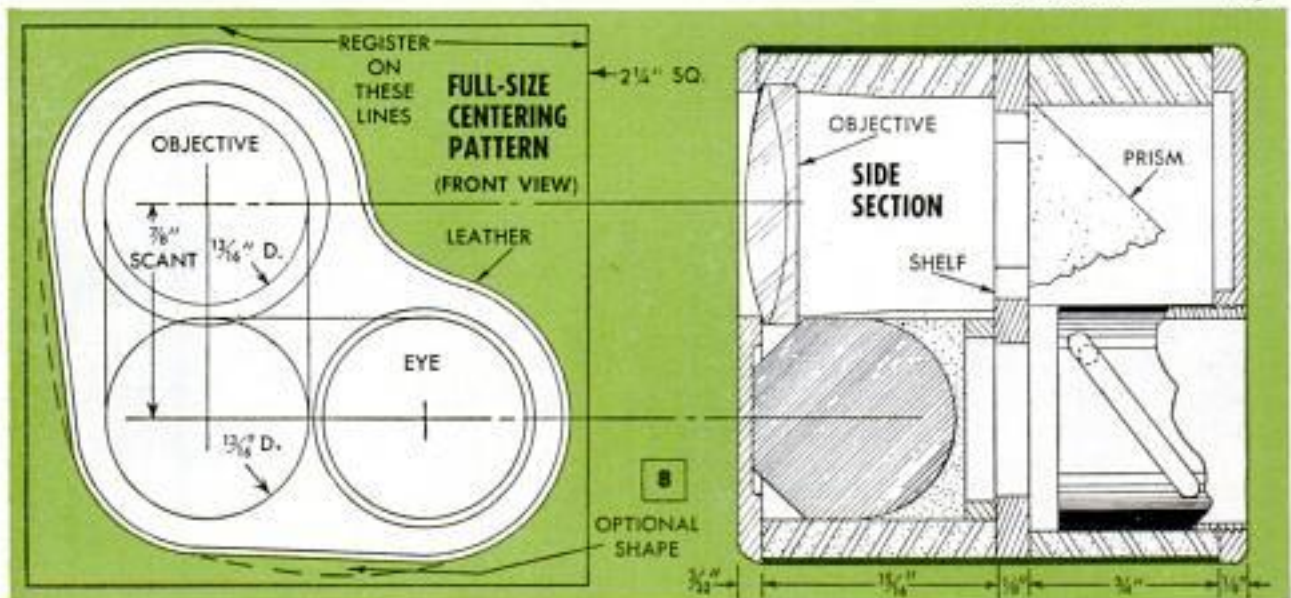
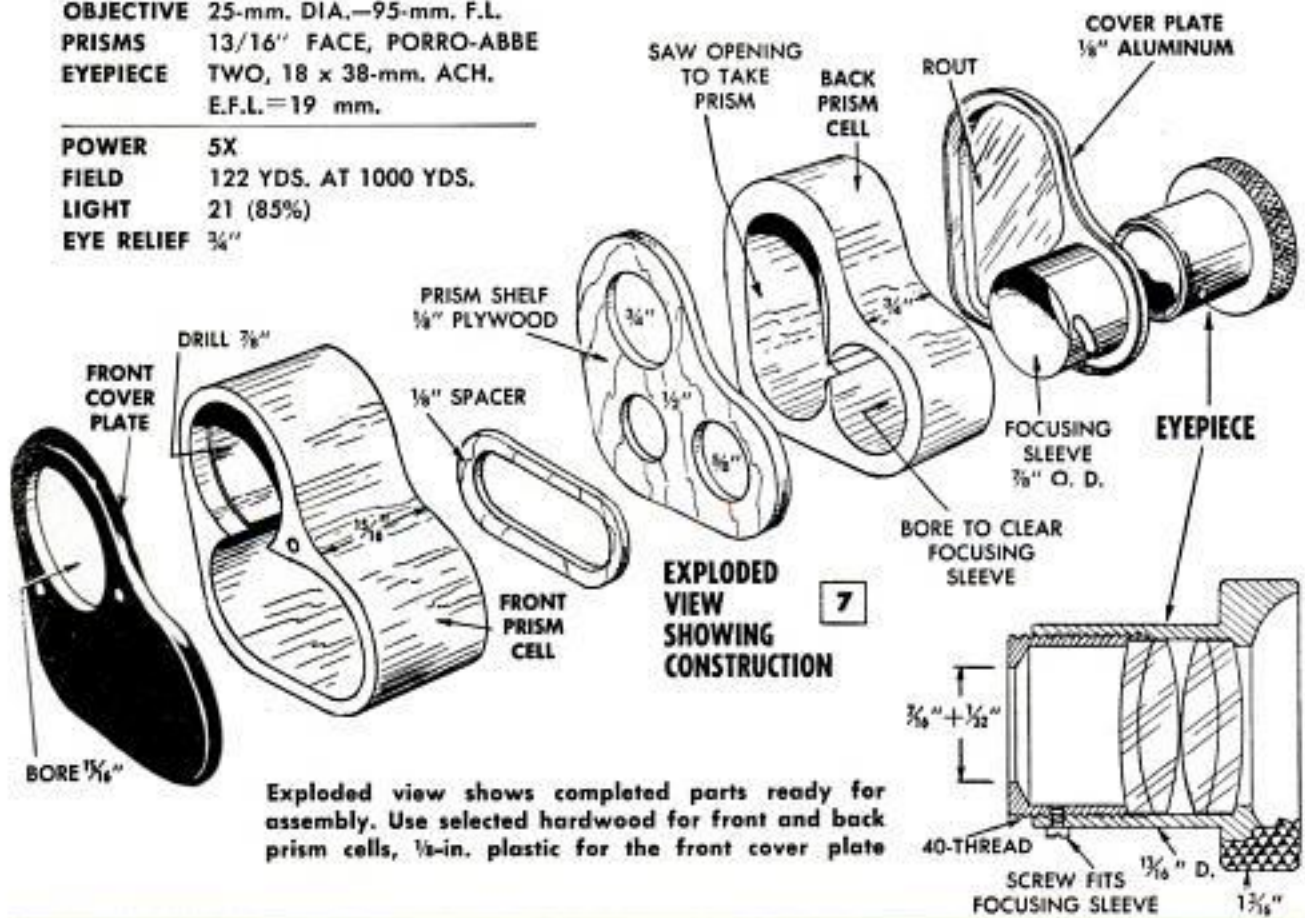

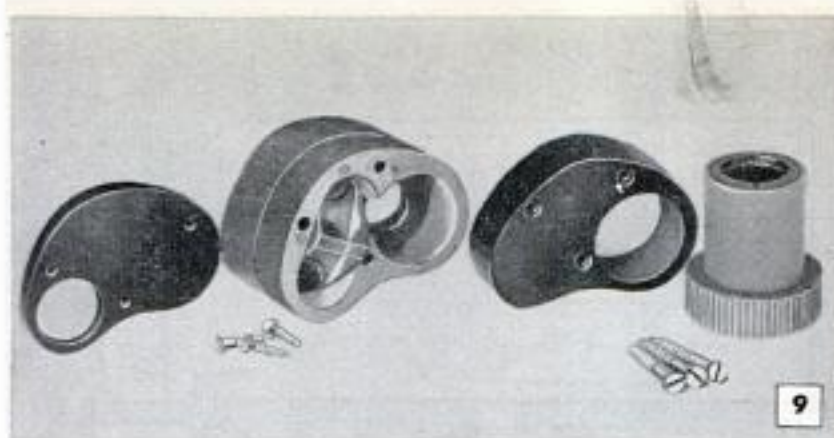
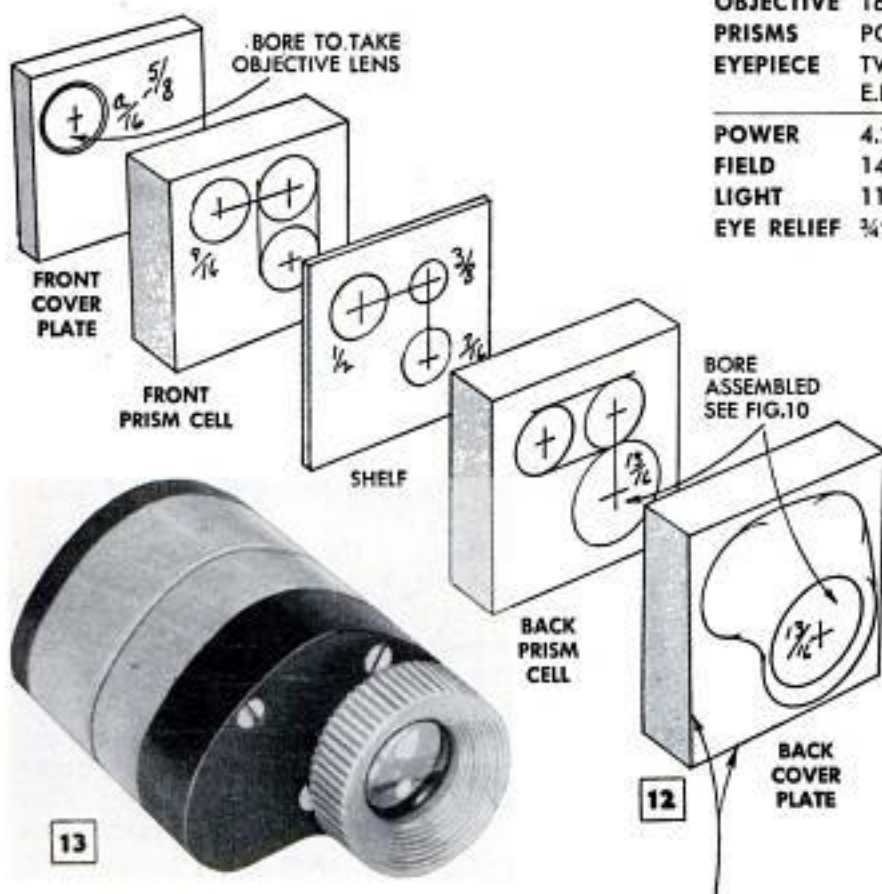

Photo at left pictures partially assembled parts of the No. 2 scope, Fig. 1. Right, boring cover plate

OBJECTIVE 16-mm. DIA. BY 80-mm. F.L.
 PRISMS PORRO-ABBE, $\frac{1}{2}$ " FACE
 EYEPIECE TWO, 18 x 38-mm. ACH.
 E.F.L.=19 mm.

POWER 4.2 X
 FIELD 140 YDS. AT 1000 YDS.
 LIGHT 11 (45%)
 EYE RELIEF $\frac{3}{4}$ "



13

12

11

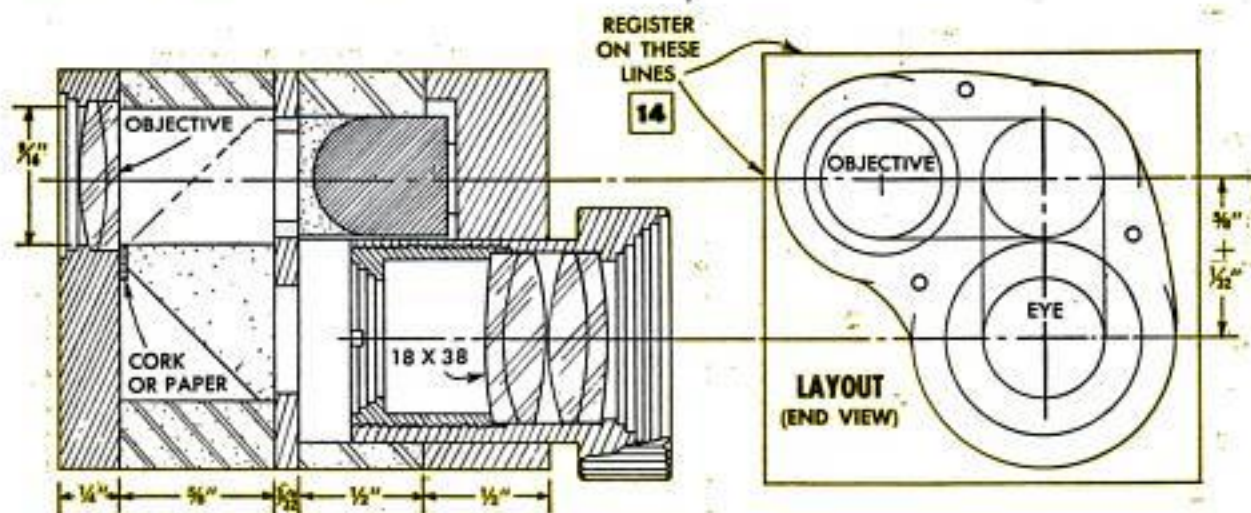

14

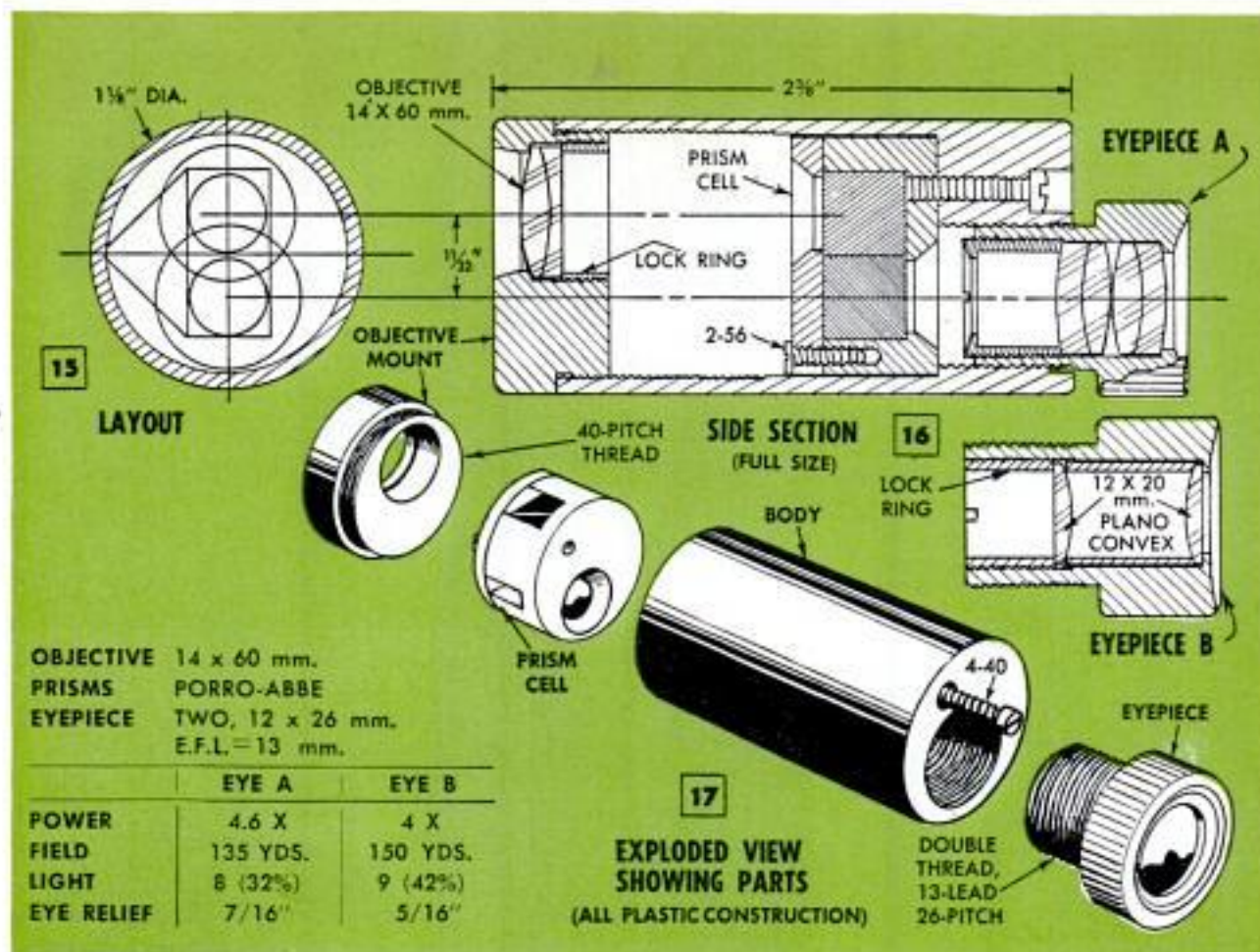

as in Figs. 11 and 12. It's especially important to make sure that the holes register. Then the two prism cells and the shelf are glued together, Fig. 9. The cover plates are held in place with wood screws. Figs. 9 and 13 picture a partial and complete assembly of the No. 2, 4X scope shown in Fig. 1. The body (prism cells) of this unit is not leather-covered as is the No. 1 scope in Fig. 1. The eyepiece in both is a plain draw-tube type and should be a snug fit. If desired it can be fitted in place with a slot-and-pin adjustment by slotting the eyepiece tube and driving a pin (small screw) from the outside of the back cover plate, Fig. 7.

The No. 3 scope in Fig. 1 is the smallest and in some respects the handiest of the four midgets shown. It is of all-plastic (black Tenite) construction. The prisms are the Porro-Abbe type and while a bit small are inexpensive. The scope is fitted with a symmetrical eyepiece composed of two 12-mm.-diameter by 26-mm.-focal-length achromats, the equivalent focal length being 13 mm. You may have some difficulty in locating these lenses, A in Fig. 16, since surplus stocks are not large. For this reason an alternate Ramsden eyepiece is shown, Fig. 16, B. The Ramsden eyepiece is less expensive than the symmetrical type, is equally good optically, but has a shorter eye relief, making it un-

suitable for use by those who must wear glasses.

Construction of the No. 3 scope begins with the layout, Fig. 15, and is detailed in Figs. 16 to 24 inclusive. The full size layout of the prisms and cell, Fig. 18, shows how the two prisms are fitted in contact, one over the other. Fig. 19 is the same layout with the paths of the various machining cuts marked. This layout is carefully marked on the end of the plug after turning, Fig. 21. Machining is best done on the milling machine with $\frac{1}{8}$ in. saw, Fig. 22, but also can be worked on the drill press with a milling vise or the lathe with a milling attachment, using a $\frac{1}{8}$ -in. end mill in both instances as the cutting tool. In a pinch you could even work this on the circular saw with a suitable holding jig. As worked on the miller, the piece finally shapes up as in Fig. 23. The two small triangular pieces, Fig. 19, will break out and should be dressed smooth with a hand grinder. Fig. 24 shows how the prisms fit in place. A little shimming with gummed paper may be needed if both prisms are not exactly the same size. The cell is cut from the plug with a parting tool, leaving a $\frac{1}{8}$ -in. thick base. A cover plate for the cell is cut from the same plug, turning this piece over to put the $\frac{5}{16}$ -in. hole on the opposite side of center. The plate is fastened with two screws.

HOW TO MAKE THE CELL FOR SMALL PORRO-ABBE PRISMS

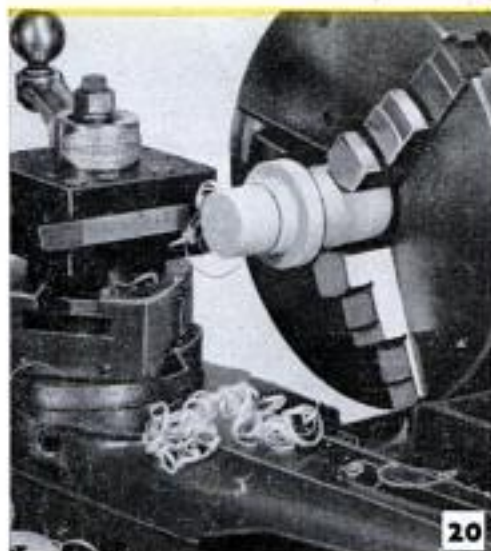
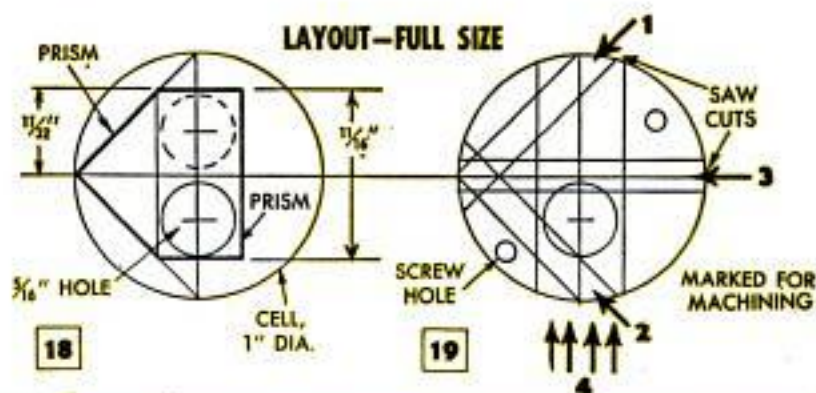

After the prism cell is made, the rest of the scope can be worked, Fig. 16. The body is made first, turning the inside to take the prism cell but leaving the outside in the original thickness for rechucking. The objective mount is worked on-center and is then off-centered to bore the objective hole. With the objective mount fitted in place, the center line for offsetting the eyepiece hole can be located by measuring or sighting. From the layout plan, Fig. 15, it can be seen that all holes, objective, prism cell and eyepiece, are worked on the same center line, and offset the same distance on either side of center.

The No. 4 scope is a departure from conventional monocular design, excellent as a pocket scope. A Leman prism is used and it is easy to mount because it comes in one piece. The simple construction involved is shown in Figs. 25 to 28 inclusive. The plastic body block should be machined flat and square to permit accurate chucking, Fig. 26, when boring the objective and eyepiece holes. The cutout to take the prism should not contact the reflecting surfaces. Allow clearance as shown in Fig. 28 for maximum light transmission. When making the plastic body, Fig. 27, it's a good idea to run the cutout slightly undersize, then hand-fit the prism by removing material from the cutout with a fine file. The eyepiece is almost identical with No. 3

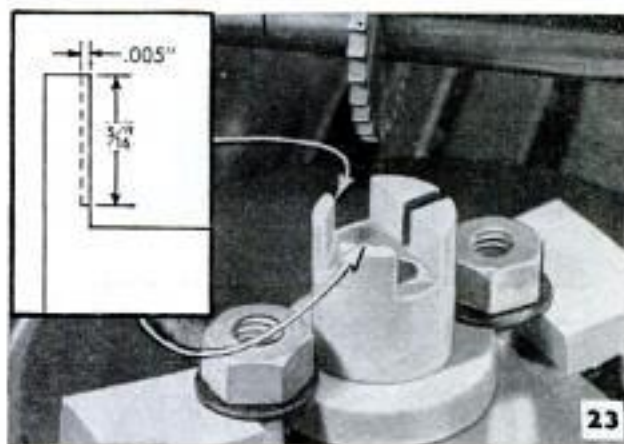

Above, prism cell for the No. 3 scope, Fig. 1, after milling to layout, Fig. 19. Note dimensions in detail. Below, cell completed with prism in place. It may be necessary to shim prism to proper alignment

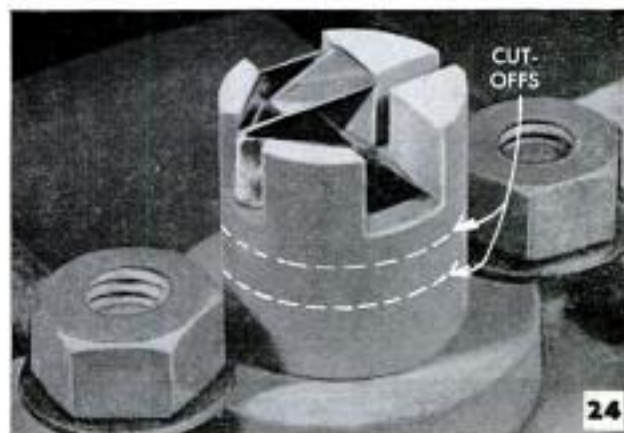

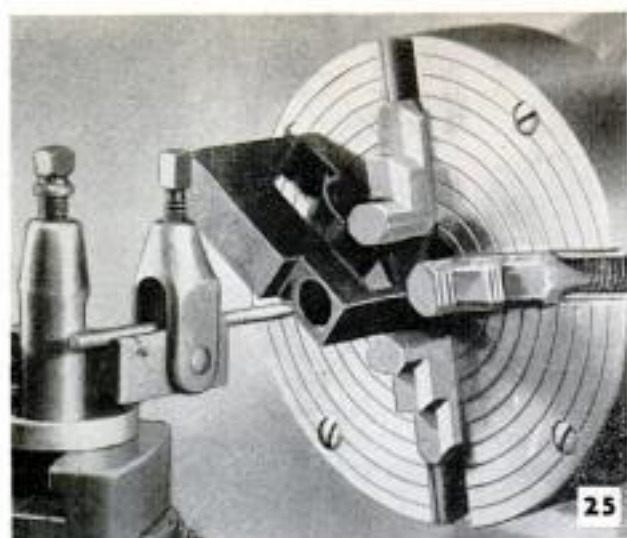

Setup in lathe for boring hole for objective, Fig. 27. Hole is shouldered, Fig. 28. Take very light cuts

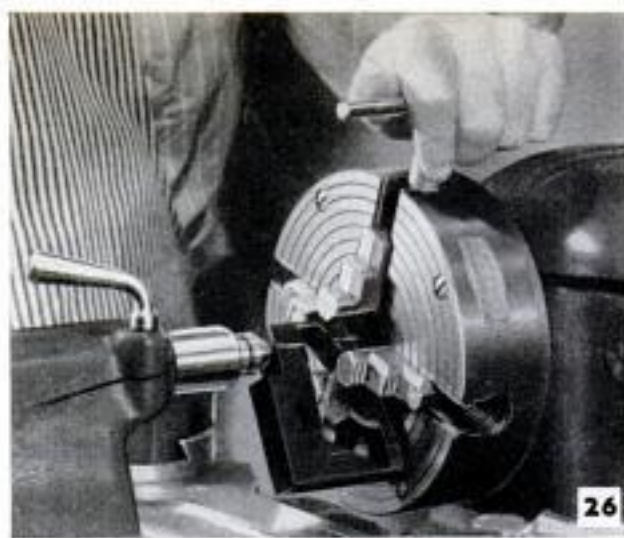

Setup in 4-jaw chuck for boring operation pictured at left. Note use of tailstock in centering work

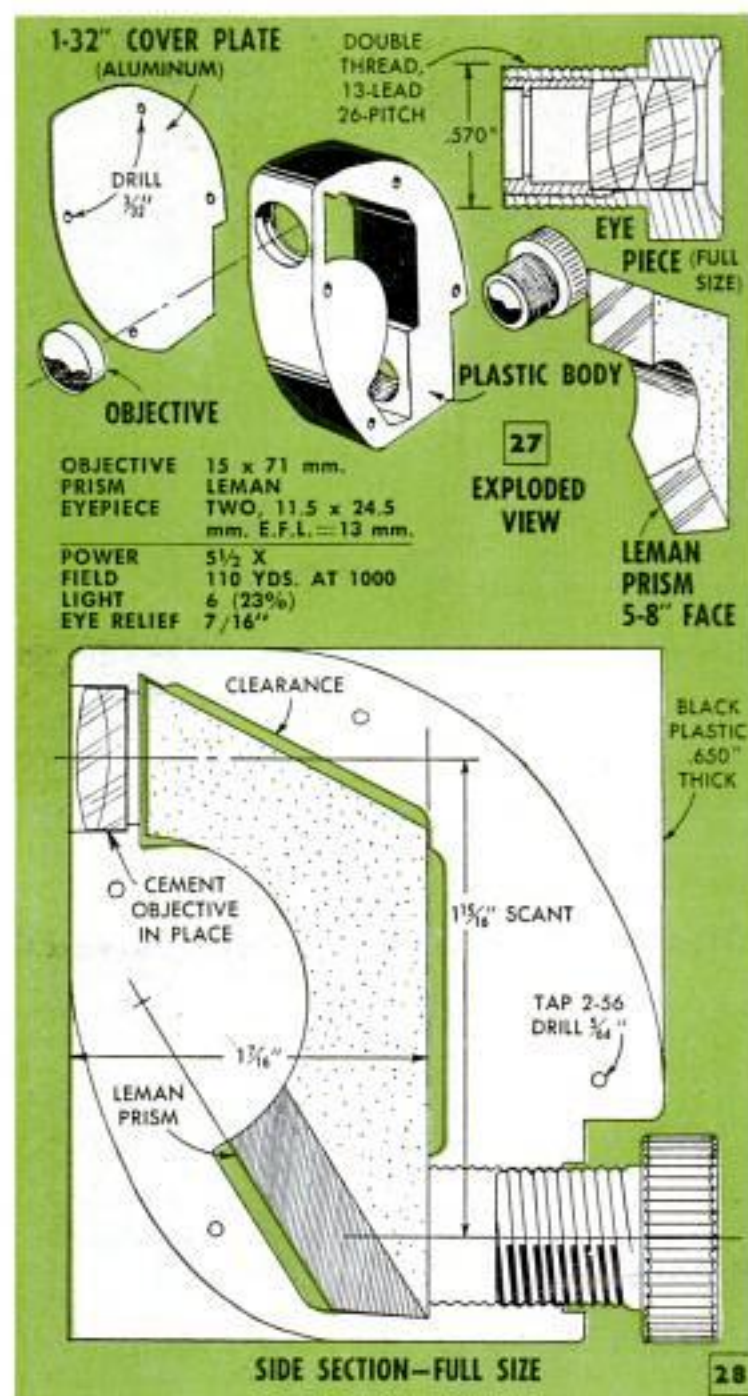

design and focuses by means of a 13-lead double thread. This is fast enough for quick focusing. However, if desired, focusing can be held to one turn with a thread of 7-lead, 28-pitch.

All four designs can be varied considerably in magnification. Generally it is not practical to go below 3X (3-power) since this power usually gives the best definition with a comparatively wide field of view. The 3-power units are the most compact of all scopes. They can be worked up about $\frac{3}{4}$ in. in diameter by $1\frac{1}{2}$ in. long. None of the midgets shown should be raised above 7X because of light loss due to the small objectives.

Higher power is obtained by using a stronger eyepiece (shorter focal length) or a longer focal length objective. The latter will increase the length of the scope by an amount equal to the extra focal length over that specified. A change in the eyepiece will not affect the size of the scope. It is a simple matter to make up two or three eyepieces to fit any scope and in this way obtain variable power. A $\frac{1}{2}$ -in. eyepiece, such as used for designs No. 3 and 4, will give 7X with design No. 1 and 6X with design No. 2 scope. ★ ★ ★

Grinding a Round Punch

Sharpening a round punch on a grinder is much simpler if the punch is chucked in a hand drill. Not only is it easier to hold the punch, but the hand drill can be used to slowly rotate it against the grinding wheel.

Micrometer and Calipers Measure Blind Recess

Measurements in blind recesses can be made with a pair of spring calipers fitted with steel buttons so that measurements can be transferred with an outside micrometer. Steel buttons are turned $\frac{1}{2}$ in. in diameter and shouldered to $\frac{3}{16}$ in., as shown in the detail. They are press-fitted into holes drilled in the caliper legs. To use the calipers, their points first are set to a known measurement between the anvils of the micrometer. Next, a measurement is made across the buttons with the micrometer. Now, slip the calipers into the blind recess and set them to measure it. Finally, measure across the buttons again. The differ-

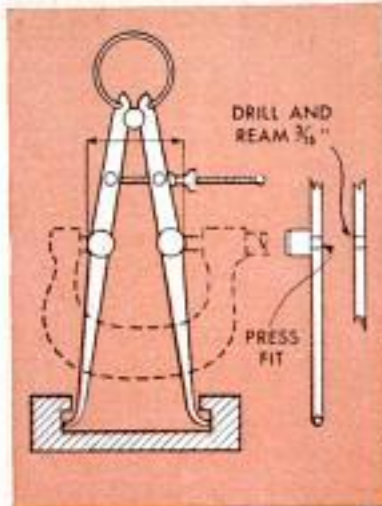

ence between the two measurements across the buttons added to the first measurement across the caliper points will determine the measurement of the blind recess.

H. J. Berber, Stillwater, Okla.

Ball-Turning Attachment for Lathe Utilizes Drill-Press Vise

Spheres can be turned quickly and accurately on a lathe with this attachment,

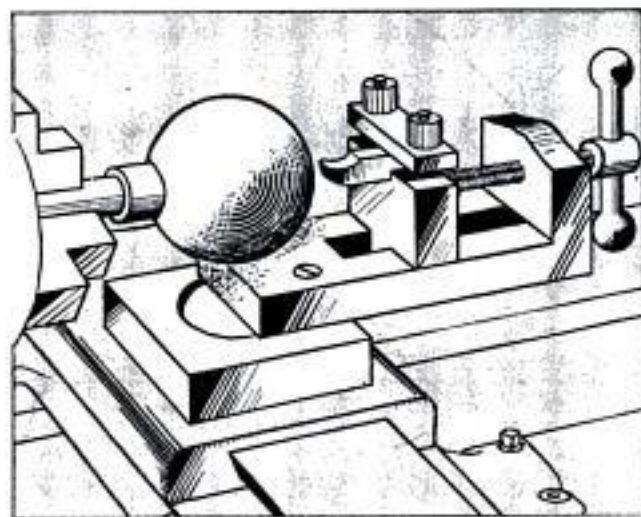

which consists of an old drill-press vise fitted on a swivel base and modified to hold a tool bit. The base will vary with each make of lathe, but primarily it bolts to the cross slide in place of the compound rest and permits the vise to rotate around the lathe center. After the stationary jaw of the vise is removed or cut away, a groove is milled in the top of the movable jaw to receive the tool bit. Two cap screws turned into tapped holes in the jaw hold a small bar which clamps the tool bit in place. Diameters of turned spheres are varied by moving the tool bit closer to the swivel center for smaller diameters and backing it away for larger. In some cases it may be necessary to shim the base to raise the tool bit to exact center. The cutting edge of the tool should be rounded so it will cut in either direction.—C. W. Woodson, Chicago.

Machinery Crankcase Filled Through Extension Funnel

Filling the crankcase of workshop equipment, such as a jigsaw, where the oil intake is difficult to get at, can be done easily and without tipping or dismantling the machine through the use of an extension funnel. The funnel is made as shown in the detail. One end of a 7-in. length of $\frac{1}{4}$ -in.-i.d. copper tubing is flared and then soldered to the bottom of a funnel from which the spout has been removed. The other end of the tubing is reduced by hammering until it fits into the oil intake. When using this funnel it is best to pour the oil slowly.

Dick Hutchinson, San Gabriel, Calif.

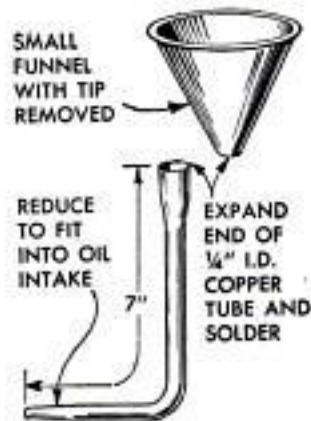

Horse-Drawn Planter Modified For Use With Tractor



This horse-drawn corn planter was modified for use with a tractor by bolting on a short length of 3-in. steel channel for a drawbar, and adding brackets to permit the entire planter to be lifted by the tractor's hydraulic system. Cables running from the marker shoes, through pulleys and down to the drawbar automatically raise the markers when the planter is lifted at the end of a row. The markers are dropped manually.

Guide Clamped to Tubing Assures Square Saw Cuts



Square hacksaw cuts on tubing and pipe are assured by using a clamp-on-type saw guide. The simplest method of doing this is to use a regular automobile-radiator-

hose clamp. If a clamp of the correct size is not available, the saw guide can be improvised from a strip of thin sheet metal bent to form a clamp and held with a nut and bolt as shown in the illustration.

Screwdriver Removes Bolts

A Phillips-type screwdriver can be used to remove a broken bolt if a regular bolt extractor is not handy. Grind a relief on each of the "blades" of the driver to increase the bite of what will be the leading edges when the driver is used as an extractor. Force the screwdriver into a hole drilled in the broken stud and turn it with clamp-type pliers to obtain greater leverage. To aid in removing a broken bolt, strike it several sharp blows to loosen rust and corrosion before drilling it.

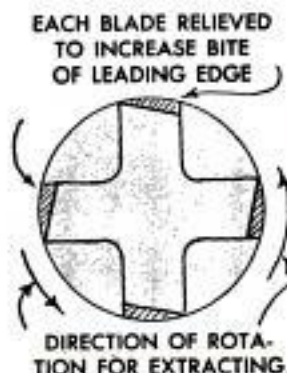

Generator Efficiency Restored By Washing Out Excess Oil

An automobile generator that is not operating properly because it has been over-oiled, can be "repaired" by cleaning oil from brushes and commutator with carbon tetrachloride. Use a pump-type oil can to force the carbon tet into the generator while it is running. The carbon tet will loosen the oil and dirt and the spinning commutator will throw off the loosened matter. Do not use gasoline or other flammable solvents for the job. Carbon tetrachloride, although nonflammable, gives off toxic fumes, so it must be used only in a well-ventilated area.



SILVER-SOLDERING Bandsaw Blades

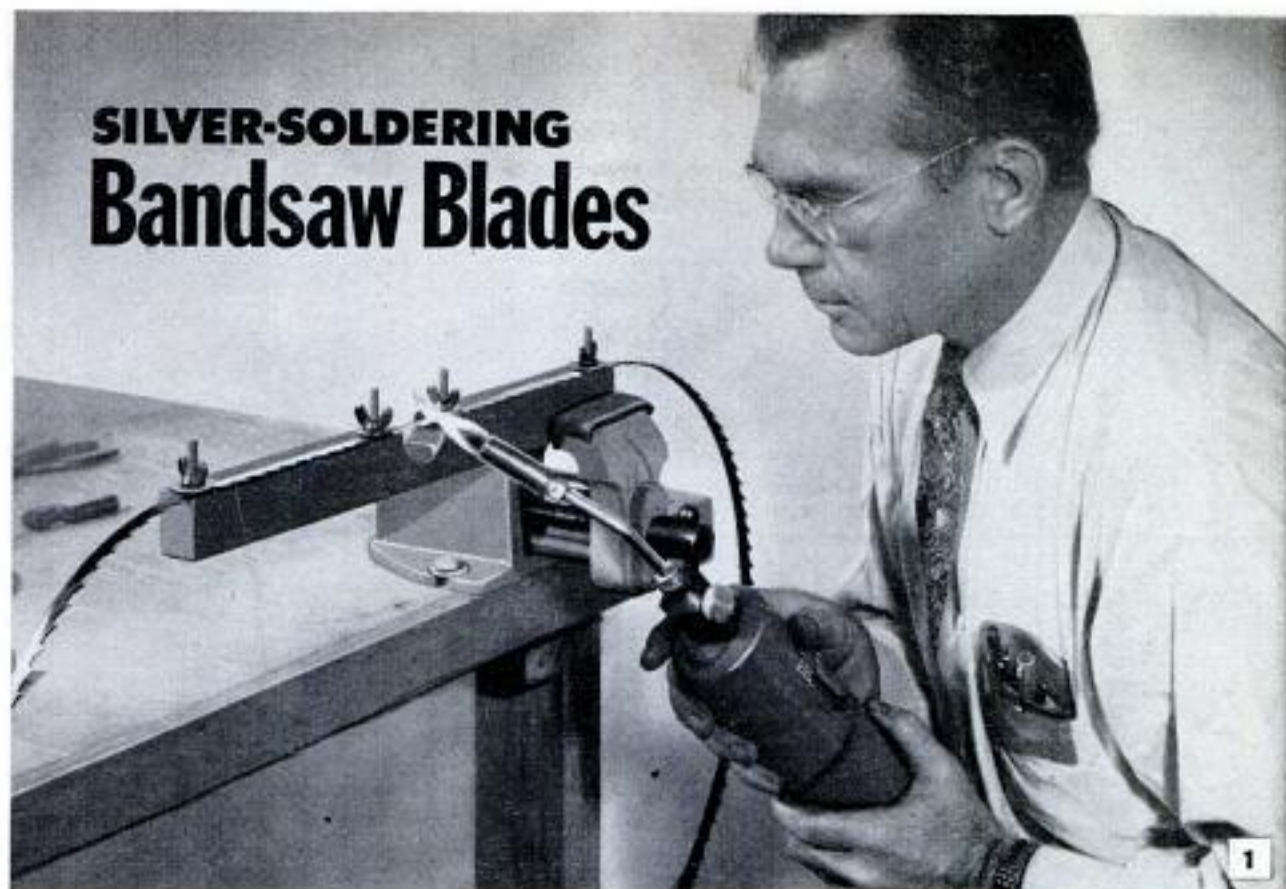

By E. R. Haan

IN SOME CASES it's an advantage to make internal cuts with a bandsaw without running in from the edge of the stock. This is easily done by drilling a hole at some convenient point within the pattern to admit the blade end as in jigsaw work. Then you cut the bandsaw blade, insert one end through the hole in the stock and bevel and silver-solder the ends as in Figs. 1 and 2. Replace the blade on the band wheels and you're ready for work. When the cutout is finished, cut the blade again, remove it from the work and bevel and re-solder the ends. The advantage of the bandsaw for this type of scrollwork is that it cuts much faster and smoother than the jigsaw, especially with narrow, skip-tooth blades. The same procedure can be used when making internal cuts in metal.

Jigs for silver-soldering: Two simple wooden jigs are made for beveling and joining the blade ends. The first one, used for beveling the ends, is pictured and detailed in Figs. 3 and 4. Methods of beveling are shown in Figs. 3 and 5, A, B and C. The method used depends on the type of blade. Bandsaw blades for cutting wood can be beveled with a file as in Fig. 3, while those used for metal cutting are harder and must be beveled by grinding, Fig. 5. The purpose of beveling the ends before joining is to obtain relatively large contacting surfaces. These form a strong joint when united with

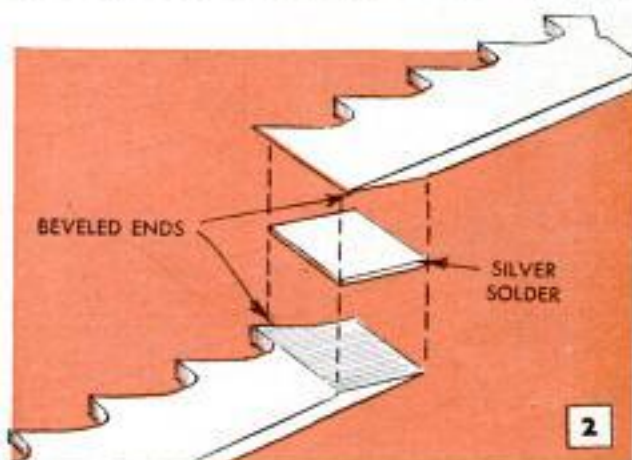

a thin film of molten silver solder, Fig. 2. The jig in Fig. 4 is especially designed for hand-filing with the unit held in a vise as in Fig. 3. However, this same type of jig also can be used for grinding as in Fig. 5. The copper strip, Fig. 4, serves a twofold purpose. It holds the blade rigidly in position when filing or grinding, and also serves to dissipate heat rapidly when grinding, preventing damage to blades which have been hardened for metal cutting. When grinding on the circular saw, detail C in Fig. 5, set the ripping fence so that the jig clears the grinding wheel and then use strips of paper between the jig and the fence to provide a means of slow-feeding to the grinding wheel, inserting a sheet of paper each time the end of the blade is moved past the wheel. When mounting the jig on the grinder, detail A in Fig. 5, be

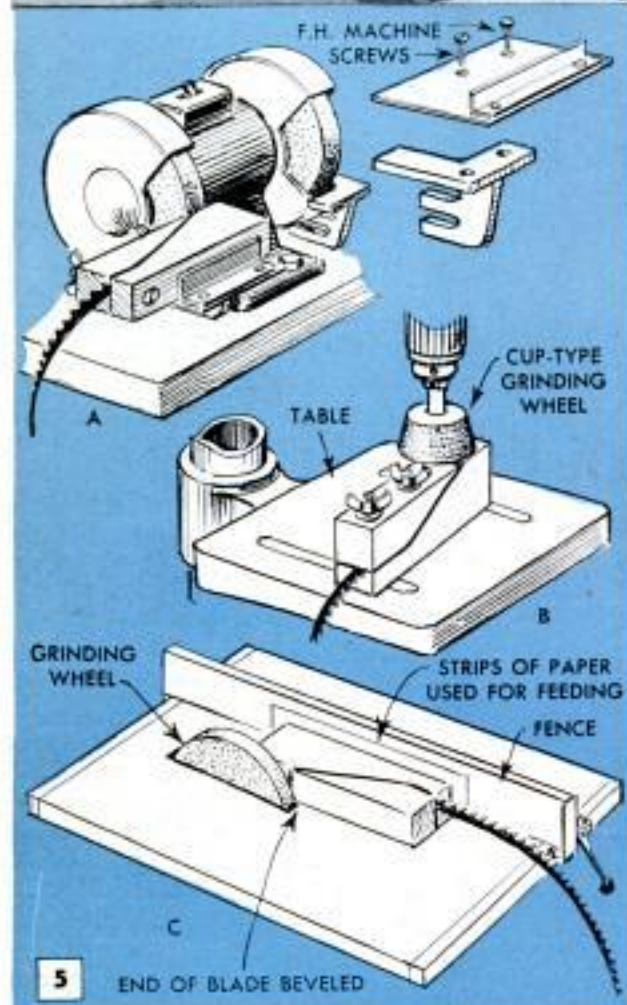
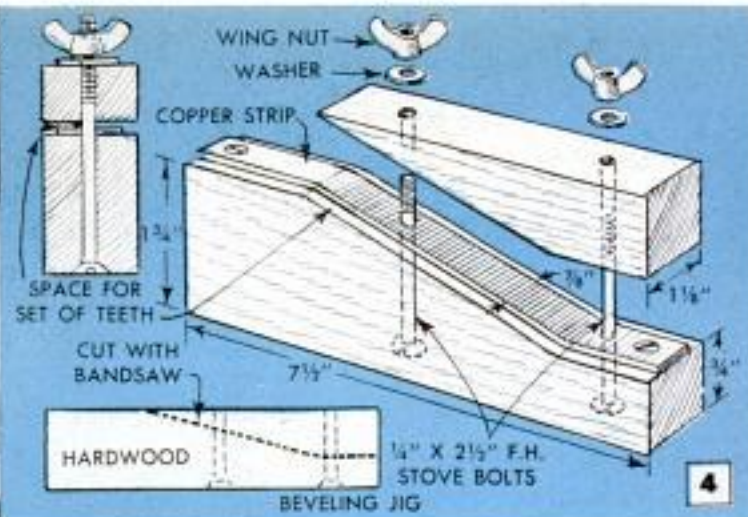
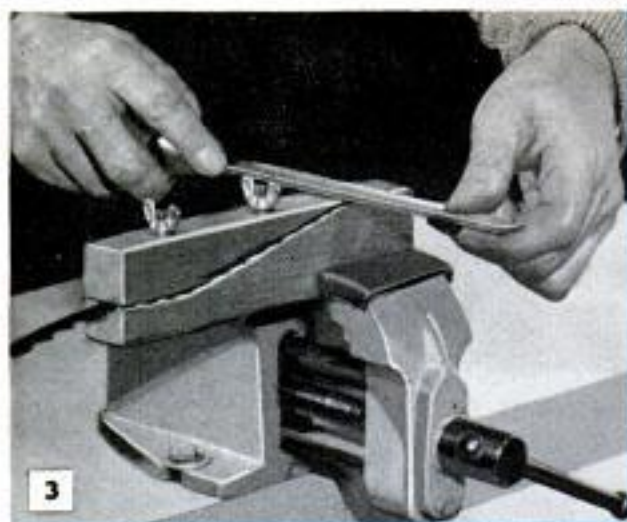

sure that the blade is located on the horizontal center line of the wheel. If it is only slightly above or below center, the end will be ground at an angle. When ends ground in this manner are joined by silver-soldering there may be a slight twist in the blade at the joint. This can cause undue wear as well as possible pounding in the blade guides on the machine. One thing to remember in this connection, always check the blade after soldering to see that it passes freely through the guides.

Clean blade ends before soldering: After cutting the blade and beveling the ends, clean with benzine or carbon tetrachloride, Fig. 6, to remove fingermarks and all traces of oil and sawdust from between the teeth. After cleaning do not touch the blade ends with the fingers.

Soldering jig: Fig. 7 details the soldering jig which is made of hardwood $1\frac{1}{4}$ in. in thickness and 12 or 15 in. long. A $\frac{3}{16} \times \frac{1}{4}$ -in. rabbet is cut on one edge. Four holes for $\frac{1}{4}$ -in. bolts are equally spaced along the length as shown. The bolts are fitted with washers and wing nuts. The semicircular cut at the center is made on a $\frac{3}{4}$ -in. radius, but can be made slightly larger if desired. The purpose of the jig is to hold the beveled blade ends tightly together with the flux and silver solder between while heat is applied with a torch of the type pictured in Fig. 1. As the blade ends are placed in position in the jig, it may be necessary to bend one or the other or both slightly upward to assure full contact of the beveled ends. Coat the ends with a paste made by mixing ordinary borax with water. The borax paste serves as a flux and should be thick enough so that when applied with a small brush as in Fig. 8, it will stay in place in the joint. Silver solder comes in sheet, roll and wire form. You can use any form but, of course, the wire solder must be hammered thin so that a small square can be cut to a size slightly larger than the bevels at the ends of the blade. Place the

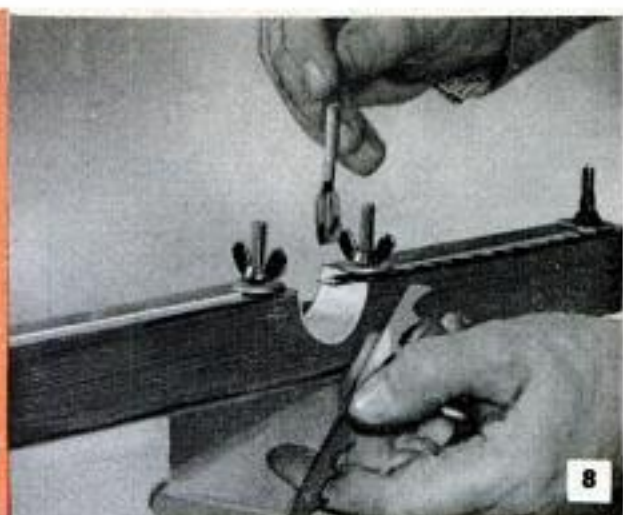
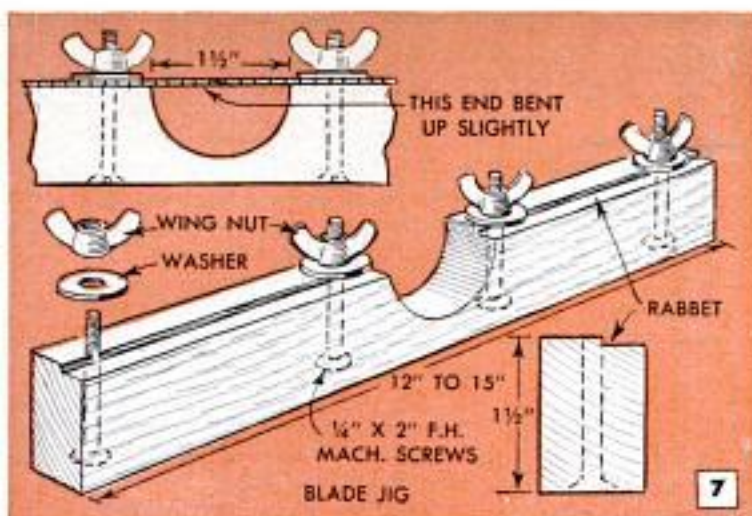

square between the bevels after fluxing and then clamp tightly in position as in Fig. 9. Be sure that the blade is correctly aligned in the jig before applying heat.

Flame-soldering: A small torch having a tip of the type that will concentrate the flame is used for soldering the blade ends. This can be one of the newer-type torches having a pressurized container, or you can use an alcohol torch with a blowpipe to concentrate the flame and produce intense heat at the tip. A spreading flame, such as that produced by an ordinary blowtorch, is not suitable for this type of soldering as it is essential to heat only that portion of the blade necessary to melt and flow the solder. After lighting the torch, adjust the tip to give a narrow flame with the point fairly well out from the torch tip. On the smaller blades, which are thin gauge, such a flame will bring the blade ends to a medium red in a few seconds. Play the flame at a slight angle both from the top and bottom of the blade ends. As soon as the solder melts and flows, withdraw the flame. On wider and heavier-gauge blades heating to the proper temperature will take a few seconds longer and the joint must be carefully watched while the flame is played from above and below at a slightly greater angle in order to heat the joint uniformly. It should come to a uniform red across the full width of the blade at the same instant to assure a joint of maximum strength.

Finishing the joint: When the work has cooled, check the thickness of the joint with a micrometer as in Fig. 11. Usually it will be somewhat thicker at the joint than the regular gauge of the blade. The joint must be reduced to the same thickness, or gauge, by filing as in Fig. 10. Move the blade in the jig as pictured so that the joint is supported. Use a fine double-cut file and remove an equal amount from each side of the blade. Reset the teeth if necessary and then test the blade on the machine to make sure the joint clears the guides. ★ ★ ★

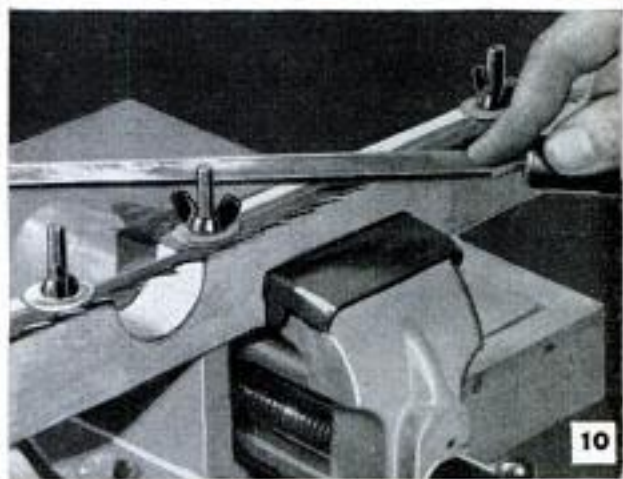
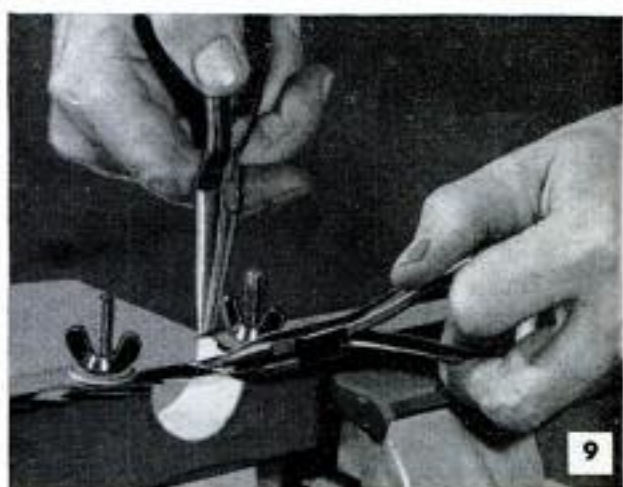

SHOPPING FOR TOOLS

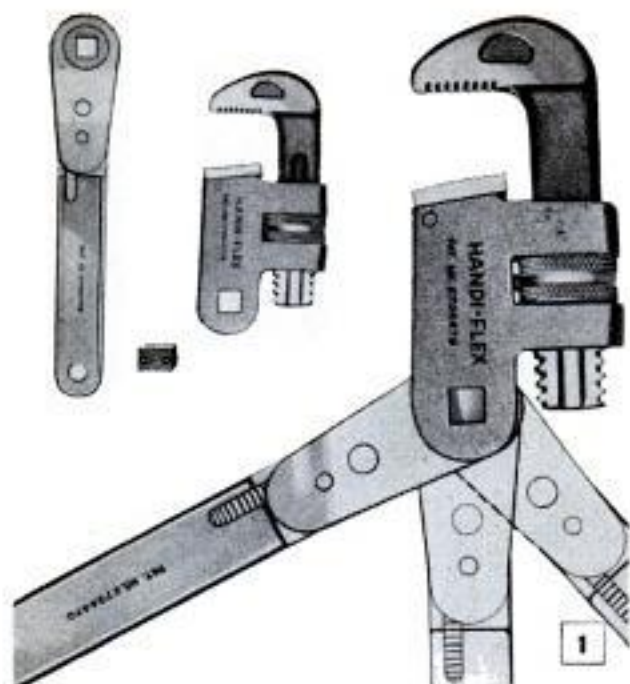

1. PIPE WRENCH has ratchet handle that can be locked in any position for working in close quarters. Handle can be detached from wrench head and used as socket driver, using a 1/2-in. square adapter. The ratchet handle provides for maximum torque in tight places, as it can be swiveled to any required position to obtain a "bite" for tightening or loosening

Todd Products Co., P.O. Box 1621, Rockford, Ill.

2. MITER BOX takes standard hacksaw, cuts metals at any angle from 90 to 45 deg. Unit can be clamped in a vise as pictured, or attached directly to the work bench. Handles stock up to 2 in. wide and 1 1/4 in. thick. Accurate angle guides hold exact adjustments when set. Bed of unit is wood that is replaced when badly cut, other parts are steel and aluminum

Riverside Enterprises, 116 Riverside, Corning, N. Y.

3. DRILL SHARPENER for bits up to 1/4 in. has 1/4 x 2 in., 120-grit wheel, which is powered by chucking its spindle in any 1/4-in. drill motor. Fixture on sharpener holds drill bits at correct angle for sharpening and gauge slots in sharpener body permit checking angle and symmetry of sharpened drill points. Unit is compact enough to be carried in small toolbox

Popular Manufacturing Co., Minneapolis, Minn.

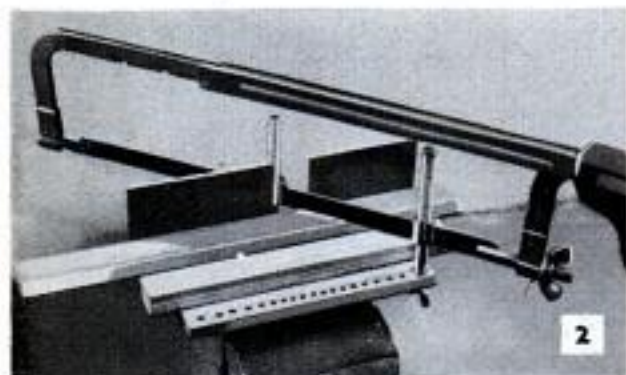

4. GRADIENT-LEVEL ATTACHMENT can be fitted on any level in a few seconds, converting it to an accurate inclinometer for establishing and checking pitch, slope or fall. Device is made of 16-ga. steel, plated for durability. Two scales on calibrated end of attachment are for 3-ft. and 4-ft. levels. From these scales measurements can be determined for any level

Carr Manufacturing Co., Tonia, Mich.

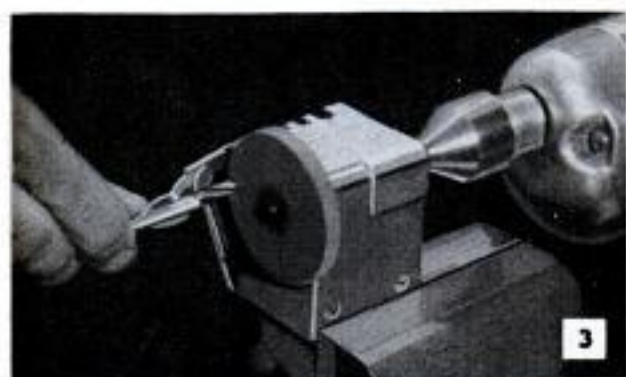

5. SLIDE SQUARE is made of dural for lifetime use. Can be used as a protractor, angle-degree finder and divider. Ideal for checking and laying out bevels and miters. A complete rafter table on the square makes roof framing a much simpler job. Complete illustrated instructions furnished with square clearly explain and picture various operations possible

Research Specialties Co., P.O. Box 8723, Los Angeles 8, Calif.

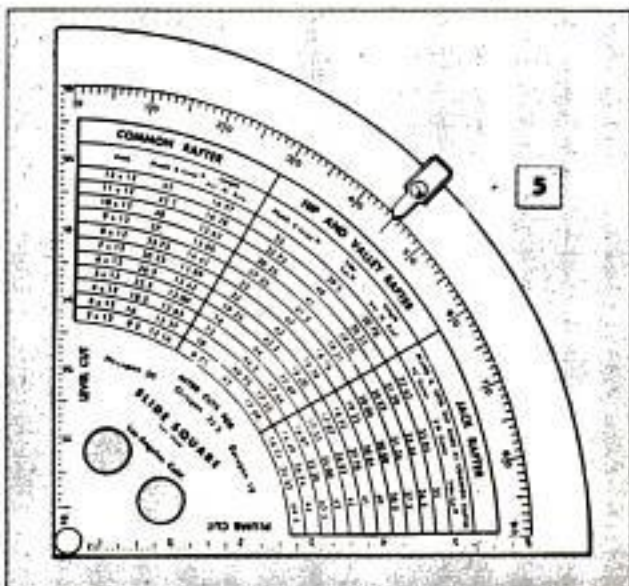

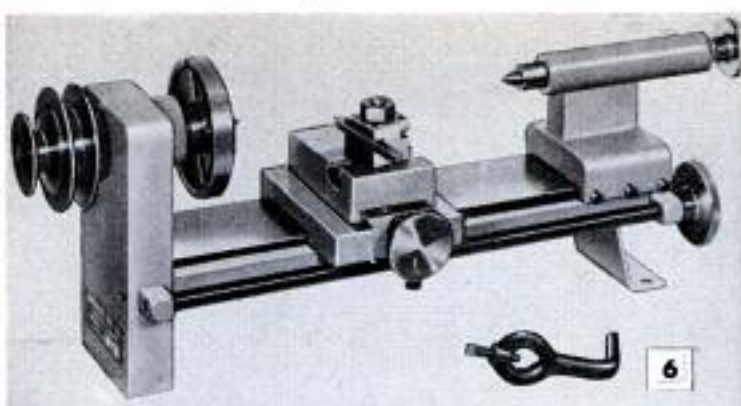

6. LOW-COST METAL-TURNING LATHE is all steel, comes complete with faceplate, driving dog and mounting bolts. Has ball-bearing headstock spindle. Lathe has a swing of 4½ in., bed is 12 in. long. Distance between centers is 7 in., tailstock travel is 1¼ in.
Rosemoor Manufacturing Co., Lansing, Ill.



7. JIGSAW ATTACHMENT for portable electric drills has circle-cutting fixture which doubles as rip gauge. Permits making straight cuts up to 10 in. wide and perfect circles up to 20 in. in diameter. Attachment clamps securely to any portable electric drill
Arrow Metal Products Co., 140 W. Broadway, New York City 13

8. EXPANSION SLEEVES permit using nails to fasten objects to masonry. Shields are flanged sleeves, the upper portions being steel, the lower portions lead. Shields are slipped into holes drilled in masonry and nails driven down into lead which expands in hole
Star Expansion Bolt Co., 147 Cedar St., New York City 6

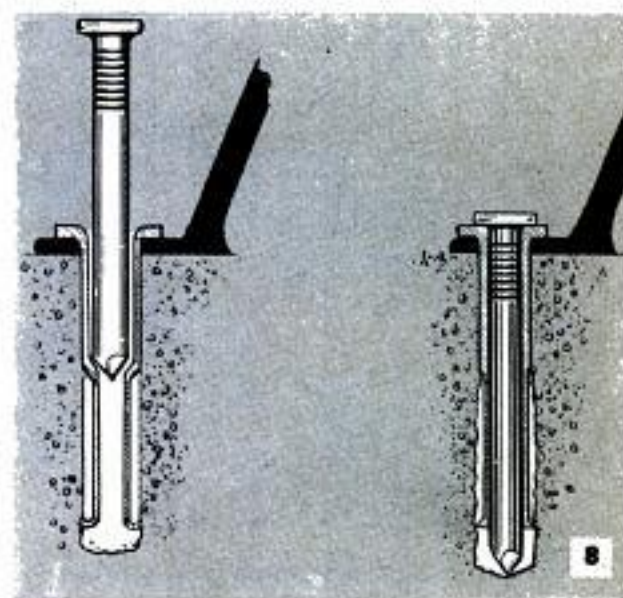

9. INTERLOCKING CONNECTORS use wedges forced into wedge receivers to assure rigid connections in furniture construction. Various types available to join components of different shapes together, and at various angles. Removing wedges permits disassembly
Interlocking Connectors, 4115 W. Belvedere Ave., Baltimore 15, Md.

10. LIGHTWEIGHT PORTABLE ROUTER for home workshop is inexpensive, yet has versatility of more costly machines. Router can be used for grooving, fluting, dovetailing and making mortises and tenons. Adapters permit using router bits with 3/8-in. shank
Mall Tool Co., 7725 South Chicago Ave., Chicago 19

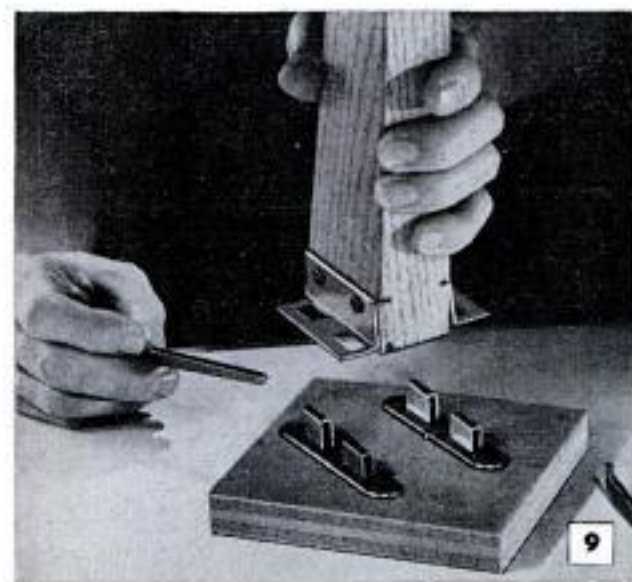

SN 58

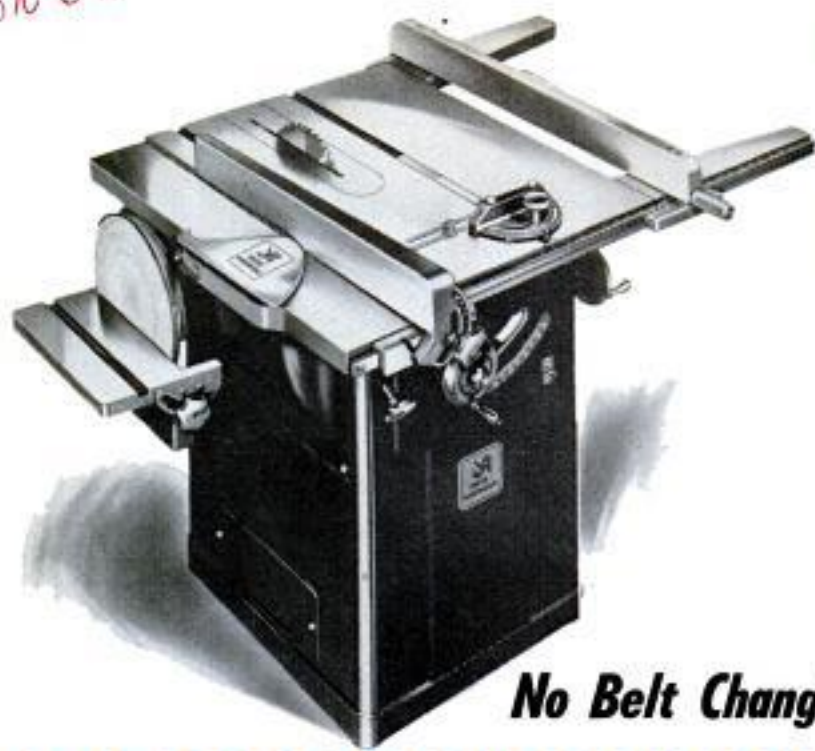

Sander is easily removed to expose power take-off for quick attachment of accessories. Powered by friction drive

No Belt Changing Is Feature of New

COMBINATION SAW-JOINTER-SANDER

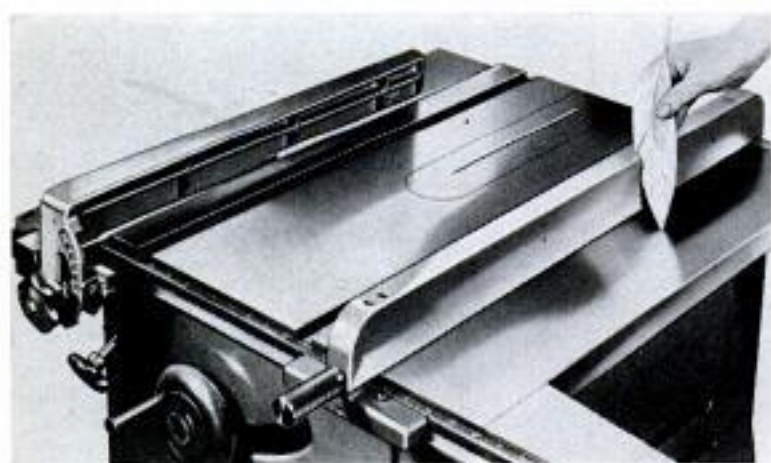

A NEWCOMER to the home-workshop market, this three-in-one machine features a saw, a jointer and a disk sander in one complete unit, and can be changed from one tool to another by merely turning a crank—no need to touch a belt. Work heads retract automatically to promote maximum safety. When saw is "up" and in use, jointer is "down" and out of the way. Cuts to center of 4-ft. panel with table extensions. Features ball-bearing rip fence, guard and power take-off.

Above, patented ball-bearing rip fence can be moved very easily and eliminates need for cumbersome micrometer adjustment. Below, change-over from an 8-in. saw to a 4-in. jointer to a 10-in. sander is done instantly by turn of wheel, no belts to shift

Below, a table surface 100 percent larger than most enables the 8-in. saw of this multipurpose machine to do the work of most 10-in. saws and rip to the center of 4-ft. material. Distance in front of saw blade is 14 in. Jointer retracts when saw is in use

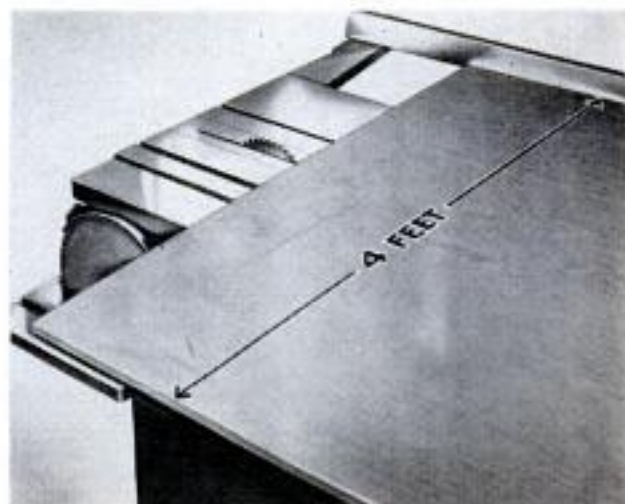
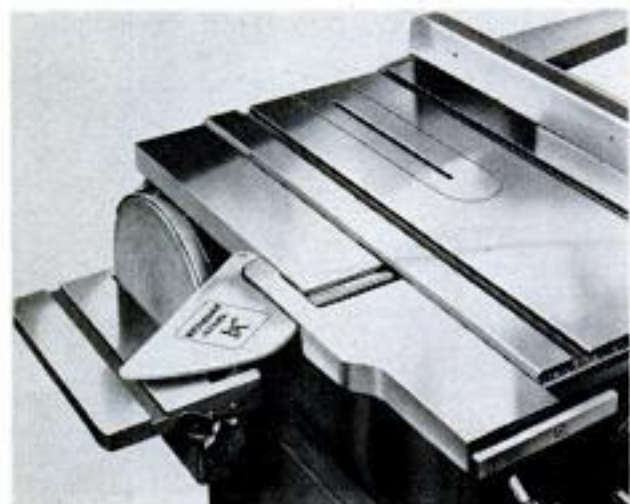

The hot one's even hotter!

'56 Chevrolet



THE BEL AIR SPORT SEDAN — one of two new 4-door hardtops.

It's the new 1956 Chevrolet—with bold new Motoramic styling . . . frisky new models . . . and more of the dynamic action that's zoomed its way into America's heart!

They're here—and even *hotter!* That's the word on the new '56 Chevrolets.

They offer new higher horsepower—ranging up to a top of 205! This is the car, you know, that smashed the Pikes Peak record! That's *proof* of the kind of performance that puts more safety and fun in your driving.

And look at that sassy new Motoramic styling—the lower, longer hood, the bold new front-end and sweeping chrome. See the new flaired fender openings and high-fashion taillights. (The left-side taillight hides the gas cap!)

The fun's at your Chevrolet dealer's. So, why wait? . . . Chevrolet Division of General Motors, Detroit 2, Michigan.



The new "Two-Ten" 2-door Sedan



The new 9-passenger Bel Air Beauville



The new Bel Air Convertible

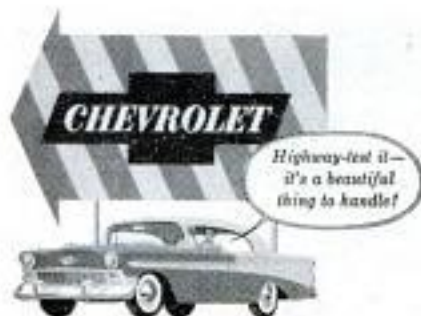

There's a just-right

Start your shopping on these pages...



Ideal "first" outfit. Brownie Holiday Camera, flashholder, flashguard, batteries, bulbs, and film. Brownie Holiday Flash Outfit complete, **\$9.75**. Camera alone, **\$4.95**

Complete ready-to-use photo-flash gift outfits . . .



Brownie Hawkeye has no "settings" to adjust. Makes 12 snapshots per roll of color or black-and-white film indoors or out. Brownie Hawkeye Flash Outfit complete, **\$14.35**. The camera alone, only **\$7.45**



Brownie Bull's-Eye lens focuses to 4 feet for close-ups, adjusts by dial for snapping "groups" or "scenes." Other deluxe features. Brownie Bull's-Eye Flash Outfit complete, **\$18.60**. The camera alone, only **\$13.50**



Kodak Duaflex—"Preview-Finder" lets you see pictures before you shoot. Kodak Duaflex Flash Outfit complete, only **\$21.75**. Duaflex Kodet Camera alone, **\$14.95** (brown-finish camera slightly higher). A Deluxe Duaflex *f/8* Camera and Flash Outfit are also available.

Deluxe Kodak Gift Kits for Color-Slide Fans . . .



An all-time color-slide favorite, the versatile Kodak Pony 135, Model C, features a fast *f/3.5* lens, 1/300 shutter. Kodak Pony 135 Outfit (camera, flashholder, case) **\$49.65**. The camera alone, **\$33.75**

Kodak Bantam RF takes Kodacolor snaps as well as full-color slides. Fine rangefinder, *f/3.9* lens, 1/300 shutter. Kodak Town-and-Country Outfit (camera, flashholder, case) **\$65.45**. Kodak Bantam RF Camera alone, only **\$49.75**



Kodak's Signet 35 features a matchless Ektar *f/3.5* Lens, coupled rangefinder, 1/300 shutter, precision controls. Kodak Signet 35 Outfit (camera, flashholder, case) **\$91.45**. The camera alone, only **\$75**

Kodak Stereo Camera for 3-D color-slides. Twin *f/3.5* lenses, 1/200 shutter. Kodak Stereo Outfit (camera, Stereo Viewer I) **\$97.25**. Camera alone, **\$84.50**. Stereo Viewer I, **\$12.75**; Viewer II, **\$23.75**



Kodak gift for everyone

finish happily at your Kodak dealer's

(Ask him about small down payments, easy terms)

New Do-It-Yourself Photo-Hobby Outfits



It's easy to develop negatives and print snapshots at home with a Kodak Photo-Hobby Outfit. There are two complete "do-it-yourself" Outfits to choose from—alike except for the snapshot printer they feature and the amount of chemicals and printing



paper they contain. Each comes with an 11 x 14-inch card (above) which explains the simple steps for developing and printing. Kodak Deluxe Photo-Hobby Outfit, \$16.95. Regular Photo-Hobby Outfit, \$9.95. The Kodak Deluxe Photo-Hobby Printer alone, only \$7.95

Home Movies—the finest family gift of them all . . .



Brownie Movie Kit with a 4-Lamp Movie Light (lamps extra) to provide plenty of light for indoor color movies. Brownie Movie Kit with $f/2.7$ lens, \$49.95. Brownie Movie Kit with fast $f/1.9$ lens, \$59.20



Complete movie-making outfit. To make color movies, a Brownie Movie Camera, $f/2.7$ lens. To show them, a Brownie Movie Projector with an $f/1.6$ lens, plus a preview screen. Brownie Movie Outfit complete, \$99.50



Welcome gifts for movie-makers. Brownie 4-Lamp Movie Light, \$8.45. Kodak Converters for 8mm Brownie Movie Cameras, Wide angle, Telephoto, \$18.50 ea. Kodachrome Movie Film, from \$3.75

Kodak Photo "Stocking Gifts" for Everybody

Film—buy it in thrifty Kodak Duo-Paks, one roll for the camera, another for a spare. Popular sizes of black-and-white, from 75¢. Kodacolor, from \$1.70. For color-slide fans—Kodaslide Dial-Lite Viewer, \$12.95; Kodaslide Pocket Viewer, \$1.95. Books for fact hunters—"How To Make Good Pictures," \$1; "How To Make Good Movies," \$2; Kodak Photoguides, \$1.75 ea. Many other gifts to choose from.

Prices are list, include Federal tax where applicable, and are subject to change without notice



Kodak
TRADE-MARK

Eastman Kodak Company, Rochester 4, N.Y.

Care and Feeding of Engines



BY
S. P. CORP

VALVE FAILURES

Valve burning, a common cause of valve failure, is often due to incorrect valve lash—or clearance between stem and rocker arm. If this is below manufacturer's specifications, valve will be held off its seat when engine warms up. If above specifications, valve head will be distorted when valve is hot. Be sure to check valve lash when tuning engine.

Valve sticking can cause burning. If stem shows a hard shiny deposit, the valve is sticking. Valve seats may not be concentric with valve guide, valve guides may be improperly installed, or your cooling system may be faulty, with poor water circulation around valve guide. If you reface valves and seats, check angles against specifications, as well as valve seat run-out (.002").



BURNED FACE

Lean fuel mixture can cause valve failure. Look for an air leak in intake manifold, checking gaskets and replacing if doubtful.



BRIGHT SPOT

BALL JOINT SUSPENSION

If your car has ball joint suspension, and steering becomes erratic, check ball joints for wear. Put upper ball joint in a vise. Put a nut on end of thread and use a torque wrench to check effort required to turn stud in assembly, which should be 25 to 40 inch-pounds. If not up to low limit, replace ball joint.

Put lower ball joint in vise, tie a cord over end of stud, and attach cord to a spring scale, with pull over end of stud. If less than 8 lbs. pull moves stud, install a new ball joint assembly.

THIS NEW MANUAL CAN BE YOURS



A postal card request will bring you this new 36-page manual of car care, profusely illustrated, with helpful hints on 52 subjects. Write for your free copy today, and when you rearing, be sure to use Sealed Power KromeX Ring Sets—the quick-seating long-wearing, oil-saving rings which fight heat, friction, abrasion and corrosion!

Your dealer has them or can get them for you! Sealed Power, Dept. G-12, Muskegon, Mich.

Sealed Power

PISTON RINGS

Clinic for Homemakers



As a service to our readers in solving the hundreds of problems pertaining to a home—inside or out—the editors of *Popular Mechanics* invite you to present your problems to The Clinic Editor for help and advice. Address your questions to The Clinic Editor, *Popular Mechanics Magazine*, 200 East Ontario Street, Chicago 11, Ill.



Refinishing Old Floor

Q—I have recently purchased an old country home in which the floors apparently never have been finished with shellac or varnish. Although there isn't much evidence of it now, I would guess that at some time they were oiled. All floors appear to be hardwood. What is the best procedure in refinishing?

—E. O., Conn.

A—If, as you say, the floors appear to have been oiled at some time, then it will be necessary to proceed with caution. If a pure linseed oil originally was used, then it probably is safe to assume that the oil is so thoroughly oxidized that it will cause no trouble with the new finish drying. However, there is always the danger that cooking fats have been spilled on the floor at some time (especially in the kitchen) and that the oil used to finish the floor originally was not of the best quality. Also there is the possibility that the floors may have been waxed over a period of time. The first step is to rent a sanding machine and sand the floors to remove embedded grime and possible discolorations and expose the bare wood. Then apply an oxalic-acid bleach, or a ready-to-use bleach, to a small area in some inconspicuous place. When the floor boards are thoroughly dry after using the bleach, apply a sealer made especially for use on hardwood floors. Allow the normal drying time and check the results. If the sealer dries properly in the allotted time, then it probably is safe to proceed with the refinishing over the whole area involved. Generally it's necessary to bleach an old floor all over in order to obtain a uniform color. Spot-bleaching is seldom satisfactory. After bleaching it also is a good idea to go over the surface lightly with fine sandpaper to cut off any wood fibers raised by the bleach. Then apply the sealer and finish with one or two coats of floor varnish. Or use one of the new floor finishes in which sealer and finishing material are combined. Old floors of maple or beech usually do not require a filler as the wood is close-grained.



Efflorescence

Q—Within the past four months or so, a white powdery substance has appeared on the outside surfaces of the brick walls of my one-year-old house. What is this coating, and how do I prevent it from spreading? —C. T., W. Va.

(Continued to page 230)

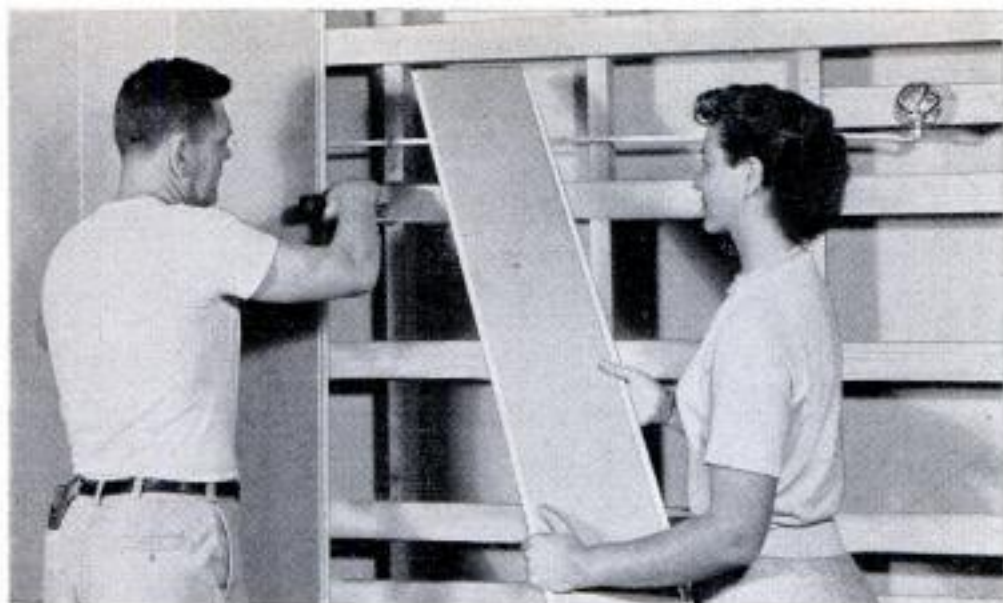

Easy-to-handle Temlok Plank goes up fast by stapling or nailing. Once pre-finished Temlok is installed the job is done—no painting or further finishing is necessary.

Lok-Bevel joint hides staples or nail heads, speeds installation, and provides neat, even joint lines.

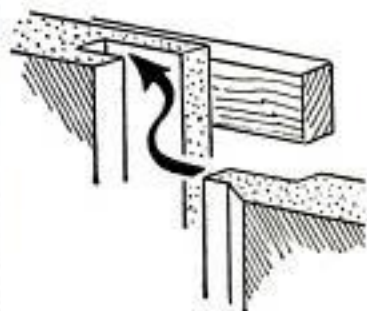

How to Build a Basement Game Room with Temlok Tile and Plank

You can do the job yourself, easily and economically, by installing Armstrong Temlok® Tile on the ceiling and Armstrong Temlok Plank on the walls. These attractive interior finishes rapidly turn an unused basement into extra living space because they build, decorate, and insulate in one application.

Start by framing the foundation walls with 2" x 4" studs on 24" centers. Then apply 1" x 3" furring strips, one foot apart.

Next, nail or staple Temlok to the furring

strips. The exclusive Lok-Bevel® joint on both Temlok Tile and Plank has an extra wide nailing flange for quick, easy installation. For sturdy lower walls, use Armstrong Temwood® backed up with Temlok Wall-board.

Armstrong Temlok interior finishes are handsomely pre-finished. Temlok Tile is available in Snow White or Light Ivory; sizes, 12" x 12", 12" x 24", 16" x 16", 16" x 32". Temlok Plank comes in a random Suntan Blend; sizes, 8", 12", and 16" wide—8' long.

For complete details, see your local lumber dealer. He'll be glad to give you help with your remodeling plans.



Basement game room is attractively finished with Temlok Tile and Plank. They offer a fast and economical way to turn wasted cellar space into comfortable living areas.

Send for free booklet, "New Ways to Remodel Your Home." Just write Armstrong Cork Company, 3512 Watch Avenue, Lancaster, Pennsylvania.



Armstrong
TEMLOK

Cushiontone® • M-67® Monowall® • Insulating Wool
Hardboards • All-Purpose Cements

Christmas
decorations
you make
with scissors

and

REYNOLDS
Do-It-Yourself
ALUMINUM



Ask for Plans Nos.
118 and 127. For
Toys, Plan No. 119.



MAKING SHINING ALUMINUM DECORATIONS is great family fun. Amazingly easy to cut with ordinary household scissors. Use them outside or in—they can't rust or lose their luster. There's special fun for grown-ups in making strong, rustproof toys as wonderful Christmas morning surprises.

Your hardware or building supply dealer has Reynolds Do-It-Yourself Aluminum plus plans for these handsome Christmas projects.

Don't forget a good supply of Reynolds Do-It-Yourself Aluminum with power tool gifts



LOOK FOR THIS RACK
AT YOUR DEALER'S

See "Frontier" Sundays on NBC-TV

REYNOLDS
DO-IT-YOURSELF
ALUMINUM

Reynolds Metals Co., Louisville 1, Ky.

Also available in Canada

(Continued from page 228)

A—According to your description the coating on the brick walls is what is called efflorescence and it is caused by soluble salts in the brick which are activated in the presence of moisture. The powdery coating appears as the water evaporates at the surface. It is an indication that moisture is present within the wall and is generally regarded as evidence of faulty workmanship which should be corrected, as it can cause serious deterioration of masonry over a period of time. Usually, patches of the coating on a masonry wall indicate leaks at the mortar joints which admit driven rainwater to some point inside the wall. It should be kept in mind that water that enters the wall in this manner may not leave it at the same spot by evaporation. Because of this, efflorescence on the surface at a given spot does not always mean that water is entering the wall at that point through a faulty mortar joint or possibly a defective flashing. There are other causes, of course, but these are less common. Also, efflorescence sometimes appears on masonry walls which are properly constructed according to good practice. Usually it will disappear if the walls are thoroughly scrubbed with water and a stiff-bristle brush. If the first washing does not remove it entirely, add muriatic (hydrochloric) acid to the water in the proportion of 1 part acid to 10 parts water. Wear rubber gloves and protect the face from spatters when applying the acid solution. If the wall is dry, dampen with a sponge, then brush on the solution. After a minute or so, rinse off with plain water. When working near window or doorframes, protect painted surfaces. Destroy any unused portion of the acid solution.

Damp Wall Spots

Q—Some months ago we moved into our new home, planning to decorate the interior later. When we moved in there were damp spots on one living-room wall, which later seemed to dry out. Now the same areas are again damp. I've searched for roof leaks, but found none. Walls are plaster over plaster base. What could cause this?—S.E., Ill.



A—It is rather difficult to say with certainty at long range, but one of two possibilities is perhaps the most likely. Cold-water pipes running from the basement to the second floor through the walls may possibly touch the plaster base. Under certain conditions moisture may condense on the pipe and run down to the point where the pipe touches the inner surface of the plaster base. A slow, drop-by-drop leak at one of the pipe joints could also be a cause. However, moisture would normally condense on the pipe only under certain conditions. With temperatures equalized, condensation would stop and the wall would dry out in a comparatively short time. Another possibility, perhaps more logical, is what masons sometimes refer to as "hot plaster" or "soft plaster," the terms generally inferring application of a faulty mixture which does not set to the same degree of hardness, resulting in spots, which absorb moisture from the air when humidity in the rooms is especially high. If you can eliminate the possibility of a water pipe as a cause of the trouble, then faulty plaster spots are perhaps the possible cause. If this is so, then the surest remedy is to remove the faulty plaster and replace it. The new patches should be allowed to dry thoroughly before decorating with paper or paint.

Concrete Expansion Joints

Q—I notice that on extremely cold days the expansion joints in my concrete sidewalk open up so far that the felt expansion strips are loose. Should I attempt to calk these joints?—H. H., Chicago.

A—We do not suggest that you calk the joints. In the case of concrete-expansion joints, the calking would simply be forced out when warm weather expanded the concrete. Using any type of calking compound outdoors in winter is difficult because the calking tends to become unworkable when cold.

**—great engineering triumph
and important extra protection
for engine parts!**

more than **90**
**SLUDGE-TRAPPING
POCKETS**

**AC OIL FILTERS top all makes
as New Car Equipment**

The unusual "inside story" of AC Oil Filter construction pictured at the left is one reason why *AC OIL FILTERS* today are standard or optional factory equipment on more new cars than any other brand.

**New paper engineering pioneered by AC
makes density-type filter obsolete!**

Oil filters came into their own when engineers found a way to filter oil through paper. How AC treats its own custom-engineered paper is a carefully guarded trade secret. But, this specially processed paper filters out damaging dust, dirt, grit or specks of metal as small as 1/100,000th of an inch . . . traps as much as 1¼ pounds of harmful material in 5,000 miles of driving. *Will not remove detergents from heavy-duty oils!*

**Exclusive AC "accordion fold" increases filter area—
prolongs filter life!**

Ten times the filtering area! More than 90 sludge-trapping pockets! Those are two of the benefits of AC's "accordion fold." This exclusive AC feature provides better filtering action through the full 5,000 miles of driving between filter changes.

**... another AC
feature story that can't
be topped!**

AC SPARK PLUG DIVISION
GENERAL MOTORS CORPORATION
FLINT, MICHIGAN



AC ENGINEERING WITH GM RESOURCES CAN ALWAYS BE LOOKED TO FOR LEADERSHIP

DECEMBER 1955

231

Copyrighted material

Looking for Something?

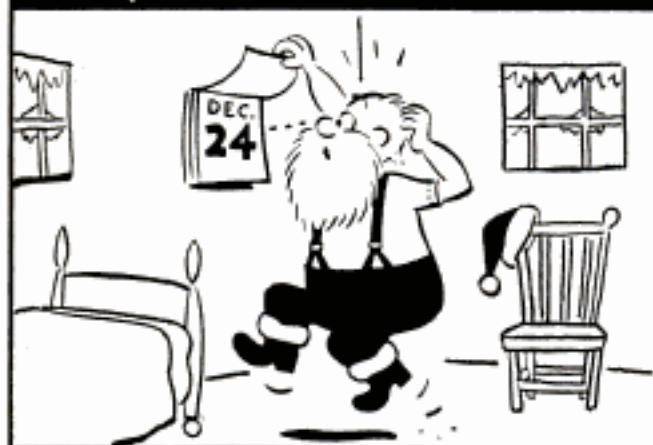

**FROM TRAVEL TO TOYS
WHATEVER YOU NEED**

Find It Fast
In The
'Yellow Pages'



Fighting the Battle of Yorktown Again

(Continued from page 155)

anchor cable and an endless rope was devised. The one-half-inch manila rope, to which the frigate is attached, is operated by a converted elevator winch mounted on shore and driven by a three-horsepower, three-phase reversible electric motor. This arrangement, plus the activities of the divers, has largely eliminated the stumps as a source of trouble. So the ship's crew has been reduced to two, one man on shore to operate the winch, and one in the boat to fire the guns.

The frigate's artillery was built by the theater's technicians. The guns are eight-inch lengths of iron pipe mounted on boards extending along the decks of the ship and fired through ports in the side of the boat facing the audience, two guns to each port. Various firing methods have been tried, including the use of priming caps and coils of resistance wire electrically heated. The cannon now have their breeches closed by a cap in the center of which a small hole has been drilled. A spoonful of a mixture of black powder and flash powder is placed in the breech-end of each gun. At the proper time, the boat's gunner sets off each charge by directing the flame of a small gas torch into the hole in the cap. This produces a large, impressive flash and considerable white smoke. Backfire is said to be negligible. When the cannon are going, the ship seems to be spouting fire all over. One night there actually was too much reality: The boat caught fire and the cannon did a machine-gun act. The bombardment was more spectacular than usual, but did not last as long.

The firing mechanism used on the prop stage cannon which provides the land-based artillery action was devised from available odds and ends. The theater staff acquired a supply of surplus Very signal pistol flares, and these proved effective as igniters for a quantity of powder placed in a length of three-inch pipe installed in each cannon barrel. At the breech is a plunger that fires the Very cartridge.

The Common Glory runs each year from about the first of July to Labor Day. The more than 50 performances per season play to a nightly audience averaging 1600 persons. The theater area is sprayed and fogged to eliminate insect pests. The cast of the show, composed of paid performers, is recruited through auditions held throughout Virginia and in New York. To clothe this cast, an extensive wardrobe of elaborate costumes is maintained. ★ ★ ★



COMPLETELY FURNISHED
Mobile Homes

COST ONLY

\$2000 TO \$7500



Decorator styled! Famous-name Appliances!



HERE'S THE ideal home for industrial or construction workers. It offers the beauty and comfort of the finest decor and facilities in every room. Yet you can *move it* and your family—wherever your work takes you.

Living rooms offer large picture windows, draw drapes, comfortable upholstered furniture, automatic heat. Dream kitchens come equipped with electric

refrigerator, gas range, twin sinks and cozy dinette. Tiled baths provide *tub and shower!*

Look for the MHMA Seal—be sure you buy a mobile home made by a member of the Mobile Homes Manufacturers Association. These are the manufacturers you can count on for the most efficient designs, advanced styling, good service and dependable construction.

Watch Dave Garroway and Steve Allen show MHMA mobile homes on "TODAY" and "TONIGHT"



MOBILE HOMES MANUFACTURERS ASSN.



Free book on newest models!

Pictures and full specifications. Write Dept. PM-125, Mobile Homes Manufacturers Assn., 20 N. Wacker Drive, Chicago 6, Illinois.



NAME _____

STREET _____

CITY _____ ZONE _____ STATE _____

HOW TO GET THE MOST OUT OF FILES

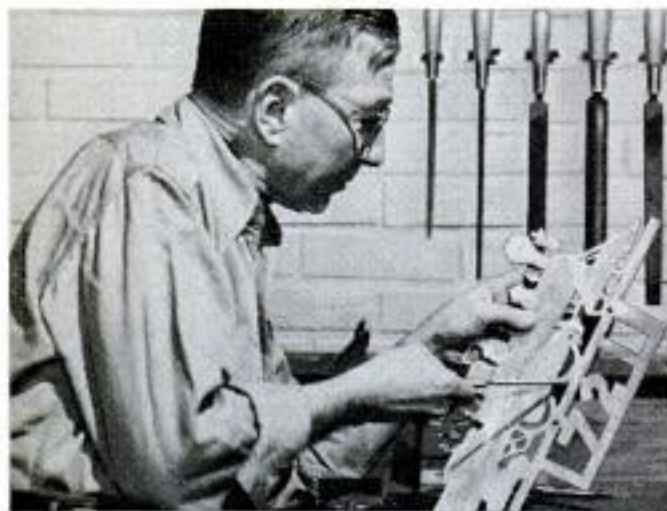

You do better work and your files last longer when you follow these few simple rules

1. CHOOSE THE RIGHT FILE FOR THE JOB.

Nicholson triangular Slim Taper, and Mill, Flat, Half Round, Round and Square Bastard files fill basic workshop needs. For coarser or finer filing, or work on special materials, there are Nicholson files especially for the job.

2. USE FILES CORRECTLY. Each kind of filing—straight, draw or lathe—has its own file grip and motion. Holding the file at exactly the desired angle is important. Work height is important, too: elbow height normally, lower for heavy filing, near eye level for precise work.

3. TAKE CARE OF FILES. Protect precisely-formed teeth by standing your Nicholson files in a rack or hanging them by their handles. *Never* throw them in with other tools or stack them. Clean often with a Nicholson File Card or Brush. A soft iron "scorer" helps remove stubborn pinnings. Chalk removes oils or grease.

At good hardware stores everywhere

Experienced craftsmen choose Nicholson files for uniform high quality and long work life.

Write for free 50-page file "textbook," "File Philosophy" tells you more about how to choose, use and care for files.

NICHOLSON U.S.A. **NICHOLSON FILE COMPANY** 22 Acorn St., Providence 1, R. I. **BLACK DIAMOND** U.S.A.
(In Canada: Nicholson File Company of Canada Ltd., Port Hope, Ontario)

NICHOLSON FILES

FOR EVERY PURPOSE

He Made a Business Of Camping Out

(Continued from page 152)

McOmber. His groups are small enough to permit personal attention to the questions, interests and education of each child. Instead of the single location a summer camp provides, McOmber's territory is the entire West.

A science teacher in the Claremont, Calif., schools, McOmber has found his background especially helpful in his business. But he believes many nonteachers with a genuine interest in youngsters could duplicate his programs. Although a year or more of part-time work is necessary to start such an endeavor, it could be made a full-time business, he believes.

His biggest investment was the station wagon. He soon found that its tires were not sturdy enough for the job, and replaced them with 15-inch truck tires and wheels at a cost of \$200.

Other equipment includes a utility trailer, an icebox, gasoline stove and lantern, tent, vacuum bottles, packsacks and pack boards, geology hammers and the like.

McOmber recently removed the rear seats of his station wagon and substituted long benches extending along each wall from the front seat to the rear door. These are padded with foam rubber for maximum riding comfort, and have increased the vehicle's capacity from 11 to 13 youngsters.

"I've found that it's important to remember that I'm working for these youngsters," McOmber says. "If they want to inspect a wrecked car or climb an uninteresting hill I never say no unless safety demands it. Many of the kids earn their own money for these trips and I like to see them have the time of their lives."

This liberal point of view backfired only once, during a 1954 trip to Yosemite National Park. The boys asked permission to fish in a nearby stream while lunch was being prepared. Soon some of the youngsters came running back carrying a dozen trout so big that McOmber knew they must have come from the breeding stock at the Yosemite fish hatchery. But by the time the boys could lead McOmber back to the scene, the fish were dead.

The ranger in charge prescribed that the boys should work around the hatchery the rest of the afternoon in payment for their mistake. When they had finished, he surprised the boys by giving them the fish for dinner, so the meat wouldn't be wasted.

"That experience taught those youngsters to think before they act," McOmber says with a grin. "And those trout were the most delicious fish I've ever tasted." ★ ★ ★

don't be "sold" . . . get the facts

Make up your own mind

about the scroll saw that's best for you!



here are the facts about the

Rockwell-built **DELTA 24" Scroll Saw**

Professional woodworkers regard this saw as the finest—at any price! It's a precision machine that makes smooth, accurate cuts, yet has proved tough through years of punishing industrial operation. This precision, this ruggedness—plus the built-in safety and ease of operation—make it ideal for your workshop. Compare these quality features:

- Only scroll saw with variable-speed drive—the right speed to cut all materials.
- Built-in blade guard protects fingers.
- Cuts stock 2" thick, rips to center of 48" panel—converts to saber saw of unlimited capacity.
- Table tilts 45° front and right, 15° left.

- Universal lower chuck holds all types of blades, sanding, filing accessories.

Get All the Facts—then Compare

You must see this saw demonstrated—try it yourself—compare it with any scroll (or jig) saw made! Then MAKE UP YOUR OWN MIND! Your Delta Dealer is listed under "TOOLS" in the classified pages of your phone book. Or send the coupon for catalog.



DELTA

QUALITY POWER TOOLS

Another Product by

Rockwell



DELTA QUALITY COSTS NO MORE

Delta Power Tool Division, Rockwell Manufacturing Co.
502M N. Lexington Avenue, Pittsburgh 8, Pa.

- Please send Delta AB Catalog showing 24" scroll saw.
- Name of my nearest Delta Dealer.
- Delta Homecraft Catalog.

Name _____

Address _____

City _____ County _____ State _____

Across Four Continents On Two Cylinders

(Continued from page 120)

showers drowned us one moment, and white-hot sun baked us dry the next as we chugged through endless banana groves and oil fields.

At Lima, we welded broken parts, rebuilt our car and enjoyed the sights. By the time we finished, the Citroen was in such good shape we decided to alter course, head inland to the Bolivian Andes, and try for an altitude record. The grueling ascent through Nazca, Cuzo and Puno to the 14,000-foot heights of La Paz and Lake Titicaca, was only a beginning. Here, llamas grazed and people moved slowly in the rarefied air. Strength left our legs, temples throbbed, and breath came in quick gasps with the least exertion. Even the Citroen throbbed. At La Paz we removed the car's side panels and doors, stripped her to nothing but engine and frame and chugged up the barren, roadless slopes of a 17,777-foot peak—an all-time high for Citroen.

From there, it was all downhill. For ten days we clattered around hairpin curves and down hair-raising mountain trails to the Chilean coast. At Iquique, we stocked supplies of food and water for the 1750 miles of desert between us and Santiago.

Stopping only to eat, we drove day and night across the wind-whipped sands in an immensity of space. By now, our tires that had been new in Colombia, were going flat at a rate of four times a day. After recuperating at Santiago for two weeks, we pressed southward to Puerto Montt, where roads and beaches gave way to precipitous mountain slopes plunging vertically into the sea.

Henri, myself and the Citroen went aboard one Captain Francisco's little 100-ton schooner plying among the islands. We were put ashore several hundred miles down the coast at Puerto Aysen, a fishing town of white houses, board sidewalks and sailors, reminiscent of a hundred Scandinavian ports. From here, the rock-bound coasts rose to the barren steppes of Patagonia. We'd heard about the terrible winds, sweeping up from the South Polar seas, that constantly batter this roadless land of rocky desolation. But we had no idea, as we set out toward our goal of Tierra del Fuego, how badly it would buffet us. Gales of 60 to 90 miles per hour lashed us in fury the entire distance. Our hands and faces stung from pebbles—up to the size of marbles—whipped into the air and driven before the blast. We drove largely by compass, since the lashing wind erased all but the faintest trace of trails. Except for an

(Continued to page 238)

IT SMELLS GRAND

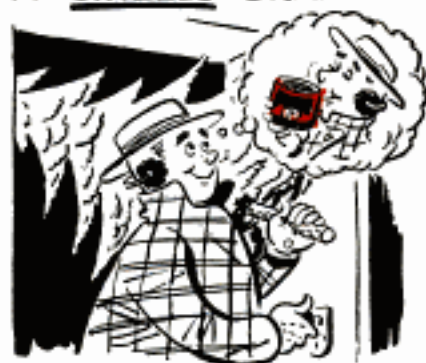

HERE'S THE SEASON'S FRAGRANCE HIT!

IT PACKS RIGHT



THERE'S LOTS OF FUN IN LOADING IT!

IT SMOKES SWEET



AND MAN—WHAT PLEASURE
WHEN IT'S LIT!

IT CAN'T BITE!



SIR WALTER RALEIGH'S BLEND OF CHOICE KENTUCKY BURLEYS IS EXTRA-AGED TO GUARD AGAINST TONGUE BITE. XMAS WRAPPED... IT MAKES A PERFECT GIFT.

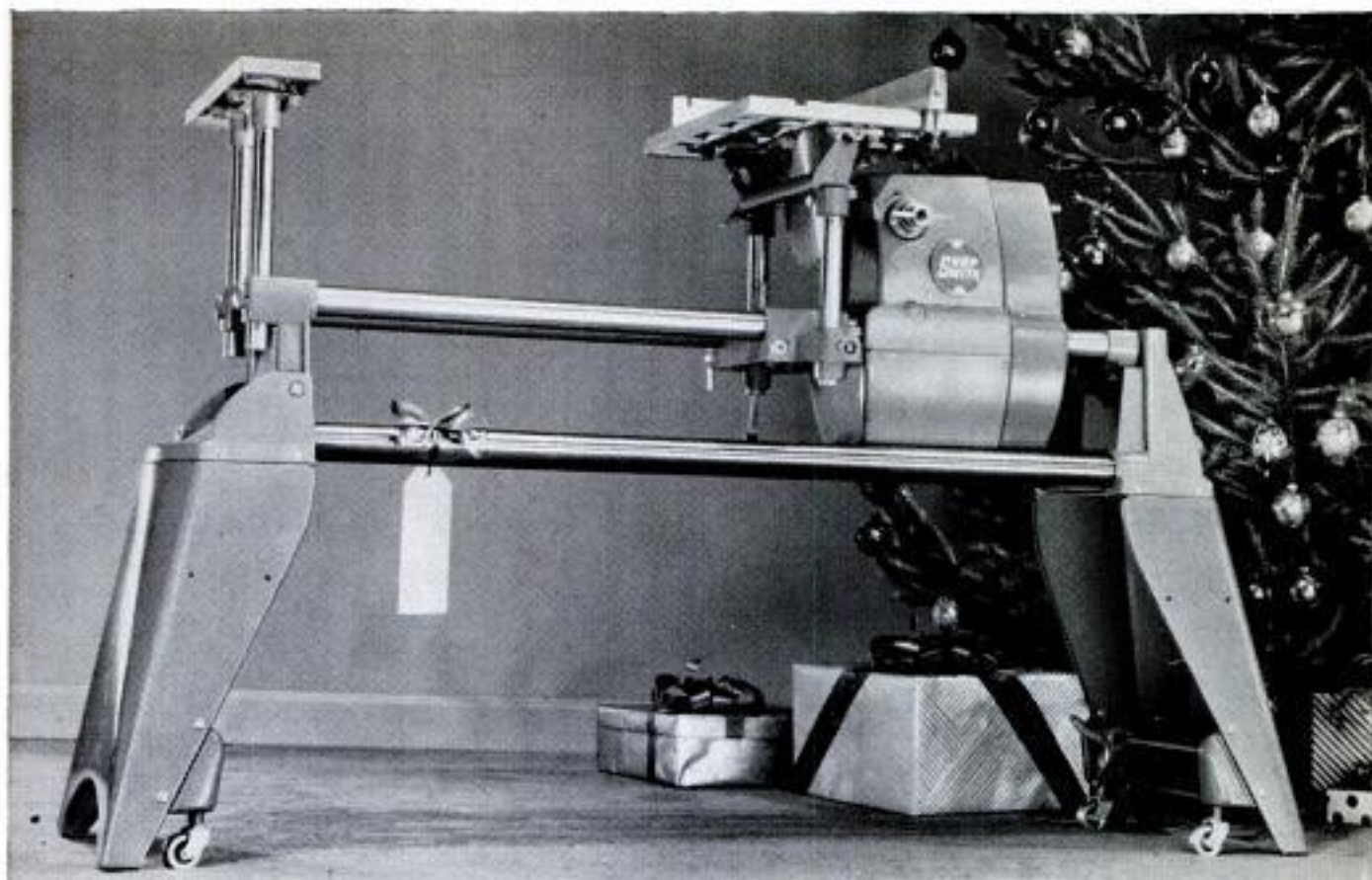

The Merry Christmas present that gets you off to a Happy New Year—

SHOPSMITH

This present has a future! SHOPSMITH® will give years of fun and work-saving service in your home.

In one magnificent machine you get a saw, disc sander, vertical and horizontal drill, lathe. Motor is $\frac{3}{4}$ hp. and built in. Speed-Dial lets you choose any speed from 700 to 5200 rpm. SHOPSMITH'S twin-tube,

fast-coupling Power-Mount lets you add jointer, jigsaw, and sprayer.

Make sure your Santa sees SHOPSMITH at your leading hardware or department store or any Montgomery Ward store. Place SHOPSMITH under your tree for as little as \$3 per week. SHOPSMITH can earn back every penny of it!

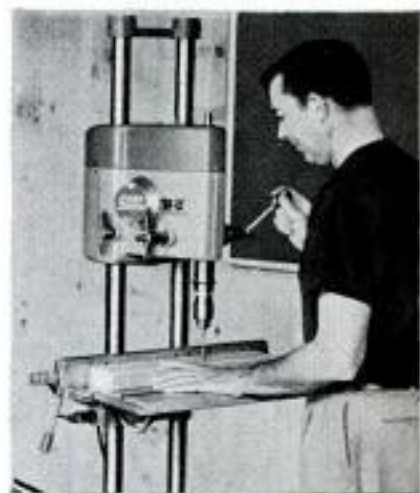

In vertical drilling—or any other operation—SHOPSMITH is accurate and foolproof. No job too big . . . none too exacting. Takes up no more space than a bicycle.

MAIL COUPON FOR 3 FREE BOOKS

1. "Project Digest," 36 pages of modern wood-working projects.

2. The valuable home-shop guide: "What to Look for When You Buy Power Tools."

3. Illustrated 20-page SHOPSMITH catalog.



MAGNA Engineering Corporation

Dept. 307-B, at factory nearest you:
Waynesdale, Fort Wayne, Indiana, OR Menlo Park, Calif.

Please send me the three free SHOPSMITH books.

Name _____

Address _____

City _____ Zone _____ State _____

If you already own SHOPSMITH, please check whether you have
SHOPSMITH Mark 5 , or SHOPSMITH Model 10 ER .

SMOOTH!



Finish rooms fast
with smooth,
strong walls of

SHEETROCK

T. M. Reg. U. S. Pat. Off.

The Fireproof Gypsum Wallboard

Walls and ceilings go up *fast* when you use tapered edge SHEETROCK. Joints are easily finished smooth and level with the wall surface. Room-height, 4' x 8' panels are simple to cut, fit and erect. Just nail them to wood framing or over old walls and ceilings. SHEETROCK walls and ceilings are strong, crack-resistant; take any decoration.

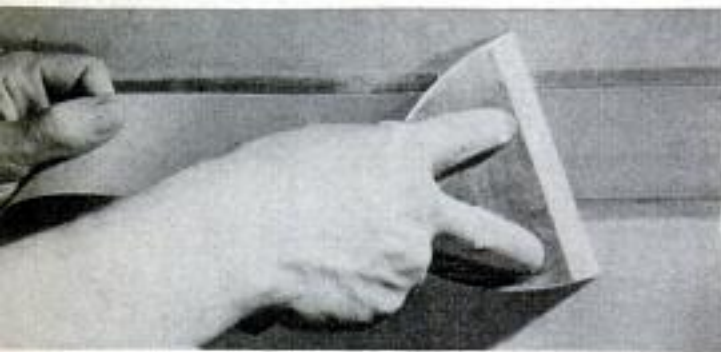

PERF-A-TAPE® JOINT SYSTEM —the secret to smoothness

Special perforated tape applied in combination with PERF-A-TAPE cement assures perfectly smooth joints. Use PERF-A-BEAD® metal corner protection to reinforce outside corner angles. For further information and FREE instruction folder, write Dept. PM 6, Chicago 6, Ill.

UNITED STATES GYPSUM

The Greatest Name in Building



occasional refugee rancher, the only signs of life were a few ostriches, guanacos and scuttling rabbits. Life was a succession of flat tires.

By Christmas, we had made the rugged 1000 miles to Punta Arenas on the Strait of Magellan. We were bedraggled and hungry. Here, where sunlight lasted 20 hours a day, we used the meager facilities of the isolated village to repair the Citroen and ready ourselves for the dash to the southernmost civilized town on the western continents—Ushuaia, on the southern coast of Tierra del Fuego. We were warned we'd never make it. There was no road. Steep rocky cliffs plunged to beaches completely inundated at high tide, and a mountain range blocked the last 10 miles. But it was worth a try.

Chilean marines agreed to sail us across the strait in a landing barge. So, at three o'clock one morning, to more head-shaking and dire predictions, we sailed south. Six hours later, our marine friends wished us well and left us on the beach at Marantiales. Following advice, we banged and bumped along the shore of a small river named Rio Grande and found shelter that night in an isolated ranch owned by a refugee Belgian who informed us there was no road at all from here. We would have to take the beach at low tide. Leaving at 8 a.m. would give us four hours to go 30 miles—plenty of time if the tires held up. If not? We might have to climb the cliffs and walk home.

Luck was with us. The tires held and by noon we were back on a so-called road, off the beach. But after 50 miles the road dwindled away to nothing but limitless waste—a land of birds, millions of them, so fearless they had to be shooed from the path with sticks. Then, a rushing river blocked the way and, halfway across, the car stuck. Baggage floated down the current as we struggled for four hours, dismantling the car panels and doors so we could pull it out. More hours were lost starting it again. Rain and snow began to pelt us, and the trail became a mire that soon froze. A dozen times we pried the car out of holes and ditches into which it skidded. Chains were little help. Our feet and hands were blue with cold, but still we inched ahead through country no car had ever traveled. In three hours we made two miles on a donkey trail leading up through the last mountain range. Suddenly, we found ourselves wedged between the cliff wall and a 500-foot precipice. We could go no further. The ledge ahead was narrower than the car. In that precarious place we had to turn the car around and find refuge

(Continued to page 240)



Finest drill of its type. Drills 1" holes in wood, 3/4" in metal—and sands, polishes, removes paint. **No. 1814 Drill with Jacobs Geared Key Chuck . . . \$25.70**

New self-powered Orbital Sander will sand in any direction without tracking, scoring or burning. **No. 580 Orbital Sander, regular \$44.95 value. Special for Christmas . . . \$39.95**

Fastest-cutting jig saw made

Actually 6 saws in one. Cuts wood, plastic, metal; cuts own starting hole in wood. **No. 480 Jig Saw with 4 assorted blades, regular \$44.95 value, Special for Christmas . . . \$39.95**

There's something Wonderful here FOR EVERY MAN ON YOUR LIST!

START A COMPLETE POWER WORKSHOP WITH THIS 4.0 amp. 1/2 h.p. 888 POWER UNIT

The Gift that keeps growing! This husky Power Unit comes completely equipped as a 3/8" drill, 6" sander and polisher. The inexpensive but beautifully engineered attachments listed below can be added any time to make a complete Power Workshop.

Special for Christmas . . . \$39.95
Regular \$44.95

Add these for a fraction of the cost of individually powered tools

"Dyno-Mite" Power Workshop
You — or the lucky recipient — can convert the sensational **888 Power Unit** to a whole workshop of power tools by adding these specially designed inexpensive attachments —

Including a 6" Portable Circular Saw, an Orbital Sander, a Portable or Bench Jig Saw, a Bench Sander, Bench Grinder, 6 1/4" Circular Bench Saw, and a Drill Press. Ask your dealer to show them to you.



with Jacobs Geared Key Chuck

TO MAKE IT EASY FOR YOU



Your dealer now has a special group of Miller's Falls Tools in Xmas packages. And ask him for the special Miller's Falls Xmas folders. Or write us direct.

For power and performance



MILLERS FALLS CO., Dept. PM-11, Greenfield, Mass.

FINEST POWER TOOLS MADE

before nightfall at 11 p.m.—three hours off. It was too dangerous to back down. Lifting, heaving and coaxing, we almost made it—then a back wheel slipped over the edge and hung, spinning, in space. Digging one foot in a crevice of the cliff wall, and using a stout sapling for a lever, Henri pried mightily against the dangling wheel while I heaved and tugged at the car. A slight gust now would have sent the teetering vehicle plunging over the edge. Inch by inch it came around. At last, numb and weary, we climbed aboard and banged down the trail to a settler's hut we had passed on the way up.

The slow return back across the strait in the landing barge, up across wind-swept Patagonia, then off to the east coast for Buenos Aires, Sao Paulo and Rio, was anticlimactic. Our second set of tires peeled off in ribbons on the desolate steppes, and we drove 2000 miles into Buenos Aires on the rims, clanking along over rocks like a rolling garbage can full of loose rivets.

The banquets, parties and hospitality of the people who welcomed us in the glamour cities of Argentina and Brazil quickly erased the grim memories of our ordeal. And, with the Citroen once more welded back in one piece, equipped with a new set of wheels and washed, things looked brighter. So bright that in Rio we made

the foolhardy decision to sail for Dakar, instead of France as originally planned, and travel back across the Sahara Desert to set another record. We would coast home via the Senegal, Sudan, Bamako on the Niger River, around the mountains to Oran, down to Casablanca, up to Rabat and Tangiers. Then, across Gibraltar, up through Spain—and Paris!

The wonder is we ever made it. We had overestimated the ability of our stout little vehicle—and ourselves. Had the car been new, we might have had no trouble—but with 25,000 miles of hideous punishment under its hood, we were asking too much. The Sahara is a cruel desert.

A few hundred miles out of Dakar, on the burning sands, our troubles began. The new tires overheated and exploded continually. The battery went dead, and we stuck pitifully time and time again in the endless horizons of loose, drifted sand. Our meager stock of drinking water was quickly consumed, as we worked, perspiring in the 120-degree heat to push the car out of sand traps. Two hundred miles from anywhere, our water was gone. For two days we went without any as we struggled to move the car a few miserable miles over the wastes. Not a living soul did we pass. Our lips blistered and tongues began to

(Continued to page 242)



CITROËN

WORLD-FAMOUS CARS WILL SOON BE AVAILABLE IN THE UNITED STATES



THE 2CV

THE CAR OF THE INTER-CONTINENTAL EXPEDITION. LOW IN PRICE — HIGH IN PERFORMANCE.

AND ALSO

THE SENSATION OF LAST OCTOBER'S PARIS AUTOMOBILE SHOW, WIDELY ACCLAIMED FOR ITS BEAUTY AND TECHNICAL SUPERIORITY.



THE DS 19

For more information, write to the distributor: **CITROËN CARS CORPORATION**
300 Park Avenue, Dept. P.M., New York 22, N. Y. EL 5-2872 • 8423 Wilshire Blvd., Dept. P.M., Beverly Hills, Calif. OL 3-4745

The Chief

WORK BENCH

Built to Last a Lifetime!

... for Christmas!

With Bottom Shelf and 18" Sq. Drawer. 2" x 6", Solid Plank, Grooved and Dovetailed Top and 1" x 8" Back Rail, Shellacked to a Smooth, Satiny Finish. ● 6 Ft. Long ● 34" High ● 26" Deep. Shipped Knock-down, with Bolts, Nuts and Screws and ABC Chart for Quick, Simple Assembly.

MOHAWK LUMBER CO. Dept. 33
14525 W. Chicago Blvd., Detroit 27, Mich.
Enclosed Check Money Order for \$
Ship CHIEF WORK BENCHES at
Quantity
\$19.95 each, F.O.B. Detroit, Mich.
 Send C.O.D., \$5 Deposit Enclosed.

NAME _____
ADDRESS _____
CITY _____ STATE _____



\$19.95

F.O.B. DETROIT

Send Check or Money Order, or Will Ship C. O. D. (\$5 Deposit)

Prompt Delivery

MOHAWK LUMBER CO.
14525 W. Chicago Boulevard
DETROIT 27, MICHIGAN

Every power and performance record in the book smashed by new '56 Dodge at Bonneville Salt Flats!



AAA CALLS TEST "MOST AMAZING DEMONSTRATION OF PERFORMANCE AND ENDURANCE IN AUTOMOTIVE HISTORY!"

Day and night, for 14 gruelling non-stop days, this new 1956 Dodge Custom Royal 4-Door Sedan shattered all American stock car records in the unlimited closed car division for every distance up to 31,224 miles. A. C. Pillsbury, AAA official in charge, wired, "This amazing performance demon-

strates the great power and rugged endurance of your fine new product." No specially equipped or "souped-up" car, this new champion was *selected at random* from the Dodge production line by AAA officials. It's the *same* car you yourself can buy today, powered by our new 230 horsepower V-8 engine.

Here's how the records fell to the dynamic new '56 Dodge!

- All-time AAA record of 92.86 mph for 14 days.
- Every AAA American and International performance and endurance record for American closed cars up to 31,224 miles.
- 27 World's Unlimited Records.
- Every International Class B record from 4,000 through 31,224 miles.
- Total of 306 records in all.
- New AAA record 114.05 mph for flying-start mile.
- New AAA record 79.55 mph for standing-start mile.



Plenty of style too! The lady in your life will go for the dramatic new Jet-Fin styling, the "Panel-Perfect" Jacquard fabrics, the Magic Touch push-button driving.

Don't buy any '56 car until
you see and drive the

New '56 DODGE

VISIT YOUR DODGE DEALER NOW

Make
MORE
Money

with this
Low Cost

"Husky
Boy"

200 ampere
air-cooled
engine driven

Arc Welder!

Welds Anywhere!

In or out of the shop, the "Husky Boy" can earn bigger profits for you. And you save more on the purchase cost. Lighter weight makes it ideal for using on small service truck for quick emergency calls.

For use in the shop, wheels and handles are available at a slight additional cost.

Full 200 amps. (not skimped)

Specially built for smaller shops requiring lighter weight and lower investment, the "Bantam Champ" gives full 200 amp.

You can "Build Your Own"

You can save even more by "Building Your Own" with this Hobart generator. Just connect the "Build-Your-Own" to your own used auto engine . . . it's perfect for small operations which do not justify a complete, factory built outfit.

AC Welder with AC Power for tools

The AC-AC Welder and Power Unit lets you do numerous repair jobs where no power is available . . . also furnishes emergency power for electric lights and power tools. 200 or 300 amp, size plus 5KW AC power.

AC Transformer type

For improved AC welding performance. Operates on single phase 220 power lines.

HOBART WELDING SCHOOL

Be your own boss! Learn profitable arc welding at the non-profit Hobart Trade School. Skilled instructors give you on-the-job training. Complete or partial courses with latest equipment. G. I. bill approved. Write for free booklet.

Welding \$1 Lessons

Complete operator's training course. 200 pages fully illustrated.

HOBART BROS. CO., BOX M-125, TROY, OHIO

"One of the world's largest builders of Arc Welders." Phone 21223

Hobart Brothers Co., Box M-125, Troy, Ohio

Please send additional data on items checked:

- | | |
|--|--|
| <input type="checkbox"/> "Husky Boy" | <input type="checkbox"/> "Bantam Champ" |
| <input type="checkbox"/> Transformer Type AC | <input type="checkbox"/> "Build Your Own" |
| <input type="checkbox"/> Hobart Welding School | <input type="checkbox"/> Welding Lessons, \$1.00 |

FREE Welder's Vest Pocket Guide
USE THE COUPON

NAME _____
ADDRESS _____
CITY _____ STATE _____

- Welder's Vest Pocket Guide

swell. That night as we lay down to sleep in the cool side of a dune, neither of us spoke. We knew another day would spell the end.

Morning brought no cheer until, suddenly, Henri gave a hoarse croak and pointed toward the horizon. There, creeping across the dunes against the sky was a camel caravan, headed our way! They were Taureg traders. No sight in the world could have been more beautiful. The brackish water from their sour goatskin sacks tasted like a cool, crystal mountain spring to our parched mouths. These Samaritans of the desert fed us, rested us and then, with one young camel hitched to the front of the Citroen, we were towed ingloriously for 20 miles to an oasis. Making emergency repairs, we managed to limp into Bamako where the car was serviced and refitted with new tires. The remainder of the journey to Oran was a nightmare of digging ourselves out of sand pits, minor breakdowns, and waiting in the scorching sun for trucks to come and tow us out of trouble. Then came Oran and the nightmares were gone. Once again we drove on flat, hardtop roads, purring along as though nothing in the world had ever stopped us.

And so we proceeded back to Paris at a tourist's amble, to the Plaza in front of Notre Dame. Under our belts was a great adventure and an assortment of outstanding records. Would we do it again? I can't speak for Henri, but I know that, for myself, I am going to be content to settle down to the pursuit of my new profession—photography. Whether or not it will take me to the corners of the world again, who knows? ★ ★ ★

**Birth of New Stars
Seen by Scientists**

Two photographs taken by Dr. George H. Herbig, astronomer at the University of California's Lick Observatory, show what scientists believe may be the birth of new stars. In the first photo, taken in 1947, there are three stars embedded in a dark cloud of dust and gas. In the second picture, taken in 1954, five stars appear, implying that the two new stars may have been born by condensation of material from the cloud. If true, the actual birth of the stars would have taken place 1600 years ago, since that is the time required for light from the Orion Nebula where the baby stars were discovered to reach earth.

☐ About 2000 languages are spoken in the world, and nearly half of this number are native to North and South America.



A STANLEY CHRISTMAS means A Happy New Year

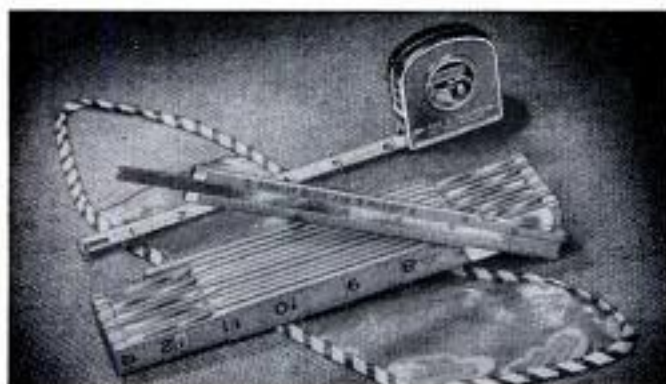

GIVE ACCURACY. It pays to be precise and say Stanley — it's a *good* rule. Here's why: a 6 ft. folding wood rule with extension slide, No. X227 — \$2.49; and an 8 ft. Pull-Push steel tape rule in free magnifying lens box, No. 1208W — \$1.19.



GIVE SMACKING SATISFACTION. This Stanley hammer is a handsome and perfectly balanced tool. The selected white hickory handle *absorbs* impact shock... keeps it away from your hand. 16 oz. No. N51-1/2 — \$3.50.



Hammers, rules and many other Stanley Tools for Christmas are now at your hardware store with special free Christmas stocking gift wrapping.



GIVE POWER FOR DRILLING AND DRIVING. Here's a work-saving combination. The 1/4" electric drill is still the most popular power tool. Stanley H41 Electric Drill — \$27.95. And the power screw driver with snap-in bits, Stanley H180 Screw Driver Attachment — \$6.95.



GIVE POWER FOR SAWING. This portable electric saw makes clean, accurate cutting quick and easy. 6" blade cuts up to 2 inches at 90 degrees, 1 1/2 inches at 45 degrees. "Motor Saver" feature protects against impact loads. Safe, sure and fast. Stanley Builders Saw H65 — \$67.50.

STANLEY



The Stanley Works • New Britain, Conn.

**TOOLS • ELECTRIC TOOLS
HARDWARE • STEEL • STEEL STRAPPING**

DEPARTMENT TE, THE STANLEY WORKS,
62D Elm Street, New Britain, Conn.

Gentlemen: Please send me

- free Tool Catalog 55
- free Electric Tool Catalog E15
- 25¢ Pocket book — "How to Work With Tools and Wood" — I enclose 25¢.

Name _____

Address _____

City _____ Zone _____ State _____

FROM ALL OVER THE WORLD...

news you want to hear
with a



hallicrafters Model S-38D—Only \$49.95

It's a fascinating, exciting hobby to listen in on the whole wide world by short wave with Hallicrafters S-38D radio. With this exceptional receiver you enjoy not only standard broadcasts . . . but can choose from the 3 international short wave bands. You, too, will praise the performance of Hallicrafters S-38D radio . . . the choice of countless governments as well as radio experts the world over. Hear the S-38D at your nearest Electronic Parts Distributor today—\$49.95 . . . or write

hallicrafters

CHICAGO 24, ILLINOIS

it's

"The Life of Riley" with

UTICA TOOLS®

says Wm. Bendix
Star of NBC-TV Show
"The Life of Riley"

Mighty amusing fellow, Riley, on your TV screen. Lots of chuckles Friday nights.

But, make no mistake about it, as William Bendix he's mighty serious in his choice of hand tools for his DO-IT-YOURSELF hobby.

"In my home workshop I find wonderful relaxation after a tough day at the studio. And in my workshop you'll find a complete variety of UTICA® Pliers and Adjustable Wrenches. They're tops," says Bendix.



THE HALLMARK OF QUALITY
UTICA DROP FORGE & TOOL CORP.
UTICA 4, N. Y.

In Canada: Adlam Tool & Supply Co., Ltd., Montreal

The Things They Do to Your Dinner!

(Continued from page 162)

right through food containers to get at the unwanted bacteria.

So there's a mighty good chance that by 1965 you'll be buying irradiated food of one sort or another. The processes are being thoroughly tested in the laboratory.

A few food technologists, however, are putting their money on another no-cooking packaging process, but this one is something of a dark horse.

"If it's bacteria we want to get rid of," reason these scientists, "what's one of the most common modern ways to do it?"

A Hypo for Your Food?

The answer is antibiotics. If they kill bacteria in people, why not in food?

The search for a cheap antibiotic to turn the trick began several years ago. The Agriculture Department's Western Regional Research Laboratory at Albany, Calif., was one of many researchers. But though the searchers have come close, they haven't quite found the right antibiotic. For the most part, the good ones are too expensive.

But many food technologists concede it is only a matter of time before foods are preserved by being given an antibiotic "shot." For a while they thought they had the answer in a drug called subtilin, but this only arrested the growth of the bacteria.

Skeptics about the new food processes are inclined to say that these ideas may be clever, but they will never replace fresh foods. This is true, up to a point.

Fresh Vegetables Are Vanishing

But most vegetables consumed in the United States today are processed. And another item to consider is the fact that food production in this country is becoming centralized in special areas hundreds and even thousands of miles from the population centers where the food is consumed. Eight states, and primarily California, now produce from 52 to 86 percent of all our frozen lima beans, peas, corn and carrots. The shipping of this produce is expensive. The new methods all offer ways to cut packing, shipping and storage costs.

Still another factor is that the average American is becoming impatient of seasons. He demands top quality and he doesn't want to pay high prices for out-of-season food. The new processes may solve these problems.

So Great Aunt Martha may scoff, but it's a good bet that before long her granddaughter will be serving dehydrofrozen peas and irradiated spinach. ★ ★ ★

ANNOUNCING THE *NEW and ONLY*

TILT ARM JIG SAW!



MODEL 2500
HEAVY DUTY JIG SAW

Now, all others are old fashioned because on the Syncro model No. 2500 blade, arm and motor tilt together 0° to 45° to either side. Work remains flat while making angled cuts. Greater control means more accurate cuts. Ready to use —no bolt-down required. 65 lbs. Cast semi-steel. 20" heavy duty, for big projects.

SYNCRO CORPORATION
Dept. 1-95, OXFORD, MICHIGAN, U.S.A.

SEE AT HARDWARES
Write Dept. 1-95 for Free
Catalog and Sanding Handbook.



MORE SYNCRO-MADE JIG SAWS SOLD THAN ANY OTHER SELF-POWERED MAKE



For your own OPERATION ATTIC

Get step-by-step directions in
**FREE "OPERATION
ATTIC" PAMPHLET**

along with new 24-page picture-packed booklet, "Friendly Home Ideas in Western Pine." Write to Western Pine Association, Dept. 416-N, Yeon Bldg., Portland 4, Ore.

Transform idle attics and extra basement space into bright, cheerful living areas—with handsome, economical Western Pines®!

The pictured top-story hideaway is a den, study, playroom and extra guestroom. Its handsome, durable Western Pine-paneled walls and

ceilings require a minimum of care, take to modern or traditional furnishings.

It costs little to build or remodel with these easy-to-work woods. They're carefully selected and seasoned, take all finishes without grain-raising. Ask your lumber dealer for an estimate.

the Western Pines

- * IDAHO WHITE PINE
- * PONDEROSA PINE
- * SUGAR PINE

TODAY'S WESTERN PINE TREE FARMING GUARANTEES LUMBER TOMORROW

DECEMBER 1955

Copyrighted material 245

IN INDUSTRY...

The grip, accuracy and durability of the Jacobs Plain Bearing Chuck have made it standard equipment all over the world. This model, especially designed for drill presses, features a Jacobs-engineered PLUS—the threaded locking collar for extra safety and more versatile use of the tool.



AND
IN THE
**HOME
SHOP**

The Jacobs Plain Bearing Chuck equipped with threaded locking collar makes any drill press a safer, surer, more versatile tool.

Safer because the threaded collar keeps chuck locked on tapered spindle regardless of speeds or type of thrust.

Surer because it's a Jacobs, the most accurate, holdingest, longest lasting chuck of its kind—anywhere.

More versatile because it eliminates the necessity of using special collet chucks or similar adapters for holding routing, carving or dovetailing bits.

When you work with a drill press or portable electric tool you'll hold your drill or bit best when you use a Jacobs Chuck. There is none better for accuracy, grip and durability. The Jacobs Manufacturing Company, West Hartford 10, Connecticut.



Jacobs
CHUCKS

If it's a Jacobs—it holds

Miami Has an Electric Nervous System

(Continued from page 148)

1934 when Ben Demby was placed in charge of the newly formed police communications system.

But the first radios he purchased and installed in the police cars crackled, buzzed and were undependable. During the month of August, especially, the ionosphere played strange tricks on policemen operating the 30-megacycle radios. A call would go out to a cruising squad car, but the sheriff's office in Hartford, Conn., would answer. The message would then be relayed to Hartford, which would contact the Miami patrolman who couldn't hear his own dispatcher.

Demby was convinced that a frequency of 155 megacycles would solve his problems. No one was using over 100 megacycles at the time, and the FCC assured him his dream was impractical.

He proceeded to rip out the old radios and install 155-megacycle sets built to his design by Communications technicians. They worked fine. Later, the same opposition and the same success were repeated when Demby's department, now expanded to cover all city communications, went to 460 megacycles.

Teletypes and Radio

Nine Teletype machines, some of them operating on circuits to municipal "clients" as well as to local police and fire stations,

(Continued to page 248)

Demby, Communications Department head, inspects experimental radio he is testing for electronics firm



STOP FROZEN PIPES!



WRAP-ON ELECTRIC HEATING TAPE



Self Adhesive! Just Wrap It On and Plug It In—It Sticks!

Easily, quickly applied. Protects water pipes, oil lines, pumps. Use thermostat for automatic operation.

Low Cost . . . Do-It-Yourself Prevent Costly Repair Bills

Trouble free, lasts for years. Protect to 50° below zero with WRAP-ON fiberglass insulation. No tools needed.

send today for your

FREE

WRAP-ON instructions

At hardware, electric, farm, poultry and trailer dealers.

WRAP-ON

Co., 340 W. Huron St.
Dept. 609, Chicago 10, Ill.



CUT RADIO CHASSIS HOLES IN 1-1/2 MINUTES OR LESS

Quickly make accurate round, square, key, or "D" openings . . . in metal, bakelite or hard rubber . . . with GREENLEE Radio Chassis Punches. Simply turn with a wrench. Many sizes. Write for details. Greenlee Tool Co., 2112 Columbia Avenue, Rockford, Illinois.

GREENLEE



BUILD FINE GRANDFATHER CLOCK NOW

The simple sensible Red-i-Kut way as thousands have—SAVE HALF SHOP TESTED PLANS "SPIRIT OF THE CENTURY" Narrow waist 83" tall or stately straight side "SPIRIT OF AMERICA." EASY-TO-FOLLOW photographs PLANS tell all—plus BROCHURE of heavy brass weight Westminster, tube chime, movements, gorgeous dials, 3 1/2" solid mahogany case kits. Send \$1.00 today—Both plans \$1.50 NOW.

KUEMPEL CHIME CLOCK CO., 7 Kuempel Bldg., Minneapolis 16, Minn.



Earn Big Money! DRY CLEAN RUGS

New Easy Way! Dry clean rugs on location in homes, stores—fast and easy—machine does hard work for you! Amazing ALM-13 machine with Float-Action Brush whirls cleaning material into rug fibers—gets out grime, dirt like magic! Use rug at once. Also, use same machine with no-tool attachments to clean, wax, polish any floor—make extra profits! Write for details.

AMERICAN Floor Surfacing Machine Co.
535 So. St. Clair St., Toledo 3, Ohio

Need an extra \$1,000, \$2,000, or more? Make it with an

IDEAL LAWNMOWER SHARPENER

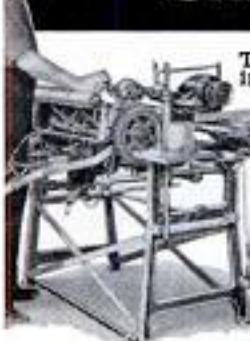

There are thousands of lawnmowers in your locality: Average \$1,000 profit per 250 mowers with customer satisfaction and repeat business assured. Provide this essential service with an Ideal Lawnmower Sharpener, the only machine that grinds the reel to "fit" the bed knife. Compare by any standard. The Ideal, backed by 53 years of experience, costs no more. Write today for complete, free catalog.

THE FATE-ROOT-HEATH COMPANY
Dept. PM-12 Plymouth, Ohio

HOLIDAY OFFER



NEW Westinghouse

MOTORS 1/2 PRICE

WITH THE PURCHASE OF ANY DARRA-JAMES QUALITY POWER TOOL

Now! Start, or add to, your home workshop at a price so low you may never be able to duplicate it again! Choose from Darra-James 25 professional quality table saws, drill presses, band saws, jig saws, jointers, sanders, lathes, etc. Get a brand-new matching Westinghouse Motor for 1/2 priced Shop and compare!

EXAMPLE #1



8" Tilting Arbor Saw (Model 28) \$38.95
1/3 HP Capacitor motor 38.20
Regular price \$77.15

NOW! BOTH ONLY \$57.85

(EXTENSIONS EXTRA)

EXAMPLE #2

12" Drill Press (Model 350B) \$56.50
1/3 HP Westinghouse motor 26.95
Regular price \$83.45

NOW! BOTH ONLY \$69.95

CLIP AND MAIL TODAY!



TOOLKRAFT CORP. DEPT. P-125
PLAINFIELD STREET, SPRINGFIELD, MASS.

Please send me your free catalog, with information and coupon needed to take advantage of your 1/2 price motor offer, and name of nearest dealer.

Please contact my favorite dealer. He is

NAME _____

CITY _____

Please send me your Power Tool Handbook. I enclose 10c to cover handling and postage.

NAME _____

STREET _____

CITY _____

Cushman

PACEMAKER

**rugged
speedy and
dependable**



Unmatched
for low
cost trans-
portation . . .
75 miles per
gallon . . .
¾¢ per
mile total
operating
cost.

Ask your
nearest
dealer for

FREE demonstration or
write for illustrated literature.

CUSHMAN MOTOR WORKS, inc.
963 No. 21, Lincoln, Nebraska



TEENUTS

steel threads in wood

TEENUTS mount flush without counter-boring. Excellent for new work or repairs . . . wood to wood, wood to metal . . . and where old screw holes have worn out. Simply drill hole for TEENUT barrel, hammer home TEENUT and its steel prongs provide rigid, permanent anchorage. Same size hole for bolt: Sizes to fit standard bolts: 6-32, 8-32, 10-24, 10-32 (4 per card), ¼-20 (3 per card), ⅜-18, ⅝-16 (2 per card).

AT HARDWARE COUNTERS
EVERYWHERE 15¢
per card



3229 South Ashland Ave., Chicago 8,
Illinois

THE **DOT** LINE

are located in the headquarters of the Communications Department.

Two radio dispatchers in Communications headquarters operate the county and suburban radio systems. These operators are in addition to the regular Miami operations: A telephone switchboard and a radio dispatcher in the fire department, a radio-dispatching system at police headquarters and a switchboard in City Hall that links all phones in the city government.

In touch with surrounding communities, the center also has direct contact with several agencies.

Pick up a telephone marked "Coast Guard" and an officer at the local Coast Guard headquarters answers immediately. Lift another receiver and a phone rings at the Strategic Air Command post in Marietta, Ga., 550 miles away. A phone call reporting bombers approaching Miami would alert the nation in 12 seconds. Meanwhile, switches in the Miami Communications Center would be pulled to set air-raid sirens sounding all over the city. Miami would start broadcasting messages over an emergency radio-communications frequency that reaches out over a 500-mile radius.

The emergency communications network, invaluable in air raids, was set up to counter havoc that Miami is familiar with—hurricanes. In touch by Teletype and radio with the United States Weather Bureau, Demby's department must alert the city when a hurricane veers too close.

(Continued to page 250)

Even the police horses in Miami are equipped with two-way radio for parade duty. Unit is walkie-talkie





PLYMOUTH



DODGE

The only factory-approved parts and



DE SOTO



CHRYSLER

accessories for Chrysler Corporation



IMPERIAL



DODGE TRUCKS

cars and trucks bear this name:

*MoPAR PARTS ARE AVAILABLE
FROM YOUR NEARBY PLYMOUTH,
DODGE, DE SOTO, OR CHRYSLER
DEALER AND FROM BETTER
REPAIR SHOPS EVERYWHERE.*

MoPAR

**PARTS DIVISION
CHRYSLER CORPORATION**



**"Put in Quaker State Motor Oil—
it's my gift to my car!"**



Super-refined from Pure Pennsylvania Grade Crude Oil, world's finest. Famous for performance, protection, economy! Try it!

QUAKER STATE OIL REFINING CORP., OIL CITY, PA.
Member Pennsylvania Grade Crude Oil Association

When the alert is sounded, it's also time for the Communications Center to secure itself against wind and flood. It does this by packing bag and baggage, IBM machine and Teletype, and transferring its entire operation to a stand-by center on the third floor of the Dade County Courthouse. The job takes 30 minutes and is accomplished without a break in communications.

Meanwhile, a bus converted into a rolling communications headquarters is heading for a flooded area on the outskirts of the city, ready to direct evacuation operations. Equipped with all ten radio circuits, telephones and a Teletype, it is the third line of defense in case of emergency. For it alone could function as a complete communications center for the Miami area.

In certain emergencies, other than hurricanes, the radio-equipped Goodyear blimp that winters for six months in Miami could serve as a radio relay and connect Miami patrol cars with cities as far away as Daytona Beach, 250 miles up the peninsula.

Last Resort

The last communications center—the fourth line of defense—is Ben Demby's personal automobile. Its instrument panel would make a Detroit designer turn handsprings of delight. Demby's array of instruments, however, has a practical purpose. By lifting various receivers and turning certain dials, he can communicate by radio with all branches of his department—wherever he may be around Miami. All the radios in the department can also contact others on the same band. So radio communications do not depend solely on one or two transmitting towers.

Demby, who has been building up the city's nervous system for over 20 years, is still convinced that improvements can be made. Once again he may raise the frequencies of city radios. Soon microwave television circuits will be set up. The projected city jail and city hall will naturally be equipped with the latest closed-circuit TV. In 1956 a location detector for mobile units will be installed. After that? "If it's invented and we need it, we'll get it," says Demby. "A modern city needs all the help that electronics can give." ★ ★ ★

Peanut Husks Pave Roads

Scientists in India are using a dark liquid obtained from peanut husks to pave dirt roads. The soil is first treated with the liquid and then dried. Calcium chloride is then applied to form a gelatinous mass in the soil and hold the tiny earth particles together. The treatment increases the soil's resistance to friction.

**GIFT FOR
YOUR MAN**



CRESCENT TOOLS available in Gift Boxes

AC 16	Six inch Crestoloy Wrench... Retail value.....	\$2.10
AC 18	Eight inch Crestoloy Wrench... Retail value.....	\$2.45
AC 110	Ten inch Crestoloy Wrench... Retail value.....	\$3.15
L 26	Six inch slip joint, thin nose Plier Retail value.....	\$1.30
T 47	Seven inch combination Snip... Retail value.....	\$2.80
TK 31 KIT	1 each AC18 wrench, L26 plier, K1304 screwdriver in red plastic kit.....	\$5.10
TP 1105	each C1161, C1162, C1163, C1164, and C1165 in red plastic pouch with clear plastic front	\$4.75
TP 1705	each C1020, C1723, C1725-B, C1729 and C1731-B in red plastic pouch with clear plastic front	\$3.85

★ No finer gift for the mechanic, home workshop fan or householder! You can't buy finer tools anywhere, and your local hardware dealer has these popular Crescent Tools gift wrapped in colorful Christmas boxes.

CRESCENT TOOLS

Give Wings to Work

*Sign of the Artisan
Symbol of Excellence*



Crescent is our trade-mark, registered in the United States and abroad, for wrenches and other tools. Sold by leading distributors and retailers everywhere and made only by **CRESCENT TOOL COMPANY, JAMESTOWN, NEW YORK**

Own a Chevrolet or Ford?

('54-'55 Chevrolet; '54-'55-'56 Ford)

Then you can enjoy the
CONVENIENCE, SAVINGS
and SMOOTHER RIDE of

Push Button POWER LUBRICATION

with **NEW**

Multi-Luber

NOW lubricate all chassis points on your car in seconds with the mere touch of a button on your dash. This amazing new high pressure system guarantees that smooth "Just Lubricated" ride . . . provides wonderful, new time-saving convenience . . . adds years of life to your car. Multi-Luber has been exhaustively tested and is available as optional equipment on current models of one of the largest car manufacturers.

Buy it installed from your car dealer, garage, or service station—or install it yourself. Kit includes complete instructions for quick and easy installation.

USE THIS BLANK TO OBTAIN
COMPLETE INFORMATION:

IN KITS
AS LOW AS
\$46⁹⁵
PLUS
INSTALLATION



LINCOLN ENGINEERING COMPANY
ST. LOUIS 20, MO.

Please send me your illustrated leaflet describing
MULTI-LUBER, and the name and address of
my nearest Multi-Luber Dealer.

NAME.....

STREET.....

CITY.....STATE.....

(Please print or typewrite)

How to Select Your Hi-Fi System

(continued from page 167)

excess of 10 oz.) for good low frequency response and low distortion. Improved performance can be obtained with coaxial speakers which have a large cone for the low frequencies and a separate small one for the highs.

The most elaborate speakers consist of three separate units: The low-frequency cone, the midrange and the high-frequency units. These parts may be assembled on one frame, as with triaxial speakers, or may be purchased separately.

When selecting speakers from the catalogue, plan to listen to those meeting your requirements: 8-12 inch units for small rooms, and 12-15 inch units for large rooms. Make certain that each unit selected will handle the full rated output power of the proposed amplifier.

ENCLOSURES



BASS REFLEX

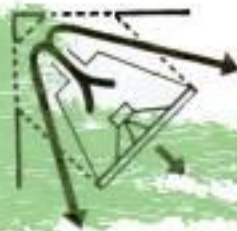

FOLDED HORN

The enclosure is almost as important to high fidelity as the speaker itself. Without it, even the finest speaker will sound flat and lifeless. Commercially, such enclosures are available in a tremendous price range, but even the least expensive of these is likely to cost more than the speaker itself. You can save some money by purchasing a speaker enclosure kit which can be assembled with only a screwdriver and a minimum of skill. Or you can construct the enclosure from plans that are available at a very low cost.

Having compiled a tentative list of components, you can walk with confidence into a showroom and request a demonstration. When doing this, it is advisable to take along your favorite high-fidelity record to be used in the listening tests.

Here, a definite pattern should be followed in making your selections. Have your



(Continued to page 254)

Hey Men!
Let's get together
this
Christmas
with...



LIONEL® Train Sets and Accessories!

Only Lionel has Magne-Traction!

New! Auto Transport Car! No. 6414. Modelled accurately after the real Evans Auto Loader, which is just now making its appearance on big railroads! Bright-red with black and gold markings, it carries four minutely-detailed scale-model removable 1955 autos! Operating knuckle-type couplers. 11" long.

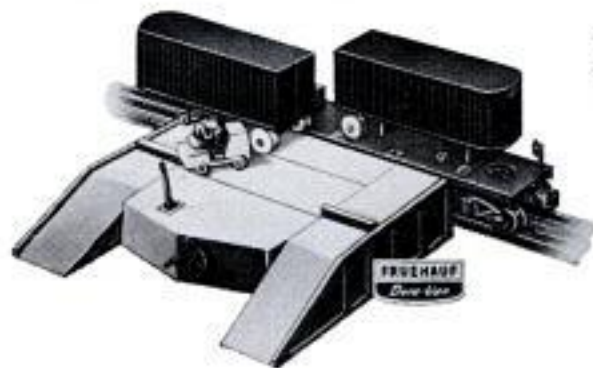
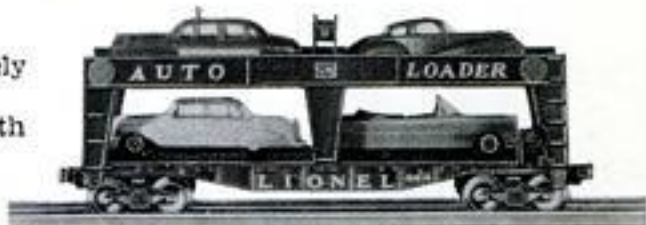

New! Gas Turbine Switcher! No. 41. Snappy looks! Snappy action for your yards! Exact model of gas switcher just built for U.S. Army! Amazing detail... doors, stacks, air scoops, front and back simulated headlights. Regular Lionel 3-position control. Remote control couplers at both ends. For "0" and "027" gauges. Switcher measures 7½" long.

New! Piggy Back Transportation Set! No. 460. Action! Action! MORE ACTION with this latest real-life R.R. innovation... "piggy back" transportation! Scale-detailed truck vans can be cranked right on and off flat car! Flat car couples to any Lionel Train. Set includes platform, flat car and vans! Platform and ramps are 14" long; platform is 5" wide and 2" high.



See them at your Lionel dealer's and get his new Lionel catalogue . . . now!

THE LIONEL CORP., 15 E. 26 STREET, NEW YORK 10, N. Y.

CHRISTMAS BONUS!

Two grand gifts for the price of one. Order now for every handy man on your list — especially if you're giving (or getting) tools for Christmas.

NEW!

BOOK OF
52 FIR PLYWOOD
HOME STORAGE
PLANS



Bonus offer! Jumbo file folder assembly of 10 plans designed for "week-end carpenters". Step-by-step plans for Christmas toys, decorations, train tables, furniture and remodeling ideas.

PLUS!

this valuable
BONUS PORTFOLIO
Fir Plywood Homecraft Projects



Complete "how-to" bible for home craftsmen. Over 90 pages of easy-to-follow plans, photos, instructions for exciting new built-ins, cabinets, storage walls, many others. Ideas galore for every room, for garden and patio. Big illustrated "how-to" section contains scores of time and money-saving tips.

regular
\$160
value

NOW!

for limited time only*

get **BOTH** 50¢
for **ONLY** 50¢

SEE YOUR LUMBER DEALER FOR FIR PLYWOOD

Order NOW to insure delivery by Christmas. Send 50c to DOUGLAS FIR PLYWOOD ASSN., Dept. 912, Tacoma 2, Wn.
*Orders must be received by Dec. 31, 1955; good U.S.A. only.

record played through the finest hi-fi system available in order to become familiar with the true timbre of high fidelity. Then, play the record again, this time switching in the various speakers on your list, one at a time. It may require several playings before you can decide which of the speakers is most pleasing.

Once the speaker has been decided upon you are ready to select the cartridge. Again, using the very best amplifier available, but with the speaker which you have already picked out, play the same record with the various cartridges on your list. At this time you should not try to determine which of the cartridges you are listening to, but you should make notations as to which ones sound best, and the degree of difference between them. In this way you can quickly eliminate all but two or three of them, and your final selection can be based on a cost-versus-improvement basis.

You are now ready to select the record changer. Using the cartridge and speaker previously chosen, listen to the record at moderate volume with the bass control of the amplifier turned to maximum. Pay particular attention to hum during the relatively soft musical passages. This is especially important if a magnetic cartridge is used. Next, listen carefully for a very annoying "waawaawaa" sound and an equally distracting "whirrrr" which indicate the presence of wow and flutter. A trace of any of these is sufficient cause to reject any particular changer.

The final piece of equipment to be selected is the amplifier. To select the best amplifier for you, proceed as follows:

1. With all components interconnected but the changer shut off, turn the volume of the amplifier under test to maximum. With the base control also at maximum, listen for hum through the speaker. With a good amplifier, hum will be noticeable only if you stand very close to the speaker.

2. Turn all tone controls to the flat position and listen to your record at a relatively loud average volume. Compare the cleanliness of the tones with the results obtained with the best amplifier in the house *playing at the same volume level*. The highest peaks should be clear and undistorted. Tone controls should be effective in both the bass and treble registers, with little or no interaction between them. The amplifier which best meets these qualifications is the one for you.

A list of some reliable radio parts distributors as well as specifications for the construction of bass-reflex speaker enclosures can be obtained from the Popular Mechanics Radio and TV Dept. upon receipt of ordinary letter postage. ★ ★ ★

You can do **ANYTHING**
with wood on the



● CROSS-CUT SAW



● MITRE



● BEVEL-MITRE



● RIP-SAW



● BEVEL-RIP



● DADO



● SHAPE



● PLANE



● ROUT



● BORE



● DISC-SAND



● DRUM-SAND



● GRIND



● ADD A LATHE



● JOINTER



● JIG-SAW

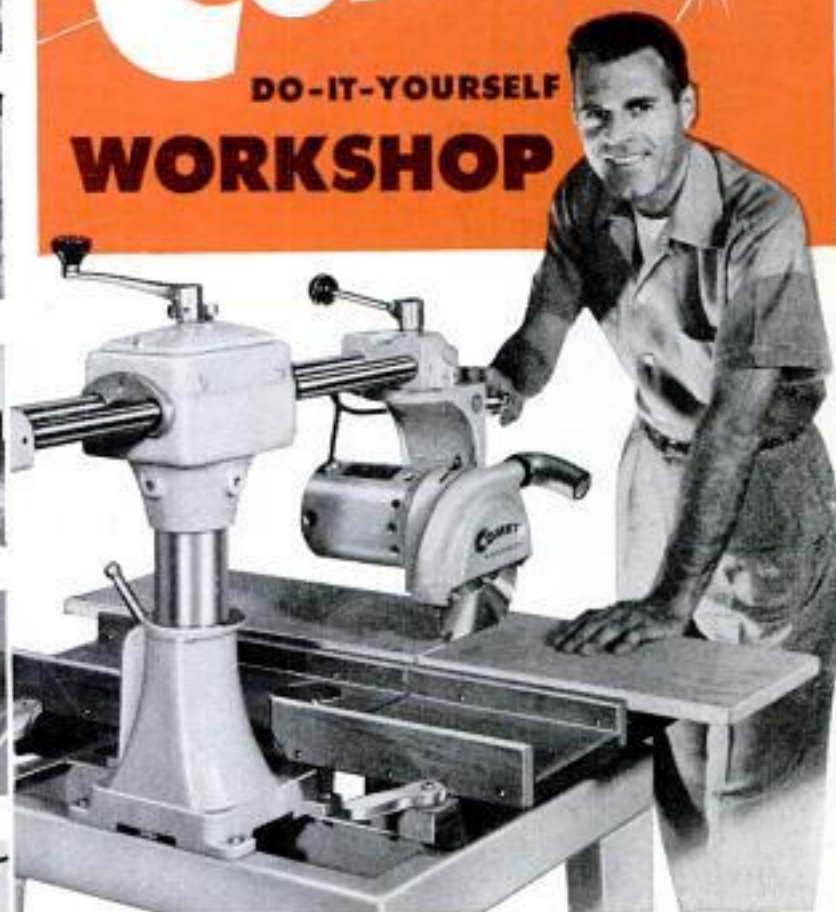

YOU don't have to buy a room full of different machines now. You can do all these jobs with the COMET WORKSHOP . . . on one machine that takes up only 28 x 30 inches . . . with one powerful 7/8 HP motor. You **DON'T** feed the wood with your fingers over a blade under the table. The COMET blade glides through the wood, from **ABOVE**, where you can see it. Then blade and motor glide back so you can see your work . . . no rigid arm in your way. The COMET is a **PROFESSIONAL** machine, used by cabinet makers, builders and woodworkers for many years. It is accurate, safe, powerful, easy to use, well built. COMETS have been used over fifteen years without a repair. With a COMET you can build anything from a shelf to a complete house, and build it **RIGHT**. Have fun and save money making it. The COMET pays for itself in a short time.

Consolidated Machinery & Supply Co., Ltd.
2033 Santa Fe Ave., Los Angeles 21, Calif.

WRITE NOW
for free literature
and name of
nearest dealer



with

FOLEY* automatic SAW FILER

"I did very well last year with my Foley equipment, sharpening about 950 saws in my spare time. About \$900 for me."

Leo H. Mix

"I have done 4 or 5 thousand saws in my spare time in the 4½ years since I got the outfit, and they are all coming back with repeat orders."

Len Crego

Make up to \$3 or \$5 an hour in Spare Time

With the high prices of food, clothing and everything else, just think what you could do with extra money every week! With a Foley Automatic Saw Filer you can file hand, band and circular saws better than the most expert hand filer. "The first saw I sharpened with my Foley Filer came out 100%" — writes Clarence E. Parsons. Cash business, no canvassing. No eyestrain — no experience needed.

FREE BOOK Shows How to Start

"MONEY MAKING FACTS" tells just what to do to start your own spare time business in your basement or garage. Just think — with a small investment, no overhead, no stock of goods to carry, you can get right into a cash business. Send coupon today — no salesman will call.



Send for FREE BOOK

FOLEY MFG. CO.,
1216-5 Foley Bldg., Minneapolis 18, Minn.
Send FREE BOOK — "Money Making Facts"

Name _____

Address _____

Jetography

(Continued from page 86)

there's canopy glare, the reflection of sun against Plexiglas. There's no escaping it. Best a jetographer can hope for is to minimize glare, shoot "around" when he can.

G-Force Is Tough "Boss"

But G-force—the multiplication of gravitational pull—is a jetographer's most unrelenting taskmaster. A sudden, heavy G-force can prematurely trigger a still camera's solenoid, jam a movie camera and warp its film, distorting the image. As if this wasn't enough, the jetographer is burdened by his crash helmet which makes view-finding tough. It's all but impossible to bring a camera close enough to the eye to align the "subject" plane in the finder.

Douglas' Walt Tufts is one jetographer who solved his "finder" problem. As always, it began with an assignment: to photograph Douglas' "Skyrocket" leaving its B-29 mother plane at 37,000 feet.

Tufts was worried. "Can't bring the view finder close enough to make sure of that shot," he fretted.

His pilot, veteran speed-jockey Lt. Col. "Pete" Everest, Jr. commiserated. "But you gotta wear that oxygen mask. There's no living without it at that altitude."

"Suppose I hold my breath?" Tufts retorted. "Nothing in the rulebook against that!"

Tufts conferred with the B-29's pilot. He agreed to signal just before the Skyrocket dropped from the bomber's belly. Close by, Tufts would be riding a T-33 camera jet, his Speed Graphic set and loaded. As the rocket plane streaked clear, he'd yank off his oxygen mask, hold his breath, bring the finder up close—and shoot.

New Breath-Holding Record

It worked. And to Walt Tufts went a new high-altitude record—for holding his breath. Walt's breath-taking photo has since splashed across scores of magazine and newspaper pages.

For all the risks, there are also the rewards—like the once-in-a-lifetimer which Northrop's Sam Orr recently brought back from a "routine" mission.

"Everything was routine," recalls Orr, "except the results . . . I was to snap the Scorpion F-89's rocket-firing sequence, get a color close-up of those 104 air-to-air rockets leaving their launchers, the whole thing shot at 30,000 feet. Northrop's flight-test engineers needed to see how the rockets lined up as they left the wing pods."

Orr climbed into an F-89's rear cockpit

(Continued to page 258)

"I picked my own spot in the Army!"

PFC. JOHN L. MILLER
Franklin, New York
Graduate, Franklin Central School

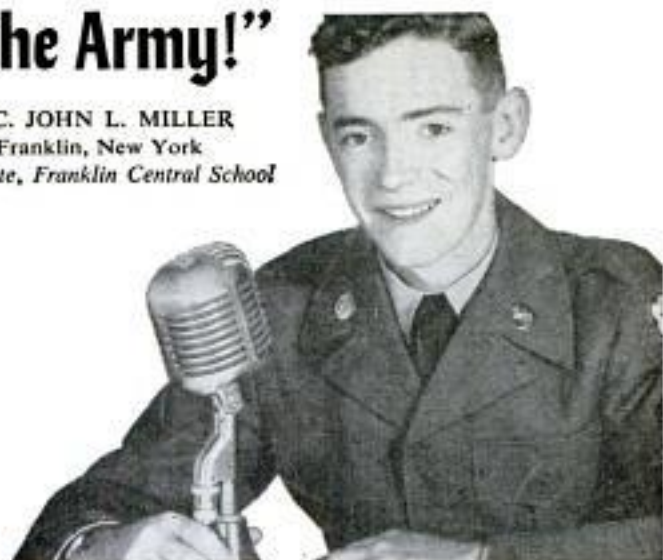

"YOU CAN, TOO— BY CHOOSING YOUR TRAINING BEFORE ENLISTMENT!"

"Yes—and I speak from experience! Right now I'm an Army specialist in radio repair. In fact, I've done so well that the Army's now giving me a *second* course in *television*! I'm pretty well set! And it's all because I entered the Army the *right* way . . . by *reserving* my training *before* enlistment. What's more, *you* can do the *same*!"

Over 100 courses ready and waiting! "There are over 100 courses to choose from—aviation, engineering, communications, medicine, guided missiles, photography—almost anything you're interested in. And you couldn't ask for finer training or better equipment. Your schooling is *guaranteed*! No if's, and's, or but's about it! The course you select is the course you'll *get*—or you *don't* enlist! That way you can't lose!"

How you can qualify. "If you have a high school diploma or its equivalent, or if you are a high school senior, you can reserve your Army schooling *right now*! See if this isn't just the deal you've been looking for."

Get CHOICE, not chance, in the ARMY!

FOR FULL DETAILS, CLIP THIS COUPON
AND MAIL IT TODAY! 

THE ADJUTANT GENERAL PM 56-1
Department of the Army, Washington 25, D. C.
Attn: AGSN

Please send me the Army booklet describing special opportunities for high school graduates.

MR.

ADDRESS.....

CITY..... STATE..... DATE OF GRAD.....

1/4" ELECTRIC DRILL

One of the first and best home power tool investments. Full powered, permanently lubricated, drill in metal, wood, concrete. Complete Drill Tool set includes horizontal stand and accessories for polishing, sanding, sharpening, cleaning, buffing.



You'll Always Be Glad
You Bought a



FLAT SANDER

Fast, powerful, light, dependable—orbital action. At 4,000 cycles per second produces fine finish on all woods, metals, fibres, etc., wherever hand sanding is usually employed.



The SIOUX name needs no introduction to the skilled mechanic who makes his living working with power tools. In the aircraft and automotive fields and in industry they're the tools the professionals have used for over 40 years!

WRITE FOR
FREE
CATALOG!



ALBERTSON & CO., INC. • SIOUX CITY, IOWA

POWER SAW

This modern SIOUX hand saw is really rugged with a world of surplus power. Available in 8 1/4", 7 1/2" and a 6 1/2" Model that will saw through 2 x 4's at a 45° angle with plenty of blade to spare.



Mitre Cuts—Adjustable base for bevel cuts from 0 to 45°, to 1 3/4" depth. Spring lift with nut adjustment is quick, accurate.



Cross Cutting—Edge of base follows line. High speed makes it many times faster than hand sawing.



Rip Sawing—Adjustable rip scale guide is plainly graduated in fractions of an inch. Blower keeps line of cut free of saw dust.



free

GET THE WORLD'S LEADING
TV & RADIO PARTS AND
EQUIPMENT CATALOG

ALLIED'S 1956 ELECTRONIC SUPPLY GUIDE

324
VALUE-
PACKED
PAGES



Save on
Everything
in
Electronics

WORLD'S
LARGEST
STOCKS

Everything for Experimenters,
Builders, Amateurs, Servicemen,
Engineers and Hi-Fi Experts

Send for ALLIED'S big 324-page Catalog, offering the world's largest selection of latest top-quality electronic equipment at lowest, money-saving prices. Features High Fidelity systems and components; recorders and phono equipment; TV tubes, antennas and accessories; Amateur station equipment; P.A. systems; test instruments; latest build-your-own kits; industrial electronic supplies—plus thousands of parts, tubes, transistors, tools and books. Get everything, get more for your money—send today for your FREE 1956 ALLIED Catalog!



ALLIED RADIO

Send for
FREE
CATALOG

ALLIED RADIO CORP., Dept. 5-MM-5
100 N. Western Ave., Chicago 80, Ill.

Rush FREE 1956 ALLIED 324-Page Catalog

Name _____

Address _____

City _____ Zone _____ State _____

with \$4000 worth of photo gear. His mainstay was to be a 4 x 5 Speed Graphic (with special finder), though he also took along a Fairchild K-20 aerial camera, a Bell and Howell 70 DH and 35-millimeter Leica. In addition, he wore a pressure suit, two parachutes, specially molded crash helmet and visor, bail-out bottle, survival kit and oxygen mask. Had he been working over water, he'd also have worn a "Mae West."

Pilots Carry Flight-Plan Cards

The mission had been carefully briefed. Both pilots had been handed a 5 x 8-inch "plan card." The cards' simple sketches (each numbered) illustrated a jetcraft's 16 most common in-flight positions. When the jetographer ordered "Plan 8," the rocket-firing pilot had merely to glance at his plan card. Plan 8 called for a three-quarters rear shot, the photo jet slightly below and behind its rocket-firing subject. Plan cards eliminate guesswork, save time and fuel and lessen the chance of a collision.

Upstairs, Orr huddled in the camera ship's rear cockpit, readied the Speed Graphic, metered his exposure and speed. Any one of a dozen miscalculations could rhubarb the mission, waste a couple thousand dollars worth of rockets—or worse.

At 30,000 feet and near the speed of sound, Orr called for Plan 8. He watched, straining at the view finder, as the subject jet jockeyed into position, slightly above the camera ship and to starboard.

Planes Draw Close

At screeching speeds, the two planes closed. Now they were 200 feet apart . . . now but 150 feet . . . now drawing even closer. . . .

Carefully, Orr drew focus, quickly rechecked his settings. Everything seemed aligned . . . both rocket pods were clearly focused . . . the sun just right . . . canopy glare at minimum. . . .

"Begin count-off," Orr rasped.

Loud in his helmet sounded the cadenced count-off . . . "10 . . . 9 . . . 8 . . ." At zero the F-89 would fire its rockets. After that, it'd be up to Orr.

"2 . . . 1 . . . zero!"

Smoke whiffed from the twin rocket pods. For a fraction of a second—just as he'd briefed it—Orr held his fire. Then he triggered the shot home. Ahead, flame balled from the Scorpion's wing tips. Like fiery javelins, 104 deadly rockets shuttled airborne.

Not for another four hours did jetographer Orr know the results. Then he learned that with one pass, he had snapped one of the sonic age's most remarkable aerial

(Continued to page 260)

ELECTRIC MOTORS — POWER KITS MAKE WONDERFUL XMAS GIFTS



Give Wilson's battery-operated motors and power accessories this Xmas. Keep your boy busy for months developing new educational projects with these exciting items. Read this list of Wilson's gifts for boys and hobbyists of all ages—and MAIL YOUR ORDER TODAY.

- *No. 7-100 Hi-Drive Motor, 1 1/2-V \$2.00
- *No. 8-100 Same for 1-V \$2.50
- *No. 3-100 Tiny Atom Motor, 1 1/2-V \$2.00
- For higher voltages \$2.50
- No. 98 Steel frame motor with gear, pinions, pulley, worm \$4.00
- *No. 3113 Tiny Atom motor assembly kit with many acc. \$3.00
- No. 1300 Small accessories kit \$1.00
- No. 3700 Large accessories kit \$3.00
- No. 4000 Deluxe accessories kit with motor \$5.00
- *No. 700 Super-Power kit with motor, speed reducer, all accessories \$10.00
- No. 88 Kit of 8 pulleys—2 belts \$2.00
- No. 3000 Vari-speed gear unit \$4.00

*Item illustrated. Ask for FREE Cat. All Wilson's motors have Permanent Alnico Magnets.

Remit with order and we pay postage in U.S.A. No C.O.D. Add 3% Sales Tax for delivery in Ohio. Write Dept. PM.

For quick delivery see your local dealer — or order direct



WILSON'S OF CLEVELAND

425 Lakeside Ave., N.W. • Cleveland 13, Ohio

1956 CATALOG—Send 35c

70 Models for 1956! See the world's finest line before you buy. Rated tops in design, styling, performance by the experts. 1956 catalog plus booklet "Boat Selection, Operation, Maintenance" \$1.00

Custom-Craft THE ORIGINAL "PACKAGED" BOAT KITS

BOAT PLANS AND FULL-SIZE: PATTERNS

Over 100 Modern plans and full size patterns. Racing classes, cruisers, inboards, outboards, sail boats. By famous designers. 6' to 30' DESIGN CATALOG only 35c. For Design Catalog plus boat building handbook send \$1.00.

CUSTOM-CRAFT (DEPT. A) BUFFALO 7, N. Y.

HEAT THAT COLD ROOM

If you have a gravity furnace that won't heat order McLarty Booster Fan. Easy to install in warm air pipe, forces heat to cold room. \$10.95 post paid.



If you have a space heater you can extend heat to adjoining rooms. Order Handifan, built to hang in upper corner of doorway, forces heat to cold rooms. \$11.95 Post Paid. Quality 110V-A.C. Motors, precision balanced blades. Send check or money order to:

McLarty Systems 2607 Dickman Rd., Battle Creek, Mich.

INTERNATIONAL DRILL • SAW

HI-SPEED COPE SAW DRILL BIT

NEW LOW PRICE Ideal as Christmas Gift

REAM • CUT

\$2⁹⁵
POST PAID
3 for \$8.50

DRILL, SAW, REAM... metal, pipe, wood, plastic, Transite, etc. Use with electric drill, slow drill press, lathe, milling machine. Drills own starting hole, upper part of bit is used to cut, saw, ream circles, ovals, squares, scrolls. Easy to use. Ideal for carpenters, mechanics, electricians, plumbers, hobbyists, etc. Abrasive resistant, high speed steel. Flutes ground from solid. Withstands severe continuous use without breaking. Resharpened free. Takes place of up to \$50.00 in tools. 1" diameter, 2" cutting sections, total length 3 1/2". Three types—All purpose, Wood, Heavy Metal. Specify type needed. Set of three \$8.50. Details on request. Shipped same day. Money-back guarantee. Dealer inquiries invited. Order Now. Send Cash, Check or Money Order to
INTERNATIONAL TWIST DRILL CORP. 418 Wyandotte, Rm. 639
Kansas City 8, Mo.

the NEW Estwing

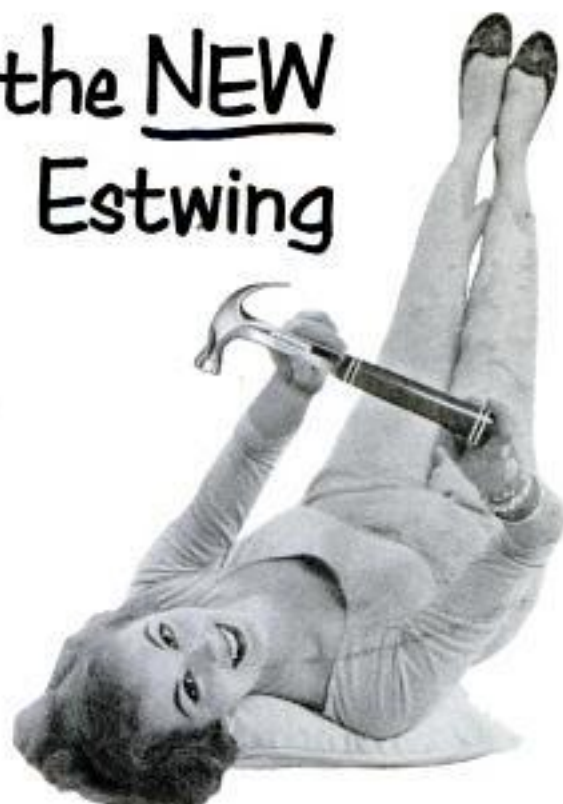

A REAL MAN'S GIFT FOR HOME AND HOBBIES

Estwing makes the world's only ONE PIECE hammers, hatchets and axes. They're GUARANTEED UNBREAKABLE in all normal use. The shock absorbing grip is made of GENUINE LEATHER.



Beautifully gift boxed . . . Ask for ESTWING in either Brite-Chrome or high polish finish at all leading hardware stores.



Send 10¢ for handy nail guide and Estwing catalog.



Estwing Mfg. Co., Dept. 12-M Rockford, Ill.

B.F. Goodrich
ASPHALT
FLOOR TILE



*saves you
time and money*

This low-cost tile withstands the rough treatment youngsters give it — lasts for years. Made in 24 beautiful colors, it can be installed on, above or below grade. You can install it yourself — precision-cut edges and true corners make the job simple, especially when you use the B. F. Goodrich Self-Installation Kit.



Send for **Free** full color folder

B. F. GOODRICH Co., Dept. PM12,
Flooring Division, Watertown 72, Mass.

Name

Address

City..... Zone..... State.....

stills. Black and white prints from the color transparency have found their way into photo galleries. But more important was the insight it gave Northrop's engineers. Caught on film was the Scorpion's mid-air reaction to rocket firing. Clearly shown was the flame pattern, the synchronization between rocket pods, the in-flight behavior of those folded-fin missiles.

No camera mounted on the ship's tail or wing tips could have equaled the results. Nothing else could have told the engineers so precisely what they needed to know. Sam Orr had once again proved jetography the sonic age's indispensable researcher.

No Place for Milquetoasts

Lockheed's Erik Miller shepherded a newsreeler, a gent with a reputation for iron nerves, to Williams AFB to film a spectacular quartet of aerial acrobats—the Acrojets. They caught first glimpse of their subjects as the four F-80s interlocked wing tips and looped, just for the fun of it.

"And you'll be riding right on their tails," a young Air Force lieutenant gestured, briefing, the goggle-eyed newsman. "Not me," he snorted.

So Miller climbed into the forward cockpit of a T-33 jet, borrowed the newsman's 35-millimeter Bell and Howell, and bolted it to the forward gunsight.

"We rode their tails all the way—never more than 15 feet from their rudders," Miller wheezes, remembering. "My pilot had trained with the Acrojets—he was their relief man. He knew all the tricks. I kept to the view finder, directing him, keeping all four jets in the finder. We rolled, looped, dived and climbed straight up to 20,000 feet. Me? I just hung on—too scared to pray."

Back to Earth

Down on the ground Miller handed the unnerved newsreeler his camera and film—and staggered off.

Recently Earl Janda, who shoots high-altitude stuff for North American, was assigned to record a Sabre Jet's instrument panel as the ship broke through the sonic barrier. The close-up was for a Hollywood picture. Janda became first jetographer to trigger a camera at better than 750 miles per hour. He also got considerably more than he'd bargained for.

"Trouble was," he explains, "I hadn't reckoned with negative G-force."

Negative Gs—unlike the positive which multiply a camera's weight—create weightlessness. It's an eerie effect, encountered as a sonic plane arcs into its super-sonic dive.

(Continued to page 262)

POWER

THROUGH
PULLEYS
AND V-BELTS

IDEAS PAY OFF

ORDER this AMAZING BOOK TODAY!

★ **FIRST BOOK OF ITS KIND . . .**

ENTER THIS *Easy Money* CONTEST

Yes we pay you to make something useful and practical for yourself. Devise a useful apparatus or product using a Congress V-Belt drive—submit a photo of it and you qualify for the \$50 Savings Bond to be awarded each month starting January 1956.

Each 6 winners during 1956 will be eligible for a bonus prize of a \$100 Savings Bond. Duplicate prizes will be awarded the dealer who certifies the contestant's entry form.

Make something useful and make money, too. There's an entry form in every book, so get started now.

This book is packed with information every mechanic should know about pulleys, v-belts, drives, bearings and includes easily understood formulae and technical data. Illustrations show a wide variety of useful products using v-belt drives. It's full of "do-it-yourself" ideas.

MAIL THIS COUPON TODAY!

CONGRESS DRIVES DIVISION, TANN CORP.
3750 E. Outer Drive, Detroit 34, Mich.

Gentlemen:

Enclosed is 25c—please send me the book "POWER Through PULLEYS and V-BELTS"—also contest entry form.

Name _____

Address _____

City _____

CONGRESS

Since 1914



ELECTRIC WELDER

AC or DC
110 Volts

The "Little Marvel" all-metal welder, 5-year written guarantee. Welds 1/4" metal or money back. Repairs tanks, tools, fenders, machine parts, etc. Complete with everything—rods, unit, eye shield, directions. \$6.95

plus 50c postage. Flame torch accessory for soldering, cutting, brazing \$3.95 complete with carbons, brass rods, flux. \$2.00 Deposit on C.O.D. 75 ampere 1/4 inch Transformer Welder \$21.95 F.O.B.

ESSAY MFG. CO., Dept. 51, Quincy 69, Mass.

\$6.95
Com-
plete

NEW! AUTOMOTIVE CATALOG

Giant 1956 Edition! Everything for car, truck, custom-styled car, hot rod . . . at **LOWEST PRICES!**

Save up to 50% on all parts, accessories! Only complete automotive buying guide. . . 50,000 items . . . 164 pages! Thousands of **hard-to-find parts**; equipment, parts for 1920 to 1956 models; **Holly-wood accessories** never before offered; **hi-speed parts**. Send your name and address and 25c (refundable with first \$5.00 order) to:

J. C. Whitney & Co., 1917 Archer, Dept. P-12, Chicago 16, Ill.



Hint for This Most Practical, Creative Gift!

Mall

22-PIECE HOME-SHOP DRILL KIT

Only
\$29.95
Complete



Model 1000 & 1 B

Enjoy a home-shop hobby. Save money on home repairs. Do these things quickly and easily with the new MALL Home Economy Kit.

It's designed and precision built to help anyone produce fine work. The MALL Kit features a high-speed electric drill with geared chuck and ball bearing. Handles many jobs such as drilling, sanding, polishing and stirring paint. And it powers many other attachments.

Hint for this basic MALL power tool set for your Christmas gift. Or give this long-remembered gift to another man in your family.

SEE YOUR MALL DEALER FOR TIME-SAVING POWER TOOLS

MALL TOOL COMPANY PORTABLE POWER TOOLS
GASOLINE • ELECTRIC • AIR

7805 South Chicago Ave., Chicago 19, Illinois

Please send me FREE literature about the MALL Home Economy Kit—Model 1000 & 1 B.

Name _____

Address _____

City _____

State _____

HU-198

CUT PERFECT GROOVES WITH *Warren* WASHERS ON YOUR SAW BLADE!

NOT ONE — NOT TWELVE — BUT 40 DIFFERENT CUTS

Engineered to cut clean, accurate, parallel grooves—just dial the desired width—40 micromatic adjustments—leave on saw for straight cuts. **GUARANTEED.** At your dealers or order direct. Arbor sizes 1/2", 3/4", 1". Send for free booklet

WARREN WASHERS COMPANY

Dept. 32, Box 98, North End Station, Detroit, Michigan



UNIT
\$4.95
per
unit

DECEMBER 1955

Copyrighted material 261

BUY SHOPMATE!

You Get All These Features!

COMPARE, point for point, and you'll see how much more do-it-per-dollar you get with *Shopmate*, PET's Big Value brand.

No. 740-6 Shop-Toter Drill and Saw Kit

New 1/4" gear-chuck drill with powerful motor; ZP-1 Drill Saw turns drill into portable saw. Welded steel tote

case; complete accessories for drilling, sawing, sanding, polishing. Big-value price, only **\$34.88**.

No. 740-5 Shop-Toter Drill Kit. Same as kit above but without ZP-1 Saw. Another Big Value, only **\$27.88**.



CHECK ✓ These Shopmate Features

- ✓ Powerful New 2-amp. AC-DC Motor
- ✓ Accurate Geared Chuck
- ✓ All-Steel Welded Shop-Toter Case
- ✓ Complete Accessory Set, including 12 sanding discs, polishing bonnet, grinding wheel, muslin pad, 7 drill bits.

No. 620 Shopmate Clutch Saw

Features exclusive Pet-O-Matic Slip Clutch. Powerful motor; guide, guard. Cuts dressed 2 x 4s at 45°. Biggest Saw value today.

Only **\$48.88**.

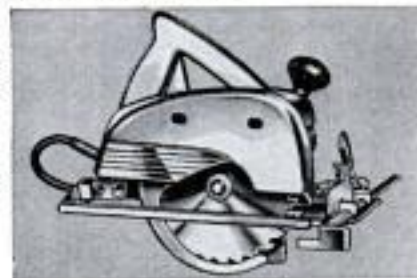

CHECK ✓ These Shopmate Features

- ✓ Powerful 4800 RPM Motor
- ✓ Cuts 2 x 4s at 45° (6 1/4" blade)
- ✓ Exclusive Pet-O-Matic Clutch eliminates kick-backs and motor burn-outs
- ✓ Depth of Cut at 90°, 0 to 2 1/8"
- ✓ Telescoping Safety Guard
- ✓ Graduated Adjustable Rip Guide



When you buy, take this ad with you as your buying guide to Shopmate values! Compare, and be sure!

Made by Portable Electric Tools, Inc.
320 West 83rd St., Dept. PM, Chicago 20

Camera focused, Janda was readying to open fire when "weightlessness" set in. Janda stared incredulously as a pack of cigarettes floated above the dashboard. His meter, slung around his neck, rose phantom-like, jabbing his jaw. Around the cockpit floated his battery case, auxiliary camera, a half dozen film magazines. With one hand he slapped at the meter. With the other he lunged for his gear. Seconds later things settled down—as a walloping positive G-force set in.

"We busted through Mach 1.0," Janda's pilot chirped.

Too Busy to Shoot

"Mach 1.0!" the jetographer groaned. "I was so busy beating off all that floating stuff I didn't even trigger the shutter!"

Northrop's flight-status photos have pioneered special gadgets and techniques to make their job easier. View finders, designed to get close to the crash helmet, aid focusing. Jetographer Paul Wheeler, an eight-year veteran to sonic photography, has installed his Speed Graphic with a stronger trip-spring, a more powerful solenoid—to prevent G-forces from prematurely triggering the shutter. Cameraman J. L. Wilkinson, a motion-picture specialist, shoots movies at 32, 48, even 64 frames per second (instead of the usual 24) to slow the action, smooth out high-altitude turbulences. Wilkinson simulates "night" shots by shooting in daylight, using Kodachrome type A without a filter, his lens closed-down about 2 1/2 stops from the daylight meter-reading. That way, the sky comes out under-exposed, prints black and "nightish."

If there's any "secret" to sonic photography, it's that it takes a jet to catch—and pace—a jet. With subject and camera planes holding the same relative speed and position, jetographers can often shoot slow—1/100 second at f 4.7 for color stills: 1/100 to 1/400 for black and white. Dives and spins take a bit more doing, and considerably faster shutter speeds.

"Gadgets and techniques help, of course," explains a Lockheed jetographer, "but Lady Luck still accounts for many of the best shots." ★ ★ ★

Porcelain-on-Aluminum Tile

Wall tile of porcelain fused to aluminum can be used when a lightweight wall covering is required. Its glass-hard finish cleans fast, resists chemicals, fire and scratches. The tile and mastic together weigh less than 18 ounces per square foot. It is easy to install, can be cut and bent to fit, and is said not to chip or craze.

SHOP by MAIL and
Save
at GROBAN'S

SURPLUS & NEW MANUFACTURE EQUIPMENT
- FOR HOME, FARM & FACTORY -
All items unconditionally guaranteed!

**RUGGED! 20 TON MASSIVE!
CAPACITY
HYDRAULIC CYLINDER**

- ALL STEEL CONSTRUCTION
- 7 1/4" BORE-15" STROKE
- DOUBLE ACTION



ITEM #1715
• 41,300 LBS. PRESSURE WITH 1000 P.S.I. PUMP OUTPUT.
• UP TO 70,000 LBS.—CAPACITY ON INTERMITTENT SERVICE.
• SOLID STEEL 2 1/2" PISTON ROD
• 1" PORTS
• OVERALL DIAMETER-10 1/2"
• DISTANCE BETWEEN CENTERS-28 1/4" CLOSED-43 1/4" OPEN.

IDEAL FOR:
• HYDRAULIC PRESSES • DUMP TRUCK BEDS • TD-18, TD-24 INTERNATIONAL HARVESTER DOZERS AND GRADERS • LEVELING RAMPS • INDUSTRIAL MACHINERY • ROAD MACHINERY • FARM MACHINERY • HYDRAULIC TAIL GATES
Replacement cost—\$260.00.
Shipping Wt.—155 lbs.
SPECIAL PRICE
F.O.B. Chicago..... **80.00**

**GROBAN FOUR-WAY
OPEN CENTER HYDRAULIC
CONTROL VALVE**

ITEM #126 — Four-way open center control valve, with built-in adjustable relief valve factory set at 1000 P.S.I. Spring loaded neutral position. For use with one double acting cylinder in neutral position.



in neutral position cylinder is locked and pump unloaded. Can be used as single unit or mounted in series. Has 3/4" pipe thread inlet and outlet. 1/2" pipe thread cylinder ports. Finger grip handle. Ship. wt. 10 1/2 lbs. **AN OUTSTANDING BUY!**
F.O.B. Chicago **21.50**

**MULTI PURPOSE
HYDRAULIC PUMP
OR MOTOR**

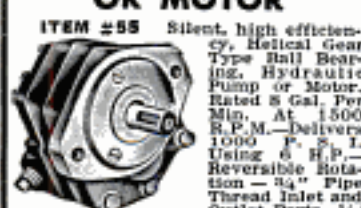

ITEM #55 Silent, high efficiency. Helical Gear Type Ball Bearing. Hydraulic Pump or Motor. Rated 8 Gal. Per Min. At 1500 P.S.I.—Delivers 1000 P.S.I. Using 6 H.P.—Reversible Rotation — 3/4" Pipe Thread Inlet and Outlet Ports—1/2" Drain Port—3/4" shaft with keyway and flat for either direct or pulley drive. Dimensions—5 3/4" high, 7 1/4" long, 5 1/4" wide. Shipping weight 18 lbs.
F.O.B. Chicago..... **45.50**

**FACTORY-TO-YOU-VALUE
PORTABLE ELECTRIC
LIGHT PLANTS**



POWER TO OPERATE:
• Electric Saw, Electric Drills, Pipe Bender.
• Refrigerator, Deep Freezer, Incubator.
• Water Pump, Radio, Lights, Air-conditioner.
BRAND NEW 1956 ITEM #1008
COMPACT — FITS IN THE TRUNK OF YOUR CAR
1000 WATTS OUTPUT, continuous duty. 115 Volts A.C. 60 cycles. 9 amps. Powered by husky, easy starting Clinton engine. Engine and generator operate at 3600 R.P.M. for maximum efficiency at minimum weight. Both units are mounted on steel base, with heavy sheet metal belt guard. Generator is self regulating, and is equipped with outlet box containing fuse and 2 A.C. convenience receptacles. Cost only 5c an hour to operate. Dimensions: Length 20 1/2", Width 12", Height 16". Shipping wt. 100 lbs. F.O.B. Chicago..... **149.50**
700 WATT-GENERATOR SET—same as above, slightly smaller—with Briggs-Stratton Engine—Model 708—F.O.B. Chicago..... **129.50**

**A. C. ELECTRIC
GENERATOR**



7 1/2 K.W. (7500 WATTS) single phase.
ITEM #110/220 volt output. 3 wire system, 2 bearing construction. 5 groove 6" V belt pulley included. Self-excited. Foot mounted. Drive generator from tractor or stand by engine. Ample power for 6 room house. Dimensions: 34" x 11 1/2". Shipping Wt. 420 lbs. F.O.B. Chicago... **295.00**

Complete control box for these generators includes A.C. rheostat, automatic voltage regulator, field rheostat, and voltmeter, already wired and ready to connect to generator. List price \$167.00. Our Price **56.45**

**BRAND NEW 1 H.P.
12 Volt Electric Motor**

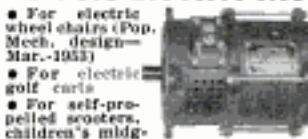

• For electric wheel chairs (Pop. Mech. design—Mar.-1953)
• For electric golf carts
• For self-propelled scooters, children's midget cars.
ITEM #308
Rated 1 H.P.—100 amps, 6000 R.P.M., 12 volts, D.C.—This double shaft motor of ball-bearing construction may be run on 6 volts for lower horsepower requirements.—Standard 3/4" shafts, nut and bolt electrical terminals, flange mounting.—Dimensions: 7" x 4 1/2" x 4 1/2". Ship. wt. 19 lbs. A real **12.50** F.O.B. Chicago

**300 AMP. D. C. GENERATORS
IDEAL FOR WELDING GENERATOR**



Type R-1, ITEM #91
rated 300 Amps.—30 Volts. Mfd. by Jack & Heints, Government Acquisition.
Cost \$189.00. Ship. wt. 55 lbs. Dimensions: 16" x 10" x 7". Complete with instructions to connect as Welder. F.O.B. Chicago..... **35.00**

ITEM #90 — When connected as a welder, this unit will deliver 200 amps for a sustained period and 250 amps for intermittent service. This generator is widely used for shop-built portable welders. Rated 200 amps, 28 volts, 2500 R.P.M., using 10 H.P. Dimensions: 15" L. x 6" W. x 8 3/4" H. Splined drive shaft. Gov't. Acq. cost \$300.00. Ship. Wt.: 51 lbs. F.O.B. Chicago... **22.50**

**ORDER DIRECT FROM AD
SATISFACTION GUARANTEED**
Send Payment Or
Purchase Order Today

FREE! — NEW CATALOG
1956 EDITION, 52 PAGES, chock-full of unsurpassed War Surplus Equipment Bargains for farm, home, factory, workshop. Write letter today.

**Brand New! 5-TON BLACKHAWK
HYDRAULIC LIFT KIT**

New Only **38.95** Complete

The Complete Kit
For — • Dumping farm wagons • Adjusting depth of plows • Hydraulic press • Hydraulic jacks • Snow plows.



COMPLETE KIT PRICE F.O.B. Chicago **38.95**
ALL OF ABOVE INCLUDED

**Brand New — U. S. Navy Cost \$146.00
OBERDORFER Self-Priming
BRONZE PUMPS**

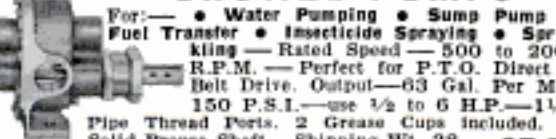

For — • Water Pumping • Sump Pump • Fuel Transfer • Insecticide Spraying • Sprinkling — Rated Speed — 500 to 2000 R.P.M. — Perfect for P.T.O. Direct or Belt Drive. Output—63 Gal. Per Min. 150 P.S.I.—use 1/2 to 6 H.P.—1 1/4" Pipe Thread Ports. 2 Grease Cups Included. 1" Solid Bronze Shaft—Shipping Wt. 38 Lbs. Save 118.50 F.O.B. Chicago.... **27.50**

To place phone orders call Webster 9-3793

GROBAN SUPPLY CO. Dept. PM-12
1139 S. WABASH AVE., CHICAGO 5, ILL.

Say You Saw It in Popular Mechanics

MAGNETS

ASSORTED MAGNETS with big list of handy uses..... 5 for \$1
POWERFUL POCKET MAGNET ideal for testing metals..... \$1
RETRIEVING MAGNET pulls tools, etc., from tank or lake..... \$4
HOT PAD MAGNETS to insert in your own hot pads..... 8 for \$1
BULLETIN BOARD MAGNETS to "pin-up" memos, etc..... 8 for \$1
EXPLORE, LEARN—Electricity, Magnetism, Electro-Magnets. Complete kit and instructions with 22 experiments and models..... \$3.98
FREE CATALOG, 100% satisfaction guaranteed..... POSTPAID
PARK MAGNETS, 2512, 1557 GREENBAY RD., HIGHLAND PARK, ILL.

MONEY for MEN ALL FREE

THE PLASTEX Industry needs manufacturers on small scale and for big production of Lamp and Clock Stands, Art Goods and Novelties in Plastex and Marble imitation. Experience unnecessary. The material makes regular 10c store sellers. Rubber moulds furnished for speed production. Small investment brings good returns. We are now placing big Chain Store Orders with manufacturers. Ambitious men have chance for real prosperity. Our Free booklet will interest and benefit you.
PLASTEX INDUSTRIES, Dept. A
3400 Third Ave. New York 56, N. Y.



IRWIN

SANTA CLAUS SPECIALS

for the home handy man, hobbyist, teen-age and professional woodworkers

No. DM(x)

Borchest Set
only **\$15.50**



13 Irwin original solid center auger bits, sizes $\frac{1}{4}$ " to 1". Beautiful hand rubbed oak chest in Christmas box with colorful gift card and transparent lid. Patented spring-steel clips hold bits in place. Sizes shown for easy selection. Each bit hardened full length for longer life.

No. 22(x) Micro-Dial Expansive Bit



only **\$3.15**

It bores accurately from $\frac{1}{8}$ " up to 3". Change sizes with easy turn of dial. Two cutters supplied with each bit.

Drop forged from special bit steel, heat treated full length. A dependable all-purpose bit that does the work of a complete set of individual sizes.

See Your Independent Hardware Dealer

IRWIN the original solid center auger bit
Wilmington, Ohio screw drivers, screw driver bits

HERE IT IS

A TOP-QUALITY RESIDENTIAL GARAGE DOOR OPERATOR FOR

only

\$98.00
COMPLETE & READY TO INSTALL

JUST A PUSH OF A BUTTON OPENS AND CLOSES YOUR GARAGE DOORS AUTOMATICALLY



with the **NEW**

Rich-Wil

98

Never before has such a top-quality work-saving appliance been available at such a low price... eliminates stooping, bending and "back-breaking" lifting. Quickly and easily installed by the do-it-yourself homeowner... Simply install in position and plug into household current. Works on all 8' to 18' one piece and sectional overhead doors with TRACK-TYPE hardware. Working parts enclosed in attractive, modern cover.

RESIDENTIAL GARAGE DOOR ELECTRIC OPERATOR
GUARANTEED CONSTRUCTION

WRITE TODAY FOR COMPLETE INFORMATION

RICH-WIL DIVISION
of Richards-Wilcox Mfg. Co.
4002 THIRD ST. • AURORA, ILL.



Ice Depot for Model Trains

Ice depots for refrigerator cars are the latest development in model railroads. When you press a button, the hatch on top of the refrigerator car opens and a little man on the platform pushes simulated ice cakes into the car. Release the button and the car hatch closes. The ice cakes are removed through the side door.

Antiglare Shade

Motorists can cut the sun's glare by pulling a transparent amber-colored shade down across the windshield. Quickly lowered or raised, the unit works like a window shade. Installed with a screwdriver without drilling any holes, it mounts at the top of the windshield molding and is held in its lowered position by a clamp.

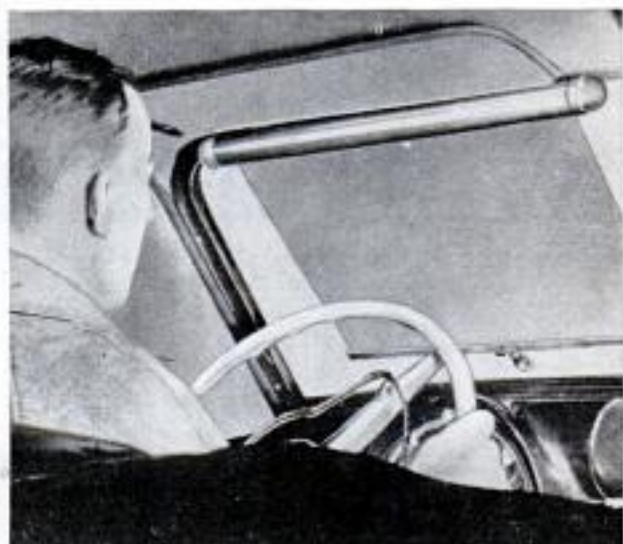

A new material for home craftsmen... NOVOPLY!



Versatile extending coffee table, #452 (50c)



Record storage cabinet, #436 (50c)



Sewing table-desk, #543 (50c)

Use Novoply to make 3 projects shown! Send coupon today for famous Easi-Bild® Patterns and get Easi-Bild's big catalog—shows over 200 handsome pieces you can make. Patterns give step-by-step illustrated instructions—take the guesswork out of build-it-yourself.

NOVOPLY® by Weldwood®

a product of

UNITED STATES PLYWOOD CORPORATION

Weldwood—The Best Known Name in Plywood

Handsome, textured NOVOPLY gives "fine furniture" look, is low in cost, works easily with all tools

Now build your own beautiful furniture with Novoply, the new do-it-yourself material that costs about the same as ordinary fir plywood.

Easy-to-work Novoply is smooth and flat, good both sides, has no grain direction to worry about. Its warp-free qualities make it perfect for sliding doors, drawers, cabinets, table tops. Novoply looks well natural or stained; comes in many sizes, in 3/8" and 3/4" thicknesses, in pine and in California redwood.

See Novoply soon at your lumber dealer's—and while you're there ask about Weldwood hardwood panels in birch, walnut, mahogany, oak and other fine woods—for wall paneling and furniture.

WT. M. REG. EASI-BILD PATTERN COMPANY

UNITED STATES PLYWOOD CORP.

Pattern Dept., P.O. Box 215, Pleasantville, N. Y.

By return mail please send me the following patterns. I enclose \$....

#452, table.....50c () #543, desk.....50c ()

#436, cabinet.....50c ()

Also send Easi-Bild Pattern catalog.....35c () PM 12-5

NAME.....

ADDRESS.....

CITY.....STATE.....

SMALL! POWERFUL!

ECONOMY TRACTOR

Unequaled value! Low price! America's finest tractor. Ruggedly built. Easy to operate. 790 lbs. Borg-Warner clutch, trans. and diff 140 to 1 reduction. 40% more drawbar pull than ordinary tractors 8-1/4 H. P. engine. 20 quick change implements. HOOD, FENDERS.

Thousands in Use Write for complete details.

Engineering Products Co.
915-K-12 Niagara Ct.
Waukesha, Wisconsin

Now is the time to change your oil and filter.

Protect your home against power interruptions with an...

ONAN Emergency ELECTRIC PLANT

Provides dependable stand-by electricity for heating system, pumps, freezer, lights, appliances. Keeps home safe, livable. Automatic start and stop. Find out how little it costs!

Write for Folder!

D. W. ONAN & SONS, INC.
3317 University Ave. S. E. • Minneapolis 14, Minnesota

A SIZE FOR EVERY NEED
400 to 75,000 watts.
Compact, quiet-running,
easy to install. Gasoline engine powered.

For the gift that packs **MAN-MAGIC!**

DOES MORE JOBS EASIER — THAN ANY OTHER TOOL MADE!

WISE-GRIP

A gift to make any man happy, handy, "hep" at his fixin'! A whole tool kit — in one tool! Jaws lock onto work with one-ton pressure. Quickly adjust — for use as a Super-Pliers, All-Purpose Wrench, Clamp and Wire Cutter. 7" and 10", cutter optional. Only \$1.85 to \$2.60 at your hardware store.

PETERSEN MFG. CO., Dept. M-12, DeWitt, Nebr.

Do more jobs better
 ... in less time...
 at lower cost
 with an Atlas

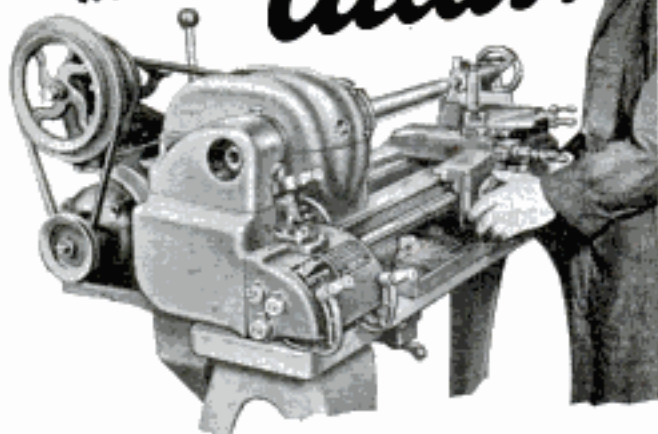

10" QUICK-CHANGE LATHE

For experimental, development and hobby work . . . or small parts production, ATLAS Precision Lathes give you many more important features that increase accuracy, speed production and cut costs than any other lathes in the lower price field!

They're the only low-cost 10" and 6" lathes to give you the precision and dependable service of Timken Tapered Roller Bearings! The ATLAS 10" Quick-Change Lathe (illustrated above) with instant selection of 54 threads or feeds, instantly reversible power cross and longitudinal feeds, 16 spindle speeds, V-Belt drive, massive precision ground bed, 5 7/8" swing over carriage and 4 to 240 threading range assure you far greater ease and speed of operation, and a much wider work range than any other lathe at or near its low price!

A feature by feature comparison will be a revelation to you! Before you buy, see your nearest ATLAS Dealer . . . use coupon below for latest catalog.



TIMKEN TAPERED ROLLER BEARINGS



QUICK-CHANGE GEARS



HEAVY-DUTY PRECISION GROUND BED

ATLAS 6" - 10" LATHES PRICES START AT **\$159.50** F.O.B. Factory



DEPENDABLE QUALITY TOOLS SINCE 1911

SEND FOR FREE CATALOG

ATLAS PRESS CO., 12-24 N. Pitcher St., Kalamazoo, Mich.
 Please send latest information on ATLAS Tools.

- 10" Lathe; 6" Lathe; Drill Press;
 Miller; Shaper; Grinder-Hone

NAME _____

ADDRESS _____

CITY, STATE _____

'55 Thunderbird Owners Like Performance And the '56 T-Bird Will Provide Even More

(Continued from page 105)

—New Mexico civil-service worker.
 "I like its smallness. I drove big cars for 14 years. Don't expect to go back to a big car ever."—Arizona editor.

"Its compactness and privacy without a back seat. No more back-seat passengers to burn upholstery and abuse car."—Wisconsin executive.

"I no longer enjoy driving any large car."—California lawyer.

And the Complaints

Although Ford has changed the Thunderbird for 1956 in some respects, it has not corrected everything the owners complained about as you will see by reading the following quotations (listed in order of frequency of mention by the 1955 owners):

"In soft-top frame, there's a bolt that cuts into the fabric when it is folded back. It happened to mine and later I saw the same one-inch cut on two others."—New York owner.

"I don't think the factory should charge for a top. One or the other should be standard equipment."—Colorado cashier.

"Soft top is not good enough for \$290 more."—Massachusetts truck driver.

"Doors rattle when hardtop is removed."—California retired owner.

"Everything under the hood is great. The body is something else. Lots of minor things that should not go wrong on a \$4200 car."—California advertising man.

"Window handles actually bend. Dealer strengthened handles by brazing a bead to them. Biggest complaint is poor assembly."—Arizona sales manager.

"Too much heat comes up through floor board."—Ohio student.

"Extreme distortion in bends of windshield can induce eye strain and dizziness."—Colorado jobber.

"Original power brakes were very difficult to operate. My dealer changed to another type at no cost to me."—Missouri doctor.

"Have replaced brake linings, brake drums, and have had many adjustments, but brakes still cause pull or swerving when applied."—New York mechanic.

"I have to drive with the seat all the way back and it tends to lock there."—Maryland naval officer.

"Seat sticks in far-back position."—California employment consultant.

"Service is miserable. Since it has the

(Continued to page 268)



ANNOUNCES

**THE WORLD'S FINEST
STEERING SYSTEM**

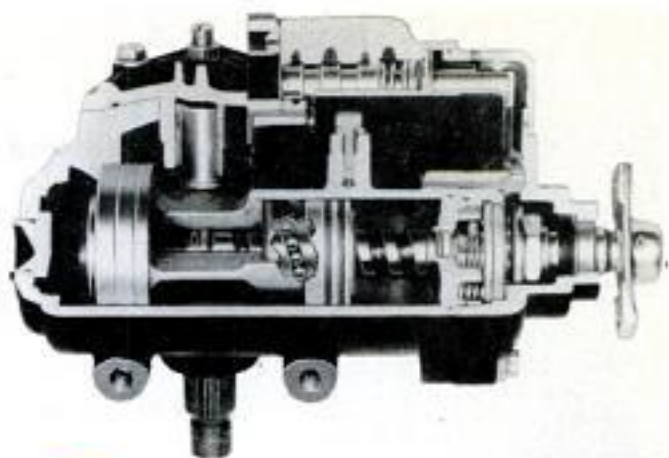

new

Safety POWER STEERING

by **Saginaw**

WITH **3** MAJOR IMPROVEMENTS FOR 1956 !



1 TWICE-AS-EASY PARKING. Revolutionary new valve design cuts maximum manual effort in half. It never exceeds 5 lbs.

2 GREATER ROAD STABILITY. New system helps hold car "on course"—assures even more secure "road feel" than ever.

3 RELAXING NEW RESPONSE. Lower-ratio wheel responds more effortlessly—reduces mental and physical fatigue.

NEW "FROM THE GROUND UP"

A completely redesigned, simplified In-Line system with only 49 parts and basic improvements in steering geometry beginning right at the front wheels. Every part has been specifically engineered for *power steering*.

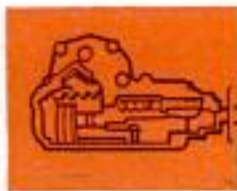

AUTOMATICALLY HELPS HOLD CAR "ON COURSE"—Precision pre-load built into ball-nut-and-worm assembly helps keep wheels centered straight ahead.

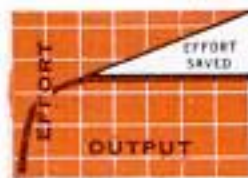

AUTOMATICALLY LIMITS MANUAL EFFORT WHILE PARKING. New reaction-limiting valve cuts in whenever turning resistance reaches predetermined point; increases power assistance to lower manual effort.

**MAIL COUPON TODAY
FOR FREE BOOKLET!**



Saginaw Steering Gear Div.
General Motors Corporation
Saginaw, Michigan (Dept. 368)

Please send free facts booklet on your NEW Safety Power Steering System

NAME _____

ADDRESS _____

CITY _____ ZONE _____ STATE _____

PENTA*

preservative keeps homes
sound, saves costly repairs



in insulating—building board

When you build your home be sure you're getting the added protection of insulation and building board that's fully protected against rot, mold, mildew and termites. Leading manufacturers ensure longer board life by treating with *PENTACHLOROPHENOL preservative. Clean, odorless PENTA keeps board sturdy longer, helps it in such applications as sheathing, siding, roof decking, lath. Make sure the board you buy is PENTA-treated; ask your building supply dealer. You'll be glad you insisted. For FREE BOOKLET, write to THE DOW CHEMICAL COMPANY, Dept. PE 873QA, Midland, Michigan.

you can depend on
DOW CHEMICALS



Mercury engine, it should be serviced by Mercury dealers."—New York artist.

"Ford dealer doesn't know the first thing about repairs or maintenance of the Thunderbird."—New York sales manager.

"On rough roads there is considerable wobble in the windshield, dash and doors, with the top off. During a hard rain, water runs into the car from under the doors."—Ohio supervisor.

"Hard top does not fit. Takes five men to get it back on after removing it. One has to sit on the top to hold it down."—Kansas advertising man.

"Carburetor is a mess to keep in tune."—Utah salesman.

"Speedometer hard to read and not accurate."—California mechanic.

"Would rather have gauges than lights for ammeter and oil pressure."—Florida musician.

"Glove-box latch is difficult to use. When door opens, contents are dumped. Performance could be increased by using a four-speed gearbox and proper rear-end ratio."—Wisconsin engineer.

"Needs a more radical cam to make more use of the big displacement. I have been beaten by smaller-displacement stock sedans equipped with power packs."—Alabama television engineer.

"I have left-leg trouble due to the angle of the floor and seat. My heel rests on the floor, but the toe has no support."—California technician.

"The only thing that I don't like are the extra-big taillights. They are too large for the size of the body."—North Dakota farmer. (For 1956, they are even larger!)

More Best-Liked Features

"Distinctive. Hottest conversational piece since the original Continental. Even the burble of the exhausts is artfully conceived. Car will become a collector's item."—Connecticut author.

"It has an air about it that no sports car can match. Every extrovert should have one! I just don't mind those monthly payments, for every time I step into my Thunderbird I feel it's so worth it."—California fashion artist.

"Getting better than 20 miles per gallon on long trips."—Ohio supervisor.

"Large displacement engine eliminates the peak tuning required on foreign jobs."—Florida loan adjuster.

"A fine answer for those who want a high-performance car but do not wish to race."—Virginia art director.

"My wife and I both have a great deal of pride in this machine. Each trip has been a pleasing experience. With it, more people

(Continued to page 270)



Gifts from SKIL...for You Mean Christmas all year long for the family!



Famous SKIL Tools help you build for your family. Power-plus and professional features let you handle big jobs in the home. Build a rumpus room! Fix the stairs! Make a cabinet! Finish the basement! SKIL Tools let you give your family *more!* Here are Christmas gifts for you that mean *family fun all year long.*

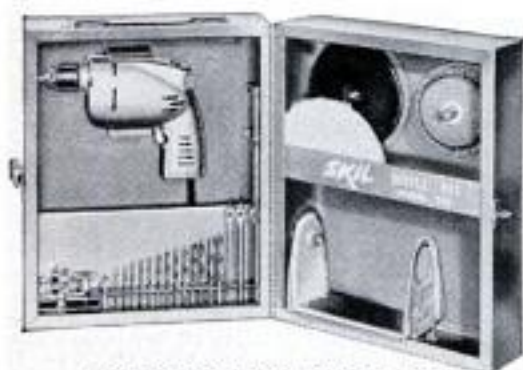

32-PIECE SKIL DRILL KIT Model 515 . . . Only \$39.95.

A whole workshop in one handy kit! 32 great tools including a powerful $\frac{1}{4}$ " SKIL Drill with geared chuck. Sand, polish, drill, buff, mix paint . . . all with the same SKIL Tool. You get all this:

Model 549 SKIL Drill with geared chuck . . . Drill Stand . . . Rubber Disc Pad . . . Polishing Bonnet . . . 5 Sanding Discs . . . 2 Arbor Adapters . . . Paint Mixer . . . Grinding Wheel . . . Wire Brush . . . Counter Sink . . . 3 Wood Augers . . . 13 Drill Bits . . . Wall Type Carrying Case.

LEARN ABOUT THE FUN SKIL TOOLS OFFER. SEE THEM AT YOUR HARDWARE, DEPARTMENT OR APPLIANCE STORE.

SKIL

BUILDERS TOOLS

Made Only by SKIL Corporation, formerly SKILSAW, Inc. 5033 Elston Avenue, Chicago 30, Ill. 3601 Dundas Street West, Toronto 9, Ontario. Factory Branches in ALL Leading Cities



6" SKIL SAW Model 526 . . . Only \$49.50.

All the exclusive SKIL features and the power of many professional saws. Sawing jobs become simple for you. Make kitchen cabinets, build a fence or finish the basement. Just look at these professional features SKIL offers:

- 6,100 r.p.m. powerful 8 ampere motor
 - Trigger switch for right or left hand control
 - Automatic safety guard
 - Tilts to 45 degrees for bevel cuts
 - Quickly converts to a bench saw
 - Extra powerful A.C.-D.C. Universal Motor
 - Rugged die cast aluminum housing
- Other models as low as \$29.95

NEW $\frac{1}{4}$ " SKIL DRILL Model 535 . . . Only \$19.95.

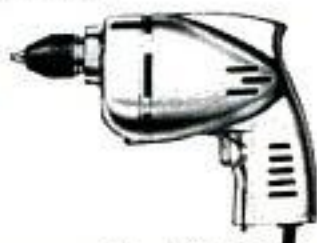

Lowest price ever for a famous quality drill. Here is the greatest tool investment you could make. Power to drill through $\frac{1}{4}$ " steel or $\frac{1}{2}$ " hard wood. Use it for hundreds of jobs, in the home, the garage or the basement. Look at these features:

- Famous Keyless Chuck
 - Self-Lubricated Bearings
 - Hardened Steel Gears
 - Pistol-Grip Handle
 - Powerful Motor
 - 2500 r.p.m. Speed
 - Trigger-Type Switch
 - Only 3 $\frac{1}{2}$ Lbs.
- Other models up to $\frac{1}{2}$ "

PENTA^{*} preservative

saves costly home repairs



in sash and exterior millwork

Your windows and doors and exterior millwork, too, will last years longer when *PENTACHlorophenol-protected against rot and termites. Your lumber dealer has or can get PENTA-treated sash and millwork right away; tell him that's what you want. Get helpful FREE BOOKLET by writing to THE DOW CHEMICAL COMPANY, Dept. PE 873QB, Midland, Michigan.

you can depend on
DOW CHEMICALS



NEW *Lynx* THREAD KIT SAVES DOLLARS IN REPAIRS AND REPLACEMENTS

Loose, worn or damaged threads are costly—cause scrap, downtime, and poor performance. Now for the first time, it's easy as A-B-C to replace these threads quickly and economically. Use Lynx* Thread Kit! All you do is (A) drill out the hole; (B) tap new threads with tap provided; and (C) wind in Lynx stainless steel inserts, using inserting tool provided. You get a permanent, back-to-original size, stronger-than-ever repair made in minutes! Wonderful for screen doors, storm doors, furniture, lawn mowers, engines, door hardware, wood joints, boats—hundreds of uses!

Each Lynx Thread Kit contains two drills, two taps, two inserting tools and supply of stainless steel wire thread inserts for most household uses—and complete instructions!

Send check or money order—no C.O.D.'s. Money back if not completely satisfied. *Reg. U.S. Pat. Off.



HELI-COIL CORPORATION
752 Shelter Rock Lane, Danbury, Conn.

Please send me a Lynx Combination Thread Kit postpaid: \$6 value for \$4. (Sizes 10-24 and 1/4-20). Covers 90% of household uses. I am enclosing \$4.

Name _____

Address _____

City _____ Zone _____ State _____ 1937

can enjoy, once again, a pure touring thrill."
—California architect.

"Adjustable steering wheel and seat height are good for me since I am short."
—Michigan artist.

"Everybody stares at the Bird, including the young ladies."
—California researcher.

"Was unable to find a suitable sports car because I have two small children. Seat is wide enough for the whole family."
—Texas cabinetmaker.

"On ice and snow the T-Bird is safer than the stock cars. I certainly feel safer."
—Ohio boltmaker.

Is It a Sports Car?

Many of the Thunderbird owners have owned foreign sports cars. To find out what they, as experienced sports-car owners, think of the American version of the sports car, we asked them to make a comparison. Here are some typical answers:

"I don't consider the T-Bird a sports car, but having had a Jag, I don't want one. The Bird is a great compromise and could be better with a little modification."
—New Mexico student.

"I have owned an MG. It is a true classic sports car. Enjoyed it every second. But the Bird is a very good family man's compromise."
—Florida naval aviator.

"I consider this a luxury passenger car of sports-car appearance—not to be confused with sports cars modified for competition. For competition, the Thunderbird should be stripped of 500 or more pounds of luxury appointments."
—California engineer.

"To sum up, the T-Bird is neither an outstanding sports car nor is it an excellent passenger car. It falls in between. I cannot see why Detroit builds compromises all the time."
—Ohio mechanical engineer.

"I have owned a Jag and an Austin-Healey. There is no comparison with the Thunderbird, which is a cut-down convertible."
—Wisconsin designer.

"One must realize that the Thunderbird is a compromise between the road racer and the family convertible. The compromise was extremely well done. The transmissions available are such that you must choose the least objectionable. The overdrive ratio is extremely bad—so low that the engine cannot develop full horsepower at high speed. However, by learning new techniques, the owner can handle the automatic transmission fairly well in cornering."
—California engineer.

"Thunderbird not finished as nice, nor is it as rigid, but will accelerate with the Jag and it's not so temperamental."
—Oklahoma store owner.

(Continued to page 272)

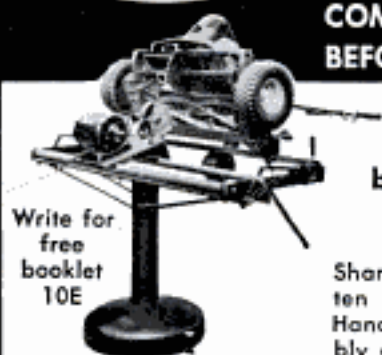
MODERN**LAWN MOWER SHARPENER****COMPARE
BEFORE YOU BUY**

Write for
free
booklet
10E

Oil remains in engine while sharpening. Bed knife sharpened in same centers — no attachments needed.

Start your own business—**increase your income**

Sharpens any mower in ten to twenty minutes. Handles complete assembly of all reel types including 36 in. power mowers. Handle, wheels, roller, and engine are not removed.

\$26300**MODERN MFG. CO.**

F.O.B. PASADENA

160 N. FAIR OAKS, PASADENA, CALIF.

ONLY
\$495
Boat included
FREE FOLDER

**BOAT KITS**

12 Models as low as \$39.95 (freight included). Fiberglass boat covering kits, marine supplies, etc. Free folders.

TAFT MARINE WOODCRAFT

DEPT. PM-12 636-39th Ave. N.E., Minneapolis 21, Minn.

BUILD D.C. WELDER!

WE SHOW YOU HOW to build this powerful welder without rewinding. Uses most any surplus aircraft generator. Produces 75-150 amps. Easy to build. **PLANS 35c** includes NEW booklet "HOW TO WELD," and **FREE WAR SURPLUS AND ELECTRICAL CATALOG.**

**LEJAY MFG. CO., 1247 Le Jay Bldg., Minneapolis 8, Minn.****MACHINE TOOL RECONDITIONING****& THE ART OF HAND SCRAPING (2nd printing)**

—USEFUL FOR DESIGN, SHOP & INSPECTION WORK—

—SEND FOR FOLDER DESCRIBING ILLUSTRATED BOOK

MACHINE TOOL PUBLICATIONS, 382 Holly Ave., St. Paul 2, Minn.**AGENTS — SELL**

Buy tools, photo equipment, sporting goods, jewelry and thousand other nationally advertised products at big discounts. Big profits selling to others. Postcard brings free plan.

TOOLS! GUNS! CAMERAS!

Get up to
40% off

AMERICAN BUYERS SERVICE HERTEL STATION, DEPT. 15

BUFFALO 16, NEW YORK



MAGNETS **225 lb. PULL**
GENUINE ALNICO — NEVER WEAKENS

AMAZING, PERMANENT MAGNETS—WILL NOT WEAKEN! NON-ELECTRIC
Retrieve guns, tackle, tools and other steel items from lake, river, piling tanks, drains or other hard-to-reach spots. Recover drills, taps, etc. from sweepings. Clear alley of harmful tacks, nails. Many other uses. Pays for itself quickly. **GUARANTEED.** Try any magnet one week. Money refunded if you are not well pleased.

No. M-725 (Weights 54 oz.) Has pull of 225 lbs. on steel block. \$15.00
No. M-625 (Weights 70 oz.) Has pull of 125 lbs. on steel block. \$ 8.50
No. M-575 (Weights 18 oz.) Has pull of 75 lbs. on steel block. \$ 6.00
No. M-500 (Weights 13 oz.) Has pull of 50 lbs. on steel block. \$ 4.00
No. M-101 U-shaped Magnet (Wt. 2 1/4 oz.) Pull of 6 1/2 lbs. 2 for \$ 1.50
No. M-30 Hobbyist assortment of five small magnets. . . . \$ 1.00
No. M-48 Powerful Hot Pad Magnets. 8 for \$1.00. 30 for \$ 3.00

Send Money Order or Check. We pay postage. No C.O.D.'s.
MIAMI MAGNET COMPANY, 3240 N. W. 27th Ave., Miami 42, Fla.

Prevent boil overs

THAT WASTE YOUR ANTI-FREEZE

... may ruin
your
radiator



Replace your
thermostat when
you put in
anti-freeze

ANTI-FREEZE TIME IS THERMOSTAT REPLACEMENT TIME

A new thermostat protects your car against overheating, loss of costly anti-freeze, waste of gas and oil. See your service station or repair shop today for either an Autostat or Bridgeport thermostat . . . made by the pioneer manufacturers of car thermostats.

Replace with
Autostat®
or
Bridgeport

FREE—"How's That Thermostat?" a pamphlet by Fredrick C. Russell, S.A.E., leading authority on car care. Write today.



Mr. Controls

Robertshaw-Fulton

CONTROLS COMPANY

FULTON SYLPHON DIVISION, KNOXVILLE, Tennessee
BRIDGEPORT THERMOSTAT DIVISION, MILFORD, Connecticut

PENTA^{*} preservative

saves costly home repairs

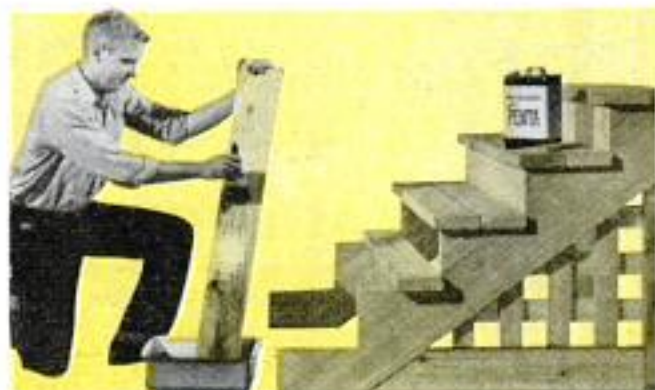

in handy one-gallon can

Protect *it* yourself with a brand-name, water-repellent preservative containing *PENTACHLOROPHENOL . . . available from most hardware and lumber dealers. Lawn furniture, steps, fences, anything you make with wood resists rot and termites *far* longer after a clean, simple PENTA application. For FREE BOOKLET, write to THE DOW CHEMICAL COMPANY, Dept. PE 873QC, Midland, Michigan.

you can depend on
DOW CHEMICALS



Do it Yourself and SAVE!

MOULDING, PLANING,
EDGING, SANDING,
JOINTING

On the Job!

Std. Model ES-1
no blower or
fiber
hold-downs

Only
\$66.50

Model ED-1 \$88.50
Deluxe with blower
and fiber hold-downs



Hand-feed Deluxe
Bench Model (as
shown) 12" x 8" Bed
Heavy cast, precision
ground. Shipping wt.
95 lb.

Here is the low-cost, hand-feed bench model Moulder-Planer you have been waiting for! Especially designed for the home workshop, hobbyist or specialty woodworking shop, this rugged machine produces fine finishes in equal stock capacities as larger, more expensive models. Selected moulding patterns can be produced in widths up to 5 3/4" Planing capacity 4" x 6" or 11" wide on second pass. Dealer franchises available. Territories open for factory reps.

SEND FOR FREE BROCHURE

of Complete Information

**EASTMAN FOUNDRY
& Machine Co., Inc.**

Dept.
PM-1255 113 Fair Street, Laconia, N. H.

Division of HERBERT MFG. CO., Inc. 1912



"Doesn't corner as well as a sports car, but rides better."—Illinois broker.

"Our Thunderbird has given us a great deal of pleasure and pride. We have always been foreign-car bugs, but could never get used to the inconveniences of side curtains. The Bird has given us the pleasure of a sports car with domestic service and parts."—Pennsylvania contractor.

"From my experience with foreign sports cars, the Thunderbird will run circles around them in the mountains, but would lose on a closed course or on the open road."—Illinois professional soldier.

"I have owned French, Italian and English sports cars and, compared with the Thunderbird, they all belong in Europe."—Connecticut club manager. ★ ★ ★

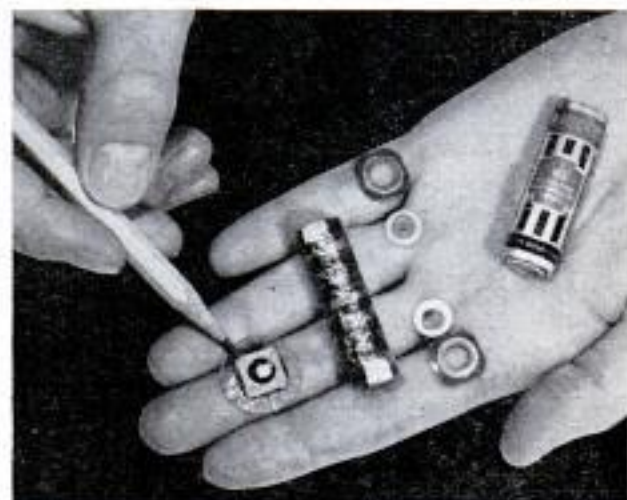

Miniature Dry Battery

"Wafer cells" stacked in a column make up a miniature dry battery with 30 percent more power and life than conventional batteries, according to the manufacturer. The midget power unit will go into transistorized hearing aids, portable radios and even heavy-duty electronic systems. Each cell is a sandwich of artificial manganese-dioxide mix between tiny disks of flat zinc and carbon electrodes. A dab of silver wax on each side of the cell conducts electricity to join the wafer cells in a series, permitting a two-inch battery to develop 22 1/2 volts, a 20-cubic inch battery to produce 300 volts. A bit of carbon replaces the old carbon rod. An airtight plastic wrapper encloses the wafer battery, which is compressed into a metal tube. The cells are produced entirely by machine in a speedy automated process.

□ World population has reached a high of over 2,500,000,000, but birth rates in Europe (except for France and Norway), Japan and the Philippines have fallen to or below pre-World War II levels.

Now!
Porter-Cable quality
in this all new
finishing sander

only \$39⁵⁰

Here's the great new finishing sander that's got *everyone* talking—with a price tag *anyone* can afford!

It's Porter-Cable's Model 145—and it's a honey! Use it for coarse, medium, and fine finishing on wood, metal, plastics, glass, and many other materials—do hundreds of sanding jobs faster and easier! Orbital motion lets you sand with, against, or across the grain, with never a gouge or ripple. Husky Universal motor has all the speed and power you'll ever need—lightweight, *balanced* design prevents fatigue.

Best of all, this rugged new Sander is built to Porter-Cable's uncompromising *quality standards*—which means long life, trouble-free service, *value* far beyond its price. See and try it soon!

MODEL 145—ONLY \$39.50 COMPLETE
Precision ball and bronze bearings throughout. Standard 9 x 11 sandpaper size provides 4 abrasive sheets for the 145. Quick-change paper clamps, sturdy die-cast aluminum housing. Weight, 5½ lbs.

Porter-Cable

Quality Electric Tools



SEE YOUR DEALER — OR MAIL COUPON TODAY!

PORTER-CABLE MACHINE CO.
514-B N. Salina St., Syracuse 8, N. Y.

Yes, send me a complete catalog sheet on the Model 145 Finishing Sander, and the name of my nearest dealer.

Name _____

Address _____

City _____ Zone _____ State _____

In Canada, write to Porter-Cable, Ltd., Box 5019,
London, Ontario. Canadian prices slightly higher.

saws • belt sanders • finishing sanders • drills • routers • planes



NEW MOSSBERG CATALOG

To make your Christmas selection easy

Complete lineup of rifles, shotguns, telescope sights and spotting scope, — all at low Mossberg prices— each readily obtainable at your dealer's.

Clip and fill in coupon now so you'll have plenty of time to pick a "Mossberg"



O. F. MOSSBERG & SONS, INC.
59712 St. John St., New Haven 5, Conn.

Send me without delay your new Christmas catalog of Mossberg Firearms available at my dealer's.

Name.....

Street.....

City..... (Zone)..... State.....

The IDEAL TOOL FOR SHOP OR HOME ONLY \$8.95



Begin or add to your do-it-yourself shop with this 40" long Flexible Power Shaft that handles like a pen. This Power Shaft will enable you to sand, buff, grind, drill, brush, and do many more important small jobs in

your own home. Run it directly from your lathe or any motor with a 3/4" or 5/16" shaft. ORDER NOW— Reduced price for limited time only \$8.95.

(Offer good only while present supply lasts).

F. W. STEWART CORPORATION
4311-13 Ravenswood Avenue, Chicago 13, Illinois

Please send.....Flexible Power Shaft(s) with handpiece and coupling for only \$8.95 ea. Check or money order enclosed. Shipping charges C.O.D.

Name.....

Address.....

City..... Zone..... State.....



Papoose Carrier

Modern kids can now enjoy the parent-back rides of an Indian papoose. A 39-ounce aluminum, steel and fabric chair for the youngster straps to the back of Mother or Father, leaving both hands free. Properly balanced, the carrier distributes the load evenly to prevent injury to the back. It folds into a flat package measuring 22 by 15 by 4 1/2 inches. When not in use for infant carrying, the unit can be employed by the sportsman to tote heavy fishing and hunting gear or as a seat for a baby in an automobile.

Extension-Cord Holder

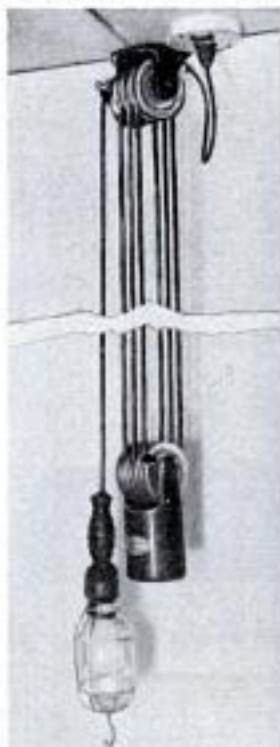

Weighted pulleys in a compact holder keep 50 feet of extension cord tangle-free and ready for use. The single cord is strung between three pulleys mounted on a ceiling bracket and three suspended pulleys mounted on a weight. The weight holds the suspended pulleys at any point where they come to rest after a length of the cord has been pulled out. Mounted on a garage or shop ceiling beside an electrical outlet, the holder supplies plenty of cord for a light or a drill.

Good News for budget-minded HANDYMEN...

now buy this basic

POWER TOOL WORKSHOP

Complete with MOTOR

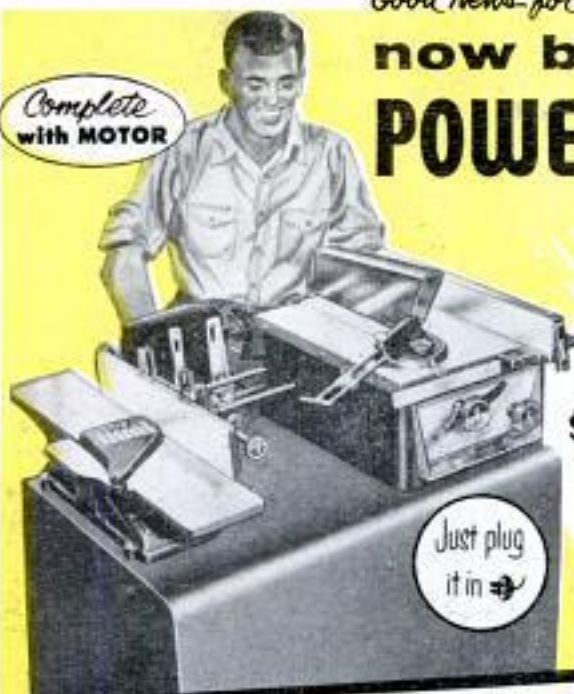

Just plug it in

for only

\$17.50 DOWN

and small monthly payments

IT'S THE NEW
Shopmaster

SAW-JOINTER COMBINATION

Now you can buy Shopmaster tools on the famous GECC Handyman payment plan. Pay only 10% down and balance in up to 18 months. Buy the Shopmaster Saw-Jointer combination or any Shopmaster tools totaling more than \$150 on this wonderful handyman payment plan. It's Shopmaster's way to give you tomorrow's power tools right now!



Look at these saw-jointer features

- Ready to plug in
- Handy switch in front
- Complete with 1/2 HP motor
- 8" saw with 2 1/2" depth, 13"x16" table size, mitre gauge and rip fence
- 4" jointer-planer with 3/8" cut, 4"x26" table and flexible guard
- All steel stand 26"x34" and 36" high
- Sealed-for-life ball bearings
- Complete only \$174.50



It's America's Greatest Power Tool Value!!

WRITE FOR FREE CATALOG

Shopmaster

ROOM 10E, 1214 SO. THIRD ST., MINNEAPOLIS, MINN.

YIPEE - A SAWHORSE IN A Jiffy

Jiffy Brackets and 2x4s are all you need. Set up and knocked down in a jiffy—no nails, screws, or bolts required. Easy to move or store. Sold by hardware and building supply stores everywhere, or order direct.

GRAND HAVEN STAMPED PRODUCTS CO., Grand Haven, Mich.

make your own Gems 29.50 F.O.B.

The Gem Maker comes complete with all necessary equipment, including a super-charged diamond blade for sawing, and all wheels for grinding, shaping and polishing; also complete instructions. The complete equipment as shown, less motor and belt, for only \$29.50, f.o.b., Burlington, Wisconsin. Write today for information and literature.

B & I MANUFACTURING CO.
Dept. 5 Burlington, Wis.

KEEP ALL SAWS SHARP

SUPER SAW FILER NO. 6
IT'S NEW! With Automatic DEPTH CONTROL ROLLERS

Automatically controls **DEPTH—ANGLE—PITCH**

Perfect bevel and angle maintained, and fool-proof depth control for all Rip, Cross-cut, and Handsaws. Precision made and calibrated for instant setting at desired angle. Can be used in any vise or clamp. Complete with file, only... **\$6.50 ppd.**

SAVE TIME AND \$\$\$

JOINT & SHARPEN CIRCULAR SAWS

Sensational new Super Filer No. 11 joints and sharpens both hand and circular saws 6" to 10" with all teeth the correct height, depth, pitch and bevel. Easy to use—when file hits hardened steel roller, teeth are finished. Saw runs true and smooth with no side pull. Complete with special 8" file \$9.95 ppd.

"TRU-CIRCLE" saw set automatically sets teeth at 10° or more \$2.95.

SEND FOR FREE CATALOG

Guaranteed
A. D. McBURNEY, 5908 Hollywood Blvd., Hollywood 28, Cal., Dept. A-125

send for **FREE CATALOG**

Snap-on Tools
"THE CHOICE OF BETTER MECHANICS"

America's Foremost money-making MECHANICS' TOOLS

It's easy to own the same "pay-off" tools used and endorsed by America's top-earning mechanics throughout the automotive, aviation and industrial fields! Snap-on tools help you handle every repair job faster, easier, better. And they LAST... pay for themselves over and over again! Start building your own tool set now with basic Snap-on units—add others any time. Genuine Snap-on tools are never sold in stores—direct to users only. Mail coupon for free catalog.

Snap-on Tools
THE CHOICE OF BETTER MECHANICS

Snap-on Tools Corporation
8062-L 28th Ave., Kenosha, Wis.

Send me free catalog. Occupation _____

Name _____

Address _____

City _____ Zone _____ State _____

FAST, LOW-COST

"Tune-up in a can"

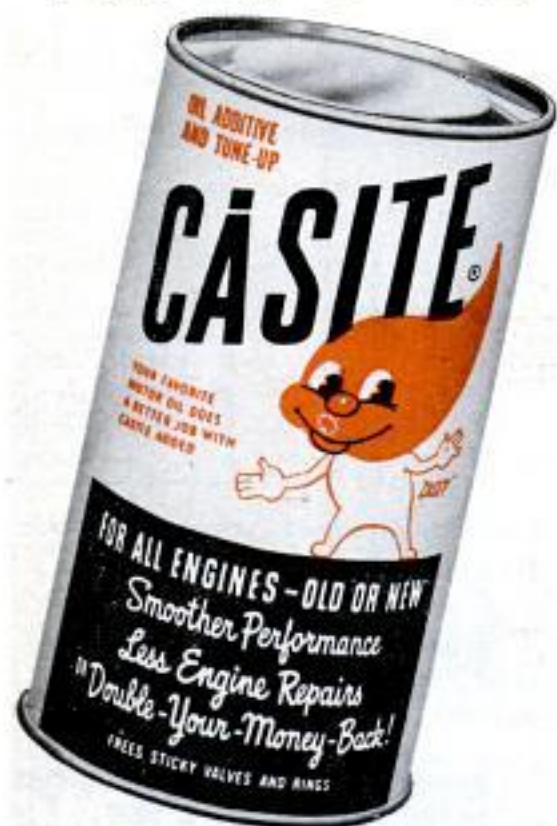

- A pint through the carburetor air intake or in the gas tank frees sticky valves and rings—restores your car's pep and power!
- A pint in the crankcase speeds cold, slow oil—cuts "start-up" wear. You get quick starts in any weather!



HASTINGS MANUFACTURING CO. • HASTINGS, MICH.

Casite, Wear Reducer, Piston Rings,
Oil Filters, Spark Plugs



Folding Cane for the Blind

Blind persons can now obtain a white cane that is folded when not in use. The lightweight cane is made of aluminum tubing coated with white plastic. When the cane is held by the wrist cord and allowed to fall freely, the four aluminum segments snap together and become a rigid unit. Rubber tubing inside the cane draws each segment of the metal tubing into the next larger diameter to a depth of one inch.

Motor Scooter Burns LPG

Already noted for its gas economy, the motor scooter now has been adapted to burn LPG. Ralph Carlton of Wauchula, Fla., converted his standard scooter into an LPG-burner with a few minor engine changes. Now he carries a bottle of propane lashed to the scooter's front end.



This year give more than a gift... GIVE A HOBBY!

This year, make your Christmas gift an investment in productive family fun! The new DREMEL Moto-Jig Saw is the most pleasurable power tool ever marketed—out-performs cumbersome jig saws costing many dollars more, yet is so easy to use even a novice becomes an expert in no time. Weighs only 12 lbs., sets up anywhere to make any corner a hobby shop! You'll make furniture, cabinets, toys, 1001 useful projects. You'll save by doing your own home repairs. Best of all, you'll unite the whole family around an exciting woodworking hobby. The DREMEL is super-safe—even women and children love it. For an eye-popping experience, try it in your own home.



NEW DREMEL MOTO-JIG SAW The Whole Family Will Love It!

Cuts 1 3/4" wood, metals, plastics!
Saws to center of 30" circle!
Super-Safe Blade Guard!
Blade faces 4 ways!

SEE YOUR DEALER. If he cannot supply, order direct on 5-day trial, money-back guarantee. Remit in full for postpaid shipment. Or send \$2 now, pay postman balance plus C.O.D. fee. DREMEL MFG. CO., Dept. M-115, Racine, Wisconsin.

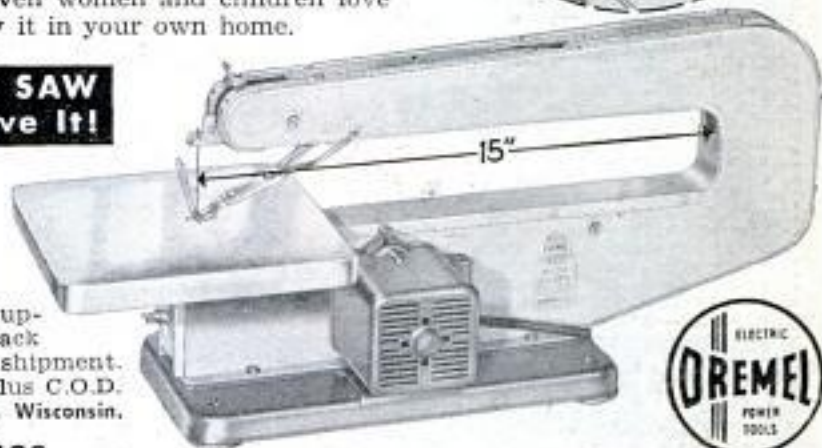

WRITE FOR POWER TOOL CATALOG

Model 8 (8" throat) \$23.50
Model 15 (15" throat) \$29.50

DREMEL Mfg. Co. Dept. M-115, RACINE, WISCONSIN

FREE CATALOG
NEW '56 MODELS
BOAT KITS

BUY DIRECT—SAVE UP TO 2/3
FACTORY TO YOU!
No Dealers!
You SAVE the dealer's Profit

23 MODELS—8 to 19 ft. —\$39 up
Finest quality Boat Kits at the lowest prices in history! Mahogany decks. Easy to build. Also: FIBERGLAS—ACCESSORIES—TRAILERS

CRAIG-CRAFT (DEPT. 20) TONAWANDA, N.Y.

P-1 GENERATORS
200-250 Amp. 24 Volt DC. 4500 RPM. Makes dandy Arc Welder. Cost \$396. Used like NEW—SPECIAL—\$12.88. GOV'T. Overhauled \$19.80 NEW \$24.75. F.O.B. York. Diagram. Free! GUARANTEED! Cat.—1000's BIG BARGAINS 10c
KARL ORT, Dept. P12M, YORK, PA.

PRECISION PLIERS

• For accurate, exacting work use the fine, small pliers jewelers and watchmakers use — Kraeuter's Precision Pliers. Matched in size and handle shape, drop forged from selected tool steel, machined and heat treated to exacting specifications. For hobby crafters, model builders, TV and radio technicians.

Buy wherever fine tools are sold in U. S. and Canada.

KRAEUTER

Get This NEW Catalog of WOOD AND WOODWORKING MATERIALS



World's Largest Selection of Finest Domestic and Imported Woods... Mouldings, Hardware, Tools. — ALL AT LOW MONEY SAVING PRICES!

Your complete wood buying guide and project book. Craftsman is your best, most complete source of finest kiln-dried domestic and rare imported woods, beautiful wood inlays, colorful handings, matched plywoods, embossed mouldings, carved ornaments, newest woodworking tools, "hard to find" cabinet hardware and fittings... more than 1,500 items! Packed with newest scroll saw patterns, project ideas & money making plans. Enclose 25c (refunded with first order) to help pay mailing, handling cost. Write now! Craftsman Wood Service Co., Dept. A-12 2729 S. Mary Street - Chicago 8, Ill.

128 PAGES
Many in full color
packed with rare, fancy & imported woods... veneers, plywoods, patterns, tools, ornaments, hardware... everything for the woodworker.
MAIL COUPON NOW!

CRAFTSMAN SERVICE CO., Dept. A-12, 2729 S. Mary St., Chicago 8, Ill.
Enclosed find 25c. Rush me new Woodworkers' Catalog Handbook.

NAME.....
ADDRESS.....
CITY.....ZONE.....STATE.....



REVOLUTIONARY NEW 'ARCO-SAW' with "DADO-ARBOR"

**CUTS ANY
GROOVE!**

**WHIZZES
THRU 2x4's!**



Not even a \$100 Portable Saw has a dado cutter! "Arco-Saw" (guaranteed to fit any 1/4" electric drill) with sensational new "Dado-Arbor" adjusts easily to cut any size groove up to 1/2" wide x 1" deep in **ONE CUT!** Graduated Depth-Bevel-Rip Gages adjust for depth of cut up to 1 3/4", angle cuts to 45°. Amazing swivel action of "Dado-Arbor" (see sketch above) cuts large grooves cleanly and accurately with little power. "Dado-Arbor" is easily removed to use the saw for straight ripping, crosscutting or angle cuts. Right angle steel gear drive and safety-yoke permit **ONE HAND** operation. Includes quick-cutting 5" Safecut Blade.



**CUT GROOVES
LIKE THESE**

**ONLY
\$12.95**

BLADES—5" Rip, X-cut or Combination \$1.75



Safety Paper Cutter

You can't injure yourself on a new paper cutter that cuts with a concealed injector-razor blade. The cutting device slides in an open channel that lets you see what you're cutting. The instrument will slice through 20 sheets of heavy paper at a time, and also cuts cloth, cardboard, drawing board, corrugated board and tissue paper. A pressure bar made of plastic reinforced with steel holds the paper in alignment.

Telescope Mounting

Hunters, tourists and bird watchers can now mount a versatile, high-powered telescope on a car window or a camera tripod. A turret adapter that holds different eyepieces is turned to bring a 15, 20, 30 or 60-power eyepiece into position.



"ARCO JIG-SAW" WITH EXCLUSIVE NEW CIRCLE- CUTTER & RIP GAGE!

Another "ARCO" FIRST! "Arco Jig-Saw" (guaranteed to fit any 1/4" drill) with Adjustable Circle-Cutter & Rip Gage saves hours of work—assures professional-looking results everytime—whether cutting circles, curved patterns, or straight cutting. Cuts perfect circles any size up to 20" diameter; rips accurate widths any size up to 10" wide. Has same capacity and cutting speed as \$55 jig saws. Does work of Jig, Keyhole, Coping, Rip, Crosscut, Band & Hack-saw! Built-in "Air-Jet" blows away sawdust. Cuts intricate patterns—however large—in plywood, plastics, metals—even cuts 2x4's! Starts inside holes. Includes blade. Converts to Table Model with either



RIPPING WITH GAGE

\$8.95 No. 500 without gages.

\$9.95 No. 550 with gages.

No. 401 "ARCO STAND" Sturdy Casting & Clamp... \$2.75
or No. 410 "ARCO DRILL-SHOP" including "Arco Stand," clamp, 1/4" drill arbor, 4" buffing wheel, 3" wire brush, 5" grindstone & rouge. Special low price... \$4.50
6 Extra Assorted Blades for wood, plastics, metals... \$1.95

SOLD AT BETTER HOWE. STORES EVERYWHERE. If not available, order direct and try these amazing tools on our **UNCONDITIONAL 10-DAY MONEY BACK GUARANTEE.** Send check or M.O. (ppd.) C.O.D.'s—plus post.

ARROW METAL PRODUCTS CO.

Dept. PM-12, 140 WEST BROADWAY, NEW YORK 13, N.Y.

NEW! PRINTED CIRCUIT Transistor Radio

Pocket size—works anywhere

- Features P-N-P Junction Transistor
- Permeability tuning, Diode detection
- Printed circuit eliminates extra wires
- Batteries last for months
- Expensive hearing aid headset included
- Furnished complete, nothing else to buy



Only **\$9.95** Postpaid
in kit form
or wired and tested
for only \$12.95

Here is a powerful, completely portable radio, employing the latest type of transistor audio amplification and printed circuitry. Tiny size, only 2 3/8" x 3 1/2" x 3/4" fits in pocket or purse. Uses so little current, batteries last for months. Kit can be assembled by anyone with just a soldering iron. Or furnished complete and tested, ready to use. Guaranteed to work. Comes complete with plastic case, batteries, headset, all parts. Nothing else to buy. Send for yours, today!

Send no money. Just pay postman \$9.95 plus C.O.D. charges, or send check or money order for \$9.95 and we pay postage.

TRADYNE, INC., 11 W. MONUMENT AVE., DAYTON 2, OHIO Dept. M-1

ALSO Adult Eshelman 2 Pass. SPORT & GOLF CARS LOWEST PRICE 70 Miles Per Gal. Free Catalog.

ESHELMAN CAR SNOW PLOW

CLEAR ROADS & DRIVEWAYS



Bolts on to car or truck in 2 minutes without tools. Clears snow 18" deep and 72" wide. Lightweight and sturdy. Order now, or write for free catalog.

ESHELMAN, Dept. SP-512
109 Light St., Baltimore 2, Md.
SHIPPING POINTS:
Baltimore, Chicago, Reno

G E A R S

In Stock - Immediate Delivery

Gears, speed reducers, sprockets, thrust bearings, flexible couplings, pulleys, etc. A complete line is carried in our Chicago stock. Can also quote on special gears of any kind. Send in your blueprints and inquiries.

Send for Complete Catalog No. 10
CHICAGO GEAR WORKS
440-50 N. Oakley Blvd., CHICAGO 12, ILL.



CUT GLASS the EASY WAY

NEW SELF-GUIDING TOOL MEASURES AS IT CUTS

Tip off glass with a ZIP Cutter! With the special, adjustable guide, you cut glass easily, accurately, and quickly. No more guesswork! Can also be used as an ordinary glass cutter. Postpaid, just... **\$1.00**
7-day MONEY BACK GUARANTEE. No C.O.D.'s
ARROW-PRODUCTS Dept. A.
Riv. Sta., P.O. Box 52, Dayton 5, Ohio



SAY YOU SAW IT IN POPULAR MECHANICS

Automatic Saw Set...

MAKE EXTRA PROFITS!

Set 400 teeth per minute on hand or band saws, 4 to 16 point, with the BeMaCo Automatic Saw Set. Fast, accurate, true hammer-anvil action sets teeth uniformly, eliminates tooth breakage. Used profitably by saw shops and manufacturers everywhere. Every machine positively guaranteed!
Write for details—today!

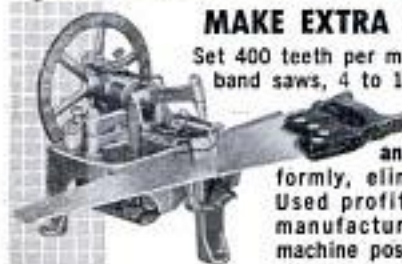

Saw Machine Division 19-C

BEAVER MFG. CO.
800 ISIS AVENUE • INGLEWOOD, CALIF.

TUNE UP YOUR RIDE

for greatest safety and comfort!



INSTALL MONRO-MATIC SHOCK ABSORBERS

Make your car ride Better than New!

You *wouldn't* drive your car with the engine out of tune. You *shouldn't* drive it with the ride out of tune!

Worn shocks rob your car of the safety and comfort that were engineered into it. Worn shocks cause broken springs, tire wear, hard steering, actual danger to you and your loved ones.

Drive in to any dealer, garage or gas station displaying Monroe's TUNE UP YOUR RIDE poster, and replace with Monro-Matic shock absorbers. You'll find your car rides *Better than New!*

So, for smoother, safer riding, see your Monro-Matic dealer—Today!



Take the **MONROE 30-DAY FREE RIDE** In Your Own Car

More car manufacturers specify Monroe Shocks than any other kind.

Send only 10c FOR LITERATURE

MONROE AUTO EQUIPMENT COMPANY, Monroe, Michigan

Enclosed find 10c for your literature on checking and installing shock absorbers.

Name.....
Address.....
City..... State.....



BEST-BORE

Wood Boring Bits

for your $\frac{1}{4}$ " electric drill

at really
LOW COST
\$2.49



8 PIECE SET

FAST, ACCURATE, EASY BORING

Best-Bore Bits bore clean, true, $\frac{1}{4}$ " to 1" holes in a jiffy in wood, plaster or plastic. Bore at an angle, into end grain or for mortising.

Bits — $\frac{1}{4}$ ", $\frac{3}{8}$ ", $\frac{1}{2}$ ", $\frac{5}{8}$ ", $\frac{3}{4}$ ", $\frac{7}{8}$ ", 1", and chrome-plated shank. In plastic case, with instruction leaflet and adjusting wrench. At progressive hardware dealers, or send money order for \$2.49.

Buy the **Parker** Line

SNELL DIVISION

PARKER MANUFACTURING CO.

WORCESTER 1, MASS., U. S. A.

SAXTON Kant-twist CLAMPS

THE NEW STANDARD IN CLAMPING DEVICES

Combines the best features of "C" and parallel clamps, provides new freedom of movement — clears work area — eliminates distorting, twisting action of conventional clamps — provides three different gripping surfaces.

"HAND-TIGHT" IS TIGHT ENOUGH.
Kant-twist clamps weigh approximately half as much as comparable C-clamps yet are 40% stronger — by actual test — this feature makes Saxton clamps extremely valuable on jobs where weight is an important factor.



MOD. NO.	MAX. OPENING	THROAT OPEN	THROAT CLOSED	PRICE EACH
1	1"	$\frac{1}{2}$ "	$\frac{5}{8}$ "	2.50
2	2"	$1\frac{1}{8}$ "	$1\frac{1}{2}$ "	3.00
3	3"	$1\frac{3}{4}$ "	2"	4.00
6	6"	$2\frac{1}{4}$ "	$3\frac{1}{2}$ "	6.50
6D	6"	$3\frac{3}{4}$ "	$5\frac{1}{2}$ "	8.50



Versatile new aid for home workshop. Ideal for model makers, ceramists, hobbyists, radio, boats, machine shops, farm and all do-it-yourself projects. No C.O.D. In California add 4% sales tax postage prepaid. Order today. Send check or money order to—

ZURCO DISTRIBUTING CO.

P.O. BOX 6769

East Los Angeles 22, Calif.

Enjoy Modern Living · Make Your Home Worth More With This Popular Mechanics Book . . .



759 PICTURES

Above: How to lay a new roof over the old.

Right: New walls over the tired old walls. A few of the 83 modern kitchen ideas.

Below: Modern ceilings for old basements.

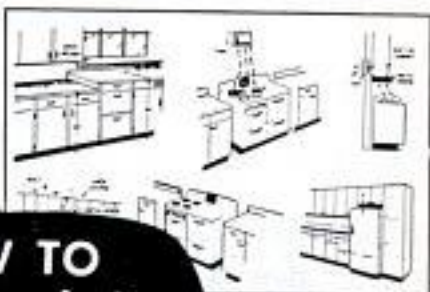

HOW TO Remodel Your Home

With Data on New Materials and Products Available to Home Owners

Here are hundreds of ways you can make a modern home out of an old house, make the house worth more and save money while doing it. If you own an old house or intend to buy one, get "How to Remodel Your Home" by E. R. Haas, formerly technical editor for Popular Mechanics. You can do the modernizing yourself or have it done for this vital book contains 547 methods and 759 illustrations covering complete modernization, adding rooms and living space, installing new kitchens and baths, adding closets, wardrobes, rumpus rooms. Complete face-lifting jobs for the outside and morale building jobs for the inside. Learn the joys and conveniences of modern living with this vital book prepared especially for the home owner. Mail coupon for your copy today.

Money Back if You Want It.

Get the book now. Check it for information that will help you improve your home for appearance, convenience and value. If not fully pleased return the book in 7 days and Popular Mechanics will refund every penny you have paid.

Big Book.
Same Size as
This Magazine.

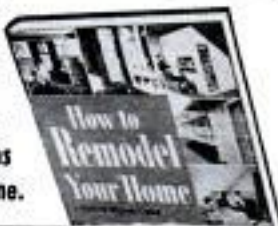

What to Do! How to Do It! How to Cut Costs and Save

In this book — 17 big helpful sections. They are:

From old to new—
Your modern kitchen — Better bathrooms — Basement rumpus rooms — Curing wet basements — Attic space and dormers — Adding rooms to the outside—Porches and breezeways — Utilizing idle space—New look for outside walls — Modern interior walls—Heat-loss and humidity controls — Roof framing and covering—Windows that modernize — Entrances and doors — Variety in floors — Wiring, plumbing heating. In all—547 money-saving articles you can use.

Use Coupon to Get Remodeling Book

POPULAR MECHANICS PRESS, 200 E. Ontario St., Chicago 11

Send at once "How to Remodel Your Home," postpaid for \$2.95. I understand I may return the book in 7 days for full refund.

- Remittance for \$2.95 enclosed. Send book postpaid.
 Send COD. I will pay postman.

Name _____

Address _____

City _____ State _____

**GIGANTIC
SAVE-TO-70%**

MAIL SALE

**WAR SURPLUS
EXCESS INVENTORY
BANKRUPT STOCK**

ARMY POWER PLANTS

- Marvelous buys in new condition Govt. surplus plants and generators. We pay freight!
- 1000-w, 115-v, 60-c, \$149.50
- 2000-w, 115-v, 60-c, \$289.50
- 3000-w, 115-v, 60-c, \$349.50
- 7500-w, 115-v, 60-c, \$890.00
- 3000-w, DC generator \$58.75

Send for free bulletin

AIR COMPRESSORS—TANKS, Etc.

- Save to 70% on air fittings, tanks, compressors, etc. See our catalog.
- Piston Air Compressor, 150 lb. . . . \$18.91
 - Air Corp 300-lb. Pressure Tank . . . \$6.79
 - Auto Pressure Switch for Motor . . . \$4.95
 - Professional Paint Spray Gun . . . \$9.95
 - Deluxe Air Kit complete . . . \$45.49

NAVY CENTRIFUGAL PUMP

- Leading make. All bronze ball bearing hi-capacity. Complete with pulley. 1 1/2" inlet, 1 1/4" outlet.
- Will pump up to 140 GPM. Pressure to 65 ft. Suction lift to 18 ft. Gov't. Cost \$85.50. Prepaid . . . \$24.61

HYDRAULIC BARGAINS

- Pump, 1000 lbs., 12 g.p.m., 400 c.p.m. . . . \$45.50
- Cylinder, 3" bore, 24" stroke, 7000 lb. lift . . . \$39.90
- Cylinder, 2" bore, 10" stroke, 3141 lb. lift. Sale . . . \$16.50
- Control Valve, for single or double acting cylinders. Sale . . . \$17.98
- Pressure Gauges, 1000 lb., 1500 lb., 2000 lb. \$3.49

HAND HYDRAULIC SYSTEM

- Build your own arbor press, wagon unloader, shop tool tester, etc. Genuine brand new Blackhawk hi-pressure hydraulic pump system. Complete unit including reservoir, check valve, etc. Will develop pressure to 8,000 lbs.! Wt. 35 lbs. Gov't. Cost over \$100. Prepaid . . . \$23.95

6-Volt HYDRAULIC PUMP

- Complete hydraulic system, 6-v DC motor operates from truck battery. Drives 2,500 lb. per sq. in. pump. Has control valve, etc.
- Use for dump trucks, snow plows, jacks, lifts, special machinery, etc.
- Leading make. P.O.B. Wt. 48 lbs. List \$121.50. SALE . . . \$45.50

SPECIAL LISTINGS

- We list below some super prepaid-to-you bargains available in limited quantities only.
- \$150 G.E. Experimental Amplifier \$6.97
 - \$15 Gov't. Sleeping Bag with Cover \$5.74
 - \$3 Finest Wood 1"x16" Chisels . . \$1.19
 - \$150 5-Row Weed Spray Outfits . \$97.65
 - \$30 Electronic Experimental Kit . \$4.99
 - \$15 Army First Aid Chests . . . \$6.95
 - Eastman Film and Paper—savings to 70%!

ELECTRONIC AUTOMATIC TIMER

- Genuine Telechron 115-volt, 60-cycle Clock Timer in beautiful red onyx case. Will handle 1000-watt load. Set for any time 0 to 15 minutes. Turns power off at proper time. Has pilot light and alarm buzzer.
- Many experimental and laboratory uses. Use for photography, sun lamps, timing studies. List \$19.95. Sale . . . \$4.95 Prepaid

PORTABLE DUAL AMPLIFIER

- Telephone repeater. Used to amplify voice in both directions. Consists of two one-way hi-gain amplifiers, filters, equalizers, keys, etc. Operates from low drain batteries.
- Wide variety uses including telephone amplifier, wire tapping, audio oscillator, etc. Excellent experimental laboratory unit. Brand new and with Gov't. data book. Gov't. cost over \$350. SALE . . . \$13.51, Ppd.

WESTERN ELECTRIC CITY TELEPHONES

- Genuine W.E. wall or desk phones, same as used on city telephone systems. Useful for inter-communication, private system, extension ringer, etc. Specify "wall" or "desk." Original cost over \$20.00. Prepaid Sale, \$4.99 each. Two for \$9.69.

SPECIAL OF THE MONTH!

AUTOMATIC REMOTE CONTROL SWITCHES

- Amazing electro magnetic switch. Complete with dial. Any circuit from 1 to 100 can be selected simply by dialing the number, uncanny response. Will work over lines up to 20 units. Used, excellent.
- Fine for inter-coms. Private automatic phone systems. remote control, experimental, etc. New Cost Over \$13.71 \$200.00. Sale, Prepaid . . .

CONTRACTOR-ARCHITECT LEVEL

- Excellent highly accurate professional instrument made by leading manufacturer. Ideal for setting foundations, grading, farm contouring, surveying, etc.
- Powerful erecting optical telescope, polished graduated degree scale, sensitive spirit bubble, etc.
- Furnished complete with 8 1/2-ft. 3-sec. rod, fine tripod and polished wood carrying case. Our 4-star buy! Prepaid to you . . . \$39.15

HI-INTENSITY FLOODLIGHTS

- G.E. Sealed Beam air force long-life extra hi-intensity parabolic precision reflector units, 24-v, 250-w, 8" size. Equivalent 2500-w ordinary life. Use 5 in series on 110-v. for 800,000 candle-power illumination effect. Light building fronts, parking lots, ball parks, outdoor jobs. Original cost, 5 units, \$39.00. SALE, 1-unit, \$1.95, 5-units, \$7.49.

CAR BATTERY SEARCH LIGHT

- Hi-intensity 6-v one mile beam. With case, colored filters. Ideal for camp, flat tires at night. Cost over \$30 . . . \$4.96 Ppd.

SPECIALS FROM PREVIOUS ADS

- 110-V Selsyn Motors . . . Pr. \$12.97
- Finest Heavy 10x12-ft. Tarps . . . \$11.99
- AC-DC Power Rectifier . . . \$18.61
- Finest 7x50 Binoculars . . . \$36.95
- Gov't. Prismatic Periscopes . . . \$2.99

We pay transportation to you except where stated "FOB Lincoln." Write for large FREE Catalog.

BURDEN SALES COMPANY
814 "O" St., LINCOLN, NEBR.

DITCH-WITCH TRENCHER



Portable DITCH-WITCH digs 4 1/2" or 6" clean, even ditches to 36" depth in all types of soil. Four rugged models. Complete unit — self-propelled. OUTDIGS 8 MEN

Write for Illustrated Literature
The CHARLES MACHINE WORKS
620 B Street Perry, Okla.

THE BEST IN PLIERS? **CHAN NEL LOCK**
CHAMPION DeARMENT TOOL CO., MEADVILLE, PA.

DO IT YOURSELF
It's Easy With . . .



Soldering's really a "cinch" . . . when you use time-tested, reliable KESTER . . . available everywhere.

FREE! "Soldering Simplified" . . . 16-page how-to-solder booklet. At your dealer or write direct.

KESTER SOLDER COMPANY
4251 Wrightwood Avenue Chicago 39, Illinois

GET THE HABIT OF READING OUR CLASSIFIED ADS.

Wonderful Opportunities Amazing Bargains

deft-finish it yourself

IT'S SO EASY



Dries in 30 Minutes

DEFT WOOD FINISH FOR ALL INTERIOR WOOD SURFACES

Clear, semi-gloss bar top finish. Deft seals, primes, finishes. Nothing else to use. Will not darken. No thinning, no brush marks. Get a professional finish every time. Use on paneling, floors, cabinets, furniture, etc. Insist on Deft, wherever paints are sold. Or write for free booklet. D-M. **DESMOND BROS., 1826 W. 54th St., Los Angeles 62, Calif.**

BUILD YOUR OWN POWER TOOLS - GIL-BILT

Exclusive GIL-BILT Build-It-Yourself Features

- No machining—build easily with hand tools only
- No blueprint reading—step-by-step pictorial plans, full scale patterns, actual photographs
- Sturdy wood, aluminum and steel construction
- Capacity and performance of commercial saws selling from \$60 to \$250.
- Proved performance. Nationally advertised and sold for 8 years. Satisfied customers around the world.

GIL-BILT 10-in. TILT/ARBOR SAW



- 27x28 in. table, 13 1/4 in. capacity in front of blade
- 10 in. blade cuts 3 1/4 in. deep, tilts full 45 degrees
- Floor model 34" high, table always stays level
- New Departure ball bearing arbor, 3/4" precision shaft turned down for 3/8" bore blades, alum. housing, shipped ready to run
- Jackscrew and 4 1/2 in. dia. handwheel lowers and raises blade
- Cast-aluminum miter gauge and self-aligning rip fence guide

GIL-BILT Metal Parts Kit includes Plans, ball bearing arbor, miter gauge and bar, rip fence guide, dado insert, lock knobs, jackscrew mechanism and handwheel, and all other metal parts (less blade)..... \$22.95
 Same Kit with 10" Combination Blade \$25.95
 Same Kit with 8" Combination Blade \$24.95

GIL-BILT 12-INCH BAND SAW



- Cuts to center of 24 inch circle
- Handles stock up to 6 inches thick
- 18x18 inch table tilts 45 degrees
- Lower wheel and drive pulley runs on sealed New Departure Ball Bearings; Upper wheel runs on two 5/8" bore Oilite Bronze bearings
- Upper wheel tension and tilt mechanism of cast aluminum, completely assembled
- Upper and lower blade guides. Each has ball thrust bearings, self-lub bronze jaws
- Rigid cast aluminum wheels fully machined ready-to-install. Heavy rubber tires
- Uses standard 78 inch blades up to 3/4 in. wide
- Fully enclosed mechanism for utmost safety

GIL-BILT Metal Parts Kit includes Plans, rubber tires, aluminum wheels, 3/4 in. blade, ball bearing spindle, tilt mechanism, blade guides, table tilt segments and all other metal parts..... \$23.95
 Return Kits in 10 days for refund if not satisfied. For shipments up to 600 miles, add 5%; over 600 add 10%.

Amount in excess of actual postage will be refunded

Order Kit now, or order Plans at \$1.00 each and Kit later less cost of plans. Write for FREE Catalog, Dept. 80-M, Lambert Field St. Louis 21, Missouri

ALSO AVAILABLE Plans & Parts Kits for 18-in. Band Saw, Belt Sander, Spindle Shaper, 8-in. Tilt/Arbor Saw

GILLIOM POWER TOOLS

WITH GIL-BILT PARTS KITS

PLANS only \$1.00 EACH POSTPAID

best fitted for your car HULL AUTO COMPASS



Your car interior possesses magnetic interferences unlike any other. Because Hull Auto Compasses have far the most positive means of compensating against such interference, they are best fitted to give YOU accurate, dependable directions.



NOW ALSO IN NEW CAR COLORS

At better dealers everywhere.

Write for literature.

HULL MFG. CO. P. O. Box 246-D12, Warren, Ohio



\$5 CASH AN HOUR!

sharpening circular saws, planer and jointer knives in your home or garage... spare time. No experience needed. Hundreds of jobs in your neighborhood... no canvassing... no selling. Only \$15 down brings you this money-maker. Write today to:

Write today for **FREE BOOK**

BELSAW MACHINERY CO, 1646 Field Bldg., Kansas City 11, Mo.

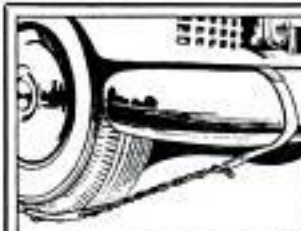

When changing tires avoid accidents with THE NEW SURE GRIP CAR HOLDER. Simple to apply. Every car owner should have one. Only **\$2.50**

Postage Prepaid
 Agent wanted
 KRIEWALDT SPECIALTY MFG. CO.
 Oconto, Wisconsin

Handy Mail Order List

Little Library of Useful INFORMATION

5 for \$1.00
 12 for \$2.00
 25¢ Each

Here at amazingly low cost is the practical help and information you have always wanted. Articles in previous issues of Popular Mechanics have been classified according to subject and are now available in these handy reprint booklets.

- How to Use Measuring Tools—Micrometers, Calipers, etc.—106.
- Power Driven Saws—74.
- Drill Presses, Grinders, etc.—79.
- Wood, Metal-Turning Lathes—81.
- Filing Machine, Hacksaw, Cut-off Wheel, Shaper—82.
- Lathe Tools You Can Make—101.
- Workbenches—Tool Cabinets—47.
- Spray Painting—94.
- From Pattern to Casting—91.
- Tool and Saw Sharpening—92.
- Sharpening Drills, Wood Bits—90.
- Successful Wood Turning—32.
- How to Read Blueprints—71.
- Metal Turning Lathe Kinks—99.
- Operating a Metal Lathe—100.
- Heat Treating, Hardening—102.
- Working With Glass—103.
- Servicing Electric Motors—75.
- Electromagnets & Solenoids—44.
- Transformer Construction—41.
- The Boy Electrician—43.
- Soldering and Brazing—17.
- Arc and Spot Welders—5.
- Electroplating With Nickel, Chromium, Cadmium, etc.—86.
- Plating Leather, Wood, etc.—87.
- Lower Your Fuel Costs—31.
- Curing Leaky Basements—45.
- Fitting a Home Game Room—55.
- Indoor & Outdoor Fireplaces—88.
- Back and Gardening—39.
- Lawn and Garden Novelties—72.
- Trellises, Pergolas, Fences—76.
- Lawn and Garden Furniture—77.
- Playground Equipment—73.
- How to Use Your Drill Press—125.
- Making Serving Trays—53.
- Knots and Ropework—105.
- Sanders—80.
- House-Wiring—89.
- Hanging Wallpaper—38.
- Built-in Fixtures—78.
- Bird Houses—7.
- Magazine Racks—49.
- Clock Cases—80.
- Book Ends—52.
- Small Tables—54.
- Smoking Stands—56.
- Desks—58.
- Book Cases—59.
- Action Toys—56.
- High Flying Kites—67.
- Telescopes—20.
- Metal Craft—28.
- Small Looms—37.
- Gem Cutting—42.
- Photo Enlargers—1.
- Photo Kinks—98.
- Cleaning Formulas—11.
- Taxidermy—9.
- Photo Lighting—119.
- Training Dogs—35.
- Small Furnaces—36.

- Working With Plastics—61.
- Simple Home Improvements—104.
- Ridding Home of Insect Pests—107.
- Children's Room Furniture—51.
- Jigsawed Novelties—57.
- Doll House & Doll Furniture—60.
- 25 Shelves You Can Make—64.
- Novelties Turned on Lathe—62.
- Inlay Pictures—Veneering—63.
- Wood, Soap Carving—65.
- Windmills & Weather-vanes—68.
- Lamps from Wood, Metal—69.
- Rustic Furniture—18.
- Wood Finishing—40.
- How to Fix Electrical Appliances—111.
- Painting Your House—117.
- Build Your Own Relays—123.
- Rowboats, Small Dinghy—63.
- Small Sail Boats—84.
- Two Outboard Runabouts—85.
- Build Own Canoe, Kayak—30.
- Build Class-E Ice Yacht—22.
- Auto Kinks, Shortcuts—10.
- Lawn and Garden Equipment—124.
- Motor-Driven Midget Cars—34.
- Stop Auto Electric Troubles—95.
- Photo Printers and Dryers—25.
- Photo Darkroom Equipment—96.
- Trick and Table Top Photos—97.
- Home Movie Equipment—118.
- Poultry Houses—108.
- Guns and Decoys—109.
- Re-Silvering Mirrors—70.
- Chemical Experiments—93.
- Log Cabins, Tourist Houses—14.
- Using Basic Tools—120.
- Farm and Garden Tractors—8.
- Building Extra Attic Rooms—23.
- Attractive Basement Rooms—24.

Check Titles Wanted, Clip, Mail with Remittance to
 POPULAR MECHANICS PRESS, Dept. 23, 200 E. Ontario, Chicago 11

A perfect paint job with half the trouble. Get your money's worth. Paint shaken on a Red Devil Paint Conditioner is ready to use right out of the can. Paint is perfectly mixed factory-fresh—needs no stirring. Ask your dealer to mix your paint on a

Red Devil PAINT CONDITIONER



FREE

How to Prepare Surfaces for Finishing. Illustrated instructions on preparing masonry, wood and metal surfaces for painting.

Red Devil Tools, Dept. 151
 130 Coit Street, Irvington, N. J.

Please send FREE copy of "HOW TO PREPARE SURFACES FOR FINISHING."

NAME _____
 ADDRESS _____
 CITY _____ ZONE _____ STATE _____

1462

CHROME VANADIUM 29 Pc. DRILL SET

Special made for speed drilling. In sturdy plastic tool roll. Finest alloy steel drills hardened and precision ground to the sharpest, longest lasting cutting edge obtainable; will easily and cleanly bite through hardwoods, plastics, aluminum, iron and the toughest steels. Unconditionally guaranteed for thousands of drillings. Full jobber length. Sizes by 64th from 1/16" to 1/2". NOW... **\$6.49** ppd.

Also available with Turned Down Shanks to fit all 1/4" drills. In individual pocket roll... **\$8.95** ppd.

60 Pc. Set WIRE GAUGE CHROME VANADIUM DRILLS

Top quality high test Chrome Vanadium Drills designed for speed drilling through toughest steels, woods, plastic, iron and aluminum. Precision ground, long-lasting cutting edges. Guaranteed to give years of satisfaction. A full 60 pc. set nos. 1 through 60. A \$14.95 value—**\$5.35** NOW ONLY... PLUS 25c PP. & HDLG.

Same set above available with Hunt Metal Index container. Only... **\$6.35** PLUS 25c PP. & HDLG.

SCOTT-MITCHELL HOUSE, INC. DEPT. DR-4, 611 BROADWAY
NEW YORK 12, N. Y.

SHAW PLOW, CULTIVATE, MOW, RAKE
BULLDOZE, SNOWPLOW
SAW WOOD

TRACTORS

Just steer it with power turn. Several walking & riding models up to 14 H.P. Low price! Write for FREE literature.

SHAW Manufacturing Co.
4512 Front St., Galesburg, Kansas
668-G.N. 4th St., Columbus, Ohio



BUILD YOUR OWN **MIDGET ROADSTER '25** BUILDS BODY & FRAME

BUILD A PONY ROADSTER or Pick-Up in a few spare hours. Uses 2 hp engine, 450 lb. loads, 70 m.p.g., plenty of speed. Designed for VERY LOW-COST assembly from PARTS BOUGHT IN YOUR NEIGHBORHOOD. Use home tools. Great for kids, sturdy utility car. COMPLETE step-by-step plans, 17 large-size pages, 30 "show-how" photos, Body templates, complete material and parts list. ONLY \$1.95 POST-PAID. Satisfied or money back.

PONY PLANS, 7641-P TEXHOMA AVE., NORTHRIDGE, CALIF.



Exclusive Double-Bearing HEAVY-DUTY PUMPS

IRRIGATE • DRAIN • CIRCULATE • SPRAY
Up to 7,500 GPH, 3,000 GPH from 25' well. Use 1/2 in. 1 HP motor, 1 1/4" inlet, 1" outlet. Stainless shaft. TYPE X-2 oilless bronze bearings. **\$10.95**

TYPE XB—Ball bearing model... **\$12.95**
Postpaid if cash with order. (West of Mex. add 50c)

MONEY BACK GUARANTEE
Centrifugal and Gear Pumps in All Sizes

LABAWCO PUMPS, Belle Mead 2A, N. J.



HELPFUL BOOKS

Send post card asking for FREE catalog

Popular Mechanics Press, 200 E. Ontario, Dept. 601, Chicago 11

POWER HACKSAW \$55.75

LESS MOTOR
F.O.B. Benton Harbor

• Rugged cast iron construction. Wt. 56 lbs., bronze bearings. Draw cut. Auto. return lift. Auto. shut-off. Vise swivels 45°. Cap. 4"x4".

Dept. PM-125
BENTON HARBOR, MICHIGAN



Double Your Income... Find a Fortune!

It's easy! Just read these FREE booklets (60c value) . . . "Treasure Hunting for Fun and Profit" and "How to Be A Successful Uranium Prospector." Others have found fortunes on vacations and in their own backyards. TIME PAYMENT PLAN! Delay may cost you money. Send for FREE booklets today!

FISHER RESEARCH LABORATORY, INC.
DEPT. 8 1961 UNIVERSITY AVE. PALO ALTO, CALIF.

Send for FREE Booklets



WAR SURPLUS AND OTHER BARGAINS SAVE UP TO 90%

PURULATOR OIL FILTERS

The perfect filter to keep motor oil or hyd. fluid clean at all times. Permanent type. Protect your pump, engine, midget racer or boat with this unit. Inlet & outlet port 1/2". Accommodates 16 GPM at 20 PSI. Mfg. brackets. A \$25 value, NEW, **\$3.85** ppd USA.



MICROSWITCH

Normally open or closed . . . dual purpose. For automatic contacting, light, sound, model train systems, chimes, etc. Approx. Govt. cost \$15. NEW. 5 for \$2 ppd. USA.



SPECIAL ON \$4770 NAVY AUXILIARY POWER UNITS AIR COOLED

Ideal for your shop, camp, cottage, farm, trailer, home, boat or mine. Makes a terrific welder for any size job. Also excellent for auxiliary power in pumping wells, operating saws, or wherever power is needed. 30D-1A Lawrence, 24V, 2 Cylinder opposed 4-cycle 10 1/2 H.P. comes complete with various generators which can be attached to standard stud mounting. 50hp. wt. cased 350 lbs. Like new. Type 2 CM70-BU-140 amps. 24V—\$125. Type P1, 200 amps. 24V—\$137.50. AC-DC NEAS (DC side 24V, 200 amps; AC side 10.5 amps., 1200 watts). 800-cycle 2400 RPM—\$142.50.



"HELIOS" ORIGINAL TOOLMAKERS VERNIER CALIPERS

ULTRAPRECISION—Imported. Used by machinists at Lockheed, Douglas, Bendix, GM, RCA, GE. Model 51/2E. Genuine Helios. Hardened lapped precision surfaces. 1/1000" and 1/128" graduations. Handy slide roll and thumb lock. Quick, accurate depth. A \$35 value. Satine finish. ALL NEW, just \$6.95. Leather carrying case, \$1 extra.



MICROMETER DEPTH GAUGE

With 3 rods to measure all depths from 0 to 3 inches by thousandths. Hardened tool steel lead screw has full 1 inch run. Base is 2 1/2" long, hardened ground and hand lapped. Accuracy guaranteed. Mfd. by Miller Falls Co. GOVT COST approx. \$30. NEW—\$10.95 ppd. USA. In velvet case.



MICROMETERS

Chrome plated, precision engineered, carefully tooling to give long life. All new 0-1" cap. **\$2.25** ea., 1-2" cap. **\$3.50**.



PRECISION GROUND SQUARES

Production engineer's squares. Accuracy guaranteed. Mfd. by Wright & Moore, Sheffield, Eng. Square blades hardened & tempered. Individually packed in wood box. Brand NEW. Fraction of original cost. 2"—\$2.75; 3"—\$3; 4"—\$3.25; 5"—\$3.50; 6"—\$3.75; 9"—\$7; 12"—\$8.75.



NEW PUMP AND MOTOR

Pump has 1" connections, built-in relief valve, adjustable up to 1500 lbs. Max capacity 6 GPM, 1 1/2 H.P., 24-volt motor, 4000 RPM. Can be used on 12 or 36 volts. Govt. cost approx. \$350—our price—NEW—\$9.95.



SENSITIVE ALTIMETER

in 10 Ft. Increments. Famous Pioneer! 0 to 35,000 ft. (inches of Mercury). Tested and inspected in our own instrument lab. Guaranteed perfect. Approx. Govt. Cost \$150. NOW ONLY **\$13.95** PREPAID!



MAMMOTH CATALOG

Biggest ever . . . new low prices . . . Send 25c for your copy today. Prices otherwise stated. Check, money order or cash. 25% deposit for C.O.D.

AIRBORNE SALES CO., INC. DEPT. PM1255
8501 Stellar Drive, Culver City, Calif.

SAY YOU SAW IT IN POPULAR MECHANICS

EXTRA VALUE

Value "plus" is built into every Gerstner Chest to guarantee long life and real service. Free Catalog.

GERSTNER TOOL CHESTS
455 Columbia St., Dayton 7, Ohio



YULETIME IS PORTABLE TOOL TIME

For the "FINISHING TOUCH"
give this new

FAIRCHILD FINISHING KIT



Fairchild's Dualine Sander is the only sander with Orbital and Strate line motion. Just what you need for doing a professional finishing job with a real factory finish.

All the things you need to finish or re-finish wood or metal. Zip-Strip varnish remover, famous Beacon Wax; wonder-working aluminum oxide and garnet sandpapers; felt pad, waxing pad and lambs-wool polish—

\$4.95

Big! New!
Complete
37-pc. KIT!

at Your Dealer, Or Write Direct
Giving Favorite Retailer's Name
ELECTRICAL PRODUCTS DIVISION

FAIRCHILD

CAMERA & INSTRUMENT CORP.
BURLINGTON • VERMONT

Amazing Tyler SPYRAL BLADE

SAWS ANY MATERIAL IN ANY DIRECTION

metal, wood,
plastics etc.

up or down, right or left,
even in circles!

World's safest
saw blade.

A MUST for every Workshop!

Does what no other Blade can Do.
Fits Standard Coping Saw or Hacksaw Frames.
NO special adapters needed! • World's safest saw blade.

You'll find hundreds of uses for Tyler Spyril Blades. There's nothing like them! The first important improvement in blades since the invention of the saw. Fun to use. Cuts so fast and easy; no chipping or tearing—leaves clean smooth edge.

At your Hardware dealer or send **\$1** for package of
12 Spyril Coping Saw Blades or 3 Spyril Hacksaw Blades.

give that Boy or Girl a

TYLER MAGIC SAW KIT

Makes hundreds of useful items so easy—just moisten gummed patterns and apply to wood supplied in Kit, then saw. Safe—can't cut the hand! Kit consists of magic saw frame, 3 Spyril blades, 12 gummed patterns, screws, brads and cutting material. Only \$1.98 plus 25c postage. Order direct from Factory. No C.O.D.'s.



TYLER MANUFACTURING COMPANY 1005 W. Arbor Vista Ave., Inglewood, Calif.

Metal Turning Lathe for Model Makers



With Ball Bearing
Headstock Spindle

For Home Work Shops, Model Builders, Hobbyists. Use it to earn money; develop inventions; make repair parts; do machine work on models.

All steel, practical lathe. Length of Bed—12"; 4½" Swing; Distance between centers—7"; Tailstock travel—1½"; 0 Center in Tailstock; 0 Center in spindle; spindle has ½" x 20 thread—¼" hole; Complete with face plate, driving dog and mounting bolts. Weight, 25 lbs. Guaranteed. Price, except motor—

only
\$25.75
f. c. b. Lansing

Rosemoor Mfg. Co., 2611 Bernice Rd., Lansing, Illinois



Blast off with DUAL
vacuum AIR HORNS!

ONLY
\$9.95

•POSTPAID

Money-back Guarantee

Compares with
\$25 to \$100
Air Horns

The voice of authority and commanding warning for safer highway driving. One BLAST and those "Road Hogs" really move over. Installed under the hood or on the front fender. Beautiful lacquer finish. Operates from intake manifold. No tank needed. Only \$9.95 complete with cylinder head bracket, steering column lever, hose, fittings, etc. Send check or money order today. We pay postage. \$1.00 deposit required on all C.O.D. orders.

THE PROTECTORED CO.
Dept. 800, 2750 N. E. 19th Street, Fort Lauderdale, Fla.

GET THE HABIT OF OUR CLASSIFIED ADS.

Wonderful Opportunities Amazing Bargains

Build Your Own Walks,
Driveway, Outdoor
Fireplace, Steps, Etc.

What to Make With
CONCRETE



The terrific high costs of even little concrete jobs are mostly for labor. Get Popular Mechanics WHAT TO MAKE WITH CONCRETE and save all the labor costs while making your home or farm ship-shape. You can lay foundations, sidewalks and driveways; build steps, outdoor fireplaces, sandboxes, tennis courts, garden and swimming pools and other installations at very little cost. Book shows all—tells all—how to make the right mixture, plan, apply and gives 50 professional short cuts. Hundreds of pictures. Only \$2.00 postpaid. Order today. Money back if not pleased.

POPULAR MECHANICS
PRESS

Dept. PM17, 200 E. Ontario
Chicago 11, Ill.



What Every Farmer Should Know About Taking Care of Farm Animals



The Most Popular Veterinary Guide
Ever Printed

This practical and helpful VETERINARY GUIDE FOR FARMERS prepares the farmer to perform many routine veterinary tasks—provides quick information that can often save the life of an animal—prevents disease in herds—saves money on the farm in a hundred different ways. Written in plain understandable language. It covers symptoms, causes of disease and prevention, and treatment of cattle, swine, sheep, horses and poultry and warns when to call in the professional veterinarian. Names, terms and phrases made clear in a separate section. Over 100,000 copies of this book are in use on American farms. 275 pages. Fully illustrated. Only \$3.95. Order today under money-back guarantee.

POPULAR MECHANICS PRESS, Dept. PM13
200 E. Ontario St. Chicago 11, Ill.

BUILD WELDER OR LIGHT PLANT

Instruc. incl. **TYPES AMPS VOLTS PRICE**
J & Heinz R1 390 24 \$27.50
 6-1, 160-220 amps, 20V, new \$19.50 used \$12.95
#11 Gen. 200 Amps, 30V, D.C. & 1250
 Watts, 800 Cy. A.C., Instructions for A.C.
 D.C. Incl. Good cond. \$19.50 New \$29.50
RHEOSTAT #27 or **CARBON FILE** for D.C.
 generators, \$6.95 Each.
174 GRP BLOWER & 1/2 H.P. MO-
TOR. Runs on 6-12 or 24 V. D.C.
 12"x17"x8" O.C. \$50.00, New \$12.95
(5) SENSATIONAL SELVNS. For con-
 trolling distance operations, etc.
 \$9.95 per pair. **(6) SOLENOID VALVES**
RENDIX #81560 for Hydraulic cyl-
 inder & remote control, cap. 1500
 P.S.I. Instructions for D.C.-A.C.
 \$35.00 value \$9.95 per pair. **(7)**
SEAN ROTATOR MOTOR #101 for
 TV, HAM, etc. reversible, 2 H.P.M.
 for D.C. or 110V. A.C. Gov't. cost
 \$150.00, \$9.95. **(8) SOLENOID #804**
 gives 1/2" or 1 1/2" travel powerful for
 locks, switches, etc. For 6-12 or 24V
 D.C. & appl. for 110V. A.C. Instruc.
 incl. \$3.95 ea., \$5.95 per pair.
(9) CUNG OIL FILTER for autos, fil-
 ters without cartridge replacements, 3/4"
 ports \$4.95. **PURULATOR #255** for
 trucks & tractors, 1" ports \$4.95 postpaid.

General SALE

MAKES IDEAL WINCH ROIST or garage door opener.
 Aircraft motor & gear
 unit, 14:1 ratio, 12 to 32 volts, hi-torque,
 belt or direct drive, \$9.95.
(1) BLACK & DECKER MOTOR & PUMP. 2
 G.P.H. 1200 R.P.M. 1/2" ports, \$9.95.
(2) CHANDLER EVANS LARGE WA-
TER PUMP. oil, insecticide, etc. 400
 G.P.H. Adj. Tiled, 1" ports \$9.95.
(3) THOMPSON PUMP & MOTOR for
 fuel, hot water, etc. 300 G.P.H. In-
 structions Inc. for Items (1) & (3) for
 D.C. & appl. for 110V. A.C. \$9.95.
ROTARY GEAR PUMP #101 for hy-
 draulic, water, or vacuum, 180 G.
 P.H. 200 P.S.I., 29" Vacuum \$7.95
(5) VOLTMETER D.C. 30 Volts, 0-300
 Ohms, \$5.95. **TACHOMETER INDI-**
CATOR, 0-10,000 R.P.M. New \$8.95.
HYDRAULIC PRESSURE GAUGE, 0-
 2000 P.S.I. 1/4" ports. \$4.95.
ANNETER 0-180 Amps., 2 1/2" face,
 \$5.50.
WATER PUMP & PESCO MOTOR.
 1/4 H.P., 200 G.P.H., runs 6-32
 Volts. Adj. press. 1" ports, \$12.95
(7) ELECTRIC ACTUATOR, 5" travel
 1/8 H.P. D.C. & appl. for 110V. A.C. Rated
 2800 lbs. Instructions incl. \$7.50.

NEW HYDRAULIC CYLINDERS

Air or Oil	Bore	Stroke	Shaft	Double Action	Price
#11	1 1/2"	6"	5/8"		\$7.95
#12	4 1/2"	10 1/2"	1 1/2"/1 3/4"		\$27.50
#11	3 1/2"	2 1/2"	1 1/4"		\$25.50

(7) HYDRAULIC PUMP BARGAINS 1500 P.S.I.
 MFG. TYPE R.P.M. G.P.H. PRICE
 Pesco (gear) 1500 198 \$9.95
 Pesco (gear) 4100 300 \$12.95
 7 Stratopump (p.d.) 3750 400 \$19.50
 Vickers 507 Cu. In. Rev. 3750 400 \$19.50
ROMEC HYD. PUMP. 600 G.P.H.
 28 H.P. 3/4" Ports. New \$19.50.
4 WAY HYD. CONTROL VALVES
 with 1 handle, 3/4" ports, #4W11, \$8.95; with
 2 handles, 1/2" p. ports, #4W27, \$9.95. For 1
 to 4 D.A. cyl. 3/4" ports incl. built in relief.
 O. C. \$160.00, Adeli #10000 \$14.50.
(7) FOUR WAY SOLENOID VALVES.
 Instruction for 24V D.C. & appl. for
 110V. A.C. off in neutral, 3/4" #1213,
 \$12.50, #324 with 1/2" ports, \$9.95, #322
 one way, normally closed, 1/2" ports, \$2.38.
SIMMONDS HYD. ACCUMULATOR, 3000 P.S.I.,
 220 Cu. in. 3/4" ports. New \$12.50. **VICKERS**
 ball type sec. 2000 P.S.I. 1/2" dia. \$9.50.
HYD. ADJ. PRESS. RELIEF VALVES, four
 3/4" ports \$4.95, with 1/2" ports \$3.95.
GENERAL SALVAGE CO. CHECK OR M.O.
 2922 E. 27 St., Dept. 74, Kansas City, Mo.

DO MORE PLANING JOBS WITH LOW COST BELSAW

Exclusive MONEY-MAKING Features: • Full 12 1/2" x 6" capacity • Power feeds at 24" a minute • Provides for Grinding Knives in the Cutterhead • Attachments for Jointing, Rabbeting, Tongue, Groove, Matching, Convert low cost rough lumber into high priced cabinet finished stock... Easy to make flooring and popular patterns. Send today for free literature and prices.
 Belshaw Machinery Co., 2056 Field Bldg., Kansas City II, Mo.

ESHELMAN Makes Winter Jobs Easier

Also Eshelman Sport CARS, LOWEST PRICE 70 Miles Per Gal. Holds 1 Adult. Free Catalog.

RAKES PLOW CULTIVATOR HARROWS NAULS SPRAYS DOZER CUTS ROLLS TILLS SNOW PLOW

1 to 8 H.P. Also Walking Tractors as Low as... \$99

Women can operate it, 1 to 8 H.P.
Shipping Points: BALTIMORE, CHICAGO, RENO
 Free Catalog Write: **ESHELMAN CO., Dept. R-512**
 109 Light St., Baltimore 2, Md.

\$50.00 PER DAY AND MORE

SAW-KEEN SERRATING AND SHARPENING TABLE KNIVES EASY - TO - OPERATE

Be your own boss, work anywhere, full or part time. Every restaurant, hotel, drive-in, etc., repeat customers. Serrated (saw-edged) table and steak knives in great demand. \$98.50 investment returns first week. Guaranteed. Write today for proven daily profit plan.

CUTTER-CRAFT PASADENA 1, CALIF.

BUILD Your Own GARAGE

Save Up to 50% of Usual Cost!
 Build your own garage and save! Wayne Leckey, Popular Mechanics Assistant Shop Notes Editor, tells and shows how in his new book *How to Build Your Own Garage*.

No Previous Building Experience Required
 If you can use a hammer and a saw you can build your own garage. Leckey tells how in simple step-by-step instructions and shows how in big, clear photos, drawings and diagrams. Everything is covered from the laying of the foundation right up to and including applying the final trim.

25 Designs—Brick, Frame and Concrete Block Construction. Complete Building Data

There are 25 different designs from which you may choose. Brick, frame and concrete block construction is fully covered. Leckey tells and shows how to pour the foundation, erect the framework, erect the roof, apply insulation and shingles, lay the driveway, install trim, flower boxes, etc. It's all there for you to read and see.

7-Day Money Back Guarantee
 Get your copy of this valuable book today. Read and use it for seven days and if it isn't entirely satisfactory return it for a full refund. Send only \$3.50 for your copy to **Dept. 90 POPULAR MECHANICS PRESS**
 200 E. Ontario, Chicago 11, Ill.

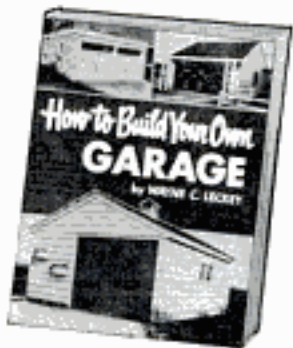

The New Model 70 UTILITY TESTER FOR REPAIRING ALL ELECTRICAL APPLIANCES MOTORS • AUTOMOBILES • TV TUBES

As an electrical trouble shooter the Model 70:

- Measures A.C. and D.C. Voltages, A.C. and D.C. Current, Resistances, Leakage, etc.
- Will measure current consumption while the appliance under test is in operation.
- Incorporates a sensitive direct-reading resistance range which will measure all resistances commonly used in electrical appliances, motors, etc.
- Leakage detecting circuit will indicate continuity from zero ohms to 5 megohms (5,000,000 ohms).
- Will test fuses, fuses, fuses, Heating Pads, Clocks, Fans, Vacuum Cleaners, Refrigerators, Lamps, Fluorescents, Fans, Switches, Thermostats, etc.
- Will test all TV tubes for open filaments, inter-plate shorts, burned out tubes, etc.

As an Automotive Tester the Model 70 will test:

- Both 6 Volt and 12 Volt Storage Batteries • Generators • Starters • Distributors • Ignition Coils • Regulators • Relays • Circuit Breakers • Cigarette Lighters • Stop Lights • Condensers • Directional Signal Systems • All Lamps and Bulbs • Fuses • Heating Systems • Horns • Also will locate poor grounds, breaks in wiring, poor connections, etc.

Non-dense resin-covered molded bakelite case, 3 1/2" x 5 1/2" x 2 1/4". Complete with all test leads. Also included is a 62 page book, giving detailed instructions for testing all electrical appliances, automotive equipment, TV tubes, etc. Only **\$15.95**

SHIPPED ON APPROVAL NO MONEY WITH ORDER - NO C.O.D.

Try it for 10 days before you buy. If completely satisfied then send \$3.50 and pay balance at rate of \$4.00 per month for 3 months — No Interest or Finance Charges. Added if not completely satisfied, return to us, no explanation necessary.

MOSS ELECTRONIC DIST. CO., Inc.
 Dept. D-188, 3849 Tenth Ave., N.Y. 34, N.Y.

Please rush 1 Model 70 I desire to pay \$15.95 within 10 days after receipt and \$4.00 per month thereafter

Name _____
 Address _____
 City _____ State _____

SPEED REDUCER-CLUTCH COMBINATION *Farm and Industrial* TRANSMISSION

Brand New SURPLUS!

Gov. Cost \$262.00

Only \$69⁵⁰

PREPAID

Speed Reducer Alone
worth triple this price!



FULLY
GUARANTEED

- Reduces speed at a 3-to-1 Ratio
- 2 Independent Outlet shafts, each separately controlled by its own Clutch
- Rated up to 3.6-HP (electric) or 7.5-HP (gas engine)
- Ball and Taper Roller Bearings thruout for smooth, quiet operation

There are unlimited farm and industrial uses where this SPEED REDUCER-CLUTCH COMBINATION can be utilized when low speeds are required—for starting heavy loads—or for engaging and disengaging machine operation without stopping the input drive. Use with any 3.6-HP to 3.6-HP motor (or 1-HP to 7½-HP engine). With input speed of 1800 RPM, ratio of 3-to-1 gives approx. 580 RPM output speed (or can be belt driven to give any desired speed). Clutches are of double disc design with non-burning asbestos friction rings . . . and have simple one-point adjustment to take up for any wear. Close grain cast iron and steel construction. Standard foot mountings.

Can be easily adapted to present drives—or for building special equipment that increases production and saves valuable man hours. A unit of this type is rarely available and hard to obtain AT ANY PRICE! Its versatility makes possible the mechanization of operations that would ordinarily be too expensive to modernize. Some of the countless applications are: machine tool drives; construction and farm machinery and equipment; winches, lifts, hoists, etc. A REAL ENGINEERING ACHIEVEMENT IN EFFICIENCY AND COMPACT DESIGN. Weight 108 lbs. Approx. size, 17½" long x 8" wide dia.

ORDER DIRECT FROM ADI We Pay Shipping Costs!
FREE Catalog of Hydraulics, Generators, Other SURPLUS
ROBERTS ELECTRIC CO., Dept. PM-343, 849 W. Grand, Chicago 22

ONE-MAN SAWMILL LOW \$50⁰⁰ DOWN AS . . .



Take BELSAW Portable Sawmill right to the trees—turn out valuable lumber for home and farm—sell to local yards—make up to \$50 a day custom sawing for neighbors. BELSAW lasts a lifetime. No crew needed. Power with tractor or auto engine. Beginners get excellent results. Send today for FREE BOOK.

FREE BOOK

BELSAW MACHINERY CO
3456 Field Bldg. Kansas City 11, Missouri

CHARGE 6 & 12V AUTO BATTERIES run auto radios, electric trains, electric shavers, etc. with . . .

6V & 12V Battery Eliminator & Charger

2 ranges: 0-8 volts (10 A continuous, 20 A intermittent), 0-16 volts (6 A cont., 12 A interm.) Continuous voltage adjustment. Separate voltmeter & ammeter. Panel fuse & auto. cut-out relay fully protect primary & secondary.

KIT \$29.95
Wired \$38.95

NEW GEIGER COUNTER KIT \$19.95
Wired \$29.95

Professional, super-sensitive—Indicates by flashes & headphone clicks. No moving parts. Complete easy instructions with each instrument. Backed by world's largest mfr. of electronic kits & instr. (46 in all) in stock at your local electronics distr.—or send to us. Write for distributor's name & FREE Catalog PM-12 Auto Batteries.

From 7% light on West Coast
EICO 84 Withers St. • Brooklyn 11, N. Y.

SURPLUS AIRCRAFT MATERIALS

COMPASS, magnetic, aircraft, type Bendix Mark VIII, 360 glass, 3½" dia., Panel mounting, lighted. Excellent condition. PP. \$9.95

COMPASS, Astro, Mark II, in carrying case, For navigating by stars, distant objects, triangulation, etc. 9½" X 4½" X 5". PP. \$7.95

CYLINDER, hydraulic, double-acting, 4" stroke X 2" dia., 1¼" shaft, ¼" tube fittings. PP. \$3.95

PUMP & MOTOR, Anti-icing, 24V, three ¼" ports, 1 in. 2 out, 2½ gph, 2½" dia. X 7" Ht. Wt. 2½ lbs. Runs AC if ground disconnected. PP. \$7.95

BALLOON TIRE, Tube & wheel & bearings, 900 X 6" size, 22" ht., 7½" wide, 6" wheel, 1½" axle size, 8 ply tire. Wt. app. 30 lbs. FOB. \$13.95 (four for \$49.50)

INSTRUMENT TEST SET, Instrument, portable (3 wheels), type C-1, 110V ac-dc. Input. Has air, oil, suction pumps, full instrument panels, accessories. \$149.50 (with master altimeter & thermometer testers. \$198.50). Gr. weight, app. 500 lbs.

LYCOMING ENGINES, RAF, type O-435-1, 160 hp., 6 cylinder, flat-topped, aircooled. Weight app. 350 lbs. 45" L X 32" W X 28" H. Use for air boats—sleighs, etc. Engine, prop., hub, a. plugs, ignition harnesses, 2 magnetos, carburetor, generator. Gross weight varies, 450 to 550 lbs. FOB, good used condition, \$125.00 up. PREPAID

AERO PARTS SUPPLY, 8102 Lockheed St., Dept. 210, Houston 17, Texas

Now You Can Upholster Any Piece of Furniture!

Upholster—Restyle Any Piece of Furniture Yourself

John Bergen, custom furniture designer, tells and shows you how to transform old out-of-date furniture into brand new smart-looking comfortable furniture in his new book **ALL ABOUT UPHOLSTERING**.

No Experience Needed

Bergen tells you every step to follow in amazingly clear easy-to-understand step-by-step instructions and then shows you how in hundreds of big, clear drawings and photos. You read and see how to strip the old frame, install new webbing and springs, apply burlap, install stuffing and padding, fit the muslin cover and the final fabric and install trim.

Use New Materials—Methods

Now you can have furniture upholstered with foam rubber, sagless springs and other new materials that add so much to comfort and durability and are so costly when included in new furniture.

Save 50% of Usual Cost

Don't pay a small fortune for new furniture when you can make your old furniture better than new! Why pay high prices to have someone else upholster and restyle your old furniture when you can do it yourself for cost of materials alone? It's easy and it's fun.

Special Chapter on Slipcovers

Learn how to make custom-made slipcovers with professional look and fit. Find out how you can realize tremendous savings by investing a few spare-time hours and the cost of a few yards of fabrics.

7-Day Money Back Guarantee

Send for your copy of **ALL ABOUT UPHOLSTERING** today. Read and use it for 7 days. If it isn't entirely satisfactory return it for a full refund.



USE THIS HANDY ORDER COUPON

POPULAR MECHANICS PRESS, Dept. AAU
200 E. Ontario St., Chicago 11, Illinois

Gentlemen:
Please send my copy of **ALL ABOUT UPHOLSTERING**. Enclosed is my remittance of \$3.50. If I am not completely satisfied with the book I will return it for a full refund after 7 days.

Name _____
Address _____
City _____ Zone _____ State _____

DIESELS FOR ORIGINAL EQUIPMENT OR REPLACEMENT POWER

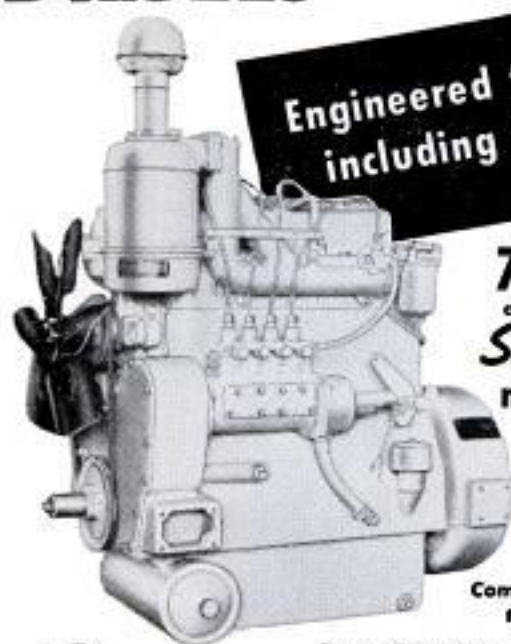

Engineered to suit including drive

78 H.P.
at 2000 R.P.M.
Sheppard
model 16

available with complete transmission, torque converter or other special equipment

Complete specifications on request

Sheppard
DIESELS

HANOVER 15, PA.

Sheppard Diesels are compact, easily engineered into existing equipment designs. Exclusive Sheppard simplified fuel injection system requires no special service training or tools making Sheppard Diesels the obvious choice to replace gasoline power as original or optional equipment. Outline your needs today. Let Sheppard help you make the switch to Diesel easily, profitably

BUILDERS OF DIESEL ENGINES, TRANSMISSIONS, REAR AXLES AND POWER STEERING UNITS FOR INDUSTRY



The fine car at half the fine-car price

FORD!

HELPFUL BOOKS

Send post card asking for FREE catalog

Popular Mechanics Press, 200 E. Ontario, Dept. 601, Chicago 11

CIVIL DEFENSE POCKET SIZE RADIO!

NO TUBES — BATTERIES OR ELECTRIC PLUG-INS NEEDED!



Ordinary radios MAY BE USELESS DUE TO RUN DOWN BATTERIES OR POWER FAILURES during atomic attacks but this NEW CD Perma-Crystal Diode Pocket Radio operates during power blackouts. Receives regular radio stations and CIVIL DEFENSE BROADCASTS. Works anywhere when used as directed. COMPLETE. SELF-CONTAINED SPEAKER PHONE. GUARANTEED TO WORK and should last for years. BE PREPARED — GET YOUR CD POCKET RADIO NOW! **SEND ONLY \$1.00** (cash, ch. mo) and pay postman \$4.99 COD postage or send \$5.99 for postpaid delivery. COMPLETE READY TO PLAY WITH CIVIL DEFENSE INSTRUCTIONS. By mail from—MIDWAY COMPANY, Dept. CPM-12, Kearney, Nebr.



Make with
(RHYMES WITH O.K.) **FIR PLYWOOD**

Exciting new way of decorating with fir plywood. Create bold, colorful designs by "weaving" slits in plywood with dowels or other inserts. Use for dramatic lighting effects, room dividers, fences, doors. Wonderful for remodeling, "do-it-yourself."

FREE BOOKLET—contains step-by-step instructions, ideas, design suggestions. See your lumber dealer or write (USA Only) Douglas Fir Plywood Association, Dept. 99, Tacoma 2, Wash.



POWER HYDRAULICS for SNOW PLOWS

Use on



TRUCKS



JEEPS



TRACTORS

HY-LO-JACK does the job **FASTER-EASIER**

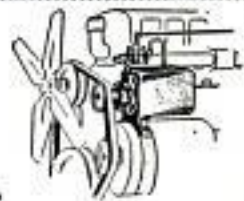

- Lifts average snow plow in 3 to 10 seconds.
- 1,000 lbs. per square in. pressure
- Quick, easy installation on new or existing equipment.
- Complete kit form, including the pump, tank, hose lines, etc.
- Electric unit also available for 6 or 12 volt systems.

* Write for Circular. See your Road Machinery, Jeep or Farm Equipment dealer.

MONARCH ROAD MACHINERY CO.
Quality Machinery since 1855
1331 Michigan St., N.E., GRAND RAPIDS, MICH.



NOW! KEEPS DRILLS at Your FINGER TIPS WITH "LAZY SAM" REVOLVING DRILL STAND

Easiest, fastest way yet to locate drills. Drill you want is always in front as stand spins freely on tip-proof base. Compact, yet holds 2 full sets, 1 to 60 and 1/16th to 1/2 by 64ths. Positions marked in large, easy-to-read numbers. Sturdy, metal construction. Complete with table top stand. Mounting brackets available for drill press or wall. Order Now! Cash with order ppd; COD postage extra.

PRECISION PRODUCTS CO. RT. 1, BOX 250, SANDY, OREGON

- Drill Stand \$4.50
 - Drill Press Bracket... \$2.85 (for 2 1/2 to 4" column)
 - Wall Bracket..... \$1.95
- SAVE! Order all 3 for \$8.95**

**BUILD
IT
YOURSELF**



MODEL BR-2

\$17.50 (Less Cabinet)
SHPG. WT. 10 LBS.

Heathkit
**BROADCAST BAND
RECEIVER KIT**

Have you ever experienced the thrill of building your own radio? Invest a few of your dollars—a few hours of your time, and build a truly worthwhile broadcast band receiver. Transformer operation eliminates potential shock hazard characteristic of "economy" AC-DC sets. Operates as radio, phono, amplifier, or tuner. Fine tone quality, excellent sensitivity. Simplified Construction Manual outlines basic theory of radio principles. Actually a radio course in itself. Price includes tubes—speaker—chassis, etc. Every part you need! Order your Heathkit Radio Kit today.

OTHER "BUILD IT YOURSELF" Heathkits

- | | |
|-------------------------|----------------------|
| Oscilloscope | Hi-Fi Preamplifier |
| Vacuum Tube Voltmeter | Battery Eliminator |
| Signal Generator | Signal Tracer |
| Amateur Transmitter | Tube Checker |
| Communications Receiver | (and over 50 others) |
| Multimeter | |
| Handitester | |
| Hi-Fi Amplifier | |

**WRITE FOR
FREE CATALOG**



HEATH COMPANY
A Subsidiary of Daystrom, Inc.
BENTON HARBOR 17, MICH.

THIS INEXPENSIVE EASY-TO-OPERATE MACHINE

Brought Mr. C. H. R. of Ohio
\$3,688.20
in one season

You, too, can be your own boss in this fine business. Spare or full time, earning big money in your garage or basement.



Yes, C. H. R. is only one of many who write about their success with the Universal Lawn Mower Grinder. Another says, "I am buying a home and my Universal is going to be a tremendous help paying for it." Whether you are buying or want to buy a home, want the security of a sound future or living comforts extra money brings, you owe it to yourself to send the coupon today. Investigate our success plan now—get everything you need to develop a good profitable business of your own.

ROGERS MFG. CO., DEPT. M-125, LINDSEY, OHIO
Fill in and mail this coupon now

Rogers Mfg. Company
Dept. M-125, Lindsey, Ohio

Gentlemen: Please rush me details about the profit possibilities of the Universal Lawn Mower Grinder.

NAME.....
ADDRESS.....
CITY..... STATE.....

**ROGERS
MANUFACTURING
COMPANY
LINDSEY,
OHIO**

BELT SANDER
for
Wood, Metal, Plastic

You will find this the handiest machine in your workshop.
Standard 3 X 24 Belt. List Free.

PRICE \$19.95 POST PAID
Satisfaction Guaranteed

GRAY BROTHERS MACHINE CO.
NEDROW 4, N. Y.

Free! 75 ORIENTALS

Brought to you from the farthest ends of the earth—these exotic valuable genuine STAMPS of the Orient! 75 all-different from Borneo Siam, China, Japan, Hong Kong, Malaya, Sarawak, Singapore—and other exciting mysterious lands of the Far East. EXTRA! Free booklet, bargain lists, fascinating offers for your free examination. Send 10c for mailing expenses.

JAMESTOWN STAMP CO., Dept. C12PM, Jamestown, N. Y.

BRONZE FOUNDRY
Schools and Home Workshops

Make your own castings of aluminum, copper, bronze, silver. Foundry sets are available in three sizes including 2400 Deg. F. blast Furnaces. \$22.50; \$29.50; and \$42.00. f.o.b. Marysville, Kans. Free Circular.

KANSAS CITY SPECIALTIES CO. P. O. Box 6022, Dept. P-12
MARYSVILLE, KANS.

Say You Saw It in Popular Mechanics

Save on all PLUMBING JOBS

When You Build - When Making Improvements - Repairs - Maintenance

Get
**POPULAR MECHANICS
Home Plumbing
Guide**



How to plan plumbing installations, select materials and fixtures.

How to save money on all plumbing jobs using approved methods.

Easy to Do Professional-Like Jobs and Save Over One-Half

Get the Popular Mechanics HOME PLUMBING GUIDE. It shows how you can do every kind of plumbing job yourself and save from a few to hundreds of dollars. Covers plans, layouts, installation, maintenance and repair. Shows what materials to get and use, where to get them and how to do a proper job with approved methods. Few, other than the simplest tools are required and some of these can be rented. Don't pay high prices for work you can do yourself. Get the HOME PLUMBING GUIDE for only \$3.50. You will be amazed how jobs you thought difficult are simplified.



- 15 Ways to Save Money**
All about modern home plumbing
How to use plumbing tools
Getting acquainted with pipe
Planning home plumbing systems
Installing and maintaining home drainage systems
Private sewage disposal systems
Causes and cures of drainage troubles
Installing home water lines
Private water supply systems
Water Heaters
Water Conditioning
Water system troubles and cures
Installing and caring for fixtures
What to do with valves and faucets

Over 500 How-to-do-it Pictures Guide You

Clip This Ad and Mail. Money Back if Not Pleased
Invest only \$3.50. Use the book for 7 days. Then if you are not satisfied return it for full refund of your money. Sent C.O.D. (U.S.A. only) if you prefer.

POPULAR MECHANICS PRESS, Dept. HPG-10, 200 E. Ontario St., Chicago 11

M.S.A. NAVY OXYGEN BREATHING APPARATUS

Over 1200 NEW Units Purchased From U. S. Navy
Each Unit Complete With 7 Extra Canisters

Fire Departments

Fire departments in 27 states have recently purchased the M.S.A. Navy Oxygen Breathing Apparatus from the FRESNO HARDWARE CO.

Each unit consists of complete breathing apparatus, instruction book and seven extra canisters. Ready for use and can be put into operation by one man in less than 2 minutes. The price of \$45.00 per unit is less than the price you would normally pay for the canisters alone. Also, a complete line of all spare parts available at a fraction of their original cost. Extra canisters are available for \$3.00 each from the FRESNO HARDWARE CO. These canisters are a standard size and may be purchased from any Mine Safety Appliance dealer.

This is a self-contained oxygen generating breathing apparatus, designed to protect the wearer in any atmosphere that is irrespirable due to presence of harmful gases, vapors, dust and smoke or a deficiency of oxygen. Its operation is independent of any outside air; the wearer breathes into a closed system which forms a

OVER \$200 VALUE \$**45⁰⁰**
PRICED ONLY . . .

This includes all freight charges on shipments made in the United States. Canadian shipments paid to point of entry only. Satisfaction Guaranteed.

COMPLETE

circuit within the apparatus. The exhaled air which contains carbon dioxide is purified and replenished with oxygen by passing through a chemical, thus promoting normal and comfortable breathing.

Including canister, it weighs only 12 $\frac{3}{4}$ lbs. and measures 4 $\frac{1}{2}$ inches at thickest point. Thus the apparatus can be worn under coat, if necessary, and allows maximum freedom of movement in all positions. Normal conversation is not impaired. There is no high pressure, nor valves to adjust. Increased demand for oxygen automatically increases the oxygen volume.

These are new units and ready to use. Compact, efficient and safe. At this price, four men can be equipped for less than the cost to equip one man with comparable equipment. Satisfaction Guaranteed.



We pay all freight or postage on U.S.A. shipments. Purchase orders accepted from all Fire Departments, City, County, State Government agencies or rated firms. Terms: Net 30 days from date of delivery. Individuals may order by sending money order or check.

FRESNO HARDWARE CO., 1820 Tulare St., Fresno 21, Calif.

AUTOMOBILE RACING—Sixth Edition

Full description with over 100 illustrations of new fast racing creations. Working drawings with step by step building instructions for successful Ford 40 Midget—Model A Roadster—Offenhauser Dirt Track Racer—Miller 158.5 m.p.h. Racer. Details on axles, frames, engines, bodies, etc., etc. Entrance Blank with rules and regulations. A book full of interest for every Auto Racing Fan, Driver, Mechanic and Owner. Money back if not satisfied.



ORDER NOW! \$1.00 POSTPAID;
Sorry, No C.O.D.'s

POPULAR MECHANICS PRESS, 202 E. Ontario St., Chicago 11, Ill.

HELPFUL BOOKS

Send post card asking for FREE catalog

Popular Mechanics Press, 200 E. Ontario, Dept. 601, Chicago 11

1/2-HP Motor SPEED REDUCER

Reduces Speed at a 20-1 Ratio

Brand New!
Guaranteed!

Mfr'd. for Army radar equipment, this reducer is a masterpiece of design and precision workmanship



For experimental and laboratory uses . . . for building special equipment that saves valuable man hours. Ratio of 20-1 gives approximately 90-RPM with 1750 motor, direct drive . . . or can be belt driven to give ANY DESIRED SPEED! Use with any size motor up to 1/2-HP. Case is cast of aluminum alloy (not die cast) and has BALL BEARINGS throughout. Heavy duty, double reduction, spur gear drive built for continuous duty. Smooth, quiet running. Base to shaft is 4 $\frac{3}{4}$ " high. Comes complete with couplings. Operates conveyors, timing devices, revolving window displays and signs, tumbling equipment and machine tool drives . . . 1,501 uses!

Gov. Cost \$86

Only \$16⁵⁰
Pre-paid

Order From AD! We Pay Shipping!

FREE CATALOG OF OTHER ELECTRICAL BUYS

ROBERTS ELECTRIC CO., Dept. PM-341, 849 W. Grand, Chicago 22, Ill.

Amazing
New Tool!

P & C[®]

All-Angle Drill

Drills Around Corners!
Adjusts to Any Angle!



Your toughest drilling jobs are a cinch with P&C's new All Angle Drill. 0 to 1/4" capacity chuck swings 270°. Handle moves 180° at right angles. Spring lock changes angles at flip of your thumb. Hollow handle stores drills. Buy it today.

P&C... THE BEST TOOLS MONEY CAN BUY.

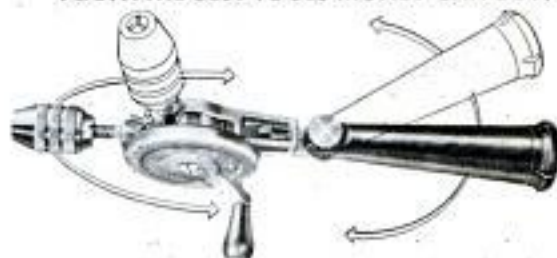

Shop from P&C merchandisers . . . over 10,000 stores.
Send 10c for tool catalog.

P & C TOOL CO. Dept. H-2 Box 5926,
Portland 22, Oregon

MAIL ORDER SPECIAL



GASOLINE

\$9⁵⁰

CAMP STOVE

ORIGINAL COST \$80

BRAND NEW U. S. ARMY FIELD RANGE Burner Unit, approx. 50,000 B.T.U., complete w/2 extra generators, unit as pictured. Cook on it, use as cabin heater. Shipping wgt. approx. 55 lbs. Size: 21 1/2" lg., 19" w., 9 1/2" h.

SPECIAL! NEW ARMY MACHETTES.....\$1.95
FOLDING FOX-HOLE SHOVELS.....\$1.00
FOX-HOLE PICK-MATTOCK.....\$1.00

All prices FOB Memphis—order now. Supply limited

J. P. DAVIDSON CO.

104 N. Front

Memphis, Tenn.

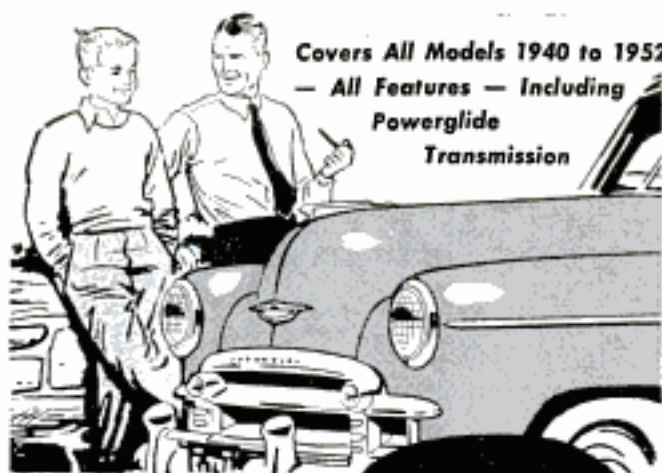

Covers All Models 1940 to 1952
 — All Features — Including
**Powerglide
 Transmission**

Get Popular Mechanics Owner's Manual

If you drive a Chevrolet—any model—1940 to 1952—get this owner's manual today. It will save you money on repairs and service; give you safe, economical and trouble-free motoring and protect your investment in your Chevrolet by keeping it constantly at top value. Can easily be worth hundreds of dollars to you in a single year.

**Chevrolet
 Owners**
 Spend Less to Own
 and Drive Your Car

Official, Authoritative Bumper to Bumper Information

Prepared by a noted automotive authority and Popular Mechanics editors with the full cooperation of Chevrolet engineers and service specialists. Covers all phases of Chevrolet operation, service and maintenance. 304 pages of practical information and hundreds of photos, diagrams, charts, and sectional views, make every part, every operation, easy to understand. Complete index enables you to put your finger on the information you want instantly.

Prevents Costly Repairs

Explains everything about your car; what can go wrong; how proper adjustment and servicing should be done; how to prevent major troubles and costly repairs later on. Even if you don't service your car at home the manual will save you important money on every day operation.

Mail Coupon Today

Mail coupon now. Send only \$3.50 for prepaid delivery or you can pay postman, plus charges. See money back guarantee in coupon.

Learn All About Chevrolet's Powerglide Automatic Transmission

Know Your Chevrolet Valve-in-Head Engine and How It Operates

Understand Chevrolet's Center Point Steering and Unitized Knee-Action.

Protect Your Investment. Know Your Chevrolet.



POPULAR MECHANICS PRESS
 200 East Ontario St., Chicago

Send Manual for Chevrolet Owners at once. If not satisfactory I will return it within 5 days and you will refund full purchase price.

Remittance for \$3.50 enclosed. Send C.O.D.

Name _____

Address _____

City _____ State _____

NEW PLANER AND HOLE SAW



**BORES
 DRILLS
 PLANES
 GROOVES**

**USE HAND
 OR POWER
 TOOLS**

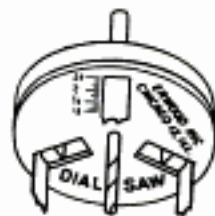

**Adjustable
 Dial the Size**

ERWOOD Dial Saw

This new adjustable rotary planer, hole saw and grooving tool is indispensable for use by home woodworkers, cabinet makers, carpenters and hobbyists for working in any kind of wood, plastics or light metals. May be used to plane, groove and cut holes from 1 1/8" to 2 1/2" diameter with any 3/4" drill or drill press. The Erwood Dial saw is made of high alloy steel, rust-resistant finish. Send only \$6.95 for this great tool postpaid today. **SATISFACTION GUARANTEED OR YOUR MONEY BACK.**

SEND ONLY \$6.95 EACH POSTPAID

ERWOOD INC., Dept. PM
 1770 Berbeau Ave., Chicago 13, Illinois

Gentlemen: Enclose find \$_____ please send me _____ Dial saws postpaid complete with two sets of cutters. If I am not completely satisfied, you will return my full purchase price.

Name _____

Address _____

City _____ State _____

Got a youngster?

(Pattern No. 53—
35¢ Pony Ride
Rocker)

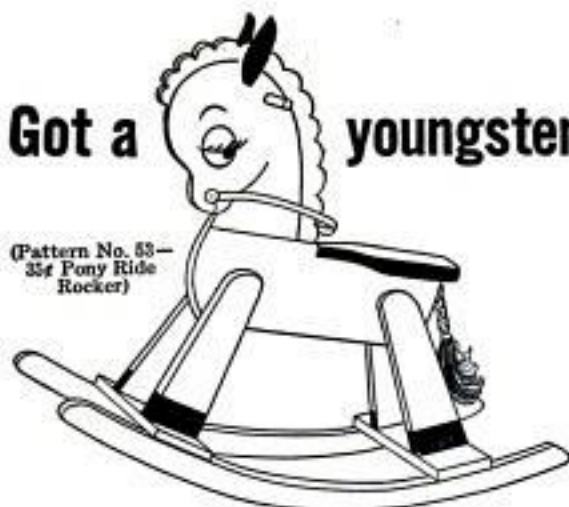

Give him his own pony. No skill or experience needed to build this rocking horse with Easi-Bild* Patterns.

Just trace simplified pattern on wood, saw and assemble. Big decorating guide insures a professional-looking paint job.

For catalog describing over 200 patterns, send 35¢ to EASI-BILD, Pleasantville, N. Y.

*T.M. Reg. Easi-Bild Pattern Company

EASI-BILD PATTERNS



Easi-Bild Patterns specify PLASTIC WOOD for a real professional job. Handles like putty—hardens into wood.

"PLASTIC WOOD"

Also Adult Size Cars at Low prices for

- GOLFERS
- AIRPORTS
- INDUSTRY
- LIGHT DELIVERY

ESHELMAN 70 MILES PER GAL. GAS CHILD'S AUTO WITH MOTOR

STURDY, SAFE FOR KIDS
Commended by "Parent's Mag."
Write for Free Catalog.

SHIPPING POINTS:
BALTIMORE,
CHICAGO, RENO.
For Free Catalog Write
Eshelman, Dept. MC-512
109 Light St.
Baltimore 2, Md.



Pat. Pend.

**Guaranteed Auto Parts
at Western Auto**

SENSATIONAL NEW HIGH SPEED DRILL MASTER

NOW turns the ordinary shop drill into HIGH SPEED DRILL. PRESS at a big saving. When DRILLMASTER is used on a 5,000 rpm drill press its top speed will be 20,000 rpm. Does the work of expensive high speed drill presses on brass, aluminum, plastics and cast iron where high speed drilling is necessary. Available for work of any size runs. Fits any 1/2" chuck, holding drills from 3/32 to 2-80. Shafts are heat treated and ground. Ball bearings and oil impregnated bearings and gear train are housed in cast aluminum. Precision made throughout. **\$62.50** Fob. Cgo. Wt. MAIL ORDER TODAY only **\$62.50** Fob. Cgo. Wt. ON C.O.D. ORDERS WE REQUIRE A 10% DEPOSIT. 22

DIRZIUS MACHINE SHOP "I", 1423-25 So. 52nd Ave., Cicero 50, Ill.



**TRY SUPERSHOP FREE
Factory To You — \$79.95**

Think of the fun you'll have and the money you'll save with your own big capacity workshop. Picture yourself sawing with the 8" ball bearing saw. Or drilling in steel with the vertical drill press. You bore with the horizontal drill—exclusive with SUPERSHOP. You sand with the 8" disc sander. You turn with the 30" lathe. You sharpen tools on the 3" grinder.



**VERTICAL
DRILL PRESS**

You are invited to TRY SUPERSHOP FREE. We will pay all shipping expense. Write for full details of this amazing FREE TRIAL PLAN. Mail postcard now.

POWER TOOLS INC.

178 Yates Ave.
Beloit, Wisc.

**WELD
BRAZE
SOLDER
CUT**



**4WAY
ONLY
\$14.75**
f.o.b. factory

WELDER
Complete with
Twin Carbon Arc
Torch and ac-
cessories... to
handle all metal-
craft work.

Acclaimed by thousands of Homeowners, Mechanics and Hobbyists as the welder of 1001 uses. Easily operated from properly wired 110 volt AC or DC line. The ideal gift with a life-long use....Order today on 10 day money back guarantee.

**FOUR-WAY WELDER CO., Dept. F2-N
1810 S. Federal St. • Chicago 16, Ill.**

AUTOMATIC RETOOTHER

MAKES NEW PROFITS

Cuts new teeth in 50 seconds—only size 4 to 16 points. Old teeth fall off as chips. Easy to operate. A perfect job.



BURR MFG. CO.

8933-N VENICE BLVD. LOS ANGELES 34, CALIFORNIA

GENUINE U.S. SIGNAL CORPS TELEPHONES AND COMMUNICATION WIRE!

**INDUSTRY—RANCHES—BUSINESS . . . SAVE TIME, STEPS, MONEY . . .
WITH YOUR OWN DIRECT LINE INTER-TELEPHONE SYSTEM.**



Join the thousands of our customers who are now saving money with these easy to install phone systems. Just string wire, connect from 2 to 8 phones and ring and talk up to 20 miles. Battery powered. Perfect performance.

New Kellogg Magneto telephones. Sturdy, trouble-free. **\$23.50** ea. per pair **\$42.50**. 225 Army field phones—factory reconditioned. Like new—per pair **\$39.50**.

OTHER PHONES AVAILABLE

C-433, latest field phone **\$29.50** pair.

EE-91 all metal field phone **\$29.50** pair.

Desk phone and magneto ringer box **\$29.50** pair.

New sound powered handsets **\$27.50** pair.

ALL WEATHER—ALL PURPOSE WIRE on original factory reels. For communications—blasting and intercom. Hundreds of other uses. W110H 18 ga. 2-conductor insulated copper-steel conductors.

New—Perfect, Select Grade **Grade 1, Unused, like new**

1/2 mile reels . . . **\$15.00** 1/2 mile reels . . . **\$10.00**

1 mile reels . . . **\$27.50** 1 mile reels . . . **\$17.50**

WD12/TT—new 2-cond. field wire, Polyethylene plastic, 1/2 mi. reels . . . **\$20.95**

Insulators—Porcelain. Box of 75 . . . **\$3.95**

Send ck. or m.o. . . no c.o.d.'s . . . all prices f.o.b. Sacramento. California buyers add 3% tax. Other wire and phones not listed. **LORIS SALES, P.O. Box 1896-B12, Sacramento, Calif.**

Save...FACTORY TO YOU!

CLEAR PLASTIC AUTO SEAT SLIP COVERS

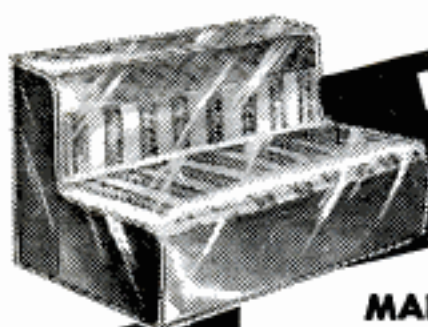

**HEAVY
DUTY
8 GAUGE**

MADE OF

\$4.95
each

Firestone

Velon®

PROTECTS upholstery from children's shoes, pets' dirty paws and shedding, grease and dust. No installation problems . . . custom tailoring allows covers to slip on or off in just seconds. Water repellent . . . cleans with just a wipe. Fits all cars. **SAVE!** Just one cleaning bill could more than pay for these high quality covers!

**SOLD BY
MAIL ONLY!**

**Money Back
Guarantee!**

AUTO COVER MFG. CO.
Box 15701, Los Angeles 15, California

Enclosed is \$_____ for _____ covers

Make _____ Year _____ Body Style _____

Front Seat \$4.95 . . . Rear Seat \$4.95
(including tax and postage)

NAME _____

ADDRESS _____

CITY _____ STATE _____

INGENIOUS *New* SLIDE RULE



The S-M slide rule is a SIMPLIFIED, MULTI-PURPOSE, precision calculating instrument designed especially for beginners, grade school students, mechanics, high school students and others who frequently work with figures. A special copyrighted instruction book, written so you can understand it, contains over 250 practical problems with answers printed in the back of the book. The EASY TO FOLLOW instructions teach, without the need of pencil and paper, multiplication, division, proportion, square roots and combinations of multiplication and division. This book is FREE with the purchase of each 10" S-M PROFESSIONAL MODEL SLIDE RULE. **\$1.50** post-in PROTECTIVE CASE—All for only _____ paid Guaranteed. Send check or money order. Sorry, no C. O. D.'s.

C. V. ORE Box 305 Harvey, Illinois

NAME _____

STREET _____

ADDRESS _____ ZONE _____ STATE _____

READY CUT HOMES

\$2150 AND UP DIRECT FROM MILL

YOU SAVE the items which help make today's building cost expensive: high labor cost, contractor's profit and overhead, insurance, architect's fees. Cut-to-Fit eliminates usual lumber and material waste, also costly mistakes. Anyone can assemble. Simple, easy-to-follow plans furnished and each part numbered. Complete with all lumber, roofing, nails, glass, hardware, paint, doors, windows. Freight paid. Low-cost building plans sold separately if desired. 57 Homes and Floor Plans.



**5 EASY PAY PLANS
COLOR CATALOG**

Send **25c**

INTERNATIONAL MILL & TIMBER CO.
Dept. PM-125 Bay City, Mich.

FLOOR LEVELING JACKS

Do a professional job yourself on uneven floors and sagging doors. Just set jack on cement block or bricks and adjust nut. Price \$1.85 F.O.B. Write for folder or order from ad.

Ray Haupt Machine Shop
Bartlesville, Oklahoma

OVERLOAD SPRINGS



\$9.95 Per Pair For cars and trucks. Front and rear. Gives 2,000 lbs. extra capacity for all 1/2, 3/4, and 1 ton trucks, 500 or 2,000 lb. Size 1,000 lbs. extra for all cars. \$11.95 Easily installed. Guaranteed. State make, model. Dealers wanted.
BRINKMAN MFG. CO.
2315 CLAY, DEPT. 15-D, TOPEKA, KAN.

ALUMINUM SOLDER

Solders with soldering iron or torch, anything aluminum, also other metals to aluminum with added use of ordinary non-acid fluxed lead solder such as rosin-core solder. 1/4th Lb. solder and instructions, \$1.50. Post Pd. USA.
RAY ADCOX ENTERPRISES 2210 N. 48th ST., DEPT. 2C, EAST ST. LOUIS, ILL.

GET THE HABIT OF OUR CLASSIFIED ADS.

Wonderful Opportunities Amazing Bargains



10 ALNICO V MAGNETS \$1.00

Powerful, permanent, rust-proof Alnico V magnets have 1000 uses in home, workshop, drafting room, plant. Hold notes, lists, prints, maps, work sheets. Magnetize pot holders, towels—perfect for cupboard door closures. Postpaid, no C.O.D.'s. Fun for all! Order today.

Dept. P1, **MAGNEX, Inc.**, 851 Broadway, Denver 3, Colorado

64" FLEXIBLE SHAFT USE AS WOVEN WIRE CORE DRILL \$5.95

REAL BARGAIN—cannot be duplicated for \$15.00. Coupling fits 1/2" or 3/4" motor shaft (state which); other end fits standard chuck. Durable, heavy. Use it for grinding, polishing, buffing, drilling, etc. Heavier constr. Chuck for same only \$1.25. Send check or money order and we will ship P.P. prepaid or C.O.D. Plus Postage. Money refunded if not satisfied.



L. C. DOWNEY CO. — Dept. M
8004 TRAYMORE AVE., PHILA. 18, PA.

SAVE ON PALLEY DO-IT-YOURSELF BARGAINS

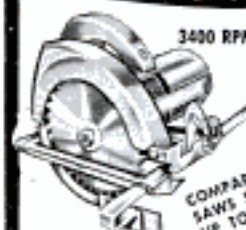

NEW 3400 RPM 1/2 HP POWER SAW

RIPS - CROSSCUTS CUTS A FINISHED 2x4 LIKE A KNIFE THROUGH BUTTER

Only 1998 Complete with 5-1/2" Blade

A rugged, professional type, adjustable saw. Will cut any angle from 0 to 45°. Has an adjustable (0 to 8") rip fence. Safety-trigger switch on handle. Full 1/2 HP Universal AC-DC, 110-120 Volt, 60 cycle motor. Weighs only 8 1/2 lbs. Thousands already sold. Your satisfaction guaranteed.

EXTRA SAW BLADES - Available in Rip, Crosscut or Combination. Please Specify . . . price per each **275 EA.**

SAVE 50% on Genuine Select PHILIPPINE MAHOGANY PLYWOOD

BUY DIRECT FROM IMPORTER
Ideal For Fine CABINET WORK, FURNITURE, Paneling DENS, OFFICES, HOTELS, etc.

Our prices are LESS THAN DOMESTIC PLYWOOD at WHOLESALE. This selected LUAN MAHOGANY meets the most rigid specifications. It is WEATHER and WATER RESISTANT. You'll be amazed at the beauty of this fine wood. Its rich golden elegance will thrill you. Rotary cut for beauty of grain. Both sides sanded and ready to use. Bonded with finest resin adhesive. Face side unjointed.

See for YOURSELF FREE SAMPLE on request!

Available in three thicknesses - 3mm (approx. 1/8"), 4mm and 1/4". ALL orders shipped by special Truck for lowest rates. No order accepted for less than 100 lbs. - equal to (6) 1/4" sheets, (5) 4mm sheets or (3) 3mm.

3mm (1/8") x 3ft. x 6ft. - \$5.00 value. **179 PER SHEET** (Min. order 8 sheets)

4mm x 4ft. x 8ft. - \$7.50 value. **389 PER SHEET** (Min. order 6 sheets)

1/4" x 4ft. x 8ft. - \$9.50 value. **499 PER SHEET** (Min. order 4 sheets)

NEW! 34 Pc. HOME WORKSHOP DRILL • SAND • BUFF GRIND POLISH • MIX PAINT

Famous Make **1/4" ELECT. DRILL WITH JACOBS CHUCK**

Another Palley exclusive. A sturdy, all-purpose drill for all home work shop and "DO-IT-YOURSELF JOBS." 1800 RPM AC-DC motor. Automatic trigger with lock action.

Kit contains: 1/4" Drill with Jacobs chuck, 7 carbon steel drills, 8-piece spindle adapter, polishing bonnet, sanding disc, grinding & buffing discs, drill stand, etc. Complete in metal case.



COMPLETE KIT **\$16.88** 24.95 VALUE

HARDWOOD LEGS WITH BRASS TIPS BUILD OR RESTYLE YOUR OWN FURNITURE

Beautifully turned, fully seasoned hardwood legs. Smoothly sanded and complete with brushed Brass tip and sturdy steel mounting plate. Available Finished or Unfinished - Finished units come in Blonde, Silver Fox, Mahogany or Charcoal Black. Please Specify type. Price per set of 4 with Brass tip.

SIZE	FINISHED	UNFINISHED	SIZE	FINISHED	UNFINISHED
4"	\$2.65	\$2.15	14"	\$4.40	\$3.95
6"	3.00	2.65	16"	4.75	4.40
8"	3.55	3.00	18"	5.35	4.75
12"	3.95	3.55	26"	6.25	5.35

NEW 4-SPEED HOBBY MOTOR

A rugged, precision built electric motor - operates on 110 volt, 60 cycle current. Originally built for the Navy - NOW converted for YOU! Has four take-off shafts turning at 5, 25, 150 and 4000 RPM. Cost Government approximately \$35.00 NOW . . .

995

BOLO KNIFE & CASE

Made of top quality Vanadium steel. 15" long. Ideal for clearing brush. With sturdy belt sheath.



198



ARMY MACHETTE

Has 22" Vanadium steel blade. A hardwood handle. Sturdy belt sheath. 27" overall. . . . **ONLY 198**

Palley SUPPLY COMPANY

AAF SURVIVAL PONCHO Complete Rain Protection with this roomy Poncho. Has built-in hood with throat lacing for tight fit. Can be used as an emergency tent or tarpaulin - when it is stretched out makes a fine ground cover. (see view at right)



395

Save on Manufacturer's Surplus and Closeouts! Top Quality. Ideal for Nooks, Chairs, Beds, Patio, etc. Add 75¢ cutting charge on ALL orders under \$5.00.

SLAB STOCK

Thick	Per Sq. Ft.	Thick	Per Sq. Ft.
1/4"	25¢	3/4"	75¢
3/8"	38¢	1"	\$1.00
1/2"	50¢	1-1/4"	1.35

CORED STOCK

Thick	Per Sq. Ft.	Thick	Per Sq. Ft.
1-1/2"	\$1.00	3"	\$2.80
2"	1.50	4"	3.00
2-1/2"	1.90	6-1/2"	3.20

PALLEY 100-200-300 POWER MICROSCOPE

An ideal Xmas Gift for the Student, Amateur Scientist, etc. Study insects, plant life, plant tissue, etc. Has fine ground and polished lenses. Precision ALL-METAL construction - this is NOT A TOY! The triple, revolving objective lens turret will allow you to select 100X - 200X or 300 power magnification. Has right or left hand rack & pinion adjustment for smooth, precise movement. Body inclines 90°. Adjustable plane sub-stage mirror. Complete in sturdy, dovetailed hardwood case.

ONLY 895



A XMAS GIFT THRILL RADIO RECEIVER

Here's a COMPLETE RADIO RECEIVER that picks up STANDARD BROADCAST STATIONS without using batteries or electricity! Just plug in the headset, antenna and ground wires and tune in your favorite program. You'll be amazed at the STRONG, CLEAR SIGNAL. Has a 100KC tuning range. Comes complete with Receiver, Antenna and Ground wires plus a Headset with two 2000 Ohm ear phones. NOT A TOY - A Genuine Crystal Receiver!

WITH HEADSET **ONLY 395**

Order From This Ad. Pay by M.O. or check. P.O.'s accepted from D&B firms. 1¢ deposit with C.O.D.'s. All Prices FOB Los Angeles.

2263 E. VERNON AVE. DEPT. PM-12. LOS ANGELES 58, CALIF.

PURIFY YOUR WELL WATER

Economy Chlorinator feeds solution thru your pump. Kills germs, sulphur odor . . . improves color and taste. Send \$9.95 for complete unit, instructions and year's guarantee. Dime brings further details. **ECONOMY 5717 Taft Hollywood, Florida**

Say You Saw It in Popular Mechanics

FIND URANIUM!!!

Prospecting made easy with Goldak's new U-238C triple-action geiger counter! Also famous line of metal locators, from \$49.50. Send 25¢ for radioactive uranium sample! **FREE DETAILS.** Dealer Inquiries Welcome.



GOLDAK COMPANY 1542 W. Glenoaks Blvd., Glendale, Calif.

KING MIDGET - WORLDS LOWEST PRICED CAR



Lower Priced, greater performance. Drive it for 75¢ per week. Also KING MIDGET JUNIOR, finely engineered, less than one-third cost of any comparable car, one twelfth cost of large cars. Agents wanted. **IT WILL PAY YOU TO GET THE FACTS.** Send 25¢ for literature and agents proposition on both cars, or \$1 (refunded first order) for this plus actual assembly book and service manual.

MIDGET MOTORS MFG. CO., Athens 1, Ohio



Now Anyone Can Smooth Rough Stuff!

Save yourself a lot of scraping and sandpapering with the new SMOOTHY. Easy to use as a black-board eraser! Has four scientifically designed star blades imbedded in tensioned plastic that will last indefinitely. Works quickly on rough plaster, wood, floors. Removes paint and varnish without messy liquids.

Order now for Christmas.

AT YOUR DEALER, or — SEND \$1 TO:

FORTUNE LABORATORIES
1405 MAINE STREET • DES MOINES, IOWA

BARRON Drill Press TOOLS



FOR WORKSHOP AND INDUSTRIAL USES...

Over 40 precision built woodworking tools and accessories... Hi-Speed Router Bits—Rotary Surface Sanders & Drum Sanders—Safety Shaper Cutters—Dovetail Cutters—Large Auxiliary Metal Tables—All Metal Shaper Fences—Spindle Adapters—Handy Bench Vises. Many other items indispensable for accurate, useful, versatile workshop use. Every tool sold on complete satisfaction or your money back. See your Barron Dealer. Ask for special folder — "24 Extra Uses for Your Drill Press."

ROTARY PLANER

Planes • Rabbits
Tenons • Panels
Routs • Bevels

Only \$8.50 COMPLETE

BARRON TOOL CO. INC.
312 Architects Bldg., Detroit 1, Mich.

FREE Workshop Guide & Catalog

24-Page Illustrated DO-IT-YOURSELF PROJECTS BOOK

Describes attic finishing, built-in cabinets, add-a-room, recreation room, kitchen remodeling, summer cottage and farm projects. Helpful information on how to get started, planning, cost estimating, materials purchasing, proper procedures, nail charts, moulding designs, etc. Send 25c and also receive 52-PAGE POWER TOOL CATALOG.

BOICE-CRANE CO., 943 Central — Toledo 6, Ohio



Auxiliary Accelerator...

LEFT FOOT PEDAL

Step on the gas with either foot with equal ease. Drive relaxed.

Guaranteed for the life of the car — which originally installed on. FITS ALL CARS.



PRICE \$6.95 Delivered to You

ORDER FROM R. V. LEHNER, Ness City, Kansas

SAVE MONEY on SURPLUS PARTS for MILITARY TYPE TRUCKS & JEEPS

4 & 6 wheel drive. FREE catalog to Jeep owners. State make truck or Jeep. (New Jeep Tops, steel or canvas all models). AMERICAN AUTO PARTS CO., Inc., 1830 Locust, Kansas City, Mo.

Say You Saw It in Popular Mechanics

NEW "WIZARD" TOOL DRILL GRINDING GUIDE

MAKE OLD DRILLS LIKE NEW...

For repairing dull and broken twist drills up to 1/2" in diameter. One piece cast Aluminum. Simple. Anyone can use it. Order yours today. \$1.00 post-paid.

BRASS CASTING CO. P. O. Box 3056 Memphis 9, Tenn.



Whatever your hobby

Model building, whittling, Indiancrafts, leather, plastics or any other creative handicraft

x-acto knives, tools & sets

designed by craftsmen and precision-made for fine craftsmanship

will help you do a better job

and get more fun and satisfaction from your hobby.

Build Model Planes?

Send 10c for 32 page book. Full size plans, instructions for 4 models, articles, helpful hints.

X-acto 28 page catalog—25c



x-acto
KNIVES • TOOLS
HANDICRAFT KITS

No. 86 X-ACTO HOBBY CHEST—\$12.00



X-ACTO, INC., 48-45 Van Dam St., Long Island City 1, N. Y.

BLACK IRON SWITCH PLATES

Single	\$1.35	Triple	1.95
Double	1.65	Outlet	1.65

Send 10c for New 120 Page Catalog (about 1000 illustrations) of UNUSUAL HOME ACCESSORIES.

WILLIAM Spencer

NO C.O.D. PLEASE

RANCOCAS WOODS, NEW JERSEY

PORTABLE LIGHT PLANTS

1300-1500 WATT PLANT
115v. 60 cyc. AC Push Button Start. Powered by a 3 1/2 HP. Clinton engine. Combines big output with easy portability. Provides emergency power for operating any oil burner, sump pump, freezer, television, lights, communications systems, etc. which require up to 1500 watts. (Item 22) Wt. 110 lbs. Reg. \$475 value. Factory price... **\$239.50**

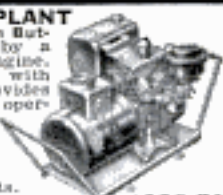

1750 Watt Plant Powered by 4.5 HP Briggs engine. Electric starting & battery charging built-in! Factory price... **\$279.50**

MASTER-LITE 2500 Watt Plant

110/120 v. 60 cyc. AC. A powerful plant, ruggedly constructed and yet designed for easy portability. Can be started by rope or built-in 12 v. electric push button starter. Built-in winding to charge battery. Powered by a 10 HP Briggs engine, complete with all accessories. Includes control box, voltmeter, and handy plug-in power receptacle. An ideal plant for permanent or stand-by service. Wt. 225 lbs. Reg. price \$645.00 (Item 21) Factory Price... **\$329.50**

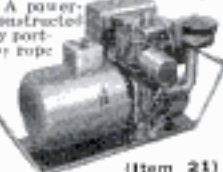

3500 Watt Plant Push Button Start (Item 23) 115 v. 60 cyc. AC. Similar to above, but larger and 50% more capacity. Wt. 270 lbs. Reg. \$740. Factory Price... **\$370.50**

DUAL VOLTAGE 110/220 for any of above plants—\$30 additional

get MASTER MECHANIC'S BEDROCK FACTORY PRICES

600-700 WATT PLANT

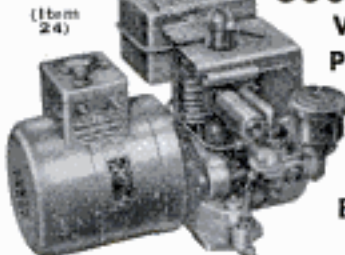

115 v. 60 cyc. AC Powered by a rugged 2 HP, easy starting Briggs engine. No wiring necessary! just plug in and operate. Plenty of current for any oil burner, freezer, brooder, emergency lights, etc. which require up to 700 watts. Ideal for television and radios. Complete with voltmeter and built-in winding to charge 4 v. auto batteries. (Item 24) Wt. 75 lbs. Easily fits in car trunk. Be prepared if storm knocks out power lines... **\$143.50**
Regular \$275.00 value... **\$199.50**

PUSH BUTTON START

LESS THAN WHOLESALE

GIANT 2000-2500 WATT PLANT

110-120 v. 60 cyc. AC. Absolutely the best made — exclusive dynamically balanced armature; heavy windings develop up to 2000 watt output for motor starting. Skid mounted — portable. Powered by an easy starting Briggs or Wisconsin 6 HP engine—complete with all accessories; engine easily disconnected for other uses. Big outlet box, voltmeter, no wiring necessary. Ample current for all purposes. Factory warranty. (Item 31) Wt. 210 lb. Reg. price \$585. Special at... **\$299.50**
Same plant with electric self starter (Item 31a)... **\$359.50**
Generator only and control box... **\$169.50**
DUAL VOLTAGE 110-220 available on any of above models for \$28.00 additional.

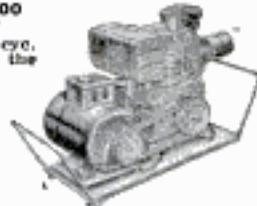

HI-LINE 6000 WATT PLANT

115/230 v. 60 cyc. AC. A brute of a power plant with a rugged 14.6 hp Wisconsin engine. Plenty of electricity for ranges, water heaters, freezers, pumps, machinery, etc. Affords both 110 and 220 volts. (Item 162)



52 pc. SOCKET SET



Highest quality, guaranteed non-breakable sockets made by Husky. Beautifully matched chrome trim will alloy absolutely the best. Contains a complete set of 28 sockets in 1/2" drive, 3/4" drive and 1 1/2" drive, plus all necessary extensions, handles, spacers, reversible ratchets, etc.; all unroad, guaranteed against breakage. A beautiful set of tools that will handle any job in a big doghouse steel box. Wt. 37 lbs. (Item 205) List price \$62.90. Factory Special... **\$27.95**

EXTENSION CORD



100 ft. extra heavy duty, made of specially insulated No. 14-2 conductor wire, non-prone to break. (50) **\$8.95**
No. 10-2 POWER CABLE. Heavy duty. Very flexible, rubber covered, 50 ft. with male and female fittings. Wt. 9 lbs. (Item 592a) **\$10.45**
50 ft. without fittings (Item 592) **\$9.45**
No. 12-2 POWER CABLE. Very flexible rubber covered, special outside shield for grounding power tools, etc. 50 ft. (Item 199) Wt. 8 lbs. **\$12.95**

JET STEAM MASTER

Now, a super efficient portable steam generator that produces live steam at 100 lbs. pressure in 60 seconds from a cold start! Produces large volume of high pressure steam on 2 pints of fuel oil. Instantly cleans sticky grease, dirt, rust, old paint, etc. off implements and road machinery. Pays for itself in a few weeks, sterilizes soil. 50 lbs. as it cleans—milk equipment, etc. Fully automatic—oil fired with new, built-in lifetime bronze water circulating pump. Draws water from faucet or bucket. Simple and safe—anyone can use it! Built-in safety valve. Complete with 1 1/2 ft. of high pressure steam hose and new triple-efficiency steam gun that automatically mixes in soap solution if desired. Wt. 250 lbs. Item 463. **\$329.50**



MASTER MECHANIC'S DC ARC WELDERS



Built in our own factory, these big, industrial capacity, portable welders provide terrific performance, yet are sold direct-to-you at bedrock factory prices—hundreds of dollars less than you'd expect! Senior model (shown in illustration, left) has high capacity DC welding unit—easily welds any thing up to 2 1/2" plate using 1/4" to 1/2" rods. Built in stabilizer and cooling system makes arc easy to strike and hold. Dual control rheostat provides low heat soldering, brazing, and welding from 30 to 300 amps. Comes complete with instructions, guarantee and triple V-belt or flat pulley. Easy to hook up and easy to operate.

WELDER ONLY — DUAL CONTROL MODEL. Same as above—drive with your tractor, jeep or gas engine of 14 HP or more. (Item 38a) Wt. 110 lbs. \$450 value **\$99.75**

THE POWER MASTER

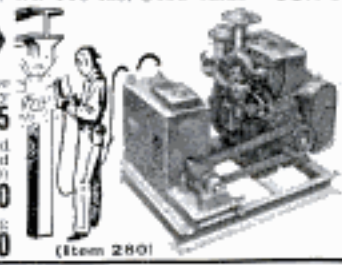

WELDER ONLY—STANDARD MODEL. Same as above but with single rheostat for heavy metal welding only. (Item 38b) Wt. 110 lbs. \$400 value. Special! **\$99.75**

COMPLETE POWER MASTER. (Illustrated at right) powered by a 14.6 hp., air cooled Wisconsin engine. Wt. 480 lbs. (Item 280) Compares with welder costing \$1200. Factory Special... **\$449.50**

WELDING KIT. Two 10 ft. leads, welding helmet, electrode holder, ground clamp. Sold only with welder at **\$10.50**

JET FLOW BLOWER



Tremendous air movement (1800 CFM) and quiet operation make this double inlet 10" turbine blower unbeatable for heating, cooling, drying and air conditioning. Ideal for attic or barn ventilation, converting gravity heating to forced air; spray booth exhausts, etc. Operates with any 1/4, 1/2 or 1/2 HP motor. Oversized, long life bearings. Includes variable speed motor pulley and belt. Dimensions 10" h x 18" x 16 1/2". Outlet opening 11" x 11 3/4". Wt. 45 lbs. Item 245. Reg. \$54.50. **\$29.50** Factory Special...

HEAVY DUTY 1/2 HP motor for above blower... **\$17.95**

12" TURBINE BLOWER Similar to above, but larger with 2400 CFM capacity. Wt. 65 lbs. (Item 245a) Reg. \$70.00. Factory Spec. **\$34.75**

Variable Speed Selector

Heavy duty, made by B. F. GOODRICH for industrial use. Provides instant speed changes for any drives. For machine tools, dryers, printing, conveyors, production lines, hoists—any operation requiring variable speed. Employs reliable "trouble free" planetary system. No hydraulic power losses. Infinite range, smooth operation, easy installation. 3 sizes: 1/2-1 hp. 36 lbs.; 1-2 hp. Wt. 55 lbs.; 2-3 hp. Wt. 105 lbs. Reg. list \$228, \$252 and \$352. Our prices **\$79.50, \$89.50 and \$114.50**

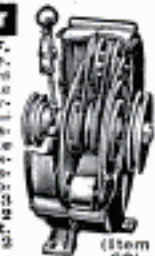

10" Fan, wt. 8 lbs. (Item 10K)... **\$11.95**
12" Fan, wt. 10 lbs. (Item 10D)... **\$12.95**

CONDITIONAIRE VENTILATING FANS

Save big money installing your own exhaust fan. Efficient propeller type blade moves huge volume of air quietly and effortlessly. Heavy welded frame — pre-drilled for easy installation. Just cut opening and bolt in place. Continuous duty motors. Ideal for attics, restaurants, garages, barns, chicken houses, etc. Control manually or with thermostat.



Blade Opening CFM	Wt.	Item	Price
16"	18 1/4"	2025 19 lb.	365a \$27.95
18"	19 1/4"	3600 27 lb.	365b \$31.95
20"	21 1/4"	4100 30 lb.	365c \$39.95

THERMOSTATS: BARN type (range 40°-60°), Wt. 2 lbs. \$6.95.

9 TON HYDRAULIC PRESS

A tremendously powerful hydraulic press, capable of exerting 18,000 lbs. pressure. Pays for itself many times over—straightening bent connecting rods, king pins, crankshafts, axles, link pins and bars — or pushing out frozen bearings and bushings. Developed pressure under precise control and visible at all times on accurate gauge. Complete with both large and small anvils and jigs to straighten any kind of curve or bend. (Item 464) Wt. 110 lbs. Actual list price \$365. Our special close-out price.



Send check or M.O. Prices f.o.b. Factory. 10 Day Money back guarantee. SEND 10c for... **MASTER MECHANIC MFG. CO.,** DEPT. 1004 **Burlington, Wis.** **BIG 1956 Catalog**

SOUTH BEND 14½" LATHES

Make Tough Jobs
EASY

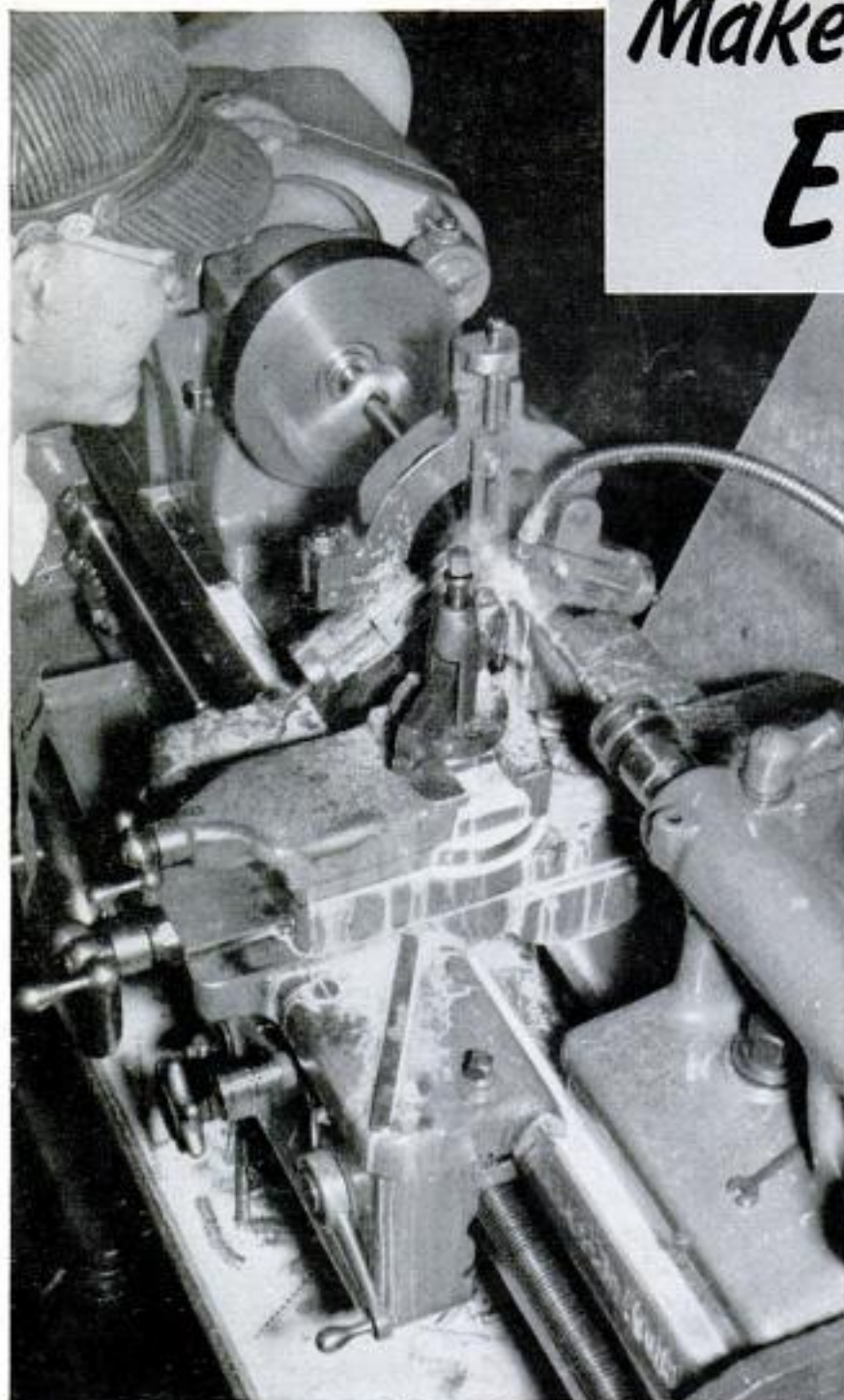

When tolerances start slowing up output, then is the time you need South Bend 14½" Lathes. Many plants have found they can save manhours and material by running the tough operations on these precision lathes — this is the type of work they do best. Their versatility enables you to keep them busy on a wide variety of work with a minimum of set-up time. Many attachments are available for special classes of work. Find out now how these lathes can give you efficient machining — *mail the coupon below today.*

BASE PRICE \$1809

SPECIFICATIONS

SWING: 14½" over bed and saddle wings; 10¼" over saddle with chip guard removed.

BED LENGTHS: 5, 6, 7 and 8 feet.

DISTANCE BETWEEN CENTERS: 24½ to 60½ inches.

COLLET CAPACITY: 1 inch.

SPINDLE BORE: 1½ inches.

SPINDLE SPEEDS: Eight . . . 30 to 875 r.p.m.

POWER LONGITUDINAL FEEDS: 48 R.H. or L.H., .0015" to .0841".

POWER CROSS FEEDS: 48, .0006" to .0315".

THREAD CUTTING: 48 R.H. or L.H. pitches, 4 to 224 per inch.

CROSS SLIDE TRAVEL: 10 inches.

Compared with our costs
OUR PRICES ARE LOWER
than they were back in 1941

PAGES UP
MATERIALS UP
PRICES UP ONLY

131%

49%



\$69.50

295

SEND INFORMATION CHECKED:

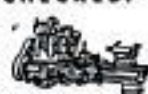

9" and 10" BENCH LATHES



10" to 16-34" FLOOR LATHES



DRILL PRESSES

TOOL GRINDERS



½" & 1" Collet TURRET LATHES



7" BENCH SHAPERS

Name _____ Street _____

City _____ State _____

Since 1906 • SOUTH BEND LATHE • South Bend 22, Indiana



PRINTED
IN
U.S.A.

Copyrighted material



give yourself

years of fun

with your family

WONDERFUL GIFT with a wonderful future . . . an Evinrude for Christmas! Passport to a new world of family recreation and adventure! A gift to thrill every member of the family with the promise of fun-filled holidays for years to come. *And so easily yours!* See your nearby Evinrude dealer . . . let him show you the fabulous '56 line of 9 *Whispering Power* Evinrudes —3 to 30 horsepower—a model just right for powering every type of family boat, smallest runabout to smart and able cruiser. Now, 3 models with finger-touch electric starting. Ask about the Evinrude gift certificate plan, with a modest deposit now and delivery priority for your Evinrude whenever you say the word. Your old motor brings top trade-in *right now!* Look for your dealer's name under "Outboard Motors" in your phone book. For free full-color catalog of the complete Evinrude line, write **EVINRUDE MOTORS**, 4161 N. 27th Street, Milwaukee 16, Wisconsin.

*a Whispering Power
Evinrude
for Christmas*

A Division of Outboard, Marine & Mfg. Company
In Canada: Manufactured by Evinrude Motors, Peterborough



Evinrude

Recreational Powerboat Motors



ial

WELLER TOOLS

MAKE A MERRY CHRISTMAS

FOR ANY HANDYMAN



TO GIVE OR RECEIVE...

Ideal Gifts For Hundreds of Homcraft Jobs

This POWER SANDER AND POLISHER

puts satin-smooth finishes on new wood in just a few effortless minutes; sands down old paint fast and easily; feathers dry-wall seams perfectly; and polishes waxed surfaces to a handsome, high gloss. With 14,400 power strokes a minute the Weller Sander is almost impossible to stall. 25 square inch sanding area is twice that of comparable tools; straight-line action sands with the grain, goes all the way into corners. Low design, less than 3' high, goes under low places.



**WELLER
POWER SANDER**
\$14.95

COMPLETE SOLDERING SET includes everything needed for joining metal parts, making electrical connections, sealing leaks and seams. *Weller Soldering Gun* heats in 5 seconds, has triggermatic control and 2 spotlights; *Wire Brush* cleans parts to be soldered; *Soldering Aid* makes tight wire twists; with famous *Kester Solder*... all in a handy storage case. Ideal too, for model railroading and other hobbies.



**WELLER
SOLDERING KIT**
\$7.95

AVAILABLE AT YOUR HARDWARE DEALER

WELLER Electric Corp.
Easton, Pa.