

NOVEMBER 1955

35 CENTS

# POPULAR MECHANICS MAGAZINE

WRITTEN SO YOU CAN UNDERSTAND IT

REG. TRADE MARK, GREAT BRITAIN, NO. 40426

REG. U.S. PAT. OFF.

**MORE 1956 CARS ON PARADE**

*For the Craftsman*

**DECORATE WITH  
PLASTIC LAMINATES**

**Make Your Own  
ARC WELDER**



*Felix Polm*

**The New Continental—Page 81**

Copyrighted material

Learn how homeowners everywhere  
save money by installing their own

# MATICO TILE FLOORING



*MATICO's New Improved  
Install-It-Yourself System  
Makes It Easy!*



1—Mark straight lines through the center of the room in both directions, using a chalk and line.

2—With a notched trowel, spread adhesive evenly over floor and allow to "set."



3—Press tiles into position. You can walk on MATICO as soon as floor is in place.



Yes, you can enjoy colorful, durable MATICO Asphalt Tile Flooring in your home at amazing low cost by installing MATICO yourself. You can't buy a more economical type of luxury flooring than MATICO. It lasts for years... is easy to keep sparkling clean and comes in 29 striking decorator colors that can't wear off because colors and marbleization go clear through the tile.

It's a cinch to install, too, with MATICO's tested install-it-yourself instruction booklet... tile calculator... and special tool kit. Why, you can finish a room in just a few hours.

Why put up with a dingy, worn-out floor when it costs so little to install a MATICO tile floor yourself.

See your classified telephone directory for the name of your MATICO dealer.



**MASTIC TILE CORPORATION OF AMERICA**  
Houston, Tex. • Joliet, Ill. • Long Beach, Calif. • Newburgh, N.Y.

Manufacturers of:  
Confetti • Aristoflex • Parquetry • Maticork • Asphalt Tile  
• Rubber Tile • Vinyl Tile • Cork Tile • Plastic Wall Tile

MASTIC TILE CORPORATION OF AMERICA  
Dep't. M2-11, P.O. Box 986, Newburgh, N. Y.  
Please send me MATICO's money-saving install-it-yourself instruction kit and complete color chart.

Name .....

Address .....

City..... Zone..... State.....

4673

**HERE'S WHY  
I'M ONE OF THE  
MILLION MEN WHO  
HAVE SWITCHED TO  
HOLIDAY!**



**Only HOLIDAY gives  
you this Custom  
Blend for Mildness!**

Yes, five famous tobaccos skillfully blended into a mixture of unequalled flavor, aroma and mildness. These fine tobaccos, selected from all parts of the world, are blended with a base of cool-smoking white burley . . . Each tobacco adds its own distinctive flavor and aroma to make Holiday America's finest pipe mixture. We suggest you try a pipeful . . . enjoy its coolness, flavor and aroma . . . and see for yourself why more and more men who smoke mixtures are switching to Holiday as a steady smoke.



These are the five famous tobaccos which give Holiday its mildness and aroma.

**HOLIDAY gives you  
this Heat-Sealed  
Wrap-Around Pouch!**

Holiday tobacco leaves our blending line with just the right moisture content. And it stays that way because Holiday is the only mixture which has the Wrap-Around pouch. Sealed air-and-water tight, it guarantees you a fresher, cooler-smoking tobacco.



**AT YOUR DEALER'S**

**IF YOU PREFER  
A BLEND OF  
STRAIGHT  
BURLEYS**

Try Edgeworth—choice cool-smoking white burleys in the air-tight pouch. America's finest pipe tobacco.



Get this guaranteed "Oldie London" Pipe and two full-size pouches of Holiday tobacco for only \$1.00. The pipe is fine, hand-rubbed imported briar . . . with genuine hard rubber bit . . . carbonized bowl for cooler smoking. If your dealer is unable to supply you, use this handy order blank.

Name \_\_\_\_\_  
Address \_\_\_\_\_  
City \_\_\_\_\_ State \_\_\_\_\_

Mail with \$1.00 to "Oldie London," Larus & Brother Company, Inc., Richmond, Va.  
Offer Good Only in U. S. A.

PM-11

**This One**



XXLL-F92-96Z8

# A GIANT FOR ITS SIZE!

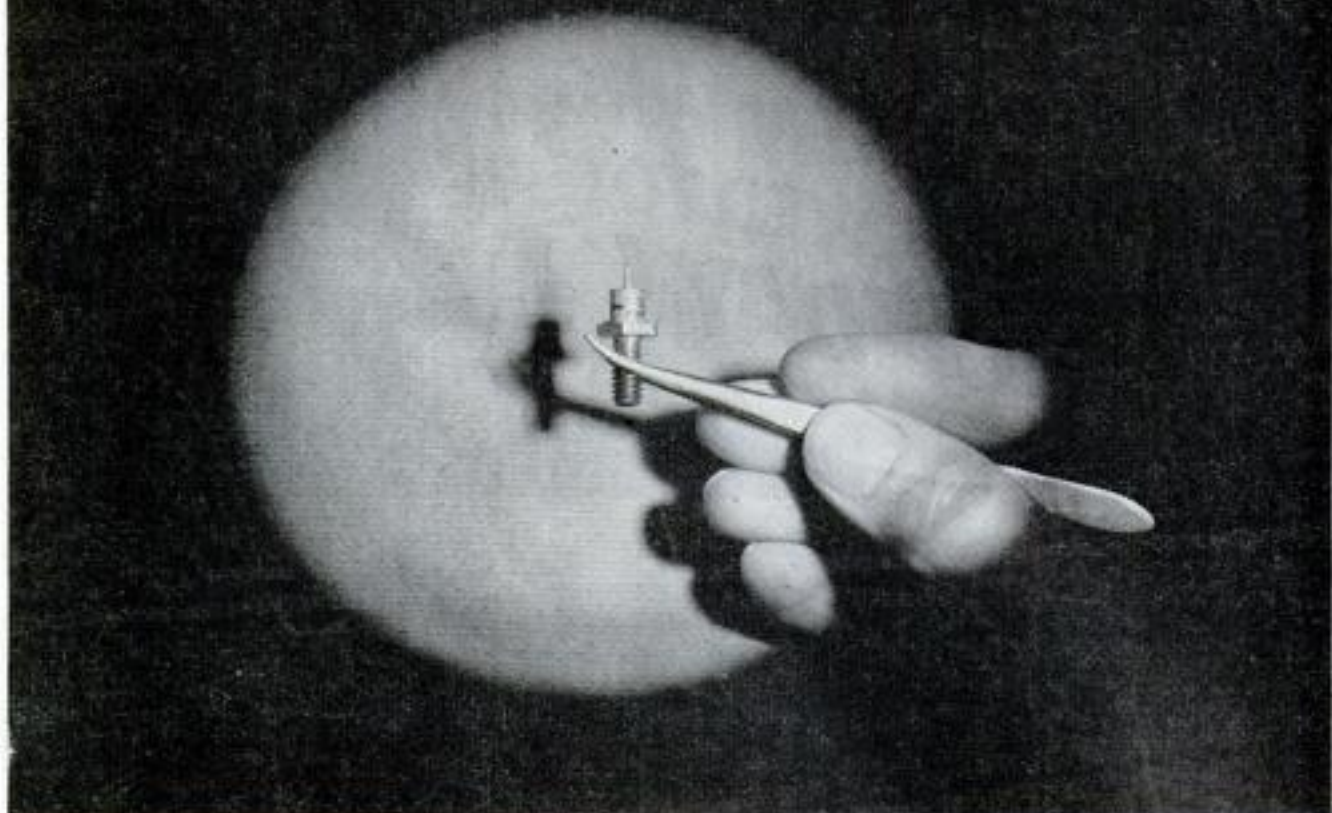

## Telephone science produces an important new rectifier

At Bell Laboratories one line of research is often fruitful in many fields. Latest example is the silicon power rectifier shown above.

Product of original work with semi-conductors—which earlier created the transistor and the Bell Solar Battery—the new rectifier greatly reduces the size of equipment needed to produce large direct currents. It is much smaller than a tube rectifier of equal performance and it does not require the bulky cooling equipment of other metallic rectifiers.

In the Bell System the new rectifier will supply direct current more economically for telephone calls. It can also be adapted to important uses in television, computers, industrial machines, and military equipment. Thus, Bell Telephone Laboratories research continues to improve telephony—while it helps other fields vital to the nation.

**BELL TELEPHONE LABORATORIES**



IMPROVING TELEPHONE SERVICE FOR AMERICA PROVIDES  
CAREERS FOR CREATIVE MEN IN SCIENTIFIC AND TECHNICAL FIELDS



Above, new rectifier (held in pliers) is contrasted with comparable tube rectifier and its filament transformer, rear. Mounted on a cooling plate, lower center, the new rectifier can easily supply 10 amperes of direct current at 100 volts, that is, 1000 watts—enough to power 350 telephones.

# Popular Mechanics Magazine

Registered in U. S. Patent Office and Canada

H. H. WINDSOR, Founder

H. H. WINDSOR, JR., Editor and Publisher



## Next Month

Full of adventure, Jacques Cornet and Henri Lochon sat in Paris and dreamed of driving down the Pan American Highway, from the United States to Tierra del Fuego, at the tip of South America. The dream progressed into a plan, and soon, in a tiny two-cylinder Citroën, they chugged out of Quebec. Then ugly rumors began to reach them. There was a Pan American Highway, but it came to an abrupt halt at the border of Guatemala. Beyond that there were jungles, swamps, trails and trouble. Since they had come this far, they didn't want to turn around and so the trip continued. It turned out to be one of the most daring and exciting automobile trips in history. They eventually reached the bottom of South America, and then began the return trip to Paris, through more fabulous and difficult lands such as the Sahara desert. Their trip, illustrated with color photographs, is in the December issue

Information not listed on articles in the index, starting on page 74, frequently is listed in the WHERE-TO-FIND-IT LIST, which is available to readers without charge. A copy may be obtained by writing to the Bureau of Information, Popular Mechanics, 200 E. Ontario, Chicago 11, Ill.

Published monthly by Popular Mechanics Company, 200 E. Ontario St., Chicago 11, Ill. H. H. Windsor, Jr., president; Wm. Harrison Petridge, exec. vice-pres.; D. F. Windsor, vice-president and secretary-treasurer; H. H. Windsor III, vice-president; W. T. Windsor, vice-president; Clover L. Perkins, advertising manager; Alan M. Devoe, circulation manager. Single copy in the United States and Canada, 35 cents; subscription rates in the United States and possessions, Canada, Philippines and countries of the Pan-American Postal Union, 1 year \$3.00; 2 years, \$4.00; 3 years, \$8.00. To all other countries add \$1.00 a year over United States prices for overseas postage. If you plan to move, notify us at least 30 days in advance so you will not miss an issue. Give both your old and new addresses. Entered as Second Class Matter, September 15, 1903, at the Post Office at Chicago, Illinois, under Act of March 3, 1879. Entered as Second Class Matter at Post Office Dept., Canada. Registered by Second Class Matter at the Post Office at Mexico, D. F., Mexico, June 20, 1950. Copyright 1955 by Popular Mechanics Company. Copyright under International Copyright Union. Copyright in France. All rights reserved under Pan-American Copyright Union. Printed in the United States of America.

Volume 104 NOVEMBER 1955 Number 5

Address all communications to: 200 E. Ontario St., Chicago 11, Ill.

Managing Editor.....Roderick M. Grant  
 Assistant Managing Editor.....Wayne Whittaker  
 Shop Notes and Crafts Editor.....James R. Ward  
 Radio-Television, Electronics Editor.....Lothar Stern  
 Associate Editor.....Clifford B. Hicks  
 Associate Editor, Automotive.....Arthur R. Railton  
 Associate Editor, Shop Notes and Crafts.....Wayne C. Leckey  
 Assistant Editor, Shop Notes.....W. Clyde Lamney  
 Assistant Editor, Makeup.....John C. Dalen  
 Automotive Correspondent.....Leo Donovan  
 Art Director.....Frank Beatty  
 Assistant Editors—Leonard F. Hiltz, Jay W. Hedden, Elliott H. McCleary, Emily Mullaney, Earl F. Wobeck  
 Eastern Editor.....Richard F. Dempewolf  
 Empire State Bldg., Room 2906, New York City 1  
 Western Editor.....Thomas E. Stimson, Jr.  
 Suite 1010, 3460 Wilshire Blvd., Los Angeles 5, Calif.  
 London Manager.....Douglas W. Wedderspoon  
 Eagle House, Jermyn St., London S. W. 1, England  
 Director, Bureau of Information.....Allan Carpenter  
 200 E. Ontario St., Chicago 11

### Advertising Offices

Chicago: 200 E. Ontario St., Whitehall 4-0100; New York: Empire State Bldg., 350 Fifth Ave., Longacre 5-7580; Detroit: General Motors Bldg., TRinity 5-8711; Cleveland: Hanna Bldg., 1422 Euclid Ave., PRespect 1-0456; Los Angeles: Tishman Bldg., 3460 Wilshire, DUmkirk 2-8458; San Francisco: Russ Bldg., 235 Montgomery St., YUkon 2-0823.

## In This Issue . . .

Bill Ford Revives a Classic—the Continental	81
Make Way for the Micro-Midgets	86
The New Automobiles for 1956	89
Detroit Listening Post	99
Christmas Gift Section	100
Mass Attack on the World's Mysteries	107
Testing . . . Testing . . . Atoms at Work	117
Fine Nut and Bolt Photography	126
A New Eye Scans the Stars	134
Where They Learn to Test Jets	136
Science Puts the Taste in Olives	150
Radio, TV and Electronics	157

## For the Craftsman . . .

Save Space With This Family Desk	161
Dowel Craft	168
Sheath Set for Knife and Hatchet	172
Solving Home Problems	176
Patterncraft—Santa Claus Lawn Cutouts	180
Four to Go—A New Family Game	186
Twin Brush Floor Polisher	190
Controlling Engine Ping	201
Arc Welder for the Home Shop	207
Shopping for Tools	218
Clinic for Homemakers	224

See pages 74, 76 and 78

for other items and manufacturers of available products

**NEW!** *the motor you'll asked for...*

KIEKHAEFER  
**MERCURY**

**MARK 30 turbo 4**

See it at your dealer's now!



6½ gal. remote fuel tank  
standard equipment

A 30 h.p. Alternate Four, weighing only 110 lbs. . . . the exclusive Mercury carrying handles actually make it seem lighter . . . available with 12-volt electric starter and generator . . . all the quality Mercury features.

Proved by years of brutal field testing, backed by experience only Mercury has from building more than two million horsepower of famous 4 cylinder Thunderbolt engines! The finest, smoothest, most powerful engine in its class . . . fully qualified to wear the Mercury trade mark.

**MERCURY . . . THE MOST POWERFUL NAME IN OUTBOARDS**  
**REMEMBER . . . A FOUR IS BOUND TO BE BETTER**

©1956 KIEKHAEFER CORPORATION, Fond du Lac, Wis. Features of Mercury motors are protected by issued or pending patents.



got a

**MECHANICAL SKILL?**

**You'll go places  
FASTER in the  
**U.S. AIR FORCE!****

**HERE'S WHY:** Men with mechanical skills find that they can get ahead in the U. S. Air Force. As an Airman, you'll have the chance to develop your technical ability and learn a skill that will pay well — and win you extra stripes. Such interesting

career fields as Aircraft and Engine Maintenance, Rocket Propulsion and Intricate Equipment Maintenance are open to you, if you qualify.

Don't delay—visit your local Air Force Recruiter, or mail the coupon.

**SEND FOR YOUR FREE BOOKLET**

**U. S.  
AIR FORCE**



M-28-PM

AIRMAN INFORMATION BRANCH  
Box 2202, Wright-Patterson AFB, Ohio

Please send me more information on my opportunities as an Airman in the U. S. Air Force.

Name \_\_\_\_\_

Address \_\_\_\_\_

City \_\_\_\_\_ Zone \_\_\_\_\_ State \_\_\_\_\_

# You Put a New Twist in Your Work—



PROTO ADJUSTABLE WRENCHES have thin, extra strong jaws for narrow spaces, yet deep enough to seat both hex and square nuts. Sturdy I-beam handles give great strength with less weight.

PROTO PIPE WRENCHES are engineered for light weight and good balance. They have deep, sharp teeth to give you a better "bite". A wide selection in both Normal and Heavy-duty types will handle all of your jobs.

Buy them from your dealer today! Send 10¢ for catalog of entire line to

### PLOMB TOOL COMPANY

2255H Santa Fe Ave.  
Los Angeles 54, Calif.



Adjustable and heavy-duty pipe wrench.



"Give your work the PROFESSIONAL TOUCH"



Eastern Factory, Jamestown, N.Y. • Canadian Factory, London, Ont.

## ACROSS THE DESK



### "Crusette," Brazilian Style

I am sending you two photos of my recently completed version of "Crusette," described in your May 1954 edition. No difficulty was experienced in construction and the performance is all that can be desired.

I had great difficulty in obtaining a suitable plywood out here in Brazil, and am not too happy about the quality finally used, so made a small modification which may be of interest to your readers, as it can apply to any plywood-sheeted boat. After fitting



the plywood sheeting as shown in the drawings, I fitted a closing strip of thin aluminum sheeting well painted with red-lead paint, before fixing the half rounds. The aluminum is secured with small brass brads spaced about every half inch. This aluminum sheet definitely seals the edge of the plywood sheet and eliminates water getting between the plies, and also any tendency for splitting of the top ply is avoided.

As you can see from the photo, I have made a trailer to pull the boat behind my Model-A Ford.

Anthony R. Gill,  
c/o Dunlop do Brasil, S.A.,  
Caixa Postale 490,  
Campinas, Brasil.

(Continued to page 8)



# This **FREE SAMPLE LESSON** will prove you can become an expert **BOOKKEEPER... ACCOUNTANT** **OR C.P.A.**



This well-paid  
LaSalle-trained  
Accountant's  
success could  
be yours.

## FREE SAMPLE LESSON

We offer you this free sample lesson so that you can prove to yourself that you CAN master Accountancy—quickly, thoroughly—in spare time at home.

You will see exactly how LaSalle's famous "Problem Method" works... how you are led step-by-step through actual accounting work—learning by doing and not by study of theory alone. First you tackle easy problems, then more difficult ones—until soon you master them all. And at every step you have the close personal guidance of LaSalle's large staff of C.P.A. instructors.

## HIGHER ACCOUNTANCY

By the LaSalle Problem Method..

### • Practical Accounting

Assignment 1

THE BALANCE SHEET



QUOTING from the "Journal of Accountancy," the authoritative organ of the professional accountants of the United States:  
"The accounting profession is probably the best paid in the world. If there be a profession in which the average compensation is higher, it is not known to us."  
"There is need for accountants. There is ample opportunity for advancement. There is no prospect that the supply will overtake the demand within the lifetime of even the youngest of us."

LaSalle Extension University  
A Correspondence Institution  
CHICAGO

**THIS SAME LESSON HAS STARTED HUNDREDS OF THOUSANDS** toward well-paid accounting careers—in business, government, and as C.P.A.'s. Even without previous knowledge, progress is rapid—earning power climbs fast. This sample lesson shows why.

**I**f you have been envying the high incomes and good jobs enjoyed by thousands of men and women Accountants today... incomes ranging from \$4,000 to \$10,000 and more per year... why not launch such a career for yourself?

Do you doubt that you can?

Then let us send you—without cost or obligation—the same Lesson Number One with which LaSalle has started several hundred thousand

men and women toward successful accounting careers. We want you to see for yourself how this remarkable method, originated by LaSalle, makes Accountancy simple, interesting, practical, and certain... how it leads you step-by-step to a complete mastery of Accounting—and on up to the coveted degree of Certified Public Accountant if you so aspire.

It doesn't matter whether you've had previous bookkeeping experience, or whether you don't know a debit from a credit. Whether you wish to qualify as an expert bookkeeper, advanced accountant, cost accountant, auditor, government accountant, income tax specialist, or public accountant... you'll find in LaSalle's Problem Method the exact plan to prepare you rapidly and inexpensively—in spare hours at home—without losing a day from your present job.

So right now, today... if you are an adult, employed, and earnestly ambitious for rapid advancement in this highest-paying of all professions... send your name and address on the coupon below. We'll send the free sample lesson—plus our 48-page book outlining today's career opportunities and how you can qualify for them. A coupon like this has started many thousands toward greater success. It can do the same for you. Mail it today!

### Clip Coupon... Mail TODAY!

LaSalle Extension University... A Correspondence Institution  
Dept. 1164H, 417 S. Dearborn Street, Chicago 5, Illinois

YES, I want to see how LaSalle's "Problem Method" works... how I can qualify for high-pay Accountancy positions. Send Free Sample Lesson—also your 48-page book, "Accountancy, the Profession That Pays"—all without cost or obligation.

Name.....Age.....

Street Address.....

City, Zone & State.....

Present Position.....



**Nearly 10%  
of all C.P.A.'s  
in the U.S. have  
been trained by the  
LaSalle Problem  
Method**

## GOOD-PAY JOBS IN 5 BIG FIELDS

If you were an expert accountant right now, chances are you would find yourself among the highest-paid of all professional men and women. Surveys show that accountants earn more than those in other major professions.

There are five big fields of opportunity open to Accountancy-trained men and women... opportunities that are wide open and highly inviting, offering maximum income and job security in good times or bad. And under LaSalle's "Problem Method" you can start earning while still learning—either in spare-time or full-time employment... or in business for yourself with no capital required.

Get the latest information by sending for our 48-page book, "Accountancy, the Profession That Pays"... plus free sample lesson. The coupon at right will bring both to you without cost or obligation. LaSalle Extension, 417 S. Dearborn St., Chicago 5, Ill.

# EASY TO EARN EXTRA MONEY



**OPERATE YOUR OWN BUSINESS  
AT HOME . . . GET INTO**

## LEATHERCRAFT

People love to buy individually styled leather articles. Hand tooled Ladies Bags sell from \$15 to \$50 each, other articles accordingly. Everyone is a potential customer. Turn your Spare Time into "Overtime" Pay. Any one—any age—can easily learn Leathercraft. You need no expensive machinery or training—just your hands, a table and your spare time, and you can begin earning **EXTRA MONEY** at home! Concentrate on a project of your choice. Produce larger articles as you expand. **START NOW!** Deal with the Nation's Leading Leathercraft Supplier . . . **TANDY!**

**FREE  
CATALOG**

**tandy**  
LEATHER COMPANY



**81 TANDY STORES COAST-to-COAST  
TO SERVE YOU BETTER...FASTER!**

**SEND COUPON TODAY!**

TANDY LEATHER CO.  
P. O. BOX 791-RF,  
FORT WORTH, TEXAS  
PLEASE SEND LEATHERCRAFT CATALOG.

Name.....  
Address.....  
City..... Zone..... County..... State.....

(Continued from page 6)

### To the Editor:

Enclosed is a snapshot of a fireplace I have constructed in a rumpus room. It is made of 104 mahogany and maple squares six inches by six inches which I have spun

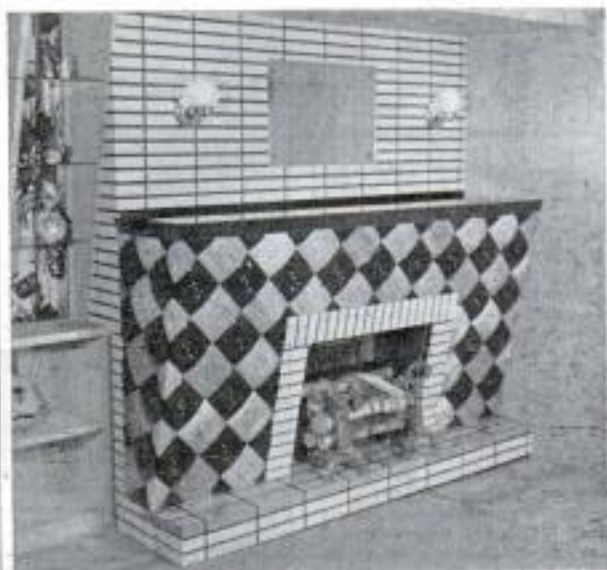

on a lathe. The fireplace was six feet by four feet. Roman brick above is also artificial, made of scraps of wood toned yellow. The fireplace took me about four months to build, spare time.

Jim Jackson,  
Edmonton, Alta., Can.

### To the Editor:

Due to many letters I have received from the article "Art of Carpentry Taught by Kits" having a bearing on my work in the



January 1955 issue of *Popular Mechanics*, I would like to explain just what my Minimalistic Construction (Beginner Carpentry) Kit embraces and how these kits may be obtained.

Any school having an industrial-arts  
(Continued to page 14)

# How to pass a genius

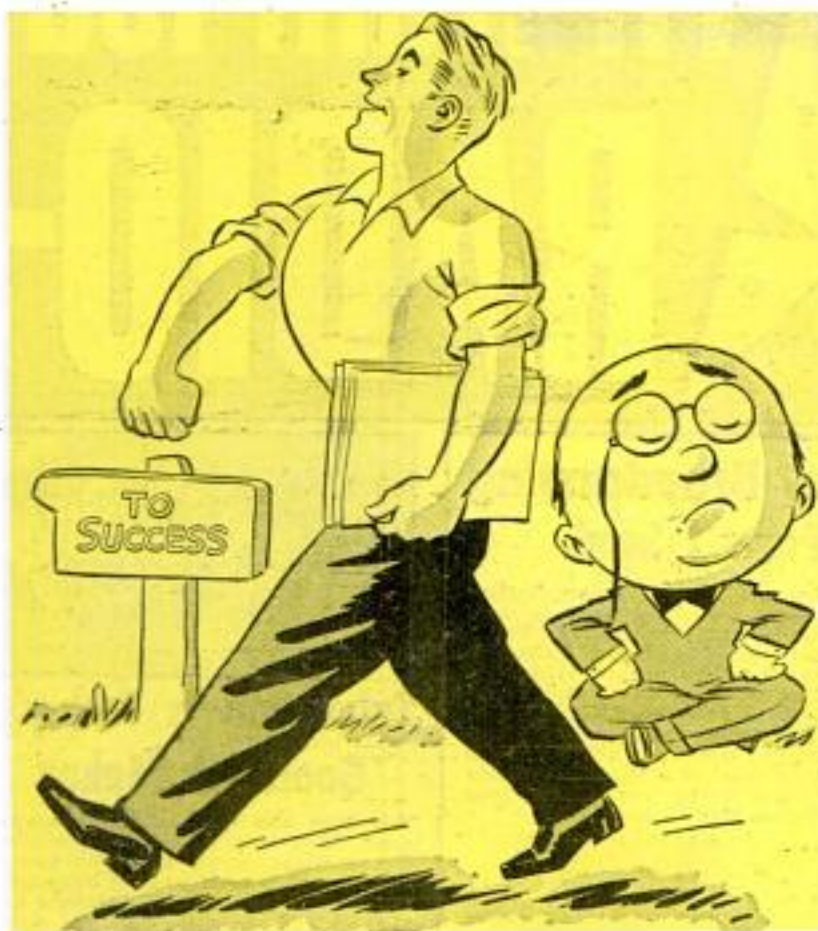

All of us can't be geniuses. But any ordinarily talented mortal can be a success—and that's more than some geniuses are.

Now, as in Æsop's time, the race doesn't always go to the one who potentially is the swiftest. The *trained* man has no trouble in passing the genius who hasn't improved his talents.

In good times and bad times, in every technical and business field, the *trained* man is worth a dozen untrained ones, no matter how gifted.

The International Correspondence Schools can't make you into a genius. For more than 60 years, however, I. C. S. has been helping its students to become *trained, successful leaders*—and it can do the same for you.

Mark your special interest on the coupon. Don't be like the unsuccessful genius who wastes his life in dreaming of what he intends to do. *Act now!*

For Real Job Security—Get an I. C. S. Diploma! I. C. S., Scranton 9, Penna. Member, National Home Study Council

## INTERNATIONAL CORRESPONDENCE SCHOOLS

ICS

BOX 59299L, SCRANTON 9, PENNA.

(Partial list of 277 courses)

- Without cost or obligation, send me "HOW TO SUCCEED" and the opportunity booklet about the field BEFORE which I have marked X (plus sample lesson):
- |  |   |  |  |  |
|--|---|--|--|--|
| <p><b>ARCHITECTURE and BUILDING CONSTRUCTION</b></p> <ul style="list-style-type: none"> <li><input type="checkbox"/> Air Conditioning—Refrig.</li> <li><input type="checkbox"/> Architecture</li> <li><input type="checkbox"/> Architectural Interior</li> <li><input type="checkbox"/> Building Contractor</li> <li><input type="checkbox"/> Building Maintenance</li> <li><input type="checkbox"/> Carpenter and Mill Work</li> <li><input type="checkbox"/> Estimating</li> <li><input type="checkbox"/> Heating</li> <li><input type="checkbox"/> Painting Contractor</li> <li><input type="checkbox"/> Plumbing</li> <li><input type="checkbox"/> Reading Arch. Blueprints</li> </ul> <p><b>ART</b></p> <ul style="list-style-type: none"> <li><input type="checkbox"/> Cartooning</li> <li><input type="checkbox"/> Commercial Art</li> <li><input type="checkbox"/> Fashion Illustrating</li> <li><input type="checkbox"/> Magazine Illustrating</li> <li><input type="checkbox"/> Show Card and Sign Lettering</li> <li><input type="checkbox"/> Sketching and Painting</li> </ul> <p><b>AUTOMOTIVE</b></p> <ul style="list-style-type: none"> <li><input type="checkbox"/> Auto Body Rebuilding</li> <li><input type="checkbox"/> Auto Elec. Technician</li> <li><input type="checkbox"/> Auto-Engine Tune Up</li> <li><input type="checkbox"/> Automobile</li> </ul> | <p><b>AVIATION</b></p> <ul style="list-style-type: none"> <li><input type="checkbox"/> Aeronautical Engineering Jr.</li> <li><input type="checkbox"/> Aircraft &amp; Engine Mechanic</li> </ul> <p><b>BUSINESS</b></p> <ul style="list-style-type: none"> <li><input type="checkbox"/> Advertising</li> <li><input type="checkbox"/> Bookkeeping and Accounting</li> <li><input type="checkbox"/> Business Administration</li> <li><input type="checkbox"/> Business Correspondence</li> <li><input type="checkbox"/> Public Accounting</li> <li><input type="checkbox"/> Creative Salesmanship</li> <li><input type="checkbox"/> Federal Tax</li> <li><input type="checkbox"/> Letter-writing Improvement</li> <li><input type="checkbox"/> Office Management</li> <li><input type="checkbox"/> Professional Secretary</li> <li><input type="checkbox"/> Retail Business Management</li> <li><input type="checkbox"/> Sales Management</li> <li><input type="checkbox"/> Stenographic-Secretarial</li> <li><input type="checkbox"/> Traffic Management</li> </ul> <p><b>CHEMISTRY</b></p> <ul style="list-style-type: none"> <li><input type="checkbox"/> Analytical Chemistry</li> <li><input type="checkbox"/> Chemical Engineering</li> <li><input type="checkbox"/> Chem. Lab. Technician</li> <li><input type="checkbox"/> General Chemistry</li> <li><input type="checkbox"/> Natural Gas Prod. &amp; Trans.</li> <li><input type="checkbox"/> Petroleum Engineering</li> <li><input type="checkbox"/> Plastics</li> <li><input type="checkbox"/> Pulp and Paper Making</li> </ul> | <p><b>CIVIL, STRUCTURAL ENGINEERING</b></p> <ul style="list-style-type: none"> <li><input type="checkbox"/> Civil Engineering</li> <li><input type="checkbox"/> Construction Engineering</li> <li><input type="checkbox"/> Highway Engineering</li> <li><input type="checkbox"/> Reading Struct. Blueprints</li> <li><input type="checkbox"/> Sanitary Engineering</li> <li><input type="checkbox"/> Structural Engineering</li> <li><input type="checkbox"/> Surveying and Mapping</li> </ul> <p><b>DRAFTING</b></p> <ul style="list-style-type: none"> <li><input type="checkbox"/> Aircraft Drafting</li> <li><input type="checkbox"/> Architectural Drafting</li> <li><input type="checkbox"/> Electrical Drafting</li> <li><input type="checkbox"/> Mechanical Drafting</li> <li><input type="checkbox"/> Mine Surveying and Mapping</li> <li><input type="checkbox"/> Plumbing Drawing and Estimating</li> <li><input type="checkbox"/> Structural Drafting</li> </ul> <p><b>ELECTRICAL</b></p> <ul style="list-style-type: none"> <li><input type="checkbox"/> Electrical Engineering</li> <li><input type="checkbox"/> Electrical Maintenance</li> <li><input type="checkbox"/> Electrician</li> <li><input type="checkbox"/> Contracting</li> <li><input type="checkbox"/> Lineman</li> </ul> <p><b>HIGH SCHOOL</b></p> <ul style="list-style-type: none"> <li><input type="checkbox"/> Commercial</li> <li><input type="checkbox"/> Good English</li> <li><input type="checkbox"/> High School Subjects</li> <li><input type="checkbox"/> Mathematics</li> </ul> | <p><b>LEADERSHIP</b></p> <ul style="list-style-type: none"> <li><input type="checkbox"/> Foremanship</li> <li><input type="checkbox"/> Industrial Supervision</li> <li><input type="checkbox"/> Leadership and Organization</li> <li><input type="checkbox"/> Personnel-Labor Relations</li> </ul> <p><b>MECHANICAL AND SHOP</b></p> <ul style="list-style-type: none"> <li><input type="checkbox"/> Gas—Electric Welding</li> <li><input type="checkbox"/> Heat Treatment</li> <li><input type="checkbox"/> Metallurgy</li> <li><input type="checkbox"/> Industrial Engineering</li> <li><input type="checkbox"/> Industrial Instrumentation</li> <li><input type="checkbox"/> Industrial Supervision</li> <li><input type="checkbox"/> Internal Combustion Engines</li> <li><input type="checkbox"/> Machine Design-Drafting</li> <li><input type="checkbox"/> Machine Shop Inspection</li> <li><input type="checkbox"/> Machine Shop Practice</li> <li><input type="checkbox"/> Mechanical Engineering</li> <li><input type="checkbox"/> Quality Control</li> <li><input type="checkbox"/> Reading Shop Blueprints</li> <li><input type="checkbox"/> Refrigeration</li> <li><input type="checkbox"/> Sheet Metal Worker</li> <li><input type="checkbox"/> Tool Design</li> <li><input type="checkbox"/> Toolmaking</li> </ul> <p><b>RADIO, TELEVISION</b></p> <ul style="list-style-type: none"> <li><input type="checkbox"/> Industrial Electronics</li> <li><input type="checkbox"/> Practical Radio TV Eng'g</li> <li><input type="checkbox"/> Radio and TV Servicing</li> <li><input type="checkbox"/> Radio Operating</li> </ul> | <ul style="list-style-type: none"> <li><input type="checkbox"/> Television Technician</li> </ul> <p><b>RAILROAD</b></p> <ul style="list-style-type: none"> <li><input type="checkbox"/> Air Brakes</li> <li><input type="checkbox"/> Car Inspector</li> <li><input type="checkbox"/> Diesel Locomotive</li> <li><input type="checkbox"/> Locomotive Engineer</li> <li><input type="checkbox"/> Section Foreman</li> </ul> <p><b>STEAM AND DIESEL POWER</b></p> <ul style="list-style-type: none"> <li><input type="checkbox"/> Combustion Engineering</li> <li><input type="checkbox"/> Diesel—Elec.</li> <li><input type="checkbox"/> Diesel Eng's</li> <li><input type="checkbox"/> Electric Light and Power</li> <li><input type="checkbox"/> Stationary Fireman</li> <li><input type="checkbox"/> Stationary Steam Engineering</li> </ul> <p><b>TEXTILE</b></p> <ul style="list-style-type: none"> <li><input type="checkbox"/> Carding and Spinning</li> <li><input type="checkbox"/> Cotton, Rayon, Woolen Mfg.</li> <li><input type="checkbox"/> Finishing and Dyeing</li> <li><input type="checkbox"/> Loom Fix'g</li> <li><input type="checkbox"/> Textile Des'ing</li> <li><input type="checkbox"/> Textile Eng'g</li> <li><input type="checkbox"/> Throwing</li> <li><input type="checkbox"/> Warping and Weaving</li> </ul> <p><b>MISCELLANEOUS</b></p> <ul style="list-style-type: none"> <li><input type="checkbox"/> Domestic Refrigeration</li> <li><input type="checkbox"/> Marine Engineering</li> <li><input type="checkbox"/> Ocean Navigation</li> <li><input type="checkbox"/> Professional Engineering</li> <li><input type="checkbox"/> Short Story Writing</li> <li><input type="checkbox"/> Telephony</li> </ul> |
|--|---|--|--|--|

Name \_\_\_\_\_ Age \_\_\_\_\_ Home Address \_\_\_\_\_

City \_\_\_\_\_ Zone \_\_\_\_\_ State \_\_\_\_\_ Working Hours \_\_\_\_\_ A.M. to P.M. \_\_\_\_\_

Occupation \_\_\_\_\_

Canadian residents send coupon to International Correspondence Schools, Canadian, Ltd., Montreal, Canada. . . . Special tuition rates to members of the U. S. Armed Forces.

## Our 40th Year

NRI training is thorough, practical, up-to-date. When you enroll with NRI you benefit from our 40 years of successful experience training men at home.

*J. E. Smith*

President  
National Radio Institute  
Washington, D. C.



# I'll Train You RADIO-

## You Practice Broadcasting with Parts I Send

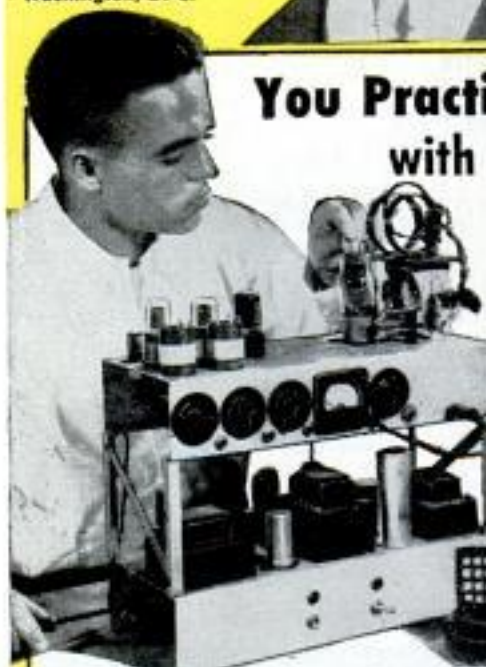

As part of my Communications Course I send you parts to build low-power Broadcasting Transmitter at left, and other equipment. Use it to get practical experience. You put this station "on the air," perform procedures demanded of station operators. An FCC Commercial Operator's License can be your ticket to a bright future. My Course trains you to get your license. Mail Coupon now!



## Television Is Today's Good Job Maker

Television now reaches from coast-to-coast. More than 25 million Television sets are already in use and require servicing; thousands more sets are being sold every week. About 200 TV stations are now on the air with hundreds more being built. This means new jobs, more jobs, better pay for trained men. The time to act is NOW! Start learning Radio-Television servicing or communications.

## You Practice Servicing with Parts I Send

Nothing takes the place of PRACTICAL EXPERIENCE. NRI training is based on LEARNING BY DOING. You use parts I send to build many circuits common to Radio and TV. You build the modern radio at right. Use Multi-tester you build to make money fixing sets. Many students make \$10, \$15 a week extra fixing neighbors' sets in spare time, starting soon after enrolling. All equipment I send is yours to keep.



## Make Extra Money in Spare Time While Learning

Keep your job while training. Many NRI students make \$10, \$15 and more a week extra fixing neighbors' Radios in spare time. The day you enroll I start sending you special booklets that show you how to service sets. Multi-tester you build helps discover and correct Radio troubles, gives PRACTICAL EXPERIENCE on circuits common to radio and TV. Mail coupon today.

## I Trained these Men at Home



Thanks  
NRI for  
Wonderful  
Start

"Right now I am doing spare-time repairs on radios and television. In the near future I intend to go into full-time servicing."—C. Higgins, Waltham, Mass.



Switched  
from Studio  
Work to  
Service

"I switched from studio work and am now holding a position as TV service technician. Enjoy my work more and more."—Norman Ward, Ridgefield Park, N. J.



Paid for  
Course  
Before  
Graduation

"By the time I graduated I had paid for my course, a car and testing equipment. Can service toughest jobs."—E. J. Streitberger, New Boston, Ohio.



\$10 to \$15  
Week  
Spare Time

"Four months after enrolling, was able to service Radios . . . averaged \$10 to \$15 a week spare time. Now have full time business."—W. Weyde, Brooklyn, N. Y.



Employed as  
Transmitter  
Operator

"A former employer recommended NRI training to me. Now employed as transmitter operator in Harrisburg."—Albert Herr, New Cumberland, Penna.

# AT HOME for Good Jobs in TELEVISION

**There is Success-Good Pay-Security for You in America's Fast Growing Industry**



## NRI Training Leads to These Jobs in RADIO-TELEVISION

### BROADCASTING

Chief Technician  
Chief Operator  
Power Monitor  
Recording Operator

### SERVICING

Home and Auto Radios  
Television Receivers  
P.A. Systems

### MANUFACTURING

Design Technician  
Service Manager  
Tester  
Research Assistant

### SHIP AND HARBOR RADIO

Chief Operator  
Radiotelephone Operator  
Assistant Operator

### GOVERNMENT RADIO

Operator in Army, Navy, Marine Corps  
Airways Operator  
Forestry Dispatcher

### AVIATION RADIO

Transmitter Technician  
Airport Transmitter Operator

### TELEVISION

Pick-up Operator  
Television Technician  
Remote Control Operator

### Service and Maintenance Technician

**POLICE RADIO**  
Transmitter Operator  
Receiver Serviceman

**DO YOU** want good pay, a job with a bright future, security? Would you like to have a profitable business of your own? If so, find out how you can realize your ambition in the fast-growing RADIO-TELEVISION industry. Even without Television, the industry is bigger than ever before. Just think, over 115 million home and auto Radios, 3000 Radio Broadcasting Stations, plus 25 million Television sets and about 200 Television Broadcasting Stations. Expanding use of Aviation and Police Radio, Micro-wave Relay, Two-way Radio for busses, taxis etc., are making opportunities for Servicing and Communications technicians and FCC Licensed Operators.

## My Training Includes Television

You get practical experience by working on circuits common to both Radio and Television. My graduates are filling jobs, making good money in both Radio and Television. Many NRI trained men start their own Radio and Television servicing business with capital earned in spare time. Let me show you how you can be your own boss; earn \$10 to \$15 a week extra even while still learning. Now is the time to get ready for success in Radio-Television. Coupon below brings you Actual Lesson and 64-page book.

## Find Out What Radio-Television Offers You

What will YOU be doing one year from today? Decide now that you are going to know more and earn more. **ACT NOW.** Send the coupon below NOW for my FREE DOUBLE OFFER. You get Actual Servicing Lesson. Also my 64-page Book, "How to Be a Success in Radio-Television." Read what my graduates are doing, earning, see equipment you practice with at home. Mail coupon now. Send in envelope or paste on postal. J. E. SMITH, President, Dept. 5MA, National Radio Institute, Washington 9, D. C. Our 40th Year.

## Actual Lesson and 64-page Book

**BOTH FREE**

The ABC's of SERVICING

How to Be a Success in RADIO-TELEVISION



Chief Engineer with Station

"I received my License and worked on ships. Am Chief Engineer at WARA, Alliboro, Mass. I am grateful to NRI for preparing me for this position."—R. D. Arnold, Rumford, R. I.

Available to **VETERANS** under G. I. Bills

## MAIL THIS NOW!

MR. J. E. SMITH, President, Dept. 5MA  
National Radio Institute, Washington 9, D. C.

Mail me Sample Lesson and 64-page Book FREE. (No salesman will call. Please write plainly.)

Name.....Age.....

Address.....

City.....Zone.....State.....

**VETS** write in date of discharge.....

"APPROVED MEMBER, NATIONAL HOME STUDY COUNCIL."

# 49½c STORM WINDOW

## protects your family all winter!

### New Trans-Kleer Storm Window Goes on In 5 Minutes Without Tools, Hooks, Screws or Nails

10.8 Sq. Ft. Window Costs only 49½c

NOW... Storm Windows need not cost you up to \$14.00 apiece. American industry has developed a lightweight flexible product that enables you to seal out wintry blasts for only 49½c a window! Imagine it! For pennies per window you can insulate EVERY ROOM in your home! This new material was developed by the Gary plant of a billion-dollar American manufacturing firm—for use by the U. S. Government during the last war. It looks like glass, yet can't peel off, never chips, shatters or rattles. Actually flexible like rubber. Has a tensile strength of over one ton per square inch. Crystal clear, not milky or yellowish like some plastic materials. Weighs less than 1/10th of the lightest glass windows ever developed. Even a large window comes to less than 8 oz. Not affected by snow, sleet, rain or dampness—because it's 100% waterproof. Won't crack even at 53 degrees BELOW FREEZING! Use and re-use it YEAR AFTER YEAR for winter comfort and protection.

### Sensational Discovery Used By Army To Fight Cold

One of the big problems of the last war was how to defend our troops and protect equipment against the ravages of Arctic winters. One of the world's greatest manufacturing companies was ordered to build a special plant and soon millions of yards of this new material was moving out to Alaska, the Aleutians, Iceland and Greenland. Finally, it was released to the public and ever since the demand has been greater than the supply! The Gary plant of famous REYNOLDS METALS COMPANY is working round-the-clock trying to supply it!

### Use Year After Year — No Upkeep Cost!

At winter's end just fold away your Trans-Kleer like cloth for use next year. You can air the room anytime, too—lift the Adheso border to let in fresh air, then press back and it's sealed tight again! Cleans easily with a damp rag. It's no wonder so many home owners, hospitals, churches and public buildings use this tried and tested REYNOLDS product! TRANS-KLEER comes in kits 36 inches by 432 inches and costs you only \$4.95 complete with Adheso border! That is enough for 10 windows—each measuring 10.8 sq. ft.—just 49½c each! In all you receive 108 SQUARE FEET for only \$4.95! Good GLASS storm windows cost from \$7.95 to \$16.00—for ten you'd have to pay \$79 to \$160.00. With this remarkable REYNOLDS product you not only save a terrific amount in the purchase price, you also cut down enormously on your fuel bills!

### Install Trans-Kleer Windows in 5 Minutes

Trans-Kleer storm windows require no nails, hooks, screws or tools. No back-breaking toil or broken glass to contend with. Cut off required amount, trim to fit the inside of your window, large or small, square, round, rectangular—it makes no difference! Then press on the special Adheso border supplied and your storm window is firmly in place. Simple, easy—a child can install them!

### Test in Your Home AT OUR RISK!

Here's your chance to get Trans-Kleer on a HOME TRIAL BASIS. You can't lose a single penny. Mail the coupon below and a 36 by 432-inch kit—108 SQUARE FEET—will be shipped you immediately, complete with Adheso border. Deposit only \$4.95 plus postage with the mailman. Try TWO windows inside any room. Test them—see for yourself how they seal out drafts. Compare the temperature—any 25c thermometer will do—compare with any other room in your home. See the difference—feel the difference! Then if you're not convinced they're every bit as effective as any storm window—why, just keep the TWO windows and return the balance and get your \$4.95 back at once!



### Just Lift Up For Airing

Trans-Kleer goes on quickly inside the window. To ventilate just lift the Adheso border. You may then open the storm window as much as you wish. Press back and you have perfect sealed-in insulation again. (See picture.) The special Adheso borders supplied with the Trans-Kleer windows will not lose their adhesiveness even if you air the



### STRETCHES WITHOUT BREAKING!

rooms daily. They seal the Trans-Kleer to the frame snugly, tightly.

### Avoid Disappointment — Order Now!

Millions of folks in the U. S. and Canada are reading this same ad in hundreds of magazines and newspapers. Despite enormous production facilities, the REYNOLDS ALUMINUM people can turn out so much and so more! Don't wait until it's too late! Play safe! Rush the coupon NOW! If you wish to save postage cost, send check, cash or m.o. for \$4.95 and the windows will be shipped postage free.

### THORESEN'S, Dept. 6-M-47

352 Fourth Ave. New York 10, N. Y.

CANADIANS: Same price! Same guarantee! Order from our Canadian Subsidiary: THORESEN LTD., 45 St. James St., West, Dept. US-47, Montreal 1, Que.

### RUSH FOR FREE HOME TRIAL!

THORESEN'S, Dept. 6-M-47  
352 Fourth Ave., New York 10, N. Y.

RUSH \_\_\_\_\_ kits of Trans-Kleer measuring 108 sq. ft. each, enough for 10 windows averaging 10.8 sq. ft. each. Include improved Adheso Sealing Border and easy picture instructions at no extra cost. I will try 2 windows and if I'm not satisfied for any reason, I'll return the remainder within one week for FULL REFUND of my money. I will keep the 2 windows free.

Payment enclosed. Send Prepaid.

Send C.O.D. plus postage.

#### CHECK AMOUNT DESIRED

1 KIT (108 sq. ft.) for 10 windows—4.95  2 KITS (216 sq. ft.) for 20 windows—8.95

Name \_\_\_\_\_

Address \_\_\_\_\_

City \_\_\_\_\_ State \_\_\_\_\_

# INVENTORS

Learn how to protect your invention. The U. S. Patent Laws provide that any new and useful art, machine, article of manufacture, or composition of matter, or any new and useful improvement thereof, may be patented if the act of invention is involved. Therefore, every inventor with a valuable invention should take advantage of the Patent Laws and proceed for patent protection in order to safeguard his rights.

A patent gives the inventor the exclusive right to prevent others from making, using, or selling the invention claimed in the patent for a period of seventeen years.

The Patent Laws were enacted for the benefit of the inventor to give him protection for the features of his invention which are patentable. These features must be properly and concisely set forth and claimed in a formal application for patent, in order to comply with the requirements of the Patent Laws. For that reason, unless the inventor is familiar with patent matters, he should engage a competent registered patent attorney or agent to represent him. We are registered to practice before the U. S. Patent Office and are prepared to serve you in the handling of your patent matters.

A specially prepared booklet entitled "Patent Guide for the Inventor", containing detailed information with respect to patent protection and procedure, together with a "Record of Invention" form will be promptly forwarded to you without obligation upon request.

---

## CLARENCE A. O'BRIEN & HARVEY JACOBSON

*Registered Patent Attorneys*

51-L DISTRICT NATIONAL BUILDING

WASHINGTON 5, D. C.

(Continued from page 8)

shop or equal, an instructor competent to teach carpentry and a class of 8th, 9th and junior high or beginners in advanced carpentry, the purchase order of such school will be honored up to one complete Minimal Construction (Beginner Carpentry) Kit for each such student so enrolled.

This is with the understanding that these kits must not be constructed by others than such students.

O. G. Hughson,  
State Building Congress,  
515 Henry Building,  
Portland 4, Ore.

#### To the Editor:

An ardent reader of your splendid magazine and a registered Illinois barber, I am enclosing a picture of a scale-model steam-type locomotive, which I have made for my little grandson. This locomotive took two years of spare-time work to construct.

The track is  $6\frac{1}{2}$  inches between the rails for this model is  $1\frac{1}{2}$  inches to the foot. It stands three feet high and with its tender is about five feet in length. It is made of steel and is ball-bearing. With its  $\frac{1}{3}$ -horsepower motor run by a covered third rail it weighs 100 pounds. 110 a.c. supplies the



motive power on a 150-foot track of scale-size iron rail.

Thought you might be interested in one of your reader's handicraft work.

Wm. V. Harmeling,  
Chicago, Ill.

☆ ☆ ☆

EDITOR'S NOTE: Since the story of the whooping crane (page 142) went to press we have word from Mr. Dickie that 17 cranes—6 young and 11 adults—have been sighted this year in their Canadian nesting grounds. The discovery aroused fresh hope that the big bird, once believed nearing extinction, is now making a comeback.

## New greaseless way to keep your hair neat all day



Prevents dry, unruly  
"musk-ox hair"

New Vitalis keeps hair in place and prevents dryness with V-7, the greaseless grooming discovery.

You never have an overslick, plastered-down look. Try it. You'll like it.



ANOTHER FINE PRODUCT  
OF BRISTOL-MYERS

## New VITALIS® Hair Tonic with V-7®



Train in Big  
**COYNE**  
Shops

# GREAT OPPORTUNITY FIELDS!



Instructor helping students check the wiring and trace the circuits of television receivers.



Instructor explaining operation and testing of a large Motor Generator.

This big fire-proof building is occupied entirely by Coyne.

## YOUNG MEN AND OLDER MEN — PREPARE FOR A CAREER WITH A FUTURE!

Conditions are changing. Many "one operation" jobs will not last. Don't be satisfied with a "no future" job. Whether 17 or up to 45 years of age, train the Coyne way for a better job and a real future in **ELECTRICITY** or **TELEVISION-RADIO**, fields that offer a world of opportunities.

## TELEVISION-RADIO      ELECTRICITY

Here at Coyne you're trained for Television, Testing, Trouble-Shooting on Radio, Public Address, F. M., Sound Units, etc. Many Coyne trained men in good jobs or own well paying Television-Radio businesses of their own.

Big future in Power Plant Work, Motors, Industrial Electronics, Armature Winding, Home and Factory Wiring, Appliances, Refrigeration, Maintenance, Illumination, etc. Lifetime job service to Coyne graduates.

### WE TRAIN YOU IN CHICAGO

Our famous Practical-Technical method gives you practical experience on a massive outlay of equipment. Actual shop work plus necessary technical training. You are trained right here in the great Coyne shops. Send for **BIG FREE BOOK**.

**APPROVED  
FOR  
VETERANS**

### START NOW—PAY LATER

Enroll now, pay most of tuition after graduation. Special plan for men of draft age. We'll help you get part-time work, if you need it to help pay living costs while at Coyne.

B. W. COOKE, President

**COYNE**  
ELECTRICAL SCHOOL

FOUNDED 1899

A TECHNICAL TRADE INSTITUTE OPERATED NOT FOR PROFIT  
500 S. PAULINA STREET, CHICAGO, Dept. 85-72H  
**ELECTRICITY ★ RADIO ★ TELEVISION ★ REFRIGERATION ★ ELECTRONICS**

## LARGEST, OLDEST, BEST EQUIPPED SCHOOL OF ITS KIND IN THE U.S.



### Mail Coupon for Big FREE Book!

Whether you prefer Television-Radio or Electricity, train on actual equipment at Coyne. We will send you a Big, fully illustrated Book "Guide To Careers in Electricity and Television-Radio". No salesman will call. Mail coupon TODAY.

B. W. Cooke, President  
COYNE ELECTRICAL SCHOOL 500 S. Paulina  
Dept. 85-72H, Chicago 12, Ill.

Send me your Big Free book. I am interested in field checked below. This does not obligate me.

TELEVISION-RADIO     ELECTRICITY

NAME.....

ADDRESS.....

CITY.....STATE.....



**For Good Pay, Interesting Work, Security**

# Learn Electric Appliance Repair

**AT HOME IN SPARE TIME**

**B**uild a better future. Get into a field where there is important work and the security that comes from knowing a good trade. The electrical appliance repair business offers OPPORTUNITY FOR YOU. Every wired home today has an average of 8 electrical appliances. Up to 10 million new appliances are sold every year. Owners pay well to keep them in repair and enjoy the convenience they provide. That means there's a fast growing need for trained men.

## Opportunities Increasing For Men Who Know This Profitable Trade

You may want to be your own boss so you can enjoy the profits of your business. Or you may want to qualify for the better job of Service Manager or Supervisor in an Appliance Servicer. Or perhaps you want to supplement your income doing electrical appliance repairs in your spare time. Opportunity in this growing field is great. Send for free book and see what the Electrical Appliance field offers you!

## Pick up \$3, \$4, \$5 an Hour in Spare Time Starting Soon

Start soon to fix electric toasters, clocks, fans, vacuum cleaners, etc. for neighbors and friends. Spare time work done in your basement, garage, or spare room can earn you \$3 to \$5 an hour. See how easy it is to increase your earning power—how you can pay for this training many times over with spare time earnings.

## Learn and Earn With This Appliance Tester You Get

This course includes the parts to build this sturdy portable appliance tester that helps you find electrical defects quickly and easily. You use it to learn and do actual electrical and appliance repair jobs. This multi-use tester helps you start making money soon after your training starts.



## ACT NOW! Get Free Book And Sample Lesson

Actual lesson proves our method is clear, practical. Book gives facts about Electric Appliance opportunities and details of our training. Act now to make your future more secure.

## Train Now for Greater Security Low Price—Easy Terms

Today's automatic electrical appliances need expert servicing. The man who knows a good trade like appliance repair has a secure future. Put your spare time to good use. Invest \$2.50 down and \$5.00 a month in a better future. Write Electrical Appliance Training, National Radio Institute, Dept. AM5, Washington 9, D. C.

### MAIL COUPON TODAY

#### NATIONAL RADIO INSTITUTE

Dept. AM5, Washington 9, D. C.

Please send me Electrical Appliance Training Lesson and Book Free. (No salesman will call.)

Name \_\_\_\_\_ Age \_\_\_\_\_

Address \_\_\_\_\_

City \_\_\_\_\_ Zone \_\_\_\_\_ State \_\_\_\_\_

APPROVED MEMBER NATIONAL HOME STUDY COUNCIL

# INVENTORS

If you believe that you have an invention, you should find out how to protect it. The first step is to have a search made of the prior pertinent U. S. patents. If a report on this search indicates that the invention appears patentable you can apply for a patent, and the specifications and claims should be prepared.

The firm of McMorrow, Berman & Davidson, with offices in Washington, D. C., is qualified to take the necessary steps for you. We can make a preliminary search on your invention, advise you whether we think it can be patented, and prepare your application for patent.

Unless you are fully familiar with the U. S. Patent Laws, we recommend that you engage the services of a Registered Patent Attorney to protect your interests. The patent laws are *your* laws. A patent gives you the right to prevent others from making, using or selling the invention claimed in your patent for a period of 17 years.

Use these patent laws for your protection. Investigate whether your invention can be patented. If you have what you believe to be an invention, we suggest that you have this firm make a search for you.

*Send for a copy of our Patent Booklet entitled "How To Protect Your Invention," containing information about patent protection and patent procedure. Along with this we will also send you an "Invention Record" form, for your use in writing down and sketching details of your invention. We will mail them promptly. No obligation. They are yours for the asking.*

## McMORROW, BERMAN & DAVIDSON

*Registered Patent Attorneys*

PATENTS • COPYRIGHTS • PATENTS

135-M VICTOR BUILDING, WASHINGTON 1, D. C.

## WHAT SECRET POWER DID THIS MAN POSSESS?



**BENJAMIN FRANKLIN**  
(A Rosicrucian)

**WHY** was this man great? How does anyone—man or woman—achieve greatness? Is it not by mastery of the powers within ourselves? Know the mysterious world within you! Attune yourself to the wisdom of the ages! Grasp the inner power of your mind! Learn the secrets of a full and peaceful life!

Benjamin Franklin—like many other learned and great men and women—was a Rosicrucian. The Rosicrucians (NOT a religious organization) first came to America in 1694. Today, headquarters of the Rosicrucians send over seven million pieces of mail annually to all parts of the world. Write for YOUR **FREE COPY** of "The Mastery of Life"—TODAY. No obligation. No salesmen. A non-profit organization. Address: Scribe P.C.G.

**THIS BOOK FREE!**



## The ROSICRUCIANS

SAN JOSE • (AMORC) • CALIFORNIA

—SEND THIS COUPON—

Scribe P.C.G.  
The ROSICRUCIANS (AMORC)  
San Jose, California  
Please send me the free book, *The Mastery of Life*, which explains how I may learn to use my faculties and powers of mind.

Name \_\_\_\_\_  
Address \_\_\_\_\_  
City \_\_\_\_\_

## KEEP YOUR CAR BATTERY FULLY CHARGED AT HOME!



With a NORKO CHARGER, you charge your battery at home—overnight—without disconnecting cables or removing battery from car. And you get better service—much longer life—from a battery kept fully charged.

A dependable NORKO CHARGER is the handiest automotive device you'll ever own. Quickly pays for itself. Operates from 110-volt home power. Compact, lightweight; sets on floor or shelf or hangs from wall. Models for 6 and 12-volt batteries. Sold by most auto stores.

If your dealer can't supply, send for FREE catalog. Many thousands of wise motorists own NORKO CHARGERS. Get yours now.

### SCHAUER MANUFACTURING CORP.

4532 Alpine Ave. Cincinnati 36, Ohio



## WORLD'S LOWEST PRICED ADDING MACHINE

**FREE TRIAL \$2.95**  
Vest Pocket Size  
TOTAL COST SEND NO MONEY  
only \$2.95 plus postage. (Send full cash if outside U.S.) Beautiful rich-looking Leatherette Case included at no extra cost. Money back in 10 days if not delighted. AGENTS WANTED.

Box 84 CALCULATOR MACHINE CO. (Mfrs.) Dept. N-55 Glenview, Illinois

## Sensational FOG-STOP Windshield Cloth



**Amazing Discovery!** Autolets with over new FOG-STOP Windshield Cleaner. Simply glide over windshield chemically-treated Milt—at once glass sparkles crystal clear. Heavy mist, frost, sleet, snow disappear like magic. Stops fogging. Sells like wild!

**SAMPLES FOR AGENTS** Sample offer sent immediately to all who send name at once. Hurry. Postcard will do. **SEND NO MONEY—just your name.** KRISTEE CO., Dept. 686, AKRON 8, OHIO

## REAL ESTATE BE A BROKER

**PAYS BIG! SEND FOR FREE, BIG, ILLUSTRATED CATALOG NOW!** Graduate report making substantial incomes. Start and run your own business quickly. Men, women of all ages, learn easily. Course covers Sales, Property Management, Appraising, Loans, Mortgages, and related subjects. **STUDY AT HOME** or in classrooms in leading cities. Diploma awarded. Write TODAY for free book! No obligation. Approved for World War II and Korean Veterans. **WEAVER SCHOOL OF REAL ESTATE (Est. 1936)** 2020R Grand Avenue Kansas City, Mo.

**FREE BOOK TELLS HOW**



men ... be TALLER!  
Step up in "ELEVATORS" and others will look UP to you. The moment you slip on these height increasing shoes you add almost 2 inches to your height. The shoes look no different, but you'll see an amazing difference in your appearance. Be sure, be smart, be taller!



For FREE Booklet and Dealer's name write to:  
**STONE-TARLOW CO., INC., DEPT. PM11-55, BROCKTON 68, MASS.**

# Now.. In Your Own Home LEARN TELEVISION RADIO-ELECTRONICS THE AMAZINGLY EFFECTIVE D.T.I. WAY

**NO PREVIOUS TECHNICAL  
EXPERIENCE NEEDED**  
NOW... get  
**EVERYTHING  
YOU NEED**  
for real Laboratory-  
type training  
**AT HOME**

-with the aid of BOTH  
HOME LAB EQUIPMENT  
and HOME MOVIES

What will mailing the coupon below do for YOU? Just this! You'll find out about one of today's most remarkable... practical ways to prepare to get into America's amazing billion dollar opportunity field of TELEVISION-RADIO-ELECTRONICS. You'll see how to get into highly interesting work that pays well... that offers one of America's most promising futures... that enables you to start your own business almost "on a shoe string," if you prefer this to a job opportunity.

And above all, you'll get some GOOD NEWS especially welcomed by men anxious to earn REAL MONEY in this growing field. For you'll see that NOW you can get the kind of practical, laboratory-type training so desirable for making real progress in Television-Radio-Electronics AND WITHOUT LEAVING HOME.

You'll see that DeVRY Technical Institute sends everything needed to set up your own HOME LABORATORY. You get and keep the same type of basic electronic equipment used in our modern Chicago Training Laboratories. You get home training that includes the knowledge and experience gained from training thousands of students first hand in Chicago. And to top it all, you use DTI's amazingly effective and exclusive home training aid—INSTRUCTIVE MOVIES. But why not get the complete story? Mail coupon today for complete facts.

1. Build over 300 fascinating experiments from 16 BIG SHIPMENTS of Electronic-Radio parts which you KEEP.
2. Build valuable commercial-type test equipment—as shown to the left—which you KEEP. This includes a quality 5 INCH oscilloscope and jewel bearing Multi-Meter—both highly useful for Television work.
3. Build and keep a big 21 INCH TV Set. (D.T.I. offers another home training in Television-Radio-Electronics, but without the TV set.)
4. Use a 16 mm. movie projector and new series of highly instructive movies—a wonderful aid to help you grasp important fundamentals faster... easier... better.
5. Enjoy well-illustrated, easy-to-read lessons with handy FOLD-OUT diagrams.
6. Get an honest-to-goodness EMPLOYMENT SERVICE to help you get a good job after graduating—or assistance in starting your OWN SALES AND SERVICE BUSINESS. Mail coupon today for the complete details.

5 INCH  
"SCOPE"

Oscilloscope

Vacuum Tube Voltmeter

21 INCH

Build and keep this BIG DTI  
Engineered TV set—easily  
converted to U.H.F. (DTI offers  
another home training, but  
without the TV set.)

Above:  
Work over  
300  
interesting  
experiments  
with this  
equipment

"ONE OF AMERICA'S FOREMOST  
TELEVISION TRAINING CENTERS"



Get this  
information-  
packed  
publication  
**FREE!**

**89 WAYS  
TO  
EARN  
MONEY  
IN TELEVISION  
RADIO  
ELECTRONICS**

MODERN  
LABORATORIES

If you prefer, get all your preparation in our new Chicago Training Laboratories—one of the finest of its kind. Ample instructors, modern equipment. Write for details!

MILITARY SERVICE!

If you're subject to military service, the information we have for you should prove very helpful. Mail coupon today.

Member of National Home Study Council

**DeVRY TECHNICAL INSTITUTE**

4141 BELMONT AVE., CHICAGO 41, ILL. Dept. PM-11-L

I would like your valuable information-packed publication showing how I can get started toward a good job or my own business in Television-Radio-Electronics.

Name \_\_\_\_\_ Age \_\_\_\_\_  
Please Print

Street \_\_\_\_\_ Apt. \_\_\_\_\_

City \_\_\_\_\_ Zone \_\_\_\_\_ State \_\_\_\_\_

D.T.I.'s Training is available in Canada

**DeVRY TECHNICAL INSTITUTE**

FORMERLY

**DeFOREST'S TRAINING, INC.**

CHICAGO 41, ILLINOIS

# HOW TO FIX ANY CAR

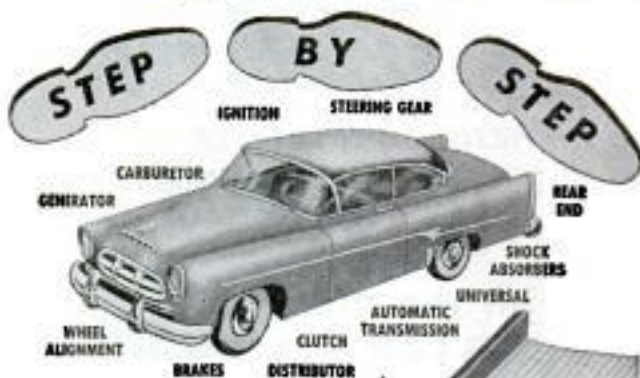

**FREE 7-DAY TRIAL**

**MOTOR'S  
AUTO  
REPAIR  
MANUAL**

ANY tune-up, service or repair job on ANY car can be as easy as A-B-C... when factory experts show you how-to-do-it one step at a time. That's why no job's too tough to handle when you've got MOTOR'S brand-new AUTO REPAIR MANUAL at your elbow!

Book "starts from scratch"—tells you WHERE to start, what TOOLS to use—How to remove, repair and replace parts. Whether you're a beginner or an expert mechanic—you can "breeze through" ANY repair on ANY make or model car built from 1940 through 1955!

Everything You Need to Know in 1000 Big ILLUSTRATED Pages! NEW, REVISED, 1000-Page Edition contains the "meat" from over 180 OFFICIAL shop manuals—simplified for YOU. 23,436 essential repair specifications on over 737 chassis models. More than 2,900 "this-is-how" pictures. 225,000 service and repair facts. Leads beginners every step of the way. Time-saving factory repair procedures for experts. Instructions and pictures so clear you CAN'T go wrong. Used by U. S. Army and Navy. 2,000,000 COPIES SOLD!

Try Book FREE 7 Days

SEND NO MONEY! Pay postman nothing. Make Manual PROVE to you what it's got. Unless you agree this is the greatest time and work saver you've ever seen—return book in 7 days and pay nothing. Mail coupon today to: MOTOR Book Dept., Desk 111, 250 W. 55 St., N.Y. 19

Same FREE Offer On MOTOR'S New Truck Repair Manual

Brand new! Covers EVERY job on EVERY popular make gasoline and Diesel truck, made from 1946 thru 1955. FREE 7-Day Trial. Check proper box in coupon.



Covers 737 Models All These Makes —1940 thru 1955

- |           |            |
|-----------|------------|
| Buick     | Kaiser     |
| Cadillac  | Lincoln    |
| Chevrolet | Mercury    |
| Chrysler  | Nash       |
| Crosley   | Oldsmobile |
| De Soto   | Packard    |
| Dodge     | Plymouth   |
| Ford      | Pontiac    |
| Frazer    | Studebaker |
| Henry J   | Willys     |
| Hudson    |            |

MAIL COUPON NOW FOR 7-DAY FREE TRIAL

MOTOR BOOK DEPT.  
Desk 111, 250 W. 55th St., New York 19, N. Y.

Rush to me at once (check box opposite book you want):

- MOTOR'S New AUTO REPAIR MANUAL. If O.K. I will remit \$2 in 7 days, \$2 monthly for 2 months and a final payment of \$96 (plus 35c delivery charges) one month after that. Otherwise I will return the book postpaid in 7 days. (Foreign price, remit \$9 cash with order.)
- MOTOR'S New TRUCK REPAIR MANUAL. If O.K. I will remit \$2 in 7 days and \$2 monthly for 3 months, plus 35c delivery charges with final payment. Otherwise I will return book postpaid in 7 days. (Foreign price, remit \$10 cash with order.)

Print Name..... Age.....

Address .....

City..... State.....

Check box and save 35c delivery charge by enclosing WITH coupon entire payment of \$6.95 for Auto Repair Manual (or \$8 for Truck Repair Manual.) Same return-refund privilege.

**INSURED TIRE SERVICE**  
**POPULAR BRANDS**  
**FREE** INSURANCE POLICY given with each used tire sold. We guarantee the amount of service you pay for.  
NOWHERE CAN SUCH QUALITY BE FOUND AT SUCH LOW PRICES!

**SPECIAL!** Deduct 10% on orders for two or more used tires

**YOU CAN'T LOSE!!**

**GOODYEAR SUBURBANITE TYPE SNOW TIRES**  
New Tire Guarantee—Factory Rebuilt  
BEST WINTER TRACTION OF ALL!

670x15	\$9.95	710x15	650x16	\$10.90
600x16		760x15	650x15	

Super Quality — Rugged Performance — 15 Months Insured Service

600x16	\$3.65	670x15	\$3.95	700x16	\$4.45	760x16	\$4.75
680x15	3.85	670x16	4.05	710x15	4.35	820x15	4.95
690x16	4.25	700x16	3.95	760x15	4.45	550x17	4.65

Supreme Quality — Nothing Finer — 30 Months Insured Service

600x16	\$5.25	475x19	\$5.45	700x15(6)	\$10.45	700x20	\$12.50
600x16(6)	6.75	640x13	4.95	780x16(8)	14.95	780x20(8)	19.50
620x16	5.75	670x12	5.35	700x17	11.95	750x20(10)	17.50
650x16(6)	7.25	710x15	5.45	750x17	16.45	825x20	21.50
700x16	6.35	760x15	5.95	750x15	10.95	900x20	19.95
700x16(6)	8.45	800x15	6.35	30x5	11.25	1000x20	20.45
550x18	4.95	820x15	6.35	600x20	10.95	1100x20	21.25
550x17	4.75	550x15	5.35	680x20	11.75	1000x22	21.05
650x15	5.25	670x16	5.15	32x6(5)	11.95	1100x22	22.75
700x15	5.35	700x16(6)	10.25	32x6(10)	12.75	1100x24	25.95

Whitewalls \$1.00 extra.

**MIDLAND TIRE SALES**  
Speedy shipments on Mail Orders. F.O.B. Chicago. Insurance policy sent with each order. Deduct 10% on orders for 3 or more used tires. Send CHECK or MONEY ORDER—No COD's.  
3701 S. Normal, Dept. PM-40, Chicago 9, Ill.

I'll Send You This Handsome SAMPLE CASE—FREE



and Show You How to Make Up to \$30.00 in a Day  
WRITE for this FREE Tailoring Sample Case packed with 150 beautiful, big-value suit and overcoat fabrics. Take orders from friends, fellow-workers, others. For fine quality, made-to-measure clothes. Pocket big cash profits in advance. Because wearing our suits and overcoats brings more orders, we make it easy for you to get your own clothes without the cost. No experience is needed. SATISFACTION GUARANTEED. SEND NO MONEY. Rush your name, address, and age—today!  
**J. C. FIELD & SON, INC., Harrison & Throp Sts. DEPT. J-1716 CHICAGO 7, ILLINOIS**

earn as **TAX EXPERT**  
**\$15 HOUR**  
Our students earn as much as \$3,000 in 3 short months preparing income tax returns in spare time. Also operate lucrative year-round Business Tax Service. Dignified home-office business. Experience unnecessary. We train you; help you start. State approved home training program. Write today for free prospectus.  
**UNION INSTITUTE, 68 Hudson, Hoboken 20D, N. J.**

**IT'S EASY...**  
**MAKE MONEY IN PHOTOGRAPHY**  
If you are over 17—good pay and fascinating work await you in photography! Start making money quickly in sparetime—step into your own studio or exciting career job. LEARN BY DOING method trains you at home! Write TODAY for FREE catalog. Also Resident Training—46th Year. Approved for Vets.  
**NEW YORK INSTITUTE OF PHOTOGRAPHY**  
Dept. 49 10 West 33 Street New York 1, New York  
**46th YEAR**

Get the facts on Mobile Living  
Get **TRAILER TOPICS MAGAZINE**  
When you subscribe to Trailer Topics Magazine, you get the latest information on Mobilehomes... Equipment... Accessories... Trailer Trips... Trailer Parks and many other interesting monthly features at only—\$3.00 for 2 years.  
**6-Month Trial Subscription \$1**  
**TRAILER TOPICS MAGAZINE (Room 1579)**  
28 East Jackson Blvd., Chicago 4, Illinois



Get more money!  
More security! More out of life!  
**Learn**



# TELEVISION • RADIO • ELECTRONICS

**Get the best!**

## Get National Schools' SHOP-METHOD HOME TRAINING!

Start now! Why wait around for that raise or promotion that may never come? Get started now in high-paying TV-Radio-Electronics! National Schools' SHOP METHOD Home Training prepares you for success in a top-salary job or in your own business. You learn all three... Television, Radio, Electronics... in one complete course. Our Shop-Tested lessons and manuals help you master all phases in shortest possible time! Send coupon, find out today!

### WHY NATIONAL SCHOOLS LEADS THE FIELD

Located in the "Television Center" of the world, our staff is in close touch with latest developments and opportunities. We give you personalized job placement assistance. We also give you confidential help with both technical and personal problems relating to your training. We show you how to make Part Time Earnings as you progress. Whether you live 30 miles away, or 3,000, you will always be pleased with our prompt, friendly service!

**DRAFT AGE?** Our home training helps you achieve specialized ratings and higher pay grades if you go in service.

We send you this precision-tested Multitester! Plus parts to build Oscillators, Receivers, Signal Generator, Continuity Checker, Combination Short Wave and Standard



Broadcast Superhet Receiver. All this equipment is part of your National Schools course. **NO EXTRA CHARGES!** Send coupon for free books!

**NATIONAL SCHOOLS**, world-famous technical trade school. Now entering our 50th year!



## NATIONAL SCHOOLS TECHNICAL TRADE TRAINING SINCE 1905

LOS ANGELES 37, CALIFORNIA

In Canada: 811 W. Hastings St., Vancouver, B. C.

• APPROVED FOR G. I. TRAINING

• BOTH HOME STUDY AND RESIDENT COURSES OFFERED

### 30 MILLION TV SETS

need regular repair! Color TV means more sets than ever before. NOW is the golden opportunity to cash in on this multi-billion-dollar industry. Or "write your own ticket" in broadcasting, manufacturing, and other specialized phases!

**YOUR AGE  
IS NO  
OBSTACLE!**

**Send for  
FREE LESSON!**

**FREE BOOK & SAMPLE LESSON**  
will convince you!  
**SEND COUPON TODAY!**



### MAIL NOW TO OFFICE NEAREST YOU!

(mail in envelope or paste on postal card)

**NATIONAL SCHOOLS, DEPT. RB-115**

4000 SOUTH FIGUEROA STREET  
LOS ANGELES 37, CALIFORNIA

OR 323 WEST POLK STREET  
CHICAGO 7, ILLINOIS

Please rush **FREE BOOK**, "My Future in Radio-Television-Electronics," and **FREE LESSON** at once. I understand there is no obligation, and no salesman will call.

NAME \_\_\_\_\_ BIRTHDAY \_\_\_\_\_ 19\_\_

ADDRESS \_\_\_\_\_

CITY \_\_\_\_\_ ZONE \_\_\_\_\_ STATE \_\_\_\_\_

Check if interested **ONLY** in Resident Training at Los Angeles.

VETERANS: Give date of discharge \_\_\_\_\_

# Inventors

If you consider your invention valuable, take these necessary preliminary steps promptly to protect it by applying for a United States patent.

Sketch and describe your invention. (For convenience in starting action on your invention, use "Evidence of Invention" form offered below.)

Sign, date and have this invention disclosure witnessed by two people capable of understanding your invention.

Have us make a preliminary search among U. S. patents already granted for similar types of invention.

We then prepare a report for you on the probable patentability of your invention and recommend your further course of action.

This firm is registered to practice before the U. S. Patent Office. We are available to assist you in the preparation and prosecution of your application for patent.

We shall be glad to send you promptly and without obligation, an instructive booklet—"Patent Protection for Inventors"—and our convenient "Evidence of Invention" form.

**VICTOR J. EVANS & Co.** *Merlin M. Evans*  
REGISTERED PATENT ATTORNEY  
130-M MERLIN BUILDING, WASHINGTON 6, D. C.

## WANTED MAN WITH CAR

### NO TIME LIKE NOW TO GET IN McNESS BUSINESS

It's no trick to make good money when you use your car as a McNess "Store on Wheels." Farmers buy everything they can from McNess Men because McNess Products are tops in quality, represent extra values. Attractive business-getting prizes and premiums; also money-saving deals to customers make selling McNess daily necessities a snap.



#### WE SUPPLY CAPITAL—START NOW!

There's no better work anywhere. Big profits, permanent, need no experience to start, and we supply capital to help you get started quick. You begin making money first day. Write at once for McNess Dealer Book. It's FREE. Tells all—no obligation. (15)

THE McNESS CO., 250 Clark St., Freeport, Ill.

**A "GOOD HAND" HELPS YOU SUCCEED!**  
**LEARN TO WRITE WELL**

Handwriting quickly improves with our easy-to-understand picture lessons! Put your spare time to good use! Send today for  FREE BOOKLET, "How to Become a Good Penman," or check volumes wanted below at \$1 each:  Business Writing  Artistic Writing  Card Writing  Bird & Design Flourishing  Engraving Alphabets, COMPLETE SET \$4.50. Ask for price list of penman's supplies.

**TAMBLYN SCHOOL of PENMANSHIP**  
S.A. Ziller, Pres., 442 Ridge Bldg., Kansas City, Mo., USA

Beautifully written, plus special pen-point for shaded writing. **OUR 33rd YEAR**  
Only 10¢

**MAKE EXTRA MONEY AT HOME!**  
**INVISIBLE REWEAVING**

Pays up to \$10 in an Hour!  
Make moth holes, cigarette burns, tears, rips, disappear from all fabrics. Little-known craft pays extra spare-time profits at home. Write today for exciting details FREE!

**FABRICON 8342 S. Prairie Avenue**  
Dept. 3211, Chicago 19, Ill.

BEFORE  
AFTER

## If Ruptured

For lasting relief your rupture must  
**BE HELD BACK DAY and NIGHT.**

Consult Your Doctor.

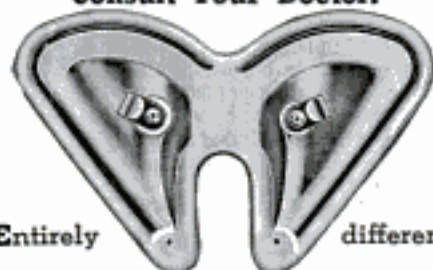

Entirely different

SOFT, FLEXIBLE, and fits neat as a glove. The famous Miller saves you TIME, MONEY, DISAPPOINTMENT. Write for my FREE booklet today.

**FRED B. MILLER** Manufacturer  
Dept. PM-A, Hagerstown, Maryland



LOWEST PRICES!

AMAZING RECEPTION!

ENTIRELY DIFFERENT!

HIGHEST QUALITY!

NEW!



The **SUPER CONSTELLATION**—the most magnificent, unique Low Boy TV you've ever seen. The screen is 21-inch "plus". Unbelievably low price!

# SAVE MONEY

## NEW ULTRA-VIDEOSONIC long range TV

### MIDWEST

## FACTORY-TO-YOU LOW PRICES 30-DAY TRIAL PERIOD



The **CONQUEROR**—the greatest performance ever. Fabulous picture screen is 21-inch "plus". Priced extra low.



The **TOWN & COUNTRY**—long range TV at its best. Famous MIDWEST screen is 21-inch "plus". Sensational low price.

### ONLY MIDWEST DARES TO GIVE YOU A 30-DAY TRIAL

You and you alone are the final judge of MIDWEST quality and performance because we give you the privilege of a 30-day trial right in your home! If you don't agree with thousands, that here is a TV receiver that meets all our claims for quality, tone and performance, return the set to us. Any money you've paid us will be refunded at once. No other manufacturer has dared to make this offer.

### MAIL COUPON FOR FREE 1956 VALUE-PACKED CATALOG OF MIDWEST ULTRA-VIDEOSONIC TV RECEIVERS

We want you to have one—they're absolutely free! Honestly, our catalog is jam-packed with a wealth of information on the new MIDWEST 1956 models, including comprehensive technical data, beautiful illustrations, complete instructions for ordering through the 30-day trial plan and a host of other interesting, informative facts about how to buy the right kind of TV set. Your catalog will show you how MIDWEST sets are specially engineered to deliver day-in, day-out trouble-free performance with the clearest, brightest picture you've ever seen. And wait until you see the beautiful styles and designs, the luxurious finishes that will lend charm and distinction to your home.

ALL SETS CARRY FAMOUS MIDWEST WARRANTY!

FREE



### YOU CAN'T BEAT MIDWEST FACTORY-TO-YOU LOW PRICES ON TV

MIDWEST has no dealers—no retail outlets—no tremendous advertising budget. That's why our prices are lower—much lower! Make us prove it . . . write for our catalog and see for yourself. BUT, while our prices are low, our quality is HIGH. No time, effort, or materials have been spared to produce these magnificent TV receivers. The new MIDWEST 1956 catalog is full of beautiful TV receivers from Table Models to Consoles. Giant, new screens are 21-inch "plus." You'll find one you like at the price you can afford.

### HUNDREDS OF THOUSANDS OF SATISFIED CUSTOMERS

We here at MIDWEST Radio & Television Corporation are proud of the reputation we have built over the last 36 years. Thousands of families have discovered, as we know you will, that MIDWEST is the most honored name in the industry. MIDWEST has always delivered a product of the highest quality at a price that everyone can afford.

### YOUR FRIENDS AND NEIGHBORS WILL BE IMPRESSED

When the huge screen, 21-inch "plus", of your new MIDWEST Ultra-Videosonic TV lights up and brings you the clearest, sharpest picture you've ever seen . . . even if you're in the poorest fringe area . . . your friends will be simply amazed. And when the golden tones from the Panasonic speaker floods the room . . . well, that will top it all off, and everyone will know that you own the very best television receiver in the neighborhood, a MIDWEST Ultra-Videosonic TV.

MIDWEST RADIO & TELEVISION CORP., DEPT. A-4  
909 Broadway, Cincinnati 2, Ohio  
Send FREE 1956 MIDWEST TV Catalog. No obligation on my part.

NAME \_\_\_\_\_  
ADDRESS \_\_\_\_\_  
CITY \_\_\_\_\_ STATE \_\_\_\_\_

**MIDWEST**

RADIO & TELEVISION CORP. • DEPT. A-4 • 909 BROADWAY, CINCINNATI 2, OHIO

# EARN BIG PAY

Industry needs skilled mechanics. GREER, leader for more than 50 years in the Trade School field, can train you quickly—You "learn by doing," using the finest equipment, under the supervision of expert technicians.

APPROVED FOR CIVILIANS  OR GI'S

## —CHOOSE YOUR TRADE—

CHECK HERE	WEEKS
<input type="checkbox"/> DIESEL MECHANICS	20
<input type="checkbox"/> AUTO MECHANICS	20
<input type="checkbox"/> BODY & FENDER	16 3/4
<input type="checkbox"/> GAS-ARC WELDING	4-12
<input type="checkbox"/> REFRIGERATION	13 1/2
<input type="checkbox"/> AIR CONDITIONING	8 1/3
<input type="checkbox"/> MACHINIST TRADE	30
<input type="checkbox"/> ADVANCED MACHINIST (includes tool & die)	32 1/2
<input type="checkbox"/> PIANO TUNING & REPAIR	36

## CHOOSE YOUR ENGINEERING COURSE

These courses are intended as terminal education for men who wish to enter the Diesel-Automotive and Refrigeration-Air Conditioning fields as technicians. These courses are designed to prepare men for supervisory positions. Students with a high school education, or equivalent, will be accepted.

<input type="checkbox"/> DIESEL AUTOMOTIVE ENGINEERING	2 years
<input type="checkbox"/> REFRIGERATION & AIR COND. ENGINEERING	18 months

## HOME STUDY COURSES

Learn at Home — Approved for Civilians & G.I.s. Write for detailed information on Courses in

- PLASTICS  
 REFRIGERATION & AIR-CONDITIONING  
 DIESEL ENGINES

## FREE EMPLOYMENT HELP

Start your career with Greer by checking your interest above and mail coupon for complete information at no obligation.

NAME \_\_\_\_\_ AGE \_\_\_\_\_

STREET \_\_\_\_\_

TOWN \_\_\_\_\_ ZONE \_\_\_\_\_ STATE \_\_\_\_\_

Established 1902 — Over 50,000 Graduates.  
53 years of continuous trade school experience  
to guide your training.

**GREER SHOP TRAINING**  
Box K, 2236 S. Michigan Ave.  
Chicago 16, Illinois



## Shrinks Hemorrhoids New Way Without Surgery

Science Finds Healing Substance That Relieves Pain—Shrinks Hemorrhoids

For the first time science has found a new healing substance with the astonishing ability to shrink hemorrhoids and to relieve pain — without surgery.

In case after case, while gently relieving pain, actual reduction (shrinkage) took place.

Most amazing of all — results were so thorough that sufferers made astonishing statements like "Piles have ceased to be a problem!"

The secret is a new healing substance (Bio-Dyne\*) — discovery of a world-famous research institute.

This substance is now available in suppository or ointment form under the name Preparation H.\* Ask for it at all drug counters—money back guarantee. \*Reg. U. S. Pat. Off.

**EARN EXTRA MONEY GROWING MIDGET TREES!**

AT HOME • SPARE TIME • FOR FUN AND PROFITS!

It's Now Amazing! FULL GROWN living dwarf trees—only 12 INCHES HIGH! Elm, orange, oak, cypress—any kind! ALL BLOOM and even BEAR FRUIT. Perfect, healthy specimens, but miniature! Make costly home decorations and beautiful expensive centerpieces (sold for over \$1,500 each). It's Fast! A new fascinating artistic HOBBY — a new \$\$\$\$\$ HOME BUSINESS! Real seed and seasonal new growing plan details, BOTH ABSOLUTELY FREE!

**FREE!** GENUINE SEED AND PLAN

NATIONAL NURSERY GARDENS, Dept. M-13  
8463 SOUTH VAN NESS, INGLEWOOD 4, CALIFORNIA

**'How to MAKE MONEY with Simple CARTOONS'**

A book everyone who likes to draw should have. It is free; no obligation. Simply address **FREE BOOK**

**CARTOONISTS' EXCHANGE**  
Dept. 911D Pleasant Hill, Ohio

**Learn ACCOUNTING**  
Business Administration

Bookkeeping, secretarial and allied subjects at home in your spare time or attend nationally approved resident school. Write for FREE Success Book giving complete details on courses, plans, rates and employment opportunities. G.I. approved. Write Dept. A.

**Hills BUSINESS UNIVERSITY AND EXTENSION SCHOOL**  
629 W. MAIN ST. OKLAHOMA CITY 2, OKLAHOMA

**LEARN METALCRAFT**  
and JEWELRY MAKING

Low Cost Home Training Now Available

Make money. Learn profitable skills and arts of decorative metal and jewelry crafts. Course is complete. Professionally prepared. Easy to master. Special tools and materials furnished.

Write for **INTERSTATE TRAINING SERVICE**  
DEPT. K-3 PORTLAND 13, OREGON

**Learn BAKING At Home**

Baking is one of America's high industries in wages. Nearly DEPRESSION-PROOF. Thorough home course lays sound foundation. If you have aptitude, write for FREE Booklet, "Opportunities in Commercial Baking."

**NATIONAL BAKING SCHOOL**  
835 Diversey Pkwy. Dept. 1358 Chicago 14, Ill.

# GOING OUT OF AUTO Seat Cover BUSINESS!

SELLING OUT 17,850  
AUTO SEAT COVERS

Values to \$5

YOUR CHOICE \$

Tough Vinyls, Nylons,  
Denims, Scotch Plaids,

Leopard & Zebra Prints,

Candy Stripes, Crystal Tones, etc.

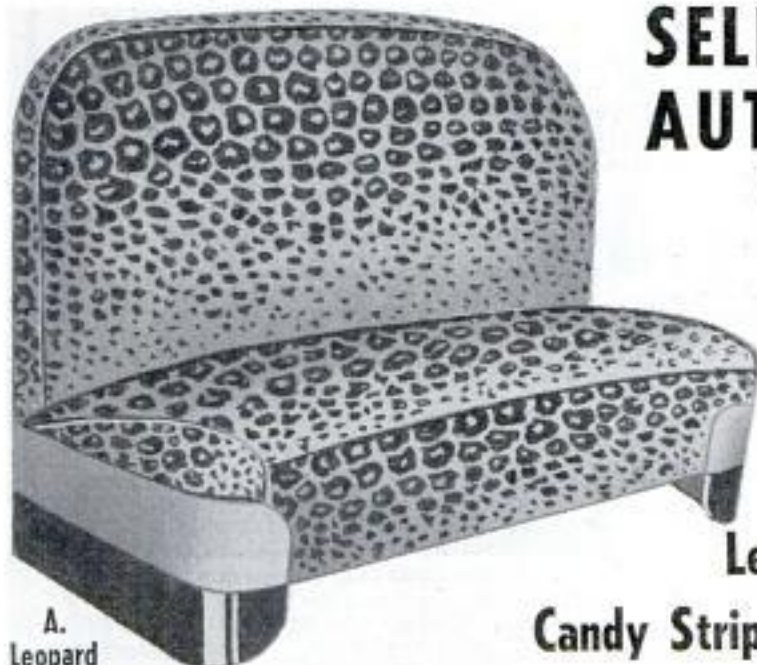

A.  
Leopard

We've been serving the public for years with choice, well-made auto seat covers—the kind any motorist would be proud to have in his car. We put our heart and soul into this business. We put out the best possible seat covers at the lowest possible price and sold hundreds of thousands. Then trouble set in. Material and labor costs mounted higher and higher. Competition set in too, from big, multi-million dollar outfits who sold on credit. Our profits vanished and so did our capital. So this is "Goodbye" to the business. It's our last seat cover ad to appear in this publication.

### TAKE YOUR CHOICE OF MANY ATTRACTIVE DESIGNS! YOUR CHOICE ONLY \$1

We have complete stocks right now! Many attractive designs! Choice materials such as modern, durable Vinyl—the miracle plastic used in so many 1955 sports cars. Or you may prefer the bright, smooth Nylons or luxury Denims that last and last. No matter your choice, you are sure of the BARGAIN OF A LIFETIME! Imagine it—only \$1 plus postage brings you the luxury and protection of a nationally advertised MOTO-MATIC cover. At this low price you couldn't buy the material ALONE! Yet you get a COMPLETED, carefully tailored seat cover for LESS than the Jobber's WHOLESALE PRICE!

### EASY TO INSTALL WITH NEW ADJUSTOMATIC FEATURE

Moto-Matic Seat Covers slide on or slide off in less than 1 minute! Nothing could be simpler—nothing could be

faster! All MOTO-MATIC Seat Covers have the famous ADJUSTOMATIC feature. They go on or off so fast, so easily! No pins! No sewing! No tacking! In an instant your car takes on that new, handsome appearance. No matter how soiled or worn out your upholstery is, no matter if you have a '39 Chevy or a '55 Caddy, these magnificent seat covers add new glamour to your car! Your friends will never—but NEVER imagine you paid so little for them.

### THIS AMAZING OFFER IS FOR A SHORT TIME ONLY!

Many thousands of people will be seeing this ad. Our stock will be sold very fast, we hope! So please make your choice at once and rush coupon TODAY. Also make a SECOND choice to protect yourself if we run out of any one design. It's a case of first come, first served. Send only \$1 plus 10c postage for each seat cover chosen. For front and rear, send only \$2.00 plus 20c postage. All sales final. No C.O.D.'s. None sold to dealers. To be fair to all, we cannot accept orders for more than a set of two for front and rear. All orders shipped promptly. NOTE: When these are gone, no more will be available. However, if your order arrives after our stocks are finished, we will return your money AT ONCE! To avoid disappointment, rush your orders today!



B.  
Candy  
Stripe

C.  
Solid

D.  
Zebra

E.  
Scotch  
Plaid

### MOTO-MATIC CO.

352 FOURTH AVE., DEPT. 6-M-150, NEW YORK 10, N.Y.

## FREE!

"POCKET TROUBLE SHOOTER" — This booklet lists hundreds of motor troubles and suggests remedies.

Your free copy may save you big sums of money on repair bills.

Shows how to make your own adjustments—how to avoid excessive repair charges.

### CLIP THIS VALUABLE COUPON—RUSH TODAY!

MOTO-MATIC CO., Dept. 6-M-150  
352 Fourth Ave., New York 10, N. Y.

RUSH me \_\_\_\_\_ Seat Cover(s) at \$1 each plus 10c postage. Also send FREE copy of "Pocket Trouble Shooter." I understand that at THIS CLOSE-OUT PRICE, ALL SALES ARE FINAL (No C.O.D.'s.) Payment is enclosed.

A.  Leopard

B.  Candy Striped \*

C.  Solid (State color) \*

D.  Zebra

E.  Scotch Plaid

NAME \_\_\_\_\_

ADDRESS \_\_\_\_\_

CITY \_\_\_\_\_

STATE \_\_\_\_\_

\*Please state SECOND color choice.

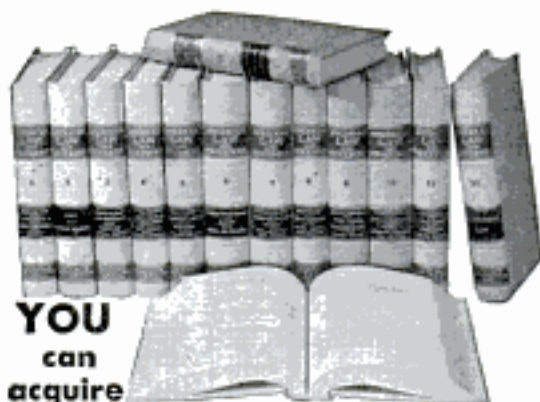

YOU  
can  
acquire

## LAW NIGHTS AT HOME! L. L. B. DEGREE

LaSalle's famous Law Library—used as reference in many Law libraries and Law offices—has enabled thousands to master Law surprisingly fast, in spare hours at home, for business and professional advancement.

These 14 remarkable volumes, compiled by leading professors and lawyers, cover the whole basic field of Law in condensed, orderly, simplified manner.

You advance rapidly with this great library, plus special lectures furnished. We guide you step-by-step with personalized Problem Method of instruction . . . you learn by doing—handling legal problems—not by memorizing rules.

Send for two FREE 48-page booklets, "Law Training for Leadership," and "Evidence," answering questions about Law and its value to you, and telling how LaSalle Law graduates are winning rapid advancement in business and public life. Mail coupon below. No obligation.

### LA SALLE EXTENSION UNIVERSITY A Correspondence Institution

417 S. Dearborn St. Dept. 1164L Chicago 5, ILL.

Send me your two FREE booklets described above, without obligation.

Name.....Age.....

Street.....

City, Zone & State.....



### SCALE MODELS

Start today collecting these imported Sports & Passenger Cars. Die cast in metal. Terrific paint job. New Models constantly being added. Postpaid. No COD please.

Porsche (German), 90c; M. G. (British), 90c; Volkswagen (German), \$1.00; Jaguar XK (British), 80c; Harley Davidson motorcycle (U.S.A.), 80c; Harley combi's (U.S.A.), \$1.00; Opel (German), \$1.00; Austin Healey (British), \$1.00; Alfa Romeo (Italy), 80c; Volkswagen Trucks all models (German), \$1.00; Vespa Scooter (Italy), 75c; Vespa w/steering, \$1.00; M.I.G. Jet (Russia), 85c; Hawker Hunter (British), 85c; Triumph TR3 (British), \$1.00.

Send check, money order or cash to  
CONTINENTAL CAR MODELS, P.O. Box 498, Buffalo, N.Y.

New York's Leading Pawnbroker

## SAVES YOU UP TO 50% ON GENUINE DIAMONDS



Send for  
free catalog  
with  
diamond  
advice!

### SEE BEFORE YOU PAY!

Tremendous savings on diamonds from unredeemed loans, bankruptcy sales and world wide below market sources. All set in latest brand new 14 Kt. gold and platinum mountings. EVERY DIAMOND GRADED ACCORDING TO NATIONALLY ACCEPTED SYSTEM. Most in your choice of 6 grades. Sworn bond guarantees quality - 10-day bonded money back guarantee. Easy payment Lay-Away plan for your convenience. References: Jewelers Board of Trade or your own bank. SEND NOW FOR FREE CATALOG.

**KASKEL'S**  
41 West 57th St. New York 19, N.Y. Dept. 507-L-13

Send FREE CATALOG and Advice about DIAMONDS without obligation.

Name.....  
Address.....

## GIVE YOUR CAR THAT 1956 LOOK!



Miracle GLASS TINT  
Sprays On. Gives Your Car  
That "Custom Look" With-  
out Usual \$80 Cost of  
Tinted Glass.

**GLASS TINT**  
sprays on, eliminates sun-  
glare and headlight glare.  
**SEND NO MONEY**  
Pay postman \$2.00 plus  
usual COD charges (or re-  
mit with order and we pay  
postage for you).

**LASTS FOR YEARS!**

BIG 8oz. SPRAY CAN

**\$2.00**

**GLASS TINT** Dept. PM-11 220 S. STATE ST.  
CHICAGO 4, ILL.

## \$14,839 In 1 Year SERVICING RADIATORS

—REX RYAN, Bloomfield, Iowa  
Hundreds earning \$8,000-\$20,000 a year serv-  
icing auto-truck-tractor radiators! New Inland  
equipment makes work easy, insures finest pro-  
fessional workmanship. "Pay-for-itself" financ-  
ing available. \$100 training course included  
free by world's largest radiator servicing manufacturer.

WRITE for free folder "Want a business of your own?"  
**INLAND MFG. COMPANY** Dept. PM-11  
1108 Jackson St., Omaha 8, Nebr.

## Personal COLOR PRINT CHRISTMAS CARDS

From your own 35mm Color Transparency  
Price includes your own color print on  
handsome, standard size Christmas  
card with matching envelope.  
MINIMUM ORDER \$2.50

**10c**  
ea  
complete

MINIFILM Dept. PM 1190 6th Ave., N.Y.C.

## MAKE CERAMICS IN YOUR KITCHEN

Make lovely vases, bowls, lamps, trays

No special skill or equipment needed. New Della Robbia  
Kit contains Miracle Clay, tools, brushes, 10 glaze col-  
ors, illus. instruction book. Clay bakes hard and durable  
in kitchen oven. Try kit 7 days at our risk. Only \$5.95  
postpaid. If not delighted return for full refund. Order  
from SCULPTURE HOUSE, Dept. A1011, 304 West 42nd  
Street, New York 36, N. Y.

## Secrets of VENTRILOQUISM Now Revealed!

Easy to learn in 60 to 90 days with our  
Home Study Course. RESULTS GUARANTEED.  
Make Money! Be Popular! Have Fun! Big Op-  
portunity! Radio, Television, Stage Appear-  
ances! For FREE information regarding price  
and terms WRITE. You must state your age.  
Dummy Catalog 35c.  
**FRED MAHER SCHOOL OF VENTRILOQUISM**  
Box 36, Studio PM-11 Kensington Station  
Detroit 24, Michigan

## THE NEW ECKEL DIAL RULE

A SLIDE RULE THAT CAN BE  
OPERATED BY ANYONE!!

**\$9.95**  
PPD.

If you can read scales, you can read  
a "Dial Rule" and perform ordinary  
multiplication, division, square root  
& evaluation of trigonometric func-  
tions with no previous experience  
necessary. No knowledge of slide rule  
theory is needed. You never lose the  
answer on "Dial Rule" for it never  
goes off the answer dial.

Clock dial numerical arrangement and  
17" scale length. "Dial Rule" is only  
4 1/2" in diameter. (Complete with easy  
instructions) Only \$9.95 postpaid . . .  
(money-back guarantee).



**LITHOCALCULATOR CO., 31 St. Joseph St., Arcadia, Calif.**

**DELEHANTY starts PRACTICAL SHOP WORK with your FIRST LESSON!**

**Only DELEHANTY gives YOU a MONEY-BACK GUARANTEE! No Risk! No Obligation!**

**NO PREVIOUS TRAINING OR EXPERIENCE NEEDED!**

**YOU GET FULL-SIZE  
21" TV SET & TUBE  
at No Extra Charge!**

**First Kit of Tools and Parts sent Immediately with First Training Unit!**

**Learn At HOME TELEVISION RADIO & ELECTRONICS**

**...We Furnish ALL Your EQUIPMENT at No Extra Cost!**

**The DELEHANTY INSTITUTE**

For nearly 50 years, there has been no finer name than DELEHANTY in the entire field of Vocational Training! More than Half a Million students have benefited by our Practical Home Study and Resident Courses. We have developed a SHOP-TRAINING-AT-HOME METHOD that is SO PRACTICAL and EFFECTIVE that it is unhesitatingly offered with an UNCONDITIONAL MONEY BACK GUARANTEE!

**FRESH, NEW, UP-TO-THE-MINUTE TRAINING THAT INCLUDES NEARLY 400 PRACTICAL SHOP PROJECTS!**

Perfected by a large staff of electronic experts, engineers, technicians and teachers with extensive practical field experience. Entirely new and up-to-date. Includes Ultra High Frequency, Color TV, Printed Circuits, Transistors, Geiger Counters, High Fidelity, and other last-minute electronic developments. You enjoy over 400 interesting and practical experiments in applied electronics during your training with 15 Big Kits of Tools, Tubes, Parts and Equipment that we furnish at NO EXTRA COST!

**EARN EXTRA MONEY SOONER!**

Because you get right down to business with practical work from the very beginning you are able to earn money quickly in spare time. By repairing radios and electrical appliances for friends and neighbors you can actually earn the money to pay for this unique Delehanty training!

**In a Matter of Months You Can Be Ready for GOOD FULL-TIME JOBS or a PROFITABLE BUSINESS OF YOUR OWN!**

**STUDY AT YOUR OWN PACE... PAY AS YOU GO, AVOID DEBT!**

DELEHANTY TRAINING is taken at your leisure . . . Order each training unit only when you want it . . . ALL UNITS at ONE LOW PRICE . . . no time payments to worry about . . . YOU PAY AS YOU GO and YOU'RE NEVER IN DEBT . . . when training is completed you owe nothing and will own and **KEEP AS YOUR OWN PROPERTY**

- 21" TV SET WITH 21" PICTURE TUBE • TOOLS
- SUPERHETERODYNE RADIO WITH ALL TUBES
- MULTITESTER-AMMETER-OHMETER-VOLTMETER
- RADIO TELEPHONE TRANSMITTER • AUDIO AMPLIFIER • OSCILLATORS • MODULATORS • RF AMPLIFIERS • OTHER ELECTRONIC DEVICES
- REFERENCE LIBRARY IN HANDSOME LOOSE-LEAF BINDERS



**MAIL COUPON TODAY FOR FREE ILLUSTRATED BOOKLET**



**NO OBLIGATION • NO SALESMAN WILL CALL**

DELEHANTY INSTITUTE OF TELEVISION PM 11-5  
 115 East 15th Street, New York 3, N. Y.

Please send me by return mail your Free Booklet "How to Achieve Success in Television, Radio and Electronics." This does not obligate me in any way.

NAME \_\_\_\_\_ AGE \_\_\_\_\_

ADDRESS \_\_\_\_\_

CITY \_\_\_\_\_ ZONE \_\_\_\_\_ STATE \_\_\_\_\_

(PLEASE PRINT - Paste on Post Card or Mail in Envelope)

**DELEHANTY INSTITUTE OF TELEVISION**  
APPROVED BY STATE OF NEW YORK  
115 EAST 15 ST., NEW YORK 3, N. Y.

# DRAFTSMEN



**CASH BIG  
PAY CHECKS!**

**Train Now for  
more success,  
greater security**

**LEARN AT HOME IN SPARE TIME  
(or at college in Chicago)**

Check the want ads in any newspaper—SEE the big-pay opportunities open to you as a draftsman. What's more, you can learn this well-paid, prestige profession at home—quickly, easily! No special talent needed. Get complete, step-by-step Chicago Tech lessons in the mail, spend a few pleasant hours studying each week. In a short time you'll be a well-trained draftsman, ready to take your pick of many good jobs. Act now!



**Free Information—Mail Coupon Today!**

Get **FREE TRIAL LESSON** plus information about C.T.C. practical training. Learn what successful Chicago Tech graduates say about high pay and opportunities in drafting. No charge, or obligation.

## CHICAGO TECHNICAL COLLEGE

P-253 Tech Bldg., 2000 So. Michigan Ave.  
Chicago 16, Illinois

Mail me **FREE** lesson with facts about big opportunities in **DRAFTING**.

Name \_\_\_\_\_ Age \_\_\_\_\_  
Address \_\_\_\_\_  
City \_\_\_\_\_ Zone \_\_\_\_\_ State \_\_\_\_\_



**GIVE THE GIFT OF  
LANGUAGE**

IT'S FUN TO LEARN

**by LINGUAPHONE**

The World's Standard Conversational Method

**FRENCH • SPANISH • GERMAN • JAPANESE  
RUSSIAN • ITALIAN • MODERN GREEK**

any of 34 languages available for **FREE 10 DAY TRIAL**

A Linguaphone Language Set is a lasting gift—an asset in business, travel, school, armed services and social life. With LINGUAPHONE you LISTEN and LEARN another language the same, easy, natural way you learned your own. AT HOME you hear 8 to 12 of the world's best native language teachers speak—you Understand—YOU SPEAK! It's like living in another country. More than a million home-study students of all ages. There's nothing like "The Gift of Language." Send TODAY for **FREE** Book and Details of **FREE TRIAL**.

**LINGUAPHONE INSTITUTE**

7-143-115 Radio City, N. Y. 20.

Please send details on **FREE TRIAL** and **FREE** Book. No obligation.

Language interest \_\_\_\_\_

Name \_\_\_\_\_

Address \_\_\_\_\_

City \_\_\_\_\_ Zone \_\_\_\_\_ State \_\_\_\_\_

Leaders For Over Half a Century in Up-To-Date Language Courses

## Wanted! HOME PRODUCERS

**BY MANUFACTURERS IN OUR  
CLEARING HOUSE SERVICE**

Become a subcontractor, casting plastic products for important companies. These manufacturers are anxious to place big and small orders for consumer and industrial demand. Thousands of easy-to-make items required now. YOU can make them.

**YOU SET YOUR OWN HOURS**

Run this profitable business in your home, spare or full time. No previous experience necessary. Here at last is opportunity to have your own successful business. Write today. Information free.

**PLASTIC SERVICE ASSOCIATES, DEPT. PB  
EAST BOSTON 28, MASS.**

**KILLS  
SMALL  
GAME!**

**NEW!** Accurate Scope-type Sight  
Pistol Grip, 250 Pellets **FREE!**

**Scope-Shot**

**ONLY 1.95**  
postpaid  
**BIG BAG 250**  
extra pellets  
50¢ p.p.

Rugged, powerful, new-type slingshot. Polished cast aluminum frame. Pistol grip stock. Easily carried. **FREE** with each **SCOPE-SHOT**: 250 high-velocity **DISINTEGRATING PELLETS** that literally explode when they hit, need valuable shooting manual! Satisfaction guaranteed. Pellets only, 250 for 50¢ p.p. **ORDER NOW.**



**GENERAL SPORTS, 4184-L Apple St., Cincinnati 23, Ohio**

Send for **FREE** 112 page  
Illustrated Catalog of Farm, Home,  
and Workshop Bargains.

Write to **WELLWORTH TRADING  
Dept. E-11 COMPANY**

1832 S. WABASH AVE.

CHICAGO 16, ILL

**It's EASY to play** The **MUSICAL SAW**

*the Glass-O-Phone the Jazz-O-Nette,  
Musical-Pitchfork, Flute-O-Phone*

If you can whistle or hum a tune, you can play these remarkable Novelty Instruments. They are played entirely by ear. Low priced. Write for **FREE** literature. **MUSSEHL & WESTPHAL, Est. 1921**  
10 FORT ST., FORT ATKINSON, WISCONSIN



**FIND OUT FREE—HAVE YOU  
GOT WHAT IT TAKES...**

**to be a FINGER PRINT EXPERT  
or TRAINED INVESTIGATOR?**

Send for free IAS Qualification Questionnaire. If in our opinion your answers indicate that you "have what it takes," then you will receive absolutely free the famous "Blue Book of Crime" . . . plus full details on how to train at home in Crime Detection and Finger Printing! IAS graduates are key men in over 800 Police Bureaus. See if YOU can train for this exciting, steady "good pay" work! No obligation. No salesman will call. Write today, stating age.

**INSTITUTE OF APPLIED SCIENCE**

(A Correspondence School Since 1918)  
1920 Sunnyside Ave., Dept. 1358 Chicago 40, Ill.

**WRITE  
TODAY**

# Exciting Christmas Gifts at INTRIGUING LOW PRICES

W. DeHavilland Co. has acquired the gold and silver stock of the liquidated 55-year-old famous jewelry firm at fraction of original cost—fine gifts of quality from the chain-stores of Henry Spero Inc., of Ansonia and Shelton, Connecticut . . . now offered by the W. DeHavilland Co. at unprecedented down-to-earth savings.

"MODERN"  
No. 1250



"NORGATE"  
No. 1250



## NATIONALLY ADVERTISED—WATCHES—DISTINGUISHED QUALITY

The brand of the illustrated watches—bearing a nationally advertised name—may not be revealed in print by manufacturer's request. However, a 15-day non-obligational trial offer carries an assurance of recognition to the most discriminating shopper. Please do not mistake these watches to be of the low or medium quality. Note the unique quality features . . . restricted to fine grade, high caliber timepieces. Factory warranties and the W. DeHavilland Co. guarantee every watch for one year. Order one or more today. Appraise it . . . test it . . . wear it for 15 days. An outside appraisal will confirm its retail value for AT LEAST twice its present price. Should you not be entirely pleased kindly return your purchase—it will not cost you a SINGLE CENT.

WM. A. ROGERS  
SILVER PLATE

"ENDEARABLE"  
No. 4575



**No. 3575** Gent's 17-jewel watch for work and sport. Not just water-resistant, but 100% waterproof. Equipped with two Incabloc shock-absorbers. Luminous face. Sweep hand. Non-magnetic. Unbreakable lifetime main-spring. Stainless steel case screw. Established retail price \$35.75. Now . . . . **\$12.90**



**No. 6750** Gent's 17-jewel at dress watch. Face of 14K solid gold raised numerals. Heavy rock crystal. Dust-resistant winder. Superbly crafted masculine case of 10K gold-filled in natural gold. Established retail price \$67.50. Now . . . . **\$22.70**



**No. 7150** Gent's 17-jewel automatic watch for dress and sport. Self-winding mechanism. Equipped with two Incabloc shock-absorbers. Dust-resistant winder. Non-magnetic. Sweep hand. Lifetime quality 14K gold-filled case in natural gold. Face available with Roman numerals, if desired. Established retail price \$71.50. Now . . . . . **\$29.85**

**No. 1250** Stainless Steel flatware, 24-piece set, service for 6. Here is stainless at its radiant best, guaranteed for a lifetime of carefree use—not to tarnish, rust or stain. Enhancing for formal occasions—practical for every-day use. Available in two patterns, "Norgate" and "modern." Order by number and pattern. Established retail price \$12.50. Now . . . . . **\$5.94**

**No. 4575** WM. A. ROGERS RE-INFORCED SILVER-PLATE. Open stock pattern—ENDEARABLE. 50-piece set—service for 8. Nationally-advertised WM. A. ROGERS—America's fine silverplate. Manufacturer's guarantee with each set. Every piece heavily plated with pure silver and re-inforced with an additional extra layer at the point of greatest wear. Finest quality hollow-handle knives with stainless steel blades of serrated edges. Ideal Christmas present. Here is the fine silverplate set she has always dreamed of—to be admired by guests on those special occasions. Now available at less than half of retail price. Established retail price \$45.75. Now . . . . . **\$19.90**



No. 995—Sterling silver  
No. 1295—Gold-filled

Photo-identification bracelets—for men, women, boys and girls. Famous brand advertised on TV. Comfort-fit expansion type. Precision built of precious, lasting metal—guaranteed against tarnish or rust. Twin-swivel frame holds four concealed photos. Ideal for Christmas giving—enduring gift of remembrance—to be treasured by a loved one forever. Name engraved free.

**No. 995**—Sterling Silver-ver-stainless back. Now . . . . . **\$5.85**

**No. 1295**—Yellow Gold-filled-stainless back. Now . . . . . **\$7.75**

**IMPORTANT**—Order by number and give name, age and sex of recipient.

**W. DEHAVILLAND POLICY**  
**\$5,000**  
—reserved in the bank of the BRIDGEPORT CITY TRUST COMPANY—stands ready to honor refunds in full, plus postage, if you are not entirely pleased within 15 days after receipt.  
Prices quoted in full—never an extra charge.

- 8 dinner knives
- 8 soup spoons
- 8 salad forks
- 8 dinner forks
- 16 teaspoons
- 1 butterknife
- 1 sugar spoon

**HOW TO ORDER:** Order watches by number; flatware by number and pattern; bracelets by number, name, age and sex. Print your name and address. Send cash, check or money-order. No COD's, please. Conn. orders add 3% sales tax.

**W. DEHAVILLAND CO.**  
DEPT. 1495- PM  
406 TRUMBULL AVENUE  
BRIDGEPORT, CONNECTICUT



IF YOU "EAT, SLEEP  
AND LIVE" CARS...  
**TURN YOUR HOBBY  
INTO A CAREER!**

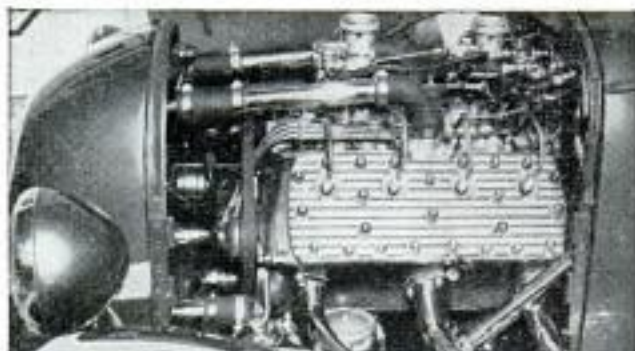

Get America's Big-time, Big-future

## AUTO MECHANICS & DIESEL COURSE *at home in your spare time!*

Los Angeles' National Schools, America's automotive Technical Trade School since 1905, now brings its famous resident Shops and Faculty direct to you at home—to prepare you to earn more money, with job security, in today's fast-moving, opportunity-filled Auto Mechanics Industry! Get your home training from the "Car Capital of The World"—America's most auto-minded city, center of Hot Rod and Sports Car activity! Mail coupon right now!

### "SHOP-METHOD" HOME TRAINING!

**YOU MASTER ALL PHASES, INCLUDING DIESEL!** All lessons fully illustrated. Latest equipment covered.



**THIS SET OF LIFETIME TOOLS IS YOURS!** Also all-metal tool box. Part of your course, yours to keep. **EARN WHILE YOU LEARN!** We show you how to start Spare Time Earnings soon after enrollment.

**ATTENTION MEN OF DRAFT AGE.** Learn how you can achieve higher rating and pay. Mail coupon *at once!* **APPROVED FOR G. I. TRAINING.** Both Home Study & Resident Courses. Free help with technical and personal problems—Job Placement Service.



Send for **FREE FACT-BOOK  
AND SAMPLE LESSON!**

**NOW! 2 offices to serve you faster!  
Mail coupon today to one nearest you!**

## NATIONAL SCHOOLS

Technical Trade Training Since 1905

LOS ANGELES 37, CALIFORNIA

IN CANADA: 811 West Hastings Street, Vancouver, B. C.

**MAIL NOW TO OFFICE NEAREST YOU!**

(mail in envelope or paste on postal card)

**NATIONAL SCHOOLS, Dept. DB-115**

4000 S. FIGUEROA STREET  
LOS ANGELES 37, CALIF.

OR 323 WEST POLK STREET  
CHICAGO 7, ILLINOIS

Send **FREE** Auto-Mechanics Book and Sample Lesson.  
No obligation, no salesman will call.

NAME \_\_\_\_\_ BIRTHDAY \_\_\_\_\_ 19 \_\_\_\_\_

ADDRESS \_\_\_\_\_

CITY \_\_\_\_\_ ZONE \_\_\_\_\_ STATE \_\_\_\_\_

Check if interested **ONLY** in Resident School Training at Los Angeles.  
VETERANS: Give Date of Discharge \_\_\_\_\_

## New FALSE PLATE for OLD IN 24 HOURS

Low As Only  
**\$15.95**



Wonderful New Scientific Method Transforms **OLD, LOOSE, Cracked or Chipped Plates into LUSTROUS BEAUTY-PINK DUPONT PLASTIC PLATES**

### MONEY BACK GUARANTEE

Why envy beautiful false teeth of others? We will transform your old, loose, cracked or chipped plate into a beautiful new, lightweight DuPont Beauty-Pink Plastic Plate, using your own teeth. All missing and broken teeth matched and replaced. Your cost amazingly low; actually save many dollars. No impression needed under our new scientific False Plate Method. 24-Hour Service.

**SEND NO MONEY** Enjoy life again, and save money on beautiful, new, natural-looking plastic plate. Rush name, address for full details sent **FREE**. If your plate is loose, we show you how to make it comfortable, tight-fitting before duplication. West Dental Laboratory, 127 N. Dearborn St., Dept. G-126, Chicago 2, Ill.

## BUILD LUGGAGE AT HOME WE SELL YOUR PRODUCTS!

**ONLY NEW HOME MONEY-MAKING PLAN IN YEARS!**

Make Luggage and cases for traveling, photographers, musicians, salesmen, electronics, tools, portables, 1001 other items. Also repair Luggage. No special equipment needed. **BIG PROFITS.** We supply complete instructions, materials—everything. Write for free details and Business Plan. **ABARSI CASE-CRAFT, Dept. G-11, 805 W. Sunset Blvd., Los Angeles 12, Calif.**

## TASOPE PHOTO-ENGRAVING PLANTS



Material Cost Of This Cut 3/4c Selling Price \$1.00 And Up

Establish your own profitable **PHOTO-ENGRAVING** business. Make cuts for newspapers, printers, and advertisers. Make etched name plates, plaques etc. Instructions furnished, no experience necessary. Sold direct from factory since 1931. First five hundred cuts sold locally or by mail will pay for plant and pay you well for your time. Write for **FREE** catalog.

TASOPE, DEPT. PM-11, AURORA, MO.

## DRAINS cellars, cisterns, wash tubs; \$6.95 IRRIGATES - CIRCULATES - SPRAYS



Type P Pump has 1,001 uses. Up to 3000 GPH; 450 GPH 80' high; or 1800 GPH from 25' well. Use 1/2 to 3/4 HP motor. Coupling included. Rust, 1" inlet; 3/4" outlet. Stainless shaft. Won't rust or clog! Postpaid if cash with order. (West of Miss. add 50c)

**MONEY BACK GUARANTEE**

Centrifugal and Gear Pumps in All Sizes

LABAWCO PUMPS, Belle Meade 7A, N. J.

# LAW

Men and women **STUDY AT HOME** for Business Success and **LARGER PERSONAL EARNINGS**, 44 years expert instruction—over 114,000 students enrolled. LL.B. Degree awarded. All text material furnished. Easy payment plan. Send for **FREE BOOK**—"Law and Executive Guidance"—**NOW!**

**AMERICAN EXTENSION SCHOOL OF LAW**

Dept. H-5, 644 N. Michigan Ave., Chicago 11, Illinois

## See the Greatest Show on Earth with this GIANT ASTRONOMICAL TELESCOPE

**\$15.00  
FULL PRICE**



Delivered ready for use. Has 43X, 75X and 100 power individually mounted eyepieces with brass focusing tube plus sun projector lens for observing sun spots and solar storms. Steel telescope tube 50 in. long. Rigid 6 ft. tripod adjustable to any height. Steel forked mounting with closely machined aluminum tripod head assembly, assured extra fine adjustments. This professional type instrument provides full power with clear vision at all times. See the moons of Jupiter, our own moon, planets, Milky Way, double stars, star clusters, etc. All for only \$15.00 **FOB Mattituck.** Sent express. COD orders require \$5.00 deposit. Satisfaction guaranteed. 200X and 400X eyepieces available at \$2.00 ea.

**SUFFOLK SCIENCE SERVICE**  
Dept. ATD-11 MATTITUCK, N. Y.



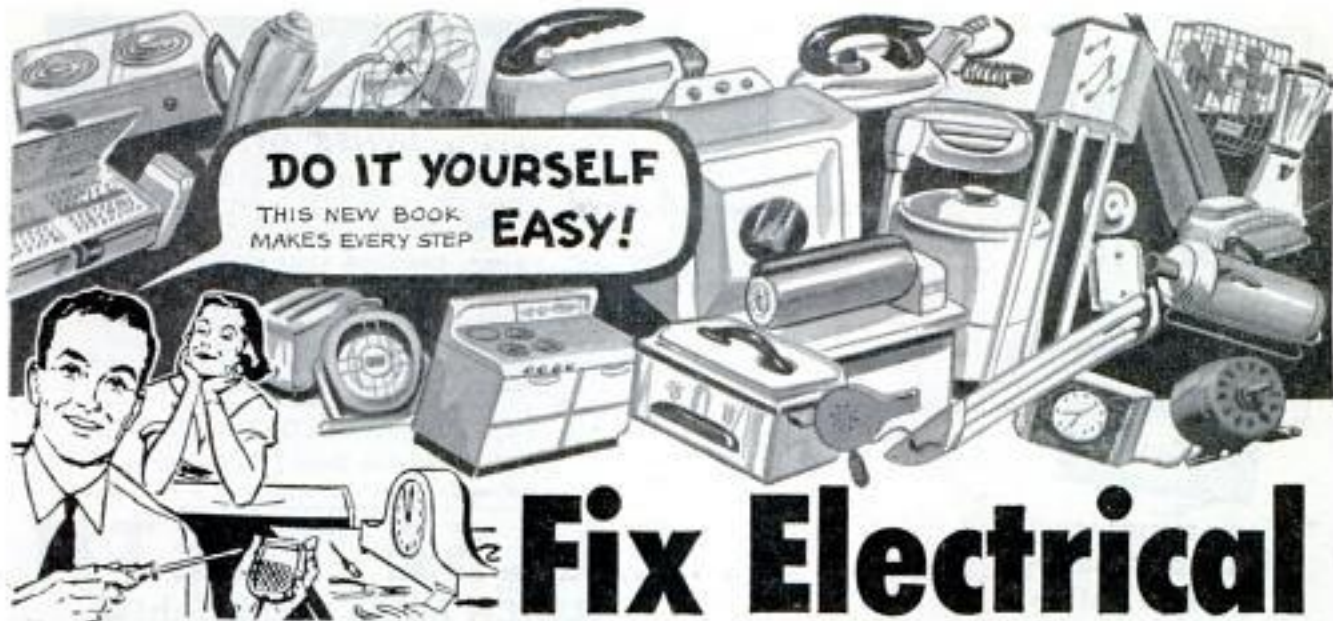

# Fix Electrical Appliances

Handle ANY job on ANY make or model!

**SAVE SERVICE COSTS UP TO \$10 AN HOUR!**

Fix your own home appliances! Avoid costly service charges! This big Manual can more than pay for itself the first time you use it!

... Even if you've never repaired an appliance before ...

This big, new how-to-fix-it book shows you how to do the toughest electrical appliance repair jobs as well as the easy ones. Step-by-step instructions PLUS almost 200 pictures guide you all the way!

**ELECTRICAL APPLIANCE SERVICE MANUAL** is a real "show-me-how" book. Just look up the appliance you want to fix.

Then go right ahead and fix it!

From complicated thermostat and timing assemblies, to appliances that get too hot, not hot enough or won't heat at all ...

From automatic washers, dryers to electric clocks, razors and all the other appliances used around the house it is a complete, easy-to-understand service guide ... Even tells how to stop radio-television interference caused by appliances.

**DON'T THROW BROKEN APPLIANCES AWAY!**

*This book shows how to fix them good as new!*

Troubleshooting charts help you locate troubles fast ... show how to make easy tests where necessary. Basic electrical principles are explained. Simple test instruments, tools and wiring problems are fully described.

*Above all, you learn to work safely ... what dangers and mistakes to avoid.*

**IN ADDITION**, you learn about servicing appliance motors PLUS appliance refinishing methods.

Everything is explained so clearly it's next to impossible to go wrong. And the complete price is only \$5.00.

Practice 10 days FREE. If book is not all you'd expect ... even of a "course" costing many times as much ... return it and don't owe us a cent!

**PRACTICE 10 DAYS FREE!**

Dept. PM115, RINEHART & CO., INC.,  
232 Madison Ave., New York 16, N. Y.

Send **ELECTRICAL APPLIANCE SERVICE MANUAL** for 10 days Free Examination. If I like book, I will then promptly remit the full price of only \$5.00 plus a few cents postage. If not, I will return book postpaid and owe you nothing.

Name.....

Address.....

City, Zone, State.....

*OUTSIDE U.S.A.—Price \$5.50 cash only. Same 10-day return privilege with money refunded.*

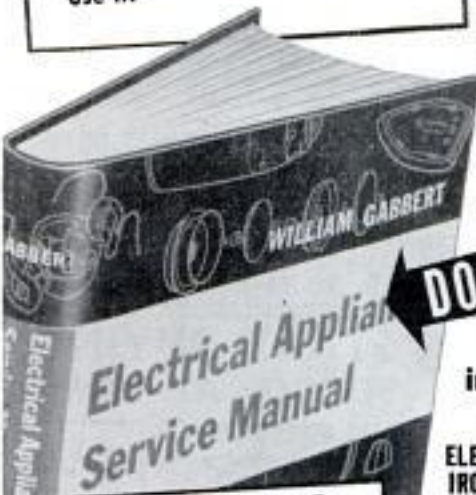

**Only \$5.00**

**NO LESSONS TO WAIT FOR!**

Everything is complete in this one 370-page book. TELLS you how ... SHOWS you how!

**MAKE EXTRA MONEY!**

This book gives you the "know how" you need to earn spare-time money repairing electrical appliances for friends and neighbors ... or to build a good-paying, full time repair business of your own.

- Easy instructions cover:**
- ELECTRIC RAZORS
  - IRONS CLOCKS
  - FOOD MIXERS
  - HOT PLATES
  - ROASTERS
  - COFFEE MAKERS
  - JUICE EXTRACTORS
  - HOT PADS
  - TOASTERS
  - WAFFLE IRONS
  - RANGES FANS
  - GRILLS
  - IRONERS
  - DRYERS
  - WASHERS (Std. & automatic)
  - CHIMES
  - WATER HEATERS
  - CLEANERS
  - FLUORESCENT LAMPS
  - ... and others

RINEHART BOOKS ARE SOLD BY LEADING BOOK STORES

**12-Star  
UTILITY PANTS**  
With Shirts to Match

**ARE  
A BETTER  
BUY**



Work comes easier  
when you "tool up"  
in comfort clothes



THERE'S more joy in any job when you slip into the relaxing ease of an Anvil matching suit. Stoop, reach, bend, twist—in any position there's comfortable freedom for action. Made of tough twills in choice of colors. Non-shrink waistband, foot-deep, double-lined safety pockets; every point of strain especially reinforced. Try out Anvil Brand for new satisfaction.

**ANVIL BRAND FACTORIES** HIGH POINT, N. C.

**High School  
at Home**

**MANY FINISH IN 2 YEARS**

No classes. No time wasted going to and from school. Progress as fast as your time and abilities permit. Standard H. S. texts supplied. Thousands enroll each year in this 58-year-old school. Send for FREE descriptive booklet.

**AMERICAN SCHOOL, Dept. H845**  
Drexel at 58th St., Chicago 37, Ill.

Without obligation, please send FREE descriptive booklet.

Name.....

Address.....

Canadian Residents: Complete Canadian Course Available.  
Write American School, 1610 Sherbrooke St., West, Montreal.

**REPAIR ANY WATCH**



**... Swiss or American**

No previous experience needed to learn modern watch repair. An enjoyable hobby or profitable career. Unique Sweazey System starts you making repairs right away. Develops your skill step by step. Teaches you modern shop methods... professional short cuts... mistakes to avoid. Learn by personal attendance or spare time home study. Individual training. Start any time. Free sample lesson. No obligation. Write today!

**CHICAGO SCHOOL OF WATCHMAKING**

2330 N. Milwaukee, Dept. 1115, Chicago 47, Illinois  
Founded 1908 • Approved for veterans

**FALSE TEETH**

**KLUTCH holds them tighter**

KLUTCH forms a comfort cushion; holds dental plates so much firmer and snuggler that one can eat and talk with greater comfort and security; in many cases almost as well as with natural teeth. Klutch lessens the constant fear of a dropping, rocking, chafing plate. 35c and 60c at druggists... If your druggist hasn't it, don't waste money on substitutes, but send us 10c and we will mail you a generous trial box.

**KLUTCH CO. Box 5593-K ELMIRA, N. Y.**

**MECHANICAL ADDRESSER COMPLETE**  
30 DAY TRIAL OFFER \$10<sup>95</sup>



Addresses anything mailable—easily, quickly, professionally. Thousands in use. Complete with supplies for 250 names. Money-back guarantee. Send check or money order or write for additional information to:  
**JACOBI ADVTG. 208 S. LA SALLE, CHICAGO 4**

**SAVE ON GOV'T REAL ESTATE**

Buy direct from Government. Surplus homes, Islands, farms, land, etc. List \$1.00. Send now and Save.  
**THE ABACUS PRESS, Dept. D, Box 169M, E. Hfd. 8, Conn.**

**AGENTS START BUYING  
SERVICE AT HOME**

**GET BIG NAME MERCHANDISE**

for your clients up to 40% less than reg. price. Operate sparetime. Sales easy as you can give sizeable discounts, still make fat comm. Postcard brings free plan.

**AMERICAN BUYERS SERVICE**  
HERTEL STATION, DEPT. R, BUFFALO 16, NEW YORK

**GET  
UP TO  
40%  
OFF**

**Earn over \$800<sup>00</sup> PER MONTH DRAFTING**

SEND FOR FREE  
SUCCESS BOOK

**CLEVELAND ENGINEERING INSTITUTE**  
DEPT. PM 11E  
6300 Euclid Ave. • Cleveland 3, Ohio

Aeronautical  Mechanical

NAME.....

ADDRESS.....

CITY..... STATE.....

No Obligation — No Salesmen

APPROVED  
FOR  
VETERANS

RECEIVE THIS SET  
OF INSTRUMENTS AT  
NO EXTRA COST



"MY INCOME JUMPED FROM \$350 UP TO \$820 PER MONTH", says G. T. WISEMAN. "My first position after I completed the C.E.I. homestudy course in Engineering Drafting more than doubled my pay. I highly recommend this valuable, easy course to anyone interested in getting ahead in life."

**CLEVELAND ENGINEERING INSTITUTE**

POPULAR MECHANICS

# GET IN ON THE TV



L. C. Lane, B.S., M.A.  
President, Radio-Television Training Association, Executive Director, Pierce School of Radio & Television.

# BOOM!

## TRAIN FOR A TOP-PAY JOB AS A TELEVISION TECHNICIAN

**NO PREVIOUS EXPERIENCE NEEDED — study AT HOME in your SPARE TIME**

Next to the atom and hydrogen bombs, the biggest noise being made today is by the booming radio-television-electronics industry.

Now, while the boom is on in full force, is the time for you to think about how you can share in the high pay and good job security that this ever-expanding field offers to trained technicians.

Just figure it out for yourself. There are more than 400 television broadcasting stations operating right now

and hundreds more to be built; more than 34 million sets in the country and sales increasing daily. Soon moderately priced color television sets will be on the market and the color stampede will be on.

All these facts mean that good jobs will be looking for good men. You can be one of those men if you take advantage of my training now — the same training that has already prepared hundreds of men for successful careers in the radio-television-electronics field.



### LEARN BY DOING

As part of your training I give you the equipment you need to set up your own home laboratory and prepare for a BETTER-PAY TV JOB. You build and keep an Electromagnetic TV RECEIVER designed and engineered to take any size picture tube up to 21-inch, (10-inch tube furnished. Slight extra cost for larger sizes.) . . . also a Super-Het Radio Receiver, AF-RF Signal Generator, Combination Voltmeter-Ammeter-Ohmmeter, C-W Telephone Transmitter, Public Address System, AC-DC Power supply. Everything supplied, including all tubes.

**EARN WHILE YOU LEARN** Almost from the very start you can earn extra money while learning by repairing radio-TV sets for friends and neighbors. Many of my students earn up to \$25 a week . . . pay for their entire training from spare time earnings . . . start their own profitable service business.

**FCC COACHING COURSE** Qualifies you for Higher Pay! Given to all my students AT NO EXTRA COST. Helps you qualify for the TOP JOBS in Radio-TV that demand an FCC license! Full training and preparation at home for your FCC license.

No experience necessary! You learn by practicing with professional equipment I send you. Many of my graduates who now hold down good paying technician jobs started with only grammar school training.

If you have previous Armed Forces or civilian radio experience you can finish your training several months earlier by taking my FM-TV Technician Course. Train at home with kits of parts, plus equipment to build YOUR OWN TV RECEIVER. ALL FURNISHED AT NO EXTRA COST!

After you finish your home study training in the Radio-FM-TV Technician Course or the FM-TV Technician Course you get two weeks, 50 hours, of intensive Laboratory work on modern electronic equipment at our associate school in New York City, Pierce School of Radio & Television. THIS EXTRA TRAINING IS YOURS AT NO EXTRA COST WHATSOEVER. My courses are complete without this extra training, however. It is just an added opportunity for review and practice.

RADIO-FM-TV  
TECHNICIAN  
TRAINING

FM-TV  
TECHNICIAN  
TRAINING

EXTRA  
LABORATORY  
TRAINING IN  
NEW YORK  
CITY  
AT NO EXTRA  
COST!

## VETERANS!

My School fully approved to train Veterans under new Korean G. I. Bill. Don't lose your school benefits by waiting too long. Write discharge date on coupon.

YOU GET THESE

free!



**MAIL THIS COUPON TODAY!**  
no salesman will call!

Mr. Leonard C. Lane, President  
RADIO-TELEVISION TRAINING ASSOCIATION  
Dept. M-11C, 52 East 19th Street, New York 3, N. Y.

Dear Mr. Lane, Mail me your NEW FREE BOOK, FREE SAMPLE LESSON, and FREE aids that will show me how I can make BIG MONEY IN TELEVISION. I understand I am under no obligation and no salesman will call.

(PLEASE PRINT PLAINLY)

Name \_\_\_\_\_ Age \_\_\_\_\_

Address \_\_\_\_\_

City \_\_\_\_\_ Zone \_\_\_\_\_ State \_\_\_\_\_

I AM INTERESTED IN:

- Radio-FM-TV Technician Course  
 FM-TV Technician Course  
 TV Cameras & Studio Technician Course

**VETERANS!**  
Write discharge date

## Radio Television Training Association

52 EAST 19th STREET • NEW YORK 3, N. Y.

Licensed by the State of New York • Approved for Veteran Training

# Learn ELECTRIC APPLIANCE REPAIR IN YOUR SPARE TIME AT HOME



## START YOUR OWN BUSINESS WITH A POTENTIAL MARKET OF 50,000,000 CUSTOMERS

**ONE BUSINESS THAT IS NOT AFFECTED BY STRIKES, DEPRESSIONS OR POLITICS**

New shop-method, home-training system gives you electrical know-how that used to take years to learn. Learn at home by building valuable testing kits, repairing your own and neighbors' appliances. It is not unusual for appliance repairmen to charge on the basis of \$5.00-\$6.00 an hour.

**FREE ILLUSTRATED BOOK**  
Shows you how you learn every phase of electrical appliance. How to make money while you learn. Write today for your FREE copy.

**CHRISTY TRADES SCHOOL**  
Dept. D-4803  
4804 North Kedzie Ave., Chicago 25

# FREE! MINT BRITISH AFRICAN STAMPS



Rush coupon today. Exciting offer! Newest issue Elizabeth II stamps — all mint, all different, all yours, — absolutely FREE! Scarce, beautiful, 2-color stamps from obscure African countries — Nigeria, Basutoland, Gambia, St. Helena — many others! And MORE — free copy helpful "Stamp Collector's Guide" — free color reproduction and story World's Rarest Stamp — free 1/2 penny Falkland Island stamp. Other valuable offers for your free inspection. Limited offer, so rush coupon today! If coupon has been clipped, rush to GARCELON STAMP CO., Dept. PM11B, Calais, Maine.

**GARCELON STAMP CO., DEPT. PM11B, Calais, Maine**  
Rush FREE mint British African Stamps and other offers.  
(PLEASE PRINT)

NAME \_\_\_\_\_  
ADDRESS \_\_\_\_\_  
CITY \_\_\_\_\_ STATE \_\_\_\_\_

## You can have a career instead of a job

Industrial growth . . . automation . . . technical advances create tremendous opportunities for engineers, accountants, management experts. Share the rewards awaiting college-trained men in engineering and commerce. Important concerns visit campus regularly to employ Tri-State College graduates. Start any quarter in this world-famed college. Approved for veterans.

### Bach. of Science degree in 27 months

in Mechanical, Civil, Electrical, Chemical, Aeronautical, Radio (TV-Electronics), Administrative Engineering; Business Administration and Accounting. 36-weeks course in Drafting; Intensive program; technical fundamentals stressed; comprehensive courses with more professional class hours.

Small classes; personalized instruction. For earnest, mature students whose time and budget requires accelerated courses and modest costs. Preparatory courses. Beautiful campus in friendly college town. Well-equipped, new and modernized buildings and labs. Enter Jan., March, June, Sept. Write Jenn McCarthy, Director of Admissions, for "Your Career in Engineering or Commerce".



## TRI-STATE COLLEGE

4115 College Avenue Angola, Indiana

## SHEET METAL BRAKES

Forms angles, locks, pans, etc. New eccentric clamps. All steel construction. Size 15" — 16 gauge steel, \$23.50; 36" — 22 ga., \$35.50. 48" — 24 ga. \$52.00. Floor Stand, \$8.



## SHEARS

FOOT SQUARING, 30"-24 ga., \$115.00  
HAND SQUARING, 36"-24 ga., \$80.00  
ANGLE SHEAR, 3 Adj. Ga. 7"-16 ga. \$16.50

ORDER DIRECT OR SEND FOR CATALOG  
VYKE MFG. CO., 2435 15th St., Denver 2, Colo.

## CABINET MAKING

**LOW COST HOME TRAINING COURSE FOR BEGINNERS & ADVANCED CRAFTSMEN**

Make money. Learn skills and secrets of fine woodworking and tool use. Professionally prepared shop method training tells and shows how. Covers everything. Easy to master.

Write for Free Booklet  
**INTERSTATE TRAINING SERVICE**  
DEPT. F3, PORTLAND 13, OREGON

## LEARN WATCH REPAIRING

**AT HOME** Modern, original instruction. Prepare for a position or start in business after completing our course. Write Today!  
**WISCONSIN SCHOOL OF WATCH REPAIRING**  
2908 N. 44th St. Dept. M Milwaukee 10, Wis.

## 25 Yulecards \$1.00 plus 35¢ postage

Personal Photo Christmas Cards, including envelopes, from your own negative.

**FREE SAMPLE** ... send snapshot negative for free sample Deluxe Yulecard. Include 6¢ stamps for handling. Negative returned with sample. No obligation. Satisfaction guaranteed. Write today **YULECARDS**,  
Dept. 28, Quincy 69, Mass. \*Div. Mail-N-Save \*T.M. Reg.

## CUT BUILDING COSTS 3/4! Make Your Own Concrete BLOCKS and BRICKS To Use or Sell



New superior moulds make absolutely square, true, easy-to-lay blocks which will pass any building code. Production is fast . . . easy. One durable \$30 machine will make four 5"x8"x12" blocks per minute—1,000 a day. Pays for itself in one day! Sell blocks for big profit . . . or save 3/4 building cost for yourself. POST CARD BRINGS FREE FOLDER.

**ECONOMY MFG. CO.**  
DEPT. P STONE MOUNTAIN, GA.

# Jet Aircraft Experiments Put \$60 to \$100.00 a Year Right Back into the Pockets of Car Owners

A strange invention, coupled with an even stranger discovery, now makes it possible for you to drive your car, your truck, or your tractor for a full year, and even longer, without changing oil. Read these startling facts.

Instead of changing oil every thousand miles, put the \$2.00 to \$3.00 right back in your pocket and drive on. Add oil only when oil level gets low. From one year's end to the next—never change your oil! And during the year, regardless of how many times you would normally replace the element in your oil filter—forget it, drive on, and put an extra dividend of \$2.50 in your pocket. Never change your filter element again as long as you have your car, even if you drive it for ten years.

Recent revelations about lubrication are so opposite to what we have been taught to believe that many people will be incredulous. Yet both the invention and the discovery are the result of modern scientific experimentation. In an age when man has learned to split the atom, nothing seems impossible. One after another the old beliefs are being discredited—replaced by more scientific, more exact knowledge.

Many years ago men working in scientific laboratories proved that lubricating oil did not lose its lubricating power merely through use. Only two elements made it necessary to change oil—ever—in a gasoline or diesel engine. One element was foreign matter—dirt, particles of metal, condensed moisture, sludge and varnish that formed as a result of heat and compression.

Now, through the perfection of a filter made of controlled porosity bronze, a simple way has been invented to filter out every vestige of foreign matter, leaving the lubricating quality of the oil the same as when new—except for the second element.

The second element that made oil changes necessary was the formation of Sulphuric acid in the oil. This acid resulted from the Sulphur that is present in all lubricating oil, combined with moisture that is condensed out of the air every time the engine is started! These acids attack the metal parts of the engine—were far more damaging than rust. These acids start to form the day after you put in fresh oil. In less than 200 miles of "stop and start" driving they are present in dangerous quantities. So, as the only way then known to get rid of the damaging acids and preserve the engine's vital metals from acid corrosion, car manufacturers recommended an oil change at least every 1000 miles.

Now a strange discovery has shown how to remove this acid—as it forms—and before it has a chance to attack the metal of the engine. Alka-magnesium, the wonder metal of the age, held the secret. By a mystifying and little known chemical process alka-magnesium alkalizes and neutralizes the acids as they form.

The controlled porosity bronze filter element proved its superiority over ordinary filters on one of the most critical areas of our National defense. It has been in use for ten years in many industrial plants. And, recently it has been adapted for use in straining or filtering the highly volatile fuels and lubricating oils used in the U. S. Army's guided missiles, jet planes and motor vehicles—uses in which unflinching performance is of the utmost importance.

Now, the combination of this invention and this Chemic-metalurgic discovery has at last been made

## WE INVITE INQUIRIES

from truck fleet owners, road construction contractors, agriculturists and others who use motorized equipment.

## DISTRIBUTORS, AGENTS:

Nation-wide demand for this revolutionary invention provides rare opportunity for local Distributors and Agents who can sell fleet owners as well as individuals. If interested check "Distributors" square in coupon.

available to owners of automobiles, new or old—trucks, one or hundreds—and tractors, of any make or model. The combined invention and discovery have been put together in one simple unit and made in 47 different sizes and shapes—each engineered specifically for top performance in a particular car, truck, or tractor.

Don't buy now. Don't buy a thing until you read the whole amazing story. Let us send you exact facts, microscopic pictures, test reports from independent laboratories and from the units of the Armed Forces. Then you can believe the unbelievable. Then

you can accept with confidence a device so new that cautious men—without this evidence—might hesitate to put it in their valuable cars. It can be installed in your car at the curb—in ten minutes. You can do it yourself with nothing more than a hand wrench. No drilling, no tapping. No tearing down of engine parts. Just remove one nut, lift a lid, and slip it into place.

Then you can—with complete security—ignore oil changes for another year or longer, ignore filter element replacement for the entire life of any car you own—and put back into your pocket the \$60.00 to \$100.00 a year you now pay for filter elements and engine oil.

No charge for information on this spectacular development. All facts free. Read—then decide whether you, too, want to join the thousands of other motorists who already are saving the money usually spent for oil changes and filter elements.

No obligation of any kind. Just send your name today. Start putting oil money in your pocket—without even changing your present crankcase oil. Whether or not you buy, as an intelligent motorist, you will want the inside facts on this revolutionary development. Send name today. All facts will be mailed free and postpaid. No salesman will call.

## MASTER MECHANICS MFG. CO.

Dept. 211 • Burlington, Wisconsin

### MASTER MECHANICS CO. Dept. 211, Burlington, Wisconsin

Please send complete FREE information about the revolutionary new discovery that permits operating any gasoline or diesel engine for a full year or longer without changing oil. Include microscopic photos, and Independent Laboratory Tests which prove the safety of using the same oil continuously. This request for information does not place me under the slightest obligation, and no salesman will call.

- I operate a personal car       I operate farm equipment  
 I operate trucks               Send facts on Distributorship

NAME \_\_\_\_\_

ADDRESS \_\_\_\_\_

CITY \_\_\_\_\_ ZONE OR R.F.D. \_\_\_\_\_ STATE \_\_\_\_\_



# ... TURN CONCRETE INTO GOLD!

**MAKE UP TO \$75 A DAY IN YOUR OWN BUSINESS**

If you want to have your own business — to start a business on your own — here's your big opportunity! New High speed, low cost General block machine produces up to 1,000 concrete blocks a day. Sell all you make to builders, supply houses, and others for homes, factories, buildings, garages. Cash in on the building boom! You can make profits of 100% to 150% — up to \$75 a day! General block machine equipped with 1/2 h.p. electric motor — or can be supplied with gasoline engine — works anywhere, in little space, indoors or out. Operates from ordinary house light socket. Simple, foolproof 3 step operation — so easy a child can do it. Makes superior 3 core blocks any size from 4" to 12". Also makes chimney, sash, corner and other types. Blocks meet any building code anywhere in the country. Materials — sand, water, cement, available anywhere. Simple illustrated operating instructions and mixing formulas for cement and sander blocks supplied with each machine. Write for FREE folder with full information.

**MOTOR DRIVEN**

R. L. T. of New York City reports: "MY GENERAL BLOCK MACHINE PAID FOR ITSELF IN FIRST 2 WEEKS!" Hundreds now in use the world over! Write for FREE details today!

**EXTRA**

Book gives floor plans for 6 sensational concrete block bungalows. Tells how to lay blocks, lay out building lines, mix concrete, build steps, porch and concrete floors all at great savings. Written by experts. Can save many times the cost of the machine! Get it now! No strings attached. Send \$1.

BOOK SENT FREE IF YOU BUY MACHINE. \$1 REFUNDED IF YOU BUY LATER.



**GENERAL ENGINES CO.**  
DEPT. M-115, ROUTE 130, THOROFARE, N. J.

## INVENTORS

PROTECT YOUR INVENTION BY A U. S. PATENT. SEND FOR FREE "INVENTION RECORD" FORM AND "PATENT INFORMATION EVERY INVENTOR SHOULD HAVE".

**CARL MILLER**  
REGISTERED PATENT ATTORNEY  
WOOLWORTH BLDG., 35th FLOOR, 115A  
NEW YORK CITY

## INVENTORS

Whether an invention is patentable can be substantially determined by a search of the U. S. Patent records. Without obligation, write for information explaining the steps you should take to secure a patent.

**JOHN N. RANDOLPH**  
Registered Patent Attorney  
201 Columbian Building, Washington 1, D. C.

## PATENTS

**C. A. SNOW & CO.**  
REGISTERED PATENT ATTORNEYS  
WRITE FOR INFORMATION TO  
428 SNOW BUILDING, WASHINGTON 1, D. C.

## INVENTORS

Send for PATENT INFORMATION Book and INVENTOR'S RECORD without obligation

**GUSTAVE MILLER**  
115-PM WARNER BUILDING WASHINGTON 4, D. C.

REGISTERED PATENT ATTORNEY  
ASSOCIATE EXAMINER  
U. S. PAT. OFF. 1922-1926  
Patent Attorney & Advisor  
U. S. NAVY DEPT. 1930-1947  
PATENT LAWYER

## Print Your Own

Cards, stationery, circulars, tags, labels, photo and movie titles, advertising, etc. Save money. Print for Others. Good Profit! Easy to learn. Raised Printing like Engraving, too. Sold direct from factory only. Write for free catalog of outfits and all details. **KELSEY PRESSES, M-37, Meriden, Conn.**

## INVENTORS

I shall be pleased to furnish you, upon request, with full information relative to patent procedure—without any obligation on your part.

**PATRICK D. BEAVERS**  
Registered Patent Attorney  
934 Columbian Building Washington 1, D. C.

STATEMENT REQUIRED BY THE ACT OF AUGUST 24, 1912, AS AMENDED BY THE ACTS OF MARCH 3, 1933, AND JULY 2, 1946 (Title 39, United States Code, Section 233) SHOWING THE OWNERSHIP, MANAGEMENT, AND CIRCULATION OF Popular Mechanics Magazine published monthly at Chicago, Ill., for October 1, 1955.

1. The names and addresses of the publisher, editor, managing editor, and business managers are: Publisher, Popular Mechanics Company, 200 E. Ontario St., Chicago 11, Ill.; Editor, H. H. Windsor, Jr., 200 E. Ontario St., Chicago 11, Ill.; Managing editor, R. M. Grant, 200 E. Ontario St., Chicago 11, Ill.; Business manager, W. H. Peiridge, 200 E. Ontario St., Chicago 11, Ill. 2. The owner is: (if owned by a corporation, its name and address must be stated and also immediately thereunder the names and addresses of stockholders owning or holding 1 percent or more of total amount of stock. If not owned by a corporation, the names and addresses of the individual owners must be given. If owned by a partnership or other unincorporated firm, its name and address, as well as that of each individual member, must be given.) Popular Mechanics Company, 200 E. Ontario St., Chicago 11, Ill.; R. H. Windsor, Jr., 200 E. Ontario St., Chicago 11, Ill.; H. H. Windsor, Jr., Trustee for H. H. Windsor III and Wm. T. Windsor, 200 E. Ontario St., Chicago 11, Ill. 3. The known bondholders, mortgagees, and other security holders owning or holding 1 percent or more of total amount of bonds, mortgages, or other securities are: (if there are none, so state.) None. 4. Paragraphs 2 and 3 include, in cases where the stockholder or security holder appears upon the books of the company as trustee or in any other fiduciary relation, the name of the person or corporation for whom such trustee is acting; also the statements in the two paragraphs above the affiant's full knowledge and belief as to the circumstances and conditions under which such stockholders and security holders who do not appear upon the books of the company as trustees, hold stock and securities in a capacity other than that of a bona fide owner. 5. The average number of copies of each issue of this publication sold or distributed, through the mails or otherwise, to paid subscribers during the 12 months preceding the date shown above was: (This information is required from daily, weekly, semi-weekly, and tri-weekly newspapers only.) Not daily publication. H. H. Windsor, Jr., Editor. Sworn to and subscribed before me this 16th day of September, 1955, Vera L. Frechill, Notary Public. (My commission expires July 17, 1958.)

## BECOME AN EXPERT IN TRAFFIC

Traffic men earn \$4,000 to \$20,000 and up. Thousands of firms need experts to rates, tariffs, regulations. We train you thereby in spare time at home for executive traffic jobs. Personal training under traffic authorities. Placement service and help. Write for free 45-page book "Traffic Management—the Fast Growing Profession".

**LASALLE Extension University, 417 So. Dearborn St.**  
A Correspondence Institution Dept. 11647 Chicago 5, Ill.

## RUPTURED

**BE FREE FROM TRUSS SLAVERY**

NOW there is a new modern Non-Surgical treatment that permanently corrects rupture. These Non-Surgical treatments are so certain, that a Lifetime Certificate of Assurance is given. Write today for our New FREE Book that gives facts that may save you painful and expensive surgery, and tells how non-surgically you may again work, live, play and love and enjoy life in the manner you desire. There is no obligation.

**Excelsior Hernia Clinic Dept. #305 Excelsior Springs, Mo.**

Learn **PRACTICAL RADIO-TV**  
with **25 BIG KITS**

of equipment I send you while  
you train with me . . . for valuable  
shop bench experience . . .



The new Sprayberry Training  
Television receiver, built and tested in sections.

I now offer this fine modern  
oscilloscope.

You build this powerful 2  
Band superhet radio receiver.

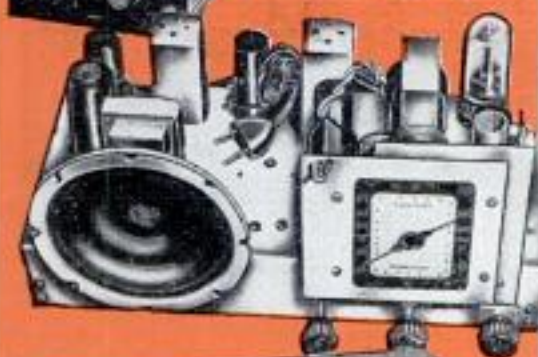

You build the new  
Sprayberry Tester . . . 18-range  
Volt-Ohm-Milliammeter readings.

In addition to modern lesson training, I also give you  
plenty of home practice on actual Radio-Television  
equipment . . . you will build and use the units shown  
here plus many more. All this equipment is yours to  
keep . . . keep everything you need to set up your shop.

Prepare for a Good Paying Job—Or Your Own Business

**"I Will Train You at Home in  
RADIO-TELEVISION  
on Liberal No Obligation Plan!"**

New Equipment! New Lessons! Enlarged  
Course! The true facts are yours in my  
big new catalog . . . **YOURS FREE . . .**  
**JUST MAIL COUPON!**



Frank L. Sprayberry  
President, Sprayberry  
Academy of Radio

I can train and prepare you in as little as 10 months to step into the big opportunity Radio-Television service field. Train *without* signing a binding contract . . . without obligating yourself to pay any regular monthly amounts. You train entirely at home in spare hours . . . you train as fast or as slowly as you wish. You'll have your choice of **THREE SPRAYBERRY TRAINING PLANS** . . . planned for both beginners as well as the more experienced man. Get the true facts about the finest most modern Radio-Training available today . . . just mail the coupon for my big new 56 page full-filled catalog plus sample lesson—both **FREE**.

**Train the Practical Way—with Actual Radio-Television Equipment**

My students do better because I train both the mind and the hands. Sprayberry Training is offered in 25 individual training units, each includes a practice giving kit of parts and equipment . . . all yours to keep. You will gain priceless practical experience building the specially engineered Sprayberry Television Training Receiver, Two-Band Radio Set, Signal Generator, Audio Tester and the new Sprayberry 18 range Multi-Tester, plus other test units. You will have a complete set of Radio-TV test equipment to start your own shop. My lessons are regularly revised and every important new development is covered. My students are completely trained Radio-Television Service Technicians.

**NEWEST DEVELOPMENTS**

Your training covers U H F, Color Television, F M, Oscilloscope Servicing, High Fidelity Sound and Transistors.

**See for Yourself . . . Make Your Own Decision  
. . . Mail Coupon Today!**

The coupon below brings you my big new catalog plus an actual sample Sprayberry Lesson. I invite you to read the facts . . . to see that I actually illustrate every item I include in my training. With the facts in your hands, you will be able to decide. *No salesman will call on you.* The coupon places you under no obligation. Mail it now, today, and get ready for your place in Radio-Television.

**SPRAYBERRY ACADEMY OF RADIO**

111 North Canal Street, Dept. 10-E, Chicago 6, Illinois

**Mail This Coupon For Free Facts and Sample Lesson**



SPRAYBERRY ACADEMY OF RADIO  
Dept. 10-E, 111 N. Canal St., Chicago 6, Ill.

Please rush all information on your ALL-NEW Radio-Television Training Plan. I understand this does not obligate me and that no salesman will call upon me. Include New Catalog and Sample Lesson **FREE**.

Name \_\_\_\_\_ Age \_\_\_\_\_

Address \_\_\_\_\_

City \_\_\_\_\_ Zone \_\_\_\_\_ State \_\_\_\_\_

It's the *Coollest*

Jet-action Carburetor  
draws in fresh air  
that cools the smoke

# YELLO-BOLE Carburetor

It's at your dealer's now . . . this marvelous pipe with the tiny Carburetor hole. It draws cooling air right up into the tobacco . . . smokes so cool and mild even *cigarette* smokers enjoy it. The bowl stays drier, too . . . no "wet heel."

Yello-Bole's famous honey-lined bowl eliminates break-in. The instant you light up, fragrant honey begins caking the bowl. Choose your Carburetor from many popular styles. Other Yello-Bole Pipes, \$1.50 to \$2.50. All are imported briar.

For free booklet, write Dept. 9 Yello-Bole, N.Y. 22

\$2.50

## Learn All About Cars!

Auto Mechanics — Automatic Transmissions  
Acetylene and Arc Welding  
Body and Fender Repair

Day-Night School 30 Years in the Same Location

### WOLVERINE SCHOOL OF TRADES

Approved Under the G.I. Bill of Rights by the State Board of Education

WOLVERINE SCHOOL OF TRADES, Dept. PM  
1400 West Fort St., Detroit 16, Mich.

Name \_\_\_\_\_

Address \_\_\_\_\_

City \_\_\_\_\_ State \_\_\_\_\_

## OWN Your Own Business



PATENTED PORTABLE EQUIPMENT

\$5 per hour

Clean and Mothproof rugs and upholstery "in the home", office, institution. If now employed, you can operate in spare time and build a permanent full-time business.

Alert dealers can gross \$5 hourly profit on service they render plus \$3 on EACH serviceman. We locally train and assist you. Easy to learn quickly established.

**DURACLEAN** cleans by absorption! No scrubbing, soaking or shrinkage. Dirt and grease vanish . . . matted pile rises . . . colors revive. Furnishings used again same day.

**DURAPROOF** resists moths and carpet beetles. Your service backed by an International Money Back 6 Year Warranty.

We furnish enough material to return your total investment. Send TODAY for FREE booklet explaining details and EASY TERMS.

**DURACLEAN CO.**, 5-16N DURACLEAN BLDG. DEERFIELD, ILL.

## STOP RUINING THAT CHROME!

Miracle product prevents rust, corrosion. Resists salt, alkali, acid indefinitely. Tested and approved by leaders in automotive field. Complete kit \$1.98 postpaid. Check or money order.

**CHROMEBOND LABORATORIES**  
2270 VALLEY DRIVE SYRACUSE, NEW YORK

**ONLY \$495** (freight included) **FREE FOLDER**

18 FT. CRUISER

**TAFT MARINE WOODCRAFT**  
DEPT. PM-11 636-39th Ave. N.E., Minneapolis 21, Minn.

**BOAT KITS**  
12 Models as low as \$39.95 (freight included). Fiberglass boat covering kits, marine supplies, etc. Free folders.

*Write Like This*

YOUR penmanship can be improved in 3 hours or corrected to your satisfaction in 10 hours' practice with my **DEFINITE HAND CONTROLS**. New way!

**WRITE OZMENT** BOX 645 34-P, ST. LOUIS, MISSOURI

**Complete OUTLINE FREE!**

**LEARN LOCKSMITHING**

Learn this fascinating, profitable trade from experts in your spare time at home! Age or physical handicap no disadvantage. Year around, steady income. Full or part time. Practical, illustrated lessons. You can make money even while learning! All materials and special tools supplied without extra charge.

**INSTITUTE OF LOCKSMITHING**, Dept. P-72  
15 PARK AVENUE RUTHERFORD, N. J.  
Lic. by N.J. State Board of Education  
Approved for Veterans

send for **FREE BOOKLET**

**Bar Bells**

Buy Direct From Factory **\$895** up

Write for free booklet and price list.

**INDEPENDENT IRON WORKS**  
2416 East 23rd Street, Dept. B  
Los Angeles 58, Calif.

## Don't Neglect Slipping FALSE TEETH

Do false teeth drop, slip or wobble when you talk, eat, laugh or sneeze? Don't be annoyed and embarrassed by such handicaps. **FASTEETH**, an alkaline (non-acid) powder to sprinkle on your plates, keeps false teeth more firmly set. Gives confident feeling of security and added comfort. No gummy, goeey, pasty taste or feeling. Get **FASTEETH** today at any drug counter.





# NOW... RCA trains you at home to be an expert technician in RADIO TV ELECTRONICS • TV SERVICING • COLOR TV SERVICING

## NOW THREE HOME STUDY COURSES

... prepared by instructors of RCA Institutes in cooperation with technicians, engineers, and training specialists of RCA. Clearly written ... easy to understand ... the same high caliber instruction as given in resident classrooms of RCA INSTITUTES.

● **COURSE I—RADIO-TELEVISION ELECTRONICS**—starts you from the ground up to a solid working knowledge of electronics. Without any previous experience, you get a thorough training in radio theory and servicing techniques for AM, FM, home and car radios ... plus an introduction to the fundamental theory and practices of television.

● **COURSE II—TELEVISION SERVICING**—prepares you to advance from radio into the expanding field of television servicing as a well-trained service technician. If you have completed Course I or are now working in the field of radio or TV, Course II will show you the many special techniques of trouble-shooting, aligning, checking, and repairing modern black and white TV sets.

**NEW TV KIT AVAILABLE WITH COURSE II**—there is no better way to learn than by *doing* and RCA Institutes has developed a large-screen TV KIT available to home study students to build while taking Course II. It has the most modern up-to-date circuitry, actually enabling you to apply at home all the latest servicing techniques.

● **COURSE III—COLOR TELEVISION SERVICING**—covers all phases of color servicing techniques. It is a practical, down-to-earth course in color theory as well as how-to-do-it servicing procedure. A natural move "up" from Course II or for those now employed in TV.

**SINCE 1909, RCA INSTITUTES** has trained thousands for successful careers in electronics. Many gradu-

ates have established their own paying business. Now this opportunity is available to you at home.

**"PAY-AS-YOU-LEARN" PLAN** ... you pay for one study group at a time, as you progress through the course. Tuition costs are amazingly low. For full details, mail coupon.

**A SERVICE OF RADIO CORPORATION OF AMERICA—RCA INSTITUTES** is licensed by the N. Y. State Education Department ... recommended by radio and television service organizations.

**SEND FOR  
FREE  
CATALOG  
NOW**



RCA Institutes, Inc., Home Study PM-115  
350 West Fourth Street, N.Y. 14, N. Y.  
Without obligation, send me FREE CATALOG on Home Study Courses in Radio, Television and Color TV. No salesman will call.

Name \_\_\_\_\_ Please Print  
Address \_\_\_\_\_  
City \_\_\_\_\_ Zone \_\_\_\_\_ State \_\_\_\_\_



**RCA INSTITUTES, INC.**  
A SERVICE OF RADIO CORPORATION OF AMERICA  
350 WEST FOURTH STREET, NEW YORK 14, N. Y.

**MAKE \$18<sup>00</sup> AN HOUR WITH New**



**PLASTIC SANDWICH MACHINE**

This new, remarkable **PLASTIC SANDWICH MACHINE** does a permanent, beautiful, professional, protective, plastic lamination job in exactly three minutes time! Amazing earnings possible in your own home or shop permanently sandwiching **PHOTOS, SOCIAL SECURITY CARDS, IDENTIFICATION CARDS, CLIPPINGS, DIPLOMAS,** etc. between sheets of clear plastic. Make **PLASTIC SANDWICHES** that cost you only 8c each, take 2-3 minutes time—yet sell for 50c to \$1.00 each! Laminating machines range from \$35.00 up.

**PLASTIC SANDWICH MACHINE CO.**  
6612 N. Clark St. Dept. LM-301 Chicago 26



**105 POWER SUPER TELESCOPE**



STAR EXPLORER MAP      108 PAGE BOOK "DISCOVER THE STARS"

Everything for the Astronomer, Hobbyist, Student, & Scout in this complete astronomical super value telescope combination. Comes ready for immediate use, consists of brilliant 33x-65x-105x telescope, 5 foot hardwood Tripod, carrying case for scope, Star Explorer map, 108 page book "Discover the Stars." 3 foot telescope (closes to 16 inches) is brass bound, has 4 precision lenses that will bring distant objects, people, moon, stars, ships, etc., 105 times closer, 11,025 area magnification. All images erect. Sturdily built tripod is equipped with universal mount that has 360 degree horizontal range & 180 degree vertical range. Locks in any position with one simple adjustment. The Star Explorer map enables you to find any star automatically. This marvelous all purpose instrument is proclaimed by Scientists as a most unusual development. Everyone that has used it is amazed at its performance and value. It will fascinate the entire family. Shipped to you complete, nothing else to buy, at the amazing low price of.....

**\$11.95** POST PAID

Satisfaction guaranteed or money refunded. We pay all delivery charges. Send check or money order to DEPT. PMS13

**CRITERION CO. 331 CHURCH ST., HARTFORD 1, CONN.**

**Super Powerful All Channel TV RECEPTION IN ALL DIRECTIONS**



**Rocket DIRECTRONIC MOTORLESS TV ANTENNA**

- 360° Electronically Switched Beam
- No Motors
- No Roof
- Orientation
- No Electric Power
- No Ghosts
- Flick of Switch Clears Picture Instantly

In the city or in an ultra-fringe area, the Directronic will outperform ordinary antennas. Only the Motorless 360° Directronic TV Antenna offers "around the compass" reception WITHOUT Rotors. Clarity of picture will amaze, it's so bright, so sharply defined. AX-599 "Serviceman's Array" contains Hi-Pac molded insulator of extremely high tensile strength, 18 hi-tensile aluminum alloy elements, 1 set of connecting stubs (3). Universal U-Clamps for masts to 1 1/2". Directronic Beam Selector, 75 feet of Tri-X Cable, 25% deposit on C.O.D. orders, please. Money Back Guarantee.

**NATIONAL ELECTRONICS OF CLEVELAND**  
6608 EUCLID AVE. Dept. P-11 CLEVELAND 3, OHIO

**MAKE INEXPENSIVE FIRE EXTINGUISHERS FROM YOUR OLD LIGHT BULBS**

**COSTS 10¢ OR LESS TO MAKE**

PROTECTS HOMES, GARAGES, FACTORIES, SHOP, BOATS, ETC. EASY TO MAKE. NO SPECIAL SKILL OR CAPITAL REQUIRED. SEND \$1.00 FOR ILLUSTRATED (COPYRIGHTED) INSTRUCTIONS.

**FRED A. LEWIS PUBLISHER**  
BOX 104-A KENSINGTON STA., BROOKLYN, N.Y.

PROFITABLE SPARE TIME MONEYMAKING OPPORTUNITY EVERY HOME A PROSPECT

**ARE YOU MECHANICALLY INCLINED?**

Are You Using Your Mechanical Ability to the Best Advantage? If not, investigate a dependable trade where your ability really pays. **WATCHMAKING** offers you that opportunity. Write for information about this profession which is stable, light clean work; no age or physical limitations. Opportunities for Watchmakers never better.

**KANSAS CITY SCHOOL OF WATCHMAKING**  
Approved for G.I. Training  
Both Resident and Home Study Courses offered  
1224 Admiral Blvd. Kansas City 6, Missouri

**SAY YOU SAW IT IN POPULAR MECHANICS**

**MONEY in DONUTS**

Make new greaseless donuts. Start in kitchen. No smoke. Sell stores. Cash daily. No experience necessary. Free recipe. No obligation. Write: **MARTIN RAY CO., 3605 SO. 15th AVENUE, MINNEAPOLIS 7, MINN.**

**\$2.95 OR 2 FOR \$5.00!**

Genuine Telephone Company Upright Telephones, tested and guaranteed with 50 ft. of wire and inter-communication instructions. Complete line of telephones, dial, magneto, etc. Write for free list. All shipments F.O.B. Simpson, Pa.

**TELEPHONE ENGINEERING CO.**  
Dept. 1125 Simpson, Pa.

**SAVE MONEY ON U S GOV'T SURPLUS**

Buy surplus direct from US Government. These are samples of the savings that can be made. Life boat \$12.00. Grinder \$4.69. Shaper \$15. Dump truck \$76.77. Tractor \$75.00. Typewriter \$7.51. Freezer \$50. Spray painter \$15.25. Motor \$4. Hunting, fishing, camping, sporting Equip, jeep, boat, tools. Hundreds others may be purchased at tremendous savings through our Bulletin "Surplus Sales." Price \$1.00.

The Abacus Press, Box 169DDD, Dept. 4, East Hfd. 8, Conn.

**BUILD HELICOPTER GLIDER**



The famous new GYRO-GLIDER, world's simplest and safest aircraft, is now available to amateur builders in plans and kits. Send \$1.00 now for three-view drawings with specifications and ask about kits and detailed building and flying instructions.

**BENSEN AIRCRAFT CORP., Dept. PM-11 P.O. Box 2621 Raleigh, N. C.**

ONLY \$1 Name \_\_\_\_\_ Address \_\_\_\_\_  
City \_\_\_\_\_ State \_\_\_\_\_

Greatest Thrill in Flying!

For real job security...

# FILL THE GAPS IN YOUR TRAINING



The pressure is mounting. Competition for jobs is growing fast. Business and industry are tightening up. Every man or woman holding a good job is now, in effect, "on probation."

Are there "weak spots" in your training? Now's the time to get after them! Six months from now may be too late.

How can you fill the gaps—quickly? International Correspondence Schools can help you! There's no faster, surer way to get exactly the training you need!

You have 277 famous, spare-time I. C. S. Courses to choose from: trade, industrial engineering, office, executive, high school. Or you can arrange for "refresher" courses, advanced training or special instruction combining two or more specific business or technical subjects.

I. C. S. has the most complete line-up of job-related instruction you can find anywhere. Courses are tailored to fit your needs. This means you waste no time on subjects you can't use. You lose no time traveling back and forth to classes. You set your own schedule—no interference with business or social activities.

Find out for yourself how quickly, how thoroughly I. C. S. can fill the gaps in your training! No obligation. Just mark and mail the coupon!

## 3 FREE BOOKS

32-page, pocket-size gold mine of facts. "How to Succeed," plus catalog outlining opportunities in field that interests you! Also, free sample lesson.

For Real Job Security—Get an I. C. S. Diploma! I. C. S., Scranton 9, Penna. Member, National Home Study Council

## INTERNATIONAL CORRESPONDENCE SCHOOLS



BOX 69299L, SCRANTON 9, PENNA.

(Partial list of 277 courses)

Without cost or obligation, send me "HOW TO SUCCEED" and the opportunity booklet about the field BEFORE which I have marked X (plus sample lesson):

- |  |   |  |  |  |
|--|---|--|--|--|
| <p><b>ARCHITECTURE and BUILDING CONSTRUCTION</b></p> <ul style="list-style-type: none"> <li><input type="checkbox"/> Air Conditioning—Refrig.</li> <li><input type="checkbox"/> Architecture</li> <li><input type="checkbox"/> Architectural Interior</li> <li><input type="checkbox"/> Building Contractor</li> <li><input type="checkbox"/> Building Maintenance</li> <li><input type="checkbox"/> Carpenter and Mill Work</li> <li><input type="checkbox"/> Estimating</li> <li><input type="checkbox"/> Heating</li> <li><input type="checkbox"/> Painting Contractor</li> <li><input type="checkbox"/> Plumbing</li> <li><input type="checkbox"/> Reading Arch. Blueprints</li> </ul> <p><b>ART</b></p> <ul style="list-style-type: none"> <li><input type="checkbox"/> Cartooning</li> <li><input type="checkbox"/> Commercial Art</li> <li><input type="checkbox"/> Fashion Illustrating</li> <li><input type="checkbox"/> Magazine Illustrating</li> <li><input type="checkbox"/> Show Card and Sign Lettering</li> <li><input type="checkbox"/> Sketching and Painting</li> </ul> <p><b>AUTOMOTIVE</b></p> <ul style="list-style-type: none"> <li><input type="checkbox"/> Auto Body Rebuilding</li> <li><input type="checkbox"/> Auto Elec. Technician</li> <li><input type="checkbox"/> Auto-Engine Tune Up</li> <li><input type="checkbox"/> Automobile</li> </ul> | <p><b>AVIATION</b></p> <ul style="list-style-type: none"> <li><input type="checkbox"/> Aeronautical Engineering Jr.</li> <li><input type="checkbox"/> Aircraft &amp; Engine Mechanic</li> </ul> <p><b>BUSINESS</b></p> <ul style="list-style-type: none"> <li><input type="checkbox"/> Advertising</li> <li><input type="checkbox"/> Bookkeeping and Accounting</li> <li><input type="checkbox"/> Business Administration</li> <li><input type="checkbox"/> Business Correspondence</li> <li><input type="checkbox"/> Public Accounting</li> <li><input type="checkbox"/> Creative Salesmanship</li> <li><input type="checkbox"/> Federal Tax</li> <li><input type="checkbox"/> Letter-writing Improvement</li> <li><input type="checkbox"/> Office Management</li> <li><input type="checkbox"/> Professional Secretary</li> <li><input type="checkbox"/> Retail Business Management</li> <li><input type="checkbox"/> Sales Management</li> <li><input type="checkbox"/> Stenographic-Secretarial</li> <li><input type="checkbox"/> Traffic Management</li> </ul> <p><b>CHEMISTRY</b></p> <ul style="list-style-type: none"> <li><input type="checkbox"/> Analytical Chemistry</li> <li><input type="checkbox"/> Chemical Engineering</li> <li><input type="checkbox"/> Chem. Lab. Technician</li> <li><input type="checkbox"/> General Chemistry</li> <li><input type="checkbox"/> Natural Gas Prod. &amp; Trans.</li> <li><input type="checkbox"/> Petroleum Engineering</li> <li><input type="checkbox"/> Plastics</li> <li><input type="checkbox"/> Pulp and Paper Making</li> </ul> | <p><b>CIVIL, STRUCTURAL ENGINEERING</b></p> <ul style="list-style-type: none"> <li><input type="checkbox"/> Civil Engineering</li> <li><input type="checkbox"/> Construction Engineering</li> <li><input type="checkbox"/> Highway Engineering</li> <li><input type="checkbox"/> Reading Struct. Blueprints</li> <li><input type="checkbox"/> Sanitary Engineering</li> <li><input type="checkbox"/> Structural Engineering</li> <li><input type="checkbox"/> Surveying and Mapping</li> </ul> <p><b>DRAFTING</b></p> <ul style="list-style-type: none"> <li><input type="checkbox"/> Aircraft Drafting</li> <li><input type="checkbox"/> Architectural Drafting</li> <li><input type="checkbox"/> Electrical Drafting</li> <li><input type="checkbox"/> Mechanical Drafting</li> <li><input type="checkbox"/> Mine Surveying and Mapping</li> <li><input type="checkbox"/> Plumbing Drawing and Estimating</li> <li><input type="checkbox"/> Structural Drafting</li> </ul> <p><b>ELECTRICAL</b></p> <ul style="list-style-type: none"> <li><input type="checkbox"/> Electrical Engineering</li> <li><input type="checkbox"/> Electrical Maintenance</li> <li><input type="checkbox"/> Electrician <input type="checkbox"/> Contracting</li> <li><input type="checkbox"/> Lineman</li> </ul> <p><b>HIGH SCHOOL</b></p> <ul style="list-style-type: none"> <li><input type="checkbox"/> Commercial <input type="checkbox"/> Good English</li> <li><input type="checkbox"/> High School Subjects</li> <li><input type="checkbox"/> Mathematics</li> </ul> | <p><b>LEADERSHIP</b></p> <ul style="list-style-type: none"> <li><input type="checkbox"/> Foremanship</li> <li><input type="checkbox"/> Industrial Supervision</li> <li><input type="checkbox"/> Leadership and Organization</li> <li><input type="checkbox"/> Personnel-Labor Relations</li> </ul> <p><b>MECHANICAL AND SHOP</b></p> <ul style="list-style-type: none"> <li><input type="checkbox"/> Gas—Electric Welding</li> <li><input type="checkbox"/> Heat Treatment <input type="checkbox"/> Metallurgy</li> <li><input type="checkbox"/> Industrial Engineering</li> <li><input type="checkbox"/> Industrial Instrumentation</li> <li><input type="checkbox"/> Industrial Supervision</li> <li><input type="checkbox"/> Internal Combustion Engines</li> <li><input type="checkbox"/> Machine Design-Drafting</li> <li><input type="checkbox"/> Machine Shop Inspection</li> <li><input type="checkbox"/> Machine Shop Practice</li> <li><input type="checkbox"/> Mechanical Engineering</li> <li><input type="checkbox"/> Quality Control</li> <li><input type="checkbox"/> Reading Shop Blueprints</li> <li><input type="checkbox"/> Refrigeration</li> <li><input type="checkbox"/> Sheet Metal Worker</li> <li><input type="checkbox"/> Tool Design <input type="checkbox"/> Toolmaking</li> </ul> <p><b>RADIO, TELEVISION</b></p> <ul style="list-style-type: none"> <li><input type="checkbox"/> Industrial Electronics</li> <li><input type="checkbox"/> Practical Radio TV Eng'ing</li> <li><input type="checkbox"/> Radio and TV Servicing</li> <li><input type="checkbox"/> Radio Operating</li> </ul> | <ul style="list-style-type: none"> <li><input type="checkbox"/> Television Technician</li> </ul> <p><b>RAILROAD</b></p> <ul style="list-style-type: none"> <li><input type="checkbox"/> Air Brakes <input type="checkbox"/> Car Inspector</li> <li><input type="checkbox"/> Diesel Locomotive</li> <li><input type="checkbox"/> Locomotive Engineer</li> <li><input type="checkbox"/> Section Foreman</li> </ul> <p><b>STEAM AND DIESEL POWER</b></p> <ul style="list-style-type: none"> <li><input type="checkbox"/> Combustion Engineering</li> <li><input type="checkbox"/> Diesel—Elec. <input type="checkbox"/> Diesel Eng's</li> <li><input type="checkbox"/> Electric Light and Power</li> <li><input type="checkbox"/> Stationary Fireman</li> <li><input type="checkbox"/> Stationary Steam Engineering</li> </ul> <p><b>TEXTILE</b></p> <ul style="list-style-type: none"> <li><input type="checkbox"/> Carding and Spinning</li> <li><input type="checkbox"/> Cotton, Rayon, Woolen Mfg.</li> <li><input type="checkbox"/> Finishing and Dyeing</li> <li><input type="checkbox"/> Loom Fix'g <input type="checkbox"/> Textile Des'ing</li> <li><input type="checkbox"/> Textile Eng'g <input type="checkbox"/> Throwing</li> <li><input type="checkbox"/> Warping and Weaving</li> </ul> <p><b>MISCELLANEOUS</b></p> <ul style="list-style-type: none"> <li><input type="checkbox"/> Domestic Refrigeration</li> <li><input type="checkbox"/> Marine Engineering</li> <li><input type="checkbox"/> Ocean Navigation</li> <li><input type="checkbox"/> Professional Engineering</li> <li><input type="checkbox"/> Short Story Writing</li> <li><input type="checkbox"/> Telephony</li> </ul> |
|--|---|--|--|--|

Name \_\_\_\_\_ Age \_\_\_\_\_ Home Address \_\_\_\_\_

City \_\_\_\_\_ Zone \_\_\_\_\_ State \_\_\_\_\_ Working Hours \_\_\_\_\_ A.M. to P.M. \_\_\_\_\_

Occupation \_\_\_\_\_

Canadian residents send coupon to International Correspondence Schools, Canadian, Ltd., Montreal, Canada. . . . Special tuition rates to members of the U. S. Armed Forces.

Go after the **BIG MONEY**

in **ELECTRICAL**  
Repair  
and Maintenance

Keeping industrial and domestic electrical machinery "going"—that's a big-pay job for thousands of men—big today—and ever-growing, in this electrical age! Get into this promising line—grow with it into bigger opportunities and get really worthwhile pay. Let this big, practical, Electrical Maintenance and Repair Library show you how—as it has hundreds of other men.

**5 volumes 2112 pages 1801 illustrations**  
Starts at beginning, and takes you step-by-step through every phase of connecting, altering, testing, repairing all types of equipment. How to install motors, generators, rewind motors; inspect, repair, start; locate trouble, test induction motors, and MUCH MORE! One entire volume crammed with trouble-shooting charts. Simple diagrams make everything crystal-clear. Gives best on-the-job practice of experts. Will help to put you in big-pay class and rate you an EXPERT electrical worker.



**FREE**  
**10-DAY TRIAL**  
Send no money. Just mail coupon. Easy payments.

McGraw-Hill Book Co., Dept. PM-11  
327 West 41st St., New York 18, N. Y.

Send me for FREE 10-Days' Examination the Electrical Maintenance and Repair Library. If not satisfied I will return books. Otherwise, I will send \$4.50, plus delivery costs, then and \$4.00 a month for 5 months, until total of \$25.00 is paid.

Name \_\_\_\_\_

Home Address \_\_\_\_\_

City & State \_\_\_\_\_

WE PAY DELIVERY cost if you enclose \$4.50 first payment WITH coupon. Same return privilege for full refund.

**RADIO CONTROL YOUR MODEL**

"CUSTOM ONLY  
MIDGET" RADIO **\$9.98**

LICENSE FREE BAND

OPERATES SAME AS \$19.99

SETS INCLUDE LONG RANGE

TRANSMITTER RADIO, RECEIVER RADIO AND CONTROL ACTUATOR ALL 3

EASY ASSEMBLY WITH OUR PARTS AND PLANS \$2.95. PLANS ALONE \$1.

RADIOMODELS BOX 34 DEPT. PM BALTIMORE 6, MARYLAND

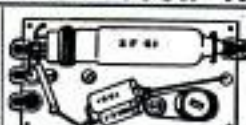

PLANE BOATS CARS  
DETAILED INFORMATION RE- & RADIO CATALOGUE 25c  
SPECIAL "SUPPLY SOURCE DIRECTORY" & \$7.00 SUPPLY COUPON... \$1.00  
BOOK "RADIO CONTROL OF MODEL AIRCRAFT" CONTAINS 14 PLANS \$3.98  
RADIO CONTROL GARAGE DOOR DETAILS... \$1.00



**SOCK-O**  
World's Most Powerful

**SUPER SLINGSHOT**

SILENT • RIFLE FAST • POWERFUL • ACCURATE

Great for small game, targets. 45 lb. pull. BIG sturdy Stock. Lively.

Raw rubber. Sweet shooting! FREE! 100 steel balls, rubber and target.

FREE!!! Thrilling SURPRISE PACKAGE with Two slings at \$2.95.

Hurry, get 2! Guaranteed. Approved by American Small Game Slingshot Assoc.

SOCK-O, PM, 4860 W. 137 St., Hawthorne, Calif.

\$1.50  
Wholesale  
No C.O.D.

**SKI KIT \$18.00 SAVE 1/2** **IDEAL CHRISTMAS GIFT**

Simply assemble and finish our new water ski kit and you have a pair of skis worth twice the price of the kit. Skis are 7 ply moulded plywood, 67 1/2" long, 7" wide, 3/8" thick. Sturdy rubber foot pieces. All parts plus instructions included — \$18.00. Order from your Michigan dealer or MICHIGAN WHEEL CO., Dept. PM-1111, Grand Rapids, Mich. C.O.D. orders accepted.

**SHORTHAND in 6 WEEKS**

Famous SPEEDWRITING shorthand. 120 words per minute. No symbols; no machines; uses ABC's. Easiest to learn, write and transcribe. Lowest cost. 100,000 taught by mail. For business and Civil Service. Typing available. 33rd year. Write for FREE booklet to: SCHOOL OF



Dept. 1511-5, 55 W. 42 St., New York 36



**250 POWER . . . .**  
Complete Telescope Lens Kit only \$3.49 postpaid  
Conquer Space. Explore the Universe, Planets, Moon Craters, New Stars, etc. Complete Lens Kit consists of 80 inch focal length ground and polished objective lens, eyepiece lenses for 50 POWER, 100 POWER, 150 POWER, 200 POWER, 250 POWER, and all necessary lens fittings. Easy to make from simple step by step instructions. (Tripod and mount not included.) Money back guarantee.

BUSSE SALES CO., Hartford 1, Conn., Dept. PM 39

**FREE AMAZING NEW BOOK "HOW TO ANSWER ADS"**



Never before have you seen anything like this. Tells you in simple language the correct way to answer ads. Gets you quicker replies—better results, and greater satisfaction. Will save you time and money and it's ABSOLUTELY FREE. No obligation whatever. Every reader of advertising should have this booklet. Send a postcard for your copy NOW. F. W. JOHNSON, Popular Mechanics Magazine, Room 600-A, 204 East Ontario Street, Chicago 11, Ill.

**RUPTURE**



RELIEF...OR YOUR MONEY BACK  
Write now for free booklet and pictures of rupture care. You can be helped...work steady, with low cost, easy to wear Web Truss, thousands satisfied.

WEB TRUSS CO. Dept. M-11, Hagerstown, Maryland

**FASTEST KNOWN SKIN RELIEF!**

Many doctors report results in 1 to 3 days with new Cuticura method

Want faster relief from pimples, rashes, other externally caused skin irritations? Wash skin thoroughly twice daily with superfatted, mildly medicated CUTICURA SOAP. Apply CUTICURA MEDICATED LIQUID frequently. You'll get instant relief from discomfort—faster healing aid—with this sensational new greaseless, fast-drying, "invisible" antiseptic. Buy at druggists. Soap, only 25¢. Liquid, 60¢, or send 10¢ to cover mailing costs for generous sample of both. Write today to CUTICURA, Dept. 16K, Malden 48, Mass.

## New Table Top Invention Puts You In... **PROFITABLE RUBBER STAMP BUSINESS**

Home Operators now make  
**\$9.40 AN HOUR** in busi-  
ness once monopolized by  
a few big companies

Special rubber stamps bring high prices—cost only pennies to make on new, low-cost table top machine. Take 27 cents worth of material, make perfect stamps, the kind businesses and offices now buy by the dozen at \$1.80 each. Make up to \$9.40 an hour. Start in spare time in your own home. Run machine on kitchen table using ordinary electrical outlet. Make any kind of stamp. We'll send you free information without obligation about this established, highly profitable business, now open to individuals for the first time. For free information send name today on a post card to Rubber Stamp Div., 1512 Jarvis Ave., Dept. R-2-M, Chicago 26, Ill.



## "WE'RE LOOKING FOR PEOPLE WHO LIKE TO DRAW" ... says

Norman Rockwell, one of America's 12 Most Famous Artists. If you like to draw, you may have talent to become a successful artist, spare or full time. Find out for sure with our scientific, 8-page **Free Art Talent Test**. Thousands paid \$1 to take it. Get it **FREE**. No obligation. Send your name, address, age to: Famous Artists Schools, Dept. 6-Y, Westport, Conn.



**FREE LEARN TV** the practical way—  
Assemble a TRANVISION TV KIT in easy stages. Pay as you wire—only \$15 for Starting Package #1. Learn while building a superb 17" to 21" screen TV Set with latest features. Ideal for Fringe Areas, adaptable to UHF. Easy — no instruments or technical knowledge required. Free Catalog describes 3 great TRANVISION TV KITS.  
Write today to Educational Dept. at—  
**TRANVISION, INC., Dept. PM, NEW ROCHELLE, N. Y.**

## STAMMER?

Get your copy of the new 18th edition of my book, "Stammering, Its Cause and Correction," which describes the Bogus Unit Method for scientific correction of stammering and stuttering. Ask, also, for free SPEECH CHART! 34th year, Benjamin N. Bogus, Dept. 553, Circle Tower, Indianapolis 4, Indiana.

GET THIS  
**FREE**  
BOOK!

## Learn SHELLCRAFT

Wonderful, New, Easy—Up to 500% Profits! Make Shell Lamps, Shell Jewelry and Novelties. Sell for **BIG PROFITS!** Markets everywhere. Hand-in-Action PLAN designed for you... to learn and earn as you succeed in Shellcraft.

**FREE** Genuine Sea Shells, full color pictures, and Hand-in-Action Plan Folder. Write:  
**NATIONAL SHELLCRAFT SCHOOL**  
635-26th ST. S., ST. PETERSBURG, FLA.



## NOW! A Practical Shop Type Home Study Course In **AUTOMATIC TRANSMISSION** SERVICING—REPAIR—OVERHAUL

Demand for automatic transmission specialists is terrific! Real big money in this field. You can learn from experts in your spare time at home, shop or garage. Easy to understand, illustrated lessons plus 3 complete transmissions included. (Each student gets a Hydramatic, Dynaflo and Fordomatic). See how easily you can start making money in this wide open field. Send for **FREE BOOKLET**.

**LINCOLN TECHNICAL INSTITUTE**  
Dept. PM-3, 472 Market St., Newark 5, N. J.  
Approved by N. J. Commissioner of Education

## I SHOW YOU HOW TO **MAKE MONEY** AT ONCE **START YOUR OWN BUSINESS** IN 2 WEEKS— AT HOME IN SPARE TIME



**PLATE**  
Baby Shoes  
IN  
**BRONZE**  
AND  
**COLOR**  
**PEARL**



MILLIONS OF  
NEW PROSPECTS  
EVERY YEAR



Now is the time to cash in on this big-paying, easy-to-operate, year-round business and you need no experience. **MATERIALS COST YOU ONLY 50c—YOU GET \$6.00!** With many actual "show-how" illustrations and step-by-step instructions, **YOU** can start earning money at once in one week. Working only a few hours you can make more money than many people make working an entire week.

### IMMEDIATE RESULTS

- Big Income
- Huge Demand
- Sales Plan
- Future Security
- Your Own Business

We will send you full details absolutely free.

**FREE!**  
MONEY  
MAKING  
PLAN

Full Details  
Without  
Obligation  
**MAIL COUPON  
TODAY!**

**KIKTAVI COMPANY, Dept. PM-5511**  
11029 S. Vermont, Los Angeles 44, Calif.

**KIKTAVI COMPANY, Dept. PM-5511**  
11029 S. Vermont, Los Angeles 44, Calif.

Send me **FREE** details of your **MONEY MAKING PLAN**, without obligation.

NAME \_\_\_\_\_  
STREET \_\_\_\_\_  
CITY \_\_\_\_\_ ZONE \_\_\_\_\_ STATE \_\_\_\_\_

**MEN-WOMEN GROW**  
**ORCHIDS**  
**IN YOUR LIVING ROOM!**

Any Climate - Maine to California  
 YEAR 'ROUND - No Equipment Needed

**BIG PROFITS** SPARE OR FULL-TIME



Fill your home with gorgeous Orchids. Huge purple Cattleyas, exquisite Cymbidiums - dozens of others! Many grow without soil, getting food from the air. White Orchids, yellows, greens, every rainbow color. No equipment needed. Start on table or window ledge.

**SUCCESSFUL HOME GROWER SHOWS YOU HOW!** Complete instructions show you step-by-step how he and his wife started with a few plants and developed a big-profit home-business-grew an Orchid collection now worth a fortune. Learn how orchids multiply, how one plant may become many, each as valuable as the first. No big investment or overhead. Takes but a few minutes a week.



Orchids have rewarded me richly - thanks to Tropical Flowerland.  
 E. V. SMART - Colorado

Big-profit orders for plants and flowers come from individuals, florists, hotels, clubs, etc. Year 'round gift. Millions sold by Mail-Order. **COMPLETE INSTRUCTIONS AND BLOOMING-SIZE ORCHID PLANT SENT FOR YOU TO EXAMINE AT HOME WITHOUT RISK.** Secrets of the experts in simple language, jam-packed with "show-how" drawings, magnificent full-color pictures of Orchids. **Send No Money!** Write NOW for your FREE FACTS that show you how to learn to grow Orchids at home. Airmail is quicker.

**TROPICAL FLOWERLAND, Dept. 31B**  
 4622 Wilshire Blvd., Los Angeles 5, Calif.

## TECHNICIANS WANTED



**GAPS IN INDUSTRY MUST BE FILLED BY MEN TRAINED TO HIGH STANDARDS . . .**

The man who really has the "know-how" will win the best position and highest pay. "Engineering Opportunities" lists many specialized home study courses written by world authorities in: Aeronautical, Civil, Mechanical, Mining, Petroleum, Structural, Electrical, Radio, Television and Plastics etc. Send today for your FREE copy of "Engineering Opportunities" to Canadian Institute of Science and Technology Ltd., Century Building, Washington, D.C.

Canadian Institute of Science & Technology Limited, 602 Century Building, 412, 5th Street, N.W., Washington, D.C.

Please forward FREE of cost or obligation of any kind your 105-page handbook, "ENGINEERING OPPORTUNITIES".

Name.....

Address.....

Course interested in..... Age.....

## Opportunity for the holder of a production-item patent!

A large manufacturing plant equipped with precision machinery will finance and manufacture, on royalty basis, patented production items.

If you have such a patent, and are interested, write:

PRODUCTION PATENT DEPT.  
 3300 W. Temple St., Los Angeles 26, Calif.

## LEARN PLASTICS



**COMPLETE LOW COST SHOP METHOD HOME TRAINING NOW AVAILABLE**

Get in on Big Money opportunities in Plastic molding, casting, forming, carving, etc. Earn as you learn with Interstate's professionally prepared course. All plastic materials furnished.

WRITE FOR FREE BOOKLET

**INTERSTATE TRAINING SERVICE**  
 DEPT. C-3, PORTLAND 13, OREGON

## FREE - Amazing Book on RHEUMATISM, ARTHRITIS

If you suffer the aches, pains and discomforts of Rheumatism, as manifested in ARTHRITIS, NEURITIS, SCIATICA or LUMBAGO, send today for the FREE Book. It reveals important facts about why drugs and medicine give only temporary relief without removing cause. Explains fully a proven, specialized system of treatment that may save you years of distress. No obligation. Write for this FREE Book today!

**BALL CLINIC, Dept. 756, Excelsior Springs, Mo.**

PLEASE SEND ME



for the time checked.  
 I am enclosing . . .

- 1 year \$3.50  
 2 years \$6.00

name

address

city

zone

state

C-115

Hand this order to your newsdealer or send it to

**POPULAR MECHANICS**  
 200 East Ontario St. Chicago 11, Ill.

## Going To BUILD A BOAT? GET THIS BOOK FREE!



WRITE FOR YOUR COPY  
and actual samples—  
FREE! Just ask for  
"Boat Book."



Build your boat easier, faster, better—  
save time, money—with STRONGHOLD  
Annular Thread Nails. Drive easily, save  
pre-drilling, hold permanently tight!

### USED IN WORLD'S FASTEST BOATS

Leading boat builders, kit makers, use  
them. Designer Ted Jones specified them  
for world-champion "Slo-Mo's." Owner  
Stan Sayres says: "The nails held when  
even screws backed out."

## INDEPENDENT NAIL & PACKING CO.

BRIDGEWATER, MASSACHUSETTS, U. S. A.

## GIANT BALLOONS 49c

They're really BIG—surplus U.S. Govt.  
(new overage) Neoprene weather, target  
balloons. GREAT FUN in the backyard: at  
parties, picnics, dances, fairs. TERRIFIC  
for high school and college PROMS. They  
attract BIG CROWDS to business open-  
ings, civic events, conventions, exhibi-  
tions, trade shows. ORDER TODAY!  
Great for Xmas. Approx. inflated sizes:

18 in. dia., 3 for 70c  
3 ft. dia., 49c—5 ft. dia., 99c  
10 ft. dia., \$1.99—13 ft. dia., \$1.99  
15 ft. dia., \$2.50

Postage paid on prepaid orders.  
Calif. residents please add sales tax.

## VOLUME SALES CO., War Assets Division

Dept. PH1155 3930 Sunset Blvd. Los Angeles 29, Calif.

## MEN WANTED

Earn \$100 Per  
Week and up  
AUTO DIESEL  
MECHANICS

Master a trade with a future—learn Auto-Diesel  
mechanics in our shops. You learn with tools  
on real equipment. Earn while you learn. Many  
of our graduates earn \$100 per week and up.  
No previous experience necessary. Day and night courses. Approved for veterans.  
Write for free bulletin.

### NASHVILLE AUTO-DIESEL COLLEGE

226 7th Ave., N., Dept. 75 Nashville 3, Tenn.

## MECHANICAL DENTISTRY

A profession offering unlimited opportunities. Most  
modern and complete course embracing every branch  
from Plating to Porcelain Work, which prepares you  
to work for Dentists or start your own business. In-  
dividual instruction—practical training in day or  
night school. No books—no classes. Catalog upon request.

McGARRIE SCHOOL OF MECHANICAL DENTISTRY  
207 N. Broad Street Dept. 47 Philadelphia 7, Penna.

## STAMP COLLECTORS

### 312 STAMPS Only 25c

Collection of 312 all different foreign  
stamps including group of sport sets  
from Nicaragua, Marino, Hungary,  
MUSICIANS of Iftni, Western Sahara,  
Guinea, Czechoslovakia. PLUS hun-  
dreds of interesting issues from the  
four corners of the world. This collection catalogs  
\$6.50 and comes to you for only 25c with our approvals.

APEX STAMP CO., Dept. 1J, P.O. Box 457, Port Ewen, N. Y.



## TELEPHONES

### Desk Stand Style

Slightly used but in excellent condition

Many Valuable Uses

Inter-House Phones House to Barn, etc.  
Loud Speakers Microphones  
Educational Purposes, Toys, etc.

Come complete, ready to use  
with wiring diagrams included. **\$2.75** Postpaid  
Two complete for only \$5.00 in U.S.A.

TELEPHONE LAMP KIT—with illustrated in-  
structions for making Desk Telephone Lamp including  
all parts (sharp, nipples, push switch, cord, plug, etc.)  
... \$6.50 Ppd. (Shade is not included).

MICROPHONE, Dept. X-3202, 1760 W. Lunt Ave., Chicago 26, Ill.

free!

## ALLIED'S SPECIAL 100-PAGE HI-FI CATALOG



Your guide to  
an easy  
understanding  
of Hi-Fi—plus  
the world's  
largest selection  
of Hi-Fi  
systems and  
components...

## send for "this is high fidelity"

The FREE book that shows you how to  
SAVE MONEY on your home music system

### DO IT YOURSELF

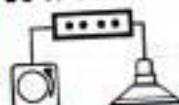

units just plug in



Install in your own  
fine cabinetry, in  
book shelves or in  
built-in wall

Here is the leading guide to  
an easy understanding of  
Hi-Fi. It's invaluable if you're  
planning a home music  
system. Shows you how to  
select a custom system to  
satisfy your own listening  
desires at lowest cost. Tells  
you what to look for in  
complete systems and  
individual units. Shows many  
handsome, practical do-it-  
yourself installation ideas.  
Offers you the world's largest  
selection of complete systems  
as well as individual  
amplifiers, tuners, changers,  
speakers, enclosures, tape  
recorders and accessories from  
which to make your money-  
saving choice. Before you  
make your selections you'll  
want to refer to this  
invaluable, informative  
ALLIED HI-FI book. Write  
for it today—it's FREE.

FREE  
HI-FI BOOK

## ALLIED RADIO America's Hi-Fi Center

ALLIED RADIO CORP., Dept. A-115  
100 N. Western Ave., Chicago 80, Ill.

Send FREE 100-Page Hi-Fi Book

Name \_\_\_\_\_

Address \_\_\_\_\_

City \_\_\_\_\_ Zone \_\_\_\_\_ State \_\_\_\_\_





# THE TOY BUSINESS IS BIG!

**MEN OR WOMEN CAN BUILD A GOOD INCOME AND SECURE FUTURE**

**... SERVICE THIS TOYTOWN CAROUSEL IN YOUR AREA**

**NOT A GET-RICH-QUICK SCHEME!**

**EARNINGS:** A solid and secure opportunity for part or full-time income.

- Good, excellent or exceptionally high bracket returns, depending on your personal initiative and willingness to follow the "Toytown Success Pattern."
- Our Company is not too interested in the financial condition or initial investment of person selected but rather the reputability and desire of Distributor to expand rapidly on profits.

**WANTED:** Spare or Full Time Distributors.

**DUTIES:** Supply and service a chain of toy retail outlets in your local markets and other highly frequented shopping centers.

- There is no selling required.
- Our remarkable "silent-salesmen" toy self-service equipment sells for you 7 days a week. You supply, service and replace sold merchandise once each week.
- You operate from your own home, but a good serviceable car is necessary.
- We require references and a personal resume.

**TOYTOWN, INC. IS ONE OF THE FASTEST GROWING TOY COMPANIES IN THE U.S.!**

A chance of a lifetime to start small and grow in an unlimited way.

**You will receive:**

- The exciting story of the Toy Business.
- A sample give-away toy.
- "How To Make Money In Our Economy."
- "So You Want To Be A Success."
- Full color reproduction of the Toytown Carousel.

Include references, age and physical condition

**AMEN INDUSTRIES, Inc., Toytown Div.**  
14620 Arminta St., Dept. PMB  
Panorama City, Calif.

Name \_\_\_\_\_

Address \_\_\_\_\_

City \_\_\_\_\_ Zone \_\_\_\_\_

**WRITE  
OR  
WIRE  
TODAY!**



**TOYTOWN CAROUSEL**

## Finish HIGH SCHOOL AT HOME

**Complete 4 Yrs. in 12 Months**

Learn More! Earn More! Enter professional or technical schools. Advance Socially. Live a Happier, Fuller Life. Individual Courses or complete schedule. **WRITE FOR SCHOOL BULLETIN.**

**ACADEMY FOR ADULTS**

30 W. Washington, Dept. PM-115, Chicago, Ill.

## 60 POWER TELESCOPE \$3.98

**VARIABLE EYEPIECE 20X-40X-60X — BRASS BOUND**

**NEW!** Three telescopes in one, 3 different magnifications. 20 power for ultra-bright images with 40 and 60 power for extra long range. Guaranteed to bring distant objects, people, sports events, ships, moon, stars, etc. 80 times as close.



Most powerful for any where near the moon. 5 sections. Closes to 1 ft. long. Contains 4 ground and polished lenses. Also used as a powerful compound microscope. Directions included. Mass production enables us to offer this instrument at amazing price of \$3.98 complete. Money back guarantee. We pay postage. Get yours now. **CRITERION CO., 331 Church St., Hartford, Conn., Dept. PMB 29**



## NEW! Leader Gun Sight

**Guaranteed Accurate**

**PRICE \$1.10 POSTPAID**

**NO GUESSING! NEW SIGHT FIGURES LEAD AUTOMATICALLY!**

Here's a simple way to improve your marksmanship IMMEDIATELY! Use Frank Chapek's sensationally successful, proved-in-the-field Leader Sight. Fits all shot-guns, single or double barrel, over and under models (except .410 ga.) Made also poly choke guns and compound barrel. Made of molded latex rubber; no scratching, marring; no screws, bolts, tools needed. Attach in seconds! **RUSH ORDER TODAY: Only \$1.10 postpaid.** (Sorry, no c.o.d.'s). Satisfaction or money back!

**CHAPEK'S LEADER SIGHT CO. SHERIDAN, WYOMING**

NOVEMBER 1955

## Make \$500 an Hour CASH PROFIT THE DAY YOU START!



**START YOUR OWN BUSINESS AT HOME... SHARPEN HOUSEHOLD, GARDEN AND SHOP TOOLS IN SPARE TIME**

Now you can turn spare time into Big Cash Profits with new Belsaw Sharp-All. Sharpen knives, scissors, shears, snips, ice skates, mower blades, hedge trimmers, grass whips, axes, chisels, screw drivers, scrapers and saws... just about any household, garden and shop tool. Your own CASH business with no inventory. No calls to make. No experience needed.

Learn how easily you can start your own spare time business. Amazing low cost easy-payment plan. Send postcard for **FREE BOOK.**

**BELSAW SHARP-ALL CO**

716 Field Bldg. Kansas City 11, Missouri



# Give ME 15 MINUTES A DAY To Prove I Can make YOU a NEW MAN!

That's all I want — just 15 minutes a day to prove I can give you a powerful body of might and muscle — with my quick "Dynamic Tension" method.

Mail coupon below — and I'll send you, absolutely free, my

**CHARLES ATLAS, Dept. 8-Y,  
115 East 23rd Street, New York 10, N. Y.**

Send me your Free Book which proves how "Dynamic Tension" can make me a NEW MAN.

Name \_\_\_\_\_ Age \_\_\_\_\_  
Address \_\_\_\_\_  
City \_\_\_\_\_ State \_\_\_\_\_

new book, "Everlasting Health and Strength." Reveals secrets that changed me from a 97-pound weakling to winner of titles, "World's Most Perfectly Developed Man." Shows how I can build you a champion body the same easy way!

I've taken thousands of flabby men and given them powerful muscles, increased measurements, amazing strength, vitality, pep. My natural "Dynamic Tension" method develops real men!

Send NOW for free copy of my book filled with pictures and body facts. Find out how I can make you the husky, big-muscled NEW MAN you can be! Mail coupon TODAY. **CHARLES ATLAS, Dept. 8-Y, 115 East 23 St., N. Y. 10, N. Y.**

**CHARLES ATLAS, holder of title, "World's Most Perfectly Developed Man."**

Mail Coupon Now For Free Book



## MEN!! TRAIN NOW FOR A BIG PAY FUTURE

### Be a Trained Diesel Man

- Diesel Construction
- Diesel Engine Repairman
- Diesel Operator
- Industrial Maintenance
- Auto Engine Rebuilding
- Bus & Truck Maintenance

Go places with DIESEL! Farms, factories and power plants, trains, ships, trucks, busses all use DIESEL POWER . . . all need DIESEL-trained men! You can start your DIESEL training at home, in spare time, with tested, proved UKI training. Course includes practical work on Diesel engines under skilled instructors. You learn the operation, maintenance, servicing of all types of Diesel engines. PLUS Scientific Motor Tune-up.

**ACT NOW!** If you have mechanical ability, you'll like DIESEL! High School diploma not necessary. Write now for FREE book, "EARNING POWER IN DIESEL."

**UTILITIES ENGINEERING INSTITUTE, Dept. DC-50  
2521 Sheffield Ave., Chicago 14, Ill. (Founded 1927)**

## LEARN UPHOLSTERY

in your spare time run your own business AT HOME



**FREE BOOK** with sample lessons

with course

**YOU MAKE SLIPPER CHAIR**



**CLUB CHAIR**



**OTTOMAN** WITH SLIP COVERS Yours to Keep or Sell

### BE YOUR OWN BOSS

Earn more from the start! Set up your own profitable business, in your own home, enjoy steady income, independence for life—in the booming field of Custom Furniture Upholstery. Right off you start learning with tools, complete frames, fabrics and materials, included FREE with your UTS course. You learn skilled professional custom upholstery, reupholstery, furniture finishing, repairs, how to make beautiful slip covers, window cornices, cushions and draperies. EARN WHILE YOU LEARN, in your spare time . . . the UTS easy way.

FREE illustrated book, with sample lessons. Get ready for well-paid job, big profits, from steady work, as your own boss, running your own business. Mail coupon NOW! Training in N. Y. School also available.

**APPROVED FOR VETERAN TRAINING**

**UPHOLSTERY TRADES SCHOOL, Dept. DS-310, 721 8<sup>th</sup> Way, N. Y. 3, N. Y.**

Send me free book "Your New Way to a Successful Career," and sample lesson. No obligation—no salesman will call.

Home Study  N. Y. School Training  
Name \_\_\_\_\_  
Address \_\_\_\_\_  
City \_\_\_\_\_ Zone \_\_\_\_\_ State \_\_\_\_\_  
 Check if Korean Veteran



## MAKE EXTRA MONEY

### Start Your Own Business

Sell tools part time, full time. Save money for your industrial and institutional use. A MILLION DOLLAR INVENTORY AT YOUR FINGERTIPS.

Buy NATIONALLY ADVERTISED hand tools, hardware, fans, motors, power tools, paints, etc., NO INVESTMENT REQUIRED. Buy as you need it. Up to 50% DEALERS DISCOUNT.  
Send \$1 Deposit for Dealers Card and mammoth dealers catalog. \$1 refunded on first purchase or returned if you are not 100% satisfied.

**SILVER HARDWARE CO., Dept. PM-11, 108 Market St., Phila. 6, Pa.**



## OWN WORLD'S FINEST CRYSTAL RADIO

Complete Kit Only **\$9.95** Money Back Guarantee

Plays anywhere. Needs no batteries or electric current. Excellent performance guaranteed. Germanium crystal diode can get stations over 500 miles away. Head phones, aerial kit included. Nothing else to buy. Assembled in minutes. Popular 5"x4 1/2"x3 3/4" personal size. Send \$2.00 deposit now, we'll mail C.O.D. plus postage. Satisfaction guaranteed.

**IDEAL FOR CHRISTMAS GIFTS!**  
**JAEGER & CO.**  
P.O. BOX 7248 SKOKIE, ILL.

## Say You Saw It in Popular Mechanics

## BIG MONEY FIELD Learn OIL HEATING

INSTALLATION — SERVICE — REPAIR

Use your spare time to advantage. Learn a trade paying big dividends. Easy to start your own business. Home study course includes steam, hot water and warm air systems. Write for catalog.

**LINCOLN INSTITUTE**

DEPT. PMB 472 MARKET ST. NEWARK, N. J.  
Approved by N. J. Dept. of Education

## MAKE TREMENDOUS PROFITS

Have Fun! Earn Big Money! Cast plaster figurines, bookends, plaques, novelties at home in your spare time with X-1 rubber mold! NO EXPERIENCE NEEDED! Models and rubber for 3 molds, only \$1.50 ppd. Send 25c (refunded with order) for 40 page catalog now!

**PLASTIC ARTS STUDIO 3403 SO. MADISON, DEPT. PM2 MUNCIE, INDIANA**



## Start a NEW BUSINESS!

or Add to your present Repair Business  
**SHARPEN DULL PIPE WRENCHES**  
PIPE TAPS & DIES  
"GUM" CIRCULAR SAWS  
Also MOTOR DRIVEN ROTARY HOME  
Write for Information

**J. C. MOORE INDUSTRIES**  
BOX M 276 FREDONIA, PA.

## Learn INTERIOR DECORATION at Home

Fascinating field for men and women. Excellent starting point for career. Practical basic training. Low tuition. Easy payments. Send for FREE 24-page booklet. Chicago School of Interior Decoration, 835 Diversey Parkway, Dept. 1358, Chicago 14

New PROFIT-PROVEN\* Home-Business!

# "I make \$400<sup>00</sup> a week!"



**SCREEN PRINT CO.**  
Dept. 2B  
15127 S. Broadway, Los Angeles 61, Calif.  
Gentlemen: Please mail me Free Revealing Details, samples, Opportunity Plan, etc.—All this is sent absolutely Free and sent to me by return mail. I am under no obligation now or ever.

NAME \_\_\_\_\_  
ADDRESS \_\_\_\_\_  
CITY \_\_\_\_\_ ZONE \_\_\_\_\_ STATE \_\_\_\_\_



\*Proves MR. J. T. ANDERSON, Inglewood, Calif.  
(Notarized statement on file in our office and open to inspection)

**READ WHAT OTHERS ARE SAYING**—Investigate! "Would not take \$1000.00 for secret...just what I have been searching the world over for." C.S., Nev.; "Making 75% of living expenses already in spare time." E.L., Ontario; "Made \$80 first week—terrific opportunity"—W.S., Iowa.

Mail Coupon and Learn Secrets Too!

Big Money?—sure it is—because Huge Profits are waiting to be "tapped" with this **MIRACLE NEW PRINTING METHOD**. Now, you may share the exciting secrets and build a big-paying **FULL OR SPARE TIME** Screen Printing Business right **IN YOUR OWN HOME**. Yes, we'll teach you, too, how to turn pennies into dollars in this newest, most sensational printing method ever invented. **WHAT IS SCREEN-PRINT?** It's an exciting new printing technique—amazingly simple and fascinating. (It may soon revolutionize the entire printing industry) **NO EXPENSIVE EQUIPMENT**, no printing press, no "cuts," no art ability, no experience is necessary—yet you can print beautiful professional jobs on **PAPER, GLASS, LEATHER, CLOTH—ANYTHING!** You print in all colors—even new "glowing" **FLUORESCENT**



**COLORS**. It's amazing—but true! **EARN PROFITS IMMEDIATELY—IN YOUR OWN HOME!** Start in your garage, basement, kitchen, spare room—anywhere! It's much easier than you think. Then expand as this new printing industry grows. **300% PROFIT** on some jobs—earn up to \$12.50 per hr. **HELP FILL THE HUGE GROWING DEMAND**. No selling because every business in your area needs Screen-Printing. You can save them up to 50% on printing, too. **WE SUPPLY EVERYTHING YOU NEED**. Never before has such a profit opportunity been offered to anyone wishing to start a full-time or spare-time "business of his own." Don't Hesitate! All the **CONFIDENTIAL FACTS** are yours if you **MAIL COUPON TODAY**—before it's too late.



Print colorful ADVERTISING DISPLAYS, SIGNS, BANNERS, POSTERS, LABELS, WALLPAPER, NOVELTIES, INSTRUMENTS, ETC. ET

## MAKE MONEY WRITING .. short paragraphs!

You don't have to be a trained author to make money writing. Hundreds now making money every day on short paragraphs. I tell you what to write, where and how to sell; and supply big list of editors who buy from beginners. Lots of small checks in a hurry bring cash that adds up quickly. No tedious study. Write to sell, right away. Send for free facts. **BENSON BARRETT, 1751 Morse Ave., Dept. 27-L, Chicago 26, Ill.**

## MASTER MIND!



**Learn Short-Cut Mathematics**  
Juggle figures, do baffling number tricks. Make people gasp at your marvelous lightning-quick mind. Multiply 4 figures by 4 figures without using old-fashioned multiplication! Big cloth-bound volume; fully illustrated course.

**Sharpen up Your Brain Power**  
Includes worked out problems, answers, etc. Sensational bargain, only \$2.95, postpaid or COD plus postage. Satisfaction guaranteed or refund. Order this amazing "Short-Cut Mathematics" today!

**NELSON-HALL CO., 210 S. Clinton St. CHICAGO 6, ILL. \$2.95 Complete**

## Want a Government Job?

**START AS HIGH AS \$4,525.00 A YEAR**  
MEN—WOMEN Prepare NOW for next exams

Thousands appointments being made. 36-page Book FREE.

**FRANKLIN INSTITUTE** (Not Gov't. Controlled)  
Dept. J-93, Rochester 4, N. Y.  
91cc Rush without charge. (1) 36-page book with list of U.S. Gov't. Jobs; (2) Tell me how to qualify for exam.

Mail Coupon Today. SURE.

Name \_\_\_\_\_  
Address \_\_\_\_\_ Age \_\_\_\_\_

## NEW Reactor Plug

**DESTROYS ENGINE ACIDS!**



**STOP ENGINE SUICIDE**

Automotive engineers say that corrosive sulphuric acid produced by fuel combustion is the greatest cause of engine wear.

Now you can prevent this damaging acid action with a simple, inexpensive crank case drain plug. The new **REACTOR PLUG** embodies a metal catalyst which destroys all engine acids! Powerful, permanent Magnetic Attractor traps damaging metal particles—filings, shavings, chips normally resulting from engine operation.

**SAVES GAS, OIL AND REPAIRS**

Your engine runs smoother, more efficiently for thousands of extra, trouble free miles. Sludge, varnish and carbon deposits caused by acids do not form. You enjoy greater gasoline economy, increased horsepower, savings on engine repairs and overhauls. **A REACTOR PLUG** can save you hundreds of dollars during the life of your car or truck!

**MONEY BACK...** If you don't notice the difference in engine power and all-around performance, if you aren't completely satisfied.

**ONLY \$2.49**  
for all makes and models of cars.

**DISTRIBUTORS & DEALERS WANTED!**  
Exclusive protected territories. Write or wire today. **REACTOR DRAIN PLUG CORP., 11766 W. Pico Blvd., Los Angeles 64, Cal.**

Please ship immediately by return postpaid mail. **REACTOR PLUGS** at \$2.49 each on money-back guarantee. Check, cash or money order enclosed.

NAME \_\_\_\_\_  
ADDRESS \_\_\_\_\_  
CITY \_\_\_\_\_ ZONE \_\_\_\_\_ STATE \_\_\_\_\_  
(MAKE, MODEL, YEAR OF CAR(S)) \_\_\_\_\_

**"TOOK IN \$217  
FIRST 10 DAYS"**

Some make more, some less  
We help you to start Your  
Own All-Year Business

**Make Big Money!** With our easily operated, highly efficient wall washer, Chas. Stelle took in \$217 gross in first ten days. E. L. Goss took in more than \$10,000 in one year. E. C. Taber wrote, "I made \$400 gross in two weeks." And no wonder—this machine washes walls 6 times faster and better than by hand. **Your Money-making Opportunity.** Enjoy independence—freedom from bosses, layoffs. Customers everywhere—homes, offices, schools, etc. Expenses low, profits high. No shop necessary; operate from home. Can start spare time until your full time is available.



Loss no time. Get all facts without obligation

**FREE BOOK! MAIL COUPON TODAY!**

- VON SCHRADER MFG. CO.
- E 10 "W" Pl., Racine, Wisconsin
- Send at once (no obligation) your FREE booklet containing information about your WALL WASHING MACHINE and how I can start my own permanent, profitable business.
- Name \_\_\_\_\_
- Address \_\_\_\_\_
- City \_\_\_\_\_ Zone \_\_\_\_\_ State \_\_\_\_\_

**C O U P O N**

**UNIVERSITY LOUDSPEAKERS, INC. Desk E-2**  
80 South Kensico Avenue, White Plains, N. Y.

Gentlemen:

Please send me information about P-S-E (University's Progressive Speaker Expansion plan for High Fidelity speaker systems).

I don't believe that P-S-E can do all you claim for it. According to you P-S-E will solve almost all my loudspeaker problems forever. That's a bold statement; I hope you can back it up.

You say that now I can buy a speaker and never worry about it becoming obsolete, or improve my present system without discarding what I have... that University speaker components, enclosures and networks have been so uniquely designed that it's possible to start an excellent basic system, at low cost, and add to it later—while enjoying immediate listening satisfaction. This is sensational!

Please send further information; mind you at no cost to me; absolutely free.

NAME \_\_\_\_\_  
ADDRESS \_\_\_\_\_  
CITY \_\_\_\_\_ STATE \_\_\_\_\_



**BUILD Your  
Own GARAGE**

**Save Up to 50% of Usual Cost!**

Build your own garage and save! Wayne Leckey, Popular Mechanics Assistant Shop Notes Editor, tells and shows how in his new book *How to Build Your Own Garage*.

**No Previous Building Experience Required**

If you can use a hammer and a saw you can build your own garage. Leckey tells how in simple step-by-step instructions and shows how in big, clear photos, drawings and diagrams. Everything is covered from the laying of the foundation right up to and including applying the final trim.

**25 Designs—Brick, Frame and Concrete Block Construction. Complete Building Data**

There are 25 different designs from which you may choose. Brick, frame and concrete block construction is fully covered. Leckey tells and shows how to pour the foundation, erect the framework, erect the roof, apply insulation and shingles, lay the driveway, install trim, flower boxes, etc. It's all there for you to read and see.

**7-Day Money Back**

**Guarantee**

Get your copy of this valuable book today. Read and use it for seven days and if it isn't entirely satisfactory return it for a full refund. Send only \$3.50 for your copy to Dept. 90  
**POPULAR MECHANICS PRESS**  
200 E. Ontario, Chicago 11, Ill.

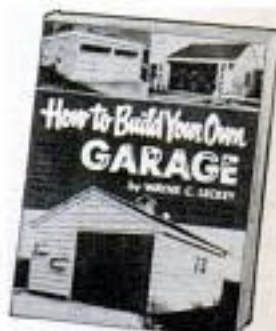

**YES! SEND**



directly  
to my door  
every month

I am enclosing

- \$3.50 for 1 year
- \$8.00 for 3 years

name \_\_\_\_\_

address \_\_\_\_\_

city \_\_\_\_\_ zone \_\_\_\_\_ state \_\_\_\_\_

Hand this order to your newsdealer or send it to

**POPULAR MECHANICS**  
200 East Ontario St. Chicago 11, Ill.

FREE TO NEW MEMBERS...

# IMPORTS

FROM FOREIGN LANDS

NOW! EASY TO START YOUR OWN  
BIG-PROFIT IMPORT-EXPORT  
BUSINESS AT HOME!

**FREE** to new members of the International Traders Guild—many unusual, useful products from France, India, Germany and other foreign lands, and trade bulletins listing hundreds of import bargains. World trade boom offers new, big-money opportunities for men and women! Now you can import at low foreign prices for buyers in your locality at high U. S. prices.

**BUY-SELL, WORLD-WIDE, WITHOUT CAPITAL**  
Big profits possible, no investment in goods. Operate a world-wide mail-order business from home, spare or full-time. Also, for your own use, big savings on clothes, tools, gems, antiques, watches, cameras, china, silk, toys, etc. (see examples at left). No matter where you live World Trade can be carried on—in small towns or large cities, anywhere. World travel opportunities. Established World Trader shows you how. Teaches you quickly at home.

**START AT ONCE-IMPORT PROFITABLE ITEMS**  
Complete training includes many exciting imports that come to you from round the world AT NO EXTRA COST. Go after big profits NOW—importing and exporting. No previous experience is required. 2000 members in 42 countries. 7th successful year. Free details, write Now. Airmail reaches us overnight.

"Business good... importing paintings... selling to gift shops." — C. Renick, Penn.

Mrs. M. G. Bowman — Her entire import of beaded purses from India bought by large department store.

The MELLINGER CO., Exporters-Importers,  
Dept. E25B, 1717 Westwood Blvd., Los Angeles 24, Calif.



# 80 PROJECTS IN METAL

you can  
build  
yourself



Exciting plans of what you can build at home... for a few cents.

- |                        |                   |
|------------------------|-------------------|
| Wrought iron furniture | Power tool stands |
| Barbecue grills        | Garden tools      |
| Ornamental iron ware   | Wagons            |
| Flower stands          |                   |

You'll say it's the best dollar you ever invested in do-it-yourself projects.

MAIL COUPON TODAY... OR WRITE DEPT. 3104

Mail To  
The Lincoln Electric Company  
Cleveland 17, Ohio

Attached is a dollar. Send my copy of the book, "Selfwelding". 80 Projects in Metal.

Name \_\_\_\_\_  
Street \_\_\_\_\_  
City \_\_\_\_\_ Zone \_\_\_\_\_ State \_\_\_\_\_

Do YOU Want to Qualify for  
A BETTER JOB AT BIGGER PAY?



# CLIMB TO SUCCESS!

in Spare Time at Home

• Jobs are calling—calling to those who want more responsible jobs, in bigger pay brackets, with increasing chances for promotion—and who have the ambition to devote some of their spare time to acquiring necessary knowledge and skill. As little as just a few hours a week, in time you can easily spare, can produce surprising results in lifting you up to higher and higher levels of employment, income and security—even eventually to management positions or a business of your own. In the coupon below are listed some of the large number of training opportunities offered by AMERICAN SCHOOL—now in its 58th year. Check the one that interests you most and fill in your name and address. Or if you prefer some other career, write the subject in the margin. Then mail the coupon without delay.

—FULL INFORMATION...NO COST...NO OBLIGATION—

AMERICAN SCHOOL, Dept. G845, Drexel at 58th, Chicago 37, Ill.

Without obligation, please send FREE and postpaid, full particulars about the subject checked below.

- |  |   |   |
|--|---|---|
| <input type="checkbox"/> Accounting              | <input type="checkbox"/> Diesel Technician        | <input type="checkbox"/> Mechanical Engineering |
| <input type="checkbox"/> Apprenticeship Courses  | <input type="checkbox"/> Drafting—Building Trades | <input type="checkbox"/> Mechanical Technology  |
| <input type="checkbox"/> Architecture & Building | <input type="checkbox"/> Drafting—Machine Trades  | <input type="checkbox"/> Metalworking Courses   |
| <input type="checkbox"/> Automotive Technician   | <input type="checkbox"/> Electrical Engineering   | <input type="checkbox"/> Plumbing—Practical     |
| <input type="checkbox"/> Better Foremanship      | <input type="checkbox"/> Electricity—Practical    | <input type="checkbox"/> Private Secretary      |
| <input type="checkbox"/> Bookkeeping             | <input type="checkbox"/> Electronics—Industrial   | <input type="checkbox"/> Retail Merchandising   |
| <input type="checkbox"/> Business Management     | <input type="checkbox"/> HIGH SCHOOL COURSES      | <input type="checkbox"/> Salesmanship—Outside   |
| <input type="checkbox"/> Civil Engineering       | <input type="checkbox"/> Machine Shop Operations  | <input type="checkbox"/> Sheet Metal Work       |
| <input type="checkbox"/> Contracting             | <input type="checkbox"/> Mathematics & Slide Rule | <input type="checkbox"/> Tool Making            |

Name \_\_\_\_\_ Occupation \_\_\_\_\_  
Home Address \_\_\_\_\_ Age \_\_\_\_\_  
City \_\_\_\_\_ State \_\_\_\_\_

Canadian Residents: Write American School, 1610 Sherbrooke St., West, Montreal

# FOUND- SPRINGFIELD RIFLES

**GUARANTEED  
EXCELLENT**

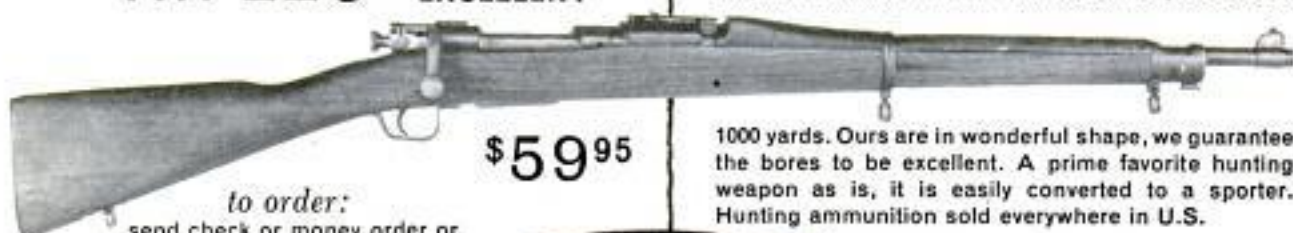

**\$59<sup>95</sup>**

*to order:*  
send check or money order or  
send \$10 per gun for C.O.D.  
Shipped F.O.B. Los Angeles  
In Calif. add 3% state tax.

**Cadmus Industries**

61 CRAFT BLDG.

5880 Hollywood Blvd., Hollywood 28, Calif.

We have received shipment of a fine lot of the famous Cal. 30-06 U.S. Springfield Model 1903. All high numbered weapons made by Remington with all milled and machined parts, no stampings. This is the world's most accurate military rifle—used by marines and snipers in World War II and Korea. Dependable at

1000 yards. Ours are in wonderful shape, we guarantee the bores to be excellent. A prime favorite hunting weapon as is, it is easily converted to a sporter. Hunting ammunition sold everywhere in U.S.

## LEARN TV REPAIR

**ALL SHOP - NO MATH  
FINISH in 6 to 16 WEEKS**

**EARN BIG MONEY! TRAIN IN CHICAGO! BE YOUR OWN BOSS!**  
Millions of TV sets mean money to you! No high school or experience needed. Color TV and radio included. Day, eve., Sat. classes. Low weekly budget tuition. Small classes. Individual instruction. Also 16 wk. shop course in AIR CONDITIONING-REFRIGERATION repair.

MAIL COUPON FOR FREE BOOKLET

MID-CONTINENT INSTITUTE (WHERE YOU LEARN BY DOING!)  
Dept. 11, 615 S. State St., Chicago 5, Ill. — Webster 9-0790

NAME \_\_\_\_\_  CHECK CHOICE  
ADDRESS \_\_\_\_\_  TELEVISION  
CITY & STATE \_\_\_\_\_  AIR COND.-REFR.

Say You Saw It in Popular Mechanics

## PREPARE FOR THE BEST JOBS IN INDUSTRY

**TRAIN  
at HOME**  
IN YOUR SPARE TIME  
or at  
**ALLIED INSTITUTE**  
in Chicago

- MECH. ENGINEER
- DRAFTSMAN
- TOOL DESIGNER
- TOOL ENGINEER
- TOOL & DIE MAKER
- MASTER MACHINIST

### NO RECESSION FOR ALLIED TRAINED MEN

**MORE JOBS THAN GRADUATES** Shortages of Draftsmen, Designers, Tool Engineers, Machinists, Tool & Die Makers are so widespread that you can pick a highly paid key job and look forward to Achievement and Security.

You can begin your training in Short Courses and continue progressively to a Bachelor Degree in 26 months.

Allied is approved by Industry, Dept. of Education, Office of Public Instruction, State of Illinois, U. S. Veterans Admin., U. S. Dept. of Justice. Accredited: C.S.A.

**SEND FOR  
FREE  
BOOKS**

**ALLIED SCHOOL of MECHANICAL TRADES**  
1338-42 South Michigan Ave. Dept. PM-11 Chicago 5, Illinois

SEND ME WITHOUT OBLIGATION INFO. ON YOUR COURSES:

HOME STUDY  RESIDENT  VETERAN  NON VETERAN

NAME \_\_\_\_\_

ADDRESS \_\_\_\_\_ AGE \_\_\_\_\_

CITY \_\_\_\_\_ STATE \_\_\_\_\_

### Build Your Own Walks, Driveway, Outdoor Fireplace, Steps, Etc.

### What to Make With CONCRETE



The terrific high costs of even little concrete jobs are mostly for labor. Get Popular Mechanics **WHAT TO MAKE WITH CONCRETE** and save all the labor costs while making your home or farm ship-shape. You can lay foundations, sidewalks and driveways; build steps, outdoor fireplaces, sandboxes, tennis courts, garden and swimming pools and other installations at very little cost. Book shows all — tells all — how to make the right mixture, plan, apply and gives 50 professional short cuts. Hundreds of pictures. Only \$2.00 postpaid. Order today. Money back if not pleased.



POPULAR MECHANICS  
PRESS

Dept. PM17, 200 E. Ontario  
Chicago 11, Ill.

## 200 ONE-EVENING PROJECTS

### Start and Finish Any One of These Projects in One Evening!

The editors of Popular Mechanics have assembled 200 projects, any one of which you can start and complete in a single evening. In a few hours' time, using only simple hand tools, you can build a coffee table, magazine rack, end table or scores of other useful projects. There are projects for the entire family. Best of all, any one may be built in just a few hours. No special skills are needed. Even if you have never built anything before, you can build the 200 projects in this big new book!

#### Step-by-Step Instructions, Show-How Photos, Drawings

First you read how to do it in famous Popular Mechanics step-by-step instructions and then actual photos, drawings and diagrams show you how it is done.

#### Each Project Costs Just 1c

Just imagine! Each project costs you only 1c. Where else today can you get so much for so little? Fill out and mail the coupon now. Full money-back guarantee, of course.



POPULAR MECHANICS PRESS, Dept. EP-1  
200 E. Ontario St., Chicago 11, Ill.

Gentlemen:  
Remittance for \$2.00 enclosed. Rush postpaid my copy of 200 ONE-EVENING PROJECTS. Unless it is entirely satisfactory I may return it in seven days for a full refund.

NAME \_\_\_\_\_

ADDRESS \_\_\_\_\_

CITY \_\_\_\_\_ ZONE \_\_\_\_\_ STATE \_\_\_\_\_

Send C.O.D. (U.S.A. only). Postage extra.

# Free! 153 GERMANY



Giant and midget-sized **STAMPS**; hated Hitler heads; blood-red swastikas; inflation issues with pre-war face of millions of dollars; Allied and Russian Occupation issues; animals, birds, airmail stamps—153 all-different, guaranteed worth \$2.46 at Catalog prices. **EXTRA!** Free booklet, bargain lists, and other fascinating offers for your free consideration. Send 10c for mailing expenses. Supplies limited. **Act NOW!**

## USE THIS HANDY COUPON

JAMESTOWN STAMP CO., D-11PM100, Jamestown, N.Y.  
RUSH my FREE Collection of 153 Germany & other offers. I enclose 10c for cost of mailing.

Name .....

Street .....

City ..... State .....

# 135 ORIENTALS only 25¢



Brought to you from the farthest corners of the earth—this amazing collection of exotic valuable **STAMPS** of the mysterious Orient! 135 all-different from Berne, Siam, China, Japan, Hong Kong, Malaya, Sarawak, Singapore, etc. Scarce Airmails, flowers, beautiful girls, temples, mountains, birds, animals. Worth \$2.61 at Catalog prices! **PLUS** free booklet. Send **TODAY!**

Falcon Stamp Co., D-11PM400F, Falconer, N.Y.

NO TANKS USED  
NEW SIMPLIFIED METHOD

## ELECTROPLATE

ANY OBJECT IN HOME, SHOP, GARAGE OR STREET  
TODAY YOU CAN BEAT ANY OTHER BUSINESS



**NOW, using NEW plating kit.**  
It's easy to electroplate any object. Complete kit and instructions on plating metal and non-metal objects, with nickel, copper, chrome, gold, etc., plus full data on obtaining all the business you desire and make **BIG MONEY** full or spare time, **ONLY \$5.95 SEND NO MONEY**—everything sent C.O.D. plus postage—**OR**

send \$5.95 now and receive it postpaid. Money back in 7 days if not satisfied.  
M. Z. SALES CO., Dept. PM-20, 113 W. 42 St., New York 36, N. Y.

## SURPLUS AIRCRAFT GENERATORS

TYPE	VOLTAGE	AMPS.	BASE	COND.	GR. WT.	PRICE
L-2	24	25	Square	OH	34	\$6.50
L-3	24	25	Square	OH	34	\$6.50
P-1	24	200	Round	U	60	\$15.00
P-1	24	300	Round	U	60	\$27.50
307-B	12	25	Square	U	20	\$10.00
ET-A	12	50	Round	N	40	\$12.50

(All have spline 1/2" x 1 1/2" shaft; Express or Motor Freight job)

Voltage Regulator, carbon pile, 24V, to 200A, w/base, \$3.50  
Relay, reverse current, 24V, to 200A, \$3.50  
Compass, magnetic, NAP, \$9.95  
Pump, hand w/rope, 1/2HP, 2 1/2" ports, D-2 \$6.95  
Engine, Aircraft, 190 and 240 HP, air cooled, \$4.95  
Good for air boats & afloats, orchard blowers, etc. \$112.50 up  
(All items job Houston; here priced from 2% to 10% of orig. cost)

**AERO PARTS SUPPLY, 8102 LOCKHEED, DEPT. 110, HOUSTON 17, TEXAS**

## YOURS FREE!

**VUER-PROJECTOR & Full Color Slide Kit—Authentic \$4.95 Value!**

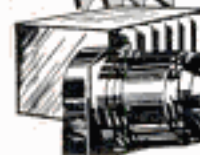

## If You're Interested In BREEDING TROPICAL FISH For Profit & Pleasure

This handsome, precision-viewing instrument and color slides are yours **FREE**—just for showing your interest in Tropical Fish Breeding! See gorgeous BETTAS, colorful TETRAS, exotic ANGEL FISH, etc., in the vibrant beauty of full color! Convince yourself Tropical Fish Breeding is the profitable, easy-to-start home business for you! Breed them in your living room, spare-room, anywhere. Success is assured because we'll buy every fish you produce! No experience or costly equipment needed. Spare-time, on a "showing".... build a \$10,000 home business! Investigate!

Write today for **FREE** details on "Profit-Proven" Success Plan & Vuur! (if under 17, ask for plan A.)

**TROPICAL FISH BREEDERS OF AMERICA**  
Dept. D-11  
Los Angeles 61, Calif.



# AUDELS HOME APPLIANCE SERVICE GUIDE

This **HANDY, Practical "How to Do It"** book for Electric & Gas Home Appliance Servicemen, Mechanics & Dealers covers Basic Principles, Servicing, Operation & Repairs of Home Appliances. Tells How to Locate Troubles, How to take Appliances Apart, How to Make Repairs, How to Assemble and Connect. Gives up to date testing methods, wiring diagrams and complete data on each appliance.



## IT PAYS TO KNOW HOW TO FIX

Toasters—Pressing Irons—Waffle Bakers—Casseroles—Roasters—Broilers—Coffee Makers—Space Heaters—Water Heaters—Ranges—Home Wiring—Shop Work—Appliance Testing—Fundamental Electricity—Fractional H.P. Motors—Food Mixers—Fans & Blowers—Vacuum Cleaners—Washing Machines—Clothes Dryers—Ironers—Dishwashers—Garbage Disposers—Refrigeration—Window Air Conditioners—Oil Burners—Drainage Pumps—Gas Ranges, Furnaces & Water Heaters—Bottled Gas Appliances.

A **SHOP COMPANION THAT ANSWERS YOUR QUESTIONS.** Easy to read and understand—over 800 pages fully illustrated—with 500 photos and diagrams—1001 Facts. A ready reference.

**\$4 COMPLETE • PAY \$1 A MONTH** TO GET THIS SERVICE INFORMATION FOR YOURSELF—FILL IN AND MAIL 7 DAY TRIAL COUPON TODAY.



Step up your own skill with the facts and figures of your trade, **Audels Mechanics Guides** contain Practical Inside Trade Information in a handy form, Fully Illustrated and Easy to Understand. Highly Endorsed. Check the book you want for 7 DAYS FREE EXAMINATION. Send No Money, Nothing to pay Postman.

## MAIL ORDER

**AUDEL, Publishers, 49 W. 23 St., NEW YORK 10, N. Y.**  
Please send me postpaid for **FREE EXAMINATION** books marked x below. If I decide to keep them I agree to mail \$1 in 7 Days on each book or set ordered and further mail \$1 monthly on each book or set until I have paid price, otherwise I will return them.

- HOME APPLIANCE SERVICE GUIDE, 800 Pages \$4
- AUTOMOBILE MECHANICS GUIDE, 1664 Pages 4
- TRUCK & TRACTOR GUIDE, 1299 Pages 4
- DIESEL ENGINE MANUAL, 575 Pages 2
- MACHINISTS HANDY BOOK, 1650 Pages 4
- WELDERS GUIDE, 400 Pages 1
- BLUE PRINT READING, 416 Pages 2
- MATHEMATICS & CALCULATIONS, 700 Pages 2
- SHEET METAL PATTERN LAYOUTS, 1100 Pages 4
- SHEET METAL WORKERS HANDY BOOK, 388 Pgs. 1
- MECHANICAL DRAWING GUIDE, 160 Pages 1
- MECHANICAL DRAWING & DESIGN, 480 Pages 2
- AIRCRAFT WORKER, 240 Pages 1
- TELEVISION SERVICE MANUAL, 434 Pages 2
- RADIOMANS GUIDE, 1040 Pages 4
- ELECTRONIC DEVICES, 216 Pages 2
- ELECTRIC MOTOR GUIDE, 1000 Pages 4
- WIRING DIAGRAMS (Light & Power), 272 Pgs. 1
- ELECTRICIANS EXAMINATIONS, 250 Pages 1
- ELECTRIC POWER CALCULATIONS, 425 Pages 2
- HANDY BOOK OF ELECTRICITY, 1440 Pages 4
- ELECTRIC DICTIONARY, 9000 Terms 2
- ELECTRIC LIBRARY, 7000 Pages (12 Book Set) 18
- SHIPFITTERS HANDY BOOK, 250 Pages 1
- REFRIGERATION & Air Conditioning, 1280 Pgs. 4
- MILLWRIGHTS & MECHANICS GUIDE, 1200 Pgs. 4
- POWER PLANT ENGINEERS GUIDE, 1500 Pages 4
- ENGINEERS & FIREMANS EXAMS, 525 Pages 1
- PUMPS, Hydraulics & Air Compressors, 1658 Pgs. 4
- OPERATING ENGINEERS LIBRARY (3 Books) 9
- MECHANICAL DICTIONARY, 950 Pages 4
- GARDENERS & GROWERS GUIDES (4 Book Set) 6
- CARPENTERS & BUILDERS GUIDES (4 Book Set) 6
- PLUMBERS & Steamfitters Guides (4 Book Set) 6
- MASONS AND BUILDERS GUIDES (4 Book Set) 6
- PAINTERS & DECORATORS MANUAL, 450 Pgs. 2
- HOUSE HEATING GUIDE, 1000 Pages 4
- OIL BURNER GUIDE, 384 Pages 1

## Check NOW!

You Can Look Over Any Guide In Your Own Home — Start the Easy Payments If Satisfied

## MAIL THIS TODAY

Name .....

Address .....

Occupation .....

Employed by .....

P11

**FREE BOOKLET!** WANT TO BECOME A **GAME WARDEN** or join **FORESTRY FISHERY or WILDLIFE SERVICES?**



Learn how to apply—at home spare-time for a stimulating outdoor career. It's revealing—enjoyable as reading your favorite outdoor magazine. Let your love of field and forest guide you to possible success and happiness working with nature's creatures amid scenic surroundings—away from the pressures of city life. We are not government sponsored but dedicated to helping you GET READY FOR THE NEXT EXAMINATION IN YOUR AREA!

- Compare These Exciting Advantages:**
- NO SPECIAL SCHOOLING NEEDED.** you don't need a college education, even a high school diploma for many fine beginning positions. Hunting, farming, military experience—all help get most outdoor jobs.
  - AGE NO HINDRANCE.** Positions have been available to men 17 to 45 years of age.
  - GOOD PAY, SECURITY.** Start at up to \$3,000 year and more! Regular increases too.
  - PRESTIGE.** The uniforms command the respect of others and symbolizes the vigilance needed to conserve America's precious resources.
  - LOW COST HOUSING.** Retirement income on many jobs with government. Many private opportunities.
  - FREE!** Large, colorful **SUCCESS BOOKLET.** Tells, explains complete facts and how to get revealing "SELECT-A-JOB" CHART. Let's you match your background, schooling, interests against possible outdoor job. Mail coupon now—today!

**HOME-STUDY EDUCATORS, DEPT. R-11**  
1036 So. La Brea, Los Angeles 19, Calif.

Rush me FREE "Job Opportunity" information. No salesman will call.

Name \_\_\_\_\_ Age \_\_\_\_\_

Address \_\_\_\_\_

City \_\_\_\_\_ Zone \_\_\_\_\_ State \_\_\_\_\_

Famous 15 and 17 Jewel **BULOVA WATCHES** \$16.95 PLUS TAX



**UNLIMITED SERVICE GUARANTEE**

**WHY PAY \$59.50? SAVE \$42.55!** Also Choice of **BENRUS GRUEN or ELGIN WATCHES**

You get these unredeemed **SERVICE** guaranteed Bulova and other movements in latest style Yellow Gold Cases at this seasonally low price because we bought out huge surplus **STOCKS** of leading New York and Md. jewelers. Order now while they last. Specify make preferred and whether men's or ladies'. Only \$16.95 plus \$1.70 tax. Order right now. **FREE TRIAL OFFER! WEAR AT OUR RISK!** Money back guarantee in 10 days if not delighted.

SEND ONLY \$1 with order. Pay balance C.O.D., plus postage. Or enclose \$16.95 plus \$1.70 tax, we pay postage. Handsome Expansion Band with orders at no extra cost.

**MARYLAND DISTRIBUTORS, Dept. 680**  
501 E. Baltimore St. Baltimore 2, Md.  
Write For Free Watch and Diamond Ring Catalog — Practically Wholesale Prices.

**UNLIMITED Service Guaranteed 17 Jewel Swiss WRIST WATCH**  
Worn by Army, Navy & Marines. **WHY PAY \$50?** Plus \$1.50 tax. **Here Only \$14.95**  
New Incubated, Shock-protected Water & Dust Tight



**Guide to HOME REPAIRS Pays for Itself 100 Times Over**

Beat the high cost of home upkeep. Save hundreds of dollars every year on carpentry, electrical, painting, plumbing and other jobs around the house with **Popular Mechanics GUIDE TO HOME REPAIRS.** Simplified how-to-do-it instruction and 646 pictures make all jobs, inside and out, easy. Covers construction, remodeling, modernizing, repairing that you can do yourself at small cost. 192 page cloth bound book only \$2.50 postpaid. Order today under our money back guarantee.

**POPULAR MECHANICS PRESS, Dept. PM16**  
200 EAST ONTARIO STREET CHICAGO 11, ILLINOIS

**FAMILY SAFE, PARTIALLY USED TIRES. CHECK MY GOLDEN RULE GUARANTEE!** "THE BLATT NAME famous in tires for 40 years." Only BLATT offers a "FREE REPLACEMENT" guarantee! Any other guarantee is USELESS where you must pay for the months service you've received. I replace FREE instantly ANY defective tire within 36 mos. FOOLISH TO PAY MORE—DANGEROUS TO PAY LESS!

**CHOOSE YOUR FAVORITE BRAND** **GOOD YEAR** **Firestone** **U. S. Goodrich, Lee & others.**

These are not Recaps—not cheap grade tires. We are selling thousands in our retail store at higher prices!

36 MONTH GUARANTEE & FREE LEAK-PROOF TUBE	70% to 80% NON-SKID	FREE This pictured tire ash tray given with 2 or more tires!
600-16 \$5.50 670-15 \$5.40 700-20 \$9.80 600-16 (6) \$5.90	SPECIAL TIRES RELEASED BY CO. ADJUSTERS!	if a tire fails in 36 months, I charge you nothing. Just slightly used. Any car size. World's top tire value (Whitewalls \$1 extra).
650-16 5.60 710-15 5.40 750-20 11.80 650-16 (6) 6.60	SNOW-TIRES	GOODYEAR SUBURBANITE type & others—any car. Factory retreads & Partially used, 26 Mos. Guar.
700-16 6.00 760-15 5.70 825-20 17.90 700-16 (6) 7.30	Send Ck. or M.O. & this ad for instant shipment. FOB Phila. I personally select your tires—as if my future depended on it. Thousands of tires shipped the world over! Read that top line again.	\$7.86
640-15 4.80 800-15 5.80 900-20 17.90 700-15 (6) 7.80		\$7.95
700-15 4.90 820-15 5.80 1000-20 17.90 700-17 8.80		
600-20 9.00 650-20 9.80 1100-20 17.90 750-16 7.50		
WHITEWALLS \$1.00 EXTRA 1000-22 19.90 750-17 9.90		

**BLATT 6th & Spring Garden Sts. Philadelphia, Pa.** **MILITARY MUD-GRIP TIRES** AA Guar. 20 Mos. AAA 36 Months 900-16 \$9.50 900-16 \$13.90 750-20 12.90 750-20 17.30

Say You Saw It in **POPULAR MECHANICS**

Now — a NEW MAGAZINE —

Long-awaited, much-needed, and here at last! — a smooth-paper monthly publication for those wanting more technical and do-it-yourself material about hi-fi. Practical, detailed, illustrated articles on sound recording and reproduction . . . on tape recording . . . wood-working . . . speaker systems. Helpful to the engineer—a REAL "MUST" for the hobbyist. All build-it-yourself designs are **PRETESTED!**

**audiocraft**

by the publishers of **High Fidelity**

**AUDIOCRAFT** — 5111 Publishing House, Great Barrington, Mass.

NAME \_\_\_\_\_

STREET \_\_\_\_\_ CITY \_\_\_\_\_ STATE \_\_\_\_\_

- 1 yr. \$3.50 (12 issues)     2 yrs. \$6.50 (24 issues)     3 yrs. \$9.00 (36 issues)     Please bill me.     Money enclosed.
- Add \$1.00 for subscriptions outside the U.S. and Canada



# LEARN MEAT CUTTING AT NATIONAL

Pay After Graduation



The steady dependable trade of Meat Cutting taught easily in 8 short weeks. YOU LEARN BY DOING under actual meat market conditions in big modern school at Toledo.

For beginners or men with experience. Get a profitable store of your own. Remember, PEOPLE MUST EAT! Big pay jobs. Free employment help. Thousands of successful graduates.

Buying, cutting, percentage, pricing, advertising, selling, etc. A complete retail meat education. National School established over 30 years. Get National training NOW. Pay your tuition in easy weekly payments

after you graduate. Send coupon for FREE 52 page school catalog — TODAY. G.I. approved.

National School of Meat Cutting, Inc., Dept. 50-X, Toledo 4, Ohio

Send me your FREE school catalog on National Training at Toledo in Meat Cutting, Meat Merchandising and Self Service Meats. No obligation. No salesman will call.

Name \_\_\_\_\_ Age \_\_\_\_\_

Address \_\_\_\_\_

City \_\_\_\_\_ State \_\_\_\_\_

Approved for training Korean Veterans

## Sub-Machine Gun Style .22

BRAND NEW - single shot

100 SHELL STORAGE FOR CARRYING EXTRA CARTRIDGES

\$19.95



**AUTOMATIC EJECTION** We believe this to be the first time that this type of firearm has been offered to the general public. Only a limited quantity of these fine, single action Sub-Machine Gun style Rifles. Crafted like famous guns used by troops and law enforcement agencies. Its accuracy is matched only by its handsome and unique appearance. Features floating bolt action with automatic recoil ejection for rapid load and fire. (Shoots .22 long Rifles only.) Has 18" barrel with deep blued finish, beautiful hardwood stock, built-in storage case holds 100 cartridges. Has finger-fitting double hand grips. Fast, easy take-down. Notched, adjustable rear sight. A real firearms bargain. Ten days free trial with 100% satisfaction guaranteed or money refunded. Shipped F.O.B. San Gabriel. Adults only. State age. **TO ORDER**, send \$19.95 in check, cash, or money order to: **WHOLESALE IMPORT CO., Box 15-E, San Gabriel, California.**

SAY YOU SAW IT IN POPULAR MECHANICS

EARN UP TO \$5 AN HOUR SPARE TIME WHILE TRAINING FOR A FULL-TIME JOB



Thousands of mechanics are needed! They earn big pay, enjoy lifetime security. Learn at home in months the new, easy CTI Shop-Method way. In weeks, you can repair cars for friends, or work spare time in a shop—get practical experience and earn extra dollars!

I TRAIN YOU AT HOME IN **AUTO MECHANICS**

I Send Tools and Tune-up Kit



You start on repair jobs quick. I send you a set of mechanic's tools and a trouble-shooting

R. C. Anderson Tune-Up Kit. Kit includes Compression Tester, Ignition Timing Light, Vacuum Gauge & Fuel Pump Tester—a CTI exclusive!



PLUS DIESEL OR BODY REPAIR

Full training on Automatic Transmissions included. You also get Diesel or Body-Fender Repair instruction if desired. I send more kits, more training. Act now.



FREE BOOK—MAIL COUPON

**COMMERCIAL TRADES INSTITUTE**

1400 Greenleaf Ave., Chicago 26, Ill. Dept. A-115

Send me your new, big FREE book which tells me how I can train at home to make big money in the automotive field.

Name \_\_\_\_\_ Age \_\_\_\_\_

Address \_\_\_\_\_

City \_\_\_\_\_ Zone \_\_\_\_\_ State \_\_\_\_\_

MEMBER, NATIONAL HOME STUDY COUNCIL

## LEARN TV in KC

UNIVERSAL TV FAMOUS FOR 24 YEARS  
1,000's OF SUCCESSFUL GRADS COAST TO COAST



Easy, quick, fascinating. Learn TELEVISION in 36 short weeks of enjoyable companionship in shop training. Wonderful job opportunities. Graduates have choice of many jobs or can establish their own TV repair shop. YOU CAN START EARNING AS MUCH AS \$150 PER WEEK. NO limit as time goes on. U.T.S. is an old established school (TV exclusive for 24 years) staffed by expert instructors, headed by one of America's first TV broadcasters. Costs so little to prepare yourself for life. No previous experience needed. Fully approved for Korean Veterans. Also fully approved course in color TV (1st in US). Send coupon now for FREE book on TV Electronic opportunities.

WRITE FOR **FREE CATALOG**

FILL OUT COUPON

UNIVERSAL TV SCHOOL  
1220M Admiral Boulevard, Kansas City, Missouri

PLEASE SEND ME INFORMATION FREE

Name \_\_\_\_\_ Age \_\_\_\_\_

Address \_\_\_\_\_

City \_\_\_\_\_ State \_\_\_\_\_

Check here if Korean Veteran

## TRAINED MEN NEEDED

### BIG PAY—GOOD FUTURE

- TELEVISION       ELECTRONICS  
 DIESEL             AUTO

WHY WORK FOR LOW PAY or risk being out of a job??? Usually the properly trained man has a steady job... through good times or bad. Even back during DEPRESSION there was a big demand for Bailey Trained men.

In only 5½ to 6 months we can train YOU to enter one of the big pay fields!

No previous experience or special education necessary. With our method of training you do not spend years pouring over books, figures, charts and graphs. You learn by rebuilding, repairing, testing and operating the most modern equipment, under the guidance of experienced, courteous and friendly instructors. This method of training gives you the experience and confidence required to step right into the big pay jobs without spending years as a mechanic's helper.

It's EASIER and COSTS LESS than you may think to get this residence shop training... we help you find part-time jobs while in school—full-time jobs after graduation. Check subject above in which you are interested and mail for complete information.

### BAILEY Technical SCHOOLS

Veteran Approved

1634 S. Grand      St. Louis 4, Mo.

NAME.....AGE.....  
 STREET.....  
 TOWN.....ZONE.....STATE.....

SAY YOU SAW IT IN  
 POPULAR MECHANICS

## WHAT TREASURES WILL YOU FIND?



**Exciting Treasure Hunt!** This big cloth bag contains over 1,000 genuine foreign postage stamps from more than 30 countries in far-away Africa, Asia, Europe, Australia, the South Seas, etc. Stamps are mostly still on paper, unpicked, unsorted, weighed out in bulk, just as received from foreign missionaries, banks, etc. Nobody knows what's inside! Worth \$10.00 or more at Standard Catalog prices. Money-back guarantee.

Only \$1.00 Post-Paid

H. E. HARRIS & CO., 1870 Transit Bldg., Boston 17, Mass.

## AMMUNITION



for a fraction of regular cost

Reload a whole carton for the cost of a few rounds of factory ammunition. Shotgun shells, rifle and pistol cartridges can be reloaded safely and easily with an inexpensive set of famous IDEAL Reloading Tools. 164 page IDEAL Reloaders Handbook... \$1.00, post-paid. Free folder on request.

**THE LYMAN GUN SIGHT CORP.**  
 MIDDLEFIELD, CONN.

## PUT YOURSELF IN BUSINESS

With Our Newest, Biggest NAME BRAND MERCHANDISE **FREE JUST OUT**  
 Housewares, gifts, jewelry, power tools, tableware, appliances, watches, etc. No investment. **BE READY FOR THE XMAS RUSH!** NEW '56 Jumbo Catalog. Bigger than ever. Impart space for your name, plus private price list too. Fully illustrated.

Plenty Of Profit... Simple To Sell

## HELPFUL BOOKS

Send post card asking for FREE catalog  
 Popular Mechanics Press, 200 E. Ontario, Dept. 601, Chicago 11

## ELECTRIFY your SEWING MACHINE

NEW LOW PRICE! \$9.95 90 DAY GUARANTEE

Buy direct from manufacturer and save! Kit comes fully wired, installed in a jiffy. Fits all machines! You get **ALL-NEW PARTS**

- Motor & Bracket
- AC-DC 115v 60c
- Multi-speed foot control
- Cord set & block
- Easy instructions
- Steel pulley & belt

**ONE MONTH SPECIAL!**  
 Reg. \$7.95 Pinking Shears  
 Only \$1.00 with kit!

**10 DAY FREE TRIAL—ORDER NOW!**  
**FREE—REG. \$2.95 SEW-LITE GIVEN WITH KIT!**  
 Send no money, pay COD or send money order and we'll pay postage. Please state whether wheel on your machine turns toward you or away from you. Shipping wt. 6 lbs.

**SENIOR SEWING MACHINE CO.**  
 Box 142 Dept. PM02 Brooklyn 6, N. Y.

## HUNTERS! CONFISCATED RUSSIAN RIFLES

\$14.50



**G-SHOT MAGAZINE** This is the late Russian Model 7.62 MM Mosin Rifle, approx. 30" barrel. Mechanically perfect. Outside: good. Bore: fair. Ballistics 2820 F.P.S. with 150 grain bullet. Ammunition available everywhere in U. S., an excellent hunting cartridge. Hinged floor plate. Russian ordnance marks on receiver. The Russians won the International Meet in Venezuela (1934) with this model rifle. These guns were confiscated from Communist revolutionaries and placed on the free world market. They are of the type used by Red Chinese in Korea. The sale of these guns in no way aids any country behind the iron curtain. A Once-in-A-Lifetime collector's item. This is the lowest price we have ever seen which would allow a man to equip himself for big game hunting. **RUSSIAN RIFLE AMMUNITION FREE.** 20 rds. full jacketed ammunition included with each rifle purchase. Additional cartridges: \$7.50 per 100 rds. For C.O.D. send \$5 deposit. All shipments F.O.B. Pasadena, Calif. residents add 3% state tax.

**GOLDEN STATE ARMS CORP.** 77 Armory Bldg., 1165 E. Colorado St., Pasadena 1, Calif.

# CHEMISTRY



## BIG LABORATORY GIVEN FREE!

Are you looking for a **WONDERFUL FUTURE** that can start at home right now? The **NATIONAL SCHOOL OF CHEMISTRY** offers a fascinating correspondence course in **PRACTICAL CHEMISTRY** which will give you a wonderful education that can be used almost immediately to increase your income and your position in life, with prospects of a **GLORIOUS FUTURE!**

The course is very **THOROUGH**, yet specially prepared to be easy to all regardless of lack of previous training. Very little theory... this is a **PRACTICAL** course with **HUNDREDS** of fascinating **EXPERIMENTS** and valuable **FORMULAS!** Students learn, almost from the start, how to make chemicals and chemical products of commercial value, how to convert wastes into money, etc. **THERE IS A GOLD MINE IN CHEMISTRY!** Why not share in it? We will open your eyes to **GOLDEN OPPORTUNITIES** you've never dreamed of; for this is a **GOLDEN AGE** for those who possess special **KNOWLEDGE!** An extensive laboratory of chemicals and equipment is included with the course at no extra cost! Just send 25c for your first lesson and **CHEMICAL KIT!** full details will be included. If you send \$1.00 we will send first 3 lessons and supplies, including "How To Make 100 New Chemicals." Absolutely no obligation! **START YOUR NEW CAREER TODAY!**

**FREE!**

**URANIUM TESTER** (ideal for field trips and **CHEMICAL PUZZLE** (worth \$2.50) both **FREE** with dollar outfit!

**NATIONAL SCHOOL OF CHEMISTRY**

POST OFFICE BOX 806-A • REDWOOD CITY, CALIFORNIA

## HELPFUL BOOKS

Send post card asking for **FREE** catalog

Popular Mechanics Press, 200 E. Ontario, Dept. 601, Chicago 11



**EARN UP TO \$100.00 PER WEEK IN YOUR SPARE TIME!**

**TEACH OTHERS TO DRIVE SAFELY...**

Earn extra money at the standard rate of \$5.00 per hour... working with Safety and Public officials with this new, specially designed **PORTABLE DUAL CONTROL!** Fits almost all late model cars... installed or removed in minutes. Millions learn to drive every year... you can teach them, safely, and earn up to \$175.00 per week full time with the **PORTABLE DUAL CONTROL**... order yours today, start earning money immediately!

For Cars with **STANDARD TRANSMISSIONS** \$30.00

For Cars with **AUTOMATIC TRANSMISSIONS** \$25.00

SPECIFY YEAR, MAKE AND MODEL



INCLUDED—FREE OF CHARGE—OUR FAMOUS COURSE "How To Be A Successful Driver-Training Instructor"

Send Check, Money Order, F.O.B. Detroit  
Portable Dual Controls, Inc., Box 82, Detroit 31, Michigan

NOVEMBER 1955



Easy as A-B-C



## Be Your Own MUSIC Teacher

PLAY ANY INSTRUMENT

LEARN AT HOME THIS QUICK MONEY-SAVING WAY

Simple as A-B-C. Your lessons consist of real selections, instead of tiresome exercises. You read real notes—no "numbers" or trick music. Some of our 900,000 students are band **LEADERS**. Everything is in print and pictures. First you are told what to do. Then a picture shows you how. Then you play it yourself and hear how it sounds. Soon you are playing your favorite music.

**STOP CHEATING YOURSELF OF THESE JOYS!**

Popularity! New friends. Gay parties. Good times. Career. Extra Money. Understand, appreciate and converse about music. Learn lives and compositions of modern and great masters... Relax! Banish worries and frustrations. Satisfy self-expression, creative urge. Gain self-confidence.

Mail coupon for Free 30-page illustrated book. Mention your favorite instrument. **U. S. SCHOOL OF MUSIC, Studio A3011, Port Washington, New York.**

**FREE BOOKLET**

**U. S. SCHOOL OF MUSIC, Studio A3011, Port Washington, N. Y.**

Please send me your **FREE** 30-page illustrated book. I would like to play (Name Instrument).

Instrument \_\_\_\_\_ Have you \_\_\_\_\_  
Instrument?

Name \_\_\_\_\_ (Please Print)

Address \_\_\_\_\_

Be a better-educated man

## BE A BETTER MAN

It's a fact. The more education you have the better job you get, the better pay you earn, the better you live. Start now to —



L. C. Lane, B.S., M.A.  
President, National Home Study School

### FINISH YOUR HIGH SCHOOL EDUCATION AT HOME

Complete 4-year course in 2 years or less

No interference with your job or social life.

Study in spare time with textbooks and modern study aids I send you.

Special Business, Mathematics, Agriculture, Industrial courses also offered.

Full credit for any high school work completed elsewhere. Start where you left off.

You get standard textbooks, Study Guides, and these **Modern Study Aids**—projector and filmstrips, phonograph and records, complete science laboratory kits.

**NATIONAL HOME STUDY SCHOOL**

50 East 19th Street, New York 3, N. Y.

Chartered by Board of Regents, University of State of N. Y.

Licensed by the State of New York

Send today for my new **FREE** catalog and sample Home Study Lesson.

**MAIL THIS COUPON TODAY!**

Mr. Leonard C. Lane, President  
NATIONAL HOME STUDY SCHOOL  
Dept. NY-11, 50 East 19th Street, New York 3, N. Y.

Dear Mr. Lane: Please send your new **FREE** CATALOG with information on High School and special Job-Training courses and **FREE** SAMPLE LESSON. I understand I am not obligated and no salesman will call.

Print Name \_\_\_\_\_ Age \_\_\_\_\_

Address \_\_\_\_\_

City \_\_\_\_\_ Zone \_\_\_\_\_ State \_\_\_\_\_

**NO SALESMAN WILL CALL!**

49

# TERRIFIC



# Sale!

**BRAND NEW  
16 X 50  
NOW \$39.95**



These "Whisper weight" 16 Power binoculars regularly sell for \$69.50. However, volume Christmas purchasers have literally reduced our costs and we are, for **THIS CHRISTMAS SALE ONLY**, passing on this saving of almost \$30.00 to you. Perfectly balanced and therefore Easy to Hold and Easy to Focus. Water-Dust resistant. 2" wide objectives assure greater illumination and brighter, sharper images. 7" high. Weighs only 27 ounces! An ideal gift for those who want Greater Power.

**RETURN IMMEDIATELY AFTER CHRISTMAS FOR REFUND IN FULL. GUARANTEE.** We know UNITED gift glasses will please even the most discriminating person. To prove our belief, we will accept all binoculars advertised here for a full refund if returned immediately after Christmas!



**7 X 35  
REGULARLY \$28.95  
NOW \$21.95**

Brand new glasses. The "Aristocrat," in its short period it has been on the market, has met national acclaim. It's an all weather performer with newest streamlined design, perfectly balanced, for ease of operation. Weighs only 20 ounces! Only 5 1/2" high! Provides brilliant, sharp images for day or night viewing! Increased sales have lowered production costs and we are passing on this \$7.00 savings to you for **THIS SALE ONLY!**

Same Day AIR MAIL SHIPMENT Add \$2.00—7 X 35; \$3.00—10 X 50. Made in Japan. Leather case, straps included. Add 10% Fed. Tax. Cash orders prepaid. C.O.D.'s require \$2.00 deposit. **UNITED BINOCULAR CO.,** Dept. ARF-9708, 9043 S. Western Ave., Chicago 20. **DEALERS WANTED.**

## ENGINEERING DEGREE IN 27 MONTHS

**Big Demand for Graduates**

**Aeronautical, Chemical, Civil, Electrical, Mechanical and Electronic Engineering (inc. Radio and TV)**

Hundreds of young men are earning B. S. **ENGINEERING DEGREES** annually in this recognized institution — year around operation. New terms start quarterly. Many students earn a major part of their college expenses in this large industrial center.

Low tuition. Competent instruction. Thorough, intense practical program. Modern, well-equipped laboratories including new physics laboratory and modern wind tunnel. Individualized instruction emphasized.

Government approved for G.I.'s. Engineering preparatory courses. Students from 48 states and 21 foreign countries. Enter December, March, June and September. Send coupon for free catalog and full information. Enroll now.

### INDIANA TECHNICAL COLLEGE

5115 E. Washington Boulevard, Fort Wayne 2, Indiana

Please send me free information on B.S. Engineering Degree in 27 months as checked.

- Aeronautical,  Chemical,  Civil,  Electrical,  Mechanical,  Electronics

Name \_\_\_\_\_

Address \_\_\_\_\_

## TO SELL • TO MARKET YOU MUST ADVERTISE

**PROVEN**

To prosper ALL products or services must be known. Only Advertising can do this.

At a moderate cost we will handle your complete problem. Without obligation write us your problem.

PACKAGE DESIGNS  
DIRECT MAIL ADV.  
ADV. ART.  
POSTERS

**Rieser & Rieser Advertising Associates**  
2119 Pine St., Philadelphia 3, Pa.

### WARN HUBS



### AUTOMATICALLY FREE-WHEEL 4-W.D.s. IN 2-WHEEL DRIVE

Free-wheeling 2-wheel drive stops front end drag! Cuts front end repairs 50% or more, saves gas, tires; gives amazing pep, performance, handling ease to 4 W.D.s! Warn Automatics engage or disengage front power train as you shift into 4-wheel drive, or out for fast, economical free-wheeling 2-wheel drive use. Automatics only also permit high speed driving in 4-wheel drive. Warn Automatic and Locking models for Willys factory approved, sold only by Willys dealers worldwide. Over 75,000 sets in use around the world. Models for other 4 W. Ds. at dealers or writers.

**RUGGED DESIGN PROVEN IN USE**  
**WARN MFG. CO.,** Riverton Box 6064-A7, Seattle 88, Wash.

## JEEP OWNERS

STA. WAGONS • JEEPSTERS • PICK-UPS /

Take full advantage of 4-wheel drive by installing a Ford V-8 engine — **MORE POWER**—steads less shifting, better traction at lower speeds, greater safety, plenty of power in high. All this is now possible by using our F-J adaptor plate. Conversion Kit \$43.25 incl. **FED. TAX.** Please indicate year of engine you will use and whether 2 or 4 wheel drive. Write for free details or send check or M.O. for prepaid delivery. Order now for early shipment.

**HOOSIER MACHINE PRODUCTS CO.**  
312 S.E. 6th St. Pendleton, Oregon



### LEARN MODERN WATCH AND CLOCK REPAIRING Complete Course—Only \$5.95

At home, spare time. Good field now... security and contentment in future. Start part-time business and **EARN** while you learn. Horology is precision instrument work... a great and growing field, seasonal opportunities. Easy self-instruction course. Full price, only \$5.95. **SEND NO MONEY.** Just pay postman, plus C.O.D. postage. Or send \$5.95 with order, we'll ship postpaid. Satisfaction guaranteed or refund. **NELSON-HALL CO.,** 210 S. Clinton St., Dept. 31V-2, Chicago 6, Ill.

### ROLLER RULE "PENCIL WITH A BRAIN"

Precision made, accurate, handy. Hold it over any surface. Measures curves and straight lines, any shape, any distance. Excellent pencil too.



**\$1.49**  
A must for architects, engineers, carpenters, plumbers, painters, students, pilots, navigators, etc. Available in inch or nautical measurements. Specify choice. **"IN ATTRACTIVE GIFT BOX"**  
**ROLLER RULE MFG. CO.**  
1319 Gaviola Ave. Long Beach 13, Calif.

### WHAM-O SPORTSMAN

**HITS LIKE A RIFLE—KILLS RABBITS, SQUIRRELS.** Powerful, silent, accurate. For hunting, target, routing pests. Sportsman's choice sold world over!  
**HUNTING SLINGSHOT**  
Heavy duty 7" oak stock. 40 steel balls, extra rubber target. **GUARANTEED. \*Professional model of Nat'l Slingshot Assn.** If your sporting goods dealer can't supply you, send \$1.50 to **Wham-O Mfg. Co. BOX B45 San Gabriel, Calif.**



Cannot channel



Easy to clean



Filters out all dirt



Traps moisture



Never needs replacing



Reduces friction

# End Filter Replacement FOREVER!

with Revolutionary New Type

## Micro BRONZE OIL FILTER



Increases engine life



Saves detergents



Unaffected by pressure



Screens out abrasives



Efficient at all temperatures



Fits all cars



Eliminates acid

1. Eliminates Engine Acids
2. Traps Damaging Moisture
3. Filters all the Dirt
4. Reduces Friction
5. Saves the Detergents



U. S. Patent App.  
No. 464498

**WHY GIVE YOUR ENGINE HALF-WAY PROTECTION?** The Micro Bronze permanent all-metal filter with the built-in acid neutralizer is the world's first filter that guards against all five engine enemies: Acids, abrasives, friction, moisture and sludge.

Made of solid but porous everlasting sintered bronze, the Micro Bronze Filter screens out all particles of dirt and abrasives larger than .00023 inch in size (so small you could put a thousand of them on the head of a pin!). The Micro Bronze positively cannot channel or blow up... operates efficiently at all temperatures... never wears out, never needs replacing, merely occasional cleaning.

**SAVES OIL CHANGES... SAVES DETERGENTS.** Your oil is good for at least 10,000 miles with a Micro Bronze Filter. All the valuable additives are kept in, not soaked up and wasted by the filter. You never need buy another replacement pack as long as you live! Used with modern detergent oils, Micro Bronze will add thousands of miles to engine life, help prevent loss of engine power, save costly oil changes, pack replacements and engine overhauls!

**DOES YOUR PRESENT FILTER PASS THE "ACID" TEST?** If you have a Micro Bronze Filter with the built-in Acid Neutralizer your engine is getting the full protection it needs! In a simple test you can easily make yourself, the Micro Bronze special element completely neutralizes acids in 60 seconds!

**BUILT-IN ACID NEUTRALIZER!**

**THE SINTERED METALS SECRET...** Before World War II, the Germans discovered how to fuse microscopic balls of metal into solid but porous form. Following the war, this secret was made available to American industry and we've developed it for Micro Bronze Filters. This is a magnification of the filter wall.

**NO EXTRA COST FOR FULL FLOW MODELS!**

**FITS EVERY CAR & LIGHT TRUCK.** A Micro Bronze Unit costs only \$6.95, including all full-flow models. Easy to install, never needs changing. Micro Bronze Filter Housing \$9.95 for all cars with no filter equipment (does not include element). Use the easy-order coupon now.

**Micro BRONZE FILTER CORP.**

11766 W. Pico Blvd., Los Angeles 64, Calif.  
Cable Address: MICRONZE

**FILTERS THE DIRT BUT NOT THE DETERGENTS**

Micro Bronze Filter Corp. Dept. PM-115  
11766 W. Pico Blvd., Los Angeles 64, Calif.

Please ship the following at once

- Conversion unit \$6.95 (including all full-flow models)
- Micro Bronze Housing Unit (Needed where car does not now have filter) \$9.95 (does not include element)

Enclosed is \$\_\_\_\_\_ full price. Factory pays all shipping costs to your door.

MAKE, MODEL & YEAR CAR \_\_\_\_\_

NAME \_\_\_\_\_

ADDRESS \_\_\_\_\_

CITY \_\_\_\_\_ ZONE \_\_\_\_\_ STATE \_\_\_\_\_

### DISTRIBUTORS WANTED

We are receiving orders from all over the world for the amazing Micro Bronze Filter, and are setting up exclusive distributorships to handle our rapidly growing dealer organization. Write, wire or phone.

# BECOME AN Electrical Engineer



- Major in Electronics or Power
- Earn B. S. Degree in 36 Months

Over 50% of the nation's industrial leaders began their careers with engineering training. Prepare now for a rewarding future as an Electrical Engineer or Engineering Technician. Enroll at the Milwaukee School of Engineering.

## Plan Your Career—Eight Courses Give You Wide Range of Study

### ENGINEERING COURSES

Electrical Engineering-Bachelor of Science Degree  
Save a valuable year through optional year 'round study.  
Electronics major ..... 36 months  
Power major ..... 36 months

### TECHNICIAN COURSES

Electro Technician ..... 12 months  
Electronic Technician ..... 12 months  
Radio Technician ..... 12 months  
Radio and Television Technician ..... 18 months

### SERVICE COURSES

Electrical Service ..... 6 months  
Radio and Television Service ..... 12 months

### MECHANICAL TECHNOLOGY COURSES

— Also available, Service and Technician courses 6 to 18 months — Heating, Refrigeration, Welding, Air Conditioning and Mechanical — B.S. Degree in Mechanical Engineering with a major in Design, Metal Fabrication, or Plant Engineering. Also, general 3-month preparatory course.

Terms open January, April, July, September  
Prior Military, Practical or Academic training evaluated for advanced credit. Faculty of specialists. 50,000 former students. Annual enrollment from 48 states and 23 overseas countries. 52nd year. Non-profit. Residence courses only. Send handy coupon today.

MS-11A



## MILWAUKEE

## SCHOOL OF ENGINEERING

MILWAUKEE SCHOOL OF ENGINEERING  
Dept. PM-1155, 1025 Milwaukee St., Milwaukee, Wis.

Send five illustrated career booklets  Electrical Technology  Mechanical Technology  Radio-Television.

I am interested in..... (name of course)

Name.....

Address.....

City..... Zone..... State.....

If veteran, indicate date of discharge.....

## Paint STRIPES with New "PAINT PEN"!

### Straight, Curved or Parallel Lines

Use like a fountain pen with any color paint to stripe furniture, bikes, autos, model planes, toys, linoleum, wall board. Beautiful clean, crisp results every time. Can't clog or smear. Also use with glue, tempera, textile paint or ceramic under glaze. Paints on wood, glass, plastic, metals, fabrics and paper. Tool complete with tip for 1/16" stripe only \$1.00 postpaid. Other complete tools with following tips, 1/64", 1/32", 3/64", 5/64", 3/32", 5/16" — \$1.50 each. Extra tips 15c each. Entire kit with tool and 7 tips — \$5.00. A 1/4" tip only \$1 each. COD's postage collect.

New! "DOUBLE-STRIPES" 5 Way Combination Model only \$2.95

Double Stripes — one wide and one narrow or two wide or two narrow at the same time.

FREE — Send postcard for complete information \$2.95 — or ORDER NOW...

WENDELL MFG. CO., Dept. 311  
4234 Lincoln Ave., Chicago 18, Ill.

\$7.00

DEALERS: Master Paint Stripping Tool in display cartons of 1 doz. FAST, Profitable seller. Write for discounts.

HOME CRAFTSMEN! New Paint Stripping Tool gives "professional" results every time, simple, easy to use. Send \$1.00 now.

MANUFACTURERS: Write today for information about industrial and production stripping tools.

## MIRACLE LIQUID CEMENT

MENDS CHINA · WOOD · METAL · GLASS · PAPER · LEATHER · IN A JIFFY!

Amazing, new discovery, E-Z MEND Liquid Cement. Bottle with special applicator brush attached to cap eliminates messy tubes. 1001 uses. Mends most everything but rubber. Works like magic. Send 50c for large 2 oz. size postpaid. You'll never be without it again.

W. COOK & CO. 1614 MORSON ROAD JACKSON 9, MISS.

FREE! 60 APPROVED EXERCISES, 68 PHOTOS with FAMOUS DAN LURIE



## BARBELLS

50 lb. set \$ 8.48 • 100 lb. set \$13.98  
150 lb. set \$20.48 • 200 lb. set \$25.98

SEND FOR FREE CATALOG

Order by mail—50% with order Balance COD. Extra WTS. 13c lb. FOB Plant.

DAN LURIE BARBELL CO.

52M11 Bristol St., Dept. 559L, Brooklyn 12, N.Y.  
SEE DAN ON T V "BIG TOP" SHOW

## WHOLESALE Electric Guitars - Parts - Build Your Own

Solid-body Spanish, amplifiers, double-necks, single-necks, triple-necks, 4-necks, auto-body mandolin, electric violin, pickup mikes, non-electric instruments, etc. 1956 Models wholesale. FREE CATALOG. Free home study course with instruments. Parts & plans available to build your own.

CARVIN CO., Box 287, PM-11, Covina, Calif.

## WHEELS WHEELS WHEELS

7" Disc Wheel 3/4" Tire 1/2" sleeve ..... 45c ea.  
8" Disc Wheel 1 1/8" Tire 1/2" sleeve ..... 70c ea.  
7" Disc Wheel 1" Tire 1/2" ball bearing ..... 80c ea.  
8" Disc Wheel 1 1/8" Tire 1/2" ball bearing ..... \$1.00 ea.  
9" Disc Wheel 1.50 semi-pneum. Tire 1 1/2" S.E. .... \$1.38 ea.  
8" Disc Wheel 2" semi-pneum. T. 1 1/2" S.E. .... \$1.50 ea.  
10" Disc Wheel 1.75 semi-pneum. T. 1 1/2" S.E. .... \$1.80 ea.  
10" Disc Wheel 2.75 semi-pneum. Tire 1 1/2" S.E. .... \$2.50 ea.  
12" Disc Wheel 1.75 semi-pneum. T. 1 1/2" S.E. .... \$1.88 ea.

Above wheel prices include hub cap. Plus Postage, C.O.D.'s accepted. AXLES—Sizes 1/16 lb., 3/8 lb., 1/2 lb.—Cut to size—End holes drilled.

UNITED WHEEL STAMPING CO.  
12131 S. PEGRIA STREET PM-11 CHICAGO 43, ILLINOIS

## A MUST FOR URANIUM PROSPECTORS!

The Radioactive CALTRON Standard  
A convenient, pocket-size radioactive source for testing and standardizing operation of geiger counters and scintillometers.

MODEL X-1 (Regular)

Check Equipment Regularly

MODEL X-2.5 (Professional)

Only \$1.00

DON'T PASS UP \$ MILLIONS!

Only \$2.50

100 millimicrogram radium source encased in plastic disc—shows if any counter is working. Instructions included.

100% SAFE—1000's in Use! No C.O.D. Send Check or M.O.  
CALTRON LABS  
P. O. Box 88 • Dept. PM-11  
Overland Park, Kansas

Duplex calibrated plastic encased radium source—mr/hr ratings stamped in. High level reading on face, low level on back.

ORDER YOURS TODAY!

MAKES A FINE GIFT!

WORLD'S  
BEST  
WANT-AD  
MEDIUM

# CLASSIFIED ADVERTISEMENTS



Advertisements in this section \$1.00 per word, each insertion, minimum 10 words, payable in advance.

To be inserted under proper classification, copy must be in our office the

20th of the second month preceding date of issue

F. W. Johnson, Manager, Classified Advertising

Popular Mechanics Magazine, 200 East Ontario Street, Chicago 11, Illinois

## YOU'LL PROFIT

By reading and answering the classified ads in this section. Hundreds of opportunities for you to make and save money

### AUTOMOBILES, MIDGET CARS

**BUILD** Midget auto. Complete drawings, pictures and list of parts \$1.00. Lee's Midget Autos, Box 82, Avila, California.

**FREE** Motor magazines; automobile literature, old, new and foreign; glossy photos, dealer books, shop manuals—Offered with non-profit organization. Write today; get on free mailing list. Auto Maniacs, Stockbridge, Mich.

**1956 PONTIACS** By mail. Buy 1 or 20. Save 26%! Write for factory prices. Pontiac Fleet Sales, Box 45144M, Airport Station, Los Angeles.

**BOYS' Power-driven auto.** Build your own. Plans 25 cents. Sypher Co., Box 39, Sta. F., Toledo, Ohio.

**ANTIQUA** Automobile color slides, 2x2. Illustrated catalog free. Universal, Box 779A, Beverly Hills, Calif.

### AUTO SUPPLIES AND EQUIPMENT

**AMAZING** Discovery. Saves gas, increases power, compression. Cuts oil, repairs. Guaranteed. Lachapelle's (patented) motor treatment. \$3.00 delivered. If dissatisfied, money refunded. Agents wanted. Free circular. Joe Dillon, Authorized Warehouse, Agents Distributor, Box 32314, Bridgeport, Ohio.

**SENSATIONAL** GE-Subzero automobile engine heater starts coldest cars, trucks, tractors immediately. Special \$3.55 (regularly \$8.95). Order for yourself, sell others locally and mailorder. Huge profits. Terrific quantity discounts. Act now! Wisniewski Inc., Milwaukee 7, Wisconsin.

**GMT-110** Discarded injector. Parts wanted. Bonus on HV. Buescher, 7120 Carnegie, Cleveland 3, Ohio.

**MANUFACTURE!** Sell your products right-away! Complete instructions. Free booklet. Jarry, 268-BA, New York City 5.

**MOTORIST**—Keep foreign matters out of your engine. Insert magnetic disk \$1.50. Art & George Co., 5170 No. Hollywood Avenue, Milwaukee 17, Wisconsin.

**SUPERCARGE** Your motor for outstanding performance and economy with sensational Superjet carburetor valve. Money back guarantee. Only \$3.95 ppd. Ericson Products, 11365 Matteson Avenue, Dept. PM-11, Los Angeles 66, California.

"PLEASE Clean my windshield." New gas cap and vent window decals remind station attendants who often neglect. 50c pair. Order today. Jay-D-Cal, 682 Cecil, Louisville 11, Kentucky.

**MOTORIST** Save gasoline Vacuumating overhitch mixtures. For free particulars, how you install on your car for introducing, write Vacuumatic, Dept. 2122, Wauwatosa, Wis. Salesmen wanted.

**JEOP Owners**—V8 power. Read Jeep owners ad, page 50.

**LATEST** Custom accessories. Items not in stores. New low prices. Continental tire kits, push-button doors, trunks, etc. New illustrated catalog, biggest ever, 25c. Eastern Auto, 3319-A South Grand, Los Angeles 7, California.

**NYLON** Auto safety belts. C.A.A. approved. Installs in any car. Highest quality. Any color. \$3.95. Lloyd, 806 Spencer, Aurora, Illinois.

**AUTO** Accessory and parts catalog. 1956 edition—All new! 184 pages. Save up to 50%—Over 50,000 items, including Hollywood accessories, hi-speed equipment, rebuilt engines, all parts and accessories for all cars and trucks; Hard-to-get parts! Send 25c (refundable). J. C. Whitney, 1919-PM Archer, Chicago 16, Illinois.

**CHEVROLET** Horsepower, Offenhauser accessories, Zephyr-type transmission gears. Send for free literature. Offenhauser Equipment Corp., Box 32218, Los Angeles 32, California.

**MILE-O-DIAL** Tells mileage obtained at a glance. Sample 25c postpaid. Agents wanted. Kenway Products, 757 No. Milwaukee St., Milwaukee 2, Wisconsin.

**AUTO** Safety belts, \$8.95 ea. Phillip's Equipment, 27 Crannell Ave., Delmar, New York.

**BUY** Wholesale—Install your own auto safety belt to exceed aircraft standards. The same approved aircraft buckle and attractive nylon webbing used in most state police cars. Beautiful maroon, green, grey. Regularly \$9.95, wholesale price \$5.95. Send \$2.00, balance c.o.d. Rodman Aircraft, Box 912, Boise, Idaho.

**BUY** Wholesale nationally advertised auto supply, thousands of other products at big discount. Free "Wholesale Plan." American Buyers, Hertel Station, Buffalo 16-G, N. Y.

**LACHAPELLE'S** 100,000 Miles treatment, for \$3.00, makes any gasoline motor better. Ferns Products, Box 71827, Los Angeles 1, Calif.; in Canada, Master, Box 216, Wellingford, Ontario.

**HORSEPOWER** By Offenhauser, send 25c for latest catalog. Offenhauser Equipment Corp., Box 32218, Los Angeles 32, California.

**AMAZING** Fiberglass! Repair anything! Save time—Money on hundreds of car, home repairs. Kit "A" (144 sq. in.) \$1.98; kit "B" (432 sq. in.) \$4.95 post-paid. At your auto store, or order direct. Illustrated booklet, 10c to cover handling. Schramm, 5434-A Higgins, Chicago 30.

**WHY** Die? Free auto safety belt literature. Lifesaving Products Co., Box 8076 Northgate Station, Seattle, Wash.

**MUFFLERS** Replaced easily with new specially designed tools. Free literature. Becker, 259 Oakdale, Akron, Ohio.

**CAR** Burning oil? Losing compression? Try Clifford's Compression Seal, Tube, \$2 postpaid. Clifford's Engineering, 452 Claim, Aurora, Illinois.

**ELECTROPLATE** Auto parts, novelties, mirrors. Easy, inexpensive home processes. Free booklet. Tyco Metals, Box 13231-BG, Houston 19, Texas.

**FORD** T parts? Try best source old car parts anywhere. Wisneski, Milwaukee 7, Wis.

**FREE** Discount catalog—Speed, power, custom equipment. Almqvist Engineering, Milford TP, Pennsylvania.

**NEW** And used parts at savings. Complete guaranteed parts service for all models cars and trucks, 1924 and later. Largest in the West. Army parts specialists. No catalog, write for quotations. Fast mail order service. Pioneer Auto and Truck Parts Co., 734 W. 13th Avenue, Denver, Colorado.

### AUTO TRAILERS

**EXCEPTIONAL** Expanding eight foot trailer. Accommodates family of five. Build yourself. Literature 10c. Framar Company, Wilmington, Mass.

**BUILD** Your own trailer! Plans for all kinds. Illustrated catalog 10c. Jim Dandy, 125-M, Wausau, Wisconsin.

**TRAILER** Parts catalog. Largest in mid-west. Send 25c. Refundable. Hanna Trailer Supply, 615 West Layton, Milwaukee, Wis., Dept. M.P.

### MOTORCYCLES, BICYCLES, MOTORSCOOTERS AND SUPPLIES

**MOTORBIKE** Engine \$7.50, Cushman motorscooter \$30, midget car, less engine \$18, engines \$5 up. (Mailorder only.) Send 25c (35c for first class mail) for new directory-catalogue Number 68, listing the above and hundreds of other bargains in new and used midget cars, motorscooters, home builders parts, plans, etc. Midget Motors Directory, Athens, Ohio.

**HARLEY-Davidsons**—America's finest used bargains! We pay shipping on motorcycles. Genuine new, used parts, accessories for current and obsolete models. Send 25c for bulletin, catalog. Knuth's (factory dealer), 1753 Muskego, Milwaukee, Wis.

**RECONDITIONED** Motorcycles and motors. Chromium accessories. Complete stock Indian parts. Expert rebuilding. Fast service. Indian Motorcycle Sales, Kansas City 27, Missouri.

### AVIATION

**AIRLINE** Steward-purser. Fly 85 hours monthly. Starting salary \$235 up. G.I. approved. Free catalog. Air-Purser School, Room 1, 1050 Nicollet Ave., Minneapolis, Minnesota.

**AMAZING.** New four-bladed boomerang, designed by aircraft engineer, soars to great heights and returns. Fascinates young and old. \$2 postpaid. American Boomerang Co., P.O. Box 521, Boulder City, Nevada.

**CYCLIC** Propulsion, latest jet propulsion system for boats and low velocity vehicles. Details \$1.00. Decker Engine Works, Plasterco, Virginia.

**AVIATION** Surplus bargain catalogue. One dime. Box 2271, Thomasville, Penna.

**HELICOPTERS**—1 And 3 man. Aviation marvels. Construct own. Instructions \$3.50, \$6.00 respectively. Mayberry Aircraft, Box 343, St. Clair Shores, Michigan.

SEE Ad under "Personal" for Confederate air force information.

**NEW.** Build the new Towercraft helicopter type glider for \$60. Simplest aircraft ever designed. Complete plans with a large illustrated instruction booklet, \$6. Towercraft Co., P.O. Box 571, Boulder City, Nevada.

**PROPELLERS** Specialty designed for airboats and snow sleds by the world's oldest manufacturer of aircraft propellers. Free literature. Flottorp Mfg. Co., G. R. Airport, Grand Rapids 8, Mich.

**PROPELLERS.** Plans, supplies for airboats, snow sleds. Catalog 10c. Gano Propellers, Box 3284-A, Ft. Worth, Texas.

**BUILD A fast, safe airboat or snow sled** from your 65-200 h.p. aircraft engine. Propellers, plans, supplies. Satisfaction guaranteed. 48 page catalog 25c. Banks-Maxwell Co., Box 3301E, Ft. Worth 5, Texas.

#### BATTERIES, GENERATORS

**EDISON** Nickel storage batteries. Any voltage, any amperage. Unconditionally guaranteed. Power plants, generators, motors. Literature. Hawley Smith Co., Croton Falls 1, N. Y.

#### ELECTRICAL SUPPLIES

**NEW 1955 Lamp parts catalog** showing everything you need to make and repair most types of lamps. Everything at lowest wholesale prices. Send only 25c today for both catalog and wholesale price list. Geason Co., Dept. 563-B11, 27 S. Desplaines, Chicago 6, Ill.

**TELEPHONE** Transmitter. Hand set type. Suitable for inter-house phones, speakers or any communication purpose. Delivered two for \$1.00. No c.o.d.'s. Telephones, Dept. C-225, 1760 Lunt, Chicago 26.

**LAMPS**—25c Brings bargain catalog showing all parts for repairing, building. Contains instructions for electrifying vases, oil lamps, etc. Gyro Lamps, 5402P Clark, Chicago 40.

**ELECTRIC** Pencil: Engraves all metals \$1.50. Beyer Mfg., 10511-H Springfield, Chicago 43.

#### WELDING, SOLDERING, PLATING

**NEW.** Timesaving oxy-acetylene outfit welds, cuts, heats, brazes. Just change tips. Light, compact, portable. Thrifty to operate, ruggedly built. Complete outfit and instructions, only \$76.50. Special economy plan for supplying gas cylinders. Write for free literature: Dept. M, Linde Air Products Company, 30 East 42nd Street, New York 17, N. Y.

**SOLDER** Metal without iron. Four packages \$1 postpaid. Edwards, Box 2750, Hollywood 28, Calif.

**"BUILD-UR-OWN"** a.c. welder and a.c. power plant with a good used engine and low cost Hobart generator. Welds anywhere and supplies 5KW stand-by power for any emergency. Write Hobartweld, Box M-1153, Troy, Ohio.

**A.C. Welders.** 4 sizes. Lowest prices. Free literature. Holzger's Serv., Canton, Kan.

**GUARANTEE** Your white metal welding. Successful procedure \$2.00. Kittell, 1305 S. Western, Tecumseh, Mich.

**BUY Wholesale!** Welding equipment direct from manufacturer. Portable welders, helmets, leads, welding rods. Free factory catalog! LeJay 47, Minneapolis, Minnesota.

**A.C. Welders,** 130 amperes, \$39.50. Morris, 1970 Inner Drive, Schenectady 3, N. Y.

**ACETYLENE** Welding outfits, new \$49.00; used \$29.00; arcwelders \$56.50. Eagle Welding, Dept. PM, 5085 Broadway, Chicago 40, Ill.

**ELECTROPLATING** Equipment, anodes and solutions for all types of plating. Instructions. Assemble your own plater and save. Free catalog. Ramyr, Dept. E-4, 1624 East First Street, Los Angeles 33, California.

#### MACHINERY, TOOLS, SUPPLIES

**LATHE.** Metal turning. English model makers. Catalog. Science Now Company, Catskill, New York.

**VALVE** Seat narrowing and porting tool. Literature free. Lewis Tools, 1621 Rheem, Richmond 5, California.

**MCCULLOCH** Chain saw parts. Special prices on Oregon chain for all makes of saws. Free price lists. Barnett Equipment, So. Glens Falls, N. Y.

**ATTENTION** Foley saw filer owners: An attachment is on the market for sharpening combination circle saws. For information write Reliable Saw Service, 35 South Hudson Street, Westmont, Illinois.

**AIR Compressor.** Build yourself. Circular 10c. Little Machines, Hamilton, Michigan.

**BUILD** Your own tools. 60 page book of drawings and catalog of castings, \$1.00. Casting Specialties Co., Thiensville 11, Wis.

**DRILLS.** Chrome-vanadium. \$6.93 postpaid complete with metal stand. 1/16 through 1/2 by 64ths. Ken-Mar Enterprises, Box 230, Milford, Conn.

**MILLING** Machine: new, complete \$149.50. Southern Machine Tool Co., Conyers 1, Georgia.

**ALLEN** Two ton power bench type punch press. \$97.50. Circular. Allen, Dept. FMB, Clinton, Missouri.

**INSTANT** Change kit, four practical tools for any 1/4" drill motor. Two saws, planer, sander; not gadgets. Free literature. Gehlco Tool Co., Box 323, Independence, Kansas.

#### ENGINES, MOTORS, DYNAMOS

**MOTOR** Bargains, rewinders supplies, instructions. Modern, 507 West 75th, Kansas City 14, Mo.

**NEW** Engines, mowers, motorbikes, Bargains. Loren, Box 436, Danville, Illinois.

**A.C. Generators,** 750 watt \$42.50. Twin cylinder compressors with 1/2 horse \$22.00. Motors 1 horse \$36.50. Butler, 1885 Milwaukee, Chicago 47.

**WINDING** Data. 225 motors, single and three phase, \$1.00. Data Company, Box 7631, Kansas City 28, Mo.

**REWIND** Motors yourself. Complete instructions \$1.00. Lewis Mfg., Howell, Michigan.

#### BOATS, OUTBOARD MOTORS

**TACHOMETER** Electronic, ideal for outboards or inboards, magneto or battery ignition, free literature. Offenhausen Equipment Corp., Box 32218, Los Angeles 32, California.

**BUY** Wholesale nationally advertised outboards, thousands other products at big discount. Free "Wholesale Plan." American Buyers', Hertel Station, Buffalo 16-H, N. Y.

**AIRPLANE** Floats, pontoons. Rubber boats. Catalogue 10c. Box 22F5, Thomasville, Penna.

**AUTOMATIC** Boat bailer \$3.95. Inquiries ans. Vacu-Jet-O, Stradling Road, Muncie, Indiana.

**"OLASBOTE"** Plastic and glass cloth for boat covering. Complete information and material price list free. Buchanan Plastics, 1728 Hamilton Road, Okemos, Michigan.

**MARINE** Conversion, Willys to Cadillac, engines, kits and parts. Catalogue and conversion hints free. Barr Marine, 2706 Castor Avenue, Philadelphia 34, Penna.

**BOAT** Plans, patterns, frame kits. Modern inboards and outboards. 11" x 22" for amateur builders. State requirements or send 40c for complete catalog. Glen Designs, Box 568, Compton, Calif.

**PLYWOOD** Boat plans, 21 for \$1.00. Catalog boat building plans 25c. The Rudder, 15 Murray Street, New York 7.

**CONVERT** Fords and Jeeps to 100% marine engines with Osco's world famous Convo-Kits. Deluxe catalogue 25c (coin). Oscomotors, 2627B Lawrence, Philadelphia 40, Penna.

**FIBERGLAS** Permanent boat waterproofing. Lowest wholesale prices. Guaranteed materials. Easy application. Full instructions. Complete kits, \$12.60 up. Free literature. Ajax Plastics, Dept. PM, P.O. Box 1323, Fort Worth, Texas.

**NEW.** Used, rebuilt marine motors. Marine conversions, fittings. Free catalog. Stokes Marine Supply, Dept. 24, Coldwater, Michigan.

**MARINE** Conversions for Ford and Jeep engines. Catalog 25c. Lehman Manufacturing Company, 972D Broad Street, Newark 2, New Jersey.

**FREE** Catalog! Boat kits, trailers, fiberglass, marine hardware. Lager Industries, Dept. M, 4452 Nicollet, Minneapolis, Minn.

**BOAT** Plans: Welded steel, wood, plywood. Outboards, inboards, cruisers, sail. Free literature, please specify type. John B. Clark, N.A., P.O. Box 51, Bay Village, Ohio.

**FULL** Size, cut-to-shape boat patterns, blueprints, 7 1/2-38 feet. New 1955 illustrated "Build a Boat" catalog of 50 naval architect-designed cruisers, runabouts, sloops, skiffs, outboard boats, sailing, racing, houseboats, 50c. Small boat hardware catalog, \$1.50. Bigger, better 1955 "How to Build Boats" book, \$2.50. Cleveland Boat Blueprint Co., Dept. A-66, Box 1651, Cleveland 4, Ohio.

**SPECIAL** Offer—Trial kit for boat repairs, home repairs. Fiber glass with revolutionary new bonding plastic. Complete information brochure 10c. Adheso Sales Co., P.O. Box 282, Nixon, N. J.

**BOAT** Patterns. Literature and illustrated boat construction book \$1.00. Germain Boat Company, West Saginaw, Mich.

**BUILD** A fast, safe airboat or snow sled from your 65-200 h.p. aircraft engine. Propellers, plans, supplies. Satisfaction guaranteed. 48 page catalog 25c. Banks-Maxwell Co., Box 3301F, Ft. Worth 5, Texas.

**JOHNSON** Outboard specialists. Used parts for all models at substantial savings. Prompt quotations. Specify model serial. Crandall-Hicks, 910 Commonwealth, Boston, Mass.

#### ATHLETIC EQUIPMENT, BODY BUILDING COURSES

**GREAT** Strength easily obtained. Send \$1 for complete arm, chest, and back muscle-building course and apparatus. Noticeable results guaranteed in 7 days or \$1 refunded. Joseph Dryer, Box 3527X, Chicago 80.

**BODY** Builders—Send \$1.00 for my muscle grind method of muscular development. Leonard Austin, The Iowa Strongman, DeSoto, Iowa.

**HANDBALANCING** Self-taught. Write. Power, 923-a W. Vine, Kalamazoo, Mich.

**STRENGTH.** Health, gain, reduce. Any age. Easy! "All You Need is a Rope!" Sensational new discovery. Free details. Roperice, 4834 Art St., Room 101, San Diego 15, California.

**MEN'S** Athletic supporters, form-fitting pouch, S.M.L. \$1.00. Poly Shop, Box 3203, Ft. Worth 5, Texas.

**100 TRICK** Knockouts for self-defense. \$1.00, 1c each. Priest, Box 251, Evanston 1, Illinois.

**FREE** Catalogue, 10c for postage appreciated. Dr. Thompson, 919 Fourth, Manhattan 30, Kansas.

#### SPORTING GOODS, GUNS, FISHING TACKLE, ARCHERY, TRAPPING

**BOW-Hunting** secrets free! New book "How to Hunt with Bow"—100's tips outwitting big, small game, bow-fishing. Revealing "How to Choose Bow" facts. Bargain catalog included. Save 50% finest tackle. All 3 free! Malibu Archery, 1036-RNO La Brea, Los Angeles 19, Calif.

**TRAPPERS** Pack 25c. Subscribe to "National Trappers Digest." America's greatest trapping magazine, \$1.00. Natural color wildlife covers. Mace, West Brooklyn, Ill.

**"HOW** To Raise Red Whopper Worms" for fishing, selling. Instructions \$2.00. Missouri Earthworm Hatchery, Bourbon, Mo.

**FREE** Fishing catalog—132 pages. Over 3000 hard to find fishing specialties. Netcraft Company, Dept. PM11, Toledo 13, Ohio.

**BUY** Wholesale nationally advertised sporting goods, thousands other products at big discount. Free "Wholesale Plan." American Buyers', Hertel Station, Buffalo 16-I, N. Y.

**ACTION** Locate fish. Patented Eyn-Trol \$1.00. Information free. Metzger Sales, 7729 Burnham Ave., Chicago 49, Illinois.

**CHERISHED** Christmas gift. Month fresh water Swiss spinners; special 6 assorted \$4.00. Catalogue, prices. Thebeo, 856, Maywood, N. J.

**TACKLE** Boxes of lifetime cypress. Easy-to-assemble kits or finished. Write for folder. Gulfstream Boat and Tackle Works, 702 Pifer Road, Houston, Texas.

**ARCHER'S** Free new illustrated catalog. Pride Archery Company, R.F.D. #1, Danbury, Connecticut.



**GOVERNMENT** Surplus ammunition—45/70 caliber \$6.50 per hundred; 30 carbine, 30/06 government \$5.95 hundred. Also ammunition, Italian, German, Jap revolvers, rifles. Free list. Hudson, P-52 Warren Street, New York City 7.

**GUNS!** Sportsmen's gun gifts! Bargain catalog 50c. Antique, modern arms, armor, rarities. Agramonte's, 201 Warburton, Yonkers 20, N. Y.

**JEOP Owners**—V8 power. Read Jeep owners ad. Page 50.

**AGENTS**—Sell trophies and sports awards. Liberal commissions. No investment. McWeeny Company, Drawer 87, West Haven, Conn.

**180 PROFUSELY** Illustrated pages antique pistols, swords, daggers, armor, etc. 50c. Robert Abels, M860 Lexington Ave., New York 21.

**TENTS**, Camping equipment. Send 10c for new 1955 100 page tent, camping equipment catalogue—handbook. Moran, 10-31R 50th Avenue, Long Island City 1, N. Y.

**MOLDS**—For making fishermen's sinkers. Free illustrated booklet. Reading Instrument Co., Box 76, Reading, Penna.

**BUY Wholesale!** Guns, fishing, sporting goods. Save 66%! Free catalogs. National Buyers Service, Box 426EC, Oakland, California.

**OLD Guns**. Current prices. Free catalog. Pioneer Books, Harriman, Tennessee.

**5000 BARGAINS**, Firearms, binoculars, war relics. Catalog 50c. Smith Firearms, Runnemede, N. J.

**MOLDS** For fisherman's sinkers, jigs, squids, casting and spinning lures. Free catalog. Sweet's Molds, Tonawanda 1, New York.

**JAP Rifle** altering to 30-06, \$6.00. Japshells, \$3.75. Catalog 5c. T. P. Shop, West Branch 11, Mich.

#### TAXIDERMY

**YOUR** Deerskins tanned and custom made into beautiful dress gloves, moccasins, handbags, coats and vests. Deal direct. Catalogue on request. J. R. Styres, Little Falls 1, N. Y.

#### BINOCULARS, TELESCOPES, MICROSCOPES, MAGNIFIERS

**BINOCULARS**, Telescopes, microscopes. Terrific values \$3.98 up. Request free money saving catalog. Criterion, Dept. P 23, Hartford, Conn.

**UNITED Binoculars**. Ideal Christmas gifts. \$2.95 to \$250.00. Free 56 page binocular-telescope catalog. United, 9043 S. Western, A-8608, Chicago 20. Dealers wanted.

**DYNASCOPE**—Sensational new reflector telescope. Send for details. Criterion Co., Dept. DP 14, Hartford, Conn.

**TELESCOPE Mirrors**. Completely finished. Free price list. Aurora Telescope Co., 286 Avenue C (PM4), Bayonne, New Jersey.

**REFLECTOR Telescope kits** \$6.25 (3") to \$175. (12"). Mirrors, cells, focusing mounts, tripods, eye-systems. Anything, everything in telescopes. Free illustrated catalog. Also ready to use telescopes from \$26 to \$176. Inquiries to Esco Products, Dept. PM-11, 1426 Willow Ave., Hoboken, N. J. Sales showroom, 166 Church St., New York City.

**BUILD** Your own reflector telescope. Complete kit: Mirrors, eyepieces, tripod, all other accessories. Request free illustrated literature. Criterion Manufacturing, Dept. KPM 10, Hartford, Conn.

**WAR** Surplus bargains! Millions of lenses, instruments, telescopes, binoculars, components and complete line of astronomical telescope items. World's greatest optical market place! Send only \$1.00 for beginner's 10-lens kit and big instruction booklet Stock 2-CH. Write for catalog CH. Free! Edmund Scientific Corp., Barrington, New Jersey.

**400 POWER** Telescope easily made. Kit includes focusing tube, erector, five finished lenses and instructions—\$3.75. Giant astronomical telescope complete with tripod \$15.00. Free information. Suffolk Science, Mattituck 3, N. Y.

**IMPORTERS'** Amazing prices, precision binoculars, 22 models. Free trial. Folder, "Binocular Selecting," catalog free. Dealers wanted. Prentiss Importers, Mercury Bldg., West Los Angeles 25, Calif.

**LOWEST** Prices, all sizes, binoculars, telescopes, microscopes. Also repaired. Free catalogue. Joe's Binocular Sales, 4627 Second Blvd., Detroit 1, Michigan.

**SPECIALISTS!** Used microscopes and accessories. Unusual slides. Supplies. Catalog free. Research Scientific Supplies, 60 Wall St., New York City 5.

**TELESCOPES**, Microscopes, binoculars, past quarter century. Comprehensive scientific instrument catalog \$1.00. None free. Dollar deductible from orders. Harry Ross, 70 West Broadway, New York 7, N. Y.

**6 THUMBS** On each hand? Even you can assemble our telescope kits from our easy instructions. Enjoy the heavens with a high precision telescope assembled in less than an hour. You'll like our complete line of telescopes, microscopes and accessories, biological stains, etc. Send for free catalog T of finest quality and newest design astronomical kits or free Catalog M of microscopes. Optical Engineering Co., 164-19 Northern Boulevard, Dept. PM, Flushing, New York.

#### PETS—DOGS, BIRDS, RABBITS, HAMSTERS, ETC.

**ENCYCLOPEDIA** Of canaries and other cage birds (including budgies) with questions and answers, \$2.75, plus 25c postage. Audubon Publishing Company, 3449 North Western, Dept. P.M., Chicago, Ill.

**DEWORMING** Powder for dogs. (Wright's the best.) It's non toxic. Guaranteed to satisfy. Send for free valuable book, and sample. Wright Laboratory, Ramona, California.

**CHINCHILLAS** (No rabbit). Registered. Guaranteed. Easily raised. Profitable. Big future. Terms. Hibner Chinchillas, Ithaca, Michigan.

**CHINCHILLAS**—Beautiful young pairs \$75.00 per pair! Free details. Consolidated Chinchillas of America, Asheboro, N. C.

**CONVERT** Cheap foods into money-making mink. Complete information free. Voight Farms: Lomira 2, Wisconsin, or Atlanta 2, Texas.

**RAISE** Mink: Free booklet, pen plans, inside secrets, feed, care. Mink are money makers. Investigate today. Lawrence Moggard, Brigham City 12, Utah.

**HAMSTERS**—Golden: young, \$3.00 pair; fully developed, \$4.00 pair. Adirondack Hamstery, Prospect 118, New York City.

**UNUSUAL** Pets: baby monkeys, ocelots, kinkajous, skunks, etc. Send 10c for complete price list. Eric O. Sonntag, 4001 W. Pico, Los Angeles, Calif.

**NEW** Flea killing collar. Works 24 hours. Guaranteed. Dogs 49c, cats 39c. Ramin Pharmacy, Williamsport, Penna.

**HAMSTERS**—The New Empress strain. Guaranteed to produce. Free details. Anderson's Hamstery, 35 Oneida, Pontiac, Michigan.

**CHINCHILLAS**—Registered sturdy stock. Wholesale. One or one hundred pairs—\$75.00 pair. Slater Chinchillas, 1535 Highland Ave., Manhattan Beach, California.

**CHINCHILLAS**. Registered. Unbelievable prices. Far-West Chinchilla, 1446A Jones, San Francisco 9, California.

**CHINCHILLAS**. Profit plus pleasure. Registered. Graded. Delivered personally. Stewart Chinchilla Ranch, Washingtonville, N. Y.

**RABBIT** Raising facts complete in 40 page illustrated book, by world's largest rabbit association, 10 cents. Address American, 36 Arba Building, Pittsburgh 17, Pennsylvania.

**CAGE-Bird** Magazine (budgies, canaries, etc.) one year, \$3.00. American Cage-Bird Magazine, 3449 N. Western Avenue, Dept. P.M., Chicago 18, Illinois.

**HUNTERS!** Raccoon Mountain and Short Creek Kennels now combined. Large number of coonhounds, foxhounds, rabbit-hounds, beaglehounds, bird-dogs, puppies. Free literature and pictures. Trial. Dures Thomas, Owner, Box 464, Boaz, Alabama.

**RAISE** Money-making Angora. New Zealand rabbits. Particulars free. White's Rabbitry, Jackson, Mich.

**DESCENTED** Skunks, monkeys, reptiles, etc. Illustrated catalogue 25c. Trails End, St. Stephen, S. C.

**BEAUTIFUL** Pure white pedigreed police puppies. Ansonia Kennels, Mose, N. Dak.

**MAKE** Money raising chinchillas, mink, pigeons, rabbits, cavies for us. Free catalog. Keeney Brothers, New Freedom 2, Penna.

**STANDARD** Rabbit Journal, Milton 3, Penna. Year \$1.00. Sample dime. Beginners manual 25c.

**GROW** Mushrooms, Cellar, shed, and outdoors. Spare, full time, year round. We pay \$3.50 lb. We paid Babbitt \$4,163.00 in few weeks. Free book. Washington Mushroom Ind., Dept. 171, 2054 Admiral Way, Seattle, Washington.

**MINK** Raising information free. Complete. Lake Superior Mink Farm, Superior, WI, Wisconsin.

**MAKE** Big money! Raise Chinchilla rabbits. Cash markets supplied. Write today! Rockhill Ranch, Sellersville 15, Penna.

**SPORTSMEN:** World's largest kennel offers 500 Pointers, Setters, Straight Cooners, Combination Hounds, Rabbit and Squirrel Dogs, Beagles, Fox and Wolf Hounds. Trial. Prices reasonable. Catalogue free. Smokey Mountain Kennels, Cleveland, Tennessee.

#### PLANTS, SEEDS, NURSERY AND GARDEN SUPPLIES

**GARDENERS**—Avoid fatigue, spade, shovel, plant with Spadeaid \$1.50, the wonder implement. Kit Engineering, 930 Sierra Vista, Fullerton, California.

**TREES** And shrubs. Raise your own from seed for shade, windbreak, snow fence, ornament, erosion control, etc. Free free planting guide, price list, write Woodlot Seed Company, Norway 9, Michigan.

**WORLD'S** Greatest cash crop. Free information. Write Ginseng Gardens, Asheville, N. C.

#### FARMS, FARM LANDS, REAL ESTATE

**STROUT** Catalog—Mailed free! Farms, homes, businesses, 36 states, coast-to-coast, 2,914 bargains described. World's largest; 55 years service. Strout Realty, 7-MP So. Dearborn St., Chicago 3, Ill.

**FLORIDA**—Several 5 acre tracts, grand climate and location. Near Gulf Mexico. For fishing, boating, bathing. Priced at \$985.00, \$20.00 down, \$20.00 month. Information write G. B. Potterfield, Owner, Union Bldg., Dept. X, Charleston, W. Va.

**FLORIDA** Lakefront homesites near Ocala forest. Excellent fishing-hunting. \$10.00 monthly without interest. Complete price \$195-\$995. Literature. Grace Parker, Paisley, Florida.

**CALIFORNIA** Farm and ranch lands. \$15 to \$35 acre. Homesites \$395. Easy terms. Free catalog. Pacific Tax Sales, 1621-A Cahuenga, Hollywood 28, Calif.

**SHINGLED** Houses: list free. Fireside Industries encouraged. Perrys, Briar Hill, Pennsylvania.

**FLORIDA** Waterfront homesites on famous Saint John's river, \$50.00 front foot. Also inland lakefront five miles from river \$195.00-\$995.00. Specify which literature. Easy monthly payments. Pine Lakes, Eustis, Florida.

**SEE** Our ad on page 32. The Abacus Press.

**FLORIDA** Winter Garden farms—Your best investment for retirement or vacation place. 5 acres, 10 acres, 20 acres. Low prices, easy terms. High, dry, beautifully wooded. Near Panama City, famous pleasure resort. World's most beautiful beaches. Grow fruits, berries, vegetables, money-making tung trees. Tung oil makes world's finest paint products. We plant and service your grove. Brochure free. Wendell Wood, Fountain, Florida.

**HOMESITES** \$400 — Convenient payments. California's finest garden section. On Morro Bay's scenic shores. Wonderful fishing, boating, bathing. Fertile soil, softest water, temperate climate, congenial community. Free literature. Richard Otto, Department M, San Luis Obispo, Calif.

**FLORIDA**—Beautiful retirement homesites near gulf coast. Excellent hunting, fishing in 9 fresh and salt water rivers. 11 bays and gulfs. \$250 at \$10 monthly. Free literature. V. M. Mathews, Box 1406, Asheville, N. C.

**FLORIDA**. Nice homesites. \$245 at \$10 monthly. Folder free. Howard Vernor, DeLand, Florida.

**MINERALS**. Grazing, investment, retirement. Timber lands, 50 acre. Terms. Listings, information free. Write Armstrongs, Shook, Missouri.

## POULTRY, FARM SUPPLIES

**POULTRY** Farmers—Broiler growers—Turkey raisers read the new American Poultry Journal for latest ideas and greater profits. 12 months, 50c. Special offer, 4 years \$1.00. American Poultry Journal, 182 North Wabash, Chicago.

## PROFITABLE OCCUPATIONS

**MONEY** In saw and lawnmower sharpening sparetime at home. Repeat cash business. Experience unnecessary. No selling. Free booklet explains. Vernon Foley Company, Columbia Heights, Minnesota.

**"HOW To Make Money With Simple Cartoons"**—A book everyone who likes to draw should have. It is free; no obligation. Simply address Cartoonists' Exchange, Dept. 911CP, Pleasant Hill, Ohio.

**WELDING** Pays big money. Learn easily at best equipped school in country. Non-profit school with low cost training. G.I. approved. Write Hobart Trade School, Box M-1192, Troy, Ohio.

**ANNOUNCING** Home study course in commercial baking. Practical basic training. Good field for those with aptitude. Free booklet. "Opportunities in the Baking Industry." National Baking School, 835 Diversey Pkwy., Dept. 3438, Chicago 14.

**MUSHROOMS** Grow boxes, barrels. Manureless process 50c. Spawn \$1.00. Gordons, 553 William, Winnipeg, Manitoba.

**BUY** Wholesale thousands nationally advertised products at big discount. Free "Wholesale Plan." American Buyers', Hertel Station, Buffalo 18-B, N. Y.

**MAKE** Money, be popular, glamorous, entertainer, show business, television, stage. Write for talent questionnaire. Show Talent Enterprises, Box 5417, Tampa, Florida.

**MAKE** Money writing short paragraphs! No tedious study. I tell you what to write, where and how to sell; and supply list of editors buying from beginners. Many small checks add up quickly. Write to sell, right away. Send for free facts. Benson Barrett, 1751 Morse, Dept. C-27-L, Chicago 26.

**FORTUNE** Possible raising fishworms and crickets. Free literature. Carter Wormery, Plains, Georgia.

**\$1500.00 MONTHLY** For truck drivers, \$1400.00 monthly for carpenters, electricians, plumbers, mechanics, \$1200.00 for clerks and laborers. Full information and complete foreign listings, with current information on Spain, Korea, Australia, Alaska and Canada, \$1.00. Current information on stateside projects, \$1.00. Dept. 3-K, Opportunities Unlimited, 1110 Commerce Bldg., St. Paul, Minn.

**MAGAZINE** Subscriptions—Best commissions, bonus. Qualified Agency, 451BE Kingston, Brooklyn 25, N. Y.

**FOREIGN, Alaskan, U.S.A. jobs!** Million Americans employed overseas! Opportunities galore. Latest copyrighted reports. Who to contact for highest paying jobs. To \$1500.00 monthly. Laborers, trades, truck drivers, equipment operators, helpers, clerical, engineers, many others. Over 52 countries—St. Lawrence project, Spain, Latin America, northern projects, Europe, Pacific, etc. Year registration-advisory service. Application forms. Unconditional money-back guarantee. Act today. Only \$2.00. Airmailed \$2.25. (C.O.D.'s accepted). International Reporter, St. Louis 1-P, Missouri.

**BUY** Wholesale 550,000 products. Literature free. Carter, Box 6011-D, Chicago.

**\$200 WEEKLY** Cleaning Venetian blinds. Free book. Burt, 2434A, Wichita 13, Kans.

**BECOME** Manufacturer! Complete manufacturing, selling instructions, guidance. Jary Associates, 398-BR, New York City 5.

**WHOLESALE** Catalog! 30-80% discounts! Appliances, musical instruments, typewriters, phonographs, watches, jewelry, recorders, housewares, etc. Consolidated Distributors, 21-14 Lafayette, Paterson 15, New Jersey.

**INVESTIGATORS** Wanted. Work furnished. Credit Correspondent Service, 517-M New York Bldg., St. Paul 1, Minn.

**MUSHROOM** Spawn plus complete instructions various processes. \$1.00. Luxur, 641 S. 19th, Newark 3, N. J.

**AUCTIONEERING**—Home study course. Diploma granted. Auction School, Ft. Smith, Ark.

**OVERSEAS**, Latin American, Alaska, Canada employment. Originator 1955 "Foreign Service Directory" up-to-minute report on military and civilian construction; oil companies; aviation; transportation; steamship; mining; government job info. How-when-where to apply. Listing firms hiring. \$1.00. Global Reports, Box 883-P, Hollywood 28, Calif.

**RAISE** Pheasants on \$100 week plan. Little capital and space can make you independent. Free details. Great Central System, Columbus 1, Kansas.

**FREE** Folio "Up to \$45,000; Unlimited Vacations." No merchandise, equipment. Unknown! Work home, sparetime! Haylings, Carlsbad, Calif.

**GROW** Mushrooms. Cellar, shed, and outdoors. Spare, full time, year round. We pay \$3.50 lb. We paid Babbitt \$4,163 in few weeks. Free book. Washington Mushroom Ind., Dept. 99, 2934 Admiral Way, Seattle, Wash.

**HOME** Workers needed! Spare time, full time. Assemble luggage and cases with our complete illustrated step-by-step instructions. We sell your product—Supply everything. Manufacturing representative needed in your area immediately. Unlimited profits possible. Investigate at our risk. Free details. Cascraft, 807-G10 Sunset, Los Angeles 12, Calif.

**FREE** Book "505 Odd, Successful Businesses." Work home. Expect something odd! Pacific, Oceanside, Calif.

**MAKE** New greaseless doughnuts in kitchen. Sell stores. Free recipes. Michael Ray, 3605 South 15th Ave., Minneapolis 7, Minnesota.

**BE** The Popular Mechanics representative in your neighborhood and earn big profits in your spare time. Write Popular Mechanics Magazine, Room 408M, 200 E. Ontario St., Chicago, Ill.

**TYPISTS**—Profitable home business. Complete copyrighted information, 50c. Gaunt, 827-A Irving, Chicago 13.

**MAKE** Money at home mailing cards, circulars, featuring fast-selling merchandise. Everything furnished. Orders filled for you. The Wm. F. Laska Co., 103 Birchwood Ave., Cranford, N. J.

**CIVIL** Service jobs—Mechanical, clerical, professional. Opportunities galore. U.S.A.; overseas. List, 50c. Job Guidance, 1714 Ocean Parkway, Brooklyn 23, N. Y.

## BOOKS, PERIODICALS, PICTURES, POSTCARDS

**POST** Cards packaged \$1.00. 54 U. S. capitals, possessions, United Nations or 54 cities. 30 packs \$13.00. Mayrose Co., Linden, N. J.

**OLD** Books, rare editions. Lists. Book Ends, Box 851, Fort Wayne 1, Indiana.

**HOW** To live without money. Howard Wildman, 308 W. 58th, New York 19, N. Y.

**USED** Books, 35c. Free list. Warfield, 6832 Riggs Road, Hyattsville, Maryland.

**650 TECHNICAL**, Scientific, business books fully described and priced. Covers 40 major subjects: Aeronautical, automotive engineering; chemistry; civil, electrical, electronic, mechanical engineering; heating, air conditioning; radio, television, etc. Completely indexed, pocket sized guide book. Send 25c postpaid. Kroch's & Brentano's, World's Largest Bookstore, 29 S. Wabash Ave., Chicago 3, Ill.

**YOUR** Little girl will love "Jump rope" and "Hopscotch." Both booklets 50c. Porpoise Bookshop, 308 Clement, San Francisco 18.

**SUBSCRIPTIONS** Accepted for all magazines. Scott Magazine Agency, 7965 Birchdale, Chicago 35, Illinois.

**BOOK** Catalog, 1000 interesting titles. Send 10c Books Publishing Co., Amityville 3, New York.

**SPARETIME** Profits taking subscriptions all magazines. Wholesale catalog free. Cassell Publishers, Westfield, New Jersey.

**NATIONAL** Geographic Magazine, 1888-1952. Periodical Service, Box 465-PM, Wilmington, Delaware.

**"FEMALE** Figure Drawing." Illustrations galore. For serious students. Only \$2.00. Southern Book Co., Box 325, Edgefield, S. C.

**BOOKS**, Government surplus. Bargain prices. Free catalog listing 50 other free catalogs. Instructional, educational, vocational subjects. Millions of volumes, new and used. Books bought, Est. 1902. Long's College Book Co., Dept. PM, Columbus 1, Ohio.

**BOOKS** Found! Any author, old or new. Rush titles wanted; no obligation. International Bookfinders, Box 3003-PM, Beverly Hills, California.

**BOOKFINDERS!** All subjects. Send wants! Jaber Book Service, 183 Hazelwood Drive, Westbury, N. Y.

**"SCIENCE** Milestones." Records march of science starting 400 years before Christ, right up to date. Amazing facts revealed. 312 pages packed with startling information that will thrill you. A real history of science. \$5.00. Literature free. Popular Mechanics Press, 200-8M East Ontario St., Chicago 11, Ill.

## GAMES, TOYS, NOVELTIES

**LARGE** Box of 25 beautiful assorted toys. Will fill many Christmas stockings. \$6.00 value, only \$2.00. Toyland, 5139 N. Clark, Chicago 40.

**100 PLASTIC** Assorted toys, attractively packaged, \$1.00. Deluxe, 3405 Southern Ave., Baltimore 14, Md.

**GAME!** Colorful naval formations! Playing instruction 50c. Flagship Clinton Company, Clinton, New York.

**MINIATURES:** Colorful destroyers, submarines, battleships. Twenty castings 50c. Flagship Clinton Company, Clinton, N. Y.

**PEOPLESS** Cribbage board, sliding pointers, large numbers, a beautiful gift item that will please any cribbage player. \$2.95 postage prepaid. Curtis Products Co., No. Woodstock, N. H.

## MAGIC TRICKS, PUZZLES, JOKER NOVELTIES

**LEARN** Ventriloquism. 3c stamp brings particulars. Smith, 801 Bigelow, Peoria 3, Ill.

**PROFESSIONAL** Catalog, 175 pages, 25c. Williams, 909 Plymouth, Ellwood City, Penna.

**VENTRILQUIAL** Lessons 50c, figures, marionettes, magic, free pictures. Finis, 624 West Third, Waterloo, Iowa.

**LARGE** Professional magic catalog 50c, and free trick. H. Seltzer, 1639 Fulton Ave., Bronx 57, N. Y.

**BE** A magician! Large professional catalog of latest tricks, 35c. Ireland, C-109 North Dearborn, Chicago 2, Illinois.

**"VENTRILQUISM** Selftaught!"—Complete book 25c. Greenview, Box 41-BC, Whitestone 57, New York.

**MAGIC** Trial lessons free. Write today! Magic School, Sparta 9, Michigan.

**EARN** Money as a magician; fine hobby. Large professional catalog \$1.25. Holden's, 120 Boylston Street, Boston, Mass.

**VENTRILLO**, Professional voice-throwing instrument and catalog 25c. Box 971-PM, Philadelphia 5.

**BEST** Magic, Joker's novelties. Lower prices. Catalog 10c. Top Hat, Evanston 12, Ill.

**DOLLAR** Magic set free with catalog 25c. 4462-PM Germantown, Philadelphia.

**3100 NOVELTIES**, Tricks, jokes, gadgets, funmakers, hobbies. Catalog 10c. Johnson-Smith, D161, Detroit 7.

**SENSATIONAL** Magician's wand 25c. Vanishes handkerchief! Catalog included. Box 1352-PM, Philadelphia 5.

**500 TRICKS**, Douglas famous catalog, 10c. Fastest magic service for 30 years. Douglas Magicland, Dept. 1, Dallas, Texas.

**LEARN** Ventriloquism. Details without obligations. Harry Harmon, Box 33, Mint Spring, Va.

**SMOKEBOMBS** 25c, 7 For \$1.00. Terific! 4463-PM Greene, Philadelphia 44.

## COINS, TOKENS, CURRENCY

**OLD** Money wanted. Do you know that coin collectors pay up to \$100.00 for certain U.S. cents? And high premiums for all rare coins? We buy all kinds. Send 4c for large coin folder. May mean much profit to you. Numismatic Co., Dept. 20, Fort Worth, Texas.

**SCARCE** Uncirculated 1955S cents 15c. 1955S dimes 40c. Price list 10c. Pm Landon, Box 836, Denver 1, Colorado.

**TWENTY** Different Indian cents \$1.00. Sayers, 1000 East Unaka, Johnson City, Tennessee.

**AMERICAN** Coins! Stamps! Extensively! Sullivan, 127-FF East Fourth, St. Paul 1, Minnesota.

## STAMP COLLECTING

**GREATEST Premium!** World-wide collection! Over 1000 different stamps from Aden, Nigeria, Korea, Macao, other exotic lands. Includes triangles, airmails, sport, animal, ship, map stamps. Catalog value over \$25.00. This exciting collection given to approval customers. Request approvals, details, today. Odd Stamps Co., Dept. A1, Box 31, Redondo Beach, Calif.

**STAMP Collecting** for pleasure and investment. Approval service established 45 years. Send for trial selection. O. J. Richardson, 22 Station, St. Petersburg 3, Florida.

**1500 STAMPS \$1.00.** Good variety. On and off paper world wide. Many pictorials. No approvals follow. Satisfaction guaranteed. Whalen, 1435-1st Ave., Oakland 6, Calif.

**CANADA** — Newfoundland collection including early issues, commemoratives, pictorials and high values. Plus set of fascinating triangle stamps. Plus set of unused British Colonies. Plus large stamp book. All four offers free. Send 10c to cover postage. Empire Stamp Corp., Dept. PM, Toronto, Canada.

**UNITED States and foreign on approval.** Sale, Box 128, Highland Springs, Virginia.

**25 SWITZERLAND** — Free to approval applicants. Joe Watson, Box 463, State College, N. Mex.

**FREE** Valuable premiums, triangles, pictorials, bicolored, etc., to approval applicants. Send postcard. Nevin Otis, Somerset, Calif.

**AUSTRALIA** — Fifty different exciting commemoratives, animals, kings, queens. This valuable Australian collection only 10c with approvals. Viking, Great Neck 8, N. Y.

**NICE** Used \$2 Harding only 50c. Quality approvals. Hutton, Box 2811, Colorado Springs, Colo.

**IMPOSSIBLE!** 20 Different U. S. commemoratives plus 4 foreign sets 10c, approvals. Complete flags free through bonus-plan. Geber, 900 Sweetzer, Los Angeles 46.

**PICTORIAL** Angola, Mozambique, Hungary, a beautiful assortment of stamps, 3 sets depicting wildlife in color, plus 100 attractive stamps, 10c to approval applicants. Modern Stamp Co., Dept. A-1, Ferrysburg, Mich.

**CHINA**, 200 Different—Ships, airs, maps, bi-colors. Fine collection. Send 25c today. Approvals. Sr-Jr Stamp Company, Box 161, Tulsa, Oklahoma.

**FREE** Sample stamp newspaper, information on collecting, special lists. Approvals. Littleton Stamp Co., Littleton A1, N. H.

**PAYING** High prices for approvals? Try ours at 1c and 2c in books of 1000. Special offers and U. S. available. Clark Stamp Co., Dept. A-45, Muskegon Heights, Mich.

**FREE** Complete set of famous Americans, flags, parks and presidentials to approval buyers. Send 5c for 15 of the above stamps plus full particulars. Triboro Stamp Company, 145 Nassau Street, Dept. 111, New York 38, N. Y.

**BOOKLET**—Free! Stamp collecting. Ten easy lessons. Approvals. Howard Moser, Highland, Illinois.

**500 DIFFERENT** Worldwide 25c with approvals. William Bacon, Wellsville, N. Y.

**U. S. Price list.** Over 400 illustrations. 25c refundable first order. Alvin Gould, Carew Tower, Cincinnati 2, Ohio.

**FIRST U. N. set.** Among world's prettiest. Only 10c. Approvals. Welles, Box 1246-R, New York City 8.

**WHY Pay more?** Pick stamps from our large collections, 2c each. Just as purchased. Be first. Premiums given. U. S. also available. Roseland Stamp Co., Dept. A-35, Spring Lake, Mich.

**CORONATIONS**, Triangles, sports, animals, free with approvals. Exotic, Box 482-M, Coral Gables 34, Florida.

**MAGNIFIER**, 1000 Hinges only 10c. Bargain lists, approvals. Buckley, 208 Ludlow Bldg., Dayton 2, Ohio.

**LUXEMBOURG**—25 Different, 10 cents. Approvals. Waha Company, 178 North 17th St., East Orange, N. J.

**2 FOREIGN** Packets 10c to approval applicants. Smith's, Box 324, Cuba, Illinois.

**WORLDWIDE** Mixture \$2. Approvals. Richard, 1632 W. 6th, Davenport, Iowa.

**BE Smart**—Stop paying high retail prices. Approvals at wholesale. Write for details. Bargain Stamps, Redlands, Calif.

**DEALERS**—Wholesale list. Postage 3c. Frank, 5631 Queensberry, Baltimore 15, Maryland.

**FREE**—Muscat Victoria! Tru-val-u approvals. Brunning, Donaldson St., Rath-erford, N. J.

**NATIONAL** Parks set used 60c, or unused flags \$1.00 with United States approvals. Say-On Stamps, Box 5118B, Long Beach 5, Calif.

**72 PAGE** U. S. catalogue free. Contains almost 1600 illustrations. Stone's, 192 Washington, Boston 8, Mass.

**5c APPROVALS.** Small countries! Big values! Moffat's, 740 Milton, Rock Hill 16, South Carolina.

**ZEPPELIN** Set free with approvals. Variety Stamps, 57-P Circuit, Newton Highlands 61, Mass.

**BRITISH** Colonial collection—Hivalues, commemoratives. Free to approval buyers. Pleasure Stamps, 1865P—52nd, Brooklyn 4, New York.

**DIFFERENT**, 500, 50c; 1000, \$1.25; 2000, \$3.00; 3000, \$11.00. Clearing approvals wholesale. K. S. Holmes, London, Canada.

**500 FINE** Mixed U. S. stamps 15c. Wright, 201 Mealey, Hagerstown, Maryland.

**FREE \$1.00** Mint Hongkong! Bargain approvals! Mayer, Box 208C, Forest Hills 75, N. Y.

**SUPERIOR** Worldwide mission mixture. Amazing variety! Half pound only \$1.50. Baye Nielsen, 4545B Harvard, Montreal 28, Canada.

**AMAZING** Savings! Picture stamps by the thousands; choose choice ones for pennies. Approvals postpaid both ways. Costs nothing to try us. The Elders, El Venado Dr., Puente, Calif.

**U. S. Commemoratives**, 100 mixed 25c. Ray Worth, 321 So. Cicero, Chicago 44.

**50 COUNTRIES!** Stamp packet from 50 countries for 10c to approval applicants. Quality Stamps, 178 Sweet, Buffalo 12, New York.

**NO Approvals**—305 Stamps \$1. Bonder Stamp Co., Ellenville, N. Y.

**305 DIFFERENT** Worldwide, 25c. Fine approvals. Roy Farr, 88 Maple, Hamilton, Canada.

**ISRAEL**—25 Different 25c. Value \$1.00. Limited supply. Approvals accompany. Yokums, Box 1327, San Antonio 6, Texas.

**100 DIFFERENT** U. S. commemoratives \$1.00. Wiggins, Box 72-P, Guild, N. H.

**MONACO**, Nudes (3) 5c. Approvals. Hannay's, 310 Quail, Albany 8, N. Y.

**100 DIFFERENT** Belgium 10c. Durham, 1021 N. Granger, Saginaw, Michigan.

**75 DIFFERENT** U. S. 10c. Approvals. Coonrod, 1413 Tapestry, Laredo, Texas.

**JAPAN** Collection. Over 50 different, unusual; exotic; only dime with approvals. Lock, 2216 E. Third, Montgomery 6, Ala.

**3,978 SOLD.** 30 Different beautiful airmails 10c. Selected approvals. Morrison, Milmont Park, Penna.

**CIPEX** Souvenir sheet plus 25 different U. S., 10c. Approvals accompany. Village Stamps, 90-39P 214 St., Queens Village 28, N. Y.

**60% DISCOUNT!** World-wide bargain approvals. Gaines, 716 South Sixteenth, Mattoon, Illinois.

**TRIANGLES**, 13 Different 6c with approvals. Nickerson, 310 Idaho, La Habra, California.

**25 DIFFERENT** Ceylon 15c with approvals. Spicka, 4032 Jaynes, Omaha 11, Neb.

**RARE** Indian states, 27 different, 10c with approvals. Excello, Box 489, Red Bank, New Jersey.

**BIRD**, Fish, animal, diamond, triangle stamps, plus worldwide packet free to approval buyers. Conquistador, 2627N Troy Road, Schenectady 9, N. Y.

**100 FOREIGN**, 20 U. S. commemoratives, 10c. Approvals. Weckerling, Box 442M, La Feria, Texas.

**FREE** Worldwide collection:—157 different stamps. Many large commemoratives and pictorials, from Belgium, France Saar, Turkey, etc. 10c to approval applicants. Knight Stamp Company, Department M, 656 Rogers Avenue, Brooklyn 28, New York.

**SENSATIONAL:** Multitude stamps with unused triangles, pictorials. Also article every collector needs. Everything only 10c to approval applicants. Murray, 4144 Warwick, Kansas City 11, Mo.

**COMPLETELY** New Fell's 1955 U. S. coin book. Lists, evaluates every coin ever minted. How many of your coins are worth money—do you know? Over 150 illustrations. Chapters on profits in buying and selling, speculation, investment, etc. Clothbound. Send no money. Pay postman \$2 (plus postage) or send \$2 (postpaid). Refundable. Fell Publishers, 388 M-13 4th Ave., New York City 16.

**WANTED** American commemorative coins. State condition, price, quantity. Von, 2200 West Capitol Avenue, West Sacramento, Calif.

**NUMISMATIC** Wholesale pricelist (free subscription). Complete "1956" (published bi-monthly) volume. E. P. Ross, 919 Crosby St., Savannah, Ga., U. S. A.

**16 PAGE** U. S. coin list 10c. Stone's, 192 Washington, Boston 8, Mass.

**VATICAN**, East Africa, Costa Rica, Austria, Sweden's coins—All 10c. Jolie, Box 19B, Brooklyn 3, N. Y.

**50,000 COINS**, Medals, bills. Lists free. Collectors magazine 10c. Nagy, 8-P South 18th, Philadelphia 3, Penna.

**1955 PROOF** Set \$3.50. 15 different Indian cents \$1.00. Retail guidebook \$1.75. Bargain catalogue 35c. Beber's, 4514 North 30th, Omaha 11, Nebraska.

**\$3,000.00** FOR 1913 Liberty head nickel. Dimes 1894-S, 1895-O, 1916-D. Quarters 1827, 1896-S, 1901-S, 1913-S, 1923-S, we pay \$5.00 to \$1,500.00. Certain dates—Lincoln cents, \$60.00. Indianheads, \$60.00. Large cents, \$50.00. Eagle cents, \$30.00. 2c pieces, \$45.00. 3c pieces, \$60.00. Half-dimes, \$50.00. Shield nickels, \$100.00. Old dimes, \$300.00. 1873 Canadian quarter, \$50.00. Hundreds of others worth \$5.00-\$50.00. Wanted—Half dollar, dollars, gold coins, paper money, etc. Know their true value. Our large illustrated guarantee buying, selling catalogue, giving complete all coin information, send \$1.00. Purchase catalogue before sending coins. Catalogue money refundable. Worthycoin Corporation, Leaders Numismatic Quotations (K-112-C), Boston 8, Massachusetts.

**FOREIGN** Coins, 10 diff., 25c. Foreign bills, 20 diff., 25c. Indian cents 10 diff., 50c. Lists. Oliver Arnold, Macon, Mo.

**FIFTY** 2x2 Coin envelopes, six page bargain lists, 10c. Economy Sales, 157 Dean, Mansfield, Mass.

**COIN** Catalogue, illustrated, 500 pages, all countries. \$4.18. Northeastern, P. O. Box 6431, Cleveland 1, Ohio.

**GIANT** Price list of coins, catalogues, albums, supplies, 20c. Canada Coin Co., Box 35, Toronto A, Canada.

**FOREIGN** Coins, 15 different uncirculated \$1.00. Lauren Benson, 2526A Middle Road, Davenport, Iowa.

**6-IN-1** Special: Magnifying glass; check list; 25 coin envelopes; giant 60 page bargain catalog; ten different Indian pennies; Mexican ten-peso. All six, \$1.00 postpaid. Ben's Coin Shop, 31 North Clark, Chicago 2, Illinois.

**U. S. Large** cent, 2c piece and bargain list, only \$1. Delmasco, Box 1123, Wilmington, Del.

**FREE!** Foreign coin, banknote and coin collectors illustrated catalog to approval service applicants. Send 3c postage. Tatham Coinco, Springfield 30, Mass.

**MORGAN** Dollars; 1878, 1887, 1890, 1891, 1897 S mint unc. \$2.00 ea. Illustrated catalogue, 25c. Shultz, Salt Lake 10, Utah.

**GET** Profit and pleasure in collecting old coins. Send 10c for 56-page illustrated coin catalog. You'll be delighted with it. Send for it now. B. Max Mehl, 370 Mehl Building, Fort Worth, Texas. Largest rare coin establishment in U. S. Established 55 years.

**COIN** Collector's Magazine. Over 1000 pages per year. Sample copy 30c; \$3.00 per year. Hewitt, 7320-J Milwaukee, Chicago 31.

**INDIAN** Cent with bargain lists 10c. Hutchinson, 3463 "I" Street, Philadelphia 34, Penna.

**WORLD'S** Greatest magazine for coin collectors and wooden nickel 10c. Lawrence Brothers, Anamosa, Iowa.

**101 DIFFERENT** Foreign bills—\$1.00 postpaid. Dwight Musser, Dunbar, West Virginia.

**FOREIGN** Coins, 35 different \$1.00. 100 different \$4.00. Claud Denney, 3406 S. Harwood, Dallas 15, Texas.

**40 COINS**, \$1.00. 100 Bills, \$1.00. 66 coins and bills, \$1.00. Oddehon, Box 482, St. Louis, Mo.

**\$12.00 CAT.** At \$1.00 only—Denmark T.B. Sanatorium seal D. Greens #81, \$3.00 in a fine mint block of four. Singles at 30c. Free stamp and seal pricelist plus "The Founder of the Christmas Seal" on card to customers. Joint orders \$5.00 postpaid. Under \$5.00 extra 15c return postage required. Mint stamps. Write: Vendelskov, Rolighedsvej 22, Copenhagen V, Denmark.

**30 DIFFERENT Commemoratives, 1893 up 10c.** U. S. approvals. K&B, Box 5, Brooklyn 15, N. Y.

**UNITED States, \$1.00 buys 20 early stamps including #26, #145, #146, #211, #234.** Approvals accompany. Whiton Paine, Westport 11, Connecticut.

**U.S. Mint plate blocks, 17c each!** Regularly 20c. Your choice #934-57, #981-1005, #1022-29. Free list. Brooks, 2352D East 23rd Street, Brooklyn 29, New York.

**COLLECTIONS** You'll like. 330 different foreign 25c, 350 different 50c, with approvals. Gandy Company, Shore Acres, New Jersey.

**VARIETY!** 35 Singles, 5 sets, souvenir sheet 25c with approvals. Philatelic Den. R.D. #1, Towanda, Penna.

**WHOLESALE** Priced approvals. No free. Erv's, 802 North Central, Marshfield, Wis.

**ASTONISHING Gift!** 40 U.S. with superior approvals. Send 5c for postage. Sparta, Box 1082, Rochester 3, N. Y.

**EXCITING "Strange countries" packet.** Free with approvals! Saxon, Vista, Calif.

**LOOK!** Ten triangles and over 50 different 10c with approvals. Bennett, Candor 3, New York.

**FREE!** 3 Months membership \$1.00 world packet. Entitles you exchange duplicates. Castle Stamp Exchange, 3957 Castleman, St. Louis 10, Mo.

**PEACE Sets.** Five mint, 1946, 35 cents to applicants of foreign set approvals. References. Maier, P.O. Box 331, Monterey, California.

**FREE Surprise packet!** Send 10c for approvals, all kinds. The O & P Company, Box 618, Lexington, Ky.

**WANTED—Stamp collections accumulations.** Murray Gold, 62-95P Saunders, Rego Park 74, N. Y.

**1000 DIFFERENT 50c.** Approvals. Queller, Box 66M, Flint, Fall River, Mass.

**SPORTS Sets.** new issues, and other popular sets sent on approval. Bailey Stamps, Box 892, Peoria, Ill.

**100 FABULOUS Stamps 5c** with penny approvals. Haystead Company, 24911 Oxford, Dearborn, Michigan.

**FREE!** Big illustrated catalog! Send today! Stamps By Mail, 2133 Lunt, Chicago 45.

**GIANT Stamp zoo free!** Fifteen different including rhinoceros, elephant, snake, tiger, zebu, kangaroo, koala bear, kookaburra, bull, horse, with approvals. Send 10c for postage and handling. Lincoln Stamp Co., St. Catharines, 518, Ontario.

**FREE Stamp album!** Serious approval applicants sending postage. Adventures, Buckland, Connecticut.

**FREE, Turkish pictorials,** request approvals. Eagle, 6916 Roosevelt, Philadelphia 49, Penna.

**20 MINT Blocks \$1.00.** Heckl, 1207 Northland, Buffalo 15, N. Y.

**COLOSSAL!** Canada wildlife, 75 different Italy, reproduction world's rarest stamp, beautiful flower triangle, mint last stamp Lithuania, 10c with approvals. Richardson Stamps, Niagara on the Lake 12, Canada.

**GERMAN Peace dove set free.** Approvals. George Richie, 1539 Sixth, Alameda, Calif.

**LOOK—100 Different large U.S. commemoratives, one dollar.** Package hinges free with order. Langfords, 83 Durham Rd., San Anselmo, Calif.

**BALLOON Stamp (mint),** plus packet of pretty pictorials, all free with handsome approvals. Lindeman, 348 Primrose, Syracuse 5, New York.

**FREE! Catalog!** About stamps. Illustrated. Free! The Stampmart, Hartford 1, Connecticut.

**126 DIFFERENT.** Includes triangle, diamond, airmails, old United States, British Colonies, animals, others; 10c with approvals. Cactus Stamps, Desert Springs 30, California.

**MORE Stamps for less money.** Exciting approvals. Mor-4-Less, Norwalk 9, Calif.

**UNITED States—\$8 different including 8 airmails, 15 commemoratives, 10c.** Approvals. Sunset, Box 47, South Gate, Calif.

**FREE United States illustrated catalog.** Bailey, 44 Bromfield, Boston, Mass.

**325 DIFFERENT Worldwide collection,** includes everything. Airmail, complete sets, triangles, bi-colors, birds, flowers, animals. Everything (catalogs over \$6.00) 25c to approval applicants. Century Stamps, Box 1090-P, Palm Springs, Calif.

**225 DIFFERENT 10c.** Approvals. Hay, 32-51 73 Street, Jackson Hgts. N. Y.

**1000 MIXED United States.** Guarantee 140 different stamps. \$1.10. Quaintance, Box 178P, Upper Sandusky, Ohio.

**FREE—Valuable U.S.A.!** (1) Scarce genuine stamp picturing first U.S.A., issued in 1847! (2) Big collection 30 all-different U.S.; ancient 19th century, valuable \$5 stamp, etc. (3) Packet gorgeous commemoratives. (4) Large illustrated U.S. catalog; 64-page, four-color Collectors' Guide; other unusual offers. Everything for only 10c covering mailing costs! Harrisco, 1061 Transit Bldg., Boston 17, Mass.

**FREE Lists general foreign sets, singles and packets.** No approvals. Snooks, Box 1715, St. Louis 2, Mo.

**36 DIFF. U.S. commemoratives 5c** approvals. Hudson's, Box 4015, Fresno 44, Calif.

**WONDERFUL Offer.** 7 complete mint sets only 10c with approvals. Reich (M26), 1633 Lawrence, Chicago 40.

**LUXEMBOURG 25 Different 5c.** Approvals. Neal, 3950 Tower, Riverside, Calif.

**FREE U.S. plate block list.** Simstaco, Box 63, Mattapan 26, Mass.

**MONACO Nudes 10c** with approvals. Royal Stamp Company, Tamaqua, Penna.

**1000 DIFFERENT 95c.** John Hoarigan, 1500 Archer Road, New York 62, New York.

**200 DIFFERENT Including Macau, Rhodesia, Mauritius, 10c** to approval applicants. Evden, Box 128, Valley Stream 50, New York.

**89 LATIN American stamps,** many pictorials, airs, 10c. Approvals included. Fred Pittsley, South Montgomery, Napa, Calif.

**201 DIFFERENT.** Plus colorful British Dominion packet only 25c. Pictorial approvals. Free list. Firland Stamp Co., Box 493, Seattle 11, Washington.

**PENNY Approvals;** thousands of bargains for pennies. Stamps, Orange, Calif.

**50 DIFFERENT Bulgaria 10c!** Approvals. Ensign Stamp Company, Dept. M, Berdan Avenue, Paterson 2, New Jersey.

**TREMENDOUS Offer!** 15 beautiful foreign sets, complete, 10c. Approvals. Farmer, 6019 Camrose, Los Angeles 28.

**U.S. Mint 797 SPA sheet, 10c** to U.S. approval applicants. D. Kelly, 153M 74th St., Brooklyn 9, N. Y.

**ILLUSTRATED Album,** hinges, gauge, detector, fifty stamps, two sets, \$1 Chile stamp, all 10c. Approvals. Cornett, 228 West 25th, New York City 1.

**FREE! U. S. price catalogue (Illustrated).** New-Way Stamp Co., Lawrence, Mass.

**HAITI, Hurricane Hazel helicopter set,** 25c with approvals. Seminole Stamps, Box 1138-P, Coral Gables 34, Florida.

**FREE U.S. Illustrated bargain catalogue.** Rothberg's, Box 60, Boston 1, Mass.

**NUDE, Pioneer, animals packet—10c** with approvals! Atlas, Eisenhower, Racine, Wisconsin.

**QUEEN Elizabeth miniature collection!** Six different colonial sets—21 handsome mint bicolors 25c. Approvals. Gannon Stamps, Box 931, Canton 1, Ohio.

**U.S. 40 Different 10c.** 40 different commemoratives 20c. Both 25c. Bargain lists. No approvals. Seidenberg, Appleton, Wis.

**THOUSANDS Of exciting stamps,** all different, yours for 1c, 2c each. Fill your album for pennies! Big collection sent for free examination. Cole, 43-A Rinewalt, Buffalo 21, N. Y.

**100 JAPAN 10c.** All different, with approvals. Gould's Stamps, Box 631, San Francisco 1, California.

**50 DIFFERENT United States 5c** with bargain approvals, lists. Bookman, Box 8245-M, Madeira Beach, Fla.

**U. S. Classics.** Over 50 yrs. old, 15 selected old-timers. Missing in biggest collections. All 15 at less than 1c each. 10c with approvals. Jaro, Box 246-T, New York City 8.

**WOW! 153 All different Germany 10c.** Zeppelins, semi-postals, airmails, high values. Big bargain lists and approvals included. Jamestown Stamp, Dept. 512, Jamestown, N. Y.

**FREE United States price list.** Mark Hanna, 335 Fifth Ave., Pittsburgh 22, Penna.

**FREE! Giant catalog.** Offering thousands of bargains. Sent with beautiful approvals. Jamestown Stamp Co., Jamestown 612, N. Y.

**FREE! Flower triangles, others.** Approvals. Delton Page, Box 201X, East Paterson, New Jersey.

**50 DIFF. U. S. commemoratives 25c.** Mammoth packet list free. Econopackets, Box 168, Riverside 9, Calif.

**STAMPS Wanted.** Mint and used, collections, accumulations. Good grades only. Buy outright if bargain. What have you? Write, give details. Vanroy Shirk, Lebanon, Penna.

**50 DIFFERENT Argentine 10c.** Approvals. Reuter, 611 W. 40th Pl., Los Angeles 37.

**100 DIFFERENT Spain 25c.** Penny approvals included. Reed, Box 940, Chicago 99, Ill.

**OLD Scarce U.S. seconds on approvals.** Slight imperfections, lowest prices. Herndon, Clintonhill Sta., Newark 8, N. J.

**SPEND Pennies!** Not dollars! Thousands of fascinating stamps to choose from our 1c and 2c approvals. No premiums. Just honest value. Pat F. Knowles, Box 2247, Van Nuys, Calif.

**AMAZING Offer!** 200 United States stamps—including commemoratives, airmails, high denominations to \$1.00. Only 10c to approval applicants! Illustrated bargain lists free. Mystic Stamp Co., Dept. 80, Camden, New York.

**FREE Sample!** Interesting, illustrated, informative! National Stamp News, Anderson, South Carolina.

**SELL Stamps to our readers.** Your ad in this space will be read by thousands of stamp buyers. I'll prove that to you. Write now for Folder "S." P. W. Johnson, Classified Advertising Manager, Popular Mechanics, 200 E. Ontario St., Chicago 11, Ill.

**50,000 STAMP Orabags 25c each.** Anderson, Box 1, Reading, Penna.

**300 DIFF. World wide 25c.** plus surprise packet. Packet list free. Econopackets, Box 168, Riverside 9, Calif.

**WORLD'S Largest stamp (7½ x 14 inches).** A real curiosity! Retailers for 50c, only 3c to approval applicants. Tatham Stamp Co., Springfield 30, Mass.

**WEIRD Diamond shape coffee stamp!** Lovely flower triangle! First American big commemorative, Greenland, idol dancer, etc. Free with approvals. Capital Stamp Co., Little Rock 2, Ark.

**100 OLD United States between 1861 and 1935, \$1.00.** Roush Stamps, 51 Chestnut, Mansfield, Ohio.

**TWO \$5.00 U. S. stamps plus 20 different, 10c** with U. S. approvals. Irwin Stamp Co., Box 1105, Brooklyn 30, N. Y.

**ECONOMICAL (5c-1c-2c-Approvals),** 22,000 varieties available. Dresel, Box 270-n, New York 23, N. Y.

**225 STAMPS For only 10c!** This mammoth value includes airmails, pictorials; stamps from strange countries cataloging up to 25c each! Also approvals. Mystic Stamp Company, Camden 80, New York.

**TRIANGLES, Birds, butterflies, flowers—**Big packet 10c with approvals. Southwest Stamps, Box 117, Long Beach 1, Calif.

**12,000 PENNY Approvals** waiting for you. Many from exotic countries, pictorials, airmails, new issues. Tilbury, Box 862, Newark 1, N. J.

**FAMOUS Men, jungle scenes, zoo.** United States commemoratives, 150 others. Ten cents with request for thrifty approvals. Casner Stamps, 247-A Riverside, El Paso, Texas.

**30,000 DIFFERENT Collector's stamps** from all parts of the world for less than 1½c each! Send \$12.50 for each book of 1,000 stamps as often as you want. J. Huppert, 1970 E. 18th St., Brooklyn 29, N. Y.

**14,000 DIFFERENT—Yours** on our streamlined systematic club plan for only 50c weekly. Big shipment every two weeks. Details free. Sjoquist, Box 217, Valley Stream 75, New York.

**GIANT Approvals.** Thousands different at 1 and 2c each. Wahl's Stamp Exchange, 7008P Farragut, Chicago 31, Ill.

MINT Commemoratives at face! Send 25c for surprise packet of all different, mint U.S. commemoratives. Mint U.S. approvals too. Western, Box 1639P, Salinas, California.

800 MIXED U.S., old, new, 25c. Lists. Weatherby, Fort Myers, Fla.

ESTONIA Carrier pigeon set free. Approvals. Canyon Stamps, Box 308, San Fernando, California.

FABULOUS United States commemorative collection—31 different 10c. Approvals. White, 516-A Avenue L, Brooklyn 30, New York.

43 DIFFERENT Armenia in complete mint pictorial sets. 25c. Approvals. Aronson, 91 Marion, Brookline 46, Mass.

INSTRUCTIVE Book on stamp collecting plus 50 different foreign stamps only 10c with approvals. Pot-O-Gold, Litchfield, Conn.

#### ANTIQUES, RELICS, INDIAN GOODS, CURIOS

4 ARROWHEADS, 2 Drills, \$2.00. Smith, 841 Tacoma, Indianapolis, Indiana.

BEAUTIFUL Obsidian arrowhead \$1.00. Catalog 50c. Penning, 158 Dolorosa, San Lorenzo, California.

AFRICAN Tribal arrowhead \$1. Zita Waters, 1383-95 East 26 Street, Brooklyn 10, New York.

RARE Indian squaw bread recipe men like. \$1.00. Guaranteed. Indian Foods, Box 2348, Okmulgee, Oklahoma.

GERUNDHEIT! Illinois. Selling 580 historical firearms. 30,000 prehistoric, stoneage Indian relics, collectors cartridges, Confederate money, coins, Revolutionary, Civil, Indian war flintlocks, muskatoons, swords, bayonets, bullet molds, powder flasks, blunderbusses, pepperboxes, Kentucky rifles, Winchester, buffalo-stagecoach carbines, frontiers, Derringers, duelling pistols, matchlocks, arrowheads, tomahawks, bannerstones, gempoints, spearheads, steer, deer, buffalo horns, mounted pheasants, owls, quail squirrels, deerheads. Agates, fossils, mineral specimens, lapidary supplies, Daguerotypes, gold dollars, bo-wood, bio-horns, violin wood. Send 35c for profusely illustrated catalog. Heike, Hobbville, Wenona, Illinois.

4 SELECTED Arrowheads \$1.00. List 5c. H. Talburt, Calico Rock, Ark.

20 FINE Ancient arrowheads \$5.00. List free. Lear's, Glenwood, Arkansas.

4 FINE Indian arrowheads \$1.00. Stone tomahawk \$2.15. List free. Arrowhead, Box 5283, Indianapolis, Indiana.

#### PRECIOUS STONES, MINERALS

GEMSTONES. Mineral specimens. Every variety. Lowest prices. Free booklet. Plummer's, 4730 Point Loma Ave., San Diego 7, Calif.

GEMCUTTING — Silvercraft illustrated magazine. Tells how to cut gems, make jewelry. 150 ads illustrating equipment, gems for collectors, cutters. Free literature. Lapidary Journal, Del Mar 2, Calif.

SAPPHIRE, Topaz, tourmaline, garnet, peridot. Five uncut gem specimens, \$1.00. Ten polished gems, baroque shaped. \$1.00. Free big bargain list jewelry, gems, profitable, easy "do it yourself" projects. O'Brien's, 1116M Wilcox, Hollywood 28, Calif.

FIND Tungsten, mercury, uranium with Mineralight. Free brochure. Write Dept. PM3, Ultra-Violet Products, South Pasadena, California.

PROFITABLE Fun with gems, minerals, rocks, jewelry. How-to magazine tells how. Four month trial \$1.00. Guaranteed. Gems and Minerals, Dept. A10, Palmdale, Calif.

ROCKHOUNDS. Eight mineral specimens. Texas hill country. \$1.00. Rockmart, 1520 Piedmont, Austin, Texas.

GENUINE Red Arizona rubies (garnets). Send quarter for packet. Bitner's, Box 1025-B, Scottsdale, Arizona.

GOLD, Silver and copper ore with catalog 50c. Gemco, Elmer Ave., Sheboygan, Wisconsin.

HANDBOOKS For rockhounds. Free list. Minpub, P.O. Box 3114, Station "A", Spokane 17, Washington.

TEN N. Mex. minerals \$1.50. Six fluorescent \$1.00, fool's gold 25c. Minerals, Winston, New Mexico.

COLORFUL Utah agate, free list. D. & E. Products, Pleasant Grove, Utah.

#### HOBBIES AND COLLECTIONS

BILD-A-Clock yourself. Free bulletin. Corry Clock, Corry, Penna.

65 ASSORTED Army patches, insignias, ribbons \$1. Surprise included. Lango, 19 East 16th St., New York City 3.

GROW Giant crystals. Free booklet. Crystocraft, Box 35, College Station, Tex.

POSTER Stamps, seals, 20 different 10c. Two different lots 35c. Green, 555 Drayton, Ferndale 20, Michigan.

STATE Souvenir decals, collectors item. 20c. Box Seventeen, Nyack, N. Y.

COLOR Slides, 2x2. Trains, fire engines, antique automobiles. Illustrated catalog free. Universal, Box 779W, Beverly Hills, Calif.

GENUINE Nazi medal \$1.00; 37 different American emblems \$1.00. Catalog 10c. Insignia Club, 550-B Fifth Avenue, New York.

NAZI Swastika armband. Genuine World War II souvenir. Limited offer. Rush \$2.00. M. Olson, 1611 Hawthorne, Minneapolis 3, Minnesota.

UNUSED Matchbook covers, 100 different \$1.00. 36 page catalog 25c. Matchcover album \$1.00. Charles Edelman, 1311C East 84, Cleveland 3, Ohio.

NAZI Medals, ribbons, armbands, flags, daggers. Big introductory packet \$1.00. Illustrated lists. Medcrafts, 1923 34th St. S.W., Calgary 2, Canada.

INVENTING Can be an interesting and profitable hobby. Write for complete particulars. Institute of American Inventors, Dept. 40-E 631-E St., N.W. Washington 4, D. C.

FREE! Leathercraft catalogue. Do it yourself! Tandy Leather, Box 397-AH, Tulsa, Oklahoma.

#### CAMERAS, PHOTO SUPPLIES

CAMERA Repairmen greatly needed! You can learn manufacturers' service methods at home, in your spare time! Free, big illustrated book tells how: Write today. National Camera Repair School, Dept. PM3, Englewood, Colorado.

PHOTOGRAPHY For pleasure or profit. Learn at home. Practical basic training. Long established school. Free booklet. American School of Photography, 835 Diversey Parkway, Dept. 3431, Chicago 14.

BUY Wholesale nationally advertised cameras, photo supplies, thousands other products at big discount. Free "Wholesale Plan." American Buyers, Hertel Station, Buffalo 16-E, N. Y.

NEW Argus C-3 outfit \$48.90, Remington '60' deluxe shaver, \$18.50. Terrific discounts, photo equipment, appliances. Free catalog. Mailers Mart, Box 135-A2, New Rochelle, New York.

FREE! Free! Free! Central Camera Co., photographic headquarters since 1899, saves you money on all photographic equipment. Send for Central Camera Co.'s free photographic bargain list today! Central Camera Co., Dept. 11-B, 230 S. Wabash, Chicago 4, Ill.

CAMERA Owners, proven money making plans without studios. Photo markets included. \$1.00. Satisfaction guaranteed. Details free. Scott's, Juniata, Nebr.

BASE Says: Quality cameras since 1910. When in Chicago visit the camera cross roads of the world, or write us for your favorite equipment, new or used. Satisfaction guaranteed. Bass Camera Co., Dept. AG, 179 W. Madison St., Chicago 2, Ill.

20 TO 50% Discount everything photographic, giftware. Free catalogue. Dart, 3812E Atlantic Avenue, Brooklyn 24, N. Y.

#### PHOTO FINISHING

SPECIAL Introductory offer. 8 jumbos 25c. 13-35c. Western Photo, PM115, Box 298, San Francisco 1, Calif.

CHRISTMAS Cards made from your negatives. Mailers, prices on request. Mac Photos, Box 469, Hackensack, N. J.

20 WALLET Prints only \$1.00 from negative or print. One laminated in plastic free. Send ad. Pearson Photo, Laurens, South Carolina.

NOW! Give everyone that favorite picture of baby, yourself, with convenient wallet photos. Send us any photo or negative with \$1.00 now for 20 photos, or \$2.00 for 50 photos, postpaid. Original returned unharmed. Mail Today Co., Altoona 16, Penna.

ONE Day service—Roll 8 exposures 40c. Roll 12-50c. Reprints 5c each. High quality giant deckle edge pictures in albums. Free mailers. Sheffield Photo Service, Box K, Sheffield, Illinois.

NO Charge developing film. Pay for prints only. Contacts 3c each. Jumbos 4c. Failures refunded. Same day service. Guaranteed. Square Deal Photos, Hutchinson 2, Kansas.

1956 CALENDAR Photo greeting cards. 4 1/2 x 5 1/2 with envelopes. 100 for \$5.00. One negative. Sample 10c. Square Deal Photos, Hutchinson, Kansas.

PORTRAITS! Personalize friends, yourself—Colorfully. No obligation. Approvals! Send photograph, dollar (refundable). Dorseprints, Ojai, California.

I Need 20,000 customers. For every \$1.00 you send you will receive \$1.50 worth of photographs from your favorite negative or photo in wallets, enlargements, or new negative. Film, paper, equipment at a discount. Wallet Photos, Box 470, Pistoria, Ohio.

PARTICULAR? Custom finishing guaranteed. 8 jumbos 35c, 12-50c. Special! 35mm. 36 exposures \$1.10. Free mailer. Flash-Photo, Box 36G, Brooklyn 4, N. Y.

TRIAL Offer—Good with ad only. One roll film developed, 8 exposures 25c, 12 exposures 35c. King sized, dated prints from roll only. Don't send negatives. Sir Walter Photo, Raleigh, N. C.

ONE Day service. 35mm. Microdial developing. 20 exposure jumbo prints \$1.00; 36 exposure \$1.49; 8 exposure rolls 35c; 12 exposure 50c. Reprints 4c. Foto Craft, Box 3146, Washington, D. C.

ENLARGEMENTS! Eight 5x7's or five 8x10's, \$1.00. Willart Enlargers, Box 967, Little Rock, Ark.

12 EXPOSURE Rolls 35c, jumbo prints. Guaranteed work, one day service. Lincoln Studios, Dept. K, Box 13, Lincoln, Nebraska.

HIGH Quality finishing—Rapid service. 8 exp., 35c; 12, 50c; 16, 75c; 20, \$1.00. Camera, Box 280, West Chester, Penna.

TWO Beautiful enlargements from each picture on roll—8 exposures 55c, 12 exposures 75c. Cut Rate Photos, Dept. B-4, Janesville, Wisconsin.

6 OR 8 Picture roll 35c. 12 or 16 picture roll 55c. Each roll developed and printed in handy album pack. Send coin with roll. No c.o.d.'s. Mailing containers sent free. Deluxe Film Service, Box 1268-A, Shreveport, Louisiana.

TWO Beautiful prints from each picture on roll. 8 exposure 40c; 12 exposures 50c. Thirty four years of satisfied customers. Quick Service. Lens Photos, Dept. J-4, Janesville, Wis.

QUALITY Kodak finishing. 8 exposure roll 35c; 12 exposure 50c; 16 exposure 60c. Reprints 4c. Fast service. Guaranteed quality. 40 years continuous operation. Be a satisfied customer. We do color. Send for mailers. Mail Order Photo Service, Box 297, Watertown, Wisconsin.

FREE Beautiful superpak ring binder album with order 8 jumbos only 35c. Quality guaranteed. Prompt service. Free mailers. Free particulars complete superior finishing service. Grand Fotos, GPOB 1410, New York 1.

JUMBO Prints from any film, 40c. United Photo, Ogden, Utah.

TOP Quality. Fast service. 8 jumbos 35c in beautiful ring binder album. 16 contacts 40c. Reprints—Jumbos 4c; contacts 3c. Satisfaction guaranteed. Free mailers and circulars. Fast-X-Photo, Box A, Jersey City, New Jersey.

#### MOTION PICTURES AND SOUND EQUIPMENT

SEND For big bargain bulletin. 16mm. sound and silent films. Gaines, Box 114-PM, Skokie, Illinois.

TAPE Recorders, tapes; wholesale prices. Carstan, 215 E. 88, New York City 28.

BEAUTIFUL Color slides and movies. Sample 10c. Eddings, Corning R-3, N. Y.

16 MM. Sound lowest rentals, features \$2.75. sales, exchanges. Movies, Box 65, Old Hickory, Tennessee.

TAPE Recorders budget plan wholesale. Bellefonte, Route 3, Anchorage, Ky.

OLDTIMERS. Keystone comedies. Chapline, 8-16mm. Megiflms, Box 5803, Washington 14, D. C.

**TAPE Recorders!** Wholesale! Free catalog! Towers, 935 North 40th, Philadelphia 4.

**GUARANTEED Savings!** All brands movie equipment! Listings, Fotosales, Box 5908A, Kansas City 11, Missouri.

**ALL Kinds 16mm sound films.** Rent, sale. Roshon, 335 Fifth, Pittsburgh 22, Penna.

**FREE!** Blackhawk's big sale catalog new and used 16mm, 8mm, films; 2"x2" color slides; used 16mm, sound projectors. Biggest stock in U.S.A. Blackhawk Films, 1200 Eastin, Davenport, Iowa.

**TAPE Recorders, tapes, accessories.** Unusual values. Dressner, Box 66M, Peter Stuyvesant Station, New York City 9.

**5,000 8-16MM, Silent-sound films.** International, 2120 Strauss, Brooklyn 12.

**8-16MM Silent-sound films.** Latest subjects. Free catalogue, sample film 10c. Garden Film, 699 Howard Ave., Brooklyn, N. Y.

**MOVIE Camera film:** 8mm, roll \$1.50, 16mm, 100' \$3.00. Free processing, Better Films, 742 New Lots, Brooklyn, N. Y.

**SAVE 50%!** Guaranteed-fresh color, b.w. movie film! 8mm., 16mm. Free catalog! Eso-R, 47th Holly, Kansas City 12, Missouri.

**FREE Sample kit.** Make movie titles in color. A-to-Z Movie Accessories, Flatiron Building, New York City 10.

**FEATURE Film rentals \$3.95.** Sale on used prints. Write "Sound Films," Box 262, Chicopee, Massachusetts.

### MUSIC AND MUSICAL INSTRUMENTS

**ACCORDIONS—Direct from importer.** Save 30% and more! Free trial. Lifetime guarantee. Trades accepted. Free catalog. Write Accordion Outlet, Dept. 115-R, 2063 W. Chicago, Chicago 22, Ill.

**NEW Invention.** Play the Marimba with electrical keyboard attached to piano, organ or stand. Free details. Frederick, Box 38, Albany, California.

**SWISS Musical movements (finest) \$2.50.** Special tunes to order. Spielman, 131 West 42nd, New York 25.

**SONGWRITERS:** Large recording company wants new songs. Royalty basis. National sales, promotion if selected. No charge for melodies. Send songs, song poems. Music Makers, Dept. E-15, Box 2507, Hollywood, California.

**PLAY Piano the first day!** Copyrighted secret. Details free. Miracle Method, Box 5203P, Phoenix, Arizona.

**PHONOGRAPH Records cheap.** Catalogue. Paramount, MC-313 East Market, Wilkes-Barre, Penna.

**POEMS, Songs wanted!** Free examination. Bengal Music, 93 Jefferson, Chelsea 50, Massachusetts.

**PIANOS, Instruments.** Bulletin 8 free! Piano Mart, 2461 Oakland, St. Louis 14.

**WHOLESALE Catalog!** 30-80% discounts! Appliances, musical instruments, typewriters, phonographs, watches, jewelry, recorders, housewares, etc. Consolidated Distributors, 21-80 Lafayette, Paterson, New Jersey.

**MUSIC Copied from your tape or records.** Manuscript copies made. Gregory, 205 East 70th, New York 21.

**SWISS Musical movements, \$1.90.** Helax, 218 West 72nd Street, New York 23.

**POEMS Needed for new songs.** Send poems for free examination, details. Immediate consideration. Songcrafters, 2724 Arcade Station, Nashville, Tenn.

**1955 ACCORDIONS—Wholesale.** Free catalog. American Accordion Center, PM-3, 5329 Belmont, Chicago.

**SONGWRITERS!** Send poems, songs. Music Service, 243 West 72nd St., PM, New York City 23.

**FREE Records of your song.** Your words, my melody. Free information. Johnny Mack's Melody Mart, 1094 West 39th Street, Dept. A, Los Angeles 37.

**ACCORDIONS, Wholesale to everyone.** Save up to 60%. All national known brands. Free catalogue. Del Principe, 29 South Cicero, Chicago 44.

**POEMS Wanted for new songs.** Send poems. Immediate consideration. Crown Music Company, 1476 Broadway, New York City 36.

**POEMS Wanted for musical setting by America's largest songwriters organization.** Immediate consideration. Five Star Music Masters, 630 Beacon Building, Boston.

**POEMS—Urgently needed to set to music!** Write clever poems, catchy rhymes. Achieve fame, money in popular music field! Send sample poems. Free evaluation. Tin Pan Alley, 1650 Broadway, Dept. E, New York City 19.

**SONGWRITERS!** Protect your ideas! Hold all songs, poems! Write for safe correct procedure first! Song Service, Dept. P, 333 W. 54th St., New York 19, N. Y.

**WANTED!** Poems for musical settings. Write Songwriters' Service, Clifton, N. J.

**WRITE Songs.** Big money and reputation. Write for information. J. Gordon Pub. Co., 4700 South California Avenue, Chicago.

**POPULAR Songs.** How to write and sell them. Write for free booklet Successful Songwriting. Gateway Songs, Box 2479, Hollywood 28, Calif.

**RETIRED Church organist composes beautiful music to sacred words.** Hymn complete \$8.00. Reginald Belcher, Terrace Place, Morristown, New Jersey.

**SONGS—Poems wanted.** Good opportunity. Hollywood Tunemasters, 1609 Vista Del Mar, Dept. U, Hollywood, Calif.

**VIOLINMAKERS, Repairers.** Fine tone wood, and all violin supplies. Send for free wholesale price list. International Sales, 414-MPM E. Baltimore St., Baltimore 2, Maryland.

### RADIO, TELEVISION AND ELECTRONICS

**REPAIR Your own TV.** Instructions compiled exclusively for your set. Simple as replacing light bulb. Send set name, chassis, model number, \$2.00. LS Engineering Company, Box 4113-PM-11, North Hollywood, Calif.

**FREE 324 Page 1956 Television, Radio, Hi-Fi, Electronics catalog!** World's largest stocks, lowest prices. Everything for experimenters, builders, amateurs, servicemen. Latest build-your-own kits, Hi-Fi, phonos, recorders, P. A., TV accessories. Thousands of parts, tubes, test instruments, tools and books. Write for free copy! Allied Radio Corp., 100 N. Western Ave., Dept. 34-L-5, Chicago 80, Ill.

**GOVT Surplus meters, TBY's, radar, parts.** List 5c. Meshna, 580 Lynn, Malden 48, Mass.

**CRYSTAL Radio builders.** Free information. Hulet, 305 Hope, Lakewood, N. J.

**NEW! Printed circuit television antenna,** smaller than a transistor. Only \$1.99 postpaid. Ekeradio, 646 North Fair Oaks, Pasadena, Calif.

**EXPERIMENTERS.** Bread board complete with 5 crystals, 5 coils, condenser and circuits \$2.00 postpaid. With used phone. \$3.00. Small Radio Laboratories, 1331 Tyler, Topeka, Kansas.

**RADIO-TV job?** FCC license training, correspondence or residence. Classes held in Hollywood and Washington. Beginners get first class commercial license in 3 months. Write Grantham School, Dept. 6X, 737 11th Street, N.W., Washington, D. C.

**FREE Television and radio troubleshooting manuals and descriptive literature upon request.** Build 15 radio circuits. "Edu-Kit" includes all parts, instructions, tester, soldering iron—Only \$19.95 complete. Progressive "Edu-Kits" Inc., Room 35B, 497 Union Ave., Brooklyn 11, N. Y.

**COMPLETE Radio-television service course \$9.50.** Tibbs Engineering, Box 732, Memphis 1, Tennessee.

**TWO Transistor printed circuit radio.** World's smallest. Kit \$12.95, earset \$3.95. Postcard brings literature. Eastern Audio, Box 115-PM Huntington Station, N. Y.

**BUILD Cigarette case radios.** Four plans, \$1.00. Cook, 4083-M Roosevelt, Midland, Texas.

**ENJOY Color now!** Easily attached 3 color television screens for all black-white screens. Send \$1—16", 12", 14"; \$1.25—18", 17"; \$2—20", 21"; \$2.50—24"; \$3—27". Postpaid. Except c.o.d.'s. Satisfaction guaranteed. Zingo Electronics, Johnstown 15, New York.

**LEARN Electronic computers?** Specialized course in electronic digital computers, and data handling systems. Write Legistics, 734 15th St. N.W., Washington 5, D. C.

**MONEY in radio, T.V., appliance repair.** Make your own tester. Most parts from old radio. Complete information \$1.00. R. Manning, P.O. Box 2216, Kansas City, Mo.

**FREE! Newark's new 1956 catalog.** A postcard will bring you 260 pages full of the latest releases and largest selections of the world's finest radio, TV, amateur, electronics and high fidelity equipment. Write today to: Newark Electric Company, 233 W. Madison St., Dept. PM-11, Chicago 5, Ill.

**GUARANTEED Simplified TV trouble shooter** automatically locates faulty tubes. \$1.00. Stern, Box 42, Hillside, N. J.

**NEW Germanium diode, variable condenser crystal radio kit \$2.95.** Phone \$1.75. Free catalogue. Clearco Crystal Co., Box 1857, Milwaukee 1, Wisconsin.

**MAKE Simple powerful distance-getting crystal radio.** Works anywhere. Illustrated booklet 25c. Money back guarantee. Jay Francis, Box 5962, Cleveland, Ohio.

**MAKE Simple, tubeless, batteryless, distance-getting radio.** Genuine Melomite crystal, detector, illustrated instructions, 50c postpaid. Allen, 427-PM5, Clinton, Missouri.

**TV Trade-in sets.** Philco, Emerson, G.E., Admiral, Motorola, Tele-King, others. List available. 16"—\$17, 12" to 17"—\$20 up. Washtek Service Co., 1501 Boston Rd., Bronx, N. Y. DA 3-9281.

### BUSINESS OPPORTUNITIES

**AVAILABLE:** For men with construction, plastering or home improvement experience. Dealership franchises for "Quik-brik," the nationally famous plastered brick. Disneyland brick buildings are Quikbrik. Builders use Quikbrik. Architects specify Quikbrik. Home owners love Quikbrik. Covers the building field. New construction of all types and modernizing. Get detailed information how you can be an exclusive Quikbrik dealer for minimum investment. Write Quikbrik, 7306 Puritan Ave., Detroit 38, Michigan.

**AMAZING Home business.** Build tubular glass fishing rods. Everything furnished. Wonderful profit. Free details. Rodman, Box 41, Wauwatosa, Wis.

**MONEY in saw and lawnmower sharpening spare time at home.** Repeat cash business. Experience unnecessary. No selling. Free booklet explains. Victor Foley Company, Columbia Heights, Minnesota.

**TERRIFIC Profits.** Nationally advertised appliances, jewelry, housewares, etc. Wholesale catalog \$1.00 (refundable). Cut-Rate Sales, Dept. M, 144 Jones Ave., New Brunswick, N. J.

**\$1000 MONTHLY Possible in collection agency business.** Free details. Write Cole Associates, Syracuse 2, N. Y.

**MAKE Big money in your spare time!** Sell nationally advertised brand name merchandise. Appliances, cookware, housewares, watches, jewelry, dry goods, clothing, sporting goods, toys, gifts, etc. Build a profitable repeat business. Send for free 124 page illustrated color catalog with separate confidential cost sheet. Merit Home Products, Dept. FM11, 167 Manhattan Ave., Brooklyn 6, N. Y.

**GO Into business for yourself—Sell nationally popular name brand items of jewelry, watches, appliances, housewares, toys, gifts, premiums, prizes.** No investment, no inventory. Send \$1 now for big new catalog. Confidential price list. Refund on first order. Halen, Inc., 125 Fifth Ave., Dept. P.M., New York, N. Y.

**YOUR Own part time business.** No selling. Customers everywhere. Nothing like this before. Free details. R. Petersen, Box 221, Cardiff, Calif.

**STEEL Concrete forms.** Make barbecues, incinerators, planters, benches. Twenty kinds. Catalog free. Vyke Co., 2435 15th St., Denver 2, Colo.

**YOU'LL Be amazed at the tremendous profit possibilities in selling the finest quality Bibles available anywhere!** Many men make \$30,000 yearly and more! Get my free proven Bible sales course plus catalog of many Morocco grain, genuine leather covered Bibles and related items. Joseph W. Cain, Wholesaler, Box 5665Q, San Antonio 1, Texas.

**BECOME Tax consultant.** Our students earn to \$3,000 in 3-month season, part-time. We train you—help you start. State approved. Union Institute, 68 Hudson, Hoboken 2D, New Jersey.

**MAKE Perfumes, other products.** Sell mail order. Catalog free. International, 6347 Farnell-PM11, Chicago 21, Illinois.

**101 WAYS To earn money.** Details free. Coleman, Box 821, Newark 2, N. J.

**NEED Cash? For "know-how and where"** write: Business Service, 203 Bank Bldg., Cole Camp, Mo.

**STRANGE "Dry" window cleaner.** Sells like wild. Replaces messy rags, liquids. Simply glide over glass. Samples sent on trial. Kristee 114, Akron, Ohio.

**WANTED! Home producers, by manufacturers in our clearing house service.** Become subcontractor, casting plastic products for these companies. Thousands of easy-to-make items required for consumer-industrial use. Cash in at home, without previous experience. Plastic Service Associates, Dept. 11-PM, East Boston 28, Mass.

**\$40.00 DAILY** With inexpensive portable sawshop equipment. Zapart, 588PM Manhattan, Brooklyn 23, N. Y.

**REBUILD Batteries; repair dolls; make rubber stamps; silk screen printing.** Catalogue "60 Ideas" free. Universal, Box 1076-A, Peoria, Ill.

**NATURAL Molding rubber, extra thick.** Free sample. Flock, W. Wooley, 115-A Donald, Peoria, Ill.

**MEN Wanted—Build luggage and cases at home.** We sell your products, supply complete instructions, materials, everything. No special equipment needed. Free details. Cascraft, 805-G23 Sunset, Los Angeles 12, Calif.

**START A buying service, buy wholesale thousands nationally advertised products.** Make big profits selling at sizable discounts. Postcard brings details. American Buyers, Hertel Station, Buffalo 16-C, N. Y.

**MAKE Money, be popular, glamorous, entertainer, show business, television, stage.** Write for talent questionnaire. Show Talent Enterprises, Box 5417, Tampa, Florida.

**LEARN Mechanical secrets. Money schemes. Advertising stunts. Servicing sewing machines. Almost free.** Purdy's, 207-M, Weatherford, Texas.

**FRANCHISES Make profits! Become exclusive franchised distributor, agency operator. Nationwide opportunities. Information rushed. National Franchise Reports, 333 North Michigan, Chicago 1.**

**MAILORDER Plans, tested moneymakers, business secrets, success schemes.** Complete booklet free with 100 double edge razor blades for only \$1.00. Worth more. Armi L. Maki Co., 8928 Portland, Detroit 17, Mich.

**"MONEY Getter's Bulletin," sample 25c.** Donovan, 791 Greenbelt, Levittown, N. Y.

**CANADIANS! 137 Plans to make money.** Local mail order. Particulars free. Lethbridge Specialties, Box 471, Lethbridge, Alberta.

**HIGHEST Commissions, all magazines.** Free catalogue, supplies, prizes, exclusive ads. Subscription Service Co., Dept. A, P.O. Box 2070, Birmingham, Alabama.

**WHOLESALE Catalog—25c.** Pictures \$75,000 merchandise. Worldwide, Box 12-E11, New York City 60.

**SENSATIONAL New profitable home career now revealed.** At long last, you too can learn the amazing techniques of the portrait studios. Don't lose out, get your share of these steady, life long dependable profits. (Some portraits sell for more than \$100.00.) Be your own boss in this uncrowded field. Complete kit \$3.00 or valuable information free. John G. Marshall Co., Dept. PM-11, 167 N. 9th St., Brooklyn, New York.

**"MAILORDER Laws and Regulations."** Discusses federal, state, local licenses, taxes, legal requirements governing mail-order businesses. Play safe. Order today. Only \$1.00. Tasker, 105 East Custis Avenue, Alexandria, Virginia.

**MAIL Order merchandise! Fast sellers! Free samples! Houstex, 3026 East Holcombe, Houston, Texas.**

**OPERATE Mailorder folio business.** Write Ballard's, 425 East Catherine, Louisville 3, Ky.

**BUY Wholesale, thousands products.** Free literature. Triple J Industries, 132 Berkshire, Bridgeport 8, Conn.

**"HOW To Profitably Operate a Mail Order Business."** Free literature. Lawrence J. Archer, Rt. #1, Navarre, Ohio.

**97 SCHEMES To make a million.** You might! Amazing information free. MB, 406-P Gorham Bldg., Minneapolis 3, Minn.

**EARN Up to \$2000.00 monthly with spare or full time route of automatic 3 in 1 Hot Drink Merchandisers using Maxwell House coffee, Bakers chocolate, Tenderleaf tea, in your community.** We train you. \$1190.00 starts you. Write Superior, 4555-BH East Warren, Denver, Colorado.

**FREE! Complete mailorder business! Terrific profits! No investment! VitaMins, 2908PM Beverly, Los Angeles 57.**

**MAKE Money at home as renewal headquarters for all magazines.** Big Christmas sales profits now. Liberal commissions. Supplies furnished. Write for free catalog. McGregor Magazine Agency, Dept. 500-B, Mount Morris, Ill.

**YOUR Opportunity.** "How to build your own mail order business." For beginners, mail dealers. 25c booklet. Satisfaction guaranteed. J. G. Smith, 163-11 25 Dr., Flushing 58, N. Y.

**\$80.00 WEEKLY.** Operate our selective mail-order business in your area, spare-time. Write House of Plastics, Paramus 34, New Jersey.

**\$200 WEEKLY Reported! No selling.** Free booklet. T. J. Surface, Roanoke 4, Virginia.

**TIN-Cans.** Turn them into cash. Thirty methods. Instructions 50c. Charles Company, 12-DXD, Norwood, Ohio.

**RAISE Earthworms—Illustrated instructions 25c.** Birchall, Box 6065-T, Orlando, Florida.

**\$2000.00 OR More possible each month.** New service. Unlimited earnings. No merchandise. Keep present job. Can operate confidentially. Men or women. All for \$3.98. Send for particulars. Checkers Service, P.O. Box 45, Winter Park, Fla.

**EARN \$2.00 Hourly, making and selling sandals!** Youngs, 1308-PM, South First, Arcadia, California.

**LAWS Every mail-order man must know.** Play safe. \$1.00 Brings concise book. G. Bookston, Box 176, Monsey, N. Y.

**GROW Mushrooms in your basement.** Start small, grow big with big profits. Send \$2.00 for simplified instructions. A. J., 590 Canada St., St. Paul 1, Minn.

**WONDERFUL Homework opportunity.** Recording for profit. Write. Baron's Recordings, Lynden, Washington.

**ESTABLISH Automatic shoe shine route.** Jiffy Shine, 1630 South Second, Philadelphia 48, Penna.

**SENSATIONAL 10,000 Word booklet "How to Build Your Own Mailorder Business."** 25c. Lee M. Dahm, 383 Box Avenue, Buffalo 11, N. Y.

**SAWDUST.** Turn it into cash. Forty methods. Instructions 50c. Charles Company, 12-DXC, Norwood, Ohio.

**WANT Monthly income plus 60% discount on own needs? Distribute our wholesale catalogs. Appliances, housewares, jewelry. Catalog and income plans \$1.00 (refundable). National Suppliers, 347M 16th Street, Ashland, Ky.**

**SELL Pen and pencil sets—Jeweled pens.** Write for catalogue. Supercraft Mfg. Co., Dept. N, 445 Broome St., New York 13, N.Y.

**BUILD A home business sharpening saws.** Wonderful profits. You'll get orders galore. No experience needed. Everything furnished. Complete details absolutely free. Max Mfg. Co., 138 Stockton Ave., San Jose, Calif.

**PROFITABLE Home collection office.** Experience unnecessary. Details. Hyatt, 411 West Walnut, Kalamazoo 42, Mich.

**MAKE-Sell polishes, cleaners, anything.** Formula catalog free. Kemixer, Park Ridge, Ill.

**ADVERTISING Book matches—Cash in on big demand!** Sell union label matches. Cuts for all businesses and political parties. Free powerhouse selling kit, low prices, protection guaranteed on repeat orders. Cash commissions. Superior Match Co., Dept. MX-1155, 7330 Greenwood, Chicago.

**\$26,500 SALES in two weeks!** Amazing radio-mail order method. Free details. Broadcast Service, 1412-K Great Northern Building, Chicago 4, Illinois.

**\$70 WEEKLY—Home, spare time.** Simplified mail bookkeeping. Immediate income, easy! Auditax, 34757AW, Los Angeles 34.

**\$1,000 MONTHLY.** Home, mailorder, free advertising method. Revealing information. Seidel, 6900-AK Sunset, Los Angeles 28.

**EARN Money at home!** Homemaker Magazine tells how. Sample 25c. Size more. 20-H East Delaware, Chicago 11.

**WHOLESALE Buyers' service!** Buy nationally advertised merchandise wholesale. Sell way below retail. Fabulous profits. Write Wholesale Buyers, Box 22-P, St. Louis 3, Missouri.

**MAKE \$10,000 Yearly!** public adjusting. Free details. Sterling, Great Neck 64, N. Y.

**UNLIMITED Export-import opportunities!** Earn big money from home. No experience or capital necessary. Write Universal Services, Clayton 5-P, Missouri.

**HOME Opportunities, sample literature, details 25c.** Gentgen Publications, Oconomowoc, Wis.

**SELL Mexican imports, terrific demand this country, beautiful gift merchandise, absolutely sells on sight.** \$2.00 brings colorful sample, details, satisfaction guaranteed. Westway, Box 312, Lockport, N. Y.

**3-WAY Profit deal.** Start a business you can carry in pocket. Sell the kit, sell the service. Amazing new slant opens huge market (mail order or direct). Rush \$1.00 for starting kit. Charles Shotis, Distributor, 14244 Flint, Melvindale, Mich.

**LEARN Modern sign painting—Commercial lettering.** Anyone can be successful. Earn \$40-\$160 per week, spare time! Sign Instruction, Box 187A, No. Chicago, Ill.

**CAPITAL Easily obtained.** Unlimited sources of money. Millions now available, for your immediate use. Any purpose. How and where, information free. Act quickly! Write today! Advance Service, Box 1377, Miami 8, Florida.

**WHOLESALE—Get the big merchandise.** Furniture, appliances, TV's, clothing, tools, auto accessories; most anything. Save half. Literature free. Associated Wholesalers Service, 1016-C So. Starr, Burlington, Iowa.

**MANUFACTURE!** Learn how to choose, produce, sell products successfully. Free booklet. Jary, 268-BZ, New York City 5.

**MAKE Extra money between now and Christmas.** Sell subscriptions to all popular magazines. Liberal commissions. For supplies write DeSales Magazine Service, 60 East 42nd St., New York 17, N. Y.

**MAKE Money helping others out of debt, stop garnishments, save jobs, re-establish credit.** Details. Borum 87, 411 W. Walnut, Kalamazoo 42, Michigan.

**WHOLESALE, Thousands items.** Supply source directory, 10c. Idealer, Park Ridge, Ill.

**\$19,000 SALES in two months.** Sensational mailorder method. Actually works. Details free. Cartier, Box 261, Gainesville, Georgia.

**RAISE Nutria for profit.** Inquire Edwin Calvert, 2 Haynes Ave., St. Catharines, Ontario.

**\$200 WEEKLY Cleaning Venetian blinds.** Free book. Burt, 2434A, Wichita 13, Kansas.

**\$5.00 HOURLY Bronzing baby shoes!** Mountings! Foster, 1520 Ardmore, Chicago 25.

**OPERATE Profitable mail order business.** Splendid opportunity. Write Blair Co., Perkinston, Mississippi.

**\$16.00 PER Pound hand spinning Angora wool at home.** Angora House, PM, Springfield, Illinois.

**"FROG Raising!"** Get ready now for next spawn. New book tells how. Folder 10c. Broel-A, Box 506, New Orleans 1, Louisiana.

**BUILD Your business on building plastics.** Easily made at home. Enormous profits. Bays Laboratory, Oklahoma City 8.

**SPECIAL—One million articles wholesale.** Catalog-directory 50c. Johnson's, 1262-T Medina, Fort Worth.

**SELL Direct and through dealers best concrete sealer and decorator.** Extra profit on contract jobs. Aquadry, 906 W. North Ave., Chicago, Ill.

**BE A landscape contractor.** Make \$20 to \$60 a day. Start with smaller projects and work into larger jobs. We show you how. Easy-to-follow home study course. Write for free book. National Landscape Institute, Dept. M-115-C, 310 S. Robertson Blvd., Los Angeles 48.

**\$100.00 WEEKLY with your telephone!** Guaranteed. Details free. Johnson, Dell Rapids, South Dakota.

**WHOLESALE Catalog! 30-80% discounts!** Appliances, musical instruments, typewriters, phonographs, watches, jewelry, recorders, housewares, etc. Consolidated Distributors, 21-11 Lafayette, Paterson 15, New Jersey.

**OPERATE Cafe, diner.** Start with minor investment. Guides reveal every step. Write for free booklet "Cafe Business." School of Restaurant Arts, BUIII, Fremont, Ohio.

**BE First.** Get the latest. Best low cost starting mail order offers. Everything furnished. Orders filled. Rush name. A. M. F. Service, Gallipolis, Ohio.

**BOOKKEEPERS.** Keep books, small firms spare time. Manual latest technique by C.P.A., \$3.00. Modern Business, Box 466, Youngstown 1, Ohio.

**JUST Like** having an oil well, have money flowing in for years. Operate steady, profitable business from home. No selling. No mailing. No telephone canvassing. No appointments to keep. Practically works itself. Business increases in value for future sale and retirement. Everything supplied. Can be started even on a budget. Send now for proven method. All information free. Write, Creators International, Box 2350, Edmonds, Wash.

**COIN Radios** and television. Buy direct from manufacturer and save: steel cabinet, modern design, coin rejector, write for prices and full story. Coin Radio & Television Corp., 190A Duane Street, New York, N. Y.

**LADIES.** Earn money at home spare time. Details free. Evans, 10431 Bonnie Drive, Garden Grove, California.

**TO \$50.00 Weekly.** Sparetime, home operated mailorder business. Successful beginner's plan. Everything supplied. Lynn, 10420-M National, Los Angeles 34.

**PLASTERCRAFT Molds,** liquid rubber, plasters, flocks, candle supplies. Catalog and manual free. Blue Rapids Supply, Blue Rapids, Kansas.

**BUY Wholesale,** 800,000 items. Write Info-Center, 216 West Jackson Blvd., Chicago, Ill.

**EXPORT Business** made easy! Expect something different. Complete setup, everything furnished. Hermes, 152 West 42, New York City 36.

**FINEST Formulas** for making world's fastest sellers. Literature free! Miller, Chemist, 1517-R, Tampa, Florida.

**ADVERTISING Business—City, country.** Low overhead, substantial income. Experienced advertising company offers complete setup. Harold, 69-S Bennett, New York City 33.

**MINIATURE Trees.** Why pay \$1.00-\$10.00 for growing secrets? Free details. Tiny Trees, Box 3684-P, Chicago 54.

**BUY Wholesale!** 100,000 name brand products! Save 66%!! Big profits selling others spare time! Free catalogs! National Buyers Service, Box 426EE, Oakland, Calif.

**GET Merchandise** orders by mail! Everything furnished—Orders filled, Big profits. Long, McKays Beach, Leonardtown 3, Md.

**\$1.75 HOURLY** Minimum, evenings. Preparing tax returns—Simplified! Auditax, 34757AT, Los Angeles 34.

**WHOLESALE!** 16-80% Discounts! Appliances, tools, etc. Catalog 25c. Levesque Supply, Atlanta, New York.

**WHAT'S New** in mailorder? Let "Mail-order World," published monthly, keep you informed. Sample, 25c. Wayne, 1233 Elden, Los Angeles 6, Calif.

**DOLLARS:** Baby record books, Kitty Kat shoes. My Baby albums, eleven thousand new prospects daily. Sold by mail, use our literature. No-Co-Ro, Oakland 6, Calif.

**WANT** Up to \$100.00 weekly deposited in your mail box? Details free! Smith, 2708-P Ladera, San Bernardino, Calif.

**BUY It** wholesale! Manufacturers, distributors offer 850,000 items. Literature free. Olsen, 1231-A East Third, Duluth 5, Minnesota.

**ELECTROPLATE** Auto parts, novelties, mirrors, baby shoes. Easy, inexpensive home processes. Free booklet. Tyco Metals, Box 1321-MM, Houston 19, Texas.

**LEARN** Sewing machine repair. How to make big money at home sparetime. New machines. Everything supplied. Write Taylor Service, Box 2126, San Bernardino, California.

**IMPORT-Export** opportunity, profitable, world-wide, mail-order business from home, without capital; or travel abroad. Established world trader ships instructions for no-risk examination. Experience unnecessary. Free details, Mellinger E701, Los Angeles 24.

**BREED** Rare tropical fish at home. Earn big money! Learn secrets! Help fill huge demand. Amazing opportunity! Free plan. Tropical Fish Breeders, Los Angeles 61, Calif.

**BE** Appointed state notary public now. Write, Stationers, Helotes, Texas.

**HOW** And where to obtain capital. Particulars free. Star Service, Wapakoneta, Ohio.

**FREE** Folio "Up to \$45,000; Unlimited Vacations." No merchandise, equipment. Unknown! Work home, sparetime! Haylings, Carlsbad, Calif.

**WE Love** our mailman—He leaves over \$1000.00 monthly in our rural mailbox. My college professor husband drafted a scientific home mailorder method. We bought a Texas ranch, live as we always wanted. Now we sell the Ranch Mailorder Method. Operates anywhere. Inquire: Eveningshade Ranch, Helotes, Texas.

**RESILVERING** Mirrors, formula 50c; two-way lookout mirrors, (No one sees you), 50c; coppered mirrors, 50c. All \$1.00. Nelko-Mir Box 3462-J, Chicago 54.

**POPCORN** And potato chip equipment. Eakins, Box 933-AB, Springfield, Ohio.

**MEN—Income** from local information. No selling. Netherco, LaVerne, California.

**RUBBER Molds** for casting plaques, figurines, novelties. Catalog illustrating over 100 fast sellers, 10c. Cascraft Studios, 508-PM Marion Street, Brooklyn 33, N. Y.

**COPUBLISH** Mail Sale Advertiser, leading mail order paper. Details, latest copy, dime. Vanroy Shirk, Lebanon, Penna.

**GROW** Mushrooms, Cellar, shed, and outdoors. Spare, full time, year round. We pay \$3.50 lb. We paid Babbitt \$4,165.00 in few weeks. Free book. Washington Mushroom Ind., Dept. 172, 2834 Admiral Way, Seattle, Washington.

**\$23 WEEKLY** Working two hours daily at home. Lycke, Box 3471-A, Cleveland 12, Ohio.

**OPERATE** Profitable mail order business. Write Walter Service, 4159-A East 112th, Cleveland 5, Ohio.

**COLORGLAZED** Concrete pottery made without molds. Patented method. Cemetery products, novelties, tiles. Basement leak-sealing. Money-making projects. Booklet, details free. Men only. National Pottery Company, Grand Rapids, Minnesota.

**MINK** Raising information free. Complete. Lake Superior Mink Farm, Superior, EEL, Wisconsin.

**FREE** Book "505 Odd, Successful Businesses." Work home. Expect something odd! Pacific, Oceanside, Calif.

**BRONZE** Baby shoes. Instructions, equipment and mountings for genuine electroplated process. Free catalog. Holly-wood Bronze Supply, Dept. B-3, 1624 East First Street, Los Angeles 23, Calif.

**YOUR Own** name brand business. No investment; no inventory. Part time or full time. Sell famous brands of appliances, housewares, silverware, radios, vacuum cleaners, lamps, tools, clocks, watches, jewelry, etc., etc., over 1000 items. Join thousands of successful independent dealers. Send for free catalog and dealer price list. H. B. Davis Corp., Dept. W. 145 W. 15 St., New York City.

**LIQUID** Rubber. Make flexible molds. Free sample. Chaney, 1130 E. 16th St., Jacksonville 6, Fla.

**GOOD** Paying business silvering mirrors, plating articles in the shop and home by late method. No tanks or shop required. Free booklet. Gunmetal Co., Ave. H, Decatur, Illinois.

**GROW** Orchids at home—Profitable, fascinating. Year 'round, Maine to California. No greenhouse. Gorgeous cattleyas, cymbidiums, etc. Successful home grower shows you how. Full details free. Flowerland, 4622 Wilshire, Los Angeles 5.

**FIX** Typewriters. Inexpensive home course teaches factory secrets. Free booklet. Write, Typewriter, Tarentum 1, Penna.

**WANT** To make big money at home? \$5 profit in an hour possible with invisible re-weaving. Make tears, holes disappear from clothing, fabrics. Steady year-round demand from cleaners, laundries, homes. Details free. Fabricon, 8334-S Prairie, Chicago 19, Ill.

**BIG** Profits raising fishworms and crickets. Free literature. Carter Farms, Plains, Georgia.

**BECOME** A game warden, professional hunter! Join forestry, park, fishery services. Good pay! Opportunities open! Free revealing "Select-Job Chart," details, job-getting secrets, Write Home Study Institute R10, Los Angeles 19, California.

**FLEXIBLE** Rubber molds for plaster and Marble figurines. Sample and large illustrated catalog 25c, refunded on first order. K-C Novelties, Dept. 205, Southampton, Mass.

**\$25 DAILY** Profits sharpening farm discs without dismantling or moving. No experience necessary. Free plan explains. B. T. Foley Company, Columbia Heights, Minn.

**UNTOUCHED** Mailorder opportunity. Establish industrial supplies mailorder business. High income, more repeats, lower overhead. Complete setup offered. Stewart Advertising, 1625 S.W. 19th St., Miami, Florida.

**METALIZE** Baby shoes, jewelry, gifts. Free catalog. Publisher, Box 73136, Los Angeles 3.

**BIG Money!** Operating home mailorder business. Sparetime, small capital. Jackson, Newfoundland, Kentucky.

**\$5 TO \$10** An hour. I've did it, I'm disabled now. Real genuine offer. Complete information \$1.00. Lucas, 2210 Carson St., Pittsburgh 3, Penna.

**WHOLESALE** Catalogue! Appliances, cameras, watches! Cam Company, 6806PM 20th Ave., Brooklyn 4, N. Y.

**GROW** Expensive herbs for us! Big profits home-business of your own. Year around profitability! We supply everything necessary! Send for free rare seeds and revealing plan. National Herb Exchange, Dept. A, Gardens, Calif.

**\$250 WEEK** Cleaning venetian blinds. Patented machinery. Free literature. Robinson, 7213E, Indianapolis 1, Indiana.

**BE** in your own business. Buy wholesale. Big profits. Get free nationally famous name brand mdse. Catalog. Dept. PM, Normandy Distributing Corp., 133 Fifth Ave., New York City, N. Y.

**SAWDUST**, Turn it into cash. Forty-nine methods. Instructions \$1.00. Sawdust Laboratories, Box 155, Islington, Ontario, Canada.

**NEWEST** Spare, full-time home business. \$5 to \$10 hour possible. Paint with suede—The finish with touch and eye-appeal. Beautiful auto dashboards, signs, radios, toys, figurines, lamps—1001 others. Complete, step-by-step instructions sent for no-risk examination. Free details. Coast, Los Angeles 61.

**IMPORT-Export** mailorder opportunities! Details. Warner, Box 6, Fort Scott, Kansas.

**MONEY** In sheer sharpening. Repeat business. Details free. W. Zell, Summitville PM-2, Indiana.

**WE'VE** Got a highly unusual deal for you on a new line of fire extinguishers. This is a new company, but you'll recognize the men behind it, who have had more than 20 years' experience in this field, when you write us, and it might pay you well to airmail us today. The Fire King Company, Inc., Dept. 13, Littleton, Colo.

**A Monthly** repeat business which you can operate in your own community. For free details write Orsak, Dept. A-101, P. O. Box 494, McKeesport, Penna.

**MAKE** New greaseless doughnuts in kitchen. Sell stores. Half profit. Free recipes. M. Ray, 3605 South 15th, Minneapolis 7.

**\$46 FROM** Square foot plywood;igsaw necessary. Details free. Woodarts, X-16, Bridgewater, Mass.

**SELL** Quilt pieces by mail! Woods Remnant Co., Bedford, Penna.

**FREE** Spawns. Free instructions. Join National Association Mushroom Growers. \$1.00. Mushrooms, 32 Kendrick, Lawrence, Mass.

**WORK** At home. Free details. Ajax Products, 734 East 236th Street, Cleveland 23, Ohio.

## MONEYMAKING OPPORTUNITIES

**MONEY** In saw and lawn mower sharpening sparetime at home. Repeat cash business. Experience unnecessary. No selling. Free booklet explains. V. Foley Company, Columbia Heights, Minnesota.

**HOME** Money making opportunity. Quentin Trent Publishing Company, 16216 Kercheval, Detroit 14, Michigan.

**WORK** From home in spare time. Start profitable magazine renewal service. We show you how; furnish everything free. No experience needed. Write McGregor Magazine Agency, Dept. 500-C, Mt. Morris, Illinois.

**GET Rich!** Make gewgaws at home. We furnish materials. Hancock, Box 97K, Lombard, Ill.

**EARN** Big money. Manufacture better mousetrap. Disposability assures reorders. \$1.00 brings complete plans. Dispos-O-Mouser, Box 2693, Dept. PM115, Sacramento, California.



**LEARN** Technical Metaphysics and insure your future. Easy, inexpensive correspondence course. Simplest method known. Diploma. Write: Premier College of Technical Metaphysics, 2532 McKenzie St., Vancouver 8, B. C., Canada.

**START A** buying service, buy wholesale thousands nationally advertised products. Make big profits selling at sizable discounts. Postcard brings details. American Buyers, Hertel Station, Buffalo 16-D, N. Y.

**PRINTING** And office supplies wholesale. 20,000 items. Literature free. Royal, Box 368-A, Cleveland 27, Ohio.

**MAKE** Money, be popular, glamorous, entertainer show business, television, stage. Write for talent questionnaire. Show Talent Enterprises, Box 5417, Tampa, Florida.

**\$170,000.00 INCOME** Possible. Unbelievable, fantastic money-maker. Informative literature \$1.00. Huebl Minkery, LeSueur, Minn.

**\$10,800 PROFITS!** Your own mailorder business! No risk! Success plan free! Treasury, 709 Webster, New Rochelle, PM-27, N. Y.

**AMATEUR** Artists, cartoonists! Turn your art ability into money. Hamilton, Box 4-PMK, Astoria 5, N. Y.

**RAISE** Sell earthworms. Instructions free. Johnny K's Hatcheries, #45 Selby, St. Paul 4, Minn.

**METAL** Castings, art, machine parts. Write Box 124, Lynwood, California.

**FOR** Profitable full, part time outdoor, indoor enterprises, write Cottage Industries, Omaha 12, Nebr.

**\$9.00 RETURNS** \$160.00. Repeats. 25c coin for sample. Ezee, Bayport 7, Mich.

**\$1,000 MONTHLY** Possible raising earthworms! Backyard, garage, basement. Complete illustrated booklet explains raising, feeding, packing, marketing. 25c postpaid! Ozark Worm Farm-J, Willow Springs, Mo.

**TYPISTS!** Make money at home! Mailers. 2 Madison, Greencastle, Indiana.

**FACTORY** Workers, earn extra money easily; no selling. Details free. Ferguson, Box 227, Harvey, Ill.

**NEW** Comedy, religious, general "T-x11" signs. To retail 50c. 15 samples, \$1.00. Lowy, 812 Broadway, Dept. 903, New York 3.

**CLOSEOUT** 50,000 GE subzero automobile engine heaters. Listed \$8.95, sample \$3.95. Terrific quantity discounts. Illustrated literature and mailorder plans \$1.00 (refundable first order). Wisniewski, Milwaukee 7, Wisconsin.

**OPERATE** "Escalator" mailorder system, selling our products or any products. Most revolutionary mailorder system known. Postcard. Selbyco, Decatur 163, Illinois.

**FREE** Descriptive literature. Make money, save money, 1000 valuable tips, all needs wholesale. Nelson Sales, Elkhorn 9, Nebraska.

**BUY** Wholesale! Fifty-seven free catalogs. Thousands items. Econ-O-Mart, 8 Perry, Whippany 2, New Jersey.

**MAKE** Money with your typewriter! Write Barnett Company, Cleveland, Ohio.

**SPLENDID** Home money making plans. Magazine 25c. William Stanton, 3762 3rd Ave., Los Angeles 18, Calif.

**CONFIDENTIAL** Instructions, guidance "How to become manufacturer, sell products rightaway." Free booklet. Jary, 268-BU, New York City 5.

**\$200 WEEKLY** Cleaning Venetian blinds. Free book. Burt's, 2434A, Wichita 13, Kans.

**EARN** Money evenings, copying and duplicating comic cartoons for advertisers. Adservice, Argyle 1, Wisconsin.

**SELL** Titania gems; far more brilliant than diamonds. Catalog free. Diamonite, 2420 77th, Oakland 5, California.

**HUGE** Profits selling mail order plans! Guaranteed. Details free. Johnson, Dell Rapids, South Dakota.

**BIG** Profits selling ties (\$2.00 value) \$6.50 dozen. Free catalog. Empire Cravats, 611-PM Broadway, New York 12.

**BRAND** New opportunity. Free details. Bellant Sales Company, Box 53, Bangor, Penna.

**SELL** Helbrus watches-jewelry. 70% discount. Wholesale catalog 25c. Dorinda, Box 77, Huntington Station, New York City.

**MAKE** Spare time money preparing and mailing sales literature. Adams Survers, 3513-AT Sunset Blvd., Los Angeles 20, Calif.

**SCHEMER** Magazine. Canfield 1, Ohio. Mailorder and business plans. Year \$2.00, sample 25c.

**PRIZE** Contests provide fabulous and confidential home income opportunities! Here's how and where to win your share! Send stamp! National Contest Bulletin, Box 2685, Miami 16, Florida.

**MAKE** Money with cameras. Professional secrets \$1.00. Brewer-Photographer, 5880 Hollywood, Hollywood 28, Calif.

**"MONEY** Getter's Bulletin." Prints helpful money-making ideas, plans, tips. Sample 25c; details free. Distributors, Box 831-D, Monessen, Penna.

**EARN** \$50.00 Daily making mats, shoes and mud guards from old tires. S and S Patents Inc., 1307 North Clark St., Chicago 10, Ill.

**BUILD** Sales by recruiting productive distributors selling direct or to retail outlets. Secure most concentrated circulation through classified columns of Salesman's Opportunity. Write for facts. Gilbert, Salesman's Opportunity, Room 1700, 850 N. Dearborn, Chicago 40.

**FREE** Folio "Up to \$45,000; Unlimited Vacations." No merchandise, equipment. Unknown! Work home, sparetime! Haylings, Carlsbad, Calif.

**SPARETIME** Profits taking subscriptions all magazines. Wholesale catalog free. Cassell Publishers, Westfield, New Jersey.

**GENERAL** Contest Bulletin. Issued monthly. Sample, 25c. 1609 1/2 East 5th, Duluth, Minn.

**GROW** Mushrooms. Cellar, shed, and outdoors. Spare, full time, year round. We pay \$3.50 lb. We paid Babbitt \$4,165.09 in few weeks. Free book. Washington Mushroom Ind., Dept. 173, 2954 Admiral Way, Seattle, Washington.

**50,000 ARTICLES** Wholesale. Source directory, dime. Nelko, Box 3462-DH, Chicago 54.

**FREE** Book "505 Odd, Successful Businesses." Work home. Expect something odd! Pacific, Oceanside, Calif.

**READ** Progressive Mailtrade, the magazine that tells how to make money by mail. Dime brings sample and special offer. Progressive Mailtrade, Box 357, Sheboygan, Wisconsin.

**ATTENTION:** Typewriter owners. Make handsome profits. Write today. Groves Company, 682, Hastings 8, Nebraska.

**START** A profitable subscription business in spare time! We need men and women (young or old) as representatives for all leading national magazines. Liberal commissions paid for new and renewal subscriptions. Start earning money in this pleasant work at once! Clip this ad and send with your name and address to: Agency Bureau, Dept. PM, Hearst Magazines, 250 West 55th St., New York 19, N. Y.

**SCHOOL** Seniors—Sell classmates America's most beautiful graduation name cards. Largest selection. Highest commission. Outsell all others. Free sample kit. Printcraft, Dept. M, 1509 Maple Street, Scranton 5, Penna.

**BUY** Wholesale! Save 66%! Appliances, furniture, jewelry, toys, sporting goods, tools. Free catalogs. National Buyers Service, Box 428EB, Oakland, California.

**HAVE** Home business—Get \$10 orders in every mail. Keep \$8.00. Everything supplied. National, Box 88-W, Dorchester 23, Massachusetts.

**PRESERVE** Living flowers to last indefinitely. Swell for gifts. Interesting hobby. Make money too. Free details. Old Town Gifts, 405 S. Clark Blvd., Clarksville, Indiana.

**BIG** Profits servicing new and renewal subscriptions for firms, clubs, churches, friends, neighbors. No experience. No investment. Free catalog and supplies. Hanson-Bennett Magazine Agency, Desk P-2, 180 N. Wabash Avenue, Chicago 1, Illinois.

**TO \$50.00** Weekly. Sparetime, home operated mailorder business. Successful beginner's plan. Everything supplied. Lynn, 10420-M National, Los Angeles 34.

**\$5 TO \$10** An hour. I've did it. I'm disabled now. Real genuine offer. Complete information \$1.00. Lucas, 2210 Carson St., Pittsburgh 3, Penna.

**BIG** Money. Mail order. Details 25c. Desert Mail Sales, Box 858-PM, Mojave, California.

**VENDING** Machines—No selling. Operate a route of coin machines and earn amazing profits. 32-page catalog free. Parkway Machine Corporation, Dept. 15, 715 Ensor St., Baltimore 2, Md.

**OVER \$200,000.00** in cash prizes offered this month. They are yours for the taking. Free details. Robert Spence, Dept. P, 7352 Central Ave., St. Petersburg 7, Fla.

## FORMULAS, PLANS, ETC.

**FORMULAS:** All kinds, latest, best. Literature free. Kemical, Park Ridge, Ill.

**REAL** Manufacturing formulas. Lists free. Cummings, Chemist, Gordon Ave., Syracuse 4, N. Y.

**PRODUCT** Analysis, manufacturing formulas, processes developed. Moderate fees. Plastics, Box 1574, Boston 4, Mass.

**MODERN** Formulas for today's fastest selling big-profit products. Literature free! Miller, Chemist, 1517-N, Tampa, Florida.

**FREE** Formula catalog. Anything analyzed \$35.00. Western Chemical, Salem, Oregon.

## PLASTICS

**PLASTICS** Home-craft course for men and women. Tells and shows how to make hundreds of fast selling plastics products. All plastics and materials for 23 projects included in course. No special tools needed. Course pays for itself. Write for free booklet. Interstate Training Service, Dept. D-3-M, Portland 13, Oregon.

**ACRYLIC** Plastic, water clear solution for coating brass lamps, silverware, chrome, fishing rods, tools, lampshades. 8 ounces \$2.50. A. B. Dunn, Department A, Box 537, Chicago 80, Illinois.

**CASTING** Plastic, new liquid resin for casting and embedding. Sample casting and complete information for only 10c. Virginia Research Laboratory, Dept. D-511, Marion, Virginia.

**PLEXIGLAS**, Fiberglass, polyester, acetate. Unique wholesale-retail catalog. 15c. Gem-O'-Lite, Box 686M, North Hollywood, California.

**NEW** Liquid casting plastic, clear, colors. Embed real flowers, insects, photos, coins. Saw, drill, carve. Send 25c for handbook. "How to Cast with Liquid Plastic." and proved success plan showing how to make money at home. Castolite, Dept. M101, Woodstock, Ill.

**PLEXIGLAS**, Lucite. Square foot cost 1/16"—\$1.15, 1/8"—\$1.52, 3/16"—\$1.86, 1/4"—\$2.21, 3/8"—\$3.28, 1/2"—\$4.38. Colors add 10%. Send 15c for postage. Aristocrat Plastics, 23-25 Sussex Avenue, Newark, N. J.

**PLEXIGLAS** Sheets for less, 1/4" 12 x 12" \$1.75. Plus 15% postage. Catalog 25c. Plastic's, Box 1812, Salt Lake City 10, Utah.

**SPECIAL** Offer—Home repair kit with powerful adhesive plastic and fiberglass. Prize contest. Complete information brochure 10c. Adhese Sales Co., Box 282, Nixon 1, N. J.

**LAMINATING** Supplies. Free price list. Solomon, 46 Cornhill, Boston 8, Mass.

**PLEXIGLAS**. Cut to size. Clear. Any thickness. Colors. Rods. Tubing. McClarin Plastics, P.O. Box 168H, Hanover, Penna.

## CHEMISTRY

**NEW** Idea chemical and apparatus outfits for home experimenting, photo-scales, microscopes, chemicals, biologicals and laboratory supplies in small quantities. Catalog 25c. Established 1931. John H. Winn, 124A West 23rd St., New York, N. Y.

**ILLUSTRATED** Catalog: Chemistry, mineralogy, biology 25c. Tracey Laboratories, Evanston, Illinois.

**CHEMICALS** And apparatus for industrial, analytical, and private laboratories. Catalog 25c. Dept. M-50, Biological Supply Co., 1176 Mt. Hope Ave., Rochester 20, N. Y.

**CHEMISTRY** For beginners. All ages. Systematic. Fascinating. First lesson 25c. Also formulas, trade secrets, expert advice on all plastics. Parkway Laboratory, R. #1, McKees Rocks, Penna.

**CHEMICALS**, Glassware. Large catalog. 25c. Laboratory Sales, Box 161-A, Brighton, Mass.

**"BEGINNERS** Chemistry." 56 page booklet, 10c. Franks, 3121 So. Racine, Chicago 8.

**AMAZING** New book of science. Experiments, formulas and catalogue of laboratory supplies. Only 25c. National Scientific Co., Dept. PM-11, 2204 W. North Ave., Chicago 47, Illinois.

## AGENTS WANTED

**BIBLE** Stories paint book for children. New painting process, harmless, not available in stores. Free sample. Retail \$1.00 per set. Religious Craftsmen, 1106 Broad Street, Providence, Rhode Island.

**WE** Put you into big mail order business, drop shipping orders, no investment. No minimum. Catalogues supplied. Terrific new sellers, tremendous profits. Turner Company, 1170 Broadway, New York 1, N. Y.

**BEAUTIFUL** Feather pictures, 200% profit! Free sample. Apartado 9036, Mexico 1, D. F.

**MEN!** Make \$1000 a month with 3-second demonstration of powerful, midjet Presto fire extinguisher to homes, offices, factories, car owners, garages, farms, etc. New chemical beats expensive extinguishers. Merlite, 114 E. 32nd, Dept. 50-B, New York City 16.

**CALENDARS.** Advertising novelties, matches. All styles, including religious, varnished, 12 sheet, girls. Hundreds of advertising novelties, book matches, etc. Fleming Calendar Co., Sales Division, 6539 Cottage Grove, Chicago 37, Ill.

**BE** Your own boss! No investment—No inventory. Big real profit-making wholesale catalog free! Dept. PM, Jay Norris, 487 Broadway, New York City, N. Y.

**YOU** Can make a fortune with miracle discovery liquid cloth. Mends everything from coats to finest hosiery. Dries soft, durable elastic texture. Sells so fast production increased 34 times already. It's sensational! Bard's Products, Dept. Q, Evanston, Illinois.

**BUY** Wholesale thousands nationally advertised products at big discount. Free "Wholesale Plan." American Buyers, Hertel Station, Buffalo 16-A, N. Y.

**AGENTS-Salesmen:** Sell beautiful hand-colored plastic enlargements and sensational new personalized photo compacts, rings, bracelets, lockets, etc. Experience unnecessary. 40% advance commissions. We deliver, collect. Wonderful sideline. Better full time. Free sample outfit. Novel Portrait Co., 3343 North Ave., Chicago, Ill.

**START** Your own business on credit. Your own boss. 1135 of our dealers sold \$5000 to \$30,000 in 1954. We supply stocks, equipment on credit. 200 home necessities. Sales experience unnecessary. Pleasant profitable business backed by worldwide industry. Write Rawleigh's, Dept. K-U-PPM, Freeport, Ill.

**WHOLESALE** Catalogue! Appliances, cameras, watches! Anelag Industries, Rochester 1, Wisconsin.

**NEW** Plastic mending tape. Just press on! Repairs clothing immediately. Lightning seller. Samples sent on trial. Kristee 77, Akron, Ohio.

**FREE** Wholesale catalogue! Famous brand appliance, cameras, watches, etc. M. B. Serv., P.O. Box 232, So. Chicago 17, Illinois.

**BUY** Wholesale, 25,000 items, catalog 25c. Matthews, 1472-B2 Broadway, New York City 36.

**GUARANTEED!** Sensational sales profits selling sensational new shavers. Demonstrator \$7.98. Free information. Write now! Paradine, 1 DeMott Place, Rockville Centre, New York.

**PRINTING!** Highest quality. Big profits. Free wholesale price list, supplies, details. Napco, 2337-A Bath Avenue, Brooklyn 14.

**AGENTS** Make big profits on stainless steel tableware. Bargain deals. Low wholesale prices. Rush name for catalog and amazing details. House of Cards, 208 S. Lamar, Amarillo, Texas.

**STARTLING** Discovery. Cleans white-wall tires like magic. Spray on. Sponge off. Whirlwind seller. Profits galore. Write for free sample offer. Chemade Products Company, 777 Bayside, Detroit 17, Mich.

**"FUN** And Profit in Selling." Booklet by retired sales manager. Inspires confidence. Helps remove mystery from selling. \$1.00. R. Hyland, P.O. Box 2216, Cleveland 9, Ohio.

**100% PROFIT** Selling imported gifts. Free catalog. Martin Importing Company, Healdsburg, Calif.

**GOOD** Profits selling Mexican feather cards. Free sample. Apartado 7118, Mexico City 1.

**SELL** Dif hand cleaners. For 35 years, the fastest selling, highest profit items in handcleaning world. Markets everywhere. Sure repeats, 100% profit, sales guaranteed or money back. Write Dif, c/o Hyb, Garwood, N. J., for information, samples, other good news.

**MAKE** \$100 Up weekly — Demonstrate, take orders. Sensational new product. Prospects everywhere, part-full time. Campbell Company, Rochelle 53, Illinois.

**\$10.00** IN Soap scraps used by nylon brush! \$1 demonstrator puts you in business! SoapMiser, 2511-B Euclid Street, Santa Monica, California.

**BIG** Profit repeater. Low cost chamois. Babrok, 11D Tannery Distributors, Hudson Falls, N. Y.

**REAL** Diamond rings. Sell direct. Make big middleman's profit. No investment. Experience unnecessary. Free catalog, details. Gleamlight, 111-R No. Columbus, Mount Vernon, N. Y.

**BUY** Wholesale 550,000 products. Literature free. Carter, Box 6911-H, Chicago.

**MANUFACTURING—**Opportunities unlimited. Start small, grow big manufacturer. Complete instructions. Jarry Associates, 266-BH, New York City 5.

**SCHOOL** Seniors—Be popular with classmates. Have spending money galore. Details free. Craftcards, Box 235-L, Pittsburgh 19, Pennsylvania.

**\$200** WEEKLY Cleaning Venetian blinds. Free book. Burt, 2434A, Wichita 13, Kans.

**AMAZING** \$1.00 Retailer! Used by men, women, children! Tremendous market! Free details. Edmunds, 3009 Weaver, Baltimore 14, Md.

**WOMEN.** Men, make money spare time plus new car as bonus for encouragement. Amazing hosiery guaranteed to wear without holes, snags, and runs, or replaced free. For example, lovely 60 gauge nylons guaranteed for as long as 1½ years, or replaced free. Write Wilkint, 17511 Wash., Greenfield, Ohio.

**MAKE** Products. Sell mailorder. Catalogue free. Imoco, 6347 Farnell, Chicago 21, Illinois.

**ZODIAC** Lucky coins — Wagon jobbers, agents. New sensational zodiac merchandise, \$1.00, \$2.00 sellers. Lucky coins, money clips, key chains. Tells lucky numbers, lucky days, person's natural abilities. Fast selling items. Profits up to 100%. Three samples, 1 each, \$3.00 postpaid. Zodiac Manufacturing Co., 1603 Lawrence, Chicago.

**YOUR** Own business—Used suits \$1.50, overcoats 85c, mackinaws 35c, shoes 12½c, ladies coats 30c, dresses 15c. Enormous profits. Catalog free. Nathan Portnoy Associates, 605 West 12th Place, Chicago 7.

**"SEE-KLEER."** Amazing new eye-glass cleaner. Prevents steam, frost. Application lasts days. Purse size plastic spray bottle. Minute demonstration makes fast sales. Wonderful profits. Free details. Staples Sales, 805 East Vine, Knoxville, Tenn.

**MAKE** Money at home as headquarters for all magazines. Earn big Christmas profits. Liberal commissions. No experience—No capital needed. Supplies furnished. Write McGregor Magazine Agency, Dept. 500-A, Mount Morris, Ill.

**NEW** Line portable electric power tools. National manufacturer sponsoring Perry Como's fall program. Send for free catalogue. Glasser Products, 389 Kingston Avenue, Brooklyn, N. Y.

**NEW** Silicone car polish. Shines without rubbing. Fast seller. Details free. Bonluth Products Company, Box 1078, Bristow, Oklahoma.

**150% PROFIT** Selling 500 name and address labels. Retail \$1.00. You keep 60c profit. Free selling kit. Bruce, Box 71-Y, Boston, 1, Mass.

**IMPORTING** Without capital. Become successful U.S.A. resident agent for leading overseas manufacturers. High income, home operated, no risk. Complete arrangements furnished including U.S.A. distribution assistance. Impex, 1974-A Comstock, Los Angeles 25.

**PROFIT** With your own wholesale, name brand catalog. Appliances, watches, jewelry, gifts, tools. Imprint your name on cover. Full or part-time sales. Details free. Robel Sales, Dept. P.M., 487 Broadway, New York 13, N. Y.

**GOLD** Or silver letters, numbers. Windows, doors, trucks, 1" to 6". 500% profits. Free samples. Atlas-T, 544 West 79th, Chicago 20.

**WANTED:** Men interested in making up to \$15,000 a year. Exclusive line of personalized articles. No investment. Free information and sales kit. Write Hook-Fast, Box 480 (PM), Roanoke, Virginia.

**TREMENDOUS** Profits! Every man, woman and child a customer. Suits \$1.50, pants 35c, dresses 20c, shoes 20c. Operate from store, home, car. Free catalog. Superior, 1250-A Jefferson, Chicago 7.

**FREE** Color catalog of religious jewelry. 100% profit. Virgin Mary heart necklace, sample \$1.00 (value \$2.50). Money back guarantee. Stephen-New York Inc., 1947 Broadway, New York 23.

**EARN** \$200 A week and up! Amazing profits are yours selling Seal-Tite, miracle puncture-proofing discovery! \$1.98 tube stops flats forever. Sure-fire appeal to America's 50,000,000 motorists! Complete sales kit free on request. M & M, Dept. M-2, 842 Third Ave., New York City 23.

**PRINTING.** Advertising salesmen—Excellent moneymaking sideline selling decalcomania name plates, small quantities. Automobile initials, sign letters. Free samples. Ralco, XL, Boston 19, Mass.

**MAKE** Extra money. Sell front door name plates to friends, neighbors. Retail \$1.98; you make \$1.00! Free selling kit. Modern Engraving Co., P.O. Box 194, Boston 14, Mass.

**\$1.00 PROFIT** Selling \$2.95 photo enlargement deal. Allen Studio, Riegler Bldg., Little Rock, Ark.

**AGENTS—** 300% Profit selling genuine gold window letters; stores and offices. Free samples. Metallic Sign Letter Co., 431-D North Clark, Chicago.

**YOUR** Ad in this space will get some good agents for you. Yes, I'll prove it. Write for Folder "A," right now. F. W. Johnson, Classified Advertising Manager, Popular Mechanics Magazine, 200 E. Ontario St., Chicago 11, Ill.

**CALIFORNIA** Sweet smelling beads. Sensational sellers. Particulars free. Mission, 2328 PR, W. Pico, Los Angeles 6, Calif.

**EARN** \$30 A day! Sell Dab-It, amazing pocket-size, stick-form, "no rime" spot remover. Works like magic! Guaranteed! M & M, Dept. M-1, 842 Third Ave., New York City 23.

**EASY** Money selling the new Pro Candid 35 mm. cameras. Your area is open for anyone to cash in on these fast-selling cameras. Selling kits furnished, cash commissions guaranteed. For complete information write Beaurline Industries Inc., 509 N. Robert Street, St. Paul 1, Minn.

**USED** And new watches. \$2.00 up. Free list. Southern Watches, Gray, Georgia.

**FOG-STOP** Windshield cloth. Instantly removes blurry mist, frost, sleet, snow. Stops windshield fogging. Samples sent on trial. Kristee, 79, Akron, Ohio.

**EASY** Handwork makes fast-selling articles. Sample free. Sunmade Company, Brockton 64, Massachusetts.

**500% PROFIT.** Retailers can't resist colorful, large "sale" signs. Big selection. Dynamic samples \$1.00. Soik, 132 West 23, New York City.

## BUY IT WHOLESALE

**BUY** Wholesale! 30-80% discount! Nationally advertised merchandise. Send \$1.00 for catalog. (Refunded on first order.) John E. Sexton Company, Garland Street, Winston-Salem, N. C.

**THOUSANDS** Nationally advertised brand name products. Discounts to 80%. Meder, 550-PM Fifth Avenue, New York City 36.

**WHOLESALE!** Double head electric shaver, case. Fully guaranteed. Retail \$27.95, wholesale \$9.95. North American Distributors, Box 1044, Lansing 4, Mich.

**THOUSANDS** Articles wholesale! Catalog \$1.00 (refundable). Evanich, Stamford (Catskills), N. Y.

**ELECTRIC** Guitars, amplifiers, parts. Wholesale. Free catalog. Carvin, PM287, Covina, Calif.

**WHOLESALE** Catalog! Housewares, appliances, watches. Postcard. Selbyco, Decatur 262, Illinois.

**BUY** Wholesale! 30-50% discount! Name brand television, refrigerators, water heaters, radios, electric housewares, power tools, etc. Catalog 25c. Marpat Distributors, Box 1485, Milwaukee, Wis.

**FREE Gift!** Plus free "Wholesale Purchasing Secrets"! Save 50%-80% nationally advertised appliances, watches, tools, gifts. Everything for home, office, workshop. Write! Panatron, 7721 J. Melrose, Hollywood 46, Calif.

**EVERYTHING!** For home, office, gifts, sports, jewelry, etc. Standard brands. Catalogs \$1.00-\$5.00, refundable. Agents deal also. Consumers-Cooperative, 2153 Lemoine, Chicago 23, Ill.

**WHOLESALE Catalog!** 30-60% discounts! Appliances, musical instruments, typewriters, phonographs, watches, jewelry, recorders, housewares, etc. Consolidated Distributors, 21-20 Lafayette, Paterson, New Jersey.

**BUY Wholesale!** Nationally known brands. Large illustrated catalog \$1.00. Refundable. D'Auria, Box 355M, Jackson, Mich.

**BARGAINS, Joblots, close-outs, 2000 items.** Save to 50%. Clothing, hosiery, toys, toiletries, gifts, jewelry, television, etc. Get acquainted. 25c brings wholesale catalog plus free \$1.00 merchandise certificate. Reliable Jobbing, 311-B North Desplains, Chicago.

**BUY Wholesale!** Save 60%! Appliances, furniture, jewelry, toys, sporting goods, tools. Free catalogs. National Buyers Service, Box 424EB, Oakland, California.

**POGO Sticks.** Will carry 150 lbs. guaranteed! \$4.50 postpaid. U. S. Industries, 803-A Macy Street, Los Angeles 12, Calif.

**INDIVIDUALS, Nationally advertised merchandise, wholesale.** Tremendous discounts. Kingsley, Chepachet, Rhode Island.

### SALESMEN—DISTRIBUTORS

**SPARE** Or full time top earnings selling America's largest low-priced line business printing and advertising specialties to every retail store and business. Big advance commissions. Complete order-winning sales kit free. National Press, North Chicago 1, Illinois.

**AD Matches!** Sell amazing designs—10, 20, 30, 40 and 240-light book matches. Bigger spot cash commissions; every business a prospect. Low prices for high quality. Repeats. Start without experience; men, women; full, part time. Buy nothing! Sales kit furnished. Match Corp., Dept. PM-71, Chicago 32, Illinois.

**SELL** Calendars. You make big money daily. Giant line. Every business buys. Also business printing, book matches, advertising specialties. Big sales outfit free. Write, Arrow Press, 515-T Fourth Ave. So., Minneapolis, Minn.

**GET** New shirt outfit free! Make \$90.00 weekly on 5 average orders a day. Famous quality made-to-measure dress and sport shirts at \$3.95 up sell fast to all men. No experience needed. Full or part time. Write: Packard Shirt Co., Dept. 135, Terre Haute, Ind.

**MEN!** Make \$1000 a month with 3-second demonstration of powerful, midjet Presto fire extinguisher to homes, offices, factories, car owners, garages, farms, etc. New chemical beats expensive extinguishers. Merlite, 114 E. 32nd, Dept. 50-B, New York City 16.

**NO** Trick to selling ties at 69c each! Free plan shows how easily you pocket \$3.33 hourly profit. Loren Specialties, 2849-A11 Birchwood, Chicago 45.

**BIG** Money-making opportunity. Exclusive line work uniforms, jackets, pants, shirts, coveralls. Advertising embroidered. Every business prospect. Outfit free. Master Div., 572 Water, Ligonier, Ind.

**SEND** \$5. For fine collection manicure sets, leather cases, kitchen knives, steak knives, post paid. Cabiri Works, Solingen-Germany.

**WHY** Work for peanuts? \$16.95 profit per unit possible with amazing new Alarm-O-Safe. Sells itself. No experience needed. Free sales kit. Merlite-Alarm, Dept. A-5011, 114 East 32nd St., New York City 16.

**FRANCHISED** Distributors make profits! Nationwide opportunities. Request interesting information immediately. National Franchise Reports, 333 North Michigan, Chicago 1.

**DELAYED** Action light switch for automobile headlights. Send for free information. \$2.00 for sample. Delayed Light Division, 3100 Fenton Road, Flint 7, Mich.

**BUY** Wholesale thousands nationally advertised products at big discount. Free "Wholesale Plan." American Buyers, Hertel Station, Buffalo 16-J, N. Y.

**SALESMEN** Calling on any trade using grinding wheels can make money selling our patented dresser. Write for proposition. Thompson Manufacturing Co., Erie, Penna.

**BIG** Money! Buy wholesale, sell retail. Dresses, children's wear, family apparel. Lowest factory prices. No stock to carry. No samples to buy. Big sales kit with actual fabrics free. C. E. Israel, Dept. P-6793, Cincinnati 25, Ohio.

**SELL** Most unique toy ever built—Safe fun for youngsters. \$15.95 profit on yard-size roller coaster. Scottel, Swanton 9, Ohio.

**SIX** Ways to sell alphabet checkers. Krume, 240 W. Eight, Dallas 8, Texas.

**MONEY**-Making opportunity! Take big profit orders for world famous patented varieties fruit trees. Also flowering shrubs, roses, vines. Big sales outfit free. Stark Bro's, Desk 30156, Louisiana, Missouri.

**WILL** You wear new suits and topcoats without one penny cost and agree to show them to friends? You can make up to \$30.00 in a day even in spare time, without canvassing. Pioneer Tailoring Co., Congress and Throop Sts., Dept. K-1226, Chicago 7, Illinois.

**ADVERTISING** Book matches—Cash in on big demand; sell union label matches. Cuts for all businesses and political parties. Free powerhouse selling kit, low prices, protection guaranteed on repeat orders. Cash commissions. Superior Match Co., Dept. M-1155, 7530 Greenwood, Chicago.

**AGENTS, Salesmen:** Sell name brand auto safety belts. 50% commission. Free details. Home Supply Service, Kiel, Wis.

**100% PROFIT, 100% Repeat.** Kograt Distributors make fortunes. Write today! Nassau Laboratories, Hackensack, N. J.

**NEW** Jobs open in selling! Send name, address for five free issues of Opportunity Magazine's money-making guide. Listing hundreds of companies who'll pay you well, full or part-time. No experience needed. Opportunity, 850 N. Dearborn, Dept. 17, Chicago 40, Ill.

**GOLDMINE** Of 600 money-makers. Copy free. Specialty Salesman Magazine, Desk 5, 307 N. Michigan, Chicago 1.

**DISTRIBUTORS**—Large profits. Terrific repeat orders. Unique Italian brooms, details free. Write P.M. Peacock, 915 Bryant, San Francisco, California.

**SALESMEN!** New or old, up your income immediately! With pocket sized pamphlet, "Thirty Laws That Govern Top Salesmen," written by outstanding author and sales executive. Practice one law daily and watch your sales increase! No need to plough through books, absorb by doing! Money back guarantee. Mail only \$1 today to Post Publications, 2 Depot Plaza (M) White Plains, N. Y.

### EDUCATIONAL AND INSTRUCTION

**WANTED:** More new writers for TV, radio, magazines, business publications, motion pictures. Learn at home for extra income or exciting full time career. Many students earn while learning. Professional instruction. Send today for free lesson and book. Palmer Institute of Authorship, Desk TM-115, 1680 N. Sycamore, Hollywood 28, California.

**BECOME** A real estate broker or salesman. Complete home study course. Free information. Kansas City Realty School, Box 6808PM, Kansas City, Missouri.

**COMPLETE** Your high school at home in spare time with 54-year-old school. Texts furnished. No classes. Diploma. Information booklet free. American School, Dept. X845, Drexel at 58th, Chicago 37, Ill.

**FREE** Trial—Complete language course for home study by Linguaphone world's standard conversational method. At home, easily, quickly learn to speak French, Spanish, German, Japanese, Russian, Modern Greek—your choice of 34 languages. It's like living in another country. Send for free book and details of 10-day free trial. No obligation. Try, don't buy! Linguaphone Institute, T-83-115 Radio City, New York 20.

**AUCTIONEERING!** Be an auctioneer. Earn big money. Term soon. Free catalog. Kansas City Auction School, Box 6808PM, Kansas City, Missouri.

**A** Pleasing dynamic singing and speaking voice can be yours! Use self-training Canfield Voco-Records. Thrilling details! 2018-A—5th Avenue South, Minneapolis 4, Minnesota.

**BLUEPRINT** Reading for machine and building trades. Train at home. Learn to read blueprints with confidence in 10 easy lessons. Earn more pay. Literature free. Belton School, 1039-2 North Lawn-dale, Chicago 51, Illinois.

**HIGH** School—No classes. Study at home. Spare time. Diploma awarded. Write for free catalog HF-58. Wayne School, 2527 Sheffield, Chicago 14, Ill.

**ENGINEERING** Degrees earned through Extension Division, American College of Engineering, Box 27724 (B), Hollywood 27, California.

**WELDING** Training pays at Hobart Welding School, Box M-1151, Troy, Ohio. VA contract. Best equipment. Catalog free.

**APPLY** For jobs by letter. Short home study course. Free trial offer. Telesis Company, Room 706, 507 Fifth Avenue, New York 17, N. Y.

**USED** Correspondence courses and educational books bought, sold, rented. Catalog free. Educational Exchange, Menlo, Georgia.

**MIDWEST** Engineering School, home study opportunity, 10923 Hillcrest, Hickman Mills, Missouri.

**HELP** Yourself! Solve personal problems by self-mastery. Free information. The Leavitt Science, Clinton 5, Illinois.

**BIG** Money in plate or pipe welding. Free catalog. G.I. approved. Tulsa Welding School, 919M E. Second, Tulsa, Oklahoma.

**INVESTIGATE** Accidents—Many earn \$750 to \$1000 monthly. Thousands of insurance companies, airlines, and steamship lines need claim investigators. We train you at home spare time. Placement counsel and help. Free book—Now! Universal Schools, Dept. 111, Box 8262, Dallas 5, Texas.

**BECOME** A draftsman: Electronics, mechanical or architectural. Complete course eight dollars. Paul Provino, 21-18 29th Avenue, Astoria 2, New York.

**MIDLAND** Linotype School, Charles City, Iowa. Civilian and Veteran Courses. Free placement. Established 1909.

**CLERGYMEN'S, Laymen's** courses. Free bulletin! Midwestern Bible School, 517 Merchants Bank Building, Indianapolis.

**TUNE** Pianos spare time. Learn quickly. Inexpensive home course. Write Stafford, 708 Rawlings, Carbondale, Ill.

**TRANSFORM** Yourself via subconscious dynamics. Free amazing brochure. Box 847 (H-11), Ocean Park, Calif.

**CAR** Owners—Save hundreds of dollars. Unique "Know Your Car" home study course teaches trouble shooting and how to make repairs. Anyone can learn. Free booklet. Roberts Technical & Trade Schools, 343 East 63rd St., New York, N. Y.

**MEDICAL** Laboratory technicians in big demand by hospitals and physicians. We train you at home. Free catalog. Century College, Desk 3, 960 Montana St., Chicago 14.

**MANUFACTURING.** Selling products successfully. Complete instructions, guidance. Free booklet. Jary Associates, 288-BJ, New York City 5.

**DEGREE** Correspondence courses, psychology, divinity, science, philosophy. Airea, 156 West 73rd Street, New York City.

**EXTRAORDINARY** Courses—Everyday future, figure control, removing eyeglasses, natural memory, improving sleep, \$2.00 each. Human Engineering, Fairhope 5, Alabama.

**ENGINEERING** Without college. You can become a licensed professional engineer, qualified for thousands of engineering jobs without college education. Write Newton, 5910 South Bend Drive, Fort Wayne, Indiana.

**COLLEGE** Degrees—Independent study. Keep employed. Brentwood College, Box 19-721, Los Angeles 19.

**ENGINEERING** Degrees earned through home-study American College of Engineering, Box 27724 (B), Hollywood 27, Calif.

**YOU** Can train for U. S. Civil Service tests! Men-women earn more. Steady work. Pass next exams. Many jobs open. Experience often unnecessary. Free 26-page book shows requirements, salaries, sample coaching. Write: Franklin Institute, Dept. K24, Rochester, N. Y.

**LEARN** Piano tuning at home. Total cost \$45. Write White-Bartenbach, 1001B Wells, Lafayette, Indiana.

**INDUSTRY** Needs draftsmen. We help you qualify. Free information. Industrial Training, 1794-A Frederick, Port Worth 7, Texas.

**MANY** Earn \$1000.00 per month operating collection agencies. Write for free bulletin. Franklin Credit, Roanoke 7, Va.

**ELECTRONIC** Paris distribution offers you a secure future at top pay in all areas. No investment necessary. Write Williams Co., Box 261, Miami 2, Fla., for information on this desirable, uncrowded field.

**PIANO** Tuning pays. Big money in spare time. Learn at home in 30 days. No musical knowledge necessary. Phonograph, records, tools and instructions furnished. Free catalog. Capital Tuning School, 16 Southwest Second, Fort Lauderdale, Fla.

**BE** A real estate broker. Study at home. Write for free book today. GI approved. Weaver School of Real Estate, 2018P Grand, Kansas City, Missouri.

**BECOME** A doctor of psychology or metaphysics. Learn secret of contentment, happiness. Win degree of Ps.D. or MsD. Correspondence only. Free book. College of Universal Truth, 5038-C Broadway, Chicago.

**INVESTIGATOR** Training. Phillips Secret Service System, 1917-B North Kenneth, Chicago 39.

**HIGH** School diploma at home. Licensed teachers—Approved materials. Southern States Academy, Box 144-MX, Station E, Atlanta, Georgia.

**SECRET** Investigation. Experience unnecessary. Investigators particulars free. George Wagner, M125 West 86th, New York 24.

**GROW** Mushrooms. Cellar, shed, and outdoors. Spare, full time, year round. We pay \$3.50 lb. We paid Babbitt \$4,163.00 in few weeks. Free book. Washington Mushroom Ind., Dept. 174, 2954 Admiral Way, Seattle, Washington.

**EARN** While you learn. Auto and diesel mechanics master this top paying trade. Many graduates earn \$100 a week and up. Approved for Korean veterans. For free information write Dept. No. 256, Nashville Auto-Diesel College, Nashville 3, Tenn.

**BOOKKEEPERS!** Increase your earnings! Operate your own simplified "Dollar-A-Week" bookkeeping and tax service. Full or spare time. Details free. No obligation. Ellis, Box 200, Cedar Grove, North Carolina.

**USED** Correspondence courses and books sold and rented. Money back guarantee. Catalog free. (Courses bought.) Lee Mountain, Pisgah, Alabama.

**PIANO** Tuning pays. Learn this profitable profession at home easily with patented Tomometer and mechanical aids. No knowledge music necessary. Diploma granted. Write for booklet. Niles Bryant School, 3731 Stockton Blvd., Dept. P, Sacramento 20, California.

**STUDY** For doctor's degree of psychology, metaphysics and divinity. Correspondence courses only. College of Divine Metaphysics, Dept. P-M, 2811 North Illinois, Indianapolis 8, Indiana.

**SPANISH** Quickly! Recordings, textbook. Special. \$6.95. Speed-O-Way, Box 32-161, Los Angeles 32, California.

**WANT** A diesel job? New opportunities to increase income. Higher pay. More money. We can help you qualify. Tools. Shop method home training. Write today! Diesel, Tractor, Heavy Equipment Division, Interstate Training Service, Dept. B-3, Portland 13, Oregon.

**PHYSICAL** Therapy and massage. We train you at home. Earn big profits from your own private practice or work with hospitals and doctors. Free catalogue. National Institute, Desk 4, 159 E. Ontario, Chicago, Ill.

#### PLAYS, STORIES, MANUSCRIPTS

**WANTED:** Book manuscripts, all subjects considered. Greenwich Book Pub., Attn. Mr. Zealand, 489 Fifth Ave., New York City.

**NO** Luck finding a book publisher? Write for free Booklet PM. Vantage Press, 120 W. 31, New York.

#### SPECIAL SERVICES

**INFORMATION** On anything. Ferguson Research Specialists, 116-14 141 St., South Ozone Park 36, N. Y.

**AT** Your service in New York. Use me as your representative in New York. Buying and selling. No errand too small; no mission too large. Odd job specialist. You are assured prompt courteous satisfactory representation. Write, telephone, cable, Atyourserv. Bert G. Senter, One East 42nd Street, New York 17, N. Y.

**INFORMATION** On most any subject. Prompt. Reasonable. Let us know your wants. Reliable Information Service, Box 173, South Lansing, Michigan.

#### ARTISTS' SUPPLIES

**IF** Interested in artist frames, canvas, canvas boards, Red Sable brushes, etc., be sure to get our money saving price lists before buying. International Sales Co., 414-APM E. Baltimore St., Baltimore 2, Md.

#### CARTOONING, COMMERCIAL ART, SHOWCARD & SIGN PAINTING, TATTOOING

**CARTOONISTS:** Amateur, professional. Prepare for animation with Max Fleischer's plan. Write Vera Coleman, Lincoln Building, New York, N. Y.

**LEARN** Sign painting at home. Test lesson free. Ben Kerns, Box 812-PM, Greenville, S. C.

**"HOW** To Make Money With Simple Cartoons"—A book everyone who likes to draw should have. It is free; no obligation. Simply address Cartoonists' Exchange, Dept. 911C, Pleasant Hill, Ohio.

**FREE** Cartooning lesson. No obligation. Write Dahlberg, Box 101PM, Brockton 69, Mass.

**PROFITABLE** Lettering is no trick, it's know-how! Money back guarantee. Ken Hobbs, PM11, Fitzgerald, Ga.

**BASIC** Training for beginners. Free talent test. Student Art Club, Kennebunkport, Maine.

**YOU** Can entertain with chalk talks. Catalog 10c. Balda The Cartoonist, Oshkosh, Wis.

**PAINT** Signs with master patterns. Set 1 1/2" to 12" high, with supplies, \$2.00; sample 3c. Eyerly, B-583, Newton, Iowa.

#### ADVERTISING AGENCIES, LETTER WRITERS, FOR ADVERTISERS

**FREE** Adwriting assistance. Mailorder ad reaching 1,600,000 families, nationwide. \$28.70 inch. Magazine, newspaper, rate-book free. Chicago Advertising Agency, Chicago 4.

**5000** LATEST Buyers of \$3 mailorder system, on labels, \$1 per 100. Make a test. Selbyco, Decatur 362, Illinois.

**GUARANTEED** Mailing lists many classifications opportunity seekers, farmers, ministers, school teachers, many others. Price lists. Write Ken-West Distributors, 7-K South Harlem Street, Worcester 4, Mass.

**ADVERTISE:** 24 Words, 100 Canadian newspapers \$5.50. Lists free. Advertising Bureau, 10511-C Springfield, Chicago 43.

**MAILING** Lists, most any classification. 1000 names \$5.00. 1000 your circulars mailed with ours \$4.00. 5000 your circulars printed and mailed \$12.95. Write Dixie Mailers, King, North Carolina.

**FREE!** 1955 Advertisers Rate and Data Directory. 52 pages! E. H. Brown Advertising Agency, 20 N. Wacker, Chicago 6.

**ADS** Placed in out of town newspapers and magazines. Low rates. Catalogue free. Ideas that pay. Baker Advertising Agency, Successors Ankrum Agency, 189 W. Madison, Chicago 2.

#### RUBBER STAMPS AND OFFICE SUPPLIES

**GUARANTEED** Quality, deep letters lasting years, 3 lines \$1.00, extra lines 25c. Stamp-It, Box 9032A, Chattanooga, Tenn.

**WHOLESALE** Prices. Complete, quality stamp service. Information. Handy Stamps, Belvue, Texas.

**FREE** Style list stock stamps. Criterion, Box 2326, Denver 25, Colo.

**LINE** 25c; 2-45c; 3-65c. Stamp Works, Auburn, Nebraska.

**RUBBER** Stamps by professional craftsmen. 3 lines \$1.00. Price list. South Coast Press, 654 East Base Line, San Bernardino, Calif.

**3 LINES,** \$1.00. Fast service. Catalogue. Johnson, 443 MacDonough, Brooklyn 33, N. Y.

#### TYPEWRITERS, DUPLICATORS, OFFICE DEVICES

**GOV'T** Surplus typewriters \$19 up. Picture list 5c. Meshna, 589M Lynn, Malden 48, Mass.

**RECONDITIONED** Typewriters, duplicating, printing devices, \$25.00 up. Supplies. Appliances. DixieGraph, King, N. C.

**RUSH!** Fyberglass eraser, Fyberglass holder and extra long life refills for only \$1.00. Harrington, Blue Ridge, N. Y.

#### PRINTING, MULTIGRAPHING, MIMEOGRAPHING, GUMMED LABELS

**100** LETTERHEADS (8 1/2x11) Printed neatly \$1.00 postpaid. Envelopes same. Blue or black ink. Stark Press, Capitola, Calif.

**OFFSET,** Letterpress, mimeographing. Economical prices, samples. Litho-Press, Madison, Tenn.

**GIFT** Boxed personal stationery. Name, address printed 150 sheets, 100 envelopes, 50 correspondence cards. All for \$2.95 postpaid. Charles Schuler, 319-C West 48th Street, New York 36, N. Y.

**OFFSET** Printing \$6.50-10.00, 8 1/2x11, 16 lb. National Letter, 1463 Broadway, New York City 36.

**PINEST** Quality printing at bargain prices. Free catalog. Hampton Printing, 601 1/2 N. Main, Wichita, Kans.

**100** 8 1/2x11 HAMMERMILL Letterheads and 100 envelopes postpaid \$1.98. H. Hudson, Centredale, R. I.

**1000** BUSINESS Cards (raised printing), \$2.95. Samples. Hontz's, 1009-P Hill, Phillipsburg, N. J.

**200** BUSINESS Cards \$1.00 postpaid. Artcraft, 95-28 Roosevelt, Flushing 72, New York.

**250** BOND Letterheads, statement or billheads \$2.00. Moyer, Milton, Penna.

**FREE** Catalog. Letterpress, offset printing. D & M Press, Sebastopol, Calif.

**HIGHEST** Quality mimeographing. Free samples, price lists. Ken-West Distributors, 7-K South Harlem Street, Worcester 4, Mass.

**BUSINESS** Letterheads. Illustrated catalogue free. Howprint, 723-G Eunice, Webster Groves 19, Mo.

**1,000** ENGRAVED Business cards \$3.50 postpaid. Over 25 type styles. Samples sent free. House of Farrell, Box 452-P, Buffalo 5, N. Y.

**QUALITY** Printing. Booklets, publications, catalogs, stationery. Free catalog. Adams Printers, 30 West Washington, Chicago 2, Ill.

**1000** EMBOSSED Business cards, one color \$3.95; two color \$4.50. Samples free. L. Watson, Box 162, St. Charles, Illinois.

**\$1.00,** 100 LETTERHEADS Or envelopes. Postpaid. Poor Boy PM, Box 1055, Little Rock, Ark.

**MIMEOGRAPHING**—Letters, price lists, formulas, instructions. Lowest prices. Lem's Letter Shop, 5716 Stanton, Detroit 8.

**500** 3/4x2 1/4 FOUR Line gummed stickers 50c. Red border \$1.00. Moritz Printery, Saginaw, Mich.

**100** LETTERHEADS, \$1.00, #6 3/4 Envelopes same, two colors, \$1.50. Broadbrook, Boxford, Conn.

**SENSIBLY** Priced business printing. Special! 250 8 1/2x11 bond letterheads, 250 #10 heavyweight envelopes, \$5.95. Postpaid, guaranteed. Free samples, quotations. Sparks Company, Box 4096, Austin, Texas.

#### PRINTING OUTFITS AND SUPPLIES

**PRESSES,** Type cabinets, supplies. List for stamp. Lincoln Press Company, 230-K Hartwell, Fall River, Mass.

**MAKE** Your own self-molding rubber stamps and printing cuts. Flexirubber, Argyle 1, Wisconsin.

**PRINTING** Presses, type, supplies. Lists 3c. Turnbaugh Service, Mounted Route, Mechanicsburg, Penna.

PRESSES, Supplies, paper, Catalog 16c. Custom, Box 211-P, Springfield, Missouri.

DO Your own printing. Save money. Simple rules. We supply everything. Print for others; good profit. Raised printing like engraving too. Have home shop. Details free. Kelsey Presses, V-11, Meriden, Connecticut.

### PATENT ATTORNEYS

**PATENTS**—Irving L. McCathran, 315 McLachlin Bldg., Washington 1, D. C. Registered Patent Attorney.

**INVENTION** Record form free and "Patent Information Every Inventor Should Have." Carl Miller, Registered Patent Attorney, Woolworth Building, New York.

**REGISTERED** Patent attorney offers services. Sanders, 6430 Evans, Chicago 37, Illinois.

**C. A. Snow & Co.**—M427, Snow Building, Washington 1, D. C. Registered Patent Attorneys. Write for information.

**INVENTORS:** When you are satisfied that you have invented something of value write me, without obligation, for information as to what steps you should take to secure a patent. Write Patrick D. Beavers, Registered Patent Atty., 935 Columbian Bldg., Washington 1, D. C.

**PATENTS.** "Proof of Invention" free. E. E. Vrooman, Registered Patent Attorney, 507 McKim Building, Washington 5, D. C.

"**INVENTOR'S** Guide" and "Record of Invention" free on request. Frank P. Ledermann, Registered Patent Attorney, 154 Nassau Street, New York City.

**INVENTORS:** Without obligation, write for information explaining the steps you should take to secure a patent. John Randolph, Registered Patent Attorney, 203 Columbian Bldg., Washington 1, D. C.

**INVENTORS:** Learn how to protect your invention. Unless the inventor is familiar with patent matters, he should engage a competent registered patent attorney or agent to represent him. We are registered to practice before the U.S. patent office and prepared to serve you in handling your patent matters. "Patent Guide for the Inventor" containing detailed information concerning patent protection and procedure with "Record of Invention" form will be forwarded to you upon request—without obligation. Clarence A. O'Brien & Harvey Jacobson, Registered Patent Attorneys, 518-K District National Building, Washington, D. C.

**INVENTORS**—If you believe you have an invention, you should find out how to protect it. The firm of McMorrow, Berman & Davidson with offices in Washington, D. C., is qualified to take the necessary steps for you. Send for copy of our patent booklet "How to Protect Your Invention." We will also send you an "Invention Record" form. No obligation. They are yours for the asking. McMorrow, Berman & Davidson, Registered Patent Attorneys, 134-K Victor Building, Washington 1, D. C.

**INVENTORS**—Take these preliminary steps toward patent protection. Sketch and describe your invention. Sign, date and have this disclosure witnessed by two people who understand your invention. Have us make a preliminary search among U.S. patents already granted for similar types of invention. We report on the probable patentability of your invention and recommend your further course of action. Write for our instructive booklet, "Patent Protection for Inventors" and convenient "Evidence of Invention" disclosure form. Victor J. Evans & Co., 131-M Merlin Building, Washington 5, D. C.

### FOR INVENTORS

**INNUMERABLE** Manufacturers waiting for inventions. Quick action. Consultations free. Superior, 338-344 North Rodeo, Beverly Hills, Calif.

**INVENTORS:** Profit from copyrighted "One Inventor's Experience" or money back. Send \$1. R. E. McLean, 5703 South Benton, Kansas City 30, Missouri.

**PATENT** Pending. No attorney required. Send two five-cent stamps for Patent Search Guide and all information. Paladin Publications, 2033 Atlantic Ave., Bellmore, N. Y.

**INVENTORS**—Send for free patent information book and inventor's record. Registered Patent Attorney, Associate Examiner, Patent Office 1922-29, Patent Attorney & Advisor, Navy Department 1930-47, Gustave Miller, 115A Warner Building, Washington 4, D. C.

**INVENTORS**—This firm is registered to practice before the United States Patent Office and available to assist you in the preparation and prosecution of your patent application. "Patent Protection for Inventors" booklet containing detailed information and steps to take toward patent protection sent promptly upon request. No obligation. Victor J. Evans & Co., 132-M Merlin Building, Washington 5, D. C.

**INVENTORS**—If you believe you have an invention, you should find out how to protect it. The firm of McMorrow, Berman & Davidson with offices in Washington, D. C., is qualified to take the necessary steps for you. Send for copy of our patent booklet "How to Protect Your Invention." We will also send you an "Invention Record" form. No obligation. They are yours for the asking. McMorrow, Berman & Davidson, Registered Patent Attorneys, 134-H Victor Building, Washington 1, D. C.

**PATENT** Pending. No attorney required. Send three three-cent stamps for five-page patent search guide, copyrighted record of invention device and full information. Paladin Publications, Atlantic and Pacific Sts., Bellmore, N. Y.

**SELF-Help** sales plan, inventions, inventive ideas. Practical, straightforward, simplified. Free outline. Adman, 255-A Glenwood, Syracuse 7, New York.

**WRITE** For free invention record form. No obligation. Frank J. Renaud, Registered Patent Attorney, 1311 G Street N.W., Washington 5, D. C.

**INVENTORS:** Send for free details of our patent application plan. Inventors Institute, 200 West 34th Street, New York City 1.

**300 LOCATIONS** Where you can make your own preliminary patent searches. 43 things to do before applying for patents. Fred Roth, 14621 Dickens St., Sherman Oaks, Calif.

**INVENTORS:** Before paying for searches, patents, market testing, or promotions, see if it would be best to make these steps for yourself. Free information. Dynavolt Company, 3310 Huntington, Newport News, Virginia.

**\$1,000,000.00 WORTH** Of new ideas and inventions may be buried in your mind. Learn how to originate money ideas. Satisfaction guaranteed. Mail only \$2.00 to Highways to Happiness, Inc., Fencon Building, Clearwater, Florida.

**MARKET** Research is vital to the sales success of any product, new or old. Increase profits. Avoid losses. A highly trained and experienced market analyst will advise on your markets. For free details, write: Market Data, 1029 Center Point Road, Cedar Rapids, Iowa.

**PATENT** Searches, including copies of nearest patents, \$5.00. Reports airmailed within 48 hours. More than 100 registered patent attorneys use my service. For free invention protection forms, write Miss Ann Hastings, P.O. Box 176, Washington 4, D. C.

**INVENTORS:** If you have an invention for sale, patented or unpatented, write Institute of American Inventors, Dept. 40A, 631-E St. N.W., Washington 4, D. C.

"**INVENTOR'S** Guide" and "Record of Invention" free on request. Frank P. Ledermann, 154 Nassau Street, New York 38, N. Y.

**INVENTION** Record form free and "Patent Information Every Inventor Should Have." Carl Miller, Registered Patent Attorney, Woolworth Building, New York.

**PATENT** Searches \$5.00. 48-hour airmail service. Invention protection forms free. Write Patent Engineering Service, 711 14th Street, N.W., Washington 5, D. C.

**SEARCHES**—Put your patent searches in the hands of a registered patent attorney or agent, as he qualifies to give a worthwhile patentability report. Record of invention form upon request and information on patent protection. Patrick D. Beavers, Registered Patent Attorney, 935 Columbian Bldg., Washington 1, D. C.

**INVENTORS:** Learn how to protect your invention. Unless the inventor is familiar with patent matters, he should engage a competent registered patent attorney or agent to represent him. We are registered to practice before the U.S. patent office and prepared to serve you in handling your patent matters. "Patent Guide for the Inventor" containing detailed information concerning patent protection and procedure with "Record of Invention" form will be forwarded to you upon request—without obligation. Clarence A. O'Brien & Harvey Jacobson, Registered Patent Attorneys, 51A-K District National Building, Washington, D. C.

**INVENTORS:** Information on patent procedure furnished on request, without obligation. John Randolph, Registered Patent Attorney, 202 Columbian Building, Washington 1, D. C.

**PATENT** Searches \$5.00. 48-hour service. Free invention protection forms. Write Raymond L. Smith, Patent Searcher, 622 Sberaton Building, Washington 5, D. C.

### INVENTIONS WANTED

**CASH** Buyers for ideas and inventions. Write National Inventors Institute, 457 Munsey Building, Washington 4, D. C., or 4097 East 131st St., Cleveland 5, Ohio.

**INVENTORS:** Hundreds of manufacturers have requested our assistance in locating marketable new products. Complete information free. Institute of American Inventors, Dept. 40-D, 631-E St. N.W., Washington 4, D. C.

**INVENTIONS** Promoted. Patented or unpatented. A-1 service for inventors since 1911. Write Adam Fisher Co., 5413 Idaho, St. Louis, Mo.

**INVENTIONS** Wanted. Patented or patent pending. 24 years experience promoting inventions. National Service Bureau, 3120 Meramec, St. Louis 18, Mo.

**INVENTORS.** Don't sell your invention patented or unpatented until you receive our offer. Write Cowgill, Box 298, Marion, Ohio.

**INVENTIONS** Wanted now by my manufacturer-clients. Patented, unpatented. Send for free form "S." Adams, Patent Broker, 80 Wall Street, New York City.

**INVENTIONS** Wanted. Patented; unpatented. Outstanding manufacturer lists. Full particulars free. Superior, 338-344 North Rodeo, Beverly Hills, Calif.

**INVENTIONS** Wanted. Patented; unpatented. Free booklet. Wilco Patent Association, Ltd., 550 Fifth Avenue, D-115, New York City 36.

**HIGHEST** Cash, royalties paid for unpatented ideas, patents. Get "Inventors Hand Book." Tells you how. Send \$2.00. We have inventors. Inventors Creative Service, 354-M South Spring, Los Angeles 13, Calif.

**INVENTORS:** If your invention is adaptable to promoting we will contract on cash or royalty. If not, we will attempt selling it for you. Special booklet free. Kessler Corporation, 511, Fremont, Ohio.

**INVENTIONS** Wanted. Patented; unpatented. Tremendous manufacturers lists. Global Marketing Service, 2420 77th, Oakland 5, California.

**PATENT** Holders—Free advertising in national magazine for your patent pending or patented product for sale to manufacturers. Pay only if patent sold on your terms. No obligation. Write for details. Syndreco, Inc., Dept. A-29-C, 205 W. 7th St., Austin, Texas.

### PATENTS FOR SALE

**INVENTORS:** Test the commercial value of your patented or unpatented inventions, quickly and inexpensively. Write for free information. Institute of American Inventors, Dept. 40-B, 631-E St., N.W., Washington 4, D. C.

### MANUFACTURING

**MODELS**—Small lot manufacturing. Metals, plastics, etc. Milburn, Burlington, Kentucky.

**WHITE** Metal castings from your metal pattern. Low mold cost. Selley, 744 Clay, Winter Park 7, Fla.

**SMALL** Lot manufacturing, models, designing, electrical, mechanical, electronic devices. Brownell Electronic Engineering, Marshall, Michigan.

**DESIGNING,** Manufacturing, machinery, parts, models. Henry, Engineer, 2136 E. Monmouth, Philadelphia, Penna.

**MANUFACTURERS!** Complete instructions, guidance: How choose, manufacture, sell products right-away, manage enterprises successfully. Free booklet, Jarry Associates, 268-BM, New York City 5.

**ANY** Metal part duplicated. Send 25c with sketch for estimated cost. Line Tool, Base Line, Michigan.

**EXPERIMENTAL** Machinist, model work, \$3.00 minimum charge. Mordus, 245 Dodd St., E. Orange, N. J.

## MODELS, MODEL SUPPLIES

**MODEL Train catalog \$1.00, refundable.** Sattler's HO Dept, 1510 Cedar Ave., Cincinnati 24, Ohio.

**SHIP** And yacht model fittings; blueprints. Send 35c for illustrated catalog listing hundreds of items. A. J. Fisher, 1092-1 Etowah Ave., Royal Oak, Mich.

**POWER Models.** Unusual steam, gasoline and traction engines, fittings, metals. Anniversary catalog 90c. Chas. Cole, Ventura, Calif.

**LIONEL American Flyer trains** repaired by factory mechanics. Fast mail service and satisfaction guaranteed. 20 to 40% electric trains and accessories. Catalog free. Mack Bros., 2041 Chicago Ave., Chicago 22.

**STREAM Engines, boilers, castings.** Catalog 35c. Anton Bohaboy, 2297 Price, Rahway, N. J.

**BALSA Wood and model aircraft.** 40-page catalog 10c. Sig Co., Montezuma, Iowa.

**SHIP Models and yacht supplies.** Complete, large 68 page catalogue 50c. Bill Wild's, 510 East 11 St., New York City 9.

**SHIP And other scale models.** Most complete line in New England. Kits, fittings, plans, books, tools, engines, motors. Illustrated catalog 25c. James Bliss & Co., Inc., Dept. 8M, 342 Atlantic Ave., Boston 10, Mass.

**MODEL Railroads, HO and O, over 850 cast metal items illustrated, catalog only 10c.** Selley, 744 Clay, Winter Park 5, Fla.

**MODEL Train, hobby catalog free.** Shannon's, 505 Franklin, Nutley 10, N. J.

**CIRCUS Wagons, railroad cars.** Enclose stamp. Box 181, Omaha 7, Neb.

**TRAINS.** Send stamped envelope for bargain list. State gauge; HO, S, American Flyer. Nixon Model, Southampton 3, Penna.

**GEARS And model supplies for the inventors.** Send 10c for catalog. Pierce Model Works, Tinley Park, Illinois.

**WORKING Steam models—Tractors, locos, marine, stationary engines, boilers, fittings, materials, castings, prints.** 1956 catalog-manual \$1.00. Tiny Power, Corvallis, Oregon.

## HOME CRAFTSMEN

**ALL Crafts, supplies.** Large free catalog. National Handicraft, 199 William Street, New York City 38.

**GIVE Wrought iron legs for Xmas.** Sample set \$3.98 prepaid. Literature free. Hibbard's, 624 Celey, Hampton, Va.

**101 FULL Size patterns.** Smart, new, gifts, novelties, lawn figures, shelves, action windmills, alphabets. Plus "Make Money Jig Sawing." Only \$1.00. Mastercraft 115M, 7041 Olcott, Chicago 31, Illinois.

**FREE! Metalcraft catalog.** Enameling supplies, copper and aluminum. J. C. Larson Co., 820 S. Tripp, Dept. 3675, Chicago 24.

**LEATHERCRAFT.** Metal enameling, beadcraft, shellcraft, metal tooling, textile painting, many other crafts. Free big illustrated catalog. Kit Kraft, Dept. 2211, Studio City 1, California.

**PLASTICS Home-craft course for men and women.** Tells and shows how to make hundreds of fast selling plastics products. All plastics and materials for 23 projects included in course. No special tools needed. Course pays for itself. Write for free booklet. Interstate Training Service, Dept. D-3-M, Portland 13, Oregon.

**WOODWORKING Course for home craftsmen.** Twenty-two manuals. Over 1000 pages. 75 training projects. Only complete home training program available today. Carefully written, profusely illustrated. Covers everything from wood selection to final finishing. Complete instruction in care and use of all hand and power tools. Prepared by expert manual training instructors. Write for free booklet. Interstate Training Service, Dept. G-3-M, Portland 13, Oregon.

**FREE! Large complete leathercraft catalog.** J. C. Larson Co., 820 S. Tripp, Dept. 3650, Chicago 24.

**KNOCKDOWN Cedar chests.** Lumber and veneers. Free price list. Giles & Kendall Company, Huntsville, Ala.

**NEW! Largest leather and craft catalog!** 1,000's of items. Send 25c (refundable with first order). Russo Handicraft Supplies, Dept. C3, 245 S. Spring, Los Angeles 12, California.

**LEATHERCRAFT.** Send 10c for new 60-page catalog of tools, supplies, kits, including metalcrafts, enameling, ceramics, all other crafts. Complete stock. Reasonable. Since 1910. Sax Bros., Dept. PM11, 1111 N. 3rd, Milwaukee, Wis.

**BUY Wholesale nationally advertised power, hand tools, thousands other products at big discounts.** Free "Wholesale Plan." American Buyers', Hertel Station, Buffalo 16-F, N. Y.

**JOLLY Life size Santa** in three dimensional effect. 5'-3" high. Easy to make. No tracing required. Just mount and paint. Only \$1.00. Mastercraft 1111M, 7041 Olcott, Chicago 31, Ill.

**GENUINE Glo-Candle wax for candle making.** Interesting. Profitable. Write for price list. Valuable instructive book 10c. Mar-Ro, Box 675-PM, McPherson, Kans.

**AMAZING Matched patterns for jigsaw.** Combinations galore. Become independent with this new idea. Complete, \$1.00. Hoover, Grand Marais, Minn.

**KNOCKDOWN Cedar chests and lumber.** Free price list. Bedford Lumber Company, Shelbyville, Tennessee.

**STYLECRAFT Sure fire hits.** "Pre-traced" leather kits. Handbags, billfolds, fillgree belts, over fifty other projects. Patterns on leather. Why trace? Just carve, assemble and lace. Large assortment "precarved" kits also available. Send 25c for catalog, free folder. Refundable first order. Apache Leather Company, 2804 E. Washington St., Phoenix, Arizona.

**VIOLINMAKERS.** Amateurs, professionals, fine tone European wood. Complete materials, tools, instructions, patterns. Illustrated catalogue, 10c. Premier Violin Supplies, Division MVP, 430 South Broadway, Los Angeles 13, California.

**SEWING Machines.** Portable, console or head only. Build cabinet yourself. Ideal Christmas gift. Importers low prices. Kochan, 4002 East 54, Cleveland 5, Ohio.

**FREE Handicraft supply and project catalog.** American Handicraft Co., Box 1479-DQ, Fort Worth, Texas.

**HUGE Profits with your jigsaw!** 10c brings valuable patterns, illustrated information. Woodarts, P-6, Bridgewater, Mass.

**FREE "Do-it-yourself" leathercraft catalog.** Tandy Leather Company, Box 791-P11, Fort Worth, Texas.

**JIGSAW, Bandsaw owners, extra profits, fun.** Free details. Dept. A, Nu-Art, Box 2235, Boston.

**LEATHERCRAFTERS: Everything you need.** Catalog 10c. Art Leather, 411 Joseph Ave., Rochester 5, N. Y.

**LAMP Size cypress knee with nipple installed \$2.00.** Cy Products, Dept. 2-M, Lafayette, La.

**ABSOLUTELY New, lovable full size toy patterns.** 15c for \$1.00. Navilla Service, R.1, Belle Center, Ohio.

**NEW Type iron table legs.** Beautiful finishes. Trimmercraft, 93 Federal, Boston, Mass.

**63 FULL Size patterns \$1.00.** Santa sleigh reindeer \$1.50. Strother, Bellington, West Virginia.

**PATTERNS For woodworkers.** 800 projects 1955 catalog 25c. Walters Hobby Shop, 207B French, Utica 4, New York.

## DO IT YOURSELF

**AWNINGS, Ventilated, aluminum, wood frame.** Materials \$3.50. Plans \$1.00. Coolshade Awnings, 125 Broad, Pawtucket, Rhode Island.

**HAVE A surprise.** Build beautiful, modern living room cabinet; with shelves and drawers; combination magazine and card rack. Can be used for table T.V. Send \$1.00 for pattern to Rodney Carver, 4815 Camden Ave. North, Minneapolis 12, Minn.

**HAMBURGER Pattle press.** Make it yourself. Drawings 35c. Art & George Co., 5170 No. Hollywood Avenue, Milwaukee 17, Wisconsin.

**BEAUTIFUL All aluminum weather vanes.** Make them with simple tools, our kits. Free folder. Wild Wind, 24 East Euclid, Spokane 21, Wisconsin.

**BEAUTIFUL Contemporary do-it-yourself furniture plans.** Free literature. McAlver Hardwood Products, Box 645, Bensenville, Ill.

**PLANS For piddlers, \$1.00 each.** 1. Emergency light plant, 300 watts, 110 volts, a.c. Made from rebuilt car generator and lawn mower engine. 2. Drill water well by hand. Rotary method. Use same pump and pipe for both drilling and producing. Very cheap and fast. 3. Push-button controls on your overhead garage door, using simple hand tools and parts usually found around the home workshop. Bennett, 2461 Lucas Drive, Beaumont, Texas.

**MAGIC "Velcoat" sprays fur or velvet finish on any article.** Multiplies value. Refinishes shoes, bags, toys, pictures, like new. 6-color kit \$4.95. Single color \$1.00. Literature free. Velcoat, Box 5172-MC, Tulsa 16, Okla.

**FREE Catalog metalworking projects.** Picnic table, swing-glider set. Utility carts. Tru-Part Mfg. Corp., 194 East 9th, St. Paul, Minnesota.

**A Basic colossal deal, build new exciting airplane kites for kids.** Plans and instructions \$1.00. Allwell, Box 4435, Detroit 28, Mich.

**"DO It Yourself Encyclopedia,"** 12 giant volumes (3,000 pages) packed with thousands of ideas, plans, gadgets and projects you can do yourself. How to weld, paint, repair most anything. How to make boats, deepfreeze, draperies, jigsaw projects and just scores of other items. How to do electric wiring, plumbing, room building. How to modernize kitchens, bathrooms. Greatest, most complete fix-it library ever offered. Written so you can understand it. You'll be thrilled when you see what these 12 big volumes contain. It's simply sensational. You must really see them to fully appreciate this exciting fix-it library. You'll fall in love with them just as soon as you open the first volume. I'll send you a descriptive circular that will open your eyes to the greatest, most complete and beautifully illustrated "Fix-it" library you ever laid your eyes on. Send a postal right now. Popular Mechanics Press, 200-DY East Ontario St., Chicago 11, Illinois.

**CLOCK Movements—Gorgeous dials, plans, kits.** See ad page 260.

**BUILD Your own coin game.** Place in cafes, bars, clubs, etc. Collect coins weekly. Illustrated plans \$2.00. Jul's Workshop, P.O. Box 1448, Lemon Grove, Calif.

**18 FULL-Size patterns.** Save money with easy-to-use, professionally designed full-size patterns. Make money selling beautiful, useful furniture. Make modern step and cocktail tables; metal lamps; cupola; 12-foot outdoor. All patterns test-built; sold with money-back guarantee. Get your free list of these convenient, economical patterns today. Popular Mechanics Press, 200-HH E. Ontario Street, Chicago 11, Illinois.

**MELT Cast iron, brass and aluminum.** Make castings for yourself and for profit. Send for literature. Ursutz Burner Co., Box 2293, Globe, Arizona.

**FURNITURE—Wrought iron legs and frames!** You assemble. Free catalogue. Phillips Furniture, East Peoria 8, Illinois.

**GEIGER Counter and metal detector kits.** Inexpensive, educational. Free literature. Electronic Applications, 3024 Lee Highway, Arlington 7, Va.

**BUILD Inexpensive concrete blockmaker.** Motor, hand. Make 500 blocks daily. Write. C. Lee, Mountain View, Oklahoma.

**DO It yourself.** What? Repair TV, build furniture, make barbecue, plumbing repairs, build boats, do house wiring, remodel home, lay tile, modernize kitchen, repair home, and scores of other things you can do yourself. Books covering each subject, only 25c. Send for descriptive list. It's free. Popular Mechanics Press, 200-LB East Ontario St., Chicago 11, Ill.

## WATCHES, OLD GOLD, JEWELRY

**GENUINE Diamonds at out-of-pawn low prices.** By liquidating unredeemed loans we offer beautiful gems at far less than original cost. Shipped free for inspection and appraisal. Write for free diamond list. Prudential Loan Association & Lloyd J. Butler Co., 133 North Clark, Dept. PM, Chicago 2, Ill.

**BANKRUPT Auction goods; Klondike, novelty jewelry findings assorted, beads, pearls, jewels, 5 pound lots \$7.50; sample \$2.00 pound.** Merchandise, 19A East 16th St., New York City 3.

**MAKE Your own costume jewelry and save money.** It's easy. Free sample earrings. Over 5,000 styles in new catalog, 25c. Barry's, 203 Ardsley Court, Newark, N. J.

**RHINESTONES.** Jewelry settings, copper enameling. Sample earring kit and catalog 25c. J & M Novelties, Dept. CM-3, Griffith, Indiana.

**WATCHMAKERS' Tools, materials, supplies, watches.** Catalog. Gales, Box 1000, Chicago 90, Illinois.

**WATCH And clock repairing books.** Free information. North American, Dept. 15-K, 2320 N. Milwaukee, Chicago 47, Illinois.

**GOLD Nugget tie tack \$4.95 postpaid.** The Trading Post, Box 624PM, Ketchikan, Alaska.

**RHINESTONES.** Send \$2.50 for five gross, value \$6.00. Free catalog. Bargain list. Ebert, Box P183, East Orange, New Jersey.

**NEW—Used watches \$5.50 up.** Hudson, 1417-36th, Louisville 11, Ky.

**DIAMOND Rings.** Guaranteed 4C quality. Factory dealer. Huge savings. Free catalog. Hedges, Amityville 187, N. Y.

**TOP Cash by return mail for your gold, silver, platinum in any form.** Satisfaction guaranteed. Information free. Noble Metals Corp., Box 1113, Santa Monica, Calif.

**DISTINGUISHED, Gentlemen's, ladies', Colored meshed watch bands.** Similar \$12.95 we sell \$2.25. State watch case silver or gold. Send m.o., check or cash. Ben-Rom Co., Dept. WB-5, 337 Clinton St., New Britain, Conn.

**WATCHMAKERS' Journal** contains instructive articles on watch repairing. \$1.00 year. Sample copy 25c. Dean Co., Box 3218-M, Daytona Beach, Fla.

**WATCHMAKERS'—Jewelers' supplies, instructions.** Catalog 25c. Bengale Company, Culver City, California.

**USED And new watches.** \$2.00 up. Free list. Southern Watches, Gray, Georgia.

**HIGHEST Cash for old gold, broken jewelry, gold teeth, watches, diamonds, silverware, spectacles, platinum.** Free information. Satisfaction guaranteed. Rose Refiners, Heyworth Bldg., Chicago 2.

**COSTUME Jewelry supplies.** Catalog and samples. 35c. Largest line in America. Milady-Fair Co., G.P.O. Box 1328, New York City 1.

**GOLD, Silver, platinum, diamonds wanted.** Cash immediately, highest prices, appraisals made. Wilmot's, 2547 102nd St., Toledo 11, Ohio.

**10 SWISS Watches \$18.00.** Catalog 10c. Berkowitz, 1150 Castlhill, New York 62.

**JEWELRY Hobbyists: Plated settings, imported rhinestones, flat backs.** Free catalog. Sextons, 416 Potomac, Buffalo 13, N. Y.

**NEW 1956 Jewelry finding and copper enameling catalog 25c.** Bergen Arts, Hackensack 9, N. J.

**MAKE Costume jewelry for fun and profit.** Catalog 25c. Bergen Arts, Hackensack 8, N. J.

#### TOBACCO, SMOKERS' SUPPLIES

**CUSTOM Pipes.** Pipe-making supplies. Tools. Instructions. Walter Miller, Germantown, Ohio.

**PIPE Smokers: Broken stems replaced.** Utter Pipe Factory, Olean, New York.

**CIGARETTES! Make your own for 5c per pack.** Have fun and save. Maker, 200 tubes, tobacco and instructions 50c. Tobacconist, Inc., 220 N. Clark, Chicago 1, Ill.

**PIPE Smokers! Use a pipe holster for convenience.** Wear with belt or suspenders. Genuine leather. Guaranteed. \$1.00. Special prices to dealers. Cardinal Products Company, P.O. Box 24, Lansdowne, Penna.

**PIPE Smokers! Cigar smokers! Free illustrated catalog offers fabulous savings on choice imported and domestic pipes, cigars, tobaccos, supplies.** Write Wally Frank, Dept. 25, 150 Nassau Street, New York 38, N. Y.

#### RAZORS, BLADES, SHARPENING

**RAZOR Blades "Extase" imported from Germany.** Unbeatable. Send 10 cents for samples or \$1.50 for 100 blade display carton. Retail \$3.50. Herbie's Barber Supplies, Dept. PM10, 1708 East 35th Street, Chicago 15.

**125 "DON Juan" double edge blades \$1.00, thousand \$5.00.** Guaranteed. Johnson, 805 Wells, St. Paul 1, Minn.

**TEN Million users cannot be wrong.** Twinplex stropper for Gillette-type blades gives smoother, many more shaves. \$2.49 postpaid. 100% satisfaction or money back. Thriftful Buyers, 28 Crescent St., Waterbury, Conn.

**BLADES—100 For \$1.00.** Microsharpened. Guaranteed smooth shaves. Double-edge. Practical gift. Bardin's, Box 321, Chicago 90, Ill.

**RAZOR And 5 blades.** 25c. Jove Products, Box 164, Maplewood, N. J.

#### FOR THE HOME

**ITALIAN Imports.** Unusual. Hand carved wooden novelties, lights, music. Descriptive folder. Games, 5105-PM Mulford, Skokie, Ill.

**METEOROLOGICAL Photo.** New. Cash order \$1.00, postpaid. P.O. Box 3107, Philadelphia 1, Penna.

**AFRAID Of fire? Protect your family from fire with automatic home Plug-Alarm.** Just plugs in any ac outlet. No wires or batteries. Sounds loudly in case of fire. Uses no electricity except when alarm sounds. Size 2 1/2"x3". Dielectric plastic case. Money back guarantee. \$6.95 prepaid. No C.O.D.'s. Send for free literature. Karday Associates, Dept. M, 220 Fifth Avenue, New York, N. Y.

**HOME Heating by new method,** combination floor and forced air. Drawings, prints, instructions \$1.00. Dual Heat, 4230 N. 33rd St., Phoenix, Ariz.

**FOAM Rubber furniture cushions.** Factory seconds. 50% discount. Free catalog. Perma-Foam, 429C Central Ave., East Orange, New Jersey.

#### OF INTEREST TO WOMEN

**FREE! 50-Piece tableware set.** For details, write: Nafziger, 3566-A Diamond Ave., Oakland 2, Calif.

**"8 MISTAKES Parents Make."** Every parent should have this new book about child training. It is free; no obligation. Simply address Parents Association, Dept. 6711, Pleasant Hill, Ohio.

**PERFUME.** Save 50%. Buy direct, in plain package. Quarter ounce, send \$1.95. Garnet of N. Y., Marvin Avenue, Shelby, Ohio.

**QUALITY Carpet warp** at reasonable prices. Write today. Carcraft Co., 153 Post Street, Boonville, N. Y.

**COLGATE'S Lustrre-Creme shampoo,** 4 lbs. \$4.85 postpaid. Geller, 2089 Matthews, New York 62, New York.

**MAKE Beautiful costume jewelry for profit and pleasure.** Finest quality stones. Free illustrated catalog. Great Lakes Plastic Co., 831 Sycamore St., Buffalo 12, N. Y.

**DRESSMAKERS.** Sewers, wholesale lists. Dress suitings, formal fabrics. Box 693, Norwalk, Conn.

**GOOD Money in weaving.** Weave rugs at home for neighbors on \$69.50 Union Loom. Thousands doing it. Booklet free. Union Looms, 153 Post St., Boonville, N. Y.

**PROFITABLE Home business.** Make fast-seller chenille monkey trees, dolls, flowers. Terrific holiday demand. Information free. Velva, Bohemia 16, N. Y.

**GROW Mushrooms.** Cellar, shed, and outdoors. Spare, full time, year round. We pay \$3.50 lb. We paid Babbitt \$4,165.00 in few weeks. Free book. Washington Mushroom Ind., Dept. 176, 2954 Admiral Way, Seattle, Washington.

**WANT To make big money at home? \$5 profit in an hour possible with invisible reweaving.** Make tears, holes disappear from clothing, fabrics. Steady year-round demand from cleaners, laundries, homes. Details free. Fabricoon, 8332-S Prairie, Chicago 19, Ill.

**FREE—Big new wholesale catalog! Up to 50% saving for you, family, friends on nationally-known gifts, jewelry, toys, appliances, Christmas cards, etc.** Also make money selling part time! Write: Evergreen Studios, Box 846-F, Chicago 42, Ill.

**"MULTIFLEX" Pie crust lifter for lifting the most delicate rolled out pie crust.** Aluminum, \$1.00 postpaid. Makes an ideal gift. H. M. Kellogg, Box 155, Stratford, Connecticut.

**DRESSES 24c; Shoes 39c; men's suits, \$4.95; trousers \$1.20.** Better used clothing, free catalog. Transworld, 164-S Christopher, Brooklyn 12, N. Y.

#### FOR SALE—MISCELLANEOUS

**HEARING Aid batteries, wholesale.** Free list. Habs, Box 51, York, Penna.

**OLD Wall telephones.** Working order, oak cabinets, hand crank for ringing. \$5.00 each f.o.b. Telephone Co., Turtle Lake, Wis.

**WAR Surplus bargains! New government releases arrive constantly, save up to 80%.** Blankets, boots, coats, tents, wearing apparel. Send for free war surplus catalog. Sioux Falls Surplus Store, Sioux Falls, South Dakota.

**ARMY And Navy surplus wool clothing and shoes.** New and used. Free price list. Lester Sturgill, 1731 Belt Street, Baltimore 30, Maryland.

**SENSATIONAL Gift items; name brands.** Lowest prices. Catalog 10c. Modern Specialties, 31 Elk Street, Amsterdam 1, N. Y.

#### WANTED—MISCELLANEOUS

**QUICKSILVER,** Sterling, silver solders, precious metals. Wholesale Terminal, Norwood, Massachusetts.

**SCRAP Mercury (quicksilver) containers supplied—Tantalum, bismuth, tungsten, Metallurgical Products Company.** Established 1909, 35th and Moore Sts., Philadelphia 45, Penna.

**PRODUCTS Wanted to sell auto, variety, chain stores.** Established 1919. Salespower. Box 818, Cleveland 22, Ohio.

**HELP Me start collection antique locks, handcuffs, etc.** Send postpaid, receive useful gift. Norman, 168-74 92 Rd., Jamaica, New York.

#### PERSONAL

**BORROW By mail from Postal Finance Co.** Employed men and women can easily obtain \$50 to \$600 fast, entirely by mail. Repay in small monthly payments. Friends, relatives, employer, tradespeople will not know you are applying for loan. Advise occupation, amount wanted. Postal Finance Co., 300 Keeline Bldg., Dept. 7X, Omaha, Nebraska.

**LETTERS Remailed 25c.** Message typewritten upon post card 50c. Souvenirs mailed. \$1.00. Confidential address \$5.00 yearly. "Back seat driver's license" 25c. Hertzoga, Box 972, Santa Barbara, Calif.

**FABULOUS Houston Sunday classifieds \$1.00.** Remails 25c. Mailing lists 1 1/2c name. Jordan, 1120 Chenevert, Houston, Texas.

**BORROWING By mail.** Loans \$50 to \$600 to employed men and women. Easy, quick. Completely confidential. No endorsers. Repay in convenient monthly payments. Details free in plain envelope. Give occupation. State Finance Co., 323 Securities Bldg., Dept. M-227, Omaha 2, Nebraska.

**SAN Diego or Los Angeles help wanted ads \$1.00 each.** San Diego remails 25c. Box 467, El Cajon, Calif.

**VANCOUVER Remails 25c.** Any business transacted. Trove, Box 462, Vancouver, Canada.

**FLORIDA Efficiency apartments for season.** W. Hobson, 1374 Third, Sarasota, Florida.

**WHAT Is your "I.Q."?** Take reliable intelligence test. Approved, scientific. Confidential report by mail. Free information. University Test Bureau, Desk M-3, Box 401, Palo Alto, California.

**SURPRISE Your friends! Honolulu remails 10c.** Act now! Fobel, 1153 Wilder, Honolulu.

**FLORIDA—Orlando, classifieds \$1.00.** Remailing 25c. Box 7571, Orlando, Fla.

**BE A Confederate air force "general" and issue "colonel" commissions and wing decals to your friends.** Information and samples 25c. Alco, Dept. S., Box 5116, Ft. Worth 8, Texas.

**YOUR Mail received—Forwarded.** Reliable. Hedgpeth, Box 830, Alhambra 23, California.

**PROTECT Money, property, possessions! Don't let wrong people get your estate.** Make own will. Proper legal form. Instructions airmailed \$1.00. Two \$1.75. Burton Lewis, 451 Orange, Denver 20, Colorado.

**TELEVISION Program reminder.** Quick glance tells time, channel of your favorite programs. Good for season. Mail 25c. Tee-Vee-Tyme, 5208 Longton, Dept. 2, Cleveland 24, Ohio.

**NOTRE Dame, South Bend remails 35c.** Schaut, 619 Kamms, Mishawaka, Indiana.

**"HOW Can I find out?" You can! Information confidentially developed.** Any matter, person, problem. Worldwide. Officially licensed. Established 1923. William Herman, 170 Broadway, New York City.

LETTERS Remailed 25c. Personal forwarding address. Monthly rates. Hicks Service, Box 1547, Washington 13, D. C.

PROFIT! Prestige! Publish a magazine under your own name! Only \$3.25 per month! Sample, details 5c! Fulmer, 910 Marion, Pharr 22, Texas.

MEXICAN Law. General Practice Attorney. Apartado 79, Juárez, Chih., México.

BUY Vitamins Direct. Amazing savings. Catalog free. Matoska, White Bear, Minn.

REMAILING 25c. Replies forwarded. Ace Service, Box 186, Tampa 1, Fla.

LETTER, Package, telegram remailing, receiving-forwarding address for rent \$2.00. McLaughlin, 800 Stewart, Columbus 6, Ohio.

CLEVELAND — Nation's highest wage-scales. Classifieds airmailed \$1.00. Letters remailed 25c. Counsel, 17811 Detroit, Cleveland 7, Ohio.

YOUR Name hand branded western style on plaque 5"x12". Attractive, useful. \$2.50. Scott Plax, Rt. 2, Box 396, San Antonio, Texas.

CHICAGO Is booming. Classified help wanted ads airmailed \$1.00, remails 25c. Scott, 7805 Birchdale, Chicago 35, Illinois.

ROMANTIC Hawaii — Reairmails \$1.00: maps, photos, classified. Sylvester, Box 1613, Honolulu, Hawaii.

MIAMI Beach, Fla., letters remailed, 25 cents. Pronto, P.O. Box 116.

#### REMAILING SERVICE

LETTERS Remailed from Chicago 25c each. Unlimited monthly \$3.00. Henry Bell, Box 596-A, Chicago 90.

AUTO Capital remails 25c. Classified \$1.00. Anderson Sales, Box 5604, Detroit 38, Mich.

PHILADELPHIA, Pa. letters remailed, 25c. Kit Gissin, 11621 Gifford St., Philadelphia 18, Penna.

FAR East air remailing, confidential, \$1.00. Frank Short, Station I, Agana, Guam.

#### TREASURE FINDERS

GEIGER Counters, metal detectors, ultra-violet mineralights, from \$29.50 up. Write for free catalogs. The Radio Co., Inc., 489 Fifth Ave., Dept. 11-PM, New York 17, N. Y.

GOLD And silver indicators. Price \$30. Box 51, Plant City, Fla.

URANIUM Finding made easy! Completely transistorized Geiger counters available for first time. Extra sensitive. Lightweight. Scientifically engineered. Unconditionally guaranteed. Also complete line prospecting instruments from \$19.95. Write for free information, maps, techniques. Universal Atomics Corp., Dept. PMS, 19 East 48th Street, New York City.

LEARN Mineralogy at home. Diploma course. Fortunes now being made in uranium and other minerals. Free catalog. Mineral Science Institute, Desk 2, 159 East Ontario, Chicago 11.

URANIUM Map U.S. 34"x53". Map portfolios individual states. Details plus radioactivity map, dime. Uranium, Box 788-G, Washington, D.C.

URANIUM Prospector master form kit saves on income tax, and protects what you find. Sample completed forms and instructions; income tax expense; prospecting permit and lease with private owner; staking claims public lands; blank forms included. Save and be safe. Satisfaction guaranteed. Postpaid \$2.50. Maurice Rogers, Box 1309, Odessa, Texas.

TREASURE. Metal, mineral locators M-scope type. Latest electronic design \$75.00 up. Geiger counters, scintillators, mineralights for uranium prospecting \$35.00 up. Fully guaranteed. Monthly payment plan available. Books "How to Be a Successful Uranium Prospector," "For Fun and Profit." Literature free upon request. Fisher Research Laboratory, Inc., Palo Alto, Calif.

URANIUM! Informative booklet gives hot known and potential locations. Government map included free. \$1.00. Uranium Research, Box 1553, College Station, Texas.

GEIGER Counters and mineral locators, assembled and kits. Free geological advice! Write for details. Frontier Instruments, Box 276, Annandale, Va.

URANIUM, Gold, silver treasure. New, power-packed, highly sensitive metal detectors, Geiger counters and mineralights, kits and assembled models from \$12.50. Lightest weight, guaranteed, free literature. Electronic Applications, 5024 Lee Highway, Arlington 7, Va.

AMAZING Triple-action Geiger counter U-238C, combines audio, neon flasher, meter. Guaranteed best available. Also metal detectors and scintillation counters from \$49.50. For radioactive uranium sample send 25c to Goldak Company, 1541 W. Glenoaks Blvd., Glendale, California.

GOLD, Silver, metal detectors. Geiger counters for uranium. Mineralights. Sensational new fully guaranteed models. None finer. Information free. Detectron Corp., 5328 Vineland Ave., North Hollywood, California.

ROCKET Mk II nucleotron. 6 times as sensitive as a Geiger counter. Only \$37.50 complete. Uses 2 supersensitive 1B85 tubes. Weighs less than 3 lbs. Plug-in probe available. 10 day trial period. 1 year guarantee. Write today for free catalogue. Webster Electric Mfg. Co., Dept. B, 3834 Clarke Street, Oakland 9, California.

#### MISCELLANEOUS

1000 BUSINESS Or personal cards \$2.00 (reg. \$5.95). Embossed \$3.99, 1050 envelopes \$6.50. No c.o.d. Send check or money order. Esquire, P.O. Box 413, Elizabeth, N. J.

PORCELAIN Patch. How and what to use. Complete instructions \$1.00. Professional finisher. Box 249, Manitou Springs, Colorado.

GUARD Against check artists. New pocket-size check protector for individual or office. \$1.00 postpaid. Hix Novelty Works, 15328 East Valley Blvd., Paente, California.

BIND Your Popular Mechanics in book form. Write for catalog. Northern Bindery, Frederic, Wis.

STUPENDOUS Mental power. Adults. (Details 10c.) Delmar Wisdom, 848 Sunny-side, Chicago 40.

BUY Wholesale thousands nationally advertised products at big discount. Free "Wholesale Plan." American Buyers, Hertel Station, Buffalo 16-K, N. Y.

SELL! Buy! Trade! Anything. In, "Trading Post Magazine." Details free! Thorne's, 525 Dewey, Jackson 40, Mich.

100 SEASHHELLS. Assorted, for gifts, collections, decorating. \$1.00. Mock, Juniper Point, Branford, Conn.

PERSONALIZE Gifts with 23K gold. Sample unit 20c. \$ for \$1.00. Virilio, Box 507, North Hollywood, Calif.

UNUSUAL Gifts and gadgets catalog. Big, different, interesting, free. Osmond's, Box 1591, Little Rock, Arkansas.

SAVE Time, money. Clothing permanently protected with York laundry marking pen (includes iron-on tape for dark fabrics). Send \$1.00 Mrs. Wurtz, Box 303, Orange, New Jersey.

FREE Lists. Screws, nuts, bolts, washers assortments for home and shop. Coe, 19 Monroe Drive, Williamsville, N. Y.

70 BIBLE Lessons, 25c. Bulletin, Box 87, Cathedral Station, New York 25.

FOR \$2.10. Your name beautifully engraved on personal name plate. Polished solid brass. Necessary for homes, apartments, mailboxes. Free catalogue. Kalco Engraving, Box 145, Woodland, California.

EARTH Satellites next year! Space travel soon! Prepare yourself. Learn amazing new things! Send postcard Dept. G-1, Palomar Institute of Astrogration, Mt. Wilson, California.

FREE Vitamin catalogue—Feel more vigorous, better, younger! Buy direct—Save! Vitamin-Center, Drawer 2318P, Detroit 31.

100 PHOTOSTAMPS \$2.00. Your snapshot on regular gummed, perforated stamps. Christmas orders now! Free samples. Counsel, 17811 Detroit, Cleveland 7, Ohio.

POSTMAN—Get that load off your back. Aluminum mailbags by Craft-Tex now available in assemble-yourself kits. Free brochure. Box 501, Austin 63, Texas.

MANUFACTURERS! Complete production, sales, management instructions, guidance. Free booklet. Jarry, 268-BC, New York City 5.

"YOU Can Win Contests": New manual tells how; write now; free details. Phillips of California, 2700A Piedmont Avenue, Berkeley, California.

NAME Brands wholesale. Park Sales, 51 Elizabeth Avenue, East Paterson, N. J.

EVERGREEN Boughs with cones. Three pieces one dollar postpaid. Howard Finney, Hamilton, Montana.

GERMAN Address lists. Anything manufactured \$1.00. Burke Associates, Manchester, Mass.

RECEIVE Mails, magazines, samples. Your name in numerous mailing lists 25c. Greenwood, Box 1116-K, New York City 8.

CHECKMATE Protects your check from forgery. Is banker approved. Details free. Roberts Distributor, 19 Outlook, Sayreville, N. J.

BE Somebody! Do things! Get somewhere with our simplified self-training plan of positive thought motivation and constructive action mastery. Eye-opening information free. Write today. Applied Christian Psychology, Inc., Box 1924-T, Louisville 1, Kentucky.

WHY Be a litter bug? Send 25c today for disposable waste container. Good for home, camp, or travel. To Box 9, Pearl Beach, Mich.

CIGARETTES—Facts free how to roll them for 10c a pack. Pete Moberly, Box 793, Owensboro, Kentucky.

INSPIRATIONAL! Rosary shrines kits. Large \$2.00; miniature 75c. Crafts for Christ, 2929M Center Ridge, Westlake, Ohio.

GERMAN Christmas item manufacturers. 100 addresses \$1.00. Manufacturers' Index, 135 Main, Woburn, Massachusetts.

YOUR Name wanted. We'll send 1000 publishers, mailers, wholesalers your name, on our list one year 25c. Dixie Mailers, King, N. C.

FORESTRY. Game warden, park, fish hatchery, patrol and wildlife conservation jobs pay well. Prepare now. Write Delmar Institute, N5, Whittier, Calif.

TAPE Recorders, accessories. Best buys. Boynton Studio, 10A Pennsylvania, Tuckahoe, N. Y.

HEAT Your home or business for almost nothing. Amazing method, thousands satisfied. Valuable information free. A. Enault, R.F.D. #1, White River Junction, Vermont.

CLOGGED Drains, cesspools and septic tanks cleaned by new powerful chemical. Solvent removes grease, soap, tree roots, etc., without expensive digging and electric rodding machines. No pumping necessary. Mix with water and pour down drain. Free details. Electric Drain Cleaning Co., Boston 34, Mass.

GROW Mushrooms. Cellar, shed, and outdoors. Spare, full time, year round. We pay \$2.50 lb. We paid Babbitt \$4,165.00 in few weeks. Free book. Washington Mushroom Ind., Dept. 175, 2954 Admiral Way, Seattle, Washington.

HOW To paint. Do it yourself. Illustrated instructive book, 25c. Catalog free. Popular Mechanics Press, 200-HP E. Ontario St., Chicago 11, Ill.

PANNING Gold—Free lesson: catalogue of mining, mineral books, supplies. Old Prospector, Box 729D1, Lodi, Calif.

RECEIVE Magazines, samples, catalogues. Mails from everywhere. Offers, hundreds. Get listed 25c. Rorick, Box 86, Cincinnati 26, Ohio.

300 BIG Mails guaranteed. Samples, plans, offers, propositions, 12 months listing, \$1.00 refundable. Wright Publications, 2270 Hubbard, Memphis 6, Tenn.

YOU Say you want something different. P.O. 116, Kokomo, Ind.

ZINC Engravings. From any photo or drawing. 5 sq. inches only \$1.00. Free price list. Miller-Hodes, 437 E. Market, Alliance, Ohio.

JEEP Owners — V8 power. Read Jeep owners ad. Page 50.

IMPORTED German razor blades. Famous name. 50 blades \$2. I am nearly blind. Frank Mason, 780 Broadway, Newark, N. J.

WHOLESALE Catalog! 30-80% discounts! Appliances, musical instruments, typewriters, phonographs, watches, jewelry, recorders, housewares, etc. Consolidated Distributors, 21-13 Lafayette, Paterson 15, New Jersey.

WHAT'S Your hobby? Be it cars, reducing, stamps, work! Specify with 25c for jokers novelty. Stommel, Box 104, Detroit 31, Michigan.

OF God, unto obedience and sprinkling. I Peter 1. Whitcomb, 308 Sycamore, Newport News, Virginia.



## EARN BIG PROFITS

WITH SMALL INVESTMENT  
START YOUR OWN BUSINESS TODAY  
*Very little equipment required*  
Manufacture products in big demand.

Formulas available for spot remover, moth spray, glass cleaner, air wash, ammonia, dince floor wax, powdered hand soap, fly spray, deodorant spray, mechanics hand soap, wall cleaner, garage floor cleaner, bath crystals, liquid bowl cleaner, water softener, dishwashing compound, drain cleanser, stain and rust remover, soapless soap, and sweeping compound.

These products are needed by industry, institutions, stores, service stations, etc. Nearly every business a prospect.

### WE HELP YOU.

20 formulas, sources of supply for all materials required, and compounding methods. For only \$2.95

Hurry—write today. Send check or money order. No C.O.D.'s.

MACO, 857 Avocado St., Anaheim, Calif.



### Home Training in Underwater

## SKIN AND LUNG DIVING

Train for fast developing opportunities in this great new sport. More and more big money will be earned by qualified divers. Training program by outstanding authority. Write at once for free information.

### DIVEMASTER

U. A. S. Corporation, Dept. PM-11,  
5637 W. 63rd Place, Chicago 38, Ill.

## LOCKSMITHING & Key Making



### PRACTICAL UP-TO-DATE COURSE—ONLY \$4.95

Easy-to-learn modern information for self-instruction. How to work on locks, de-code, make masterkeys, repair, install, service, etc. For every handyman, home owner, carpenter, mechanic, service station operator, fix-it shop, hardware dealer, gunsmith. 50 plain illustrated lessons. FULL PRICE ONLY \$4.95. SEND NO MONEY.

Just pay postman plus C.O.D. postage. Or send \$4.95 with order, we'll ship postpaid. Satisfaction guaranteed or refund.

NELSON-HALL CO., 210 S. Clinton St., Dept. LV-2, Chicago 6, Ill.

### Say You Saw It in Popular Mechanics

ENGINEERING  
DEGREE IN  
27 MONTHS

## INDIANA TECHNICAL COLLEGE

B. S. DEGREE, Aeronautical, Chemical, Civil, Electrical, Mechanical and Electronic Engineering (inc. Radio and TV), Drafting, One-year G.I. Government approved, Low rate. Earn board. Large industrial center. Students from 48 states, 21 countries. Demand for graduates. Enter December, March, June, September. Write today for catalog. 1611 E. Washington Boulevard, Fort Wayne 2, Indiana.

## BOAT FITTINGS

Aluminum • Bronze • Chrome • Stainless Steel • Fiber

A COMPLETE LINE OF MODERN DESIGN  
for

OUTBOARDS                      SAILBOATS  
STEERING WHEELS & PULLEYS      BLOCKS & TANGS

Manufactured in our plant to exacting standards

BUY DIRECT AND SAVE

SEND 10c FOR ILLUSTRATED BROCHURE  
including full descriptions and prices

### WHALING CITY MARINE CO.

56 PROSPECT ST.                      NEW BEDFORD, MASS.



# 1956 ALLIED

## ELECTRONIC SUPPLY CATALOG

324  
value-packed  
pages

Save on Everything  
in TV and Radio  
Parts & Equipment



Everything for Experimenters,  
Builders, Amateurs, Servicemen,  
Engineers & Hi-Fi Specialists

Send for ALLIED's big 324-page value-packed guide to *everything* in TV, Radio and Electronics! Select from the world's largest stocks of High Fidelity systems and components; recorders and phono equipment; TV tubes, antennas and accessories; Amateur station equipment and supplies; P.A. systems; test instruments; latest build-your-own kits; industrial electronic supplies—plus *everything* in electronic parts, tubes, transistors, tools and books. Save on everything in Electronics—send today for your FREE 1956 ALLIED Catalog.

Everything in Electronics  
From One Reliable Source

send for it

FREE  
CATALOG



ALLIED RADIO CORP., Dept. 5-L-5  
100 N. Western Ave., Chicago 80, Ill.

Rush FREE 1956 ALLIED 324-Page Catalog

Name \_\_\_\_\_

Address \_\_\_\_\_

City \_\_\_\_\_ Zone \_\_\_\_\_ State \_\_\_\_\_

# Learn to MOUNT Birds and Animals



**To All Men & Boys!**  
**Here is FUN and PROFIT!**

## Send Coupon for Free Book

Tells all about Taxidermy, and how you can learn at home to mount life-size Birds, Animals, Game-Heads, Fish. Save your valuable trophies. Decorate your home and den. Learn genuine Chrome Tanning for harness and sole leather bookskin and fine furs. Mount Common specimens, squirrels, rabbits, owls, even frogs. Into marvelous craft-work groups, both useful, humorous. Wild game not necessary. Marvellous hobby. Fascinating.

**BIG PROFITS** Turn your spare time to cash. Have a sideline profitable business. Mount game trophies for sportmen; sell your own mounts; save money and **Make Money** with expert tanning. Learn by mail from old reliable school with 400,000 graduates. **Investigate Now.** Send coupon at letter or post card **Right Now** for this marvelous **FREE BOOK.** There is no cost or obligation. Please state your **AGE.**

## FREE BOOK



Northwestern School of Taxidermy,  
2511 Elwood Bldg., Omaha, Neb.

Gentlemen—Please send me your FREE 48-page booklet explaining Taxidermy. (Please print name and state age. Use postal card if more convenient.)

Name \_\_\_\_\_ Age \_\_\_\_\_  
Address \_\_\_\_\_



**Train Animals, Pets!**  
**Self Defense!**  
**Loud Noise Like Bang of a Shot Gun!**

## PLAIED LEATHER BIG BULL WHIP

Experts knock ashes off cigaret, gun out of hand, yank people off feet, etc. Used by trainers, fishermen, etc. Grip lightly pressure is on loop, then crack or coil; snake out or back; overhand, underhand, side-arm. Neat's oil finished for pliability & long life. "Cracker" or tongue on end. Solid grip handle with loop.

6-ft. Whip \$1.98; 8-ft. Whip \$2.69.

JOHNSON SMITH & CO., Dept. 174, Detroit 7, Michigan

## Catalog of 3000 Novelties 10c

Send 10c for amazing catalog of novelties, live animals, scientific supplies, hobbies, funmakers, planes & boats, looms, magic tricks, joke articles, unusual seeds, gadget time-savers, cameras, optical goods, projectors, movies, lucky jewelry, religious novelties, disguises, musical instruments, stamps, coins, puzzles, fortune tellers, radios, auto & bike accessories, telescopes, magnifiers, compasses, banks, smokers' gadgets, artists' supplies, printing sets, engines, motors, shockers, knives, billfolds, guns, rifles, sports, books, games, plants, etc. Send 10c (3 for 25c—get for friends!).

## POWERFUL ELECTRIC GENERATOR

Generates Up To 75 Volts. Use to generate electricity to ring bells, light up lights, as a medical battery, deliver terrific electric shock as joke, many electrical experiments, classroom uses, etc. Cost over \$20 new. Used but excellent operating condition. Hand crank or gear wheel drive. Made by leading electrical companies. Each has 3, 4, or 5 five-inch 1-lb. bar magnets (alone worth more than total cost), generating armature, wire leads, gear crank, ready for use. Originally used in crank phones. Complete unit weighs over 5 lbs. Each Postpaid \$3.95 (Over 1000 miles from Detroit, send \$4.95, otherwise shipped express charges collect). Other Used Items in Good Operating Condition: Standard Upright Phones, \$3.00 each postpaid (\$3.95 over 1000 miles); Telephone Carbon Mike \$1.75 Postpaid; Ringer Box (Use with generator for battery-less bell system; complete with induction coil, condenser & bell) \$3.50 (\$4.50 over 1000 miles). Mail order to Johnson Smith Company, Dept. 174, Detroit 7, Mich.



## Enjoy Modern Living • Make Your Home Worth More With This Popular Mechanics Book . . .



759 PICTURES

Above: How to lay a new roof over the old.

Right: New walls over the tired old walls. A few of the 83 modern kitchen ideas.

Below: Modern ceilings for old basements.



# HOW TO Remodel Your Home

## With Data on New Materials and Products Available to Home Owners

Here are hundreds of ways you can make a modern home out of an old house, make the house worth more and save money while doing it. If you own an old house or intend to buy one, get "How to Remodel Your Home" by E. R. Haan, formerly technical editor for Popular Mechanics. You can do the modernizing yourself or have it done for this vital book contains 547 methods and 759 illustrations covering complete modernization, adding rooms and living space, installing new kitchens and baths, adding closets, wardrobes, rumpus rooms. Complete face-lifting jobs for the outside and morale building jobs for the inside. Learn the joys and conveniences of modern living with this vital book prepared especially for the home owner. Mail coupon for your copy today.

### Money Back if You Want It.

Get the book now. Check it for information that will help you improve your home for appearance, convenience and value. If not fully pleased, return the book in 7 days and Popular Mechanics will refund every penny you have paid.

Big Book.  
Same Size as  
This Magazine.



## What to Do! How to Do It! How to Cut Costs and Save

In this book — 17 big helpful sections. They are:  
From old to new—Your modern kitchen — Better bathrooms — Basement rumpus rooms — Curing wet basements — Attic space and dormers— Adding rooms to the outside—Porches and breezeways — Utilizing idle space—New look for outside walls — Modern interior walls—Heat-loss and humidity controls — Roof framing and covering—Windows that modernize — Entrances and doors — Variety in floors — Wiring, plumbing heating. In all—547 money-saving articles you can use.

## Use Coupon to Get Remodeling Book

POPULAR MECHANICS PRESS, 200 E. Ontario St., Chicago 11

Send at once "How to Remodel Your Home," postpaid for \$2.95. I understand I may return the book in 7 days for full refund.  
 Remittance for \$2.95 enclosed. Send book postpaid.  
 Send COD. I will pay postman.

Name \_\_\_\_\_  
Address \_\_\_\_\_  
City \_\_\_\_\_ State \_\_\_\_\_

**Mechanically Inclined?**  
**EARN GOOD MONEY ASSEMBLING AND SELLING AMERICA'S FINEST ALUMINUM STORM WINDOWS DOORS — JALOUSIES**

Buy All-Time 3 channel aluminum combination storm windows at 1/3 retail price — assemble in 18 minutes — sell for 200% profit. Approved by GOOD HOUSEKEEPING! Cash in on the fast-growing storm window industry! \$54 buys KD sample parts, tools and finished sample window.

**ALL-TIME MFG. CO.**  
 DEPT. W, 293 PARK ST., NEW BRITAIN, CONN.

**AMAZING NEW TINY RADIO**  
 Really Works—Small as a Pack of Cigarettes!

GETS LOCAL RADIO STATIONS WITH CLEAR BELL-LIKE TONES—NO STATIC OR INTERFERENCE! NEEDS NO TUBES, BATTERIES OR COMPLICATED HOOKUPS! NO AC PLUG INS! Nothing to wear out. Thousands of users—many report years of service. Uses new crystal diode and Hi-Q coil. SELF-CONTAINED SPEAKER PHONE. Just use tiny radio to take with you ANYWHERE YOU GO—ON TRIPS, VISITING, ETC.—for real fun and enjoyment—ANYTIME. Merely hook to anything that can act as antenna for local reception. Free DX antenna kit included. **SEND ONLY \$1.00** (bill, ck., mo.) and pay postman \$3.99 C.O.D. postage or send \$4.99 for p.p. delivery. COMPLETE READY TO LISTEN. MIDWAY CO., Dept. PPS-11, Kearney, Nebr.

**TRAIN**

**Your VOICE!**

**RESULTS GUARANTEED**  
 STRENGTHEN your voice this tested, scientific way. Yes—you may now be able to develop the POWER of your speaking and singing voice in the privacy of your own room. Self-training lessons, mostly silent; no music required. Write TODAY for Eugene Feuchtinger's great booklet "How to Strengthen Your Voice." It's absolutely FREE! You must state your age. Booklet mailed in plain wrapper. No salesman will call. Send your name and age RIGHT NOW! Perfect Voice Institute, 210 S. Clinton St., Studio LV-2, Chicago 6, Ill.

**\$100 STARTS YOU IN \$75,000 BUSINESS!**  
 Operate Profitable Home Mail Order Business. Everything Included. Big Profits—No Stock To Carry—We Deliver! Yours \$1.00 brings 4 self-mailing, 32 Pg., 4 color catalogs, picturing \$75,000 Nat. Adv. Watches, silverware, jewelry, etc., Details & Price sheets. (5,000 @ 5c ea.) DIRECT DIST., Dept. 11B, Box 5, N.Y.C. 36, N. Y.

Say You Saw It in Popular Mechanics

**Get info.. PLASTIC LAMINATING AT HOME!**

**Make \$20 to \$30 a Day by.. MAGIC MAIL PLAN!**

Get ORDERS and CASH from your mailman—do work in SPARE TIME at home—or expand into FULL TIME business. Send coupon for Free facts about the newest and most fascinating of all home operated businesses. For the first time a simplified machine brings the fabulous profits of Plastic Sealing and Plastic Laminating within the reach of the small operator. Anyone can learn to operate the machine with a few minutes practice—then with our Magic Mail Plan can get mail orders pouring in daily with cash in every envelope. No canvassing—no selling. We even supply the circulars you mail to bring back cash and orders. Don't waste a minute. Rush your name. We'll send you FREE and postpaid, pictures, prices, details, and all the facts you need to start. Mail coupon or send name on postcard. No charge. Warner Electric Co., 1512 Jarvis Av., Dept. L-10-N, Chicago 26, Ill.

**Make Thousands of Beautiful Art Creations**  
 COSTUME JEWELRY • CIGARETTE BOXES  
 TRAYS • CANDLESTICKS • COASTERS  
 LAMP BASES • BOOK ENDS...ALL IN  
 SPARKLING COLORED PLASTIC

THIS MAN... is taking out of the machine a Plastic Sealing Job—ordered by mail—only 11c in material cost brings back \$2.58 in cash by mail. Capacity of machine: \$25.00 profit per hour of operation.

**WARNER ELECTRIC CO., 1512 Jarvis Av. Dept. L-10-N, Chicago 26, Ill.**  
 At no cost to me, please rush complete details postage prepaid. I am under no obligation.

Name.....  
 Address.....  
 City.....Zone.....State.....

not everyone does as well, but E. O. Lockin, who started a business of his own, reports...

for 12 months I've averaged  
**\$800 PER MONTH INCOME**—  
 most of it clear profit for me!

• Mr. Lockin expresses his grateful thanks for the opportunity to make a decent living on his own. Many men have discovered how to be independent, to be free of bosses and layoffs. L. A. Eagles grossed more than \$200 his first week. R. E. Traynor says, "I made \$62 gross in one day." Others report gross up to \$12,000 per year.

How much you make depends largely on you. You need no special skill, no large investment. Can start part time until you have full time.

**No shop necessary**  
 Our Electric Rug Washer cleans rugs, carpets right on floor... helps to show their natural color and beauty. So efficient and safe, used by largest hotels and railroads.

You take no risk. Machines fully guaranteed. Mail coupon today for complete information including how to start making big profits in your own business.

**VON SCHRADER MFG. CO.**  
 RACINE, WISCONSIN

You, too, can start your own business. No special skill, no large investment required. Mail coupon today for interesting FREE book.

**VON SCHRADER MFG. CO.,**  
 E10 "R" Pl., Racine, Wisconsin

Send at once (no obligation) your FREE booklet containing information about your Electric Rug Washer and how I can start my own permanent, profitable business.

Name.....  
 Address.....  
 City.....Zone.....State.....



## Get Sure-Fire Shots with STROBOFLASH and PACEMAKER GRAPHIC®!

An ideal combination for any photographer who wants exceptional results at lowest possible cost! Professionals choose Strobeflash-equipped Pacemaker Graphics because no other equipment is so easy or inexpensive to use, yet gives such superior results. By eliminating the need for flash bulbs, Strobeflash reduces illumination cost to as little as one cent a shot! Three portable models: Strobeflash I is extremely light weight . . . battery pack fits easily into coat pocket; Strobeflash II is more powerful, has economical, long battery life; Strobeflash III gives maximum light output, plus portability . . . excellent for color. Write for free folder to Dept. PM-115, Graflex, Inc., Rochester 8, N. Y.

**GRAFLEX®** *Price-Winning Cameras*

# FREE 1956 CATALOG

## WORLD RADIO LABORATORIES

"The World's Largest Distributor of  
Amateur Radio Equipment"

Jam packed with bargains — everything in Radio, TV, and Hi Fi — for Handyman, Ham, Experimenter or Serviceman!

- Pay Only 10% Down
- Easy Terms
- Liberal Trade-Ins
- Save Over 50% on Recond. Equipment
- Over 800 Guaranteed Reconditioned Items



## WORLD RADIO LABORATORIES

3415 W. Broadway — Council Bluffs, Iowa

Leo I. Meyerson

PERSONALIZED SERVICE

### MAIL HANDY COUPON

WORLD RADIO LABORATORIES, INC. PM 11

3415 W. Broadway — Council Bluffs, Iowa

Free 1956 Catalog  Recond. Equip't. List

3'x4' U. S. Radio Map 25c

NAME \_\_\_\_\_

ADDRESS \_\_\_\_\_

CITY \_\_\_\_\_ STATE \_\_\_\_\_

## WHERE-TO-BUY-IT INDEX

Source of supply appears after items commercially available

### AUTOMOTIVE

Handy Items for Your Car—

Bumper mount provides convenient method of transporting outboard motor	122
Wastebasket that holds disposable bags keeps car interior neat	122
Warming pad makes winter driving comfortable	122
Hooked shaft on rear-window shell hangs suits and coats	122
Sealing compound ends water and dust leaks around windshields and rear windows	123
Pocket computer speeds checking of gasoline mileage	123
Boat carrier turns so one person can load boat on car	123
Dome-light cutoff enables you to deactivate switch	123
Auto burglar alarm set off by pressure on front seat (Chicago Alarm & Signal Mfg. Co., 2352 W. 111th Place, Chicago 43)	156

### AVIATION

Flying aircraft carrier launches jet fighter from bomb bay	88
Experimental turboprop fighter uses jet for extra power	114
Cross-wind landing gear latest feature of long-range bombers	115
Small autopilot for light planes (Javelin Aircraft Co., Wichita, Kans.)	134
Vertical take-off for airliners	132
Flying freight platform cushions delivery of heavy equipment	133

### CHRISTMAS SHOPPING CENTER

Holder for live Christmas trees	101
Scale-knife weighs and cleans fish	101
Cloth-faced clock comes in kit for home assembly	101
Do-it-yourself encyclopedia	102
Auto compass has its own interior dial illumination	102
Tote bin for laundry has section that lifts out	102
Home workbench comes in a kit	102
Auto-window thermometer	103
Microscope provides erect unreversed image	103
Pinless clothesline	103
Name-tape printer	103
Rocket toy with launching platform and sound effects	104
Radio bike has a radio built into the body	104
Spiral train track comes in a kit	104
Aerial sand loader	104
Space-ship toy	104
Riding tractor for lawn care	104
Wire-art kit	105
Optical hobby kit	105
Pre-cut house in miniature	105
Miniature sewing machine	105

### CONSTRUCTION

Dirt and ashes make sturdy brick	116
Cranes join to load 20-ton welder	145
Plate-glass lifter relies on suction	154
Infrared gas heater	270

### HOUSE AND HOME

Self-contained burglar alarm	115
Model railroad disappears into closet	125
Versatile easy chair with fold-out back converts into combined chair and table (Roland Provencher, 3988 Montgomery Rd., Norwood, Ohio)	141
Broken sash cords replaced with spring device (C. R. Vogt & Co., 1528 Third Ave., Moline, Ill.)	232

### MISCELLANEOUS

Radioactive batteries	78
Waterproof duck blind shelters two hunters (Porta-Blind Co., 442 Seneca, Wichita, Kans.)	85
Ship's stabilizing fins cut roll in rough seas	85
Brush-cutting saw slung from strap (Homelite Corp., Port Chester, N. Y.)	88
Amplifier spots termites (Craig Electronics, 3455 Meir St., Los Angeles 66, Calif.)	97
Small camp trailer hooks on scooter	97
Crane "launches" attic-built cabin cruiser	98
Pen-size rectifier turns a.c. to d.c.	106
Bicycle trailer carries mowers	106
"Sea Dart" planes on single ski	114
Gate for swinging	114
Machine reads traveler's checks (Burroughs Corp., Detroit 32, Mich.)	115
Subminiature battery (Elgin National Watch Co., Elgin, Ill.)	115
Plastic water scooper has small engine	116
Corn covers crop drier to increase capacity of crib (Clay Equipment Corp., 744 Fern St., Cedar Falls, Iowa)	124
\$6000 worth of flies freed in sugar cane to control borer	124
Muscle-powered duck boat retrieves downed birds	132
Motor "canned" in pump (Westinghouse Electric Corp., Chester, Pa.)	133
Floating trailer for road or river	144
Harmonica with keys	144
Plastic replaces glass in low-cost greenhouse	148
Shocked sharks	149

(Continued to page 76)

### POPULAR MECHANICS

# POWERFUL — REVERSIBLE ELECTRIC MOTOR

- Hundreds of Uses:
- BOATS
  - PLANES
  - CARS
  - CRANES
  - CAROUSELS
  - CONSTRUCTION SETS
  - and many, many more



ALL 3 FOR  
**MOTOR, GEAR BOX  
AND POWER-PACK \$2.98**

A REAL electric motor — set it measures only 1 1/2" in. Turns up to 6800 RPMs—and it's instantly reversible with the power-pack. Remote control operation! Direct drive and belt drive arrangements. Enclose check or money order for \$2.98 and we'll pay the postage. If not completely satisfied after 10 days, your money will be cheerfully refunded.

B & C CO., Box 183, Hempstead, N. Y.

# ELECTROPLATE IT YOURSELF!

NOW using NEW plating kit. It's easy to electroplate any object with the same LUSTER and DURABILITY as done by the most expensive equip. Complete kit and instructions on plating metal and non-metal objects, with Nickel, Chrome, Copper, Gold, etc. ONLY \$2.98. SEND NO MONEY—everything sent C.O.D., plus postage. OR send \$2.98 now and receive it postpaid. Money back in 7 days if not satisfied.

Tools  
Change wire  
Baby shoes

EASY INSTRUCTIONS

Mr. Z. SALES CO., Dept. G-2, 111 W. 42nd St., New York 36, N. Y.

**LOOK! A MILLION THRILLS!**

High Power **BINOCULARS**  
33 Models: \$9.95 to \$125

Free! Catalog & Book  
"How to Select Binoculars"

**BUSHNELL Binoculars**  
Dept. M11 43 E. Green  
Pasadena, Calif.

FREE TRIAL PLAN

# YOUR OWN MERCHANDISING BUSINESS!

No Investment! No Inventory! Sell nationally advertised products right out of the Rake Catalog. Biggest price advantage ever! Sensational profits for you! Write for your FREE copy today! Catalogs are available in quantity for your own imprinting.

**RAKE COMPANY**  
708-Y Sanson St., Phila., 6, Penna. MA 7-7428

# Say You Saw It in POPULAR MECHANICS

## French STYLE DUELING SWORDS SET OF TWO \$3.98

Once used in deadly combat—now an exciting sport! Learn right at home. Fun—safe—educational. These swords are made of fine blue spring steel, polished metal

guards, turned handles, rubber safety tips. Fencing teaches quick thinking, develops coordination, posture. Since the Middle Ages, Europeans have enjoyed the sport of dueling. \*Now advocated by U.S. colleges. Set includes two swords and the booklet, "The Art of Fencing". Special price. **MONEY BACK IF NOT COMPLETELY SATISFIED** At sporting goods dealers or send \$3.98 to Wham-O Mfg. Co., Box C-12 San Gabriel, Calif.

MAKE **BIG PAY** OR OWN A BUSINESS

AIR CONDITIONING and REFRIGERATION Service

# Learn AIR CONDITIONING & REFRIGERATION

Now you can break into the fast-growing, well-paid field of Air Conditioning & Refrigeration in months... now you can get practical experience as you learn! CTI's new Shop-Method plan trains you at home in spare time—trains you so thoroughly that you can begin repairing and installing units within weeks after you enroll—for pay. Get into this big, uncrowded field—and work for top pay or go into business. Mail coupon and we'll send you eye-opener facts.

## NEW! 23 BIG PRACTICAL TRAINING KITS

Look what you get!—A motor, compressor, testing gauges, controls, a complete refrigeration hi-side; mechanic's tools and supplies! You get on the job training in your own home. You build and keep an air conditioner, freezer, refrigerator or milk cooler. You get more—learn more—earn more—the CTI way.

## MAIL COUPON TODAY FOR NEW FREE BOOK

**COMMERCIAL TRADES INSTITUTE**

1400 Greenleaf Ave., Chicago 26, Ill. Dept. R-113

Send me your big FREE book which tells me how I can train at home to make big money in Air Conditioning & Refrigeration.

Name \_\_\_\_\_ Age \_\_\_\_\_

Address \_\_\_\_\_

City \_\_\_\_\_ Zone \_\_\_\_\_ State \_\_\_\_\_

MEMBER: NATIONAL HOME STUDY COUNCIL



# Colorcreting Can Be Your Big Opportunity

Local Colorcretors are Needed Everywhere

Colorcreting is a small investment enterprise, rich in sales potentials, high in income possibilities. Work is easy and fascinating. No experience required; we supply complete instructions.

Colorcreting is a building-beautifying process, with Colorcrete being pneumatically applied to new or old masonry surfaces such as concrete or stucco. Lasts indefinitely—25 years or more. Easily cleaned. Gleaming white, or a choice of 30 colors.

Colorcrete equipment is compact and portable. Easy to operate and practically wear-proof. Easy-payment terms when desired. Write at once for Opportunity Book.

**COLORCRETE** Colorcrete Industries, Inc.  
570 Ottawa Ave., Holland, Michigan

IN CANADA: DUNN MASONRY MACHINERY LIMITED  
1020 Dundas Highway, Cooksville, Ont.

**"For Christmas  
and a Lifetime"**

**USE ALL 24 VOLUMES NOW  
Pay on Easy Book a Month Payment Plan**



People who **HAVE TO BE SURE** insist on  
**ENCYCLOPAEDIA  
BRITANNICA**  
New Edition Now Available

Britannica will provide instant and authentic information on every conceivable subject . . . thought . . . or study.

It will assure every member of your family the constant companionship of the world's greatest minds as your consultant or teacher.

It will build self-confidence . . . by helping all members of your family to understand . . . and talk intelligently upon every subject that enters into the lives of successful men and women.

Britannica will enable parents to work more closely with their children at home . . . helping them build a more solid foundation in today's highly competitive society. Leading educators say too many parents leave the entire educational job up to the teacher at school.

Britannica will help every member of your family to develop informed and sound thinking.

**Accept Preview Booklet of Newest Edition**

Send now for Free 32-page Preview Booklet, giving you, without obligation, a new conception of how valuable the ENCYCLOPAEDIA BRITANNICA can be in your home.

**Mail Coupon Today! HURRY While**

**Beautiful  
FREE  
Booklet  
Lasts!**



ENCYCLOPAEDIA BRITANNICA INC., DEPT. 39-C  
425 N. Michigan Avenue, Chicago 11, Illinois

Please let me have the FREE PREVIEW BOOKLET and complete details about the Book a Month Payment Plan. I agree to show booklet to a neighbor—there is no other obligation.

NAME .....

ADDRESS .....

CITY ..... ZONE ..... STATE .....

In Canada, write E. B. Ltd., Terminal Bldg., Toronto, Ont.

(Continued from page 74)

"Saucers" strapped to swimmer's hands increase his speed (Britannia Products Co., Cuyahoga Falls, Ohio).....	149
Metal hand for holding tools restores proficiency of amputee.....	154
Puffed-wheat wallboard.....	154
Projector "draws" face (Victorlite Industries, Inc., 4117 W. Jefferson Blvd., Los Angeles 16, Calif.).....	155
Elevator "phantom" announces floors.....	156
Self-adjusting ladder legs adapt to any terrain (H. B. Industries, Inc., 1401 Middle Harbor Rd., Oakland, Calif.).....	238
Handwriting sent by wire (Autron Engineering, Inc., 1254 W. Sixth St., Los Angeles 17, Calif.).....	244
Merry-go-round film developer.....	246
Tunnel 23 miles long.....	246
Slide fastener seals protective cover (Adhesive: Miracle Adhesive Corp., 214 E. 53d St., New York City 22. Krene plastic: Bakelite Co., 260 Madison Ave., New York City 16).....	258
Pesticide kills only harmful mites.....	266

#### SCIENCE

Electronic juggling machine balances three-foot rod.....	97
Weather radar for airliners.....	116
Rotating parachute slows flight.....	133
System like wirephoto transmits pages of books or magazines.....	141
Electronic "brain" for supersonic planes.....	145

#### Radio-Television, Electronics

Roof-mounted auto radio has many features.....	157
Electronic servant works for pennies a week.....	158
Remote control for television.....	160
TV hints for the serviceman.....	160

#### Craftsman and Shop Notes Index

##### AUTOMOTIVE

Box of baking soda under car hood provides fire extinguisher.....	178
Handles for closing car doors made from range-door pulls.....	184
Spray head cools auto radiator.....	183

##### FARMING

Aluminum rack stores milking-machine inflation tubes.....	212
Automatic feeder for turkeys reduces time and labor.....	213
Snap locks hasp and staple to hold door halves together.....	213

##### HOUSE AND HOME

Family desk (Hinges: The Seng Co., 1450 North Dayton St., Chicago 22).....	161
Dowels used in door corners hold stiles to crossrails.....	166
Faucets and drain at opposite ends keep bathtub cleaner.....	166
Monkey bunk.....	167
Carved boot is case for mantel clock.....	171
Wren houses require no perches.....	174
Plastic spray bottle applies water to plaster patch.....	179
"Clothespole" in basement room utilizes chain and hooks.....	184
Block locks refuse-can lid.....	192
Two straightedges for the week-end carpenter.....	193
Luminous paint for home safety.....	194
Socket in overhead receptacle simplifies changing switch.....	194

##### HOUSEHOLD HINTS

Crutch tip on broom handle prevents marring of walls.....	170
Household uses for shellac.....	170
Pocket sewed to folding cot keeps pillow in place.....	170
Card-table movie screen.....	174
Solving Home Problems—	
Rubber force cup will open a stuck drawer.....	176
Snap fasteners coated with clear nail polish prevent loosening.....	176
Olive oil is safest and most durable finish for salad bowls.....	176
Cellulose tape prevents plug base or cube tap from turning out of socket.....	176
Shellac can be used to stainproof nailheads.....	176
Lamps cannot be easily upset if cord is attached to table rail.....	177
Alarm clock silenced by placing clock on sponge rubber.....	177
Towel bar for storing extra table leaves.....	177
Lock washer holds knob of pot cover securely.....	177
Enamel refinishes old silver plate.....	182
Furniture stains removed with salt and shortening.....	200
Window-shade movie screen mounted on back of television set.....	207

##### MISCELLANEOUS

Magnet holds ruling pens on slanted drawing board.....	165
Purse-sized mucilage container is empty nail-polish bottle.....	174

(Continued to page 78)

**IMPORTANT NOTICE**—It is the intention of this magazine to provide its readers with information regarding the latest developments in the mechanical arts. We take no responsibility as to whether the disclosures contained in our articles are covered by patents and advise readers to investigate this subject before making, using, or selling any of the products, machines, or processes described in order to avoid possible liability for patent infringements.

**WAR SURPLUS BARGAINS**

**WAR SURPLUS BARGAINS**

**\$500,000.00 INVENTORY for QUICK LIQUIDATION**

Surplus items—hundreds of them for home, shop, factory, farm and outdoor use. New items, used items, reconditioned items—all at tremendous savings—all priced for quick sale.

Page After Page of Values

This big catalog shows page after page of amazing money saving values. Write for your copy today. Send 10c in cover postage, mailing, etc. Write today! **SEND TODAY FOR YOUR COPY**

**10c**

**STARK'S** 212 W. Madison St.  
Dept. PM-11  
CHICAGO 6, ILL.

**GIANT 6 Ft. Balls**

**59c**

Great fun for Kids and Grownups. Inflate to a Giant 6 ft. across, 21 ft. around. Use anywhere. Made of genuine neoprene rubber for extra durability. Can be painted to carry your message! Terrific for attracting crowds at fairs, openings, school games, gas stations, etc.

Government surplus, never used, sold at a fraction of original cost, 59c each. (2 for \$1.00, 5 for \$2.00, dozen only \$5.00). Sorry no C.O.D.'s

20 FT. BALLS \$2.00 EACH

**NOVEL MFG.** 33 2ND AVE. DEPT. G-1274  
NEW YORK 3, N. Y.

**LAW FREE BOOK** **THE LAW TRAINED MAN**

Write today for a FREE copy of illustrated law book, "THE LAW-TRAINED MAN," which shows how to earn the professional Bachelor of Laws (LL.B.) degree through home study of the famous Blackstone Law Course. All necessary books and lessons provided. Moderate cost; convenient monthly terms. Write for FREE law training book today.

**Blackstone School of Law, 225 N. Michigan Ave.**  
Founded 1890 Dept. 58 Chicago 1, Ill.

**500 Treasured "Pirate" STAMPS**

Get this big, all-different "Treasure Chest" of 500 prized stamps from Pirate strongholds. Total catalog value over \$10. 13 extra special stamps FREE if you act quickly. Approvals. Send only 35c to **LITTLETON STAMP CO., Dept. PM-11, Littleton, New Hampshire.**

**FOR ONLY 35c**

**Be a VENTRILOQUIST**

**ALL SECRETS TOLD**

Dummies, Courses, Scripts, Monologues. Send \$1 for large revised catalogue.

(Deductible first order)

**EXPERIMENTAL SPECIALTY MFG. CO.**  
R.F.D. 3, HARTFORD CITY, IND.



**LOOK! NEW Electric Greyhound Bus 1955**

**GOES BACKWARD AND FORWARD**

Here is the sensational new 1955 scale-model Electric Greyhound Bus that captivates every child (and mommy and daddy, too). One flick of the magic gear lever and off it goes—forward or reverse. Runs for hours. Driven by an electric motor, powered by flashlight battery—safe, economical—easily replaced. Comes completely assembled with headlights, balloon-type rubber tires—durable metal body.

**SEND NO MONEY.** Rush your order today. Remit with your order and we pay postage or order C.O.D. plus postage and handling.

**MEDFORD PRODUCTS, INC.** Dept. PM9, P.O. Box 209  
Cathedral Station, New York 25, N.Y.

**\$1.98**  
POSTPAID



**BUY DIRECT and SAVE UP TO 1/2**

**on ITALIAN ACCORDIONS**

**EASY TERMS**

**Act NOW!**

Accordions of famous makes and breath-taking beauty now can be yours! Mail coupon for FREE Color Catalog and amazing Wholesale Prices.



**5 DAYS FREE TRIAL**

**MONEY BACK GUARANTEE**

**MAIL COUPON NOW**

**TRY BEFORE YOU BUY**

World's largest selection direct from Importer to you! 30 models to choose from. **SATISFACTION GUARANTEED** or your money back. Trade-ins accepted. Terms as low as \$10 monthly. Write today!

**Big Color Catalog FREE!**

Send me Free Color Catalog—full details.

Name \_\_\_\_\_

Address \_\_\_\_\_

City \_\_\_\_\_ State \_\_\_\_\_

**ACCORDION MANUFACTURERS & WHOLESALE OUTLET**

2003 West Chicago Ave., Dept. R-115, Chicago 22, Ill.

**new product digest**

Illustrated monthly magazine of new products field features exclusive valuable information for inventors, patent attorneys, and manufacturers about new products. 12 issues — \$10.

**Send \$1.00 for this month's issue to**

**New Product Digest, Dept. A 29**  
**P. O. Box 2052, Austin, Texas**

Name .....

Address .....

City ..... State .....

**SAVE ON XMAS GIFTS**

**BUY FROM IMPORTER**

**A COMPLETE CAMP KIT!**

**NEW**

**Special 12 Pc. SPORTSMAN'S KNIFE**

**IDEAL GIFT FOR FATHER, SON OR FRIEND...**



**Only 4.95 WITH HOLSTER**

**Eliminates 12 Individual Items from Pack or Tool Kit**

Here is the Perfect, Combination Knife-Tool for every Outdoor Sportsman, Hunter, Camper, Fisherman, Bay Scout, Ranger, Rancher, etc. Think of it! 11, Fine quality Steel Tools, precision made to fold easily into the heavy base covered body. In one neat, compact unit you have (1) a regular knife, (2) a fork, (3) a spoon, (4) a draw-knife, (5) a bone-saw and fish-scaler, (6) scissors, (7) a can and bottle opener, (8) a cork-screw, (9) awl punch, (10) a screwdriver and (11) a metal file. All this PLUS a genuine leather, belt holster.

**BUILD-IT YOURSELF SPECIAL FOR XMAS**



**12 inch ELECTRIC BOAT KIT with ELECTRIC MOTOR & SPOTLIGHT**

Here is a genuine electric motor drives speedboat that will make many a young sailor happier this Xmas. The hardwood hull and deck are already completed (excepting paint) and is ready for final assembly. Included in this complete kit is an electric motor, flexible coupling, drive shaft with propeller, adjustable rudder, windshield, electric spotlight and other accessories and hardware. Can be finished and ready for launching in one hour. Motor and spotlight operate on 2 standard flashlight batteries. Order now — Xmas delivery assured in Dec. 15.

**3.95 INCL. MOTOR**

**AMAZING - NEWLY DESIGNED 60 TO 450X MICROSCOPE**

**FEATURING 60, 120, 150, 180, 300 AND 450 POWER MAGNIFICATION**

**NEWLY DEVELOPED - Self-Contained SUB-STAGE LIGHT ELIMINATES NEED FOR EXTERNAL LIGHT SOURCE**

Take advantage of our tremendous foreign purchase. Ideal for use by Amateur Scientist, Student, in Home Laboratory for study of insects, plant life, etc.

**CHECK THESE FEATURES**

- 1-Triple, revolving turret with 10X, 20X, 30X precision ground & polished lenses.
- 2-Two interchangeable eyepieces, 6X and 15X with precision ground and polished lenses.
- 3-SIX MAGNIFICATIONS for all purposes - 60X, 120X, 150X, 180X, 300X and 450X.
- 4-NEW! Sub-stage with SELF-CONTAINED LIGHT. No external light source needed.
- 5-Large sub-stage mirror for use with external light sources.
- 6-All Metal Body - inclines through 90 degrees.
- 7-Special Hardwood Case and 3 glass slides.



**FREE with MICROSCOPE - 8 Pc. DISSECTING SET with hardwood case. Has Scalpel, Scissors, Tweezers, etc.**

**Only 12.95 INCLUDING DISSECT SET**

**SATISFACTION GUARANTEED OR MONEY BACK**

ORDER TODAY for Xmas Delivery - Pay by Money Order or Check. No deposit with C.O.D.'s. All prices F.O.B. Los Angeles.

**Palley SUPPLY CO.**

2263 E. VERNON AVE., DEPT. PM-11 LOS ANGELES 28, CALIF.

(Continued from page 78)

Spark from discarded lighter ignites propane equipment.....	178
Metal typewriter-eraser shield catches particles in trough.....	182
Fungicide prevents lawn mold.....	184
Worn overshoes "skidproofed".....	184
Better texture shading.....	185
Bills kept separate in wallet.....	185
Fuel tank set in carton to protect inside finish of boat.....	185
Heat bath for thermoplastics consists of salt or sand.....	188
Pocket lined with sandpaper prevents pencil loss.....	188
"Baby prints" in plaster are lifetime keepsakes.....	189
Beveled top rail of picket fence prevents children walking on it.....	192
Oversized plywood palette has greater color choice.....	192
Discarded flash-unit dry cells still usable for flashlight.....	193
Shoulder-strap tripod carrier.....	200

**TOOLS**

Modified war-surplus entrenching tool provides pick and shovel.....	175
Shelf built with hand tools appears to have machined edge.....	175
Faucet washers centers auger bit when boring hole oversize.....	188
Auto-compass adjusting tool made from brass washer.....	207
Floor flange holds lathe center.....	212
Masking tape on wood chisels protects sharp cutting edges.....	212
Chamfering edges of tubing with special lathe setup.....	213
Distributor-point block "lapped in" with sandpaper on cam.....	215
Car-axle housing forms prop to support combine tongue.....	216
Quick alignment of lathe centers.....	216
Screw holds firmly in end grain when flat is filed on threads.....	216
Hand-powered saber saw.....	217
Shopping for Tools—	
Masonry hole-cutting machine.....	218
Draftsman's ellipsograph makes quick drawings of ellipses.....	218
Tool aligner enables machinist to make quick check of machine.....	218
Self-honing saw blade for use in portable electric handsaws.....	218
Simplified slide rule designed especially for beginners.....	219
Hand sanding block for shaping and finishing wood.....	219
Variable-grip machine vise eliminates jigs and fixtures.....	219
Nailing machine doubles speed.....	219
Metal shear attachment for portable electric drill.....	219
Soldering machine operates in a manner similar to a spot welder.....	219

**WORKSHOP HINTS**

Clear chips from blind holes with battery-water syringe.....	166
Clip-type screwdriver improvised.....	166
Syrup dispenser saves solvent.....	170
Box lid provides dust catcher when drilling plastered wall.....	170
Metal "spine" guards razor blade used as hobby knife.....	171
Nut and bolt in triangle cutout locate equidistant lines.....	174
Soldering iron heated quickly with insulation around tip.....	174
Steel pulley used as holder for drilling bushings.....	175
Curing flashlight flicker.....	178
Emergency faucet repair.....	178
Plastic bottle used as bellows.....	178
Concrete-reinforcing rods held by sheet-metal strips on nails.....	179
Friction tape secures circular glass cutter.....	179
Offset in plaster-base panels reduces chances of cracking.....	179
Spring-loaded turn button needs no tightening.....	179
Small-parts tray bandsawed from wooden block.....	182
Cutting and polishing marble with home-workshop tools.....	182
Solder carried on film spool.....	182
Stronger wire splice assured by using two pairs of pliers.....	184
Muffin tin used as tray to store small parts.....	188
Plate scraper protects wood when pulling nails.....	192
Novel bathroom wastebasket.....	194
Puller balls double as knobs on shop-cabinet doors.....	194
How to use corrugated fasteners to prevent splitting work.....	194
Holder for drilling dowels made of V-belt sections.....	206
Coupled socket-head wrenches not easily misplaced.....	206
Farm-workshop overhead fan used all year around.....	206
Tape keeps spark plugs in order when removed from engine.....	206
Washers bolted to pulley replace section of flange.....	212
Sliding jig supports plane iron for accurate honing.....	212
Handsaws held in slotted rack by "self locking" wedges.....	213
Removing chips from blind hole.....	215
Blowtorch efficiency increased by adding bulb pump.....	216
V-block for drilling round stock assembled from tubing.....	216
Brush-holding solvent container.....	217
Toothpaste tubes reused for storage of special lubricants.....	217

**Radioactive Batteries**

Electrical batteries of the future may be powered by atomic radiation converted directly into electricity. Even today, some atomic batteries giving small but constant amounts of power are ready for practical use. Radioactive wastes from reactors are cheap enough to be used in such batteries. They also have a long enough life. But like other radioactive substances they require shielding to prevent radiation danger to people and damage to materials.



Amazing new weapon for sportsmen!  
**HUNTING BLOWGUN**

3 1/2 ft. precision steel barrel

Shoots like a rifle

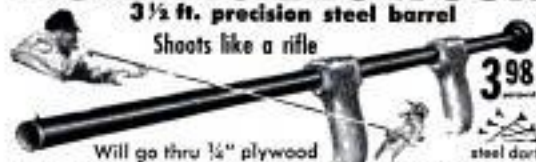

398

Will go thru 1/2" plywood

steel darts

Exciting new sport based on an improved version of the most accurate native weapon ever devised - the hunting blowgun of Borneo! Silent and very powerful - American sportsmen who first try it cannot believe their eyes! Compression of breath in tube gives amazing air power! Shoots over 300 feet. Enjoy target fun with friends. Average person can hit 2" bulls-eye at 30 ft. Precision made of the finest deep-blue steel 3 1/2 ft. long. Hardwood grips, Rubber mouthpiece. Beautiful finish. Excellent for destroying varmints. Kills without poison. Comes with target, instructions. Comes with 3 5" steel hunting darts. Extra darts 6 for \$1. Money back guarantee. S&R RESEARCH, Box 82D, San Gabriel, Calif.



Illustrated: *Mighty American Flyer 4-6-4 "Hudson"*

**NEW FOR '55!** American Flyer No. 5510T "Mountaineer" freight. Complete with smoke, choo-choo, Pull-Mor power, track, transformer. **\$29.95\***

\*Slightly higher Denver and West

**Build your model railroad with Gilbert**

**AMERICAN FLYER**

...far more realistic than any other!

Here's a real do-it-yourself hobby! You'll plan layouts, lay track, build scenery, do hundreds of other things. The sure way to realism is with American Flyer. Each train is a scale model; runs on 2-rail track; has puffing smoke and choo-choo, plus many more exclusive features. Choose from all-new American Flyer sets, from \$19.95,\* with transformer and track.

Only **American Flyer** has all these realistic features!

- Scale-Model Realism!
- 2-Rail, Flat-Top Track!
- Real Smoke and Choo-Choo!
- Rugged Pull-Mor Power!



See Brand-New-For-'55 American Flyer Trains at your dealer's today! Made by A. C. Gilbert, manufacturers of famous Erector Sets

**Send for this DOUBLE-VALUE OFFER!**

192-page book: *How to Build and Operate a Model Railroad*. Hundreds of illustrations. A wealth of ideas on how to plan and build your own railroad.

Brand new full-color American Flyer catalog. Shows you every train; all accessories, too. 44 pages of action and fun.

Both only **25¢**—write today (or catalog, only 10¢)

Gilbert Hall of Science, Dept. 24  
 Erector Square, New Haven 6, Conn.

- I enclose 25¢. Rush both big train books.
- I enclose 10¢. Rush catalog.

Name \_\_\_\_\_

Street \_\_\_\_\_

City \_\_\_\_\_

Zone \_\_\_\_\_ State \_\_\_\_\_

Valve Lifters Click? Get **PYROIL**

CLEANS, LUBRICATES, RESTORES LOST POWER



79¢

Now... Quiet 'em

Pyroil "B" added to engine oil clings to metal. Lifters won't stick and click. Pyroil fights heat, acid, corrosion. Increases mileage.

Saves gas and repairs. Get Pyroil "B" today.

Write for trial offer, Dept. PM-115,

PYROIL COMPANY,

La Crosse, Wis., U. S. A.,

Toronto, Canada

IN CANADA \$1.00

**PYROIL**

SUPER LUBRICANTS • WORLD FAMOUS SINCE 1929

**REAL ESTATE**  
 BE A BROKER

PAYS BIG! SEND FOR FREE, BIG, ILLUSTRATED CATALOG NOW! Graduates report making substantial incomes. Start and run your own business quickly. Men, women of all ages, learn easily. Course covers Sales, Property Management, Appraising, Loans, Mortgages, and related subjects. **STUDY AT HOME** or in classrooms in leading cities. Diploma awarded. Write TODAY for free book! No obligation. Approved for World War II and Korean Veterans.



**WEAVER SCHOOL OF REAL ESTATE** Dept. 10761  
 20228 GRAND AVENUE KANSAS CITY, MO.

**RADIO**

Engineering. All phases radio & electronics theory & practice; television; FM; broadcasting; servicing; aviation, marine & police radio. Prepare for good pay; 18-month course. Graduates in demand by major companies. Enter Jan., March, June, Sept. Regular campus life. Write for catalog. VALPARAISO TECHNICAL INSTITUTE, Dept. D, Valparaiso, Ind.

**PORTABLE CAR COVER** Heavy Vinyl Plastic (formerly \$8.95)

Protect Against RAIN • SUN • DUST. \$6.95

Long-lasting plastic, folds compactly, off and on in a jiffy, sturdy elastic binding gives extra security. State make, model and year—buy direct from mfr. Send \$6.95 plus 35¢ postage or sent C.O.D. BEA SALES, Dept. H-13, 125 E. 46th St., New York 17



**INSIGNIA**  
 ARMY • NAVY • MARINE

Includes Shoulder Emblems, Rates, Chevrons, O-Bars, Medals, Ribbons, Collar Insignia, etc.

**40 for \$1.00**

Limited Introductory Offer—ORDER NOW!  
 EMBLEM SALES CO.  
 P.O. Box 167, Madison Sq. Sta., N. Y. 10



## **“Feels like a new car now!”**

If years of driving have taken the pep out of your engine...if practically every stop for gas means another quart of oil—it's time for Perfect Circle 2-in-1 Chrome piston rings. They help bring new life to tired engines... restore that *new car feel*.

In Perfect Circle's 2-in-1 Chrome set, BOTH the top and oil rings are plated with thick, solid CHROME—chrome that effectively resists the terrific heat, pressure and friction that result from combustion. The entire area of

piston ring travel gets *complete* protection from wear—more than *doubling* the life of cylinders, pistons and rings. No slow, tedious break-in is necessary...rings are pre-seated at the factory.

Bring top performance back to your car! Enjoy thousands of extra miles of sustained power and positive oil control with Perfect Circles! Perfect Circle Corporation, Hagerstown, Ind.; The Perfect Circle Co., Ltd., Toronto, Ont.



## **PERFECT CIRCLE** 2-in-1 **chrome** piston rings

THE STANDARD OF COMPARISON



## Bill Ford Revives a Classic:

# THE CONTINENTAL

**W**HAT SHOULD YOU GET when you plunk down \$10,000 for an automobile? After all, it can have only four wheels and one engine just like any other car!

But the new Continental, designated the Mark II in a somewhat British accent, is unlike other cars, say its builders. For \$10,000, the Continental buyer is said to get finer quality than has ever been built into an assembly-line product before, plus an outward appearance so striking that there can be no doubt he is driving an automobile that costs \$10,000.

Let's look at these two claims for the Continental. Do they stand up?

First, what about striking appearance? Judge for yourself. The car is certainly

By Arthur R. Railton



There's just enough of the original Continental (photo top of page) in the new to continue the breed. Spare tire of new model is inside trunk, not outside as before



Because it's only 56 inches high, the Continental looks much longer than its 218 inches. From the side, its trim, graceful body has a quiet dignity

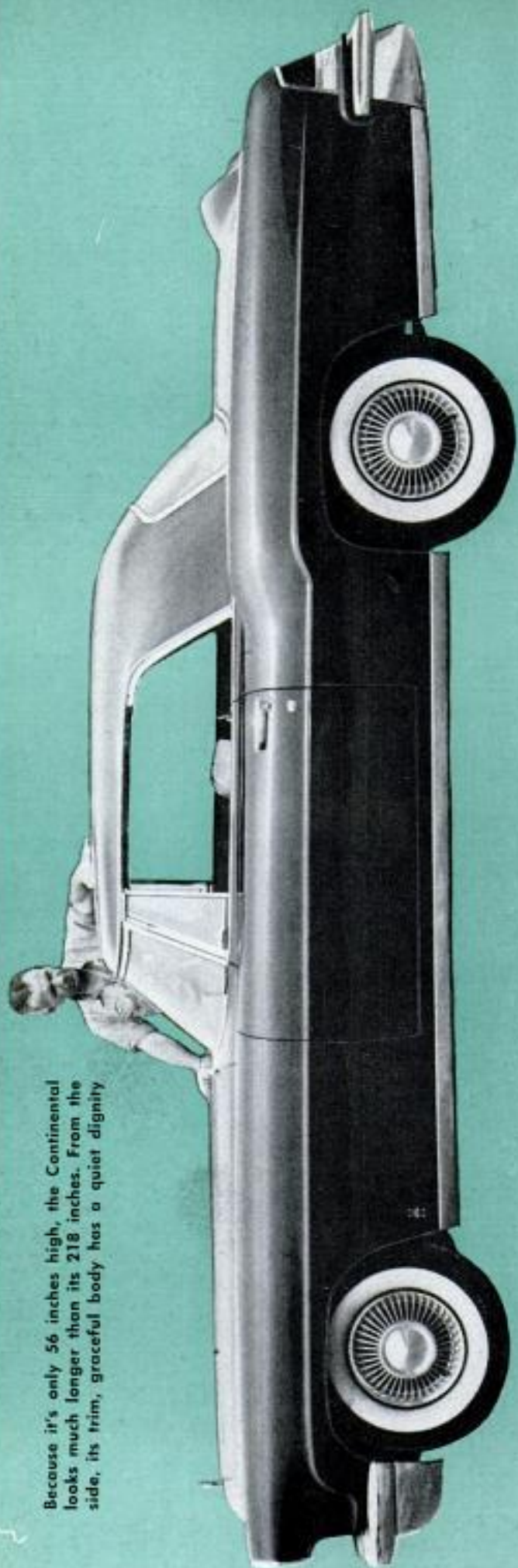

different without being freakish. There can be no doubt that it is a descendant of the original Continental. Its proportions emphasize what many persons still believe is the epitome of automotive design—the long, long hood that signifies power and the small, compact passenger compartment that denotes elegant intimacy.

It has, for this writer at least, a flashy dignity. If that sounds like a contradiction, it is! But, strangely enough, it is true. There's enough dignity to satisfy the most retiring of retired millionaires, yet with it there's enough flash to elicit wolf-calls from street urchins. Driving the new Continental, you look impressive, but you certainly won't be called a grandstander!

What about the claim of fine quality? Can any assembly-line operation live up to that promise?

Months ago when production of the new Continental was just getting under way, an inspector spotted burrs on an incoming shipment of washers. The burrs were small; the washers not of major importance. The fault would not affect by as much as a whit the operation or looks of the car.

Yet the whole shipment of washers went back. Not because the faults were critical, but because they violated the basic concept of the car—it must be as perfect as possible.

And it should be. After all, it does have a price tag that reads \$10,000 or so and when a man spends that kind of money he should get perfection.

That is Bill Ford's philosophy and the Continental Mark II is Bill Ford's baby. He has been the driving force behind the car since its conception. Months back, when the division was just starting to produce cars, this writer was startled to spot Bill Ford test-driving cars on the plant's own track. He wanted to satisfy himself that each car was right. He no longer can do that, production being what it is today, but he still spot checks Continentals as they come off the line.

To make certain each car is right, Continental established a new job classification in the

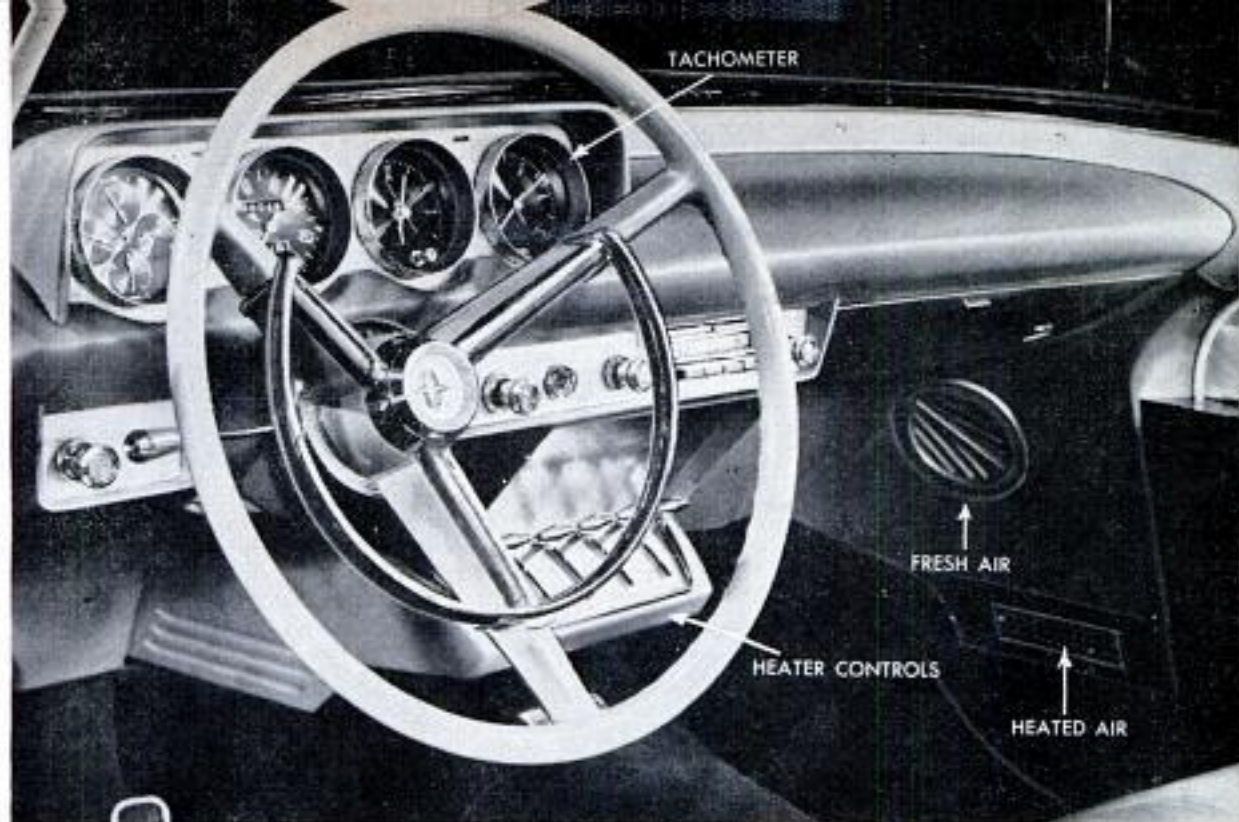

Inside or outside, the Continental is in good taste without cheesecake. The panel is simply four round dials

assembly operation — the road-test mechanic. Each Continental gets two test drives around the small but adequate test track by one of these experts. This mechanic takes the car over the railroad-tie "rattle course" and brings it in for corrections. He must do the correcting himself. There is no passing the buck. If the car has a rattle, he's got to get rid of it. If it skips a beat on acceleration, he must make it right.

Two examples will illustrate the careful planning that went into details. When the time came to select a horn, Ford and others sat for hours listening to the sounds of various horns as the car was driven past,

driven into a driveway, under the window. After hundreds of samplings, a horn was selected with just a touch of "sass" blended into its authoritative tone.

A similar amount of care was taken in the exhaust-pipe design. First, there were simply two straightback pipes, but that sounded like two four-cylinder engines, hardly impressive enough for a Continental. Finally, a rear crossover pipe was added just above the differential so the engine would sound right. There are still the two separate exhaust systems, but the crossover pipe blends the two sounds into one.

Here are some added reasons why the new Continental is a \$10,000 automobile:

Under the hood is a modified Lincoln V8 of unspecified horsepower. Dotted lines show path of exhaust pipe

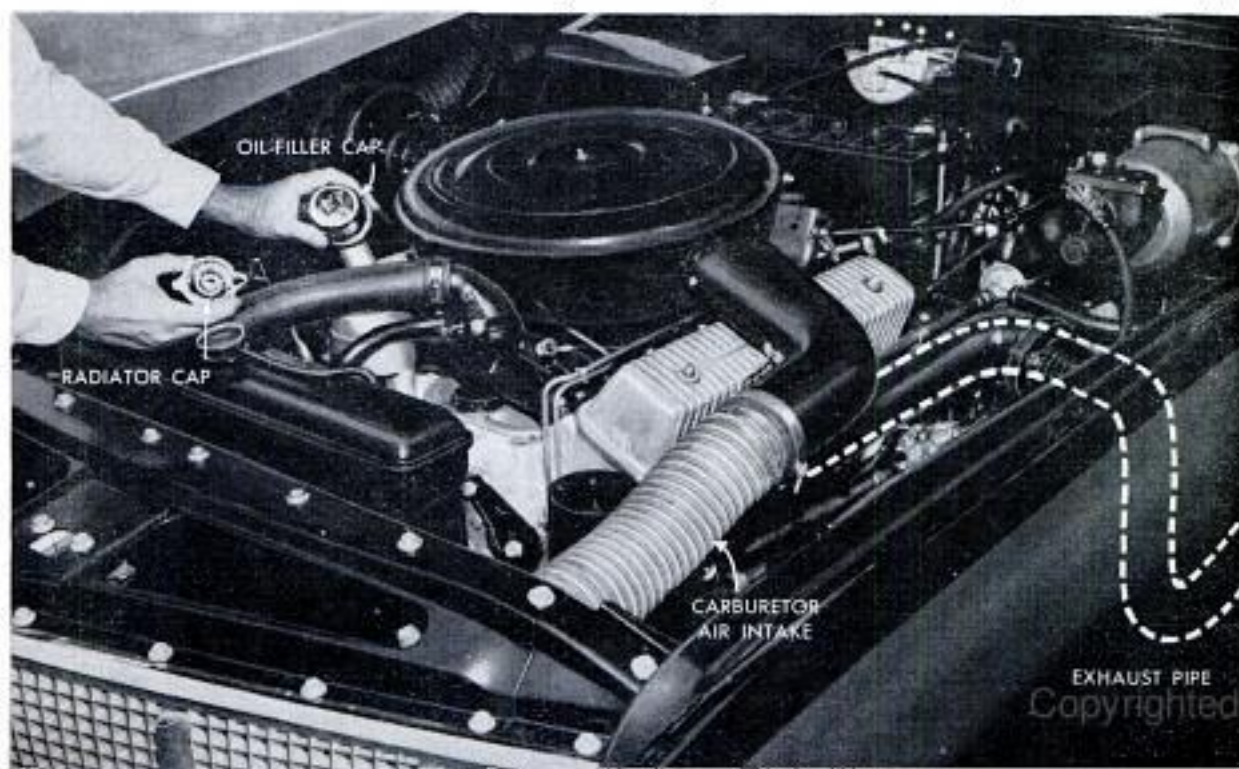

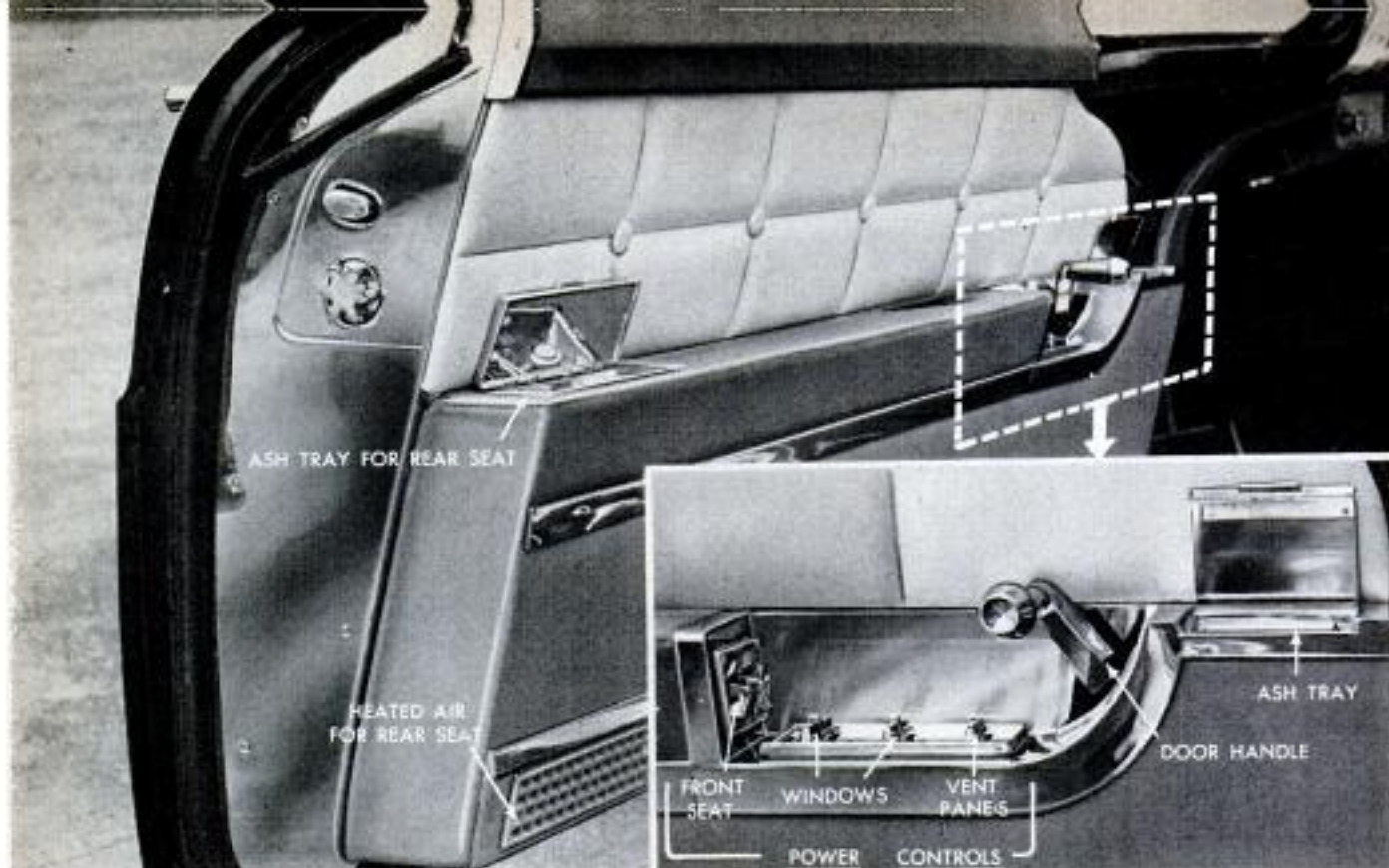

Edges of the big doors are chrome plated. Inset is the control panel. Even the vent panes are power operated



Spare-tire bulge in trunk lid is in keeping with the former Continental tradition. However, the tire location makes loading trunk very awkward

Chassis shot on the Continental assembly line. Between the tail pipes at rear is a crossover pipe (not visible here) to improve sound of exhaust

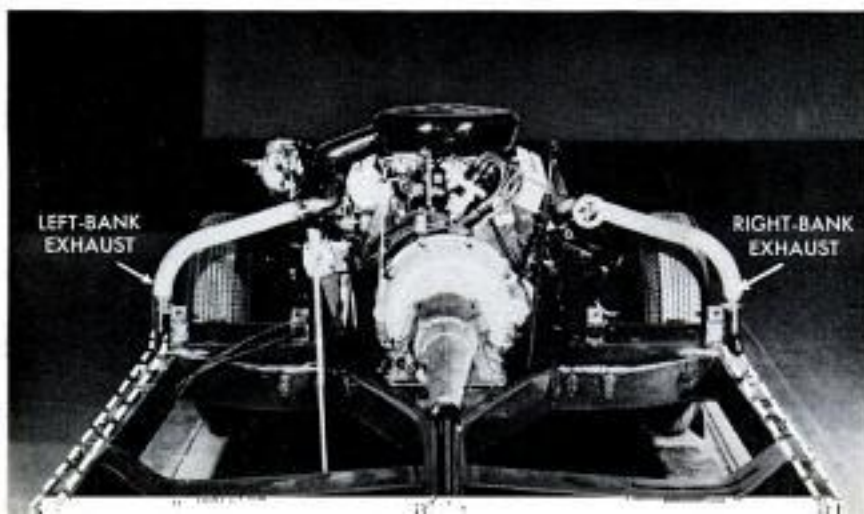

- Painting a Continental is said to take longer than the entire assembly operation of other cars. There are eight double coats altogether: 1. Two double coats of primer followed by a water-and-sand rubdown; 2. two double coats of surfacer followed by water-and-sand rubdown; 3. two double coats of color followed by oil-and-sand rubdown; 4. two added coats of color and another oil-and-sand rubdown; 5. final polishing. There are 14 single colors and five conservative two-tone combinations available.

- Chrome parts get successive layers of copper, nickel and chromium. They pass salt-spray resistance tests three times as severe as the usual S.A.E. standard. Chrome, used sparingly outside, appears in unexpected places: the radiator cap, oil-filler cap, dipstick, door edges.

(Continued to page 252)

## Waterproof Duck Blind Shelters Two Hunters

There's plenty of room for two hunters in a portable duck blind that offers shelter as well as concealment. The blind weighs only 18 pounds and can easily be carried by one man. At the hunting site the parts of the metal frame are clamped together. A canvas bag is slipped over the frame and held in place with a drawstring. A turret-type hood fastens to the base and accords back from either side to give 360-degree vision. The blind comes in a choice of colors.



## Ship's Stabilizing Fins Cut Roll in Rough Seas

Roll of a vessel, even in heavy seas, is reduced as much as 90 percent by stabilizing fins recently developed. The fins, placed midway between bow and stern and about 20 feet below the water line, feather back into the hull when not in use. They are automatically controlled from the bridge by instruments that measure the ship's impending roll. The compact sensors then transmit, through magnetic amplifiers, anti-roll signals to the hydraulic actuators of each fin shaft. The fins on a typical merchant ship are each 14 feet by 7 feet.

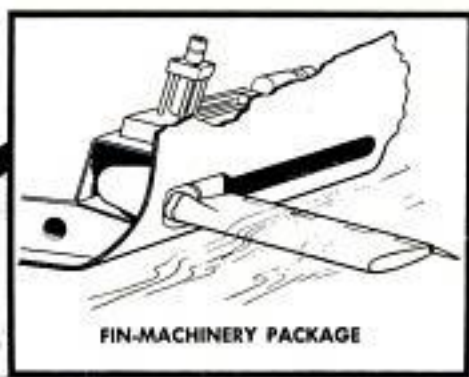
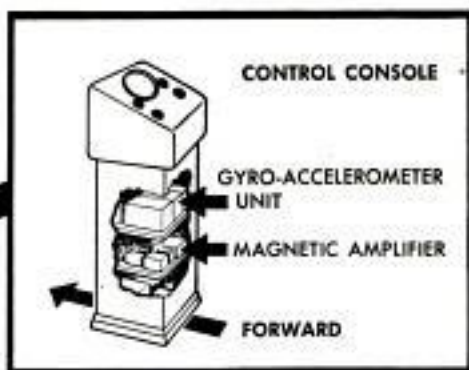
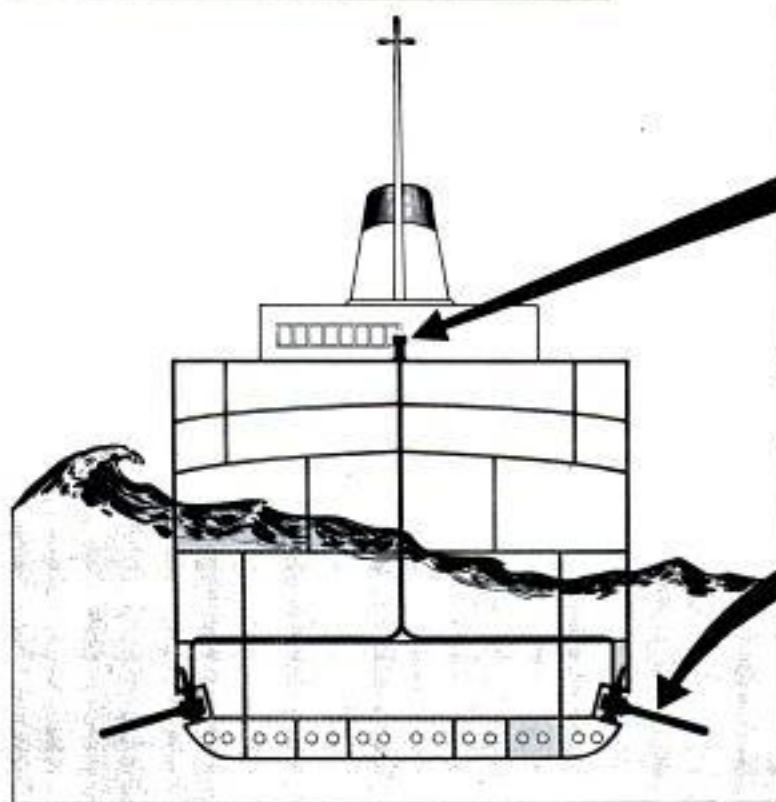



*Make Way*

## FOR THE MICRO-MIDGETS

**T**HERE'S A GROUP of youngsters in Phoenix, Ariz., who talk, sleep and eat racing. These boys, ranging in age from 12 to 16 years, build their own racing cars and put them to the checkered-flag test on their own race track every Saturday.

No one seems to know how the racing club started. The members do recall that a 16-year-old boy came on the scene one day with a  $\frac{3}{4}$ -horsepower racing job rolling on soapbox wheels. From then on, the club grew until now, about two years later, there are 25 boys piloting odd-looking homemade contraptions around the dusty oval. These racing cars, called micro-midgets, are powered by three-horsepower engines. The track is a  $\frac{1}{2}$ -mile oval.

No race drivers are more earnest than these youngsters, all of whom aspire to the big time. One of them, Loren Barnes, uses the same number on his micro that his brother, Don, uses when racing professionally in Phoenix.

The track is complete with racing flags, official timers and track stewards. With their three-horsepower engines buzzing

like excited bees and their tiny wheels churning clouds of dust, the little cars speed around the oval at up to 15 miles per hour.

The early micros used discarded washing-machine engines to drive the rear wheel of a soapbox body. Since then, the box has been junked and a bare angle-iron frame substituted. Added refinements are handmade tie rods for the front wheels, oversize drive wheel at the rear and a two-inch slab of foam rubber on the seat.

Before modifications got out of hand, the youngsters drew up a set of specifications. Over-all length is limited to 60 inches. Wheels cannot be more than 12 inches in diameter. Three-horsepower engines are the maximum that can be used.

The underslung micros are virtually nontippable, but nevertheless each racer wears a safety belt and most cars have sturdy roll bars behind the driver's seat.

With gas tank full (it holds about five quarts—enough to race for several weeks), a micro weighs about 230 pounds. No rules have been formulated on brakes, but either manual or automatic clutch is permitted.





Above, the starting lineup. Some cars have foot throttles, others use a hand control

Top speed is about 17 miles per hour. The lap record of 11.4 seconds is held by Reese Verner, 12 years old and the youngest member of the club.

Usually the youngsters build their own cars, although they do get some help from parents and older brothers. Many of the parts come from auto junk yards.

Engines are usually taken from old power lawn mowers. Each week the boys work over these noisy engines before the big 15-lap race on Saturday.

Heat trials are held prior to the event. The car with the fastest time gets the last position. Points are given to the first five finishers in the race. Occasionally, when a trophy is available, a sprint race is held with the two fastest cars competing for three laps.

Headed by 15-year-old Ed Yue, the club, so far as the boys know, is the only one of its kind. ★ ★ ★

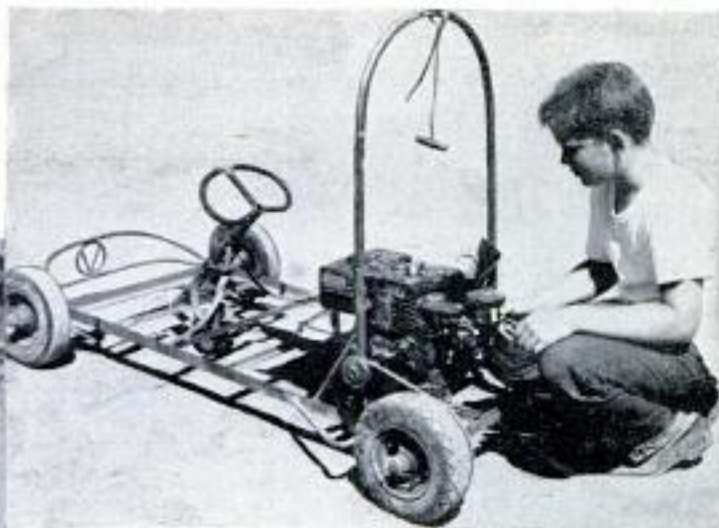

Youngest driver and lap-record holder is Reese Verner, 12



Considerable dust flies when the micros swing around the turn and into the straightaway. Each racer should have a roll bar

Post positions are determined by means of trial heats. With an official flag, the starter signals these two to get going



## Flying Aircraft Carrier Launches Jet Fighter From Bomb Bay



Convair's RB-36 bomber has become a flying aircraft carrier, capable of launching and retrieving a Republic RF-84F reconnaissance jet fighter while in flight. The fighter rides in the bomb bay and is launched and taken aboard by a boom lowered through the bay. The combination enables the Air Force to conduct long-range, high-speed reconnaissance missions. The first squadron to operate from the bomber has been activated.



## Brush-Cutting Saw Slung From Strap

Brush clearing is speeded as much as 300 percent with a powered cutter slung from a shoulder strap. A lightweight gasoline motor at the rear of a five-foot arm powers a 10-inch circular saw mounted on its tip. Handlebars mounted on the arm permit the operator to swing the brush cutter from side to side, to reach under overhanging branches or to reach high for overhead cutting and limbing. The brush cutter, an attachment for a chain-saw motor, is constructed of lightweight magnesium and aluminum alloys.



**PLYMOUTH**



Plymouth's four-door hardtop comes in the Belvedere series. Two-toning is slightly different from 1955

## **Chrysler Family Makes 1956 Debut**

**C**HRYSLER CORPORATION spent a whopping \$175,000,000 on retooling for its 1956 models—and 1956 was supposed to be an “off year” involving only facelifts.

Chrysler spent that much money, right on the heels of the big change of 1955, because it is determined never again to be “engineering-rich, styling-poor.”

Everything from the rear window back is new for 1956. Fenders flare back with what is called the Flight-Sweep motif—a step in the direction of jet-plane styling. Bigger and more emphatic than ever before, the rear fenders are eye catchers, making the roof line look lower by optical illusion. Each of the five cars in the Chrysler family has these big tail fins and easily recognized taillight designs.

But Chrysler is not ignoring engineering. There are important changes here, too. Most talked of are push-button transmission and the long-playing phonograph.

All PowerFlite-equipped cars are controlled by push buttons. A control panel, not unlike the keyboard of an adding machine, is mounted on the dashboard just to the left of the steering wheel, out of reach of children. Only four buttons are needed: One for Neutral, one for Drive, one for Low and one for Reverse. There is no Park position with PowerFlite as Chrysler still provides the separate propeller-shaft parking-brake system. Instead of moving a shift lever, the driver merely presses a button. Safety devices prevent the engagement of more than one at once or going into Reverse while traveling forward faster than 10 miles per hour.

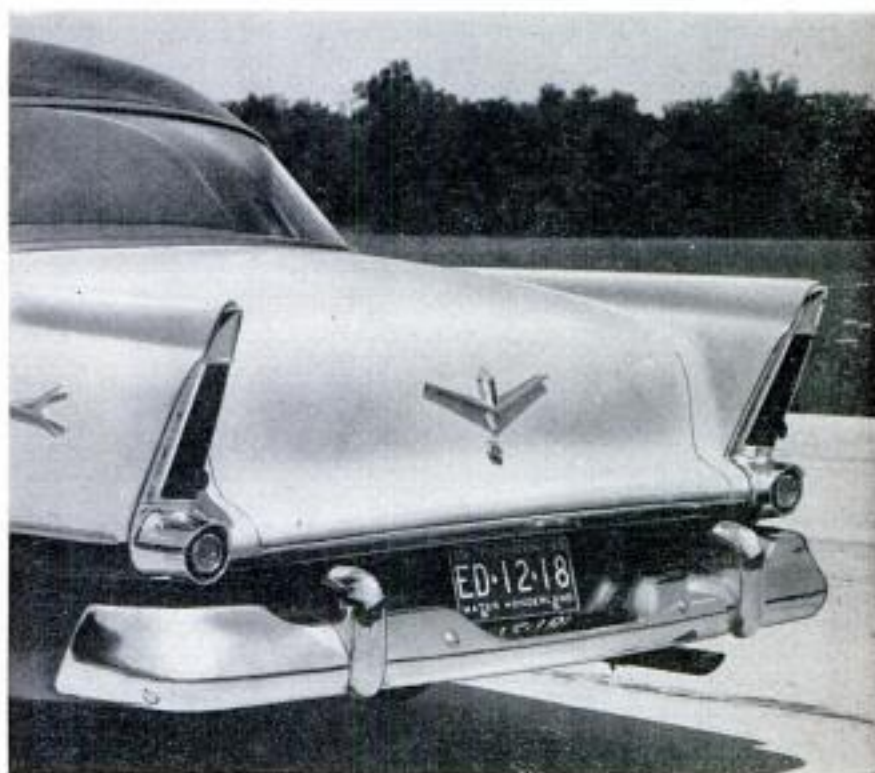

Above, cleanly sculptured are the airfoil tailfins of the '56 Plymouth. Tall, vertical taillights quickly identify the car. Below, center section of the front grille has been restyled



**DODGE**



Dodge Custom Royal Lancer two-door hardtop. Also available in this series is the four-door hardtop

### Long-Playing Phonograph

Also available through the entire corporation line is a long-playing phonograph that is mounted just below the radio on the dashboard. It plays through the radio and consists only of a turntable and pickup arm, designed so it is virtually impossible to make it jump a groove even on the roughest roads. Records are seven inches in diameter and spin at about 16 revolutions per minute. One record will play for about 45 minutes. Because of the ultra-long-playing design, no automatic changer is needed. Once every 45 minutes or so, you flip the record over or change it for a new one, an operation that Chrysler says can be accomplished without taking your eyes off the road.

Four-door hardtops are available through the whole line with Plymouth, Dodge, De Soto, Chrysler and Imperial all offering them.

The entire line now has the 12-volt electrical system and new safety door latches. Seat belts are available as dealer-installed options, as they were last year.

Here, in summary, are additional high-points of each division's 1956 cars:

### Plymouth

Large, cleanly chiseled rear fenders are definitely of airfoil shape. Grille and other front-end chrome have been simplified, although basic styling is unchanged.

Plymouth's new V8 engine is bigger,

From the rear, you'll recognize the Dodge by the bold diagonal lines. Note the dual radio antennas

Above, you can get a long-playing phonograph on any Chrysler Corporation car. It mounts under dash

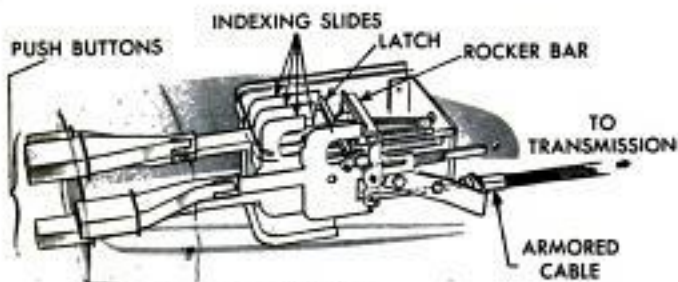

Below, arrow points to push buttons for transmission. Sketch, above, shows how it operates with one cable

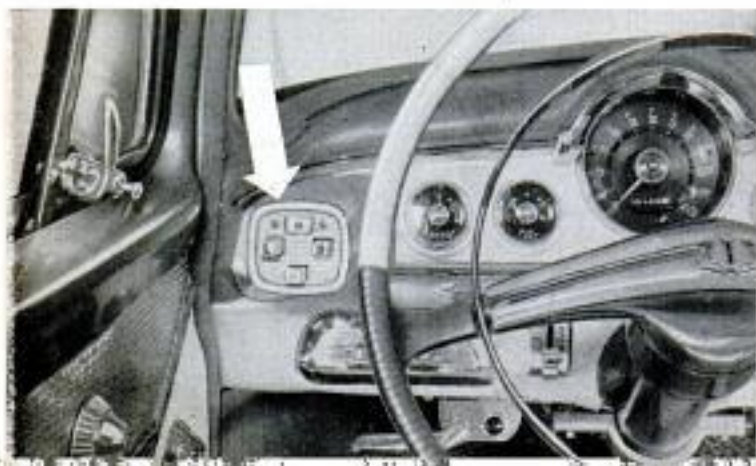



DE SOTO

For the first time in years, the De Soto grille has no vertical bars or teeth. Instead, it uses this mesh. Parking lights are inside the bumper guards

having a 277-cubic-inch displacement and an 8.0:1 compression ratio. Dual-throat carburetor is standard. The bore is 3.75 inches (up from last year's 3.56) and the stroke is 3.13 (down from last year's 3.25) to make the engine well over-square.

Optional is a power pack with a four-barrel carburetor and dual exhausts. Horsepowers are not available at this writing, although on power-pack engines it is expected to be around 200.

The six-cylinder is unchanged except for a slight increase in compression ratio (7.6:1).

Combustion chambers in the V8 have been reshaped. Valves are larger and intake ports improved for better breathing. Turbulence caused by valve action has been reduced. Fuel mixture burns more evenly and gasoline economy is said to be improved noticeably. New mechanical valve tappets improve the lightweight valve train. As previously, the Plymouth V8 uses regular gasoline.

The four-door hardtop is available only in the Belvedere series. All station wagons for 1956 are in a separate series, known as the Suburban. There are three basic



De Soto taillight assembly is three separate lights. Below, profile of two-door hardtop



**CHRYSLER**



**New Yorker uses two-toning to emphasize its finlike rear fenders. Exhaust pipes are invisible in rear view**

models: the two-door with two bench seats; the four-door with two bench seats; and the four-door with three bench seats. The most luxurious of the wagons, the Sport Suburban, has a permanent luggage rack built into the roof.

Dashboard layout has been changed. The oil and ammeter dials have been replaced with flashing lights. All engine instruments are now directly in front of the driver.

Plymouth has gone back to the pull-type door handles, dropping the push-button type used in 1955.

**Longer this year by 5½ inches, the Imperial has bigger rear fenders, larger and jauntier gunsight taillights**

### **Dodge**

Two-toning on the Dodge Lancer series has been changed to put the emphasis on the finlike rear fenders. The sharp dip of the chrome strip comes just a few inches forward of the taillights. The four-door hardtop is in the Lancer series.

The new Super-Powered Super Red Ram V8, as it is called, develops 230 horsepower with its optional power pack, consisting of a four-barrel carburetor, dual exhausts,

(Continued to page 254)

**IMPERIAL**



Copyrighted material

# 1956 Cadillac

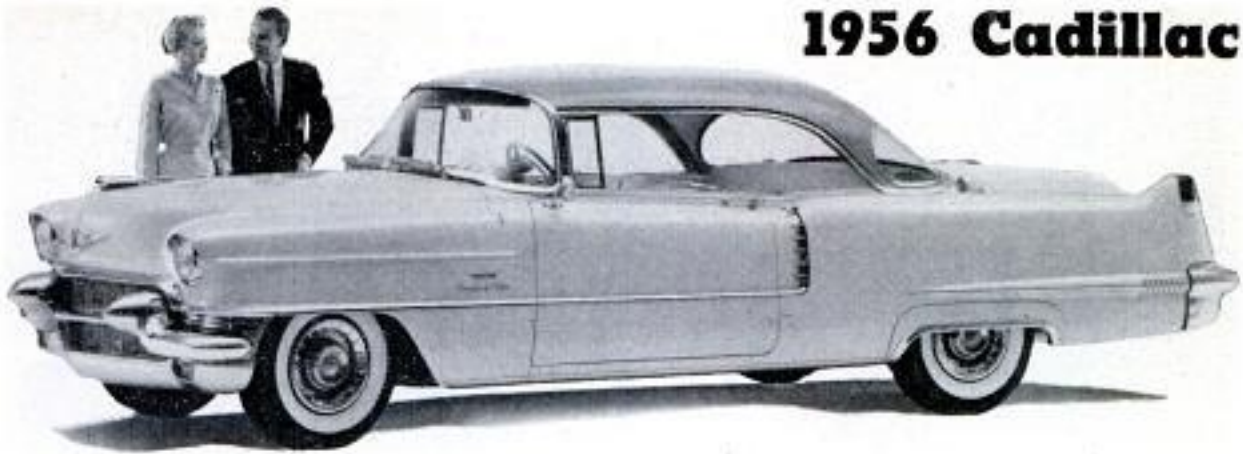

**BIG NEWS** at Cadillac is mechanical: A new engine and a Hydra-Matic that uses a dump-and-fill clutch and two sprag clutches to shift gears without jerking (see below). The new V8 engine has a 365-cubic-inch displacement (last year: 331). Horsepower is 285 on the Cadillac, 305 on the Eldorado. Both develop 400 pound feet of torque. Over-all ratio of power steering is 19.5:1, faster than last year's 21.3:1.

Styling maintains the Cadillac look. New are wider headlight hoods, parking lights in bumpers, an aluminum grille which you

can get in yellow-gold color if you wish. Rear bumper is restyled to make the rear end appear lower. More chrome trim is apparent. There is even a delicate chrome line running along upper portion of the rear fender, right up to the famed fishtail.

Also new: Center-mounted glove compartment; two ash trays and lighters on dash; antenna drops completely out of sight into small well in front fender; power seat tilts as well as moves back and forth, up and down; hump in front floor is lower; air conditioning available on convertibles.

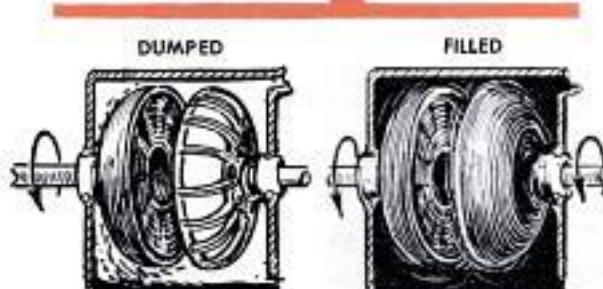
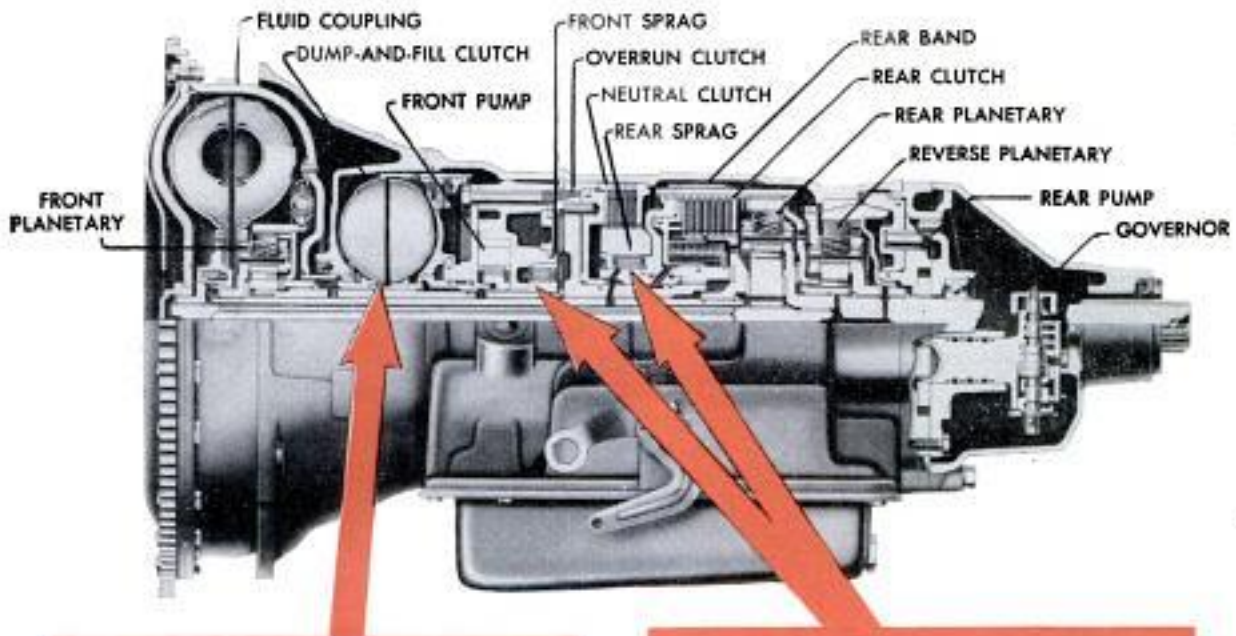

Dump-and-fill clutch is a fluid coupling that transmits torque when full of oil (right), disengages without jerk when oil is dumped



Sprag clutch turns freely one way (left) but as planetary reaction tries to go the other way, the tiny pawls jam so it cannot rotate



*Packard Patrician*

## **1956 Packard, Clipper**



*Clipper Custom*



*Caribbean Convertible*





**1** With temperatures in the 90s, workman "ices" a 35-percent hill by spreading liquid soap over it



**2** Car equipped with regular rear end tries the hill. Right wheel spins on soap. Smoke is from tire



**3** Car can climb no higher than point of arrow even though its left wheel is on clear pavement

## **Packard "Ices" a Hill in September To Prove Its New Differential Works**

### **and Caribbean**

ONCE AGAIN, Packard has come up with something new. In 1955, it was the self-levelizing torsion-bar suspension. This year, there are two innovations (both optional at extra cost): 1. A new rear end that makes winter driving less hazardous, and, 2. A push-button transmission.

New in the rear end is the differential. The function of any differential is to let one rear wheel go faster than the other so the car can turn corners without scuffing tires. Packard's new differential tends to keep both wheels going at the same speed if there is a difference in traction so you won't get stuck when the going is tough. It is, as Packard engineers like to say, "reluctant to differentiate."

It distributes torque to both wheels so a Packard can pull away from other cars on ice-covered hills. It channels power to the rear wheel with more traction instead of to the wheel with less as does a standard differential (see photos on this page for a visual demonstration).

You can imagine what this differential will do on ice or snow. And it helps in the rain or even in dry weather when cornering fast because it transfers torque to the outside wheel to which centrifugal force has moved most of the weight.

#### **Push-Button Transmission**

Packard has push-button controls for its Ultramatic transmission. The control panel is right under the steering wheel in the same place the shift lever used to be. Controls are electrical and the buttons depress as easily as adding-machine keys. You can't accidentally depress two at once, nor can you activate Reverse or Park when the car is moving faster than five miles per hour.

Here's another safety factor: The transmission can't be taken out of Park unless the ignition key is turned

(Continued to page 268)



**4** Strip is "re-iced" to duplicate original conditions. Soap is so slick, workman can't walk on it



**5** Car with new differential goes up hill without any hesitation. Closeup, below, of tire tracks is proof wheel did not slip on soap





## 1956 Pontiac

Four-door hardtops are available in all three Pontiac lines. Shown here is the top-price Star Chief version

FIRST OF THE General Motors cars to offer 1956 models, Pontiac features a four-door hardtop and the new Hydra-Matic.

The hardtop or pillarless four-door sedan (shown above) is 1½ inches lower than a standard four-door sedan. Yet rear-seat legroom is 40.7 inches (standard four-door's is 42.0 inches). Rear-seat hiproom is 62.8 inches (standard's is 63.1 inches).

The redesigned Hydra-Matic retains its previous high-performance, high-economy four-speeds-forward advantages, but eliminates jerky shifts by eliminating the bands that caused them. These bands, which formerly put the planetary units in

and out of reduction, required frequent adjustment to prevent jerkiness. This year, bands are not used (except for one that functions only during down-hill braking in Low). A second, smaller fluid coupling acts as a dump-and-fill clutch to smooth out gear changes. For an explanation of the sprag clutch and the dump-and-fill clutch which provide jerk-free shifts, see page 93.

Displacement of the V8 engine has been increased to 316.6 cubic inches by boring out the cylinders to 3.94 inches. Stroke remains unchanged at 3.25 inches. Horsepower is 227 on Star Chief models, 205 and 192 on the others.

Some of the styling changes you will note are new grille, bumper, two-toning, chrome bands recessed in hood



## Electronic Juggling Machine Balances Three-Foot Rod

Science has come up with an electronic "trained seal" that keeps a three-foot rod in perfect balance (right). The machine, designed by Reeves Instrument Corporation, was used to entertain visitors at the German Industries Fair in Hanover. A light on top of the swaying rod shines on two photoelectric cells above. The cells transmit information on the rod's movement to an electronic "brain" that actuates mechanical arms which reposition the bottom tip of the rod. The brain, previously used to predetermine performance of unbuilt guided missiles, may be used in the future to guide industrial processes.



## Amplifier Spots Termites

You can track down termites with an electronic listener that amplifies the characteristic sounds of the wood-boring insects. It is designed to tune in on dry-wood termites, which obtain water from the natural humidity of the air. The five-pound unit (left) consists of earphones, a battery-operated amplifier with volume control and filter selector, a pick-up unit with an on-off switch and a vibration-sensing needle. A record of termite sounds familiarizes the operator with characteristic noises. A carrying case completes the kit. At work, the operator taps a suspected area. This causes any termites below to relay alarm signals—sharp signal raps—which are picked up by the detecting unit. The method eliminates probe-and-drill techniques which sometimes do more damage than the insects.

## Small Camp Trailer Hooks on Scooter

Vacationers in Europe don't have to own a car to pull their camping trailer—they can use a regular motor scooter. The small, two-wheeled trailer, scaled down to match a scooter's size, still has enough sleeping room for two persons. An unusual trailer hitch encircles the entire rear end of the scooter. The trailer contains two air mattresses.

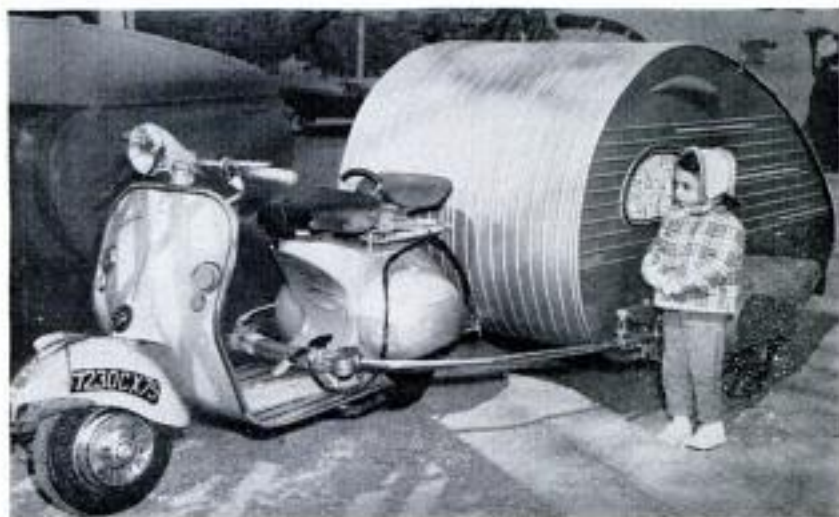



Boat suspended from crane swings off launching platform. Hole was cut in side of house to get boat out

## Crane "Launches" Attic-Built Cabin Cruiser

"LAUNCHING" a 19-foot cabin cruiser recently built on the second floor of a Kansas home meant: 1. Tearing out a wall, 2. Building a scaffold and 3. Hiring a huge construction crane to lower the craft safely to the ground. Charles E. Boeppler of

Leavenworth, Kans., working at night and on weeks ends, built the *Bobbe-B* in the unfinished upstairs of his home. He spent more than 600 spare-time hours in constructing the solid mahogany boat, which he says is in the \$3000 to \$4000 class.

**T**HERE'S SOMETHING wrong somewhere! As the 1956 cars come out, they're all bigger and more powerful. Even with the current safety emphasis, power boosts are spectacular. Every car but one will have at least one model with 200 or more horsepower.

Yet, while all this is happening, an unbelievable event takes place in the background. A car, small and underpowered by 1956 standards, can't keep its dealers supplied, so spectacular are its sales. And all this without free trips to Paris, free TV sets, free groceries or discounts. And with no advertising worth mentioning.

**What is this unbelievable car? It is the tiny, buglike Volkswagen. Its dealers even have waiting lists for second-hand models.**

Volkswagen sold over 10,000 cars in the first half of 1955, will probably sell 30,000 for the year. For October delivery, the factory had orders for 8600 cars from its American dealers. In 1954, they sold only 6300 Volkswagens here. That means almost 500-percent increase and still going up. No American car even comes close to that record—and yet the VW is no longer than last year's, has no additional power.

How is this possible? Some observers say it is simply that American makers have deserted the entire area of the small car. There just is no place for the small-car buyer to go except to go foreign. And, if sales prove anything, he's beginning to go there. There just aren't any small American cars any more. There are big cars and bigger cars.

Volkswagen bought a former Studebaker plant in New Jersey and is installing machine tools in it. The sedan bodies will be stamped and assembled there (convertibles and commercial bodies will be made in Germany). Engine and power-train parts will come from Germany. Within three years, one high VW source claims, Americans will buy 250,000 Volkswagens a year. Unbelievable? Perhaps, but who would have said we would buy 30,000 this year?

What will Detroit do if this VW claim comes true? Will it build a small car? It's a good bet, it will.

#### 1956 Tooling Costs

Most of the 1956 cars are face lifts, with no sheet-metal changes. Yet the estimated bill for these changes (plus costs of expanded facilities) is \$750,000,000. For 1957, the change-over bill is expected to hit \$1,000,000,000 (that, my friend, is a billion dollars!). So you can see there are big changes coming.

Studebaker is hot for 1956—much hotter than expected. You won't recognize the sedans, so extensive are the changes, de-

## Detroit Listening Post



By Leo Donovan

spite the use of the same body shell. The squared-up front end has a handsome mesh grille. Rear fenders are higher, rear deck is raised. Concave side panels are gone. The car has been Americanized again.

**But Studebaker's smash hit is its sports line—the Hawks. These have fresh styling: New hood, rear deck, flashy tailfins! One of them, the Golden Hawk, is a bomb! Horsepower is secret, but the engine can't be disguised—it's a Packard V8 with four-barrel carburetor. Horsepower is probably 270. That power in a 3375-pound coupe makes it sizzle. It has a better power-weight ratio than any U. S. car.**

In a test run in the rain, the Hawk averaged 114 miles per hour for 2½ miles with two hefty men aboard. The day before, the same car averaged 121 miles per hour on a dry track. Acceleration is terrific.

The Rambler, all new for 1956, will be out in December. Those who have seen it say it's controversial. Some like it enthusiastically. Others say it's been ruined! All seem to think it is different. It's not a copy of any other car. It does not have the by-now - almost - universal forward - slanting headlights and backward - slanting taillights. It is only a little longer, but quite a bit wider, inside at least. And as one insider describes it, "It's been jazzed up like a Christmas tree!"

It will offer a four-door hardtop. The engine will be a new overhead-valve six. The V8 may come later in the year.

#### Hardtops Take Over

A Mercury spokesman, discussing the company's forthcoming four-door hardtop, said he expects 30 percent of Mercury sales to be of that model. Add in the two-door hardtop and the total is about 70 percent.

Ivan Wiles, Buick general manager, says he expects about 90 percent of the Buicks sold in 1955 to be hardtops. By 1957, Wiles predicts there may be no Buicks built with conventional doors.

**Tidbits for 1957:** Most cars will have 14-inch wheels. Heights will be down three inches. Suspensions will make news.



**TWINKLER UNIT** operates three to six strings of lights on your Christmas tree. It turns each string on and off at different rate for twinkling effect  
 Shopping Ranch, Dept. 17, Box 368, Scottsdale, Ariz.

**SPOTLIGHT** (left) plugs into cigarette lighter on instrument panel of car and has 12-foot cord. It was designed for TV-radio servicemen making night calls  
 General Electric Co., Schenectady, N. Y.

# Christmas

**BOW PISTOL** for sportsmen hurls arrows at high speed and has range of 150 yards. Arrows will penetrate a coyote at 30 yards. The bow is made of aluminum alloy. Outfit includes six arrows and target  
 Malibu Archery Co., 1036 S. La Brea Ave., Los Angeles 19, Calif.



**AIR-SPEED INDICATOR** is mounted on hood of car and permits driver to check speed without taking eyes from road. It is combined with an insect deflector. Dial is transparent green-tint Plexiglas  
 Bohm & Haas Co., Washington Square, Philadelphia 5, Pa.

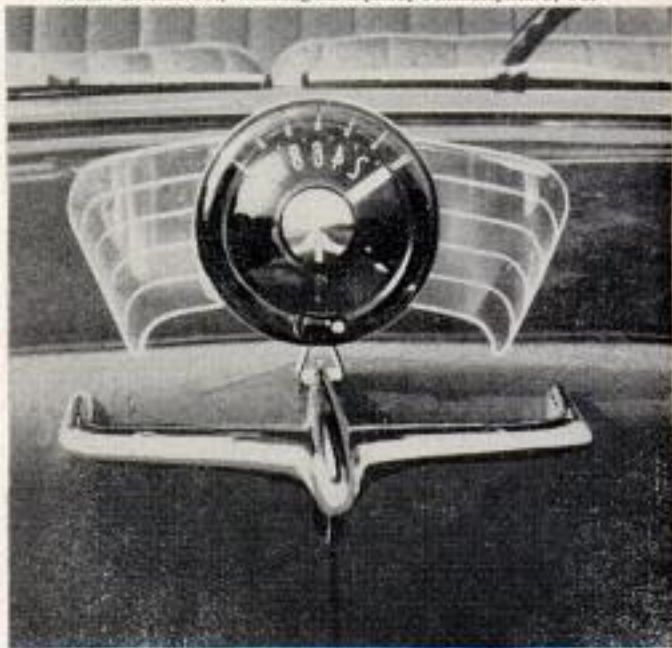



**HOLDER** for live Christmas trees is made of steel with green enamel rust-resistant finish. Tip-proof holder is 10 inches deep, 20 inches in diameter  
 Mutio Manufacturing Co., 1800 20th St. N.E., Canton, Ohio

**SCALE-KNIFE** for weighing and cleaning fish opens to become a notched yardarm scale. It gives accurate weights from 10 ounces up to 12 pounds  
 Thorsen's, Dept. F5FK, 352 Fourth Ave., New York City



# Shopping Center

**CLOTH-FACED CLOCK** comes in a kit for home assembly using any fabric you choose to match or harmonize with draperies, upholstery or wall coverings. The kit includes the assembled works, hands, numeral indicators and adhesive for applying fabric. Photo at left shows fabric being trimmed with razor blade after it is in place. When new face is desired the special adhesive makes it possible for fabric to be peeled off with ease  
 Herschelle Hall Clock Co., McMillan St. and Essex Place, Cincinnati 6, Ohio

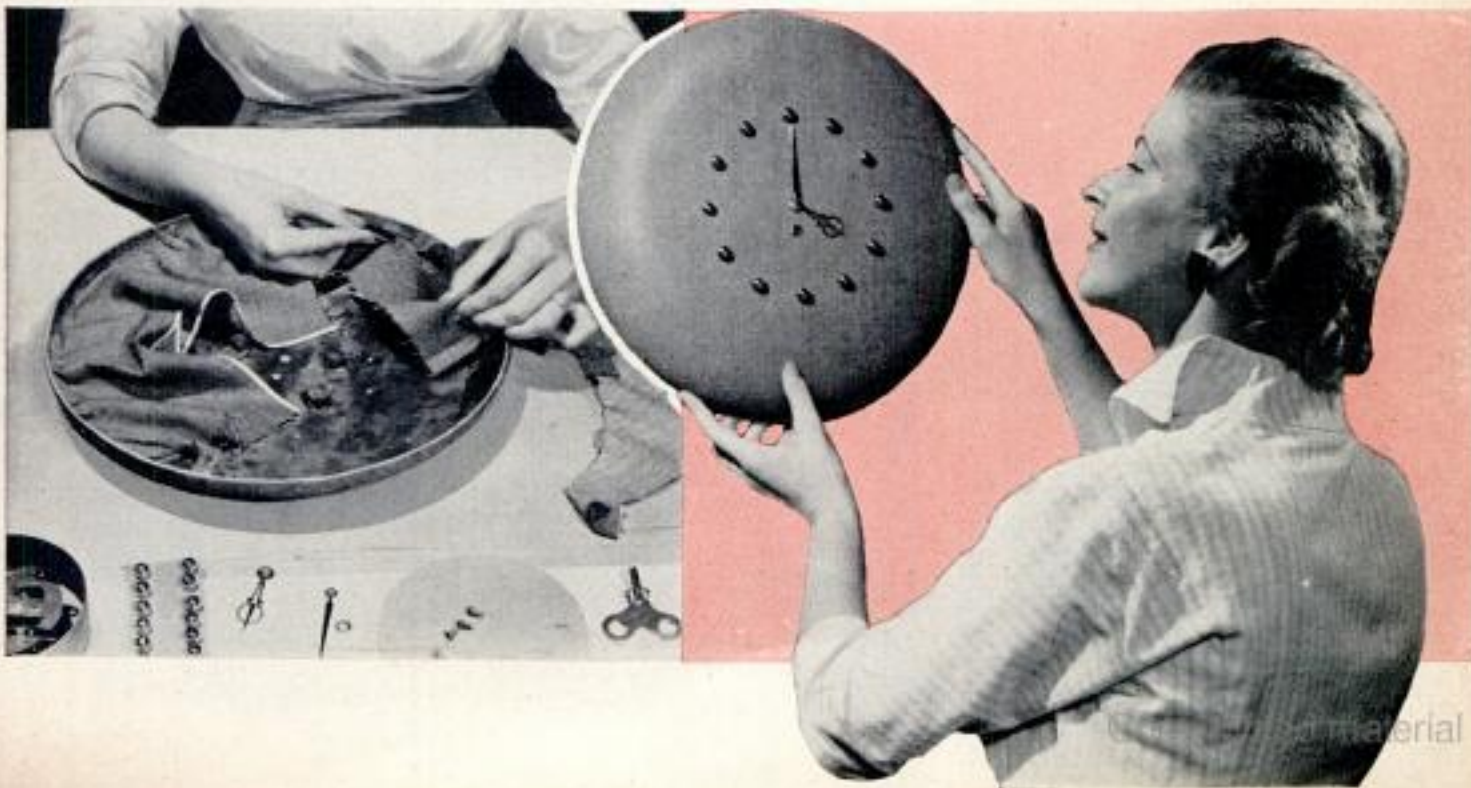



**DO-IT-YOURSELF ENCYCLOPEDIA** consists of 12 volumes of directions for making and repairing almost everything in the field of home craft: Furniture making, remodeling, plumbing, wiring, heating, also car repairs  
 Book Dept., Popular Mechanics Magazine, 200 E. Ontario, Chicago 11



**AUTO COMPASS** has its own interior dial illumination and is available in all of the new pastel shades of the '55 cars  
 Hull Manufacturing Co., Warren, Ohio

# Christmas Shopping

**TOTE BIN** for laundry has section that lifts out. Metal bar serves as a towel rack and handle for carrying the bin  
 Hall Products Inc., Carterville, Ill.

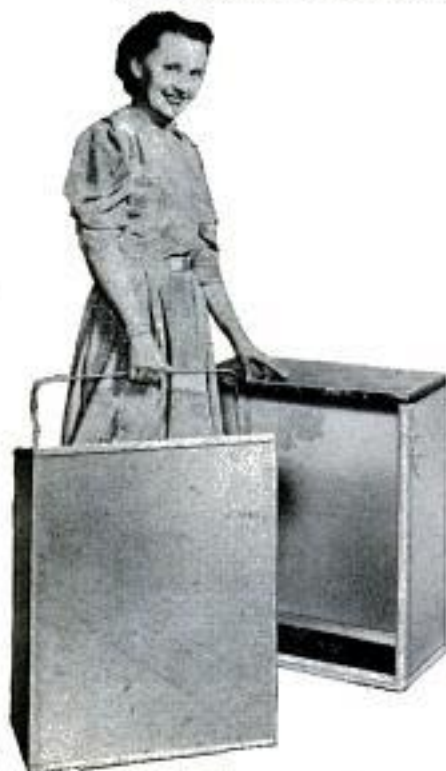

**HOME WORKBENCH** has precut metal frame and comes in a kit. It can be set up in 30 minutes. Plywood panels (not included) can be bolted to the frame to serve as bench top and shelf. Workbench is five feet long  
 Structo System, Inc., Elyria, Ohio

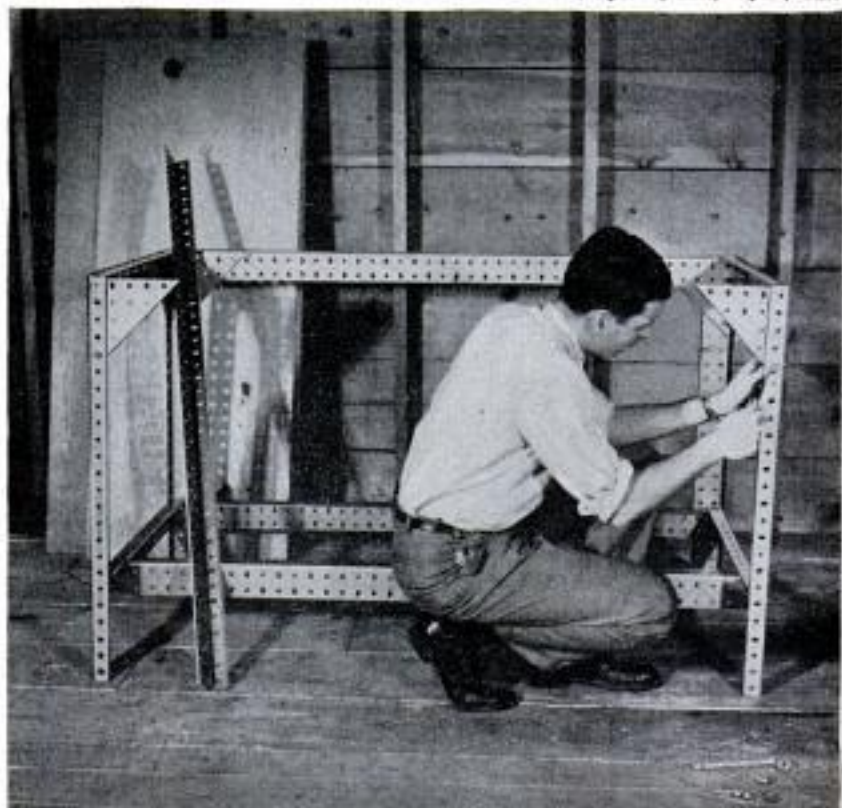



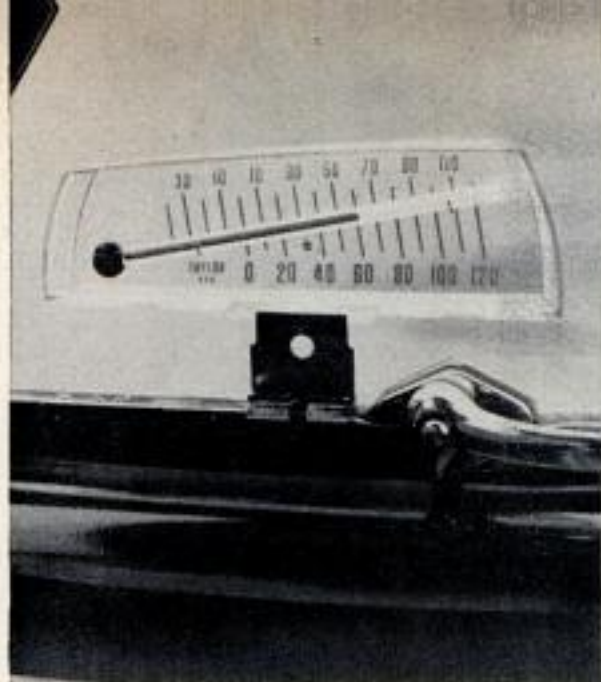

**AUTO-WINDOW THERMOMETER** clips onto right-hand vent window and gives outside temperature. When window is closed and locked it cannot be removed.  
Taylor Instrument Companies, 95 Amos St., Rochester 1, N. Y.



**MACROSCOPE** (for studying objects that can be seen with naked eye) provides erect unreversed image. Designed in three sizes for students and hobbyists.  
Bausch & Lomb Optical Co., 635 St. Paul St., Rochester, N. Y.

# Center

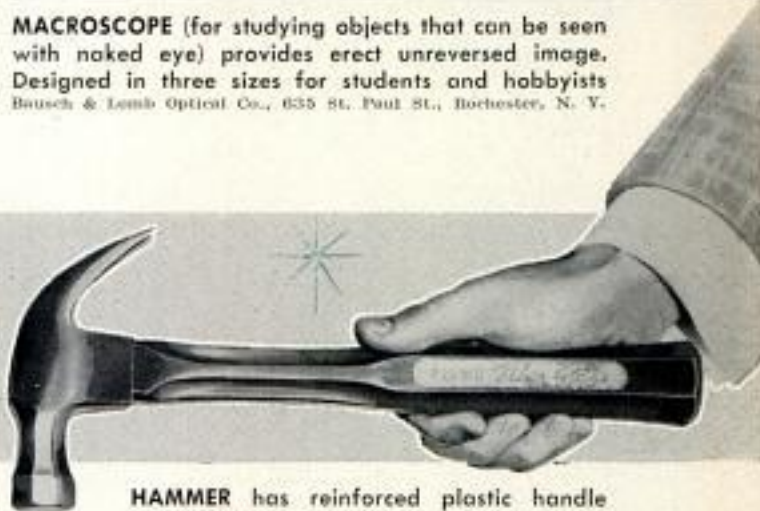

**HAMMER** has reinforced plastic handle  
Fayette R. Plumb, Inc., Philadelphia, Pa.

**PINLESS CLOTHESLINE** is made of twin strands of plastic-coated steel wire with a special twist. Wheel-like spreader runs along line to attach wash.  
Demman Manufacturing Co., 1 Washington Ave., Providence 5, R. I.



**NAME-TAPE PRINTER** comes with plastic type and enough iron-on tape to print 300 to 400 labels. The compact printer is operated by turning a crank.  
Reynolds Industries, Inc., 2100 Colorado Ave., Santa Monica, Calif.

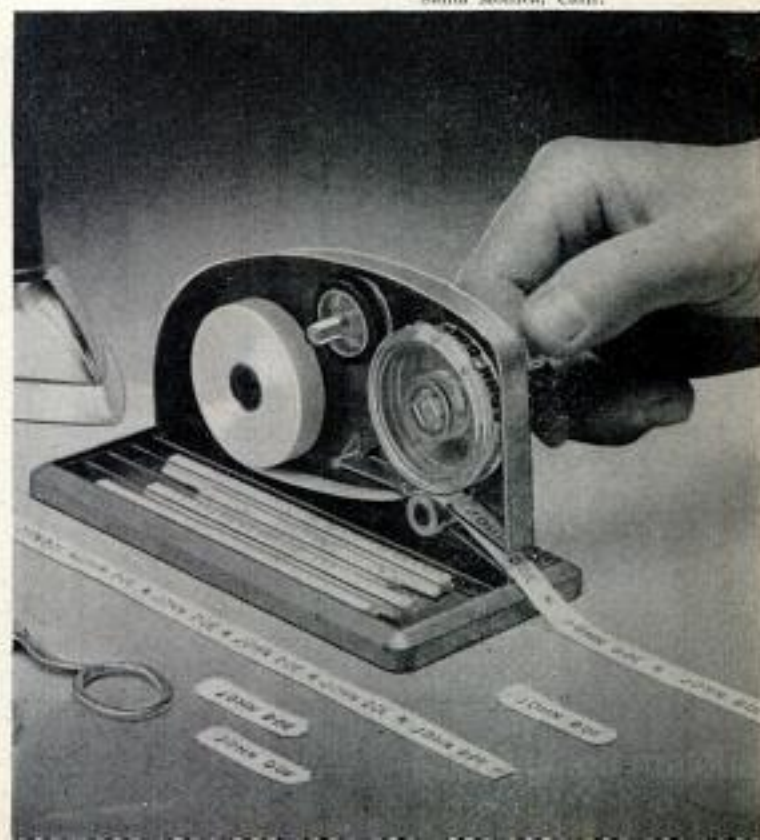



**ROCKET TOY** with launching platform and sound effects will delight the youngsters. The toy is released by spring action. Siren is operated by crank  
 Ideal Toy Corp., 200 Fifth Ave., New York City



**RADIO BIKE** has a radio built into the body. It is powered by a battery over the rear wheel. The radio is shockproof and has 100-mile station range  
 Huffman Manufacturing Co., 117 Gilbert Ave., Dayton, Ohio

# Christmas Shopping

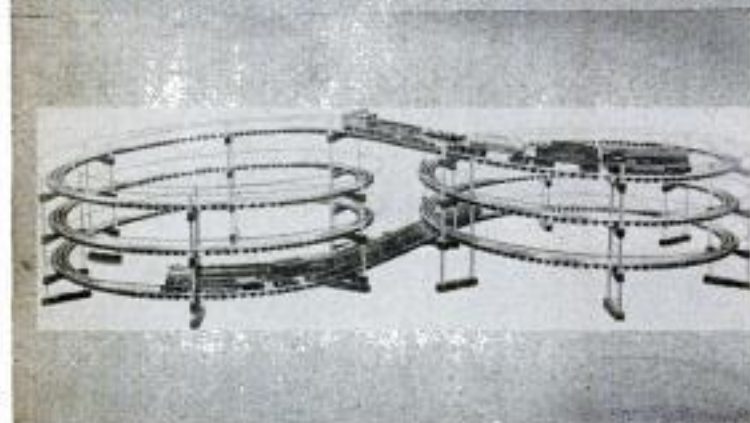

**SPIRAL TRAIN TRACK** comes in a kit with the upright brackets assembled. It's for electric sets  
 Jack Built Toy Co., 1401 W. 8th St., Los Angeles 17



**AERIAL SAND LOADER** complete with crane and truck scoops the sand and conveys it to the hopper  
 Mound Metalcraft Co., Mound, Minn.

**SPACE-SHIP TOY** zooms to 300 feet with jet stream of water when the pressure tank is opened up  
 Park Plastics Co., 940 Park Ave., Linden, N. J.



**RIDING TRACTOR** with a 2½-horsepower gasoline engine can easily pull leaf sweeper or lawn mower  
 Strunk Equipment Co., Coatesville, Pa.





**WIRE-ART KIT** can be used to make a variety of figures or knickknacks. It can be combined with pipe cleaners and other materials for odd effects  
*X-Acto, Inc., 48-41 Van Dam St., Long Island City 1, N. Y.*



**OPTICAL HOBBY KIT** includes lenses, prisms, mirrors, color filters, optical bench, periscope housing, lens frames, various stands and the necessary holders  
*American Optical Co., Southbridge, Mass.*

# for Juniors

**PRECUT HOUSE** in miniature is put together like the real thing. Kit contains over 550 pieces including glue, chimney, floor plan and the directions  
*Toy Construction Kits, Inc., P.O. Box 145, Niagara Falls, N. Y.*



NOVEMBER 1955

**MINIATURE SEWING MACHINE** is precision designed and will do various types of sewing like a regular model. Guard protects fingers from needle  
*Singer Sewing Machine Co., C/O Young & Rubicam, Inc., 285 Madison Ave., New York City 17*



105



## Bicycle Trailer Carries Mowers

Full equipment for lawn-mowing jobs is carried around in a bicycle trailer by a Tacoma, Wash., boy. The 30 by 48-inch trailer, made of  $\frac{1}{2}$ -inch plywood, is braced with strap iron and rides on a  $\frac{5}{8}$ -inch axle. It holds a power and hand mower, two grass catchers, an edger, broom and trimming shears, and is easily pulled by a geared bicycle.

Everything needed for a professional lawn-mowing job is carried in trailer

## Bent-Rod Clothes Rack Fits Between Car Seats

All the suits and dresses needed on a long trip can be carried in an unwrinkled condition with a clothes rack that fits between the seats of an automobile. The base of the metal rack rests on the floor of the car, leaving enough room for two to ride in the rear seat. The rack can also be used in the home as an extra rack for children's clothes. It is short enough to be used by a preschool child.

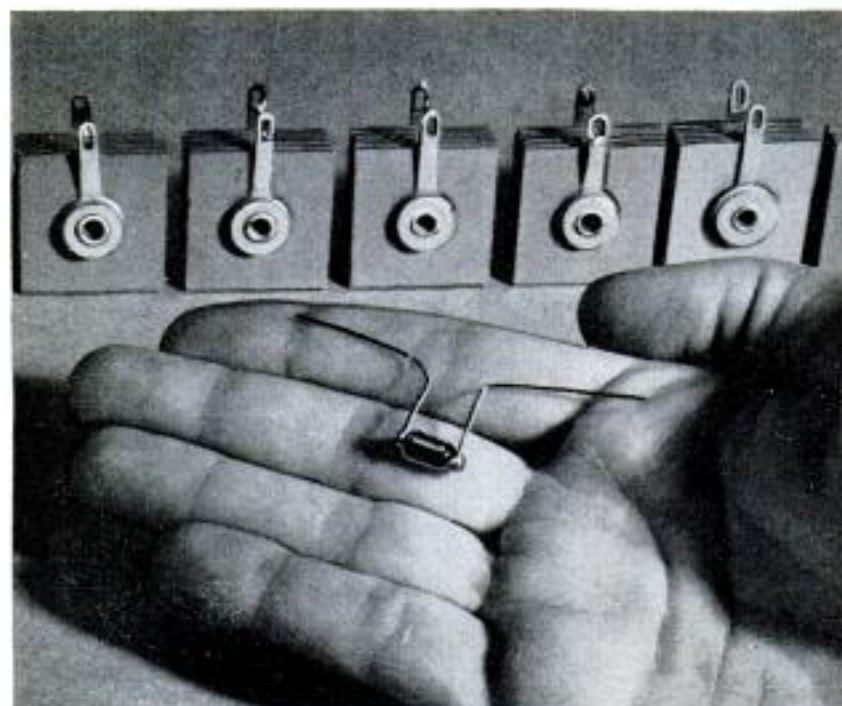

Tiny silicon power rectifier in man's hand does job of seven selenium rectifiers like the ones in background, used in TV sets, switchboards

## Pea-Size Rectifier Turns A.C. to D.C.

Alternating current is changed into direct current by a tiny rectifier the size of a pea. Heart of the transistorlike device is a silicon wafer smaller than the head of a pin. Developed by Bell Telephone Laboratories, the rectifier could be used in charging storage batteries used in automobiles and telephone central offices, to operate electric motors and could take the place of conventional rectifiers in TV sets. It is said to last indefinitely, to resist heat, and would replace large, low-efficiency rectifiers that need bulky cooling equipment in order to prevent overheating.



General Mills photo

Plastic balloons will carry instruments to heights never reached by man

Come July 1, 1957—the start of the International Geophysical Year—scientists will begin a 'round-the-world and 'round-the-clock



# MASS ATTACK ON THE EARTH'S MYSTERIES

By Dr. Sydney Chapman

*Chairman, International Committee for the International Geophysical Year*

**I**N 1957 A GREAT research enterprise shared by 41 nations will begin. The aim of the research is to increase our knowledge of the planet we all inhabit, the earth. It will be a period of special effort to be concentrated in what is called the International Geophysical Year (IGY), but it will actually be a year and a half extending from July 1, 1957, to the end of 1958. It is called *geophysical* because it will concern mainly the earth's physical aspects—the land, seas and atmosphere.

The atmosphere, because it "makes" our weather and climate, affects our daily life and food supply. Though long studied, the

causes and mechanisms of its changes are still shrouded in mysteries. Not so long ago its pressure, temperature, humidity, winds and rainfall were measured only near the ground. Now it is explored in height by instruments borne aloft by aircraft, balloons or rockets. Among the latest of the many surprising features thus revealed are

Doctor Chapman, one of the world's outstanding scientists, was born and educated in England. He has left his mark on many fields of science including astronomy, mathematics and natural philosophy. At the present time he is visiting professor of geophysics at the University of Alaska and is associated with the High Altitude Observatory, University of Colorado.

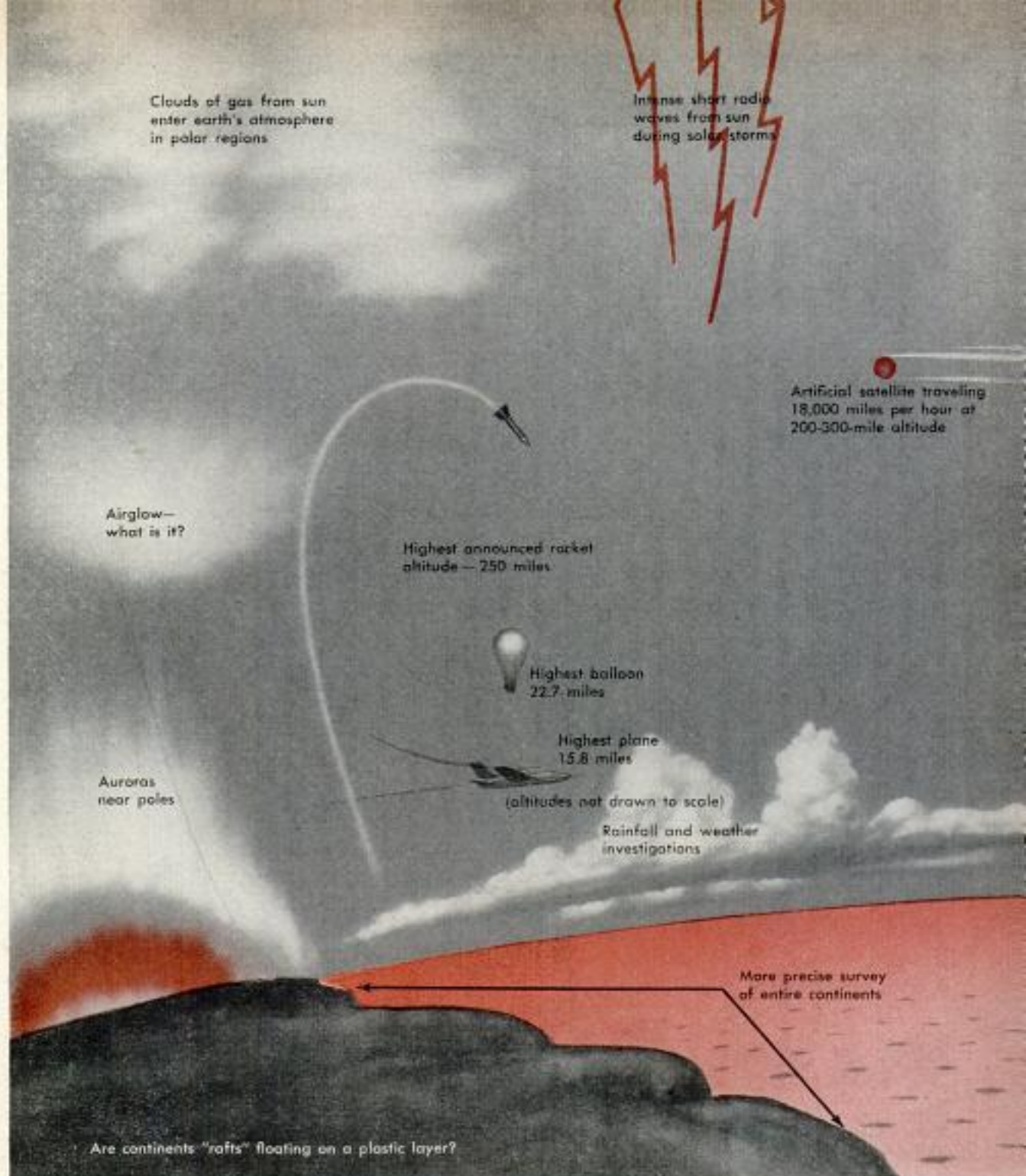

Drawing (not to scale) shows some mysteries of the earth and its atmosphere that will be probed during IGY

the jet streams—swift, meandering rivers of air somewhat comparable with that oceanic river, the Gulf Stream. It is essential to explore the air upward if we are to understand and predict the atmospheric changes, and it is important also for air transport, ever moving to higher levels.

**Greatest Heights Ever Reached**

The IGY observations of the atmosphere will be more widespread and will reach to a greater average height than ever before. Their simultaneous continuance for more than a year will give them much greater

value than similar observations, equally long continued, but made at different times and at different places.

The water of the oceans is an element more sluggish than the fast-wandering air, but its changes of temperature and its slow but far-traveling currents greatly affect the atmosphere. Ocean currents are generated by sunlight heating the water unequally in different places. These currents transport warmth and cold to the sea, the land and the air in other regions. The evaporation from the seas starts the grand cycle of rainfall and snowfall upon which agriculture

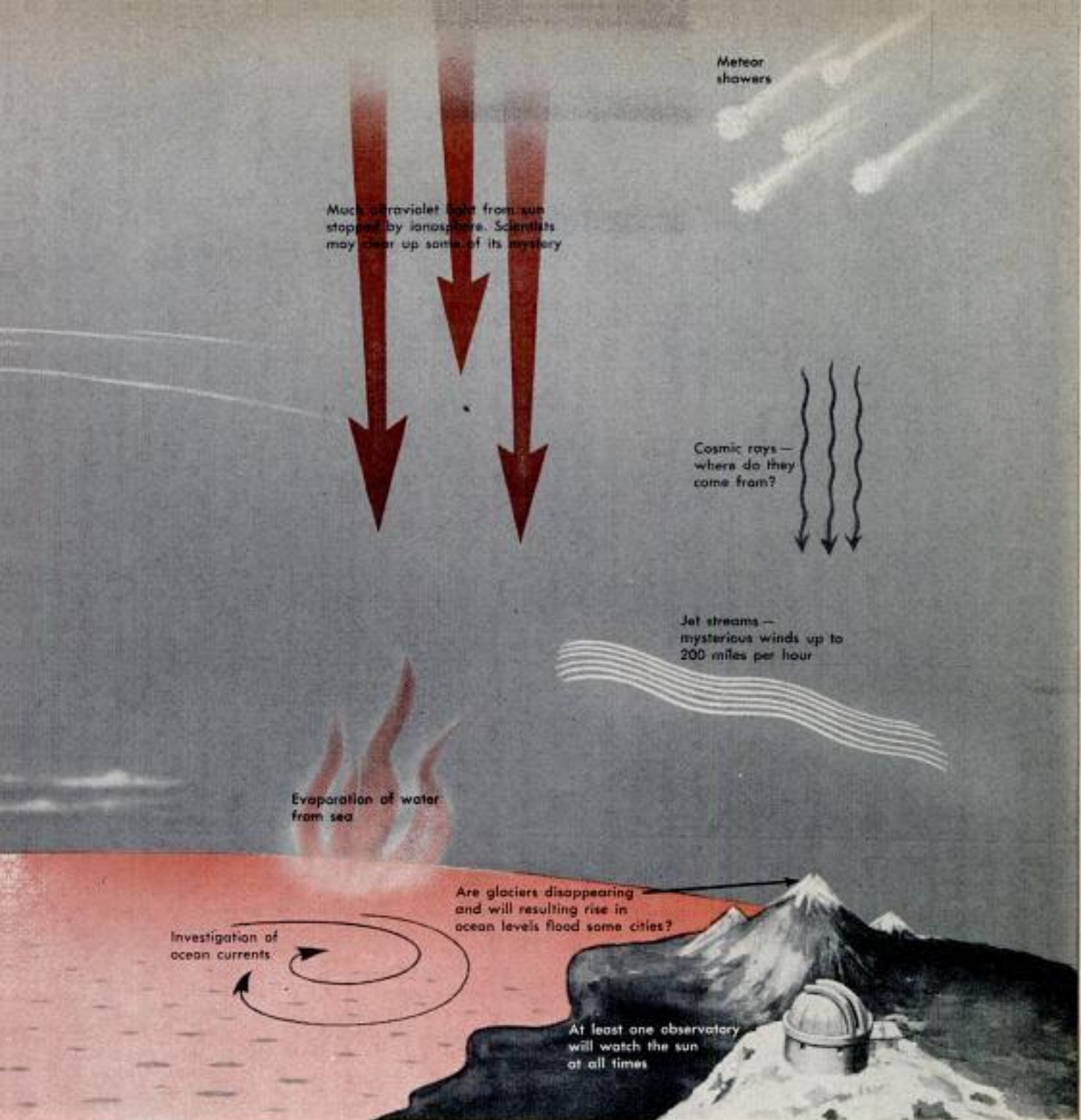

depends. The heating and evaporation also alter the salt content and density of the sea water and influence its teeming population, from which we draw so much of our food. To properly understand either the oceans or the atmosphere we must gain a greater knowledge of both, again by widespread simultaneous observations. Hence the International Geophysical Year will include an extensive program of oceanographic research.

A high region of the atmosphere, above 60 miles, will engage attention, although it is above the level of weather changes and air transport. In this region, called the ionosphere, an important part of the air

consists of electrically charged particles, positive and negative, ions and electrons. In the lower atmosphere, except in thunderstorms, these electric particles are few and insignificant. The ionosphere is of interest to mankind especially because it affects radio communication, which it can both help and hinder. It is ionized, or rendered electrical, mainly by ultraviolet light from the sun, which it absorbs, thereby shielding the ground from these rays. The sun also adds to the ionization by streams or clouds of gas which it sends forth; much of the gas is guided by the earth's magnetism so it enters the atmosphere at high speed, especially in the polar regions, where it



Aerobee-Hi rocket is designed specifically for research. United States will fire over 200 rockets for IGY



Air Force photos

Technicians make final adjustments to rocket. It carries parachute for lowering delicate instruments



produces polar light or aurora. At times when such solar particles are pouring thickly upon the outer atmosphere, these lights are especially brilliant and widespread. The ionosphere is highly disturbed, so much so that we speak of the event as an *ionospheric storm*. These storms occur most often when there are many and frequent spots on the sun and when brilliant eruptions of light occur among the sunspots; they are called solar flares, and are part of what may be called *solar storms*. When these solar storms take place near the edge of the sun's disk, great prominences or visible outpourings of solar gas can be seen. Much of this gas falls back onto the sun, but also much escapes and, when it passes over the earth, an ionospheric storm is produced, with brilliant northern (and southern) lights. During the progress of these solar storms the sun also sends out intense radio waves of short length.

Pole-to-pole chain of stations along one meridian will give meteorologists clearer understanding of weather





High Altitude Observatory photos

Top photo of sun, made by coronagraph above, shows disturbance that disrupts radio communication on earth

### One Observatory Always on Watch

Because of the great influence of solar storms upon the ionosphere and thereby on radio communication, solar observation will be stepped up to new levels of intensity during the International Geophysical Year. The aim will be that at least one solar observatory will be watching the sun; as the rotation of the earth carries each observatory in turn away from the sun, from day to darkness, one or more other observatories will take up the watch. Clouds may obscure the sun from view at some observatories at a particular time, but it is hoped that enough solar observatories will take part in the watch to insure continuous observation. Thus the astronomers as well as the earth scientists will play an important part in the International Geophysical Year.

The solar storms affect communications by cable as well as by radio. The interference with cable telegraphy has been known for nearly a century, and was found to be linked with disturbances of the earth's magnetic field, called *magnetic storms*

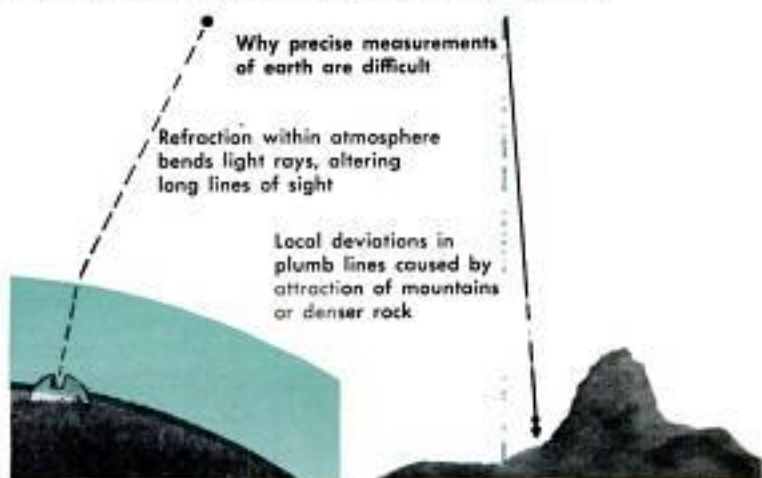

Drawing above shows two reasons why precise surveys of continents are difficult. Below, centrifugal force acting on satellite will cancel pull of gravity



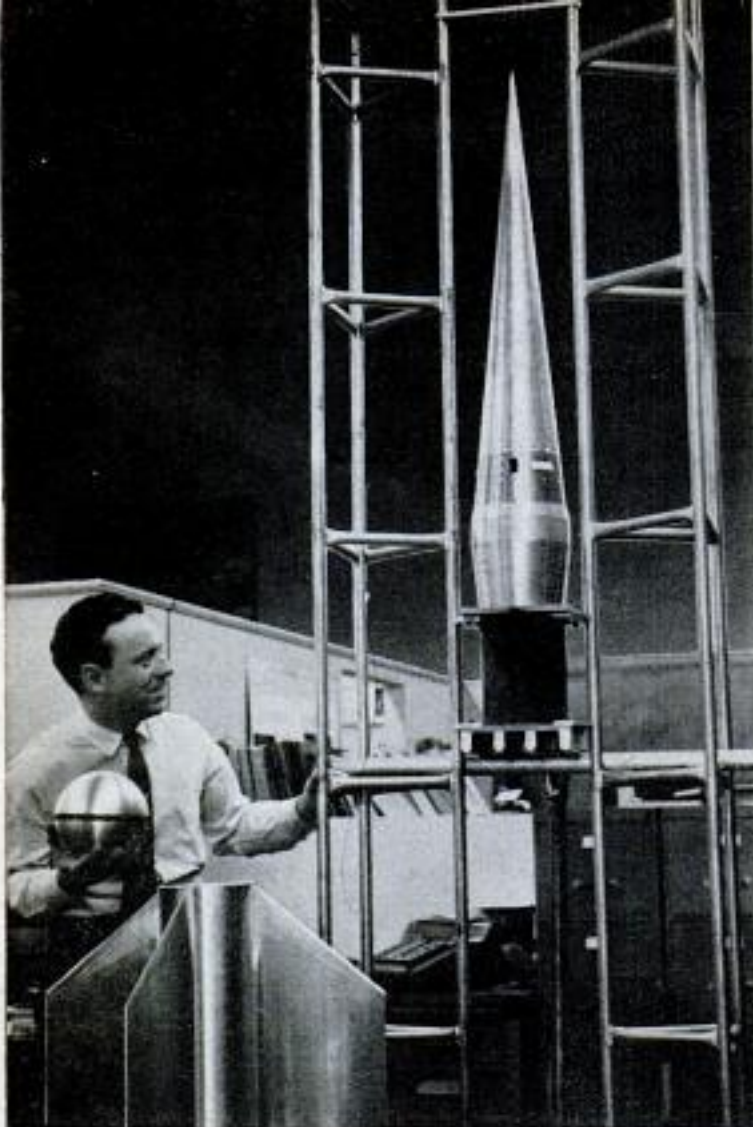

Needle nose of a new rocket will carry an aluminum sphere, crammed with gear, into upper atmosphere

when intense. Magnetic storms are closely linked with great auroral displays, and like them are especially strong in high latitudes, but they affect the whole earth simultaneously. They sometimes develop very suddenly, all places becoming affected within a single minute. The close connections between magnetic, ionospheric, solar and auroral storms make it important to observe them simultaneously, continuously and as fully as possible. This will be one of the



University of Michigan photos  
Ball, dropped from rocket, will measure its own rate of descent and radio this information back to earth

chief goals of the scientists during the IGY. In this great detective attack, it is well to neglect no clue that may help unravel the physical mysteries of our planet. One such clue is given by the usually very faint light constantly emitted by the air in the ionosphere; it is called the airglow. It is worldwide, and quite different from the often far brighter auroral light. Other clues are afforded by the cosmic rays that perpetually

(Continued to page 260)

Planes using jet stream save time. One of the goals of IGY is more information on these mysterious winds

Pan American World Airways drawing

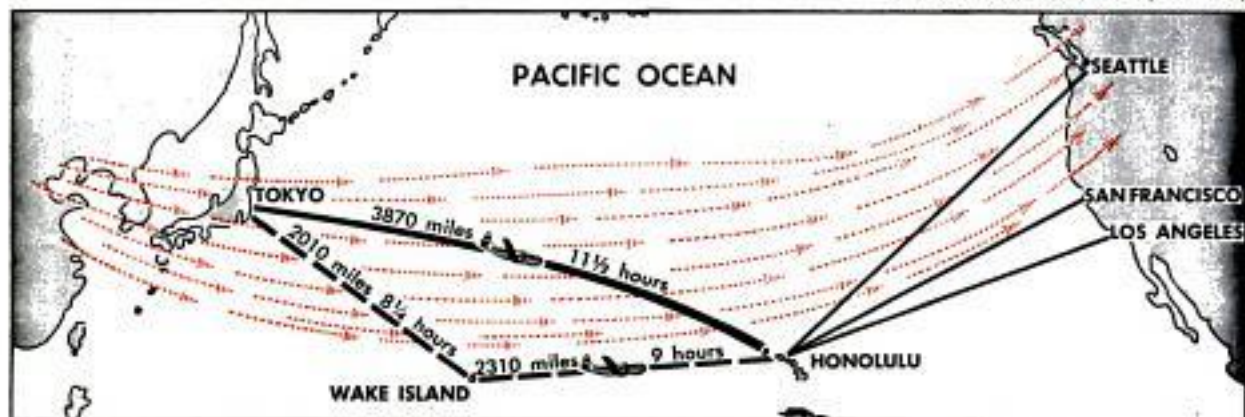

# KEEPING UP WITH THE ATOM

**I**T MAY BE a few years before you can buy a compact little atomic furnace to heat your home, but the time will come, scientists assure us. Robert E. Ferry, general manager of the Institute of Boiler and Radiator Manufacturers, has disclosed a tentative plan for a home-size nuclear power plant that would cost about \$1500 and provide heat, summer air conditioning and hot water at an annual operating cost of \$50. The fuel would be nuclear "ash," by-product of an atomic-energy process, and the heat developed in the household atomic pile would be transferred probably by liquid sodium to a hot-water system. Many problems remain to be solved, one of them the safe shielding of the radioactive elements.

☆☆☆

Typewriters have been turned into deluxe thermometers in the Hanford atomic plant at Richland, Wash. (below, right). To get efficient production, a constant check on heat conditions within atomic piles is a "must," for excessive heat is damaging. That is why the temperatures inside the reactors are measured by thousands of thermocouples which develop voltages in proportion to nearby temperatures. The thermocouples are connected one by one to the typewriter before complex equipment goes into action to turn the temperature data by means of a code signal into a temperature chart; each signal is a different centigrade degree and operates a typewriter key. The printing of temperatures on a chart can now be done at once, whereas it used to take hours and the data was far outdated before a chart could be finished. But the new charts will show which reactor areas are too hot for safety and which are too cool for maximum plutonium production.

☆☆☆

More food for a hungry world, perhaps better food and more efficient crops are a possibility through the mutation of species by atomic radiation. Entirely

new species have already been produced by irradiating plants and causing changes in their hereditary characteristics. Experimental work in Sweden has proved that subjecting barley and other test plants to atomic rays could produce new varieties with larger yield per acre, or leave the yield unchanged while effecting other improvements in the plant. At the present stage of experiments there is no way of predicting what kind of mutation may result when seed is exposed to radiation, but studies are being made along this line and the scientists hope to learn how to control the mutations by varying the kind and dosage of radiation. Agricultural scientists have been developing and altering plant species for many years through breeding experiments based on natural mutations, but the mutation rate can be speeded up thousands of times by the radiation method.

☆☆☆

Hazards to the public have been reduced to the minimum in the atomic tests on the Nevada desert. In five major test programs no one has incurred any dangerous radiation exposure off the site, and no injuries to eyes have been reported. The test area comprises 600 square miles, surrounded by a 4000-square-mile Air Force gunnery range and more miles of sparsely settled land. Aircraft are warned to stay clear of

(Continued to page 248)

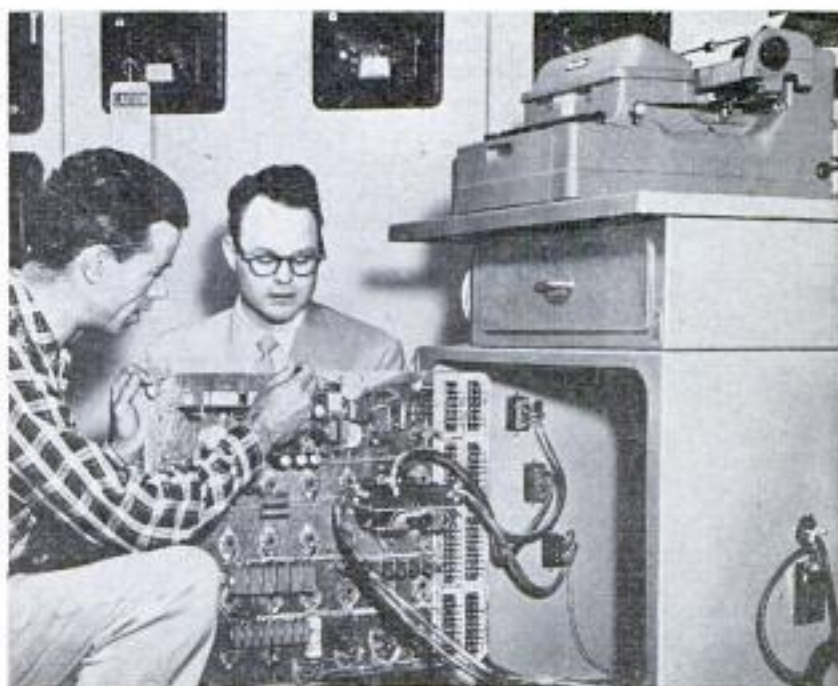



### Experimental Turboprop Fighter Uses Jet for Extra Power

Undergoing initial tests in California, the Air Force's experimental turboprop fighter, the Republic XF-84F, is the first of its type to use an afterburner for jet thrust to augment propeller propulsion. It is designed to provide test data on supersonic

propellers, turboprop engines and the feasibility of turboprop fighter aircraft. The engine converts jet thrust into propeller power through a gearbox and shaft. At the same time, additional jet power is provided through the tail pipe or afterburner.

### Gate for Swinging

Modern children without front gates to swing on get an old-fashioned thrill from two gates set up on a playground in West Allis, Wis. Each gate is mounted on a bearing so that it turns in a full circle. The gates are the most popular pieces of equipment on the playground, authorities report.

This latest piece of playground equipment has West Allis children going in circles. It is well braced



### "Sea Dart" Planes On Single Ski

Newest version of the Convair XF2Y-1 "Sea Dart" has been equipped with a single water ski, in place of twin skis used on other models, as a part of the Convair-Navy hydrodynamic-research program. The Sea Dart is the first jet seaplane ever built and cruises at subsonic speeds in level flight.

## Machine Reads Traveler's Checks

Banks now have a machine that can read checks. The machine, developed by Burroughs Corporation, reads traveler's checks at a rate of 7200 per hour and automatically punches the information on cards. The equipment consists of a reader and a punch. Through electronics and a special photoelectric process, the reader scans the printed numbers on every traveler's check, and punches a card to correspond. The card is used to operate other equipment which carries out the accounting operation. The machine's ability to recognize characters may make it applicable to the processing of bonds and securities, income-tax statements and personal loans.



## Subminiature Battery

About as small as half a penny, a tiny battery delivers a constant voltage for as long as two years. The semicircular battery delivers 1.15 volts. The use of the metal, indium, eliminates leakage permitting the case to be very thin. An Elgin National Watch Company development, the battery can be made in any shape and may power a future electric wrist watch.



## Self-Contained Burglar Alarm

No electrical wiring is needed to install a self-contained burglar alarm powered by battery. The simple unit rings a bell when it is moved, and stops sounding only when it is switched off by a key. It is placed on the floor by any door or window, and protection is extended by using nylon trip cords. The alarm is made in England.



## Cross-Wind Landing Gear Latest Feature of Long-Range Bombers

The Strategic Air Command's B-52 Stratofortress bombers are rolling off the assembly lines equipped with cross-wind landing gear. The gear, prepositioned from the control cabin, permits the airplane to

take off or land in a "crabbing" attitude that cancels out the effect of the wind across the runway. All four of the dual-wheel main-gear units swivel to either side to maintain a correct heading.





Tiny screen of weather-mapping radar is installed in center of instrument panel, while radar controls are mounted above the windshield



### Plastic Water Scooter Has Small Engine

You can skim over the water at eight miles per hour on a little circular boat invented by a West Berlin engineer. The pressed-plastic craft weighs about 44 pounds, has a small motorcycle-type engine and is steered with handle bars. One gallon of gasoline is used in seven hours of running time. If you happen to fall off, the boat starts turning in circles to give you a chance of boarding it.



### Weather Radar For Airliners

Weather-mapping radar is being installed in all planes of the United Air Lines fleet, making United the first airline in the world to adopt this device as standard equipment. Focused on apparently solid storm clouds, it shows corridors for smooth flight around turbulent areas, and can spot the weather for the pilot as far as 150 miles ahead.

### Dirt and Ashes Make Sturdy Brick

Rice-hull ashes, ordinary dirt and asphalt make up a lightweight, low-cost building brick developed at Louisiana State University. The brick could be used for farm buildings and may be used in shelters for protection against atomic fallout. Not only does it have good insulation qualities, but it is said to absorb radiation well. It becomes increasingly hard with age until it finally reaches the consistency of soft sandstone. Rice-hull ashes, according to the university, are almost 95 percent silica.

# Testing . . . Testing . . . ATOMS AT WORK



At a once desolate spot in Idaho the AEC's materials-testing reactor is doing vital service for industry

THREE BOTTLES hang on a wall. Through their polyethylene sides can be seen fascinating future possibilities for industry.

The bottles are in an office of the Atomic Energy Commission at Idaho Falls, Idaho. One bottle is . . . well, just a bottle. Nothing special has happened to it. The second bottle is shrunken and twisted like an old fishing hat tossed in a closet corner. It has been heated at 126 degrees C. for 30 minutes. Except for being slightly more transparent, the third bottle looks exactly like the first. It, too, has been given a 30-minute blast of heat, but first it was gamma-irradiated at the materials-testing-reactor installation of the National Reactor Testing Station near Arco, Idaho.

Possibilities uncorked by this bottle

By Rafe Gibbs



Rising out of the big beyond in southern Idaho is the world's most powerful atomic reactor

"Universal coffin" is the name given this cannonlike instrument which is used to shield experimental materials

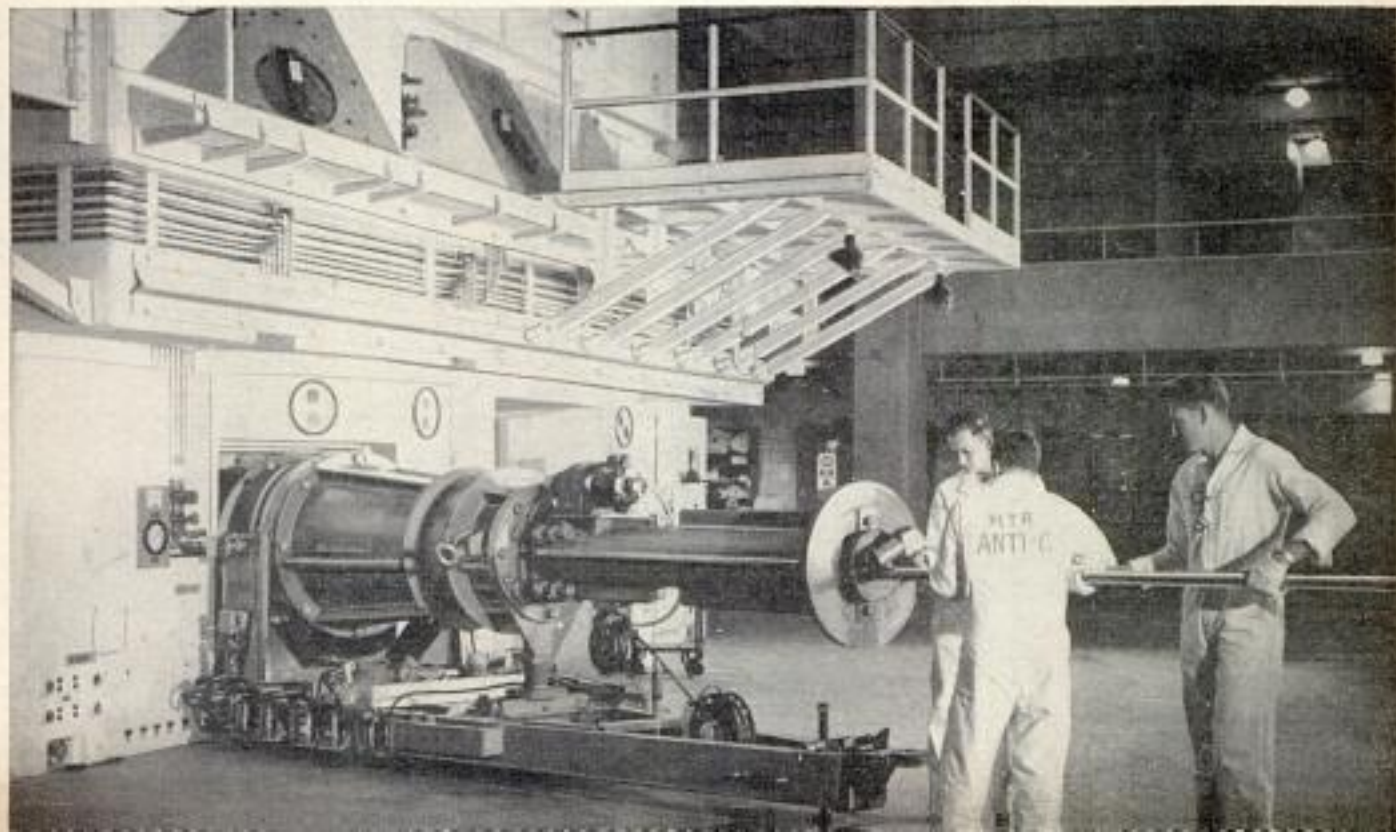

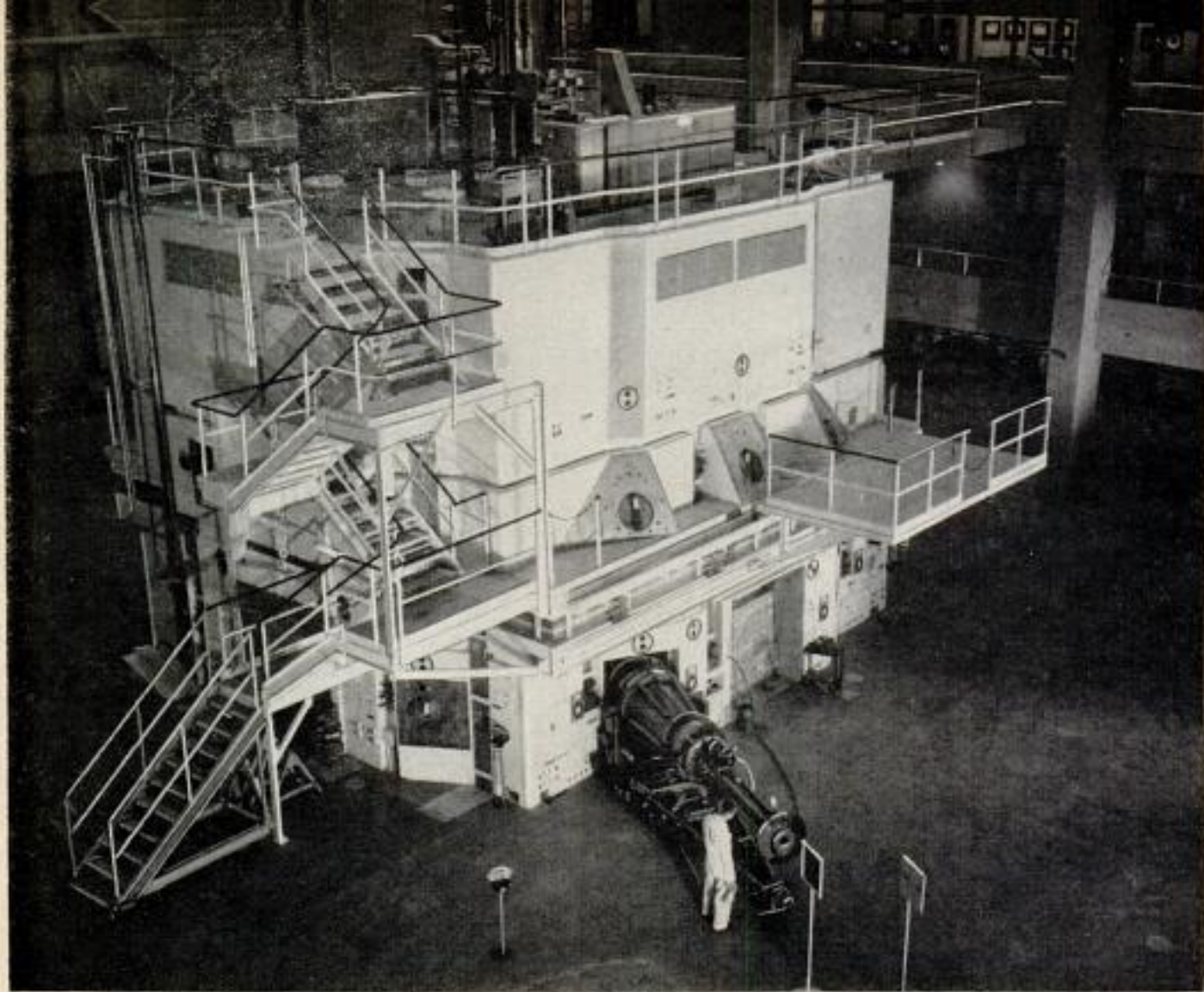

There's a cleared area 40 feet wide all around the huge reactor, giving plenty of room to maneuver "coffin"

research are many and far-reaching. If, for instance, plastics can be treated by irradiation to withstand extreme heat and cold—and detailed studies are now being conducted in this field—a parade of new uses will be started. Many plastics failed in certain applications because they do

not stand up under temperature extremes.

But of special significance at this time is the fact that the industrial-type research was carried out as a sort of by-product use of the world's "hottest" reactor, a reactor which produces 30,000 kilowatts within its "furnace" space which, without its shield-

Cans of food are irradiated under 18 feet of water in experiments on preservation of various foods

Control room of reactor is jammed with instrument panels and moving graphs under constant surveillance

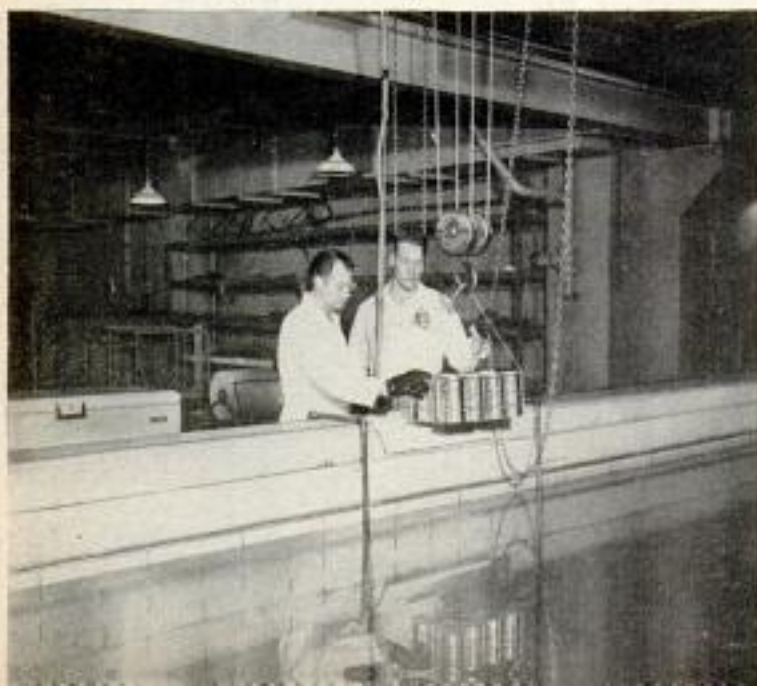



ing, is only the size of a foot locker.

This superreactor, costing about \$18,000,000, was originally set up primarily to test the effects of intense neutron radiation on materials and fuel elements to be used in future reactors. It can be used simultaneously, however, for a variety of other testing purposes and for the production of radioisotopes. Ever since it went into operation in 1952 the eyes of industry have looked with envy on the potentialities of the reactor, but it is only within the last year that space has been made available for some irradiations for industry.

Joseph Campbell, commissioner of the U. S. Atomic Energy Commission, recently commented:

"The present savings (to industry), and I emphasize present savings, through the use of radioisotopes alone are in the order of \$100,000,000 a year. My guess is that within the next 10 years American industry will increase the savings to 10 times the present value, or in the neighborhood of \$1,000,000,000 a year."

What makes the giant materials-testing reactor in Idaho especially significant in view of this statement is simply that the reactor can turn out radioisotopes much faster than any other reactor in existence, can produce radioisotopes of greater intensity than is possible with any other reactor, and can produce to a marked degree effects barely discernible in lesser neutron fields. So industry today has a phenomenal new tool for its advancement.

Just five years ago the site of this powerful atomic device in the shadow of the Lost River Mountains would have been one of the last places on earth considered of industrial significance. The 400,000 acres now utilized by the National Reactor Testing Station were sagebrush-covered desert land, largely populated with jack rabbits. What energy existed was found mostly in the rabbits, which had to do a lot of scrambling for food. Some cattle and sheep grazed on the land.

It was here, however, that engineers found exactly the right combination of physical characteristics, including such things as isolation, in which to carry out

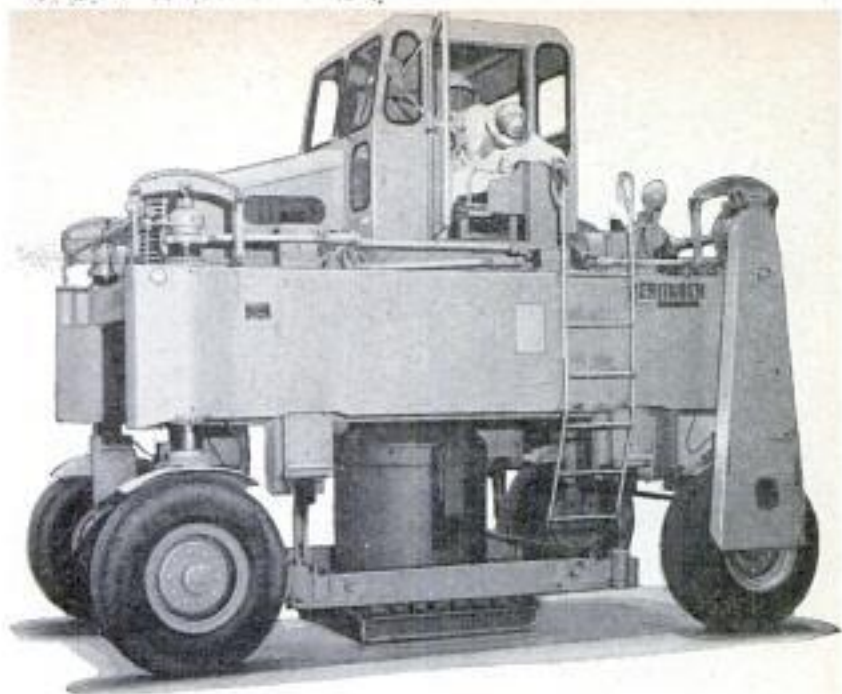

Small boy could carry the radioactive material, but its heavy lead container requires the lifting strength of a big machine

Top plug of the reactor is so heavy it takes a huge crane to lift it. One man stands by to check radiation level

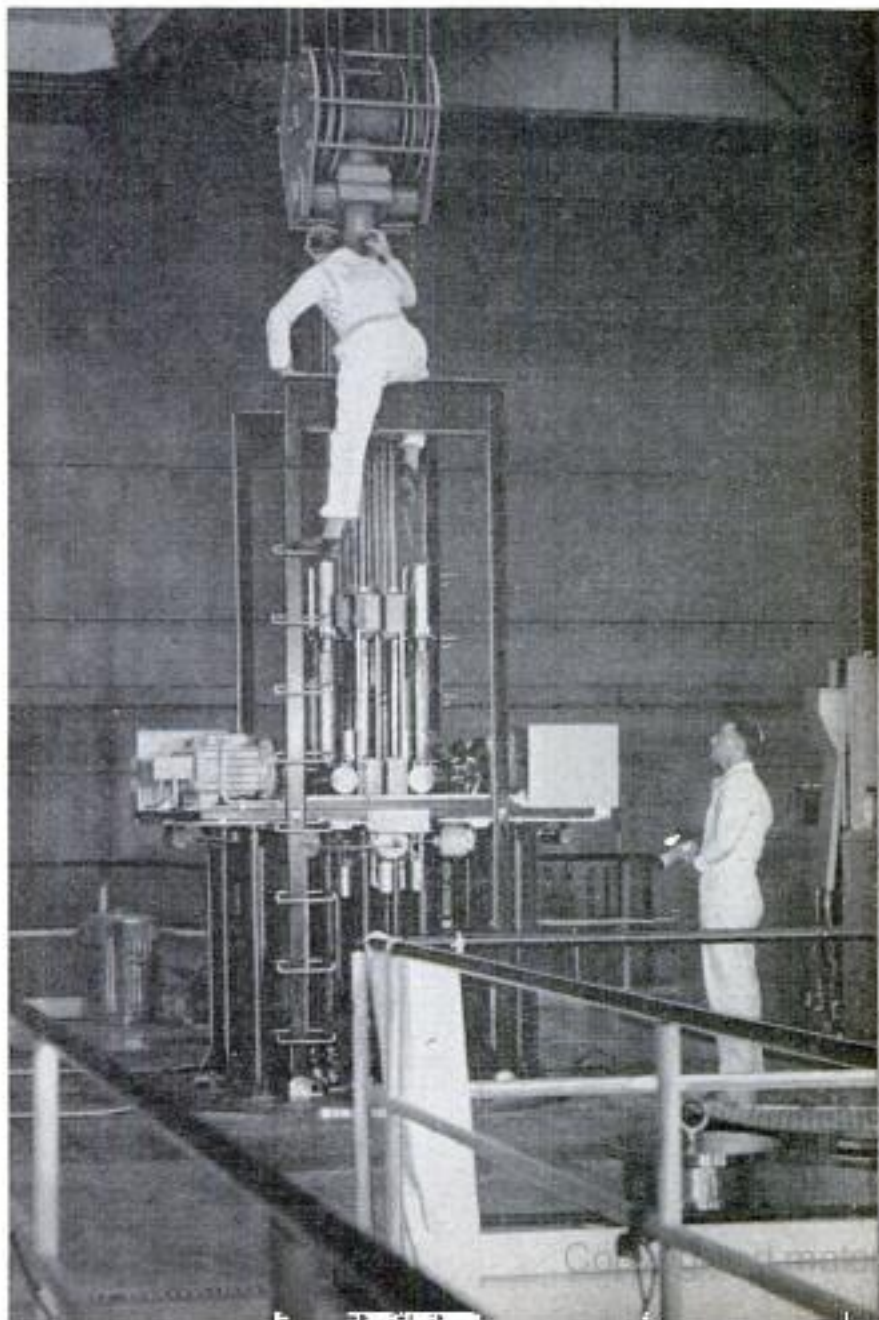

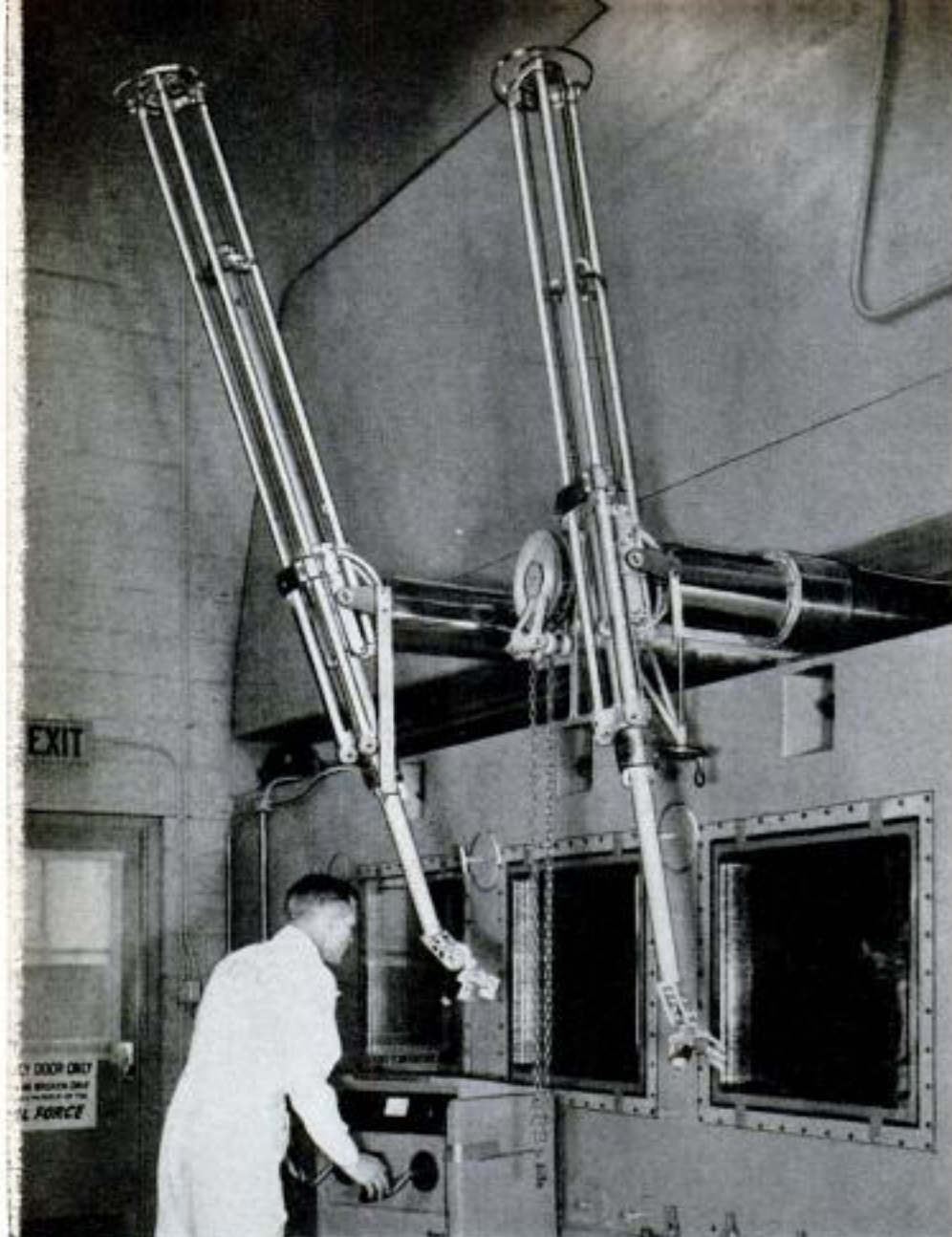

Scientist can only move experimental materials inside reactor with remote-control manipulators, which serve as extensions of his arms and hands.

advanced work without public hazard, water, suitable building conditions and adequate supplies of labor.

So in 1950, big trucks loaded with men and equipment churned across the dusty plains. A shepherd, pulling out with his wagon, commented to a trucker who had stopped to ask directions:

"I hope you fellows put up more than a couple of shanties out here, because it will be mighty lonesome for the folks if you don't."

Some contractors' shanties were erected, but from them has grown a \$100,000,000 plant. The once desolate area is now dotted with modern, streamlined buildings with smokestacks reaching 250 feet into the sky.

And there is no reason for lonesomeness. Even the scientists brought to the station have plenty of colleagues for talking shop—and highly technical shop it is. At the station are about 400 scientists and technicians, and the percentage of doctorate

degrees runs about the same as that on an average university campus.

It was here that the "powerhouse" was spawned for the *Nautilus*, the world's first atomic submarine. Currently the sensation of the seas, the *Nautilus* has led to a prediction by a member of the congressional atomic committee that an atom-powered airplane, capable of flying around the world several times without stopping, would be in operation in this country in five years. And what the Idaho station has done for the armed forces, it may now, through the materials-testing reactor, do in an equally spectacular way for industry.

The reactor with its unique high intensity of flux—10 to 100 times that available elsewhere—did not suddenly spring into existence. In fact, work was started on it long before anybody thought about planting it out in Idaho.

Planning began at the Oak Ridge National Laboratory in Tennessee in December 1945. By August 1946, a design had taken shape on the drawing board that was

essentially that of the reactor as it is today. Final design and development were a joint enterprise of the Oak Ridge Laboratory and the Argonne National Laboratory at Chicago.

At the station, the scientists can still tell you the exact minute when the reactor became critical or chain reacting. Said one with all the preciseness of a railroad conductor:

"It was at 11:19 p.m.—Mountain Standard Time—on March 31, 1952."

The minute was both tense and historical because the operators were generating a flood of neutron radiation of an intensity never before released by man in a machine. And they went at it gradually, for the reactor did not attain full design power until May 1952. Operation has been smooth ever since with no loss of time due to shutdowns except for those constituting a regular part of the operating program.

The materials-testing reactor is one of

three now operating at the Idaho station, but it is in a class and a building by itself. The building is small—about 130 feet square by 80 feet high—but entering it you get the idea of vast space because of the 40 feet of clear area on all sides of the reactor. The reactor itself is a giant, intricate piece of equipment, standing 24 feet high.

Here you have speed that is speed.

One of the reactor's instruments, known as a "fast chopper neutron spectrometer," measures neutron speeds up to 3,000,000 miles per hour.

The tremendous output of neutrons from the materials-testing reactor tops everything previously reported—500 trillion per square centimeter per second—compared with 50 trillion produced by the Canadian heavy-water reactor at Chalk River, Ont.

Bombardment of the neutrons against atoms of various chemical elements produces radioisotopes. The ordinary atoms are made unstable or radioactive in the process, and they then give off unseen rays that can be detected by a geiger counter. The materials-testing reactor has more than 100 ports in which specimens can be exposed to neutron bombardment for irradiating—virtually mass production of radioisotopes. Almost daily someone comes up with a new use for these isotopes.

Recently, for instance, the owner of a moderate-sized ranch-type house got a \$400 heating bill for one month. The house was warmed by a radiant-heating system with copper tubes buried in the concrete floors. There just had to be a serious leak in the pipes. But how could it be found without tearing up the whole floor?

A commercial laboratory added the radioisotope Iodine-131 to the water in the heating system. A technician with a geiger counter then explored the floor with all the intentness of a prospector looking for uranium. When the counter started to click frantically, the technician knew he was over the leak because of the great increase of gamma radiation in the large amount of water surrounding the spot. Already this principle for detection of hidden leaks has been expanded and is being widely applied in industry.

(Continued to page 234)

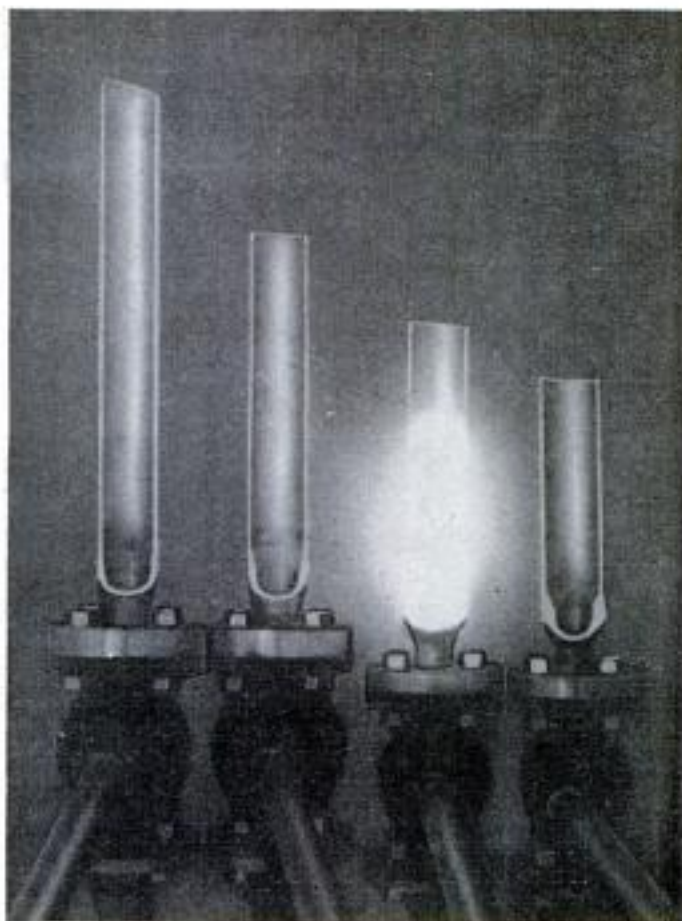

Hydraulic shuttles above are called "rabbits." Here one glowing rabbit returns after carrying sample into reactor



At left is a standard bottle made of polyethylene. Below left is a bottle of the same type which has been heated at 126 degrees C. for 30 minutes. Below is a gamma-irradiated bottle which has been exposed to the same heat. Irradiation has produced heat resistance





# Handy ITEMS for

**E**VERY CAR that comes off a Detroit assembly line is complete—it can be driven without adding anything but gas, oil and water. But millions of car owners are not satisfied with assembly-line equipment. As a result the automotive-accessory business sells \$1,000,000,000 worth of goods



**BUMPER MOUNT** provides convenient method of transporting your outboard motor. Attached to front or rear bumper, the 22-pound mount holds outboard motors of any size without interfering with normal use of car. It tilts back to give access to trunk

Lawncraft Sales Company, Salem, Ill.



**WASTEBASKET** that holds disposable bags helps keep car interior neat. The wax-paper liners can be used to hold peach pits, apple cores and other moist trash. The detachable plastic container fastens to the dash, door panels, seat backs or cowl kick pads

Advance Enterprises, Inc., 423 Norway St., York, Pa.

**WARMING PAD** makes winter driving comfortable. Developed and manufactured in Germany, the electric pad is plugged into the cigar-lighter socket. If you prefer, you can use it to keep your feet warm. The pad is made for use with 6, 12 or 24-volt systems

**HOOKED SHAFT** that rests on rear-window shelf will hang several suits and coats, permitting you to retain well-pressed look while traveling. Top of shaft is flattened to fit between window frame and glass. Nut at base is rotated to adjust shaft height

Wallace Intra National, 1036 N. Dearborn St., Chicago 10, Ill.

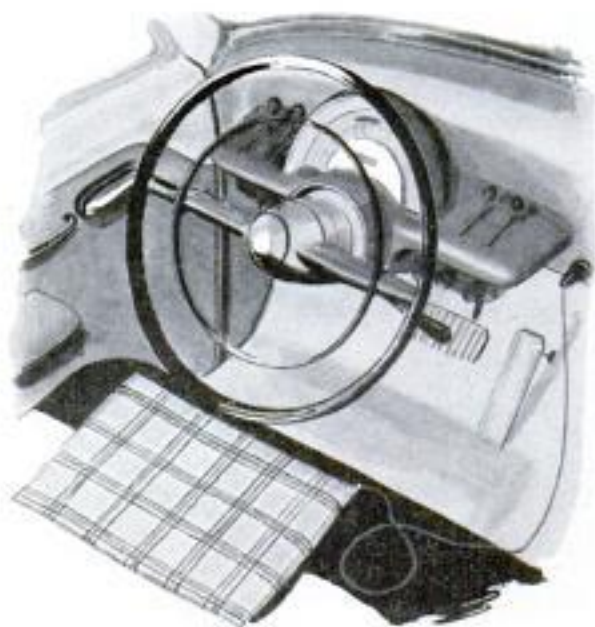

# YOUR CAR

a year. More than 1000 manufacturers keep 50,000 retail outlets supplied with items ranging from bug deflectors (complete with propellers) to continental tire kits (which, incidentally, are big sellers at the moment). On these two pages are other items you'll see in your auto store. ★ ★ ★

**SEALING COMPOUND** ends water and dust leaks around windshields and rear windows. Nonhardening, the compound does become firm to the touch. It won't damage upholstery, says the manufacturer. Although not gummy, it sticks to metal, glass and rubber  
Super Seal Products Co., 1235 35th Ave., Oakland 1, Calif.

**POCKET COMPUTER** speeds checking of gasoline mileage. When slide is moved to number of miles run, miles-per-gallon figure shows in slide opening opposite number of gallons used. Gas and oil purchases can be recorded on a ruled section of the metal unit  
MIRMO, 800 S. Ada St., Chicago 7, Ill.



**DOME-LIGHT CUTOFF** enables you to deactivate the dome-light switch so the light does not go on when the car door is opened. It prevents drain on the battery during repairs to the interior. With it, you can open the door while at a drive-in theater  
DeActivator Inc., P.O. Box 232, Anderson, S. C.

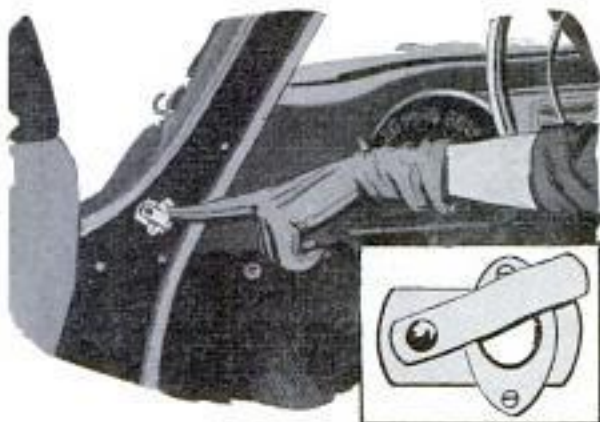

**BOAT CARRIER** turns so one person can load boat on car from either side. Hardwood rollers ease the boat on and off. Made in two sizes, unit adjusts to fit boats up to 53 and 61 inches wide. It is designed to fit all cars with rain gutters

Tomloe Carrier Company,  
Oconto, Wis.





## Small Autopilot For Light Planes

Weighing only 12 pounds, a small, single-axis autopilot has been designed to keep light planes in straight flight without constant pilot attention. The autopilot is built by the Javelin Aircraft Co., Wichita, Kans., and uses a gyro to maintain direction. The gyro, spinning at 15,000 revolutions per minute, can be manually overpowered by the pilot at any time. Tilting of the plane reacts against the gyro's tendency to remain on its spinning axis and controls automatically turn the rudder.

Single-axis autopilot stabilizes light plane in flight by rudder control

## \$6000 Worth of Flies Freed in Sugar Cane to Control Borer

Sugar-cane growers of Louisiana have imported \$6000 worth of parasitic flies (price: five for a dollar) in the hope that they will help to control the sugar-cane borer. These flies deposit eggs at the entrance to holes the borers make in sugar-

cane stalks. When the eggs hatch, the fly larvae move into the holes where they feed on the larvae of the borer. Tests in Trinidad indicated a 75-percent kill of borers on one plantation by the end of the second year after release of the flies.

## Corn Covers Crop Drier to Increase Capacity of Crib

Up to 50 percent more corn can be stored in a crib which is equipped with a new crop drier. The drier can be installed in the driveway of an existing crib or built into a new one. A metal frame runs the length of the crib to provide a duct. The corn

then is placed in both cribs and above the duct. The fan, installed at one end of the duct, is portable and can also be used to dry hay. Through use of the drier, corn can be picked at 30 percent moisture and is available to sell 30 to 40 days earlier.

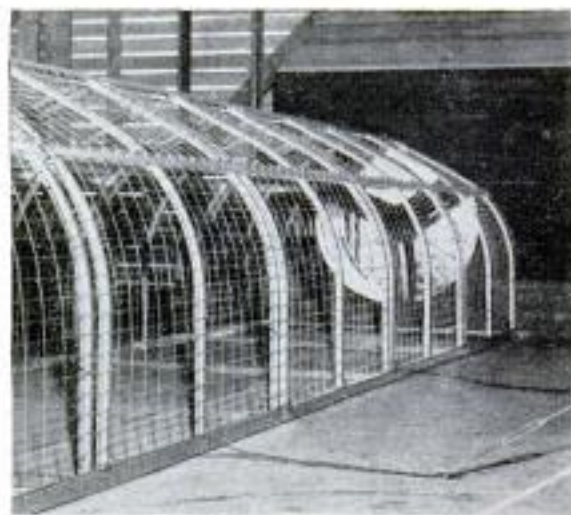

# Model Railroad Disappears Into Closet

WHEN REX KOURY of Hollywood, Calif., is through working on his model-railroad layout, he simply folds it up into a closet. Koury, Hollywood music director for the ABC radio network, has a room in his home which he devotes to model railroading. The HO-gauge track is the equivalent of two miles, full scale. The layout depicts the business district of a small town and contains more than 25 houses, stores and railroad structures. It is mounted on a panel measuring  $6\frac{1}{2}$  by 10 feet, with the operating controls in a separate cabinet. The back of the panel is hinged to a closet-like structure, and when Koury wants to convert the room into a guest room he removes the rolling stock and pivots the panel up and into the closet.

Top, folded up, there's no sign of the layout.  
Right, controls in a cabinet operate trains





Hine tests light intensity on piece of equipment he is photographing with a huge camera. The camera has a motor-driven mount to permit easy maneuvering

## FINE NUT AND BOLT



**D**OING THE IMPOSSIBLE is taken for granted at the photo studio of Sheldon Hine, technical photographer in Fort Wayne, Ind.

Specializing in photos for industrial and scientific use, Hine has earned a reputation for solving photographic problems which stumped research departments of the photographic "big guns."

Much of his specialized work for local industrial firms deals with highly technical devices, but Hine simply refers to it as "fine nut and bolt photography."

Through close attention to detail and using a vast technical knowledge he picked up in spare-time research, he has put his cameras and related specialized equipment to work solving intricate problems for industries.

One local electronics firm was turning out an extremely delicate electrical meter which had a hard-to-locate "bug." Sample meters shipped across the country lost their accuracy, apparently because of a change in the weight of the tiny needle.

Through a special photographic setup employing high-quality lenses, plus meticulous care in developing, Hine made huge enlargements showing that vibration was causing the meter needle to deposit a metal coating on the "pin" at the end of the scale. Though this coated spot was much smaller than a pinhead, Hine identified it and its source by means of his photographs. From then on, the meters were shipped with a battery wired on to keep the needle from bouncing on the pin during transportation.

Another electronics manufacturer was having trouble with special military-quality radio tubes in armed-forces applications, so Hine was assigned the job of photographing the interiors of these tiny "peanut" electronic tubes and making extreme



**Sheldon Hine of Fort Wayne, Ind., is a technical photographer who specializes in doing the impossible. He calls it**

# PHOTOGRAPHY

By Marshall Lincoln

enlargements of them so that almost microscopic defects could be seen easily.

Using these photos as guides, it was possible for the engineers to design better tubes for armed-forces electronics gear.

It was while he was with the Navy during World War II that he developed a photographic training device which others had given up as an impossible task.

While in the Special Devices Center of the Office of Naval Research, he found a way to coat a relief model of a ground area with a light-sensitive emulsion, giving the relief model a much more accurate presentation than the hand-painted models previously used.

While rising from lieutenant (jg) to lieutenant commander from 1942 to 1946, he developed various projectors and other optical systems used in training naval aviators. He also designed and supervised installation of the topographic laboratory on the command ship *USS Mount Olympus* and trained the crew for its operation.

After the war, a whole new system of lighting was developed by Hine as a result of the needs of his industrial clients.

Called "shadow-free photography," or

"photography with high revealing power," the system of lights makes possible photos of tiny parts of deep cavities with no shadows to hide details.

Two kinds of light are involved; each one may be mounted on the front of a camera to provide all the illumination needed for making photographs.

Heart of the "Class A Hinelight" is a "beam splitter," or partly silvered mirror, which is mounted at a 45-degree angle to the camera lens. A high-powered projector bulb with a set of condenser lenses is mounted at one side of the lens so that light from the bulb will strike the mirror and be reflected forward onto the object being photographed. The camera lens "shoots through" the mirror without "seeing" the projector bulb.

This arrangement makes the light strike the subject as if the light came from the center of the camera lens; consequently the object being photographed throws no shadows visible from the camera position.

Used on most of Hine's industrial photography is the "Class B Hinelight." An elaboration of the common ring light, this outfit consists of eight rings mounted with

**This Light**

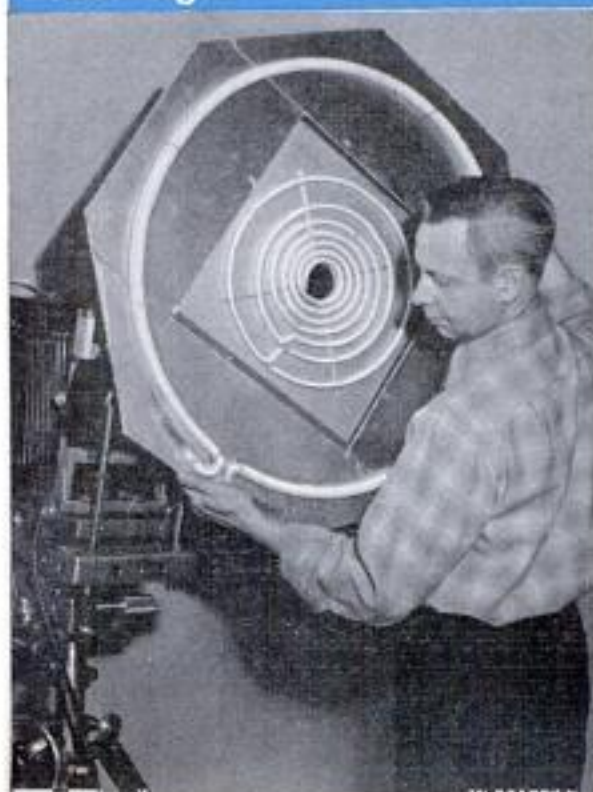

**Flashed This Picture**

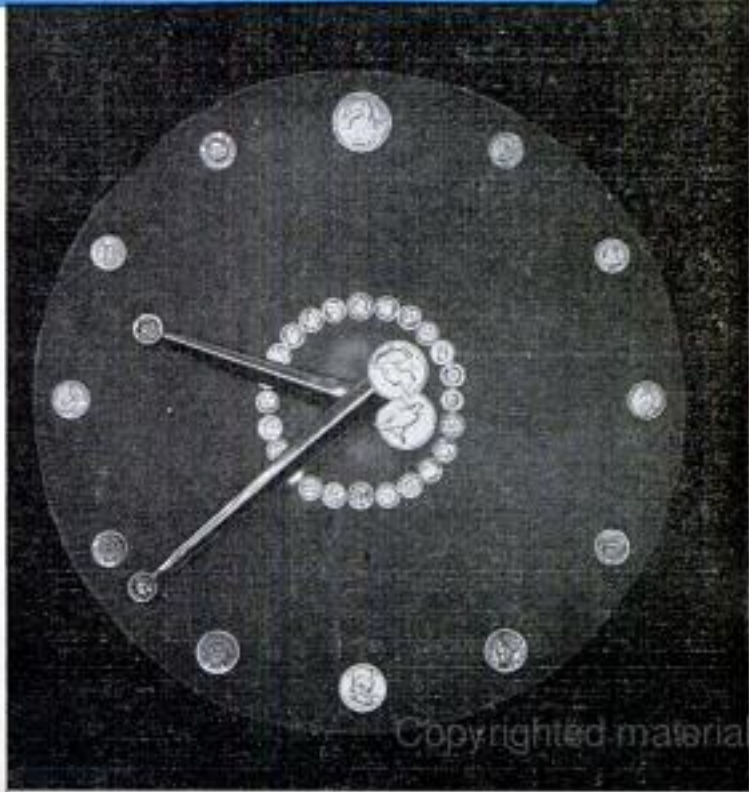

Copyrighted material



A 35-millimeter camera and focusing device are fitted on the back of a 4-by-5 Linhof for telephotos and close-ups

Light in special reflector is used as a "shadow killer" when shooting room interiors. Regular room lights provide the primary illumination



Hine shoots 4-by-5 stereo photos with standard press camera by using two lenses on board with rear divider

a common center. All eight rings are mounted on a flat reflector, which is attached to the front of his camera so that the camera lens peeps through the center of the rings.

To convince the Patent Office that his Class B light was better than the conventional one-ring lights commonly found today, Hine made a series of photographs of the same object, a white star on a white background, to show how many shadows are cast by a single ring and how the number and intensity of shadows decrease as one, two, three, five and seven larger rings are added to the original ring.

The Class A Hinelight is used mainly on close-up photography or photos of deep cavities, while he uses the Class B Hinelight for other general photos such as radio equipment and machinery.

Although these special lights enable Hine to turn out top-quality photos in a short time, he doesn't mind spending several days making a single photo, even designing special equipment for the job.

When he was called on to photograph an unusual and intricate clock for a Fort Wayne bank, he found it necessary to build a special light just for this one photo.

Rare coins used as numerals and pointers on the clock face presented a problem: Ordinary flood or flash lights produced glaring reflections on some of the coins.

Hine solved the problem by building a special ring light for the photo. This light was about four feet in diameter and was mounted on the front of the camera along with a Class B Hinelight. Size of the huge ring was calculated to provide uniform reflections from the circle of coins representing numerals on the clock face, while a

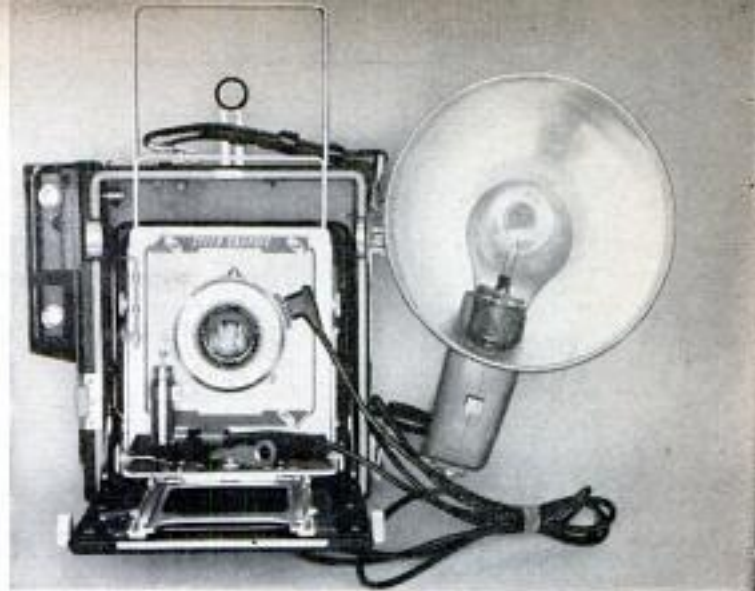

All tones from blackest black to whitest white are recorded in this photo made with Class B Hinelight

Class B Hinelight illuminated the hands and a smaller decorative circle of coins without bothersome glare.

Hine regularly "does the impossible" for the Farnsworth Electronics Co. in Fort Wayne when he copies an extremely delicate line made by an electronic recording device which traces on graph paper the results of electrical measurements.

Expert copying firms tried this job and gave it up, saying the line was too faint to be copied successfully.

Again special lights built by Hine came to the rescue. He decided that high-contrast copying film would do the job if illumination on the graph paper was carefully controlled. He built two sets of fluorescent lights, one below and one above the copy board. Carefully designed flat reflectors made the light level across the board nearly uniform, and a few patches of tape spotted on the light bulbs gave necessary critical

Hine uses compressed air to clean negatives. Photo made down a gun barrel shows nose of bullet at other end

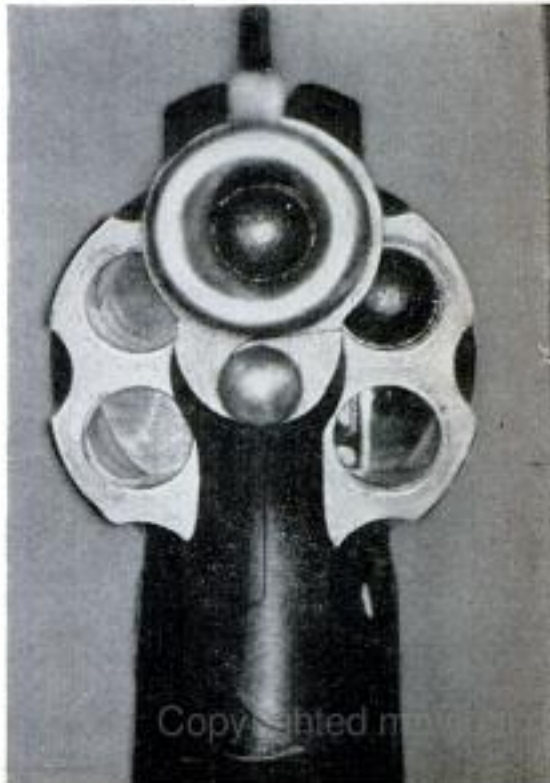
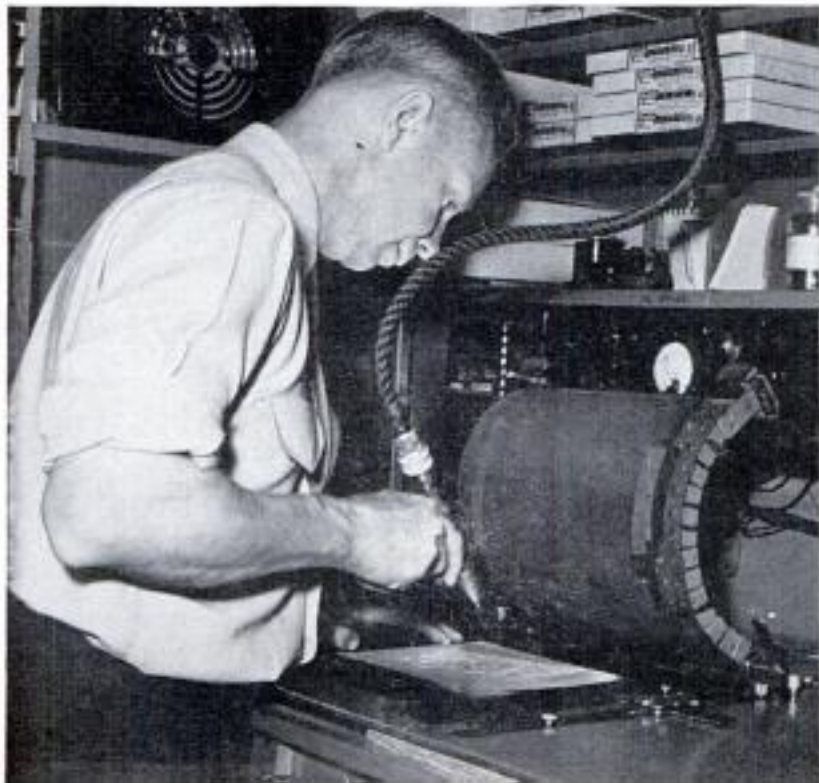

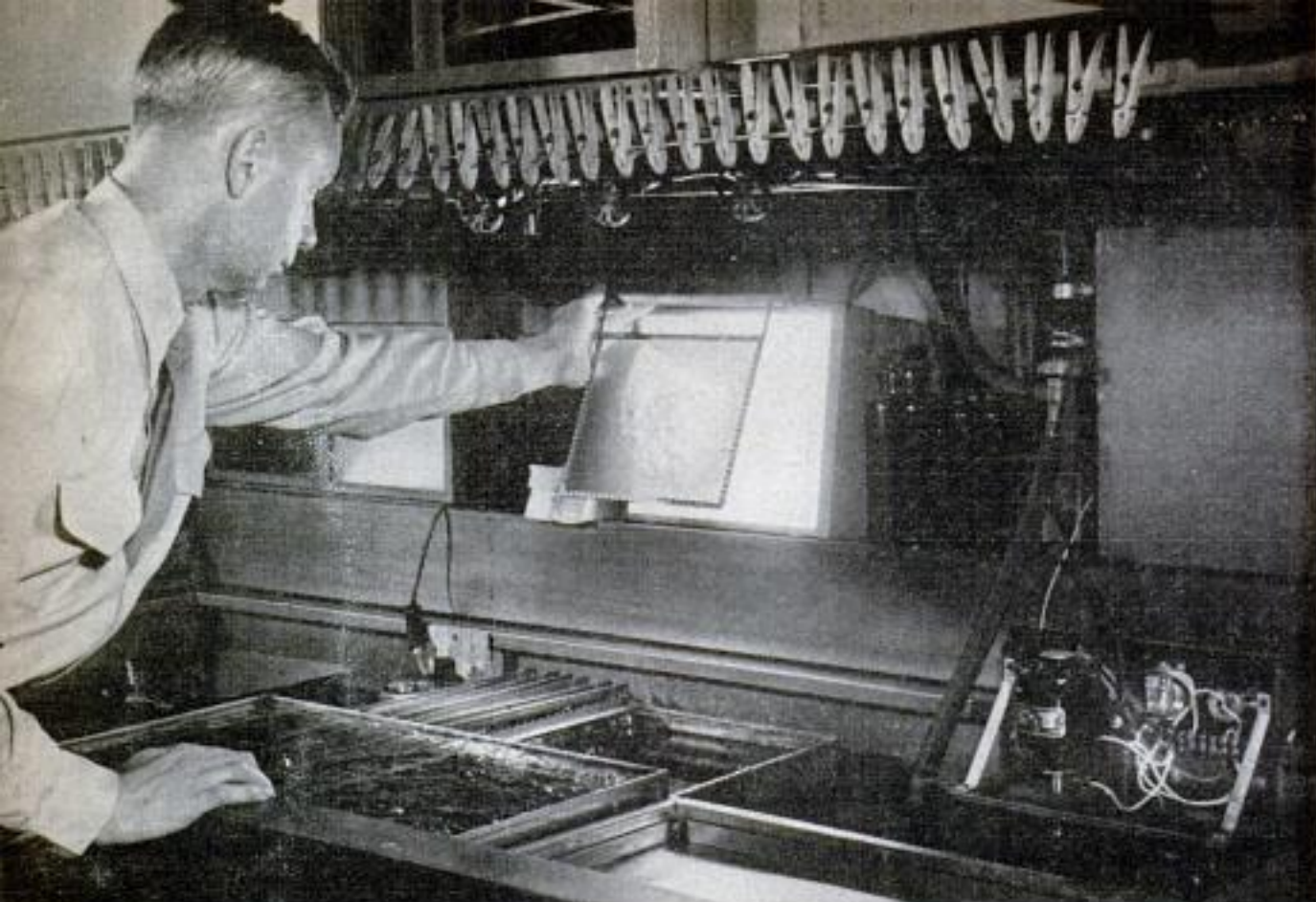

Thermostats control temperature of film developers. Aspirator bubbles water to agitate negatives being washed

Hine puts one of his shadowless lights to work photographing a piece of machinery. Reflectors cover lamp when not in use



adjustment so that meter readings were constant over the entire copying surface.

Careful control of film exposure is all that is necessary now to produce top-notch copies of the delicate graph lines.

To turn out high-quality photographs for industrial purposes and to live up to his own high standards, Hine has built much of his own equipment and has installed in his darkroom facilities for controlling time and temperature "down to a gnat's hair."

His "dream darkroom" looks like a combination power station and plumbing shop, with lights, cables, pipes, valves, thermostats and relays scattered about in profusion, each one a vital part in Hine's setup for producing photos of top quality.

Much of the work of building the darkroom facilities and most of the cabinet work in his office-studio were done by his father, H. S. Hine, a man equally at home with a saw or developing tray. In addition to doing carpentry and machine work, he helps out with the processing, doing all the film developing and helping do the printing when a big rush order demands "all hands on deck."

Critical control of time and temperature, plus careful use of high-

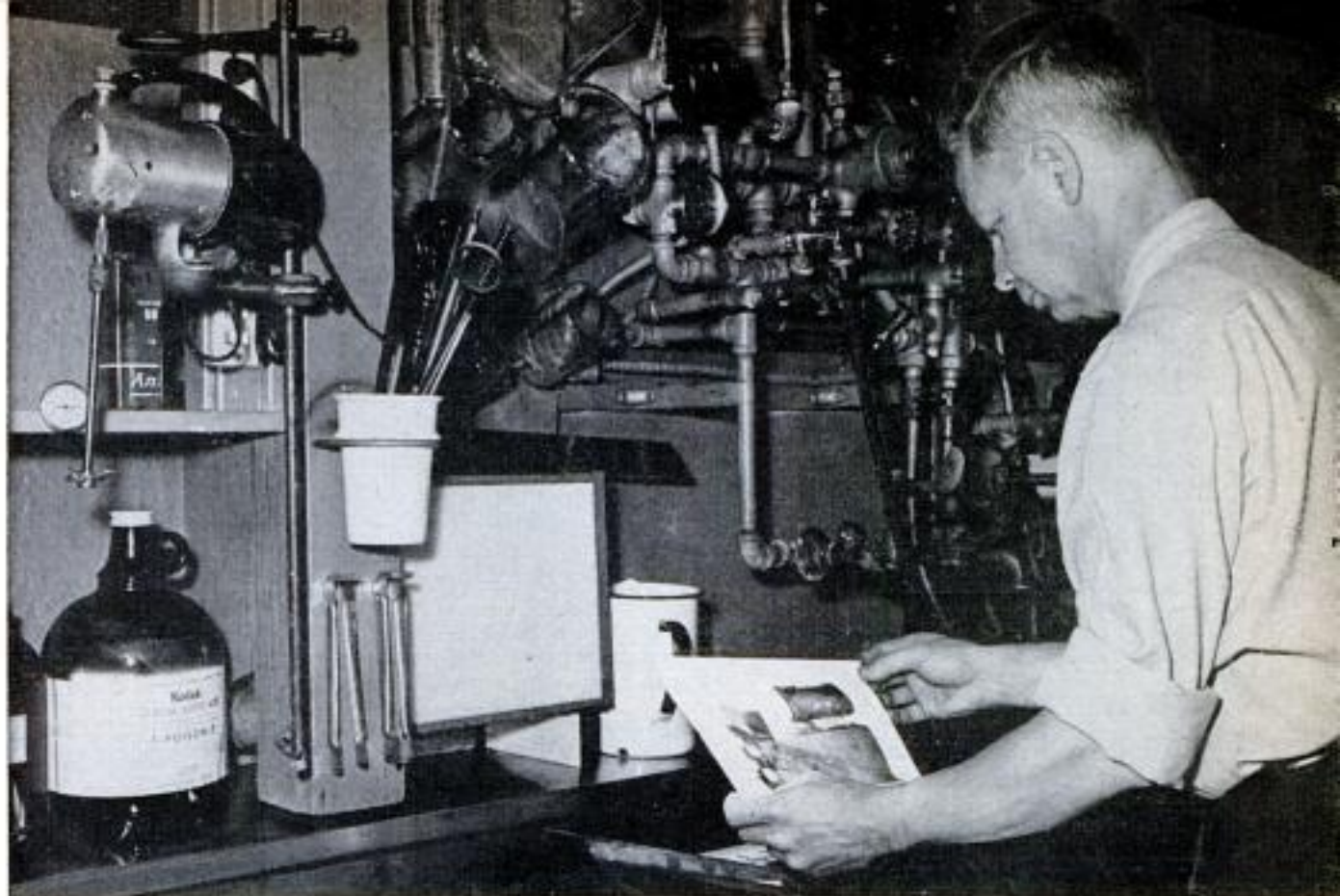

Maze of plumbing mixes hot and cold water to produce desired 72 degrees. Power mixer, left, stirs chemicals

quality lenses are the watchwords in Hine's darkroom.

After many experiments, he chose 72 degrees Fahrenheit as the ideal processing temperature, rather than the conventional 68 degrees.

Automatic controls keep all his processing solutions at this temperature, and even his film drier is designed to keep his negatives at this temperature while drying, thus keeping grain size negligible. All tanks

used in film developing are immersed in a water bath which is kept at 72 degrees by thermostatic controls.

Water circulating in the print-processing sink is kept at this temperature by an elaborate "plumber's nightmare" over the sink. Through use of this maze of pipes, thermometers, special valves and other gadgets, Hine's water supply is automatically adjusted to proper temperature.

(Continued to page 228)

Instead of dodging, Hine air-brushes thin areas of negative with red dye when enlarging or contact printing

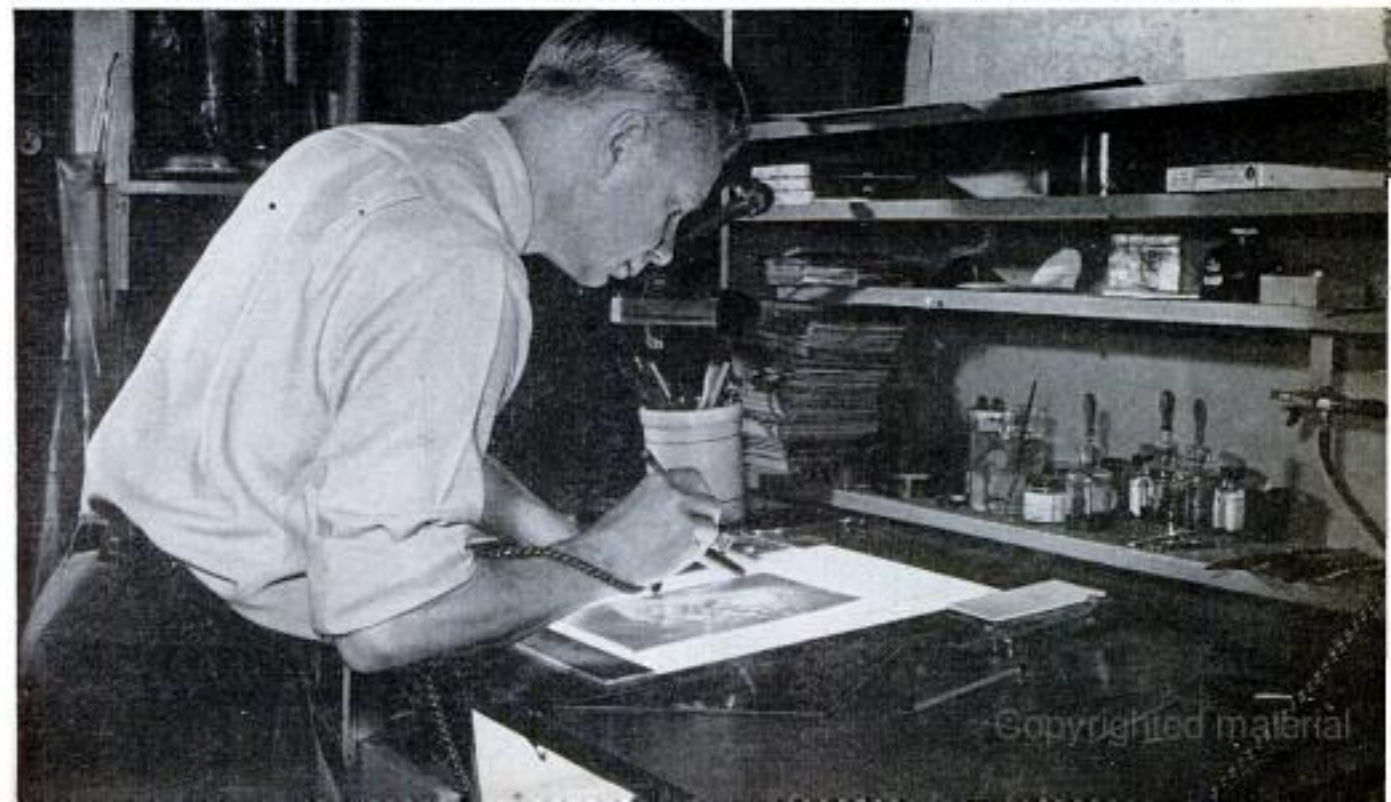

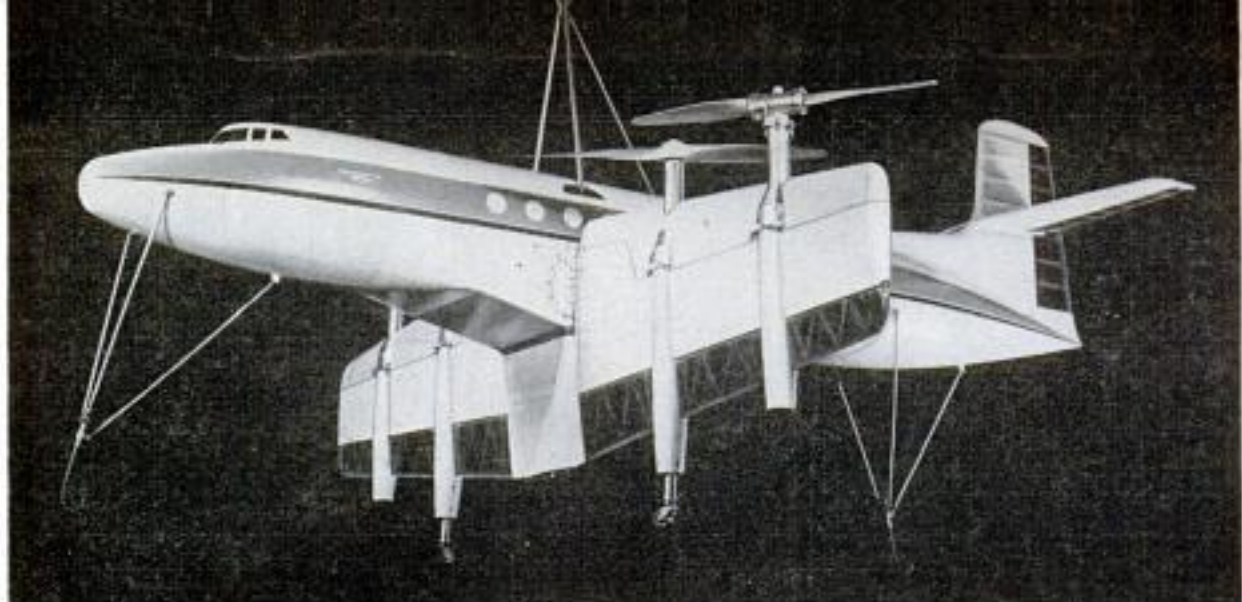

## Vertical Take-off For Airliners

Vertical take-off and landing is one of the ideas under investigation by NACA as a possible solution to the nation's costly airport-construction problem. Two of the methods tested on model airliners at the Ames Aeronautical Laboratory of the NACA are shown in the photos. In one, the wings and propellers are turned to the vertical. In the other, the slip stream is redirected through sets of extra wings and flaps that look like Venetian blinds. This latter system permitted hovering, take-off and landing while the fuselage of the model was nosed upward 15 degrees from the horizontal.

Experiments in planes capable of vertical take-offs are being pushed as larger planes, requiring long expensive runways, go into service. Here are just two of many recent VTO designs

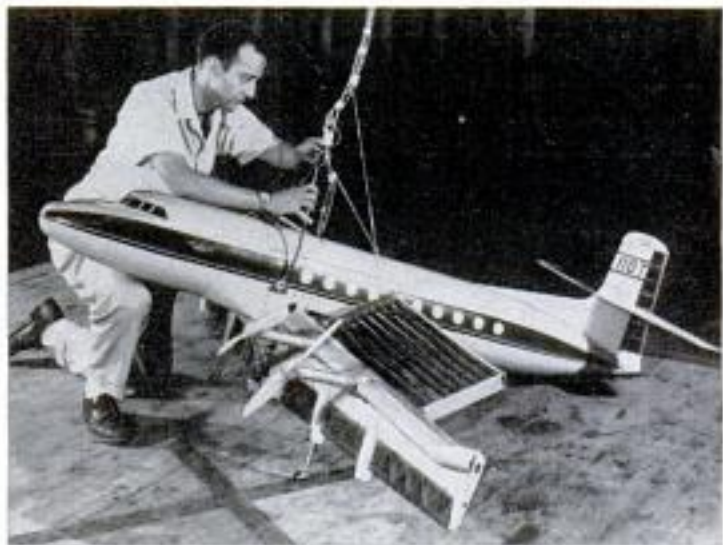

## Muscle-Powered Duck Boat Retrieves Downed Birds

Duck hunters are a hardy and ingenious lot, and Earl Blevins, of Rices Landing, Pa., a member of the tribe, proves it by

coming up with a paddle-wheeled boat to be used for shooting and for retrieving the downed birds. The boat is small enough to be carried in the trunk of a car. Basic machinery of the paddle wheels is a pair of bicycle sprockets mounted in the sides of the boat and fitted with hand cranks and paddles. As a safety measure, he has equipped the boat with floats similar in principle to those used on outrigger canoes. The floats were made by sealing the ends of lengths of downspouting, and are attached to the sides and the stern with metal braces.



Craft is made seaworthy by outrigger-type floats

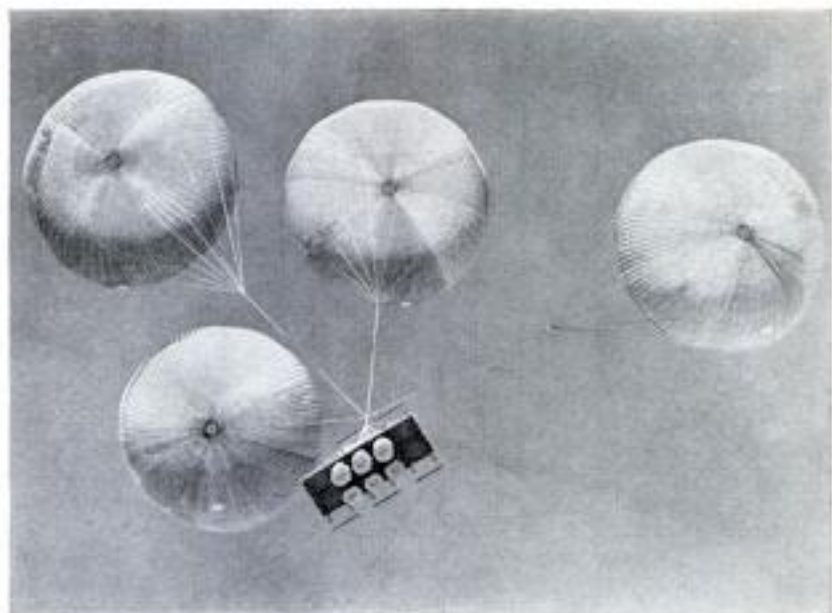

## Flying Freight Platform Cushions Delivery of Heavy Equipment

Platforms made of magnesium and provided with collapsible rubber bags resembling barrels on the underside to absorb landing shocks are the Air Force's newest approach to the problem of heavy-equipment delivery to ground troops by means of parachute drops. Four to 10 air cushions are fixed to each platform and carry loads up to 25,000 pounds. When such a load is dropped from a cargo plane, a rush of air

fills the cushions and a diaphragm closes automatically to keep them inflated. When the load hits the ground, the compressed air in each cushion takes up the shock, then forces out a rubber plug, permitting the air to escape. Then as the cushion deflates, the load is lowered to the ground. Tests show that the cushions cut ground impact so that a 1000-pound load hits with a force of 12,000 pounds instead of 35,000.

## Rotating Parachute Slows Flight

Spinning at the rate of 1500 to 3000 revolutions per minute, a new type of perforated parachute called Rotafoil is intended to slow and to stabilize flight and descent. Studies by the manufacturer indicate that one of these chutes weighing only four pounds can stabilize and prevent tumbling of a falling object weighing as much as 6000 pounds. It is not intended for humans.

## Motor "Canned" in Pump

Civilian industry has put into use a "canned motor" pump like the one developed for atomic submarines. Both the stationary outer coils and the rotating portion, or "rotor," are canned in metal and the circulated water flows through the space between them. A unit is being used to circulate boiler feed water in a closed-loop system in the Possum Point, Va., electric generating station. The pump is said to be leakproof.

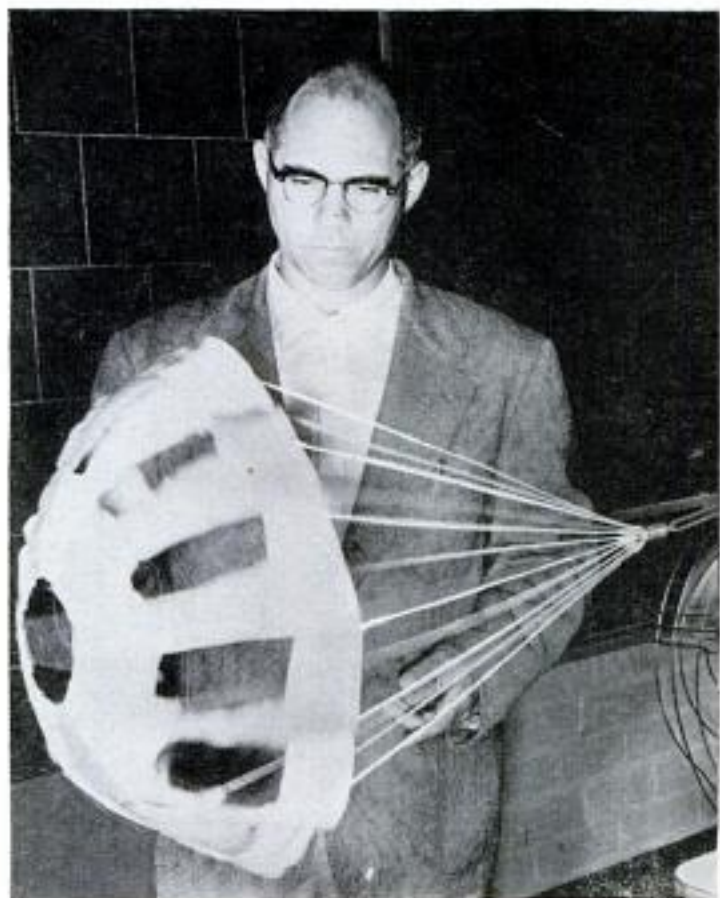



Astronomer steps from elevator into booth at upper end of telescope. Below, outside view of observatory



Seventy-ton fork of the instrument dwarfs man standing beside it



## A New Eye Scans the Stars

**A**STRONOMERS who are studying the distant reaches of the universe will have the aid of a new tool this winter. A giant 120-inch telescope is scheduled to go into operation in early 1956 at the University of California's Lick Observatory on Mount Hamilton near San Jose.

The instrument is the second largest in the world, ranking next to the 200-inch telescope on Mount Palomar near San Diego. Its range is approximately 900 light-years. It will be used in studies of distant galaxies in a cooperative program with other observatories.

The tube of the telescope is actually an open framework of large-diameter steel pipe. The 16-inch-thick 4-ton Pyrex



mirror is supported at the lower end of the tube. At the top of the tube, at the prime focus where the light gathered by the big mirror comes to a point, is located a small booth in which an astronomer will ride the telescope for some types of celestial observations.

The telescope rests in a huge, hollow, 70-ton steel fork, the first mount of its kind for a large instrument, one that will permit observations in virtually any part of the visible sky. A motor inside the hollow fork drives the 35-ton tube and mirror while another motor rotates the fork. Other motors rotate the 96-foot dome inside which the telescope is located. An elevator inside the dome permits an astronomer to ride to the prime focus no matter at what attitude the telescope is placed.

The new Lick instrument was built at a cost of \$2,500,000. Grinding and polishing of the big mirror consumed two years of painstaking work, and work is being completed on 10 secondary mirrors that will be used in various ways to focus the light gathered by the 120-inch disk. In addition, photoelectric recording apparatus for measuring the brightness of stars is being installed.

Pending installation of the mirror, steel slabs and a concrete disk were placed in the bottom of the telescope during orientation and testing of the drive mechanisms.

With the new telescope, Lick becomes the possessor of the world's newest as well as one of the world's oldest large astronomical telescopes. Still in use is the big 36-inch refracting telescope that was installed on Mount Hamilton in 1888.

★ ★ ★



Open-framework section of the telescope is 53 feet long. Below, Dr. C. D. Shane, director of Lick Observatory, and a technician inspect a working model of the new instrument. The 120-inch telescope will be the second largest in the world and will have a range of 900 light-years

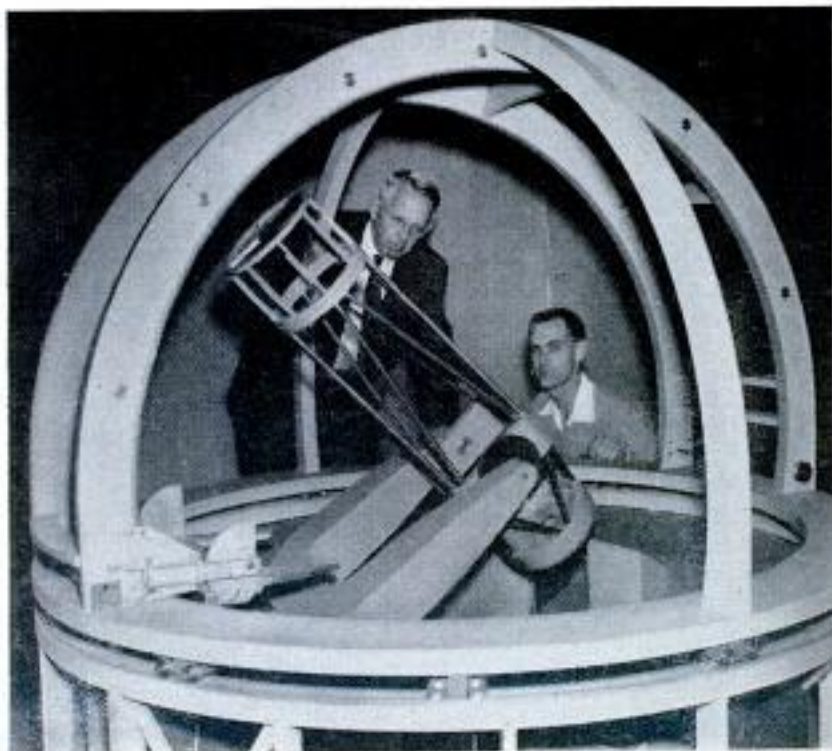



U. S. A. F  
TEST PILOT SCHOOL

# Where They Learn to Test Jets

**T**HE NEW experimental fighter was making a tower fly-by at top speed, 30 feet off the ground. There was a crash of sound from its afterburner as it hurtled past and seconds later it was almost out of sight. By now its pilot was calling the tower to report the readings that his air speed and Mach indicators had shown during the fly-by.

"Okay, okay," the tower replied. "Come around again, Ed. Take it slow this time, for altimeter calibration. And watch your altitude. You were stirring up dust on your last pass!"

High-speed and slow-speed runs only a

*By Glenn Infield* few feet off the deck aren't

recommended for ordinary pilots, but the flier who was making the instrument checks in this new fighter was far from ordinary. He was one of the experimental test pilots attached to the Flight Test Center at Edwards Air Force Base in the California desert. More than that, he is a graduate of the Experimental Flight Test Pilot School that the Air Force operates at Edwards.

This is the only test-pilot school in the Air Force and there are only two like it in the world. One is that of the Navy at Patuxent, Md. The British have the other.

The job of the test-pilot school is to produce men who are a match for the planes they will fly. These planes are the newest experimental designs that may be adopted later as standard bombers or fighters if performance and safety come up to Air Force requirements. To test such aircraft a pilot must be an expert in engineering evaluation as well as in flight technique. He must have the boldness of a buccaneer, the mental precision of a slide rule and the insight of a top-notch reporter.

Only 15 men at a time are selected from Air Force personnel for the special schooling. Each student is an accomplished flier even before he enters the school, for a basic requirement is that he have a minimum of 1500 hours of diversified flying time. He must be a lieutenant, captain, or major, between the ages of 23 and 33, with a knowledge of college mathematics and aeronautics and preferably at least two years of engineering training.

However, certain requirements may be waived if a pilot has an exceptional record. A few graduates of the test school, including Maj. Charles E. Yeager and Douglas test pilot Bill Bridgeman, had very little formal training in engineering.

The course is a grueling six months of concentrated classroom work, home study and flying. It keeps the student busy nearly every day of the week from early morning until as late as midnight. Sundays and holidays theoretically are free but often a student finds that he must fly on those days to complete projects in the tightly jammed schedule. The first four weeks of the course take the student from the use of the slide rule up through algebra, trigonometry and physics to integral and differential calculus.

Graduates are qualified to accomplish both Phase II and Phase IV flight testing performed by the Air Force; that is, they are trained to evaluate the performance and stability and control characteristics of an aircraft. In the classrooms the students are taught the routine for testing and evaluating the level flight and climb performance of a plane, then they are taught the methods by which the



Trained jet pilot starts over with T-28 at test-pilot school

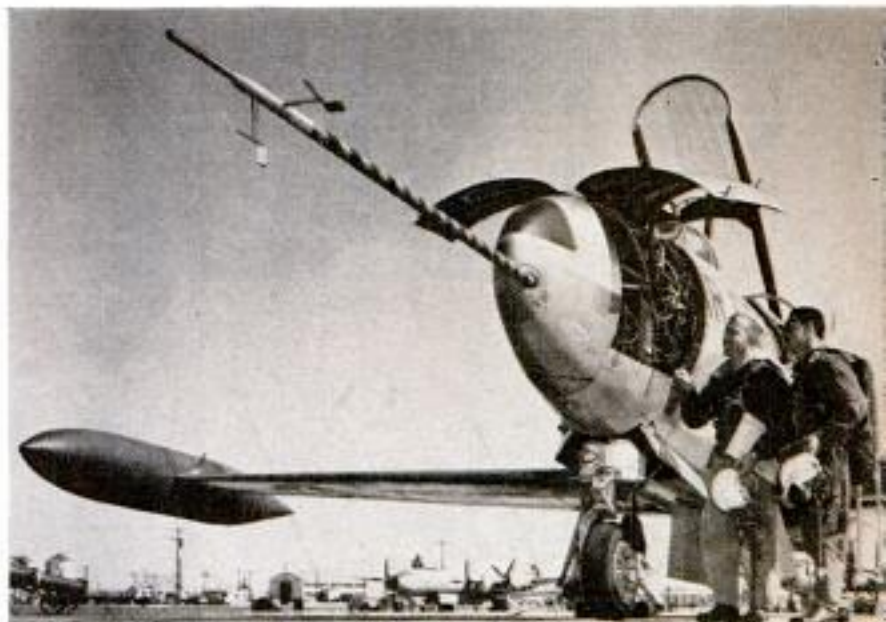

Next step is to Lockheed T-33, fitted with instrument boom



Hottest aircraft operated by school is the F-86 jet fighter

Delta-wing fighter YF-102A undergoing typical flight tests





Six of USAF's top test pilots and some of the planes they have tested. Left to right, Maj. Charles Yeager, Maj. H. G. Russell, Col. F. J. Ascani, Brig. Gen. J. S. Holtner, Lt. Col. Jack Ridley, and Maj. Arthur Murray

safety and ease of control of the plane can be determined.

Classroom studies are balanced by about 70 hours of flight time in the trainers, fighters and bombers attached to the school. During all flights except in the single place F-84 and F-86 an instructor accompanies the student pilot.

Just as in the case of an actual experimental plane, a special instrument panel is mounted on each trainer, with a motion-picture camera automatically recording every detail of the flight.

Typical flights include maximum per-

formance take-offs, a check climb for altitude and maximum performance landings in which the plane is stalled a foot off the ground. One test is to take a plane aloft and make several dives to check for possible unusual reactions. An unusual reaction might be the need for more pressure on the control stick. The student writes this on a clipboard attached to his knee, regains altitude, and dives again. He may note on his new dive that he had to hold left rudder and that he had felt rudder pulsations.

The student learns that when he is instructed to do a 5G pull-out, he doesn't just



Special instrument panel is installed in plane being flight tested. Camera records instrument readings

stick the nose of the plane down and close his eyes. He has to check and double-check the instruments, watching the Gs pile up as he starts his pull-out and all the time a camera is clicking away at its instrument panel, recording the filmed truth of what he did or didn't do on the dive.

As one of the stability tests he makes aileron rolls as rapidly as he can, at various speeds. This was a mild and pleasant maneuver in older, slower aircraft; in a fast jet it can be a queasy experience if the pilot isn't in top physical shape.

He makes side slips at various speeds, all at high altitude because some of the controls blank out in a side slip and he can anticipate a spin. He will need plenty of altitude if that happens when testing a new plane in the future.

He learns how best to control a plane that has an after center of gravity, causing it to handle very poorly. This is part of a series of tests for handling a plane under various loading conditions. As part of the stability tests, too, he studies the compressibility effects that are encountered at very high speeds.

A test pilot not only flies a plane to



Film is projected after flight. Student pilot prepares his flight report after reading instruments

learn how to operate it best, he checks out every part of it. He notes the way the drag chute operates when landing (does it produce enough deceleration?) and he fires all the guns or rocket armament (any malfunctions?) with which the plane is equipped.

The student may spend six or eight hours writing a report of all that happened on a flight. He must provide the engineers with a professional report of the plane's behavior. There is no purpose in a test flight if the pilot's report is not clear and concise so that the engineers can iron out the "bugs" in a new plane.

Operations at the test-pilot school begin in the very early morning, before sunrise. The pilots have learned that the air in this desert area is still during this time, making it the best part of the day for student testing. Most of the morning is spent on various types of flights or in studying the film taken of the instruments on the day before. Ground school takes up the afternoon.

There are other activities for the test-pilot trainees. During the six months they visit the aircraft industries in the Los Angeles area and confer with aeronautical and design engineers. They tour NACA's Ames Laboratory at Moffett Field near San Francisco; check out in the ejection seat

Republic F-84 Thunderjet launched from truck-mounted platform uses a booster bottle to provide necessary extra kick





Project engineer records instrument readings during testing of C-124C Globemaster as test pilot watches

on the specially constructed stand at Williams Air Force Base, Ariz., and in the high-altitude chamber, also at Williams.

Physical endurance during these check-outs is closely observed. When a test pilot hurtles through the air so fast that the paint peels off his "aerial hot-rod," he has to be in tiptop shape. If a student fails to withstand the check-outs at Williams he is automatically relieved from the school.

Mostly, washouts are for academic deficiencies. Failure to keep up with class in calculus, aerodynamics or physics has sent a number of students back to their squadrons, though otherwise they were excellent test-pilot material.

"There is a good reason for this," explains Lt. Col. John R. Amann, school commander. "An experimental test pilot associates with the top engineering brains of the aircraft factories. He must be able to understand what they are talking about and he should be able to make intelligent contributions in a discussion about a new aircraft. Mathematics and many of the physical sciences have become important tools of his trade."

A graduate of the school, if accepted as

an experimental test pilot, first spends six months in routine test flying at Edwards. After that he may be assigned to a major project. This could consist of taking complete charge of the Air Force flight testing of a brand-new plane.

But not all graduates are retained at Edwards. Possibly only the two top men in every class of 15 are assigned as experimental test pilots at the Flight Test Center. Still, there are many interesting jobs for the others.

Some may be assigned to other centers of the Air Research and Development Command, others go back to their original commands where they check-out their fellow pilots. Still others are needed as acceptance pilots at the factories that are delivering production aircraft to the Air Force, others go overseas to test-fly aircraft that have been shipped abroad. They are needed, wherever they go.

Men like Major "Chuck" Yeager do this experimental work day in and day out, flying that isn't covered in a textbook, piloting that pits a man against the strangest and most dangerous forces of the universe. And they do it for the regular pay of their rank—nothing extra. A comparative civilian job would pay \$15,000 to \$30,000 a year. Why do they do it?

Most of them just shrug their shoulders and say, "It's a fascinating challenge to your ability. Sort of keeps you on your toes, stops you from falling asleep on the job."

There is no doubt about test pilots staying awake on the job. These "you build 'em, we'll fly 'em" pilots don't dare sleep.

Bill Bridgeman called the shot when he said "Stop thinking and boom!—before you can collect yourself, you're fresh out of space."

But despite the rigors and dangers involved, pilots clamor for assignment to the world's toughest flying school. ★ ★ ★

How good is the Russian MIG-15? Here one is taxied out for tests at Wright-Patterson Air Force Base

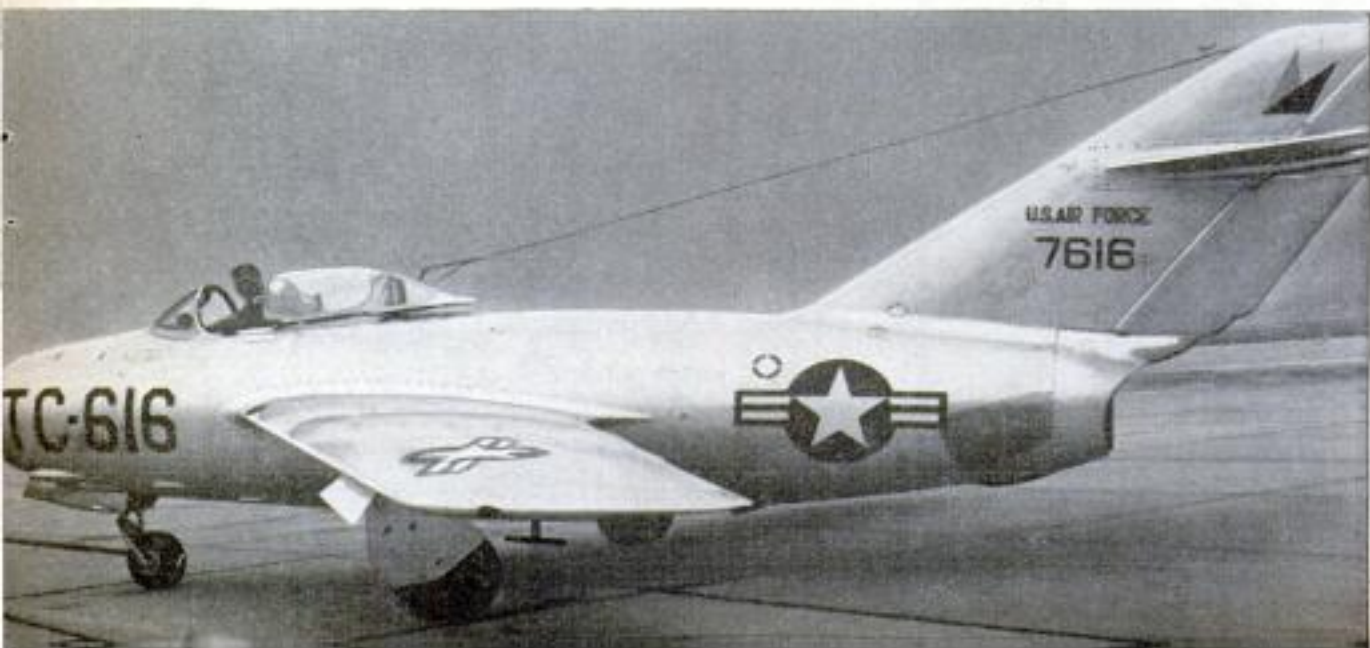

## Versatile Easy Chair With Fold-Out Back Converts Into Combined Chair and Table



Both chair and table are combined in a piece of furniture built by upholsterer Roland Provencher. A section of the chair back swings forward and down at a slight

push to become a Formica-covered table. The arms of the chair double as legs of the table, which is suitable for study or for games. It is now in production.

## System Like Wirephoto Transmits Pages of Books or Magazines

Excerpts from scientific books and journals go by wire from the Library of Congress in Washington, D. C., to the National Institutes of Health at Bethesda, Md., 13 miles away. A system similar to Wirephoto

transmits the information, which is reconverted to print at the rate of 15 inches per minute. The method permits much wider service without having the books and magazines leave the library.



# On the Trail of the Whooping Crane



By Francis Dickie

Photo by Fred W. Lahrman

Famous photograph by Fred W. Lahrman of three whooping cranes in flight was model for Canadian stamp

**A** BUSH FIRE raged in Wood Buffalo Park, in the wild country of northwest Canada. Pilot Don Landells, in a Bell helicopter, was rushing forest engineer G. Wilson and extra fire-fighting equipment to the scene from headquarters at Fort Smith. As they churned along, Wilson suddenly tapped Landells on the shoulder and pointed down.

Visible below them were two large white

Wild, inaccessible region of Northwest Territory of Canada where whooper's nesting area was found

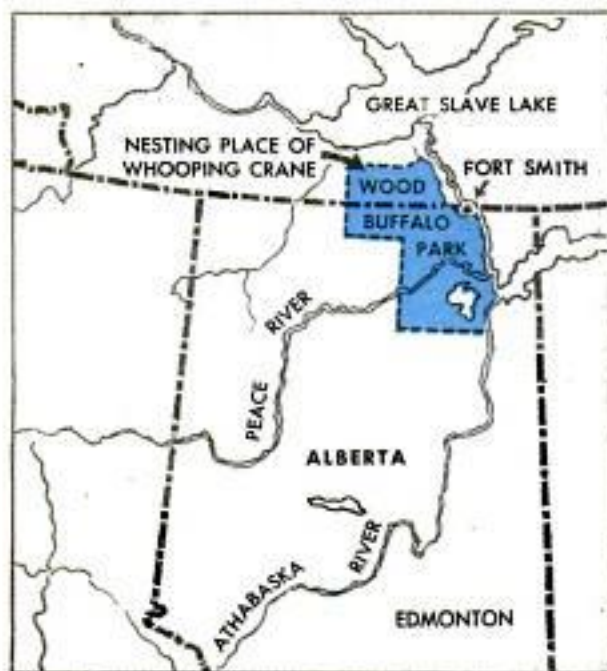

birds. Since birds of this size were rare in this region, Landells took a few moments from his emergency flight to circle back low for a better look. In addition to the two white birds, he could also see a smaller one of reddish color. Almost immediately he identified them as rare whooping cranes—two parents and a young bird at a nesting site. He carefully noted the location and then went on with his mission.

Later, when he arrived back at Fort Smith, Landells related his discovery to W. A. Fuller, mammalogist for the Northwest Territories Administration, who immediately recognized Landells' discovery as one of tremendous importance to ornithologists. For the whooping crane, North America's largest rare bird, has nearly reached the point of extinction.

During the past 32 years, ornithologists have been searching desperately for the nesting place of this bird, in the hope that once it was found, efforts could be put forth to save the crane from the fate of the great auk and the passenger pigeon. These latter are now no more than myths, having passed from the face of the earth. In the past 10 years, efforts to locate the whooping crane's nesting place were increased tremendously, but to no avail.

The whooping crane, scientifically named *Grus Americana*, is a beautiful, dignified bird, standing four feet three inches, with a six-foot wingspread. One cause of its decreasing number is the fact that it sometimes lays only one egg a year; sometimes





Aerial view of section in which whooping cranes nest. Area is difficult to enter except by helicopter

two; three are exceptional. Another cause is the fact that, in spite of widespread appeals, hunters shoot down the migrating flocks at their resting stops.

In 1935, the United States Fish and Wildlife Service set aside 47,261 acres near Austwell, Tex., as the Aransas Whooping Crane Refuge. This area was selected because the birds always returned to it for the winter. And in the refuge an exact count of the number of cranes in existence each year was possible.

Figures show that in 1950 there were 33 whoopers in the wild state on the refuge. By 1954, only 21 birds were returning from the northern Canada nesting grounds. This decrease in the population was mute evidence that the unlawful shooting of the crane by hunters continued. It should be noted that the decrease leaves out any count of young birds which must have been hatched during these years.

In 1945, the endeavor to save the crane was boosted by the formation of the Cooperative Whooping Crane Project. In this, the National Audubon Society joined the Wildlife Service, giving large additional funds. In

(Continued to page 230)



Above, two whoopers flying low over their nest, and below, one of the majestic birds about to take off. These are the only photographs ever taken of the whooping crane in its nesting grounds, and were shot by pilot Don Landells from a helicopter

Photos by Don Landells





### Floating Trailer For Road or River

One English family is at home on a road or on a river. A trailer-boat built for his family by boat designer Alan Eckford is quickly convertible. Two men can easily slide it off its undercarriage into the water. Built of laminated marine wood, the craft was constructed at a cost of \$1350. It is powered in the water by an outboard motor.

Backed up to the shore, trailer easily slides off its undercarriage and slips into water

### Harmonica With Keys

You play a new German harmonica by pressing the keys on an accordion-type keyboard. With the instrument you can play harmonic chords with as many different tones as desired and in any desired key. The instrument produces tones when air is inhaled or exhaled, and requires no more air than standard harmonicas.

☐ An estimated 1,055,000 brick houses were built in the United States last year—29 percent of all homes constructed.



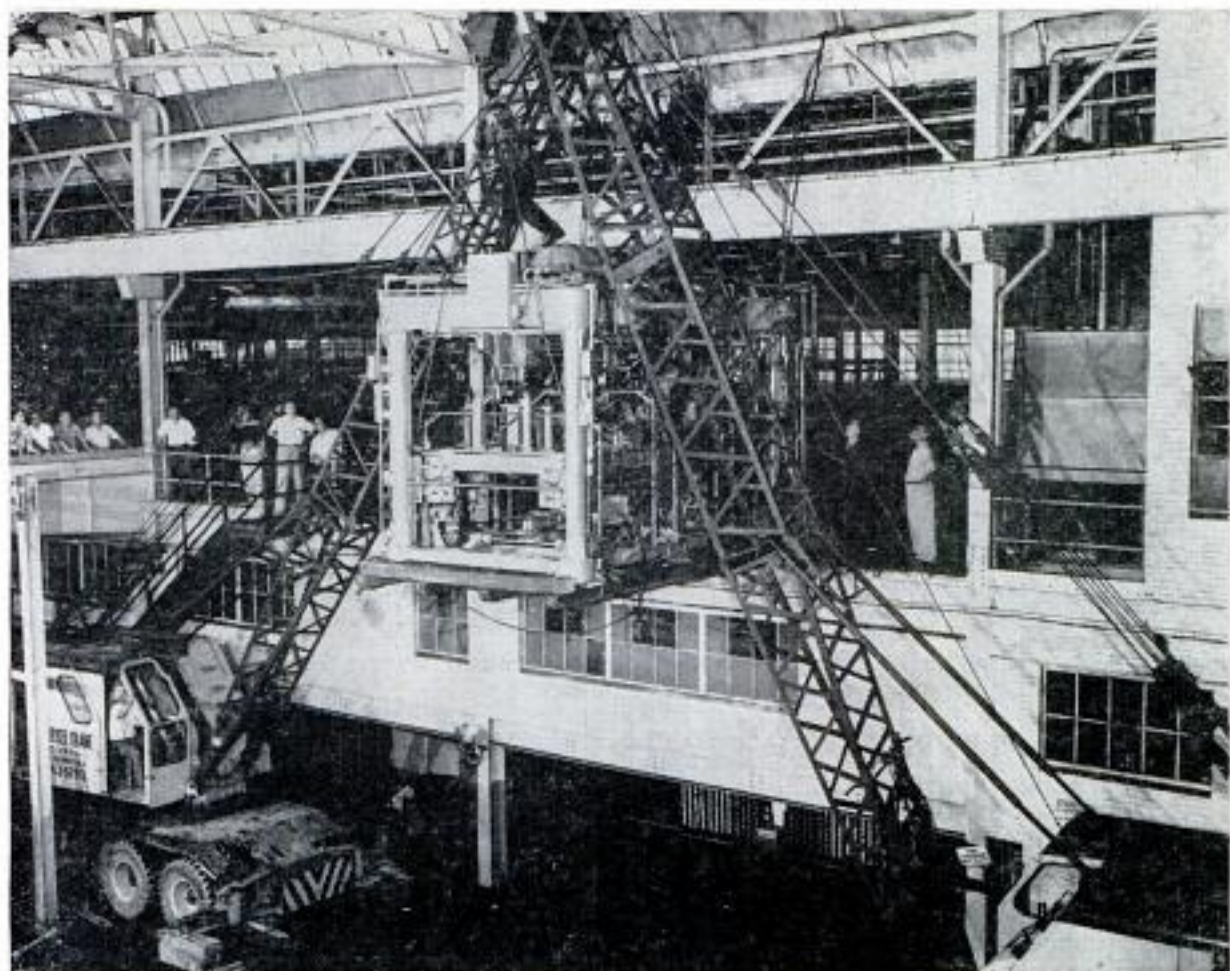

## Cranes Join to Load 20-Ton Welder

Cables strain as 20-ton welding machine is lowered by two cranes in the old plant

Heavy-duty cranes had all they could handle in a 20-ton welding machine that was taken from the second floor of Ford's Edgewater, N. J., assembly plant. The machine was loaded on a railroad flatcar for

the 26-mile trip to Ford's new plant at Mahwah, N. J. More than 100 moving vans and between 200 and 300 railroad cars were used to move equipment from the old plant. Biggest item was the welding machine.

## Electronic "Brain" For Supersonic Planes

Air Force planes operating at supersonic speeds may be equipped with a new electronic "brain" capable of doing 60,000 additions or subtractions in a second. The computer, known as Tradic, was developed at Bell Telephone Laboratories. In its final form it will probably occupy less than three cubic feet of space. The computer contains nearly 800 tiny transistors. Less than 100 watts of power will operate Tradic, which can run through 250 different steps of computation and come up with an answer in about  $\frac{1}{1000}$  second. The machine provides answers to problems of trigonometry by drawing dots on an oscilloscope in geometric patterns.

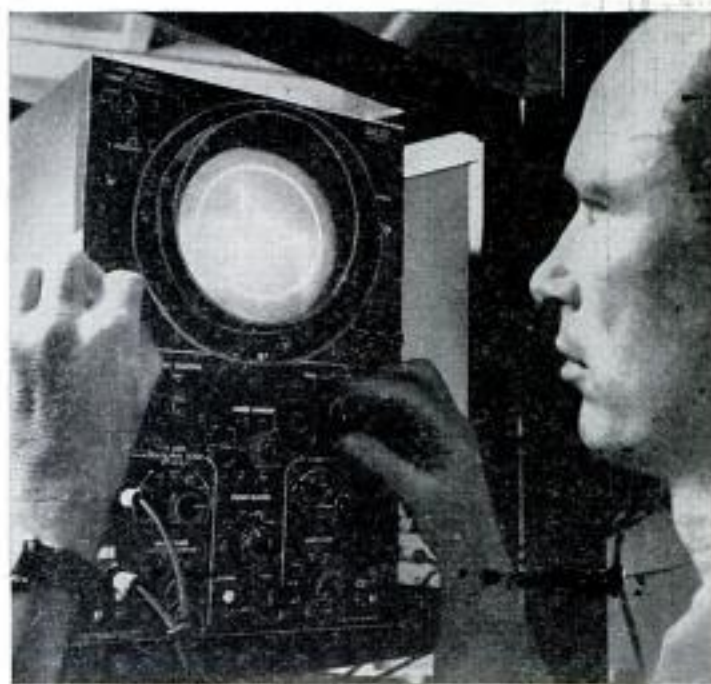

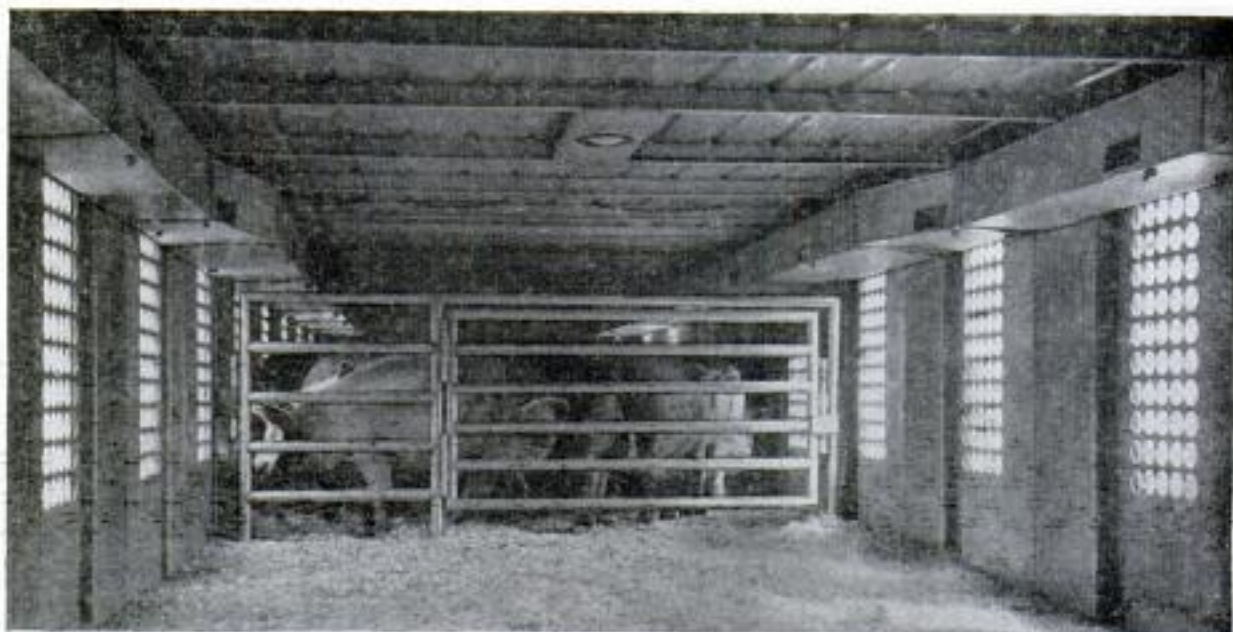

Double-decked, air-conditioned luxury liner transports hogs across western half of country in comfort

## Ham-on-the-Hoof Trailer

By B. F. Sylvester

**N**O MATTER what you've heard on the matter, a hog prefers to be clean. Furthermore, he has sensitive feelings that are easily hurt, can't stand cold, can't stand heat and is finicky about comfort. Edwin B. Hutton, a long-distance hauler from Boise, Idaho, heard about the hog's prima-donna temperament and decided that pampering him might be good business.

Hutton is now completing the first year's operation of a fancy, air-conditioned van liner for pigs, designed for pampering, which makes weekly trips from Omaha to the Pacific Coast. The van takes 152 slaughter hogs, averaging 215 pounds each, to San Francisco in 48 to 54 hours, as against rail time of 76 to 80 hours. Omaha sends 15,000 hogs a week to the West Coast, still mostly by rail. The truckers began to move in two years ago, and an increasing number of pigs are going that way.

Though summer temperatures run from 100 to 120 degrees for almost half the distance, no hog has died from heat in the van. The total death loss was three of undetermined cause in one shipment last fall. Don Diez, who buys for West Coast packers on the Omaha market, says a death loss of one hog in a freight car of 150 can be expected, as well as two or three cripples due to jamming around in the switchyards. Cripples are only occasional in the Hutton van.

Further, Diez asserts the weight shrinkage is about 6 percent as against 8 by rail; and the packer gets a 1½ to 2-percent

increase in marketable pork. Trucking effects a saving on feed-and-water stops at \$25 each, making the trip with one stop while the railroads take two.

Hutton's trailer, with an all-aluminum body, saves two tons in weight which is replaced profitably with hogs. The trailer is 36 feet long, more than 7 feet wide and stands 12 feet high—virtually a freight car on rubber. It has two decks, with a removable aluminum floor for the upper deck. There are 18 windows on each side and four on each end, each with 24 portholes.

Jack Sherwood, Denver electrical contractor worked out an air-conditioning system for the trailer. A 2500-watt power plant, a 30-gallon tank and pump are carried underneath the body to keep inside temperatures 15 degrees cooler than outside summer heat. An example of its usefulness is in Wyoming, where a through shipment of hogs cannot be unloaded without clearance from the governor. The problem of what to do with the load until repairs can be made would present a tough situation for a conventional truck. The driver of this truck has only to turn on the air conditioning until the truck is able to proceed.

The ham-on-the-hoof van liner is a \$34,000 job. The responsibility for getting it and \$6000 worth of butcher hogs halfway across the continent in summer heat or winter ice, every week in the year, falls on the shoulders of 220-pound Sewell Simmons and 140-pound Ronnie Hansen.

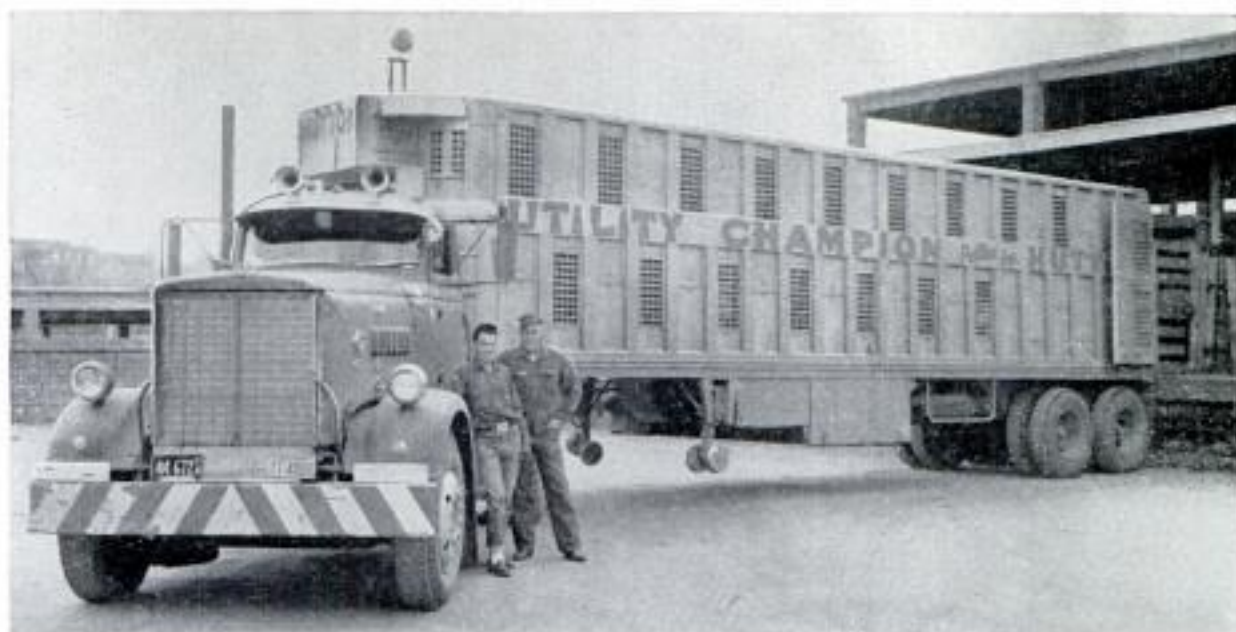

Van liner cost \$34,000 to build, and can haul \$6000 load of butcher hogs to West Coast markets per week

Simmons was not a trucker but a farmer when he joined up with Hutton. Hansen had only a bacon-and-pork-chop acquaintance with pigs. Hansen has the tough, diplomatic job of persuading the pigs to enter the trailer. He loads 152 hogs in 20 minutes.

Let us say Simmons and Hansen are taking a shipment to the Armour plant in San Francisco the last week of July. They spend three hours getting the van ready, bedding the floors with four inches of sawdust before backing it against a loading chute. Simmons takes the hogs from their pen and delivers them to Hansen who coaxes the animals into four compartments.

At one time, yard loaders and unloaders used prod poles and loud voices. A live-stock-conservation board has put a stop to that. Yelling gets them excited and off their feed. Punching with a pole produces blemishes and bruises which cut down the cash value. A man who made a study of the subject once figured it costs \$3.75 to kick a hog.

Simmons aims to leave at 4 p.m. to provide two cool nights and a half day of Nevada desert. He takes the first shift while Hansen enters a sleeper berth behind the driver's seat.

There is a halt near Columbus, Neb., for a required 75-mile stop, where Simmons looks at the hogs and checks the 18 tires.

The van reaches Grand Island, Neb., in four hours for a 15-minute fuel stop and to pick up sandwiches to eat on the way.

The hogs lie down in the sawdust and sleep all the way to Salt Lake City where they have a four-hour feed and water stop. The speed is 45-50 miles an hour in Nebraska and Wyoming and gets up to 55

beyond Salt Lake City where the drivers make time to beat the desert heat. They leave Salt Lake City about 10 o'clock at night and cover as much ground as possible before daylight. Arriving in Winnemucca, Nev., at six o'clock they are done with the desert in four hours on a wide, straight highway, reaching Reno at 10.

There are slowdowns, such as Sherman Hill in Wyoming, Echo Canyon in Utah and Donner Pass in California. The long ascent of Sherman Hill reduces speed to 35 miles per hour. The descent, about eight miles, into Laramie is a tricky business calling for speed of 10-15 miles per hour. Many a truck has been lost on the deceptively steep grade of Telephone Gulch. First thing a careless driver knows, he is rolling too fast and can't do anything about it. He tries the brakes, they heat up and burn out. Then he loses his gears and winds up in a ditch or against the mountain.

The toughest section is Donner Pass which rises sharply cutting speed to seven miles per hour and has all the weather from Alaska, Canada and the Northwest. This is concentrated trouble on 130 miles of mountain driving from Reno, Nev., to Auburn, Calif., which takes five hours.

Except for 40 miles of stoplights all the way in from Vallejo, the rest of the trip is a breeze. The van crosses the Oakland Bay bridge and skirts lower San Francisco to the Armour plant. After unloading the hogs, Simmons and Hansen spend time with hose, rags, soap and water in cleaning the trailer. They leave the truck to be serviced, except the brakes, which no one touches but Hansen. They seek out a truckers' hotel for a few hours' sleep before starting a return load to the Midwest. ★ ★ ★



Purdue expert erected this plastic greenhouse on his farm. Structure half this size can be built for \$75

## Plastic Replaces Glass in Low-Cost Greenhouse

YOU CAN GROW your own vegetables and even flowers this winter in a plastic-covered greenhouse that covers 400 square feet and costs only \$75 to build. Heating will add to the cost, but you may decide it's worth the expense to have blooms and fresh vegetables in midwinter. Designed at Purdue University, the back-yard greenhouse consists of a plastic cover stretched over a wooden framework of two-by-twos and two-by-fours. The framework is rigid, yet there are no shadow-casting cross braces. It is of truss design, with glued-and-

Plastic-covered swing-out windows provide ventilation for experimental greenhouse at Purdue University



nailed gusset plates at all joints in the trusses. The cover, which is replaced every year for about \$10, withstands heavy winds, hail, rain and snow. It is easily patched. The plastic retains moisture exceedingly well, which makes for less watering. Because the covering is slightly opaque, heat from the sun does not build up in the plastic greenhouse as much as it does in the conventional hothouse. Swingout windows made of plastic-covered wooden frames are opened for short periods every day or so to ventilate the building.

Two-by-fours and two-by-twos make up simple framework of greenhouse. Braces at joints give strength

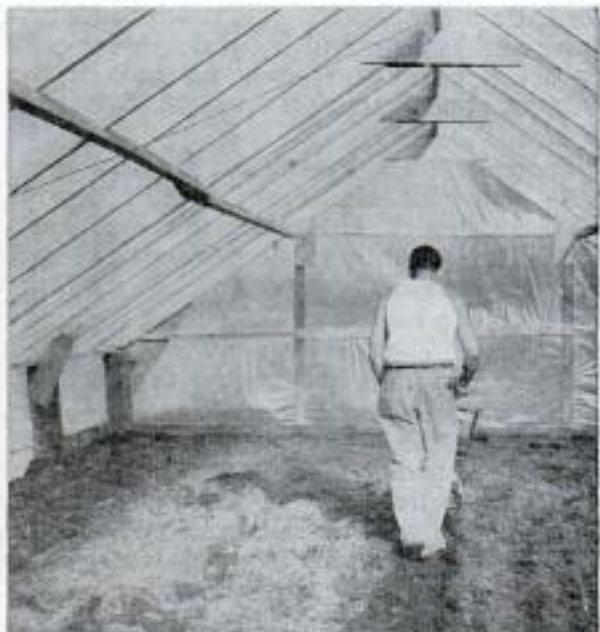

# Shocked Sharks

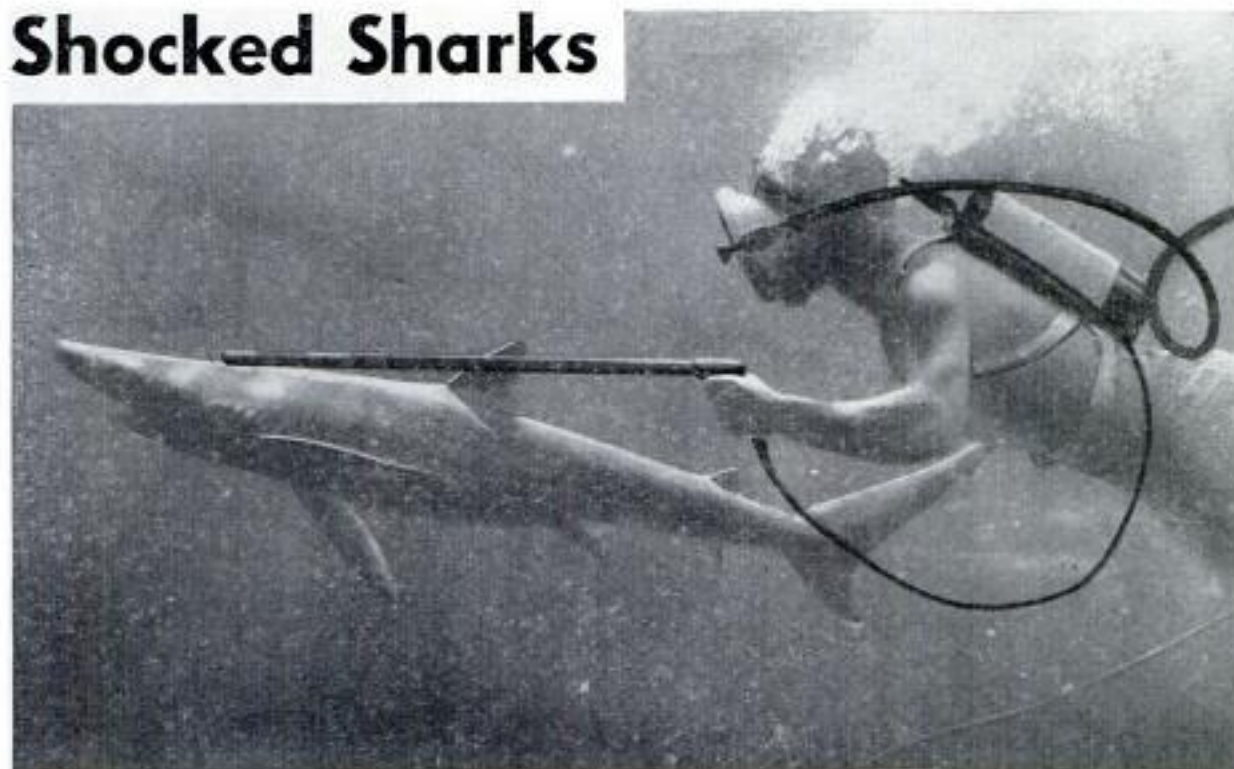

Shocking news for sharks, barracudas, sting rays and other undersea creatures that frighten skin divers is the development of an electronic shark repeller, a wand which generates an electrical beam to send the fish scurrying for less-populated waters. The wand consists of a watertight unit housing an electrode which releases

directional electrical waves when a trigger switch is pulled. The diver remains in a neutral zone while the electrified zone is adjacent to the end of the wand. Fish retreat the moment they come in contact with the electrified zone. The repeller was designed for skin divers, frogmen, life-raft survivors and scientists.

## "Saucers" Strapped to Swimmer's Hands Increase His Speed

Swimmers can now boost their speed by wearing paddles on their hands as well as fins on their feet. The saucer-shaped paddles are strapped on the backs of the hands,

leaving the fingers free for grasping. According to the inventor, the saucers boost a swimmer's speed 25 percent by increasing the amount of water he can push.



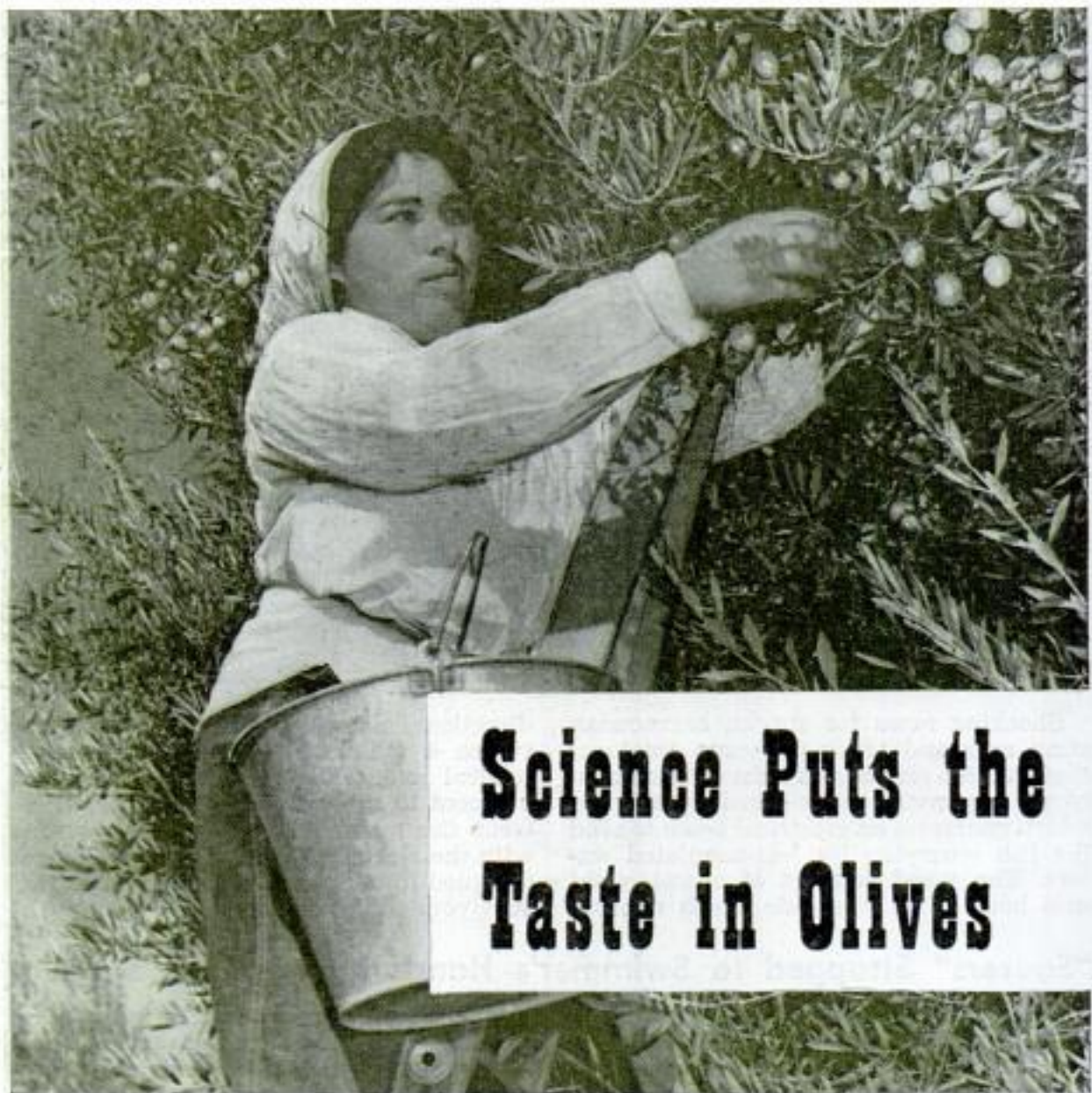

## Science Puts the Taste in Olives

By Jack B. Kemmerer

**T**HOUGH OLIVES ARE KNOWN and eaten throughout the civilized world, few persons, aside from those living in olive-producing countries, know that olives undergo extensive treatments before they are ready for the table. In fact, when picked they are bitter as gall, and California olive growers delight in offering the unwary tourist a handful of the luscious-appearing fruit fresh off the tree.

Olives contain an extremely bitter substance that must be removed before the fruit is edible. Contrary to the condition existing in most fruits, the bitterness remains in all stages of development in the olive.

However, even people of ancient times knew how to remove this extreme bitterness, and the olive has played an important role in the lives of many people. Its daily

use in the eastern part of the world is so widespread that in Spain olive oil is known as the "poor man's butter." A Spanish peasant often makes his lunch of a small loaf of bread which has been liberally soaked with olive oil.

The olive, oldest fruit known to mankind, dates back to and even before the beginning of recorded history. It is known to have existed for more than 4000 years and received frequent mention in the Bible.

Olives made their appearance in the New World through groves planted by Spanish missionaries in Mexico and South America. The Franciscan missionaries introduced the fruit to California when they established their first mission at San Diego in 1769.

As the missions were extended up the length of California the Franciscans took





**Avalanche of green olives pours from mobile bin into big tank where bitterness is removed before pickling**

the olive along and planted orchards at each new site. The padres and others who planted olives in the early days had but one thought in mind—olive oil. The ripe, canned olive, which forms the basis of the California industry today, was not then known.

Most of the Franciscan fathers were from Spain and Italy and familiar with the pickled Spanish olive of their homelands. Numerous attempts were made to duplicate this prized delicacy in California but their efforts were not highly successful at that time.

**Acres of barrels of Spanish-type green olives are left to ferment in the warm sun for about six months**

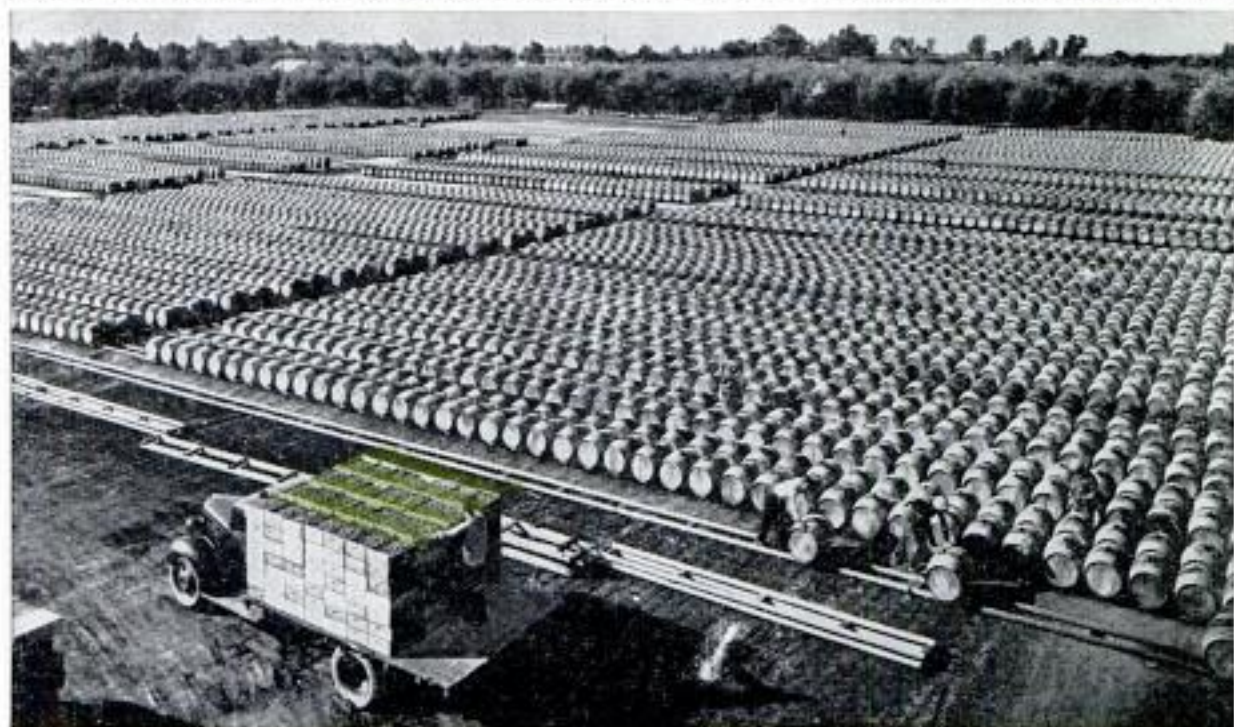



Green olives are pumped from washing vats into 50-gallon barrels and covered with a weak brine solution

These ripe olives are being moved by air pump from one vat to another. Pump protects fruit from damage



Eventually, someone found the fruit of the olive tree could be permitted to ripen fully before picking and curing. This was never attempted in the old countries because of a fruit pest that destroyed olives if they were allowed to remain on the tree until ripe. A simple method of treating the olives to completely remove the bitterness laid the foundation for the ripe-olive industry which flourishes in California today.

This new product was unique; there was no other olive like it in all the world. It was not cured in salt and it had no bitterness whatever; on the contrary, the ripe olive possessed a smooth, oily and nutlike flavor. By 1910 the open cask of ripe olives was a familiar seasonal item in all general stores.

Many people took part in the discovery that gradually changed the olive tree from an oil well to a food factory. Frederic T. Bioletti, a scientist at the University of California, contributed greatly to the field of olive culture and curing through extensive investigations into olive spoilage.

Shortly thereafter, Mrs. Freda Ehamnn, pioneer olive grower, discovered a method of sealing olives in cans and then steaming the cans at high temperature. About the same time, a retired San Diego sea captain, C. M. Gifford, also found that he could pack ripe olives in cans and the olive industry was off to a new start.

Ripe-olive processing and canning is a simple and yet complex operation. Let's take a trip through the plant of the Lindsay Ripe Olive Company, Lindsay, Calif.,

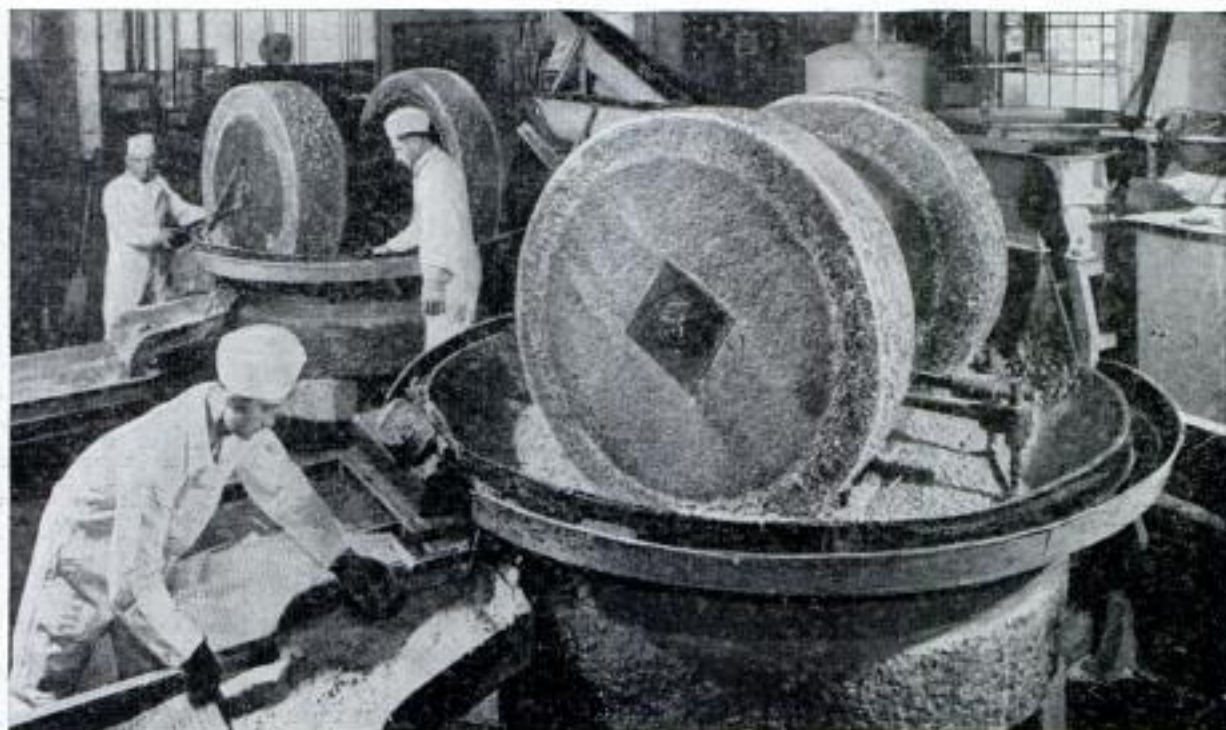

Stone wheels weighing 2500 pounds each grind olives (pits and all) into mash from which oil is pressed

world's largest olive packer. Lindsay's chief chemist, J. R. Webster, is a well-known expert in the field with many years of olive experience.

The olive-harvesting season begins in September and runs through October with as much as 270 tons of fresh fruit received at the plant in a single day. Unlike other fruits, however, olives can be stored and kept fresh in a light-brine solution for as long as a year without damage to the fruit.

Olives arrive at the plant in lugs holding

35 to 40 pounds which are placed on a conveyor which automatically dumps the fruit into a deleafer. The olives roll onto the sorting belt where clusters are broken up and twigs and leaves removed.

Leaving the sorting table the olives pass through an automatic grader which separates them according to size. The smallest olives drop into mobile bins for transfer to the Spanish green-olive process. The remaining fruit moves through flumes to

(Continued to page 240)

Ripe-olive processing vats expose fruit to air which oxidizes olives and turns them black in 24 hours

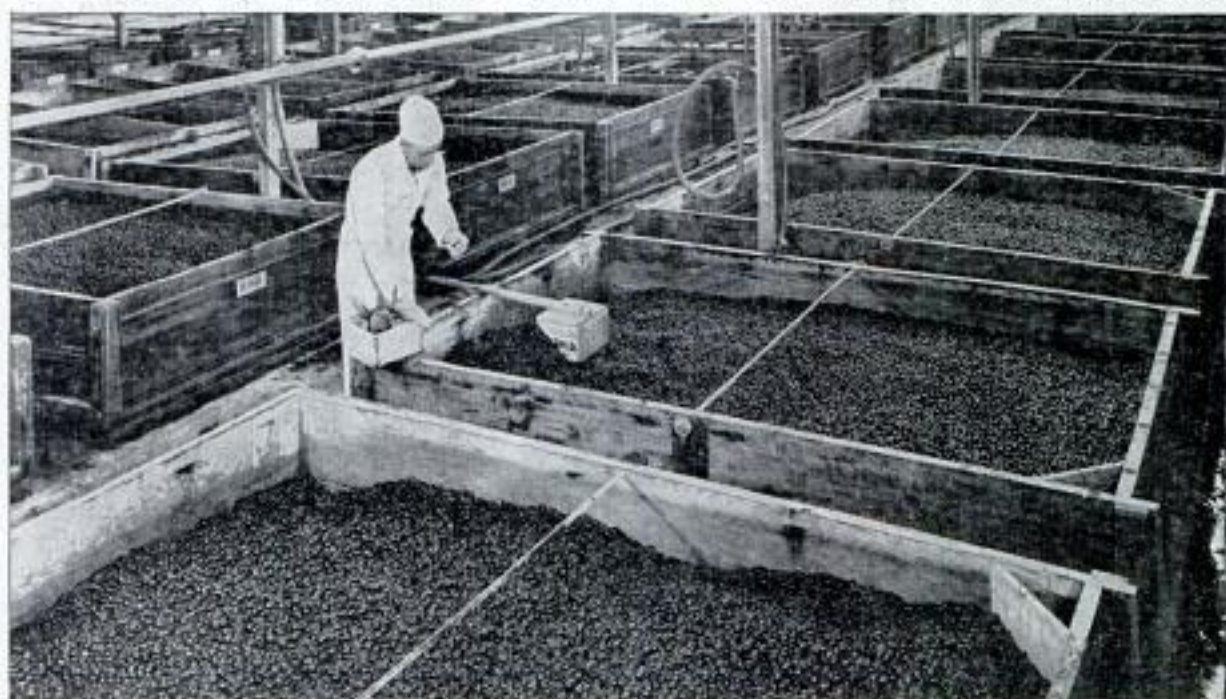

## Metal Hand for Holding Tools Restores Proficiency of Amputee



Inventor Roberts, right, looks on as Travis operates mechanical hand to tighten bolts

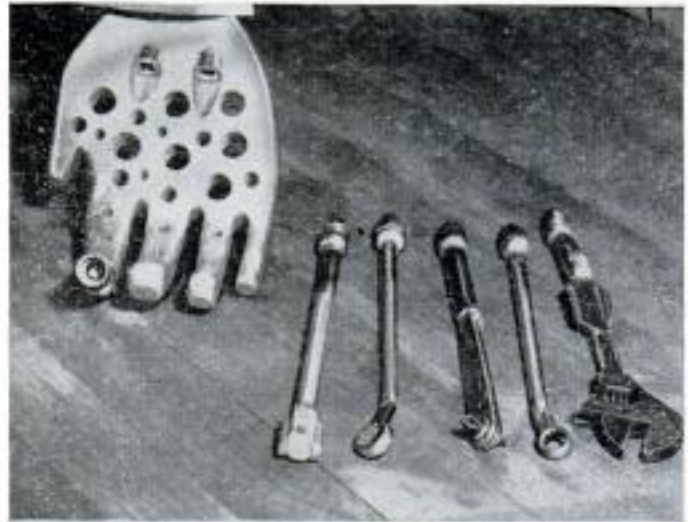

Perforations in the lightweight metal hand hold variety of tools adapted for the purpose. "Fingers" hold tools steady

S/Sgt. Herman Roberts, a machinist at Altus Air Force Base, Okla., is not the man to leave a fellow worker without proper tools. Learning about the handicap under which James H. Travis, a one-armed mechanic at the same base, worked, Roberts set out to ease the problem. He designed and turned out a metal hand with built-in sockets and fingers so

arranged that hand tools, such as wrenches and screwdrivers, could be grasped firmly. He then redesigned and built tools that best fit the artificial hand. Travis says that Roberts' invention aids him materially in his work. Now he can tighten nuts and bolts, a task that was formerly impossible for him. Roberts is working on a new hand lighter than the original 1½-pound model.



### Plate-Glass Lifter Relies on Suction

Workers installing a new plate-glass window on a Paris shop don't have to worry about dropping and breaking the huge sheet. An octopuslike tool takes over the job. Four big suction cups attached to metal arms hold the glass while a crane lifts it into place.

### Puffed-Wheat Wallboard

Puffed wheat compressed to about a quarter of its volume under heat and bonded with plastics forms a panel that rivals plywood and wallboard. Inventor of the new construction material is Washington, D. C., research scientist Stanley F. Reed, who says that it is light, strong, weatherproof and insulating, and could sell for 30 to 40 percent less than competing products. It contains chemicals which make it proof against rodents and termites and can be faced with metal, wood or plastics. Reed developed the panel to answer the wheat-surplus problem.



Movie criminal's photo pulled from files closely matches composite made under direction of witness



Witness tells operator which facial segments match those of criminal. This is a scene from new movie

## Projector 'Draws' Face

WITNESSES OF A CRIME can describe the appearance of the criminal while a police detective makes up a picture of him with a new projecting instrument. The unit holds various slides with different-shaped noses, lips and other facial segments. A composite of different facial segments projected on the screen becomes a picture of the criminal. The police then check through their "mug" files to obtain photos of criminals that closely match the composite on the screen. Used by Los Angeles police, the unit has also caught the fancy of Hollywood script writers. It will be shown in use in a new movie, *The Steel Jungle*.





Bandage is sprayed on affected area. Right, old method of covering burns requires doctor and armload of bandages. For the same area, new method requires only two Aerosol bombs

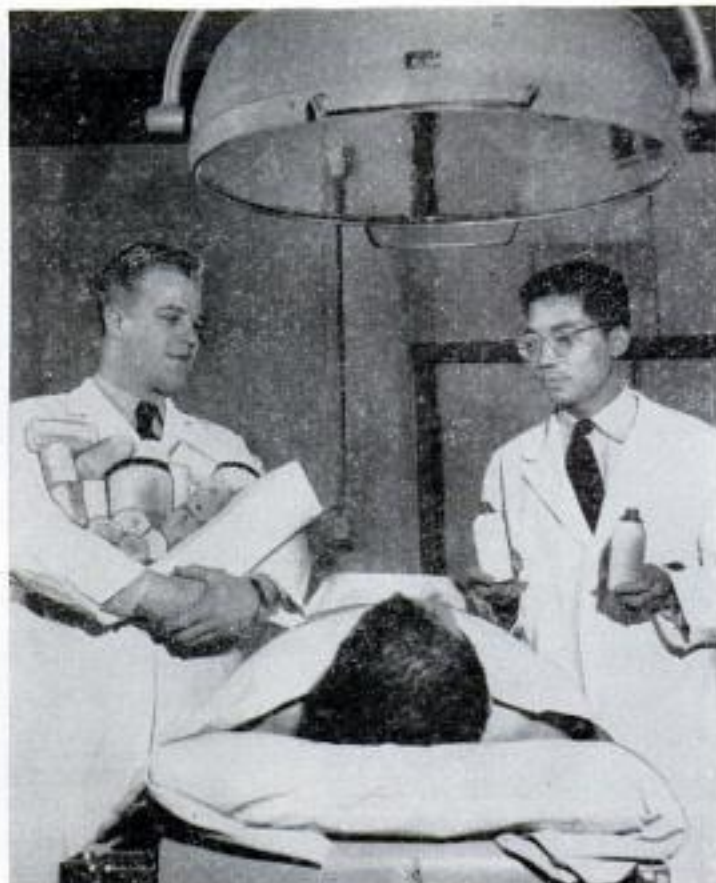

## Spray-on Plastic Bandage Provides "Window" for Inspection

Aerosol bombs now have invaded the field of medical bandaging. A new type of bandage is sprayed on the wound. The bandaging material is a polyvinyl plastic which quickly solidifies to form a coating over the damaged tissue. The new dressing, particularly useful in bandaging burns, can be applied much faster than ordinary bandages, can be used by untrained personnel and is applicable to parts of the body where pressure bandages can't be used. It is transparent and therefore allows inspec-

tion of the damaged tissue without removal of the dressing, is flexible so it can be applied to joints, seals out bacteria and seals in body fluids. The dressing is of special interest to civil-defense authorities, as it requires little storage room and can be applied quickly by anyone. To bandage a 50-percent body burn by conventional methods requires a doctor, 2½ pounds of ointment and 120 yards of bandage. The same area can be bandaged by two medical corpsmen with four of the new bombs.



### Auto Burglar Alarm Set Off By Pressure on Front Seat

Would-be auto thieves are frightened away by a burglar alarm that is attached to the springs of a car's front seat. Any pressure on the seat turns on the auto horn, which continues to blast until the intruder has left. The device then resets itself for the next time. A control switch, clamped to the car dash, connects the detector to the horn. When the owner leaves his car, he sets the control switch to operate the alarm. The alarm fits all models and can be removed easily for quick installation in another car.

### Elevator "Phantom" Announces Floors

"Phantom" voices in push-button elevators designed for department-store use will announce the floors and the wares to be obtained there, ask shoppers to step to the rear and admonish those who block the doors. Hidden loudspeakers in each car will be connected to a tape play-back machine. The unit is recorded and synchronized with car movement.

## Roof-Mounted Auto Radio Has Many Features

IF YOU OWN a convertible, this is definitely not the radio for you. But, if you've been wanting to install a radio in a truck, for example, and don't have enough room on your dashboard, here's the answer to your problem. The radio isn't restricted to trucks, however, since its many features make it ideally suited for installation in most station wagons, passenger cars and cabin cruisers.

Anyone planning an automobile-radio installation is primarily interested in three things: Initial cost, performance and upkeep. In all three fields, this setup is claimed to be superior to conventional, dash-mounted jobs. Weighing less than 7 pounds, including antenna, the radio is available for both 6 and 12-volt operation for about \$55. It is easily installed by drilling a  $\frac{5}{8}$ -inch hole through the roof and connecting a single wire from the radio to the ignition switch.

Performancewise, the overhead, air-

plane-style mounting of this six-tube, slug-tuned radio is said to provide remarkable freedom from static, engine and road noises. The in-line position of the speaker permits more sound to reach the listener, so that the volume need not be turned up to the point of distortion, even when driving at a good clip. A fixed-length antenna, connected to the receiver by a 5-in. lead, permits proper matching of the antenna to the receiver under all conditions, thus increasing the set's sensitivity.

As to the upkeep, it is quite conceivable that the vibrationproof rubber shock mountings and the excellent ventilation will considerably increase the life of the various parts.

When service is required, you don't have to be a contortionist to get at the radio. Nor do you have to pay a serviceman to remove and reinstall it. Merely take off four easily accessible wing nuts, and the radio is ready for the service bench.

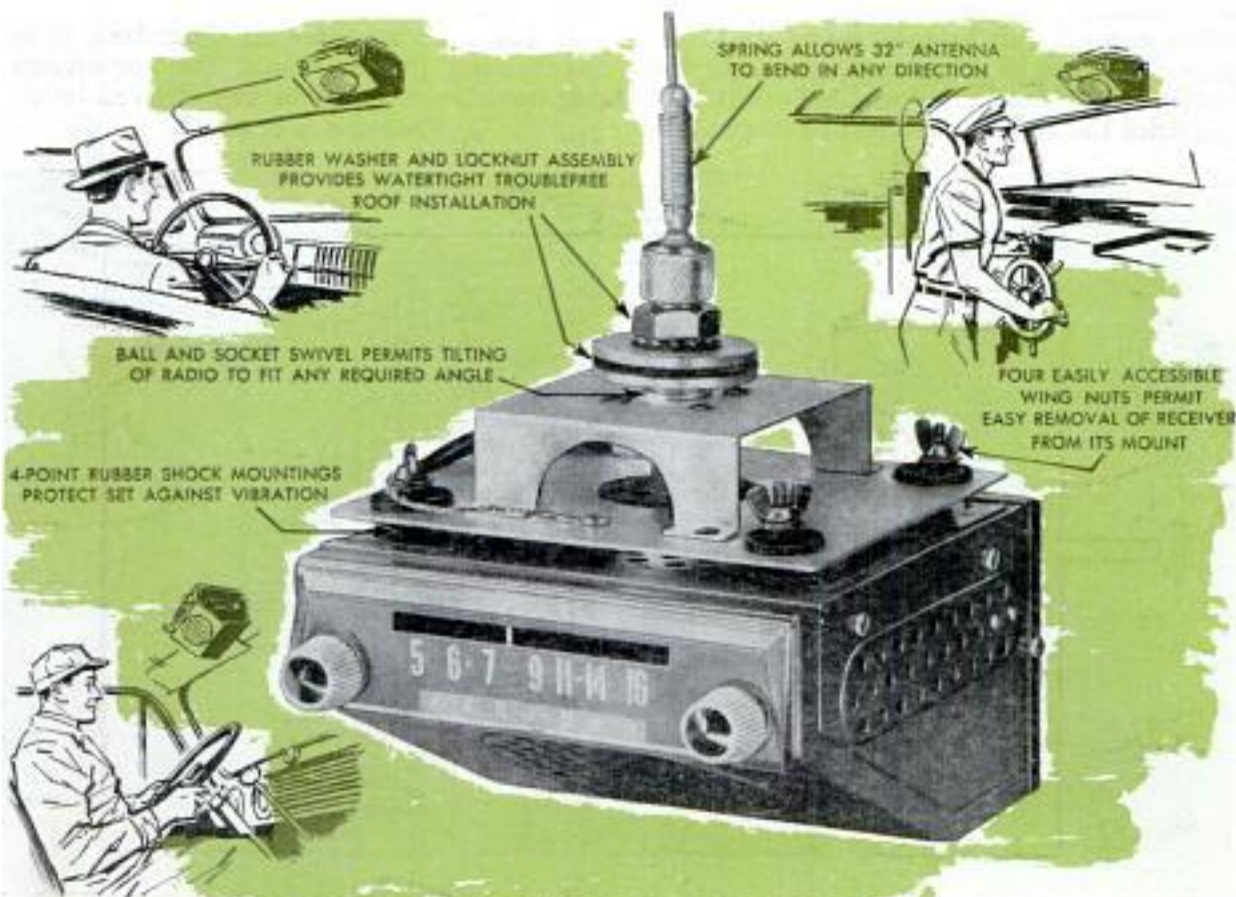

# ELECTRONIC SERVANT

## Works for Pennies a Week

By John R. Satter

**T**HIS VERSATILE electronic unit has numerous applications around the home, shop or office. It is a light-operated photoelectric switch which can automatically activate any electric device, such as lights, bells, chimes or motors with the coming of darkness or by interrupting a light beam.

This particular model, which was built by the author in one evening, has been turning the hall lights of a four-family house on and off much more efficiently than the owner possibly could—as proven by the reduced electric bills.

The parts for building the unit should cost about \$10.00, including any BX wiring to the fuse box if that type of installation is desired. They are available from stock at any large radio distributor or mail-order house.

The simplicity of the construction can be seen from the schematic diagram below, and from the simplified wiring diagram on the opposite page. Since the layout of parts is not at all critical, the unit can be built on any type of chassis. Even a wooden box is satisfactory. If desired, the entire unit, tubes and all, can be completely enclosed, provided some holes are drilled into the enclosure for ventilation and to permit light to strike the light-sensitive phototube.

The model is so designed that an external device is activated when the light striking the phototube is removed or dimmed. In the event of tube or parts failure within the switch, the controlled device will be activated until it is shut off manually.

The sensitivity of the unit is adjusted by means of the potentiometer R4. The setting of this control determines at what level of illumination the controlled device will be turned on. To test the operation of the photoelectric switch, after the wiring has been completed, the following procedure can be used.

1. Rotate the sensitivity control to the approximate mid-point position and plug the line cord of a lamp into socket S1. Turn the lamp on and apply power to the photoelectric switch.

2. As soon as power is applied, the lamp should light and remain lit for about 30 seconds (long enough for the tube in the unit to warm up). Then it will go out.

3. Make the room as dark as possible and rotate the sensitivity control until the lamp is again lit.

If the unit operates as described, it is functioning properly and the sensitivity can now be adjusted to any desired level.

(Continued to page 250)

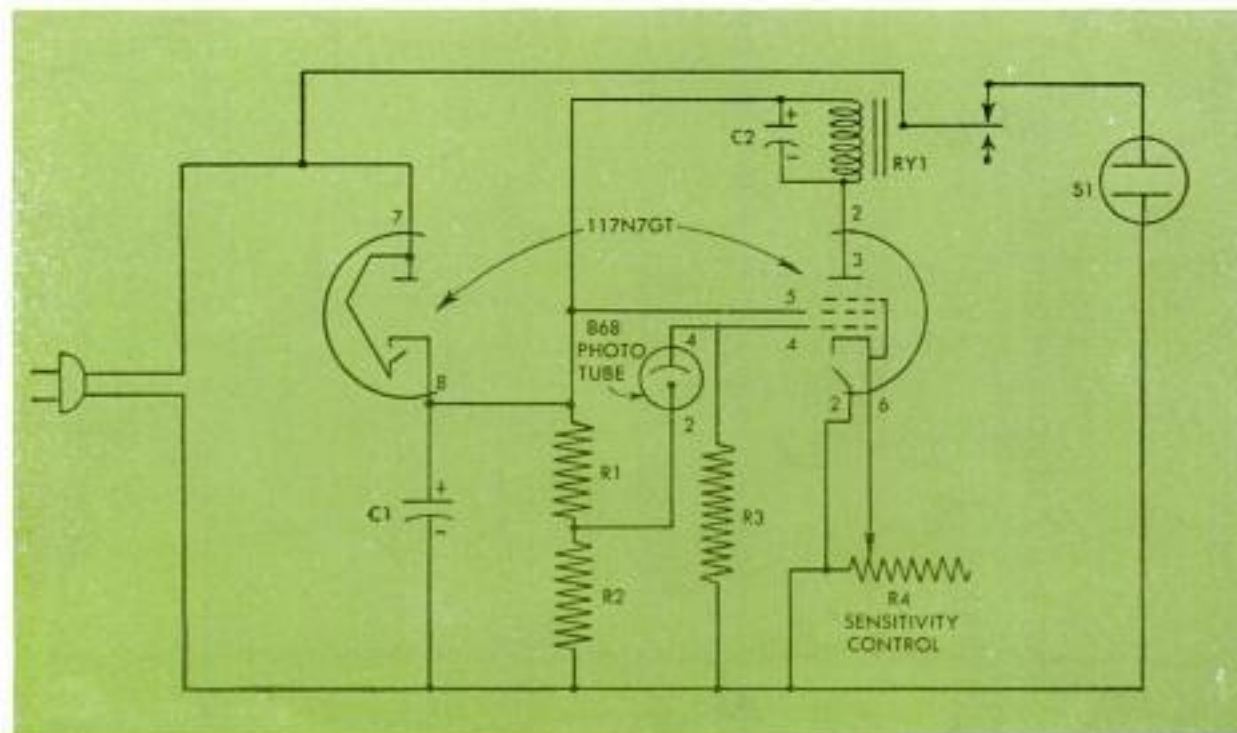



## LIST OF MATERIALS

R1, R2—1 megohm, 1 watt resistors  
 R3—4.7 megohm, 1 watt resistor  
 R4—5000-ohm control, Ohmite CU5021 or equivalent  
 C1—40 mfd. 150 v. elec.  
 C2—10 mfd. 50 v. elec.  
 RY1—5000-ohm plate-circuit relay, Potter Brumfield type LS5  
 S1—A.c. receptacle, Amphenol 61-F1  
 117N7GT Tube  
 868 Phototube  
 Metal case, 4 x 4 x 2 in., Bud CU-883  
 4-prong tube socket, Amphenol 78S4  
 Octal tube socket, Amphenol 88-8  
 Line cord and plug  
 Rubber grommet to fit  $\frac{3}{8}$ " hole  
 Assorted screws, nuts, hookup wire, solder (rosin core)

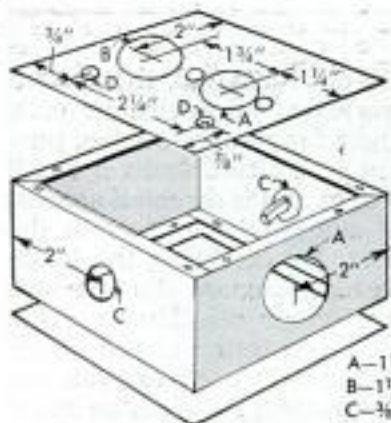

A—1 1/4" HOLE  
 B—1 1/4" HOLE  
 C—3/8" HOLE  
 D—TO CLEAR #6 SCREW

Above: Photo showing tubes, socket S1 and control R4. Left: Chassis layout with dimensions and hole sizes. Below: Diagram showing location of parts

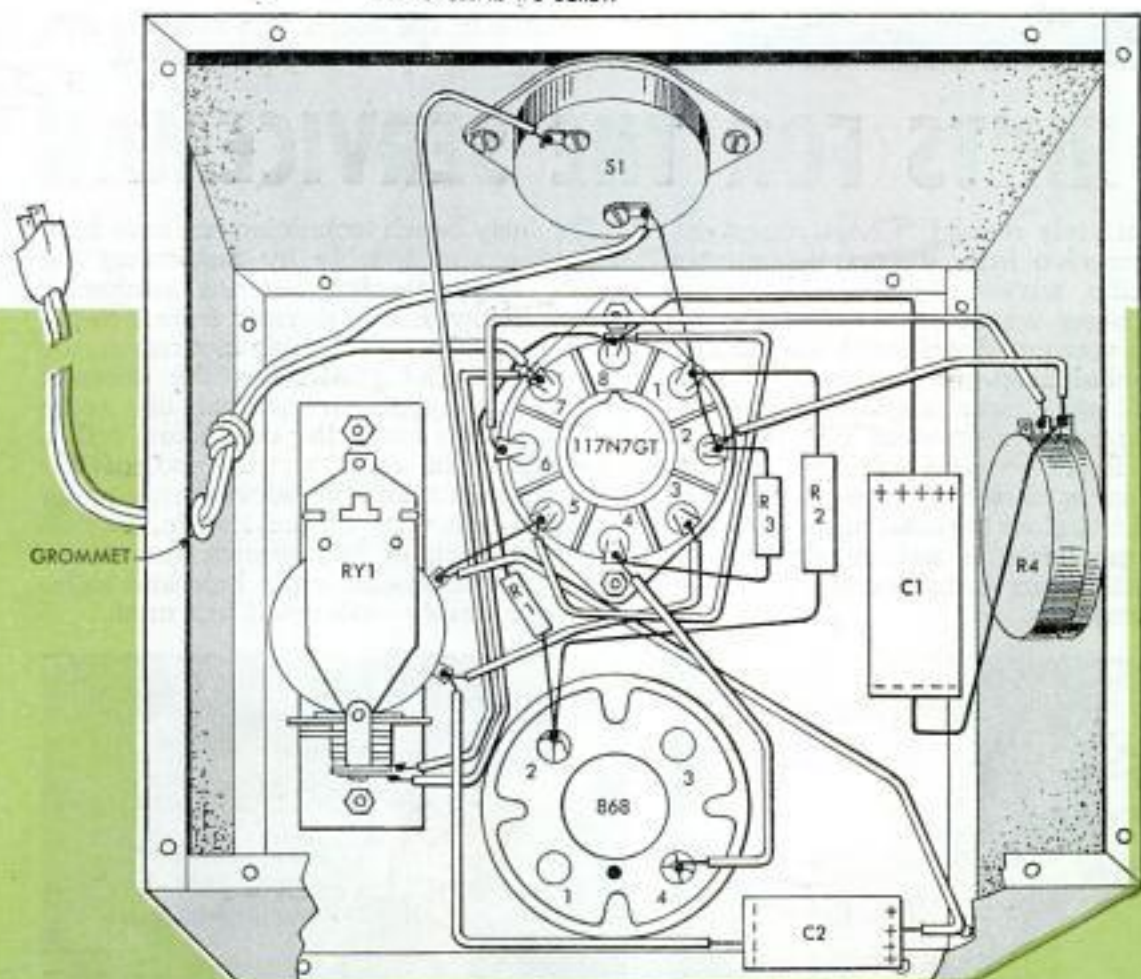

# REMOTE CONTROL FOR TELEVISION



Provisions for remote control receive special emphasis in many new television receivers. At left, a control called Tun-O-Magic is used to turn the receiver on and off, and switch channels from a remote location. The device consists of a cylindrical control attached to a 20-foot cable. Channel switching is accomplished by pushing a button on top of the control. A switch on the side permits the receiver to be turned on or off. The device operates a rotary solenoid attached to the tuner of the set.



Somewhat less conventional, the system at left uses a series of photoelectric cells and a beam of light for remote-control purposes. The beam is emitted from a small pistol-shaped gadget and is directed against one of the four sensitive windows in the corners of the set. By directing the beam to the lower left hand corner, the operator can turn the set on or off. The two top windows control the rotation of the tuner, while the lower right is used to tune out commercials. The system requires no interconnecting wires and can be used from anywhere in the room. The receiver may also be manually operated, if desired.

# TV HINTS FOR THE SERVICEMAN

Appropriately named "Ghost Arrester," the inexpensive little gadget below may provide the answer to those annoying double images which are troubling many television viewers. Specifically designed to correct unbalanced-line conditions, the arrester will not eliminate ghosts due to improper antenna alignment or reflected signals. However, it is effective against double images caused by running the television lead-in close to metal pipes and steel building materials, as well as other conditions causing an unbalanced line. It is easily installed.

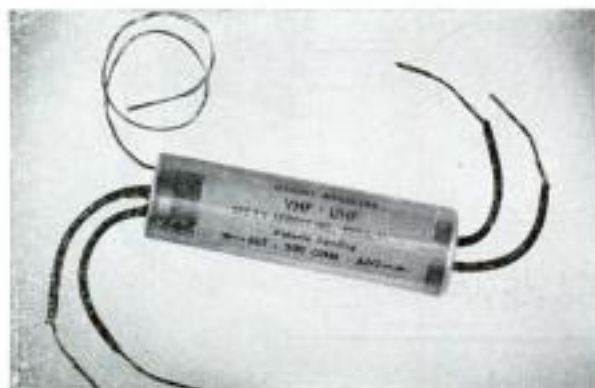

The busy bench technician can save himself time and trouble by fashioning the handy spring-tension antenna connector shown below. Easily devised from two paper clips and a spring-type clothespin, the connector quickly attaches the antenna lead-in to the antenna terminals of a radio or TV set. To make the connector, drill a small hole in each handle end of the clothespin. Attach a metal washer, a paper clip and one wire of the lead-in, in that order, to each of two screws. Insert one screw into each clothespin hole and tighten the assembly with small hex nuts.

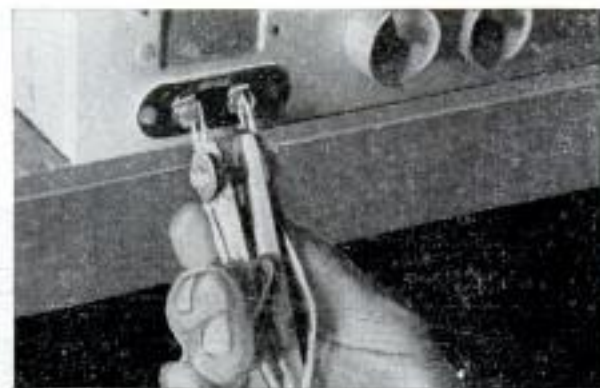

the

POPULAR  
MECHANICS

## CRAFTSMAN

By Anthony Tubacki

A TYPEWRITER DESK →

A SEWING CABINET ↓



## Save Space With This FAMILY DESK

**O**PEN THE DOOR on one side of this attractive kneehole writing desk and out comes a sewing machine. Open the opposite door and out comes a typewriter. What could be more ideal for family use in a small home, especially an apartment, where every foot of space counts? There are the usual number of drawers for storage and the center kneehole drawer is fitted with dividers for thread, buttons and other sewing needs.

The original desk was made of birch and oak, the oak being used for parts which are not exposed. Veneer-faced hardwood plywood is used for the wide side and back pieces. The dimensions given on the two following pages are such as to accommodate any standard portable typewriter and electric sewing machine. If an upright-style typewriter is to be used, the length of the desk can be altered to suit. Basically, the

desk consists of two pedestals which, except for the sliding mechanisms, are made alike. The square members that form the posts are grooved as indicated, keeping in mind that right and left-hand members must be cut. Panels of 1/4-in. plywood fit the grooves in the posts. These need not be the full length of the posts, only long enough to assure that the mitered base members will overlap the lower edges. The side assemblies of each pedestal are joined together with three drawer frames which are installed before the mitered base members are added.

Each drawer frame is fitted with a plywood dust panel, and the two lower frames in each pedestal are fitted with a drawer runner to slide in a guide fastened to the underside of each drawer. The special hinges which are used to bring the inner face of the doors nearly flush with the







Both portable typewriter and sewing machine hang inside their respective compartments and to raise them to a working position, you first pull them out to engage the track on the door and then swing them up

inner faces of the posts when the doors are open, are set in notches  $\frac{3}{16}$  in. wide and 1 in. deep. The detail to the right of Fig. 1 shows how the hinges are installed in the posts. The hinge notches can be formed by drilling a series of adjacent holes and cleaning out the waste with a sharp chisel. The hinges are simply surface-mounted on the doors. The base members, by the way, are added to the four sides of each pedestal and scroll-cut only across the front. The squared drawing will permit a full-size pattern to be made for the scroll.

The pedestals are joined together with two rails plus a drawer frame. The rails are shown below Fig. 4, rail B differing from rail A in that it is wider at the center to accommodate a  $\frac{1}{4}$ -in. groove for the back panel. The rails are notched as indicated to fit around the posts and are doweled and screwed to them, the rails being spaced 3 in. apart. The drawer frame is made like the others and is doweled to the posts at the front corners and further braced by two scroll-cut brackets. At the rear, the frame rests on the lower rail. Adding the plywood panel to the back of the center-drawer compartment and doweled the desk top to the posts completes the desk proper. The top, incidentally, is made of solid stock, edge-glued to the required width, and shaped around the four edges. An alternate method of forming the top is

to glue and nail a suitable stock molding to the edges of a panel of  $\frac{3}{4}$ -in. plywood, mitering the molding at the corners. The desk top is attached with short  $\frac{1}{4}$ -in. dowels, a dowel being placed in the top of each post.

Figs. 2 and 7 detail the sliding mechanism for the typewriter shelf. As shown, two grooved pieces which are fastened permanently to the front and rear posts, provide a track for a third sliding member that carries the hinged typewriter shelf. The latter assembly slides forward on another grooved member which is mounted in line and screwed to the door. Note in Fig. 7 that the sliding member is grooved on the back side as shown to clear the hinge leaf. A short pin inserted in the groove of the track attached to the door will provide a stop for the slide. A spring latch attached to the facing post supports the typewriter shelf in a raised position. The typewriter is bolted securely to the shelf.

Figs. 3, 4 and 6 detail the sliding and pivoting mechanism for the sewing machine. In some respects it is similar to the slide for the typewriter in that it, too, slides out on a track attached to the door. The original wooden base of the machine is used and pivoted on a  $\frac{1}{2}$ -in. rod in such a way as to bring the top of it flush with the desk top when the machine is swung up. It is held in this position by a hinged support. Note the section of molding which is

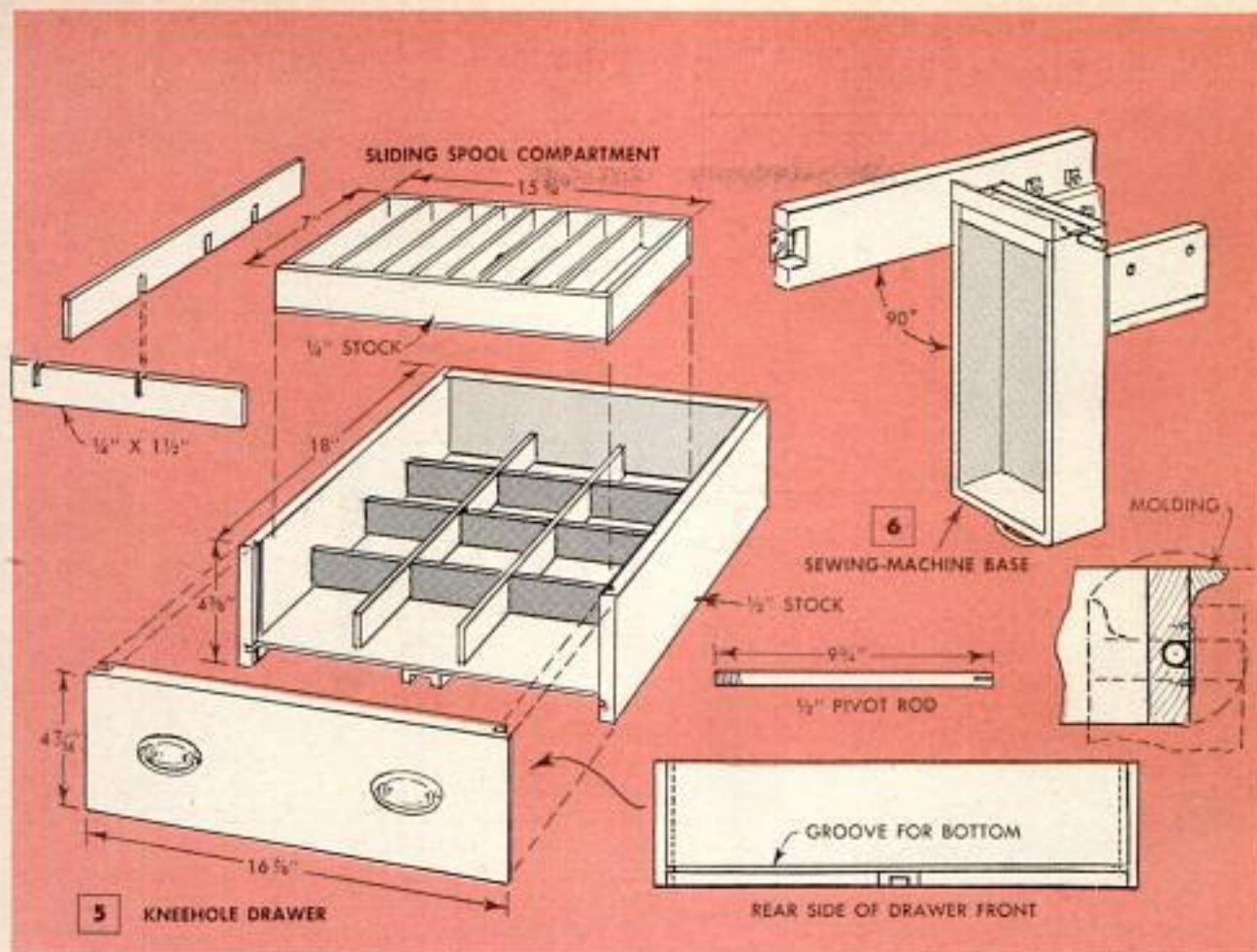

attached to the edge of the machine base and which is shaped to conform to the shaped edge of the desk top. A sliding-bolt gate latch attached to the free end of the support engages a hole in the post. A hole is provided in the bottom of the sewing-machine base for the cord which is run to a duplex receptacle mounted in the back of the desk. This in turn is wired to an

extension cord. This makes it handy to plug in a desk lamp, radio or other appliance. Fig. 8 shows how a drawer is put together. Two drawers are used in each pedestal. The doors are made to look like drawers by running saw cuts across the front to represent drawer rails and each dummy drawer is fitted with the same type pull as used on the other drawers. ★ ★ ★

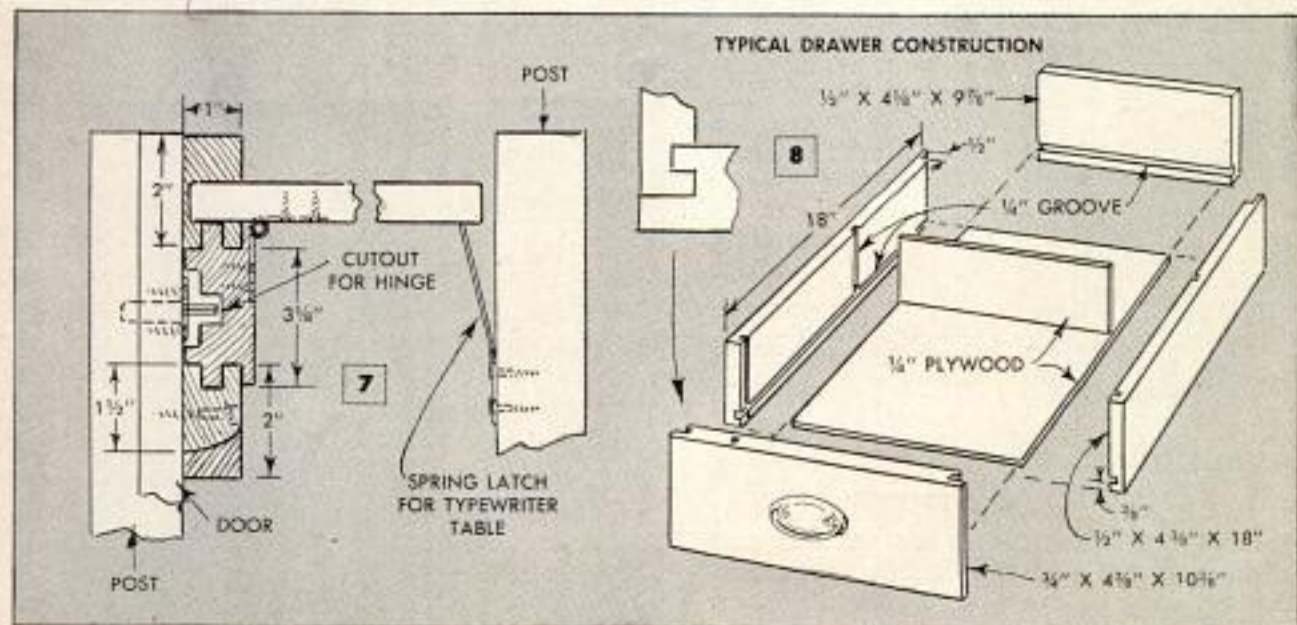

## Magnet Holds Ruling Pens On Slanted Drawing Board

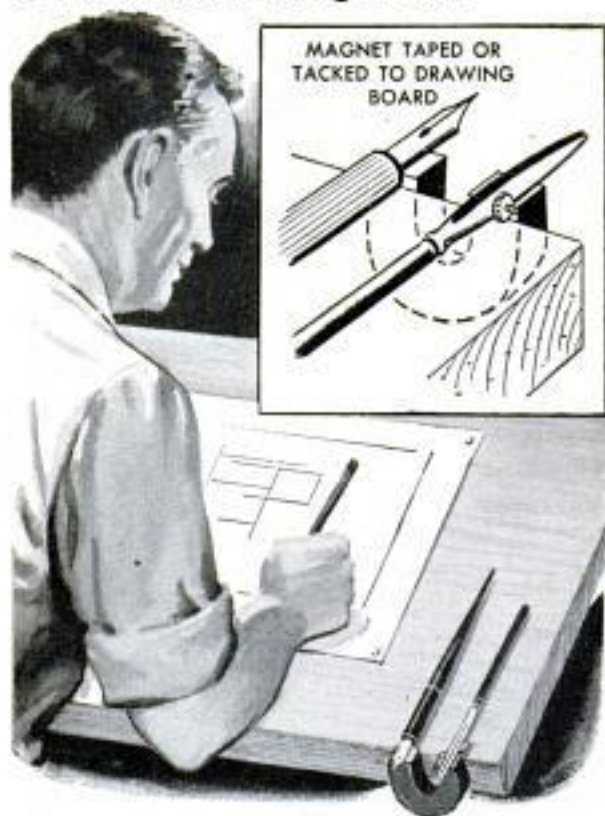

Ruling and lettering pens may be held on a slanted drawing board by using a small permanent magnet taped or tacked to the edge of the board. The magnet is located on the top or bottom edge of the board, depending on personal preference, so the steel penpoints contact it. Even wet pens can be placed on the board with no worry about them rolling off onto the floor.

Leonard W. Mitchell, Marion, Ky.

## Clear Chips From Blind Holes With Battery-Water Syringe



Instead of risking eye injury by blowing into a blind hole to clear it of drill chips, use a battery-water syringe. The long tube of the syringe will reach into awkward locations and to the bottoms of deep holes.

## Faucets and Drain at Opposite Ends Keep Bathtub Cleaner

When the bathtub was installed in our new home, we had the faucets placed at one end and the drain placed at the other. We find that the tub is now much easier

to clean, for when the clean water is let into the tub it forces the dirty water down the sloping tub bottom to the drain, instead of back into the tub, as is the case with the standard installation.—Stanley Clark, East Bradenton, Fla.

## Dowels Used in Door Corners Hold Stiles to Crossrails

When moisture causes the stiles and crossrails of a door to spread apart, a repair can be made by installing dowels diagonally through the door corners. Remove the door from its hinges, wipe the opened joints with glue and pull the stiles against the crossrails with bar clamps. Drill  $\frac{1}{2}$  or  $\frac{3}{4}$ -in. holes diagonally through the door corners and drive in dowels as shown. Wipe the dowels and inside of holes with glue before assembly. Cut the projecting ends of the dowels flush with the door edges and sand smooth. When the glue has set, rehang the door.

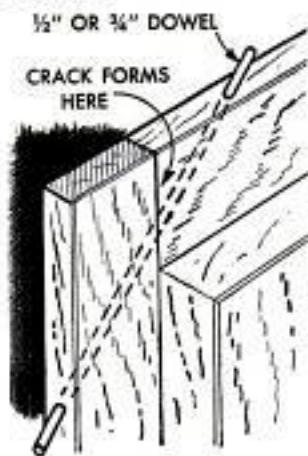

## Clip-Type Screwdriver Improvised

Next time you need to turn a screw in an awkward location, tie two paper clips to the end of a screwdriver blade with a rubber band as shown. The screwhead is slipped between the projecting loops of the clips and is held by tension of the rubber band. When the screw is turned tightly into the work, the screwdriver is pulled away from the screwhead.—Glen F. Stillwell, Manhattan Beach, Calif.





# MONKEY BUNK

DIFFERENT and yet practical, this monkey bunk makes bedtime an adventure for your youngster. The bunk itself is built over a small toy closet that offers plenty of shelf space along its three walls. As dimensioned, the bunk will take a standard bunk-bed mattress, or it may be built larger for a twin-bed mattress. The uprights, shelves and bed rails are of 1-in. lumber with  $\frac{3}{8}$ -in. plywood being used to support the mattress and cover the outside wall of the closet. The ladder consists of a length of 1 x 8 with rungs of 1-in. dowel. Note how the dowels are notched to fit across the back of the 1 x 8 upright which is screwed to the bunk side and the ceiling.

Hi Sibley, Nuevo, Calif.



Dowel-rung ladder serves double duty in providing guard rail for bed. Note the bookcase that is built in at foot of bed

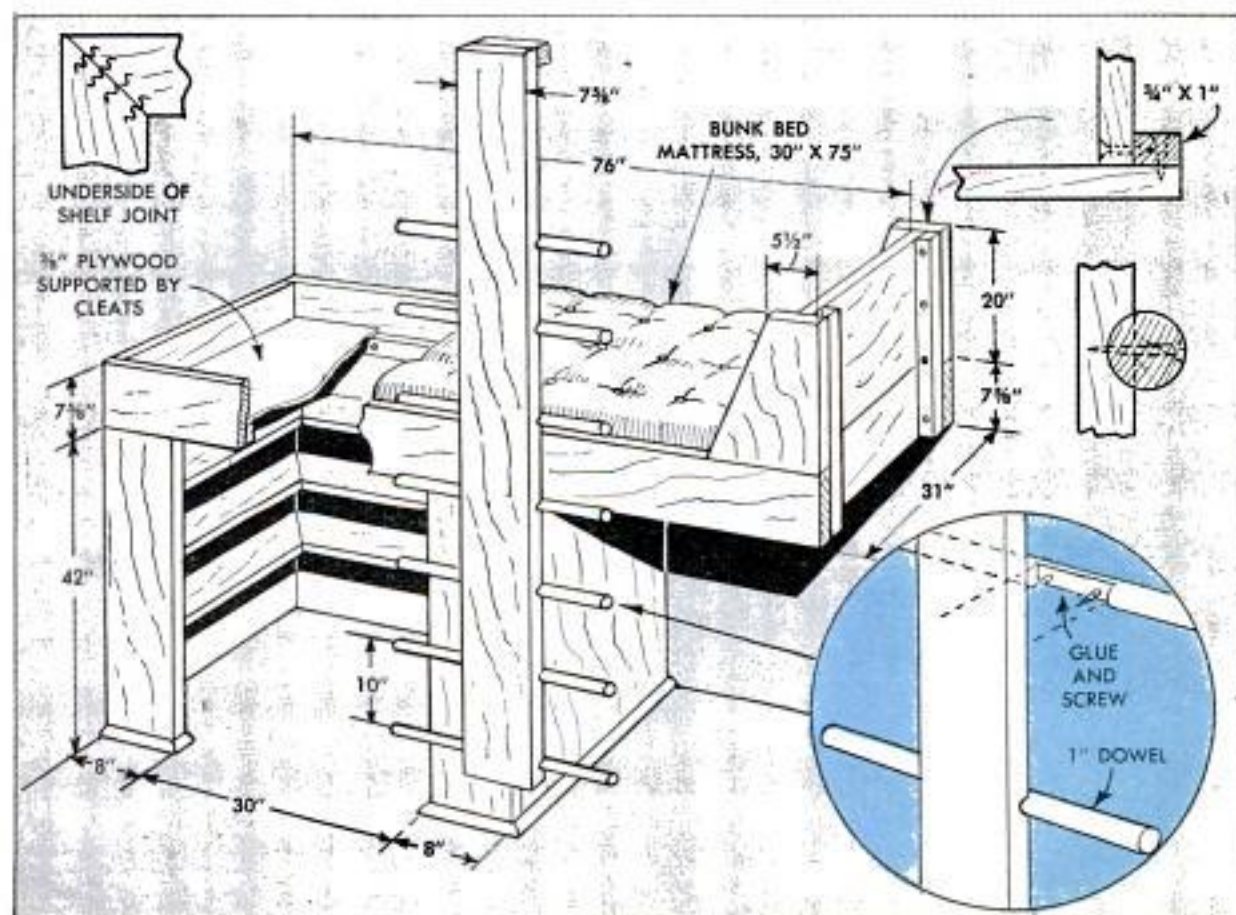

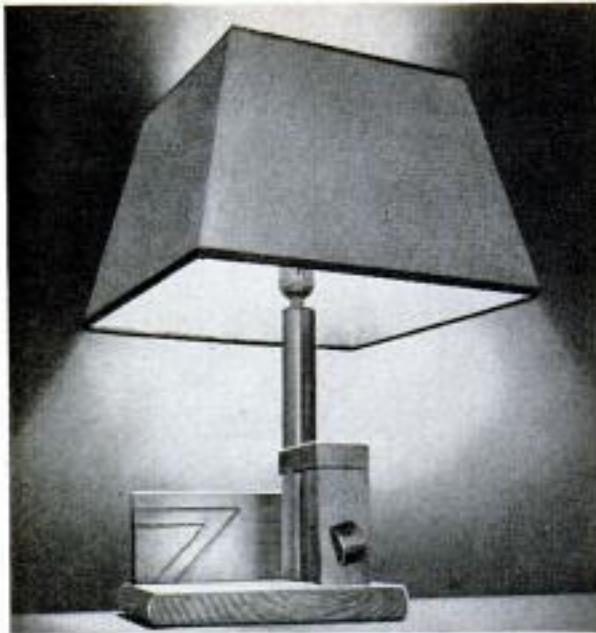

Unique lamp has a column formed by a single dowel. Modernistic base consists of several pieces of scrap wood sanded, stained as desired and then varnished

# DOWEL CRAFT

BY LUCIEN R. GREIF

*Although frequently overlooked or forgotten, the dowel is one of the most versatile pieces of preshaped hardwood available—ideal for home-shop projects*

**WOODEN DOWELS**, which generally are thought of as a means of strengthening a joint in woodworking, actually have hundreds of other applications. Shown on these two pages are a few of the many ways that dowels can be used as the main components of useful home-workshop projects.

The unusual lamp pictured at the top of the page requires only a single length of fairly large diameter dowel, plus a few pieces of scrap wood. A length of  $\frac{1}{4}$ -in. electrical pipe is fitted in a hole drilled through the dowel. The pipe is allowed to project at both ends. A lamp harp is screwed to the upper end, a locknut to the lower end.

Shown at the bottom of the page are two projects, a tie rack and a shoe rack, which consist simply of lengths of dowels and pieces of plywood.

In the illustration on the opposite page, dowels fitted in a bookcase are used to file phonograph records, five records fitting between each pair of vertical dowels. Another dowel screwed to the shelf prevents the records from rolling out.

Fig. A at the bottom of the page shows a toy-storage wagon, in which dowels are utilized to cage-in large toys. The box at the end of the wagon is used for smaller toys.

Another lamp made of dowels is detailed in Fig. B. Five dowels are set in blind holes in two squares of plywood, the center dowel being drilled to receive a length of electrical pipe. Section A-A shows how the lamp base is grooved to permit leading the lamp cord out the side.

The flowerpot or bric-a-brac shelf pictured in Fig. C is made by gluing the ends of six dowels in blind holes in a 4 x 5-in. piece of plywood and a 1 x 4-in. strip of plywood.

The "clothes horse" in Fig. D has a length of 2 x 4 for a body, a block of wood for a head and dowels for legs, ears and tail. The horse provides a convenient place for children to hang clothes when they are too busy to open a closet door. If made sturdy, the horse also might carry a young TV cowboy. ★ ★ ★

Tie rack can be designed to hold any number of ties by lengthening and adding more dowels. Dimensions of shoe rack also may be changed to accommodate additional pairs

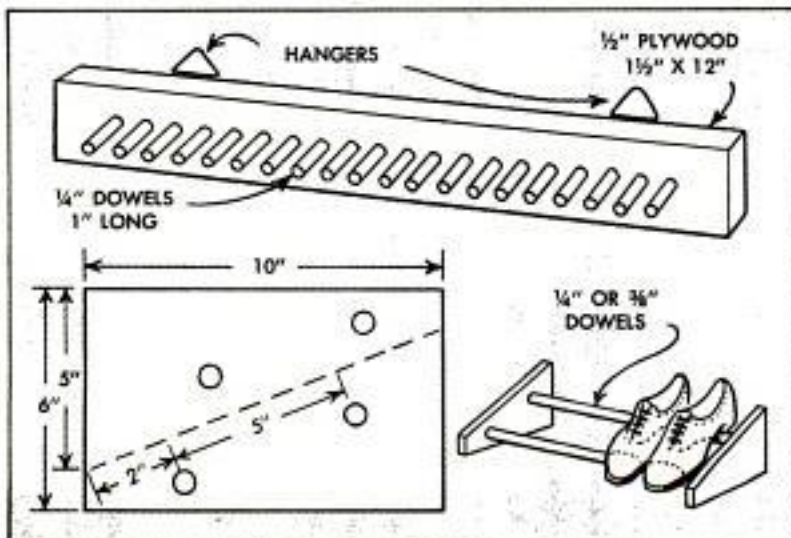

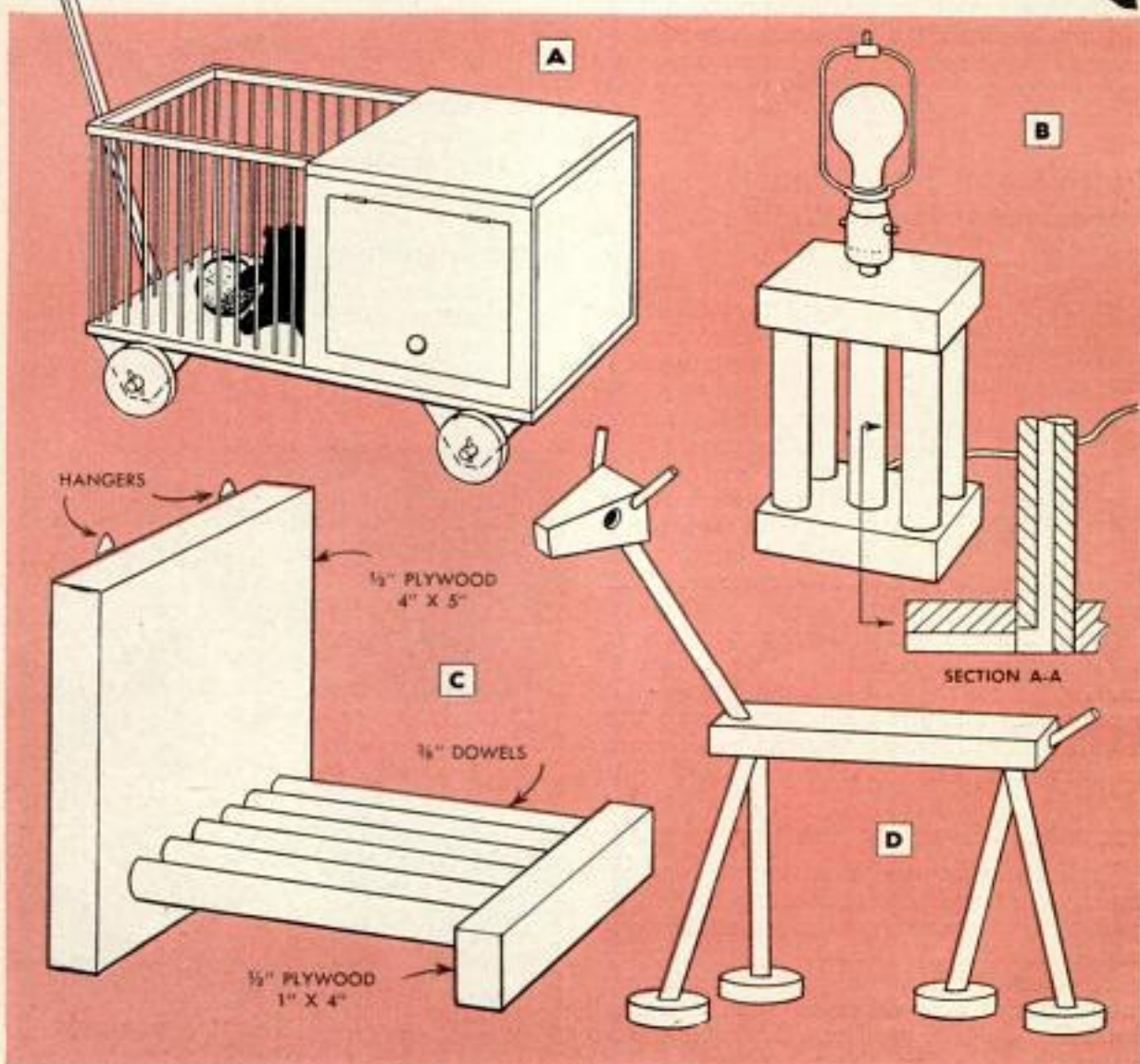

## Box Lid Provides Dust Catcher When Drilling Plastered Wall

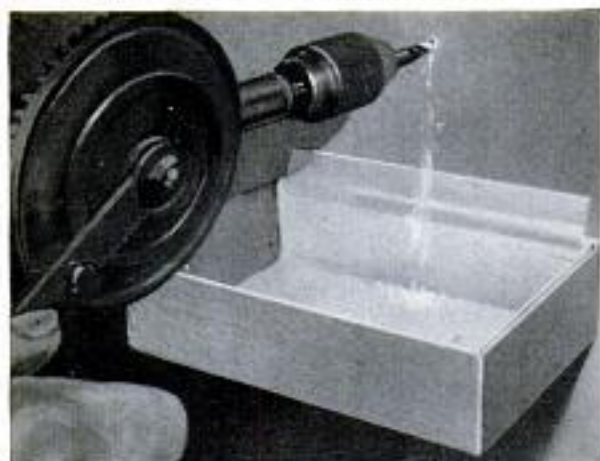

There will be no need to clean up a floor and baseboard after drilling a hole in a plastered wall if a cardboard-box cover is taped to the wall beneath the work area to catch the plaster dust. Use masking tape to attach the cover. If the wall is papered, test a small spot to make sure the paper will not be damaged when the tape is removed. Use two or three thumbtacks in place of the tape, should the latter tear the wallpaper.

## Crutch Tip on Broom Handle Prevents Marring of Walls

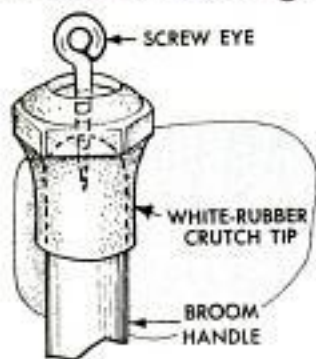

Leaning a painted broom handle against a wall carelessly often leaves marks that are difficult to remove, especially from wallpaper. To avoid this, push a white-rubber crutch tip onto the end of the handle.

The crutch tip will not leave marks even though the broom may fall against the wall with some force. If a screw eye at the end of the handle is used for hanging the broom, remove it temporarily and drill a hole through the crutch tip so the screw eye can be inserted through it.

## Household Uses for Shellac

Shellac can be used in a number of ways around the home as an aid to easier house-cleaning and simpler maintenance. For example, coating the cover of a cookbook with clear shellac will permit removing finger marks and smudges with a damp cloth. Easy cleaning of paint or wallpaper around a light switch is assured if the

area adjacent to the switch is protected with clear shellac; the color of paint or wallpaper is not affected. If you want to apply new wallpaper over old, and there are any grease spots, coat them with shellac to prevent the grease "bleeding" through the new paper. Worn spots on a varnished floor can be matched to the rest of the floor by first applying one or two coats of orange shellac. After the shellac is dry, revarnish the entire floor. When the index tabs on a dictionary, Bible or other book become curled from use, straighten them out and coat with two coats of clear shellac to keep them flat and resistant to wear.

Blanche Campbell, Los Angeles, Calif.

## Pocket Sewed to Folding Cot Keeps Pillow in Place

The problem of having a pillow slide off a folding cot can be eliminated by sewing a strip of cloth across the head of the cot as shown. Slipped into the pocket thus formed, the pillow will stay in place and remain clean.



## Syrup Dispenser Saves Solvent

When adding solvent to paint, use a glass syrup pitcher of the type shown. The glass lets you see exactly how much is in the container and the snap top lets you measure it to the drop.



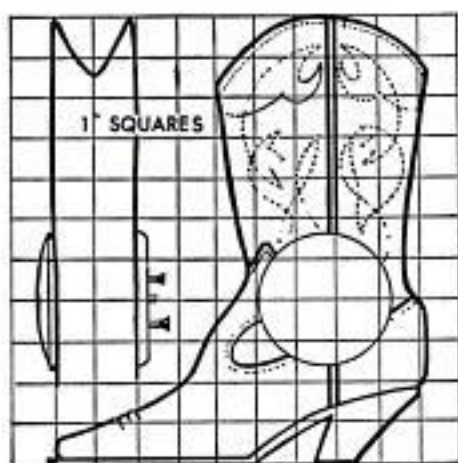

## Carved Boot Is Case for Mantel Clock

An inexpensive electric clock is easily turned into a novel timepiece that will complement the rustic decor of a ranch-styled living room. Simply carve a "Western" boot from a wooden block 2 x 8½ x 11 in. and fit the clockworks into it.

The first step is to remove the clockworks from the case, keeping the face and crystal intact as a unit to retain the dust seal and permit easy transfer. Next outline the boot shape on the block of wood and cut it out on a bandsaw or jigsaw. Hardwoods are best and will take a finish to resemble polished leather. Then cut the opening in the block to take the works, using the diameter of the collar on the works

side of the clock's face flange as a guide.

Outline the sole by making a cut parallel with the bottom of the boot and carve out enough wood to make the sole project about ¼ in. Shape the heel with a wood rasp and the top of the boot with a drawknife.

"Stitching" can be applied with a clock gear run over the wood to leave impressions of the gear teeth.

When the boot case is finished, insert the clockworks and fasten the back plate. If the clock is to be used on a table, either attach a wooden base or weight it with lead. For a hanging position use three small wooden pins to keep the control knobs away from the wall.

## Metal "Spine" Guards Razor Blade Used as Hobby Knife

Although a single-edge razor blade is safer than a double-edge blade to use as a hobby knife, the cutting edge still presents a hazard when the blade is stored or carried. To eliminate this hazard, cover the edge with the "spine" taken from the back of another single-edge blade. Heat the

spine, which is a small metal channel, to a dull red so it expands and can be pulled off the blade. The spine will slip snugly over the cutting edge of a single-edge blade, yet can readily be removed when the blade is used. This will be found easier to use than the usual method of wrapping with tape.

# SHEATH SET for Knife and Hatchet

By Lee Woods

**H**ANDSOME IN APPEARANCE, yet rugged enough to be appreciated by an outdoorsman, the knife and hatchet sheaths shown on these pages have several advantages over the usual homemade types.

First, they can be worn separately, Figs. 3 and 6, or worn together as a set, Fig. 9. Worn as a set, either tool can be removed from its own sheath without removing or releasing the other one.

Second, rivets, which are used on the knife-edge side of many sheaths, are avoided because they dull the cutting edge of a tool when it is drawn past them.

Third, because the sheaths are designed primarily for the outdoorsman, D-rings are used on the keeper straps instead of snap fasteners. The latter, although acceptable for general use, are too easily opened by heavy brush when the wearer is walking in a thickly wooded area. Once the keeper strap is released, the knife also can be pulled from its sheath by undergrowth.

Fig. 4 indicates another advantage of the design of the knife sheath. The keeper strap



is located so that it "locks" the sheath on a belt loop. The sheath then cannot slide around to the front of the wearer's belt where it would be possible to force the point of the knife through the sheath and into the wearer's leg should he kneel suddenly.

The sheaths are cut to fit individual knives or hatchets. Fig. 5 indicates the general method used in laying out the hatchet sheath. Tab D, which is almost the length of the sheath, is cut as part of the

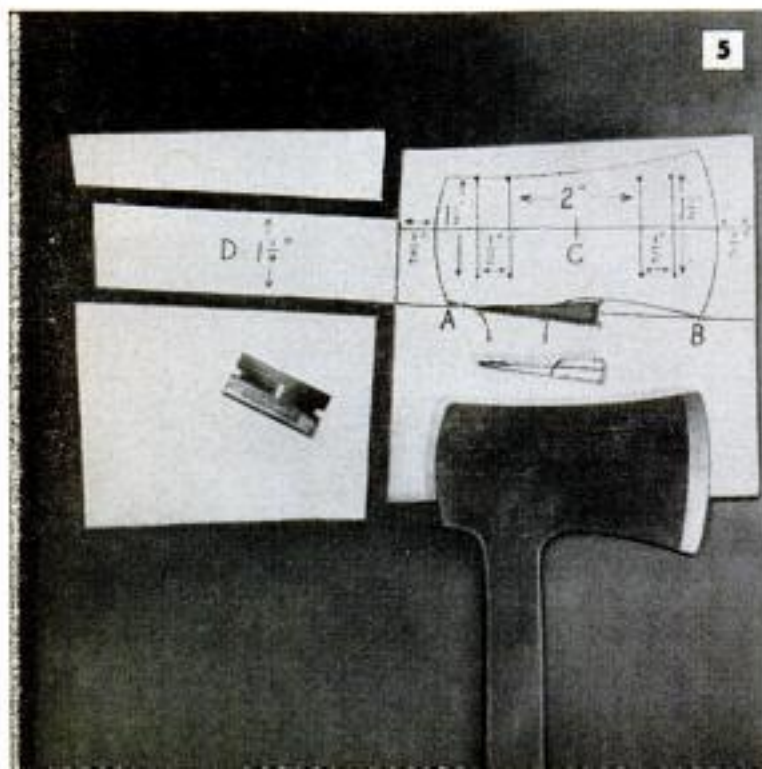

MAKE SHEATH TO FIT INDIVIDUAL KNIFE

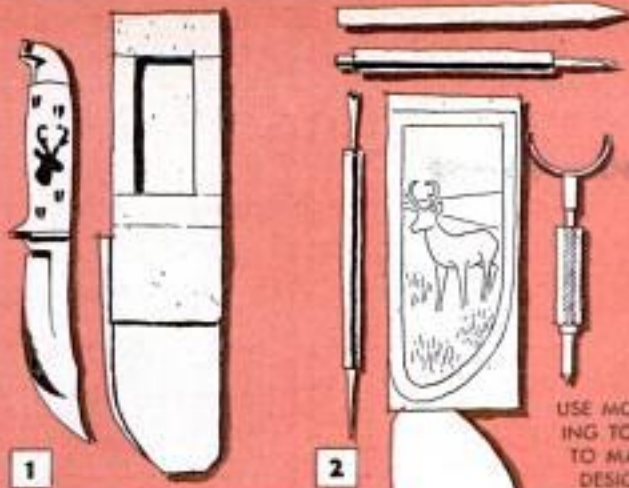

USE MODELING TOOLS TO MAKE DESIGN

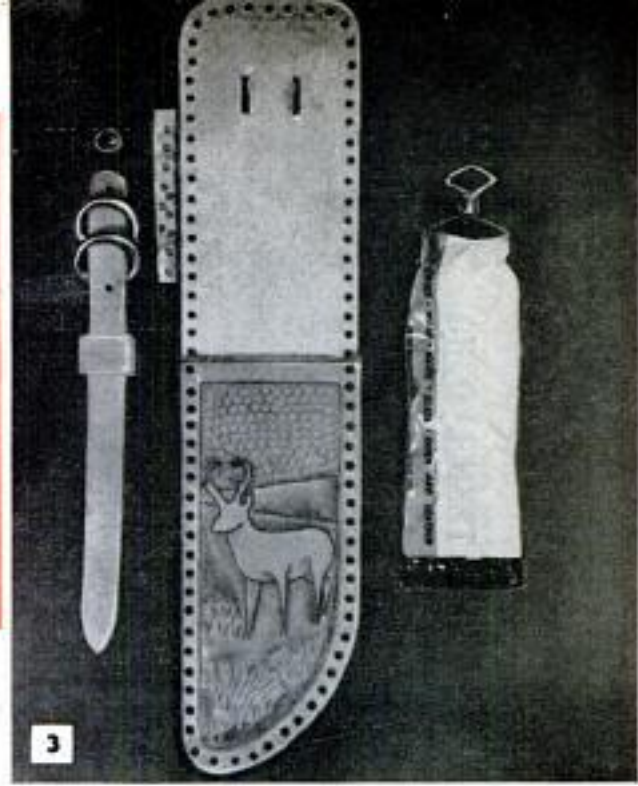

sheath. The finished product is shown in Fig. 6. Fig. 9 indicates how the tab is used to hold the knife sheath, the hatchet-sheath keeper strap being passed through the holes in the end of the tab to hold the knife sheath to the hatchet sheath.

The knife sheath is cut from a long strip of leather which then is folded and fitted with a reinforcing piece on the lower end as indicated in Fig. 1. Fig. 2 shows how a paper pattern is used to transfer a design to the leather when it is to be tooled. If the sheaths are not to be tooled, the only tools required to make them are a razor blade for cutting and trimming the leather, an awl—which can be a cut-down ice pick—and a heavy needle and thread. The cord used to lace the edges of the sheaths is a plastic type available at hobby shops that carry leathercraft supplies. Before sewing or lacing the sheaths, cement the parts together, Fig. 7, so they cannot become misaligned.

If a design is to be worked into the leather, modeling tools also would be required. Any painting or dyeing should be done before lacing the sheaths, Fig. 8. In the examples shown, the sheaths were decorated to complement the plastic handles of the knife and hatchet. ★ ★ ★

KEEPER PREVENTS SHEATH FROM SLIDING

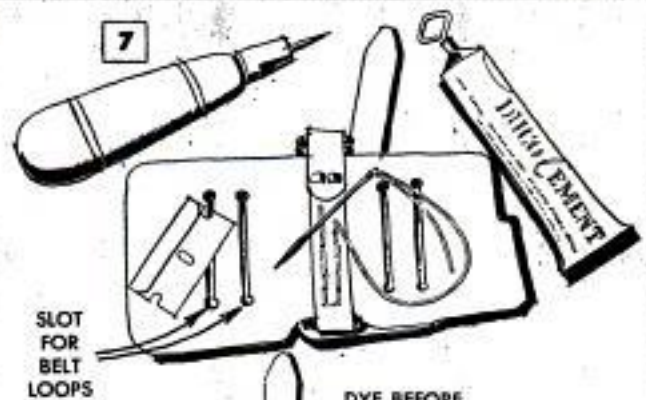
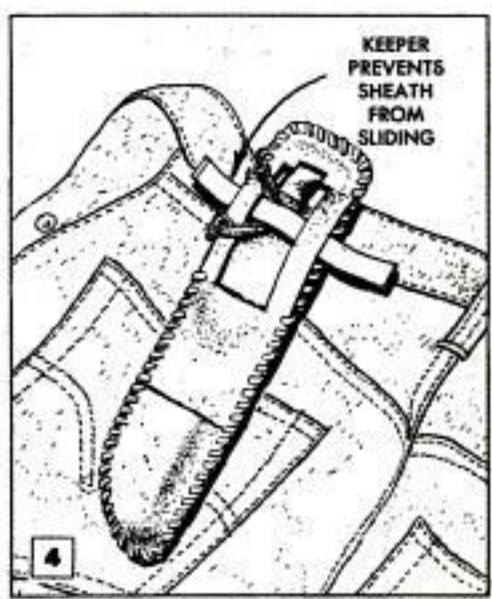

SLOT FOR BELT LOOPS

DYE BEFORE LACING

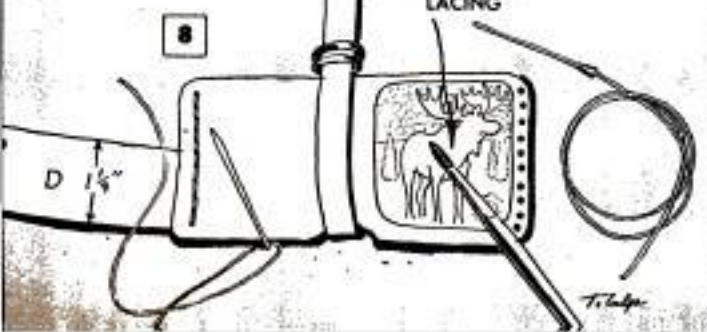

## Card-Table Movie Screen



An ordinary folding card table can be set up quickly to provide a movie screen when a regular screen is not at hand. Open two of the legs and set the table top in a vertical position on another table so the legs act as horizontal braces. If the card-table top is dark colored, cover it with a bed sheet or a piece of white paper.

## Nut and Bolt in Triangle Cutout Locate Equidistant Lines

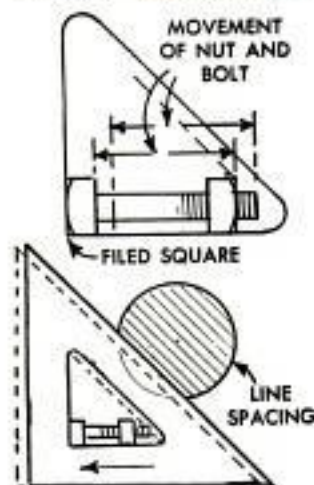

A small nut and bolt inside a drawing-triangle cutout will permit accurate spacing of parallel lines. First, the rounded corner of the cutout, adjacent to the right angle of the triangle, is filed square. The nut then is adjusted on the bolt to determine the line spacing. Triangle and bolt are now moved alternately in one direction. Lines ruled at the triangle edge will be equidistant. Although a hex-head nut and bolt can be used, a square-headed bolt and nut can be handled more easily.

## Wren Houses Require No Perches

Disappointed when wrens refused to occupy houses he had built for them, one homeowner investigated and learned that his mistake was installing perches at the entrance of each house. Wrens land directly in the entrances of their homes and re-

quire no perches. However, sparrows and other birds use the perches to attack and harass the wrens. The smaller birds thus have learned to avoid houses fitted with perches.

## Soldering Iron Heated Quickly With Insulation Around Tip

An electric soldering iron can be brought to working temperature more quickly if it is insulated during the warm-up period. Simply force the tip into a can filled with loose insulation. After the iron is at operating temperature, remove it from the insulation.



## Purse-Sized Mucilage Container Is Empty Nail-Polish Bottle

If you have need for a small, leakproof container of mucilage for emergency re-sealing of envelopes and packages, utilize an empty nail-polish bottle. Clean the bottle and its brush with nail-polish remover or lacquer thinner and fill with mucilage. The brush in the bottle cap can be used as an applicator.



Keep a pair of cotton gloves near the freezer, to wear when handling and rearranging the frozen-food packages so that your hands won't become chilled.



## Shelf Built With Hand Tools Appears to Have Machined Edge

Only hand tools are required to make this attractive entrance-hall shelf that appears to have a machine-molded edge. Dimensions of the shelf can be varied to suit a particular location; the original shelf measured 8 in. long and 5 in. wide. The top of the shelf is made from two pieces glued together, the lower piece being about  $\frac{3}{8}$  in. smaller than the top. Round the edge of the top piece and leave the edge of the lower piece square to provide a molded-edge effect on the finished shelf. The shelf brace consists of two pieces, a straight length that fits flat against a wall and a curved piece that supports the shelf. The

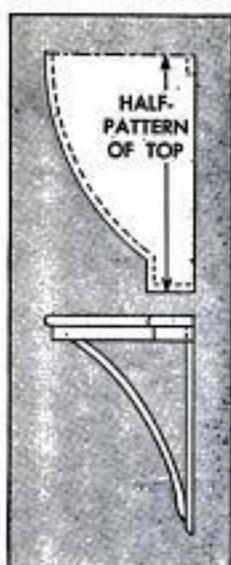

latter is jigsawed from a single piece of wood. — Bertram Brownold, Cedarhurst, N. Y.

## Modified War-Surplus Entrenching Tool Provides Pick and Shovel

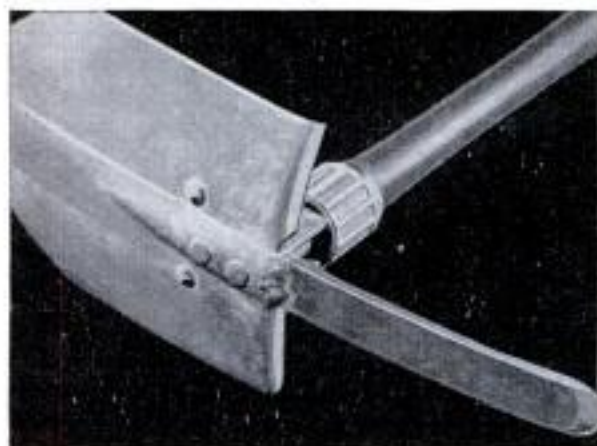

A war-surplus entrenching tool of the type shown can be modified for use as a handy camping tool or to carry in the trunk of an automobile for digging out of snow or mud. For use in hard-packed soil, a pick is added to the entrenching tool by welding and riveting a length of auto-spring leaf to project from the heel of the shovel as shown in the upper photo. When the tool is used as a shovel, the pick is folded flat

alongside the handle. Replacing the pivot pin of the tool with a nut and bolt permits quick removal of the pick-shovel so the handle can be fitted on a hatchet head as shown in the lower photo. The hatchet head is drilled to receive the bolt.

J. A. Anderson, Norfolk, Va.

## Steel Pulley Used as Holder For Drilling Bushings

When a drill-press vise is not available and small bushings must be drilled or reamed accurately, a steel pulley can be used to hold them vertically on a drill-press table. The bushing is slipped into the pulley hub and prevented from turning or twisting by tightening the setscrew against it. The pulley is large enough to permit the operator to hold it firmly during the drilling.

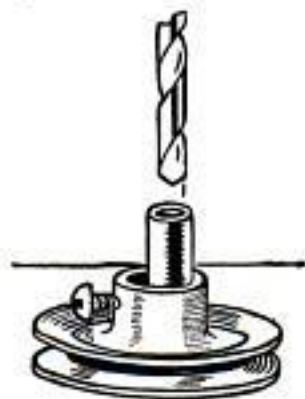

Worn or faded spots on automobile bodies and fenders can be touched up without leaving ridges if the paint is applied with a small brush and then the outer edge feathered by means of a circular motion with the thumb.



**1. RUBBER FORCE CUP** of the type ordinarily used in cleaning sink drains usually will open a stuck drawer when everything else fails, especially narrow drawers with only one pull. If latter has loosened or is damaged, then force cup is the only safe means of opening drawer without damage

**2. SNAP FASTENERS** often pull loose in light fabrics after only a short period of use. This tendency can be prevented by coating the area around the fastener with fingernail polish which is a clear lacquer that will not discolor light fabrics. Apply sufficient polish to saturate the fabric

**3. OLIVE OIL** is safest and most durable finish for salad bowls, breadboards and cutting boards used in the kitchen when preparing foods. Apply oil with a soft cloth and allow utensil to stand over night. Wipe off the excess oil and polish with a dry cloth. Renew finish periodically

**4. CELLULOSE TAPE** placed across a plug base or a cube tap as illustrated prevents the base or tap from turning out of socket when bulb is unscrewed. Only one strip of tape is pictured but it may be advisable to use two or more strips should the bulb be unusually difficult to remove

**5. SHELLAC** can be used effectively to stainproof nailheads used in fastening various types of wallboards over which wallpaper is applied. Shellac prevents rusting of the nailheads, which is the cause of the discoloration. Apply not only to the nailhead but also to the adjacent area



**6. LAMPS** on small occasional tables cannot be easily upset by children if the lamp cord is attached to the table rail in the manner pictured. Turn a screw eye into back face of rail, or into table top, then tie the cord to it with a shoelace. Knot should be fairly tight so cord cannot slip



**7. ALARM CLOCKS** of the spring-driven type often tick annoyingly loud when placed on a dresser or night stand. Silence the tick by placing the clock on a sound-dampening pad cut from  $\frac{3}{8}$  or  $\frac{1}{2}$ -in.-thick sponge rubber. Pad should be cut slightly larger than over-all size of clock base to prevent tipping

**8. TOWEL BAR** makes a good, safe rack for storing those extra table leaves in a closet or other out-of-the-way location. Stand one leaf on end against the wall and mark its height. Then screw the towel bar to the wall at an angle, the high end just above the mark. This permits the leaves to be placed under the bar from the side

**9. LOCK WASHER** holds knob of a pot cover securely in place simply by preventing the screw from loosening, which nearly always happens sooner or later due to handling. Place washer under knob rather than under head of screw. Then turn knob down tightly. Use lock washer of a size that fits screw

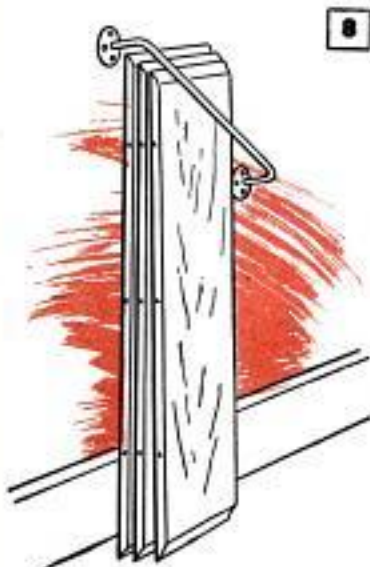

## Box of Baking Soda Under Car Hood Provides Fire Extinguisher



A box of household baking soda kept in a holder under the hood of your car will provide a fire extinguisher that is effective against gasoline and oil fires. Make a sheet-metal holder for the box and fasten it to the side of the engine compartment with sheet-metal screws. Wrap the box with aluminum foil to prevent moisture from caking the soda. To fight a fire, the soda is sprinkled on the flames. The soda generates carbon-dioxide gas which smothers the fire.

## Plastic Bottle Used as Bellows



An empty plastic "squeeze" bottle can be used as a handy bellows for blowing dust and chips out of blind holes and other awkward locations. To remove any residue of the original contents, rinse the bottle with water or solvent. Permit it to dry thoroughly so that the air ejected will be free of moisture. When using a bellows of any type, make sure the eyes are protected against flying particles.

## Spark From Discarded Lighter Ignites Propane Equipment

Cigarette lighters that do not work well enough to perform their original function, but still produce a strong spark, can be used in a number of ways to eliminate the

need for matches. Propane torches, lamps and stoves can be ignited by holding the lighter at the edge of the gas stream and striking a spark into the stream. Use no fluid in the lighter. The best lighter for this kind of use is the windproof type.

## Emergency Faucet Repair

When the screw that holds a faucet washer was found to be completely corroded away, the faucet was repaired in the following manner: The screw hole had corroded over-size so it could not be tapped for a

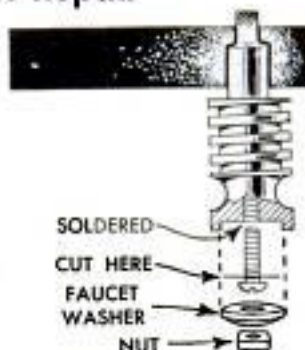

larger-size screw. Instead, a brass machine screw was soft-soldered in the hole, cut off and fitted with a brass nut to hold the faucet washer. It might be necessary to cut off the corners of the nut to provide clearance for the washer seat.

C. L. Sample, N. Augusta, S. C.

## Curing Flashlight Flicker

If a flashlight flickers because of a poor ground connection between the case spring and the case, the problem can be corrected easily. Pull the spring out of the case and solder a length of light, flexible wire to it. Cut the wire slightly longer than the length of the flashlight case and solder the free end of the wire to a point just below the threads on the inside of the flashlight case. Keep it clear of the switch. Push the spring back down inside the case and a direct ground connection between dry cells and flashlight case is assured.—Elbert Robberston, Port Washington, N. Y.

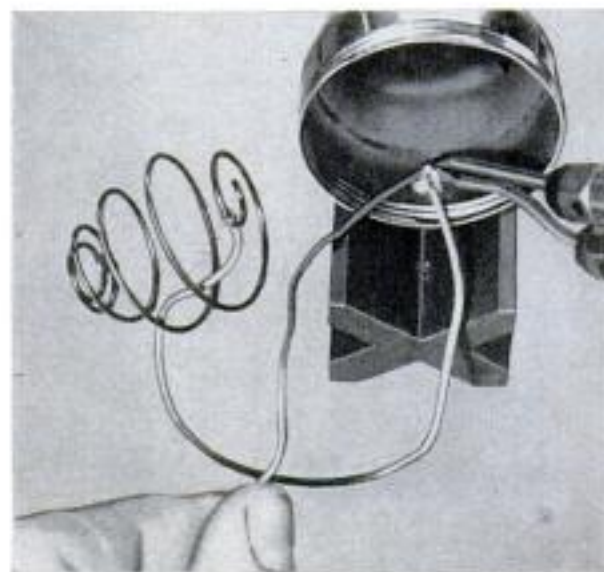

## Spring-Loaded Turn Button Needs No Tightening



A compression spring fitted on a screw that holds a turn button will eliminate the need for loosening and tightening the screw when removing or installing storm windows and screens that

might vary in fit and thickness. The spring permits the turn button to be rotated, but keeps it under constant pressure. When the spring and two washers are installed as shown, a longer screw is required than with the turn button alone.

## Concrete-Reinforcing Rods Held By Sheet-Metal Strips on Nails

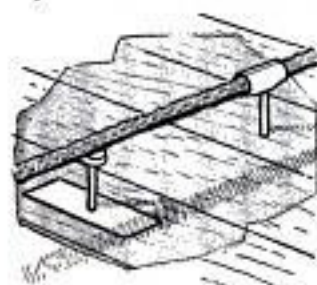

An easy way of supporting concrete-reinforcing rods at the right height above horizontal wooden forms is to use nails and sheet metal strips about 3 in. long. The nails are driven through

the strips and into the form to project the desired height. Then the rods are placed on the heads of the nails and the metal strips lifted up and wrapped around them. To keep the rods at a uniform height above the form, use a block of wood as a gauge when driving the nails.

## Friction Tape Secures Circular Glass Cutter

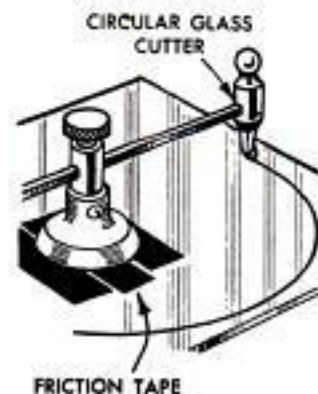

When scoring glass with a circular glass cutter that is not provided with a nonslip centerpiece, a slight movement of the latter may ruin the work. Such movement can be avoided by simply sticking two or three short lengths of friction

tape to the glass. Space the strips apart to provide a flat surface. Adhesive tape, while not as good for the purpose as friction tape, will help in keeping the centerpiece from slipping.



## Offset in Plaster-Base Panels Reduces Chances of Cracking

Eliminating the unbroken line between rows of Rocklath will considerably reduce the chances of plaster cracking in the middle of a long-span ceiling. An offset is cut in the ends of a number of panels, as shown in the illustration, to produce a staggered line lengthwise of the panels. The panel ends are offset in the usual manner, adjacent rows being nailed to alternate joists.

Michael Ligocki, Gary, Indiana.

## Plastic Spray Bottle Applies Water to Plaster Patch

An ideal method of applying water when patching plaster is to use a plastic squeeze bottle fitted with a spray nozzle. The spray will thoroughly saturate the edges of the old plaster so it will not absorb water from the patch. The latter condition results in the patch not bonding satisfactorily with old plaster surrounding it.



# PATTERNCRAFT



# CHRISTMAS LAWN CUTOUTS

Outdoor Christmas decorations are many and varied, but there is nothing like a jolly old Santa to give a cheerful greeting to passersby. It's easy to cut this smiling fellow from 1/4-in. plywood or hardboard by following the squared pattern on the opposite page. If you use plywood, be sure that it is exterior grade. After the pattern has been cut out, give front, back and edges a priming coat of paint. Then, again using the pattern, draw in the features and clothing details. Finish by applying flat paint or enamel in the desired colors. A simple wooden prop fastened to the back of the cut-out is all that is needed to keep Santa standing in the front lawn



## FULL-SIZE PATTERNS

You will save time and do a better job if you trace the Santa, or the sleigh and reindeer shown below, from a full-size pattern. Either or both of these attractive patterns can be obtained from Patterncraft, Popular Mechanics Press, 200 E. Ontario St., Chicago 11. For the Santa, Plan No. 121, send 50 cents. The price of the sleigh and reindeer patterns, Plan No. 122, is \$1.00. Be sure to mention the plan number when placing your order

Santa's bright colors stand out during day, can be lighted at night

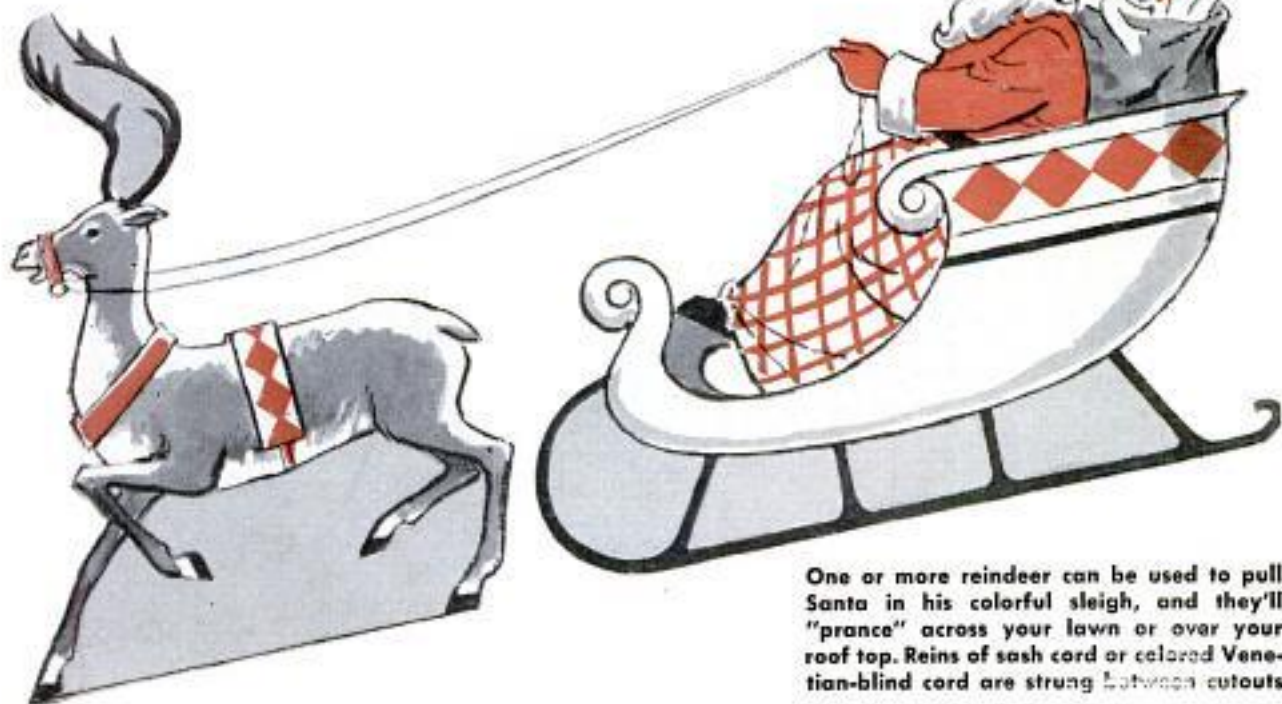

One or more reindeer can be used to pull Santa in his colorful sleigh, and they'll "prance" across your lawn or over your roof top. Reins of sash cord or colored Venetian-blind cord are strung between cutouts



### Metal Typewriter-Eraser Shield Catches Particles in Trough

A typewriter will stay in good condition longer if eraser particles are caught in a trough bent on the edge of an eraser shield as indicated, instead of being allowed to fall into the typewriter. The shield is cut from thin, rustproof metal. Before the trough is bent on the shield, holes are drilled in the latter and filed square or rectangular as required. The sides of the holes then are filed to a taper so erasures can be made to the very edges of the holes.

### Small-Parts Tray Bandsawed From Wooden Block



A tray for brads, nails, screws and other small parts can be bandsawed from a length of 2 x 4 as shown in the detail. This provides round-bottom compartments for easy removal of the contents. Nailing two strips of plywood across the open ends of the compartments completes the job. For a more finished look, strips can be nailed to all four sides.

### Cutting and Polishing Marble With Home-Workshop Tools

Having an old marble table top to be reduced in size for use on a small table, one home craftsman did the job with a 7-in.

abrasive cutoff wheel on a table saw. In order to maneuver the marble, which was  $\frac{7}{8}$  x 21 x 52 in., an auxiliary table of  $\frac{3}{4}$ -in. plywood was placed over the saw table. Short pieces of  $\frac{1}{4}$ -in. dowel served as rollers to facilitate feeding the marble into the cutoff wheel. A tin can having a small nail hole near the lower end lubricated the wheel when placed on the slab to direct water at the point of contact between the wheel and the marble. Polishing the marble was done with a disk sander, starting with No. 24 grit abrasive, then using No. 60 and finally No. 100. Final polishing was done with jeweler's rouge and water applied with a piece of felt. The marble finish was protected with a coat of white shellac, cut with equal parts of alcohol. A final high luster was given to the dry shellac by cleaning it with fine steel wool and applying a coat of paste wax.

E. M. Hawes, Marietta, Ohio.

### Solder Carried on Film Spool

Carrying a full roll of wire solder in a toolbox often is inconvenient and unnecessary. Simply unroll enough for a job and wind it on an empty film spool.



### Enamel Refinishes Old Silver Plate

If you have some old candlesticks, or other silver-plated objects that are too badly worn to be polished again, give them a new and attractive appearance by painting them with refrigerator enamel. The hard bright gloss looks much like a porcelain finish and is easy to keep clean.

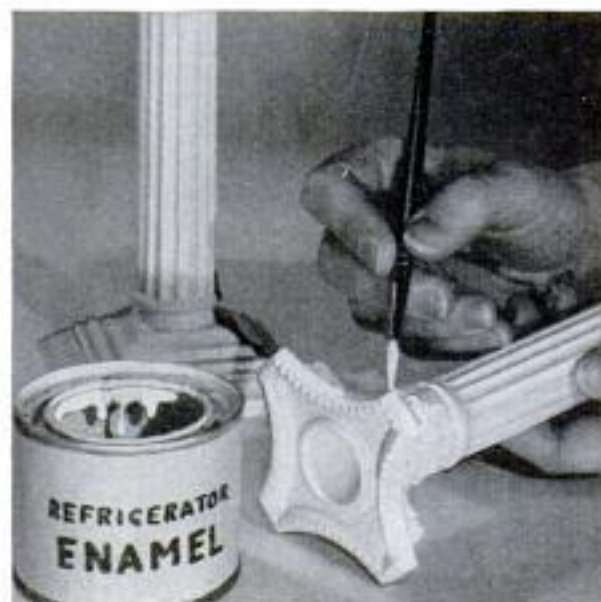





Refrigerator door will be easier to close if the latch is rubbed lightly with a grease stick. Other latches and sash locks in house respond equally well



For smooth operation of firearm bolts and slides, lubricate with grease stick. However, stick provides no substitute for oiling of precision mechanisms

## "OIL" IT WITH A GREASE STICK

By J. W. Rocke, Jr.

You will find the grease stick a welcome addition to your lubricating supplies. The heavy-bodied coating of grease applied by the stick stays put and often does the trick where other lubricants prove unsatisfactory. It's clean, nonstaining and easy to use on everything from hinge pins to rotary can openers

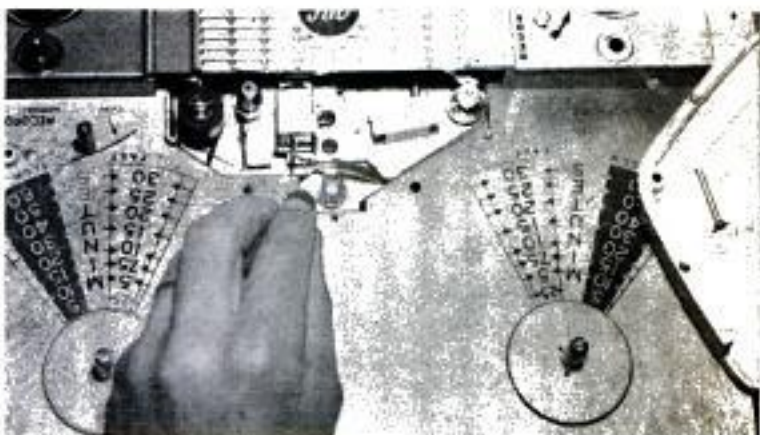

Whether it's for the head of a tape recorder or mechanism of a record changer, grease stick provides effective lubricant that won't work into delicate parts

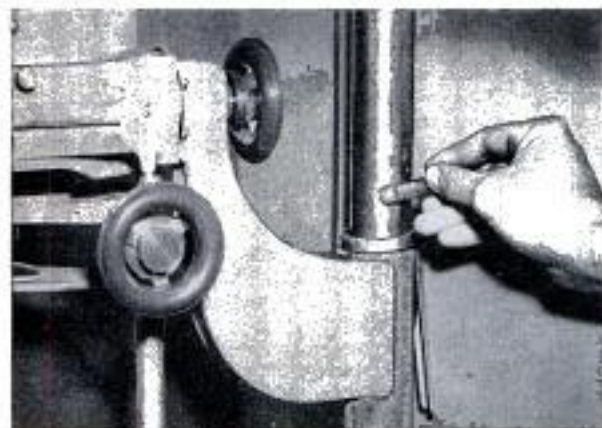

The grease stick has its place in the darkroom, too. It provides a clean lubricant for enlarger columns and slides, tripods, pan heads and many other items

A light film from the grease stick lubricates the breaker cam on a small-engine magneto. It also serves as a substitute lubricant for car distributor



Right at home around the car, the grease stick will smooth operation of the ash tray, glove-compartment latch, etc., in addition to the usual lubricating jobs

By applying a few strokes of the grease stick to both sides of your handsaw blade you can reduce binding considerably. Even helps when using dull saw





### "Clothespole" in Basement Room Utilizes Chain and Hooks

A removable "clothespole" for hanging coats in a basement game room can be made from a length of chain and several clothesline hooks. If the basement ceiling is low enough, the hooks can be driven into floor joists on a line parallel with a wall. The chain is hooked from one to another. Where the ceiling is high, turn the hooks into screw anchors set in the basement wall. When it is not needed, the chain is lifted from the hooks and stored.

W. P. Nelson, Lombard, Ill.

### Worn Overshoes "Skidproofed"



To assure firmer footing on ice-covered sidewalks "skidproof" the smooth bottoms of worn overshoes or rubbers with strips of waterproof adhesive tape. Clean the bottoms thoroughly and allow to dry.

Apply the strips across the soles and heels at right angles to the length as shown.

### Fungicide Prevents Lawn Mold

Snow mold, a condition that causes areas of a lawn to be withered and yellow in the spring after a winter of heavy snowfall, can be alleviated by using a number of preventive measures. The mold is caused by fungi that are active at low temperatures. Apply fungicide in early winter just before the first heavy snowfall. Since nitrogen seems to encourage snow-mold fungi, do not apply nitrogen-rich fertilizer after

August. Because the mold remains active longer under cover of snow, avoid piling snow alongside driveways and sidewalks. Instead spread out the snow so it all melts at about the same time. Fescue and bentgrass lawns are highly susceptible to snow mold, while Kentucky bluegrass is resistant to the disease.

### Stronger Wire Splice Assured By Using Two Pairs of Pliers

When splicing electrical wires, use two pairs of pliers to assure a strong joint and positive connection. Grip the wires at the base of the splice with one pair of pliers and use the second pair to twist the wires together. When taping the splice, start below the stripped portion of the wire to provide complete insulation of the splice.



### Handles for Closing Car Doors Made From Range-Door Pulls

Chrome-plated handles of the type used on the oven doors of a kitchen range can be used to provide rigid grips for the insides of car doors not equipped with door pulls. The handles not only allow the doors to be closed without pulling on the latch handles or window cranks, but also serve as emergency handholds. Locate the handles beneath the car-door windows with sheet-metal screws.



☞ To measure a half glass of liquid, when a glass has straight sides, pour out the liquid until its surface reaches from the mouth to the opposite side of the bottom.

# BETTER TEXTURE SHADING

By Enno R. Haan

Here's an improvement on the method of using rough surfaces, such as book covers, sandpaper and files, to obtain textured shading effects on drawings. Instead of rubbing a pencil over the drawing after it has been placed on the textured surface, cut out a piece of carbon paper to fit the area to be shaded. Then place a piece of celluloid over the carbon and use a small wooden roller to produce the impression, as shown below. This method of shading gives sharper results in blacks and whites than those possible by the pencil-rubbing process, permitting clear line engravings to be made from pen-and-ink drawings thus shaded. However, care must be taken not to rub the shaded portions, as the carbon will smudge. To prevent smudging, spray the drawing with a fixing solution. It's best to use paper having a smooth surface.

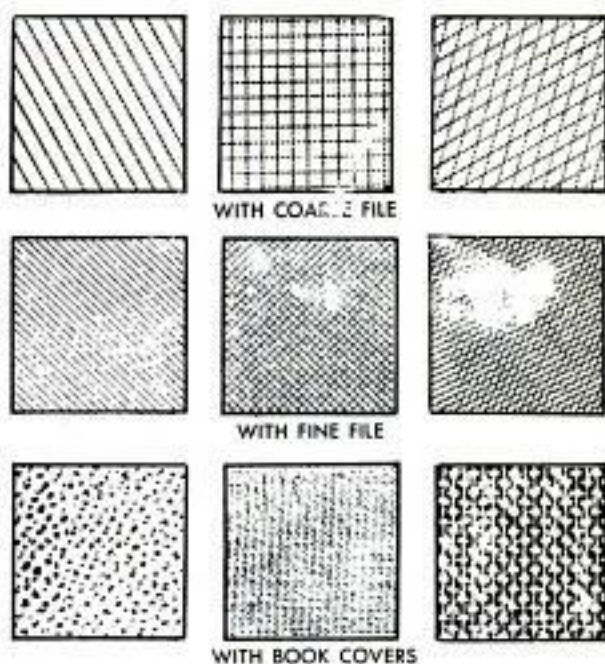
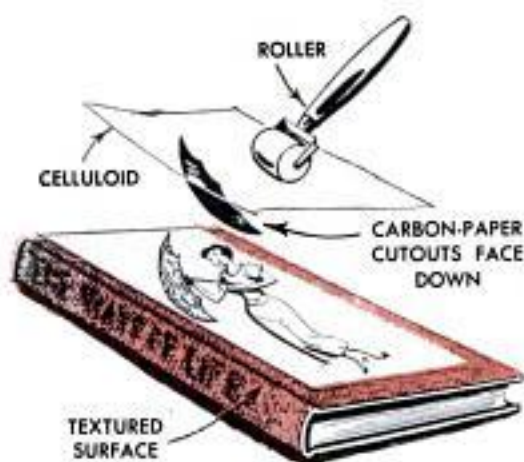

## Fuel Tank Set in Carton to Protect Inside Finish of Boat

The cardboard carton in which a portable fuel tank for an outboard motor is packed is used by one boatowner to protect the inside finish of his boat. The tank is removed

from the carton, a piece of heavy cardboard is fitted in the bottom and the tank replaced. With care, the carton lasts two seasons. When it wears out, another can be obtained from an outboard dealer.

Clinton R. Hull, Santa Ana, Calif.



## Bills Kept Separate in Wallet

Fitted in your wallet, a piece of thin plastic the length of a dollar bill and 1 in. wider, does a twofold job. It serves as a divider between one-dollar bills and those of larger denominations, with the extra 1 in. of plastic folded down over the latter. The folded portion prevents a larger bill being removed by mistake when reaching for a single, and also prevents anyone seeing how much money is in the wallet.

Mrs. Michael Fey, New York City.

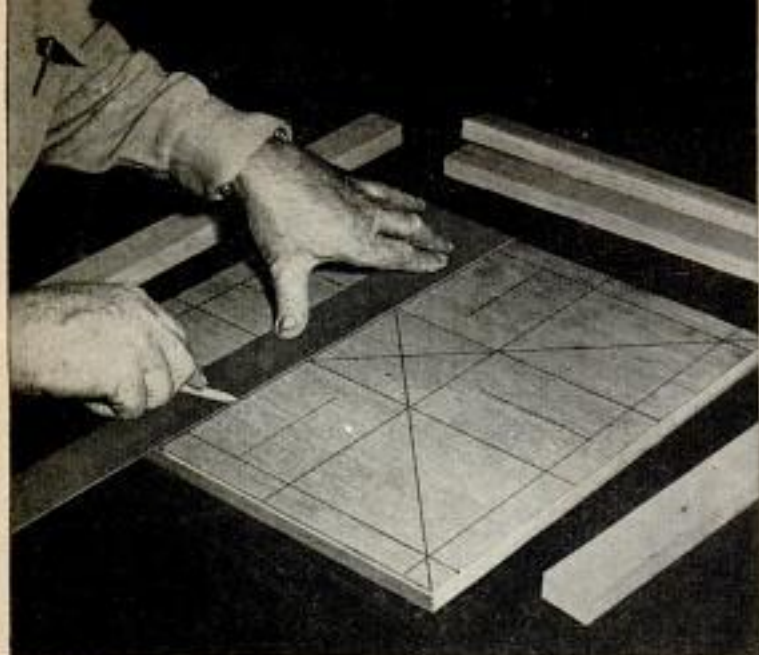

Layout of game board is begun by drawing lines directly on  $\frac{3}{8}$ -in. plywood, using straightedge as above

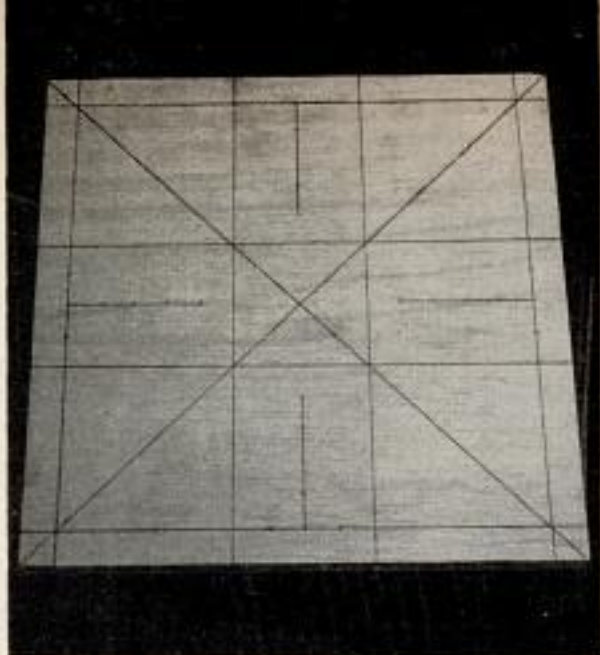

The layout consists of basic 5-in. squares at corners, with diagonals and short home lines drawn in

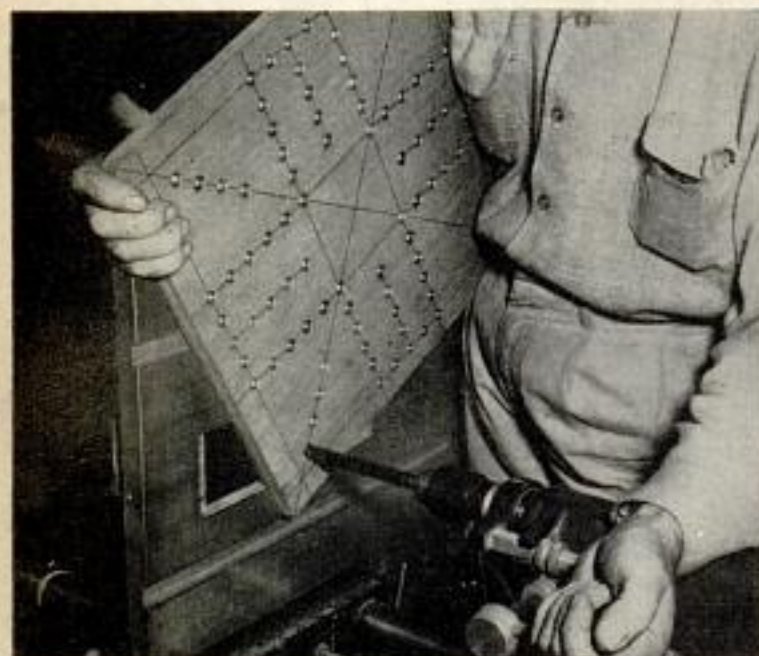

Above, holes are spotted 1 in. apart and drilled with  $\frac{1}{2}$  or  $\frac{3}{8}$ -in. bit just deep enough to retain marble. Board is sanded to remove pencil lines after drilling and again after painting holes, as below



Note above that base, starting-point and home holes are painted color to match each set of four marbles. Photo below shows finished board which has been coated with clear lacquer. Molding is optional

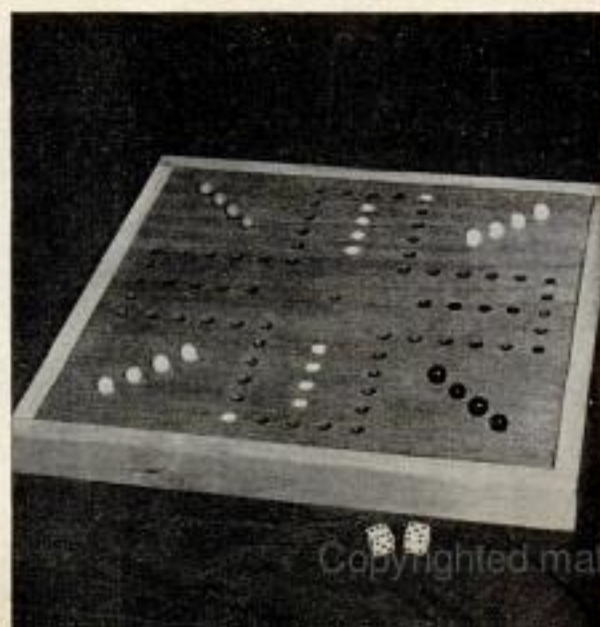

# FOUR TO GO—A NEW FAMILY GAME

**T**HIS NEW GAME furnishes hours of fun for two, three or four players. Object of the game, which is played on a board made as shown below, is to try to be the first player to move four marbles from the "base" through the center of the cross pattern to "home." Rolling a pair of dice determines the moves. When one player's marble lands on a space occupied by another player, the first player must return his marble to base. The play moves clockwise around the board.

The player rolling the highest number on the dice begins the play. He has four marbles, as do the other players, of a color corresponding to the color of his base. The marbles are placed in the four base spaces which are to the left of the player. He gets one roll and must roll either a "6" or a "1" to bring a marble to the starting point. Once at the starting point, the marble is moved ahead on the player's next throw of the dice. Since only one marble may be moved for each of the dice, a player must have two marbles in play to utilize the numbers on both dice. Players must move when possible, but may move any of their marbles in play according to either die.

The player gets a free throw of the dice for each 6 that he rolls, and in moving around the board he may pass another player's marble but not one of his own. A marble may be moved into the center space at any time the final count ends on the center, provided that the center can be



entered from one of the first three corner holes clockwise from the player. Note arrows. To leave the center, the player must throw a 1. He then moves his marble to the corner just to the right of home. The marbles must be played through the starting point and then to home, arriving at the final count of the roll. A partial count of either die may not be used. ★ ★ ★

By  
Shep Shepherd

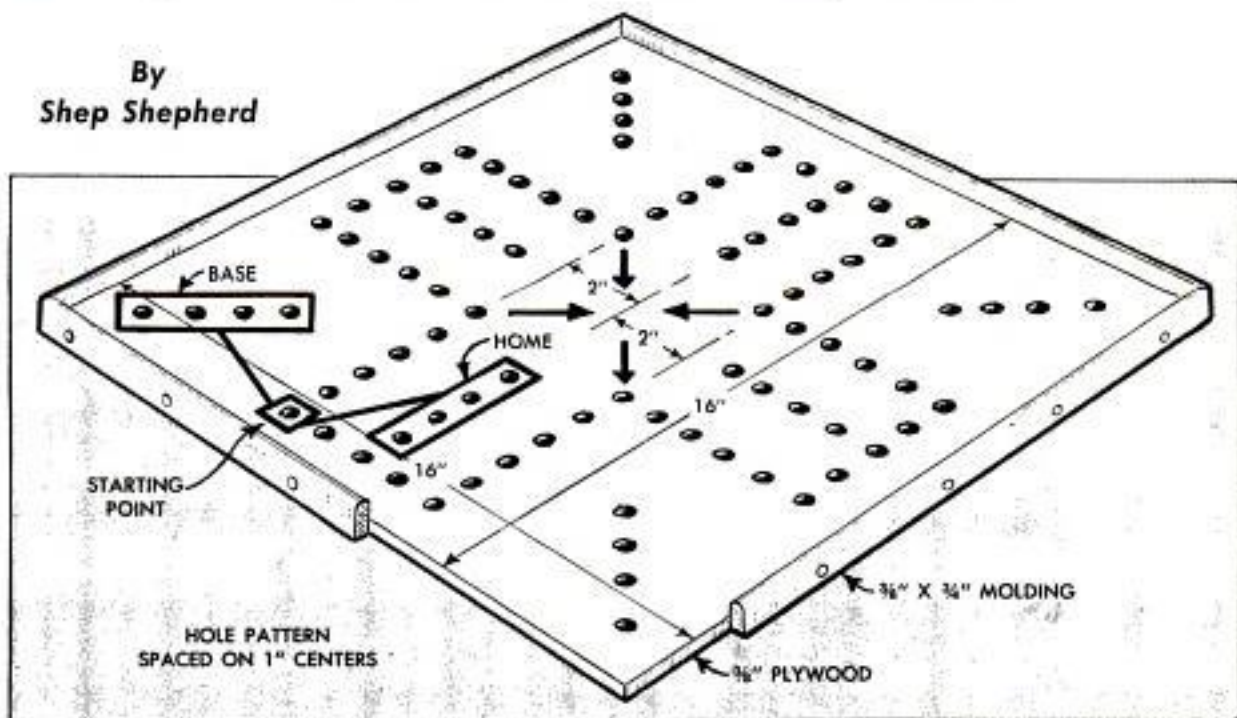

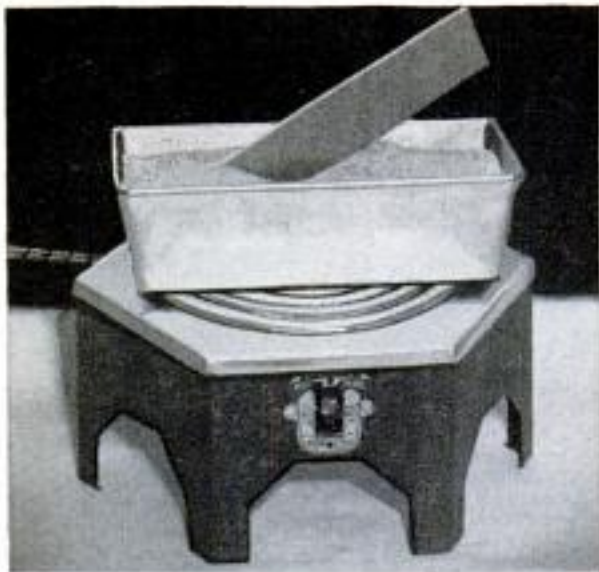

### Heat Bath for Thermoplastics Consists of Salt or Sand

Preparing thermoplastic material for bending and forming can be accomplished without elaborate handling. Fill a metal baking pan with fine sand or table salt and heat it over a thermostatically controlled hot plate. The plastic piece is pushed into the sand or salt and left until it is soft enough to work. Because the temperature inside the sand or salt is higher than at the surface, remove the plastic before it seems to be quite ready and test it for working.

Simon S. Palestrant, Bronx, N. Y.

### Pocket Lined With Sandpaper Prevents Pencil Loss

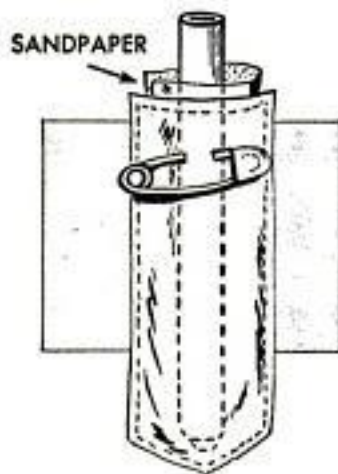

Frequent loss of pencils from his overall pocket prompted one carpenter to line the pocket with sandpaper. A strip of the paper is folded double and cut so it projects slightly above the pocket. To assure that the paper does not fall out, a safety pin is used.

### Spray Head Cools Auto Radiator

Spraying water over the front of the radiator eliminated the problem of overheating in an older-model car that was used to pull a heavy trailer. A length of copper tubing is fastened across the top of the radiator and drilled with pinholes provides a "spray head." The tubing extends back to

a truck-type electric fuel pump in the trunk of the car which pumps water from a junked automobile gasoline tank also in the trunk. When the car engine shows signs of overheating, as when pulling up a long grade, flipping a switch on the instrument panel actuates the electric fuel pump and water is pumped to the radiator spray head to bring down the temperature.

### Muffin Tin Used as Tray To Store Small Parts

A muffin tin can be utilized as a tray for storing small parts. For further convenience, the tray can be made into a drawer to slide under a work-bench or table top by

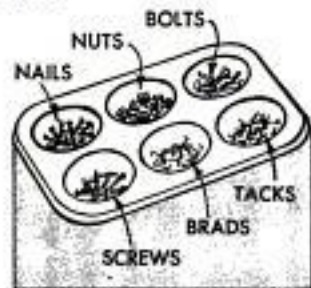

nailing cleats to the underside of the top on which the rolled edges of the tray can slide. A small tab should be attached to the end to facilitate pulling the drawer out when it is to be used. If there is frequent need for a number of small parts, it would be worthwhile to build a cabinet to hold several of the muffin tins.

### Faucet Washer Centers Auger Bit When Boring Hole Oversize

When enlarging a hole in wood with an auger bit, use a faucet washer of the same diameter as the hole to assure that the bit is centered. The hole in the washer will center the lead screw and, being soft, the washer will not damage the cutting edge of the bit.

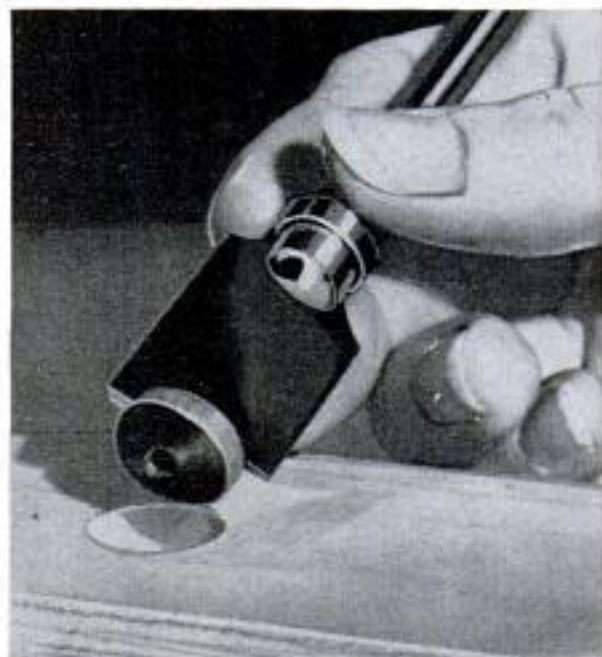

# "BABY PRINTS" IN PLASTER ARE LIFETIME KEPSAKES

By Ralph T. Moore

IF YOU, like many parents, want to keep lasting mementos of your youngster's babyhood, preserve your baby's hand and foot prints on these unique wall plaques. Common puttylike products, such as calking compound, ordinary putty or child's modeling clay, may be used to obtain the prints. Most any product that will retain an impression and also permit plaster of paris to set will do the job.

You will need about 1 lb. of putty. Roll this out on a piece of board or plywood to roughly 6 in. square. The surface of the putty should be smooth and flat. Then moisten the baby's hand or foot with water and press it gently but firmly into the putty. Don't rush this part of the procedure, but use a slow, steady pressure without trying to press too deeply into the putty. Remove the hand or foot slowly from the mold so the putty does not adhere to the skin. If the resulting print is not satisfactory, roll the putty smooth and make another impression.

For the next step, make a square frame from four pieces of  $\frac{1}{4}$  x  $1\frac{1}{2}$  x 6-in. plywood. Force this down over the putty to form a dam around the print. Cut a piece of  $\frac{1}{4}$ -in.-mesh hardware cloth 5 in. square and twist a loop of thin copper wire into the mesh about 1 in. from one corner. This becomes a sturdy loop with which the finished plaque may be hung.

Next mix plaster of paris with water, stirring until smooth, grease the surface of the mold so the casting will not stick to it and pour the plaster of paris into the mold. Press the hardware cloth completely into the plaster with the wire loop at the upper corner of the plaque. Then smooth out the plaster and allow it to set overnight.

After the plaster has set, pull the frame apart and remove the casting from the mold. Permit it to cure for several days and sand and bevel all sharp edges. Seal the plaster with a coat of shellac which, when dry, may be followed with a colored-enamel or metallic finish. If you like, glue felt to the back of the plaque.



Hand or foot impression is made in putty which has been rolled smooth on a piece of plywood



Plywood dam is set up around impression and plaster of paris is poured into mold, above. Hardware cloth, photo below, reinforces plaque



WTM '57

# TWIN-BRUSH FLOOR POLISHER

By David W. Murphy



**B**ESIDES SAVING PLENTY of elbow grease in keeping your floors beautifully waxed, this homemade twin-brush floor polisher will save the usual rental fees, plus the inconvenience of carting the machine back and forth, and actually will do a better job of polishing than the common single-brush type. If you already have a 1/4 or 1/2-hp. electric motor, the polisher can be made for less than \$10.00.

The pullapart drawing on the opposite page shows the main parts that must be purchased, namely, the motor, four V-pulleys, two V-belts, four bronze bushings and two 6-in. circular floor brushes. The bronze bushings used in the original can be purchased for about 60 cents each from a dealer of Boston Gear products. The pulleys are sandwiched between plywood plates which are held 2 in. apart by two spacer blocks screw-fastened to small mounting blocks attached to the plates. Except for the 3-in. hole for the motor shaft, both plates are drilled alike and may be clamped together for boring to assure perfect alignment. The brush spindles are lengths of steel tubing which turn in bronze



bushings press-fitted in 3-in. plywood disks. These disks also are slotted for lateral adjustment and are centered over the 1-in. brush-shaft holes. Regular 1/2-in. machine bolts are used inside the tubing to mount the brushes. The sectional drawing shows how several washers are used to provide clearance between the brushes and the mounting bolts that

Underside view of polisher. Note rubber bumper tacked to rim to prevent marring

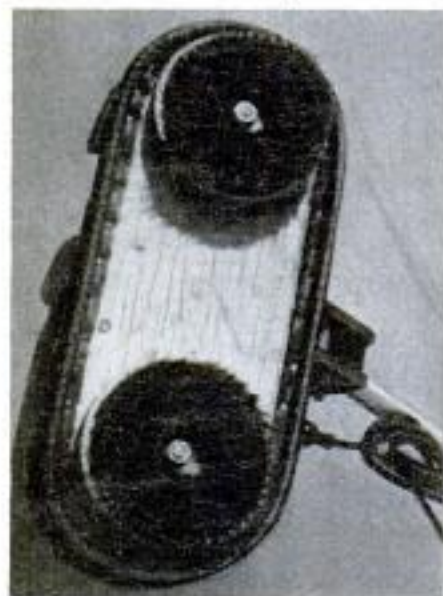

hold the bushing disks. The motor is mounted in a vertical position on two aluminum rails bolted to the top plate. If your motor has a mounting bracket like that shown in the drawing, it may be bolted directly to the top plate. If your motor is of the conventional type that has the mounting bracket on the side, it still can be mounted on end by using the threaded bolt holes that hold the end housing on the motor. Drill the mounting holes in the rails to align with the holes in the end housing and replace the original bolts with longer ones. If direction of rotation causes the brushes to loosen, simply reverse the position of the leads in the motor to reverse the direction. A sheet-metal guard is tacked to the edges of the plates to enclose the belts and pulleys, and the handle is made as detailed. Note that the top of the handle bracket is held to the motor with a bolt which is turned into a tapped hole in the side of the motor. Sponge-rubber upholstery welting is tacked around the edges of the plates to protect furniture from marring. The motor can be wired to a toggle switch located in the handle. ★ ★ ★



*5" (BOSTON GEAR WORKS  
BRONZE FB-1013-6)*

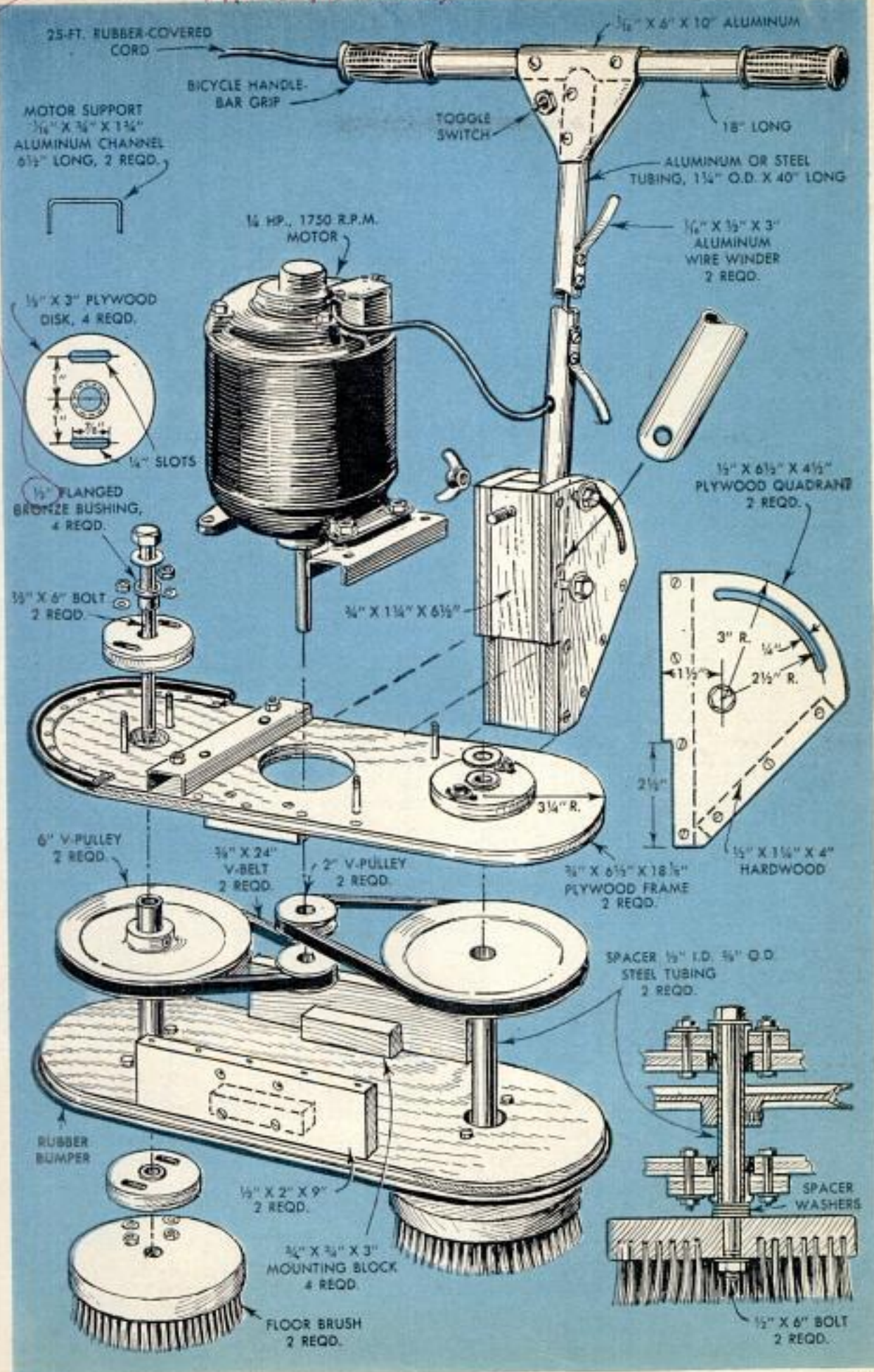

## Oversized Plywood Palette Has Greater Color Choice



Desiring a more extensive color selection than could be fitted on a small palette, one artist designed this oversize plywood palette which holds 36 different colors. Holes are drilled in the plywood to accommodate flanged, screw-type bottle caps. Tube colors can be squeezed into the caps, or water-color cakes may be used. In the latter case, it is necessary to wrap paper strips around the pans which hold the paints, so they fit snugly in the bottle caps. The top three rows as shown hold 18 hues evenly graded around the color cycle, from green-yellow, yellow, orange-yellow, yellow-orange, orange, red-orange, etc., back to lemon yellow. The diagonal arrows connect complementary hues. The other 18 hues in the palette are neutralized or grayed colors.

Walter L. White, Indianapolis, Ind.

## Plate Scraper Protects Wood When Pulling Nails



Slotted as indicated, a rubber plate scraper provides an ideal shield to protect finished wood surfaces when driving or pulling nails. When a nail is pulled, the hammer head is rested on the scraper blade as shown. If

a shield larger than that provided by the scraper is desired, one can be cut from an old rubber sink pad or car floor mat.

## Beveled Top Rail of Picket Fence Prevents Children Walking on It

As a safety measure, one contractor who builds picket fences bevels the top rail as shown. The slanting surface eliminates the temptation to children who might try dangerous stunt-walking and balancing acts on the fence. Fence strength is not affected and the bevel prevents many accidents which might occur if the rail were flat. The bevel also acts as a watershed, preventing water from standing on the rail.—G. E. Hendrickson, Argyle, Wis.

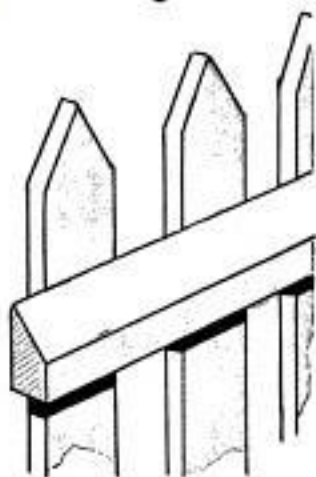

## Block Locks Refuse-Can Lid

Even though a refuse can is knocked over by roaming dogs, the lid will stay on tightly if this hinged block is used under the bail. The block is cut as indicated to straddle the handle and is hinged to the lid with two 1-in. butt hinges. If the lid handle is small, it may be necessary to replace it with one that will project far enough above the folded block to permit gripping it.—R. S. Howard, Milton, Wis.

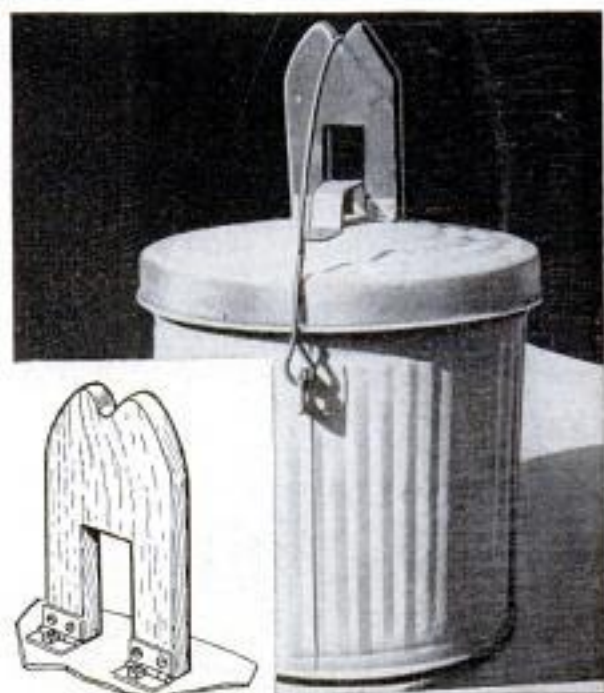

## Two Straightedges for the Week-End Carpenter

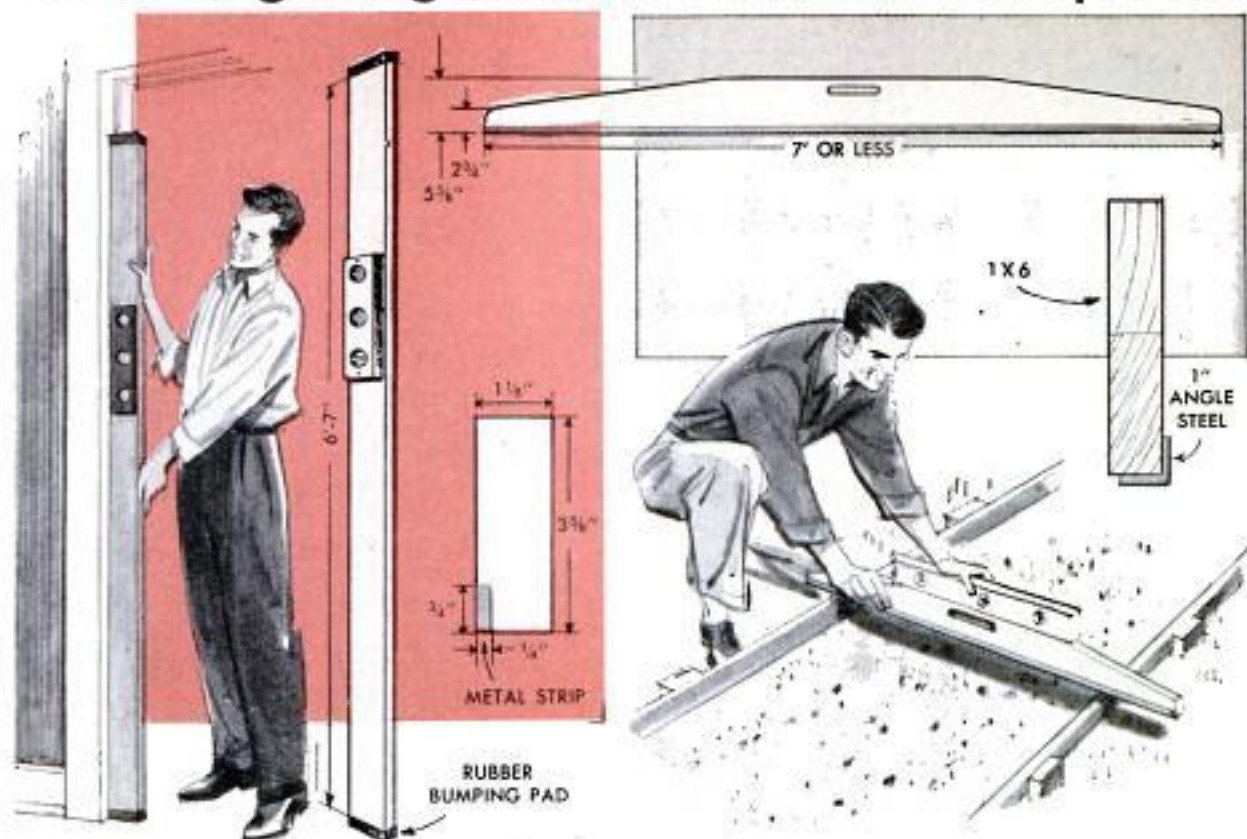

Homeowners who are tackling do-it-yourself jobs that range from framing a doorway to laying a new sidewalk will have need for these two simple-to-make straightedges. The one pictured in the illustration at the left can be used to plumb a doorjamb, level floor joists and to mark wallboard or plywood for cutting. The straightedge shown in the illustration at the right is useful for grading purposes, setting sidewalk forms and other leveling jobs. Both straightedges are used in conjunction with a level. In one, a leveling device, which can be purchased for the purpose, is fastened permanently to the face of the straightedge to save holding it. Although this frees one hand, a regular level may be held against the straightedge

instead. Fitting metal strips along the edges saves wear. Angle steel is used in the case of one, while flat bar stock is set flush in a rabbet cut in the edge of the other. The latter provides a durable cutting edge along which a knife can be used in scoring various materials. Rubber pads can be fitted to the ends as shown to prevent marring the floor or head jamb when the straightedge is used to check a door opening. Although not shown, a small wooden block about  $\frac{1}{2}$  in. thick nailed to the edge of the straightedge at each end will allow the straightedge to span any bow that might be in the doorjamb and which otherwise might interfere with plumbing the jamb. Once jambs are plumb bow can be corrected with wedges.—J. G. Jensen, Chicago.

### Discarded Flash-Gun Dry Cells Still Usable in Flashlight



In most cases, dry cells no longer strong enough for use in photoflash units are still strong enough for use in a flashlight. Wrapping the dry cells with light cardboard will increase the diameter to fit the flashlight case. Usually the spring in the bottom cap of the case can be stretched to make contact with the shorter dry cells.

☐ When mailing stamps for return postage or in payment for merchandise, dust a little talcum over the mucilage to keep them from sticking together.

## How to Use Corrugated Fasteners To Prevent Splitting Work



When corrugated fasteners are used at mitered joints, crossing the wood grain at 45 deg. as shown in the upper detail, portions of the wood may be weakened and chip off so the joint has little strength. To avoid this, bend the fasteners at right angles as in the center detail, so they will be in line with the wood grain. Generally it is better to use corrugated fasteners having widths less than half the thickness of the stock to be joined. Drive the fasteners from the opposite sides, locating them so they are not opposite each other. The fasteners also can be used to join two pieces of stock together when a split turning is made. The fasteners are driven into the end of the stock beyond the limits of the turning.

## Fuller Balls Double as Knobs On Shop-Cabinet Doors

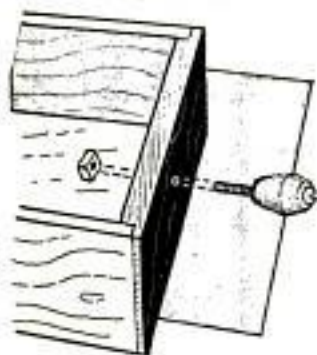

Knobs for shop-cabinet drawers can be made by using rubber fuller balls. Attach them to the drawers with small-diameter stove bolts. The rubber knobs are easy to grasp and are virtually breakproof.

## Luminous Paint for Home Safety

Spots of luminous paint located at strategic points in and around the house will help prevent accidents and save tempers.

Try putting a spot on the corner of the house next to a service walk, another on an elusive light switch, and perhaps one on the edge of an opened door that presents a nighttime hazard.

Ted Otsu, Vancouver, B.C., Canada.

## Socket In Overhead Receptacle Simplifies Changing Switch

When the pull-chain-type switch in an overhead receptacle required frequent replacement because of heavy use, one homeowner installed a "screw-in switch." The receptacle switch was pulled to the "on" position and the chain removed. A combination socket and double plug of the type shown, which has its own pull-chain switch, was screwed into the receptacle. Replacing the switch now is merely a matter of changing the socket plug.

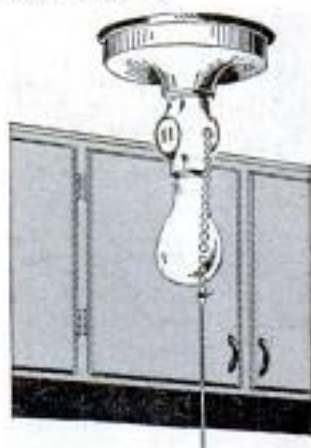

## Novel Bathroom Wastebasket

An unusual bathroom wastebasket that matches the wall tile of the room can be assembled easily. The sides of the basket are of 1/4-in. plywood, each large enough to take two standard 8 1/4-in. plastic tiles. The bottom is made of 3/4-in. stock. After the wooden parts are assembled, the tile is applied, with beaded outside-corner molding of aluminum used for the corners, bottom and top edges. A 6-ft. strip of this material is needed to complete the basket. For extra convenience, chromium cabinet handles can be attached to two sides.





## DO YOUR BATHROOM IN LAMINATE

**R**IGHT NOW there are probably counter tops and table tops in your house that are covered with decorative laminate. A damp cloth will wipe them clean and they won't chip, scratch or corrode. They are just about as troublefree and convenient as a covering material can be.

All of these advantages combine to make the same decorative laminate the ideal covering for your bathroom walls. Just think—those hard-to-clean walls and cabinets can be covered with a completely water-repellent material that never needs painting or polishing. Once your bathroom is done in decorative laminate, you can forget about redecorating.

The photo above and the one at the right are similar views of the same bathroom. Decorative Textolite by General Electric was used on walls and cabinets

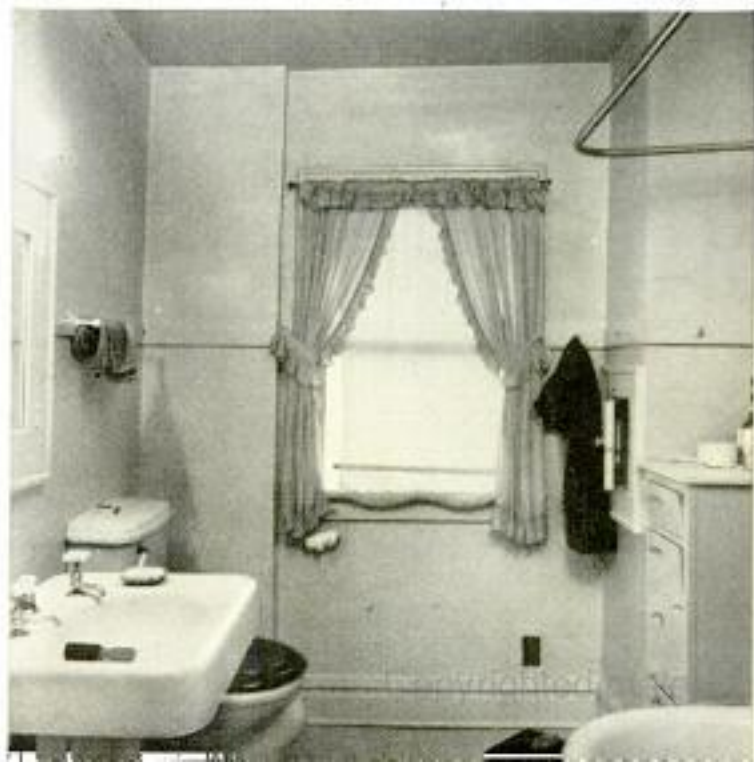

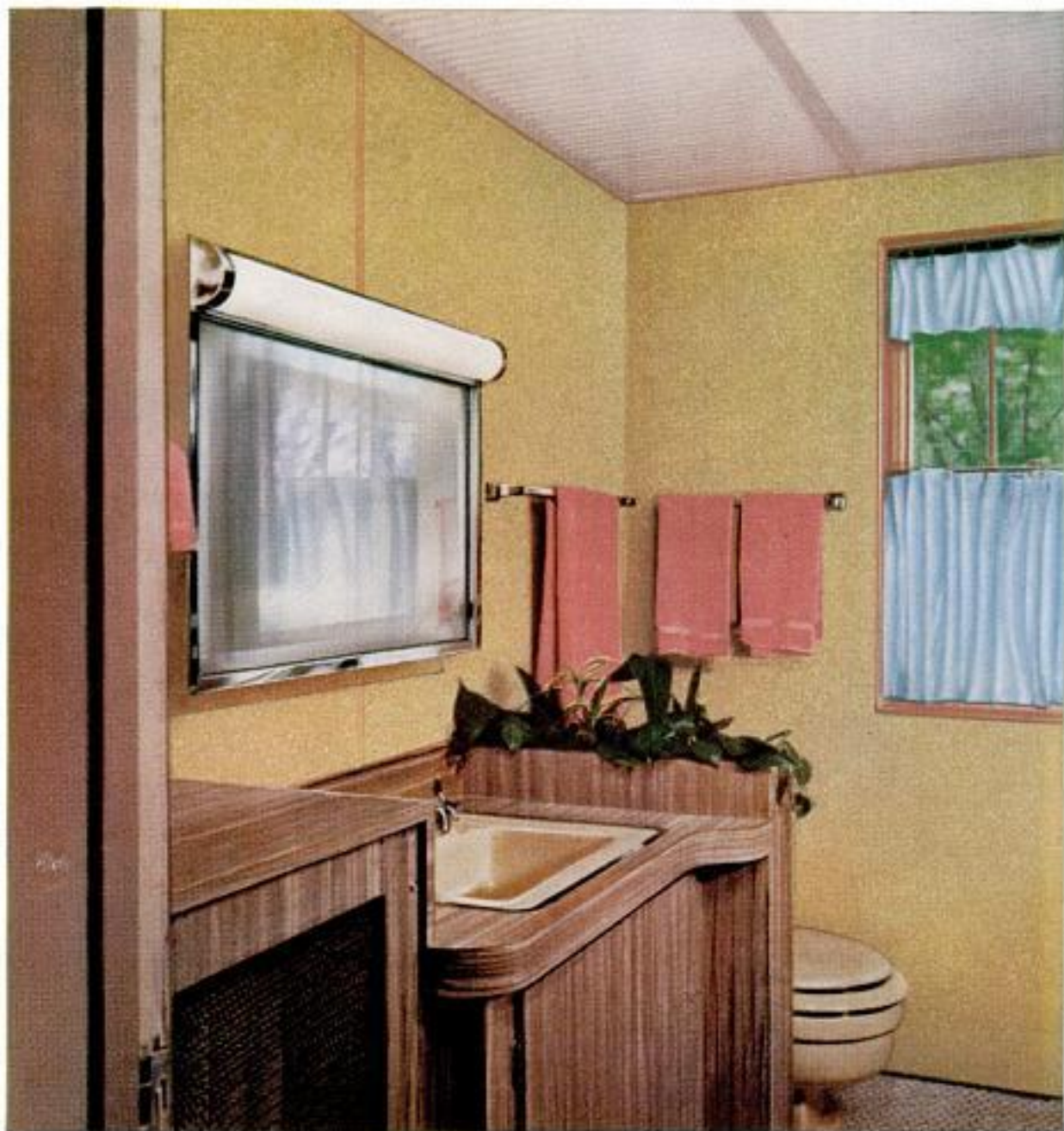

Lavatory finished in laminate of a wood-grain pattern contrasts nicely with linen pattern on walls

The photographs on these pages show you how a typical old-fashioned bathroom was completely remodeled and redecorated with plastic laminate called Textolite. Compare the hard-to-maintain painted walls in the "before" picture with the striking transformation in the two full-color photos.

The decorative laminate, which is  $\frac{1}{16}$ -in. thick, can be applied over existing plaster or dry walls that are in relatively good condition. If the plaster is loose, the walls should be covered with  $\frac{1}{8}$ -in. hardboard or  $\frac{1}{4}$ -in. plywood which is nailed to the studs. If the laminate is to be applied directly to the existing wall, all paint runs or torn seam tapes should be removed. Raised portions of the plaster should be sanded flush with the rest of the wall sur-

face and any large breaks or holes patched beforehand.

Installation of the laminate is easiest if as much wood trim as possible is removed from the room. As it is difficult to remove the window stool it is best to cut a  $\frac{1}{16}$ -in. space for the laminate between the stool and the wall with a handsaw. Window and door trim that cannot be removed without considerable trouble usually can be pried up sufficiently to permit sliding the laminate behind it. Notice in the bathroom that window trim was not replaced. Instead a matching end-cap molding was used around the window and door.

It is important that all sheets of laminate be laid out and cut to size and shape before applying any adhesive. The first step



Lavatory framing, cutout for medicine cabinet and part of hardboard underlayment are shown above

is to divide the wall into equal sections, each being approximately the same width as the sheet of laminate. The finished installation is better looking if all the pieces of laminate are about the same width. Draw vertical lines on the wall surface at points where the edges of the sheets will be set. Use a plumb bob to be sure that the lines are vertical.

Since the ceiling line is the most conspicuous all the sheets of laminate should be scribed and filed to match along the ceiling line. All openings, of course, should be measured from the ceiling. Lay out the holes to be cut in the sheet and drill a

Hardboard or 1/4-in. plywood panels nailed to studs provide smooth surface for application of laminate



NOVEMBER 1955



Plywood top for lavatory is assembled and checked for fit before the plastic laminate is applied to it

starting hole with a 1/2-in. twist drill in two opposite corners of the cutout. Then cut out the hole with a keyhole saw. Temporarily install the laminate without cementing it, to be sure that the cutout sheet fits properly. The sheet should slip behind trim and cabinets without binding.

The laminate is simple to cut. The lines are scored on the face of the sheet with a sharp ice pick or awl, the cut being made deep enough so that the core material of the laminate is apparent. Then hold a straightedge against the scored line and pull upward on the sheet until it breaks off. Edges that will not be covered

Divider molding is added to edge of laminate already in place. Molding is cut short to clear medicine cabinet



197



Molding is tapped in place by using wooden block to cushion hammer blows. Adhesive anchors molding



After next piece of laminate has been cut to size, adhesive is spread on wall surface and on laminate

After adhesive loses tacky feeling, panel is slipped in place. Tap corners with block for good adhesion



with molding should be filed smooth. If available, a portable router can be used to trim the sheet to size and also for the cutouts. The laminate should be supported almost to the point of cut.

The adhesive used for plastic laminates is available in two types. One is designed for industrial application and is too quick-acting for practical use by the home craftsman. The second type does not set as rapidly and permits sliding the sheets into place and making minor adjustments in position. This is the type to use. In this installation, G. E. Pressure Contact Adhesive, Type B, was used.

Begin the cementing operation with the section of laminate that is most difficult to handle. Using a spatula, place gobs of the adhesive on the wall and spread it out with the notched spreader which is supplied with the adhesive. Again using the spatula, butter the back of the laminate with a thin coat of the adhesive. Wait until the adhesive on both wall and panel is no longer tacky to touch, then place the laminate against the wall and slide it into place. When the sheet is in position, it should be rolled firmly with a rolling pin.

The divider molding should be precut to the proper length before starting the installation. As soon as the laminate panel is in place, select a piece of molding of the proper length, spread some adhesive on the back of the molding and force the flange along one side behind the edge of the laminate. The exposed flange of this molding may be nailed to the wall, if desired. However, in most cases, the adhesive will anchor the molding securely.

After the molding is in place and the adjoining piece or pieces have been cut to size, spread adhesive on the wall and on the back of the next piece of laminate. Then apply it in the same way as before.

In order to get satisfactory bonding pressure in the corners, a block of wood is placed on the surface of the laminate and tapped with a hammer. When fitting the last panel into a corner, cement a strip of inside-corner molding to the laminate before applying the latter to the wall surface. Simply put the molding in place along the edge of the sheet before applying the adhesive to the back of the sheet, and then coat both the sheet and the molding with the thin layer of adhesive.

When the wall installation is complete, clean off all excessive adhesive with a special adhesive cleaner and replace any trim and electrical cover plates. Original baseboards may be used again, if you like, or rubber or asphalt base shoe can be purchased and applied over the laminate.

You will notice in the photographs that a built-in lavatory was installed in this





To cut laminate, score face through to core with ice pick or awl, using a straightedge as a guide



After scoring, hold the straightedge firmly against the scored line and bend the panel upward to break

bathroom. The lavatory, which incorporates a radiator cover and a planter, was completely finished with decorative laminate in a wood-grain pattern. The top piece of the lavatory is of  $\frac{3}{4}$ -in. plywood cut and assembled to fit and then covered with laminate. The doors of the linen cabinet at the far corner of the room also are covered with laminate to match the vanity. The decorative laminate is applied to these pieces in much the same way as it is to the walls, except that no molding is used to conceal the corner joints. To obtain neat-appearing joints apply the laminate to the front first. File it carefully flush with the plywood top. Then add the top piece, filing it flush with the front laminate, using downward strokes of the file. Hold the latter at 10-deg. angle to avoid scratching the material. ★ ★ ★

Adhesive is applied to wall surface with notched spreader and to back of laminate panel with spatula

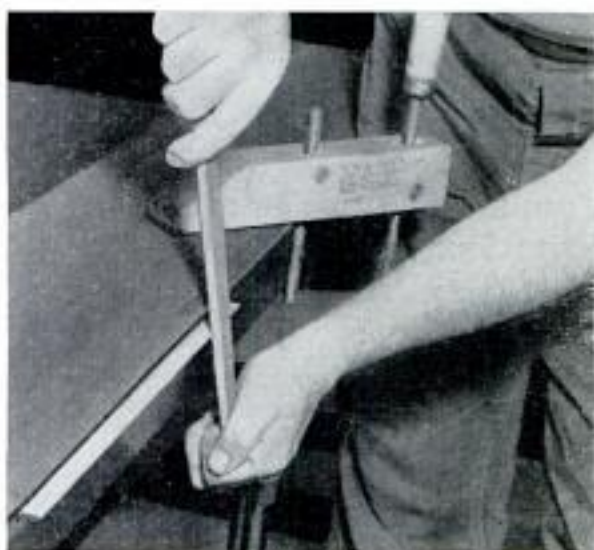

Laminate edges not covered with molding are smoothed with single-cut file, as above. After panel is in place it should be rolled with rolling pin or tile roller to assure a firm bond to the wall surface





### Furniture Stains Removed With Salt and Shortening

White rings and stains on furniture tops, resulting when glasses or dishes are left on a varnished finish, often can be removed by using vegetable shortening and salt. Sprinkle the stains with salt, then rub gently with a clean cloth dipped in shortening. When the stain is removed, wash the surface immediately and re wax. In cases where the stain is extremely stubborn, the only solution is to sand and refinish the surface.

### Estimating Paint Needed For House Exterior

If you have wondered how to figure the number of gallons required to paint the outside of your house, use the following method: First, determine the number of square feet to be covered by multiplying the distance around the house by the average height. Increase the average height by 2 ft. before multiplying, to allow for gables.

### Build Your Own Reed Organ

No Rube Goldberg contraptions but fine reed musical instruments, these Tom Thumb organs in beautiful little cabinets are ideal for the home, small church or service club. One is made from a used accordion, the other from a kit which can be amplified "electronically." Be sure to read "Homemade Organs," beginning next month.

Now find out how many square feet a gallon of paint will cover (it usually is printed on the paint-can label) and divide the square feet of the house by that number. The type of surface to be painted also must be considered. A surface that is rough, dry and porous will take up to 20 percent more paint. Concrete block will require up to 50 percent more paint for the first coat. A corrugated-metal surface needs one-third more paint than a flat metal one, and narrow-lap siding takes 10 percent more than wide-lap siding.

### Key Groups Separated on Chain By Strip of Cellulose Tape

When convenience requires that two groups of keys be separated on a key chain, use a strip of cellulose tape. Slide the two groups to opposite ends of the chain and wrap the tape around the chain to form two loops. It takes only a moment to unwrap the tape when keys are to be added or removed.



### Masonry Joints Flame-Dried Before Being Calked

When joints in concrete or masonry are sealed with calking compound or asphalt cement, the surfaces of the joint must be absolutely dry to assure adherence of the calking materials. Joints in contact with the ground, such as those between basement floors and walls, tend to remain damp and must be dried artificially. This can be done with a torch as shown. *Caution:* Wear safety glasses or a face shield, and do not concentrate the heat in one spot in the joint. Steam resulting from heating trapped moisture in concrete may cause a minor explosion that will hurl fragments.



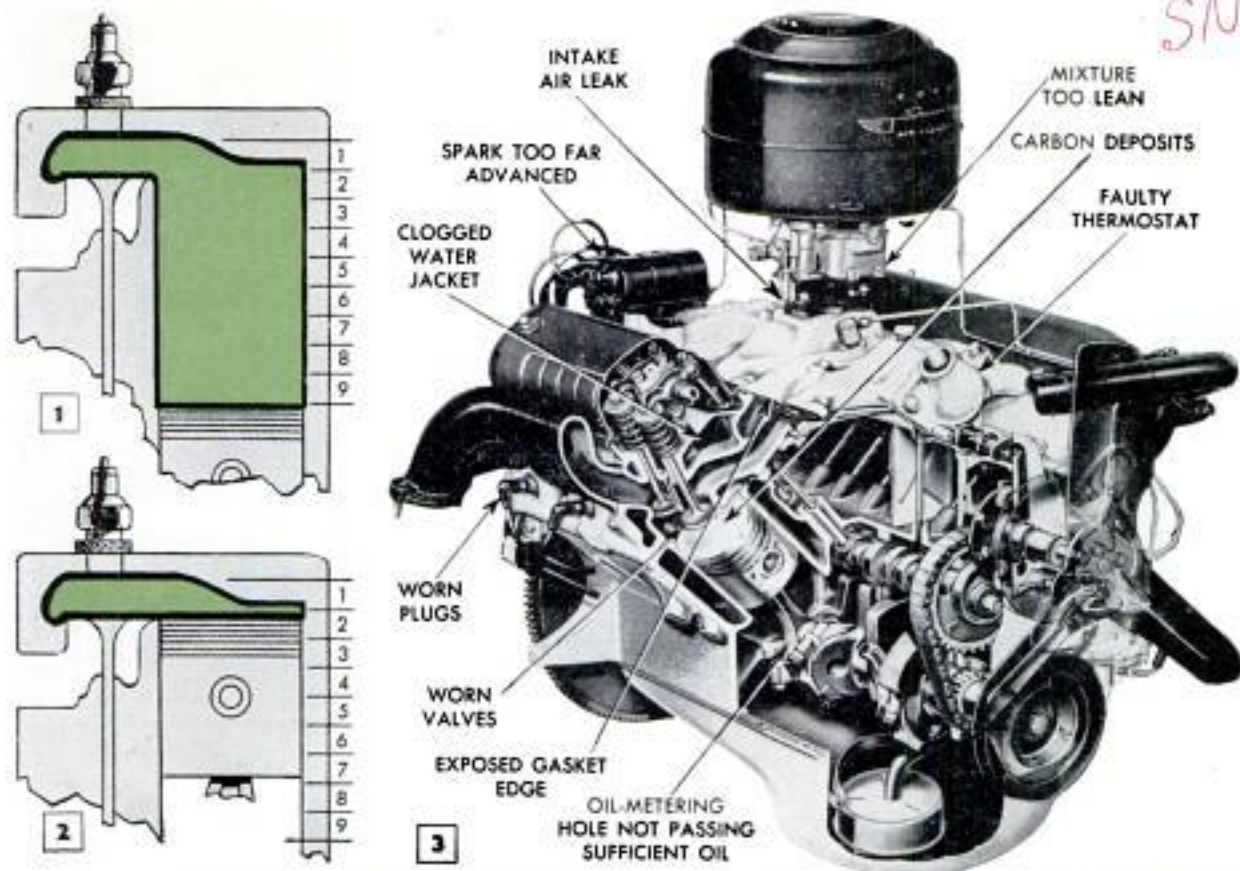

## CONTROLLING ENGINE PING

By Ed Packer

**M**ECHANICS AND MOTORISTS generally call it engine ping, but fuel ping or fuel knock is perhaps a more descriptive term. Common causes are continued use of fuel of too low an octane rating, engine wear, carbon deposits, pre-ignition, incorrect carburetor setting and spark timing. There also are other contributing causes, Fig. 3.

Engine compression and power increase with each new car model. Figs. 1 and 2 show graphically how the fuel charge is compressed in late-model engines. The details are for the purpose of illustration and do not apply to any one model. The details

in Fig. 4 show the progress of normal spark ignition of the compressed fuel charge. Ignition is progressive from the plug electrodes to the opposite side of the combustion chamber, with heat and pressures building up steadily against the piston head. In right-hand detail, Fig. 4, the piston is beginning the power stroke. Uniform burning of the fuel charge and the resulting expansion of the gases are what drive the piston downward on the power stroke.

Detonation, or ping, occurs when secondary ignition takes place in the combustion chamber as in the upper details in

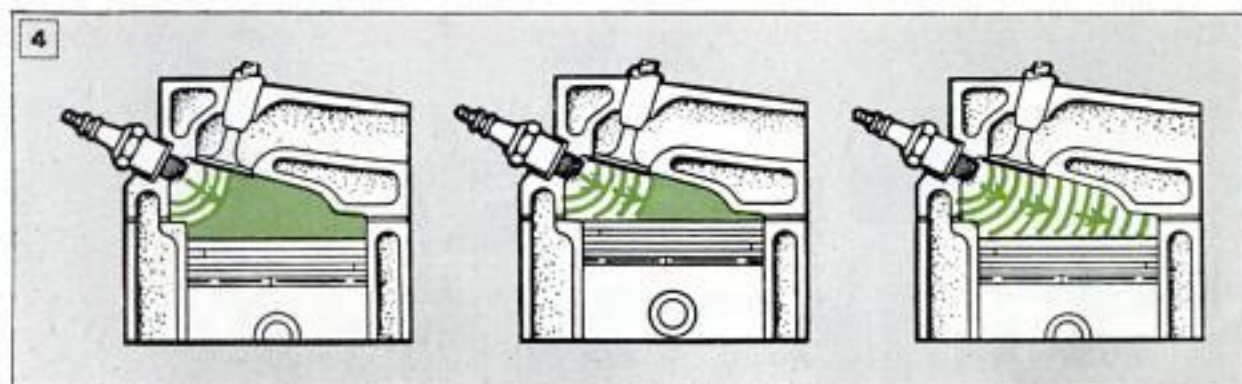

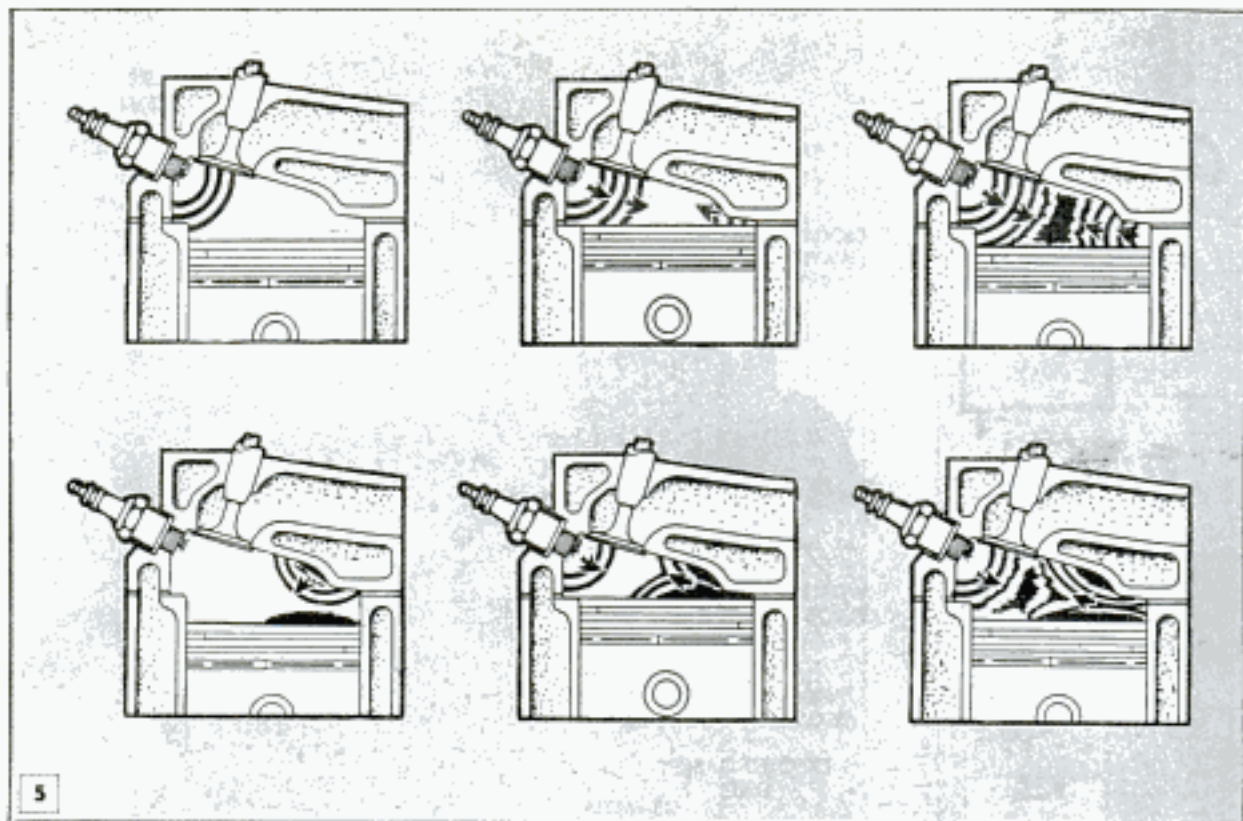
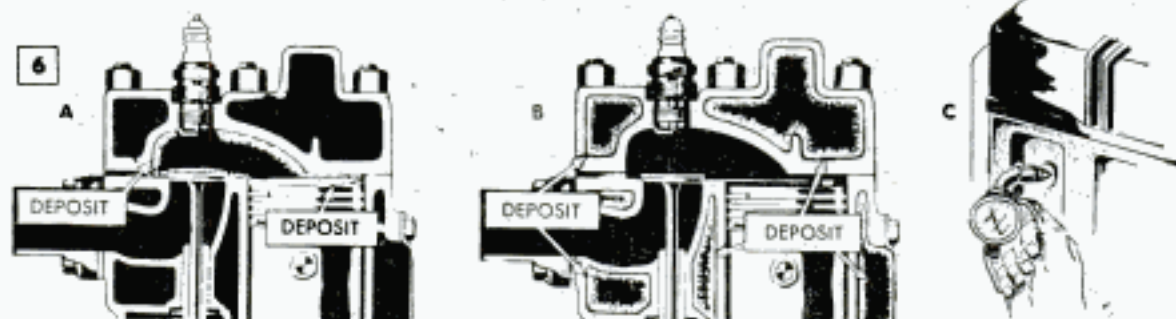

Fig. 5. Ignition begins at the plug electrode in the normal manner but excessive heat and pressure, due usually to some abnormality, raise the temperature of that portion of the fuel charge opposite the plug to the ignition point. The greatly increased pressure resulting from the "dual" explosion causes the audible ping. This can seriously damage pistons, rings, wrist pins and connecting-rod bearings if not corrected.

The lower details in Fig. 5 show the progress of preignition of the fuel charge. Note in the view at the left, Fig. 5, that the fuel charge is already partially ignited before spark ignition takes place as in the center detail. The end result is a dual explosion of the fuel charge, right-hand detail, which is not only wasteful of fuel but also is destructive of engine parts if permitted to continue over a period of time. Preignition usually is caused by carbon deposits which become incandescent due to abnormal conditions within the cylinder.

The higher the compression of the engine

the more sensitive it is to changed conditions that tend to increase the compression or raise internal temperatures. If the normal area of the combustion chamber is reduced, even slightly, by a layer, or deposit, of carbon the effect is to increase compression pressure. In addition to raising the pressure, carbon deposit raises the engine temperature. High-performance, high-compression engines have been developed to a point of perfection which does not permit appreciable carbon deposit in the cylinders or any undue amount of foreign matter in the cooling system, Fig. 6, details A and B. Because of this, it's always good insurance against trouble to pressure-flush or reverse flush the cooling system periodically, Figs. 7 and 8, check or change the thermostat, Fig. 3, and also check compression in the cylinders as in Fig. 6, detail C, using a compression gauge made for the purpose. To make a compression test, bring the engine to operating temperature, then stop it and remove all the plugs. Place the compression gauge



in the spark-plug hole and turn the engine over with the starter. Repeat this procedure for each cylinder, recording the readings for each one. A comparison of the readings of two or more periodic checks will show up any variation. If, for example, the compression readings show an increase, it's a fairly reliable indication that carbon is building up in the combustion chamber of the cylinder or cylinders having the higher readings. On the other hand, should the readings show a decrease of pressure, it's time to think about worn piston rings or valve defects, Fig. 3.

The oiling system of the engine works closely with the cooling system in the dissipation of heat. Oil is thrown from the crankshaft to all internal parts of the engine. The hottest of the larger moving parts are the pistons, especially the undersides of the heads. These surfaces are constantly cooled by the oil spray thrown from the crankshaft. As the oil drains back into the engine pan it carries with it heat from all the surfaces which it contacts. The pan, being in the air stream passing under the car, dissipates the heat at a fairly rapid rate. As the oil thickens in service, its ability to transfer heat lessens proportionally. Continued service at high temperatures drives off the lighter parts of the oil; the oil remaining circulates less freely and the temperature of the engine gradually increases. Because of this tendency it is important to change the oil at regular intervals. Badly worn engine bearings, Fig. 9, also partially clogged metering holes, Fig. 3, can greatly reduce the amount of oil thrown onto the pistons and other parts. This will cause the engine to operate at a higher temperature.

When the spark plugs are removed for cleaning, or for any other reason, always reinstall them with new gaskets. Be sure to remove the old gasket from each plug. Double gaskets may change the heat range of a plug sufficiently to cause severe ping in the cylinder affected. Also, be sure that plugs are of the correct heat range for the engine model and the driving conditions

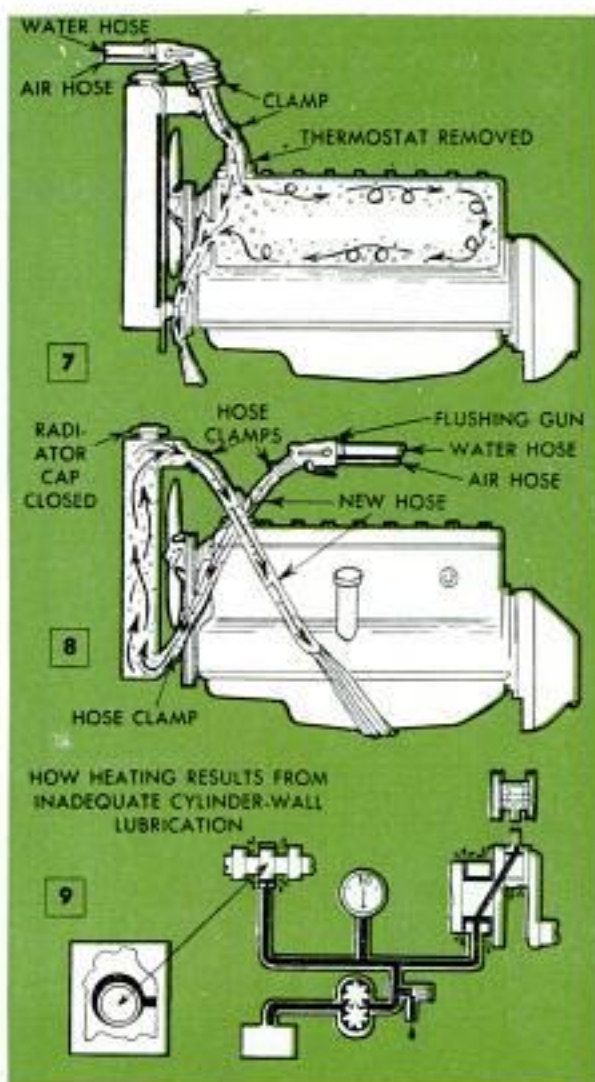

imposed, Fig. 10. Badly worn plugs with knife-edged electrodes, Fig. 11, should be replaced, as the fuel savings alone will likely return the cost of the replacements within a short time.

In some cases a lean fuel mixture is a cause of ping. Often the mixture is leaned out because of a slight air leak, either at the carburetor mounting pad, the intake manifold or the windshield wiper. Spark too far advanced for the load conditions is another cause. Retard the spark a little at a time, Fig. 12, driving the car after each setting, until no pinging is heard. ★ ★ ★



## Corner Shelves Permanently Installed by Using Metal Channels



A neat method of permanently installing corner shelves, such as those between wall and cabinet above a sink, is to use metal channels into which the edges of the shelves fit snugly. The channels are notched at 90 deg., as indicated, so they can be bent to fit in the corner. Rounded tabs formed on

the ends of the channels are bent down to hold the shelves in place. If shelves of 1/4-in. glass are installed, chrome-plated auto-window channels may be used.

## Metal Baffle in Fireplace Eliminates Smoky Condition

If not resulting from downdrafts, a smoky condition in a fireplace can be eliminated by reducing the area opening into the room. The area should not exceed 10 times the flue area for chimneys less than 22 ft. high. For chimneys over 22 ft. high, the opening should not exceed 12 times the flue area. The size of the opening can be reduced by installing a piece of 1/8-in. sheet steel across the inside of the opening at the top.



## Do-It-Yourself MATERIALS GUIDE for the Homeowner and Handyman

### Cross Indexed for Easy Use

If you've ever walked into a hardware store without knowing exactly what you need (and walked out without being sure of what you'd bought), you'll want a copy of this new guide that lists all the specifications for all Do-It-Yourself materials. With this book, you'll know exactly what to look for, and how to save money when you buy.

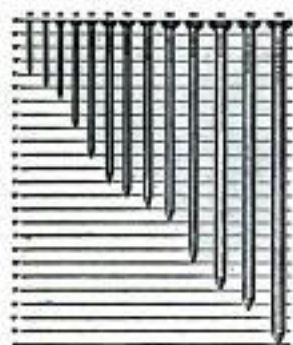

Need to know how long a 50d (penny) nail is? In the Do-It-Yourself Materials Guide, charts like the one at the left (4 1/2 times larger in the book) will show you it's 5 3/8 inches.

The chart at the right, of common wood-screw sizes and gauges, is typical of the dozens of illustrations (all much larger) in the book. Now you'll know how to choose and where to use building and hobby materials.

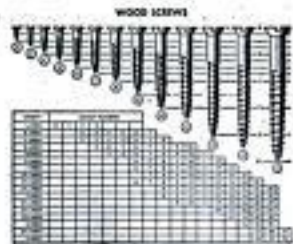

### A Key to Buying and Using:

Adhesives	Fuses	Plumbing
Bolts	Glass	Plywood
Bricks	Hinges	Roofing
Conduit	Locks	Siding
Doors	Millwork	Tile
Fiberglass	Paint	Wiring

... Plus 31 other basic products.  
For only \$3.50 you can get this 160-page guide that will save you time and money every time you buy supplies. So send your order today to:

POPULAR MECHANICS PRESS, 200 East Ontario Street, Chicago 11, Illinois

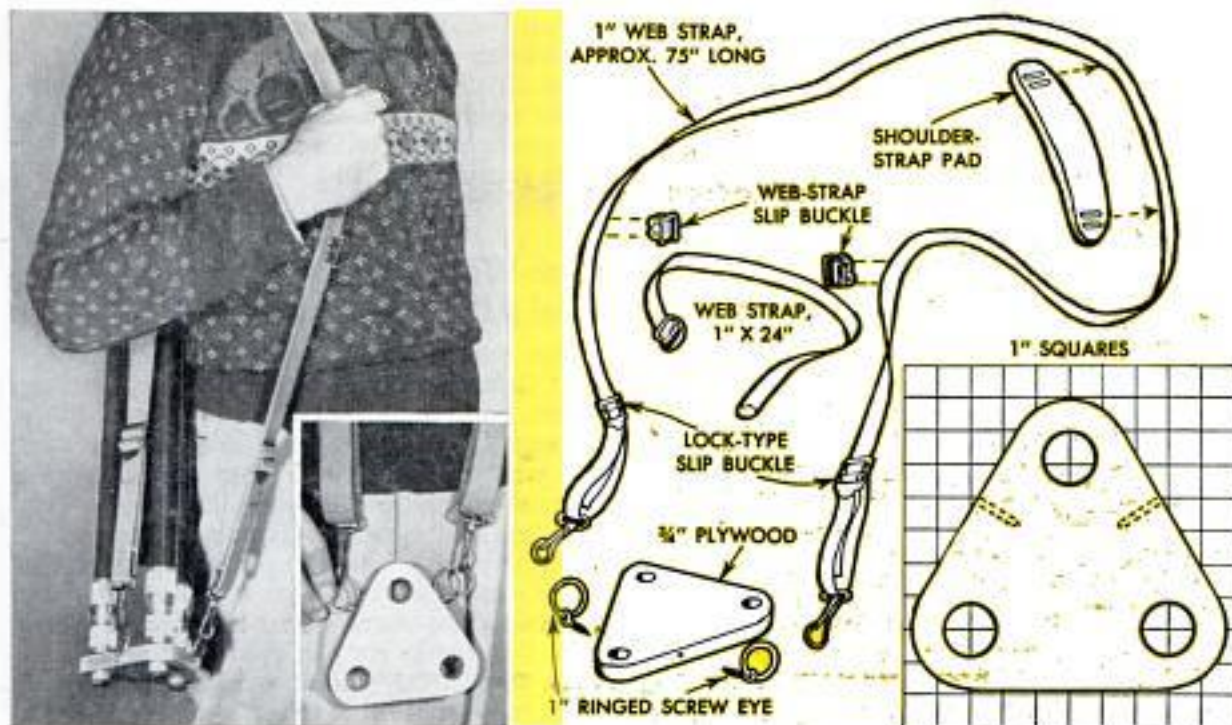

# Shoulder-Strap TRIPOD CARRIER

By M. G. Winterton

BESIDES PROVIDING a most convenient way of carrying a tripod and camera when out on a movie-making jaunt, this shoulder-strap carrier permits me to use my tripod as a unipod in a jiffy for on-the-spot shots of sporting events which demand steady camera support. In addition, I can quickly change over from a unipod to an extended tripod by merely lifting the tripod out of the carrier.

The triangular-shaped carrier is cut from a scrap of  $\frac{3}{4}$ -in. plywood. While a pattern is given, actual over-all size must be determined by the tripod at hand. Since mine has tubular legs I drilled holes for the legs, but if you happen to have a wooden tripod with square legs, square openings can be jigsawed in the carrier. In either case, the spacing of the holes should be such as to permit a slight spread to the tripod for better stability. The web strap material and fittings can be purchased at most sporting-goods stores. The drawing shows what the complete strap assembly looks like, two slip buckles being attached to the main strap for a short safety strap which is used to prevent the camera from tipping forward when used as a unipod. To tote the tripod from the shoulder the safety strap is removed from its unipod position and used to lash the carrying strap to the tripod head, thereby forming a shoulder sling as shown in the photo above. The inset photo shows how the carrier lies flat against the body when the tripod is removed.



Suspended from the neck, the carrier provides stable support for the tripod when used as a unipod. The use of the tripod head for both upward and downward angles is retained by merely reversing the direction of tripod head

## Holder for Drilling Dowels Made of V-Belt Sections

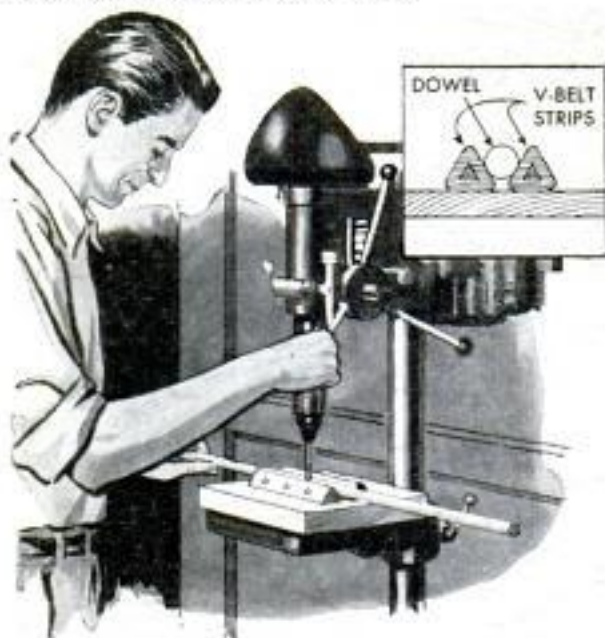

An ideal method of holding dowels while drilling them on a drill press is to use a "V-block" made by tacking sections of V-belt to a wooden block. The material of the belt provides sufficient friction to prevent the dowels from rotating.

## Coupled Socket-Head Wrenches Not Easily Misplaced

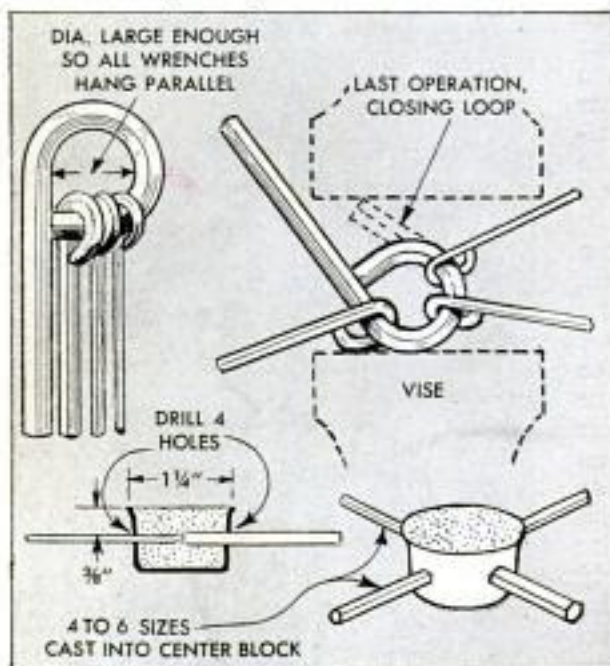

Simplify picking the right size socket-head wrench and prevent losing them by keeping the wrenches together with one of two methods. The first method is to anneal the end of each wrench, except the largest size, and bend a loop in the end. Finally,

anneal the largest wrench, slip the loops of the others over it, then bend a loop to enclose all the wrenches as indicated in the upper details. A second method of keeping the wrenches together is to insert them into holes punched in the side of a deep bottle cap and fill the cap with molten lead.

## Farm-Workshop Overhead Fan Used All Year Around

The overhead fan in this farm shop is used in all seasons to carry away welding fumes, and in summer circulates the air to keep the building cool. The blade of the fan, which was carved from a 6-ft. length of straight-grained lumber, is mounted on an arbor bolted vertically to a ceiling beam. A large pulley on the opposite end of the arbor combines with a small pulley on the fractional-horsepower electric motor to turn the blade at fairly slow speed. The large size of the blade permits it to move a considerable volume of air at slower speed.

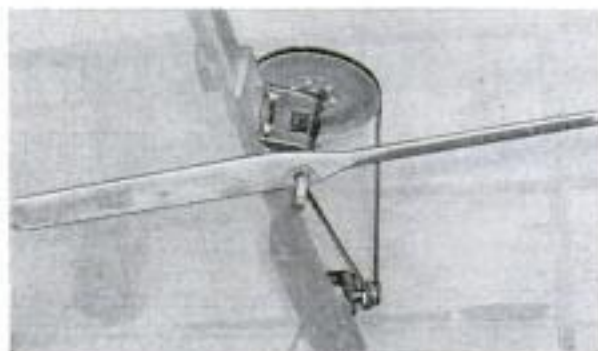

## Tape Keeps Spark Plugs in Order When Removed From Engine

One mechanic uses a wide strip of masking tape to hold spark plugs taken from an engine being checked. As they are removed, the plugs are laid on the strip in correct order. The free end of the tape strip then is placed across the plugs and pressed around them so they are held securely. Held in the tape "package" each plug is readily checked to determine the condition of its particular cylinder. As an example, an oil-fouled plug might indicate a cracked piston or broken ring land.





SN 57  
4  
~~5058~~

# Shop Notes

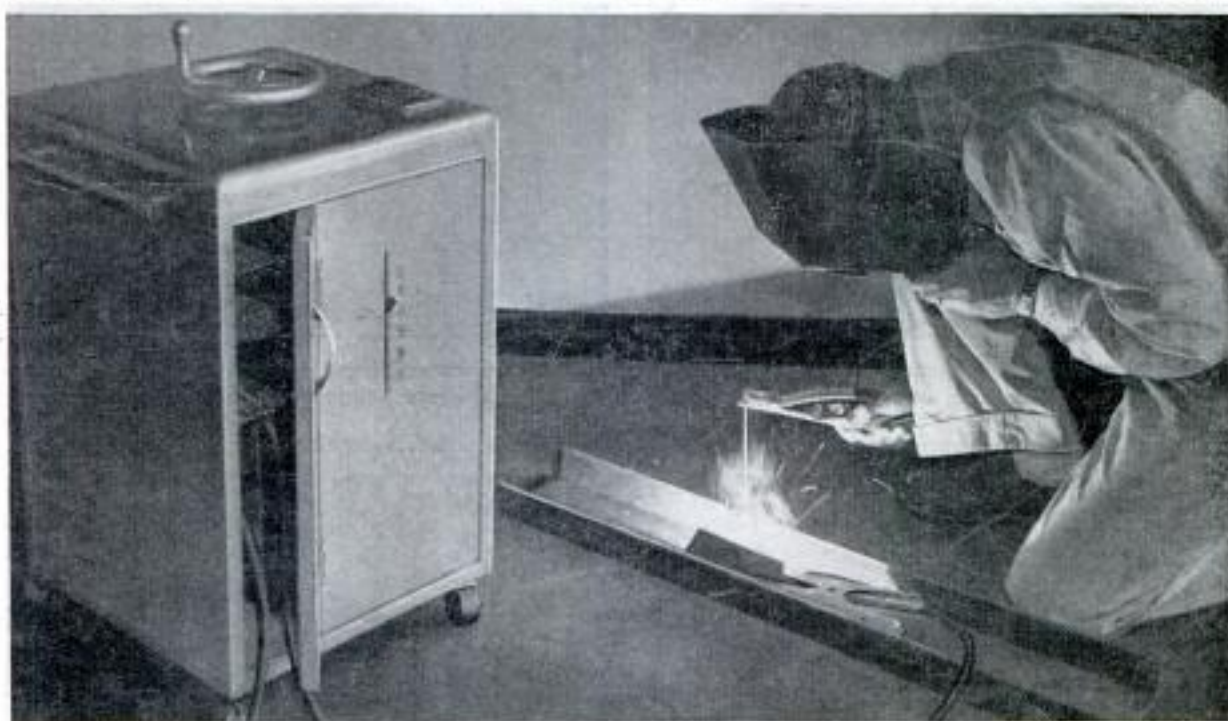

1. Shop-built welder constructed entirely with hand tools works as well as many manufactured products

## ARC WELDER FOR HOME SHOP

By J. W. Wilson and M. C. Anderson

THERE IS NOTHING like an arc welder for assembling metalworking projects quickly and permanently. Besides saving many tedious hours of drilling and bolting, welding produces a more rigid assembly than other methods of construction. Also, when equipped with a carbon-arc tip, an electric welder will supply local heating for bending metals, brazing and soldering.

The electric-arc welder described in this article is especially designed for home-workshop construction, being made of materials available in most localities, and requiring only hand tools to make it. Welding, which is required in the later stages of

assembly, can be done by using the semi-finished welder itself.

The primary source of material for the welder is a discarded tank-type, utility-pole transformer. The one used in the original welder is shown in Figs. 3 and 4, after being removed from its oil-filled tank. This transformer is a General Electric 5 kva. Get a transformer of this type, if you can, since the wire sizes on both primary and secondary windings are usable for the welder. Such transformers usually are not difficult to find, because they are considered obsolete by most power companies and are being replaced by newer types.

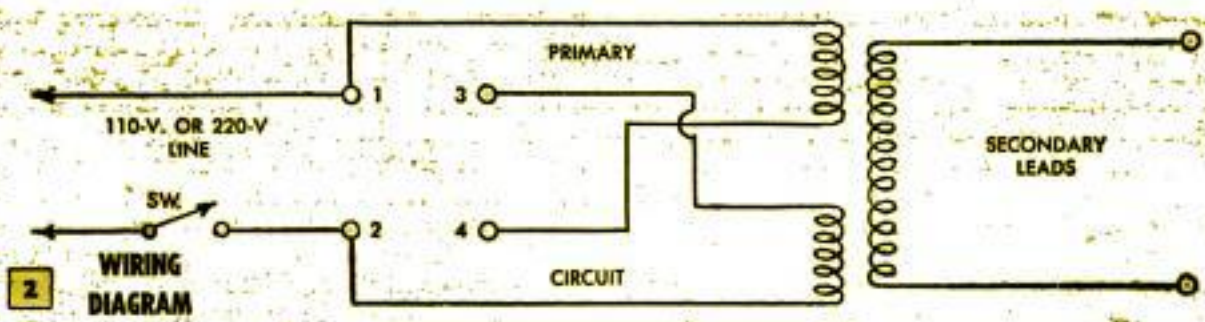

2 WIRING DIAGRAM



3. Pole transformer is removed from its oil-filled tank and distribution ring and wire leads discarded



4. Remove outer "legs" of transformer. Use knife blade to separate L-shaped laminations as indicated

5. Unwind wire from transformer coil onto reel made from scrap wood. Turntables simplify this operation



When selecting a transformer, pull the lid off the tank and check the wire size and type of core. Later-model transformers are built with spiral-wound cores, or with cores other than the L-shaped sections used in the 5 kva. Assembly of the welder transformer is much simpler with the L-shaped sections, although, with some modifications, other types can be used. Wire size is important, because the 20-ga. wire wound on the primary coils of some transformers is too small to be used in the welder coils.

Begin construction of the welder by removing the transformer from its tank and discarding the lead distribution ring and core clamps. Next, remove the outer legs of the transformer, as shown in Fig. 4, prying apart with a knife to aid disassembly. Now unwind the coil wire onto a reel, Fig. 5. If there are two sizes of wire in the transformer, use a separate reel for each size. The reels can be assembled from scrap wood, since they will be used only once. Also, two improvised turntables will help in the unwinding and unreeling operation.

The first step in making the coils for the welder is to make a coil form as shown in Fig. 20. A form with the dimensions given

will accept the correct amount of 10-ga. wire. Note that the core of the form is cut diagonally so the form can be disassembled for removal of the finished coil, Figs. 8 and 20.

Wind the two primary coils, using two strands of 10-ga. wire. The two 10-ga. wires provide the equivalent of one 8-ga. wire. If you are using a size of wire other than 10 ga., check the chart on page 211 to determine the number of strands required to equal 8-ga. wire. The single secondary coil is wound with five strands of 10-ga. wire, or any equivalent of 3-ga. wire.

Figs. 6, 7, 8 and 9 show the steps in winding the coils. Cut strips of heavy paper just wide enough to fit between the sides of the coil form and wrap three layers of the paper on the core of the form before beginning to wrap the coil, Fig. 6. Pull about 6 in. of wire through the hole in the coil form to provide a lead wire, and wrap it heavily with tape or fit it with an insulating sleeve. Begin winding the coil, keeping the wire turns as close together as possible. Tape any cracks that appear in the wire insulation. When the first layer of turns is complete, cover it with a strip



**6.** Wrap a strip of heavy paper around each layer of turns, shellac the paper, then wind another layer

**8.** One bolt holds halves of coil form together, so it can be disassembled to permit removing finished coil

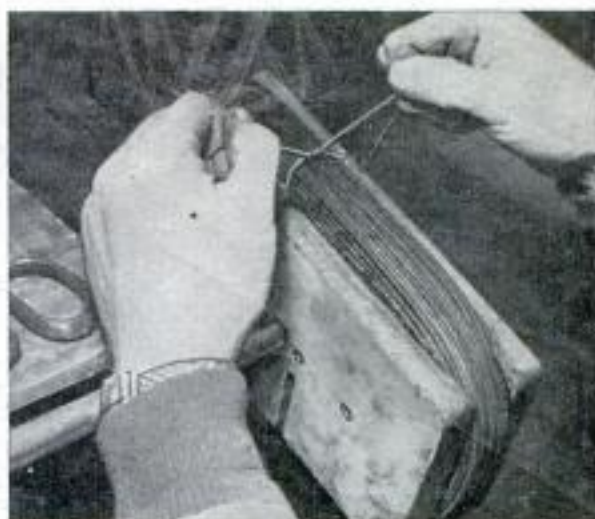
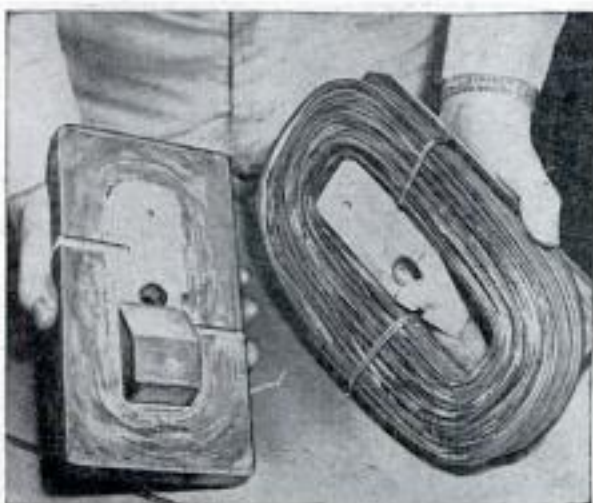

**7.** When coil winding is completed, tie coil as shown, slipping string through slots sawed in coil form

**9.** Finished coils are saturated with shellac or insulation varnish, then wrapped with plastic tape



of paper, shellac the paper, then continue on to the next layer. Repeat the operation until 64 turns of wire are in the coil. Tie the coil through the slots in the coil form, Fig. 7, cut off the wire, leaving a 6-in. lead, and remove the coil from the form, Fig. 8. Both primary coils have 64 turns of wire equivalent to 8-ga. wire; the single secondary coil has 28 turns of wire equivalent to 3-ga. The finished coils should be saturated with shellac or insulating varnish and, when dry, wrapped with plastic electrical tape, Fig. 9.

With the coils finished you are ready to build the transformer by stacking the core. Make a jig to support the three coils while doing it. The jig, Fig. 10, is simply three blocks nailed to a piece of plywood. Light crosspieces support the core as it is stacked. In most transformers of the type used to build the welder, the core is made of laminations having legs of different widths. Use only the wide laminations for the welder. Begin stacking the core, alternating the

L-shaped laminations to produce a rectangular core, Figs. 10 and 18. The height of the finished core is 6 in., which requires that the loose stack be slightly higher. Angle-steel frames are used to clamp the core, Fig. 11. Four welded joints are required in the frames. They can be welded by wiring the welding transformer as indicated in Fig. 2, and using the control slug manually to control the welding current, Fig. 13.

The control slug is made by stacking transformer laminations to a thickness of 1 in. The slug then is wound with plastic and cotton tape and shellacked. The two outside laminations are cut longer than the others to permit pinning the slug to the adjusting mechanism, Fig. 15. Be sure the slug is small enough to slide freely down inside the welding transformer, Fig. 21.

If the welder is to be used on 110 volts, connect terminals 1 and 3 together, and 2 and 4 together by copper bars. If 220 volts are used, connect the three coils in series

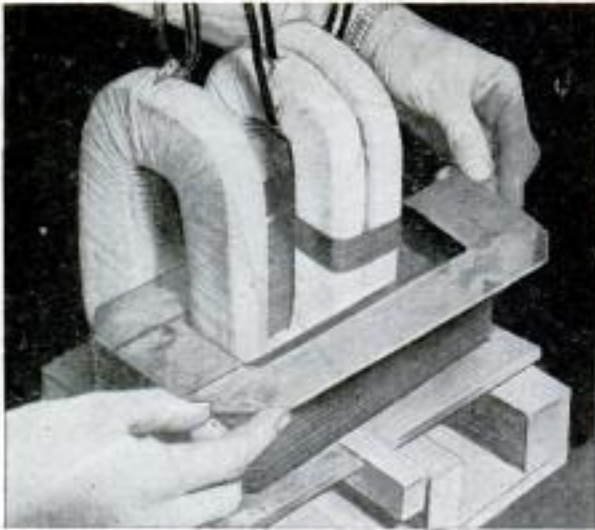

**10.** Three coils are held upright and in position by jig, while core laminations are stacked around them

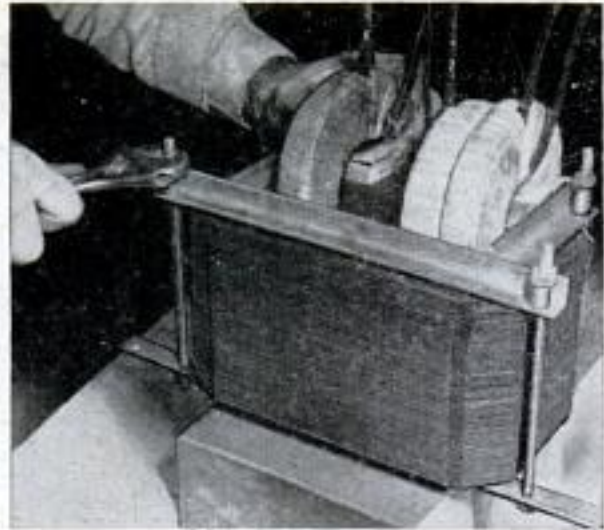

**11.** Core clamps are tightened snugly, then laminations are tapped flush and clamps pulled down tight

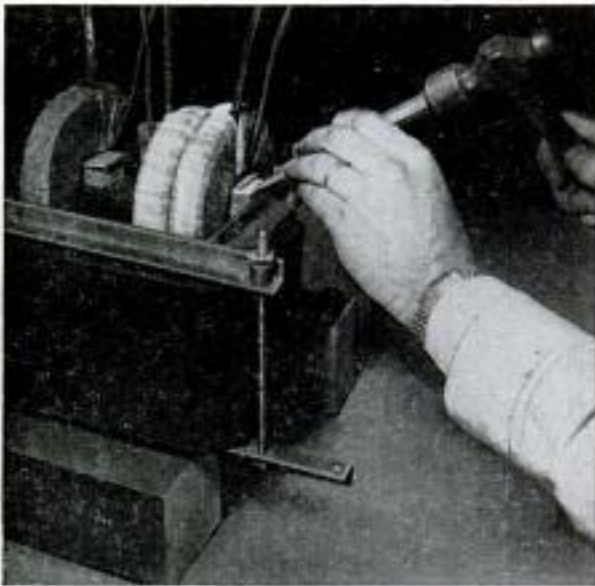

**12.** Hardwood wedges are driven between coils and core, paper or fiber strips protect insulation on coils

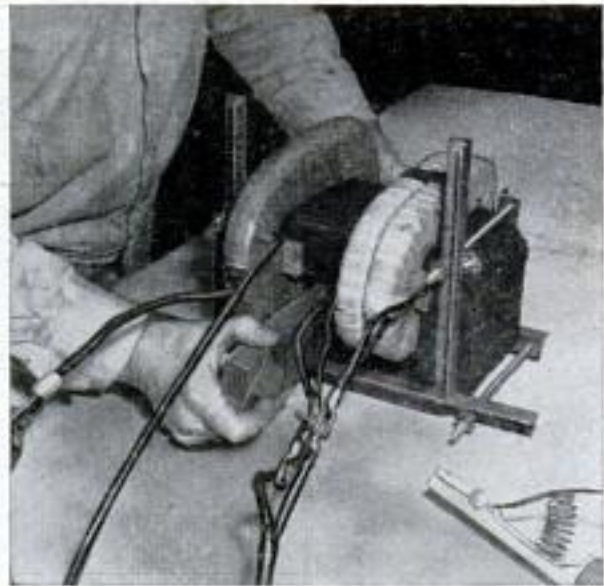

**13.** Semifinished welder can be used for welding by inserting control slug and operating it manually

**14.** "Building its own house," the welder is used to weld the joints of the angle-steel cabinet frame

**15.** Counterbored block screwed to underside of cabinet top supports bearing for control mechanism

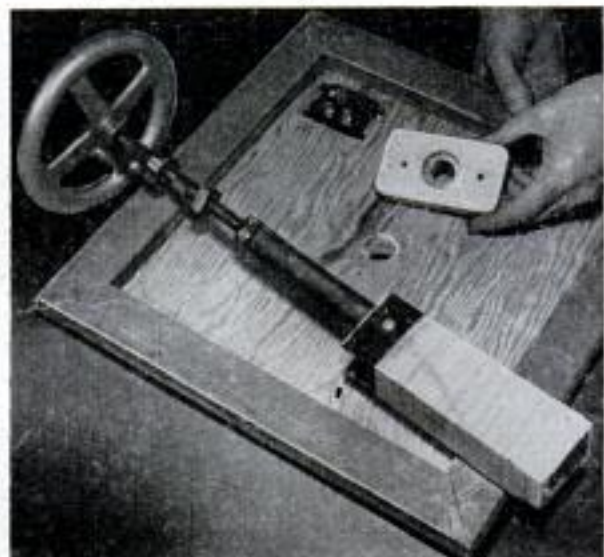
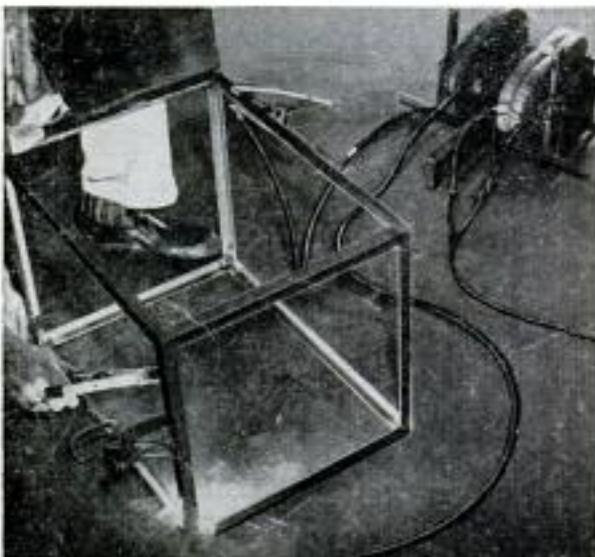

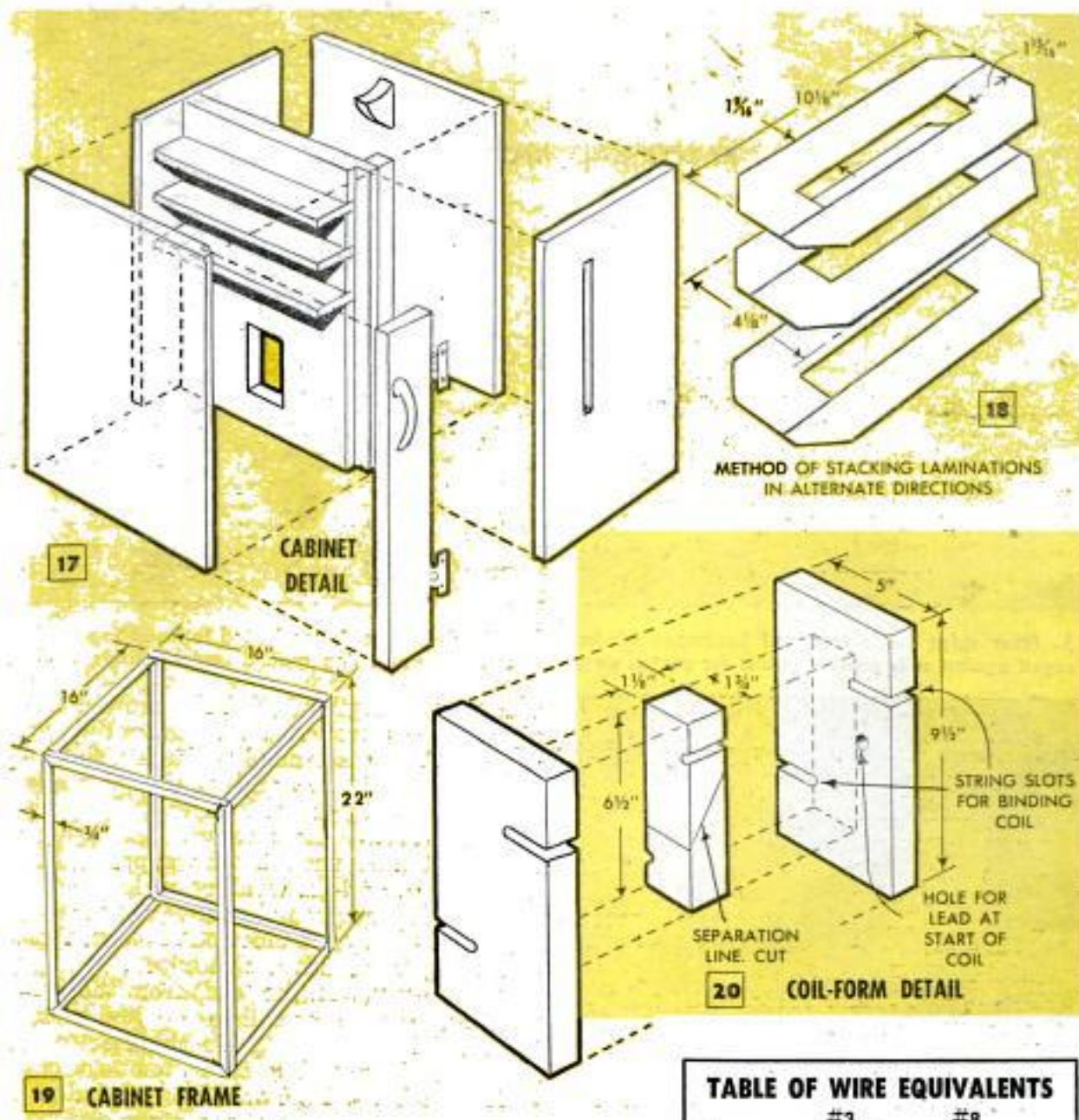

by connecting only terminals 3 and 4 together.

After the clamping frames are welded together, fit threaded rods at the corners, Fig. 11, and draw the frames together snugly. Gently tap all the laminations of the core until they are flush, then tighten the holding rods firmly. After the core is clamped, wedge the coils in place with hardwood wedges, Fig. 12. Use cardboard or fiber spacers between the wedges and coils to prevent damaging insulation.

Fiber spacers also are cemented to the long sides of the inside of the transformer core, Fig. 21, and wedged in place with hardwood blocks. The blocks and spacers act as guides for the control slug. The adjusting mechanism for the control slug is shown in Fig. 24. A length of threaded rod turns in a nut welded to the end of a length of pipe which is pinned to the control slug. As the rod turns into the nut it raises or lowers the slug. A ball bearing recessed into the welder-cabinet top supports the mechanism.

The welder cabinet is built around an angle-steel frame, Figs. 14 and 19. Fig. 17 shows the general

TABLE OF WIRE EQUIVALENTS		
	#3	#8
# 6	2 strands	—
# 7	3 strands	—
# 8	4 strands	1 strand
# 9	4 strands	2 strands
#10	5 strands	2 strands
#11	7 strands	2 strands
#12	8 strands	3 strands
#13	10 strands	3 strands
#14	13 strands	4 strands
#15	16 strands	5 strands
#16	20 strands	7 strands

arrangement of the cabinet. The 3/4-in.-plywood cabinet top is fitted with an apron of 2 x 2s. The welding transformer is mounted inside the cabinet on two steel flats welded to the angle-steel frame. Holes are drilled in the flats to receive the ends of the core-clamping rods. An indicator for the welder can be made by

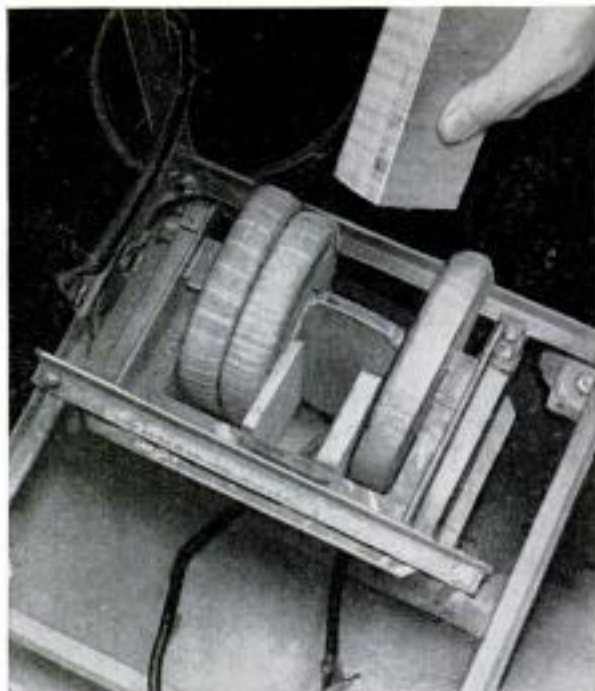

**21.** Fiber strips inside core and hardwood blocks wedged against coils provide guides for control slug

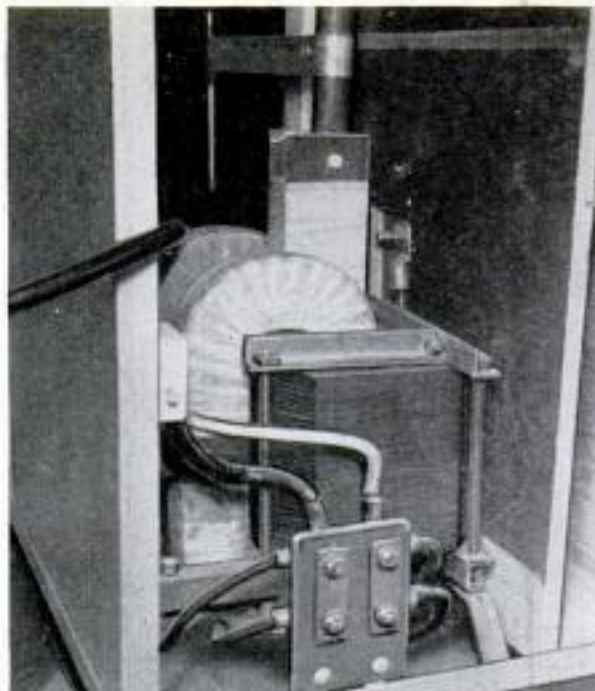

**22.** Leads from coils are bolted to insulating block to simplify connecting ground and electrode leads



**23.** Decal numbers equally spaced along indicator slot permit judging relative heat at any setting

clamping a length of steel flat around the pipe of the control slug. The end of the flat is pointed, and extended through a slot in the cabinet, Figs. 22 and 23. Decal numbers are equally spaced along the slot to indicate relative heat ranges. A heavy-duty switch is used in the supply line. About 30 ft. of 4-ga. welding cable will be required for the ground and welding leads. A ground clamp and electrode holder, plus a welding mask also are required.

For convenience, the leads from the primary and secondary coils are bolted to an insulated block, Fig. 22, so the electrode and ground wires can be bolted to them with brass bolts. Pipe or tubing is used for cabinet handles, and the casters can be welded or bolted to the cabinet frame. The material used to cover the welder-cabinet frame can be either hardboard or sheet metal as desired. ★★★

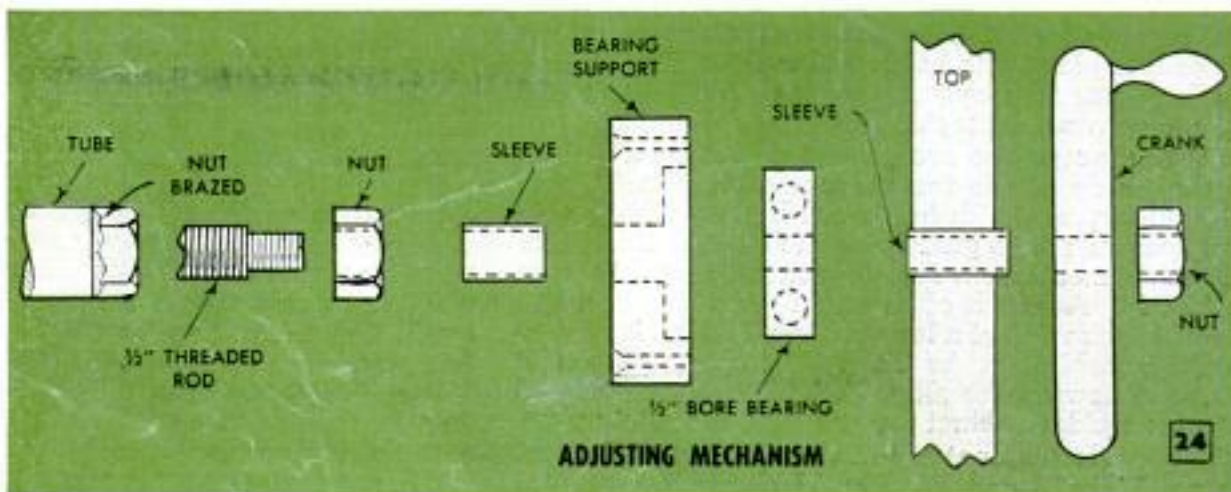

## Snap Locks Hasp and Staple To Hold Door Halves Together

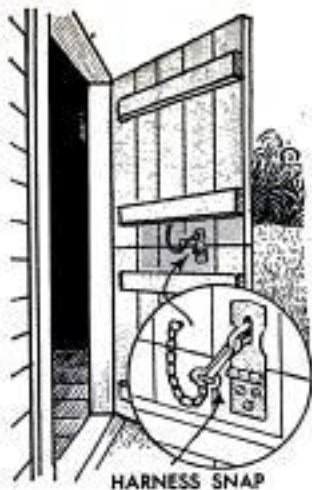

HARNES SNAP

Because a one-piece door sometimes is more convenient to use, one farmer locks the upper and lower halves of a two-piece barn door together with a hasp and staple. The hasp is screwed to the lower half of the door so it drops out of the way when not in use. A harness snap used

to lock the hasp to the staple is hung on a length of chain screwed to the upper half of the door as indicated in the detail.

## Chamfering Edges of Tubing With Special Lathe Setup

Chamfering the outer edge of the ends of several hundred lengths of tubing was done at the rate of several a minute by using a lathe setup consisting of three tool bits and a pilot chucked in a three-jaw chuck. The pilot is a length of steel round shouldered to fit snugly inside the tubing. Each of the tool bits is ground to a 45-deg. angle with considerable clearance to assure that the cutting edges of the bits contact the work piece. Chamfering different sizes of tubing requires only changing pilot sizes. The same tool bits are used for all diameters. To use the setup, the operator holds a length of tubing in his hand, slips it over the pilot and forces it lightly against the rotating tool bits.

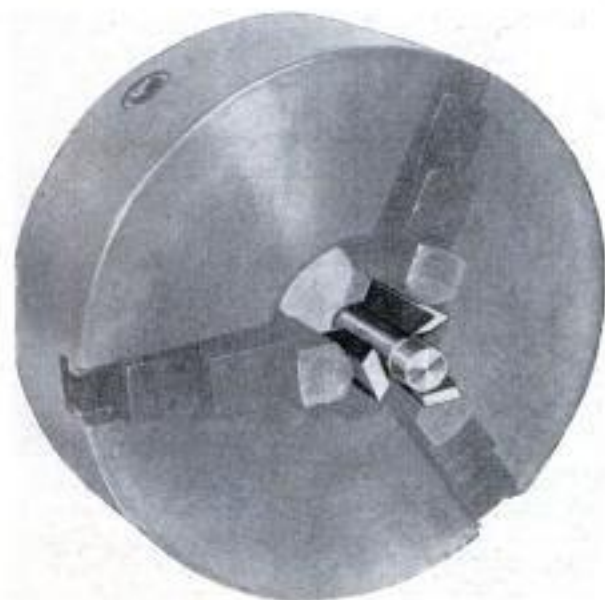

NOVEMBER 1955



## Automatic Feeder for Turkeys Reduces Time and Labor

A minimum of time and labor is required to supply mash to growing turkeys when this automatic mash feeder is used. Controlled by a timer, the feeder discharges mash onto a conveyor system that runs in a narrow metal trough the length of the turkey house. The long trough provides more eating space for the birds, yet requires less floor space than a hand-filled trough. Depending on the number of birds in the house, the automatic feeder can be set to discharge more or less feed each hour.

## Handsaws Held in Slotted Rack By "Self Locking" Wedges

Handsaws are locked in this rack simply by slipping the blades into the slots and pulling downward. The rack is a 2 x 4 in which slots are sawed 1 in. deep. Holes then are drilled through to intersect the slots. Marbles or steel balls dropped into each hole act as wedges.

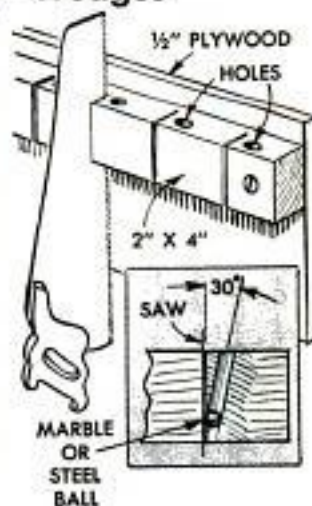

213

SN 57

X385



# GRINDING LATHE TOOLS

By Sam Brown

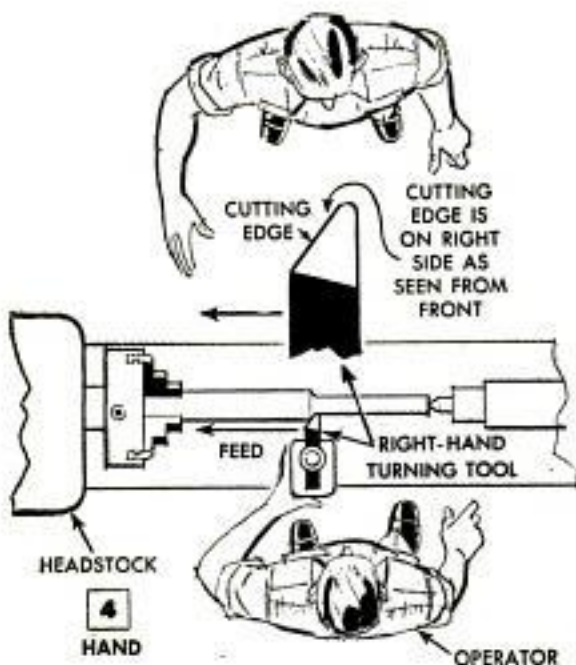

ALTHOUGH grinding lathe tools looks complicated to the beginner, they are perhaps the easiest of all cutting tools to sharpen. You can shape them freehand and, as long as enough clearance is allowed to prevent rubbing, almost any kind of shape will cut and do satisfactory work.

One of the first things learned about lathe tools is that all cutters are mounted "on center," as in Fig. 6. It is easy to locate any tool bit at the right height by using a height gauge made from a scrap of metal, Fig. 1. Some operators like special tool-post rings, Figs. 2 and 3, to automatically locate often-used tools at the right height. Still another way to set the tool height is by reference to a line scribed on the tailstock ram, Fig. 8.

Lathe tools are named according to their application and profile shape. Some standard shapes are shown in Fig. 5. The "hand" is called from a front view of the cutter, Fig. 4.

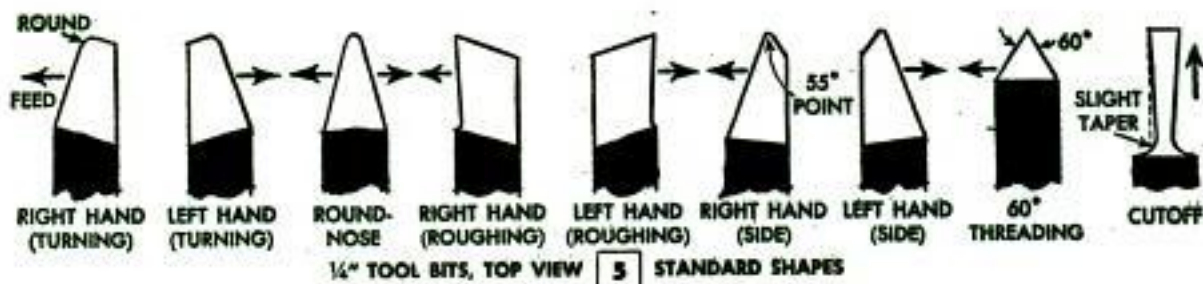



The front and side clearances of a lathe tool are satisfactory if both are 10 deg. although variations are sometimes useful. The front clearance is measured from a tangent line at the point of contact, Fig. 6. Side clearance, Figs. 9 and 10, is easy to understand. Back rake and side rake, Figs. 12 to 17, give the tool a certain wedge angle, which should be blunt enough to cut without dulling, yet not require excessive pressure. A back rake of about 15 deg. is a good value for turning steel. If you use a toolholder with a 15-deg. inclined slot, Fig. 13, the back rake is obtained without grinding the cutter. Large cutters mounted in an angle-type milling attachment can be given any desired amount of back rake by tilting the attachment, Fig. 14.

Exact adherence to any specified rake angle is not necessary since tools function quite well over a wide range of angles. An angle gauge can be made or purchased, Figs. 11 and 20, and is a useful aid for the beginner. Some manufactured gauges of this type have one side at 20 deg. to be used for front clearance, as shown by dotted line in Fig. 20. This large front clearance angle is for use in connection with a tool setting 5 deg. above center as in Figs. 21 and 22.

Edge and end-cutting angles, Fig. 19, are not too important but are of interest in that they reflect the favored shapes used by different turners. Some operators make extensive use of the plain square shape with zero side-edge angle, D. However, this is a rough cutter and should be confined to roughing operations. The conventional shape of a turning tool is shown in A, with side-edge angle about 20 deg. and end-edge about 15 deg. This cutter puts most of the thrust lengthwise with the work, B, with just enough back thrust to hold the slack

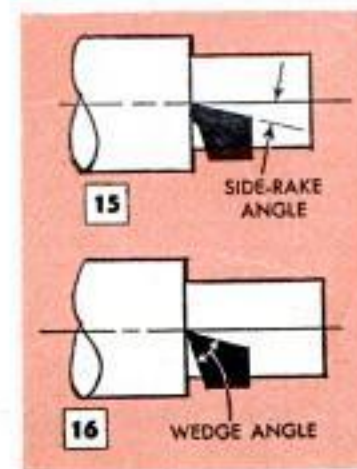
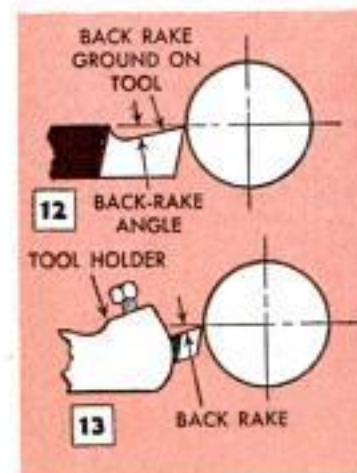
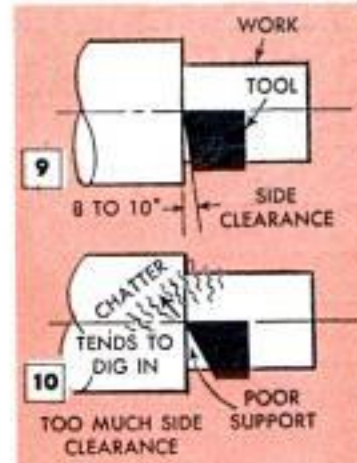
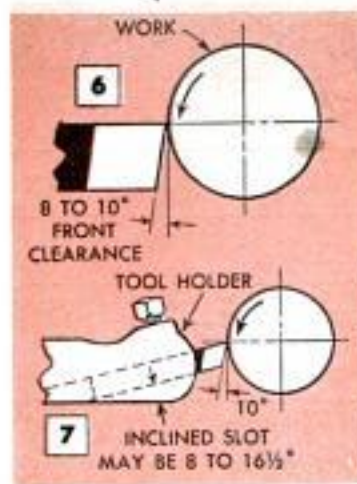

## 18 TOOL ANGLES AND WORK SPEEDS

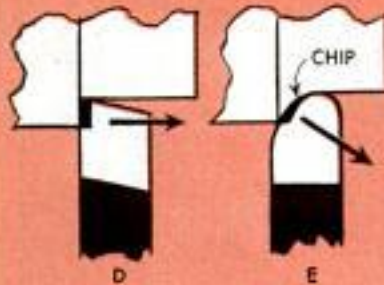
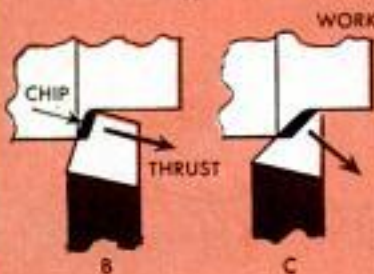
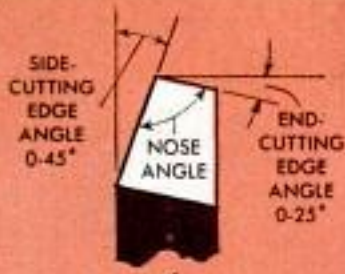

19 EDGE AND END-CUTTING ANGLES

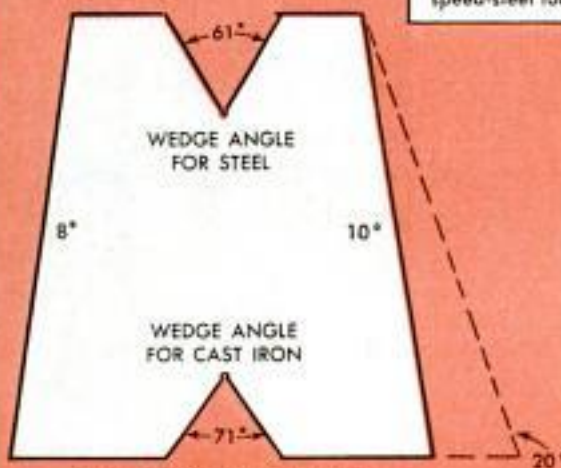

20 TOOL-ANGLE GAUGE (APPROX. FULL SIZE)

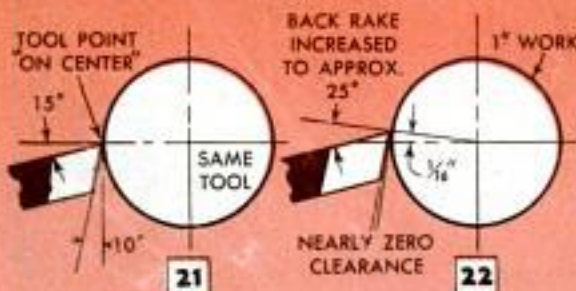

21 22 EFFECT OF HEIGHT ON RAKE AND CLEARANCE

MATERIAL	FRONT CLEARANCE	SIDE CLEARANCE	BACK RAKE	SIDE RAKE	F.P.M. SPEED
STEEL (MILD COLD ROLLED)	8-10°	8-10°	15°	20°	80-120
STEEL (MEDIUM HARD)	8-10°	8°	12°	14°	60-100
STEEL (HARD AND TOUGH)	8-10°	8°	10°	12°	40-60
CAST IRON	8°	8°	5°	12-15°	50-80
MAGNESIUM	10°	10°	10°	5°	150 AND UP
ALUMINUM	8-10°	8-10°	30-40°	10-20°	200 AND UP
COPPER (FREE MACHINING)	8-10°	5-10°	0°	5-10°	100-200
COPPER (TOUGH)	8-15°	10°	10°	20°	75-150
BRASS (FREE CUTTING)	8°	2-8°	0°	0-5°	120 AND UP
BRONZE (PHOSPHOR)	10°	10°	15°	20°	60-120
FIBER	15°	12°	0°	0°	80
PLASTICS (THERMO-SETTING)	10°	10°	0°	0°	100 AND UP
PLASTICS (THERMO-PLASTIC)	10°	10°	10°	15°	150 OR LESS

Angles are measured from true horizontal and vertical planes of work and are for tools set "on center." Work speeds in feet per minute (F.P.M.) are for high-speed-steel tools.

in the cross-feed screw. Excessive drag angles, C, are favored by many turners. A cutter like this cuts smoothly but leaves a large amount of uncut metal when working to a shoulder. The round edge tool, E, does excellent finishing.

The actual grinding of a lathe tool is simple. It should be held in the toolholder for convenient handling and can be ground on either the side or rim of the wheel as desired. High-speed steel can be ground either wet or dry, the best home-shop practice being dry grinding, avoiding overheating and letting the tool cool in air, not water. The life of a tool is greatly prolonged if the cutting edge and top surface are honed. Although the table, Fig. 18, gives specific angles, remember that 10 deg. front and side clearance with a modest amount of back and side rake will produce a satisfactory tool. However, back rake and side rake vary considerably, as shown by the varying degrees of angle given in the chart. Lathe speed also is a definite factor in proper cutting. A tool will quickly become dulled and, in some cases, damaged, if lathe speed is too high. At the opposite extreme, a very slow speed used on some materials rapidly dulls the tool. ★ ★ ★

SN 57

# HAND-POWERED SABER SAW

Better and faster than a keyhole saw on straight or curved cuts, the hand-powered saber saw's wide metal foot holds the blade perpendicular to the surface during the cut. The blade is driven on downstroke by pressure on the handle and the spring returns the handle to the up position when pressure is released. Close-fitting parts are necessary to smooth operation and to prevent kinking of the saw blade on the cutting stroke. Make the slide, filler blocks and handle from hardwood or plywood.

Carl S. Bates, Chicago.

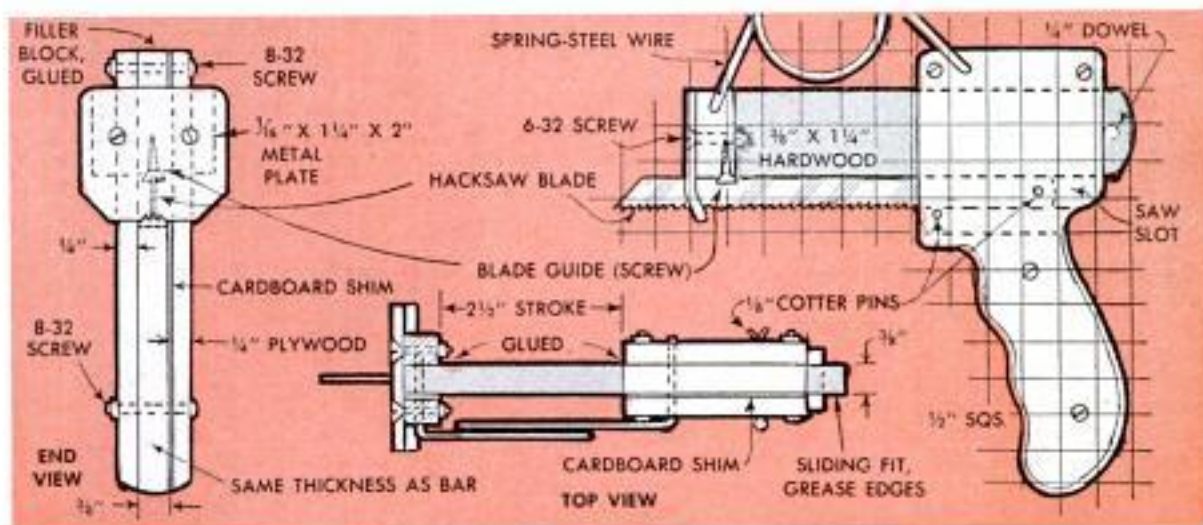

## Toothpaste Tubes Reused for Storage of Special Lubricants

Special distributor lubricants, Prussian blue and other similar materials that are used infrequently and in small quantities can be stored in empty toothpaste or shaving-cream tubes. The tubes are unrolled and the bottoms cut off. Compressed air can

be used to "pop" them open. The inside of the tube then is washed clean and thoroughly dried. Material which is to be stored in the tube now is ladled in through the cutoff bottom. The bottom then is flanged over and the screw cap turned on tightly.



NOVEMBER 1955

## Brush-Holding Solvent Container

A few cuts with tin snips on an empty tin can will permit converting it to a brush-holding container for paint thinner or brush cleaner. Bend the cut portions of the can as indicated, so they grip the brush by the handle or ferrule. — Ken Murray, Colon, Mich.



217

# SHOPPING FOR TOOLS

**MASONRY HOLE-CUTTING MACHINE** is fitted with a self-sharpening diamond drill bit for cutting holes through hard aggregate from  $\frac{1}{2}$  to 10 in. in dia. and up to 18 in. deep. Deeper holes are possible by fitting an extension shaft on the drill bit. Average drilling time for a 6-in. hole to a depth of 1 ft. is less than two minutes. Available in two models with 1 and 2-hp. motors

Metro Drilling Machines, Inc., 110 20th St., N.W., Washington 6, D.C.

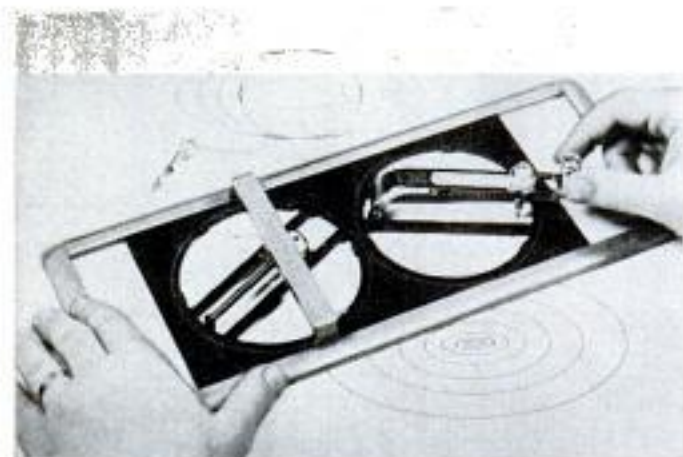

**DRAFTSMAN'S ELLIPSOGRAPH** makes quick work of drawing ellipses of any desired size and degree. Eliminates use of templates and saves hours of time on jobs where it is necessary to transpose orthographic flat plans to pictorial presentations. No mathematical calculations are necessary as self-calculating charts are included for all average ellipse requirements. Comes complete with stylus

Fowler Engineering, 1109 Maple Street, Whittier 2, Calif.

**TOOL ALIGNER** is designed to measure parallel, horizontal and vertical alignment in one setting. Comes complete with shafts which provide mountings for dial indicators of standard types. Enables machinist to make a quick check of machine before setup in the toolroom and also out in the shop where critical accuracy is essential to production of the job according to specification. Also comes in handy and saves a lot of time when setting up new machines

King Instrument Co., 804 Northwest Bank Bldg., Minneapolis 2, Minn.

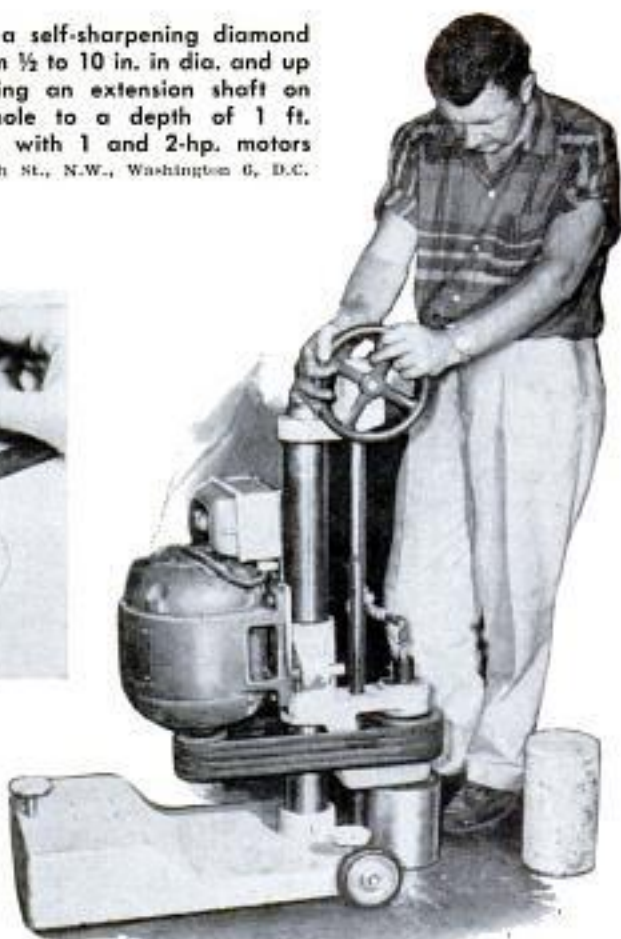
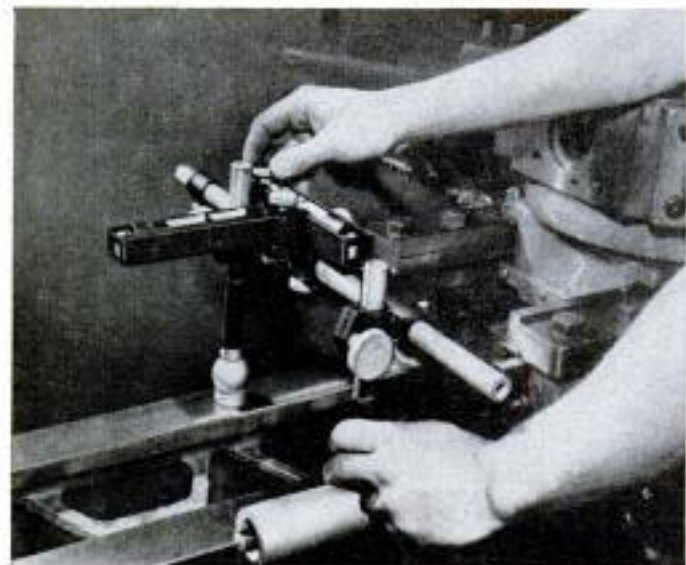

**SELF-HONING SAW BLADE** made especially for use in portable electric handsaws. Blade cuts in either direction, one set of teeth doing the cutting while the second set is honed to a new sharpness by contact with wood as blade passes through cut. Made from a special alloy steel and has rust-resistant, glare-free black finish. Available in sizes of 5 $\frac{3}{4}$ , 7 $\frac{1}{4}$  and 8 $\frac{1}{4}$  in. dia. Lasts four times as long as regular blades and saves the time usually spent sharpening

Skil Corp., 5035 Elston Ave., Chicago 30



**SIMPLIFIED SLIDE RULE** has been designed especially for beginners. Rule comes in two colors with magnifier for easy reading and the price includes carrying case and instruction book that covers details of its use  
C. V. Oro, 14906 Center Ave., Harvey, Ill.



**HAND SANDING BLOCK**, or "file," for shaping and finishing wood, plastics and metal comes with the abrasive triple-coated on chip-board tubes, both round and square. Tubes are 10 in. long and 1 in. in dia., or 1 in. square  
Diamilite Mfg. Co., 2301 Main St., Santa Monica, Calif.

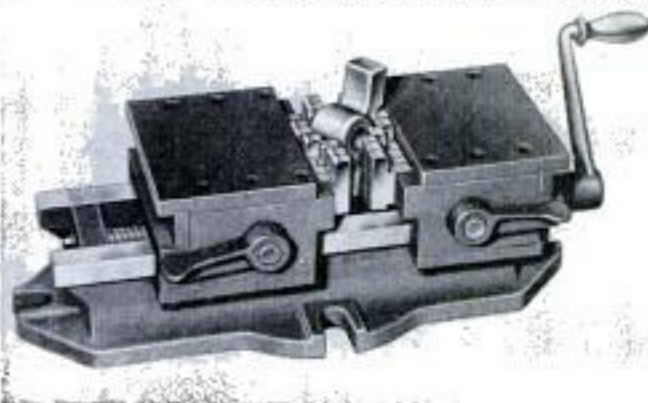

**VARIABLE-GRIP MACHINE VISE** eliminates jigs and fixtures normally used to hold work of irregular shape for drilling and machining operations. Base is designed with mounting pads to fit nearly all types of machine-tool tables  
American Positive Grip Vise Corp., Olive St., Williamansett, Mass.

**NAILING MACHINE** doubles the nailing speed of one man on such jobs as shingling and applying siding and flooring. Unit feeds and positions nails automatically, the mechanism being actuated by a light blow on plunger with soft hammer. Used in any position without undue fatigue on part of operator. Weighs 2 lb.  
Vera Products, 4041 Ridge Ave., Philadelphia 29, Pa.



**METAL SHEAR** comes as attachment for portable electric drill. Adjustable clamping device grips body of drill as pictured, aligning drill chuck with spindle which drives shear. Makes straight, curved cuts  
Ger-Am Company, 9450 Vanderpool Ave., Chicago

**SOLDERING MACHINE** operates in a manner similar to a spot welder, except that carbon tips contact work. Tips are clamped onto work by means of special hand-piece supplied. Specially designed for soldering tubing  
Wassco Electric Products Co., 126 W. Cass St., Joliet, Ill.

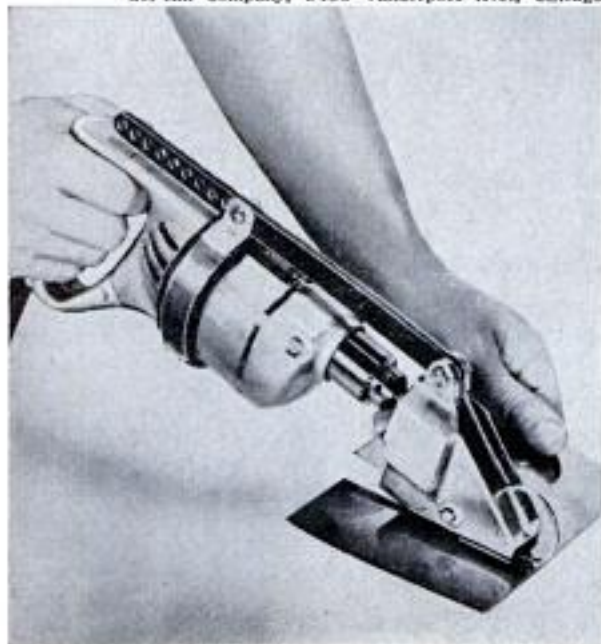



### Electrified Post Drill Has Idler "Clutch"

A post drill in one farm workshop was electrified by replacing the hand crank with a large V-belt pulley and driving it from a motor mounted above the drill. The V-belt is kept taut by an idler pulley mounted on a pivoted arm that is kept under tension by a screen-door spring. To stop the drill while the motor continues running, an extension on the idler shaft is used as a handle to pull the idler away and slacken the belt.

### Wagon Box Held in Place By Bent Horseshoes

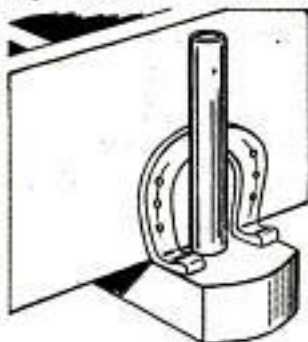

Wooden bolster cleats under a wagon box are not always effective in preventing the box from sliding back and forth on the bolsters when the wagon is driven over rough ground. In such cases, rivet bent horseshoes to the sides of the wagon box as indicated so they will bear against the bolster stakes. The horseshoes will not interfere with removal of the box.

### Threading a Short Pipe Nipple

Threading a pipe nipple that is too short to be held in a vise is done easily by using a coupling and a length of pipe on which

an extra-long thread has been cut. The long thread permits turning about two thirds of the length of the coupling onto the pipe. When the short nipple, which has been threaded on one end before being cut, is turned into the coupling, it butts against the end of the pipe before the threads seat. After the short nipple has been threaded it can be removed with firm hand twist or a slight assist with an internal wrench.

R. S. Hart, Seattle, Wash.

### Full-Length Coating on Matches Assures Moistureproofing

Dipping match heads in melted paraffin does not provide full protection against moisture, since water still can soak into the wood or paper stem, then travel up to the head. For thorough waterproofing, dip the matches so the stems are entirely coated. Paper matches so treated are not affected by perspiration when carried in a workman's pocket and similarly treated wooden matches are ideal for the outdoorsman.



### Improvised Ball-Bearing Puller

An emergency method of pulling a ball bearing from a shaft when a bearing puller is not available, is to use two open-end wrenches. The wrench jaws should be wide enough to straddle the bearing. The shaft—in this case an armature shaft from a generator—is gripped in a vise. As pictured, the ends of the jaws act as fulcrums for the wrenches, which then are used simultaneously as pry bars to move the bearing. If the bearing binds after being moved, the shaft may be relocated in the vise to permit taking another "bite" with the wrenches.

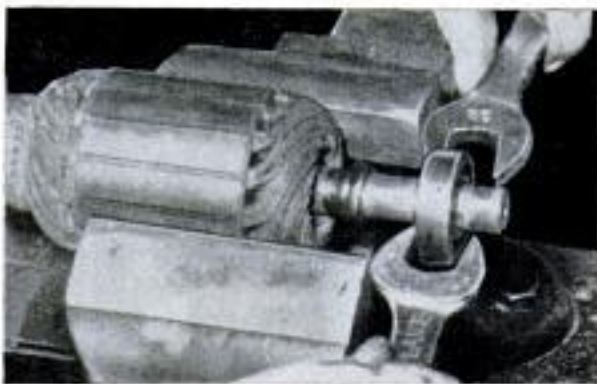

POPULAR MECHANICS

# Texaco Tips On Car Care



## Safety check your heater hose connections

If the rubber tubing between your heater and motor block is weak, it may break and splash your engine with the coolant and anti-freeze. Carefully inspect these hose connections. Interior linings on hoses three or four years old may have separated and the entire connection should be replaced. You'll find your heater will work better, too. Your nearby Texaco Dealer has a stock of new tubing on hand.

## Safeguard your chassis with proper lubrication

Marfak chassis lubrication protects your car against winter weather. It's tough and stretchy . . . clings tightly to points of wear and friction . . . won't squeeze out, jar out or wash out. So you get smooth, cushiony motoring for 1,000 miles or more. And remember — your car is lubricated by chart, not by chance. Today, drive in for longer lasting Marfak chassis lubrication. See your Texaco Dealer, the best friend your car has ever had.



**TEXACO DEALERS IN ALL 48 STATES**

*Texaco Products are also distributed in Canada and in Latin America*

THE  
TEXAS  
COMPANY

TUNE IN: TEXACO STAR THEATER starring JIMMY DURANTE, on TV Saturday nights, NBC.

## NEW DO-IT-YOURSELF KITS

➤ **Develop your own negatives . . .**

➤ **Print your own snapshots . . .**



### **. . . and do it the easy way with a Kodak Photo-Hobby Outfit**

It's a thrill to watch a blank sheet of paper change into a familiar snapshot scene right before your eyes. And with a Kodak Photo-Hobby Outfit that thrill can be *yours*.

If you're a beginner—you'll like the simple, compact, "no-fuss" versatility of the new do-it-yourself Photo-Hobby Outfits. With Velite Printing Paper, for instance, you don't even turn off the room lights in order to print sparkling snapshots. Just subdue the brightest lights, add water to three chemicals, and start printing. To develop

negatives you darken a room long enough to place a roll of exposed film in the developing tank, then switch on the lights. The chemicals do the rest.

If you're an experienced amateur—a Photo-Hobby Outfit can be a handy time-saver for making your "proofs." As for the extra pictures other members of the family want, here's a thought: With a Photo-Hobby Outfit, they can print their own snapshots and photo-greeting cards. Best of all, they'll enjoy doing it!

Now—read the details below.

### **New Kodak De Luxe Photo-Hobby Outfit**

**\$16.95**

**Similar Outfit with Printing  
Frame instead of Photo-  
Hobby Printer**

**\$9.95**



Here's what you get in this outfit—1. A Kodak Photo-Hobby Printer, Model A, with a built-in lamp socket (takes a 60-watt lamp for Velite Paper, or 15-watt lamps for other Kodak contact-printing papers); a hinged platen, red safety light, switch for controlling exposure time. 2. Kodacraft Printing Mask Set with openings to fit all popular-sized negatives. 3. Kodacraft Roll-Film Tank with two aprons for 127 and 620-120 film

sizes. 4. 16 ozs. liquid Kodak Versatol Developer. 5. 16 ozs. Kodafix Solution. 6. Six 8-oz. packets of Kodak Universal Stop Bath. 7. 100-sheet package of 2½" x 3½" Kodak Velite Paper. 8. 4-oz. plastic measuring cup. 9. Three 5" x 7" Tenite Rocker Trays. 10. Kodak Glass Stirring Rod. 11. Kodak Darkroom Thermometer. 12. 2 Plastic Film Clips. 13. Blotter Book for drying prints. 14. Viscose Sponge. Also, Simplified Instruction Card.



## New Photo-Hobby Outfits feature "Do-It-Yourself" Instruction Cards

Packed with each of the two outfits described on the previous page is a big 11 x 14-inch card. On one side are simple 1-2-3 instructions for *developing* negatives . . . the other side for *printing*. You can't miss. It's the easiest-to-follow guide you've ever seen.

**P. S. for Christmas**—Either one of the new Kodak Outfits makes a wonderful gift for snapshot fans of any age. Want one for yourself? Drop a hint in the right place—now! Want one for someone else? You'll be making someone very happy!



## When you need more Photo-Hobby Outfit materials . . .

Next time you visit your photo dealer, ask him to show you the Kodak chemicals that have been prepared for do-it-yourself hobbyists. Some of them come in ready-mixed liquid form. Others are in handy foil packets—you simply mix the powder with water and it's ready for use. Here are several chemicals particularly suitable for home use. (The first two are Photo-Hobby Outfit liquid chemicals you'll want to replace, along with Velite Printing Paper, before your original supply runs out.)

**Kodak Versatol Developer**—An economical "all-purpose" developer. Dilute 1:7 (1 part developer to 7 parts water) for developing negatives in a tank. For clear, sparkling prints, dilute 1:3. 8-oz. bottle, \$.35. Quart, \$1.



**Kodafix Solution**—A concentrated hardening-fixing bath which makes the images permanent on film and paper. Requires only the addition of water to prepare it for use. Quart bottle (to make 1 gallon), \$1.



**Kodak Microdol Liquid Developer**—For even finer-grain negatives (hence finer-grained prints) than an all-purpose developer can provide, use Microdol for developing your *negatives*, and Versatol (see above) for developing your snapshot *prints*. Microdol comes ready for use without dilution. 1 quart, \$1.



**Kodak Rapid Selenium Toner**—Usable at various dilutions to give your snapshot images permanent cold-brown tones. 8-oz. bottle, \$1.05



**Kodak Brown Toner**—Dilutes 1:32 to give snapshot images warm-brown tones. 8-oz. bottle, \$.90.



**Kodak Photo-Flo Solution**—Highly concentrated wetting agent that lets water run off film and paper surfaces without leaving water marks and streaks. Note to 35mm users: As you may know, 35mm film differs from paper-backed roll film in that it has gelatin on one side and a plastic base on the reverse (instead of gelatin on both sides). Kodak Photo-Flo does a remarkable job in wetting *both* the plastic base and gelatin surface to let the water run off without leaving streaks or spots. No need to even sponge the film. 4-oz. bottle (to make 6 gallons), \$.45; 16-oz. bottle (to make 24 gallons), \$.90.



Ask to see the handy foil packets of Kodak chemicals, too.

Prices are list, include Federal Tax where applicable, and are subject to change without notice.

**Eastman Kodak Company**  
Rochester 4, N. Y.

NOVEMBER 1955

**Kodak**  
TRADE-MARK

223

# Care and Feeding of Engines



BY  
S. P. CORP

## VALVE ADJUSTMENT

Before you start to adjust valves, consult manufacturer's specifications and know the answers to these questions: 1. Should your valves be set hot or cold? 2. What are the intake valve tappet clearances? 3. What are the exhaust valve tappet clearances?

Tappet clearances *below* specifications will make camshaft open valves too early and close them late, which can cause exhaust valve burning. **NEVER REDUCE VALVE TAPPET CLEARANCE TO ELIMINATE NOISE.** Instead, look for worn tappets or misalignment of valves in the guides.

Tappet clearances *above* specifications cause camshaft to open intake valve late and close too early, reducing amount of fuel entering cylinder, and losing power. The same condition in exhaust valves imposes an extra load on connecting rod bearings. Always follow specifications!

**NOTE:** These facts do not apply to valves with hydraulic valve lifters.

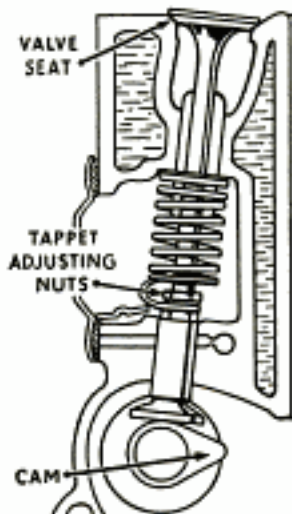

## LOCATING A MYSTERIOUS MISS

If a cylinder misses, look for corrosion in the distributor cap. Pull each wire out of the cap and clean sockets with a wire brush. If corrosion has eaten away the metal, or terminals are eroded, get a new cap. Also check to see that carbon brush is not chipped or broken. Inspect rotor for cracks or oxidation at the tip. If tip is burned, the resulting gap could cause that mysterious miss. In such a case, you need a new cap and a new rotor.

## GET THIS FREE MANUAL

Send a postal card request for your free copy of "Care and Feeding of Engines," the new illustrated manual of car care. It contains helpful hints on everything from Air Cleaners to Windshield Wipers. When you re-ring, use Sealed Power KromeX Ring Sets for fast break-in, immediate oil control, and double ring life. Solid chrome faces on top compression ring and oil ring side rails fight heat, friction, corrosion. Sealed Power, Dept. G-11, Muskegon, Michigan.



# Sealed Power

## PISTON RINGS

# Clinic for Homemakers



As a service to our readers in solving the hundreds of problems pertaining to a home—inside or out—the editors of *Popular Mechanics* invite you to present your problems to The Clinic Editor for help and advice. Address your questions to The Clinic Editor, *Popular Mechanics Magazine*, 200 East Ontario Street, Chicago 11, Ill.

## Ladders Not Painted

**Q**—I'm curious to know why it is that one never sees a new ladder painted or otherwise finished. I'm referring to ladders that one purchases at a local hardware store or from a building-materials dealer. I once saw a man at an auction sale refuse to bid on a ladder that had been painted. Later I asked him why. He said that it would be easy to hide flaws in a ladder with paint. Is that the reason?—*J. L., Pa.*



**A**—Correct. It's an old custom, or perhaps we should say sales policy, at one time adopted by manufacturers of ladders and continued more or less regularly down to the present time. The prospective purchaser at the auction you refer to was possibly a little more than ordinarily cautious, but his reason for not bidding on the used ladder—we suppose it was freshly painted—was quite logical whether or not he had any reason to believe that the ladder in question was faulty. However, if you purchase a new ladder it's always a good idea to finish it, either with white shellac or with a good clear finish of the outdoor type.

## Complete Fertilizer

**Q**—What is a complete fertilizer for use on lawns and gardens? I have been told by a neighbor that I should have the soil tested and then apply a complete fertilizer before attempting to rebuild an old lawn that has become fouled with weeds. Grass grows only in scattered areas. Should I proceed as advised, or what do you suggest?—*U. L., Ky.*



**A**—Your neighbor is right so far as he went in advising you. But if we can judge correctly from your description of the condition of your lawn, he did not go far enough. We think it would be well to have the soil tested, but unless this is done correctly the test will be of little value. First, you should plot the lawn, that is divide it into areas of 4 to 8 sq. ft. and take a soil sample from each plot. Place the samples in small glass vials (usually

(Continued to page 226)

**Don't  
forget  
your  
change!**



Mighty well-trained dog!

Trained to register *two* important things! Change oil in your car at factory-recommended intervals—and—change your AC Oil Filter every 5,000 miles! If you forget your change you'll be "out" money, important money should your engine be damaged. So, take the AC Sludgehound's friendly tip. Change filter. Be sure the filter change is to an AC—the filter that takes out every tiniest particle of grit, dirt, dust, metal—to really protect your engine. An AC Oil Filter won't remove the valuable detergents used in today's heavy-duty engine oils.

Ask for the best—AC.



Watch  
**BIG TOWN**  
NBC-TV

10 times the  
filtering area ↓



↑ More than 90  
sludge-trapping pockets



AC SPARK PLUG DIVISION • GENERAL MOTORS  
CORPORATION • FLINT, MICHIGAN

THE ONLY FACTORY-APPROVED FILTER FOR CADILLAC • BUICK • OLDSMOBILE • PONTIAC • CHEVROLET • GMC

NOVEMBER 1955

225

Copyrighted material

# TIME SAVING TIPS

ALL YOU NEED IS A TUBE OF

## DU PONT DUCO CEMENT

REG. U.S. PAT. OFF.



### WATERPROOF

Secure outdoor nameplates for any kind of weather with tough, waterproof "Duco" Cement.



Re-set loose bathroom tiles with "Duco" Cement—strong, waterproof bond prevents breakage!



### STRONG

Put loose umbrella handles back on to stay with tight-gripping "Duco" Cement.



Stiffen wobbly picture frames fast—just put tough "Duco" Cement in mitered corners and on backing.



### CLEAR

Give broken fingernails first aid with clear "Duco" Cement—can't be seen, stops further damage!



Patch torn wire screening. Transparent "Duco" Cement lets light in, keeps bugs out.



### FLEXIBLE

Put name tags in your over-shoes with "Duco" Cement—it's flexible, won't come loose when you walk.



Repair leather wallets, compacts, coin purses like new with strong, flexible "Duco" Cement.



NEW CAP HAS HANDY APPLICATOR TIP



BETTER THINGS FOR BETTER LIVING  
... THROUGH CHEMISTRY

(Continued from page 224)

you can obtain these from your druggist) and then make a drawing showing the location of each plot. Number the plot and the soil sample taken from it. Then when you get the results of the test, you will know exactly what different areas of the lawn need to build fertility to the required levels. Send the samples to your State Experiment Station, usually a department of the state university. Generally, the tests are made free of charge for residents of the state. In the meantime apply a herbicide (weed killer) to those areas infested with weeds. Old lawns are greatly benefited by spiking, by hand on small areas, or with a power tool if available. This loosens and aerates the soil and permits fertilizer and moisture to penetrate to greater depths. When the results of the soil test are at hand they will show both deficiencies and excesses, if any, of plant nutrients. Deficiencies are easily corrected by applying a complete fertilizer of the recommended formula. This you can determine by running a check of all soil plots which were originally measured and recorded by number on the chart you prepared. However, it should be remembered that use of the correct fertilizer alone will not make up for a lack of other good practices in growing a lawn. These also should be carried out on a regular schedule.

### Refinishing Piano

Q—I have an upright piano I wish to refinish. It is, I would guess, about 25 years old and either the wood or the finish, or both, have darkened so much that the grain shows only in the lighter areas. The finish is quite badly checked, so much so that it is rough to the touch. I tried smoothing it with sandpaper. Although there was some improvement, the final result was not very satisfactory. I think the wood is mahogany. How should I proceed?

—Y. S., Colo.



A—If the piano was built as recently as you say, then there is a good chance that at least the larger panels are of plywood faced with mahogany veneer. Smaller parts are probably cut from some other wood and are of solid stock stained and finished to match the panels. If this assumption is correct, then the first step is to remove the top panel and run a test before attempting work on any other exposed part. The top panel usually is hinged and it will be necessary to remove all the screws in the continuous hinge before the top panel can be lifted off. Coat the finished surface with a varnish remover, allow it to "work" at least 15 minutes, then scrape off the softened finish. Then try scraping the surface, either with a hook-sharpened cabinet scraper or a small piece of glass cut with a true edge. Work carefully to avoid cutting through the thin veneer. When the wood has been scraped back to the "white," sand with fine-grit sandpaper to remove the raised fibers. In this process you will remove a part of the filler which was originally used. In refinishing we would suggest that you use a brown-mahogany filler and stain. Apply the stain first and wipe off to get the shade you want. After the stain is dry, follow with the filler tinted to a slightly darker shade than the stain. Apply with a soft cloth, allow it to partially set, then wipe off the excess across the grain. When dry, sand lightly with the grain and apply a sealer. Allow the sealer to dry overnight. Then follow with a high-quality pale varnish or a water-white lacquer of the brushing type. If you can rent a sprayer, it is recommended that you apply the final coats by spraying rather than brushing. After the first coat is thoroughly dry go over it lightly with fine steel wool, 000 or finer, and then apply the second coat. When this is dry, rub to a mirror surface with rubbing compound (available through your paint dealer).

# FUEL'S PARADISE...



**CARBURETORS  
BY ROCHESTER!**

Gas mileage stretches out to a happy *maximum* when you install a Rochester Carburetor! Rochester does the perfect fueling job smoothly and efficiently, year after dependable year! That's why fuel's no stranger in *this* paradise! Cadillac, Buick, Oldsmobile, Pontiac and Chevrolet . . . *they depend on Rochesters!* Relax—get a Rochester on the job for you, today!

Insist on...

**CARBURETORS BY ROCHESTER**

ROCHESTER  
PRODUCTS  
DIVISION OF  
GENERAL MOTORS  
CORPORATION  
ROCHESTER N.Y.



**free****GET THE WORLD'S LEADING  
TV & RADIO PARTS AND  
EQUIPMENT CATALOG****ALLIED'S 1956  
ELECTRONIC SUPPLY GUIDE****324  
VALUE-  
PACKED  
PAGES****Save on  
Everything  
in  
Electronics****WORLD'S  
LARGEST  
STOCKS****Everything for Experimenters,  
Builders, Amateurs, Servicemen,  
Engineers and Hi-Fi Experts**

Send for ALLIED's big 324-page Catalog, offering the world's largest selection of latest top-quality electronic equipment at lowest, money-saving prices. Features High Fidelity systems and components; recorders and phono equipment; TV tubes, antennas and accessories; Amateur station equipment; P.A. systems; test instruments; latest build-your-own kits; industrial electronic supplies—plus thousands of parts, tubes, transistors, tools and books. Get everything, get more for your money—send today for your FREE 1956 ALLIED Catalog!

**ALLIED RADIO****Send for  
FREE  
CATALOG****ALLIED RADIO CORP., Dept. 5-LL-5  
100 N. Western Ave., Chicago 80, Ill.** Rush FREE 1956 ALLIED 324-Page Catalog

Name \_\_\_\_\_

Address \_\_\_\_\_

City \_\_\_\_\_ Zone \_\_\_\_\_ State \_\_\_\_\_

**Fine Nut and Bolt Photography***(Continued from page 131)*

The input voltage to his two horizontal enlargers and contact printer is kept constantly at 110 volts by means of a transformer which automatically compensates for variations in line voltage. Variable resistors are in the wiring circuit of his enlargers and printer so that the voltage may be cut down if necessary, as when printing on film rather than paper.

Horizontal enlargers are preferred by Hine for their versatility and freedom from vibration. Specially built timers on enlargers and printer keep printing time regulated down to 0.1 second so that in producing large numbers of prints, he can keep all prints uniform. On his contact printer is a highly accurate electronic timer custom built for him. It contains precision components and will time print exposures down to 0.1 second with 99.9-percent accuracy.

"Save time," is Hine's motto in the dark-room, a motto made necessary by his industrial clients who sometimes demand quick service to prevent holding up production in their plants.

One way he cuts down developing time is through use of a special print developer composed of one part Dektol, one part Ardol and two parts water. He finds this gives good tones in both dark and light areas, with a 30-second normal developing time.

If the job requires it, though, he doesn't mind spending a lot of time. One picture took the better part of two days to print and process. It was a photo of a horse. The owner wanted the print toned to match the horse's color.

After two days of experimenting, the right toner-paper-developer combination was found to achieve the result.

To make such jobs easier, he keeps a huge notebook filled with sample prints showing the results of hundreds of such combinations.

Having the patience required for such experimenting and the insatiable appetite for knowledge about everything photographic have helped Hine win recognition among industries and among other professional shutter bugs as a "photographer's photographer," a fact proven a couple of years ago when his technical achievements won him an Associateship in the Photographic Society of America. ★ ★ ★

☞ A new passenger-carrying record for land-based planes was set recently when the Air Force's XC-99 double-deck transport, an experimental version of the B-36 bomber, landed at Fort Worth, Tex., with 212 persons aboard.

# THE **CONTINENTAL** MARK II



Continental Division • Ford Motor Company

America's Newest and Most Distinctive  
Motor Car—Equipped with the World's  
Newest and Most Advanced  
Spark Plugs!

*Turbo-Action*

## CHAMPIONS



**AMAZING ADHESIVE DISCOVERED!**

# Glues without presses, clamps, nails!

New Weldwood® Wizard  
Bonds Instantly...  
Permanently on Contact!



Use it to modernize kitchen  
counters, table tops, etc. with  
Micarta and other plastics  
quicker, easier than ever before!

Weldwood Contact Cement works like magic! No need for clamps or presses. Just apply...let dry...then bring laminate and surface together! Instantly you get a permanent bond!

**PUT UP PLYWOOD WITHOUT NAILS!** Do it yourself with Weldwood Contact Cement. Revolutionary new method—faster, easier. No nail holes to spoil finished surfaces!

**1001 JOBS MADE EASIER** around home, shop, garage. Weldwood Contact Cement bonds any combination of wood, glass, leather, paper, cloth, fiberglass, metal (including do-it-yourself aluminum).

In tubes, bottles, cans. 25¢, 35¢, 60¢ and larger sizes at hardware, paint and lumber dealers, and variety stores. Mail coupon for leaflet!

\*Trademark

## United States Plywood Corporation

Dept. 127, 55 W. 44th St., N. Y. 36

Please send me information on Weldwood Contact Cement.

Name \_\_\_\_\_

Address \_\_\_\_\_

City \_\_\_\_\_ Zone \_\_\_\_\_ State \_\_\_\_\_

## On the Trail of the Whooping Crane

(Continued from page 143)

1946, the most far-reaching and costly field research in connection with any bird was begun. It was carried on by famous ornithologist Robert P. Allen and pilot-biologist Robert H. Smith.

In 3½ years they journeyed 20,000 miles by small plane, and 6000 miles by Jeep. Covering parts of Nebraska, Louisiana, Texas, Mexico and a million square miles of northern Canada, they sought all available information about the birds.

In the spring of 1951, Smith and Allen trailed a dozen whooping cranes by plane from the Texas refuge, hoping to follow them to their nesting site, for unless the nesting place was found there was no hope of renewing the species. For 2500 miles from southern Texas to the 60th parallel, they managed to keep the rare birds in sight—the most unusual job of air-detective shadowing ever recorded. When they reached the 60th parallel, they felt sure they were nearing their goal and their hopes were high.

Then suddenly a white, widespread and impenetrable fog blanketed the area. The two scientists lost sight of their quarry and their pursuit ended in failure.

In 1922, the last previous sightings of whooping-crane nesting grounds had been made in Saskatchewan, at points 300 miles apart. But these sightings were of no value to present-day ornithologists because the cranes had long since moved on to new homes.

It was the knowledge of this long struggle on the part of scientists to find the nesting place of the crane that caused Fuller to become excited when pilot Landells indicated that he had seen whooping cranes tending a nest. It meant that the long search might be over. Fuller immediately wanted to see the site, and Landells, armed with a camera, took him over the area.

The pictures on page 143 were taken by Landells from the open door of his helicopter. They are the first and only pictures of whooping cranes in their new nesting grounds, and they are the most unusual close-up air photos of the bird ever taken.

Wood Buffalo Park, where the discovery was made is a 17,300-square-mile area, laid out by the Canadian government in 1926 as a wildlife sanctuary. It lies in the Slave River region of the Northwest Territories. The purpose of the park was to protect the buffalo, who was fast disappearing at the time. Now 15,000 of the big beasts roam

(Continued to page 232)



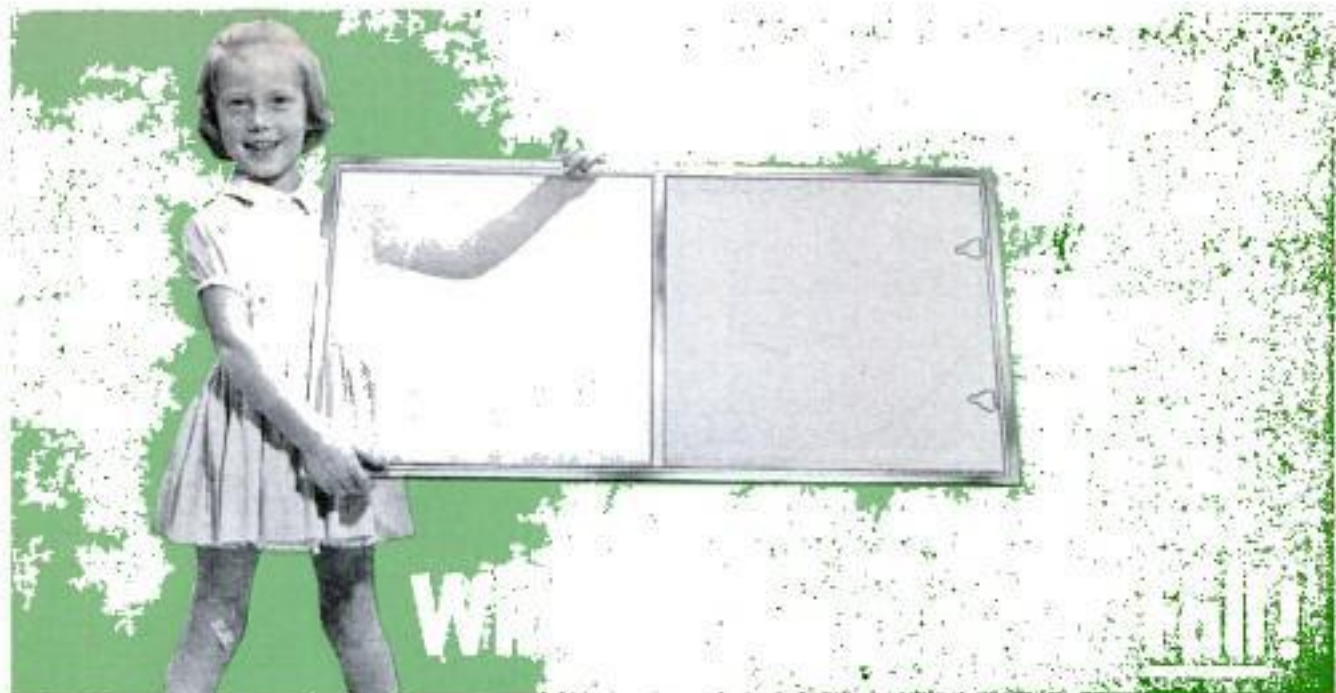

## YOU BET, WITH THESE HOMESHIELD<sup>®</sup> SCREEN KITS

HE'S ASSEMBLING ALUMINUM SCREENS IN HIS SPARE TIME  
...SAVING UP TO 50%...AND MAKING EXTRA MONEY, TOO!



MANY USES :

### YOUR HOME



### CABINS



### COMMERCIAL BLDGS.

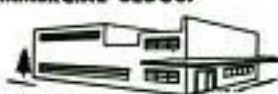

### APARTMENTS



### AS SIDELINE BUSINESS



Make your spare time pay off now, assembling Homeshield screens. Don't wait till spring when you're busy outside. Just put 'em together this fall and winter in your workshop or basement, when conditions are best. Make 'em for your home, cabin, or shop and save money . . . make 'em for neighbors, apartment houses or businesses, and *make money!*

**No more repairing or repainting!** Replace your heavy, old-type screens or screen your new home with these sparkling, cost-saving screens. Thousands already in use . . . it's a *proven* new product that'll dress up your home for *life!*

**These screen kits are complete,** contain Aluminum frames, Fiberglas screening corner locks, installation hardware, clear directions — even a miter box. Anyone can assemble them in 5 simple steps!

- Aluminum full-frames *never* need painting
- Easy-to-handle FIBERGLAS<sup>®</sup> screening can't rust, corrode or stain
- LIGHTWEIGHT — easy to install or remove in a jiffy.

No ladders needed!

NOW is the time to act. You'll *save up to half* by making your lifetime screens with these kits this winter.

Ask your hardware or lumber yard dealer for Homeshield screen kits. If not available, ORDER DIRECT for speedy mail shipment! MONEY-BACK GUARANTEE if not completely satisfied. You simply *can't* lose.

Please send me kits for full screens as indicated:

- |                                |                                |
|--------------------------------|--------------------------------|
| Up to 24½" x 48" at \$4.58 ( ) | Up to 36½" x 56" at \$6.18 ( ) |
| Up to 32½" x 56" at \$5.78 ( ) | Up to 36½" x 72" at \$7.62 ( ) |
|                                | Up to 48½" x 72" at \$9.48 ( ) |

Please send me kits for sliding half screens as indicated:

- |                                 |                                 |
|---------------------------------|---------------------------------|
| Up to 28½" x 28½" at \$3.82 ( ) | Up to 36½" x 36½" at \$5.00 ( ) |
| Up to 32½" x 32½" at \$4.42 ( ) | Up to 48½" x 48½" at \$6.98 ( ) |

Name .....

Street .....

City ..... State .....

Shipped postpaid. Send check or money order. No COD's please

**AMERICAN SCREEN PRODUCTS CO., 807 N.W. 20th St., Miami, Fla.**

# Make These "Around-The-House" Ideas A Reality with REYNOLDS DO-IT-YOURSELF\* ALUMINUM

and your ordinary wood-working tools

Easy and quick to build whether you have a workshop or not. New Easi-Bild † patterns are simple to follow. Your nearby hardware or building supply dealer has Reynolds Do-It-Yourself Aluminum. Reynolds Metals Company, 2494 S. Third St., Louisville 1, Ky.



**Window Greenhouse.** Can be made to fit any window. Requires glass and Do-It-Yourself Aluminum. Easi-Bild Pattern No. 566.



**Bathroom Valet.** Requires wood, Do-It-Yourself Aluminum Tubing and sheet. Easi-Bild Pattern No. 29.



**Serving Tray.** Combines aluminum, Weldwood, Naugatop, Redwood and fasteners. Easi-Bild Pattern No. 52.

## REYNOLDS DO-IT-YOURSELF ALUMINUM

is also available in Canada

\*T.M. REYNOLDS METALS CO. †T.M. EASI-BILD PATTERN CO.

Aluminum Plans and Patterns Service  
P.O. Box 1623, Louisville, Kentucky

Enclosed please find \$..... for the following Easi-Bild patterns:

- No. 29 Bathroom Valet—35c  
 No. 52 Serving Tray and Table—25c  
 No. 566 Window Greenhouse—50c

Name.....

Address.....

City..... Zone..... State.....



the preserve and the threat of extinction has been removed.

Landells continued to watch the area and says that he never saw the young bird again. He discovered another pair of mature birds about 15 miles from the first nest, and later saw a single bird about the same distance from the first pair in another direction. Five birds in this small area have proved to scientists that this is truly the long-sought nesting grounds. Furthermore, Landells noted that on later trips, whenever he passed over the first nest sighted, he found the two birds still there.

As a result of this discovery, wildlife specialists traveled into Wood Buffalo Park to study the giant birds. It was a difficult journey, requiring three tries by canoe, plane and helicopter before completion. And reports from these observers indicate that, in addition to the 21 adult birds, there are now four nestlings who may grow to migrate with the flock this winter. If all goes well, 25 birds will fly into Texas, and this slight increase in the whooper's population may mean the beginning of their comeback as a game bird.

The United States and Canadian governments are cooperating to protect the birds, and to stop the slaughter of the cranes on their migratory trips. A great deal of publicity is being given the crane to help in this fight. For example, the Canadian Government has issued a five-cent stamp showing two of the whoopers in full flight.

Perhaps this concentrated effort will soon make the buglelike voice of the whooper a common sound over the central United States and Canada during migration seasons. ★ ★ ★

## Broken Sash Cords Replaced With Spring Device



Broken sash cords can be replaced with a spring device which holds the sash open at any height and at the same time eliminates rattles. It consists of a corner bracket with a flat spring which bows outward. In most cases, according to the manufacturer, the springs can be installed without removing the sash.

# NOW!

AN OPEN-MESH SANDPAPER!

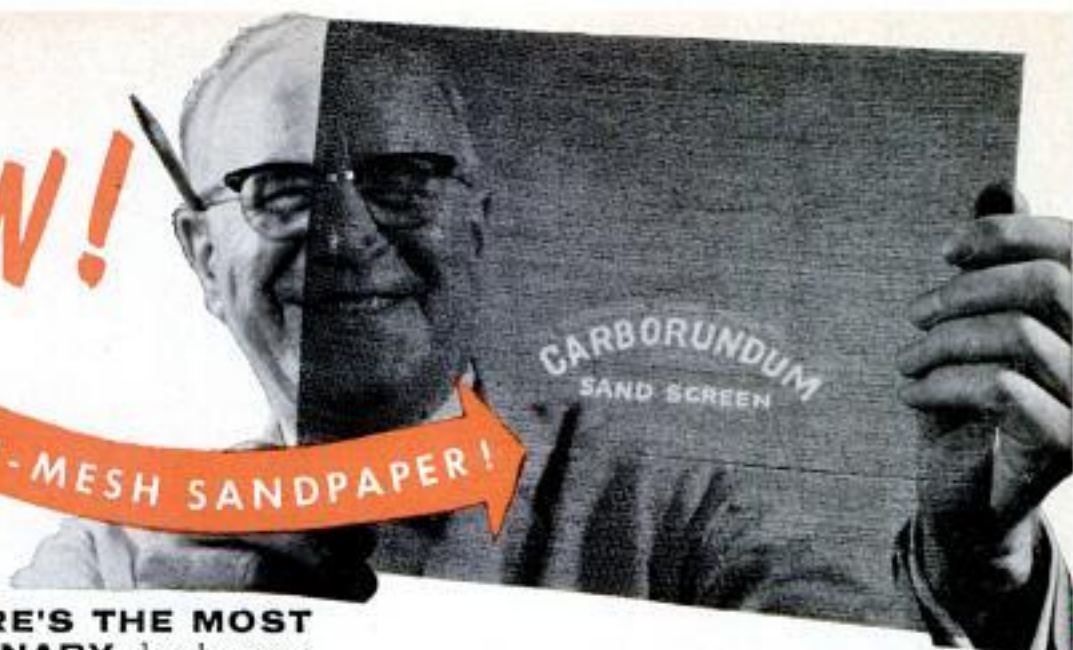

**HERE'S THE MOST REVOLUTIONARY** development since sandpaper was invented...for faster sanding on wood, metal and paint. "SAND SCREEN" is abrasive all over—on both sides. It lasts 7 to 15 times longer than conventional sandpapers...cannot clog or glaze, because the removed material flows right through the open mesh. Use "SAND SCREEN" by hand or machine—it folds and tears easily to any size.

**GET "SAND SCREEN"** at your Hardware or Building Supply Dealer in handy 9x11" sheets, discs, and cut sheets to fit your oscillating or vibrating sander.

# SAND SCREEN

- ➔ **abrasive on both sides!**
- ➔ **material flows right through!**

## LOOK FOR THESE DISPLAYS...

of other cost-cutting, time-saving abrasive products designed for home craftsmen.



● **PROFESSIONAL SANDING PAPERS**

Flint Paper, Emery Cloth, Garnet Paper, Aluminum Oxide Paper and Waterproof Paper in 9x11" sheets. A complete range for every job.

● **NIAGARA® BRAND GRINDING WHEELS**

Aluminum oxide abrasive grain cuts faster, lasts longer. Sizes to fit every portable and bench grinder, in Fine, Medium and Coarse.

● **Flexbac® PAD KIT**

Flexible foam-rubber pad attaches to 1/4" electric drill, sands contours and curves without swirl marks. Discs stick tight with adhesive.

# CARBORUNDUM

REGISTERED TRADE MARK

... **FIRST** with the **BEST** in everything **ABRASIVE**

90-513

## Testing . . . Testing . . . Atoms at Work

(Continued from page 121)

Operators of oil pipelines running across the nation long had a peculiar and expensive problem. Different kinds of oil are run through the pipes at different times, and there are switch points just as there are on railroad lines. Now, suppose a switch is to be made from one grade of petroleum to another. How does the operator know just when to turn the valve?

In the past he was not too certain, so on the average, he wasted about 50 barrels or \$500 worth of oil in the operation. But now the radioisotope Antimony-124 has been added to a new type of oil coming along the pipeline. When a geiger counter attached to the outside of the pipe starts to click, an operator turns the valve. Estimated saving to the oil industry: \$500,000 a year.

The radio-detection industry, born nine years ago, has already grown into a \$20,000,000-a-year business. In 1946, the AEC's Oak Ridge atomic pile was almost the only source of radioisotopes for industry, and still is the biggest producer, having sent about 40,000 shipments to more than 1700 purchasers. Meanwhile, Brookhaven National Laboratory in New York and the Argonne National Laboratory have come

into the picture. And now there is the materials-testing reactor in Idaho. Adding materials-testing reactor to the list should give industry the same glow of satisfaction that comes to a football coach who has just signed up a 220-pound fullback, fast and smart.

Industry, for instance, is now looking to the materials-testing reactor and its fellow radioisotope producers for aid in measuring the thickness of metal. Friction tests at the Massachusetts Institute of Technology show that by making a metal radioactive it is possible to detect the transfer of only  $\frac{1}{100,000,000,000}$  ounce from one surface to another. But first the metal must be made radioactive—usually by insertion in a reactor—and that is where the materials-testing reactor comes significantly into the picture because it can do the job with neutron intensities not available elsewhere.

Then there is radiography, a method for detecting hidden cracks and irregularities in such things as metal castings by directing rays through a sensitive emulsion. The materials-testing reactor is specially adapted to provide radiation sources such as cobalt for this equipment, and has been extensively used for this work.

Medicine and agriculture are also concerned. Among the newest aids to medicine,

(Continued to page 236)

### IT SMELLS GRAND



WANT AROMA WITH "LIFT"? MAN, HERE'S HOW

### IT PACKS RIGHT



AND IT PACKS SO NEAT IT RATES A BOW

### IT SMOKES SWEET



IT'S THE PIPE-BLEND CHAMP YOU MUST ALLOW

### IT CAN'T BITE!

SIR WALTER RALEIGH'S BLEND OF CHOICE KENTUCKY BURLEYS IS EXTRA-AGED TO GUARD AGAINST TONGUE BITE.



## FREE!

24-PAGE BOOKLET ON PIPE CARE. JUST WRITE TO: SIR WALTER RALEIGH DEPT. G5, LOUISVILLE, KY.

## Seal Metal Casement Windows with **DUSTITE**

**Reduces Drafts, Heat Loss!**

Now get year 'round protection against weather. New Dustite Gasket keeps out cold in winter, prevents drafts, retards condensation, saves fuel! Seals out sand and dust storms.

Install it yourself. No tools needed. Does not interfere with normal window operation. Tough, vinyl plastic lasts life of window.

Measure around your windows, and order now. Only 13c a foot. (Minimum order 10 ft.) Enclose check or money order. We pay postage. 10-day money-back guarantee. . . Or write for free sample and literature.

### **DUSTITE PRODUCTS CO.**

6 Canterbury Drive • Dayton 9, Ohio

Thousands of Installations from Coast to Coast



### **ELECTRIC WELDER**

AC or DC  
110 Volts

The "Little Marvel" all-metal welder, 3-year written guarantee. Welds 1/4" metal or money back. Repairs tanks, tools, fenders, machine parts, etc. Complete with everything—rods, unit, eye shield, directions. \$6.95 plus 50c postage. Flame torch necessary for soldering, cutting, brazing \$3.95 complete with carbons, brass rods, flux. \$2.00 Deposit on C.O.D. 1/4 inch Transformer Welder \$21.95 F.O.B.

**\$6.95**  
Complete

ESSAY MFG. CO., Dept. 51, Quincy 69, Mass.

### **DITCH-WITCH TRENCHER**



Portable DITCH-WITCH digs 4 1/2" or 6" clean, even ditches to 36" depth in all types of soil. Four rugged models. Complete unit—self-propelled. **OUTDIGS 8 MEN**. Write for illustrated literature.

The CHARLES MACHINE WORKS  
620 B Street Perry, Okla.

### **Accurate Easy LEVELING**

for FOOTINGS . . . . . FLOORS etc.

Accuracy and dependability of expensive instruments—simple, fast, durable. A professional builders' level.



WRITE FOR FREE DETAILS ON MODERN LIQUID LEVELING

HYDROLEVEL Suite 915, 407 S. Dearborn, Chicago 5

### **KING MIDGET—WORLD'S LOWEST PRICED CAR**



Lower Priced, greater performance. Drive it for 75c per week. Also KING MIDGET JUNIOR, finely engineered, less than one-third cost of any comparable car, one twelfth cost of large cars. Agents wanted. **IT WILL PAY YOU TO GET THE FACTS.** Send 25c for literature and agents proposition on both cars, or \$1 (refundable first order) for this plus actual assembly book and service manual.

**MIDGET MOTORS MFG. CO., Athens 1, Ohio**

## **BIG VALUE TEAM!** **NEW! Two BY Four Saw Attachment** works with Drill, Saw Table



"Gives you all the features, performance of a professional power saw"



### **CUTS FULL 2" DRESSED LUMBER**

Amazing new TWO BY FOUR Attachment makes all sawing easy! Cuts 1-11/16" at 90°, 1-3/8" at 45°. Professional power saw features, too; Telescope Guard, Rip Fence Guide, Bevel and Depth Adjustments. Easy-grip handle for one-hand perfectly balanced use. Any Cummins 1/4" pistol grip geared chuck drill runs it. At your Cummins Dealer—Now!

**ONLY \$14.95**

### **New Saw Table has Para-lock Rip Fence!**

TWO BY FOUR Attachment hooks to new Saw Table in seconds. Table has exclusive **PARA-LOCK Rip Fence Guide**—automatically aligns guide with blade. Table top 14-3/4" x 15-1/2". Easy to add wood extension for 24" x 24" surface. Complete with 10" miter gauge \$12.95.



MODEL 624

### **get a Cummins Drill for better job results**



Cummins Drills run quieter, smoother, longer. They're made better, with shock-proof gears, double-coil motors, dynamically balanced armatures—to give better job results. Cummins Model 304, shown, \$24.95 Others from \$19.95 to \$34.95

© J. O. M. C., 1955

**Get FREE Power Tools Book**

*John Oster*

MANUFACTURING CO.  
Dept. CPT, 5055 N. Lydell  
Milwaukee, Wis.

Please send full-color booklet showing 64 ways to use power tools, and where to buy them.

NAME \_\_\_\_\_

ADDRESS \_\_\_\_\_

CITY \_\_\_\_\_ STATE \_\_\_\_\_



**Stopping too often for oil shows your power is fading . . . and it's time to replace your Piston Rings!**

Having to buy too much oil and gas, and slow pickup reveal POWER FADE! Your rings are badly worn—you're wasting money on lost power.

Top performance is gone. And despite the extra oil used, vital engine parts remain starved for oil. This is not only costly and wasteful, but is a warning of expensive repairs to come later.

See your motor specialist for a ring check-up. If he recommends a ring change, it will pay you to install Hastings replacement rings. They're engineered exclusively for worn engines to quickly stop power fade, oil-pumping and gasoline waste.

All the safety and driving enjoyment of full-powered performance are yours again with Hastings Rings . . . it's the best money you can spend on your car.

HASTINGS MANUFACTURING CO., HASTINGS, MICHIGAN  
HASTINGS LTD., TORONTO

*Piston Rings, Casite, Oil Filters, Spark Plugs*

**\* TOUGH but oh so gentle**



**HASTINGS**

STEEL-VENT PISTON RINGS

*Regular or Chrome-Faced*

**\* TOUGH on oil-pumping • GENTLE on cylinder Walls**

for example, are small, relatively inexpensive and portable thulium X-ray units such as the one developed by the Argonne National Laboratory. These produce X rays of remarkable efficiency, although models are as small as three inches in diameter, six inches long and weigh approximately 10 pounds. When produced in quantity, the Argonne type is expected to cost under \$200, but will do many jobs now requiring large machines worth tens of thousands of dollars. The materials-testing reactor, as one of its new assignments, irradiates the thulium for the portable devices.

The University of Michigan, under contract to the AEC, has completed a design of a facility capable of irradiating 20 tons of potatoes in an hour and giving them a shelf life of two years. The potatoes are not made radioactive, however, and will definitely not cause one's stomach to glow in the dark.

Perhaps the newest agriculture possibility for materials-testing reactor mass-production radiation comes with the discovery that insect pests in grains can be destroyed or made sterile with radiation. Insects cause an average annual grain-storage loss of approximately 150,000,000 bushels, valued at \$250,000,000.

Handy on the spot, the Idaho Potato Growers, Inc., cooperative of Idaho Falls, is considering using radiation sources of the materials-testing reactor for studies on some of its dehydrated products. A lot of persons in Idaho, in fact, are now talking about the possibility of new industries springing up around the reactor. But such businesses need not necessarily be located near the reactor.

Lewis L. Strauss, chairman of AEC, addressing the New England Council in Boston, explained:

"Availability of the materials-testing reactor for public use means that you in New England, for instance, could use the reactor to test products to see if new and desirable qualities could be developed in them. The reactor can prepare tracers for use in following the products of a distillation column; it can make a machinery item, like a gear, radioactive for wear tests, and it can perform many other services, limited only by the ingenuity of engineers."

But whether the industry is in Massachusetts or Idaho, it must have its experiments performed by the contractor operating the reactor—Phillips Petroleum Company. No private concern can send its scientists to do their own experimenting at the reactor. Reason: security.

Also, all requirements of the atomic-energy program take precedence over the

(Continued to page 238)

# Bench Saw Owners SAVE \$10



on a  
**CRAFTSMAN**  
REG. TRADE MARK  
**Molding  
Cutter Set**  
Separate Prices  
Total \$19.95 **\$9.95**



You get Molding Cutter Head and  
6 Cutter Bits Sets shown. 17 cutter  
bit sets available at Sears stores



## Convert your Bench Saw to a Jointer-Planer and Shaper

We want you to share with us the tremendous savings offered in this Molding Cutter Set. By special arrangement with our manufacturer we can again offer this amazing Molding Cutter Set at our **LOW SALE PRICE** during the months of November and December. We know of no comparable set selling at anywhere near this low price. Go to your nearest Sears Retail Store and see it for yourself. It saves lumber costs, and it saves time. Sale priced until December 31, 1955 . . . only \$9.95.

Number of designs are actually limited only by your own imagination. Cutter bits are made from special heat-treated tool steel; 1 inch wide. Vertical slot in back of blade assures alignment in molding head. Six different cutter bit sets included as shown above: (A) 3 Bead ( $\frac{1}{4}$  in.) cutter; (B) 1-in. Planer and Jointer; (C) Glue Joint Cutter; (D)  $\frac{3}{4}$  and  $\frac{1}{2}$  in. Quarter Round Cutter; (E) Cabinet Door Lip Cutter; (F) Base Mold Cutter. In plastic box, with wrench, spacer washer and bushings.

**CRAFTSMAN** Hand and Power Tools by **SEARS, ROEBUCK and CO.**  
Famous for fine quality . . . precision performance . . . low price!

## IDEAL PHOTO GIFT

Perfect Flash Pictures *every time!*



The ONLY Meter  
for FLASH!

ORDER BY MAIL TODAY \$14.95

Gives the right f-stop . . . you can't miss. Every flash outfit needs Flash-Mate. Pays off in saved film and bulbs. Doubles as range finder.

Shipped prepaid and gift boxed. Send \$14.95 by Check or Money Order. COD's accepted.

**NORWOOD FLASHCRAFT - Dept. P**  
3018 EAST FOOTHILL BLVD. PASADENA 8, CALIF.

## A CLUE FOR TREASURE HUNTERS



No need for a map to find this treasure—there's big money waiting for you as near as the floor next door! Just about every home, old and new, needs floors sanded. Ambitious men, all ages, can earn a good living—\$50 and more a day—surfacing floors with a run-easy American sander. Minimum investment, no waiting to learn—start earning the first day! Men needed now! Be own boss! Send today for booklet "Opportunities in Floor Surfacing", enclosing 25c in coin or stamps to cover handling.



**THE AMERICAN**<sup>®</sup>  
FLOOR SURFACING MACHINE CO.  
ESTABLISHED 1903

535 So. St. Clair St.

Toledo 3, Ohio

nongovernment experiments in areas of the reactor. There is a charge, based on all costs involved including depreciation, overhead and operating expenses, but still considered low enough to bring the service within the means of qualified research organizations.

"To date the National Reactor Testing Station has had six major design contracts plus countless small jobs," says Allan C. Johnson, manager of the AEC's Idaho operations office. "Our average design and construction load has been at the annual rate of \$12,000,000 to \$15,000,000. And the year ahead will be a busy one."

Meanwhile, this question is asked of industry: What are your problems? "Idaho" in Indian means "Light on the Mountains," and some atomic rays from the western state may bring many brilliant industrial developments. ★ ★ ★

## Self-Adjusting Ladder Legs Adapt to Any Terrain

Self-adjusting legs attached to the rails of a ladder make it possible to use it on steps and uneven terrain. With the device bolted in place, the user puts his weight on the first rung of the ladder to lock the legs in place automatically. They can be unlocked only by hand. Equipped with non-slip feet and weighing only five pounds, the device can be transferred easily from ladder to ladder.

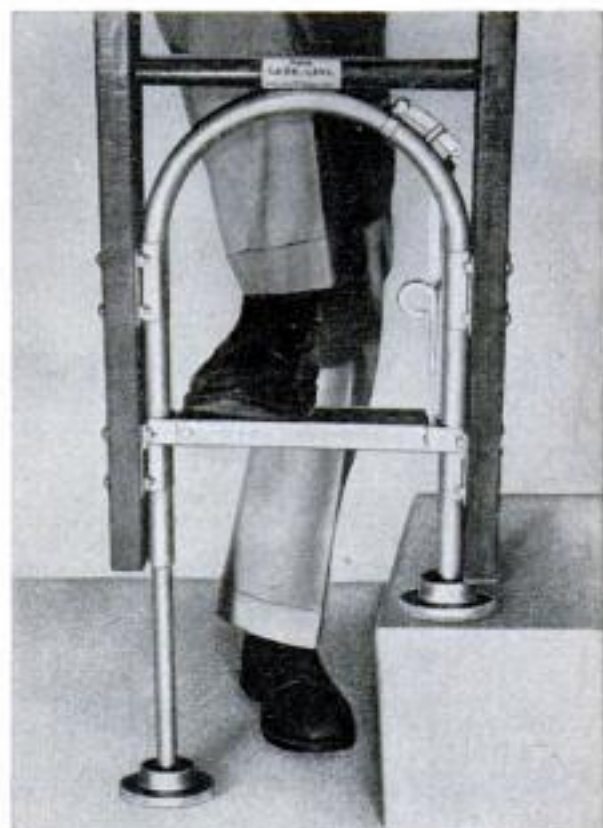

POPULAR MECHANICS



# HOW TO GET A SAFE MUFFLER AND SAVE UP TO \$8.00 BESIDES

26 gauge inner shell—22 gauge outer shell.

33% heavier double shell lasts longer.

Non-clogging extruded holes—  
no whistling, no restriction.

16 gauge, spun-locked,  
blowout-proof steel heads.

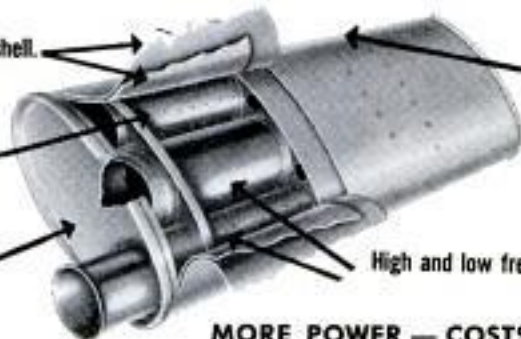

Crimped seams  
eliminate  
weak points.

High and low frequency tuning chambers.

**MORE POWER — COSTS LESS.** Scientifically designed to keep back pressure at a minimum, Silentone gives top performance and mileage. Many Silentone stores install, at big savings. (Install it yourself and save up to \$8.)

Like that deep sports-car tone? Ask to hear what a Dynatone would sound like on your car. Your dealer has a recording, also Dynatone duals and headers.

## SILENTONE MUFFLERS

Dept. 2L, Toledo 1, Ohio

Sold only by America's Leading Automotive Chain Stores

A leaking muffler is dangerous *long before* it gets noisy, particularly now when you're driving with closed windows. You can be killed in 2½ hours by one hatful of carbon monoxide gas from a leaking muffler. One cupful slows your reaction *dangerously*. You're safer with Silentone's double-wrapped shell, a third heavier than in ordinary mufflers: protects you against dangerous leaks, makes your muffler dollar go farther by lasting up to 33% longer.

### LARGEST SANDING AREA

25 sq. inches **\$14.95**

The Weller Power Sander and Polisher has no equal in its price class. Reciprocating type motor almost impossible to stall. Straight-line action gets into corners and sands smooth. Write for catalog.

**WELLER ELECTRIC CORP.**  
816 Packer St., Easton, Pa.



### FIND URANIUM!!!

Prospecting made easy with Goldak's new U-238C triple-action geiger counter! Also famous line of metal locators, from \$49.50. Send 25c for radioactive uranium sample! FREE DETAILS, Dealer Inquiries Welcome.

**GOLDAK COMPANY** 1542 W. Glenoaks Blvd., Glendale, Calif.



Need an extra \$1,000, \$2,000, or more? Make it with an

### IDEAL LAWNMOWER SHARPENER



There are thousands of lawnmowers in your locality: Average \$1,000 profit per 250 mowers with customer satisfaction and repeat business assured. Provide this essential service with an Ideal Lawnmower Sharpener, the only machine that grinds the reel to "fit" the bed knife. Compare by any standard. The Ideal, backed by 53 years of experience, costs no more. Write today for complete, free catalog.

**THE FATE-ROOT-HEATH COMPANY**  
Dept. PM-11 Plymouth, Ohio

### Get This NEW Catalog of WOOD AND WOODWORKING MATERIALS



World's Largest Selection of Finest Domestic and Imported Woods... Mouldings, Hardware, Tools, —ALL AT LOW MONEY SAVING PRICES!

Your complete wood buying guide and project book. Craftsman is your best, most complete source of finest kiln-dried domestic and rare imported woods, beautiful wood inlays, colorful bandings, matched plywoods, embossed mouldings, carved ornaments, newest woodworking tools, "hard to find" cabinet hardware and fittings... more than 1,500 items! Packed with newest scroll saw patterns, project ideas & money making plans. Enclose 25c (refunded with first order) to help pay mailing, handling cost. Write now! **Craftsman Wood Service Co., Dept. A-11 2729 S. Mary Street - Chicago 8, Ill.**

**128 PAGES**

**Many in full color**

packed with rare, fancy & imported woods... veneers, plywoods, patterns, tools, ornaments, hardware... everything for the woodworker.

**MAIL COUPON NOW!**

**CRAFTSMAN SERVICE CO., Dept. A-11, 2729 S. Mary St., Chicago 8, Ill.**

Enclosed find 25c. Rush me new Woodworkers' Catalog Handbook.

NAME.....  
ADDRESS.....  
CITY.....ZONE.....STATE.....

NOVEMBER 1955

239



You can do those **BIG PAY Jobs** with this **LOW COST HOBART**

**"Husky Boy" air-cooled engine drive arc welder**

**Welds Anywhere!**

In or out of the shop, the "Husky Boy" can earn bigger profits for you. And you save more on the purchase cost. Lighter weight makes it ideal for using on small service truck for quick emergency calls. For use in the shop, wheels and handles are available at a slight additional cost.

**Full 200 amps. (not skimped)**  
Specially built for smaller shops requiring lighter weight and lower investment, the "Bantam Champ" gives full 200 amp.

**You can "Build Your Own"**  
You can save even more by "Building Your Own" with this Hobart generator. Just connect the "Build-Your-Own" to your own used auto engine . . . it's perfect for small operations which do not justify a complete, factory built outfit.

**AC Welder with AC Power for tools**  
The AC-AC Welder and Power Unit lets you do numerous repair jobs where no power is available . . . also furnishes emergency power for electric lights and power tools. 200 or 300 amp. size plus 5KW AC power.



**AC Transformer type**  
For improved AC welding performance. Operates on single phase 220 power lines.

**Welding Lessons \$1.00**  
Complete operator's training course. 200 pages fully illustrated.

**HOBART WELDING SCHOOL**  
Be your own boss! Learn profitable arc welding at the non-profit Hobart Trade School. Skilled instructors give you on-the-job training. Complete or partial courses with latest equipment. G. I. bill approved. Write for free booklet.

Check these **Low investment HOBART welders too!**



200 Ampere Bantam Champ



Generator for "Building Your Own"



Transformer Type AC Welder

**Vest Pocket Guide FREE!**

**HOBART BROS. CO., BOX M-115, TROY, OHIO**  
"One of the world's largest builders of Arc Welders" Phone 21 223

**Hobart Brothers Co., Box M-115, Troy, Ohio**  
Please send additional data on items checked:

"Husky Boy"     "Bantam Champ"     Welders' Vest Pocket Guide

Transformer Type AC     "Build Your Own"

Hobart Welding School

Welding Lessons, \$1.00

NAME \_\_\_\_\_

ADDRESS \_\_\_\_\_

CITY \_\_\_\_\_ STATE \_\_\_\_\_

**Science Puts the Taste in Olives**

(Continued from page 153)

6000-gallon, redwood storage tanks and is stored in a light-brine solution. The olives are held in these tanks until needed for curing and canning.

As they are needed for curing, the olives are pumped from the storage tanks to numerous sorting belts for removal of over-ripe or damaged fruit. From here they move into the ripe-olive processing tanks.

In the processing or curing vats the olives receive alternate applications of caustic solution, water and air, over a period of nine days. Between the applications of caustic solution and washing with water the olives are exposed to air for periods of 24 to 48 hours. This oxidizes the fruit and gives it the familiar black color of the ripe olive.

Upon completion of these processes, the caustic and bitter factors are leached from the fruit by immersing in fresh water. The water is changed every four hours and the olives receive nine complete washings.

After being freed of caustic and their bitterness, the olives are put in brine and the solution raised to 185 degrees. The fruit is treated twice with brine, each treatment lasting for 24 hours.

Olives are now ready for canning and flumed to the second size-grader. This grader makes a final separation, insuring uniform canning sizes. From the size-grader

(Continued to page 242)

Inspector crosses stile over heaping conveyor that carries olives from receiving area into the plant



# New G-E *All-Weather* Headlamps protect you from 3 night driving hazards!

Replace your present headlamps now! A pair costs so little

## 1. THEY HELP YOU SEE THROUGH FOG, RAIN, SNOW

The top photo at right was taken with ordinary headlamps. A man changing a tire a short distance ahead is practically invisible in the fog. The bottom picture shows the identical scene, this time with General Electric *All-Weather* Headlamps. Now the man changing a tire is clearly seen through the fog—and in time to stop.

G-E *All-Weather* Headlamps help you see through fog, rain and snow far better than ordinary headlamps. The uncontrolled upward light from ordinary headlamps reflects off the fog and back into the driver's eyes, as blinding "kick-back" glare. But G-E *All-Weather* Headlamps have a specially designed shield over the lower beam filament. It blocks out the uncontrolled upward light making it easier to see in fog, rain and snow, with little or no interference from kick-back glare.



## 2. THEY MAKE IT EASIER TO SEE THE ROAD AGAINST ONCOMING HEADLAMPS

Photo at left below shows how you see against oncoming headlamps when your car has ordinary headlamps. 50 feet beyond the oncoming car, a pedestrian can barely be seen. In photo at right, your car now has G-E *All-Weather* Headlamps. The pedestrian is now clearly visible. Your seeing distance along the right-hand curb is increased by as much as 80 feet.



OLD HEADLAMP



NEW G-E *All-Weather* HEADLAMP

## 3. THEY PUT LIGHT FAR DOWN THE ROAD TO LET YOU SEE CURVES, DIPS AND OBSTACLES

General Electric *All-Weather* Headlamps are more powerful than ordinary headlamps. The 6-volt size, for instance, gives 25% more light! Since the fog shield does not cover the upper-beam filament, you get maximum light for distant seeing in clear weather. The extra light is spread over a wide area, including the shoulders of the road, to show curves and obstacles while they're still far away.



## REPLACE PRESENT HEADLAMPS NOW—G-E *All-Weather* HEADLAMPS FIT YOUR CAR

Don't wait until your present headlamps burn out. Put General Electric *All-Weather* Headlamps on your car today! Miniature Lamp Dept., General Electric, Nela Park, Cleveland 12, Ohio.



*Progress Is Our Most Important Product*

**GENERAL  ELECTRIC**

# BUY SHOPMATE!

## You Get All These Features!

**COMPARE**, point for point, and you'll see how much more do-it-per-dollar you get with *Shopmate*, PET's Big Value brand.

### No. 740-6 Shop-Toter Drill and Saw Kit

New 1/4" gear-chuck drill with powerful motor; ZP-1 Drill Saw turns drill into portable saw. Welded steel tote case; complete accessories for drilling, sawing, sanding, polishing. Big-value price, only **\$34.88**.



**No. 740-5 Shop-Toter Drill Kit.** Same as kit above but without ZP-1 Saw. Another Big Value, only **\$27.88**.

### CHECK ✓ These Shopmate Features

- ✓ Powerful New 2-amp. AC-DC Motor
- ✓ Accurate Geared Chuck
- ✓ All-Steel Welded Shop-Toter Case
- ✓ Complete Accessory Set, including 12 sanding discs, polishing bonnet, grinding wheel, muslin pad, 7 drill bits.

### No. 620 Shopmate Clutch Saw

Features exclusive Pet-O-Matic Slip Clutch. Powerful motor; guide, guard. Cuts dressed 2 x 4s at 45°. Biggest Saw value today.

Only **\$48.88**.



### CHECK ✓ These Shopmate Features

- ✓ Powerful 4800 RPM Motor
- ✓ Cuts 2 x 4s at 45° (6 1/4" blade)
- ✓ Exclusive Pet-O-Matic Clutch eliminates kick-backs and motor burn-outs
- ✓ Depth of Cut at 90°, 0 to 2 1/8"
- ✓ Telescoping Safety Guard
- ✓ Graduated Adjustable Rip Guide



When you buy, take this ad with you as your buying guide to Shopmate values! Compare, and be sure!

Made by Portable Electric Tools, Inc.  
320 West 83rd St., Dept. PM, Chicago 20

the olives are conveyed to a final sorting belt, where workers again inspect them, removing any poor-quality fruit. The olives then proceed to the filling and canning lines.

Following canning the olives are put into large cookers where the temperature is raised to 242 degrees and held for 62 minutes for complete sterilization of the completed product. They are now cooled, labeled, cased and ready for shipment to the tables of the United States and the world.

Meanwhile, the small olives that were taken out in the first size-grader are being prepared for the Spanish green-olive process. They are placed in a caustic soda to remove bitter factors, then carefully washed and pumped into 50-gallon barrels. The wash water is replaced with 10 to 15 percent brine, barrel heads go on, and the barrels are rolled into the fermenting yards to let nature take its course.

When fermentation is complete, usually about six months, the barrels are rolled into the plant, and the olives size-graded, inspected and returned to the barrels of brine for shipment to other packers.

Over-ripe fruit is unsuited for canning, yet it is good material from which to make rich olive oil. The olives intended for the oil press are washed in warm water and taken to a disintegrator for grinding of the flesh and pits. This material moves to bull wheels for further grinding and then is put into strong, flat bags and placed in the primary hydraulic press, where a pressure

(Continued to page 244)

Olive cans are hand-filled, but most operations on the fast-moving canning lines are done by machines





FOR CHRISTMAS, SHOW HER

## ...what you can do for a tired room with \$33\* worth of Weldwood Sea-Swirl\*

Give yourself a gift of easy-to-use Weldwood Sea-Swirl—and you can give the whole family a surprise they'll enjoy for years! You'll be amazed at the new warmth and charm you can give a room with a wall of Weldwood Plywood Paneling.

It's easy to work with Weldwood. In just a few hours you can sit back and admire your handiwork—the subtle, textured beauty that only real wood offers. Ask your lumber dealer to help you plan this wonderful Christmas surprise. Or see the complete Weldwood line at one of our 87 showrooms in principal cities.



### ASK YOUR LUMBER DEALER FOR **Weldwood®** HARDWOOD PLYWOOD

A product of  
United States Plywood Corporation  
World's Largest Plywood Organization



\*Weldwood Sea-Swirl captures the clear, weathered look of driftwood, and enough for a 12' x 8' wall costs just \$33. Or you may prefer Surfwood®—it costs only \$26 for the same wall.

#### GET BIG, NEW DO-IT-YOURSELF BOOK!

This brand-new 40-page booklet shows how to panel a wall, how to glue and finish plywood... gives all kinds of tips for home craftsmen plus dozens of pictures of projects you can make with plywood. Send 25¢ for your copy today!

United States Plywood Corporation  
Box 61, New York 46, New York



Enclosed is 25¢ for the new Weldwood Do-It-Yourself book. Please rush my copy. PM-11-B

NAME.....  
ADDRESS.....  
CITY.....STATE.....

**FREE BOAT KIT CATALOG**

8' to 14' Models from \$39.95 incl. freight

- Assemble your own boat
- No experience necessary
- Save 1/2 to 2/3 "factory built" prices

12 ft. Runabout Pictured.

Write: Marine Hardware, Fiberglass, & Trailers  
DEPT. B 4452 NICOLLET AVE. MINNEAPOLIS 9, MINN.

**LUGER INDUSTRIES**

**IT HOLDS—And How!**

For BEST RESULTS you can always depend on Wilhold Glue. Clean to use! Damp-proof! Invisible when dry! In plastic applicators, tubes, jars.

At your hardware or building supply store

**WILHOLD WHITE GLUE** 39¢

WILHOLD PRODUCTS CO., Los Angeles 31 • Chicago 44

Protect your home against power interruptions with an...

**ONAN Emergency ELECTRIC PLANT**

Provides dependable stand-by electricity for heating system, pumps, freezer, lights, appliances. Keeps home safe, livable. Automatic start and stop. Find out how little it costs!

Write for Folder!

**D. W. ONAN & SONS, INC.**  
3315 University Ave. S. E. • Minneapolis 14, Minnesota

**A SIZE FOR EVERY NEED**  
400 to 75,000 watts. Compact, quiet-running, easy to install. Gasoline engine powered.

## TURN YOUR SPARE TIME INTO \$5 an HOUR EXTRA CASH

Earn Big Money in Your Own Home with the BELSAW SHARP SMITH



Thousands of Belsaw users have proved that sharpening circular saws, grinding planer and jointer knives is profitable. Many have given up regular jobs to devote their entire time to their own money-making business.

The initial investment is only \$15 down payment. The space required is small... 15 square feet in your home or garage.

No experience is necessary. A beginner can produce expert work the day his Belsaw arrives.

The demand is in your own neighborhood... constantly expanding. More and more circular saws are used by professionals, carpenters, contractors... plus the thousands with basement workshops. All these circular saws need dependable sharpening... the kind you can give them with a Belsaw.

You do the jobs in your own home in your own spare time. No punching the time clock. If you want to take the day off to go fishing, it's yours for the taking. Every man has dreamed of being his own boss. With your Belsaw you can make it possible.

Write today for actual experiences of Belsaw owners... and Free Book, "Lifetime Security with Your Own Business."

FREE Book



**BELSAW MACHINERY CO**

1646 Field Bldg., 315 Westport Rd., Kansas City 11, Mo.



As many as 14 different metals and alloys are used to produce bearings for the light, medium and heavy-duty engines that power today's trucks. These specially-made bearings assure fine performance under the extremes of load, temperature, speed that are met in truck operation.

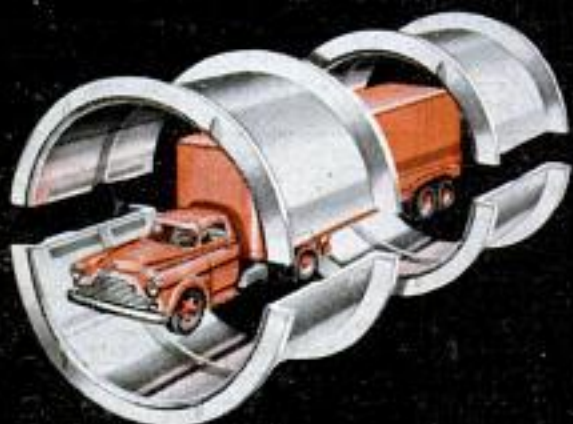

## FEDERAL-MOGUL BEARINGS . . .

*A Control Factor in Performance*

Trucking service is the "professional" test for every automotive part. Engine bearings, for example, have to take the day-and-night pounding of highway hauling and city delivery. Bearings carry the engine load . . . meter the lubricating oil. They must give maximum mileage, to make payloads *really* pay! Modern precision bearings answer these demands with two to five times the mileage of the bearings of only 15 years ago. Federal-Mogul bearings are preferred by the big truck and bus fleets, for bearing replacement, by 2 to 1. Replace with Federal-Mogul oil-control bearings to renew engine power and pick-up. They are engineered for the job!

for New Power . . .

**FEDERAL-MOGUL**

Oil-Control Bearings



RESEARCH • DESIGN • METALLURGY •  
PRECISION MANUFACTURING • SERVICE

of five tons per square foot is applied. Bags are then moved to secondary presses where a pressure of 30 tons per square foot is applied. Oil and juice from the presses are separated by centrifuging. The oil is then washed, filtered and stored for two months to permit settling of impurities before packaging.

The tree that bears the olive has long been one of nature's wonders. It is the longest lived and producing of any fruit tree and it has been claimed that trees more than 1000 years old are still bearing olives in commercial quantities.

The olive tree thrives and produces best in a dry, warm climate where there is plenty of water but no summer rains, fog or extreme cold. The industry now centers in the old countries, along the borders of the Mediterranean Sea and in California.

The war gave domestic olives a big boost and olive growing has developed into a major California industry. It looks as if the olive, both green and ripe, is here to stay. ★ ★ ★

## Handwriting Sent by Wire

Write a message on the pad of a new electronic instrument and a duplicate appears instantly on a receiver many miles away. Handwriting can be transmitted over cables, telephone wires or via radio. A ball-point pen is used to inscribe messages and maps, figures and formulas. Carbon copies can be made on both the transmitter and receiver. The units operate on ordinary alternating current.





spectacular beauty...  
dazzling performance  
the fabulous new Evinrude

*Lark*



**CHALLENGING NEW CONCEPT** in outboard design . . . the Evinrude Lark . . . headliner for '56! A truly custom motor that lends added distinction to the handsomest runabout. Crisp, dynamic lines that plainly proclaim superb performance . . . *and it's there!* At your finger tips. Breath-taking getaway when you give the word to 30 tautly eager horsepower. *Commanding* power so wonderfully quiet and smooth that riding is like sailing. *Obedient* power that spins to life at the touch of a button. And *thrifty* power as well . . . with the new Cruis-Throttle that gives you up to 20% more miles per gallon. See your Evinrude Dealer—look for his name under "Outboard Motors" in your phone book. For free catalog, write **EVINRUDE MOTORS, 4134 North 27th Street, Milwaukee 16, Wisconsin.**

*free!* Big, full-color catalog of the complete Evinrude line for 1956. Now *nine* great models with smooth, quiet Whispering Power. Three brilliant "Thirties." New electric starting Fastwin. New Fisherman and Sportwin. With revolutionary new Eas-A-Matic starting on five models! Write for catalog today!

A Division of Outboard, Marine and Mfg. Co.  
In Canada: Mfd. by Evinrude Motors, Peterborough



**Evinrude**

*Pioneers in quiet Outboard Motors*

**READ  
THE  
GUARANTEE  
THAT  
"SOLD" ME!**



**SYNCRO POWER UNITS  
GUARANTEED  
AGAINST BURN-OUT DURING  
YOUR OWNERSHIP OR  
REPLACED FREE!**

**THE  
FAMILY  
JIG SAW**

Basic power tool for Dad! Safest for children! Model 208 has full 15" throat, 10" x 10" table. For projects, recreation.



**FIRST AND ONLY  
TILTING ARM JIG SAW**

On Model 2500 work stays flat while making angled cuts—arm, blade and motor tilt together 0° to 45° to either side. 20". Heavy duty. 65 lbs. cast semi-steel.



**DELUXE HEAVY DUTY  
SANDER KIT**

Model 900 sander in 900-D Kit (with metal case, 48 asstd. papers, polish pad) outsands other portables. Easy to handle. Features exclusive "Multi-Motion" sanding pad action.



Model 900 sander also available without sight-saving lamp or metal case.

**FINISH SANDER KIT**

Model 504. Light, powerful. Easiest for vertical use. Multi-Motion action. Metal case, sandpaper, polish pad.



**SEE AT HARDWARES**  
Write Dept. I-85 for Free Catalog and Sanding Handbook.



**SYNCRO CORPORATION**  
Dept. I-85 OXFORD, MICHIGAN U.S.A.



**Merry-Go-Round Film Developer**

Roll film is developed in just seven minutes with the help of a merry-go-round developing tank. The tank contains seven separate cups into which are poured the developer, short stop, hypo, wash water and other solutions. All these cups are immersed in a bath of running water that assures temperature control. Once the film has been loaded on the adjustable reel and placed in the cover turret, the cover is locked in position to make the tank light-proof. From then on the entire operation is conducted under normal lighting. The reel of film is immersed in the first cup which contains a one-minute developer, then for a half minute in the second cup of short stop. Next it goes to the fixer, then into another water rinse to be followed by a bath in a neutralizer. After another wash, the film is immersed in a wetting agent that cuts the drying time.

**Tunnel 23 Miles Long**

One of the longest tunnels ever built may be bored beneath the sea to link two Japanese islands. Japan's National Railway Corporation is making plans for a 23-mile tunnel between the main island of Honshu and the northernmost island of Hokkaido. It will take an estimated 10 years to build the long tunnel and the cost is expected to be about \$140,000,000.



**POWER**  
THROUGH  
**PULLEYS**  
AND **V-BELTS**

# IDEAS PAY OFF

**ORDER this AMAZING BOOK TODAY!**

★ **FIRST BOOK OF ITS KIND . . .**

## ENTER THIS *Easy Money* CONTEST

Yes we pay you to make something useful and practical for yourself. Devise a useful apparatus or product using a Congress V-Belt drive—submit a photo of it and you qualify for the \$50 Savings Bond to be awarded each month starting January 1956.

Each 6 winners during 1956 will be eligible for a bonus prize of a \$100 Savings Bond. Duplicate prizes will be awarded the dealer who certifies the contestant's entry form.

Make something useful and make money, too. There's an entry form in every book, so get started now.

This book is packed with information every mechanic should know about pulleys, v-belts, drives, bearings and includes easily understood formulae and technical data. Illustrations show a wide variety of useful products using v-belt drives. It's full of "do-it-yourself" ideas.

**MAIL THIS COUPON TODAY!**

**CONGRESS DRIVES DIVISION, TANN CORP.**  
3750 E. Outer Drive, Detroit 34, Mich.

Gentlemen:  
Enclosed is 25c—please send me the book "POWER Through PULLEYS and V-BELTS"—also contest entry form.

Name \_\_\_\_\_

Address \_\_\_\_\_

City \_\_\_\_\_

# CONGRESS

Since 1914



Treasure and Mineral  
**LOCATORS**  
**GEIGER-COUNTERS**  
can be purchased on monthly  
payment plan. Free literature.  
**FISHER RESEARCH LABORATORY, Inc.**  
PALO ALTO, CALIF.



## HOW TO GET A NEW GARAGE DOOR AT LESS THAN HALF PRICE!

Yes, you can have a swing-up garage door like the one shown here—complete with Stanley Swing-Up Hardware for less than half what you'd normally pay!

How? Build it yourself from Easi-Bild's\* Pattern No. 86. It's easy! No special tools—no special skill! Just follow the clear, "can't-go-wrong" directions of the pattern. Tells you everything—including what materials to buy,

where and when to use them. Stanley Garage Door Set is simplicity itself to install. You'll be amazed how quickly you can do the job—and mighty proud of your results.

Ask your dealer for Simplified Directions for Installing Stanley Garage Hardware and Easi-Bild Pattern, Or use coupon below. \*Trade Mark Reg. U.S. Pat. Off. — Easi-Bild Pattern Co.

EASI-BILD PATTERN CO., Dept. 62N, Pleasantville, N.Y.

Enclosed is 50¢ in coin, money order, check for  
Garage Door Pattern No. 86

Please send Simplified Directions for installing  
( ) Single ( ) Double Garage Door Hardware.

NAME \_\_\_\_\_

ADDRESS \_\_\_\_\_

CITY \_\_\_\_\_

ZONE \_\_\_\_\_

STATE \_\_\_\_\_



## NEW WHEELED TRAILER JACK SAVES YOUR ACHING BACK!

Solid steel threaded shaft. Fits any trailer. Handle folds, wheel removes for road travel. Only \$16.96 postpaid. We make trailer axle assemblies, couplers and jacks. Find out about 'em today!

**HAMMER BLOW  
TOOL COMPANY**  
WAUSAU 13-K, WIS.

## GIVE MEASURING TOOLS THIS CHRISTMAS....



### YOU'LL FIND **LUFKIN TOOLS**

Will Fill Your Christmas List . . .  
And Not Empty Your Pocketbook!

For The Home Handyman  
Or Lady-Of-The-House  
**WHITE CLAD  
MEZURALL TAPE RULE**  
6, 8, 10 and 12 ft. lengths.  
Snow white line, jet black figures,  
extra strong featherweight  
magnesium case.

98c to \$1.89



For The Do-It-Yourself  
Or Home Craftsman

**SUPER WHITE CLAD  
MEZURALL TAPE RULE**  
Wide 3/4-inch line, 1/2-inch centers  
indicated, 10 and 12 ft.  
lengths. Extra strong feather-  
weight case. Extra big self-  
adjusting end book.

\$2.39 and \$2.89



For The Lawn and Garden  
Enthusiast Or Outdoor  
Construction Worker

**WHITE CLAD BANNER  
LONG STEEL TAPE**  
25, 50, 75 and 100 ft. lengths.  
Snow white line with jet black  
markings. Attractive maroon vinyl  
covered case.

\$3.50 to \$6.50



ALL LUFKIN WHITE CLADS ARE PACKAGED IN  
ATTRACTIVE, REUSABLE PLASTIC CASES . . . MAKING  
IDEAL CHRISTMAS PACKAGES.

BUY **LUFKIN** TAPES • RULES •  
PRECISION TOOLS  
FROM YOUR HARDWARE, LUMBER OR TOOL DEALER  
THE LUFKIN RULE CO. • SAGINAW, MICH.

## Keeping Up With the Atom

(Continued from page 113)

the area during atomic tests, and road blocks halt motorists. After the blast, planes track the atomic clouds and take samples of the contaminated air, and 90 United States Weather Bureau stations and 10 Atomic Energy Commission posts around the country make tests of any radioactive fall-out. Shock waves have caused some property damage in nearby communities but no personal injuries have been recorded from the waves.

☆☆☆

The Geneva atomic conference was told that the world will need eight times as much useful energy by the year 2000 as it uses now, and only atomic energy will be able to supply the demand as our coal, oil and gas reserves dwindle.

☆☆☆

They're even tracing the flow of mud and silt in river channels with radioactive elements. The British have tried it on the Thames River, using radioactive ground glass to test the movement of mud.

☆☆☆

To learn how effective a synthetic drug is in the treatment of leprosy, the drug is being tagged with radioactive sulphur and administered to patients experimentally in India.

☆☆☆

Liquid metals and other materials, instead of water, may cool nuclear reactors, generate steam and transfer heat. Dr. S. G. Bauer of Rolls-Royce, Ltd., Derby, England, has listed 20 different materials which could, because of the range of their melting and boiling points, be substituted for water in power reactors. These include organic compounds of carbon and silicon, inorganic salts, caustic soda, sulphuric acid and certain chemical elements and metallic alloys. Water has been found to be an excellent material for absorbing heat at one point of the power cycle and releasing it at another, where it can be made to do useful work. However, it has the disadvantage in a power reactor of slowing neutrons. This has led to the search for liquid metals and other materials which might be pumped through the pipes of a heat exchanger. Dr. Bauer points out that not all the materials he lists may be suitable as heat-transfer fluids. A suitable material must not only have the proper range of boiling points, but must resist corrosion and fire.

☆☆☆



It's a Jig Saw!



It's a Router!



It's a Shaper!

# ROUTO-JIG

## Amazing new 3-in-1 tool!

Now! See and try the revolutionary *quality* tool that puts dozens of new skills at your fingertips — Porter-Cable's sensational new Routo-Jig! *Three most-wanted tools in one!*

Use Routo-Jig as a portable router, for mortising, grooving, rabbeting. Use it as a rotary jig saw—cut intricate contours and freehand shapes. Use it as a shaper, for accurate moulding, beading, joining.

Routo-Jig gives you truly *professional* results every time—in fine cabinet work, furniture-making, home improvements, shop work of every kind. And you can own it *complete* at a big \$7.00 saving—if you act now!

**Special introductory offer!** Model 140 Routo-Jig, complete with Router Base, Jig Saw Base, and Shaper Table—\$61.95 value—now only **\$54.95!**

### Porter-Cable

*Quality Electric Tools*



SEE YOUR DEALER — OR MAIL COUPON TODAY!

PORTER-CABLE MACHINE CO.  
514-A N. Salina St., Syracuse 8, N. Y.

Yes, send me a complete catalog sheet on the Model 140 Routo-Jig, and the name of my nearest dealer.

Name \_\_\_\_\_

Address \_\_\_\_\_

City \_\_\_\_\_ Zone \_\_\_\_\_ State \_\_\_\_\_

saws • belt sanders • finishing sanders • drills • routers • planes

any 3 of these

**33**

**PLANS FREE\***

be a "do-it-yourself" Santa

... make your own  
Christmas decorations, toys and  
gifts for "home and family"  
with easy-to-use **FIR PLYWOOD!**



 **CHRISTMAS DECORATIONS  
TOYS, GIFTS**

No. 1—Special folder  
includes plans for Giant Santa • Choir Boy • Angel and  
Candle • Giant Building Toy • Magazine Rack • Toy  
Trailer • Cutting Boards



**7 plans for BUILT-INS**

- |                             |                            |
|-----------------------------|----------------------------|
| 2. Living Room Storage Wall | 6. Hi-Fi Music and TV Wall |
| 3. Sectional Storage Wall   | 7. Odds and Ends Cabinet   |
| 4. Attic Storage Wall       | 8. Shelf Door Wardrobe     |
| 5. Child's Storage Wall     |                            |



**10 plans for  
KITCHEN FEATURES**

- |                                    |                          |
|------------------------------------|--------------------------|
| 9. Breakfast Snack Bar             | 14. Canned Goods Closet  |
| 10. Snack Bar Overhead Cabinet     | 15. Kitchen Desk         |
| 11. Movable Cleaning Cart          | 16. Sink Cabinet         |
| 12. Drawer Unit for Built-in Range | 17. Sliding Spice Rack   |
| 13. Movable Laundry Cart           | 18. Oven Utensil Cabinet |



**5 plans for FURNITURE**

- |                           |                        |
|---------------------------|------------------------|
| 19. Buffet Chest          | 22. Toy Storage Blocks |
| 20. Stacking Cabinets     | 23. Workshop Bench     |
| 21. Storage Bed Headboard |                        |



**4 plans for  
OUTDOOR STORAGE**

- |                         |                          |
|-------------------------|--------------------------|
| 24. Patio Furniture Set | 26. Garden Work Center   |
| 25. Child's Playhouse   | 27. Outdoor Storage Wall |



**6 plans for BOATS**

- |                          |                              |
|--------------------------|------------------------------|
| 28. 8' Pram Dinghy       | 31. 13 1/2' Outboard         |
| 29. 9' Flat Bottom Skiff | 32. 15' Knockabout Sailboat  |
| 30. 11 1/2' Skiff        | 33. 20' Marconi-Rigged Sloop |

**See your Lumber Dealer**

... for fir plywood and "how-to" suggestions.  
Many dealers also have plans listed above.

\* Up to 3 plans free; send 10c for each additional 3 plans.  
Order by plan number from Douglas Fir Plywood Assn.  
Dept. 911, Tacoma, Washington. (Good in U.S.A. Only)

**Electronic Servant Works for Pennies**

(Continued from page 158)

If the switch is used to turn on a light at a predetermined level of darkness, care must be taken in the placement of the unit so that the controlled light does not strike the phototube. Unless this precaution is observed, the relay in the circuit will open and close very rapidly, and the controlled light will flicker on and off continuously.

Any current required to activate the controlled device must flow through the contacts of the relay within the switch. These contacts can handle loads up to 600 watts, approximately 5 amperes at 117 volts. While this is sufficient for most applications, it is suggested that the current requirements of the controlled device be carefully checked in order to prevent damage to the relay contacts.

In the event that the load current exceeds the relay ratings, an auxiliary relay can be employed. A.c. relays are available with current ratings of 8, 10, 15 and 20 amperes and it is a relatively simple matter to select the one best suited to your particular requirements.

When an auxiliary relay is used, its coil must be connected directly across socket S1, and the controlled device is attached to its contacts. As a result, any control current will flow through the heavy-duty relay, while only a small amount of current actually flows through the contacts of the switch relay.

In addition to turning lights on and off, the photoelectric switch can be used as an automatic announcer to ring a bell or chime when someone enters a shop or office. For such applications, the switch should be used in conjunction with an external light source, such as a prefocused electric lamp which can be purchased at any hardware store. In such cases, the phototube should be completely shielded so that only the light from the desired source strikes its cathode. When this light is interrupted by the opening of a door, an electric bell or buzzer connected to socket S1 will announce the visitor.

When the switch is used in conjunction with a prefocused light and an electric counter, it can be used to count objects moving down an assembly line, or the number of persons passing a given point. These, and innumerable other applications, make the construction of the photoelectric switch a highly worthwhile project.

A list of mail-order houses where the materials for this project can be obtained is available from the Popular Mechanics Radio and Electronics department upon receipt of ordinary letter postage. ★ ★ ★

# Power-Mount — GIVES YOU 5 MORE REASONS FOR WANTING SHOPSMITH!



Power-Mount is the exclusive SHOPSMITH® feature that lets you take advantage of SHOPSMITH'S ¾-hp. motor and Speed-Dial to operate other tools.

Two auxiliary spindles drive jointer, jigsaw, sprayer. Each of the tools is mounted on your SHOPSMITH with twin-tubes.

**1** Power-Mount saves you money by eliminating need for extra stands, motors, pulleys, etc.

**2** Power-Mount saves you space — simply store tools "on-the-wall" when not in use on SHOPSMITH.

**3** Power-Mount lets you add the rugged 4" MAGNA Jointer for use with SHOPSMITH for simultaneous saw-jointing.

**4** Power-Mount lets you add the big 18" MAGNA Jigsaw for use alone ... or with SHOPSMITH for jigsaw-disc (or drum) sanding operations.

**5** Power-Mount lets you add the versatile new MAGNA Paint Sprayer for painting or staining projects that you build on your SHOPSMITH.



There are many more reasons why you'll want SHOPSMITH in your workshop. See and try this versatile power workshop at your leading hardware or department store or any Montgomery Ward store. It's yours for as little as \$3 a week.

## MAIL COUPON FOR 3 FREE BOOKS

1. "Project Digest." 36 pages of modern woodworking projects.

2. The valuable home-shop guide: "What to Look for When You Buy Power Tools."

3. Illustrated 20-page SHOPSMITH catalog.



## MAGNA Engineering Corporation

Dept. 311-B, at factory nearest you:  
Waynedale, Fort Wayne, Indiana, OR Menlo Park, Calif.

Please send me 3 free books.

Name \_\_\_\_\_

Address \_\_\_\_\_

City \_\_\_\_\_ Zone \_\_\_\_\_ State \_\_\_\_\_

If you already own SHOPSMITH, check whether you have SHOPSMITH Mark 5 , or SHOPSMITH Model 10 ER .



**Christmas decorations—easy with  
MASONITE PRESWOOD  
FREE patterns show how!**

It's fun to make your own Yuletide decorations. And it's easy with strong, rigid Masonite Tempered Preswood.

These low-cost panels withstand snow and rain. They won't split, splinter or crack. They cut easily with hand or power saw and they take paint beautifully.

Send for your free pattern plan . . . shows how to make the Santa and reindeer, and the Christmas card displayer shown above. Has many other Christmas time ideas, too. You can get Preswood® at your local lumber dealer's.

Look for this man  He makes the difference

**MASONITE® CORPORATION**

MANUFACTURER OF PRESWOOD PANEL PRODUCTS

Dept. PM-11, Box 777, Chicago 90, Ill.

Please send me your free pattern plans for Christmas decorations.

Name.....

Address.....

Town.....Zone.....

County.....State.....

In Canada: Masonite Corporation, Gatineau, Quebec

**Bill Ford Revives a Classic:  
The Continental**

(Continued from page 84)

- The leather in the Continental's upholstery (and 23 of 49 interior-trim schemes are all leather) comes from Bridge of Weir, Scotland, where barbed-wire enclosures are never used because the cattles' hides might be damaged by the barbs. This leather is tediously hand-worked in Scotland to make it supple.

- Each engine is tested on a dynamometer alone, then with its transmission attached, and finally in the car.

- Each transmission is tested individually in a test vehicle before being shipped to the Continental assembly plant.

- Glove compartment and trunk are lined with the same fine carpeting used on the floor.

- Vent panes as well as windows are motorized with the driver's control on a shelf in the door.

- It takes 90 man-hours to assemble the Continental—a figure believed to be two or three times higher than for other American cars. Daily production is a mere 10 to 16 cars.

- About 300 persons work in the assembly plant and 47 of them are inspectors. That is an inspector for every six workers, a very high ratio.

- Bodies are checked on a gauge and must come within a tolerance of  $\frac{25}{1000}$  inch.

Don't make the error of calling this car the 1956 Continental. It isn't. It is the Continental Mark II, meaning the second of a series. There are no plans for yearly changes. When a change does come, the new model will be the Mark III. That might be one, two or five years from now.

Have you noticed there is no talk about horsepower and torque? This was no oversight. While the rest of the industry shouts about its added power, the Continental people are mum.

The engine is a modified Lincoln V8 and it obviously puts out as much (probably more) power as Lincoln's 285 horsepower and 401 pound feet of torque. But all you'll get from Continental sources is a smile when you ask how much. Their answer is simple: "Horsepower is adequate."

And, on the theory that when you buy a \$10,000 automobile you don't have to rely on such incidentals as horsepower to impress your friends, Continental says it will continue to stay aloof in the horsepower claiming race.

Having driven the Continental, I can say quite honestly that they are right—the horsepower is adequate! ★ ★ ★

POPULAR MECHANICS

# Get the battery with the **GIANT PLATES**

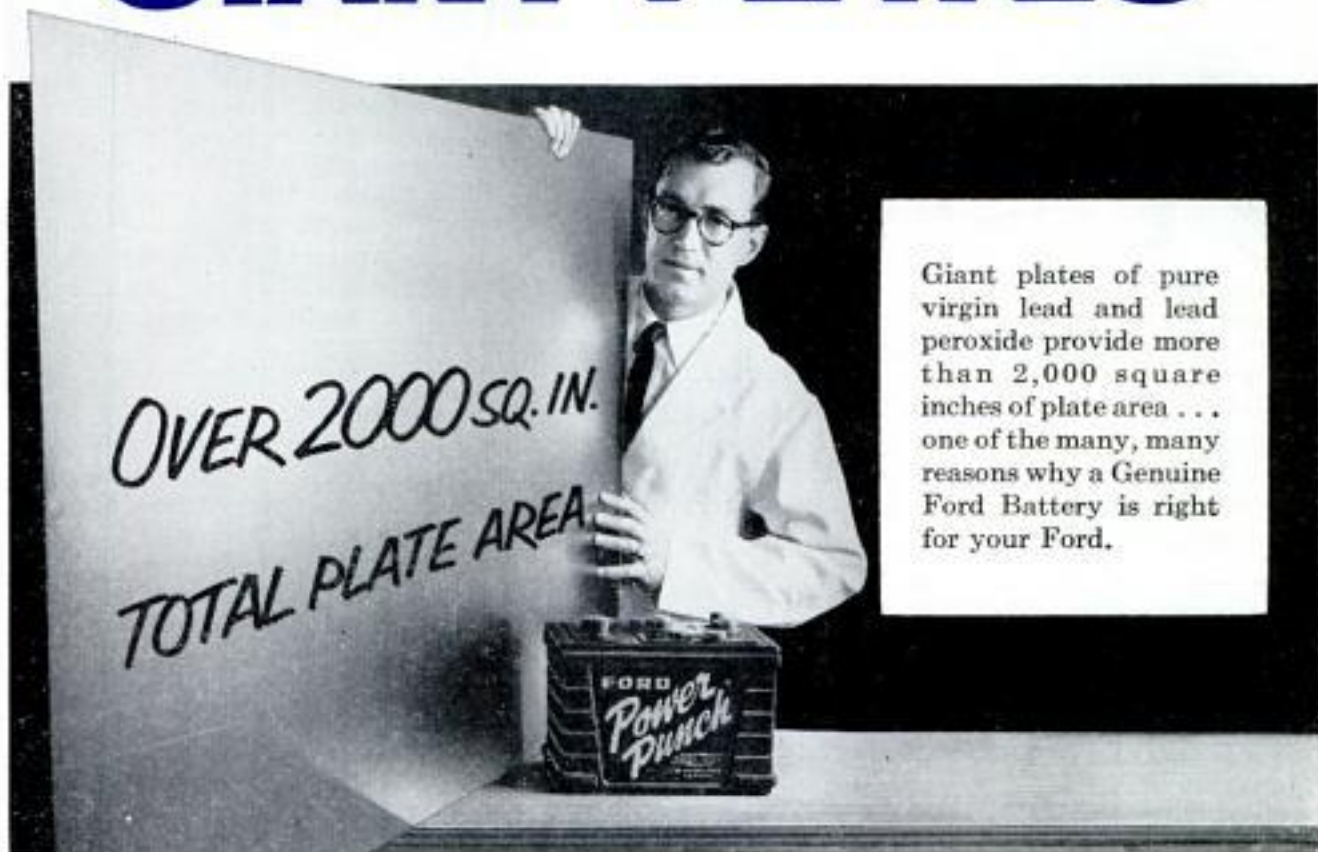

Giant plates of pure virgin lead and lead peroxide provide more than 2,000 square inches of plate area . . . one of the many, many reasons why a Genuine Ford Battery is right for your Ford.

*Genuine Ford "Power Punch" Batteries have extra big plates to give you greater power and longer life*

Now's the time to make sure for the cold months ahead, your Ford is ready to give you all the ready-to-go performance that was originally built into it.

A simple check by your dealer will tell if a new battery is advisable. If necessary, he can supply the Genuine Ford "Power Punch" battery with exactly the *right* capacity for your Ford's electrical system. Ford "Power Punch" batteries, like all Genuine Ford Parts, must pass exhaustive tests

by the men who originally built your Ford before being approved for manufacture.

Remember, whenever replacements will add to your Ford's "go," always insist on Genuine Ford Parts—they're made right, to fit right, to last longer.



**Keep your Ford all Ford**

# \$35,000 REWARD FOR URANIUM



Here's your chance to "cash in!" Over \$3,750,000 in Government Bonuses have been paid for URANIUM discoveries in the past 2 years. Currently \$175,000 a month is paid to people like you.

Precision Geiger Counters and Scintillators are the finest instruments made for URANIUM prospecting. These highly sensitive instruments are compact, lightweight and ruggedly built for field use. Prices start at \$29.95.

### CONTACT YOUR NEAREST DEALER

or write direct to factory for  
FREE 12-PAGE CATALOG and  
our 24-PAGE BOOKLET with  
"64 QUESTIONS AND ANSWERS  
ON GEIGER COUNTERS  
AND SCINTILLATORS."

PROSPECTORS  
RELY ON...



### MAIL TODAY FOR FREE INFORMATION

Name \_\_\_\_\_ Title \_\_\_\_\_  
Company \_\_\_\_\_  
Address \_\_\_\_\_ City \_\_\_\_\_ State \_\_\_\_\_

**P**RECISION RADIATION INSTRUMENTS, INC.  
4223 PMW. Jefferson Blvd., Los Angeles 16, Calif.  
*World's Largest Manufacturer of Radiation Instruments*

Insist on *Evans* TAPES  
"The Mathematical Genius"  
At Your Hardware Store

6-ft.  
pocket tape  
only 98¢



Available, too, in 8, 10, 12-ft. lengths.  
Each with FREE plastic utility case.  
Automatically  
figures for you in  
feet and inches or  
total inches.  
Also in 6, 8, 10, 12-ft. King-Size Tapes.



## Chrysler Family Makes Its 1956 Debut

(Continued from page 92)

special manifolding and other high-power extras. Horsepower on the standard Super Red Ram V8 is 218 on the 315-cubic-inch engine. All Dodge V8 engines this year have a single rocker-arm shaft. The hemispheric-head double-shaft design has been dropped. Stroke is increased to 3.80 inches. Compression ratio is now 8.0:1. The smaller Coronet V8 has a 270-cubic-inch displacement, 8.0:1 compression ratio.

The Dodge Six is available in certain models of the Coronet and Suburban lines (as with Plymouth, station wagons are a separate series this year).

### De Soto

From the front, the De Soto has an entirely different look for 1956. The familiar toothed grille has been replaced by a simple mesh design on which a broad "V" is mounted. Bumpers, front and rear, are new and the front parking lights are mounted inside the two bumper guards.

Horsepower is now 255 on the Fireflite and 230 on the Firedome. Both have 330.4-cubic-inch displacement, the difference being carburetion. The Fireflite has four barrels; the Firedome only two.

Stroke is increased by almost one half inch to 3.80 inches. Compression ratio is now 8.5:1, up from last year's 7.5:1. Valves have been made larger and ports redesigned for better breathing.

Taillights are distinctive, consisting of a three-turret assembly. The top turret is combination taillight and stop light. The center turret is a white back-up light. The bottom turret is an extra taillight, giving the De Soto four taillights!

The horn has been given a third tone to lend a more authoritative triad sound, says De Soto. Door handles are now of the easy-to-grab pull type, the flush design of last year being dropped.

### Chrysler and Imperial

Definite steps have been taken to separate the Windsor and New Yorker for 1956. Front grilles are different, although maintaining the same theme. Windsor grilles have only three horizontal bars while on the New Yorker there are about a dozen slender chrome strips. Chrome trim on such spots as the rear fenders also provides separate identifications.

Among the engineering changes is the new center-plane brake said to increase brake-lining life by as much as 20,000

(Continued to page 256)



Good News for budget-minded HANDYMEN...

now buy this basic

# POWER TOOL WORKSHOP

Complete  
with MOTOR

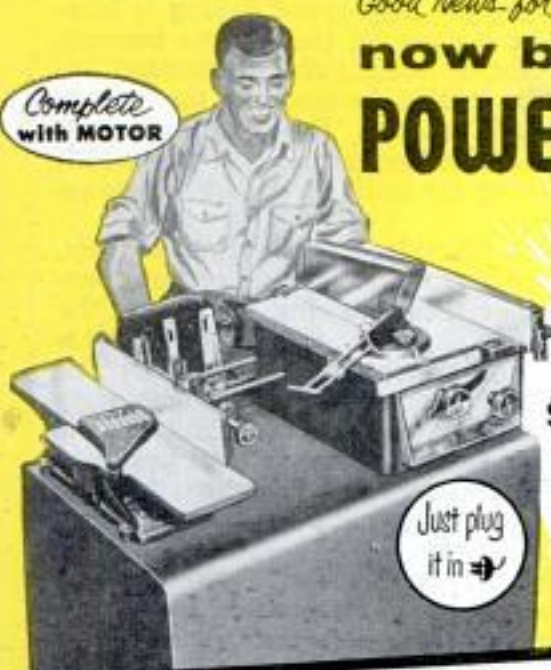

Just plug  
it in

for only

\$ **17.50**  
DOWN

and small  
monthly  
payments

## IT'S THE NEW Shopmaster

### SAW-JOINTER COMBINATION

Now you can buy Shopmaster tools on the famous GECC Handyman payment plan. Pay only 10% down and balance in up to 18 months. Buy the Shopmaster Saw-Jointer combination or any Shopmaster tools totaling more than \$150 on this wonderful handyman payment plan. It's Shopmaster's way to give you tomorrow's power tools right now!



Look at these saw-jointer features

- Ready to plug in
- Handy switch in front
- Complete with 1/2 HP motor
- 8" saw with 2 1/2" depth, 13"x16" table size, mitre gauge and rip fence
- 4" jointer-planer with 3/8" cut, 4"x26" table and flexible guard
- All steel stand 26"x34" and 36" high
- Sealed-for-life ball bearings
- Complete only \$174.50



It's America's Greatest Power Tool Value!!

WRITE FOR FREE CATALOG

# Shopmaster

ROOM 10D, 1214 SO. THIRD ST., MINNEAPOLIS, MINN.

## NEW, IMPROVED CALCULATOR FOR WOODWORKERS only 25c



Instantly gives information on lumber, nails, concrete mixes, painting materials, etc. Convenient, simple to read. Just set dial for nail specifications, to convert linear to board feet, find bit sizes for screws, compare characteristics of woods. 6" diameter heavily varnished cardboard. Send 25c, no stamps, please to Greenlee Tool Co., 2111 Columbia Avenue, Rockford, Illinois.

## McKENDREE DUCK PICKER



### Pick ducks with power!

Attachment for 1/4-inch or larger electric drill...picks a duck clean in four minutes. Won't bruise the skin or scatter feathers. Send cash, check or M.O. now.

**U.S.A. AND CANADA \$6.00 PPD.**

All other countries \$8.50 ppd.

(Air mail extra—shipping weight 8 oz.)

## McKENDREE PRODUCTS CO.

DEPT. PM

1893 Del Moro • Klamath Falls, Oregon

NOVEMBER 1955

# SCHALK'S WOOD PUTTY



Not a plastic—  
contains real hard wood

Recommended  
by Peter Putter



Here's the Wood Putty that won't shrink. You can mold, model, plane, saw, sandpaper it. You can color, stain, paint, varnish it. It fills nail holes, cracks in floor, furniture, plywood; sets door pulls. And, when mixed with varnish instead of water, it becomes a waterproof material for boat repairs or exterior use. All you need for 101 odd jobs around home, farm and workshop—Schalk's Wood Putty—the wood putty with real wood!

At paint, hardware, building supply stores

SCHALK CHEMICAL CO., 351 East 2nd St., Los Angeles 12

255

Own a '55 Chevrolet or Ford?

Then you can enjoy the  
CONVENIENCE, SAVINGS  
and SMOOTHER RIDE of

## Push Button POWER LUBRICATION



**WHAT IS MULTI-LUBER?** The newest of power assists for your car, as revolutionary as power brakes and power steering. MULTI-LUBER means *power lubrication* at the press of a button on your dash. No more long waits between "grease jobs." Grease with ease whenever you please! A touch of your finger delivers an exact amount of refinery-pure lubricant to every chassis bearing in seconds. Adds years to the life of your car!

*Buy it installed from your car dealer, garage, or service station—or install it yourself. Kit includes complete instructions for quick and easy installation.*

USE THIS BLANK TO OBTAIN  
COMPLETE INFORMATION:

IN KITS  
AS LOW AS  
**\$41<sup>95</sup>**  
PLUS  
INSTALLATION



LINCOLN ENGINEERING COMPANY  
ST. LOUIS 20, MO.

Please send me your illustrated leaflet describing  
MULTI-LUBER, and the name and address of  
my nearest Multi-Luber Dealer.

NAME.....

STREET.....

CITY.....STATE.....

(Please print or typewrite)

miles. Twenty-five percent less pedal effort is required, yet high-speed fading is lessened. The brakes get their name because they consist of floating shoes mounted between two plates located on the center plane of the linings. Braking forces are thus transmitted equally across the width of the lining for uniform pressure against the drum.

On both Chrysler and De Soto models, the heater burns gasoline for instant operation rather than drawing heat from the engine's slow-to-warm cooling system. Air heated to 100 degrees is obtained from the heater in 15 seconds. With outside temperatures near zero, the car interior is brought up to 60 degrees in about five minutes. The heater will decrease gasoline economy only about one-half mile per gallon while in use.

Horsepower on the New Yorker V8 and the Imperial has been boosted to 280, up considerably from last year's 250 horsepower. Displacement is now 354 cubic inches, compression is 9.0:1 and four-barrel carburetors and dual exhausts are standard. Incidentally, Chrysler has taken a bold step in removing all evidence of exhaust pipes from the rear end at a time when other stylists are emphasizing them with chrome embellishments. Chrysler tail pipes curve downward out of sight, invisible from the rear.

The Windsor Spitfire V8 now has 331-cubic-inch displacement and a compression ratio of 8.5:1. Horsepower is 225, with 250 horsepower being available as an option involving four-barrel carburetor and dual exhausts.

Imperial styling changes are principally in the rear fender. The fenders are longer and sweep upward. Even more jaunty than last year are the gunsight taillights that have been moved farther back on the fender crown and enlarged.

Wheelbase of the 1956 Imperial is increased by three inches and over-all length by 5½ inches. The rear bumper is unmarred by exhaust ports or tail-pipe extensions of any type.

The electric clock on the Imperial has an automatic adjusting mechanism. If the clock is running slow, the operation of setting the hands ahead to the correct time also advances the speed control so the clock runs a little faster. After one or more settings, the clock will be adjusted correctly.

Improved handling with less sway and roll at the rear has resulted from a modification of the Imperial's Hotchkiss drive. The modification consists of two pieces of rugged spring steel attached to the frame

(Continued to page 258)

SHOP by MAIL and  
**Save**  
at GROBAN'S

**SURPLUS & NEW MANUFACTURE EQUIPMENT**  
- FOR HOME, FARM & FACTORY -  
All items unconditionally guaranteed!

**SAVE \$30.30 ON THIS PESCO  
HYDRAULIC  
CONTROL VALVE**

ITEM #371V  
FOR SAFE POSITIVE CONTROL OF HYDRAULIC CYLINDERS AND MOTORS - 4 BUILT-IN RELIEF VALVE - factory set at 1200 P.S.I. • FOUR-WAY VALVE - to operate one double acting cylinder • OPEN CENTER - with valve in neutral, cylinder is locked in position and pump is unloaded. • SPRING RETURN TO NEUTRAL • FULLY BALANCED PLUNGER • EASILY STACKED INTO 2, 3, or 4 valve combinations for multiple cylinder operation. • 8 gal. per min. capacity at 1200 P.S.I. • 1" pipe ports • CONNECT PUSH RODS TO HANDLE FOR REMOTE CONTROL • EASY MOUNTING • LIST PRICE - \$46.80 • YOU SAVE \$16.50. • DIMENSIONS - 3 1/2" x 4 1/2" x 2 1/2" - Ship. Wt. 5 lbs. F.O.B. Chicago. . . . . **16.50**

**PESCO GEAR TYPE  
HYDRAULIC PUMP**

Compact - Powerful - Reliable  
ITEM #160 - Especially designed for belt drive from fan belt, power take-off, drive pulley, electric motor or small gas engine. Equally suitable for direct coupling.  
Pedestal type mounting with two bolt holes for 3/4" hold-down bolts. Standard 1/2" pipe thread inlet and outlet ports. Delivers 4.5 GPM at 1000 P.S.I. at 2800 RPM with 4 HP. Hardened steel gears turn in dense oilite bronze bearings. Rotation - clockwise facing shaft. Guaranteed trouble-free service. Ship. wt. 6 lbs. F.O.B. Chicago. . . . . **22.50**

**DOUBLE ACTION  
HYDRAULIC CYLINDERS**

ITEM #31C - 3 1/2" bore, 11" stroke. Alloy steel cylinder wall. Micro-Homed and all steel 1 1/2" diameter piston rod. 19 1/2" overall length closed. Clevis mounting at base and shaft. Will lift 9625 lbs. with 1000 PSI Pump Pressure. Uses 3/8" tubing fittings. Fits into pipe thread. Two 1/2" x 1 1/2" x 3/8" Stud. A \$102.00 value. Shipping weight. . . . . **25.00**

ITEM #16C - 1 1/2" bore, 26" stroke. Will lift 1760 lbs. with 1000 lbs. pump pressure. Great for hay loaders, etc. 1" stainless steel piston rod. Postpaid. . . . . **16.95**

ITEM No. 33C - 1 1/2" bore, 4 1/2" stroke, alloy steel barrel, aluminum alloy ends, clevis mounting at both ends, lifting capacity 1760 lbs. in approximately 1/2 second using 1000 P.S.I. - overall length closed - 15 1/2". Has 2 - 1/2" pipe thread ports. Postpaid. . . . . **8.95**

**FREE! - NEW CATALOG**  
1956 EDITION, 52 PAGES, chock-full of unsurpassed War Surplus Equipment Bargains for farm, home, factory, workshop. Write letter today.

**Brand New! 5-TON BLACKHAWK  
HYDRAULIC LIFT KIT**

New Only **38.95** Complete  
The Complete Kit  
For - • Dumping farm wagons • Adjusting depth of plows • Hydraulic press • Hydraulic jack • Snow plows.  
KIT CONSISTS OF:  
1 - Brand new Blackhawk Model No. P-153 - Hydraulic hand pump with built-in oil tank and release valve. Rated from 1200 P.S.I. - to 5000 P.S.I. 2 1/2" handle. Dim. 8" x 6" x 4" Item #82 . . . . . **22.50**  
1 - 6 Ft. length double wire braided rubber covered hydraulic hose - tested to 20,000 lbs. Item #2784 . . . . . **3.95**  
1 - Hydraulic cylinder, 2" bore, 6" stroke, husky 1" solid steel shaft. Will lift 35,000 lbs., using pump pressure. Standard clevis mounting. May be used for double action service. Item #41C10 . . . . . **12.50**  
2 - Qts. non-foaming hydraulic fluid. . . . . **1.00**  
All necessary hydraulic fittings. Total ship. wt. - 40 lbs.  
**COMPLETE KIT PRICE 38.95**  
ALL OF ABOVE INCLUDED F.O.B. Chicago

**FACTORY-TO-YOU-VALUE  
PORTABLE ELECTRIC  
LIGHT PLANTS**

POWER TO OPERATE:  
• Electric Saw, Electric Drills, Pipe Bender.  
• Refrigerator, Deep Freezer, Incubator.  
• Water Pump, Radio, Lights, Air-conditioner.  
COMPACT - FITS IN THE TRUNK OF YOUR CAR  
1000 WATTS OUTPUT, continuous duty. 115 Volts A.C. 60 cycles, 9 amps. Powered by husky, easy starting Clinton engine. Engine and generator operate at 3600 R.P.M. for maximum efficiency at minimum weight. Both units are mounted on steel base, with heavy sheet metal belt guard. Generator is self regulating, and is equipped with outlet box containing fuse and 2 A.C. convenience receptacles. Cost only 5c an hour to operate. Dimensions: Length 20 1/2", Width 12", Height 16". Shipping wt. 100 lbs. F.O.B. Chicago. . . . . **149.50**  
700 WATT-GENERATOR SET - same as above, slightly smaller - with Briggs-Stratton Engine - Model 70S - F.O.B. Chicago. . . . . **129.50**

**U. S. NAVY ALL BRONZE CENTRIFUGAL PUMP**

These all bronze Centrifugal Pumps are ideal for use as marine bilge pumps, circulating pumps, fire protection or irrigation, car-washing, de-watering, basement sump pumping, lawn sprinkling. Will pump water, oil, brine, gasoline, DDT and sulphur compounds. Equipped with 6" adjustable "V" pulley, 2" dia. inlet and outlet. 180 GPM capacity. Inlet and outlet take hose with 2 1/4" inside diameter. Dimensions 11" x 8" x 11".  
Total head-feet Speed H.P. GPM  
25 3000 RPM 3 180  
35 3000 RPM 1 1/2 90  
20 2400 RPM 1/2 75  
Back plate may be rotated for most convenient inlet position. Shipping weight 31 lbs. Govt. cost \$29.50. F.O.B. Chicago. . . . . **29.50** ITEM #384

To place phone orders call WEBster 9-3793  
**GROBAN SUPPLY CO.** Dept. PM-11  
1139 S. WABASH AVE., CHICAGO 5, ILL.

**BELT DRIVEN  
A. C. GENERATORS**

Ideal for powering electric tools, oil burner, refrigerator, lights, or other appliances requiring up to 700 watts of power. 700 WATTS, 115 Volts, 60 cycles A.C. 3600 R.P.M. Compact, self-regulating generator with V Belt pulley and double outlet receptacle. Rotation counterclockwise. May be driven by tractor or auxiliary gasoline engine. Requires 2 HP minimum. Dimensions: 10" long x 8" high x 6" wide. Shipping wt. 27 lbs. F.O.B. Chicago. . . . . **59.50**  
Model 1010 - 1000 WATTS (Same as above) F.O.B. Chicago. . . . . **79.50**

**GROBAN HYDRAULIC  
SPEED REDUCER  
with FINGERTIP CONTROL**

FOR: • Reamer Drives • Midget Cars • Feed Mills • Canning Machines • Conveyors • Lathes • Milling Machines • Motor Boats • Cream Separators • Garden Tractors • Pumps.  
Variable output speeds from 0 to input speed available by moving control handle. Locking handle maintains setting. Use input power of 1/2 to 1 1/2 H.P. Shafts 5/8" diam. Input rotation counter-clockwise facing shaft. Input speed 750 R.P.M. 7 1/2" x 7 1/2" x 1 1/2" Gov't acquisition cost \$428.00. Ship. wt. 31 lbs. Complete with 2 qts. of oil and full instructions. F.O.B. Chicago. . . . . **54.50**

**BRAND NEW! 1 H.P.  
12 VOLT ELECTRIC MOTOR**

• For electric wheel chairs (Psy. Mech. design - Mar.-1955)  
• For electric golf carts  
• For self-propelled scooters, children's mid-let cars.  
Rated 1 H.P. - 100 amps., 600 R.P.M., 12 volts, D.C. - This double shaft motor of ball-bearing construction may be run on 8 volts for lower horsepower requirements. - Standard 1/2" shafts, nut and bolt electrical terminals, flange mounting - dimensions: 6" x 6" x 4 1/2". Ship. wt. 19 lbs. A real value at. . . . . **12.50** F.O.B. Chicago

**ORDER DIRECT FROM AD  
SATISFACTION GUARANTEED**  
Send Payment Or  
Purchase Order Today

**Say You Saw It in Popular Mechanics**

**MAGNETS**

ASSORTED MAGNETS with big list of handy uses. . . . . **5 for \$1**  
POWERFUL POCKET MAGNET ideal for testing metals. . . . . **\$1**  
RETRIEVING MAGNET pulls tools, etc., from tank or lake. . . . . **\$4**  
HOT PAD MAGNETS to insert in your own hot pads. . . . . **8 for \$1**  
BULLETIN BOARD MAGNETS to "pin-up" memos, etc. . . . . **8 for \$1**  
EXPLORE, LEARN - Electricity, Magnetism, Electro-Magnets. Complete kit and instructions with 22 experiments and models. . . . . **\$3.98**  
FREE CATALOG, 100% satisfaction guaranteed. . . . . **POSTPAID**  
PARK MAGNETS, 2511, 1557 GREENBAY RD., HIGHLAND PARK, ILL.

**MONEY MEN ALL FREE**

THE PLASTEX Industry needs manufacturers on small scale and for big production of Lamp and Clock Strands, Art Goods and Novelties in Plastex and Marble imitation. Experience unnecessary. 1/2 material makes regular 10¢ store sellers. Rubber moulds furnished for speed production. Small investment brings good returns. We are now placing big Chain Store Orders with manufacturers. Ambitious men have chance for real prosperity. Our free booklet will interest and benefit you.

**PLASTEX INDUSTRIES, Dept. A**  
3400 Third Ave. New York 56, N. Y.



## Now Anyone Can Smooth Rough Stuff!

Save yourself a lot of scraping and sandpapering with the new SMOOTHY. Easy to use as a blackboard eraser! Has four scientifically designed star blades imbedded in tensioned plastic that will last indefinitely. Works quickly on rough plaster, wood, floors. Removes paint and varnish without messy liquids.

Order now for Christmas.

AT YOUR DEALER, or — SEND \$1 TO:

**FORTUNE LABORATORIES**

1405 MAINE STREET • DES MOINES, IOWA

## Basket-Weave Fencing



- for outdoor or indoor use
- quick and easy to build
- longer lasting

Build it with Homasote — the oldest, strongest, weatherproof, insulating - building board on the market. Homasote can be cut into special Fence Panels measuring 6' x 8'. Simply weave the panels on posts 4' apart. No cracking; saws and nails easier than wood.

Costs less than any other satisfactory material. Smooth, finished; takes any paint or stain you select. And it is weatherproof; (for 40 years there have been no storehouses at the Homasote Plant).

Fencing is only one of 100 uses for Homasote. Mail the coupon today for 3 illustrated folders suggesting 18 interesting and practical make-it-at-home projects—from furniture to complete rooms, ceiling and floor treatments, lily pools.



### MAKE IT AT HOME — WITH HOMASOTE

HOMASOTE COMPANY

Department L-6, Trenton 3, N. J.

I enclose 10c for 3 Make-It-At-Home Folders

NAME .....

ADDRESS .....

CITY.....ZONE.....STATE.....

My lumber dealer is:.....

and to each end of the rear axle housing. These struts also take up part of the engine torque, relieving the rear springs of some of this stress.

The Imperial offers a transistor radio that has no tubes. Drawing so little current that it operates ten times as long as a conventional radio on one battery charge, the transistor set has no vibrator, power transformer, rectifier or other parts required to develop high-voltage alternating current. No warm-up time is necessary. Turn the set on and you get reception instantly. It takes less current to operate the radio than it does to light the radio's dial light.

★ ★ ★



## Slide Fastener Seals Protective Cover

Sealed in place by an integral slide fastener that locks two preformed edges together, Protektinsul plastic covering is designed for use on insulated pipes or ducts. The covering is made of Krene plastic, which is highly resistant to moisture, mold and mildew and protects against electrolytic corrosion. The slide fastener permits access to the protected pipe or duct at any time.





# GRAVELLY Snow Blower

**Optional Self Starter**

**5-HP . . . SAVE YOUR HEART!**

- Blows snow where you want it—handles any snow, deep or light, wet or dry.
- Or use Snowplow attachment . . . 48" wide. Both powered by powerful 5-HP Gravelly. Only 2 of 23 year 'round tools! . . . *Easy Pay Plan—only 20% down!*

Write today for FREE 24-page "Power vs Drudgery" Booklet.



**GRAVELLY TRACTORS, INC.**  
BOX 1163 DUNBAR, W. VA.

**FIELD-TESTED FOR 34 YEARS**

## ACE TOOLS



Be permanently toolled-up for every operation on your Metal Cutting Lathe.

No. 8-A Ace Tool Set for 9" and 10" Swing Lathes—fits shank size 3/8" x 3/4". Includes Turning, Cutting-off, Boring, Knurling and Threading Tools with high speed cutters, blades and wrenches. 8 complete tools in fitted steel case—nothing else to buy. See your local dealer or order direct.

ARMSTRONG BROS. TOOL CO. \$26<sup>35</sup>  
5268 W. Armstrong Ave., Chicago 30, Ill.



## Find URANIUM!!

GEIGER COUNTERS for uranium detection. All models and sizes — from low-cost, portable to super-sensitive airborne units. Prices start at \$37.50. Also TREASURE DETECTORS and MINERALITES. • FREE INFORMATION •

**Detectron, Corp.**  
5528 Vineland, North Hollywood, Calif.

Insist on  
**Evans  
TAPES**

50 ft.-100 ft. long  
At your hardware store  
For building and gardening measuring.

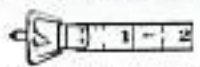

SPECIAL HOOK-RING ATTACHMENT FOR EASY ONE-MAN MEASURING

each with FREE plastic utility case and



# "ARCO JIG-SAW" WITH EXCLUSIVE NEW CIRCLE- CUTTER & RIP GAGE!

Another "ARCO" FIRST! "Arco Jig-Saw" (guaranteed to fit any 1/4" drill) with Adjustable Circle-Cutter & Rip Gage saves hours of work—assures professional-looking results everytime—whether cutting circles, curved patterns, or straight cutting. Cuts perfect circles any size up to 20" diameter; rips accurate widths any size up to 10" wide. Has same capacity and cutting speed as \$55 jig saws. Does work of Jig, Keyhole, Coping, Rip, Crosscut, Band & Hook-saw! Built-in "Air-Jet" blows away sawdust. Cuts intricate patterns—however large—in plywood, plastics, metals—even cuts 2x4's! Starts inside holes. Includes blade. Converts to Table Model with either



**RIPPING WITH GAGE**

**\$8.95** No. 500 without gages.  
**\$9.95** No. 550 with gages.

- No. 401 "ARCO STAND" Sturdy Casting & Clamp . . . \$2.75
- or No. 410 "ARCO DRILL-SHOP" incl. "Arco Stand", 1/4" drill arbor, 4" buffing wheel, 3" wire brush, 3" grindstone & rouge . . . \$4.50
- 6 Extra Asst. Blades for Wood, plastics, metals . . . \$1.95



# REVOLUTIONARY NEW 'ARCO-SAW' with "DADO-ARBOR"

**CUTS ANY  
GROOVE!**

**WHIZZES  
THRU 2x4's!**



Not even a \$100 Portable Saw has a dado cutter! "Arco-Saw" (guaranteed to fit any 1/4" electric drill) with sensational new "Dado-Arbor" adjusts easily to cut any size groove up to 1/2" wide x 1" deep in ONE CUT! Graduated Depth-Bevel-Rip Gages adjust for depth of cut up to 1 3/4", angle cuts to 45°. Amazing swivel action of "Dado-Arbor" (see sketch above) cuts large grooves cleanly and accurately with little power. "Dado-Arbor" is easily removed to use the saw for straight ripping, crosscutting or angle cuts. Right angle steel gear drive and safety-yoke permit ONE HAND operation. Includes quick-cutting 5" Safecut Blade.



CUT GROOVES LIKE THESE

ONLY  
**\$12.95**

BLADES—5" Rip, X-cut or combination \$1.75  
SOLD AT BETTER HOWE STORES EVERYWHERE. If not available, order direct and try these amazing tools on our UNCONDITIONAL 10-DAY MONEY BACK GUARANTEE. Send check or M.O. (incl. C.O.D.'s—plus post.

**ARROW METAL PRODUCTS CO.**  
Dept. PM-11, 140 WEST BROADWAY, NEW YORK 13, N. Y.

# NEW!



## with new Flexible **Weldwood® Wood-Trim®**

No more exposed edges when you make things of plywood—things like tables, desks, cabinets or other projects. Wood-Trim covers the edge with real wood veneer... gives a real "pro" finish. Apply it in minutes—without clamping, ironing, sawing, nailing, using Weldwood Contact Cement or Weldwood Presto-Set Glue.

And you'll invent countless decorative uses for Wood-Trim, too! For instance, you'll trim lamp shades and picture frames with Wood-Trim, decorate coffee tables, clocks, waste baskets, etc.

At hardware, paint and lumber dealers or write for free leaflet. Dept. 307.

UNITED STATES PLYWOOD CORP., N.Y. 36, N.Y.

8 Ft. rolls  
1" wide,  
79¢ each.  
Oak,  
African  
Mahogany,  
Walnut,  
Birch or Fir.



### BUILD FINE GRANDFATHER CLOCK NOW

The simple sensible *Real-Kit* way as thousands have—**SAVE HALF. SHOP TESTED PLANS "SPIRIT OF THE CENTURY"** Narrow waist 85" tall or stately straight side **"SPIRIT OF AMERICA."** **EASY-TO-FOLLOW** photographic PLANS tell all—plus **BROCHURE** of heavy brass weight Westminster tube chime, movements, gorgeous dials, 34" solid mahogany case kits. Send \$1.00 today—Both plans \$1.50 NOW.

KUEMPEL CHIME CLOCK CO., 7 Kuempel Bldg., Minneapolis 16, Minn.

## HOME REPAIR TIP No. 18



### LEAKY SINK TRAP?

Seal it with waterproof "SCOTCH" 33 Plastic Tape. Tough, stretchy tape fits tight, sticks tight. Plastic resists oil, water, corrosion. Mend frayed electric cords, wrap

rough tool handles, too, with "SCOTCH" 33 Plastic Tape—39¢ or 79¢ at stores everywhere. Made by Minnesota Mining and Mfg. Co., St. Paul 6, Minn. © 1955 3M Co.

## Mass Attack on the Earth's Mysteries

(Continued from page 112)

pour with great speed into the atmosphere from outside. Some of them can traverse it completely and even embed themselves many yards deep in the land or oceans. They represent a weak flow of energy compared with what we receive daily from the sun; but for such very minute particles, some of them have remarkably great individual energy, far exceeding what man has so far been able to impart to charged atoms by his most powerful cyclotrons and other devices. It is still uncertain whether the cosmic rays are generated within the solar system or in the far depths of space, but it is known that during some solar and magnetic storms their flow is altered by as much as 10 percent, though other storms, equally intense, do not affect the flow. Cosmic rays and the airglow will be studied the world over during the IGY.

### Surveying the Continents

Besides these phenomena of the sun, the atmosphere and the oceans, problems of the solid body of our globe will receive attention during the IGY. The greatest of these concern the size and shape of the earth. The different continents can be surveyed, though this is not easy for land masses so large that their surfaces are substantially curved. The measurements involve long lines of sight, along which the rays of light are bent by refraction, depending on the moisture and varying density of the air. Also, a plumb line has different directions in different places and is subject to local deviations by the attraction of mountains or denser rocks. It is still more difficult to extend the survey across the oceans between the continents, whose mutual distances are known less accurately than if the earth's surface were all land.

Some scientists think that the continents have changed their positions relative to one another and to the bulk of the earth, as if they were great rafts of rocks and plains and mountains, floating and slowly drifting on a denser layer, partly plastic. Such speculations may be checked by measurements of our globe at different epochs; only the highest accuracy will suffice for a reliable comparison, and then only over a long period, perhaps a century or centuries. The IGY may, for the first time in history, provide sufficiently accurate data for such a future comparison.

Other long-term comparisons of our globe may be of value. One of these concerns the glaciers. If these diminish by increased melting or reduced snowfall, there

(Continued to page 262)

POPULAR MECHANICS

# Get these BIG NEW **POPULAR MECHANICS** BOOKS at your newsstand



**HOMEOWNER'S DO-IT-YOURSELF IDEA BOOK.** Here is a treasury of useful, time-saving hints and shortcuts which will make home upkeep a hundred times easier. Learn to cope with wobbly furniture, old plastering, outdoor paint jobs; improve your home with new porches, ventilating system, wood panelling; use the hundreds of tips to make your household run more smoothly..... **75c**

**FIX-IT-YOURSELF TELEVISION MANUAL.** Here is a new edition of the most successful television book ever published. Tells *why* a set breaks down and *how* to prevent such breakdowns; explains clearly the electronics of TV as well as new developments in color and UHF. Avoid expensive service fees—repair your TV set yourself!..... **75c**

**FIX-IT-YOURSELF AUTO REPAIR MANUAL.** Experts have written this book to apply to any make, model, and year of car. It contains complete information on servicing your own transmission, brakes, ignition, generator, body, and cooling system, as well as hundreds of money-saving motoring shortcuts and tips on buying a used car..... **75c**

**POPULAR MECHANICS' WHAT TO MAKE, 1956.** Most famous of PM's annuals, this book offers hundreds of fascinating projects for the home craftsman. Here are more than 500 things to make—for pleasure or profit—including a model Jaguar sports car, a folding workshop, family-sized boats, and stunning free-form furniture..... **75c**



## KLEAN-STRIP Remover makes any refinishing job easier

- Breaks bond between any finish and surface
- One application removes many coats
- Fast-acting, non-messy, easy to use
- Leaves surface smooth, dry, ready to refinish
- Needs no neutralizing or afterwash
- Buy Klean-Strip where you buy paint

**NON-INFLAMMABLE**  
**KLEAN-STRIP**  
**PAINT REMOVER**

The Klean-Strip Co., Inc.

2340 S. Lauderdale, Memphis 6, Tenn.



## NEW Lynx THREAD KIT SAVES DOLLARS IN REPAIRS AND REPLACEMENTS

Loose, worn or damaged threads are costly — cause scrap, downtime, and poor performance. Now for the first time, it's as easy as A-B-C to replace these threads quickly and economically. Use Lynx\* Thread Kit! All you do is (A) drill out the hole; (B) tap new threads with tap provided; and (C) wind in Lynx stainless steel inserts, using inserting tool provided. You get a permanent, back-to-original size, stronger-than-ever repair made in minutes! Wonderful for screen doors, storm doors, furniture, lawn mowers, engines, door hardware, wood joints, boats — hundreds of uses!

Each Lynx Thread Kit contains two drills, two taps, two inserting tools and supply of stainless steel wire thread inserts for most household uses — and complete instructions!

Send check or money order — no C.O.D.'s. Money back if not completely satisfied. \*Reg. U. S. Pat. Off.



**HELI-COIL CORPORATION**

751 Shelter Rock Lane, Danbury, Conn.

Please send me a Lynx Combination Thread Kit postpaid: \$6 value for \$4. (Sizes 10-24 and 1/4-20). Covers 90% of household uses. I am enclosing \$4.

Name \_\_\_\_\_

Address \_\_\_\_\_

City \_\_\_\_\_ Zone \_\_\_\_\_ State \_\_\_\_\_ 1957

will be more water in the sea and the sea level will rise. Too much melting of the snow and glaciers might submerge some of the greatest cities of the globe. During the International Geophysical Year glaciers and snow cover will be measured in many parts of the world, both on the ground and from the air.

Observers in the antarctic and in remote islands and other places seldom visited by scientists, will make other kinds of observations: Earthquake records and measurements of the earth's attraction, or gravity, are examples.

### International Polar Years

The IGY is not the first large-scale international geophysical study of the earth. Indeed, it was first proposed in a more limited form as the third International Polar Year (IPY). The pioneer enterprise of this kind was the first IPY, which occupied 13 months of 1882-1883; its object was to improve arctic knowledge of meteorology, magnetism and the aurora. It greatly enhanced scientific knowledge of the arctic. Fifty years later, in 1932-1933, a second IPY was organized, again mainly for arctic studies but with an increased program of related observations in lower latitudes also.

In April 1950, on my first postwar visit to the United States, I was privileged to be the guest, with a small group of American geophysicists, of Prof. J. A. Van Allen (now of Iowa State University) at his home in Silver Spring, Md. After dinner, the organization of a third IPY after 25 instead of 50 years was proposed by my friend Dr. Lloyd Berkner, one of the pioneers in ionospheric studies. A main reason for his proposal was the great advance in many techniques of measurement since 1933, partly through the stimulus given by World War II and the development of radar and rockets.

The proposal was warmly received by the group and later in 1950 Doctor Berkner and I brought it formally before international scientific bodies with which we were connected. Their support was forthcoming, and this led in 1951 to the adoption of the proposal by the International Council of Scientific Unions (ICSU). This body in 1952 appointed the nucleus of an international committee to organize the third IPY and also invited the nations to set up national committees to formulate plans, along suggested lines, for their shares in the enterprise. In 1952 the plan was widened to include the study of the whole earth, and the proposed third IPY thus gave place to the first IGY.

(Continued to page 264)



**You can do  
anything  
with  
wood  
on the**

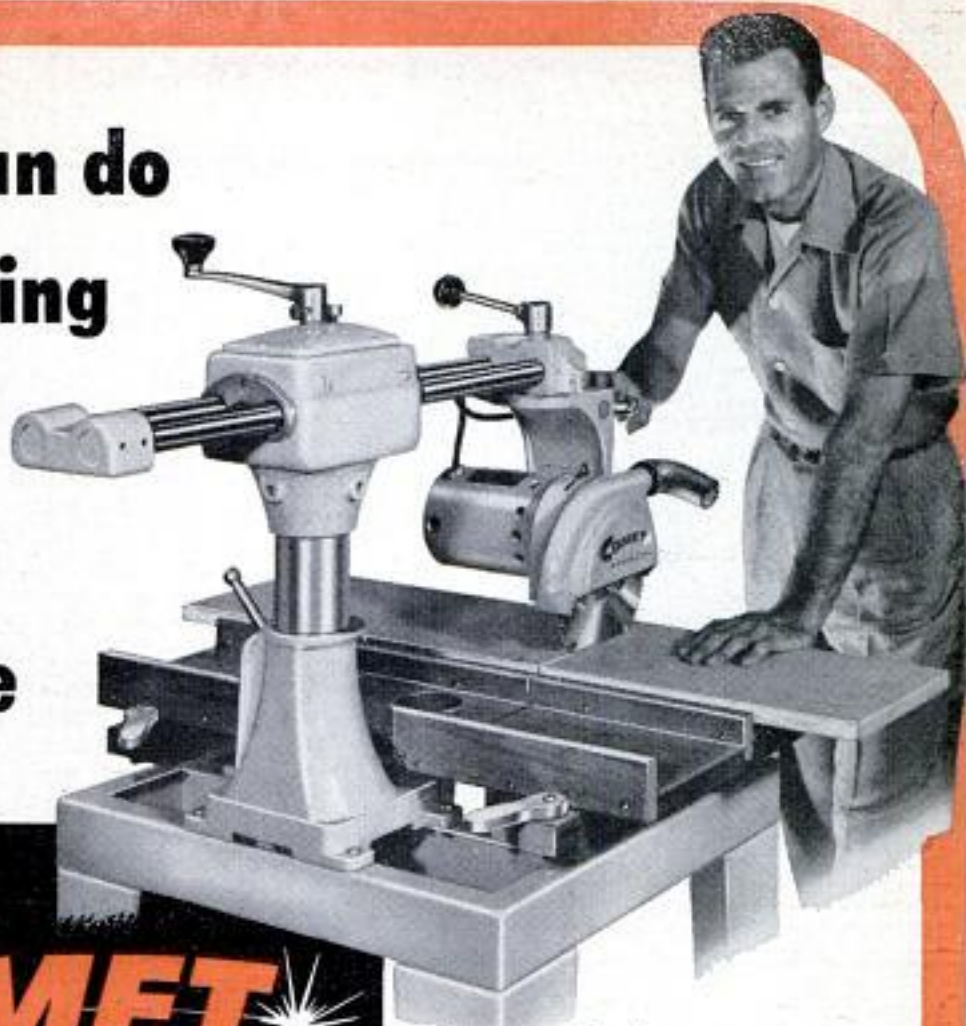

**COMET**

**Complete  
Do-It-Yourself  
WORKSHOP**

**YOU can do all these jobs:**

CROSS-CUT	RABBET
MITRE	PANEL-RAISE
COMP. MITRE	SHAPE
BEVEL RIP	CARVE
TAPER RIP	ROUT
TENON	BORE
DADO	

and with five simple accessories you have:

A LATHE	SANDER-GRINDER
JOINTER	POWER TAKE-OFF
JIG SAW	

**W**ould you like to make things like a professional cabinet maker? Then don't get a flimsy power saw you'll want to sell later. Get a *professional* machine you'll enjoy for years. Get a Comet! You *glide the blade through the wood* . . . *above* the wood where you can see the blade go right down your pencil mark. You *don't* shove wood (and fingers) over a blade that's *under* the wood. The Comet is safe, accurate, powerful, easy to use. You can build anything from a piece of furniture to an entire house . . . on one machine only 28 x 30 inches! Builders and cabinet shops use Comets, and recommend them for home workshops.

**CONSOLIDATED MACHINERY & SUPPLY CO., LTD.**  
2033 SANTA FE AVENUE • LOS ANGELES 21, CALIFORNIA

**WRITE NOW**  
FOR FREE LITERATURE  
AND NAME OF YOUR  
NEAREST DEALER

**NEW SHELDON-BUILT**  
*Sebastian*  
**GEARED HEAD  
 PRECISION LATHES**

Today's best buy in modern tool room lathes with swings of 13" and 15". Completely designed and built by Sheldon with "Zero Precision" tapered roller spindle bearings, 1 3/4" hole through spindle, 60 pitch gear box, 1-piece double walled apron, 1-shot oiling system, cam-action lock tailstock, easy shifting spindle speed dial and heavy, beautifully styled pedestal base.

Test the quality, work capacity and performance of these new lathes. The most lathe for the money.



Priced from \$2063.00 up.

Write for Sebastian Bulletin and name of your local dealer.

**SHELDON MACHINE CO., Inc.**  
 4267 North Knox Avenue, Chicago 41, Ill.

PLUMBING	ELECTRICAL	HOLDING	WOODWORKING

**YOU NAME  
 THE JOB-AND  
 VISE-GRIP  
 DOES IT  
 QUICKER!**

WORKS!

HOME REPAIR	PORTABLE VISE	TURNING

**MAKES EVERY JOB EASY . . .  
 HOME - FARM - FACTORY - SHOP**

You can tackle ANY job—with Vise-Grip! LOCKS onto work with Ton-Grip! Turns, twists, pulls, cuts, h-o-l-d-s. So MANY tools in one! 7" and 10", cutter optional. \$1.85 to \$2.60 at your dealer.

PETERSEN MFG. CO., Dept. M-11, DeWitt, Nebr.

**Nations to Share Costs**

The international committee was enlarged in 1953 and 1954. Doctor Berkner is vice-chairman of the committee, of which I was elected chairman; the secretariat is at Brussels, under Dr. M. Nicolet. The relatively small funds needed for the central planning of the IGY are provided by ICSU and UNESCO. The actual programs of observation will be paid for by the nations that execute them; the cost of the whole enterprise, which is one of voluntary cooperation between many nations, has been estimated to exceed \$100,000,000.

Russia, which took a valuable part in the first and second international polar years, in 1954 announced its intention to share in the IGY. Communist China also has joined the effort. In this country in 1953 Congress voted over \$2,000,000 for the preparatory work of the United States and this year placed a considerably larger sum in charge of the National Science Foundation for the main United States effort; much more will be contributed in auxiliary aid, naval and air transport and logistics. A United States Navy icebreaker, the *Atka*, already has made a south-polar journey to survey possible United States sites for coastal antarctic IGY stations. Other sites will be inland, one United States site being at the South Pole itself. Thirteen nations are expected to set up antarctic stations, probably about 20 stations in all.

The IGY is a period of concentrated widespread effort, but there will be special periods within it. Among these special periods will be three Regular World Days each month, fixed beforehand; they will include some predictable events like eclipses and meteor showers. For weather observers there will be longer special periods of 10 days, one in each of the six quarter-years of the IGY.

**World Alerts**

But the onset of solar, ionospheric, magnetic and auroral storms cannot be predicted long ahead. Several are expected to occur during the International Geophysical Year, which will be near the peak of the next sunspot maximum. The close watch to be kept on the sun will indicate, some days ahead, when there is a special chance (though not a certainty) of such storms; notices of World Alerts will then be issued from a central predicting agency—probably located at Boulder, Colo. They will be distributed within each participating nation to its own stations concerned with the geophysical observations. By this means it is hoped that all stations will be fully ready

(Continued to page 266)



# PENTA\* CLEAN PRESERVATIVE KEEPS HOMES SOUND YEARS LONGER



## IN INSULATING—BUILDING BOARD

When you build your home be sure you're getting the added protection of insulation and building board that's *fully* protected against rot, mold, mildew and termites. Leading manufacturers ensure longer board life by treating with \*PENTACHLOROPHENOL preservative. Clean, odorless PENTA keeps board sturdy longer, helps it in such applications as sheathing, siding, roof decking, lath. Make sure the board you buy is PENTA-treated; ask your building supply dealer. You'll be glad you insisted.



## IN SASH AND EXTERIOR MILLWORK

Your windows and doors, and exterior millwork, too, will last years longer when PENTA-protected. Your lumber dealer has or can get PENTA-treated sash and millwork right away; tell him that's what you want.



## IN HANDY ONE-GALLON CAN

Protect it yourself with a brand-name, water-repellent preservative containing PENTA . . . available from most hardware and lumber dealers. Lawn furniture, fences, steps, anything you make with wood will serve much longer after a clean, simple PENTA application.

THE DOW CHEMICAL COMPANY  
Dept. PE 872Q, Midland, Michigan

- Send me information on PENTA-treated insulating board, sash and millwork.
- Send me FREE BOOKLETS, "Handyman's Guide to Home Wood Preservation" and "Treat Your House to Longer Life".
- Send me name of nearest PENTA and water-repellent solution dealer.

Name \_\_\_\_\_

Address \_\_\_\_\_

City \_\_\_\_\_ Zone \_\_\_\_\_ State \_\_\_\_\_



*you can depend on*  
**DOW CHEMICALS**

# WINTER TIME IS CHECK UP TIME

Don't forget your  
car's thermostat!



Weakest link in your trouble-free winter driving comfort may be a faulty thermostat. It can impair a car's cooling system, cause boil-overs, loss of costly anti-freeze, wastage of gas and oil. That's why you should have your car thermostat checked today. Ask your service station for a check-up now. And if a new thermostat is needed, be sure to specify AUTOSTAT or Bridgeport... the modern car thermostats that protect your car, save you money, give you comfortable driving all winter long. Types available for all car makes and models, including those with new pressurized cooling systems.

## ANTI-FREEZE TIME IS THERMOSTAT REPLACEMENT TIME

Replace with

**Autostat**<sup>®</sup>  
OR  
**Bridgeport**  
1954

FREE—"How's That Thermostat?" a pamphlet by Frederick C. Russell, S.A.E., leading authority on car care. Write today.

Made By The Pioneer Manufacturer of Car Thermostats. Sold by leading service stations and repair shops. Ask for them by name.



Mr. Controls

**Robertshaw-Fulton**  
CONTROLS COMPANY

FULTON SYLPHON DIVISION, KNOXVILLE, Tennessee  
BRIDGEPORT THERMOSTAT DIVISION, MILFORD, Connecticut

to observe the storms if they do occur. When the continuing developments on the sun render it suitable, a Special World Interval will be declared about 12 hours in advance, to continue until terminated by the predicting agencies. During such Special World Intervals the most intensive ionospheric, magnetic and auroral observations will be made. This should make it possible for any of those auroras which on occasions become visible from the tropics to be properly observed for the first time.

### Greatest Effort

The IGY is unquestionably the greatest international effort yet made in the study of the earth and sun. One of the most striking advances in the techniques to be used, as compared with the second IPY, is in the exploration of the upper atmosphere by rockets, launched from the ground or from balloons, and perhaps also from aircraft. And of course the United States government has announced its intention of launching artificial earth satellites for observations during IGY. In the IGY rocket program, the United States will play the major part, but France, England, Australia and perhaps other countries hope also to contribute. Plans of the United States include the firing of over 200 rockets from land, ship and balloon, from United States continental stations, Churchill in Canada, in the antarctic, and from ships in the Pacific and the Arctic and Antarctic Oceans.

### Commended by President

The IGY has been commended by President Eisenhower as an enterprise of great prospective material benefit to mankind, and as likely to contribute to more peaceful and cooperative international relations. The sails seem spread in a favorable breeze. May clear skies in one or another part of the globe permit a continuous watch on the sun; but it is hoped that the sun will not be too peaceful throughout the IGY. May it give us at least a few stormy periods, not indeed in the weather region near the ground, but aloft in the ionosphere whence the aurora shines down upon us. ★ ★ ★

### Pesticide Kills Only Harmful Mites

Eggs and larvae of injurious plant mites are killed by a Dutch-developed chemical that leaves beneficial honeybees and other insects unharmed. Tedion V 18 in tests killed all the eggs and larvae of several harmful mites, though adult mites were unaffected. The chemical appears to be safe for the sprayer and for the consumer of treated vegetable products.

**MODERN****LAWN MOWER SHARPENER****COMPARE BEFORE YOU BUY**

Write for free booklet 10E

Oil remains in engine while sharpening. Bed knife sharpened in same centers — no attachments needed.

Start your own business—increase your income

Sharpens any mower in ten to twenty minutes. Handles complete assembly of all reel types including 36 in. power mowers. Handle, wheels, roller, and engine are not removed.

**\$26300****MODERN MFG. CO.**

F.O.B. PASADENA

160 N. FAIR OAKS, PASADENA, CALIF.

**STUDENTS • ARTISTS • DRAFTSMEN • ARCHITECTS • ENGINEERS • CONTRACTORS • SALESMEN**



**draftette CUTS DRAWING TIME**

**IN HALF, IMPROVES ACCURACY—NEATNESS**

Speeds up sketches of any kind! A precision-accurate portable drafting machine that clips on any tablet, sketch pad, notebook. Covers area to 11" x 17". Eliminates need for ruler, protractor, T square, triangle. Compact, lightweight, made of sturdy anodized aluminum. Carry in pocket, briefcase, etc. Last a lifetime. Order Now! Cash, Ch., M.O., **\$3.95** SATISFACTION GUARANTEED. Postpaid . . .

Dealer jobber inv. invited.

**BAUMBACH ENGIN. CO.** Dept. PM-511-10147 Halbrecht San Fernando, California

**SAY YOU SAW IT IN POPULAR MECHANICS**



Make fascinating wire miniatures with

**SUW wire art**

**CREATIVE - SIMPLE - ENTERTAINING**

Send 89c for complete kit

**x-acto Inc.** 48-45 Van Dam St., L.I.C. 1, N.Y.

**RCA GEIGER COUNTERS****Christmas Gifts That Count!**

. . . for yourself or that extra-special uranium prospector! You know you are giving the finest . . . backed by the greatest name in electronics—RCA.

Full vision, easy-to-read meter. Compact, lightweight, self-contained. Rugged, durable construction. All-weather metal case—easy to decontaminate. As easy to use as a portable radio. Includes AEC booklet, complete instructions, batteries, and radioactive test sample. **6 models . . . from \$119.50\***

Write Section K63MM for illustrated folder.



**RADIO CORPORATION OF AMERICA**  
Radiation Detection Equipment  
Harrison, N. J.

\*List Price (Optional)

# BIG Money-Saver

## Atlas

### 6" JOINTER-PLANER



**For Furniture, Remodeling, Construction**

Whatever you want to do—"finish out" a house or a room, remodel, make kitchen cabinets or furniture—this Atlas 6" jointer-



Rear table is wide to support big boards.



New type fence mount assures fast set up—greater rigidity and accuracy.



Cutter head removes for sharpening blades without disturbing their setting.

planer is the tool to own.

You can plane mirror-smooth surfaces in seconds with the Atlas—rabbet, chamfer, taper, edge.

Table and fence are both big for big board work . . . precision-ground for smoothness and accuracy. Fence is rigid—triple supported, easily positioned, has width-of-rabbet scale.

Atlas has no equal in value for the home shop, contractor, or commercial shop. See it at your dealer's, or send post card or coupon for catalog.

**NEW MODERN FURNITURE PROJECT BOOK**

16 complete, easy-to-follow plans for beautiful modern furniture . . . chairs, lamps, tables, etc. Build your own! Have fun! Save! — Only \$5.50 postpaid, \$6.65 outside U.S.A.

**ATLAS PRESS CO.**

1124 Pitcher St., Kalamazoo, Mich.

Please send catalog showing jointer-planer. Inclosed is \_\_\_\_\_ for \_\_\_\_\_ plan book.

Name \_\_\_\_\_

Address \_\_\_\_\_

City, State \_\_\_\_\_

# Shark Brand Swedish Chisels



## MAKE YOUR JOB EASIER

You'll do neater, more accurate woodworking with SHARK BRAND SWEDISH CHARCOAL STEEL paring chisels . . . hold their sharpness 3 times longer than ordinary chisels.

Write for new folder Dept. PM

**Sandvik** SAW & TOOL  
DIVISION OF SANDVIK STEEL, INC.  
1702 NEVINS RD., FAIR LAWN, N. J.



Caribbean cushions are reversible. One side is fabric (back cushion), other side is leather (seat cushion)

## 1956 Packard, Clipper and Caribbean

(Continued from page 95)

on. That means children cannot release the transmission and let your parked car roll down a hill.

### Top Horsepower So Far

Packard's V8 engine develops 290 horsepower. The Caribbean V8 puts out 310 horsepower, the highest in the industry so far this year. Torque of both engines (and Packard emphasizes that torque is more important than horsepower) is 405 pound feet (also tops in the industry) at 2800 revolutions per minute.

The Clipper has 270 horsepower in the Custom series and 240 horsepower in the Super and Deluxe series. Torque is 380 on the Custom, 350 on the others.

Packard claims to have increased fuel economy considerably despite the increased displacement by raising the compression ratio to 10:1.

(Continued to page 270)

Control box for Packard's push-button shift is just below steering wheel where shift lever used to be



# BUILD IT FIX IT with AMBROID

- Ready-to-use
- Fast drying
- High tensile strength
- Transparent
- Waterproof

**IT STAYS STUCK**

Dries entirely by evaporation of the solvent. Quick setting—no distortion. Ideal for assembling, repairing, home crafts, electrical work, factory, workshop or household use. Send postcard for free literature.

**EIE** Try Ambroid in your business, too. For over 40 years recognized as the leading industrial adhesive of its type.

Art galleries, museums, and leading industrial concerns, rely on AMBROID

**TRY A TUBE TODAY**—At most hardware stores and hobby shops. If your dealer cannot supply you, send 30c for big 2 oz. tube, postpaid. Money back guarantee.

**AMBROID** WEYMOUTH 88, MASS.

**BURGESS**  
*flashlight*  
**BATTERIES**

ASK FOR THEM AT YOUR FAVORITE STORE

A QUALITY DRY BATTERY FOR EVERY PURPOSE

SEALED IN STEEL AND PLASTIC

"CURSES, ANUDDER GUY WIT' BURGESS BATTERIES!!!"

The gift that says ...

"Best Wishes"  
ALL YEAR ... FOR YEARS  
**HULL AUTO COMPASS**  
NOW ALSO IN  
NEW CAR COLORS

*Beaconlite*  
ILLUMINATED 1945  
STREAMLINE  
NON-ILLUMINATED 1946



The famous, fine instrument name in Auto Compasses.  
At better dealers everywhere. Write for literature.

HULL MFG. CO. P. O. Box 246, D-11, WARREN, OHIO

**INTERNATIONAL DRILL • SAW**

**HI-SPEED COPE SAW DRILL BIT**

**NEW LOW PRICE**  
Ideal as Christmas Gift

REAM • CUT

**\$2.95**  
POST PAID  
**3 for \$8.50**

DRILL, SAW, REAM ... metal, pipe, wood, plastic, Transit, etc. Use with electric drill, slow drill press, lathe, milling machine. Drills own starting hole, upper part of bit is used to cut, saw, ream circles, ovals, squares, scrolls. Easy to use. Ideal for carpenters, mechanics, electricians, plumbers, hobbyists, etc. Abrasive resistant, high speed steel. Flutes ground from solid. Withstands severe continuous use without breaking. Resharpens free. Takes place of up to \$50.00 in tools. 1" diameter, 2" cutting sections, total length 3 1/2". Three types—All purpose, Wood, Heavy Metal. Specify type needed. Set of three \$8.50. Details on request. Shipped same day. Money-back guarantee. Dealer inquiries invited. Order Now. Send Cash, Check or Money Order to  
**INTERNATIONAL TWIST DRILL CORP.** 518 Wyodette, Rm. 638  
Kansas City 6, Mo.

**NEW**

**CRAFTSMAN'S**  
**CATALOG**

with \$5  
in discount  
coupons

Get this 88 page catalog **TODAY.**

88 illustrated pages, full of information and low prices on items for the home handyman. Everything from plywoods, lumber, veneers, mouldings and glues, to hardware and furniture trim; several pages of easy plans, lamp parts, metals and a section of bandings and inlays ... not to mention the money saving \$5 in discount coupons.

Please enclose 25c for handling and postage. This will be credited to your first order.

**Minnesota Woodworkers Supply Co.**  
1713 Olson Hwy., Minneapolis 5, Minn.

**WILLIAMS NEW LOCKING ADJUSTABLE  
MAKES OTHER ADJUSTABLE  
WRENCHES OLD FASHIONED!**

The  
Greatest  
Adjustable Wrench  
Improvement  
in Over 40 Years

AVAILABLE  
AT NO EXTRA  
COST

**PUSH UP TO LOCK**

**PUSH DOWN  
TO UNLOCK**

JUST A FLICK OF THE  
THUMB-OR FINGER LOCKS OR  
UNLOCKS THE ADJUSTMENT INSTANTLY  
AT ANY OPENING YOU SELECT

- POSITIVE LOCK
- NO OBSTRUCTIONS
- RAPID ADJUSTMENT
- NO FUMBLING
- ONE HAND OPERATION
- INCREASED SAFETY
- STRUCTURALLY SOUND
- DROP-FORGED and HEAT-TREATED
- SELECTED ALLOY STEEL
- CHROME PLATED FINISH



**LOOK FOR THIS DISPLAY!**

You'll find it in leading hardware and building supply stores. Try the 6, 8, 10 or 12" size for convincing proof that they beat any "Adjustable" on the market.

**J. H. WILLIAMS & CO.**

400 Vulcan Street

Buffalo 7, N. Y.

**POWER HYDRAULICS  
for SNOW PLOWS**

Use on



TRUCKS



JEeps



TRACTORS

**HY-LO-JACK**  
does  
the job  
**FASTER-  
EASIER**



- Lifts average snow plow in 3 to 10 seconds.
- 1,000 lbs. per square in. pressure
- Quick, easy installation on new or existing equipment.
- Complete kit form, including the pump, tank, hose lines, etc.
- Electric unit also available for 6 or 12 volt systems.

\* Write for Circular. See your Road Machinery, Jeep or Farm Equipment dealer.

**MONARCH ROAD MACHINERY CO.**

Quality Machinery since 1856

1331 Michigan St., N.E., GRAND RAPIDS, MICH.

The Ultramatic transmission now has an aluminum casing to reduce its weight by about 95 pounds, making it the lightest in America, according to Packard. This weight reduction improves weight distribution. It is now 52 percent on the front wheels and 48 percent on the rear.

The torsion-bar suspension and levelizer have been extended through the Clipper line.

**Styling Changes**

A neat trick in upholstery is the reversible Caribbean seat cushion. One side of the upholstery is fabric, the other side is leather. The cushion itself is all foam rubber. You can use the leather by day and the fabric by night. Or you can take the cushions with you for comfortable seating at a picnic or ball game.

Stylewise, the cars have had a major facelift. Both have distinctive front bumpers with a grille built into them below the main horizontal member. Front fenders have been made longer and headlights repositioned slightly. Rear fenders on the Clippers are also longer, taillights are enlarged and dual exhausts are worked neatly into the underside of the rear bumper.

The Packard is now available in more than 60 paint colors or combinations. In fact, on a special-order basis, you can have a Packard painted in any color or combination of colors you want—you can even have it painted to match your mother-in-law's complexion, if you wish. ★ ★ ★

**Infrared Gas Heater**

Construction workers are kept warm on outdoor jobs by a portable infrared heater that burns any kind of natural or manufactured gas. The burners are located in a reflector mounted on a standard that projects from a wheeled fuel tank. The unit may see use by hunters and campers, since it can also be used to broil fish and game and heat tents, cabins and trailers.





# TURBINES - NOW AVAILABLE FOR CIVILIAN USE

## KITS FROM - \$59.50



### FEATURES:

- ONE PRIMARY MOVING PART
- NO AUXILIARY COOLING
- USES LOW COST FUEL
- LIGHT WEIGHT SMALL VOLUME
- SELF CONTAINED GEARBOX
- .685 SQ. FT. FRONTAL AREA
- CORROSION RESISTANT CONST.

Having applied mass production techniques with sound engineering we have developed a series of low cost gas turbines. This type unit is applicable to automotive, aircraft, marine, and industrial usage. It is the engine of the future as well as the present. Its ultramodern design will remain current for years to come.

**TRECO PRODUCTS, DEPT. 20, 1364 WOODLAND HILLS DR., ATLANTA 5, GEORGIA**



**60 LBS.**

Send \$1.00 for catalogue containing prices, photographs, sectional drawings, technical data, etc., refunded on first order, or send \$5.95 for catalogue plus a bound set of blueprints.

### BUILD YOUR OWN MIDGET ROADSTER \$25 BUILDS BODY & FRAME



BUILD A PONY ROADSTER or Pick-Up in few spare hours. Uses 2 hp engine, 450 lb. loads, 70 m.p.h., plenty of speed. Designed for VERY LOW-COST assembly from PARTS BOUGHT IN YOUR NEIGHBORHOOD. Use home tools. Great for kids, sturdy utility car. COMPLETE step-by-step plans. 17 large-size pages, 30 "show-how" photos. Body templates, complete material and parts list. Only \$1.00 post-paid. Satisfied or money back.

PONY PLANS, 7641-L TEXHOMA AVE., NORTHRIDGE, CALIF.

### SHARPEN DRILLS YOURSELF

New low-cost SAV-A-DRILL Sharpener, complete with grinding wheel, fits any electric drill, sharpens 1/8" to 3/4" drills. No adjustments to make. No bench grinder needed. Satisfaction guaranteed.

**\$2.95**



POSTPAID

**POPULAR MFG. CO.** 4115 Glencrest Road Minneapolis 16, Minn.

### CRESCENT TOOLS

*Give Wings to Work*

ASK YOUR  
HARDWARE  
DEALER

### DO MORE PLANING JOBS WITH LOW COST BELSAW



Exclusive MONEY-MAKING Features: • Full 12 1/4" x 6" capacity • Power feeds at 24" a minute • Provides for Grinding Knives in the Cutterhead • Attachments for Jointing, Rabbeting, Tongue, Groove, Matching, Convert low cost rough lumber into high priced cabinet finished stock... Easy to make flooring and popular patterns. Send today for free literature and prices.

Belsaw Machinery Co., 2056 Field Bldg., Kansas City 11, Mo.

LOW DOWN  
PAYMENT  
EASY  
TERMS

### DRILL • SAW • REAM • CUT

ALL WITH ONE BIT!

### BEAVER SPEED SAW DRILL BIT



ONLY  
**\$2.45** each  
3 for \$7.00  
POSTPAID

Beaver's new improved high speed side cutting drill bit can be used on any electric drill, drill press, lathe or milling machine. Made from the finest American high speed steel. 3 1/2" long. 2" side cutting section, 1/4" diameter. Designed to cut steel, wood, plastic, aluminum, etc. A versatile time-saving tool for EVERYONE. Money back guarantee! Three types available: All-Purpose, Wood and Heavy Metal—specify type desired. Buy them from your dealer today! Or send cash, check or money order NOW.. SET OF 3 MAKES AN IDEAL GIFT. Dealer inquiries invited.

### BEAVER DRILL & TOOL COMPANY

3008B McGee Trafficway

Kansas City 8, Missouri

### FREE TV AND RADIO SERVICING MANUALS



AND DESCRIPTIVE LITERATURE. BUILD 15 RADIO CIRCUITS AT HOME WITH NEW DELUXE 1956 PROGRESSIVE RADIO "EDU-KIT"

ONLY **\$19.95** COMPLETE

All parts, instructions, Soldering Iron, Test-er included. 30 Day Money Back Guarantee. PROGRESSIVE "EDU-KITS" INC. Room 3398 Progressive Building 492 Union Ave., Brooklyn 11, N. Y.

Gentlemen: Please Rush me Free Descriptive Literature concerning "EDU-KIT." Also send me Free Radio-TV Servicing Literature. No obligation.

NAME \_\_\_\_\_  
ADDRESS \_\_\_\_\_  
CITY \_\_\_\_\_ ZONE \_\_\_\_\_ STATE \_\_\_\_\_

CLIP THIS TO GET

# NEW! DELCO LOW PRICE WATER PUMP

WELLMASTER JUNIOR JET

SHALLOW WELL PUMP



Precision-Engineered and Quality-Built By...

GENERAL MOTORS  
**DELCO**

Only **\$89.95** f.a.b. Rochester (Suggested List Price Model 33372 as illustrated)

- No other pump can match this new Delco Jet for PRICE... and QUALITY... in 1/2 HP class!
- New simplicity... only ONE moving part... New compactness... Self-adjusting capacity... New durability... All at new Low Prices!

**WRITE!** for Full Information or Call Your Delco Water Pump Dealer Today!

DELCO APPLIANCE DIVISION

GENERAL MOTORS CORPORATION  
Dept. PM3, Rochester 1, New York

## change your portable drill to a high power tool with SUPREME VERSAMATIC



only \$14.95  
ppd.

**REVERSES**

with a flick of wrist

**BOOSTS POWER • REDUCES SPEED**

Hand Clutch Type Control! With this amazing new attachment on your quarter inch electric drill, you've got a versatile tool for all kinds of heavy jobs. Its 7 to 1 speed reduction steps up power in proportion . . . plenty of drive for big diameter drilling and tapping, and at the lowest speeds needed for such work. It's a power wrench, for running nuts on or off; it's a whiz of a power screwdriver for handling even the largest screws in any number. Useful for every one, and invaluable for the pro. The **VERSAMATIC** is easy to use, reverses with a flick of the wrist. Rugged planetary gear cuts speed from 7 to 1 forward, 6 to 1 reverse. Comes in complete kit containing slotted screwdriver, Phillips bit, adapter for 1/4 inch socket sets (square drive), wrench pin and 12 page instruction book. Adapter 1/2 inch chuck available at \$7.50 extra.



### Adjustable CIRCLE CUTTER

Adjustment of from 1/8" to 4"; equipped with high speed ground tool bit; body and cross bar are made of hardened tool steel; centers ground and polished; the square shank permits its use in either drill chuck or hand brace. Perfect for cutting holes in sheet steel, aluminum, wood, plastics, hard materials. Only \$1.89 PPD. Send Check or M.O. C.O.D. fees extra. **MONEY BACK GUARANTEE**

SCOTT-MITCHELL HOUSE, INC. Dept. SV-8, 611 Broadway, New York 12, N. Y.

### LAFAYETTE GEIGER COUNTER KIT WITH HIGH SENSITIVITY VICTOREEN TUBE 1B85

Lafayette Geiger Counter Kit with High Sensitivity Victoreen 1B85 tube, makes this one of the most outstanding kits in the country. This tube is used only in the most expensive equipment. Easy to build, at only a fraction of the price, of commercial instruments of this type. Just turn it on, flip the high voltage switch and listen to the clicks. Kit includes all parts, tube, carrying case, 22 1/2" and 1 1/2" volt Batteries. Complete instructions for quick assembly. Ship. wt. 1 1/2 lbs.



KT-75 .....Net 14.95

### 2 TRANSISTOR POCKET RADIO KIT

Packed into a 2 1/2" x 3 1/2" x 1 1/2" plastic case. This Two Transistor plus crystal diode radio kit offers many surprises, utilizing a regenerative detector circuit with transformer coupled audio stage, gives you high gain and excellent selectivity. Pulls in distant stations with ease with more than ample earphone volume. Kit comes complete with two transistors, crystal diode, loopstick, Arsonne transistor audio transformer, resistors, condensers, plastic case, etc. Including schematic and instructions.

KT-88 Complete kit with Miniature Dynamic Earphones .....Net 13.75  
Less Earphones .....Net 11.80



### IMPORTED BINOCULARS

All have coated lenses — clamped in prisms — light weight all metal bodies. Complete with case and straps.

F-182	— 8x, 15	I.P.	— NET 19.75
F-105	— 8x, 30	I.P.	— NET 17.95
F-15	— 7x, 35	I.P.	— NET 17.95
F-183	— 7x, 35	C.P.	— NET 20.95
F-103	— 7x, 50	I.P.	— NET 21.50
F-164	— 7x, 50	C.P.	— NET 24.95
F-117	— 10x, 35	C.P.	— NET 23.95
F-104	— 12x, 50	I.P.	— NET 27.95
F-518	— 16x, 50	C.P.	— NET 31.50
F-185	— 20x, 50	C.P.	— NET 37.50

132 page, electronic buying Guide, Transistors, radio, TV, Hi-Fidelity, Drafting supplies, microscopes, check full of buys at great savings. Write today for **FREE COPY**.

LAFAYETTE RADIO Dept. NK 100 - 6th Avenue, ENCLOSE POSTAGE WITH ORDERS New York 13, N. Y.

# Now You Can Upholster Any Piece of Furniture!

## Upholster—Restyle Any Piece of Furniture Yourself

John Bergen, custom furniture designer, tells and shows you how to transform old out-of-date furniture into brand new smart-looking comfortable furniture in his new book **ALL ABOUT UPHOLSTERING**.

## No Experience Needed

Bergen tells you every step to follow in amazingly clear easy-to-understand step-by-step instructions and then shows you how in hundreds of big, clear drawings and photos. You read and see how to strip the old frame, install new webbing and springs, apply burlap, install stuffing and padding, fit the muslin cover and the final fabric and install trim.

## Use New Materials—Methods

Now you can have furniture upholstered with foam rubber, sagless springs and other new materials that add so much to comfort and durability and are so costly when included in new furniture.

## Save 50% of Usual Cost

Don't pay a small fortune for new furniture when you can make your old furniture better than new! Why pay high prices to have someone else upholster and restyle your old furniture when you can do it yourself for cost of materials alone? It's easy and it's fun.

## Special Chapter on Slipcovers

Learn how to make custom-made slipcovers with professional look and fit. Find out how you can realize tremendous savings by investing a few spare-time hours and the cost of a few yards of fabrics.

## 7-Day Money Back Guarantee

Send for your copy of **ALL ABOUT UPHOLSTERING** today. Read and use it for 7 days. If it isn't entirely satisfactory return it for a full refund.



## USE THIS HANDY ORDER COUPON

POPULAR MECHANICS PRESS, Dept. AAU  
200 E. Ontario St., Chicago 11, Illinois

Gentlemen:

Please send my copy of **ALL ABOUT UPHOLSTERING**. Enclosed is my remittance of \$3.50. If I am not completely satisfied with the book I will return it for a full refund after 7 days.

Name \_\_\_\_\_

Address \_\_\_\_\_

City \_\_\_\_\_ Zone \_\_\_\_\_ State \_\_\_\_\_

# INSULATE Right With ZONOLITE®



Says **DANNY KAYE**, star of "THE COURT JESTER" Paramount comedy hit in VistaVision... color by Technicolor  
You don't even have to be "handy" to insulate your own home in 4 miraculously short hours with Zonolite vermiculite insulating fill. Pour it, level it, *leave it!* Start saving immediately on fuel bills—Zonolite often pays for itself in two or three seasons. Rotproof, rodent-proof, 100% fireproof. Guaranteed to outlast life of your home. Send coupon today.

as low as  
**\$67<sup>60</sup>**  
insulates an average attic

**DO IT YOURSELF** in one afternoon... save up to 40% on fuel bills

Mail This Coupon Today

ZONOLITE COMPANY,  
Dept. PM115, 135 S. LaSalle St.  
Chicago 3, Illinois

Please rush me how-to-do-it free booklet HI-47 "Safety, Comfort, Savings in Your Home."

Name \_\_\_\_\_  
Address \_\_\_\_\_  
City \_\_\_\_\_  
Zone \_\_\_\_\_ State \_\_\_\_\_

NOW ON SALE WHEREVER LUMBER AND BUILDING MATERIALS ARE SOLD

**SHAW** PLOW, CULTIVATE, MOW, RAKE  
BULLDOZE, SNOWPLOW  
SAWWOOD

## TRACTORS

Just steer it with power turn. Several walking & riding models up to 14 H.P. Low price! Write for FREE literature.

**SHAW Manufacturing Co.**  
4511 Front St., Galesburg, Kansas  
668-GN, 4th St., Columbus, Ohio

### Exclusive Double-Bearing HEAVY-DUTY PUMPS

IRRIGATE • DRAIN • CIRCULATE • SPRAY  
Up to 7,500 GPH, 3,000 GPH from 25' Well. Use 1/2 to 1 HP motor, 1 1/2" inlet, 1" outlet. Stainless shaft. TYPE X—2 oilless bronze bearings. **\$10.95**  
Won't rust. TYPE XB—Ball bearing model. **\$12.95**  
Postpaid if cash with order. (Post of Miss. add 5c)

**MONEY BACK GUARANTEE**  
Centrifugal and Gear Pumps in All Sizes

**LABAWCO PUMPS, Belle Mead 2A, N. J.**

### P-1 GENERATORS

200-250 Amp, 24 Volt DC, 4500 RPM. Makes dandy Arc Welder. Cost \$390. Like NEW. SPECIAL \$11.88 FOB Texas. \$12.88 FOB York. Diagram Free. GOVT. Overhauled \$19.80. GUARANTEED NEW Cal.—1000's In Use. **KARL ORT, Dept. P11M, York, Pa.**

## DON'T DIG 'TIL YOU KNOW WHERE

The most amazing instrument you've ever seen! New **MAGNA PROBE** traces water, gas, and metal or tile sewer lines. Saves hours of unnecessary digging. Finds hidden springs and underground streams. Just as efficient over concrete as bare ground. Sensitive to depth of 20 ft. Works indoors or outdoors. **MAGNA PROBE** works by scientific principle of dissimilar metals and elements attracting and opposing one another like magnetic electricity. So simple—a child can use it. **GUARANTEED TO WORK!**

Complete with easy-to-use instructions  
**TODAY!** Send check or money order (no C.O.D.'s) to:  
**THE MAGNA PROBE CO.**  
6022 Mayfield Road Cleveland 24, Ohio

ONLY **\$2.98**  
Post-paid

## SENSATIONAL NEW 8" MULTI-PLIER

A PROTO TOOL

### INCREASES PRESSURE 10 TIMES

"A chest of tools in one." 3 pt. composed leverage grips like a pipe wrench. More pressure—more hold! Non-slip, heat treated carbon steel jaws open parallel to 1 1/2 in. 4-slot adjustments. Securely holds all shaped objects. Chrome plated. Handiest tool of them all. Order yours now!  
No. 234. Prepaid U. S. Only. **\$2.95**

**JAY-DEE SALES CO.** 3304 N. SAN FERNANDO BLVD. BURBANK, CALIF.

FREE! 68 page PROTO Tool Catalog with Order — or send 10c

## 1/2-HP Motor SPEED REDUCER

Reduces Speed at a 20-1 Ratio

**Brand New! Mfr'd. for Army radar equipment, this reducer is Guaranteed!** a masterpiece of design and precision workmanship

For experimental and laboratory uses... for building special equipment that saves valuable man hours. Ratio of 20-1 gives approximately 90-RPM with 1150 motor, direct drive... or can be belt driven to give ANY DESIRED SPEED! Use with any size motor up to 1/2-HP. Case is cast of aluminum alloy (not die cast) and has BALL BEARINGS throughout. Heavy duty, double reduction, spur gear drive built for continuous duty. Smooth, quiet running. Base to shaft is 4 1/2" high. Comes complete with couplings, Operates: conveyors, timing devices, revolving window displays and signs, turning equipment and machine tool drives... 1,001 uses!

**Gov. Cost \$86**  
**Only \$16<sup>50</sup>** Pre-paid

Order From AD! We Pay Shipping!

FREE CATALOG OF OTHER ELECTRICAL BUYS  
**ROBERTS ELECTRIC CO., Dept. PM-329, 849 W. Grand, Chicago 22, Ill.**

**AMERICA'S LARGEST STOCKS OF JEEP PARTS**

**LOWEST PRICES! SATISFACTION GUARANTEED!**

*The King of Jeeps*

FREE JEEP CATALOG — WRITE FOR IT TODAY!

## BRAND NEW CAPSTAN WINCHES

NEW LOW PRICES 6000 lb. capacity. Accurately machined gears provide for smooth efficient operation. Suitable for both front or rear mounting. May be used on jeeps or trucks. All units are brand new and fully guaranteed.

**EACH \$25<sup>00</sup>**

## FRONT AXLE SHAFTS

Army or Civilian

LONG **\$40.65** SHORT **\$34.48**

The "K" Free Wheeling FLANGE Saves Gas Stops Growl Simple—Easy Conversion FROM 4 TO 2 WHEELS **\$19.95** Per Set Complete With Ball Bearings

## EASILY INSTALLED JEEP KING SNOW PLOW

Takes 2 minutes. Blade size 22" x 72". Strut tubes and blade designed to withstand maximum load. Adjustable safety chains. Complete. **F.O.B. Chicago \$199.50**

## THE JEEP KING ALL STEEL CAB

All steel tops completely insulated. All windows equipped with Pittsburgh Safety Glass. Free sliding door windows. Inside of doors enameled black. Tops primed for painting.

HALF CAB **\$125.00** FULL CAB **\$185.00** F.O.B. OHIO

**SPECIAL SERVICE TO GARAGES AND SERVICE STATIONS**

Thousands of other Jeep parts and accessories available. **SHOP BY MAIL—Order Direct From This Today.** TERMS: Net cash with order. Open account to rated firms only. C.O.D. shipments should have 25% deposit with order. Minimum order \$1.50. Inquiries invited from dealers, exporters and quantity buyers.

**BERG TRUCK & PARTS CO., INC.**  
1608 S. WABASH AVE., DEPT. 15, CHICAGO 16, ILLINOIS



Please every member of your family!  
Give the gift everyone can use!



with 13 sq. in. sanding pad... \$14.85



Model 2000 Sander, with steel case, 21 sq. in. sanding pad, \$24.50



Model 53 Sander, heavy-duty rotary motor, 24 sq. in. sanding pad, \$34.85

**NEW DREMEL**  
**Model B Moto-Sander**  
IT SANDS — Flawlessly!  
IT POLISHES — Perfectly!  
IT MASSAGES — Soothingly!

and it features

— **STRAIGHT-LINE-ACTION** —

Set yourself for a new high in excitement when you get your first look at the new DREMEL Model B Moto-Sander. Here's versatile performance that will make the whole family itch to put it to work! The Model B is a combination sander-polisher-massager that delivers 14,400 straight-line strokes per minute, for perfect finishes guaranteed free of orbital scratches and swirls. It has power-to-spare for finish sanding, furniture polishing, a host of jobs in every home.

**SEE YOUR DEALER.** If he cannot supply, order direct on 5-day trial, money-back guarantee. Remit in full for postpaid shipment. Or send \$2 now, pay postman balance plus COD. fee.

**DREMEL MFG. CO., Dept. L-115, Racine, Wisconsin**

WRITE FOR POWER TOOL CATALOG

**DEPEND ON DREMEL FOR NEW IDEAS IN POWER TOOLS!**

**NEW! PERSONAL POCKET RADIO**

LISTEN WHILE YOU WALK, RIDE, WORK!



Slips in any pocket—WL only 9 ozs. Size 2 3/4" x 4 3/4" x 1 1/4". Beautiful Black Gold plastic case. NO HOOKUPS — NO WIRES — NO PLUG-INS! Self contained with 150 hour life flashlight batteries. (Available anywhere) and BUILT-IN ANTENNA!

**GUARANTEED RECEPTION OF RADIO STATIONS TO 50 miles—up to 1500 miles for powerful stations!** Has new Patented Super-regenerative Triode tube and transformer audio stages for sharp selectivity and sensitivity! Easy to use top controls (while walking). Almost invisible plastic foam personal carrying lets you alone listen while you walk, visit, work, ride or sleep—anytime—anywhere. Money Back guarantee—1 year service guarantee.

**SEND ONLY \$5.00** (Ch. Mo) and pay postman \$14.95 plus postage on delivery or send \$19.95 for postpaid delivery. Get YOUR Tinytone REAL pocket radio now and be ready to listen to Civil Defense alarms, news, music, sports, etc. on a moment's notice. Not a Kit or plaything! Shipped complete with batteries—Ready to listen!—Order now—today.

**WESTERN RADIO Dept. APM-11 Kearney, Nebraska**

**What to Make with CONCRETE**



Even little concrete jobs cost big money — mostly for labor. Get Popular Mechanics **WHAT TO MAKE WITH CONCRETE** and save all the labor cost while making your home or farm ship-shape. Book shows all—tells all — how to make the right mixture, plan, apply and gives 50 professional short cuts. Hundreds of pictures. Only \$2.00 postpaid. Order today. Money back if not pleased.

**POPULAR MECHANICS PRESS, Dept. PM9, 200 E. Ontario St., Chicago 11**

Build Your Own Fireplace, Driveways, Walks, Etc.

Also Adult Size Cars at Low prices for

- GOLFERS
- AIRPORTS
- INDUSTRY
- LIGHT DELIVERY

**ESHELMAN 70 MILES PER GAL. GAS CHILD'S AUTO WITH MOTOR**

STURDY, SAFE FOR KIDS

Commended by "Parent's Mag." Write for Free Catalog.

SHIPPING POINTS: BALTIMORE, CHICAGO, KENO. For Free Catalog Write Esheleman, Dept. MC-511 109 Light St., Baltimore 2, Md.



ALSO ADULT GOLF CARS

Pat. Pend.

**The Chief's WORK BENCH**

Built to Last a Lifetime!

With Bottom Shelf and 18" Sq. Drawer. 2" x 6", Solid Plank, Grooved and Dovetailed Top and 1" x 8" Back Rail, Shellacked to a Smooth, Satiny Finish. • 6 Ft. Long • 34" High • 26" Deep. Shipped Knock-down, with Bolts, Nuts and Screws and ABC Chart for Quick, Simple Assembly.

**MOHAWK LUMBER CO. Dept. 33 14525 W. Chicago Blvd., Detroit 27, Mich.**  
Enclosed  Check  Money Order for \$...  
Ship... **CHIEF WORK BENCHES** at Quantity  
\$19.95 each, F.O.B. Detroit, Mich.  
 Send C.O.D., \$5 Deposit Enclosed.

NAME \_\_\_\_\_  
ADDRESS \_\_\_\_\_  
CITY \_\_\_\_\_ STATE \_\_\_\_\_

Prompt Delivery

**MOHAWK LUMBER CO.**

14525 W. Chicago Boulevard  
DETROIT 27, MICHIGAN



**\$19.95**  
F.O.B. DETROIT

Send Check or Money Order, or Will Ship C. O. D. (\$5 Deposit)

POPULAR MECHANICS

# This year give more than a gift... GIVE A HOBBY!

This year, make your Christmas gift an investment in productive family fun! The new DREMEL Moto-Jig Saw is the most pleasurable power tool ever marketed—out-performs cumbersome jig saws costing many dollars more, yet is so easy to use even a novice becomes an expert in no time. Weighs only 12 lbs., sets up anywhere to make any corner a hobby shop! You'll make furniture, cabinets, toys, 1001 useful projects. You'll save by doing your own home repairs. Best of all, you'll unite the whole family around an exciting woodworking hobby. The DREMEL is super-safe—even women and children love it. For an eye-popping experience, try it in your own home.



## NEW DREMEL MOTO-JIG SAW The Whole Family Will Love It!

Cuts 1 3/4" wood, metals, plastics!  
Saws to center of 30" circle!  
Super-Safe Blade Guard!  
Blade faces 4 ways!

**SEE YOUR DEALER.** If he cannot supply, order direct on 5-day trial, money-back guarantee. Remit in full for postpaid shipment. Or send \$2 now, pay postman balance plus C.O.D. fee. DREMEL MFG. CO., Dept. L-115, Racine, Wisconsin.

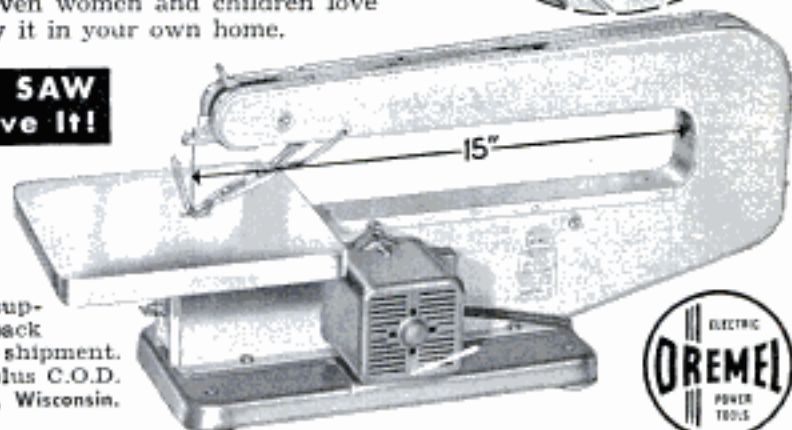

Model 8 (8" throat) \$23.50  
Model 15 (15" throat) \$29.50

WRITE FOR POWER TOOL CATALOG

DREMEL Mfg. Co. Dept. L-115, RACINE, WISCONSIN

## 695 HEAVY OIL-PH-BALL BEARINGS PUMPS MILLIONS OF GALS.



IRRIGATE, SPRAY, DRAIN OR FILL ANYTHING—ANYWHERE! Will not Rust—Clog—or Leak. Patented Seal. Pumps 2800 gph, 420 gph at 75' high or 1600 gph from 25' well. Six blade impeller. Threaded for pipe. 3/4" inlet, 1/2" outlet. Use 1/2 to 3/4 hp motor. \* 7500 gph 9.95  
Heavier 2800 gph 8.95 Heavier 11.95  
Check, MO or COD—Money Back Guarantee  
FREE Literature—Comparison Charts  
U. A. T. ENG. & MFG. CO. HICKSVILLE 273, NEW YORK

Say You Saw It in Popular Mechanics

## BUILD D.C. WELDER!

WE SHOW YOU HOW to build this powerful welder without rewinding. Uses most any surplus aircraft generator. Produces 75-350 amps. Easy to build. PLANS 35c includes NEW booklet "HOW TO WELD," and FREE WAR SURPLUS AND ELECTRICAL CATALOG.



LEJAY MFG. CO., 1247 LeJay Bldg., Minneapolis 8, Minn.

## BLACK IRON SWITCH PLATES

Single \$1.35 Triple 1.95  
Double 1.65 Outlet 1.65  
Send 10c for New 120 Page Catalog  
(about 1000 illustrations) of  
UNUSUAL HOME ACCESSORIES.

WILLIAM  
Spencer

NO C.O.D.  
PLEASE

RANOCAS WOODS, NEW JERSEY

## The New Model 70 UTILITY TESTER FOR REPAIRING ALL ELECTRICAL APPLIANCES MOTORS • AUTOMOBILES • TV TUBES

As an electrical trouble shooter the Model 70:

- Measures A.C. and D.C. Volages, A.C. and D.C. Current, Resistances, Leakage, etc.
- Will measure current consumption while the appliance under test is in operation.
- Incorporates a sensitive direct-reading resistance range which will measure all resistances commonly used in electrical appliances, meters, etc.
- Leakage detecting circuit will indicate continuity from zero ohms to 5 megohms (5,000,000 ohms).
- Will test heaters, Irons, Boilers, Heating Pads, Clocks, Ferns, Vacuum Cleaners, Refrigerators, Lamps, Fluorescents, Fans, Switches, Thermostats, etc.
- Will test all TV tubes for open filament, inter-element shorts, burned out tubes, etc.

As an Automotive Tester the Model 70 will test:

- Both 6 Volt and 12 Volt Storage Batteries • Generators • Starters • Distributors • Ignition Coils • Regulators • Relays • Circuit Breakers • Cigarette Lighters • Stop Lights • Condensers • Directional Signal Systems • All Lamps and Bulbs • Fuses • Heating Systems • Horns • Also will locate poor grounds, breaks in wiring, poor connections, etc.

Mandates round-covered molded bakelite case, 3 1/2" x 5 1/2" x 2 1/4". Complete with all test leads. Also included is a 66 page book giving detailed instructions for testing all electrical appliances, automotive equipment, TV tubes, etc. Only \$15.95

**SHIPPED ON APPROVAL  
NO MONEY WITH ORDER—NO C. O. D.**

Try it for 10 days before you buy. If completely satisfied then send \$2.95 and pay balance at rate of \$4.00 per month for 3 months — No Interest or Finance Charge. Address: If not completely satisfied, return to us, no explanation necessary.

MOSS ELECTRONIC DIST. CO., Inc.  
Dept. D-182, 3849 Tenth Ave., N.Y. 34, N.Y.

Please rush 1 Model 70 I agree to pay \$2.95 within 10 days after receipt and \$4.00 per month thereafter

Name \_\_\_\_\_  
Address \_\_\_\_\_  
City \_\_\_\_\_ State \_\_\_\_\_

# STOP SAGGING REARS!



with  
**LOW-COST**

## AIR LIFT PNEUMATIC SPRING BOOSTERS

Car got that "middle age spread" look? Even new cars need help for overloads of luggage, equipment or extra passengers. AIR LIFTS fit between leaf springs and frame — inflate with air to support overloads up to 1000 lbs! Perfect for vacation trips, and so easy to install. See your dealer or write for his name.

Most  
Models  
\$20



**FREE!** . . . tip-packed literature on Air Lift remedies for sagging rears. Write Dept. 411.



**AIR LIFT COMPANY,**  
LANSING, MICHIGAN

## UTICA® Adjustable Wrenches

**FOR THE BEST  
IN  
GOOD TURNS**



LOOK FOR  
THE NAME  
**UTICA®**

Yes, many, many good turns because they offer you a very special UTICA feature. The jaws surfaces are extra hardened by UTICA's own process of electronic induction. Jaws resist nicks and burrs, stay smooth and new-like up to 10 times longer than ordinary adjustable wrenches.

An adjustable wrench is a mighty handy tool, but be sure to look for the name UTICA on the handle. Sizes from 4" up to 18"

**THE HALLMARK OF QUALITY**  
**UTICA DROP FORGE & TOOL CORP.**  
UTICA 4, N. Y.

In Canada: Adlam Tool & Supply Co., Ltd., Montreal



# MENDS MOST ANYTHING

*"HOLDS LIKE IRON"*

Used by fine furniture makers. Ideal for home and office. In ¼ oz. or 2½ oz. sizes.

**DRIVE ANYWHERE-**

**DINSMORE  
AUTO  
COMPASS**

*with CONFIDENCE!*

These modern, fully jeweled compasses show you the right way—the short cuts. Save time and money! Surpasses rigid auto makers' tests. Send for Free Folder—"Pants, Knives and Compasses."

ONLY COMPASS  
APPROVED BY  
AUTO MAKERS!

**DINSMORE INSTRUMENT CO.**

1802-41 KELSO ST., FLINT 1, MICHIGAN



**TRAVELITE \$5.95**  
(ILLUMINATED)

**GUIDEWAY \$4.95**  
(NON-ILLUMINATED)

Say You Saw It in Popular Mechanics

## CUT GLASS the EASY WAY

NEW SELF-GUIDING TOOL MEASURES AS IT CUTS

Zip off glass with a ZIP Cutter! With the special, adjustable guide, you cut glass easily, accurately, and quickly. No more guesswork! Can also be used as an \$1.00 ordinary glass cutter. Postpaid, just... 7-day MONEY BACK GUARANTEE. No C.O.D.'s. **ARROW-PRODUCTS Dept. A.** P.O. Box 52, Dayton, Ohio



## DO YOUR OWN REPLATING ... IT'S EASY

It's a cinch to make worn articles look spankin' new with this fully equipped kit. Add new sparkle and lustre to tools, silverware, jewelry, sports equipment, etc. **ONLY \$3.95.** SEND NO MONEY, pay postman on delivery, or send \$3.95, we pay postage. **MONEY BACK** if not delighted.



**LEJAY Mfg. Co., 1292 LeJay Bldg. Minn. 8, Minn.**

## What Every Farmer Should Know About Taking Care of Farm Animals



**The Most Popular Veterinary Guide  
Ever Printed**

This practical and helpful **VETERINARY GUIDE FOR FARMERS** prepares the farmer to perform many routine veterinary tasks—provides quick information that can often save the life of an animal—prevents disease in herds—saves money on the farm in a hundred different ways.

Written in plain understandable language. It covers symptoms, causes of disease and prevention, and treatment of cattle, swine, sheep, horses and poultry and warns when to call in the professional veterinarian. Names, terms and phrases made clear in a separate section. Over 100,000 copies of this book are in use on American farms. 275 pages. Fully illustrated. Only \$3.95. Order today under money-back guarantee.

**POPULAR MECHANICS PRESS, Dept. PM13**  
200 E. Ontario St. Chicago 11, Ill.

POPULAR MECHANICS

Copyrighted material

# FREE PLAN

## tells how to start your own business FILING SAWS



Here is a steady CASH business you can start in your own basement or garage in your spare time and make up to \$3 or \$5 an hour. You can file hand, band and cross-cut circular saws on the Foley Saw Filer. No eyestrain—no experience needed. "The first saw I sharpened with my Foley Filer came out 100%"—writes Clarence E. Parsons. Every saw you sharpen with the Foley Saw Filer brings you more customers. "I rented a two-car garage and have all the work I can do"—Charles H. Smith.

**FREE BOOK** "Money Making Facts" shows just how you can start at home in spare time with small investment, no overhead—and develop into a full-time repair shop. Send coupon today for this practical plan. No salesman will call.

### SEND COUPON FOR FREE BOOK

FOLEY MFG. CO.

1116-S FOLEY BLDG.  
MINNEAPOLIS 16, MINNESOTA

Send Free Book "Money Making Facts"

Name \_\_\_\_\_

Address \_\_\_\_\_



### 24-Page Illustrated DO-IT-YOURSELF PROJECTS BOOK

Describes attic finishing, built-in cabinets, add-a-room, recreation room, kitchen remodeling, summer cottage and farm projects. Contains helpful information on how to get started, planning, cost estimating, materials purchasing, and proper procedures, also nail charts, moulding designs, etc. Send only 25c and also receive FREE 52-PAGE POWER TOOL CATALOG.

BOICE-CRANE COMPANY, 943 Central Avenue, Toledo 6, Ohio

Also Adult  
Eshelman  
2 Passenger  
Sport Cars  
Golf Cars  
1/5 The  
Price  
of any  
other Auto  
70 Miles  
Per Gal.  
Free Catalog.

MAKES  
FLOWS  
CULTIVATES  
HARROWS  
HAULS  
SPRAYS  
SAWS  
GRZER  
MOWS  
CUTS  
ROLLS  
TILLS  
SNOW  
FLOW

**ESHELMAN**

FOR  
Better LAWNS  
And GARDENS



Women can operate it.  
1 to 8 H.P.

Shipping Points:  
BALTIMORE,  
CHICAGO, RENO

Free Catalog Write:  
ESHELMAN CO., Dept. R-512  
109 Light St.,  
Baltimore 2, Md.

\$69

### Guaranteed Auto Parts at Western Auto



### PUNCH PRESS

2 Ton Power Bench Type  
Make Your Shop Complete  
Powerful — Dependable — Economical  
Easily make your own dies for light stamping, forming, riveting etc. Ideal for production or experimental work. Replaces more expensive presses. Requires only 1/2 H.P. motor. Weight 105 lbs. Fully guaranteed. Only \$97.50 less motor. Write for free circular.

Dealer inquiry invited  
ALVA F. ALLEN, Dept. PM, Clinton, Missouri

\$97.50

### DO IT YOURSELF!

#### SAVE ON SERVICE CALLS —

Test your own TV and Radio Tubes with the Home Service Tester. Also tests appliances for shorts and broken wires or elements, light bulbs, fuses, motors, flash bulbs, and any other electrical equipment. Same tube tester now being used by over 25,000 TV and Radio Servicemen. Quick — shock-proof — no technical knowledge required. Save Money Now—by ordering TODAY! Satisfaction guaranteed or your money back. Complete with easy instructions...

\$4.95

EA.  
POSTPAID



Lindaily Products 2626 W. 103rd Pl., Dept. MP-11  
Chicago 43, Ill.

### WELD BRAZE SOLDER CUT



4WAY  
ONLY  
\$14.75  
i.e.b. factory

Acclaimed by thousands of Homeowners, Mechanics and Hobbyists as the welder of 1001 uses. Easily operated from properly wired 110 volt AC or DC line. The ideal gift with a life-long use... Order today on 10 day money back guarantee.

FOUR-WAY WELDER CO., Dept. F2-M  
1810 S. Federal St. • Chicago 16, Ill.

WELDER  
Complete with  
Twin Carbon Arc  
Torch and ac-  
cessories... to  
handle all metal-  
craft work.

### AMERICAN MACHINE & TOOL CO. MODEL CHANGEOVER SALE SAVE \$800 ON THIS TILT ARBOR SAW



NOW  
\$1695

All year a great buy at regular price of \$24.95—this 8-inch Plans Centric Tilt Arbor Power Saw is a spectacular bargain at \$16.95 during model changeover period. This big saving is possible by our patented construction, our manufacturing facilities, and our distribution methods. Top-quality saw features the original Plans Centric Patented Ball-Bearing Floating Drive, Patented Plans Centric Cradle Suspension, and Plans Centric Patented Rip Fence that locks front and rear against the table surface. Every part in this fine saw is manufactured in our own factories. All cast iron and steel construction. Crosscuts, rips, bevels, mitres, dados, cuts compound angles. Massive cast mitre gauge. Heavy steel base fastens to any workbench. Uses any standard 1/4 or 1/2 h.p. motor. INCLUDED: 8" Simonds Combination Blade at no extra charge. We start soon on 1956 models. During model changeover you can have this fine 1955 at a saving of \$8.00. Send check, M.O. or sent C.O.D.

- LOOK AT ALL THESE SPECIAL FEATURES:**
- Blade tilts, table stays level. Blade adjusts to any angle up to 50°.
  - Single Hand Wheel Control, Tilts and tightens blade with a twist of the wrist. Blade rises and lowers; cuts from 0" to 2 1/2".
  - Precision-ground cast iron table. Perfect flatness resists nicking and wear.
  - Self-aligning rip fence. Adjustable to be parallel to blade or give clearance either way.
  - Patented Motor Mount takes any standard 1/4 or 1/2 h.p. motor. Motor rides on ball bearing rollers. Keeps belt tight, transmits full power.
  - Heavy long-lasting, all-metal construction. Built for a lifetime. Shipping weight 25 lbs.

**FAMOUS AMERICAN  
IRONCLAD GUARANTEE**  
Try any Plans Centric power tool for ten days. If, for any reason, you are dissatisfied, return the merchandise for full and complete refund—no questions asked. This famous guarantee has been offered on sales of more than 3 1/2 million power tools, and it has never been violated.

WRITE FOR FREE CATALOG  
Big bargains in home workshop power tools

AMERICAN MACHINE & TOOL COMPANY  
ROYERSFORD 17, PA.

don't be "sold"

...get the facts



MAKE

about



## DELTA SHOP

### Famous one-motor combination of full-size power tools

It's a Saw It's a Jointer It's a Drill Press It's a Sander

The ONLY right combination of basic power tools. The U. S. Chamber of Commerce says this about multipurpose tools: "The machine which is used most should be the basis of this tool . . ."

The DeltaShop is built around the Circular Saw—the basic, most-used woodworking tool. It also includes the full-size Delta Homecraft Jointer, Drill Press, and Sander. Not a collection of attachments, but a combination of real Delta Quality Power Tools operated on one motor.

Exclusive "Tool-at-a-time" Plan makes it easy to own. The DeltaShop is the only combination tool you can buy "a-tool-at-a-time," as your budget permits.

See the Exclusive Delta Saber Saw Attachment: Makes curve cutting machines of both the DeltaShop and the Delta 8" Tilting Arbor Saw! Unlimited capacity for internal and external curved work.



### Individual Tools or All-Purpose Combination?

Which is best for you? Only you can decide that—after you have weighed the facts about your workshop space, the kind of work you want to do, and the condition of your pocket-book. But your Delta Dealer can help with impartial facts because Delta, oldest and largest power tool producer, makes both combination and individual tools to suit every need and budget.



### Are All Power Tools Equally Accurate, Rugged?

No, no more than all cars, TV sets or washing machines are equally good. The precision, economy, and fun you get out of a power tool depend on the skill, experience, and craftsmanship the builder puts into it. For many years, Delta Power Tools have set the standards of quality—and true economy—in thousands of industrial plants, school shops, and finest home workshops.



**Delta Homecraft 8" Tilt Arbor Saw:** The finest made for home shop use. Also available are Delta 10" and 12" tilting arbor saws.



**Delta Homecraft 8" Tilt Table Saw:** Gives you big saw results at small saw cost. Also available: Delta 10" tilting table saw.



**Delta Homecraft 16" Scroll Saw:** Rugged enough for Dad—safe enough for the children. Also larger 24" scroll saw available.



**Delta Homecraft 11" Wood Lathe:** Turns beautiful forms in wood, plastics, light metals. Delta 12" 4 and 16-speed models available.



world's most complete line of power tools

for Home Workshops . . . Industry . . . Builders . . . Schools . . . Custom Shops

53 MACHINES . . . 246 MODELS . . . OVER 1300 ACCESSORIES

Copyrighted material



# UP YOUR OWN MIND

## the power tools best for you!



### Are Power Tool Accessories Important?

Very—because the right accessories can almost double the usefulness of many power tools, at extremely low cost. And because Delta's 1300 accessories are designed as part of the world's most complete power tool family, many of them can be used with several tools. That's an added advantage you get from the "first family" of power tools.



### How Much Do Good Power Tools Cost?

Some brands are sold largely on price—but buying on price alone can be a very expensive "economy," if you don't get value for what you spend. Delta makes tools in several price ranges; which is best for you only you can decide. But of this you can be sure: any Delta Power Tool in any price range represents a real bargain value!



### Let Your Delta Dealer Help You Get The Facts

Let him demonstrate the famous Delta-Shop, and individual Delta Power tools. Actually operate them yourself and see why Delta tools—at prices far lower than you'd expect, are the biggest power tool values in America. Then compare with any other brand of power tools made, and **MAKE UP YOUR OWN MIND!**

You'll find your Delta Dealer listed under "TOOLS" in the yellow pages of your telephone book, or you can see Delta Homecraft Tools at leading hardware and department stores. Send coupon for free fact book.



**Delta Homecraft Deluxe 4" Jointer:** Also available: Delta 4" jointers, 6" Long Bed jointer, and 8" Long Bed jointer.



**Delta Homecraft 4" Jointer:** You get many built-in quality features found in larger Delta jointers—at exceptionally low cost.



**Delta Homecraft Saw-Jointer:** Combines 8" circular saw and 4" jointer on one stand with one motor. Larger model available.



**Delta Homecraft 11" Drill Press:** Do countless jobs with this multi-purpose tool. Delta 14" and 17" models also available.



**Delta Homecraft 10" Band Saw:** Curved and straight line cutting even in hardwood. Delta 14" Band Saw also available.



**Delta Homecraft High Speed Shaper:** Makes smooth, professional-looking shaped edges. Larger shaper also available.



**Delta Homecraft 8 1/2" Disc Sander:** Finishes wood, plastics, ivory, non-ferrous metals satin smooth. Larger model available.



**Delta Homecraft General Purpose Grinder:** Sharpens, buffs, polishes—has many other uses. A sensational value at its low price.

SEND FOR FREE FACT BOOK NOW!

**DELTA** QUALITY POWER TOOLS

Another Product by **ROCKWELL**

DELTA QUALITY COSTS NO MORE!



Delta Power Tool Div., Rockwell Manufacturing Co.,  
502-L N. Lexington Ave., Pittsburgh 8, Pa.

- Please send me free, illustrated booklet on Delta Power Tools.
- Please send me names of Delta Dealers nearest me.
- Please send catalog of Delta literature on power tools, plans, and projects.

Name \_\_\_\_\_

Address \_\_\_\_\_

City \_\_\_\_\_ County \_\_\_\_\_ State \_\_\_\_\_

Copyrighted material

# Snap-on Tools FOR MAINTENANCE AND SERVICE

In the maintenance of all industrial machinery, the right tools save precious hours... help mechanics do more and better work. Throughout industry—aviation—construction—petroleum—automotive—agriculture... Snap-on tools and special tool sets are the outstanding choice for efficient maintenance and product assembly work. They cost less to use because they last many times longer than cheap tools. Write today for free catalog of more than 4,000 Snap-on tools.

**SNAP-ON TOOLS CORPORATION**  
8062-K 28th Ave. • Kenosha, Wis., U.S.A.

\*Snap-on is the trademark of Snap-on Tools Corp.

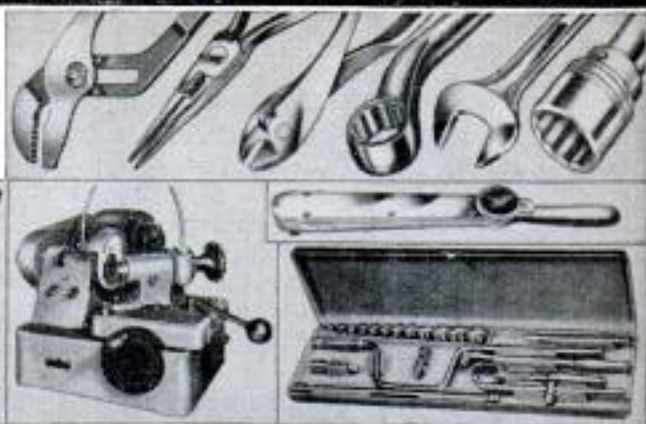

## CHARGE 6 & 12V AUTO BATTERIES

run auto radios, electric trains, electric shavers, etc. with...

### 6V & 12V Battery Eliminator & Charger

2 ranges: 0-8 volts (10 A continuous, 20 A intermittent), 0-16 volts (5 A cont., 12 A interm.) Continuous voltage adjustment. Separate voltmeter & ammeter. Panel fuse & auto. cut-out relay fully protect primary & secondary.

**KIT \$29.95**  
Wired \$38.95

### FIND URANIUM!

**KIT \$19.95**  
Wired \$29.95

### NEW GEIGER COUNTER

Professional, super-sensitive — Indicates by flashes & headphone clicks. No moving parts. Complete easy instructions with each instrument. Backed by world's largest mfr. of electronic kits & instr. (45 in all!) In stock at your local electronics distr. — or send to us. Write for distributor's name & FREE Catalog PM-11 (not batteries)

**EICO** 84 Withers St. • Brooklyn 11, N. Y.

## NEW! AUTOMOTIVE CATALOG

1956 Edition! Everything for car, truck, custom-styled car, hot rod... at **LOWEST PRICES!** Save up to 50% on all parts, accessories! Only complete automotive buying guide... 60,000 items... 164 pages! Thousands of hard-to-find parts; equipment, parts for 1920 to 1956 models; **Holly-wood accessories** never before offered; **hi-speed parts.** Send your name and address and 25c (refundable with first \$5.00 order) to:

J. C. Whitney & Co., 1917 Archer, Dept. P-11, Chicago 16, Ill.



## FREE AMAZING NEW BOOK "HOW TO ANSWER ADS"



Never before have you seen anything like this. Tells you in simple language the correct way to answer ads. Gets you quicker replies—better results, and greater satisfaction. Will save you time and money and it's **ABSOLUTELY FREE.** No obligation whatever. Every reader of advertising should have this booklet. Send a postcard for your copy NOW. F. W. Johnson, Popular Mechanics Magazine, Room 600-A, 204 East Ontario Street, Chicago 11, Illinois.

## BUILD YOUR OWN POWER TOOLS—GIL-BILT

**Exclusive GIL-BILT Build-It-Yourself Features**

- No machining—build easily with hand tools only
- No blueprint reading—step-by-step pictorial plans, full scale patterns, actual photographs
- Sturdy wood, aluminum and steel construction
- Capacity and performance of commercial saws selling from \$60 to \$250.
- Proved performance. Nationally advertised and sold for 8 years. Satisfied customers around the world.

**WITH GIL-BILT PARTS KITS**  
PLANS only \$1.00 EACH POSTPAID

### GIL-BILT 10-in. TILT/ARBOR SAW

- 27x28 in. table, 13 1/4 in. capacity in front of blade
- 10 in. blade cuts 3 1/4 in. deep, tilts full 45 degrees
- Flare model 3 1/4" high, table always stays level
- New Departure ball bearing arbor, 3/8" precision shaft turned down for 3/8" bore blades, alum. housing, shipped ready to run
- Jackscrow and 4 1/2 in. dia. handwheel lowers and raises blade
- Cast-aluminum miter gauge and self-aligning rip fence guide

GIL-BILT Metal Parts Kit includes Plans, ball bearing arbor, miter gauge and base, rip fence guide, dado insert, lock knobs, jackscrow mechanism and handwheel, and all other metal parts (less blade)..... \$22.95  
Same Kit with 10" Combination Blade \$25.90  
Same Kit with 8" Combination Blade \$24.90

### GIL-BILT 12-INCH BAND SAW

- Cuts to center of 24 inch circle
- Handles stock up to 8 inches thick
- 18x18 inch table tilts 45 degrees
- Lower wheel and drive pulley runs on sealed New Departure Ball Bearings: Upper wheel runs on two 5/8" bore Oilite Bronze bearings
- Upper wheel tension and tilt mechanism of cast aluminum, completely assembled
- Upper and lower blade guides. Each has ball thrust bearings, self-lub bronze jaws
- Rigid cast aluminum wheels fully machined ready-to-install. Heavy rubber tires
- Uses standard 78 inch blades up to 3/4 in. wide
- Fully enclosed mechanism for utmost safety

GIL-BILT Metal Parts Kit includes Plans, rubber tires, aluminum wheels, 3/4 in. blade, ball bearing spindle, tilt mechanism, blade guides, table tilt segments and all other metal parts..... \$23.95  
Returns kits in 10 days for refund if not satisfied.  
For shipments up to 600 miles, add 5%; over 600 add 10%.

Amount in excess of actual postage will be refunded.  
Order Kit now, or order Plans at \$1.00 each and Kit later less cost of plans. Write for FREE Catalog. Dept. 80-L, Lambert Field St. Louis 21, Missouri

## GILLIEN POWER TOOLS

## How to Build Your Own GARAGE

Save as Much as 50% of Usual Construction Costs

Get Popular Mechanics' brand new book **How to Build Your Own Garage** by Wayne Leckey, Assistant Shop Notes Editor, and find out how you can build your own garage at savings of 50% of usual cost. Leckey tells in famous step-by-step instructions and shows in big, clear photos, drawings and diagrams how to perform every building operation from laying the concrete to installing the final trim. There are 25 designs. Brick, frame, and concrete block fully covered. Send \$3.50 for your copy. 7-day money back guarantee.

POPULAR MECHANICS PRESS, 200 E. Ontario, Chicago 11, Ill.

## Put Up This APPROVED Fireplace and Chimney YOURSELF in 4 Hours NO MORTAR.. NO MASONRY

Save more than half! Full-sized wood-burning fireplace and chimney. Safety clearances built in. Labeled by Underwriters Laboratories Inc. Sets right against wood floors, walls, studs, joists. Fully engineered, tested, proved — won't smoke. Triple-wall chimney of stainless steel and aluminum. Realistic brick-finish aluminum top. Write for FREE details!

## Majestic FIREPLACE

The Majestic Co., Inc., 456 Erie St., Huntington, Ind.

## NEW ELECTRONIC GARAGE DOOR OPERATOR



YOU can assemble your own operator and save almost half the cost. New Bellford-Matic kits are now furnished with quick-disconnect, automatic light and control box factory wired and tested—at no increase in price. Top quality components assure trouble-free operation. Detailed drawings and easy-to-follow assembly instructions with each kit. Post Controlled Kit, Model PCK-1L, only \$69.00. Radio Controlled Kit, Model RCK-1L, only \$119.00 F.O.B. Factory. Complete, nothing else to buy. Fully guaranteed. Send for folder of complete line.

Dealer inquiries invited

**Bellford-Matic, Inc.**

Dept. P.M., Maurice Ave., Cleveland 27, Ohio



## NEW LIVE LATHE CENTER

**TIMKEN** DOUBLE ROW TAPERED ROLLER BEARING

- #2 Morse Taper Shank • Hardened & Precision Ground 60° removable point
- TIMKEN Roller Bearing Absorbs High Radial & Thrust Loads • 1 5/8" dia. x 5 1/2" Overall Length • Grease Seal Protects Bearing.

ONLY **\$9.75** POST PAID (Reg. 29.50)

**MONEY BACK GUARANTEE.**



Seaboard Industrial Supply Corp. 128 N. 3rd Street Dept. M, Phila. 6, Pa.

## ONE-MAN SAWMILL LOW \$50.00 AS DOWN

Take BELSAW Portable Sawmill right to the trees—turn out valuable lumber for home and farm—sell to local yards—make up to \$50 a day custom sawing for neighbors. BELSAW lasts a lifetime. No crew needed. Power with tractor or auto engine. Beginners get excellent results. Send today for FREE BOOK.

**BELSAW MACHINERY CO.**  
121 2456 Field Bldg., Kansas City 11, Missouri

## NEW "WIZARD" TOOL DRILL GRINDING GUIDE

MAKE OLD DRILLS LIKE NEW... CAN'T WEAR OUT

For re-pointing dull and broken twist drills up to 1/2" in diameter. One piece cast Aluminum. Simple. Anyone can use it. Order yours to-day. \$1.00 post-paid.

**BRASS CASTING CO.** \$1.00  
P. O. Box 3056 Memphis 9, Tenn.

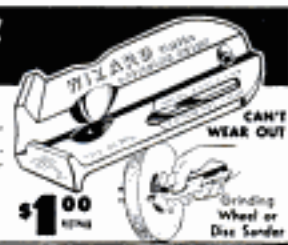

Say You Saw It in Popular Mechanics

## MAKE YOUR OWN FOLDING TABLES IN MINUTES... AND SAVE MONEY!

WITH TABLECRAFTERS' TUBULAR STEEL FOLDING TABLE LEGS

You simply screw leg assemblies to your table top. They're sturdy and rustproof. Won't collapse...yet fold easily for storage. For banquet, buffet, hobby, work and game tables.

**COMPLETE KIT FOR ONE TABLE \$8.95**

Send check or money order and we'll pay postage. Write Dept. "C."

**TABLECRAFTERS** 6731 CASTOR AVE., PHILADELPHIA, PA.

**ATTENTION!** SHOW THIS AD TO THE COMMITTEE OF YOUR CHURCH, LODGE OR OTHER ORGANIZATIONS. THEY'RE ENTITLED TO SPECIAL DISCOUNTS.



## WAR SURPLUS AND OTHER BARGAINS SAVE UP TO 90%

**P1 GENERATORS**  
Electric Auto-Lite, 200 Amps, 24 Volt, 4400 RPM. Dandy arc welder. Wt. 53 lbs. Approx. GOVT. cost \$450. Like NEW, \$12.50 incl. easy diagram.

**SENSATIONAL GENERATOR BUY!!**  
**Famous Navy NEA-3 Generator.** Combination AC-DC Type. AC voltage—115 V. DC voltage—24 V. 200 Amp. 2 complete generators in 1... 2 separate fields and 2 separate armatures on same shaft yet no larger than regular aircraft generator. Ideal for home, farm and shop lighting plants by hooking wires to AC side. DC side can be used for welding and operating war surplus low voltage hobby motors and equipment. Weight 24 lbs. NEW. Approx. GOVT. COST \$350. NEW \$27.50 used perfect \$18.00

**SPECIAL CARBON PILE TYPE VOLTAGE REGULATOR** to go with above generator. Incl. mounting base and completely enclosed in steel-mesh box. Helms maintain constant current and prevents pulsation. Ideal for installation with above generator for lighting plant. Wt. 5 lbs. Complete NEW. Approx. GOVT. COST \$90. Now only \$7.95

**NEW PUMP AND MOTOR**  
Pump has 1" connections, built-in relief valve, adjustable up to 1500 lbs. Max capacity 6 GPM, 1 1/2 H.P., 24-volt motor, 4000 RPM. Can be used on 12 or 36 volts. Govt. cost approx. \$350—our price—NEW—\$9.95.

**SENSITIVE ALTIMETER** in 10 Ft. increments. Famous Pioneer! 0 to 35,000 ft. (inches of Mercury). Tested and inspected in our own INSTRUMENT lab. Guaranteed perfect. Approx. Govt. Cost \$150. NOW ONLY \$13.95 PREPAID!

**MICROMETER DEPTH GAUGE**  
With 3 rods to measure all depths from 0 to 3 inches by thousandths. Hardened tool steel lead arrow has full 1 inch run. Base is 2 1/2" long, hardened ground and hand lapped. Accuracy guaranteed. Mfd. by Millers Falls Co. GOVT COST approx. \$30. NEW—\$10.95 incl. USA. In velvet case.

**MICROMETERS** Chrome plated, precision engineered, carefully tooling to give long life. All new 0-1" cap. \$2.25 ea., 1-2" cap. \$3.50.

**NEW IMPROVED MODEL MAUSER-TYPE PRECISION 1/1000" VERNIER CALIPERS**  
Quick, handy, accurate. 6" Vernier Calipers. Glass hardened, lapped measuring surfaces. Fine engraved scales—1/1000" and 1/128" for inside, outside & depth measurements. Friction thumb release. Larger capacity. 2 gib adjustments. Reg. \$25. Now only \$7.95. Leather case \$1 extra.

**PORTABLE POWER PLANT**  
Ideal for light welding. For boats, camps, emergency lights, battery charger, 3000 W. 30 V. 5 HP. Complete with carbon pile voltage regulator and ammeter. Like new, tested. Shock mounted. Deluxe type. Approx. Govt. Cost \$700. Shpg. Wt. 200 lbs. \$72.50.

**NEW 1955 CATALOG** Biggest ever... new low prices... Send 25c for your copy today. Prices otherwise stated. Check, money order or cash. 25% deposit for C.O.D.

**AIRBORNE SALES CO., INC. DEPT. PM1155**  
8501 Stellar Drive, Culver City, Calif.

**TOOL PROTECTION** For complete protection to precision tools, house them in a Gerstner Chest. Free Catalog.  
**GERSTNER TOOL CHESTS**  
455 Columbia St., Dayton 7, Ohio

**AUTOMATIC RETOOTHER** for HAND SAWS  
MAKES NEW PROFITS

Cuts new teeth in 30 seconds—any size 4 to 16 points. Old teeth fall off on chips. Easy to operate. A perfect job.

**BURR MFG. CO.**  
8933-M VENICE BLVD. LOS ANGELES 34, CALIFORNIA

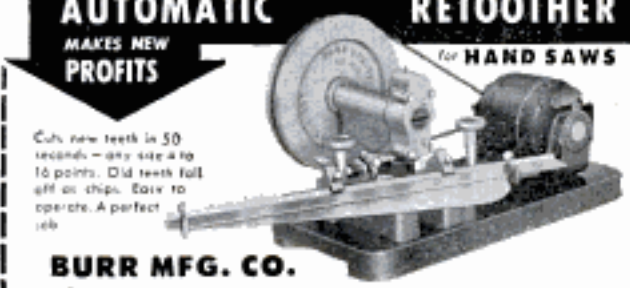

## HARLEY-DAVIDSON DEALER OPPORTUNITIES

A few excellent opportunities are available to sell and service the world-famous Harley-Davidson motorcycle for pleasure, police, and commercial work. If you are mechanically inclined, like outdoor activities, enjoy selling and are willing to work to build a successful business for yourself, we want to hear from you.

Tell us about yourself; your age, business background and how much money you have to start — motorcycle experience desirable but not essential. You'll receive a prompt reply telling you about our franchise, factory co-operation and our extensive national advertising support.

Write Department PM-1

**HARLEY-DAVIDSON MOTOR CO.**  
MILWAUKEE 1, WISCONSIN

ALSO  
Adult  
Eshelman  
2 Pass.  
SPORT  
& GOLF  
CARS  
LOWEST  
PRICE  
70 Miles  
Per Gal.  
Free  
Catalog.

### ESHELMAN CAR SNOW PLOW CLEARS ROADS & DRIVEWAYS



Bolts on to car or truck in 2 minutes without tools. Clears snow 16" deep and 72" wide. Lightweight and sturdy. Order now, or write for free catalog.

ESHELMAN, Dept. SP-511  
100 Light St., Baltimore 2, Md.  
SHIPPING POINTS:  
Baltimore, Chicago, Reno

THE BEST  
IN PLIERS? **CHAN NEL LOCK**  
CHAMPION DeARMENT TOOL CO., MEADVILLE, PA.

Say You Saw It in Popular Mechanics

### KEEP ALL SAWS SHARP



**SO EASY!** With this new filing jig and jointer anyone can now sharpen any hand saw like new! When file hits hardened steel rollers teeth are finished and EXACTLY SAME HEIGHT. All teeth cut and saw runs true and smooth. Jig and instructions \$2.95 postpaid. Free literature. **SAVE TIME AND \$\$\$**



**JOINT & SHARPEN CIRCULAR SAWS**  
Sensational new Super Filer No. 11 joints and sharpens both hand and circular saws 6" to 10" with all teeth the correct height, depth, pitch and bevel. Easy to use—when file hits hardened steel roller, teeth are finished. Saw runs true and smooth with no side pull. Complete with special 8" file \$9.95 ppd. "TRU-CIRCLE" saw set automatically sets teeth at 10° or more \$2.95.

Guaranteed



**SUPER DRILL GRINDER**  
Sharpens round shank drills from 3/32" in diameter, up to 1/2" in diameter, up to 6" long. Grinds old drills like new in 4 different point angles, using hand or power grinding wheels... \$2.95

**DEPTH ANGLE PITCH CONTROL**  
Automatic DEPTH CONTROL Rollers



**SUPER SAW FILER NO. 6**  
Automatically controls

**IT'S NEW!**  
Perfect bevel and angle maintained, and fool-proof depth control for all Rip, Crosscut and Handsaws. Precision made and calibrated for instant setting at desired angle. Can be used in any vise or clamp. Complete with file, only \$6.50 ppd. **SEND FOR FREE CATALOG**

A. D. McBURNEY, 5908 Hollywood Blvd., Hollywood 28, Cal., Dept. A-115

## Save on all PLUMBING JOBS

When You Build · When Making Improvements · Repairs · Maintenance

Get  
POPULAR MECHANICS  
Home Plumbing  
Guide



How to plan plumbing installations, select materials and fixtures.

How to save money on all plumbing jobs using approved methods.

Easy to Do Professional-Like Jobs and Save Over One-Half

Get the Popular Mechanics HOME PLUMBING GUIDE. It shows how you can do every kind of plumbing job yourself and save from a few to hundreds of dollars. Covers plans, layouts, installation, maintenance and repair. Shows what materials to get and use, where to get them and how to do a proper job with approved methods. Few, other than the simplest tools are required and some of these can be rented. Don't pay high prices for work you can do yourself. Get the HOME PLUMBING GUIDE for only \$3.50. You will be amazed how jobs you thought difficult are simplified.

Clip This Ad and Mail. Money Back if Not Pleased

Invest only \$3.50. Use the book for 7 days. Then if you are not satisfied return it for full refund of your money. Sent C.O.D. (U.S.A. only) if you prefer.

Over 500 How-to-do-it Pictures Guide You



POPULAR MECHANICS PRESS, Dept. HPG-10, 200 E. Ontario St., Chicago 11

## SEND ME



every month so I am sure to see each new issue. Here's

- \$3.50 for 1 year  
 \$8.00 for 3 years

name \_\_\_\_\_

address \_\_\_\_\_

city \_\_\_\_\_

zone \_\_\_\_\_

state \_\_\_\_\_

Hand this order to your newsdealer or send it to

**POPULAR MECHANICS**  
200 East Ontario St. Chicago 11, Ill.

## BUILD WELDER OR LIGHT PLANT

Instruc. incl. TYPES AMPS VOLTS PRICE  
 Westinghouse T1 200 24 \$15.50  
 J & Helas RL 300 30 \$25.50  
 G.-I. 100-250 amps. 30V. new \$15.00 used \$12.05  
**D. C. Rheostat or Voltage regulator \$6.95 ea.**  
**Makes Ideal Light Plant & Battery Charger.**  
 G.K. 2511 Generator gives 1250 Watts 800  
 cv. 115 V. A.C. & 200 Amps. 30 V. D.C.  
 Good Condition \$17.50. New \$27.50.  
**174 AMP BLOWER & MOTOR.** 1/2 H.P.;  
 20 amp. 11000 R.P.M. runs on 6-12  
 or 24 V. D.C. 12"x12"x8". New \$12.95.  
**(5) SENSATIONAL SELVINS.** For con-  
 trolling distance operations, etc. \$9.95  
 per pair. (6) Solenoid VALVES. Bendix  
 281500 for hydraulics, distance op-  
 eration, etc. Up to 1000 P.S.I. \$7.90  
 per pair. (7) BEAM ROTATOR MOTOR  
 #101 for TV, Hi-Fi, FM, reversible, 2  
 H.P.M. for D.C. or 110V. A.C. Gov'l.  
 cost \$150.00. \$9.95. (8) SOLENOID  
 #804 gives 1/2" or 1 1/2" travel, power-  
 ful for locks, switches, etc. \$4.95  
 per pair postpaid. INSTRUCTIONS  
 incl. with all items (for D.C. &  
 Appl. for 110V. A.C.)  
**(9) CUNO OIL FILTER** for autos, fil-  
 ters without cartridge replacements, 3/4"  
 ports \$4.95. PURGLATOR #255 for  
 trucks & tractors. 1" ports \$4.95 postpaid.

## General SALVAGE CO. SALE

**WATER PUMP with MOTOR**  
 1 1/2 H.P., 2000 R.P.M. for 6-12, or  
 24V. D.C. 200 g.p.h. per hr. with relief valve  
 & adjustable pressure. 1" ports. \$12.95.  
**(1) BLACK & DECKER MOTOR & PUMP.** 2  
 G.P.H. 1200 R.P.M. 1/2" ports. \$8.95.  
**(2) CHANDLER EVANS LARGE WATER**  
**PUMP.** oil, insecticide, etc. 400  
 G.P.H. 1" ports. \$7.95.  
**(3) THOMPSON PUMP & MOTOR** for  
 fuel, hot water, etc. 300 G.P.H.  
 \$7.95. Instructions incl. for items  
 1&3 for D.C. & appl. for A.C.  
**ROTARY GEAR PUMP #101** for hy-  
 draulic, water, or vacuum. 180 G.  
 P.H. 200 P.S.I., 29" (mercury) \$6.95  
**(5) VOLTMETER D.C.** 30 Volts, zero  
 center, 300 ohms. \$4.95. \*TACH-  
 OMETER INDICATOR, 0 to 10,000  
 R.P.M. \$7.95. \*HYDRAULIC PRES-  
 SURE GAUGE, 0 to 2000 P.S.I. 1/2"  
 ports. \$4.95. \*VACUUM GAUGE,  
 Range 0 to 10 inches Mercury. \$3.50  
**(6) GLIDER TOW BAR.** Rated 100-  
 600 lbs. & releases load when lever  
 is pulled. 14"x13 1/2". Wt. 10 lbs.  
 \$7.50. (7) ELECTRIC ACTUATOR,  
 5" travel 1/2 H.P. D.C. & appl. for 110V. A.C.  
 Rated 2500 lbs. Instructions incl. \$7.95.

## NEW HYDRAULIC CYLINDERS

Double Action	Bore	Stroke	D. Sqnrt	Price
#1	Air or Oil	1 1/2"	6"	\$7.50
#2	Air or Oil	3"	8"	\$8.50
#12	Air or Oil	4"	10 1/2"	\$25.50
#11	Air or Oil	3"	24"	\$27.50

**(4) HYDRAULIC PUMPS (P. Displacement)**  
 Mfg. Type Rpm Gph 1500 Psi  
 Stratospower (p.d.) 3750 400 \$17.50  
 (incl. built in relief, reversible)  
**(5) VICKERS (p.d.)** 3750 400 \$19.50  
 1.507 cu. in. rev. #P7282713-251  
 Pisco (Gear) 1500 108 \$9.95  
 Pisco (Gear) 4300 350 \$12.95  
**SIMMONDS HYD. ACCUMULATOR.** 3000 P.S.I.  
 220 Cu. in. 3/4" ports. New \$12.50. VICKERS  
 ball type acc. 2000 P.S.I. 5 1/2" dia. \$5.50.  
**ADOL FOUR WAY HYD. CONTROL VALVES**  
 for 1 D.A. cyl. 3/4" ports. #27. \$7.95; for  
 2 D.A. cyl. 1/2" port. #20. \$9.95; for 1 to  
 4 D.A. cyl. 3/4" ports. #10000. \$14.50.  
**(7) FOUR WAY SOLENOID VALVES.**  
 Instruction for 24V D.C. & appl. for  
 110V. A.C. off in neutral. 3/4" #123.  
 \$12.50. #124 with 1/2" ports. \$9.95. #322  
 one way normally closed 3/4" ports. \$3.50.  
**PESCO HYD. FLOW EQUALIZER** 1500 P.S.I.  
 \$9.95. VICKERS UNLOADING VALVE, 1/2"  
 ports. \$8.95.  
**GENERAL SALVAGE CO. CHECK OR M.O.**  
 2922 E. 27 St., Dept. 73, Kansas City, Mo.

## NEW BENJAMIN SUPER CO2 GAS CARBINE - \$16.50

Hi-LO (2 Stage) Jet Power  
 Cal. .177 or .22  
**RIFLED**  
 Shoots  
 Pellets  
 & Darts  
**IDEAL FOR TARGET & SMALL GAME**  
**SAFE - ECONOMICAL - ACCURATE**  
**CONVENIENT - PRACTICAL - NON TOXIC**  
**EASY TO OPERATE - NO PUMPING - NO FLINCHING.**  
 Get 40 SHOTS from each 10¢ STANDARD SIZE CO2  
 (Soda) CARTRIDGE. Up to 3/4" penetration.  
 Ask your DEALER for DEMONSTRATION. **FREE Folder**  
**BENJAMIN AIR RIFLE CO.**  
 896 MARION ST., ST. LOUIS 4, MO., U.S.A.

## Say You Saw It in POPULAR MECHANICS

### Handy Mail Order List Little Library of Useful INFORMATION

- Here at amazingly low cost is the practical help and information you have always wanted. Articles in previous issues of Popular Mechanics have been classified according to subject and are now available in these handy reprint booklets.
- How to Use Measuring Tools—Micrometers, Calipers, etc.—106.
  - Power Driven Saws—74.
  - Drill Presses, Grinders, etc.—79.
  - Wood, Metal-Turning Lathes—81.
  - Filing Machine, Hack Saw, Cut-off Wheel, Shaper—82.
  - Lathe Tools You Can Make—101.
  - Workbenches—Tool Cabinets—47.
  - Spray Painting—94.
  - From Pattern to Casting—91.
  - Tool and Saw Sharpening—92.
  - Sharpening Drills, Wood Bits—93.
  - Successful Wood Turning—32.
  - How to Read Blueprints—71.
  - Metal Turning Lathe Kinks—99.
  - Operating a Metal Lathe—100.
  - Heat Treating, Hardening—102.
  - Working With Glass—103.
  - Servicing Electric Motors—75.
  - Electromagnets & Solenoids—44.
  - Transformer Constructions—41.
  - The Boy Electrician—43.
  - Soldering and Brazing—17.
  - Arc and Spot Welders—5.
  - Electroplating With Nickel, Chromium, Cadmium, etc.—86.
  - Plating Leather, Wood, etc.—87.
  - Lower Your Fuel Costs—31.
  - Curing Leaky Basements—45.
  - Fitting Home Game Room—55.
  - Indoor & Outdoor Fireplaces—88.
  - Backyard Gardening—39.
  - Lawn and Garden Novelties—72.
  - Trellises, Pergolas, Fences—76.
  - Lawn and Garden Furniture—77.
  - Playground Equipment—73.
  - How to Use Your Drill Press—125.
  - Making Servicing Trays—53.
  - Knots and Rope-work—105.
  - Working With Plastics—61.
  - Simple Home Improvements—104.
  - Ridding Home of Insect Pests—107.
  - Children's Room Furniture—51.
  - Jigsawed Novelties—57.
  - Doll House & Doll Furniture—60.
  - 25 Shelves You Can Make—64.
  - Novelties Turned on Lathes—62.
  - Inlay Pictures—Veneering—63.
  - Wood, Soap Carving—65.
  - Windmills & Weather-vanes—68.
  - Lamps from Wood, Metal—69.
  - Rustic Furniture—18.
  - Wood Finishing—40.
  - How to Fix Electrical Appliances—111.
  - Painting Your House—117.
  - Build Your Own Relays—123.
  - Rowboats, Small Dinghy—83.
  - Small Sail Boats—84.
  - Two Outboard Runabouts—85.
  - Build Own Canoe, Kayak—30.
  - Build Class-E Ice Yacht—22.
  - Auto Kinks, Shortcuts—10.
  - Lawn and Garden Equipment—124.
  - Motor-Driven Midget Cars—34.
  - Stop Auto Electric Troubles—95.
  - Photo Printers and Dryers—25.
  - Photo Darkroom Equipment—96.
  - Trick and Table Top Photos—97.
  - Home Movie Equipment—118.
  - Poultry Houses—108.
  - Guns and Decoys—109.
  - Re-Silvering Mirrors—70.
  - Chemical Experiments—93.
  - Cop Cabins, Tourist Houses—14.
  - Using Basic Tools—120.
  - Farm and Garden Tractors—8.
  - Building Extra Attic Rooms—23.
  - Attractive Basement Rooms—24.

- Sanders—80.
- House-Wiring—89.
- Hanging Wallpaper—38.
- Built-in Fixtures—78.
- Bird Houses—7.
- Magazine Racks—49.
- Clock Cases—50.
- Book Ends—52.
- Small Tables—54.
- Smoking Stands—56.
- Desks—58.
- Book Cases—59.
- Action Toys—66.
- High Flying Kites—67.
- Telescopes—20.
- Metal Craft—38.
- Small Looms—37.
- Gem Cutting—42.
- Photo Enlargers—1.
- Photo Kinks—98.
- Cleaning Formulas—11.
- Taxidermy—9.
- Photo Lighting—119.
- Training Dogs—35.
- Small Furnaces—36.

Check Titles Wanted, Clip, Mail with Remittance to  
**POPULAR MECHANICS PRESS, Dept. 23, 200 E. Ontario, Chicago 11**

6-ft. only  
**\$149**  
 Insist on  
*Evans*  
**TAPES "KING-SIZE"**  
 At your hardware store  
**EXCLUSIVE!** Belt clip for handy carrying.  
 Also available in 8, 10, 12-ft. lengths with free plastic utility case.



Do you work all day with  
**COLD FEET?**  
**NOW,**  
 at last, a new, modern, low priced electric foot warmer that will keep you healthy, happy and comfortable  
 Help prevent colds with...  
**ELECTRO MAT**



Check stand cashiers, secretaries, assembly line workers, housewives, office workers, theatre cashiers, machine operators, telephone operators, and many others throughout the country are now singing the praises of the Electro Mat. There is no further need to work all day with cold feet. Many colds, causing absenteeism and irritability, can be directly traced to cold feet. **Safe and Economical**

Size 14" x 21" light-weight, portable  
**PETERSON RUBBER MAT CO.**  
 5508 N. Halifax Arcadia, California  
 Consumes less power than a 75 watt light bulb.  
 Mail your check or money order today for **ONLY \$7.95**  
 PREPAID  
 Please send me \_\_\_ Electro Mats at \$7.95 each **IMPORTANT SAVING:**  
 If 6 or more ordered, price is only \$6.95 each.  
 C.O.D. Enclose \$1.00 deposit with order.  
 Prepaid  
 Name \_\_\_\_\_  
 Address \_\_\_\_\_  
 City \_\_\_\_\_ State \_\_\_\_\_  
 PLEASE PRINT CLEARLY

Get the Practical Help You Need With These

# POPULAR MECHANICS BOOKS

Use Them to  
Save Time and Money  
Make Extra Money  
Enjoy Hobbies and  
Pastimes  
Build Your Own Home  
Improve Farm Income  
Get the Most Out of  
Your Home Workshop  
Enjoy Better Living



You may examine any books that interest you. Full purchase price refunded on books returned in 7 days. Order by number in coupon below. All books are cloth bound and fully illustrated with photos, drawings, plans and working diagrams. Some in color. Only Popular Mechanics with 53 years of publishing experience and tremendous facilities can give you such practical and helpful how-to-do-it books so moderately priced. Order today. Prompt shipment and guaranteed delivery. Order by number in coupon below

## HOME SHOP

**SIXTY POWER TOOLS AND HOW TO BUILD THEM (1)** How to turn scrap and discarded materials into power tools at little cost. ....\$2.50

**POWER TOOLS AND HOW TO USE THEM (2)** Expert advice on selection and use of power tools for the home shop. ....\$2.50



**PLANNING YOUR HOME WORKSHOP (3)** The six basic power tools, floor plans, layouts, etc. ....\$2.50

**PORTABLE POWER TOOLS (4)** Practical information on the selection, care and use of portable power tools. ....\$2.50

**WELDING, BRAZING AND SOLDERING (5)** All the tricks and know-how of good soldering, welding, etc. ....\$1.75



## HOMES - BUILDING

**YOUR HOME AND HOW TO BUILD IT YOURSELF (6)** Hundreds of amateur builders have built this six room home themselves. ....\$3.00

**CONCRETE BLOCK HOUSE (7)** Built in many communities for less than \$4500. ....\$2.00

**RANCH HOUSE BOOK (Build It Yourself) (8)** Exciting new ranch type home with five or six rooms you can build yourself. ....\$3.50

**PRECUT HOUSE BOOK (9)** Smart, modern home featured in the March, 1955, issue. ....\$2.50

**GUIDE TO HOME REPAIRS (10)** Money and time saving information for home owners. ....\$2.50

**HOW TO BUILD YOUR OWN GARAGE (11)** Popular Mechanics own collection of designs, plans and building information for amateur builders. ....\$3.50

**HOME PLUMBING GUIDE (12)** Approved methods, materials and how-to-do-it instructions. ....\$3.50

**LAWNS AND GARDENS (13)** How to grow the best lawns and gardens in any neighborhood. ....\$2.00

**HOW TO PAINT WITH BRUSH AND SPRAY (14)** Includes interior and exterior painting, walls, woodwork and furniture finishing. ....\$2.50

## AUTO BOOKS

**AUTO OWNERS MANUALS** By C. E. Packer. Cover all models from 1940 to 1953.

**MANUAL FOR PLYMOUTH OWNERS. (15)** ....\$3.50

**MANUAL FOR CHEVROLET OWNERS. (16)** ....\$3.50

**MANUAL FOR FORD OWNERS. (17)** ....\$3.50

**AUTO REPAIR MANUAL (18)** How to avert auto troubles, make repairs on all makes, models, years. ....\$3.50

**POPULAR MECHANICS AUTO ALBUM (19)** Most fascinating of all auto books. From the first cars to the cars of tomorrow. ....\$3.00

## SAVE WITH THESE

**TELEVISION MANUAL (20)** New and timely money-saving complete repair guide for the TV set owner. ....\$3.00

**RADIO, TV AND ELECTRONICS HANDBOOK (21)** Ideal book for the student, beginner and experimenter. ....\$2.50

**ALL ABOUT UPHOLSTERY (22)** How to do all types of upholstery and save 50% of the cost. ....\$3.50

**ELECTRICAL FIX-IT BOOK (23)** How to repair and service all types of electrical appliances. ....\$2.00

## WHAT TO MAKE

**WHAT TO MAKE AND HOW TO MAKE IT** Volumes 1 to 12. Average 175 projects to volume. Each. Give volume number with prefix (WM) ....\$1.75

**12 Volume set (24)** There are over 3,000 projects in this 12 volume set. Complete instructions for each. ....\$18.00

**1956 Volume, (25)** ....\$2.50

**1955 Volume, (26)** ....\$2.00

**WHAT TO MAKE FOR CHILDREN (27)** 175 projects—things to make from discarded and inexpensive materials. ....\$2.00

**100 BEST WOODWORKING PROJECTS (28)** Cream-of-the-crop projects. Selected by Popular Mechanics editors for their popularity. ....\$2.00

**100 BEAUTIFUL PIECES OF FURNITURE YOU CAN MAKE (29)** Real furniture projects for the craftsman with few tools. ....\$3.00

**23 BOATS YOU CAN BUILD (30)** Build a boat for pleasure or profit—row boat, sail boat, power craft. ....\$2.00

**YOU CAN MAKE A STRADIVARIUS VIOLIN (31)** Full set of actual size plans in pocket in the cover. ....\$3.50

**WHAT TO MAKE WITH CONCRETE (32)** Covers walks, walls, pools, fireplaces and ornamental garden pottery. ....\$2.00



## OUTDOORS - SPORTS

**OUTDOOR SPORTS MANUAL (33)** 200 helpful articles for hunters, fishermen, trappers, etc. Hundreds of ideas on fishing tackle, guns, traps, boats, motors, etc. ....\$2.00

**FAMILY BOOK OF GAMES AND SPORTS (34)** Treasury of over 500 outdoor and indoor games of all kinds for children and adults. ....\$2.95

**GUIDE TO GOOD HUNTING AND TRAPPING (35)** How, where and when to hunt all game animals. Special section on birds, guns and hunting dogs. ....\$3.00

## FOR GIFTS - FOR BETTER LIVING

**HOW TO BUILD AND ENJOY YOUR OWN OUTDOOR KITCHEN (38)** How to build and use outdoor living facilities. ....\$2.00

**FOOD FOR HOME USE (40)** How to produce and conserve food from farms and home gardens. ....\$3.00

**FIFTY YEARS OF POPULAR MECHANICS (41)** The fascinating story of invention, scientific discoveries and mechanical developments from the pages of Popular Mechanics during its first 50 years. ....\$5.00



**ALBUM OF AVIATION (42)** A history of famous flights and flyers commemorating the anniversary of 50 years of powered flight. Hundreds of thrilling photographs and drawings. ....\$3.00

**PICTORIAL HISTORY OF AMERICAN TRANSPORTATION (43)** Fascinating gift book featuring 50 years of an America on the move. ....\$5.00

## FOR CHILDREN

**MR. WIZARD'S SCIENCE SECRETS (44)** By TV's famous Don Herbert. Collection of safe, simple experiments children can make at home. ....\$2.95

**BOY MECHANIC (45)** New edition with all new material. Hundreds of things a boy can easily make at home. ....\$2.95

**BOY SCIENTIST (46)** Perfect introduction to wonders of science for young people, ages 10-16. ....\$3.95

## FOR FARMERS

**HOG PROFITS FOR FARMERS (47)** A "must" book for every hog producer. ....\$3.00

**FARM MANUAL (48)** A book every farm home should have. More than 150,000 sold to date. ....\$3.00

**VETERINARY GUIDE FOR FARMERS (49)** Enables farmers to perform most veterinary tasks. ....\$3.95



## USE THIS MONEY BACK ORDER COUPON

**POPULAR MECHANICS PRESS, 200 E. Ontario St., Chicago 11, Ill.**

Send Popular Mechanics books as indicated by numbers.

Number				
Number				

Remittance for \$\_\_\_\_\_ enclosed. Send postpaid.

Send C.O.D. I will pay postman for books and delivery.

I understand I may return book within 7 days and you will refund the full purchase price. (Attach extra sheet to coupon if more space is needed.)

Name \_\_\_\_\_

Address \_\_\_\_\_

City \_\_\_\_\_ Zone \_\_\_\_\_ State \_\_\_\_\_

**AMAZING BARGAINS—SAVE TO 100%**  
**75 MOUNTED WHEELS AND MINIATURE CUTTERS**



Regular \$11.00  
 Value, Only

**\$4.50**  
 Post Paid

For cutting and grinding on wood, metal or plastic. Includes 26 mtb. wheels and points on 3/32" shanks; 24 miniature cutters on 3/32" shanks; 25 short shank min. cutters. Will fit all electric drills and hand grinders.

**FLEXIBLE SHAFT \$9.50 Value \$4.95**



Fits all electric drills & hand power tools. 35 3/4" long. Oilite bearings. Core of specially wound, high carbon steel wire in flexible steel casing. Will accommodate tool shafts up to 1/4" dia. For lathes, electric drills, etc.

10 Hi-Speed Steel & Carbon Drills \$1.00  
 Popular Sizes up to 1/4" Post-paid \$2.75

5 Woodworkers Drills \$2.95  
 From 1/4" to 5/8" on 1/4" shank.  
 5 Hi-speed steel Drills \$1.95  
 1/4" to 1/2" Diameter.

**SCHUPACK SUPPLY CO.** 7331 Cottage Grove, Dept. PM-7  
 Chicago 19, Ill.  
**NEW ILLUSTRATED CATALOG, 10c**

**Find Uranium** with a professional type **GEIGER COUNTER**



Whether you prospect full time or part time, you need good equipment to make your efforts pay off! The **MAGNA PROBE Geiger Counter** is a full size unit designed especially for convenient use in the field. It has a transistor-amplified loudspeaker, adjustable tone pitch, 4 sensitivity ranges to 100,000 cm, and weighs only 3 lbs. It is furnished with an aluminum-wall counter tube, batteries, shoulder strap, instruction manual, and radio active sample. Right now, fabulous uranium strikes are being made! You, too, may hit-it-rich! Don't miss your chance, write immediately for free brochure containing complete information on the **MAGNA PROBE Geiger Counter**.  
**MAGNA PROBE CO., 6042 Mayfield Rd., Cleveland 24, Ohio**

**Say You Saw It in POPULAR MECHANICS**

**"TAPEREDGE" JOINT-R-DISC** for CIRCULAR SAWS  
 Saves buying a jointer. Makes perfect joints, and more, finishes perfect circles. Made of hard temper aluminum alloy. Feed work as you would to a saw blade. Complete with 6 extra assorted abrasives and special cement. To order—give arbor size, 8" — \$4.00, 9" or 10" — \$5.50 **POSTPAID**. Sold on a money back guarantee. Free catalog.

**M. D. LEE TOOL CO.**  
 Box 22-M, Irondequoit Branch, ROCHESTER 17, N.Y.

**180° OFFSET DRIVE** (REDUCTION GEAR)  
 \$6 to 1. For use where tremendous power at low take-off RPM is desired. 6 gears rotate on self lubricated Hi-Speed Ball Bearings. 9/8"x1 1/4" shafts. 5"x8"x6" overall. \$12.97 **POSTPAID**. Illus. Cat. 10c.  
**KARL ORT, Dept. PM11, York, Pa.**

**Have a Motorized Shop at Low Cost**  
 Make Your Own **POWER TOOLS**

Popular Mechanics Book Shows How to Make 60 Machines from Scrap and Discarded Materials  
 Get **SIXTY POWER TOOLS** and HOW TO BUILD THEM, the sensational new Popular Mechanics book. Build your own lathe, drill press, sander, circular and hand saw and other power tools at a cost of only a few dollars each. Use old auto parts, pipe and wood and odds and ends that cost little or nothing. Every detail of construction is given in plain language you can understand and follow. Hundreds of pictures and plans show every step to follow in making the power tools you want. Clip this ad and mail with name, address and only \$2.50, or we will send C.O.D. (U.S.A.). You'll be amazed with the fine, practical tools you can make and how little they cost. Your money back if you return the book in 7 days. Order today.  
**Over 250 Pictures**  
**POPULAR MECHANICS PRESS, Dept. PT-1, 200 E. Ontario St., Chicago 11**

**800 Watt PORTABLE LIGHT PLANT**

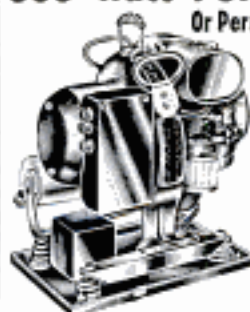

Or Permanent Power Plant

**BRAND NEW!**  
**SAVE!**  
 Regularly \$600  
**SURPLUS!**

Famous **HOMELITE** \$119.75  
 UNIT!

**Fully Guaranteed!**

Ideal for emergencies in maintenance and construction work... Powerful light for farms, logging camps, oil fields, mines, boats, docks, beaches, trailers.

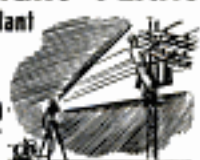

Exclusive Gov't. release shipped in perfect new condition!

**GENERATOR** Rated at 600-Watt D.C., 24 volts, but will deliver 800-Watts continuously. Compound wound generator. Entire unit is drip-proof, splash-proof construction for operation under most miserable weather conditions. Built-in filter eliminates radio static. Field rheostat for close output adjustment. Overload capacity well above rated output.

**ENGINE** Famous Homelite single cylinder engine, aircooled, 2-cycle. Easy rope start. Dust and rain-proof ignition. Built-in automatic governor. Fool-proof pressure vapor lubrication system. Adjustable jet-type carburetor.

Unit also charges batteries of 6, 12 and 24 volts. Includes powerful 600-Watt (500,000 candlepower) sealed beam light mounted on 5 ft. tripod. Light is removable and can be mounted anywhere. Can be turned in a complete circle or up and down as needed. Has 20 ft. connecting cable.

**INCLUDES**  
 Searchlight  
 4x Telescope  
 Accessories  
 Tripod

**INCLUDED FREE!** Extra parts worth \$200.00 that are sufficient to rebuild the entire outfit... including five extra 600-Watt Mazda lamps, PLUB waterproof, rubber CARRYING CASE for generating plant. (Plant weighs only 75 lbs.) Shipped from New York, Chicago, Nashville or Ft. Worth.

**SURPLUS! INDUSTRIAL STEEL TRAILER**

1,001 Uses for Contractors, Mfg. Plants, Farms, Etc.



Brand New!

**OUTDOOR TRANSPORTATION**  
 New construction and maintenance equipment can be transported long distances over unimproved ground to place of use — faster, safer!

**INCREASE PLANT PRODUCTION**  
 Now heavy loads of manufactured parts can be moved to next stage of production with ease and speed! Easily pulled by **ONE MAN**—or attach to jeep, car, tractor or truck (pulled by "T" tow bar.)

**PNEUMATIC TIRES and Timken Taper Roller Bearings**  
**Carries 2,500 Lbs.! Ready to GO! Only \$425.00**  
 Gov. Cost \$292.00

A natural for moving heavy, concentrated weights such as: Generating plants; Compressors; Welders; Power tools; Farm and industrial equipment. Ideal for moving manufactured parts in plant to next production operation. Rugged steel construction. Two standard 400X18 pneumatic tires and tubes. Bed dimensions are 25"x36" . . . wheel span can be increased to hold very large, wide items. Real bargain! Shipped fob from San Francisco, Chicago or New York.

**Smooth Rolling! Built to last a lifetime! Fully Guaranteed**  
**—Order While Both Guaranteed Values Last—**  
**FREE CATALOG of other Electrical Buys!**

**ROBERTS ELECTRIC CO., Dept. PM-330, 849 W. Grand, Chicago 22, Ill.**

**do it faster...better!**



**PLIERS, CHISELS, PUNCHES, SNIPS, ADJUSTABLE WRENCHES**

Buy wherever fine tools are sold in U. S. and Canada.

**KRAEUTER**

GIGANTIC  
SAVE-TO-70%

# MAIL SALE

WAR SURPLUS  
EXCESS INVENTORY  
BANKRUPT STOCK

## ARMY POWER PLANTS

Marvelous buys in new condition Gov't. surplus plants and generators. We pay freight!



- 1000-w, 115-v, 60-c, \$149.50
- 2000-w, 115-v, 60-c, \$289.50
- 3000-w, 115-v, 60-c, \$349.50
- 7500-w, 115-v, 60-c, \$590.00
- 3000-w, DC generator \$58.75

Send for free bulletin

## AIR COMPRESSORS—TANKS, Etc.

Save to 70% on air fittings, tanks, compressors, etc. See our catalog.

- Piston Air Compressor, 150 lb. .... \$18.91
- Air Corp 300-lb. Pressure Tank .... \$6.79
- Auto Pressure Switch for Motor .... \$4.95
- Professional Paint Spray Gun .... \$9.95
- Deluxe Air Kit complete .... \$45.49

## NAVY CENTRIFUGAL PUMP



Leading make. All bronze ball bearing hi-capacity. Complete with pulley, 1 1/2" inlet, 1 1/2" outlet.  
• Will pump up to 140 GPM. Pressure to 65 ft. Suction lift to 18 ft. Gov't. Cost \$65.50. Prepaid ..... \$24.61

## SPECIAL LISTINGS

We list below some super prepaid-to-you bargains available in limited quantities only.

- \$150 G.E. Experimental Amplifier \$6.97
- \$40 Pressure 8" Gauge 100 Lbs. \$9.17
- \$15 Gov't. Sleeping Bag with Cover \$5.74
- \$3 Finest Wood 1"x16" Chisels \$1.19
- \$150 5-Row Weed Spray Outfits \$97.65
- \$30 Electronic Experimental Kit \$4.99
- \$15 Army First Aid Chests \$6.95
- Eastman Film and Paper—savings to 70%!

## HYDRAULIC HAND PUMP

Build your own arbor press, wagon unloader, shop tool tester, etc. Genuine brand new Blackhawk hi-pressure hydraulic pump system. Complete unit including reservoir, check valve, etc. Will develop pressure to 8,000 lbs! Wt. 35 lbs. Gov't. Cost over \$100. Prepaid ..... \$23.95



## SPECIAL OF THE MONTH!

### CONTRACTOR-ARCHITECT LEVEL

Excellent highly accurate professional instrument made by leading manufacturer. Ideal for setting foundations, grading, farm contouring, surveying, etc.  
Powerful erecting optical telescope micrometer adjustment, polished graduated degree scale, sensitive spirit bubble, etc.  
Furnished complete with 8 1/2-ft. 3-sec. rod, fine tripod and polished wood carrying case.  
Our 4-star buy!  
Prepaid to you.....

**\$39.15**

## SPECIALS FROM PREVIOUS ADS

- Step-by-step Telephone Switches ..... \$12.91
- 110-V Selayn Motors ..... Fr. \$12.97
- Finest Heavy 10x12-ft. Tarp ..... \$11.99
- Giant Light with Motor ..... \$48.90
- AC-DC Power Rectifier ..... \$15.61
- Finest 7x50 Binoculars ..... \$36.95
- Gov't. Prismatic Periscopes ..... \$2.99

We pay transportation to you except where stated "FOB Lincoln." Write for large FREE Catalog.

**BURDEN SALES COMPANY**  
813 "O" St., LINCOLN, NEBR.



Ideal gift for your do-it-yourself friends. ACE SUPER SET, 39 pieces, best quality taps and adjustable dies in 17 popular sizes and threads. Complete with wrenches and accessories in unbreakable plastic box. Price \$18.95 postpaid. Write to:  
**TAILORED TOOLS, INC.**  
Sharon, Mass.

## AUTOMOBILE RACING—Sixth Edition

Full description with over 100 illustrations of new fast racing creations. Working drawings with step by step building instructions for successful Ford 60 Midget—Model A Roadster—Offenhauser Dirt Track Racer—Miller 158.5 m.p.h. Racer. Details on axles, frames, engines, bodies, etc., etc. Entrance Blank with rules and regulations. A book full of interest for every Auto Racing Fan, Driver, Mechanic and Owner. Money back if not satisfied.



ORDER NOW! \$1.00 POSTPAID!  
Sorry, No C.O.D.'s

POPULAR MECHANICS PRESS, 202 E. Ontario St., Chicago 11, Ill.

### Say You Saw It in Popular Mechanics

## NEW 1956 164-PAGE FREE CATALOG

FOR ALMOST 30 YEARS THE OUTSTANDING \$\$\$-SAVING BUYING GUIDE FOR EVERYTHING IN RADIO, TV AND ELECTRONICS!



**EXPERIMENTERS! BUILDERS! HAMS! SERVICEMEN! ENGINEERS!**  
Always right at your fingertips, whatever your need — Radio or TV parts, Ham Gear, Builders Kits, Test Instruments, Public Address, Recorders, Hi-Fi, Books — plus a large selection of hand and power tools and 21 pages of interesting Bargains!

## BURSTEIN-APPLEBEE CO.

Dept. R, 1012-14 McGee St., Kansas City 6, Mo.  
Send Free B-A Catalog No. 561.

SEND FOR IT TODAY!

Name.....  
Address.....  
City..... State.....

MAKE A "Stradivarius" VIOLIN

—For Pleasure  
—For Profit  
—For Your Own Use

BOOK AND PLANS ALL YOU NEED

You Can Do It at Little Cost!  
It's Easy! It's Fun!

Here is the "top" of all home crafts projects. Make a violin—a replica of a famous "Strad"—the original of which sold for \$80,000.00. Joe Reed who has made hundreds of fine violins makes the job so easy —so inexpensive—on his new book, "You Can Make a 'Stradivarius' Violin." You don't need any tools. Reed shows you how to make all the tools you need from old table knives, worn out files, sheet metal, etc. Eight full-size plans, 16x23 inches, folded into the book give you every detail in actual size.

**Violins Bring High Prices**  
Make a violin and you probably will never want to sell it. But good tone modern violins bring terrific prices, yet the materials cost comparatively little. With Reed's plans and step-by-step instructions you can make such a violin for yourself. 15 chapters guide you in selection of wood, fashioning the belly, back, sides, mold, lining, neck, scroll, purfling. Other chapters cover varnishing, finishing, stringing. Others show how to make tools and clamps at little or no cost.

**Order Book Today. Money Back if Not Satisfied.**  
Make your own violin for pleasure or profit. Get book and plans now. Clip this ad and mail with check, money order or cash for only \$3.50 or we will ship C.O.D. Money back in 7 days if not satisfied.

**FULL SCALE PLANS INCLUDED**  
Working plans, drawn to full scale, are included in a special pocket inside the book where they may be withdrawn for quick and easy reference.

**POPULAR MECHANICS PRESS** Dept. 30, 200 E. Ontario St., Chicago



**Complete Instructions**  
**8 Actual Size Plans**  
**How to Make the Tools You Need**  
**Where to Get the Materials**  
You trace or work direct from actual size plans. No measurements to translate or confuse you. You see the entire violin in the plans. You read the how-to-do-it instructions in the book.

\$3.50 Cloth Bound



# Build a Better Garage for One Half the Cost!

Get New Popular  
Mechanics Book Be-  
fore You Build, Buy  
or Plan Any Garage

How to Build Your Own  
**GARAGE**

Over  
500  
Pictures

Build It Yourself or  
Have it Built—Either  
Way You Save and  
Get a Better Garage

## The Answer to All Garage Problems

Here is the answer to every garage problem. If you can use a hammer and saw, you can save hundreds of dollars on a fine new, modern garage. Get "How to Build Your Own Garage," Popular Mechanics' simplified How-to-Do-It book for the amateur builder and follow the pictures and instructions. If you prefer to have your garage built by others, get this book first for it can solve any garage problem you may have.

Prepared especially for the inexperienced builder by Wayne C. Leckey, associate crafts editor of Popular Mechanics, with the assistance of many builders, manufacturers and associations in the building, lumber and hardware fields. It TELLS HOW in simplified, step-by-step instructions—SHOWS HOW with hundreds of plans, diagrams and actual photographs.

### Money Back Guarantee

Mail the coupon for "How to Build Your Own Garage" today. Use the book for 7 days and return it for full refund if it does not please you. You can't lose under the P. M. guarantee of satisfaction or your money back.



Two-car frame garage amateur can build and getting garage under cover with large sheets of plywood. Both illustrations from the book.

### 25 Designs to Choose From

Every type—every style—every size. All shown in actual photographs to help you make your own choice. Actual building plans available for many of the garages shown.

## Use This Money Back Coupon

POPULAR MECHANICS PRESS, Dept. GB-2  
200 E. Ontario St., Chicago 11, Ill.

Send at once, "How to Build Your Own Garage" under your 7 day trial, money-back guarantee.  Remittance for \$3.50 enclosed. Send postpaid.  Send C.O.D. (U.S.A. only). I will pay postman \$3.50 plus charges.

Name \_\_\_\_\_

Address \_\_\_\_\_

City \_\_\_\_\_ Zone \_\_\_\_\_ State \_\_\_\_\_

## Save...FACTORY TO YOU! CLEAR PLASTIC AUTO SEAT SLIP COVERS



**HEAVY  
DUTY  
8 GAUGE**

MADE OF

**\$4.95**  
each

**Firestone**

**Velon®**

**PROTECTS** upholstery from children's shoes, pets' dirty paws and shedding, grease and dust. No installation problems . . . custom tailoring allows covers to slip on or off in just seconds. Water repellent . . . cleans with just a wipe. Fits all cars. **SAVE!** Just one cleaning bill could more than pay for these high quality covers!

**SOLD BY  
MAIL ONLY!**

**Money Back  
Guarantee!**

**AUTO COVER MFG. CO.**

Box 15701, Los Angeles 15, California

Enclosed is \$\_\_\_\_\_ for \_\_\_\_\_ covers

Make \_\_\_\_\_ Year \_\_\_\_\_ Body Style \_\_\_\_\_

Front Seat \$4.95 . . . Rear Seat \$4.95  
(including tax and postage)

NAME \_\_\_\_\_

ADDRESS \_\_\_\_\_

CITY \_\_\_\_\_ STATE \_\_\_\_\_

**\$50.00  
PER  
DAY  
AND  
MORE**

**SERRATING  
AND SHARPENING  
TABLE KNIVES**

**SAW-KEEN** PORTABLE, ELECTRIC,  
EASY - TO - OPERATE

Be your own boss, work anywhere, full or part time. Every restaurant, hotel, drive-in, etc., repeat customers. Serrated (saw-edged) table and steak knives in great demand. \$98.50 investment returns first week. Guaranteed. Write today for proven daily profit plan.

**CUTTER-CRAFT** 58-R SOUTH RAYMOND  
PASADENA 1, CALIF.

**PROTECT  
YOUR  
ENGINE!**

**45¢**  
a quart



**INSIST ON WOLF'S HEAD**  
100% PURE PENNSYLVANIA

Scientifically fortified—protects against sludge, corrosive acids, rusting—even in severe winter driving.

Free-flowing—assures easier starts, less battery drag. Protects engine parts with rich, tough lubrication.

Enables modern, high-compression engines to deliver maximum power. *You'll use less oil, too, with WOLF'S HEAD!*

**WOLF'S HEAD OIL REFINING CO., INC.**  
OIL CITY, PA.

**THIS INEXPENSIVE EASY-  
TO-OPERATE MACHINE**

Brought Mr. C. H. R. of Ohio  
**\$3,688.20**  
in one season



You, too, can be your own boss in this fine business. Spare or full time, earning big money in your garage or basement.

Yes, C. H. R. is only one of many who write about their success with the Universal Lawn Mower Grinder. Another says, "I am buying a home and my Universal is going to be a tremendous help paying for it." Whether you are buying or want to buy a home, want the security of a sound future or living comforts extra money brings, you owe it to yourself to send the coupon today. Investigate our success plan now—get everything you need to develop a good profitable business of your own.

**ROGERS MFG. CO., DEPT. M-115, LINDSEY, OHIO**  
**Fill in and mail this coupon now**

Rogers Mfg. Company  
Dept. M-115, Lindsey, Ohio

Gentlemen: Please rush me details about the profit possibilities of the Universal Lawn Mower Grinder.

NAME.....

ADDRESS.....

CITY..... STATE.....

**ROGERS  
MANUFACTURING  
COMPANY  
LINDSEY,  
OHIO**



**BUILD**  
your own **SMITH  
AIR COMPRESSOR**

Operates spray guns, rock drills, tampers, paving breakers, sandblasting... Uses only 1 gallon of gas an hour! Famous the world over! Capacity 60 cu. ft.; pressure up to 100 lbs. per sq. inch. Just order the Smith Compressor Head and Accessories with complete instructions for assembling. All you need is a Ford Motor and shop facilities. Head equipped with high speed compressor valves; automatic unloading and idling.

Write for complete information!

**GORDON SMITH & COMPANY, Inc.**  
410 College Street • Bowling Green, Ky.



**SMALL! POWERFUL!**

**ECONOMY  
TRACTOR**

Unequaled value! Low price!

America's finest tractor. Ruggedly built. Easy to operate, 190 lbs. Borg-Warner clutch, trans. and diff 140 to 1 reduction. 40% more drawbar pull than ordinary tractors 8-1/4 H. P. engine. 20 quick change implements. HOOD, FENDERS.

Thousands  
in Use

Write for  
complete  
details.

**Engineering Products Co.**  
915-K-11 Niagara Ct.  
Waukesha, Wisconsin

**VARIABLE SPEED** HYDRAULIC POWER TRANSMISSION



It has infinite speeds 0 to 550. Reverse. Automatic Overload Protection; Adjustable Torque up to 180 inch pounds. 3/4" Input and Output Shafts. It will handle 1/2 to 1 1/2 H.P. Motor. Case measures 7 1/2" long, 7" high, 6 1/2" wide. VALUE OVER \$300. Shipping Wt. 25#. On C.O.D. Orders we require a 10% only Deposit.

**\$54.50**

Fob. Chicago

**DIRZIUS MACHINE SHOP "H" 1423-25 So. 52nd Ave., Cicero 50, Ill.**

**SAVE MONEY on SURPLUS PARTS for  
MILITARY TYPE TRUCKS & JEEPS**

4 & 6 wheel drive. FREE catalog to Jeep owners. State make truck or Jeep. (New Jeep Tops, steel or canvas all models). **AMERICAN AUTO PARTS CO., Inc., 1830 Locust, Kansas City, Mo.**

**POWER HACKSAW \$55.75**

LESS MOTOR  
F.O.B. Benton Harbor

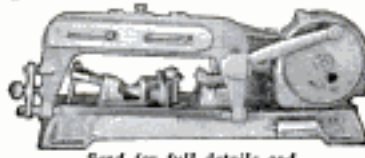

• Rugged cast iron construction. Wt. 56 lbs., bronze bearings. Draw cut. Auto. return lift. Auto. shut-off. Five swivels 45°. Cap. 4"x4".

Send for full details and name of nearest dealer.

**EXCEL MACHINE TOOLS** Dept. PM-115 BENTON HARBOR, MICHIGAN

**SAY YOU SAW IT IN  
POPULAR MECHANICS**



**MAGNETS 225# PULL**  
GENUINE ALNICO—NEVER WEAKENS

**AMAZING, PERMANENT MAGNETS—WILL NOT WEAKEN! NON-ELECTRIC**

Retrieve guns, tackle, tools and other steel items from lake, river, plating tanks, drains or other hard-to-reach spots. Recover drills, taps, etc. from sweepings. Clear alley of harmful tacks, nails. Many other uses. Pays for itself quickly. GUARANTEED. Try any magnet one week. Money refunded if you are not well pleased.

No. M-725 (Weights 54 oz.) Has pull of 225 lbs. on steel block. \$15.00

No. M-625 (Weights 70 oz.) Has pull of 125 lbs. on steel block. \$ 8.50

No. M-525 (Weights 38 oz.) Has pull of 75 lbs. on steel block. \$ 6.00

No. M-500 (Weights 13 oz.) Has pull of 50 lbs. on steel block. \$ 4.00

No. M-101 U-shaped Magnet (Wt. 2 1/2 oz.) Pull of 6 1/2 lbs. 2 for \$ 1.50

No. M-30 Hobbyist assortment of five small magnets. . . . \$ 1.00

No. M-48 Powerful Hot Pad Magnets. 8 for \$1.00. 30 for \$ 3.00

Send Money Order or Check. We pay postage. No C.O.D.'s.

**MIAMI MAGNET COMPANY, 3240 N. W. 27th Ave., Miami 42, Fla**

**POPULAR MECHANICS**

## STOP FROZEN PIPES!



### ELECTRIC HEATING TAPE

**Self Adhesive! Just Wrap It On and Plug It In—It Sticks!**

Easily, quickly applied. Protects water pipes, oil lines, pumps. Use thermostat for automatic operation.

**Low Cost . . . Do-It-Yourself Prevent Costly Repair Bills**

Trouble free, lasts for years. Protect to 50° below zero with WRAP-ON fiberglass insulation. No tools needed.



FARM



HOME



TRAILER

send today for your

**FREE**

WRAP-ON instructions

At hardware, electric, farm, poultry and trailer dealers.

**WRAP-ON**

Co., 340 W. Huron St. Dept. 608, Chicago 10, Ill.

## LOOK! All New - All Precision - All Deluxe SUPERSHOP MODEL X

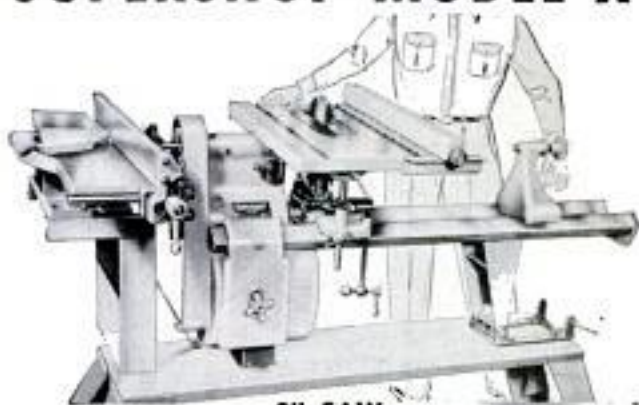

8" SAW

**WE PAY ALL FREIGHT FOR YOUR FREE HOME TRIAL**

**ONLY \$139.50 EASY PAY PLAN**



Vert. Drill Press



Hor. Drill Press



8" Sander



30" Lathe



5" Grinder

Never before have you seen so much deluxe, precision-built power tool workshop at any price! Designed for the man who wants the best. Massive cast and precision-machined headstock, self-centering inverted "V" bedways (like precision metal lathes), exclusive non-friction speed changer, extra-large cast and precision-ground saw table. 100% ball bearing. Lifetime-lubricated. You save by ordering direct from factory. You are invited to test Supershop Model X in your home FREE. Mail coupon or postcard for FREE brochures, photos, details, specifications, accessory list — and amazing freight prepaid FREE HOME TRIAL PLAN. All free.

**MAIL COUPON OR POSTCARD TODAY**

**FREE CATALOG**  
NEW '56 MODELS  
**BOAT KITS**

**BUY DIRECT—SAVE UP TO 2/3 FACTORY TO YOU!**  
No Dealers! You SAVE the dealer's Profit

**23 MODELS—8 to 19 ft.—\$39 up**  
Finest quality Boat Kits at the lowest prices in history! Mahogany decks. Easy to build. Also: FIBERGLAS—ACCESSORIES—TRAILERS

**CRAIG—CRAFT (DEPT. 20) TONAWANDA, N. Y.**

**AGENTS — SELL TOOLS! GUNS! CAMERAS!**

Buy tools, photo equipment, sporting goods, jewelry and thousand other nationally advertised products at big discounts. Big profits selling to others. Postcard brings free plan.

**AMERICAN BUYERS SERVICE** HERTEL STATION, DEPT. 15 BUFFALO 16, NEW YORK

**Get up to 40% off**

### "GLUEKY'S GLUE ADVICE"

#### HOW TO BUILD YOUR OWN FURNITURE

## USE ROGERS GLUE

Send 15 cents with your name and address to Rogers Glue, Gloucester, Mass.

- 1) Get a full-size jar of Rogers Glue.
- 2) "Rogers Book of Woodworking Shop Notes," for 1955, jam-packed with helpful ideas.
- 3) A set of exciting new woodworking project plans of easy-to-make beautiful furniture and toys.

**SAVE MONEY — HAVE FUN — EARN MONEY**

Your woodworking hobby can save you money for repairs or the purchase of new furniture . . . It can make profits for you in the sale of pieces made in your spare time. Send for your plan, notes and Rogers Glue. Now! Ask for Rogers Glue at your Local Hardware Store.



**ROGERS**

*the best* LIQUID FISH GLUE  
GLOUCESTER, MASS.



Over 3,885 lbs. Actual Tensile Strength per Square Inch.

**POWER TOOLS, INC.** 177 Yates Avenue  
Beloit, Wisconsin

NAME \_\_\_\_\_

ADDRESS \_\_\_\_\_

CITY \_\_\_\_\_ STATE \_\_\_\_\_

# Amazing Tyler SPYRAL BLADE

**SAWS ANY MATERIAL IN ANY DIRECTION**  
metal, wood, plastics etc. up or down, right or left, even in circles!

World's safest saw blade.

**A MUST for every Workshop!**

Does what no other Blade can Do  
Fits Standard Coping Saw or Hacksaw Frames  
NO special adapters needed! • World's safest saw blade.

You'll find hundreds of uses for Tyler Spyrals. There's nothing like them! The first important improvement in blades since the invention of the saw. Fun to use - cuts so fast and easy; no chipping or tearing—leaves clean smooth edge.

At your Hardware dealer or send **\$1** for package of 12 Spyrals Coping Saw Blades or 3 Spyrals Hacksaw Blades.

give that Boy or Girl a  
**TYLER MAGIC SAW KIT**  
Makes hundreds of useful items so easy - just moisten gummed patterns and apply to wood supplied in Kit, then saw. Safe - can't cut the hand! Kit consists of magic saw frame, 3 Spyrals blades, 12 gummed patterns, screws, brads and cutting material. Only \$1.98 plus 35c postage. Order direct from factory. No C.O.D.'s.

**TYLER MANUFACTURING COMPANY** 1005 W. Arbor Vista Ave., Inglewood, Calif.

**These brand new SPERRY Gun Sights**  
Cost the Air Force nearly \$200  
Can you use one at this pennies-on-the-dollar price?



**\$5.88**  
TAX AND POSTPAID

7.45 west of Mississippi  
**EXPERIMENTERS  
INVENTORS  
TINKERERS  
LABORATORIES**

Here's a partial list of  
of what's inside!

- Silver Surface Optical Mirrors
- Electrical Fittings, Switches
- Big, 1½-inch F:1.9 Optical Lens
- Scores of fine Gears... Cams
- 3 Miniature Differentials
- A 24-volt Rheostat and Lamp

Frankly we don't know what you'll do with these remarkable instruments! But we do know they're about the most amazing and intricate things we've seen. They're the original, super-secret (now declassified) Sperry gun sights that made our gunners the most deadly in the war. They're chock full of marvelously made gears, cams, wheels and electrical equipment, and put together with the precision and accuracy of a fine watch! Many individual parts are worth more than the price you pay now for the entire unit! Dimensions, about 8x6x6 inches; weigh 8 lbs. Brand new in original government cartons. Send for yours today.

RUSH YOUR ORDER TO:

**JOSEPH SALES Co.** Rm. 506-1740 E. 12th St.  
CLEVELAND 14, OHIO



**INSTALL YOUR OWN FURNACE HUMIDIFIER!**

Enjoy healthy air! Fully automatic Combustioneer Humidifier is easy to install in any warm air furnace — coal, gas or oil. Can't rust, corrode, or leak. For 13" to 20" plenum, \$20. For 22" to 25" plenum, \$22. Both postpaid. Comes complete with all fittings and instructions. Check or Money Order.

**STEEL PRODUCTS ENGINEERING CO.**  
1241 W. COLUMBIA SPRINGFIELD, OHIO

best hardware... for hard wear

**® GRIFFIN HINGES**

at your hardware or building supply store

GRIFFIN MFG. CO., ERIE, PA.

**make your own Gems** 29.50 FOR

The Gem Maker comes complete with all necessary equipment, including a super-charged diamond blade for sawing, and all wheels for grinding, shaping and polishing; also complete instructions. The complete equipment as shown, less motor and belt, for only \$29.50. f.o.b., Burlington, Wisconsin. Write today for information and literature.

**B & I MANUFACTURING CO.**  
Dept. 5 Burlington, Wis.

**DO YOUR OWN SURVEYING:**

IT'S EASY to run lines and set grades with the ACE SURVEY-SCOPE... a simplified Transit. NO TECHNICAL EXPERIENCE NECESSARY! Instrument complete with 54" Extension Tripod, Plumb-bob and Universal Stand with 360° Horizontal and 120° Vertical Range. FREE CIRCULAR ON REQUEST. Money Refunded If Not Satisfied.

**ACE STEEL CO., 12401 Cloverdale, Detroit 4, Michigan**

POSTPAID \$29.75  
ADD SALES TAX IF ANY

**"DO IT YOURSELF"**  
IT'S EASY WITH  
**KESTER SOLDER**



Soldering's really a "cinch"... when you use time-tested, reliable KESTER... available everywhere.

FREE! "Soldering Simplified"... 16-page how-to-solder booklet. At your dealer or write direct.

**KESTER SOLDER COMPANY**  
4251 Wrightwood Avenue Chicago 39, Illinois

## SAVE ON PALLEY SPECIAL VALUES



**3400 RPM 1/2 HP POWER SAW**  
 COMPARES TO SAWS  
 SELLING UP TO \$49.50  
 WITH A 5 1/2" BLADE **Only 19.98**  
**RIPS - CROSSCUTS**  
**CUTS A FINISHED 2x4 LIKE A**  
**KNIFE THROUGH BUTTER**

A rugged, professional type, adjustable saw. Will cut any angle from 0 to 45°. Has an adjustable 0 to 7° rip fence. Safety-trigger switch on handle. Full 1/2 HP Universal AC-DC, 110-120 Volt, 50 cycle motor. Weighs only 8 1/2 lbs.

## GIVE THE KIDS A THRILL

### WITH THIS AMAZING RADIO RECEIVER

Here's a COMPLETE RADIO RECEIVER that picks up STANDARD BROADCAST STATIONS without using batteries or electricity! Just plug in the headset, antenna and ground wires and tune in your favorite program. You'll be amazed at the STRONG, CLEAR SIGNAL. Has a 100KC tuning range! Comes complete with Receiver, Antenna and Ground wires plus a Headset with two 2000 Ohm ear phones. **HOT A TOY - A Genuine Crystal Receiver!**



**WITH HEADSET ONLY 3.95**

### NAVY 6 POWER TELESCOPE

A remarkable Navy Superlens Binocular! It's originally designed as an Azimuth Telescope which mounted above the Gyro Compass. Has approximately 6 POWER MAGNIFICATION. Finest quality, fully coated lenses, Crosshair reticle. Adjustable eyepiece. Spare prisms. Two stop-on filters - one for sun the other for haze. Complete in wood case. New condition.

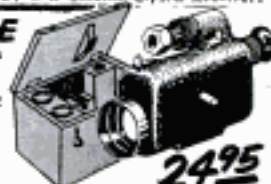

**24.95**

### HARDWOOD LEGS WITH BRASS TIPS

#### BUILD OR RESTYLE YOUR OWN FURNITURE

Beautifully turned, fully seasoned hardwood legs. Smoothly sanded and complete with brushed Brass tip and sturdy steel mounting plate. Available Finished or Unfinished - Finished units come in Blonde, Silver Fox, Mahogany or Charcoal Black. Please Specify type. Price per set of 4 with Brass tip.

SIZE	FINISHED	UNFINISHED	SIZE	FINISHED	UNFINISHED
4"	\$2.65	\$2.15	14"	\$4.40	\$3.95
6"	3.00	2.65	16"	4.75	4.40
8"	3.55	3.00	18"	5.35	4.75
12"	3.95	3.55	28"	6.25	5.35

### PRESSURE TANKS



G1 Type Stainless Steel. Shatterproof and rustless. Has reinforcing ribs and its pressure tested up to 400 PSI. Has a high safety factor. Both ends have 1/4" pipe ports. It's ideal for use as a buoy, for drinking water supply, air supply for underwater fishing, diving, painting, spraying, cooking, etc.

G1 - 12 1/2" x 24" Stainless Steel **10.95**  
 Comstar Resistant Steel Tanks **3.95**  
 D-2 Tank, 500 cu. in. capacity  
 A-4 Tank, 104 cu. in. capacity **1.95**



### VICKERS HYDRAULIC TRANSMISSION

Self-contained, constant torque at all speeds with variable volume, reversible piston pump which supplies piston hydraulic motor. Has 2 H.P. Automatic pressure dash pot for smooth control. Power output RPM - 0 to 1/3 input RPM in both directions. Input RPM 1800 continuous, 4000 intermittent. Ideal for Lathes, Dupliator setup on Mills, Conveyors, Small Cars, Drives, etc. **44.50**

4" SPLINE SHAFTS for input and power take-off on above. Pair \$2.50

INPUT & TAKE-OFF PLATE ASSEM. To adapt Trans. to pulley drive. Has 1/2" keyway shaft. High speed bearings. **20.00 SET**

### VICKERS VARIABLE DISPLACEMENT HYDRAULIC PUMP

Just Received in stock! Model AA2032B. Has a built-in relief valve set at 2225 PSI. Continuous operating pressure is 1850-2000 PSI. The displacement is .600 cu. in. per rev. Swivel type inlet and outlet ports are 7/8" male tube. Cost Government surplus, \$1500 each. **NEW 129.00**

### SAVE 50% ON NEW PALLEY HYDRAULIC CYLINDERS

Send Today for latest CATALOG showing our New line of Palley Hydraulic Cylinders. Built by us to meet the most rigid requirements.

### NEW JACK & HEINTZ 2-SPEED ENERGIZER

Used as auxiliary power source to activate aircraft starters. Has 2-speed control for 200 RPM low or 275 RPM high. Heavy duty gear box gives extremely high torque. Power 110-115V AC. Easy to convert to many power uses. **27.50**

### 180° OFFSET DRIVE

For use where tremendous power at low take-off RPM's desired. 6 gears rotate on self-lubricating, hi-speed roller bearings. 85 to 1 gear ratio. Shafts are 1 1/2" & 3/8" dia. All NEW! **12.95 NEW**

### NYLON ROPE



Finest Quality, Lustrous White. Has tremendous tensile strength.

SIZE	Strength	PRICE
1/4" Nylon	1300 lbs.	8¢ run. ft.
3/8" Nylon	2700 lbs.	13¢ run. ft.
1/2" Nylon	5000 lbs.	27¢ run. ft.
1" Nylon	18,000 lbs.	50¢ run. ft.

### SOUND POWER PHONES

Used by Navy for Gun Control. An ideal emergency communication system because each set is "sound" powered - no other power needed. Will reach any point-to-point in a radius of 1/2 mile. Each set includes 2 phones on chest plate, 2 headsets, button switches and approx. 35 ft. of wire. **PER SET 9.95**

### HOIST

Excellent for Machine Shop, Garage, Truck, Boat, etc. Has 2500 lb. lift capacity through a 24 to 1 gear ratio. Bronze worm gear drives. 18 ft. of high tensile strength 3/16" steel cable. **NEW!**

### HOIST MOUNTING FRAME

Specially designed for mounting the above winch. Frame only **4.50**

### PORTABLE WINCH HOIST

LIFTS 1500 POUNDS - Made originally as a Bomb Hoist. Has 21 to 1 gear ratio. A 40" tubular arm extension with a 3" pulley. Drum has 12 ft. of 3/16" steel cable. Operating handle has ratchet brake. For "awing about" loading. \$125 VAL. **22.50**

### Genuine Select PHILIPPINE MAHOGANY LUAN PLYWOOD



Ideal For Fine CABINET WORK, FURNITURE, Paneling DENS, OFFICES, HOTELS, etc.

Our prices are LESS THAN DOMESTIC PLYWOOD at WHOLESALE. This selected LUAN MAHOGANY meets the most rigid specifications. It is WEATHER and WATER RESISTANT. You'll be amazed at the beauty of this fine wood. Its rich golden elegance will thrill you. Rotary cut for beauty of grain. Both sides sanded and ready to use. Bonded with finest resin adhesive. Face side unpeined.

Available in three thicknesses - 3mm (approx. 1/8") 4mm (approx. 3/16") and 1/4". All orders shipped by Special Truck for lowest rates. No order accepted for less than 100 lbs. - equal to (8) 3mm sheets, (6) 4mm sheets or (4) 1/4" sheets.

3mm (1/8") x 3 ft. x 8 ft. \$5.00 VALUE <b>1.79 PER SHEET</b> Minimum order 8 sheets	4mm x 4 ft. x 8 ft. \$7.50 VALUE <b>3.89 PER SHEET</b> Min. order 6 sheets	1/4" x 4 ft. x 8 ft. \$9.50 VALUE <b>4.99 PER SHEET</b> Min. order 4 sheets
---	---	--

**TRANSLUCENT FIBERGLASS PANELS**  
 Special Purchase of 500,000 sq. feet. Save 40%. Finest Quality. In ALL lengths and widths. Full range of colors. As described in Oct., '54 issue of Popular Mechanics. Write for Free Booklet & Samples. 85¢ sq. ft. value... **49¢**

ORDER FROM THIS AD - Pay by Money Order or Check. Purchase Orders accepted from D&B firms. 50% dep. with C.O.D.s. Prices F.O.B. our store!!

**PALLEY SUPPLY CO** 2243 E. VERNON AVE., DEPT. PM-31 LOS ANGELES 58, CALIF.

# earn BIG PROFITS SHARPENING HAND SAWS

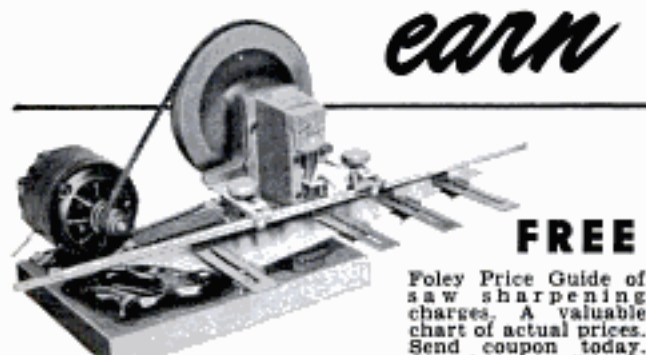

The Foley Saw Retoucher cuts perfect new teeth right over old ones in less than 1 minute, without removing saw handle. Makes filing easy. Takes all hand saws 4 to 16 points per inch. Relieves eye-strain. No experience needed.

### FREE

Foley Price Guide of saw sharpening charges. A valuable chart of actual prices. Send coupon today. No salesman will call.

**FOLEY MFG. CO.** 1170-S FOLEY BLDG. MINNEAPOLIS 18, MINNESOTA  
 Send FREE Price Guide & Foley Retoucher circular.

Name \_\_\_\_\_  
 Address \_\_\_\_\_

**IN YOUR CAR RADIATOR...  
GUARANTEED  
TO STOP RUST!**

**WATER STAYS  
CRYSTAL CLEAR  
FOR OVER  
ONE YEAR**

Just one can of  
MAC'S NO. 13 re-  
moves rust and scale  
... prevents costly  
repairs. Get MAC'S  
NO. 13 today.



**AT SERVICE  
STATIONS EVERYWHERE**

**MAC'S SUPER GLOSS CO., INC.**  
Los Angeles 42, California

Super-honed wheel and special axle, perfect design and workmanship guaranteed. Long life and perfect, easy cuts. Factory-sealed packaging for your protection.

**Red Devil  
GLASS CUTTERS**

**FREE** How To Cut Glass. Illustrated instructions on tools and methods of cutting glass.

**Red Devil Tools.** Dept. 150  
130 Coit Street, Irvington, N. J.  
Please send FREE copy of "HOW TO CUT GLASS."

NAME \_\_\_\_\_  
ADDRESS \_\_\_\_\_  
CITY \_\_\_\_\_ ZONE \_\_\_\_\_ STATE \_\_\_\_\_

**BARRON Drill Press TOOLS**



**FOR WORKSHOP AND  
INDUSTRIAL USES...**

Over 40 precision built woodworking tools and accessories... Hi-Speed Router Bits—Rotary Surface Sanders & Drum Sanders—Safety Shaper Cutters—Dovetail Cutters—Large Auxiliary Metal Tables—All Metal Shaper Fences—Spindle Adapters—Handy Bench Vises. Many other items indispensable for accurate, useful, versatile workshop use. Every tool sold on complete satisfaction or your money back. See your Barron Dealer. Ask for special folder — "24 Extra Uses for Your Drill Press."

**ROTARY PLANER**

- Planes • Rabbits
- Tenons • Panels
- Routs • Bevels

Only \$8.50 COMPLETE

**BARRON TOOL CO. INC.**  
302 Architects Bldg., Detroit 1, Mich.



**"FEATHER-LIGHT" LEVEL MAGNIFIES!**



**NEW EMPIRE ACRA-LITE NO. 1521**

ONE THIRD LIGHTER than aluminum, ACRA-LITE Magnesium levels handle like a breeze! Easier to read, too, with "Full-View" magnifying vial cover plates. You'll want yours now! Order from your dealer, or direct.

**EMPIRE LEVEL MFG. CO.**      **EMPIRE ACRA-LITE Level**  
10930 W. Potter Rd., Dept. PM,      No. 1521, 24", Only \$6.70  
Milwaukee 13, Wis.      28", \$7.60, 48", \$13.50



**BRONZE FOUNDRY**

Schools and Home Workshops

Make your own castings of aluminum, copper, bronze, silver. Foundry sets are available in three sizes including 2400 Deg. F. blast Furnaces. \$22.50; \$29.50; and \$42.00. f.o.b. Marysville, Kans. Free Circular.

**KANSAS CITY SPECIALTIES CO.** P. O. Box 6022, Dept. P-11  
MARYSVILLE, KANS.

**MACHINE TOOL RECONDITIONING**

**& THE ART OF HAND SCRAPING**  
—USEFUL FOR DESIGN, SHOP & INSPECTION WORK—  
SEND FOR FOLDER DESCRIBING ILLUSTRATED BOOK  
MACHINE TOOL PUBLICATIONS, 382 Holly Ave., St. Paul 2, Minn.



**MAKE YOUR OWN Modern  
COCKTAIL TABLE**

—with distinctive AIRFORM Metal Legs by Nord-Craft — Just attach (with furnished screws) to flat surface for expensive-looking decorator effect. Sturdy steel, black satin finish, brass ferrule. Leg tilts out for smart appearance, added strength. New life for old sofas, chairs, tables, TV, chests. Set of 4 legs prepaid: 6"—\$6.95; 8"—\$7.45; 12"—\$7.95; 16"—\$8.95; 20"—\$9.45; 22"—\$9.95; 28"—\$11.95. No C.O.D.'s. Enclose and send check or M.O. today.

**NORD-CRAFT INDUSTRIES** Dept. B  
Box 565, Madeira, Ohio



**The Modern PLASTIC  
for lasting Home Repairs**

PERMANENTLY mends cracks or holes in wood, tile, stone or plaster. Sticks and stays put—Does not chip, shrink or fall out. Easy to use. Economical. Mold it, chisel it, polish or paint it. The big 4-lb. can is obtainable from your lumber, paint or hardware dealer at \$1.25; or will be shipped direct postpaid (in U. S.) for \$1.50. Complete satisfaction guaranteed or your money refunded.

**DONALD DURHAM CO.**  
Box 804-T Des Moines, Iowa

## PORTABLE LIGHT PLANTS

### 1300-1500 WATT PLANT

115v, 60 cyc. AC. Push Button Start. Powered by a 3 1/2 HP. Clinton engine. Combines best output with easy portability. Provides emergency power for operating any oil burner, sump pump, freezer, television, lights, communications systems, etc. which require up to 1500 watts. (Item 22). Wt. 110 lbs. Reg. \$475 value, Factory price... **\$239.50**

1750 Watt Plant Powered by 4.5 Briggs engine starting & battery charging built-in. Factory price... **\$279.50**

### MASTER-LITE 2500 Watt Plant

110/120 v. 60 cyc. AC. A powerful plant, ruggedly constructed and yet designed for easy portability. Can be started by rope or built-in 12 v. electric push button starter. Built-in winding to charge battery. Powered by a big 5-1/2 HP Briggs engine, complete with all accessories. Includes control box, voltmeter, and handy plug-in power receptacle. An ideal plant for permanent or stand-by service. Wt. 220 lbs. Reg. \$945.00 (Item 23) Factory Price... **\$329.50**

3500 Watt Plant Push Button Start (Item 23)

115 v. 60 cyc. AC. Similar to above, but larger and 3 1/2 hp. capacity. Wt. 270 lbs. Reg. \$760. Factory Price... **\$379.50**

DUAL VOLTAGE 110/220 for any of above plants—\$10 additional

## 52 pc. SOCKET SET



Highest quality, guaranteed non-breakable sockets made by Husky. Beautifully matched chrome thin wall alloy absolutely the best. Contains a complete set of 52 sockets in 1/2" drive, 3/4" drive and 1/2" drive, plus all necessary extensions, handles, spacers, reversible ratchets, etc.; all uncoated, guaranteed against breakage. A beautiful set of tools that will handle any job in a big doghouse steel box. Wt. 17 lbs. (Item 24) List price \$62.00. Factory Special... **\$27.95**

## 44 Pc. SOCKET SET

(Item 506) Same unconditionally guaranteed, non-breakable sockets as above. Complete range of 21 sockets from 1/4" thru 1 1/2" drive; 6 7/16" drive, 1-1/16" drive and 1/2" drive, plus all necessary extensions, handles, spacers, reversible ratchets, sliding "T" head, all angle coupling, 1/2" speeder, 1/4" breaker, 3 pc. high chrome alloy combination wrench set and 8 pc. offset wrench set in big doghouse tool box with ample room for other tools. Reg. \$49.50. Wt. 16 lb. .... **\$21.95**

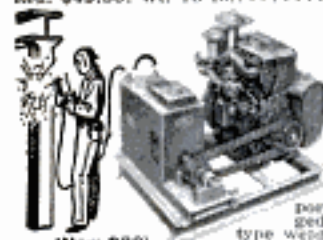

## MASTER DC ARC WELDERS

Now! a portable, rugged, industrial type welder with terrific performance, yet at a price hundreds of dollars less than you'd expect. Senior model meets for years of trouble-free, continuous service. High capacity DC welding unit enables you to tackle any job with confidence—easy welds anything up to 2" plate using from 1/16" to 3/4" rods. Built-in stabilizer and cooling system makes arc easy to strike and hold. Dual control rheostat provides low heat soldering, brazing and welding from 30 to 300 amps. Complete with instructions, guarantee and triple V-belt or flat pulley. You can pay more, but you can't buy a better welder.

WELDER ONLY—DUAL CONTROL MODEL. Same as above, but drive with your tractor, jeep or gas engine of 14 HP. or more. (Item 25a). Wt. 110 lbs. \$450 value. .... **\$119.50**

WELDER ONLY—STANDARD MODEL. Same as above but with single rheostat for heavy metal welding only. (Item 28). Wt. 110 lbs. \$400 value. Special... **\$99.75**

COMPLETE POWER MASTER (Illustrated above) powered by a 14.6 hp., air cooled Wisconsin engine. Wt. 450 lbs. (Item 250) Compares with welder costing \$1200. Factory Special... **\$449.50**

WELDING KIT Two 10 lb. leads, welding helmet, electrode holder, ground clamp. Sells only with welder at... **\$10.50**

## get MASTER MECHANIC'S BEDROCK FACTORY PRICES

## 600-700 WATT PLANT

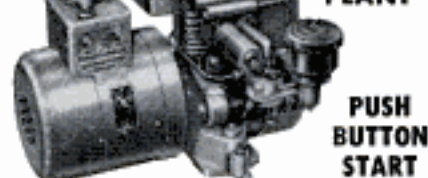

110 v. 60 cyc. AC. Powered by a rugged 2 HP. easy starting Briggs engine. No wiring necessary: just plug in and operate. Plenty of current for any oil burner, freezer, brooder, emergency lights, etc. which require up to 700 watts. Ideal for television and radios. Complete with voltmeter and built-in winding to charge 6 v. auto batteries. (Item 24) Wt. 75 lbs. Easily fits in car trunk. Be prepared if storm knocks out power lines. Regular \$275.00 value... **\$143.50**

1000-1200 Watt Plant (Item 45) same as Item 24 but larger generator and engine... **\$199.50**

## MASTER MECHANIC'S LIVE STEAM

in 30 seconds from a cold start!

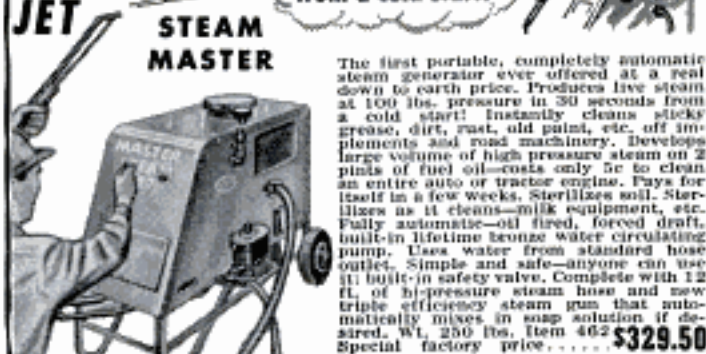

## JET STEAM MASTER

The first portable, completely automatic steam generator ever offered at a real down to earth price. Produces live steam at 100 lbs. pressure in 30 seconds from a cold start! Instantly cleans sticky grease, dirt, rust, old paint, etc. off implements and road machinery. Develops large volume of high pressure steam on 2 pints of fuel oil—costs only 5c to clean an entire auto or tractor engine. Pays for itself in a few weeks. Sterilizes soil. Sterilizes as it cleans—milk equipment, etc. Fully automatic—oil fired, forced draft, built-in lifetime bronze water circulating pump. Uses water from standard hose outlet. Simple and safe—anyone can use it built-in safety valve. Complete with 12 ft. of high pressure steam hose and new triple efficiency steam gun that automatically mixes in soap solution if desired. Wt. 250 lbs. Item 462... **\$329.50**

## EXTENSION CORD

heavy duty and very flexible. Neoprene 14-2 cable. 20 year quality. Wt. 12 lbs. (Item 185) 100 ft. Complete with rubber plug and outlet. A terrific buy at only **\$8.95**

No. 10-2 POWER CABLE. Heavy duty. Very flexible, rubber covered. 50 ft. with male and female fittings. Wt. 9 lbs. (Item 502a) **\$10.45**

No. 12-2 POWER CABLE. Very flexible rubber covered, special outside shield for grounding power tools, etc. 50 ft. (Item 199) Wt. 8 lbs. **\$4.95**. 100 ft. (Item 200) **\$12.95**

## HI-FLO Centrifugal PUMP

completely self-priming! No foot valve required! Tremendous capacity—100 gal. per min. Special impeller enables pump to handle mud, or sandy water. Simple to operate—simply start engine and watch the water go. Powered by a rugged, easy-starting 2 HP Briggs engine. Pre-lubricated sealed bearings for years of heavy low-cost service. Wt. 70 lbs. (Item 502) **\$134.50**

## 9 TON HYDRAULIC PRESS

A tremendous power hydraulic press, capable of exerting 18,000 lbs. pressure. Fits for itself many times over—straightening bent connecting rods, king pins, crankshafts, axles, link pins and bars—or pushing out frozen bearings and bushings. Developed pressure under perfect control and visible at all times on accurate gauge. Complete with both large and small anvils and dies to straighten any kind of curve or bend. (Item 404) Wt. 110 lbs. Actual list price \$300. Our special close-out price... **\$69.50**

## LESS THAN WHOLESALE

### GIANT 2000-2500 WATT PLANT

110-120 v. 60 cyc. AC. absolutely the best made—exclusive dynamicaly balanced armature heavy windings developed up to 5000 watt overload for motor starting. Skid mounted—portable. Powered by an easy starting Briggs or Wisconsin 6 HP engine—complete with all accessories; engine easily disconnected for other uses. Big outlet box, voltmeter, no wiring necessary. Ample current for all purposes. Factory warranty. (Item 31) Wt. 210 lb. Reg. price \$585. Special at... **\$299.50**

Same plant with electric self starter (Item 31a)... **\$359.50**

Generator only and control box... **\$169.50**

DUAL VOLTAGE 110-220 available on any of above models for \$28.00 additional.

### DIESEL LIGHT PLANT

(Item 1660) Diesel Master—11-12 kw. 110/220 v. AC single or 3 phase. 1800 rpm direct connected. Electric Self-starter. Engineered for permanent power where continuous low-cost, heavy duty service is important. Wt. 1350 lb. (Item 1660)

Reg. list \$3650.00 **\$1895.00**

### GAS DRIVEN PLANT. 10-11 kw

115-230 v. 60 cyc. AC. single or 3 phase, powered by 4 cylinder Wisconsin air cooled engine. Belt driven. Simple, reliable. 5 V-belt drive mounted on rugged steel skid. (Item 217) with crank start! Wt. 900 lb. Factory price... **\$1075.00**

Same plant with self-starter... **\$1145.00**

We make every type and size of light plants—Write, giving us your requirements!

## HEATING & VENTILATING FAN

(Item 10) Easily installed in furnaces, pipes, forces even heat to all rooms. Overrange removes kitchen smoke and odors. Powerful continuous duty motor. 110-120 v. AC. Mount in wall or ceiling to ventilate any area. Quiet, super-efficient fan moves huge volume of air. (400 to 600 CFM)

8" Pipe, wt. 5 lb. .... **\$6.85**

9" Pipe, wt. 6 lb. .... **\$7.85**

10" Pipe, wt. 7 lb. .... **\$8.85**

12" Pipe, wt. 8 lb. .... **\$9.85**

HEAVY DUTY FAN. Semi-enclosed motor, suitable for spray booths, restaurant exhausts, poultry houses, etc. 10" Fan, wt. 8 lbs. (Item 100) **\$11.95**

12" Fan, wt. 10 lbs. (Item 100b) **\$12.95**

## CONDITIONAIRE VENTILATING FANS

Save big money installing your own exhaust fan. Efficient propeller type blade moves huge volume of air quickly and effortlessly. Heavy welded frame pre-drilled for easy installation. Just cut opening and bolt in place. Continuous duty motor. Ideal for auto, restaurants, garages, barns, chicken houses, etc. Control manually or with thermostat.

Blade Opening CFM Wt. Item

16" 1814" 2925 19 lb. 305a **\$27.95**

18" 1914" 3600 27 lb. 305b **\$31.95**

20" 2114" 4100 30 lb. 305c **\$39.95**

## JET FLOW BLOWER

Tremendous air movement (1800 CFM) and quiet operation make this double inlet 10" turbine blower unobtainable for heating, cooling, drying and air conditioning. Ideal for attic or barn ventilation, converting gravity heating to forced air; spray booth exhausts, etc. Operates with any 1/4, 1/2 or 3/4 HP motor. Oversized, long life bearings. Includes variable speed motor pulley and belt. Dimensions 19" hi x 18" x 10 1/2". Outlet opening 13" x 11 3/4". Wt. 45 lbs. Item 245. Reg. \$54.00. Factory Special... **\$27.50**

HEAVY DUTY 3/4 HP motor for above **\$16.95**

12" TURBINE BLOWER Similar to above, but larger with 2400 CFM capacity. Wt. 65 lbs. (Item 245a) Reg. \$70.00. Factory Special... **\$34.50**

Send check or M.O. Prices F.o.b. Factory. 10 day Money back guarantee. SEND 10c for... **BIG 1956 Catalog** Burlington, Wis. DEPT. 60-L

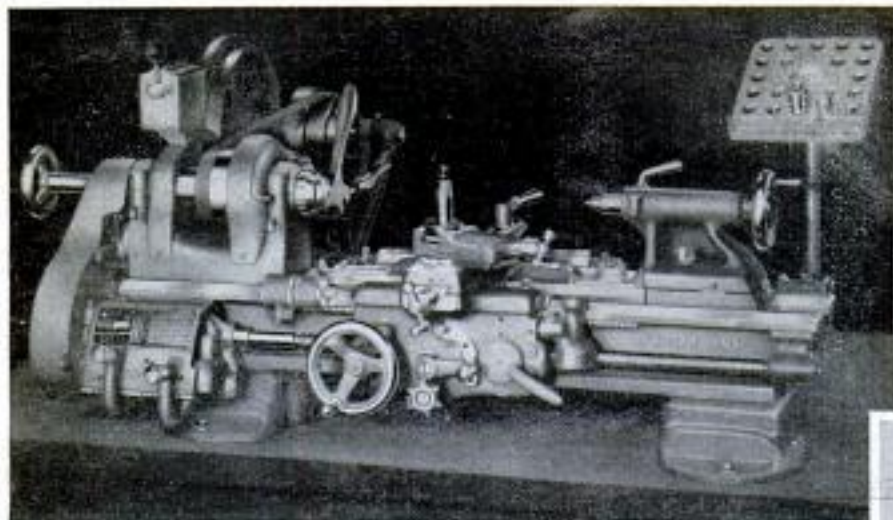

9" x 3" Toolroom Bench Lathe with toolroom attachments, less electrical equipment, f.o.b. factory, **\$608**

# South Bend

**Built Better**  
TO GIVE YOU A  
**Better Buy**



10" Pedestal Grinder with wheels and lights, but less motor, f.o.b. factory, **\$248**



7" Bench Shaper with light, vise and pressure lubrication but less metal bench and motor, f.o.b. factory, **\$551**

South Bend Machine Tools contribute to the skill and ability of the most expert technician because they are a match for the most exacting tolerances required. Versatile and easy to operate they enable you to do more and better work. Quality built throughout, they represent maximum value at minimum cost. Regardless of the kind of machine work you do, it will be to your advantage to learn more about South Bend. Mail coupon for complete information without obligation.

### TIME PAYMENTS

only **3¼%**

annual interest on original unpaid balance. Low down payment and monthly installments.

Compared with our costs  
**OUR PRICES ARE LOWER**  
than they were back in 1941

WAGES UP <b>155%</b>	MATERIALS UP <b>131%</b>	PRICES UP ONLY <b>49%</b>
-------------------------	-----------------------------	------------------------------

Prices are closely tied to costs. Costs are still rising. Buy now before increased costs necessitate higher prices.

**SEND INFORMATION CHECKED:**

**9" and 10" BENCH LATHES**     **10" to 16-24" FLOOR LATHES**     **DRILL PRESSES**     **TOOL GRINDERS**     **½" & 1" Collet TURRET LATHES**     **7" BENCH SHAPERS**

Name \_\_\_\_\_ Street \_\_\_\_\_

City \_\_\_\_\_ State \_\_\_\_\_

Building Better Tools Since 1906 • **SOUTH BEND LATHE** • South Bend 22, Indiana





**17 pt. Plug**  
**shows 11% fuel**  
**saving in**  
**stock American**  
**automobile!**



New electrode system still fires clean, hot and steady past 50,000 car miles! You may now order a set of these remarkable LIFE-TIME spark plugs from this advertisement . . .

**50,000 CAR MILES!** Before LIFE-TIME development, the spark plug was the most often replaced part of your car. Engineers agreed that "creeping paralysis," gradual electrode disintegration, carbon buildup, widening gap, burning, blistering, insulator failure could waste one gallon in ten. The LIFE-TIME plug goes far beyond the life of the average set of tires, the average battery, firing clean, hot and steady at 50,000 car miles! Most spectacular spark plug research breakthrough in 50 years allows unprecedented warranty. WE GUARANTEE GREATER GAS MILEAGE—GREATER ACCELERATION—A MAJOR POWER INCREASE—OR YOUR MONEY BACK.

**HOW 17 PT. FIRING WORKS**

Note electrodes closely. A circular arcing area (four concave segments). Gap being the same from all points. Electricity has property of arcing from coldest point. Current also arcs more readily from apex of two planes than from face of a flat, metallic surface. Note that there are 16 apexes (where two planes meet) — all the same distance from the center electrode.

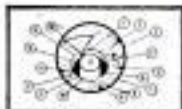

**SPARK ROTATES AROUND CIRCLE.** Normal heat and spark erosion are spread around the entire 360 degrees and around the whole circumference of the center electrode.

**PLATONIUM-NICKEL ALLOY ELECTRODES**— Metallurgists' first major step beyond platinum aircraft plug electrodes. Arcing points of this material have continued to function after the equivalent of 120,000 car-miles.

**SPECIAL SINTERED CORUNDUM INSULATOR**— Made of gem-like mineral which conducts heat 20 times better than ordinary porcelain. Special shape (seen beneath electrodes) is designed to vaporize and exhaust wet carbon and oil.

**INDIVIDUAL INSPECTION**— Each LIFE-TIME Spark Plug is tested for firing in oil and for resistance to 30,000 volts/CM.

**PERMANENT GAP**— After months of use, LIFE-TIME Spark Plugs mike at exact factory pre-gap.

**SELF-CLEANING FOR LIFE**— Confined gases exploding in chamber formed by multiple electrodes reclean arcing surfaces with each firing stroke.

**"THANKS FOR YOUR WONDERFUL LETTERS"**



The real test of a spark plug is "What will it do in my own car?" Take the above dynamometer test on a 1951 Buick Super. It shows an 8 horsepower gain with Life-Time 17-point plugs. That was a 12 1/2% hp gain at 2000 RPM. You don't need a dynamometer with Life-Time Plugs. You can feel the difference both in your ride and your pocketbook. Try a set and let me hear from you about them. Many Thanks.

*Frank Williams*

Inventor of the LIFE-TIME Spark Plug

CONTINENTAL MFG. CORP., CULVER CITY, CALIF.



**NOW ORDER REGISTERED SET FOR YOUR CAR AT POPULAR PRICE!**

this registered set of LIFE-TIME Spark Plugs in proper series (heat range and gap) for the car you indicate in coupon. NOW AVAILABLE FOR AMERICAN & EUROPEAN PASSENGER CARS, TRUCKS, BOATS, FARM EQUIPMENT, INDUSTRIAL ENGINES.

**DEALERS AND DISTRIBUTORS**— The LIFE-TIME Spark Plug is now in full production. Write for full details. Distributors: Please inquire as to status of your territory.

• LIFE-TIME Spark Plug Division  
 • CONTINENTAL MANUFACTURING CORP.  
 • Washington Blvd. at Motor Ave., Culver City 106, California

Gentlemen: Please mail postpaid \_\_\_\_\_ set(s) (registered) of LIFE-TIME Spark Plugs in proper heat range and gap for my car at \$1.19 per plug (set of six, \$7.14, set of eight, \$9.52). (Or send \$1 per set, balance C.O.D.) California residents add 3% tax.

• Make of my car is \_\_\_\_\_ year \_\_\_\_\_  
 • Model \_\_\_\_\_ No. cyl. \_\_\_\_\_  
 • I enclose \$ \_\_\_\_\_ (check, cash or money order)  
 • Name \_\_\_\_\_  
 • Address \_\_\_\_\_  
 • City \_\_\_\_\_ Zone \_\_\_\_\_ State \_\_\_\_\_

*"PRESTONE" BRAND anti-freeze protects  
your car from freeze-ups all winter long!*

## Guarantee

"National Carbon Company, A Division of Union Carbide and Carbon Corporation, specifically guarantees that 'Prestone' brand anti-freeze, if used according to printed directions\* in normal water cooling systems, will protect the cooling system of your car against freezing and clogging from rust formation for a full winter; also that it will not boil away, will not cause damage to car finish, or to the metal or rubber parts of the cooling system, and that it will not leak out of a cooling system tight enough to hold water."

*\*Ask your dealer for copy.*

You're SET, You're SAFE, You're SURE,  
when you find the **GREEN TAG** attached by your dealer



# PRESTONE

## ANTI-FREEZE

LIST PRICE **\$3<sup>25</sup>** A GALLON, 85¢ PER QUART

The terms "Prestone" and "Eveready" are registered trade-marks of Union Carbide and Carbon Corporation  
NATIONAL CARBON COMPANY • A Division of Union Carbide and Carbon Corporation • 30 E. 42nd St., N. Y. 17, N. Y.