

OWNERS REPORT ON CHRYSLER, HUDSON

POPULAR MECHANICS

MAGAZINE

WRITTEN SO YOU CAN

OCTOBER 1955
35 CENTS

**SPECIAL! 50-Page
Home Section**

Introducing the PM Young-Family House . . .
One-man remodeling jobs . . . An album of
medium-priced homes . . . How to bring your
kitchen up-to-date . . . Tips from color ex-
perts . . . Planning for future improvements
. . . An idea for your home on every page



**Build a carport
—Page 190**

THE PM YOUNG-FAMILY HOUSE—PAGE 153



Presenting

AMERICA'S
MOST BEAUTIFUL
OUTBOARD
MOTORS



NEW! THE JOHNSON
Javelin
30 HP . ELECTRIC STARTING
CONCEALED CONTROLS



Johnson Sea-Horses have a *new* sparkle—the flash of gorgeous styling in Holiday Bronze and Spray White! They're *smart*. They *gleam*. You'll recognize them at once as something new and beautiful in outboard motoring.

**NOW 9 MODELS
3 TO 30 HP!**

For 1956 there are *nine* Johnsons—a complete range of sizes—from the lightweight "3" to the spectacular new "30." Never before has Johnson offered such on-the-nose power selectivity!

Most breath-taking of all is the new Javelin, Johnson's custom model for distinctive outboard craft. Electric starting. Concealed controls. Holiday Bronze and Spray White, with bright wrap-around cowling of polished stainless steel. Owner's initials available. Here is *fashion* in outboard boating—HIGH fashion and no mistake!

See the new models at your Johnson Dealer's. Look for his name under "Outboard Motors" in your classified telephone directory.

Free! Write for your copy of the *new* Sea-Horse Booklet, describing all models.

JOHNSON MOTORS
400 Pershing Road, Waukegan, Illinois
A DIVISION OF OUTBOARD, MARINE
& MANUFACTURING COMPANY
In Canada: Mfd. by Johnson Motors, Peterborough

Johnson
SEA-HORSES
FOR DEPENDABILITY

FOR 1956

*JAVELIN	30 hp . .	\$580.00
*SEA-HORSE 30	30 hp . .	550.00
SEA-HORSE 30	30 hp . .	460.00
*SEA-HORSE 15	15 hp . .	450.00
SEA-HORSE 15	15 hp . .	360.00
SEA-HORSE 10	10 hp . .	320.00
SEA-HORSE 7½	7½ hp . .	240.00
SEA-HORSE 5½	5½ hp . .	215.00
SEA-HORSE 3	3 hp . .	145.00

*Electric Starting. Prices f.o.b. factory, subject to change. OBC certified brake $\frac{1}{2}$ " at 4000 rpm (30's at 4500 rpm).



Make all the storm sash for a 6 room house in one weekend

Reynolds Do-It-Yourself* Aluminum Sash Sections with New Corner Locks Make Job Faster and Easier — Make Stronger, Better Looking Storm Sash

You literally *snap* this new type of Reynolds Do-It-Yourself Storm Sash together . . . yet they fit more perfectly, are much stronger than ever before. With a little quickly gained experience you can complete a storm sash unit in half an hour. Light weight, non-rusting, never need painting.

storm sash in two panels and have the convenience of replacing only the lower section of storm sash with handsome aluminum screens in the Spring.

Your Reynolds *Do-It-Yourself* Aluminum dealer has complete storm sash and screen materials plus *free instructions* for building.

Interchangeable with Screens

The new Reynolds Do-It-Yourself Storm Sash materials are a perfect match with screen framing members. Build your larger



SEE your hardware or building supply dealer for complete instructions and materials. . . . He will help you determine your materials needs — he has a library of plans for all kinds of *Do-It-Yourself* Aluminum uses.

available in Canada

REYNOLDS DO-IT-YOURSELF ALUMINUM

Look for this rack at your dealer's!

*T. M. Reynolds Metals Company

REYNOLDS METALS COMPANY, 2500 South Third Street, LOUISVILLE, KENTUCKY

CHAMPION SPARK PLUGS SCORE 16th CONSECUTIVE GOLD CUP VICTORY!

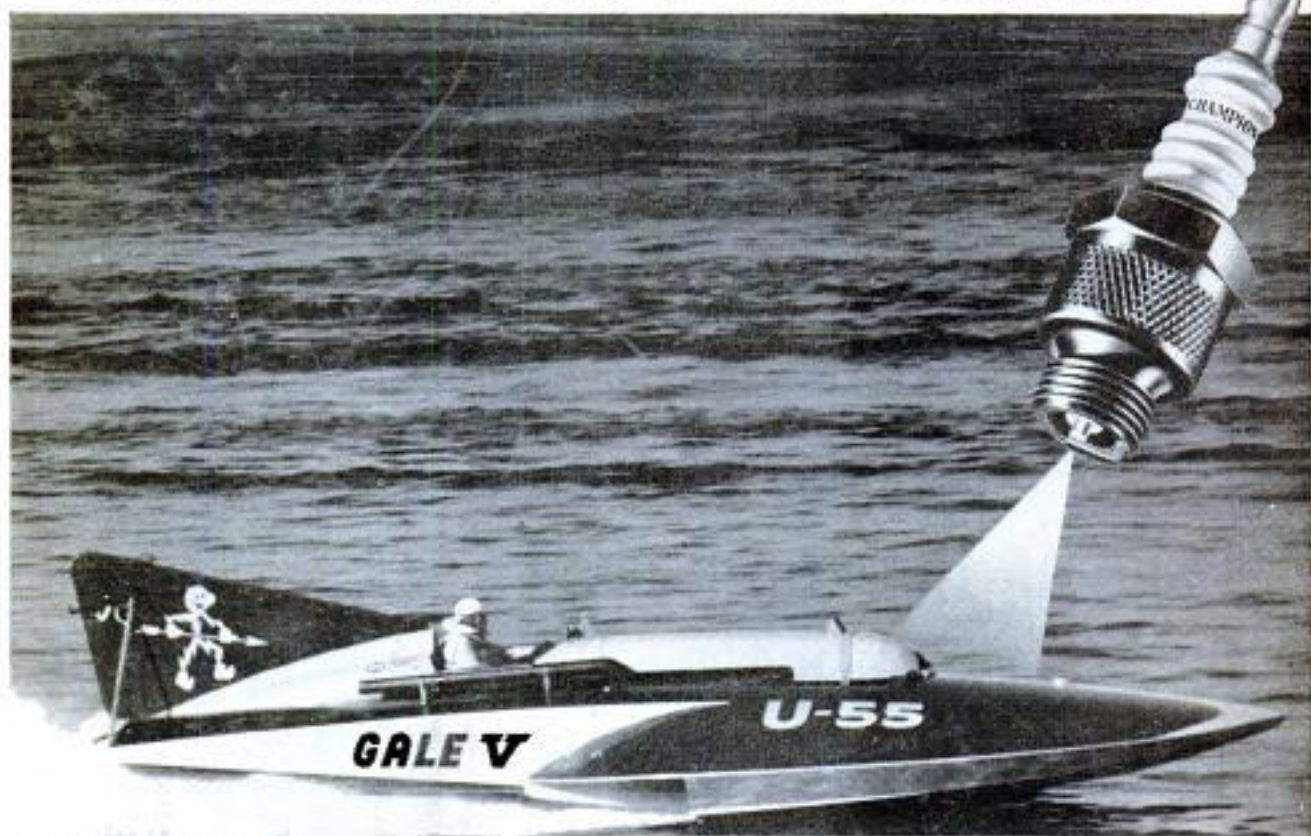

The Gold Cup, most coveted trophy in American hydroplane racing.

"We are thankful that we used Champions, the world's finest spark plugs, in our Gale V to win the Gold Cup." —Lee and Joe Schoenith

The sixteenth consecutive victory of a Champion-equipped boat in the Gold Cup, was preceded this year by Champion's twenty-fifth victory in the Indianapolis "500" and the winning of the Mobilgas Economy Run for the sixth straight year.

And to date in NASCAR Grand National competition 22 of 23 races have been won by Chrysler, Oldsmobile, Hudson, Chevrolet and Buick stock cars using Champions.

Any engine worth its gasoline deserves Champions. And now is a mighty good time to see your nearby Champion dealer and start getting all the performance you're paying for!

**EXCLUSIVE 5-RIBS
MEAN QUICK STARTS**

CHAMPION

Popular Mechanics Magazine

Registered in U. S. Patent Office and Canada

H. H. WINDSOR, Founder

H. H. WINDSOR, JR., Editor and Publisher



Next Month

GOT A SECRET? We have. We know what all the 1956 cars look like. And we're itching to tell you. But we can't say a word except about Ford, Lincoln and Mercury (see page 102). Next month, we'll be able to show you nine more of them. Right now, we're only giving you this sneak-peek of two of them in silhouette (you'll have to guess which of the nine these are—we won't tell). Secrecy is a big thing in Detroit. The car you see above proves it. Those slipcovers hide the exterior styling changes for 1956. Parts of the proving ground where this photo was taken can be seen from nearby hills. Long-range cameras have given competitors advance photos of new models in previous years. This year, the new cars are wearing slipcovers to foil the "enemy spies." In November, you'll see what they are hiding



Information not listed on articles in the index, starting on page 88, frequently is listed in the WHERE-TO-FIND-IT LIST, which is available to readers without charge. A copy may be obtained by writing to the Bureau of Information, Popular Mechanics, 200 E. Ontario, Chicago 11, Ill.

Published monthly by Popular Mechanics Company, 200 E. Ontario St., Chicago 11, Ill. H. H. Windsor, Jr., president; Wm. Harrison Peirce, exec. vice-pres.; D. F. Windsor, vice-president and secretary-treasurer; H. H. Windsor III, vice-president; W. F. Windsor, vice-president; Clover L. Perkins, advertising manager; Alan M. Deyoe, circulation manager. Single copy in the United States and Canada, 35 cents; subscription rates in the United States and possessions, Canada, Philippines and countries of the Pan-American Postal Union, 1 year \$3.50; 2 years, \$6.00; 3 years, \$8.00. To all other countries add \$1.00 a year over United States prices for overseas postage. If you plan to move, notify us at least 30 days in advance so you will not miss an issue. Give both your old and new addresses. Entered as Second Class Matter, September 15, 1903, at the Post Office at Chicago, Illinois, under Act of March 3, 1879. Entered as Second Class Matter at Post Office Dept., Canada. Registered as Second Class Matter at the Post Office at Mexico, D. F., Mexico, June 20, 1950. Copyright 1955 by Popular Mechanics Company. Copyright under International Copyright Union. Copyright in France. All rights reserved under Pan-American Copyright Union. Printed in the United States of America.

Volume 104 OCTOBER 1955 Number 4

Address all communications to: 200 E. Ontario St., Chicago 11, Ill.

Managing Editor.....Roderick M. Grant
 Assistant Managing Editor.....Wayne Whittaker
 Shop Notes and Crafts Editor.....James R. Ward
 Radio-Television, Electronics Editor.....Lothar Stern
 Associate Editor.....Clifford B. Hicks
 Associate Editor, Automotive.....Arthur R. Railton
 Associate Editor, Shop Notes and Crafts.....Wayne C. Leckey
 Assistant Editor, Shop Notes.....W. Clyde Lamney
 Assistant Editor, Crafts.....Frank N. Stephany
 Assistant Editor, Makeup.....John C. Dalen
 Automotive Correspondent.....Leo Donovan
 Art Director.....Frank Beatty
 Assistant Editors—Leonard F. Hiltz, Jay W. Hedden, Elliott H. McCleary, Emily Mullaney, Earl F. Wobeck
 Eastern Editor.....Richard F. Dempewolf
 Empire State Bldg., Room 2906, New York City 1
 Western Editor.....Thomas E. Stimson, Jr.
 Suite 1010, 3460 Wilshire Blvd., Los Angeles 5, Calif.
 London Manager.....Douglas W. Wedderspoon
 Eagle House, Jermyn St., London S. W. 1, England
 Director, Bureau of Information.....Allan Carpenter
 200 E. Ontario St., Chicago 11

Advertising Offices
 Chicago: 200 E. Ontario St., Whitehall 4-0100; New York: Empire State Bldg., 350 Fifth Ave., LOngacre 5-7580; Detroit: General Motors Bldg., TRinity 5-8711; Cleveland: Hanna Bldg., 1422 Euclid Ave., PRospect 1-0456; Los Angeles: Tishman Bldg., 3460 Wilshire, DUmkirk 2-8458; San Francisco: Russ Bldg., 235 Montgomery St., YUken 2-0823.

In This Issue . . .

Fireman Strikes Uranium With PM Geiger Counter	97
He Spies on Satellites	106
Detroit Listening Post	112
Can Our Tanks Take It?	115
Owners Report on the Chrysler	124
Owners Report on the Hudson	129
Watch Out for the Stamp Fakers!	134

Special Housing Section

Color Tips for Your Home	145
New Ceilings With Pre-Pasted Plastic Tile	151
The PM Young-Family House	153
One-Man Remodeling Jobs	157
PM's 1955 Parade of Homes	161
Plan for Future Improvements as You Build	168
Retirement House Has No Bedrooms	170
Is Electric Heating for You?	173
Modern Kitchens	181
Build Your Own Carport	190

For the Craftsman . . .

Solving Home Problems	198
It Pays to Weather-Strip	203
Toys That Walk and Crawl	207
Patterncraft—Night Stand	211
Stop Rust in Your Home—Part II	218
Metal Shaper for Your Shop	227
Cut Moldings on Your Circular Saw	234
Shopping for Tools	240
Radio, TV and Electronics	245

See pages 88, 90 and 92

for other items and manufacturers of available products



Temlok's Lok-Bevel joint simplifies stapling or nailing, provides neat, even joint lines.

12" x 12" Temlok Tiles go up fast over 1" x 3" furring strips spaced 12" on centers. For fastening, use staples with 1/2" legs or 3d box nails.



How to Build an Attic Bedroom with Temlok Tile and Plank

It's easy and inexpensive to turn unused attic, basement, or porch areas into extra living space with Armstrong Temlok® Tile and Plank. These sturdy ceiling and wall finishes save you money because they build, insulate, and decorate in one easy installation.

Start the job by framing the space to the room size you want. Then nail 1" x 3" furring strips at right angles to the framing members to provide a nailing base for the interior finish.

Next, staple or nail Temlok to the furring strips. The special Lok-Bevel® joint on both Temlok Tile and Plank has an extra wide nailing flange for quick, easy installation. Besides hiding all nail heads and staples, this tongue-and-groove joint assures a neat, professional-looking joint line. Once Temlok is installed, the job is done. Tile and plank are pre-painted.

Get prices and details on Armstrong Temlok Tile and Plank from your local lumber dealer.



This comfortable attic bedroom was built at remarkably low cost with Armstrong Temlok Tile on the ceiling and Armstrong Temlok Plank on the walls.

Send for free booklet, "New Ways to Remodel Your Home." Just write Armstrong Cork Company, 3710 Watch Avenue, Lancaster, Pennsylvania.

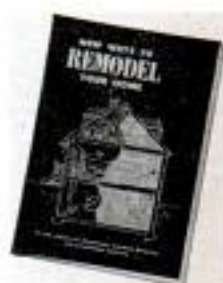

Armstrong
TEMLOK

Cushiontone® • M-67® Manowall® • Insulating Wool
Hardboards • All-Purpose Cements

POPULAR MECHANICS

Copyrighted material

STOP DRAFTS!
SAVE MONEY!

Seal your doors with

ONLY
\$2⁴⁹
TO SEAL
A DOOR

DRAFTITE

* DO IT YOURSELF

... EASILY
... QUICKLY

THE NEW ALUMINUM WEATHERSTRIP



WHAT IS DRAFTITE?

- a new, *do-it-yourself* weatherstrip that seals doors; made by the largest and oldest manufacturer of weatherstripping.
- a sealtite wool pile fabric rubber-locked on aluminum strips.
- aluminum strip will not rust or corrode; keeps its shape, lasts for years.

SAVES YOU MONEY

- for your comfort, seals door against penetrating drafts.
- pays for itself... cuts fuel bills; keeps cold out, keeps heat in.
- keeps out dust.

EASILY INSTALLED

- anyone who can drive a nail can apply DRAFTITE to door frame in a matter of minutes.

*TRADEMARK

Available at Leading Hardware Stores and Lumber Yards



The Standard Products Co.

BUILDING PRODUCTS DIVISION, LEXINGTON, KENTUCKY

OCTOBER 1955

This One



41G5-6S5-YS7L

5

Copyrighted material

Long-Play (33 $\frac{1}{3}$ RPM) Hi-Fidelity

10 ALL-TIME GREAT JAZZ CLASSICS



A Treasury of Jazz FEATURING
COLEMAN HAWKINS
ART TATUM
EDDIE CONDON
SIDNEY BECHET
ERROLL GARNER
DIZZY GILLESPIE
TEDDY WILSON
PEE WEE RUSSELL
JACK TEAGARDEN
CHARLIE PARKER
AND DOZENS OF OTHER "GREATS"!

Playing
 "Jelly Roll Blues"
 "Honeysuckle Rose"
 "Basin St. Blues"
 "Relaxin' at Camarillo"
 etc.

Not \$1 each —
 But \$1 for ALL TEN

Yes, you get ALL TEN of these "all-time great" jazz masterpieces for just \$1.00, no strings attached!

We make this amazing offer to show you the quality of Jazztone Society recordings, obtainable nowhere else! Every jazz style and era, virtually the whole history of jazz can be traced in the wide range of these selections. But only by hearing these dazzling performances can you appreciate their technical and artistic excellence, their wonderful high fidelity on noise-free vinylite.

How The Jazztone Society Operates

As a Trial Member you are not obligated to buy any records from us—now or ever. Future releases are described to you *in advance*. You may try any of these—FREE—without paying a penny in advance. Pay only for those you *keep* at the Member's low price of only \$2.75, plus a few cents shipping, per 12 inch long-playing disc, containing about *one hour* of the best jazz obtainable. A saving of 40% off the usual retail price. Start your high fidelity jazz library with these 10 classics for only \$1. Mail coupon with a dollar *now* while supply lasts. Money-back guarantee.

The Jazztone Society, Inc., Dept. PM-10
 43 West 61st Street, New York 23, N. Y.

Enclosed is \$1 in full payment for the recordings of 10 Jazz Classics. Enroll me as a Trial Member. Privileges: No purchase obligation ever! Advance notice of future releases. 5-day free trial on any discs. I may reject records before or after receipt; may cancel membership at any time. For future l.p. discs I keep, I'll pay only \$2.75 each, plus shipping . . . saving 40% off usual retail price! . . .

LIMIT: Only one sample package per customer

Name.....
 Address.....
 City.....Zone.....State.....
 Canada: 105 Bond St., Toronto 2, Ont.

ACROSS THE DESK



Dick Dempewolff, our Eastern Editor in New York, is not the Paul Bunyan type. Speaking strictly of his physical displacement, we should describe him as of less than average size. When he built the *Popular Mechanics* precut cabin a year ago (see



PM, March 1955) he lost a few indispensable pounds. How many more pounds he shed recently when riding the rugged range of the Army's Aberdeen Proving Ground in tanks and other monsters we have not dared to ask. That's Dick, second from the left in the M51 above, still able to smile as he gathers firsthand material for the article you'll see on page 115: "Can Our Tanks Take It?"

To the Editor:

"What Can We Do About Smog?" A very tantalizing question which your magazine presented very well (*PM*, July 1955). The most amazing fact discussed is that in a highly industrialized community (Los Angeles, Calif.) 1000 tons per day or 33 $\frac{1}{3}$ percent of the pollution is from automobiles.

As you have shown, there is a revolution in the making which will stop air pollution by automobiles. The vehicle powered by gas-turbine engines will not pollute the air with carbon monoxide. Gas-turbine engines use large quantities of excess air for dilution to tolerable working temperatures. This characteristic dilution gives exhausts which contain air, carbon dioxide and very minute quantities of carbon monoxide. Additives are not required for automotive gas-turbine fuels. Absence of additives will eliminate the lead and bromine-type compounds in gasoline-engine exhausts.

(Continued to page 8)



To the man who wants to enjoy
an ACCOUNTANT'S CAREER



FREE SAMPLE LESSON

IF you're that man, here's something that will interest you.

Not a magic formula—not a get-rich-quick scheme—but something more substantial, more practical.

Of course, you need something more than just the desire to be an accountant. You've got to pay the price—be willing to study earnestly, thoroughly.

Still, wouldn't it be worth your while to sacrifice some of your leisure in favor of interesting home study—over a comparatively brief period? Always provided that the rewards were good—a salary of \$4,000 to \$10,000?

An accountant's duties are interesting, varied and of real worth to his employers. He has *standing!*

Do you feel that such things aren't for you? Well, don't be too sure. Very possibly they *can* be!

Why not, like so many before you, investigate LaSalle's modern Problem Method of training for an accountancy position?

Just suppose you were permitted to work in a large accounting house under the personal supervision of an expert accountant. Suppose, with his aid, you studied accounting principles and solved problems day by day—easy ones at first—then more difficult ones. If you could do this—and could turn to him for advice as the problems became complex—soon you'd master them all.

That's the training you follow in principle under the LaSalle Problem Method.

You cover accountancy from the basic Principles right up through Accountancy Systems and Income Tax Procedure. Then you add C. P. A. Training and prepare for the C. P. A. examinations.

As you go along, you absorb the principles of Auditing, Cost Accounting, Business Law, Statistical Control, Organization, Management and Finance.

Your progress is as speedy as you care to make it—depending on your own eagerness to learn and the time you spend in study.

Will recognition come? The only answer, as you know, is that success *does* come to the man who is really *trained*. It's possible your employers will notice your improvement in a very few weeks or months. Indeed, many LaSalle graduates have paid for their training—with increased earnings—before they have completed it! For accountants, who are trained in organization and management, are the executives of the future.

**Get Free Sample Lesson—Also
 "Accountancy, The Profession That Pays"**

For your own good get all the facts. Write for Free Sample Lesson—also 48-page book "Accountancy, The Profession That Pays." They will prove that Accountancy offers brilliant futures to those who aren't afraid of serious home study, and will show the wide range of opportunities that exist today. No cost or obligation. If you want a position of higher income, greater prestige and professional standing . . . MAIL THE COUPON NOW!

**Over 4,000 Certified
 Public Accountants among
 LaSalle alumni**

Member, National Home Study Council

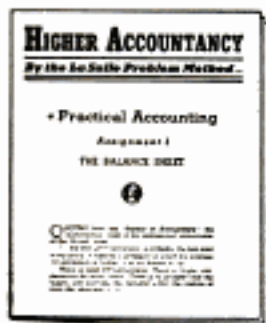

LASALLE EXTENSION UNIVERSITY
 A CORRESPONDENCE INSTITUTION

417 S. Dearborn St. Dept. 1064H Chicago 5, Ill.

I want to be an accountant. Send me without obligation, Free Sample Lesson—also "Accountancy, The Profession that Pays."

Name.....Age.....

Address.....

City, Zone & State.....



DON'T WASTE ANTI-FREEZE THIS WINTER!

**Two New Compounds Give
Your Radiator 4-WAY Protection**



**NEW PERMATEx COOLING SYSTEM
CLEANER AND CONDITIONER**



CLEANER IN TOP—

- Cleans out rust and scale
- Dissolves oil and grease

CONDITIONER IN BOTTOM—

- Stops rust reforming*
- Stops leaks and seepage*

*Exclusive with Permatex

No other product you can buy today gives you this complete, 4-way protection for your car's cooling system. New Permatex Cleaner removes all rust, scale, lime, oil and grease... to both increase your radiator's efficiency, and help your heater work better during cold weather. The Conditioner keeps rust from reforming and stops leaks and seepage (exclusive Permatex features). You don't waste anti-freeze—don't risk a frozen radiator. Permatex Cooling System Cleaner and Conditioner is quick and easy to use yourself (only 4 steps—against 5 with any other product).

Beat winter to the punch! Get this new Permatex product at your service station or auto supply shop, now.

PERMATEx COMPANY, INC.

Brooklyn 35, N.Y.

Kansas City 15, Kans.

Over 50 Chemical Products
for Better Automotive Maintenance

(Continued from page 6)

So—at least a 33 $\frac{1}{3}$ -percent answer to the question "What Can We Do About Smog?" is—use *gas-turbine engines!*

W. M. M. Fowden, Jr., CDR, USN,
Annandale, Va.

☆☆☆

Few architects have had the opportunity of Rudard A. Jones to study the space needs of families in regard to their homes. As assistant director of the Small Homes Council, University of Illinois, he supervised tests over a period of years in "laboratory" homes occupied by real families.



We believe he was the best choice of all architects in the country to design the *PM Young-Family House* which makes its debut on page 153. Recently, he was borrowed by the State Department from the university and loaned to the Colombian government for two years. There he is living in Bogota with his wife, Ruth, and daughter, Wendy, designing small homes for Colombian workers.

To the Editor:

I was very much interested in the article and pictures on "Ice Carving" by John F. Krich in the June issue of *Popular Mechanics*, especially so because I too have made ice carving my hobby and, being in one of the hottest places in the world, I enjoy it very much, both as a good hobby to stay cool, and also it adds to my income.

Being a chef by trade, I make most of

(Continued to page 14)

Cast your ballot for a successful future!

277 I.C.S. COURSES



Whether you stand at a machine or sit at a desk . . . whether you're making \$75 a week or \$75 hundred a year . . . whether your interest is Power Plants or Paper Pulp, Advertising or Electronics . . . chances are I.C.S. has exactly the course you need to get ahead.

I.C.S. is not only the oldest and largest correspondence school. It also offers the most courses, 277 in all. Each one success-proved by graduates who rose to top technical and administrative positions. Chief engineers. Superintendents. Foremen. Managers. Executive assistants.

I.C.S. Courses cover bedrock facts and theory plus practical, on-the-job applications. No skimping. Texts

are prepared by leading business and industrial authorities working with I.C.S. editors and educators. They are constantly being reviewed and revised in line with current developments.

As an I.C.S. student, you study in your spare time, set your own pace. No time lost getting to class or waiting for slower students to catch up. If you wish, I.C.S. will make progress reports to your employer. You win recognition as a "comer," one who is ready to move ahead. Thousands of students report pay increases and promotions within a few months of enrollment. All graduates win the coveted, approved I.C.S. diploma.

3 FREE BOOKS! Check the subject that interests you in the coupon below. I. C. S. will rush you (1) a special book outlining your opportunities in this field, (2) the 32-page gold mine of career tips, "How to Succeed," (3) a sample I. C. S. lesson (Math.) demonstrating the famous "I. C. S. Method." "X" MARKS OPPORTUNITY.

For Real Job Security—Get an I. C. S. Diploma! I. C. S., Scranton 9, Penna. Member, National Home Study Council

INTERNATIONAL CORRESPONDENCE SCHOOLS



BOX 23299K, SCRANTON 9, PENNA.

(Partial list of 277 courses)

Without cost or obligation, send me "HOW TO SUCCEED" and the opportunity booklet about the field BEFORE which I have marked X (plus sample lesson):

- | | | | | |
|--|---|--|--|---|
| <p>ARCHITECTURE and BUILDING CONSTRUCTION</p> <ul style="list-style-type: none"> <input type="checkbox"/> Air Conditioning—Refrig. <input type="checkbox"/> Architecture <input type="checkbox"/> Architectural Interior <input type="checkbox"/> Building Contractor <input type="checkbox"/> Building Maintenance <input type="checkbox"/> Carpenter and Mill Work <input type="checkbox"/> Estimating <input type="checkbox"/> Heating <input type="checkbox"/> Painting Contractor <input type="checkbox"/> Plumbing <input type="checkbox"/> Reading Arch. Blueprints <p>ART</p> <ul style="list-style-type: none"> <input type="checkbox"/> Cartooning <input type="checkbox"/> Commercial Art <input type="checkbox"/> Fashion Illustrating <input type="checkbox"/> Magazine Illustrating <input type="checkbox"/> Show Card and Sign Lettering <input type="checkbox"/> Sketching and Painting <p>AUTOMOTIVE</p> <ul style="list-style-type: none"> <input type="checkbox"/> Auto Body Rebuilding <input type="checkbox"/> Auto Elec. Technician <input type="checkbox"/> Auto-Engine Tune Up <input type="checkbox"/> Automobile | <p>AVIATION</p> <ul style="list-style-type: none"> <input type="checkbox"/> Aeronautical Engineering Jr. <input type="checkbox"/> Aircraft & Engine Mechanic <p>BUSINESS</p> <ul style="list-style-type: none"> <input type="checkbox"/> Advertising <input type="checkbox"/> Bookkeeping and Accounting <input type="checkbox"/> Business Administration <input type="checkbox"/> Business Correspondence <input type="checkbox"/> Public Accounting <input type="checkbox"/> Creative Salesmanship <input type="checkbox"/> Federal Tax <input type="checkbox"/> Letter-writing Improvement <input type="checkbox"/> Office Management <input type="checkbox"/> Professional Secretary <input type="checkbox"/> Retail Business Management <input type="checkbox"/> Sales Management <input type="checkbox"/> Stenographic-Secretarial <input type="checkbox"/> Traffic Management <p>CHEMISTRY</p> <ul style="list-style-type: none"> <input type="checkbox"/> Analytical Chemistry <input type="checkbox"/> Chemical Engineering <input type="checkbox"/> Chem. Lab. Technician <input type="checkbox"/> General Chemistry <input type="checkbox"/> Natural Gas Prod. & Trans. <input type="checkbox"/> Petroleum Engineering <input type="checkbox"/> Plastics <input type="checkbox"/> Pulp and Paper Making | <p>CIVIL, STRUCTURAL ENGINEERING</p> <ul style="list-style-type: none"> <input type="checkbox"/> Civil Engineering <input type="checkbox"/> Construction Engineering <input type="checkbox"/> Highway Engineering <input type="checkbox"/> Reading Struct. Blueprints <input type="checkbox"/> Sanitary Engineering <input type="checkbox"/> Structural Engineering <input type="checkbox"/> Surveying and Mapping <p>DRAFTING</p> <ul style="list-style-type: none"> <input type="checkbox"/> Aircraft Drafting <input type="checkbox"/> Architectural Drafting <input type="checkbox"/> Electrical Drafting <input type="checkbox"/> Mechanical Drafting <input type="checkbox"/> Mine Surveying and Mapping <input type="checkbox"/> Plumbing Drawing and Estimating <input type="checkbox"/> Structural Drafting <p>ELECTRICAL</p> <ul style="list-style-type: none"> <input type="checkbox"/> Electrical Engineering <input type="checkbox"/> Electrical Maintenance <input type="checkbox"/> Electrician <input type="checkbox"/> Contracting <input type="checkbox"/> Lineman <p>HIGH SCHOOL</p> <ul style="list-style-type: none"> <input type="checkbox"/> Commercial <input type="checkbox"/> Good English <input type="checkbox"/> High School Subjects <input type="checkbox"/> Mathematics | <p>LEADERSHIP</p> <ul style="list-style-type: none"> <input type="checkbox"/> Foremanship <input type="checkbox"/> Industrial Supervision <input type="checkbox"/> Leadership and Organization <input type="checkbox"/> Personnel-Labor Relations <p>MECHANICAL AND SHOP</p> <ul style="list-style-type: none"> <input type="checkbox"/> Gas—Electric Welding <input type="checkbox"/> Heat Treatment <input type="checkbox"/> Metallurgy <input type="checkbox"/> Industrial Engineering <input type="checkbox"/> Industrial Instrumentation <input type="checkbox"/> Industrial Supervision <input type="checkbox"/> Internal Combustion Engines <input type="checkbox"/> Machine Design-Drafting <input type="checkbox"/> Machine Shop Inspection <input type="checkbox"/> Machine Shop Practice <input type="checkbox"/> Mechanical Engineering <input type="checkbox"/> Quality Control <input type="checkbox"/> Reading Shop Blueprints <input type="checkbox"/> Refrigeration <input type="checkbox"/> Sheet Metal Worker <input type="checkbox"/> Tool Design <input type="checkbox"/> Toolmaking <p>RADIO, TELEVISION</p> <ul style="list-style-type: none"> <input type="checkbox"/> Industrial Electronics <input type="checkbox"/> Practical Radio TV Eng'ing <input type="checkbox"/> Radio and TV Servicing <input type="checkbox"/> Radio Operating | <ul style="list-style-type: none"> <input type="checkbox"/> Television Technician <p>RAILROAD</p> <ul style="list-style-type: none"> <input type="checkbox"/> Air Brakes <input type="checkbox"/> Car Inspector <input type="checkbox"/> Diesel Locomotive <input type="checkbox"/> Locomotive Engineer <input type="checkbox"/> Section Foreman <p>STEAM AND DIESEL POWER</p> <ul style="list-style-type: none"> <input type="checkbox"/> Combustion Engineering <input type="checkbox"/> Diesel—Elec. <input type="checkbox"/> Diesel Eng's <input type="checkbox"/> Electric Light and Power <input type="checkbox"/> Stationary Fireman <input type="checkbox"/> Stationary Steam Engineering <p>TEXTILE</p> <ul style="list-style-type: none"> <input type="checkbox"/> Carding and Spinning <input type="checkbox"/> Cotton, Rayon, Woolen Mfg. <input type="checkbox"/> Finishing and Dyeing <input type="checkbox"/> Loom Fixing <input type="checkbox"/> Textile Des'ing <input type="checkbox"/> Textile Eng'g <input type="checkbox"/> Throwing <input type="checkbox"/> Weaving and Weaving <p>MISCELLANEOUS</p> <ul style="list-style-type: none"> <input type="checkbox"/> Domestic Refrigeration <input type="checkbox"/> Marine Engineering <input type="checkbox"/> Ocean Navigation <input type="checkbox"/> Professional Engineering <input type="checkbox"/> Short Story Writing <input type="checkbox"/> Telephony |
|--|---|--|--|---|

Name _____ Age _____ Home Address _____

City _____ Zone _____ State _____ Working Hours _____ A.M. to P.M. _____

Occupation _____

Canadian residents send coupon to International Correspondence Schools, Canadian, Ltd., Montreal, Canada. . . . Special tuition rates to members of the U. S. Armed Forces.

Our 40th Year

NRI training is thorough, practical, up-to-date. When you enroll with NRI you benefit from our 40 years of successful experience training men at home.

J. E. Smith

President
National Radio Institute
Washington, D. C.



I'll Train You RADIO-

You Practice Broadcasting with Parts I Send



As part of my Communications Course I send you parts to build low-power Broadcasting Transmitter at left, and other equipment. Use it to get practical experience. You put this station "on the air," perform procedures demanded of station operators. An FCC Commercial Operator's License can be your ticket to a bright future. My Course trains you to get your license. Mail Coupon now!



Television Is Today's Good Job Maker

Television now reaches from coast-to-coast. More than 25 million Television sets are already in use and require servicing: thousands more sets are being sold every week. About 200 TV stations are now on the air with hundreds more being built. This means new jobs, more jobs, better pay for trained men. The time to act is NOW! Start learning Radio-Television servicing or communications.

You Practice Servicing with Parts I Send

Nothing takes the place of PRACTICAL EXPERIENCE. NRI training is based on LEARNING BY DOING. You use parts I send to build many circuits common to Radio and TV. You build the modern radio at right. Use Multi-tester you build to make money fixing sets. Many students make \$10, \$15 a week extra fixing neighbors' sets in spare time, starting soon after enrolling. All equipment I send is yours to keep.



Make Extra Money in Spare Time While Learning

Keep your job while training. Many NRI students make \$10, \$15 and more a week extra fixing neighbors' Radios in spare time. The day you enroll I start sending you special booklets that show you how to service sets. Multi-tester you build helps discover and correct Radio troubles, gives PRACTICAL EXPERIENCE on circuits common to radio and TV. Mail coupon today.

I Trained these Men at Home



Thanks
NRI for
Wonderful
Start

"Right now I am doing spare-time repairs on radios and television. In the near future I intend to go into full-time servicing."—C. Higgins, Waltham, Mass.



Switched
from Studio
Work to
Service

"I switched from studio work and am now holding a position as TV service technician. Enjoy my work more and more."—Norman Ward, Ridgesfield Park, N. J.



Paid for
Course
Before
Graduation

"By the time I graduated I had paid for my course, a car and testing equipment. Can service toughest jobs."—E. J. Streltenger, New Boston, Ohio.



\$10 to \$15
Week
Spare Time

"Four months after enrolling, was able to service Radios . . . averaged \$10 to \$15 a week spare time. Now have full time business."—W. Weyde, Brooklyn, N. Y.



Employed as
Transmitter
Operator

"A former employer recommended NRI training to me. Now employed as transmitter operator in Harrisburg."—Albert Herr, New Cumberland, Penna.

AT HOME for Good Jobs in TELEVISION

There is Success-Good Pay-Security for You in America's Fast Growing Industry



NRI Training Leads to These Jobs in RADIO-TELEVISION

BROADCASTING

Chief Technicians
Chief Operator
Power Monitor
Recording Operator

SERVICING

Home and Auto Radios
Television Receivers
P.A. Systems

MANUFACTURING

Design Technician
Service Manager
Tester
Research Assistant

SHIP AND HARBOR RADIO

Chief Operator
Radiotelephone Operator
Assistant Operator

GOVERNMENT RADIO

Operator in Army, Navy, Marine Corps
Airways Operator
Forestry Dispatcher

AVIATION RADIO

Transmitter Technician
Airport Transmitter Operator

TELEVISION

Pick-up Operator
Technician
Remote Control Operator

SERVICE and MAINTENANCE Technician

POLICE RADIO
Transmitter Operator
Receiver Serviceman

DO YOU want good pay, a job with a bright future, security? Would you like to have a profitable business of your own? If so, find out how you can realize your ambition in the fast-growing RADIO-TELEVISION industry. Even without Television, the industry is bigger than ever before. Just think, over 115 million home and auto Radios, 3000 Radio Broadcasting Stations, plus 25 million Television sets and about 200 Television Broadcasting Stations. Expanding use of Aviation and Police Radio, Micro-wave Relay, Two-way Radio for buses, taxis etc., are making opportunities for Servicing and Communications technicians and FCC Licensed Operators.

My Training Includes Television

You get practical experience by working on circuits common to both Radio and Television. My graduates are filling jobs, making good money in both Radio and Television. Many NRI trained men start their own Radio and Television servicing business with capital earned in spare time. Let me show you how you can be your own boss; earn \$10 to \$15 a week extra even while still learning. Now is the time to get ready for success in Radio-Television. Coupon below brings you Actual Lesson and 64-page book.

Find Out What Radio-Television Offers You

What will YOU be doing one year from today? Decide now that you are going to know more and earn more. ACT NOW. Send the coupon below NOW for my FREE DOUBLE OFFER. You get Actual Servicing Lesson. Also my 64-page Book, "How to Be a Success in Radio-Television." Read what my graduates are doing, earning, see equipment you practice with at home. Mail coupon now. Send in envelope or paste on postal. J. E. SMITH, President, Dept. 5KA, National Radio Institute, Washington 9, D. C. Our 40th Year.

Actual Lesson and 64-page Book BOTH FREE

The ABC's of SERVICING

MAIL THIS NOW!

MR. J. E. SMITH, President, Dept. 5KA
National Radio Institute, Washington 9, D. C.

Mail me Sample Lesson and 64-page Book FREE. (No salesman will call. Please write plainly.)

Name..... Age.....

Address.....

City..... Zone..... State.....

VETS write in date of discharge.....

"APPROVED MEMBER, NATIONAL HOME STUDY COUNCIL"

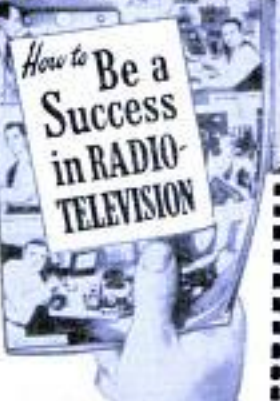

Chief Engineer with Station

"I received my License and worked on ships. Am Chief Engineer at WARA, Attleboro, Mass. I am grateful to NRI for preparing me for this position."—R. D. Arnold, Rumford, R. I.

Available to **VETERANS** under G. I. Bills

OUTSTANDING GIFT VALUES

DIRECT FROM IMPORTER TO YOU

Mighty Midget SPY CAMERA



ONLY! 2⁹⁵

This precision-make camera is tiny—only 2" by 1 1/4" Designed for detective & espionage work; can be hidden in palm of hand. Gives pictures of unbelievable sharpness! All metal, gold plated. Coated lens, speed shutter, professional viewfinder. Instant AND time settings. Snap in secret—makes great candid shots! FREE with each camera; pigskin leather case & 2 rolls of film. Special family price—3 for 7.98.

SAVE

ter, professional viewfinder. Instant AND time settings. Snap in secret—makes great candid shots! FREE with each camera; pigskin leather case & 2 rolls of film. Special family price—3 for 7.98.

No. 48..... 2.95

17-JEWEL AUTOMATIC WATER-RESISTANT WATCH



Runs under water!

Completely shock and water-repellent! Winds itself with the movement of your arm! Hairline sweep

second hand—chromed & stainless steel case—17 jewels—Incabloc shock absorber. Accurate, durable. Formerly sold for MUCH more! Guarantee certificate and gift case included. Extremely good looking.

No. 238..... 24.95



3⁹⁵

SWISS ARMY TYPE KNIFE

10 TOOLS IN ONE—the Swiss Army knife is recognized as the most compact multi-purpose tool ever devised. This new Korium version is the lowest price ever asked for the Swiss knife! Finest Solingen steel. Has scissors, saw, icepick, jackknife, screwdriver, awl, can opener, bottle opener, corkscrew & pen-knife. Solid Vidal handle; belt attachment. Length, 3 1/2".

No. 88..... 3.95

1⁹⁸



GET 30 BETTER SHAVES FROM ONE BLADE!

HONIKRON—new marvel of German ingenuity—gives you 30 OR MORE SHAVES FROM A SINGLE BLADE! Honer & conditions old & new double-edge blades to an unbelievable sharpness. Does it in a few seconds—just whisk the plunger back & forth a few times and you have a factory sharp blade!

No. 3..... 1.98

1⁹⁸



POCKET MICROSCOPE GIVES

2,500

TIMES AREA MAGNIFICATION!

Measures but 2 1/4 inches—but this microscope from West Germany gives GIANT POWER & PERFORMANCE! Metal design—optically ground precision lenses. Gives 2,500 times area magnification! Clear, sharp images—see Nature's wonders, examine liquids, textiles, insects, cells, stains, tissue, etc. 2 special slides given. Simple eyepiece focusing.

No. 12..... 1.98



POWERHOUSE BINOCULARS

Give 16 times area magnification!

4⁹⁸

From Western Germany comes this latest model Powerhouse binocular which gives you much better viewing up to 25 miles!

New model features interior fluoride coated lenses—a feature hitherto found only in expensive glasses. Gives 16 times area magnification! Hinge model—adjusts to exact space between your eyes. Handsome leather carrying case included. No distortion—you get clear, sharp images. Sorry, only one to a customer.

No. 6..... 4.98



3-color POLICE FLASHLIGHT

Throws red, white & green beam!

1/2 PRICE!

99c

The famous 3-Color Police Flashlight can now be yours! Police & fire departments have been ordering 'em by the carload—N.Y. City policemen alone have ordered thousands! Pushbuttons give you red, green or white beam instantly. Hi-Glo reflector increases beam intensity—visible miles away! Great for highway emergencies. Formerly sold for as much as \$5.00. ALL-METAL DESIGN.

No. 75..... 99¢

5 DAY TRIAL — TAKE YOUR PICK AT OUR RISK!

Enjoy any article on this page at our risk! If you are not satisfied in every way—if you are not convinced of the big value, your purchase price will be refunded at once—no questions asked! Send check, cash or m.o. for quick delivery FREE to your home. COD's shipped plus postage charges. Please mention item NUMBER when ordering. Supplies of some items are limited. Please rush your order TODAY to avoid disappointment! Save with confidence! Buy direct from one of the world's great importers.

THORESEN'S

352 FOURTH AVENUE

DEPT. 6-L

NEW YORK 10, N. Y.



INVENTORS

Learn how to protect your invention. The U. S. Patent Laws provide that any new and useful art, machine, article of manufacture, or composition of matter, or any new and useful improvement thereof, may be patented if the act of invention is involved. Therefore, every inventor with a valuable invention should take advantage of the Patent Laws and proceed for patent protection in order to safeguard his rights.

A patent gives the inventor the exclusive right to prevent others from making, using, or selling the invention claimed in the patent for a period of seventeen years.

The Patent Laws were enacted for the benefit of the inventor to give him protection for the features of his invention which are patentable. These features must be properly and concisely set forth and claimed in a formal application for patent, in order to comply with the requirements of the Patent Laws. For that reason, unless the inventor is familiar with patent matters, he should engage a competent registered patent attorney or agent to represent him. We are registered to practice before the U. S. Patent Office and are prepared to serve you in the handling of your patent matters.

A specially prepared booklet entitled "Patent Guide for the Inventor", containing detailed information with respect to patent protection and procedure, together with a "Record of Invention" form will be promptly forwarded to you without obligation upon request.

CLARENCE A. O'BRIEN & HARVEY JACOBSON

Registered Patent Attorneys

51-K DISTRICT NATIONAL BUILDING

WASHINGTON 5, D. C.

AFTER SHAVING
Dims Shine
Feels Fine
Doesn't Show



Also
 available
 in Canada

Finishing touch for every shave!
 Neutral tint — crisp scent!

MENNEN
 AFTER-SHAVE TALC
FOR MEN

(Continued from page 8)

my ice carvings to be used at various banquets and buffets and other special occasions when the king and other members of the royal family visit our district.

Strange as it may seem, I learned to carve ice in Arabia, using ice pick and wood chisels for tools, and 300-pound blocks of ice.

Fred O. Menz,
 Arabian American Oil Co.,
 Dhahran, Saudi Arabia

To the Editor:

Enclosed is a set of photographs of articles made by students at the Boys Technical Institute in Elazig, Turkey. For instructions and illustrations the boys used old copies of *Popular Mechanics* given them by our office in Ankara, Turkey.

We feel that you might be interested in this example of the use made of your publication in other parts of the world.

Robert W. Shackleton,
 U. S. Information Agency,
 Washington, D. C.



How to look good to your boss



The old tricks of "flattery" and "bluff" no longer work—though men still try them. Here's a new technique that seems to be paying off.

WITHIN the next twelve months, someone you work with will hit the jackpot on promotion. Overnight he'll jump to a key position—and everybody will wonder why.

Chances are, he's cashing in on a new way to impress the boss—*self-improvement on the QT.*

With jobs getting tighter, employers are giving the cold eye to men who obviously are trying to make an impression without anything to back it up. The phony eager beavers, overtime hounds and front office pets are due for a rude awakening.

Sincerity, honest work and *interest beyond the job* are getting the nod. And top dog is the man who uses his *spare* time to train for advancement.



I.C.S. sees this showing up in a great new surge of interest in advanced technical and business courses.

Men who look into correspondence training are suddenly clipping coupons and enrolling. Current I.C.S. students include a good many college graduates. Also engineers seeking courses in business management. And men who need a quick brush-up or refresher course.

Says James L. Morgan of the Morgan Cotton Mills, Inc., "We keep an eye on our I.C.S. students. They may study alone at home. But the results show up in their work—and make possible promotions otherwise impossible." Mr. Morgan speaks from experience—his own I.C.S. experience.

For Real Job Security—Get an I. C. S. Diploma! I. C. S., Scranton 9, Penna. Member, National Home Study Council

INTERNATIONAL CORRESPONDENCE SCHOOLS

ICS

BOX 60299K, SCRANTON 9, PENNA.

Without cost or obligation, send me "HOW TO SUCCEED" and the opportunity booklet about the field BEFORE which I have marked X (plus sample lesson):

- | | | | | |
|--|---|--|---|--|
| <p>ARCHITECTURE and BUILDING CONSTRUCTION</p> <ul style="list-style-type: none"> <input type="checkbox"/> Air Conditioning—Refrig. <input type="checkbox"/> Architecture <input type="checkbox"/> Architectural Interior <input type="checkbox"/> Building Contractor <input type="checkbox"/> Building Maintenance <input type="checkbox"/> Carpenter and Mill Work <input type="checkbox"/> Estimating <input type="checkbox"/> Heating <input type="checkbox"/> Painting Contractor <input type="checkbox"/> Plumbing <input type="checkbox"/> Reading Arch. Blueprints <p>ART</p> <ul style="list-style-type: none"> <input type="checkbox"/> Cartooning <input type="checkbox"/> Commercial Art <input type="checkbox"/> Fashion Illustrating <input type="checkbox"/> Magazine Illustrating <input type="checkbox"/> Show Card and Sign Lettering <input type="checkbox"/> Sketching and Painting <p>AUTOMOTIVE</p> <ul style="list-style-type: none"> <input type="checkbox"/> Auto Body Rebuilding <input type="checkbox"/> Auto Elec. Technician <input type="checkbox"/> Auto-Engine Tune Up <input type="checkbox"/> Automobile | <p>AVIATION</p> <ul style="list-style-type: none"> <input type="checkbox"/> Aeronautical Engineering Jr. <input type="checkbox"/> Aircraft & Engine Mechanic <p>BUSINESS</p> <ul style="list-style-type: none"> <input type="checkbox"/> Advertising <input type="checkbox"/> Bookkeeping and Accounting <input type="checkbox"/> Business Administration <input type="checkbox"/> Business Correspondence <input type="checkbox"/> Public Accounting <input type="checkbox"/> Creative Salesmanship <input type="checkbox"/> Federal Tax <input type="checkbox"/> Letter-writing Improvement <input type="checkbox"/> Office Management <input type="checkbox"/> Professional Secretary <input type="checkbox"/> Retail Business Management <input type="checkbox"/> Sales Management <input type="checkbox"/> Stenographic-Secretarial <input type="checkbox"/> Traffic Management <p>CHEMISTRY</p> <ul style="list-style-type: none"> <input type="checkbox"/> Analytical Chemistry <input type="checkbox"/> Chemical Engineering <input type="checkbox"/> Chem. Lab. Technician <input type="checkbox"/> General Chemistry <input type="checkbox"/> Natural Gas Prod. & Trans. <input type="checkbox"/> Petroleum Engineering <input type="checkbox"/> Plastics <input type="checkbox"/> Pulp and Paper Making | <p>CIVIL, STRUCTURAL ENGINEERING</p> <ul style="list-style-type: none"> <input type="checkbox"/> Civil Engineering <input type="checkbox"/> Construction Engineering <input type="checkbox"/> Highway Engineering <input type="checkbox"/> Reading Struct. Blueprints <input type="checkbox"/> Sanitary Engineering <input type="checkbox"/> Structural Engineering <input type="checkbox"/> Surveying and Mapping <p>DRAFTING</p> <ul style="list-style-type: none"> <input type="checkbox"/> Aircraft Drafting <input type="checkbox"/> Architectural Drafting <input type="checkbox"/> Electrical Drafting <input type="checkbox"/> Mechanical Drafting <input type="checkbox"/> Mine Surveying and Mapping <input type="checkbox"/> Plumbing Drawing and Estimating <input type="checkbox"/> Structural Drafting <p>ELECTRICAL</p> <ul style="list-style-type: none"> <input type="checkbox"/> Electrical Engineering <input type="checkbox"/> Electrical Maintenance <input type="checkbox"/> Electrician <input type="checkbox"/> Contracting <input type="checkbox"/> Lineman <p>HIGH SCHOOL</p> <ul style="list-style-type: none"> <input type="checkbox"/> Commercial <input type="checkbox"/> Good English <input type="checkbox"/> High School Subjects <input type="checkbox"/> Mathematics | <p>LEADERSHIP</p> <ul style="list-style-type: none"> <input type="checkbox"/> Foremanship <input type="checkbox"/> Industrial Supervision <input type="checkbox"/> Leadership and Organization <input type="checkbox"/> Personnel-Labor Relations <p>MECHANICAL AND SHOP</p> <ul style="list-style-type: none"> <input type="checkbox"/> Gas—Electric Welding <input type="checkbox"/> Heat Treatment <input type="checkbox"/> Metallurgy <input type="checkbox"/> Industrial Engineering <input type="checkbox"/> Industrial Instrumentation <input type="checkbox"/> Industrial Supervision <input type="checkbox"/> Internal Combustion Engines <input type="checkbox"/> Machine Design—Drafting <input type="checkbox"/> Machine Shop Inspection <input type="checkbox"/> Machine Shop Practice <input type="checkbox"/> Mechanical Engineering <input type="checkbox"/> Quality Control <input type="checkbox"/> Reading Shop Blueprints <input type="checkbox"/> Refrigeration <input type="checkbox"/> Sheet Metal Worker <input type="checkbox"/> Tool Design <input type="checkbox"/> Toolmaking <p>RADIO, TELEVISION</p> <ul style="list-style-type: none"> <input type="checkbox"/> Industrial Electronics <input type="checkbox"/> Practical Radio TV Eng'ng <input type="checkbox"/> Radio and TV Servicing <input type="checkbox"/> Radio Operating | <p><input type="checkbox"/> Television Technician</p> <p>RAILROAD</p> <ul style="list-style-type: none"> <input type="checkbox"/> Air Brakes <input type="checkbox"/> Car Inspector <input type="checkbox"/> Diesel Locomotive <input type="checkbox"/> Locomotive Engineer <input type="checkbox"/> Station Foreman <p>STEAM AND DIESEL POWER</p> <ul style="list-style-type: none"> <input type="checkbox"/> Combustion Engineering <input type="checkbox"/> Diesel—Elec. <input type="checkbox"/> Diesel Eng's <input type="checkbox"/> Electric Light and Power <input type="checkbox"/> Stationary Fireman <input type="checkbox"/> Stationary Steam Engineering <p>TEXTILE</p> <ul style="list-style-type: none"> <input type="checkbox"/> Carding and Spinning <input type="checkbox"/> Cotton, Rayon, Woolen Mfg. <input type="checkbox"/> Finishing and Dyeing <input type="checkbox"/> Loom Fix'g <input type="checkbox"/> Textile Des'ing <input type="checkbox"/> Textile Eng'g <input type="checkbox"/> Throwing <input type="checkbox"/> Waring and Weaving <p>MISCELLANEOUS</p> <ul style="list-style-type: none"> <input type="checkbox"/> Domestic Refrigeration <input type="checkbox"/> Marine Engineering <input type="checkbox"/> Ocean Navigation <input type="checkbox"/> Professional Engineering <input type="checkbox"/> Short Story Writing <input type="checkbox"/> Telephony |
|--|---|--|---|--|

Name _____ Age _____ Home Address _____

City _____ Zone _____ State _____ Working Hours _____ A.M. to P.M. _____

Occupation _____

Canadian residents send coupon to International Correspondence Schools, Canadian, Ltd., Montreal, Canada. . . . Special tuition rates to members of the U. S. Armed Forces.



**Want better pay,
steady work and
a way to make
extra money?**

Learn at Home IN YOUR SPARE TIME to Fix Electrical Appliances

To build a better future, get into a field where there's much important work and the security that comes from knowing a good trade. Servicing electrical appliances offers that OPPORTUNITY. Every wired home has an average of 8 electrical appliances. Up to 10 million new appliances are sold every year and owners pay well to keep them in repair. That's making a fast-growing need for trained men.

Start Soon to Earn \$3, \$4, \$5 an Hour Extra in Your Spare Time

Start soon to fix electric toasters, clocks, fans, vacuum cleaners and other appliances for neighbors and friends. Work in your basement, garage or spare room. Pick up \$3 to \$5 an Hour *extra* that way. It's easy to increase your earning power—to pay for this training many times over with your spare time earnings.

Learn and Earn with Multi-Use Tester Built with Parts We Send

This course includes the parts to build a portable, sturdy Appliance Tester that helps you locate electrical defects quickly and easily. You use it to learn and do actual electrical appliance repair jobs. If you want better pay learn this good

trade. No need to give up your present job. You can train at home in your spare time for only \$2.50 down and \$5.00 a month. A small price to pay for increased earnings, a more secure future. Paste coupon below on a 2c postal or mail in envelope for free book and sample lesson. Address National Radio Institute, Dept. AK5, Washington 9, D. C.

**2c TO MAIL THIS
COUPON MAY START
YOU TO SUCCESS
LESSON AND BOOK
FREE**



**NATIONAL RADIO INSTITUTE
Dept. AK5, Washington 9, D. C.**

Please send me Electric Appliance Training lesson and book free.
(No salesman will call.)

Name _____ Age _____

Address _____

City _____ Zone _____ State _____

APPROVED MEMBER NATIONAL HOME STUDY COUNCIL

INVENTORS

If you believe that you have an invention, you should find out how to protect it. The first step is to have a search made of the prior pertinent U. S. patents. If a report on this search indicates that the invention appears patentable you can apply for a patent, and the specifications and claims should be prepared.

The firm of McMorrow, Berman & Davidson, with offices in Washington, D. C., is qualified to take the necessary steps for you. We can make a preliminary search on your invention, advise you whether we think it can be patented, and prepare your application for patent.

Unless you are fully familiar with the U. S. Patent Laws, we recommend that you engage the services of a Registered Patent Attorney to protect your interests. The patent laws are *your* laws. A patent gives you the right to prevent others from making, using or selling the invention claimed in your patent for a period of 17 years.

Use these patent laws for your protection. Investigate whether your invention can be patented. If you have what you believe to be an invention, we suggest that you have this firm make a search for you.

Send for a copy of our Patent Booklet entitled "How To Protect Your Invention," containing information about patent protection and patent procedure. Along with this we will also send you an "Invention Record" form, for your use in writing down and sketching details of your invention. We will mail them promptly. No obligation. They are yours for the asking.

McMORROW, BERMAN & DAVIDSON

Registered Patent Attorneys

PATENTS • COPYRIGHTS • PATENTS

135-L VICTOR BUILDING, WASHINGTON 1, D. C.

Lost your Power?

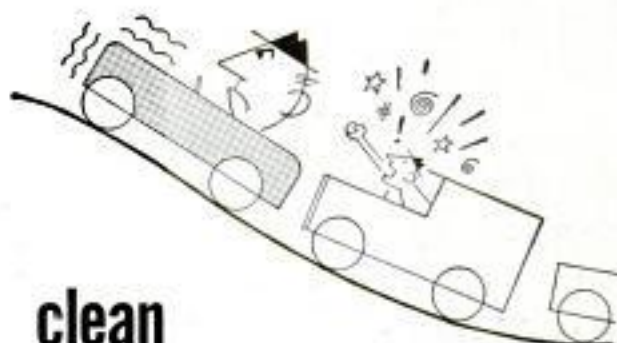

clean your carburetor with **GUMOUT**

Every slight grade seem like you're climbing Pike's Peak? A dirty, gummed-up carburetor may be holding you back. Stands to reason. Your carburetor is built to deliver peak performance when it's new. But when gum deposits build up and clog tiny gas and air passages, the delicate fuel-air ratio is upset. Only cure: clean it!

But... the carburetor doesn't have to be taken apart to clean it!

GUMOUT does the job for you—while you drive. A little GUMOUT added to your gas tank regularly (every 60 to 90 days) dissolves all gum in the fuel system... keeps your carburetor good and clean. There's nothing like GUMOUT.



GET YOUR POWER MOWER AND OUTBOARD MOTOR READY FOR WINTER STORAGE

Send for new "POWER MOWER" folder (No. PM-355) and new "OUTBOARD MOTOR" folder (No. OB-455). Tell how to prepare your power mower and outboard for winter storage—to keep them in top operating condition.

GUMOUT is sold by service stations, garages, auto supply dealers, and hardware stores everywhere.

GUMOUT DIVISION, Pennsylvania Refining Company
2671 Lisbon Road, Cleveland 4, Ohio

CHEMISTRY



BIG LABORATORY GIVEN FREE!

Are you looking for a **WONDERFUL FUTURE** that can start at home right now? The **NATIONAL SCHOOL OF CHEMISTRY** offers a fascinating correspondence course in **PRACTICAL CHEMISTRY** which will give you a wonderful education that can be used almost immediately to increase your income and your position in life, with prospects of a **GLORIOUS FUTURE!** The course is very **THOROUGH**, yet specially prepared to be easy to all regardless of lack of previous training. Very little theory... this is a **PRACTICAL** course with **HUNDREDS** of fascinating **EXPERIMENTS** and valuable **FORMULAS**. Students learn, almost from the start, how to make chemicals and chemical products of commercial value, how to convert wastes into money, etc. **THERE IS A GOLD MINE IN CHEMISTRY!** Why not share in it? We will open your eyes to **GOLDEN OPPORTUNITIES** you've never dreamt of; for this is a **GOLDEN AGE** for those who possess special **KNOWLEDGE!** An extensive laboratory of chemicals and equipment is included with the course at no extra cost! Just send 25¢ for your first lesson and **CHEMICAL KIT**; full details will be included. If you send \$1.00 we will send first 5 lessons and supplies, including "How To Make 100 New Chemicals." Absolutely no obligation! **START YOUR NEW CAREER TODAY!**

NATIONAL SCHOOL OF CHEMISTRY
POST OFFICE BOX 606-A • REDWOOD CITY, CALIFORNIA

SHINE WITHOUT 'POLISH'



Cars Glean Like Mirror

NEW MEN! WOMEN! So easy a child can do it! Amazing "Dry" Polish puts mirror-like shine on car **WITHOUT 'POLISH'**. No messy paste, liquids, waxes. Simply glide over car. **PRESTO!** Leaves hard, lustrous, long-lasting protective Wax Coating. Take orders! Earn money!

SAMPLES FOR TRIAL

Sample offer sent immediately to all who send name at once. Just a postcard will do. **SEND NO MONEY**—just your name.
KRISTEE CO., Dept. 685, Akron 8, Ohio

MAKE TREMENDOUS PROFITS

Have Fun! Earn Big Money! Cast plaster figurines, bookends, plaques, novelties at home in your spare time with 3-D, rubber molds! **NO EXPERIENCE NEEDED!** Models and rubber for 3 molds, only \$1.50 pld. Send 25¢ (refunded with order) for 40 page catalog now!
PLASTIC ARTS STUDIO 3403 50. MADISON, DEPT. PM2
MUNCIE, INDIANA

SCIENTIFIC CRIME DETECTION



IT'S EASY TO LEARN
Let us teach you in your own home. Learn Finger Printing, Firearms Identification, Police Photography, Criminal Investigation Methods thoroughly, quickly, at small cost. Over 800 of all U. S. Bureaus of Identification employ I. A. S. students or graduates. Write today, stating age.

INSTITUTE OF APPLIED SCIENCE, 1920 Sunnyvale Ave., Dept. 1357
(A Correspondence School Since 1910) **Chicago 46, Ill.**

LEFAX TECHNICAL DATA BOOKS

POCKET SIZE • LOOSE LEAF

Printed on loose leaf, 6 hole, 6 1/2" x 3 1/2" bond paper, each book contains about 140 pages of technical data, condensed, accurate, essential, for engineer, technical worker, student, business man. **\$1.25 each**

Architecture	Surveying	Mech'l Drawing	Metalurgy
Home Heating	Surveying Tables	Machine Design	Hydraulics
Illumination	Highway Eng'g.	Machinist's Data	Radio
Electrician's Data	General Math	Mech. of Materials	Television & FM
Builder's Data	Math Tables	Pwr. Trans. Mach.	Electricity, AC
Lumber Data	Physics	Thermo. Tbls. & Charts	Electricity, DC
Air Conditioning	Trig-Lag Tables	Phys. & Thermo. Data	AC Motors & Gen'rs.
Building Constr.	Gen'l Chemistry	Metals	Transformers, Relays & Meters
Reinf. Concrete	Chemical Tables		
Piping Data	Analytic Chem.		

Write for **FREE** catalogs (2000 listings). See how helpful LEFAX can be to you. Send \$1.25 book, or \$6 for any five books to

LEFAX PUBLISHERS, Dept. PM-9, PHILADELPHIA 7, PA.

THESE MEN ARE GETTING PRACTICAL TRAINING IN **ELECTRICITY**

—**ELECTRONICS**

On Real:

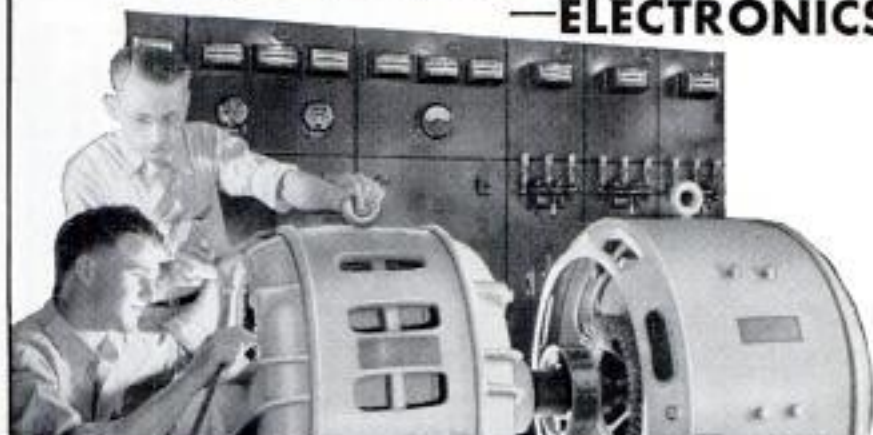

**A.C. and D.C. MOTORS
GENERATORS
SWITCHBOARDS
CONTROLLERS
WIRING JOBS
APPLIANCES
ELECTRONIC UNITS**

(Shown at left—Instructor explaining operation and testing of a large Motor Generator in our A.C. Department.)

AND **TELEVISION-RADIO**

On Real:

**TELEVISION SETS
RADIO RECEIVERS
F.M.
(Frequency Modulation)
ELECTRONICS
RECORD CHANGERS
AUTO RADIOS**

PUBLIC ADDRESS Systems
(Right — Instructor helping students check the wiring and trace circuits of television receivers.)



Train in the great **SHOPS** of **COYNE**

Largest, Oldest, Best Equipped School Of Its Kind In The U. S.

Whether 17 or up to 45 years of age, prepare for your future now. Don't be satisfied with a "No Future" job. Train the Coyne way for a better job in a field that offers a world of opportunities in the years ahead.

FINANCE PLAN Enroll now, pay most of tuition later. Part-time employment service while training, if needed.

WE TRAIN YOU IN CHICAGO. At Coyne you learn on real, full-size equipment. Trained instructors show you how, then you do practical jobs yourself. No previous experience or advanced education needed.

CLIP COUPON NOW for big new illustrated Coyne book "Guide to Careers in **ELECTRICITY** and **TELEVISION-RADIO**". No obligation; no salesman will call. Get vital facts now!



*Mail Coupon for
Big Free Book*

**APPROVED
FOR
VETERANS**

**B. W. COOKE, President
COYNE ELECTRICAL SCHOOL.**

500 S. Paulina St., Chicago 12, Ill. Dept. 75-72H
Send **BIG FREE** book and details of your training offer. This does not obligate me and no salesman will call. I am interested in:

ELECTRICITY **TELEVISION-RADIO**

NAME

ADDRESS

CITY.....STATE.....

B. W. COOKE, Pres. **COYNE** FOUNDED 1899
ELECTRICAL SCHOOL

A TECHNICAL TRADE INSTITUTE OPERATED NOT FOR PROFIT
500 S. PAULINA STREET, CHICAGO, Dept. 75-72H
ELECTRICITY ★ RADIO ★ TELEVISION ★ REFRIGERATION ★ ELECTRONICS

OCTOBER 1955

19

HOW TO FIX ANY PART OF ANY CAR

QUICKLY--EASILY--RIGHT!

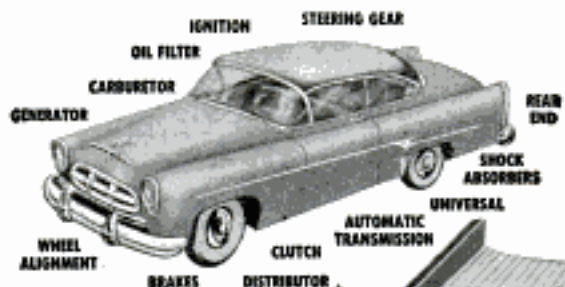

FREE 7-DAY TRIAL

Whether you're a beginner or an expert mechanic—now you can "breeze through" any "fix-it" job from simple carburetor adjustment to complete overhaul. Just look up job in index of MOTOR'S Brand-New 1955 Auto Repair Manual. Follow simple step-by-step directions, clear pictures. Presto—the job is done!

No guesswork! MOTOR'S MANUAL takes you from "scratch"—shows WHERE to start, WHAT tools to use. Covers EVERY job on EVERY car built from 1946 thru 1955!

Everything You Need to Know "Boiled Down" from 160 Official Shop Manuals

NEW, REVISED, ENLARGED. 1955 Edition contains the "meat" from over 160 OFFICIAL shop manuals—simplified for YOU. 21,436 essential repair specifications on 737 chassis models. Over 1,000 big pages. More than 2,900 "this-is-how" pictures. 225,000 service and repair facts. Leads beginners every step of the way. Time-saving factory repair procedures for experts. Instructions and pictures so clear you CAN'T go wrong. Used by U. S. Army and Navy.

Try Book FREE 7 Days

SEND NO MONEY! Pay postman nothing.

Make Manual show you what it's got. Unless you agree this is the greatest time and work saver you've ever seen—return book in 7 days and pay nothing. Mail coupon today to: MOTOR—Book Dept., Desk 110, 250 W. 55th St., New York 19, N. Y.

MOTOR'S AUTO REPAIR MANUAL

Covers 737 Models All These Makes

- Buick
- Cadillac
- Chevrolet
- Chrysler
- Crosley
- De Soto
- Dodge
- Ford
- Frazier
- Henry
- Hudson
- Kaiser
- Lincoln
- Mercury
- Nash
- Oldsmobile
- Packard
- Plymouth
- Pontiac
- Studebaker
- Willys

2,000,000 Copies Sold!

Same FREE Offer On MOTOR'S Truck and Tractor Manual

Covers EVERY job on EVERY popular make gasoline truck, tractor made from 1946 thru 1954. FREE 7-Day Trial. Check proper box in coupon.



MAIL COUPON NOW FOR 7-DAY FREE TRIAL

MOTOR BOOK DEPT.
Desk 110, 250 W. 55th St., New York 19, N. Y.
Rush to me at once (check box opposite book you want):

- MOTOR'S New AUTO REPAIR MANUAL. If O.K., I will remit \$2 in 7 days, \$2 monthly for 2 months and a final payment of \$6 (plus 35c delivery charges) one month after that. Otherwise I will return the book postpaid in 7 days. (Foreign price, remit \$2 cash with order.)
- MOTOR'S New TRUCK & TRACTOR REPAIR MANUAL. If O.K., I will remit \$2 in 7 days, and \$2 monthly for 2 months, plus 35c delivery charges with final payment. Otherwise I will return book postpaid in 7 days. (Foreign price, remit \$2 cash with order.)

Print Name..... Age.....

Address.....

City..... State.....

Check box and save 35c delivery charge by enclosing WITH coupon entire payment of \$6.36 for Auto Repair Manual (or \$8 for Truck & Tractor Repair Manual.) Same return-refund privilege.

FINE WORK CLOTHES
AT LESS THAN
1/3 COST!
STERILIZED, CLEAN-AS-NEW

Surplus Stock. Terrific Values!



PANTS Worth \$3.95 new! You get 4 used pairs for less than the price of 1 new pair! Navy or green. Send waist and inside leg measurements.

99c
4 for \$3.75

SHIRTS to Match. (Made to sell for \$2.99). 4 for the price of 1! Sturdy fabrics for long tough wear. Send neck size.

79c
4 for \$2.99

COVERALLS. Made to sell for \$5.95. Yours for less than 1/3! Send chest measurement.

\$1.95
3 for \$5.45

MONEY BACK GUARANTEE If you're not convinced these are terrific bargains, return 'em within 10 days for full refund. Order today. C.O.D., or send money and we'll pay postage.

\$1.00 Deposit Required on C.O.D. Orders.

TRU VALU SALES CO. Dept. PM-22 1294 E. 9th St. Cleveland 14, Ohio

BE A LEADER IN AVIATION

Parks graduates are known worldwide as leaders in aviation—their education is the finest offered. Advance faster... earn more in less time! Become a Parksman!

B.S. degree in 3 yrs. from Saint Louis University—Aero. Eng., Aero. Adm., Maint. Eng.

Non-degree courses—A & E Mechanics, Private, Commercial, Instrument, Flight Instructor and Multi-engine Ratings... CAA-Approved.

All Parks schooling approved for Veterans. Write for full information.

PARKS COLLEGE ARNOLD HALL EAST ST. LOUIS, ILL.

TELEPHONES



Desk Stand Style
Slightly used but in excellent condition

Many Valuable Uses
Inter-House Phones House to Barn, etc.
Loud Speakers Microphones
Educational Purposes, Toys, etc.

Come complete, ready to use with wiring diagrams included. Two complete for only \$5.00. **\$2.75** Postpaid in U.S.A. **TELEPHONE LAMP KIT**—with illustrated instructions for making Desk Telephone Lamp including all parts (lamp, nipples, push switch, cord, plug, etc.)... \$6.50 Ppd. (Shade is not included).

MICROPHONE, Dept. X3102, 1760 W. Lunt Ave., Chicago 26, Ill.

WRITE: BREVITYPE INSTITUTE, SAN DIEGO, CALIF. DEPT. 1822

LEARN THE WORLD'S SIMPLEST, SPEEDIEST SHORTHAND WRITE FOR FREE LESSONS

FREE—please send me typical lessons, details on Brevitype—world's simplest, speediest shorthand—first machine shorthand in shorthand coding. Tell me how I learn Brevitype in 30 days through your personally guided home-study course. Show me how switching to Brevitype, as hundreds have, prepares me for security as a stenographer, secretary, court or hearing reporter here, and abroad, in business or Civil Service—helps me increase my salary 50% to 100%. Include costs and budget plans.

BREVITYPE SHORTHAND
THE EASY-TO-LEARN MACHINE



Guaranteed by Good Housekeeping

MODERN: TYPEWRITER KEYBOARD! NO CODING! FAST ABC!

THE BREVITYPE MACHINE, WHICH CARRIES THIS SEAL, COMES WITH THIS COURSE

Now... Get Everything You Need
to Learn and Master

TELEVISION

RADIO-ELECTRONICS

... AT HOME!

Use **REAL** commercial-type equipment
to get practical experience

Your future deserves and needs every advantage you can give it! That's why you owe it to yourself to find out about one of the most **COMPLETE**, practical and effective ways now available to prepare **AT HOME** for America's billion dollar opportunity field of **TELEVISION-RADIO-ELECTRONICS**. See how you may get and keep the same type of basic training equipment used in one of the nation's finest training laboratories... how you may get real **STARTING HELP** toward a good job or your own business in Television-Radio-Electronics. Mail the coupon today for complete facts—including 89 ways to earn money in this thrilling newer field.



21 INCH

Build and keep this **BIG DTI** Engineered TV set—easily converted to U.H.F. (DTI offers another home training, but without the TV set.)

Here's the **REAL THING!**

SET UP YOUR OWN
HOME LABORATORY

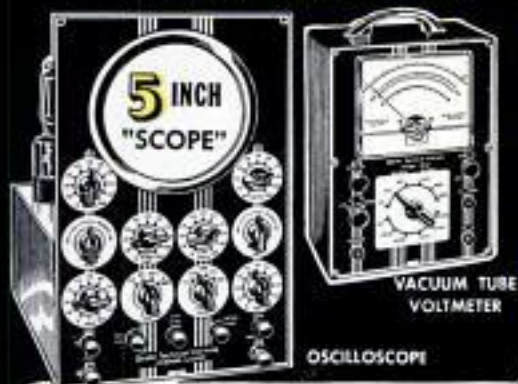

MEMBER OF NATIONAL HOME STUDY COUNCIL

Act Now! Mail Coupon Today!

DEVRY TECHNICAL INSTITUTE
4141 BELMONT AVE., CHICAGO 41, ILL.—DEPT. PM-10-L

I would like your Opportunity News Bulletin showing "89 Ways to Earn Money in Television-Radio-Electronics"; also, complete facts about the training opportunity made possible by your organization.

Name _____ (PLEASE PRINT) Age _____
Address _____ Apt. _____
City _____ Zone _____ State _____

D.T.I.'s Training is available in Canada

D. T. I., ALONE, INCLUDES BOTH MOVIES and HOME LABORATORY In addition to easy-to-read lessons, you get the use of **HOME MOVIES**—an outstanding training advantage—plus 16 big shipments of Electronic parts. Perform over 300 interesting experiments for practical experience. Build and keep real commercial-type test equipment shown at left.

Modern Laboratories

If you prefer, get all your preparation in our new Chicago Training Laboratories—one of the finest of its kind. Ample instructors, modern equipment. Write for details!



HOME MOVIES

Get information-packed
publication
FREE!

MILITARY SERVICE
If you're subject to military service, the information we have for you should prove very helpful. Mail coupon today.

"One of America's Foremost
Television Training
Centers"



DEVRY TECHNICAL INSTITUTE

CHICAGO 41, ILLINOIS

FORMERLY

DEFORST'S TRAINING, INC.

Inventors

If you consider your invention valuable, take these necessary preliminary steps promptly to protect it by applying for a United States patent.

Sketch and describe your invention. (For convenience in starting action on your invention, use "Evidence of Invention" form offered below.)

Sign, date and have this invention disclosure witnessed by two people capable of understanding your invention.

Have us make a preliminary search among U. S. patents already granted for similar types of invention.

We then prepare a report for you on the probable patentability of your invention and recommend your further course of action.

This firm is registered to practice before the U. S. Patent Office. We are available to assist you in the preparation and prosecution of your application for patent.

We shall be glad to send you promptly and without obligation, an instructive booklet—"Patent Protection for Inventors"—and our convenient "Evidence of Invention" form.

VICTOR J. EVANS & Co. *Merlin M. Evans*
REGISTERED PATENT ATTORNEY
130-L MERLIN BUILDING, WASHINGTON 6, D. C.

KEEP YOUR CAR BATTERY FULLY CHARGED AT HOME!



With a NORKO CHARGER, you charge your battery at home—overnight—without disconnecting cables or removing battery from car. And you get better service—much longer life—from a battery kept fully charged.

Priced as low as \$14.95

A dependable NORKO CHARGER is the handiest automotive device you'll ever own. Quickly pays for itself. Operates from 110-volt home power. Compact, lightweight; sets on floor or shelf or hangs from wall. Models for 6 and 12-volt batteries. Sold by most auto stores.

If your dealer can't supply, send for FREE catalog. Many thousands of wise motorists own NORKO CHARGERS. Get yours now.

SCHAUER MANUFACTURING CORP.
4532 Alpine Ave. Cincinnati 36, Ohio

Make Extra Money At Home

BEFORE **INVISIBLE REWEAVING** **AFTER**

PAYS UP TO \$10.00 IN AN HOUR!
Here's your chance for spare-time earnings at home! Do the INVISIBLE REWEAVING in your own community. Make cuts, burns, moth holes, tears in dresses, suits, all fabrics DISAPPEAR! Do it at home—in spare time. Demand from tailors, cleaners, dent. stores, laundries, individuals. Profits up to \$10 for 1 hour's work reported! Write for details, **FABRICON CO., 8342 S. Prairie Ave., Dept. 3210, Chicago 19, Ill.**

WORLD'S LOWEST PRICED ADDING MACHINE Vest Pocket Size FREE TRIAL \$2.95
IDEAL FOR BUSINESS AND PERSONAL USE—GUARANTEED ACCURATE. Not a toy. Operates with only a finger flick. Adds, subtracts, multiplies, divides. Counts up to one billion. Pays for itself over and over. Ideal Gift—for Business, Income Tax and School use. **MONEY BACK GUARANTEE.** Send name and address. Postman only \$2.95 plus postage. (Send full cash if outside U.S.) Beautiful rich-looking Leatherette Case included at no extra cost. Money back in 10 days if not delighted. **AGENTS WANTED.**
CALCULATOR MACHINE CO., (Mfgs.)
Box 84 Dept. 0-35 Glenview, Illinois

SEND FOR THIS FREE!
HOW TO BREAK and TRAIN HORSES
Make money. Know how to break and train horses. Write today for this book **FREE**, together with special offer of a course in Animal Breeding. If you are interested in Gaiting and Riding the saddle horse, check here () Do it today—now.
BEERY SCHOOL OF HORSEMANSHIP
Dept. 11010 Pleasant Hill, Ohio

Free Book on Arthritis And Rheumatism

HOW TO AVOID CRIPPLING DEFORMITIES

An amazing newly enlarged 44-page book entitled "Rheumatism" will be sent free to anyone who will write for it.

It reveals why drugs and medicines give only temporary relief and fail to remove the causes of the trouble; explains a proven specialized non-surgical, non-medical treatment which has proven successful for the past 36 years.

You incur no obligation in sending for this instructive book. It may be the means of saving you years of untold misery. Write today to The Ball Clinic, Dept. 756, Excelsior Springs, Missouri.



Get more money!
More security! More out of life!



Learn TELEVISION • RADIO • ELECTRONICS

Get the best!

Get National Schools' SHOP-METHOD HOME TRAINING!

Start now! Why wait around for that raise or promotion that may never come? Get started *now* in high-paying TV-Radio-Electronics! National Schools' SHOP METHOD Home Training prepares you for success in a top-salary job or in your own business. You learn *all three*... Television, Radio, Electronics... in one complete course. Our Shop-Tested lessons and manuals help you master all phases in shortest possible time! Send coupon, find out today!

WHY NATIONAL SCHOOLS LEADS THE FIELD

Located in the "Television Center" of the world, our staff is in close touch with latest developments and opportunities. We give you personalized job placement assistance. We also give you confidential help with both technical and personal problems relating to your training. We show you how to make Part Time Earnings as you progress. Whether you live 30 miles away, or 3,000, you will always be pleased with our prompt, friendly service!

DRAFT AGE? Our home training helps you achieve specialized ratings and higher pay grades if you go in service.

We send you this precision-tested Multitester! Plus parts to build Oscillators, Receivers, Signal Generator, Continuity Checker, Combination Short Wave and Standard

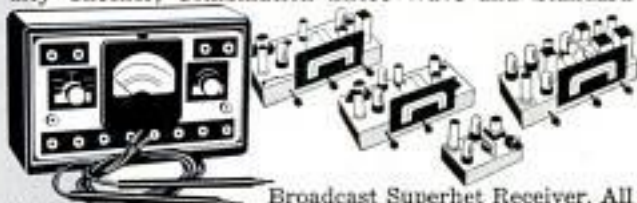

Broadcast Superhet Receiver. All this equipment is part of your National Schools course. **NO EXTRA CHARGES!** Send coupon for free books!

NATIONAL SCHOOLS, world-famous technical trade school. Now entering our 50th year!



NATIONAL SCHOOLS TECHNICAL TRADE TRAINING SINCE 1905

LOS ANGELES 37, CALIFORNIA

In Canada: 811 W. Hastings St., Vancouver, B. C.

• APPROVED FOR G. I. TRAINING

• BOTH HOME STUDY AND RESIDENT COURSES OFFERED

30 MILLION TV SETS

need regular repair! Color TV means more sets than ever before. NOW is the golden opportunity to cash in on this multi-billion-dollar industry. Or "write your own ticket" in broadcasting, manufacturing, and other specialized phases!

**YOUR AGE
IS NO
OBSTACLE!**



Send for
FREE LESSON!
FREE BOOK & SAMPLE LESSON
will convince you!
SEND COUPON TODAY!

MAIL NOW TO OFFICE NEAREST YOU!

(mail in envelope or paste on postal card)

NATIONAL SCHOOLS, DEPT. RB-105

4000 SOUTH FIGUEROA STREET
LOS ANGELES 37, CALIFORNIA

OR 323 WEST POLK STREET
CHICAGO 7, ILLINOIS

Please rush **FREE BOOK**, "My Future in Radio-Television-Electronics," and **FREE LESSON** at once. I understand there is no obligation, and no salesman will call.

NAME _____ BIRTHDAY _____ 19__

ADDRESS _____

CITY _____ ZONE _____ STATE _____

Check if interested **ONLY** in Resident Training at Los Angeles.

VETERANS: Give date of discharge _____

This 49½¢ STORM protects your family

LOW COST HEALTH PROTECTION

The new Trans-Kleer storm window is wonderfully transparent—you can hardly see it. Yet it shuts out winter's chill blasts and saves dollars in your fuel bills. Yet the window illustrated here costs only 49½ cents!

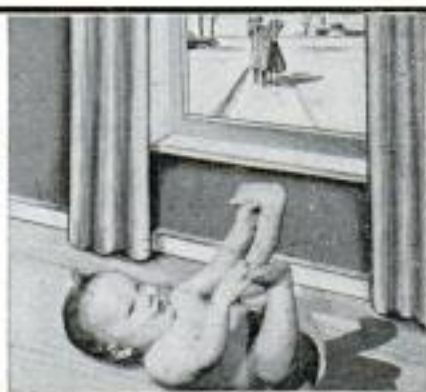

NOW . . . Storm Windows need not cost you up to \$14.00 apiece. American industry has developed a lightweight flexible product that enables you to seal out wintry blasts for only 49½¢ a window! Imagine it! For pennies per window you can insulate EVERY ROOM in your home! This new material was developed by a billion-dollar American defense firm—for use by the U. S. Government during the last world war. It looks like glass, yet can't peel off, never chips, shatters or rattles. Actually flexible like rubber. Has a tensile strength of over one ton per square inch. Crystal clear, not milky or yellowish like some plastic materials. Weighs less than 1/10th of the lightest glass windows ever developed. Even a large window comes to less than 8 oz.! Not affected by snow, sleet, rain or dampness—because it's 100% waterproof. Won't crack even at 53 degrees BELOW FREEZING! Use and re-use it YEAR AFTER YEAR for winter comfort and protection.

Sensational Discovery Used By Army To Fight Cold

One of the big problems of the last war was how to defend our troops and protect equipment against the ravages of Arctic winters. One of the world's greatest industrial firms was ordered to build a special plant and soon millions of yards of a new material was moving out to Alaska, the Aleutians, Iceland and Greenland. It was not available to the public because every inch went to protect our men, vehicles, planes and weapons. Finally, it was released to the public and ever since the demand has been greater than the supply!

LIFT ADHESO BORDER FOR AIRING



To ventilate the room, just lift from the bottom after first loosening the Adheso border. Then reseal—you'll find it seals as tightly as when first applied to the frame. It is TOP QUALITY adhesive material and retains its effectiveness over long periods of time.

NEW TRANS-KLEER STORM WINDOW GOES ON OR OFF IN ONLY 5 MINUTES!

**NO HOOKS — NO NAILS
NO TOOLS — NO SCREWS**

ONLY 49½¢ FOR 10.8 SQ. FT. WINDOW!

Install Trans-Kleer Windows in 5 Minutes!

Trans-Kleer storm windows require no nails, hooks, screws or tools. No back-breaking toil or broken glass to contend with. Cut off required amount, trim to fit the inside of your window large or small, square, round, rectangular—it makes no difference! Then press on the special Adheso border supplied and your storm window is firmly in place. Simple, easy—a child can install them! And Trans-Kleer windows, because of the LOW CONDUCTIVITY development of Reynolds engineers, give you real winter protection, actually keeps wintry blasts out of your home.

Use Year After Year— No Upkeep Cost!

At winter's end just fold away your Trans-Kleer like cloth for use next year. You can air the room at any time, too—lift the Adheso border to let in fresh air, then press back and it's sealed tight again! Clean easily with a damp rag. It's no wonder so many home owners, hospitals, churches and public buildings use them! TRANS-KLEER comes in kits 36 inches by 432 inches and costs you only \$4.95 complete with Adheso border! That is enough for 10 windows—each measuring 10.8 sq. ft.—just 49½¢ each! In all you receive 108 SQUARE FEET for only \$4.95! Good GLASS storm windows cost from \$7.95 to \$16.00—for ten you'd have to pay \$79.00 to \$160.00. With Trans-Kleer you not only save a terrific amount in the purchase price you also cut down enormously on your fuel bills!

Over 2 Million Windows Sold Last Year

For years, demand for Trans-Kleer has outstripped the supply. Lucky buyers of the first windows told their neighbors and the word spread. Last year alone, over 2,000,000 were sold, yet thousands of folks were disappointed when the supply ran out. Advertising had to be curtailed and our huge supply was exhausted earlier than anticipated. There will be another wild scramble for them this year. Production has been planned for 2,500,000 this year—but even this huge total might not be enough unless you act FAST!

Test in Your Home AT OUR RISK!

Here's your chance to get Trans-Kleer on a HOME TRIAL BASIS. You can't lose a single penny. Mail the coupon below and a 36 by 432-inch kit—108 SQUARE FEET—

WINDOW all winter!

will be shipped to you immediately, complete with Adheso border. Deposit only \$4.95 plus postage with the mailman. Try TWO windows in any room. Test them—see for yourself how they seal out drafts. Compare the temperature—any 25c thermometer will do—compare with any other room in your home. See the difference—feel the difference. Then if you're not convinced they're every bit as effective as ANY storm window—why, just keep the TWO windows and return the balance and get your \$4.95 back at once!

MAKE THIS TEST!



On a windy day, hold a lit match inside a closed window . . . the first gust of wind will blow it out. Now put up your Trans-Kleer window . . . a lit match will NOT blow out EVEN IF YOU KEEP YOUR REGULAR WINDOW OPEN!

ADVICE TO READERS To Obtain Best Results From Storm Windows

Good storm windows, whether of glass, thermopane, plastic or Trans-Kleer can save you many dollars on fuel bills—if they are well sealed. Follow these 5 rules carefully: 1. Check for leaks. 2. Make sure window fits tight. 3. Caulk aluminum type before installing. 4. Store wooden frame type in dry place to prevent warping. 5. Replace all cracked panes at once. With the development of Trans-Kleer you have no storage or caulking problems, no shattering glass, no panes to replace, no leaks to seal, no hard toil to install or remove! They go on the **INSIDE** of the regular windows.

The Adheso border on your Trans-Kleer seals your home in—all winter long. You have no **LEAKAGE** worries. You get greater warmth—greater health protection. And for only pennies!

Trans-Kleer permits you to air your rooms simply, easily. You merely lift the border to let stale air out, fresh air in. Then press back in one second and you have perfect insulation again. This can't be done with certain other type plastic windows. Freezing weather is on its way. Play safe! Get your Trans-Kleer now! Orders received too late will be returned at once. Rush coupon now and avoid disappointment!

Avoid Disappointment— Order Now!

Millions of folks in the U.S. and Canada are reading this same ad in hundreds of magazines and newspapers. Don't wait until it's too late! Play safe! Rush the coupon NOW! If you wish to save postage cost, send check, cash or m.o. for \$4.95 and the windows will be shipped postage free.



STRETCHES WITHOUT BREAKING!

THIS SUPERB NEW STORM WINDOW STRETCHES WITHOUT BREAKING! Has tensile strength of over 1 ton per square inch. You can push it with your foot and it stretches—then springs back undamaged. Now produced by the famous Reynolds Metals Co. Installs quickly and easily inside regular windows of any size or shape. Millions now in use throughout the U. S. and Canada.

THORESEN'S

352 Fourth Ave., Dept. 6-L-47, New York 10, N. Y.

RUSH FOR FREE HOME TRIAL! THORESEN'S, Dept. 6-L-47

352 Fourth Avenue, New York 10, N. Y.

RUSH the following kits TRANS-KLEER measuring 108 SQUARE FEET each (enough for 10 windows averaging 10.8 square feet each). Include improved ADHESO Sealing Border and easy picture instructions. This order is on a Home Trial—money back guarantee basis. I must be satisfied in every way. I shall use enough material for 2 WINDOWS in any room of my house—without obligation. They must seal out drafts. I must SEE the difference on my thermometer. I must FEEL the difference. Then, if I am not convinced that they are every bit as effective as any costly storm window in the market—if I am not satisfied for any reason, I shall KEEP the 2 windows FREE returning the remainder in the next week for quick refund of the FULL PRICE—no questions asked!

CHECK AMOUNT DESIRED BELOW —Note Special Quantity Savings—

- | | |
|---|---|
| <input type="checkbox"/> 1 KIT (108 Sq. Ft.)
for 10 windows—\$4.95 | <input type="checkbox"/> 2 KITS (216 Sq. Ft.)
for 20 windows—\$8.95 |
| <input type="checkbox"/> 3 KITS (324 Sq. Ft.)
for 30 windows—\$11.95 | <input type="checkbox"/> 6 KITS (648 Sq. Ft.)
for 60 windows—\$20.95 |
- () Payment enclosed. () Send COD plus postage.
RUSH postage FREE.

Name _____

Address _____

Town _____ State _____

CANADIANS: Save tariff by ordering direct from THORESEN'S LTD., 45 St. James St., West, Dept. 05-47, Montreal 1, Que. Same prices. Same money back guarantee. Immediate delivery from Montreal.

These great minds were Rosicrucians . . .



Francis Bacon Benjamin Franklin Isaac Newton

WHAT SECRET POWER DID THEY POSSESS?

Why were these men great?

How does anyone—man or woman—achieve greatness? Is it not by mastery of the powers within ourselves?

Know the mysterious world within you! Attune yourself to the wisdom of the ages! Grasp the inner power of your mind! Learn the secrets of a full and peaceful life!

Benjamin Franklin, statesman and inventor . . . Isaac Newton, discoverer of the Law of Gravitation . . . Francis Bacon, philosopher and scientist . . . like many other learned and great men and women . . . were Rosicrucians. The Rosicrucians (NOT a religious organization) have been in existence for centuries. Today, headquarters of the Rosicrucians send over seven million pieces of mail annually to all parts of the world. Address: Scribe O.W.T.

THIS BOOK FREE



The ROSICRUCIANS

San Jose (AMORC) California, U.S.A.

—SEND THIS COUPON—

Scribe O.W.T.
The ROSICRUCIANS
(AMORC)
San Jose, California, U.S.A.
Please send me the free book, *The Mastery of Life*, which explains how I may learn to use my faculties and powers of mind.

Name _____
Address _____
City _____
State _____

INSURED TIRE SERVICE
POPULAR BRANDS

FREE INSURANCE POLICY given with each used tire sold. We guarantee the amount of service you pay for.

NOWHERE CAN SUCH QUALITY BE FOUND AT SUCH LOW PRICE!

SPECIAL! 10% on orders for two or more used tires

YOU CAN'T LOSE!!

GOODYEAR SUBURBANITE TYPE SHOW TIRES

New Tire Guarantee—Factory Rebuilt
BEST WINTER TRACTION OF ALL!

670x15	\$9.95	710x15	650x16	\$10.90
600x16		760x15	650x15	

Super Quality — Rugged Performance — 15 Months Insured Service

600x16	\$3.65	670x15	\$3.95	700x16	\$4.45	760x16	\$4.75
650x15	3.85	670x16	4.05	710x15	4.35	820x15	4.95
650x16	4.25	700x15	3.95	760x15	4.45	550x17	4.65

Supreme Quality — Nothing Finer — 30 Months Insured Service

600x16	\$8.25	475x19	\$5.45	700x15 (6)	\$10.45	700x20	\$12.50
600x16 (6)	8.75	640x15	4.95	750x16 (8)	15.95	750x20 (R)	15.50
650x16	8.75	670x15	5.35	700x17	11.95	750x20 (10)	17.50
650x16 (6)	7.25	710x15	5.45	750x17	16.45	825x20	21.60
700x16	6.35	760x15	5.95	750x15	10.95	900x20	19.95
750x16 (6)	8.45	800x15	6.35	30x8	11.25	1000x20	20.45
550x18	4.95	820x15	6.35	600x20	10.95	1100x20	21.25
650x17	4.75	550x15	5.35	650x20	11.75	1000x22	21.95
650x18	5.25	670x16	5.15	32x8 (8)	11.95	1100x22	22.75
700x18	5.35	700x16 (6)	10.25	32x6 (10)	12.75	1100x24	25.95

Whitewalls \$1.00 extra.

MIDLAND TIRE SALES

Speedy shipments on Mail Orders. P.O.B. Chicago. Insurance policy sent with each order. Deduct 10% on orders for 2 or more used tires. Send CHECK or MONEY ORDER—No COD's.

3701 S. Normal, Dept. PM-39, Chicago 9, Ill.

KILLS SMALL GAME!

NEW! Accurate Scope-type Sight Pistol Grip, 250 Pellets FREE!

Scope-Shot

ONLY \$1.95 postpaid
BIG BAG 250 extra pellets
50 p.p.

Rugged, powerful, new-type slingshot. Polished cast aluminum frame. Pistol grip stock. Easily carried. FREE with each SCOPE-SHOT: 250 high-velocity DISINTEGRATING PELLETS that literally explode when they hit, and valuable shooting manual! Satisfaction guaranteed. Pellets only, 250 for 50c p.p. ORDER NOW.

GENERAL SPORTS, 4184-K Apple St., Cincinnati 23, Ohio

How to Write Short Stories, Mysteries, Articles

Willing to spend a few hours a week learning to write so you may earn \$500 to \$1500 a year part-time? Or many thousands full time? Earn while learning. H. F. Wenderoth sold first story for \$240. Free sample lesson and book, "Art of Writing Salable Stories," tells how unique home-study method gives you thorough, professional training in writing for magazines, radio-TV, movies. Write today!

PALMER INSTITUTE OF AUTHORSHIP, Since 1917
1680 N. Sycamore Desk T-105 Hollywood, Calif.

\$14,839 in 1 Year SERVICING RADIATORS

—REX RYAN, Bloomfield, Iowa
Hundreds earning \$8,000-\$20,000 a year servicing auto-truck-tractor radiators! New Inland equipment makes work easy. Insures finest professional workmanship. "Pays-for-itself" financing available. \$100 training course included free by world's largest radiator servicing equipment manufacturer.

WRITE for free folder "Want a business of your own?"

INLAND MFG. COMPANY Dept. PM-10
1108 Jackson St., Omaha 8, Nebr.

EXTRA MONEY
Selling EXCLUSIVE PARAGON Cushion Shoes

Even if Now Employed

Enjoy your own lifetime, independent shoe business without investment. Steady repeats. To \$4.00 pair advance commissions. Big bonus. Make \$50 and more a week in full or spare time. 115 latest smart styles. Magic cushion. Easy to start. Write for FREE OUTFIT today!

PARAGON SHOE COMPANY
79 Sudbury St., Dept. 20, Boston 16, Mass.

Remarkable NEW Training Plan by A Reputable OLD School!

NO EXPERIENCE NEEDED
 This *New* PRACTICAL
DELEHANTY PLAN entails
 NO RISK, NO OBLIGATION
Money Back Guarantee

EARN EXTRA MONEY in SPARE TIME in a few weeks! And GOOD FULL TIME JOBS at HIGH PAY...or a PROFITABLE BUSINESS of YOUR OWN in matter of months!

Learn **TELEVISION** RADIO & ELECTRONICS
 AT HOME
 We Furnish ALL Your EQUIPMENT without Extra Charge!



The DELEHANTY SCHOOL

...one of America's foremost Vocational Training Centers for nearly Half a Century with over Half a Million students...has developed this remarkable New Shop-Training-At-Home Method. Perfected by a large staff of electronic experts, engineers, technicians and teachers with extensive practical field experience. Right up to the minute in every phase of TELEVISION, RADIO and ELECTRONICS, including U.H.F., COLOR TV, HIGH FIDELITY, etc.

PRACTICAL SHOP WORK STARTS with FIRST LESSON! with TOOLS and PARTS that WE FURNISH IMMEDIATELY!!

There's no other course quite like this! No need to plow laboriously through difficult uninteresting theory lessons before getting into actual practical work!

The DELEHANTY "LEARN-BY-DOING" method makes every lesson a thrilling new experience! You get a big kit of quality tools and parts with your very first lesson... you start right in with practical shop assignments which are an interesting part of every lesson...nearly 400 shop jobs in all!!

SET YOUR OWN PACE!

DELEHANTY TRAINING lets you study and experiment at your leisure...Order new Training Units only as you want them... Pay as you go at your convenience! You move steadily forward until you attain the high level of technical knowledge and skill that marks DELEHANTY graduates as thoroughly competent RADIO, F-M and TELEVISION TECHNICIANS.

YOU PAY AS YOU GO YOU'RE NEVER IN DEBT!

When you complete your DELEHANTY TRAINING you will owe nothing!

YOU WILL HAVE AS YOUR OWN PROPERTY:

- 21" TV SET WITH 21" PICTURE TUBE • SUPERHETERODYNE RADIO WITH ALL TUBES
- MULTITESTER-AMMETER, OHMMETER, VOLTMETER • OSCILLATORS • MODULATORS
- RADIO TELEPHONE TRANSMITTER • TOOLS
- RF AMPLIFIERS • AUDIO AMPLIFIER
- OTHER ELECTRONIC DEVICES • REFERENCE LIBRARY IN DURABLE LOOSE-LEAF BINDERS



MAIL COUPON TODAY FOR FREE ILLUSTRATED BOOKLET

NO OBLIGATION • NO SALESMAN WILL CALL

DELEHANTY SCHOOL OF TELEVISION PM 105
 115 East 15 Street, New York 3, N. Y.

Please send me by return mail your Free Booklet "How to Achieve Success in Television, Radio and Electronics." This does not obligate me in any way.

NAME _____ AGE _____

ADDRESS _____

CITY _____ ZONE _____ STATE _____

(PLEASE PRINT — Paste on Post Card or Mail in Envelope)

DELEHANTY SCHOOL of TELEVISION

LICENSED BY STATE OF NEW YORK

115 EAST 15 ST., NEW YORK 3, N. Y.

TUNE UP! PEP UP! Fix Up Any Car!



Handle ANY job on ANY make, model, part!

Just look up the make, model and part of the car you want to fix!

This giant Chilton "ALL CARS" Repair Manual helps you locate the trouble fast . . . then shows exactly how to fix it.

No guesswork! Everything is explained so clearly it's next to impossible to go wrong even if you've never repaired or adjusted a car before.

Gives complete service details on practically every part of EVERY model of the 29 leading car makes from June 1940 to the present—over 600 models!

SHOWSHOW! TELLSHOW! EVERY STEP OF EVERY JOB!

Shows what work-saving shortcuts to take . . . what adjustments to make . . . what mistakes to avoid . . . even what standard tools to use. Minor details often so puzzling to beginners are fully explained.

Has 904 giant, manual-size pages. Weighs 4 1/2 pounds. Almost 3000 clear pictures explain things step by step. 58 Trouble-shooting Charts and 353 Quick Check Data Tables speed your work. Thousands of parts and service specifications save you time and money.

Published each year by Chilton—world's largest automotive publishers. Used for Army-Navy training. Try it 10 days at our risk!

GIANT NEW EDITION

Covers Every Model of Three 20 Makes Since 1940—Over 15 years of cars!

BUICK • CADILLAC • DE SOTO
KAISER • MERCURY
CHEVROLET • DODGE • FORD
LINCOLN • OLDSMOBILE
CHRYSLER • FRAZER • NASH
PACKARD • PLYMOUTH
HENRY J • HUDSON • WILLYS
PONTIAC • STUDEBAKER

READ WHAT THESE USERS SAY!



EASY! "The Chilton how-to-do-it pictures are worth the entire price of the manual."
Melvin Wade, Penna.



FAST! "Thanks to my Chilton Manual, I did a job in an hour another mechanic had worked on all day!"
Gene Arnold, Iowa.

PRACTICE 10 DAYS FREE!

THE CHILTON CO., Dept. PM-105
3605 Chestnut St., Philadelphia 39, Pa.

Send me the big 904-page CHILTON "ALL CARS" REPAIR MANUAL (Price \$6.95) for 10-day FREE EXAMINATION. If I like Manual, I will then promptly remit \$1.95 (plus 45c postage and handling); then send \$2.50 each month for two months. Otherwise I will return manual postpaid in 10 days and owe you nothing. **SAVE!** Send \$6.95 with order and we pay postage-handling charge. Same return privilege.

Name.....

Address.....

City, Zone, State.....

(OUTSIDE U.S.A.—Price \$8.95 cash with order. 10-day return privilege with money refunded.)

— Chilton books are sold by leading book stores. —

You can have a career instead of a job

Industrial growth . . . automation . . . technical advances create tremendous opportunities for engineers, accountants, management experts. Share the rewards awaiting college-trained men in engineering and commerce. Important concerns visit campus regularly to employ Tri-State College graduates. Start any quarter in this world-famed college. Approved for veterans.

Bach. of Science degree in 27 months

In Mechanical, Civil, Electrical, Chemical, Aeronautical, Radio (TV-Electronics), Administrative Engineering; Business Administration and Accounting. 36-weeks course in Drafting; Intensive program: technical fundamentals stressed: comprehensive courses with more professional class hours.

Small classes: personalized instruction. For earnest, mature students whose time and budget requires accelerated courses and modest costs. Preparatory courses. Beautiful campus in friendly college town. Well-equipped, new and modernized buildings and labs. Enter Jan., March, June, Sept. Write Jean McCarthy, Director of Admissions, for "Your Career in Engineering or Commerce".



A "GOOD HAND" HELPS YOU SUCCEED!
LEARN TO WRITE WELL

Handwriting quickly improves with our easy-to-understand picture lessons! Put your spare time to good use; send today for **FREE BOOKLET**, "How to Become a Good Penman," or check volumes wanted below at \$1 each: Business Writing Artistic Writing Card Writing Bird & Design Flourishing Engineering Alphabets, COMPLETE SET \$4.50. Ask for price list of penman's supplies.

Beautifully written, plus special pen-point for shaded writing. **OUR 53rd YEAR**
Only 10¢

TAMBLYN SCHOOL OF PENMANSHIP
S.A. Ziller, Pres., 442 Ridge Bldg., Kansas City, Mo., USA

'How to MAKE MONEY with Simple CARTOONS'

A book everyone who likes to draw should have. It is free; no obligation. Simply address **FREE BOOK**

CARTOONISTS' EXCHANGE
Dept. 910D Pleasant Hill, Ohio

LEARN WATCH REPAIRING

AT HOME Modern, original instruction. Prepare for a position or start in business after completing our course. Write Today!
WISCONSIN SCHOOL OF WATCH REPAIRING
2908 N. 44th St. Dept. M Milwaukee 10, Wis.

STAMMERING

may be overcome by re-education of vocal muscles and speech mechanism. Scientific Home Method for adults & children by EX-STAMMERER based on physiology of speech leads to **FLUENT SPEECH**. Write:
Dept. PM-3, VOCAL METHODS
P.O. BOX 5123 SAN ANTONIO, TEXAS

RUPTURED?

WE GUARANTEE RELIEF OR YOUR MONEY BACK

Forget rupture pain and worry from trusses that gouge your thighs, hips, or spine—that may aggravate your condition! Cluthe **GUARANTEES TO HOLD** your reducible groin rupture (inguinal hernia) against strain, with comfort you never dreamed possible. You can work and play again without nagging fear or embarrassment. Amazing lightweight Cluthe has been tested and proved in 500,000 cases. Is individually made by Master Fitters to YOUR measurements. No cutting springs, no straps, no harness to bind your skin. 100% waterproof and sanitary. Wear it bathing or swimming. Send for **FREE** book, "Help for the Ruptured". Gives scientific, authoritative facts on rupture care and details of **UNCONDITIONAL GUARANTEE** and 60-day trial offer.

CHAS. CLUTHE & SONS Dept. 31, Bloomfield, N. J.

FOR REPAIRING RADIO AND TV

The New Model 670-A

SUPER METER



A COMBINATION
VOLT-OHM MILLIAMMETER
PLUS CAPACITY REACTANCE
INDUCTANCE AND DECIBEL
MEASUREMENTS

ADDED FEATURE:

Built in ISOLATION TRANSFORMER reduces possibility of burning out meter through misuse.

SPECIFICATIONS:

D.C. VOLTS: 0 to 7.5/15/75/150/750/1,500/7,500 Volts
A.C. VOLTS: 0 to 15/30/150/300/1,500/3,000 Volts
OUTPUT VOLTS: 0 to 15/30/150/300/1,500/3,000 Volts
D.C. CURRENT: 0 to 1.5/15/150 Ma. 0 to 1.5/15 Amperes
RESISTANCE: 0 to 1,000/100,000 Ohms 0 to 10 Megohms
CAPACITY: .001 to 1 Mfd. 1 to 50 Mfd. (Good-Bad scale for checking quality of electrolytic condensers.)
REACTANCE: 50 to 2,500 Ohms 2,500 Ohms to 2.5 Megohms
INDUCTANCE: .15 to 7 Henrys 7 to 7,000 Henrys
DECIBELS: -6 to +18 +14 to +38 +34 to +58

The Model 670-A comes housed, in a rugged crackle-finished steel cabinet complete with test leads and operating instructions.

28⁴⁰

The new streamlined model TC-55

TUBE TESTER



QUICKLY AND EFFICIENTLY TESTS RADIO AND TV TUBES INCLUDING: SEVEN PIN MINIATURES; EIGHT PIN SUBMINARS, OCTALS AND LOCALS; NINE PIN NOVALS

YOU CAN'T INSERT A TUBE IN THE WRONG SOCKET.

It is impossible to insert the tube in the wrong socket when using the new Model TC-55. Separate sockets are used, one for each type of tube base. If the tube fits in the socket it can be tested.

"FREE-POINT" ELEMENT SWITCHING SYSTEM.

The Model TC-55 incorporates a newly designed element selector switch system which reduces the possibility of obsolescence to an absolute minimum. Any pin may be used as a filament pin and the voltage applied between that pin and any other pin, or even the "top-cap."

CHECKS FOR SHORTS AND LEAKAGES BETWEEN ALL ELEMENTS. The Model TC-55 provides a super sensitive method of checking for shorts and leakages up to 5 Megohms between any and all of the terminals.

ELEMENTAL SWITCHES ARE NUMBERED IN STRICT ACCORDANCE WITH R.M.A. SPECIFICATION.

One of the most important improvements, we believe, is the fact that the 4 position fast-action snap switches are all numbered in exact accordance with the standard R.M.A. numbering system. Thus, if the element terminating in pin No. 7 of a tube is under test, button No. 7 is used for that test.

The Model TC-55 comes complete with operating instructions and charts. Use it on the bench—use it for field calls. A streamlined carrying case, included at no extra charge, accommodates the tester and book of instructions.

26⁹⁵

FOR REPAIRING ALL ELECTRICAL APPLIANCES MOTORS AND AUTOMOBILES

The New Model 70 UTILITY TESTER



As an electrical trouble shooter the Model-70:

- Measures A.C. and D.C. Voltages, A.C. and D.C. Current, Resistances, Leakage, etc.
- Will measure current consumption while the appliance under test is in operation.
- Incorporates a sensitive direct-reading resistance range which will measure all resistances commonly used in electrical appliances, motors, etc.
- Leakage detecting circuit will indicate continuity from zero ohms to 5 megohms (5,000,000 ohms).
- Will test Toasters, Irons, Brailers, Heating Pads, Clocks, Fans, Vacuum Cleaners, Refrigerators, Lamps, Fluorescents, Fans, Switches, Thermostats, etc.

Handsome round-cornered molded bakelite case, 3 1/2" x 5 1/2" x 2 1/4". Complete with all test leads. Also included is a 64 page book giving detailed instructions for testing all electrical appliances, automotive equipment, etc.

As an Automotive Tester the Model 70 will test:

- Both 6 Volt and 12 Volt Storage Batteries
- Generators
- Starters
- Distributors
- Ignition Coils
- Regulators
- Relays
- Circuit Breakers
- Cigarette Lighters
- Stop Lights
- Condensers
- Directional Signal Systems
- All Lamps and Bulbs
- Fuses
- Heating Systems
- Horns
- Also will locate poor grounds, breaks in wiring, poor connections, etc.

15⁸⁵

SHIPPED ON APPROVAL NO MONEY WITH ORDER - NO C.O.D.

Try any of the above instruments for 10 days before you buy. If completely satisfied then send down payment and pay balance as indicated on coupon. **No Interest or Finance Charges Added!** If not completely satisfied return unit to us, no explanation necessary.

MOSS ELECTRONIC DISTRIBUTING CO., INC.
 Dept. D-169, 3849 Tenth Ave., N. Y. 34, N. Y.
 Please send me the units checked. I agree to pay down payment within 10 days and to pay the monthly balance as shown. It is understood there will be no finance, interest or any other charges, provided I send my monthly payments when due. It is further understood that should I fail to make payment when due, the full unpaid balance shall become immediately due and payable.

Model 70 ... Total \$15.85 \$3.85 within 10 days. Balance \$4.00 monthly for 3 months.

Model 670-A. Total \$28.40 \$7.40 within 10 days. Balance \$3.50 monthly for 6 months.

Model TC-55. Total \$26.95 \$4.95 within 10 days. Balance \$5.00 monthly for 4 months.

Name
 Address
 City Zone State



IF YOU "EAT, SLEEP
AND LIVE" CARS...
**TURN YOUR HOBBY
INTO A CAREER!**

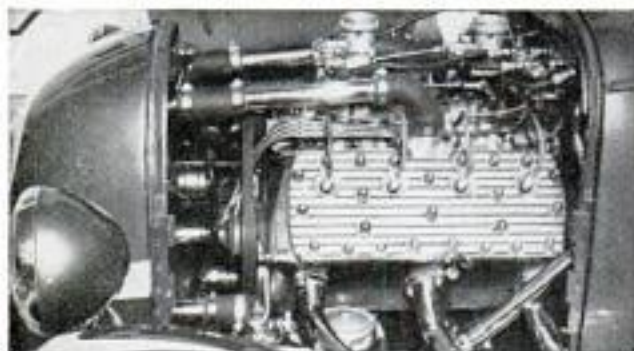

Get America's Big-time, Big-future

AUTO MECHANICS & DIESEL COURSE at home in your spare time!

Los Angeles' National Schools, America's automotive Technical Trade School since 1905, now brings its famous resident Shops and Faculty direct to you at home—to prepare you to earn more money, with job security, in today's fast-moving, opportunity-filled Auto Mechanics Industry! Get your home training from the "Car Capital of the World"—America's most auto-minded city, center of Hot Rod and Sports Car activity! Mail coupon right now!

"SHOP-METHOD" HOME TRAINING!

YOU MASTER ALL PHASES, INCLUDING DIESEL! All lessons fully illustrated. Latest equipment covered.



THIS SET OF LIFETIME TOOLS IS YOURS! Also all-metal tool box. Part of your course, yours to keep. **EARN WHILE YOU LEARN!** We show you how to start Spare Time Earnings soon after enrollment.

ATTENTION MEN OF DRAFT AGE. Learn how you can achieve higher rating and pay. Mail coupon at once!

APPROVED FOR G. I. TRAINING. Both Home Study & Resident Courses. Free help with technical and personal problems—Job Placement Service.



Send for **FREE FACT-BOOK AND SAMPLE LESSON!**
NOW! 2 offices to serve you faster!
Mail coupon today to one nearest you!

NATIONAL SCHOOLS

Technical Trade Training Since 1905

LOS ANGELES 37, CALIFORNIA

IN CANADA: 811 West Hastings Street, Vancouver, B. C.

MAIL NOW TO OFFICE NEAREST YOU!

(mail in envelope or paste on postal card)

NATIONAL SCHOOLS, Dept. DB-105

4000 S. FIGUEROA STREET OR 323 WEST POLK STREET
LOS ANGELES 37, CALIF. CHICAGO 7, ILLINOIS

Send **FREE** Auto-Mechanics Book and Sample Lesson.
No obligation, no salesman will call.

NAME _____ BIRTHDAY _____ 19____

ADDRESS _____

CITY _____ ZONE _____ STATE _____

Check if interested **ONLY** in Resident School Training at Los Angeles.
VETERANS: Give Date of Discharge _____

America's Great Diamond Values

OUT OF PAWN... SAVE UP TO 50% and more

GENUINE DIAMONDS

VALUES FROM \$10 TO \$10,000

TOP QUALITY

Send for Brand New **36 PAGE FREE ILLUSTRATED CATALOG**

Over 100,000 satisfied customers have bought their diamonds from Berman's

MONEY-BACK GUARANTEE ALL DIAMONDS RESET IN BRAND NEW MODERN MOUNTINGS

Our Reference: Your own bank or any mercantile agency.

Berman's Diamond Loan Bank
Dept. P —BERMAN BLDG., BALTO. 1, MD.

LAW FREE BOOK THE LAW TRAINED MAN

Write today for a **FREE** copy of illustrated law book, "THE LAW TRAINED MAN," which shows how to earn the professional Bachelor of Laws (LL.B.) degree through home study of the famous Blackstone Law Course. All necessary books and lessons provided. Moderate cost; convenient monthly terms. Write for **FREE** law training book today.

Blackstone School of Law, 225 N. Michigan Ave.
Founded 1890 Dept. 57 Chicago 1, Ill.

BUILD LUGGAGE AT HOME WE SELL YOUR PRODUCTS!

ONLY NEW HOME MONEY-MAKING PLAN IN YEARS!

Make Luggage and cases for traveling, photographers, musicians, salesmen, electronics, tools, portables, 1001 other items. Also repair Luggage. No special equipment needed. **BIG PROFITS.** We supply complete instructions, materials—everything. Write for free details and Business Plan. **ABARSI CASE-CRAFT, Dept. G-10, 805 W. Sunset Blvd., Los Angeles 12, Calif.**

earn as TAX EXPERT

**\$15
HOUR**

Our students earn as much as \$2,000 in 2 short months preparing income tax returns in spare time. Also operate lucrative year-round Business Tax Service. Dignified home-office business. Experience unnecessary. We train you; help you start. State approved home training program. Write today for free prospectus.

UNION INSTITUTE, 68 Hudson, Hoboken 20C, N. J.

REAL ESTATE BE A BROKER

PAYS BIG! SEND FOR FREE, BIG, ILLUSTRATED CATALOG NOW! Graduates report making substantial incomes. Start and run your own business quickly. Men, women of all ages, learn easily. Course covers Sales, Property Management, Appraising, Loans, Mortgages, and related subjects. **STUDY AT HOME** or in classrooms in leading cities. Diploma awarded. Write TODAY for free book! No obligation.

Approved for World War II and Korean Veterans
WEAVER SCHOOL OF REAL ESTATE (Est. 1936)
2020R Grand Avenue Kansas City, Mo.

FREE BOOK TELLS HOW

NEW FALSE PLATE

FROM YOUR OLD ONE IN **18 HOURS**

AS LOW AS **\$14.95**



Send us your old broken, cracked or loose plates and we'll transform them into new lightweight wonder plastic plates. **NO IMPRESSIONS** needed with our revolutionary method. We use your own old plates. We remake them completely in only 18 hours. Missing teeth carefully matched and replaced. We **GUARANTEE TO SATISFY YOU OR REFUND YOUR MONEY.** **SEND NO MONEY!**—Send us your name today and we'll RUSH COMPLETE DETAILS. Begin to enjoy life right now. Clip this Ad; save it and send for free facts.

CHICAGO DENTAL PLATE LABORATORY • Dept. PM10-55
30 N. Dearborn St. • Suite 807 • Chicago 2, Ill.

BECOME A Mechanical Engineer

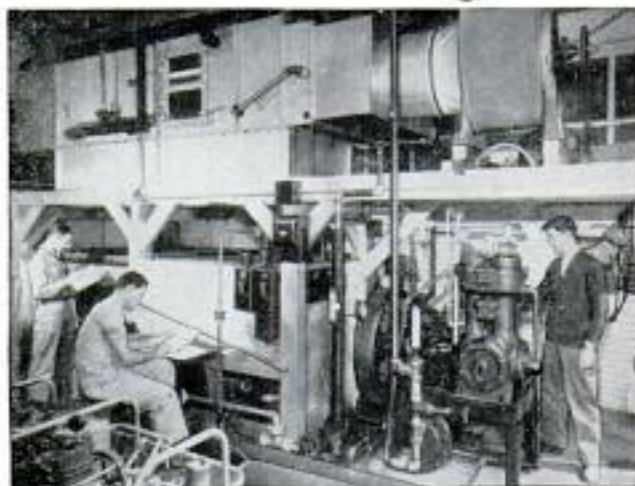

B. S. Degree in 36 months

 Mechanical Engineers hold respected, well-paying, and highly interesting jobs in many fields of industry. You can prepare now . . . for a secure future and a well-paid career as an engineer or engineering technician at the Milwaukee School of Engineering.

Choose from these courses at the Milwaukee School of Engineering

ENGINEERING 36 months, Bachelor of Science Degree

- Mechanical Engineering with a major in Design, Metal Fabrication or Plant Engineering.
- Electrical Engineering with a major in Electronics or Power.

SERVICE 6 to 12 months

- Electricity ● Heating
- Refrigeration ● Welding

TECHNICIAN 12 to 18 months

- Radio and Television
- Electronics
- Electrical Power
- Mechanical Technician
- Air Conditioning
- Welding

General preparatory course — 3 months.

TERMS OPEN JANUARY, APRIL, JULY, SEPTEMBER
Faculty of specialists. Over 50,000 former students. Annual enrollment from 48 states and 23 overseas countries. *Non-profit. 52nd year.* Military, Practical or Academic training evaluated for advanced credit. Approved for Veterans Training. Write for details today.

MILWAUKEE SCHOOL OF ENGINEERING

MS-8A

MILWAUKEE SCHOOL OF ENGINEERING
Dept. PM-1055, 1025 N. Milwaukee
Milwaukee 1, Wisconsin

Send free illustrated career booklets Radio-TV
 Mechanical Technology Electrical Technology

I am interested in _____ (name of course)

Name _____ Age _____

Address _____

City _____ Zone _____ State _____

If veteran, indicate date of discharge _____

OWN a Business

\$5 HOURLY Profit . . .
Even If NOW Employed

Alert dealers average \$5 hourly profit on own service plus \$3 on EACH serviceman. You can profitably operate part time while building a full time business. We locally train and assist you.

Clean and Mothproof, Rugs and Upholstery
Duraclean cleans by absorption! No scrubbing, soaking or shrinkage. Dirt, grease and unsightly spots vanish as if by magic . . . matted pile rises . . . colors revive.
Duraproof protects against moths and carpet-beetle damage. Makes materials resistant to both. Backed by an International Money-Back 6-Year Warranty.
No experience needed. Easy to learn. Quickly established. Nationally advertised Services rendered "in the home." You are trained in your own home town. No Shop Needed. We furnish enough materials to return your TOTAL investment. Territories limited. Write today for FREE booklet explaining details and Easy Terms.
Duraclean Co., 5-160 Duraclean Bldg., Deerfield, Ill.

FREE-U.S. STAMPS

U. S. 1943 Bi-Colored Flag of Occupied Nations (as illustrated) Airmails, Commemoratives, Regular Issues, included in this collection of 25 selected, all different, genuine U. S. Stamps.

PLUS VALUABLE U. S. \$5.00 STAMP. Everything for 10c to cover mailing expenses. Approvals included. Act at once.

WILLET CO. P. O. BOX 511, Dept. 707; Port Chester, N. Y.



FREE! 60 APPROVED EXERCISES, 68 PHOTOS
with **FAMOUS DAN LURIE**
BARBELLS

50 lb. set \$ 8.48 • 100 lb. set \$13.98
150 lb. set \$20.48 • 200 lb. set \$25.98

LOW DIRECT PRICE

SEND FOR FREE CATALOG
Order by mail—50% with order balance. COD, Extra WTS. 13c lb. FOB Plant.
DAN LURIE BARBELL CO.
52M10 Bristol St., Dept. 559K, Brooklyn 12, N.Y.
SEE DAN ON T V "BIG TOP" SHOW

CABINET MAKING

LOW COST HOME TRAINING COURSE FOR BEGINNERS & ADVANCED CRAFTSMEN

Make money. Learn skills and secrets of fine woodworking and tool use. Professionally prepared shop method training tells and shows how. Covers everything. Easy to master.

INTERSTATE TRAINING SERVICE
DEPT. F3, PORTLAND 13, OREGON

25 Yulecards \$1.00 plus 35¢ postage

Personal Photo Christmas Cards, including envelopes, from your own negative.

FREE SAMPLE . . . send snapshot negative for free sample Deluxe Yulecard. Include 6¢ stamps for handling. Negative returned with sample. No obligation. Satisfaction guaranteed. Write today **YULECARDS**, Dept. 17, Quincy 69, Mass. *Div. Mail-N-Save *T.M. Reg.

Grow authentic, LIVE dwarf trees!
Fascinating hobby! Fabulous profit!

GROW MINIATURE TREES
SEND FOR FREE SEED & INFORMATION!

MINIATURE NURSERY CLUB
Dept. JJ-10, P.O. Box 8794,
Los Angeles 8, Calif.

Learn BAKING At Home

Baking is one of America's high industries in wages. Nearly DEPRESSION-PROOF. Thorough basic home course lays sound foundation. If you have aptitude, write for FREE Booklet, "Opportunities in Commercial Baking."
NATIONAL BAKING SCHOOL
835 Diversey Parkway Dept. 1357 Chicago 14, Ill.

POWERFUL — REVERSIBLE ELECTRIC MOTOR

Hundreds
of Uses:

- BOATS
- PLANES
- CARS
- CRANES
- CAROUSELS
- CONSTRUCTION SETS
- and many, many more



ALL 3 FOR
\$2.98

A REAL electric motor — yet it measures only 1x1x1 1/2 in. Turns up to 2800 RPMs—and it's instantly reversible with the power-pack. Remote control optional! Direct drive and belt-drive arrangements. Enclose check or money order for \$2.98 and we'll pay the postage. If not completely satisfied after 10 days, your money will be cheerfully refunded.

B & C CO., Box 183, Hempstead, N. Y.

YOUR OWN BUSINESS!

YOUR OWN HOURS!

UP TO
\$74.20
PER WEEK!



SEND FOR
FREE
CATALOG

Just 3 pairs per day brings you \$74.20 weekly! No experience needed. Just show nationally known Cushion Shoes to friends, neighbors, co-workers. 127 styles. Daily Commissions; Big Extra Cash Bonus. Samples at no cost! Write **TODAY** for FREE Catalog and details of this amazing **EXTRA CASH** opportunity!

TANNERS SHOE CO.
629 Brockton, Mass.

PRINTS POST CARDS

Learn how both large and small businesses are boosting sales with new advertising machine. Write today for **FREE** illustrated **BOOK** of unique advertising plans, money-making ideas for your business. **Cardmaster**, 1920 Sunnyside, Dept. 12-L, Chicago 40, Ill.



ARE YOU MECHANICALLY INCLINED?

Are You Using Your Mechanical Ability to the Best Advantage? If not, investigate a dependable trade where your ability *really* pays. **WATCHMAKING** offers you that opportunity. Write for information about this profession which is stable, light clean work; no age or physical limitations. Opportunities for Watchmakers never better.

KANSAS CITY SCHOOL OF WATCHMAKING

Approved for G.I. Training
Both Resident and Home Study Courses offered
1224 Admiral Blvd. Kansas City 6, Missouri

New Way to Improve Your English

POOOR English can handicap you more than you may realize. What may seem like a little error to you is a sign of lack of education to others. A command of effective English makes you more forceful, confident . . . opens up greater opportunities to you.

Don't allow yourself to be embarrassed by mistakes in grammar, spelling, pronunciation, use of words. In just 15 minutes a day—Sherwin Cody's 100% Self-Correcting Invention can greatly improve your English. 32-page **FREE** book on English tells all about it. No obligation. No agent will call. Address: **SHERWIN CODY COURSE IN ENGLISH**, 5810 Central Drive, Port Washington, N. Y.



Sherwin Cody

**FREE
BOOK**



What will you be doing 2 years from now?

If you like to draw—
this message is for you

LOOK AHEAD TWO YEARS.

Will you be making enough money for the good things of life . . . doing the kind of work you love to do . . . enjoying the security and independence that come with a real profession?

In a remarkably short time, you could be achieving this wonderful life . . . yes, starting on a fascinating, money-making art career . . . *if you have talent.* Here's how to find out: The remarkable Art Talent Test developed by America's 12 Most Famous Artists—an 8-page test for which thousands have paid \$1.00!—will reveal your natural ability to draw—your sense of observation, imagination and design. The Art Talent Test will be sent to you by mail **FREE**—and will be graded for you by a professional artist, without any cost to you.

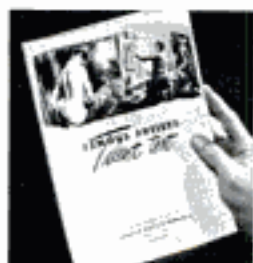

Mail coupon. You may discover that you are the one person in a hundred who could be enjoying a career in art—two years from now!

America's 12 Most Famous Artists

Norman Rockwell	Al Parker
Jon Whitcomb	Ben Stahl
Stevan Dohanos	Robert Fawcett
Harold Von Schmidt	Austin Briggs
Peter Helck	Dong Kingman
Fred Ludekens	Albert Dorne

FREE! Famous Artists
Talent Test for
Men and Women

FAMOUS ARTISTS SCHOOLS

Studio 6-X, Westport, Conn.

Send me without obligation your Art Talent Test.

NAME _____ AGE _____

(PLEASE PRINT)

ADDRESS _____

CITY, ZONE, STATE _____

EARN BIG PAY

Industry needs skilled mechanics. GREER, leader for more than 50 years in the Trade School field, can train you quickly—You "learn by doing," using the finest equipment, under the supervision of expert technicians.

APPROVED FOR CIVILIANS OR GI'S

— CHOOSE YOUR TRADE —

CHECK HERE	WEEKS
<input type="checkbox"/> DIESEL MECHANICS	20
<input type="checkbox"/> AUTO MECHANICS	20
<input type="checkbox"/> BODY & FENDER	16½
<input type="checkbox"/> GAS-ARC WELDING	4-12
<input type="checkbox"/> REFRIGERATION	13½
<input type="checkbox"/> AIR CONDITIONING	8½
<input type="checkbox"/> MACHINIST TRADE	30
<input type="checkbox"/> ADVANCED MACHINIST (includes tool & die)	32½
<input type="checkbox"/> PIANO TUNING & REPAIR	36

CHOOSE YOUR ENGINEERING COURSE

These courses are intended as terminal education for men who wish to enter the Diesel-Automotive and Refrigeration-Air Conditioning fields as technicians. These courses are designed to prepare men for supervisory positions. Students with a high school education, or equivalent, will be accepted.

<input type="checkbox"/> DIESEL AUTOMOTIVE ENGINEERING	2 years
<input type="checkbox"/> REFRIGERATION & AIR COND. ENGINEERING	18 months

HOME STUDY COURSES

Learn at Home — Approved for Civilians & G.I.s. Write for detailed information on Courses in

- PLASTICS
 REFRIGERATION & AIR-CONDITIONING
 DIESEL ENGINES

FREE EMPLOYMENT HELP

Start your career with Greer by checking your interest above and mail coupon for complete information at no obligation.

NAME _____ AGE _____

STREET _____

TOWN _____ ZONE _____ STATE _____

Established 1902 — Over 50,000 Graduates.
52 years of continuous trade school experience
to guide your training.

GREER SHOP TRAINING
Box J, 2236 S. Michigan Ave.
Chicago 16, Illinois



PIPE SMOKERS!



Get this guaranteed
OLDE LONDON PIPE
and 2 full-size pouches of
HOLIDAY
Pipe Mixture

The Olde London Pipe is imported briar, has hard rubber bit, carbonized bowl. If your dealer can't supply you, write **OLDE LONDON, Larus & Brother Co., Inc., Richmond, Va.** Offer good only in U.S.A.

Only \$1.00

GIANT BALLOONS



They're really BIG—surplus U.S. Govt. (new coverage) Neoprene weather, target balloons, GREAT FUN in the backyard! at parties, picnics, dances, fairs, TERRIFIC for high school and college PROMS. They attract BIG CROWDS in business openings, civic events, conventions, exhibitions, trade shows. ORDER TODAY! Approx. inflated sizes:

18 in. dia., 3 for 70c
3 ft. dia., 49c—5 ft. dia., 99c
10 ft. dia., \$1.59—13 ft. dia., \$1.95
15 ft. dia., \$2.50

Postage paid on prepaid orders.
Calif. residents please add sales tax.

VOLUME SALES CO., War Assets Division

Dept. PM-1055 3930 Sunset Blvd. Los Angeles 29, Calif.

Learn ACCOUNTING Business Administration

Bookkeeping, secretarial and allied subjects at home in your spare time or attend nationally approved resident school. Write for FREE Success Book giving complete details on courses, plans, rates and employment opportunities. G.I. approved. Write Dept. A.

Hills BUSINESS UNIVERSITY AND EXTENSION SCHOOL
619 W. MAIN ST. OKLAHOMA CITY 2, OKLAHOMA

AGENTS START BUYING SERVICE AT HOME

GET BIG NAME MERCHANDISE

for your clients up to 40% less than reg. price. Operate sparetime. Sales easy as you can give sizeable discounts, still make fat comm. Postcard brings free plan.

AMERICAN BUYERS SERVICE

HERTEL STATION, DEPT. B, BUFFALO 16, NEW YORK

GET UP TO 40% OFF

Super Powerful All Channel TV RECEPTION IN ALL DIRECTIONS

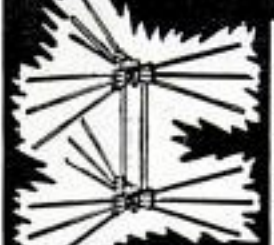

Rocket DIRECTRONIC MOTORLESS TV ANTENNA

- 360° Electronically Switched Beam
- No Motors
- No Roof
- Orientation
- No Electric Power
- No Ghosts
- Flick of Switch Clears Picture Instantly

In the city or in an ultra-fringe area, the Directronic will outperform ordinary antennas. Only the Motorless 360° Directronic TV Antenna offers "around the compass" reception WITHOUT motors. Clarity of picture will amaze, it's so bright, so sharply defined. AX-599 "Serviceman's Array" contains Hi-Fac molded insulator of extremely high tensile strength, 18 hi-tensile aluminum alloy elements, 1 set of connecting studs (3), Universal U-Clamps for masts to 1½". Directronic Beam Selector, 75 feet of Tri-X Cable, 25% deposit on C.O.D. orders, please. Money Back Guarantee.

AX-599 Directronic \$16.95

You pay postage

NATIONAL ELECTRONICS OF CLEVELAND
6608 EUCLID AVE. Dept. P-10 CLEVELAND 3, OHIO

LIFT OUT WINDOWS

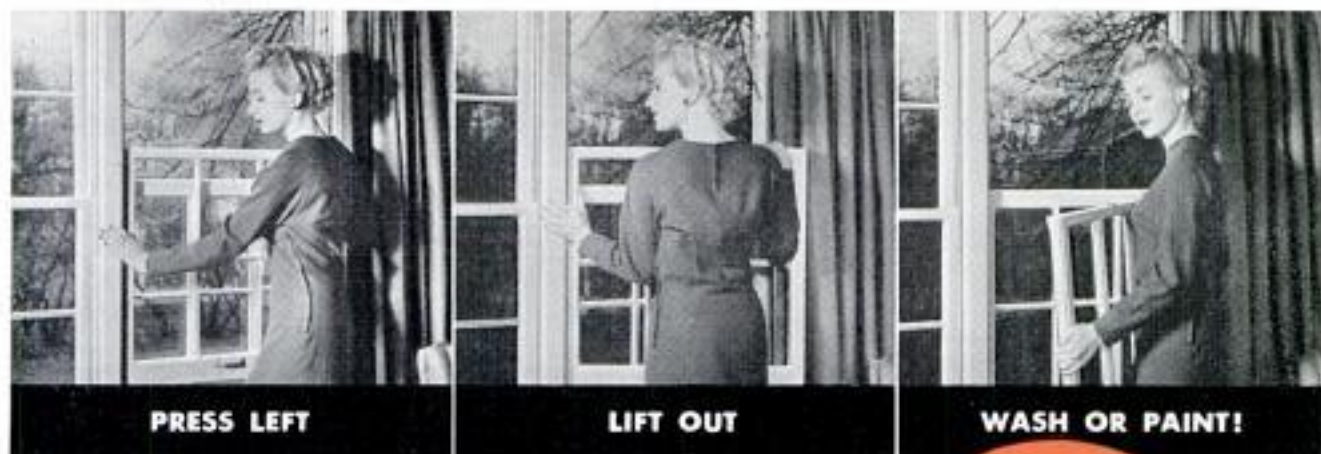

PRESS LEFT

LIFT OUT

WASH OR PAINT!

Weather tight! Balanced right!

R·O·W windows lift out for quick, safe washing or painting *inside* the home.

They are weather-tight in all seasons because spring-pressure compensates for seasonal changes—insures a snug fit.

Equipped with LIF-T-LOX, they are beautifully balanced for easy operation. *LIF-T-LOX* does not attach to the sash—does not interfere at all with the wonderful lift-out feature.

R·O·W is the registered trade-mark of the R·O·W Sales Co.



In normal operating position, (spring-plunger above lock-tab) LIF-T-LOX balances sash for easy operation.



Upon removal of sash, lock-tab grips channel automatically—stays "locked" in position until sash is replaced.



Sash may be replaced in any position—spring plunger will automatically reengage when plunger is above lock-tab.

Details show minor October '55 changes

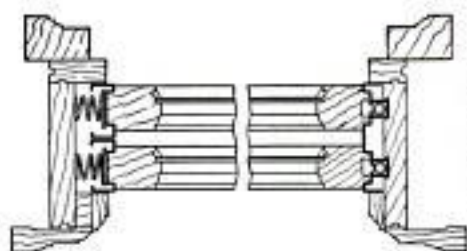

LIF-T-LOX, indicated on the right side here, does not interfere with the patented ROW spring-pressure mechanism shown on the left.

See your lumber dealer or write:

R·O·W SALES COMPANY, 1388 ACADEMY AVE. • FERNDALE 20, MICHIGAN

Here's the Kind of MEN I Build!



CHARLES
ATLAS

Will You Let Me
PROVE I Can Make
YOU a New Man?

THOMAS
MANFRE
One of
Charles Atlas'
pupils... win-
ner of Atlas
Championship
Cup.



I don't care how old or young
you are, or how ashamed of
your present physical condition
you may be. Just give me 15
minutes a day, and I'll start
giving you RESULTS that you
can SEE, FEEL, and MEASURE
with a tape! I can broaden your
shoulders, strengthen your back,
develop your whole muscular
system INSIDE and OUTSIDE! I
can add inches to your chest...
give you a vice-like grip... help
make your legs powerful... help
drain your body so
full of strength,
red-blooded vital-



By your friends will be amazed!
WRITE FOR FREE BOOK. 32
pages about how "Dynamic Ten-
sion" changed me from 97-lb.
weakling into "World's Most Per-
fectly Developed Man"—and what
I'll prove it can do for YOU!
CHARLES ATLAS, Dept. 8-K, 115
E. 23rd Street, New York 10, N.Y.

CHARLES ATLAS, Dept. 8-K
115 East 23rd St., New York 10, N. Y.

Send me—absolutely FREE—a copy of your fa-
mous book, "Everlasting Health and Strength"—32
pages, crammed with photos and valuable advice.
No obligation.

Name _____ Age _____

Address _____ (Please print or write plainly)

City _____ State _____

Sworn statement from Charles Lemming reads:

"After starting my own business,
I've averaged

\$100 A DAY

—most of it clear profit!"

Not everyone does as well...
Mr. Lemming owns 2 machines

• In small city, Mr.
Lemming started his own
business, averaged \$100 a
day during first year. Many
have succeeded. For ex-
ample, George Held grossed
\$350 in single week.

• How much you earn
depends largely on you. No
special skill, no large investment. Can start
spare time until full time available.

No shop necessary. Operate from home.
Clean upholstered furniture on customers'
premises—homes, hotels, motels, etc. Auto
upholstery, too. Profits high.

• To be free of bosses, layoffs, start your
own successful business. Mail coupon today.

SEND COUPON TODAY FOR FREE BOOK

• VON SCHRADER MFG. CO.
• N 10 "D" Pl., Racine, Wisconsin

Please rush your FREE booklet telling how I
can start my own profitable, year-round elec-
tric Upholstery-Cleaning business. Request
incurs no obligation.

Name _____

Address _____

City _____ Zone _____ State _____

INVENTORS

PROTECT YOUR INVENTION BY A
U. S. PATENT. SEND FOR FREE
"INVENTION RECORD" FORM AND
"PATENT INFORMATION
EVERY INVENTOR SHOULD HAVE".

CARL MILLER
REGISTERED PATENT ATTORNEY

WOOLWORTH BLDG., 35th FLOOR, 105A
NEW YORK CITY

INVENTORS

Whether an invention is patentable can be substantially
determined by a search of the U. S. Patent records. With-
out obligation, write for information explaining the steps
you should take to secure a patent.

JOHN N. RANDOLPH

Registered Patent Attorney

201 Columbian Building, Washington 1, D. C.

PATENTS

C. A. SNOW & CO.

REGISTERED PATENT ATTORNEYS

WRITE FOR INFORMATION TO

428 SNOW BUILDING, WASHINGTON 1, D. C.

HELPFUL BOOKS

Send post card asking for FREE catalog
Popular Mechanics Press, 200 E. Ontario, Dept. 601, Chicago 11

INVENTIONS WANTED

If you want to market, or sell, your invention for cash or royalties.
Write for our Free Booklet. Send no drawings. We also welcome hear-
ing from firms, or private capital, wishing to review inventions in
any field. We will be glad to send notice of our clients' inventions.

GLOBAL MARKETING SERVICE

1404 Mitchell Street Dept. PD Oakland 1, Calif.

INVENTORS

Send for
PATENT INFORMATION REGISTERED PATENT
Book and ATTORNEY

INVENTOR'S RECORD ASSOCIATE EXAMINER
without obligation U.S. PAT. OFF. 1922-1929

GUSTAVE MILLER Patent Attorney & Advisor

105-PM WARNER BUILDING U. S. NAVY DEPT. 1930-1947
WASHINGTON 4, D.C. PATENT LAWYER

INVENTORS

I shall be pleased to furnish you,
upon request, with full information
relative to patent procedure—without
any obligation on your part.

PATRICK D. BEAVERS

Registered Patent Attorney

934 Columbian Building Washington 1, D. C.

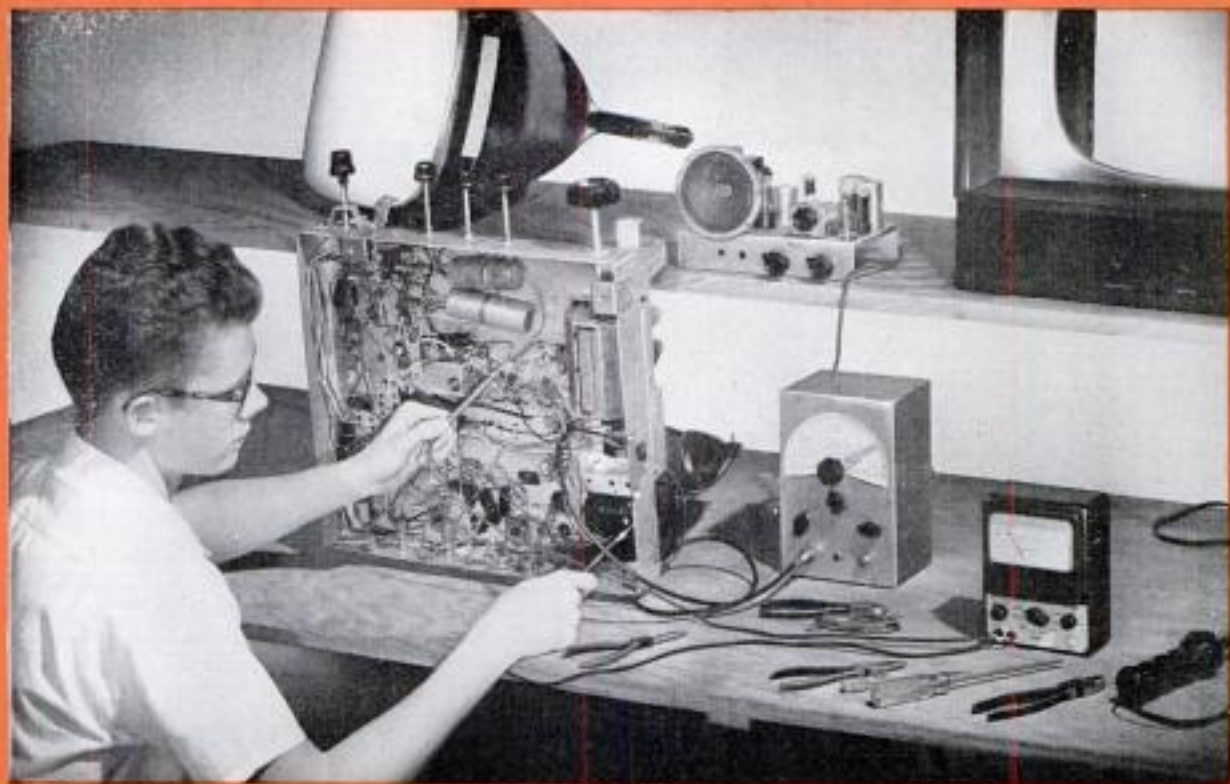

NOW... RCA TRAINS YOU AT HOME IN RADIO-TV ELECTRONICS

NEW AND UP-TO-DATE HOME STUDY COURSE . . . Clearly written by men with years of servicing and teaching experience. Easy to understand . . . step-by-step instruction.

NO PREVIOUS EXPERIENCE REQUIRED. This Home Study Course was specifically prepared for students with no previous electronics training . . . for those who want a sound foundation in this exciting field.

A PRACTICAL COURSE . . . You receive completely workable kits and perform valuable experiments to demonstrate the theory learned. In fact, many students will be able to do service work *even before* they complete all the lessons.

YOU BUILD AND KEEP THESE FINE INSTRUMENTS SHOWN

- a multimeter
- a 6 tube superheterodyne receiver
- an r.f. signal generator
- a television receiver

SINCE 1909, RCA INSTITUTES trained thousands of men in Radio-TV Electronics in our Resident Classes. Many have well-paying jobs in industry; some have established their own business. *Now* this opportunity is available to you at home.

"PAY-AS-YOU-LEARN" PLAN . . . There is no binding contract. You pay for one study group at a time, as

you progress through the course. The cost for everything—including the high quality equipment that you receive and build—is amazingly low. **RCA INSTITUTES**—a service of Radio Corporation of America—is licensed by the New York State Education Department . . . recommended by radio and television service organizations.

**SEND FOR
FREE
CATALOG
NOW**



RCA INSTITUTES, INC.
A SERVICE OF RADIO CORPORATION OF AMERICA
350 WEST FOURTH STREET, NEW YORK 14, N. Y.

RCA Institutes, Inc., Home Study Dept. PM-105
350 West 4th Street, New York 14, N. Y.

Without obligation, send me **FREE CATALOG** on the Home Study Course in Radio-TV-Electronics. No salesman will call.

Name _____

Please Print

Address _____

City _____ Zone _____ State _____



**YOU
can
acquire**

LAW NIGHTS AT HOME! L. B. DEGREE

LaSalle's famous Law Library—used as reference in many Law libraries and Law offices—has enabled thousands to master Law surprisingly fast, in spare hours at home, for business and professional advancement.

These 14 remarkable volumes, compiled by leading professors and lawyers, cover the whole basic field of Law in condensed, orderly, simplified manner.

You advance rapidly with this great library, plus special lectures furnished. We guide you step-by-step with personalized Problem Method of instruction . . . you learn by doing—handling legal problems—not by memorizing rules.

Send for two FREE 48-page booklets, "Law Training for Leadership," and "Evidence," answering questions about Law and its value to you, and telling how LaSalle Law graduates are winning rapid advancement in business and public life. Mail coupon below. No obligation.

LA SALLE EXTENSION UNIVERSITY A Correspondence Institution

417 S. Dearborn St. Dept. 1064L Chicago 5, ILL.

Send me your two FREE booklets described above, without obligation.

Name.....Age.....

Street.....

City, Zone & State.....

ENGINEERING DEGREE IN 27 MONTHS

Big Demand for Graduates

Aeronautical, Chemical, Civil, Electrical, Mechanical and Electronic Engineering (inc. Radio and TV)

Hundreds of young men are earning B. S. ENGINEERING DEGREES annually in this recognized institution — year around operation. New terms start quarterly. Many students earn a major part of their college expenses in this large industrial center.

Low tuition. Competent instruction. Thorough, intense practical program. Modern, well-equipped laboratories including new physics laboratory and modern wind tunnel. Individualized instruction emphasized.

Government approved for G.I.'s. Engineering preparatory courses. Students from 48 states and 21 foreign countries. Enter December, March, June and September. Send coupon for free catalog and full information. Enroll now.

INDIANA TECHNICAL COLLEGE

5105 E. Washington Boulevard, Fort Wayne 2, Indiana

Please send me free information on B.S. Engineering Degree in 27 months as checked.

- Aeronautical, Chemical, Civil, Electrical,
 Mechanical, Electronics

Name.....

Address.....



**Use my TESTED SALES
PLAN to make an extra
\$50.00 every week!**

Just a few hours each week — evenings, Saturdays — can add \$50 to \$100 to your regular income. Be a factory representative for Charles Chester patented Air-Cushion shoes — bring new comfort to friends, neighbors, co-workers — dress, work, leisure shoes for all the family sold only direct from factory to wearer. No investment is required — you make no deliveries, no collections. Just collect deposit from your customers; we do the rest!

STEADY AUTOMATIC REPEAT BUSINESS

Satisfied customers reorder constantly! CHARLES CHESTER representatives offer more than 140 styles, in a tremendous size range, 1-18, AAA to EEE. No Experience Needed — our tested, proven Sales Plan shows you how! Write today for details and FREE SALES KIT!



**AIR-
CUSHION
SHOES**



CHARLES CHESTER SHOE COMPANY
559 Foundry St., Brockton, Mass.

RUPTURED

BE FREE FROM TRUSS SLAVERY

NOW there is a new modern Non-Surgical treatment that permanently corrects rupture. These Non-Surgical treatments are so certain, that a Lifetime Certificate of Assurance is given. Write today for our New FREE Book that gives facts that may save you painful and expensive surgery, and tells how non-surgically you may again work, live, play and love and enjoy life in the manner you desire. There is no obligation. Excelsior Hernia Clinic Dept. 8305 Excelsior Springs, Mo.

LEARN PLASTICS



COMPLETE LOW COST SHOP METHOD HOME TRAINING NOW AVAILABLE

Get in on Big Money opportunities in Plastic molding, casting, forming, carving, etc. Earn as you learn with Interstate's professionally prepared course. All plastic materials furnished.

**WRITE FOR
FREE
BOOKLET**

INTERSTATE TRAINING SERVICE
DEPT. C-3, PORTLAND 13, OREGON

MONEY in DONUTS

Make new greaseless donuts. Start in kitchen. No smoke. Sell stores, Cash daily. No experience necessary. Free recipes. No obligation. Write! MARTIN RAY CO., 3605 SO. 15th AVENUE, MINNEAPOLIS 7, MINN.

GIANT FLASHLIGHT



66,000 CANDLEPOWER

World's most powerful! Uses 6 batteries to create power like 25 cells. Higher voltage. Signals 20 miles. Extreme distance bullseye spot. Optic type reflector. Biggest beam! Every home needs it. Ideal hunter's light. Vacation, fishing etc. Uses gas filled sealed beam bulb.

ELTO CO., Dept. P-10, 18442 Grand River, Detroit 23, Mich.

**NEW
HI-BRED
METEOR
\$4.99**

2 for \$9.99
Add 50c postage. Ex. King size batteries 6 for \$1.50

See the Greatest Show on Earth with this GIANT ASTRONOMICAL TELESCOPE

**\$15.00
FULL PRICE**



Delivered ready for use. Has 45X, 75X and 100 power mounted eyepieces with brass focusing tube plus sun projector lens for observing sun spots and solar storms. Steel telescope tube 30 in. long. Rigid 6 ft. tripod adjustable to any height. Steel forked mounting with closely machined aluminum tripod head assembly assures extra fine adjustments. This professional type instrument provides full power with clear vision at all times. See the moons of Jupiter, our own moon, planets, Milky Way, double stars, star clusters, etc. All for only \$15.00 FOB Mattituck. Sent express. COD orders require \$3.00 deposit. Satisfaction guaranteed. 200X and 400X eyepieces available at \$2.00 ea.

SUFFOLK SCIENCE SERVICE
Dept. ATD-10 MATTITUCK, N. Y.

POPULAR MECHANICS

Copyrighted material

17 pt. Plug shows 11% fuel saving in stock American automobile!

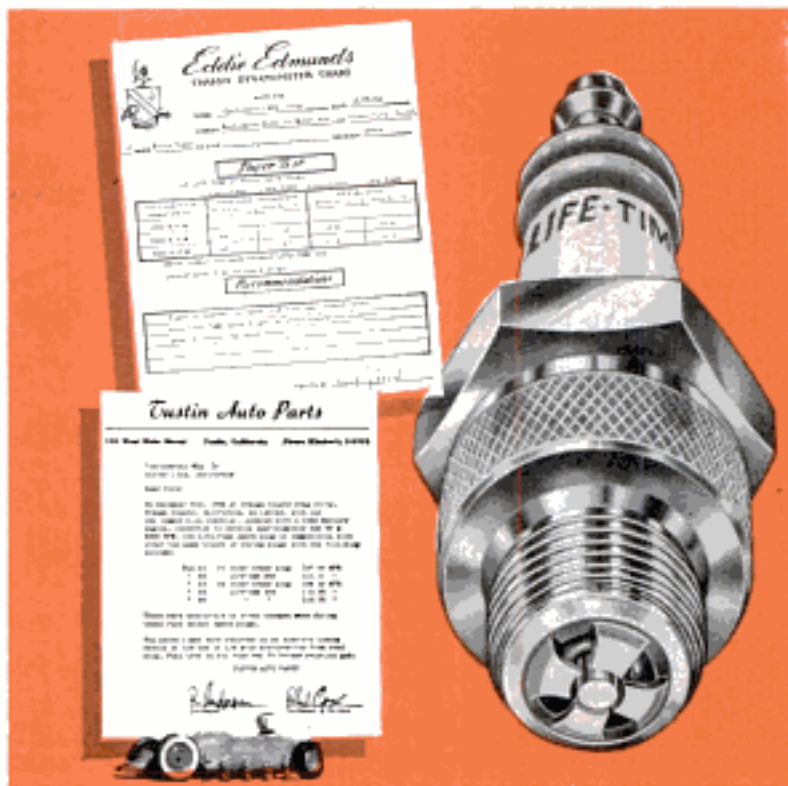

New electrode system still fires clean, hot and steady past 50,000 car miles! You may now order a set of these remarkable LIFE-TIME spark plugs from this advertisement . . .

50,000 CAR MILES! Before LIFE-TIME development, the spark plug was the most often replaced part of your car. Engineers agreed that "creeping paralysis," gradual electrode disintegration, carbon buildup, widening gap, burning, blistering, insulator failure could waste one gallon in ten. The LIFE-TIME plug goes far beyond the life of the average set of tires, the average battery, firing clean, hot and steady at 50,000 car miles! Most spectacular spark plug research breakthrough in 50 years allows unprecedented warranty. We GUARANTEE GREATER GAS MILEAGE—GREATER ACCELERATION—A MAJOR POWER INCREASE—OR YOUR MONEY BACK.

HOW 17 PT. FIRING WORKS

Note electrodes closely. A circular arcing area (four concave segments). Gap being the same from all points. Electricity has property of arcing from coldest point. Current also arcs more readily from apex of two planes than from face of a flat, metallic surface. Note that there are 16 apexes (where two planes meet) — all the same distance from the center electrode.

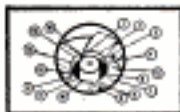

SPARK ROTATES AROUND CIRCLE. Normal heat and spark erosion are spread around the entire 360 degrees and around the whole circumference of the center electrode.

PLATINIUM-NICKEL ALLOY ELECTRODES— Metallurgists' first major step beyond platinum aircraft plug electrodes. Arcing points of this material have continued to function after the equivalent of 120,000 car-miles.

SPECIAL SINTERED CORUNDUM INSULATOR— Made of gem-like mineral which conducts heat 20 times better than ordinary porcelain. Special shape (seen beneath electrodes) is designed to vaporize and exhaust wet carbon and oil.

INDIVIDUAL INSPECTION— Each LIFE-TIME Spark Plug is tested for firing in oil and for resistance to 30,000 volts/CM.

PERMANENT GAP— After months of use, LIFE-TIME Spark Plugs mike at exact factory pre-gap.

SELF-CLEANING FOR LIFE— Confined gases exploding in chamber formed by multiple electrodes reclean arcing surfaces with each firing stroke.

"THANKS FOR YOUR WONDERFUL LETTERS"



The real test of a spark plug is "What will it do in my own car?" Take the above dynamometer test on a 1951 Buick Super. It shows an 8 horsepower gain with Life-Time 17-point plugs. That was a 12 1/2% hp gain at 2600 RPM. You don't need a dynamometer with Life-Time Plugs. You can feel the difference both in your ride and your pocketbook. Try a set and let me hear from you about them. Many Thanks.

Frank Edwards

Inventor of the LIFE-TIME Spark Plug

CONTINENTAL MFG. CORP., CULVER CITY, CALIF.



NOW ORDER REGISTERED SET FOR YOUR CAR AT POPULAR PRICE!

this registered set of LIFE-TIME Spark Plugs in proper series (heat range and gap) for the car you indicate in coupon. Now AVAILABLE FOR AMERICAN & EUROPEAN PASSENGER CARS, TRUCKS, BOATS, FARM EQUIPMENT, INDUSTRIAL ENGINES.

DEALERS AND DISTRIBUTORS — The LIFE-TIME Spark Plug is now in full production. Write for full details. Distributors: Please inquire as to status of your territory.

* LIFE-TIME Spark Plug Division
 * CONTINENTAL MANUFACTURING CORP.
 * Washington Blvd. at Motor Ave., Culver City 11, California
 * Gentlemen: Please mail postpaid ___set(s) (registered) of LIFE-TIME Spark Plugs in proper heat range and gap for my car at \$1.19 per plug (set of six, \$7.14, set of eight, \$9.52). (Or send \$1 per set, balance C.O.D.) California residents add 3% tax.
 * Make of my car is _____ year _____
 * Model _____ No. cyl. _____
 * I enclose \$ _____ (check, cash or money order)
 * Name _____
 * Address _____
 * City _____ Zone _____ State _____

WHAT ALL AUTO MECHANICS WANT TO KNOW

1664 PAGES



This Big Practical Book gives full information with working diagrams covering the principles, construction, ignition, service and repair of modern cars, trucks and buses.

Diesel Engines, Hydramatic & Fluid Drives Fully Explained.

A complete Guide of 1664 pages, with over 1500 illustrations showing inside views of working parts, with instructions for service jobs.

IT PAYS TO KNOW

How to fit pistons—How to locate engine knocks. How to fit connecting rod bearings—How to service main bearings—How to recondition valves—How to time valves—How to adjust fan belts—How to adjust carburetors and chokes. How to rebuild a clutch—How to service automatic transmissions—How to service brakes—How to adjust steering gear—How to cope with ignition troubles—How to service distributors—How to time ignition—How to "tune up" an engine.



\$4 COMPLETE • PAY \$1 A MO.
TO GET THIS ASSISTANCE FOR YOURSELF SIMPLY FILL IN AND MAIL COUPON TODAY.

Step up your own skill with the facts and figures of your trade. Audels Mechanics Guides contain Practical Inside Trade Information in a Handy Form. Fully Illustrated and Easy to Understand. Highly Endorsed. Check the book you want for 7 DAYS FREE EXAMINATION. Send No Money. Nothing to pay postman.

MAIL ORDER



Check NOW!

You Can Look Over Any Guide In Your Own Home — Start the Easy Payments If Satisfied

MAIL THIS TODAY



AUDEL, Publishers, 49 W. 23 St., NEW YORK 10, N. Y.

Please send me postpaid for FREE EXAMINATION books marked (X) below. If I decide to keep them I agree to mail \$1 in 7 Days on each book or set ordered and further mail \$1 monthly on each book or set until I have paid price, otherwise I will return them.

- AUTOMOBILE MECHANICS GUIDE, 1664 Pages, \$4
- TRUCK & TRACTOR GUIDE, 1299 Pages . . . 4
- DIESEL ENGINE MANUAL, 575 Pages . . . 2
- MACHINISTS HANDY BOOK, 1650 Pages . . . 4
- WELDERS GUIDE, 400 Pages . . . 1
- BLUE PRINT READING, 416 Pages . . . 2
- MATHEMATICS & CALCULATIONS, 700 Pages . . . 2
- SHEET METAL PATTERN LAYOUTS, 1100 Pages . . . 4
- SHEET METAL WORKERS HANDY BOOK, 388 Pgs. . . 1
- MECHANICAL DRAWING GUIDE, 160 Pages . . . 1
- MECHANICAL DRAWING & DESIGN, 480 Pages . . . 2
- AIRCRAFT WORKER, 240 Pages . . . 1
- TELEVISION SERVICE MANUAL, 434 Pages . . . 2
- RADIONICS GUIDE, 1040 Pages . . . 4
- ELECTRONIC DEVICES, 216 Pages . . . 2
- ELECTRIC MOTOR GUIDE, 1000 Pages . . . 4
- WIRING DIAGRAMS (Light & Power), 272 Pgs. . . 1
- ELECTRICIANS EXAMINATIONS, 250 Pages . . . 1
- ELECTRIC POWER CALCULATIONS, 425 Pages . . . 2
- HANDY BOOK OF ELECTRICITY, 1440 Pages . . . 4
- ELECTRIC DICTIONARY, 9000 Terms . . . 2
- ELECTRIC LIBRARY, 7000 Pages (12 Book Set) . . . 18
- SHIPFITTERS HANDY BOOK, 250 Pages . . . 1
- REFRIGERATION & Air Conditioning, 1280 Pgs. . . 4
- MILLWRIGHTS & MECHANICS GUIDE, 1200 Pgs. . . 4
- POWER PLANT ENGINEERS GUIDE, 1500 Pages . . . 4
- ENGINEERS & FIREMANS EXAMS, 525 Pages . . . 1
- PUMPS, Hydraulics & Air Compressors, 1658 Pgs. . . 4
- OPERATING ENGINEERS LIBRARY (3 Books) . . . 9
- MECHANICAL DICTIONARY, 950 Pages . . . 4
- GARDENERS & GROWERS GUIDES (4 Book Set) . . . 6
- CARPENTERS & BUILDERS GUIDES (4 Book Set) . . . 6
- PLUMBERS & Steamfitters Guides (4 Book Set) . . . 6
- MASONS AND BUILDERS GUIDES (4 Book Set) . . . 6
- PAINTERS & DECORATORS MANUAL, 450 Pgs. . . 2
- HOUSE HEATING GUIDE, 1000 Pages . . . 4
- OIL BURNER GUIDE, 384 Pages . . . 1
- HOME APPLIANCE SERVICE GUIDE, 800 Pages . . . 4

Name.....
Address.....
Occupation.....
Employed by.....

P10

HOBBIES FOR Profit

**Have Fun! Make Big Money!
We Show You How!**



CASTING



GLASS ETCH

Enjoy hobbies that make money! Make beautiful and UNUSUAL items for the home and business. Make exquisite jewelry, ceramics, without a kiln, toys, dolls, puppets, tools, Planters, embedded Plastics, Metal Enamelling, etc. Learn Jewelry Making, Wirecraft, Photocraft, Woodcraft, Metalcraft, Leathercraft, Mold Making, Bait Making, Gemcraft, Plastic Laminating, Lampcraft, Feathercraft, Basket Weaving, etc. Over 1000 Golden Opportunities! Send 25c for giant-sized catalog giving full facts on all these Hobbies.



MOLDING



PLASTER

HOBBIES FOR PROFIT
6612 N. Clark Street
Dept. HP-103, Chicago 26, Ill.

QUICK CASH! **SELL NEW INSULATED**
Extra-Warm JACKETS!



SEND FOR FREE SALES KIT!

Now go into business without spending a cent! Nothing like this before! Amazing new lightweight jackets, shoes, now available with same type subzero INSULATION as used in U.S. Army Coldbar Suits, Keeps body heat IN—keeps cold, wind and dampness OUT! Make \$120 Extra Income in a month by taking orders in spare time for just \$ of these miracle combinations in a week! Mason has 150 fast-selling shoe and jackets styles for men, women. Not sold in stores—folks must buy from you! Friends, fellow workers will stuff your pockets with cash for these. Get complete Sales Kit Free by writing now! **Mason Shoe Mfg. Co., Dept. MA749, Chippewa Falls, Wis.**

INVENTORS: Get ACTION!

Your invention may be worth a fortune, but it must be sold. Let long-established experts, with a record of success, act for you. You want results, action NOW, not in a year or two. Earl Lykins, Huntington, West Virginia inventor writes: "You sold my invention in 4 months!" Another inventor, A. G. Whaley, Oak Harbor, Ohio, writes, "Thanks to you, my invention is on the market today." Write TODAY for your FREE copy of our special booklet.

KESSLER SALES CORPORATION, Dept. D510, Fremont, Ohio

Shrinks Hemorrhoids New Way Without Surgery

Science Finds Healing Substance That Relieves Pain—Shrinks Hemorrhoids

For the first time science has found a new healing substance with the astonishing ability to shrink hemorrhoids and to relieve pain—without surgery.

In case after case, while gently relieving pain, actual reduction (shrinkage) took place.

Most amazing of all—results were so thorough that sufferers made astonishing statements like "Piles have ceased to be a problem!"

The secret is a new healing substance (Bio-Dyne*)—discovery of a world-famous research institute.

This substance is now available in suppository or ointment form under the name *Preparation H.** Ask for it at all drug counters—money back guarantee. *Reg. U. S. Pat. Off.

ARE YOU TOO OLD TO LEARN?

not at all, scientists say

New tests show that: your ability to think increases with age; your powers of deduction are greater; your judgment is better.

In the I. C. S. files are thousands of cases of men and women of every age. Their successes, their promotions, their raises prove that men and women past school age can learn!

I. C. S. GIVES YOU EXPERT GUIDANCE FREE! Do you have the feeling you're "stuck" in your job? Your trained I. C. S. counselor will appraise your abilities, help you plan for the future.

IT'S NEVER TOO LATE TO GET STARTED! You study with I. C. S. at home, in your spare time. There's no interference with business or social activity. Famous I. C. S. texts make learning easy. Don't delay. Pick your field from the coupon below. And mail it today!



3 FREE BOOKS

36-page, pocket-size guide to advancement, a gold mine of tips on "How to Succeed." Big catalog outlining opportunities in your field of interest. Also sample lesson (Mathematics).



"I tried studying my work on my own, but I never got the good out of it that came from my I. C. S. Course. My salary has been increased 73.3%!"

E.L.B.
Ohio

"I am president of a small corporation. A year ago I enrolled with I. C. S. as the most practical means available to me to learn what I needed."

W.J.A.
Michigan



"It's been so long since I went to school, I've forgotten much. But now that I'm taking an I. C. S. Course, I have confidence in my ability again."

H.A.R.
New Jersey



Actual statements.
Posed by models.

For Real Job Security—Get an I. C. S. Diploma!

I. C. S., Scranton 9, Penna.

Member, National Home Study Council

INTERNATIONAL CORRESPONDENCE SCHOOLS

ICS

BOX 99299K, SCRANTON 9, PENNA.

(Partial list of 277 courses)

Without cost or obligation, send me "HOW TO SUCCEED" and the opportunity booklet about the field BEFORE which I have marked X (plus sample lesson):

- | | | | | |
|--|---|--|---|--|
| <p>ARCHITECTURE and BUILDING CONSTRUCTION</p> <ul style="list-style-type: none"> <input type="checkbox"/> Air Conditioning—Refrig. <input type="checkbox"/> Architecture <input type="checkbox"/> Architectural Interior <input type="checkbox"/> Building Contractor <input type="checkbox"/> Building Maintenance <input type="checkbox"/> Carpenter and Mill Work <input type="checkbox"/> Estimating <input type="checkbox"/> Heating <input type="checkbox"/> Painting Contractor <input type="checkbox"/> Plumbing <input type="checkbox"/> Reading Arch. Blueprints <p>ART</p> <ul style="list-style-type: none"> <input type="checkbox"/> Cartooning <input type="checkbox"/> Commercial Art <input type="checkbox"/> Fashion Illustrating <input type="checkbox"/> Magazine Illustrating <input type="checkbox"/> Show Card and Sign Lettering <input type="checkbox"/> Sketching and Painting <p>AUTOMOTIVE</p> <ul style="list-style-type: none"> <input type="checkbox"/> Auto Body Rebuilding <input type="checkbox"/> Auto Elec. Technician <input type="checkbox"/> Auto-Engine Tune Up <input type="checkbox"/> Automobile | <p>AVIATION</p> <ul style="list-style-type: none"> <input type="checkbox"/> Aeronautical Engineering Jr. <input type="checkbox"/> Aircraft & Engine Mechanic <p>BUSINESS</p> <ul style="list-style-type: none"> <input type="checkbox"/> Advertising <input type="checkbox"/> Bookkeeping and Accounting <input type="checkbox"/> Business Administration <input type="checkbox"/> Business Correspondence <input type="checkbox"/> Public Accounting <input type="checkbox"/> Creative Salesmanship <input type="checkbox"/> Federal Tax <input type="checkbox"/> Letter-writing Improvement <input type="checkbox"/> Office Management <input type="checkbox"/> Professional Secretary <input type="checkbox"/> Retail Business Management <input type="checkbox"/> Sales Management <input type="checkbox"/> Stenographic-Secretarial <input type="checkbox"/> Traffic Management <p>CHEMISTRY</p> <ul style="list-style-type: none"> <input type="checkbox"/> Analytical Chemistry <input type="checkbox"/> Chemical Engineering <input type="checkbox"/> Chem. Lab. Technician <input type="checkbox"/> General Chemistry <input type="checkbox"/> Natural Gas Prod. & Trans. <input type="checkbox"/> Petroleum Engineering <input type="checkbox"/> Plastics <input type="checkbox"/> Pulp and Paper Making | <p>CIVIL, STRUCTURAL ENGINEERING</p> <ul style="list-style-type: none"> <input type="checkbox"/> Civil Engineering <input type="checkbox"/> Construction Engineering <input type="checkbox"/> Highway Engineering <input type="checkbox"/> Reading Struct. Blueprints <input type="checkbox"/> Sanitary Engineering <input type="checkbox"/> Structural Engineering <input type="checkbox"/> Surveying and Mapping <p>DRAFTING</p> <ul style="list-style-type: none"> <input type="checkbox"/> Aircraft Drafting <input type="checkbox"/> Architectural Drafting <input type="checkbox"/> Electrical Drafting <input type="checkbox"/> Mechanical Drafting <input type="checkbox"/> Mine Surveying and Mapping <input type="checkbox"/> Plumbing Drawing and Estimating <input type="checkbox"/> Structural Drafting <p>ELECTRICAL</p> <ul style="list-style-type: none"> <input type="checkbox"/> Electrical Engineering <input type="checkbox"/> Electrical Maintenance <input type="checkbox"/> Electrician <input type="checkbox"/> Contracting <input type="checkbox"/> Lineman <p>HIGH SCHOOL</p> <ul style="list-style-type: none"> <input type="checkbox"/> Commercial <input type="checkbox"/> Good English <input type="checkbox"/> High School Subjects <input type="checkbox"/> Mathematics | <p>LEADERSHIP</p> <ul style="list-style-type: none"> <input type="checkbox"/> Foremanship <input type="checkbox"/> Industrial Supervision <input type="checkbox"/> Leadership and Organization <input type="checkbox"/> Personnel-Labor Relations <p>MECHANICAL AND SHOP</p> <ul style="list-style-type: none"> <input type="checkbox"/> Gas—Electric Welding <input type="checkbox"/> Heat Treatment <input type="checkbox"/> Metallurgy <input type="checkbox"/> Industrial Engineering <input type="checkbox"/> Industrial Instrumentation <input type="checkbox"/> Industrial Supervision <input type="checkbox"/> Internal Combustion Engines <input type="checkbox"/> Machine Design-Drafting <input type="checkbox"/> Machine Shop Inspection <input type="checkbox"/> Machine Shop Practice <input type="checkbox"/> Mechanical Engineering <input type="checkbox"/> Quality Control <input type="checkbox"/> Reading Shop Blueprints <input type="checkbox"/> Refrigeration <input type="checkbox"/> Sheet Metal Worker <input type="checkbox"/> Tool Design <input type="checkbox"/> Toolmaking <p>RADIO, TELEVISION</p> <ul style="list-style-type: none"> <input type="checkbox"/> Industrial Electronics <input type="checkbox"/> Practical Radio TV Eng'ng <input type="checkbox"/> Radio and TV Servicing <input type="checkbox"/> Radio Operating | <ul style="list-style-type: none"> <input type="checkbox"/> Television Technician <p>RAILROAD</p> <ul style="list-style-type: none"> <input type="checkbox"/> Air Brakes <input type="checkbox"/> Car Inspector <input type="checkbox"/> Diesel Locomotive <input type="checkbox"/> Locomotive Engineer <input type="checkbox"/> Section Foreman <p>STEAM AND DIESEL POWER</p> <ul style="list-style-type: none"> <input type="checkbox"/> Combustion Engineering <input type="checkbox"/> Diesel—Elec. <input type="checkbox"/> Diesel Eng's <input type="checkbox"/> Electric Light and Power <input type="checkbox"/> Stationary Fireman <input type="checkbox"/> Stationary Steam Engineering <p>TEXTILE</p> <ul style="list-style-type: none"> <input type="checkbox"/> Carding and Spinning <input type="checkbox"/> Cotton, Rayon, Woolen Mfg. <input type="checkbox"/> Finishing and Dyeing <input type="checkbox"/> Loom Fix'g <input type="checkbox"/> Textile Des'ing <input type="checkbox"/> Textile Eng'g <input type="checkbox"/> Throwing <input type="checkbox"/> Warping and Weaving <p>MISCELLANEOUS</p> <ul style="list-style-type: none"> <input type="checkbox"/> Domestic Refrigeration <input type="checkbox"/> Marine Engineering <input type="checkbox"/> Ocean Navigation <input type="checkbox"/> Professional Engineering <input type="checkbox"/> Short Story Writing <input type="checkbox"/> Telephony |
|--|---|--|---|--|

Name _____ Age _____ Home Address _____

City _____ Zone _____ State _____ Working Hours _____ A.M. to P.M. _____

Occupation _____ Canadian residents send coupon to International Correspondence Schools, Canadian, Ltd., Montreal, Canada. . . . Special tuition rates to members of the U. S. Armed Forces.

Learn ELECTRIC APPLIANCE REPAIR IN YOUR SPARE TIME AT HOME



START YOUR OWN BUSINESS WITH A POTENTIAL MARKET OF 50,000,000 CUSTOMERS

New shop-method, home-training system gives you electrical know-how that used to take years to learn. Learn at home by building valuable testing kits, repairing your own and neighbors' appliances. It is not unusual for appliance repairmen to charge on the basis of \$5.00-\$6.00 an hour.

FREE ILLUSTRATED BOOK
Shows you how you learn every phase of electrical appliance. How to make money while you learn. Write today for your FREE copy.

CHRISTY TRADES SCHOOL
Dept. D-4703
4804 North Kedzie Ave., Chicago 25

ONE BUSINESS THAT IS NOT AFFECTED BY STRIKES, DEPRESSIONS OR POLITICS

I'll Send You This Handsome SAMPLE CASE—FREE!



Make up to \$30.00 in a Day!

Your Own Tailored Suits Without 1¢ Cost

If you want to make more money, spare time or full time, rush the coupon below today for this big, valuable tailoring Sample Case packed with 150 beautiful, big-value suit and overcoat samples. Just show the samples and last-minute styles to friends, fellow-workers, others. Take their orders for fine made-to-measure clothes—and pocket BIG CASH PROFITS in advance. No experience, no tailoring knowledge needed—and no money needed, ever. WE SUPPLY EVERYTHING FREE... sample case, sample suitings, equipment, complete instructions. Start making money first day!

Use Spare Evenings... Weekends... Make Money... Get Suits!
It's easy to make money taking orders in just spare time—lunch-time, evenings, weekends. When men see the fine fit, quality and value of our suits—THEY ORDER! So we make it easy for you to get your own personal suits and overcoats without paying even one penny. Don't wait! Rush coupon with your name, address, and age for FREE Sample Case.

W. Z. GIBSON, INC., Dept. H-516
500 South Throop Street, Chicago 7, Illinois

W. Z. GIBSON, INC., Dept. H-516
500 S. Throop St., Chicago 7, Ill.
Please rush ABSOLUTELY FREE the valuable Sample Case with suit fabrics and style display. Include instructions, money-making plans and details for getting my own suits without paying one cent.

Name..... Age.....
Address.....
City..... State.....

100 YEAR OLD U. S. STAMPS



Believe it or not, but ours is the only firm capable of sending "On Approval" all U. S. stamps, even those over 100 years old, and all foreigners too, incl. Roosevelts, Coronations etc. Try it and see! Send 10c for our introductory bargain of 50 diff. U. S. and state whether approvals shall be U. S., foreign or both.

GLOBUS STAMP CO. 268-4th Ave., Dept. 213
New York 10, N. Y.

BECOME AN EXPERT IN TRAFFIC

Traffic men earn \$4,000 to \$10,000 and up. Thousands of firms need experts on rates, tariffs, regulations. We train you thoroughly in spare time at home for executive traffic jobs. Personal training under traffic authorities. Placement courses and help. Write for free 46-page book "Traffic Management—the Fast Growing Profession."

LASALLE Extension University, 417 So. Dearborn St.
A Correspondence Institution Dept. 1064T Chicago 5, Ill.

MEN WANTED Earn \$100 Per Week and up

Master a trade with a future—learn Auto-Diesel mechanics in our shops. You learn with tools on real equipment. Earn while you learn. Many of our graduates earn \$100 per week and up. No previous experience necessary. Day and night courses. Approved for veterans. Write for free bulletin.

NASHVILLE AUTO-DIESEL COLLEGE
226 7th Ave., N., Dept. 75 Nashville 3, Tenn.

DRAINS cellars, cisterns, wash tubs; \$6.95



IRRIGATES - CIRCULATES - SPRAYS
Type J Pump has 1,001 uses. Up to 3000 GPH; 450 GPH 80' high; or 1800 GPH from 25' well. Use 1/6 to 3/4 HP motor. Coupling included free. 1" inlet; 3/4" outlet. Stainless shaft. Won't rust or clog! Postpaid if cash with order. (West of Miss. add 50¢)

MONEY BACK GUARANTEE
Centrifugal and Gear Pumps in All Sizes
LABAWCO PUMPS, Belle Meade 7A, N. J.

RADIO

Engineering. All phases radio & electronics theory & practice; television; FM; broadcasting; servicing; aviation, marine & police radio. Prepare for good pay; 18-month course. Graduates in demand by major companies. Enter Jan., March, June, Sept. Regular campus life. Write for catalog.

VALPARAISO TECHNICAL INSTITUTE, Dept. D, Valparaiso, Ind.

Send for **FREE** 112 page Illustrated Catalog of Farm, Home, and Workshop Bargains.

Write to **WELLWORTH TRADING COMPANY**
Dept. E-10
1832 S. WABASH AVE. CHICAGO 16, ILL

RUPTURE



RELIEF...OR YOUR MONEY BACK
Write now for free booklet and pictures of rupture care. You can be helped...work steady, with low cost, easy to wear Web Truss, thousands satisfied.

WEB TRUSS CO. Dept. PM-10, Hagerstown, Maryland

Now read what has happened to
GEORGE ADAMSKI
 since he wrote the famous incidents
 in *Flying Saucers Have Landed*

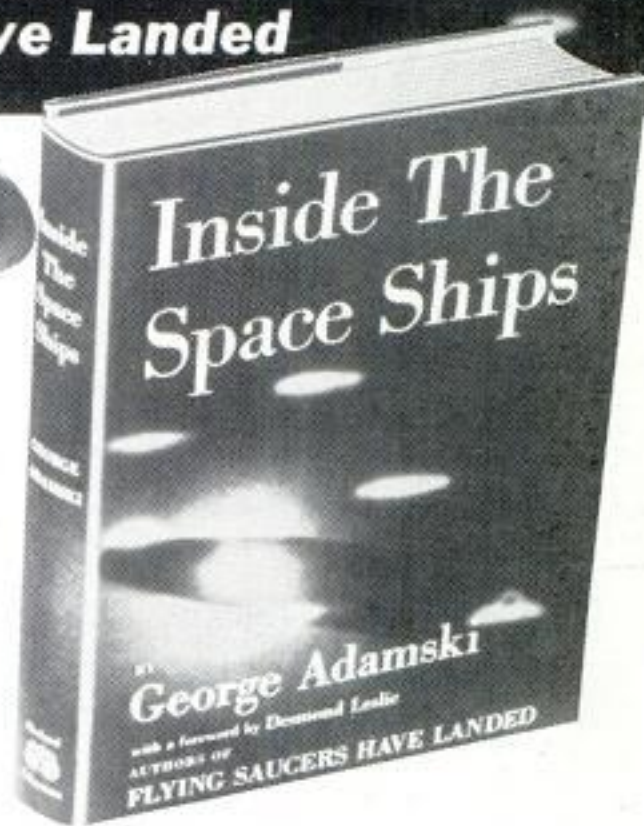
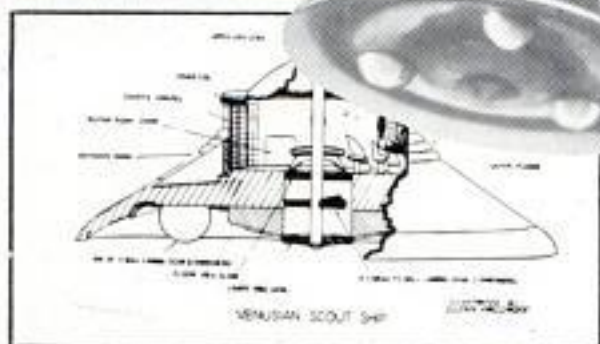

INSIDE THE SPACE SHIPS is Adamski's own story of what has happened to him since that memorable November 20, 1952, when he first made personal contact with a man from another world . . .

SINCE December 13, 1952, when he took the first, now-famous photographs of the saucer that brought his original visitor . . .

Now Adamski tells of his first meeting, a few months later, with a second man from another world — *his first meeting with one who speaks to him*. This second visitor takes him to a Venusian Scout (flying saucer) that in turn transports him to a mother ship. Later, he is conveyed in both a Saturnian Scout and a Saturnian mother ship. Adamski tells us what transpires in these space craft, and what the men and women from other worlds have told him.

Adamski's photographs of flying saucers, originally published in *Flying Saucers Have Landed*, are now world-famous as witnesses in other parts of the world have succeeded in taking photographs identical with his.

"Astonishing book, no one can read it without thoughtful weighing of the conclusions — that life on the other parts of the universe may conceivably have progressed far beyond the limitations of our troubled-earth. For my money, this is infinitely better reading than any science fiction."

— VIRGINIA KIRKUS

NOW, in **INSIDE THE SPACE SHIPS**, Adamski gives us 16 photographs and other illustrations, not only of the flying saucers, but of the great space ships from which they are launched. The main group of these photographs was taken in April, 1955—and neither the photographs nor a description of them has ever before been published!

TO GET YOUR COPY, FILL IN THE COUPON BELOW:

ABELARD-SCHUMAN, INC., Dept. PM
 404 Fourth Avenue, New York 16, N. Y.

Please send me at once . . . copy (ies) of **INSIDE THE SPACE SHIPS** personally autographed by Mr. Adamski. I understand that my payment herewith for this order also entitles me to be placed on Mr. Adamski's mailing list, at no additional charge, and that I will be kept informed of Mr. Adamski's further activities.

NAME

ADDRESS

CITY.....ZONE.....STATE

I enclose (cash, money order or check) for \$3.50 per copy, you paying postage and all other expenses

Please send C.O.D., I'll pay postman \$3.50 plus C.O.D. postage on delivery

CHECK ONE:

FOR WORK... OR PLAY



Anvil Brand utility clothes are so comfortable and smart you'll like their all-purposeness. Heavy duty outfits in all styles and hardy, washable fabrics. Sportswear, too, for men and boys. See your retailer's display of Anvilwear. Learn how reasonably you can buy more clothes comfort and durability.

ANVIL BRAND FACTORIES HIGH POINT, N. C.



Enjoy real security . . . earn top wages . . . get ahead faster. Learn a trade where Trained Men are always in demand. High starting salary, plus hundreds of opportunities for advancement in the fast-growing Oil Burner industry, which U. S. Government predicts will double in size in next few years. We teach you Installation, Operation, Maintenance and Servicing. Complete course. Remember, Trained Men command best jobs — highest wages. Our Oil Burner graduates are 100% employed.

LEARN AND EARN IN YOUR SPARE TIME

Put your spare time to work. Learn a specialized trade. No previous experience or special education necessary. Act today! Cash in tomorrow! Earn while you learn, doing repair jobs in your own area. Low tuition, only \$5 starts you! Tools furnished. Send coupon now! No obligation. No salesman will call.

Mass Trades has trained thousands for success since 1938.

RESIDENT SCHOOL — APPROVED FOR VETERANS

WRITE NOW FOR FREE SAMPLE LESSON AND BOOKLET

MASS. TRADES
166 High Street, Boston 10, Mass.
Please send me FREE sample lesson and booklet

NAME AGE

ADDRESS

CITY ZONE STATE

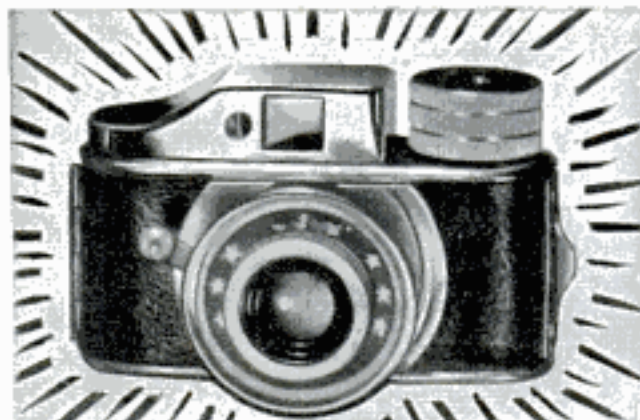

Amazing Miniature Gold-Plated SPY CAMERA — Only \$2.98 ppd.

Precision-made, amazingly small — only 2" wide, 1 1/4" tall! Professional view finder, fast shutter, time and instant setting. Take clear, sharp pictures in secret. Amaze family and friends with hilarious candid shots. Made to last a lifetime; all exposed metal parts **GENUINE GOLD PLATED**. Only \$2.98 for complete outfit postpaid. Three outfits only \$8.40 ppd. Satisfaction guaranteed.

FREE! we include with your camera order leather carrying case and strap PLUS 2 rolls of film (20 pictures). **SOURCES FOR LOW-COST, SPEEDY DEVELOPING SENT WITH CAMERA OUTFIT!**

MODERN MERCHANDISE CO.
DEPT. 625, 169 W. MADISON ST.
CHICAGO 2, ILLINOIS

NO TANKS USED
NEW SIMPLIFIED METHOD



ELECTROPLATE

ANY OBJECT IN HOME, SHOP, GARAGE OR STAY!
YOUR OWN WELL PAYING ELECTROPLATING BUSINESS.

NOW, using NEW plating kit.

It's easy to electroplate any object. Complete kit and instructions on plating metal and non-metal objects, with nickel, copper, chrome, gold, etc., plus full data on obtaining all the business you desire and make **BIG MONEY** full or spare time. **ONLY \$5.95 SEND NO MONEY**—everything sent C.O.D. plus postage—OR send \$5.95 now and receive it postpaid. Money back in 7 days if not satisfied.

M. Z. SALES CO., Dept. PM-10, 113 W. 42 St., New York 36, N. Y.

Write Like This

YOUR penmanship can be improved in 3 hours or corrected to your satisfaction in 10 hours' practice with my **DEFINITE HAND CONTROLS**. New way!

WRITE **OZMENT** BOX 665
34-P, ST. LOUIS, MISSOURI

Complete
OUTLINE
FREE!

BE A LANDSCAPE CONTRACTOR

Make \$20 to \$60 a day. Millions of new and old homes, estates, etc., need modern landscaping. Contracting is full time job for those who want to start own business. Start with smaller projects, and work into larger jobs. We show you now. Easy-to-follow Home Study Course. Hundreds of successful graduates. Write for **FREE Book**.

NATIONAL LANDSCAPE INSTITUTE

310 S. Robertson Blvd. Dept. M-105 Los Angeles 48, Calif.

NEW! Leader Gun Sight

Guaranteed
Accurate



PRICE

\$1.00
POSTPAID

NO GUESSING!

NEW SIGHT FIGURES LEAD AUTOMATICALLY!

Here's a simple way to improve your marksmanship **IMMEDIATELY!** Use Frank Chapek's sensationally successful, proved-in-the-field **Leader Sight**. Fits all shot-guns, single or double barrel, over and under models (except .410 ga.) also poly choke guns and compressor barrels. Made of molded latex rubber; no scratching, marring; no screws, bolts, tools needed. Attach in seconds! **RUSH ORDER TODAY!** Only \$1.00 postpaid. (Sorry, no c.o.d.'s). Satisfaction or money back!

CHAPEK'S LEADER SIGHT CO., SHERIDAN, WYOMING

First Choice of Hobbyists— new Gilbert HO Trains!

Rugged 0-6-0 Pennsy switcher hauls three ultra-detailed freights. Just the thing to start your pike. No. HO-320, only \$39.95



Here's Why!
Only Gilbert HO
has all this!

- real puffing smoke
- timed choo-choo sounds
- NMRA developed couplers
- 2-radius track (15" and 18")
- live spring trucks
- authentic painted cars
- accurate 9/64" scale

America's top do-it-yourself hobby: planning, building and running your own model railroad. Do it better with the best—Gilbert HO trains.



Send for **FREE**
Gilbert HO Catalog!

The A. C. Gilbert Company, Dept. E-10
New Haven 6, Connecticut

Please rush **FREE** Gilbert HO Catalog.

Name _____

Street _____

City _____

Zone _____

State _____

AMAZING NEW TINY RADIO

Really Works—Small as a Pack of Cigarettes!



GETS LOCAL RADIO STATIONS WITH CLEAR BELL-LIKE TONE—NO STATIC OR INTERFERENCE! NEEDS NO TUBES, BATTERIES OR COMPLICATED TROUBLESHOOTING! NO AC PLUG! NOTHING TO WEAR OUT. Thousands of users—many report years of service. Uses new crystal diode and HI-Q coil. SELF-CONTAINED SPEAKER PHONE. Just the tiny radio to take with you ANYWHERE YOU GO—ON TRIPS, VISITING, ETC.—for real fun and enjoyment—ANYTIME. Merely hook to anything that can act as antenna for local reception. Free DX antenna kit included. **SEND ONLY \$1.00** (bill, ck., mo.) and pay postman \$3.00 C.O.D. postage or send \$4.00 for P.O. delivery. COMPLETE READY TO LISTEN. MIDWAY CO., Dept. PPN-10, Kearney, Nebr.

HELPFUL BOOKS

Send post card asking for **FREE** catalog

Popular Mechanics Press, 200 E. Ontario, Dept. 601, Chicago 11

make it with **60¢** worth of sand & cement
SELL IT FOR \$2000

every home a prospect for these patented "LIFETIME" **CONCRETE INCINERATORS**

Make big profits manufacturing rust proof, fire proof, almost indestructible concrete incinerators in your own backyard or garage . . . full or part time. Sell to home-owners, hardware, department and garden supply stores. Phila. manufacturer doing big volume with Sears, Roebuck; large department stores. Easy to follow instructions and all needed equipment supplied. Exclusive protected franchise—No competition! Territories going fast. Write immediately for full details. Dept. PM105, T. C. TOR, 2113 Bellevue St., Phila. 40, Pa.



Do you work all day with

COLD FEET?

NOW,

at last, a new, modern, low priced electric foot warmer that will keep you healthy, happy and comfortable



Help prevent colds with...
ELECTRO MAT

Check stand cashiers, secretaries, assembly line workers, housewives, office workers, theatre cashiers, machine operators, telephone operators, and many others throughout the country are now singing the praises of the Electro Mat. There is no further need to work all day with cold feet. Many colds, causing absenteeism and irritability, can be directly traced to cold feet. *Safe and Economical*

Size 14" x 21"
light-weight,
portable

Consumes less power than a 75 watt light bulb. Mail your check or money order today for **ONLY**

\$7.95

PREPAID

PETERSON RUBBER MAT CO.
5508 N. Halifax Arcadia, California

Please send me ___ Electro Mats at \$7.95 each **IMPORTANT SAYING:**

If 6 or more ordered, price is only \$6.95 each.

C.O.D. Entless \$1.00 deposit with order.

Prepaid

Name _____
Address _____
City _____ State _____

PLEASE PRINT CLEARLY

New Table-Top Machine COSTS LITTLE... PUTS YOU IN PROFITABLE RUBBER STAMP BUSINESS

Home operators now make spare time profits of \$9.40 AN HOUR in business once monopolized by a few big companies

Special rubber stamps bring high prices, yet cost only pennies to make on new low-cost machine. Take 27 cents worth of material, make perfect stamps, the kind factories, individuals, and offices in your neighborhood now have to send away for at \$1.80 each. Make up to \$9.40 an hour. Start in spare time at home. We furnish all equipment, and material, plus eight different easy ways to get orders from local customers. Machine uses any electrical outlet. Makes any kind of stamp up to 3" x 5" in size. We'll send you free information without obligation about this established, highly profitable business, now open to individuals for the first time. Mail coupon today to **Rubber Stamp Div., 1512 Jarvis Ave., Dept. R-2-L, Chicago 26, Ill.**



**Rubber Stamp Div., Dept. R-2-L
1512 Jarvis Ave., Chicago 26, Ill.**

Please rush free information. Tell me how to get into the profitable rubber stamp business on small investment. Mail everything free. No salesman will call.

Name

Address

City Zone State



... but what do others think?

Now, be sure you're tall enough! Change to "ELEVATORS" and grow almost 2 inches, instantly!

"ELEVATORS" don't give away your secret! They look as smart, feel as comfortable as other fine street, dress or sport shoes.

But they make you taller!

Try a pair, see what a tremendous difference "ELEVATORS" make. Be sure, be smart, be taller.

Styles for Street, Dress, Sport.



THE ORIGINAL AND GENUINE
ELEVATORS
WEIGHT-INCREASING SHOES
"YOUR PERSONAL PROMOTER"
MADE IN U.S.A. BY STONE-TARLOW CO., INC.

STONE-TARLOW CO., INC.
Dept. PM10-55, Brockton 68, Mass.

Premier Grade \$19.95
DeLuxe Grade \$21.95

Mail Coupon for FREE Booklet

Please send Free Booklet and name of nearest dealer. I understand no salesman will call.

NAME

Address

City State

If Ruptured

For lasting relief your rupture must BE HELD BACK DAY and NIGHT.

Consult Your Doctor.



Entirely different

SOFT, FLEXIBLE, and fits neat as a glove. The famous Miller saves you TIME, MONEY, DISAPPOINTMENT.

Write for my FREE booklet today.

FRED B. MILLER Manufacturer
Dept. PM-A, Hagerstown, Maryland

COLOR PRINTS

FROM YOUR COLOR FILMS
KODACHROME • ANSCOCROME
EKTACHROME • ANSCO COLOR
4x5 50c | 5x7 \$1 | 8x10 \$2 Satisfaction or money back
AUTHORIZED ANSCO COLOR LABORATORY
COLORFAX LABORATORIES
1160-J Bonifant St., Silver Spring, Maryland

25¢
2 1/4 x 3 1/4
Minimum order \$1
No COD's, please.

LEARN LOCKSMITHING

Learn this fascinating, profitable trade from experts in your spare time at home! Age or physical handicap no disadvantage. Year around, steady income. Full or part time. Practical, illustrated lessons. You can make money even while learning! All materials and special tools supplied without extra charge.
INSTITUTE OF LOCKSMITHING, Dept. P-71
15 PARK AVENUE RUTHERFORD, N. J.
Lic. by N.J. State Board of Education
Approved for Veterans

MECHANICAL DENTISTRY

To make Crowns, Plates, Bridgework, etc., for Dentists. Easy practical way to learn mechanical dentistry at home in spare time. FULL EQUIPMENT OF TOOLS AND MATERIALS INCLUDED WITH COURSE. Low tuition. Easy terms. Write for FREE BOOK about this money making profession that is not affected by machine age.
McCARRIE SCHOOL OF MECHANICAL DENTISTRY
207 N. Broad St., Dept. 46, Philadelphia 7, Pa.

Bar Bells

Buy Direct From Factory \$8.95 up
Write for free booklet and price list.
INDEPENDENT IRON WORKS
2416 East 23rd Street, Dept. B
Los Angeles 58, Calif.

All New Supermatic
RETRACTABLE PEN
New 4" Long Cartridge
4 for \$1
12 for \$3.00
100 for \$24.00
Instant drying. Will not leak, smear or transfer.
Available with red, blue, black or green ink. Send check or money order. Money back guaranteed.
Larger Quantity & Inprint Prices on Request.
Barclay Distributors, Dept. 159, P. O. Box 45, Forest Hills, N. Y.

Refills to fit
PAPER-MATE
and all
RETRACTABLE PENS
6 for \$1.00
Choice of Red, Blue, Black or Green Ink.

Make SURE, SAFE INSULATED ELECTRICAL CONNECTIONS

The New SUPER *ChAMP* Hand Tool

The ONE Tool for ALL Wire Sizes used in Home Wiring, Appliances, Automobiles.

DOES ALL THESE THINGS BESIDES

CRIMPS Solderless Terminals and Connectors without solder or tape for safe connections.

CUTS Wire, making clean, sharp cut through Insulation and Conductor.

STRIPS Wire sizes #22-#10. Gauges assure proper length for sure, safe crimp.

SHEARS Bolts and screws without damaging threads — no filing or hack sawing.

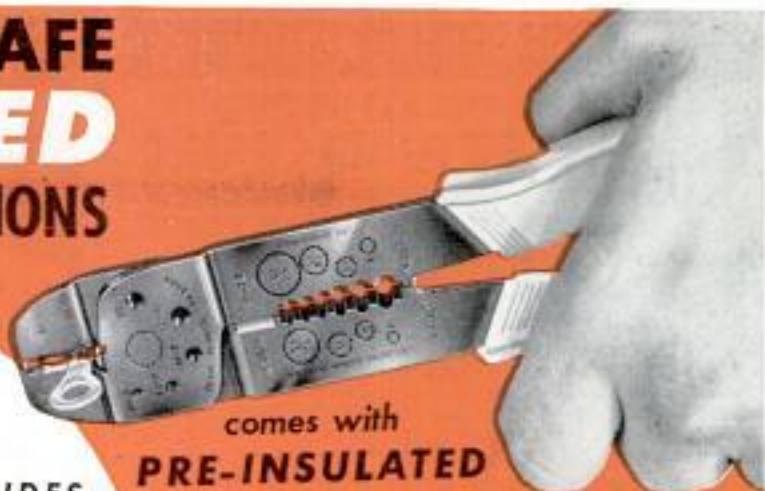

comes with
PRE-INSULATED



FREE with Each TOOL

ORDER DIRECT—USE COUPON

Only
\$3.95

Post Paid

Satisfaction guaranteed or money back. Send check or money order for \$3.95. (Ohio residents add 12c sales tax.)

T. W. Berger, Inc.
National Distributor Consumers and Dealers
AIRCRAFT-MARINE PRODUCTS, Inc.
1315-CT American Bldg., Cincinnati 2, Ohio

T. W. Berger, Inc.
National Distributor Champ Tool
1315-CT American Bldg., Cincinnati 2, Ohio

Send me post paid the new super Champ Hand Tool. I am enclosing \$3.95. (Ohio residents add 12c sales tax.)

check money order

NAME _____

ADDRESS _____

CITY _____ ZONE _____ STATE _____

Do YOU Want to Qualify for
A BETTER JOB AT BIGGER PAY?



CLIMB TO SUCCESS! in Spare Time at Home

• Jobs are calling—calling to those who want more responsible jobs, in bigger pay brackets, with increasing chances for promotion—and who have the ambition to devote some of their spare time to acquiring necessary knowledge and skill. As little as just a few hours a week, in time you can easily spare, can produce surprising results in lifting you up to higher and higher levels of employment, income and security—even eventually to management positions or a business of your own. In the coupon below are listed some of the large number of training opportunities offered by AMERICAN SCHOOL—now in its 58th year. Check the one that interests you most and fill in your name and address. Or if you prefer some other career, write the subject in the margin. Then mail the coupon without delay.

—FULL INFORMATION...NO COST...NO OBLIGATION—

AMERICAN SCHOOL, Dept. G745, Drexel at 58th, Chicago 37, Ill.

Without obligation, please send FREE and postpaid, full particulars about the subject checked below.

- | | | |
|--|---|---|
| <input type="checkbox"/> Accounting | <input type="checkbox"/> Diesel Technician | <input type="checkbox"/> Mechanical Engineering |
| <input type="checkbox"/> Apprenticeship Courses | <input type="checkbox"/> Drafting—Building Trades | <input type="checkbox"/> Mechanical Technology |
| <input type="checkbox"/> Architecture & Building | <input type="checkbox"/> Drafting—Machine Trades | <input type="checkbox"/> Metalworking Courses |
| <input type="checkbox"/> Automotive Technician | <input type="checkbox"/> Electrical Engineering | <input type="checkbox"/> Plumbing—Practical |
| <input type="checkbox"/> Better Foremanship | <input type="checkbox"/> Electricity—Practical | <input type="checkbox"/> Private Secretary |
| <input type="checkbox"/> Bookkeeping | <input type="checkbox"/> Electronics—Industrial | <input type="checkbox"/> Retail Merchandising |
| <input type="checkbox"/> Business Management | <input type="checkbox"/> HIGH SCHOOL COURSES | <input type="checkbox"/> Salesmanship—Outside |
| <input type="checkbox"/> Civil Engineering | <input type="checkbox"/> Machine Shop Operations | <input type="checkbox"/> Sheet Metal Work |
| <input type="checkbox"/> Contracting | <input type="checkbox"/> Mathematics & Slide Rule | <input type="checkbox"/> Tool Making |

Name _____ Occupation _____

Home Address _____ Age _____

City _____ State _____

Canadian Residents: Write American School, 1610 Sherbrooke St., West, Montreal

MAKE YOUR NATURAL ABILITY PAY

Train to become a Professional **DIESEL & AUTO MECHANIC**

• HIGH INCOME • SECURE FUTURE • LEARN AT
LOW COST • STUDY UNDER EXPERTS

With U. S. Trade School training you probably can earn \$100 a week on your first job. We help you earn money in Kansas City while you learn, we help you get a job after graduation.

How many so-called mechanics do you know who can really repair a 1955 Ford-O-Matic, Power-Glide, Hydra-Matic, etc.? How many can repair Power Steering equipment for cars or trucks? How about the "12-volt system"?

YOU'LL BE AHEAD OF THE OLDER MEN IN EVERY WAY!

You'll learn by doing, by working in shops and labs. Expert class instruction in theory and practice by career mechanics with national reputations. Ultra-modern classrooms and shops. Newest equipment. We've trained men for the U. S. Army, state rehabilitation offices, and for leading transportation corporations. Write for complete information. No obligation. Approved for veterans.

MAIL COUPON FOR FACTS

U. S. TRADE SCHOOLS, Dt. P-1, 500 E. 11th St., Kansas City, Mo.

NAME.....

STREET.....

CITY.....ZONE.....STATE.....

KOREAN VETERAN



... TURN CONCRETE INTO GOLD!



MAKE UP TO \$75 A DAY IN YOUR OWN BUSINESS

If you want to have your own business — to start a business on your own — here's your big opportunity! New high speed, low cost General block machine produces up to 1,000 concrete blocks a day. Sell all you make to builders, supply houses, and others for the building boom! You can make profits of 100% to 150% — up to \$75 a day! General block machine equipped with 1/2 h.p. electric motor — or can be supplied with gasoline engine — works anywhere, in little space, indoors or out. Operates from ordinary house light socket. Simple, foolproof 3 step operation — so easy a child can do it. Makes superior 3 core blocks any size from 4" to 12". Also makes chimney, ash, corner and other types. Blocks meet any building code anywhere in the country. Materials — sand, water, cement, available anywhere. Simple illustrated operating instructions and mixing formulae for cement and binder blocks supplied with each machine. Write for FREE folder with full information.

**MOTOR
DRIVEN**

R.L.T. of
New York City 19-
ports: "MY GENERAL
BLOCK MACHINE
PAID FOR ITSELF
IN FIRST 2 WEEKS!"

Hundreds now in
use the world over!
Write for FREE details today!

EXTRA

Amazing illustrated
book gives floor plans for 6 sensational concrete block bungalows. Tells how to lay blocks, lay out building lines, mix concrete, build steps, porch and concrete floors all at great savings. Written by experts. Can save many times the cost of the machine! Get it now! No strings attached. Send \$2.

BOOK SENT FREE IF YOU BUY MACHINE,
\$1 REFUNDED IF YOU BUY LATER.

GENERAL ENGINES CO.

DEPT. M-105, ROUTE 130, THOROFARE, N. J.



Tells How You Can Learn to **FREE MOUNT BOOK BIRDS!**



Learn At Home

Men, Boys, Hunters, Fishermen, mount and save your lovely wild-game trophies. Be a Taxidermist. Mount Birds, Animals, Heads, Fish, Tan skins. YOU learn easily, quickly in spare time. Have a grand home-museum. The finest and the greatest hobby known, for sportsmen. Fun, real profits.

FREE BOOK

Yes, FREE. Beautiful strange, valuable Book, telling all about Taxidermy. Contains over 100 beautiful game-pictures. And it's yours FREE, if you rush your request. You can mount all kinds of wild-game, and common specimens too. We can positively TEACH YOU. So GRASP this opportunity. RUSH letter or postal for this amazing FREE BOOK. Don't delay. State your AGE. N. W. SCHOOL OF TAXIDERM, 2510 Elwood Bldg., Omaha 2, Neb.

SAVE MONEY ON U S GOV'T SURPLUS

Buy surplus direct from US Government. These are samples of the savings that can be made. Life boat \$12.00. Grinder \$4.69. Shaper \$15. Dump truck \$76.77. Tractor \$75.00. Typewriter \$7.51. Freezer \$50. Spray painter \$15.25. Motor \$4. Hunting, fishing, camping, sporting Equip, jeep, boat, tools. Hundreds others may be purchased at tremendous savings through our Bulletin "Surplus Sales." Price \$1.00.

The Abacus Press, Box 169DDD, Dept. 4, East Hfd. 8, Conn.

\$2.95 OR 2 FOR \$5.00!

Genuine Telephone Company Upright Telephones, tested and guaranteed with 50 ft. of wire and inter-communication instructions. Complete line of telephones, dial, magneto, etc. Write for free list. All shipments F.O.B. Simpson, Pa.

TELEPHONE ENGINEERING CO.
Dept. 10855 Simpson, Pa.

PLEASE SEND ME



for the
time checked.
I am enclosing . . .

- 1 year \$3.50
 2 years \$6.00

name

address

city

zone

state

Hand this order to your newsdealer or send it to

POPULAR MECHANICS
200 East Ontario St. Chicago 11, Ill.

**SAVE 75%
ON**

WORK CLOTHES!

SURPLUS STOCK FROM MIDWEST SUPPLY FIRM!
Terrific values you've got to see to believe!



SHIRTS 79c

Made to sell for 2.99! Now Only 4 for \$2.99

What a buy! 4 for the price of one! These shirts, though used, are washed, sterilized and ready for long, tough wear. In blue, tan or green. Send name, address, neck size.

PANTS to match Unbelievable 99c

Bargains! Sold for 3.95. Now only 4 for \$3.75

Send waist measure and inside leg length.

COVERALLS . . . wear 'em used and save plenty! Originally 5.95. Now only 3 for \$5.75

Send chest measurement.

SHOP COATS . . . fully reconditioned. Take advantage of this rock-bottom price. *Send chest measurement. Now only 3 for \$5.00

SATISFACTION GUARANTEED! Your money back if you can't beat these bargains anywhere! You can't lose so order TODAY for immediate delivery! Pay postman or send money with your order and save postage. \$1.00 deposit on C.O.D. orders.

GALCO SALES CO. Dept. 1310

7120 Harvard Ave. • Cleveland 5, Ohio

IT'S EASY . . .

MAKE MONEY IN PHOTOGRAPHY

If you are over 17—good pay and fascinating work await you in photography! Start making money quickly in sparetime—step into your own studio or exciting career job. **LEARN BY DOING** method trains you at home! Write TODAY for FREE catalog. Also Resident Training. 46th Year. Approved for Vets.

NEW YORK INSTITUTE OF PHOTOGRAPHY
Dept. 49 10 West 33 Street New York 1, New York
46th YEAR

EARN AS YOU LEARN SHELLCRAFT

Wonderful, New, Easy—Up to 500% Profits! Make Shell Lamps, Shell Jewelry and Novelties. Sell for **BIG PROFITS!** Markets everywhere. Hand-in-Action PLAN designed for you . . . to learn and earn as you succeed in Shellcraft.

FREE Genuine Sea Shells, full color pictures, and Hand-in-Action Plan Folder. Write.

NATIONAL SHELLCRAFT SCHOOL
633-26th ST. S., ST. PETERSBURG, FLA.



LAW Men and women **STUDY AT HOME** for Business Success and **LARGER PERSONAL EARNINGS**, 44 years expert instruction—over 114,000 students enrolled. LL.B. Degree awarded. All text material furnished. Easy payment plan. Send for **FREE BOOK**—"Law and Executive Guidance"—NOW!

AMERICAN EXTENSION SCHOOL OF LAW
Dept. H-4, 664 N. Michigan Ave., Chicago 11, Illinois

SAVES LIVES!

Safety Belt for Automobiles



Minimize accident injuries to children and adults. 3600 lb. test webbing; approved airplane safety buckle. Specify: Driver, Front Seat Passenger or Rear Seat. Color: Red-Blue-Green-Gray. No COD. Money-back guarantee. \$12.95 value—**\$6.95** ppd. NOW ONLY . . .

MODERN ACCESSORIES CO.
3839 S. Madison, Cincinnati 12, Ohio

**I WILL TRAIN YOU FOR
RADIO-TELEVISION**



Frank L. Sprayberry, President

**ON MY EXCLUSIVE
NO-OBLIGATION
NO-RISK TRAINING PLAN**

Let me prove to you . . . without cost or obligation . . . that I can prepare you to be a Radio-Television Serviceman in 10 Months or Less

Let the true facts speak for themselves! That's why I want you to have my big new catalog and an actual sample lesson of Sprayberry Training . . . both **FREE!** Read, then make up your own mind! Train on my exclusive **NO OBLIGATION PLAN . . .** which means you **DO NOT** sign any kind of time payment contract. You pay for and accept your training as fast or as slowly as you wish. Prepare now for big paying jobs in Radio-TV or your own business. I will help you earn while you learn . . . in spare hours at home.



Get Practical Experience with 25 Kits of Radio-TV Parts

Practical experience counts most. In addition to modern lessons, you train with actual parts and equipment. Build the famous Sprayberry Training Television Set, Multi-Range Tester, 2-Band Radio, other Test Equipment—all yours to keep. Get latest training

on Color TV, Transistors, Hi-Fi and UHF Conversions . . . included to make your training more valuable.

You owe it to yourself to get all the facts . . . Mail coupon for catalog and sample lesson — FREE

See for yourself . . . in actual pictures and descriptions . . . why Sprayberry Radio-Television Training offers more. Backed by almost 25 years of training experience. Three training plans to suit your exact needs. Rush coupon today for big new catalog and sample lesson. No obligation; no salesman will call.

TWO BIG FREE BOOKS

SPRAYBERRY ACADEMY OF RADIO

Dept. 10-D, 111 N. Canal St., Chicago 6, Ill.



Mail Coupon Today!

SPRAYBERRY ACADEMY OF RADIO Dept. 10-D, 111 N. Canal St., Chicago 6, Ill. Mail for FREE Facts and Sample Lesson

Please rush catalog on your **ALL-NEW** Radio-Television Training Plans. I understand this does not obligate me and that no salesman will call. Include Sample Lesson FREE.

Name _____ Age _____
Address _____
City _____ Zone _____ State _____

"I DOUBLED MY INCOME— Am My Own Boss— in CUSTOM UPHOLSTERY"



**Leonard Schroeder, Former Low Paid
Accountant—Increases Earnings 110%**

"I was an accountant earning a meagre salary before UTS training in upholstery. Upon graduating, I got a much bigger paying job as an upholsterer. Now I've better than doubled my income in my own business."

WHAT DO YOU WANT? Your Own Profitable Business—A Steady Job—Substantial Sparetime Earnings—A More Secure Future? They're all waiting for YOU in the Big-Opportunity Field of Custom Furniture Upholstery.

The big nationwide housing boom has created a great demand for trained upholsterers. Prepare for this well-paid trade—easily, quickly. You can earn as you learn to make good money all year 'round at home, in your own shop, or in a well-paid job. The practical N. Y. State-approved UTS Course teaches you professional custom furniture upholstery, reupholstery, slip-covers, furniture finishing, window cornice, cushion, and drapery making. You get—FREE—ALL tools, complete frames and materials.

FREE ILLUSTRATED BOOK WITH SAMPLE LESSON! Our FREE book, "YOUR NEW WAY TO A SUCCESSFUL CAREER" with Sample Lesson shows you how. **WRITE TODAY!** Training in N. Y. School also available. UTS, Dept. DR-305, 721 B'way, N. Y. 3

**MATERIALS FREE
WITH COURSE
YOU MAKE**



**Yours to keep
or sell**

MAIL COUPON TODAY

APPROVED VETERANS FOR

**UPHOLSTERY TRADES SCHOOL, Dept. DR-305
721 Broadway, New York 3, N. Y.**

Please send me FREE book with FREE Sample Lesson. No obligation—no salesman will call.
 Home Study In N. Y. School Training

Name _____
Address _____
City _____ Zone _____ State _____
 Check if Korean Veteran

105 POWER SUPER TELESCOPE



Everything for the Astronomer, Hobbyist, Student, & Scout in this complete astronomical super value telescope combination. Comes ready for immediate use, consists of brilliant 32x-65x-105x telescope, 5 foot hardwood Tripod, carrying case for scope, Star Explorer map, 108 page book "Discover the Stars," 3 foot telescope (telescopes to 16 inches) is brass bound, has 4 precision lenses that will bring distant objects, people, moon, stars, ships, etc., 105 times closer. 11,025 area magnification. All images erect. Sturdily built tripod is equipped with universal mount that has 360 degree horizontal range & 180 degree vertical range. Locks in any position with one simple adjustment. The Star Explorer map enables you to find any star automatically. This marvelous all purpose instrument is proclaimed by Scientists as a most unusual development. Everyone that has used it is amazed at its performance and value. It will fascinate the entire family. Shipped to you complete, nothing else to buy, at the amazing low price of

\$11.95
POST PAID

Satisfaction guaranteed or money refunded. We pay all delivery charges. Send check or money order to DEPT. PMS12

CRITERION CO. 331 CHURCH ST., HARTFORD 1, CONN.



FULLY GUARANTEED TIRES COST LESS!

Nationally famous FIRESTONE, GOODRICH, U. S. ROYAL, GOODYEAR, and other makes. Every tire selected and inspected for your safety.

BUY WITH CONFIDENCE FROM PYRAMID TIRE WHITE WALL TIRES \$1 EXTRA

HIGH GRADE TIRES GUARANTEED 12 MONTHS

600x16 4.14	700x16 5.14	32x6(8) 8.84	825x20 14.24
650x16 4.54	670x15 4.74	32x6(10) 10.84	900x20 13.34
650x15 4.34	650x20 7.84	750x20(8) 8.54	1000x20 14.14
700x15 4.64	700x20(8) 8.94	750x20(10) 9.94	1100x20 16.14

AAA PREMIUM GRADE GUARANTEED 18 MONTHS

550x15 5.48	700x15 5.98	760x15 5.58	750x20(10) 14.98
600x16 5.28	700x16 6.78	550x17 5.48	825x20 18.68
600x16(6) 6.58	700x16(6) 7.98	600x20 5.78	900x20 18.98
640x15 5.68	750x16(6) 8.98	650x20 12.88	1000x20 19.98
650x16 5.78	800x16 6.88	700x20 12.88	1000x22 21.98
650x16(6) 6.98	820x15 7.48	32x6(8) 10.48	1100x20 20.98
650x15 6.97	110x15 6.08	32x6(10) 12.48	1100x22 21.98
670x16 6.18	550x18 5.98	750x20(8) 12.98	1100x24 23.98

MILITARY SPECIAL AA Guaranteed 12 Months—
 900x16 10.69 1000x20 19.98
 750x20 10.98 1100x20 21.98
AAA GUARANTEED 18 MONTHS
 900x16 14.98 • 750x20 16.48

NEW TREAD GUAR. 24 MOS.
 600x16 8.98
 600x16(6) 9.98
 700x15(6) 15.95
 750x20(8) 24.98

Largest stock of used tires in the East. Thousands of satisfied customers. Write for Free Catalogue. MONEY ORDER OR CHECK WITH ORDER. NO C.O.D.'s

PYRAMID TIRE CO.
 3333-35 North 5th St.
 Dept. M., Phila. 22, Pa.

FREE LEARN TV

the practical way—

Assemble a TRANSVISION TV KIT in easy steps. Pay as you wire—only \$15 for Starting Package #1. Learn while building a superb 17" or 21" screen TV Set with latest features. Ideal for Fringe Areas, adaptable to UHF. Easy—no instruments or technical knowledge required. Free Catalog describes a great TRANSVISION TV KITS.

Write today to Educational Dept. at—
TRANSVISION, INC., Dept. PM, NEW ROCHELLE, N. Y.

PUT YOURSELF IN BUSINESS

With Our Newest, Biggest NAME BRAND MERCHANDISE FREE JUST OUT

Housewares, gifts, jewelry, power tools, tableware, appliances, watches, etc. No investment. BE READY FOR THE XMAS RUSH!

WRITE TODAY TO DEPT. KJ
 487 B'WAY.
 ROBEL SALES N. Y. 13, N. Y.

NEW '58 Jumbo Catalog. Bigger than ever. Imprint space for your name, plus private price list too. Fully illustrated.

STAMMER?

Get your copy of the new 18th edition of my book, "Stammering, Its Cause and Correction," which describes the Bogue Unit Method for scientific correction of stammering and stuttering. Ask, also, for free SPEECH CHART, 34th year. Benjamin N. Bogue, Dept. 553, Circle Tower, Indianapolis 4, Indiana.

GET THIS FREE BOOK!

STAMP COLLECTORS

308 DIFFERENT STAMPS 25¢

including scarce Trieste collection; United Nations Issue, Olympics, latest wild animal set—in gorgeous multi-color showing the Lion, Bear, Chamois, Deer, etc. Stamps from riot-torn Trieste are becoming very scarce. These are only part of the big collection of 308 all different foreign stamps Catalogue \$7.00 that you get for only 25¢ to introduce our approvals.

**IDEAL STAMP CO., Dept. 3A, P. O. Box 64
 West Farms Station, New York 60, N. Y.**

NOW! A Practical Shop Type Home Study Course In

AUTOMATIC TRANSMISSION

SERVICING—REPAIR—OVERHAUL

Demand for automatic transmission specialists is terrific! Real big money in this field. You can learn from experts in your spare time at home, shop or garage. Easy to understand, illustrated lessons plus 3 complete transmissions included. (Each student gets a Hydramatic, Dynaflow and Fordomatic). See how easily you can start making money in this wide open field. Send for FREE BOOKLET.

LINCOLN TECHNICAL INSTITUTE
 Dept. PM-2, 472 Market St., Newark 5, N. J.
 Approved by N. J. Commissioner of Education



Leo Kerber, Shakopee, Minn. "Awhile ago I tried for one of these scholarships. I didn't think my sketch could win, but it did! I've learned a lot from the art course—and have already sold quite a bit of my work."



DRAW THIS GIRL'S HEAD

5 inches high. Use pencil only. All drawings must be received by Nov. 30, 1955. None returned. Winner notified. Amateurs only. Our students not eligible.

DRAW ME!

TRY FOR A FREE 2-YEAR ART SCHOLARSHIP WORTH \$335⁰⁰

Prize: Two years of free training for career in advertising art or illustrating—plus a series of art textbooks and a professional drawing outfit!

Scholarship is offered by a famous homestudy art school—world's largest. Many of its graduates are earning real money, today, in the art field.

You're trained by professional artists. You get individual coaching, guidance. Mail your drawing today!

ART INSTRUCTION, INC.
STUDIO 10135—500 S. 4th Street
Minneapolis 15, Minnesota

Please enter my attached drawing in your November contest.

-(PLEASE PRINT)-

Name _____ AGE _____
Address _____ City _____
Zone _____ County _____ State _____
Occupation _____ Phone _____

10135

This Amazing New LIFE-SAVER Can Bring You the BIGGEST MONEY OF YOUR LIFE!

50,000,000 MOTORISTS NEED FUTURELINE SAFETY BELTS!

Start a "Crusade For Safety" in your community and help reduce the tragic toll of deaths and injuries from auto accidents by introducing this new safety belt. Never was there a bigger profit opportunity just waiting to be cashed in on! Right in your own back yard you have thousands of red-hot prospects for the amazing new FUTURELINE Safety Belt. Car and truck owners will buy fast—2, 3 and 4 sets of FUTURELINE Safety Belts at a time. And the market is so "wide-open" you can practically name your own earnings!

FutureLine QUALITY IS THE FINEST

These new safety belts have a bursting strength of more than 3,000 pounds, exceeding all aviation (CAA) safety standards! 100% nylon webbing, a quick-release buckle that's easy to get into, or out of... only one model for any car, any seat, any adult or child... all in a complete easy-to-install kit that sells for only \$8.95. 3 easy sales a day, averaging 3 belts per car, can earn you \$270 in a week. 2 easy selling plans make FUTURELINE the hottest new money-maker on the market! Write for details!

POWERFUL PUBLICITY "PRE-SELLS" FOR YOU!

Magazines, newspapers, radio and television have told and sold the need for safety belts for you. Some States already have laws making safety belts required auto equipment. The public is already sold; now it's up to you to cash in with this new FUTURELINE Safety Belt! Rush the coupon for FREE SAMPLE Offer, plus all the details on how you can make the biggest money of your life! Be sure to write today!

How to Start "A CRUSADE For SAFETY"

- Make Your Car Your Salesroom!** Install 2 belts in front seat of your car for money-making demonstration.
- One Belt Sells Others!** No car is safe without 2 to 4 FUTURELINE Belts. Average sale is 3 belts.
- One Motorist Sells Others!** Customers tell their friends—actually help you sell more belts!

RUSH COUPON FOR FREE SAMPLE OFFER!

FUTURELINE CORP., Dept. P-8
173 W. Madison St., Chicago 2, Ill.

YES! Rush all the FUTURELINE details, plus your FREE SAMPLE Offer.

Name _____

Address _____

City _____ Zone _____ State _____

FUTURELINE CORP., 173 W. Madison St., Dept. P-8, Chicago 2, Ill.

GROW Living MIDGET TREES!

EARN EXTRA MONEY

- AT HOME
- IN SPARE TIME
- FOR FUN AND PROFITS!



It's New! Amazing! At last, the little known method of growing miniature IMINGI trees can be yours. FULL GROWN, dwarf trees—only a few inches high. Beautiful miniature fir, orange oak, Chinese elm, peach, vine, cypress—any kind! ALL BLOOM and even BEAR FRUIT! All perfect healthy specimens—but miniature in size! Make costly home decorations and expensive centerpieces.

Costs only pennies—takes only minutes per week. IT'S FASCINATING—Fun! A new, sensational hobby—a new profitable \$355 business. Send for free revealing plan details and real seed.

These trees are being purchased by STORES CLUBS • HOTELS • FLORISTS • HOUSEWIVES • INTERIOR DECORATORS • COLLECTORS • HOBBYISTS—A Big Money Opportunity FOR YOU.

FREE! GENUINE SEED AND PLAN!

National Nursery Gardens, Dept. M-10
8463 So. Van Ness Avenue
Inglewood 4, Calif.

Rush me FREE plan and seed IMMEDIATELY!

Name _____

Address _____

Zone _____

City _____

State _____



Choose Your New Home from



Garlinghouse HOME PLANS

Choose from Hundreds of Plans in These Beautiful

PLAN BOOKS

All Styles — 1 to 4 Bedrooms

- **"NEW SMALL HOMES"**
Over 80 new plans in popular new sizes—650 to 1175 sq. ft. floor space, 1, 2 and 3 bedrooms 50c
- **"RANCH AND SUBURBAN"**
128 ranch plans most practical for town and country 50c
- **"DELUXE SMALL HOMES"**
Our largest selection—155 modern, time-tested designs. \$1.00
- **"HOMES IN BRICK"**
Many of these 115 tested designs of medium and large homes are in color \$1.00
- **"BLUE RIBBON HOMES"**
2nd Edition. 63 pages of homes proved popular by actual sales. Many in color 50c
- All 5 above books for \$3.00 Postpaid—
- Our Complete Home Plan Library—18 books and over 1,250 Home Designs—Only \$8.00, a \$2.50 Saving.

Complete Plans for "Do It Yourself" or Contracting Part or All

These beautiful books contain hundreds of photographs, colored drawings, floor plans and descriptions—making it easy and economical to select the home you desire to build. Complete working plans, specifications, lumber and mill lists available for each design at **Low Cost**—enabling you to get contractors bids quickly—or to figure doing part or all the work yourself.

The moderate price of these plans is your best investment when building, since you know in advance what you are getting, thus avoiding misunderstandings. 24 hour service on plans with a money-back guarantee if unused plans are returned in five days. Our plan service used by builders and lumber dealers for over 40 years—America's largest.

ORDER TODAY — All Books Mailed Postpaid

L. F. GARLINGHOUSE CO., INC., Box PM-24 TOPKA, KANSAS

BULOVA WATCHES Famous 15 and 17 Jewel \$16.95 PLUS TAX WHY PAY YOU \$58 SAVE \$42



close \$16.95 plus

FREE! Handsome Expansion band with orders at no extra cost.

SERVICE Guaranteed—17 Jewel Swiss WRIST WATCH Worn Plus by Army, Navy & Marines. Thousands sold for... \$14.95 PLUS TAX

New Incublock, Shock-Protected Water & Dust Tight

AIR MAIL XMAS DELIVERY GUARANTEED!

ALSO GRUEN, WALTHAM, OR ELGIN MOVEMENTS ORIGINALLY \$58 Under OPA

You get these unredeemed **SERVICE** guaranteed Bulova and other movements in latest style Yellow Gold Cases at this sensationally low price because we bought out HUGE SURPLUS STOCKS of leading New York and Md. jewelers. Order now while they last. Specify make preferred and whether men's or ladies'! Only \$16.95, plus \$1.70 tax. Order right now.

FREE TRIAL OFFER! WEAR AT OUR RISK! MONEY BACK GUARANTEE IN 10 DAYS IF NOT DELIGHTED!

SEND ONLY \$1 with order. Pay balance C. O. D. plus postage. Or we pay postage if you enclose \$1.70 tax.

MARYLAND DISTRIBUTORS

Dept. 677,
501 E. Baltimore St.,
Baltimore 2, Md.

Write for Free Watch and Diamond Ring Catalog — Practically Wholesale Prices.



DRAW The First Day! NO LESSONS! NO TALENT!

New Amazing Invention—"Magic Art Reproducer." You can draw Your Family, Friends, Anything From REAL LIFE—Like An Artist! Even If You CAN'T DRAW A Straight Line! Anything you want to draw is automatically seen on any sheet of paper thru the "Magic Art Reproducer." Then easily follow the lines of the "picture image" with a pencil for an original "professional looking" drawing. Also reduces or enlarges. SEND NO MONEY! Free Trial! Pay Postman on delivery \$1.98 plus postage. Or send only \$1.98 with order and we pay postage. Money Back Guarantee.

NORTON PRODUCTS, Dept. 5810T, 296 Broadway, N. Y.

HOW TO DOUBLE YOUR SALARY! FREE LESSON

MAKE BIG MONEY with your NATURAL COMMON SENSE in a high paying, prestige job. Our graduates PROVE that you can more than double or triple your salary. Industry desperately needs trained men. Men like you have saved business millions of \$555 every year. IEC can train you for this wide open field of TIME STUDY. Your pay is excellent. Your future secure. Wonderful chances for promotion. Write today for your FREE LESSON. NO salesman will call. FREE JOB help for students. Indicate whether you want home-study or Chicago resident training information.

INDUSTRIAL ENGINEERING COLLEGE 3309F W. WASHINGTON CHICAGO 24, ILL.



NEW! IMPROVED SUCTION CELLAR DRAINER

PUMPS 300 GALLONS AN HOUR!

DRAINMASTER takes the curse out of basement flooding problems. Operates on normal city water pressure. Electric power failure is no problem. Made of "life-time" solid brass, no moving parts to wear or adjust. Just connect to a handy faucet with garden hose, turn on faucet and **DRAINMASTER** is working. Flood water is removed Right Down to the floor, no sump needed. Many other drain and pumping jobs are "dick-saw" for **DRAINMASTER**. . . ask for the NEW Flat Bottom Model at your favorite Hardware Store, or add 30c for handling and postage and we'll rush **DRAINMASTER** to your aid. Write To: \$1.95 M. P. WHITE CO., Dept. 4-PM, 55 Stuart St., Boston 16, Mass.

What Every Mason Wants



We have important Masonic books and lodge supplies for Blue Lodge, Chapter, Commandery, Scottish Rite, and Shrine.

OUR RITUALS ARE USED THE WORLD OVER Send for free catalog of books and rituals for Masons, Odd Fellows, Knights of Pythias, Knights of Columbus, Elks, etc.

EZRA A. COOK, Publisher, P.O. Box 796, 10A, Chicago 90, Ill.

SAY YOU SAW IT IN POPULAR MECHANICS

BUILD HELICOPTER GLIDER



The famous new **GYRO-GLIDER**, world's simplest and safest aircraft, is now available to amateur builders in plans and kits. Send \$1.00 now for three-view drawings with specifications and ask about kits and detailed building and flying instructions.

BENSEN AIRCRAFT CORP., Dept. PM-10 P.O. Box 2621 Raleigh, N. C.

ONLY \$1 Name _____ Address _____ City _____ State _____

Greatest Thrill in Flying!

New PROFIT-PROVEN* Home-Business!

"I make \$400⁰⁰ a week!"



SCREEN PRINT CO.

Dept. 2
15127 S. Broadway, Los Angeles 61, Calif.
Gentlemen: Please mail me Free Revealing Details, samples, Opportunity Plan, etc.—All this is sent absolutely Free and sent to me by return mail. I am under no obligation now or ever.

NAME _____
ADDRESS _____
CITY _____ ZONE _____ STATE _____

SCREEN
TRADE MARK REG.
PRINT



free!

Complete REVEALING DETAILS, Authentic SAMPLES, Proven Big-Money OPPORTUNITY PLAN, "HOW-TO" BOOKLET. Learn the secrets. Rush this coupon TODAY!



*Proves MR. J. T. ANDERSON, Inglewood, Calif.
(Notarized statement on file in our office and open to inspection)

Big Money?—sure it is—because Huge Profits are waiting to be "tapped" with this **MIRACLE NEW PRINTING METHOD**. Now, you may share the exciting secrets and build a big-paying **FULL OR SPARE TIME Screen Printing Business right IN YOUR OWN HOME**. Yes, we'll teach you, too, how to turn pennies into dollars in this newest, most sensational printing method ever invented. **WHAT IS SCREEN-PRINT?** It's an exciting new printing technique—amazingly simple and fascinating. (It may soon revolutionize the entire printing industry) **NO EXPENSIVE EQUIPMENT**, no printing press, no "cuts," no art ability, no experience is necessary—yet you can print beautiful professional jobs on **PAPER, GLASS, LEATHER, CLOTH—ANYTHING!** You print in all colors—even new "glowing" **FLUORESCENT**

COLORS. It's amazing—but true! **EARN PROFITS IMMEDIATELY—IN YOUR OWN HOME!** Start in your garage, basement, kitchen, spare room—anywhere! It's much easier than you think. Then expand as this new printing industry grows. **300% PROFIT** on some jobs—earn up to \$12.50 per hr. **HELP FILL THE HUGE GROWING DEMAND**. No selling because every business in your area needs Screen-Printing. You can save them up to 50% on printing, too. **WE SUPPLY EVERYTHING YOU NEED**. Never before has such a profit opportunity been offered to anyone wishing to start a full-time or spare-time "business of his own." Don't Hesitate! All the **CONFIDENTIAL FACTS** are yours if you **MAIL COUPON TODAY**—before it's too late.

READ WHAT OTHERS ARE SAYING—Investigate! "Would not take \$1000.00 for secret...just what I have been searching the world over for," C.S., Nev.; "Making 75% of living expenses already in spare time." E.L., Ontario; "Made \$80 first week—terrific opportunity"—W.S., Iowa.

Mail Coupon and Learn Secrets Too!

Print colorful ADVERTISING DISPLAYS, SIGNS, BANNERS, POSTERS, LABELS, WALLPAPER, NOVELTIES, INSTRUMENTS, ETC. ET

BUILD MUSCLES & HEALTH with BODY BUILDER

Only \$1.00 post-paid

This new Chest Pull Body Builder develops powerful he-man muscles F.A.S.T. Ideal for the beginner to give him a real start in championship muscularity and perfect for the more advanced bodybuilder to combine with his regular training for faster, all around muscle growth. Body Builder is wonderful for developing massive arms, shoulders, chest and back. Mail your order today. Only \$1.00 postpaid. No C.O.D.

MEDFORD PRODUCTS, Inc.
Dept. PM10, P.O. Box 209 Cathedral Sta., N.Y. 25, N.Y.

BOWS—ARROWS—MATERIALS

Easy to make your own
BOWS—ARROWS—EQUIPMENT

Illustrated Hand-Book 84 pgs. 75c, tells you how! Large Colored Catalog 5c—Send for it!

Ask your dealer for "Stemmler's Archery" (Oldest Mfr. in U.S.A.)

L. E. STEMMLER CO.
Manorville (Box 1) L. I., N. Y.



GOVERNMENT JOBS
START HIGH AS \$4,205.00 A YEAR

Prepare Now for next Examinations. Vets get preference. **MEN-WOMEN**. Mail Coupon Today.

Franklin Institute, Dept. H-93, Rochester 4, N.Y.
Sirs: Rush without charge, (1) 36-page book with list of U. S. Government Jobs; (2) Tell me how to prepare for one.

Name _____
Address _____

TRAINED MEN NEEDED

BIG PAY—GOOD FUTURE

TELEVISION ELECTRONICS
 DIESEL AUTO

WHY WORK FOR LOW PAY or risk being out of a job??? Usually the properly trained man has a steady job... through good times or bad. Even back during DEPRESSION there was a big demand for Bailey Trained men.

In only 5½ to 6 months we can train YOU to enter one of the big pay fields!

No previous experience or special education necessary. With our method of training you do not spend years pouring over books, figures, charts and graphs. You learn by rebuilding, repairing, testing and operating the most modern equipment, under the guidance of experienced, courteous and friendly instructors. This method of training gives you the experience and confidence required to step right into the big pay jobs without spending years as a mechanic's helper.

It's EASIER and COSTS LESS than you may think to get this residence shop training... we help you find part-time jobs while in school—full-time jobs after graduation. Check subject above in which you are interested and mail for complete information.

BAILEY Technical SCHOOLS
Veteran Approved

1634 S. Grand St. Louis 4, Mo.

NAME.....AGE.....
STREET.....
TOWN.....ZONE.....STATE.....

DRAFTSMEN



**CASH BIG
PAY CHECKS!**

**Train Now for
more success,
greater security**

**LEARN AT HOME IN SPARE TIME
(or at college in Chicago)**

Check the want ads in any newspaper—SEE the big-pay opportunities open to you as a draftsman. What's more, you can learn this well-paid, prestige profession at home—quickly, easily! No special talent needed. Get complete, step-by-step Chicago Tech lessons in the mail, spend a few pleasant hours studying each week. In a short time you'll be a well-trained draftsman, ready to take your pick of many good jobs. Act now!



Free Information—Mail Coupon Today!

Get FREE TRIAL LESSON plus information about C.T.C. practical training. Learn what successful Chicago Tech graduates say about high pay and opportunities in drafting. No charge, or obligation.

CHICAGO TECHNICAL COLLEGE

N-253 Tech Bldg., 2000 So. Michigan Ave.
Chicago 16, Illinois

Mail me FREE lesson with facts about big opportunities in DRAFTING.

Name _____ Age _____

Address _____

City _____ Zone _____ State _____



**Now—You Can Own and Play a
Famous
Make
Italian ACCORDION**

Save UP TO 50%

Choose from famous quality makes
at lowest WHOLESALE prices . . .

Get the facts about owning and playing the accordion . . . it's easy and loads of fun! You order on NO RISK PLAN . . . 5 DAYS FREE TRIAL! Save up to 50% off regular price. Easy, convenient terms. You choose from the finest and most famous Italian accordion makes for which we are authorized direct factory distributors. FREE home study course included. Find out about the fun and profit in store for the accordion owner. Rush coupon for big Color Catalog and low Wholesale Prices! yours FREE. No obligation. Write TODAY! Accordion Manufacturers & Wholesalers Outlet

2003 W. Chicago Av. Dept. R105, Chicago 22, Ill.

Accordion Manufacturers & Wholesalers Outlet • MAIL COUPON!
2003 W. Chicago Ave., Dept. R105, Chicago 22, Ill.
Send big FREE Color Catalog, best terms, lowest wholesale prices.

NAME _____

ADDRESS _____

CITY _____ ZONE _____ STATE _____

SAVE \$65 ON THIS LUXURIOUS \$100 CONTOUR CHAIR 34.95 FOR
Everything Needed Complete To Put It Together In One Evening



Genuine
FOAM
RUBBER

Scientifically correct design for restful, beautiful, relaxing. Adjusts for perfect sitting or reclining comfort. Proved beneficial to heart, nerves . . . most popular chair in the home. Firestone foam rubber and washable, pliable genuine Duran upholstery. Would cost \$100 or more in any store, shipped all ready to put together in less than one evening by anyone who can use a screwdriver. No cutting, no drilling, no skill needed. A woman can do it. Order now! Everything needed for only \$34.95, f.o.b. Balto. State color wanted: forest green, lipstick red, cedar brown, strata blue. Enclose \$5 deposit, balance C.O.D. Money back guarantee. Returns in 10 days if not satisfied. Order now.

BESTECRAFT, Dept. 65, Timonium, Maryland
Make Money selling and Assembling Contour Chairs for friends



... Swiss or American

Unique Sweazy System starts you making repairs right away. Develops your skill step-by-step. Teaches modern methods . . . professional short cuts. Learn by personal attendance or spare time home study. Approved for veterans. Free Sample Lesson. No obligation. Write today!

CHICAGO SCHOOL OF WATCHMAKING

2320 Milwaukee, Dept. 1105, Chicago 47, Ill.

Build your own GAS TURBINE ENGINE!



Order these plans today

GAS TURBINE ENGINE, simplest design, one evening project anyone can make. How to make pulse jet engine and rocket engine parts from fire clay castable material. One-man helicopter pictures and description. Ram jet engine testing information and ram jet helicopter pictures and description. All in one order from this ad, complete, \$1.98, C.O.D. \$2.49. Get other information too. Rush Order.

J. HOUSTON MAUPIN, Dept. 58, Tipp City, Ohio

SOCK-O World's Most Powerful
SUPER SLINGSHOT
SILENT • RIFLE FAST • POWERFUL • ACCURATE
Great for small game, targets. 45 lb. pull. BIG sturdy Stock, Lively. Raw rubber. Sweet shooting! FREE! 100 steel balls, rubber and target. FREE!!! Thrilling SURPRISE PACKAGE with Two slings at \$2.95. Navy, get 2! Guaranteed. Approved by American Small Game Slingshot Assoc.
\$1.50 WHOLESALE No C.O.D.
SOCK-O, PM, 4860 W. 137 St., Hawthorne, Calif.

Learn PRODUCT PROMOTION

Start a national business from home promoting your own new product ideas. Learn to sell through retailers, wholesalers, chains, agents or by mail. Expert instruction. Details free.

DOUGLAS BANNING, Dept. A

40 South Los Robles Avenue, Pasadena 1, California

TASOPE PHOTO-ENGRAVING PLANTS



Material Cost Of This Cut Mac Selling Price \$1.00 And Up

Establish your own profitable PHOTO-ENGRAVING business. Make cuts for newspapers, printers, and advertisers. Make etched name plates, plaques etc. Instructions furnished, no experience necessary. Sold direct from factory since 1931. First five hundred cuts sold locally or by mail will pay for plant and pay you well for your time. Write for FREE catalog.

TASOPE, DEPT. PM-10, AURORA, MO.

WARN HUBS AUTOMATICALLY FREE-WHEEL 4-WDs. IN 2-WHEEL DRIVE



RUGGED DESIGN PROVEN IN USE

WARN MFG. CO., Riverton Box 6064-A7, Seattle 88, Wash.

Free-wheeling 2-wheel drive stops front end drag! Cuts front end repairs 50% or more, saves gas, tires; gives amazing pep, performance, handling ease to 4 W.D.s! Warn Automatics engage or disengage front power train as you shift into 4-wheel drive, or out for fast, economical free-wheeling 2-wheel drive use. Automatics only also permit high speed driving in 4-wheel drive. Warn Automatic and Locking models for Willys factory approved, sold only by Willys dealers worldwide. Over 70,000 sets in use around the world. Models for other 4 W. Ds. at dealers or write:

WOULD YOU LIKE TO RECEIVE STACKS OF LETTERS LIKE THESE EACH WITH MONEY FOR YOU?

I have found a proven formula for quick success in making money. Others I've shared it with also have been successful. Would you like to know about it?

It's simpler than you might think — just buying good imports at next-to-nothing foreign prices and selling them in the U.S. by mail order or at wholesale to stores.

To most people, importing smacks of mystery, romance — and "costly" things for collectors. Actually, any capable and ambitious man or woman should learn import-export quickly. And, there are thousands of beautifully made imports obtainable at trifling cost abroad to sell in the U.S. by mail order. There are also great opportunities in exporting U.S. products.

Native villages in Africa, romantic Vienna, bustling Copenhagen, mysterious Hong Kong — yes, countryside hamlets and great cities all over the world produce fascinating products.

Using my plan, you don't have to travel abroad unless you want to. You don't even have to know a foreign language. And, there is no face-to-face selling in mail order.

I have proven this plan with 103 imports — and the opportunities for the sale by mail of thousands more are breathtaking in their possibilities. Hunting knives and binoculars from Germany, silverware from Sheffield, England — hand-carved art objects from Africa — all costing less than \$1 abroad have values up to \$5 or more here and are big sellers by mail order.

Monthly bulletins sent free to those who follow my plan show suppliers of new and desirable imports.

As I write this, I am receiving as many as 1,000 cash orders a day for imported clocks — all by mail order. They cost me only 65¢ and I sell them far below the U.S. market — a terrific bargain and a wonderful seller. And, I don't stock them as they are shipped direct to the buyers from abroad, *after I receive the cash.*

So you see, it is even possible to conduct a business of this kind without investing in merchandise.



Mrs. McGinn, one of my students in Illinois, operates a gift shop and sells Arabian perfume by mail order. F. Basler, N. J., sells Aztec bird feather pictures from Mexico to stores and by mail order.

You might ask, "Why do you let others in on your plan? Why don't you keep it all for yourself?" The answer is that items for import are countless. No one person could possibly handle even a small proportion of them. There's plenty of business in import-export for you and me and many others.

If you are sincere and really open-minded to a new and different opportunity — one which may change your whole idea of the kind of money you can make in your own full or part time business — write today for full details. Air mail reaches me overnight.

B. L. Mellinger, Director, Dept. E25A
1717 Westwood, Los Angeles 24, Calif.

— — — — AIR MAIL THIS COUPON NOW — — — —

B. L. Mellinger, The Mellinger Co., Dept. E25A
1717 Westwood, Los Angeles 24, Calif.

Mr. Mellinger: Without obligation, show me the big profits to be made through World Trade, especially in mail order from my own home.

Print Name.....

Address.....

Town & Zone..... State.....

500 PRINTED NAME & ADDRESS LABELS 25c

To get your name on our mailing list we will send you 500 gummed labels printed with any name and address, for 25c. Stick on letters, pgs., books, etc. (SPECIAL: 5 sets \$1.00 same or different name on each set).

WESTERN STATIONERY • Dept. 1227A • Topeka, Kansas



Opportunity for the holder of a production-item patent!

A large manufacturing plant equipped with precision machinery will finance and manufacture, on royalty basis, patented production items.

If you have such a patent, and are interested, write:

PRODUCTION PATENT DEPT.
3300 W. Temple St., Los Angeles 26, Calif.

Say You Saw It in Popular Mechanics

see for yourself!

Capra Gems

more dazzling than diamonds
at 1/30 the cost!



FREE Booklet

Get full facts, FREE, on the most amazing discovery by modern science—CAPRA GEMS. A miracle of science described in recent issues of *Saturday Evening Post* and *Reader's Digest*. They're more dazzling than diamonds, yet cost much less. CAPRA GEMS' refractive quality is actually higher than diamond! Brilliantly beautiful, dazzling CAPRA GEMS are hand cut, hand polished and hand selected . . . priced within the reach of all who love fine gems.

A 1-carat diamond stone costs you approximately \$1000. A comparable choice selected, 1-carat CAPRA GEM is yours for \$24, federal tax included . . . and can be bought in small easy payments.

GET THE FACTS NOW

Valuable illustrated booklet shows a wide selection of men's and women's rings. Gives full details, including prices and settings . . . shows all CAPRA GEMS actual size. Limited supply, so send today without delay. No charge, no obligation. Get all the facts on CAPRA GEMS . . . more dazzling than diamonds. **SEND NO MONEY.** CAPRA GEM CO., Dept. PM-105, P.O. 5145, Philadelphia 41, Pa.

TERRIFIC!

USED 16 x 50
Regularly sold at \$69.50
NOW \$37.60

These are not "used" in the sense that someone else owned them, but their frames have been scratched or some of the paint rubbed off while being taken off of the shelves or when handled on our viewing fringe. Their cases, too, sometimes show scuff marks. **OPTICALLY AND MECHANICALLY THEY ARE A-1.** 7" high. Water-dust resistant. 2" wide objectives assure greater illumination and brighter sharper images. Weight only 27 ounces!



SALE
20 POWER
Regularly \$39.95
NOW \$29.95

Brand new glasses. Never in the 100 years since Carl Zeiss invented binoculars has it been possible to get a **20 POWER PRISMATIC BINOCULAR** that weighed only **18 OUNCES!** Precision made. Individual focus with removable, screw-in protective caps. Lens are color corrected. Handsome crackle finish with satin chrome trim. Increased sales have lowered production costs and we are passing on this \$10.00 savings to you for this sale!

30 DAY NO RISK TRIAL

If not satisfied return for full refund. Made in Japan. Leather case, straps included. Add 10% Fed. tax. Cash orders prepaid. C.O.D.'s require \$2.00 deposit. **UNITED BINOCULAR CO., Dept. ARF-0008, 9043 S. Western Ave., Chicago 20, DEALERS WANTED!**

Free! VALUABLE U.S.A!



Scarce genuine postage stamp as illustrated, picturing first U.S.A. (issued in 1847!); **PLUS** big collection of 30 all-different United States; 19th century, valuable \$5 stamp, etc... **PLUS** packet beautiful Commemorative including '93 Columbian, Boy Scouts, Wild West, and many others. **EXTRA!** Big illustrated U. S. catalog; 64-page Collectors' Guide—and other attractive offers for your consideration. Send 10c for mailing costs. Act NOW!

H. E. HARRIS & CO.

1665 Transit Bldg., Boston 17

LEARN TV in KC

UNIVERSAL TV FAMOUS FOR 24 YEARS
1,000's OF SUCCESSFUL GRADS COAST TO COAST



Easy, quick, fascinating. Learn TELEVISION in 36 short weeks of enjoyable companionship in shop training. Wonderful job opportunities. Graduates have choice of many jobs or can establish their own TV repair shop. **YOU CAN START EARNING AS MUCH AS \$150 PER WEEK.** No limit as time goes on. U.T.S. is an old established school (TV exclusive for 24 years) staffed by expert instructors, headed by one of America's first TV broadcasters. Costs so little to prepare yourself for life. No previous experience needed. Fully approved for Korean Veterans. Also fully approved course in color TV (1st in US). Send coupon now for FREE book on TV Electronic opportunities.

WRITE FOR

FREE CATALOG

FILL OUT COUPON

UNIVERSAL TV SCHOOL
1220M Admiral Boulevard, Kansas City, Missouri

PLEASE SEND ME INFORMATION FREE

Name _____ Age _____

Address _____

City _____ State _____

Check here if Korean Veteran

KODACHROME STEREO

20 Exp.—1956 Dated
3 Rolls 9.99 5 Rolls 16.95

ANSCOCHROME STEREO

20 Exp.—1956 Dated
1 Roll 3.50 3 Rolls 9.75
Prices above incl. Dev. & Stereo Mounting

35mm KODACHROME

20 Exp.—1956 Dated
FACTORY PACKAGES
3 Rolls 5.55 6 Rolls 10.50

35mm ANSCOCHROME

20 Exp.—1956 Dated
FACTORY PACKAGES
1 Roll 2.65 3 Rolls 7.25
Price incl. Dev. & Mfg.

MOVIE KODACHROME

1956 **FACTORY PACKED** Daylight or Type A

8mm 25ft. Double Rolls | 16mm 100 ft. Roll

4 Rolls \$9.45 | 1 Roll \$7.15

7 Rolls 14.99 | 3 Rolls 19.95

MODEL FILM COMPANY DEPT. D10

78 West 47th St., New York 36, N. Y.

FREE GERMAN HUNTING KNIFE



4-INCH BLADE

We give you handiest hunting and fishing knife you've ever had! Has 4-INCH LONG highly tempered steel blade—VERY SHARP! Attractive handle. We send knife FREE to acquaint you with our below-wholesale bargains. Please send 25c for handling. NO LIMIT—but send 25c handling for each knife. Order TODAY!

HUNTING KNIFE, Dept. K-62, Box 881, St. Louis, Mo.

\$1300 BUILDS INCOME DUPLEX

FINANCIAL SECURITY!



Build your own 24'x36' concrete block duplex, complete for \$1300. 5 1/2" floor, steel windows, rock wool insulated, no block cutting necessary. Each side contains 11'x17' Living Room and Kitchenette, 10'x11' bedroom, 6'x9' bath and four closets. Genuine blueprint, scale 1/4"=1', step by step instructions, and material cost list, \$1.00 post. Money back guarantee. \$1300 BLOCK GARAGE APARTMENT, 22'x24', Liv. Room, Kit, bath and two bedrooms. Double garage below. Plan \$1.00.

BAILEY BUILDERS, 915 Pyramid Bldg., Little Rock, Ark.

WHOLESALE Electric Guitars - Parts - Build Your Own

Solid-body Spanish, amplifiers, double-necks, single-necks, triple-necks, 4-necks, solid-body mandolin, electric viola, pickup mikes, non-electric instruments, etc. 1956 Models wholesale. FREE CATALOG. Free home study course with instruments. Parts & plans available to build your own.

CARVIN CO., Box 287, PM-9, Covina, Calif.

WHEELS WHEELS WHEELS

- 7" Disc Wheel 3/4" Tire 3/8" sleeve 45c ea.
 - 8" Disc Wheel 1 1/8" Tire 1/2" sleeve 70c
 - 7" Disc Wheel 1" Tire 1/2" ball bearing 80c ea.
 - 8" Disc Wheel 1 1/4" Tire 1/2" ball bearing \$1.00 ea.
 - 6" Disc Wheel 1.50 semi-pneum. Tire 1/2" S.B. \$1.35 ea.
 - 8" Disc Wheel 2" semi-pneum. T. 1/2" S.B. \$1.50 ea.
 - 10" Disc Wheel 1.75 semi-pneum. T. 1/2" S.B. \$1.50 ea.
 - 10" Disc Wheel 2.75 semi-pneum. Tire 3/8" S.B. \$3.20 ea.
 - 12" Disc Wheel 1.75 semi-pneum. T. 1/2" S.B. \$1.85 ea.
- Above wheel prices include hub cap. Plus Postage. C.O.D.'s accepted. AXLES—Steels 3/16 in., 1/2 in., 3/4 in.—Cut to size—End holes drilled.

UNITED WHEEL STAMPING CO.

12131 S. PEORIA STREET PM-10 CHICAGO 43, ILLINOIS



AUTOMOTIVE Safety BELT

Made of rugged two inch nylon webbing, with airplane release polished buckles. Colors to blend with your car. Meets all CAA requirements, recommended by National Safety Council, insurance companies.

Send check or money order, postpaid. Please indicate color.

M & H COMPANY
301 So. 8th St.
Colton, California

Single belt
\$7.95
two for
\$15.00

MODERN TRANSPARENT ROOF



Plates Replaced \$5.00

Genuine Dupont Plastic NEW FALSE PLATE

From Your Old, Loose Plate **NO IMPRESSION NEEDED** New, revolutionary Duplication System actually transforms your old, loose, cracked, chipped plate into a new, natural-pink Dupont Plastic Plate with same teeth or new, natural matched teeth. **ONE DAY SERVICE!**

SEND NO MONEY—just your name and address for FREE details. Save at our low price! Highest prices paid for Dental Gold. **ALL-STATE DENTAL LABORATORIES, 22 W. Madison, Dept. 750, Chicago 2.**

Only **\$18.95**

30-DAY MONEY-BACK TRIAL



PLAITED LEATHER **BIG BULL WHIP**

Experts knock ashes off cigaret, gun out of hand, yank people off feet, etc. Used by trainers, ranchmen, etc. Grip lightly (pressure is on loop), then crack or coil; snake out or back; overhand, underhand, side-arm. Neat's oil (finished for pliability & long life. "Cracker" or tongue on end. Solid grip handle with loop. 6-ft. Whip \$1.98; 8-ft. Whip \$2.69.

JOHNSON SMITH & CO., Dept. 162, Detroit 7, Michigan

Catalog of **3000** Novelties **10c**

Send 10c for amazing catalog of novelties, live animals, scientific supplies, hobbies, funmakers, planes & boats, looms, magic tricks, joke articles, unusual seeds, gads, get timersavers, cameras, optical goods, projectors, movies, lucky jewelry, religious novelties, disguises, musical instruments, stamps, coins, puzzles, fortune tellers, radios, auto & bike accessories, telescopes, magnifiers, compasses, banks, smokers' gadgets, artists' supplies, printing sets, eye glasses, motors, smokers, knives, billfolds, guns, rifles, sports, books, games, plants, etc. Send 10c (3 for 25c—get for friends!). JOHNSON SMITH & CO. Dept. 162 Detroit 7, Michigan

MAKE MONEY WRITING

.. short paragraphs!

You don't have to be a trained author to make money writing. Hundreds now making money every day on short paragraphs. I tell you what to write, where and how to sell; and supply big list of editors who buy from beginners. Lots of small checks in a hurry bring cash that adds up quickly. No tedious study. Write to sell, right away. Send for free facts. **BENSON BARRETT, 1751 Morse Ave., Dept. 27-K, Chicago 26, Ill.**

MAKE CERAMICS IN YOUR KITCHEN

Make lovely vases, bowls, lamps, trays

No special skill or equipment needed. New Della Robbia Kit contains Miracle Clay, tools, brushes, 10 glaze colors, illus. instruction book. Clay bakes hard and durable in kitchen oven. Try kit 7 days at our risk. Only \$5.95 postpaid. If not delighted return for full refund. Order from **SCULPTURE HOUSE, Dept. A1010, 304 West 42nd Street, New York 36, N. Y.**

BOAT KITS

12 Models as low as \$39.95 (freight included). Fiberglass boat covering kits, marine supplies, etc. Free folders.



18 FT. CRUISER

TAFT MARINE WOODCRAFT

DEPT. PM-10 636-39th Ave. N.E., Minneapolis 21, Minn.

High School at Home

MANY FINISH IN 2 YEARS

No classes. No time wasted going to and from school. Progress as fast as your time and abilities permit. Standard H. S. texts supplied. Thousands enroll each year in this 58-year-old school. Send for **FREE** descriptive booklet.

AMERICAN SCHOOL, Dept. 4745 Drexel at 58th St., Chicago 37, Ill.

Without obligation, please send **FREE** descriptive booklet.

Name.....

Address.....

Canadian Residents: Complete Canadian Course Available. Write American School, 1610 Sherbrooke St., West, Montreal.

NOW! A NEW WAY TO LEARN

AIR CONDITIONING and REFRIGERATION

FOR MORE PAY OR YOUR OWN SHOP

Over 100 million air conditioning and refrigeration units are in use today. Millions more will be installed in homes and industry. *Repair and installation offer you a real opportunity to earn top pay or go into business. It's easy—and takes just a few months—to learn this highly-paid, secure trade. CTI will train you at home in spare time with its proven Shop Method. Investigate your chances!*

23 big practical training kits



You get motor, compressor, testing gauges, controls; a complete refrigeration hi-side—as well as mechanic's tools and supplies.

The coupon below brings you complete details about this new, easy and different way of getting on-the-job training in your own home town.

BUILD YOUR OWN AIR CONDITIONER OR FREEZER

You build (and keep) an air conditioner, freezer, home refrigerator or milk cooler as a part of your training. Get the facts **NOW**—about America's fastest-growing industry!

MAIL COUPON TODAY FOR VALUABLE FREE BOOK

COMMERCIAL TRADES INSTITUTE

1400 Greenleaf Ave., Chicago 26, Ill. Dept. R-105.

Send me your big **FREE** book which tells me how I can train at home to make big money in Air Conditioning & Refrigeration.

Name..... Age.....

Address.....

City..... Zone..... State.....

MEMBER—NATIONAL HOME STUDY COUNCIL

Say You Saw It in Popular Mechanics



Blink-O-Lite for EMERGENCIES



Installs easily in trunk of any car. Starts flashing an amber warning signal when bracket is opened. Swivels 360°. Specify 6 or 12 volt battery.

\$6.95

Complete No C.O.D.'s Postage Prepaid

ORDER TODAY!

SAFETY-LITE CO. Dept. PM-10

620 N. MAY STREET CHICAGO 22, ILLINOIS

Please send me..... Blink-O-Lite (s) at \$6.95 each.

6 Volt Battery 12 Volt Battery Enclosed is \$.....

Name.....

Address.....

City..... Zone..... State.....

ELECTRICAL WIRING JOBS

Official
CODE RULES
made clear by
PICTURES!

2 GIANT now made Easier!
Volumes Surer! SAFER!
3168 Pictures!

Newest idea in ages! Official National Electrical Code rules made crystal-clear by PICTURES! Books contain thousands of pictures explaining every Code rule, parts of rules, exceptions, etc. Based on latest Code . . . shows how to do a right job every time. Saves you time, money, inspection headaches. Pictures are big and clear . . . on 8 1/2"x11 page size . . . over 1600 pages. Covers things like wiring design and protection, wiring methods, hazardous locations, etc.

ELECTRICAL CODE DIAGRAMS

A few minutes study a day makes you a real Code expert . . . helps you on the job every day.

- Speeds your electrical planning and installation
- Saves costly errors, expensive violations
- Numbered exactly like Code for quick reference



FREE TRIAL!
EASY TERMS

McGRAW-HILL BOOK CO., Dept. PM-10 (This offer applies to U. S. only)
327 West 41st St., New York 36, N. Y.

Send for 10 days' FREE trial Segall's ELECTRICAL CODE DIAGRAMS, 2 vols. If not satisfied, I will return books. Otherwise I will send \$5.00, plus delivery charges, then \$5.00 a month until \$25.00 is paid. (We pay delivery if you remit with coupon; same return privilege.)

Name _____
Address _____
City & State _____
Employed by _____ PM-10

"TOOK IN \$217
FIRST 10 DAYS"

Some make more, some less

We help you to start Your Own All-Year Business

Make Big Money! With our easily operated, highly efficient wall washer, Chas. Stelle took in \$217 gross in first ten days. E. L. Goss took in more than \$10,000 in one year. E. C. Taber wrote, "I made \$400 gross in two weeks." And no wonder—this machine washes walls 6 times faster and better than by hand. Your Money-making Opportunity. Enjoy independence—freedom from bosses, layoffs. Customers everywhere—homes, offices, schools, etc. Expenses low, profits high. No shop necessary; operate from home. Can start spare time until your full time is available.



LOSE NO TIME. GET ALL FACTS WITHOUT OBLIGATION

FREE BOOK! MAIL COUPON TODAY!

- VON SCHRADER MFG. CO.
- N 10 "W" Pl., Racine, Wisconsin
- Send at once (no obligation) your FREE booklet containing information about your WALL WASHING MACHINE and how I can start my own permanent, profitable business.
- Name _____
- Address _____
- City _____ Zone _____ State _____

MAKE YOUR OWN
FOLDING TABLES
IN MINUTES . . .
AND SAVE MONEY!

WITH TABLECRAFTERS'
TUBULAR STEEL
FOLDING TABLE LEGS



You simply screw leg assemblies to your table top. They're sturdy and rustproof. Won't collapse . . . yet fold easily for storage. For banquet, buffet, hobby, work and game tables.

COMPLETE KIT
FOR ONE TABLE \$8.95

Send check or money order and we'll pay postage. Write Dept. "C."

TABLECRAFTERS 6731 CASTOR AVE., PHILADELPHIA, PA.

ATTENTION!
SHOW THIS AD TO THE
COMMITTEE OF YOUR
CHURCH, LODGE OR
OTHER ORGANIZATIONS.
THEY'RE ENTITLED TO
SPECIAL DISCOUNTS.

250 POWER



Complete Telescope Lens Kit only \$3.49 postpaid

Conquer Space. Explore the Universe, Planets, Moon Craters, New Stars, etc. Complete Lens Kit consists of 80 inch focal length ground and polished objective lens, eyepiece lenses for 50 POWER, 100 POWER, 150 POWER, 200 POWER, 250 POWER, and all necessary lens fittings. Easy to make from simple step by step instructions. (Tripod and mount not included.) Money back guarantee.

BUSSE SALES CO., Hartford 1, Conn., Dept. PM 38

BUILD YOUR OWN MIDGET ROADSTER \$25 BUILDS BODY & FRAME



BUILD A PONY ROADSTER or Pick-Up in few spare hours. Uses 2 hp engine, 450 lb. loads, 70 m.p.g., plenty of speed. Designed for VERY LOW-COST assembly from PARTS BOUGHT IN YOUR NEIGHBORHOOD. Use home tools. Great for kids; sturdy utility car. COMPLETE step-by-step plans. 17 large-size pages, 30 "show-how" photos. Body templates, complete material and parts list. Only \$1.95 post-paid. Satisfied or money back.

PONY PLANS, 7641-J TEXHOMA AVE., NORTHRIDGE, CALIF.

Say You Saw It in Popular Mechanics

Finish HIGH SCHOOL AT HOME

Complete 4 Yrs. in 12 Months

Learn More! Earn More! Enter professional or technical schools. Advance Socially. Live a Happier, Fuller Life. Individual Courses or complete schedule. WRITE FOR SCHOOL BULLETIN.

ACADEMY FOR ADULTS

30 W. Washington, Dept. PM-105, Chicago, Ill.

Watch Repairing Pays Big Money Learn at home



Watch repairers in great demand. Train step-by-step in 10 easy lessons. We furnish all tools and 15 jewel watch and practice movement. Turn spare time into cash. A licensed school. Low cost. Send for FREE book today.

ILLINOIS SCHOOL OF WATCH REPAIRING
2870 Elston Ave., Dept. PM-105, Chicago 18, Ill.



\$298 REVERSIBLE AUTO SEAT COVERS

Each ORDER FROM MFR. AND SAVE

Colorful SNAKE AND ZEBRA DESIGN AND LEOPARD-COWHIDE DESIGN. Can Be Used On Either Side. Water and Stainproof. Tailored With Side Grip Panels For Tight Fit. Sewn With NYLON Thread For Long Wear. Simple To Install. Dress Up Your Car With A Set Of Either Of These Colorful Expensive Looking Covers!

10 DAY MONEY BACK GUARANTEE

Choice Of SPLIT Or SOLID Front Seat Only \$298. Complete Set For Both Front & REAR ONLY \$500. When Ordering Specify Choice Of Design Wanted. Make of Car and Seat Style. Enclose Payment And Save Postage Or Sent COD.

MARDO SALES CORP., Dept. LS-27
480 Lexington Ave., New York 17, N. Y.

LEARN MEAT CUTTING AT NATIONAL

Pay After Graduation



The steady dependable trade of Meat Cutting taught easily in 8 short weeks. **YOU LEARN BY DOING** under actual meat market conditions in big modern school at Toledo.

For beginners or men with experience. Get a profitable store of your own. Remember, **PEOPLE MUST EAT!** Big pay jobs. Free employment help. Thousands of successful graduates.

Buying, cutting, percentage, pricing, advertising, selling, etc. A complete retail meat education. National School established over 30 years. Get National training **NOW**. Pay your tuition in easy weekly payments

after you graduate. Send coupon for **FREE** 52 page school catalog — **TODAY**. G.I. approved.

National School of Meat Cutting, Inc., Dept. 50-W, Toledo 4, Ohio

Send me your **FREE** school catalog on National Training at Toledo in Meat Cutting, Meat Merchandising and Self Service Meats. No obligation. No salesman will call.

Name _____ Age _____
 Address _____
 City _____ State _____
 Approved for training Korean Veterans

**ENGINEERING
DEGREE IN
27 MONTHS**

B. S. DEGREE, Aeronautical, Chemical, Civil, Electrical, Mechanical and Electronic Engineering (inc. Radio and TV), Drafting. One-year G.I. Government approved. Low rate. Earn board. Large industrial center. Students from 48 states, 21 countries. Demand for graduates. Enter December, March, June, September. Write today for catalog. 1610 E. Washington Boulevard, Fort Wayne 2, Indiana.

INDIANA TECHNICAL COLLEGE

LEARN METALCRAFT and JEWELRY MAKING



Low Cost Home Training Now Available
 Make money. Learn profitable skills and arts of decorative metal and jewelry crafts. Course is complete. Professionally prepared. Easy to master. Special tools and materials furnished.

Write for **INTERSTATE TRAINING SERVICE**
 Free Booklet DEPT. K-3 PORTLAND 13, OREGON

HELPFUL BOOKS

Send post card asking for **FREE** catalog
 Popular Mechanics Press, 200 E. Ontario, Dept. 601, Chicago 11

AUTO MECHANICS... Learn SUPER-TUNE

Join 1000's of Sun-Trained Men Now Enjoying Increased PROFITS... PRESTIGE... ENGINE KNOWLEDGE!

***ELECTRONIC TUNE-UP TESTING** Course now offered at Sun's Modern Training Center, Chicago. Complete in 4 weekly units: *Test Equipment Operation; Automotive Electricity; Modern Tune-Up Procedure; Service Merchandising*—take any or all, **COST IS LOW!** Write to: Sun Electric Corp., Dept. PM1, Harlem & Avondale, Chicago 31, Ill.

RUN A CAFE OR DINER

I can show you how to get into this marvelous business. Opportunities plentiful when you know how to proceed. Be independent! Learn every phase of the business from how to get started quickly on small investment to menu planning, food preparations, money-making methods, the 7 ways to finance your first place. 20 fact-filled lessons in course. Study at home. Free trial. Money-back guarantee. Write today for **FREE** booklet.

SCHOOL OF RESTAURANT ARTS, Box 110-D, Fremont, Ohio
 Please send me, without obligation, my copy of "Cafe, Diner Business."
 Name _____
 Address _____

NEW BENJAMIN SUPER CO₂ GAS CARBINE — \$16.50

HI-LO (2 Stage) Jet Power
 Cal. .177 or .22
RIFLED TARGET & SMALL GAME
SAFE — ECONOMICAL — ACCURATE
CONVENIENT — PRACTICAL — NON TOXIC
EASY TO OPERATE — NO PUMPING — NO FLINCHING.
 Get 40 SHOTS from each 1/2" STANDARD SIZE CO₂ (Soda) CARTRIDGE. Up to 3/4" penetration.
 Ask your DEALER for DEMONSTRATION.
BENJAMIN AIR RIFLE CO.
 896 MARION ST., ST. LOUIS 4, MO., U.S.A.

NEW BENJAMIN .177 or .22 CO₂ ROCKET Gun Pistol with HI-LO JET POWER..... \$15.00

FREE Folder

PLASTIC "GUARD ALL" WATCH GUARD

Protects Your Watch While Working

UNBREAKABLE

SNAPS ON!...SNAPS OFF!

Practical watch protection for the mechanic, construction worker, machinist, trucker, painter, laborer or executive. Strong, sturdy, clear plastic watch guard, guards your watch from mean blows, hard scratches and tough knocks. Keeps out dirt. gives extra shock protection. Costs so little. Save money and worry. Get a couple!

Only **25¢ ea.**
 5 for \$1.00
 No C.O.D.'s

AT WORK OR PLAY
FOR EVERYONE IN THE ARMED FORCES
 Distributors Inquiries Welcome

MANSOL, 142A Little Street, Belleville, N.J.

free!

1956 ALLIED

ELECTRONIC SUPPLY CATALOG

324
value-packed
pages

Save on Everything
in TV and Radio
Parts & Equipment



Everything for Experimenters,
Builders, Amateurs, Servicemen,
Engineers & Hi-Fi Specialists

Send for ALLIED's big 324-page value-packed guide to *everything* in TV, Radio and Electronics! Select from the world's largest stocks of High Fidelity systems and components; recorders and phono equipment; TV tubes, antennas and accessories; Amateur station equipment and supplies; P.A. systems; test instruments; latest build-your-own kits; industrial electronic supplies—plus *everything* in electronic parts, tubes, transistors, tools and books. Save on everything in Electronics—send today for your FREE 1956 ALLIED Catalog.

Everything in Electronics
From One Reliable Source

send for it

FREE
CATALOG

ALLIED RADIO

ALLIED RADIO CORP., Dept. 5-K-5
100 N. Western Ave., Chicago 80, Ill.

Rush FREE 1956 ALLIED 324-Page Catalog

Name _____

Address _____

City _____ Zone _____ State _____

BE A CLAIM INVESTIGATOR



INVESTIGATE ACCIDENTS! Many earning \$750 to \$1000 a month. Thousands of insurance companies, airlines, steamship lines and Government Offices need Claim Investigators. Also big opportunities for your own spare time business. We train you at home. National Placement Service FREE of extra charge. Bill King writes: "Your course has paid off for me with large earnings. You can quote me—your Adjuster Training Course is worth many times the cost." Write TODAY for FREE book.

UNIVERSAL SCHOOLS

University Park, Dept. PM-10, Box 8202, Dallas 5, Texas

LEARN TO
BECOME A **GAME WARDEN**
or GOVT. HUNTER. Join FORESTRY, FISHERY, or WILDLIFE Services. Excellent opportunities! Good pay (\$2500 to \$10,800 a year). Pleasant Work, Prestige, Real Security, Healthful Working Conditions, and Retirement Income can all be yours. Help fill the demand in your area. Make your love of the outdoors become your business. Learn at home in spare time—it's Easy! Fun! Fascinating! (If over 17 years old.) Complete, illustrated **FREE!** booklet that gives you complete facts. **SUPPLY LIMITED—send your name and address now—TODAY!**

HOME STUDY EDUCATORS, Dept. R-10
1036 S. La Brea Los Angeles 19, Calif.

HOW TO

PEOPLE
60 to 80

CAN APPLY FOR LIFE INSURANCE

Let us send you complete information about Old American's \$1000 old line legal reserve life insurance policy. No one will call on you. Handle entirely by mail. Just send name, address and age to Dept. L1069M, OLD AMERICAN INS. CO., 1 W. 9th, K. C., Mo.

SEND ME

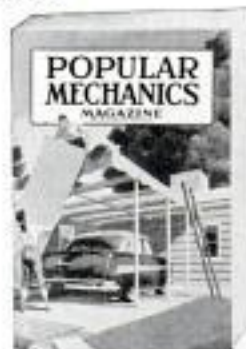

every month so I am sure to
see each new issue. Here's

- \$3.50 for 1 year
 \$8.00 for 3 years

name _____

address _____

city _____

zone _____

state _____

Hand this order to your newsdealer or send it to

POPULAR MECHANICS
200 East Ontario St. Chicago 11, Ill.

Make Money Manufacturing Concrete Drain Tile



Manufacturers of concrete drain tile are in the driver's seat. Why? Because their basic costs are not burdened by freight, distribution and breakage costs—items which the clay tile people have to pass along. Net results: concrete tile can sell for less, yet show a generous profit.

The market is big—and getting bigger. Not only because of increased farm drainage, but also because drain tile are needed in home building, reclamation projects, highway construction, and many other purposes.

Tile made on the Champion are outstanding in quality—dense, strong, uniform and truly round. All sizes up to 12" diameter. Easy to make, because the Champion Machine is simple, compact, and requires no skilled labor. Business is a low-investment opportunity, with equipment available on terms. Write for catalog.



W. E. DUNN MFG. CO.
522 W. 24th Street, Holland, Mich.



IN CANADA: DUNN MASONRY MACHINERY LIMITED
970 Dundas Highway, Cooksville, Ont.

SCALE MODELS

Start today collecting these imported Sports & Passenger Cars. Die cast in metal. Terrific paint job. New Models constantly being added. Postpaid. No COD please.

Parache (German), 90c; M. G. (British), 90c; Volkswagen (German), \$1.00; Jaguar XK (British), 80c; Harley Davidson motorcycle (U.S.A.), 80c; Harley combi's (U.S.A.), \$1.00; Opel (German), \$1.00; Austin Healey (British), \$1.00; Alfa Romeo (Italy), 80c; Volkswagen Trucks all models (German), \$1.00; Vespa Scooter (Italy), 75c; Vespa w/sidecar, \$1.00; M.L.O. Jet (Russian), 85c; Hawker Hunter (British), 89c; Triumph TR2 (British), \$1.00.

Send check, money order or cash to

CONTINENTAL CAR MODELS, P.O. Box 498, Buffalo, N.Y.

Secrets of VENTRILOQUISM Now Revealed!

Easy to learn in 60 to 90 days with our Home Study Course. **RESULTS GUARANTEED.** Make Money! Be Popular! Have Fun! Big Opportunity! Radio, Television, Stage Appearances! For FREE information regarding price and terms WRITE. You must state your age. Dummy Catalog 25c.

FRED MAHER SCHOOL OF VENTRILOQUISM
Box 36, Studio PM-10, Kensington Station
Detroit 24, Michigan

SHORTHAND IN

Famous SPEEDWRITING shorthand. 120 words per minute. No symbols; no machines; uses ABC's. Easiest to learn, write and transcribe. Low cost. 300,000 taught by mail. For business and Civil Service. Typing available. 33rd Year. Schools in over 400 cities. Write for FREE booklet to:

Speedwriting
Dept. 1510-S
55 W. 42 St., N.Y. 36, N.Y.

6
WEEKS

MAKE EXTRA MONEY

Start Your Own Business

Sell tools part time, full time. Save money for your industrial and institutional use. A MILLION DOLLAR INVENTORY AT YOUR FINGERTIPS.

Buy NATIONALLY ADVERTISED hand tools, hardware, fans, motors, power tools, paints, etc., NO INVESTMENT REQUIRED. Buy as you need it. Up to 30% DEALERS DISCOUNT.

Send \$1 Deposit for Dealers Card and mammoth dealers catalog. \$1 refunded on first purchase or returned if you are not 100% satisfied. SILVO HARDWARE CO., Dept. PM-10, 108 Market St., Phila. 6, Pa.



PLAY RIGHT AWAY

ANY INSTRUMENT

—even if you don't
know a single note now!

NOW it's EASY to learn ANY instrument. No boring exercises. Even if you don't know a single note now, we'll have you playing delightful pieces RIGHT AWAY—right from your FIRST lesson! And properly, BY NOTE. Simple as A-B-C. Make amazing progress. No special "talent" needed. Learn at home in spare time, without a teacher. Only a few cents per lesson. Soon you can play any piece you wish. 900,000 students. (Now in our 57th successful year.)

FREE 36-PAGE ILLUSTRATED BOOK

—just send this ad, with your name and address filled in below to: U. S. School of Music, Studio A3010, Port Washington, N. Y. (No obligation, no salesman will call.)

Name _____

Address _____



How Do You Rate?

Do people you know look UP to you
or DOWN at you?

Your EDUCATION is what makes the difference.

FINISH YOUR HIGH SCHOOL EDUCATION AT HOME

Complete 4-year course in 2 years or less

No interference with your job or social life. Study in spare time with textbooks and modern study aids I send you.

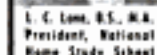

L. C. Lane, U.S. N.A. President, National Home Study School

Special Business, Mathematics, Agriculture, Industrial courses also offered.

Full credit for any high school work completed elsewhere. Start where you left off.

You get standard textbooks, Study Guides, and these Modern Study Aids—projector and filmstrips, phonograph and records, complete science laboratory kits.

NATIONAL HOME STUDY SCHOOL

50 East 19th Street, New York 3, N. Y.

Chartered by Board of Regents, University of State of N. Y.

Licensed by the State of New York

Send today for my new FREE catalog and sample Home Study Lesson.

MAIL THIS COUPON TODAY!

Mr. Leonard C. Lane, President
NATIONAL HOME STUDY SCHOOL
Dept. NY-10, 50 East 19th Street, New York 3, N. Y.

Dear Mr. Lane: Please send my new FREE CATALOG with information on High School and special Job-Training courses and FREE SAMPLE LESSON. I understand I am not obligated and no salesman will call.

Print Name _____ Age _____

Address _____

City _____ Zone _____ State _____

NO SALESMAN WILL CALL!

① I SHOW YOU HOW TO
MAKE MONEY AT ONCE
 ② START YOUR OWN BUSINESS
 IN 2 WEEKS—
 AT HOME
 IN SPARE TIME



PLATE BABY SHOES IN REAL BRONZE & COLORED PEARL

IF YOU ACT NOW, I will show you how to start earning extra money immediately—in spare time or full time. I WILL SHOW YOU HOW to start your own profitable business with my complete course and easy-to-understand illustrated instructions. Contains trade secrets of ALL processes and all my TESTED and PROVED METHODS of operating a successful business. Absolutely NO PREVIOUS EXPERIENCE needed. Send coupon today for FREE details of my MONEY MAKING PLAN for you and be convinced.

FREE!

MONEY MAKING PLAN

Full Details Without Obligation

MAIL COUPON TODAY!

KIKTAVI CO., Dept. PM-5510
 11029 S. Vermont, Los Angeles 44, Calif.

Send me FREE details of your MONEY MAKING PLAN, without obligation.

NAME _____
 STREET _____
 CITY _____ ZONE _____ STATE _____

PREPARE FOR THE BEST JOBS

IN INDUSTRY

- MECH. ENGINEER
- DRAFTSMAN
- TOOL DESIGNER
- TOOL ENGINEER
- TOOL & DIE MAKER
- MASTER MACHINIST

NO RECESSION FOR ALLIED TRAINED MEN

MORE JOBS THAN GRADUATES Shortages of Draftsmen, Designers, Tool Engineers, Machinists, Tool & Die Makers are so widespread that you can pick a highly paid key job and look forward to Achievement and Security.

You can begin your training in Short Courses and continue progressively to a Bachelor Degree in 26 months.

Allied is approved by Industry, Dept. of Education, Office of Public Instruction, State of Illinois, U.S. Veterans Admin., U.S. Dept. of Justice. Accredited: C.S.A.

SEND FOR **FREE** BOOKS

ALLIED SCHOOL of MECHANICAL TRADES
 1338-42 South Michigan Ave. Dept. PM-10 Chicago 5, Illinois

SEND ME WITHOUT OBLIGATION INFO. ON YOUR COURSES:

HOME STUDY RESIDENT VETERAN NON VETERAN

NAME _____
 ADDRESS _____ AGE _____
 CITY _____ STATE _____

NEW! PERSONAL POCKET RADIO

LISTEN WHILE YOU WALK, RIDE, WORK!



Slips in any pocket—Wt. only 9 oz. Size 2 3/4" x 4 3/4" x 1 1/4". Beautiful Black Gold plastic case. NO HOOKUPS — NO WIRES — NO PLUG-INS! Self contained with 120 hour life flashlight batteries. (Available anywhere) and BUILT-IN ANTENNA!

GUARANTEED RECEPTION OF RADIO STATIONS TO 50 miles—up to 1500 miles for powerful stations! Has new Patented Super-regenerative Diode tube and transformer audio stages for sharp selectivity and sensitivity! Easy to use top controls while walk—listen while you walk, visit, work, ride or sleep—anytime—anywhere. Money Back guarantee—1 year service guarantee.

SEND ONLY \$5.00 (Ck. Mo) and pay postman \$14.95 plus postage on delivery or send \$19.95 for postpaid delivery. Get YOUR Tingsone HEAL pocket radio now and be ready to listen to Civil Defense alarms, news, music, sports, etc. on a moment's notice. Not a Kit or anything! Shipped complete with batteries—Ready to listen!—Order now—today.

WESTERN RADIO Dept. APM-10 Kearney, Nebraska



Homeowner's DO-IT-YOURSELF IDEA BOOK

Popular Mechanics Press has come out with a new type of book. Now you can have, in one volume, information on every kind of job and project around the home. Learn how to upholster with foam rubber... use prefinished paneling... lay flagstone walks. Fix wobbly chairs and faded carpets. Sharpen scissors, remove paint, modernize old doors. 160 pages long—over 900 subject listings in the handy index. Ask your dealer for a copy today.

only 75¢ at
 YOUR FAVORITE NEWSSTAND

BE YOUR OWN BOSS

Make Hundreds of \$ Spare or Full Time Work

NO EXPERIENCE NEEDED
 Here is the ideal business with no previous experience or large investment required and no high-priced equipment to buy. A business that will return dollars for the pennies you invest.

YOU CAN CAST ANYTHING
 With Flexible Mold Making and Ornamental Casting, an amazing fact-packed book, you learn how you can cast practically any article in concrete, plaster, imitation marble or any other casting material using a marvelous new process. You can make ash trays, novelties, garden and lawn ornaments and hundreds of other highly profitable items that cost you but a few cents and sell for as much as \$5.00 and more. Why you can even make true-to-life full-sized busts of your neighbors and friends.

NO EXPENSIVE MOLDS TO BUY
 Why buy high-priced molds from others? Learn how you can make your own molds quickly, easily and inexpensively with materials that can be used over and over. You get copyrighted formulas, complete instructions and detailed how-to-do-it photographs as well as complete sources of supply for the few inexpensive materials you need. This is the only book printed in America today that contains instructions for making profitable papier-mache casts.

MONEY BACK GUARANTEE
 Start on your road to extra income and independence today. Send only \$1.98 for your copy of Flexible Mold Making and Ornamental Casting. Complete satisfaction guaranteed or your money refunded within seven days.

POPULAR MECHANICS PRESS, Dept. 46
 200 E. ONTARIO ST., CHICAGO 11, ILL.

You can make simply and cheaply



TUBE FREE WITH EVERY TIRE AT NO EXTRA COST



EXPERIENCE IS THE BEST TEACHER. OUR MANY YEARS PROVES YOU CAN'T GET MORE. WHY PAY MORE? LOW OVERHEAD—LARGE VOLUME SALES & SMALL PROFITS BRING YOU THESE "LOWEST PRICES."



WHAT GOOD IS A TIRE WITHOUT A TUBE? 22 YEARS AT THIS ADDRESS. FREE TUBES.

WHITE WALLS \$1.00 EXTRA
20 MOS. WRITTEN GUARANTEE

600-16	\$4.42	820-15	\$5.42	600-20	\$7.72	32x8 (8)	\$11.72
650-16	4.82	700-15	4.62	650-20	8.82	32x8 (10)	12.62
700-16	5.32	670-15	4.42	700-20	9.42	900-20	15.62
680-15	4.52	710-15	4.42	750-20	10.22	1000-20	15.82
760-15	4.72	800-15	5.22	825-20	16.72	1100-20	17.62

GOOD USED TIRES — NOT RECAPS

FREE If you buy 2 or more Passenger 4-ply tires, WE GIVE ONE tire FREE, on each order, on request. Does not include W.W. or Truck Tires. This offer on 36 Mos. Tires only.

Specialists in Truck Tires—Selected for Toughest Jobs—Tops in Value

600-16	\$5.52	475-19	\$4.82	700-15 (6)	\$7.52	700-20	\$9.92
600-16 (6)	8.92	640-18	4.32	750-16 (8)	8.72	750-20 (10)	15.72
680-16	8.72	670-18	5.32	760-17	8.52	750-20 (8)	11.92
680-16 (6)	8.62	710-18	5.32	760-17	10.32	825-20	18.92
700-16	6.02	760-18	5.32	825-15	12.92	900-20	17.92
750-16 (6)	7.52	800-18	5.92	800-20	9.02	1000-20	17.92
550-18	4.52	820-15	5.92	550-20	9.82	1100-20	19.92
550-17	3.72	670-16	5.32	32x8 (8)	12.02	1100-22	18.92
650-15	5.52	760-16	7.02	32x8 (10)	13.92	1000-22	20.92
700-15	4.92	700-16 (6)	7.32	750-15	10.72	1100-24	23.02

SNOW TIRES FACTORY RETREAD SNOW TIRES AND OTHERS 30 MO.
\$7.92 UP Write for sizes and prices

Thousands of tires shipped all over the U.S.A. All tires shipped F.O.B. Phila. Send Check or M.O. with this ad. Dept. 2. No C.O.D.
STANDARD 834 N. Broad St., Philadelphia 30, Pa.

TRAIN Your VOICE!
RESULTS GUARANTEED
STRENGTHEN your voice this tested, scientific way. Yes—you may now be able to develop the POWER of your speaking and singing voice in the privacy of your own room. Self-training lessons, mostly silent; no music required. Write TODAY for Eugene Feurthinger's great booklet "How to Strengthen Your Voice." It's absolutely FREE! You must state your age. Booklet mailed in plain wrapper. No salesman will call. Send your name and age RIGHT NOW! Perfect Voice Institute, 210 S. Clinton St., Studio KV-2, Chicago 6, Ill.

The finest of Gifts...
ENCYCLOPAEDIA BRITANNICA

SAY YOU SAW IT IN POPULAR MECHANICS

WHILE THEY LAST! 107 "IRON CURTAIN" Stamps
Sensational Stalin stamp plus 106 others, all different, from Russia, Bulgaria, Romania, Czechoslovakia, Ukraine, etc. Hard-to-get, smuggled from behind the infamous Iron Curtain! Guaranteed worth nearly \$2.50 at Standard Catalog prices! ALSO valuable booklet! "How to Recognize Rare Stamps" and other fascinating offers. All for only 10¢ covering postage and handling. Send Today!
KENMORE STAMP CO., Milford H-723 N.H.



TODAY'S PHOTO MIRACLE

Telefoto through Binoculars

Imagine capturing intimate scenes at impossible distances... remote candid of children, elusive wildlife, news and fast action shots, ships peeping over the horizon... all with true perspective, undistorted, razor sharp, color faithful... arm's length close! New thrills! New fun!



BINO-FOTO*

Use your present camera. BINO-FOTO Units fit single- and twin-lens reflexes; 35mm cameras; 8mm and 16mm movie cameras. They increase your lens power 700%!

Lightweight and incredibly simple to mount, easy to use. Inexpensive, too. And the Binocular (BUSHNELL-engineered to photo standards), is of course a superlative viewing instrument. Use it separately whenever you wish!

For all the exciting details—name of nearest dealer—clip coupon.

*U. S. Pats. App. For

FREE! MAIL TODAY!



D. P. Bushnell & Co., Inc., Dept. 177 Bushnell Bldg., Pasadena 1, California

Send me full details and dealer's name

I have a.....CAMERA

NAME.....

ADDRESS.....ZONE.....

CITY.....STATE.....

Save! Install Your Own **MUSIC-RADIO-INTERCOM System**

Talk From Any Room to All Rooms. Enjoy Radio or Records in Every Room



Musi-Kom

It had to come! A combination music-radio-intercom system for homes! Musi-Kom is the system home builders all over the country are installing in new homes, available now, for the first time as a do-it-yourself item. This attractive, functional, built-in-the-wall system allows you to talk from any room to all rooms... to enjoy radio programs or recorded music in every room... to answer the front door from the master unit... and contains this sensational "baby-sitter" feature that all parents love, simply turn the talk switch in the baby's room to the lock position and every sound from this room will be heard throughout the house! Each station has talk switch and volume control. Any handyman can install in a few hours in a house under construction, takes less than a day in homes already built. No radio or electrical knowledge is necessary. Kit is pre-assembled, ready to operate as soon as you install and plug it into an AC-DC outlet. Kit consists of one master unit, four sub-stations and one front door speaker plus all necessary wire, rough-in forms, complete, easy-to-follow instructions and sells for the amazing price of only \$155.97. Thousands now in use. Not a toy but a precision built system that will save time and footsteps and add tremendous pleasure to your home life PLUS adding hundreds of dollars in value and sales appeal to your home. Write for FREE literature and name of nearest dealer or order direct. Examine 15 days. Money cheerfully refunded if not satisfied.

HOME MUSIC SYSTEMS, INC., Dept. PM, 644 Madison, Memphis, Tenn.

FASTEST KNOWN SKIN RELIEF!

Many doctors
report results
in 1 to 3 days
with new
Cuticura
method



Want faster relief from pimples, rashes, other externally caused skin irritations? Wash skin thoroughly twice daily with superfatted, mildly medicated CUTICURA SOAP. Apply CUTICURA MEDICATED LIQUID frequently. You'll get instant relief from discomfort—faster healing aid—with this sensational new greaseless, fast-drying, "invisible" antiseptic. Buy at druggists, only 60¢—or send 10¢ for generous sample. CUTICURA, Dept. 16J, Malden 48, Mass.



BUILD 15 RADIO
CIRCUITS AT HOME WITH THE NEW DELUXE
1956 PROGRESSIVE RADIO "EDU-KIT"
ONLY **\$19.95** COMPLETE

All parts, instructions, Soldering Iron, Test-er included. 30 Day Money Back Guarantee.
PROGRESSIVE "EDU-KITS" INC.
Room 537-B, Progressive Building
497 Union Ave., Brooklyn 11, N. Y.

Gentlemen: Please Rush me Free Descriptive Literature concern- ing "EDU-KIT." Also send me Free Radio-TV Servicing Litera- ture. No obligation.

NAME _____
ADDRESS _____
CITY _____ ZONE _____ STATE _____

WATCHMAKING

Learn at home • FREE sample lesson • Approved for Vets.
CHICAGO SCHOOL OF WATCHMAKING
2330 N. MILWAUKEE AVE., DEPT. 1105-A, CHICAGO 47, ILL.



**I HELPED T.E.H. MAKE \$14 A DAY
WHILE STILL LEARNING!**

T. E. H.—West Virginia. "By the time I finished half your course, I was making \$14.00 per day. I have made enough on the side to more than pay for the course."

H. T. ARMSTRONG

Learn ELECTRIC APPLIANCE REPAIR & SERVICE

WE TEACH:

How to Repair
Washing Machines
Vacuum Cleaners
Electric Ranges
Lamps, Motors,
Irons, etc.,
REFRIGERATION
and
House Wiring
At Home
In Your
Spare Time!

For a man handy with tools, and happiest when working with his hands, OPPOR- TUNITY is Wide Open Today in this great and growing field. Everyone is a customer for the man trained to service electric appliances.

Open Your Own Shop

Our practical Home Course teaches you this business from A to Z—preparing you to take a well paid job or open your own shop. You can actually start in your basement or garage with the tools we send you . . . before finishing.

We
Include An
**ELECTRICAL
APPLIANCE
TESTER**
A Big Kit of Tools
at NO EXTRA
COST

MAIL THIS COUPON for FREE BOOK

H. T. ARMSTRONG
PACIFIC TRAINING SCHOOLS Dept. P-5510
11029 S. Vermont, Los Angeles 44

Dear Sirs: Please send me, without obligation, your free booklet and complete details.

Name _____
Address _____
City _____ Zone _____ State _____

Do a Real Professional-Like Job
Yourself and SAVE

HOW TO PAINT

With Brush and Spray

Covers All Painting Methods and
Materials

You can do professional-like painting and finishing jobs yourself and save about two-thirds of the cost. Sam Brown, noted craft authority, makes it so easy for you in his book, HOW TO PAINT WITH BRUSH AND SPRAY. Order your copy now and enjoy this tremendous saving. It covers exterior painting, wall and interior decorating, furniture finishing, con- crete painting—every type of painting with brush, spray gun, roller and other methods. Tells what finish is best; what materials to use, etc. No previous experience needed. Fully illustrated. Order by mail. Only \$2.50. Money back if not pleased.

POPULAR MECHANICS PRESS, Dept. PM18
200 E. ONTARIO ST., CHICAGO 11, ILL.



YOU CAN BUILD A VIOLIN FOR PLEASURE OR PROFIT



Now you can build a rich toned mellow violin modeled after a famous "Strad." YOU CAN MAKE A STRADIVARIUS VIOLIN contains 3 full scale plans plus complete instructions. You work directly from the plans with no confusing scale of dimensions to translate. Detailed instructions for each step including varnishing and stringing—even shows how to build your own tools. Cloth bound. Order today from

POPULAR MECHANICS PRESS . . . \$3.50
200 EAST ONTARIO STREET, CHICAGO 11, ILLINOIS

Be a VENTRILOQUIST

ALL SECRETS TOLD

Dummies, Courses, Scripts, Mon- ologues. Send \$1 for large re- vised catalogue.

(Deductible first order)

EXPERIMENTAL SPECIALTY MFG. CO.
R.F.D. 3, HARTFORD CITY, IND.



**WAR
SURPLUS
BARGAINS**

WAR SURPLUS BARGAINS

**\$500,000.00 INVENTORY
for QUICK LIQUIDATION**

Surplus items—hundreds of them for home, shop, factory, farm and outdoor use. New items, used items, recondi- tioned items—all at tremendous savings—all priced for quick sale.

Page After Page of Values

This big catalog shows page after page of amazing money saving values. Write for your copy today. Send 10c to cover postage, mailing, etc. Write today! **SEND TODAY FOR YOUR COPY**

10c

STARK'S 212 W. Madison St.
Dept. PM-10
CHICAGO 6, ILL.

TOY DISTRIBUTORS WANTED

FULL OR SPARE TIME

JUST \$99.50 STARTS YOUR OWN TOY DEPARTMENT CHAIN!



GET ON THE TOY WAGON!

Over 250 million dollars in toys sold every day! Get your share of this tremendous volume by starting your own chain of Toy Departments right now! More than 35 million children under 15 constantly demand — and get, toys. These children and their millions of parents are YOUR toy customers!

"MOMMY, BUY ME A TOY!"

This is the cry of every child — each and every time they see a toy. No mother, father or grandparent can say "NO" when their children ask for TOYTOWN high quality Toys — priced from 9¢ to 99¢! Everybody can afford them — everybody buys them!

TOYTOWN CAROUSELS DO ALL THE WORK!

Put the remarkable TOYTOWN "Silent Salesman" CAROUSEL to work for you 7 days a week — right now! Placed in Food Stores, Drug Stores, Beauty Shops, Laundromats — wherever people stop or shop — colorful TOYTOWN CAROUSELS are powerful and irresistible magnets. TOYTOWN Toys sell on sight! All YOU do is count profits — NET PROFITS.

TOYTOWN TOYS GUARANTEED TO SELL!

That's right! You get a 100% iron-clad written guarantee... any slow-selling Toy, or toys left unsold after holiday seasons can be returned for a Free-Exchange. Dollar-for-Dollar! You can't lose! You must make money!

SPARE TIME BUSINESS — FULL TIME PROFITS

Start with a single TOYTOWN CAROUSEL... it takes just 10 minutes, once each week to service. Simply replace Toys sold with new Toys... collect your money from the store owner. It's strictly a consignment and cash business — as simple as that. Yes... you can build a chain of TOY DEPARTMENTS — 5, 10 even 50 TOYTOWN CAROUSELS on your profits alone!

DISTRIBUTORS BEING APPOINTED NOW

This is no get-rich-quick scheme but a sound opportunity for YOU to build a secure future with IMMEDIATE PROFITS! We are not interested in your financial resources or initial investment. We are interested in your reliability and desire to expand on your profits. If you are sincerely interested in a full or part-time business opportunity, mail the coupon immediately for complete detailed information. Include age, background and personal references. NO OBLIGATION WHATEVER!

YOU GET FREE "THE TOY BUSINESS AND YOU" SAMPLE GIVE-AWAY TOY COLOR PHOTO OF TOYTOWN CAROUSEL other FASCINATING INFORMATION

IMMEDIATE ALL-YEAR INCOME

Amen Industries, Inc., Toytown Div. — PMA
14620 Arminta Street, Van Nuys, Calif.

Name _____
Address _____
City _____ State _____

INVENTIONS WANTED

Inventors, don't sell your invention, patented or unpatented, until you get our offer. For inventions of merit and promise we will finance development and patent applications if needed. We place behind your invention technical and sales experts. All types of inventions handled, none too large or small to receive our detailed attention. We have world-wide facilities. UNIVERSAL INVENTION SALES, 478 South Main Street, Marion, Ohio

LOCKSMITHING & Key Making

PRACTICAL UP-TO-DATE COURSE—ONLY \$4.95
Easy-to-learn modern information for self-instruction. How to work on locks, de-code, make master-keys, repair, install, service, etc. For every handyman, home owner, carpenter, mechanic, service station operator, fix-it shop, hardware dealer, gunsmith, 51 plain illustrated lessons. FULL PRICE ONLY \$4.95. SEND NO MONEY, with 10¢ shipping. Satisfaction guaranteed or refund. NELSON-HALL CO., 210 S. Clinton St., Dept. KV-2, Chicago 6, Ill.

MEN! TRAIN NOW FOR A BIG PAY FUTURE IN

DIESEL

& SCIENTIFIC MOTOR TUNE-UP

GO PLACES WITH DIESEL! Farms, factories and power plants, trains, ships, trucks, busses all use DIESEL POWER... all need DIESEL-trained men! You can start your DIESEL training at home, in spare time, with tested, proved U E I training. Course includes practical work on Diesel engines under skilled instructors. You learn the operation, maintenance, servicing of all types of Diesel engines, PLUS Scientific Motor Tune-up.

ACT NOW! If you have mechanical ability, YOU'LL LIKE DIESEL! High School diploma not necessary. Write now for FREE book, "RAINING POWER IN DIESEL."
UTILITIES ENGINEERING INSTITUTE, Dept. DC-49
2521 SHEFFIELD AVENUE, CHICAGO 14, ILL.

- Diesel Construction
- Diesel Engine Repairman
- Diesel Operator

COUPON

UNIVERSITY LOUDSPEAKERS, INC. Desk E-1
80 South Kensico Avenue, White Plains, N. Y.

Gentlemen:
Please send me information about P-S-E (University's Progressive Speaker Expansion plan for High Fidelity speaker systems).

I don't believe that P-S-E can do all you claim for it. According to you P-S-E will solve almost all my loudspeaker problems forever. That's a bold statement; I hope you can back it up.

You say that now I can buy a speaker and never worry about it becoming obsolete, or improve my present system without discarding what I have... that University speaker components, enclosures and networks have been so uniquely designed that it's possible to start an excellent basic system, at low cost, and add to it later—while enjoying immediate listening satisfaction. This is sensational! Please send further information; mind you at no cost to me; absolutely free.

NAME _____
ADDRESS _____
CITY _____ STATE _____

SEND NO MONEY!
just rush order
coupon below

Your Credit is Good
on our confidential
payment plan

BULOVA WATCHES

**NO MONEY DOWN
10-DAY FREE TRIAL**

Get a famous Bulova the easy way... no money down, low monthly payments. All you need is a regular income. Rush the coupon below for 10-day Free Home Trial. Send no money!

"Clipper"—17 jewel automatic waterproof. Sweep second hand, radium dial & hands, expansion band. **\$59.50. No Money Down. Pay Only \$8.00 a Month**

Bulova "Senator B"—17 jewels, shock-resistant, unbreakable, mainspring, luxury expansion band. **\$39.75. No Money Down. Pay Only \$5.00 a Month**

"Senator FW"—17 jewel waterproof, unbreakable mainspring, radium hands & dial, expansion band. **\$49.50. No Money Down. Pay Only \$7.00 a Month**

You Can't Go Wrong!
If you decide to keep your watch send small monthly payments until full amount paid. No strings, no red tape.



LE ROY'S JEWELERS, 633 S. BROADWAY, LOS ANGELES, CALIF.

Please rush the Bulova Watch at \$_____ on your Easy Confidential Credit Plan. I agree to pay \$_____ a month until the full price is paid or return the watch within 10 days.

NAME _____
ADDRESS _____
CITY _____ STATE _____
EMPLOYED BY _____

Free! 153 GERMANY



Giant and midget-sized **STAMPS**; hated Hitler heads; blood-red swastikas; inflation issues with pre-war face of millions of dollars; Allied and Russian Occupation issues; animals, birds, airmail stamps—153 all-different, guaranteed worth \$2.46 at Catalog prices. **EXTRA!** Free booklet, bargain lists, and other fascinating offers for your free consideration. Send 10c for mailing expenses. Supplies limited. **Act NOW!**

USE THIS HANDY COUPON

JAMESTOWN STAMP CO., D-10PM100, Jamestown, N.Y.
RUSH my FREE Collection of 153 Germany & other offers. I enclose 10c for cost of mailing.

Name _____
Street _____
City _____ State _____

135 ORIENTALS only 25¢

Brought to you from the farthest corners of the earth—this amazing collection of exotic valuable **STAMPS** of the mysterious Orient! 135 all-different from Burma, Siam, China, Japan, Hong Kong, Malaya, Sarawak, Singapore, etc. Scarce Airmails, flowers, beautiful girls, temples, mountains, birds, animals. Worth \$2.64 at Catalog prices! **PLUS** free booklet. Send **TODAY!**

Falcon Stamp Co., D-10PM400F, Falconer, N.Y.

Paint STRIPES with New "PAINT PEN"!

Straight, Curved or Parallel Lines

Use like a fountain pen with any color paint to stripe furniture, bikes, autos, model planes, toys, linoleum, wall board. Beautiful clean, crisp results every time. Can't clog or smear. Also use with glue, tempera, textile paint or ceramic under glaze. Paints on wood, glass, plastic, metals, fabrics and paper. Tool complete with tip for 1/16" stripe only \$1.90 postpaid. Other complete tools with following tips, 1/64", 1/32", 3/64", 5/64", 3/32", 1/4" — \$1.50 each. Extra tips 75c each. Entire kit with tool and 7 tips—\$5.00. A 1/4" tip only \$1 each. COD's postage collect.

New! "DOUBLE-STRIP" 5 Way Combination Model only \$2.95

Double Stripes—one wide and one narrow or two wide or two narrow at the same time. **FREE**—Send postcard for complete information. **\$2.95**—or **ORDER NOW...**



\$1.00

DEALERS: Master Paint Stripping Tool in display cartons of 1 doz. **FAST, Profitable** seller. Write for discounts.

HOME CRAFTSMEN! New Paint Stripping Tool gives "professional" results every time, simple, easy to use. Send \$1.00 now.

MANUFACTURERS: Write today for information about industrial and production striping tools.

WENDELL MFG. CO., Dept. 40
4234 Lincoln Ave., Chicago 18, Ill.

EARN EXTRA MONEY



IT'S EASY TO LEARN LEATHERCRAFT

... the fascinating hobby that turns spare time into profit and pleasure. Learn this easy way to **MAKE EXTRA MONEY**. Make all kinds of hand-tooled leather goods. Tandy has everything for Leathercraft.

WRITE FOR **FREE CATALOG**

Tandy LEATHER CO. "NATIONWIDE—A TANDY STORE NEAR YOU"
P. O. BOX 751—FORT WORTH, TEXAS

HELPFUL BOOKS

Send post card asking for **FREE catalog**

Popular Mechanics Press, 200 E. Ontario, Dept. 601, Chicago 11

Powerful, Permanent, Personal

LEIGH Pocket MAGNET
Retrieves dropped screws, needles or parts. Removes chips and filings from threads, ways and blind holes. Gathers and holds ball bearings, etc. Identifies magnetic material, etc. Shipped postpaid for \$1.00. Order now **\$1.00**
Spring Specialty Co. • 26 Fifth Ave., Maywood, Ill.

KEEP Your SAWS SHARP and True Cutting..

CIRCULAR FILER
Sharpen circular saws like an expert. Two simple adjustments for 6" to 12" blades with 1/2" to 13/16" centers. Keeps saw true and sharp. Complete with file, \$6.95.

HAND SAW FILER
Do it yourself. Precision filing easy without experience. Positive pitch and angle with this handy guide. Fits any hand saw. Complete with file. Guaranteed, \$2.95.

JOINTER and SAW SET
Now you can joint and set your circular saws with ease. Get blades absolutely round... the set uniform and accurate. Takes 6" to 12" saws with 1/2" to 7/8" centers. Complete with file, \$4.95.

2 SIMPLE ASSEMBLIES
TWO JOBS DONE

THE SPEED CORP., C.O.D., postage extra
Dept. PM 4734 N. Albina, Portland, Ore.

FREE OFFER TO POPULAR MECHANICS READERS

MAIL THIS
Certificate
TODAY!

✓ **START YOUR OWN HOME BUSINESS SPARE OR FULL TIME**

MAKE UP TO **\$10**
AN HOUR - AT HOME
...WITH 50¢ WORTH OF

MICRO-FLUFF!

GOOD FOR SAMPLE KIT AND PLAN

NELS IRWIN, Coast Industries, Dept. 2A
Los Angeles 61, Calif.

Please rush me FREE Micro-Fluff sample kit and Plan for starting my own home business. I am under no obligation. This Certificate entitles me to this offer free of charge.

NAME _____

ADDRESS _____ ZONE _____ STATE _____

CITY _____

FREE • SAMPLE KIT & PLAN • FREE!



I'LL SEND YOU FREE...
A MICRO-FLUFF
SAMPLE KIT AND
ILLUSTRATED PLAN

HIGH LIVING COST GOT YOU DOWN? Want an extra \$100 or more added to your monthly pay check for a few SPARE TIME hours AT HOME? That's what I wanted a few years ago when I ran across an Old-World formula for applying short cotton fibers to practically any surface so that it looked and felt like costly velvet or rayon.

THE PROCESS AMAZED ME. I spent several years of experimenting and developed the NEW FLOK-KRAFT MICRO-FLUFF METHOD of applying short fibers of Rayon in many colors, as well as cotton.

NO OVERHEAD, or Expensive Equipment You can start in your basement, garage, service porch, or on card table in bedroom. With an hour's practice you can apply a few pennies worth of MICRO-FLUFF to a yard or two of butcher paper, and make it look like \$15-a-yard velvet for window displays in fine jewelry stores. (jewelers love this!) gift, or department stores. Takes only minutes and little effort.

MICRO-FLUFF is Beautiful, Long Wearing Comes in every rainbow color, long lasting, has the TOUCH APPEAL of luxurious velvet, goes on nearly any surface... paper, metal, wood, glass, plastic, plaster, rubber, etc. Line silverware, hosiery drawers, and jewelry boxes, decorate lamps and shades, finish auto trunks and dash boards or glove compartments, recover women's party shoes, phonograph turntables. Apply to toys, figurines, plaques, signs, store displays, instrument cases - 1001 other items, new or old. MICRO-FLUFF makes old objects beautiful, salable - increases value of many new products by 500%.

BIG-PROFIT ORDERS come from neighbors, gift shops, stores of all kinds. Every household has several items you can save from discard. Decorate jewelry, department store display cases, windows. Also supply them with fast-selling FLOK-KRAFTED gifts and other merchandise. Every neighborhood needs a FLOK-KRAFTER. Help us fill HUGE DEMAND.

I'LL HELP YOU START RIGHT AWAY. Since succeeding beyond my wildest dreams in my own FLOK-KRAFT business, I have concentrated on helping ambitious men get started toward a successful future. My plan is designed to help you start at home in spare time, and build gradually toward a full-time business if you wish. Start RIGHT NOW. Fill out and mail the Certificate at the top of this advertisement today. I'll rush you FREE a MICRO-FLUFF Sample Kit and Illustrated Plan that shows you how to get started AT ONCE. I'll also arrange to send you the complete FLOK-KRAFT MICRO-FLUFF outfit to try out right in your home, without risk. Outfit includes simple instructions, hundreds of show-how illustrations that make everything easy, specially designed, high-velocity Applicator and generous supply of FLOK-KRAFT MICRO-FLUFF - EVERYTHING YOU NEED TO START RIGHT AWAY. You owe it to yourself to investigate. SEND NO MONEY. RUSH Valuable Certificate TODAY by Airmail. I'll show you how to START MAKING MONEY AT ONCE!

NELS IRWIN, Coast Industries, Dept. 2A, Los Angeles 61, Calif.

The Chief

Steel 5-Shelf Unit

75 Inches High
36" Wide—12" Deep

... Hundreds of Uses

- Offices • Churches
- Schools • Garages
- Stores • Homes
- Shops • Greenhouses
- Hobby Shops

Adjustable shelves, back braced... green metallic finish Shipped K. D.

10⁸⁸ F.O.B. Detroit

15" depth 12.38
18" depth 13.88

MOHAWK LUMBER & SUPPLY COMPANY

14525 W. Chicago Blvd., Detroit 28 Mich.

Ship _____ Shelf Units as follows: 12" deep _____ 15" deep _____ 18" deep _____

F.O.B. Detroit. Enclosed Check M.O. for \$ _____

\$3 deposit with C.O.D. NAME _____

orders ADDRESS _____

FREIGHT CITY _____ STATE _____

EXPRESS

MEN-WOMEN GROW

ORCHIDS

IN YOUR LIVING ROOM!

Any Climate - Maine to California

YEAR 'ROUND No Equipment Needed

BIG PROFITS SPARE OR FULL TIME

Fill your home with gorgeous Orchids. Huge purple Cattleyas, exquisite Cymbidiums - dozens of others! Many grow without soil, getting food from the air. White Orchids, yellows, greens, every rainbow color. No equipment needed. Start on table or window ledge.

SUCCESSFUL HOME GROWER SHOWS YOU HOW! Complete instructions show you step-by-step how he and his wife started with a few plants and developed a big-profit home-business - grew an Orchid collection now worth a fortune. Learn how orchids multiply, how one plant may become many, each as valuable as the first. No big investment or overhead. Takes but a few minutes a week.

Big-profit orders for plants and flowers come from individuals, florists, hotels, clubs, etc. Year 'round gift. Millions sold by Mail-Order.

COMPLETE INSTRUCTIONS AND BLOOMING-SIZE ORCHID PLANT SENT FOR YOU TO EXAMINE AT HOME WITHOUT RISK. Secrets of the experts in simple language, jam-packed with "show-how" drawings, magnificent full-color pictures of Orchids. Send No Money! Write NOW for your FREE FACTS that show you how to learn to grow Orchids at home. Airmail is quicker.

TROPICAL FLOWERLAND, Dept. 31A
4622 Wilshire Blvd., Los Angeles 5, Calif.



Orchids have rewarded me richly - thanks to Tropical Flowerland.
E. V. SMART - Colorado

HP MEANS 'HIGH PAY' TO MEN IN
AUTO MECHANICS
 LEARN AMERICA'S NO. 1 TRADE AT HOME



The auto industry is roaring ahead—producing up to 174,000 new cars per week! Thousands of trained mechanics are needed right now—and these jobs offer top pay. You can learn this fascinating trade at home—in months—thru easy CTI Shop-Proved lessons . . . and earn as you learn. Better get the facts—Mail coupon now!

YOU GET VALUABLE TOOLS

As part of your training you get and keep this valuable set of professional tools with metal box. Helps you start earning money soon after you enroll!



YOU GET THIS TUNE-UP KIT

Exclusive! Only CTI provides you with this costly tune-up kit. Like every good mechanic, you too will use it to locate engine troubles and do professional tune-up work.



MAIL COUPON FOR FREE BOOKLET

COMMERCIAL TRADES INSTITUTE

1400 Greenleaf Ave., Chicago 26, Ill. Dept. A-108

Send me your big FREE book which tells me how I can train at home to make big money in the automotive field.

Name _____ Age _____

Address _____

City _____ Zone _____ State _____

MEMBER—NATIONAL HOME STUDY COUNCIL

RADIO CONTROL YOUR MODEL PLANES BOATS CARS

"CUSTOM MIDGET" RADIO \$9.98

LICENSE FREE BAND

OPERATES SAME AS \$50.00 SETS. INCLUDES LONG RANGE TRANSMITTER RADIO, RECEIVER RADIO AND CONTROL ACTUATOR ALL 3 PARTS ASSEMBLY WITH OUR PARTS AND PLANS \$9.95. PLANS ALONE \$1.

RADIOMODELS BOX 36 DEPT. PM BALTIMORE 6, MARYLAND

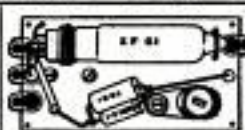

DETAILED INFORMATION AND RADIO CATALOGUE \$2.00

SPECIAL "SUPPLY SOURCE DIRECTOR" A \$7.00 SUPPLY COUPON \$1.00

BOOK "RADIO CONTROL OF MODEL AIRCRAFT" CONTAINS 14 PLANS \$3.98

RADIO CONTROL GARAGE DOOR DETAILS \$1.00

HIGH WAGES!

Are being paid to Operators of Bulldozers, Draglines, Back Hoes, Earthmovers and Motor Graders. Contractors want our graduates. Learn these skills NOW

National School of Heavy Equipment Operation P.O. Box 8243-D-3, Charlotte, N. C.

Please send me your School Catalog FREE

Name _____

Street Address _____

City _____ State _____



WELD IT YOURSELF IN A JIFFY!

Weld, Cut, Braze, Solder; Iron, Steel, Brass, Bronze, Aluminum and other metals safely and easily. Make your wrought iron furniture, porch railings, fences, knock-knacks and other metal specialties. With this fine equipment anyone can do professional-like work with little practice. The Dynamic is an industrial type transformer arc welder designed to operate from any properly wired 110 volt AC line.

NOW as a FALL SPECIAL you will receive an \$8.00 Twin Carbon Arc Torch FREE to complete your welding workshop. Order TODAY!

Literature on larger equipment available on request.

DYNAMIC WELDER COMPANY, 1808 S. Federal Street, Dept. D2-K, Chicago 16, Illinois

EASY PAY PLAN
 Low down-payment. Pay as you weld. Money back guarantee. Complete outfit including special FALL GIFT.
Only \$38.50
 F.G.B. Factory

**PROFIT-MAKING FRANCHISE
 SELL FIBERGLASS SWIMMING POOLS**

For Home, Club, and Park Installation



National company offers opportunity of exclusive sales territories with an ever-growing business. Meet public demand for this popular swimming pool by organizing your own sales and service agency. Sell and install complete packaged pools of from 15' to 49' in length. Sell accessories.

Here's your chance to enter a most lucrative business at a reasonable investment. Write immediately for our liberal offer.

DELORICH ENTERPRISES, INC.

12955 Biscayne Boulevard

North Miami, Florida



Let me show you

HOW TO SPEAK AND WRITE LIKE A COLLEGE GRADUATE

I have helped thousands of men and women who have not had college training in English to become effective speakers, writers, and conversationalists. With my new C. I. METHOD, you can stop making mistakes, build up your vocabulary, speed up your reading, develop writing skill, learn the "secrets" of conversation. You don't have to go back to school. Takes only 15 minutes a day at home. Costs little. 32-page booklet mailed FREE upon request. Send me a card or letter TODAY!

Don Bolander, Career Institute
 Dept. 10510, 25 East Jackson, Chicago 4, Illinois

**SAY YOU SAW IT IN
 POPULAR MECHANICS**



Have a Motorized Shop at Low Cost

Make Your Own **POWER TOOLS**

Popular Mechanics Book Shows How to Make 60 Machines from Scrap and Discarded Materials

Get SIXTY POWER TOOLS AND HOW TO BUILD THEM, the sensational new Popular Mechanics book. Build your own lathe, drill press, sander, circular and band saw and other power tools at a cost of only a few dollars each. Use old auto parts, pipe and wood and odds and ends that cost little or nothing. Every detail of construction is given in plain language you can understand and follow. Hundreds of pictures and plans show every step to follow in making the power tools you want. Clip this ad and mail with name, address and only \$2.50, or we will send C.O.D. (U.S.A.). You'll be amazed with the fine, practical tools you can make and how little they cost. Your money back if you return the book in 7 days. Order today.



Over 250 Pictures

POPULAR MECHANICS PRESS, Dept. PT-1, 200 E. Ontario St., Chicago 11

THIS TANK HOLDS

**4,538 TROPICAL FISH
WORTH \$2,456⁶⁵!**

**EARN BIG PROFITS
In Your Spare Time!**

WOW!

—AND YOU BREED THEM IN YOUR SPARE TIME—IN YOUR HOME



If you have a little space in a SPARE ROOM, PORCH, BASEMENT, GARAGE ... ANYWHERE. Investigate this "chance of a lifetime" opportunity of breeding rare tropical fish for profit. The tropical fish "BOOM" IS JUST BEGINNING and here's your opportunity to cash in on it now. Experts estimate \$780 MILLION DOLLARS will be spent on tropical fish within next ten years. Investigate now—Rush coupon below.

YES BOB, I BREED THEM IN MY BACK PORCH. THEY ALMOST SELL THEMSELVES. TOO. BELIEVE ME THE 'BOOM' HAS STARTED

DID IT COST YOU MUCH TO START?

NO—ONLY A FEW DOLLARS, A LITTLE SPACE AND MY SPARE TIME AND THE LITTLE KNOWN BREEDING SECRETS ARE ALL YOU NEED TO START. IF YOU'RE INTERESTED—LEARN THE FACTS TODAY!—THE "BIG BOOM" HAS STARTED SO CASH IN ON IT **NOW!**

Join others that are saying: "Business prospects amazing." J. K., Ga. "Dealers want all I can breed." J. P., Ore. "Pays off large dividends." R. D., N. Y., etc.



1 and 2 FREE!
(BOTH)

MAIL THIS COUPON BELOW TODAY!

IT'S EASY! Once you know the SECRETS you may breed exotic ANGEL FISH; Zebra striped DANIO; beautiful GOURAMI; majestic FIGHTING FISH; the mysterious weather predictors—and BRILLIANTLY BEAUTIFUL rare tropicals of every kind. Sell for up to \$35.00 pr. *Amazing Profits!*

SOME TROPICAL FISH LAY TO 600 EGGS AT A TIME. That's why tropical fish breeding is so profitable. Nature multiplies your \$\$.

This advertisement is an **URGENT APPEAL OPPORTUNITY**. Orders backlogged in many areas. **RUSH coupon NOW!**

TROPICAL FISH BREEDERS OF AMERICA, Dept. D-10, 15121 S. Broadway, Los Angeles 61, Cal.



Tropical Fish Breeders of America, Dept. D-10, 15121 S. Broadway, Los Angeles 61, Calif. Please Rush FREE COLORFUL BOOKLET and amazing VUER-PROJECTOR KIT details to me. Both Free! Sending for these does not obligate me in any way.

Name _____ Age _____
Address _____
City _____ Zone _____ State _____

Say You Saw It in POPULAR MECHANICS



**You Can Be a
Manufacturer
of BRIKRETE**

"The World's Most Modern Masonry" is produced in a chain of independently owned local plants. That's why such low prices go

along with such high quality without sacrifice of manufacturing profits. Local

materials and local labor cut freight and distribution. Brikrete brings a super-masonry down to price levels of frame. Gives owners incentive to buy.

Brikrete has design, size, and color in keeping with the modes of today. Self-contained insulation values—12" long—8" or 4" thick—range of 14 colors. Suited to every kind of construction—residential, commercial, industrial.

Many territories are open for additional local plants. Franchise protection. Equipment available on easy terms, or basic machine can be leased to responsible operators. Write today for interesting Brikrete Book No. 2.

Brikrete Associates, Inc.
402 W. 25th Street
Holland, Mich.



**The World's
Most Modern Masonry**

IN CANADA: DUNN MASONRY MACHINERY LIMITED
800 Dundas Highway, Cooksville, Ont.

**MAKE
\$18⁰⁰
AN HOUR
WITH
New**



PLASTIC SANDWICH MACHINE

This new, remarkable PLASTIC SANDWICH MACHINE does a permanent, beautiful, professional, protective, plastic lamination job in exactly three minutes time! Amazing earnings possible in your own home or shop permanently sandwiching PHOTOS, SOCIAL SECURITY CARDS, IDENTIFICATION CARDS, CLIPPINGS, DIPLOMAS, etc. between sheets of clear plastic.

Make PLASTIC SANDWICHES that cost you only 8c each, take 2-3 minutes time—yet sell for 50c to \$1.00 each! Laminating machines range from \$35.00 up.

PLASTIC SANDWICH MACHINE CO.

6612 N. Clark St. Dept. LM-201 Chicago 26

**FREE
SAMPLE**
and illustrated
literature, NO
obligation.



I'll Give You BULLDOG COURAGE In 48 Hours —or no cost!



DAVID V. BUSH

Are you timid? Bashful? Self-conscious? Are you afraid of people—afraid of superiors? Give me 48 hours and I'll give you **BULLDOG COURAGE**, I'll make you bristle with fighting Determination, or refund your money.

Thousands of men and women are being held back—made miserable—made unhappy. Why? Simply because of bashfulness—self consciousness—fear of criticism—business worries—and dozens of other fears.

Yet fear is **ABSOLUTELY UNNECESSARY**. An amazing method has been discovered which banishes fear. No trouble. No inconvenience. No long waiting for results. This method is perfectly simple—perfectly natural—perfectly logical. It works almost instantly. Try it. You will be astonished! In just a few hours you may find yourself brimming over with splendid new courage—new daring—new self-confidence.

Only \$1 David V. Bush gives you his secrets of real he-man courage in his famous book called "Spunk." It is one of the most startling books ever written. You can't read it without a quickening of your pulse—without a surge of red-blooded courage.

This book is declared to be the masterpiece of David V. Bush who has astounded throngs in America's greatest cities and shown thousands the way to health, prosperity and self-confidence. Write for this amazing book today. Send only \$1 in full payment. If you are not delighted, if your fears are not gone by the time you read this book, return the book within 10 days and your money will be instantly refunded.

INSPIRATIONAL PUBLISHING HOUSE, Dept. PM1055 Mehospany, Pa.

I enclose \$1.00 for a copy of "Spunk." You agree to refund if I return in 5 days.

Name _____

Address _____

City _____ Zone _____ State _____

LEARN TV REPAIR ALL SHOP - NO MATH FINISH in 6 to 16 WEEKS

EARN BIG MONEY! TRAIN IN CHICAGO! BE YOUR OWN BOSS! Millions of TV sets mean Money to you! No high school or experience needed. Color TV and radio included. Day, eve., Sat. classes. Low weekly budget tuition. Small classes, individual instruction. Also 16 wk. shop course in AIR CONDITIONING-REFRIGERATION repair.

MAIL COUPON FOR FREE BOOKLET
MID-CONTINENT INSTITUTE (WHERE YOU LEARN BY DOING!)
Dept. 10, 618 S. State St., Chicago 5, Ill. — Webster 9-0790

NAME _____ CHECK CHOICE
ADDRESS _____ TELEVISION
CITY & STATE _____ AIR COND.-REFR.

URANIUM = \$\$\$

CASH-IN ON GOVERNMENT BONUSES!
OVER \$4,000,000 ALREADY PAID!

Learn how a U.A.C. Geiger or Scintillation Counter can find Uranium \$85 for you. All counters UNCONDITIONALLY GUARANTEED: AEC Evaluated; tested and approved by our scientific laboratory. Write for free maps, techniques, information on extra-sensitive, lightweight instruments from \$24.95.

The Geiger Flasher—
A proven uranium
finder for only \$24.95!

The Completely
Transistorized
Geiger Gun—\$149.50

UNIVERSAL ATOMICS CORPORATION
Dept. M10 19 East 48th St. New York 17, N. Y.

POSTCARD PRINTER

\$10.95
Complete

Prints fast, easy on postcards, cartoons, envelopes, etc. at a cost of only a few cents per 1,000. 30-day trial offer, Money-Back Guarantee. Send check or money order or write for additional information.

JACOBI ADVERTISING
208 S. LaSalle St., Chicago 4

Natural Sponges

HIGH QUALITY DEEP SEA
9 in. DIA. 2.50

THE SIZE OF A DINNER PLATE. FULL NATURAL FORM, NO CUTS. 2.50 EA.—2 FOR 4.70—3 FOR 6.75

Send check, cash or M.O. We pay Postage, C.O.D., unless Postpaid Collect.
GLADIATOR SPONGE CO., 809 So. Euclid, Oak Park, Ill.

500 Treasured "Pirate" STAMPS

Get this big, all-different "Treasure Chest" of 500 pressed stamps from Pirate strongholds. Total catalog value over \$10. 8 extra special stamps FREE if you act quickly. Approvals. Send only 35c to **LITTLETON STAMP CO., Dept. PM-10, Littleton, W. W.**

FOR ONLY 35c

SAVE ON GOV'T REAL ESTATE

Buy direct from Government. Surplus homes, islands, farms, land, etc. List \$1.00. Send now and Save.
THE ABACUS PRESS, Dept. D, Box 169M, E. Hfd. 8, Conn.

YOUR OWN MERCHANDISING BUSINESS!

No Investment! No Inventory! Sell nationally advertised products right out of the Rake Catalog. Biggest price advantage ever! Seasonal profits for you! Write for your FREE copy today! Catalogs are available in quantity for your own imprinting.

RAKE COMPANY
708-Y Sesson St., Phila. 6, Penna. MA 7-7426

FAMILY SAFE, PARTIALLY USED TIRES. CHECK MY GOLDEN RULE GUARANTEE!

"THE BLATT NAME famous in tires for 40 years." Only BLATT offers a "FREE REPLACEMENT" guarantee! Any other guarantee is USELESS where you must pay for the months service you've received. I replace FREE instantly ANY tire failing within 36 mos.—defective or not. FOOLISH TO PAY MORE—DANGEROUS TO PAY LESS!

CHOOSE YOUR FAVORITE BRAND GOODYEAR

These are not Recaps—not cheap grade tires. We are selling thousands in our retail store @ \$7.95 ea.

36 MONTH GUARANTEE & FREE LEAK-PROOF TUBE			
600-16 \$5.50	670-16 \$5.40	700-20 \$9.80	600-16 (R) \$8.90
650-16 \$6.60	710-16 \$5.40	750-20 11.80	650-16 (R) 8.60
700-16 6.00	760-16 5.70	825-20 17.90	700-16 (R) 7.30
640-18 4.80	800-18 5.80	900-20 17.90	760-16 (R) 7.80
760-18 4.70	820-18 5.80	1000-20 17.90	700-17 8.80
800-20 9.00	850-20 9.80	1100-20 17.90	760-16 7.50
WHITEWALLS \$1.00 EXTRA		1000-22 19.90	750-17 9.90

MARVIN BLATT 6th & Spring Garden Sts. Philadelphia, Pa.

MILITARY MUD-GRIP TIRES
AA 36-20 Mos. 9.90
AAA 38 Months 12.90
AAA 38 Months 13.90
AAA 38 Months 17.30

If you buy 2 or more TIRES you get an extra tire FREE! (not W.V., Snow or Truck tires.) Be wise! Why buy only one! **FREE TUBE!**

FREE Firestone This gorgeous pictured Tire Ash Tray with your name on it, given with 2 or more tires.

SPECIAL TIRES RELEASED BY CO. ADJUTANTS! If a tire fails in 36 months, I charge you nothing. Just slightly used. Any car size. World's best tire value (Whitewalls \$1 extra). Free tire after trial. **\$7.86**

SHOW-TIRES Goodyear Suburbanite type & others—any car. \$7.95 Factory retreads & Partially used. 26 Mos. Guar. \$7.95

Send Cl. or M.O. & this ad for instant shipment. FOB Phila. I personally select your tires—as if my future depended on it. Thousands of tires shipped the world over! Read that top line again.



Cannot channel



Easy to clean



Filters out all dirt



Traps moisture



Never needs replacing



Reduces friction

End Filter Replacement FOREVER!

with Revolutionary New Type

Micro BRONZE OIL FILTER

1. Eliminates Engine Acids
2. Traps Damaging Moisture
3. Filters all the Dirt
4. Reduces Friction
5. Saves the Detergents

U. S. Patent App. No. 464498

WHY GIVE YOUR ENGINE HALF-WAY PROTECTION? The Micro Bronze permanent all-metal filter with the built-in acid neutralizer is the world's first filter that guards against all five engine enemies: Acids, abrasives, friction, moisture and sludge.

Made of solid but porous everlasting sintered bronze, the Micro Bronze Filter screens out all particles of dirt and abrasives larger than .00023 inch in size (so small you could put a thousand of them on the head of a pin!). The Micro Bronze positively cannot channel or blow up... operates efficiently at all temperatures... never wears out, never needs replacing, merely occasional cleaning.

SAVES OIL CHANGES... SAVES DETERGENTS. Your oil is good for at least 10,000 miles with a Micro Bronze Filter. All the valuable additives are kept in, not soaked up and wasted by the filter. You never need buy another replacement pack as long as you live! Used with modern detergent oils, Micro Bronze will add thousands of miles to engine life, help prevent loss of engine power, save costly oil changes, pack replacements and engine overhauls!

DOES YOUR PRESENT FILTER PASS THE "ACID" TEST? If you have a Micro Bronze Filter with the built-in Acid Neutralizer your engine is getting the full protection it needs! In a simple test you can easily make yourself, the Micro Bronze special element completely neutralizes acids in 60 seconds!

BUILT-IN ACID NEUTRALIZER!



THE SINTERED METALS SECRET... Before World War II, the Germans discovered how to fuse microscopic balls of metal into solid but porous form. Following the war, this secret was made available to American industry and we've developed it for Micro Bronze Filters. This is a magnification of the filter wall.

NO EXTRA COST FOR FULL FLOW MODELS!

FITS EVERY CAR & LIGHT TRUCK. A Micro Bronze Unit costs only \$6.95, including all full-flow models. Easy to install, never needs changing. Micro Bronze Filter Housing \$9.95 for all cars with no filter equipment (does not include element). Use the easy-order coupon now.

Micro BRONZE FILTER CORP.
11766 W. Pico Blvd., Los Angeles 64, Calif.
Cable Address: MICRONZE

FILTERS THE DIRT BUT NOT THE DETERGENTS

Micro Bronze Filter Corp. Dept. PM-105
11766 W. Pico Blvd., Los Angeles 64, Calif.

Please ship the following at once

- Conversion unit \$6.95 (including all full-flow models)
- Micro Bronze Housing Unit (Needed where car does not now have filter) \$9.95 (does not include element)

Enclosed is \$_____ full price. Factory pays all shipping costs to your door.

MAKE, MODEL & YEAR CAR _____

NAME _____

ADDRESS _____

CITY _____ ZONE _____ STATE _____

DISTRIBUTORS WANTED

We are receiving orders from all over the world for the amazing Micro Bronze Filter, and are setting up exclusive distributorships to handle our rapidly growing dealer organization. Write, wire or phone.

Copyrighted material



Rigid double-cone construction



Waterproof



Saves engine repairs



Unconditionally guaranteed



Easy to install



Saves oil



All-metal construction



Built-in acid neutralizer



Increases engine life



Saves detergents



Unaffected by pressure



Screens out abrasives



Efficient at all temperatures



Fits all cars



Eliminates acid



**I call this
machine . . .**

**"my little
money maker"**

It can be put anywhere in the house—in the kitchen, the basement, or the attic and it goes on making money for you whether you're there or not. Three times a day—while you're at work, while you're asleep, or while you're at the movies—it turns out a product that sells for \$6.00 and the cost of raw materials is only 54c. It will make 3 a day or 6 a day, just according to the way you set the switch, and the profit on each one is more than \$5. I'll be glad to tell you how to get one of these little money makers working for you.

By James Q. Mason

What a fellow makes in his regular job today is hardly enough to make ends meet. Higher taxes, higher costs of food and rent and almost everything else raise hob with the savings account. And I say that what a fellow puts away is even more important than what he makes. It would worry me sick if I couldn't save a little against a rainy day.

And that makes it almost necessary to make some extra money. There are lots of ways to do it, too. The magazines and newspapers are full of ads for agents to sell things. But if I had to make a living by selling, from house-to-house, I'm afraid I'd starve to death. I like to make something with my hands and either sell it by mail or let the stores sell it for me. There are lots of people like me.



Another thing: Lots of men—and women, too—don't want to get mixed up with something that might hurt them on their jobs. They want a plan they can operate at home—in spare time—one that they can work at any time they please and one that doesn't need any rented store or hired help.

And that's where my little money maker rings the bell.

Let's say you're like me. You want to make some extra money but you don't want to do any selling. All right—take a look at what you can do with this machine. I'll give you some facts that I discovered and your own common sense will tell you they're true.

If you're going to make something, it ought to be something that lots of people want—something that lots of people buy. It shouldn't be something that sells at just certain seasons—but all year 'round. And, it shouldn't be any flash in the pan. It's got to be steady—year after year—something that's not here today and gone tomorrow.



Well, give a thought to this: What's more permanent than babies? Ever since I can remember there's been more and more babies born every year. Last year three and a half million. This year more. Next year, more yet. Then answer this question and tie it in with your thinking: What's stronger than mother's love for her baby? And what is more powerful than love or sentiment in making people buy things. Now you've got the idea.

Every year millions of mothers want their babies' first

shoes preserved as mementos. These mothers have the shoes "bronzed" as they call it—by electroplating. Electroplating coats the shoes with copper and preserves them forever. And there's no big company that has a corner on the business of metalizing baby shoes.



Almost all of this work is done by little fellows in their kitchens or basements. Lots of orders come to you by mail when you send out circulars letting mothers know you can do the work. Lots of stores take orders, but they

have to turn over the work to you. There are six or seven ways to get orders without making any house-to-house calls. The big job is keeping up with them.

You see, you can clean up six pair of shoes in a few minutes. In a few minutes more you can dip them in the hardening solution like you see in the picture. Then you spray them with a conductive coating and hang two pair in the tank on copper wires. Just turn the switch and walk away. The machine does the rest. Eight hours later those shoes are ready to take out of the tank, burnish and mount and ship or deliver. Two pair every eight hours, whether you are asleep, awake or at the movies.



The materials cost 54c a pair. The retail price you get for electroplating is \$6.00—so the profit is more than \$5.00 a pair. Since you can do six pair a day you can see what the profit is, and the beauty of it is that the machine doesn't cost much. Almost anyone can afford the equipment and the book you get tells how to run the machine and how

to get orders. Anyone can follow the instructions.

Of course, there's a lot more information than what I can give here. But write me a note or send me a postcard with your name on it and I'll send you all the information right away by mail. I'll show you how to start; what you need to buy; where to get it at the lowest price; how to get orders coming in seven different ways; and everything you want to know about the business. When you get all the facts, you can decide whether you want to get a "little money maker" of your own. Everything I send you now is free—no charge and no obligation. I'll be glad to help you get a start. Address me, James Q. Mason, 1512 Jarvis Avenue, Chicago 26, Illinois. There's no catch to it. No one will call to try to sell you anything. I'll mail everything free, postage prepaid. Then you can decide. Write to me right away so I can help you get started making money.

**WORLD'S
BEST
WANT-AD
MEDIUM**

CLASSIFIED ADVERTISEMENTS



Advertisements in this section \$1.00 per word, each insertion, minimum 10 words, payable in advance.

To be inserted under proper classification, copy must be in our office the

20th of the second month preceding date of issue

F. W. Johnson, Manager, Classified Advertising

Popular Mechanics Magazine, 200 East Ontario Street, Chicago 11, Illinois

YOU'LL PROFIT

By reading and answering the classified ads in this section. Hundreds of opportunities for you to make and save money

AUTOMOBILES, MIDGET CARS

BOYS' Power-driven auto. Build your own. Plans 25 cents. Sypher Co., Box 39, Sta. P., Toledo, Ohio.

FREE Motor magazines; automobile literature, old, new and foreign; glossy photos, dealer books, shop manuals. Offered with non-profit organization. Write today; get on free mailing list. Auto Maniacs, Stockbridge, Mich.

SEND For free sample copy. Franson's Motor News, Eugene, Oregon.

ANTIQUA Automobile color slides, 2x2. Illustrated catalog free. Universal, Box 779A, Beverly Hills, Calif.

AUTO SUPPLIES AND EQUIPMENT

AMAZING Fiberglass! Repair anything! Save time—Money on hundreds of car, home repairs. Kit "A" (144 sq. in.) \$1.98; kit "B" (482 sq. in.) \$4.95 post-paid. At your auto store, or order direct. Illustrated booklet, 10c to cover handling. Schramm, 5434-A Higgins, Chicago 30.

"U-FAB" Log manifold kits—Available for all overhead V-8's. Four-carb \$17.50. Six-carb \$21.50. C. O. D.'s o.k. Crower Equipment Co., 1946 Moore St., San Diego 1, California.

WHY Die? Free auto safety belt literature. Lifesaving Products Co., Box 8076 Northgate Station, Seattle, Wash.

COMPRESSION Gauges, plastic hose, leather paints. Catalog. Schreiber Imports, 2542 E. Anaheim, Long Beach 4, Calif.

LACHAPELLE'S Patented treatment. Will make your car better. Write, Dan Ferns, Box 71837, Los Angeles 1, Calif. In Canada, Master, Box 216, Welland, Ontario.

AVOID Death or injury. Install safety belts in your car. Free literature. Jacobs Sales Co., 1449 Redondo, Garland, Tex.

GMT-110 Discarded injector parts wanted. Bonus on HV. Bares, 7120 Carnegie, Cleveland 3, Ohio.

AMAZING Discovery. Saves gas, increases power, compression. Cuts oil, repairs. Guaranteed. Lachapelle's (patented) motor treatment. \$3.00 delivered. If dissatisfied, money refunded. Agents wanted. Free circular. Joe Dillon, Authorized Warehouse, Agents Distributor, Box 32313, Bridgeport, Ohio.

MUFFLERS Replaced easily with new specially designed tools. Free literature. Becker, 259 Oakdale, Akron, Ohio.

VALVE Seat narrowing and porting tool. Literature free. Lewis Tools, 1621 Rheem, Richmond 5, California.

CAR Burning oil? Losing compression? Try Clifford's Compression Seal, Tube, \$2 postpaid. Clifford's Engineering, 452 Claim, Aurora, Illinois.

AUTO Safety belts. \$9.95 valve. Now \$4.95. Blue or gray. Money-back guarantee. Safety, 114 W. Hubbard, Chicago 10, Illinois.

BUY Wholesale nationally advertised auto supply, thousands other products at big discount. Free "Wholesale Plan." American Buyers, Hertel Station, Buffalo 16-G1, N. Y.

SUPERCHARGE Your motor for outstanding performance and economy with sensational Superjet Carburetor Valve. Money-back guarantee. Only \$3.95 ppd. Ericson Products, 11365 Matteson Avenue, Dept. PM-10, Los Angeles 66, California.

STOP Burning oil with Ring-In. Guaranteed to re-seat rings and valves. Improve combustion and compression. Increase horsepower. Takes less than 30 minutes. No other product like it. Money back guarantee. Lasts up to 10,000 miles. \$3.00 ppd. \$1.00 deposit for c.o.d. A & M Company, 616 So. Serrano Ave., Los Angeles 5, Calif.

NEW And used parts at savings. Complete guaranteed parts service for all models cars and trucks, 1924 and later. Largest in the West. Army parts specialists. No catalog, write for quotations. Fast mail order service. Pioneer Auto and Truck Parts Co., 734 W. 13th Avenue, Denver, Colorado.

WORLD'S Best carburetor. Increase in pep and mileage guaranteed. Complete details \$1.00. Settlmyer Enterprises, P.O. Box 853, Kannapolis, N. C.

CRANKSHAFT Grinder, hand operated. Makes bearings fit without taking engine apart. \$3.75. Literature. L. D. McGee, 719 Cascade St., Wenatchee, Wash.

MOTORIST Save money with Redm-Air automatic, calibrated gas saver. Wanted agents. Write Redm-Air, 1430 W. North Ave., Chicago 22, Ill.

FORD T parts? Try best source old car parts anywhere. Wisneski, Milwaukee 7, Wis.

TAPPET Noises in Mercurys, Fords and Chevrolets stopped with our silencers. Literature. Kaye Products, 2067B S. Layton Blvd., Milwaukee 15, Wis.

AMAZING Cloth eliminates windshield fogging. Year's supply. \$1.00 postpaid. Guaranteed. Burnie, 1818P West Haskell, Tulsa, Okla.

ALIGN-A-Matic outperforms all drive over alignment devices. \$22.50. Align-A-Matic, 62 Gaston St., W. Orange, N. J.

ELECTROPLATE Auto parts, novelties, mirrors. Easy, inexpensive home processes. Free booklet. Tyco Metals, Box 13231-BG, Houston 19, Texas.

AUTO Accessory and parts catalog. 1955 edition—All new! 148 pages. Save up to 50%. Over 50,000 items, including Hollywood accessories, hi-speed equipment, rebuilt engines, all parts and accessories for all cars and trucks! Hard-to-get parts! Send 25c. Refundable. J. C. Whitney, 1919-PM Archer, Chicago 16, Illinois.

FREE Discount catalog—Speed, power, custom equipment. Almqvist Engineering, Milford TP, Pennsylvania.

AUTO TRAILERS

TRAILER Parts catalog. Largest in mid-west. Send 25c. Refundable. Hanna Trailer Supply, 615 West Layton, Milwaukee, Wis., Dept. M.P.

TRAILER Building manual illustrated \$1.00. Booklet 25c. Craftsman Books, Box 1153, Milwaukee 1, Wis.

EXCEPTIONAL Expanding eight foot trailer. Accommodates family of five. Build yourself. Literature 10c. Pramur Company, Wilmington, Mass.

BUILD Your own trailer! Plans for all kinds. Illustrated catalog 10c. Jim Dandy, 125-M, Wausau, Wisconsin.

MOTORCYCLES, BICYCLES, MOTORSCOOTERS AND SUPPLIES

SERVICYCLE \$20.00; Whizzer motorbike \$25.00; Cushman motorscooter \$25.00; midget auto \$25.00. Rush 25c (35c first class mail) for new catalog #957 listing many other amazing bargains in motors, midget cars, motorscooters, motorbikes, construction plans. Associated, Box 534, Toledo, Ohio.

PARTS, Pistons, new, used. Harley, Indian, Henderson, list 10c. Ballak, 811 N. 9th, St. Louis 1, Missouri.

RECONDITIONED Motorcycles and motors. Chromium accessories. Complete stock Indian parts. Expert rebuilding. Fast service. Indian Motorcycle Sales, Kansas City 27, Missouri.

CUSHMAN Motorscooter \$15, Servicycle \$20, midget car chassis \$25, less engines. Motorbike engine \$5, outboard \$5. (Mail-order only). Send 25c (35c first class mailing) for directory-catalogue Number 67, just out, listing these and hundreds of other bargains in new and used midget cars, motorscooters, parts, plans, etc. Midget Motors Directory, Athens, Ohio.

HARLEY-Davidsons — America's finest used bargains! We pay shipping on motorcycles. Genuine new, used parts, accessories for current and obsolete models. Send 25c for bulletin, catalog. Knuth's (factory dealer), 1753 Muskego, Milwaukee, Wis.

AVIATION

HUNDREDS Of surplus airplane parts at materials cost. List 10c. Machinecraft, Box 305, Troy, Ohio.

BUILD Helicopter power plants. Plans—Ramjet \$2.00, Pulse-jet \$2.50. Vincent Rose, 2191 Lytton Ave., Pittsburgh 13, Pennsylvania.

AIRLINE Steward-purser. Fly 85 hours monthly. Starting salary \$235 up. O.I. approved. Free catalog. Air-Purser School, Room U, 1030 Nicollet Ave., Minneapolis, Minnesota.

LIGHTPLANE Building Manual \$1.00. circular 25c. Craftsman Books, Box 1153, Milwaukee 1, Wis.

PROPELLERS Specially designed for airboats and snow sleighs by the world's oldest manufacturer of aircraft propellers. Free literature. Plotter Mfg. Co., G. R. Airport, Grand Rapids 8, Mich.

PROPELLERS, Plans, supplies for airboats, snow sleighs. Catalog 10c. Gano Propellers, Box 3284-A, Ft. Worth, Texas.

HELICOPTER, One man. Experimental marvel. Construct own. Instructions \$3.50. Mayberry Company, Box 343, St. Clair Shores, Michigan.

AMAZING—New four-bladed boomerang, designed by aircraft engineer, soars to great heights and returns. Fascinates young and old. \$2 postpaid. American Boomerang Co., P.O. Box 521, Boulder City, Nevada.

BUILD A fast, safe airboat or snow sleigh from your 65-200 h.p. aircraft engine. Propellers, plans, supplies. Satisfaction guaranteed. 48 page catalog 25c. Banks-Maxwell Co., Box 3301E, Ft. Worth 5, Texas.

ENTHUSIASTS, Keep abreast with the helicopter industry. Receive the exclusive bulletins published by the American Helicopter Club. Information supplied on request. Club membership also open. Wm. MacLaughlan, 378 Baldwin, Jersey City 6, N. J.

BATTERIES, GENERATORS

EDISON Nickel storage batteries. Any voltage, any amperage. Unconditionally guaranteed. Power plants, generators, motors. Literature. Hawley Smith Co., Croton Falls 1, N. Y.

ELECTRICAL SUPPLIES

LAMPS—25c Brings bargain catalog showing all parts for repairing, building. Contains instructions for electrifying vases, oil lamps, etc. Gyro Lamps, 5402P Clark, Chicago 40.

ELECTRIC Pencil; Engraves all metals \$1.50. Beyer Mfg., 10511-H Springfield, Chicago 43.

MAKE Fluorescent fixtures: Plans, circuits, diagrams; plus discount catalog of kits, parts and fixtures—35c. Shoplite Co., Box 63M, Nutley 10, New Jersey.

LIFETIME Plug 9c each. Renew with new fuses 15-20-25-30 amp, 5 for 10c, 100 for \$1.10. Valentine Mfg. Company, Owosso, Michigan.

NEW 1955 Lamp parts catalog showing everything you need to make and repair most types of lamps. Everything at lowest wholesale prices. Send only 25c today for both catalog and wholesale price list. Gearon Co., Dept. 503-B10, 27 S. Desplains, Chicago 6, Ill.

WELDING, SOLDERING, PLATING

"BUILD-UP-OWN" a.c. welder and a.c. power plant with a good used engine and low cost Hobart generator. Welds anywhere and supplies 5kw stand-by power for any emergency. Write Hobartweld, Box M-1053, Troy, Ohio.

NEW All-in-one oxyacetylene outfit welds sheet, plate; cuts heavy steel; heats; brazes. Uses interchangeable tips. Portable, easy to operate. Complete with instructions, \$76.50. Gas cylinders on special moneysaving plan. Write for free information: Dept. M, Linde Air Products Company, 30 East 42nd Street, New York 17, New York.

BUILD Arc welder the easy way using aircraft generator. Plan 10c including catalog welder-kits, hydraulic-kits, etc. Dunbar Mfg., 6600 Sylvan Road, Houston 23, Texas.

A.C. Welders, 130 amperes, \$39.50. Morris, 1070 Inner Drive, Schenectady 3, N. Y.

ACETYLENE Welding outfits, new \$49.00; used \$29.00; arcwelders \$56.50. Eagle Welding, Dept. PM, 5085 Broadway, Chicago 40, Ill.

MAGNA-Weld lenses for welders who need glasses. The Magna-Weld lens is an optically ground magnifying inside cover glass 4"x4 1/4". Fits all standard helmets. Number one weak power, number two stronger power. Price \$5.00 each. Satisfaction guaranteed. Industrial Optical Co., P.O. Box 414, Jacksonville, Florida.

ELECTROPLATING Equipment, anodes and solutions for all types of plating. Instructions. Assemble your own plater and save. Free catalog. Ramyr, Dept. E-4, 1624 East First Street, Los Angeles 33, California.

MACHINERY, TOOLS, SUPPLIES

CRANKSHAFT Grinding equipment bargain. Will finance. Send references. Eaton Roller & Manufacturing Co., Box 304, Eaton, Indiana.

WHOLESALE Tool catalog. Send \$1.00. Yuhas, 3250 Theodore, Detroit 11, Mich.

MILLING Machine, complete prints 25c. Low cost on parts. Lewis Machine Tool, Los Nietos, Calif.

ALLEN Two ton power bench type punch press. \$97.50. Circular. Allen, Dept. PMB, Clinton, Missouri.

INSTANT Change kit, four practical tools for any 1/2" drill motor. Two saws, planer, sander; not gadgets. Free literature. Gehlco Tool Co., Box 323, Independence, Kansas.

NEW Steel shelving 6 feet high, 36" wide, 12 inches deep, with 5 adjustable shelves, \$9.95 complete. No c.o.d.'s. Corco Tool, 5636 Lake Park, Chicago 37, Illinois.

TOOL Sale, indicators Federal #D818 \$15.00; reamers, drills, taps, others. Genex, P.O. B. 465, Sun Valley, Calif.

MILLING Machine: Bench model. \$149.50. Southern Machine Tool Co., Conyers 1, Georgia.

LATHE, Model making, English manufacture. Catalog. Science Now Company, Catskill, New York.

ENGINES, MOTORS, DYNAMOS

1 1/2 H.P. (\$53.50) gas engines now \$23.50 f.o.b. Factory guarantee. Brand new—Finest. Northern, 172 Merrimac St., Boston, Mass.

NEW Gasoline engines. Electric tools. Motorbike, mower kits, Bargains. Catalog 10c. Loren, Box 436, Danville, Illinois.

WINDING Data, 225 motors, single and three phase. \$1.00. Data Company, Box 7631, Kansas City 28, Mo.

REWIND Motors yourself. Complete instructions \$1.00. Lewis Mfg., Howell, Michigan.

BOATS, OUTBOARD MOTORS

"GLASBOTE" Plastic and glass cloth for boat covering. Complete information and material price list free. Buchanan Plastics, 1728 Hamilton Road, Okemos, Michigan.

MARINE Conversion, Willys to Cadillac, engines, kits and parts. Catalogue and conversion hints free. Barr Marine, 2706 Castor Avenue, Philadelphia 34, Penna.

BUY Wholesale nationally advertised outboards, thousands other products at big discount. Free "Wholesale Plan." American Buyers', Hertel Station, Buffalo 16-H1, N. Y.

BOAT Plans, patterns, frame kits, Modern inboards and outboards, 11'-22' for amateur builders. State requirements or send 40c for complete catalog. Glen Designs, Box 568, Compton, Calif.

GLASTICOTE, Paint, boat hardware, and accessories. Complete catalog \$1.00. Marine Associates, Box 6188-m, Long Beach 11, California.

PLYWOOD Boat plans, 21 for \$1.00. Catalog boat building plans 25c. The Rudder, 15 Murray Street, New York 7.

CONVERT Fords and Jeeps to 100% marine engines with Osco's world famous Convo-Kits. Deluxe catalogue 25c (coin). Osco Motors, 3627B Lawrence, Philadelphia 40, Penna.

FIBERGLAS Permanent boat waterproofing. Lowest wholesale prices. Guaranteed materials. Easy application. Full instructions. Complete kits, \$12.50 up. Free literature. Ajax Plastics, Dept. PM, P.O. Box 1323, Fort Worth, Texas.

NEW, Used, rebuilt marine motors. Marine conversions, fittings. Free catalog. Stokes Marine Supply, Dept. 24, Coldwater, Michigan.

MARINE Conversions for Ford and Jeep engines. Catalog 25c. Lehman Manufacturing Company, 972D Broad Street, Newark 2, New Jersey.

FREE Catalog! Boat kits, trailers, fiberglass, marine hardware. Luger Industries, Dept. M, 4452 Nicollet, Minneapolis, Minn.

BOAT Plans: Welded steel, wood, plywood. Outboards, inboards, cruisers, sail. Free literature, please specify type. John B. Clark, N.A., P.O. Box 51, Bay Village, Ohio.

FIBER-Glass cars! Hollow—they float! Send for free folder. Plastic Age Co., San Fernando, California.

FULL Size, cut-to-shape boat patterns, blueprints, 7 1/2-38 feet. New 1955 illustrated "Build a Boat" catalog of 50 naval architect-designed cruisers, runabouts, sloops, skiffs, outboard boats, sailing, racing, houseboats, 50c. Small boat hardware catalog, \$1.50. Bigger, better 1955 "How to Build Boats" book, \$2.50. Cleveland Boat Blueprint Co., Dept. A-66, Box 1651, Cleveland 4, Ohio.

SPECIAL Offer—Trial kit for boat repairs, home repairs. Fiber glass with revolutionary new bonding plastic. Complete information brochure 10c. Adheso Sales Co., P.O. Box 262, Nixon, N. J.

BOAT Patterns. Literature and illustrated boat construction book \$1.00. German Boat Company, West Saginaw, Mich.

BUILD A fast, safe airboat or snow sleigh from your 65-200 h.p. aircraft engine. Propellers, plans, supplies. Satisfaction guaranteed. 48 page catalog 25c. Banks-Maxwell Co., Box 3301F, Ft. Worth 5, Texas.

MARINE Conversions Ford and Jeep. Catalog 25c. Gershel Engineering, Ocean-side, New York.

JOHNSON Outboard specialists. Used parts for all models at substantial savings. Prompt quotations. Specify model serial. Crandall-Hicks, 910 Commonwealth, Boston, Mass.

ATHLETIC EQUIPMENT, BODY BUILDING COURSES

STRENGTH, Health, gain, reduce. Any age. Easy! All you need is a rope! Sensational new discovery! Free details. Rope-ercise, 4834 Art St., Room 101, San Diego 15, California.

MEN'S Athletic supporters, underwear. Free price list. Poly Shop, Box 3203, Ft. Worth 5, Texas.

BUILD Powerful arms, chest, shoulders! 22 exercises. \$1. Ponsad, Box 601-B, 1100 Market, Wilmington 99, Del.

FREE Catalogue, 10c for postage appreciated. Dr. Thompson, 919 Fourth, Manhattan 30, Kansas.

BARBELLS, Exercise equipment. Courses. Free booklet. Good Barbell Co., Reading, Penna.

"HOW TO BOX" Joe Louis' famous fight book. Packed with pictures, information, instructions. Only \$1.00! Paradise, 1 DeMott Place, Rockville Centre, New York.

SPORTING GOODS, GUNS, FISHING TACKLE, ARCHERY, TRAPPING

GOVERNMENT Surplus ammunition—45/70 caliber \$6.50 per hundred; 30 calibre, 30/06 government \$5.95 hundred. Also Italian, German, Jap revolvers, rifles. Free list. Hudson, P-32 Warren Street, New York City 7.

REELS Wholesale. Pflueger supreme \$23.50; Ocean City # 251, \$18.40; South Bend #915, \$11.25; Cox #25C, \$21.95. Prompt delivery, prepaid. Barry Sales, Box 234, Miami 50, Florida.

TROUT Fishing, Stag at Eve, Mallards in Flight, Yacht Race, Collies, Thorough, and Palomino coded oil painting kits in size 12"x16". Each kit \$2.95 postpaid, also North Woods Retreat size 18"x24", \$6.95 postpaid. You can paint in oils the first time you try. Send for free literature. Rafox, P.O. Box 1256, Decatur, Illinois.

SWIMMERS! Send \$3.95 for imported French mask. Catalog of skin divers' equipment and books 25c. Aquafun PM, Davenport, Iowa.

100 PROFUSELY Illustrated pages antique pistols, swords, daggers, armor, etc. 50c. Robert Abels, M860 Lexington Ave., New York 21.

TENTS, Camping equipment. Send 10c for new 1955 100 page tent, camping equipment catalogue-handbook. Morsan, 10-21R 50th Avenue, Long Island City 1, N. Y.

MOLDS—For making fishermen's sinkers. Free illustrated booklet. Reading Instrument Co., Box 78, Reading, Penna.

3000 BARGAINS. Firearms, binoculars, war relics. Catalog 50c. Smith Firearms, Rummel, N. J.

MOLDS For fisherman's sinkers, jigs, squids, casting and spinning lures. Free catalog. Sweet's Molds, Tonawanda 1, New York.

JAP Rifle altering to 30-06, \$6.00. Jap shells, \$3.75. Catalog 5c. T. P. Shop, West Branch 11, Mich.

GUNS! Guns! Guns! New-used hunting bargains. Mausers, Lugers, Kentuckies, Winchester, antique arms. Catalog 50c. Ed Agramonte, Inc., 201 Warburton, Yonkers 20, N. Y.

BUY Wholesale! Guns, fishing, sporting goods. Save 60%! Free catalogs. National Buyers Service, Box 426EC, Oakland, California.

OLD Guns. Current prices. Free catalog. Pioneer Books, Harriman, Tennessee.

TRAPPERS Pack 25c. Worms without digging method \$2. Mace, West Brooklyn, Illinois.

MONTI Swiss spinners. Amazingly successful fish catchers for lake and stream. Catalogue, prices. Thebco, 834 Maywood, New Jersey.

GOLFERS. Practice at home. Foam rubber golfballs, \$1.00 dozen. Klein, 1804 Harrison, New York City 53.

FREE Fishing catalog—132 pages. Over 3000 hard to find fishing specialties. Netcraft Company, Dept. PM10, Toledo 13, Ohio.

BOW-Hunting secrets free! New book "How to Hunt with Bow"—100's tips out-witting big, small game, bow-fishing. Revealing "How to Choose Bow" facts. Bargain catalog included. Save 50% finest tackle. All 3 free! Malibu Archery, 1036-ROC La Brea, Los Angeles 19, Calif.

BUY Wholesale nationally advertised sporting goods, thousands other products at big discount. Free "Wholesale Plan." American Buyers', Hertel Station, Buffalo 16-II, N. Y.

MANY Modern, antique guns. List 10c coin. Ed Howe, 52 Main, Coopers Mills, Maine.

AMMUNITION—50% Discount. Catalog 25c. List 200 calibers. Pacific Firearms, 1517 Gardner, Los Angeles 46, Calif.

TAXIDERMY

YOUR Deerskins tanned and custom made into beautiful dress gloves, moccasins, handbags, coats and vests. Deal direct. Catalogue on request. J. R. Styres, Little Falls 1, N. Y.

BINOCULARS, TELESCOPES, MICROSCOPES, MAGNIFIERS

IMPORTERS' Amazing prices, precision binoculars, 22 models. Free trial. Folder, "Binocular Selecting," catalog free. Dealers wanted. Prentiss Importers, Mercury Bldg., West Los Angeles 25, Calif.

LOWEST Prices, all sizes, binoculars, telescopes, microscopes. Also repaired. Free catalogue. Joe's Binocular Sales, 4827 Second Blvd., Detroit 1, Michigan.

TELESCOPES, Microscopes, binoculars, past quarter century. Comprehensive scientific instrument catalog \$1.00. None free. Dollar deductible from orders. Harry Ross, 70 West Broadway, New York 7, N. Y.

SHOPPING? All good merchants do! Our buyer flew to Japan to shop. Result—Better binocular and microscope values! 6-600 power! Catalogue on request to dealers only. Tanross Supply, 1075 N.W. 71st St., Miami, Florida. Exclusive Tasco importers.

45X TO 400X telescopes easily made. Five finished lenses and building instructions, \$3.75. Giant astronomical telescope completely assembled with 6 ft. tripod, \$15.00. Free information. Suffolk Science, Mattituck 3, N. Y.

SPECIALISTS! Used microscopes and accessories. Unusual slides. Supplies. Catalog free. Research Scientific Supplies, 60 Wall St., New York City 5.

BUILD Your own reflector telescope. Complete kit: Mirrors, eyepieces, tripod, all other accessories. Request free illustrated literature. Criterion Manufacturing, Dept. KPM9, Hartford, Conn.

BINOCULARS. Telescopes, microscopes; terrific values \$3.98 up. Request free money saving catalog. Criterion, Dept. P34, Hartford, Conn.

UNITED Binocular buys! America's largest selection. Free 56 page binocular-telescope catalog, \$3.95 to \$250.00! United, 9043 S. Western, A-8608, Chicago 20. Dealers wanted.

REFLECTOR Telescope kits \$6.25 (3") to \$175. (12"). Mirrors, cells, focusing mounts, tripods, eye-systems. Anything, everything in telescopes. Free illustrated catalog. Also ready to use telescopes from \$25 to \$175. Inquiries to Esco Products, Dept. PM-10, 1428 Willow Ave., Hoboken, N. J. Sales showroom, 166 Church St., New York City.

DYNASCOPE—Sensational new reflector telescope. Send for details. Criterion Co., Dept. DF13, Hartford, Conn.

6 THUMBS On each hand? Even you can assemble our telescope kits from our easy instructions. Enjoy the heavens with a high precision telescope assembled in less than an hour. You'll like our complete line of telescopes, microscopes and accessories, biological stains, etc. Send for free catalog T of finest quality and newest design astronomical kits or free Catalog M of microscopes. Optical Engineering Co., 164-19 Northern Boulevard, Dept. PM, Flushing, New York.

WAR Surplus bargains! Millions of lenses, instruments, telescopes, binoculars, components and complete line of astronomical telescope items. World's greatest optical market place! Send only \$1.00 for beginner's 10-lens kit and big instruction booklet Stock 2-CH. Write for Catalog CH, free! Edmund Scientific Corp., Barrington, New Jersey.

MICROSCOPES, Binoculars, everything optical and photographic direct from importer. Lowest prices. Catalog 25c. Magnification Instrument Co., 2 East 45 Street, New York City.

PETS—DOGS, BIRDS, RABBITS, HAMSTERS, ETC.

CHINCHILLAS—Registered sturdy stock. Wholesale. One or one hundred pairs—\$75.00 pair. Slater Chinchillas, 1535 Ruhlman Ave., Manhattan Beach, California.

TREATISE on breeding canaries for profit. Only \$1.00. Free copy of bird magazine included. Audubon Publishing Company, 3449 N. Western Ave., Dept. P.M., Chicago 18, Illinois.

GUINEA Pigs. Backyard business. Booklet free. Taylors, 426A, Hapeville, Georgia.

CHINCHILLAS, Registered. Unbelievable prices. Par-West Chinchilla, 1446A Jones, San Francisco 9, California.

RABBITS. Back yard business. Booklet free. Tayco Rabbitry, Hapeville, Georgia.

CHINCHILLAS. Profit plus pleasure. Registered. Graded. Delivered personally. Stewart Chinchilla Ranch, Washingtonville, N. Y.

RABBIT Raising facts complete in 48 page illustrated book, by world's largest rabbit association, 10 cents. Address American, 36 Arba Building, Pittsburgh 17, Pennsylvania.

CAGE-Bird Magazine (budgies, canaries, etc.) one year, \$3.00. American Cage-Bird Magazine, 3449 N. Western Avenue, Dept. P.M., Chicago 18, Illinois.

HUNTERS! Raccoon Mountain and Short Creek Kennels now combined. Large number of coonhounds, foxhounds, rabbit-hounds, beaglehounds, bird-dogs, puppies. Free literature and pictures. Trial. Dares Thomas, Owner, Box 464, Boaz, Alabama.

RAISE Money-making Angora, New Zealand rabbits, Particulars free. White's Rabbitry, Jackson, Mich.

CHINCHILLAS. Genuine South American, N.C.B.A. Registered and pedigreed. Clean, gentle, easy to raise. Valuable fur. As low as \$100 per pair. Literature 25c. For prices and terms, write, V. Le Gare, Rt. #2, Ottawa, Illinois.

HAMSTERS—Golden: young, \$3.00 pair; fully developed, \$4.00 pair. Adirondack Hamstery, Prospect 112, New York City.

DESCENDED Skunks, monkeys, reptiles, etc. Illustrated catalogue 25c. Trails End, St. Stephen, S. C.

BEAUTIFUL Pure white pedigreed police puppies. Ansonia Kennels, Mose, N. Dak.

MAKE Money raising chinchillas, mink, pigeons, rabbits, cavies for us. Free catalog. Keeney Brothers, New Freedom 2, Penna.

STANDARD Rabbit Journal, Milton 3, Penna. Year \$1.00. Sample dime. Beginners manual 25c.

GROW Mushrooms. Cellar, shed, and outdoors. Spare, full time, year round. We pay \$3.50 lb. We paid Babbitt \$4,165.00 in few weeks. Free book. Washington Mushroom Ind., Dept. 171, 2954 Admiral Way, Seattle, Washington.

MINK Raising information free. Complete. Lake Superior Mink Farm, Superior, Wis.

MAKE Big money! Raise Chinchilla rabbits. Cash markets supplied. Write today! Rockhill Ranch, Sellersville 15, Penna.

SPORTSMEN: World's largest kennel offers 500 Pointers, Setters, Straight Cooners, Combination Hounds, Rabbit and Squirrel Dogs, Beagles, Fox and Wolf Hounds. Trial. Prices reasonable. Catalogue free. Smokey Mountain Kennels, Cleveland, Tennessee.

HUNTERS. Finest hunting hounds. Reasonable. Trial. Free list, pictures. Okaw River Kennel, Cowden C-41, Illinois.

ANGORAS, Chinchillas. World's most profitable rabbits! Catalog free. Grinsteads, Edwardsville, Illinois.

HAMSTERS—The New Empress strain. Guaranteed to produce. Free details. Anderson's Hamatery, 35 Oneida, Pontiac, Michigan.

PLANTS, SEEDS, NURSERY AND GARDEN SUPPLIES

GINSENG, Goldenseal roots bring up to \$12 pound. Full information. F. M. Collins, Viola, Iowa.

WORLD'S Greatest cash crop. Free information. Write Ginseng Gardens, Asheville, N. C.

RAISE Your shrubs, trees from seed. Free planting guide, price list. Woodlot Seed Co., Norway, Michigan.

10 PEACH Trees, 2 ft., \$3.49. Free catalog folder. Globe Nurseries, Dept. PM, McMinnville, Tenn.

AMAZING Brazilian plant grows from leaf. Money-back guarantee, 50 cents. Mommson, Cross River, N. Y. Details free.

10 SHADE Trees, 3 ft., \$3.98. Globe Nurseries, McMinnville, Tenn.

FARMS, FARM LANDS, REAL ESTATE

FLORIDA Bound? Make money in Florida real estate. Sell, buy, invest, trade. Learn how with this easy to read Florida real estate survey. Details free. T. Ewig, 5120 Fifth Ave. S., St. Petersburg, Florida.

FLORIDA Winter Garden farms—Your best investment for retirement or vacation place. 5 acres, 10 acres, 20 acres. Low prices, easy terms. High, dry, beautifully wooded. Near Panama City, famous pleasure resort. World's most beautiful beaches. Grow fruits, berries, vegetables, money-making tung trees. Tung oil makes world's finest paint products. We plant and service your grove. Brochure free. Wendell Wood, Fountain, Florida.

CALIFORNIA Ranch and farm lands \$15 to \$35 acre. Homesites \$395. Easy terms. Free catalog. Pacific Tax Sales, 1621-A Cahuenga, Hollywood 28, Calif.

ROADSIDE Home, garage, nothing down. List free. Perrys, Brier Hill, Penna.

SEE Our ad on page 66. The Abacus Press.

HOMESITES \$400 — Convenient payments. California's finest garden section. On Morro Bay's scenic shores. Wonderful fishing, boating, bathing. Fertile soil, softest water, temperate climate, congenial community. Free literature. Richard Otto, Department M, San Luis Obispo, Calif.

FLORIDA—Beautiful retirement homesites near gulf coast. Excellent hunting, fishing in 9 fresh and salt water rivers. 11 bays and gulf. \$250 at \$10 monthly. Free literature. V. M. Mathews, Box 1406, Asheville, N. C.

NEW Strout catalog, just out! Mailed free! Farms, homes, businesses, 35 states, coast-to-coast, over 3,000 bargains described. World's largest! 55 years service. Strout Realty, 7-MP So. Dearborn St., Chicago 3, Ill.

FLORIDA. Nice homesites, \$245 at \$10 monthly. Folder free. Howard Vernor, DeLand, Florida.

MINERALS. Grazing, investment, retirement. Timber lands, 86 acre. Terms. Listings, information free. Write Armstrongs, Shook, Missouri.

PROFITABLE OCCUPATIONS

WHOLESALE Catalog! 30-40% discounts! Appliances, musical instruments, typewriters, phonographs, watches, jewelry, recorders, housewares, etc. Consolidated Distributors, 21-14 Lafayette, Paterson 13, New Jersey.

WELDING Pays big money. Learn easily at best equipped school in country. Non-profit school with low cost training, G.I. approved. Write Hobart Trade School, Box M-1032, Troy, Ohio.

MAKE Money writing short paragraphs! No tedious study. I tell you what to write, where and how to sell; and supply list of editors buying from beginners. Many small checks add up quickly. Write to sell, right away. Send for free facts. Benson Barrett, 1751 Morse, Dept. C-27-K, Chicago 26.

ANNOUNCING Home study course in commercial baking. Practical basic training. Good field for those with aptitude. Free booklet. "Opportunities in the Baking Industry." National Baking School, 635 Diversy Pkwy., Dept. 3437, Chicago 14.

JOBS To \$1500 monthly. All trades. So. America, The Islands, U.S. fare paid. Application forms. Free information. Write Dept. 76G, National, 1020 Broad, Newark, New Jersey.

INVESTIGATORS Wanted. Work furnished. Credit Correspondent Service, 517-M New York Bldg., St. Paul 1, Minn.

MUSHROOMS Grown boxes barrels. Manureless process 50c. Spawna \$1.00. Gordons, 533 William, Winnipeg, Manitoba.

WE Operate a successful television rental business by telephone from our home. Literature free. Alpha Television Rental, 1106 Clayton La., Austin, Texas.

MUSHROOM Spawna plus complete instructions various processes. \$1.00. Luxur, 641 S. 19th, Newark 3, N. J.

AUCTIONEERING—Home study course. Diploma granted. Auction School, Ft. Smith, Ark.

OVERSEAS, Latin American, Alaska, Canada employment. Originator 1955 "Foreign Service Directory" up-to-minute report on military and civilian construction; oil companies; aviation; transportation; steamship; mining; government job info. How-when-where to apply. Listing firms hiring. \$1.00. Global Reports, Box 883-F, Hollywood 28, Calif.

RAISE Pheasants on \$100 week plan. Little capital and space can make you independent. Free details. Great Central System, Columbus 1, Kansas.

FREE Fello "Up to \$45,000; Unlimited Vacations." No merchandise, equipment. Unknown! Work home, sparetime! Haylings, Carlsbad, Calif.

GROW Mushrooms. Cellar, shed, and outdoors. Spare, full time, year round. We pay \$3.50 lb. We paid Babbitt \$4,165 in few weeks. Free book. Washington Mushroom Ind., Dept. 99, 2954 Admiral Way, Seattle, Wash.

HOME Workers needed! Spare time, full time. Assemble luggage and cases with our complete illustrated step-by-step instructions. We sell your product—Supply everything. Manufacturing representative needed in your area immediately. Unlimited profits possible. Investigate at our risk. Free details. Cascraft, 807-G10 Sunset, Los Angeles 12, Calif.

FREE Book "505 Odd, Successful Businesses." Work home. Expect something odd! Pacific, Oceanside, Calif.

MAKE New greaseless doughnuts in kitchen. Sell stores. Free recipes. Michael Ray, 3605 South 15th Ave., Minneapolis 7, Minnesota.

BE The Popular Mechanics representative in your neighborhood and earn big profits in your spare time. Write Popular Mechanics Magazine, Room 408M, 200 E. Ontario St., Chicago, Ill.

CHICAGO Jobs newsletter. Customized. Details free. Bensen, 408 Mills, Joliet, Illinois.

EVERYBODY Likes candy. Learn to make professionally home. Our 45th year. Ragsdale Candies, D6, East Orange, New Jersey.

TYPISTS—Profitable home business. Complete copyrighted information. 50c. Gaunt, 827-A Irving, Chicago 13.

FOREIGN, Alaskan, U.S.A. Jobs! Latest copyrighted reports! Who to contact for highest paying jobs. To \$1500.00 monthly. Laborers, trades, truck drivers, equipment operators, helpers, apprentices, clerical, engineers. Over 52 countries—St. Lawrence project, Spain, Latin America, Europe, Asia. Year registration-advisory service. Application forms. Unconditional money-back guarantee of satisfaction. \$2.00. Airmailed \$2.25. (cod's accepted). International Reporter, Central Station, St. Louis 1-A, Missouri.

LOS Angeles help wanted classified Sunday edition airmailed \$1.00. Room 404, 1700 W. 8th St., Los Angeles 17, Calif.

MAKE Money at home mailing cards, circulars, featuring fast-selling merchandise. Everything furnished. Orders filled for you. The Wm. F. Liska Co., 103 Birchwood Ave., Cranford, N. J.

JOBS, Opportunities! Sunny, progressive Phoenix, Arizona. Complete local classified airmailed \$1. Alfano, Box 2664, Phoenix.

BUY Wholesale thousands nationally advertised products at big discount. Free "Wholesale Plan." American Buyers', Hertel Station, Buffalo 16-B1, N. Y.

\$10,800 PROFITS! Your own mailorder business! No risk! Success plan free! Treasury, 709 Webster, New Rochelle L-31, N. Y.

CONFIDENTIAL Reports on best paying jobs with travel, adventure and top pay. Construction, aviation, shipping, laborers, clerical, trades, unusual opportunities, all types of work. Foreign and U.S. Only \$2.00, including year advisory service. (\$2.25 airmail.) Guaranteed best service of this type available or double your money back. Research Services, Box 2904-FMB, St. Louis 17, Missouri.

CIVIL Service jobs—Mechanical, clerical, professional. Opportunities galore. U.S.A.; overseas. List, 30c. Job Guidance, 1714 Ocean Parkway, Brooklyn 23, N. Y.

MAGAZINE Subscriptions. Highest commissions. Bonus. Qualified Publications, 451CT Kingston, Brooklyn 25, N. Y.

MAKE Money with your typewriter! Barnett, 4033-T Verona, Cleveland 21, Ohio.

JOB Opportunities in booming southwest! Send \$1 for classified listings of jobs open in high paying industries. Southern Business Agency, 4717 Gulf Freeway, Houston, Texas.

\$1300.00 MONTHLY For truck drivers. \$1400.00 monthly for carpenters, electricians, plumbers, mechanics. \$1200.00 for clerks and laborers. Full information and complete foreign listings, with current information on Spain, Korea, Australia, Alaska and Canada, \$1.00. Current information on state-side projects, \$1.00. Dept. 3-J, Opportunities Unlimited, 1110 Commerce Bldg., St. Paul, Minn.

CHOICE Jobs, all types, to \$1,500 monthly. Information free. Write, Jackson, Newfoundland, Kentucky.

OPPORTUNITIES. Current job listings Miami, New York, any major city rushed to you—\$1.00. Apartment listings 25c extra. Cambrie, 3318 82nd St., Jackson Heights, New York.

BOOKS, PERIODICALS, PICTURES, POSTCARDS

WILL Find and furnish books wanted, old, rare, or new. Occidental Bookfinders, 7962 Princess Street, La Jolla, California.

HAWAII, Scenic, colorful. Eight postcards, \$1.00. Stu, 306 - 7th, Honolulu 18, T.H.

PICTURE Post cards, made from your photograph. 1000, \$11.00. Raum's, 4154 Fifth Street, Philadelphia 40.

MEDICAL Books, all subjects. Special offer to laymen. Reduced prices. Write for free list. Milbon Medical Book Co., 6643 Newgard, Chicago 26, Ill.

GIFT Bibles, Protestant, Catholic. Testaments, religious library, Bible stories, Bible on records, children's books, home medical, 100 others. Free lists. Florence Moody, Farmington, Maine.

SPARETIME Profits taking subscriptions all magazines. Wholesale catalog free. Cassell Publishers, Westfield, New Jersey.

NATIONAL Geographic Magazines, 1888-1932. Periodical Service, Box 465-PM, Wilmington, Delaware.

BOOKS, Government surplus. Bargain prices. Free catalog listing 30 other free catalogs. Instructional, educational, vocational subjects. Millions of volumes, new and used. Books bought. Est. 1902. Long's College Book Co., Dept. PM, Columbus 1, Ohio.

BOOKS Found! Any author, old or new. Rush titles wanted; no obligation. International Bookfinders, Box 3003-PM, Beverly Hills, California.

BOOKFINDERS! All subjects. Send wants! Jaher Book Service, 183 Hazelwood Drive, Westbury, N. Y.

ATOM Bombed Nagasaki, Japan, 12 photos \$1.00. Makins Pictures, Box 609, Bremerton, Wash.

"SCIENCE Milestones." Records march of science starting 400 years before Christ, right up to date. Amazing facts revealed. 312 pages packed with startling information that will thrill you. A real history of science. \$5.00. Literature free. Popular Mechanics Press, 300-5M East Ontario St., Chicago 11, Ill.

"FEMALE Figure Drawing." Illustrations galore. For serious students. Only \$2.00. Southern Book Co., Box 325, Edgefield, S. C.

BOOK Catalog, 1000 interesting titles. Send 10c. Books Publishing Co., Amityville 3, N. Y.

POCKET Novel books, 8 for \$1.00. Mixed selection. George's, Lombard and Central, Baltimore 2.

GAMES, TOYS, NOVELTIES

TRAIN, Erector, chemistry sets. Free literature. Lynch, 402-PM Hazlett, Baltimore 29.

LARGE Box beautiful assorted toys. \$6.00 value \$2.00. Toyland, 5139 North Clark St., Chicago 40, Illinois.

100 PLASTIC Toy soldiers \$1.25 postpaid. Kiddies love them. Adams Company, Heafford Junction, Wisconsin.

MAGIC TRICKS, PUZZLES, JOKER NOVELTIES

"MAGIC Double Eyes." "Mysterious Marie." Dime each. Mandel, 1200 Avenue H, Brooklyn, New York.

LEARN Ventriloquism for TV fun and fortune. Simplified complete course. Send \$2.98. Omnibus, 656 Clinton Ave., Newark, New Jersey.

MAGIC Trial lessons free. Write today! Magic School, Sparta 9, Michigan.

FREE Deck trick cards with catalog 50c. 1746-PM Market, Philadelphia 3.

EARN Money as a magician; fine hobby. Large professional catalog \$1.25. Holden's, 120 Boylston Street, Boston, Mass.

VENTRELLO. Professional voice-throwing instrument and catalog 25c. Box 971-PM, Philadelphia 5.

BEST Magic, Joker's novelties. Lower prices. Catalog 10c. Top Hat, Evanston 12, Ill.

DOLLAR Magic set free with catalog 25c. 4462-PM Germantown, Philadelphia.

WOODEN Nickel, catalog, trick, 10c. Magic. 1,500,399 tricks and jokes, Box 1375, San Antonio 6, Texas.

3100 NOVELTIES. Tricks, jokes, gadgets, funmakers, hobbies. Catalog 10c. Johnson-Smith, D101, Detroit 7.

SENSATIONAL Magician's wand 25c. Vanishes handkerchief! Catalog included. Box 1352-PM, Philadelphia 5.

500 TRICKS, Douglas famous catalog, 10c. Fastest magic service for 30 years. Douglas Magician, Dept. 1, Dallas, Texas.

COMPLETELY Illustrated 72 page magic catalog 25c. Stowell, Woodstock, New York.

LEARN Ventriloquism. Details without obligations. Harry Harmon, Box 33, Mint Spring, Va.

SMOKEBOMBS 25c. 7 For \$1.00. Terrific! 4463-PM Greene, Philadelphia 44.

FOR The best—Magic, jokes, and novelties. Send 50c for special offer (new big catalogue and mysterious \$1.00 trick). Universal Magic and Novelty Company, 824 South Michigan Street, South Bend 18, Indiana.

FRANKENSTEIN Mask (rubber) \$1.00. Gigantic feet \$1.00. 1746-PM Market, Philadelphia 3.

COINS, TOKENS, CURRENCY

FOREIGN Coins. 15 different uncirculated \$1.00. Lauren Benson, 2526A Middle Road, Davenport, Iowa.

7 COINS Of India (British) \$1.00. Joel Tillberg, Proctor 4, Vermont.

6-IN-1 Special: Magnifying glass; check list; 25 coin envelopes; giant 60 page bargain catalog; ten different Indian pennies; Mexican ten-peso; All six, \$1.00 postpaid. Ben's Coin Shop, 31 North Clark, Chicago 2, Illinois.

U. S. Large cent, 2c piece and bargain list, only \$1. Delmaco, Box 1123, Wilmington, Del.

FREE! Foreign coin, banknote and coin collectors illustrated catalog to approval service applicants. Send 3c postage. Tatham Coinco, Springfield 30, Mass.

MOROCCAN Dollars; 1878, 1887, 1890, 1891, 1897 8 mint unc. \$2.00 ea. Illustrated catalogue, 25c. Shultz, Salt Lake 10, Utah.

GET Profit and pleasure in collecting old coins. Send 10c for 56-page illustrated coin catalog. You'll be delighted with it. Send for it now. B. Max Mehl, 370 Mehl Building, Fort Worth, Texas. Largest rare coin establishment in U. S. Established 55 years.

COIN Collector's Magazine. Over 1000 pages per year. Sample copy 30c; \$3.00 per year. Hewitt, 7326-J Milwaukee, Chicago 31.

INDIAN Cent with bargain lists 10c. Hutchinson, 3463 "I" Street, Philadelphia 34, Penna.

WORLD'S Greatest magazine for coin collectors and wooden nickel 10c. Lawrence Brothers, Anamosa, Iowa.

OLD Money wanted. Will pay fifty dollars for nickel of 1913 with Liberty head (no buffalo). We pay cash premiums for all rare coins. Send 4c for large coin folder. May mean much profit to you. Numismatic Co. Dept. 20, Fort Worth, Texas.

COMPLETELY New Fell's 1955 U.S. coin book. Lists, evaluates every coin ever minted. How many of your coins are worth money—do you know? Over 150 illustrations. Chapters on profits in buying and selling, speculation, investment, etc. Clothbound. Send no money. Pay postman \$2 (plus postage) or send \$2 (postpaid). Refundable. Fell Publishers, 386 M-12 4th Ave., New York City 18.

101 DIFFERENT Foreign bills—\$1.00 postpaid. Dwight Musser, Dunbar, West Virginia.

TWENTY Different Indian cents \$1.00. Sayers, 1000 East Unaka, Johnson City, Tennessee.

FOREIGN Coins, 35 different \$1.00, 100 different \$4.00. Claud Denney, 3406 S. Harwood, Dallas 15, Texas.

FREE U. S. coin list. Stone's Coin Store, 192 Washington, Boston 8, Mass.

40 COINS, \$1.00. 100 Bills, \$1.00, 66 coins and bills, \$1.00. Oddehon, Box 482, St. Louis, Mo.

FOREIGN Coins, 10 diff. 25c. Foreign bills, 20 diff. 25c. Lists. Oliver Arnold, Macon, Mo.

50,000 COINS, Medals, bills. Lists free. Collectors magazine 10c. Nagy, 8-P South 18th, Philadelphia 3, Penna.

1955 PROOF Set in plastic holder \$3.50. Giant bargain catalogue 35c. Retail guidebook \$1.75, premium handbook \$1.00. Beber's, 4514 No. 30th, Omaha 11, Nebr.

SOMALIA, Morocco, Chile, Spain, Mexico coins—All 10c. Jolie, Box 19C, Brooklyn 3, N. Y.

FIFTY 2x2 Coin envelopes, six page bargain lists, 10c. Whitman coin folders, all types, any amount, 25 cents each, postpaid. Economy Sales, 157 Dean, Mansfield, Mass.

STAMP COLLECTING

"BIG Indian" airmails (Guatemala), king-size, engraved, flown set of four, plus Japan's historic "Pearl Harbor Attack" complete mint set—All for 25c! Exciting beauty for your collection. Send quarter today. Handsome approvals too. Burt, 324-S Pauline, Memphis 4, Tenn.

PICTORIAL Mixture. \$8.00 catalog value, only \$1.00. Amazing bargain for dealer or collector. Guaranteed. George Cochran, 1383 Hillcrest, Akron 7, Ohio.

FREE—Scarce Alenstein! Tru-Val-U approvals. Brunning, Donaldson St., Ruthersford, N. J.

GERMAN Peace dove set free. Approvals. George Richie, 1539 Sixth, Alameda, Calif.

75 DIFFERENT United States commemoratives, 50c. Solomons, Box 22-MO, Cambria Heights 11, New York.

ITALY—100 Different including many large pictorial stamps, 19c with approvals. DeRespinis, G.P.O. Box 771T, New York 1, New York.

FREE: Giant illustrated catalogue 1,000 different packets. Crazy bargains. Send 10c postage. Approvals. Cut Rate, Blue Springs 8, Missouri.

PREPAID To you! Albums and accessories. Lists and bonus offers free. Delaney, 44 Bromfield, Boston 8, Mass.

NICE Used \$2 Harding and \$5 Coolidge only \$1.00 postpaid; Quality approvals. Hutten, Box 2611, Colorado Springs, Colo.

LOOK—100 Different large U. S. commemoratives, one dollar. Package hinges free with order. Langfords, 53 Durham Rd., San Anselmo, Calif.

PETER Pan stamps—Gorgeous complete mint set (bicolored), plus genuine flown Arabian airmail stamp, all 10c. Approvals. Decker, 7801 Nall, Prairie Village 15, Kansas.

SAUDI-Arabia plus 25 different French colonies 10c with approvals. Adlex, 367-M Park Ave., Newark 7, New Jersey.

BALLOON Stamp (mint), plus packet of pretty pictorials, all free with handsome approvals. Lindeman, 348 Primrose, Syracuse 5, New York.

1500 STAMPS \$1.00. Good variety on and off paper. Worldwide. Many pictorials. No approvals follow. Satisfaction guaranteed. Whalen, 1435 First Ave., Oakland, Calif.

U. S. Used different commemoratives: 100, \$1.00; 150, \$1.55; 200, \$2.75; 250, \$5.95. Regular issues: 100, 70c; 200, \$1.85. Walter Ure, 2926 Stewart, Kansas City 4, Kansas.

50 DIFFERENT Netherlands pictorials. Cat. over \$2.00. 25c with approvals. Valley Stamp Co., Stephens City, Va.

25 DIFFERENT Luxembourg, 10 cents. Approvals. Waha Company, 178 No. 17th Street, East Orange, N. J.

FREE Stamps! With bargain approvals. Rejd, Box 42, Houtzdale, Pennsylvania.

ROOSEVELTS, San Marino—Set 10c; approvals. Bala Stamps, Bala-Cynwyd, Pennsylvania.

FIRST U. N. set. Among world's prettiest. Only 10c. Approvals. Welles, Box 1246-R, New York City 8.

300 DIFFERENT Given free with approvals. Particulars. Windsor Stamps, 8334 Cornell Ave., Chicago 17.

FREE! Catalog! About stamps. Illustrated. Free! The Stampmart, Hartford 1, Connecticut.

FREE U. S. catalogue. Contains almost 1,000 illustrations; over 10,000 delightful bargains. Stone's, 192 Washington, Boston 8, Massachusetts.

HAWAII 5 Different 20c with U. S. approvals. Stamp Shop, 719 Pierce, Sioux City, Iowa.

FREE U. S. lists. (Wholesale or below.) Schad, 3127 Avalon, Palo Alto, Calif.

126 DIFFERENT. Includes triangle, diamond, airmails, old United States, British Colonies, animals, others; 10c with approvals. Cactus Stamps, Desert Springs 30, California.

UNITED STATES—58 different including 8 airmails, 15 commemoratives, 10c. Approvals. Sunset, Box 47, South Gate, Calif.

MORE Stamps for less money. Exciting approvals. Mor-4-Less, Norwalk 9, Calif.

UNBEATABLE! Ten complete mint sets only 5c. Mailed with United Nations stamps. Approvals. Sunlite, Box 1259-Z, New York City 17.

FREE: Mint British Colonies from Brunei, Papua, New Guinea, Caymans, Gilbert Ellice, Seychelles, Sarawak, Grenada. Free with approvals. Viking, Great Neck 8, N. Y.

SPECIAL 1000 Different stamps \$1.00. Thom, 4808 - 15th Avenue, Minneapolis 17, Minnesota.

COLORFUL Triangles free! Approvals too. Gernert, 4233-B Alton, Louisville 7, Kentucky.

AMERICAN Stamps! Coins! Extensively! Sullivan, 127-F East 4th, St. Paul 1, Minn.

FABULOUS Collection—Large U. S. commemoratives. Only 10c. Approvals. Raymax, 39-Z Maiden Lane, New York City 38.

300 DIFF. 5c With approvals. Gray, Box 708, Hollywood 28, California.

312 MIXED U. S. only 10c to "Gold Nugget Approval" applicants! Nothing like them. Kessel's, Box 6116, Tucson, Arizona.

135 DIFFERENT U. S. commemoratives \$1. Request approvals. Harold Holub, 18 East 198th Street, New York 68, N. Y.

CANADA. 1954 Issues, queens, wildlife, commemoratives, 11 var., only 20c with attractive approvals. Rheasme, 6591 11th Ave., Montreal 36, Canada.

FREE United States illustrated catalog. Bailey, 44 Bromfield, Boston, Mass.

FREE U. S. \$1.00 presidential, German peace issue. Bala Stamps, Bala-Cynwyd, Pennsylvania.

1000 DIFFERENT 50c. Approvals. Ouellette, Box 666M—Flint, Fall River, Mass.

EGYPT. 25 Different 10. Free set. Bellet Stamps, Hazel Park, Mich.

325 DIFFERENT Worldwide collection, includes everything. Airmail, complete sets, triangles, bi-colors, birds, flowers, animals. Everything (catalogs over \$5.00) 25c to approval applicants. Century Stamps, Box 1090-P, Palm Springs, Calif.

BARGAIN Grabbag 40 cts. Big lot with sets, blocks, free gift \$1. Extra special \$2. Giant assortment \$3. Persil, 436 N. Y. Ave., Brooklyn 25, N. Y.

IMPOSSIBLE! 20 Different U. S. commemoratives plus 4 foreign sets 10c, approvals. Complete flags free through bonus-plan. Geber, 900 Sweetzer, Los Angeles 46.

MONACO Transportation triangles; helicopters, ships, 1001 different pictorial commemoratives given approval buyers. William Deem, Ravenswood, West Virginia.

333 DIFFERENT Pictorials featuring British, French Colonies, airs, charities, large popes, Monaco princes, Netherlands admirals, Asia, Africa, plus hundreds more. 25c with approvals at 1/2 catalog. Serious adults only. Kingsway Stamps, Dept. 92, Fulton, Maryland.

BARGAINS! Choose the stamps you want from our worldwide approval books. Big discounts. Conquistador, 2627L Troy Road, Schenectady 9, N. Y.

TONGA, Bicolored, unused, 5 different, 15c. Low priced attractive approvals, lists accompany. Sav-On Stamps, Box 5118G, Long Beach 5, Calif.

ICELAND. 25 All different hard to get items to sincere approval applicants for only 50c. No dealers please! William Penn Stamp Co., P.O. Box 303, Philadelphia 5, Penna.

CANADIAN Wildlife stamps; beaver, moose, bighorn sheep, walrus, bear, 10c with approvals. Richardson Stamps, Niagara-on-the-Lake 23, Canada.

FREE! Big illustrated catalog! Send today! Stamps By Mail, 2133 Lunt, Chicago 45.

ASTONISHING Gift—40 U.S. with super approvals. Send 5c for postage. Sparta, Box 1083, Rochester 3, N. Y.

50 COUNTRIES! 300 Different from 50 countries, 20 cents to approval applicants. Quality Stamps, 178 Sweet, Buffalo 12, New York.

LUCKY? Gambler collection 25c. Merkel Stamps, 45 Cherry, Holyoke, Mass.

PRICE List, foreign and U.S. No approvals. Stamps, 5000 Miami, St. Louis 9, Mo.

SUPER Grabbags. U.S. or foreign, 10c. Monjar, Fairmount, Cincinnati 14, Ohio.

CIPEX Souvenir sheet plus 25 different U.S. 10c. Approvals accompany. Village Stamps, 90-39 214 St., Queens Village 28, N. Y.

225 DIFFERENT 10c. Approvals. Hay, 33-51 73 Street, Jackson Hgts. N. Y.

1000 MIXED United States. Guarantee 140 different stamps. \$1.10. Quaintance, Box 178F, Upper Sandusky, Ohio.

COMPLETE Those pages. We have large collections from which to choose stamps at 2c each. Just what you need. Values ignored. Also U.S. Clark Stamp Co., Dept. A-47, Muskegon Heights, Mich.

FREE—Valuable U.S.A.! (1) Scarce genuine stamp picturing first U.S.A., issued in 1847! (2) Big collection 30 all-different U.S.; ancient 19th century, valuable 85 stamp, etc. (3) Packet gorgeous commemoratives. (4) Large illustrated U.S. catalog; 64-page, four-color Collectors' Guide; other unusual offers. Everything for only 10c covering mailing costs! Harrisco, 1061 Transit Bldg., Boston 17, Mass.

GIGANTIC Collection free. Includes triangles, early United States, animals, commemoratives, British Colonies, high value pictorials, etc. Complete collection plus big illustrated magazine all free. Send 5c for postage. Gray Stamp Company, Dept. PM, Toronto, Canada.

FREE Lists general foreign sets, singles and packets. No approvals. Snooks, Box 1715, St. Louis 2, Mo.

CORONATIONS, Triangles, animals, sports, free with approvals. Exotic, Box 482, Coral Gables 34, Fla.

36 DIFF. U.S. commemoratives 5c approvals. Hudson's, Box 4015, Fresno 44, Calif.

SPACEPHOBIA? Fill your pages from our 1c-2c books of 1000. BKL Company, Box 324, Astor Sta., Boston 23, Mass.

DIFFERENT, 500, 50c; 1000, \$1.25; 2000, \$3.00; 5000, \$11.00. Clearing approvals wholesale. K. S. Holmes, London, Canada.

HOUSE Alterations cause free stamps. Write Sophus Jensen, Coupeville, Wash.

SIX Fascinating travel triangles 10c; attractive approvals accompany. Quality Stamps, 15-14 Ellis Ave., Fairlawn, New Jersey.

20 JAPAN Free, with approvals by country. Goble Approvals, 931 Emwell, Ferndale 20, Mich.

CANADA Totem pole 10c with bargain approvals. Wilson's, Grand Haven, Mich.

50 DIFFERENT Big pictorials 10c. Scott, 2653 Midwood, Toledo, Ohio.

200 DIFFERENT, including Roosevelt triangle, 10c to approval applicants. M. Avalon Stamp Company, Springfield, Mass.

TOPS! Free book, "How to Collect Stamps." Send for your copy today! Approvals, Littleton Stamp Co., Littleton E1, N. H.

WANT More for your dollar? Try our large books of low priced attractive approvals including U.S. Also premium card for free stamps. Roseland Stamp Co., Dept. A-37, Spring Lake, Mich.

FREE Complete set of famous Americans, flags, parks and presidentials to approval buyers. Send 5c for 15 of the above stamps plus full particulars. Triboro Stamp Company, 145 Nassau Street, Dept. 110, New York 38, N. Y.

1000 BEAUTIFUL Mounted stamps for you to look over. Pick and choose at 1c to 5c each! Wolverine Stamp Service, Dept. A-25, Fruitport, Mich.

FREE Stamp magazine, 327 different stamps 25c. Including Indonesia, Newfoundland, British Colonies, Vatican, Red Russia, Hitler heads, Indian states, animals, airmails, French Colonies, rarities, unusuals. Wonderful bargain. Approvals, Niagara Stamp Co., St. Catharines 21, Ontario.

FREE! Large new profusely illustrated catalog of United States postage issues complete; 64-page, four-color Stamp Collectors' Guide; other unusual offers. Write today! Harrisco, 1053 Transit Bldg., Boston 17, Mass.

CANADA—10 Different Queen Elizabeth free with approvals. Lee Hoover, Box 3594, Portland, Oregon.

WONDERFUL Offer. 7 complete mint sets only 10c with approvals. Reich (M26), 1033 Lawrence, Chicago 40.

LOOK! Ten triangles and over 50 different, 10c with approvals. Bennett, Candor 3, N. Y.

50 DIFFERENT India 10c with low priced approvals. Seco, Box 131, Flushing 55, N. Y.

OVER 200 Different better stamps. Beautiful triangle set, pictorials, 10c. Approvals, Greene, 4301 46th Street, Long Island City 4, N. Y.

LUXEMBOURG 25 Different 5c. Approvals, Neal, 3950 Tower, Riverside, Calif.

TREMENDOUS Accumulation, unusual, scarce collections, odd lots, mixtures, packets. Closing out cheap. List free. Alstelo, Maynard, Massachusetts.

QUEEN Elizabeth triangles, only 10c, with approvals. Variety Stamps, 57-T Circuit, Newton Highlands 61, Mass.

SUPERIOR Worldwide mission mixture. Amazing variety! Half pound \$1.50. Baye Nielsen, 4545B Harvard, Montreal 28, Can.

\$150,000 CHINESE Set plus gigantic catalog 10c. No approvals. Martin Band, 154-P Nassau, New York City 30.

WASHINGTON Bicentennial set, used, complete only 15c to applicants for our medium priced United States and Canada approvals. NACO, 682 Pearl, Benton Harbor, Michigan.

FAROUC, 27 Different Egypt 10c with approvals. Excello, Box 489, Red Bank, New Jersey.

FREE U.S. plate block list. Simstaco, Box 63, Mattapan 26, Mass.

CANADA Plate blocks, \$1.00. J. Soberman, Box 91, Station K, Toronto, Canada.

100 FOREIGN, 20 U.S. commemoratives, 10c. Approvals, Weckerling, Box 442L, La Feria, Texas.

25 ITALY Commemoratives 25c with approvals. Spicka, 4032 Jaynes, Omaha 11, Nebraska.

MONACO Nudes 10c with approvals. Royal Stamp Company, Tamaqua, Penna.

DUCK Stamp—U. S., 25c with approvals. Jester Stamp Co., Milford, Delaware.

U.S. Commemoratives, 100 mixed 25c. Ray Worth, 321 So. Cicero, Chicago 44.

U.S. 55 Coolidge—25c. Approvals, Gatewood, Box 346, Winston-Salem, N. C.

1000 DIFFERENT 95c. John Hourigan, 1500 Archer Road, New York 62, New York.

25 COMMEMORATIVES, 25 Colonies, 25c with approvals. Rosner, 1542 South Kil-dare Ave., Chicago 23, Illinois.

FREE Surprise packet! Send 10c for approvals, all kinds. The O & P Company, Box 618, Lexington, Ky.

200 DIFFERENT including Macau, Rhodesia, Mauritius, 10c to approval applicants. Eviden, Box 128, Valley Stream 50, New York.

POPULAR German airmails. Two complete sets. Ten cents, with new approvals. Boger, 3401 Oakmont, Philadelphia 36, Penna.

99 LATIN American stamps, many pictorials, airm. 10c. Approvals included. Fred Pittsley, South Montgomery, Napa, Calif.

301 DIFFERENT, Plus colorful British Dominion packet only 25c. Pictorial approvals. Free list. Firland Stamp Co., Box 493, Seattle 11, Washington.

PHILIPPINES — 20 Different free with adult 2c approvals. Moffat's, 740 Milton, Rock Hill 15, South Carolina.

50 STAMPS Free with lagniappe approvals. Guyton, Box 1275, Monroe, Louisiana.

U.S. Mint complete sets specially priced! Flags #909-21, \$1.00; famous Americans #839-93, \$7.25; national parks, perforated, #740-49, \$1.50; imperforated, #756-63, \$1.75. Free price list. Brooks, 2352P East 23rd Street, Brooklyn 29, New York.

FREE Triangles, 6 mint Monaco, 10c handling. Approvals. Bruce Stamp Co., 64-46B 114th St., Bayside 64, New York.

EXCITING "Strange countries" packet. Free with approvals! Saxon, Vista, Calif.

FREE—25 Diff. India with approvals. Scheerer, Box 301, Pottsville, Penna.

OLD Stamps wanted. I will pay \$100.00 each for 1924 1c green Franklin stamps, rotary perforated eleven (up to \$1000.00 each unused). Send 10c for large illustrated folders showing amazing prices paid for old stamps and coins. Baker-Stamps, (PM-510), 50 Berkshire, Rockville Centre, New York.

WANTED—Stamp collections, accumulations. Murray Gold, 62-95P Saunders, Rego Park 74, N. Y.

PENNY Approvals; thousands of bargains for pennies. Stamps, Orange, Calif.

50 DIFFERENT Bulgaria 10c! Approvals. Ensign Stamp Company, Dept. M, Berdan Avenue, Paterson 2, New Jersey.

TREMENDOUS Offer! 15 beautiful foreign sets, complete, 10c. Approvals. Farmer, 6919 Camrose, Los Angeles 28.

U.S. Mint 797 SPA sheet, 10c to U.S. approval applicants. D. Kelly, 153M 74th St., Brooklyn 9, N. Y.

FREE Packet of triangles. Approvals. William Hicks, 57 McLean, Wilkes-Barre, Penna.

ILLUSTRATED Album, hinges, gauge, detector, fifty stamps, two sets, \$1 Chile stamp, all 10c. Approvals. Cornett, 228 West 25th, New York City 1.

FREE! U. S. price catalogue (illustrated). New-Way Stamp Co., Lawrence, Mass.

FREE Gifts! Fabulous prizes! Astounding offers! Adventure Studio, Buckland, Connecticut.

HATTI, Hurricane Hazel helicopter set, 25c with approvals. Seminole Stamps, Box 1138-P, Coral Gables 34, Florida.

FREE U.S. Illustrated bargain catalogue. Rothberg's, Box 60, Boston 1, Mass.

NUDE, Pioneer, animals packet—10c with approvals! Atlas, Eisenhower, Racine, Wisconsin.

QUEEN Elizabeth miniature collection! Six different colonial sets—21 handsome mint bicolours 25c. Approvals. Gannon Stamps, Box 931, Canton 1, Ohio.

U.S. 40 Different 10c, 40 different commemoratives 20c. Both 25c. Bargain lists. No approvals. Seidenberg, Appleton, Wis.

THOUSANDS Of exciting stamps, all different, yours for 1c, 2c each. Fill your album for pennies! Big collection sent for free examination. Cole, 43-A Rinewalt, Buffalo 21, N. Y.

100 JAPAN 10c. All different, with approvals. Gould's Stamps, Box 631, San Francisco 1, California.

50 DIFFERENT United States 5c with bargain approvals, lists. Bookman, Box 8245-M, Madeira Beach, Fla.

U. S. Classics. Over 50 yrs. old. 15 selected old-timers. Missing in biggest collections. All 15 at less than 1c each. 10c with approvals. Jaro, Box 246-T, New York City 8.

WOW! 153 All different Germany 10c. Zeppelins, semi-postals, airmails, high values. Big bargain lists and approvals included. Jamestown Stamp, Dept. 512, Jamestown, N. Y.

FREE United States price list. Mark Hanna, 335 Fifth Ave., Pittsburgh 22, Penna.

FREE! Giant catalog. Offering thousands of bargains. Sent with beautiful approvals. Jamestown Stamp Co., Jamestown 612, N. Y.

FREE Animals, birds, triangles, flowers, ships, locomotives, kings, dictators, multi-colored, historical, geographical, musical, battles, giants, midgets and over 100 others. Fascinating story approvals. Send 10c handling, please. Lincoln Stamp Co., St. Catharines 318, Ontario.

FREE! Flower triangles, others. Approvals. Delton Page, Box 201X, East Paterson, New Jersey.

50 DIFF. U. S. commemoratives 25c. Mammoth packet list free. Econopackets, Box 168, Riverside 9, Calif.

STAMPS Wanted. Mint and used, collections, accumulations. Good grades only. Buy outright if bargain. What have you? Write, give details. Vanroy Shirk, Lebanon, Penna.

FREE 105 British Colonials, pictorials, Mauritius, Tanganyika, Pakistan, Nigeria, Rhodesia, Singapore. Fascinating story approvals. Send 10c handling, please. Lincoln Stamp Co., St. Catharines 218, Ontario.

50 DIFFERENT Argentine 10c. Approvals, Reuter, 611 W. 40th Pl., Los Angeles 37.

EXCITING New book, "How to Collect Stamps, Coins, Paper Money." Packed with amazing facts; information worth dollars. Fully illustrated, 160 pages. 75c. Popular Mechanics Press, 200-ST E. Ontario St., Chicago 11, Ill.

100 DIFFERENT Spain 25c. Penny approvals included. Reed, Box 980, Chicago 90, Ill.

OLD Scarce U.S. seconds on approvals. Slight imperfections, lowest prices. Herfield, Clintonhill Sta., Newark 8, N. J.

SPEND Pennies! Not dollars! Thousands of fascinating stamps to choose from our 1c and 2c approvals. No premiums. Just honest value. Pat F. Knowles, Box 2247, Van Nuys, Calif.

AMAZING Offer! 200 United States stamps—including commemoratives, airmails, high denominations to \$1.00. Only 15c to approval applicants! Illustrated bargain lists free. Mystic Stamp Co., Dept. 80, Camden, New York.

FREE Sample! Interesting, illustrated, informative! National Stamp News, Anderson, South Carolina.

SELL Stamps to our readers. Your ad in this space will be read by thousands of stamp buyers. I'll prove that to you. Write now for Folder "S." P. W. Johnson, Classified Advertising Manager, Popular Mechanics, 200 E. Ontario St., Chicago 11, Ill.

50,000 STAMP Grabbags 25c each. Anderson, Box 1, Reading, Penna.

300 DIFF. World wide 25c, plus surprise packet. Packet list free. Econopackets, Box 168, Riverside 9, Calif.

BARGAIN Hunters attention! Free stamp magazine, 1000 interesting stamps for your approval inspection. Completely catalogued, substantially reduced. Free toongs and hinges with purchase. Niagara Stamp Co., St. Catharines 31, Ontario.

WORLD'S Largest stamp (7½ x 14 inches). A real curiosity! Retail for 50c, only 3c to approval applicants. Tatham Stamp Co., Springfield 30, Mass.

WEIRD Diamond shape coffee stamp! Lovely flower triangle! First American big commemorative, Greenland, idol dancer, etc. Free with approvals. Capital Stamp Co., Little Rock 2, Ark.

100 OLD United States between 1861 and 1935, \$1.00. Roush Stamps, 51 Chestnut, Mansfield, Ohio.

TWO \$5.00 U. S. stamps plus 20 different, 10c with U. S. approvals. Irwin Stamp Co., Box 1105, Brooklyn 30, N. Y.

ECONOMICAL ½c-1c-2c-Approvals, 22,000 varieties available. Dressel, Box 270-n, New York 25, N. Y.

225 STAMPS For only 10c! This mammoth value includes airmails, pictorials; stamps from strange countries catalogued up to 25c each! Also approvals. Mystic Stamp Company, Camden 80, New York.

TRIANGLES. Birds, butterflies, flowers—Big packet 10c with approvals. Southwest Stamps, Box 117, Long Beach 1, Calif.

GERMAN Colonies—10 different 25c. Approvals. Sr-Jr Stamp Company, Box 141, Tulsa, Oklahoma.

12,000 PENNY Approvals waiting for you. Many from exotic countries, pictorials, airmails, new issues. Tilbury, Box 862, Newark 1, N. J.

FAMOUS Men, jungle scenes, zoo. United States commemoratives, 100 others. Ten cents with request for thrifty approvals. Casner Stamps, 347-A Riverside, El Paso, Texas.

FINE Approvals. Fast, personal service. What countries do you prefer? I'll send their stamps. Skinner, 438 Locust, Long Beach 12, California.

30,000 DIFFERENT Collector's stamps from all parts of the world for less than 1½c each! Send \$12.50 for each book of 1,000 stamps as often as you want. J. Huppert, 1970 E. 18th St., Brooklyn 29, N. Y.

1000 DIFFERENT Worldwide stamps \$1.00. Universal, P.O. Box 6, Kenosha, Wisconsin.

14,000 DIFFERENT—Yours on our streamlined systematic club plan for only 50c weekly. Big shipment every two weeks. Details free. Sjoquist, Box 217, Valley Stream 75, New York.

MINT Commemoratives at face! Send 25c for surprise packet of all different, mint U.S. commemoratives. Mint U.S. approvals too. Western, Box 1689P, Salinas, California.

I want to send you proof of the wonderful pulling power of Popular Mechanics classified pages. What's your proposition? Write me today. Include literature if possible. P. W. Johnson, Manager Classified Advertising, Popular Mechanics Magazine, 200 E. Ontario St., Chicago 11, Ill.

800 MIXED U.S., old, new, 25c. Lists. Weatherby, Fort Myers, Fla.

GIANT Approvals. Thousands different at 1 and 2c each. Wahl's Stamp Exchange, 705P Farragut, Chicago 31, Ill.

ZEPPELIN Set plus 24 planes, airmails 10c. Approvals. Casto, Box 357, Dunbar, West Virginia.

41 BEAUTIFUL Austrian landscapes, costumes, only 25c with finest approvals. Henry Faville, 1104 Garfield, Madison 5, Wis.

AIRMAILS! 25 Different Latin Americans—10c with approvals. Riedell, Greensburg, Penna.

SEVEN Mint fascinating Pacific Islands, Papua, Tokelau, Samoa, etc. Approvals. 10c. Roy Farr, 88 Maple, Hamilton, Canada.

ESTONIA Carrier pigeon set free. Approvals. Canyon Stamps, Box 808, San Fernando, California.

BRITISH Colonial collection—Hivalues, commemoratives, topicals. Free to approval buyers. Pleasure Stamps, 1865A—32nd, Brooklyn 4, New York.

FABULOUS United States commemorative collection—31 different 15c. Approvals. White, 516-A Avenue L, Brooklyn 30, New York.

100 DIFFERENT U.S. 25c. Approvals. Taylor, Box 61, Belvidere, N. J.

TWENTY-Five foreign stamps one dime with approvals. Buffalo Philatelic Agency, Box 83, Buffalo 15, N. Y.

FREE C34-6 used U.S. airmails with approvals. North Andover Stamp, North Andover 1, Mass.

43 DIFFERENT Armenia in complete mint pictorial sets. 25c. Approvals. Aronson, 91 Marion, Brookline 46, Mass.

INSTRUCTIVE Book on stamp collecting plus 50 different foreign stamps only 10c with approvals. Pot-O'-Gold, Litchfield, Conn.

ANTIQUES, RELICS, INDIAN GOODS, CURIOS

PREHISTORIC Fossilized leaves. Two specimens \$1.00. Box 3044, Birmingham 6, Ala.

SIX Arrowheads or bone bead \$1.00. Charles Palmer, 435 Washington Road, McKeesport, Penna.

GESUNDHEIT! Illinois. Selling 580 historical firearms, 30,000 prehistoric, stoneage Indian relics, collectors cartridges, Confederate money, coins, Revolutionary, Civil, Indian wars flintlocks, muskatoons, swords, bayonets, bullet molds, powder flasks, blunderbusses, pepperboxes, Kentucky rifles, Winchester, buffalo-stagecoach carbines, frontiers, Derringers, duelling pistols, matchlocks, arrowheads, tomahawks, bannerstones, gempoints, spearheads, steer, deer, buffalo horns, mounted pheasants, owls, quail, squirrels, deerheads, Agates, fossils, mineral specimens, lapidary supplies, Daguerrotypes, gold dollars, bo-wood, bio-horns, violin wood. Send 35c for profusely illustrated catalog. Heike, Doodeville, Wenona, Illinois.

4 SELECTED Arrowheads \$1.00. List 5c. H. Talburt, Calico Rock, Ark.

8 PERFECT Arrowheads \$2.00. George Smith, 841 Tacoma, Indianapolis, Indiana.

20 FINE Ancient arrowheads \$5.00. List free. Lear's, Glenwood, Arkansas.

4 FINE Indian arrowheads \$1.00. Stone tomahawk \$2.15. List free. Arrowhead, Box 5283, Indianapolis, Indiana.

PRECIOUS STONES, MINERALS

GEMSTONES. Mineral specimens. Every variety. Lowest prices. Free booklet. Plummer's, 4720 Point Loma Ave., San Diego 3, Calif.

GEMCUTTING—Silvercraft illustrated magazine. Tells how to cut gems, make jewelry. 150 ads illustrating equipment, gems for collectors, cutters. Free literature. Lapidary Journal, Del Mar 2, Calif.

SAPPHIRE, Topaz, tourmaline, garnet, peridot. Five uncut gem specimens, \$1.00. Ten polished gems, baroque shaped, \$1.00. Free big bargain list jewelry, gems, profitable, easy "do it yourself" projects. O'Brien's, 1116M Wilcox, Hollywood 38, Calif.

FIND Tungsten, mercury, uranium with Mineralight. Free brochure. Write Dept. PM8, Ultra-Violet Products, South Pasadena, California.

MAKE Your fall vacation pay off. Let "Uranium Prospecting" show you how. Most complete guide available. Send \$3, check, cash or money order. Prospectors Supply Co., V & T Bldg., Carson City, Nev.

TEN N. Mex. minerals \$1.50, six fluorescent \$1.00, fools gold 25c. Minerals, Winston, New Mexico.

PROFITABLE Fun with gems, minerals, rocks, jewelry. How-to magazine tells how. Four month trial \$1.00. Guaranteed. Gems and Minerals, Dept. A10, Palmdale, Calif.

HOBBIES AND COLLECTIONS

NAZI Swastika armband. Genuine World War II souvenir. Limited offer. Rush \$2.00. M. Olson, 1611 Hawthorne, Minneapolis 3, Minnesota.

WANTED Old cigarette cards. Write Charles Bray, East Bangor, Penna.

UNUSED Matchbook covers, 100 different \$1.00. 36 page catalog 25c. Match-cover album \$3.00. Charles Edelman, 1311C East 84, Cleveland 3, Ohio.

PAINT In oils the first time you try. Finest coded oil painting kits that money can buy. Size 12"x16" \$2.95; size 18"x24" \$6.95 postpaid. Many lovely subjects from which to choose. Send for free literature. Balox, P.O. Box 1256, Decatur, Illinois.

NAZI Medals, ribbons, armbands, flags, daggers. Big introductory packet \$1.00. Illustrated lists. Medcrafts, 1923 34th St. S.W., Calgary 2, Canada.

INVENTING Can be an interesting and profitable hobby. Write for complete particulars. Institute of American Inventors, Dept. 40-E 631-E St., N.W. Washington 4, D. C.

GROW Giant crystals. Free booklet. Crystocraft Co., Box 35, College Station, Texas.

FREE! Leathercraft catalogue. Do it yourself! Tandy Leather, Box 397-AH, Tulsa, Oklahoma.

COLLECT Miniature foreign, state, and historical flags. Sample and catalog \$1.00. Griffin and Gray, 72-05 67 Street, Glendale 27, N. Y.

MINIATURES: Colorful destroyers, submarines, battleships, 16 individual castings 30c. Flagship Clinton Company, Clinton, New York.

50 ARMY Insignia \$1.00. Insignia Mart, 103A Broadway, New York 3, N. Y.

NEW, 15 Different match covers 10c. Box 392, Rochester 1, N. Y.

CAMERAS, PHOTO SUPPLIES

PHOTOGRAPHY For pleasure or profit. Learn at home. Practical basic training. Long established school. Free booklet. American School of Photography, 835 Diversey Parkway, Dept. 3431, Chicago 14.

CAMERA Owners, proven money making plans without studios. Photo markets included. \$1.00. Satisfaction guaranteed. Details free. Scott's, Juniata, Nebr.

BUY Wholesale nationally advertised cameras, photo supplies, thousands other products at big discount. Free "Wholesale Plan." American Buyers, Hertel Station, Buffalo 16-El, N. Y.

FREE! Free! Free! Central Camera Co., photographic headquarters since 1899, saves you money on all photographic equipment. Send for Central Camera Co.'s free photographic bargain list today! Central Camera Co., Dept. 10-B, 230 S. Wabash, Chicago 4, Ill.

CAMERAS—100% Profit selling world's smallest German spy camera. Ideal Christmas present! Free literature. German-American Import Company, 3033 Hamilton Avenue, Baltimore 14, Md.

NEW Argus automatic projector \$48.90, Lewyt #77 vacuum \$31.90. Terrific discounts. Photo equipment, typewriters, appliances, free catalog. Mallers Mart, Box 135A, New Rochelle, New York.

BASS Says: Quality cameras since 1910. When in Chicago visit the camera cross roads of the world, or write us for your favorite equipment, new or used. Satisfaction guaranteed. Bass Camera Co., Dept. AG, 179 W. Madison St., Chicago 2, Ill.

CAMERA Repairmen greatly needed! You can learn manufacturers' service methods at home, in your spare time! Free, big illustrated book tells how: Write today. National Camera Repair School, Dept. PM4, Englewood, Colorado.

20 TO 50% Discount everything photographic, giftware. Free catalogue. Dart, 3812E Atlantic Avenue, Brooklyn 24, N. Y.

PHOTO FINISHING

FREE Film! Write for free mailers. Vets Film, Montalvo, California.

TRIAL Offer—Good with ad only. One roll film developed, 8 exposures 25c, 12 exposures 35c. King sized, dated prints from roll only. Don't send negatives. Sir Walter Photo, Raleigh, N. C.

ENLARGEMENTS! Eight 5x7's or five 8x10's, \$1.00. Wilart Enlargers, Box 967, Little Rock, Ark.

12 EXPOSURE Rolls 35c, jumbo prints. Guaranteed work, one day service. Lincoln Studios, Dept. K, Box 13, Lincoln, Nebraska.

20 BILLFOLD Prints from your photograph. Portrait paper, \$1.00. Blackhawk Studio, 1616 26 St., Rock Island, Ill.

HIGH Quality finishing—Rapid service. 8 exp., 35c; 12, 50c; 16, 75c; 20, \$1.00. Camera, Box 280, West Chester, Penna.

EKTACHROME—Ansochrome processing. Roll \$1.00. National Color Corporation, Box 55 Northside, Atlanta 3, Georgia.

TWO Beautiful enlargements from each picture on roll—8 exposures 55c, 12 exposures 75c. Cut Rate Photos, Dept. B-4, Janesville, Wisconsin.

6 OR 8 Picture roll 35c, 12 or 16 picture roll 55c. Each roll developed and printed in handy album pack. Send coin with roll. No c.o.d.'s. Mailing containers sent free. Deluxe Film Service, Box 1268-A, Shreveport, Louisiana.

TWO Beautiful prints from each picture on roll. 8 exposure 40c; 12 exposures 50c. Thirty four years of satisfied customers. Quick Service, Lens Photos, Dept. J-4, Janesville, Wis.

QUALITY Kodak finishing. 8 exposure roll 35c; 12 exposure 50c; 16 exposure 65c. Reprints 4c. Fast service. Guaranteed quality. 40 years continuous operation. Be a satisfied customer. We do color. Send for mailers. Mail Order Photo Service, Box 297, Watertown, Wisconsin.

FREE Beautiful superpak ring binder album with order 8 jumbos only 35c. Quality guaranteed. Prompt service. Free mailers. Free particulars complete superior finishing service. Grand Fotos, GPOB 1410, New York 1.

ROLL Film finished 5x7, 8 exposure, \$1.00; 12 exposure, \$1.50. Wheeler Photo, Coal Mt., W. Va.

JUMBO Prints from any film, 40c. United Photo, Ogden, Utah.

SPECIAL Introductory offer. 8 jumbos 25c, 12—35c. Western Photo, PM105, Box 298, San Francisco 1, Calif.

TOP Quality. Fast service. 8 jumbos 35c in beautiful ring binder album. 16 contacts 40c. Reprints—Jumbos 4c; contacts 3c. Satisfaction guaranteed. Free mailers and circulars. Fast-X-Photo, Box A, Jersey City, New Jersey.

FREE! Illustrated — "Colorful Portraits Glorify Your Photographs!" Lowest prices. Colorstudio, Ojai, California.

NOW You can give your favorite picture to friends, relatives and classmates, with convenient sized wallet photos: 20 for \$1.00 or 50 for \$2.00 postpaid. Original returned unharmed. Money back if you're not delighted. Mail Today Co., Altoona 16, Penna.

MOTION PICTURES AND SOUND EQUIPMENT

TAPE Recorders! Wholesale! Free catalog! Towers, 935 North 40th, Philadelphia 4.

GUARANTEED Savings! All brands movie equipment! Listings. Photosales, Box 5908A, Kansas City 11, Missouri.

MOVIE-Makers! Save 50% on your 8-16mm. film and do-it-yourself processing equipment. Free catalog. Superior Bulk Film Co., 442 N. Wells, Chicago 10.

ALL Kinds 16mm sound films. Rent, sale. Roshon, 335 Fifth, Pittsburgh 22, Penna.

FREE! Blackhawk's big sale catalog new and used 16mm., 8mm. films; 2"x2" color slides; used 16mm. sound projectors. Biggest stock in U.S.A. Blackhawk Films, 1200 Eastin, Davenport, Iowa.

TAPE Recorders, tapes, accessories. Unusual values. Dressner, Box 66M, Peter Stuyvesant Station, New York City 9.

5,000 8-16MM. Silent-sound films. International, 2120 Strauss, Brooklyn 12.

8-16MM. Silent-sound films. Latest subjects. Free catalogue, sample film 10c. Garden Film, 690 Howard Ave., Brooklyn, N. Y.

MOVIE Camera film: 8mm. roll \$1.50, 16mm. 100' \$3.00. Free processing. Better Films, 742 New Lots, Brooklyn, N. Y.

SAVE 50%! Guaranteed-fresh color, b.&w. movie film! 8mm., 16mm. Free catalog! Eoo-R, 47th Holly, Kansas City 12, Missouri.

FREE Sample kit. Make movie titles in color. A-to-Z Movie Accessories, Flatiron Building, New York City 10.

TAPE Recorders, tapes; lowest prices. Carstan, 215 E. 80, New York City 28.

FEATURE Film rentals \$3.95. Sale on used prints. Write "Sound Films," Box 262, Chicopee, Massachusetts.

MUSIC AND MUSICAL INSTRUMENTS

PLAY Piano the first day! Copyrighted secret. Details free. Miracle Method, Box 5203P, Phoenix, Arizona.

WRITE Your own words and music. Send \$3.95. Simplified complete course. Practical musicianship. Omnibus, 636 Clinton Ave., Newark, N. J.

MUSIC Copied from your tape or records. Manuscript copies made. Gregory, 206 East 70th, New York 21.

WHOLESALE Catalog! 30-80% discounts! Appliances, musical instruments, typewriters, phonographs, watches, jewelry, recorders, housewares, etc. Consolidated Distributors, 21-80 Lafayette, Paterson 15, New Jersey.

POEMS Wanted for new songs. Send poems. Immediate consideration. Crown Music Company, 1476 Broadway, New York City 36.

POEMS—Urgently needed to set to music! Write clever poems, catchy rhymes. Achieve fame, money in popular music field! Send sample poems. Free evaluation. Tin Pan Alley, 1650 Broadway, Dept. E, New York City 19.

POEMS Wanted for musical setting by America's largest songwriters organization. Immediate consideration. Five Star Music Masters, 630 Beacon Building, Boston.

ACCORDIONS—Direct from importer. Save 50% and more! Free trial. Lifetime guarantee. Trades accepted. Free catalog. Write Accordion Outlet, Dept. 105-R, 2003 W. Chicago, Chicago 22, Ill.

4000 POPULAR Song rhyming word sets, complete book \$2.00. 1955 popular song writing home study course \$10.00, trial lesson \$2.00. Times Square Music School, 1658 Broadway, New York 19, N. Y.

POEMS. Songs wanted! Free examination. Bengol Music, 93 Jefferson, Chelsea 50, Massachusetts.

SONGWRITERS. Free details. Melody \$5.00. Paramount, 1944 Linwood, Toledo, Ohio.

SONGWRITERS: Large recording company wants new songs. Royalty basis. National sales, promotion if selected. No charge for melodies. Send songs, song poems. Music Makers, Dept. E-14, Box 2507, Hollywood, California.

PLAY Piano classics without lessons, talent. New game "Music Like Magic," \$1. K. Irwin, 1029 E. 29 St., Brooklyn 10, N. Y.

SONGWRITERS—Success, fame, fortune if talented. Songs revised, composed, published, promoted by largest firm. Free appraisal. Since 1943. Postcard to Nordyke Publishing Co., 6000 Sunset Blvd., Hollywood 28, PM, Calif.

SWISS Musical movements, \$1.90. Helax, 218 West 72nd Street, New York 23.

POEMS Needed for new songs. Send poems for free examination, details, immediate consideration. Songcrafters, 2724 Arcade Station, Nashville, Tenn.

1955 ACCORDIONS—Wholesale. Free catalog. American Accordion Center, PM-3, 5329 Belmont, Chicago.

SONGWRITERS! Send poems, songs. Music Service, 243 West 72nd St., PM, New York City 23.

FREE Records of your song. Your words, my melody. Free information. Johnny Mack's Melody Mart, 1094 West 39th Street, Dept. A, Los Angeles 37.

ACCORDIONS. Wholesale to everyone. Save up to 60%. All national known brands. Free catalogue. Del Principe, 29 South Cicero, Chicago 44.

SONGWRITERS! Protect your ideas! Hold all songs, poems! Write for safe correct procedure first! Song Service, Dept. P, 333 W. 36th St., New York 19, N. Y.

WANTED! Poems for musical settings. Write Songwriters' Service, Clifton, N. J.

WRITE Songs. Big money and reputation. Write for information. J. Gordon Pub. Co., 4700 South California Avenue, Chicago.

POPULAR Songs. How to write and sell them. Write for free booklet Successful Songwriting. Gateway Songs, Box 2470, Hollywood 28, Calif.

PHONOGRAPH Records cheap. Catalogue. Paramarc, MC-313 East Market, Wilkes-Barre, Penna.

RETIRED Church organist composes beautiful music to sacred words. Hymn complete \$3.00. Reginald Belcher, Terrace Place, Morristown, New Jersey.

SONGS—Poems wanted. Good opportunity. Hollywood Tunemasters, 1609 Vista Del Mar, Dept. U, Hollywood, Calif.

VIOLINMAKERS. Repairers. Fine tone wood, and all violin supplies. Send for free wholesale price list. International Sales, 414-MPM E. Baltimore St., Baltimore 2, Maryland.

RADIO, TELEVISION AND ELECTRONICS

FREE 324 Page 1956 Television, Radio, Hi-Fi, Electronics catalog! World's largest stocks, lowest prices. Everything for experimenters, builders, amateurs, servicemen. Latest build-your-own kits, Hi-Fi, phonos, recorders, P. A., TV accessories. Thousands of parts, tubes, test instruments, tools and books. Write for free copy! Allied Radio Corp., 100 N. Western Ave., Dept. 34-K-3, Chicago 80, Ill.

SURPLUS Walkie-talkies, meters, parts. Bargain list 5c. Meshna, 580 Lynn, Malden 48, Mass.

ALL Parts to build "Loopstick" Germanium diode radio. Finest, most sensitive yet designed. Complete with instructions \$2.95 postpaid. TV Sales, P.O. Box 44, Yonkers, New York.

BUILD 15 Radio circuits at home—Progressive Radio "Edu-Kit" only \$19.95 complete. Free electric soldering iron and radio tester with "Edu-Kit." No radio background required. 30-day unconditional money back guarantee. Order direct or send for free descriptive literature, no obligation. Valuable radio and TV repair guide sent on request, no charge, no obligation. Progressive "Edu-Kits" Inc., Room 34-B, Progressive Building, 497 Union Avenue, Brooklyn 11, N. Y.

REPAIR Your own TV. Instructions compiled exclusively for your set. Simple as replacing light bulb. Send set name, chassis, model number, \$2.00. L.S. Engineering Company, Box 4113-PM-10, North Hollywood, Calif.

FUSED AC line plug protects TV and home. Easily installed. With extra fuses, \$1.00. Plaza Television, 1408 Huntoon, Topeka, Kansas.

MONEY In radio, T.V., appliance repair. Make your own tester. Most parts from old radio. Complete information \$1.00. R. Manning, P.O. Box 2216, Kansas City, Mo.

15 TESTED One-tube circuits 25c, including "Radiobuilder" magazine, catalog. Laboratories, 328-C Fuller, Redwood City, California.

WALKIE-Talkie. Build wireless two-way portable radiophone for less than \$10.00. Plans 50c. Springfield Enterprises, Box 54-B10, Springfield Gardens 13, New York.

NEW Germanium diode, variable condenser crystal radio kit \$2.95. Phone \$1.75. Free catalogue. Clearco Crystal Co., Box 1857, Milwaukee 1, Wisconsin.

RADIO-TV service course. Begin repairing radios and TV in 30 days. Inquire Radio Service School, 3502 Mills Avenue, Austin 3, Texas.

RADAR Reflectors—Govt. surplus. New. Made of eleven costly monel screen panels 32"x22"x22". Six 22" aluminum rods. Hinged for instant use. Folds into compact 2"x2"x25". Make radio, T.V. antennas at fraction of govt. cost. Only \$7.61. A.C.A. Services, 201 N. 12th St., Sacramento 14, California.

MAKE Simple powerful distance-getting crystal radio. Works anywhere. Illustrated booklet 25c. Money back guarantee. Jay Francis, Box 5963, Cleveland, Ohio.

COMPLETE Radio-television course. \$9.50. Tibbs Engineering, Box 752, Memphis 1, Tennessee.

MAKE Simple, tubeless, batteryless, distance-getting radio. Genuine Melomine crystal, detector, illustrated instructions. 50c postpaid. Allen, 427-PM5, Clinton, Missouri.

TV Trade-in sets. Philco, Emerson, G.E., Admiral, Motorola, Tele-King, others. List available. 10"—\$17, 12" to 17"—\$20 up. Washtek Service Co., 1501 Boston Rd., Bronx, N. Y. DA 3-9281.

CRYSTAL Radio experimenters. Write Leslie Hulet, 303 Hope, Lakewood, N. J.

TELEVISION Can sell your product faster for less money. Free information. Tele-sales, Box 24A, New York City 19.

BUSINESS OPPORTUNITIES

"HOT Dog on a stick." Something new, Dixie Hot Dog Mix. Scientifically blended with spices. Just add water. Sticks, bags all accessories, advertising material furnished. Steady supply and exclusive territories. Also Snow Ball, cotton candy machines, etc. For free information write National Industries, Inc., Wallace, N. C.

TO \$50.00 Weekly. Sparetime, home operated mailorder business. Successful beginner's plan. Everything supplied. Lynn, 16420-M National, Los Angeles 34.

MONEYMAKING Mailorder business plan, free! Write, George Lenhoff, Lincoln 8, Nebraska.

DOLLARS Daily! No canvassing! Free proof! Mailmaris, Cincinnati 36-F, Ohio.

SELL Polics by mail. Free list gives low cost source. Ballard's, 425 East Catherine, Louisville 3, Ky.

PLASTERCRAFT Molds, liquid rubber, plasters, flocks, candle supplies. Catalog and manual free. Blue Rapids Supply, Blue Rapids, Kansas.

OPERATE Profitable mail order business. Splendid opportunity. Write Blair Co., Perkinston, Miss.

BUY Wholesale, 850,000 items. Write Info-Center, 216 West Jackson Blvd., Chicago, Ill.

UNUSUAL Opportunity, handspinning Angora wool. Fascinating, profitable. Angora House, PM, Springfield, Illinois.

EXPORT Business made easy! Expect something different. Complete setup, everything furnished. Hermes, 152 West 42, New York City 36.

FINEST Formulas for making world's fastest sellers. Literature free! Miller, Chemist, 1517-R, Tampa, Florida.

ADVERTISING Business—City, country. Low overhead, substantial income. Experienced advertising company offers complete setup. Harold, 69-S Bennett, New York City 33.

MINIATURE Trees. Why pay \$2.00-\$10.00 for growing secrets? Free details. Tiny Trees, Box 3684-P, Chicago 54.

BUY Wholesale! 100,000 name brand products! Save 65%!! Big profits selling others spare time! Free catalogs! National Buyers Service, Box 426EE, Oakland, Calif.

GET Merchandise orders by mail! Everything furnished—Orders filled. Big profits. Long, McKays Beach, Leonardtown 3, Md.

\$3.75 HOURLY Minimum, evenings. Preparing tax returns—Simplified! Auditax, 3475TAT, Los Angeles 34.

WHOLESALE! 10-30% Discounts! Appliances, tools, etc. Catalog 25c. Levesque Supply, Atlanta, New York.

WHAT'S New in mailorder? Let "Mail-order World," published monthly, keep you informed. Sample, 25c. Wayte, 1238 Elden, Los Angeles 6, Calif.

NEW, Unique plan can earn hundreds of dollars for you. Free details. No obligation. Write: Best Distributors, 200 West 34th St., New York City 1, Suite 1003.

"FROG Raising!" Season just starting. Get this year's eggs. New book tells how. Folder 10c. Broel-A, Box 306, New Orleans 1, Louisiana.

DOLLARS: Baby record books, Kitty Kat shoes, My Baby albums, eleven thousand new prospects daily. Sold by mail, use our literature. No-Co-Ro, Oakland 6, Calif.

WANT Up to \$100.00 weekly deposited in your mail box? Details free! Smith, 2708-P Ladera, San Bernardino, Calif.

BUY It wholesale! Manufacturers, distributors offer 850,000 items. Literature free. Olsen, 1231-A East Third, Duluth 3, Minnesota.

ELECTROPLATE Auto parts, novelties, mirrors, baby shoes. Easy, inexpensive home processes. Free booklet. Tyco Metals, Box 13231-MM, Houston 19, Texas.

WHOLESALE, Thousands of items. Supply source list, 10c. Idealer, Park Ridge, Ill.

LEARN Sewing machine repair. How to make big money at home sparetime. New machines. Everything supplied. Write Taylor Service, Box 2126, San Bernardino, California.

IMPORT-Export opportunity, profitable, world-wide, mail-order business from home, without capital; or travel abroad. Established world trader ships instructions for no-risk examination. Experience unnecessary. Free details. Mellinger E701, Los Angeles 24.

BREED Rare tropical fish at home. Earn big money! Learn secrets! Help fill huge demand. Amazing opportunity! Free plan. Tropical Fish Breeders, Los Angeles 61, Calif.

HOW And where to obtain capital. Particulars free. Star Service, Wapakoneta, Ohio.

BE Appointed state notary public now. Write, Stationers, Helotes, Texas.

I want to send you proof of the wonderful pulling power of Popular Mechanics classified pages. What's your proposition? Write me today. Include literature if possible. F. W. Johnson, Manager Classified Advertising, Popular Mechanics Magazine, 200 E. Ontario St., Chicago 11, Ill.

FREE Folio "Up to \$45,000; Unlimited Vacations." No merchandise, equipment. Unknown! Work home, sparetime! Haylines, Carlsbad, Calif.

MONEY in sparetime fixit shop at home. Repeat cash business. Experience unnecessary. No selling. Free booklet explains. Victor Foley Company, Columbia Heights, Minnesota.

WE Love our mailman—He leaves over \$1000.00 monthly in our rural mailbox. My college professor husband drafted a scientific home mailorder method. We bought a Texas ranch, live as we always wanted. Now we sell the Ranch Mailorder Method. Operates anywhere. Inquire: Eveningshade Ranch, Helotes, Texas.

RESILVERING Mirrors, formula 50c; two-way lookout mirrors. (No one sees you), 50c; coppered mirrors, 50c. All \$1.00. Nelko-Mir Box 3462-J, Chicago 54.

POPCORN And potato chip equipment. Eakins, Box 933-A5, Springfield, Ohio.

MEN—Income from local information. No selling. Neherco, LaVerne, California.

RUBBER Molds for casting plaques, figurines, novelties. Catalog illustrating over 100 fast sellers, 10c. Castcraft Studios, 568-PM Marlon Street, Brooklyn 33, N. Y.

COPUBLISH Mail Sale Advertiser, leading mail order paper. Details, latest copy, dine. Vanroy Shirk, Lebanon, Penna.

GROW Mushrooms. Cellar, shed, and outdoors. Spare, full time, year round. We pay \$3.50 lb. We paid Babbitt \$4,165.00 in few weeks. Free book. Washington Mushroom Ind., Dept. 172, 2954 Admiral Way, Seattle, Washington.

\$25 WEEKLY Working two hours daily at home. Lycke, Box 2471-A, Cleveland 12, Ohio.

OPERATE Profitable mail order business. Write Walter Service, 4159-A East 112th, Cleveland 5, Ohio.

COLORGLAZED Concrete pottery made without molds. Patented method. Cemetery products, novelties, tiles. Basement leak-sealing. Money-making projects. Booklet, details free. Men only. National Potteries Company, Grand Rapids, Minnesota.

MINK Raising information free. Complete. Lake Superior Mink Farm, Superior, EEL, Wisconsin.

FREE Book "505 Odd, Successful Businesses." Work home. Expect something odd! Pacific, Oceanside, Calif.

VENDING Machines—No selling. Operate a route of coin machines and earn amazing profits. 32-page catalog free. Parkway Machine Corporation, Dept. 72, 715 Ensor St., Baltimore 2, Md.

BRONZE Baby shoes. Instructions, equipment and mountings for genuine electroplated process. Free catalog. Hollywood Bronze Supply, Dept. B-3, 1624 East First Street, Los Angeles 33, Calif.

YOUR Own name brand business. No investment; no inventory. Part time or full time. Sell famous brands of appliances, housewares, silverware, radios, vacuum cleaners, lamps, tools, clocks, watches, jewelry, etc., etc., over 1000 items. Join thousands of successful independent dealers. Send for free catalog and dealer price list. H. B. Davis Corp., Dept. W, 145 W. 15 St., New York City.

LIQUID Rubber. Make flexible molds. Free sample. Chaney, 1130 E. 16th St., Jacksonville 6, Fla.

GOOD Paying business silvering mirrors, plating articles in the shop and home by late method. No tanks or shop required. Free booklet. Gunmetal Co., Ave. H, Decatur, Illinois.

GROW Orchids at home—Profitable, fascinating. Year 'round, Maine to California. No greenhouse. Gorgeous cactileas, cymbidiums, etc. Successful home grower shows you how. Full details free. Flowerland, 4622 Wilshire, Los Angeles 5.

FIX Typewriters. Inexpensive home course teaches factory secrets. Free booklet. Write, Typewriter, Tarentum 1, Penna.

\$200 WEEKLY Cleaning Venetian blinds. Free book. Burt, 2434A, Wichita 13, Kansas.

WANT To make big money at home? \$5 profit in an hour possible with invisible re-weaving. Make tears, holes disappear from clothing, fabrics. Steady year-round demand from cleaners, laundries, homes. Details free. Fabricon, 8334-S Prairie, Chicago 19, Ill.

YOU'LL Be amazed at the tremendous profit possibilities in selling the finest quality Bibles available anywhere! Many men make \$30,000 yearly and more! Get my free proven Bible sales course plus catalog of many Morocco grain, genuine leather covered Bibles and related items. Joseph W. Cain, Wholesaler, Box 5065P, San Antonio 1, Texas.

BECOME A game warden, professional hunter! Join forestry, park, fishery services. Good pay! Opportunities open! Free revealing "Select-Job Chart," details, job-getting secrets. Write Home Study Institute R10, Los Angeles 19, California.

TELEVISION Repair business. \$39.50 total cost. Amazing 1 day training. No studying. New proven technique. Make \$15 to \$20 day immediately! No experience needed. Investigate! Free home-business plan. Write Electronic Engineering, 1036-PO So. LaBrea, Los Angeles 19, Calif.

MAKE Beautiful colored mantels, building and flagstone from concrete. Instructions \$2.00. Stonetex, 533 Manhasset Rd., Pittsburgh 27, Penna.

BIG Profits raising fishworms and crickets. Free literature. Carter Farms, Plains, Georgia.

BE A landscape contractor. Make \$20 to \$60 a day. Start with smaller projects and work into larger jobs. We show you how. Easy-to-follow home study course. Write for free book, National Landscape Institute, Dept. M-103-C, 310 S. Robertson Blvd., Los Angeles 4E.

FLEXIBLE Rubber molds for plaster and Marble figurines. Sample and large illustrated catalog 25c, refunded on first order. K-C Novelties, Dept. 205, Southampton, Mass.

\$1,000 MONTHLY Possible in collection agency business. Free details. Write Cole Associates, Syracuse 2, N. Y.

EARN Up to \$2000.00 monthly with spare or full time route of automatic 3 in 1 hot drink merchandisers in your community. We train you. Write Superior, 4555-H East Warren, Denver, Colorado.

\$25 DAILY Profits sharpening farm discs without dismantling or moving. No experience necessary. Free plan explains. B. T. Foley Company, Columbia Heights, Minn.

FRANCHISES Make profits! Become exclusive franchised distributor, agency operator. Nationwide opportunities. Information rushed. National Franchise Reports, 333 North Michigan, Chicago 1.

UNTOUCHED Mailorder opportunity. Establish industrial supplies mailorder business. High income, more repeats, lower overhead. Complete setup offered. Stewart Advertising, 1625 S.W. 19th St., Miami, Florida.

CONCRETE Specialty manufacturing. Profitable new business. Steel forms for twenty items. Catalog free. Vyke Co., 2435 15th St., Denver 2, Colo.

\$5.00 HOURLY Bronzing baby shoes! Mountings! Foster, 1320 Ardmore, Chicago 26.

WHOLESALE Catalog! 30-80% discounts! Appliances, musical instruments, typewriters, phonographs, watches, jewelry, recorders, housewares, etc. Consolidated Distributors, 21-11 Lafayette, Paterson 15, New Jersey.

METALIZE Baby shoes, jewelry, gifts. Free catalog. Publisher, Box 73136, Los Angeles 3.

BIG Money! Operating home mailorder business. Sparetime, small capital. Jackson, Newfoundland, Kentucky.

UNLIMITED Earnings weekly, spare time; never-before-offered set of proven, successful plans. Herco-B, 319 Sea, Quincy 69, Mass.

\$5 TO \$10 An hour. I've did it, I'm disabled now. Real genuine offer. Complete information \$1.00. Lucas, 2210 Carson St., Pittsburgh 3, Penna.

MAKE Perfumes, other products. Sell mailorder. Catalog free. International, 6347 Farnell PM-10, Chicago 21, Illinois.

WHOLESALE Catalog \$1, refunded. Quality Sales, Box 26, College Park, Md.

WHOLESALE Catalog! Appliances, cameras, watches! Cam Company, 6806PM 20th Ave., Brooklyn 4, N. Y.

GROW Expensive herbs for us! Big profits home-business of your own. Year around profitability! We supply everything necessary! Send for free rare seeds and revealing plan. National Herb Exchange, Dept. A, Gardena, Calif.

FREE Booklet concerning hundreds profitable businesses started sparetime at home. Richard Company, Box 366-P, Hayward, Calif.

\$250 WEEK Cleaning venetian blinds. Patented machinery. Free literature. Robinson, 7213B, Indianapolis 1, Indiana.

REPAIR Sewing machines. Mechanical secrets, money schemes, advertising stunts. Booming! This vocation! \$1.00 lesson free. Purdy's, Box 207-M, Weatherford, Texas.

ARE You prepared to profit in the mail-order business? Free details. Albert D'Agostino, 144-17-A, Flushing 54, N. Y.

BE In your own business. Buy wholesale. Big profits. Get free nationally famous name brand mdse. Catalog, Dept. PM, Normandy Distributing Corp., 133 Fifth Ave., New York City, N. Y.

SAWDUST, Turn it into cash. Forty-nine methods. Instructions \$1.00. Sawdust Laboratories, Box 163, Islington, Ontario, Canada.

MAKE Big money in your spare time! Sell nationally advertised brand name merchandise. Appliances, cookware, housewares, watches, jewelry, dry goods, clothing, sporting goods, toys, gifts, etc. Build a profitable repeat business. Send for free 118 page illustrated color catalog with separate confidential cost sheet. Merit Home Products, Dept. PM10, 107 Manhattan Ave., Brooklyn 6, N. Y.

NEWEST Spare, full-time home business. \$5 to \$10 hour possible. Paint with suede—The finish with touch and eye-appeal. Beautifully auto dashboards, signs, radios, toys, figurines, lamps—1001 others. Complete, step-by-step instructions sent for no-risk examination. Free details. Coast, Los Angeles 61.

START Home manufacturing business. Make cleaners, soaps, polishes, cosmetics. Free literature. Kemix, Park Ridge, Ill.

IMPORT-Export mailorder opportunities! Details. Warner, Box 6, Fort Scott, Kansas.

YOU'LL Be amazed at the tremendous profit possibilities in the finest quality Bibles available anywhere! Many men make \$30,000 yearly and more! Get my free proven Bible sales course plus catalog of highest quality Bibles and related items. Joseph W. Cain, Wholesaler, Box 3063Q, San Antonio 1, Texas.

GROW Earthworms. Raise anywhere, sell breeding stock, soil culture, fishbait. Instructions free with orders. California Wonder Worm Farm, Box 4083 Catalina Station, Pasadena, California.

WHOLESALE Pricelist—Refrigerators, washers, televisions, power tools, typewriters, appliances, 23c. Belmont, 861-839 Dumont Ave., Brooklyn 7, N. Y.

START Profitable home business. Seal in plastic—Photos, licenses, documents, etc. No equipment needed. Agents-dealers, sell special "machineless" laminating kits; local, by mail. Everybody a prospect. Sales plans, details and complete laminating kit \$1 postpaid. Satisfaction guaranteed. Garen Sales, 1569-M7 Ridge, Zanesville, Ohio.

MONEY In shear sharpening. Repeat business. Details free. W. Zell, Summitville PM-2, Indiana.

SELL Subscriptions, all magazines. Free catalogue, supplies, prizes, exclusive aids. Subscription Service Co., Dept. A, P.O. Box 2070, Birmingham, Alabama.

PUSH-Button power mower. Terrific seller. Penn Grant, Grantham, Penna.

START Your own money-making mail order business the surest way, most likely to succeed! Hawkins, Box 1378, Sioux City 2, Iowa.

SHINE Cars without polish. New invention. Lightning seller. Cars gleam like mirror. Samples sent on trial. Kristee 113, Akron, Ohio.

VITAMINS! Terrific profits! Direct and mailorder sales to homes, offices, stores and get your own needs wholesale. Details free. VimVite, 2963PM Beverly, Los Angeles 57.

ADVERTISING Book matches—Cash in on big demand; sell union label matches. Cuts for all businesses and political parties. Free powerhouse selling kit, low prices, protection guaranteed on repeat orders. Cash commissions. Superior Match Co., Dept. MX-1055, 7530 Greenwood, Chicago.

MEN Wanted—Build luggage and cases at home. We sell your products, supply complete instructions, materials, everything. No special equipment needed. Free details. Casecraft, 805-G22 Sunset, Los Angeles 12, Calif.

START A buying service, buy wholesale thousands nationally advertised products. Make big profits selling at sizable discounts. Postcard brings details. American Buyers, Hertel Station, Buffalo 16-C1, N. Y.

WORK From home in spare time. Start profitable magazine renewal service. We show you how; furnish everything free. No experience needed. Write McGregor Magazine Agency, Dept. 500-B, Mt. Morris, Illinois.

RUN Cafe, diner. How to get started, menus, foods, revealed in home training. Write for free book "Cafe, Diner Business." School of Restaurant Arts, BU110, Fremont, Ohio.

BECOME Tax consultant. Our students earn to \$3,000 in 3-month season, part-time. We train you—help you start. State approved. Union Institute, 68 Hudson, Hoboken 2C, New Jersey.

WE'VE Got a highly unusual deal for you on a new line of fire extinguishers. This is a new company, but you'll recognize the men behind it, who have had more than 20 years' experience in this field, when you write us, and it might pay you well to airmail us today. The Fire King Company, Inc., Dept. 12, Littleton, Colo.

MAIL Order minded? We list your name with over 500 mail order businesses. You receive fabulous mails. Money-making ideas, books, magazines, samples, etc. Tremendously worthwhile service only \$1. Satisfaction guaranteed. Mallorama, Box 476M, Lynbrook, N. Y.

\$100.00 WEEKLY. Mail-order distributors wanted. Work at home sparetime. Experience unnecessary. Write: National Distributors, 240 Rt. 17, Paramus 17, N. J.

SELL Mexican imports. Beautiful merchandise that sells on sight. Be first in your community. \$3.00 brings valuable sample, details. Westway, Box 312, Lockport, N. Y.

\$80.00 WEEKLY. Operate our selective mail-order business in your area, sparetime. Write House of Plastics, Paramus 31, New Jersey.

GIANT 100 Page catalog! Wholesale prices! BTS Products, Box 217, Oakland 18, N. J.

BANANA Syrup business—Formula \$1.00. Amark, 101 Weld, Rochester 5, New York.

\$70 WEEKLY—Home, spare time. Simplified mail bookkeeping. Immediate income, easy! Auditax, 3475TAS, Los Angeles 34.

A Monthly repeat business which you can operate in your own community. For free details write Grask, Dept. A-101, P. O. Box 494, McKeesport, Penna.

WANT Lifetime income? Distribute our wholesale catalogs, 1900 nationally advertised products, 60% savings. No selling. Wholesale catalog and monthly income plan \$1.00 (refundable). First National Supply Co., 347K - 16th Street, Ashland, Kentucky.

WRITE For: Free folio. Latest collection home retirement, business plans, 137 helpful formulas. LCL Distributors, 5909 Petersburg Road, Evansville 11, Indiana.

MAKE Extra money between now and Christmas. Sell subscriptions to all popular magazines. Liberal commissions. For supplies write DeSales Magazine Service, 60 East 42nd St., New York 17, N. Y.

MAKE Tough, attractive building plastic, easily 88 1/2% waste, 101 uses, 800% profit. Exclusive district. Grab it. Bays Laboratory, Oklahoma City 9.

PROFITABLE Home collection office. Experience unnecessary. Details. Hyatt, 411 West Walnut, Kalamazoo 42, Mich.

MEXICAN Leathercraft at the lowest price. Write to Santuario Hermanos, 831 E. Madison St., Brownsville, Texas.

BUY Wholesale name brand items. Triple J Industries, 132 Berkshire, Bridgeport 8, Conn.

EARN \$2.00 Hourly, making and selling sandals! Youngs, 1308-PM, South First, Arcadia, California.

MAKE Money helping others out of debt. Stop garnishments, save jobs, re-establish credit. Details. Borum \$7, 411 West Walnut, Kalamazoo 42, Michigan.

CASH For sawdust (forty methods). Tincans (thirty methods). Newspapers (eighteen methods). Instructions 50c each. All three \$1.00. Charles Company, 13-DXZ, Norwood, Ohio.

\$26,500 SALES in two weeks! Amazing radio-mail order method. Free details. Broadcast Service, 1412-F Great Northern Building, Chicago 4, Illinois.

\$1,000 MONTHLY, Home, mailorder, free advertising method. Revealing information. Seidel, 6000-AJ Sunset, Los Angeles 28.

MAIL-Order success. Follow our informative treatise 25c. Griffe Enterprises, Box \$1, Station D, Toledo 8, Ohio.

WHOLESALE! 10,000 Name brand products 30-60% discounts! New illustrated catalog. Terrific business plans included free! National Distributors, Paramus 11, New Jersey.

AMBITIOUS? We establish you in your own business, supply catalogues, circulars etc., ship orders under your name, paid or c.o.d., show you exactly what to do. Household items needed in every home. Sell direct, by mail or through agents. Complete details absolutely free. Write Topval Corp., Lindenhurst 718, New York.

LEARN New product promotion. Start national business from home promoting your own new product ideas. Sell through retailers, wholesalers, agents or by mail. Expert instruction. Details free. Banning A6, 45 South Los Robles Avenue, Pasadena 1, California.

MAKE New greaseless doughnuts in kitchen. Sell stores. Half profit. Free recipes. M. Ray, 3605 South 15th, Minneapolis 7.

PRINT Without a printing press! Amazing new method! Print colorful signs, banners, cards, posters, glasswear; anything at home. Big profits. Money-making opportunity! We supply everything. Beautiful sample, home-business plan free! Write Screen-Print Company, PM-10, Los Angeles 61, California.

35% TO 30% Discounts. Dealers authorization certificate and catalog \$3.00, limitation per county. Your chance to go in for appliance and jewelry mail order business at your own home. Frank Reiser, Manager, Box 1765, Paterson, N. J.

\$35,000.00 BONUS Offered by U. S. government—Fortunes being made in uranium! Free booklet shows "How To Make Money Prospecting for Uranium." Please enclose 10c for handling, postage. Geiger Co., 195-PM10b Sackett Street, Brooklyn 31, N. Y.

EARN Money at home spare time. Details free. Evans, 10431 Bonnie Drive, Garden Grove, Calif.

WANTED! Home producers, by manufacturers in our clearing house service. Become subcontractor, casting plastic products for these companies. Thousands of easy-to-make items required for consumer-industrial use. Cash in at home, without previous experience. Plastic Service Associates, Dept. 10-PM, East Boston 28, Mass.

LIQUID Marble—Brushed, sprayed! Mold novelties, tile. Particulars free. Marbleizing Service, Edwardsville, Illinois.

PROFITABLE Home mail-order business! \$20 to \$40 daily sparetime. Unusual! Edwards, Box 45733E, Los Angeles 45.

HOW And where to obtain money. Many ways to use your time to make big money. How I started with \$28 and built assets over half million dollars. Complete information postpaid \$2.00. Money-back guarantee. Particulars free. Business Consultants, 5851 N.E. 2nd Avenue, Dept. "C" Miami 37, Florida.

\$46 FROM Square foot plywood; jigsaw necessary. Details free. Woodarts, X-16, Bridgewater, Mass.

SENSATIONAL New profitable home career now revealed. At long last, you too can learn the amazing techniques of the portrait studios. Don't lose out, get your share of these steady, life long dependable profits. (Some portraits sell for more than \$100.00.) Be your own boss in this uncrowded field. Complete kit \$3.00 or valuable information free. John G. Marshall Co., Dept. PM-10, 187 N. 9th St., Brooklyn, New York.

SELL Quilt pieces by mail! Woods Remnant Co., Bedford, Penna.

MEN With cars or trucks—Start your own profitable business. No selling, no capital required. Complete plan \$1. Jack Lehrer, 156 Beach 86th Street, Rockaway Beach, N. Y.

FREE Spawn. Free instructions. Join National Association Mushroom Growers. \$1.00. Mushrooms, 32 Kendrick, Lawrence, Mass.

PEARL—And metalcote baby shoes: Brushplate gold, silver, copper. Castwood plastic novelties, etc. Big wholesale catalog. Liquid rubber, molds, models, casting, coloring, glazing materials. Samples 25¢ postpaid. Homecraft, 940-44 Belmont, Chicago.

UNCLAIMED Watches pay big profits. All brands. \$4.95 up. Illustrated folder free. Cosmos Sales, 81 East 125 St., New York, Dept. 26.

WHY Make others rich? Your home can be your factory. We supply parts, you assemble. Hanco, Box 97, Lombard, Ill.

HYBRID Earthworm business and stock; unusual and profitable, tremendous future potential, well established and advertised, nationwide coverage; 7 bins worms, est. \$3,500; 7 bins capsules—est. 297,500; 7 bins or 1,650 lbs. rejuvenator fertilizer, 3 rabbits, direct mail advertising material, good will; est. value \$20,535; these business items could easily be moved by truck to any location and business continued from there; sacrificed at \$12,000. F. & W. Stevens, Strout Realty, Main St., Marshfield, Mass.

BROCHURE, 400 Positions, profitable occupations for people over 60. Stommel, Box 104, Detroit 31, Michigan.

WORK At home. Free details. Ajax Products, 734 East 236th Street, Cleveland 23, Ohio.

MONEYMAKING OPPORTUNITIES

BRAND New opportunity. Free details. Reliant Sales Company, Box 55, Bangor, Penna.

LEARN Technical metaphysics and insure your future. Easy, inexpensive correspondence course. Simplest method known. Diploma. Write: Premier College of Technical Metaphysics, 2552 McKenzie St., Vancouver 8, B. C., Canada.

SELL Helbros watches-jewelry, 70% discount. Wholesale catalog 25¢. Dorinda, Box 77, Huntington Station, New York City.

MAKE Spare time money preparing and mailing sales literature. Adams Surveys, 3513-AT Sunset Blvd., Los Angeles 26, Calif.

SCHEMER Magazine, Canfield 1, Ohio. Mailorder and business plans. Year \$2.00, sample 25¢.

OPPORTUNITY Mails three months 25¢. Donovan, 791 Greenbelt, Levittown, N. Y.

PRIZE Contests provide fabulous and confidential home income opportunities! Here's how and where to win your share! Send stamp! National Contest Bulletin, Box 2685, Miami 16, Florida.

MAKE Money with camera. Professional secrets \$1.00. Brewer—Photographer, 3880 Hollywood, Hollywood 28, Calif.

"MONEY Getter's Bulletin." Prints helpful money-making ideas, plans, tips. Sample 25¢; details free. Distributors, Box 831-D, Monessen, Penna.

EARN \$50.00 Daily making mats, shoes and mud guards from old tires. S and S Patents Inc., 1307 North Clark St., Chicago 10, Ill.

MAKE To \$300 extra. New! Different! No selling! No mailorder! Details free. J-M Enterprises, 601 1/2-A North Marsalis, Dallas 3, Texas.

DOLLARS in baby record books, baby shoe kits. Liebig Industries, Beaver Dam 2, Wisconsin.

FREE Literature describing moneymaking mailorder plans. Lewis Barlett, Richland, Georgia.

BUILD Sales by recruiting productive distributors selling direct or to retail outlets. Secure most concentrated circulation through classified columns of Salesman's Opportunity. Write for facts, Gilbert, Salesman's Opportunity, Room 1700, 850 N. Dearborn, Chicago 40.

FREE Folio "Up to \$45,000; Unlimited Vacations." No merchandise, equipment. Unknown! Work home, sparetime! Haylings, Carlsbad, Calif.

SPARETIME Profits taking subscriptions all magazines. Wholesale catalog free. Cassell Publishers, Westfield, New Jersey.

GENERAL Contest Bulletin. Issued monthly. Sample, 25¢. 1600 1/2 East 5th, Duluth, Minn.

GROW Mushrooms. Cellar, shed, and outdoors. Spare, full time, year round. We pay \$3.50 lb. We paid Babbitt \$4,165.00 in few weeks. Free book. Washington Mushroom Ind., Dept. 173, 2954 Admiral Way, Seattle, Washington.

50,000 ARTICLES Wholesale. Source directory, dime. Nelko, Box 3462-D, Chicago 54.

FREE Book "505 Odd, Successful Businesses." Work home. Expect something odd! Pacific, Oceanside, Calif.

READ Progressive Mailtrade, the magazine that tells how to make money by mail. Dime brings sample and special offer. Progressive Mailtrade, Box 357, Sheboygan, Wisconsin.

ATTENTION: Typewriter owners. Make handsome profits. Write today. Groves Company, 682, Hastings 3, Nebraska.

START A profitable subscription business in spare time! We need men and women (young or old) as representatives for all leading national magazines. Liberal commissions paid for new and renewal subscriptions. Start earning money in this pleasant work at once! Clip this ad and send with your name and address to: Agency Bureau, Dept. PM, Hearst Magazines, 250 West 55th St., New York 19, N. Y.

\$100 OR More month spare time at home. Free information. World Sales Co., Box 179 PM, Ripley, Mississippi.

SCHOOL Seniors—Sell classmates America's most beautiful graduation name cards. Largest selection. Highest commission. Outsells all others. Free sample kit. Printcraft, Dept. M, 1509 Maple Street, Scranton 5, Penna.

BUY Wholesale! Save 66 2/3%! Appliances, furniture, jewelry, toys, sporting goods, tools. Free catalogs. National Buyers Service, Box 426EB, Oakland, California.

HAVE Home business—Get \$10 orders in every mail. Keep \$8.00. Everything supplied. National, Box 88-W, Dorchester 22, Massachusetts.

PRESERVE Living flowers to last indefinitely. Swell for gifts. Interesting hobby. Make money too. Free details. Old Town Gifts, 405 S. Clark Blvd., Clarksville, Indiana.

EARN Big money. Manufacture better mousetrap. Disposability assures reorders. \$1.00 brings complete plans. Dispos-O-Mouser, Box 2693, Dept. PM106, Sacramento, California.

NEW Comedy, religious, general T"x11" signs. 7c retail 50c. 15 samples, \$1.00. Lowy, 812 Broadway, Dept. 888, New York 3.

TREMENDOUS Profits selling genuine leather wallets (\$2.00 values), \$15.00 doz. Dorow, 1129 S. 34th, Milwaukee 15, Wis.

NEW Mail order opportunities. Free details! Central Sales, Robbins, N. C.

AMATEUR Artists, cartoonists. Turn your art ability into money. Hamilton, Box 4-PMA, Astoria 5, N. Y.

THOUSANDS Articles wholesale! Catalog \$1.00 refundable. Evanich, Stamford (Catskills), N. Y.

PRINTING And office supplies wholesale. 20,000 items. Literature free. Royal, Box 368-A, Cleveland 27, Ohio.

BIG Profits servicing new and renewal subscriptions for firms, clubs, churches, friends, neighbors. No experience. No investment. Free catalog and supplies. Hanson-Bennett Magazine Agency, Desk P-2, 180 N. Wabash Avenue, Chicago 1, Illinois.

TO \$50.00 Weekly. Sparetime, home operated mailorder business. Successful beginner's plan. Everything supplied. Lynn, 10420-M National, Los Angeles 34.

\$5 TO \$10 An hour. I've did it. I'm disabled now. Real genuine offer. Complete information \$1.00. Lucas, 2210 Carson St., Pittsburgh 3, Penna.

\$9.00 RETURNS \$160.00 Repeats. 25c coin for sample. Ezee, Bayport 7, Mich.

EARN Money evenings, copying and duplicating comic cartoon for advertisers. Adservice, Argyle 1, Wisconsin.

START A buying service, buy wholesale thousands nationally advertised products. Make big profits selling at stable discounts. Postcard brings details. American Buyers, Hertel Station, Buffalo 16-D, N. Y.

ADDRESS Big hunting bound circulars. Earn cash commission. Write—Okaw River Kennel, Corden E-5, Illinois.

BIG Money. Mail order. Details 25c. Desert Mail Sales, Box 859-PM, Mojave, California.

LEARN Directing money-raising campaigns for churches, institutions. Spare time. Earned \$3065 in six weeks my first campaign on \$50 investment. Short course backed by 35 years experience. William Arbogast, 229 East Mason Avenue, Alexandria, Virginia.

HONEST Money fast, formulating top building specialty product. Free information. Larstone, 3419-9 East, Salt Lake City 6, Utah.

\$1,000. MONTHLY Possible raising earthworms! Backyard, garage, basement. Complete illustrated booklet explains raising, feeding, packing, marketing. 25c postpaid! Ozark Worm Farm-J, Willow Springs, Missouri.

SELL Sparetime from free wholesale catalog. Nationally advertised watches, jewelry, appliances. Save on personal needs. Big discounts, earn huge profits. No investment. Louis Perloff, Dept. PM, 723 Walnut St., Philadelphia, Penna.

\$5-\$10 AN Hour teaching driver training in your own car. Information, dime-stamps. Driving School Services, Box 428P, Coleta, California.

YOU Cast metal products. Free literature. Box 124, Lynwood, California.

50 MONEY Making plans and fountain pen, only 50c (coin). Satisfaction guaranteed. Campbells Studio, Millwood, Ky.

OPPORTUNITIES To save money and make money through products and services offered in new Coronet Family Shopper. See October Coronet now on sale at newsstands, or write Coronet Family Shopper, Dept. M, 488 Madison Ave., New York 22, N. Y.

EARN Cash weekly making perfumes. Write Stuart, Stevensville 3, Md.

SELF-Help books, courses. Free lists. Ralph Underhill, Beebe, Arkansas.

SELL Tintania gems; far more brilliant than diamonds. Catalog free. Diamonite, 2429 77th, Oakland 5, California.

OPERATE "Escalator" mailorder system, selling our products or any products. Most revolutionary mailorder system known. Postcard, Selbyco, Decatur 161, Ill.

TYPISTS! Make money at home. Mailing, 2 Madison, Greencastle, Indiana.

\$100-\$400 MONTHLY Possible using pen-typewriter! Stamp brings home moneymaking opportunities "Packette," Argensio, B-208, Rutherford, N. J.

VENDING Machines—No selling. Operate a route of coin machines and earn amazing profits. 32-page catalog free. Parkway Machine Corporation, Dept. 15, 715 Ensor St., Baltimore 2, Md.

NEW Comedy, religious, general T"x11" signs. 7c retail 50c. 15 samples, \$1.00. Lowy, 812 Broadway, Dept. 897, New York 3.

WANT To go in business for yourself without capital? We show you how. Start part time your own home. Postcard brings details absolutely free. Topval Corp., Lindenhurst 720, New York.

PROFIT From your power tools. Manufacture new invention. Territory available, first offering. Free information. Roy Calais, 5665 Lemonwood, Baton Rouge, La.

ONE Hundred to five hundred percent profits importing low-cost fast-selling merchandise direct from Japan. Airmail \$1 for price list and simple home-business plan anyone can operate. Francis Justice Co., Akasaka P.O. Box 7-A, Tokyo, Japan.

OPERATE Profitable magazine subscription service. Earn big Christmas profits. New telephone plan. Handle renewals for all magazines. No experience or investment. Rush name. McGregor Agency, Dept. 500-C, Mount Morris, Illinois.

PROFITABLE Home business adds to retirement income. Operating information for interesting mailorder business. World Sales Co., Box 179 PM, Ripley, Mississippi.

AMAZING Profits! Free particulars. Peltcher, 4781 El Cajon Blvd., San Diego 15, California.

EXCEPTIONALLY Profitable homework opportunity. Free information. Baron's Recording, Lynden, Wash.

EARN \$10,000-\$25,000 Annually. "24 Avenues to Success" tells how. Booklet 25c. Valleypress, Descanso 3, California.

EARN \$10,000.00 Typing at home! New book reveals tried and proved formula for securing profitable typing work, with or without experience. Only \$2.00. Satisfaction guaranteed. Order today. Felgen, Dept. PM-10, Box 1125, Oak Park, Ill.

NEARING 60? Want salaried position, (no selling). Send for free information about a book listing many possibilities for you. G. & L. Company, 7312-B Antioch Road, Merriam, Kansas.

OVER \$200,000.00 in cash prizes offered this month. They are yours for the taking. Free details. Robert Spence, Dept. P, 7352 Central Ave., St. Petersburg 7, Fla.

\$145,000 INCOME Possible developing experimental mink. Complete information \$1.00. Huebl Minkery, LeSueur, Minn.

FORMULAS, PLANS, ETC.

FREE Formula catalog. Anything analyzed \$25.00. Western Chemical, Salem, Oregon.

MAKE Extra money, part or full time. 100 formulas only \$1. Ann Graham, 507-A Fifth Avenue, New York City 17.

15 EASY-To-make money-making formulas \$3.00. Write Jim & Jim, 552 W. O'Connor St., Lima, Ohio.

LIFETIME Business! Manufacture extremely profitable products! Lists free! Thermolab, Peoria 4, Ill.

MODERN Formulas for today's fastest selling big-profit products. Literature free! Miller, Chemist, 1517-N, Tampa, Florida.

FORMULAS; All kinds, latest, best. Literature free. Kemixal, Park Ridge, Ill.

REAL Manufacturing formulas. Lists free. Cummings, Chemist, Gordon Ave., Syracuse 4, N. Y.

PRODUCT Analysis, manufacturing formulas, processes developed. Moderate fees. Plastics, Box 1574, Boston 4, Mass.

ONE Commercial formula and catalog \$2.00. Millet-PM-Chemist, 1709 W. 7th St., Los Angeles 17, Calif.

PLASTICS

PLASTICS Home-craft course for men and women. Tells and shows how to make hundreds of fast selling plastics products. All plastics and materials for 23 projects included in course. No special tools needed. Course pays for itself. Write for free booklet. Interstate Training Service, Dept. D-3-K, Portland 13, Oregon.

LAMINATING: Information, sample free. Plastic Press, Box 13, St. Louis 14, Missouri.

PLEXIGLAS Sheets for less. 1/2" x 12" \$1.75. Plus 15% postage. Catalog 25c. Plastic's, Box 1812, Salt Lake City 10, Utah.

SPECIAL Offer—Home repair kit with powerful adhesive plastic and fiberglass. Prize contest. Complete information brochure 10c. Adhese Sales Co., Box 282, Nixon 1, N. J.

PLASTIC Glue, 30 times stronger ordinary glue, easy to use. Kit \$1.50. Dunn, Box 5537, Chicago 80, Illinois.

PLEXIGLAS, Lucite. Square foot cost 1/16", \$1.15; 1/8", \$1.52; 3/16", \$1.86; 1/4", \$2.21; 3/8", \$3.28, 1/2", \$4.38. Colors add 10%. Send 15¢ for postage. Aristocrat Plastics, 23-25 Sussex Avenue, Newark, N. J.

LAMINATING Supplies. Free price list. Solomonson, 46 Cornhill, Boston 3, Mass.

PLEXIGLAS: Sheets, rods, tubes—Clear, tinted. Ideal for boat windshields. Paper-thin acetate. Vinylite sheets, rolls; Fiberglass. Polyester boat coatings; casting, embedding plastic. Plastic sign letters. Wholesale-retail factory distributor. Instructive catalog, 15c. Airmailed 25c Gem-O-Lite, 5350P Riverton, North Hollywood, Calif.

PLASTIC, Sheets, rods, tubes, etc. Free catalog. Parker Specialties, 9895 Monica, Detroit 4, Michigan.

PLEXIGLAS. Cut to size. Clear. Any thickness. Colors. Rods. Tubing. McClarin Plastics, P.O. Box 168H, Hanover, Penna.

CHEMISTRY

CHEMISTRY, Biology. Catalog 25c. Laboratory Sales, Box 161-A, Brighton, Mass.

AMAZING New Book of Science. Experiments, formulas and catalogue of laboratory supplies. Only 25c. National Scientific Co., Dept. PM-10, 3204 W. North Ave., Chicago 47, Illinois.

NEW Idea chemical and apparatus outfits for home experimenting, photo-scales, microscopes, chemicals, biologicals and laboratory supplies in small quantities. Catalog 25c. Established 1931. John H. Winn, 124A West 23rd St., New York, N. Y.

ILLUSTRATED Catalog: Chemistry, mineralogy, biology 20c. Tracey Laboratories, Evanston, Illinois.

CHEMICALS And apparatus for industrial, analytical, and private laboratories. Catalog 25c. Dept. M-50, Biological Supply Co., 1176 Mt. Hope Ave., Rochester 20, N. Y.

AGENTS WANTED

DAVY Crockett still steps sell like wildfire. Amazing demand, profits. Particulars. FunCraft, 1013 Garfield, Aurora 10, Ill.

MEN. Money! Miracle Glasstint tints windshield. Gives marvelous glare-proof protection, plus 1956 look. Sprays on in fifty. Reduces glare from sun, headlights. Lasts for years. Auto, truck owners buy on sight. Profits 100% up. Rush postcard for free details. Glasstint, 220 S. State, Dept. PM-10, Chicago.

COMBINATION Crucifix and sick call set. Indispensable every Catholic home. Sell for \$2.75; cost you \$1. Hundred lots. Regular \$5 retail value. Send \$1.50 sample. Mackley, 104 Worth St., New York City 13.

SELL Imported giftwares. Illustrated catalog free. Adams Associates, 30 West Washington, Chicago 2, Illinois.

MEN: Make \$1000 a month with 3-second demonstration of powerful, midjet Presto fire extinguisher to homes, offices, factories, car owners, garages, farms, etc. New chemical beats expensive extinguishers. Only \$3.98 with big profit. Merlite, 114 E. 32nd, Dept. 50-A, New York 16.

MAKE Money at home as headquarters for all magazines. Earn big Christmas profits. Liberal commissions. No experience—No capital needed. Supplies furnished. Write McGregor Magazine Agency, Dept. 500-A, Mount Morris, Ill.

60% PROFIT On cosmetics—Famous nationally advertised Hollywood Cosmetics pay 60%! Makes \$25 day up! Hire others. For free samples, details, write Stadio Girl, Glendale, Calif., Dept. PM-105.

BE Your own boss! No investment—No inventory. Big real profit-making wholesale catalog free! Dept. PM, Jay Norris, 445 Broome St., New York City, N. Y.

NEW Way to make money! Sell nothing yourself. Just offer free item to women for every two they sell for you. Household wares needed in every home. Postcard brings catalogue and details of amazing new kind of money-making plan. Absolutely no obligation. Topval Corp., Lindenhurst 31, New York.

TAKE Orders for chain saws, supplies. Good commission. Bero Bros., Newark 9, Ohio.

NEW Line portable electric power tools. National manufacturer sponsoring Perry Como's fall program. Send for free catalogue. Glasser Products, 389 Kingston Avenue, Brooklyn, N. Y.

REAL Diamond rings. Sell direct. Make big middleman's profit. No investment. Experience unnecessary. Free catalog, details. Gleamlight, 111-R No. Columbus, Mount Vernon, N. Y.

MAKE Money introducing world's cutest children's dresses. Big selection, adorable styles. Low prices. Complete display free. Rush name. Harford, Dept. P-5341, Cincinnati 25, Ohio.

MAKE Money selling outstanding line of regular ties, square ends, reversibles, feather, plaited, bows, knitted, Kerchief sets, mufflers. Free catalog. Philip's Neckwear, 30 W. 22nd, Dept. 415, New York City 10.

CASH In on tremendous demand for new cheap burglar alarm for automobiles, homes, stores. Nothing like it. Everybody wants one. 300% profit. Unique sample offer. Northwest Electric Co., 416-M Main, Mitchell, S. Dak.

WOMEN, Men, make money spare time plus new car as bonus for encouragement. Amazing hosiery guaranteed to wear without holes, snags, and runs, or replaced free. For example, lovely 60 gauge nylon guaranteed for as long as 1 1/2 years, or replaced free. Write Wilknit, 17510 Wash., Greenfield, Ohio.

YOUR Own business—Used suits \$1.50, overcoats 65c, mackinaws 35c, shoes 12 1/2c, ladies coats 30c, dresses 15c. Enormous profits. Catalog free. Nathan Portnoy Associates, 1218AA South Jefferson, Chicago 7.

NEW Silicone car polish. Shines without rubbing. Fast seller. Details free. Bonluth Products Company, Box 1078, Bristol, Oklahoma.

"FUN And Profit in Selling." Beginner's booklet by retired sales manager. Inspires confidence. Helps remove mystery from selling. Only \$1.00. R. Hyland, P.O. Box 2216, Cleveland 9, Ohio.

BUY Wholesale, 25,000 items, catalog 25c. Matthews, 1472-B1 Broadway, New York City 36.

CHAMOIS. Low cost top quality direct imports. 20x30 \$2.00. Babrok, PMS, Hudson Falls, N. Y.

BEAUTIFUL Feather pictures. 200% profit! Free sample. Apartado 9036, Mexico 1, D. F.

START Your own business on credit. Your own boss. 1135 of our dealers sold \$5000 to \$30,000 in 1954. We supply stocks, equipment on credit. 200 home necessities. Sales experience unnecessary. Pleasant profitable business backed by worldwide industry. Write Rawleigh's, Dept. J-U-PPM, Freeport, Ill.

SELL Amazing value 21 for \$1.00 Christmas, all occasion greeting card assortments. Newest tall cards, unusual wrappings, novelties. Profits to 100% plus bonus. Write for feature boxes on approval, 77 free samples personal Christmas cards, stationery, free catalog. Selling guide. New England Art Publishers, North Abington 1033-H, Mass.

SHINE Shoes without polish. New invention. Lightning seller. Shoes gleam like mirror. Samples sent on trail. Kristee 76, Akron, Ohio.

150% PROFIT Selling 500 name and address labels. Retail \$1.00. You keep 60c profit. Free selling kit. Bruce, Box 71-Y, Boston, 1, Mass.

IMPORTING Without capital. Become successful U.S.A. resident agent for leading overseas manufacturers. High income, home operated, no risk. Complete arrangements furnished including U.S.A. distribution assistance. Impex, 1974-A Comstock, Los Angeles 25.

PROFIT With your own wholesale, name brand catalog. Appliances, watches, jewelry, gifts, tools. Imprint your name on cover. Full or part-time sales. Details free. Robel Sales, Dept. P.M., 487 Broadway, New York 13, N. Y.

WANTED: Men interested in making up to \$15,000 a year. Exclusive line of personalized articles. No investment. Free information and sales kit. Write Hook-Fast, Box 480 (PM), Roanoke, Virginia.

TREMENDOUS Profits! Every man, woman and child a customer. Suits \$1.50, pants 35c, dresses 30c, shoes 20c. Operate from store, home, car. Free catalog. Superior, 1250-A Jefferson, Chicago 7.

FREE Color catalog of religious jewelry. 100% profit. Virgin Mary heart necklace, sample \$1.00 (value \$2.50). Money back guarantee. Stephen-New York Inc., 1947 Broadway, New York 23.

CHRISTMAS—All occasion cards, novelties and gift items. Largest selection. Highest profits. Satisfaction guaranteed. Send for sample offer coupon now! Klotz Distributing Co., Dept. 89A, 1012 Western Ave., Toledo, Ohio.

EARN \$200 A week and up! Amazing profits are yours selling Seal-Tite, miracle puncture-proofing discovery! \$1.98 tube stops flats forever. Sure-fire! Appeal to America's 50,000,000 motorists! Complete sales kit free on request. M & M, Dept. M-2, 842 Third Ave., New York City 22.

PRINTING, Advertising salesmen—Excellent money-making sideline selling decalcomania name plates, small quantities. Automobile initials, sign letters. Free samples. **Ralco, XL, Boston 19, Mass.**

GOLD Or silver letters, numbers. Windows, doors, trucks, 1" to 6", 500% profits. Free samples. **Atlas-T, 544 West 79th, Chicago 20.**

MAKE Extra money. Sell front door name plates to friends, neighbors. Retail \$1.98; you make \$1.00! Free selling kit. **Modern Engraving Co., P.O. Box 194, Boston 14, Mass.**

\$1.00 PROFIT Selling \$2.95 photo enlargement deal. **Allen Studio, Riegler Bldg., Little Rock, Ark.**

AGENTS—300% Profit selling genuine gold window letters; stores and offices. Free samples. **Metallic Sign Letter Co., 431-D North Clark, Chicago.**

YOUR Ad in this space will get some good agents for you. Yes, I'll prove it. Write for Folder "A" right now. **F. W. Johnson, Classified Advertising Manager, Popular Mechanics Magazine, 200 E. Ontario St., Chicago 11, Ill.**

CALIFORNIA Sweet smelling beads. Sensational sellers. Particulars free. **Mission, 2328 FR, W. Pico, Los Angeles 6, Calif.**

RUN Spare-time greeting card and gift shop at home. Show friends samples of our new 1955 Christmas and all-occasion greeting cards and gifts. Take their orders and earn to 100% profit. No experience necessary. Costs nothing to try. Write today for samples on approval. **Regal Greetings, Dept. 78, Ferndale, Mich.**

EARN \$30 A Day! Sell Dab-It, amazing pocket-size, stick-form, "no ring" spot remover. Works like magic! Guaranteed! **M & M, Dept. M-1, 842 Third Ave., New York City 22.**

EASY Money selling the new Pro Candid 35 mm. cameras. Your area is open for anyone to cash in on these fast-selling cameras. Selling kits furnished, cash commissions guaranteed. For complete information write **Beurline Industries Inc., 508 N. Robert Street, St. Paul 1, Minn.**

BUY Wholesale 450,000 products. Literature free. **Carter, Box 6011-B, Chicago 80.**

SCHOOL Seniors—Earn sensational profits selling classmates America's most beautiful graduation name cards. Largest selection. Outsell all others. Free sample kit. **Printcraft, Dept. M, 1509 Maple Street, Scranton 5, Penna.**

MAKE More money showing Elmira greeting cards this Christmas! Why more? Because Elmira offers more variety; beautiful cards for every taste, every purse. You get heart-warming, old-fashioned favorites and smartly simple ones for today's tastes. No matter who you sell, Elmira has a style to please everybody from grandmother to young Mrs. Executive. Send today for free personalized samples, catalog and sparkling assortments on approval with personalized stationery, imprinted napkins and lovely gift wrap-pings! **Elmira Greeting Card Co., Elmira 201, N. Y.**

GOOD Profits selling Mexican leather cards. Free sample. **Apartmento 7113, Mexico City 1.**

USED And new watches. \$2.00 up. Free list. **Southern Watches, Gray, Georgia.**

MAKE Perfect auto polish. Add water to concentrate. Free private labels. Employ salesmen. **Fripco, Dept. M1055, Box 765, Youngstown 1, Ohio.**

FOG-STOP Windshield cloth. Instantly removes blurry mist, frost, sleet, snow. Stops windshield fogging. Samples sent on trial. **Kristee, 79, Akron, Ohio.**

SELL Sunshine cards, the name quality has made famous. No investment or experience necessary. 21 card deluxe tall slim assortment sells on sight! Imprints, Currier-Ives, religious, gift wraps, many others. Samples on approval, write: **Sunshine Art Studios, Inc., Dept. PM-10, Springfield 1, Mass., Pasadena 1, Calif. (Note: East of Rockies address Springfield office.)**

BUY Wholesale thousands nationally advertised products at big discount. Free "Wholesale Plan." **American Buyers, Hertel Station, Buffalo 16-A1, N. Y.**

BIGGER Profits selling greeting cards. Get list of sensational factory surplus bargains. \$1.25 boxes for 50c, \$1 boxes for 35c—while they last! Big line new 1955 Christmas cards, stationery, gifts. Assortments on approval. Personalized samples free! **Midwest Cards, 1113 Washington, Dept. 557-F, St. Louis 1, Mo.**

AT Last! Something new and sensational in latest tall Christmas cards. Make extra money fast! Show satins, velours, metallics. Gets easy orders. Pays up to 100% profit. 30 free samples. With name 50 for \$1.50. Big line. Amazing convertible pen-pencil, napkins, gifts, stationery. Several \$1.00 boxes on approval. **Puro Greetings, 2801 Locust, Dept. 340-M, St. Louis, Mo.**

TAKE Orders: Nurses, beauticians, waitresses uniforms. Highest commissions. Spare time. Repeat sellers. Everything supplied. **Manner, 3203-B Barnes Ave., New York 67, N. Y.**

PRINTING! Highest quality. Big profits. Free wholesale price list, supplies, details. **Napco, 2337-A Bath Avenue, Brooklyn 14.**

ENGRAVED Look! Embossed personalized stationery. Sells with ease. True money-maker. **Crestline, Box 21181, Los Angeles 21.**

YOU Can make a fortune with miracle discovery liquid cloth. Mends everything from boats to finest hosiery. Dries soft, durable elastic texture. Sells so fast production increased 34 times already. It's sensational! **Bard's Products, Dept. G, Evanston, Illinois.**

EASY Handwork makes fast-selling articles. Sample free. **Sunmade Company, Brockton 64, Massachusetts.**

500% PROFIT. Retailers can't resist colorful, large "sale" signs. Big selection. Dynamic samples \$1.00. **Soik, 152 West 23, New York City.**

WE Put you into big mail order business, drop shipping orders, no investments. No minimum. Catalogues supplied. Terrific new sellers, tremendous profits. **Turner Company, 1170 Broadway, New York 1, N. Y.**

WANTED Agents, salesmen, distributors, jobbers. \$204 weekly selling miracle Double-Gloss, car wax, paste, restores showroom new to cars in minutes without tiresome buffing or rubbing. Waxes, glaze, cleans, and polish in one easy operation. Wipe on, let dry, wipe off, leaves the shiniest gloss possible to obtain on automobile finish, one application lasts 6 months. Rush \$1 for 1/2-lb. can demonstrator, retail \$2.00. **Norman Wiggs & Company, 1408 E. 52nd Street, Los Angeles 11, Calif.**

BUY IT WHOLESALE

WHOLESALE: Nationally advertised merchandise. Illustrated catalog 50c. **Gray, Box 708, Hollywood 28, California.**

WHOLESALE Catalog! 30-80% discounts! Appliances, musical instruments, typewriters, phonographs, watches, jewelry, recorders, housewares, etc. Consolidated Distributors, 21-20 Lafayette, Paterson 15, New Jersey.

BUY Wholesale! Nationally known brands. Large illustrated catalog \$1.00. Refundable. **D'Auria, Box 355M, Jackson, Mich.**

VALUABLE Free gift! Free "Wholesale Purchasing Secrets"! Save 40%-50%-80% nationally advertised appliances, watches, power tools, gifts. Everything for home, office, workshop. Write! **Panatron, 7721 S. Melrose, Hollywood 46, Calif.**

BARGAINS, Joblots, close-outs, 2000 items. Save to 50%. Clothing, hosiery, toys, toiletries, gifts, jewelry, television, etc. Get acquainted. 25c brings wholesale catalog plus free \$1.00 merchandise certificate. **Reliable Jobbing, 311-B North Des-plaines, Chicago.**

BUY Wholesale! Save 66%! Appliances, furniture, jewelry, toys, sporting goods, tools. Free catalogs. **National Buyers Service, Box 426EB, Oakland, California.**

THOUSANDS Nationally advertised brand name products. Discounts to 80%. **Meder, 550-PM Fifth Avenue, New York City 36.**

WHOLESALE Catalogue, general merchandise. Rush \$1.00 (refundable). **Wayne Bros., Dept. B-2, 740 Adams St. N. E., Minneapolis 13, Minn.**

POGO Sticks. Will carry 150 lbs. guaranteed! \$4.50 postpaid. **U. S. Industries, 803-A Macy Street, Los Angeles 12, Calif.**

FREE Catalog. Save. Buy vitamins direct. **Wholesalers, Bayport 7, Mich.**

WHOLESALE Catalog. Appliances, cameras, watches, Postcard. **Selbyco, Decatur 261, Illinois.**

BUY It wholesale. Appliances, cameras, tools. Rush 50c for catalog to **Edward Clemens, 318 W. Bridge St., Morrisville, Penna. (Refundable.)**

ELECTRIC Guitars, amplifiers, parts, wholesale. Free catalog. **Carvin-PM287, Covina, Calif.**

INDIVIDUALS, Nationally advertised merchandise, wholesale. Tremendous discounts. **Kingsley, Chepachet, Rhode Island.**

YOUR Cost as little as 25c on dollar! Household items needed in every home. Sell direct, by mail or to agents. Catalogue, confidential distributors' wholesale prices and money-making plans absolutely free. Rush postcard to **Topval Corp., Lindenhurst 324, New York.**

SALESMEN—DISTRIBUTORS

NEW Insulated jackets, shoes sell fast! Be first to take orders for amazing insulated leather shoes, jackets. Keep body heat in, cold, dampness, wind out. We furnish complete sales outfit free. Big monthly earnings possible on just 2 daily sales. 190 other money makers. Send postcard today. **Mason Shoe, MC88, Chippewa Falls, Wis.**

SALESMEN! New or old, up your income immediately! With pocket sized pamphlet, "Thirty Laws That Govern Top Salesmen," written by outstanding author and sales executive. Practice one law daily and watch your sales increase! No need to plough through books, absorb by doing! Money back guarantee. Mail only \$1 today to **Post Publications, 2 Depot Plaza (M) White Plains, N. Y.**

NO Trick to selling ties at 69c each! Free plan shows how easily you pocket \$1.33 hourly profit. **Loren Specialties, 2849-A10 Birchwood, Chicago 45.**

\$6.75 PROFIT On every sale of Lightning portable adding machines, retail \$14.95. Rush season just ahead. Don't delay, write for free colored photo, full details now. **Lightning Adding Machine Sales Co., Dept. A153, 2306 W. Slauson Ave., Los Angeles 43, Calif.**

100% PROFIT. Past money for you! Take orders for Sweet Georgia Brown cosmetics. Colored people buy it quick. Free sample. Write **Valmor, 2451-AC Michigan, Chicago 16.**

FREE Car deodorizer to salesmen selling to homes. **Odor-Zone, Yantic, Conn.**

AD Matches! Sell amazing designs—10, 20, 30, 40 and 240-light book matches. Bigger spot cash commissions; every business a prospect. Low prices for high quality. Repeats. Start without experience; men, women; full, part time. Buy nothing! Sales kit furnished. **Match Corp., Dept. PM-70, Chicago 32, Illinois.**

BIG Money-making opportunity. Exclusive line work uniforms. Jackets, pants, shirts, coveralls. Advertising embroidered. Every business prospect. Outfit free. **Master Div., 571 Water, Ligonier, Ind.**

\$8000 PROFIT A Year—From just one sale a day! Keep safe, only full-size personal safe sold direct, lets you offer low-cost fire and theft protection that all homeowners, farmers and businessmen need—and less than 5% have! \$73.95 sale means \$26.45 profit, plus big bonus. No competition. Exclusive territory. Full details from **Manufacturer, John D. Brush & Co., 578 West Ave., Rochester, N. Y.**

SELL Calendars. You make big money daily. Giant line. Every business buys. Also business printing, book matches, advertising specialties. Big sales outfit free. Write, **Arrow Press, 515-S Fourth Ave. So., Minneapolis, Minn.**

STOP Thief! Amazing new portable safety box with built-in burglar alarm selling wild to business, individuals. Roars out loud alarm for 5 hours at slightest touch. Positive protection for cash, valuables. Low priced, anybody can afford. Write for sample offer. **Merlite-Alarm, 114 E. 32nd St., Dept. A-5010, New York 16.**

FRANCHISED Distributors make profits! Nationwide opportunities. Request interesting information immediately. **National Franchise Reports, 333 North Michigan, Chicago 1.**

ANYONE Can sell famous Hoover uniforms for beauty shops, waitresses, nurses, doctors, others. All popular miracle fabrics—Nylon, dacron, orlon. Exclusive styles, top quality. Big cash income now, real future. Equipment free. **Hoover, Dept. W-100, New York 11, N. Y.**

EARN \$30 A day showing our famous boots. Part or full time. No experience necessary. Write for free sales outfit. No obligation. **Jim Richards Shoe Co., Dept. M-10, Wellesley Hills, Mass.**

QUICKIE Electric. Cooks, bakes, fries. World's finest. 50% deal. Approval offer. Smith Agency-31, Excelsior Springs, Mo.

ADVERTISING Book matches—Cash in on big demand; sell union label matches. Cuts for all businesses and political parties. Free powerhouse selling kit, low prices, protection guaranteed on repeat orders. Cash commissions. Superior Match Co., Dept. M-1665, 7530 Greenwood, Chicago.

MONEY-Making opportunity! Take big profit orders for world famous patented varieties fruit trees. Also flowering shrubs, roses, vines. Big sales outfit free. Stark Bro's, Dept. 30106, Louisiana, Missouri.

GET New shirt outfit free: Make \$90.00 weekly on 5 average orders a day. Famous quality made-to-measure dress and sport shirts at \$3.95 up sell fast to all men. No experience needed. Full or part time. Write: Packard Shirt Co., Dept. 134, Terre Haute, Ind.

BUY Wholesale thousands nationally advertised products at big discount. Free "Wholesale Plan." American Buyers, Hertz Station, Buffalo 16-J1, N. Y.

AGENTS, Salesmen. Sell Futardine auto safety belts. 50% commission. Free details. Home Supply Service, Kiel, Wis.

WILL You wear new suits and topcoats without one penny cost and agree to show them to friends? You can make up to \$30.00 in a day even in spare time, without canvassing. Stone-Field, 432 South Throop St., Dept. J-926, Chicago 7, Illinois.

BIG Money selling sandal lawn aerators to home owners. 1000 prospects. Make a tip top lawn. Send for sample at wholesale price, \$3.54. Garden Specialties Division, 406 S. Main St., Los Angeles 13, Calif.

MEN! Make \$1000 a month with 3-second demonstration of powerful, Midget Presto fire extinguisher to homes, offices, factories, car owners, garages, farms, etc. New chemical beats expensive extinguishers. Only \$3.98 with big profit. Merlite, 114 E. 34th, Dept. 50-A, New York 18.

MAKE Up to 75c profit on each dollar! Household items needed in every home. Have others sell for you on commission. Sell wholesale to agents. Postcard brings details absolutely free. Topval Corp., Lindenhurst 325, New York.

GOLDMINE Of 600 money-makers. Copy free. Specialty Salesman Magazine, Desk 5, 307 N. Michigan, Chicago 1.

DISTRIBUTORS—Large profits. Terrific repeat orders. Unique Italian brooms, details free. Write P.M. Peacock, 913 Bryant, San Francisco, California.

NEW Jobs open in selling! Send name, address for five free issues of Opportunity Magazine's money-making guide, listing hundreds of companies who'll pay you well, full or part-time. No experience needed. Opportunity, 850 N. Dearborn, Dept. 17, Chicago 40, Ill.

EDUCATIONAL AND INSTRUCTION

IT'S Fun learning a language by Linguaphone, world's standard conversational method. At home, quickly, easily learn to speak French, Spanish, Japanese, German, Russian, Modern Greek—Your choice of 34 languages. It's like living in another country. Complete recorded courses on free trial. Send for free book and details, no obligation. Try, don't buy! Linguaphone Institute, T-83-106 Radio City, New York City 20.

BLUEPRINT Reading for machine and building trades. Train at home. Learn to read blueprints with confidence in 10 easy lessons. Earn more pay. Literature free. Belton School, 1638-Y North Lawndale, Chicago 51, Illinois.

LEARN Piano tuning at home. Total cost \$63. Write White-Bartenbach, 1001B Wells, Lafayette, Indiana.

COLLEGE Degree—Independent study. Keep employed. Brentwood College, Box 19-721, Los Angeles 18.

WELDING Training pays at Hobart Welding School, Box M-1051, Troy, Ohio. VA contract. Best equipment. Catalog free.

INDUSTRY Needs draftsmen. We help you qualify. Free information. Industrial Training, 1704-A Frederick, Fort Worth 7, Texas.

MIDWEST Engineering School, home study opportunity, 10923 Hillcrest, Hickman Mills, Missouri.

WANTED: More new writers for TV, radio, magazines, business publications, motion pictures. Learn at home for extra income or exciting full-time career. Many students earn while learning. Professional instruction. Send today for free lesson and book. Palmer Institute of Authorship, 1880 N. Sycamore, Desk TM-105, Hollywood, Calif.

COMPLETE Your high school at home in spare time with 58-year-old school. Texts furnished. No classes. Diploma. Information booklet free. American School, Dept. XT45, Drexel at 58th, Chicago 37, Ill.

7 PRINCIPLES Of Mental Association—\$2. Unity of Knowledge Publications, 818 South 26th Street, Arlington 3, Virginia.

MANY Earn \$1000.00 per month operating collection agencies. Write for free bulletin. Franklin Credit, Roanoke 7, Va.

ELECTRONIC Parts distribution offers you a secure future at top pay in all areas. No investment necessary. Write Williams Co., Box 261, Miami 2, Fla., for information on this desirable, uncrowded field.

CORRESPONDENCE Courses, educational books bought, sold, rented. Catalog free. Willard Bayles, 211 Essex, Hackensack, New Jersey.

BE Somebody! Do things! Get somewhere with our simplified self-training plan of positive thought motivation and constructive action mastery. Eye-opening information free. Write today. Applied Christian Psychology, Inc., Box 1924-X, Louisville 1, Kentucky.

STUDY At home for commercial radio licenses. Free sample lesson. Very reasonable fee. Write Radio License Aids, Box 456, Limestone, Maine.

PIANO Tuning pays. Big money in spare time. Learn at home in 30 days. No musical knowledge necessary. Phonograph, records, tools and instructions furnished. Free catalog. Capital Tuning School, 16 Southwest Second, Fort Lauderdale, Fla.

GUN Stock refinishing, profitable business, interesting hobby. Free information. Refinishing School, Dept. PM, 1711 Purdue St., Lafayette, Indiana.

TRANSFORM Yourself via subconscious dynamics. Free amazing brochure. Box 247 (H-10), Ocean Park, Calif.

WORK For U. S. gov't! Men-women, 18-55. Start high as \$350.00 month. Qualify now! 16,000 jobs open. Experience often unnecessary. Get free 36-page book showing jobs, salaries, requirements, sample tests. Write: Franklin Institute, Dept. J24, Rochester, N. Y.

A Pleasing dynamic singing and speaking voice can be yours! Use self-training Canfield Voco-Records. Thrilling details! 2018-A—5th Avenue South, Minneapolis 4, Minnesota.

BE A real estate broker. Study at home. Write for free book today. GI approved. Weaver School of Real Estate, 2018P Grand, Kansas City, Missouri.

UNIVERSITY Degrees by residence, correspondence. Golden State University, Box 2883, Hollywood, Calif.

BECOME A doctor of psychology or metaphysics. Learn secret of contentment, happiness. Win degree of Ph.D. or M.S.D. Correspondence only. Free book. College of Universal Truth, 5038-C Broadway, Chicago.

INVESTIGATOR Training. Phillips Secret Service System, 1917-B North Kenneth, Chicago 39.

AUCTIONEERING. Be an auctioneer. Earn big money. Term soon. Write for catalog. Kansas City Auction School, Suite 307, Shankman Building, 3119 Troost, Kansas City, Missouri.

HIGH School diploma at home. Licensed teachers—Approved materials. Southern States Academy, Box 144-MX, Station E, Atlanta, Georgia.

SECRET Investigation. Experience unnecessary. Investigators particulars free. George Wagner, M125 West 86th, New York 24.

GROW Mushrooms. Cellar, shed, and outdoors. Spare, full time, year round. We pay \$3.50 lb. We paid Babbitt \$1,165.00 in few weeks. Free book. Washington Mushroom Ind., Dept. 174, 2954 Admiral War, Seattle, Washington.

EARN While you learn. Auto and diesel mechanics master this top paying trade. Many graduates earn \$100 a week and up. Approved for Korean veterans. For free information write Dept. No. 256, Nashville Auto-Diesel College, Nashville 3, Tenn.

MEDICAL Laboratory technicians in great demand. We train you in your own home. Catalogue free. Imperial Technical Institute, Box 973-J, Austin, Texas.

BOOKKEEPERS: Increase your earnings! Operate your own simplified "Dollar-A-Week" bookkeeping and tax service. Full or spare time. Details free. No obligation. Ellis, Box 300, Cedar Grove, North Carolina.

USED Correspondence courses and books sold and rented. Money back guarantee. Catalog free. (Courses bought.) Lee Mountain, Pisgah, Alabama.

PIANO Tuning pays. Learn this profitable profession at home easily with patented Tunometer and mechanical aids. No knowledge music necessary. Diploma granted. Write for booklet. Niles Bryant School, 3731 Stockton Blvd., Dept. P, Sacramento 20, California.

STUDY For doctor's degree of psychology, metaphysics and divinity. Correspondence courses only. College of Divine Metaphysics, Dept. P-M, 2811 North Illinois, Indianapolis 8, Indiana.

BECOME An expert real estate broker or salesman. Make money anywhere. Complete home study course. Free information. Kansas City Realty School, Suite 307, 3119 Troost, Kansas City, Missouri.

SPANISH Quickly! Recordings, textbook. Special, \$6.95. Speed-O-Way, Box 32-161, Los Angeles 32, California.

WANT A diesel job? New opportunities to increase income. Higher pay. More money. We can help you qualify. Tools. Shop method home training. Write today! Diesel, Tractor, Heavy Equipment Division, Interstate Training Service, Dept. B-3, Portland 13, Oregon.

PHYSICAL Therapy and massage. We train you at home. Earn big profits from your own private practice or work with hospitals and doctors. Free catalogue. National Institute, Desk 4, 159 E. Ontario, Chicago, Ill.

PLAYS, STORIES, MANUSCRIPTS

NO Luck finding a book publisher? Write for free Booklet PM. Vantage Press, 120 W. 31, New York.

SPECIAL SERVICES

INFORMATION On most any subject. Prompt. Reasonable. Let us know your wants. Reliable Information Service, Box 173, South Lansing, Michigan.

EXPERT Answer to almost any question. Reasonable rates. Miller's Research Bureau, Route One, Murray, Kentucky.

ARIZONA, California, For \$2.00 I will answer your individual questions as to climate, job opportunities, real estate, consumer prices, etc. Vince, R.R. 1, Box 353, Colton, California.

INFORMATION On anything. Ferguson Research Specialists, 116-14 141 St., South Ozone Park 36, N. Y.

ARTISTS' SUPPLIES

IF interested in artist frames, canvas, canvas boards, Red Sable brushes, etc., be sure to get our money saving price lists before buying. International Sales Co., 414-APM E. Baltimore St., Baltimore 2, Md.

CARTOONING, COMMERCIAL ART, SHOWCARD & SIGN PAINTING, TATTOOING

PAINT Signs—Learn at home. Amazing easy instructions. Biggest complete course with 324 illustrations (18 in colors) \$5 postpaid. Circulars free. Eric Matthews, 2325 Cass, St. Louis 8, Missouri.

PAINT Signs with master patterns. Set 1 1/2" to 12" high, with supplies, \$9.00; sample 3c. Everly, B-583, Newton, Iowa.

"HOW To Make Money With Simple Cartoons"—A book everyone who likes to draw should have. It is free; no obligation. Simply address Cartoonists' Exchange, Dept. 910C, Pleasant Hill, Ohio.

"QUICKIE Course in Drawing." Send to: today, Home and Office Libraries, University Sta. 43-PM, Fayetteville, Arkansas.

BASIC Training for beginners. Free talent test. Student Art Club, Kennebunkport, Maine.

YOU Can entertain with chalk talks. Catalog 10c. Baida The Cartoonist, Oshkosh, Wis.

ADVERTISING AGENCIES, LETTER WRITERS, FOR ADVERTISERS

GUARANTEED Mailing lists many classifications opportunity seekers, farmers, ministers, school teachers, many others. Price lists. Write Ken-West Distributors, 7-K South Harlem Street, Worcester 4, Mass.

ADVERTISING Layouts. Free samples. Bernzoff, 299 E. 162 St., New York City.

NO-Money-Down radio advertising! Pay stations small percentage after sales. Eliminates high time rates. Profitable! Edwards, Box 45793A, Los Angeles 45.

ADVERTISE: 24 Words, 100 Canadian newspapers \$3.50. Lists free. Advertising Bureau, 10511-C Springfield, Chicago 43.

MAILING Lists, most any classification. 1000 names \$5.00. 1000 your circulars mailed with ours \$4.00. 5000 your circulars printed and mailed \$12.95. Write Dixie Mailers, Kings, North Carolina.

ADS Placed in out of town newspapers and magazines. Low rates. Catalogue free. Ideas that pay. Baker Advertising Agency, Successors Ankrum Agency, 189 W. Madison, Chicago 2.

FREE! 1955 Advertisers Rate and Data Directory. 52 pages! E. H. Brown Advertising Agency, 20 N. Wacker, Chicago 6.

ADVERTISE — 24 Words, 20 big newspapers, \$30.00. Newspaper, magazine, rate-book free. Chicago Advertising Agency, Chicago 4.

ADVERTISING. Marketing questions answered, \$1. Hicks, Wendover Road, Rye, N. Y.

RUBBER STAMPS AND OFFICE SUPPLIES

THREE Lines \$1.00. Free stamp pad. Barber, 596 Girard, Marion, Ohio.

LINE 25c; 2-45c; 3-55c. Stamp Works, Auburn, Nebraska.

POCKET Rubber stamp, 3 lines, self inking, plastic case. Rushed air mail same day order received. Hadfield Stamps, 205 West Crosstimbers, Houston 16, Texas.

RUBBER Stamps by professional craftsmen. 3 lines \$1.00. Price list. South Coast Press, 654 East Base Line, San Bernardino, Calif.

3 LINES. \$1.00. Fast service. Catalogue. Johnson, 443 MacDonough, Brooklyn 33, N. Y.

WHOLESALE Prices. Complete stamp service. Take orders. Handy Stamps, Bellevue, Texas.

FIRST Line 50c; additional lines 25c. Stamp Works, Victoria, Kansas.

TYPEWRITERS, DUPLICATORS, OFFICE DEVICES

RE-INK For your typewriter or adding machine ribbon. Gives new life to three ribbons. Economical, easy to apply, long lasting, practical. Equally effective on two color ribbons. Re-inking the black, rejuvenates the red. Send 35c to Ink Products, 49 Lake St., Nashua, N. H.

RUSH! Pyrex glass eraser. Erases ink, typing. \$1.00. Kenneth Harrington, Blue Ridge N. Y.

RECONDITIONED Typewriters, duplicating, printing devices, \$25.00 up. Supplies. Appliances. DixieGraph, King, N. C.

PRINTING, MULTIGRAPHING, MIMEOGRAPHING, GUMMED LABELS

1000 EMBOSSED Business cards \$2.95. Decco Service, Box 5825, St. Louis 21.

100 LETTERHEADS (8 1/2 x 11) Or envelopes \$1.00 postpaid. Everett-Printing, 243 54th, East Paterson, N. J.

HIGHEST Quality mimeographing. Free samples, price lists. Ken-West Distributors, 7-K South Harlem Street, Worcester 4, Mass.

SAVE On envelopes. #10, \$8.75 per M (5M lots). Equally low prices, all sizes. Central Show Printing Co., Mason City, Iowa.

BUSINESS Letterheads. Illustrated catalogue free. Howprint, 723-G Eunice, Webster Groves 19, Mo.

1,000 ENGRAVED Business cards \$3.50 postpaid. Over 25 type styles. Samples sent free. House of Farrell, Box 452-P, Buffalo 5, N. Y.

QUALITY Printing. Booklets, publications, catalogs, stationery. Free catalog. Adams Printers, 30 West Washington, Chicago 2, Ill.

CARDS \$2.95 Per 1000 postpaid. General Printing. Send copy for quick quotation. Economy Printers, Box 8251, Tampa 4, Florida.

GIFT Boxed personal stationery. Name, address printed 150 sheets, 100 envelopes, 50 correspondence cards. All for \$2.95 postpaid. Charles Schuler, 319-C West 48th Street, New York 19, N. Y.

ATTRACTIVE Printing at attractive prices. Letter brings samples. Starks Printery, 2926A Jerome Street, Dallas 23, Texas.

BUSINESS Cards, mailing labels. Samples free. Brown, 1714 Cardinal, Indianapolis 27, Ind.

BONUS Value printing catalog free. Lidco, Box 11121, Ft. Worth 10, Texas.

PRINTING — Reasonable. Catalog 10c. (Double deducted first order.) Foty Printers, 16721 Prospect, Wayzata, Minnesota.

MIMEOGRAPHING Special offer. Samples free. Butterworth, 489 Henry, Detroit 1, Mich.

FINEST Quality printing at bargain prices. Free catalog. Hampton Printing, 601 1/2 N. Main, Wichita, Kans.

100 8 1/2 x 11 WATERMARKED Letterheads \$1.00 postpaid, envelopes same. Other printing, samples free. R. Hussey Printing, Abbeville, Miss.

1000 EMBOSSED Business cards, one color \$3.95; two color \$4.50. Samples free. L. Watson, Box 162, St. Charles, Illinois.

\$1.00 100 LETTERHEADS Or envelopes. Postpaid. Poor Boy PM, Box 1055, Little Rock, Ark.

MIMEOGRAPHING — Letters, price lists, formulas, instructions. Lowest prices. Lem's Letter Shop, 5719 Stanton, Detroit 8.

500 3 1/2 x 2 1/4 FOUR Line gummed stickers 50c. Red border \$1.00. Moritz Printery, Saginaw, Mich.

100 LETTERHEADS, \$1.00, #6 3/4 Envelopes same, two colors, \$1.50. Broadbrook, Botsford, Conn.

100 LETTERHEADS, 8 1/2 x 11. Carefully printed \$1.00 postpaid. Envelopes same. Race Printers, Hudson, New York.

OFFSET Printing \$5.50—1000, 8 1/2 x 11, 16 lb. National Letter, 1463 Broadway, New York City 36.

HIGHEST Quality printing! Free price list. Napco, 2337-PM Bath Avenue, Brooklyn 14.

100 ENVELOPES. Printed 2-colors \$1.25. Box 523, Rochester 2, N. Y.

200 BUSINESS Cards \$1.00 postpaid. Artercraft, 85-28 Roosevelt, Flushing 72, New York.

SENSIBLY Priced business printing. Special! 250 8 1/2 x 11 bond letterheads, 250 #10 heavyweight envelopes, \$5.95. Postpaid, guaranteed. Free samples, quotations. Sparks Company, Box 4096, Austin, Texas.

FREE Catalog. Letterpress, offset printing. D & M Sales, Sebastopol, Calif.

CIRCULARS, Catalogs, booklets, forms, etc. Campbell, 14256 Maiden, Detroit 13, Michigan.

\$1.00 PER 100 Letterheads, envelopes, invoices, cards. Free quotations. Valleypress, Descanso 3, California.

ADS Running under this heading sell printing. Ask me for proof. I'll gladly send you amazing facts. Ask for Folder "P" F. W. Johnson, 200 E. Ontario St., Chicago 11, Ill.

PRINTING OUTFITS AND SUPPLIES

PRESSES, Supplies, paper. Catalog 10c. Custom, Box 211-P, Springfield, Missouri.

PRESSES, \$5.50. Printers bargain list. Sc. R. Cundiff, Blueford, Illinois.

MAKE Your own self-molding rubber stamps and printing cuts. Plexirubber, Argyle 1, Wisconsin.

DO Your own printing. Save money. Simple rules. We supply everything. Print for others; good profit. Raised printing like engraving too. Have home shop. Details free. Kelsey Presses, V-11, Meriden, Connecticut.

PRESSES, Type cabinets, supplies. List for stamp. Lincoln Press Company, 220-J Hartwell, Fall River, Mass.

PATENT ATTORNEYS

INVENTORS — Take these preliminary steps toward patent protection. Sketch and describe your invention. Sign, date and have this disclosure witnessed by two people who understand your invention. Have us make a preliminary search among U.S. patents already granted for similar types of invention. We report on the probable patentability of your invention and recommend your further course of action. Write for our instructive booklet, "Patent Protection for Inventors" and convenient "Evidence of Invention" disclosure form. Victor J. Evans & Co., 131-L Merlin Building, Washington 6, D. C.

INVENTORS: Learn how to protect your invention. Unless the inventor is familiar with patent matters, he should engage a competent registered patent attorney or agent to represent him. We are registered to practice before the U.S. patent office and prepared to serve you in handling your patent matters. "Patent Guide for the Inventor" containing detailed information concerning patent protection and procedure with "Record of Invention" form will be forwarded to you upon request—without obligation. Clarence A. O'Brien & Harvey Jacobson, Registered Patent Attorneys, 51B-K District National Building, Washington, D. C.

INVENTORS — If you believe you have an invention, you should find out how to protect it. The firm of McMorrow, Berman & Davidson with offices in Washington, D. C., is qualified to take the necessary steps for you. Send for copy of our patent booklet "How to Protect Your Invention." We will also send you an "Invention Record" form. No obligation. They are yours for the asking. McMorrow, Berman & Davidson, Registered Patent Attorneys, 134-G Victor Building, Washington 1, D. C.

PATENTS — Irving L. McCathran, 315 McLachlen Bldg., Washington 1, D. C. Registered Patent Attorney.

INVENTION Record form free and "Patent Information Every Inventor Should Have." Carl Miller, Registered Patent Attorney, Woolworth Building, New York.

REGISTERED Patent attorney offers services. Sanders, 6430 Evans, Chicago 27, Illinois.

C. A. Snow & Co. — M427, Snow Building, Washington 1, D. C. Registered Patent Attorneys. Write for information.

INVENTORS: When you are satisfied that you have invented something of value write me, without obligation, for information as to what steps you should take to secure a patent. Write Patrick D. Beavers, Registered Patent Atty., 935 Columbian Bldg., Washington 1, D. C.

PATENTS. "Proof of Invention" free. E. E. Vrooman, Registered Patent Attorney, 507 McKim Building, Washington 5, D. C.

"INVENTOR'S Guide" and "Record of Invention" free on request. Frank F. Ledermann, Registered Patent Attorney, 154 Nassau Street, New York City.

INVENTORS: Without obligation, write for information explaining the steps you should take to secure a patent. John Randolph, Registered Patent Attorney, 203 Columbian Bldg., Washington 1, D. C.

FOR INVENTORS

FREE Patent booklet and record of invention on request. H. Lawrence Blasius, 15 Park Row, New York City.

INVENTORS Send for free details of our patent application plan. Inventors Institute, 200 West 34th Street, New York 1.

INVENTORS. Let us help you sell your patent. Parker Products, Kenney, Ill.

INVENTORS: Learn how to protect your invention. Unless the inventor is familiar with patent matters, he should engage a competent registered patent attorney or agent to represent him. We are registered to practice before the U.S. patent office and prepared to serve you in handling your patent matters. "Patent Guide for the Inventor" containing detailed information concerning patent protection and procedure with "Record of Invention" form will be forwarded to you upon request—without obligation. Clarence A. O'Brien & Harvey Jacobson, Registered Patent Attorneys, 51A-K District National Building, Washington, D. C.

INVENTORS—If you believe you have an invention, you should find out how to protect it. The firm of McMorrow, Bertram & Davidson with offices in Washington, D. C., is qualified to take the necessary steps for you. Send for copy of our patent booklet "How to Protect Your Invention." We will also send you an "Invention Record" form. No obligation. They are yours for the asking. McMorrow, Bertram & Davidson, Registered Patent Attorneys, 134-F Victor Building, Washington 1, D. C.

INVENTORS—This firm is registered to practice before the United States Patent Office and available to assist you in the preparation and prosecution of your patent application. "Patent Protection for Inventors" booklet containing detailed information and steps to take toward patent protection sent promptly upon request. No obligation. Victor J. Evans & Co., 133-L Meritt Building, Washington 6, D. C.

MARKET Research is vital to the sales success of any product, new or old. Increase profits. Avoid losses. A highly trained and experienced market analyst will advise on your markets. For free details, write: Market Data, 1029 Center Point Road, Cedar Rapids, Iowa.

PATENT Pending. No attorney required. Send two five-cent stamps for Patent Search Guide and all information. Paladine Publications, 203B Atlantic Ave., Bellmore, N. Y.

EXCLUSIVE: Electro mechanical research center reveals simple, inexpensive methods of handling inventions. Full protection plus direct help from the United States patent office. Manufacturers are anxious to buy if properly contacted. Send for your free copy of "Inventor or Investor" and find out how successful inventors operate. No obligation. The Dynavolt Company, 3310 Huntington, Newport News, Virginia.

INVENTORS—Send for free patent information book and inventor's record. Registered Patent Attorney, Associate Examiner, Patent Office 1922-29, Patent Attorney & Advisor, Navy Department 1930-47, Gustave Miller, 86A Warner Building, Washington 4, D. C.

PATENT Searches, including copies of nearest patents, \$5.00. Reports airmailed within 48 hours. More than 160 registered patent attorneys use my service. For free invention protection forms, write Miss Ann Hastings, P.O. Box 176, Washington 4, D. C.

INVENTORS: If you have an invention for sale, patented or unpatented, write Institute of American Inventors, Dept. 40A, 631-E St. N.W., Washington 4, D. C.

"**INVENTOR'S** Guide" and "Record of Invention" free on request. Frank P. Ledermann, 154 Nassau Street, New York 38, N. Y.

INVENTION Record form free and "Patent Information Every Inventor Should Have." Carl Miller, Registered Patent Attorney, Woolworth Building, New York.

INVENTORS: Information on patent procedure furnished on request, without obligation. John Randolph, Registered Patent Attorney, 292 Columbian Building, Washington 1, D. C.

SEARCHES—Put your patent searches in the hands of a registered patent attorney or agent, as he qualifies to give a worthwhile patentability report. Record of invention form upon request and information on patent protection. Patrick D. Beavers, Registered Patent Attorney, 836 Columbian Bldg., Washington 1, D. C.

PATENT Searches \$5.00. 48-hour airmail service. Invention protection forms free. Write Patent Engineering Service, 711 14th Street, N.W., Washington 5, D. C.

PATENT Searches \$5.00. 48-hour service. Free invention protection forms. Write Raymond L. Smith, Patent Searcher, 622 Sheraton Building, Washington 5, D. C.

IDEAS, Inventions. Use our design, research, development service. You are protected. Write Mechanical Development Co., 218 East Bay St., Savannah, Georgia.

INVENTIONS WANTED

INVENTIONS Wanted. Patented; unpatented. Have outstanding manufacturer lists. Full particulars free. Superior, 338-342 North Rodeo, Beverly Hills, Calif.

INVENTIONS Sold—Commission basis. National Patent Sales, 1312 East 44th, Richmond 24, Virginia.

INVENTORS: Inventions needed immediately, all fields. Demand never greater. We franchised one for Lykins, West Virginia inventor in 4 months. Write for free special booklet. Kessler Corporation, 510X, Fremont, Ohio.

INVENTIONS Wanted. Patented; unpatented. Free booklet. It's worth getting our offer. Wulco Patent Association Ltd., D-105, 550 Fifth Avenue, New York City 36.

INVENTIONS Wanted by manufacturers. Patented, unpatented. Send for free form "S." Adams, Patent Broker, 80 Wall Street, Financial District, New York City.

PROMOTION, financing, searching, patenting. Complete inventors service since 1930 brings results. Free invention analysis. Inventors Project Engineers, 188 West Randolph, Chicago 1.

CASH Buyers for ideas and inventions. Write National Inventors Institute, 457 Munsey Building, Washington 4, D. C., or 4097 East 131st St., Cleveland 5, Ohio.

INVENTIONS Wanted. Patented; unpatented. Tremendous manufacturers lists. Global Marketing Service, 1404 Mitchell, Oakland 1, California.

INVENTORS: Hundreds of manufacturers have requested our assistance in locating marketable new products. Complete information free. Institute of American Inventors, Dept. 40-D, 631-E St. N.W., Washington 4, D. C.

INVENTIONS Promoted. Patented or unpatented. A-1 service for inventors since 1911. Write Adam Fisher Co., 5418 Idaho, St. Louis, Mo.

INVENTIONS Wanted. Patented or patent pending. 24 years experience promoting inventions. National Service Bureau, 3120 Meramec, St. Louis 18, Mo.

INVENTORS, Don't sell your invention patented or unpatented until you receive our offer. Write Cowgill, Box 298, Marion, Ohio.

PATENTS FOR SALE

LARGEST Selection. State requirements. Superior Inventions, 338-344 North Rodeo, Beverly Hills, Calif.

INVENTORS: Test the commercial value of your patented or unpatented inventions, quickly and inexpensively. Write for free information. Institute of American Inventors, Dept. 40-B, 631-E St. N.W., Washington 4, D. C.

A New original and ornamental design for beaded rosettes. Julia Engelmer, 325 North Craig St., Pittsburgh 13, Penna.

MANUFACTURING

DESIGNING, Manufacturing, machinery, parts, inventions, models. Henry, Engineer, 2136 E. Monmouth, Philadelphia, Penna.

MODELS—Small lot manufacturing. Metals, plastics, etc. Milburn, Burlington, Kentucky.

MODELS, MODEL SUPPLIES

LIVE Steam castings and supplies. Catalogue 25c. Yankee Shop, Box 275, Danvers, Mass.

SHIP And yacht model fittings; blueprints. Send 35c for illustrated catalog listing hundreds of items. A. J. Fisher, 1002-I Etowah Ave., Royal Oak, Mich.

POWER Models. Unusual steam, gasoline and traction engines, fittings, metals. Anniversary catalog 50c. Chas. Cole, Ventura, Calif.

LIONEL American Flyer trains repaired by factory mechanics. Fast mail service and satisfaction guaranteed. 20 to 40% electric trains and accessories. Catalog free. Mack Bros., 2041 Chicago Ave., Chicago 22.

STEAM Engines, boilers, castings. Catalog 35c. Anton Bohaboy, 2297 Price, Rahway, N. J.

BALSA Wood and model aircraft. 40-page catalog 10c. Sig Co., Montezuma, Iowa.

SHIP Models and yacht supplies. Complete, large 68 page catalogue 50c. Bill Wild's, 510 East 11 St., New York City 9.

SHIP And other scale models. Most complete line in New England. Kits, fittings, plans, books, tools, engines, motors. Illustrated catalog 25c. James Bliss & Co., Inc., Dept. 5M, 342 Atlantic Ave., Boston 10, Mass.

HOME CRAFTSMEN

FREE! Metalcraft catalog. Enameling supplies, copper and aluminum. J. C. Larson Co., 820 S. Tripp, Dept. 5575, Chicago 24.

101 FULL Size patterns. Smart, new, gifts, novelties, lawn figures, shelves, action windmills, alphabets. Plus "Make Money Jig Sawing." Only \$1.00. Mastercraft 105M, 7041 Olcott, Chicago 31, Ill.

GENUINE Glo-Candle wax for candle making. Interesting. Profitable. Write for price list. Valuable instructive book 10c. Mar-Ro, Box 675-PM, McPherson, Kans.

BIG Full size patterns of Santa, sleigh and reindeer for roof or lawn. Complete directions for making, painting and lighting. \$1.00. Mastercraft, 106M, 7041 Olcott, Chicago 31, Ill.

LAMP Size cypress knee with nipple installed \$2.00. Cy Products, Dept. 2-L, Lafayette, La.

SWISS Musical movements, for every musical project. Literature, tune lists 10c. Walters Hobby Shop, 207B French, Utica 4, New York.

AMAZING Matched patterns for jigsaw. Combinations galore. Become independent with this new idea. Complete, \$1.00. Hoover, Grand Marais, Minn.

89 FULL Size jig saw patterns of beautiful shelves, ornaments, toys, novelties. Plus "How, Where to Sell." Only \$1.00. Mastercraft 104M, 7041 Olcott, Chicago 31, Illinois.

WOODWORKING Course for home craftsmen. Twenty-two manuals. Over 1000 pages. 75 training projects. Only complete home training program available today. Carefully written, profusely illustrated. Covers everything from wood selection to final finishing. Complete instruction in care and use of all hand and power tools. Prepared by expert manual training instructors. Write for free booklet. Interstate Training Service, Dept. G-3-K, Portland 13, Oregon.

FREE! Large complete leathercraft catalog. J. C. Larson Co., 820 S. Tripp, Dept. 5550, Chicago 24.

LEATHERCRAFT. Metal enameling, beadcraft, shellcraft, metal tooling, textile painting, many other crafts. Free big illustrated catalog. Kit Kraft, Dept. 2210, Studio City 1, California.

LEATHERCRAFT. Send 10c for new 60-page catalog of tools, supplies, kits, including metalcrafts, enameling, ceramics, all other crafts. Complete stock. Reasonable. Since 1910. Sax Bros., Dept. PM10, 1111 N. 3rd, Milwaukee, Wis.

BUY Wholesale nationally advertised power, hand tools, thousands other products at big discounts. Free "Wholesale Plan." American Buyers', Hertel Station, Buffalo 16-F1, N. Y.

PLASTICS Home-craft course for men and women. Tells and shows how to make hundreds of fast selling plastics products. All plastics and materials for 23 projects included in course. No special tools needed. Course pays for itself. Write for free booklet. Interstate Training Service, Dept. D-3-K, Portland 13, Oregon.

LEATHERCRAFT Supplies at lowest prices. "Craftool" stamps. Catalog 10c. Crown Leather, 22 Spruce Street, New York 38.

KNOCKDOWN Cedar chests and lumber. Free price list. Bedford Lumber Company, Shelbyville, Tennessee.

129 NEW Full-size jigsaw patterns. Artist-drawn. \$1. Craftplans, 1321-A South Michigan, Chicago 5.

STYLECRAFT Sure fire hits. "Pre-traced" leather kits. Handbags, billfolds, fillgree belts, over fifty other projects. Patterns on leather. Why trace? Just carve, assemble and lace. Large assortment "precarved" kits also available. Send 25c for catalog, free folder. Refunded first order. Apache Leather Company, 2894 E. Washington St., Phoenix, Arizona.

VIOLINMAKERS. Amateurs, professionals, fine tone European wood. Complete materials, tools, instructions, patterns. Illustrated catalogue. 10c. Premier Violin Supplies, Division MVP, 430 South Broadway, Los Angeles 13, California.

WROUGHT Iron legs, various sizes. One set or a car load. Literature free. Hibbard's, 424 Celey, Hampton, Va.

MAKE Beautiful jewelry. Introductory kit and catalog with easy instructions \$1.00. Catalog alone 25c. Hobby Jewelers' Supply, Inc., Box 489, Providence 1, R. I.

LEATHER, Tools, lacings, supplies. Free catalog. National Handicraft, 199 William St., New York City 38.

LEATHERCRAFTERS: Everything you need. Catalog 10c. Art Leather, 411 Joseph Ave., Rochester 5, N. Y.

SEWING Machines. Portable, console or head only. Build cabinet yourself. Ideal Christmas gift. Importers low prices. Kochan, 4003 East 54, Cleveland 5, Ohio.

SANTA Sleigh, reindeer 56x80, \$1.50. Buck, doe, two fawns \$1.00. Strother, Box 128-16, Bellington, West Virginia.

SURPLUS Professional drafting tables. Tilt top, adjustable height. Brand new. 24"x36" \$20.00, 30"x42" \$25.00. Prepaid. Professional Supplies, Booneville 1, Miss.

FREE Handicraft supply and project catalog. American Handicraft Co., Box 1479-DQ, Fort Worth, Texas.

20 WOODWORKING Patterns, actual size, for electric trains; passenger depot, signal tower, etc., \$1.00. Bell Plans, RD#22, 362 East 59th St., Brooklyn 3, New York.

HUGE Profits with your jigsaw; 10c brings valuable patterns, illustrated information. Woodarts, P-6, Bridgewater, Mass.

FREE "Do-it-yourself" leathercraft catalog. Tandy Leather Company, Box 791-P11, Fort Worth, Texas.

DO IT YOURSELF

BUILD Your own coin game. Place in cafes, bars, clubs, etc. Collect coins weekly. Illustrated plans \$2.00. Jul's Workshop, P.O. Box 1448, Lemon Grove, Calif.

LATEST Enameling on copper kit. No kiln or furnace required. Everything furnished for complete fabrication, \$3.95 postpaid. Now you can make your own lovely earrings, cuff-links, brooches, and many other original jewelry pieces. Ralox, P.O. Box 1296, Decatur, Illinois.

18 FULL-Size patterns. Save money with easy-to-use, professionally designed full-size patterns. Make money selling beautiful, useful furniture. Make modern step and cocktail tables; metal lamps; cupola; 12-foot outboard. All patterns test-built; sold with money-back guarantee. Get your free list of these convenient, economical patterns today. Popular Mechanics Press, 200-HH E. Ontario Street, Chicago 11, Illinois.

MELT Cast iron, brass and aluminum. Make castings for yourself and for profit. Send for literature. Ursutz Burner Co., Box 2293, Globe, Arizona.

FURNITURE—Wrought iron legs and frames! You assemble. Free catalogue. Phillips Furniture, East Peoria 3, Illinois.

GEIGER Counter and metal detector kits. Inexpensive, educational. Free literature. Electronic Applications, 5024 Lee Highway, Arlington 7, Va.

DO It yourself. What? Repair TV, build furniture, make barbecue, plumbing repairs, build boats, do house wiring, remodel home, lay tile, modernize kitchen, repair home, and scores of other things you can do yourself. Books covering each subject, only 25c. Send for descriptive list. It's free. Popular Mechanics Press, 200-LB East Ontario St., Chicago 11, Ill.

PAINT Concrete with professional results. Bric-Kleen prevents hot spots, peeling, scaling. Safer, non-fuming liquid acid in dry form. \$1.00 postpaid can treats 100 sq. ft. Garman Co., 1254 Grover, St. Louis 23, Mo.

EMERGENCY Light plant. Good scout project. 300-watt, 110 volts AC. Rebuilt car generator, lawn mower engine. Plans \$1.00. Bennett, 2461 Lucas Drive, Beaumont, Texas.

HAMBURGER Pattie press. Make your own! Drawings 35c. Art & George Co., 5170 North Hollywood Ave., Milwaukee 17, Wisconsin.

DRILL Water well by hand. Rotary method. Use same pump and pipe for both drilling and producing. Very cheap and fast. Plans \$1.00. Bennett, 2461 Lucas Drive, Beaumont, Texas.

CLOCK Movements—Gorgeous dials, plans, kits. See ad page 312.

MAKE Wear reducing upper cylinder lubricant. Improve performance. Save half the cost prepared products. We ship concentrate. Merely add oil. Free details. Lube Oil Co., 501 Coombs, Fort Wayne, Indiana.

RUG Makers all wool materials for hooking, braiding. Mixed shades, 5 pounds \$5.00 postpaid U.S. Florence Moody, Farmington, Maine.

MAGIC "Velcoat" sprays fur or velvet finish on any article. Multiplies value. Refinishes shoes, bags, toys, pictures, like new. 6-color kit \$4.95. Single color \$1.00. Literature free. Velcoat, Box 5172-MB, Tulsa 16, Okla.

BUILD Inexpensive concrete blockmaker. Motor, hand. Make 500 blocks daily. Write: C. Lee, Mountain View, Oklahoma.

ALL Aluminum overhead garage door with jamb or track hardware in do-it-yourself kit. Simple tools, easy assembly. Write for literature. Stevens Thuet Co., P.O. Box 9116, Long Beach 10, California.

BEAUTIFUL Contemporary do-it-yourself furniture plans. Free literature. McAleer Hardwood Products, Box 645, Bensenville, Ill.

WATCHES, OLD GOLD, JEWELRY

RHINESTONES, Jewelry settings, copper enameling. Sample earring kit and catalog 25c. J & M Novelties, Dept. CL-3, Griffith, Indiana.

WATCH And clock repairing books. Free information. North American, Dept. 15-J, 2320 N. Milwaukee, Chicago 47, Illinois.

GUARANTEED Good watch \$5.50. Price list. Hudson, 1417-26th, Louisville 11, Ky.

MAKE Your own costume jewelry and save money. It's easy. Free sample earrings. Over 5,000 styles in new catalog. 25c. Barry's, 103 Ardley Court, Newark, N. J.

WATCHMAKERS—Jewelers' supplies, instructions. Catalog 20c. Bengale Company, Culver City, California.

USED And new watches. \$2.00 up. Free list. Southern Watches, Gray, Georgia.

COPPER Enamelling, complete supplies, information. Valuable catalog free. Bergen Arts, 128MR Main, Hackensack, N. J.

HIGHEST Cash for old gold, broken jewelry, gold teeth, watches, diamonds, silverware, spectacles, platinum. Free information. Satisfaction guaranteed. Rose Refiners, Heyworth Bldg., Chicago 2.

COSTUME Jewelry supplies, catalog and samples. 35c. Largest line in America. Milady-Fair Co., G.P.O. Box 1328, New York City 1.

GOLD, Silver, platinum, diamonds wanted. Cash immediately, highest prices, appraisals made. Wilmot's, 2547 102nd St., Toledo 11, Ohio.

MAKE Costume jewelry for fun and profit. Catalog 25c. Bergen Arts, 128MR Main, Hackensack, N. J.

10 SWISS Watches \$18.00. Catalog 10c. Berkowitz, 1150 Castlehill, New York 62.

JEWELRY Hobbyists: Plated settings, imported rhinestones, flat backs. Free catalog, Sextons, 416 Potomac, Buffalo 13, N. Y.

RHINESTONES. Send \$2.50 five gross. Value \$6.00. Free bargain list, catalog, jewelry supplies. Ebert, Box p183, East Orange, New Jersey.

DIAMOND Rings, jewelry. Direct factory dealer discounts. Free catalog. Hedges, Amityville 187, N. Y.

TOBACCO, SMOKERS' SUPPLIES

PIPE Smokers! Cigar smokers! Free illustrated catalog offers fabulous savings on choice imported and domestic pipes, cigars, tobaccos, supplies. Write Wally Frank, Dept. 25, 150 Nassau Street, New York 38, N. Y.

PIPE-Making supplies. Special tools. Instructions. Walter Miller, Germantown, Ohio.

CIGARETTES—Facts free how to roll them for 10c a pack. Pete Moberly, Box 792, Owensboro, Kentucky.

RAZORS, BLADES, SHARPENING

RAZOR And 5 blades. 25c. Jove Products, Box 164, Maplewood, N. J.

IMPORTED Blades. Swedish blue steel. Extra thin for cleaner shaves, 40—\$1.00, 100—\$2.10. Acme Sales, 3565 Trent Ave., Cleveland 9, Ohio.

TEN Million users cannot be wrong. Triplex strapper for Gillette-type blades gives smoother, many more shaves. \$2.49 postpaid. 100% satisfaction or money back. Thriftite Buyers, 38 Crescent St., Waterbury, Conn.

BLADES—100 For \$1.00. Microsharpened. Guaranteed smooth shaves. Double-edge. Bardin's, Box 321, Chicago 90, Ill.

FOR THE HOME

FOAM Rubber furniture cushions. Factory seconds, 50% discount. Free catalog. Perma-Foam, 429C Central Ave., East Orange, New Jersey.

COLORFUL Painted portraits. immortalize family members—Distinctively! Lowest prices! Illustrations free. Medorstudio, Ojai, California.

COLORFUL Blue glass pony shoe ashtray, \$1.00 postpaid. Syd. Ewan, Wildwood, New Jersey.

ALUMICONE; Amazing discovery, polishes, cleans, protects aluminum doors, windows, etc. Kit includes stainless steel-wool, \$2.00 ppd. Mark "A" Products, P.O. Box 24, New York 68, N. Y.

OF INTEREST TO WOMEN

"8 MISTAKES Parents Make." Every parent should have this new book about child training. It is free; no obligation. Simply address Parents Association, Dept. 6710, Pleasant Hill, Ohio.

PERFUME, Save 50%. Buy direct, in plain package. Quarter ounce, send \$1.95. Garnet of N. Y., Marvin Avenue, Shelby, Ohio.

QUALITY Carpet warp at reasonable prices. Write today. Carcraft Co., 153 Post Street, Boonville, N. Y.

SEWING Ideas 25c; jewelry making 25c, handcraft manual 15c; all three 50c. Leisure Products, 416 Rose, West Hazleton 1, Penna.

KNITTERS. Read fine print needlework instructions easily. Read-A-Line magnifies single line obscures others, 29c. Tillyberry, Route 1, Waukesha, Wisconsin.

COLGATE'S Lustré-Creme shampoo, 4 lbs. \$4.95 postpaid. Geller, 2089 Matthews, New York 62, New York.

A Dress shop in your home. No investment. Liberal sales commissions. Write Bellecraft Fashions, 111-YS Eighth Ave., New York.

MAKE Beautiful costume jewelry for profit and pleasure. Finest quality stones. Free illustrated catalog. Great Lakes Plastic Co., 851 Sycamore St., Buffalo 12, N. Y.

DRESSMAKERS. Sewers, wholesale lists. Dress suitings, formal fabrics. Box 863, Norwalk, Conn.

GOOD Money in weaving. Weave rug at home for neighbors on \$69.50 Union Loom. Thousands doing it. Booklet free. Union Looms, 153 Post St., Boonville, N. Y.

PROFITABLE Home business. Make fast-seller chenille monkey trees, dolls, flowers. Terrific holiday demand. Information free. Velva, Bohemia 16, N. Y.

GROW Mushrooms. Cellar, shed, and outdoors. Spare, full time, year round. We pay \$1.50 lb. We paid Babbitt \$4,165.00 in few weeks. Free book. Washington Mushroom Ind., Dept. 176, 2954 Admiral Way, Seattle, Washington.

WANT To make big money at home? \$5 profit in an hour possible with invisible reweaving. Make tears, holes disappear from clothing, fabrics. Steady year-round demand from cleaners, laundries, homes. Details free. Fabricon, 8333-S Prairie, Chicago 19, Ill.

FREE—Big new wholesale catalog! Up to 50% saving for you, family, friends on nationally-known gifts, jewelry, toys, appliances, Christmas cards, etc. Also make money selling part time! Write: Evergreen Studios, Box 846-P, Chicago 42, Ill.

DOLLS—Dressed, undressed, Dollar Doll Club. Peggy's Dolls, Jefferson City 5, Mo.

FOR SALE—MISCELLANEOUS

DISCOUNTS Over 50%! Appliances, housewares. Gift with every purchase! Richco Products, Box 283, Deerfield, Ill.

WAR Surplus clothing. New tanker jacket, \$6.95. B-15 style jacket, fur collar, full quilted wool lining, \$7.95. Sizes 34 to 50. Jungle cloth navy N-1 jackets, alpaca lined, zipper front, \$13.75. Sizes 36 to 46. Postpaid east of Miss. Send money to Lester Sturgill, 1731 Belt Street, Baltimore 30, Maryland.

HEARING Aid batteries, wholesale. Free list. Habs, Box 51, York, Penna.

OLD Wall telephones, Working order, oak cabinets, hand crank for ringing, \$5.00 each f.o.b. Telephone Co., Turtle Lake, Wis.

WAR Surplus bargains! New government releases arrive constantly, have up to 80%. Blankets, boots, coats, tents, wearing apparel. Send for free war surplus catalog. Sioux Falls Surplus Store, Sioux Falls, South Dakota.

PATENTED Multiple purpose wrench. John Ericsson, Rte. 3, Box R-130, Auburn, Wash.

WANTED—MISCELLANEOUS

WANTED: \$1.00 To \$5.00 mailorder items. Almar Sales, 188 W. Randolph St., Chicago 1.

QUICKSILVER. Sterling, silver solders, precious metals. Wholesale Terminal, Norwood, Massachusetts.

SCRAP Mercury (quicksilver) containers supplied — Tantalum, bismuth, tungsten. Metallurgical Products Company, Established 1909, 35th and Moore Sts., Philadelphia 45, Penna.

\$1.00 LB. — Mercury (quicksilver). Charles Grace, 1534 Beale St., Linwood, Pennsylvania.

PERSONAL

PROTECT Money, property, possessions! Don't let wrong people get your estate. Make own will. Proper legal form, instructions airmailed \$1.00. Two \$1.75. Burton Lewis, 451 Orange, Denver 20, Colorado.

LETTERS Reaired: Any U.S. or possessions post office. 50c. Frazer, Box 504, Springfield, Oregon.

BEVERLY Hills, UCLA, Hollywood: Remails and souvenirs? 20c! Confidential receiving-forwarding. Sealed inquiries acknowledged. Dwaynehurst, 722 Westholme, Los Angeles 24.

REMAILING 25c. Sunday classified \$1.00. Morris, 3521 Noriega Street, San Francisco, California.

RESURRECTION On earth—Not heaven. Free. Write: Harvest, Jefferson City, Mo.

BORROWING By mail. Loans \$50 to \$600 to employed men and women. Easy, quick. Completely confidential. No endorsers. Repay in convenient monthly payments. Details free in plain envelope. Give occupation. State Finance Co., 323 Securities Bldg., Dept. L-227, Omaha 2, Nebraska.

REMAILS. Ten scenic cards \$1.00—2708 N. Laura, Millwood, Washington.

BUY Vitamins direct. Amazing savings. Catalog free. Matoska, White Bear, Minn.

REMAILING 25c. Replies forwarded. Ace Service, Box 186, Tampa 1, Fla.

LETTER. Package, telegram remailing, receiving-forwarding address for rent \$2.00. McLaughlin, 800 Stewart, Columbus 6, Ohio.

MEXICAN Legal matters. A. Espejo, Box 234, Hermosillo, Sonora, Mexico.

"HOW Can I find out?" You can! Information confidentially developed. Any matter, person, problem. Worldwide. Officially licensed. Established 1922. William Herman, 170 Broadway, New York City.

LETTERS Reaired 25c. Personal forwarding address. Monthly rates. Hicks Service, Box 1547, Washington 13, D. C.

PROFIT! Prestige! Publish a magazine under your own name! Only \$3.25 per month! Sample, details 5c! Filmer, 910 Marion, Pharr 22, Texas.

MEXICAN Law. General Practice Attorney. Apartado 79, Juárez, Chih., México.

SECRET Mail address. \$3 month. Hedg-peth, Box 830, Alhambra 23, California.

FABULOUS Houston Sunday classifieds \$1.00. Remails 25c. Jordan, 1120 Cheneyvert, Houston, Texas.

TELEVISION Program reminder. Quick glance tells time, channel of your favorite programs. Good for season. Mail 25c. Tee-Vee-Tyme, 3208 Longton, Dept. 2, Cleveland 24, Ohio.

CHARGE Accounts opened by mail. Catalog free. Osgoods, 1320-P Prospect, New York City 59.

"KEEP 'Em guessin'." Remails Chicago 25c. Employment ads \$1.00. Kelleys, 20 West Jackson, Suite 602, Chicago 4, Ill.

IMPORTANT! Establish legal birth record! How? Write: Jenkins, Doniphan, Missouri.

NOTRE Dame, South Bend remails 35c. Schaut, 619 Kamms, Mishawaka, Indiana.

HOMEWORK Wanted by handicapped veteran. Meredith, 1073 Blvd., Shreveport 28, Louisiana.

BORROW By mail from Postal Finance Co. Employed men and women can easily obtain \$50 to \$600 fast, entirely by mail. Repay in small monthly payments. Friends, relatives, employer, tradespeople will not know you are applying for loan. Advise occupation, amount wanted. Postal Finance Co., 200 Keeline Bldg., Dept. TV, Omaha, Nebraska.

HOW To be saved, and know it. Free leaflet, free catalog. Sacramento Bible House, 2316½ Jay St., Sacramento, Calif.

ADDRESSING—Mailing service. Write or call collect. M. Pavini, 80 Snow Street, Pitchburg, Massachusetts, Tel. 3-9012.

AMAZING Profits! Free particulars. Peltcher, 4761 El Cajon Blvd., San Diego 15, California.

WHAT Is your "I.Q."? Take reliable intelligence test. Approved, scientific. Confidential report by mail. Free information. University Test Bureau, Desk M-2, Box 401, Palo Alto, California.

REMAILING SERVICE

LETTERS Reaired historic Philadelphia 25c. Armand Busico, 1035 Jackson St., Philadelphia, Penna.

"GATEWAY To Dixie," remails 25c, rates. Tucks Treasures, Corinth, Miss.

REMAILS 25c—Classified \$1.00. Reair-mail \$1.00. Sharkey, Box 151, 22nd Street Station, Saint Petersburg, Florida.

NEW York airport remails 25c. Reair-mails 50c. Pails, Box 127, Lga. Airport, Flushing, N. Y.

TREASURE FINDERS

URANIUM Prospector master form kit saves on income tax, and protects what you find. Sample completed forms and instructions; income tax expense; prospecting permit and lease with private owner; staking claims public lands; blank forms included. Save and be safe. Satisfaction guaranteed. Postpaid \$2.50. Maurice Rogers, Box 1309, Odessa, Texas.

FREE Atomic location map, copy. Uranium information. Send \$1.00. Airtarveys, Box #206, Lafayette, California.

"URANIUM Prospecting," the complete book you've been waiting for. Step by step procedures for prospectors in every state. Handsome, full-sized edition. 150 pp. Over 60 illustrations. Copyrighted Sept., '53. Send \$3. check, cash or money order. Prospectors Supply Co., V & T Bldg., Carson City, Nev.

TREASURE. Metal, mineral locators M-scope type. Latest electronic design \$75.00 up. Geiger counters, scintillators, mineralights for uranium prospecting \$35.00 up. Fully guaranteed. Monthly payment plan available. Books "How to Be a Successful Uranium Prospector." "For Fun and Profit." Literature free upon request. Fisher Research Laboratory, Inc., Palo Alto, Calif.

GEIGER Counters, metal detectors, ultra-violet mineralights, from \$29.50 up. Write for free catalogs. The Radiac Co., Inc., 489 Fifth Ave., Dept. 10-PM, New York 17, N. Y.

URANIUM Deposits map, 42"x58"; prospector's manual; three government maps radioactive areas. All \$3.00. Uranium, Box 788-F, Washington, D. C.

BE Advised before deciding to prospect uranium. "63 Questions and Answers" 50c. Walter Chess, Box 2141, Sacramento 10, California.

URANIUM Hunters! Know what you're looking for! 15 accurate 35mm color slides of uranium ores plus vlexer and monograph. "Identifying Uranium," \$10 postpaid. Min-Lab, 43 W. McDowell, Phoenix, Arizona.

GEIGER Tubes \$5. Build your own instrument. Scintillation crystals from \$7. Amplifiers; H.V. supplies. Circuits \$1. Uranium yearbook \$2. Uranium prospecting instruments, all types. Western Radiation Laboratory, 1107 West 24th Street, Los Angeles 7, California.

URANIUM! Informative booklet gives hot known and potential locations. Government map included free. \$1.00. Uranium Research, Box 1533, College Station, Texas.

GEIGER Counters and mineral locators, assembled and kits. Free geological advice; Write for details. Frontier Instruments, Box 276, Annandale, Va.

URANIUM. Gold, silver treasure. New, power-packed, highly sensitive metal detectors, Geiger counters and mineralights, kits and assembled models from \$12.50. Lightest weight, guaranteed, free literature. Electronic Applications, 3024 Lee Highway, Arlington 7, Va.

AMAZING Triple-action Geiger counter U-2380, combines audio, neon flasher, meter. Guaranteed best available. Also metal detectors and scintillation counters from \$49.50. For radioactive uranium sample send 25c to Goldak Company, 1541 W. Glenoaks Blvd., Glendale, California.

GOLD, Silver, metal detectors. Geiger counters for uranium. Mineralights. Sensational new fully guaranteed models. None finer. Information free. Detector Corp., 5528 Vineland Ave., North Hollywood, California.

"SNOOPER" Geiger counter only \$29.95 complete. Super sensitive. Pocket size. Find a fortune in uranium. Order now. Send \$5.00, balance c.o.d. Money-back guaranteed. Free catalog—Scintillators and larger uranium and metal detectors. Precision Radiation Instruments, 4223PMC W. Jefferson Boulevard, Los Angeles 16, California.

ROCKET Mk II nucleotron. 6 times as sensitive as a geiger counter. Only \$37.50 complete. Uses 2 supersensitive 1B85 tubes. Weighs less than 3 lbs. Plug-in probe available. 10 day trial period. 1 year guarantee. Write today for free catalogue. Webster Electric Mfg. Co., Dept. B, 3824 Clarke Street, Oakland 9, California.

"HOW To Make Money Prospecting for Uranium." Free booklet. Send 10c for handling, postage. Geiger Co., 195-10a Sackett Street, Brooklyn 31, N. Y.

MISCELLANEOUS

FREE Booklet tells how to clean clogged cesspools, septic tanks. Dept. 65, Suburban Products, Box 6531, Philadelphia 38.

GERMAN Christmas item manufacturers. 100 addresses \$1.00. Manufacturers' Index, 135 Main, Woburn, Massachusetts.

YOUR Name wanted. We'll send 1000 publishers, mailers, wholesalers your name, on our list one year 25c. Dixie Mailers, King, N. C.

WHOLESALE Catalog! 30-50% discounts! Appliances, musical instruments, typewriters, phonographs, watches, jewelry, recorders, housewares, etc. Consolidated Distributors, 21-13 Lafayette, Paterson 13, New Jersey.

FORESTRY. Game warden, park, fish hatchery, patrol and wildlife conservation jobs pay well. Prepare now. Write Delmar Institute, N3, Whittier, Calif.

NEW Device locks electric cord plugs in receptacle. Sample \$1.30. Information dime. Carmean, Hutchinson, Kansas.

TAPE Recorders, accessories. Best buys. Boynton Studio, 10A Pennsylvania, Tuckahoe, N. Y.

BUY Wholesale thousands nationally advertised products at big discount. Free "Wholesale Plan." American Buyers, Hertel Station, Buffalo 16-K1, N. Y.

TEN Novelty imported Christmas cards from Mexico City, \$1.00. Importer, Box 644, Solana Beach, Calif.

HEAT Your home or business for almost nothing. Amazing method, thousands satisfied. Valuable information free. A. Enault, R.F.D. #1, White River Junction, Vermont.

MASONS—Shriners. Find this item irresistible; send \$1.00 for sample and quantity prices. Tubal, Box 54, Ocean City, N. J.

LUXURIOUS Solid stainless tableware, lasting beauty, needs no polishing. Convincing prices. Illustrative folder free. Warrens Specialties, 20417 Gladstone, Warrensville Ht's., Ohio.

YOUR Little girl will love "Jump rope" and "Hopscotch." Both booklets 50c. Porpoise Bookshop, 308 Clement, San Francisco 18.

BE Somebody! Do things! Get somewhere with our simplified self-training plan of positive thought motivation and constructive action mastery. Eye-opening information free. Write today. Applied Christian Psychology, Inc., Box 1824-Y, Louisville 1, Kentucky.

SELL! Buy! Trade! Anything. In "Trading Post Magazine." Details free! Thorne's, 525 Dewey, Jackson 40, Michigan.

FOOT Sufferers—Get quick relief with my foot balancers. Interesting literature free. **Kindschl Foot Appliances**, 331 W. Jefferson, Dallas 8, Texas.

COLORFUL Portraits. "Glorify Persons Portrayed!" Your selection! materials, payments from \$3.00! Brochure. **Dorsarts**, Ojai, California.

SENSATIONAL Introductory offer. Native handmade gift item \$1.00 postpaid anywhere in U.S.A. **Island Novelty**, Box 344, Roosevelt, Puerto Rico.

EVERGREEN Boughs with cones. Three pieces one dollar postpaid. **Howard Finney**, Hamilton, Mont.

LIKE Full mail boxes? Interesting offers galore, 25c. **Traylor's Enterprises**, La Feria, Texas.

PAINT A lovely religious painting in oils the first time you try. **Christ in the Garden**, size 18"x24" \$6.95 postpaid, also **Sacred Heart**, **Angelus**, and **Old Mission** in size 12"x16" each \$2.95 postpaid. Many other subjects from which to choose. Send for free literature. **Ralox**, P.O. Box 1256, Decatur, Illinois.

DOUBLE Your income! It's easy! Just send for two free booklets (60c value) "Treasure Hunting for Fun and Profit" and "How to Be a Successful Uranium Prospector." Others have made fortunes. Here's your chance. Time payment plan available. Send for free booklets today! **Fisher Research Laboratory, Inc.**, Dept. 3, 1961 University Ave., Palo Alto, Calif.

RECEIVE Hundreds samples, offers, magazines. Large list 25c. **Mail Center of Los Angeles**, 7101 Apperson, Tujunga 1, Calif.

CLOGGED Drains, cesspools and septic tanks cleaned by new powerful chemical. Solvent removes grease, soap, tree roots, etc., without expensive digging and electric rodding machines. No pumping necessary. Mix with water and pour down drain. Free details. **Electric Drain Cleaning Co.**, Boston 34, Mass.

ZINC Engravings. From any photograph or drawing, 5 inches, only \$1.50. Free price list. **Miller-Hoiles**, 437 E. Market, Alliance, Ohio.

GROW Mushrooms. Cellar, shed, and outdoors. Spare, full time, year round. We pay \$3.50 lb. We paid **Babbitt \$4,165.00** in few weeks. Free book. **Washington Mushroom Ind.**, Dept. 175, 2954 Admiral Way, Seattle, Washington.

HOW To paint. Do it yourself. Illustrated instructive book. 25c. Catalog free. **Popular Mechanics Press**, 200-HP E. Ontario St., Chicago 11, Ill.

PANNING Gold—Free lesson; catalogue of mining, mineral books, supplies. **Old Prospector**, Box T29D1, Lodi, Calif.

RECEIVE Magazines, samples, catalogues. Mails from everywhere. Offers, hundreds. Get listed 25c. **Rorick**, Box 88, Cincinnati 28, Ohio.

300 BIG Mails guaranteed. Samples, plans, offers, propositions, 12 months listing, \$1.00 refundable. **Wright Publications**, 2270 Hubbard, Memphis 8, Tenn.

PROTECT Your possessions, quickly, permanently with York laundry marking pen, (includes iron-on-tape for dark fabrics). Send \$1.00. **Mrs. Wurtz**, 646 Prospect Ave., West Orange, New Jersey.

Find a Fortune on vacation, hunting, fishing trips!

Pin-Point URANIUM with super-sensitive **VIC-TIC GEIGER COUNTER**

First with "Miracle" Transistors! First with Self-Contained Speaker! World's finest, most advanced radiation detection field instrument! Four sensitivity ranges... no carphones to wear... weighs just 3 lbs. Literally *triples* your chances—detects deposits ordinary counters miss!

\$125.00 postpaid (\$25 dep. req. on C.O.D.) Same day shipment. Money Back Guarantee.

ELECTRONIC INSTRUMENT CO., Dept. 29-C, 1035 Santa Barbara St., Santa Barbara, Calif.

Free! Illus. Brochure on VIC-TIC, compl. line Mineralogists, Scintillation Counters, Prospecting Books, Tables.

HIGH BLOOD PRESSURE?

A home Blood Pressure Gauge now tests your pressure at home as often as you wish! That's how to avoid unexpected strokes, heart and kidney damage, insomnia, headaches, etc. Full particulars on how to test pressure and what to do for your condition are included with this dependable mercury gauge. It is simply constructed so it can be operated alone and it actually pays for itself in less than a week. Free descriptive circular sent on request.

THE STANDARD UNIT \$5.98 postpaid Or C.O.D. plus postage. Contains everything that is needed, including functional stethoscope.

THE DELUXE UNIT \$9.23 postpaid Or C.O.D. plus postage. Same outfit as standard unit, but includes genuine professional stethoscope.

JOY SPECIALTY COMPANY Scientific Instrument Dept. 2320-A W. Hubbard Street Chicago 12, Illinois

FREE

A NEW HOME INDUSTRY

GEARS **FISHING LURES** **JEWELRY GEMS** **HANDLES KNIVES - DIALS** **STATUES FIGURINES**

OPPORTUNITIES UNLIMITED

Let us show you how extremely easy and PROFITABLE it is to make beautiful and useful things out of **LIQUID PLASTIC, LIQUID MARBLE, LIQUID IVORY, LIQUID GLASS, CERAMIC, ETC.** . . . as easy as pouring water out of a glass! Make novelties, jewelry, gifts, artware, toys, tools, dies, jigs, jigsaws, ceramics . . . a million useful things! We supply everything—**MATERIALS and INSTRUCTIONS!**—Send only 25c for big 64 page catalog of casting materials, molds and accessories and we will include free of extra cost a remarkable book, **"THE WONDERS OF LIQUID PLASTICS"** . . . that will open your eyes to wonders you never dreamed of! Send 25c today—this may be the lucky coin that will start the most fascinating and profitable phase of your life!

PLASTICAST COMPANY
6612 N. CLARK ST. DEPT. PG-102 CHICAGO 26, ILLINOIS

SAY YOU SAW IT IN POPULAR MECHANICS

Here You Can Find a Solution to Practically ANY MECHANICAL PROBLEM!

- PARTIAL CONTENTS:**
- Accumulators
 - Air Conditioners
 - Alarms
 - Amplifiers
 - Anchors
 - Anti-Friction
 - Baffles
 - Ball Joints
 - Bearings
 - Red Plastics
 - Blosses
 - Brakes
 - Burners
 - Cams
 - Chains
 - Chain Gears
 - Checks
 - Clucks
 - Circular Motions
 - Clamps
 - Cleaners
 - Clutches
 - Compressed Air
 - Power
 - Connecting Rods
 - Conveyors
 - Cooling
 - Cotters
 - Couters
 - Covers
 - Cranes
 - Cranks
 - Crushing
 - Cutting
 - Electric Power
 - Drilling
 - Electric Power
 - Electron Tubes
 - Elevators
 - Engines
 - Expanders
 - Fasteners
 - Feeders
 - Filters
 - Gauges
 - Gears
 - Generators
 - Governors
 - Grinders
 - Grips
 - Guides
 - Heating
 - Humidifiers
 - Hydraulic Power
 - Indicators
 - Infra-Red
 - Keys
 - Levers
 - Loaders
 - Links
 - Locks
 - Lubricators
 - Magnesium
 - Measuring
 - Speed
 - Heat
 - Pressure
 - Mixing
 - Motors
 - Nozzles
 - Parallel Motions
 - Pawls
 - Pipes
 - Pivots
 - Propulsions
 - Pumps
 - Raisings
 - Ratchets
 - Refrigeration
 - Reciprocating
 - Motion
 - Regulators
 - Rocket
 - Propulsion
 - Safety Devices
 - Sandblasting
 - Devices
 - Scales
 - Sea Wave Power
 - Separators
 - Shafting
 - Shifting Gears
 - Shields
 - Shock Absorbers
 - Sifting
 - Signals
 - Slides
 - Slings
 - Sounds
 - Springs
 - Startings
 - Steam Power
 - Stokers
 - Swivels
 - Striking
 - Sound Receivers
 - Tappets
 - Thermistats
 - Traps
 - Valves
 - Vibrators
 - Washing
 - Winding
 - etc.



A BOOK with OVER 8000 ILLUSTRATIONS WITH DESCRIPTIONS of Mechanical Movements, Devices, Contrivances and Details



If you work with machinery of any kind, you may be called upon to derive or improve some job or machine. To do this, you either have to rely on memory, experience or ingenuity. Here in this new book—**THE ENGINEERS' THESAURUS** by Herbert Harkimer—you will find over 8000 IDEAS and SUGGESTIONS for accomplishing any kind of motion, force or work! It is a compilation of the contrivances, parts, details, tools, machines, devices and means—designed and developed by countless engineers, machinists and inventors over the years—to effect any motion or task. The material has been painstakingly assembled and classified, from many sources—research books, engineering brochures, patent drawings, catalogs, etc. It is, by far, the largest collection ever gathered in one book—and the only one which shows, side by side, the many different means and methods for accomplishing any particular task!

Each item, each device, each method is illustrated—there are 8000 such illustrations—and each carries a pertinent description of its make-up and function. **THE ENGINEERS' THESAURUS** is a monumental work. It is 20"x8 1/2", 500 pages, printed on coated paper, cloth-bound.

Order By Mail

No one has ever asked for such a book, but we guarantee of money-back if not satisfied stands.

Price only \$5.98

Griffin Publishing Co., Dept. P163 400 Madison Ave., New York 17, N.Y.

Send me a copy of **THE ENGINEERS' THESAURUS** by Herbert Harkimer. If not satisfied, can return book for refund.

I enclose \$5.98; send book for refund.

Send book c.o.d. for \$5.98 plus 62c total delivery charges.

Send book and bill us, \$5.98 plus 16c postage. (This privilege only to concerns with Dues & Bradstreet rating.)

Name.....

Company.....

Address.....

City.....Zone.....State.....

A copy belongs in every reference library, school—every shop, plant, factory—with every machinist, engineer, student, inventor.

Less than a year ago a hobby of the Very Wealthy NOW within the reach of everyone

America's Newest Craze... 3-DIMENSIONAL STEREO

IN FULL COLOR! Fantastic New Big Profit Field for Salesmen - Distributors

Imagine! Thousands upon Thousands of People have paid over \$300 to capture the charm—the True-to-Life Depth—the brilliant full color that only 3-Dimensional Stereo could bring, but now—

THE SAME BEAUTY
THE SAME DEPTH
THE SAME COLOR

for about $\frac{1}{3}$ of previous cost!



An opportunity to "get in" on one of the most fabulous money-making opportunities of the age. Through the wonder of the color stereo, you can now show everybody how to take pictures that are true-to-life—just as true as the eyes see them. And you can get this new wonder-camera that takes true pictures for lifelike 3 Dimensional at a price so low everyone can afford it.



Backed by powerful new kind of selling plan that is a "Powerhouse" for producing sales like magic! No prospect will ever say they are not interested!

EASY PAY TERMS BOOM YOUR SALES!

If you want to "get set"—if you want more money, full-time, part-time—then write quick, be first in your territory. Write TODAY for amazing facts!

Delta Stereo

LENNOR ENGINEERING CO. DEPT. 4, 5614 N. CLARK ST. CHICAGO 26, ILL.

MAIL ORDER SPECIAL



GASOLINE

\$9⁵⁰

CAMP STOVE

ORIGINAL COST \$80

BRAND NEW U. S. ARMY FIELD RANGE Burner Unit, approx. 50,000 B.T.U., complete w/2 extra generators, unit as pictured. Cook on it, use as cabin heater. Shipping wgt. approx. 55 lbs. Size: 21 1/2" h., 19" w., 9 1/2" d.

SPECIAL! NEW ARMY MACHETTES.....\$1.95
FOLDING FOX-HOLE SHOVELS.....\$1.00
FOX-HOLE PICK-MATTOCK.....\$1.00

All prices FOB Memphis—order now. Supply limited

J. P. DAVIDSON CO.

104 N. Front

Memphis, Tenn.

start a big profit business with a small investment EARN UP TO \$200 a DAY

Manufacturing Exciting New

RAINBOW ROCK

Concrete Slump Brick in your back yard

Earn big building boom profits with Rainbow Rock, the colorful new building brick that's taking the country by storm. Sell all you can make to contractors, builders, building supply houses. RAINBOW ROCK CUTS LABOR COSTS BY 1/3! Amazing low cost machine makes modern slump brick 24" long (3 times the length of ordinary brick) in a variety of widths and pastel colors... up to 1500 bricks a day! NEEDS NO SPECIAL SKILL. Operates indoors or out. Full instructions and valuable mixing formulae supplied. YOU CAN START EARNING BIG MONEY NOW. PAY AS YOU PROFIT! A limited number of machines available on easy payment terms, NOW is the time to start. Write today for free literature and full information.

GENERAL ENGINES CO., INC.
Dept. MR-105—Route 130,
Theramore, N. J. - Tilden 5-5401



STEEL PIER SENSATION
Lustrous RAINBOW ROCK fireplace wall in living room of the "Home of the Century" in Atlantic City, N. J.'s Steel Pier... acclaimed by over 500,000 Summer, 1953 visitors as the most beautiful they'd ever seen! Endorsed by the Pier's famous architect, William F. B. Koels.



Makes beautiful, decorative fences, garden walls, garages, outside walls, room separators, etc.

Guide to

HOME REPAIRS



Pays for Itself 100 Times Over

Beat the high cost of home upkeep. Save hundreds of dollars every year on carpentry, electrical, painting, plumbing and other jobs around the house with Popular Mechanics GUIDE TO HOME REPAIRS. Simplified how-to-do-it instruction and 646 pictures make all jobs, inside and out, easy. Covers construction, remodeling, modernization, repairing that you can do yourself at small cost. 192 page cloth bound book only \$2.50 postpaid. Order today under our money back guarantee.

POPULAR MECHANICS PRESS, Dept. PM16
200 EAST ONTARIO STREET CHICAGO 11, ILLINOIS

Become a Doctor of PSYCHOLOGY

Win the degree of Ps.D. Learn the secret of contentment, happiness. Solve mental worries. Experience the revelation of truth. Correspondence only. Individual help. Write for FREE book. **COLLEGE OF UNIVERSAL TRUTH, 5038-B Broadway, Chicago.**

BIG MONEY FIELD

Learn OIL HEATING INSTALLATION - SERVICE - REPAIR

Use your spare time to advantage. Learn a trade paying big dividends. Easy to start your own business. Course includes steam, hot water and warm air systems. Write for catalog.

LINCOLN INSTITUTE

DEPT. PMA 472 MARKET ST. NEWARK, N. J.

Say You Saw It in Popular Mechanics



PUMP WATER FAST!

Drains Wash Tubs, Cellers, Cisterns. Famous #7 pumps 2800 gph. 420 gph. at 75' high or 1600 gph. from 25' well. Sturdy rustproof alloy metal. Six blade impeller. 3/4" inlet, 1/2" outlet. Standard pipe threaded. Uses any 1/2 to 3/4 H.P. Motor. Will not leak or clog. Iron clad guarantee. Send check, M.O., or sent C.O.D. **IN U.S. \$650**

Irrigate, Fill Tanks, Draw Well Water. Heavy duty #8 pumps 7000 gph. —3000 gph. 75' high 3000 gph. from 25' well. Rustproof alloy metal. 8 blade impeller. 1" inlet, 1" outlet. Standard pipe threaded. Will not leak or clog. Iron clad guarantee. Send check, M.O., or sent C.O.D. **\$995**

Free Catalogue—Gear Pumps, Large Centrifugal IN U.S. Pumps, Deep and Shallow Well Pumps, Sump Pumps.

MOORE MANUFACTURING CO.
SWEDESBORO 1, NEW JERSEY

TENSE NERVOUS HEADACHES

call for STRONGER Yet SAFER ANACIN[®]

Won't Upset The Stomach

Anacin not only gives stronger, faster relief from pain of headache, but is also safer. Won't upset the stomach and has no bad effects. You see, Anacin is like a doctor's prescription. That is, Anacin contains not just one but a combination of medically proven, active ingredients. Scientific research has proved no single drug can give such strong yet such safe relief as Anacin. Buy Anacin Tablets today!



ELECTROPLATE IT YOURSELF!

NOW using NEW plating kit. It's easy to electroplate any object with the same LUSTER and DURABILITY as done by the most expensive equip. Complete kit and instructions on plating metal and non-metal objects, with Nickel, Chrome, Copper, Gold, etc. ONLY \$5.95. SEND NO MONEY—everything sent C.O.D. plus postage. Money back in 7 days if not satisfied.

EASY INSTRUCTIONS

TOOL KIT

CHROME WORK

BABY SHOES

N. Z. SALES CO., Dept. G-1, 113 W. 42nd St., New York 36, N. Y.

FREE CATALOG

Over 300 books on Fishing, Hunting, Home Repairs and Improvements, Bricklaying, Welding, Home Workshop, Power Tools, Hobbies, Crafts, Home Building, Trades, Making Money at Home, Furniture Making, Woodworking, Carving, Photography, Art, Drawing, Mechanisms, Engineering, Refrigeration, Plumbing, Radio-TV, Electricity, Automobiles, Farming, Livestock, Gardening, Decorating, Painting, many, many more. Send for yours today.

POPULAR MECHANICS PRESS, 200 E. Ontario St., Chicago 11

the new Mossberg 200

TOP QUALITY 12 Ga. 3 Shot Pump Shotgun

for as little as \$46.95



For skeet, trap and field.

No. 200K 12 Ga. with C-LECT-CHOKE \$49.95

They said it couldn't be done. But here it is! Another Mossberg "first"!

Smoothest pump action ever. Choice of interchangeable choke tubes or C-LECT CHOKE.

- Detachable clip magazine • Chambered for all 2 3/4" shells including Magnum • Full length stock—beavertail nylon fore-end
- Firing position indicator • Thumb-operated safety • Disconnecting trigger to avoid "doubles"
- And many other features.

New No. 200D Identical with 200K except with interchangeable choke tubes instead of C-LECT-CHOKE \$46.95

YOUR MOSSBERG DEALER WANTS TO SHOW YOU THESE REMARKABLE GUNS.

Prices shown are \$1.00 higher west of Rockies

Send for free catalog.

O. F. MOSSBERG & SONS, INC. 59710 St. John St. New Haven 5, Conn.



YOU BUILD EICO KITS

in one evening. SAVE 50% & LEARN

Easy Instructions | Vacuum Tube Voltmeter
38 Instruments | KIT \$25.95 | Wired \$39.95

Write now for FREE Catalog . . . PM-10

Electronic Instrument Co., Inc. • 84 Withers St. • Brooklyn 11, N. Y.

NOW! BUY BRAND NEW PUNCTURE STRANGLING TUBELESS TIRES AT LESS THAN DEALERS' COST—ALL FIRST QUALITY & PERFECT TUBELESS TIRES

Not SECONDS or Blemished. Puncture strangling TUBELESS that virtually eliminates blowouts. Deep clawlike slots extend through more than 80% of the tread for skid resistance and traction. Low warehouse prices forbid mention of the brand . . . the oldest and finest name in the tire industry. Buy with confidence from Father & Son, Same management, same location since 1919. REFERENCES: Citizens Nat'l Bank, 1624 Sunset Blvd., L. A. 26. United States Rubber Co., 500 & E. 4th St., Los Angeles; Los Angeles Chamber of Commerce. Order C.O.D. (\$10 Deposit) Check or M.O. All tires sold on

MONEY BACK GUARANTEE IF NOT COMPLETELY SATISFIED.

SIZE	30,000 MILE TREAD DEPTH		EST. TAX
	LIST PRICE	YOUR PRICE	
6.40x15	\$28.03	\$18.18	\$1.06
6.70x15	29.50	19.12	1.21
7.10x15	32.35	20.96	1.27
7.60x15	35.45	22.97	1.39
8.00x15	39.45	25.56	1.48
8.20x15	40.90	26.50	1.53
WHITE			
6.40x15	\$34.35	\$22.36	\$1.06
6.70x15	36.10	23.39	1.21
7.10x15	39.65	25.69	1.27
7.60x15	43.45	28.18	1.39
8.00x15	48.30	31.20	1.48
8.20x15	50.10	32.46	1.53

SIZE	40,000 MILE TREAD DEPTH		EST. TAX
	LIST PRICE	YOUR PRICE	
6.40x15	\$56.55	\$28.78	\$1.06
6.70x15	59.85	29.98	1.21
7.10x15	70.05	35.03	1.27
7.60x15	76.75	38.38	1.39
8.00x15	85.20	42.60	1.48
8.20x15	88.45	44.23	1.53

VALVES & MOUNTING INSTRUCTIONS INCLUDED FREE

REMEMBER! YOU CAN'T BUY HIGHER QUALITY TIRES AT ANY PRICE!

All prices FOB Los Angeles, Calif.

Ask for prices on subed and truck tires. Also Mud & Snow Tires. Dealer Inquiries Invited.



SATISFACTION GUARANTEED OR YOUR MONEY BACK

Father & Son Tire Service, 2000 Glendale Blvd., Los Angeles 39, Calif.

Confidence. Please ship the following Tubeless Tires:

QUANTITY _____ SIZE _____ BLACK OR WHITE _____

24 in. gear _____ 28 in. gear _____ Make & Year of Car _____

NAME _____

ADDRESS _____

CITY _____ STATE _____

Fill in enclosing check or M.O. _____ This C.O.D. (\$10 Dep.)

We are a business firm listed in "Who's Who" and "Business" 30 day open acct. (Include purchase order) C&S, Inc., 608 4th St. Example: QUAN. 4, PRICE \$18.12 ea., EX. TAX \$1.21 ea., TOTAL \$81.32

FROM ALL OVER THE WORLD...

news you want to hear with a

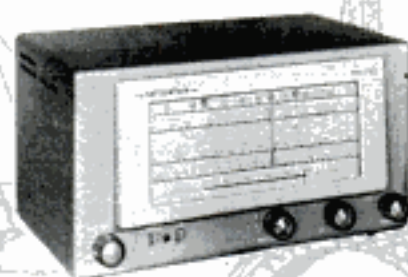

hallicrafters Model S-38D—Only \$49.95

It's a fascinating, exciting hobby to listen in on the whole wide world by short wave with Hallicrafters S-38D radio. With this exceptional receiver you enjoy not only standard broadcasts . . . but can choose from the 3 international short wave bands. You, too, will praise the performance of Hallicrafters S-38D radio . . . the choice of countless governments as well as radio experts the world over. Hear the S-38D at your nearest Electronic Parts Distributor today—\$49.95 . . . or write

hallicrafters

CHICAGO 24, ILLINOIS

OWN A



With a Triumph—you're in for some real fun at very low cost. Hours of pleasure and miles of fun filled travel are yours for only a few cents. Triumph's amazing mileage means that you save on gas without any sacrifice of speed. 4 cycle single cylinder and twin cylinder models. See your nearest Triumph dealer

for easy monthly payments and free demonstration. He will teach you to ride.

SEVEN NEW MODELS

FROM \$449.00

- "jet wing" double seat.
- front and rear springing
- gear position indicator
- sparkling colors with chrome
- easy to ride

Rush this coupon to nearest address below. Dept. P

The Triumph Corporation
Towson, Baltimore 4,
Maryland

Johnson Motors, Inc.
267 W. Colorado St.
Pasadena 1, Calif.

Send me absolutely FREE the 1955 Triumph MOTORCYCLE Catalogue in full color. If under 16 years of age, check square for special pictures.

NAME.....

ADDRESS.....

PHONE.....

WHERE-TO-BUY-IT INDEX

Source of supply appears after items commercially available

AUTOMOTIVE

Auto jack adjusts to slope.....	94
Double-ended lift truck faces both directions.....	101
Detroit Listening Post.....	112
Are these '57 Chryslers?.....	113

AVIATION

First German engine since war powered by Volkswagen engine.....	101
First jet transport for private flying.....	119
Proposed glider would soar to 70,000-foot height.....	121
Giant traveling paint booth used to spray plane parts.....	123
Double-delta wing on Swedish jet.....	141
Take-off run of turboprop transport is nine times its length.....	141

HOUSE AND HOME

Ready-made aids for do-it-yourself builders—	
Disappearing stairway with hydraulic checks (Precision Parts Corp., 400 N. First St., Nashville 7, Tenn.).....	166
Plastic garage door admits light to garage (Tilt-A-Door Corp., 3400 E. Outer Drive, Detroit 34, Mich.).....	166
Precast shower floor (Flat Metal Mfg. Co., 9801 Belmont Ave., Franklin Park, Ill.).....	166
Plastic wall covering (National Vacuum Molding Corp., 923 Old Nepperham Ave., Yonkers, N. Y.).....	168
Carpeting is laminated to an underlay of foam latex and hardboard (Luxor Products Co., 369 S. Maple St., Akron 2, Ohio).....	167
Prefabricated fireplace installed in six hours (Uni-Bilt Div., Vega Industries, Inc., Syracuse 5, N. Y.).....	167
No-putty window (The Donley Brothers Co., Miles Ave., Cleveland 5, Ohio).....	167
Storm-screen door (The Weather-Proof Co., Cleveland, Ohio).....	167
Fire-warning system (Minneapolis-Honeywell Regulator Co., 3753 Fourth Ave., Minneapolis 8, Minn.).....	264
Window-sill covering (Kenwood Engineering Co., Inc., 265 Colfax Ave., Kenilworth, N. J.).....	294

MISCELLANEOUS

Supersonic sled (Radioplane Co., Van Nuys, Calif.).....	101
Midget drill pierces hair.....	111
Detachable holder keeps tennis balls clamped to racket (Madden Mfg. and Sales Co., 2321 Lincoln Blvd., Venice, Calif.).....	113
Crickets chirp tell temperature.....	114
Heavy-machinery trailer detaches wheels from bed for loading (Buhl Machine Works, Buhl, Idaho).....	114
Pontoons fasten to feet.....	114
Triple shade of flexible shop lamp doesn't get hot (Swivelier Co., Inc., 43 34th St., Brooklyn 32, N. Y.).....	121
Flying photographer shoots flash picture of plane in mid-air.....	122
Directional signals for bike (Mrs. Damar, 125 Damar Bldg., Newark 5, N. J.).....	122
Fire-escape reel.....	140
Fans at race track view finish on television screen.....	144
Asbestos-aluminum insulation blanket (Infra Insulation, Inc., 525 Broadway, New York City 12).....	298
Proposed Indian statue would tower 250 feet.....	308
Headrest for travelers.....	324
Little grease gun (Universal Lubricating Systems, Inc., 747 Allegheny Ave., Oakmont, Pa.).....	324
Plastic seals sewer-pipe joints (B. F. Goodrich, Akron, Ohio).....	330

SCIENCE

Drugs sterilized by electrons.....	122
Hydraulic arm—new hope for paralytics.....	128
High-school atom lab.....	133
Electronic stethoscope picks up extremely low sounds (General Motors Corp., General Motors Bldg., Detroit 2, Mich.).....	140
Electrons sort the mail.....	142
Color-television network now reaches 46 states.....	144
Lever action on rifle has built-in trigger (Winchester Repeating Arms Co., Div. of Olin Industries, New Haven, Conn.).....	144

Craftsman and Shop Notes Index

AUTOMOTIVE

Clothespin holds valve stem while tire is mounted.....	206
Rattling hub caps silenced by using gasket cement.....	232
Carburetor fuel-level gauge.....	233
Emergency connecting-rod repair made with aluminum foil.....	239

(Continued to page 92)

NEW Govt. Release!
Original
Cost
\$444.00

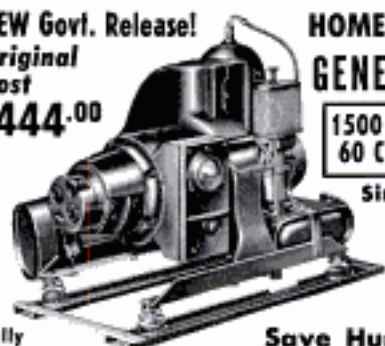

**HOMELITE "Carryable"
GENERATING PLANT**
1500 WATT
60 CYCLE, **\$189.00**

Single Phase, A.C.

Carrying handles for
easy portability. Fits
easily in car trunk

Fully
Guaranteed

Save Hundreds of \$ \$ \$

PAYS FOR ITSELF! Saves time, labor and money. Provides on-the-spot power for CONSTRUCTION, etc. where none is available or expensive to run in. LARGE ENOUGH for Floodlights; Saws; Pumps; and many more labor-saving, heavy-duty machines. Ideal as a stand-by emergency power plant to duplicate house current. Plenty of power for lights, refrigerator, deep freeze, oil burner, radio, etc. Specifications below CAN'T BE MATCHED anywhere at this price!

GENERATOR 1500-1700 Watts, 115 Volts, 60 cycle, single phase, AC. Overload capacity well above its rated output. Excellent automatic voltage regulation plus Field Rheostat for even closer adjustment. Built-in Shock-mounted Volt Meter. Oversize brushes.

ENGINE Famous Homelite single cylinder engine. Air cooled; two cycle. Easy rope start. Dust and rain-proof ignition system. Built-in automatic governor. Footproof pressure vapor lubrication system. Adjustable jet-type carburetor.

This Precision power plant has ball and needle bearings throughout and costs only 5c an hour to operate. Satisfaction Guaranteed.

SUPPLY LIMITED! IMMEDIATE DELIVERY! ORDER FROM AD
FREE Catalog of Compressors, Motors and Welders

ROBERTS ELECTRIC CO., Dept. P-315, 849 W. Grand, Chicago 22, Ill.

10 LARGE NEW TOWELS 5¢

Most terrific towel value in U. S.! When you buy 10 of these wonderful, new, full-size towels made of unwoven rayon and cotton for only \$1.00, we'll send TEN MORE for 5¢—or TWENTY in all for \$1.05! Others charge \$1.00 for FIVE towels! But order TODAY while supply lasts! Make wonderful gifts. Money-back guarantee. Agents wanted. Make big money.

TOWEL SHOP, Dept. 456, Box 881, St. Louis, Mo.



Home Training in Underwater

**SKIN AND
LUNG DIVING**

Train for fast developing opportunities in this great new sport. More and more big money will be earned by qualified divers. Training program by outstanding authority. Write at once for free information.

DIVEMASTER

U. A. S. Corporation, Dept. PM-10,
5637 W. 63rd Place, Chicago 38, Ill.

Say You Saw It in Popular Mechanics

POWERFUL MIDGET TV ANTENNA



Amazing Television Invention!

Fits Into Palm of Your Hand
AS CLEAR A PICTURE AS
WITH 535 ANTENNAS!

Installed in seconds! Hidden From View! This Powerful Midget outperforms far costlier antennas. Weighs only few ozs. Works on all frequencies. Sensational value, \$1.

MONEY BACK GUARANTEE

Junk that old unsightly weak-pulling TV Antenna for this handy, newest Evans All Frequency TV Antenna. See the difference immediately. So low-priced you can't afford to be without this "Midget Wonder." Mechanism fully concealed. Perfect for apts. where outdoor antennas are prohibited.

Clip This Ad and Mail with Only \$1 plus Dime for Postage We'll ship postpaid to your door. If not delighted with improved TV reception, return in 10 days for full refund. Order for yourself and friends today while this BARGAIN OFFER remains in effect.

EVANS RADIO CO., Dept. B-A, 650 Asbury, Evanston, Ill.

"Do-it-yourself"

**KITCHEN
CABINETS**



New book gives step-by-step directions, material lists, building pointers, "show-how" illustrations, for making every type of cabinet for the modern kitchen.

**SAVE \$500
OR MORE**

Now you can SAVE HUNDREDS OF DOLLARS on kitchen cabinets! Build your own with the aid of this great new "do-it-yourself" guide. Tells you everything you need to know. Large, clear drawings show every detail of construction. Easy-to-follow text gives you valuable pointers on how to save work, save on materials, and get a professionally-perfect job.

INCLUDES 70 TYPES OF CABINETS, plus dozens of ideas for ingenious labor-saving, step-saving kitchen units.

**"HOW TO BUILD CABINETS
FOR THE MODERN KITCHEN"**

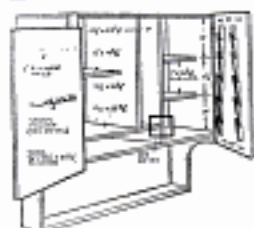

By **ROBT. P. STEVENSON**
Asst. Managing Editor,
Popular Science

TELLS YOU HOW TO BUILD: Over-Range Refrigerator Cabinet, Over-the-Range Cabinet, Sliding-Door Cabinet, Adjustable Shelf Cabinet, Mix-Center Wall Cabinet, Over-the-Sink Cabinet, Wall Vegetable Bin, Tool Hanging Cabinet, Swing-Shelf Cabinet, Combination Sink Cabinet, Tray and Bread Cabinet, Platter Cabinet, Laundry Hamper, Screen-Bottom Vegetable Drawers, Pop-Up Mixer Shelf, Beside-the-Range Towel Rack, Rolling Vegetable Bin, Sink Pull-Out Racks, Revolving Wall Cabinet, Lifting-Counter Cabinet, Pass-Through Serving Center, Canned Goods Storage Cabinet, Storage Wall, Folding Wall Table, Under-the-Counter Table, Curved-Seat Breakfast Nook, Snack Bar, Kitchen Desk, AND MUCH, MUCH MORE! FULLY ILLUSTRATED.

FREE 10-DAY TRIAL, SEND NO MONEY

See for yourself how this great new book helps you save money and gives you expert guidance on how to build your own kitchen cabinets. Mail coupon below for free-trial copy. After 10 days' trial, keep it and pay only \$4.95, plus few cents postage. Or return book and owe not a penny. MAIL COUPON NOW.

**SIMMONS-BOARDMAN BOOKS, Dept. PM-1055
30 Church Street, New York 7, N. Y.**

Send me for 10 DAYS' FREE EXAMINATION, "How to Build Cabinets for the Modern Kitchen." I will either return it in 10 days and owe nothing, or send only \$4.95 (plus shipping charge) in full payment.

Name _____

Address _____

City & State _____

SAVE! Send \$4.95 with this coupon and we will pay postage. Same return and refund privileges.

DO-IT-YOURSELF!



Modernize with prefinished MARLITE PLANK & BLOCK

A hammer, saw, and level are all you need for beautiful walls, quickly installed. Planks (16" x 8") and Blocks (16" square) with exclusive tongue and groove joint are easily applied over old or new walls. Soilproof baked finish fused to a tempered hardboard never needs painting, cleans with a damp cloth. Ten "Companion Colors," plus 4 distinctive wood patterns, practical for every home interior.

Write for free folder and do-it-yourself instructions, or see your lumber dealer. Marsh Wall Products, Inc., Dept. 1042, Dover, Ohio. Subsidiary of Masonite Corp.

Marlite Plank and Block
Patent Applied For

Made with genuine Masonite® Tempered Duolux®



GRAFLEX® STROBOFLASH



**CUTS FLASH COSTS
TO AS LITTLE
AS 1c A SHOT**

Graflex Strobeflash units cut flash costs to as little as a cent a shot. Fits most cameras with

built-in flash. Rugged and weather-tested, all models and accessories are interchangeable for single or multiple use. Electronic triggering protects shutter contacts. Three-wire safety circuit eliminates switches. Scientific reflector design gives even illumination without "hot spots." Priced from \$89.00. Write for free folder: Dept. PM-105, Graflex, Inc., Rochester 8, N. Y.

Price includes federal tax where applicable and is subject to change without notice.

GRAFLEX® *Price-Winning Cameras*

(Continued from page 90)

FARM AND FARMING

Children kept out of hayloft.....	224
Wheeled "granary" towed to hogs saves many steps.....	224
Wrench on front of tractor handy for corn cultivator.....	224
Fence gate "livestock proofed".....	222
Reduce salt-block waste by using nail keg.....	232
Quick-coupling tractor hitch.....	233
One-man logging operation permitted by modified truck.....	239

HOUSE AND HOME

New ceilings from old with pre-pasted plastic tile.....	151
Shoe rack on closet door saves time and space.....	172
Home office under stairway.....	177
Utility cabinet for your kitchen.....	189
Build your own carport (Tennessee Fabricating Co., 1516 Grimes St., Memphis 6, Tenn.; Kawneer Co., 714 N. Front St., Niles, Mich.; Universal Fabricated Products Co., 80 E. Jackson Blvd., Chicago; Pilon Plastics Co., El Segundo, Calif.).....	190
Painted nursery walls decorated.....	196
Illuminated flower bowl is nighttime decoration.....	197
Special music from old piano.....	201
Name in reflective tape identifies mailbox.....	202
Helpful hints for flowerpots.....	208
Ductless stovepipe cleaning.....	210
Removable fence section provides oversize gate.....	212
Candle sconce and shelf in wood.....	213
Trellises mounted with flat-bar brackets quickly removed.....	216
Compact portable workshop built inside cabinet.....	226
Lowering outside supply tank prevents oil-stove leak.....	226

HOUSEHOLD HINTS

Neckties cleaned in fruit jar.....	197
Solving Home Problems—	
Dustpan rack made from spool.....	198
Bobby pin over neck of funnel permits easy pouring.....	198
Hot-dish holders from corrugated paper.....	198
Upholstery welts "renewed" with nylon yarn.....	198
Storm door kept open with long hook.....	199
Small cotton swab makes an excellent touch-up brush.....	199
Paint splatters easily removed with steel wool.....	199
Steel-wool pad keeps putty knife clean.....	199
Lightweight level improvised for jobs around the house.....	200
Nail hole in plastered wall repaired with wood putty.....	212
Quickly improvised clipboard.....	226

PHOTOGRAPHY

Modified floodlamp reflector produces softer shadows.....	222
Odd-shaped masks around prints provide variety in photo album.....	222
Paper punch marks transparencies.....	222
Sequence of slides indicated by diagonal lines on edges.....	222
Pen converted to lens brush.....	222
Swinging shelves for your enlarger.....	225
Holder for film transparencies.....	225
Loop tied in rubber band to provide finger grip.....	225

MISCELLANEOUS

Heated wheel joins plastic yard goods.....	195
"Electrified" fish pole flashes light when catch is hooked.....	197
Illuminated "balloon face" for nighttime fun.....	200
Cellulose tape over knuckle aids removal of ring.....	200
Pipe cleaner used for "brushing" spaces under ring setting.....	201
Playing narrow-groove records for square dancing.....	202
Display-card holders improvised from paper clips.....	202
Asphalt strips provide seal between foundation and sill.....	202
Tent-pole "clothes hooks" fold when not being used.....	206
Permanent anchoring stakes swiveled on dividing board.....	206
Corrugated paper in tape spool holds artist's brushes.....	212
Uses for pressure-type adhesives.....	217
Safe torch for burning webs and nests of tree spiders.....	223

(Continued to page 94)

IMPORTANT NOTICE—It is the intention of this magazine to provide its readers with information regarding the latest developments in the mechanical arts. We take no responsibility as to whether the disclosures contained in our articles are covered by patents and advise readers to investigate this subject before making, using, or selling any of the products, machines, or processes described in order to avoid possible liability for patent infringements.

when one burns out...



don't get rid of all three—

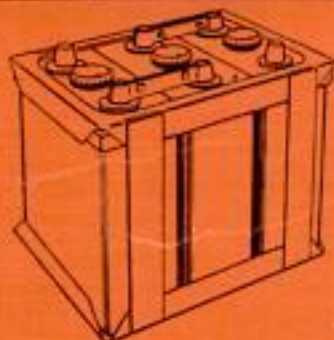

NOW, A PREMIUM BATTERY—WITH REPLACEABLE CELLS! THE STARTLING **NEW** CELLOMATIC

The most practical battery design of half a century is incorporated into the new Cellomatic—*individually demountable and replaceable cells*. This outstanding and highly functional feature means that the consumer's battery dollar is no longer reduced to the pennies of salvage when for **ANY** reason a cell in his battery goes dead. Now, instead of buying a complete new battery, the motorist need replace only one cell.

"POWER DRY PACK" Another equally revolutionary feature of the new Cellomatic is "Power Dry Pack." This amazing scientific advancement not only gives the Cellomatic the power and stamina of a truly premium battery but also eliminates the handling of acid. The Cellomatic can be shipped dry anywhere in the world and **NO ACID NEED BE HANDLED AT ANY TIME!** ONLY THE ADDITION OF DISTILLED WATER IS NECESSARY! And in the "Power Dry Pack" state the Cellomatic battery can be stored in your garage or warehouse **INDEFINITELY** without harm.

ONLY
\$24⁹⁵
SIX VOLT
CARS OR TRUCKS

The amazing **PLUS** features of the Cellomatic make it truly a premium battery selling at a popular price. The finest materials coupled with spectacular engineering and scientific advancements establish the Cellomatic as the only battery buy for you. The keynote of the Cellomatic battery is economy, for when and if needed, individual cells can be replaced for as low as 50¢.

OTHER OUTSTANDING FEATURES: ✓ Individual, universally sized cell cases are made of rugged, colorful "high impact" polystyrene. ✓ Space channels between cells allow cooling, free air circulation between and around the cell cases at all times. ✓ Harmful vibration and shock are greatly reduced by a foam rubber mat that "nests" under each cell. ✓ A steel frame enclosing and supporting the individual cells is an integral part of the Cellomatic battery.

The Cellomatic is the only battery in the world that carries a perpetual guarantee. Unlike batteries with limited guarantees, Cellomatic can be transferred from one vehicle to another and from one owner to another under the same perpetual guarantee. No complicated warranty or guarantee slips are needed. The Cellomatic battery is its own guarantee.

**PERPETUAL
GUARANTEE**

ORDER BY MAIL TODAY!
If no dealer near you, use coupon.
WE GUARANTEE IMMEDIATE SHIPMENT.

NOTE:
NEW
ADDRESS

CELLOMATIC SALES CORPORATION

186 No. Canon Drive, Beverly Hills, Calif., Suite 201
Please ship a new Cellomatic 6 volt automotive battery.

For _____
Make & Model, year of car or truck.

I enclose () \$24.95 in cash, check or money order. There will be no charge for shipping or handling.
I enclose () \$5.00 deposit, will pay balance C.O.D.

Name _____

Address _____

City _____ Zone _____ State _____

CELL O MATIC

CELLOMATIC SALES CORPORATION
BEVERLY HILLS, CALIF.

For distributor or dealer information please give details of your organization and of area interested in.

Copyrighted material

EASY-TO-BUILD CHRISTMAS IDEAS

Dollhouse, Playhouse-PlayStore and Outdoor Christmas Cards Made with Upson Panels



Build this clever Dollhouse from full-size Easi-Bild pattern. Complete floor plan. Roof lifts up. Paint like your house. Size: 23" across front, 17" high. A perfect Xmas gift. Decorate, make furnishings, too. Use Upson $\frac{3}{16}$ " Panels, saw

clean, paint easily, stand up to rough handling, assure beautiful job. For Easi-Bild pattern, send 50c and coupon today!

A new interest for kids. A Playhouse-PlayStore 4' long x 5 $\frac{1}{2}$ ' high. Room for shelves, furniture. Fun to build. Beginners can do it with Upson $\frac{3}{16}$ " Panels. Cinch to paint. Use colorful decoration. Send 60c for Easi-Bild Pattern complete with easy-to-follow directions, pictures. Build for Xmas.



Something different for Xmas decoration. Beautiful 4' x 7' holiday scene for front yard. Light at night. Easi-Bild pattern shows how to cut out church, lettering

Made from pebbled-surfaced Upson $\frac{3}{16}$ " Panels. Withstand snow, rain. Upson Panels are the finest. Be sure, insist on the name "Upson." Send 50c for pattern.

Complete patterns, step-by-step pictures. Full directions and materials list. Easy for skilled or unskilled. Check choice on coupon and send with money. Patterns also at lumber dealer's.

upson / DO-IT-YOURSELF / panels

PROVEN QUALITY YOU CAN TRUST

THE UPSON COMPANY

51110 Upson Point, Lockport, N. Y.

Please check patterns desired. Enclose cash with order.

Dollhouse 50c Playhouse-PlayStore 60c

Holiday Scene 50c

Name _____

Address _____

City _____

State _____

45th



Year

(Continued from page 92)

TOOLS

Drill-press vise utilized as base die for forming sheet metal.....	223
C-clamps on broken spring leaf provide temporary repair.....	223
Shopping for Tools—	
Motor-powered-paint scraper.....	241
Hand-powered spring winder.....	241
Micrometer handwheel.....	241
Smoothing tool takes the place of a sand block.....	241
Eye shield.....	242
Self-closing tweezers.....	242
Metal-strapping tool.....	242
Roller lapping machine.....	242
Height gauge is aid in setting circular saw.....	243
Drill-bit holder.....	243
Glue-gun assembly for use on air line.....	243
Rubber-faced auxiliary jaws for metal-working bench vise.....	243
Two-speed bandsaw has built-in motor.....	243
Combination tool is converted to portable router.....	244
Spin drier for paint roller fits chuck of $\frac{1}{2}$ -in. portable electric drill.....	244
Battery lantern.....	244

WORKSHOP HINTS

Graphite applied to inside of lock with toy balloon.....	172
Vise used as wood clamp.....	172
Prussian blue locates high spots when refitting wooden door.....	200
Radio interference from tools eliminated by condenser.....	200
Grease protects clamp pads.....	202
Curves bent in flat steel by using vise-held jig.....	205
Nail kept carried more easily.....	205
Efficient paint scraper utilizes adjustable-wrench leverage.....	209
Grooved nut used to clean rusted bolt threads.....	209
Damaged screw threads restored.....	210
Emergency barn bracket.....	210
Extension chute for jointer.....	210
Rubber-covered bottom rung is safety step on ladder.....	210
Opener for vacuum-packed cans.....	212
"Spiked feet" on ladder bottom prevent slipping.....	216
Socket-wrench set measures fillets and coves.....	223
Foil strips in wound coil simplify soldering taps.....	224
Taped drill-press table keeps block in place.....	224
Bench stop hooks between boards in top of bench.....	232
Inexpensive small end mills.....	232
Holder separates leads of multiwire cable.....	233
Nails fastened to bins identify contents.....	233
"Thrust bearing" converts motor for use in vertical position.....	233
Holes punched in spring steel without annealing.....	239
Constant-speed throttle control uses rod and coil spring.....	240
Sturdy metal sawhorses fold flat to save space.....	240

Auto Jack Adjusts to Slope

Triangular construction of a new bumper jack permits safe tire changing even on slanting road shoulders. The adjustable base of the jack rests flat on sloping ground. The brace is adjusted and locked so that the main shaft of the jack is absolutely vertical. A crank on top is used to raise or lower the jack, which can be folded compactly when not in use.



PUT YOURSELF IN THE *Top-Paying* TELEVISION PICTURE...

Today, when demand for trained men is higher than ever before, pay is higher than ever before, you can train AT HOME in your SPARE TIME to become a Television Technician.



NO EXPERIENCE NEEDED... Many of my successful graduates had no more than a grammar school education.



L. C. Lane, B.S., M.A.
President, Radio-Television
Training Association.
Executive Director, Pierce
School of Radio & Television.

VETERANS!

My school fully approved to train Veterans under new Korean G.I. Bill. Don't lose your school benefits by waiting too long. Write discharge date on coupon.

GOOD SPARE TIME EARNINGS

Almost from the very start you can earn extra money while learning by repairing radio-TV sets for friends and neighbors. Many of my students earn up to \$25 a week... pay for their entire training from spare time earnings... start their own profitable service business.

OPTIONAL: 2 WEEKS TRAINING IN NEW YORK CITY AT NO EXTRA COST

You get two weeks, 50 hours, of intensive laboratory work on modern electronic equipment at our associate school in New York City — Pierce School of Radio and Television. And I give you this AT NO EXTRA COST whatsoever, after you finish your home study training in the Radio-FM-TV Technician Course or FM-TV Technician Course. However, your home study course is complete even without this two-week laboratory session. It is only one of the many Extras available to you from RTTA if you want it.

CHOOSE FROM THREE COMPLETE COURSES covering all phases of Radio, FM and TV

1. Radio, FM and Television Technician Course — no previous experience needed.
2. FM-TV Technician Course — previous training or experience in radio required.
3. TV Cameraman and Studio Technician Course — advanced training for men with Radio or TV training or experience.

Radio Television Training Association

52 EAST 19th STREET • NEW YORK 3, N. Y.

Licensed by the State of New York • Approved for Veteran Training



C-W Telephone Transmitter



Combination Voltmeter-Ammeter-Ohmmeter



Public Address System



AF-RF Signal Generator



Super-Het Radio Receiver



ENOUGH EQUIPMENT TO SET UP YOUR OWN HOME LABORATORY

As part of your training I give you the equipment you need to set up your own home laboratory and prepare for a BETTER-PAY TV JOB. You build and keep an Electromagnetic TV RECEIVER designed and engineered to take any size picture tube up to 21-inch, (10-inch tube furnished. Slight extra cost for larger sizes.)... also a Super-Het Radio Receiver, AF-RF Signal Generator, Combination Voltmeter-Ammeter-Ohmmeter, C-W Telephone Transmitter, Public Address System, AC-DC Power supply. Everything supplied, including all tubes.

FCC COACHING COURSE

Qualifies you for Higher Pay! Given to all my students AT NO EXTRA COST after TV Theory and Practice is completed. Helps you qualify for the TOP JOBS in Radio-TV that demand an FCC License! Full training and preparation at home for your FCC License.

MY FREE AIDS SHOW YOU HOW AND WHERE TO GET A BETTER PAY JOB IN TELEVISION

See for yourself how my simple, practical methods can make success as easy for you as they have for my hundreds of graduates.

MAIL THIS COUPON TODAY

Mr. Leonard C. Lane, President
RADIO-TELEVISION TRAINING ASSOCIATION
Dept. M-10C, 52 East 19th Street, New York 3, N. Y.

Dear Mr. Lane: Mail me your NEW FREE BOOK, FREE SAMPLE LESSON, and FREE club that will show me how I can make BIG MONEY IN TELEVISION. I understand I am under no obligation and no salesman will call.

(PLEASE PRINT PLAINLY)

Name _____ Age _____

Address _____

City _____ Zone _____ State _____

I AM INTERESTED IN:
 Radio-FM-TV Technician Course
 FM-TV Technician Course
 TV Cameraman & Studio Technician Course

VETERANS!

Write discharge date

NO SALESMAN WILL CALL!

TORO



**10-INCH DELUXE
TILT-ARBOR SAW***
(8-inch models available)

NOW! Professional quality in a new line of home power tools!

See the difference? From the rugged extra-heavy steel castings, to the precision-ground mirror-polished working surfaces, Toro power tools give you a new standard of quality in home workshop power equipment.

Look at that 10-inch tilt-arbor saw! The single, massive, out-in-front control either tilts, or raises and lowers the blade. And check these other "out-in-front" Toro features: the integral casting of rip-fence track and table... the smooth-sliding rip

fence that locks solidly in place, front and back, with quick lever-action.

No wonder the new Toro power tools are so accurate! They're backed by 40 years' experience in building precision power equipment—including the world's most complete line of power mowers.

See this professional quality line of Toro power tools at your dealer's soon—or mail coupon below for a deluxe full-color catalog.

**Table extensions and stand optional.*

TORO MANUFACTURING CORP. Minneapolis 6, Minn., Dept. 105



YES! I'd like a free copy of the deluxe Toro power tools catalog!

NAME.....

ADDRESS.....

CITY.....ZONE...STATE.....



16-inch jig saw



4 & 6-inch
jointer-planer



4-inch
belt sander



10-inch
band saw



12-inch
drill press

POPULAR MECHANICS MAGAZINE



February 1949 issue told Ashby how to build fortune-finding geiger counter

POPULAR OCTOBER 1955 MECHANICS

WRITTEN SO YOU CAN UNDERSTAND IT
VOL. 104 NO. 4

IN FEBRUARY 1949 an alert and adventurous Los Angeles fireman named Jesse Ashby read an article in *Popular Mechanics* that described how to build a simple geiger counter at home. Today Ashby owns a major interest in one of California's most promising uranium mines, 2200 acres of red-hot pay dirt that is one of the biggest bonanzas in the Far West—discovered with his homemade counter.

Ashby's public-servant-to-riches story reads like a scenario that Hollywood would reject for being "too unbelievable." But it's true—and it offers vivid, real-life

By Griff Borgeson

A Fireman Strikes Uranium With a PM Geiger Counter

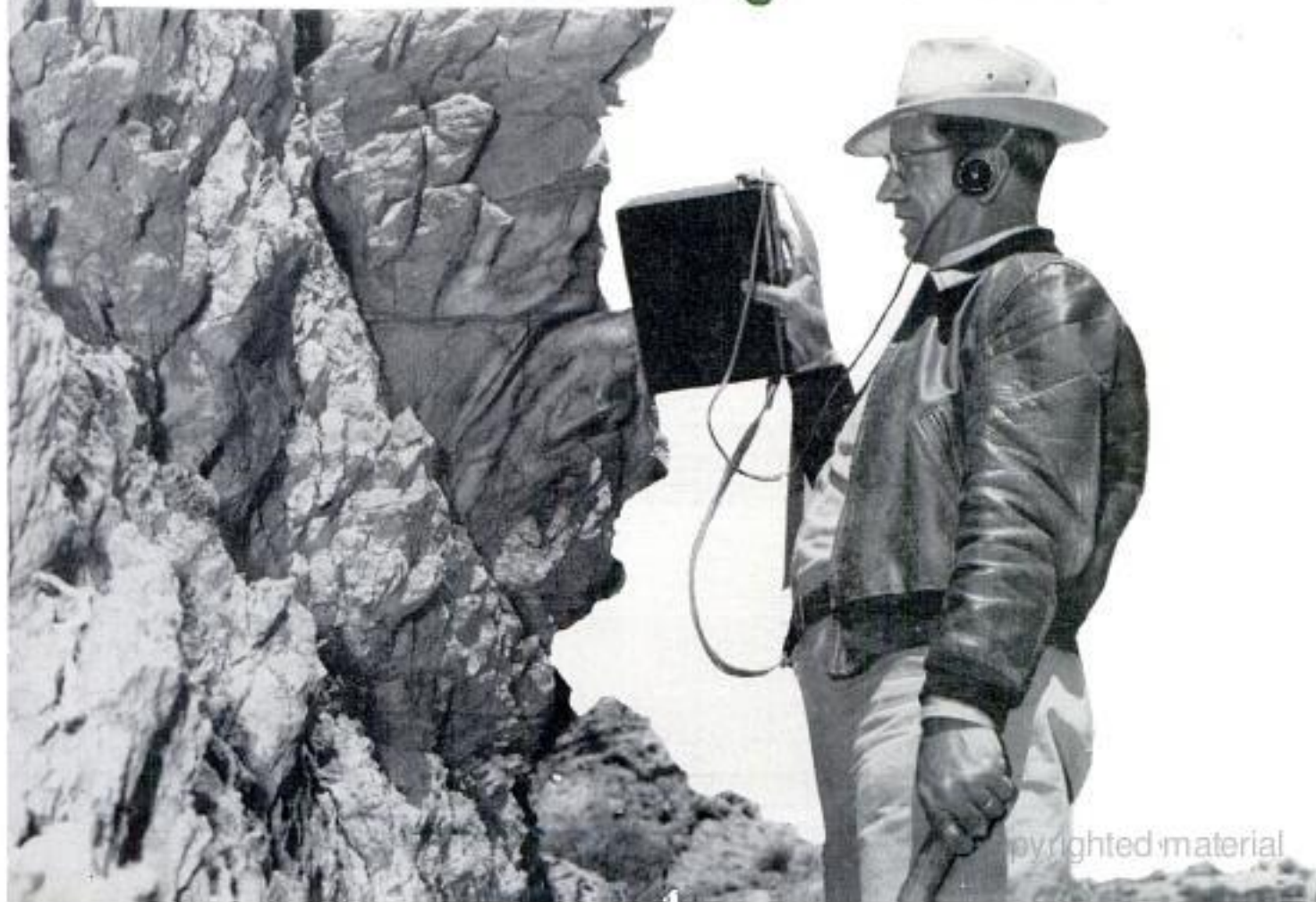



Miners wheel another load of rich uranium ore from the mine. Below, cross-section drawing shows suspected geological formation in the discovery area. Formation is entirely different from sedimentary deposits in Colorado

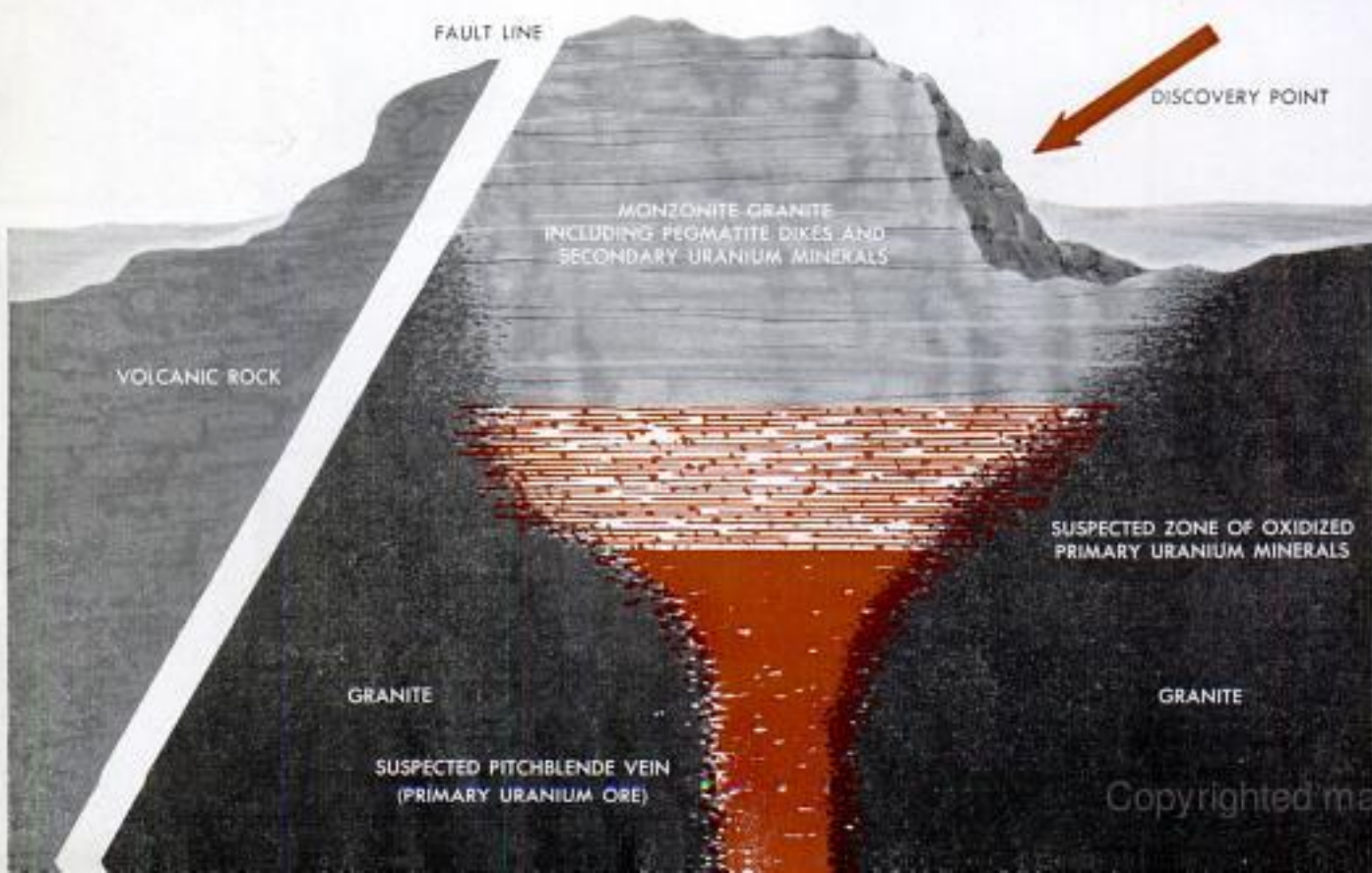

proof that it sometimes takes no more than enterprise, luck and a little do-it-yourself talent to make a full-fledged uranium king.

Back in early 1949 Ashby was a captain in the Sun Valley branch of the Los Angeles Fire Department. He had an amateur interest in mineralogy, and his pretty wife Joan was an enthusiastic "rockhound." The two Ashbys often spent Jesse's days off collecting mineral specimens in the nearby Mojave Desert, and they had just started to attend night classes in mineralogy at a local high school.

One night at class the Ashbys heard a talk by Gilbert La Bine, discoverer of the fabulously rich deposits of pitchblende—pure uranium oxide—at La Bine Point, in Canada.

"I'm convinced that there's uranium in California, even though no one has found any here yet," he told his listeners. "It's up to you amateur and professional prospectors to find it."

La Bine showed the class ore specimens from his mine and demonstrated how they made a geiger counter clatter.

On their way home afterward Ashby told his wife flatly, "I'm going to get me a geiger counter, and I'm going to find some of that stuff!"

In those days a fairly serviceable geiger counter cost around \$200 or \$250. In spite of his enthusiasm, Ashby just couldn't invest that kind of money in an instrument. But then a fellow fireman solved the problem by bringing Ashby a copy of the February 1949 issue of *Popular Mechanics*, with the article on how to build a geiger counter in a lunch box.

This happened early in April, and Ashby went to work building his counter as soon as the parts arrived from the suppliers.

"The plans were very clear and simple, and I followed them exactly," he recalls, "except that I didn't have a lunch box handy, so I made a wooden container with the same inside dimensions."

On the last day of April he finished the counter and tested it with the radioactive

Today Ashby's instruments, in addition to old PM counter, left, include assay counter, center, that tells percentage of valuable ore in sample and scintillometer with long-range sensitivity

radium dial of his wrist watch. It worked.

The next day, May 1, was Joan Ashby's birthday, and Jesse had the day off.

"Let's head for the desert," he suggested. "While you hunt for agate I'll try out the counter."

About 90 miles from home, on a smoothly paved road in the Mojave, Ashby had a sudden impulse to stop and check his counter against a huge outcrop of rock just a few hundred feet off the highway. The counter buzzed wildly.

Ashby looked at Joan and said doubtfully, "Must be a bad connection."

"It has to be," she said. "Nobody's this lucky!"

But they checked and rechecked. Jesse





Ore from Ashby's mine is being stockpiled pending reconstruction of old mill that will concentrate it



Ashby determines value of ore sample by holding it against tube of his assay counter, watching needle

Map shows route taken by Ashby to scene of uranium strike. Mine is only about 90 miles from Los Angeles



would move away from the outcrop and the clicks would simmer down. Then he'd move back and they'd sizzle again.

And that was it. On his first stop, his first time out with the lunch-box counter, Ashby discovered what is now called the Rosamond Uranium Field. The discovery was a big one, and it took the Ashbys a long time to trace the limits of the ore body. They kept very quiet about their find until they knew just where and how far it extended. The counter did an unerring job in giving them this information.

Today Jesse Ashby's stroke of luck has grown into a big mining organization. Recently he decided that the property was too big for his own Uranium Mines, Inc., to handle alone, and consolidated with the Verdi Development Company.

Mining experts say that Ashby's strike is the most important in California to date. It is a formation entirely different from the layered shales of the Colorado plateau in which the uranium enrichment was deposited by sedimentary action. Ashby's strike is of uranium-rich rock in place, and the geologists suspect that it will get richer at depth, eventually turning into primary pitchblende, the purest uranium ore.

With the Rosamond Field under control, Ashby now spends much of his time exploring new prospects that are offered to his company by prospectors in most of the states west of the Rockies. Although he now uses the most costly, sensitive instruments that money can buy, he still keeps "the old lunch bucket" on the mantel at home.

"It put me in business," he says, "and I'll always respect it." ★ ★ ★

First German Plane Since War Powered By Volkswagen Engine

Powered by a Volkswagen engine, the first plane built in Germany since the end of World War II was put on exhibition at the fifth annual German Airport Day at Bremen recently. The plane is a glider-type, modernized for power, and has been named "The Motor Raab." Price-tagged at \$4000, the plane is said to fly for five hours on just five gallons of gasoline.

Spectators admire tiny Volkswagen engine in Raab

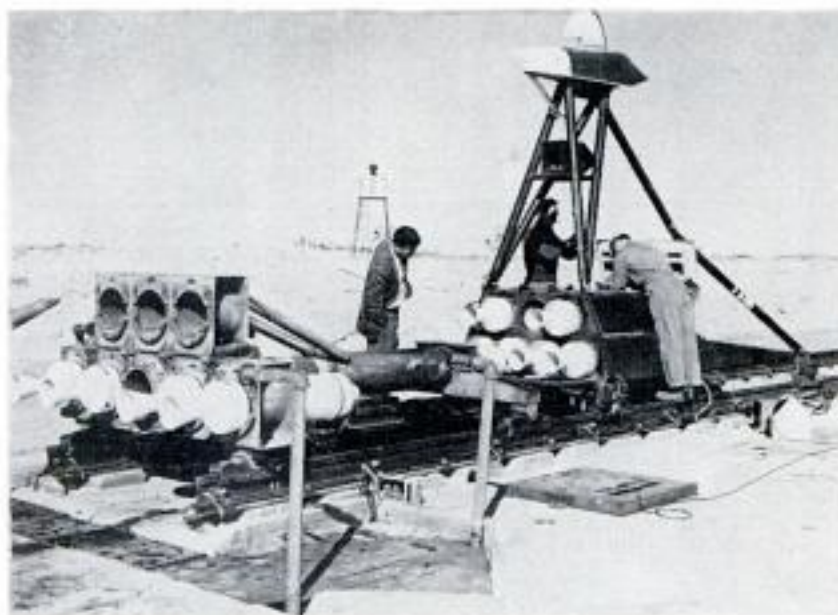

Supersonic Sled

Less than five seconds from start, a new rocket-propelled sled achieved a supersonic speed of 18 miles per minute—believed to be the world's record for a land vehicle. Built for the Air Force Flight Test Center at Edwards Air Force Base, the rail-mounted sled attained its 1100-mile-per-hour speed with the aid of a two-stage thrust. Eight rockets on a pusher sled gave the initial thrust, and seven on-board rockets the secondary thrust.

Double-Ended Lift Truck Faces Both Directions

There is no rear end to a two-way truck that has all controls duplicated for travel in either direction. One set of controls faces forward, the other rearward. All four wheels can be driven and steered. In addition, there is a lift fork on one end, either front or rear, depending on the way the truck is moving. A 100-horsepower engine powers the English vehicle.

For the first time, in April, more than 3,000,000 revenue passengers were carried by scheduled airlines in a single month.





Uncluttered, clean styling gives the 1956 Lincoln a quiet dignity, but its 285 horsepower makes it a bomb!

Lincoln Gets All-New Styling; Ford, Mercury Stress Safety

By Arthur R. Railton

WHAT CAN BE DONE to a race-winning car to give it the boulevard ride and make it radiate prestige—all the while retaining roadability?

Lincoln, first of the Ford Motor Company 1956 cars to debut, tossed that problem at its engineers who, they say, have solved it.

The 1956 Lincoln is high-styled with an all-new body that is longer, lower and wider than last year's. It has the full-wrap windshield that spread through the indus-

try like an epidemic in 1955. Abeam, the Lincoln is as uncluttered and sleek as a mink jacket. Chrome is limited to a stone shield in the form of a long, tapering spear that extends from rear bumper to front-wheel cutouts.

Horizontal chrome lines form the front grille and make the already wide car seem even wider. Park and direction lights are housed in the grille's main bar.

Similar horizontal lines emphasize the

Dash has been kept simple too. Accelerator linkage goes through the fire wall, leaving floor holeless

Spokes of Lincoln's concave steering wheel absorb impact, keeping driver from being impaled on column



width at the rear. You'll recognize Lincoln coming or going. Twin exhaust pipes end in chrome orifices (Lincoln calls them "jet pods") that are worked into the rear bumper. Enormous triangular taillights mark the ends of rear fenders that overhang the axle by about five feet.

Under the hood, Lincoln enlarged its V8 engine to a 368-cubic-inch displacement (bore and stroke are both up). Horsepower is 285 (up from 225) and torque is 401 pound feet (up from 342).

Despite this power boost, Lincoln's emphasis (as in the entire Ford Motor Company) is on safety. Here are some innovations: Safety latches to keep doors from flying open during a crash, spilling occupants on the roadway; concave steering wheel, shaped like a shallow funnel, which flattens on impact to absorb energy and protect the driver's chest from the column; optional seat belts and a shatterproof rear-view mirror.

Other interesting points are: Compression is now 9.0:1; electrical system is 12-



Ford's safety equipment (arrows) includes padded sun visors, padded dash, concave steering wheel and seat belts. Rear-view mirror is shatterproof

volt; carburetor air is rammed through an intake scoop inside the front grille and ducted directly into the air cleaner (a

Most noticeable styling change in Ford is in the chrome molding of the Fairlane series. It dips farther back

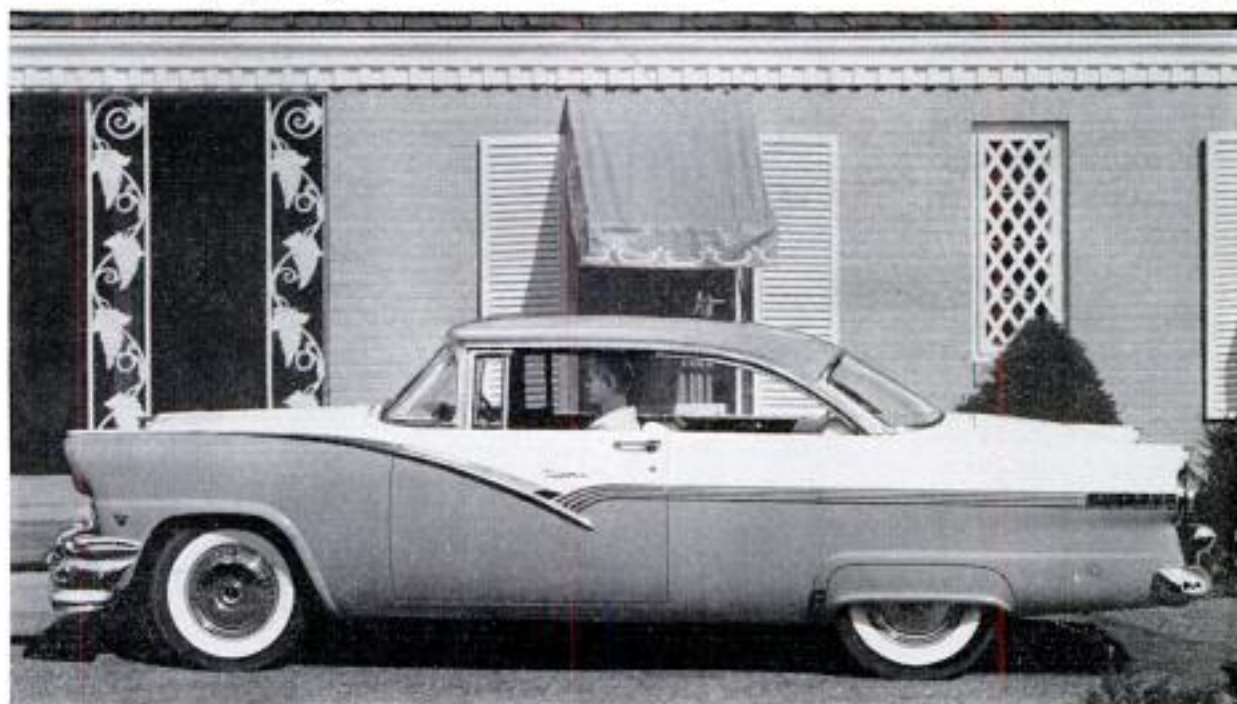



Ford Customline models feature a new chrome trim that runs the full length of the car. Grille is restyled

thermostatic valve directs the air over the exhaust manifold in winter to warm it, eliminating carburetor icing); sound-deadening blankets completely line all sides of the engine compartment to hush an already quiet engine; dual-diaphragm spark advance improves acceleration during the transient period from part to full throttle and prevents annoying "ping"; accelerator linkage is through the fire wall, leaving the floor unperforated; valves are larger and



Mercury also has a restyled grille, new two-toning

their lift increased for improved breathing.

Riding quality of the 1956 Lincoln is noticeably softened over last year, but with slight, if any, sacrifice of roadability. Brief road tests of 1956 engineering-prototype cars disclosed no apparent loss. Despite the body being 12 inches longer and 250 pounds heavier, handling is virtually as good as on last year's acknowledged fine-handling car. Acceleration is excellent, showing a 10 percent improvement in the 0-to-40 range, 14 percent in the 0-to-80 range. Top speed is up 4 percent, say Lincoln engineers.

Ford Gets More Power

The 1956 Ford continues with the same body shell and exterior sheet metal as in 1955. Restyled areas are the front grille, taillights and various chrome trimmings.

Under the hood, though, there are meaty changes. The engine is bigger and flexes more muscle (and, it should be added, will probably use more gas). Horsepower is up

(Continued to page 328)





KEEPING UP WITH THE ATOM



WHAT WOULD HAPPEN if an atomic power-generating plant ran away—would an overheated reactor blow up and subject the neighborhood to deadly radiation of an atomic bomb? The danger is minor. To find out, atomic scientists deliberately let a nuclear reactor “run away” at Los Alamos, N. Mex., in 1953; the results have just been made public. The atomic power plant was allowed to overheat until the fuel elements were partly melted, then all controls were removed. A half mile away the scientists watched. Chunks of melted, twisted metal flew 350 feet from the site of the reactor, but the blast sounded to the watchers like that of “a moderate amount of chemical explosive.” While X rays from the atomic explosion were detected by instruments a half mile distant, the peak dosage was only one thousandth of a deadly dose and no large fraction of the actual reactor core material escaped the site as airborne material.



☆☆☆

Smoke and gases—not heat—trigger a new fire detector that employs radioactive materials. Inside the unit is a cold-cathode tube, plus two independent chambers. One chamber is sealed, the other open to the atmosphere. Bits of radioactive material inside the chambers ionize the air, making

it electrically conductive. Normally, each chamber is adjusted to give equal voltage. But when smoke or gas enters the open chamber, its voltage increases. Current flows from the open chamber to the sealed chamber and thence to the starter electrode in the cold-cathode tube. The starter electrode triggers a current flow from the cathode to the anode. This completes a circuit to set off a relay that sounds an alarm. Any number of units can be installed, all

(Continued to page 286)

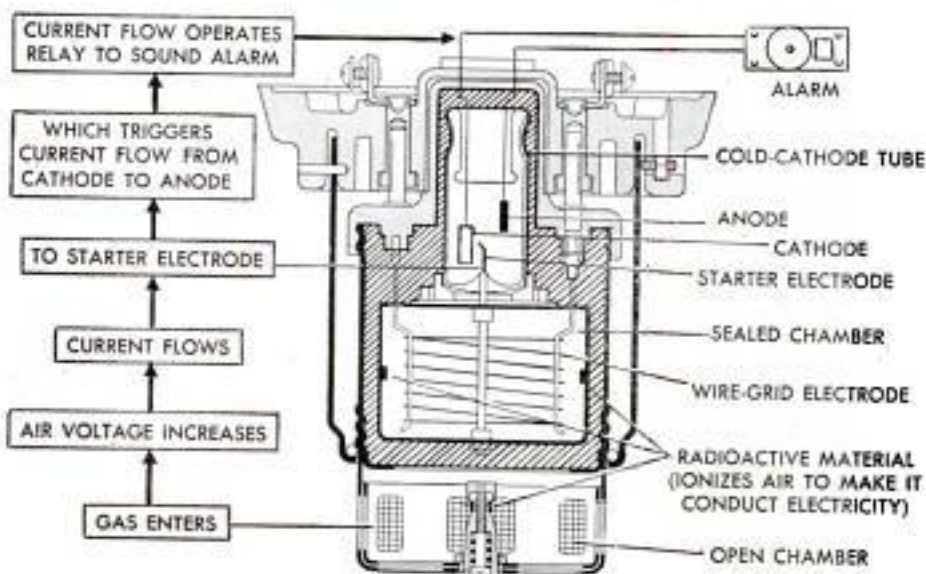



Professor Tombaugh uses a blank globe to locate, by triangulation, hypothetical satellites of the earth

He Spies on Satellites

By Thomas E. Stimson, Jr.

HHEADQUARTERS, Outer Space Patrol." That's a fitting name for the odd metal shed from which a close watch will be kept on the satellite that the United States plans to launch in 1957-58.

Situated on the grounds of Lowell Observatory in Flagstaff, Ariz., the small building contains telescope-cameras so powerful they can record an object the size of a tennis ball at a distance of 1000 miles.

From this shed the United States already is maintaining a surveillance of the space that surrounds the earth, all the way out to the moon.

From here, presumably, regular observations are being made of the earth's first artificial satellite that is rumored to have been launched into space a year ago.

Exclusively reported in the May 1955 issue of *Popular Mechanics*, the existence of this manmade moon has not yet been officially confirmed. But unofficially it is understood that our first artificial satellite is still sweeping around the earth. The latest information is that its orbit is slowly changing into an ellipse because of the pull of the moon.

Possibly the success of this first experiment lies behind the announcement that we will launch an instrument-carrying satellite two years from now, in connection with the International Geophysical Year, to gather new information about outer space. Scientists say that the instrument satellite will be positioned at 200 to 300 miles altitude and will whiz

FLIGHT SEQUENCE





AEROBEE PITCHES DOWN
AND THIRD STAGE FIRES
AT 300 MILES



AEROBEE BURNS OUT
AND BEGINS COASTING
AT 410,000 FEET



AEROBEE FIRED
AT 110,000 FEET

Modified Aerobee rocket has been proposed
as a satellite. Right, smoke from booster
hides launching tower as rocket zooms up

around the earth every 90 minutes. The satellite, they report, will be about the size of a basketball, though this may refer only to its diameter. Several different sizes and shapes may be launched during the satellite program.

One proposal made by Aerojet Corporation, manufacturers of JATO and other rocket units, is to use a modified Aerobee sounding rocket as the satellite. The Aerobee is 20 feet long and 15 inches in diameter, powered with a liquid-fueled motor and launched by means of a solid-fuel booster unit. One 30-foot version, the Aerobee-Hi, has carried 100 pounds of instruments to an altitude of 123 miles.

Aerojet's idea for the satellite is to use an extra large booster under the rocket. This would lift the Aerobee to about 20 miles, at which point its own motor would take over until it is parallel with the earth. At the peak of its climb, about 300 miles, a small solid-propellant motor in the nose would fire, detaching the nose from the body of the rocket and accelerating the nose to an orbital velocity of about 16,000 miles per hour. There would be room in the nose cone for various measuring instruments plus telemetering circuits that would radio information back to earth.

Data on pressures, temperatures, cosmic rays and other phenomena could be obtained this way. But the actual tracking of the rocket itself will be done by astronomical instruments. The altitude of the satellite, its speed and direction of movement can be measured most precisely by the instruments already in use at Flagstaff. The eventual descent of the satellite into the atmosphere and its disintegration will be forecast





Plain wooden box houses Schmidt telescope so powerful it could spot a tennis ball 1000 miles away

with the aid of the same instruments.

Until now, the principal use of these instruments has been the seeking of any small natural satellites that the earth may possess.

Scientists suspect that these objects may exist, though none has been detected even by the world's most powerful telescopes. Until recently no one cared whether nearby space was totally empty or contained a satellite population, nor had anyone figured out a way of searching for them.

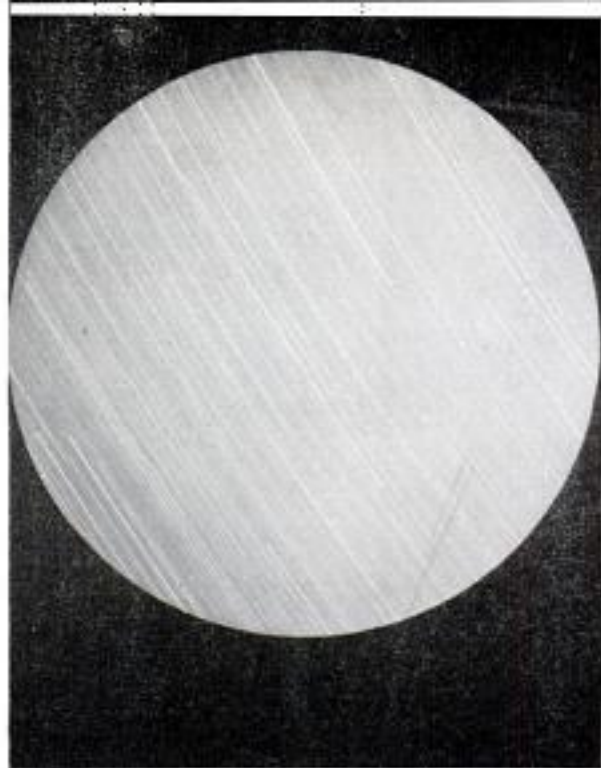

Typical film from satellite search shows long star trails. Satellite would appear as two bright dots

Such bodies might be chunks of debris left over from the creation of the moon or they could consist of material captured from an asteroid that had swept through earth's gravitational field.

A small natural satellite might be less than the size of an automobile or it might measure many miles across. It could be a solid mass or simply a loose jumble of rocks. Information about natural satellites, if they exist, would be extremely valuable in mapping out the program for artificial

Roof of an unimpressive metal shed is rolled back to expose telescope that now is searching for satellites

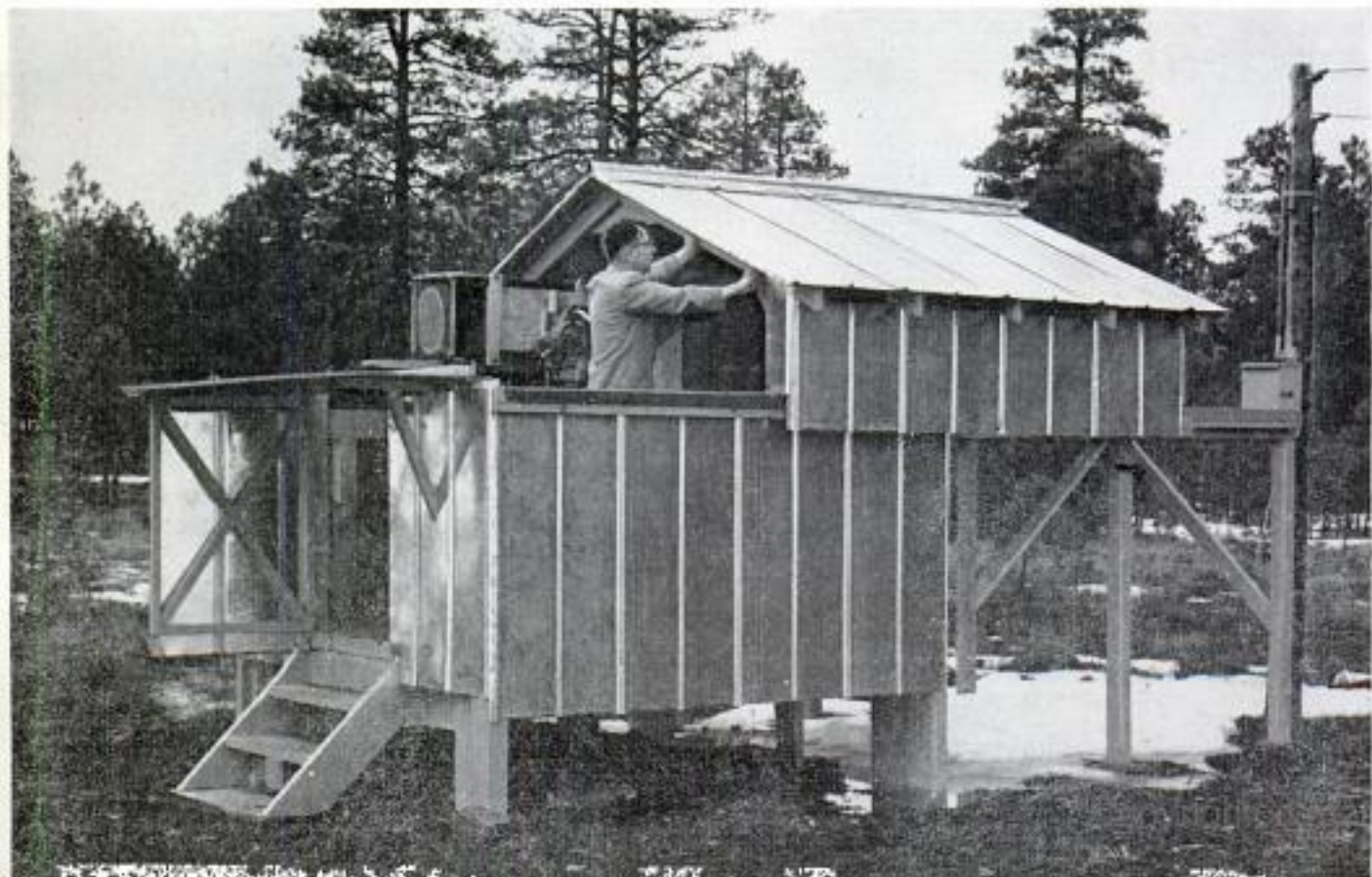

erial



Telescope is pointed away from sun after dark and before dawn, when satellite would be "full" like a moon
Professor Tombaugh suggests the use of satellite and cameras to measure great distances on earth accurately

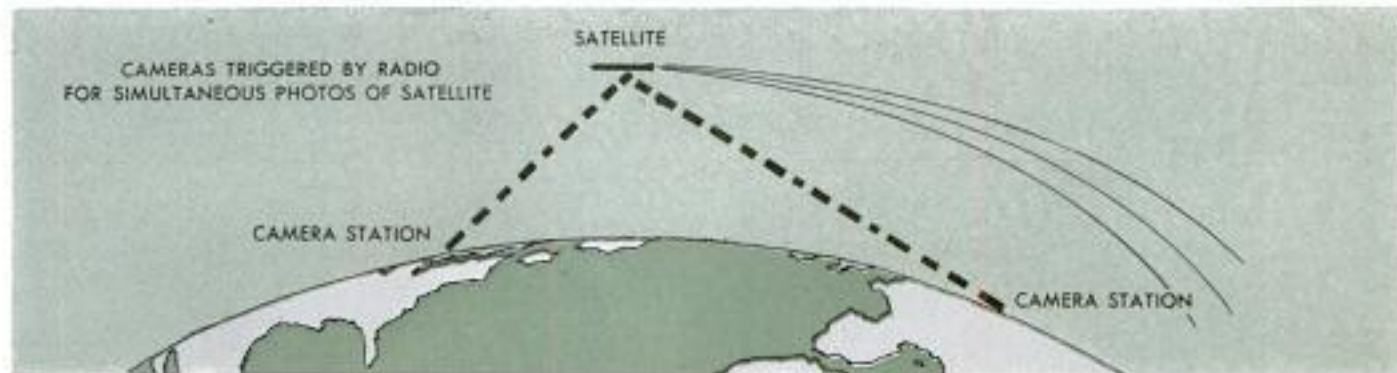

satellites, their altitudes and orbits.

The search for any such natural objects is being conducted by astronomer Clyde W. Tombaugh for the Army's Office of Ordnance Research. Professor Tombaugh is the discoverer of "Planet X," now known as Pluto, the planet that is farthest from the sun. He is an authority on finding hypothetical objects in the sky. Yet for his satellite search he had to invent brand-new methods. No previous astronomical technique would perform the job.

His discovery of Pluto came about after other astronomers concluded that an unknown object was affecting the motions of some of the outer planets. An undiscovered planet was suspected. Its probable position was worked out and many photographs were made of that part of the sky. But no new object was found. "Planet X" remained a mystery until Professor Tombaugh took up the search. He recalculated, much more precisely, the position that the unknown body would have to occupy. Then he pointed a telescope in that direction. He was rewarded by photographs containing an image of the object.

This method won't work for small earth satellites. If they exist they are too small to affect the motions of the earth and moon, so there is no theoretical way of pinpointing their locations. Nor can they be detected by telescopes that are geared to turn at the same rate at which the stars move across the sky. A small, close-in satellite would move too rapidly to build

up an image on film in a telescope that is turning at the usual rate.

Professor Tombaugh overcame this problem by calculating the speed at which a theoretical satellite would move across the sky, then geared his instruments (a Schmidt reflecting telescope with a 13-degree field and a K-24 aerial camera with a 40-degree field) to move at the same rate. This way, a satellite would literally stand

(Continued to page 332)

Drive mechanism of the telescope is set at speed at which a theoretical satellite would move across the sky at certain altitude

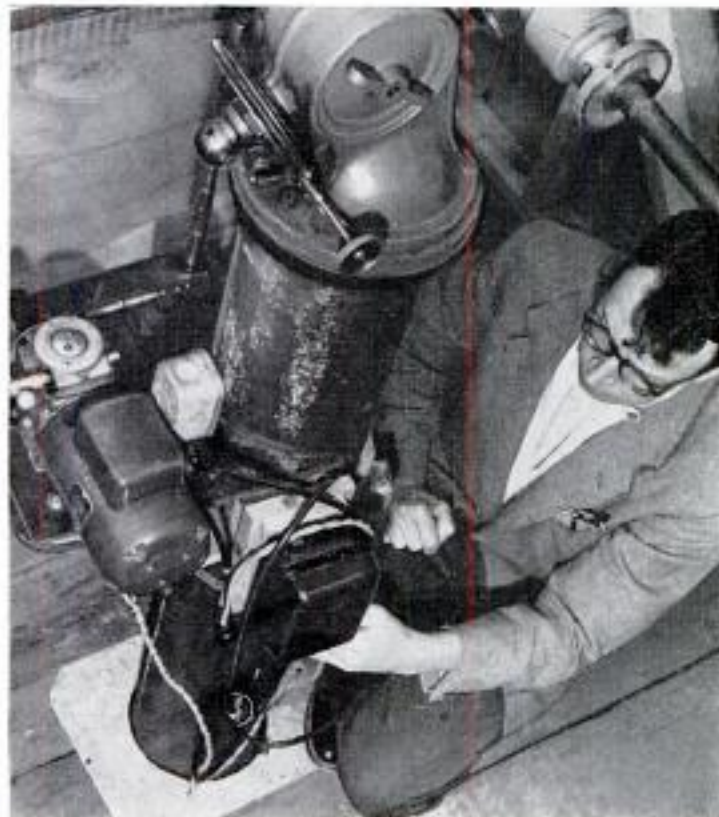



Morane Saulnier 760, French twin-jet executive transport, cruises above East River on demonstration flight

First Jet Transport for Private Flying

BUSY EXECUTIVES who fly can now look forward to jet-propelled airborne offices with the announcement that the first private executive jet transport is being demonstrated throughout the United States and Canada. The plane is the M-S 760, a French design brought to the United States by the Beech Aircraft Corporation. If there appears to be a demand for such a plane, Beech will manufacture it in this country.

Boasting a top speed of 405 miles per hour, the plane is a four-place, twin jet. The cabin is pressurized to maintain a

cabin altitude of 7800 feet when the plane is flying at 20,000. Its maximum range, cruising at 294 miles per hour at 23,000 feet, is 970 miles. Contemplated price tag on the M-S 760 is \$300,000.

To provide better visibility for both pilot and passengers, all occupants sit forward of the leading edge of the wing, inside a one-piece bubble canopy. They are protected against excessive sunlight by adjustable curtains overhead. In addition to being pressurized, the cockpit is also air conditioned.

Equipment, such as radio, electric motors and actuators, is easily accessible in the nose compartment

Spacious cockpit of M-S 760 is air conditioned and pressurized. Ladder stows in rear-cockpit armrest



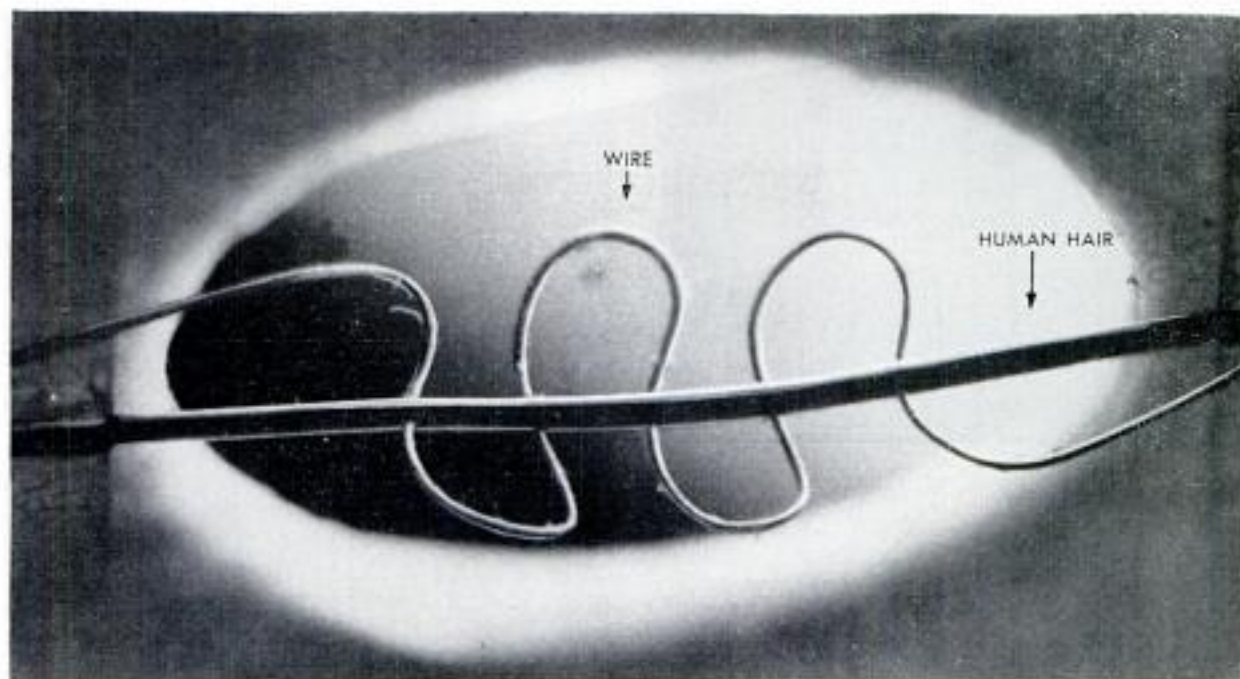

Midget Drill Pierces Hair

IT'S ONE THING to split a hair; it's another to drill holes in it. Precision-instrument makers of General Electric not only have drilled holes in a hair but have threaded wire through the holes. The technicians use a one-mil (.001-inch) drill so small it can't be seen by the naked eye, so delicate it could be broken by accidental contact with a piece of paper tissue. Working with a microscope, the steady-handed craftsmen can lace a one-mil wire through something even smaller than human hair—a strand of nylon stocking. All this has its practical applications. The ultrasensitive drill press is located in the engineering laboratory machine shop, where the highly skilled instrument makers are on call for unusual tasks in connection with experimental developments. The drill is used to make orifices in leak disks that control the flow of gas into a vacuum chamber, to drill tiny fuel-injection nozzles and to make holes for electron beams in X-ray equipment. Usually, smaller drills run at high speeds. But when using the one-mil size, drill operators must slow down the drill press to about 1800 revolutions per minute.

Microscopic view shows .001-inch-thick wire threaded through holes drilled in a human hair by the diminutive drill press



Instrument maker peers through a microscope as he brushes away minute chips left by drill too small to be seen by naked eye. Drills below range from .01-inch to .001-inch (beside pin)

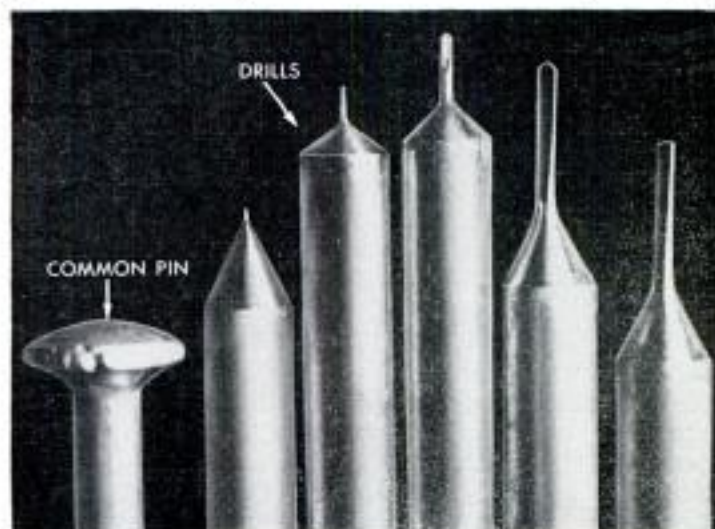

Detroit Listening Post



By Leo Donovan

THIS WILL BE a year of refinement. On all except two cars, Lincoln and Rambler, the emphasis will be on refining the details—the big changes will wait for 1957.

A company can only engineer so much in any single year. When it brings out all-new bodies and, in some cases, all-new engines as was done in 1955, there isn't time for the important luxury details that the public loves to talk about and, more important, loves to buy and show the neighbors.

Lincoln, as you see on page 102, is new. Rambler, as you will see in December, is the same. But the rest of the pack has spent the year refining its details.

Here are some of them:

Push-button shifts. There will be two approaches here. One company's push-button shift is mechanical; another's is electrical. One is left-hand operated; the other right-hand operated. Both will cause lots of talk.

Push-button locking. You'll be able to lock all four doors, the glove compartment and perhaps even the trunk with just one motion in a 1956 car. No more checking to see if each door is locked individually. A single locking control will do the job for you.

Powered no-drafts. One 1956 model gives the driver complete mastery of his windows. He can even flip the no-draft vents open and shut by touching a button.

Heating system. Instantaneous heat is what comes from a new heater that burns gasoline instead of taking heat from the engine's cooling system. No warm-up is needed. The factory-installed heater mounts inside the engine compartment.

Sweep-second hands. Many 1956 cars will have clocks with sweep-second hands. With this added convenience the driver can check his 0-60 time at every stoplight.

Upholstery. After 1955, it's difficult to believe that there can be anything new here. But there is. One company will offer a completely redesigned seat unlike anything you've seen. It will have reversible upholstery. By day, it can be sporty with

bright colors. By night, it can go formal to match your evening clothes.

Music. If you prefer music without commercials, you'll welcome the latest accessory—a high-fidelity phonograph built into the dashboard. It uses a record that plays for an hour or more without changing.

Here Comes the Wedge

The front's going down and the back's coming up. In a style trend that should continue for several years, Chrysler is becoming wedge-shaped with a lower hood and a higher rear deck.

Virgil Exner, vice-president of Chrysler Corporation styling, points out that this trend is common to racing boats, jet planes and cars. And, he says, it is aerodynamically sound. His three latest "idea cars" (see page 113) follow this trend and, no doubt, so will the 1957 production models.

Before the Thunderbird, stylists at Ford considered the teardrop as the shape of the immediate future. But now Ford, too, is emphasizing rear ends rather than de-emphasizing them as with a teardrop.

General Motors' stylists have six new "dream cars" planned for the year's Motorama. Four of them are under construction now. Two more are just coming off the drawing boards. They will be more elegant than their predecessors, of course, and will have new styling features that may be worked into production models shortly.

The Cadillac Eldorado Brougham, being groomed to compete with the Continental Mark II, may not be out until January.

The Two-Year Cycle

So competitive has the sales struggle become among manufacturers (it is even fiercer among dealers) that complete model changes may be made every two years from now on—or at least after 1957, the next year for big changes.

Since the end of World War II, the industry has been on a three-year cycle. To reduce it to a two-year cycle means scrapping costly tools and fixtures 33 percent sooner. What such a change will do to the smaller volume producers is not pleasant to consider. Amortization costs per car would have to go up drastically.

Incidentally, the term "facelift" is not a fair one these days. It is generally used in a disparaging way to describe how little is new on a new model. But facelifts today cost big money. It is estimated that the industry is spending \$350,000,000 in new tools for 1956, a year of facelifts generally. New rear decks, such as Chrysler will offer, cost many millions and the term facelift is not adequately descriptive. The industry needs a new word.

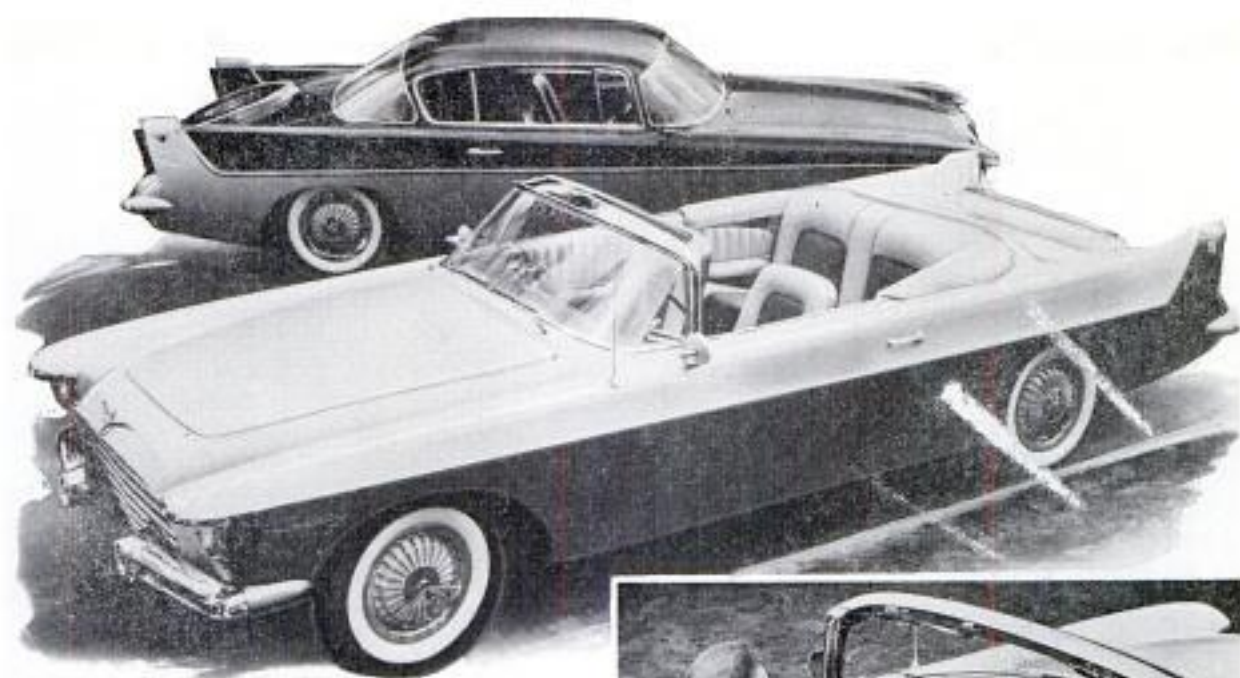

Are These '57 Chryslers?

Chrysler's idea cars may offer clues to the '57 line. Above, four-passenger Flight Sweep hardtop and convertible. Right, control console fits over hump between bucket seats. Below, two-seat Falcon roadster. Things to look for: Bodies seven inches lower than today's; simpler grilles; curved side windows; emphatic tail fins; long headlight hoods



Detachable Holder Keeps Tennis Balls Clamped to Racket

Three tennis balls are clamped to a racket for handy carrying by an easily attached or detached bracket. The device clamps to the handle and holds the tennis balls against the strings by spring tension. It is hinged to allow quick removal of one or more balls. Made of steel with rubber cushioning, it is finished in chrome or in various colors. It may be used in conjunction with a racket press.

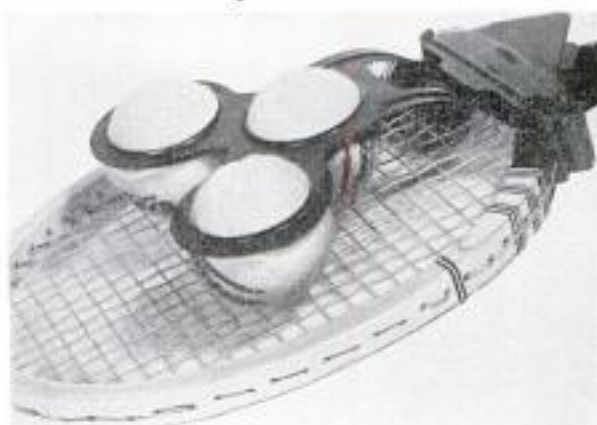

☐ Belgrade, Yugoslavia, will be the site of an experimental TV station scheduled to begin permanent service early in 1957.

Heavy-Machinery Trailer Detaches Wheels From Bed for Loading



When a new heavy-machinery trailer is about to be loaded, the axle is unlocked and the bed pushed back over the wheels. With the front edge of the bed resting directly on top of the wheels, the angle of slope is small and loading is easy. After loading, bed and load are pulled forward over the wheels until the wheels are again in the wheel wells and the bed rests on its axle. A remote control locks the axle in position for travel. The 8 by 16-foot trailer has a hand winch.

With bed pushed back over wheels, loading is easy. Below, travel position

Cricket Chirps Tell Temperature

No thermometer? You can tell the temperature by listening to a cricket, which has a built-in thermometer according to engineers of Minneapolis-Honeywell Regulator Company. To find out the temperature, count the chirps for 14 seconds, then add 40. For example, 40 chirps in 14 seconds indicate a temperature of 80 degrees. Some Oriental peoples keep crickets in miniature cages as household pets.

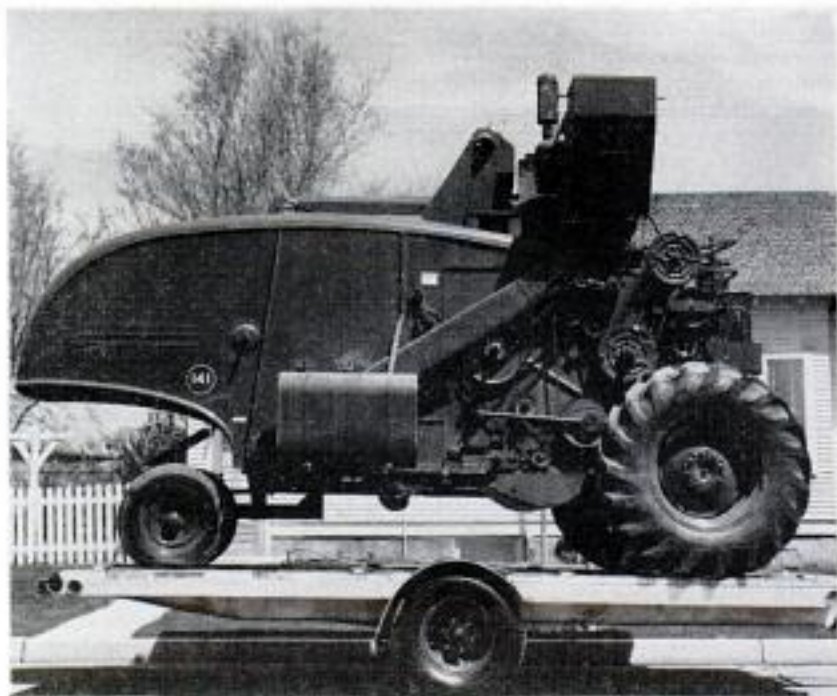

Pontoons Fasten to Feet

Now you can attach a pair of pontoons to your feet and scoot around on top of the water, more or less like a water bug. A long pole with a paddle at each end is used for propulsion. A single paddle may also be used. The pontoons, 12 feet long, are made of aluminum tubing. They were invented by Dezso Nemeeth, a Hungarian refugee now living in Italy.

A CROSS A PASTORAL VALLEY in southern Maryland, the rumble of a giant M51 beats heavily on the sleepy afternoon. This tank-recovery vehicle weighs 58 tons and has a chunky boom the size of a bridge girder jutting over its tail. It's capable of squatting on its haunches and heaving a light tank in the air on the end of its massive lift. With a thundering roar it dips, plunging down the near-vertical slope in a maelstrom of noise and flying mud.

Nobody would pilot a \$205,000 vehicle with such abandon unless he was trying to break it up deliberately. And that's just what the driver of that machine was doing. The 48-mile series of nightmarish courses is the world's worst road.

Hideous as it is, the road carries a steady round of traffic. Tanks, trucks, trailers, gun carriers and odd-looking amphibious vehicles roar and buck over its frightening hills day and night, wham through its "shell holes," flounder in quagmires, slither around curves knee-deep in thick mud. For this ugly "highway" is the Army's torture rack for every new automotive development proposed for military service.

The maze of courses is laid out on 75,000 acres of hills, plains, swamps and ocean

CAN OUR TANKS TAKE IT?

By
Richard F. Dempewolf

M51 tank-recovery vehicle roars along 589-foot "road" paved with loose granite rocks each 2 feet wide





Before a new tank such as this M47 can qualify for service, it must be able to leap three-foot vertical wall at Munson without coming apart



Amphibious Otter must withstand 10 or 20 miles of these concrete bumps before taking other tests. Below, rotary plow keeps roads unpleasant

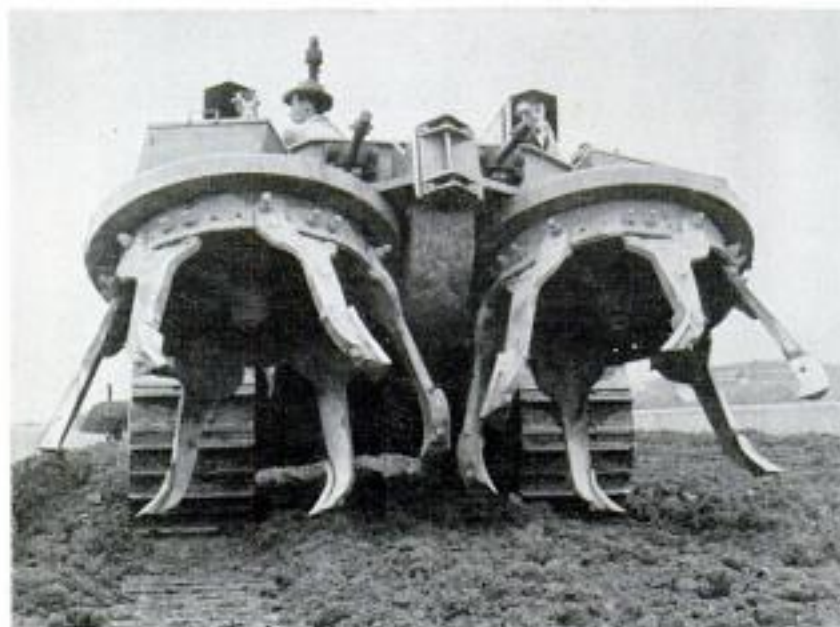

bay that comprise the Army's Aberdeen Proving Grounds, just north of Baltimore. The man responsible for devising many of them, and for operating them, is A. H. "Bud" Ford, a tall heavy-set fellow who started busting things up for the Army in 1944 when, he recalls, "the only Army vehicle test course was an open field with a few ditches." Today, Bud Ford and his 70 test drivers, plus expert machinists, operate a thumping big business under Eugene C. Barbero, chief of the Automotive Division of Aberdeen's Development and Proof Services.

Their job is to take every pilot model of proposed equipment that moves on wheels or tracks (as well as improvements and accessories) and literally drive them to complete collapse. "We've got to know just how much they'll take before they come apart," Ford explains. It's his duty to make sure that the vehicles accepted by the United States Army at least match those of any potential enemy. In effect, it's a shakedown cruise on wheels—to locate the bugs and suggest ways to eliminate them.

Actually, those 48 miles involve five separate courses.

At the Perryman cross-country testing area, vehicles groan under capacity load to test pulling power, speed, braking, maneuverability, suspension systems and shake-apart characteristics on "flat" country. Most of it is about as flat as a roller coaster. Part is a succession of huge potholes for heavy tanks and tracked vehicles; another section has "little" hummocks and holes only three or four feet deep for the smaller tracks. There's a



Truck with capacity load of soil ended up in this gully after its brakes failed. Accidents are few

two-mile straightaway for speed, seven miles of endurance run and a circular track for drawbar-pull tests.

At Churchville, vehicles get a dose of severe hills under the worst possible conditions. "We keep after it," says Myron Rider, supervisor in charge of the course. "The ruts and bumps have a tendency to flatten, so we gouge them out with dozers." In wet weather, Churchville is a river of mud; in drought it becomes a treacherous bog of powdered clay two feet deep; in winter it is a series of ice-coated ski-jump slides. Fillings have been jarred from a driver's teeth when the road was frozen, but it's also great for tearing power trains to pieces, overloading engines, transmissions and differentials, and testing traction



M41 cargo truck flipped over after the steering failed on a speed run at Perryman. Driver was unhurt

mobility under tough winter conditions.

Across 30 miles of miserable bog and soft sand beaches on Poole's Island in the Chesapeake Bay, weird-looking new amphibians like the Gull, Otter and Super Duck flounder up to their cabs in muck and tree roots, in a morass where the nearest hard bottom is 10 feet down. "In some places you can drive a 20-foot pole down in it and the thing will disappear," Ford claims. "Most dubious vehicles go in with a tow-line attached. Just in case." Engineers continually plow up the broad sand beaches to keep them soft and horrible for landing operations. A gigantic rotary plow that looks like a tank with a pair of four-foot-wide steel egg beaters on its rear, pulverizes the soil to a depth of about two feet.

Perryman mudbath is continually churned by tracks of vehicles like this 58-ton M51, which can tow a tank





Before it ever gets to Churchville or Perryman, every tank must wham through deep fording basin at Munson



Amphibious Super Duck, like fish out of water, bucks a mud wash on four-mile torture course at Churchville

Churchville's rutted route takes vehicles right through a stream to test fording ability. This is an M47 tank



On the ear-shattering cross-country trails at H-Field, you'll see the new T43 heavy tank, the M44 self-propelled gun and an array of new mobile weapons bawling away at targets while bouncing over shell holes, boulders and six-foot embankments. Mobile guns, big and small, are shot until they literally melt or explode under pounding combat conditions.

Most unusual obstacle course of all, though, is Munson, right on Aberdeen's main post. It comprises some 20 man-made hazards designed to drown, rack, bend, jolt, vibrate or tear tanks and trucks to pieces on a continuous destructive run. Here, war machines shudder at top speed over a half mile of concrete washboards that vary from 6 to 12-inch waves, some even, some staggered. Nuts and bolts shake loose and parts fall off. Slopes varying from 5 to 60 percent check the vehicle's brakes, fuel-system efficiency and resistance to oil starvation while it "stands on its tail." Will a tank's gun turret swing properly when the thing is almost vertical? "We soon find out on the 60-percent slope," says Ford. "A man can't walk up that hill with leather-soled shoes. I've seen tanks slide backward on it while the tracks ground forward at full power. To play safe with heavy equipment



Flat-bed Jeep under test on Munson course has folding steering wheel that permits driver to walk alongside

we tie it by a cable to a heavy tank that drifts down the other side and acts as a brake in case something lets go."

In a cobblestone bowl 84 feet across, trailers are pulled in a continuous circle by a whirling arm until their wheels fall off. Roaring tanks and trucks grind their

Massive new M44 self-propelled gun climbs the steepest grade at Munson. Here, tanks often spin and slide





Big tanks, like this M47 hitting the mud at Perryman, become covered with as much as two tons of caked mud



Newest mobile weapon to take the bumps and churn through the mud at Perryman is M44 155-millimeter self-propelled howitzer

New supply carrier must be able to climb over the 30-inch vertical barrier at Munson. Test also proves clearance of truck



tracks, spin wheels and snap drive shafts along an 800-foot stretch of two-foot-deep loose sand. Like a bellyhopper hitting the water, they wham into the "mud wallow," a 250 by 950-foot bowl of slurp that gums up anything not properly sealed, and provides a powerful abrasive for wearing out vital moving parts improperly protected.

The vehicle under test may roll over a series of huge alternating humps known as the "frame twister," heave and shudder across almost a mile of wavy, lumpy "Belgian Blocks." It may slither through the controlled-soil basin where mud is made in any consistency desired. It may even be forced to tow a mammoth dynamometer that drags its heels just to make things tougher. It will plunge through a fording basin almost completely submerged, slam through a carefully engineered shell hole 4½ feet deep and 25 feet across, leap an adjustable gap to test its "bridging" ability, jump vertical walls up to 30 inches high. To test stability, it rumbles around a "roll over" track that slopes so steeply sideways that drivers would fall out if not lashed to their seats. "Our idea is not to test the drivers, however," Ford explains, "and when we're suspicious of a vehicle, we take precautions.

(Continued to page 288)

Proposed Glider Would Soar to 70,000-Foot Height

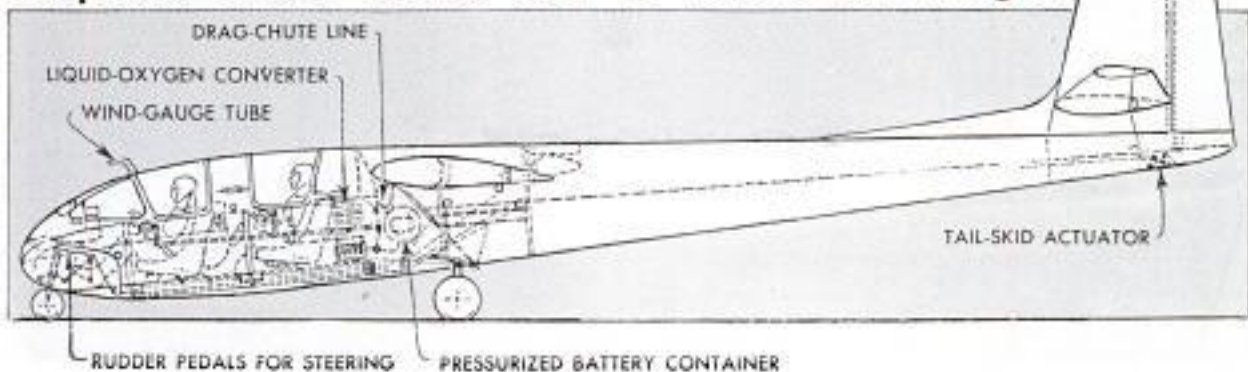

Soaring on the winds to 70,000 feet would be possible in a strato-sailplane designed by glider experts. The craft would have the same wingspan as an airliner (100 to 120 feet versus the 117 feet of a DC-7) and would carry two men plus instruments for flights of eight hours or longer. At its ceiling it would have a forward speed in excess of 200 miles per hour. Glider pilots already have soared to 45,000 feet on strong updrafts in California and were afraid to go higher because of lack of pressurization. The new craft, designed by the Southern California Soaring Association, will have a pressure cabin with oxygen plus heating equipment for comfortable operation in the thin sub-zero upper air. The strato-sailplane is proposed as a research vehicle for acquiring information about upper air currents that cannot be easily obtained by rockets or balloons. One proposed study would be of the jet stream.

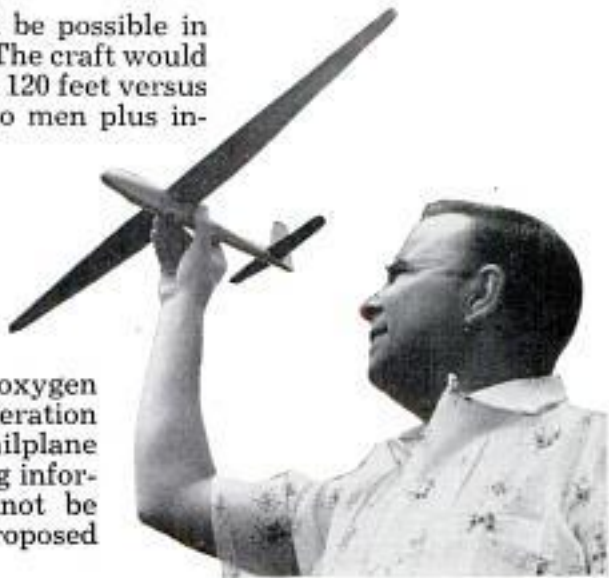

Triple Shade of Flexible Shop Lamp Doesn't Get Hot

You won't accidentally burn yourself on a new shop lamp with a metal shade that never gets hot. Protecting the lamp's reflector are two additional shades, one inside the other. At the top of the lamp are air vents to allow the escape of heated air

from the 100-watt incandescent bulb. The lamp is suspended from a flexible arm on a fixture that can be clamped on a work bench, drafting board or table or attached directly to lathes, sewing machines or other power tools.



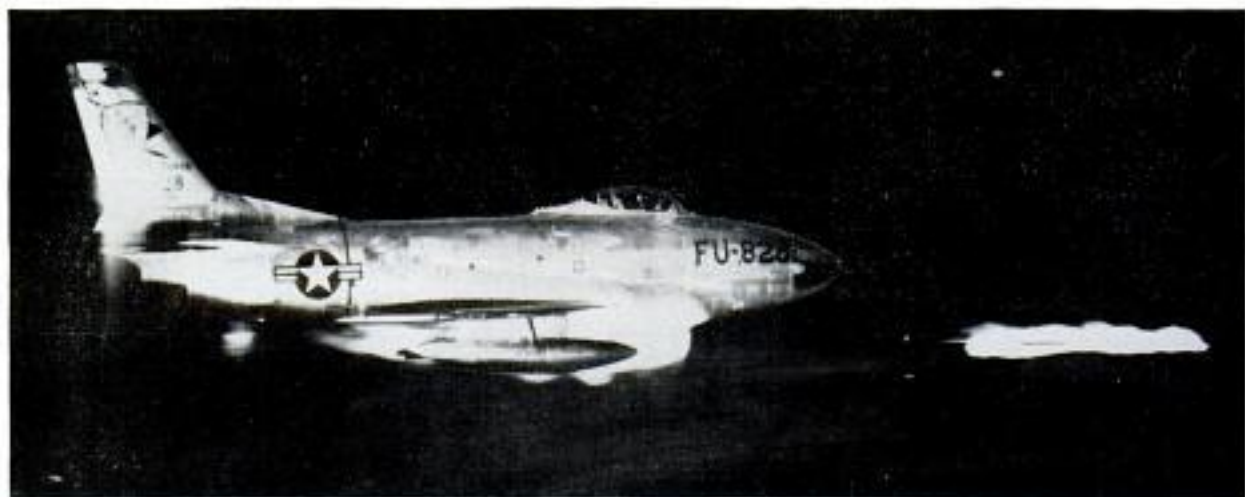

Flying Photographer Shoots Flash Picture of Plane in Mid-Air

Some people, like Detroit photographer James Burns, will go to almost any lengths to get a good picture. To shoot a night picture of a jet plane firing a rocket, he mounted six flash reflectors in a salvaged fuel tank that he took aloft with him on a jet trainer. When the two planes were 60 feet apart and flying at 350 miles per hour, Burns clicked his camera and tripped a switch that fired three large flash bulbs in the side-mounted tank. The opening cut in the fuel tank had been covered with a sheet of Plexiglas to protect the flash units from wind. Several flash units were used so that more than one picture could be taken in one flight. The project was sponsored by General Electric to dramatize the 25th anniversary of flash photography.

Shot above of Air Force all-weather jet fighter interceptor is first night in-flight jet-to-jet flash picture showing rockets being fired. Below, technicians install the flash reflectors in side tank



Directional Signals for Bike

Right or left turns are automatically signaled by directional lights for bicycles. Operated by standard flashlight batteries, the flashing signals are actuated by an automatic switch when the handle bars are turned. The lights can be attached to the bicycle frame or handle bars and are visible from the front, rear or either side.

Drugs Sterilized by Electrons

Sterilization of drugs already sealed in their containers is now being done with electron "bullets." The electrons, generated by a 2,000,000-volt Van de Graaff accelerator, and traveling about 175,000 miles per second, kill all living organisms in the drugs in a fraction of a second without appreciably raising the temperature or affecting the potency of the drug.

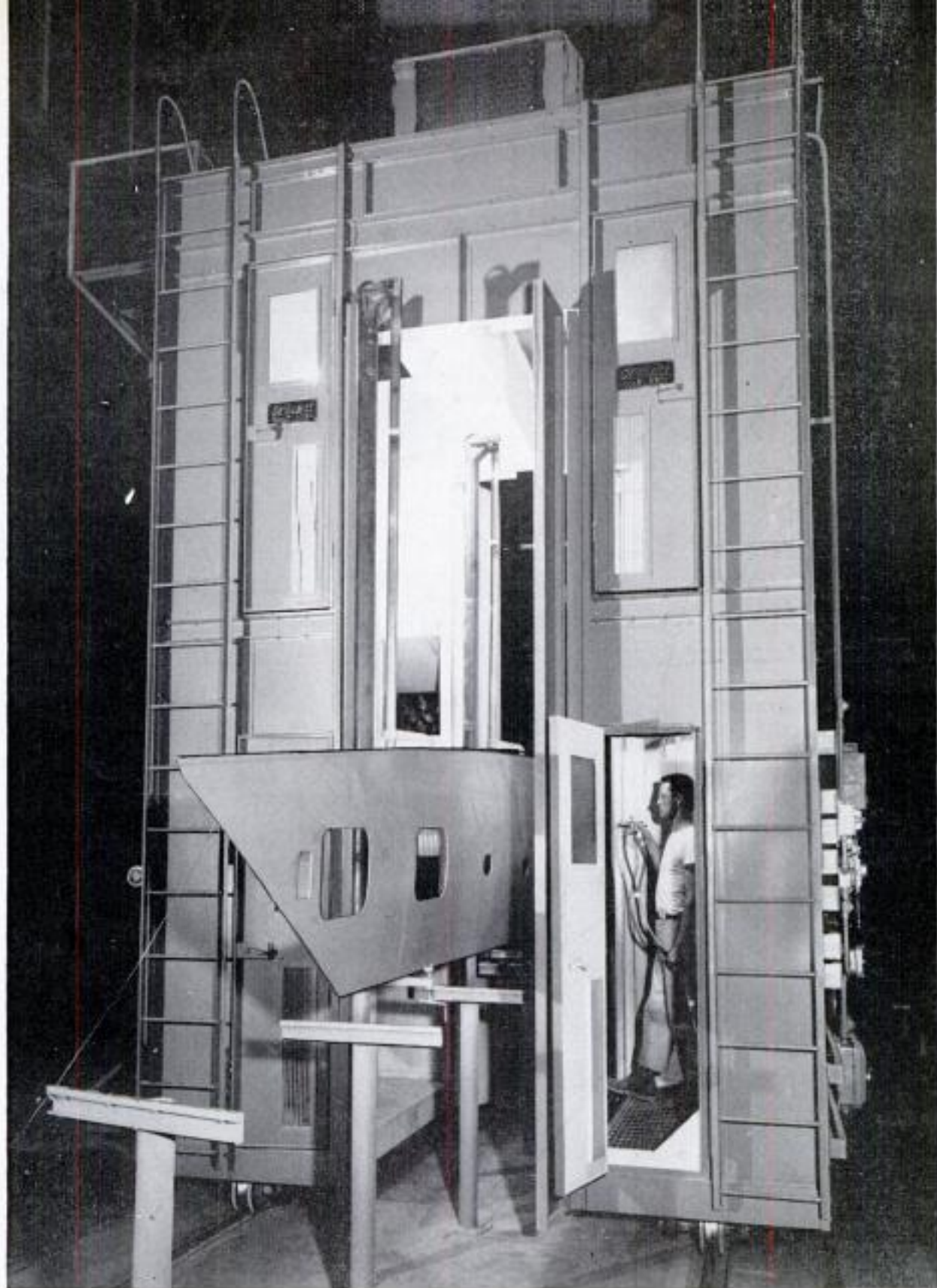

Giant Traveling Paint Booth Used to Spray Plane Parts

PAINTING of wing skins and spar chords of the B-47 Stratojet and the B-52 Strato-fortress in the Wichita, Kans., plant of the Boeing Airplane Company is now done in a giant mobile spray booth, 17 feet high. Clicking along a 110-foot track, the booth has an adjustable painter's platform on each side, enabling either of two operators to run the machine. The booth can travel

at speeds up to 25 feet per minute, and all power units, air compressors and exhaust systems, along with necessary fire-protection apparatus, are self-contained. During full operation, only 12,000 cubic feet of air per minute are expelled through an escape trench leading to the discharge tower. A comparable stationary booth requires 10 times that amount of air.

OWNERS REPORT:

Best-Liked Features:

"I like the easy way the Chrysler handles at all times -- on the road, in the city or through a field."

Iowa Farmer

"It has ample power -- lots of scat. And the best ride on the road today."

Ohio Business man

Most-Wanted Changes:

"Body could be more free of squeaks and rattles and possibly more economical on gasoline."

Iowa livestock dealer

"I don't like the door handles. Glove compartment is too small."

Washington field manager



By Floyd Clymer

THE TEST CAR, a Chrysler New Yorker V8 four-door sedan, was driven from Detroit via Indianapolis to Los Angeles for a distance of 2736 miles, which included some additional testing in the desert and back roads.

This car is powered by the Firepower 331.1-cubic-inch engine with hemispherical combustion chambers, developing 250 horsepower at 4600 revolutions per minute.

The car has good handling characteristics. Even with the typical Chrysler front-



Complaints:

"Interior styling is in bad taste. Too many colors. Should have a single-color upholstery."

Connecticut salesman

"Change outside door handles."

Illinois druggist

Why Buy Chrysler?

"I have always driven Chryslers."

Colorado printer

"The New Look!"

Illinois insurance man

CLYMER TESTS THE 1955 CHRYSLER NEW YORKER

end softness and some "roll" when cornering at high speeds, it is easy to handle and very responsive to the steering wheel. With the rear seat loaded with luggage and passengers, there was a tendency to hit bottom on severe bumps. The engine is free of vibration. It is the fastest stock four-door sedan that I have tested. It seems to loaf at 100 miles per hour and does 110 without much effort. The top speed by speedometer was 120 miles per hour—actual top speed

(Continued to page 300)

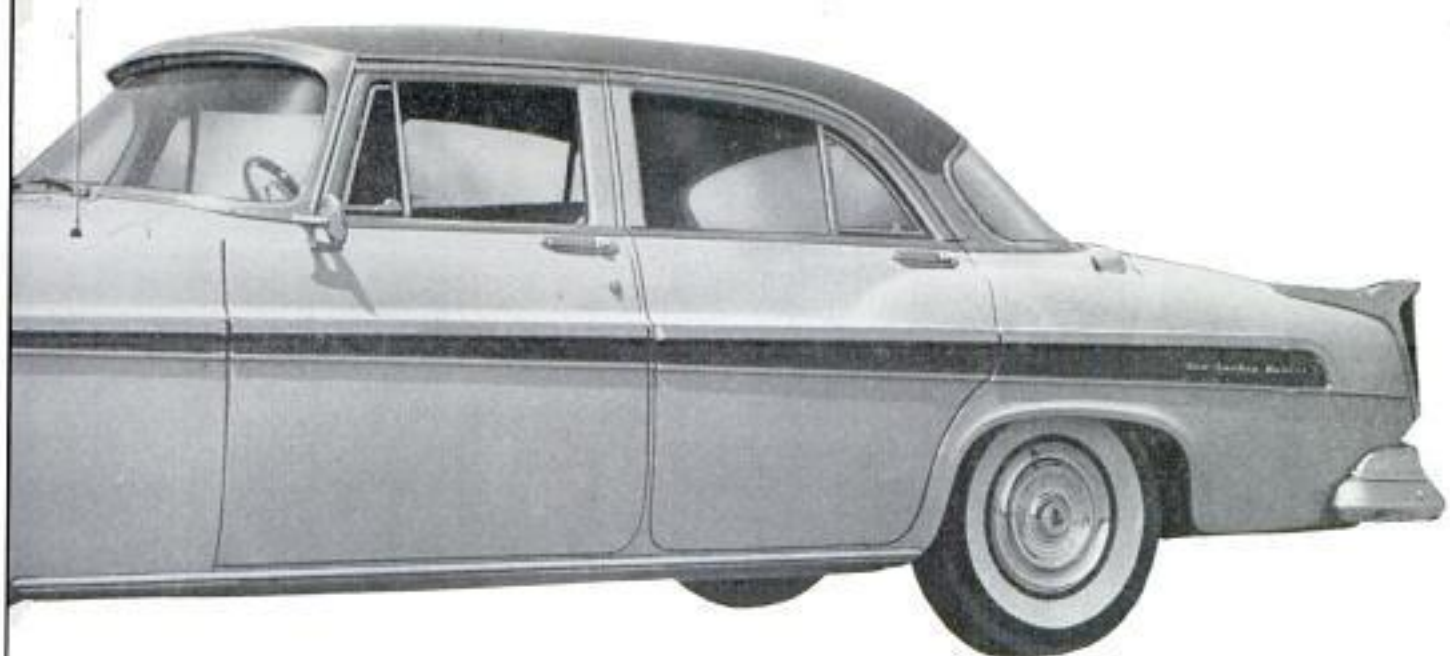

CHRYSLER OWNERS STILL SAY HANDLING IS BEST FEATURE

By Chrysler Owners

CHRYSLER SPENT MILLIONS on its new body style for 1955 (and sales figures show it paid off), but the owners are not infatuated by a pretty face: They still pick handling ease as the best-liked feature just as they did in 1954.

Once again this is a tribute to Chrysler engineering and its power steering, in particular. The big Chrysler handles like a small car, say the owners.

"It handles like a toy. Very nicely."—Illinois store owner.

"Power steering is the finest. General over-all handling is excellent."—Illinois salesman.

"I like the easy way the Chrysler handles at all times—on the road, in the city or through a field."—Iowa farmer.

But the owners like other things about the Chrysler. Second on the list of best-liked features is the car's performance. With the big 188 and 250-horsepower engines, it's no wonder that owners brag about power and performance.

Chrysler owners complain about the dashboard, especially the location and size of glove compartment (arrow)



Percentages from *PM* Poll of Chrysler Owners

Dealer service

Excellent	59%
Average	28%
Poor	13%

What did you trade in?

Chrysler	57½%
De Soto	5½%
Dodge	5½%
Plymouth	2½%
Other Big Three make	14½%
Independent make	6½%
No trade	8%

How was trade-in allowance?

Chrysler-product traders

Above average	33%
Average	58%
Below average	9%

Other Big Three traders

Above average	33%
Average	57%
Below average	10%

Independent traders

Above average	50%
Average	50%
Below average	0%

OVER-ALL RATING OF THE CHRYSLER

Excellent	81%
Average	17%
Poor	2%

Would buy another Chrysler?

Yes	77%
Might	22%
No	1%

Why did you buy Chrysler?

Previous ownership	31%
Exterior styling	22%
Engine, performance	5%
Best deal on trade	4%
Excellent dealer service	4%

What should be changed?

Improve interior quality	7%
Exterior door handles	5%
PowerFlite transmission	5%
Dashboard layout	2%
Needs no changes at all	45%

Most-Frequent Complaints

Squeaks and rattles	12%
Uses too much gas	12%
Small glove compartment	7%
Awkward door handles	7%
Water and dust leaks	7%
Upholstery poor, hard to clean	6%
Poor assembly	6%
Lacks headroom	5%
Poor heater, defroster	4%

22% of the owners made no complaints at all

Best-Liked Features

Handling ease	49%
Power, performance	37%
Riding comfort	35%
Body styling	25%
Visibility	9%
Roadability	7%
Dependability	5%
Power steering	5%
Roominess	4%

"Terrific response when you need it."—Illinois salesman.

Third on the best-liked list is riding comfort, fourth is the all-new body styling.

"So comfortable to ride in, like sitting in a big easy chair."—Iowa owner.

"All roads seem to smooth out no matter how rough they are."—Massachusetts dry cleaner.

"For many years I have made trips between Minnesota and Denver, usually driving straight through over 800 miles. With my advancing years, I have found these journeys increasingly difficult. However, since buying my 1955 Chrysler, the last three trips have been the least difficult due to handling ease and comfort."—Colorado businessman.

"Good looking without being flashy."—Vermont retired owner.

"Best-looking car on the market. Fine, simple lines."—Georgia housewife.

"Attractive curving lines. Not squat or boxlike."—Illinois executive.

"Styling is good. But then I liked the Airflow back in the Thirties."—Connecticut surgeon.

Owners Do Complain

The most frequently mentioned complaint was more annoying than serious—but there is nothing more aggravating than squeaks and rattles in a new car.

"There are several minor but annoying squeaks and rattles. In general, structural rigidity is excellent."—Washington, D. C., lawyer.

"Irritating noises in the body which

cannot be located."—Georgia salesman.

Next on the list of complaints is a very common one: The car uses too much gas.

"I don't like the low gas mileage. I expected about 14 miles per gallon in the city and 17 on long trips with this Windsor. Instead I am getting 9 and 12 miles per gallon. Transmission is excellent if it does not affect mileage, but I am sure it does."—Arkansas minister.

There were 22 percent of the Chrysler owners who did not register a single complaint about their new cars.

Third on the list of complaints is the size and location of the glove compartment. It is too far to the right and it is very small, say the owners.

Fourth most-frequent complaint is about the flush-mounted outside door handles. (Incidentally, advance news is that these will be different on the 1956 models.)

"Exterior door handle is poor design. Difficult to open door, particularly for children or when carrying bundles."—Delaware sales manager.

Water and dust leaks are listed as the fifth most-frequent complaint.

"Leaks even after undercoating."—Iowa salesman.

Why Buy Chrysler?

Asked to list the one factor that most convinced them to buy a Chrysler, the owners give previous ownership as the most common reason. Second is the new body styling; third, the engine performance; fourth, the good deal the Chrysler dealer offered; and, fifth, good dealer service.



Driving position is excellent, say owners, and Clymer agrees. A few say not enough room under wheel

"I have driven Chryslers since 1936 with very, very little trouble of any kind."—Iowa retired farmer.

"The new design and forward-look advertising sold me."—Illinois radio-time salesman.

Slightly more than half (57½ percent) of the owners traded in Chryslers. Another 13½ percent traded in another Chrysler Corporation car (Plymouth, Dodge or De Soto). There were 14½ percent of the owners who traded in other "Big Three" cars, 6½ percent traded an independent make (Studebaker, Packard, Nash, Hudson or Kaiser), and 8 percent made no trade at all.

Trade-in allowances offered by the Chrysler dealers seemed about as generous for other Big Three traders as for Chrysler traders. The owners who traded an independent make seem to think they did better, but the sample was small and perhaps not reliable. See the percentages on page 126 for a detailed summary of this.

Most-Wanted Change

Asked to list the one specific change they want made on their Chryslers, the owners do not agree in any large numbers on anything, except the 45 percent who say no change is necessary since they like the car as it is.

But 7 percent do ask that something be done about the interiors.

"Change the interior. Styling is in bad taste."—Connecticut salesman.

"Upholstery colors too glaring."—Washington, D. C., insurance executive.

"Upholstery is not in keeping with the fine styling and high mechanical standards of this car."—Iowa owner.

Chrysler owners also want the exterior door handles changed for easier operation. Quotations on this have already been given.



Some of the owners don't like front-grille styling. Clymer likes the fact that there are no projections

Third most-wanted change is the Power-Flite transmission. Some say it is too jerky when initially engaged, other say it downshifts too sharply, others say it downshifts at the wrong speed.

"Drops into low gear at too high a speed—12 miles per hour."—Illinois teacher.

Here are some quotations listing other changes the owners would like:

"I would try to make the glove compartment bigger. I would move the wiper-control switch to where the cigarette lighter is and vice versa (of course, I don't smoke)."—Iowa telephone worker.

"Move the windshield-wiper switch closer to driver."—Utah railroad engineer.

"Why can't some thought be given to design interior for storage of maps, sun glasses, etc.?"—Illinois dentist.

(Continued to page 304)

TEST DATA

1955 CHRYSLER NEW YORKER
Four-Door Sedan with PowerFlite

Acceleration Test

¼ mile from zero	- - - - -	19.2 seconds
½ mile from zero	- - - - -	31.7 seconds
0 to 30 miles per hour	- - - - -	4.5 seconds
0 to 60 miles per hour	- - - - -	15.6 seconds
Top speed by speedometer	- - - - -	120 miles per hour
True top speed about 110 miles per hour		

Economy Test

Constant-Speed Mileage

At constant 30 miles per hour	- -	21.2 miles per gallon
At constant 50 miles per hour	- -	17.9 miles per gallon
At constant 60 miles per hour	- -	16.4 miles per gallon
At constant 75 miles per hour	- -	12.1 miles per gallon

Cross-Country Mileage

Detroit, Mich., to Indianapolis, Ind.	-	15.1 miles per gallon
Indianapolis to Kansas City, Mo.	-	15.6 miles per gallon
Kansas City to Albuquerque, N. Mex.	- - -	16.4 miles per gallon
Albuquerque to Los Angeles	- -	15.6 miles per gallon
(Regular and premium gasoline used)		

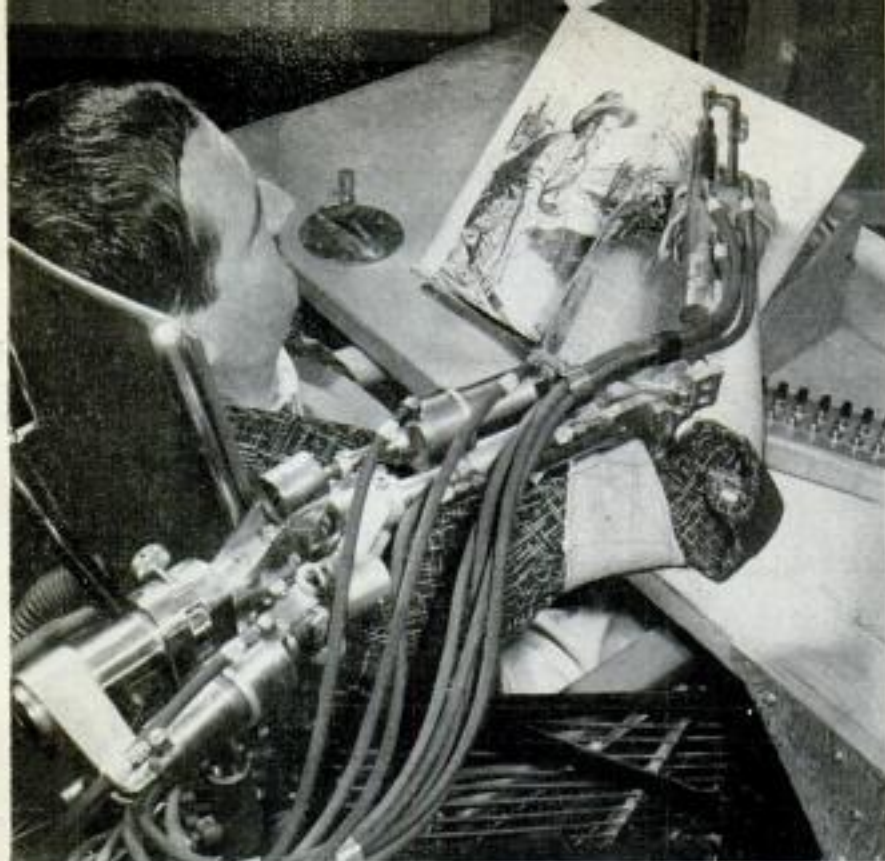

Intricate construction of mechanical arm's hydraulic cylinders and hosing can be seen as patient thumbs magazine held on rack



Path of light bulb in photograph traces the extent of the hydraulic arm's reach

Hydraulic Arm—*New Hope for Paralytics*

FOOT PEDALS regulate a hydraulic arm built for a polio victim who has lost control of his arms but still has some strength in his legs. It was developed by engineers at North American Aviation for a fellow employee and is not yet being manufactured. With it, Marv Pulliam can feed himself, type a letter, turn book pages, answer the telephone and tune TV. The patient's arm is suspended by web straps from the

flexible boom that is the hydraulic arm. Eight rubber hoses supply the actuating cylinders with fluid pressured by an electric pump. The thumb and right hand fit into plastic guides while the index finger and middle fingers work in metal caps. The guides and caps are hydraulically controlled, as are wrist, elbow and arm supports. The speed of movement varies with the pressure exerted on the pedals.

Typing is possible with the mechanical arm, though such a feat involves long training and patience

Polio-stricken Marv Pulliam, for whom mechanical arm was built, lifts glass and sips through straw



OWNERS REPORT on the HUDSON

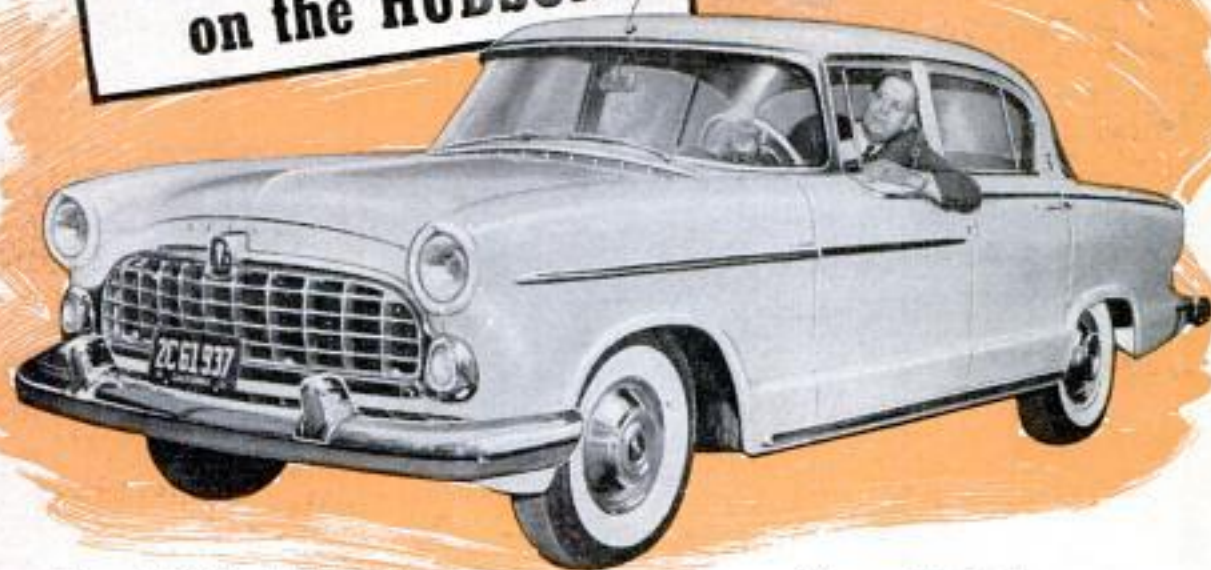

Best-Liked Feature:

"Most comfortable riding car I have ever driven. It absorbs road shock and does not tire you on long trips."

North Carolina textile worker

Why Buy Hudson?

"I bought Hudson because of past performance. Have owned them for 20 years."

Maine clerk

Complaint:

"Windshield-wiper switch in very poor place. Difficult to turn on and off."

Ohio division manager

Most-Wanted Change:

"Steering wheel should be lower. The shift quadrant is too hard to see."

Alabama salesman

HUDSON OWNERS PRAISE RIDE, HANDLING EASE AND STYLING

By Hudson Owners

HUDSON FOR 1955 made the biggest change in the whole industry. As a result of the creation of American Motors (by the merger of Hudson and Nash), the new Hudson is all different except for its power plant and even that is all new if you buy a V8. It is built in a different factory, in a different state, by different workers.

What do owners of this different Hudson think about their cars? To find out we asked 1000 of them and here are their answers.

The best-liked feature among the owners in 1955 is the same as it was in 1954: The comfortable ride of the Hudson. Second in the list of best-liked features is also the same: Handling. Third in 1954 was durability, but the 1955 owners put styling third.

Roadability was fourth in 1954, but has dropped to seventh in this year's model.

Here are some quotations from Hudson owners on the subject of riding comfort:

"Most comfortable riding car I have ever driven. It absorbs the road shock and does not tire or cramp you on long trips."—North Carolina textile worker.

"Rides wonderfully. The seats fit your back."—New York oilworker.

"You never tire from its smooth ride."—Pennsylvania railroad fireman.

Hudson's handling ability was given second place on the best-liked list:

"I drive about 86,000 miles per year, about eight hours a day. It is easy to handle, not tiring."—Alabama salesman.

"Hudson handles very well on curves



Hudson now has coil springs in the rear and a torque-tube drive. Clymer does not like this system with its greater unsprung weight

Reclining seats make a big hit with Hudson owners as does the new wrap-around windshield. Some complain of dash layout though



at fast speeds." — Florida dry cleaner.

Third of the best-liked features is the new 1955 styling.

"Smart styling, especially the grille. It gives the car a more-expensive look." — Massachusetts realtor.

"I like its distinctive styling. You don't see yourself coming and going. Other cars too similar." — New Jersey principal.

And Owners Complain, Too

Although there were 29 percent of the owners who didn't have a single thing to complain about, others did. Their most-frequent complaint was about the windshield wipers and wiper control switch.

Fourteen percent of the owners reported that either the wipers or the switch or both were inadequate or hard to use.

"Windshield wipers do not work at all times. They seem to stick around the curve of the glass. Wiper control switch and ignition key too close to steering post." — Washington school superintendent.

"Windshield wiper does not work when you step on the gas. This is the only fault that I can find." — Wisconsin park official.

"Wiper switch in very poor place. Difficult to turn on and off." — Ohio division manager.

"Rubber hoses on vacuum wipers do not hold up." — Texas schoolteacher.

"Wipers do not have enough power in them." — Illinois postal supervisor.

Second most-frequent complaint was the position of the steering wheel.

"Steering wheel is up too high. Should be lower." — Massachusetts milkman.

Third complaint was that the 1955 Hudson looks too much like a Nash.

"Looks too much like a Nash. It should be lowered." — New York design engineer.

Why Buy a Hudson?

The most frequently given reason for buying a Hudson is previous experience with the car, an experience that obviously must have been pleasant.

(Continued to page 132)



CLYMER TESTS the HUDSON HORNET V8

By Floyd Clymer

THE TEST CAR was the Hornet V8 four-door sedan with Ultramatic transmission and air conditioner. The test was from the factory in Kenosha, Wis., to Los Angeles, a distance of 2510 miles, including off-highway tests.

Powered by the Packard-built 320-cubic-inch V8 engine, this car is a new kind of Hudson. Including air conditioning, the car is some 325 pounds heavier than the previous six-cylinder Hornet.

Due to Hudson's 1955 drastic change and its acquisition by a new company, I somehow expected a mediocre automobile, at least until the change-over "bugs" were ironed out. But much to my surprise, very few bugs showed up. One surprise was that I could see less difference in the handling characteristics between the old and new models than anticipated.

The engine is extremely smooth, with minimum vibration. Acceleration is really good and the car has a surprisingly fast top speed. Top speedometer reading was only 100 miles per hour, which appeared

slow to me. Upon checking, the speedometer was found to be approximately seven percent slow. Actual top speed was about 107 miles per hour. This is the first car I've tested in which the speedometer was slow instead of fast.

Hudson now has torque-tube drive, a system I have never liked. In spite of the fact that Henry Ford built 19,000,000 torque-tube-drive Model Ts and Buick has gotten by with it for many years, I still prefer less rear unsprung weight. There is a little hopping around of the rear end when cornering fast or on washboard roads, due to the weight of torque-tube and radius rods used to tie the rear end together. In favor of torque-tube design, it must be said this construction does assure a rigid rear end and good alignment under all conditions. With Hudson's coil springs in the rear, the torque-tube radius-rod combination is necessary with conventional American car design.

The extremely long front coil springs

(Continued to page 280)

Percentages From PM Poll of Hudson Owners

OVER-ALL RATING OF THE HUDSON

Excellent	62%
Average	32%
Poor	6%

Miles per gallon in city

Hornet V8.....	13.1	m.p.g.
Hornet 6.....	14.1	m.p.g.
Wasp 6.....	16.7	m.p.g.

Miles per gallon on trips

Hornet V8.....	16.2	m.p.g.
Hornet 6.....	16.8	m.p.g.
Wasp 6.....	19.9	m.p.g.

Oil consumption of V8

None	32%
Some	62%
Considerable	6%

Oil consumption of 6

None	86%
Some	14%
Considerable	0%

What did you trade in?

Hudson	79%
Nash	2%
Big Three make	11%
Independent make	2%
No trade	6%

How was trade-in allowance?

Hudson-Nash traders	
Above average	43%
Average	53%
Below average	4%

Other traders

Above average	50%
Average	50%
Below average	0%

Would buy another Hudson?

Yes	74%
Might	23%
No	3%

Why did you buy Hudson?

Previous ownership	49%
Trade-in allowance	12%
New styling	11%
Dealer service	4%
Ride	3%
Six-cylinder engine	3%

What should be changed?

Lower steering wheel	9%
Return to step-down	8%
Improve wipers	6%
More power in Wasp	4%
Make shift dial visible	4%
Move hand-brake handle	3%
No changes needed	34%

Most-Frequent Complaints

Wipers and wiper switch	14%
Steering wheel too high	9%
Looks like Nash	7%
Water leaks	7%
Poor roadability	7%
Poor gas mileage	6%
Noisy engine	6%

29% of the owners made no complaints at all.

Best-Liked Features

Riding comfort	43%
Handling ease	33%
Body styling	20%
Performance of Hornet	19%
Roominess	16%
Reclining seats	14%
Roadability	14%

TEST DATA

1955 HUDSON HORNET V8
Four-Door Sedan with Ultramatic

Acceleration Test

¼ mile from zero	19.5 seconds
½ mile from zero	32.2 seconds
0 to 30 miles per hour	4.8 seconds
0 to 60 miles per hour	15.9 seconds
Top speed by speedometer	100 miles per hour
True top speed about 107 miles per hour (Speedometer actually 7 percent slow)	

Economy Test

Constant-Speed Mileage	
At constant 30 m.p.h.	21.4 miles per gallon
At constant 50 m.p.h.	17.4 miles per gallon
At constant 60 m.p.h.	15.9 miles per gallon
At constant 75 m.p.h.	12.4 miles per gallon

Cross-Country Mileage	
Kenosha, Wis., to Indianapolis, Ind.	14.8 miles per gallon
Indianapolis to Dodge City, Kans.	15.8 miles per gallon
Dodge City to Gallup, N. Mex.	15.6 miles per gallon
Gallup to Los Angeles	14.9 miles per gallon
(Regular and premium gasoline used)	

"I always buy Hudsons. They are durable. I have driven 80,000 miles with the same clutch. No major repairs."—Massachusetts insurance agent.

Here are some other reasons why owners bought Hudsons. They are quoted in order of frequency of mention.

"Hudson was the only car that was willing to give what I wanted for my Jaguar in a trade."—Chicago lathe operator.

"I buy Hudsons because I get a good trade-in allowance. I refuse to take a beating on a trade for a Big Three car."—Illinois insurance agent.

"People say there is no resale to Hudson. Well, I got a good deal on my old one by buying this Hudson. And after driving a Hudson for three years I wanted to own another one."—Illinois brickmason.

"Styling makes Hudson owners proud. It is a distinction to have one."—Washington, D. C. Army officer.

"Dealer service convinced me. The cars have been honest products and the dealer interested in keeping me satisfied."—Oregon sanatorium operator.

"I bought it because of that big six-cylinder engine. It never gives any trouble."—Illinois machinist.

"One of the main reasons for buying this Hudson was the reclining seats and beds. They should be in all cars."—North Carolina traveling man.

"The one thing that most convinced me was my wife—she liked the color."—Maine accountant.

What Should Be Changed?

When asked to list the one thing that they wanted changed, the Hudson owners repeated their complaint about the steering wheel being too high. Second on the list is a desire to return to the step-down body design. Third is improved windshield wipers. These and others are described below in order of frequency of mention.

"Steering wheel is too high. I am very short and had to have it lowered."—Ohio housewife.

"I would like to go back to the old step-down design and roadability. A Hudson owner is fanatical about his car. There still is no car like the step-down design. The only good Hudson feature retained is the Six and this has been hurt with use of torque-tube drive and rigid engine mounting."—Colorado salesman.

Quotations about the windshield wipers have been given already.

"I can't see the transmission quadrant because of the large steering column. Have to lean far forward to see where to shift."—Pennsylvania clerk.

Other Best-Liked Features

Fourth on the list of best-liked features was the power and performance of the Hornet. This and other features are described in the following quotations (listed in order of frequency of mention):

"I like the fast pickup in city driving. I like its cruising speed on the highway at 80 miles per hour without forcing it."—Illinois steelworker.

"Has lots of snap when needed for passing."—Ohio salesman.

"The new V8 engine is smooth and powerful."—Oregon engineer.

Incidentally, the number of V8 owners in the survey was too small to provide us with an accurate sample. All percentages and comments apply only to six-cylinder Hudsons unless otherwise stated.

"I like the roominess. Wide seats, no crowding. Plenty of headroom, front and rear."—Illinois owner.

"Wide and roomy. Has lots of trunk space for the tools that I need for my work."—Illinois cement mason.

"I like the reclining seats and the radio with the twin speakers in dash."—Pennsylvania crane operator.

"We take a 5000-mile trip every year on vacation and use our car's reclining seats so we have no motel expenses."—Michigan salesman.

"It holds the road. I never have to worry and fight it when I speed."—Ohio waiter.

"I like the engine best. Have never had engine trouble with a Hudson."—Connecticut salesman.

(Continued to page 276)

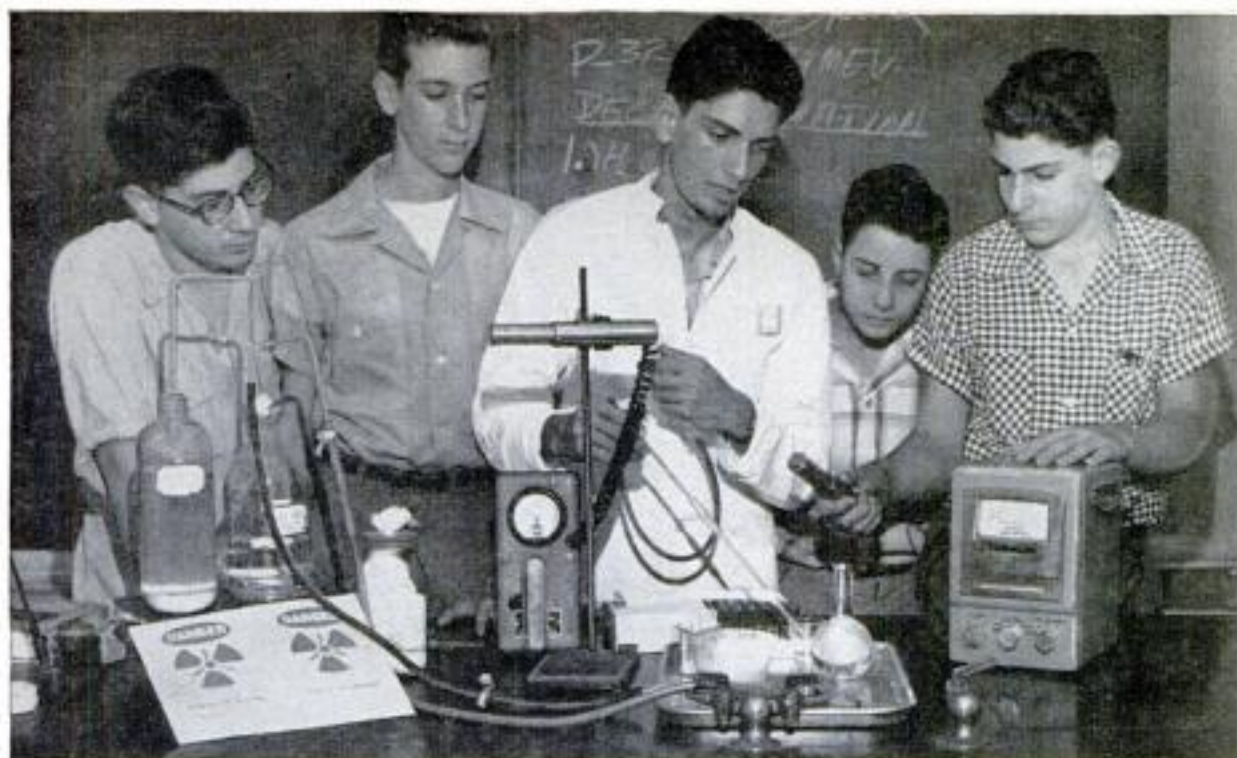

Lab experiments aid classroom studies. Staff members of laboratory stay after school to work on projects

HIGH-SCHOOL ATOM LAB

ISOTOPES and gamma rays have lost their mystery for a group of Miami Beach, Fla., high-school students who operate their own atomic laboratory.

The junior scientists use radioactive materials obtained from Oak Ridge to supplement their studies of plant nutrition, photosynthesis, and zoology. Their lab, a 6 by 16-foot room adjoining a biology classroom at Miami Beach High School, contains instruments like an isotope rate meter and a survey meter donated or purchased at cut rates from equipment firms. In a nearby darkroom, the boys obtain X-ray pictures of plant and tissue sections containing radioactive tracer material.

Although the radioactive chemicals used by the group are not extremely dangerous, the boys take no chances. Remote-handling tools, brick shields and containers lined with concrete and lead are used for protection against gamma rays.

The lab was started in 1953 by student Charles Yulish, who by letters and visits persuaded the AEC and equipment firms to aid him in setting up a genuine radioisotope laboratory for educational use. Since then, the lab has received shipments of nine different kinds of radioisotopes.

Peter Roller, above right, checks radioactivity of chemicals with an isotope rate meter. Chuck Yulish, below, watches a mirror as he extracts radioactive Fe-59 from a beaker shielded behind bricks. Yulish, founder of the lab, was aided by his biology teacher





Expert uses quartz lamp to compare fluorescence of ink on a questionable stamp with ink on a genuine one. Stamp at top right was overprinted for airmail service. Below it is a fake. Note differences in type

Watch Out for the **STAMP FAKERS!**

By Ernest A. Kehr
Stamp News Editor,
New York Herald Tribune

SOME 20,000,000 men, women and children in America enthusiastically collect stamps. In fact, their enthusiasm frequently surpasses their technical knowledge. Obliging fakers have moved into this market, producing and selling imitation stamps as the real thing.

To combat this ever-increasing field of fakery, professional dealers, philatelic societies and individuals have had to establish laboratories for the scientific examination of postage stamps.

These laboratories have become necessary because none of our regular crime-investigation agencies is equipped to track down chicanery in this field. Governments protect themselves against the counterfeiting of stamps which are valid for postage, but they generally ignore stamps which have only a collector's value.

Knowing that their chances of being

caught are slim, and the chances of being prosecuted if they are identified even slimmer, the stamp fakers have enjoyed a heyday. They imitate hundreds of specimens for which philatelists pay fancy prices because the stamps are obsolete and scarce.

There are four general classes of philatelic fakes.

1. Imitation of an actual postage stamp.

Counterfeiters usually spurn this first class. Printing methods today are so advanced that successful imitation is all but impossible. Besides, the jeopardy of inviting the Secret Service and Postal Inspectors is too great. It is the only kind of counterfeiting which will bring swift, certain action by federal agents.

Fifty years ago, however, counterfeiters in Europe exploited this field for all it was worth. Their spurious products still may be found in grandfathers' collections. But



Top, triangular Latvian stamp was issued in 1920. Below it is a counterfeit produced five years later, with changes in aircraft and lettering. Top, right,

Mexico overprinted 300 stamps to honor Amelia Earhart. Faker printed imitation, below, which might have sold for up to \$250 if it had gone undetected

anyone with only a rudimentary knowledge of printing methods can spot these lithographed imitations of intaglio-printed originals at 20 yards. They don't fool anyone but the tyro so are the least dangerous of stampdom's fakes.

2. Imitated overprints and postal markings.

This second class really provides the philatelic sleuth with most of his headaches for it is one which fakers have most widely and profitably used to fleece the unsuspecting stamp collectors.

In many instances governments, unable to produce special stamps for special occasions, use existing stocks and hurriedly overprint them to fill some provisional postal need. In 1928, for instance, the purser of the SS *Ile de France* took a common 1½-franc stamp and had the ship's printer add a very simple "10 Fr." to prepay charges on ship-to-shore airmail. The basic

Sleuth compares enlarged photo of suspected stamp with similar enlargement of real thing, checking the minutest details





This fake fooled a New York dealer. Stamp was allegedly issued in Jaffa in 1872. Sleuth suspected a fraud because Arabic address made no sense. Right, real giveaway was watermarked paper, first used in 1886

stamp today still is worth about a dime while the genuine overprint sells for roughly \$300.

This is the natural setup for the faker. He buys supplies of the cheap basic stamp and with a basement printing press adds his own overprint.

"Port Fouad," applied to an Egyptian stamp of 1926, ups its philatelic worth from \$9 to about \$125. A rather crude "Aero Correo," put on a Honduran stamp worth 25 cents, changes its market value to \$5000.

There are literally hundreds of other examples that have lured the faker and mulcted the uninformed collector.

3. Faked "covers."

Making a faked "cover" is a faker's favorite field. A cover is an envelope or wrapper with all stamps and postal markings still affixed. A genuine postage stamp may be worth \$10, but if it is still affixed to the envelope on which it was used it may be worth as much as \$100. The faker will get a genuine stamp and a cheap contemporary envelope, put the two together and peddle the result as a real cover.

Not long ago, one of the fakers found a letter franked with a common United States three-cent stamp of 1857. This stamp was removed and a rare 90-cent stamp substituted. A little fancy brushwork and a forged postmark turned it into what appeared to be a rare philatelic gem.

Less than a decade ago, a British faker realized that collectors were paying fancy prices for envelopes franked with stamps issued for various colonies to commemorate the coronation of King George VI and Queen Elizabeth, although the unused

stamps of this series were rather common. He spent a few shillings for photoengravings of the genuine postmarks, pasted thousands of unused stamps on envelopes and added these imitation postmarks and made substantial profits before he was exposed.

4. Repairing damaged stamps.

Even the slightest defect will destroy the philatelic value of a postage stamp. A microscopic tear or a missing perforation tooth can drop the value as much as 90 percent. The stamp fakers take damaged copies of rare stamps and so expertly repair them that the average collector is fooled into believing he is being offered a perfect specimen. Some of these fakes, when examined by experts, have been found to consist of as many as four parts of different stamps cleverly laminated to form one "superb stamp."

An allied racket is the removal of postmarks, so that stamps may be offered as more valuable "unused" specimens. High-denomination British colonial stamps often are used for fiscal purposes. Because such stamps are philatelically taboo, the fakers get deeds, passports and other documents on which 10-shilling or £1 stamps had been used to pay revenue fees. With a bit of chemistry they eradicate the violet cancellation and add fake gum to the back of the stamp. Then they offer it as an unused stamp to some unsuspecting collector who thinks he is getting a bargain.

Most of the cleverest fakers never touch the great rarities. They confine their activities to doctoring material worth between \$5 and \$250. They know that they can dispose of 100 counterfeits at \$10 much

more readily than two at \$500 each.

In the first place the market for lower-priced stamps is much greater. In the second place their chances of detection are much smaller. The existing professional laboratories charge a minimum fee of \$5 to examine a questionable stamp. A collector will spend that much to be sure that a \$200 stamp is really genuine; he will not spend \$5 for a certificate of genuineness for a stamp which he bought for \$5 or \$10.

Since counterfeiting and fakery are so prevalent, and because officially established agencies are doing little to combat the evil, some dealers, societies and individuals maintain philatelic laboratories to do their own private sleuthing.

A philatelic lab is as full of scientific instruments as any research center. Their techniques, too, are modern. A stamp examined by qualified experts is subjected to so many tests that the philatelic sleuth usually will know more about the paper, inks and printing processes used for the stamp than the Postmaster General who originally authorized it.

Photographs of the questionable stamp are made and enlarged as much as 50 diameters, then compared with stamps known to be genuine. Under such examination, even the tiniest of differences in engraving, type shapes and sizes are betrayed or confirmed.

They are subjected to infrared and ultraviolet rays that reveal repairs not visible under ordinary magnification. Since faked ink invariably is different from that used on the original stamps, variations in fluorescence always show up in the laboratory. More recently, X-ray machines have been added to philatelic detection. Dr. Herbert Pollack of Chicago, and Dr. Harold S. Cheavin of London, both

(Continued to page 272)

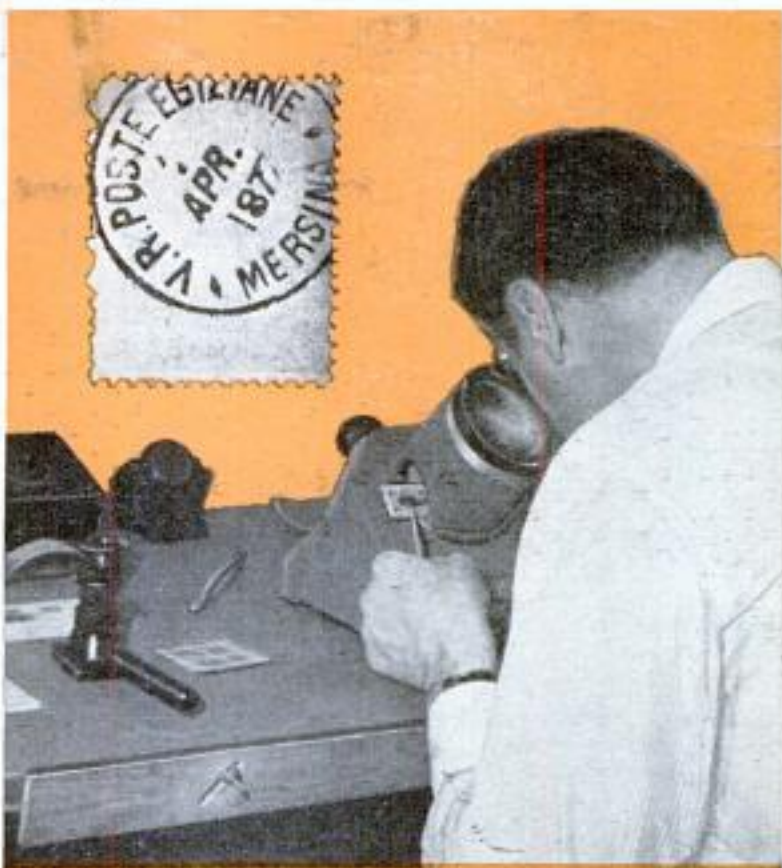

Electric viewer permits philatelic sleuth to check paper and printing. Top, filter brings out the postmark, eliminates all other details



At left is stamp partially obliterated by postmark. At right is same stamp as seen under X ray, showing all the details. Below, left, is a rare stamp offered as a "very fine, unused specimen." Ultraviolet light revealed that a postmark had been removed to boost value



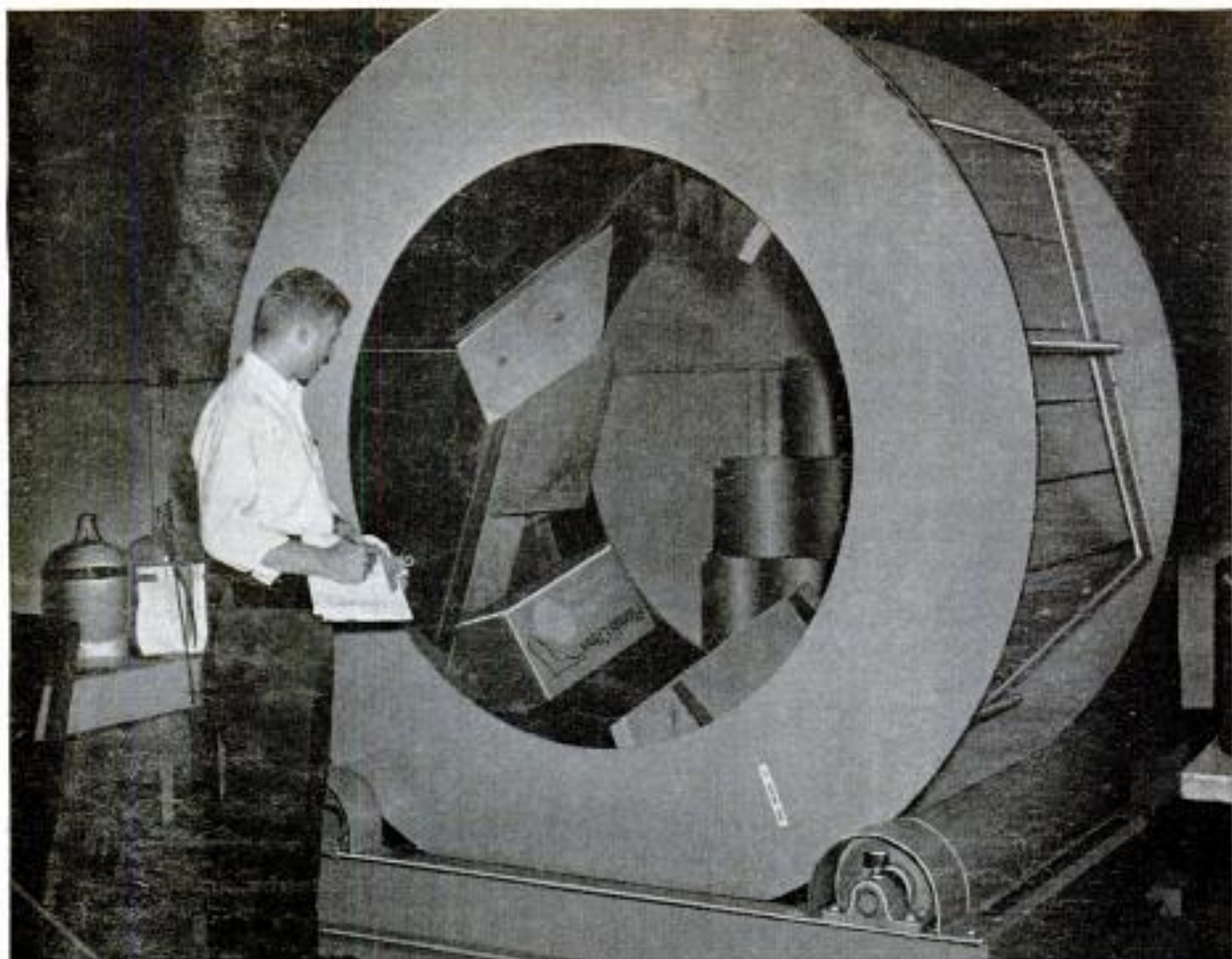

In one rugged test at the institute, a seven-foot drum smashes paperboard cartons against baffle boards

Plotting a Future for Paper

EACH WEEK brings a good many strange requests to the Institute of Paper Chemistry at Appleton, Wis. One company wants help in developing wallpaper with a built-in insecticide to kill flies. Another wants advice on making a paper rug, a paper raincoat or a paper umbrella. Still another wants to work out an insect-resistant container, a wrapper that will impart a particular flavor to food, or a pop bottle with a built-in drinking straw.

Many of these requests are turned down as impracticable. But others, such as the fly-killing wallpaper, the latex-impregnated rug and the bug-baffling container have been successfully developed at the institute or with its help.

Less spectacular but more important are the institute's basic-research projects to produce better paper products.

On a gloomy day back in October 1929, a handful of men gathered at Appleton. History records that particular day as Black Friday—the day of the fateful stock-market crash—but to these men it was the founding day of a unique institution.

Later, three hopeful students showed up at the campus to become the institute's first students. They started their work under a staff of four men, with equipment valued at \$50. Today the institute has a staff of 235 and an annual operating budget of about \$1,500,000. In the years since that Black Friday in 1929, it has conferred doctor's degrees on 132 students, many of whom are executives in the paper industry today.

The institute was founded by the paper companies themselves in a unique experiment to fuse industry and education. It has a threefold purpose: To produce "scientific generalists"—men thoroughly trained in every phase of the industry, with vision and imagination to carry the industry into new fields in the future; to push forward the frontiers of knowledge through basic and applied research; and to maintain a central information depot for the industry.

Each year, members of the staff travel thousands of miles, searching out able college seniors for the coming year. In general, each of these young men must be in

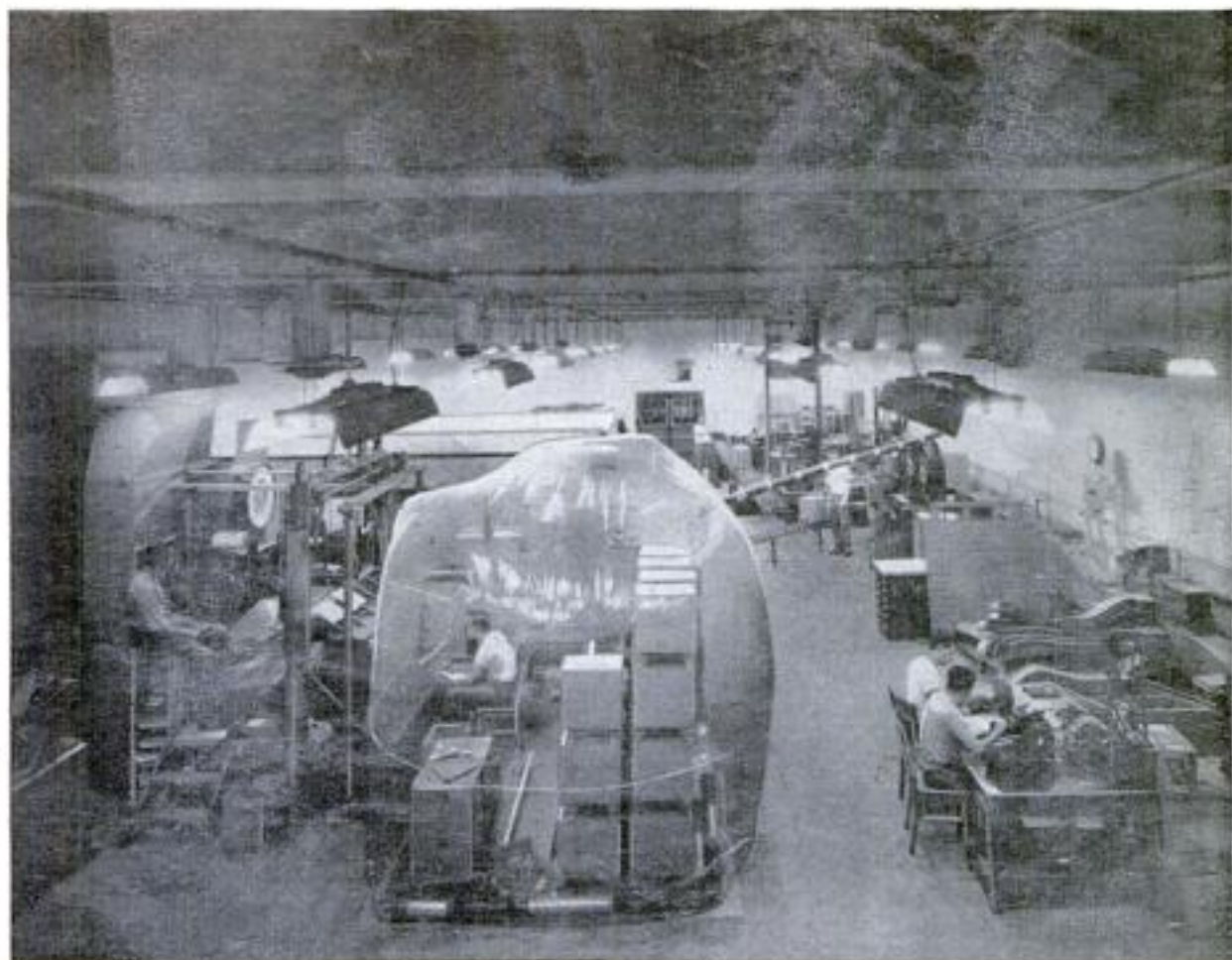

Paper and cartons are tested under various humidities and temperatures in isolarium, an inflated plastic bag

the upper 10 percent of his graduating class, must have a degree in chemistry or chemical engineering and must meet strict personality requirements. From 15 to 24 men are selected, and each of them is awarded a scholarship of \$1500 a year. Of this fund, \$1000 is for his living expenses, so it is possible for the frugal student to obtain four years of postgraduate work without spending a penny. During the depression one outstanding student came, as he confessed later, "to get a meal ticket." Now he's vice-president of a company.

Since T'sai Lun invented paper about A.D. 100, papermaking has been more of an art than a science. There are about 3,870,000,000 papermaking fibers in a ton of pulp, but even the scientists at the institute admit there is much they don't know about these fibers. One goal of the institute is to train its graduates so well in basic science that in future years the industry will be operating on precise knowledge rather than rule-of-thumb experience.

The ratio of faculty members to students at the institute is 1 to 1.7. In his final year the student pitches into a research problem of his own. Meanwhile the 235 staff members are carrying on continual research.

Many of these projects delve into the

problem of utilizing waste products. Each year the paper mills of the United States and Canada must dispose of some 2,500,000 tons of lignin, up to 600,000 tons of fermentable sugars, 125,000 tons of acetic acid and 200,000 tons of lime. Of this waste material, lignin—the organic substance that, with cellulose, forms the major portion of wood—receives the greatest attention. Some institute scientists see the day when lignin may rival coal tar and petroleum as a source of synthetic chemicals. They are attacking lignin from every conceivable angle in an attempt to crack its secrets.

Already they have developed processes for deriving vanillin from lignin, and vanillin in turn has been transformed into a whole series of chemicals. In addition they have created mucilages, adhesives, plastics, tanning agents, soaps, fertilizers, highway treatments, fungicides and medicines from waste products. It's quite possible that the time may come when by-products of the industry are as valuable as the pulp itself.

Not long ago a pathologist at Vanderbilt University undertook a study of histoplasmosis, a relatively rare disease which was almost always fatal when fully developed.

(Continued to page 258)



Fire-Escape Reel

Fire victims can lower themselves to the ground at the rate of six feet per second with a spring-wound "rescue reel." It consists of a 65-foot length of steel cable wound inside a metal ball that is hooked on the end of a rescue ladder. The victim straps on a safety belt hooked to the cable

and steps out the window. His weight causes the cable to pay out slowly in a safe descent. When he reaches the ground, the rescued person releases the safety belt and the cable winds up again. The device, operating somewhat like a window shade, was developed for use in West Berlin.

Electronic Stethoscope Picks Up Extremely Low Sounds

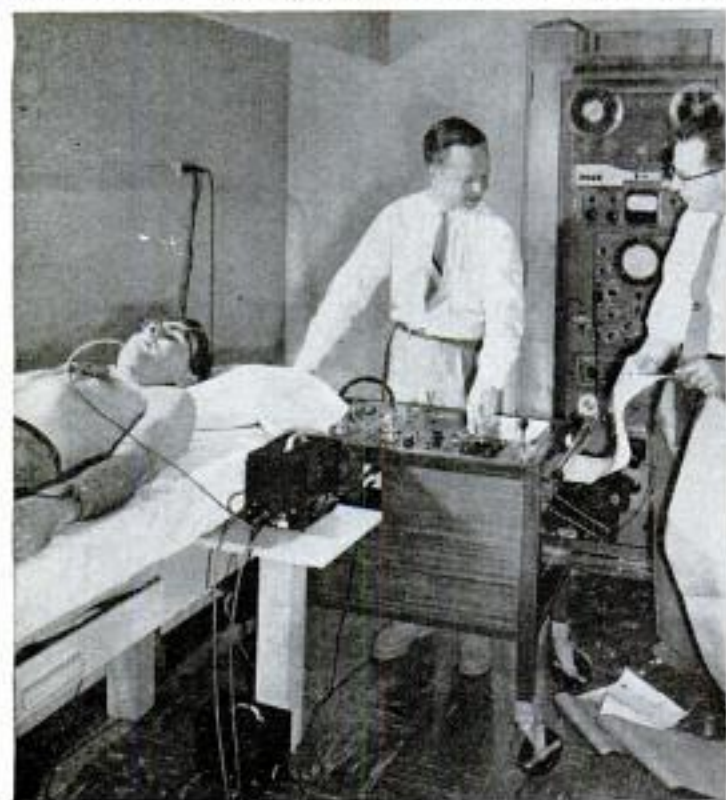

Heart sounds too low to be heard through a stethoscope register on a medical instrument developed by General Motors and the Medical College of South Carolina. A cross between a stethoscope and an industrial inspection tool, the Electro Stethograph picks up sounds as low as one cycle per second. Results are pictured on an oscilloscope or with a writing device that traces lines on graph paper. "Parent" of the instrument is the Surfagage, which has a tiny diamond stylus that is traced over highly machined automotive parts. Scratches cause vibrations that are detected by a sensitive pickup. The pickup is linked to a transducer that translates the vibrations into electrical signals. Attaching a stethoscope diaphragm to the pickup transformed the Surfagage into the Stethograph.

☐ Flameproof nylon net has been developed by a British company.



Take-Off Run of Turboprop Transport Is Nine Times Its Length

After an eight-second, 855-foot take-off run, the Lockheed C-130A Hercules recently took to the air for the first time. The take-off run was only nine times the length of the 54-ton air freighter, the Air Force's first production turboprop cargo transport. By the time it reached the end of the 10,000-

foot runway, the plane was 2500 feet aloft. According to Lockheed observers, it climbed off the field and gained altitude much faster than the jet chase planes that followed the flight. The plane returned to its Marietta, Ga., base an hour later, landing in an even shorter distance.

Double-Delta Wing On Swedish Jet

Representing a completely new principle in aircraft design, the SAAB-210 jet fighter is now being flight tested by the Swedish Air Force. The wing of this plane is of a double-delta design and differs from the average wing in that its length is much greater than its span. Another of the plane's unique features is the fact that the center of gravity can be moved by the pilot during flight. This is done by pumping liquid between trim tanks in the nose and tail.

☐ Scheduled United States airlines—domestic, territorial and overseas—had their best safety record in 1954. Thirty-nine companies had no fatal accidents. Three domestic airline accidents cost the lives of 16 passengers and seven crew members, adding up to the lowest passenger-death rate in history—.09 deaths per 100 million passenger miles.

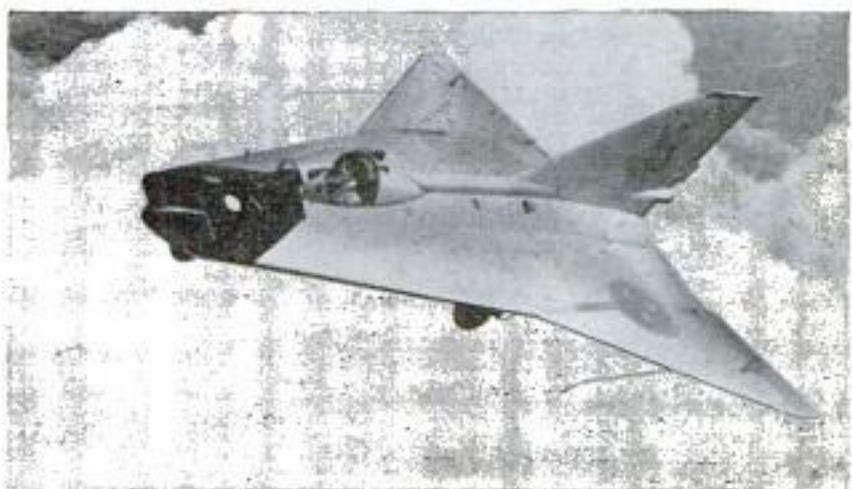
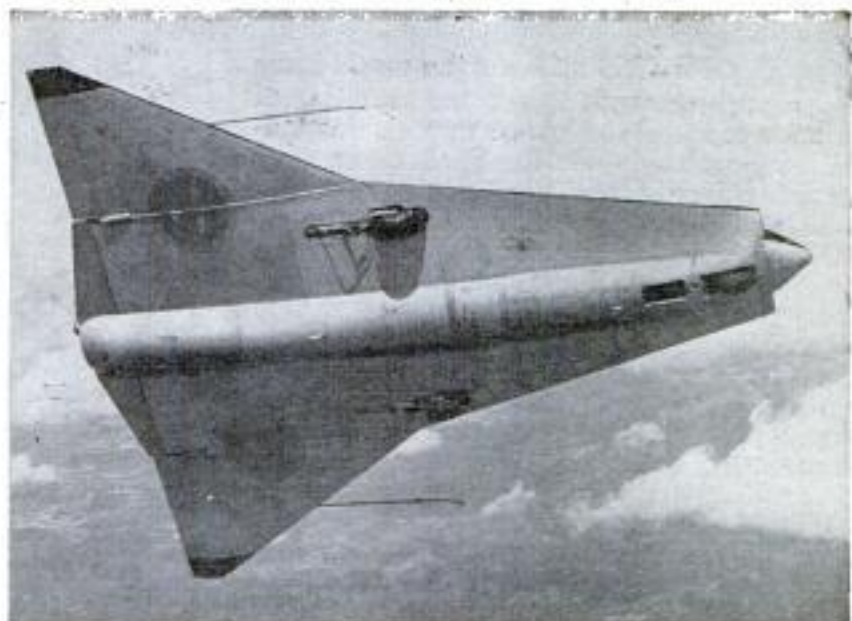

Inside the post office, one man stacks the incoming mail in the hoppers of coding machines



Machine feeds envelopes in front of operator. He presses keys which print addresses in code on backs of envelopes

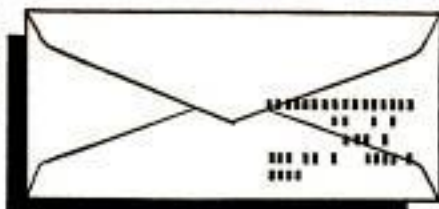

Above is a typical coded letter. Below, transport belts stack envelopes from the coding units



ELECTRONS SORT *the* MAIL

POST OFFICES all over the world have always depended upon individual mail sorters to speed the letters to their destinations. Sorters break the mail down into zones. Other sorters take all the zone letters and sort them into subdivisions.

Canada now is installing a robot system to sort the mail. Eventually the Canadian Post Office hopes to have a fully electronic system.

Here's the way the new system works:

A clerk deposits the incoming mail in the hopper of a coding machine. The envelopes are fed automatically to a window in front of an operator. The operator glances at the handwritten address and punches keys on the machine to print the address in code on the back of the envelope. The envelope then goes to a stacker.

An operator carries a bundle of coded envelopes to the distributor, which sends them one by one through an electronic reader. The reader, upon instructions from the electronic "brain," decides which of 16 stacks is the appropriate one for the letter.

Each of these 16 stacks then is run through another reader and sorted into 16 subdivisions. The result is 256 subdivisions of the mail.

The Canadian Post Office visualizes for the future an electronic robot that will be able to read typewritten and some handwritten addresses. Meanwhile it will be testing its new robot, which has a much greater memory capacity than most human sorters. ★ ★ ★

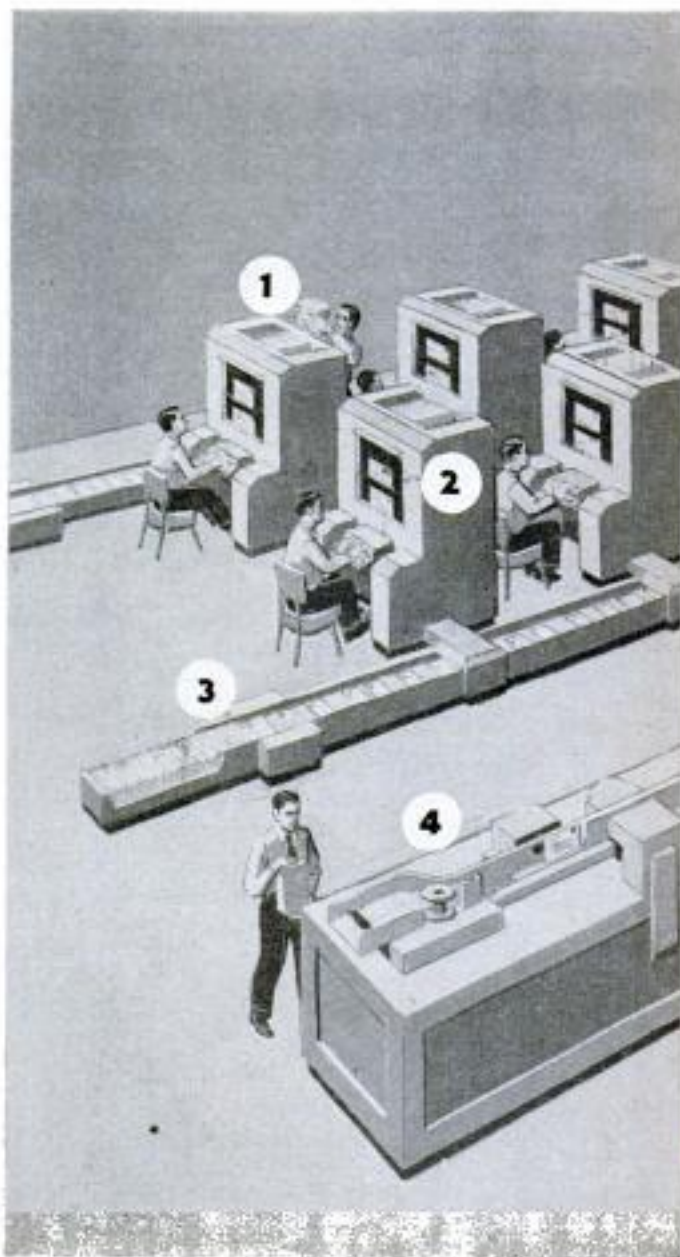



4 Envelopes are transferred to electronic reader which, upon instructions from electronic "brain," sorts coded mail into 16 stacks

5 Each stack goes into another reader for a further breakdown into 16 smaller groups

6 Each of resulting stacks is mail for one small area. These envelopes are bundled for delivery

Code-marked card goes on top of each bundle for identification when the bundle is dropped into distribution bag

Webster

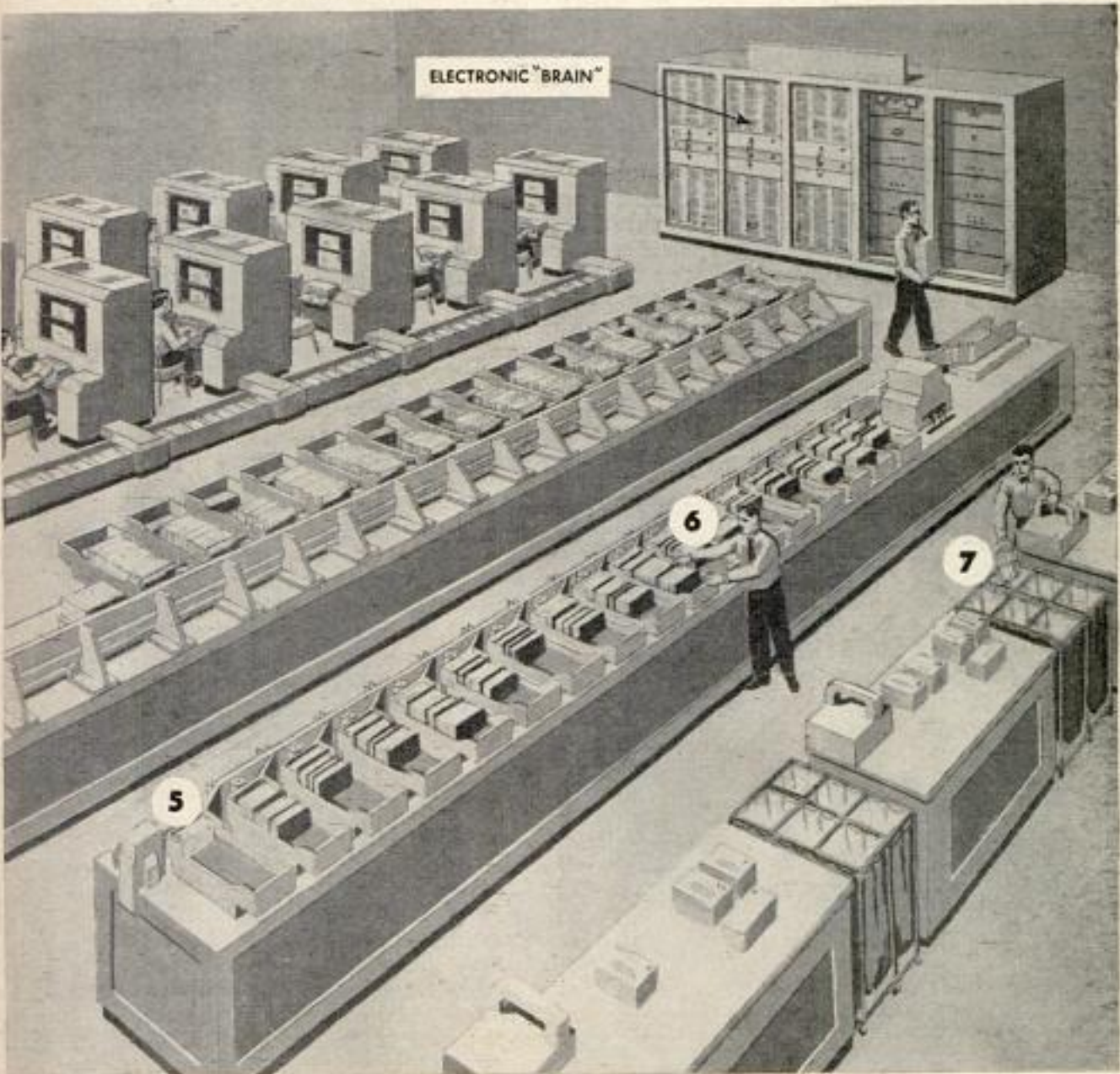

ELECTRONIC "BRAIN"

Lever Action on Rifle Has Built-in Trigger



Rifle, under test in bench-rest firing, has a trigger built into the lever. In operating the lever, the rifleman keeps his finger within the trigger guard. Parts of the lever action and receiver mechanism are shown at right

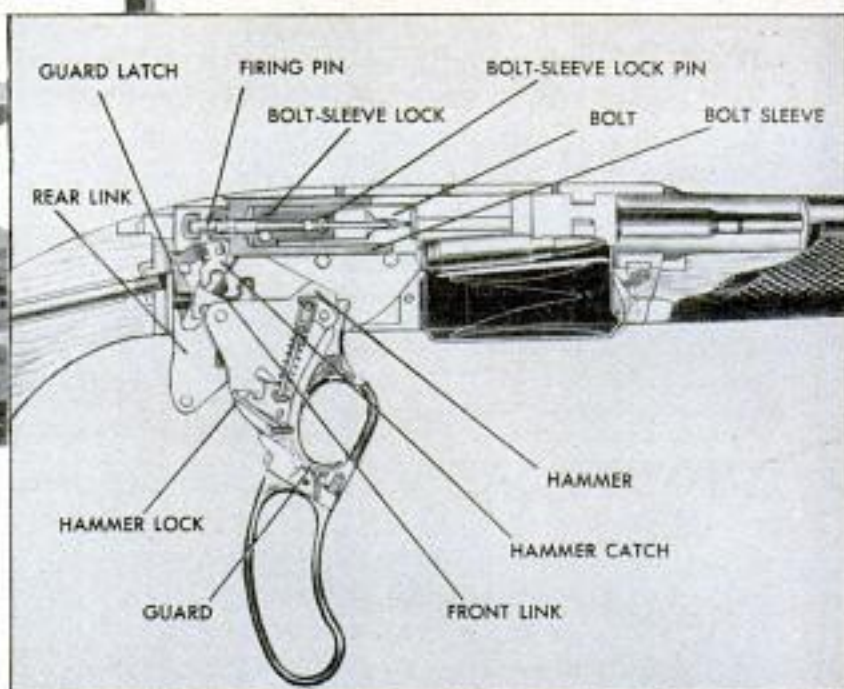

Called the Model 88, a new Winchester lever-action rifle has a trigger mechanism built into the lever. This makes it possible to combine the rapid fire of a lever action with the accuracy of a bolt action. The rifle has a rotating front-locking bolt which permits the use of high-velocity, high-powered cartridges. When the rifleman operates the lever, he keeps his finger within the trigger guard. As soon as the lever moves, the trig-

ger action is interrupted. If the trigger is squeezed through the entire stroke of the lever, it must be released again after the rifle is cocked in order to fire. The rifle's magazine has a capacity of five rounds if it is inserted with the action open. Shells are ejected at a 45-degree angle which permits low mounting of a scope on the center of the receiver. This is said to be the first lever-action rifle with a one-piece stock.

Fans at Race Track View Finish on Television Screen



Racing fans at Roosevelt Raceway, Westbury, N. Y., can see the finish of a horse race, no matter where they are seated, by watching a big television screen. The track is equipped with a closed-circuit television system with big-screen projection. The system permits patrons far from the finish line or those sitting at odd angles to see a close-up of the finish on the 20 by 20-foot screen.

Color-Television Network Now Reaches 46 States

Color TV can be received in every state of the Union except Idaho and Montana. The Bell television network totals over 69,000 miles, with 47,000 channel miles equipped for color television. Color-TV facilities are installed in 247 stations in 138 cities. Also in the network are 48,000 channel miles of radio relay facilities and 21,000 channel miles of cable facilities. In 1948, this network totaled only 900 channel miles.



Courtesy of Carl Koch, Techbuilt, Inc.
 Proper use of color lends distinction to this modern home; sketch below shows the important color areas

COLOR TIPS for YOUR HOUSE

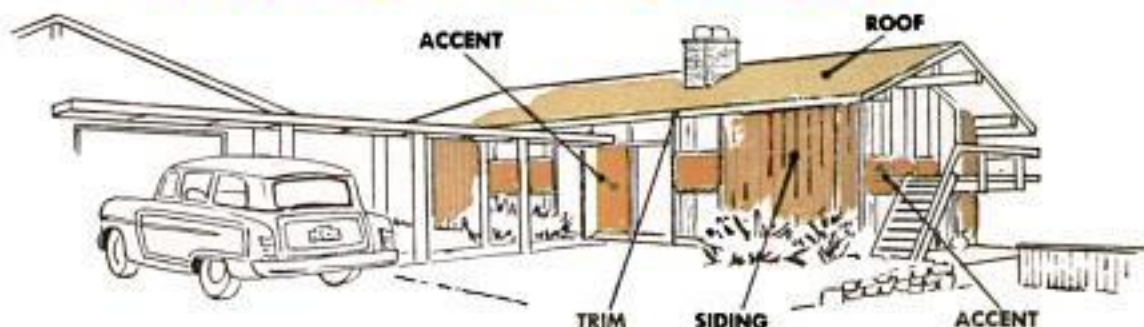

MOST OF THE EXPERTS — building contractors, real-estate salesmen, and a whole new profession known as color stylists—agree that use of the right colors will add \$1000 or more to the value of your house whether it be new or old.

With this thought in mind, *Popular Mechanics* has asked some of the nation's leading authorities on color and architecture to pass along their best tips to our readers. These include Beatrice West, associate of the New York Chapter, the American Institute of Architects, whose color schemes have helped sell more than 100,000 houses in 36 states; members of the distinguished TAC (The Architects Collaborative) of Cambridge, Mass.; Carl Koch, famed originator of the Techbuilt house, and W. Lockwood Martling, Jr., the Chicago architect

who has wrought miracles with color in remodeling "old clunkers."

"Just a few years ago, John Q. Public lived in a white house, wore a blue suit with a white shirt and drove a black car," says Beatrice West. "Today his house may rival the rainbow in beautiful colors, his shirt may be pink and his car a fire-engine red or yellow. He prefers color movies and looks forward to owning a color-TV set."

With all this color splashing over the landscape, there has developed a crying need for information on how to achieve harmonious color effects. Should that door be painted red or green or peacock? And what about the gable? The roof? The trim?

"You can work wonders with color tones," says Miss West, "whether you are building a new house or remodeling an old



Here are some approved



ROOF



WHITE

SIDING



CHARCOAL

TRIM



PEARL GRAY

ACCENT *



CARNATION RED

color schemes for your home



WHITE-MARBLE CHIPS



REDWOOD



LIGHT SPRUCE



PEACOCK



GRAY GREEN



GRAY GREEN



WHITE



NASTURTIUM



FROST BLEND



SPRUCE



LIGHT SPRUCE



CANARY



PASTEL RED



FRESCO RED



OYSTER WHITE



DRESDEN

WHITE-ROCK CHIPS



SAGE



WHITE



LIME



* Color schemes by Beatrice West applied to PM ranch house



Courtesy of W. Lockwood Martling, Jr.
Once a drab old-timer (above at right) this remodeled house is now gayest in the block; terra-cotta color lowers house
Hedrick-Blessing photo, courtesy W. S. Dippoun Co.
This house of soft greens and white illustrates the proper use of the contrasting red accent color on large front door



one. Color is design. It is also a means of expressing individuality. Never underestimate the power of color—for better or worse. That's why it should be handled with care. The right colors can make a small house look big or a big house look just right. And just as easily the wrong colors can make a small house appear smaller and a tall ungainly house taller. Color can turn a spotlight on architectural detail or hide it—whatever you desire. One nice thing about color is that it costs no more to put on the right one than it does the wrong."

An incident that happened in Dallas early in Miss West's career best illustrates the power of color. It was right after World War II and despite the housing shortage a development of prefabricated houses did not sell. Miss West, who was then working as an architect in her native Texas, was asked by the prefab manufacturer to visit the project and tell him what was wrong. There she found row after row of white houses with blue shutters and mottled roofs of red, blue and green. She worked out a color plan for the entire project of 300 houses and fixed up a model for demonstration purposes. All the houses were sold in a single week end and Beatrice West had found herself a new career. Soon she was planning the color for Levitt projects and National Homes.

"I am glad that the public has awakened to the glory of color on homes," she says, "but it's obvious that too many have plunged into the use of color without knowing



any of the rules. This produces what has been called the 'banana split' house complete with cherry on top. A lot of people let their tastes run wild with too many materials and clashing colors. I recall one house with a gray roof, a combination of green shingles and lime-colored siding, some stone on one side and brick on the other. The trim was painted shocking pink and a chartreuse awning finished it off—and I mean finished."

Carl Koch agrees on the dangers of using too much color in the wrong places. However, he feels that the experts should not squelch any person's desire for self-expression in the color of his home.

"With the Techbuilt house we try to provide as much opportunity for individual expression as possible," he says. "On the other hand, houses in a group should relate to each other, and color is an important way to do this."

Koch feels that houses of reasonable size should be subdued in over-all tones with the bright color accents confined to small areas such as doors and window panels.

Traffic stoppers like the banana-split house are something all homeowners are urged to avoid. But how does one obtain pleasing color effects with a professional touch? Are there any rules to keep from



Beatrice West, color expert, consults with builder on a color scheme. "Start with the roof," she says

going overboard? The answers to both questions can be found in these 10 simple rules:

1. *Know the color areas of your house.* Generally, there are four distinct color areas: roof, siding, trim and accent. The positions of the first three are obvious. The accent area is usually small, such as a door or shutters, and is painted in contrast to the general tone of the house. The split-level house sometimes introduces a fifth color area when asbestos, plywood or some other material is used for part of the siding.

2. *Roof.* You start here. Remember the roof color is the key to the color scheme of any house. If you are building a new home,

(Continued to page 260)

Trim areas of houses (dotted red lines) reveal the architectural lines of a house—good or bad. Good lines of Rudolph Matern house at bottom were painted a contrasting color to point up attractive design

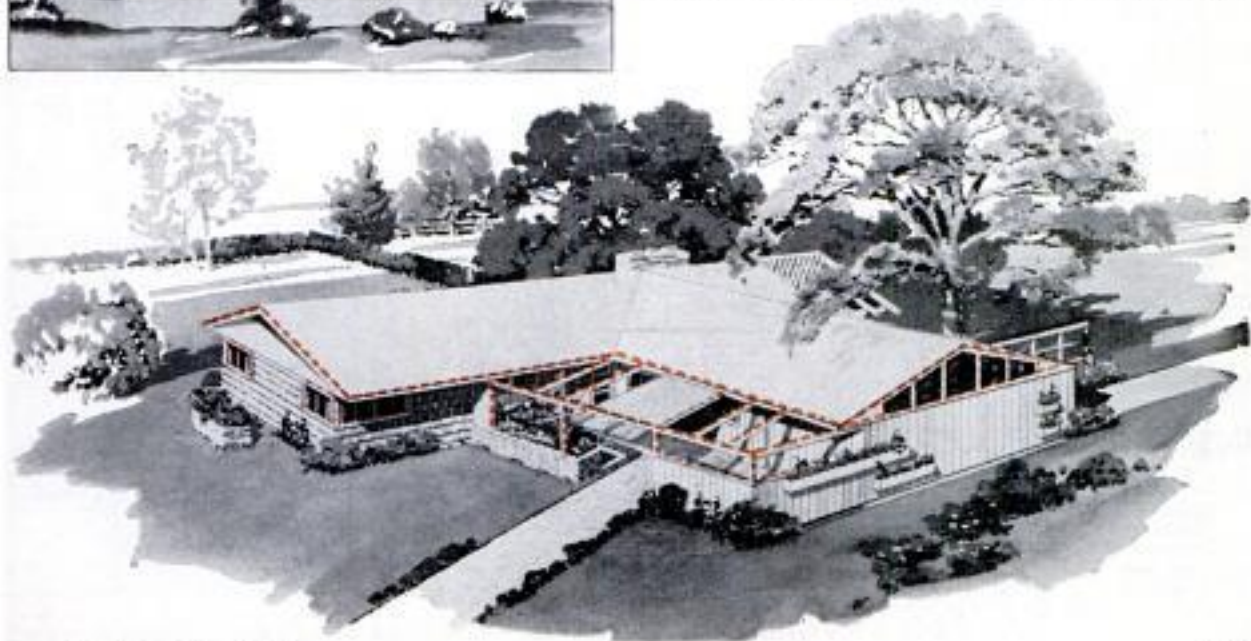



Check List

FOR RATING YOUR HOME ---OR BUYING A NEW ONE

[Score 10 for perfect (unqualified "yes"), 8 for good, 5 for fair, 0 for bad.
Superior rating, 450 to 500; good, 350 to 450; fair, 250 to 350; poor, 150 to 250.]

THE NEIGHBORHOOD

1. Is the neighborhood attractive?.....
(Big trees, well-kept homes, near park or pond)
2. Do you like the kind of people who live in the neighborhood?.....
3. Are streets curved or arranged to discourage through traffic?.....
4. Are the houses uncrowded?.....
5. Do houses offer pleasing variety of design?.....
6. Do homes have fair range of size and price?.....
(Desirable for normal community)
7. Do houses have varied window arrangement on front?.....
(All should not have picture windows)
8. Are some houses set farther back than others?.....
(Desirable)
9. Is public transportation convenient?.....
10. Are churches, schools, hospital, library, stores within reasonable distance?.....
11. Is house far enough away from any annoying railroad, airport, major highway, factory, dump or swamp?.....

THE OUTSIDE OF THE HOUSE

12. Is the house attractive?.....
(Simple in design with few materials, projections or "cute" decorations)
13. Is rear appearance pleasing?.....
14. Is the house easy to maintain?.....
(Such as painting)
15. Are large glass areas protected by roof overhang?.....
(They should be)
16. Is living-room floor proper distance above ground?.....
(Less than 12 inches good, over 18 inches poor. Does not apply to sloping lot.)
17. Is there provision for outdoor living?.....
(Porch, terrace, patio)
18. Is house reasonably private from street and neighbors?.....
(Fences, trellises, hedges, etc.)
19. Is there a turnaround so you don't have to back into street?.....
20. Is the lot big enough?.....
(Frontage of 75 feet or more good, less than 60 feet poor; or 7500 square feet good, under 6000 poor.)
21. Are there gutters on roof?.....
22. Is attic well ventilated?.....
(Louvers on gables, slots under eaves)
23. Is lot suitable for family needs?.....
(Games, gardening, etc.)
24. Is service entrance inconspicuous?.....

INSIDE THE HOUSE

25. Is living room arranged to avoid front-door traffic?.....
(Score zero if main entrance opens into living room)
26. Can you reach bedrooms without going through living room?.....
(If you can, score 10)

27. Is living room attractive?.....
(Windows on at least two sides, pleasant view, large enough for entertaining, door to porch or terrace, privacy from street or neighbors, fireplace, adequate storage)
28. Is dining room or area convenient to kitchen?.....
29. If kitchen opens into dining area, can it be closed off if need be?.....
(Desirable)
30. Is cabinet and work space adequate in kitchen?.....
(Including cabinets with sink or range, over 11 feet frontage good, under 8½ feet poor; should have 1½-foot counter on each side of sink, on at least one side of range and opening side of refrigerator.)
31. Is total length of "work triangle" between sink, range and refrigerator between 12 feet and 20 feet?.....
(Under 12 feet or over 20 feet poor. Traffic should not cross triangle.)
32. Are laundry facilities adequate?.....
33. Is service entrance handy to kitchen, laundry, garage?.....
34. Is bathroom well designed?.....
(Score 0 if tub is under window)
35. Are walls around tub and shower of tile?
36. Are there shutoff valves at each fixture in bathroom?.....
37. Is the number of bedrooms adequate and are they large enough?.....
38. Do all bedrooms have cross-ventilation?
39. Are closets big enough?.....
(Minimum 36 inches per person and 22 to 24 inches deep)
40. Is total floor area of all closets adequate?.....
(Over 60 square feet is good, under 40 poor)
41. Is there adequate storage space for trunks, boxes, sleds, screens, lawn mower and garden tools, summer furniture, bicycles, etc.?.....
(Over 50 square feet for general storage is good, under 30 square feet poor)
42. Is garage or carport big enough?.....
(Minimum 10 feet by 20 feet for one car)
43. Is water heater of proper size?.....
(Minimum 30 gal.; 3-bedroom house with 1½ baths, 40 gal.; 2 baths, 50 gal.)
44. Is there a light switch at entrance to every room?.....
45. Are electric circuits sufficient in number?.....
(Count fuse plugs or toggle switches in box—6 or more good, 4 or less poor)
46. Are there enough light receptacles on walls?.....
(Minimum, one double receptacle on each wall 3 feet long or more; two on each wall 15 feet long or more)
47. If there is a basement, is it dry?.....
(The neighbors will know)
48. Are the heating and cooling systems adequate in size and efficient in performance?.....
(If you are not an expert, get one.)
49. Is the sewer or septic tank satisfactory?.....
(Check with health department.)
50. Was the house designed by a good architect and constructed by a reputable builder?.....

TOTAL

(Adapted from material supplied by Southwest Research Institute, San Antonio, Tex., and Small Homes Council, University of Illinois)

NEW CEILINGS FROM OLD WITH

**PRE-PASTED
PLASTIC
TILE**

HOME SECTION

Wet the back, press in place and the cracked-ceiling problem is taken care of for good. New bamboo-texture tile conceals cracks, requires no special tools, adds smart modern look

Alternating direction of tile texture produces smart-looking basket-weave pattern when tiling is completed

MOST EVERY HOME has cracked plastered ceilings, whether minor or otherwise. Filling and repainting last but a few months, then the cracks reappear. Homeowners who have been faced with this periodic job will be interested in a flexible plastic tile that makes quick work of adding a new face to a bad-looking ceiling.

The tile are applied like floor tile but come with the backs already coated with adhesive which is activated simply by wetting with water. Available in nine different colors, the tile have a deep-textured appearance of bamboo wood and when laid at right angles to each other, they form an attractive basket-weave pattern. Each tile measures 8 x 8 in., is approximately $\frac{1}{16}$ in. thick and cuts like cardboard with either ordinary scissors or a photo trimmer. Being



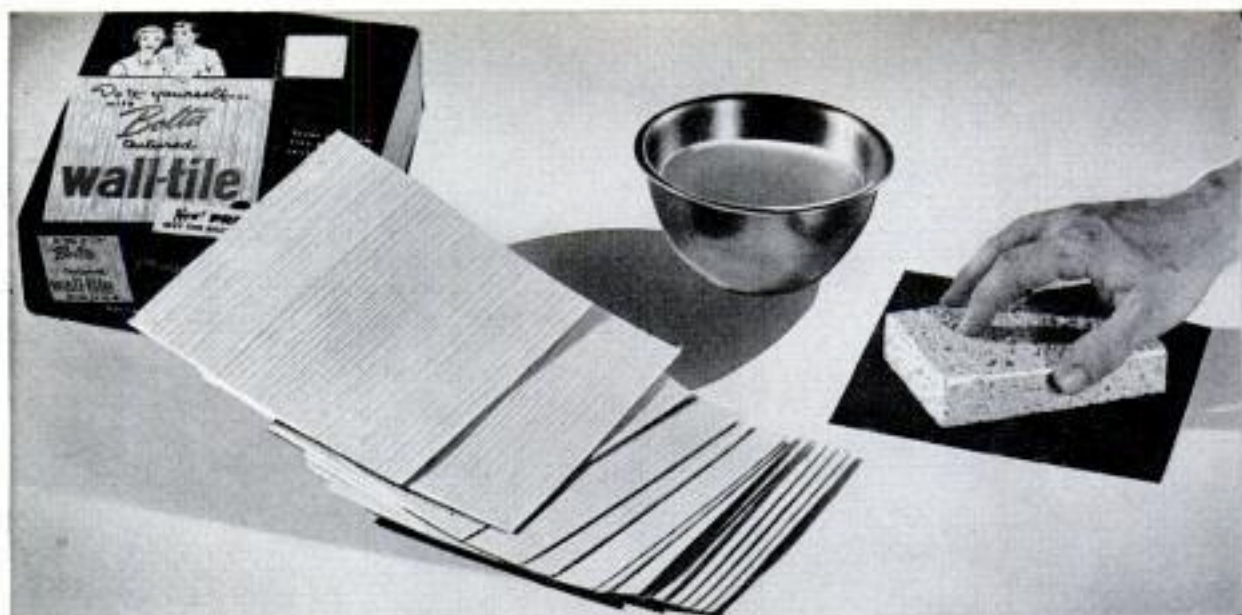

Adhesive on back of tile is activated with water. A few strokes with wet sponge make adhesive sticky



Above, cardboardlike tile is easily cut with regular scissors, cutting through from rear side. Below, paste filler, same color as tile, is used to fill any tile joints that might not be tight-fitting



of plastic, the tile is readily cleaned with soap and water, saving decorating costs.

Your first step is to divide the ceiling into four equal parts as shown below. Wetting the tile is done best with a sponge; it doesn't take much water to make the tile sticky. In applying the starting tile make sure it is placed squarely with the center lines and in contact with the surface at all points. Watch to see that each succeeding tile is placed at right angles to the adjacent one and tight against it. A wallpaper seam roller is ideal for rolling down the joints. A special matching paste filler is furnished for filling any open joints. This is pressed in with the finger and the excess rubbed off with a cloth. Adhesive smudges on the tile surface can be easily wiped off with a damp cloth as you go along. Tile also may be applied to cracked walls. ★ ★ ★

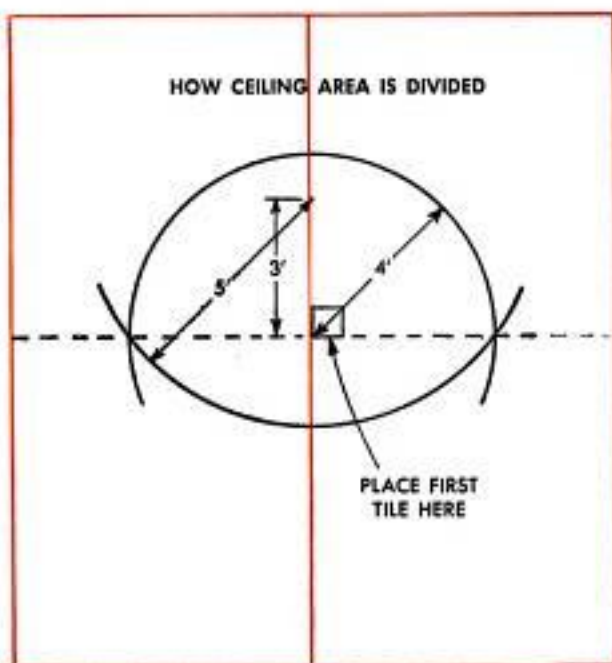



This attractive home was designed especially for *PM* families by Rudard A. Jones, A.I.A., Small Homes Council, University of Illinois. He has won national acclaim for space studies on houses

Introducing The *PM* Young-Family House

By Wayne Whittaker

THERE'S A LOT OF EXCITEMENT and originality in this new split-level home designed for *PM* readers with a young family. Interesting features include a lower-level playroom within sight of a ground-level kitchen, an outdoor living area with fireplace and terrace, a private-entrance courtyard and—of course—a cheery workshop for the male members of the family.

The ideal way to design a home for any family is to make a careful study of the family's way of life. This results in a custom-built house tailored to needs and

pocketbooks, usually a compromise between dreams and cash on hand.

One thought, however, is uppermost in the minds of the young father or mother planning a house. Whom is the house for? The answer is almost universal:

"The children!"

The Small Homes Council at the University of Illinois has made space studies for a number of years with real families living in "laboratory" homes. So the Editorial Staff of *Popular Mechanics* asked Rudard A. Jones, assistant director of the council,

Blueprints for this house are available for \$12.50. Write: Plans Dept., *Popular Mechanics Magazine*, 200 East Ontario Street, Chicago 11

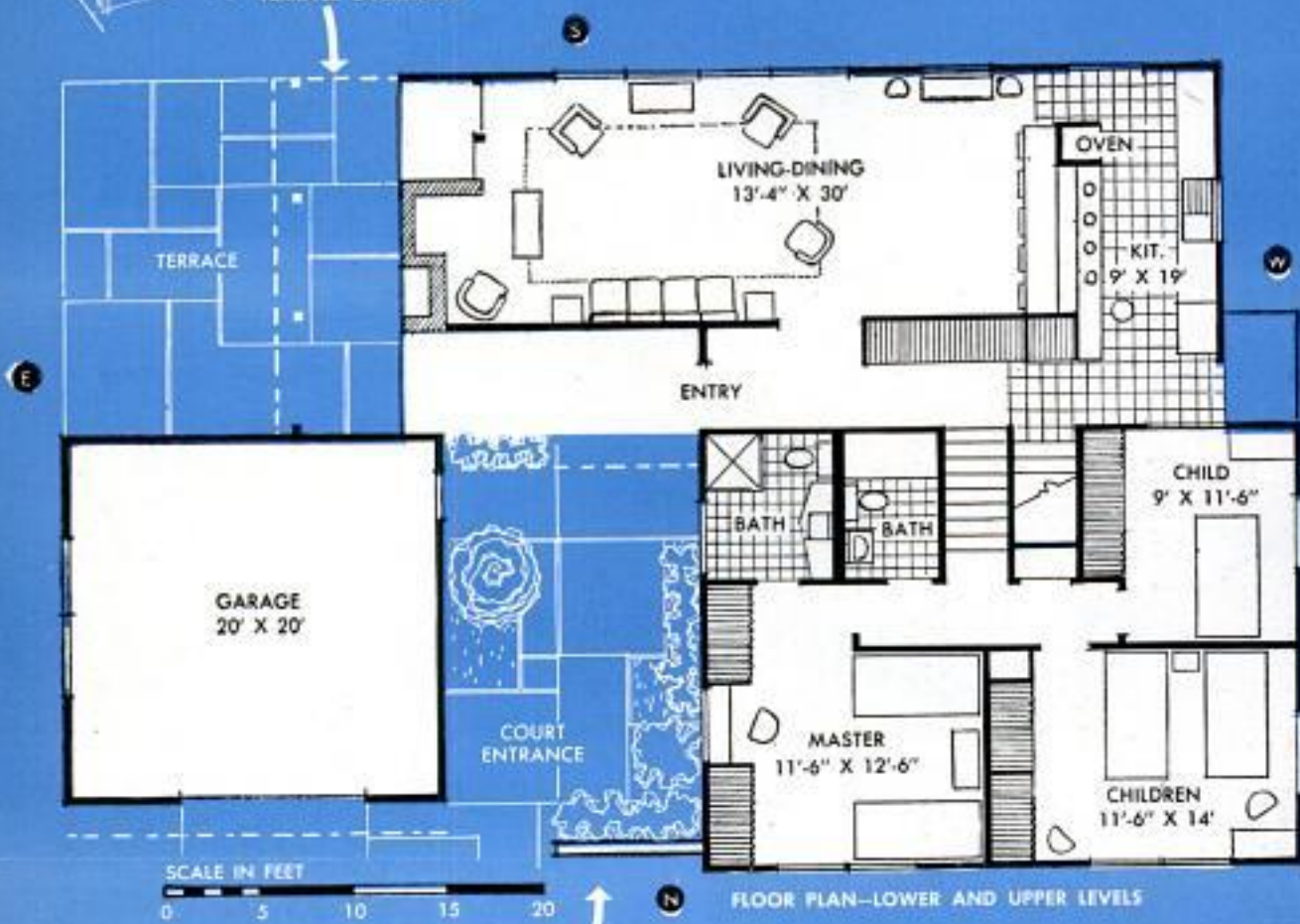

to design a home for the typical young PM family. This family consists of a father and mother in their early thirties, a daughter of nine and sons of six and two.

Introducing our readers to the family for whom this home was designed will be, in thousands of cases, like saying, "I want you to meet yourself." The family's life is centered in and around the home. They own a car, a dog and a TV set. They have no servants and they are proud of the fact that their house was designed for easy maintenance. Almost all of their entertaining, both for adults and children, is done in the home. Except for the children's school, the coming and going is 99 percent by the family car. Most of their meals are eaten in the kitchen area, but they don't like to feed their friends there. When the weather permits they prefer to live out-of-doors as much as possible. They consider three bedrooms and two bathrooms a necessity in their home.

The outside of the house presents an interesting silhouette of part flat and part gable roof. Exterior materials of horizon-

tal wood siding, panels of asbestos board and concrete block create a harmonious effect. The home has an intriguing entrance through a court partly shielded from the street by a wing wall that extends across the front of the house. This house lends itself to a variety of color treatments. The one selected by the architect consists of a white roof, charcoal siding, pearl gray on the trim and concrete block across the front, and a wall of deep red behind the entrance courtyard.

The house provides 1364 square feet of living area and has a living-dining space 30 feet long and 13 feet 4 inches wide.

To keep everybody in the family happy, Jones chose the split-level type of home.

"We settled on the split-level because this house makes it possible to take the greatest advantage of all available space," he explains. "In the conventional house, much of the basement area is wasted as far as living space is concerned. This area in our split-level house is only two feet below grade. It is light, cheerful and well ventilated—a perfect place for workshop,

Lower-level playroom is visible from kitchen through baluster-type open space on one side of hallway



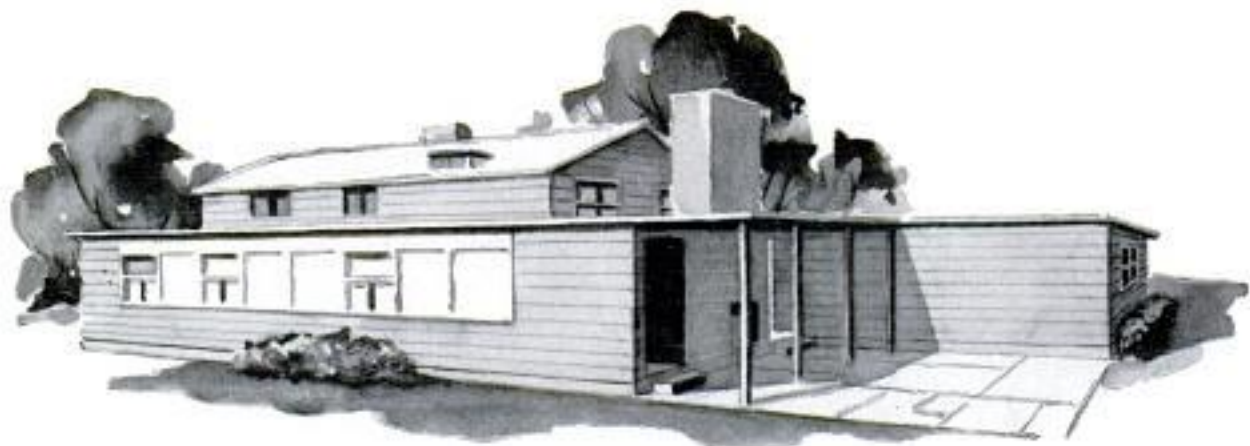

Rear view shows outdoor living area with fireplace, also flat-roofed kitchen, dining and living-room area

playroom and the laundry. I consider the placement of the playroom in relation to the kitchen one of the outstanding features."

From her work area in the kitchen, the mother can look directly across the hall space and through an open-banister effect right down into the playroom. Thus, she can keep an eye on the children while at work and they can see her. This eliminates one of the greatest banes of the young mother — keeping the children out from underfoot and providing them a cheerful place for play activity without messing up the living room or dining area. If the family feels a need to hide the playroom from the eyes of visitors, an attractive bamboo curtain or screen can be closed in front of the opening.

The playroom is handy to a service entrance and no small muddy shoes have to track through any room of the house to reach it. Adjoining the playroom are dad's workshop, the laundry and space for a

small lavatory which may be added later.

Location of the sleeping rooms on the upper level gives a nice feeling of security. Features of this area include a bathroom especially for the children and a private bathroom for the parents opening from the master bedroom. All sleeping rooms have good cross-ventilation, adequate closet space and asphalt-tile floors for easy maintenance. The bedrooms are far removed from the living-dining-entertainment area.

The kitchen and dining area were designed with step-saving in mind. A bar for daily informal eating is located with a pass-through to the cooking range and food-preparation counter. Food can be served directly from range to plates. The pass-through is also handy when the dining-room table is pulled out and the family dines formally. Although not shown in the plans, a folding screen may be placed between the dining area and the living room

(Continued to page 296)

By substituting carport for garage, house can be built for considerably less money and on a smaller lot

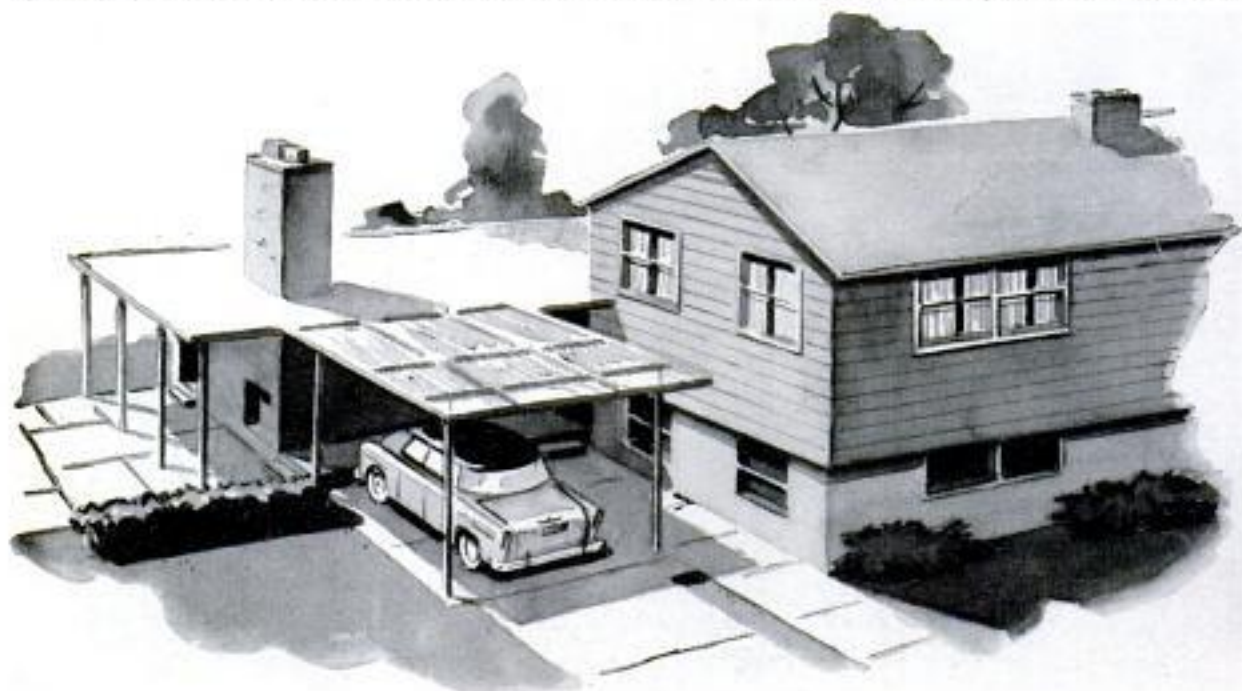



BEFORE



AFTER

ONE-MAN REMODELING JOBS

By W. Clyde Lamme

OFTEN IT TAKES only a simple change in architectural detail to bring a dated house right up to the day before tomorrow in appearance and livability inside and out. In some older structures you may wish to retain certain desirable characteristics of the old and add only a touch of new. Many older homes, especially those built within the last 50 years or so, are either square with a hip roof, or some variation of the common L-shape with gables and valleys in the roof design. Usually they are built full two-story with an attic and a dormer, or dormers, of unattractive detail and

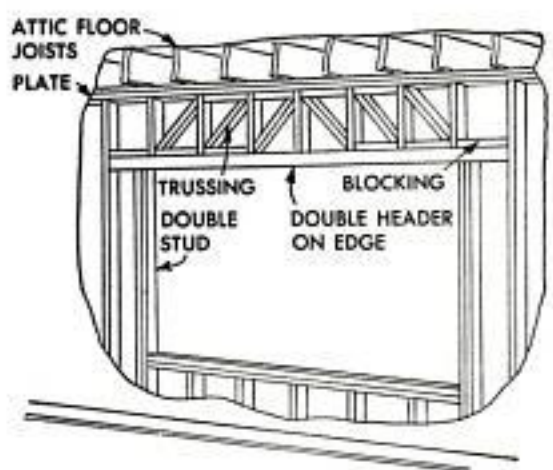

BEFORE



AFTER

doubtful utility. Some old homes — often more than a half century old—have very attractive boxed and molded cornices and front-corner trim of a distinctive design.

Typical examples of these types are shown in the upper and lower views on the preceding page. The home in the lower before-and-after views was "up dated" to the owner's satisfaction by painting the exterior in an attractive color combination and adding a room-width window to make the interior more livable and the exterior more attractive. The old square home in the before-and-after views at the top of the preceding page was face-lifted by removing the ponderous porch and adding three multipaned windows and a door framed in reeded columns and a broken pediment. No other part of the structure was altered, either inside or out. The change in appearance not only adds inestimably to the value of the property, but also lends something to pride of ownership as well.

These two are typical one-man remodeling jobs, that is, they can be handled by the owner himself, even when he has only a limited amount of spare time for the work. The nature of the procedure on either job is such that the entire project need not be completed in a day or a week. It can be worked out a window or a door at a time. When working alone on such projects as installing windows and doors, keep a waterproof tarpaulin handy so that you can cover the opening quickly should a sudden shower catch you with the job unfinished. The same precaution is carried out when it is necessary to remove or alter a dormer and reroof the opening.

Before you cut large openings in walls, especially in full two-story structures, it is necessary to plan the installation of a suitable header to support the weight above the opening. Framing in a large window is an example and the detail on the preceding page shows one recommended method. It is used when framing in a large sash in either a one-story or two-story structure, unless the building is balloon-framed, as were many of the older two-story homes. In this type of framing the studs extend from the sill, or sole, as the case may be, to the rafter plate at the second story. Then it's the usual practice to cut the studs over the opening and support the ends on a header built up by spiking two 2 x 10s together and then placing edgewise. The ends of the header are carried across to full-length studs beyond the limits of the rough opening. Truss bracing like that detailed is not ordinarily installed.

Small one-story homes generally lend themselves to modernizing by simple exterior changes. The one pictured before and after at the top of this and the opposite



BEFORE

This home is typical of many built 50 or more years ago. Enclosed porch is probably a later addition



BEFORE

It would be hard to judge the age of this house, but it has been around a long time. Below, this small home of later type lends itself to simple remodeling



BEFORE



AFTER

A new enclosed porch of modern design, new wide siding, attic louvers, a flower box and new plantings got this result — put the original structure in a new age group in value, appearance and in livability



AFTER

Above, note the before at the left and the after above. It's the same house, an outstanding example of what can be done with an old structure in good condition.

Below, the "picture window" replacement not only "upgrades" the exterior appearance of a small house, it also gives a feeling of greater space in the interior

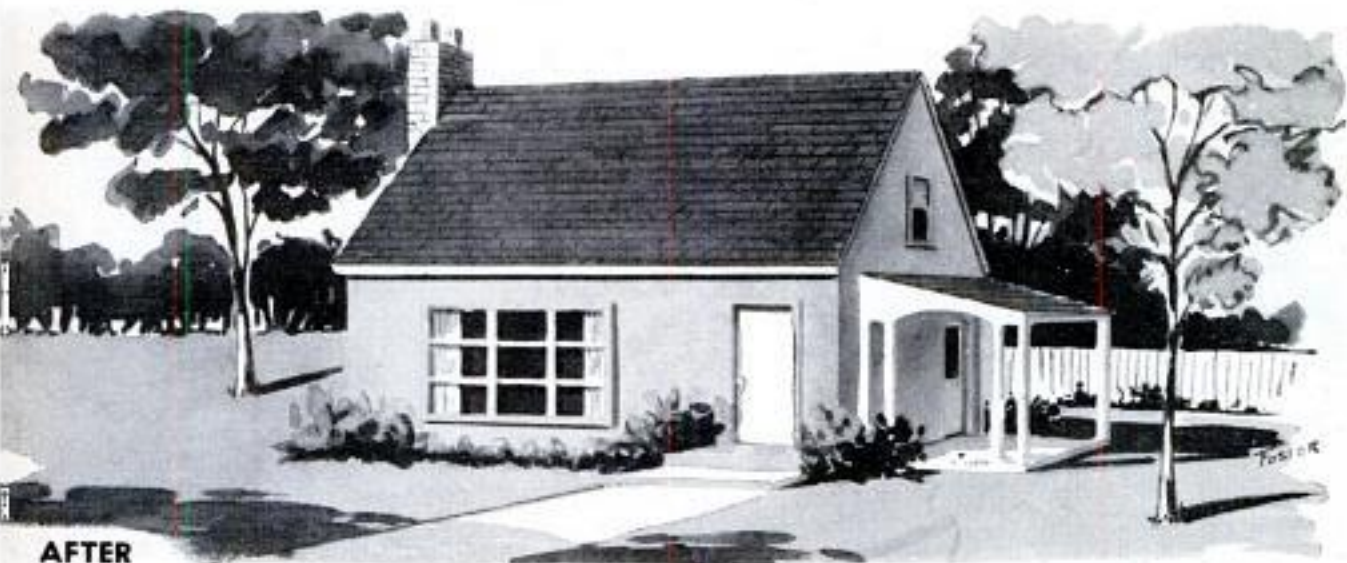

AFTER



Sometimes a window is unattractive because of its proportions or location. Here's an example of what novel ornamental shutters will do for such a defect



When nothing else seems suitable, a stone planter usually will do the trick. It's easy to build and even when there's nothing growing in it, it's still attractive



Above, a fence is hardly a remodeling job in itself, but it may supplement the work nicely. Below, same thing is true of yard divider. It has a number of practical uses, depending on location and purpose

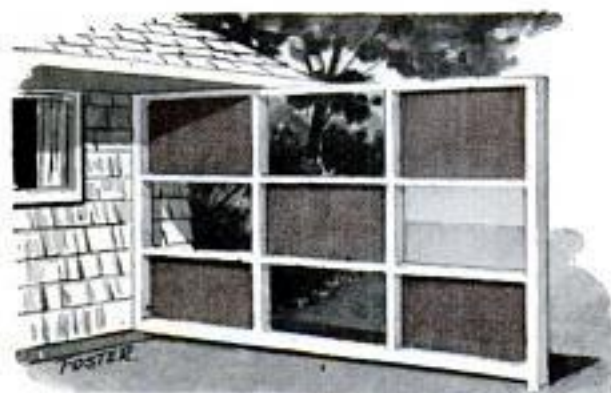

160

page is a good example of what can be done. Note especially the change in appearance alone made by wide siding and the rebuilding of the existing porch. In this case it was found advisable to remove the imitation brick exterior, make a few minor repairs and add attic louvers before rebuilding the enclosed porch and finishing the job with wide siding. The only major structural change in this job is the porch, which was rebuilt completely in order to achieve the desired harmony of line and exterior detail.

The larger home pictured in before-and-after views in the center illustrations on the preceding pages is something special. At first sight it looks like an undertaking beyond the capacity of one man to carry out even though he might be skilled in the work. But look at the illustrations a little more closely and you will see that the only major changes are the building of an attached two-car garage and the half porch which replaces the original and is a continuation of the garage roof line. The dormer was removed to straighten the roof line of the main structure. The owner replaced the original window sash on the second story and added two new windows downstairs. Then he added new siding and ornamental shutters, removed one chimney and rebuilt the other. In this case the question to be decided is not so much whether one man can handle the job, but whether he has sufficient time to devote to it. With one man making all the moves necessary to carry out such a project it's going to be a long time between start and finish. A lot of time can be saved by subcontracting such jobs as pouring the garage floor and rebuilding the chimney. Hiring an architect to plan the job for you is money well spent. He can save you both time and effort, even on jobs less involved than the one in question. Savings realized by doing the work yourself will be considerable.

Often a small home of more recent type can be greatly improved in appearance and livability simply by changing a window or door or adding an open porch. The small home pictured in the before-and-after views at the bottom of the preceding pages is an example. The "picture" window gives a feeling of greater space in the living room and at the same time has the effect of lengthening the structure. The porch can be anything desired, open like that shown, a carport, or enclosed with screen or glass.

In addition to remodeling the structure itself, there are other architectural details, or "applique," which can be included as a part of the job, or independent of it. The sketches on this page suggest four such applications. In these details placement determines beauty and utility. ★★★

POPULAR MECHANICS

PARADE OF HOMES

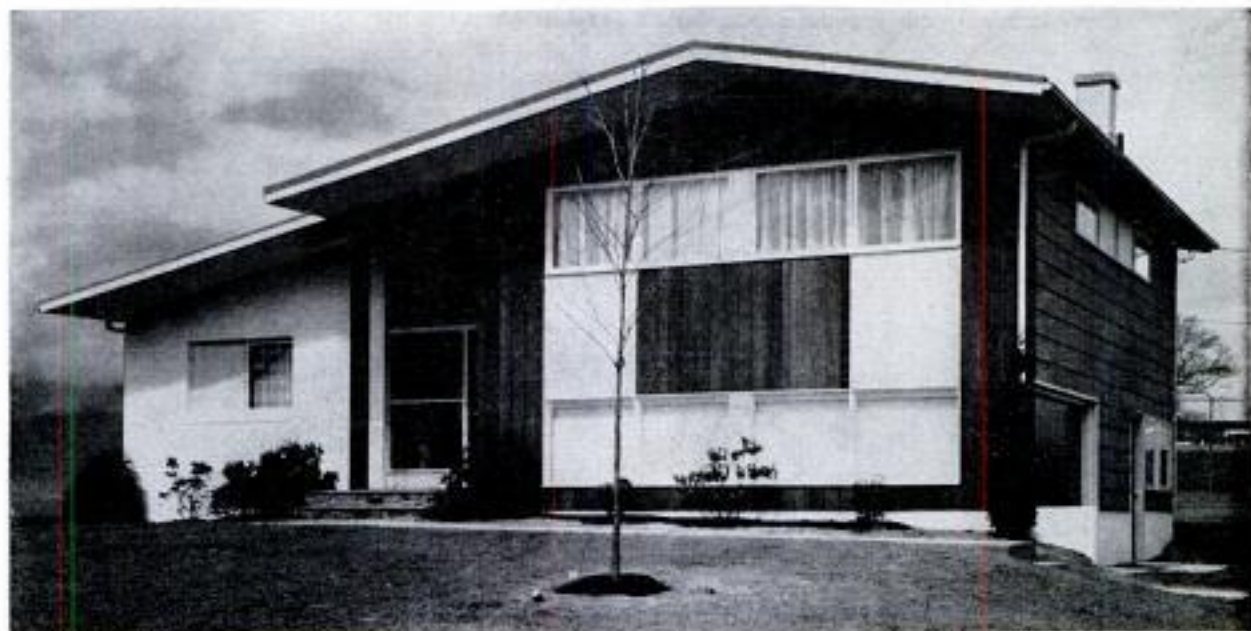

This split-level home was built in Wayne, Pa., by Madway Engineers and Constructors. It was designed by Theodore Bradow. Exterior materials are brick, Philippine mahogany, plywood and asbestos panels. Home provides large storage area



Three bedrooms, 2½ baths
 Floor area—1685 square feet
 Cost—\$18,500 (including lot)

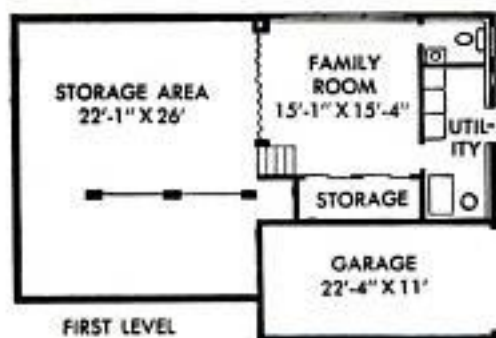

ON THESE PAGES *Popular Mechanics* pays tribute to the combined genius of architects and builders that has made Americans the best-housed people in the world. The eight new homes pictured here were selected from hundreds of medium-cost homes and, in our opinion, represent the best in contemporary design, good construction and economy. Two are split-level homes, five have one story and one is a two-story house with part of the first floor below ground level. We salute the planners and builders.

Three bedrooms, 2½ baths
 Floor area—1425 square feet
 Cost—\$20,000 (including lot)

Architect Rudolph A. Matern designed this split level which was built on Long Island by Morton Brothers. Price includes built-in oven and range. Exterior is brick and wood siding. Living room has beamed studio ceiling, window wall and decorative open stairway to bedroom level. Basement area provides additional 499 square feet. Two-car garage on front is convenient for family coming and going

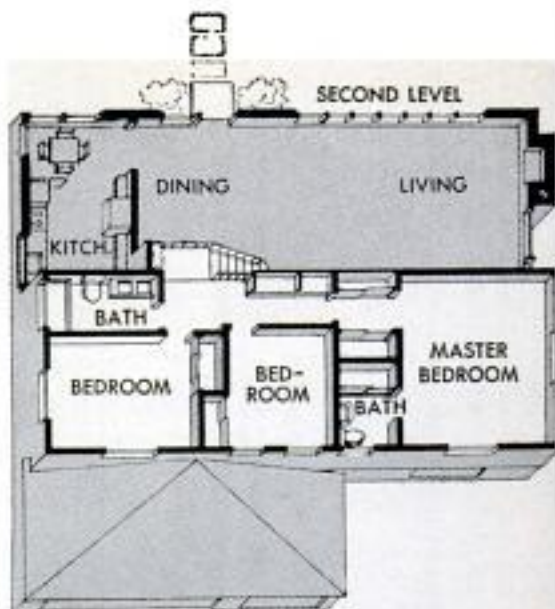

Three bedrooms, two baths
 Floor area—1800 square feet
 Cost—\$18,900 (not including lot)

Planned for low-cost construction, this rectangular house was designed by Edward H. Fickett and built by G.M.B. Corp. in Los Angeles County. Exterior materials are brick, stucco and redwood with a built-up type roof of colored rock. Foundation is concrete slab and construction is post and beam. Unique skylight area separates bedrooms from living space. House plan is available in six variations



Three or four bedrooms, 1½ baths
 Floor area—2000 square feet
 Cost—\$23,950 (including lot)

This prefabricated Techbuilt house is built around a core containing the utilities and immovable fixtures such as stairs, chimney, fireplace and bathrooms. It was designed by Carl Koch, Techbuilt, Inc., of Cambridge, Mass., and built by Mayer-Raisher Bros., Inc., in St. Louis. Cost of the house has varied in different parts of the country. Roof, walls and floor are formed of Techbuilt panels. For exterior, Mayer-Raisher used brick veneer and horizontal wood siding. The non-load-bearing interior partitions can be shifted for numerous floor plans to accommodate growing families



HOME SECTION

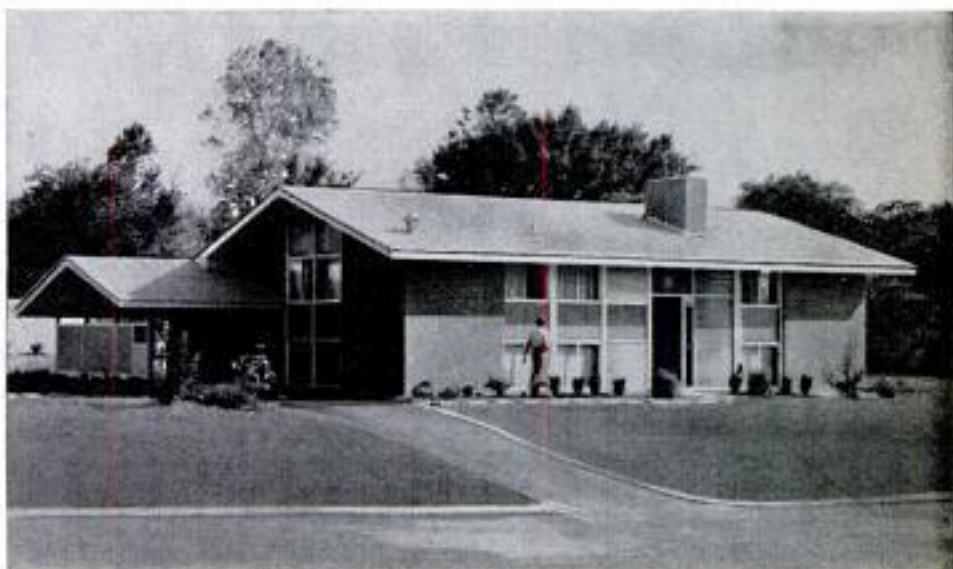
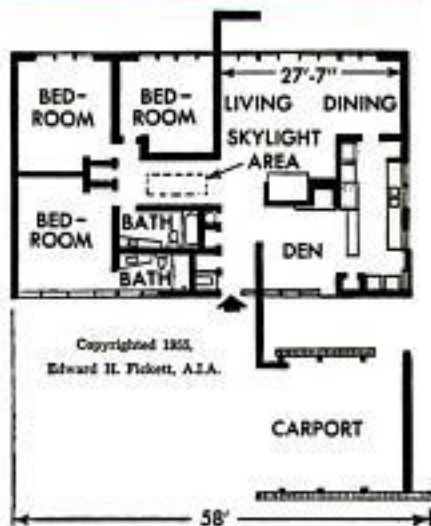

OCTOBER 1955

163

Three bedrooms, two baths
 Floor area—1466 square feet
 Cost—\$17,000 (not including lot)

Designed and built by the Crawford Corporation, Baton Rouge, La., this prefabricated house features a living area oriented toward the rear. A sectional glass wall in living room overlooks garden. Exterior is brick veneer and cedar shakes with a marble-chip roof. This low-pitched roof has a 42-inch overhang. Photo on this page shows rear view of home built in Louisville

Kara Steiler photos



Three bedrooms, 1½ baths
 Floor area—1500 square feet
 Cost—\$16,500 (including lot)

Place Homes, Inc., South Bend, Ind., calls this the "Gradement Home" because space equivalent to basement is brought up to grade in unfinished wing. This area can be finished as playroom and workshop, den, family room or for extra bedrooms. Foundation is concrete slab and exterior is vertical wood siding except for gables. The architect for this precut home is William H. Weist

Photo by Hube Henry, Hedrich-Blessing



Two bedrooms, one bath
 Floor area—1240 square feet
 Cost—\$17,000 (not including lot)

This farmhouse was designed for expansion to three to five bedrooms by the University of Illinois College of Agriculture in a housing-research program with other colleges. The plan has many variations including with and without basement. Between garage and kitchen is a workroom, or farm office, which is a feature of the house. Big windows and panels add interest to exterior



Three bedrooms, 1 bath
 Floor area—1250 square feet
 Cost—\$17,500 (not including lot)

Open-plan interior and glass walls at rear give a feeling of spaciousness to this home designed by The Architects Collaborative and built in Lexington, Mass., by the Moore Construction Company. Exterior is redwood vertical siding; foundation, concrete slab. Living-room floor is cork and house is radiant-heated. Roof is shed-type and beams extend through glass walls



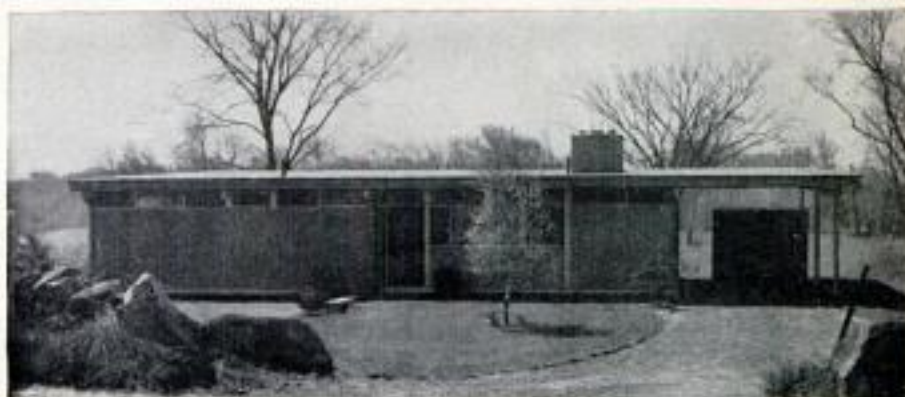
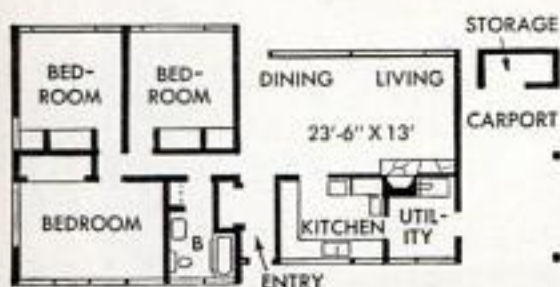
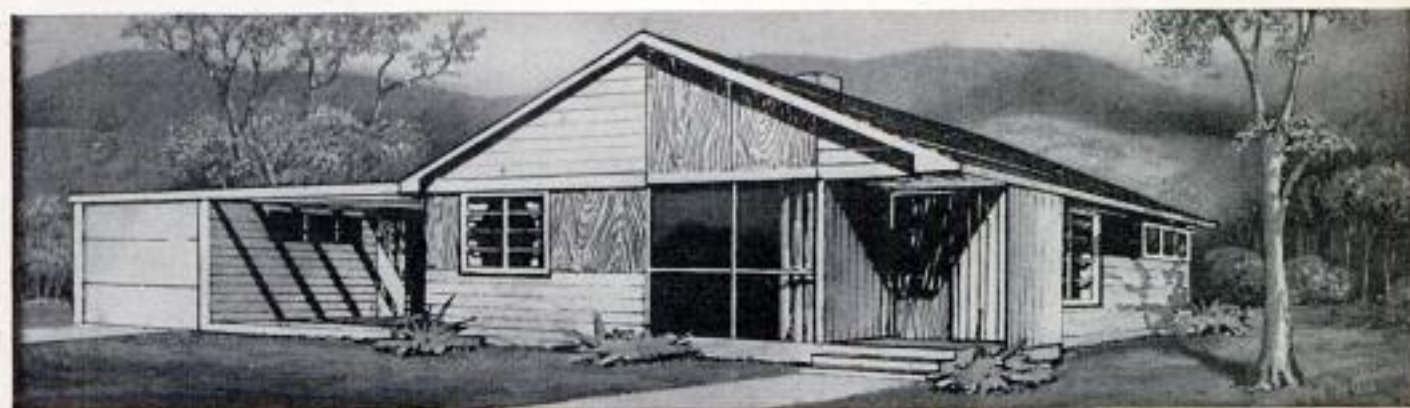

READY- *for the* DO-IT-

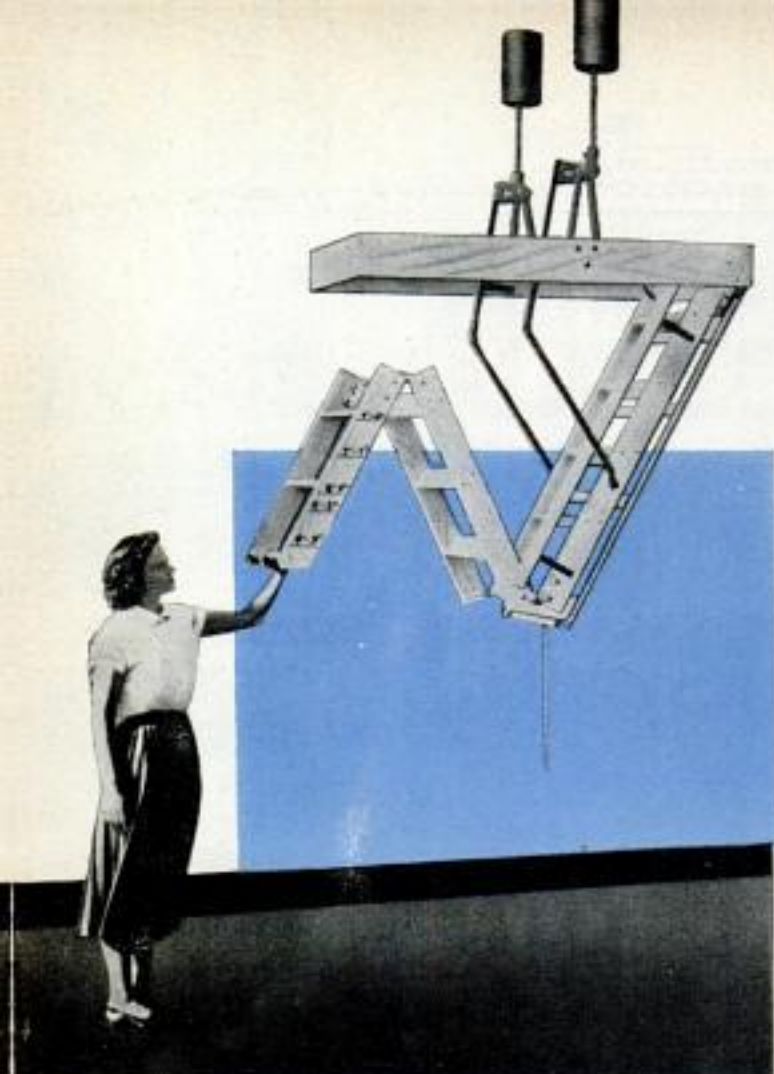

DISAPPEARING STAIRWAY with hydraulic checks is easy to install and saves building attic stairs. The frame fits 26 by 54-inch ceiling openings and is available in two new models to suit varied heights
Proclaton Parts Corp., 400 N. First St., Nashville 7, Tenn.

PLASTIC GARAGE DOOR (below at right) admits light to garage through translucent panels. It can be raised to serve as an attractive awning. Doors are made in many colors and never require painting
Tilt-A-Door Corp., 3800 E. Outer Drive, Detroit 34, Mich.

PRECAST SHOWER FLOOR floats on the subfloor and will not crack as the building settles. All you have to do is cut a hole in the subfloor for the drain connection, slide unit into place and calk around drain
Flat Metal Mfg. Co., 9801 Belmont Ave., Franklin Park, Ill.

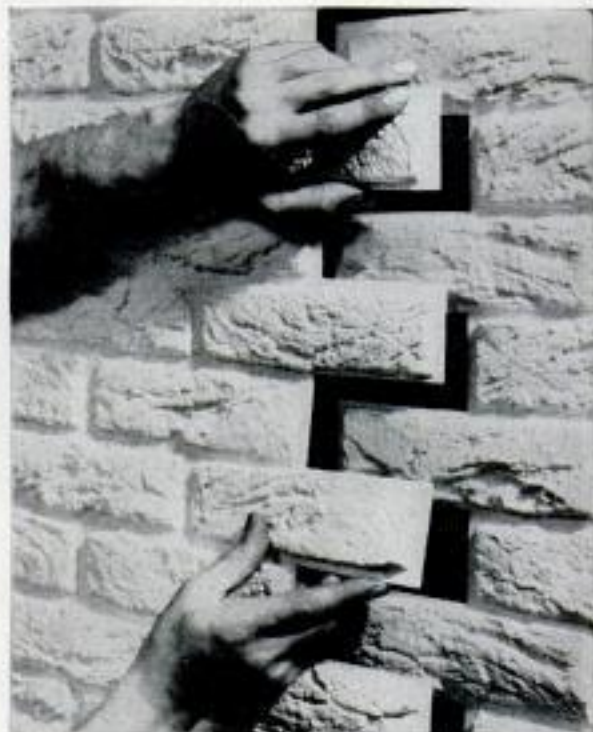

PLASTIC WALL COVERING reproduces the texture and color of brick or stone. Molded in two by four-foot sheets, it is easy to install with an adhesive applied to back of mortar lines. Precut half bricks snap out for interlocking. Scissors will cut sheets
National Vacuum Molding Corp., 929 Old Nepperhan Ave., Yonkers, N. Y.

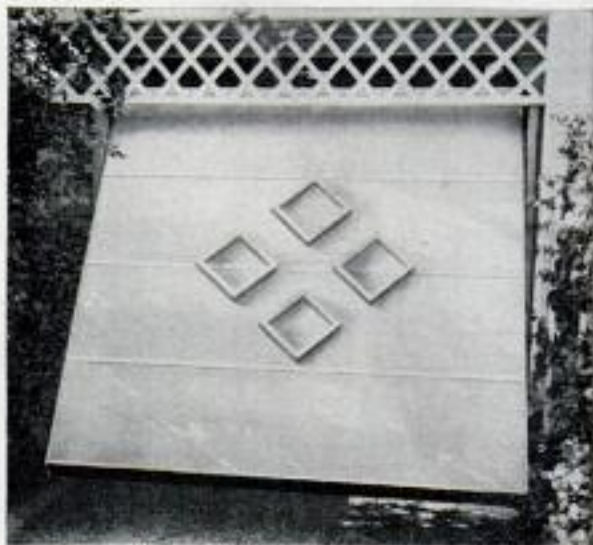

MADE AIDS

YOURSELF BUILDERS



CARPETING IS LAMINATED to an underlay of foam latex and hardboard and supplied in four-foot squares that are laid like tile. Seams do not show
Luxor Products Co., 360 S. Maple St., Akron 2, Ohio



PREFABRICATED FIREPLACE can be installed in six hours with simple tools. It is made of steel with stainless-steel trim and has sturdy ceramic firebox
Uni-Bilt Div., Vega Industries, Inc., Syracuse 5, N. Y.



NO-PUTTY WINDOW has a new-type clip centered at the bottom of each pane and two on each side. A tight joint is maintained between glass and sash with felt gasketing. Requires no special skill to install
The Donley Brothers Co., Miles Ave., Cleveland 5, Ohio

STORM-SCREEN DOOR features a compartment inside the kickplate for storage of screen or storm panels. This door, called the Kangaroo, saves time and effort at seasonal change-over, also storage
The Weather-Proof Co., Cleveland, Ohio

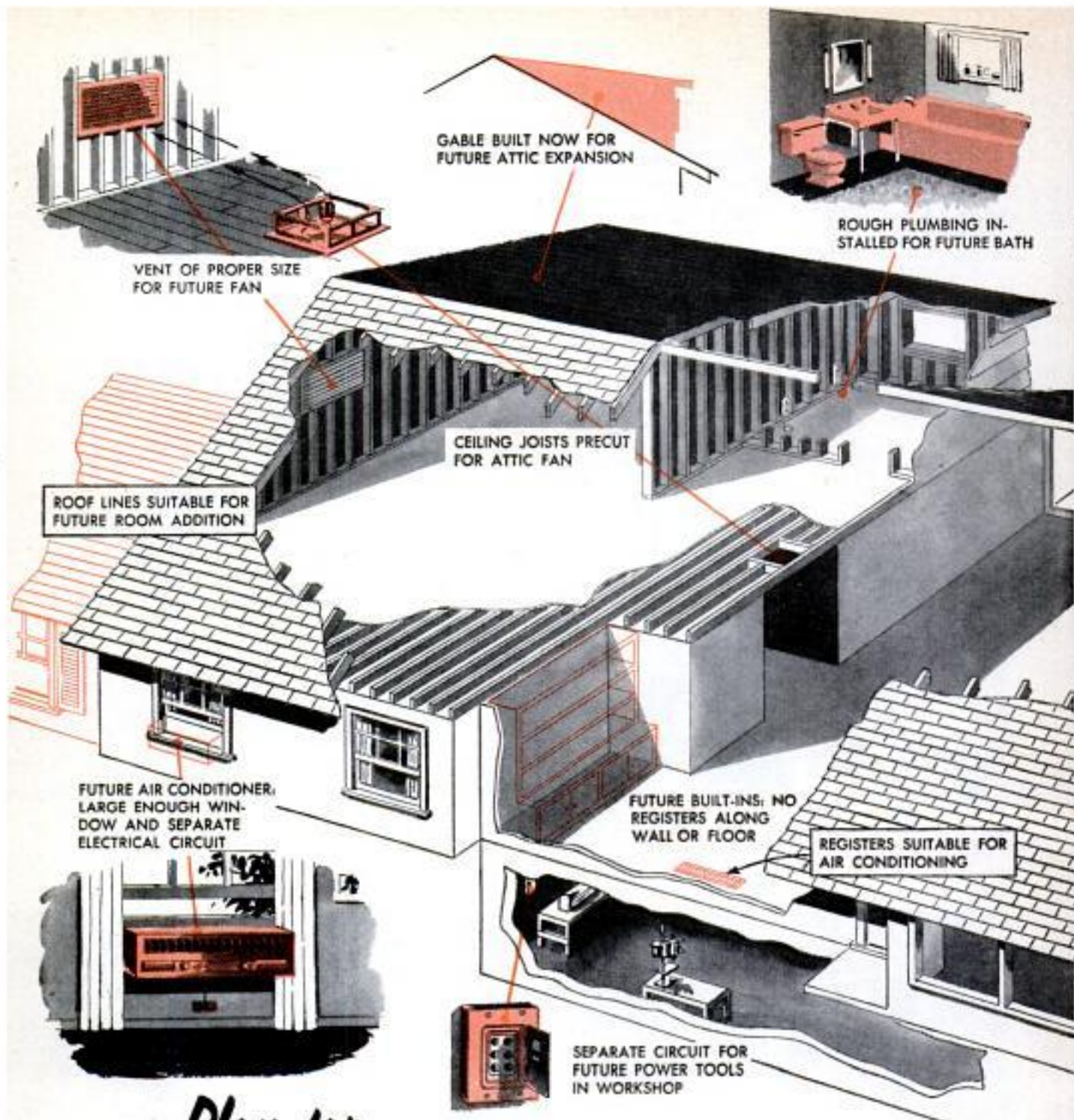

Plan for **FUTURE IMPROVEMENTS** *as You Build*

ELIMINATE THIS, do without that, cut every corner. This is the discouraging experience you likely will undergo when you build a new home. There are just not enough dollars in the nest egg to pay for everything you want. But you can plan for future improvements as you build. For example, if you hope to have a dishwasher eventually, plan the kitchen cabinets so

the dishwasher will simply replace one of the cabinet sections. Planning some built-ins in certain areas? Be sure there are no heat outlets, cold-air returns or electrical outlets in those spots. The house shown above has features taken from several different types of homes. Use the drawing as a check list in planning for the future—now. ★★★

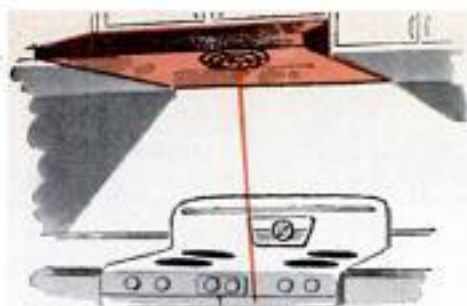

DUCT SPACE AND ELECTRICAL OUTLET FOR FUTURE KITCHEN VENTILATING FAN



CABINETS DESIGNED FOR EASY CONVERSION TO BUILT-IN RANGE AND OVEN

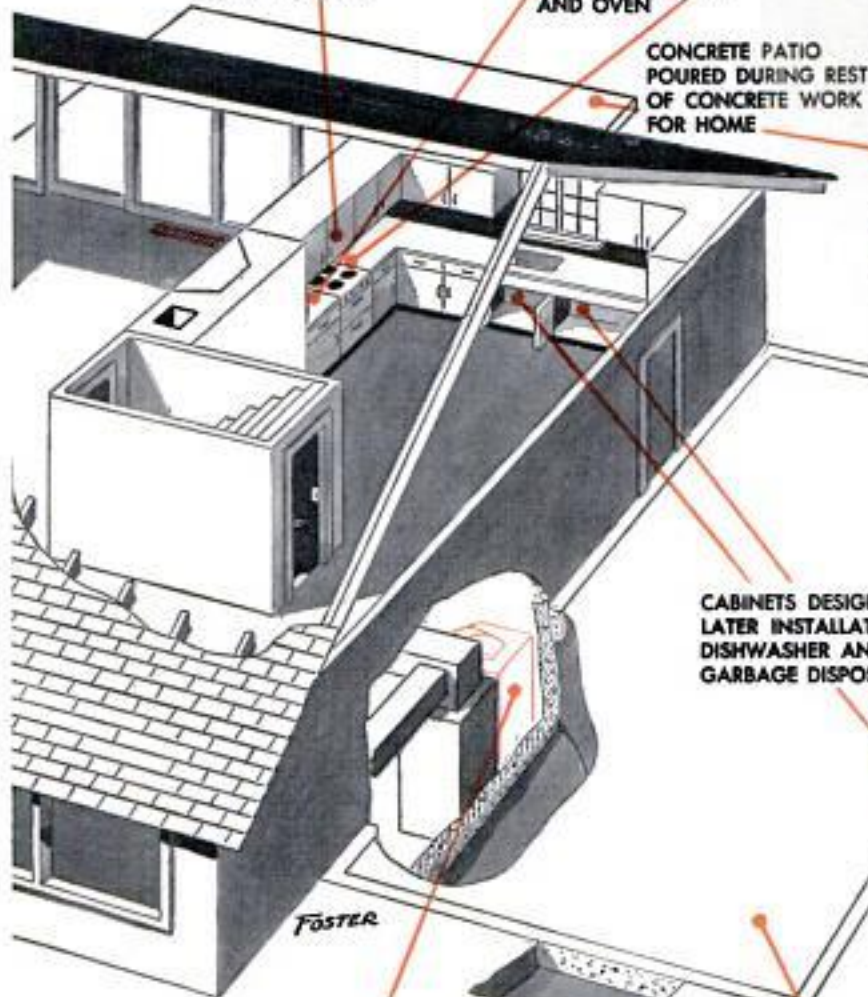

CONCRETE PATIO POURED DURING REST OF CONCRETE WORK FOR HOME



CABINETS DESIGNED FOR LATER INSTALLATION OF DISHWASHER AND GARBAGE DISPOSER

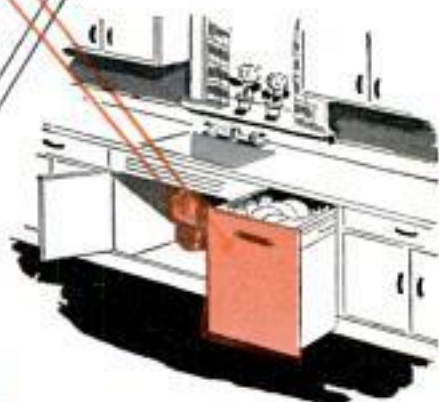

SPACE LEFT FOR AIR CONDITIONER BESIDE FURNACE



FOOTINGS AND SLAB POURED FOR GARAGE



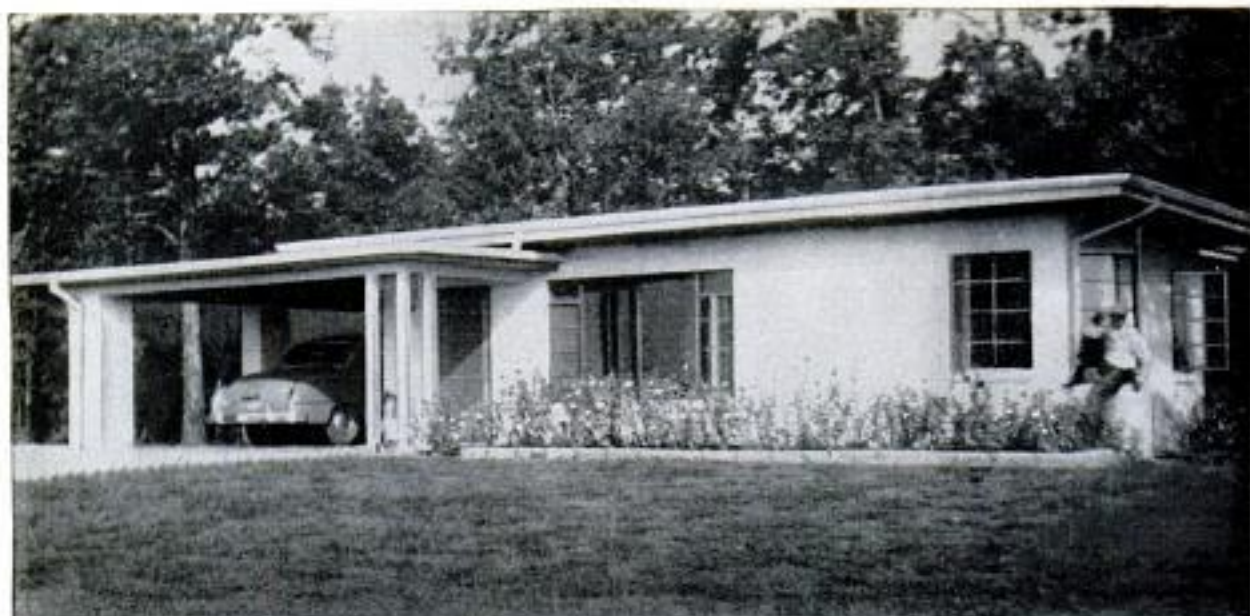

This three-room concrete-block house was designed for two things—spacious interior effect and economy

Retirement House Has no Bedrooms

WE WANT A SMALL HOUSE with lots of elbow room," a retired couple of Laredo, Tex., told Paul T. Haagen, well-known Chicago architect. He designed them a house with only 1075 square feet of floor area and with a living room 16 by 31 feet. The other two rooms, both good sized, are the combination bathroom and dressing room and the kitchen. Each room does double or triple duty. Attractive corner couches in one corner of the living room convert to beds at night and a folding partition provides privacy. Clothes closet, dresser and other bedroom paraphernalia are housed in the big bathroom. The kitch-

en also serves as dining room and utility room with its washing machine and drier. A small closet at one end of the carport houses the heating unit. The house was built of concrete blocks at a cost of \$10,000, entirely contracted. The interior walls were merely painted, but in most climates they would have to be furred and plastered or finished with wallboard. Variations of this basic plan include a gable instead of a flat roof, a basement with stairs going down from the closet marked "heat," an enclosed garage instead of the carport and the addition of a bedroom (see plan). Frontage, with carport, is 49 feet 6 inches.

Another version of the same house shows different treatment of the windows; roof can be flat or gable

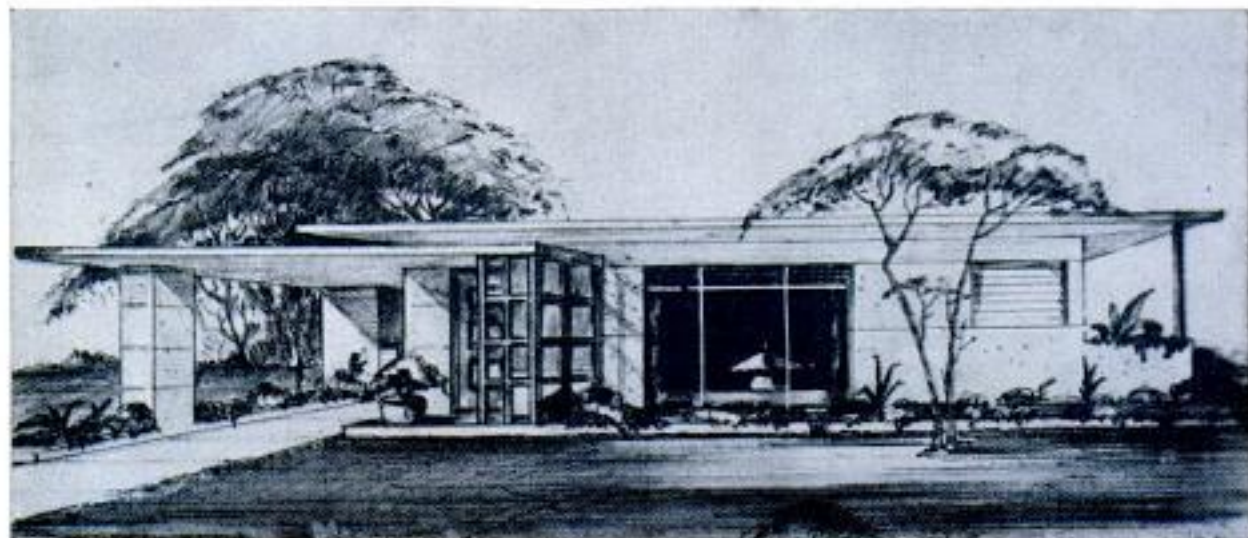



With couch beds and folding partition this end of the attractive living room becomes a bedroom at night

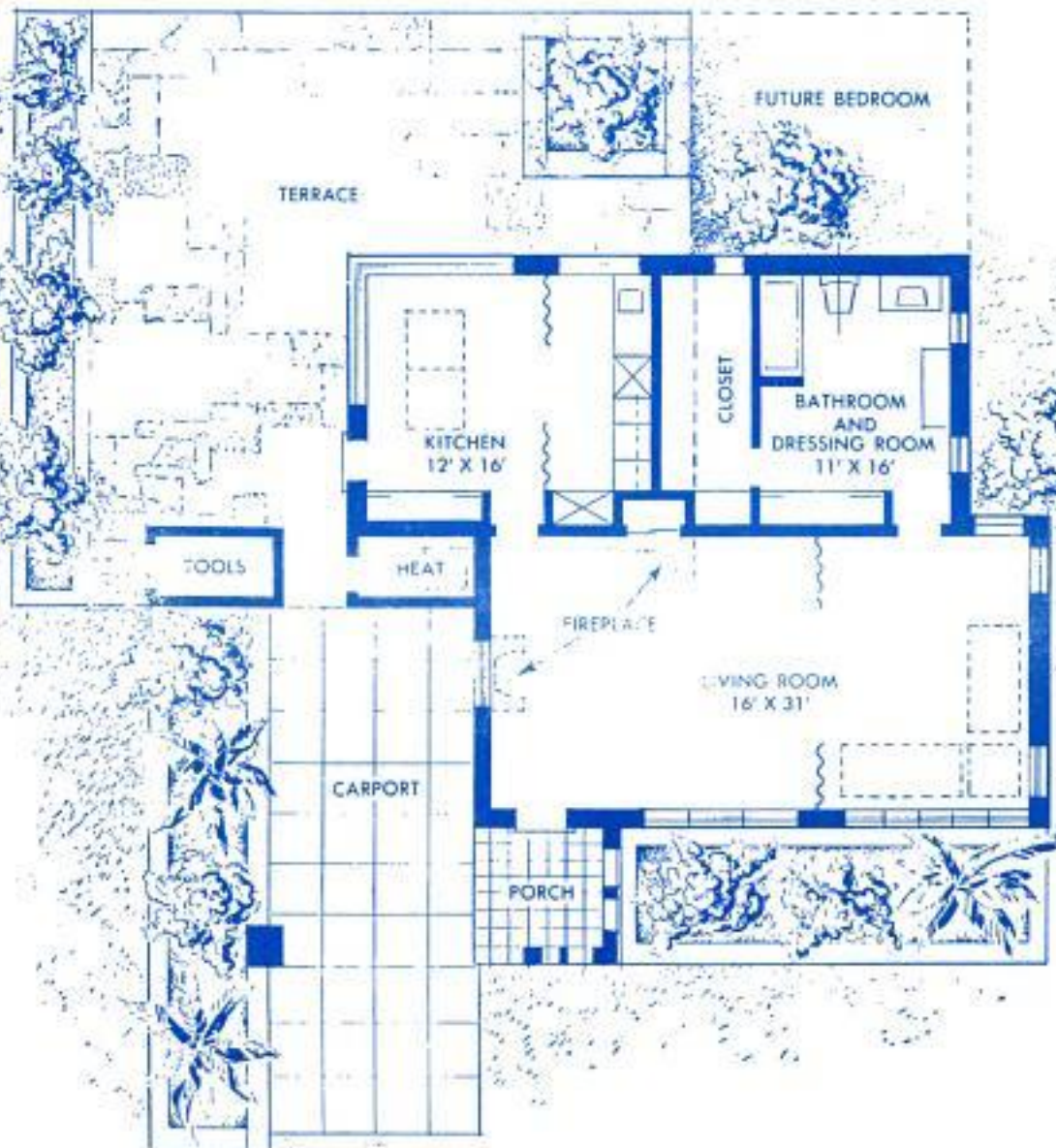

Shoe Rack on Closet Door Saves Time and Space

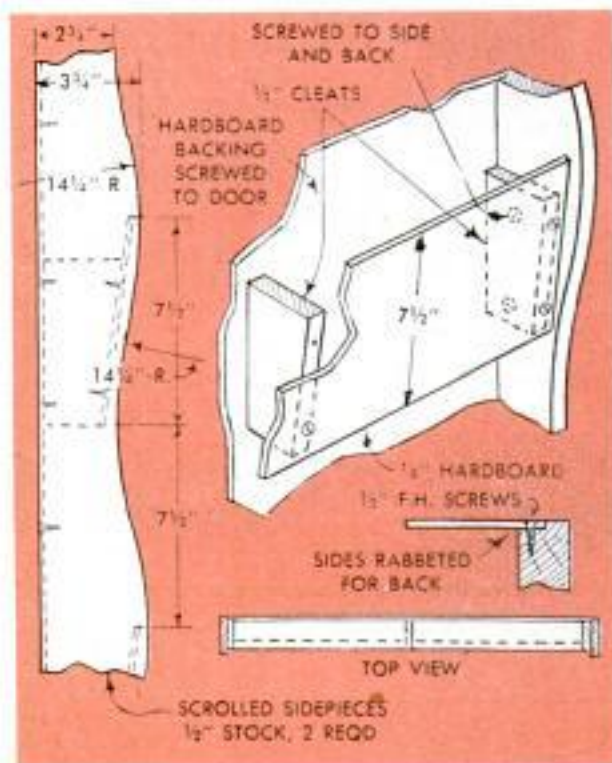

Attached to the back of a closet door, this specially designed shoe rack holds from 15 to 20 pairs of shoes in a minimum of space. It can be made half length if desired, or full length as pictured. The scrolled sides are cut from $\frac{1}{2}$ -in. stock, the back from $\frac{1}{4}$ -in. hardboard and the racks from $\frac{1}{8}$ -in. hardboard. The sidepieces are rabbeted to take the edges of the back panel, which is fastened with screws. Each rack is attached

to three cleats, two of which are screwfastened to the sidepieces and the third to the center of the back panel. The latter is installed with the smooth face to the front. When locating the cleats be sure that they are equally spaced. Sides and racks are finished to match the door by applying an undercoater and following with two coats of paint or enamel in the color required. Attach to the door with screws.

Graphite Applied to Inside of Lock With Toy Balloon



When the inside of a lock is to be lubricated with dry graphite, a more thorough job can be done with a toy balloon than with the usual applicator. Squirt a small

quantity of the graphite into the balloon and inflate it to about half its usual capacity. Hold the mouth of the balloon over the lock keyhole and gently tap the balloon with a finger while releasing the air. The graphite will be forced into the lock in a fine dust spray.

Vise Used as Wood Clamp

A machinist's vise can be used as an emergency clamp if the bench on which it is mounted is secured to a wall. Open the vise about halfway and place the work between the vise and the wall. Shim up with scrap wood and tighten the "clamp" by closing the vise.



W. H. McClay, Pasadena, Calif.

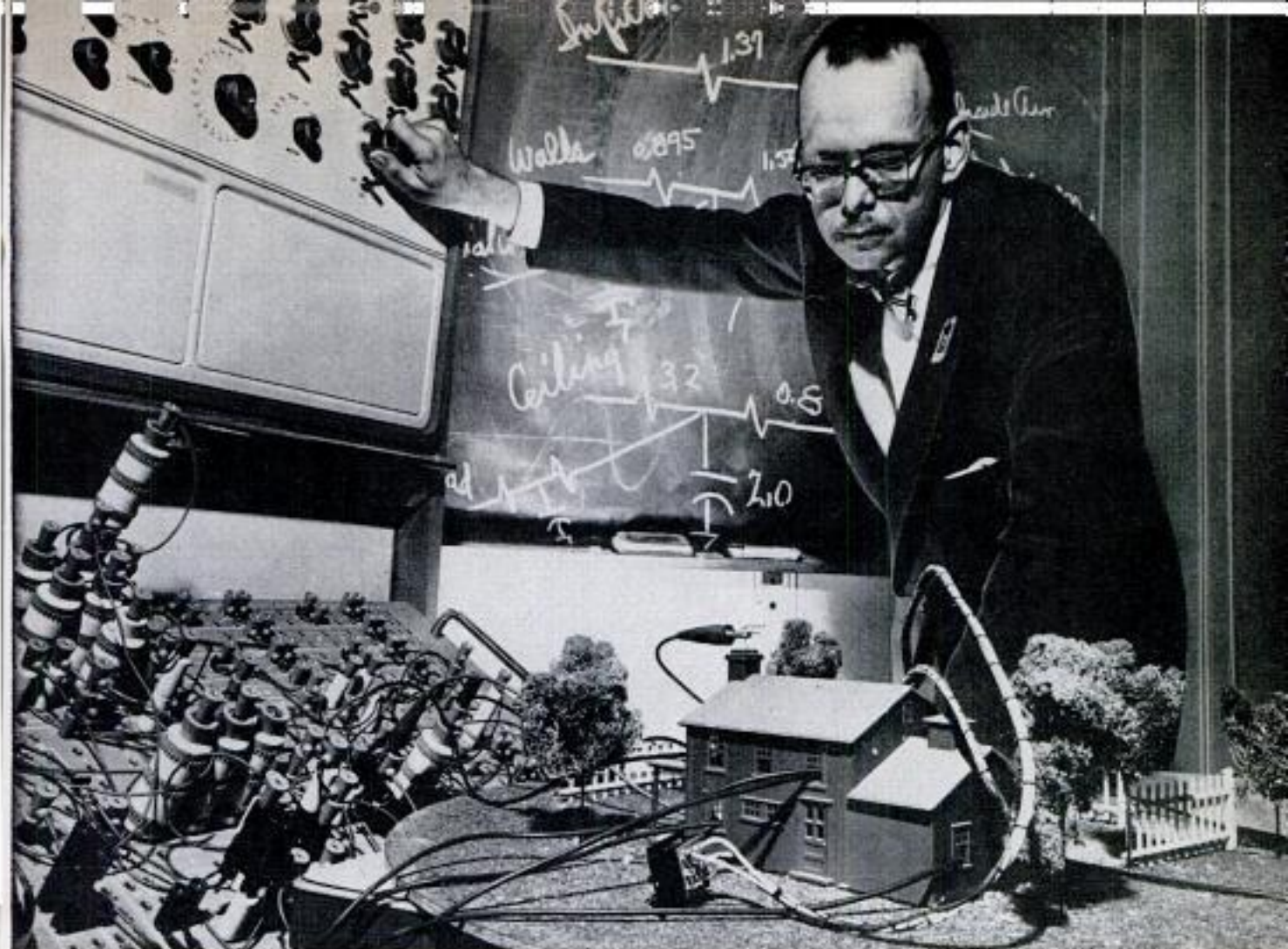

General Electric photo

Research engineer uses miniature house, maze of wires and computer to learn more about heating requirements

Since man first built a fire in a cave he has been interested in finding a better way to heat his home. Here is authentic information that will help you find an answer to an important question:

IS ELECTRIC HEATING FOR YOU?

By Elliott H. McCleary

YOUR NEXT HOME may have no chimney or furnace. Even though you live far north of the Mason-Dixon line, you would have no ashes to haul, no fuel lines to clean.

Even on the coldest days you would be kept toast-warm by an all-electric heating system. The heat would come from a heat pump, cables buried in the ceiling, radiant glass panels in the walls, baseboard or wall convectors or ceiling panels of conductive rubber.

Today, in Vancouver, Wash., Atlantic City, N. J., South Bend, Ind., and St. Louis, Mo., hundreds of homes are being equipped with all-electric heating systems. Tomorrow electric heating may be as common as other systems.

If you live in an area where electric

power is plentiful, electric heating may not be as costly as you think. An 1100-square-foot house near Detroit is heated by electricity for \$165 a year. A St. Louis house with 1000 square feet has an annual electric-heating bill of \$195. A ranch-style home in Fort Wayne, Ind., with 1289 square feet, is heated by kilowatts for \$158 a year.

Actually, these heating bills are much greater than they would be with conventional systems. "The same houses could be heated with gas or oil at one half or one third this annual cost," according to Prof. Seichi Konzo, nationally known heating expert at the University of Illinois. "Electric heating is expensive, even when power rates are low and standard fuels are high."

But many people are willing to pay a premium for the advantages of electric



General Electric photo

All-electric heat pump built into wall heats and cools entire home. The unit can be painted or wallpapered

heating. And the low installation cost of certain forms of electric heating results in big initial savings. The various types of heating panels eliminate the need for duct-work. No chimney is necessary and no extra space is needed for heating equipment. Houses can be closed in faster at a saving to the builder. These combined savings may reach \$1500 per house.

A 1000-square-foot house can be equipped

with electric panels for a cost to the contractor of \$450 to \$750, depending upon the local climate and the type of system used. This cost includes the price of individual room thermostats.

In all cases, electrically heated houses must be insulated to the hilt.

"In new homes," says Professor Konzo, "I specify six inches of mineral wool in the ceilings, the use of two-by-six in place of

Rubber heating panel is quickly cemented to ceiling. Rearrangement of molecules makes rubber conductive

U. S. Rubber Co. photo

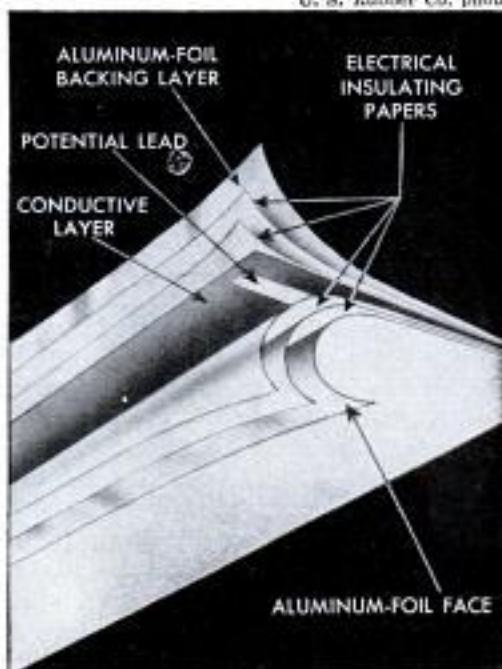

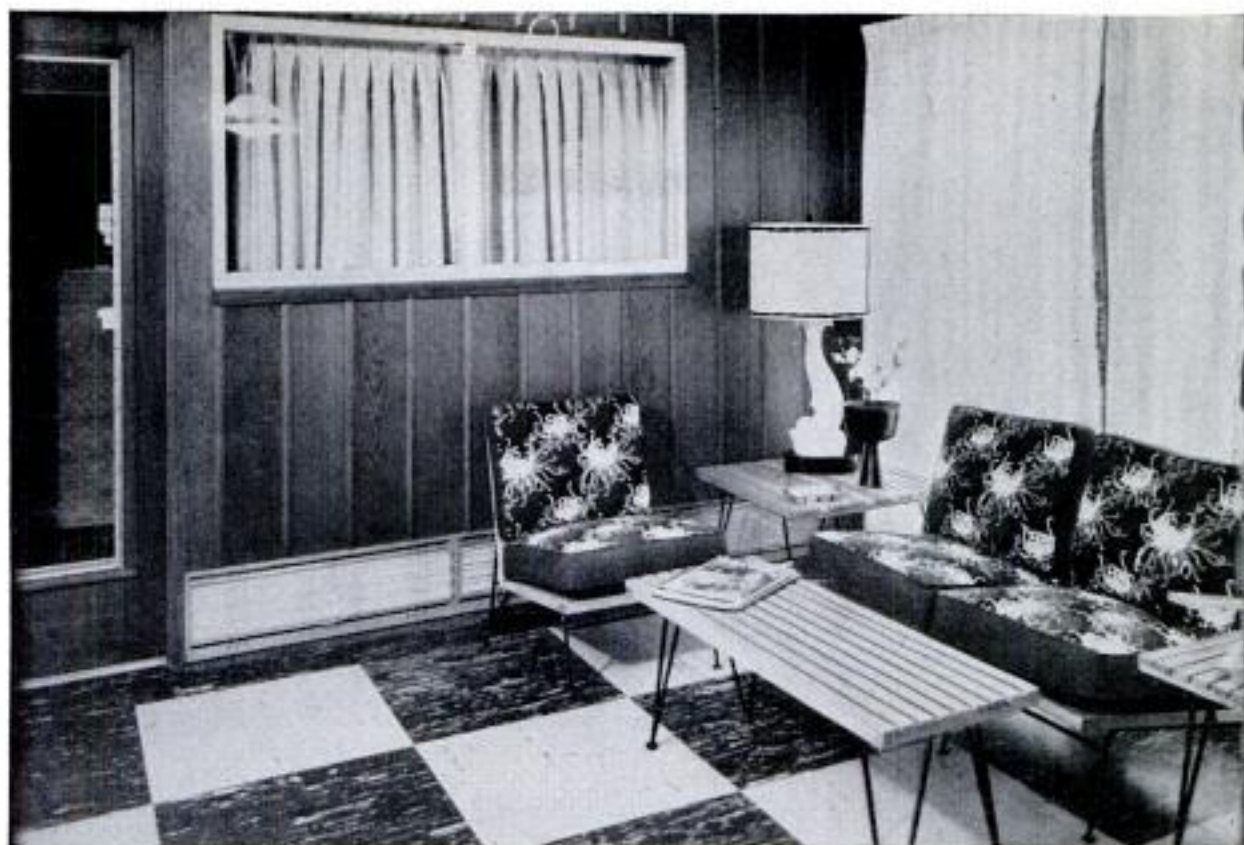

Electriglas Corp. (Bergenfield, N. J.) photo

Radiant-glass panels along baseboard consist of heating wire fused into glass. Each room has thermostat

two-by-four studdings, and completely filled with mineral wool, the minimum use of windows and the maximum use of double panes as well as weather stripping for windows. I try to design for a total fuel bill of \$120 for the season, knowing full well that with gas I could do it for about \$45."

There are two radically different forms of electric heating.

One is resistance heating. Electric heat-

ing cables may be tacked to the ceiling and then covered with plaster or a second layer of plasterboard. A similar type is the conductive-rubber panel, which is cemented to the ceiling and then painted to match surroundings. Radiant glass panels consist of heating wire safely embedded in glass sheets which are fastened to the wall. Baseboard or wall convectors, often placed beneath windows, consist of heating cable

Wall and baseboard convectors have heating wire embedded in a core of ceramic inside metal-finned pipe

Electrovector, Inc. (Brooklyn 12, N. Y.) photo

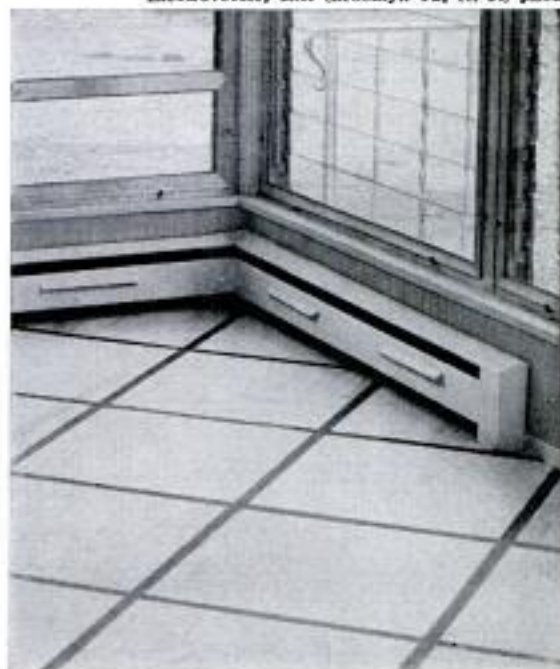
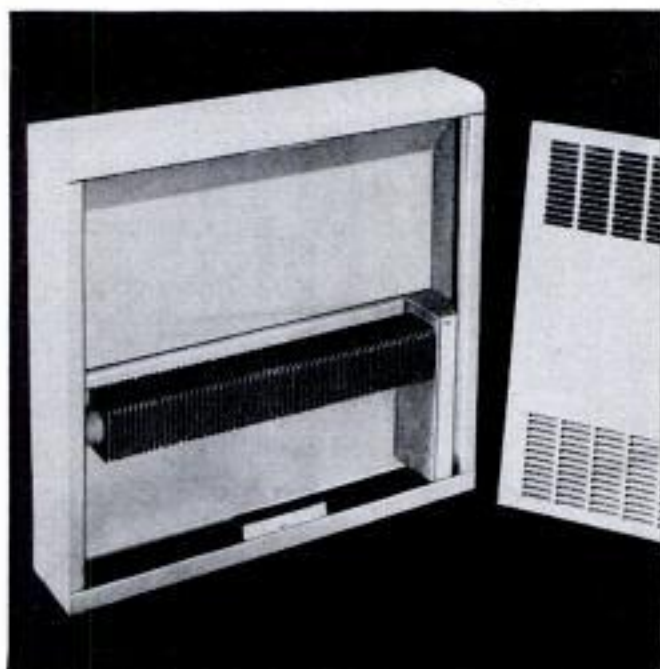



General Electric photo

Heating cable stapled to ceiling is covered with plaster or a second layer of dry wall. Cutaway shows insides of heat pump that replaces home furnace

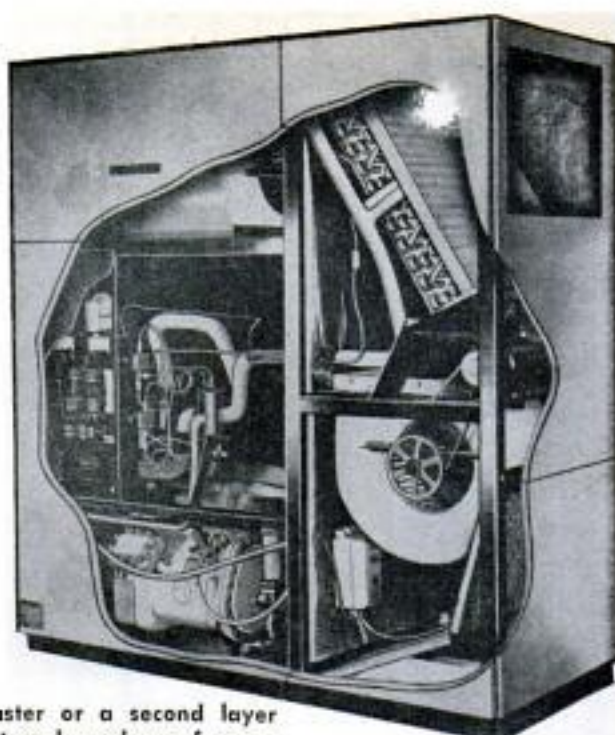

Westinghouse photo

inside pipes mounting fins that increase the heating surface. Heating units similar to portable bathroom heaters may also be built into the walls.

All forms of resistance heating have the same theoretical efficiency, although there are differences in the efficient and uniform distribution of that heat. All are usually equipped with individual room thermostats, so that uniform heating throughout the house is possible. There is no heat loss caused by overheating one section of the house in order that another section may be adequately heated.

The second form of electric heating is the heat pump. Although supplemental resistance heating is used with this system during freak cold periods, the normal operation of the heat pump does not depend upon resistance heat.

The heat pump extracts heat from outside air and uses it to warm inside air. It is basically a modified air conditioner. In the summer it takes heat from inside air and transfers it to outside air. In the winter it reverses this process, removing heat from outside air and giving it to inside air. This same principle of heat transference is what causes the blast of hot air emitted by your electric refrigerator.

Heat pumps are more expensive to install than are other forms of electric heating. It costs \$2500 to \$3000 to install a heat pump for a three-bedroom house with 1200 to 1500 square feet. This cost includes the expense of all the ductwork needed for such a system of central heating. It also includes the cost of a complete air-conditioning system for summer cooling.

On the other hand, heat pumps are the cheapest form of electric heating once they're installed. At any time of the year, they produce more heat per kilowatt than does any form of resistance heating. On some days, their theoretical efficiency is three times as great. When annual operation costs of a heat pump and a form of electric-resistance heating are compared, the difference is not this striking. Part of the reason is that the heat-pump bill includes the cost of summer cooling as well as winter heating. It also includes the cost of running an electric blower.

Heat pumps, because they include air conditioning and have a high installation cost, are now being sold to the semiluxury market. Recently, 460 medium-high-price homes in a project near Los Angeles were equipped with heat pumps.

It will be a while before mass production brings prices down. There are only about 6000 or 7000 heat pumps installed all over the nation.

Resistance heating is most popular in lower-priced homes that will not include air conditioning. For this reason, resistance heating is being pushed as an attractive feature of low-cost project homes.

The advantages of electric heating, no matter which type, range from cleanliness to convenience. If you have a heat pump, the air is filtered winter and summer. If you have radiant heat, draperies and upholstery are not laden with dirt blown up from the floor. There are no fumes or odors of combustion, no soot, no ashes, no grates to replace or fuel tanks to bother with.

(Continued to page 284)

HOME OFFICE Under Stairway

By Kenneth R. MacDonald

UNDER THE STAIRWAY of many two-story homes is an area often wasted or used for catch-all storage that can be converted into a home office, sewing room, hobby room, a study room for children or a quiet retreat for adults. In the case illustrated, the space, which was approximately 5 x 8 ft., was converted into an office for use by a magazine writer. A door may be used for complete privacy, or an arched opening into the adjoining room may be provided. And, if desired, the partition wall can be eliminated entirely to provide merely a cozy corner under the stairway.

In this case, the wall was eliminated entirely and a desk and storage shelves built in as indicated in the photo. Storage shelves were provided under the stair risers by supporting them on cleats nailed to the stair stringers. One end of the desk top, which is a piece of $\frac{5}{8}$ -in. plywood, is supported on a pedestal containing a large filing drawer and the other end is supported on a large cleat nailed to one of the stair risers. A typewriter is located in an opening cut in the desk top and is supported on a shelf directly under the top. In addition to supporting the typewriter, this shelf also provides additional storage space for writing materials.

Below the desk and behind the first three stair risers, large shelves were provided by nailing cleats directly to opposite walls. If you wish to finish the desk with varnish, hardwood-faced plywood should be used. If the finish is to be paint, fir plywood will do.

Illumination is provided by a spotlight on the ceiling. The wall above the desk may be finished to match the adjoining room or, as in this case, it can be finished to contrast with the room and thus help set off the corner.

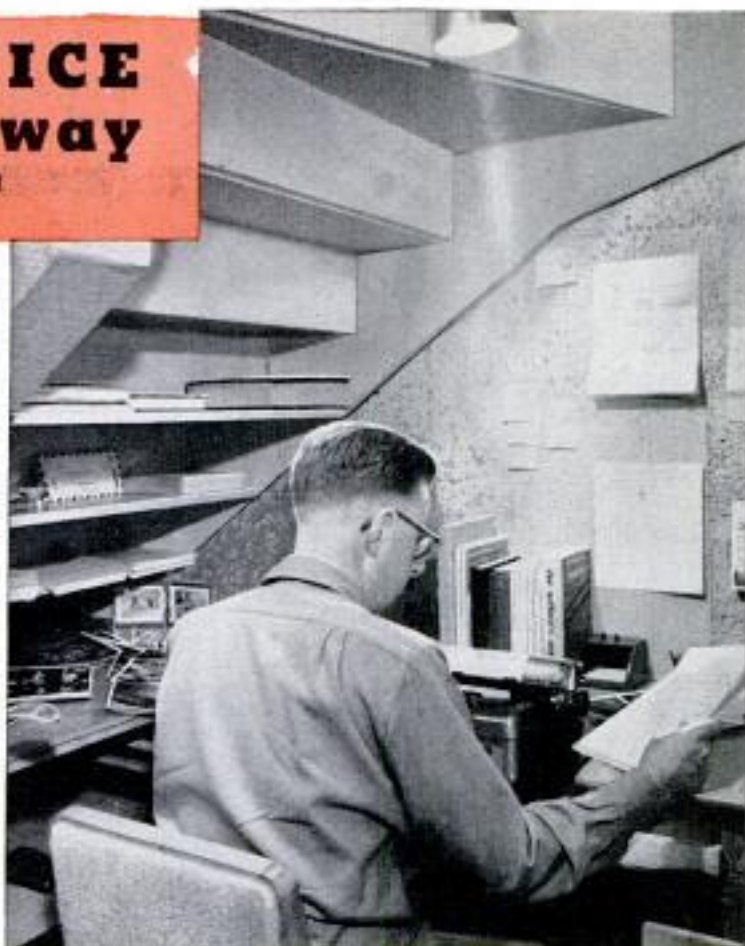

Notice above the compact yet efficient office that can be built under a stairway in a space no larger than 5 x 8 ft.

Details below show arrangement of plywood desk, filing drawer and storage shelves. Shelves are supported under stair risers

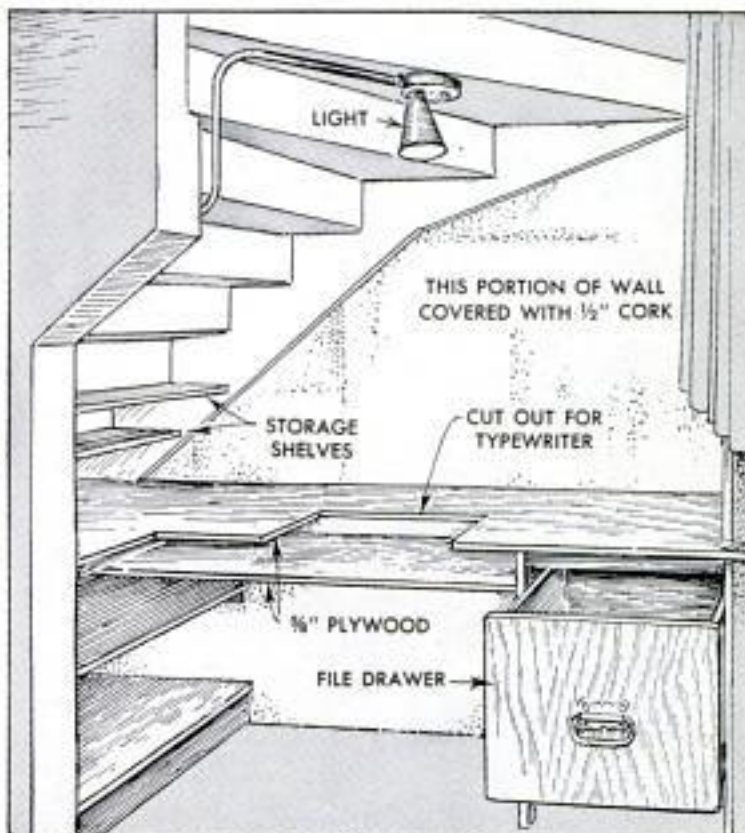

X590



MAKE YOUR OWN...

Aluminum WINDOW SCREENS

Lightweight metal screens do not warp, rot or rust and do not need painting

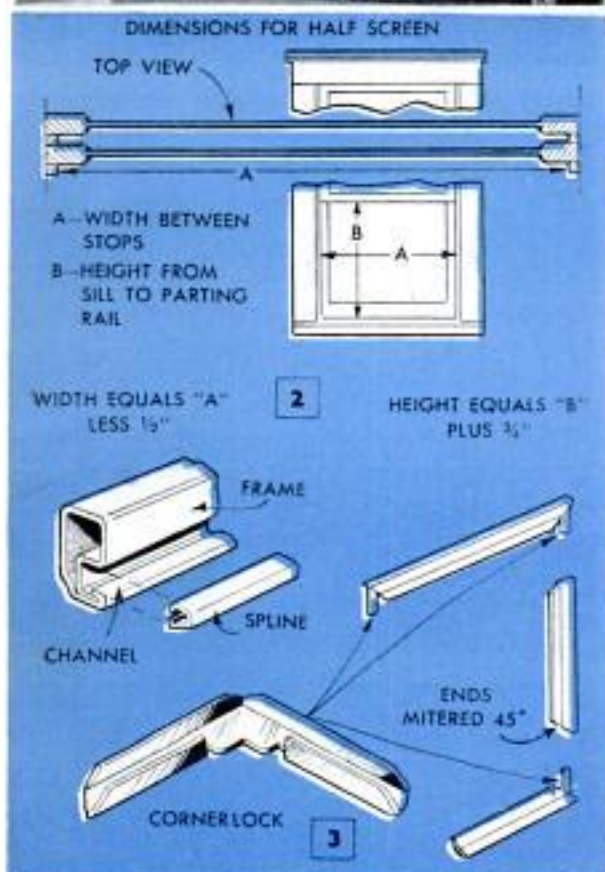

YOU'LL FIND IT EASY and fascinating to make window screens from stock aluminum parts obtainable at nearly all hardware stores. Tubular frame members have grooves for splines that hold the screen securely. The frame pieces are mitered at the corners and held together by means of slip-in corner locks as shown in the lower details of Fig. 3. The screen material may be aluminum, glass fiber or plastic.

For half screens on double-hung windows as shown in Fig. 1, take measurements as indicated in the details of Fig. 2. Cutting the miters at a 45-deg. angle is next. This must be done accurately with a hacksaw or other fine-tooth saw used in a miter box as in Fig. 4. One commercial kit of window-screen parts, the "Homeshield" made by American Screen Products Co., includes a miter box. This is screwed to a block which is gripped in a vise. After marking the frame stock for length and removing the splines, cut the miters. Put the pieces in the miter box so that the spline groove is face down. Make the miter cuts so the spline groove will be along the shortest edge. After sawing, remove burrs and sharp edges with a small file or sandpaper. To assemble, simply push the frame pieces onto the corner locks. Then cut the splines to length so the ends butt together at corners as in Fig. 7.

Application of screen cloth or wire is next. Lay the frame on a smooth bench top, with the spline grooves up. It is important that the frame be held squarely while installing the screen. On full-length screens, the frame is held in this position by means of finishing nails or with wood strips nailed to the bench top. Put a piece of 1/2-in. plywood inside the frame to hold up the



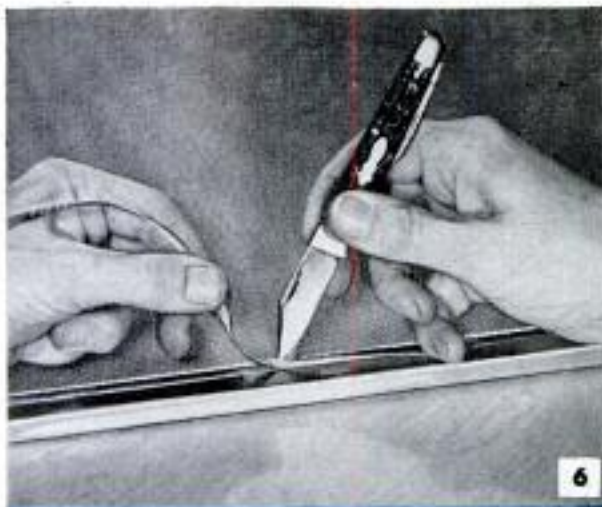

wire mesh so it will not sag at the center while assembling.

Glass-fiber or plastic screen is cut to the outside dimensions of the frame. Keep the screen square with the frame and force one spline into its groove at one edge as shown in Fig. 5. Tap a plywood or hardboard block with a hammer to force the spline into the groove gradually, moving the block back and forth. Repeat the procedure at the opposite edge and then at the other edges. Don't bow the frame by pulling the screen material too tight. Trim off excess glass-fiber screen with a knife or razor blade as shown in Fig. 6.

When using aluminum screen, bend the screen downward into the groove with a putty knife or screwdriver. The screen should fit along the inside edge of the groove only, where it will be held securely by the spline. After installing one edge, cut the screen at the other edge carefully with tin snips, cutting between two strands of wire. Then bend down the wire edge as before and install the spline.

Half screens can be held by means of aluminum retaining channels $\frac{1}{2}$ in. wide and $\frac{3}{4}$ in. deep. Drill three holes in each channel for roundheaded wood screws with which they are fastened to the inside of the window stops. Cut off the upper ends of the channels as shown in Fig. 7; this permits screens to be inserted easily.

Full-length screens do not fit between stops of a window like half screens, but fit against the storm-sash stops, and are the same width and height as storm sash. A center brace is required on full-length screen frames. This is a length of channel stock, as shown in Fig. 8, cut at both ends and drilled so that sheet-metal screws can be used for fastening it to the screen frame. Fig. 9 shows how a full-length screen is attached to a window frame, with brackets made especially for the purpose. Two small hooks are fitted at the bottom edge. These have a screw eye with a machine-screw

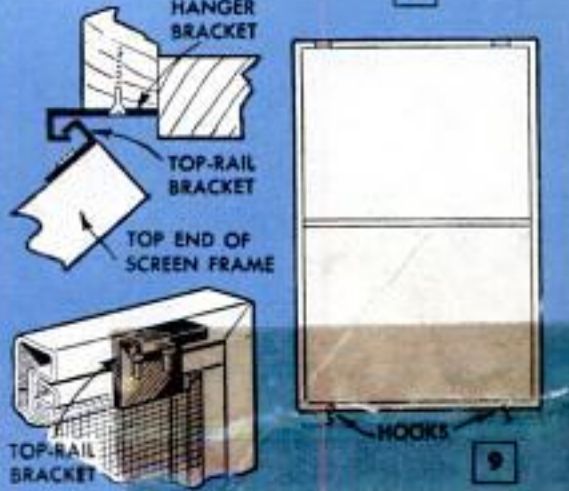
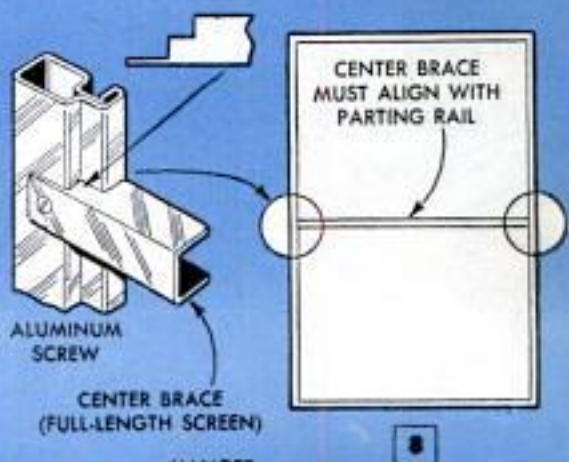
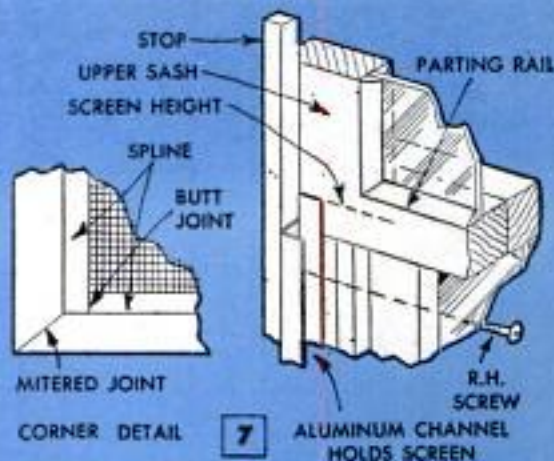

How to Make Strong Wood-Frame Window Screens



10

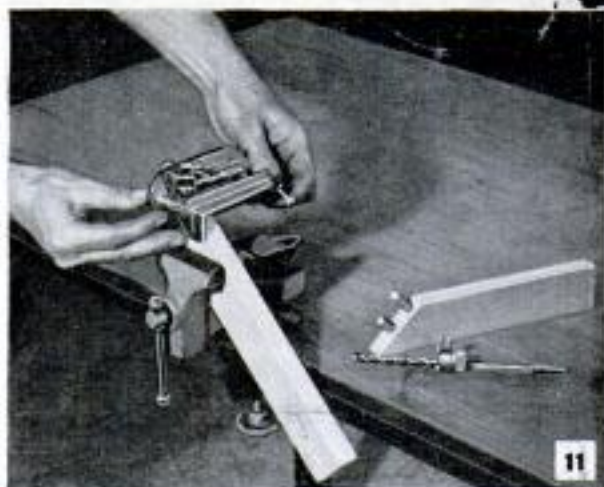

11

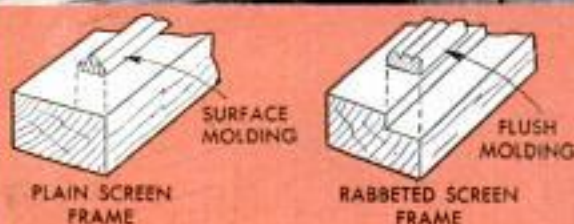

12 SCREEN-FRAME STOCK $\frac{3}{4}$ " OR $1\frac{1}{8}$ "

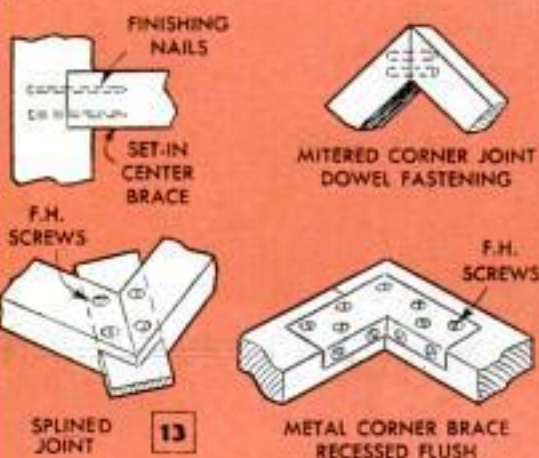

13

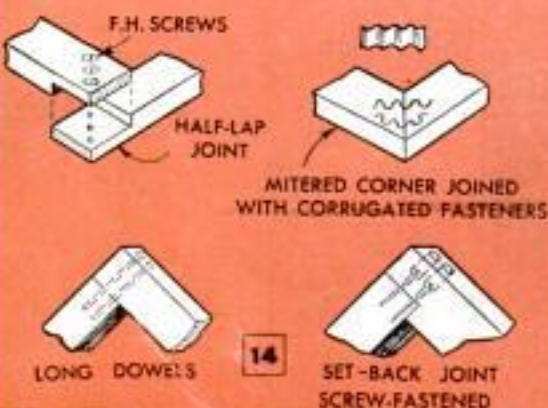

14



thread which permits fastening with nuts. Standard thicknesses of wooden window-screen frames are $\frac{3}{4}$ and $1\frac{1}{8}$ in. The latter thickness is preferable, but some older window frames do not accommodate it. This you can determine by measuring as shown in Fig. 10. Screen-frame stock may be plain, with the molding tacked on, or it may be rabbeted so the molding comes flush, Fig. 12.

A full-length screen requires a cross brace. This is let into the side members to obtain greatest strength, Fig. 13. There are numerous ways to make good corner joints. While the use of corrugated fasteners, Fig. 14, enables quick assembly, other methods assure stronger and more-durable joints.

A mitered corner, Fig. 13, having two blind dowels located at right angles to the miter cuts, is exceptionally neat and strong. Registering dowel holes can be bored in perfect alignment by using a dowel-boring jig as shown in Fig. 11. The mitered strips are pictured for the purpose of illustrating method of making the joint. In the absence of such a jig, you can substitute a spline for dowels on a mitered corner, which also produces a neat and strong joint, Fig. 13.

Corners also can be half-lapped, or they can be butted together and held with dowels or wood screws, or by means of metal plates, Figs. 13 and 14. Of all the joints detailed, the mitered corner joint with dowel-and-glue fastening and the butt joint with recessed corner brace are perhaps the strongest and most durable, especially for full-length frames. Most of the assemblies shown, particularly the doweled, splined and half-lapped kinds, require a coat of waterproof glue on all contacting surfaces for maximum strength. A good, time-proved method of getting a screen taut on a wooden frame is to bow the frame slightly as shown in the lower detail, Fig. 14, while the screen is being attached. ★ ★ ★



St. Charles Kitchens photo
 Typical of today's modern kitchen, this attractive one combines efficiency and charm. Cooking-appliance peninsula divides room into two separate work areas. Kitchen features custom-built steel cabinets

The Modern Kitchen

By E. R. Haan

WHAT A DIFFERENCE between today's kitchens and those of only a few years ago! Built-in cooking units, including wall oven-broilers and counter-top cooking plates or burners, have contributed greatly to the 1955 kitchen look. Inconspicuous or concealed hoods with forced draft instantly dispose of cooking odors and excess humidity. Under-sink grinders and quickly accessible incinerators dispose of food leftovers, vegetable peelings and similar waste, and automatic washers "do the dishes" with the greatest of ease.

Wall oven-broilers: Wall oven-broilers are installed at comfortable waist height to eliminate stooping, and may

Close-up view of built-in cooking appliances in another kitchen. Waist-high oven-broiler saves stooping. Stove hood contains exhaust fan
 Calorie Stove Corp. photo





Frigitaire photos

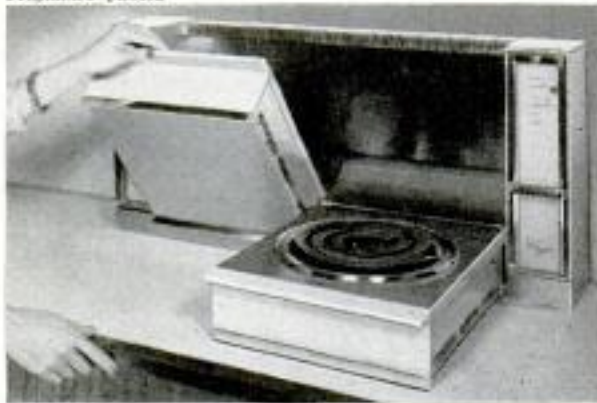

In this attractive kitchen, electric counter-top cooking units fold out of way and turn off automatically

have a single, horizontally pivoted door, or twin, vertical doors that open or close in synchronism when either one is handled. Some units have a door fitted with a window. Two such ovens can be located side by side.

Completely insulated and vented at the front, most wall ovens have several heat ranges which are automatically and manually controlled in regard to both time and temperature.

Counter-top cooking units: Most surface cooking units fit into a cutout portion of a counter, have two to four burners or heating elements of various sizes. Frequently such units are located on an "island" or "peninsula" so that food being prepared can be reached from either side. Individual electric counter-top cooking units that fold back and turn off automatically are advantageous in that they do not require cutting out part of a counter.

Instant fume disposal: Instant elimination of cooking odors, smoke and humidity is possible by installing an



St. Charles Kitchens photo

Stainless-steel counter tops are sanitary and durable. Twin sinks have sound-deadening undercoating



The Formica Co. photo

Lustrous, colorful counter tops of hard laminated plastic also give "lifetime" wear; resist heat, stains, acids

inconspicuous metal hood equipped with an exhaust blower. This is located above surface cooking units or ranges so that cooking fumes are picked up at their source and quietly whisked outdoors through a duct that can be located in the space formed by a drop ceiling. Some of these units have an extra inlet located at the top of a wall cabinet to remove hot air at ceiling level.

"Lifetime" counter coverings: Lustrous, colorful counter coverings of great durability are available. Besides being resistant to mechanical damage under normal conditions of use, they are heat, stain, acid and alkali resistant, and are impervious to moisture so that they will not rot or deteriorate at sink edges or near faucets. These include a number of plastic materials,

Large kitchens are becoming popular again. In basementless homes many kitchens must also house laundry appliances as well as freezer. Inclusion of adequate food-serving area is fast becoming a must

The Formica Co. photo



pygriated material



Marsh Wall Products, Inc., photo

Above, beautifully prefinished 16-in. squares of hardboard offer a modern tile treatment for kitchen walls. Squares are applied with special concealed clips that fit grooved edges of squares

Below, in direct contrast, this kitchen shows walls of regular 4 1/4-in. plastic tile applied from floor to soffit. Notice how windmill insert in attractive tile floor relieves plainness
Hachmeister, Inc. photo



ceramic tile, stainless steel and Monel metal. Stainless-steel drainboards for sinks are extensions of the sink sides so that there are no joints. Parts of counters near cooking units may have stainless-steel inserts. Counter sections used for mixing, chopping and cutting may consist of tongue-and-grooved maple strips. Counters often are prefabricated to specified sizes and are covered with plastic coverings by manufacturers. The new, hard plastic laminates may also be applied successfully by homeowners themselves when replacing worn and deteriorating older coverings. In some prefab counters, both the counters and back splashboards are united and covered as a single unit with a continuous, unbroken layer of sheet plastic.

Wall and floor coverings:

Wall coverings for kitchens include ceramic tile, structural glass, panels or "tiles" of aluminum, stainless steel or enameled sheet metal; also many kinds of plastic tile and sheet plastics, as well as plywood, hardboard and wallboards of various kinds. Many of these are prefinished and are available in the form of large panels, "planking" and squares. Sometimes panels can be attached directly to a plastered wall by means of an adhesive as recommended by the manufacturer, or they may be fastened with clips, nails or staples to suitable backings as advised. Interlocking joints on some kinds conceal the clips or nails used for fastening.

Floors of ceramic tile or terrazzo are beautiful and give long-lasting service. Resilient floor coverings include numerous products such as linoleum, cork and various kinds of plastic tiles, which often can be applied by homeowners themselves at considerable saving.

Large, multipurpose kitchens:

Kitchens in many homes must serve a number of purposes besides that of food preparation and dishwashing. This is particularly true in basementless homes where limited space makes it necessary to put laundry equipment and a food



Libby-Owens-Ford Glass Co. photo

Corrugated glass conceals cooking area of kitchen from occupants of breakfast nook without loss of light

freezer in the kitchen. Frequently the laundry area is separated from the food-preparation area by cabinets.

In planning efficient utilization of kitchen space, use can be made of specially designed equipment such as a one-piece kitchen unit that includes an electric range, dishwasher, sink and disposal unit and a combination washer-drier.

In addition to the high-grade steel and wooden kitchen cabinets that are manufactured, it is also possible to build your own from stock lumber and plywood.

Kitchen-cabinet dimensions: Standard height of base cabinets is 35 or 36 in., the depth is 20 to 24 in., and the length is variable. Wall cabinets are 12 or 13 in. in depth, and the standard heights are 18, 24, 30 and 36 in. A drop ceiling over wall cabinets often presents a much better appearance than a void above them. Spacing between a wall cabinet and the counter of a base cabinet varies from 15 to 18 in. Counters usually project an inch or so beyond the front of base cabinets.

Drop ceilings: Framing and covering of a drop ceiling are shown in Fig. 3. Framing can be built separately and then attached to the wall and ceiling, nailing it to studs or joists if possible, after which the covering material is added. Where framing pieces do not cross joists, but run in the same direction, they are attached to a wall covering such as plaster by means of toggle bolts or other suitable screw anchors. The front of a drop ceiling should come flush with the front of the wall cabinets. No covering is needed on the bottom of the drop ceiling since it comes directly above a wall cabinet.

Wall cabinets: Wall-cabinet construction is detailed in Fig. 3. Sides, top and bottom



St. Charles Kitchens photo

Step-saving dish-storage cabinet between cooking and food-serving areas is accessible from either side



General Electric Co. photo

Recently developed wall-cabinet-type refrigerator-and-freezer unit eliminates extra steps and stooping

Electric range, dishwasher, disposal unit and washer-drier are all contained in a single prefabricated unit

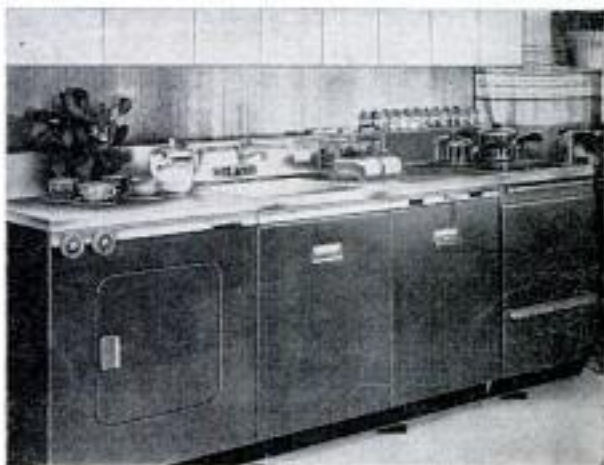



Libby-Owens-Ford Glass Co. photo

are of $\frac{3}{4}$ -in. int. although $\frac{5}{8}$ or $\frac{1}{2}$ -in. plywood can be used to reduce costs. A cleat under the top, screwed to the top and to the sides, and also a length of angle iron under the raised bottom, provide the means of attachment to a wall, with long wood screws that will extend no less than 1 in. into wall studs. Use of screws for this purpose permits the removal of cabinets at any time as may be desired. The wall forms the cabinet back. The front framing of the cabinet has mitered or half-lapped joints. The frame must be perfectly square. It is screwed to the plywood sides, top and bottom. Rows of equidistant blind holes in the sides are drilled before the cabinet is assembled. These accommodate metal shelf supports.

At corners two wall cabinets may be neatly joined to a corner cabinet as shown in Fig. 1. The corner space is accessible through a door which is set at a 45-deg. angle. Top and bottom of the corner cabinet are joined by a corner post, which is screwed to corner studs. Dowels can be used for joining the top and bottom of the corner cabinet to the adjacent wall cabinets.

Cabinet doors and hinges: Three types of hinged cabinet doors are shown in Fig. 2. Lip-edge doors may be made from $\frac{5}{8}$ or $\frac{3}{4}$ -in. plywood. The 7-ply kind is least apt

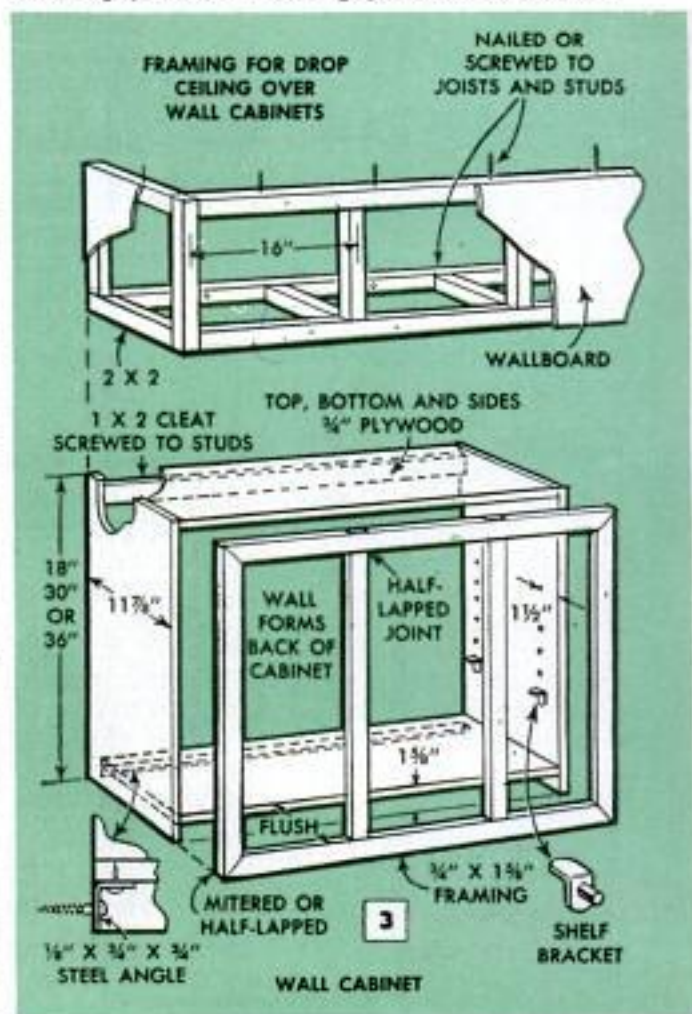
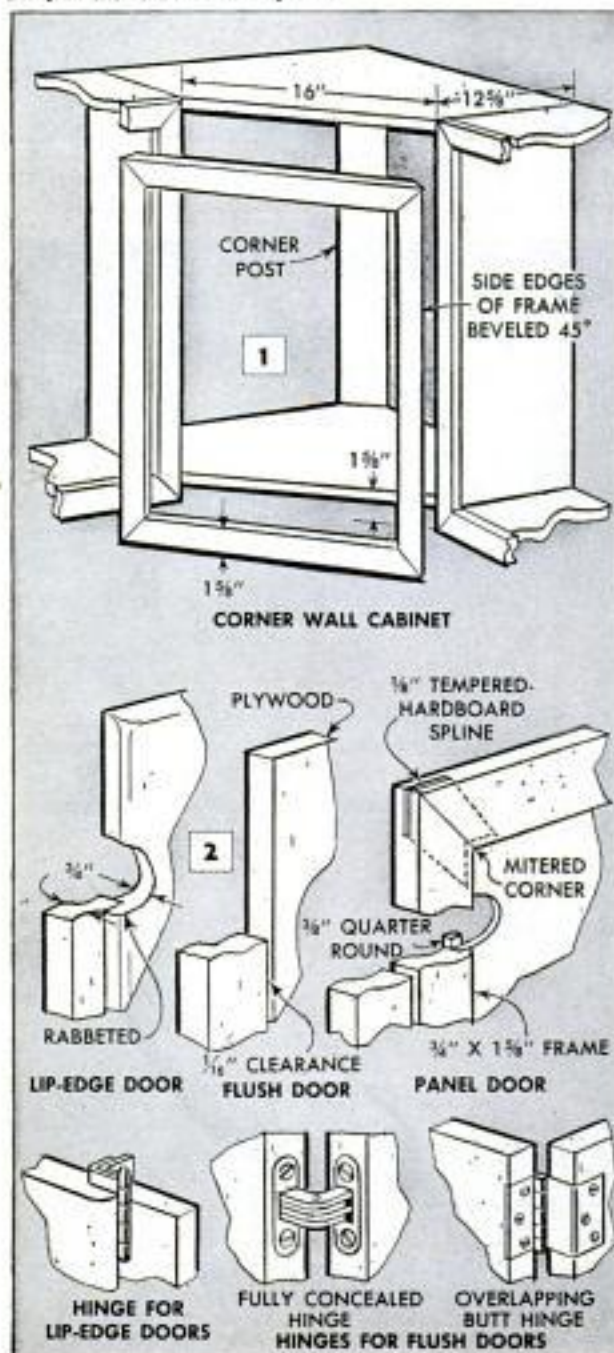

to warp. A lip-edge door also may consist of a tempered-hardboard panel that projects $\frac{3}{8}$ in. beyond the edges of the frame to which it is attached. Flush doors may be single panels of $\frac{3}{4}$ or $\frac{5}{8}$ -in. plywood, or wood frames with inserted or attached panels of thinner plywood or hardboard. Mitered corners of the frames may be slotted for tight-fitting splines of $\frac{1}{8}$ -in. hardboard, which are glued in place to provide considerable added strength and rigidity. Fig. 2 shows three types of cabinet hinges that are least conspicuous when installed.

Sliding cabinet doors: Cabinets can be provided with sliding doors instead of hinged doors. Such doors can be made of corrugated glass, glass fiber, plywood or hardboard. Top and bottom edges of the doors should be set with mastic in metal channels that will resist wear. The door bindings slide in wider metal channels and they may be provided with tiny rollers or a ball-bearing track for easy action. Wall cabinets have either a vertical or a sloping front; either type may have sliding doors.

Base cabinets: Building of base cabinets is shown in Fig. 4. To get them absolutely level, the base may have to be shimmed up at spots if the floor is uneven or sloping. The shims should be nailed down so that

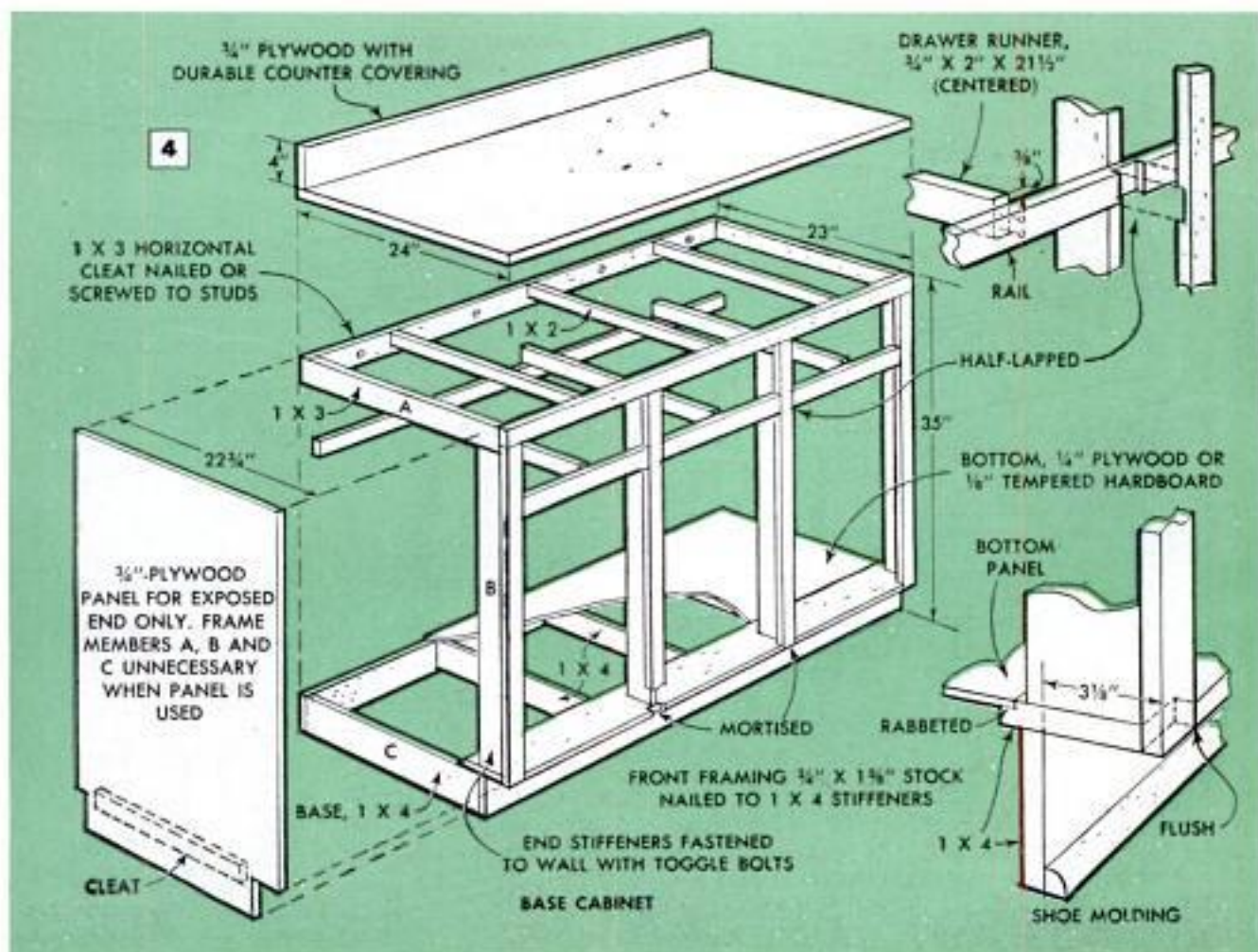



Typical drawer construction is shown in the details presented in the drawings below. Easy operation is assured by the use of drawer rollers that are applied with nails at the four points indicated in the drawing

they will not shift. The bottom of the cabinet may be $\frac{3}{4}$ -in. plywood, but cost can be reduced by using $\frac{1}{8}$ -in. tempered hardboard, nailed or screwed to crosspieces spaced 16 in. apart, and laid in a rabbet of the horizontal front frame member. In the method of construction shown, the front framing is reinforced by stiffeners, which, resting on the base, transfer all weight from the counter to the base, therefore the framing is not subjected to any strain. Partitions of $\frac{3}{4}$ -in. plywood can be substituted for stiffeners.

Drawer arrangements: Drawer construction is shown in Figs. 5 and 6. Two alternate arrangements of the back are possible. One is to fit the back into grooves cut in the sides so it rests on the bottom, detail A. The other is to have the back grooved to accommodate the bottom, detail B, in which case it extends past it. The sides and front also are grooved to take the bottom. Fig. 5 also shows the installation of inexpensive rollers that make drawers easy to open and close. The narrow between-cabinets storage unit shown in Fig. 6 uses space normally wasted. These storage units may have a narrow shelf and sliding doors. If the units are longer than 24 in., the shelf should be supported at the center. ★★★

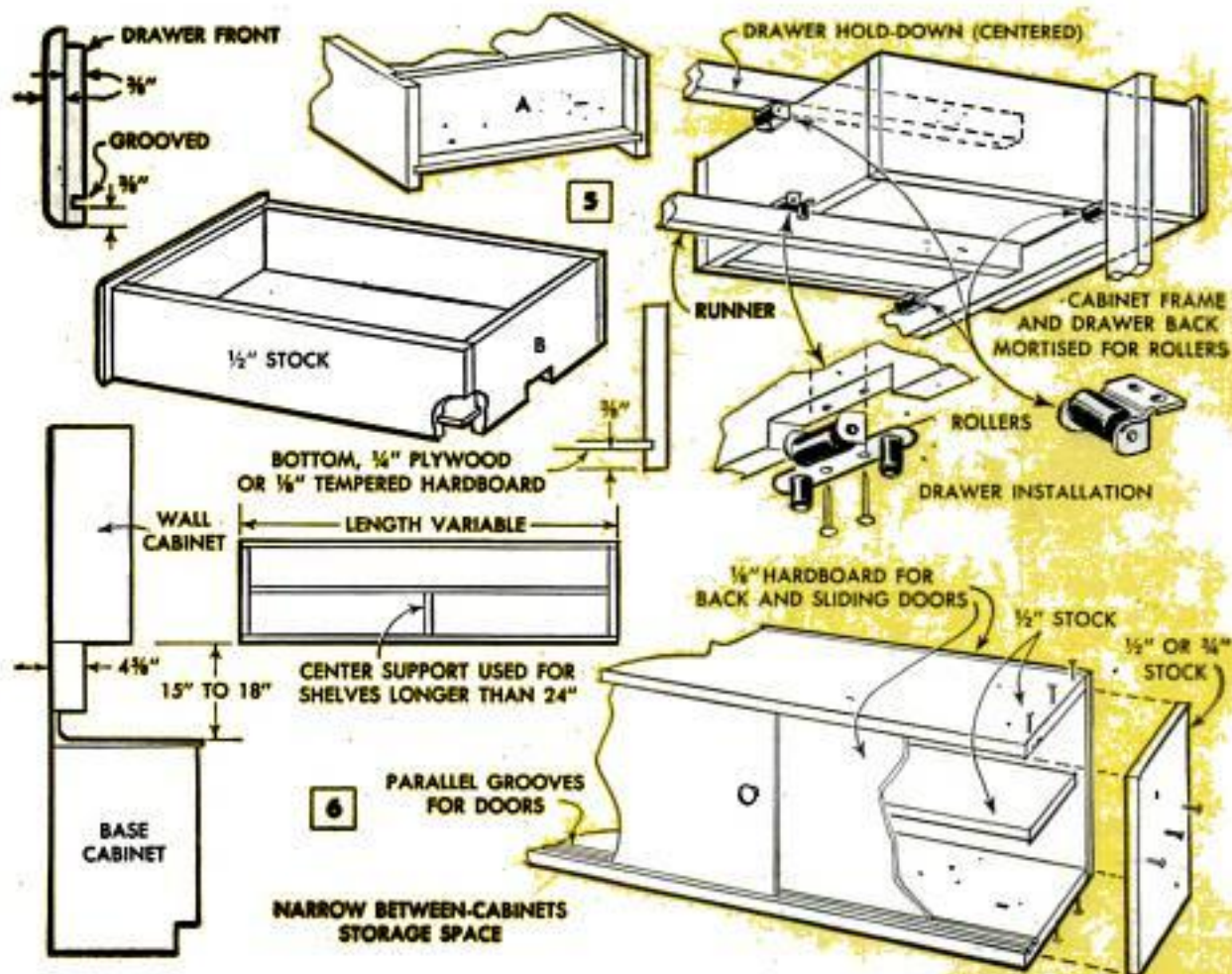

UTILITY CABINET

for your kitchen

ANY ADDITION to the convenience and storage facilities of the kitchen is worth carrying out, especially if it saves time and steps. This handy wall cabinet has been designed to provide storage space for cookbooks and recipe files and also to serve as a wall rack for tissues, wax paper and paper towels. The dimensions given on the detail of the construction are those of the original cabinet. To fit the cabinet into your own kitchen you may have to make some changes. However, the construction is simple and the size can be altered without affecting the usefulness of the unit. Before cutting stock, make careful measurements of the space the cabinet is to fit. Then cut parts accordingly for width and length. If the cabinet is to be painted, use plywood for the sides, top and shelves. Facing strips and other small parts should be cut from solid stock. The lower panel, which is slotted for tissues and wax-paper tabs, is cut from $\frac{1}{4}$ -in. plywood and fitted into stopped rabbets cut in the vertical facing strips. Although not shown in the detail, the lower edge can be fitted into a groove cut in the horizontal facing strip. The back also is cut from $\frac{1}{4}$ -in. plywood. The lower shelf is pivoted at the back and is fitted loosely so that it can be swung upward for insertion of paper-towel, tissue and wax-paper refills. The pivots are pins made by driving small screws into the ends of the shelf near the back edge and then cutting off the heads, leaving about $\frac{1}{2}$ in. of the body of the screw projecting. These projections enter small holes drilled in the side panels. The bottom is slotted to permit passage of the paper-towel strip and is fitted with a tearing strip made by attaching a hacksaw blade to a cleat screwed to the bottom piece. To obtain a clean tear, it's best to use a hacksaw blade with fine teeth, about 20 or 22 teeth to the inch. The second shelf can be positioned anywhere you want it and the ends can be fitted into dados (grooves) as shown or supported on small cleats screwed and glued to the side panels. Do a thorough job of sanding before painting or enameling. Round all exposed edges slightly and then apply a sealer or undercoater. Sand lightly after allowing time for drying and finish with two coats of enamel in the color desired. When locating the cabinet on the kitchen wall, place it so the top shelf is within easy reach from the floor without using a step-stool.



A cabinet like the one pictured provides space for cookbooks, recipe files and a separate compartment for tissues, wax paper and paper towels, all within easy reach. Unit saves steps, time and drawer space

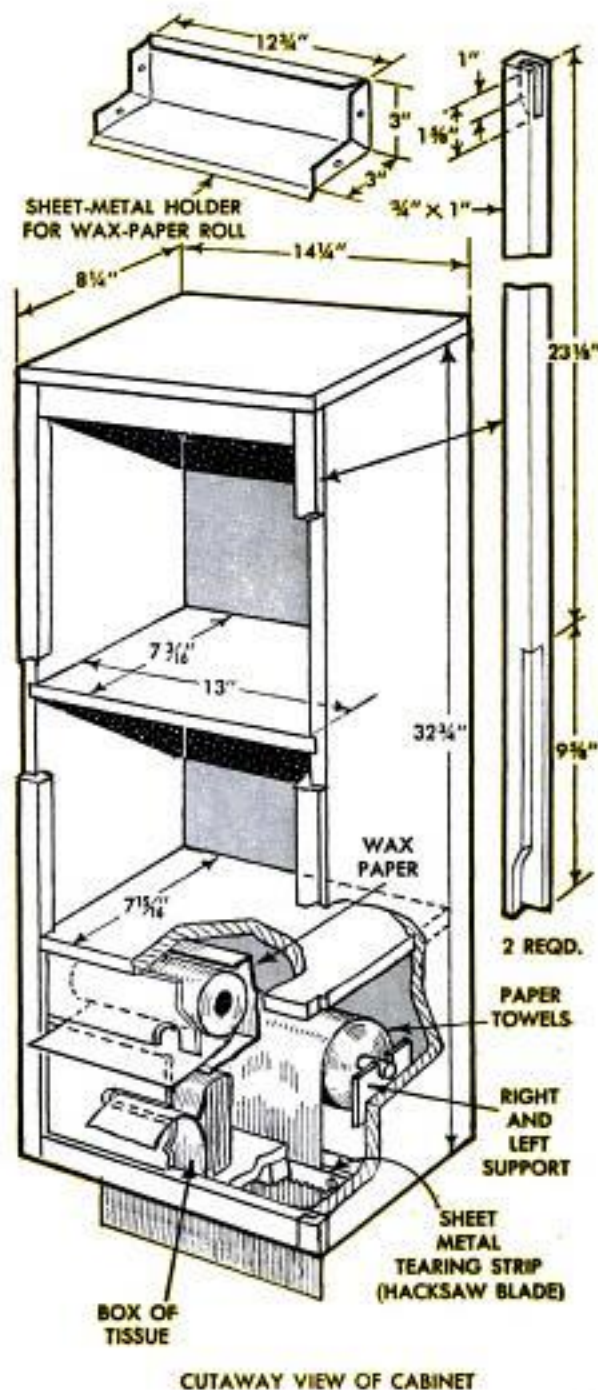

X149

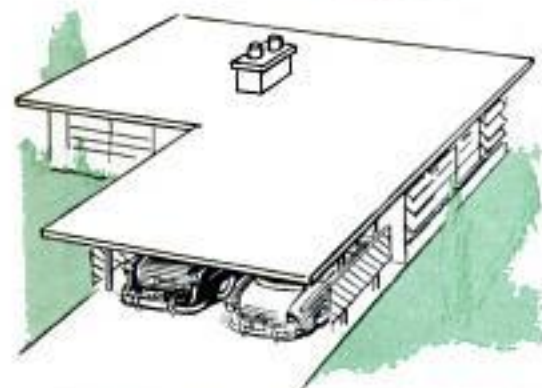

Kawneer Co. photo

One of several prefab carports on the market that comes knocked down and can be attached to house in a short time

BUILD YOUR OWN

MODERN ARCHITECTURE of new homes as well as high costs is causing many home builders to substitute carports for garages. The modern ground-hugging home with its open atmosphere just naturally needs the airiness of a carport to complement it.

As shown on these pages carports are of many types. Some may be purchased knocked down and assembled by the homeowner, photo above, while prefabricated metal roofs only may be purchased in other cases, the owner providing the understructure, Fig. 2. Or, they may be built completely by the owner in the conventional manner.

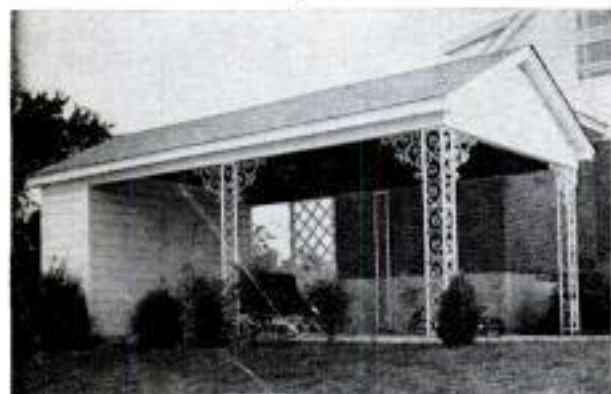

Tennessee Fabricating Co. photo

Ornamental-iron columns do a lot to dress up a carport and provide durable, nonrotting support posts

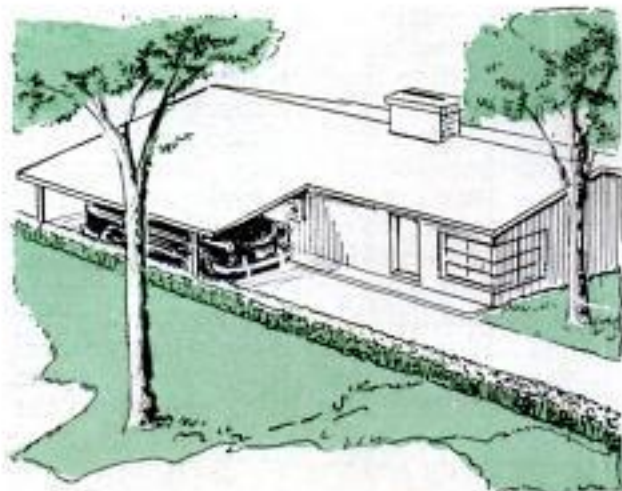

POPULAR MECHANICS

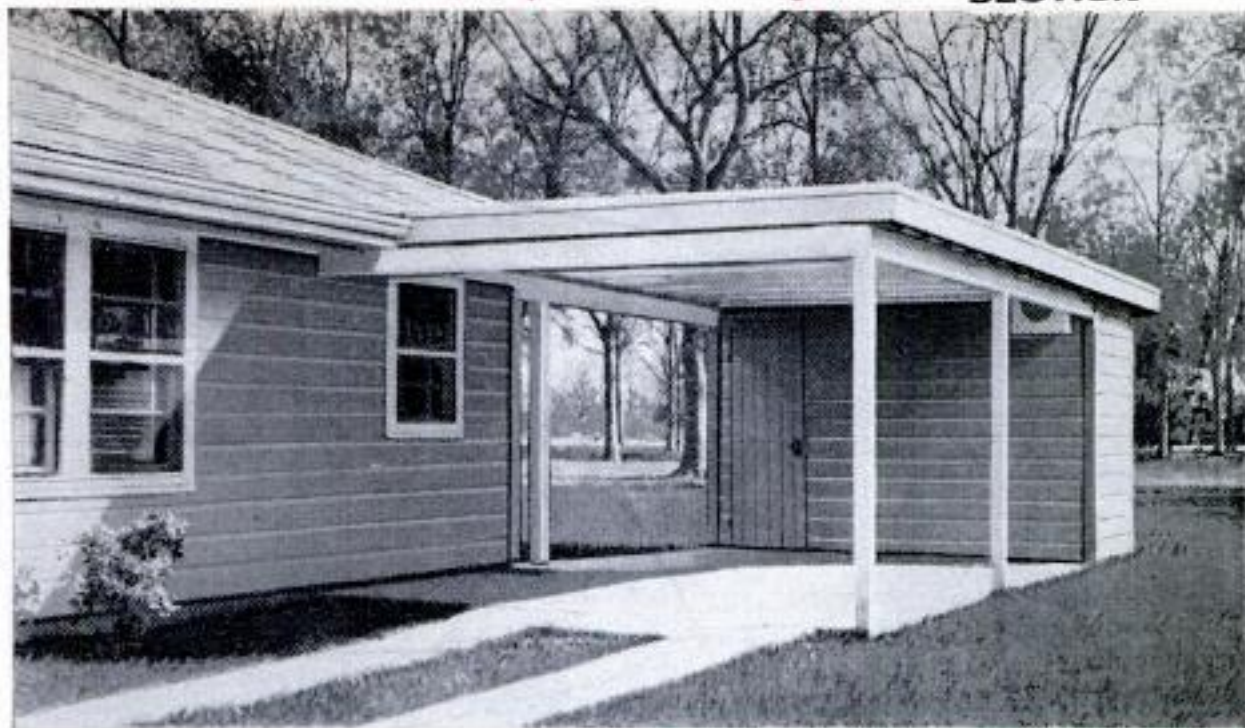

Most practical type of carport has one end housed-in to provide storage for bikes and garden equipment

CARPORT

Minimum advisable dimensions for a one-car shelter are 10 ft. wide, 20 ft. long and 7 ft. high. The protection provided by a carport can be further increased by locating it in complete shade and away from prevailing winds. For example, an inside corner of an L or U-shaped house may enclose a carport on two sides.

The illustrations on the opposite page show several suggested types. A carport like the top one should have fairly uniform distribution of its weight on the angular supports, which may be lengths of 3-in. pipe embedded in large concrete footings. Ornamental-iron columns as shown in the lower photo are sometimes preferred to wooden posts or steel pipes. A flat roof may serve as a sun deck reached by a second-floor door.

General details of building an attached carport having a conventional shingled roof are shown in Fig. 1. Start construction by nailing or lag-screwing a header to the wall. Sometimes it can be attached without removing any siding.

For rigid attachment to a brick wall use lag screws and expansion sleeves or other suitable wall anchors set in holes. Next, set up the posts or pipe supports and install a girder across them. Rafters may rest on the girder, the rafters being toenailed to it. Or, they may be assembled like the arrangement in the lower detail of Fig. 1. If

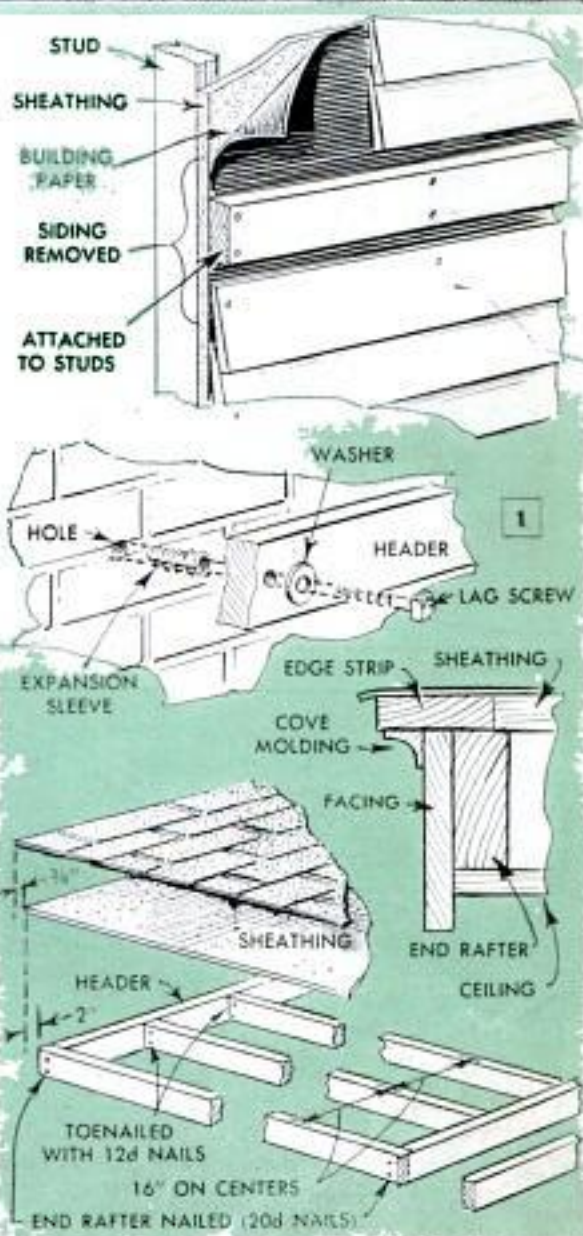



Courtesy Universal Fabricated Products Co.

This simple build-it-yourself carport features a lightweight aluminum roof that comes in kit form pre-cut to fit a supporting wooden framework of stock lumberyard material. Supporting framework goes together as detailed below, the various members being drilled at the points indicated for bolting together. Corrugated roof panels are lapped and caulked to make watertight joints. Roof kit, which includes four post sockets and all screws and bolts, retails for about \$200. Add about \$25 for the wood

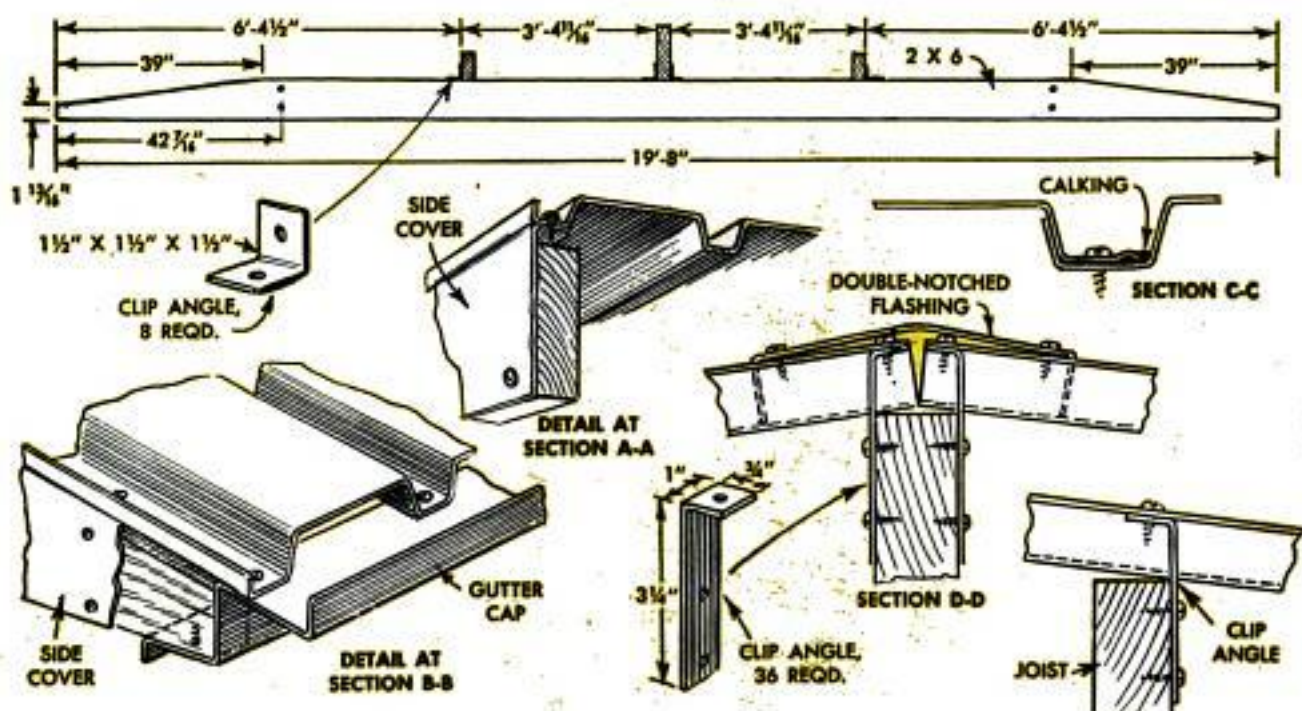
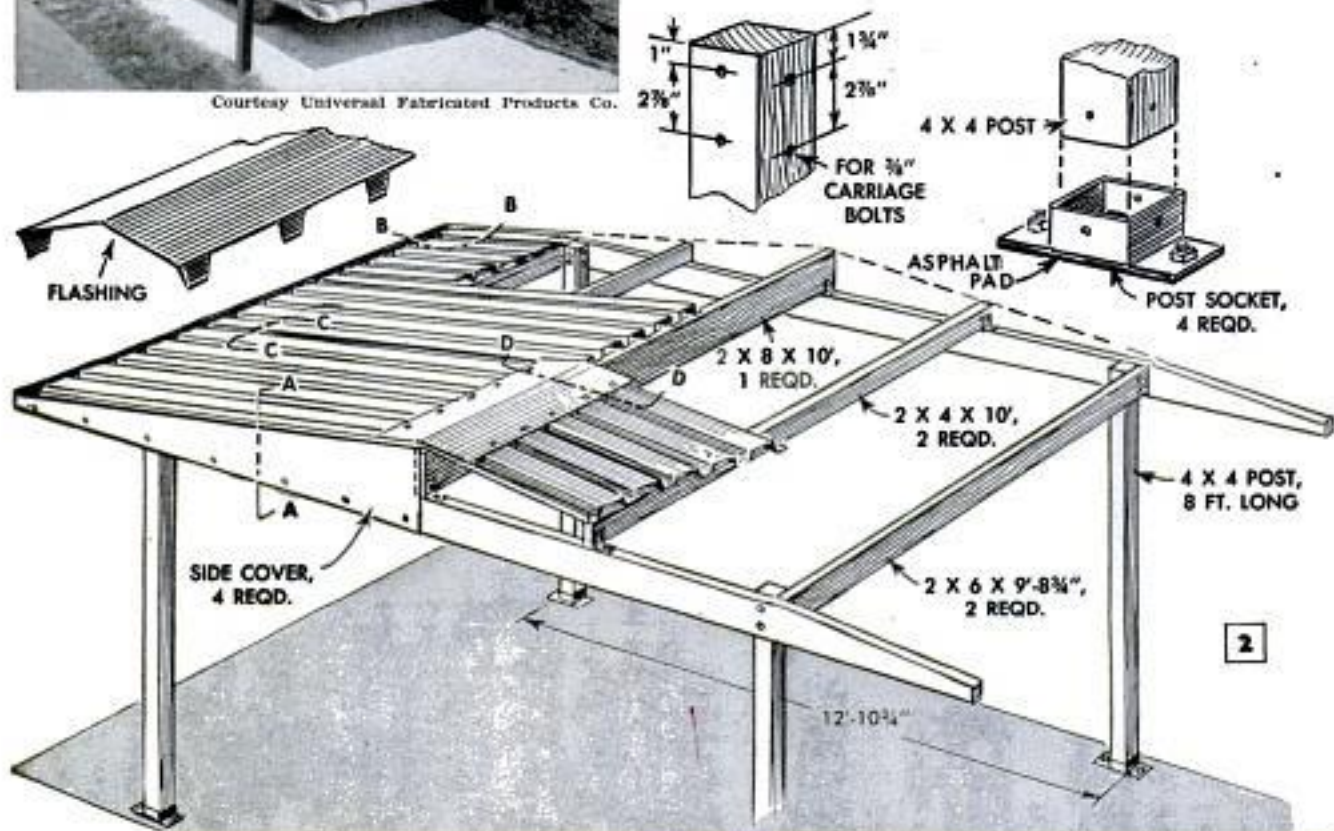

rafter length between supports does not exceed 10 ft., 2 x 4s may be used. But for spans from 10 to 14 ft., use 2 x 6s.

Corrugated glass-fiber panels make an ideal roof for carports. Besides being translucent, the material is strong and lightweight and may be sawed and drilled. Under the glass fiber, single 2-in. rafters can be spaced 24 in. apart but for 32-in. spacing, use 4-in. stock or two 2-in. rafters nailed together. Bridging is installed as in Fig. 4 for strength and appearance. The joining edges of corrugated roofing panels are sealed by strips of special mastic tape, or by applying calking compound. Nail or screw holes should be pilot-drilled through the roofing material. Nails for attaching glass-fiber panels have resilient washers under the heads.

The lower-left details of Fig. 4 show how pipe can be substituted for wooden rafters to support a glass-fiber roof. The pipes are spaced to come under joining edges of adjacent panels. For attachment, use non-rusting machine screws fitting tapped holes in the pipe. The screws should also have resilient washers under their heads.

For leakproof joints between house wall and carport roof, it is best to install sheet-metal flashing. The flashing goes under the siding or shingles of the house and over the shingles of the carport roof as in detail A of Fig. 3. For flashing on corrugated roofing use sheet lead bent to conform to the corrugations as in detail B. Flashing between a brick wall and a roof, details C and D, is embedded in mortar. When the carport roof runs diagonally across brick courses, flashing is done with two layers of



Filon Plastic Corp. photo

Corrugated glass-fiber panels are perfect for covering roof of carport. Material is translucent, featherweight and comes in many colors

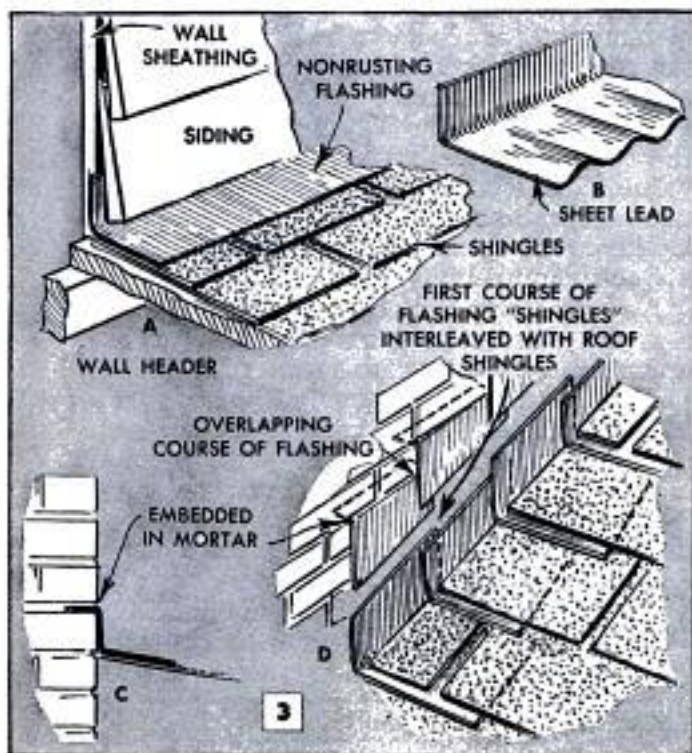

OCTOBER 1955

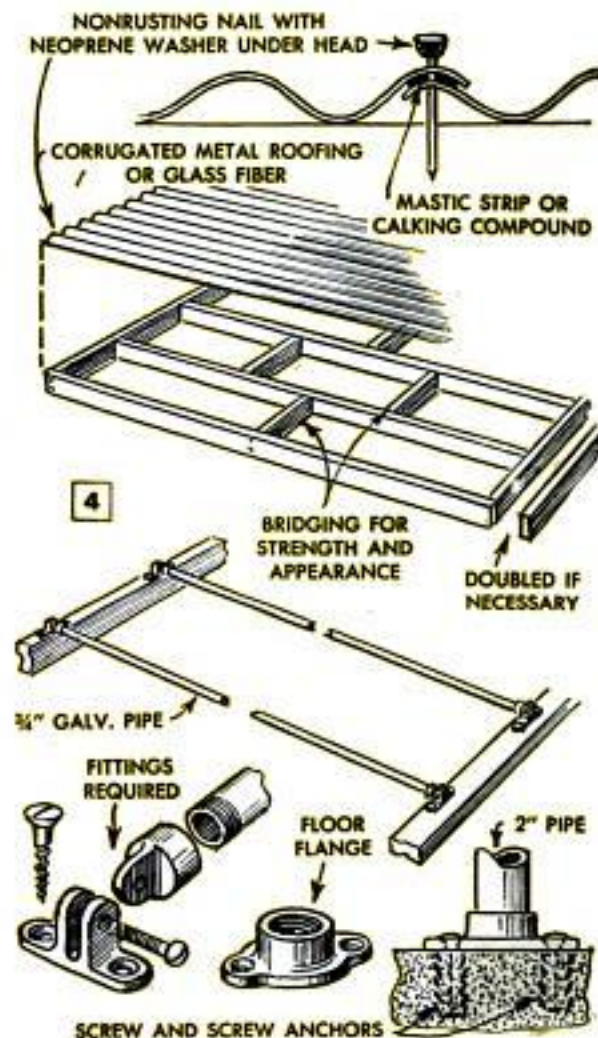

193

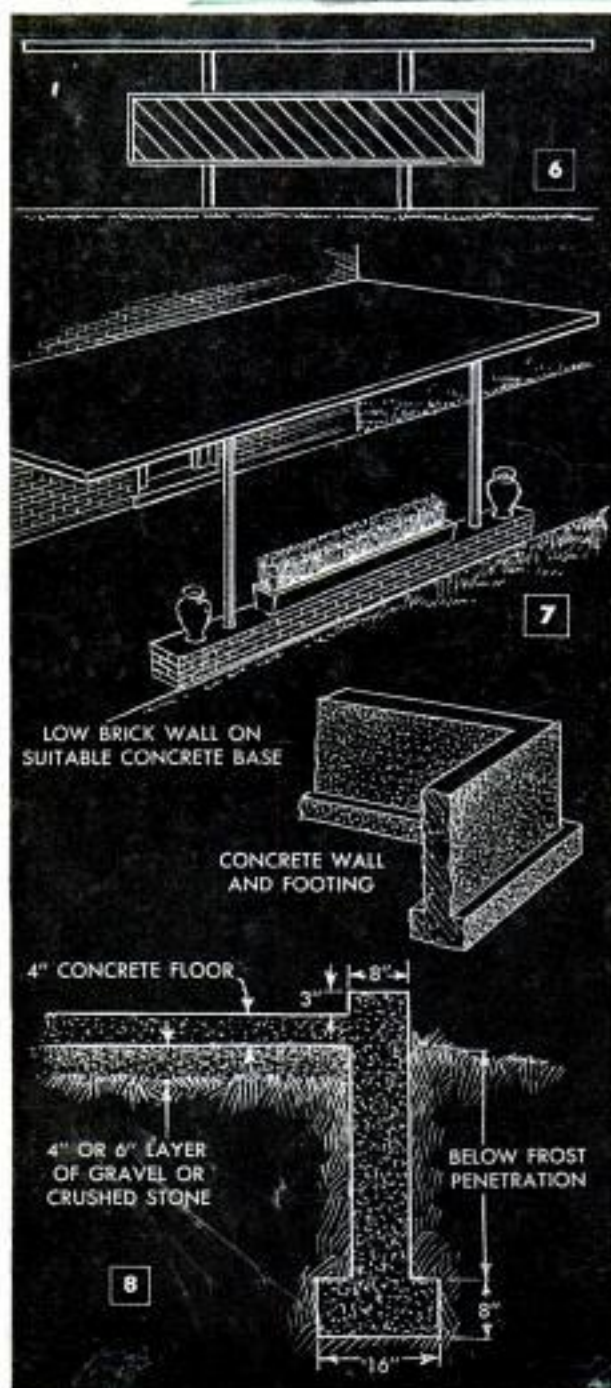

"metal shingles" as indicated in detail D.

The roof supports may be wooden posts, ornamental-iron columns or steel pipe. The latter should not be smaller than 2 in. in dia. As the pipe is threaded at both ends and is screwed into floor flanges, it can be adjusted easily for height. The upper flange is attached to the underside of the roof girder or header with wood screws. The lower flange is attached to a concrete slab or to a foundation wall by means of screws and screw anchors as shown in the lower-right detail of Fig. 4.

Fig. 5 shows a woven-wood weatherbreak that gives protection against weather and also provides privacy. It can be made from lengths of 1-in. lumber, or from strips of tempered hardboard. End posts can be built up from 1-in. lumber as detailed, to cover the ends of the woven boards. The ornamental panel shown in Fig. 6 may consist of natural-finish, bevel-edge boards arranged at a 45-deg. angle and held in a grooved frame. The V-joints produced by the beveled edges have definite decorative value. The low brick wall shown in Fig. 7 can be combined with a planter. A simple trellis covered with climbing vines also is attractive and will provide shade.

A gravel or crushed-stone floor often is entirely satisfactory for a carport. If a concrete floor is desired, this generally is laid before erecting the carport, although it can be added later. A concrete floor is much more durable if reinforced with welded wire mesh made especially for this purpose. The earth under a slab floor should be well drained. In northern climates much frost damage can be avoided by proper drainage.

Where a carport is to be transformed to a garage later, with walls like those of the house, concrete foundation walls and footings should be provided as shown in Fig. 8. In northern climates the footings should be set below frost penetration. ★★★

the

POPULAR
MECHANIC

CRAFTSMAN

WTM:57



By Clifford B. Hicks

ARE YOU CRAMPED for space to sleep overnight guests? One answer to the problem is a "bedroom" that folds into a bookcase in the manner pictured above. Two single beds, of the type that fold, roll into the lower compartment of this built-in. The space above the bed compartment is utilized for bookshelves, spaced as required. The photo above shows the lower bed compartment fitted with shutter doors, one pair of doors to each bed section. If desired, you can substitute panel doors or flush doors cut from $\frac{3}{4}$ -in. plywood. On the original built-in pictured, the shutter doors were made in the home shop to fit the space available. However, in most instances, standard ready-made shutter doors can be fitted, either by trimming the stiles and rails, or cutting the facing strips wider.

The dimensions given are only general in both height and width of the unit. The first

step is to make careful measurements of the space you have available. Then measure the beds folded, so that you have the over-all height and width plus the necessary allowance for clearance to permit them to be moved in and out of the compartments easily. Dimensions of folding beds of the type utilized may vary somewhat, so it is best to check each one individually.

The lower compartment consists of two end panels and a center divider, all cut from $\frac{3}{4}$ -in. plywood. To install, remove the baseboard and fasten the side panels and divider to the wall and floor with steel angle brackets. When the unit is installed in a corner, one end panel is simply screwed to the wall. The top of the compartment is cut to size from $\frac{3}{4}$ -in. plywood and attached to the panels with glue and finishing nails. Fit facing strips to the exposed edges of the top and nail and glue in place. If you wish to cover the top with linoleum or a

wood-grained plastic laminate, now is the time to do it. Sand the top smooth before cementing the plastic.

The endpieces and center divider of the upper bookcase section are cut from 1 x 8-in. solid stock. All three are dadoed (grooved) to take the ends of the bookshelves, the divider on both sides at the same points. You can, of course, use narrow cleats to support the shelves. You have a choice of using the room ceiling as the top of the bookcase, or of fitting a separate top piece. In either case, finish shelves and vertical members with facing strips, fastening the strips with glue and small finishing nails. Set the nailheads below the surface and fill the holes with wood putty. Nail a filler strip to the bottom of the top in line with the facing strips. Ordinarily, this should be $\frac{3}{4}$ x $\frac{3}{4}$ in., but the width may be varied to suit the doors available. In any case, the height of the openings must be sufficient to clear the folded beds. The inner edges of the door stiles should be beveled slightly so that they close without binding against the edges of the center facing strip. Hang the doors with surface hinges and fit each pair with bar latches as pictured. Be sure that each door clears the floor sufficiently to

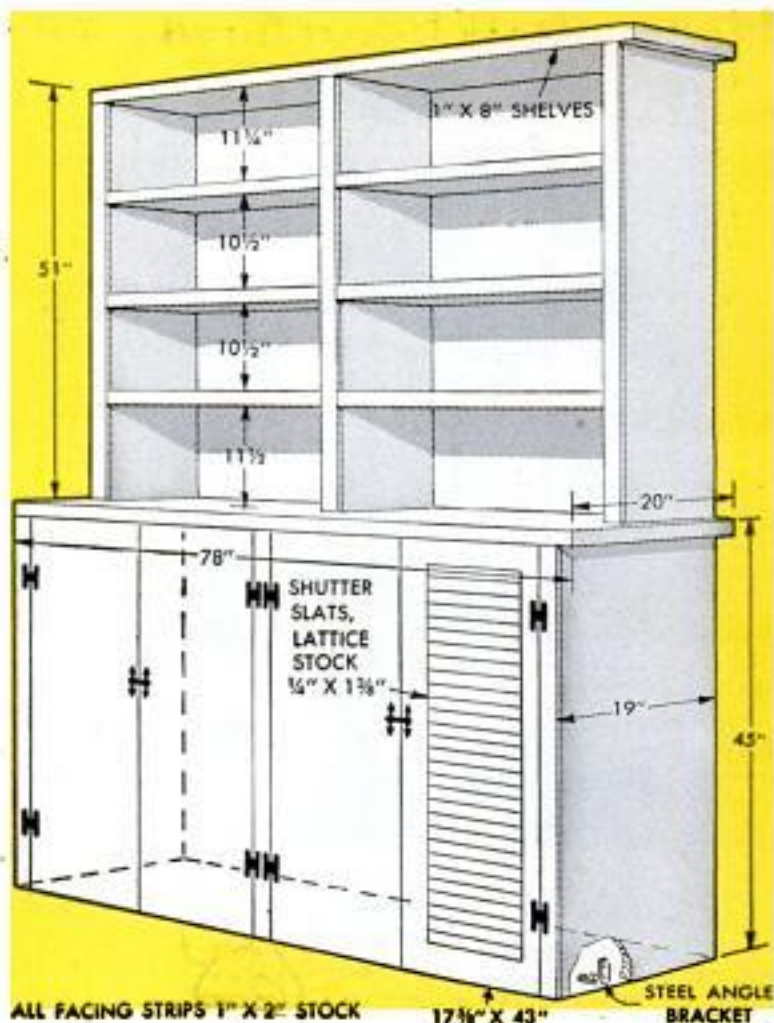

permit it to open and close freely. Then cut and refit whatever portions of the baseboard are necessary. Finally, apply an undercoater and paint to match the color of either the wall or the woodwork. ★ ★ ★

Heated Wheel Joins Plastic Yard Goods

Plastic yard goods of the thermosetting type can be joined or seamed by using a heated wheel as is done in manufactured items. A soldering iron is used as the heating element in the homemade wheel. Remove the copper tip from the soldering iron

and substitute a short length of copper tubing, the end of which is flattened. A hole is drilled near the end of flattened portion to permit mounting a small copper washer with a screw and nut. The washer must turn freely on the screw. In use, the heated wheel is run over the material to be joined, using enough pressure for complete fusion.



Painted Nursery Walls Decorated

When a child's room is painted and a contrasting color of enamel is used for trim, utilize the leftover trim enamel for unusual wall decorations. Simply enamel sheets of thin paper and allow them to dry. Then cut out animal or other figures from the reinforced paper. Use paste, rather than glue, to attach the figures, since paste will wash off easily when the walls are washed before the next redecorating.

Illuminated Flower Bowl Is Nighttime Decoration

A large copper or brass flower bowl is strikingly attractive at night when illuminated so that light shines up through the plant. Two pin-type, or other screw-mounted sockets, are fastened to the bottom of the bowl by small angle brackets. Each bracket is cut from a strip of sheet brass $\frac{3}{4}$ in. long and 2 in. wide, each leg of the angle being 1 in. After the sockets are installed on the angles, if the pin-type socket is used, a fiber disk is fitted between the socket and cap to insulate the cap from the angle. In the pin-type socket, two pins in the cap are forced through the wire to make contact when the cap is screwed on the socket. Two holes are drilled in the bowl for the canopy switch and line cord. A rubber grommet

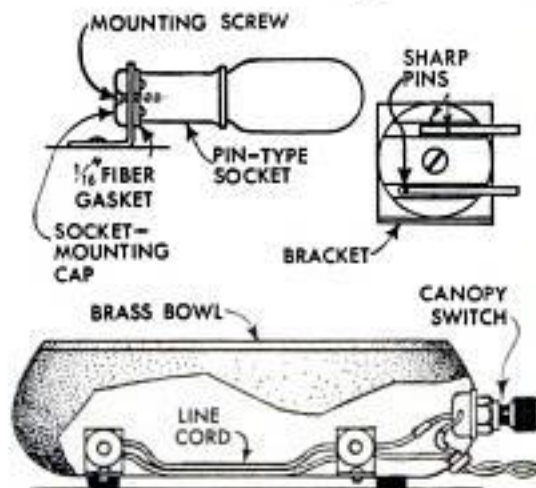

protects the wire from the sharp edge of the hole. Two 25-watt appliance lamps will furnish ample illumination at moderate cost. Unusual decorator effects can be obtained by using colored bulbs instead of regular white ones.

Clinton R. White, Costa Mesa, Calif.

"Electrified" Fish Pole Flashes Light When Catch is Hooked

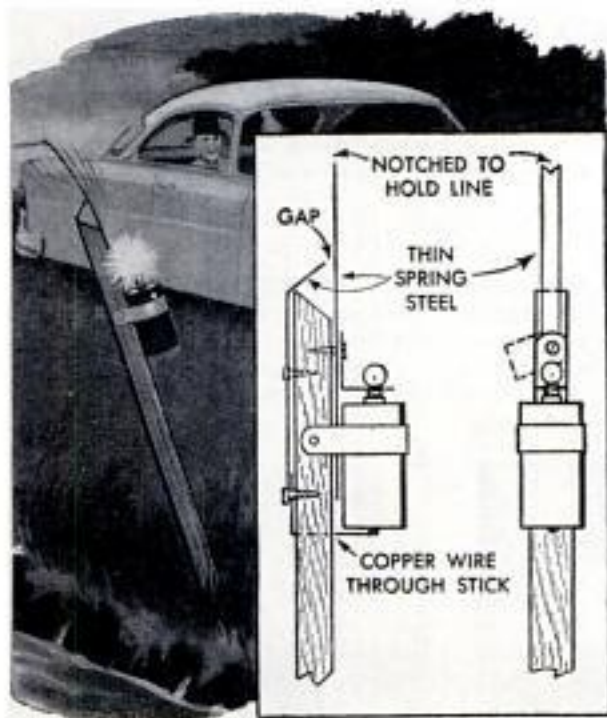

You can sit in the comfort of your car when fishing on cold nights and let the fish signal when he is caught by turning on a light with this "electric" fishing pole. The pole consists of a length of wood to which a strip of spring steel is screwed to hold the line. A flashlight bulb in an L-shaped bracket is in constant contact with the center terminal of a flashlight dry cell and with the spring steel. The dry cell is held on the pole with a sheet-metal strap. A

copper wire contacts the bottom of the dry cell, passes through the pole and is soldered to a metal strip screwed to the opposite side of the pole. The metal strip projects above the end of the pole and is bent so there is a gap between it and the spring-steel strip. Tension on the fishing line bends the spring steel so it contacts the strip and closes the circuit to turn on the light. The dry cell should have a cover to insulate it from the steel strip.

Joseph E. Desrosiers, Coventry, R. I.

Neckties Cleaned in Fruit Jar

Soiled neckties and other small articles can be dry cleaned in a fruit jar. Fill the jar to within 2 or 3 in. of the top with cleaning solvent, drop in the tie and screw the cover on tightly. Then shake vigorously for several minutes to loosen the dirt. Finally remove the tie and hang it in a ventilated place to dry. **Caution:** Remember when working with cleaning solvents that some of them are flammable and all of them must be used in a well-ventilated room. The jar may be used also with soap or detergent and water to wash small articles.



Solving HOME PROBLEMS

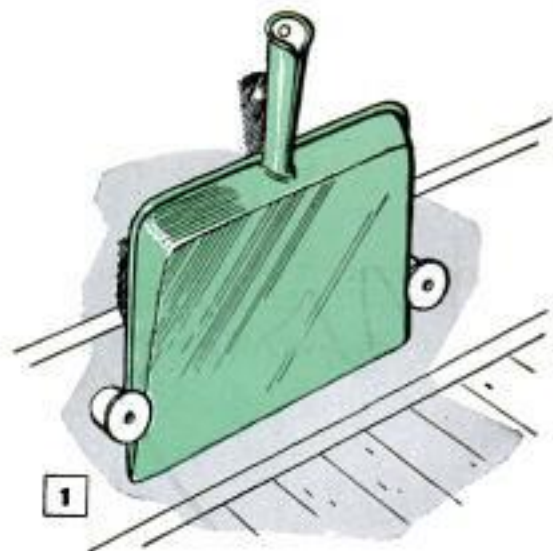

1. THE DUSTPAN is always easier to locate when you provide a rack made especially for it. Rack must serve a twofold purpose—hold the pan securely and provide incentive to replace it each time immediately after use. Cut a medium-sized thread spool in half and then nail the halves to the baseboard



2. A FUNNEL of the type having a smooth neck, or spout, may cause trouble when pouring liquid through it into a glass container. The smooth neck prevents the escape of air from the container as the liquid enters. You can easily avoid the trouble by slipping a bobby pin over the neck of the funnel as shown

3. HOT-DISH HOLDERS not only should serve the purpose, they should be attractive as well. Single-faced corrugated paper used in window displays comes in a variety of showy colors and designs and is well suited for use in making hot-dish mats. Cut disks from the material selected and coat each side with water glass, applying two coats. This stiffens the corrugations and makes the material fireproof

4. UPHOLSTERY WELTS on chair and sofa cushions usually are first to show signs of wear. However, the original newness can be restored by overcasting the worn welt with colored nylon yarn in manner shown



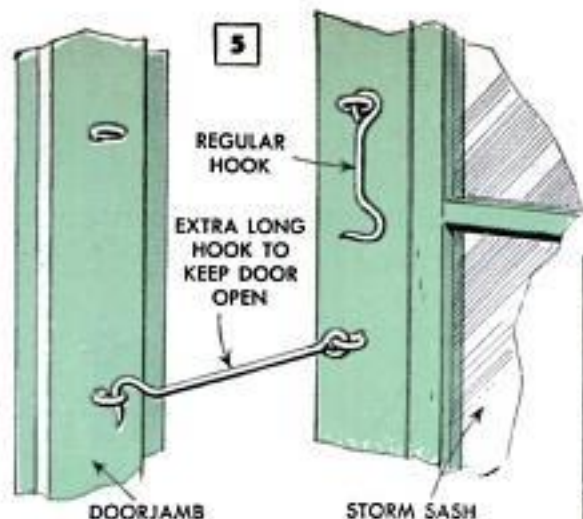

5. A STORM DOOR can be held partly open on winter days when extra ventilation is desirable simply by installing a long hook below the regular one. The rigid hook is much more satisfactory than the wedges often used, as it prevents the door from being blown open by wind. This can result in broken hinges or damage to the door itself. Hook is made from wire and two screw eyes

6. SMALL COTTON SWAB makes an excellent touch-up brush, especially where you have to work close to an edge without smearing paint or enamel on other parts. Swab, or applicator, is made by winding a small pledget of cotton on end of a toothpick or meat skewer. Wind the cotton tightly so that there are no trailing wisps to carry the paint beyond the line. Especially useful for applying heavy enamels

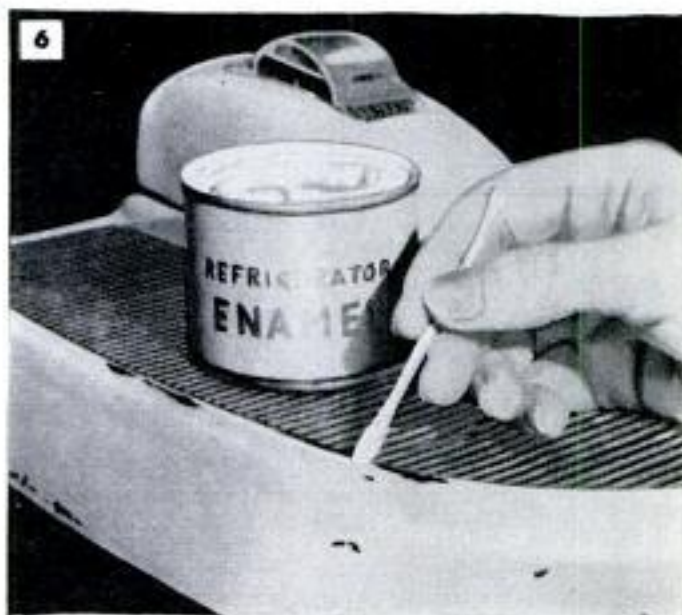

7. PAINT SPATTERS are easily removed from linoleum or hardwood floors with fine steel wool, even after the paint has partially hardened. Use light pressure and a short stroke, just long enough to cover the spot without dulling the finish on the surrounding area more than necessary. Wax and polish to eliminate any dull spots that may have been caused. Method usually is better than using solvents

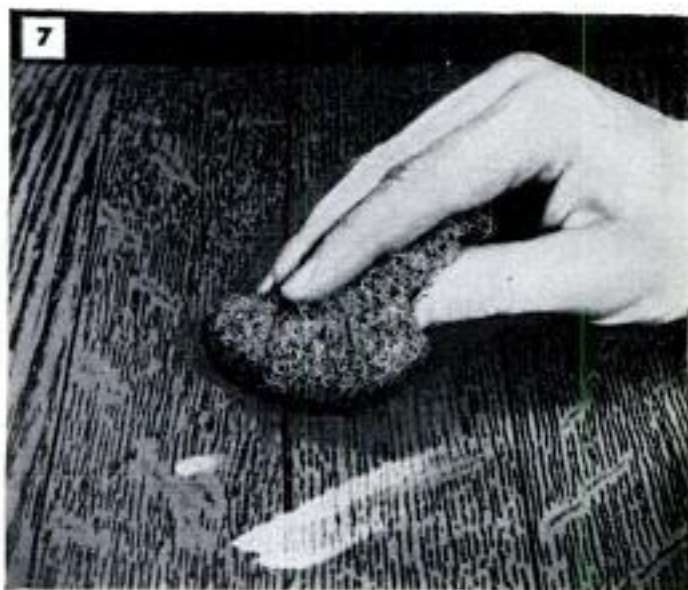

8. STEEL-WOOL PAD keeps putty knife clean when you're glazing sash or replacing a broken pane. Form a pad of medium-fine steel wool and pour linseed oil on it. Then keep it handy to clean the putty-knife blade frequently as you work. Saves time and the job goes faster as the pad not only cleans the blade thoroughly, but coats it with oil as well. This coating enables you to put an especially smooth glaze on a fillet of putty

Illuminated "Balloon Face" For Nighttime Fun



Fun for Halloween and all gala after-dark occasions, this illuminated face will please any youngster. Tape, a balloon, heavy paper, a flashlight and a little imagination for painting the features on the balloon are all that are needed. The balloon is inflated and painted, then the paper is rolled into a cone, the large end of which fits snugly over the balloon. The small end of the cone is fitted over a flashlight, and both balloon and light are taped to the cone.

Cellulose Tape Over Knuckle Aids Removal of Ring



A tight-fitting ring sometimes can be pulled over a swollen knuckle by using strips of cellulose tape. Narrow strips of the tape are cut and fitted over the knuckle as shown. The tape grips the skin of the finger, preventing it from

being forced into a ridge ahead of the ring, and also provides a smooth sliding surface.

A. H. Waychoff, Phoenix, Ariz.

Prussian Blue Locates High Spots When Refitting Wooden Door

When refitting a door, a tube of Prussian blue can be used to simplify the job. Rub a small amount of the color along the door-frame where the door contacts it, then

open and close the door several times. The color will be transferred to the edge of the door most heavily where it is binding, thus indicating the spots that must be planed off to provide a satisfactory fit.

Radio Interference From Tools Eliminated by Condenser

Much of the radio interference caused by the use of electrical tools in the workshop can be eliminated by wiring a condenser across the line that carries current for the tool. One method is to bend the pig-tails of a .01-mfd., 600-volt capacitor (condenser) to fit into one side of a 3-way plug. After the pig-tails are inserted in the plug and make contact, the condenser is taped in place. As shown in the illustration, the 3-way plug is then used between the tool cord and the wall outlet. This method will also eliminate some of the interference caused by an electric razor.

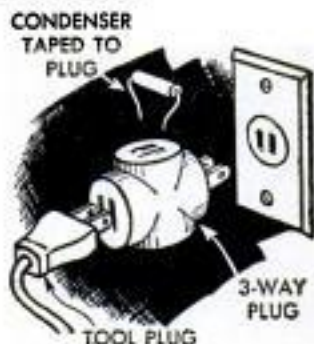

Lightweight Level Improvised For Jobs Around the House

Improvised from a yardstick and a small level, a lightweight but long level can be used for dozens of jobs around the house. Easily held with one hand, the level can be used to align large pictures, scribe level lines for installing wall tile and similar jobs. Make sure the yardstick to be used is straight by holding it edgewise on a table or other flat surface. When attaching the level to the yardstick, place both on a flat surface and align their bottom edges.



☞ To restore the color to a faded rug, sponge a small portion at a time with hot water, to which a little ammonia has been added. Use a clean duster to dry it thoroughly.

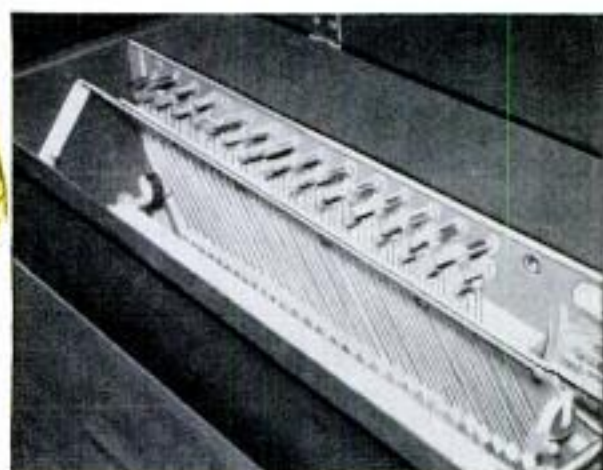
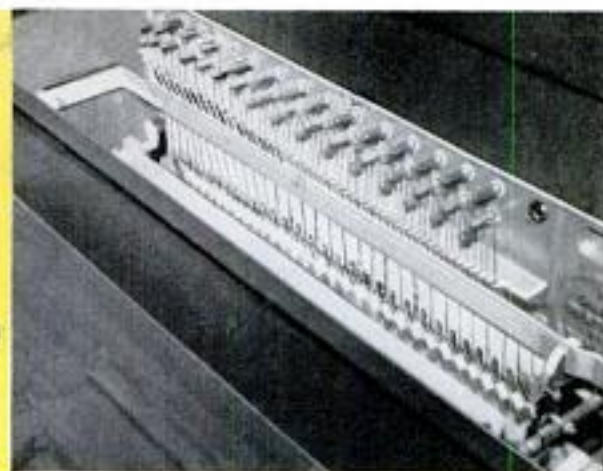
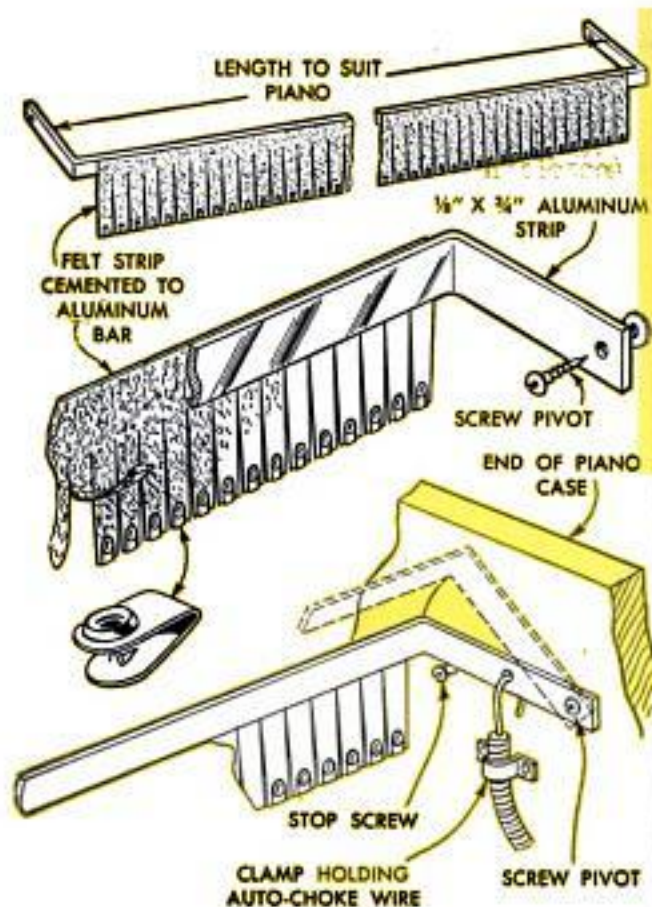

SPECIAL MUSIC FROM OLD PIANO

That popular "mandolin and guitar" tone can be achieved on your recreation-room piano by installing the simple attachment pictured in the photos. It consists of an aluminum strip, or bar, with the ends bent at right angles and pivoted to the ends of the piano case. A strip of felt is cemented to the outer face of the bar. The felt is cut to form separate tabs, as many tabs as there are felt-faced hammers. A pencil mark is made on each tab at the point where it is struck by the hammer. Then the felt tab is cut off just below the pencil mark and a pinch-type paper clip is installed at the end of each tab as shown in the details above.

This finished, turn stop screws into each end of the piano case to hold the bar in position. Obtain an auto-choke button and cable, cut to the required length and install as in the lower detail. The control button should project from the front panel of the piano case in a position where it is easily reached. Adjust the control so that when the button is pulled out the felt tabs will be lowered to a position in line with the hammers with the bar against the screw stops. When the button is pushed in, the control should lift the felt tabs clear of the hammers as in the lower photo.

L. F. Vogt, Westfield, N. J.

Pipe Cleaner Used for "Brushing" Spaces Under Ring Setting



You'll be surprised how effectively a pipe cleaner works in brushing out the dirt from tiny openings between the prongs of a ring setting and also under it. Dip the cleaner in soapy water, or a detergent solution which helps to loosen dirt quickly and restores the ring to pleasing brilliancy. Pipe cleaners also are effective for getting into chain links, fine filigree work of jewelry, and openings in intricately formed porcelain pieces such as statuary.

Display-Card Holders Improvised From Paper Clips



When display-card holders are not available, simple ones can be improvised from wire paper clips. Bend each clip in half and insert a card in the double-loop half. Two or more clips may be required on larger display cards.

Name in Reflective Tape Identifies Mailbox



Strips of reflective tape are used to print the name on this roadside mailbox. At night the name is clearly visible at some distance in the beams of auto headlights, providing easy identification of the farm owner. The reflective tape

also clearly indicates the presence of the mailbox so there is less chance of it being struck by a car.

A. M. Wettach, Mt. Pleasant, Iowa.

Playing Narrow-Groove Records For Square Dancing

Even though the turntable mechanism of a phonograph is mounted on springs, an additional shock-absorbing mounting is

necessary when playing narrow-groove records if any undue vibration is present. To provide the additional shockproofing, place the phonograph on a piece of $\frac{3}{4}$ -in.-thick sponge rubber. The phonograph needle then will not jump out of the record groove even when the phonograph is played for a floor-shaking square dance.

Thomas P. Ramirez, Fond du Lac, Wis.

Asphalt Strips Provide Seal Between Foundation and Sill

A more airtight joint between building foundation and sill plate can be provided by using strips of $\frac{1}{2}$ -in.-thick asphalt-saturated material, which is available at most building-supply yards. Because no water is used, the asphalt strips eliminate the moisture problem present when the sill plate is bolted down on a bed of wet mortar. Spaces, resulting from drying and shrinking of the sill plate, thus are avoided.



Grease Protects Clamp Pads

Chipping dried glue off the pads of clamps will not be necessary if a coating of petroleum jelly or grease is applied to the pads before the clamps are fitted on the object being held. Any excess glue which squeezes onto the clamp pads is not wiped off but allowed to dry. The dried glue then is brushed off with the fingers.



By washing crevices and corners of a cupboard or of a room itself with an alum-water solution, you can destroy red ants easily without damaging the woodwork.

SN 58



SPRING-BRONZE STRIPPING



Circular saw makes easy work of grooving each sash



ZINC RIB STRIPPING

DOOR-BOTTOM STRIPPING



ADHESIVE-BACKED FELT STRIPPING

IT PAYS TO WEATHER-STRIP

Heat is a costly item and when allowed to escape through windows and doors it's like money pouring through a hole in your pocket. Weather stripping will help "plug the hole" and save up to 37 percent of the total heat loss in an average five-room home.

By Wayne C. Leckey

DO YOU KNOW there is a hole equivalent to the size of a saucer in every non-weather-stripped window in your home? That's what the 21 lineal ft. of $\frac{3}{16}$ -in. clearance crack around a double-hung sash equal, and it's through this crack that a large amount of heat goes out and dirt-laden air comes in. Tests by the Weather-strip Research Institute show that a 15-m.p.h. wind against a non-weather-stripped window admits more than 45,000 cu. ft. of air—cold and damp—every 24 hrs.

Weather-stripping doors and windows is a job most any handy homeowner can do himself. Of the many different types of window weather stripping, the zinc rib-strip type is perhaps the most permanent, although it does require more work to install than, for example, the stick-on type pictured in Figs. 7 and 8. Special grooving

planes and routers are used by professional installers, but the man with a home shop can cut grooves with a saw and drill press.

To install zinc rib-stripping on double-hung sash, first carefully remove the window stops, take out the lower sash and set it aside. Next, remove the left-hand parting bead. This is a $\frac{3}{8}$ x $\frac{3}{4}$ -in. wooden strip that forms a channel for the upper sash and which normally is a press fit in a groove in the window frame. In most cases, this bead is stuck with paint and requires careful prying to get it out. With this strip removed, the upper sash can be lifted out. Fig. 4 shows how each sash must be grooved and rabbeted for the zinc strips. A plain strip is used along the bottom of the lower sash, while a corrugated strip is used across the upper sash. In each case, a $\frac{5}{16}$ -in. groove is cut in the edges of the sash to fit



2 Interlocking hook strips are nailed to beveled check rails to seal opening between upper and lower sash

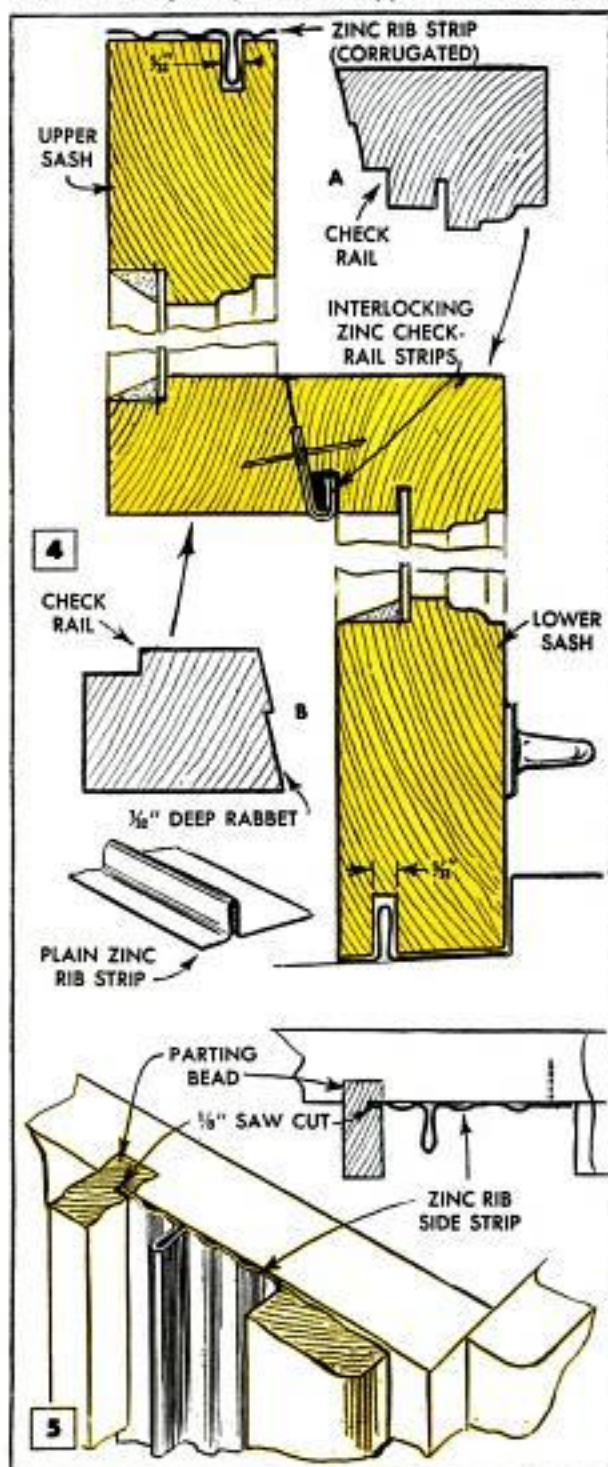
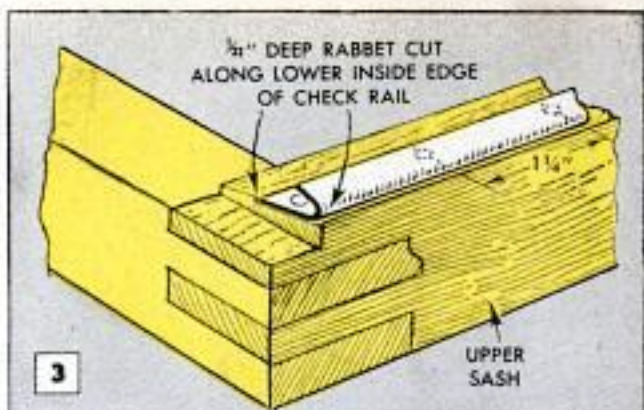

over the lip of the weather stripping. A circular saw is used to cut the grooves in the manner shown in Fig. 1.

Similar grooves are cut in both sides of the upper and lower sash to ride on corrugated strips placed vertically and tacked to the sides of the frame as in Fig. 5. Here you'll notice, too, that a saw cut is made $\frac{1}{8}$ in. deep in the inside face of each parting bead to help anchor the strips in place.

A portion of the upper ends of the zinc side strips must be cut out so they will clear the sash-cord pulleys. Where the side strips meet the head and sill strips, the ends of the side strips have to be cut at a 45-degree angle so the ribs of the head and sill strips will pass under. Nail the head strip to the frame, spacing the nails 3 in. apart.

The interlocking hook strips along the check rails, Fig. 4, are nailed in rabbets. The shallow rabbet in the beveled face of the upper check rail, detail B, can be cut easily with a circular saw, but the stepped rabbet in the lower sash, detail A, requires cutting with a router bit in a drill press and with the sash supported at an angle. The sectional drawing, Fig. 4, shows how the two strips hook snugly together when both sash are closed. Figs. 2 and 3 show how the large hook strip is nailed flush across the edge of the upper sash. The other strip is nailed similarly.



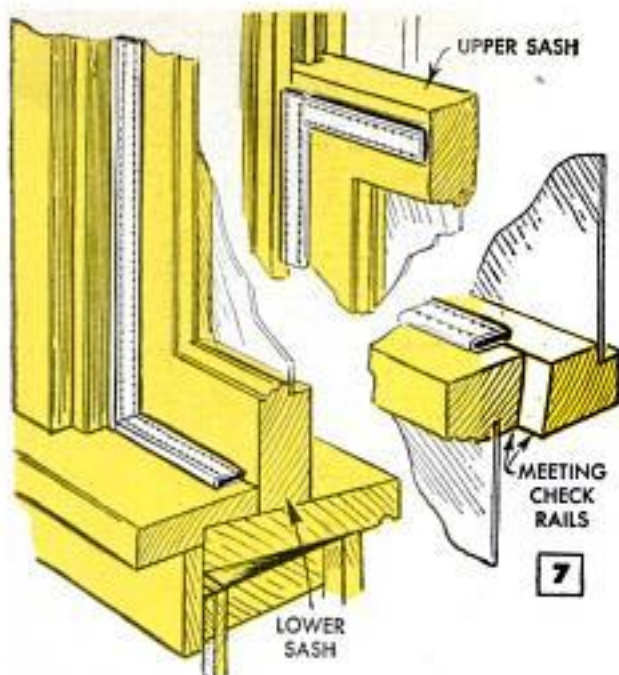

7

The upper right-hand side strip is held with a nail at the top and one at the bottom and with a nail above and below the pulley slot. Now to replace the sash: Place the upper left-hand side strip in its groove and slide both the sash and strip into the frame, adjusting the side strip to fit over the head strip. Nail as before, Fig. 6, and replace the parting bead. To replace the lower sash, fasten the right-hand side strip in place by inserting the flange of the strip in the saw cut in the parting bead and drive one nail at the top and one at the bottom inner edge of the strip. Install the lower left-hand side strip in the same way as the upper sash, replace the inside stops and finally nail the sill strip in position.

Spring-bronze weather stripping is used to weather-strip doors and is nailed to the jambs of the doorframe so the contact edge is about $\frac{1}{8}$ in. from the edge of the stop, Fig. 9. The important thing is to get the strip stretched properly so there are no buckles in the contact edge. Put on the head strip first, spacing the nails 1 in. apart to avoid buckling and resulting air leakage. Next, miter the upper end of each side strip and then fasten with a nail near the top and another 1 in. below. Stretch the bronze strip by driving an awl or ice pick through it near the lower end and into the wood. Press downward on the awl to stretch the strip, leaving the awl in the wood. Drive one nail at the middle, one at the bottom and two in between. Complete the nailing 1 in. apart as before. After the strip is nailed, the flange must be adjusted up or down so it touches the edge of the door at all points. If it must be raised slightly, run a dull-pointed tool along the crease of the strip a couple of times with an even, firm pressure.



Chas. Ayers Co. photo

Adhesive-backed felt weather stripping is pressed on and pulled off like masking tape. Ideal for apartment and home renters. Provides an effective seal

8

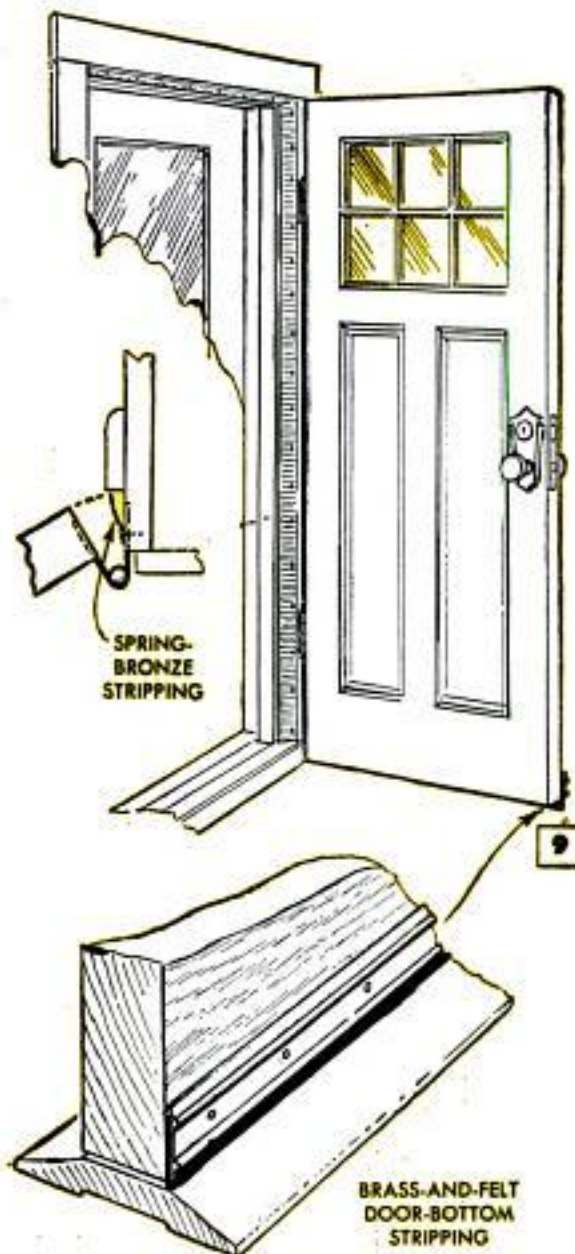

9

Nail Kegs Carried More Easily



When it's necessary to carry a couple of opened kegs, just fit them with large-sized C-clamps as shown, tightening the clamps securely so they cannot slip off. A keg then can be picked up in each hand, using the clamps as handles. The usual awkwardness of carrying a keg with two hands is thus eliminated.

Permanent Anchoring Stakes Swiveled on Dividing Board

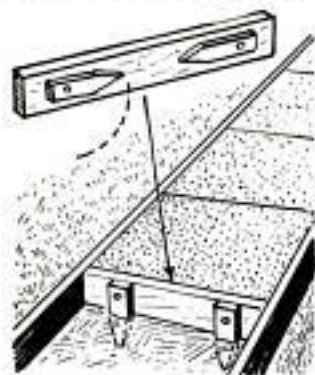

To save time, one contractor attaches anchoring stakes permanently to his concrete-walk dividing boards. The stakes are bolted in place so that they can swing up out of the way when the boards are loaded on a truck or stored. When the

dividing board is put in position on a job, no time need be wasted in hunting for stakes or in shaping new ones.

Clothespin Holds Valve Stem While Tire Is Mounted

The use of an ordinary spring-type clothespin can make the changing of a tire much easier. After the valve stem has been pushed through the wheel hole, clamp the

clothespin over it so that it cannot slip back through while the tire is being positioned and mounted on the rim.

Howard E. Moody, Upper Jay, N. Y.

Tent-Pole "Clothes Hooks" Fold When Not Being Used

The problem of where to hang coats and other items in a tent is solved by using folding "clothes hooks" on the tent poles. As shown in the drawing, each hook consists of two links of wire and a screw eye. The short link hooks into the screw eye which is driven into the tent pole. The

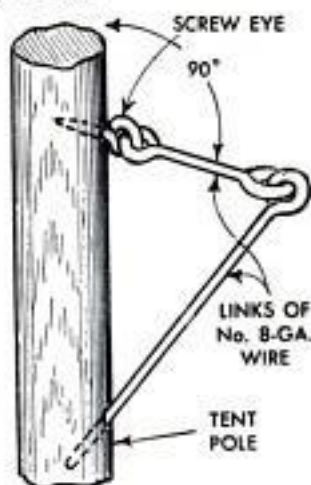

straight end of the other link is fitted into a hole drilled in the tent pole at an angle that holds the upper link at right angles to the pole. When a hook is not being used, lifting the lower link out of the hole permits the hook to drop down and hang flat against the pole.

Curves Bent in Flat Steel By Using Vise-Held Jig

A simply made jig for bending curves in flat steel consists of two threaded steel pegs and a short piece of steel angle. The pegs are 1/4-in. lengths of 1/2-in. steel rod, threaded and turned into tapped holes in one side of the angle. The pegs are spaced 1/4 in. apart. Flat steel up to 1/8 x 1 in. can be bent in the jig.

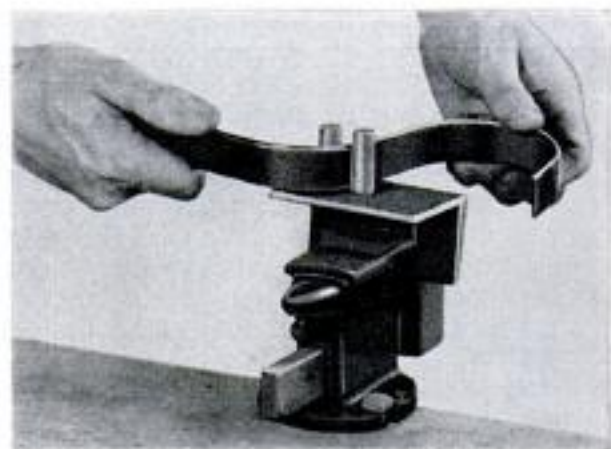

☛The students in ceramics courses of one western college have found a use for cigarette ashes. These are mixed with sand and clay to produce an excellent pottery glaze.

Window-Shade Movie Screen Mounted on Back of Television Set

Because a television set is located so everyone in the room can see it, a hideaway movie screen fitted to the back of the set also will be properly located for best viewing. The hideaway screen is a regular window shade fitted in window-shade brackets screwed to the back of the set. When the shade is pulled up for use, a wire hook at the center of the shade engages a screw driven into the wall behind the television set to hold the screen in position. A screw eye driven into the back of the set holds the hook when the screen is lowered. For a better movie screen, purchase regular screen material and staple it to the roller.

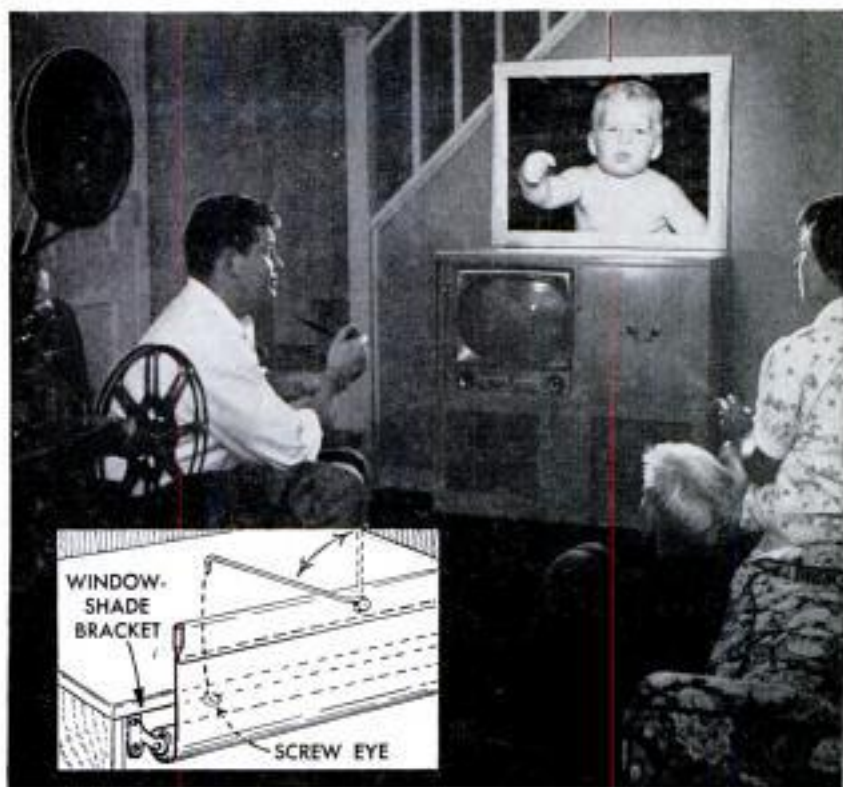

Heater Fan Used for Thawing Frozen Pipe in Outside Wall

A frozen waste or water-supply pipe in an outside wall can be thawed by forcing warm air from a heater fan into the wall between the studs where the pipe is located. To make an opening in the wall, bore holes and use a keyhole saw to cut through the subfloor directly under the wall plate and also through the plate itself. If the wall contains batt or blanket-type insulation, there is an air-circulation space between the insulation and the outside sheathing

into which the warm air should be directed. This space also probably provides access to the frozen pipe, since the latter would not be likely to freeze if the insulation had been properly installed between it and the sheathing. If the frozen pipe is a waste line and the fitting at the lower end has a clean-out plug, open the plug and insert a length of rubber hose or tubing up to the point of obstruction. Connect the hose to the hot-water faucet and flush away the ice.

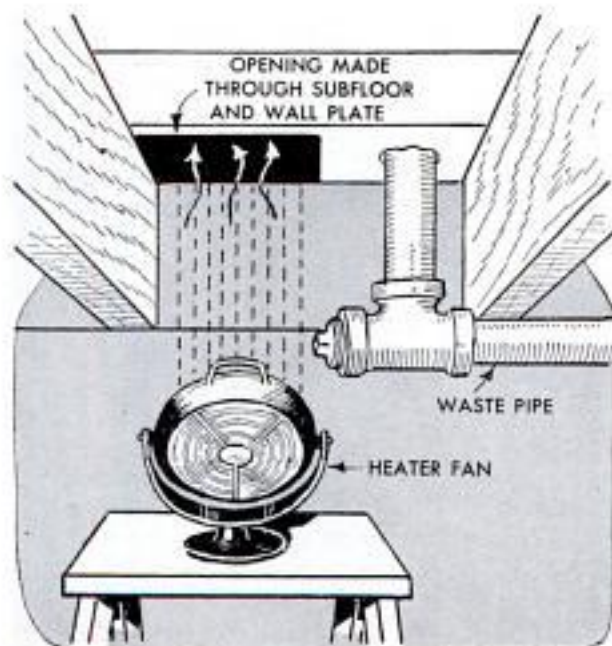

Auto-Compass Adjusting Tool Made From Brass Washer

Turning the compensating screw on an auto compass is much easier than with the edge of a coin, as is recommended. The tool is simply a brass washer soldered to a length of brass rod. A flat is filed on one edge of the washer so it fits snugly in the screw slot. Brass does not cause a magnetic effect on the compass and the handle of the tool provides leverage not available when using a coin.—Charles Erwin Cohn, Chicago.



Helpful Hints For Flowerpots

Want flowerpots to look more cheerful, cause less damage to woodwork and retain moisture for better plant growth? Check the hints on these pages



A quick method of adding beauty to an ordinary flowerpot is to set it into an inverted lamp shade

Generous-sized piece of sponge dropped into flowerpot before adding soil acts as moisture retainer, reducing need for frequent watering of potted plant

When potted plant must be left for several days without being watered, soak soil, then fit cardboard disk in top of pot to reduce moisture evaporation





Wren house is made by fitting wooden disk in top of flowerpot, enlarging hole in bottom to size of quarter



Cork cemented to window sill will prevent flowerpot from being tipped over or knocked off accidentally. Hole in pot bottom is fitted over the cork

To successfully grow plant slip started in water, gradually add soil to replace water. When container is filled, break it and place plant and soil in pot



OCTOBER 1955



Coat of paint inside flowerpot will seal porous clay and prevent moisture from evaporating rapidly. Use rubber-base, or other paint that won't harm plants

Rubber fruit-jar ring cemented to bottom of flowerpot helps in two ways. It will prevent pot from sliding and also will keep water marks off woodwork



209

Copyrighted material

Rubber-Covered Bottom Rung Is Safety Step on Ladder



Providing a rubber cushion on the bottom rung of a ladder will prevent possible accidents resulting when a workman descends the ladder carrying a load. The different "feel" of the rubber cushion will warn the workman of the bottom rung and thus prevent possible jarring or stumbling. The cushion is a length of rubber garden hose slit to fit over the rung and taped or tacked in place.

Damaged Screw Threads Restored



When a spare is not available, the threads on a damaged screw may be restored with cutting-type pliers. Rest the points of the pliers on a board and turn the screw between them with a screwdriver. Run the screw through several times.

Dustless Stovepipe Cleaning

To clean a smoke pipe without soot flying over the basement, separate the pipe carefully at the joints and place one end of each section in a bucket of water. Then

rap the outside of the section with a stick, so that the soot inside is jarred loose. It will then fall into the water.

Emergency Barn Bracket

In an emergency, a bracket for use in the barn or shop, to support a scale, a lantern or other light item, can be made by driving a nail into the wall and hooking the claw of a hammer on it as shown. The nail should be driven in far enough so that the hammer handle hangs straight out from the wall. The ring of the appliance may be slipped over the handle, or if the ring is too small, a loop of twine can be tied to the appliance and then slipped over the handle.

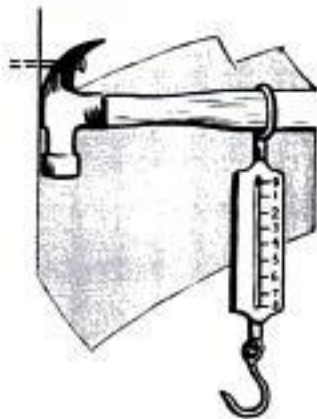

Extension Chute for Jointer

A simple sheet-metal extension on the chip chute of a jointer will discharge chips and shavings into a waste box for easy disposal. As the shortness of the regular chutes is the reason that much of the waste drops onto the floor, the extension should be long enough to reach well into a box as shown. Fit the extension on hooks so it can be lifted out when not used.

M. C. Anderson, San Lorenzo, Calif.



PATTERNCRAFT

MODERN NIGHT STAND

This eye-catching night stand, which offers two spacious shelves plus a roomy storage drawer, is designed as a companion piece for the twin-bed headboard detailed on the Patterncraft pages last month. However, it will fit in nicely with many modern furniture designs if made of the same type of plywood and finished similarly. The shelf section is built separately and fastened to the drawer unit with 1-in. angle irons. Rabbits at the tops of the endpieces hide the joints between the shelf and drawer units.

FULL-SIZE PATTERNS

If following magazine details is troublesome or difficult for you, make the night stand the easy way—use a full-size pattern with complete directions. To obtain your pattern, send 50 cents to Patterncraft, Popular Mechanics Press, 200 East Ontario Street, Chicago 11. Be sure to ask for Plan No. 120

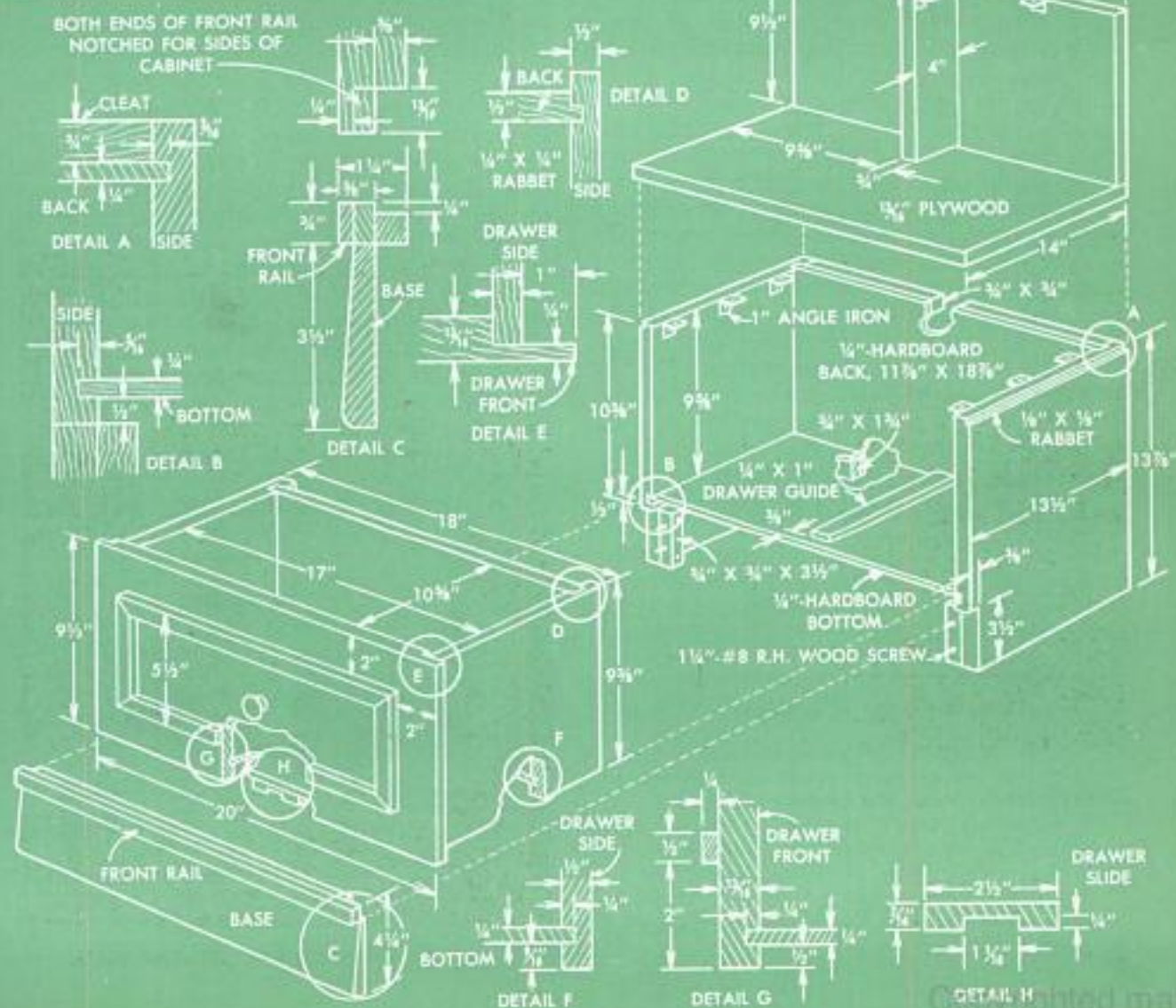

Removable Fence Section Provides Oversize Gate



If your back yard is completely fenced in except for a narrow gate across a walk, and you have experienced occasional need for a wider passageway, try the following idea: Where the fence joins the house wall, as is customary, a wider opening can be provided. To do this, drive two or three large screw eyes into the house wall in vertical alignment to take a removable rod. Bend the top end to prevent it from slipping through the top screw eye. On a wire fence, twist lengths of heavy wire to loop around the rod and fence stays. On a wooden fence, use either screw eyes or drilled metal plates instead of wire, and also cut the rails at the first post for another detachable connection. For attachment to a brick or stone wall, drive the screw eyes into expansive sleeves fitted into holes drilled in the mortar joints.

Nail Hole in Plastered Wall Repaired With Wood Putty

When a nail on which a picture is hung breaks out of a plastered wall, wood putty can be used to repair the hole and permit re-driving the nail in the same spot. If the

Three-in-One Kneehole Desk

which houses both a portable sewing machine and a typewriter will appeal to almost anyone who has limited space. It's a real space saver as well as a good-looking piece of furniture. Watch for this functional desk in the November issue where it's shown in full color with complete details. You can make one like it in birch or mahogany

hole is small, just press the putty firmly into it; if it is quite large, build in from the sides with putty. Let each layer dry before applying the next one.

Bureau of Industrial Service, Inc.

Corrugated Paper in Tape Spool Holds Artist's Brushes

A practical holder for artist's brushes can be made by rolling a strip of light corrugated cardboard and inserting it in the center opening of an adhesive-tape spool. The ends of the brush handles are slipped into the corrugations. The spool flanges keep it from tipping.

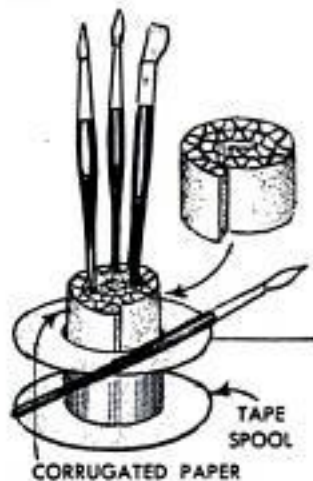

Opener for Vacuum-Packed Cans

Vacuum-packed coffee cans and other key-opened tins may be opened easily by using this tool, which is made from a piece of drill rod or a small screwdriver. Using a screwdriver makes it unnecessary to fashion a handle. Anneal the end of the blade by heating it to a dull red color and then allowing it to cool slowly. Next, saw off the tip, leaving the shank about 3 in. long. Hacksaw a slot in the end of the shank about $\frac{3}{4}$ in. deep. Pushing the spiral of metal off the tool after the can is opened is done by a slide on the tool. The slide is made by drilling a hole through a short length of plastic rod counterboring and adding a straight spring which bears against the shank of the tool for friction. The chance of cut fingers is eliminated and the large convenient handle makes it much easier to open cans with this tool than with the usual wire key.

J. B. Mullen, Barrington, Ill.

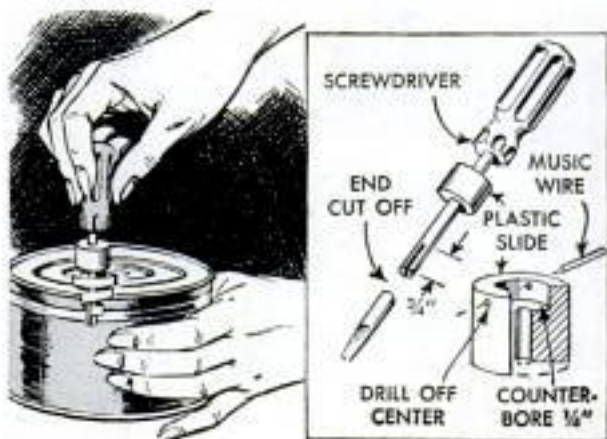

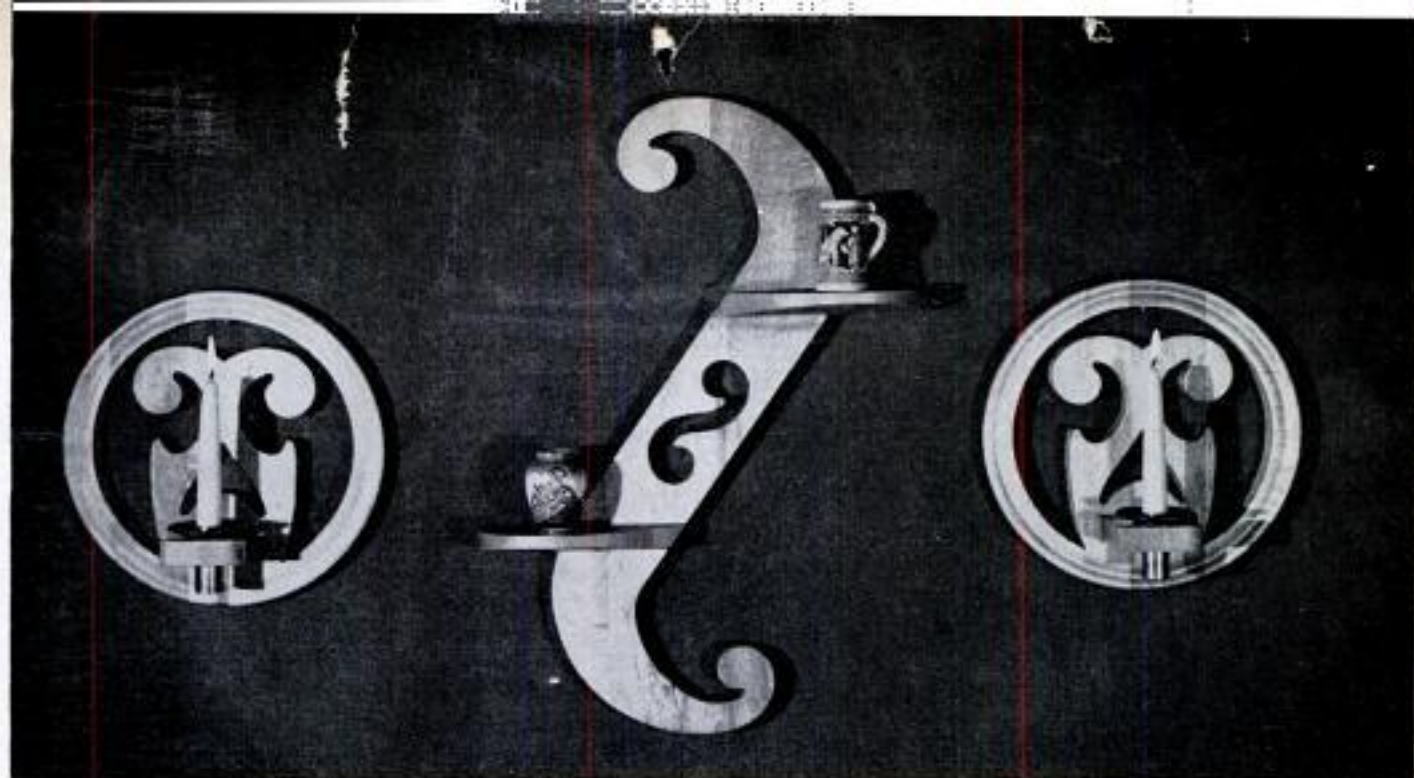

CANDLE SCONCE AND SHELF IN WOOD

THAT BLANK SPACE on the living or dining-room wall—here's one good answer to the question of what to do about it. The candle sconces, in pairs with the wall shelf, have a decorative individuality that provides just the right finishing touch. Both are simple projects made by jigsawing and turning hardwoods selected for attractive grain. Jigsaw two disks to the diameter

given, mount in the wood lathe and turn the rims to the shape shown. Then jigsaw cutouts in each and fit candleholders. Make the holder and shelves by band or jig sawing to the pattern and sanding the edges smooth. Jigsaw the cutout at the center. Note how the shelves are beveled. Finish all three pieces in the natural color of the wood.—R. J. De Cristoforo, New York City.

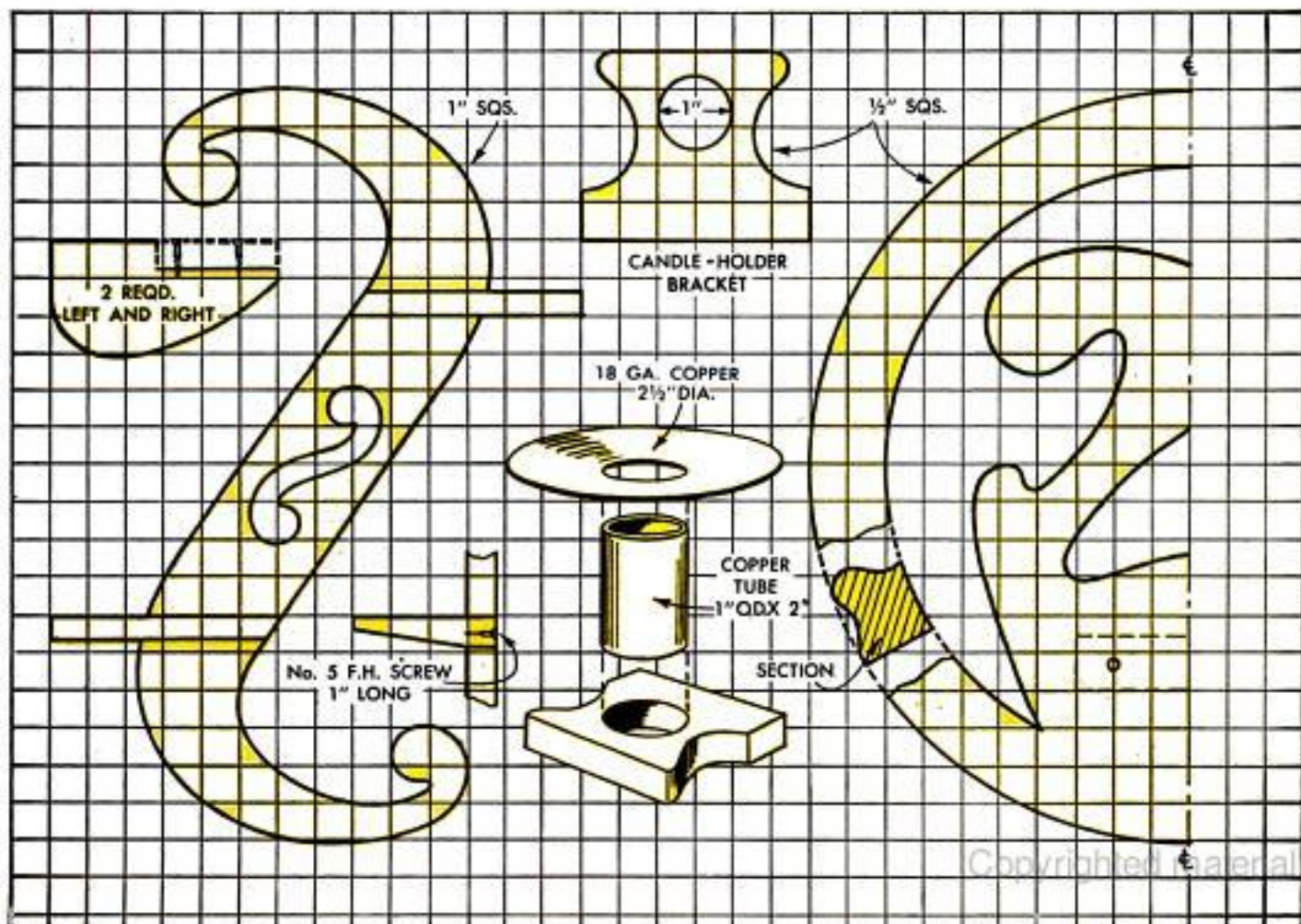

HOW TO INLAY YOUR

By Robert E. Jackson

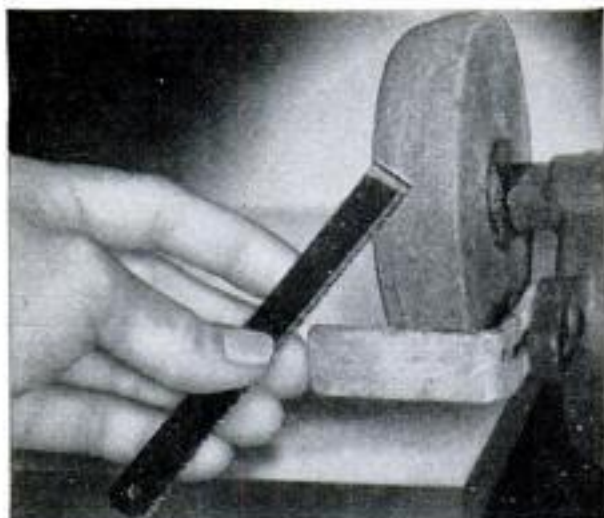

When no carving chisel is available, make one by grinding a sharp edge on a piece of hacksaw blade

DIAMOND INLAYS and forearm, grip-cap and butt-plate liners give any rifle stock that custom-made look that goes well on the gun rack or in the field. Doing the job yourself is easier than you think as the diamond inlays and liners come ready-made, the inlays in contrasting colors. The photo of the inlaid rifle stock at the right on the opposite page pictures a typical inlay-and-liner job on a standard stock of plain walnut. A forearm cap of black plastic has been added as a special custom-rifle feature. Many riflemen would prefer the larger diamond inlay in the stock and the smaller in the forearm, but that's a matter of individual choice. Liners under the forearm tip, grip cap and butt plate can be cut from

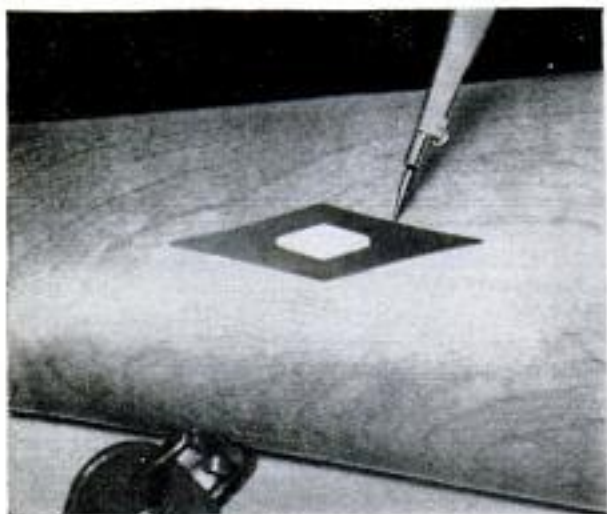

Mark inlay outline on stock with sharp scribe. Marks should be deep enough so they are easily followed

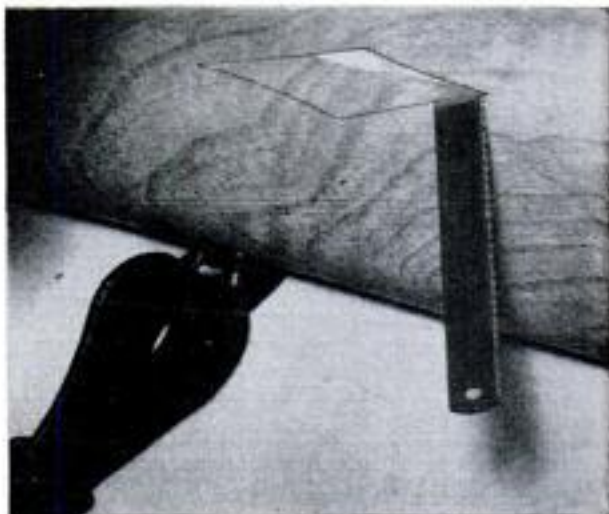

Cut down on pattern lines with improvised chisel. Care must be taken to obtain straight, smooth cut

Apply cement to bottom of recess. Be sure to spread to a coating of uniform thickness over whole surface

Tap inlay in place over cement, using softwood under hammer to avoid marring stock or cracking the inlay

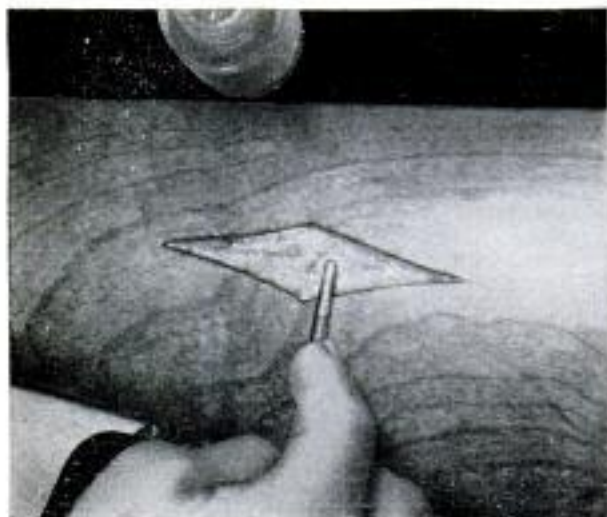

GUNSTOCK

white or colored plastic, $\frac{1}{16}$ or $\frac{1}{8}$ in. in thickness and dressed after installation with a file and 8-0 sandpaper. The photos show the six steps in locating and recessing a two-color diamond inlay in the buttstock. Stock inlays usually appear best when located slightly below the halfway point measured between the tip of the comb and the center of the butt plate. Mark around the inlay with a sharp scriber. Then make a suitable chisel by breaking a hacksaw blade and grinding one end to a keen edge. Remove the waste after cutting down on the pattern lines. The depth of the recess should be slightly less than the thickness of the inlay. Cement in place, tap into close contact with a hammer and block of softwood, then improvise a clamp to apply pressure until the cement hardens. ★ ★ ★

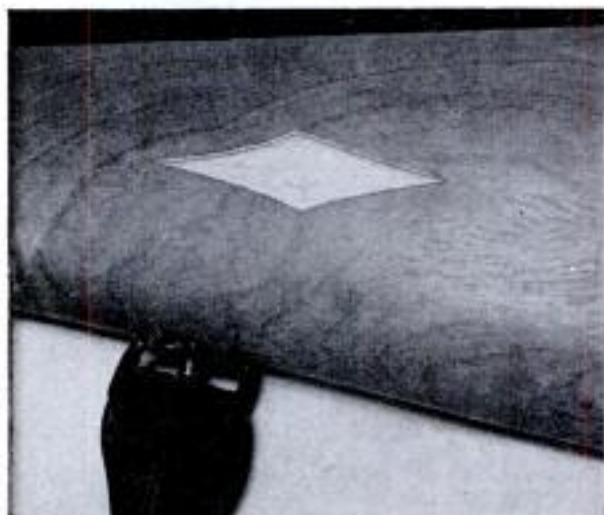

The finished recess should be slightly less in depth than thickness of inlay. This allows for finishing

After tapping inlay in place over cement, improvise a clamp to apply pressure until the cement hardens

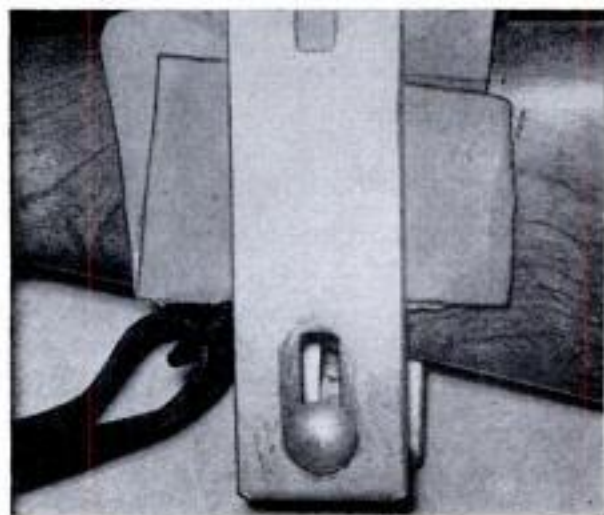

OCTOBER 1955



215

Copyrighted material

Trellises Mounted With Flat-Bar Brackets Quickly Removed



By using brackets bent from flat aluminum, trellises can be rigidly attached to wood or masonry walls in a manner that permits quick removal for painting or repairing the wall. Generally, four brackets are needed, but for a narrow trellis two near the bottom and one centered at the top are sufficient. Best appearance results if the trellis is spaced about 5 in. from the

wall. To make the brackets, drill $\frac{1}{8}$ -in. holes near the ends of 7-in. lengths of $\frac{1}{8}$ x 1-in. flat bar. Then bend the brackets at right angles 1 in. from each end, making the bends in opposite directions. For mounting the brackets on wooden walls, use wood screws; on masonry use screw anchors or expansion sleeves. The trellis is fastened to the brackets with $\frac{1}{4}$ -in. bolts and washers.

"Spiked Feet" on Ladder Bottom Prevent Slipping

A ladder used only for outside work, and never on paved surfaces, can be fitted with "spiked feet" to prevent slipping. The spiked feet are Z-shaped brackets, bent from $\frac{1}{8}$ or $\frac{1}{4}$ -in. flat steel. Dimensions will vary with ladder size. Screws are driven into the edge of the ladder through the upper leg of the Z-bracket. To reduce the chance of splitting, screws are not driven into the bottom of the ladder.

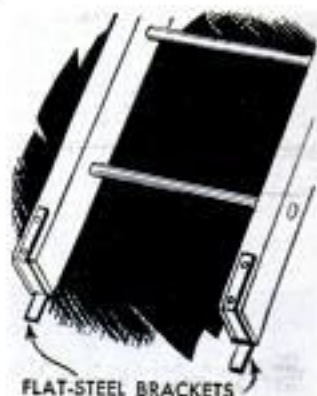

FIX-IT-YOURSELF TELEVISION MANUAL

For less than the cost of most new parts, you can learn how to maintain your TV set — and make many repairs yourself!

INCLUDES LATEST DATA ON COLOR AND ULTRA-HIGH-FREQUENCY TELEVISION

Complete, Reliable, Authoritative

John Derby, famous electronics engineer, has written another fact-filled, money-saving book. **ALL ABOUT TELEVISION** was bought by 200,000 savings-minded people, and the demand for it is larger than ever. But, with so many new developments in the field, Mr. Derby and Popular Mechanics Press realized a completely new book should be published. One aimed directly at the man who wants to make his own repairs.

Covers the Entire Subject

TELEVISION MANUAL will tell you, with no technical doubletalk, *everything* about television transmission and reception. It will expand your knowledge and enable you to handle 3 out of 4 TV repairs. Never again will you not understand what you're doing with a TV set. You'll know whether to call a professional or do the job yourself.

All the Latest Information

Now you can learn how color TV works, how to care for, and how to enjoy most fully that color set when you get it. **TELEVISION MANUAL** will show you how to take advantage of the new UHF networks and how to convert your present set to ultra-high-frequency. It will answer almost any question you may have about television.

MONEY-BACK GUARANTEE

TELEVISION MANUAL is guaranteed to satisfy you, to save you money—if not, you can return it within ten days for a full refund of the purchase price. So send your order, with a remittance of only \$3.00, *today!*

Popular Mechanics Bookshop

208 East Ontario Street
Chicago 11, Illinois



Uses for Pressure-type ADHESIVES

PORTABLE TYPEWRITER

Your portable typewriter, adding machine or other office machine that tends to "creep" when in use, will stay put when you coat the rubber feet with a thin film of pressure-sensitive adhesive. This material does not harden like glue or mucilage, but remains in a semiplastic state and prevents movement of light typewriters and other equipment used on a table. Can be moved without affecting holding power of adhesive



MOVIE TITLES

When making up amateur-movie titles one problem is obtaining an adhesive that will hold individual letters in position on the surface of various materials used as backgrounds. With a pressure-sensitive adhesive it is possible to place the letters or numerals and then change them about until the arrangement and spacing are just what you want. Adhesive will hold even if letters have been removed several times

STENCILS

Ever have a stencil slip and smear the job at the last critical moment? When this happens there's nothing to do but remove the ruined pattern and try again. For a crisp, clean job stick the stencil to the surface with a pressure-sensitive adhesive and you'll be sure of the final result. When applying the adhesive to the back of the stencil, be especially careful to spread in a uniform film so there is no excess at the edges



STAMP COLLECTIONS

Philatelists—stamp collectors, in case you didn't know—like an adhesive that permits them to mount stamps in an album, also remove individual specimens at any time without damage and mount on backing paper for exhibits, or for sale or trade. With the right adhesive this can be done a number of times without damaging stamps or album. Spread adhesive in a thin film. Remove excess by rubbing with finger

SPECIAL TAPE

You can make adhesive tape in any width or length required by cutting strips from crepe paper and coating either one or both sides with a pressure-type adhesive. It sticks anywhere, to almost any dry surface, and it stays stuck until you pull it off for reuse somewhere else. Works fine when used as a paint guard, as you can use the same length of tape over and over. Still another use for this special adhesive is holding paper shelf trim, especially that attached to the edges. Beats tacks or any other type of fastener



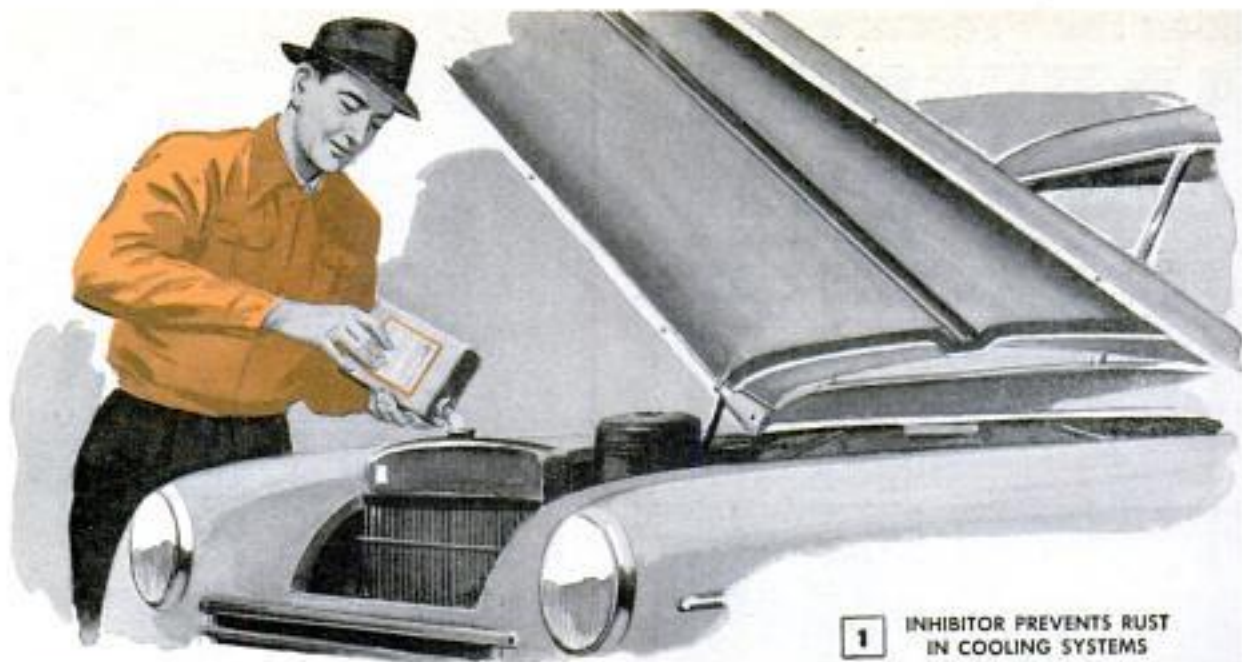

1 INHIBITOR PREVENTS RUST IN COOLING SYSTEMS

STOP RUST IN YOUR HOME

By J. B. Mullen

PART II

THERE'S NO MYSTERY about what causes the tiny discolorations that sometimes appear on the mirror-bright surfaces of stainless-steel kitchen utensils and especially stainless-steel cutlery. You're looking at the results of electrochemical corrosion. Although stainless steel is one of the inert metals and resists most corrosive agents, it still is more active than silver, as you will see from the activity series of metals charted in Fig. 3. It's there you can

put your finger right on the cause—an active metal placed in water with a less-active metal. Wet or soiled silverware in contact with stainless-steel knives, forks and spoons will start a corrosion couple which is low on the activity scale, but nevertheless is sufficiently active to cause damage to the stainless-steel ware. Corrosion of this type usually is localized and generally takes the form of fine pits because both metals are low in the activity

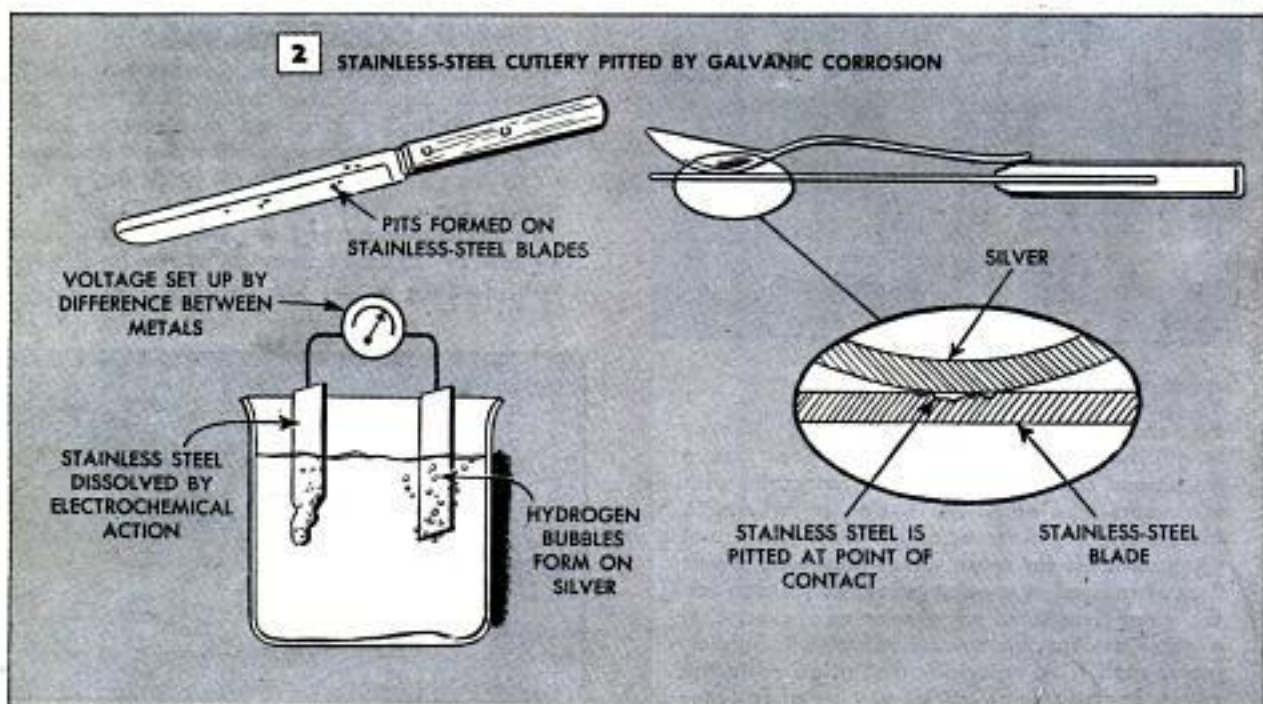

series and the more-active metal is pitted at the point of contact, Fig. 2. For this reason it is only rarely that the damage involves larger areas. However, it should be remembered that about the only effective prevention is to avoid placing the two types of tableware in contact in a drawer or tray while wet. Deep pits in stainless steel cannot be removed effectively, but the small black spots which show first can sometimes be polished out with a rubbing or polishing compound.

Common salt is the unsuspected source of many household corrosion troubles and the damage can range from deep corrosion of the family-car fenders to unsightly and ruinous pits in valuable silverware. Silver salt shakers are especially vulnerable, but other silver items may be involved if salty foods are placed in them and remain for any appreciable length of time. The large black spots on silver are practically impossible to remove entirely as generally the erosion has progressed to a considerable depth before the surface discoloration is noticeable. In some cases, the blemishes can be made less objectionable simply by putting the process of electrochemical corrosion to good use. Place the affected silverware in an aluminum utensil and then add water and sodium bicarbonate (baking soda) in the proportions of 1 oz. of sodium bicarbonate to 1 pint of water. Place the utensil on the kitchen range and bring the solution to a rolling boil, Fig. 4. In this process you form a corrosion cell in which the silverware is the cathode and the aluminum utensil the anode. In the process

3 CORRODED END

- MAGNESIUM
-
- ZINC
-
- ALUMINIUM
-
- CADMIUM
-
- IRON & STEEL
-
- SOLDER
-
- LEAD & TIN
-
- COPPER & ALLOYS
-
- NICKEL
-
- STAINLESS STEEL
-
- SILVER
-



PROTECTED END

4 REMOVING TARNISH FROM SILVERWARE



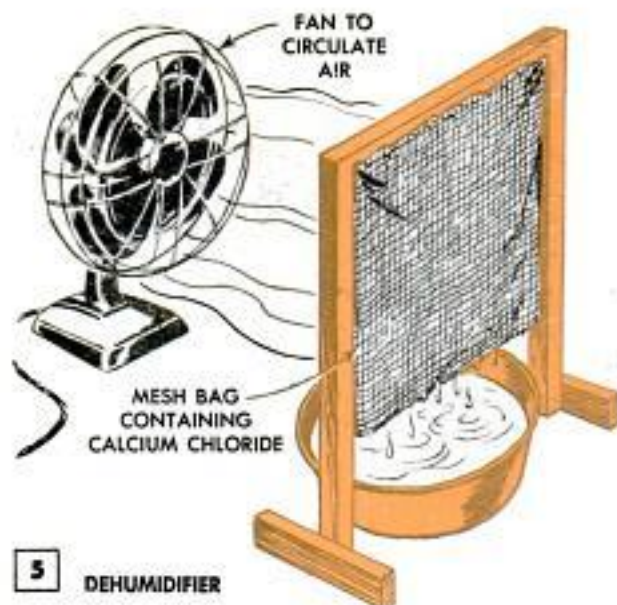

5 DEHUMIDIFIER

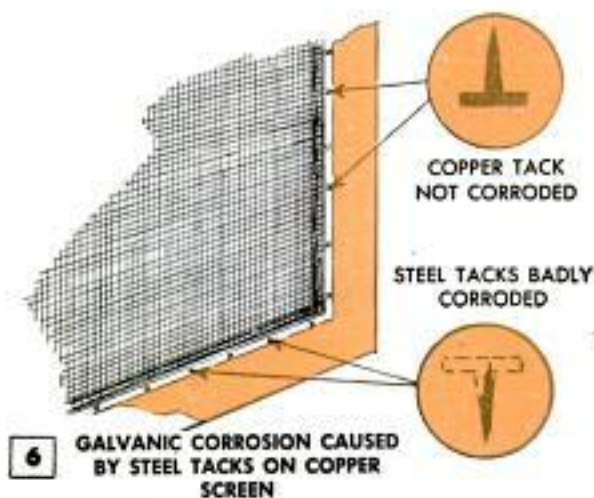

6 GALVANIC CORROSION CAUSED BY STEEL TACKS ON COPPER SCREEN

the tarnish, which is silver sulphide, is converted back to silver at the cathode and the "plating" process not only removes the tarnish, but in most instances helps to efface the blemishes and the very small amount of metal removed from the aluminum utensil will in no way affect its usefulness. Ordinary tarnishing of silver is caused by hydrogen sulphide which is present in the atmosphere in varying quantities (more in and near large cities) in eggs and other foods, and in cooking gas. Tarnishproof chests and bags, which are especially treated to absorb hydrogen sulphide and also prevent it from reaching the surface of the silverware in quantity, are the best means of preventing tarnish, which is a mild form of corrosion.

Washing machines and other laundry equipment often become rather badly corroded, especially where the water is hard. Hard water forms a curdy material with soaps and this forms a film around certain parts which, if not removed, will collect on the surface of the metal and prevent rapid drying of the surface. Liquid trapped under this film causes the concentration-cell corrosion that does the damage. In extreme cases parts may be rendered unserviceable in a comparatively short period of time. However, this damage is easy to prevent simply by removing the affected parts at the end of each use period and washing and rinsing them thoroughly to remove any sediment that may have collected. Leave the machine open so that all parts dry quickly after use. Synthetic detergents ordinarily do not deposit the damaging film as fast as do regular soaps. The use of soft water also will materially reduce the amount of film deposit per washing. However, in either case it is good practice to clean the machine thoroughly after use.



7 TOOLS KEPT IN DAMP BASEMENTS SHOULD BE PROTECTED WITH INHIBITOR

Basements are nearly always damp due to the high humidity of the air in the room or rooms. This can cause serious damage to tools, furnaces, laundering equipment and other items made of metal that may be stored in the basement during the summer months. Fig. 5 shows how to set up a simple and inexpensive dehumidifier which is quite effective in removing excess moisture from the air. A small electric fan to circulate the air speeds up the process considerably if operated at intervals aggregating perhaps two or three hours daily. However, the unit is fairly efficient when used without the aid of the fan.

Tools, Fig. 7, are especially susceptible to damage by rust if not protected with a film of oil, or better, an inhibitor made especially for the purpose. The latter forms a protective film over the metal which prevents the formation of corrosion cells even though the surfaces "sweat" during long periods of storage in racks or drawers. The film will withstand a certain amount of handling without breaking or rubbing off, hence it has a greater protective value than ordinary oil. Special inhibitors also are available to prevent corrosion in auto radiators, Fig. 1.

If you build your own screens, or repair those already in use, always use tacks or staples made from the same metal as the screen wire; otherwise galvanic corrosion will cause damage within a short time, Fig. 6. Don't use steel tacks or staples to fasten copper screen. For the same reason never use steel nails or screws to fasten gutter and downspout supports made from aluminum. Use aluminum nails to fasten aluminum, steel nails to fasten steel and so on in all cases where the parts form a metal-to-metal contact.

Garbage cans, garden sprayers and pails are typical of the household containers made from steel and galvanized. Although the galvanizing still will protect the metal even though the zinc coating is punctured or otherwise damaged, the units can be made to give much longer service if the suggestions given in Fig. 8 are carried out. Galvanized pails should be thoroughly rinsed after use and stored in an inverted position so that any water remaining inside can drain away quickly. Knapsack garden sprayers should be emptied immediately after use and thoroughly rinsed. Then invert the tank to permit water to drain away. Nearly all garden insecticides in liquid form are at least mildly corrosive and should always be stored in a glass container, rather than one of metal. Set the garbage can on wooden blocks and, if possible, keep it in a dry place where the blocks do not absorb undue amounts of moisture. ★ ★ ★

8 CARE OF GALVANIZED EQUIPMENT

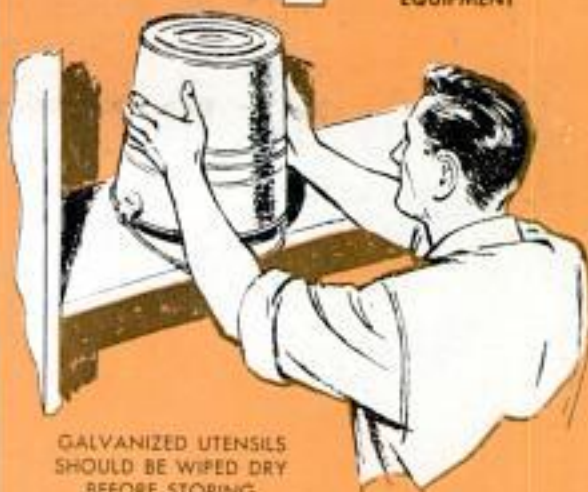

GALVANIZED UTENSILS SHOULD BE WIPED DRY BEFORE STORING

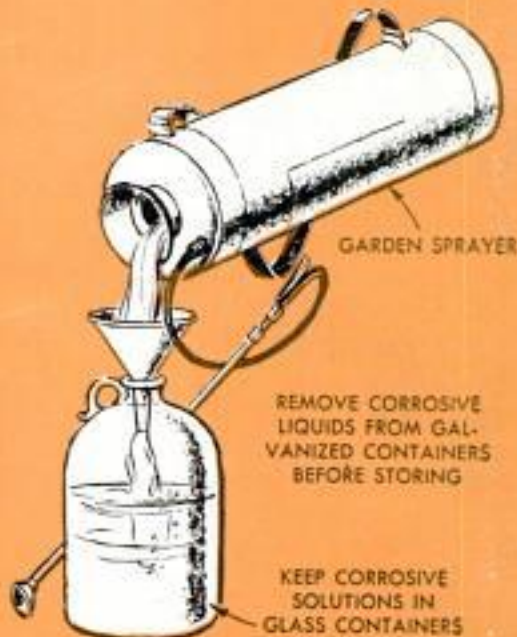

GARDEN SPRAYER

REMOVE CORROSIVE LIQUIDS FROM GALVANIZED CONTAINERS BEFORE STORING

KEEP CORROSIVE SOLUTIONS IN GLASS CONTAINERS



KEEP THE GARBAGE CAN ON WOODEN BLOCKS

Odd-Shaped Masks Around Prints Provide Variety in Photo Album



When making contact prints for a photo album, one photographer assures variety in appearance by using masks patterned from lens covers. A lens cover is placed on a sheet of black paper and a razor blade used to cut around it. Cookie cutters and other irregularly shaped objects can be used to provide an infinite number of mask shapes.

Paper Punch Marks Transparencies

A paper punch can be used to mark film slides so they can be inserted in a projector right side up. Simply punch a hole near the upper right-hand corner of each slide. Thus you can tell when the slide is in the proper position, even when operating the projector in a darkened room.

Mrs. Lawrence Allen, Lynchburg, Va.

Pen Converted to Lens Brush

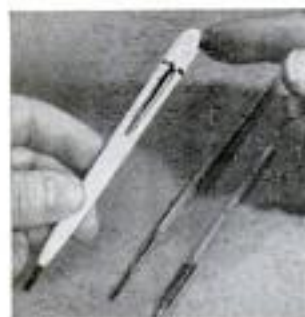

Replacing the ink cartridge in a retractable-ballpoint pen with a small camel's-hair brush will provide a lens brush that can be clipped to a pocket and be ready for use at the press of a button. Remove the ink cartridge and cut the handle of the brush to match its length. Slip the brush into the cartridge spring and reassemble the pen. The brush now can be retracted or extended in the same manner as the ball-point cartridge.

Endless Belts for Action Toys

Narrow strips cut from discarded sanding belts can be used to provide long-wearing endless belts for children's action

toys. Loops of twine, generally used to transmit power from small electric motors or crank-powered mechanisms, quickly stretch or break, but with ordinary care the sanding-belt strips will give good service for quite some time.

Sequence of Slides Indicated By Diagonal Lines on Edges

You can tell at a glance whether or not a series of colored photo transparencies are in the proper sequence if you draw two lines of different colors diagonally across the edges as shown. Two colors are necessary to show whether slides belonging at one end of the series have been placed accidentally in reverse at the other end, where the lines might still be in alignment.

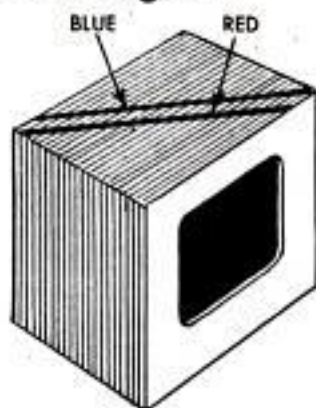

Modified Floodlamp Reflector Produces Softer Shadows

A photo floodlamp can be modified to produce a softer light by installing a disk of aluminum foil in front of the bulb. Most of the direct rays are blocked off by the disk so only reflected light reaches the subject. The disk is stapled or tied to a length of wire which is hooked to the edge of the floodlamp reflector as shown.

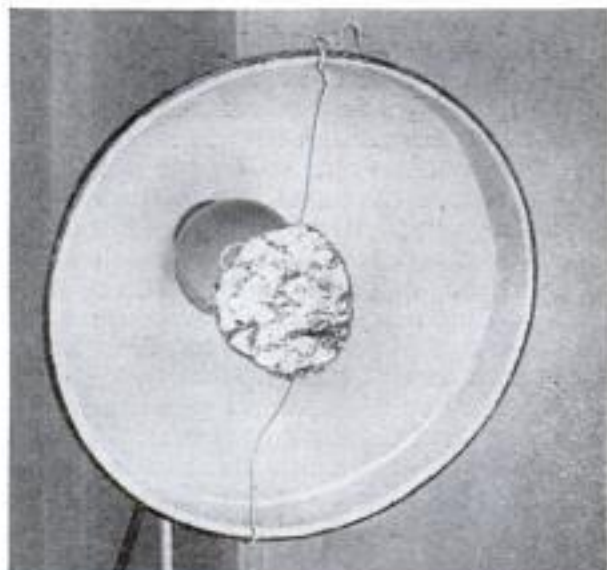

☐ Vinegar is a good solvent to use in cleaning fountain pens. Dismantle the pen, soak the parts in vinegar for an hour or two, rinse in water, dry and reassemble.

Drill-Press Vise Utilized as Base Die for Forming Sheet Metal

Because a drill-press vise has jaws that are parallel to each other and at a true right angle to the base, it can be used in conjunction with the leverage provided by a drill press as an accurate die for forming sheet metal. A turned sphere chucked in the press as in the upper left-hand detail forms sheet-metal U-bends. Once the jaws are set, dozens of duplicate bends can be made. The upper right-hand detail shows a method of making hold-down clips, using a forming die which consists of a carriage bolt on which a steel washer has been welded. Sheet-metal channels as long as the vise jaws are wide can be pressed by using a steel flat welded to a round bar which is chucked in the drill press. Clamping the vise jaws

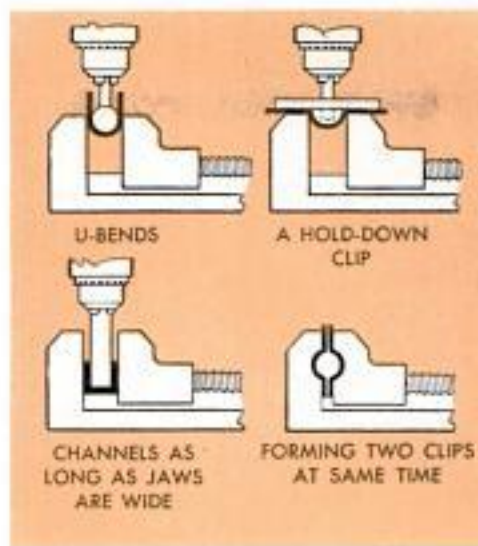

together and drilling a horizontal hole between them will permit forming two clips at once against a round bar as shown in the lower right-hand detail. Clamp a doubled-sheet-metal shim between the jaws for die clearance when drilling horizontal hole.

C-Clamps on Broken Spring Leaf Provide Temporary Repair

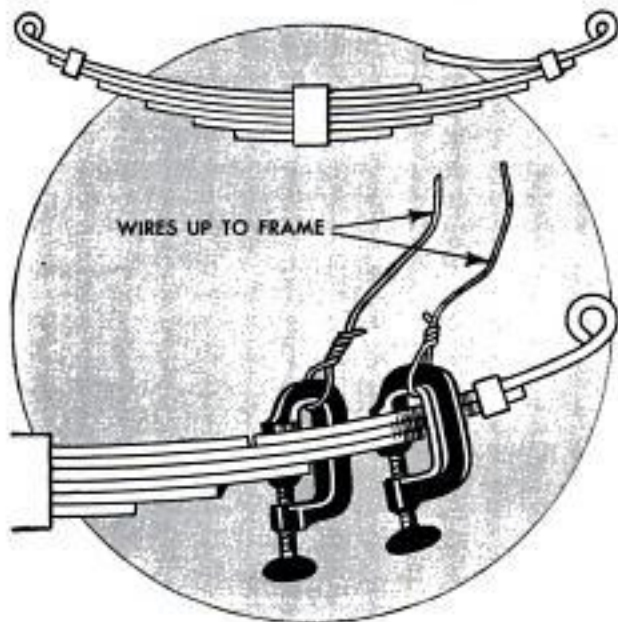

When the main leaf of a spring on his delivery truck broke, one driver used two heavy-duty C-clamps to make a temporary repair so the rest of the deliveries could be made. The first clamp was fitted near the end of the spring so the broken end was forced down enough to permit fitting on the other clamp. If a bumper jack is available, it could be used to lift the weight of the truck so the spring leaf would lie flat. Both clamps then were turned tight. A length of wire was fastened to each clamp and to the truck frame to provide a "safety

chain," in the event that a clamp would slip off while the truck was moving. For greater strength in a temporary repair, a steel flat could be placed across the break and clamped in place.

Nathan Schoenbrun, Scranton, Pa.

Socket-Wrench Set Measures Fillets and Coves

When it is necessary to measure the radius of a fillet or cove and no radius gauge is available, use a socket-wrench set to do the job. The wide range of sizes in most sets will permit you to find one socket which will match the radius of the article to be measured.

Safe Torch for Burning Webs And Nests of Tree Spiders

A practical torch for burning the nests or webs of tree spiders can be made by nailing a scrap of insulation board on the end of a pole. Saturate the board with kerosene or fuel oil. When ignited the "torch" will burn for a considerable length of time.





Wheeled "Granary" Towed to Hogs Saves Many Steps

A feed house built on the frame and wheels of an old manure spreader makes it possible to keep a supply of sacked or loose feed close to hogs in fields which are at a distance from feed barns. Short boards fitted in cleats on the doorframe permit adjusting the size of the door opening when loading the feed house with loose grain. Different kinds of feeds are kept separated by removable partitions. When the feedhouse is empty, a tractor is used to tow it back to the feedbarn for refilling.

Taped Drill-Press Table Keeps Block in Place

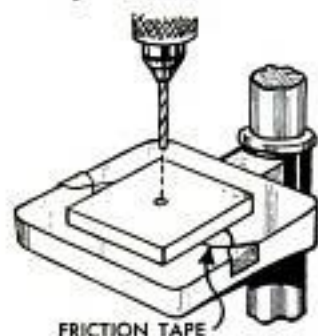

The problem of preventing a drill block from sliding off a drill-press table when a piece of work is removed can be solved by fitting the table with a strip of friction tape. Lay the strip across the table, sticky side up, then twist over the ends and press them against the sides of the table. When pressed onto the tape the block will be held securely for all practical purposes.

Foil Strips in Wound Coil Simplify Soldering Taps

Soldering taps on a closely wound wire coil, without "shorting" adjacent turns, is possible by using strips of aluminum foil to which solder will not adhere. Fold the strips until they are thick enough to pro-

vide a snug fit between the turns. The foil will fold back out of the way of the soldering iron and, when the soldering is finished, can be removed easily:

Harvey Muller, Danboro, Pa.

Children Kept Out of Hayloft

To prevent his small children from climbing into the hayloft of the barn where they might fall and be injured, one farmer covered the first five rungs of the built-in ladder with a simple gate as shown in the illustration. A latch was placed at a height that was out of reach of the children. The gate, made of 1 x 4 lumber cross-braced, was wide enough to fit between the ladder rails and was hinged directly to one rail.

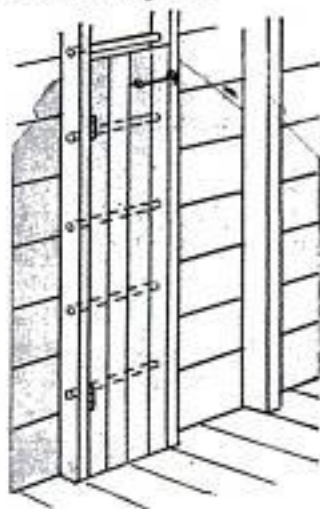

Wrench on Front of Tractor Handy for Corn Cultivator

An adjustable wrench hung on a bracket at the front end of a tractor is always close at hand for adjusting a cultivator or other front-mounted implements. In this case, a hanger was made for the wrench by fastening a long carriage bolt to a headlight bracket with two nuts and lock washers, the head of the bolt being cut off and the bolt end bent up at right angles.

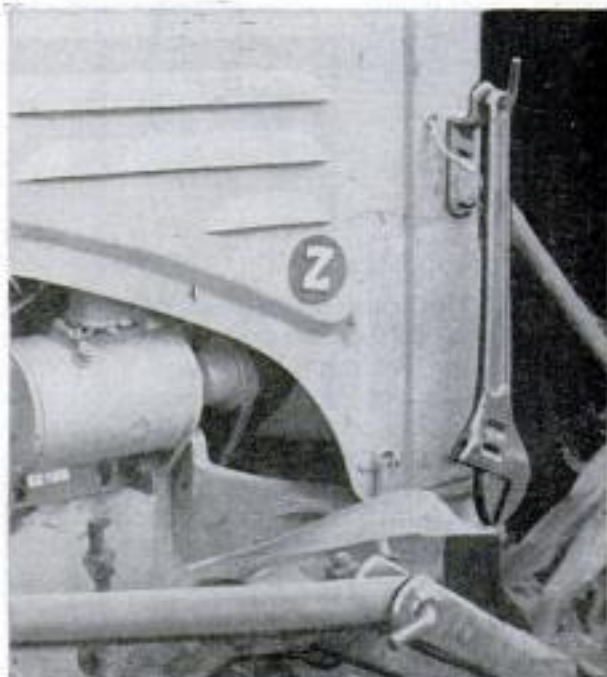

SWINGING SHELVES for your enlarger

ANYTHING that contributes to convenience in the darkroom, especially a small one, is well worth the building. These swinging shelves, which attach to your enlarger, are a good example. The shelves are made of $\frac{1}{8}$ -in. hardboard and each one has a raised edging of the same material to keep small items in place. Both shelves are supported by a bracket attached to the enlarger arm as pictured. The details below show the construction of the original unit, but some changes will be necessary in order to adapt the assembly to enlargers other than the one shown. The size of each shelf, given in the crosshatched detail at the right, can be varied to suit individual requirements. However, the length given is about the maximum when using $\frac{1}{8}$ -in. hardboard. If you require a somewhat longer shelf, then use $\frac{1}{4}$ -in. hardboard. Glue the edging to the shelves before cutting to the final dimension. The plastic clamping block, a part of the bracket, permits the shelves to be adjusted vertically. Loosening the wing nuts on the lower ends of the bolts permits them to swing.

M. G. Winterton, Tacoma, Wash.

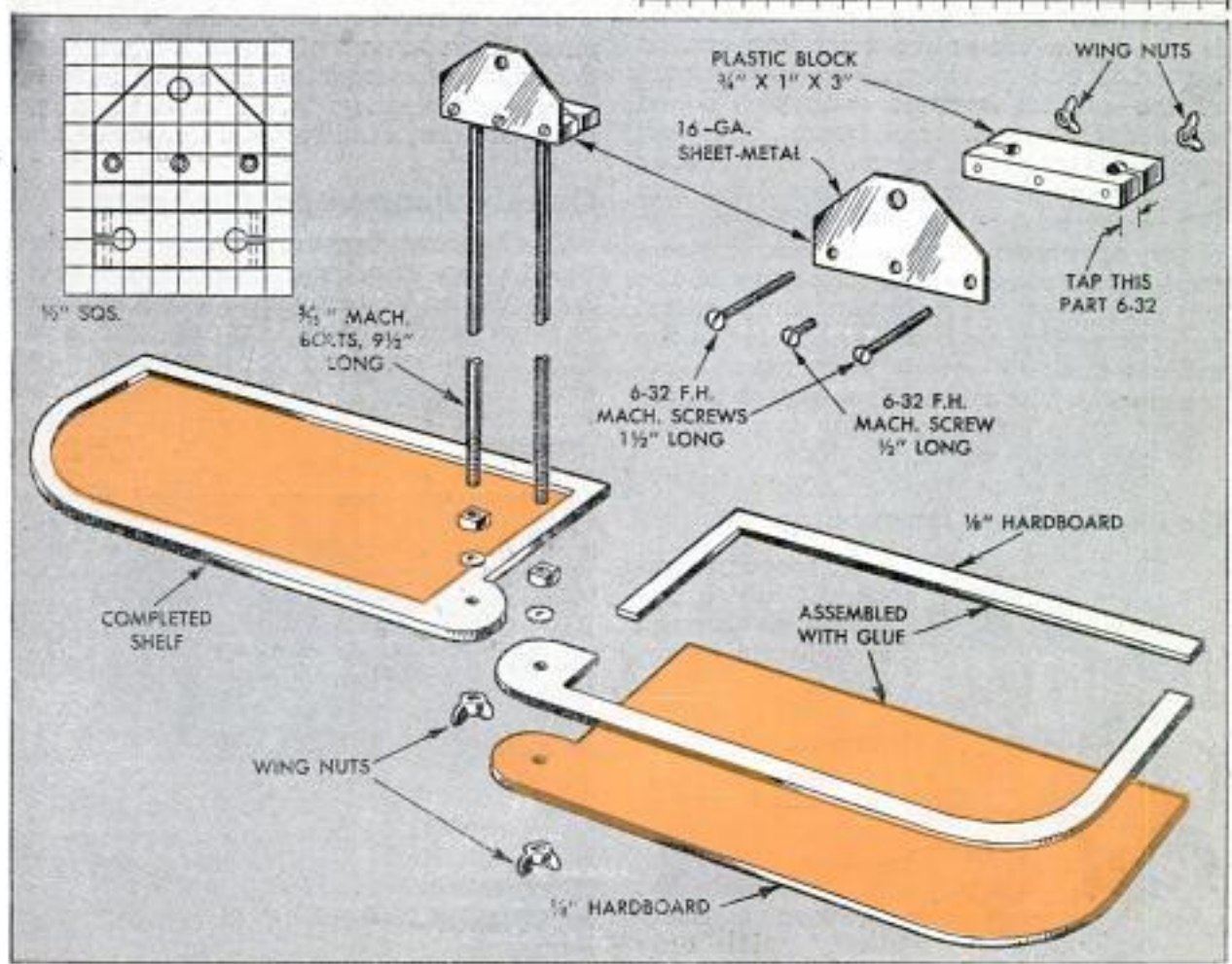
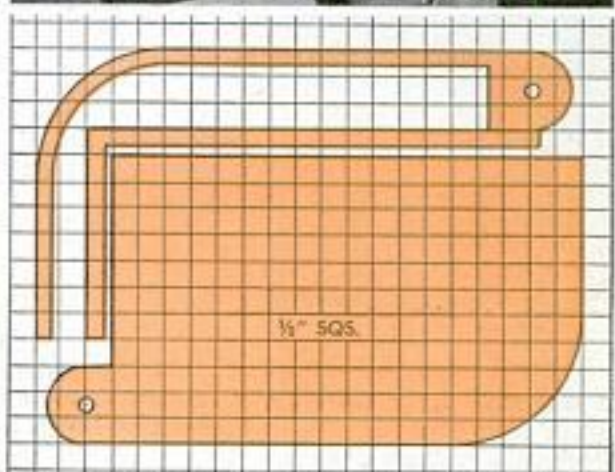

Compact Portable Workshop Built Inside Cabinet



Faced with the dual problem of limited space and the possibility of having to move in a short time, one homeowner built a compact home workshop in a metal clothes cabinet. The space occupied by the cabinet is small and the entire workshop can be moved in one operation. The bottom part of the cabinet is fitted with partitioned drawers for tools and small parts. The work surface is plywood covered with rubber tile. Narrow shelves have been fitted into the upper part of the cabinet for storage of jars of screws, nails, etc. A small fluorescent light bolted to the underside of the top shelf provides sufficient illumination, and two receptacle boxes are bolted to the cabinet back to permit plugging in electrical tools. The cabinet is not intended for heavy work, but is ideal for small repair jobs and hobby work.

Holder for Film Transparencies

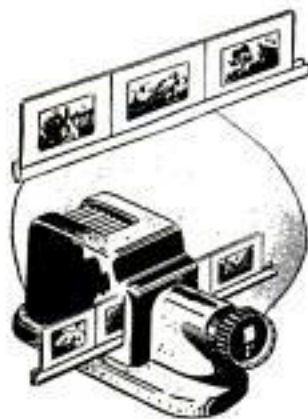

To speed up running 35-mm. transparencies through a slide projector, fold a $\frac{3}{4}$ x 12-in. strip of sheet aluminum to form a channel that will hold six transparencies. This will enable them to be run through the viewer consecutively with only

one handling. To further reduce handling, make several holders and load them ahead of time, arranging pictures and holders in the order desired.

Mildred C. Algots, Glendale, Calif.

Loop Tied in Rubber Band To Provide Finger Grip

A finger grip in the rubber band usually snapped around a reel of movie film when it is stored will save time and temper when the band is removed. Make the finger grip by tying a knot near one end of the band. The resulting loop is easily gripped with the fingers.



Lowering Outside Supply Tank Prevents Oil-Stove Leak

The problem of leakage through a carburetor shut-off valve in an oil space heater when the fuel is gravity-fed from an outside tank, can be overcome by reducing the height of the tank. Designed for a low-pressure supply, the valve cannot retain the added force resulting from a raised tank. A positive supply of fuel will be assured if the bottom of the tank is only 6 or 8 in. above the inlet line of the carburetor. To prevent damage to the valve from foreign particles, install an oil filter in the line.

Quickly Improvised Clipboard

A clipboard for use around the house that has several advantages over the regular type, can be made from a piece of corrugated cardboard and spring-type paper clamp. The board can be made any desired size, is lightweight and can be disassembled for storage, or the cardboard simply discarded.



X603

SN 57



SHOP NOTES

METAL SHAPER FOR YOUR SHOP

By S. S. Miner

A METAL SHAPER is indispensable for certain machining operations where flat surfaces must be produced within very close limits, such as machining flats on castings, cutting keyways, rabbets and grooves and reducing the thickness of stock to a given dimension. This one has a 3-in. stroke, is manually operated and has been especially designed to reduce machine operations in the construction to the minimum. Cold-rolled-steel flats and squares are utilized for nearly all operating parts and the frame and base. These parts you can purchase cut to size with "store" edges at a very reasonable cost per piece. Joining edges and flat surfaces can be finished by hand to remove saw or flame marks and square the surfaces for fitting.

One thing to keep in mind before begin-

ning the construction: Hole layouts are given on the parts dimensioned on the following pages, but the hole sizes have been omitted. The reason is that you have a choice of two methods of assembly. On the original machine the parts were joined with socket-head screws, the screwheads countersunk flush. The alternate method is to drill the body and tap holes only, omitting the counterbores. This latter method effects a considerable saving in construction time and does not impair the efficiency of the machine in any way. Use 1/4-in. socket-head screws or hex-head screws except where other thread sizes are given. The length of the screw is determined by the thickness of the stock and also the location of the screw.

Begin construction with the base plate,

the two side plates and the bed block. Only the front edge of the base plate, the bottom edges of the side plates and the front end of the bed block are finished. This must be done with care to assure flat, true surfaces. Next, lay out and drill the body-hole pattern in the base plate and side plates and then use these three members as jigs when drilling the tap holes in the ram guides and the bottom edges of the side plates. Note the location of the dowel-pin holes in the various parts. Holes for the dowel pins are drilled and reamed so that the pins are a medium-tight drive fit. When body holes and holes for the dowel pins are drilled the parts must be clamped together securely. Then drill and ream the pinholes first. Drive the pins in part way before drilling the tap holes.

When the side plates and bed block are in place on the base plate the next parts to make and fit in place are the ram, the operating lever and the crossrail and saddle. The saddle cannot be made complete until the cross-feed screw bracket has been made and fitted. Note that the ram is slotted for the operating lever, counterbored, and that a round, $\frac{63}{64}$ in. long and $1\frac{1}{2}$ in. in dia., is turned on one end. This must be done in a metal lathe to assure the necessary accuracy. The ram must be a smooth sliding fit in the guides. Some light filing and smoothing with abrasive will be necessary to achieve the required fit. Note in the ram detail that section A-A gives the oilhole plan. These holes must be drilled before final assembly.

Make the operating lever and link next. Note in the lever detail that it consists of three parts, two of which are brazed to the third at a 45-deg. angle. Section A-A shows how the meeting edges are beveled before brazing. Form a radius on the body of the lever to provide a landing for the stop screw. Top end of the lever can be fitted with a plastic knob, or a handhold is easily shaped by grinding and filing. The link, which is a part of the lever assembly, consists of two steel squares pinned and screwed to a spacer. In this case the heads of the socket-head screws must be countersunk flush for clearance. Note also that the link pivot pin is grooved to provide a seat for the end of the retaining screw. The link is provided with bronze bushings.

The head assembly consists of the head block and the toolhead slide, the latter built up from steel squares and flats as detailed, the parts of the slide being assembled with screws and pins. The head block is a swiveling clamp which fits over the round turned on the end of the ram. When the assembly is complete with the down-feed bracket and tool block the entire assembly can be swiveled on the ram to locate the cutting

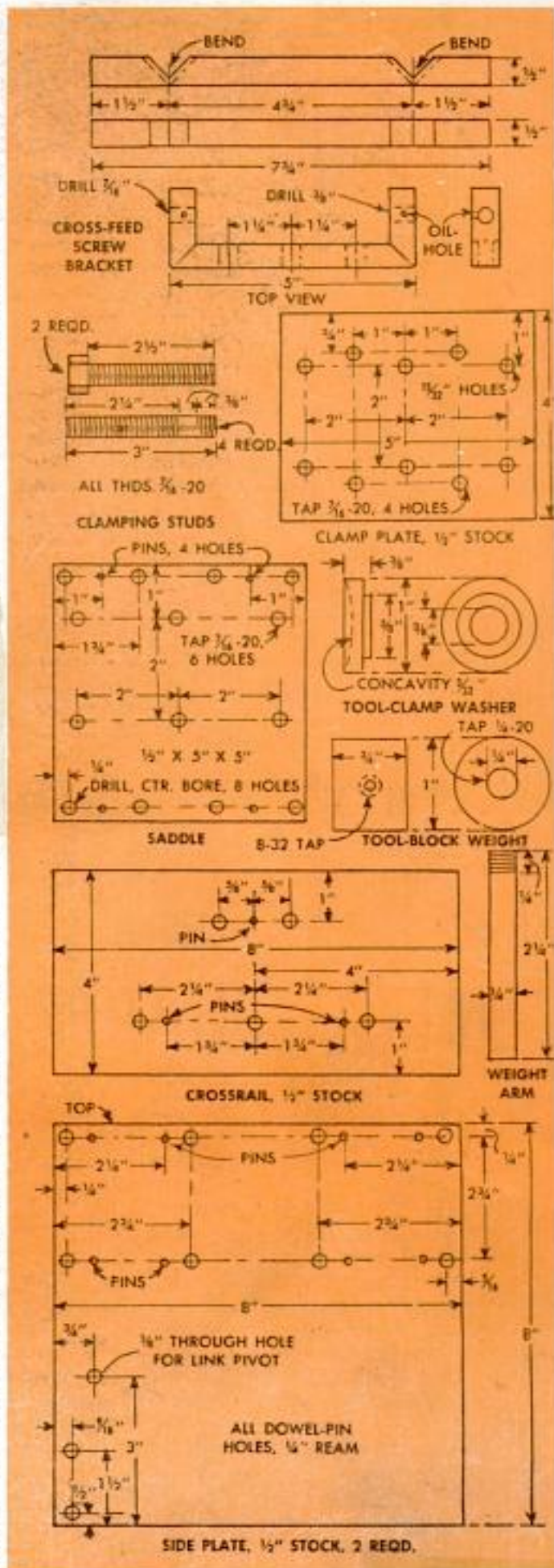

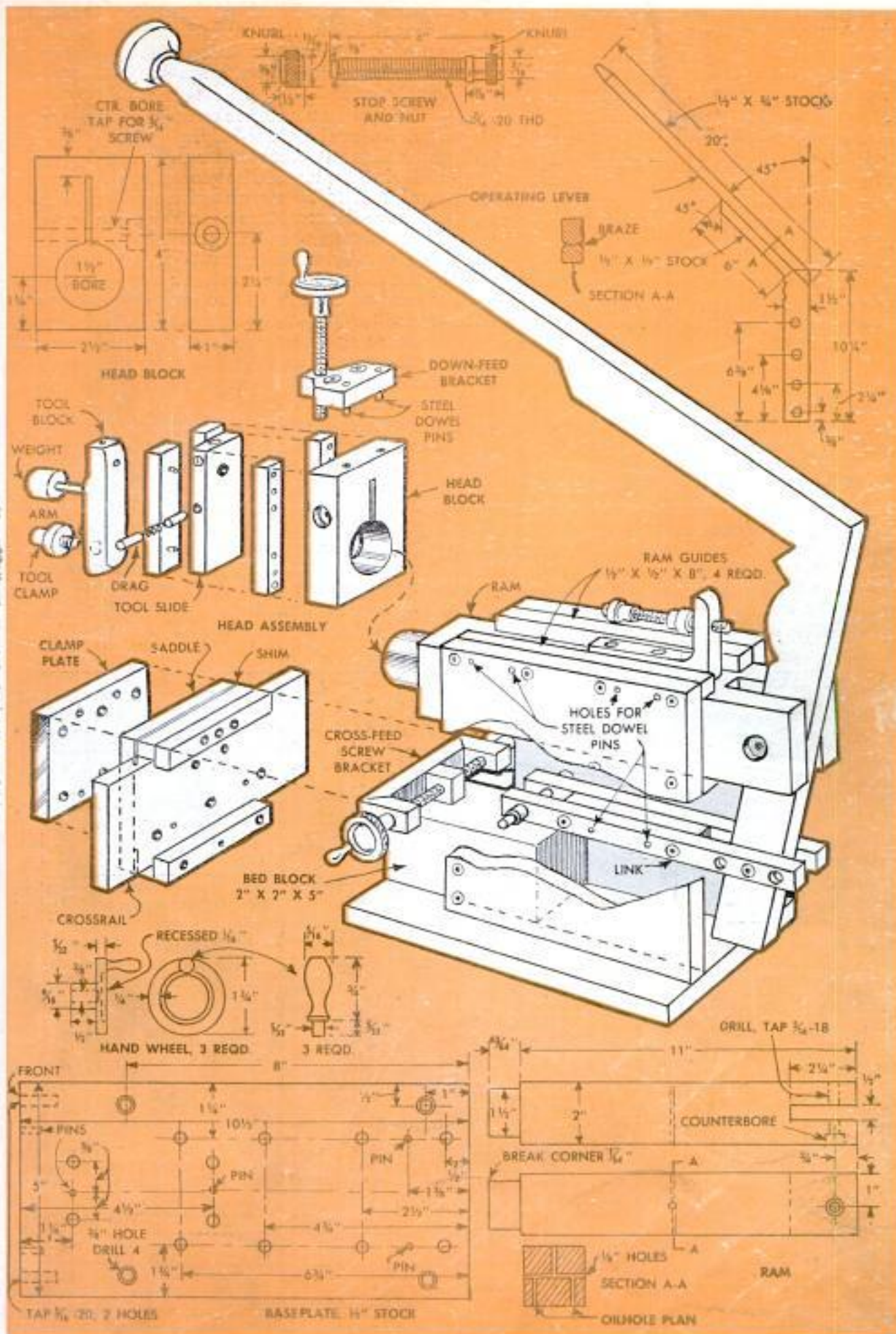

tool at any desired angle with the work. Note that the toolhead is fitted with a spring-loaded drag, which has the effect of taking slack out of the down-feed screw and also to prevent chattering on heavy cuts.

Beginning construction of the assembly with the head block, bore the block to $1\frac{1}{2}$ -in. dia. before slotting. The slot is cut with two hacksaw blades placed side by side in the saw frame. Take time to assure a straight cut and finish with a file. Then counterbore and tap for the clamping screw, the counterbore on one side of the slot, the tap hole on the other. Next, turn and thread the down-feed and cross-feed screws in the lathe. Now, note that the end of the toolhead is drilled to take the end of the down-feed screw and that the lower end of the down-feed screw is grooved to take the shouldered end of a retaining screw. Drill this hole to a depth of about $\frac{3}{16}$ in. and test-fit the end of the down-feed screw before final assembly. There will be a slight amount of end play in the screw and it is necessary to make sure that it will clear when run up or down. If it should bind on the bottom of the hole you will have difficulty adjusting the cutting tool. With the toolhead and slide completed and the parts fitted in the final assembly, dis-

assemble and fit the down-feed screw bracket. Note that it is both pinned and screwed in place and care must be taken to assure a true fit on the upper end of the head block.

The head assembly is completed with the addition of the tool-holding block. Note especially the elongated hole in the upper end of this block. The elongation permits the block to swing outward on the back stroke of the ram. The counterweight drops it into cutting position again as it clears the edge of the stock being cut. This elongation of the hole must be worked with a file and several tests made as the job progresses to assure just the right amount of clearance. The cutting tool is held in place by means of the washer detailed and a socket-head screw turned into a tapped hole near the lower end of the block.

The cross-feed screw bracket is made by notching and bending a length of square stock. Note in the details that one leg of the bracket (after bending and brazing) is drilled $\frac{1}{16}$ in., the other $\frac{3}{8}$ in. Note also that the screw is shouldered to three diameters to permit it to be slipped into place after the bracket is bent to form. However, before assembling the screw in the bracket it is necessary to make the lug through which the screw is threaded at assembly.

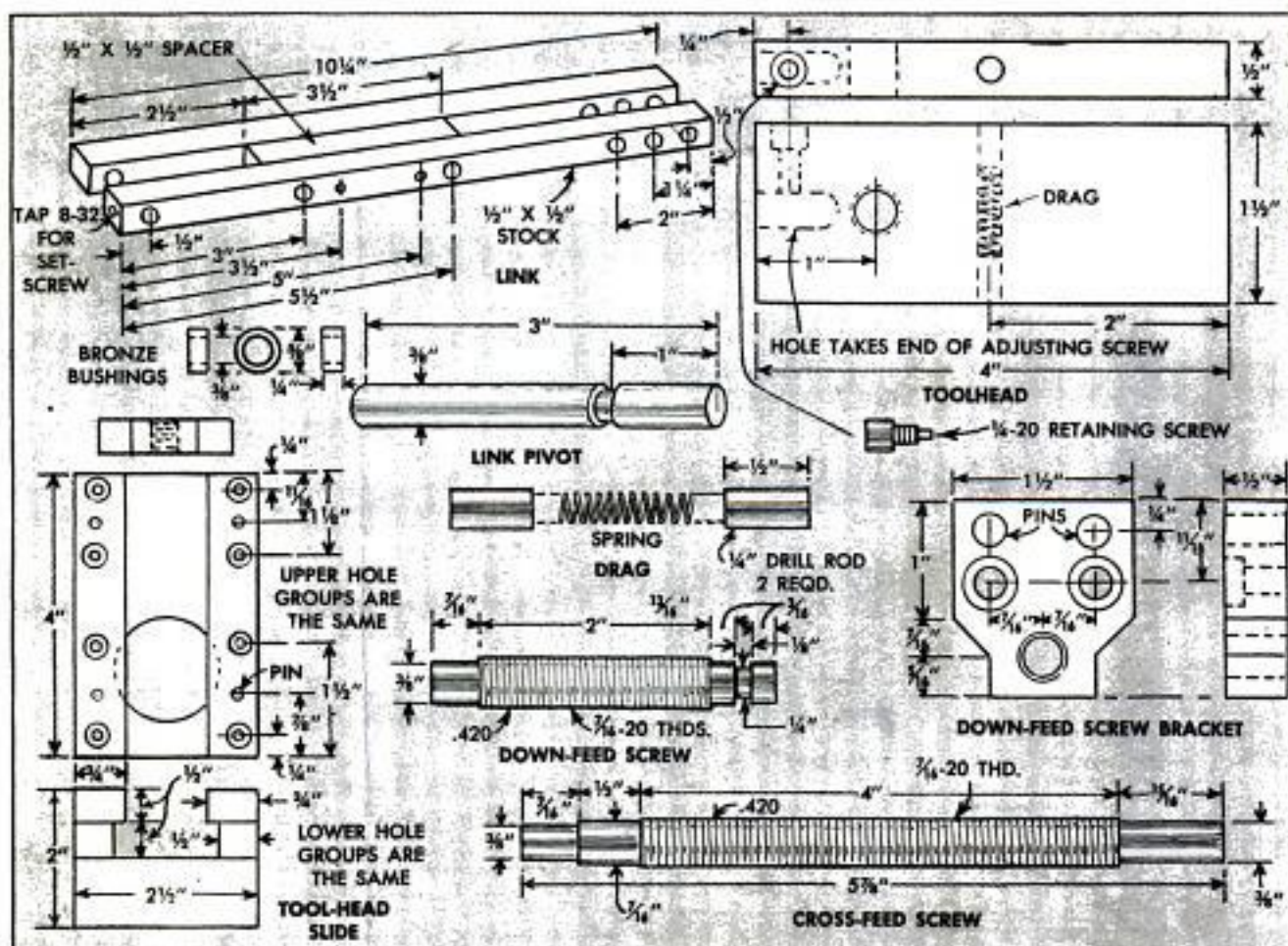

This lug has a bottom hole which fits over a fillister-head screw turned into a hole tapped into the bed block. When making these parts a careful layout is essential to assure correct location of the holes so that the screw runs freely throughout the length of the threaded section. This is important as it should be remembered the feed of the work is by hand. If the screw is correctly aligned when assembled, but still has considerable drag, disassemble, and remount the screw in the lathe. Take a light cut over the threads to reduce the contact to about 60 to 70 percent. Usually this will ease the fit sufficiently so that the screw will run freely. Three handwheels are required, one for the down-feed screw, the other two for the cross-feed.

The stop-screw bracket is not detailed as it is necessary to fit it to the machine in order to assure that the stop is correctly positioned to assure contact with the landing on the operating lever. Take measurements from the assembly and make the bracket accordingly from $\frac{1}{2}$ -in. stock.

The saddle and clamp plate are the last parts to be made and fitted. The clamp plate is carried on four studs made as detailed and screwed into holes tapped in the saddle. Clamping is done by tightening nuts run onto the threaded ends of the studs. After assembly, test all parts. ★ ★ ★

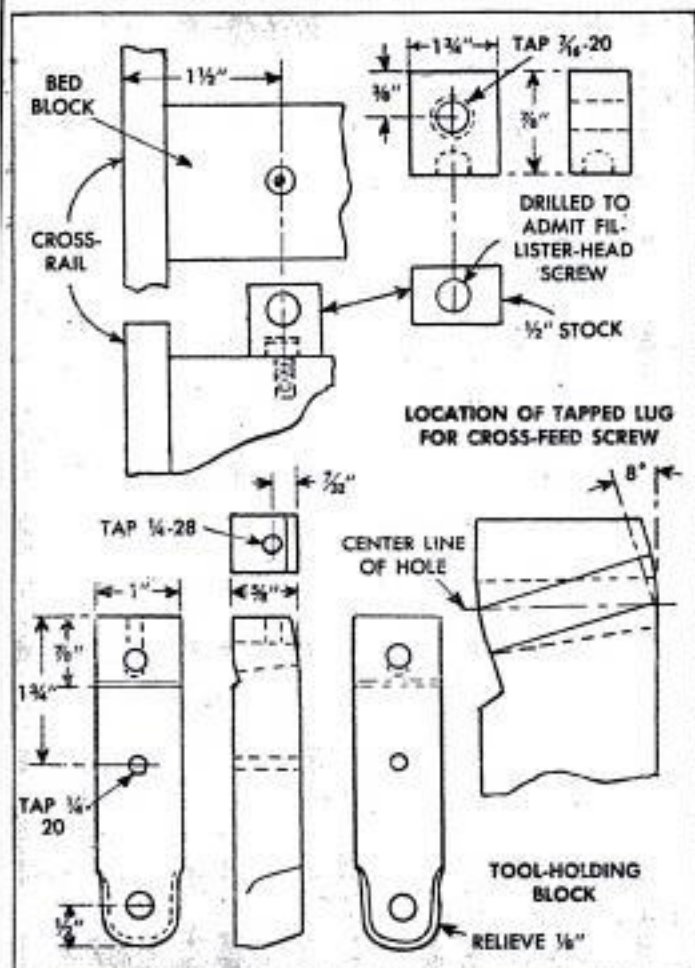

OCTOBER 1955

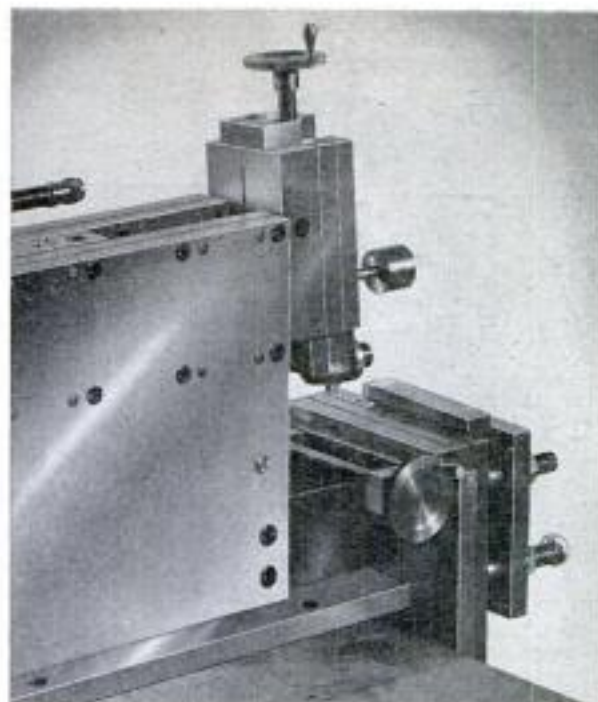
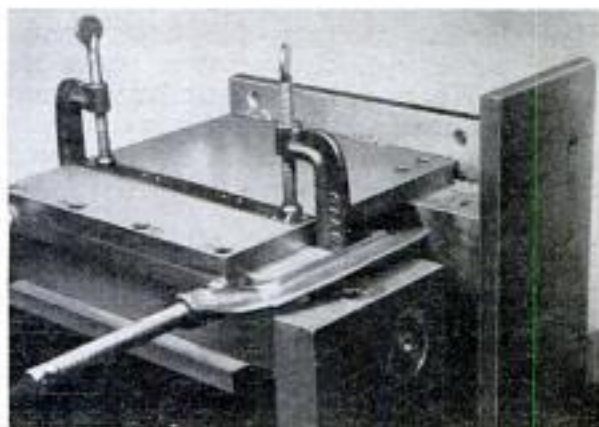
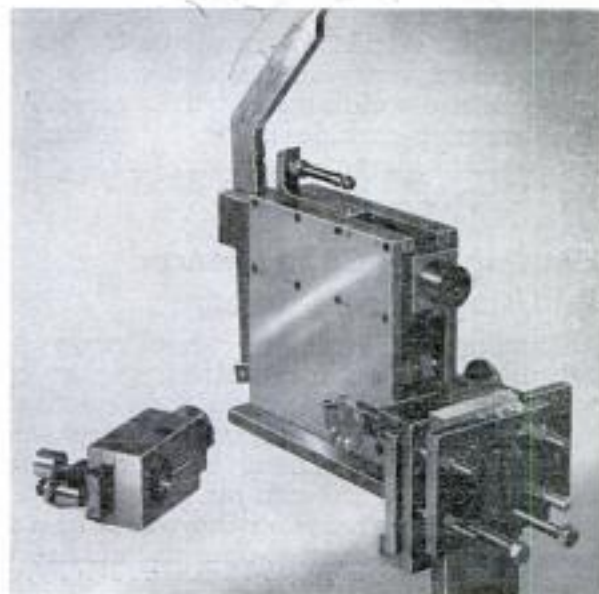

Photo shows head assembly and crossrail, saddle and clamp plate in position with work clamped in place



Above, method of clamping parts in position for fitting and drilling screw holes. Below, head assembly removed showing round turned on end of square ram



231

Bench Stop Hooks Between Boards In Top of Bench



If your bench top is made up of several boards with open joints, a neat sheet-metal bench hook for holding light work can be bent as shown to fit between the boards. Held in this manner, the hook cannot shift, yet is quickly removed when not needed. Where it would be advantageous, as for continued use, the hook may be permanently fastened with a couple of small nails.

Inexpensive Small End Mills



Small end mills, used for machining oil grooves in sleeve bearings, can be made quickly and inexpensively from roundheaded machine screws and tungsten-carbide

blanks. The blanks are fitted into the screw slots and oxyacetylene welded with a low-temperature welding rod. After assembly, the tungsten-carbide blank is ground to the desired shape.—Eutectic Welding Alloys Corp., Flushing, N. Y.

Rattling Hub Caps Silenced By Using Gasket Cement

Rattling hub caps and wheel rings can be silenced with hard-setting gasket cement. Spread a thin layer of the cement on the hub cap or ring where it contacts the wheel. Allow the cement to partially harden and replace the cap on the wheel. Be sure to smear grease on the wheel first to assure that the cement does not adhere to the wheel. When the cement has set, the

grease can be wiped off. If the metal of the contact point has lost its spring, place a small amount of cement behind the metal to stiffen it. Permit it to dry thoroughly before snapping hub cap or ring back on the wheel.

Reduce Salt-Block Waste By Using Nail Keg

To reduce waste of salt blocks of the type having a hole in the middle, place each one on an empty nail keg fitted with a projecting length of pipe. The pipe is pushed through a hole drilled in the bottom of the up-turned keg and



driven into the ground. The salt block then is slipped over the pipe to rest on the keg. Being off the ground, the salt will not dissolve from ground moisture nor become muddy and unappetizing to livestock.

G. E. Hendrickson, Argyle, Wis.

Fence Gate "Livestock Proofed"

Livestock cannot open the bolt lock on this gate when a hinged safety catch keeps the bolt from being drawn back. The catch consists of a nut welded to the free half of a butt hinge which has one leaf screwed to the gate. When the bolt is pushed into a hole in the gate post, the hinge leaf automatically drops. The nut prevents the bolt from being drawn back until the hinge leaf is lifted.

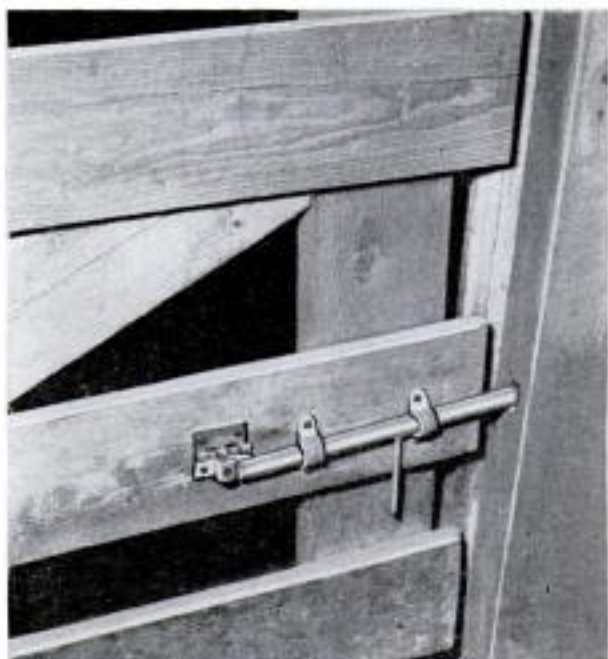

Holder Separates Leads Of Multiwire Cable



One electrician keeps the various leads in a multiwire cable separated when making connections by using a holder made from a short length of auto-radiator hose. The wires are simply pulled into

a number of slits cut in one end of the hose. One side of the hose is slit its entire length so the holder can be removed from the cable after all connections have been made.

Carburetor Fuel-Level Gauge



A gauge for accurately determining the fuel level in a carburetor float bowl can be made from a 1-ft. length of clear plastic tubing and a modified float-

bowl drain plug. A spare plug is drilled and a 1-in. length of copper tubing is soldered into the hole. The plug is substituted for a drain plug in the carburetor to be checked and the plastic tubing is slipped over the copper tubing. When checking the fuel level, the engine is run at idle speed and the plastic tubing held vertically as shown. Compare the fuel level in the carburetor being tested with the level in a similar carburetor on an engine which is known to be operating satisfactorily.

"Thrust Bearing" Converts Motor For Use in Vertical Position

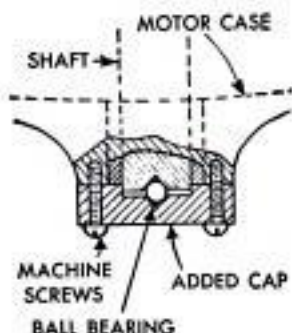

Often an electric motor designed for horizontal use can be fitted with a single steel ball at one end of the shaft to permit using it vertically. The thrust bearing is a hardened-steel ball bearing that fits in two mating

conical center holes, one in the end of the motor shaft and one in an added cap. The latter is machined to fit on the boss of the motor case so that the attachment screws will not interfere with the shaft bearings. To assure adequate lubrication of the thrust bearing, install a grease fitting in the cap.



Nails Fastened to Bins Identify Contents

A convenient supply of nails, readily identified for size and type, is a feature in this farm workshop. The nail bins are 1-gal. antifreeze cans cut in half. A nail fastened to the front of each bin identifies the contents. Special shelves for the bins are built between the 2 x 4 wall studs so that no floor space is required.

Quick-Coupling Tractor Hitch

Faster hitching and more positive control when backing implements hitched to a tractor are possible with this rigid coupling. A length of steel rod is bent to a U-shape to slip over the end of the drawbar and then welded to a short piece of flat steel the same width as the drawbar. Welding a twisted clevis to the end of the flat steel results in the rigid coupling shown.

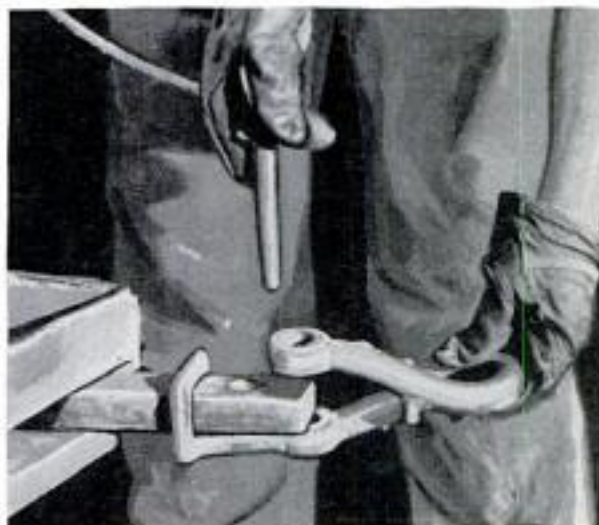

SN 57

CUT MOLDINGS on your circular saw

By Sam Brown



Wooden auxiliary fence is cut out simply by raising the rotating cutter. Cutout should be deeper than average molding cut



NEARLY ALL common straight moldings can be cut on the circular saw, using a special cutterhead that replaces the regular blade. Molding heads come in two and three-knife types, either one of which will produce smooth, clean work at standard saw-arbor speeds. Shallow moldings usually can be cut in one pass of the stock, only a few of the more involved shapes requiring two or more passes. By tilting the head and making adjacent cuts, almost any shape required can be made. Straight cuts can be run on the outside edge of the stock with a simple cutout fence to aid in working the stock past the cutterhead, but where the shapes are more complicated, or where whole-edge cuts must be made, it's regular practice to make up auxiliary jigs and guides to suit the job.

Mechanics of cutting: The molding heads, Fig. 1, generally require a special cutout fence or an equivalent wood facing with cutout, Fig. 2, fastened to standard fence. For a permanent fence, the style shown in Fig. 3 is excellent, the clamping wing nuts being recessed to permit working on both sides of the fence. The work can be advanced to the cutter in a flat position, Fig. 5, or in a vertical position, Fig. 6. Some cutter shapes permit only one work position, while others allow the work to be flat or vertical as desired. Generally, when a

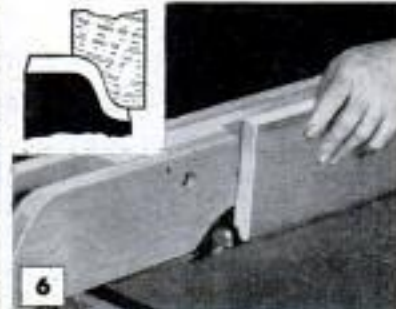
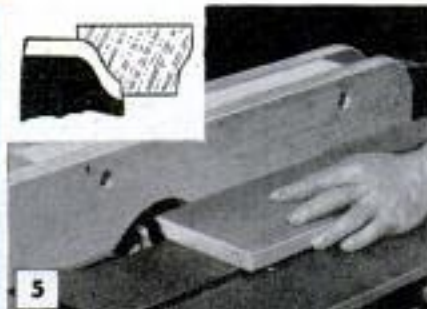
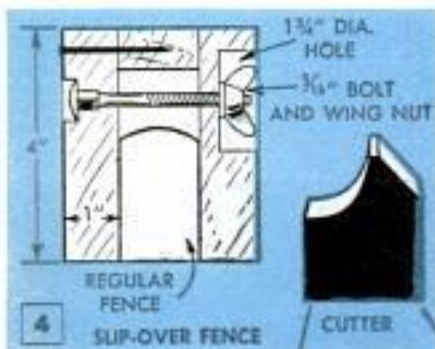

FLAT

VERTICAL



RIGHT SIDE

LEFT SIDE

OUTSIDE CUT

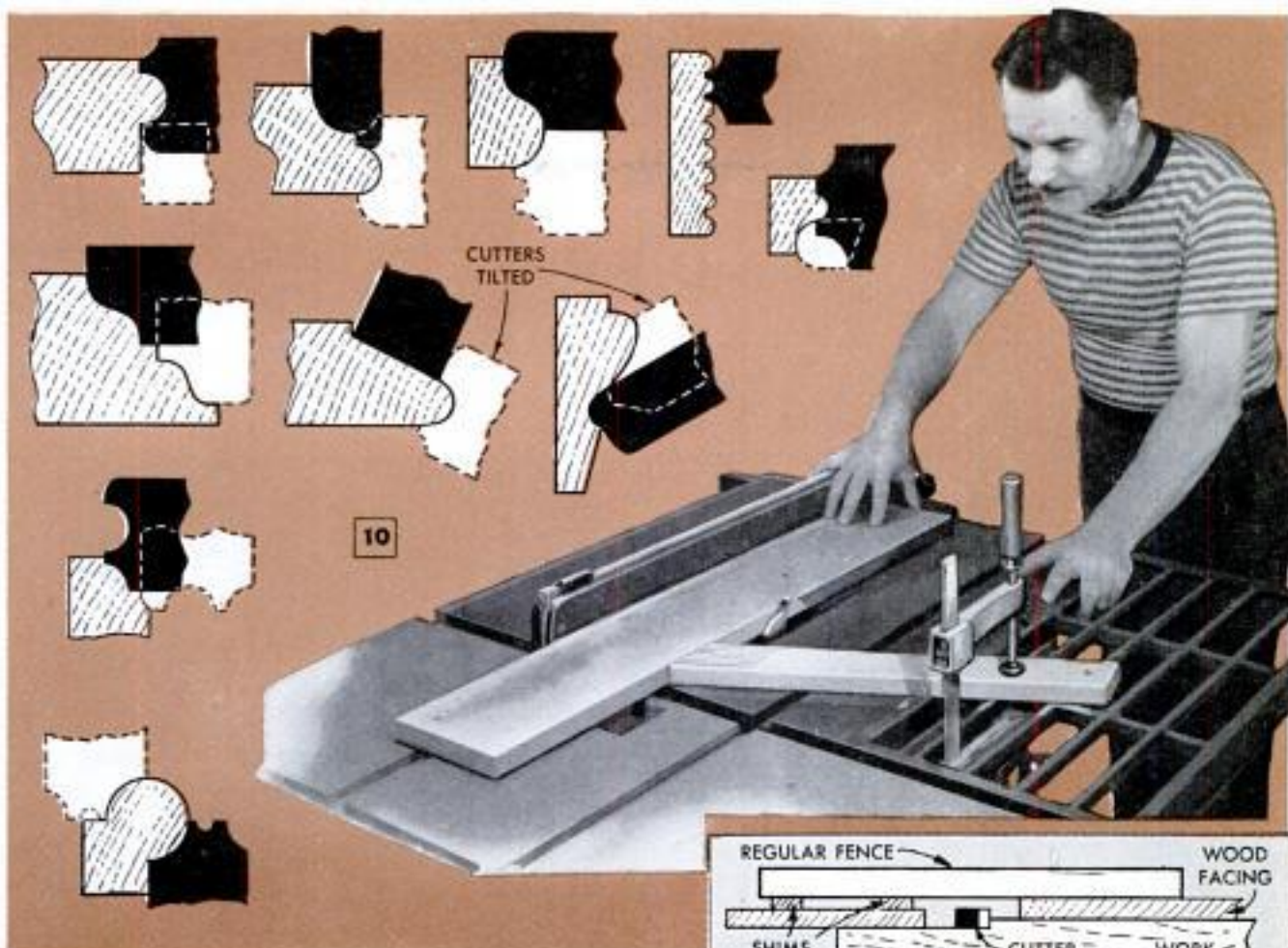

choice is allowed, the flat position is the more convenient. Cutting is done on the right or left side of cutter as required by the cutter shape, the cuts in Figs. 7 and 8 being typical examples. The standard technique of cutting is to mold on the inside, that is, the cut is made on the edge of the work next to the fence. Occasionally, cutting on the outside, Fig. 9, can be done to advantage.

Outside cutting: As shown in Figs. 9 and 10, outside cutting requires a hold-in for safe operation. A molding cutter is not like a saw—it cuts almost as well sidewise as straight ahead. Hence, when making a cut on the outside, the hold-in is needed to prevent the cutter from hogging into the work. The specific cut shown—sweep-jointing an edge with straight dado knife—produces a fairly smooth surface, although not equal to the regular radial cut. Jointing in this manner is advantageous in smoothing a very rough edge.

Whole-edge cuts: Most cuts made with the molding head leave some uncut wood to serve as a guide against the fence or table. When the whole edge is removed, it is necessary to offset the outfeed fence or table in the same manner as in jointer or shaper work. When the fence is the guide, this is done with a two-piece fence, Fig. 11, with the outfeed portion shimmed to the

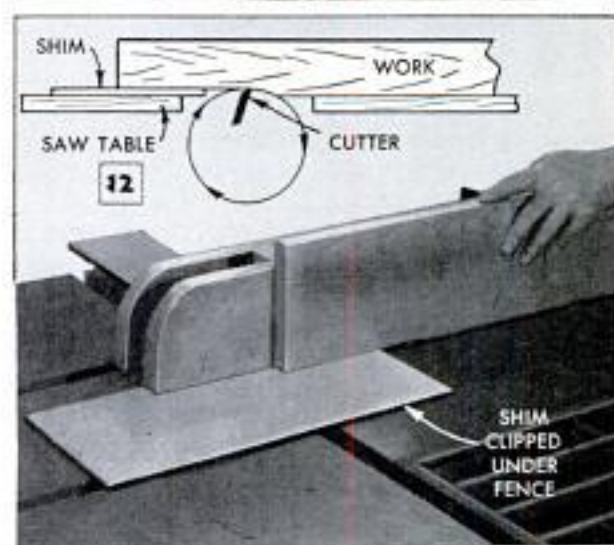
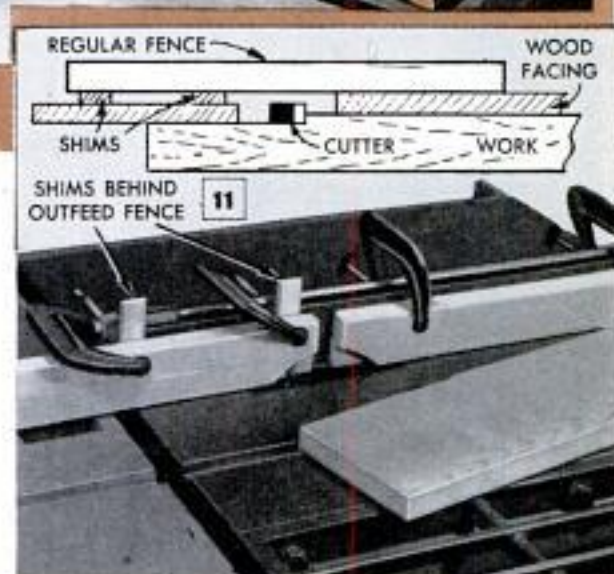

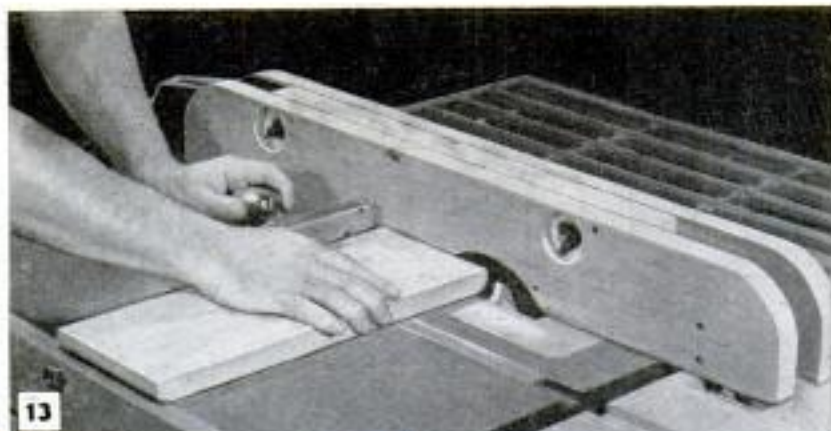

13

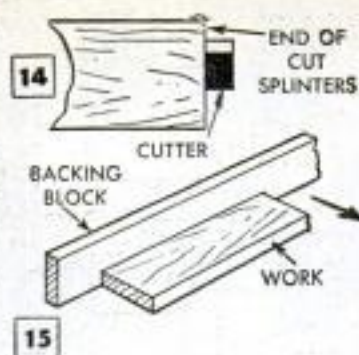

14

15

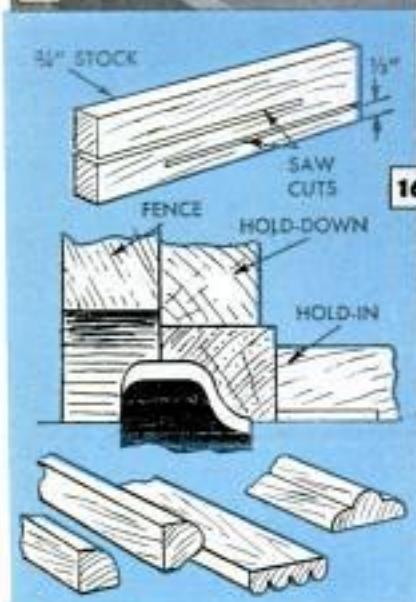

16

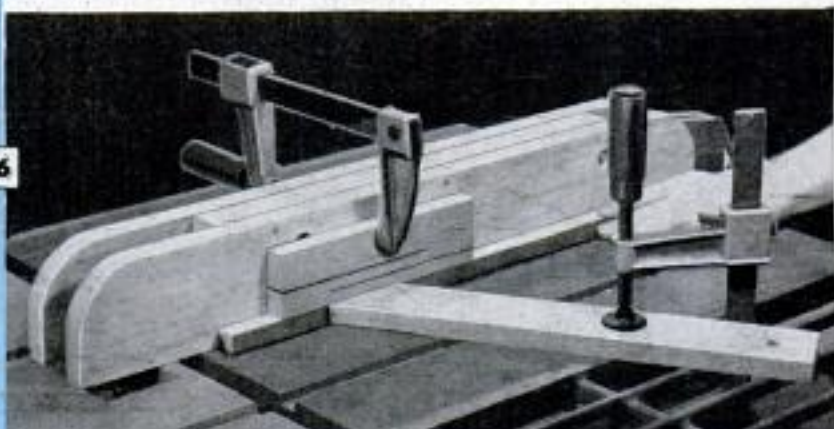

When it is necessary to mold across end grain, run these cuts first. Where only end grain is molded, use a backing block to prevent splintering, which is likely to occur as cutter passes edge. Narrow strips require a hold-down and hold-in clamped to saw table and fence as in lower photo. These must be correctly adjusted

desired depth of cut. A thin piece of metal or plastic is used in a similar manner when the table is the guiding surface, Fig. 12.

End cuts: End cuts across the grain, Fig. 13, will always splinter a little at the end of the cut, Fig. 14. When the work is molded all around, the splintered ends are cleaned by with-the-grain cuts, which are done last. If the ends only are to be cut, a backing block, Fig. 15, will prevent tearing. It also is good practice to slow up on the feed at end of the cut. If the end cut must be worked with the piece in vertical position, it is necessary to use some form of tenoning-jig support, as shown in Fig. 30.

Strip moldings: Much molding-head work is in the form of strip moldings. To handle this small stock, it is necessary to use both a hold-down and a hold-in, Fig. 16. With the setup made as shown, strips can be pushed into the cutter one after the other in rapid succession. When only a few pieces of strip molding are needed, the alternate method of working the shape on the edge of a wide board is often used.

Other operations: Various other operations with the molding head are shown on opposite page, Figs. 17 to 28 inclusive, and described in the accompanying captions. Cove cutting with the molding head, Fig.

23, is an especially useful technique, and the use of the roundnose cutter makes the job cleaner and faster than similar work done with a saw blade.

Joinery work: Other than moldings, the molding head does a remarkable variety of joinery work. Straight dado cutters, Fig. 36, available in all standard widths, do all the jobs of dadoing, rabbeting and grooving common to the dado head. Dado cutters are a little different from shaped cutters in that the face is milled, as shown. This gives a rake angle to the sides of the cutter. Side cuts are cleaner and the cutter stays sharp longer than a conventional straight knife.

The drawer-joint cutter, Figs. 29, 30 and 31, is one of several one-purpose cutters. This cutter is symmetrical and cuts both parts of the front-to-side drawer joint, Fig. 29. The front of the drawer is cut first. In this operation, the depth of cut is equal to side-stock thickness; the uncut wood on face can be an approximate $\frac{1}{8}$ in. The side of the drawer is cut with work flat on table, Fig. 31. Test this on scrap stock and you will see how the joint fits.

The door-lip cutter is another special-purpose knife which rabbets and rounds the edge in one pass, Fig. 32. One of many applications of the 45-deg.-angle cutter is the

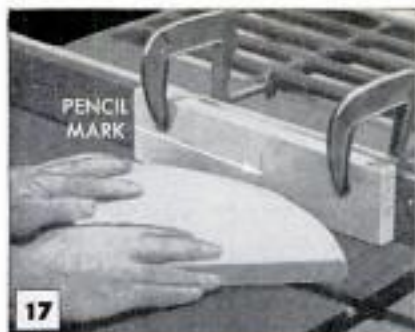

Curved work can be run freehand by keeping work tangent to center line of cutter. Works fairly well on both hard and soft wood where the mold is shallow. Usually it's best to run cut in several passes as otherwise it is difficult to hold the stock. Circular work can be molded quite easily, but requires a careful setup on an overhead pivot pin, or a V-block as detailed at the right. When molding edge of a disk more than 8 to 10 in. in dia. the V-block method usually is best

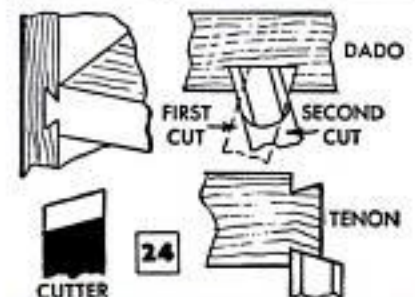

Dovetail grooving is easily done with a straight dado cutter ground at an angle of 11 deg. Groove is run with the cutter tilted 11 deg. as pictured and detailed. Work must be reversed for the second cut. Dovetail tenon is cut with the same cutter in a vertical position, the depth being accurately adjusted to give a dovetail of the correct width. It's a good idea to test the setting by running a cut on a piece of waste stock, readjusting the setting if necessary until the dovetail is a snug, sliding fit. Cutters must be razor sharp

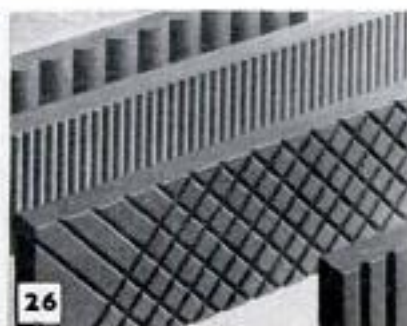
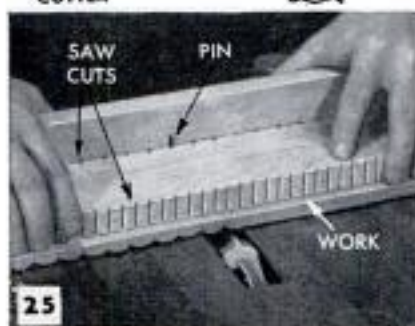

Ornamental moldings in a variety of pleasing patterns can be made by running repeat cuts across grain, using a notched or saw-cut template against a stop pin as pictured above. In making moldings of this type, accurate spacing of cuts is of the first importance. Another job for which a molding head is well suited is surfacing short lengths of rough lumber to take out wind and warp. Use straight cutters, 1 in. wide, in the head, joint piece and nail supporting runners to each edge

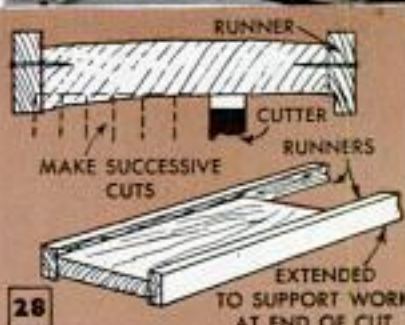

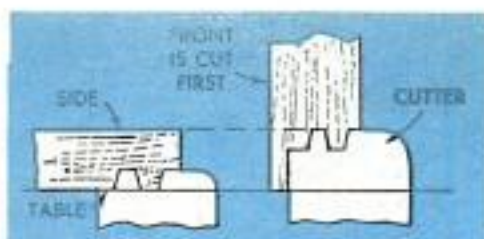

29



31



32

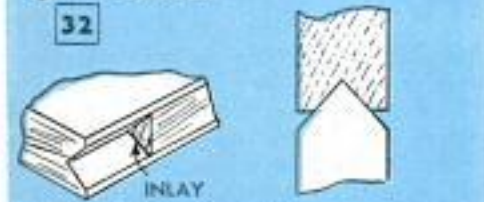

33

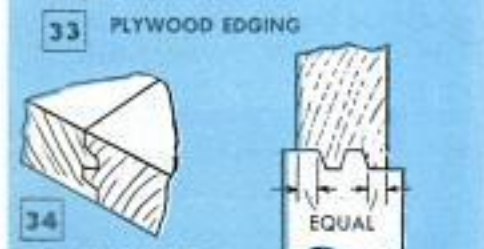

34



35



36

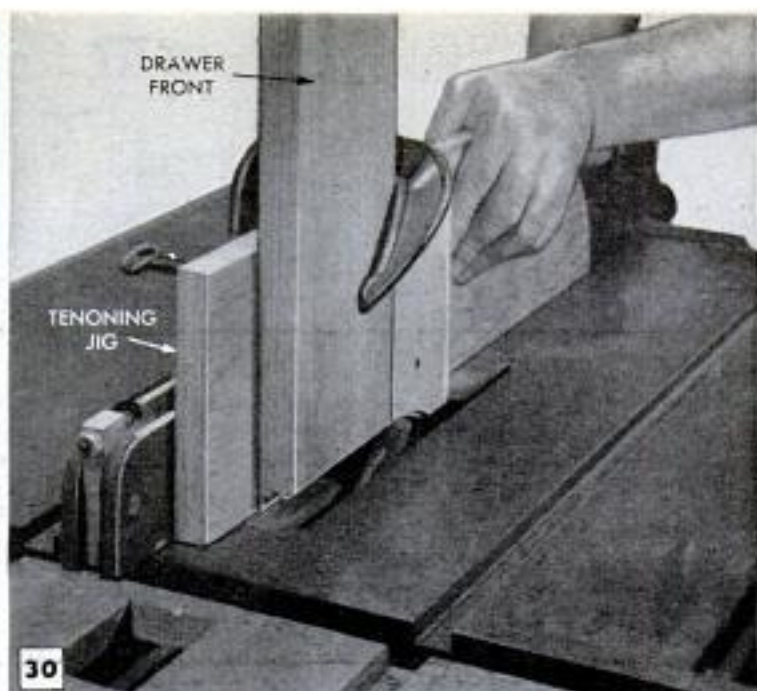

30

grooving of plywood edges to take an inlay facing, Fig. 33. The symmetrical glue-joint cutter is a one-purpose knife, used only for making glue joints. The work must be exactly centered on the cutter, Fig. 34. Properly centered, any two pieces will fit together when one of the pieces is reversed end for end. When the work has a definite face side, the reversal is done while cutting, molding one piece with face side next to fence and the joining piece with the face side away from fence.

The older style of tongue-and-groove glue joint, Fig. 35, still is preferred by many cabinetmakers. This is run with two cutters, one making the groove and the other the tongue. Both cutters are the same length so that when the depth setting is made for one, the same setting is used for the other. All work is done in the same position, that is, with face side to the fence or away from the fence as desired. When this is done, only approximate centering is required. Tongue-and-groove cutters can also be used for drawer and corner joints.

Molding shapes: Hundreds of molding shapes can be made with available cutters. A study of the samples shown in Fig. 10 will give you the general idea of how cuts are combined to produce various moldings. One special feature of molding-head work is that the cutter is easily tilted to any angle, greatly increasing the scope of pattern shapes.

Safety: The molding head is safe, quiet, easy to use. The main safety pointer is one common to all woodworking machines: Never run short, thin work. Specifically, watch out for short or thin work which may, when cut, fall through the table opening or slip into the fence cutout. ★ ★ ★

☐ When sandpaper cemented to a disk sander with pressure adhesive becomes loosened at the edge, it can be recemented by pressing with a hot clothes iron. Place the disk in a horizontal position and, as the heat of the iron softens the cement, place weights on the paper to hold it flat until cement sets.

One-Man Logging Operation Permitted By Modified Truck

By modifying his pick-up truck, one farmer has made lifting and hauling heavy logs a one-man operation. The support arch over the tail gate is shaped from the steel rim of a manure-spreader wheel. A length of carrier track, of the type used in dairy barns, is run from the arch to the top of the truck cab. First, using the arch as support, one end of the log is raised by means of a cable and a hand hoist, after which the truck is backed up until the log is supported on the bed. Then the end of the log is chained to the carrier. Next, the cable is fastened near the lower end of the log and hoisted. As the log rises, it slides forward on the



track. When sufficiently well supported, the log is chained and lashed with cable to prevent it from swaying or sliding back.—William Gilman, Middletown Springs, Vt.

Emergency Connecting-Rod Repair Made With Aluminum Foil

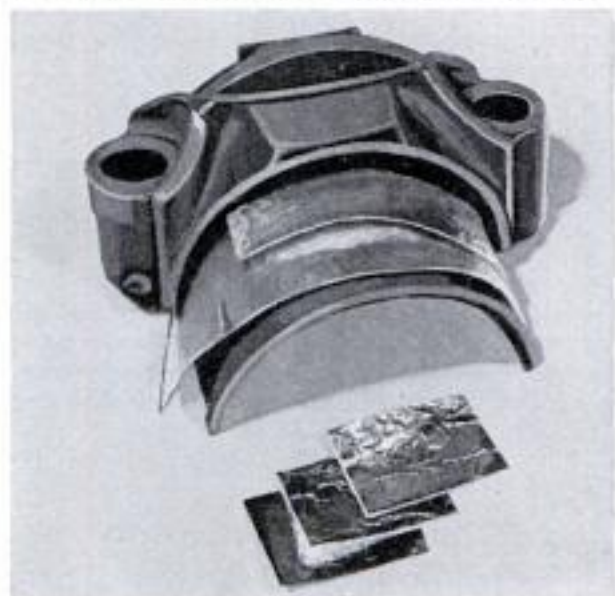

Aluminum foil can be used as an emergency repair to tighten a loose connecting-rod bearing in a car engine, or as a semi-permanent repair in a stationary gasoline engine used for light service. First, cut a number of $\frac{1}{2}$ -in.-wide strips of foil slightly shorter than the full length of the bearing insert, place them on the insert of the connecting-rod cap and tighten the cap on the rod. Remove or add strips until there is a noticeable drag when the crankshaft is turned by hand. Remove the cap and discard one strip of foil—the thickness of the strip assures oil clearance in the bearing. Place one half of the remaining number of strips behind the upper insert, after punch-

ing oilholes in them, and fit the other half of the strips behind the lower insert. The first strip, nearest the insert, is slightly shorter than the insert, the next strip is about one half this length. If a third strip is required, it should be slightly shorter than the second. The aluminum-foil shims should not be considered a permanent repair for a loose connecting-rod bearing in an automobile engine. The worn insert should be replaced with a new one as soon as it can be obtained.

Holes Punched in Spring Steel Without Annealing

Holes can be punched in spring steel, such as a clock spring, without the necessity of annealing it by center-punching just hard enough to cause a protrusion at the point where the hole is wanted, and then grinding off the protrusion. Repeat the operation until the hole is the desired diameter. This method can be used on metal up to about $\frac{1}{16}$ in. thick. Care should be taken not to strike the punch too hard, which might cause the steel to break or crack.



SN 57

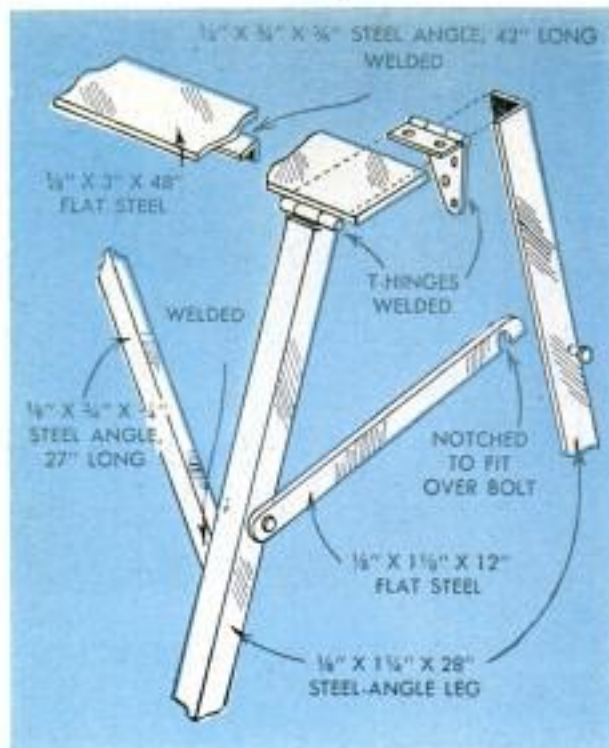

Sturdy Metal Sawhorses Fold Flat to Save Space

Regular wooden sawhorses are bulky items to store and carry. But this is not so with these sturdy all-metal ones which fold flat to take less room in both car and shop. About seven dollars will buy all the materials and a few dollars more will pay for the welding if you are not equipped to do it yourself. The dimensions given may be varied to suit. The top, for example, can be shortened to 3 ft. if you prefer. The flat-steel top has a stiffening member of angle steel tack-welded every few inches to the underside, and regular T-hinges are welded at each end as shown. The long leg of each hinge is tack-welded to angle-steel legs and

then bracing members, tack-welded to the underside of the top at the center point, are welded to the inside of the legs on one side of the horse. Finally, tie braces of flat steel are pivoted to the braced legs and notched at the opposite ends to hook over the projecting heads of short bolts fitted in the folding legs. If desired, the threaded ends of the bolts can be left projecting and fitted with washers and wing nuts to permit tightening the tie braces in place. Two coats of implement paint or similar enamel recommended for application to metal will keep the horses from rusting.

Walter Rudolph, Fairview, Pa.

Constant-Speed Throttle Control Uses Rod and Coil Spring

A simple, constant-speed throttle control for a stationary gasoline engine can be made from a length of steel rod and a coil spring. Bent to the shape shown, the rod is fitted at a convenient location on the en-

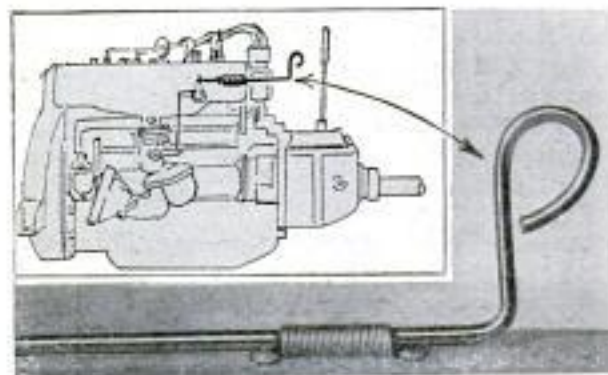

gine. The spring then is slipped over the rod and screwed to an adjacent surface by means of eyes bent in the spring ends. One end of the spring is screwed in place first. The location for the screw hole at the opposite end of the spring is determined by moving the spring end to one side until it binds against the rod. With all pull-back springs removed from the throttle linkage, the friction of the spring against the rod will hold any desired throttle setting, yet permit easy adjustment when necessary.

Ed Packer, Oak Park, Ill.

☐ A molded egg carton makes a handy tray for nuts, bolts, screws and other small parts. Coat the carton with shellac to make it more durable.

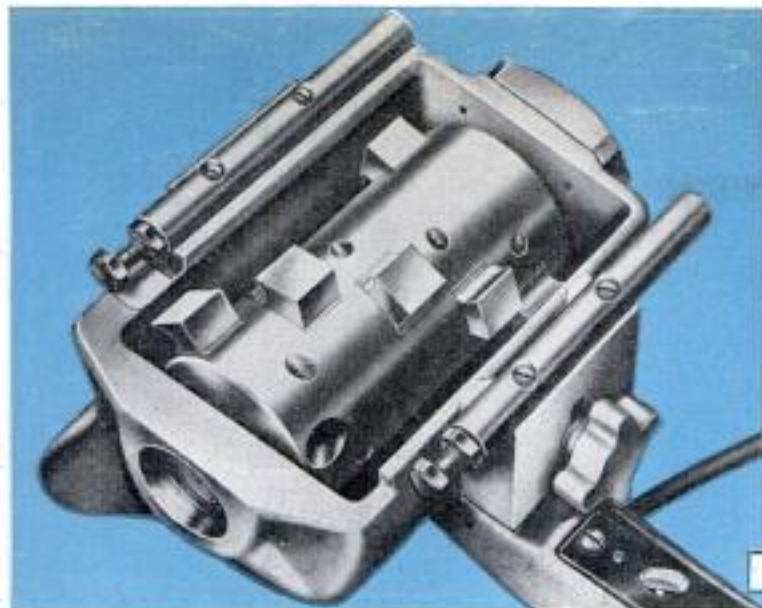

SHOPPING FOR TOOLS

1. MOTOR-POWERED PAINT SCRAPER eliminates hand labor entirely when scraping paint from clapboards, also reduces the constant fire hazard present when removing old paint with a blowtorch. Consists of a specially designed head which rotates at motor speed through a flexible shaft. In use the power unit is carried over the shoulder knapsack-fashion

Stow Mfg. Co., 443 State St., Binghamton, N. Y.

2. HAND-POWERED SPRING WINDER makes any type of spring with any number of coils and pitch desired within the capacity of the unit. Spring diameter and pitch are easily changed by simple adjustments. These features make the tool especially adapted to use in small shops for repair and replacement of springs of a variety of types and sizes. Unit is designed to attach to a bench or table by means of a clamping device

General Cement Co., Rockford, Ill.

3. MICROMETER HANDWHEEL replaces the standard tailstock handwheel on small lathes and makes it possible to do extremely accurate reaming and drilling to depth. The large micrometer dials also aid in making various types of setups between centers where highly accurate control of movement of tailstock center is essential. Dial also is furnished separately

Strine Machine Shop, Cardington, Ohio

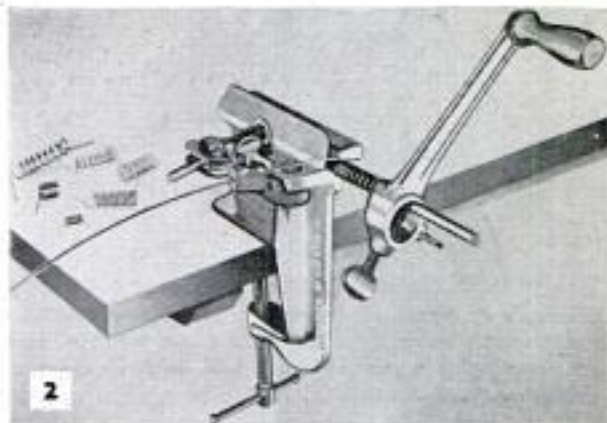

4. SMOOTHING TOOL takes the place of a sand block and a hand plane where it is necessary to work across end grain when fitting doors, sash and screens. Also is especially effective for smoothing plywood edges. Works equally well with the grain on both hard and soft wood. Removes old paint faster than sandpaper or scrapers. Consists of four specially hardened toothed blades anchored in grooves cut in a hardwood block

Fortune Laboratories, 1405 Main St., Des Moines, Iowa

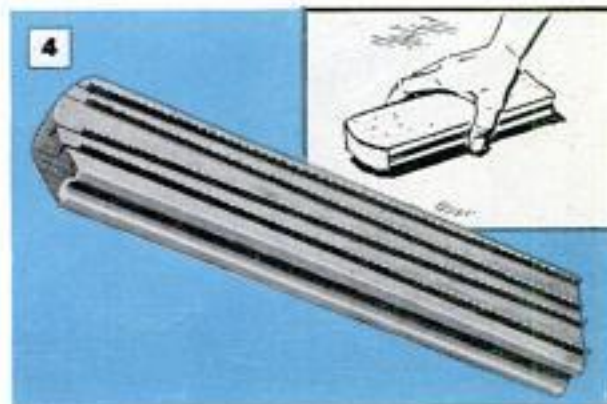

SHOPPING FOR TOOLS

(Continued from
preceding page)

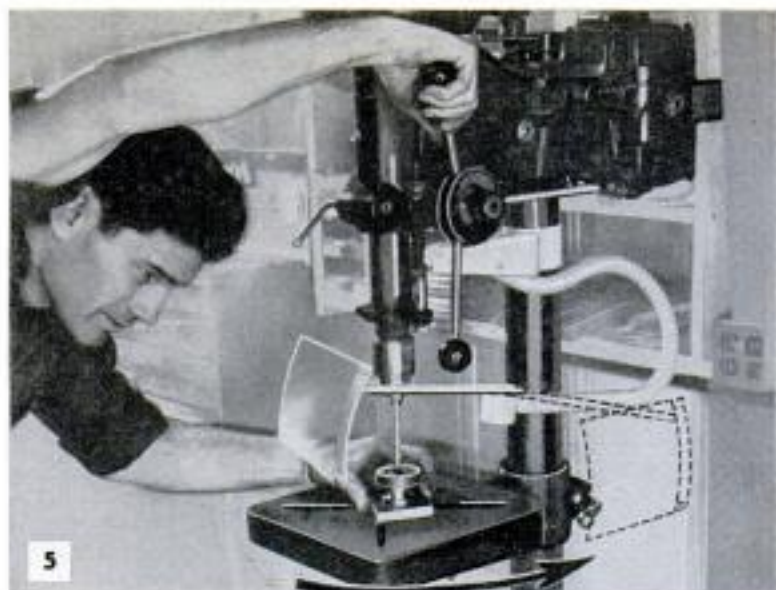

5. EYE SHIELD automatically positions and retracts with each machine cycle when repetitive work is being machined. As pictured in operation on a drill press, shield is adjusted to move into position during the first 1/2 in. of spindle travel. As the spindle is returned to the original position the shield retracts automatically. Easily adjusts to any work position

Hard & Co., 3500 Pontiac Rd., Ann Arbor, Mich.

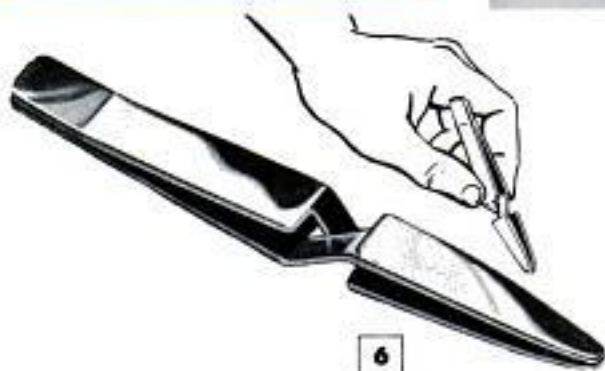

6. SELF-CLOSING TWEEZER is a necessary aid in any assembly operation which involves picking up, holding or clamping small parts in modelmaking, fly tying, making jewelry and in certain kinds of leathercraft. The self-closing, cross-acting feature permits the tweezers to be used as clamps for holding parts in position for soldering or tying, as they grip and hold with a uniform pressure until they are released

X-Acto, Inc., 48-41 Van Dam St., Long Island City 1, N. Y.

7. METAL-STRAPPING TOOL greatly enlarges the application of metal strapping as a fastener and connector and also as a binder and hanger for pipe, coils and certain hose connections which must be clamped and supported in position. Tool is only slightly larger than a heavy-duty pliers and automatically tensions the strapping and cuts off the excess by the simple operation of side levers. Easily carried in toolbox

Independent Metal Strap Co., Inc.,
230 Third St., Brooklyn 15, N. Y.

8. ROLLER LAPPING MACHINE laps metal, glass or plastic plugs, rods and pins to an extremely fine, accurate finish. Machine consists of two precision-ground rollers of cast iron, one 3 and the other 6 in. in dia. Rollers are parallel, 12 in. long and rotate in adjustable bearings. Large roller is cast with dual internal air chambers, each one vented by four openings. This provision holds temperature of work at a uniform level

Spitfire Tool Co., 2931 N. Pauls Rd., Chicago 41

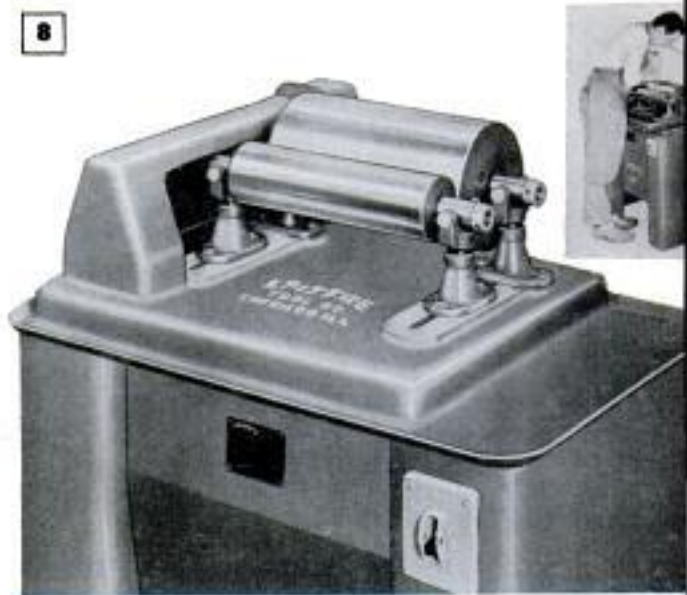
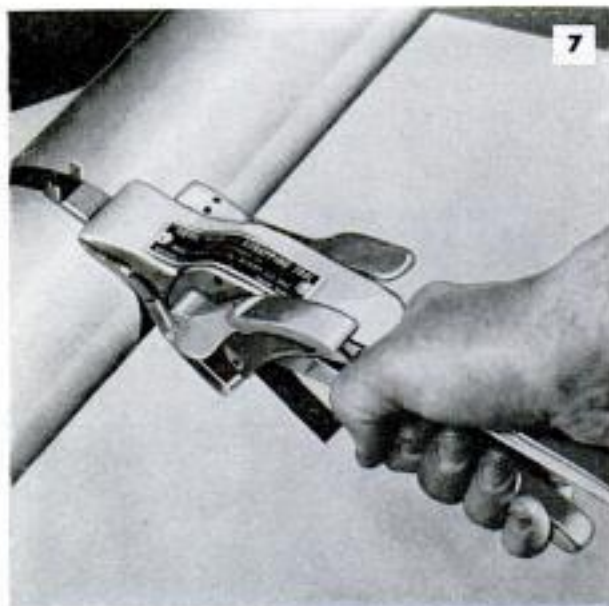



9. HEIGHT GAUGE is aid in setting circular saw, dado and jointer heads to precise depth of cut. Also useful when setting up shapers, as the knives can be set to the correct height without the use of a rule or other measuring tool. Fine for relocating jointer knives in the head after sharpening, also for setting the outfeed table at correct height. Plunger is graduated

Adams Products Co., 119 Ann St., Hartford 3, Conn.

10. DRILL-BIT HOLDER attaches directly to portable electric-drill cord. Holds 13 bits, 1/16 in. through 1/4 in. by 64ths in the fractional sizes. Easy to attach or remove from the cord, no rewiring necessary. Cord is threaded through the holder, which can be positioned at any convenient point along its length. Made of rubber, the holder cannot be broken even by the roughest use. Also handy to carry in pocket or toolkit

The Donart Co., 425 E. Plymouth Circle, Minneapolis 16, Minn.

12. GLUE-GUN ASSEMBLY for use on air line has a capacity of 16 oz. and comes complete with pressure gauge, regulator valve and 10-ft. air hose with connectors. Easy to clean as there is no tank or fluid hose. Useful to those who use catalyst glues having a limited effective pot life, and also for those who use cold glues on an interrupted schedule

John P. Fox Co., 5514 York Blvd., Los Angeles 42, Calif.



OCTOBER 1955

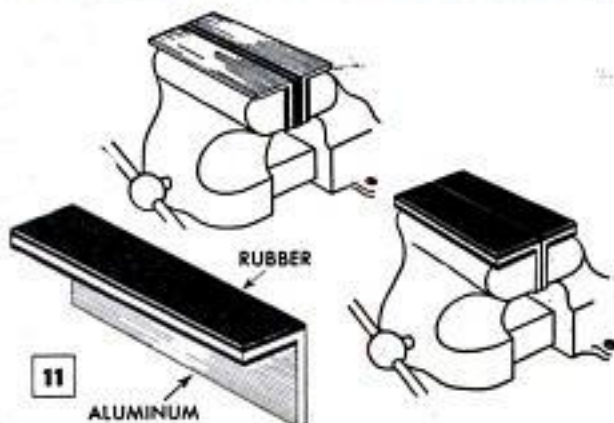
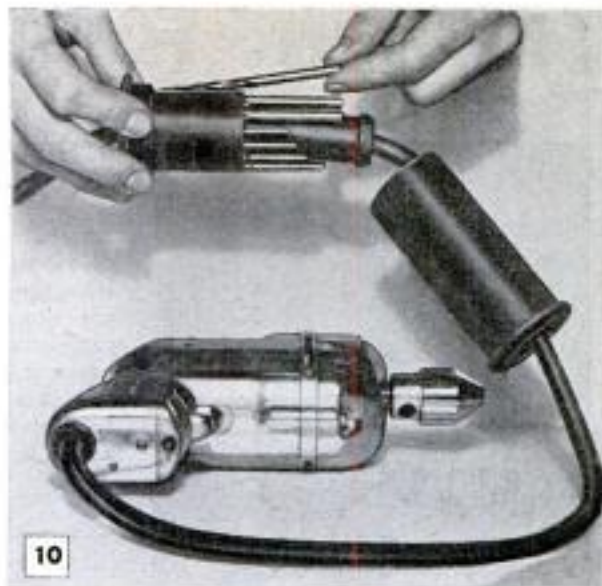

11. RUBBER-FACED AUXILIARY JAWS fit any metal-working bench vise and enable the user to grip or hold delicate work that would be marred or otherwise damaged by metal vise jaws. Holds irregular shapes

Truck Scale & Research Corp.,
1415 3rd St., S. St. Petersburg, Fla.

13. TWO-SPEED BANDSAW has built-in motor and is of three-wheel type with deep throat for handling wide stock. Third wheel is fitted with a tracking and tensioning device for band blades of varying widths

Victoria Guild, 137 Kensington Ave., Jersey City 4, N. J.



243

SHOPPING FOR TOOLS



COMBINATION TOOL is quickly converted to portable router, rotary jigsaw, dovetailer, by a change of motor to special tables, jigs and bits which are supplied either as regular equipment or as accessories. At left, unit is pictured set up as shaper, making rabbet cut on long, narrow stock

Porter-Cable Machine Co.,
Syracuse, N. Y.

Photos at right show three applications of new combination tool for home workshops. In top photo, unit is set up for cutting dovetails as used in drawer construction. Center photo pictures a dadoing operation, using special router bit and edge guide. Lower photo shows rotary jigsaw in use



SPIN DRIER for paint rollers fits chuck of any 1/4-in. portable electric drill. Spins a paint roller dry in a few seconds. Just dip the roller in nonflammable solvent, force the spinner inside and lower into a pail

Star Sponge & Supply Co., 8031 Blackstone Ave., Chicago 19

BATTERY LANTERN has several new and novel features. Two 6-volt batteries wired in parallel form the case, or frame. Red warning light flashes 50 times per minute and is operated by separate toggle switch

Burgess Battery Co., Freeport, Ill.

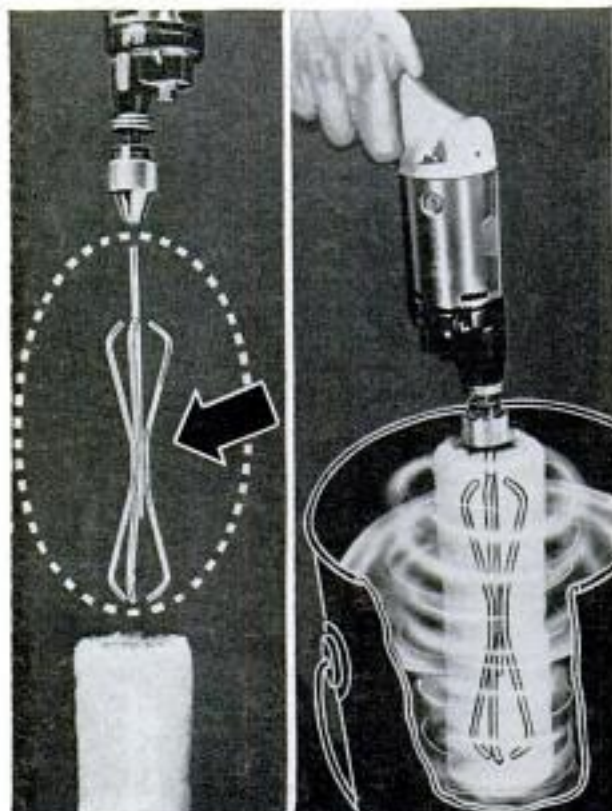

RADIO



TELEVISION ELECTRONICS

APARTMENT-SIZE HI-FI SYSTEM MAKES MUSIC LIVE

IF YOU'VE BEEN listening to your favorite records on an old-fashioned phonograph because a high-fidelity system is too great a strain on the budget, here's a system that will both amaze and delight you. By devoting a few evenings of your time you can build this amplifier-speaker system

at a surprisingly low cost. When completed, you'll probably find that your records contain high and low notes which have never been reproduced before and that the music will take on a lifelike quality which makes listening a real pleasure.

The system consists of an amplifier, a speaker and a speaker enclosure especially



PARTS LIST FOR SPEAKER ENCLOSURE

Part	Description
1	5" x 5" x 1/8". Cut 4-5/16" dia. center hole.
2	5" x 12" x 3/8".
3	5" x 15 1/2" x 3/8". Cut one edge to provide a 40° angle.
4	5" x 10 3/4" x 3/8".
5	5" x 13 1/2" x 3/8". Cut one edge to provide 85° angle.
6*	20" x 35 1/2" x 1/4". 2 pieces needed.
7	5" x 8" x 3/8". Cut edges to provide angles of 40° and 50° respectively.
8	5" x 12" x 3/8". Cut one edge to provide 45° angle.
9	5" x 10 1/2" x 3/8". Cut edges to provide angles of 85° and 50° respectively.
10	5" x 12 3/4" x 3/8". Cut edges to provide angles of 70° and 20° respectively.
11	5" x 35 1/2" x 3/8".
12*	5 5/8" x 20" x 3/8". File and sand width of piece after assembly for perfect fit.
13	5" x 19 3/8" x 3/8".

Speaker: Jensen extended range, type P5TX
2-conductor cable, any desired length.

Phone plug: Mallory type 75 or equivalent
Wood glue, headless brads, grille cloth, front trim.
* These parts should be made of good 1/4-in. ply-wood. All other parts can be white pine or fir.

ENCLOSURE ASSEMBLY INSTRUCTIONS

- Step 1. Glue and nail parts 1, 2, 3, 4 and 5.
Step 2. Glue and nail parts 6, 11, 12 and 13.
Step 3. Glue and nail parts 7, 8, 9 and 10.
Step 4. Glue and nail the assembly of step 1 to the assembly of steps 2 and 3.
Step 5. Mount speaker as shown in exploded view and solder the leads of a two-conductor cable to the speaker voice coil. Bring cable out through hole in rear of cabinet after knotting the cable just inside the cabinet to prevent a strain on the speaker lugs. Solder phone plug to external end of cable.
Step 6. Glue and nail opposite side (same as part 6) to the assembly.
Step 7. Construct front angle trim and attach grille cloth of any desired color, as shown in the exploded view, and attach this to main cabinet.

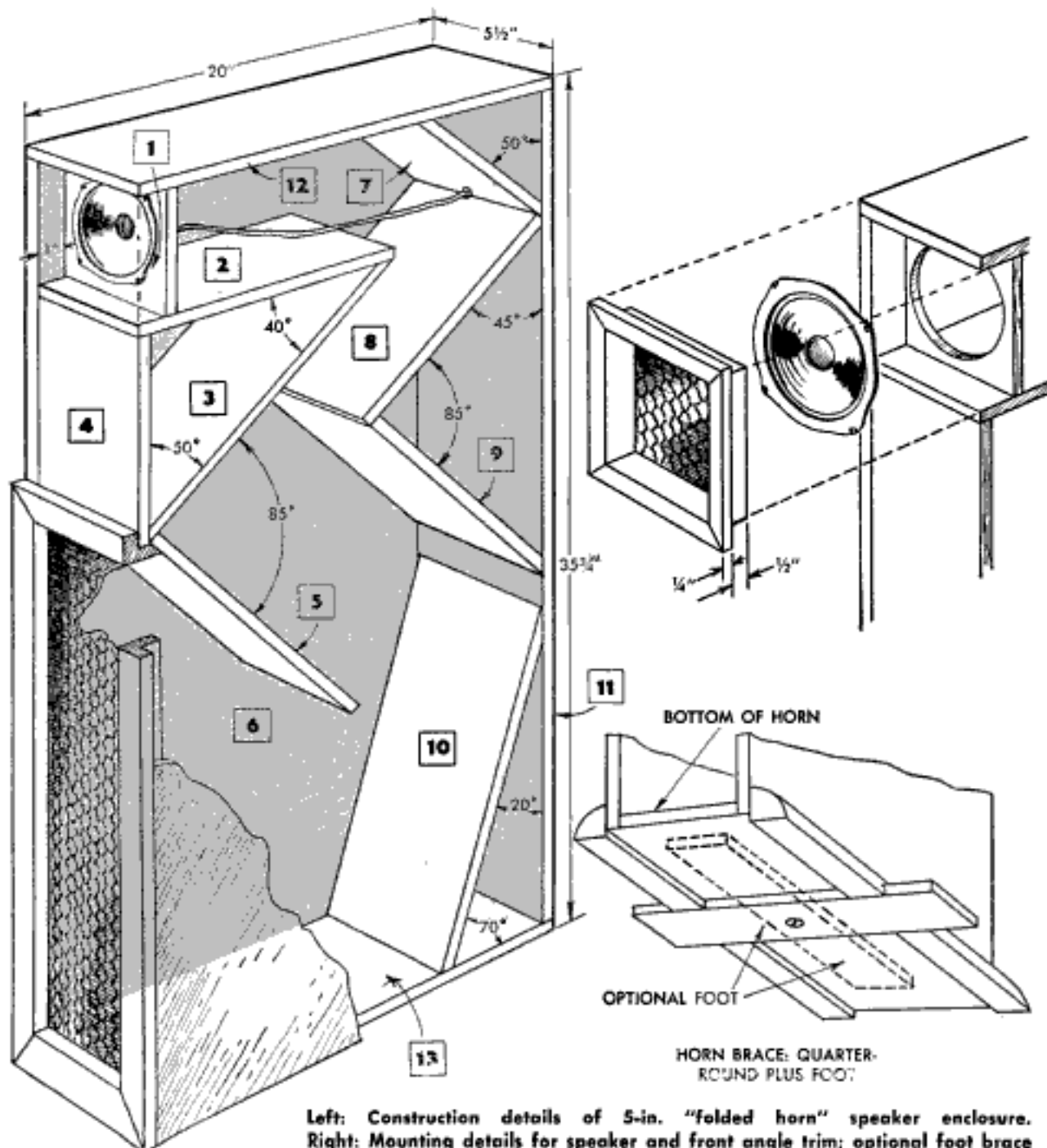

Left: Construction details of 5-in. "folded horn" speaker enclosure. Right: Mounting details for speaker and front angle trim; optional foot brace

designed for a small apartment where space is at a premium. The enclosure is only 5½ in. wide and blends in admirably with almost any type of furniture arrangement.

The speaker system. Much of the success of the entire system depends upon the speaker enclosure. The design principles shown here are used in expensive cabinets for large speakers. Yet, the fact that this same design, when applied to enclosures for small speakers, will provide immeasurable improvement for these units seems to have been overlooked. Here, then, is a "folded horn" type 5-in.-speaker enclosure which provides twice as much sound power, with greatly improved bass characteristics, as ordinary cabinets.

The detailed construction diagram for this enclosure, together with a list of the required materials and a recommended assembly procedure, is shown on page 246. To provide a mechanically strong cabinet all pieces must be accurately cut and all joints must be airtight. The use of a good wood glue and a sufficient number of nails (headless brads are preferred) to add strength to the assembly is a requisite.

In order to turn out a nice-looking job, some care should be used when fastening the inside boards to the side pieces. One good method is to pencil mark the location of the boards on the inside of the side pieces. Then, using a bit with a very small diameter, drill holes through the side panels at all points where brads are to be used. You can then start the brads from the outside with assurance that they will hit the boards inside.

The speaker should be installed before the final side is fastened into place. Any type of two-wire cable, such as ordinary

lamp cord, is suitable for the speaker leads. The length of the cable is of no consequence, but you should tie a knot in the cable at the point where it is brought out the rear of the cabinet. This prevents a strain on the speaker lugs in the event that the cord is inadvertently pulled.

Some front angle trim and grille cloth to fit the front openings of the enclosure are the final items of construction.

The amplifier uses a new television-type output tube in a push-pull triode output circuit. It produces a full 4 watts of audio power with a total distortion so low, less than 5%, that it is discernible only to a highly trained listener. The volume is more than adequate for any size living room and will probably have to be turned down to keep the neighbors from complaining.

Following the super fidelity principle (*PM*, Feb. 1953), two wide-range tone controls are included. These permit the selection of practically any bass or treble frequency tilt to compensate for any particular record, room acoustics or personal preference. The amplifier is designed for use with any crystal or ceramic phono cartridge. Full power output is obtained with an input of only 0.3 volts.

Construction of the amplifier is so simple that anyone can build it in a couple of evenings with a minimum number of tools. A soldering iron, a screwdriver, a pair of long-nose pliers with diagonal cutters and some means for drilling and reaming the required number of holes in an aluminum chassis are about all that's needed.

Begin the project by purchasing all of the necessary parts as listed in the parts

(Text continued to page 268)

(Wiring diagrams on page 248)

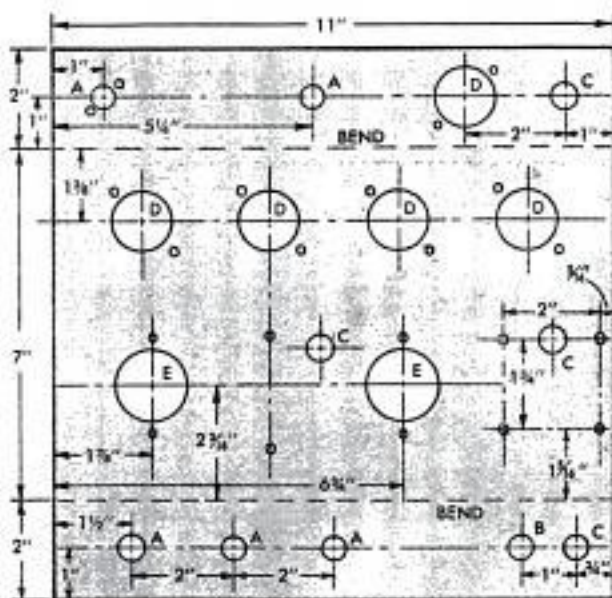

TOP OF CHASSIS LAYOUT

LEGEND

- A—3/8" HOLES
- B—3/16" HOLES
- C—1/8" HOLES
- D—1 3/16" HOLES
- E—1 1/2" HOLES
- UNMARKED HOLES TO CLEAR NO. 6 SCREW (27 DRILL)

Left: Diagram showing sizes and locations of chassis holes. Below: Photo shows locations of major parts

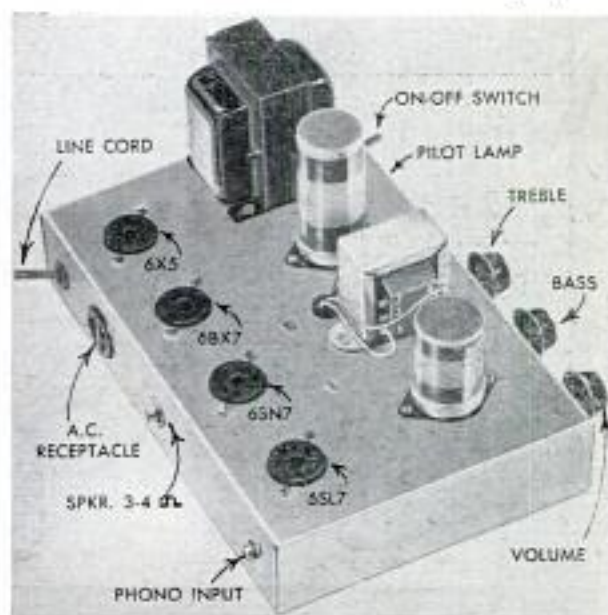

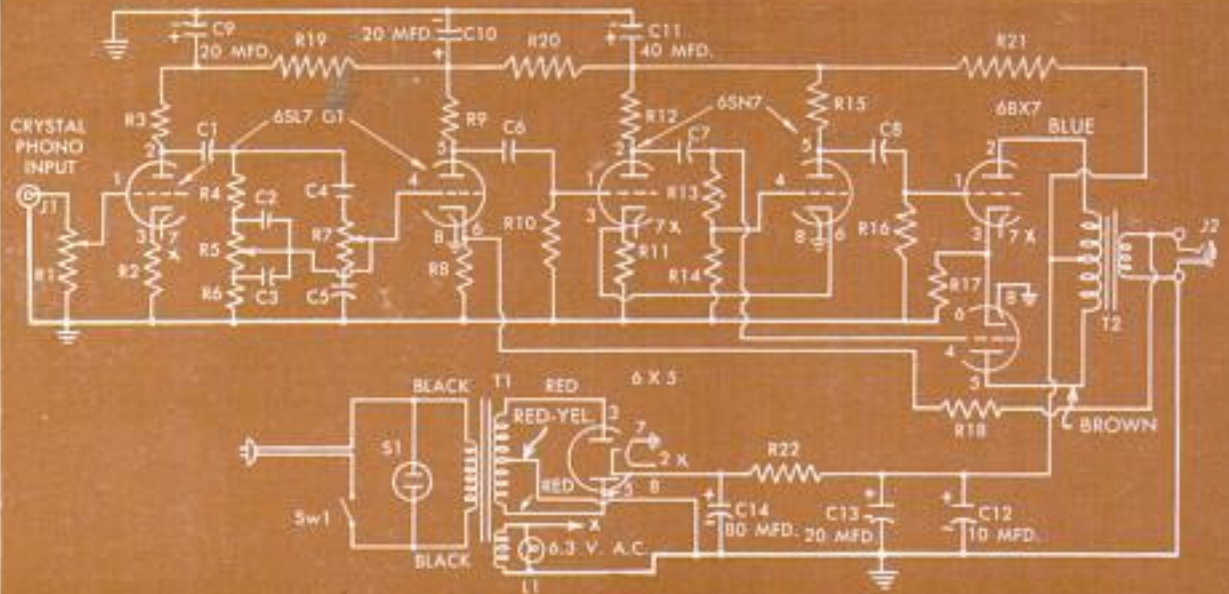

Schematic diagram of 4-watt amplifier can be used to check your work after wiring has been completed

Pictorial wiring diagram of amplifier. Use of colored crayon to fill in lines will help prevent errors

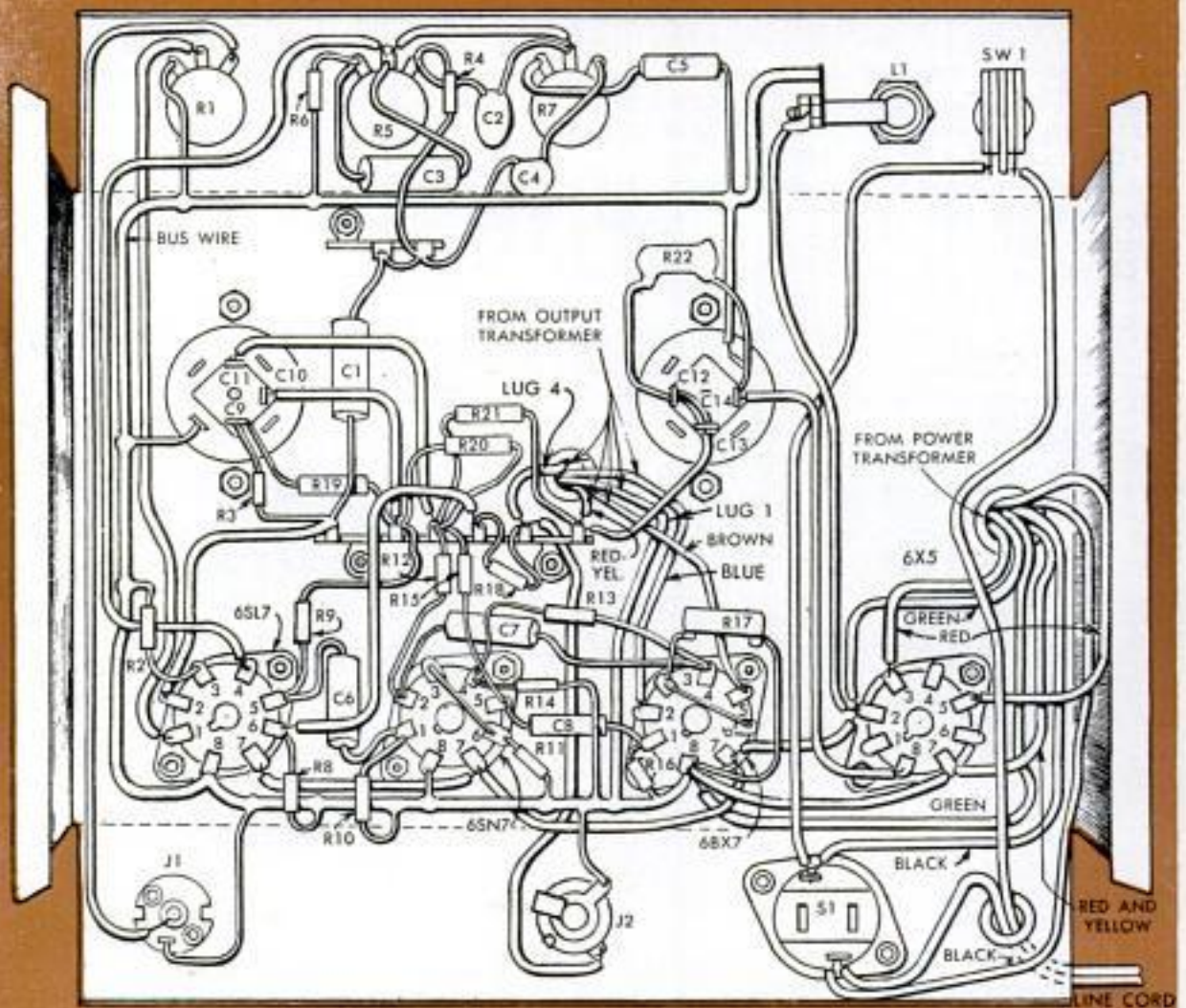

**NEW
1956
MODEL**

POWER TOOLS

CRISP DESIGN . . . MORE EFFICIENCY . . . MODERN COLOR STYLING

See these 1956 advance models of America's most modern line of power tools at your hardware now. Write for Free Syncro Power Tool Catalog, Sanding Handbook.

EXAMPLES OF ANGLED CUTS
DONE ON A FLAT TABLE



SYNCRO POWER UNITS
GUARANTEED
AGAINST BURN OUT DURING
YOUR OWNERSHIP OR
REPLACED FREE!

ANNOUNCING
THE **ONLY**

TILTING ARBOR JIG SAW

Now . . . all others are old fashioned! Because, on new Syncro model 2500, your work remains flat while making angled cuts. Blade, arm and motor tilt together. Just "dial" for angled cuts. Modernize your shop with the *only* tilt arbor jig saw! Comes ready to use—no bolting down. 65 lbs., cast semi-steel. 20-in. throat, 180 sq. in. table. Use heavy duty "2500" for big projects. See at hardware, write for catalog, price.



Precision-ground table is always level for greater control—easier, more accurate sawing . . .

AMERICA'S ONLY *MULTI-MOTION SANDERS



**Almost all wood grain is naturally crooked and irregular. Only Syncro patented "Multi-Motion" sanding pad action can sand with such grain and completely finish the whole surface.*

Model 900-D DeLuxe Sander Kit

Heavy duty sander. Outsands, outlasts others. Easy to handle. No "jumping". With metal case, polish pad, 48 assorted sandpapers. *Model 900 Heavy Duty Sander* comes without sight-saving work lamp or metal case.

Model 504 Finish Sander Kit

Light. Powerful. Easiest for vertical use. In metal case, sandpapers, polish pad.



Family Jig Saw

Basic power tool for Dad! Safest for children. Full 15" throat, 10" x 10" table. For projects and recreation.

Remember:
More Syncro-
made jig saws sold
than any other
self-powered
model

Don't buy trouble - buy
SYNCRO
SAWS AND SANDERS

FREE
Valuable
Sanding Hand-
book, Catalog.
Write.

SYNCRO CORPORATION — Dept. 1-75 — OXFORD, MICHIGAN U. S. A.

Copyrighted material

FREE!

**. . . at your
hardware dealer or
lumber yard!**

this big 64-page

**POPULAR
MECHANICS**

**how-
to-
do-
it**

idea book



It's loaded with valuable do-it-yourself ideas, hints and projects — straight from the editors of Popular Mechanics! And it contains the advertisements of hundreds of manufacturers of do-it-yourself tools and materials. Not only is this valuable 64-page booklet a pocket library of useful information, but it's a complete buyer's guide to quality tools and materials! This useful booklet will be available during October at many leading hardware and lumber dealers throughout the country.

Visit your dealer today and get your *free* copy while the supply lasts! While you're there, examine his extensive stock of do-it-yourself tools and materials . . . he'll have many of the items featured in the big 64-page booklet! If you want any additional information, ask him! He's your helpful friend and advisor . . . waiting to serve you . . . ready to help you buy wisely! And whatever you buy, the fact that it's advertised in Popular Mechanics is your assurance of quality and satisfaction!

POPULAR MECHANICS MAGAZINE

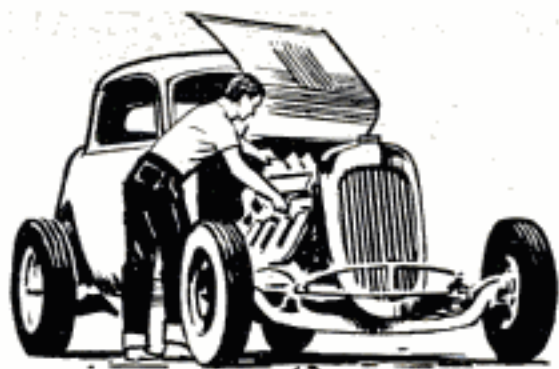

**MECHANICAL
SKILLS
CAN GET
YOU
AHEAD
IN THE
U. S.
AIR FORCE**

Here's why —

If you're interested in mechanics, join the U. S. Air Force. As an Airman you may develop your technical ability and learn a skill that will pay well...and win you extra stripes. Such interesting career fields as Aircraft and Engine Maintenance, Rocket Propulsion and Intricate Equipment Maintenance are open to you, if you qualify. Don't delay — see your local Air Force Recruiter or mail the coupon, *today*.



**YOU GO
PLACES
FASTER
IN THE
U. S. AIR FORCE**

AIRMAN INFORMATION BRANCH
Box 2202, Wright-Patterson AFB
Ohio

M-19-PM

Please send me more information on my opportunities as an Airman in the U. S. Air Force.

Name _____

Address _____

City _____ Zone _____ State _____

When you buy a Signet Slide Projector you buy "Screen Brilliance"

You know that it takes a really superb optical system to make your favorite color slides "come to life" on the screen. Because we're especially proud of the optical system in our Kodaslide Signet line of 2 x 2 slide projectors, we'd like you to see what a Signet can do for *your* pet slides. Your dealer can show you Signets in the six different combinations of lenses, lamps, and slide changers shown below.

These are some of the special features you'll like when you evaluate a Signet by *your own* senses of sound, touch, and sight:

BY SOUND—Turn the master control switch to "blower" position. Hear that low whir? It's from an impeller-type blower that is channeling cool air over all the internal surfaces. But apart

from its mechanical efficiency, the nice thing about this blower is its "shush." Won't compete with conversation or soft background music.

BY TOUCH—Snap the master control switch to its various positions. Rotate the lens barrel. Try the slide feeding action, the unique elevating mechanism. Notice how simply, how precisely, everything works? That's the secret of the Signet's exceptional handling ease.

BY SIGHT—With a slide in place, switch on the lamp and focus the lens. Notice that the images are crisp, sharp, and evenly lighted over the *entire* slide area. Above all, notice their brilliancy—even in the shadow areas. With a Signet, you can actually project a bright image in subdued room light.



Kodaslide Signet 300 Projector

with automatic changer
only \$69.50

Kodak Projection Ektanon 5-inch, f/3.5 lens; Lumenized optics; 300-watt lamp; impeller-type blower; 2-way switch; individual leg tilt; automatic changer centers slides, returns them to 36-slide magazine; sea-foam green finish.



Kodaslide Signet Projector Case

holds projector with regular take-up changer, receiver and slide file box, or projector with automatic (36-slide magazine) changer and slide file box. Now only \$9.95

There's a Signet for you in this 6-way selection

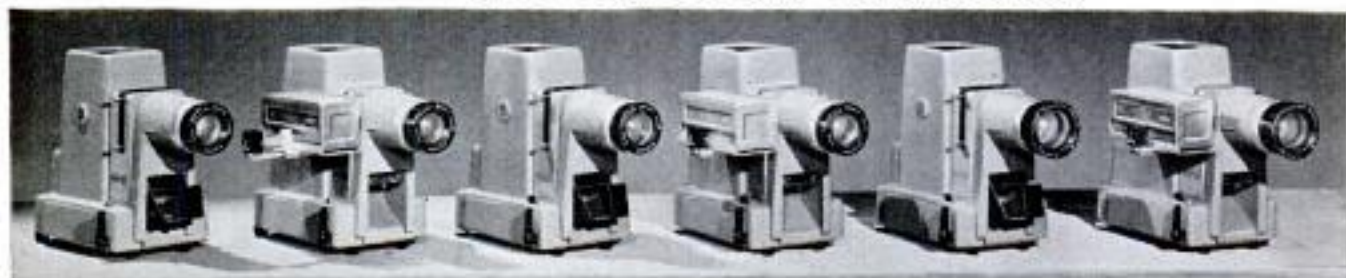

Signet 300 f/3.5 with take-up slide changer (otherwise same as described above), \$59.50

Signet 300 f/3.5 with automatic slide changer (see description above for details), \$69.50

Signet 500 with 5-inch, f/3.5 lens; 500-watt lamp; some versatility as 300. Frosty beige, \$72.50

Signet 500 f/3.5 with automatic slide changer (otherwise same as described at left), \$82.50

Signet 500 with 5-inch, f/2.8 extra-fast lens; 500-watt lamp; regular take-up slide changer, \$79.50

Signet 500 f/2.8 with automatic slide changer (otherwise same as described at left), \$89.50

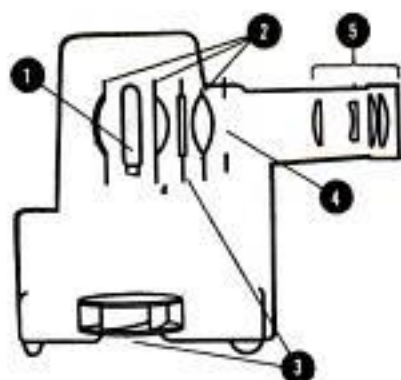

What makes a Signet stand out?

That's easy. Performance. The kind of big, brilliant screen results that give any slide fan a thrill of satisfaction.

What accounts for the Signet's ability to project a superior screen image? In the cross-sectional diagram of a Signet, above, you'll notice that a powerful projection lamp (1) has been aligned between a front-surfaced hemispherical mirror and two Lumenized (hard-coated) condensers. This snug arrangement (2) concentrates and beams an exceptionally strong shaft of light through the color slide.

Since all lamps radiate heat, Kodak engineers have given the Signet the finest of cooling systems. The combination of a panel of heat-absorbing glass and an impeller-type blower (3), plus internal air baffles, protect the Signet inside and out. The housing doesn't even become hot to the touch.

A good picture has to be a steady picture. The regular slide changer on a Signet permits slides to be fed in singly from the top (4). It's a fast, smooth method that never jars the projector. With an automatic changer, slides are fed into the projector in any sequence from a 36-slide magazine—again without jarring the screen image.

The edge-to-edge sharpness and color clarity of a Kodak Projection Ektanon Lens (5) speaks for itself the instant you project a slide in a living room, classroom or auditorium. Ask your dealer to show you a lens-lamp-changer combination to suit your needs.

Prices are list, include Federal Tax where applicable, and are subject to change without notice

Ask your dealer about small down payments and easy terms

Eastman Kodak Company
Rochester 4, N.Y.

CHECK THESE OUTSTANDING SIGNET FEATURES		Kodak TRADE-MARK		
KODASLIDE SIGNET 500	KODASLIDE SIGNET 300	FEATURE		
X	X	Projection Lens — $f/3.5$, 5-inch Lumenized Kodak Projection Ektanon Lens		
X		$f/2.8$, 5-inch Lumenized Kodak Projection Ektanon Lens		
X	X	Condenser System —Two Lumenized close-coupled condenser lenses collect and deliver maximum light to slide; aluminized glass reflector		
X		Projection Lamp —500-watt, medium preference base (also accepts 300- or 200-watt)		
	X	300-watt, bayonet base		
X	X	Operation —Automatic push-pull slide changer feeds slides in any sequence, skip or repeat, returns them to 36-slide magazine		
X	X	Regular take-up slide changer stacks in sequence; accepts Kodaslide Box for group slide filing and storage		
X	X	Takes single-frame stereo adapter		
X	X	Elevation —Individually spring-loaded front legs for 0-12° elevation		
X		Adjustable rear leveling leg		
X	X	Cooling —Quiet, impeller-type blower gives full-pressure cooling; channels cool air over all internal surfaces		
X	X	Aluminum heat-dissipating panels channel flow of air		
X	X	Extra-thick heat-absorbing glass		
X	X	Construction —Sturdy, die-cast aluminum housing		
X		Electrical System —3-position switch permits blower to operate independently of lamp. Thus, blower can be left on to accelerate cooling after projection		
	X	2-position switch, Blower and lamp operate together		
	X	Operates on 105-125 volts, AC. Long 12-foot attachment cord facilitates electrical connection		
X	X	Styling and Finish —Streamlined, functional design. All controls on right for convenience		
X		Frosty beige finish		
	X	Sea-foam green finish		
		Projection Throws		
		Long Dimension of Projected Picture	Distance from Projector Lens to Screen	
			35mm slides	828 slides
X	X	30 inches	10 feet	8 ½ feet
X	X	40 inches	13 feet	11 ½ feet
X	X	4 feet	15 ½ feet	13 ½ feet
X	X	5 feet	19 feet	17 feet
X	X	6 feet	23 feet	20 ½ feet
X	X	7 feet	25 ½ feet	23 feet
X	X	8 feet	29 feet	26 feet
X	X	9 feet	32 ½ feet	29 ½ feet

Care and Feeding of Engines



BY
S. P. CORP

ONE CAUSE OF HARD STARTING

When you start your engine, the mixture in the carburetor should be rich. Extra air added to the mixture makes it lean, causing hard starting. A badly worn throttle shaft will let in extra air—enough to affect combustion seriously. Check this shaft and replace it if it is worn to a point where it has an excessive amount of play. If the bearing surface of the throttle body is worn, replace the whole unit. This can be done by removing the carburetor, separating the lower section—which is the throttle body—and putting in a new or rebuilt body.



This can be done by removing the carburetor, separating the lower section—which is the throttle body—and putting in a new or rebuilt body.

WATCH TORQUE WHEN TIGHTENING BOLTS

After every fall and spring tune-up, let engine run till warmed up. Then use manufacturer's specifications in tightening bolts on cylinder head, intake and exhaust manifolds, and valve cover with a torque wrench. Over-tightening can distort engine block, causing cylinders to go out of round. Special care must be used with the valve cover bolt, which may, if too tight, distort valve cover, breaking gasket seal and allowing oil to escape to outside of engine. Average torque specifications:

- Cylinder head bolts. 55 to 65 ft.-lbs.
- Manifold bolts. 15 to 20 ft.-lbs.
- Valve cover bolts. 10 to 15 ft.-lbs.

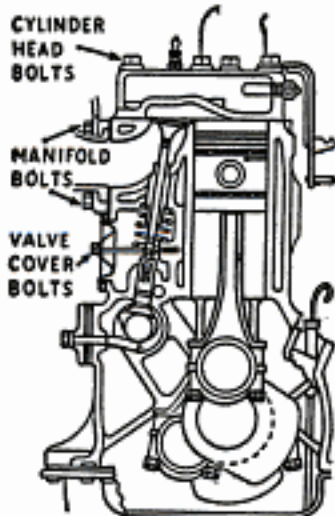

FREE MANUAL OF CAR CARE

"Care and Feeding of Engines" is a new illustrated manual which is free on request, and which may save you a lot of money. A card with your name and address will bring your copy by return mail. And when you re-ring, be sure to use Sealed Power KromeX Ring Sets—for quick seating, immediate oil control, and double ring mileage. Top ring has solid chrome face to fight heat, friction, abrasion, and corrosion. They are the best rings money can buy, and your dealer has them or can get them for you. Sealed Power, Dept. G-10, Muskegon, Michigan.



Sealed Power

PISTON RINGS

Clinic for Homemakers



As a service to our readers in solving the hundreds of problems pertaining to a home—inside or out—the editors of Popular Mechanics invite you to present your problems to The Clinic Editor for help and advice. Address your questions to The Clinic Editor, Popular Mechanics Magazine, 200 East Ontario Street, Chicago 11, Ill.



Clogged Drain

Q—I live in an older home having downspouts leading into tile drains. Lately during heavy rainstorms a small quantity of water has backed into the basement. It has seemed to me that the water is backing from the storm sewer, but my plumber says it is due to a partial stoppage of the downspout drains. Who is likely to be right?—O.P., Pa.

A—We think it likely your plumber is correct in his assumption. This is a fairly common occurrence in older installations where basement-floor drains and those from the downspouts lead to a single tile. Often these drains were laid with open-joint tile and the joints were not covered. In time one or more of the individual tiles may tip slightly out of line, opening the joint and permitting dirt and possibly gravel fill to enter and cause a partial stoppage. Slate particles from a composition roof, leaves and pieces of broken shingle tabs may also find their way into the drains through the downspouts. Tree roots are another possibility as the fine roots can force their way into the tile through the open joints. Any of these materials in sufficient quantity can result in a partial stoppage of the drains leading from the downspouts, causing the water to back into the basement. Where the stoppage is only partial, the quantity of water would ordinarily be small. Probably the first step is to have the drains rodded to clear away any obstruction that can be removed by this procedure. Should this be ineffective due to a tipped individual tile or one that has collapsed, then the only other permanent remedy is to ditch down to the drains, remove the original tile and replace with bell-end tile with cemented joints.



Canvas Roof Deck

Q—I want to build a sun porch with a flat deck and I'd like to know how to cover the deck with canvas. What does one put on first over the joists and how is the canvas laid? How is it flashed to the wall to obtain a waterproof joint? Is there some special waterproofing compound? How is it applied?—T. F., Kans.

(Continued to page 256)



**Spark plug engineering
takes another
great stride forward**

**with
CONDUCTASEAL**

**AC engineers fuse metal and ceramics
to form the world's first current-
conducting spark plug seal!**

For years spark plug engineers have tried to solve the problem of seals that eventually break down and permit gas leakage between the center electrode and spark plug insulator.

Loss of compression is bad enough, but the results are even more far-reaching because plug heat range is seriously affected. Plug insulators and electrodes get hotter than they should . . . plug tips operate at temperatures far different from that for which they were designed . . . and car performance suffers.

But, AC engineers have found the answer! AC's patented and exclusive *Conductaseal* feature guarantees uniform spark plug heat range and holds heat right where it should be . . . in the famous recessed Hot Tip, where it burns away carbon and oil deposits as soon as they form. This keeps plugs clean longer . . . boosts power . . . saves as much as one gallon out of every ten.

Why not have a set of lively Hot Tip AC's installed in your car? Get a new set every 10,000 miles.



**Holds heat right where
you want it—in the
famous AC HOT TIP!**



AC SPARK PLUG DIVISION • GENERAL MOTORS CORPORATION • FLINT, MICHIGAN

YOUR CHRISTMAS SPIRIT IS SHOWING...



when you decorate your roof, porch, lawn or living room with these jolly figures

They are bright, colorful, cheerful — and 30" to 40" high. You can buy the finished figures — or the figures that merely need painting — or you can make them yourself, from start to finish.

If you are a real do-it-yourselfer, you select the full-size Easi-Bild* Pattern and trace it onto a sheet of Homasote Type RD. The pattern gives you complete instructions for every step, including the painting, specifies all materials. Your finished figure can be used outdoors or in. (You can tack the Santa Claus onto the front door and put a sleigh in front of the Christmas tree, to hold the gifts.)

From a single Santa Claus to a complete Nativity Scene (often a group project for school, church or club), you have a project that is worthwhile, satisfactory, and easy.

Homasote is the oldest and strongest insulating-building board on the market. Type RD is $\frac{21}{32}$ " thick, ideal for this purpose. The material saws and nails easier than wood, takes any paint or stain, lasts for years.

For finished figures, for unpainted figures (together with painting instructions and the paints), for the complete package of Easi-Bild Pattern, RD Homasote and paints—visit your local Homasote dealer. Or—use the coupon below to order any of the patterns, or secure the name of your nearest Homasote dealer.

*T.M. Reg. Easi-Bild Pattern Company

MAKE it at home...with HOMASOTE

HOMASOTE CO., Dept. K-6, Trenton 3, N. J.

I enclose.....for which send the following patterns:

- Santa Claus—35¢ Reindeer—35¢ Choir Boys—50¢
 Jolly Snowmen—35¢ Nativity Scene—\$3.00
 Sleigh—50¢ Send name of nearest Homasote Dealer

NAME.....

ADDRESS.....

CITY.....ZONE.....STATE.....

(Continued from page 254)

A—First of all, the joists are covered with tongue-and-groove flooring. Use 2 x 8, or better, 2 x 10 joists spaced on 16-in. centers if the span is more than 10 ft. It's a good idea to prime the tongued-and-grooved edges of the flooring boards before laying. Plane or sand smooth after laying, then apply two coats of outside oil-base paint. After this is thoroughly dry, coat the surface with paste white lead, spreading to a uniform thickness with a spreader of the type used in applying linoleum cement. Lay the canvas immediately, lapping about $1\frac{1}{2}$ in. at the joints and fastening with copper tacks. The flashing is carried up under the siding board and the horizontal flap is coated with paste white lead before the final strip of roof canvas is laid. Be sure, before permitting the paste lead to dry, that the canvas is pressed into close contact at all points. Allow the roof to dry for two weeks, then finish with two or three coats of outside oil-base paint in the color desired. White is preferred due to its reflective properties. The deck must be repainted every two to three years. Such a roof deck is not normally designed to be walked upon. If it is to be used as a sun deck, the surface should be protected with wood-slat walkways. These can be built in sections and fitted together to cover the whole roof area, or only a part of it, as desired. Although specifications usually call for 2 x 4s spaced on 16-in. centers as support for the slats, you can use 2 x 2s spaced on 10-in. centers. When the slat sections are laid be sure that they are laid with the 2 x 4 or 2 x 2 supports parallel with slope of the roof so that water will drain away readily. Remove the slat sections during the winter months.

Fall Lawn Seeding

Q—How late in the fall can one seed a lawn with a reasonable chance of success? I am given different answers to this question. Some say it depends on the winter, the weather at the time of seeding. Others say not later than the first week in October and some are positive the only time to seed is in the spring. I'm concerned primarily about the best time to seed a new lawn, of course, but I'd like to know about the proper time to spot-seed an old lawn for best results. How about the use of fertilizer on the new seeding?—C. N., Ind.



A—All of your informants are more or less correct in that conditions at the time of seeding and afterward determine to some extent the success of the project. The seeding can fail in spring as well as fall; in fact, any time between. A heavy rain can ruin a spring seeding and a sharp early fall freeze may catch a seeding just after germination, before the plants have developed a strong root system. Late spring seedings are always endangered by hot, dry weather, even though a watering schedule is carefully carried out. However, in your locality it should be possible to seed a lawn as late as mid-October with a reasonable chance of success. This assumes that the seedbed has been properly prepared beforehand and that soil deficiencies have been corrected by application of fertilizer of the correct analysis to provide a complete plant food. Many gardeners and homeowners prefer to seed both old and new lawns in the fall because this season offers the chance of getting the lawn established ahead of the weeds, which are always the main problem in spring seedings, especially in new lawns. Old lawns can be spot-seeded in the fall to good advantage and over-all seedings can be carried out whenever fertilizer is spread. Place a small quantity of fertilizer in the spreader hopper first, then a layer of seed and a layer of fertilizer and so on until the hopper is filled.



The Right STANLEY Tool



TO ROUT

The rugged little work horse of the workshop in 90% of your woodworking jobs. Versatile, light weight and high speed, its motor is used to power the plane shown. *H15 Router* — \$39.95.

New! Router-Plane Kit

Combines H15 and H106 with gauge and bit in handy fitted carrying case. *H100* — \$89.95.



TO PLANE

This tool is a wonder for smooth and easy planing. Just right for fitting storm and screen doors and windows, trimming wood, plastic or aluminum veneers on table and counter tops. When you have H15 Router, Kit is all you need to convert to power plane. *H106 Plane Adapter Kit* — \$29.50.

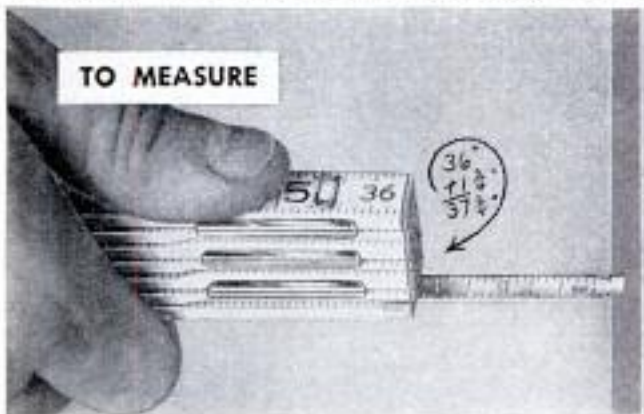

TO MEASURE

Accurate measurement is fundamental in jobs of all kinds. Here is a new Stanley Zig-Zag Extension Rule with accuracy-plus features. Extra thick first leg has brass slide for inside measurements. Rule opens to even numbers, convenient marking gauge at 2", 4", 6", 8", etc. Plastic finish on sticks and nickel silver joints ensure longer useful service. *6 ft. No. X246 Extension Rule* — \$2.10.

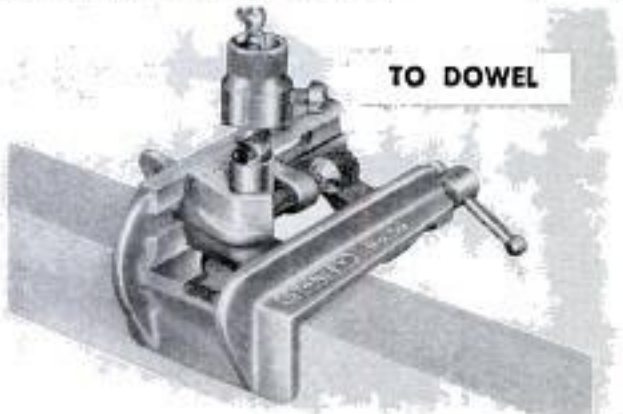

TO DOWEL

Joining two pieces of wood together is one of the first jobs a woodworker masters... and it isn't really mastered until you do it with dowels. Here's a jig from the Toolbox of the World that makes good doweling easy. With it you can bore holes accurately in edge, end or surface of wood. 6 guides for $\frac{3}{16}$ to $\frac{1}{2}$ inch bits and depth gauge furnished. *No. 59 Doweling Jig* — \$5.95.

STANLEY

The Stanley Works

Tools - Electric Tools

HARDWARE • STEEL STRAPPING • STEEL

Department TE, The Stanley Works,
620 Elm St., New Britain, Conn.

Gentlemen:

Please send me () free Tool Catalog

() free Electric Tool Catalog

Check Catalog(s) you want.

Name _____

Address _____

City _____ Zone _____ State _____

Looking for Something?

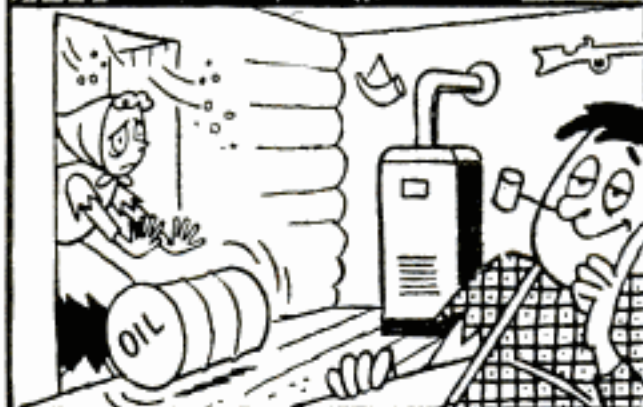

**FROM OIL BURNERS TO OVERALLS
WHATEVER YOU NEED**

Find It Fast
In The
'Yellow Pages'



Plotting a Future for Paper

(Continued from page 139)

The institute brought to his attention a new compound derived from the industry's waste. Using it as a medicine, he succeeded in curing histoplasmosis.

Research problems sometimes become mysteries for a scientific detective. In one case, crackers packed in paperboard boxes developed a strong, unpleasant odor. An institute scientist tested the crackers themselves, followed the box through the manufacturing process and investigated the inside wrappers. Blind alleys. At last he located the culprit—a drier used in the ink on the label.

While investigating a stream for possible pollution, an institute scientist noticed that a moldlike growth on the stream's surface resembled pulp fibers. From this random observation has come the startling possibility that someday we may be using mold-grown fibers to make our paper. In experiments at the institute, a drop of liquid containing thousands of these tiny plants is placed in a vessel holding water and chemical compounds. Within a few hours, cottonlike fibers appear on the surface and multiply with astonishing speed. Staff members make no claim that enormous quantities of pulp ever will be produced in this way, but they've made excellent paper from the fibers and the process seems to warrant further investigation.

Still another big area of research is in the use of hardwoods for pulp. For example, in Wisconsin's 16,000,000 acres of forest, only 20 percent of the trees are softwoods from which pulp usually is made. Now, thanks to research at the institute and other institutions, many of the hardwood species of this country are being used.

How will we meet the pulpwood demands of the future? This question is continually asked at the institute, and some of the answers are being worked out there. Today we use nearly 400 pounds of paper per person each year. By 1975 authorities estimate we'll be using 500 pounds per person. According to the institute staff, this problem will be licked by meeting it on a broad front. The industry will push through reforestation projects, make better use of the entire tree, utilize new species, improve species through hybridization, find new sources of plant fibers—and just possibly it will manufacture pulp from mold growths.

At least part of these answers will come from the students who are studying today at the Institute of Paper Chemistry, for they will be the leaders of the industry tomorrow. ★ ★ ★

What a whale of a difference

Natural Viscosity makes !

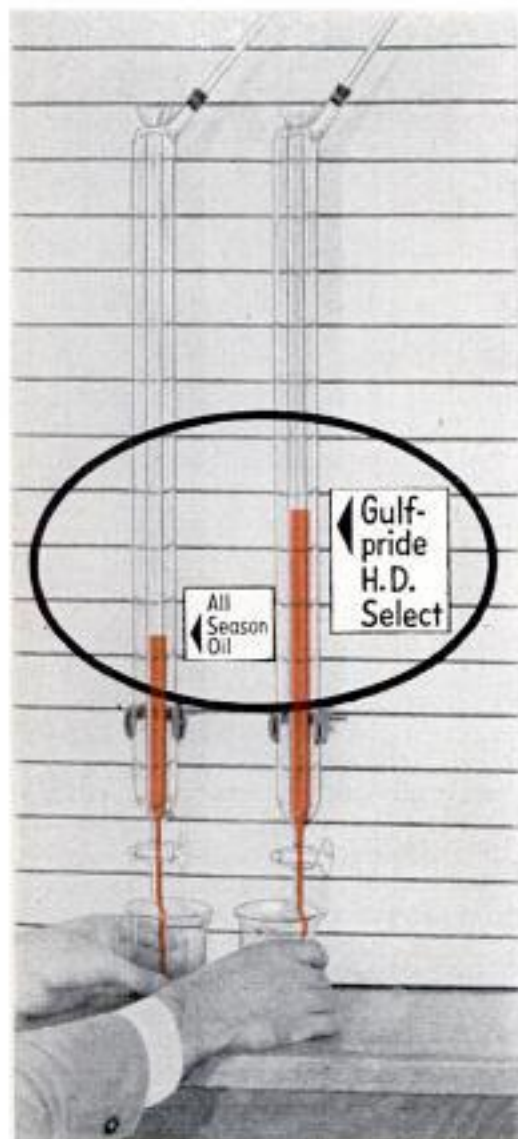

As delivered to the consumer, New Gulfpride H.D. Select SAE 30 and a typical 10W/30 multi-viscosity oil are about equal in viscosity or "body."

But see what happens after 300 miles of use in an engine. The multi-viscosity oil, in the viscosimeter at left, runs out much faster than before. The reason is that the thickeners, used to bolster the viscosity of multi-vis oils, *start to break down* within as few as 25 miles. The oil loses efficiency—while oil consumption increases.

Gulfpride H.D. Select, on the other hand, has *natural viscosity*—contains no thickeners that break down in service. And so, as the viscosity test shows, Gulfpride H.D. Select flows at the same rate as before, stays tough and full-bodied . . . assures lower oil consumption.

That's just one of the benefits you get from new Gulfpride H.D. Select Motor Oil. In addition, new Gulfpride H.D. Select . . .

- Controls carbon
- Combats corrosive acids, rust and deposits
- Provides the toughest protective film ever developed in a motor oil.

New Gulfpride H.D. Select is available in 3 grades —SAE 10W, SAE 20/20W, SAE 30. Lets you follow the manufacturer's recommendations *for your car during each season.*

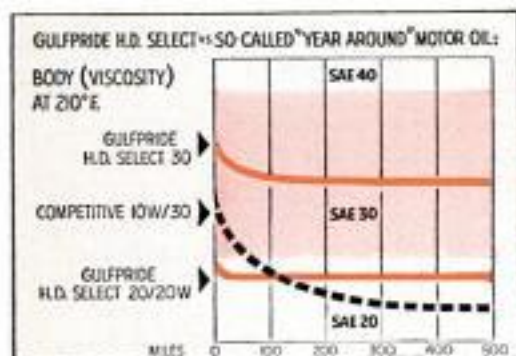

See how *Gulfpride H.D. Select Oil* holds its viscosity in service as compared with a typical "all-season" multi-viscosity oil.

New Gulfpride H.D. Select



The only motor oil in the world super-refined by the Alchlor Process for modern high-compression engines.

BEST-BORE Wood Boring Bits for your 1/4" electric drill at really low cost

\$2.49



FAST, ACCURATE, EASY BORING

Best-Bore is the only detachable bit set whose boring range begins at 1/4" and goes to 1". You'll be amazed at the ease of boring holes in wood, panel board, plaster, plastic or composition. Best-Bore Bits make clean, true holes — at an angle, into end grain or for mortising. Also ideal for hard to reach places and for boring overhead.

Bits — 1/4", 3/8", 1/2", 5/8", 3/4", 7/8", 1", chrome-plated shank packed in handy plastic case, complete with instruction leaflet and tightening wrench. On sale at all hardware dealers.



Buy the **Parker** Line

SNELL DIVISION
PARKER MANUFACTURING CO.
WORCESTER 1, MASS., U. S. A.

Color Tips for Your House

(Continued from page 149)

you have a wide selection; if the house is older but the roof too good to replace, you are immediately limited in your color range. A light-colored roof (white, pale gray, ice green) makes a house appear taller. Use it on one-story homes. A dark roof makes a house appear lower. Use darker colors on two or three-story houses. If a combination of colors is used on a tall house, use the darker color above and a lighter one below. Choose your roof colors with extreme care because a roof should last 20 years.

3. *Siding.* Light colors are best for the smallest houses and there should not be too sharp a contrast between siding and roof colors. This rule can be broken when a white or very light roof is used. A low ranch-type house with dark roof and dark siding looks as if it had been pushed into the ground. If your house is the larger rambling type, a darker tone of siding with a light roof produces a pleasing effect. If part of the house is stone or brick, the siding color should pick up a tone from these materials. Contrasts between the color of the stone or brick and the siding break up the lines of the house. Keep this in mind wherever you use color: Do not do anything to break up the flowing architectural line of the house. Remember this, particularly, when you consider painting the garage door or some other good-size area a color that is in contrast to the siding. However, brick is often painted a color contrasting to the body of the house in a split-level in order to give a horizontal line.

4. *Trim.* The trim color can be the same as the siding, a lighter tone of the same color or in complete contrast. For example, white makes a fine trim for charcoal siding, or possibly light tan if the siding has a cocoa color. Ordinarily, a satisfactory trim color can be achieved by adding white to the siding paint until a lighter shade appears. The trim may be painted the same color as the siding, especially if the architectural lines of the house should be concealed. Trim color may be used on the garage doors with good effect if the contrast to the siding is not too sharp.

5. *Accent.* It is in this area that most of the color atrocities occur. This is the little splash of contrasting color that makes or breaks any color scheme. The most common mistake in regard to accent color is using it on the trim. Never use it on the eave, door or window trim, soffits, corner boards or fascia boards. Also, be careful of putting it on the garage door unless the

(Continued to page 262)



Free plan shows how to build this modern "entertainment center"!

It's the practical answer to half a dozen problems. It's easy to build and paint—with Masonite Presdwood and our free plan.

You can separate living and dining areas, or keep drafts away when the front door is opened. You'll store plenty of household items in the roomy cabinets and drawers. You'll use the secretary desk for writing letters and keeping household accounts.

You can even install a record changer in one section and two speakers in another vibration-free area. There's room for books,

games and refreshment supplies.

The entire unit is designed on a modular basis—build as much or as little as you need. You'll enjoy working with Presdwood®—that strong, sturdy, grainless panel material that never splits, splinters or cracks. Works smoothly with hand or power tools, stays in place and takes lasting, beautiful finishes.

Send the coupon for your free plan. Then see your lumber and building materials dealer for versatile Masonite Presdwood.

Look for this man  He makes the difference

MASONITE PRESWOOD
PANEL PRODUCT OF MASONITE® CORPORATION

MASONITE CORPORATION
Dept. PM-10, Box 777, Chicago 90, Ill.

Please send me free plans for the Presdwood Room Divider and your Presdwood Idea Book.

Name

Address

Town Zone

County State

THE LOCK THAT

*can't be lost
can't be misplaced
can't be stolen*



Master HASP LOCK

- Padlock, bolt and hasp *all in one* — just slide the bolt to lock or unlock!
- Laminated case construction — like a bank vault door — for greater strength!
- Heavy-gauge reinforced steel — wide-ribbed construction — no hinge pin!
- All screws locked in — protected screw seatings!
- Rust-proofed throughout with pure cadmium!

Get powerful protection for your possessions . . . get a MASTER HASP LOCK — at hardware stores and locksmiths everywhere. Other MASTER PADLOCKS from 25¢ to \$4.00, in a variety of sizes.

*World's Largest
Padlock Manufacturers*



Master Padlocks

ALWAYS ON GUARD DAY AND NIGHT



MASTER LOCK CO. Milwaukee 45, Wisconsin

house is unusually long and the chosen accent color is a cool one in some tone of blue or green. The safest places on most houses for the accent color are: The front door, a window box or trellis, a couple of well-placed shutters (if a two-story house has shutters on the first floor only), siding panels (often found on the split level of contemporary design), picture-window frame, lally column and screen or fence panels. If the accent color is picked up from the front door and carried to a panel in a wing wall or screen, a house apparently gains in size. The color of the neighbor's houses should also be considered, particularly in the selection of the accent color. Some of Miss West's most successful accent colors (carefully chosen for contrast with various color schemes) include carnation red, peacock blue, nasturtium orange, Dresden blue, and lime. None are primary colors. In dealing with these vivid accent colors, always keep in mind that a wet paint sample looks different from a dry one, also that color grows in intensity on larger areas.

6. *Gable ends.* Small homes look larger if gable ends are painted in the siding color. Trim color may be used on larger houses for the gable ends or in places where you want to call attention to some architectural effect, or if you want to reduce a vertical appearance. Don't get fancy with a combination of colors or stripes in this area.

7. *Fences or screens.* Trim, accent color or a combination of both may be used on fences, screens (open fences) or wing walls that extend out from the sides of a house.

8. *Patios and outdoor-living area.* Be sure that the colors used here harmonize with adjoining exterior and interior color schemes. With the use of colored concrete brick, now available in many shades, a patio can provide a year-round bright spot even in the winter.

9. *Ugly architectural features.* Hide them by painting the same color as the surrounding area. If trim or accent color is used on a bad feature of a house, it stands out like a beacon. This is particularly true of older houses.

10. Remember that a bad color scheme is worse than no color at all. Make sure of your scheme before you paint. Mistakes are costly to correct.

One of the great difficulties is deciding how a house will look by merely studying color schemes. Architect Martling solved this problem for his clients with numerous black and white prints of houses and a box of colored chalk. This makes it possible to try various combinations and get the general effect.

(Continued to page 264)

For a fraction of the cost of individually powered tools, you can own this

DYNO-MITE POWER WORKSHOP

REGISTERED U. S. PATENT OFFICE

... built around the rugged 1/3 h.p. 888 POWER UNIT

No. 881 6" PORTABLE SAW ATTACHMENT ... \$17.95

No. 8815 7-to-1 SPEED REDUCER ... \$12.45

No. 886 PORTABLE JIG SAW ATTACHMENT with 4 blades \$11.45

No. 887 BENCH JIG SAW TABLE ... \$1.95

No. 882 ORBITAL SANDING ATTACHMENT ... \$15.95

No. 883 6 1/2" BENCH SAW ATTACHMENT ... \$26.40

No. 884 SAW TABLE EXTENSIONS ... \$5.70 per pair

No. 885 SAW GUARD \$2.80

No. 881 BENCH STAND ... \$3.40

No. 889 6" DISC BENCH SANDER ATTACHMENT \$8.95

No. 8810 4" BENCH GRINDER ATTACHMENT \$6.80

No. 8816 DRILL PRESS VISE \$5.95

No. 8814 DRILL PRESS STAND \$19.95

Regular ~~\$44.95~~
SPECIAL FOR CHRISTMAS ONLY \$39.95

Complete with 3/8" Jacobs Geared Key Chuck ... 6" rubber pad ... three 6" sanding discs ... 6" polishing bonnet ... wheel arbor ... and reversible side handle.

It's the biggest buy in power tools today! Start with the 888 Basic Power Unit fully equipped as a 3/8" Drill, 6" Disc Sander, and 6" Polisher for only \$39.95. Then by adding the inexpensive attachments you'll have all the power tools necessary to make practically any project quick and easy. All built with the craftsmanship and quality that have made Millers Falls Tools world famous. Start your Dyno-Mite Power Workshop now. See and try the 888 at your hardware dealer's today!

For power and performance — ask for

Millers Falls

Finest Power Tools Made



FREE FOLDERS describing the whole Millers Falls line of Dyno-Mite Power Tools. Ask for them at your hardware dealer's or write:

MILLERS FALLS CO. • Dept. PM-10 • Greenfield, Mass.

Makes it a cinch to
DO-IT-YOURSELF



**NOW! APPLY MICARTA
or other Plastic Surfacing
WITHOUT CLAMPS
OR PRESSES!**

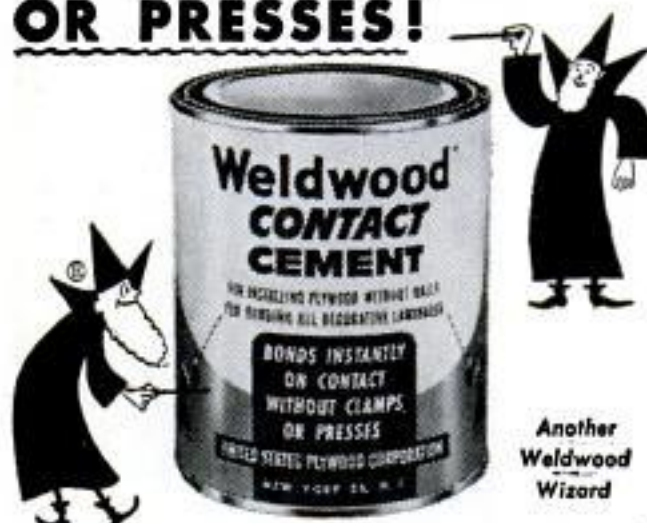

Another
Weldwood
Wizard

**Use amazing new Weldwood®
Contact Cement! Bonds instantly...
permanently on contact! Makes it
easy to modernize table tops, kit-
chen counters, bathroom surfaces!**

Weldwood Contact Cement works like magic! No need for clamps or presses. Just apply... let dry... then bring laminate and surface together! Instantly you get a permanent bond!

PUT UP PLYWOOD WITHOUT NAILS! Do it yourself with Weldwood Contact Cement. Revolutionary new method—faster, easier. No nail holes to spoil finished surfaces!

1001 JOBS MADE EASIER around home, shop, garage. Weldwood Contact Cement bonds any combination of wood, glass, leather, paper, cloth, Fiberglas® and metal (including do-it-yourself aluminum).

In tubes, bottles, cans, 25¢, 35¢, 60¢ and larger sizes at hardware, paint and lumber dealers and variety stores. Mail coupon for leaflet!

United States Plywood Corporation

Dept. 122, 55 W. 44th St., N. Y. 36

Please send me information on Weldwood Contact Cement.

Name _____

Address _____

City _____ Zone _____ State _____

The modern, or contemporary house, lends itself to distinctive color treatment—far more so than the traditional houses of the past. The Architects Collaborative, exponent of the best in contemporary architecture, has this to say about color:

"Our residential exteriors seem to lend themselves best to a basic single-color treatment, with well-defined areas like doors and panels as color accent spots. We avoid the use of extremely bright primary colors. For instance, instead of primary red we use a vivid shade of vermilion or terra cotta. Instead of primary blue, we use cerulean or Prussian blue. Greens seem most difficult of all to handle, especially in competition with nature's colors. Landscaping can be arranged to provide for changing color around the house."

One thing is certain: Whatever you decide to do about the color on that front door or that panel in the fence, no two persons will see eye to eye on the subject. However, knowing a few basic rules, especially in the use of accent color, should help. And don't worry too much about breaking a rule once in a while. Even the experts do that. ★★★

Fire-Warning System

Fire-sensing units can now be spotted throughout your house and connected to a central warning system that rings a bell and tells where the fire is. One of three lights on the panel flashes on to indicate a fire in the basement, in the attic, or on the first or second floor. Up to 10 fire-sensing units can be located in each zone. The fire-detectors are activated by abnormally high air temperatures.



POPULAR MECHANICS

NOW! Put up Plywood Panels Without Nails!

It's a revolutionary construction technique! Made possible by a new adhesive...Weldwood Contact Cement! Lets you put up plywood with ease. Ends nail-setting and puttying. No finishing unsightly nailholes. You install the plywood panels directly to studs or furring strips. Makes pre-finished plywood paneling more practical than ever before!



Weldwood Contact Cement bonds instantly without clamps or presses. 1001 uses in every home, shop, garage. For bonding wood, aluminum and other metals, cloth, felt, paper, leather, fiberglass, rubber. Wonderful for applying Micarta - without clamps or presses.

NOW! A Special Weldwood® Glue for Hobbyists!



It's ready-to-use! It sets fast! It bonds like magic! It's Weldwood Presto-Set Glue! The first white glue worthy of the Weldwood name. Just brush or swab on. Bonds wood to wood...wood to cloth...cloth to paper...upholstery fabrics to wood...leather to leather... many other uses. Jobs can often be worked in 20 minutes after gluing. It forms a bond that stays strong.

See how it speeds things around your workshop... see how it handles toughest jobs like magic!

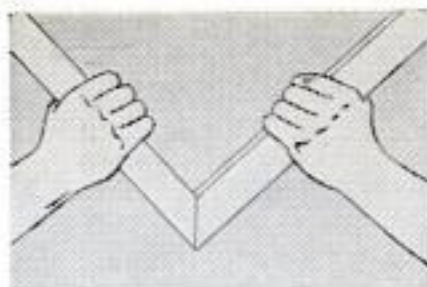

Makes Glued Joints even Stronger than Wood!

When your job demands professional results... or where water-resistance is important... use the glue that professional cabinetmakers love to use... Weldwood Plastic Resin Glue. It's just about the best wood glue there is! Actually makes glued joints stronger than the wood itself! Grows even stronger with age. Highly water-resistant, stain and rot-proof. Spreads smoothly and easily. A little goes a long way. Where quality counts most, there's no substitute for Weldwood Plastic Resin Glue - deservedly America's largest selling wood glue.



Weldwood Glues - First Choice of Professionals!

Industrial woodworkers, builders and professional cabinetmakers know their glue. They know the difference between a glue that sets in 20 minutes and a glue that takes hours. They know the difference between a glue that bonds wood to wood, wood to cloth, cloth to paper, upholstery fabrics to wood, leather to leather... many other uses. Jobs can often be worked in 20 minutes after gluing. It forms a bond that stays strong. Weldwood hard ever, builders makers are a job, so to good enough. best in

Weldwood® Glues... Satinlac® Firzite® are available at all hardware, lumber and paint dealers.

Make Inexpensive Plywood Look Rich and Costly!



Here's the easy way to "tame wild grain" on fir plywood stain jobs... and get the appearance of expensive woods. Start with a base coat of Clear Firzite®! Subdues wavy grain. Helps end grain raise and checking. For oak, walnut, or mahogany stains, add colors-in-oil.

How to Get that "Woodsy" Blond or Pickled Effect!

Blond, pickled or wiped effects are really popular. Get them easily on any kind of wood, without a "painty" or artificial look - with White Firzite. It brings out the handsome "woods" quality. For tinted effects add colors-in-oil. (On soft wood or fir plywood paint jobs, White Firzite as an undercoater helps prevent grain raise and checking.)



Quick Way to Accent Natural Beauty of all Woods!



Apply Satinlac® for a rich satiny effect which wears well and is easily maintained. The full beauty of the wood grain is accentuated and protected! Won't discolor with age. Dries so quickly, it's ready for the next coat in 3 or 4 hours.

*Trademark

UNITED STATES PLYWOOD CORPORATION

Dept. 91, 55 West 44th St.
New York 36, N. Y.

Send me leaflets on:

- Weldwood Plastic Resin Glue Satinlac
 Weldwood Presto-Set Glue Firzite
 Weldwood Contact Cement

NAME _____

ADDRESS _____

CITY _____ ZONE _____ STATE _____

Don't Be "Sold" . . . Get The Facts



10" TILTING ARBOR UNISAW®

It's a fact that 72% of U. S. school shops are equipped with Delta Unisaws. The Unisaw is a rugged, big capacity saw that offers you more built-in quality features and more precision adjustments than any other saw of its size—or price. It has the speed needed for fast, economical cutting . . . the precision accuracy needed for exacting, high quality work . . . the rugged durability that gives years of safe, dependable operation. Here are just a few of the many Delta quality features that make the Unisaw the most widely used circular saw in industrial plants and in the finest home workshops, as well as the majority of school shops:

- Cuts stock up to 3 $\frac{1}{8}$ " thick, rips to center of a 50" panel.
- Big 27" x 36" table accurately ground for precision work.
- Patented Auto-set Miter Gage permits angle cuts from 0° to 60° with automatic stops at 90° and 45° right and left.
- Husky rip fence locks front and rear with controls up front.
- Blade guard with anti-kickback fingers prevents kickback of work.
- Has sealed, lubricated-for-life ball bearings.

DELTA QUALITY COSTS NO MORE

Copyrighted material

MAKE UP YOUR OWN MIND

about the circular saw best for your needs

Here Are The Facts About

Rockwell-built DELTA Circular Saws:

Delta makes the most complete line of circular saws on the market—ranging from the big 12" tilting arbor saws for industrial uses to the 8" tilting table saw. Every Delta saw is built to the highest standards of quality—built to do its job with precision, ease of operation and safety. Professional woodworkers in industrial plants,

school shop instructors and home workshop experts recognize Delta saws as the finest made. And Delta also makes the most complete line of accessories, many of which are interchangeable from one tool to another. That's another extra value you get from the world's oldest and largest power tool manufacturer.



Homecraft 8" Tilting Arbor Saw

Light in weight, yet rugged in construction. Popular with small shop owners and builders, as well as home workshop enthusiasts. Offers many of the outstanding quality features found in the Delta Unisaw.

- Cuts stock 2 1/4" thick, rips to center of 48" panel.
- 22" x 15" work table scientifically ribbed to prevent warping.
- Only the blade tilts, table always remains level.
- Sealed, lubricated-for-life ball bearings.

PLUS DELTA'S COMPLETE LINE OF ACCESSORIES

With inexpensive Delta accessories, anyone of these saws can be transformed into a tool of many uses—you can cut dados, tenons, mouldings, miters, and bevels in addition to accurate cross-cutting and ripping.

DELTA QUALITY POWER TOOLS
Another Product by **ROCKWELL**



Homecraft 8" Tilting Table Saw

A low-cost, all-purpose saw designed expressly for home owners—and hundreds of home owners have proved it to be ideal in making home repairs plus the many other jobs found in every home.

- Cuts stock up to 2 1/4" thick, rips to center of a 15" panel.
- Has 15" x 18" work table.
- Table tilts a full 45° right.
- Miter gage swivels right and left 60°.

GET ALL THE FACTS— THEN COMPARE!

See Delta's complete line of circular saws—actually operate them yourself. Then compare with any other circular saw and **MAKE UP YOUR OWN MIND!** See your Delta Dealer—he's listed under "TOOLS" in the classified pages of your phone book. And send the coupon for free catalog

Delta Power Tool Division, Rockwell Manufacturing Co.
502-K North Lexington Avenue, Pittsburgh 8, Pa.

Please send me the following:

- Name of my nearest Delta Dealer
- Delta AB Catalog
- Delta Homecraft Catalog

Name _____

Address _____

City _____ County _____ State _____

Copyrighted material



The Oil Filter that Guards
the *Life*
of your car engine

Grime doesn't pay in your engine. It robs you of oil life and trouble-free engine service. That's why it's smart to rely on WIX to police your oil and stop costly engine repairs.

wix
ENGINEERED FILTRATION

WIX HEVI-DUTY Oil Filter Cartridges more than meet automotive engineers' specifications for filtering efficiency — and do not disturb additives in today's heavy-duty oils. Ask your Serviceman for a WIX Cartridge the next time he changes your oil. There's one designed especially for your car—to keep your oil *clean* and your engine sweet-running—to protect your engine *and* your pocketbook.

POROSITE—the modern, pleated paper WIX Cartridge for Full Flow Filtration Systems.



WIX CARTRIDGES
are priced \$1.50
as low as

WIXITE—the outstanding depth-type WIX Cartridge for Partial Flow Systems.

OIL FILTERS **wix** CARTRIDGES
AUTOMOTIVE • INDUSTRIAL • RAILROAD
WIX CORPORATION • GASTONIA, N. C.
IN CANADA: WIX ACCESSORIES CORP. LTD., TORONTO

Apartment-Size Hi-Fi System Makes Music Live

(Continued from page 247)

list below. Then, punch and drill the chassis in accordance with the chassis layout diagram, and mount the various parts which must be fastened to the chassis with

AMPLIFIER PARTS LIST

RESISTORS

- R1, R5, R7— $\frac{1}{2}$ -meg. controls, audio taper
IRC 13-133, or equivalent
R2, R8, R11—2200-ohm, $\frac{1}{2}$ -watt
R3, R4, R9—100,000-ohm, $\frac{1}{2}$ -watt
R12, R15—100,000-ohm, $\frac{1}{2}$ -watt (1% or matched)
R6—10,000-ohm, $\frac{1}{2}$ -watt
R10, R13, R16—470,000-ohm, $\frac{1}{2}$ -watt
R14—27,000-ohm, $\frac{1}{2}$ -watt
R17—300-ohm, 5-watt, wire-wound
R18—22,000-ohm, $\frac{1}{2}$ -watt
R19, R20, R21—10,000-ohm, 1-watt
R22—200-ohm, 5-watt, wire-wound
(All resistors are 10% unless otherwise specified)

CAPACITORS

- C1, C3, C6, C7, C8—.05-mfd., tubular
C2—.005-mfd., disk-ceramic
C4—.001-mfd., disk-ceramic, 600-V.
C5—.01-mfd., tubular
C9, C10, C11—20-20-40/250-volt electrolytic
Mallory FP 320
C12, C13, C14—10-20-80/400-400-350-volt
electrolytic Mallory 333.B
(All capacitors 400-volt unless otherwise specified)

TUBES

- 6SL7GT, 6SN7GT, 6BX7GT, 6X5GT

MISCELLANEOUS

- T1—Power transformer, Stancor PC8419
T2—Output transformer, Stancor A3852
S1—A.C. receptacle, Amphenol 61-F
Sw1—S.D.S.I. toggle switch, H & H 20994-EW
J1—Phono-input jack
J2—Open-circuit jack, Mallory A-1
L1—Pilot lamp, type 51
1—Chassis, 2x7x11 in., Bud CB-1193
1—Line cord and plug
4—Octal sockets, Amphenol MIP-8
3—Knobs
1—8-terminal tie strip
1—2-terminal tie strip
1—Pilot-lamp bracket, Dialco type 431
1—Length of #14 tinned-copper bus wire
Assorted screws, nuts, lock washers and grommets,
hookup wire and rosin-core solder

screws and nuts. See the photograph on page 247 for the correct location of these parts.

The leads from the power and output transformers, as well as the line cord, are brought into the chassis through rubber grommets, and the filter capacitors should be mounted with the fiber wafers on top of the chassis so that the metal cans of the capacitors do not touch the chassis. All ground connections will be made to a common bus wire which is grounded to the chassis only at the input and output jacks.

When the major parts have been installed, the actual wiring can begin. It is suggested that the bare #14 bus wire be connected first. This wire runs from the pilot lamp, around one end of the chassis, and is finally anchored to pin 8 of the 6BX7 tube. The wiring details are clearly illustrated in the simplified wiring diagram on page 248.

Keep all wire leads as short and direct
(Continued to page 270)

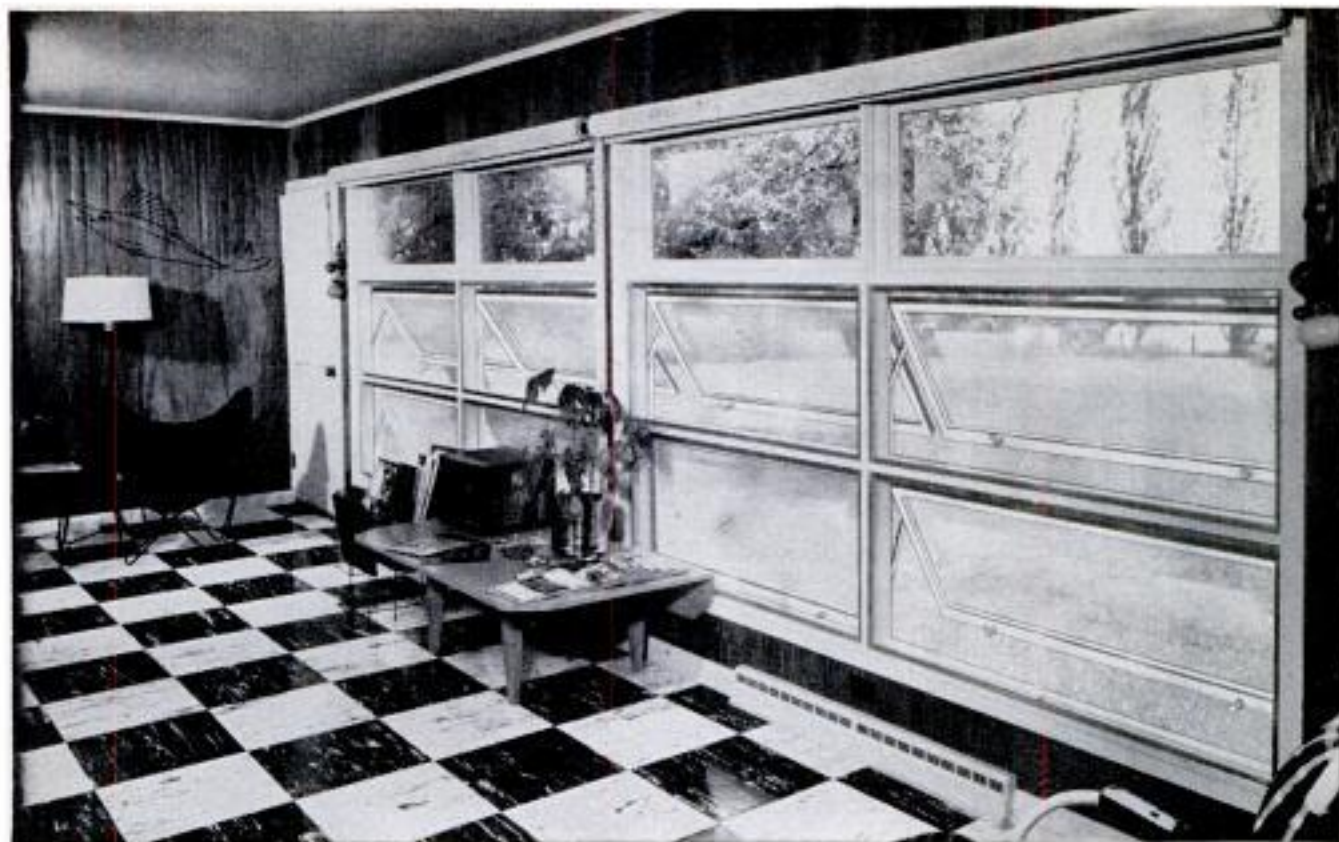

Wonder window provides a THOUSAND combinations—it's the Curtis Convertible

Here's the easy, low-cost way to have exactly the windows you want! The new Curtis Silentite Convertible is an *entirely* different kind of window. It's so designed that you can stack the sash both vertically and horizontally—use one basic unit to provide right or left swing casements, awning sash, ribbon windows and more than a thousand window combinations.

And this better, preservative-treated wood window is *ready to install*. It comes complete with operating hardware—simple, effective insulating glass—complete weather-stripping. You can get the Silentite Convertible in ten sizes of sash units—five sizes of louvre units to use with sash—three stationary frames for picture windows. Remember, the Curtis Convertible is a quality wood window—guaranteed by Curtis! Get the facts now—about Curtis Convertibles and other ready-to-install Curtis Woodwork for your home.

CURTIS WOODWORK
Heart of the home

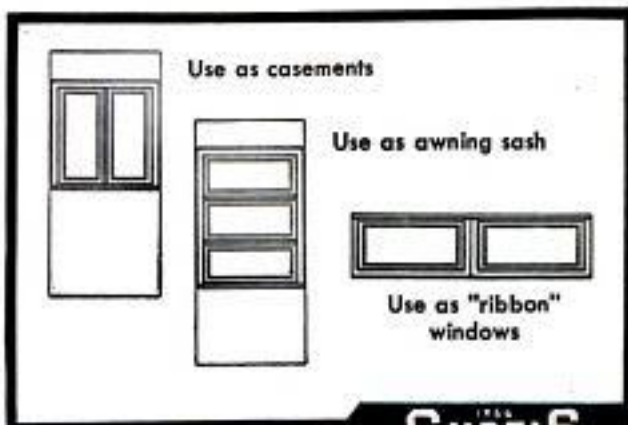

CURTIS
WOODWORK
SILENTITE
the Insulated window

PSE-10-55
Curtis Companies Service Bureau
200 Curtis Building
Clinton, Iowa

Please send me literature on these Curtis Woodwork products:

- Convertible windows
- Weather-tight double hung windows
- Casement windows
- Birch kitchen cabinets
- Entrances and doors

Name.....

Address.....

City.....State.....

TIME SAVING TIPS

ALL YOU NEED IS A TUBE OF DU PONT DU CO CEMENT

REG. U.S. PAT. OFF.



STRONG

To tighten loose screws, coat them with strong "Duco" Cement—holds fast even in plaster!



Train ivy on strings attached to house with tough, weatherproof "Duco" Cement.



Emergency repair for flashlight lens—"Duco" Cement lets light through, seals rain out.

CLEAR



Put loose inlays back to stay—clear "Duco" Cement resets mother-of-pearl beautifully!



Put broken soap dishes, toothbrush racks back in service with waterproof "Duco" Cement.

WATERPROOF



To waterproof matches for camping, just dip in "Duco" Cement and wipe smooth.



Restore cracked book bindings—tough, flexible "Duco" Cement takes a lot of hard use!

FLEXIBLE



Fix belts. Rejoin layers of leather with strong, flexible "Duco" Cement.



NEW CAP HAS HANDY APPLICATOR TIP



BETTER THINGS FOR BETTER LIVING
... THROUGH CHEMISTRY

as possible without actually stretching them from one connection to another. All leads and parts connected to pins 1 and 4 of the amplifier tube should be kept close to the chassis and as far removed from other leads as possible. This precaution will prevent oscillations and hum pickup.

None of the parts is critical with exception of resistors R12, R15 and R18. R12 and R15 should be 1% resistors. While the actual values are not important, it is essential that the values are within 1% of each other in order to obtain balanced operation. Resistor R18 should be of the value specified in the parts list if the amplifier is to be used with a 3 to 4-ohm speaker. A higher value will reduce the amount of feedback and thus reduce the fidelity. A lower value may give rise to low-frequency oscillations which will cause motorboating.

Operation. Interconnecting the various parts comprising the phono system is simple. All modern record players and changers, whether separate units or incorporated in a cabinet with other components, have an output lead with a plug to fit the phono input jack of the amplifier. Merely connect this plug to the input jack, and connect the plug on the speaker leads to the speaker jack of the amplifier. Then, rotate the amplifier tone controls to their approximate mid positions (this is the flat-tone control setting) and plug the a.c. cord of the record player into the a.c. receptacle on the rear of the amplifier.

Turn the amplifier and record player on by means of the amplifier on-off switch. Permit the amplifier to warm up for a minute before playing a record, and then you're all set to hear some fine music.

For best operation, the mouth of the speaker should be facing away from the phono pickup to prevent acoustic feedback. The enclosure should be set up with the speaker at the top, so that it is approximately at ear level. This permits best reception of the high tones which are radiated in a comparatively narrow beam. The low notes are reinforced in the enclosure and are radiated at a relatively wide angle.

If the amplifier is wired correctly, the system will provide excellent performance immediately. However, if loud howls or squeals are heard through the speaker, there is a good chance that the negative feedback circuit is providing positive feedback instead. To correct this, merely reverse the connections of the red and blue output-transformer leads.

The speaker system or the amplifier can be used individually, with other components. Used together, these units will convince you that low-cost components can, indeed, provide high-fidelity results. ★ ★ ★

BUY SET AND SAVE \$3.72

**CRAFTSMAN 5-PIECE
PROPANE
TORCH
SET**

**2300° F
FLAME**

*A few of the
MANY JOBS you can do . . .*

- Solder silver
- Burn off paint
- Light fires
- Melt lead, etc.
- Singe chickens
- Soften putty
- Soften asphalt tile
- Sweat copper fittings
- Free nuts and bolts
- Thaw out frozen pipes
- Economically solve any job that needs heat or flame

Regular
Price \$12.60
Special at

\$8.88
Complete

You Save \$3.72
Until Dec. 31st

Long-lasting
throw-away
cylinder



UTILITY BURNER HEAD for heavy duty flame. Replaces PENCIL FLAME BURNER HEAD on angle tube.



FLAME SPREADER to heat large surfaces, to lay asphalt tile, etc. Use on Utility Burner Head.



SOLDERING TIP for flat surface soldering work . . . large coverage. Use on Pencil Flame Burner Head.

**Makes a Handy GIFT for
Hobbyist or Professional**

Packed specially in a colorful Christmas gift box, this master torch set makes a handy gift for the handyman! Powered by clean-burning propane, the fuel used in city buses! So safe, women use it every day for soldering jewelry, etc. When sold separately, cylinder and accessories cost \$12.60—you save \$3.72 by buying the set. Priced at \$8.88 at your Sears Retail Store until Dec. 31st.

Lightweight—a little less than 3 lbs.—torch handles easily . . . you can use it with just one hand. **Lights instantly** . . . with no pumping, priming or preheating! Turn gas jet, strike a match, and it's lit. Flame adjusts from needle-fine to coarse. Burns clean and hot in any position—even upside down! Does heavy duty work—from removing paint to melting aluminum—at a constant 2300° F. When long-lasting cylinder is empty, throw it away!

10-inch cylinder has 23/4-inch diameter . . . packs easily in tool box or pocket. Contains 1 1/2 liquid pints. Excess pressure relief valve on top. **UL listed.** All parts of high quality steel. Accessories interchange easily to do a countless number of special jobs. Convenient . . . practical . . . low cost . . . this CRAFTSMAN Propane Torch Set makes ordinary blow torches obsolete. With easy-to-follow instructions. (Replacement cylinders cost \$1.95.) At your nearest Sears Retail Store. Save \$3.72 until Dec. 31st only. Set \$8.88



CRAFTSMAN Hand and Power Tools by **SEARS, ROEBUCK and CO.**
Famous for fine quality . . . precision performance . . . low price!



solves woodworking problems in seconds!

Speed your jobs, get answers to countless building and woodworking questions immediately! Improved GREENLEE Woodworking Calculator converts linear to board feet, gives nail specifications, tool sharpening tips. Compares woods, gives bit sizes for screws, concrete mixes, painting information, etc. Convenient . . . simple to read. 6" diameter . . . heavily varnished cardboard. Special offer by the makers of famous GREENLEE tools . . . **Only 25c** (no stamps please)

TOOL FOR CRAFTSMEN
GREENLEE

The GREENLEE line of fine tools includes auger bits, electric drill bits, chisels, gouges, spiral screw drivers, drawknives, and many more. At leading hardware and building supply dealers.

GREENLEE TOOL CO.,
2110 Columbia Ave., Rockford, Ill.

Watch Out for the Stamp Fakers!

(Continued from page 137)

have been perfecting techniques with this instrument to detect fakery in the stamp world.

The stamp expert never relies solely upon mechanical instruments. He depends heavily upon a vast store of specialized knowledge which the faker rarely has. In 1906, for instance, Norway overprinted an obsolete stamp to use up existing supplies. A faker recently got quantities of the common basic stamp and decided to up their worth by adding his own overprint.

When one of these was offered for examination, it passed all the routine tests, so cleverly had the imitation been produced by the faker.

The questionable stamp, nevertheless, was declared fake. The basic stamp had been printed in two different shades of violet ink at two different times. The stamp expert knew that Norway used only stamps of the second printing for this provisional. The faker did not, and so applied his deceptively good imitation surcharge to stamps of the first printing.

There have been many counterfeiters who produced excellent forgeries, but there has never been a single one which is perfect. And thanks to the efforts of the philatelic sleuths, the stamp-collecting fraternity is constantly being notified every time a new type of fake is discovered. With this dissemination of knowledge the faker is finding it difficult to peddle his wares and so is being driven out of the racket.

Only last year a group of British stamp dealers wrote the final chapter to the 50-year career of the cleverest and most notorious of all modern counterfeiters, who made a fortune from his chicanery solely because no government agencies molested his activities until philatelic sleuths got on his trail.

Counterfeiters will operate only as long as they have victims who'll buy their wares. You are a potential victim if you do any or all of the following:

1. Look for too many bargains.
2. Buy stamps from persons you do not know to be experienced and reliable.
3. Buy stamps about which you know too little.
4. Accept stamps without a reliable, written guarantee.
5. Accept stamps which have not been examined by a qualified philatelist. ★ ★ ★

Biggest single consumer of electric power in the United States is the Atomic Energy Commission, which last year took four percent of the nation's output.

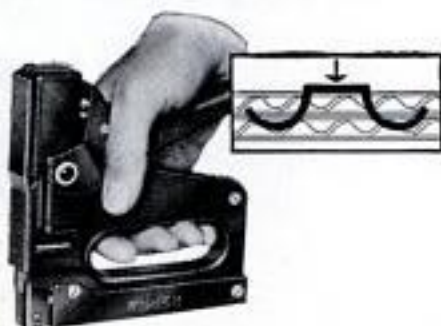
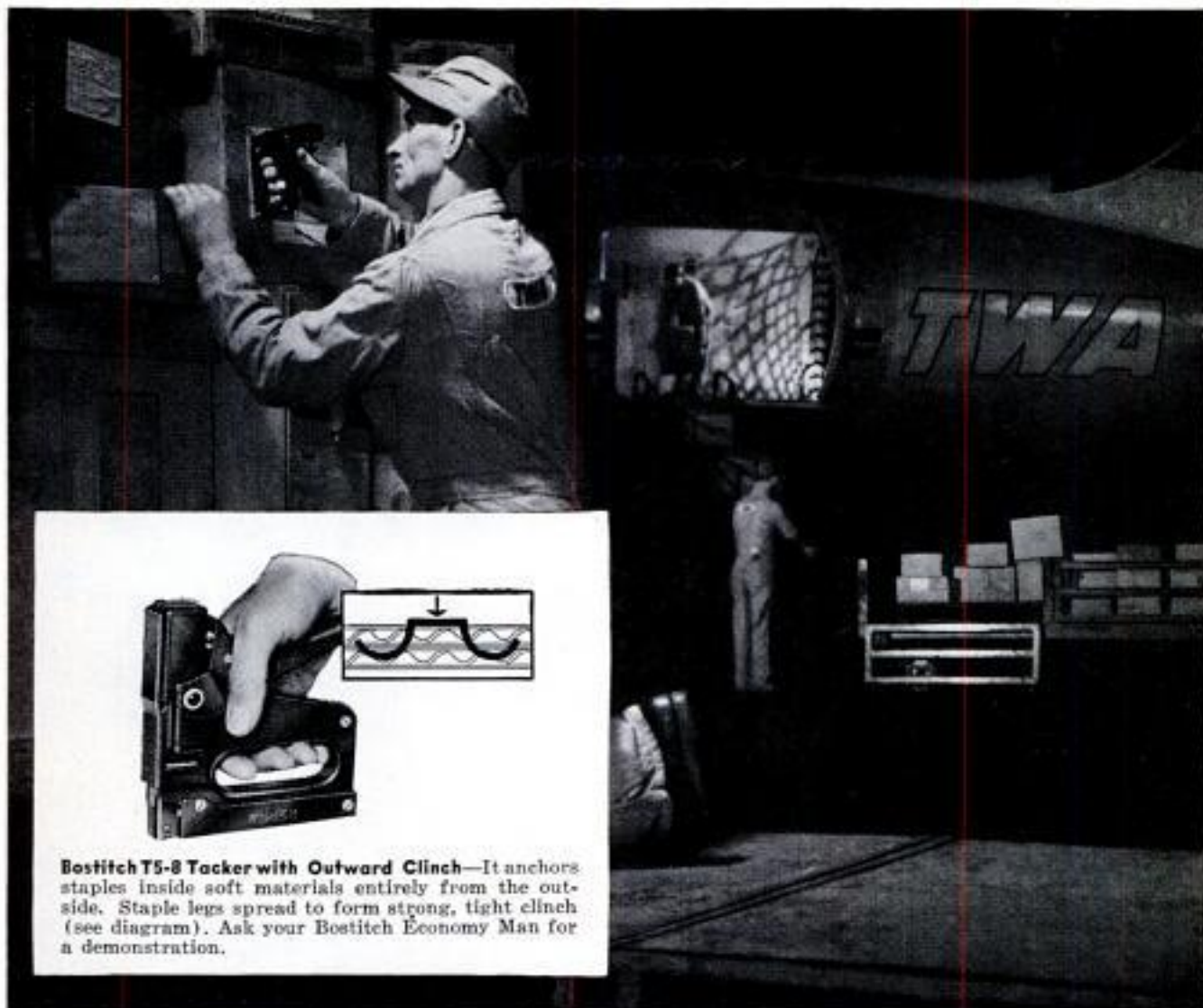

Bostitch T5-8 Tacker with Outward Clinch—It anchors staples inside soft materials entirely from the outside. Staple legs spread to form strong, tight clinch (see diagram). Ask your Bostitch Economy Man for a demonstration.

STAPLES HOLD BETTER AT ONE-TENTH THE COST! Trans World Airlines overlook no detail in assuring the safe, swift arrival of air freight shipments. Shipping bills fastened to cartons with even the best tape sometimes tore loose in damp climates. And taping cost \$14 per thousand bills, not counting time taken to apply.

A Bostitch Economy Man suggested stapling the bills with a new Bostitch tacker that "spread-eagles" staple legs inside carton walls. TWA tried it, found stapling four times faster than taping and far superior in holding power. Cost: \$1.40 a thousand. Now all major TWA stations are Bostitch-equipped.

How much can you save by switching to Bostitch stapling?

Your Bostitch Economy Man can tell you. He's one of 350 trained fastening specialists working out of 123 cities in the U. S. and Canada. There are over 800 kinds of Bostitch staplers in his cost-cutting repertoire. Look up "Bostitch" in your telephone directory, or check the coupon at the right.

Fasten it better and faster with



BOSTITCH, Inc., 550 Mechanic St., Westerly, R. I.

I'd like to know exactly how stapling can cut costs in our fastening operations. I'm particularly interested in the applications checked below:

HI-SPEED PRODUCTION FASTENING

- stapling vs. riveting
- stapling vs. spot welding
- stapling vs. screws or bolts
- stapling vs. glue or cement
- stapling vs. tape
- stapling vs. tacks or nails
- stapling vs. solder
- stapling vs. wire or string

PACKAGING and CARDING

- sealing bags (cloth, paper or plastic)
- mounting products on display cards
- fastening items to individual cards

SHIPPING ROOM ECONOMIES

- preparing cartons for filling
- sealing filled cartons
- lining or padding crates
- applying shipping bills or tags

BUILDING APPLICATIONS

- applying asphalt roofing
- laying underfelt
- installing ceiling tile
- applying insulation
- installing low-voltage wiring
- applying shake shingle siding

OFFICE EFFICIENCIES

- filing
- routing
- posting
- binding folders and reports
- preparing advertising dummies

Name _____ Position _____

Company _____

Address _____

City _____ Zone _____ State _____

Completely NEW and ORIGINAL

Paramount wood



THE SECRET OF SIMPLICITY IS PARAMOUNT'S

"MAGIC-BOOM"!



Exclusive! The basic principle of Paramount's patented "Magic-Boom" is a combination Pinch-Lock Pivot Block Bearing that permits sliding, rotating and tilting movements never before possible in a multi-tool. Provides unlimited work combinations and new adaptations . . . precise alignment from one tool position to another!

MULTI-PURPOSE TOOL..

worker

Compact! Rugged! Simple to operate!

Does all complex woodworking jobs quickly and safely!

Simplicity of design eliminates mechanical troubles!

If you ever thought multi-tools were complicated to handle, confusing to operate, or troublesome to maintain—*get ready to change your mind!* A new engineering idea has made possible the greatest advancement in home workshop history. Not until now has there been a multi-purpose power tool so simple and compact in design—so easy to operate—so rugged in construction—so trouble-free in performance.

Compact—Only 2 feet square! Versatile—Unlimited work combinations!

Portable—Take it from job to job! Precision—To industrial standards!

If you are interested in a home workshop, or are considering the purchase of a power tool, you owe it to yourself to see the new Paramount Woodworker. The purchase of a home workshop tool is an investment for a lifetime of power tool satisfaction and trouble-free service. Shop every multi-tool on the market. Compare them one against the other. There is no better way to prove to yourself the

value and advantages of owning a new Paramount Woodworker!

Get the facts! Mail the coupon below for immediate information and name of your nearest dealer. See and operate the new Paramount Woodworker—examine the features that make it the most revolutionary multi-tool on the market. Once you do, you'll never be satisfied with any other power tool!

Only

\$279⁵⁰

COMPLETE

ASK DEALER FOR EASY TERMS

Mail this coupon today!

Paramount

with motor and attachments, ready to plug in.

PARAMOUNT WOODWORKER, Dept. PM-10

Ideal Metal Products, Inc., 1644 West LaFayette, Detroit 16, Michigan

Please send me complete information about the new Paramount Woodworker and the name of my nearest dealer.

NAME _____

ADDRESS _____

CITY _____ ZONE _____ STATE _____

TWO SAWS!



Standard cut-off saw and self-retracting push-up saw. Correct speed automatically fixed.

A LATHE!

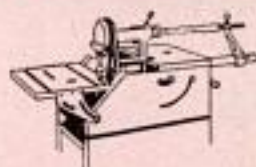

Tilting, sliding and rotating feature for set-up flexibility.

A HORIZONTAL DRILL!



No limit to length of work. Finger-tip micro-adjustment for accurate set-ups.

A DRILL PRESS!

A 360° radial drill press. Precision control raises and lowers head without strain.



A SANDER!



Largest sanding table in home workshop field. Engineered drive insures correct speed.

Hudson Owners Praise Ride, Handling Ease and Styling

(Continued from page 132)

"Engine is easily worked on by the owners. No overhead valves."—Wisconsin farmer.

"I drive it for less cost per mile than any other full-size car. Hudson isn't a popular car, but if more people could be given the keys and made to drive one in a test drive, there would be more sold."—Iowa insurance man.

"Visibility is good. No distortion and no difficulty getting into car because of the pillar."—Illinois sales manager.

"I like the single-unit body which holds rattles to a minimum."—Michigan teacher.

Those of you who follow these surveys regularly will note that the Hudson is one of the very few cars in which squeaks and rattles are not listed high among the complaints. Fewer than one percent of the Hudson owners mentioned rattles.

"I like the brakes' safety feature (the hydraulic and mechanical linkage)."—Pennsylvania furnace man.

"I like the idea of having mechanical brakes if the hydraulic system fails."—Indiana farmer.

"I like the way it drives like a big car, feels like one, looks like one and is very

comfortable too."—New Jersey executive.

"Dependable. Any independent has to be better to sell."—Illinois carpenter.

"I drive 131 miles round trip each day to work five days a week and my Hudson has never failed me in any way."—Indiana owner.

"The spare tire is out of the trunk which gives you much needed room for luggage when traveling."—North Dakota cattle buyer.

Other Complaints

Listed in order of frequency of mention are the following complaints of owners:

"The only complaint I have is that it leaks when it rains. The drain rubber around the leading edge of the door doesn't line up."—New Jersey glassworker.

"Car rides fine but the secure, road-hugging feeling of the old Hudson is gone. You have to drive this car at all times."—Ohio factory worker.

"Engine too small for the Wasp Hollywood. It can hardly pull itself up a hill."—Minnesota parts man.

"Not pleased with gas mileage. This is my first Hydra-Matic and I don't believe I will buy my '56 with automatic transmission."—Colorado sales manager.

"Disgusted with the service. Garage tells

(Continued to page 278)

1955 HUDSON SPECIFICATIONS

ENGINE	HORNET 6	HORNET V8	WASP
Type	6-cyl. in-line, L-head	V8 OHV	6-cyl., in-line, L-head
Bore and stroke	3-13/16 x 4 1/2 in.	3-13/16 x 3 1/2 in.	3 x 4.750 in.
Piston displacement	303 cu. in.	320 cu. in.	202 cu. in.
Brake horsepower	160 at 3800 r.p.m.	208 at 4200 r.p.m.	115 at 4000 r.p.m. (with power kit 126 at 4000 r.p.m.)
Compression ratio	7.5 to 1	7.8 to 1	7.5 to 1
Transmission	3-speed conventional, overdrive, or Hydra-Matic	3-speed conventional, overdrive, or Ultramatic	3-speed conventional, overdrive or Hydra-Matic
GENERAL			
Wheelbase	121 1/4 in.		114 1/4 in.
Tread, front	59 1/2 in.		59 1/2 in.
Tread, rear	60 1/2 in.		59-11/16 in.
Tire size	710 x 15 tubeless		6.70 x 15 tubeless
Weight, unladen	3495 lb.	3806 lb.	3254 lb.
Turn-circle diameter	45 ft. 2 in.		41 ft. 10 in.
Steering-wheel turns, lock to lock	4.6 turns		4.3 turns
Length over-all	209 1/4 in.		202 1/4 in.
Width over-all	78 in.		78 in.
Height over-all	62 1/4 in.		61 3/4 in.
CAPACITIES			
Gasoline	20 gal.	20 gal.	20 gal.
Oil	7 qt.	5 qt.	5 qt.
Water	18 1/2 qt.	20 qt.	13 qt.
INTERIOR DIMENSIONS			
Front hiproom	65 in.		
Rear hiproom	64 1/2 in.		
Front headroom	37 1/2 in.		
Rear headroom	36 in.		
Front legroom	42 1/2 in.		
Rear legroom	40 1/8 in.		

Give Your Home the "NEW LOOK"



with **SIoux** Quality **ELECTRIC TOOLS!**

SIoux POLISHER-SANDER



IT'S FOR HIM



IT'S FOR HER

Complete Polisher-Sander Kit including SIOUX No. RC-1865

Electric Polisher-Sander; Molded rubber backing pad; 6" wool polishing pad; 1/2 pt. Auto Polish; 1/2 pt. Sioux-Venir (Wax); and package of fine, medium and coarse sanding discs. Only..... \$31.25
Optional extra drill chuck and set of drills.....\$3.45
Handle for polishing floors.....\$2.50



IT'S A POLISHER



IT'S A SANDER



IT'S A DRILL

SIoux FLAT SANDER

Here is the successor to tedious hand sanding. Oscillating, orbital action at 4,000 cycles a minute produces the smoothest finish on wood, fibre, metal, any material which you would sand by hand. No. 1850... \$45.80



SANDS WOOD SATIN SMOOTH



SANDS JOINTS SMOOTH



SANDS RUST OFF METAL

SIoux 1/4" ELECTRIC DRILL



No. RC-1822 Drill Tool Set with complete accessories for drilling, grinding, sharpening, wire brushing, polishing, etc. \$39.75

- Hole saws to 3/4"
 - Small design
 - Full powered
 - Lightweight
 - Permanently lubricated
- Drill 1/4" in steel
No. RC-1885 1/4" Electric Drill.....\$22.95



CLEAN



POLISH



DRILL



SHARPEN

SIoux ELECTRIC SAW

Powerful, rugged, with a world of surplus power. Perfectly lubricated; Motor, glass insulated; Helical, heat treated, steel gears; Blower keeps line of cut free of dust; Positive safety guard; 6 1/4" Saw Blade saws through 2x4's at 45° angle with plenty of blade to spare.



RC-1806
6 1/4" Heavy Duty \$74.50



MITRE CUTS



RIP SAWING



CROSS CUTS

STANDARD THE WORLD OVER

IN THE AIRCRAFT AND AUTOMOTIVE FIELDS AND IN INDUSTRY, THEY'RE THE TOOLS THE PROFESSIONALS HAVE USED FOR OVER 40 YEARS!

WRITE FOR YOUR FREE CATALOG



ALBERTSON & CO., INC., SIOUX CITY, IA.

"TWINSULATE" THIS WEEKEND



**SLASH HEAT BILLS up to 25%
with new double-action INSULATION**



Insulate your attic with new Gold Bond TWINSULATION®. Cut this winter's heat bills... and make your house up to 15° cooler next summer. TWINSULATION gives you a core of heat-blocking fireproof rock

wool *plus* a heat-reflecting covering of silvery aluminum *all* around it. This double-action combination keeps winter furnace-heat in, and summer sun-heat out! If you have an average size attic you can TWINSULATE it in a few hours. Do it this weekend!

NATIONAL GYPSUM COMPANY • BUFFALO 2, N. Y.

Send for booklet. Shows you how much money Gold Bond TWINSULATION can save you in heat bills. Mail coupon now!



NATIONAL GYPSUM COMPANY
Dept. PM-105, Buffalo 2, N. Y.

I enclose 10¢ for "Home Insulation" booklet.

Name

Address

City Zone County State

me they can't get parts."—Michigan owner.

"Tappets are very noisy."—Massachusetts kitchen manager.

"Sloppy assembly. Wiring not well organized. My car was an early model and may have been rushed through without careful attention."—Illinois editor.

"Hydra-Matic jerks something terrible. Hard to get at engine to work on it."—Indiana owner.

"Glaring design mistake is the second muffler that hangs down exposed to view."—Florida advertising executive.

"Dash and glove compartment are not very attractive."—Illinois machinist.

"I am 5 feet 8 inches tall and must practically throw myself over fender to check oil. Dipstick should be in handier position."—Illinois superintendent.

"Left ash tray almost inaccessible to driver because of shift lever. Handles for front windows too low on doors."—West Virginia postal clerk.

"Dry-disk clutch is stiff. Far inferior to old wet clutch."—Ohio inspector.

"Cannot adjust tappets while engine is idling. Should have door under fender to get at tappets."—Indiana machinist.

"Vent windows in front doors do not deflect enough air to prevent turbulence in rear seat."—Wisconsin clergyman.

"I cannot move the front seat forward or backward while driving."—Oregon housewife.

"Two-door Hollywood with reclining seats has exposed pawl on seat mechanism that damages clothing when getting in and out of back seat."—New York manager.

"Car bed somewhat disappointing. Very uncomfortable by itself because back seat is too low. Air mattress some help, but not enough. Needs a specially shaped mattress to level back seat."—California actuary.

"Hand brake is too low. Foot hits handle when moving from gas to brake pedal."—New York toolmaker.

"Trunk cover should have better lock and handle."—Minnesota superintendent.

"Rear doors do not open wide enough."—Illinois salesman.

There you have it—the good and bad about the 1955 Hudson, as reported by the owners themselves. On page 131 are detailed percentages summarizing this survey.

Turn back to page 131 for Clymer's road test of the Hornet V8.

☐ As an educational service, school children during summer vacations are allowed to fly between Birmingham and London at reduced round-trip rates of ten shillings (\$1.40) when empty seats are available on British European Airways liners.

"Miss
MOPAR"
says...

EXHAUST FUMES
CAN BE DANGEROUS
Does Your Muffler
LOOK LIKE THIS?

BE SAFE
BE SURE!
Let Us Install a
Safety Engineered
MOPAR MUFFLER

LOOK FOR THIS DISPLAY
—and get your MoPar
muffler—at your Plymouth,
Dodge, De Soto or Chrysler
dealer and from many
better repair shops.

GET
A
MUFFLER
CHECK
TODAY

Mufflers can be dangerous without being noisy!

It's a *smart idea* to have your muffler checked periodically! Even tiny leaks can mean *carbon monoxide* in your car's interior. (It takes only a small amount of this deadly gas to cause drowsiness and possible accidents!)

Next time you stop for service, have your muffler checked. If you need a new muffler, *play safe*—get a *double-walled* MoPar muffler, designed especially for your Chrysler Corporation car or truck.

MOPAR

PARTS DIVISION • CHRYSLER CORPORATION

GONE!



Most wallboard joints disappear with just one coat of these . . .

TEXOLITE* latex paints



TEXOLITE TEXTURE
Sand Finish
17 colors!



TEXOLITE RIPPLE
Smooth Stipple Finish
12 colors!

No priming...No mixing

One coat conceals wallboard joints finished with PERF-A-TAPE* system; all minor surface imperfections, too. Flows on freely and evenly with a brush or roller; dries fast to a luxurious textured-finish without "painty" odor. Ideal for imperfect plastered surfaces, too. See your TEXOLITE paint dealer or write Dept. PM-5,300 West Adams St., Chicago 6, Ill.

*T. M. REG. U. S. PAT. OFF.



UNITED STATES GYPSUM

Clymer Tests the Hudson Hornet V8

(Continued from page 131)

(about twice as long as used by most makes), controlled by direct-acting Monroe shock absorbers, do a good job of dampening the ride. Even over the most severe bumps at high speeds, the ride is solid and bottoming is almost impossible. Maneuverability, control and stabilizing on the corners are excellent.

The new Ultramatic transmission seems smoother than other Ultramatics I have tested recently. It is a four-element unit, utilizing a torque converter plus automatic upshift in gears (at driver's option depending on throttle position). I especially like the fact that, if the throttle is depressed about halfway at moderate speeds, the downshift takes place and it is smooth. Passing gear is available by flooring the throttle at speeds below 55. Below 15 miles per hour downshift to low is automatic.

The shift quadrant necessitates the driver leaning forward to see the position of the indicator, as the high steering-wheel hub obstructs vision. There is difficulty in locating the various driving positions. The movement of the shift lever is too short and sensitive. The transmission itself, however, is a thoroughly reliable unit.

The seating and driving position is comfortable, but the position of the steering wheel is awkward. There is not enough slant to the column and the top of the wheel is too high, especially with a short person, and it obstructs highway vision directly in front of the hood—which in itself is long, wide and rather massive. (I understand this will be changed by the time this is in print.)

The wrap-around windshield extends farther back into the door panel than most others. There is ample room for entry through the front doors, with very little knee obstruction from the body panel curve against which the front door closes. Thumb pressure required to open the doors from the outside is rather heavy. The location of the armrest on the door is good, but the window sill is rather high for comfortable driving with the elbow resting on the sill.

The windshield wipers are vacuum-operated. They have more sweep and do a better job of wiping into the corners on both sides than most. Transparent colored visors reduce glare and can be seen through while driving against the sun.

There is an ash tray on each side of a large drawer-type glove compartment. I like this glove compartment better than the hinged-door type.

The interior is luxurious and spacious

(Continued to page 282)

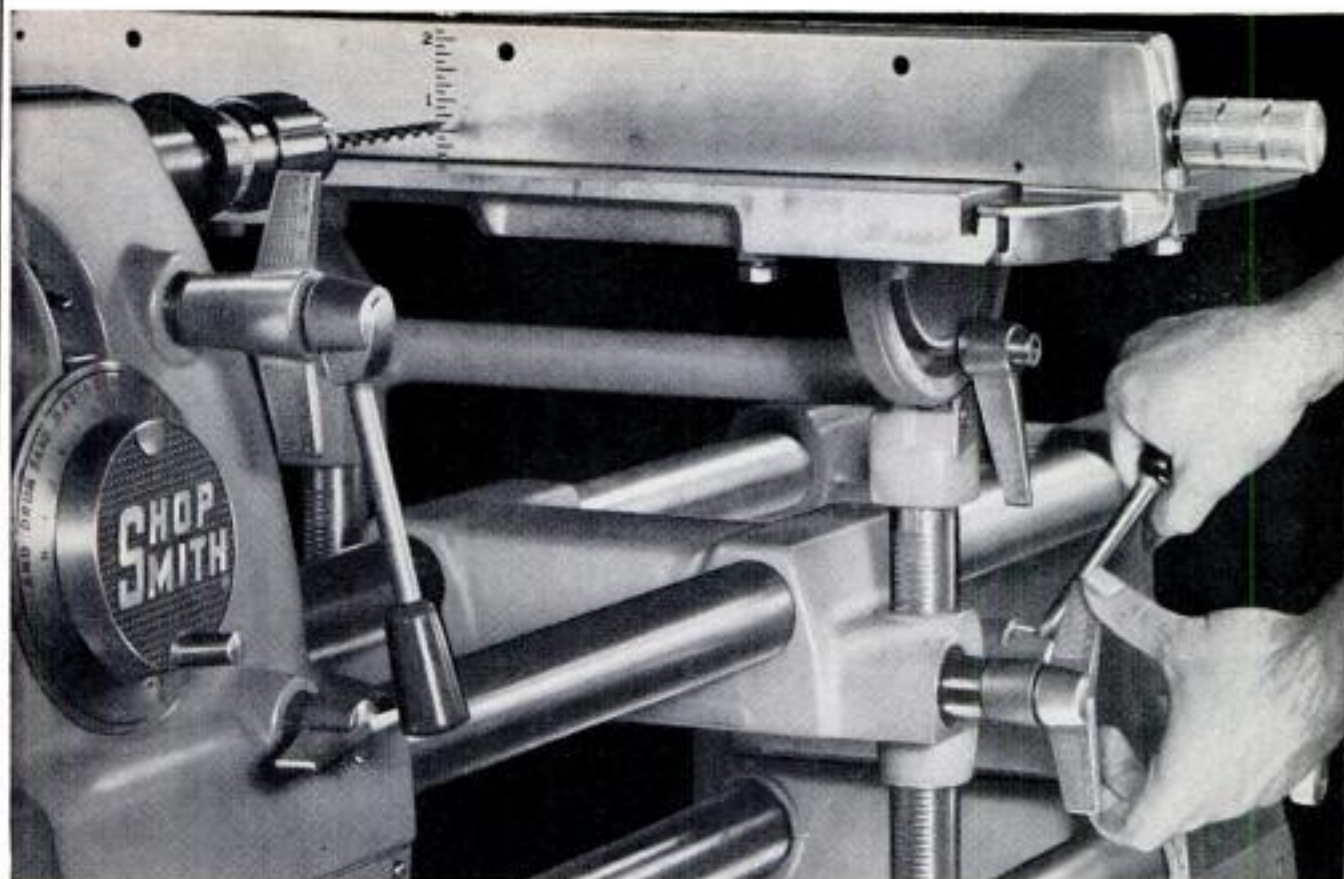

Why *LONG* any *LONGER*?

NOW YOU CAN OWN SHOPSMITH FOR AS LITTLE AS \$3 A WEEK

SHOPSMITH® precision performance, its unequalled versatility, its compact beauty can now be yours to enjoy for as little as \$29 down, \$3 per week under the new Magna Tool-Time Plan. Your SHOPSMITH can actually earn its \$289.50 total cash price out of savings on work it will do for you around your home.

See SHOPSMITH demonstrated soon—at leading hardware and department

stores or any Montgomery Ward store. Note exclusive Power-Mount, the powerful ¾-hp. built-in motor, the fast, easy convertibility from one tool to another. Feel the surge of power as you dial any speed from 700 to 5200 rpm. At this moment you'll make up your mind to join the ranks of proud owners of SHOPSMITH.

Why not? SHOPSMITH is so easy to own. So wonderful to use.



For sawing

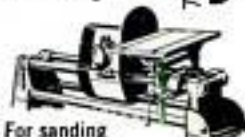

For sanding



For lathe turning



For vertical and horizontal drilling

MAIL COUPON FOR 3 FREE BOOKS

1. "Project Digest," 36 pages of modern wood-working projects.

2. The valuable home-shop guide: "What to Look for When You Buy Power Tools."

3. Illustrated 20-page SHOPSMITH catalog.



MAGNA Engineering Corporation

Dept. 305-B, at factory nearest you:
12819 Coit Road, Cleveland 8, Ohio, OR Menlo Park, Calif.

Please send me 3 free books.

Name _____

Address _____

City _____ Zone _____ State _____

If you already own SHOPSMITH, please check whether you have
SHOPSMITH Mark Y or SHOPSMITH Model 10 ER .

NEW WILLIAMS LOCKING ADJUSTABLE WRENCH

JUST A FLICK OF THE THUMB OR FINGER LOCKS OR UNLOCKS THE ADJUSTMENT INSTANTLY AT ANY OPENING YOU SELECT

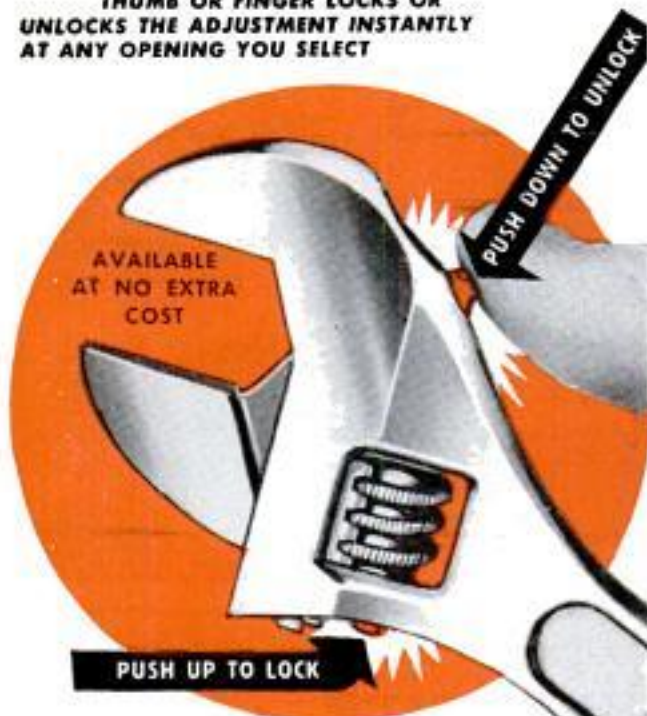

This is the BIG NEWS in adjustable wrenches . . . written up in leading publications. The Williams locking device is simple, efficient and practical . . . the new favorite of mechanics. You'll want a full set when you see these features . . .

- POSITIVE LOCK
- NO OBSTRUCTIONS
- RAPID ADJUSTMENT
- NO FUMBLING
- ONE HAND OPERATION
- INCREASED SAFETY
- STRUCTURALLY SOUND
- DROP-FORGED and HEAT-TREATED
- SELECTED ALLOY STEEL
- CHROME PLATED FINISH

The Greatest Adjustable Wrench Improvement in Over 40 Years

LOOK FOR THIS DISPLAY AT YOUR DEALER'S STORE



You'll see Williams Locking Adjustable Wrenches in 6, 8, 10 and 12" sizes. Try them yourself for convincing proof that they beat any "Adjustable" on the market . . . and they cost no more

J. H. WILLIAMS & CO.

400 Vulcan Street

Buffalo 7, N. Y.

with adequate headroom. The brake pedal is rather high in relation to the throttle. It should be wider for ease of operation with the left foot, which automatic-transmission drivers should learn to use.

Unit-type body-chassis construction is used. Body and chassis are welded as one unit. This not only makes for a stronger body but I have always felt that such bodies have fewer squeaks and rattles than the conventional type in which the body is bolted to the chassis. Not one squeak or rattle developed during the entire test.

The emergency brake operated by the right hand is in an awkward position, especially when the ash tray is pulled out. In my judgment, no car has better foot brakes than Hudson. We were caught in a cloudburst at Greensburg, Kans., where floodwater over the highway was hub deep for miles. The highway was closed for most of one night and for four hours, with all traffic stalled, the car stood in this water yet during the entire trip to Los Angeles when brakes were used often, and many times at high speeds, there was very little fading. The pedal hadn't lost more than one half inch of effective movement on the entire trip. Hudson has continued to build in a mechanical reserve-brake linkage that takes hold in the last inch of the brake-pedal movement should hydraulic pressure fail. It is a valuable safety feature.

In that severe rain, not a drop of water leaked into the body, which indicates good assembly and careful checking.

There was considerable heat across the Midwest and I was impressed with the air-conditioning system. Both the condenser and the compressor are located under the hood and the entire air-conditioning unit is mounted below the instrument panel on the right side of the car. The combined heater-air-conditioner provides fresh cool air if it is hot or heated air in cold weather. Certainly no car has a better air-conditioning unit for average hot-weather use than Hudson. The price is \$395, nearly half of the cost of most other units which I have found to be no better and in some respects not so good.

I still rate Hudson as the safest car built in America. I say this because of several features: 1. The unit construction whereby the chassis and body are welded together as one single unit; 2. the high quality of Hudson brakes and the added reserve safety feature of a mechanical linkage to take over should the hydraulic system fail; 3. the roadability, general handling characteristics and maneuverability of the car, and 4. its excellent acceleration and power which enable the driver to get out of the way in an emergency. ★ ★ ★

FIRST BOOK of its KIND!

A "must" for every home mechanic

A comprehensive text book that tells you about pulleys, drives, V-belts, bearings, with formulae, technical data—profusely illustrated—full of "make-it-yourself" ideas. Useful products for home or shop, plus many other uses.

MAKE IT YOURSELF!

Get your copy of this excellent book on "Power through Pulleys and V-Belts." It's packed with information and ideas and your entry form. Make a useful product and make money, too. Act today—get a head start.

You can make many unique and unusual but very useful items with a small motor, a couple of pulleys, a v-belt and odds and ends of salvaged material. There are many useful items such as power tools, pumps, fans, blowers, paint sprayers, compressors, power lawn mowers, miniature cars and all sorts of useful products.

**ENTER THIS GREAT
CONTEST**
\$50 and \$100 Bonds
A prize every month
Bonus prizes every 6th month
Write direct or ask your dealer.

**SEND
THIS
COUPON
TODAY**

CONGRESS DRIVES DIVISION
TANN CORPORATION
3750 E. Outer Drive, Detroit 34, Mich.

Gentlemen:

Enclosed is 25c—please send me the book "POWER Through PULLEYS and V-BELTS"—also contest entry form.

Name _____

Address _____

City _____

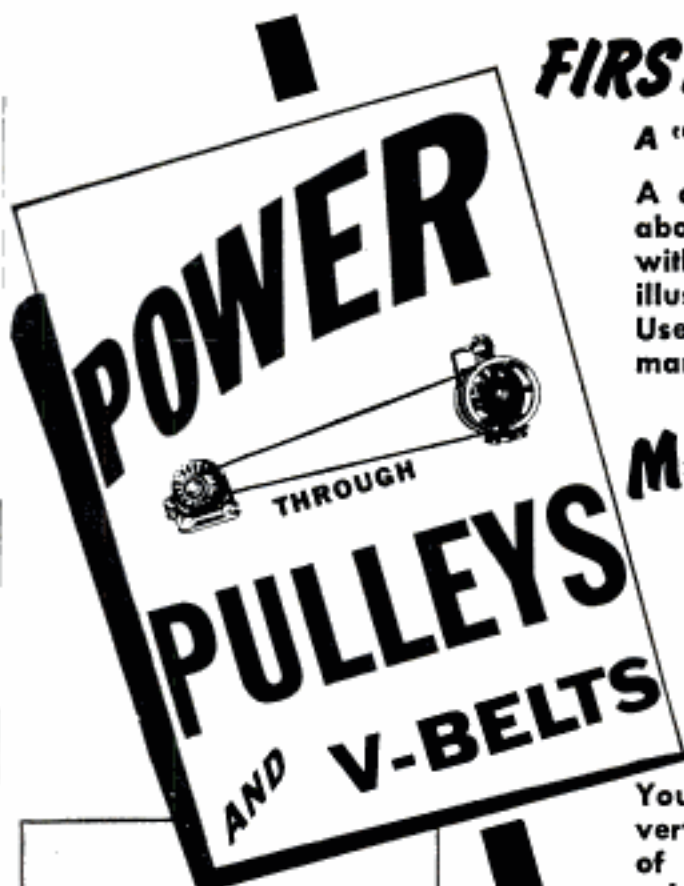

Take a note
from
sticking
trumpet
valves!



Free your car's engine from harmful deposits to UNLOCK HORSEPOWER

Trumpet or engine, deposits can cause valves and other vital parts to stick. Then rhythm is gone and the *tune* goes sour. In your engine it means lost power, wasted gasoline, excessive wear.

Pennzoil with Z-7 disperses all harmful contaminants, lets the *Tough-Film*® lubricate completely—*unlocking* engine horsepower for instant response, better gasoline economy.

Next time, change to Pennzoil with Z-7 and *feel* the difference!

Sound your  for the
LONG QUART

NOW with
Z-7
the POWER
INGREDIENT



Switch now at this sign

BETTER DEALERS
IN EVERY STATE FEATURE PENNZOIL® PRODUCTS

© 1955, The Pennzoil Co., Oil City, Pa., Member Penn. Grade Crude Oil Assn., Permit No. 2

Is Electric Heating for You?

(Continued from page 176)

Electric heating is safe. There is no flame, no possibility of an explosion, no trouble with an overheated chimney.

Which type of electric heating is best?

If you want a complete ducted system of air conditioning for your house you will probably favor a heat pump. Heat pumps offer the benefit of all-year air filtration. The house climate is similar to that of a home heated by conventional forced-air means.

Heating by resistance wires is probably the simplest form of heating known. Once installed, radiant-heating units require no care. Radiant heating is uniform and free of noise and drafts. Individual room thermostats keep each room at exactly the right temperature, and floor and ceiling temperatures even in rooms that are heated by ceiling panels are said to vary only three degrees.

Opponents of radiant heating claim that windows cloud up and that odors and smoke accumulate because of a lack of air circulation with this system. The backers of radiant heating say this just isn't true. Fresh air is constantly seeping into the best-insulated house, they say, causing gentle circulation throughout the home. They point out that these difficulties do not plague the users of conventional steam-radiator systems, which require no blowers either.

How long do the systems last? The life of a heat pump is said to be comparable to that of an electric refrigerator—15 or 20 years. Replacement or repair of the motor and of other parts is not expensive. Electric radiant-heating systems are said to last indefinitely.

The cost of electric heating varies greatly throughout the nation. But, wherever you live, your annual heating bill will probably be more if you use electricity rather than coal, oil or gas. Part and occasionally all of this difference can be recovered by savings in installation and building costs if you use resistance heat. If you install a heat pump, you will still probably pay more for heating than if you had used a conventional system. But you will receive air conditioning in the same package. If you happen to live in a mild climate, the cost of heating will be negligible in any case. A good estimate of the cost of heating your home by electricity can probably be secured from your local electric utility company, which should be told of your electric heating plans.

If you do decide to switch to electric heating, you'll be following a growing trend. ★ ★ ★

On flats, contours,
curves...

Flexbac[®] PAD

sands 'em all
... perfectly!

NOW
a disc sander that
won't leave swirl marks!

YOUR HOME WORKSHOP needs this sensational new FLEXBAC[®] PAD KIT, that does away with hand sanding, cuts refinishing time in half.

- Attaches to any quarter-inch electric drill.
- Flexible foam rubber pad hugs every curve.
- Discs hold tight with pressure-sensitive adhesive.
- Entire face of disc is usable — no center nut.
- Easy to peel off and replace discs.
- Perfect for removing paint...for rough and finish sanding.
- Works on metal, wood and plastics.

GET A FLEXBAC[®] PAD KIT

from your local Hardware or Building Supply Dealer. One demonstration will convince you it's the slickest sanding pad ever made. There's nothing like it!

**Only \$7.00
COMPLETE**

including adapter for
3/4" drill and can
of adhesive restorer.

LOOK FOR THESE DISPLAYS of other cost-cutting, time-saving abrasive products designed for home craftsmen:



- **COMBINATION SHARPENING STONES**
Specially made for keeping keen edges on your steel tools. Coarse on one side, fine on the other.



- **"HANDY-SANDY" DISCS**
For use with the FLEXBAC[®] PAD. Packed in handy envelopes, in five grit sizes, Extra Fine to Coarsest.



- **NIAGARA[®] BRAND GRINDING WHEELS**
Aluminum oxide abrasive grain is fast-cutting, long-lasting. Sizes to fit every home grinder, in Fine, Medium and Coarse.

CARBORUNDUM

REGISTERED TRADE MARK

... **FIRST** with the **BEST** in everything **ABRASIVE**

60-654

MORE ROOM IN YOUR



For Storage



5 Year
written
GUARANTEE
furnished with
each unit

PRECISION

Folding Stairway

AMERICA'S No. 1 STAIRWAY

SEVEN
EXCLUSIVE FEATURES

- 1—HYDRAULIC SAFETY CHECKS
- 2—ACTUATED BY COUNTERWEIGHTS
- 3—LIFETIME ROLLER BEARINGS
- 4—RUGGED AND STRONG
- 5—INSULATED DOOR PANEL
- 6—FULL WIDTH SAFETY TREADS
- 7—FITS ANY CEILING HEIGHT

TWO STANDARD SIZES:
8'9" AND 9'9"
Approved by leading
ARCHITECTS, BUILDERS,
and LENDING AGENCIES
LISTED IN SWEET'S

No Other Stairway Offers So Much



1 Year
GUARANTEE

SIMPLEX

Folding Stairway

QUALITY PLUS LOW COST

New!

BALANCED SPRING
ACTION for effortless
operation.

- SIMPLE AND EASY TO OPERATE
- RUGGED AND STRONG
- TWO STANDARD SIZES—8'3" AND 9'9"
- NO. 1 KILN DRIED LUMBER—HEAVY GALVANIZED STEEL—ALL PARTS SECURED BY BOLTS AND SCREWS—NO NAILS
- SHIPPED IN ONE PACKAGE
- MANUFACTURED IN PRECISION'S MODERN PLANT

BUILT FROM QUALITY MATERIALS FOR SERVICE AND DURABILITY—Economically Priced—Precision Engineered—Quality Built—Investigate now low prices on this superbly-engineered and quality-built stairway.

WRITE FOR FREE ILLUSTRATED FOLDER

PRECISION PARTS CORP.

400-PM NORTH FIRST STREET • NASHVILLE 7, TENN.

Please send me full information on

- PRECISION SIMPLEX

NAME _____

ADDRESS _____

CITY _____ ZONE _____ STATE _____

Keeping Up With the Atom

(Continued from page 105)

connected to a central indicator that tells where the fire is and to another instrument that rings alarms, closes fire doors and performs other fire-protection functions.



Scientists at the Geneva atomic conference foresaw the eventual use of an inexhaustible supply of heavy hydrogen from the oceans for the production of energy by controlled fusion of light elements. While the hydrogen bomb is already developed, scientists have yet to put the fusion of light elements under control for generating power.



Eight large companies have joined forces to build the first nuclear reactor to be operated by private industry for research in industrial and medical fields. The participants are the Continental Can Co., Chas. Pfizer & Co., American Tobacco Co., Corning Glass Works, International Nickel Co., United States Rubber Co., Socony Mobil Oil Co. and AMF Atomics, a subsidiary of the American Machine & Foundry Co.



Florida landowners and farmers can readily determine the radioactivity of their soil samples on their own. Researchers at the University of Florida's College of Engineering have established an atomic-energy tester which the public can use in testing their samples for radioactivity. If the counter registers a sufficient amount of activity, the soil is taken to the experts for a series of tests to determine whether or not the mining of the parent lode is economically feasible.



POPULAR MECHANICS

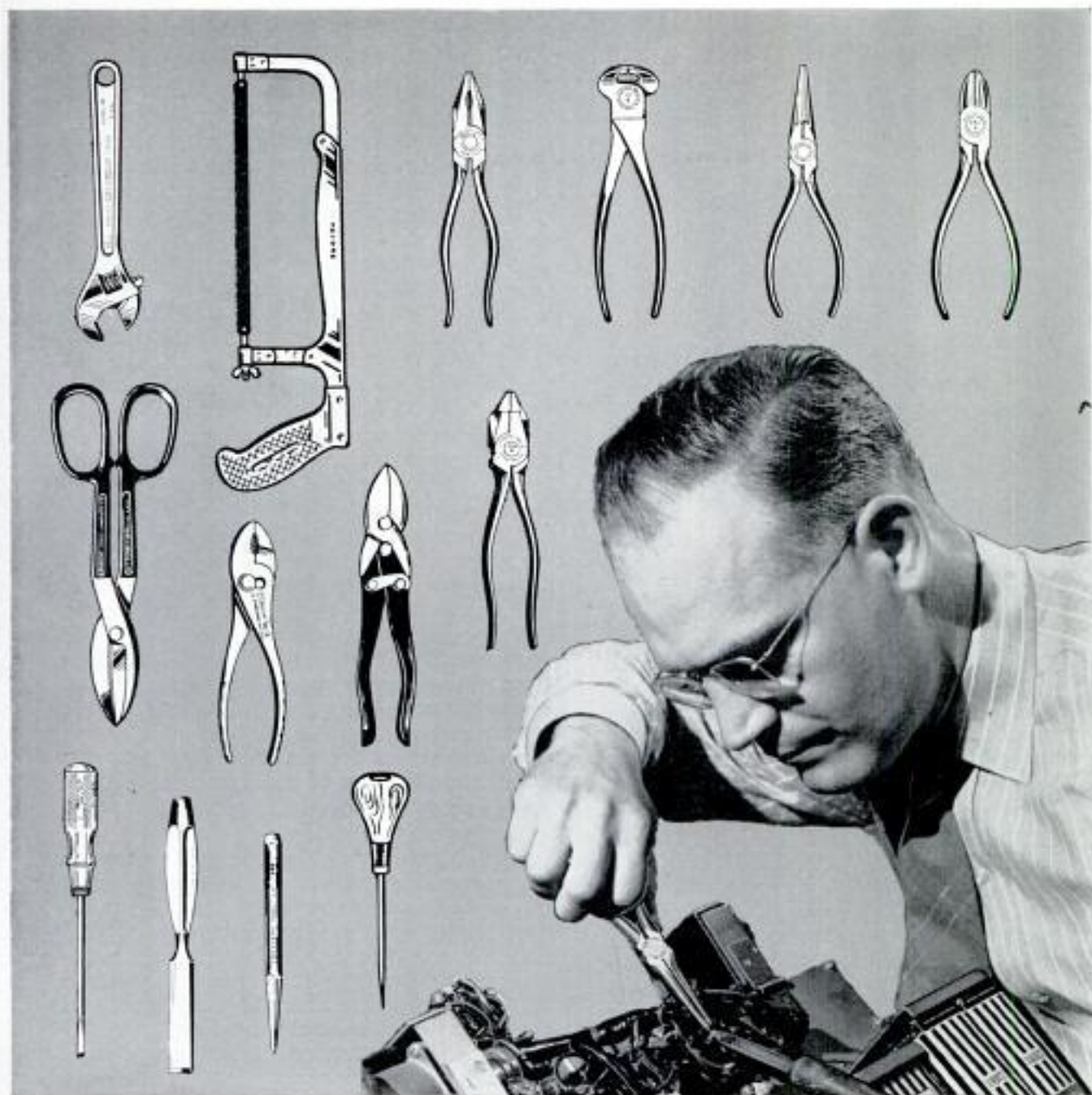

BACKGROUND FOR PERFORMANCE

Amateur or professional — artisan or handyman — whether you build, repair, tinker or maintain valuable equipment... you can do it better and easier with CRESCENT and CREST-OLOY TOOLS. Sold by Hardware Dealers and Industrial Distributors everywhere.

CRESCENT TOOLS

Give Wings to Work

*Sign of the Artisan
Symbol of Excellence*

Crescent is our trade-mark, registered in the United States and abroad, for wrenches and other tools. Sold by leading distributors and retailers everywhere and made only by
CRESCENT TOOL COMPANY, JAMESTOWN, NEW YORK

NEW IRWIN BIT*
SPEEDBOR "88"

Exclusive hollow
 ground point →

steps-up
 efficiency of small
 1/4" electric drills

Now bore faster, cleaner, deeper holes with small 1/4" electric drills and drill presses. No clogging, no binding. No wobble, no run-off either. New Irwin Speedbor "88" wood bits with exclusive hollow ground point and new spade-type cutters breeze through hard or soft woods, plywood, plastic. Forged in one piece from solid bar of special high carbon steel and hardened full-length to stay sharp much longer. Easy to resharpen with hand file. Size markings on both sides of head for quick selection. Hang-a-Bit hole for storing on nail or pin. Sizes 4/16" to 16/16". See the new Irwin Speedbor "88" when you visit your independent hardware dealer. *Patent Pending



on workshop shelf. As low as \$2.98.

SPEEDBOR "88"

ROLL SETS

Durable red plastic rolls with individual pocket for each bit. Available in 4, 6 and 11 bit sets. Compact roll conveniently fits in tool box or



only
69¢
 each
 any size
 4/16" to
 16/16"

at your independent hardware dealer

IRWIN
 Wilmington, Ohio

the original solid
 center auger bit
 •
 screw drivers
 screw driver bits

Can Our Tanks Take It?

(Continued from page 120)

Recently we had a van we knew might roll, so we built outriggers on it."

The 70 men who take the Army's vehicles on these punishing rides are a hardy lot, as good machinists as they are drivers. All are trained to become supervisors. "They have the most automotive know-how in the world," says Ford. "There are no 'cowboys' or 'daredevils' in this outfit. Any fool can smash a truck by slamming it off the road and into a tree. That's not the idea. But we can't have pussyfooters, either, or the vehicles would be dodging ruts and holes all day, and getting no true workout. Our men must drive consistently to the outer limits of safety, until parts give way under concentrated but normal rough use you'd find on a battlefield."

Most of that "normal rough use" would stand your hair on end. Yet Aberdeen's test drivers, who log up a half million miles of dangerous driving a year, have a far better record than civilians riding on flat concrete. The one and only lost-time accident in two years involved a man repairing—not driving—his vehicle. He leaned over to get a tool and cut his eyelid on a cotter pin. That doesn't mean there haven't been some narrow escapes that could have been fatal except for the skill of the drivers.

On the big hill at Churchville, tanks have snapped their tracks, lost control and gone on nerve-shattering dives into the brook at the bottom. Last winter a big 240-millimeter gun carriage spun backward and slid down on the ice, its locked tracks zipping along like gigantic runners under a sled. It thumped to a halt at the bottom and the driver climbed out unscathed. An M47 tank missed the turn at the bottom, plowed through an abandoned stone farmhouse and went roaring away virtually unscratched in a cloud of flying masonry and dust, the driver's crash-helmeted head tucked safely under the hatch rim. On a perfectly flat straightaway at Perryman, the steering mechanism on a roaring heavy tank went haywire. The driver hit the brakes, exploded a drum and wound up on an embankment at 53-percent list. The monster was so delicately balanced that the driver didn't dare move. Shifting his 200 pounds could have upset the equilibrium and rolled the multiton vehicle over him. A crane was summoned to hoist him out.

Just how much of a beating those courses can give a vehicle is indicated by the flood of breakdown reports that pours into Operations each day. "We may start with 35 vehicles running on all courses in the

(Continued to page 290)



It's a Jig Saw!



It's a Router!



It's a Shaper!

ROUTO-JIG

Amazing new 3-in-1 tool!

Now! See and try the revolutionary *quality* tool that puts dozens of new skills at your fingertips — Porter-Cable's sensational new Routo-Jig! *Three most-wanted tools in one!*

Use Routo-Jig as a portable router, for mortising, grooving, rabbeting. Use it as a rotary jig saw—cut intricate contours and freehand shapes. Use it as a shaper, for accurate moulding, beading, joining.

Routo-Jig gives you truly *professional* results every time—in fine cabinet work, furniture-making, home improvements, shop work of every kind. And you can own it *complete* at a big \$7.00 saving—if you act now!

Special introductory offer! Model 140 Routo-Jig, complete with Router Base, Jig Saw Base, and Shaper Table—\$61.95 value—now only **\$54.95!**

Porter-Cable

Quality Electric Tools



SEE YOUR DEALER — OR MAIL COUPON TODAY!

PORTER-CABLE MACHINE CO.
5140 N. Salina St., Syracuse 8, N. Y.

Yes, send me a complete catalog sheet on the Model 140 Routo-Jig, and the name of my nearest dealer.

Name _____

Address _____

City _____ Zone _____ State _____

saws • belt sanders • finishing sanders • drills • routers • planes

INSTALL TRUSCON SERIES 138 DOUBLE-HUNG WINDOWS YOURSELF!



THIS FREE BOOK SHOWS HOW

Step-by-step guide and clear pictures show you exactly how to install Truscon Double-Hung Steel Windows in frame, brick veneer, masonry or concrete-block construction. Hammer, screwdriver and level are the only tools you need.

You buy Truscon Series 138 Windows from your dealer *ready to install*. All hardware is factory-attached. Stainless steel weatherstripping and tape balances are built in. These steel windows won't rot, warp, swell or shrink. Won't rattle or stick. Will last a lifetime. Types and sizes for every home style. Storms and screens available, too.

Send coupon today. No obligation.

**TRUSCON STEEL DIVISION
REPUBLIC STEEL
YOUNGSTOWN 1, OHIO**



**TRUSCON STEEL DIVISION,
REPUBLIC STEEL**

1126 Albert Street • Youngstown 1, Ohio
Please rush free book showing how to install
Truscon Double-Hung Steel Windows, Series 138.

Name

Address

City Zone State

K-8461

morning." says Charlie Dewey, "and by noon only four will be operating."

When a new vehicle comes in, a driver is assigned to it. He lives with the machine through all test phases, often walking it through the shops for its initial "tear-down" examination. Once reassembled, the machine begins its tortures. In a cold room it is frosted to 70 degrees below zero and started up, to see how it will function under arctic conditions. In a hot room it is baked to a sizzling 165 degrees and operated to test its desert stamina. Past that hurdle, driver and engineers wham it over the Munson torture racks in an effort to flunk it out quickly if it has a basic-design fault.

"One of the first indignities we inflict on a new truck," Ford reveals, "is to pick it up with a crane—one hook on front, one at the back. That tells us something about the frame. Recently, a 2½-ton truck we lifted folded like a book."

What the cranes don't do to a frame, the frame twister will. Anything riding across that 400-foot stretch of 28-inch alternating humps must be able to writhe like a snake and come out in one piece. "We've had 'em pretzel so badly that bolts sheared and popped out like bullets," says Ford. "Fans cut through radiators, axles crack in two. One tough-looking truck frame bent like an elbow halfway across. Plenty of vehicles have had to be picked off the middle of that thing with a crane."

Naturally, running tracked vehicles across the twister wouldn't prove much. So tanks have a special torture bed—589 feet of jagged granite rocks. "Three or four trips across that rock pile will tear a new set of rubber-cleated tracks to shreds, twist the steel beyond repair," Ford says, "but tests like that have brought vast improvements. Track on a heavy tank used to be shot in 200 miles of normal use. Today they'll do many, many times that."

But for pure grinding punishment, all the men agree that nothing at Munson is harder on a vehicle (or driver) than the Belgian Block road—a battering mile of rough, wavy cobbles on which the vehicles are driven around and around until something vital falls off. "Men riding the huge traction units on which the 280-millimeter atomic cannon rode when it was being tested on that road couldn't stay in the cab at anything over 12 miles per hour," Smitty recalls. "Sometimes, everything but the item being tested comes apart. A year ago we were towing a high-priority gun carriage on a 50-mile dose of Belgian Blocks. The carriage did fine. But we destroyed five tow trucks in 30 of those miles, and finally had to complete the test using

(Continued to page 292)

Good News for
budget-minded
HANDYMEN...



NOW BUY THIS BASIC POWER TOOL WORKSHOP

by **SHOPMASTER**

Complete
with MOTOR



for only

\$ **17** ⁵⁰
DOWN
and Small
monthly
payments

FROM YOUR

Shopmaster
HARDWARE & LUMBER DEALER

Now you can buy Shopmaster tools on the famous GECC Handyman payment plan. Pay only 10% down and balance in up to 18 months. Buy the Shopmaster Saw-Jointer combination or any Shopmaster tools totaling more than \$150 on this wonderful handyman payment plan. It's Shopmaster's way to give you tomorrow's power tools right now!



Just plug it in 
flip the switch and operate

To Complete Your Workshop
Add These Other Quality
SHOPMASTER TOOLS
on easy **GECC** payment plan



10" Tating Table
BAND SAW



12" Bench Model
DRILL PRESS



20" Jig Saw
Includes Motor

OTHER SHOPMASTER TOOLS



8" Tilting Arbor
Floor Model Saw



6" Ball Bearing
Jointer-Planer



12" Floor Model
Drill Press

Plus Complete Line of Accessories

Look at the features on this
Shopmaster Saw-Jointer Combination

- Ready to plug in and operate
- Comes complete with 1/2 HP motor
- Big husky 8" tilting arbor saw with 2 1/2" depth capacity, 13"x16" table size, mitre gauge and rip fence
- Rugged 4" jointer-planer with 1/8" cut, 4"x26" table and flexible guard
- All steel stand is 26" deep, 34" long and 36" high
- Handy switch is conveniently located in front
- Both tools have sealed-for-life ball bearings
- Saw-jointer combination, stand and motor sell for only \$174.50

It's America's Greatest Power Tool Value!
Write for **FREE** Catalog



Shopmaster

ROOM 10C, 1214 SOUTH THIRD ST., MINNEAPOLIS, MINN.

CHAN NEL LOCK pliers
*The most versatile
 tools on your bench*



insist on...

CHAN NEL LOCK

TRADE MARK REG. U. S. PATENT OFFICE



here's why

Look for the Channellock line when you're shopping for hand tools. Channellock pliers offer features that you can't get with other makes. And when you buy a Channellock plier, ask to see the full line—you'll find a style and model to do any job better.



THE PLIER DESIGN THAT OBSOLETEs ALL OTHERS

CHAMPION D•ARMENT TOOL CO. • MEADVILLE, PA.

a modified light tank as the prime mover."

Once a vehicle has passed the quick shakedown at Munson, the driver takes over. If it's on tracks, he'll probably bounce it over 7000 miles of Munson, Perryman and Churchville before he's through. If it's on wheels, it will get up to 15,000 or more miles of punishment. Smitty, who put in 11 years as a test driver before retiring to office work, reels off the routine. "Usually 40 machines are running in each eight-hour shift around the clock," he says. "A driver's schedule generally calls for cycles of 500 miles. Each runs about 25 miles per shift—and that's a workout."

Every day for eight hours, the battered driver pilots his bucking charge over the same holes and ruts, back and forth, grinding the sobbing, creaking pile of machinery to pieces. Every few hours, he must stop to see if everything he started with—down to the last bolt—is still there. Usually it isn't. Twice a day, he must wash four inches of caked mud from his vehicle with high-pressure hose and lubricate his monster. It isn't unusual for a tank to come in from Perryman laden with two tons of caked mud. In winter, when it's frozen, tanks grind to a halt and the stuff must be loosened with a blowtorch first. Then, cleanup is a four-hour operation.

Perryman and Churchville are toughest on the drivers. Two years ago it rained for three weeks and there were actually five-acre lakes over the "road," with deep ravines hidden under the wavelets. "One driver rammed his tank into a seven-foot pond, conked out and sat marooned on the turret until we went after him in a boat," Smitty recalls.

At its best, Perryman is a rolling sea of mud. The rocking action of the heavy tracked vehicles piles up huge hummocks seven to ten feet high, with water-filled gullies between. Ride the copilot's turret in an M51 over the mess at full speed, as this author did, and you get the effect of sailing a 30-foot launch on a heavy sea. Only this sea is lumpier. Each time you hit a gully and plunge into a lake, the spray that hits you is brown and gritty with mud. Drivers at Perryman change clothes four or five times a day. An amateur (as this one will testify) can wind up after one run at Perryman with black and blue welts around his midriff from whamming the rim of the cockpit as the machine pitches and jolts—first forward, then backward, then sideways over the "roller coaster" course. Drivers soon learn to ride with their charge, "posting" like a horseback rider to ease the pounding. Copilots, who take inside temperature readings occasionally, have

(Continued to page 294)

YOU CAN PULL A
Mobile Home
 WHEREVER YOUR JOB
 TAKES YOU! ONLY
\$2000 TO \$7500
FURNISHED

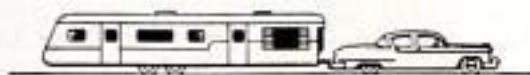

● With a mobile home, there's *no house hunting*. When you move from job to job, there are *no family separations*. You simply hitch your completely furnished home to your car and take it with you.

Every room is completely furnished with the newest furniture, fixtures and appliances, including electric refrigerator, gas range and twin sinks.

Some models offer air conditioning, built-in television facilities and automatic garbage disposal units.

Look for the MHMA Seal—be sure you buy a mobile home *made* by a member of the Mobile Homes Manufacturers Association. These are the manufacturers you can count on for the most efficient designs, advanced *styling*, good service and dependable construction.



**FURNISHINGS INCLUDED
 IN THE PRICE**

The price includes sofa, chairs, beds, vanity, dinette and major appliances. Also, draw drapes to cover the picture windows when you want privacy.

Tub and Shower are among the complete bathroom facilities offered in today's modern mobile homes. Note the gleaming porcelain fixtures and beautiful tile walls.



Watch Dave Garroway and Steve Allen show MHMA mobile homes on "TODAY" and "TONIGHT" over NBC-TV.

Free book on newest models!

Pictures and full specifications. Write Dept. PM-105, Mobile Homes Manufacturers Assn., 20 N. Wacker Drive, Chicago 6, Illinois.

Name _____
 Street _____
 City _____ Zone _____ State _____



**MOBILE HOMES
 MANUFACTURERS ASSN.**

YOU'LL EARN BIG MONEY

with
HOBART
"Simplified"

**ARC
WELDING**



AC Welding and DC Power

Double your earnings doing repair and construction work, away from power lines. "Build Your Own" gives you AC welding—plus electric power for operating tools, lights, etc. Use a gasoline engine, or hook to drive shaft with V belt.

Welds Anywhere!
Air Cooled Portable
Engine Drive

With the "Musky Boy" 200 amp. arc welder you can do profitable general shop and outside repair work; emergency service on pickup trucks—all on a low investment. It's compact and lightweight—easy to transport. For extra convenience when used inside, wheels and handles easily bolt to the unit, and are available at slight extra cost.



**300 Amp. Electric
Portable Arc Welder**

Superior performance with true economy should make this welder your choice for 9 out of 10 welding jobs. Remote Control • 1000 Welding Heat Gradations • Oversize 4 Pole Exciter • Sirocco Type Cooling Fan • Vibrationless Steel Shaft • Polarity Control are Hobart features that assure faster, better, low cost welds.



**The Hobart
Welding School**

America's most modern. Every type of training. Equipment latest and best.



You'll like Hobart Electrodes

Hobart's complete line, precision made and rigidly inspected, solves every welding problem.

Hobart Brothers Co., Box M-105, Troy, O.
"One of the world's largest builders of arc welders"

HOBART BROTHERS CO., BOX M-105, TROY, O.

Send complete details on items checked.

Electric Drive Gas Drive Generator
 Only Air Cooled Gas Drive Hobart
Trade School Electrodes Accessories

NAME _____

ADDRESS _____

CITY _____ STATE _____

FREE!



Check here for your very pocket welding guide

become seasick in the heaving belly of a tank at Perryman. At the end of a day's run on this course, driver and copilot wash down the steel hulk, as well as themselves, and take off for home with a hum in their ears that may last an hour or more. But not before a report has been turned in. For driver reports are the key to constant improvement of all the Army's automotive equipment. Typical remarks will read like this:

"Engine backfired through air cleaner when accelerating. Lost safety pin out of tow bar and bar unhooked once. Bars turned and sheared safety pins. Tow bar is bent at towed-load end. Noted pin started to work out of pintle block. Engine still pulls down transmission. Seems to be shifting out of lockup too late. Opened auxiliary gen. ½ hour. Noticed Number 5 shock absorber on towed load had bolts sheared out of top brackets. Washed and found three top brackets loose. Need welder to weld them to hull."

The classic remark made by a proud manufacturer who brought his latest product to Aberdeen for a going-over, is still quoted with a chuckle by everyone at the rugged Proving Grounds. "Well, I'm giving you a fine machine," the man said, "all painted and shiny. And when you're through with it I'll probably get it back on a shovel."

He was right. But because of Aberdeen's torture courses, today's Army vehicles are the toughest, ruggedest and most efficient in the business. Tank-engine performance has jumped from 100 to 400 hours of useful life, due largely to the things these men discovered. Tracks that used to split up under a few quick turns on rock or concrete go many more hundreds of miles under the roughest kind of treatment. Developments in suspension, clearance and accessory mounts have improved to a point where they are nearly indestructible. And these are only a few of the things that the jockeys riding mechanical steeds over the world's worst roads have helped to produce. Where they leave off, the fellows with drawing boards and slide rules start over again, in the constant effort to develop the world's best army on wheels. ★ ★ ★

Window-Sill Covering

Unsightly and rotting window sills can be hidden by a new covering made of aluminum. The cap, made in different styles to cover all types of window sills, is slipped into saw cuts made at the bottom of the parting strips and the window casing. It is secured with aluminum nails.

NOW! A Genuine *SKIL* Saw for only \$29.95

Built to handle 95% of your
"home and hobby" Jobs

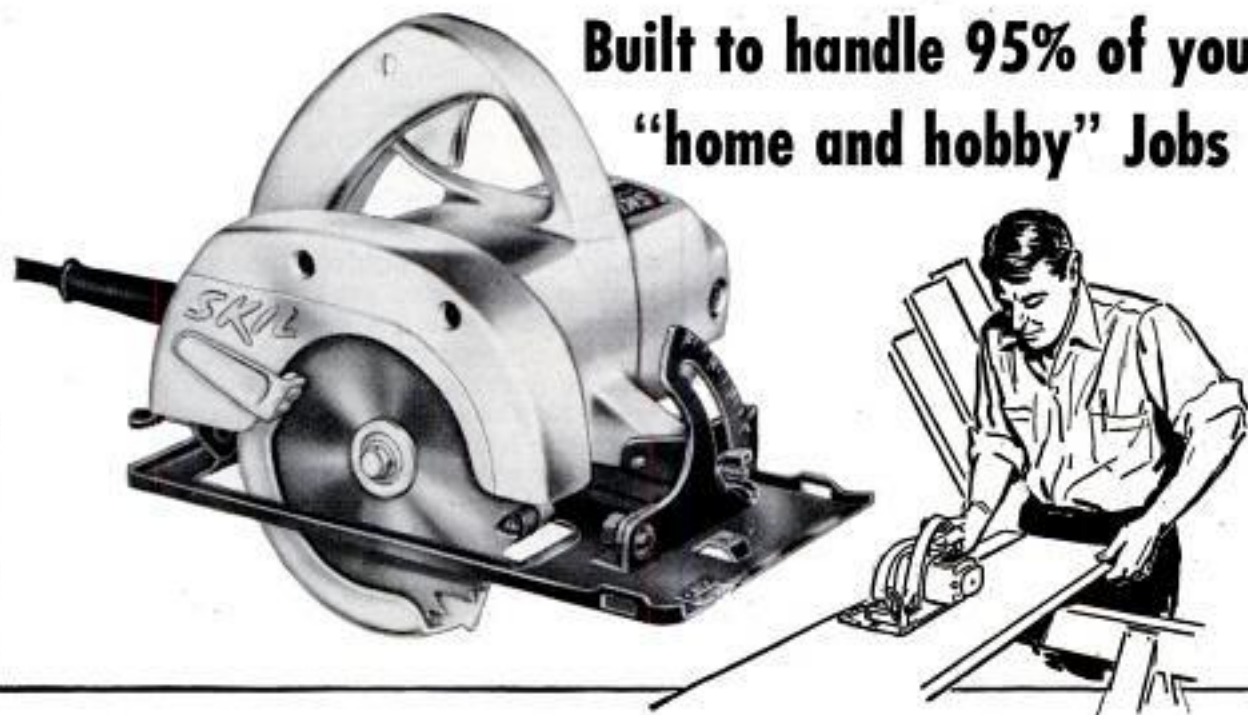

Here's all the power and performance you need for almost any home or workshop sawing job—at a fraction of the price you'd pay for a heavier saw! This quality SKIL saw has ample capacity to speed through paneling, plywood, tongue-and-groove board and shelving. Makes quick work of Celotex, wall board,

Formica and other materials. Cuts 2 by 4's simply by flipping the board. Lightweight comfort-grip handle for easy one-hand operation. Cuts to 1-5/32" vertical depth, makes 45° bevel cuts to 1" depth. This is a "must" for every home. Ask for a demonstration at your Hardware Dealer's today!

No Other Saw Offers these Famous SKIL Features for Only \$29.95!

- Powerpacked motor • Guard lift-depth and bevel adjustments • Trigger-type switch • Built-in sawdust blower • Telescoping blade guard • Comfort-grip handle

4 1/4" SKIL SAW, Model 504

does these and many more sawing jobs! Build screens, storms, sashes! Build cabinets or built-ins! Build a spare room in attic or basement!

SKIL

BUILDERS TOOLS

Made Only by SKIL Corporation, Formerly SKILSAW, Inc.
5033 Elston Ave., Chicago 30, Illinois
3604 Dundas Street West, Toronto 3, Ontario
Factory Branches in ALL Leading Cities

Win a Ford Victoria—or One of Many Other Valuable FREE Prizes!

It's easy to win—there's nothing to buy!
Enter the big SKIL Grand Prize Contest!
Entry blanks at your Hardware Dealer's!

COVER YOUR OLD FLOORS WITH BEAUTIFUL OAK



Just nail down **BRUCE Prefinished FLOORING**

...it's already sanded and finished!

DO-IT-YOURSELF!—It's easy to give your home the modern style and lasting beauty of solid hardwood floors. Just nail Bruce Prefinished Flooring over your old floor... or over a wood subfloor in new rooms. These beautiful oak floors are completely finished at the factory. You can start enjoying them immediately without the bother, mess and delay of on-the-job sanding and finishing.

Choice of designs—There's a Bruce Prefinished Floor to suit your home and tastes: ever-popular Strip; informal Ranch Plank; the exciting new dark-finished Fireside Plank; or distinctive Block, which also can be installed in mastic over concrete. All have the famous Bruce "Scratch-Test" finish, factory-applied for beauty, durability and easy upkeep.

Economical—A new Bruce Prefinished Floor costs less than a good rug or carpet. Ask your lumber dealer for an estimate. Mail coupon for helpful installation booklet.



FREE HOW-TO-DO-IT FOLDER

E. L. Bruce Co.
Box 397-B, Memphis 1, Tenn.
Send free booklet, "How to Install
Bruce Prefinished Hardwood Floors."

Name

Address

Bruce PREFINISHED Oak Floors

By the world's largest hardwood flooring maker

The PM Young-Family House

(Continued from page 156)

if the family wishes greater privacy. Other kitchen features are a waist-high oven, built-in counter-type range, dishwasher, garbage disposal and cabinets within easy reach.

For entertaining, the large living-and-dining area becomes one room. The house was planned to face north with a south exposure for the living-room windows. Entrance to the living room is handy to the front door, but traffic to kitchen or bedrooms does not go through this room. Both living and dining areas have cork floors, eliminating expensive wall-to-wall carpet.

A door opens from the living room onto a side terrace, or outdoor living area. The terrace is shielded on three sides by the house, garage and a fence with the open side looking out toward the back yard. This terrace provides an excellent outdoor play space for the children and is partly visible from the living room, dining and kitchen areas for purposes of supervision. An outdoor fireplace with a grill on the terrace provides a good entertainment feature. If a screened porch is desired, the flat living-room roof may be extended over part of the terrace. "The do-it-yourself craftsman can save money," says Jones, "if he does this section himself."

Actually, the house could be built as a do-it-yourself project as easily as a one-story ranch-type home. The outside walls on the lower floor are made of concrete blocks. The central bearing for the floor above (bedroom area) is a steel girder on steel posts. The floor framing is made of 2 by 10 joists, 16 inches on center. Working drawings for the house show conventional roof construction, but it could be built with easy-to-handle nail-glued trusses developed by the Small Homes Council and Purdue University. The living-room-kitchen section is built over crawl space.

The windows are a combination fixed-glass and awning type; all may be double glazed with storm panels or may be purchased with insulating glass that is never removed. Screens are fitted to the inside. Heat is supplied by a three-zone baseboard radiation system with forced hot water. The three-zone system provides for separate thermostatic controls for the three different levels of the house. Thus, if the south-side level has a lower heat demand during the day, the supply to that area will be reduced. The separate control also keeps the sleeping area at a lower temperature during the night without affecting the rest of the house.

(Continued to page 298)

DO IT TOGETHER . . . YOU AND . . .

DUO-FAST

WINDOWS NEED PUTTY?

**Do it Yourself
with the
DUO-FAST
PUTTY KNIFE**

WORKS LIKE A CHARM

Patented end packs, shapes, trims putty with one stroke. No skill or experience needed. Anyone can use it.

Handy scraper on other end for dozens of other household uses.

A quality tool, won't break or rust, Guaranteed. If your dealer can't supply you, order direct.



00
ppd



101 JOBS

**Done Fast and
Easy with**

**DUO-FAST
STAPLE TACKERS**

YOUR FAVORITE TOOL

Just squeeze the handle, and in goes the tight-holding staple right where you want it. You will use it over and over for all sorts of tacking jobs. Drives staples from 3/16" to 9/16". A great tacker that's fully guaranteed.



- Insulation
- Ceiling Tile
- Building Papers
- Weatherstrip
- Upholstering
- Screens
- Rug Pads
- Many Others

**Mail this
Coupon
Today!**

FASTENER CORP. - Do-It-Yourself Dept.
860 Fletcher St., Chicago 14

- Send data on Duo-Fast Putty Knife.
 Send data on Duo-Fast Staple Tacker

NAME _____

ADDRESS _____

CITY & STATE _____

FASTENER CORP. - 860 Fletcher St., Chicago 14

Be Your Own Boss in the Profitable Excavating Business!

**CUSTOM OPERATORS OF
SHERMAN POWER DIGGERS EARN**

UP TO \$1,000 AND MORE PER MONTH!

Wherever you live, you'll find plenty of profitable work the whole year 'round for this versatile outfit . . . not just a "trencher" but an all-purpose excavating machine! Custom operators everywhere are making big money with Sherman Power Diggers. One bought a farm with just 3 years' profits! Work for builders, contractors, utilities, and municipalities on such jobs as • SEPTIC TANKS and DRAINFIELDS • SEWER LINES • FUEL TANK INSTALLATIONS • FOUNDATIONS and FOOTINGS • GAS and WATER LINES • FIELD TILING and many others. The Sherman Power Digger travels quickly from job to job, digs at a fraction of the cost of manual labor. It's simple to operate, easy to maintain, built to last . . . and, complete with tractor, actually costs less than many new cars! Send now for complete information about the easy-to-get jobs for your Sherman Power Digger. No obligation.

SHERMAN PRODUCTS, Inc.
Dept. 1720 Royal Oak, Michigan

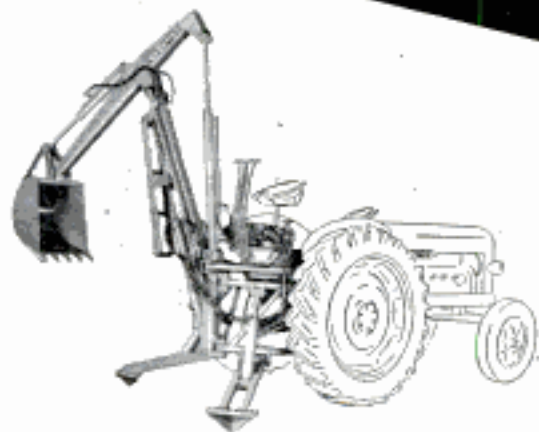

Send Now for FREE LITERATURE!

SHERMAN PRODUCTS, Inc.
Dept. 1720 Royal Oak, Michigan

Please send me complete information on the Sherman Power Digger

NAME _____

ADDRESS _____

CITY _____

STATE _____

How to choose a paintbrush that does faster, streak-free work



Here's why it pays you to use a brush with Du Pont TYNEX nylon bristles



1. No break-in! You don't have to soak or flex a new brush . . . if it has "Tynex" nylon bristles.



2. Full paint pickup! Specially tipped and flagged "Tynex" bristles hold a full load of paint.



3. Smooth, even flow! Anyone can do streak-free work, because each tapered "Tynex" bristle provides better, more even flow.



4. Easier to clean! They're the easiest-to-clean bristles there are! Paint loosens quickly in any commercial cleaner, rinses out thoroughly.

FREE! 8-page booklet full of helpful painting tips. Write Du Pont Company, Polychemicals Dept. PM-10, Wilmington 98, Del.



"Tynex" is the registered trade-mark for Du Pont nylon bristles.

BETTER THINGS FOR BETTER LIVING . . . THROUGH CHEMISTRY.

It is estimated that the house and garage as shown on these pages would cost approximately \$22,000 in the Urbana, Ill., area. This does not include the lot. However, the cost can be reduced considerably by delaying construction of the garage, substituting a carport for the garage or omitting the paved terrace and fireplace. The house could be finished with one bathroom, leaving the second bath and basement lavatory for later do-it-yourself projects. The owner could do all of his interior decorating and put in all of the basement partitions.

A carport could be built by extending the flat roof over the court entrance. This would also make it possible to put the house on a smaller lot.

One of the best recommendations for this PM Young-Family House is that the architect who designed it has incorporated many of its features (including lower-level playroom) into his own new split-level home.

★ ★ ★

Asbestos-Aluminum Insulation Blanket

Paper-thin asbestos combined with aluminum forms a new insulation blanket that resists fire. In addition, the accordion-fold blanket stops heat and vapor. Easily installed with staplers, the blanket is made for 16 and 24-inch joists and is available in rolls 125 to 375 feet long. It can be used on ceilings, roofs and crawl spaces. The paper-thin asbestos withstands temperatures up to 800 degrees before disintegrating; the aluminum sheeting, shielding both sides of the asbestos, melts at 1220 degrees.

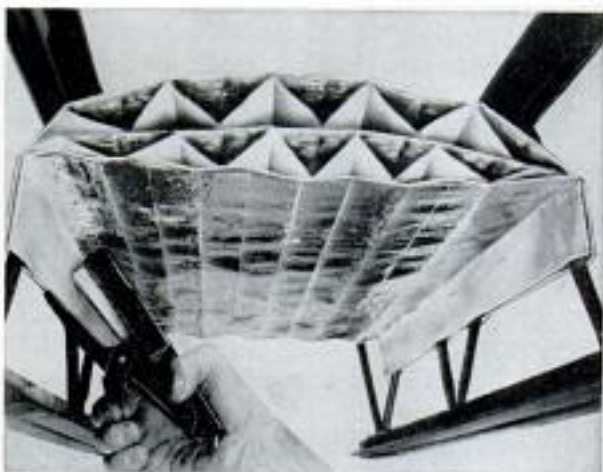

☐ In one violent electrical storm studied by scientists, it was estimated that lightning generated every three minutes 200,000,000 kilowatts of power—equal to the rate of electric power generated in the United States.

It's **EASIER** to
**"DO-IT-
 YOURSELF"**
 when Indestro
**UTILITY
 HOLDERS**
 ... keep tools in easy reach!



Householders, Car Owners, Mechanics, Home Workshop Hobbyists! You'll want to mount these handy Utility Holders on the wall alongside your work bench... a convenient place to keep wrenches and sockets where they can be quickly removed or returned. You always know where to find them. Wall-Klips or Holders actually cost you nothing as they are included with Indestro Wrench and Socket Sets described here.

See them at the hardware, implement, auto supply or variety store that sells Indestro Tools, or write us for name of your nearest Indestro Dealer.

Double-Duty Wall-Klips included with these socket sets

Bright red or green baked enamel finish Wall-Klip of sturdy, one-piece construction that keeps tools orderly and firmly in place yet easily removable as needed. Two key-slots for wall mounting. Wall-Klip with following 19-piece Indestro Socket Set No. 1454: 1/2" Hex Drive: 8 Sockets, 7/8" to 1 1/4"; 6 3/4" Ratchet; 9 1/4" L-handle, Screw Driver Adaptor; 1/2" Hex Drive: 5 Hex and 2 Square Sockets and 4" L-handle. An 11-piece set with Wall-Klip is also available, if preferred.

Klip-Tite Holders included with these Indestro Wrenches

Box End Wrenches illustrated are packaged in red-enameled metal holders that open up to form convenient wall-bracket with two holes for easy mounting. Six wrenches in Klip-Tite Holder:

No. 910-5W, Range 3/8" to 1": Set includes 3/8 x 7/16", 1/2 x 9/16", 5/8 x 11/16", 3/4 x 25/32", 13/16 x 7/8", 15/16 x 1". Also available with Combination Wrenches.



INDESTRO MFG. CO.
 NORTH KILDARE at SCHUBERT • CHICAGO 39, ILLINOIS



IDEAS

and Plans
 for Your
GARAGE

Here's a 32-page Plan Book that includes 12 smart garage designs and sensible floor plans, how-to-build instructions, material lists, driveway sketches, etc.

Plans provide for the 9' wide Strand Garage Door (gives you a full 12" of extra width; saves banged up fenders!). This popular all-steel door will stay new for a lifetime; you get permanently easy operation. No warping, swelling, sagging—ever. Strand doors are galvanized with a heavier, hot-dipped zinc coat for rust protection and clinging base for paint.

You get big savings, too. Low first cost—because of huge production. Lowest installation cost, because of one-piece door leaf and factory-assembled hardware. See Strand 9' x 7', 8' x 7' and 16' x 7' doors—at your lumber dealer's.

Plan to Do it Yourself?

Strand is the quickest, easiest of all doors to install!

STRAND
 ALL-STEEL-GALVANNEALED
 GARAGE DOORS

Strand Garage Door Division
 Detroit Steel Products Co., Dept. PM-10
 2253 E. Grand Blvd., Detroit 11, Michigan

Please send 32-page booklet of Garage Plans and Ideas. I'm enclosing 10c for postage and handling.

Please send free 12-page booklet showing how to modernize my garage.

Name _____
 Address _____
 City _____ Zone _____ State _____

Own a '55 Chevrolet or Ford?

Then you can enjoy the
CONVENIENCE, SAVINGS
and SMOOTHER RIDE of

Push Button POWER LUBRICATION



with **NEW**

Multi-Luber

WHAT IS MULTI-LUBER? Like power steering, and power brakes, MULTI-LUBER means *power lubrication* for your car at the press of a button on your dash. No more long waits between "grease jobs." Grease with ease whenever you please! A touch of your finger delivers an exact amount of refinery-pure lubricant to every chassis bearing in seconds. Adds years to the life of your car!

Buy it installed from your car dealer, garage, or service station—or install it yourself. Kit includes complete instructions for quick and easy installation.

USE THIS BLANK TO OBTAIN
COMPLETE INFORMATION:

IN KITS
AS LOW AS
\$41⁹⁵
PLUS
INSTALLATION



LINCOLN ENGINEERING COMPANY
ST. LOUIS 20, MO.

Please send me your illustrated leaflet describing
MULTI-LUBER, and the name and address of
my nearest Multi-Luber Dealer.

NAME.....

STREET.....

CITY.....STATE.....

(Please print or typewrite)

Clymer Tests the Chrysler

(Continued from page 124)

being about 110 miles per hour as the speedometer was about seven percent fast.

Chrysler's power steering is good even though one is inclined to over-steer until accustomed to it. Little effort is required to turn the wheel and the front wheels straighten themselves after cornering without help from the driver. The 3½ turns of the wheel from lock to lock is rather fast for an American car, but it is highly desirable and makes for better cornering control and easier parking.

Chrysler's brakes are perfect for normal driving, although there was slight fading when used at extreme high speeds. The brakes were power-assisted and pedal action therefore extremely light.

Chrysler's PowerFlite transmission is fully automatic, consisting of a torque converter and two-speed planetary gear set. The torque converter and planetary gear break-away ratio is 4.47:1. Upshift takes place from 15 to 65 miles per hour, depending upon throttle opening. This can be a smooth operation with careful use of the throttle, but it can be a rough shift if the throttle is used carelessly. The downshift automatically takes place at 11 miles per hour and is a little on the rough side. By depressing the throttle below 60 miles per hour the automatic downshift takes place quickly and with a noticeable surge of instant forward motion. Above 60, the passing gear does not operate and it would be better if it did up to at least 70. PowerFlite is a strong, well-engineered unit that takes abuse and gives very little trouble.

The test car was equipped with Airtemp air conditioning. Controls can be quickly adjusted to desired temperature. A blower with a three-speed adjustment enables the driver to select the desired temperature. The fresh and cold-air inlet is mounted on the deck in back of the rear seat, the air being sent forward across the top of the car. This makes for good distribution.

No squeaks or rattles developed. And the most severe water test possible was experienced in a rainstorm of almost cloud-burst proportions in Oklahoma. In the middle of the afternoon rain and hail came down so hard that all cars on the highway stopped for about ten minutes, but no water seeped into the test car.

The New Yorker is a massive car with excellent bumper protection. Both front and rear bumpers are practical for either parking protection or pushing a stalled car, which still has to be done occasionally.

The interior is luxurious, with quality

(Continued to page 302)

Imagine!



My daddy's making Window Screens *in the* **Fall!**

YOU BET, WITH THESE HOMESHIELD® **SCREEN KITS**

HE'S ASSEMBLING ALUMINUM SCREENS IN HIS SPARE TIME
...SAVING UP TO 50%...AND MAKING EXTRA MONEY, TOO!

MANY USES:

YOUR HOME



CABINS

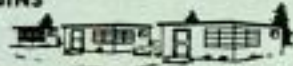

COMMERCIAL BLDGS.

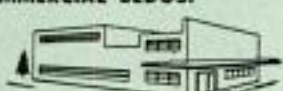

APARTMENTS

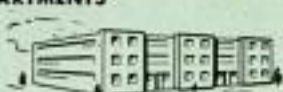

AS SIDELINE BUSINESS



Use coupon. Sizes shown are the maximum size screen which can be made from each kit. So just check the kit size which is the same as or larger than your present screen size.

Make your spare time pay off now, assembling Homeshield screens. Don't wait till spring when you're busy outside. Just put 'em together this fall and winter in your workshop or basement, when conditions are best. Make 'em for your home, cabin, or shop and save money... make 'em for neighbors, apartment houses or businesses, and make money!

No more repairing or repainting! Replace your heavy, old-type screens or screen your new home with these sparkling, cost-saving screens. Thousands already in use... it's a proven new product that'll dress up your home for life!

These screen kits are complete, contain Aluminum frames, Fiberglass screening corner locks, installation hardware, clear directions — even a miter box. Anyone can assemble them in 5 simple steps!

- Aluminum full-frames *never* need painting
- Easy-to-handle FIBERGLAS® screening can't rust, corrode or stain
- LIGHTWEIGHT — easy to install or remove in a jiffy. No ladders needed!

NOW is the time to act. You'll save up to half by making your lifetime screens with these kits this winter.

Ask your hardware or lumber yard dealer for Homeshield screen kits. If not available, ORDER DIRECT for speedy mail shipment! MONEY-BACK GUARANTEE if not completely satisfied. You simply can't lose.

Please send me kits for full screens as indicated:

Up to 24½" x 48" at \$4.58 ()	Up to 36½" x 56" at \$6.18 ()
Up to 32½" x 56" at \$5.78 ()	Up to 36½" x 72" at \$7.62 ()
	Up to 48½" x 72" at \$9.48 ()

Please send me kits for sliding half screens as indicated:

Up to 28½" x 28½" at \$3.82 ()	Up to 36½" x 36½" at \$5.00 ()
Up to 32½" x 32½" at \$4.42 ()	Up to 48½" x 48½" at \$6.98 ()

Name

Street

City State

Shipped postpaid. Send check or money order. No COD's please

AMERICAN SCREEN PRODUCTS CO., 807 N.W. 20th St., Miami, Fla.

EVERY SKILLED CRAFTSMAN,
MECHANICAL HOBBYIST AND
DO-IT-YOURSELFER SHOULD
HAVE THIS NICHOLSON

HANDY FILE

TWO FILES
IN ONE:

DOUBLE CUT ON ONE
SIDE—SINGLE CUT
ON OTHER SIDE

Like those inseparable Siamese twins, the Nicholson HANDY FILE is *two files in one*. Either or both are always at hand... in the single-cut side for smoothing and edge sharpening; the double-cut side for fast stock removal.

Flat forged-on orange-colored handle makes the HANDY FILE easy to carry—in hip or leg pocket. Hang-up hole makes it easy to store and find. Cellophane wrapping brings it to you rust-and-moisture free. Made by the world's foremost file manufacturer, you can be sure it is unbeatable in long-lasting quality.

(Also made in Black Diamond brand)

At hardware stores everywhere

FREE new edition of Nicholson's famous 52-page book, "File Philosophy." Write to



NICHOLSON FILE COMPANY
22 Acorn St., Providence 1, R.I.



(In Canada: Nicholson File Company of Canada Ltd., Port Hope, Ontario)

NICHOLSON FILES

FOR EVERY PURPOSE



upholstering and appointments throughout. The doors feel solid and operate easily. I'm not impressed with the double operation necessary to open the doors: You push the front end with the thumb, which ejects a handle to be pulled by the hand.

Instruments are well located. I especially like the trip-mileage indicator and the speedometer dial. Even though there is an upper horn ring, there is no vision obstruction of the instruments. The speedometer needle is red against a black background and when driving against the sun, reading is difficult. The gauges for fuel, oil, temperature and amperes are needle type, which I think is much better than warning lights. Chrysler uses the six-volt electrical system.

The shift selector is mounted on the instrument panel and, as one becomes more accustomed to it, it seems to have some advantages over the conventional type mounted on the steering column. The windshield wipers are two-speed, electric and highly desirable even if a bit noisy. The wiper blades do not extend far enough on the outer edges of the windshield, but this is normal for modern cars with the massive windshields. The small glove compartment is mounted in the right side of panel.

Fresh air is admitted inside the body through a push-up cowl ventilator. The key starter is well located within three inches of the shift selector. The emergency brake operates at the rear of the transmission, as on all Chrysler products, and is effective. The rear-view mirror is wide, but when the car is heavily loaded, it is difficult to place the mirror in any position where you can see back farther than 100 yards.

Taillights are mounted high at the back end of the rear fenders. They appear as chromed gadgets that might have been added as an afterthought, or bought by the owner as an accessory from some speed shop. While they are functional and serve their purpose satisfactorily, they are not in keeping with Chrysler quality.

The car had 7000 miles on it at the time I left Detroit. I added three quarts of oil the first 1000 miles, possibly because the short-stroke engine had not been used hard enough to seat the piston rings, as it had been used around Detroit. After several hundred miles of fast and hard driving, the oil mileage improved greatly. At the end of the test I covered nearly 1000 miles before adding a quart of oil.

I have tested many fine automobiles over all types of terrain. Although there are a few things that I do not like, in my judgment Chrysler is the best automobile manufactured in America today. I say this because of its all-around qualities such as power, roadability and comfort. ★ ★ ★

DO-IT-YOURSELF

Save hundreds of Dollars on
BEAUTIFUL CARPORT or PATIO with



Sturdilite

MULTI-PURPOSE ALUMINUM ROOF SHELTER

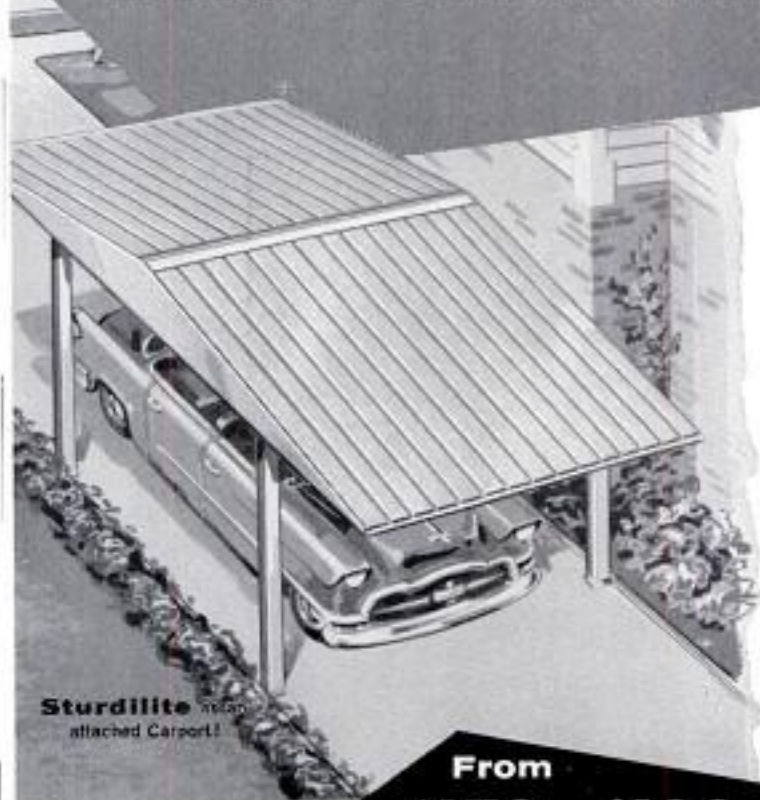

Sturdilite as an attached Carport!

You'll say it's fun — it's so quick and easy to erect your own carport or patio with the sensational money-saving Sturdilite Aluminum Roof Shelter!

Made of famous Reynolds Life-Time aluminum, Sturdilite is a pre-fabricated roof unit engineered for easiest possible erection. It is available in 4 distinctive designs. You select the design best suited to harmonize with the architectural style of your house.

Big and roomy, up to 20' x 10', Sturdilite will accommodate largest cars, with room to spare! May be erected attached to your house, or completely separate.

MANY OTHER USES! Anybody handy with simple tools can erect a Sturdilite unit in a weekend or less! Ideal for carport or terrace, it also makes a wonderful patio covering, screened or glazed porch, backyard play house, swimming pool shelter, golf course shelter and many other structures!

From
\$179 to \$199

delivered
direct from
manufacturer

SEND FOR FREE

illustrated brochure containing
complete descriptions of sizes and
designs, uses and prices.



CLIP AND MAIL THIS COUPON TODAY

STURDILITE DIVISION
Universal Fabricated Products Co.
80 East Jackson Blvd., Chicago 4, Illinois

Rush me complete information about the STURDILITE
Multi-Purpose Aluminum Roof Shelter.

Name _____

Street Address _____

City, Zone and State _____



Sturdilite as an unattached Carport!



Sturdilite as a screened porch!



Sturdilite as a backyard playhouse!

STURDILITE DIVISION
UNIVERSAL FABRICATED PRODUCTS CO.
80 East Jackson Blvd. Chicago 4, Illinois

REPLACE YOUR

**OLD
WOOD
CELLAR
DOOR**



**WITH A
MODERN
ALL-STEEL
BILCO
DOOR**

DO IT YOURSELF

IN JUST 3 TO 4 HOURS

Think of it! Only a few hours of pleasant work to replace your unsightly, troublesome wood hatchway with a lifetime, weathertight BILCO . . . the door installed on tens of thousands of new homes.

PAYS FOR ITSELF! Cost so little, yet never needs repair or replacement. Operates at a touch. Smooth, trim appearance adds amazing new beauty to your home.

Rush coupon TODAY for free folder and "Do It Yourself" pamphlet showing step by step replacement of wood hatchway.

THE BILCO CO.
DEPT. 43
NEW HAVEN, CONN.

**AMERICA'S FINEST
BASEMENT DOOR**

Gentlemen: Please send me "Do It Yourself Pamphlet" along with other literature showing sizes.

Name

Street

City State

Chrysler Owners Still Say Handling Is Best Feature

(Continued from page 127)

"Cover for gas filler should be radically redesigned. Gas-station attendants can't open it without a screwdriver—they don't have long fingernails like executives."—Ohio physician.

"For perhaps the few of us die-hards who prefer dignity rather than alarm in the

1955 CHRYSLER SPECIFICATIONS

	Windsor	New Yorker
ENGINE		
Type	8-cyl., V-type, OHV	
Bore and stroke	3.63 x 3.63 in.	3.81 x 3.63 in.
Piston displacement	301 cu. in.	331 cu. in.
Compression ratio	8.0 : 1	8.5 : 1
Brake horsepower	188 at 4400 r.p.m.	250 at 4600 r.p.m.
Transmission	Three-speed conventional std.; torque converter with gears optional.	Torque converter with gears standard.
GENERAL		
Shipping weight (4-door sedan unladen)	3925 lb.	4160 lb.
Steering ratio (overall)	20.4:1 (16.2:1 with power steering)	
Steering wheel, lock-to-lock	5.5 turns (3.5 turns with power steering)	
Turning radius	23 ft. 3 in.	23 ft. 3 in.
Wheelbase	126.0 in.	126.0 in.
Tread, front	60.2 in.	60.2 in.
Tread, rear	59.6 in.	59.6 in.
Height over-all (unladen)	60.6 in.	60.9 in.
Width over-all	79.1 in.	79.1 in.
Length over-all	218.6 in.	218.8 in.
Road clearance	6.2 in.	6.5 in.
CAPACITIES		
Oil	5 qt.	5 qt.
Water	24 qt.	25 qt.
Gasoline	20 gal.	20 gal.
INTERIOR DIMENSIONS		
Front-seat width	63.3 in.	63.3 in.
Rear-seat width	64.0 in.	64.0 in.
Headroom, front	35.0 in.	35.0 in.
Headroom, rear	34.5 in.	34.5 in.
Legroom, front	44.6 in.	44.6 in.
Legroom, rear	44.8 in.	44.8 in.

color of our cars, it would be nice if there were a greater selection of tones in the more subdued range."—Illinois owner.

Other Best-Liked Features

The following quotations of Chrysler owners describe other best-liked features in order of frequency of mention.

"Visibility. You sit high and can see where you are going."—Illinois owner.

"I like the safe feeling you have on curves. Roadability excellent."—Iowa service manager.

"Dependability. I use a car in my business and must have one I can depend on to keep going."—Iowa insurance man.

"I like the power steering best. My wife is delighted with the way the car responds."—Delaware chemical engineer.

(Continued to page 306)

Holt's WORLD-FAMOUS Do-It-Yourself Products

For the Motorist
and the Home

PISTON SEAL—

For restoring power and compression, stopping piston slap and reducing oil consumption.

GUN GUM—

For mending leaky mufflers, sealing pipes and joints.

BATREPAIR—

An acid-proof battery weld.

HOLTWELD—

For repairing cracked cylinders.

RADWELD—

For repairing leaky radiators.

NO-CRODE—

For keeping battery terminals clean.

SUPERTUNE COMPRESSION PRIMER—

For maintaining top engine tune-up.

LOY—

For permanently repairing anything broken, cracked, loose or leaky—metal, wood, glass, plastic, porcelain. It's real metal in a tube.

TRADE MARK
Piston Seal
ORIGINAL

Restores Power and Compression! Stops Piston Slap! Reduces Oil Consumption! Increases Mileage!

Good for 10,000 miles of carefree driving. Next best thing to a complete motor overhaul... at 1/20 the cost. Today's biggest seller. Millions of tubes have been sold throughout the World during the past 18 years. Undeniably safe for even the finest engines. Endorsed by leading technical automotive experts.

Easy to use

\$4.95 a tube **POSTPAID** for most cars

Stop Danger of Carbon Monoxide Gas

Holt's GUN-GUM MUFFLER SEAL

Sets like a weld in a few minutes!

\$1.69 CAN

No Tools Necessary Apply by Hand

Mends leaky mufflers—seals pipes and joints

Write for full details

At every Auto and Accessory Store
TREGLOWN CO., Inc., Fanwood 57, N. J.

Canada: 1366 Greene Ave., Montreal 6 (Prices slightly higher in Canada)

BUILD IT **FIX IT**

with

AMBROID

- Ready-to-use
- Fast drying
- High tensile strength
- Transparent
- Waterproof

IT STAYS STUCK

Dries entirely by evaporation of the solvent. Quick setting—no distortion. Ideal for assembling, repairing, home crafts, electrical work, factory, workshop or household use. Send postcard for free literature.

Try Ambroid in your business, too. For over 40 years recognized as the leading industrial adhesive of its type.

Art galleries, museums, and leading industrial concerns, rely on **AMBROID**

TRY A TUBE TODAY—At most hardware stores and hobby shops. If your dealer cannot supply you, send 30¢ for big 2 oz. tube, postpaid. Money back guarantee.

AMBROID WEYMOUTH 88, MASS.

SPEEDY RIVETS

simply swat with a hammer

Fasten leather, cloth, paper, plastics. Quick, secure, permanent repairs... ideal for craftwork, too. Simply make a hole in each part to be fastened, push rivet together through holes, place on firm surface and swat with a hammer. Gilt, nickel, black, brown finishes. Large (6 per card) or small (10 per card) sizes.

AT HARDWARE COUNTERS EVERYWHERE

15¢ per card

THE DOT LINE

3229 S. Ashland Ave., Chicago 8, Ill.

Turn your summer porch
into a
**YEAR 'ROUND ROOM with
Gold Bond Building Products**



**Build it yourself
for only \$18* a month**

Your present porch can be the framework. With roof and floor already in place, just close in the sides and complete the room with easy-to-use Gold Bond Building Products. Staple up new fireproof Twinsulation... heat bills are cut as much as 25%... keeps your new room up to 15° cooler in summer. Build sturdy walls with Gold Bond Gypsum Wallboard. Decorate with scrubable Velvet Wall Paint.

*Cost of materials over 24 months—prices vary in some localities. Send coupon for complete, easy-to-follow instructions for building the room shown above.

**NATIONAL GYPSUM CO.
BUFFALO 2, N. Y.**



MAIL COUPON TODAY

NATIONAL GYPSUM COMPANY
Dept. PM-105, Buffalo 2, N. Y.

Enclosed is 10¢. Please send me Gold Bond How-To-Do-It Plan No. 16, showing me how to build my extra room.

Name.....

Address.....

City.....Zone.....County.....State.....

"Roominess. It's our family car. Enough room all around and I'm 6 feet 3."—Georgia salesman.

"Power brakes. The wide brake pedal is a splendid convenience. I stop the car using my left foot."—Illinois attorney.

"I like the shift lever on the dash. It is up there out of the way. Set it and forget it."—Arkansas truck executive.

"My first choice is the over-all safety. Well-engineered car."—Wyoming farmer.

"Trunk is most spacious and for a salesman like myself it gives more room than usual to store sample cases."—Illinois traveling salesman.

"Comfort, performance and handling are the best in the business. About the only thing this car doesn't have is snob appeal."—Illinois purchasing agent.

And More Complaints

"Bright colors in interior are beautiful, but nylon seats very hard to keep clean."—Massachusetts Army man.

"Interior a little too fancy for farmers."—Iowa farmer.

"Never again will I buy a white-finish interior."—Illinois attorney.

"Haphazard workmanship on interior. The dashboard was set in crooked."—Ohio bartender.

"I am 6 feet 2 and can't wear a hat while driving. Roof too low."—Massachusetts traveling salesman.

"Defrosting system poorest I have ever used."—Ohio shop superintendent.

"Heater poor. People in back are cold, in front are roasted."—Washington ship captain.

"Windshield-wiper control out of reach to the right. Cowl control is under the dash where you can't see if it is open for summer or winter driving."—Illinois owner.

"Speedometer extremely hard to read at night."—Illinois nurse.

"Back end drags in driveway entrance with four in the car. I think the rear springs are too weak."—Georgia businessman.

"Brakes chatter when applied at high speeds."—Minnesota salesman.

"Rear-view mirror an atrocity. Can see only lower half of car following."—Illinois retired owner.

"Interior colors so repulsive they made my wife ill. Had portions of interior repainted at my own expense."—Illinois food broker.

"Should have easier method of adjusting front seat. My wife says present latch is awkward for her."—Georgia owner.

"Chrysler has done everything this year except eliminate the old-fashioned, trap-door air vent on cowl."—Vermont owner.

(Continued to page 308)



THE WORLD'S ONLY
ONE PIECE
HAMMERS · HATCHETS · AXES

GUARANTEED UNBREAKABLE
in all normal use

HEAD CAN'T FLY OFF. ESTWING unbreakable tools are forged in one piece. Saves all danger and expense of loose, broken or splintered handles. **PERFECT, PERMANENT BALANCE** for the easiest swing, most powerful drive. **SHOCK ABSORBING GRIP** is **GENUINE LEATHER** proven most comfortable and durable in all climates.

AT LEADING
HARDWARE STORES
FREE CATALOG



ESTWING MFG. CO., Dept. 10-M, Rockford, Illinois

\$4.25

HOME REPAIR TIP No. 19



PROTECT OUT-DOOR WIRING with "SCOTCH" 33 Plastic Tape wrapped tightly around joints and splices. Tough tape stretches to make waterproof seal, resists sunlight, oil and corrosion. Wrap splintery tool handles, too, with smooth, tight-sticking "SCOTCH" 33 Plastic Tape—39¢ or 79¢ at stores everywhere. Made by Minnesota Mining & Mfg. Co., St. Paul 6, Minn. © 1955 3M Co.

light, oil and corrosion. Wrap splintery tool handles, too, with smooth, tight-sticking "SCOTCH" 33 Plastic Tape—39¢ or 79¢ at stores everywhere. Made by Minnesota Mining & Mfg. Co., St. Paul 6, Minn. © 1955 3M Co.

DO IT YOURSELF

It's Easy
With ...



Soldering's really a "cinch" . . . when you use time-tested, reliable KESTER . . . available everywhere.

FREE! "Soldering Simplified" . . . 16-page how-to-solder booklet. At your dealer or write direct.

KESTER SOLDER COMPANY
4251 Wrightwood Avenue Chicago 39, Illinois

cuts
PAINING HOURS
to MINUTES

PERMITE
Spray Enamel

Just press the button and paint—no brush, no muss, no fuss. The sure-action, guaranteed spray head, insures smooth, even coat, like a professional paint job. Selection of 13 popular quick-drying colors, including Wrought Iron Black, Appliance White and a Clear Plastic. Also new **SMUDGE-PROOF ALUMINUM**, no silvery "rub-off"—wonderful for chairs, toys. With a few cans of "Do-it-Yourself" Permitem Spray Colors on hand, home painting chores are a picnic. Ask your paint or hardware dealer for Permitem Spray Enamels in the 12-oz. economy can.

ALUMINUM INDUSTRIES, Inc.
Permitem Paint Division Cincinnati 11, Ohio



"We want the finest quality motor oil — Quaker State!"



Super-refined from Pure Pennsylvania Grade Crude Oil, world's finest. Famous for performance, protection, economy! Try it!

QUAKER STATE OIL REFINING CORP., OIL CITY, PA.
Member Pennsylvania Grade Crude Oil Association

"Difficult getting in and out." — Ohio funeral director.

"Trunk sometimes freezes shut in cold weather and is impossible to open until it warms up." — Utah student.

"Front grille should be simpler design." — Illinois toolmaker.

"Have changed tires 24 times and still have road thumping. Tire people say it is the car; car people say it is the tires." — Massachusetts park operator.

"Backup lights are in the wrong place. Always being broken by other car's bumper." — Illinois hardware dealer.

That is what the owners have to say about the 1955 Chrysler. For a detailed breakdown of likes, dislikes and other important information look at the percentage chart on page 126. ★ ★ ★

Turn back to page 124 for Clymer's road test of the Chrysler New Yorker.

Proposed Indian Statue Would Tower 250 Feet

Taller than the Statue of Liberty, a 250-foot granite Indian has been designed for a site near Gallup, N. Mex. The statue is to be the centerpiece of a \$9,000,000 project that includes a museum, a research center and a 30,000-seat amphitheater. It is to be designed in sections and assembled over a framework of steel. An elevator will be erected on the inside of the statue to carry tourists to the top. (The Statue of Liberty is 151 feet high and stands on a 154-foot pedestal.)



**CUT THE BOLT YOU NEED
TO ANY LENGTH**

**HEAT AND BEND
TO ANY SHAPE**

24" and
36" lengths

7 SIZES

$\frac{1}{4}$ " $\frac{3}{16}$ " $\frac{1}{2}$ " $\frac{3}{8}$ " $\frac{7}{16}$ "
 $\frac{1}{2}$ " $\frac{3}{8}$ " $\frac{3}{4}$ "

REDI-BOLT

THREADED STEEL RODS

Ask Your Hardware Dealer or Write

REDI-BOLT, Inc., 5330 Indianapolis Blvd., E. Chicago, Ind.

**Install these superior
HYDRAULIC CONTROLS
Yourself!**

Smooth acting directional control valves — excellent feathering characteristics — minimum restrictions — performance comparable to the best. High performance hydraulic motor which may be used as pump — 16 gal. capacity at 1000 RPM and 1000 psi — May be used in combination to provide a fluid power transmission with a 10 horsepower capacity. Valve \$16.95, Motor-Pump \$56.50. Set up your own hydraulic systems for post-hole diggers, loaders, unloaders, stackers, dumping equipment, automatic lathe feeds, home shop presses. Sold by units or package including tanks.

OIL POWER CO., BOX 172, WAUKESHA, WIS.



MONEY for MEN ALL DATA FREE

THE PLASTEX Industry needs manufacturers on small scale and for big production of Lamp and Clock Stands, Art Goods and Novelties in Plastex and Marble imitation. Experience unnecessary. Ure material makes regular 10¢ store sellers. Rubber moulds furnished for speed production. Small investment brings good returns. We are now placing big Chain Store Orders with manufacturers. Ambitious men have chance for real prosperity. Our Free booklet will interest and benefit you.

PLASTEX INDUSTRIES, Dept. A

3400 Third Ave. New York 56, N. Y.



It's easy to . . .
BUILD IT! FIX IT!
with **Handy Horse**
**ALL METAL
FOLDING HORSE**

\$595

Indoors, outdoors, lots and lots of uses all around the house. Handy Horse is virtually indestructible. Folds completely for storing—carrying. Strong, steady on any surface.

Sold by Hardware and lumber dealers everywhere

Manufactured by
FEDERAL HARDWARE PRODUCTS
Division Federal Aircraft Works,
3456 No. Wash. Ave. Mpls. 12, Minn.

FEDERAL
Handy Horse
500



**DISSTON
HAS THE EDGE.**

in home workshop tools



You'll have every reason to be proud of your Disston tools—the choice of professional craftsmen. Fast, clean-cutting Disston DeLuxe circular saw blades, for both bench machines and portable electric hand saws, give your handiwork the expert's touch. Made of Disston's own steel, famous for its outstanding edge-holding properties, these saws provide long, satisfying service.

You'll get rewarding results and new pleasure in woodworking with other fine Disston tools: dado heads . . . wood band saws . . . wood-turning chisels and gouges . . . files and rasps.

See the great line of Disston tools at your nearest hardware store. Be sure to write for **FREE** copy of Disston's handy Saw, Tool & File Manual.

HENRY DISSTON & SONS, INC.
1011 TACONY, PHILADELPHIA 35, PA.
IN CANADA: 2-20 FRASER AVE., TORONTO 3, ONT.



The story behind FORD'S exclusive new LIFEGUARD DESIGN

More than two years of intensive safety research and testing by Ford engineers in cooperation with universities, medical authorities and other safety experts have disclosed some interesting new data on accident injuries—and what can be done to reduce them.

For example, it was found that most serious injuries in accidents were caused by *three* common occurrences.

First... the driver being thrown against the steering post. This called for positive action, so Ford designed a new Lifeguard steering wheel with a shorter steering post and a specially-designed wheel that serves as a protective cushion in the event of an accident.

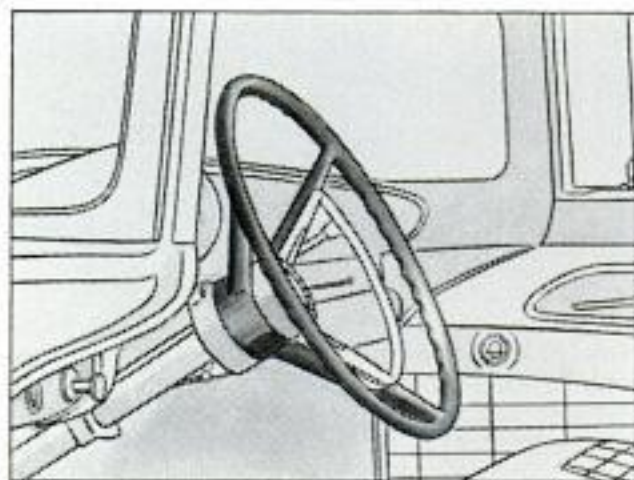

New Lifeguard Steering Wheel. Hub of wheel is more than three inches below plane of rim. Three uniformly spaced spokes are designed to yield under impact and reduce possibility of driver being thrown against the top of the steering column.

Second... occupants being thrown forward against hard surfaces within the car. This called for special padding of the instrument panel and sun visors. So, Ford for '56 is offering optional Lifeguard padding for these vital areas.

Third... occupants being thrown out of the car. Ford approached this problem in two ways. There are new optional Lifeguard seat belts available to hold driver and passengers securely in their seats. And every '56 Ford has new Lifeguard door latches that feature *double-grip* construction to reduce the possibility of doors springing open under impact.

For the *full* Ford Lifeguard design story—visit your Ford Dealer—soon!

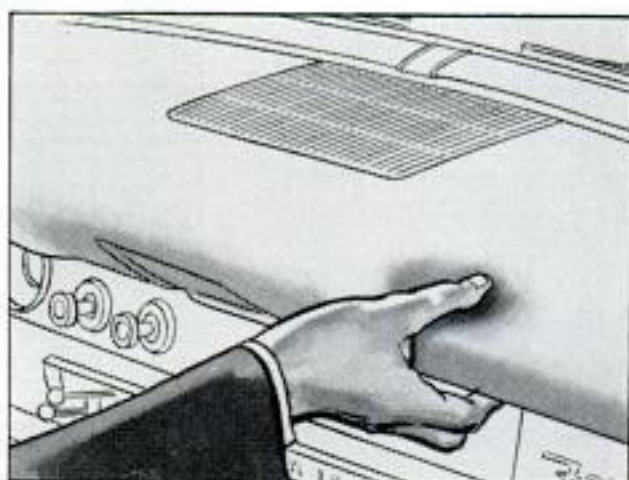

New Lifeguard Padding. The composition and uniform cellular-like structure of the new Lifeguard padding material results in an extraordinary ability to absorb shock. For example, tests show it is five times as shock absorbent as foam rubber.

Let Lifeguard design start protecting

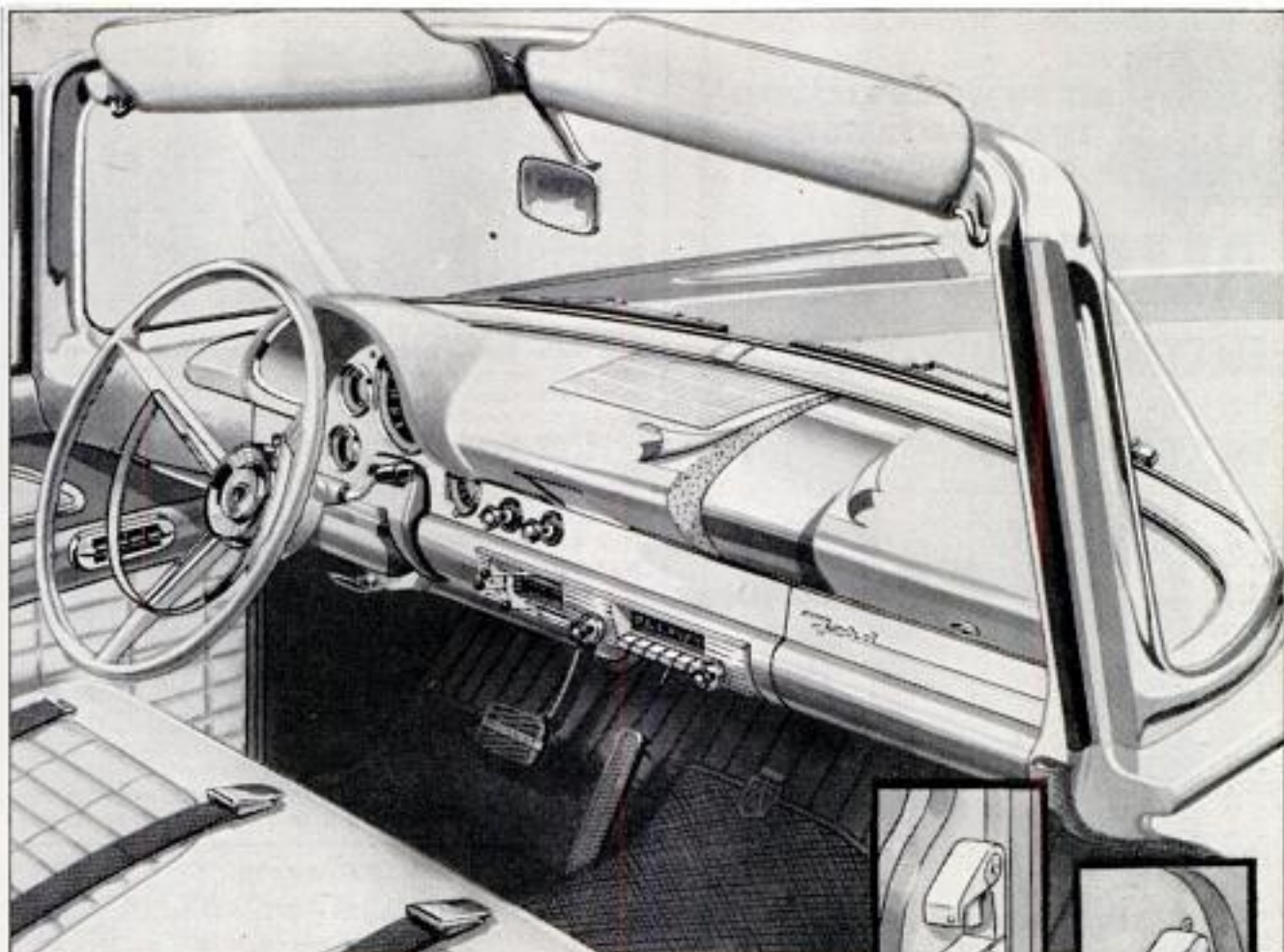

You will be safer in a '56 Ford with Lifeguard design



New Lifeguard Seat Belts. They're one-third stronger than CAA requires for aircraft. Each belt is securely anchored to all-steel flooring which is reinforced by husky steel plates. Buckles permit easy one-hand adjustment and finger-tip release.

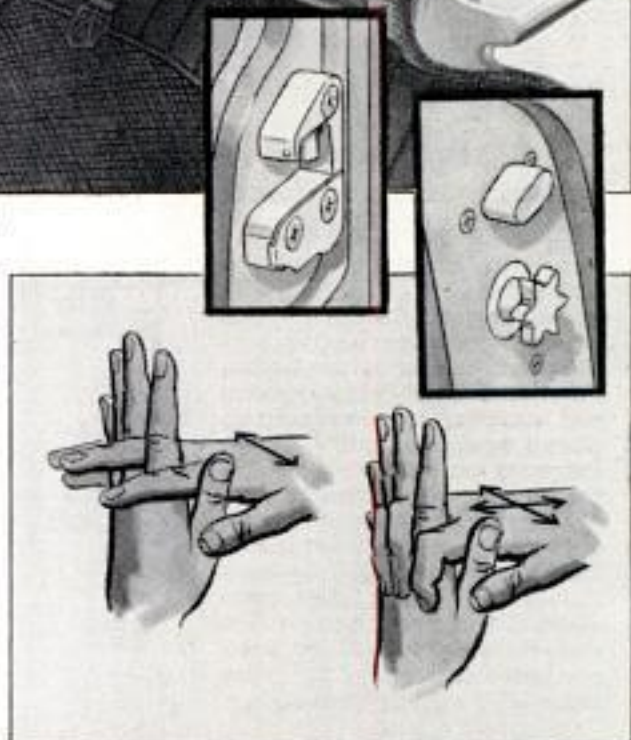

New Lifeguard Door Latches. Conventional single-grip latches may disengage (like fingers above at left) and allow doors to open under impact. Lifeguard double-grip latches (like fingers above at right) resist disengagement fore-and-aft, in-and-out.

you now in the **'56 FORD**

free

GET THE WORLD'S LEADING TV & RADIO PARTS AND EQUIPMENT CATALOG

ALLIED'S 1956 ELECTRONIC SUPPLY GUIDE

324 VALUE-PACKED PAGES



Save on Everything in Electronics

WORLD'S LARGEST STOCKS

Everything for Experimenters, Builders, Amateurs, Servicemen, Engineers and Hi-Fi Experts

Send for ALLIED's big 324-page Catalog, offering the world's largest selection of latest top-quality electronic equipment at lowest, money-saving prices. Features High Fidelity systems and components; recorders and phono equipment; TV tubes, antennas and accessories; Amateur station equipment; P.A. systems; test instruments; latest build-your-own kits; industrial electronic supplies—plus thousands of parts, tubes, transistors, tools and books. Get everything, get more for your money—send today for your FREE 1956 ALLIED Catalog!



ALLIED RADIO

ALLIED RADIO CORP., Dept. 5-KK-5
100 N. Western Ave., Chicago 80, Ill.

Rush FREE 1956 ALLIED 324-Page Catalog

Name _____

Address _____

City _____ Zone _____ State _____

Send for FREE CATALOG

BURKS

SUPER TURBINE PUMPS LAST LONGER



ONLY PUMP WITH LIFE-LOK FEATURE

Thanks to the LIFE-LOK feature, the BURKS Super Turbine Water System lasts up to 40% longer than any other kind, delivers more gallons per minute and provides "like-new" performance and efficiency when other types would be worn out. It's completely automatic—self-priming.

FREE BOOK PICTURES PUMP DETAILS

Send today for "The Story of Burks"—a 32-page book giving detail drawings, graphs, etc. See why BURKS is finest engineered system . . . why it delivers more water per hour . . . why it's the finest water system you can buy. Write to—

DECATUR PUMP CO., 61 Elk St., Decatur 70, Ill.

DITCH-WITCH TRENCHER



Portable DITCH-WITCH digs 4½" or 6" deep, even ditches to 36" depth in all types of soil. Four rugged models. Complete unit—self-propelled. OUTDIGS 8 MEN
Write for Illustrated Literature

The CHARLES MACHINE WORKS
620 B Street Perry, Okla.



Auxiliary Accelerator..

LEFT FOOT PEDAL

Step on the gas with either foot with equal ease. Drive relaxed.

Guaranteed for the life of the car— which originally installed on. FITS ALL CARS.



PRICE \$6.95 Per 4 ORDER FROM
Delivered to You R. V. LEHNER, Ness City, Kansas



BUILD FINE GRANDFATHER CLOCK NOW

The simple sensible Red-i-Kut way as thousands have— SAVE HALF. SHOP TESTED PLANS "SPIRIT OF THE CENTURY" Narrow waist 83" tall or stately straight side "SPIRIT OF AMERICA." EASY-to-FOLLOW pantograph PLANS tell all—plus BROCHURE of heavy brass weights Westminster, tube chime, movements, gorgeous dials, ¾" solid mahogany case kits. Send \$1.00 today—Both plans \$1.50 NOW. KUENPEL CHIME CLOCK CO., 27 Kuempel Bldg., Minneapolis 16, Minn.



FIND URANIUM!

New invention using sun's energy! All you need for prospecting! More reliable than Geiger counters for determining uranium value! Used by professionals. You can strike it rich! Includes 4 valuable uranium ores, Money-back guarantee. Postpaid. Dept. PM-10; CMG Industries, 615 So. 2nd, Laramie, Wyoming, or your dealer.

URANI-TECTOR \$8.49
URANIUM KIT

GUARANTEED

★ Easy to Install - No Special Tools

STOP THAT DRIP! DRIP! DRIP!

THIS ONE REALLY WORKS!!!

Push-Tite Friction Free Replacement Stem with Stainless Steel Balls

Increases service life per washer 10 to 20 times. New Design square top stem FITS ALL HANDLES. NOW AVAILABLE AT MANY HARDWARE AND PLUMBING DEALERS. If your local retailer cannot supply, order direct. Specify Hot or Cold. Prepaid U. S. A. Per Stem \$1.98

DEALER INQUIRIES INVITED — Write

ROLL-TITE CO. 5225-27 W. FIGUEROA STREET
LOS ANGELES 42, CALIFORNIA

Free brochure on request . . . absolutely no obligation

**spray paint it
yourself!**



Faster... better... easier!
Anyone can quickly learn to do a professional job of spray painting. Takes less skill than brush painting... 4 to 6 times faster. Pictured... *Pressure Maid*... rugged compact air compressor of cast-iron construction... single cylinder

... direct drive... piston type... not a diaphragm. Precision built for the smaller jobs. Sprays paints, varnishes, enamels, stains, disinfectants, insect sprays. Priced so low first good-sized job pays for it. Run in on test line to make it *trouble-free*. Write for literature on the *Complete Line* including new *Pressure Pal* (\$42.50 fob factory) to 1046 Railroad Avenue, Harrison, Ohio.

CAMPBELL-HAUSFELD

Protect that gun!

3-IN-ONE oils your gun and prevents rust—never gums up the way many oils do! Ideal for fishing tackle too!



"3-IN-ONE" OIL

FREE CATALOG
NEW '56 MODELS
BOAT KITS

BUY DIRECT—SAVE UP TO 2/3



FACTORY TO YOU!

No Dealers!
You SAVE the dealer's Profit

23 MODELS—8 to 19 ft. —\$39 up
Finest quality Boat Kits at the lowest prices in history! Mahogany decks. Easy to build.
Also: FIBERGLAS—ACCESSORIES—TRAILERS

CRAIG—CRAFT (DEPT. 20) TONAWANDA, N. Y.

Aim HIGH—Aim LOW!

You don't need a third hand with a Delta Reddy-lite. Hang it up. Set it down. Aim the 800-ft. beam anywhere! Uses 6-volt battery. See your dealer. Yours, less battery, for **\$350** only.....



Delta ELECTRIC CO.
Marion, Ind.

REDDYLITE 360° Swivel ELECTRIC LANTERN

Floor Surfacing Contractors NEEDED!



- ★ BIG PAY
- ★ FULL or PART TIME
- ★ AGE No Barrier
- ★ Minimum Investment

Highly Respected Profession Offers You Unusual Opportunity to BE YOUR OWN BOSS

Thousands of men of all ages have found financial security and happiness in a phase of the building and remodeling industry that has become as necessary as the hammer and nails. The pay scale is high for those who are willing to work; many earn \$50 a day and more. No great physical stamina required—men from 18 to 80, even with physical handicaps, enjoy this pleasant year 'round indoor work where earnings are limited only by the amount of time you devote to it. The American Floor Surfacing Machine Co., a 50-year-old pioneer firm and leader in the industry, shows you how to quickly make good in this stable business. No schooling, no special talent or skills required. Only small investment in sander gets you started. Send coupon for "money-making booklet" entitled "Opportunities in Floor Surfacing"—enclose 25c in coin or stamps to cover handling.



AMERICAN FLOOR MACHINES

SEND ↓

The American Floor Surfacing Machine Co.
335 So. St. Clair St.
Toledo 3, Ohio

Here is 25c in stamps or coin for booklet "Opportunities in Floor Surfacing", telling me how I can start my own floor sanding business.

Name.....

Street.....

City..... State.....

**CARPENTERS
PLUMBERS
CONSTRUCTION MEN
HOBBYISTS**

Ask for
Style 4249-1

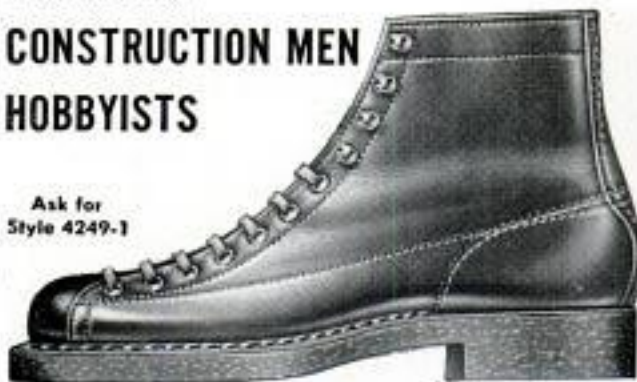

... Designed with the working man in mind! Note how the shoe is laced from top to toe—allows you to adjust laces for most comfort whether you're working in a squatting or standing position. Long-wearing cork composition non-slip soles. Genuine rawhide laces. C&E 6-11 & 12



Write for name of nearest dealer. Peters Shoe Company, Box PM10, 1505 Washington Ave., St. Louis 3, Missouri.

**NEW Easy-to-Use
SOLDER**



**Solders metals instantly
... just apply Swif
and heat**

Swif is real 50/50 Tin-Lead solder with flux in paste form that makes all kinds of soldered connections permanently—and fast. No separate flux needed. Just apply Swif by squeezing the unbreakable plastic tube and heat with torch or iron—on small jobs even a match will do the job perfectly. Each tube holds enough solder for hundreds of jobs. Swif has been used by professional plumbers for years. At hardware stores, hobby shops, plumbing dealers, auto stores. 69¢.

HERCULES CHEMICAL CO., INC.
332 Canal St., New York 13, N. Y.

314



**PRECISION
PLIERS**

• For accurate, exacting work use the fine, small pliers jewelers and watchmakers use — Kraeuter's Precision Pliers. Matched in size and handle shape, drop forged from selected tool steel, machined and heat treated to exacting specifications. For hobby crafters, model builders, TV and radio technicians.

Buy wherever fine tools are sold in U. S. and Canada.

KRAEUTER



Sharpen Your Own Drills

New low-cost SAV-A-DRILL Sharpener, complete with grinding wheel, fits any electric drill, sharpens 1/8" to 1/4" drills. No adjustments to make. No bench grinder or mounting necessary. Remit with order, save COD charges.

\$2.95
POST-PAID
Money-Back
Guarantee

POPULAR MFG. CO. 4115 Glencrest Road
Minneapolis 5, Minn.

**695 HEAVY OIL-IMP-BALL BEARINGS
PUMPS MILLIONS OF GALS.**



IRRIGATE, SPRAY, DRAIN or FILL ANYTHING—ANYWHERE! Will not Rust—Clog—or Leak. Patented Seal. Pumps 2800 gph, 420 gph at 75' high or 1600 gph from 25' well. Six blade impeller. Threaded for pipe. 3/4" inlet, 1/2" outlet. Use 1/2 to 3/4 hp motor . . . 7500 gph 9.95
Heavier 2800 gph 8.95 . . . Heavier 11.95
Check, 30¢ or COD—Money Back Guarantee
FREE Literature—Comparison Charts

U. A. T. ENG. & MFG. CO. HICKSVILLE 273,
NEW YORK

**"NEED BACK ISSUES
to round out your
Shop Notes Files?"**

This special offer is being made exclusively to Popular Mechanics readers . . . We have a few hundred surplus copies of SHOP NOTES for 1947, '49 and '52. . . . On the newsstands, the 1947 annual sold for 50¢, 1949 and 1952 for \$1.00 each. . .

Now, while the supply lasts, you can have all three collections of shop projects and do-it-yourself know-how at a saving of 40%!

All orders must be accompanied by your remittance (if your order reaches us too late, we'll refund your money by return mail). Remember—the supply is limited, so send your order today and save over \$1!

Popular Mechanics Press
200 E. Ontario St.,
Chicago 11, Ill.



**\$2.50
VALUE
for only
\$1.49
POSTPAID**

POPULAR MECHANICS

ASSEMBLE IT YOURSELF

FINE CONTEMPORARY
FURNITURE
AND SAVE
MORE THAN
55%

SEND 25c
FOR
CATALOG



BOOKCASE
HEADBOARD BED
Our Price: \$32.85*
Retail Value: \$59.95

Full range of distinctive, style-coordinated pieces and suites by one of America's leading furniture designers. In beautifully-grained solid Appalachian Ash. All machined, planed and sanded, ready to assemble in a night with just hammer and screwdriver. Interlocking dovetail joints clearly numbered. Send only 25c for big illustrated catalog including wood sample and finishing tips—save over 55%!



DESK
Our Price: \$48.95*
Retail Value: \$90.00



SINGLE DRESSER
Our Price: \$39.95*
Retail Value: \$73.00

SHOW-OFF, Inc. 179 Main Street,
Jamestown, N.Y.

"Where the Great Furniture of America Is Made"

*Plus small shipping charge

AMAZING NEW BATTERY WELDER REPAIRS ANYTHING!



Only \$395

Including large assortment of welding, brazing and carbon rods.

New wonder tool for the homecraftsman and hobbyist. Operates from any 6 volt car battery. Quickly, easily repairs fenders, sheet metal, radiators, etc. Avoid expensive trips to the repair shop... this welder quickly pays for itself.

SEND NO MONEY. Pay postman \$3.95 plus postage; or send \$5.95, we pay postage. MONEY BACK in 10 days if not completely satisfied.

LEJAY Manufacturing Co., 2747 Lejay Bldg., Minneapolis, Minn.

5 in 1 SAW including TREE PRUNER

Five high-temper carbon steel saws with easy-lock handle. Special double edge 16" tree-pruning blade plus panel, mitre, compass, and metal cutting saws. A saw for every household use. Complete set shipped postpaid. Money-back guarantee.



Send... \$2.39

16500 Jas. Couzens
Detroit 21, Mich.

ANTLIS PRODUCTS CO. Dept. 10P

EARN GOOD MONEY IN SPARE OR FULL TIME.

With a Universal Lawn Mower Grinder

Have a business of your own in your garage or basement, sharpening lawn mowers. Be your own boss. Small investment. We furnish everything you need to start. Write FREE Dept. M-105 today for complete details



ROGERS MANUFACTURING CO.
LINDSEY, OHIO

An Outstanding METAL HAND PUNCH

with unusual
performance

Needed by every
Mechanic in every
Shop

No. 5 Jr. HAND PUNCH

CAPACITY—1/4" THRU 18
Ga. Mild Steel. 3/32" —
1/8" — 5/32" — 3/16" —
7/32" — 1/4" — 9/32" —
Punches and Dies Furnished.

ORDER YOURS TODAY!

Write for FREE Catalog on other tools.

WHITNEY METAL TOOL CO., Dept. PM-10, Rockford, Ill.



Weights
2 3/4 lbs.

THROAT
DEPTH
2 inches **only \$9.25**

Postpaid in
U.S.A.

BUILD

it today...
the Glumac way!



IT'S EASY TO APPLY THESE FACTORY-STAINED CEDAR SHAKE SIDEWALLS . . . SAVE 2/3!

No fitting, no finishing with Glumacs. Big 16 x 46-3/4" units are factory fitted, stained in your choice of colors, come to you complete with stained shakes bonded to tapered backer board.

GLUMACS IDEAL FOR THE BUILD-IT-YOURSELF HOMEOWNER

Each carton contains 11 units with matching colored nails — just two cartons cover 100 sq. ft. of sidewall at recommended 14" exposure. Save 2/3 on application costs... with a better home for less. See your lumber dealer, Perma Products Co., Dept. PM-10, Cleveland 22, Ohio.

SHAKERTOWN

GLUMAC UNITS

FACTORY
STAINED
CEDAR
SHAKES



**How \$19.95 can save
your family, your home...**



You're asleep. A fire starts. Every second is vital.

Automatically, a loud clear alarm sounds. Gives you precious extra time that can save your life, your family's, your home.

Only \$19.95, the Edwards Home Fire Alarm stands guard . . . watches over your loved ones every minute of every day and night. Gives added assurance too when there's a baby sitter that your children will be safe.

Easy to install. Run bell wire to heat-sensitive Edwards detectors. Fasten them to ceiling in furnace room, storage area. Mount signal unit in or near bedrooms. Connect the two detectors, plug in. That's all. (For protection in every room, use additional detectors, \$3.50 each.) Signal unit is only 5"x7". . . UL listed, 2" detectors operate at 140°.

At electrical or hardware dealers. Automatic, electric, fool-proof, Edwards Home Fire Alarm gives permanent peace of mind, freedom from fear of fire . . . for only \$19.95. Act now.



Available in flush and plug-in models.

So sensitive a lighted match sets off alarm!



EDWARDS HOME FIRE ALARM

Fire alarm systems for schools, hospitals, industries, offices . . . since 1872.

MAILING THIS TODAY MAY ONE DAY SAVE YOUR LIFE

.....

• EDWARDS CO., INC., Dept. PM-10, Norwalk, Conn.

• Please send further information on the Home Fire Alarm.

• (In Canada: Address Owen Sound, Ontario)

• Name _____

• Address _____

• City _____ State _____

.....

WONDER PASTE

makes it easy

Paint comes off clean

The painter's favorite remover. Softens up the toughest paint, varnish, enamel or shellac so it comes off in one easy scraping. Harmless to wood, metal, veneers and hands. Won't run on upright surfaces. Get Wonder-Paste at paint and hardware stores.

● Write for leaflet and advice on removing.
Wilson-Imperial Co., 119 Chestnut St., Newark 5, N.J.

FIND URANIUM!!!

Prospecting made easy with Goldak's new U-238C triple-action geiger counter! Also famous line of metal locators, from \$49.50

Send 25c for radioactive uranium sample!

FREE DETAILS. Dealer Inquiries Welcome.

GOLDAK COMPANY 1542 W. Glensaks Blvd., Glendale, Calif.

ELECTRIC WELDER

AC or DC
110 Volts

The "Little Marvel" all-metal welder, 5-year written guarantee. Welds 1/4" metal of money back. Repairs tanks, tools, fenders, machine parts, etc. Complete with everything—rods, unit, eye shield, directions. \$6.45 plus 50c postage. Flame torch accessory for soldering, cutting, brazing \$3.95 complete with carbons, brass rods, flux. \$2.00 Deposit on C.O.D. 1/4 inch Transformer Welder \$19.95 F.O.B.

\$6.45
Complete

ESSAY MFG. CO., Dept. 51, Quincy 69, Mass.

SAVE! INSTALL YOUR OWN MATICO TILE FLOOR

Send 10c for complete do-it-yourself instruction kit today! Makes installation easy!

MASTIC TILE CORP. OF AMERICA
Dept. P5-10, P. O. Box 986, Newburgh, N. Y.

FIND THE WOOD STUD IN YOUR WALL WITH A FORD DOWSER BALL

Indispensable when hanging pictures, mirrors, shelves; and when making alterations. The original Stud Finder.

YOU MAY NEED ONE TOMORROW!
The roll of the ball finds the actual STUD in the wall.

NO MAGNETS!
Only \$2.00 post. Money-back guarantee; no C.O.D.'s please. Usual trade discounts to dealers.

\$2.00
POST PAID

FORD PRODUCTS Dept. P-5, PORT CHESTER, N. Y.

Automatic Saw Set..

MAKE EXTRA PROFITS!

Set 400 teeth per minute on hand or band saws, 4 to 16 point, with the BeMaCo Automatic Saw Set. Fast, accurate, true hammer-anvil action sets teeth uniformly, eliminates tooth breakage. Used profitably by saw shops and manufacturers everywhere. Every machine positively guaranteed!

Write for details—today!

Saw Machine Division 18-C

BEAVER MFG. CO.

800 ISIS AVENUE • INGLEWOOD, CALIF.

PROTO Low-Cost ADDA-UNIT TOOLS



No. 9950

marked molded openings for each size, keeps every tool in proper place.

No. 9950: 1/2" Drive Socket Set — \$15.03 (incl. holder 15" hinge handle, ten 3/8" drive, 12 pt. sockets 3/16"-1")

No. 9931: Open End Wrenches \$8.14 (incl. holder, 5 wrenches 3/16"-3/4")

No. 9953: Pliers — \$7.99 (incl. holder, 6" thin nose plier, 4 1/2" midjet plier, 8" multi-plier, 9 1/2" utility plier)

No. 9937: Comb. box & open End Wrenches — \$8.40 (incl. holder, 6 wrenches 1/4"-3/4")

No. 9942: Adjust. & Pipe Wrenches — \$8.64 (incl. holder, 2 adj. wrenches, 6" & 10", 2 pipe wrenches 8" & 14")

SAVE TIME AND EXPENSE!
Get Your Genuine PROTO TOOLS Prepaid

For prompt PREPAID (in U.S.) delivery send check or money order to



No. 9931



No. 9953



No. 9937



No. 9942

JAY-DEE SALES CO.

3304 N. SAN FERNANDO BLVD.
BURBANK, CALIF.

FREE! 68 page PROTO Tool Catalog with Order — or send 10c

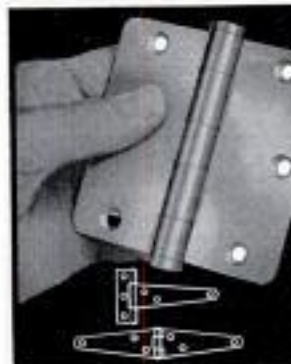

best hardware . . .
for hard wear
GRIFFIN
HINGES

at your hardware or
building supply store

GRIFFIN MFG. CO., ERIE, PA.

SHEET METAL BRAKES

Forms Angles, locks, pans,
etc. Quick clamp. All steel.
15"—16 ga. steel, \$23.50;
36"—22 ga., \$35.50; 48"—
24 ga., \$52.00.



Stand, \$8.00.

Foot Power Squaring Shear, 30"—24 gauge.

Bench Shear 7"—18 ga., 3 adj. gauges, \$16.50.

Sheet Metal Folders 15"—1/4 to 1"—24 ga. \$16.50.

ORDER DIRECT OR SEND FOR CATALOG
VYKE MFG. CO., 2435 15th St., Denver 2, Colo.

Insist on
Evans
TAPES

50 ft.-100 ft. long
At your
hardware store
For building and
gardening measuring.

each with FREE
plastic utility case
and

\$4.49
from

SPECIAL HOOK-RING ATTACHMENT
FOR EASY ONE-MAN MEASURING

Elmer says:

Glue it better with a Borden glue!

ELMER'S® GLUE-ALL

. . . strong, easy-to-use plastic
glue bonds any porous material!

It's quick-setting, won't stain. Handy squeeze applicator speeds your job. Ideal for any indoor work with wood, paper, cloth. Comes in 8 oz., 4 oz. and 1 1/4 oz. squeeze bottle, and 3/4 oz. plastic tube.



ELMER'S® CONTACT CEMENT

. . . bonds all plastic laminates
to plywood without clamps,
nails, or presses!

Highly resistant to heat and water. Outperforms other contact cements in laboratory stress tests. It's the contact cement used by professionals. Sizes from 1-pint to 5-gallons.



ELMER'S® WATERPROOF GLUE

. . . the completely waterproof
glue for any outdoor or indoor
job where moisture is a
problem!

Makes a bond that will outlast wood itself. Use it on any joint subject to water, weather, acids or alkalis. Also glues dense resin-impregnated or oily woods. In sizes from 1/4 pint to 5-gallons.

THE *Borden* COMPANY
350 Madison Ave., New York 17, N. Y.

Now—Do-it-Yourself and SAVE!

Cement Jobs are Quick, Easy with SAKRETE

Ready-to-use cement!



Send 25c for 48-page Book

Photos, diagrams, etc. for hundreds of cement jobs with Ready-mixed SAKRETE. SAKRETE, INC., Dept. 14, Cincinnati 17, Ohio.

It's easy to hang a door with the NEW



with the NEW
**McKINNEY
NON-MORTISE
HINGE**

Simple • Easy • No Chiseling



- No Mortising
- Self-Aligning
- E-Z-Out Pin
- Heavy Gauge
- No Special Tools

3 Finishes: Dull Brass, Nickel or Bonderized Prime Coat
Send for Free Folder and Installation Instructions on McKinney Non-Mortise Hinges.

McKINNEY MANUFACTURING COMPANY
1715 Liverpool Street, Pittsburgh 33, Pa.

Name _____

Address _____

City _____ Zone _____ State _____

DO MORE PLANING JOBS WITH LOW COST BELSAW

Exclusive MONEY-MAKING features:



- Full 12 3/4 in. x 6 in. capacity
- Power feeds at 24 ft. a minute. (Easily adjusted for lower feed rate)
- Machined cast iron bed; adjustable rolls, total bed length 42 in.
- Provides for Grinding Knives in the Cutterhead.
- Attachments for Jointing, Rabbeting, Tongue, Groove, Matching.

Belsaw Multi-Duty Planer for cabinet shops, builders, lumber yards, woodworking plants and spare time work shops... Now you can convert low cost rough and random size lumber into high priced cabinet finished stock... Easy to make flooring and popular patterns. Belsaw quickly returns cost with savings on raw material... profits on finished stock.

Send Today for FREE literature on Belsaw, the LOW COST, high speed production planer.

BELSAW MACHINERY CO

2056 Field Bldg • Kansas City 11, Missouri

LOW DOWN
PAYMENT
EASY
TERMS

BRONZE FOUNDRY

Schools and Home Workshops

Make your own castings of aluminum, copper, bronze, silver. Foundry sets are available in three sizes including 2400 Deg. F. blast Furnace. \$22.50; \$29.50; and \$42.00. f.o.b. Marysville, Kans. Free Circular.

KANSAS CITY SPECIALTIES CO. P. O. Box 6022, Dept. P-10 MARYSVILLE, KANS.

Print Your Own



Cards, Stationery, Advertising, labels, circulars, photo and movie titles, church work, tags, etc. Save money. Sold direct from factory only. Raised printing like engraving, too. **Print for Others, Good Profit.** Have a home print shop. Easy rules supplied. Pays for itself in a short time. Write for free catalog of outfits and all details.

KELSEY PRESSES, N-37 MERIDEN, CONN.

REPLACEMENT TOOL HANDLES



5 SIZES Your tools work easier, more comfortably—with new AB Long-Life Replacement Handles. FIVE sizes, 3 1/2" to 5", fit most tools—wrenches, files, chisels, awls, screw drivers. Lead alloy ferrite holds tool secure. Just press it on!

A B MFG. CO. Dept. P, 1168 N. 80th Place Milwaukee 8, Wisconsin

The New Holtite Drill Press Clamp



Slide to clear when not in use. Adjustable 360°. Special wrench included. Price \$4.10 P.P. U.S. & Can.

T. M. KANGUS & SON
MITCHELL, S. DAK.

KING MIDGET—WORLD'S LOWEST PRICED CAR



Lower Priced, greater performance. Drive it for 75c per week. Also KING MIDGET JUNIOR, finely engineered, less than one-third cost of any comparable car, one twelfth cost of large cars. Agents wanted. **IT WILL PAY YOU TO GET THE FACTS.** Send 25c for literature and agents proposition on both cars, or \$1 (refunded first order) for this plus actual assembly book and service manual.

MIDGET MOTORS MFG. CO., Athens 1, Ohio

LUBRIPLATE
KEEPS TOOLS LIKE NEW
PREVENTS RUST
AND LUBRICATES TOO!



TRY LUBRIPLATE! Not an old-fashioned oil that runs off or gets gummy. LUBRIPLATE is a new, white and clean, semi-fluid lubricant that stays put.

• In handy 20¢, 35¢ and 95¢ tubes at Sporting Goods, Hardware, Marine and Auto Supply Stores.

• Dealers write to LUBRIPLATE DIVISION, Fiske Bros. Refining Co., Newark 5, N.J.

LUBRIPLATE
THE MODERN LUBRICANT

DO IT YOURSELF!

SAVE ON SERVICE CALLS —

Test your own TV and Radio Tubes with the Home Service Tester.

Also tests appliances for shorts and broken wires or elements, light bulbs, fuses, motors, flash bulbs, and any other electrical equipment. Same tube tester now being used by over 25,000 TV and Radio Servicemen. Quick — shock-proof — no technical knowledge required. Save Money Now — by ordering TODAY! Satisfaction guaranteed or your money back. Complete with easy instructions...

\$4.95
EA.
POSTPAID



Lindaily Products 2626 W. 103rd Pl., Dept. MP-10
Chicago 43, Ill.

Now is the time to change your oil and filter.

CUT GLASS the EASY WAY
NEW SELF-GUIDING TOOL MEASURES AS IT CUTS

Zip off glass with a ZIP Cutter! With the special, adjustable guide, you cut glass easily, accurately, and quickly. No more guesswork! Can also be used as an ordinary glass cutter. Postpaid, just... **\$1.00**

7-day MONEY BACK GUARANTEE.
ARROW-PRODUCTS Dept. A.
P.O. Box 52, Dayton, Ohio



INTERNATIONAL DRILL-SAW

HIGH SPEED COPE SAW DRILL BIT

NEW LOW PRICE

REAM • CUT

DRILL, SAW, REAM... metal, pipe, wood, plastic, Transite, etc. Use with electric drill, slow drill press, lathe, milling machine. Drills own starting hole, upper part of bit is used to cut, saw, ream circles, ovals, squares, scrolls. Easy to use. Ideal for carpenters, mechanics, electricians, plumbers, hobbyists, etc. Abrasive resistant, high speed steel. Flutes ground from solid. Withstands severe continuous use without breaking. Resharpens free. Takes place of up to \$50.00 in tools. 1" diameter, 2" cutting sections, total length 3 1/2". Three types—All purpose, Wood, Heavy Metal. Specify type needed. Set of three \$8.50. Details on request. Shipped same day. Money-back guarantee. Dealer inquiries invited. Order Now. Send Cash, Check or Money Order to

\$2.95
POST PAID
3 for \$8.50

INTERNATIONAL TWIST DRILL CORP. 618 Wyandotte, Em. 637
Kansas City 6, Mo.



BEFORE—just an ordinary unfinished basement.



AFTER—see what a difference Weldwood makes! Weldwood Novoply® walls add a textured look that turns basement into beautiful, practical children's playroom. Large panels make it easy to plan, easy to do.

New do-it-yourself book by Weldwood shows you

how to wood panel a wall • how to make a plastic laminate sink top • how to saw and work plywood • how to finish plywood • what to do about a "problem" basement • how to glue plywood and has all kinds of tips for the home craftsman. Plus dozens of pictures of finished projects!

SEND FOR THIS BIG 40-PAGE BOOK TODAY! And see your lumber dealer for beautiful Weldwood Hardwood Plywoods and superior Weldwood Douglas Fir Plywood or, to see the complete line, visit any of the 87 United States Plywood showrooms in principal cities.

Weldwood®
HARDWOOD PLYWOOD

Made by the World's Largest Plywood Organization

United States Plywood Corporation PM 10-5
Box 61, New York 46, New York

Enclosed is 25¢ for your new "Weldwood Do-It-Yourself" book. Please rush my copy!

Name
Address
City State

NEW, DUAL-PURPOSE APPLIANCE



IT'S A
BAR-B-Q

Patent Applied For



3 1/2
BU.
CAP.



IT'S A PORTABLE

BLITZ-BURNER

(TRADE-MARK)

FOR HOME, LAWN, GARDEN WASTE

The new ARMCO Aluminized Steel BLITZ-BURNER is the cleanest, safest, most efficient outdoor appliance ever designed for the collection, storage and disposal of waste basket contents, leaves, etc. Can be quickly converted into an attractive barbecue . . . simply invert the dome to seal off inside of container and insert low-cost charcoal burner and grill accessory.

STAYS GOOD-LOOKING FOR YEARS!

Made of rust and corrosion resistant Armco Aluminized Steel. Special combustion dome induces fast, complete burning . . . eliminates flying ash . . . reduces smoke. Rolls easily wherever you want to use it on rubber-tired wheels. Burns safely anywhere! Heavy cold-rolled steel bottom, you need not scorch your lawn or driveway!

FREE \$4.95 BAR-B-Q

For a limited time only, every Blitz-Burner purchaser will receive a regular \$4.95 Blitz-Burner Barbecue Accessory **FREE OF CHARGE!** Write today for full details on this Special Introductory Offer, illustrated literature, Free Barbecue Cap and delicious Blitzburger recipe.

MONTAMOWER DISTRIBUTING CO. (MFR.)

PM10 KEELER BUILDING GRAND RAPIDS 2, MICH.

Exclusive Double-Bearing HEAVY-DUTY PUMPS

IRRIGATE • DRAIN • CIRCULATE • SPRAY
Up to 3,500 GPH. 3,000 GPH from 25' well. Use 1/2
up to 1 HP motor. 1 1/4" inlet; 1" outlet. Stainless shaft.
TYPE X-2 oilless bronze bearings. **\$10.95**
Won't rust.

TYPE X-B—Ball bearing model. \$12.95

Postpaid if cash with order. (West of Miss. add 30¢)

MONEY BACK GUARANTEE

Centrifugal and Gear Pumps in All Sizes

LABAWCO PUMPS, Belle Mead 2A, N. J.



PLEASANT JOURNEY GUARANTEED



HULL AUTO COMPASS

The one famous name
in Auto Compasses
for 22 years.

Beaconlite \$6.95

Streamline \$4.95

NOW ALSO
IN NEW
CAR COLORS

At better dealers everywhere
Write for literature.



HULL MFG. CO. P. O. Box 246, D-10
WARREN, OHIO

NEW IMPROVED

Contour Copy

Copies exact outline
of any object!

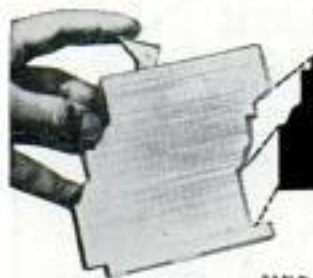

Carpenters, Bricklayers, Welders,
Mechanics, Linoleum Layers, Hobbyists,
many, many others—To get exact outline,
unlock and press each blade
forward so unit fits snugly around ob-
ject or outline to be copied, then lock
and copy outline on any desired sur-
face for cutting or fitting. Exact fit
assured.



Uses Unlimited — Time Saving

4" \$5.90 — 7" \$8.90 — 10" \$11.90
Special lengths—\$1.50 an inch.

W. L. BUSH Co. — 1570 N. W. Bank Bldg., Minneapolis 2, Minn.

VARIABLE SPEED

HYDRAULIC POWER
TRANSMISSION



It has Infinite Speeds 0 to 550. Reverse,
Automatic Overload Protection; Adjustable
Torque up to 180 inch pounds. 3/4" input
and Output Shafts. It will handle 1/2 to
1 1/2 H.P. Motor. Case measures 7 1/2"
long, 7" high, 6 1/2" wide. VALUE OVER
\$300. Shipping Wt. **\$54.50**
25¢. On C.O.D. Orders
we require a 10% only
Deposit. Feb. Chicago

DIRZIUS MACHINE SHOP "G" 1423-25 So. 52nd Ave., Cicero 50, Ill.

POWER HACKSAW \$55.75

LESS MOTOR
F.O.B. Benton Harbor



Send for full details and
name of nearest dealer.

• Rugged cast iron con-
struction. Wt. 56 lbs.,
bronze bearings. Draw
cut. Auto. return lift.
Auto. shut-off. Vise
swivels 45°. Cap. 4"x4".

EXCEL MACHINE TOOLS BENTON HARBOR, MICHIGAN

Guaranteed Auto Parts at Western Auto

MAGNETS

ASSORTED MAGNETS with big list of handy uses. 5 for \$1
POWERFUL POCKET MAGNET ideal for testing metals. \$1
RETRIEVING MAGNET pulls tools, etc., from tank or lake. \$4
HOT PAD MAGNETS to insert in your own hot pads. 8 for \$1
BULLETIN BOARD MAGNETS to "pin-up" memos, etc. 8 for \$1
ZERO-ZONE sensational new ice box, freezer thermometer. \$1
Write for free booklet including heavy retrieving magnets, also rods,
bars, discs, sizes. 100% satisfaction guaranteed. POSTPAID
PARK MAGNETS, 2510, 1557 GREENBAY RD., HIGHLAND PARK, ILL.

AGENTS — SELL

TOOLS! GUNS!
CAMERAS!

Buy tools, photo equipment, sport-
ing goods, jewelry and thousand
other nationally advertised prod-
ucts at big discounts. Big profits
selling to others. Postcard brings
free plan.

Get up to
40% off

AMERICAN BUYERS SERVICE HERTEL STATION, DEPT. 15
BUFFALO 16, NEW YORK

KROIL LOOSENS RUSTY FROZEN PARTS



12,000 industrial plants now use Kroil for emergencies
like frozen bolts, pipe threads, bearings, etc. Kroil creeps
into millionth inch spaces to dissolve rust and dried
grease . . . guaranteed to loosen stuck-together metal
parts or money back—gallon \$3.85 f.o.b. Factory or send
\$1.50 for two 8 oz. spout cans postpaid.

KAND LABS., 1032 Thompson Lane, NASHVILLE 11, TENN.

MODERN**LAWN MOWER SHARPENER****COMPARE
BEFORE YOU BUY**

Write for
free
booklet
10E

Oil remains in engine while sharpening. Bed knife sharpened in same centers — no attachments needed.

Start your own
business—increase
your income

Sharpens any mower in ten to twenty minutes. Handles complete assembly of all reel types including 36 in. power mowers. Handle, wheels, roller, and engine are not removed.

\$26300**MODERN MFG. CO.**

F.O.B. PASADENA

160 N. FAIR OAKS, PASADENA, CALIF.

STOP! DRILLING HOLES WITH A HAMMER!

Use **ROCKET** DRILLS

FASTER BETTER COST LESS

- USED WITH ANY ELECTRIC DRILL MOTOR
- DRILL SMOOTH HOLES IN ANY CONCRETE OR MASONRY
- ALL SIZES 1/4" THRU 2"

TUNGSTEN CARBIDE CUTTERS

ROTARY CONCRETE-MASONRY DRILLSROCKET CONCRETE DRILL COMPANY
DANA POINT, CALIFORNIA**SAVE FUEL DOLLARS**WITH A **PORTABLE FLUE GAS ANALYZER**COMPLETE CO₂ READING **SEND TO-DAY:**
TAKES ONLY 20 SECONDS Complete facts on how toSAVE FUEL DOLLARS and
maintenance man hours!
*NO OBLIGATION**THERMCO**
LABORATORIESJOHNSON ROAD
MICHIGAN CITY, INDIANA**MENDS
MOST ANYTHING****"HOLDS LIKE IRON"**

Used by fine furniture makers. Ideal for home and office. In 1/4 oz. or 2 1/2 oz. sizes.

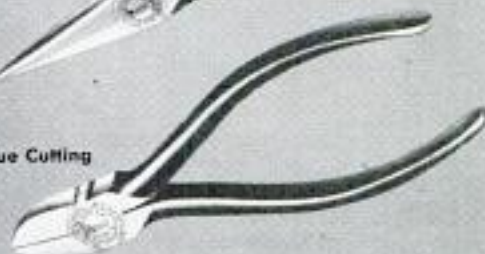
**3 KLEINS
EVERYONE NEEDS**201-NE
Side Cutting
Plier301
Long Nose
Plier202
Oblique Cutting
Plier

Here are three pliers everyone needs. With these Kleins on your workbench or in your tool kit you are equipped for any job where pliers can assist you.

And, of course, you have pride of ownership too, for as everyone knows, Kleins are the standard of quality in pliers—have been "since 1857."

201-NE—The famous side cutter originated by Klein. In 6", 7", 8" or 9" sizes.

301—You will be amazed at how many times a day you will use this handy long nose plier. Ideal for reaching into confined places, holding small parts, etc. In 5", 6" or 7" sizes.

202—This Klein oblique cutter is a tool that good workmen can't do without. Cuts close and clean and the knives stay sharp for years. In 5" and 6" sizes.

Good hardware dealers everywhere carry Kleins.

LOOK FOR THIS DISPLAY

Your hardware store can supply just the Klein Plier for your needs.

**Mathias KLEIN & Sons**

Established 1857

Chicago, Ill., U.S.A.

7200 McCORMICK ROAD • CHICAGO 45, ILLINOIS

SHELDON

CHICAGO

U.S.A.



12" Backgeared Shaper
Big shaper accuracy and features. 13 1/2" stroke—capacity for most shop and toolroom work; frees large costly shapers for special jobs. Rigidly built with back-gear variable speed drive.

Write for catalog

Size "0" Milling Machine
for tool room, shop or production work. Modern, compact design, modern features but low in price available with or without back-gearing. Hand or power longitudinal feed. Shipped completely assembled, ready for work.

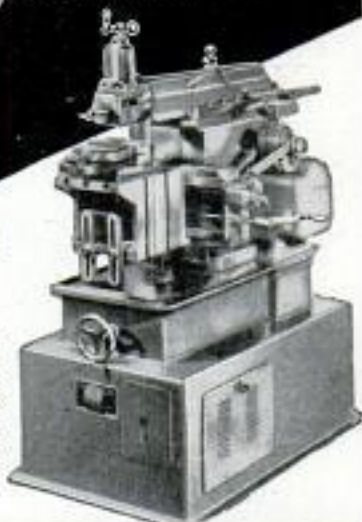

SHELDON MACHINE CO., Inc.
4268 N. Knox Ave., Chicago 41, Illinois

Now You Can Do It Yourself



CONFINE DESTRUCTIVE
COOKING HEAT,
GREASE and STEAM
TO YOUR STOVE

It's the Most Important
Protection You Can Give Your
Expensive Decorations and Furnishings!

Anyone who can use a keyhole saw, hammer and screw-driver can easily install a Vent-A-Hood. Work a miracle in your home! The cooking odors you smell drifting throughout your home are hot, buoyant animal fats or vegetable oils cooling and settling to become a rancid, ruinous film on woodwork, walls and furnishings. Vent-A-Hood consumes Summer's stifling cooking heat and Winter's steamy, greasy cooking vapors before they can touch your home... providing real home comfort and saving money year after year. Vent-A-Hood traps odors which wall or ceiling fans cannot. Vent-A-Hood is complete with simple-to-follow step-by-step instructions.

Vent-A-Hood

1901 Plantation Rd. • Dallas, Texas

Please send more information about Vent-A-Hood Cooking Ventilation Equipment:

Name _____

Address _____

City _____ State _____



HOME COOKING VENTILATION SPECIALISTS

5 TINY ELECTRIC MOTORS Serve HOBBY-SCIENCE-INDUSTRY

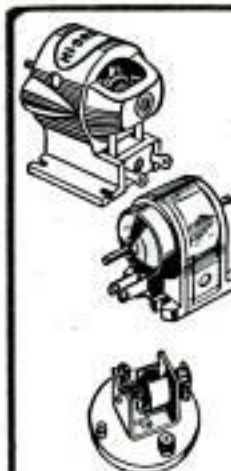

Wilson's offers you five tiny battery-operated motors—one for every use—1 1/2 to 6 volts—all sturdy, powerful and low in cost. Will operate hobby items, toys, research devices, recorders, rotaries, industrial models. This list may help solve many of your motorizing problems.

- *No. 7-100 Hi-Drive Motor, 1 1/2-3V \$2.00
- *No. 8-100 Same for 3-6V \$2.50
- *No. 3-100 Tiny Atom Motor, 1 1/2-3V \$2.00
- For higher voltages... \$2.50
- *No. 96 Steel frame motor with gear, pinions, pulley, worm \$4.00
- No. 3113 Tiny Atom motor assembly kit with many acc. \$3.00
- No. 1300 Small accessories kit \$1.00
- No. 3700 Large accessories kit \$3.00
- No. 4000 Deluxe accessories kit with motor \$5.00
- No. 700 Super-Power kit with motor, speed reducer, all accessories \$10.00
- No. 88 Kit of 8 pulleys—2 belts \$2.00
- No. 3000 Vari-speed gear unit \$4.00

*Items illustrated. Ask for PRICE Cat.

All Wilson's motors have Permanent Alnico Magnets.

Remit with order and we pay postage in U.S.A. No C.O.D. Add 3% sales tax for delivery in Ohio. Write Dept. PM

For quick delivery see your local dealer — or order direct



WILSON'S OF CLEVELAND

425 Lakeside Ave., N.W. • Cleveland 13, Ohio

SAVE MONEY on SANDING Belts and discs

Clean out wood dust, paint & varnish with new SAN-KLEEN dressing stick, doubles **ONLY \$1.00** belt life, speeds up work. **POSTPAID**

BANES MARINE CO.

154 Randolph Pl.

West Orange, New Jersey

WHY TAKE LESS THAN THE BEST?

Insist on **EAGLE Folding RULES**
With *Coil Spring Joints*

GUARANTEED AGAINST JOINT FAILURE FOREVER

EAGLE RULE MFG. CORP. N.Y. 59, N.Y.

FREE OIL FILTER REPLACEMENTS

No more Filter Elements to buy! Get the ZENICK Permanent Porous Bronze Filter Element for only \$3.95! Full Flow \$7.95. For all cars & light trucks. Also, Vaporizer that saves 3 miles per gal. \$3.00. State car make when ordering. Money Back Guarantee. Dealer Inquiries Invited.



ZENICK PRODUCTS CORP. Dept. 2
Box 2461, Los Angeles 54, California

Say You Saw It in Popular Mechanics



MAGNETS **225# PULL**
GENUINE ALNICO—NEVER WEAKENS

AMAZING, PERMANENT MAGNETS—WILL NOT WEAKEN! NON-ELECTRIC Retrieve guns, tackle, tools and other steel items from lake, river, plating tanks, drains or other hard-to-reach spots. Recover drills, taps, etc. from sweepings. Clear alley of harmful tacks, nails. Many other uses. Pays for itself quickly. GUARANTEED. Try any magnet one week. Money refunded if you are not well pleased.

- No. M-725 (Weights 54 oz.) Has pull of 225 lbs. on steel block. \$15.00
- No. M-625 (Weights 70 oz.) Has pull of 175 lbs. on steel block. \$ 8.50
- No. M-575 (Weights 18 oz.) Has pull of 75 lbs. on steel block. \$ 6.00
- No. M-500 (Weights 13 oz.) Has pull of 50 lbs. on steel block. \$ 4.00
- No. M-101 U-shaped Magnet (Wt. 2 1/4 oz.) Pull of 6 1/2 lbs. 2 for \$ 1.50
- No. M-201 Pocket Magnet (Wt. 1 1/2 oz.) Pull of 4 lbs. 2 for \$ 1.15
- No. M-35 Hobbyist assortment of eight small magnets. . . . \$ 1.50
- No. M-48 Powerful Hot Pad Magnets. 8 for \$1.00, 30 for \$ 3.00

Send Money Order or Check. We pay postage. No C.O.D.'s.
MIAMI MAGNET COMPANY, 3240 N. W. 27th Ave., Miami 42, Fla.

POPULAR MECHANICS

It's easy, inexpensive to build this handsome space-saver

Against a paneled or painted wall, it combines a wealth of shelves, commodious cabinets and magazines on display. Easy to build of Western Pine woods, it can be the feature of a room.

The woods of the Western Pines* are a pleasure to work with. Clean-cutting, even-grained, smooth-surfaced, they come carefully selected and well-seasoned, take all finishes without grain-raising. See them at your lumber dealer's—ask him for an estimate.

FREE—“INSTALLING AND COLORING YOUR WALLS OF WESTERN PINES.” Also, “FRIENDLY HOME IDEAS IN WESTERN PINE,” new 86-photo booklet of building and remodeling ideas. Write for both to WESTERN PINE ASSOCIATION, Dept. 414-N, Yeon Bldg., Portland 4, Oregon.



the **Western Pines**

- *IDAHO WHITE PINE
- *PONDEROSA PINE
- *SUGAR PINE



Find URANIUM!!

GEIGER COUNTERS for uranium detection. All models and sizes — from low-cost, portable to super-sensitive airborne units. Prices start at \$37.50. Also TREASURE DETECTORS and MINERALITES. • **FREE INFORMATION** •

Detectron CORP.
5528 Vineland, North Hollywood, Calif.

Make your own Gems 29.50 F.O.B.

The Gem Maker comes complete with all necessary equipment, including a super-charged diamond blade for sawing, and all wheels for grinding, shaping and polishing; also complete instructions. The complete equipment as shown, less motor and belt, for only \$29.50, f.o.b., Burlington, Wisconsin. Write today for information and literature.

B & I MANUFACTURING CO.
Dept. 5 Burlington, Wis.

Protect your home against power interruptions with an...

ONAN Emergency ELECTRIC PLANT

Provides dependable stand-by electricity for heating system, pumps, freezer, lights, appliances. Keeps home safe, livable. Automatic start and stop. Find out how little it costs!

Write for Folder!

D. W. ONAN & SONS, INC.
3313 University Ave. S. E. • Minneapolis 14, Minnesota

A SIZE FOR EVERY NEED
400 to 75,000 watts. Compact, quiet-running, easy to install. Gasoline engine powered.

for
Saws that Cut
TODAY...
TOMORROW...
ALWAYS...
it's **SANDVIK!**

Made of genuine Swedish Charcoal Steel... hardened, tempered and filed to produce the finest, sharpest, longest lasting cutting edges you've ever seen. Extra high crown, perfect balance, easy-grip handle. Compare a Sandvik saw with any ordinary make. The difference in the way it cuts will convince you that there's no finer handsaw made.

Be sure to look for the Sandvik "Fish & Hook" trade mark. See your hardware dealer or write us for handsaw folder. Dept. PM-3

"Fish & Hook"
Brand of Quality

Sandvik Saw & Tool

DIVISION OF SANDVIK STEEL INC.
1702 NEVINS ROAD, FAIR LAWN, N. J.
SANDVIK SAWS SERVE THE WORLD



KLEAN-STRIP Remover makes any refinishing job easier

- Breaks bond between any finish and surface
- One application removes many coats
- Fast-acting, non-messy, easy to use
- Leaves surface smooth, dry, ready to refinish
- Needs no neutralizing or afterwash
- Buy Klean-Strip where you buy paint

NON-INFLAMMABLE KLEAN-STRIP PAINT REMOVER

The Klean-Strip Co., Inc.
2340 S. Lauderdale, Memphis 6, Tenn.



Headrest for Travelers

If you can't afford a Pullman berth on your next trip, a French inventor has a second-best answer. You can lean your weary head against a foam-rubber pillow anchored to the window or wall by rubber suction cups. The lightweight pillow can be used on plane, train or bus.



PRECUT AND PANELIZED for EASY ERECTION

It is easier than you think to build an attractive two or three bedroom home when you select an LFI panelized house package specially designed for easy erection in minimum time. You can save thousands of dollars and have a home that will be the envy of the neighborhood. Your home will be shipped to the building site in factory assembled, panelized sections using architecturally approved construction and clearly marked precut material. Complete plans, erection instructions and specifications are furnished.



Send \$1.00 for plans and details

Department L

LUMBER FABRICATORS, INC.
FORT PAYNE, ALABAMA

Little Grease Gun

It's scarcely larger than the palm of your hand, but a midget grease gun develops 3000 pounds of pressure. Especially designed for greasing hard-to-reach spots, the gun can be operated with one hand. It holds four ounces of grease. The lightweight gun, made of aluminum, will not corrode under the worst possible conditions.



SHOP BY MAIL and **SAVE at GROBAN'S**

SURPLUS & NEW MANUFACTURE EQUIPMENT FOR HOME, FARM & FACTORY ALL ITEMS UNCONDITIONALLY GUARANTEED!

A. C. ELECTRIC GENERATOR

 7 1/2 K.W. (7500 WATTS) single phase. ITEM #G-75-D 110/220 volt output. 3 wire system, 2 bearing construction. 5 groove 6" V belt pulley included. Self-excited. Foot mounted. Drive generator from tractor or stand by engine. Ample power for 6 room house. Dimensions: 34" x 11 1/2". Shipping Wt. 420 lbs. F.O.B. Chicago **295.00**

Complete control box for these generators includes A.C. rheostat, automatic voltage regulator, field rheostat, and voltmeter, already wired and ready to connect to generator. List price \$167.00. Our Price **56.45**

BELT DRIVEN A. C. GENERATORS

Ideal for powering electric tools, oil burner, refrigerator, lights, or other appliances requiring up to 700 Watts of power. 700 WATTS. 115 Volts. 60 cycles A.C. 3600 R.P.M. Compact, self-regulating generator with V Belt pulley and double outlet receptacle. Rotation counterclockwise. May be driven by tractor or auxiliary gasoline engine. Requires 2 HP minimum. Dimensions: 10" long x 8" high x 6" wide. Shipping wt. 27 lbs. F.O.B. Chicago **59.50**

Model 1010 — 1000 WATTS (Same as above) F.O.B. Chicago **79.50**

MULTI PURPOSE HYDRAULIC PUMP OR MOTOR

 ITEM #55 Silent, high efficiency. Helical Gear Type Ball Bearing. Hydraulic Pump or Motor. Rated 8 Gal. Per Min. At 1500 R.P.M.—Delivers 1000 P. S. I. Using 6 H.P.—Reversible. Fittings — 3/4" Pipe Thread Inlet and Outlet Ports—1/4" Drain Port—3/4" shaft with keyway and flat for either direct or pulley drive. Dimensions—5 1/2" high, 7 1/2" long, 5 1/4" wide. Shipping weight 18 lbs. F.O.B. Chicago **45.50**

ORDER DIRECT FROM AD SATISFACTION GUARANTEED
Send Payment Or Purchase Order Today

FREE CATALOG

52 PAGES, chockfull of unsurpassed War Surplus Equipment Bargains for farm, home, factory, workshop. Write letter today.

FACTORY-TO-YOU-VALUE PORTABLE ELECTRIC LIGHT PLANTS

 POWER TO OPERATE:
• Electric Saw, Electric Drills, Pipe Bender.
• Refrigerator, Deep Freezer, Incubator.
• Water Pump, Radio, Lights, Air-conditioner.

BRAND NEW 1955 ITEM #1008
COMPACT — FITS IN THE TRUNK OF YOUR CAR
1000 WATTS OUTPUT, continuous duty. 115 Volts A.C. 60 cycles. 9 amps. Powered by husky, easy starting Clinton engine. Engine and generator operate at 3600 R.P.M. for maximum efficiency at minimum weight. Both units are mounted on steel base, with heavy sheet metal belt guard. Generator is self regulating, and is equipped with outlet box containing fuse and 2 A.C. convenience receptacles. Cost only 5c an hour to operate. Dimensions: Length 20 1/2", Width 12", Height 16". Shipping wt. 100 lbs. F.O.B. Chicago **149.50**
700 WATT-GENERATOR SET—same as above, slightly smaller—with Briggs-Stratton Engine—Model 708—F.O.B. Chicago **129.50**

Brand New! 5-TON BLACKHAWK HYDRAULIC LIFT KIT

The New Only **38.95** Complete
Complete Kit
For — • Dumping farm wagons • Adjusting depth of plows • Hydraulic press • Hydraulic jack • Snow plows.
KIT CONSISTS OF:
Item #116-1—Brand new Blackhawk Model No. P-101—Hydraulic hand pump with built-in oil tank and release valve. Rated from 100 P.S.I.—to 500 P.S.I. 2 1/2" handle. Dim. 8" x 6" x 6" Item #282 **22.50**
1—6 Ft. length double wire braid rubber covered hydraulic hose—tested to 20,000 lbs.— Item #2784 **3.95**
1—Hydraulic cylinder, 2" bore, 6" stroke, husky 1" solid steel shaft, will lift 10,000 lbs., using pump pressure. Standard rivet mounting. May be used for double action service. Item #41C1C **12.50**
2—Gss. non-foaming hydraulic fluid. **1.00**
All necessary hydraulic fittings.
Total ship. wt.—40 lbs.
COMPLETE KIT PRICE 38.95
ALL OF ABOVE INCLUDED F.O.B. Chicago

GROBAN FOUR-WAY OPEN CENTER HYDRAULIC CONTROL VALVE

 ITEM #126—Four-way open center control valve, with built-in adjustable relief valve factory set at 1000 P.S.I. Spring loaded neutral position. For use with one double acting cylinder. In neutral position cylinder is locked and pump unloaded. Can be used as single unit or mounted in series. Has 3/4" pipe thread inlet and outlet, 1/2" pipe thread cylinder ports. Finger grip handle. Ship. wt. 10 1/2 lbs.
AN OUTSTANDING BUY!
F.O.B. Chicago **21.50**

To place phone orders call WEBster 9-3793

GROBAN SUPPLY CO. Dept. PM-10
1139 S. WABASH AVE., CHICAGO 5, ILL.

GROBAN HYDRAULIC SPEED REDUCER with FINGERTIP CONTROL

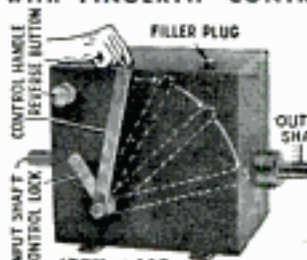
 FILLER PLUG
CONTROL HANDLE
REVERSE BUTTON
CONTROL LOCK
INPUT SHAFT
OUTPUT SHAFT
ITEM #115

FOR: • Reamer Drives • Midget Cars • Feed Mills • Canning Machines • Conveyors • Lathes • Milling Machines • Motor Boats • Cream Separators • Garden Tractors • Pumps.
Variable output speeds from 0 to input speed available by moving control handle. Locking handle maintains setting. Use input power of 1/2 to 1 1/2 H.P. Shafts 5/8" diam. Input rotation counter-clockwise facing shaft. Input speed 250 R.P.M. 1/2" x 7 1/2" x 1 1/2". Gov't acquisition cost \$428.00. Shpg. wt. 31 lbs. Complete with 2 qts. of oil and full instructions. F.O.B. Chicago **54.50**

SELF-PRIMING ALL BRONZE & MONEL GEAR PUMP

ITEM #383—USE FOR:
• Sprinkling • Irrigation • Insecticide Spraying • Sump Pump • Fuel Transfer • Home Water Systems • Dewatering • Salt Water, Chemical, Acid Pumping.

FEATURES • Needle Bearing Construction • 1 1/2" Pipe Thread Inlet, 1 3/4" Hose Outlet • Standard 3/4" Keyed Shaft • All Bronze Body & gears, Monel Shaft • Equipped with Drain Cocks, Grease Cup, Steel Internal Drive Gears for long, trouble free service.
CAPACITY: From 10 to 80 Gal. Per Min. At Speeds from 550 to 2400 Rev. Per Min. Using from 1/2 to 16 Horse Power. For Pressures to 160 lbs. Ship. wt. 56 lbs. U. S. Navy Cost \$168.00. F.O.B. Chicago **39.50** Ea. Two for **75.00**

DOUBLE ACTION HYDRAULIC CYLINDER

ITEM #31C—3 1/2" bore, 11" stroke. Alloy steel cylinder wall, Mirror-Honed and all steel 1 1/4" diameter piston rod. 194g" overall length closed. Clevis mounting at base and shaft. Will lift 9625 lbs. with 1000 PSI Pump Pressure. Uses 3/8" tubing fittings. Fittings for pipe threads two 3/8" MPT @ 35¢ A \$102.00

 value. Shipping weight 11 lbs. FOB Chicago **25.00**

24-Page Illustrated DO-IT-YOURSELF PROJECTS BOOK
Describes attic finishing, built-in cabinets, add-a-room, recreation room, kitchen remodeling, summer cottage and farm projects. Contains helpful information on how to get started, planning, cost estimating, materials purchasing, and proper procedures, also nail charts, moulding designs, etc. Send only 25c and also receive FREE 52-PAGE POWER TOOL CATALOG.
BOICE-CRANE COMPANY, 943 Central Avenue, Toledo 6, Ohio

Also Adult Size Cars at Low prices for
• GOLFERS
• AIRPORTS
• INDUSTRY
• LIGHT DELIVERY

ESHELMAN 70 MILES PER GAL. GAS CHILD'S AUTO WITH MOTOR
STURDY, SAFE FOR KIDS
Commended by "Parent's Mag."
Write for Free Catalog.
SHIPPING POINTS: BALTIMORE, CHICAGO, RENO.
For Free Catalog Write Esheleman, Dept. MC-510 309 Light St., Baltimore 2, Md.
 ALSO ADULT GOLF CARS
Pat. Pend.

TURN YOUR SPARE TIME INTO \$5 an HOUR EXTRA CASH

Earn Big Money in
Your Own Home
with the BELSAW
SHARP SMITH



Thousands of Belsaw users have proved that sharpening circular saws, grinding planer and jointer knives is profitable. Many have given up regular jobs to devote their entire time to their own money-making business.

The initial investment is only \$15 down payment. The space required is small... 15 square feet in your home or garage.

No experience is necessary. A beginner can produce expert work the day his Belsaw arrives.

The demand is in your own neighborhood... constantly expanding. More and more circular saws are used by professionals, carpenters, contractors... plus the thousands with basement workshops. All these circular saws need dependable sharpening... the kind you can give them with a Belsaw.

You do the jobs in your own home in your own spare time. No punching the time clock, if you want to take the day off to go fishing, it's yours for the taking. Every man has dreamed of being his own boss. With your Belsaw you can make it possible.

Write today for actual experiences of Belsaw owners... and Free Book, "Lifetime Security with Your Own Business."

FREE
Book



BELSAW MACHINERY CO

1646 Field Bldg., 315 Westport Rd., Kansas City 11, Mo.

STANSTRIP* seals out water, snow, dust and drafts -seals in heat



For the bottom
of overhead-type
garage doors

DO IT YOURSELF
QUICKLY
...EASILY

StanStrip is a Do-It-Yourself product, easily installed... a durable, live rubber weatherstrip that seals out weather and cushions door closing. Lasts for years. Pays for itself quickly. Available at leading hardware and lumber dealers.

*Trade-Mark



The Standard Products Co.
BUILDING PRODUCTS DIVISION
Port Clinton, Ohio

6-ft. only
\$149



Insist on
Evans
TAPES "KING-SIZE"

At your hardware store



EXCLUSIVE! Belt clip for handy carrying.
Also available in 8, 10, 12-ft. lengths with free plastic utility case.



Write
for
Bulletin
VT-273

and Radio Active Sample, complete for \$125.00. Additional accessories available include SIX PACK of high sensitivity Bismuth Geiger Tubes (15 times more sensitive than standard tube), hand probe, and deep-hole probe can readily be plugged into built-in jack. Vic-Tic was designed by the same staff of engineers who developed the first instrumentation for Atomic Science. Fully Guaranteed. Order now for immediate shipment.

VICTOREEN INSTRUMENT CO. 5804 HOUGH AVENUE CLEVELAND 3, OHIO

FREE
BOAT
KIT
CATALOG

Write:

8' to 14' Models from \$39.95 incl. freight

- Assemble your own boat
- No experience necessary
- Save 1/2 to 2/3 "factory built" prices



Marine Hardware, Fiberglass, & Trailers

UGER INDUSTRIES DEPT. B 4432 NICOLLET AVE. MINNEAPOLIS 9, MINN.

IT'S HERE!! THE INTERMIX MATCHING PUTTY KIT

Easy to match any conventional stain or natural wood color simply by kneading together. Commercial package contains 8-9 oz. tubes of colored putty \$1.50. Household package contains 3-5% oz. tubes of colored putty and 1-2% oz. tube of 100% white wood putty \$1.25. Full directions on package. Shipped Parcel Post C.O.D. **BIG TREE COLORED PUTTY CO., East Aventura, N. Y.**

ELECTRIC MOTOR



\$150
Post paid

A low-cost, dependable motor with many uses. Ideal for displays, pumps, fans, heaters, toys. No radio interference. Every one guaranteed. Write for free catalog.

PENNSYLVANIA WHOLESALE DISTRIBUTORS
103 N. 6th STREET PHILADELPHIA 6, PA.

How to Build Your Own GARAGE



Save as Much as 50%
of Usual Construction Costs

Get Popular Mechanics' brand new book **How to Build Your Own Garage** by Wayne Leckey, Assistant Shop Notes Editor, and find out how you can build your own garage at savings of 50% of usual cost. Leckey tells in famous step-by-step instructions and shows in big, clear photos, drawings and diagrams how to perform every building operation from laying the concrete to installing the final trim. There are 25 designs. Brick, frame, and concrete block fully covered. Send \$3.50 for your copy. 7-day money back guarantee.

POPULAR MECHANICS PRESS, 200 E. Ontario, Chicago 11, Ill.

NO NAILS
NO BOLTS
NO SCREWS

YIPEE-EE
A SAWHORSE
IN A JIFFY



WITH **Jiffy** SAWHORSE BRACKETS

ALL WELDED construction. Use any 2x4's for legs and cross bar.

SET UP OR knocked down instantly. Easy to move from job to job, and easy to store.

FOR SALE BY most hardware and lumber stores. If your dealer cannot supply you, write us direct.



At Work



At Home



GRAND HAVEN STAMPED PRODUCTS CO.
GRAND HAVEN, MICH.

Carpenters' NAILPULLER Pocket size!

Powerful, Easy to Use, Handy as a Hammer!

Satisfaction guaranteed up to tenpenny nails.

POSTPAID
U.S. ONLY

\$1.74

No C.O.D.
No Stamps.



Only 12" long.

Carpenters' favorite. Convenient in tight places, carries in pocket. Tool steel counteracting jaws driven into wood under nailhead. Double leverage with hammer. All steel, rustproofed.
K-D Mfg. Co., 526 N. Plum St., Lancaster, Pa.

URANIUM AND METALS

Easily located with the new M-Scope Instruments. Superior Performance. Prices \$35.00 up. Monthly payment plan. Booklets "How to be a Successful Uranium Prospector"—"For Fun and Profit" free upon request.

FISHER RESEARCH LABORATORY, INC.
PALO ALTO CALIF.

OIL FILTER REFILLS... 10c

Filters off the full length of the Pack

10,000 Sq. In. of Filtering Surface

Plates Last Indefinitely

Here's News! Ordinary toilet paper makes an ideal oil filter. Laboratory tests prove it cleans oil faster and better than popular makes of filter elements. All you need is a simple set of **RETLIF ADAPTER PLATES**... and you can start using ordinary toilet paper rolls in your present oil filter. For proof and descriptive literature, send name and address to:

RETLIF CORPORATION, Dept. 153
915 No. Highland Ave., Los Angeles 38, Calif.



Free Power Tool Book

COMPLETELY NEW 60-PAGE 1955-56 CATALOG of wood and metal-working equipment, portable electric tools, welders, motors and shop accessories. Wards own **POWER-KRAFT** tools plus other famous name equipment—Shopsmith, Black & Decker, Stanley, Logan, Dremel, Speedway, Westinghouse, etc. New listings include: Sunbeam electric drill, drill kit; saw and sander; new Magna "Shop-on-the-wall" power tools; over 200 new McCall "Iron-on" and Easy-bid patterns for workshop projects. Helpful hints on choosing and using tools.

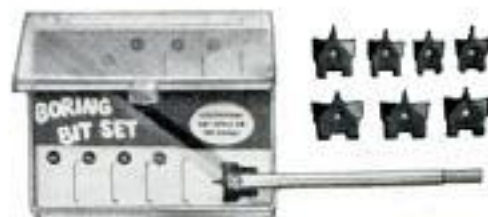

Boring Bit Set... Only \$1.50

SPECIAL 30-DAY INTRODUCTORY OFFER. Regular \$1.98 Boring Bitset only \$1.50 Postpaid if you request our free catalog before Nov. 15, 1955. Drills smooth holes up to 1 in. diameter in wood, formica, wall-board, plaster, etc. Fits any 1/4 in. electric drill. Six interchangeable bits 3/8 to 1 in. Plastic box.

Montgomery Ward

Chicago 7, Ill. • Baltimore 32, Md. • Albany 1, N.Y.
St. Paul 1, Minn. • Denver 17, Colo.
Kansas City 11, Mo. • Portland 10, Ore.
Oakland 16, Cal. • Ft. Worth 1, Tex.
Clip and mail to nearest city above—NOW!

MONTGOMERY WARD, Dept. KR-PM10

Please send Wards Free Power Tool Book.

Enclosed find \$1.50. Send me Boring Bit Set and Wards Free Power Tool Book.

Name..... (Please PRINT Plainly)

Street Address or Route and Box No.....

Post Office..... State.....

\$35,000 REWARD

FOR URANIUM



Here's your chance to "cash in!" Over \$3,750,000 in Government Bonuses have been paid for URANIUM discoveries in the past 2 years. Currently \$175,000 a month is paid to people like you.

Precision Geiger Counters and Scintillators are the finest instruments made for URANIUM prospecting. These highly sensitive instruments are compact, lightweight and ruggedly built for field use. Prices start at \$29.95.

CONTACT YOUR NEAREST DEALER

or write direct to factory for
FREE 12-PAGE CATALOG and
our 24-PAGE BOOKLET with
"64 QUESTIONS AND ANSWERS
ON GEIGER COUNTERS
AND SCINTILLATORS."

PROSPECTORS
RELY ON...

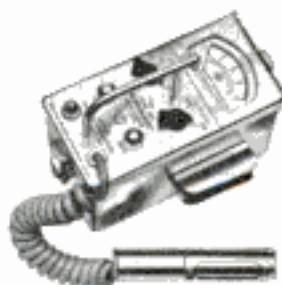

MAIL TODAY FOR FREE INFORMATION

Name _____ Title _____

Company _____

Address _____ City _____ State _____

PRECISION RADIATION INSTRUMENTS, INC.
4223 PMW. Jefferson Blvd., Los Angeles 16, Calif.
World's Largest Manufacturer of Radiation Instruments

\$3 to \$5 an hour
IN SPARE TIME

WITH NEW FOLEY PRECISION GRINDER

Make \$3 to \$5 an hour in your own spare time business. Low cost machine sharpens circular saws, rotary mower blades, ice skates, discs sanding, polishing, buffing. Easy to operate—no experience needed. Send coupon today for Free circular. No salesman will call.

FOLEY MFG. COMPANY
1073-S Feley Bldg.
Mississippi 18, Miss.

Send Free Circular on Foley Precision Grinder.

Name _____

Address _____

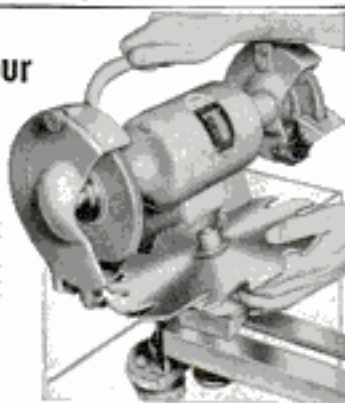

Lincoln Gets All-New Styling; Ford, Mercury Stress Safety

(Continued from page 104)

from last year, although exact figures are not available for release at this writing. It will probably be 200 horsepower in the Fairlane and Wagon series that have a V8 of 292 cubic inches, the same as last year's Mercury, and a four-barrel carburetor. Mainline and Customline models retain the 272-cubic-inch engine. New on all V8s is an automatic choke, Ford being the only American car to have a hand choke as it still does on its six-cylinder models. The electrical system is 12-volt.

Ford's main emphasis, like Lincoln's, is on safety. Concave steering wheel, safety door locks, shatterproof rear-view mirror are standard. Also standard are strengthened front-seat track systems and securely anchored rear-seat cushions.

Engineers stress that these changes, important as they may be, are not primarily intended to save lives in high-speed crashes (although they will help, of course). They are designed to reduce death and injury in accidents at 40 miles per hour or under. Pennsylvania Turnpike research shows that 50 percent of the actual impacts occur at lower speeds than you might expect because drivers have had time to decelerate before the collision.

Padded areas on dash and sun visors are covered with plastic foam, an energy-absorbing material that does not rebound like foam rubber, an energy-storing material. Favorite demonstration of Ford personnel is to swing lustily at the dashboard with a clenched fist, hitting it sharply without injury to fist or panel. Sun visors are thickly padded because test crashes at Cornell Aeronautical Laboratory (whose recommendations Ford has followed) show that the area above the windshield is a prime target for passengers' heads.

Other Ford features include: Increased compression ratios (8.4:1 for Fordomatic V8; 8.0:1 for hand-shift V8 and all sixes); better breathing and carburetion plus a new spark curve have improved performance; fixed-anchor brakes eliminate the movable cam and simplify adjustment; a new twist in automatic motoring is the self-locking convertible top (simply press a button and the top goes up and locks itself against the windshield header, making it unnecessary for the driver to reach up and lock it by hand); also new is a Parklane station wagon, lushly carpeted from wall to wall; all models have a redesigned dashboard for improved instrument visibility; station wagons have a new front sway bar.

(Continued to page 330)

GRAVELY with Starter makes



Snow Removal

A SNAP

• Save your heart! . . . Powerful Gravelly Tractor with push-button starter, 48-inch Snowplow attachment takes all the work from snow removal!

23 DIFFERENT TOOLS

• 23 attachments to save your time and work all year long. *Easy Pay Plan . . . only 20% down, 18 months on balance.* Write today for FREE 24-page "Power vs Drudgery" Booklet.



GRAVELLY TRACTORS, INC.
BOX 1063 DUNBAR, W. VA.

FIELD-TESTED FOR 34 YEARS



Ideal gift for your do-it-yourself friends. ACE SUPER SET, 39 pieces, best quality taps and adjustable dies in 17 popular sizes and threads. Complete with wrenches and accessories in unbreakable plastic box. Price \$18.95 postpaid. Write to:

TAILORED TOOLS, INC.
Sharon, Mass.

No Leak Lamp

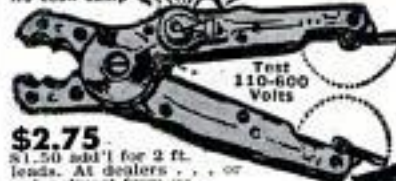

TEST Circuits, Fuses, Outlets easily, quickly, safely. Shockproof. Pull fuses 10 to 100 Amp.

\$2.75

\$1.50 add'l for 2 ft. leads. At dealers . . . or order direct from us. Mailed POSTPAID

STAR FUSE CO., 233 Canal St., New York 13, N. Y.

HANDIEST TOOLS

HARGRAVE CLAMPS

for every SHOP NEED



Ask your dealer for a copy of HARGRAVE Catalog No. 115 or write

THE CINCINNATI TOOL CO.
1987 WAVERLY AVE.
CINCINNATI 12, OHIO

It's easy to Panel a Room . . . or a Wall



to Match Your Beautiful HARDWOOD Doors

Why not? The work is simple. The cost is low when you do it yourself. The result—elegant, beautiful, and so professional looking. It's easy to finish...easy to maintain...and it lasts and lasts.

See your local lumber dealer for how-to-do-it suggestions and panels in these species. Write HPI for helpful folder on paneling Rooms with Doors to match.

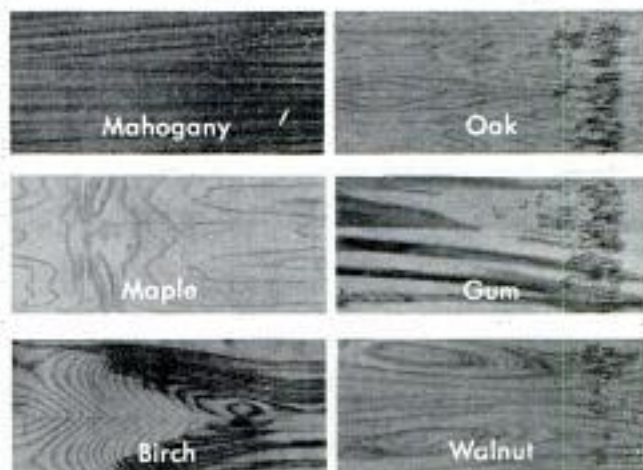

Hardwood Plywood... Natural Wood Fabricated in America

The HPI trademark identifies American mills operating under a rigid 5-point quality control program. It's your assurance of quality.

HARDWOOD PLYWOOD INSTITUTE
600 South Michigan Avenue • Chicago 5, Ill.

When buying...
Be Sure and See



WORK-LITE

When drilling...
See and Be Sure

The WORK-LITE 1/2" Electric drill is another Fairchild First... It's the only drill with a built-in work light. You will like the other superior Fairchild features too! The WORK-LITE has a Jacobs geared key chuck and key holder. A Fairchild-built universal motor produces power galore for continuous hard use. Precision ball bearings provide ultra-smooth operation. Has the famous Cutler-Hammer lock action trigger switch. Light weight, rust proof aluminum housings have gleaming ROLL-BRITE finish. U.L. approved for industrial use yet still remains in the popular price class.

\$26.95

SEE YOUR DEALER . . . OR ORDER DIRECT

FAIRCHILD INDUSTRIES
110 MAIN STREET BURLINGTON, 2 VT.



Don't be a "WALLFOULER"

USE



WALLGRIPS
HOLLOW WALL
SCREW ANCHORS



Securely fasten pictures, cabinets, curtain and shelf brackets to wood, plaster, wallboard, gypsum, cinder block, marble, hollow tile . . . like a professional. Only Rocket WALLGRIPS have "Knee Action" for effortless tightening—"Positive Stop" for guaranteed anchorage—



← "Outside Wrench" that prevents marring of walls.

FREE PAMPHLET! "Don't be a WALLFOULER." Write Dept. PM-10 WHEREVER HARDWARE IS SOLD

ROCKET DEVICES CORPORATION
142 Liberty Street • New York 6, N.Y.
Rocket Devices (Canada): Montreal, Toronto, Winnipeg, Vancouver

Mercury for 1956

Big brother of the Ford, Mercury offers all the safety features listed above and additional horsepower also.

Three engine choices are available: A 9.0:1-compression-ratio engine of 225 horsepower on all Montclair and Monterey models equipped with automatic transmission; and 8.4:1 engine of about 215 horsepower (exact figure not available at this writing) on Custom automatics; and an 8.0:1 engine of 210 horsepower on all hand-shift and overdrive models.

All three engines have a 312-cubic-inch displacement (up 20 inches from 1955). All have four-barrel carburetors. The new automatic choke, integral with the carburetor, uses filtered, exhaust-heated air.

Montclairs and Montereys have dual exhausts as standard. The electrical system is 12-volt. Valve lift is increased to give the better breathing that means more power. A new lower-priced car is offered: The Medalist, a two-door austerity model in the Custom series. Also available is a low-silhouette four-door sports sedan in the Monterey series.

Combustion chambers have been rounded somewhat to reduce preignition. Mercury has the same double-diaphragm spark advance as Lincoln. Suspension is somewhat softer for increased comfort on the boulevard. Exterior styling changes are limited to the front grille, taillights and chrome trim. ★ ★ ★

Plastic Seals Sewer-Pipe Joints

Joints between lengths of clay sewer pipe are made rootproof and watertight by flexible-plastic sealing rings. The rings, made of Koroseal, are molded permanently to the ends of the pipe sections. When two ends are pushed together, the rings squeeze against each other to form a compression seal which resists water and roots. The plastic is not affected by chemicals.



How do you know it's a good house?

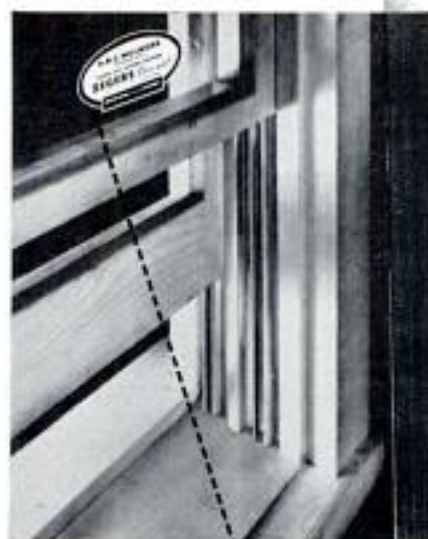

Be wise! Check, poke and peer into the *window construction*. Open and shut the windows. Do they move easily and quietly? Wiggle them. Do they fit snugly? Are they properly weatherstripped? Look for *all* these things because the quality of windows usually reveals the quality of the entire house.

Be *sure* of quality! Look for windows equipped with Zegers Dura-seal . . . the *combination* metal weatherstrip and sash balance that operates silently and at the touch of a finger. Dura-seal keeps out cold and drafts . . . keeps your home warmer and cleaner in the winter . . . *saves 30% to 40% in fuel*. Keeps out dirt and dust in the summer . . . seals the house perfectly for air conditioning.

Look for the Dura-seal sticker on the glass and for the name embossed on the metal! It's your assurance of quality. *Your builder or architect knows about Zegers Dura-seal . . . ask him! Your retail lumber dealer sells complete window units equipped with Dura-seal. See him now.*

Look for the Name
on the Window

ZEGERS, INCORPORATED
Chicago, Illinois

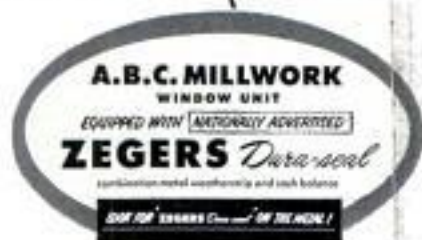

ZEGERS *Dura-seal*

COMBINATION METAL WEATHERSTRIP AND SASH BALANCE

NEW

CRAFTSMAN'S CATALOG

with \$5 in discount coupons

Get this 88 page catalog TODAY.

88 illustrated pages, full of information and low prices on items for the home handyman. Everything from plywoods, lumber, veneers, mouldings and glues, to hardware and furniture trim; several pages of easy plans, lamp parts, metals and a section of bandings and inlays . . . not to mention the money saving \$5 in discount coupons.

Please enclose 25c for handling and postage. This will be credited to your first order.

Minnesota Woodworkers Supply Co.
1713 Olson Hwy., Minneapolis 5, Minn.

WORKSHOP WONDERS

with **WISE-GRIP**

You'll Find NEW USES Every Day

Model 10W, 10" \$2.60

Does More Jobs Easier than Any Other Tool!

Fixin' is fast—and FUN!—with Vise-Grip. A squeeze of the hand locks jaws onto work with terrific non-slip grip. A super-pliers, all-purpose wrench, wire cutter, hand vise, and clamp—all in one! 7" and 10", cutter optional, \$1.85 to \$2.60. At your dealer—today!

Made Only By
PETERSEN MFG. CO., Dept. M-10, DeWitt, Nebr.

FOR THE FASTEST "NEXT SHOT"

MARLIN 336

IS YOUR NUMBER!



Marlin 336 Regular Carbine . . . in calibers 30/30, .32 Spl. and .35, full tubular magazine with 6-shot capacity. \$68.95*.
Deluxe Sporting Carbine (Model 336-SD). 2/3 tubular magazine, 5-shot capacity, 30/30, .32 Spl. and .35 calibers. \$89.95*.



Marlin Side Ejection throws spent cartridges out the side . . . out of harm's way, out of your line of sight . . . not up in front of eyes.



Lowest Center 'Scope Mounting. Marlin side-ejection design and low hammer spur permit lowest possible mounting of 'scope sights.



Marlin's Matchless Lever Action works as quick as you can flick your wrist . . . a major achievement in engineering design.

Write your own ticket!

There's a Marlin 336 to meet *your* specifications. Calibers 30/30, .32 Spl. and .35 Rem. Rifle, carbine and sporting carbine models. Sold throughout Canada, too.

**Prices slightly higher west of Rockies; subject to change without notice*

THE NAME FOR GAME

Marlin

FINE GUNS SINCE 1870

VALUABLE COUPON — MAIL TODAY

The Marlin Firearms Co., Dept. PM-10
New Haven, Conn.
Send me catalogue with information and photo-illustrations of Marlin Guns. Also send a pack of (please check) single or double edge Marlin Razor Blades. I enclose 10¢ for handling.

Name _____

Street _____

City _____ Zone _____

County _____ State _____

He Spies on Satellites

(Continued from page 109)

still and produce a heavy photo image. Ordinary stars would trail out into long thin lines of light on the film. This explains the odd streaks of starlight on the telescope photo that accompanies this article.

A telescope with normal sidereal drive turns at a constant 15 degrees per hour. The satellite-seeking instruments are geared to turn at rates that range as high as 1500 degrees per hour.

But the problem isn't quite that simple, explains Professor Tombaugh. "The speed of a satellite depends on its distance from earth," he says. "The closer it is, the faster it must move to maintain an orbit."

To overcome this complication, the astronomer divided the space around the earth into numerous concentric spheres or depth zones. He calculated the average orbital speed for each zone, then explored each zone by adjusting the variable-speed drive of the telescope to suit.

"What we seek on the film are two dots of light, one above the other," he explains. "The two dots would show that we had picked up an object moving at an angular rate corresponding to that of the telescope drive. Short streaks would indicate a suspect that was moving at not quite the calculated speed.

"The double image (one dot above the other) is created by making an offset in telescope declination about halfway through the five-minute exposure. This is done on purpose to avoid spurious images such as might be created by a speck of dust on the film. Dust wouldn't produce the offset image and so can easily be identified as spurious."

Occasionally Professor Tombaugh finds a bright diagonal line on a film, running at an angle to the long star trails. It has been produced by a meteor. Another film may show intermittent dashes of light, possibly with a bright white line alongside them. These are made by an aircraft, the short streaks being created by the winking navigation light on the plane's wing tip.

Just as the moon is visible because it reflects the light of the sun, small satellites can be detected only by the sunlight that they reflect toward the earth. This wouldn't be much at best, and part of the time a satellite would be only partly "full" or would be in the earth's shadow.

So in some procedures, the observing staff deliberately searches in a direction away from the sun. They point their instruments east right after the sun sets in the west, and west just before dawn. This gives

(Continued to page 334)

HIGH QUALITY
ELECTRIC TOOLS

BY

Sunbeam®

THE BEST ELECTRIC APPLIANCES MADE

Famous for SUNBEAM MIXMASTER, SHAVEMASTER, Etc.

DRILL KIT



INCLUDES:

1/4" Drillmaster, 10 finest high-speed steel bits, 6 sanding discs, rubber backing pad, wire wheel brush, buffing wheel and compound, polishing bonnet, bench stand, arbor adaptor set.

Roomy all steel carrying case

Sunbeam DRILLMASTER

Maximum Safe Power
Greater Efficiency
Higher Torque
Lower Temperature Rise

Mean greater usefulness, faster drilling. 1/4 in. drill with Jacobs Geared Chuck, \$24.95. Same with Keyless Chuck, \$21.95

Sunbeam DRILL KIT

Top quality, carefully selected accessories—the most practical kit for the home workshop

Kit including drill with Jacobs Geared Chuck, \$39.95
With Keyless Chuck, \$36.95

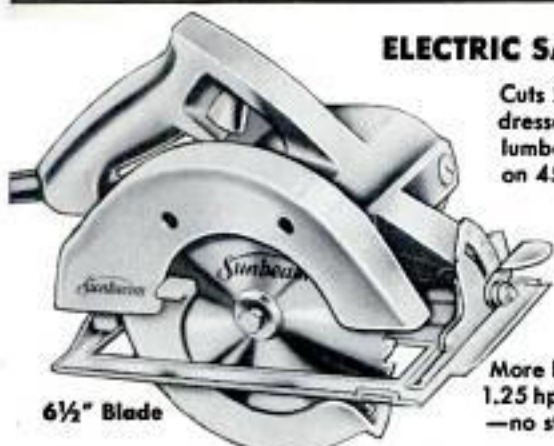

ELECTRIC SAW

Cuts 2" dressed lumber on 45°

More Power
1.25 hp motor
—no stalling

6 1/2" Blade

Compare the saw—the performance—the price—it's your outstanding saw value—with 2 conductor cord, only \$56.25, with 3 conductor cord and adaptor plug, \$57.50

ELECTRIC SANDER

The Sander that
STOOD UP
Over 1000
Hours in continuous use test

Lightweight—only 4 1/2 lbs.

More Powerful Sunbeam Motor

Orbital Motion gives best results

Only \$42.50

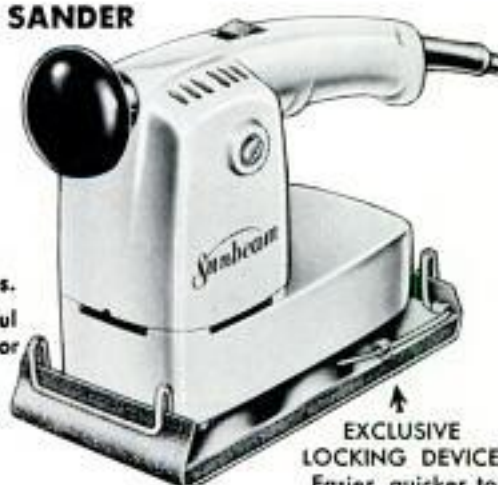

EXCLUSIVE LOCKING DEVICE
Easier, quicker to change abrasives

Sunbeam CORPORATION, Dept. 233, 5600 W. Roosevelt Rd. Chicago 50, Ill.

101 FREE TIPS

For the Handyman
who works with wood

SEND
for this informative booklet
ON

WOODLIFE
The Original
WATER REPELLENT
PRESERVATIVE



Anything made of wood — and this folder illustrates 101 items — should have the water repellency, resistance against warping, swelling and shrinking — and immunity against termites and decay — made possible with Woodlife.

Woodlife is the original water repellent wood preservative containing PENTACHLOROPHENOL that should be on every handyman's work shelf — along with this folder which shows how to apply Woodlife to 101 household wood-working projects.

Woodlife is made by the makers of P.A.R., the water repellent, glossless finish that protects and restores the natural beauty of Redwood and Red Cedar.

Send for the "101 TIPS" Booklet, TODAY!

Protection Products MANUFACTURING COMPANY

Dept. Q

Kalamazoo, Michigan

When you repair, remodel or build, always ask for
Woodlife-treated lumber!

Red Devil

FP33 HOME FLOOR CONDITIONER

The world's most popular
style floor conditioner

Counter-rotating brushes mean perfect floor conditioning with a finger-tip touch. Eliminates all drudgery from scrubbing, waxing, polishing, buffing. Will steel wool dirt and grime from wood and all floor surfaces.

How to Maintain
Wood Floors. Illustrated
instructions on polishing,
cleaning, varnishing, waxing
and sanding wood floors.

FREE

Red Devil Tools. Dept. 149
130 Coit Street, Irvington, N. J.

Please send FREE copy of "HOW TO MAINTAIN WOOD FLOORS."

NAME _____

ADDRESS _____

CITY _____ ZONE _____ STATE _____

1964

maximum reflection of sunlight from any object that happens to be out in space.

Why not use radar instead of light-gathering instruments for the search? Because, explains Professor Tombaugh, radar is much less effective than light in detecting small objects at great distances. It's true that radar signals have been reflected back from the moon, but the moon is a large body. It bounced back a signal because of its size.

Professor Tombaugh's method of seeking satellites is so sensitive that not only could it detect a white tennis ball 1000 miles away, it would reveal a white-painted rocket the size of a V-2 at the distance of the moon. It could record a dark meteorite about one foot in diameter 1000 miles out in space.

Professor Tombaugh is closemouthed about his results. He won't say whether or not any small natural satellites have been discovered. He does say, however, that newspaper reports of 18 months ago announcing the discovery of natural satellites at 400 and 600 miles out are not correct. He adds that there is no connection between the search program and the reports of so-called flying saucers.

Aside from seeking satellites, the new technique has several other useful applications in astronomy. It lends itself to systematic searching for small planetoids (asteroids) that occasionally cross the earth's orbit. To date only a dozen of them have been discovered, each time by accident, yet it is thought that there may actually be hundreds of these objects. Too, the rapid-drift technique may reveal a great number of small comets that are not now known to exist.

Another field is the search for the new class of variable stars known as "flare" stars. These suddenly increase in brightness by as much as two magnitudes, then return to normal brilliance within five minutes. It has been suggested that these sudden outbursts of energy represent the detonation of natural equivalents of enormous hydrogen bombs. The processes that cause the outbursts are of very great astrophysical interest.

The best method of seeking flare stars in the past was slow and tedious. It consisted of carefully comparing pairs of photographs of the same region of the sky under a special microscope. The rapid-drift technique gives the same information almost at a glance. A mere bright spot in the long drawn-out trail of a star would indicate that a flare star had been active.

One of Professor Tombaugh's proposals is to use an artificial satellite in measuring

(Continued to page 336)



BENCH



DRILL PRESS



POWER SAW



CLAMP



WRENCH

Amazing NEW Vise does work of 5 Tools!

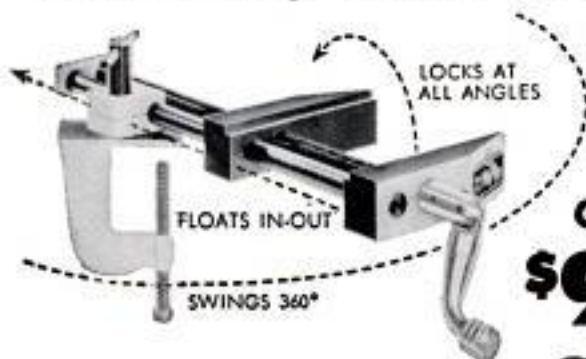

MITY 7 is versatile... for drilling, sawing, routing, planing, shaping, chiseling and 1001 other jobs. MITY 7 handles work no other vise can hold... at any angle, any position. MITY 7 is made of tough steel, precision-machined for a lifetime of rugged service. See your dealer or order today!

ONLY
\$9⁹⁸

Another **AMF** Product

Mity 7 Vise

Locks work tightly at any angle! Use on bench, power saw, drill press, as 9" C-clamp and wrench

FLOAT-LOCK CORPORATION
224-A GLENWOOD AVENUE, BLOOMFIELD, N. J.
ENCLOSED IS \$_____ for _____ MITY 7 Vise(s)
@ \$9.98 ea. Check Money order. Float-Lock pays the postage.

NAME _____

ADDRESS _____

CITY _____ ZONE _____ STATE _____

10-DAY MONEY BACK GUARANTEE

Last year's profit \$3,000!

with a **FOLEY AUTOMATIC SAW FILER**



"Last year's profit amounted to \$3,000. Not so bad for a one-man outfit"—from Chas. C. Hough. James B. Williams wrote us—"I made \$765 last year filing saws, and it sure comes in handy. I do this work in my spare time." Men in communities of all sizes make up to \$3 or \$5 an hour with the Foley Saw Filer working full time or part time.

It's no trick to take care of the saw filing for your neighborhood hardware or lumber dealer — plus looking after the saws for farmers, townspeople, manual training departments and factories. The Foley files all hand saws, also band and cross-cut circular saws. It's a repeat cash business, no canvassing, no eyestrain and no experience needed.

Send Coupon for **FREE BOOK**
SHOWS HOW TO START

"MONEY MAKING FACTS" shows just how you can start at home in your spare time working in your basement or garage. It's an immediate cash business that can develop into a full-time repair shop. Send coupon today—no salesman will call.

FOLEY MFG. COMPANY

1016-5 Foley Building, Minneapolis 18, Minnesota

Send me free book "MONEY MAKING FACTS"

Name _____

Address _____



IN INDUSTRY...

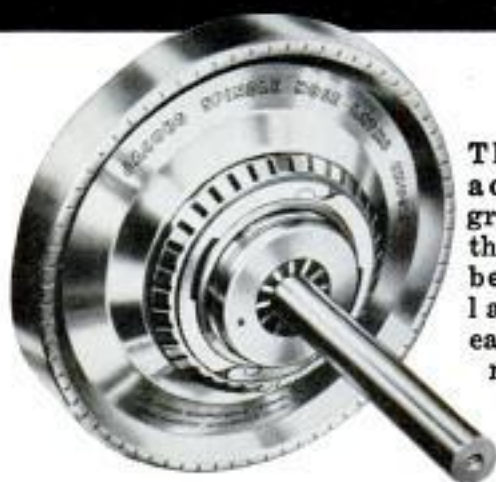

The simplicity, accuracy and gripping power of this Jacobs Rubber-flex collet lathe chuck earned one of the most coveted of engineering awards.



AND

IN THE

**HOME
SHOP**

The Rubber-flex collet is also available in the Jacobs Hex-Key chuck for your portable electric drill.

It *looks* different from conventional chucks, because it *is* different. A quarter turn of a standard Allen key gives you tremendous holding power. It actually produces a gripping leverage ratio of 1000 to 1! Another quarter turn easily releases the twist drill. When you see an electric drill equipped with the Jacobs Hex-Key chuck you can be sure the manufacturer has planned well, to give you top value for your portable drill dollar.



Jacobs
CHUCKS

If it's a Jacobs - it holds

great distances on earth to within an accuracy of several feet. The oceans never have been spanned by surveyor's instruments, hence no one knows the exact distance and direction from, say, New York City to Rome.

By making simultaneous photographs of an artificial satellite from several locations on earth, accurate azimuth and elevation angles would be obtained for geodetic triangulation over great distances.

"That's one possibility," says Professor Tombaugh, "and there are others. A curious thing about astronomy is that we have explored the universe to a distance of 2,000,000,000 light-years away and yet never before have we made a thorough search of our own immediate neighborhood. Now we are trying to learn what is very close to home for the first time."

And, now that we are launching a program of artificial satellites, Professor Tombaugh's sky-sweeping telescopes will be used to keep track of them. ★ ★ ★

Rapid-Reading Kit

You can teach yourself to read faster and better with a complete home rapid-reading kit. Included in the kit is a plastic card holder designed to promote reading by phrases instead of by individual words. The device has a spring-powered shutter which is released to expose a phrase on the card for $\frac{1}{25}$, $\frac{1}{50}$ or $\frac{1}{100}$ of a second. A total of 43 cards containing over 900 phrases and numbers are furnished with the device. The kit includes instructions and booklets.





REVOLUTIONARY

"TWIN-ORBIT"
Sander - Polisher

CRAFTSMAN

DOES EVERYTHING any ELECTRICAL POLISHER OR SANDER WE HAVE TESTED WILL DO!



\$47.95

COMPACT CARRYING CASE ONLY \$5 DOWN ON SEARS EASY PAYMENT PLAN
Sturdy welded metal construction throughout, with blue enamel finish. Machine bracket holder and special accessories trays on each side of case. Complete case \$6.00 extra.

STURDY ALUMINUM HANDLE ATTACHMENT
Easy to attach handle converts "Twin-Orbit" to floor sander-polisher, rug shampooer, etc. in seconds.
Light weight, heavy duty, finished aluminum handle with rubber grip. Convenient extension switch at finger tip reach near top of handle. Wing-out controlled clamp at lower end of handle attaches to "Twin-Orbit" machine handle in seconds for floor sanding and polishing, rug shampooing, etc. Handle attachment \$4.95 extra.

BONNET SET Two soft lamb wool bonnets for furniture, car, and other fine polishing. Bonnets washable for reuse.
SANDING DISCS Twelve durable sanding discs of all textures.
SANDING JACKETS Sturdy all rubber jackets for use with sanding discs. Jackets can be cleaned for reuse.

CLEANER & POLISHER Used with the "Twin-Orbit," Sears' cleaner and polish eliminates back-breaking effort... thoroughly cleans car surface and leaves an unusually durable protective coating.
ADHESIVE Pressure sensitive adhesive to hold sanding discs securely in place.

PLUS
DOING ALL THESE THINGS EQUALLY AS WELL



HERE'S WHY THE "TWIN-ORBIT" Is Different

Sears new "Twin-Orbit" is not just another polisher... It is a power polisher with TWO HEADS that work with a motion just like hand polishing—speeded up 250 times... not rotary, not vibrating. Proven in its use of polishing delicate aircraft finishes... the "Twin-Orbit" is the ONLY power sander-polisher completely safe from marring or burning.

Even in the most inexperienced hands, the "Twin-Orbit's" safe, speedy action gives professional results...with less effort and time—thus making it ideal for everyone around the house to use.

OLD POLISHING ACTION

High speed "single-action" rotary polishers can burn and mar surfaces...may cause costly damage in a split second...thus demand expert handling.



NEW "TWIN-ORBIT" ACTION

Sears "Twin-Orbit" gives smooth, even action...the same as hand action (semi-circular), speeded-up 250... will not burn or mar any surface—even in the most inexperienced hands.



Mother doing her housework... father in his workshop, junior earning extra money polishing cars—everyone in the family will find Sears "Twin-Orbit" offers many ways to save effort, time, and cost.

PLUS MANY OTHER HOUSEHOLD USES!

SEE IT DEMONSTRATED AT YOUR SEARS STORE
or look for it in your Sears Catalog
Sold only by SEARS ROEBUCK AND CO.

ride for pennies...
 save dollars with
 the New 1956
HARLEY-DAVIDSON
HUMMER



only \$17 per month*

up to 100 miles
 per gallon

You can buy and ride the Harley-Davidson Hummer for little more than the change in your pocket. And what an *easy* answer to your get-to-work problem. With a Hummer you leave home later . . . get back sooner. In and out of heavy traffic in a jiffy. No parking worries with a Hummer either. Try it . . . ride it — at your Harley-Davidson dealer today. Or, write us for FREE literature.

*After minimum down payment, includes fire, theft, collision insurance, Federal tax, freight and carrying charge.

HARLEY-DAVIDSON MOTOR CO.
 DEPT. P., MILWAUKEE 1, WISCONSIN



**"Soup Can" Gas Generator
 Produces 850 Horsepower**

Hardly bigger than a can of soup, a gas generator capable of producing 850 jet horsepower has been developed for use in guided-missile propulsion systems. The generator converts liquid hydrogen peroxide into a high-pressure, high-temperature gas stream of free oxygen and steam. The gas stream is directed against a turbine wheel to produce power. Development engineers say that jet horsepower from the tiny unit has been varied from as little as 50 to about 1800 by simply adjusting the incoming-liquid flow rate, and that units can be built to operate from a few seconds to a number of hours. Possible industrial applications of the generator include use as a source of energy for rotating machinery, or as a quick, reliable source of steam. Development of the generator took place in the General Electric Company's Aircraft Gas Turbine Development Department.

Leaf Analysis Helps Citrus

Chemical analysis of tree leaves has helped boost the production of Florida citrus groves from 150 to 350 boxes per acre, reports the United States Department of Agriculture. The leaves, reduced to ashes, are tested for their mineral content. Deficiencies of certain elements in the leaves indicate the type of fertilizers and trace elements the trees need for top yields. Tung producers have also been benefited by leaf testing.

with BIG 3/4 hp motor!



New 1956 AMF DeWalt "Power Shop" makes all home woodworking easy!

Here, in one big-capacity machine, is a complete home workshop . . . that gives you . . .

- The *power* you need for any operation
- 3-D versatility to handle any home project
- The *professional accuracy* to do any job quickly, easily, expertly
- The built-in *safety* you want in your home

See a demonstration of the new 1956 AMF DeWalt Power Shop at your dealer's today. Now more than ever, it's the finest, safest, most complete home workshop you can buy.

\$239 delivered (saw blade and 3/4 hp. motor included). EASY BUDGET TERMS



New 3/4 hp. direct-drive, custom-built motor. Rugged, reserve power for the toughest jobs — staying power for steady use.



Easy, safe, top-side cutting. Always see your mark and your cut — never work "blind." Saw moves above the work.



Straight-line material handling. Arm swings 360°. Motor rotates 360°—tilts past 90°. Material always moves straight on level table.



No floor space needed. Built into work bench, arm swings clear of work area . . . swings back when needed.



Exclusive New Shaper-Jointer Fence. Converts saw to a 2" jointer at 1/3rd the cost. Positions work for accuracy, safety.



Exclusive New Shaper Guard. A DeWalt "First" safety accessory. Totally encloses knives and spindle—raises for adjusting work.

Complete versatility. Simply change tool on motor shaft. Your AMF DeWalt saws, dadoes, shapes, sands, bores, routs, surfaces, joints. It buffs, grinds, turns, cuts curves . . . does everything in woodworking.

New safety. New safety key switch — one of many DeWalt home safety features — turns power on or off. Take key with you and your family is completely protected.



AMF DeWalt, Dept. PM-55-10, Lancaster, Pa.
In Canada: DeWalt Canada, Ltd., Guelph, Ontario

- Please send me Free Colorful 20-page Booklet on how to do everything in woodworking . . . easily.
- Please send me Free plans on how to build a home workbench.

Name _____

Address _____

City _____ Zone _____ State _____



SEND COUPON TODAY!

New "PULL-GEAR" SPEED-REDUCING PULLEY

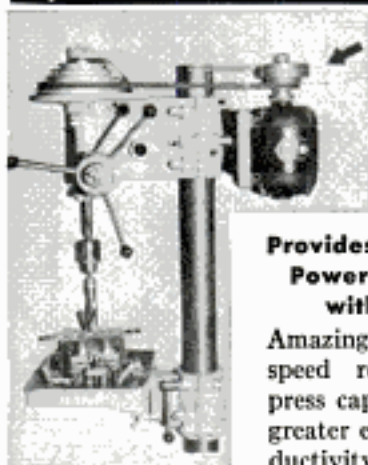

Provides Correct Speed and Power to Drill Up to 1 3/8" with 1/2 H.P. Motor

Amazing new internally geared speed reducer doubles drill press capacity. Greater power, greater efficiency, greater productivity.

Provides the correct speed and power for larger drilling, reaming, tapping and boring on light presses. Easily installed in five minutes. Adaptable to all type machines. Spindle speed range approx. 45 to 3000 RPM. Made in 3 motor shaft sizes: 1/2"-5/8"-3/4". Write for literature.

WRITE FOR LITERATURE

THE PULL-GEAR CO.

25427 Mound Road
Center Line, Mich.

Snap-on MAGNETIC

PICK-UP TOOLS

Indispensable for retrieving nuts, bolts, any small iron or steel objects that fall into hard-to-get-at spots. Powerful, permanent Alnico magnets are fitted into slender handles. Two popular types. Order direct from factory.

PT-27—Large pick-up with hinged head for round-the-corner accessibility. Length 16 1/2". Sliding handle extends to 27". Lifts 24 oz. Price.....\$1.90

PT-6—Handy pocket size pick-up with clip. Small but powerful—lifts 16 oz. Price.....\$1.10

Snap-on Tools
THE CHOICE OF BETTER MECHANICS

Snap-on Tools Corporation
8062-J 28th Ave., Kenosha, Wis.

I enclose check , money order for \$.....
(Add local sales tax if any.) Send me PT-27 , PT-6 ,
Tool Catalog , postpaid.

Name.....

Address.....

City.....Zone...State.....

©Snap-on is the trademark of Snap-on Tools Corporation

INSIST ON THE GENUINE CHESNEY



Self contained Saw Horse "Speed Clamp" Galvanized Brackets

Have a saw horse handy for painting or carpentry. A base for pine-pole or picnic table, a strong support for trailer or boat. Chesney "Speed Clamp" Brackets will do the job quicker, easier, and then be ready for the next job. No nails, bolts or screws required.

Available at retail lumber yards, hardware stores and building supply dealers.

Chesney INC.

\$3.95
PER PAIR

720 Towne Ave.,
Los Angeles 21, Calif.

NEW! AUTOMOTIVE CATALOG

1955 Edition! Everything for car, truck, custom-styled car, hot rod... at **LOWEST PRICES!** Save up to 50% on all parts, accessories! Only complete automotive buying guide...50,000 items...148 pages! Thousands of hard-to-find parts; equipment, parts for 1920 to 1955 models; **Holly-wood accessories** never before offered; **hi-speed parts.** Send your name and address and 25c (refundable with first \$5.00 order) to:

J. C. Whitney & Co., 1917 Archer, Dept. P-10, Chicago 16, Ill.



Find a Fortune!

There's no mystery about it. Read these FREE booklets (regular price 60c) and get started right away. Every day's delay may cost you money. **TIME PAYMENT PLAN** available. Send a card now!

FISHER RESEARCH LABORATORY, INC.
Dept. 4, 1961 University Ave., Palo Alto, Calif.



MAKE YOUR OWN Modern COCKTAIL TABLE

—with distinctive **AIRFORM** Metal Legs by Nord-Craft... just attach (with furnished screws) to flat surface for expensive-looking decorator effect. Sturdy steel, black satin finish, brass ferrule. Leg tilts out for smart appearance, added strength. New life for old sofas, chairs, tables, TV, chests. Set of 4 legs prepaid: 6"—\$6.95; 9"—\$7.45; 12"—\$7.95; 16"—\$8.95; 20"—\$9.45; 22"—\$9.95; 28"—\$11.95. No C.O.D.'s. Enclose and send check or M.O. today.

NORD-CRAFT INDUSTRIES Dept. B
Box 565, Madeira, Ohio

Also Adult
Eshelman
2 Passenger
Sport Cars
Golf Cars
1/5 The
Price
of any
other Auto
70 Miles
Per Gal.
Free Catalog.

ESHELMAN
FOR Better LAWNS
And GARDENS
Women can operate it.
1 to 8 H.P.
Shipping Points:
**BALTIMORE,
CHICAGO, RENO**
Free Catalog Write:
ESHELMAN CO., Dept. R-510
109 Light St.,
Baltimore 2, Md.



9 tools in 1

Mechanics, first time on market. This tool does work that no other single or combination tool ever did before with strip metal: straight cutting, punching, bending, flattening, equal length cutting, equal bending, equal punching, rolling. More than 1001 possibilities for every Home Owner, Home Workshop, Hobbyists. Money back guarantee. No C.O.D.'s. Postpaid.

Introductory price for this high quality tool only **\$6.95** Tool with kit—50 screws, nuts, screw driver, 15 ft. nickel plated steel strip... **\$8.75**

THE HOLLY CO., 2737 N. PINE GROVE AVE.
DEPT. PM-10, CHICAGO 14, ILL.



STANLEY

Screw-Mate



**DOES 4 JOBS AT ONCE
AND MAKES IT EASY!**



No. 1525 Stanley Screw-Mate Countersink

This marvelous little tool does 4 jobs at once... quickly, easily and right. 1/4" shank for hand drill, power drill or drill press. Makes (1) pilot hole, (2) shank clearance, (3) it countersinks, and (4) drills exactly correct screw depth in one operation! Holding power of screws is increased to the maximum. Here's professional woodworking made easy by Stanley Screw-Mate!

At your favorite hardware store. 22 sizes at 75¢ each; 2 extra large sizes \$1.25 each. If your dealer can't supply you, let us send you the 5 most popular sizes of Stanley Screw-Mates... 3/4" x #7, 1" x #8, 1 1/4" x #8, 1 1/4" x #10 and 1 3/4" x #12 in handy holder. Ask for No. 1525B set. Send your check or money order for \$3.69, and dealer's name to Stanley Tools, 620 Elm Street, New Britain, Conn., and this Screw-Mate set will be sent post-paid by return mail.

1525B



MAKE UP TO \$5 AN HOUR WITH

EASISHARP



Big profits in your spare time sharpening scissors. We show you how to start making money immediately. This is your chance now to have your own business and a steady income. Sharpen a pair of scissors in less than two minutes. A child can operate it. Weighs only 10 lbs. Every home, barber, tailor, dressmaker—everybody uses scissors and all need sharpening two to four times a year. Don't let some one else beat you in this opportunity. Write immediately to

**MONEY
MAKING
SALES PLAN FREE**

SERR-EDGE MACHINE CO., 9731 Lorain Ave., Cleveland, Ohio

180° OFFSET DRIVE

(REDUCTION GEAR)

86 to 1. For use where tremendous power at low take-off RPM is desired. 6 gears rotate on self-lubricated Hi-Speed Ball Bearings. 3/8" x 1 1/4" shafts. 5"x6"x6" overall. \$12.87 Postpaid. Illus. Cat. 10c.

KARL ORT, Dept. PM10, York, Pa.



Insist on *Evans* TAPES POCKET SIZE At Your Hardware Store

6, 8, 10, 12-ft.
lengths
from **98¢**
with FREE
plastic utility
case.



Self-adjusting sliding
hook starts you at
zero for accurate inside
or outside measuring.

Build your youngster this **TWO-IN-ONE** **ROOM!**



Do it easily with *Gold Bond* Insulation Board

HERE'S a room that serves as bedroom *and* play-room for that busy youngster of yours. Build one like it *yourself* in your present unused space. It's easy with Gold Bond Insulation Plank and Tile.

This lightweight material decorates, insulates and sound-conditions all at the same time. Get these pre-finished planks and tiles in handsome



ivory, or in combinations of pastel colors that blend with every decoration scheme. They need no painting. Ready-cut and ready to install on walls and ceilings. Sounds stay muffled, winter heat stays in, summer heat stays out...and children stay thrilled!

**NATIONAL GYPSUM COMPANY
BUFFALO 2, N. Y.**

Your personal copy of Gold Bond's Plan No. 14, showing you how to build a room with Gold Bond Insulation Plank and Tile, is waiting for you. Mail the coupon today!



MAIL COUPON TODAY!

NATIONAL GYPSUM COMPANY
Dept. PM-105, Buffalo 2, N. Y.

Enclosed is 10¢. Please send me my copy of Gold Bond How-To-Do-It Plan No. 14."

Name.....
Address.....
City.....Zone.....County.....State.....

BUILD WELDER OR LIGHT PLANT *General* SALE

Instruc. Incl. TYPES AMPS VOLTS PRICE
Westinghouse PI 200 24 \$15.50
J & Helas HI 300 24 \$25.50
G.-I. 160-250 amps, 30V, new \$19.50 used \$12.95

511 Gen. 200 Amps, 30V. D.C. & 1250 Watts, 800 Cy. A.C. Instructions for A.C. D.C. Incl. Good cond. \$19.50 New \$29.50

RHEOSTAT #R27 or CARBON FILE VOLT. REG. for D.C. generators. Instructions, \$5.95 Each

BRASS HAND FIRE EXTINGUISHER, quart \$4.95 stainless, 4 GALLON, F. EXT. & INSECTICIDE PUMP, nozzle & hose, Wt. 15 lbs. \$2.95 (add postage)

SENSATIONAL SELSYNS. For controlling distance operations, etc. \$9.95 per pair. (6) SOLENOID VALVES. Bendix #81560 for hydraulics, distance operation, etc. Up to 1500 P.S.I. \$7.50 per pair. (7) BEAM ROTATOR MOTOR #101 for TV. HAM. FM, reversible, 2 R.P.M. for D.C. or 110V. A.C. Gov't. cost \$150.00. \$9.95. (8) SOLENOID #804 gives 1/2" or 1 1/4" travel, powerful for locks, switches, etc. \$4.95 per pair postpaid. INSTRUCTIONS Incl. with all items No. 5, 6, 7, 8, for D.C. & Appl. for 110V. A.C.

CUNG OIL FILTER for autos, filters without cartridge replacements. \$5.95 ports, \$4.95.

PUROLATOR #255 for trucks & tractors. 1" ports, \$4.95.

MAKES IDEAL WINCH HOIST Aircraft starter motor for 12 to 32 Volts, belt or direct drive, high torque & power. \$9.95.

SPEED REDUCER, 10:1 ratio, rated 10 H.P. \$6.45

(1) BLACK & DECKER MOTOR & PUMP, 2 G.P.H. 1200 R.P.M. 1/4" ports, \$8.95.

(2) CHANDLER EVANS LARGE WATER PUMP, oil, insecticide, etc. 400 G.P.H. 1" ports, \$7.95.

(3) THOMPSON PUMP & MOTOR for fuel, hot water, etc. 300 G.P.H. \$7.50. Instructions incl. for items 1&2 for D.C. & appl. for A.C.

ROYALTY GEAR PUMP #201 for hydraulic, water, or vacuum, 180 G. P.H. 200 P.S.I. 2" (mercury) \$8.95

(5) VOLTMETER D.C. 80 Volts, zero center, 300 ohms, \$4.95. #TACHOMETER INDICATOR, 0 to 10,000 R.P.M. \$4.95. #HYDRAULIC PRESSURE GAUGE, 0 to 2000 P.S.I. 1/4" ports, \$4.95. #VACUUM GAUGE, Range 0 to 10 inches Mercury, \$3.50

(6) SLIDER TOW BAR, rated 100,000 lbs., & release lever when lever is pulled. 14"x3 1/4". Wt. 10 lbs. \$7.50.

(7) ELECTRIC ACTUATOR, 5" travel, 1/2 H.P. D.C. & appl. for 110V. A.C. Rated 2500 lbs. Instructions incl., \$7.50.

NEW HYDRAULIC CYLINDERS

Stock	Bore	Stroke	D. Shaft	Price
#11 (d.a.)	1 1/4"	6"	3/8"	\$7.95
#12 (d.a.)	1 1/2"	4"	3/8"	\$8.50
#70 (s.a.)	4"	10"	3/4"	\$17.50
#111 (s.a.)	3"	24"	1-3/16"	\$27.50

(7) HYDRAULIC PUMP BARGAINS 1500 P.S.I. MPG. TYPE R.P.M. G.P.H. PRICE
Pesco (gear) 1500 198 \$9.95
Pesco (gear) 4300 360 \$12.95
7 Siratopower (p.d.) 3750 400 \$17.50

Agel FOUR WAY HYD. CONTROL VALVES for 1 D.A. cyl. 3/8" ports, #27, \$7.95; for 2 D.A. cyl. 3/8" ports, #620, \$9.95; for 1 to 4 D.A. cyl. 3/8" ports, #10060, \$14.50.

(7) FOUR WAY SOLENOID VALVES. Instruction for 24V D.C. & appl. for 110V. A.C. off in neutral, 3/8" ports, #1213, \$12.50. #324 with 1/4" ports, \$9.95. #322 one way normally closed 1/4" ports, \$2.35.

HYD. PRESS. RELIEF VALVES ADJ. to 1500 P.S.I. Four 3/8" ports, \$4.95; with three 1/4" ports, \$3.95; with two 1/4" ports, \$2.50.

12-32 Volts PUMP & MOTOR UNITS. Adj. Press.
(1) PESCO, 1/2 H.P., 2000 R.P.M., 900 G.P.H., 1" Ports (water) \$9.95
(2) HOMEC, 28 H.P., 2500 R.P.M., 900 G.P.H., 3/4" Ports, (hydraulic) \$19.50.

GENERAL SALVAGE CO. CHECK OR M.O. 2022 E. 27 St., Dept. 72, Kansas City, Mo.

1956 CATALOG—Send 35c
70 Models for 1956! See the world's finest line before you buy. Rated tops in design, styling, performance by the experts. 1956 catalog plus booklet "Boat Selection, Operation, Maintenance" \$1.00

BOAT PLANS AND FULL-SIZE PATTERNS

Over 100 Modern plans and full size patterns. Racing classes, cruisers, inboards, outboards, sail boats. By famous designers. 6' to 30' DESIGN CATALOG only 35c. For Design Catalog plus boat building handbook send \$1.00.

CUSTOM-CRAFT (DEPT. A) BUFFALO 7, N. Y.

Custom-Craft
THE ORIGINAL "PACKAGED"
BOAT KITS

DRILL • SAW • REAM • CUT
ALL WITH ONE BIT!
BEAVER SPEED SAW DRILL BIT

ONLY \$2.45 each
3 for \$7.00 POSTPAID

Beaver's new improved high speed side cutting drill bit can be used on any electric drill, drill press, lathe or milling machine. Made from the finest American high speed steel. 3 1/2" long, 2" side cutting section, 1/4" diameter. Designed to cut steel, wood, plastic, aluminum, etc. A versatile time-saving tool for EVERYONE. Money back guaranteed. Three types available: All-Purpose, Wood and Heavy Metal—specify type desired. Buy them from your dealer today! Or send cash, check or money order NOW.

SET OF 3 MAKES AN IDEAL GIFT.
Dealer inquiries invited.

BEAVER DRILL & TOOL COMPANY
3008B McGee Trafficway Kansas City 8, Missouri

PRECISION BUILT

Cabinet-making at its finest gives you a chest to be proud of. Free Catalog.

GERSTNER TOOL CHESTS
455 Columbia St., Dayton 7, Ohio

START YOUR HOME WORKSHOP WITH THIS BASIC POWER TOOL

Mall
Model 149B Improved
1/4" Electric Drill

• More Speed
• Greater Power
• Ball Bearing Construction

\$23.95
with Geared Chuck

Start with the versatile Model 149B. It drills in wood, metal, plastics, and ceramics. Then add low cost Mall attachments to do other shop jobs. The drill makes every attachment a power tool... at a fraction of the cost of buying special power tools for every job. It's the money-saving way to build a home workshop.

SEE YOUR MALL DEALER TODAY FOR THE BEST POWER TOOLS—AT LOW PRICES

Enjoy the Fascinating Story of the Horseless Carriage!
It's thrilling, fascinating, informative. From the very first gasoline-propelled buggy to the cars of today and the atomic auto of the future. The first cars—the men who made them—the scrambled start and development of the fabulous auto industry—the story of auto racing—160 thrilling action pictures—old-time cars—racing cars—early auto advertising—automotive oddities. Listing of 2000 U. S. autos included. Ideal gift book. Cloth bound, only \$3.00 by mail. Money back if not pleased. Paper covered edition \$1.00 at newsstands.

POPULAR MECHANICS PRESS, Dept. PM15, 200 E. Ontario St., Chicago 11

NEW ToDo Finish

- ALCOHOL PROOF
- WATER PROOF
- NAIL POLISH PROOF
- HEAT RESISTANT
- SCRATCH RESISTANT
- CLEAR NON-YELLOWING

Easy to apply, this new finish is an adaptation of a proven industrial coating. Designed so that anyone can obtain a professional finish.

Send NOW for FREE Professional finishing pamphlet with easy to follow steps for finishing NEW and OLD furniture.

ToDo finishes are available in colors upon request.

FREE MALL TOOL CO. PORTABLE POWER TOOLS GASOLINE • ELECTRIC • AIR
7805 South Chicago Avenue, Chicago 19, Ill.

Send me your FREE Do-It-Yourself Booklet.

Name _____
Address _____

HD-120

FENOLIC INTERNATIONAL, INC.
527 Lexington Ave., N. Y. C.

Name _____
Address _____
City _____ State _____

Please send me _____ gals. of ToDo @ \$2.98
 Please send me _____ gals. of ToDo @ \$1.98
 Please send me FREE ToDo finishing pamphlet.
No COD'S. Postage paid FREE East of Miss.
DEALER'S INQUIRIES INVITED

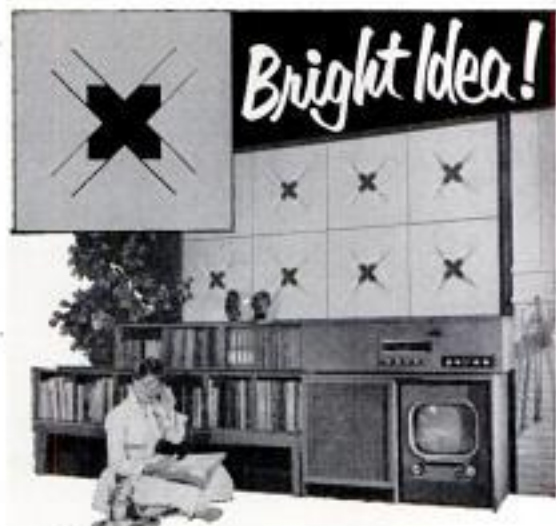

Bright Idea!

Make with
(RHYMES WITH O.K.) **FIR PLYWOOD**

Exciting new way of decorating with fir plywood. Create bold, colorful designs by "weaving" slits in plywood with dowels or other inserts. Use for dramatic lighting effects, room dividers, fences, doors. Wonderful for remodeling, "do-it-yourself."

FREE BOOKLET—contains step-by-step instructions, ideas, design suggestions. See your lumber dealer or write (USA Only) Douglas Fir Plywood Association, Dept. 99, Tacoma 2, Wash.



SAXTON Kant-twist CLAMPS

THE NEW STANDARD IN CLAMPING DEVICES

Combines the best features of "C" and parallel clamps, provides new freedom of movement—clears work area—eliminates distorting, twisting action of conventional clamps—provides three different gripping surfaces.

"HAND-TIGHT" IS TIGHT ENOUGH.

Kant-twist clamps weigh approximately half as much as comparable C-clamps yet are 40% stronger—by actual test—this feature makes Saxton clamps extremely valuable on jobs where weight is an important factor.



MOD. NO.	MAX. OPENING	THROAT OPEN	THROAT CLOSED	PRICE EACH
1	1"	1/2"	9/8"	2.50
2	2"	1 1/8"	1 1/2"	3.00
3	3"	1 3/4"	2"	4.00
6	6"	2 1/4"	3 1/2"	6.50
6D	6"	3 3/4"	5 1/2"	8.50



Patents Pending. Other sizes available upon request. No C.O.D. In California add 4% sales tax. Order today. Send check or money order to—

ZURCO DISTRIBUTING CO.

P.O. BOX 6769

East Los Angeles 22, Calif.



REVOLUTIONARY NEW
'ARCO-SAW'
with "DADO-ARBOR"
CUTS ANY
GROOVE!

WHIZZES
THRU 2x4's!



Not even a \$100 Portable Saw has a dado cutter! "Arco-Saw" (guaranteed to fit any 1/4" electric drill) with sensational new "Dado-Arbor" adjusts easily to cut any size groove up to 1/2" wide x 1" deep in **ONE CUT!** Graduated Depth-Bevel-Rip Gages adjust for depth of cut up to 1 3/4", angle cuts to 45°. Amazing swivel action of "Dado-Arbor" (see sketch above) cuts large grooves cleanly and accurately with little power. "Dado-Arbor" is easily removed to use the saw for straight ripping, crosscutting or angle cuts. Right angle steel gear drive and safety-yoke permit **ONE HAND** operation. Includes quick-cutting 5" Safecut Blade.



CUT GROOVES
LIKE THESE

ONLY

\$12.95

"ARCO JIG-SAW"
WITH EXCLUSIVE NEW
CIRCLE-
CUTTER
& RIP
GAGE!



Another "ARCO" FIRST! "Arco Jig-Saw" (guaranteed to fit any 1/4" drill) with Adjustable Circle-Cutter & Rip Gage saves hours of work—assures professional-looking results everytime—whether cutting circles, curved patterns, or straight cutting. Cuts perfect circles any size up to 20" diameter; rips accurate widths any size up to 10" wide. Has same capacity and cutting speed as \$55 jig saws. Does work of Jig, Keyhole, Coping, Rip, Crosscut, Band & Hack-saw! Built-in "Air-Jet" blows away sawdust. Cuts intricate patterns—however large—in plywood, plastics, metals—even cuts 2x4's! Starts inside holes. Includes blade. Converts to Table Model with



RIPPING
WITH GAGE

ONLY
\$8.95 No. 500
without
gages.
\$9.95 No. 550
with
gages.

"ARCO STAND" Sturdy
Casting \$2.75
6 Extra Blades \$1.95

SOLD AT BETTER HOME STORES EVERYWHERE. If not available, order direct and try these amazing tools on our UNCONDITIONAL 10-DAY MONEY BACK GUARANTEE. Send check or M.O. (ppd.) C.O.D.'s—plus post.

ARROW METAL PRODUCTS CO.

Dept. PM-10, 140 WEST BROADWAY, NEW YORK 13, N.Y.

**IN YOUR CAR RADIATOR...
GUARANTEED
TO STOP RUST!**

**WATER STAYS
CRYSTAL CLEAR
FOR OVER
ONE YEAR**

Just one can of
MAC'S NO. 13 re-
moves rust and scale
... prevents costly
repairs. Get MAC'S
NO. 13 today.



**AT SERVICE
STATIONS EVERYWHERE**

MAC'S SUPER GLOSS CO., INC.
Los Angeles 42, California

**WIN VALUABLE
PRIZES**

→ *in the big*
**DURO MASTER
Power Tool Contest!**

- No tools to buy
- No products to make
- No essays to write
- No rhymes to finish
- No photos to take
- No power tools to own

Here's your opportunity to win a complete 5 piece power tool workshop with stand and motor or any one of 99 other valuable power and hand tool prizes! It's easy, it's fun—you just give us a name for our new motorizing principle which is an exclusive Duro development. You can see this amazing motorizing idea at your favorite hardware or building supply dealer as part of the Duro Master Power Tool display. Study it, try it, use it — then just name it! Contest begins September 15th—ends December 15th.

Write for Entry Blank

If your dealer is not now displaying Duro Master Power Tools, write us direct for full contest details including entry blank, list of prizes and rules; plus Power Tool catalog and pictures of "Motor Mount." Write Today.

Duro Metal Products Co.
2693 No. Kildare Ave., Chicago 39, Ill.

**Get Our Big Manual of
WOOD & "HARD-TO-GET" ITEMS**

For home craftsmen, wood workers, industrial art departments, furniture repair men, hobbyists, cabinet makers, etc. Send only 50c today for your copy.

A few of the items we sell: Inlays, fancy cabinet wood, lumber, Ebony, Holly, Dimension cut lumber, lignum vitae, Carving Blocks, Turning Squares, 120 kinds of veneers, Abrasive papers, archery woods, bill-board clamps, binowings, bed fasteners, blueprints, Chair braces, brass chain, brass fencing, Craftsmen books, candlestick holders, candlestick sockets, card table hardware, casters, Chair cane, ceramic tiles, clamp nails, crib hardware, Dowels and dowel pins, dowel centers, drawer rollers, felt, Floor finishes, foam rubber, Furniture clamps, complete professional finishing materials, Folding tablelegs, hand tools, furniture pulls, modern and period, chest and ornamental hardware, all types of hinges and locks, small box hardware, Inlaid picture kits, Inlaid card table tops, leather working tools, Micarta, revolving Lazy Susans, musical movements, moulded wood carvings, Metalcraft material, Moto sander, nut bowl hardware, Picture frame moldings, Pre Cut Wood Pix, perforated steel panels, pillar standards, plastics and plexiglass, internal carrying bits, plastic polishing compounds, Electric routers, sanders, foot rheostats, hand drills, sprayers, revolving fixtures for television tables, chairs, etc. Filter rush, screw hole buttons, spiral saw blades, sliding door track, sharpening stones, home owners specialties, 100 woods, ski woods, platform rocker springs, Table leaf supports, tack rags, thermometer cards, turned furniture legs, typewriter fixtures, Complete upholstery supplies, Veneer presses, wood burning pens, wood working instructions, black and copper wrought iron hardware, zipper wire.

Send fifty cents today (refunded on 1st order) for your copy of the Country's leading Catalog, "Constantine Manual for Craftsmen" too!

ALBERT CONSTANTINE & SON, Inc.
Dept. PM-105, 2050 Eastchester Road, New York 61, N. Y.

GIGANTIC SURPLUS SALE — SAVE UP TO 85%

IMPORTED PRECISION SQUARES

Accuracy Within—Tenth		Accuracy Within—Hundred	
2"	1.50	6"	2.20
3"	1.70	8"	2.50
4"	1.80	10"	3.00
5"	2.00	12"	3.50

B.C. GENERATORS For Welding
P.I. 24V. 300 Amp. \$11.50
R.I. 30V. 300 Amp. \$20.50
Guaranteed Perfect! Incl. Diagram
Include Check or M.O.
F.O.B. Los Angeles

MAUSER type Vernier Calipers
—6" Capacity—1/1000"
graduations—Fast, Accurate measurements for O.D., I.D., Depth—All hardened chrome-steel, Reg. \$11.95—**\$6.50** closeout price

NEW HI-SPEED DRILLS
30 ea. #47 to 21/64" \$3.50
Assorted sizes

METRO PRECISION TOOL CO. 1807 S. La Cienega
Los Angeles 35, Calif., Dept. M10

\$1.35 VALUE for only 89¢

Here's a bargain you shouldn't miss! A few copies of HOME KINKS '52 and '53 and USEFUL IDEAS '54 are still available. The combined value of these three money-saving books is \$1.35—but, if you act now, you can have all three to round out your files of P.M. annuals for only 89c postpaid! Mail your check or money order today to:

Popular Mechanics Press
200 E. Ontario St.,
Chicago 11, Ill.



Only **HOLD-E-ZEE**
The Original AUTOMATIC GRIP
SCREWDRIVERS

PROVIDE THESE FEATURES:

- **LOK-BLOK** that makes blade twist and impact proof.
- **GRIPPER** that snaps back—recedes deep into handle, giving full blade use.
- **HAND GROUND BITS**—chrome vanadium, chrome plated blades.

YET COST NO MORE THAN ORDINARY SCREWDRIVERS

UPSON BROS., INC., ROCHESTER 14 N. Y.

At Leading Dealers
Everywhere!



AMERICA'S
LARGEST STOCKS
of JEEP PARTS



The King of Jeeps

LOWEST PRICES!
SATISFACTION
GUARANTEED!

BRAND NEW CAPSTAN WINCHES

NEW LOW PRICES



6000 lb. capacity. Accurately machined gears provide for smooth efficient operation. Suitable for both front or rear mounting. May be used on jeeps or trucks. All units are brand new and fully guaranteed.

EACH
\$25.00

NEW CANVAS TOPS



Specify Military or Civil.
\$22.50

The "K" Free Wheeling FLANGE Saves Gas Stops Growl Simple-Easy Conversion FROM 4 TO 2 WHEELS
\$19.95 Per Set

Slightly soiled NEW Military Tops, special... **\$17.50**

Complete With Ball Bearings

BRAND NEW ARMY SURPLUS AMPHIBIOUS JEEP KITS, consisting of all rubbers for steering assembly, drive shafts, axles, and includes brake hoses, fan belts, spark plug, grease retainers and all other seals.

SPECIAL \$17.50 while they last



THE JEEP KING ALL STEEL CAB
All steel tops completely insulated. All windows equipped with Pittsburgh Safety Glass. Free sliding door windows. Inside of doors enameled black. Tops primed for painting.

HALF CAB \$125.00 FULL CAB \$185.00 f.o.b. OHIO

FREE JEEP CATALOG — WRITE FOR IT TODAY!

Thousands of other Jeep parts and accessories available. **SHOP BY MAIL—Order Direct From This Today.** TERMS: Net cash with order. Open account to rated firms only. C.O.D. shipments should have 25% deposit with order. Minimum order \$1.00. Inquiries invited from dealers, exporters and quantity buyers.

BERG TRUCK & PARTS CO., INC.

1608 S. WABASH AVE., DEPT. 14, CHICAGO 16, ILLINOIS



Whatever your hobby

Model building, whittling, Indiancrafts, leather, plastics or any other creative handicraft

x-acto knives, tools & sets

designed by craftsmen and precision-made for fine craftsmanship

will help you do a better job

and get more fun and satisfaction from your hobby.

Whittling your hobby?

Send 10c for 40 page booklet with detailed instructions and plans for 34 projects.

X-acto 28 page catalog—25c



No. 82 X-ACTO KNIFE CHEST — \$4.20



X-ACTO, INC., 48-45 Van Dam St., Long Island City 1, N. Y.

6 in 1 tool!



A MUST FOR SHOP OR HOME

First and only combination grinder-hone with flat, reversible oilstone revolving slowly at 110 rpm. 120-grit one side for whetting, 320-grit other side for final honing. Puts sharpest possible edge on knives, cutting tools and implements. Butchers report sharpening knives better in one-third the time. Woodworkers, machinists, shop instructors acclaim its amazing efficiency.

SO MANY USES

A national magazine says the ATLAS GRINDER-HONE "represents the first basic change in grinder design, appearance, and efficiency in several decades." Grinding wheel is medium-grit aluminum oxide running at 3000 rpm. With adapter and accessories, you can buff, polish, clean, sand. Precision built with life-sealed shielded ball bearings. Adjustable tool rests. Indispensable for home or shop.



HONES — at correct speeds and exact angles for razor sharpness.



GRINDS — knives, shears, tools and implements to correct sharpening edge.



POLISHES — trays, silverware; removes rust, corrosion, paint; sands irregular surfaces.

Atlas GRINDER-HONE

SEND FOR THESE BOOKS
FREE CATALOG — showing all ATLAS woodworking machines.
MODERN FURNITURE PROJECTS — 16 easy-to-follow plans for modern chairs, lamps, tables, etc. Only 50c (65c outside U.S.A.)



ATLAS PRESS COMPANY
1024 N. PITCHER ST.
KALAMAZOO, MICH.



PRECISION BUILT FOR PRECISION PERFORMANCE

UTICA®

UTILITY PLIERS

WITH THE

WIDE MOUTH

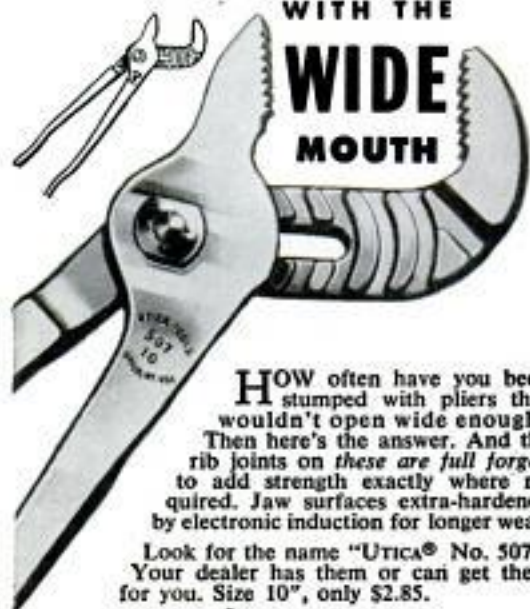

How often have you been stumped with pliers that wouldn't open wide enough? Then here's the answer. And the rib joints on these are full forged to add strength exactly where required. Jaw surfaces extra-hardened by electronic induction for longer wear.

Look for the name "Utica® No. 507." Your dealer has them or can get them for you. Size 10", only \$2.85.



TRADE-WIND BATHROOM VENTILATOR-LIGHT

NEW BEAUTY
FOR YOUR
BATHROOM!



GIVES YOU FRESH AIR PLUS BRILLIANT LIGHT
EASILY INSTALLED

Here's the finest gift you can give yourself . . . and your bathroom! An easily installed combination light and fresh air ventilator which keeps your bathroom always fresh and free from steamed up mirrors and damp walls. F.H.A. and UL approved for inside or outside baths in existing or new homes. Beautifully designed in bright chrome with alba-lite glass. Mounts flush in ceiling. Complete instructions tell you how to install between ceiling joists with connection to nearest electric circuit.

MAIL COUPON FOR COMPLETE INFORMATION

Trade-Wind Motorfans, Inc.
7755 Paramount Blvd., Dept. PM, Rivera, California
Please send me full color brochure on Trade-Wind Ventilators.
Name _____
Address _____

ANSWERS YOUR PRESSING PROBLEMS



Hundreds of pressing tests can be conducted on this compact Carver Laboratory Press, the same reliable equipment used in professional, industrial and government labs. Ideal for home workshop. Accurately controlled pressures to 20,000 lbs., temperatures to 600°F. Various standard accessories available. Send for free descriptive bulletin.

FRED S. CARVER INC.
HYDRAULIC EQUIPMENT
SUMMIT, NEW JERSEY



Hobbyists ATTENTION

World's Greatest Tiny Motor Value

New MIGHTY MOTOR

Small but mighty. Weighs only 2 oz. Durable, long lasting. Has hundreds of uses for hobbyists. Runs on 2 flashlight batteries. Fine for Toy Motor Boats, Airplanes, Erector sets, Bar-B-Q Spitters, Electronic items, etc.

American made. Not an import. Motor alone sells everywhere for \$2.50. While our present supply lasts we offer motor, plus gear, reduction gear with shaft, battery holders and reversible switch. A \$3.65 value sent postpaid for only **\$1.50** (4 COMPLETE SETS FOR ONLY \$5.00)

PLEASE SEND CASH, CHEQ. OR M.O. . . . NO C.O.D.'S
Large quantity buyers write for prices

GENERAL TOOL CO. 1439 GRAND AVE.
KANSAS CITY 6, MO.

BUILD D.C. WELDER!

WE SHOW YOU HOW to build this powerful welder without rewinding. Uses most any surplus aircraft generator. Produces 75-350 amps. Easy to build. PLANS 35c includes NEW booklet "HOW TO WELD," and FREE WAR SURPLUS AND ELECTRICAL CATALOG.



LEJAY MFG. CO., 1247 Le Jay Bldg., Minneapolis 8, Minn.

SAVE MONEY on SURPLUS PARTS for MILITARY TYPE TRUCKS & JEEPS

4 & 6 wheel drive. FREE catalog to Jeep owners. State make truck or Jeep. (New Jeep Tops, steel or canvas all models). AMERICAN AUTO PARTS CO., Inc., 1830 Locust, Kansas City, Mo.



10 ALNICO V MAGNETS \$1.00

Powerful, permanent, rust-proof Alnico V magnets have 1000 uses in home, workshop, drafting room, plant. Hold notes, lists, prints, maps, work sheets. Magnetize pot holders, towels — perfect for cupboard door closures. Postpaid, no C.O.D.'s. Fun for all! Order today.

Dept. PL, MAGNEX, Inc., 851 Broadway, Denver 3, Colorado

LAWN LIKE A GOLF GREEN! AERATE! Get A Reviva-Turf



Fits any reel-type hand or power mower. Moisture, seed, fertilizer goes down. Get a healthier lawn—fewer weeds.

REPLACES LAWN MOWER ROLLER

Deep Root Growth. Aerate as You Mow!

Order by size: 16", \$4.95; 18", \$7.95; 20", \$9.95; 21", \$10.95; 24", \$11.95. Special sizes on request.

Add \$1.50 for postage, packing.

ENGMAN MANUFACTURING CO.

1317 Locust Street
Des Moines 9, Iowa

SCHALK'S WOOD PUTTY



Not a plastic—
contains real hard wood

Recommended
by Peter Putter



Here's the Wood Putty that won't shrink. You can mold, model, plane, saw, sandpaper it. You can color, stain, paint, varnish it. It fills nail holes, cracks in floor, furniture, plywood; sets door pulls. And, when mixed with varnish instead of water, it becomes a waterproof material for boat repairs or exterior use. All you need for 101 odd jobs around home, farm and workshop—Schalk's Wood Putty—the wood putty with real wood!

At paint, hardware, building supply stores

SCHALK CHEMICAL CO., 351 East 2nd St., Los Angeles 12

NEW "WIZARD" TOOL DRILL GRINDING GUIDE

MAKE OLD DRILLS LIKE NEW...

For re-pointing dull and broken twist drills up to 1/2" in diameter. One piece cast Aluminum. Simple. Anyone can use it. Order yours today. \$1.00 post paid.

BRASS CASTING CO. P. O. Box 3056 Memphis 9, Tenn.



\$1.00
POST PAID

BUILD YOUR OWN POWER TOOLS—GIL-BILT WITH PARTS KITS



TILT/ARBOR SAW

- 27x28 in. table, 13 1/2 in. capacity in front of blade
 - 10 in. blade cuts 3 1/4 in. deep, tilts full 45 degrees
 - Floor model 34" high, table always stays level
 - New Departure ball bearing arbor, 3/4" precision shaft turned down for 3/8" bore blades, alum. housing, shipped ready to run
 - Jackscrew and 4 1/2 in. dia. handwheel lowers and raises blade
 - Cast aluminum miter gauge and self-aligning rip fence guide
- GIL-BILT Metal Parts Kit includes Plans, ball bearing arbor, miter gauge and bar, rip fence guide, dado insert, lock knobs, jackscrew mechanism and handwheel, and all other metal parts (less blade).....\$22.95
Same Kit with 14" Combination Blade...\$28.90
Same Kit with 8" Combination Blade...\$24.90

GIL-BILT 12-INCH BAND SAW

Ball bearing drive, rigid cast aluminum wheels, rubber tires. Handles stock up to 6 inches thick. Cuts to center of 24" circle. 18 x 18 inch 1311 table. Capacity and performance of band saws setting for \$80 and up. Plans and all metal parts in kit with 1/4" blade \$23.95
Return Kits in 10 days for refund if not satisfied. For shipments up to 600 miles, add 5%; over 600 add 15%. Amount in excess of actual postage will be refunded.

PLANS
only
\$1.00
EACH
POSTPAID

Write for FREE Catalog.

Also Available: Plans & Parts Kits for 18" Band Saw, Belt Sander, Spindle Shaper, 8" Tilt-Table Saw



GILLIOM POWER TOOLS

Dept. 80-K, Lambert Field
St. Louis 21, Missouri

OCTOBER 1955

347

Your Lumber and
Building Material
Dealer

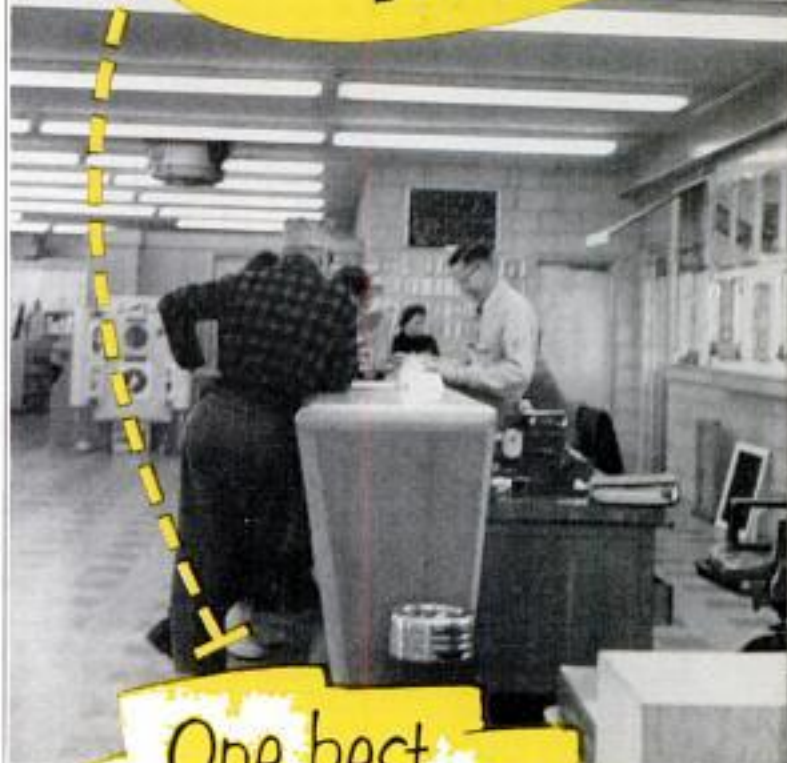

One best
one stop
source.....

FOR ALL HOME-OWNER AND HOBBY-CRAFT NEEDS

Buy your "do-it-yourself" requirements where the professional builder buys—at your neighborhood Lumber & Building Material dealer's.

You'll find him a one-stop source for the best in power and hand tools... cabinets, plywood, paints, hardware, wallboard and floor coverings... all kinds of lumber and building materials—all of professional quality... and in price ranges to fit your budget.

There are more than 20,000 Lumber & Building Material dealers from Coast to Coast—in big city and small town, stocked and equipped to serve and advise you as capably as they serve the nation's professional builders.

When you buy from your building material dealer you get the same dependable advice about materials and which tools are best that the professional builder gets... advice that saves time and money.



This message sponsored by . . .

**BUILDING
SUPPLY NEWS**

Always the FIRST
Dealer Merchandising Publication

**GIGANTIC
SAVE-TO-70%**

MAIL SALE

**WAR SURPLUS
EXCESS INVENTORY
BANKRUPT STOCK**

ARMY POWER PLANTS

Marvelous buys in new condition Govt. surplus plants and generators. We pay freight!



- 1000-w, 115-v, 60-c, \$149.50
- 2000-w, 115-v, 60-c, \$289.50
- 3000-w, 115-v, 60-c, \$349.50
- 7500-w, 115-v, 60-c, \$500.00
- 3000-w, DC generator \$58.75

Send for free bulletin

AIR COMPRESSORS—TANKS, Etc.

Save to 70% on air fittings, tanks, compressors, etc. See our catalog.

- Piston Air Compressor, 150 lb. . . . \$18.95
- Air Corp 300-lb. Pressure Tank . . . \$6.79
- Auto Pressure Switch for Motor . . . \$4.95
- Professional Paint Spray Gun . . . \$9.95
- DeLuxe Air Kit complete . . . \$45.49

NAVY CENTRIFUGAL PUMP



Leading make. All bronze ball bearing hi-capacity. Complete with pulley. 1 1/2" inlet, 1 1/4" outlet.
Will pump up to 140 GPM. Pressure to 65 ft. Suction lift to 18 ft. Gov't. Cost \$63.50. Prepaid \$24.61

SPECIAL LISTINGS

We list below some super prepaid-to-you bargains available in limited quantities only.

- \$150 G.E. Experimental Amplifier \$6.97
- \$40 Pressure 8" Gauge 100 Lbs. \$9.17
- \$15 Gov't. Sleeping Bag with Cover \$5.74
- \$3 Finest Wood 1"x16" Chisels \$1.19
- \$150 5-Row Weed Spray Outfits \$97.65
- \$30 Electronic Experimental Kit \$4.99
- \$15 Army First Aid Chests . . . \$6.95
- Eastman Film and Paper—savings to 70%!

HYDRAULIC HAND PUMP

Build your own arbor press, wagon unloader, shop tool tester, etc. Genuine brand new Blackhawk hi-pressure hydraulic pump system. Complete unit including reservoir, check valve, etc. Will develop pressure to 8,000 lbs.! Wt. 35 lbs. Gov't. Cost over \$100. Prepaid \$23.95



SPECIAL OF THE MONTH!

CONTRACTOR-ARCHITECT LEVEL

Excellent highly accurate professional instrument made by leading manufacturer. Ideal for setting foundations, grading, farm contouring, surveying, etc.
Powerful erecting optical telescope micrometer adjustment, polished graduated degree scale, sensitive spirit bubble, etc.
Furnished complete with 8 1/2-ft. 3-sec. rod, fine tripod and polished wood carrying case.
Our 4-star buy!
Prepaid to you **\$39.15**



SPECIALS FROM PREVIOUS ADS

- Step-by-step Telephone Switches . . \$13.91
- 110-V Selayn Motors \$12.97
- Finest Heavy 10x12-ft. Tarps . . . \$11.99
- Giant Light with Motor \$48.90
- AC-DC Power Rectifier \$18.61
- Finest 7x80 Binoculars \$36.95
- Gov't. Prismatic Periscopes . . . \$2.99

We pay transportation to you except where stated "FOB Lincoln." Write for large FREE Catalog.

BURDEN SALES COMPANY
812 "O" St., LINCOLN, NEBR.

BUILD 10 RADIO CIRCUITS AT HOME \$12.95 COMPLETE

With the Universal Radio "Educator-Kit." Includes All parts, Instructions and Tester. 30 Day Money-Back Guarantee.

UNIVERSAL KITS CORP.

Room 538-B, Universal Building, 16 Skillman Ave., Brooklyn 11, N.Y.

Gentlemen: Please Rush me Free Descriptive Literature concerning "Educator Kit." Also send me Free Radio-TV Servicing Literature. No obligation.

Name _____
Address _____
City _____ Zone _____ State _____

PAGE HOME WORKSHOP MACHINES

Page Power Tools help the home handyman every step of the job. Every machine precision-made, with finest parts! **LOW PRICES!**

- 8" Ill-Arbor SAW
- 14" Drill Press
- 18" Jig Saw
- 10" Band Saw

PAGE TOOLS, 1910M South 81 St., Milwaukee, Wis.

Popular Mechanics Book for Pleasure or Profit

23 BOATS You Can Build

Build the boat you have always wanted. Build it for fun or to sell at a profit. Get Popular Mechanics 23 BOATS YOU CAN BUILD—row boats, canoes, sail boats, power boats and other craft including a 25 foot cabin cruiser. Book includes more than 500 photos, plans, diagrams and working drawings, plus step by step instruction that anyone can follow. Only simple tools needed. Material list of lumber, hardware, fittings, etc., included. Order today under money-back guarantee. Only \$2.00 postpaid.
POPULAR MECHANICS PRESS, Dept. PM3, 200 E. Ontario St., Chicago 11

YES! SEND



directly to my door every month

- I am enclosing
- \$3.50 for 1 year
 - \$8.00 for 3 years

name _____
address _____
city _____ zone _____ state _____ A-105

Hand this order to your newsdealer or send it to
POPULAR MECHANICS
200 East Ontario St. Chicago 11, Ill.

ARROW GUN TACKER THE MODERN NAILING METHOD



for **1001 DO-IT-YOURSELF NAILING JOBS**

5 TIMES FASTER THAN HAMMER & NAILS!

Now! Breeze through nailing jobs with almost effortless ease! Automatic, one-hand operation does it faster, cheaper and better! 100 staples cost only 5¢! Ideal for applying ceiling tile, insulation, upholstering, screening, cornices, wire fencing, etc. Ask for demonstration at your local hardware or building material dealer. Write for FREE Do-It-Yourself brochure.

ARROW FASTENER CO., INC.
DEPT. PM, ONE JUNIUS STREET
BROOKLYN 12, NEW YORK

NEW LUFKIN

MAGNETIC BASE TOOLS
make your work easier



No. 350X

LUFKIN

MITI-MITE Magnetic Base FLUORESCENT LAMP with Magnifier

High intensity lighting coupled with 4-power magnifier. Two 5" lamps operate at body temperature, are protected by plastic chip shield. Adjustable goose neck with full swivel. Strong permanent magnets in base for quick positioning.

LUFKIN

MITI-MITE Magnetic Base SURFACE GAGE

Is both a surface gage and an indicator holder. Permanent magnet can be turned off for easy positioning. Fully-adjustable spindle with fine adjustment screw. Scriber can be used below base when desired.

No. 300B



WRITE FOR FREE MITI-MITE BOOKLET

383 BUY LUFKIN TAPES • RULES • PRECISION TOOLS
FROM YOUR TOOL DISTRIBUTOR

THE LUFKIN RULE COMPANY, Saginaw, Michigan

NEW Lynx THREAD KIT SAVES DOLLARS IN REPAIRS AND REPLACEMENTS

Loose, worn or damaged threads are costly—cause scrap, downtime, and poor performance. Now for the first time, it's easy as A-B-C to replace these threads quickly and economically. Use Lynx* Thread Kit! All you do is (A) drill out the hole; (B) tap new threads with tap provided; and (C) wind in Lynx stainless steel inserts, using inserting tool provided. You get a permanent, back-to-original size, stronger-than-ever repair made in minutes! Wonderful for screen doors, storm doors, furniture, lawn mowers, engines, door hardware, wood joints, boats—hundreds of uses!

Each Lynx Thread Kit contains two drills, two taps, two inserting tools and supply of stainless steel wire thread inserts for most household uses—and complete instructions!

Send check or money order—no C.O.D.'s. Money back if not completely satisfied. *Reg. U.S. Pat. Off.



HELI-COIL CORPORATION
750 Shelter Rock Lane, Danbury, Conn.

Please send me a Lynx Combination Thread Kit postpaid; \$6 value for \$4. (Sizes 10-24 and 1/4-20). Covers 90% of household uses. I am enclosing \$4.

Name _____

Address _____

City _____ Zone _____ State _____ 1957

BUY SHOPMATE! You Get All These Features!

COMPARE, point for point, and you'll see how much more do-it-per-dollar you get with *Shopmate*, PET's Big Value brand.

No. 740-6 Shop-Toter Drill and Saw Kit

New 1/4" gear-chuck drill with powerful motor; ZP-1 Drill Saw turns drill into portable saw.

Welded steel tote case; complete accessories for drilling, sawing, sanding, polishing. Big-value price, only **\$34.88.**

No. 740-5 Shop-Toter Drill Kit. Same as kit above but without ZP-1 Saw. Another Big Value, only **\$27.88.**



CHECK ✓ These Shopmate Features

- ✓ Powerful New 2-amp. AC-DC Motor
- ✓ Accurate Geared Chuck
- ✓ All-Steel Welded Shop-Toter Case
- ✓ Complete Accessory Set, including 12 sanding discs, polishing bonnet, grinding wheel, muslin pad, 7 drill bits.

No. 620 Shopmate Clutch Saw

Features exclusive Pet-O-Matic Slip Clutch. Powerful motor; guide, guard. Cuts dressed 2 x 4s at 45°. Biggest Saw value today.

Only **\$48.88.**

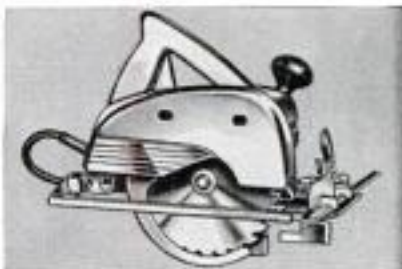

CHECK ✓ These Shopmate Features

- ✓ Powerful 4800 RPM Motor
- ✓ Cuts 2 x 4s at 45° (6 1/4" blade)
- ✓ Exclusive Pet-O-Matic Clutch eliminates kick-backs and motor burn-outs
- ✓ Depth of Cut at 90°, 0 to 2 1/8"
- ✓ Telescoping Safety Guard
- ✓ Graduated Adjustable Rip Guide



When you buy, take this ad with you as your buying guide to Shopmate values! Compare, and be sure!

Made by Portable Electric Tools, Inc.
320 West 83rd St., Dept. PM10, Chicago 20

LIMITED **Darra James** OFFER

NEW Westinghouse
MOTOR
1/2 PRICE

WITH THE PURCHASE OF ANY
DARRA-JAMES QUALITY POWER TOOL

Now! Start, or add to, your home workshop at a price so low you may never be able to duplicate it again! Choose from Darra-James 25 professional quality table saws, drill presses, band saws, jig saws, jointers, sanders, lathes, etc. Get a brand-new matching Westinghouse Motor for 1/2 price! Shop and compare!

EXAMPLE #1



8" Tilting Arbor
Saw (Model 28) \$38.95
1/3 HP Capacitor
motor 38.20
Regular price \$77.15

NOW! BOTH
ONLY **\$57.85**
(EXTENSIONS EXTRA)

EXAMPLE #2

12" Drill Press (Model
350B) \$56.50
1/3 HP Westinghouse
motor 26.95
Regular price \$83.45

NOW! BOTH
ONLY **\$69.95**

CLIP AND MAIL TODAY!



TOOLKRAFT CORP.
PLAINFIELD STREET, SPRINGFIELD, MASS.

Please send me your free catalog, with information and coupon needed to take advantage of your 1/2 price motor offer, and name of nearest dealer.

Please contact my favorite dealer. He is

NAME _____

CITY _____

Please send me your Power Tool Handbook. I enclose 10c to cover handling and postage.

NAME _____

STREET _____

CITY _____

shorter drilling time! longer drill life!

New!

TIME SAVER JR
BORING SET

ONLY

\$198



FULLY
GUARANTEED

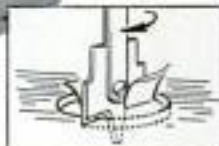

8 hard tempered, blue spring steel bits (9/16" to 1")—easily interchangeable on one shaft—(fits any 1/4" chuck)—in handy hinged-cover plastic case.

Bore holes fast and true — cross grain, end grain, at any angle — up to 1-inch diameter with your 1/4" electric drill. Save your time, save your drill!

Razor action, cool running TIME SAVER Bits take less power... cut fast with less torque, less thrust through any material. Drill through Wood • Formica • Masonite Plywood • Leather • Celotex • Sheet Rock • Plaster Lucite • Soft Sheet Metals. TIME SAVER Bits last long and hold edge. When necessary, they're easily resharpened or inexpensively replaced.

Available at your favorite hardware dealer...or write direct.

**NEW BLADE-TYPE
BITS DRILL
FASTER, EASIER,
CHEAPER**

TIME SAVER P.O. BOX 1221 JOLIET, ILLINOIS



Pella[®]
**WOOD
FOLDING
DOORS**

Decorative • Convenient • Economical

Now you can use the floor and wall space that swinging doors waste. Pella Wood Folding Doors fold compactly against the door jamb like an accordion. Ideal for closets, bedrooms, kitchen... and as folding partition between living and dining rooms. Anyone can install, quickly, easily. Completely packaged with hardware, fittings, installation instructions. Heights to 10', widths to 30'. Natural wood finishes and unfinished. Investigate today!

CLIP AND MAIL TODAY

ROLSCREEN COMPANY
Dept. G-82, Pella, Iowa

Please send complete literature on Pella Wood Folding Doors.

NAME _____

ADDRESS _____

CITY _____ ZONE _____ STATE _____

NEW FOR THE HOBBYIST AND CRAFTSMAN! DREMEL 15" Moto-Jig Saw gives you

more capacity!
cutting speed!
safety features!

... and more family fun than any other jig saw anywhere near its price!

Here's jig saw performance to make your eyes pop! The new **HEAVY DUTY Model 15 Moto-Jig Saw** is a real workhorse—rips through 1 3/4" wood—even a 2 x 4. Powered by a built-in **ROTARY MOTOR** (not a vibrator) it outperforms the clumsy and expensive cast iron type jig or band saw of the past. Now you can repair things around the house—build toys for the children—make beautiful new furniture, window valances, cupboards, etc. It's the first really safe jig saw—a foolproof blade guard eliminates all chance of finger injury. Weighs only 12 lbs. You can set up shop anywhere—actually convert a card table into a workshop! Deep 15" throat permits cutting to center of 30" circle. New **ROCKER ACTION** principle obsoletes all others. Until you've tried the new DREMEL you'll never know the money saving fun and excitement of a really modern power tool. Try it—bring it home—introduce your whole family to the new thrill in hobby and workshop tools.

SEE YOUR DEALER: If he cannot supply, order direct on 5-day trial, money back guarantee. Or send \$2, pay postman balance plus C. O. D. fee.

DREMEL MFG. CO., Dept. 115-K, Racine, Wis.

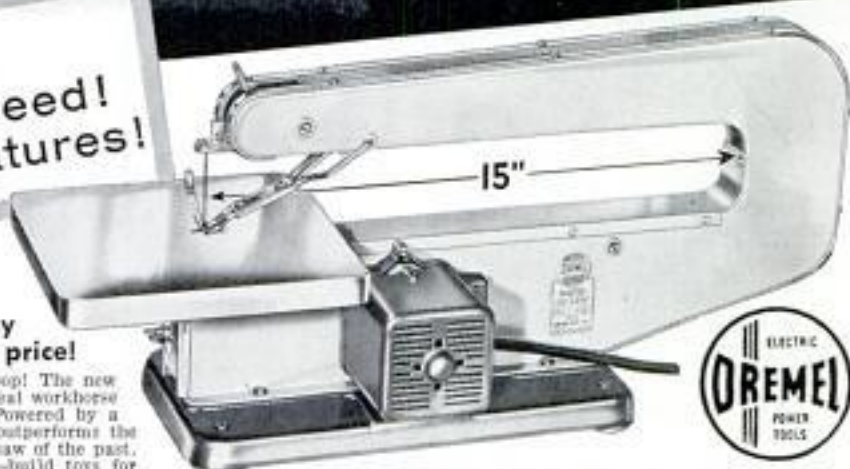

Beautifully styled in attractive brown and beige! **\$29.95**

Sensational Model 8 Moto-Jig Saw

Already a favorite with thousands of hobbyists and craftsmen. Same features, cutting speed and power as the new Model 15—with smaller (8") throat capacity. Cuts 1 1/2" wood—weighs only 9 1/2 lbs. Compact, portable and quiet running. No TV or radio interference. A record breaking value **\$23.50**



WRITE FOR POWER TOOL CATALOG

DEPEND ON DREMEL FOR NEW IDEAS IN POWER TOOLS!

REGO Model GV Universal Welding Torch

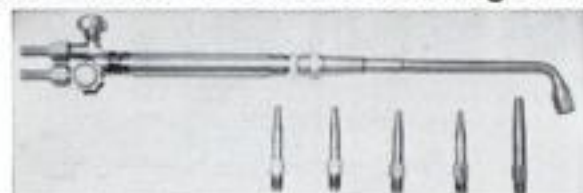

Manufactured by Bastian-Blessing. Complete with hose fittings, wrench and 5 welding tips #GP42, 48, 54, 62 & 70. 18" overall length. All new and perfect. Individually boxed. Regular \$49.95 value. **ONLY \$14.95 PPD.**

Send check or money order today

AL HELLER MACHINERY CO.

763 S. San Pedro St.

Los Angeles 14, Calif.

Metal Turning Lathe for Model Makers



With Ball Bearing Headstock Spindle

For Home Work Shops, Model Builders, Hobbyists. Use it to earn money; develop inventions; make repair parts; do machine work on models.

All steel, practical lathe. Length of Bed—12"; 4 1/2" Swing; Distance between centers—7"; Tailstock travel—1 1/2"; 0 Center in Tailstock; 0 Center in spindle; spindle has 1/2" x 20 thread—1/4" hole; Complete with face plate, driving dog and mounting bolts. Weight, 25 lbs. Guaranteed. Price, except motor—

only \$25.75

f.o.b. Lansing

Rosemoor Mfg. Co., 2607 Bernice Rd., Lansing, Illinois

Enjoy "City Water Service"

wherever you buy...or build!
costs less to buy

MODERN NO-TANK PUMP

Goulds Balanced-Flow Jet is a full-capacity shallow-well water system—yet small enough to install easily anywhere. You save because there's *no* costly tank, fewer fittings to buy. Self-adjusting flow delivers exact amount of water wanted at one or more taps at the same time, within capacity. Trouble-free, quiet, can't lose its prime!



... less to install!

GOULDS pumps inc.

DEPT. PM-1055, SENECA FALLS, N.Y.

Enclosed is 10c. Send 20-page pump booklet and distributor's name.

Name.....

Address.....

YOU GET MORE WITH GOULDS

AMERICAN MACHINE & TOOL CO. MODEL CHANGEOVER SALE SAVE \$800 ON THIS TILT ARBOR SAW

All year a great buy at regular price of \$24.95—this 8-inch Plana Centric Tilt Arbor Power Saw is a spectacular bargain at \$16.95 during model changeover period. This big saving is possible by our patented construction, our manufacturing facilities, and our distribution methods. Top-quality saw features the original Plana Centric Patented Ball-Bearing Floating Drive, Patented Plana Centric Cradle Suspension, and Plana Centric Patented Rip Fence that locks front and rear against the table surface. Every part in this fine saw is manufactured in our own factories. All cast iron and steel construction. Crosscuts, rips, bevels, mitres, dados, cuts compound angles. Massive cast mitre gauge. Heavy steel base fastens to any workbench. Uses any standard 1/4 or 1/2 h.p. motor. INCLUDED: 8" Simonds Combination Blade at no extra charge. We start soon on 1956 models. During model changeover you can have this fine 1955 at a saving of \$8.00. Send check, M.O. or sent C.O.D.



NOW
\$16.95

LOOK AT ALL THESE SPECIAL FEATURES:

- Blade tilts, table stays level, blade adjusts to any angle up to 50°.
- Simple Hand Wheel Control, Tilts and tightens blade with a twist of the wrist. Blade rises and lowers; cuts from 0" to 2 1/4".
- Precision-ground cast iron table. Perfect flatness resists nicking and wear.
- Self-aligning rip fence. Adjustable to lie parallel to blade or give clearance either way.
- Patented Motor Mount takes any standard 1/4 or 1/2 h.p. motor. Motor rides on ball bearing rollers. Keeps belt tight, transmits full power.
- Heavy long-lasting, all-metal construction. Built for a life-time. Shipping weight 23 lbs.

FAMOUS AMERICAN IRONCLAD GUARANTEE

Try any Plana Centric power tool for ten days. If, for any reason, you are dissatisfied, return the merchandise for full and complete refund—no questions asked. This famous guarantee has been offered on sales of more than 3 1/2 million power tools, and it has never been violated.

WRITE FOR FREE CATALOG
Big bargains in home
workshop power tools

All power tools sent express collect

AMERICAN MACHINE & TOOL COMPANY
ROYERSFORD 10, PA.

NEW DIESEL to replace gasoline engines on any 20 h.p. Job

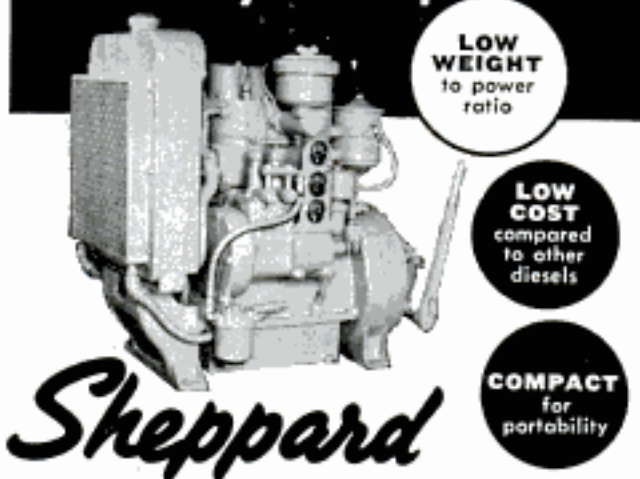

LOW
WEIGHT
to power
ratio

LOW
COST
compared
to other
diesels

COMPACT
for
portability

MODEL 17 - 20 H.P. DIESEL
removes the big factors which barred Diesel power from many uses. Compact in size, relatively low in weight, the Model 17 fits into the same space as any gasoline engine of equal rating. Mass produced, the Model 17 is comparable in price, too. Available as a complete power package including transmission, torque converter, generator or any other special equipment needed.

Sheppard Diesels • Hanover, Pa.

FREE FOLDER
gives complete
details

DEALERS
Write for special
Sheppard Model
17 dealer plan.
No stocking re-
quired.

Need an extra \$1,000, \$2,000, or more? Make it with an

IDEAL LAWNMOWER SHARPENER



There are thousands of lawnmowers in your locality; Average \$1,000 profit per 250 mowers with customer satisfaction and repeat business assured. Provide this essential service with an Ideal Lawnmower Sharpener, the only machine that grinds the reel to "fit" the bed knife. Compare by any standard. The Ideal, backed by 53 years of experience, costs no more. Write today for complete, free catalog.

THE FATE-ROOT-HEATH COMPANY
Dept. PM-10 Plymouth, Ohio

GREASE GUNS LOADED WITH NEW CARTRIDGE

A clean grease job you can do yourself. Ideal for automobile, farm machinery, boat, and industry.

The Grease Tube is the new, efficient, clean way to fill Alemite-type hand grease guns. Eliminates the dirty, greasy, old fashioned method of filling grease guns by simply loading a clean cartridge of grease.

SPECIAL INTRODUCTORY OFFER!

Heavy duty 8000 P.S.I. grease gun and 1 lb. grease cartridge. **\$5.00**
For only Postpaid

This new improved cartridge contains special high quality, all-purpose lithium grease. Cartridge refillings 35c plus postage.

Dealer inquiries invited.

THE GREASE TUBE CO.

221 S. PACIFIC AVENUE, REDONDO BEACH, CALIF.



P-1 GENERATORS

200-250 Amp. 24 Volt DC. 4500 RPM. Makes dandy Arc Welder. Cost \$398. Like NEW. SPECIAL \$11.88 FOB Texas. \$12.88 FOB York. Diagram Free. GOVT. Overhauled \$19.80. GUARANTEED! NEW Cat.—1000's Big Bargains—10c.

KARL ORT, Dept. P10M, York, Pa.

OWN A... FORD?

FIX IT YOURSELF!

Popular Mechanics Magazine has published an Owners Manual covering all 1941 to 1952 models of Ford cars . . . So accurate mechanics use it . . . so simple a woman can understand it.



Save money on your Ford car repairs. Prevent trouble. Enjoy care-free driving. Increase trade-in value. Avoid major repairs by fixing minor troubles before they get serious. Get sparkling performance at all times. Has 272 pages, more than 350 photos, diagrams, tables, charts, breakdown drawings, plus clear, non-technical directions that make all repairs simple as A B C. Written by Ed Packer with the assistance of the Ford Motor Company. Shows you how to diagnose all Ford troubles by feel, sound, sight, smell and performance. Simple trouble shooting. Permanent repairs. Emergency repairs. Plus, "How to get value from garages."

MONEY BACK IF IT DOESN'T SAVE MORE THAN IT COSTS!

One minor repair will save the cost ten times over. Read it. Then you decide. If you don't see that you'll save more than the cost, send it back for refund. SEND NO MONEY. Send postcard. Ask for the Ford Manual. Postman will deliver C.O.D. for \$3.50 plus postage. Or, save postage by sending \$3.50 with order. Send today. Save its cost on your next repair.

POPULAR MECHANICS PRESS

200 E. Ontario, Dept. 90, Chicago 11, Illinois

YOU DO A BETTER JOB WITH

P&C PUNCHES and CHISELS

There's a BIG difference in chisels and punches. You need P&C quality to go through the toughest steel with speed and ease.



- Quality P&C Alloy Steel
- Properly Heat Treated
- Comfortable Grip
- Polished Flats & Points
- Properly Balanced

Buy P&C today... the best tools money can buy. Shop from P&C Merchandisers, in over 10,000 stores.



P&C TOOL CO.
Dept. H6, Box 5926,
PORTLAND 22, OREGON

Supreme POWER SCREW DRIVER DRILL ATTACHMENT

Fits All Drills, 1/4" and Larger . . . Takes the Work Out of Using Screws.

Clamp this new unit in your drill—just like a bit, and see how fast and easy it runs every screw up tight! Light, compact and fool-proof, this attachment is actually a screwdriver blade with a built-in clutch. The splining drill chuck drives the screw only when you press with the drill. Release your pressure, and the friction clutch releases the screw end. Changeable blades included for either slotted head or Phillips screw, with Allen wrench and complete instruction. For screws up to 3/16" (three-sixteenths) diameter only \$4.95 plus 35c handling and postage. Also \$6.95 PLUS Heavier Duty model for screws to 1/4" diameter—only 35c



SURPLUS TEMPERED STEEL CIRCULAR SAW BLADES



Cross Cut • Rip • Combination Not just ordinary, impregnated blades, but first quality heavy gauge tempered tool steel blades designed especially for long rugged use, and made right here in America. Available in 4", 5" and 8" diameter with 1/2" and 3/4" bores to fit all popular makes of hand, power, and table saws.

ONLY **99c** EA.

Reg. to \$4.95 ea. (plus 20c for each blade to cover P.P. and handling)

Will fit SKIL, SHOP SMITH, STANLEY, BLACK & DECKER, MALL, DELTA, DEWALT, CRAFTSMAN and most other equipment.

4" RIP, CROSS CUT, or COMBINATION with 1/2" bore only, Reg. \$1.50, NOW, post. 59c
5" RIP, CROSS CUT or COMBINATION with 3/4" bore only, Reg. \$2.25, NOW, plus 20c handling and postage, 79c
10" RIP, CROSS CUT, or COMBINATION 2 1/2" bore, Reg. \$9.50, NOW, plus 20c handling and postage, \$1.59
GILT PRICE, post.

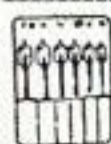

6 Pc. POWER AUGER BIT SET
Made of finest tool steel specially tempered and hardened to give years of quick, clean, easy drilling. Shanks will fit all electric drills. Packed in sturdy heat treated, compartmented plastic tool roll. Sizes 3/8", 1/2", 5/8", 3/4", 1", and 1 1/4". **\$1.98**



6 Pc. METAL CUTTING FILE SET
Made from the best quality tool steel, designed for the requirements of mechanics, watch and jewelry craftsmen. Compartmented plastic kit contains the following 5 1/2" long needle files with round shanks and high test cutting qualities: round, half round, flat, oval, knife, square. (plus 10c handle & post.) **98c**

Send check or M.O., C.O.D. charges extra. **MONEY BACK GUARANTEE.**
SCOTT-MITCHELL HOUSE, INC. Dept. MS-07, 611 Broadway, New York 12, N. Y.

Hastings Oil Filter Cartridges keep oil clean from filter change to filter change* when replaced as normally recommended... The reason is **DENSITE**



Densite—an amazing new type of filtering material—is made of millions of selected raw cotton fibres, pressure packed so oil must flow through countless tiny openings, pass many surfaces of fibres. The most microscopic abrasives cling to these fibres—and stay there!

Next time you change oil—change your filter cartridge. Ask for Hastings and have clean motor oil *all the time!*

* As proven by tests conducted in accordance with U. S. Bureau of Standards procedure.

HASTINGS MANUFACTURING COMPANY
HASTINGS, MICHIGAN

HASTINGS

OIL FILTER CARTRIDGES with DENSITE

America's favorite...



sold and serviced nationally

CUSHMAN MOTOR WORKS, inc.

962 No. 21 Lincoln, Nebraska

Cushman EAGLE

THE TOP TRANSPORTATION BUY

- Up to 75 miles per gallon
- 3/4c per mile total operating cost
- Endurance proved

Own a Cushman Eagle for as little as \$5.00 a week.

See your nearest dealer for FREE demonstration or write for illustrated literature.

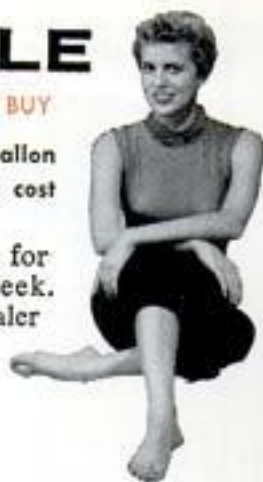

MACHINE TOOL RECONDITIONING

& THE ART OF HAND SCRAPING

—USEFUL FOR DESIGN, SHOP & INSPECTION WORK—

—SEND FOR FOLDER DESCRIBING ILLUSTRATED BOOK

MACHINE TOOL PUBLICATIONS, 382 Holly Ave., St. Paul 2, Minn.

WAR SURPLUS AND OTHER BARGAINS SAVE UP TO 90%

SPECIAL ON \$4770 NAVY AUXILIARY POWER UNITS AIR COOLED

Ideal for your shop, camp, cottage, farm, trailer, home, boat or mines. Makes a terrific welder for any size job. Also excellent for auxiliary power in pumping wells, operating saws, or wherever power is needed. 300-1A Lawrence, 24V. 2 Cylinder opposed 4-cycle 10 1/2 H.P. comes complete with various generators which can be attached to standard steel mounting. Shop. wt. cased 350 lbs. Like New. Type 2 CMTD-B1-140 amps., 24V — \$125. Type P1, 200 amps., 24V — \$137.50. AC-DC NEA5 (DC side 24V, 200 amps., AC side 10.5 amps., 1200 watts), 800-cycle 2400 RPM — \$142.50.

FIELD COOKING UNIT & HEATER

Terrific for hunters, ranch, home, farm, civilian defense, boat, camp, trailer, barbecue, etc. Burns any type gasoline. Burner 100 3/4" dia. Unit approx. 23" x 21" x 10". Has 2 tanks (21 1/4" x 5 3/4") with welded seams, 3 brass valves, 3 air filters, air gauge to 80 lbs.

NEW Korean war surplus. Wt. 95 lbs., boxed. Approx. GOV'T cost \$150. Complete with 2 spare energizers and orifice cleaner (compare this price) — \$10.50

MICROMETERS Chrome plated, precision engineered, carefully tool to give long life. All new 0-1" cap. \$2.25 ea., 1-2" cap. \$3.50.

MICROMETER DEPTH GAUGE

With 3 rods to measure all depths from 0 to 3 inches by thousandths. Hardened tool steel lead screw has full 1 inch run. Base is 2 1/2" long, hardened ground and hand lapped. Accuracy guaranteed. Mfd. by Miller Falls Co. GOV'T COST approx. \$30. NEW — \$10.95 incl. USA. In velvet case.

"HELIOS" ORIGINAL TOOLMAKERS VERNIER CALIPERS

ULTRAPRECISION — Imported. Used by machinists at Lockheed, Douglas, Bendix, GM, RCA, GE. Model 51/2E. Genuine Helios. Hardened lapped precision surfaces. 1/1000" and 1/128" graduations. Handy slide rest and thumb lock. Quick, accurate depth. A \$35 value. Satin finish. ALL NEW. Just \$6.95 Leather carrying case, \$1 extra.

REVERSIBLE RATCHET WRENCH

A must for the mechanic working on diesels, ships, farm machinery, trucks, bridges, oil fields, mining and all heavy equipment. Terrific leverage. Four foot Lowell safety steel socket reversible ratchet wrench with sockets for 2 3/4", 2 9/16" and 3 1/8" hexagon nuts. Navy surplus. Approx. Gov't. cost \$125 a set. Wt. 50 lbs. Brand New — \$10.95 per set.

SENSITIVE ALTIMETER In 10 Ft. Increments. Famous Pioneer! 0 to 35,000 Ft. (Inches of Mercury). Tested and inspected in our own instrument lab. Guaranteed perfect. Approx. Gov't. Cost \$150. NOW ONLY \$13.95 PREPAID!

NEW 1955 CATALOG Biggest ever... new low prices... Send 25c for your copy today. Prices F.O.B. Culver City unless otherwise stated. Check, money order or cash, 25% deposit for C.O.D.

AIRBORNE SALES CO., INC. DEPT. PM1055
8501 Stellar Drive, Culver City, Calif.

AUTO REPAIR MANUAL

Save money by making auto repairs yourself! Keep your car in the best possible running condition! Learn how to protect your trade-in value! *Auto Repair Manual*, by the Editors of POPULAR MECHANICS PRESS, can be used with any make, model or year of car. It's filled with money-saving shortcuts and maintenance procedures—will pay for itself the first time you work on your car. It's 160 pages long and has photos and diagrams to illustrate every point. Every car-owner should have a copy of this book. So get yours.



only 75¢

NOW ON SALE AT ALL NEWSSTANDS

100 BEST Woodworking Projects

SELECTED FOR YOU BY POPULAR MECHANICS EDITORS

Enjoy the fun — the pride — of making things. Get 100 BEST WOODWORKING PROJECTS, complete with simplified instruction, plans, diagrams and more than 400 how-to-do-it pictures. Make all kinds of furniture, baby carriages, clocks, lamps, book shelves, fireplaces and other useful articles at little or no cost. Send only \$2.00 with name and address. Money back if not pleased.

POPULAR MECHANICS PRESS, Dept. PM6, 200 E. Ontario St., Chicago 11

\$35,000 BONUS OFFERED BY THE U. S. GOVERNMENT FOR URANIUM

FREE BOOKLET! "HOW TO MAKE MONEY PROSPECTING FOR URANIUM"

Tells where to look, how to stake claims, how to sell, equipment needed—plus many other facts to help you cash-in on rich Uranium rewards. (Please enclose 10c for postage & handling.)

U. S. GEIGER CO., Dept. PM-10, 195 Sackett St., B'KLYN 31, N.Y.

do it faster...better!



PLIERS, CHISELS, PUNCHES, SNIPS, ADJUSTABLE WRENCHES

Buy wherever fine tools are sold in U. S. and Canada.

KRAEUTER

NEW FOR THE HOBBYIST AND CRAFTSMAN! DREMEL model B Moto-Sander gives you

more

versatility
beauty
capacity

PLUS
STRAIGHT-LINE ACTION

that can't scratch the finest finish!

Set yourself for a new high in excitement when you get your first look at the new DREMEL Model B Moto-Sander. Here's a black-and-yellow enamel beauty that leads the field in styling and efficiency. And here's versatile performance that will make the whole family itch to put it to work! The Model B is a combination sander-polisher-massager that delivers 14,400 straight-line strokes per minute, for perfect finishes guaranteed free of orbital scratches and swirl. It has power-to-spare for finish sanding, furniture polishing, a host of jobs in every home. See it . . . bring it home . . . you'll never understand how you ever got along without it!

SEE YOUR DEALER. If he cannot supply, order direct on 5-day trial, money-back guarantee. Remit in full for postpaid shipment. Or send \$2 now, pay postman balance plus C.O.D. fee.

DREMEL MFG. CO., Dept. 115-K, Racine, Wisconsin
WRITE FOR POWER TOOL CATALOG



with 13 sq. in. sanding pad . . . **\$14.85**



Model
2000 Sander,
with steel case,
21 sq. in.
sanding pad . . . **\$24.50**



Model 53
Sander, heavy-duty
rotary motor, 24
sq. in. sanding pad. **\$34.85**

DEPEND ON DREMEL FOR NEW IDEAS IN POWER TOOLS!

ARMSTRONG LATHE TOOLS



There is a correct ARMSTRONG TOOL HOLDER for every operation on Lathes, Planers, Slotters and Shapers. Shown at left are:

1. *Turning Tool*—for roughing, finishing and fillet work.
2. *Boring Tool*—for boring and internal threading.
3. *Threading Tool*—for thread cutting.
4. *Cutting-off Tool*—for lathe cutting-off work.

ARMSTRONG Lathe Tools are designed to give greater strength, maximum clearance and correct cutting angle. They are the most efficient and economical lathe tools you can buy. Write for Catalog

OVER 250 SIZES AND TYPES
ARMSTRONG BROS. TOOL CO.
5268 W. ARMSTRONG AVE. • CHICAGO 30, ILL.

Insist on
Evans
TAPES
KING-SIZE
At your
hardware
store



6-ft. **\$1.49**
only

3/4" wide
blade stands
up straight
for one-man
upright
measurement.



Also available in 8, 10,
12-ft. lengths with
free plastic utility case.

INSULATE Right With ZONOLITE®



Says **DANNY KAYE**, star of "THE COURT JESTER" Paramount comedy hit in VistaVision . . . color by Technicolor
You don't even have to be "handy" to insulate your own home in 4 miraculously short hours with Zonolite vermiculite insulating fill. Pour it, level it, leave it! Start saving immediately on fuel bills—Zonolite often pays for itself in two or three seasons. Rotproof, rodent-proof, 100% fireproof. Guaranteed to outlast life of your home. Send coupon today. c

as low as
\$67.60
insulates an
average attic

DO IT YOURSELF in one afternoon . . . save up to 40% on fuel bills

Mail This
Coupon Today

ZONOLITE COMPANY,
Dept. PM105, 135 S. LaSalle St.
Chicago 3, Illinois

Please rush me how-to-do-it
free booklet HI-47 "Safety,
Comfort, Savings in Your Home."

Name _____

Address _____

City _____

Zone _____ State _____

NOW ON SALE WHEREVER LUMBER AND BUILDING MATERIALS ARE SOLD

Schupack's Amazing Tool Bargains! All Brand New! Save up to 100%!

75 MOUNTED WHEELS & MINIATURE CUTTERS

 For cutting and grinding on wood, metal or plastic. Includes 26 mtd. wheels and points on 3/32" shanks; 24 miniature cutters on 3/32" shanks; 25 short shank min. cutters. Will fit all electric drills and hand grinders.
\$4.50 Post-Paid
 Regular \$11.00 value.

FLEXIBLE SHAFT—ONLY

 Fits all electric drills & hand power tools. 35 3/4" long. Oilite bearings. Core of specially wound, high carbon steel wire in flexible steel casing. Will accommodate tool shafts up to 1/4" dia. For lathes, electric drills, etc.
\$4.95 Post-Paid

2 DRUM SANDERS

 With 12 bands in Assorted Grits. 1 1/2" dia. x 1" long on 1/4" arbor with 12 bands
\$1.50 Post-Paid
ONE DRUM, 1" DIA. x 1" LONG ON 1/4" ARBOR WITH 6 EXTRA SLEEVES
\$1.00 Post-Paid
 4 Woodwork Drills from 1/4" to 1/2" on 1/4" shank \$2.00
 NEW ILLUSTRATED CATALOG 50c

30 Assorted Drills
 Hi-speed steel & carbon. Up to 1/2" dia. \$2.75 Set #20 Ppd.
5 Hi-speed steel Drills
 1/4" to 1/2" Dia. \$1.95

15 Assorted Drills
 From 1/16" to 1/2" high speed steel and carbon. Set #17 Only . . . Ppd. \$3.95

12 Assorted Drills
 High speed & carbon steel, from 1/8" to 1/2". Set #21 Ppd. . . . \$3.60

5 Wordworkers Drills
 From 1/4" to 5/8" on 1/4" shank. Set No. 15 . . . Ppd. \$2.95

5 Larger Drills
 From 1/2" to 1-1/64" High speed Steel, and carbon. Set No. 19 Ppd. \$7.50

12 MOUNTED WHEELS and points on 1/4" Shank.

 For grinding on plastic wood, soft and hard metals. Regular List Value \$8.40.
\$2.95 Post-Paid
 36 for \$7.50

18 MOUNTED POINTS ON 3/32" SHANK
 12 MTD. WHEELS ON 1/4" SHANK \$3.60
18 ROTARY CUTTERS

 Assorted sizes cutter on 1/4" or 3/32" shank. Will fit all hand grinders. Ideal for cutting wood, metal, or plastic. Brand new.
 Value \$13.50
\$5.85 Post-Paid

ADAPTER CHUCK

 With 2 interchangeable collets, opening from 3/32" to 9/16" on 1/4" mandrel. Price each only
\$1.50 Post-Paid
 ADAPTER CHUCK. From 60 to 80 on 3/32 in. Mandrel \$1.00

SCHUPACK SUPPLY CO., 7331 COTTAGE GROVE AVE., DEPT. PM-6 CHICAGO 19, ILL. SEND CHECKS OR M. O. NO COD'S PLEASE

POWER HYDRAULICS for SNOW PLOWS

Use on

TRUCKS
JEEPS
TRACTORS

HY-LO-JACK does the job **FASTER-EASIER**

- Lifts average snow plow in 3 to 10 seconds.
- 1,000 lbs. per square in. pressure
- Quick, easy installation on new or existing equipment.
- Complete kit form, including the pump, tank, hose lines, etc.
- Electric unit also available for 6 or 12 volt systems.

* Write for Circular. See your Road Machinery, Jeep or Farm Equipment dealer.

MONARCH ROAD MACHINERY CO.
 Quality Machinery since 1856
 1331 Michigan St., N.E. GRAND RAPIDS, MICH.

Say You Saw It in Popular Mechanics

MAKE WHITE SIDEWALL TIRES LOOK LIKE NEW!

TERRIFIC PRODUCT! TERRIFIC DEAL!

SPECIAL INTRODUCTORY OFFER 98¢

The giant size Aerosol can of AERO-WITE, the magic foam-syn, white sidewall tire cleaner for only 98c. Spray it, sponge it off . . . no mess, no trouble. Send check or money order, today. No C.O.D.'s. Add 25c for postage.

DEALERSHIP IN YOUR TERRITORY MAY POSSIBLY BE OPEN. WRITE FOR CATALOG SHEET AND PRICE SHEET AND SPECIAL DEALER DISCOUNTS AFTER YOU'VE SEEN AERO-WITE'S MIRACLE ACTION.

National Chemical Laboratories, Inc.
 WEST PALM BEACH, FLA.



GIANT-SIZE AERO-SOL

WELDING PAYS OFF

Welders always in demand. Big Pay. WE SHOW YOU HOW. 35c brings Complete "How To Weld" instructions plus "Build-It-Yourself" welder plan for 350 amp. welder made from surplus aircraft generator. SEND 35c NOW, your first step toward good paying welding career.

LEJAY MFG. CO., 2147 LeJay Bldg., Minneapolis 8, Minn.

FREE AMAZING NEW BOOK "HOW TO ANSWER ADS"



Never before have you seen anything like this. Tells you in simple language the correct way to answer ads. Gets you quicker replies—better results, and greater satisfaction. Will save you time and money and it's ABSOLUTELY FREE. No obligation whatever. Every reader of advertising should have this booklet. Send a postcard for your copy NOW. F. W. JOHNSON, Popular Mechanics Magazine, Room 600-A, 204 East Ontario Street, Chicago 11, Ill.

Save up to 33% on new portable electric plants

New 1955 design portable electric plants by nationally-known manufacturer of electric light and power plants for cabins, cottages, trailers, contractors, ranchers.

Model 800 — 800 Watts 120 Volt 60 cycle single phase A.C. Lightweight Briggs & Stratton Engines. No wiring necessary. Supplies current for any oil burners, freezers, brooders, emergency lights, etc. up to 800 Watts. Weighs 80 lbs. **ONLY \$154.50**

Model 1200 — Same as Model 800 but with 50% more power. Provides electricity for pumps, freezers, lights, oil burners which require up to 1200 Watts. Weight 87 lbs. **ONLY \$189.50**

Model 2500 — 120 Volt 60 cycle A.C. ruggedly constructed power plant. Handles all electrical requirements up to 2500 Watts. Excellent for permanent or standby installations. Weight 210 lbs. **ONLY \$299.00**

Units rated at Continuous Output. Manual or electric push button start with receptacle outlets and D.C. battery charging circuit. Prices F.O.B. Oshkosh. Send check or money order. Write for complete information.

10 Day Money Back Guarantee

ENGEN COMPANY Dept. P.M.P.O. Box 615, Oshkosh, Wisconsin

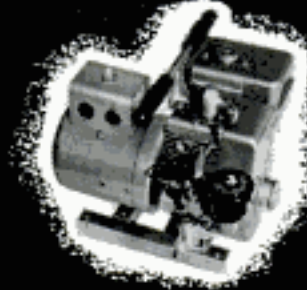

**STOP
COSTLY HEATING**

Leaks



Use Smooth-On No. 1, the IRON repair cement. It hardens like metal, fills cracks and holes in any casting, pipe, radiator, or fitting. Does the job by expanding inside the repair, gets stronger with age. Withstands water, steam, gas, fire, and smoke, stops wasteful drafts in conversion jobs.

FREE 48-Page Repair Handbook gives details for these and dozens of other repairs. Written so you can "do

it yourself." Get a copy at your own hardware store or drop us a card. Sent postpaid. Dept. 37

SMOOTH-ON MANUFACTURING COMPANY
572 Communipaw Avenue, Jersey City 4, N. J.

SMOOTH-ON

Amazing Tyler SPYRAL BLADE
SAWS ANY MATERIAL IN ANY DIRECTION

metal, wood, plastics etc. up or down, right or left, even in circles!

World's safest saw blade.

A MUST for every Workshop!

Does what no other Blade can Do
Fits Standard Coping Saw or Hacksaw Frames.
NO special adapters needed! * World's safest saw blade.

You'll find hundreds of uses for Tyler Spyrals. There's nothing like them! The first important improvement in blades since the invention of the saw. Fun to use - cuts so fast and easy; no chipping or tearing - leaves clean smooth edge.

At your Hardware dealer or send \$1 for package of 12 Spyrals Coping Saw Blades or 3 Spyrals Hacksaw Blades.

give that Boy or Girl a
TYLER MAGIC SAW KIT
Makes hundreds of useful items so easy - just moisten gummed patterns and apply to wood supplied in Kit, then saw. Safe - can't cut the hand! Kit consists of magic saw frame, 3 Spyrals blades, 12 gummed patterns, screws, brads and cutting material. Only \$1.98 plus 25c postage. Order direct from factory. No C.O.D.'s.

TYLER MANUFACTURING COMPANY 1005 W. Arbor Vista Ave., Inglewood, Calif

LOOK! All New - All Precision - All Deluxe SUPERSHOP MODEL X



8" SAW

**WE PAY ALL
FREIGHT FOR
YOUR FREE
HOME TRIAL**

**ONLY
\$139.50
EASY
PAY
PLAN**



Vert. Drill Press



Hor. Drill Press



8" Sander



30" Lathe



5" Grinder

Never before have you seen so much deluxe, precision-built power tool workshop at any price! Designed for the man who wants the best. Massive cast and precision-machined headstock, self-centering inverted "V" bedways (like precision metal lathes), exclusive non-friction speed changer, extra-large cast and precision-ground saw table. 100% ball bearing, lifetime-lubricated. You save by ordering direct from factory. You are invited to test Supershop Model X in your home FREE. Mail coupon or postcard for FREE brochures, photos, details, specifications, accessory list - and amazing freight prepaid FREE HOME TRIAL PLAN. All free.

**MAIL COUPON OR
POSTCARD TODAY**

POWER TOOLS, INC. 176 Yates Avenue
Beloit, Wisconsin

NAME _____
ADDRESS _____
CITY _____ STATE _____

IDEAL XMAS GIFT

Get him the NEW—SENSATIONAL



MODEL J5-50
ALL PURPOSE
JIG SAW
\$37.95

DENVER AND WEST \$38.25

Will Saw 2 inch Lumber. Adjustable Base. 2200 Strokes per Minute. Powerful AC-DC Motor. 115 Volt, 60 Cycles. 3 Blades Included. Cuts ALL Materials—wood, plastics, metal. Compact. Light Weight—only 3¼ pounds.

ONE YEAR GUARANTEE

All Duwel Tools are thoroughly inspected and tested and are guaranteed against any defects.

Order this most wanted "Do-It-Yourself" tool today from your Hardware Dealer or Lumber Yard. If not available, order directly from:

Duwel Manufacturing Corporation
1218 S. Western Ave., Dept. PM-10
Chicago 8, Illinois



- EXCLUSIVE WITH DUWEL
- "Built-in" adjustable base for bevel cutting to 45° angles.



Cuts opening without drilling a starting hole.



Saw cuts any shape.

Koenig ALL-STEEL CABS for JEEPS

FULL AND HALF CABS



★ PROTECTION — from weather and burglary.

★ SAFETY — All-steel, welded construction. No rivets. Safety glass used throughout.

Available in full cabs (cover entire body), and half cabs (cover front passenger compartment).

★ COMFORT — Full air-spaced head lining and door lining. No vibration.

★ CONVENIENCE — Roll-down windows, full opening.

KING POWER WINCHES

For all Willys Jeeps, 4WD trucks and station wagons... also for Ford, Chevrolet, International and Dodge trucks.

Dependable pull power designed to fit specific pull and hoist needs. King power winches have pull capacities of 8,000 to 19,000 lbs.



Koenig Cabs and King Winches for Willys vehicles are available through Willys Motors, Inc., and Willys-Overland Export Corp. distributors or dealers. Write for descriptive literature.

Koenig

IRON WORKS, Inc.

Dept. M, 2214 Washington Ave.

HOUSTON 10, TEXAS

\$50⁰⁰
PER DAY
AND MORE

SERRATING AND SHARPENING TABLE KNIVES

SAW-KEEN PORTABLE, ELECTRIC, EASY - TO - OPERATE

Be your own boss, work anywhere, full or part time. Every restaurant, hotel, drive-in, etc., repeat customers. Serrated (saw-edged) table and steak knives in great demand. \$98.50 investment returns first week. Guaranteed. Write today for proven daily profit plan.

CUTTER-CRAFT 58-P SOUTH RAYMOND PASADENA 1, CALIF.

WELD **BRAZE** **4WAY**
SOLDER **CUT** **ONLY \$14.75**
f.e.b. factory **WELDER**

Acclaimed by thousands of Homeowners, Mechanics and Hobbyists as the welder of 1801 uses. Easily operated from properly wired 110 volt AC or DC line. The Ideal gift with a life-long use... Order today on 30 day money back guarantee.

FOUR-WAY WELDER CO., Dept. F2-K
1810 S. Federal St. • Chicago 16, Ill.

Complete with Twin Carbon Arc Torch and accessories... to handle all metal-craft work.

SHAW PLOW, CULTIVATE, MOW, RAKE
BULLDOZE, SNOWPLOW
SAW WOOD

TRACTORS

Just steer it with power turn. Several walking & riding models up to 14 H.P. Low price! Write for FREE literature.

SHAW Manufacturing Co.
4510 Front St., Galesburg, Kansas
668-G-N, 4th St., Columbus, Ohio

Say You Saw It in Popular Mechanics

COMPLETE RIB KITS

11' to 25', inboards and outboards, cruisers, runabouts, utilities. Complete Rib, Bowster and Transom Kits. You buy plywood and save freight costs. Also full-size patterns and plans. Large catalog 50 cents or state requirements.

CULVER CRAFT Box 381P Downey, Cal.

ELECTRICAL TESTING IS
A "SNAP"! with
AUTO-TEST
AUTO-TONG

- INSTANTLY checks complete electrical system without disconnecting a single wire!
- SNAPS around current carrying conductor of any car or truck.
- FULL YEAR GUARANTEE!

Quickest, most amazing testing device ever developed. An Ammeter and Voltmeter in one—accurate, easy to use. In cushioned metal case. WRITE TODAY for full details and prices.

Auto-Test INC. 600 S. Michigan Ave. Chicago 5, Illinois

SAVE ON PALLEY DO-IT-YOURSELF BARGAINS

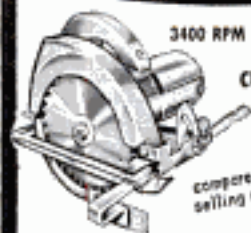

3400 RPM 1/2 HP POWER SAW

CUTS THROUGH A FINISHED 2x4 LIKE A KNIFE THROUGH BUTTER — RIPS—CROSSCUTS

compared to saws selling up to \$9.50

Only 19.98 Complete with 5-1/2" Blade

A rugged, professional type, adjustable saw. Cut any angle, 0 to 45°. Has adjustable (0 to 6") rip fence. Safety-trigger switch on handle. Full 1/2 HP Universal AC-DC, 110-120 Volt, 60 cycle motor. Weighs only 6-1/2 lbs. A sensational Value—**SATISFACTION GUARANTEED**

HARDWOOD LEGS WITH BRASS TIPS

BUILD OR RESTYLE YOUR OWN FURNITURE

Beautifully turned, fully seasoned hardwood legs. Smoothly sanded and complete with Brushed Brass tip and sturdy steel mounting plate. Available Finished or Unfinished — Finished units come in Blonde, Silver Fox, Mahogany or Charcoal Black. Please Specify type. Price per set of 4 with Brass tip.

SIZE	FINISHED	UNFINISHED	SIZE	FINISHED	UNFINISHED
4"	\$2.65	\$2.15	14"	\$4.40	\$3.95
6"	3.00	2.65	16"	4.75	4.40
8"	3.55	3.00	18"	5.35	4.75
12"	3.95	3.55	26"	6.25	5.35

FIRST QUALITY



NEW 4-SPEED BARBECUE MOTOR

A rugged, precision built electric motor — operates on 110 volt, 60 cycle current. Originally built for the Navy — NOW converted for YOU! Has four take-off shafts turning at 5, 25, 150 and 4000 RPM.

9.95

Cost Government approximately \$35.00 NOW...

STEEL BARBECUE SPIT—Has 4 adjustable steel prongs. Comes complete with coupling to fit motor.

3.50

12 oz. PORTABLE STOVE FOR HUNTER—HIKER—ETC.

Smallest, most compact, yet entirely practical cooking stove you've ever seen. NO PUMPING — NO PRIMING necessary — entirely self-generating. Has collapsible grill for frying pan or coffee pot. Burns 2-1/2 hours on one filling of regular gas. ALL BRASS construction. Weighs 12ozs. Ideal for Prospector, Camper, Hiker, Picnic, etc. Guaranteed 1 year.

3.98



AIR CORPS RUBBER BOATS

Ideal for Fishing and Hunting. Made to top Gov't Specs. Reconditioned & ready to use. Order Today!

1 MAN **22.50** 7 MAN **69.50** 10 MAN **115.00**

COLLAPSIBLE OARS **1.25 EA.**

HAND AIR PUMP **3.95**

LARGE Volume HAND AIR PUMP **5.49**

ARMY OFFICER'S POCKET COMPASS

An all-purpose, precision instrument for the Hunter, Hiker, Surveyor, Sportsman, Boy Scout, etc. Can be used for map orientation, taking azimuth readings or as a guide on unfamiliar terrain. The bezel ring is marked in 3° notches. Easy computation and rotates through 360 degrees. Has a special "peep" sight and hairline guide in lid.



3.95

5.95 VALUE

NEW NAVY CHEST WADERS

Made to top Gov't specs of finest quality rubber with worn felt inner lining. Comes up to your chest. Has built-in boots, shoulder straps and vulcanized seams. Sizes: Med., Lrg. **NEW! \$25.00 value... 7.95**

NEW NAVY WADE BOOTS

Made of top quality vulcanized NYLON — vulcanized to Latex rubber shoe. Shoe is insulated against cold & has grip tread sole. Boot is high height. Order one size larger than shoes. Sizes 8, 9, 10 and 11. **3.49**

NAVY WADING SUIT

For Surf or Deep Stream Fishing or wherever it is necessary to protect the body or clothes from mud, moisture, etc. Made to top Gov't specifications of heavy duty rubberized canvas with vulcanized seams. Covers the body from neck to feet with built-in rubber gloves and boots. Sizes: Medium and Large. **9.95 NEW**

ARMY STEELFRAME RUCKSACK

Army Ski-Trooper Rucksack made of heavy duty duck. Has one large and 3 small compartments. Adjustable straps and bindings. Mounted on lightweight, comfortable, all-steel tubular frame. Ideal for hunter, hiker, boy scout, prospector, etc. **8.95**

ARMY FOLDING SHOVEL

Carry it in your emergency shovel. Blade folds to form shovel or pick. **1.75**

SAVE 50% on Genuine Select PHILIPPINE MAHOGANY PLYWOOD

BUY DIRECT FROM IMPORTER

Ideal For Fine CABINET WORK, FURNITURE, Paneling DENS, OFFICES, HOTELS, etc.

Our prices are LESS THAN DOMESTIC PLYWOOD at WHOLESALE. This selected LUAN MAHOGANY meets the most rigid specifications. It is WEATHER and WATER RESISTANT. You'll be amazed at the beauty of this fine wood. Its rich golden elegance will thrill you. Retery cut for beauty of grain. Both sides sanded and ready to use. Banded with finest resin adhesive. Face side unjoined.

See for YOURSELF FREE SAMPLE (on request)

Available in three thicknesses — 3mm (approx. 1/8"), 4mm and 1/4". ALL orders shipped by special Truck for lowest rates. No order accepted for less than 100 lbs. — equal to (4) 1/4" sheets, (6) 4mm sheets or (15) 3mm.

3mm (1/8") x 24" x 48" ft. — \$5.00 value. **1.79 PER SHEET** Minimum order 5 sheets

4mm x 48" x 96" ft. — \$7.50 value. **3.89 PER SHEET** Min. order 6 sheets

1/4" x 48" x 96" ft. — \$9.50 value. **4.99 PER SHEET** Min. order 4 sheets



TRANSLUCENT FIBERGLASS PANELS

Special purchase of 500,000 sq. ft. SAVE 40%. Finest Quality. In all lengths and widths. Full range of colors. As described in Oct., '54 issue of Popular Mechanics. Write for FREE Booklet and Sample. 85¢ sq. ft. value. **49¢**

Solve one Manufacturer's Surplus and Closeouts! Top Quality. Ideal for Stools, Chairs, Beds, Patio, etc. Add 75¢ cutting charge on ALL orders under \$5.00.

SLAB STOCK

Smooth both sides. A solid but spongy material. Ideal for all types of posts.

Thick	Per Sq. Ft.	Thick	Per Sq. Ft.
1/4"	25¢	3/4"	75¢
3/8"	38¢	1"	\$1.09
1/2"	50¢	1-1/4"	1.25

FOAM RUBBER

Smooth on top and cored on the bottom for maximum resilience.

Thick	Per Sq. Ft.	Thick	Per Sq. Ft.
1-1/2"	\$1.00	3"	\$2.40
2"	1.50	4"	3.00
2-1/2"	1.90	4-1/2"	3.20

CAN & BOTTLE OPENER

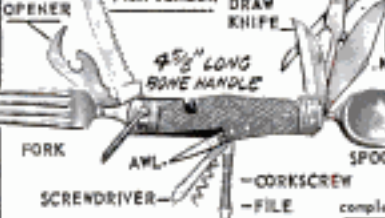

FORK, SCREWDIVER, BONESAW & FISH-SCALER, SCISSORS-DRAW KNIFE, 4 1/2" LONG BONE HANDLE, AWL, SPOON, CORKSCREW, FILE

12 PC. IMPORTED SPORTSMAN'S KNIFE

A COMPLETE CAMP KIT. Only **4.95** \$12.95 VALUE. complete with genuine leather holster!

Here is the perfect combination Knife-Tool for every Outdoor Sportsman, Hunter, Camps, Fisherman, Boy Scout, Prospector, Rancher, etc. Think of it! It'll fit, fine quality Steel Tools, precision made to fold easily into the heavy base covered body. In one neat, compact unit you have (1) a regular knife, (2) a fork, (3) spoon, (4) draw-knife, (5) bone saw & fish scaler, (6) scissors, (7) can & bottle opener, (8) cork-screw, (9) owl punch, (10) screwdriver, (11) a metal file. All this PLUS a genuine leather Belt Holster. ORDER NOW while we can still guarantee delivery!

BARGAINS FOR THE HUNTER-CAMPER ETC.

WATERPROOF BEDROLLS
Large 60" x 96" heavy duty duck canvas bedroll. Has many pockets in each and is held extra gear. An ideal enclosed ground cloth for a sleeping bag or air mattress. With (3) ft. straps & buckles. **4.95**

URANIUM PICK AND HAMMER
Ready to pick or crack rocks. 7-1/2" head. Handle 14 1/2". Weight 22 ozs. **1.39**

ARMY CANTEEN, CUP AND BELT
Genuine U.S. Army equipment. Consists of a first quality 1 quart Canteen and aluminum Cup with folding handle, both of which fit snugly into an insulated canvas cover. Cover attaches to web type pistol belt. **ONLY 2.59**

MARINE BOLD KNIFE AND CASE
Made of top quality Vanadium steel. 15" long. Ideal for clearing brush. With sturdy belt sheath. **1.98**

U.S. ARMY MACHETTE
Has 22" Vanadium steel blade. A hardwood handle. Sturdy belt sheath. 27" overall... **NEW 1.98**

ARMY PICMATTOCK
Small, easy to use. Has a 12" steel head with a Mattock on one side and a Pick on the other. Has a 3 1/2" hardwood handle. With canvas case. **NEW 1.29**

ORDER FROM THIS AD. Pay by Money Order or Check. 1/2 deposit with C.O.D.s. P.O.s accepted from D&B firms. All prices F.O.B. Los Angeles.

PALLEY SUPPLY CO

2263 E. VERNON AVE., DEPT. PM-10 LOS ANGELES 58, CALIF.

HOLD your work!

with "Jorgensen" and "Pony"

CLAMPS—used by industry—sold thru tool dealers everywhere!

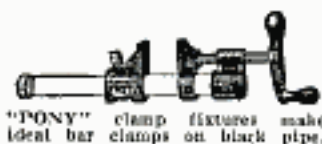

"PONY" clamp fixtures make ideal bar clamps on black pipe.



"JORGENSEN" and "PONY" "C" clamps are available in many styles and sizes.

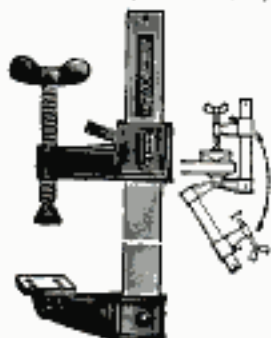

"JORGENSEN" hinged clamps—Something NEW! Mount on any bench or saw horse—out of the way when not in use—swing up into clamping position. Slide in steel track for "sideways" adjustment.



Genuine "JORGENSEN" hand screws—the favorite in shops for over 50 years!



"PONY" spring clamps—extra handy for the busy craftsman.

These and many other designs described in literature sent FREE upon request. For big, 32-page "HOW-TO-CLAMP-IT" catalog, send 25c.

ADJUSTABLE CLAMP COMPANY

"The Clamp Folks"

421 NO. ASHLAND AVE.

CHICAGO 22, ILL.

Get This NEW Catalog of WOOD AND WOODWORKING MATERIALS



World's Largest Selection of Finest Domestic and Imported Woods... Mouldings, Hardware, Tools, —ALL AT LOW MONEY SAVING PRICES!

Your complete wood buying guide and project book. Craftsman is your best, most complete source of finest kiln-dried domestic and rare imported woods, beautiful wood inlays, colorful handings, matched plywoods, embossed mouldings, carved ornaments, newest wood-working tools. "hard to find" cabinet hardware and fittings... more than 1,500 items! Packed with newest scroll saw patterns, project ideas & money making plans. Enclose 25c (refunded with first order) to help pay mailing, handling cost. Write now! Craftsman Wood Service Co., Dept. A-10 2729 S. Mary Street - Chicago 8, Ill.

128 PAGES Many in full color

packed with rare, fancy & imported woods... veneers, plywoods, patterns, tools, ornaments, hardware... everything for the woodworker.

MAIL COUPON NOW!

CRAFTSMAN SERVICE CO., Dept. A-10, 2729 S. Mary St., Chicago 8, Ill.

Enclosed find 25c. Rush me new Woodworkers' Catalog Handbook.

NAME.....

ADDRESS.....

CITY.....

ZONE.....

STATE.....

BARRON Drill Press TOOLS

FOR WORKSHOP AND INDUSTRIAL USES...



ROTARY PLANER

Planes • Rabbits
Tenons • Panels
Routs • Bevels

Only \$8.50 COMPLETE

Over 40 precision built woodworking tools and accessories... Hi-Speed Router Bits—Rotary Surface Sanders & Drum Sanders—Safety Shaper Cutters—Dovetail Cutters—Large Auxiliary Metal Tables—All Metal Shaper Fences—Spindle Adaptors—Handy Bench Vises. Many other items indispensable for accurate, useful, versatile workshop use. Every tool sold on complete satisfaction of your money back. See your Barron Dealer. Ask for special folder — "24 Extra Uses for Your Drill Press."

FREE Workshop Guide & Catalog

BARRON TOOL CO. INC.
302 Architects Bldg., Detroit 1, Mich.

Waterproof, Repair and Patch

Practically Anything in the House

Amazing LIQUID RUBBER

Rub-R-ize

Available at Hardware, Paint & Dept. Stores



Comes in 5 Colors & Transparent

RUBBER MAGIC INC., 4312 Third Ave., Brooklyn 32, N.Y.

NEW TURBO-TYPE PAINT MIXER

Revolutionary turbo design mixes, homogenizes, your paint in 1/2 the time it would take by hand. Gives a smooth even blend. Centrifugal force creates turbulence. Won't damage can. Doesn't splash or throw paint. Full 9" shaft. Easy to use — attach to any electric drill — mixes any paint regardless of consistency. Sold on a money back guarantee. ORDER NOW — send \$1 (plus 10c for postage) total \$1.10 to: HIGHLAND MACHINE CO., 3213 Superior, Cleveland, Ohio.

ONLY \$1.

BUILD YOUR OWN TRAILER



SAVE UP TO \$700. Write for FREE CIRCULAR showing pictures and floor plans of complete HOUSE TRAILERS you can build yourself. Six styles, 8 to 26 foot lengths. Write today. No salesman will call. Rolling Homes, P.O. Box 1014b Wilmington, California

KEEP ALL SAWS SHARP

SUPER SAW FILER NO. 6

IT'S NEW! With Automatic DEPTH CONTROL ROLLERS DEPTH—ANGLE—PITCH

Perfect bevel and angle maintained, and fool-proof depth control for all Rip, Cross-cut, and Hand Saw. Precision made and calibrated for instant setting at desired angle. Can be used in any vise or clamp. Complete with file, only... \$6.50 and SAVE TIME AND \$\$\$



SHARP SAWS CUT TRUER

JOINT & SHARPEN CIRCULAR SAWS

Sensational new Super Filer No. 11 joints and sharpens both hand and circular saws 6" to 10" with all teeth the correct height, depth, pitch and bevel. Easy to use—when file bits hardened steel roller, teeth are finished. Saw runs true and smooth with no side pull. Complete with special 8" file \$9.95 and "TRU-CIRCLE" saw set automatically sets teeth at 10° or more \$2.95.

Guaranteed SEND FOR FREE CATALOG A. D. MCBURNEY, 5908 Hollywood Blvd., Hollywood 28, Cal., Dept. A-105

PORTABLE LIGHT PLANTS

GIANT 2000-2500 WATT PLANT
110-120 v. 60 cyc. AC. Absolutely the best made—exclusively dynamically balanced armature; heavy windings develop up to 5000 watt overload for motor starting. Solid mounted—portable. Powered by an easy starting Briggs or Wisconsin 6 HP engine—complete with all accessories; engine easily disconnected for other uses. Big outlet box, voltmeter, no wiring necessary. Ample current for all purposes. Factory warranty. (Item 31) Wt. 210 lb. Reg. price \$585. Special at... **\$299.50**
Same plant with electric self starter (Item 31a)... **\$359.50**
Generator only and control box... **\$169.50**
DUAL VOLTAGE 110-220 available on any of above models for \$28.00 additional.

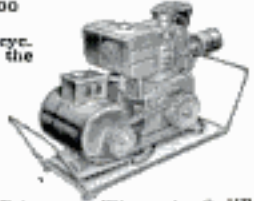

HI-LINE 4000 WATT PLANT
(Item 162) Push Button Start 115-230 v. 60 cyc. AC. A brace of a power plant with a rugged 14.6 hp. Wisconsin engine. Plenty of electricity for ranges, water heaters, freezers, pumps, machinery, etc. Affords both 110 and 220 volts. Ideal where heavy current is needed. Wt. 590 lbs. Easily worth \$995. With crank start... **\$585.50**
Factory price... **\$645.00**
Same plant, but with self-starter, **\$645.00**

Highest quality, guaranteed non-breakable sockets made by Husky. Beautifully matched chrome thin wall alloy absolutely the best. Contains a complete set of 28 sockets in 1/4" drive, 3/8" drive and 1/2" drive, plus all necessary extensions, spacers, reversible ratchets, etc.; all unexcelled, guaranteed against breakage. A beautiful set of tools that will handle any job in a big doghouse steel box. Wt. 17 lbs. (Item 205) List price \$62.90. Factory special... **\$27.95**

52 pc. SOCKET SET



HI-FLO Centrifugal PUMP

Completely self-priming! No foot valve required. Tremendous capacity—300 gal. per min. Special impeller enables pump to handle muddy or sandy water. Simple to operate—simply start engine and watch the water go. Powered by a rugged, easy-starting 2 HP Briggs engine. Pre-lubricated sealed bearings for years of heavy low-cost service. Reg. 1 1/2" Model. Item 502. Wt. 70 lbs. Factory price... **\$134.50**
2" Model (150 gal. per min.) with 2 1/2 HP engine. Item 502a. 90 lbs. Fact. Spec. **\$154.50**

Variable Speed Selector
Heavy duty, made by B. F. GOODRICH for industrial use. Provides instant speed changes for any drive. For machine tools, dryers, printing, conveyors, production lines, hoists—any operation requiring variable speed. Employs reliable "trouble free" planetary system. No hydraulic power losses. Infinite range, smooth operation. Easy installation. Sizes: 1/2 hp. 30 lbs.; 1-2 hp. wt. 55 lbs.; 2-3 hp. wt. 105 lbs.; Reg. list \$228, \$252 and \$352. Our prices... **\$79.50, \$89.50 and \$114.50**

JET FLOW BLOWER
Tremendous air movements (1800 CFM) and quiet operation make this double inlet 10" turbine blower unbeatable for heating, cooling, drying and air conditioning. Ideal for attic or barn ventilation, converting gravity heating to forced air; spray booth exhausts, etc. Operates with any 1/4, 1/2 or 1 1/2 HP motor. Over-sized, long life bearings. Includes variable speed motor pulley and belt. Dimensions 19" h x 18" x 16 1/2". Outlet opening 13" x 14 3/4". Wt. 45 lbs. Item 245. Reg. \$54.50. Factory Special... **\$27.50**
HEAVY DUTY 1/2 HP motor for above **\$16.95**
12" TURBINE BLOWER Similar to above, but larger with 2400 CFM capacity. Wt. 65 lbs. (Item 245a) Reg. \$70.00. Factory Spec. **\$34.50**

Send check or M.O. Prices L.A. Factory. 10 day Money back guarantee. SEND 10c for... **MASTER MECHANIC MFG. CO., DEPT. 202, Burlington, Wis.**

TERRIFIC SAVINGS at MASTER MECHANIC'S bedrock factory prices!

600-700 WATTS PUSH BUTTON START
115 v. 60 cyc. AC. Powered by a rugged 2 HP easy starting Briggs engine. No wiring necessary! Just plug in and operate. Plenty of current for any oil burner, freezer, brooder, emergency lights, etc. which require 1/2 to 1 amp. Complete with voltmeter and built-in wiring to charge 4 v. auto batteries. (Item 24) Wt. 70 lbs. Easily fits in car trunk. Be prepared if storm knocks out power lines. Reg. \$275 value... **\$143.50**
1000-1200 Watt Plant (Item 45) same as Item 24 but larger generator and engine with 50% greater output... **\$199.50**

1300-1500 WATT PLANT
115 v. 60 cyc. AC Push Button Start. Powered by a 3 1/2 HP. Clinton engine. Combined big output with easy portability. Provides emergency power for operating any oil burner, sump pump, freezer, televisions, lights, communications systems, etc. which require up to 1000 watts. (Item 22) Wt. 110 lbs. Reg. \$475 value. Factory price... **\$239.50**
1750 Watt Plant Powered by 4.5 Briggs engine. Electric starting & battery charging built-in. Factory price... **\$279.50**

MASTER-LITE 2500 Watt Plant
110/120 v. 60 cyc. AC. A beautiful plant, ruggedly constructed and yet designed for easy portability. Can be started by rope or built-in 12 v. electric push button starter. Built-in wiring to charge battery. Powered by a big 5.43 HP Briggs engine complete with all accessories. Includes control box, voltmeter, and handy plug-in power receptacle. An ideal plant for permanent or stand-by service. Wt. 225 lb. Reg. price \$645.00. (Item 21) Factory Price... **\$329.50**
3500 Watt Plant Push Button Start (Item 23) 115 v. 60 cyc. AC. Similar to above, but larger and 30% more capacity. Wt. 270 lbs. Reg. \$760. Factory Price... **\$379.50**
Dual Voltage 110/220 available for above plants for \$30.00 additional.

HEATING & VENTILATING FAN
(Item 10) Easily installed in furnace pipes. Forces even heat to all rooms. Over range removes kitchen smoke and odors. Powerful, continuous duty motor, 110-120v. AC. Mount in wall or ceiling to ventilate any area. Quiet, super-efficient fan moves huge volume of air, (400 to 600 CFM).
8" Pipe, wt. 5 lb. **\$6.85**
9" Pipe, wt. 6 lb. **\$7.85**
10" Pipe, wt. 7 lb. **\$8.85**
12" Pipe, wt. 8 lb. **\$9.85**
HEAVY DUTY FAN. Semi-enclosed motor, suitable for spray booths, restaurant exhausts, poultry houses, etc. 10" Fan, wt. 8 lbs. (Item 10E)... **\$11.95**
12" Fan, wt. 10 lbs. (Item 10D)... **\$12.95**

CONDITIONAIRE VENTILATING FANS
Save big money installing your own exhaust fan. Efficient propeller type blade moves huge volume of air quietly and effortlessly. Heavy welded frame—pre-drilled for easy installation. Just cut opening and bolt in place. Continuous duty motors. Ideal for attics, restaurants, garages, barns, chicken houses, etc. Control manually or with thermostat.
Blade Opening CFM Wt. Item
16" 18 1/2" 2925 19 lb. 365a **\$27.95**
18" 19 1/2" 3600 27 lb. 365b **\$31.95**
20" 21 1/2" 4100 30 lb. 365c **\$39.95**

EXTENSION CORD
Heavy duty and very flexible. Neoprene 14-2 cable 30 year quality. Wt. 12 lbs. (Item 185) 100 ft. Complete with rubber plug and outlet. A terrific buy at only **\$8.95**
NO. 10-2 POWER CABLE. Heavy duty, very flexible, rubber covered, 50 ft. with male and female fittings. Wt. 9 lbs. (Item 592a) **\$10.45**
50 ft. without fittings (Item 592)... **\$9.45**
NO. 12-2 POWER CABLE. Very flexible rubber covered, special outside shield for grounding power tools, etc. 50 ft. (Item 190) wt. 8 lbs. **\$6.95.** 100 ft. (Item 200)... **\$12.95**



NEW PERMA-CLEAR permanent bronze oil filter
Magnified section of new micron-size bronze ball screen in the finest filter yet model
Built-in ACID NEUTRALIZER
CHANGE OIL ONLY ONCE A YEAR!
Never replace this filter, just give it a periodic rinse in gasoline. A permanent, non-clogging filter that protects oil longer, adds years to engine life, reduces friction and increases power. Revolutionary new filter element made of micron size bronze balls formed under tremendous heat and pressure into a far finer screen than can be woven from any metal or cloth. Super-porous, yet non-absorbent. It passes anti-sludging oil additives and detergents, but filters out the tiniest particles of hard carbon metal or water. Assure your engine of a perfect, clear film of oil for 20,000 miles. Only "Perma-Clear" is made with controlled porosity, insuring uniform filtering action. Only "Perma-Clear" can offer 47 different models, each one specifically designed for a certain engine. Unconditional 30 day money back guarantee. Shipped postpaid.
CONVERSION KIT—fits your present filter (only specify filter make and model no.) \$9.85
COMPLETE FILTER for engine 806 equipped with any filter... \$14.95

9 TON HYDRAULIC PRESS
A tremendously powerful hydraulic press, capable of exerting 18,000 lbs. pressure. Pays for itself many times over—straightening bent connecting rods, king pins, crankshafts, axles, link pins and bars or straightening out broken bearings and bushings. Developed pressure under precise control and visible at all times on accurate gauge. Complete with both large and small anvils and dies to straighten any kind of curve or bend. (Item 404) Wt. 110 lb. Actual list price \$365. Our special **\$69.50** close-out price... **\$69.50**

JET STEAM MASTER
Now, a super efficient portable steam generator that produces live steam at 100 lbs. pressure in 60 seconds from a cold start. Produces large volume of high pressure steam on 2 pints of fuel oil. Instantly cleans sticky grease, dirt, rust, old paint, etc. off implements and road machinery. Pays for itself in a few weeks. Sterilizes soil. Sterilizes milk equipment, etc. Fully automatic—oil fired with new, built-in circulating water pump. Draws water from bucket, simple and safe—anyone can use its built-in safety valve. Complete with 12 ft. of hi-pressure steam hose and new triple efficiency steam gun that automatically mixes in soap solution if desired. Wt. 250 lbs. Item 405. Special factory price... **\$329.50**

MASTER DC ARC WELDERS
Now! a portable, rugged, industrial type welder with terrific performance, yet at a price hundreds of dollars less than you'd expect. Sensor model made for years of trouble-free, continuous service. High capacity DC welding unit enables you to tackle any job with confidence—easily welds anything up to 2" plate using from 1 1/2" to 1/4" rods. Built-in stabilizer and cooling system makes arc easy to strike and hold. Dual control rheostat provides low heat soldering, brazing and welding from 30 to 300 amps. Complete with instructions, guarantee and triple V-belt or flat pulley. You can pay more, but you can't buy a better welder.
WELDER ONLY—DUAL CONTROL MODEL. Same as above, but drive with your tractor, jeep or gas engine of 14 HP or more. (Item 280) Wt. 110 lbs. \$420 value... **\$119.50**
WELDER ONLY—STANDARD MODEL. Same as above but with single rheostat for heavy metal welding only. (Item 281) Wt. 110 lbs. \$400 value. Special... **\$99.75**
COMPLETE POWER MASTER (Illustrated above) powered by a 14.6 hp., air cooled Wisconsin engine, Wt. 480 lbs. (Item 280) Compares with welder costing \$1200. **\$449.50** Factory Special...

WELDING KIT Two 10 ft. leads, welding helmet, electrode holder, ground clamp. Sold only with welder at... **\$10.50**



CENTERS AND DRILL PADS



STEEL AND BRASS COLLETS



BALL BEARING LIVE CENTER



HANDWHEEL COLLET ATTACHMENT

YOU CAN DO MORE WITH SOUTH BEND LATHES because of the very complete line of practical attachments available. Only a few are shown here. Send for complete catalog.



SAFETY and STANDARD LATHE DOGS



FOLLOWER AND STEADY RESTS



ADJUSTABLE COLLET BUSHING CHUCK



South Bend Attachments will enable you to do more and better lathe work. Write for our new Attachment Catalog.

SOUTH BEND LATHE
BUILDING BETTER TOOLS SINCE 1906 • SOUTH BEND 22, INDIANA



HANDLEVER BED TURRET



TELESCOPIC TAPER ATTACHMENT



EXTERNAL GRINDER



MILLING ATTACHMENT

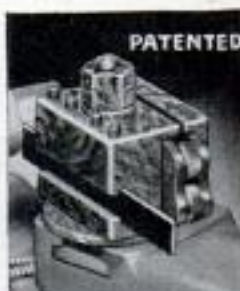

PATENTED
10 in 1 TOOL BLOCK

Compared with our costs
OUR PRICES ARE LOWER
than they were back in 1941

<p>WAGES UP 155%</p>	<p>MATERIALS UP 131%</p>	<p>PRICES UP ONLY 49%</p>
---------------------------------	-------------------------------------	--------------------------------------

Prices are closely tied to costs. Costs are still rising. Buy now before increased costs necessitate higher prices.

SEND INFORMATION CHECKED:

<input type="checkbox"/> 9" and 10" BENCH LATHES	<input type="checkbox"/> 10" to 16-24" FLOOR LATHES	<input type="checkbox"/> DRILL PRESSES	<input type="checkbox"/> TOOL GRINDERS	<input type="checkbox"/> 1/2" & 1" Collet TURRET LATHES	<input type="checkbox"/> 7" BENCH SHAPERS
--	---	--	--	---	---

Name _____ Company _____
Street _____ City & State _____

Building Better Tools Since 1906 • SOUTH BEND LATHE • South Bend 22, Indiana



Look what **FORMICA** did for Mother's Old Chest and Daddy's Army Foot Locker



This chest of drawers and toy box are typical of the beautiful practical children's furniture you can improvise with the help of Formica and simple tools.

You need not limit your Formica handiwork to any one room in the house. You can use one of Formica's authentic wood grains to resurface a living room table or use one of the new high style colors to replace your worn out sink top. The same Formica used by professional craftsmen is sold in sheets at lumber and linoleum dealers.

Send for a free copy of complete step-by-step picture instructions and actual samples of Formica.



Formica Contact Bond Cement is available from your dealer where Formica sheets are sold. An ordinary rolling pin gives all the pressure you need. Toothed spreader free with cement.



DEMAND THIS CERTIFICATION

This mark certifies genuine
REMOVE WITH SOAP AND WATER



THE FORMICA COMPANY

4596 Spring Grove Ave., Cincinnati 32, Ohio

Seeing is believing. If this wash-off identification is not on the chest, it's not FORMICA.

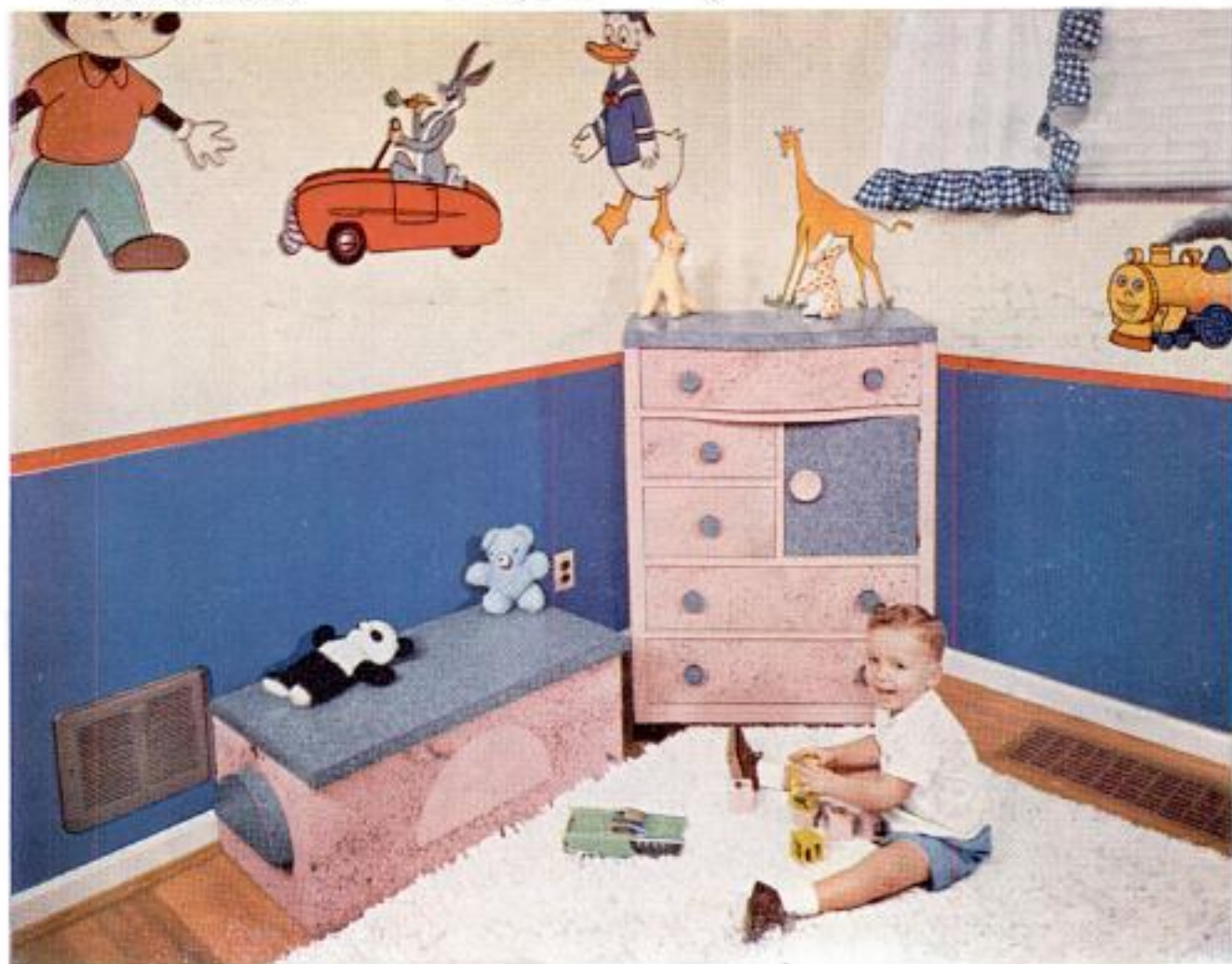

**NOW...TRY
YOUR HAND**

with these 2 NEW
WELLER TOOLS

**POWER SANDER
and Polisher**

Here's power and performance that exceeds any sander in its price class. 25 square inches of sanding area • Straight-line action—no bucking; sands and polishes *with the grain*; goes all the way into corners • Less than 3" high—fits into tight places • Practically impossible to stall • Takes theirk out of work for only \$14.95



**COMPLETE
SOLDERING SET**

Here's everything you need for scores of home repair and hobby jobs. Kit contains: 100 watt Soldering Gun with instant heat, dual spotlights, and low-cost replaceable tip features; supply of famous Kester Solder; Soldering Brush for cleaning connections; Soldering Aid for opening old joints, twisting wire, etc. . . . all in a sturdy cardboard case for only \$7.95



Ask Your Hardware Dealer
For A Demonstration,
Or Write Direct For
Catalog Bulletins.

Weller

**ELECTRIC
CORP.**

808 Packer Street
Easton, Penna.