

AUGUST 1955

35 CENTS

T1
P54
V.104
No. 2

POPULAR MECHANICS

MAGAZINE

WRITTEN SO YOU CAN UNDERSTAND IT

REG. U.S. PAT. OFF. TRADE MARK GREAT BRITAIN, No. 40428

REG. U.S. PAT. OFF.



Navy Hideout—Page 105

REPORT on the **DE SOTO**

For the Craftsman

BUILD A PLAYHOUSE
your children can live in

No wonder it's called
"Miracle Vinyl-Flooring"!



MATICO ARISTOFLEX

RESISTS GREASE, ACID, ALKALI AND GRIME!

You'll call it "miracle flooring," too, when you see for yourself how rugged, durable MATICO Aristoflex shrugs off household acid, alkali and grease... stays new and sparkling looking with easy damp moppings. Biggest miracle of all is the price! Produced especially to meet the needs of homeowners everywhere, MATICO

Aristoflex is low in cost... gives you more for your money. And you can install economical Aristoflex in every room in your home... from basement to attic. See Aristoflex in 13 rich, clear colors at your MATICO dealer soon. You'll find him listed in your classified telephone directory.



MASTIC TILE CORPORATION OF AMERICA

Houston, Tex. • Joliet, Ill. • Long Beach, Calif. • Newburgh, N. Y.

Manufacturers of: Confetti • Aristoflex • Parquetry • Maticork
Asphalt Tile • Rubber Tile • Vinyl Tile • Cork Tile • Plastic Wall Tile

INSTALL IT YOURSELF AND SAVE!



It's easy! Just mark a straight line through the center of your room in both directions, using a chalk and line. Be careful not to cover up your guide lines.



With a notched trowel, spread adhesive over one-half of your room at a time. Leave only a thin coat of adhesive on the floor.



After adhesive becomes tacky, snap the tiles into place. Do not slide tiles or adhesive will push up between the tiles.



Here's the best part! Show your wife your handiwork. (Don't tell her what a cinch it is with MATICO's easy-to-follow instructions).

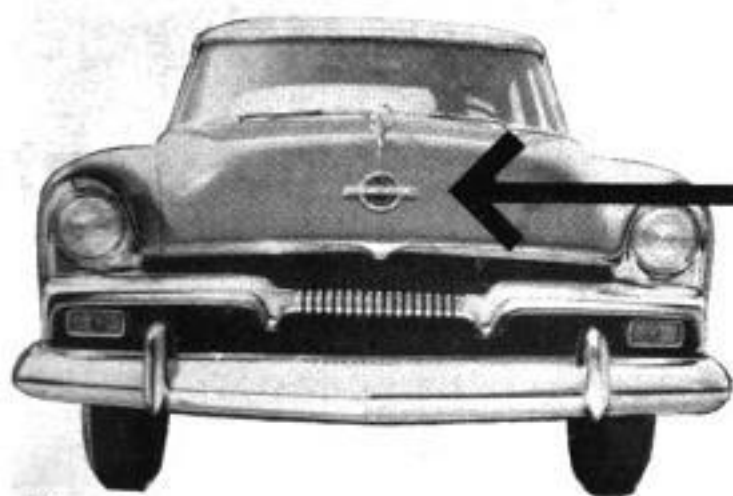

This, Too, Is **THE FORWARD LOOK**



What's different about this Plymouth?

Two things are different. First, this is the one you can't buy. Second, it has a radically different kind of engine—the Chrysler Corporation *gas turbine* engine! This experimental car runs with no carburetor, no piston rings, no radiator, one spark plug and on ordinary fuel. Although there are years of research and testing ahead before it could be mass-produced, this prototype is in operation *now!*

This is one of many continuing research projects of **THE FORWARD LOOK***. As each new advance is perfected, it will be made

*Engineers interested in this kind of advanced research & development, write to Chrysler Engineering, Box 1118, Detroit 31, Mich.

available to you . . . for it is the thesis of **THE FORWARD LOOK** to keep you ahead in car performance, in safety, and in styling.

You have only to see and drive the new Plymouth, Dodge, De Soto, Chrysler and Imperial today to know why these cars are winning such universal public acceptance. **THE FORWARD LOOK** is going full-speed ahead with new ideas, new designs, and a major program of expansion to keep up with your demand. **THE FORWARD LOOK** is on the move! Keep your eye on it!



CHRYSLER CORPORATION

PLYMOUTH · DODGE · DE SOTO · CHRYSLER · IMPERIAL

Copyright 1955 by Chrysler Corporation

Tops in TV Drama—"Climax!"—CBS-TV, Thursdays

Only **CHAMPIONS**
give you the two things you want
most from spark plugs...

OUTSTANDING PERFORMANCE!

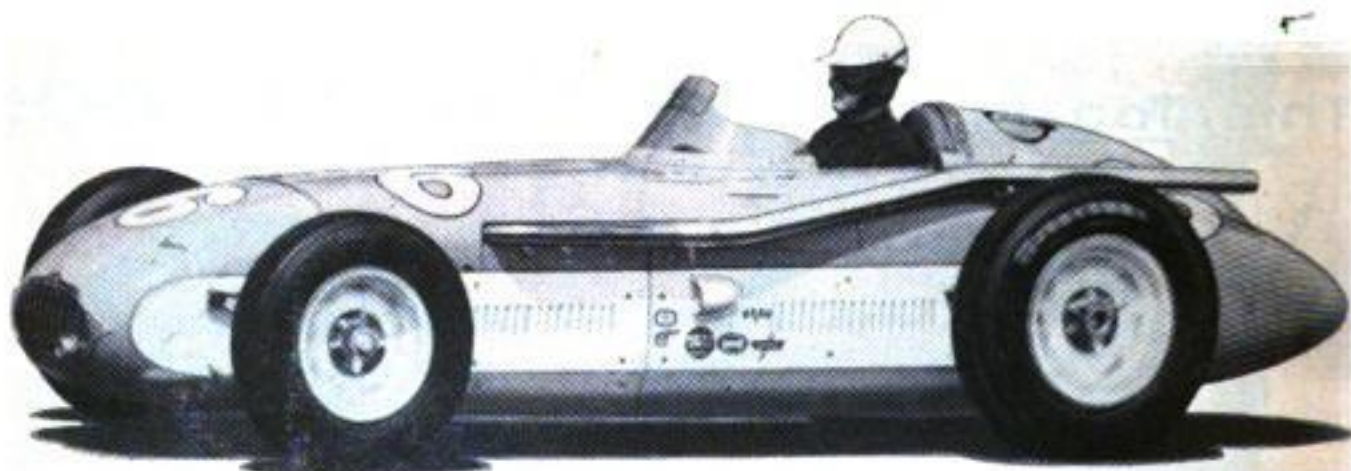

Champions score twenty-fifth victory in Indianapolis "500"! Bob Sweikert, with a winning average of 128.209 m.p.h., and *all other finishers* used Champions!



OUTSTANDING ECONOMY!



Five-rib Champions score sixth straight victory in Mobilgas Economy Run. A Champion-equipped Studebaker Commander averaged 27.4 miles per gallon to win the 1955 Sweepstakes Trophy in 1323-mile economy test!

CHAMPION SPARK PLUG COMPANY, TOLEDO 1, OHIO

INSIST ON 5-RIB

CHAMPION

SPARK PLUGS

Popular Mechanics Magazine

Registered in U. S. Patent Office and Canada

H. H. WINDSOR, Founder

H. H. WINDSOR, JR., Editor and Publisher



Next Month

SEVERAL MONTHS AGO PM heard rumors of a new passenger train so unique in conception and so inexpensive to build that it could well set the pattern for rail travel in the future. We finally pinned down the train on drawing boards at Electro-Motive in La Grange, Ill. Sure enough, the idea was a big departure from anything in existence. Electro-Motive is floating bus bodies on rail trucks and pulling the resulting train with a locomotive of a new breed. The train promises a luxury ride at the price of a bus fare. While Electro-Motive was building the train, we were building an article around it. Above you see an artist starting an illustration for next month's significant feature, "Ten Buses Grow Into a Train"

Information not listed on articles in the index, starting on page 58, frequently is listed in the WHERE-TO-FIND-IT LIST, which is available to readers without charge. A copy may be obtained by writing to the Bureau of Information, Popular Mechanics, 200 E. Ontario, Chicago 11, Ill.

Published monthly by Popular Mechanics Company, 200 E. Ontario St., Chicago 11, Ill. H. H. Windsor, Jr., president; Wm. Harrison Petridge, exec. vice-pres.; D. F. Windsor, vice-president and secretary-treasurer; H. H. Windsor III, vice-president; W. T. Windsor, vice-president; Clover L. Perkins, advertising manager; Alan M. Deyoe, circulation manager. Single copy in the United States and Canada, 35 cents; subscription rates in the United States and possessions, Canada, Philippines and countries of the Pan-American Postal Union, 1 year \$3.50; 2 years, \$6.00; 3 years, \$8.00. To all other countries add \$1.00 a year over United States prices for overseas postage. If you plan to move, notify us at least 30 days in advance so you will not miss an issue. Give both your old and new addresses. Entered as Second Class Matter, September 15, 1903, at the Post Office at Chicago, Illinois, under Act of March 3, 1879. Entered as Second Class Matter at Post Office Dept., Canada, Registered as Second Class Matter at the Post Office at Mexico, D. F., Mexico, June 20, 1950. Copyright 1955 by Popular Mechanics Company. Copyright under International Copyright Union. Copyright in France. All rights reserved under Pan-American Copyright Union. Printed in the United States of America.

Volume 104 AUGUST 1955 Number 2

Address all communications to: 200 E. Ontario St., Chicago 11, Ill.

Managing Editor.....Roderick M. Grant
 Assistant Managing Editor.....Wayne Whittaker
 Shop Notes and Crafts Editor.....James R. Ward
 Radio-Television, Electronics Editor.....Lothar Stern
 Associate Editor.....Clifford B. Hicks
 Associate Editor, Automotive.....Arthur R. Railton
 Associate Editor, Shop Notes and Crafts.....Wayne C. Leckey
 Assistant Editor, Shop Notes.....W. Clyde Lamney
 Assistant Editor, Crafts.....Frank N. Stephany
 Assistant Editor, Makeup.....John C. Dalen
 Automotive Correspondent.....Leo Donovan
 Art Director.....Frank Beatty

Assistant Editors

Leonard F. Hiltz, Jay W. Hedden, Elliott H. McCleary, Emily Mullaney
 Eastern Editor.....Richard F. Dempewolff
 Empire State Bldg., Room 2906, New York City 1
 Western Editor.....Thomas E. Stimson, Jr.
 Suite 1010, 3460 Wilshire Blvd., Los Angeles 5, Calif.
 London Manager.....Douglas W. Wedderspoon
 Eagle House, Jermyn St., London S. W. 1, England
 Director, Bureau of Information.....Allan Carpenter

200 E. Ontario St., Chicago 11

Advertising Offices

Chicago: 200 E. Ontario St., Whitehall 4-0100; New York: Empire State Bldg., 350 Fifth Ave., Longacre 5-7580; Detroit: General Motors Bldg., TRinity 5-7811; Cleveland: Hanna Bldg., 1422 Euclid Ave., PProspect 1-0456; Los Angeles: Tishman Bldg., 3460 Wilshire, DUnkirk 2-8458.

In This Issue . . .

Rangers on the Trail of the Lost	65
Uranium Hunt by Jeep	72
It's Lonesome Up in Space	75
Kit and Caboodle	84
Detroit Listening Post	86
The Sign Language of Industry	90
Big-Game Sculptress	96
Honeycomb House	102
Sweden's Navy Joins the Underground	105
One Way to Earn a Living	110
Forestry in A.D. 2005	114
They Pay to Fish	122
The Owners Report on the '55 De Soto	126
Smoke-Eating Catalyst	132
Streamlining the Highway Freighter Would Save Gas	136
What's New for Your Home	140
Keeping Up With the Atom	142
Radio, TV and Electronics	145

For the Craftsman . . .

Tote Case for Your Guns	149
Sidewalk Sports Car	152
How Modern Detergents Work	157
Solving Home Problems	162
Patterncraft—Traditional Magazine Rack	167
Playtime Cottage—Part II	169
Quiet Those Car-Body Squeaks	184
Farm Repair and Improvement With Concrete	190
What You Can Do With Gun-Type Soldering Irons	198
Shopping for Tools	202

Other items, and manufacturers of available products described, are listed on pages 58, 60 and 62

Add a beautiful extra room at low cost



1. It's easy and economical to turn unused attic, basement, and porch areas into extra living space with Armstrong Temlok® Tile and Plank. These do-it-yourself materials save you money because they build, decorate, and insulate in one simple operation. After the room is framed, nail up and level 1" x 3" furring on 12" centers.

2. Fast installation of both Tile and Plank is assured by Temlok's exclusive Lok-Bevel® joint. The extra wide nailing flange hides all nails or staples and provides a neat, even joint line that helps you do a professional-looking job. Temlok Tile comes factory-painted in Snow White and Light Ivory. Temlok can be repainted when desired.



3. Easy-to-handle Temlok Planks are quickly nailed or stapled to the wood furring. The Lok-Bevel joint assures correct fit and easy installation. Once Temlok is installed, the job is done. There is no painting to do because Temlok Plank comes factory-finished in a handsome Suntan Blend that harmonizes with almost any color scheme.

4. Comfort is a big extra you get with Temlok because its built-in insulation helps make your rooms warmer in winter, cooler in summer. You'll see this extra insulation value reflected in fuel savings, too. Don't be cramped for living space when you can remodel unused areas easily and economically with Armstrong Temlok Tile and Plank.

For the free booklet, "New Ways to Remodel Your Home," write Armstrong Cork Company, 3708 Watch Avenue, Lancaster, Pa. Get prices and other details on Temlok Tile and Plank and the entire line of Armstrong Building Products from your local lumber dealer.

Armstrong TEMLOK

M-67® Monowall® • Cushiontone® • Hardboards • Insulating Wool • All-purpose Cements

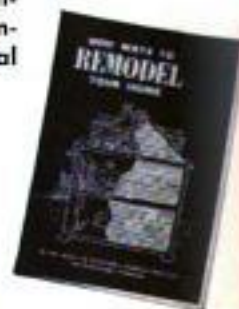

WHY A MILLION MEN HAVE SWITCHED TO **HOLIDAY!**



Only HOLIDAY gives you this Custom Blend for Mildness!

Yes, five famous tobaccos skillfully blended into a mixture of unequalled flavor, aroma and mildness. These fine tobaccos, selected from all parts of the world, are blended with a base of cool-smoking white burley . . . Each tobacco adds its own distinctive

flavor and aroma to make Holiday America's finest pipe mixture. We suggest you try a pipeful . . . enjoy its coolness, flavor and aroma . . . and see for yourself why more and more men who smoke mixtures are switching to Holiday as a steady smoke.

HOLIDAY gives you this Heat-Sealed Wrap-Around Pouch!

Holiday tobacco leaves our blending line with just the right moisture content. And it stays that way because Holiday is the only mixture which has the Wrap-Around pouch. Sealed air-and-water tight, it guarantees you a fresher, cooler-smoking tobacco.



THE
COOLEST SMOKING
MIXTURE
YOUR PIPE
EVER HAD!

AT YOUR DEALER'S

**IF YOU PREFER
A BLEND OF
STRAIGHT
BURLEYS**

Try Edgeworth—
choice cool-
smoking white
burleys in the
air-tight pouch.
America's finest
pipe tobacco.



Get this guaranteed "Olde London" Pipe and two full-size pouches of Holiday tobacco for only \$1.00. The pipe is fine, hand-rubbed imported briar . . . with genuine hard rubber bit . . . carbonized bowl for cooler smoking. If your dealer is unable to supply you, use this handy order blank.

Name _____

Address _____

City _____ State _____

Mail with \$1.00 to "Olde London," Larus & Brother Company, Inc., Richmond, Va.
Offer Good Only in U. S. A.

PM-8

Learn to Repair ELECTRIC APPLIANCES

at Home in Spare Time

**Fast Growing Field offers
Good Pay, Interesting
Work, Security**

Get into a field where you can do important work, have a secure future. Electrical appliance repair offers OPPORTUNITY FOR YOU. Every wired home has an average of 8 electrical appliances. Up to 10 million new appliances are being sold every year. Owners pay well to keep them in repair and enjoy the convenience they provide. That means a fast growing need for trained men.

Learn and Earn with Tester You Build

Our training includes the parts to build a sturdy, portable appliance tester following our illustrated, easy-to-understand instructions. This multi-use tester helps you locate electrical defects quickly and easily, equips you to do professional trouble-shooting. You use it to learn electrical appliance repair techniques. Gives you the practical training of actually building the tester and a valuable piece of equipment for future use.

Earn \$3, \$4, \$5 an Hour Spare Time

Start soon to repair electric toasters, fans, irons, mixers, vacuum cleaners, etc. for your neighbors and friends. Spare time work done at your convenience in your basement, garage, or spare room can earn you from \$3 to \$5 an hour. See how easy it is to increase your earning power—how you can pay for this training many times over with the money you'll earn in your spare time. Mail coupon.

Train Now for Greater Security Low Price—Easy Terms

Today's automatic electric appliances need expert servicing. The man who knows this good trade has a secure future. Put your spare time to good use. Enroll now for \$2.50 down and \$5.00 a month. A small investment can assure a better future. Address Electrical Appliance Training, National Radio Institute, Dept. AH5, Washington 9, D.C.

**FREE Lesson and Book
MAIL this NOW**

NATIONAL RADIO INSTITUTE

DEPT. AH5, WASHINGTON 9, D. C.

Please send me lesson and book free. (No salesman will call.)

Name _____ Age _____

Address _____

City _____ Zone _____ State _____

ACROSS THE DESK



To the Editor:

New Zealand is only a small country enjoying good sporting facilities. There is ample opportunity for boating and fishing. We started building boats as a hobby and now market a line of 15-foot outboard cabin cruisers and runabouts. Your several articles on outboard cabin cruisers interested us so much that we drew up plans



similar to the designs of the craft you illustrated (*PM*, April 1954). The photo shows our light 15-foot marine ply craft doing 20 m.p.h. powered with a 14-horsepower Evinrude outboard motor. What started out as an interesting hobby is now quite a thriving sideline. Wishing your magazine *Popular Mechanics* all success for the future.

D. Wrigley,
Douglas Wrigley & Co. Ltd.,
239b Queen Street,
Onehunga, Auckland, N. Z.

To the Editor:

My attention has just been called to an item on page 85 of your March issue describing equipment to "rejuvenate" burned-out fluorescent lamps. Although, on the surface, this is indeed a very ingenious device, we felt that perhaps it might mislead enough of your readers to cause them some embarrassment, and that you might like to have us give you a true interpretation of this product from an engineering standpoint.

Basically, the most important factor controlling the life of a fluorescent lamp is the emission material placed on the electrode at the time of manufacture. Once this material has wasted away during use, the electrode can supply no more electrons

(Continued to page 8)

This **FREE SAMPLE LESSON** will prove you can become an expert **BOOKKEEPER... ACCOUNTANT** OR **C.P.A.**

This well-paid
LaSalle-trained
Accountant's
success could
be yours.



THIS SAME LESSON HAS STARTED HUNDREDS OF THOUSANDS toward well-paid accounting careers—in business, government, and as C.P.A.'s. Even without previous knowledge, progress is rapid—earning power climbs fast. This sample lesson shows why.

IF you have been envying the high incomes and good jobs enjoyed by thousands of men and women Accountants today... incomes ranging from \$4,000 to \$10,000 and more per year... why not launch such a career for yourself?

Do you doubt that you can?

Then let us send you—without cost or obligation—the same Lesson Number One with which LaSalle has started several hundred thousand

men and women toward successful accounting careers. We want you to see for yourself how this remarkable method, originated by LaSalle, makes Accountancy simple, interesting, practical, and certain... how it leads you step-by-step to a complete mastery of Accounting—and on up to the coveted degree of Certified Public Accountant if you so aspire.

It doesn't matter whether you've had previous bookkeeping experience, or whether you don't know a debit from a credit. Whether you wish to qualify as an expert bookkeeper, advanced accountant, cost accountant, auditor, government accountant, income tax specialist, or public accountant... you'll find in LaSalle's Problem Method the exact plan to prepare you rapidly and inexpensively—in spare hours at home—without losing a day from your present job.

So right now, today... if you are an adult, employed, and earnestly ambitious for rapid advancement in this highest-paying of all professions... send your name and address on the coupon below. We'll send the free sample lesson—plus our 48-page book outlining today's career opportunities and how you can qualify for them. A coupon like this has started many thousands toward greater success. It can do the same for you. Mail it today!

Member, National Home Study Council

Clip Coupon... Mail TODAY!

LaSalle Extension University... A Correspondence Institution
Dept. 864H, 417 S. Dearborn Street, Chicago 5, Illinois

YES, I want to see how LaSalle's "Problem Method" works... how I can qualify for high-pay Accountancy positions. Send Free Sample Lesson—also your 48-page book, "Accountancy, the Profession That Pays" ...all without cost or obligation.

Name.....Age.....
Street Address.....
City, Zone & State.....
Present Position.....



HIGHER ACCOUNTANCY

By the LaSalle Problem Method..

• Practical Accounting

Assignment 1

THE BALANCE SHEET



QUOTING from the "Journal of Accountancy," the authoritative organ of the professional accountants of the United States:
"...the accounting profession is probably the best paid in the world. If there be a profession in which the average compensation is higher, it is not known to us.
There is need for accountants. There is ample compensation for accountants. There is no prospect that the supply will overtake the demand within the lifetime of even the youngest of us."

LaSalle Extension University
A Correspondence Institution
CHICAGO

FREE SAMPLE LESSON

We offer you this free sample lesson so that you can prove to yourself that you CAN master Accountancy—quickly, thoroughly—in spare time at home.

You will see exactly how LaSalle's famous "Problem Method" works... how you are led step-by-step through actual accounting work—learning by doing and not by study of theory alone. First you tackle easy problems, then more difficult ones—until soon you master them all. And at every step you have the close personal guidance of LaSalle's large staff of C.P.A. instructors.

**Nearly 10%
of all C.P.A.'s
in the U.S. have
been trained by the
LaSalle Problem
Method**

GOOD-PAY JOBS IN 5 BIG FIELDS

If you were an expert accountant right now, chances are you would find yourself among the highest-paid of all professional men and women. Surveys show that accountants earn more than those in other major professions.

There are five big fields of opportunity open to Accountancy-trained men and women... opportunities that are wide open and highly inviting, offering maximum income and job security in good times or bad. And under LaSalle's "Problem Method" you can start earning while still learning—either in spare-time or full-time employment... or in business for yourself with no capital required.

Get the latest information by sending for our 48-page book, "Accountancy, the Profession That Pays"... plus free sample lesson. The coupon at right will bring both to you without cost or obligation. LaSalle Extension, 417 S. Dearborn St., Chicago 5, Ill.

BALKY Power Mower?



SPUTTERING Outboard?

Clean the
carburetor
with...



GUMOUT

What's more maddening than a stubborn power mower or outboard? Fact is, winter storage and infrequent use often make them ornery. Gum and dirt build up in the carburetor and fuel system. Result: hard starting, rough idling, and stalling. And there's no adjustment that will compensate for gum and dirt. Only thing to do is clean the carburetor!

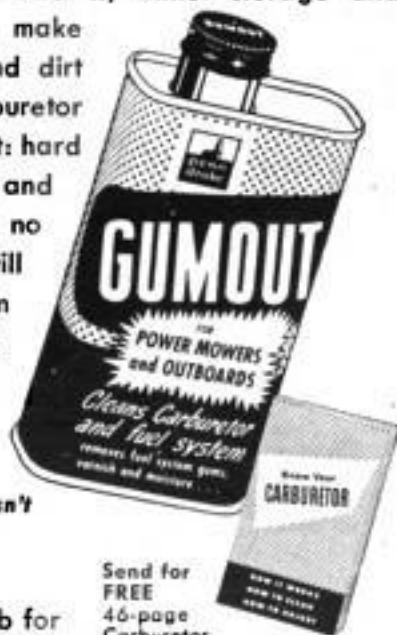

ut—the carburetor doesn't
ave to be taken apart
to clean it!

GUMOUT does the job for you—while the engine's running. Just pour a little GUMOUT in the gas tank. It dissolves the gum . . . cleans out the fuel system . . . keeps the carburetor as clean as new. There's nothing like GUMOUT!

GUMOUT is sold by service stations, garages, auto supply dealers, and hardware stores everywhere.

GUMOUT DIVISION • Pennsylvania Refining Company
2671 Lisbon Road, Cleveland 4, Ohio

Send for
FREE
46-page
Carburetor
Handbook. Gives you all
the answers. Good to have.

Your CAR needs GUMOUT, too. A dirty carburetor causes stalling, lazy pick-up, excessive gas consumption. Add GUMOUT to your gas tank every two or three months. GUMOUT cleans your carburetor while you drive.

(Continued from page 6)

and the lamp "burns out." Short of dismantling it and replacing the initial material, there is nothing that can restore its life.

E. W. Beggs,
Manager, Fluorescent and Vapor Lamps,
Commercial Engineering Dept.,
Westinghouse Electric Corp.,
Bloomfield, N. J.

To the Editor:

Dallas' famous steel "turntable" bridge, built across the Trinity River in 1912 to let river boats pass, is being wrecked. During all the years of its existence it turned only 10 times.

The bridge was firmly built and extensively used but never had to be turned for



boats as there were no boats. A recent bond issue called for a new road and the erection of a new bridge. The old turntable bridge was sold by county officials to a wrecking company that wanted the steel. So on Sunday, April 10, the old bridge was turned for its last time—turned so the bridge would be in a better position for wreckers.

William Allen Ward,
Dallas, Tex.

To the Editor:

Your letter and pictures on Chinook winds, published in the June 1955 *Popular Mechanics*, pages 6-10, immediately excited my interest, then my irritation. The letter is full of misinformation.

(Continued to page 10)

Can you profit by their mistakes?

"Not getting enough education"

You needn't make that mistake. You can get that better job, those big promotions, the regular raises that so many I. C. S. students report. And you can do it without

"going to school," without interfering with your present job or your social life.

YOU can study with I. C. S. at home, in your spare time!

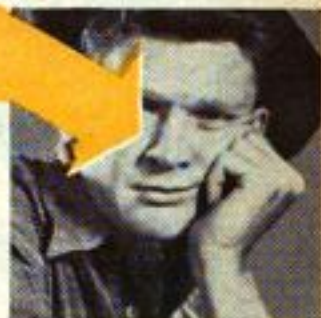

"Wrong choice of career"

When you study with I. C. S. you have 277 courses to choose from. And part of our job here at I. C. S. is not only giving you instruction

but making sure you pick the course that's right for you!

YOU get expert guidance FREE from I. C. S.!



"Failed to seize opportunities"

Your opportunity is right here on this page. Don't pass it by. Don't put it off. Mail the coupon now and let us send you our 3-book career kit.

YOU get 3 FREE books if you mail the coupon today!

1. 36-page gold mine of information, "How to Succeed."
2. Career Catalog outlining opportunities in your field.
3. Sample I. C. S. lesson (Math.).



For Real Job Security—Get an I. C. S. Diploma! ... Easy-pay Plan ... I. C. S., Scranton 9, Penna.

INTERNATIONAL CORRESPONDENCE SCHOOLS

ICS

BOX 70299H, SCRANTON 9, PENNA.

(Partial list of 277 courses)

Without cost or obligation, send me "HOW TO SUCCEED" and the opportunity booklet about the field BEFORE which I have marked X (plus sample lesson):

ARCHITECTURE and BUILDING CONSTRUCTION

- Air Conditioning—Refrig.
- Architecture
- Architectural Interior
- Building Contractor
- Building Maintenance
- Carpenter and Mill Work
- Estimating
- Heating
- Painting Contractor
- Plumbing
- Reading Arch. Blueprints

ART

- Cartooning
- Commercial Art
- Fashion Illustrating
- Magazine Illustrating
- Show Card and Sign Lettering
- Sketching and Painting

AUTOMOTIVE

- Auto Body Rebuilding
- Auto Elec. Technician
- Auto-Engine Tune Up
- Automobile

AVIATION

- Aeronautical Engineering Jr.
- Aircraft & Engine Mechanic

BUSINESS

- Advertising
- Bookkeeping and Accounting
- Business Administration
- Business Correspondence
- Public Accounting
- Creative Salesmanship
- Federal Tax
- Letter-writing Improvement
- Office Management
- Professional Secretary
- Retail Business Management
- Sales Management
- Stenographic-Secretarial
- Traffic Management

CHEMISTRY

- Analytical Chemistry
- Chemical Engineering
- Chem. Lab. Technician
- General Chemistry
- Natural Gas Prod. & Trans.
- Petroleum Engineering
- Plastics
- Pulp and Paper Making

CIVIL, STRUCTURAL ENGINEERING

- Civil Engineering
- Construction Engineering
- Highway Engineering
- Reading Struct. Blueprints
- Sanitary Engineering
- Structural Engineering
- Surveying and Mapping

DRAFTING

- Aircraft Drafting
- Architectural Drafting
- Electrical Drafting
- Mechanical Drafting
- Mine Surveying and Mapping
- Plumbing Drawing and Estimating
- Structural Drafting

ELECTRICAL

- Electrical Engineering
- Electrical Maintenance
- Electrician Contracting
- Lineman

HIGH SCHOOL

- Commercial Good English
- High School Subjects
- Mathematics

LEADERSHIP

- Foremanship
- Industrial Supervision
- Leadership and Organization
- Personnel-Labor Relations

MECHANICAL AND SHOP

- Gas—Electric Welding
- Heat Treatment Metallurgy
- Industrial Engineering
- Industrial Instrumentation
- Industrial Supervision
- Internal Combustion Engines
- Machine Design—Drafting
- Machine Shop Inspection
- Machine Shop Practice
- Mechanical Engineering
- Quality Control
- Reading Shop Blueprints
- Refrigeration
- Sheet Metal Worker
- Tool Design Toolmaking

RADIO, TELEVISION

- Industrial Electronics
- Practical Radio-TV Eng'ng
- Radio and TV Servicing
- Radio Operating

TELEVISION Technician

RAILROAD

- Air Brakes Car Inspector
- Diesel Locomotive
- Locomotive Engineer
- Section Foreman

STEAM AND DIESEL POWER

- Combustion Engineering
- Diesel—Elec. Diesel Eng's
- Electric Light and Power
- Stationary Fireman
- Stationary Steam Engineering

TEXTILE

- Carding and Spinning
- Cotton, Rayon, Woolen Mfg.
- Finishing and Dyeing
- Loom Fix'g Textile Des'ing
- Textile Eng'g Throwing
- Warping and Weaving

MISCELLANEOUS

- Domestic Refrigeration
- Marine Engineering
- Ocean Navigation
- Professional Engineering
- Short Story Writing
- Telephony

Name _____ Age _____ Home Address _____

City _____ Zone _____ State _____ Working Hours _____ A.M. to P.M. _____

Occupation _____

Canadian residents send coupon to International Correspondence Schools, Canadian, Ltd., Montreal, Canada. Special tuition rates to members of the U. S. Armed Forces.

Make BIG MONEY! Amazing New subzero **INSULATED** Jackets and Shoes!

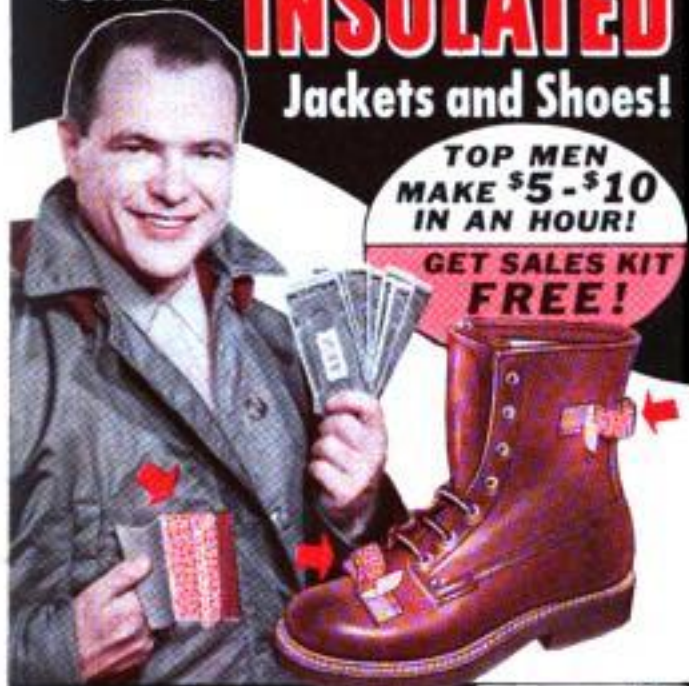

Same Type Subzero Insulation
as in U.S. Army Coldbar Suit!
QUICK CASH IN SPARE TIME!



**HOLDS YOU AFOAT
INDEFINITELY!**

Now! Start a highly profitable business without investing a cent! Act quick, be **FIRST** in town to take orders for sensational new Mason **INSULATED** Jackets and Shoes... results of a remarkable scientific discovery: a new miracle insulation with thousands of vinyl air cells that provide perfect "dead air space" insulation! ● Keeps you **WARM** even at Arctic temperatures! ● **DRY** in downpours (can't absorb water)! ● **Protected from strong WINDS!** It's the same type miracle insulation used in famous U.S. Army Coldbar Suit! Because Mason products are **not** sold in stores, folks **must** buy from **YOU!**

Take orders for just 2 Insulated Shoe & Jacket combinations a day in spare time and you'll earn \$90 Extra Income in one week!

"Miracle" Features Make Money for You FAST!

Your friends, fellow workers, truck drivers, gas station, construction men — hundreds right around home will fill your pockets with cash! Lightweight jacket covered with water-repellent Nylon, has detachable hood. Both boots, shoes are rugged leather, feature Air Cushion insoles, Neoprene Cush-N-Crepe outsoles. With this miracle combination, walk out in cold, wet, snowy or windy weather and stay warm and dry! **ADDED FEATURE!** Men wearing, Insulated Jacket & Shoes plus Mason's Insulated *Pants* can float in water *indefinitely!* Outdoorsmen will buy all **THREE** from you!

190 OTHER Money-makers!

You'll have 190 **OTHER** fast-selling shoes, jackets to help you build a big, repeat-order business! **EVERYBODY** needs shoes, jackets. Nationally advertised Mason products sell *fast*. You offer 170 styles for men, women; dress, sport, work shoes, boots, 28 jacket styles. **You actually feature more shoes in a greater range of sizes, widths than any store in your town!**

To start this exciting business *right away*, rush coupon **NOW**. You'll receive **FREE** a powerful **Jacket & Shoe Sales Kit** including Air Cushion demonstrator, How-to-make-Big-Money Booklet, *everything* else you need to start making **BIG CASH PROFITS** the very first hour!

MASON SHOE MFG. CO., Dept. MA747, Chippewa Falls, Wis.

Send for **FREE** Outfit!

Mr. Ned Mason, Dept. MA747,
Mason Shoe Mfg. Co., Chippewa Falls, Wis.
Yes! I want to be **FIRST** to take orders and make **QUICK CASH**
in spare time with Mason's amazing new Insulated Jackets & Shoes!
Rush my powerful **FREE** Sales Kit!

NAME.....
ADDRESS.....
TOWN.....STATE.....

(Continued from page 8)

Chinook winds, known in Europe as Foehn winds, occur on the lee sides of all high mountain ranges in all parts of the world, with no known exceptions.

Ronald L. Ives,
Williamsville, N. Y.

To the Editor:

This spring I entered a microscope in a district Junior Academy Science contest at DeKalb (Ill.), won first place and won second place in the state contest. I thought you might be interested as I got my idea from the book *Boy Mechanic* published for you by Simon and Schuster.

The microscope in the book showed the

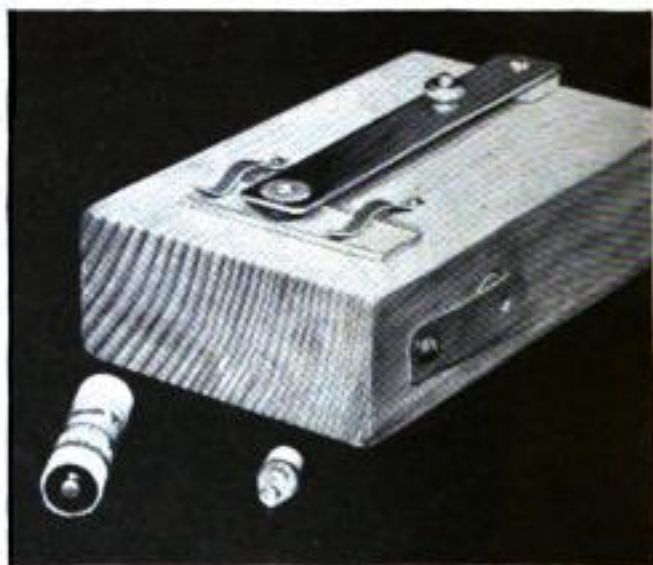

battery as a separate unit. I talked it over with dad and he suggested I use my own ideas and make a more compact model. I knew what I wanted so I proceeded, using the trial-and-error method.

Materials used: 2 pen-light bulbs, pen-light flashlight battery, light socket from an old flashlight, bell wire, block of wood 2 by 4 by 6 inches, strip of steel $\frac{1}{16}$ by $\frac{3}{4}$ by 5 inches, scrap-brass shim stock, 2 brass washers, 2 brads, 3 miscellaneous screws, a plastic pie container.

Method: The lens was made by breaking the magnifying tip off a flashlight bulb (I broke three before I had one that was satisfactory). A center punch was used to countersink the brass washers to fit the contour of the edge of the lens.

The hole on one end of the strip of steel was drilled about $\frac{1}{16}$ inch larger than the diameter of the lens. A washer was glued to the lens and strip of steel. Another washer was put on the opposite side of the steel strip to cover the sharp edge of the lens. Two holes were drilled on the end opposite the lens for the adjusting screw and hold-down.

(Continued to page 242)



I Will Send You BOTH FREE

J. E. SMITH, President
National Radio Institute
Washington 9, D. C.

ACTUAL LESSON

The ABC's of SERVICING

How to be a SUCCESS in RADIO-TELEVISION

64 PAGE BOOK

See How I Train You at Home in Spare Time for Good Pay Jobs in RADIO-TELEVISION

You Practice Broadcasting with Equipment I Send

As part of my Communications Course I send you kits of parts to build the low-power Broadcasting Transmitter shown at left. You use it to get practical experience putting this station "on the air," to perform procedures required of broadcasting station operators. An FCC Commercial Operator's license can be your ticket to a better job and a bright future. My course gives you the training you need to get your license. Mail coupon below. See in my book other valuable equipment you build and keep.



You Practice Servicing with Equipment I Send

Nothing takes the place of PRACTICAL EXPERIENCE. That's why NRI training is based on LEARNING BY DOING. You use kits of parts I furnish to build many circuits common to both Radio and Television. With my Servicing Course you build the modern receiver shown at right. You also build an Electronic Multitester which you can use to help fix sets while training at home. Many students make \$10, \$15 a week extra fixing neighbors' sets in spare time, starting soon after enrolling. I send you special booklets that show you how to fix sets. Mail coupon for 64-page book and actual Servicing Lesson, both FREE.



TRAINING plus OPPORTUNITY is the PERFECT combination. The sample lesson I send will prove to you that it is practical to keep your job while TRAINING right in your own home for better pay and a brighter future. My 64-page book should convince you that Radio-Television is truly today's field of OPPORTUNITY.

TELEVISION MAKING JOBS, PROSPERITY

Radio, even without Television, is bigger than ever. 115 million home and auto Radios create steady demand for service. 3000 Radio stations give interesting, good pay jobs to operators, technicians. NOW ADD TELEVISION, 25 million Television homes and the total growing rapidly. 200 Television stations on the air and hundreds more under construction. Color Television soon to be a reality. Government, Aviation, Police, Ship, Micro-wave Relay, Two-way Communications for buses, taxis, trucks, railroads are growing fields providing good jobs for men who know Radio-Television. All this adds up to good pay now, a bright future later for men who qualify.



START SOON TO MAKE \$10, \$15 A WEEK EXTRA

An important benefit of Radio-Television training is that you can start to cash in fast. Many men I train fix neighbors' sets, make extra money, starting soon after they enroll. Multitester built with parts I send helps locate and correct set troubles. Read at left how you build actual equipment that gives you practical experience, brings to life what you learn from my lessons.



MEN OF ACTION NEEDED MAIL COUPON TODAY

Act now to enjoy more good things of life. Get the benefit of my 40 years' experience training men at home. Take NRI training for as little as \$5 a month. Many NRI graduates (some with only a grammar school education) make more in two weeks than the total cost of training. Find out about this tested way to better pay. Mail coupon below today for Actual Lesson and 64-page Book — BOTH FREE. J. E. SMITH, President, National Radio Institute, Dept. 5HA, Washington 9, D. C. OUR 40TH YEAR.

I TRAINED THESE MEN AT HOME



"Started repairing Radios six months after enrolling. Earned \$12 to \$15 a week, spare time." — ADAM KRAMLIK, JR., Sunnyside, Pennsylvania.



"I've come a long way in Radio and Television since graduating. Have my own business on Main Street." — JOE TRAVERS, Asbury Park, New Jersey.



"Manager of meat market when I began. Answered ad for Radio serviceman. Got job. Pay increased 50% in year." — C. CARTER, San Bernardino, California.



"Am with WCOC. NRI course can't be beat. Passed exam for first class Radio-Phone license with no trouble at all." — JESSE W. PARKER, Meridian, Miss.



"Am with WNBT as video control engineer on RCA color project. Owe a lot of my success to your textbooks." — WARREN DEEM, Malverne, N. Y.

AVAILABLE TO VETERANS UNDER GI BILLS

Good for Both — FREE

Mr. J. E. SMITH, President, Dept. 5HA
National Radio Institute, Washington 9, D. C.

Mail me Sample Lesson and 64-page Book, FREE. (No salesman will call. Please write plainly.)

Name _____ Age _____

Address _____

City _____ Zone _____ State _____

VETS write in date of discharge



SAVE! 40 to 70% BUY DIRECT FROM THE IMPORTER!



29c

Dogbone Wrench Fits ALL Nuts & Bolts!

This is the very, very lowest price that this new, handy all-purpose tool has ever been sold for... Just imagine, only 29 cents! Fits all standard nuts & bolts from 1/4 to 9/16th inch—square & hex bolts & nuts. Saves time & labor—actually ten socket wrenches in one! Only 4 in. long—but super-efficient! Solingen Steel. The Best! No. 14. (Formerly \$1.00—now 29c)



FREE!

3-COLOR POLICE FLASHLIGHT

Sensational 3-color Police flashlight yours—absolutely free—with orders of \$5 or more! Gives red, green or white beam in an instant thru push-button control. Converts from spotlight to floodlight by twist of head frame. Same type model thousands of New York City policemen now use. Throws brilliant beam visible for miles. Now selling at 1.98 but it's yours as a gift! Offer good for limited time only! See the selected list of items below—buy with confidence on a satisfaction-or-money-back guarantee! You get these wonderful values because you're buying DIRECT from the importer! Send today to:

THORESEN'S, Dept. 6-HC

352 Fourth Ave. New York 10, N. Y.



1.98

SAVE \$3 ON AEROMAT FOUNTAIN BRUSH! WASHES CARS, FLOORS, WINDOWS

This Hi-Pressure fountain brush is available to you direct from the factory—you save \$3 as a result! Attach to your garden hose and wash your car sparkling clean in 7 to 10 minutes! Detergent pills (supplied with brush) go in brush head and a special rotary action gives you sudsy spray. Easy, simple! 5-ft. telescopic handle. Silky Durostyrene brush. Complete kit only 1.98. Order No. 444

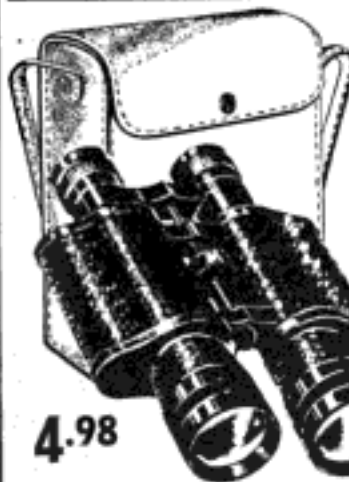

4.98

Powerhouse Binoculars Give 16 Times Area Magnification!

From Western Germany comes this latest model Powerhouse binocular which gives you much better viewing up to 25 miles! New model features interior fluoride coated objective lenses—a feature hitherto only found in expensive glasses. Gives 16 times area magnification! Hinge model—adjusts to exact space between your eyes. Handsome leather case given free of extra charge. No distortion; you get clear, sharp images. Sorry, only one to a customer. Only \$4.98, tax & postage included. Order No. 6.

SWISS ARMY Type Knife gives 10 tools in 1!

- | | |
|-------------|---------------|
| saw | awl |
| ice-pick | can opener |
| scissors | corkscrew |
| jackknife | small knife |
| screwdriver | bottle opener |

The most famous utility knife in the world at a greatly reduced price! The Swiss Army knife is recognized by sportsmen and hobbyists to be the most compact multi-purpose tool ever developed. This new Korium version is made of the finest Solingen steel. Each of the 10 separate tools is easy to open—easy to use—no jamming or slipping. Has belt attachment or can be carried in pocket. 3 3/4 inches. Solid Vidal handle. Solingen steel assures years of dependable service even with roughest handling. Regularly \$8 to \$12—now 3.95. No. 88.



3.95



1.98

COMBI-MATIC 7-in-1 All-Purpose Optical Glass

Imagine! 7 optical instruments in one compact unit! Telescope, field glasses, magnifying mirror, fire starter, sun dial timepiece, compass and reading glass. Folds into small space—carry in pocket. This amazing gadget is imported from Western Germany. Finely ground optical lenses—precision made by skilled craftsmen. Now yours at the low, low price of 1.98. No. 93



4.98

Amazing Kronogram Watch Measures Speed, Distance—Gives Accurate Time!

This Swiss wonder watch gives you accurate time always—and beside, measures distances, times sports, photos, lab work, even lightning flashes! Has 2 push-buttons, tachymeter dials, split second calibrations. Sturdy, dependable time-keeper. Handsome metal band and instructions included. No. 236. Only 4.98. Add 5% tax—Total 5.48



1.98

GET 30 BETTER SHAVES FROM 1 BLADE!

Here's great news for you fellows with tender skins! This marvel of German ingenuity gives you 30 better shaves per blade! The Honkron soon pays for itself—it hones & conditions any double-edge blade—old or new—in a few seconds! Sharpens & smooths both edges at once! Saves you many times original cost. One of the greatest ideas out of the new Germany... order by No. 3. \$1.98



88c

SPECTOSCOPES Regularly \$1.98—Now 88c

These internationally famous binocular-spectacles are now being sold at a price that only we, as exclusive importers can offer! Sold all over the U.S. & Canada for up to \$5, this is the first and only time that the Spectoscope has been offered at this low, low price. Wear 'em just like eyeglasses—use 'em for sports, nature, TV, reading, etc. 88c plus 12c tax. No. 90.



3.95

MONARCH Hunting Knife

The most unique knife of the year—made by the renowned craftsmen of Solingen, West Germany. Dramatic reindeer scene enduringly deep-etched in the blade—in 4 colors. Superb handle in stag and Vibra-metal. Six inch blade of heavy-duty Solingen steel. 10" over-all. Tough—rugged—sharp! A collector's item; one that graces a rec room or den wall. Genuine cowhide sheath included. No. 82. Only 3.95.



300-POWER MICROSCOPE AT NEW LOW PRICE!

Just compare our price on this superb 300, 200, 100 Power TRIPLE turret microscope with similar ones! All-metal construction... precision-tooled threadings... finely ground, highly polished Achromatic lenses... latest most scientific design. Extra sturdy for rough student & lab use. Compare with any instrument sold for up to \$35.00 and you'll marvel at this special import price! \$9.94. No. 198

Order items by number on guarantee of satisfaction or money back. Send m.o., check or cash for free delivery. (COD's sent plus postage.) Rush to:

THORESEN'S, Dept. 6-HC

352 FOURTH AVE. NEW YORK 10, N. Y.



Newest German Telescope Enlarges Area 144 Times, Gives Sharp, Clear Close-ups!

Extra power—full Super sharp & clear! Real triumph of West German industry and wizardry! Nothing under \$10.00 can beat it! Ideal for great distances, plane & ship spotting, celestial work, etc. Draw tubes of chrome plated steel. Coated objective lens. Superb quality and workmanship. A really great bargain at this special price... only 4.98. Order by No. 43.



1.98

SACRIFICE!

Black Forest Hunting Knife Now 1/2 Price

This is possibly the greatest offer this 80-year old firm has ever made! The famed Black Forest hunting knife is regularly sold for \$3.95. It's solid Solingen Steel, gracefully crafted—but tough, rugged! Sharp enough to shave with! Metal-tipped leather sheath included at no extra cost. A collector's item and a swell home decoration. Now at 1/2 price! \$1.98. Supply limited—Order by No. 80.



INVENTORS

Learn how to protect your invention. The U. S. Patent Laws provide that any new and useful art, machine, article of manufacture, or composition of matter, or any new and useful improvement thereof, may be patented if the act of invention is involved. Therefore, every inventor with a valuable invention should take advantage of the Patent Laws and proceed for patent protection in order to safeguard his rights.

A patent gives the inventor the exclusive right to prevent others from making, using, or selling the invention claimed in the patent for a period of seventeen years.

The Patent Laws were enacted for the benefit of the inventor to give him protection for the features of his invention which are patentable. These features must be properly and concisely set forth and claimed in a formal application for patent, in order to comply with the requirements of the Patent Laws. For that reason, unless the inventor is familiar with patent matters, he should engage a competent registered patent attorney or agent to represent him. We are registered to practice before the U. S. Patent Office and are prepared to serve you in the handling of your patent matters.

A specially prepared booklet entitled "Patent Guide for the Inventor", containing detailed information with respect to patent protection and procedure, together with a "Record of Invention" form will be promptly forwarded to you without obligation upon request.

CLARENCE A. O'BRIEN & HARVEY JACOBSON

Registered Patent Attorneys

51-H DISTRICT NATIONAL BUILDING

WASHINGTON 5, D. C.

WHAT ALL AUTO MECHANICS WANT TO KNOW

1664 PAGES



This Big Practical Book gives full information with working diagrams covering the principles, construction, ignition, service and repair of modern cars, trucks and buses.

Diesel Engines, Hydramatic & Fluid Drives Fully Explained.

A complete Guide of 1664 pages, with over 1500 illustrations showing inside views of working parts, with instructions for service jobs.

IT PAYS TO KNOW

How to fit pistons—How to locate engine knocks, How to fit connecting rod bearings—How to service main bearings—How to recondition valves—How to time valves—How to adjust fan belts—How to adjust carburetors and chokes, How to rebuild a clutch—How to service automatic transmissions—How to service brakes—How to adjust steering gear—How to cope with ignition troubles—How to service distributors—How to time ignition—How to "tune up" an engine.

\$4 COMPLETE • PAY \$1 A MO.
TO GET THIS ASSISTANCE FOR YOURSELF SIMPLY FILL IN AND MAIL COUPON TODAY.

Step up your own skill with the facts and figures of your trade. Audels Mechanics Guides contain Practical Inside Trade Information in a Handy Form. Fully illustrated and Easy to Understand. Highly Endorsed. Check the book you want for 7 DAYS FREE EXAMINATION. Send No Money. Nothing to pay postman.



MAIL ORDER

AUDEL, Publishers, 49 W. 23 St., NEW YORK 10, N. Y.

Please send me postpaid for FREE EXAMINATION books marked (x) below. If I decide to keep them I agree to mail \$1 in 7 days on each book or set ordered and further mail \$1 monthly on each book or set until I have paid price, otherwise I will return them.

- AUTOMOBILE MECHANICS GUIDE, 1664 Pages, \$4
- TRUCK & TRACTOR GUIDE, 1299 Pages 4
- DIESEL ENGINE MANUAL, 575 Pages 2
- MACHINISTS HANDY BOOK, 1650 Pages 4
- WELDERS GUIDE, 400 Pages 1
- BLUE PRINT READING, 416 Pages 2
- MATHEMATICS & CALCULATIONS, 700 Pages, 2
- SHEET METAL PATTERN LAYOUTS, 1100 Pages 4
- SHEET METAL WORKERS HANDY BOOK, 388 Pgs. 1
- MECHANICAL DRAWING GUIDE, 160 Pages 1
- MECHANICAL DRAWING & DESIGN, 480 Pages 2
- AIRCRAFT WORKER, 240 Pages 1
- TELEVISION SERVICE MANUAL, 434 Pages 2
- RADIONANS GUIDE, 1040 Pages 4
- ELECTRONIC DEVICES, 216 Pages 2
- ELECTRIC MOTOR GUIDE, 1000 Pages 4
- WIRING DIAGRAMS (Light & Power), 272 Pgs. 1
- ELECTRICIANS EXAMINATIONS, 250 Pages 1
- ELECTRIC POWER CALCULATIONS, 425 Pages 2
- HANDY BOOK OF ELECTRICITY, 1440 Pages 4
- ELECTRIC DICTIONARY, 9000 Terms 2
- ELECTRIC LIBRARY, 7000 Pages (12 Book Set) 18
- SHIPFITTERS HANDY BOOK, 250 Pages 1
- REFRIGERATION & Air Conditioning, 1280 Pgs. 4
- MILLWRIGHTS & MECHANICS GUIDE, 1200 Pgs. 4
- POWER PLANT ENGINEERS GUIDE, 1500 Pages 4
- ENGINEERS & FIREMANS EXAMS, 525 Pages 1
- PUMPS, Hydraulics & Air Compressors, 1658 Pgs. 4
- OPERATING ENGINEERS LIBRARY (3 Books) 9
- MECHANICAL DICTIONARY, 950 Pages 4
- GARDENERS & GROWERS GUIDES (4 Book Set) 6
- CARPENTERS & BUILDERS GUIDES (4 Book Set) 6
- PLUMBERS & Steamfitters Guides (4 Book Set) 6
- MASONS AND BUILDERS GUIDES (4 Book Set) 6
- PAINTERS & DECORATORS MANUAL, 450 Pgs. 2
- HOUSE HEATING GUIDE, 1000 Pages 4
- OIL BURNER GUIDE, 384 Pages 1
- HOME APPLIANCE SERVICE GUIDE, 800 Pages 4

Check NOW!

You Can Look Over Any Guide In Your Own Home — Start the Easy Payments If Satisfied

IL TODAY

Name _____
Address _____
Occupation _____
Employed by _____ P-8



WIN YOUR WAR against INSECTS!

NEW miracle Lindane kills flies, sandflies, mosquitoes, flying moths, wasps, spiders, roaches, silverfish. Simply light amazing EXTERMO cones, containing Lindane—and insects are killed. Lights easily, burns like a cigarette! No oily spray or residue—no tricky gadgets. 16 EXTERMO Cones and burner \$1 postpaid. Full year's supply, 48 Cones, \$2. GUARANTEED or your money back. Sorry, no C.O.D.'s. Mail to AVON-STRAND, CO. 2420 So. Dearborn, Chicago Ill.

FREE BOAT KIT CATALOG

8' to 14' Models from \$39.95 incl. freight

- Assemble your own boat
- No experience necessary
- Save 1/2 to 2/3 "factory built" prices



Write: Marine Hardware, Fiberglass, & Trailers

LUGER INDUSTRIES DEPT. B 4452 NICOLLET AVE. MINNEAPOLIS 9, MINN.

BE A PROFESSIONAL HAIR and SCALP SPECIALIST

MEN — WOMEN

Learn this attractive profession by mail and work from your home or office. Earn up to \$50 and more each day from clients who call on you. NO CHARGE FOR INSTRUCTION. You merely use our materials. ALL PARTICULARS FREE.

MELVILLE CO.
P.O. BOX 75414, Dept. PM-1, Los Angeles 5, Calif.

COLOR PRINTS

FROM YOUR COLOR FILMS
KODACHROME • ANSCOCROME
EKTACHROME • ANSCO COLOR

4x5 50c | 5x7 \$1 | 8x10 \$2 Satisfaction or money back

AUTHORIZED ANSCO COLOR LABORATORY
COLORFAX LABORATORIES
Dept. J85, Box 3521, Georgetown Sta., Washington 7, D. C.

25c
2 1/4 x 3 1/4
Minimum order \$1
No COD's, please

INSURED TIRE SERVICE POPULAR BRANDS

FREE INSURANCE POLICY given with each used tire sold. We guarantee the amount of service you pay for.

NOWHERE CAN SUCH QUALITY BE FOUND AT SUCH LOW PRICE!

YOU CAN'T LOSE!!

Super Quality — Rugged Performance — 15 Months Insured Service			
600x16	\$3.65 670x15	\$3.95 700x16	\$4.45 760x16
650x15	3.85 670x16	4.05 710x15	4.35 820x15
650x16	4.25 700x15	3.95 760x15	4.45 550x17

Supreme Quality — Nothing Finer — 30 Months Insured Service			
600x16	\$5.25 475x19	\$5.45 700x15 (6)	\$10.45 700x20
600x16 (6)	6.75 640x15	4.95 750x16 (8)	15.95 750x20 (8)
650x16	5.75 670x15	5.35 700x17	11.95 750x20 (10)
650x16 (6)	7.25 710x15	5.45 750x17	16.45 825x20
700x16	6.35 760x15	5.95 750x18	10.95 900x20
750x16 (6)	8.45 800x15	6.35 30x5	11.25 1000x20
850x18	4.95 820x15	6.35 600x20	10.95 1100x20
850x17	4.75 550x13	5.35 650x20	11.75 1000x22
850x15	5.25 670x16	5.15 32x6 (5)	11.95 1100x22
700x15	5.35 700x16 (6)	10.25 32x6 (10)	12.75 1100x24

Whitewalls \$1.00 extra.

MIDLAND TIRE SALES Speedy shipments on Mail Orders. F.O.B. Chicago. Insurance policy sent with each order. Deduct 10% on orders for 2 or more used tires. Send CHECK or MONEY ORDER—No COD's.

3701 S. Normal, Dept. PM-37, Chicago 9, Ill.

How long since your last raise?

Sure, you've had a "cost of living increase." But what about the *big* pay boost?—the kind the boss asks you not to talk about and the kind that starts you thinking about a new car, a better home, luxuries for your family!

If you've had one of these in the past six months, stop reading right here. If not, it's time to start doing something about it.

Look around you. The men who are advancing are the trained men. They've learned special skills that bring them higher pay. It's the men without training who get what's left.

What are you going to do about it? Just wait and hope for the jackpot to pay off? If you really want the *big money*, you can start by getting the necessary training at home in your spare time.



wide choice of courses

I. C. S. offers a total of 277 different courses — 277 roads to advancement. Among them is the one you want. You'll find the lessons modern, simple, easy to understand. Each one you study takes you farther along the road to knowledge and success.

machine operator to shop foreman

"When I enrolled for my I. C. S. course in Carpentry and Millwork, I was a machine operator. Today, eleven months later, I am a shop foreman. As a consequence my salary has been increased 73.3%."



Why Home Study?

When you learn the I. C. S. way, your time is your own. Arrange your schedule to suit yourself. No tiresome traveling to and from school. No classes missed because of other engagements. Home study through I. C. S. has proved out for millions of ambitious men and women. You, too, can use it to get ahead!

International Correspondence Schools offer you a course in 277 success-proved subjects. You get the practical plus the bedrock facts and theory. You earn while you learn. Students often report their first *big* pay increases right after enrolling.

Read carefully the list of subjects in the coupon below. Pick out the field of study that interests you most—the one with the greatest future for you. Then mark and mail the coupon and *find out* what I. C. S. can do for you. All it costs is a stamp or a postcard. Why not do it right away—it may be the most important step you've ever taken!

For Real Job Security—Get an I. C. S. Diploma! ... Easy-pay Plan ... I. C. S., Scranton 9, Penna.

INTERNATIONAL CORRESPONDENCE SCHOOLS

ICS

BOX 64299H, SCRANTON 9, PENNA.

(Partial list of 277 courses)

Without cost or obligation, send me "HOW TO SUCCEED" and the opportunity booklet about the field BEFORE which I have marked X (plus sample lesson):

- | | | | | |
|--|---|--|--|--|
| <p>ARCHITECTURE and BUILDING CONSTRUCTION</p> <ul style="list-style-type: none"> <input type="checkbox"/> Air Conditioning—Refrig. <input type="checkbox"/> Architecture <input type="checkbox"/> Architectural Interior <input type="checkbox"/> Building Contractor <input type="checkbox"/> Building Maintenance <input type="checkbox"/> Carpenter and Mill Work <input type="checkbox"/> Estimating <input type="checkbox"/> Heating <input type="checkbox"/> Painting Contractor <input type="checkbox"/> Plumbing <input type="checkbox"/> Reading Arch. Blueprints <p>ART</p> <ul style="list-style-type: none"> <input type="checkbox"/> Cartooning <input type="checkbox"/> Commercial Art <input type="checkbox"/> Fashion Illustrating <input type="checkbox"/> Magazine Illustrating <input type="checkbox"/> Show Card and Sign Lettering <input type="checkbox"/> Sketching and Painting <p>AUTOMOTIVE</p> <ul style="list-style-type: none"> <input type="checkbox"/> Auto Body Rebuilding <input type="checkbox"/> Auto Elec. Technician <input type="checkbox"/> Auto-Engine Tune Up <input type="checkbox"/> Automobile | <p>AVIATION</p> <ul style="list-style-type: none"> <input type="checkbox"/> Aeronautical Engineering Jr. <input type="checkbox"/> Aircraft & Engine Mechanic <p>BUSINESS</p> <ul style="list-style-type: none"> <input type="checkbox"/> Advertising <input type="checkbox"/> Bookkeeping and Accounting <input type="checkbox"/> Business Administration <input type="checkbox"/> Business Correspondence <input type="checkbox"/> Public Accounting <input type="checkbox"/> Creative Salesmanship <input type="checkbox"/> Federal Tax <input type="checkbox"/> Letter-writing Improvement <input type="checkbox"/> Office Management <input type="checkbox"/> Professional Secretary <input type="checkbox"/> Retail Business Management <input type="checkbox"/> Sales Management <input type="checkbox"/> Stenographic-Secretarial <input type="checkbox"/> Traffic Management <p>CHEMISTRY</p> <ul style="list-style-type: none"> <input type="checkbox"/> Analytical Chemistry <input type="checkbox"/> Chemical Engineering <input type="checkbox"/> Chem. Lab. Technician <input type="checkbox"/> General Chemistry <input type="checkbox"/> Natural Gas Prod. & Trans. <input type="checkbox"/> Petroleum Engineering <input type="checkbox"/> Plastics <input type="checkbox"/> Pulp and Paper Making | <p>CIVIL, STRUCTURAL ENGINEERING</p> <ul style="list-style-type: none"> <input type="checkbox"/> Civil Engineering <input type="checkbox"/> Construction Engineering <input type="checkbox"/> Highway Engineering <input type="checkbox"/> Reading Struct. Blueprints <input type="checkbox"/> Sanitary Engineering <input type="checkbox"/> Structural Engineering <input type="checkbox"/> Surveying and Mapping <p>DRAFTING</p> <ul style="list-style-type: none"> <input type="checkbox"/> Aircraft Drafting <input type="checkbox"/> Architectural Drafting <input type="checkbox"/> Electrical Drafting <input type="checkbox"/> Mechanical Drafting <input type="checkbox"/> Mine Surveying and Mapping <input type="checkbox"/> Plumbing Drawing and Estimating <input type="checkbox"/> Structural Drafting <p>ELECTRICAL</p> <ul style="list-style-type: none"> <input type="checkbox"/> Electrical Engineering <input type="checkbox"/> Electrical Maintenance <input type="checkbox"/> Electrician <input type="checkbox"/> Contracting <input type="checkbox"/> Lineman <p>HIGH SCHOOL</p> <ul style="list-style-type: none"> <input type="checkbox"/> Commercial <input type="checkbox"/> Good English <input type="checkbox"/> High School Subjects <input type="checkbox"/> Mathematics | <p>LEADERSHIP</p> <ul style="list-style-type: none"> <input type="checkbox"/> Foremanship <input type="checkbox"/> Industrial Supervision <input type="checkbox"/> Leadership and Organization <input type="checkbox"/> Personnel-Labor Relations <p>MECHANICAL AND SHOP</p> <ul style="list-style-type: none"> <input type="checkbox"/> Gas—Electric Welding <input type="checkbox"/> Heat Treatment <input type="checkbox"/> Metallurgy <input type="checkbox"/> Industrial Engineering <input type="checkbox"/> Industrial Instrumentation <input type="checkbox"/> Industrial Supervision <input type="checkbox"/> Internal Combustion Engines <input type="checkbox"/> Machine Design-Drafting <input type="checkbox"/> Machine Shop Inspection <input type="checkbox"/> Machine Shop Practice <input type="checkbox"/> Mechanical Engineering <input type="checkbox"/> Quality Control <input type="checkbox"/> Reading Shop Blueprints <input type="checkbox"/> Refrigeration <input type="checkbox"/> Sheet Metal Worker <input type="checkbox"/> Tool Design <input type="checkbox"/> Toolmaking <p>RADIO, TELEVISION</p> <ul style="list-style-type: none"> <input type="checkbox"/> Industrial Electronics <input type="checkbox"/> Practical Radio TV Eng'ing <input type="checkbox"/> Radio and TV Servicing <input type="checkbox"/> Radio Operating | <ul style="list-style-type: none"> <input type="checkbox"/> Television Technician <p>RAILROAD</p> <ul style="list-style-type: none"> <input type="checkbox"/> Air Brakes <input type="checkbox"/> Car Inspector <input type="checkbox"/> Diesel Locomotive <input type="checkbox"/> Locomotive Engineer <input type="checkbox"/> Section Foreman <p>STEAM AND DIESEL POWER</p> <ul style="list-style-type: none"> <input type="checkbox"/> Combustion Engineering <input type="checkbox"/> Diesel—Elec. <input type="checkbox"/> Diesel Eng'g <input type="checkbox"/> Electric Light and Power <input type="checkbox"/> Stationary Fireman <input type="checkbox"/> Stationary Steam Engineering <p>TEXTILE</p> <ul style="list-style-type: none"> <input type="checkbox"/> Carding and Spinning <input type="checkbox"/> Cotton, Rayon, Woolen Mfg. <input type="checkbox"/> Finishing and Dyeing <input type="checkbox"/> Loom Fix'g <input type="checkbox"/> Textile Des'ing <input type="checkbox"/> Textile Eng'g <input type="checkbox"/> Throwing <input type="checkbox"/> Warping and Weaving <p>MISCELLANEOUS</p> <ul style="list-style-type: none"> <input type="checkbox"/> Domestic Refrigeration <input type="checkbox"/> Marine Engineering <input type="checkbox"/> Ocean Navigation <input type="checkbox"/> Professional Engineering <input type="checkbox"/> Short Story Writing <input type="checkbox"/> Telephony |
|--|---|--|--|--|

Name _____ Age _____ Home Address _____

City _____ Zone _____ State _____ Working Hours _____ A.M. to P.M. _____

Occupation _____

Canadian residents send coupon to International Correspondence Schools, Canadian, Ltd., Montreal, Canada. . . . Special tuition rates to members of the U. S. Armed Forces.

FIX TV

AND RADIO RIGHT AWAY!



—even if you never fixed
a lamp or doorbell before!

Amazing New Low-Cost Instruction Manual
Skips Hard-to-Understand "Theories"—
Tells HOW-TO-DO-IT in PLAIN ENGLISH

AT LAST—a well-known
EXPERT tells you in
PLAIN ENGLISH how to
fix TV or radio sets! Starts
you right off doing simple
repairs. Within weeks, you
can tackle tough jobs on
your own and friends' sets
—get a service shop job...
even start your own money-
making business at home!

NO complicated formula-
las! NOT a theory book!
Deals only with parts that
go wrong in sets — HOW to
find the trouble — and the
EASY way to FIX IT!

Why It's So Easy

John Markus, Associate
Editor of *Electronics Mag-*
azine spent FOUR years
making this one-volume
manual practical and easy-
to-follow—even for the most
"unhandy" beginner. A-B-
C directions and 700 clear
photos, diagrams, and draw-
ings show exactly WHAT
and HOW to fix, step-by-
step. Includes everything
you need to know: where
and how to buy tubes and
parts; how to test tubes
WITHOUT a tube tester;
how to use 58 common TV
controls; simple "cures" for
common troubles; how to fix
loudspeakers, phono pickups, an-
tennas — and more.

SEND NO MONEY

Mail coupon — without money!
When book arrives try it out on
your own or neighbors' sets. Make
it pay for itself in 10 days or don't
keep it. Mail coupon NOW to:
McGraw-Hill Book Co., Inc., Dept.
PM-8, 327 West 41 St., N. Y. City 36.

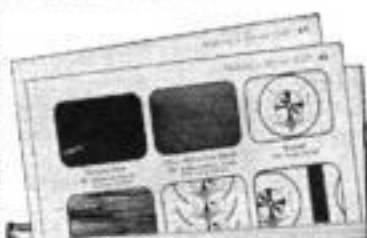

TELEVISION AND RADIO REPAIRING

TRY IT
FREE
FOR
10 DAYS

Tells How to "Cash In"
ON THE BIG DEMAND FOR
TV-RADIO REPAIRING

Make extra money
fixing sets for friends
and neighbors in spare
time...start your own
full-time business. Book
tells how to get start-
ed; tubes to stock; how
to make a service call.
Start fixing
sets and mak-
ing money be-
fore you're
half-way
through book.



FREE 10-DAY TRIAL COUPON

McGraw-Hill Book Co., Dept. PM-8,
327 West 41st St., New York 36, N. Y.

Please send me for 10 days' FREE EXAMINATION,
John Markus' "Television and Radio Repairing." If not
delighted, I may return book, pay nothing. Otherwise,
I will send only \$1.95 plus few cents delivery; then 3
monthly installments of \$2.00 each.

Name.....

Address.....

City..... Zone..... State.....

SAVE MONEY. Check here if enclosing full price
of \$7.95 WITH coupon. Then WE pay all delivery
charges. Same 10-day return privilege. (Offer good in
U.S.A. only.) PM-8

KEEP YOUR CAR BATTERY FULLY CHARGED AT HOME!



With a NORKO CHARGER, you
charge your battery at home—
overnight—without disconnecting
cables or removing battery from
car. And you get better service
—much longer life—from a bat-
tery kept fully charged.

Priced as low
as \$14.95

A dependable NORKO CHARGER is the handiest automotive
device you'll ever own. Quickly pays for itself. Operates from
110-volt home power. Compact, lightweight; sets on floor or shelf
or hangs from wall. Models for 6 and 12-volt batteries. Sold by
most auto stores.

If your dealer can't supply, send for FREE catalog. Many thou-
sands of wise motorists own NORKO CHARGERS. Get yours now.

SCHAUER MANUFACTURING CORP.

4532 Alpine Ave.

Cincinnati 36, Ohio

BE A LEADER IN AVIATION

Parks graduates are known world-
wide as leaders in aviation — their
education is the finest offered. Ad-
vance faster . . . earn more in less
time! Become a Parksmen!

B.S. degree in 3 yrs. from Saint Louis Uni-
versity — Aero. Eng., Aero. Adm., Maint. Eng.

Non-degree courses—A & E Mechanics, Private, Com-
mercial, Instrument, Flight Instructor and Multi-engine
Ratings . . . CAA-Approved.

All Parks schooling approved for Veterans.
Write for full information.

PARKS COLLEGE ARNOLD HALL
EAST ST. LOUIS, ILL.

DRAINS cellars, cisterns, wash tubs; \$6.95 IRRIGATES - CIRCULATES - SPRAYS



Type P Pump has 1,001 uses. Up to 3000 GPM; 450
GPH 80' high; or 1800 GPH from 25' well. Use 1/8
to 3/4 HP motor. Coupling included free. 1" inlet;
2 1/2" outlet. Stainless shaft. Won't rust or clog!
Prepaid if cash with order. (West of Miss. add 50¢)

MONEY BACK GUARANTEE
Centrifugal and Gear Pumps in All Sizes
LABAWCO PUMPS, Belle Meade 7A, N. J.



... Swiss or American

Unique Sweazy System starts you making
repairs right away. Develops your skill
step-by-step. Teaches modern methods...
professional short cuts. Learn by personal
attendance or spare time home study.
Approved for veterans. Free Sample Les-
son. No obligation. Write today!

CHICAGO SCHOOL OF WATCHMAKING
2330 Milwaukee, Dept. 185, Chicago 47, Ill.



MEN! TRAIN NOW FOR A BIG PAY FUTURE IN DIESEL & SCIENTIFIC MOTOR TUNE-UP

- Diesel Construction
- Diesel Engine Repairman
- Diesel Operator
- Industrial Maintenance
- Auto Engine Rebuilding
- Bus & Truck Maintenance

Go places with DIESEL! Farms, factories and
power plants, trains, ships, trucks, busses all use
DIESEL POWER. . . all need DIESEL-trained
men! You can start your DIESEL training at
home, in spare time, with tested, proved U E I
training. Course includes practical work on Diesel
engines under skilled instructors. You learn the
operation, maintenance, servicing of all types of
Diesel engines. PLUS Scientific Motor Tune-up.

ACT NOW! you'll like Diesel! High School
diploma not necessary. Write now for Free book
"EARNING POWER in DIESEL." Act Today!

UTILITIES ENGINEERING INSTITUTE

2521 Sheffield Ave., Dept. DC-48, Chicago 14, Ill. (Founded 1927)

INVENTORS

If you believe that you have an invention, you should find out how to protect it. The first step is to have a search made of the prior pertinent U. S. patents. If a report on this search indicates that the invention appears patentable you can apply for a patent, and the specifications and claims should be prepared.

The firm of McMorrow, Berman & Davidson, with offices in Washington, D. C., is qualified to take the necessary steps for you. We can make a preliminary search on your invention, advise you whether we think it can be patented, and prepare your application for patent.

Unless you are fully familiar with the U. S. Patent Laws, we recommend that you engage the services of a Registered Patent Attorney to protect your interests. The patent laws are *your* laws. A patent gives you the right to prevent others from making, using or selling the invention claimed in your patent for a period of 17 years.

Use these patent laws for your protection. Investigate whether your invention can be patented. If you have what you believe to be an invention, we suggest that you have this firm make a search for you.

Send for a copy of our Patent Booklet entitled "How To Protect Your Invention," containing information about patent protection and patent procedure. Along with this we will also send you an "Invention Record" form, for your use in writing down and sketching details of your invention. We will mail them promptly. No obligation. They are yours for the asking.

McMORROW, BERMAN & DAVIDSON

Registered Patent Attorneys

PATENTS • COPYRIGHTS • PATENTS

135-H VICTOR BUILDING, WASHINGTON 1, D. C.

HOW TO FIX ANY CAR

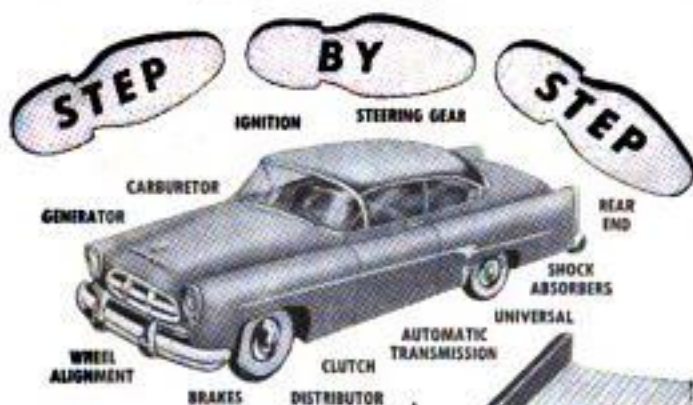

FREE 7-DAY TRIAL

MOTOR'S AUTO REPAIR MANUAL

ANY tune-up, service or repair job on ANY car can be as easy as A-B-C. . . . When factory experts show you how-to-do-it one step at a time. That's why no job's too tough to handle when you've got MOTOR'S brand-new AUTO REPAIR MANUAL at your elbow!

Book "starts from scratch" — tells you WHERE to start, what TOOLS to use—How to remove, repair and replace parts. Whether you're a beginner or an expert mechanic—you can "breeze through" ANY repair on ANY make or model car built from 1940 through 1955!

Everything You Need to Know in 1000 Big ILLUSTRATED Pages!

NEW, REVISED, 1000-Page Edition contains the "meat" from over 160 OFFICIAL shop manuals—simplified for YOU. 23,436 essential repair specifications on over 737 chassis models. More than 2,900 "this-is-how" pictures. 225,000 service and repair facts. Leads beginners every step of the way. Time-saving factory repair procedures for experts. Instructions and pictures so clear you CAN'T go wrong. Used by U. S. Army and Navy. 2,000,000 COPIES SOLD!

- Covers 737 Models All These Makes —1940 thru 1955**
- Buick Kaiser
 - Cadillac Lincoln
 - Chevrolet Mercury
 - Chrysler Nash
 - Crosley Oldsmobile
 - De Soto Packard
 - Dodge Plymouth
 - Ford Pontiac
 - Frazer Studebaker
 - Henry J Willlys
 - Hudson

Try Book FREE 7 Days

SEND NO MONEY! Pay postman nothing. Make manual PROVE to you what it's got. Unless you agree this is the greatest time and work saver you've ever seen—return book in 7 days and pay nothing. Mail coupon today to MOTOR book Dept., Desk 18, 50 W. 55 St., N.Y. 19

Some FREE Offer On MOTOR'S Truck and Tractor Repair Manual

Covers EVERY job on EVERY popular make gasoline and Diesel truck. Tractor made from 1946 thru 1954. FIVE 7-Day Trial. Check proper box in coupon.

MAIL COUPON NOW FOR 7-DAY FREE TRIAL

MOTOR BOOK DEPT.
Desk 18, 250 W. 55th St., New York 19, N. Y.

Rush to me at once (check box opposite book you want!):

MOTOR'S New AUTO REPAIR MANUAL. If O.K., I will remit \$2 in 7 days, \$2 monthly for 2 months and a final payment of \$5c (plus 35c delivery charges) one month after that. Otherwise I will return the book postpaid in 7 days. (Foreign price, remit \$9 cash with order.)

MOTOR'S New TRUCK & TRACTOR REPAIR MANUAL. If O.K., I will remit \$2 in 7 days and \$2 monthly for 2 months, plus 35c delivery charges with final payment. Otherwise I will return book postpaid in 7 days. (Foreign price, remit \$10 cash with order.)

Print Name..... Age.....

Address

City..... State.....

Check box and save 35c delivery charge by enclosing WITH coupon entire payment of \$6.50 for Auto Repair Manual (or \$8 for Truck & Tractor Repair Manual.) Same return-refund privilege.

TUBE FREE WITH EVERY TIRE AT NO EXTRA COST

EXPERIENCE IS THE BEST TEACHER. OUR MANY YEARS PROVES YOU CAN'T GET MORE. WHY PAY MORE? LOW OVERHEAD—LARGE VOLUME SALES & SMALL PROFITS BRING YOU THESE "LOWEST PRICES." WHAT GOOD IS A TIRE WITHOUT A TUBE? 22 YEARS AT THIS ADDRESS. FREE TUBES.

20 MOS. WRITTEN GUARANTEE

600-16	\$4.42	820-15	\$5.42	600-20	\$7.72	32x6 (8)	\$11.72
650-16	4.82	700-15	4.62	650-20	8.82	32x6 (10)	12.62
700-16	5.32	670-15	4.42	700-20	9.42	900-20	15.62
650-15	4.52	710-15	4.42	750-20	10.22	1000-20	15.82
760-15	4.72	800-15	5.22	825-20	16.72	1100-20	17.62

GOOD USED TIRES — NOT RECAPS

FREE If you buy 2 or more Passenger 4-ply tires, WE GIVE ONE tube FREE on each order, on request. Does not include W.W. or Truck Tires. This offer on 36 Mos. Tires only.

Specialists in Truck Tires—Selected for Toughest Jobs—Tops in Value

36 MOS. WRITTEN GUARANTEE WITH EVERY TIRE

600-16	\$5.52	475-19	\$4.82	700-15	\$7.52	700-20	\$9.52
600-16 (D)	5.92	640-15	4.22	750-16 (8)	8.72	750-20 (10)	12.62
650-16	5.72	670-15	5.22	700-17	8.82	750-20 (8)	11.92
650-16 (D)	6.62	710-15	5.52	750-17	10.32	825-20	18.52
700-16	6.02	760-15	5.82	825-15	12.92	900-20	17.92
750-16	7.52	800-15	5.92	600-20	9.02	1000-20	17.92
850-16	4.52	820-15	5.92	650-20	9.82	1100-20	19.92
350-17	3.72	670-16	5.32	32x6 (8)	12.02	1100-22	18.92
650-15	5.52	760-16	7.02	32x6 (10)	13.92	1000-22	20.02
700-15	4.92	700-16 (D)	7.32	750-15	10.72	1100-24	23.02

WHITE WALLS \$1.00 EXTRA

"EXTRA SPECIAL" Lot just received all size 4 ply pass. FREE TIRE with 2 or more of these also.—W.W. \$1.00 Extra **\$7.52**

Thousands of tires shipped all over the U.S.A. All tires shipped F.O.B. Phila. Send Check or M.O. with this ad. Dept. 2. No C.O.D.

STANDARD 834 N. Broad St., Philadelphia 30, Pa.

FOR BIG MEN ONLY!

SIZES 10 to 16 WIDTHS AAA to EEE

We SPECIALIZE in large sizes only. Sizes 10 to 16; Widths AAA to EEE. Last-Tops; Wing Tips; Hand-Sewn Mocassins; Cordovans; Dress Oxford; Work Shoes; Socks; Slippers; Rubber. Enjoy the finest in fit, comfort, style at amazingly low cost. Mail only. Write TODAY for FREE Style Book!

KING-SIZE, INC.
599 BROCKTON, MASS.

SEND FOR FREE CATALOG

MECHANICAL DENTISTRY

To make Crowns, Plates, Bridgework, etc., for Dentists. Easy practical way to learn mechanical dentistry at home in spare time. FULL EQUIPMENT OF TOOLS AND MATERIALS INCLUDED WITH COURSE. Low tuition. Easy terms. Write for FREE BOOK about this money-making profession that is not affected by machine age.

MCCARRIE SCHOOL OF MECHANICAL DENTISTRY
207 N. Broad St., Dept. 44, Philadelphia 7, Pa.

LEARN LOCKSMITHING

Learn this fascinating, profitable trade from experts in your spare time at home! Age or physical handicap no disadvantage. Year around, steady income. Full or part time. Practical, illustrated lessons. You can make money even while learning! All materials and special tools supplied without extra charge.

INSTITUTE OF LOCKSMITHING, Dept. P-69
15 PARK AVENUE RUTHERFORD, N. J.
Lic. by N.J. State Board of Education
Approved for Veterans

send for FREE BOOKLET

GARAGE YOUR CAR

Vinyl Plastic **ADD YEARS TO ITS LIFE!**

PORTABLE GARAGE

\$10 value NOW ONLY \$6⁹⁵ POSTPAID

Beautiful opaque-white waterproof garage covers any car, anywhere, in seconds! Protects finish from rain, salt air corrosion, sun, dust! Keeps animals, prowlers away! Strong! Durable! Folds easily to small, compact size. Also covers boats, furniture, machinery, etc. Check or money order; no C.O.D. Immediate shipment.

GOTHAM HOBBY CORP., Dept. M8, 107 E. 126th St., New York 35

Train in Big
COYNE
Shops

GREAT OPPORTUNITY FIELDS!

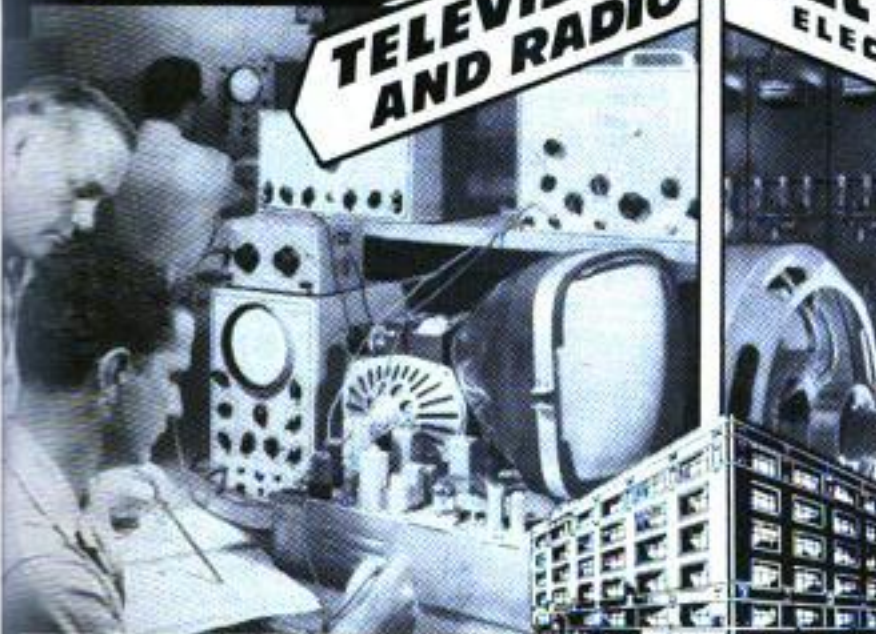

Instructor helping students check the wiring and trace the circuits of television receivers.



Instructor explaining operation and testing of a large Motor Generator.

This big fire-proof building is occupied entirely by Coyne.

YOUNG MEN AND OLDER MEN— PREPARE FOR A CAREER WITH A FUTURE!

Conditions are changing. Many "one operation" jobs will not last. Don't be satisfied with a "no future" job. Whether 17 or up to 45 years of age, train the Coyne way for a better job and a real future in **ELECTRICITY** or **TELEVISION-RADIO**, fields that offer a world of opportunities.

TELEVISION-RADIO **ELECTRICITY**

Here at Coyne you're trained for Television, Testing, Trouble-Shooting on Radio, Public Address, F. M. Sound Units, etc. Many Coyne trained men in good jobs or own well paying Television-Radio businesses of their own.

Big future in Power Plant Work, Motors, Industrial Electronics, Armature Winding, Home and Factory Wiring, Appliances, Refrigeration, Maintenance, Illumination, etc. Lifetime job service to Coyne graduates.

LARGEST, OLDEST, BEST EQUIPPED SCHOOL OF ITS KIND IN THE U.S.



Mail Coupon for Big FREE Book!

Whether you prefer Television-Radio or Electricity, train on actual equipment at Coyne. We will send you a Big, fully illustrated Book "Guide To Careers in Electricity and Television-Radio". No salesman will call. Mail coupon TODAY.

WE TRAIN YOU IN CHICAGO

Our famous Practical-Technical method gives you practical experience on a massive outlay of equipment. Actual shop work plus necessary technical training. You are trained right here in the great Coyne shops. Send for BIG FREE BOOK.

**APPROVED
FOR
VETERANS**

START NOW—PAY LATER

Enroll now, pay most of tuition after graduation. Special plan for men of draft age. We'll help you get part-time work, if you need it to help pay living costs while at Coyne.

R. W. COOKE, President

COYNE
ELECTRICAL SCHOOL

FOUNDED 1899

A TECHNICAL TRADE INSTITUTE OPERATED NOT FOR PROFIT
500 S. PAULINA STREET, CHICAGO, Dept. C5-72H
ELECTRICITY ★ RADIO ★ TELEVISION ★ REFRIGERATION ★ ELECTRONICS

B. W. Cooke, President
COYNE ELECTRICAL SCHOOL 500 S. Paulina
Dept. C5-72H, Chicago 12, Ill.

Send me your Big Free book. I am interested in field checked below. This does not obligate me.
 TELEVISION-RADIO ELECTRICITY

NAME.....

ADDRESS.....

CITY..... STATE.....

These great minds were Rosicrucians . . .



Francis Bacon Benjamin Franklin Isaac Newton

WHAT SECRET POWER DID THEY POSSESS?

Why were these men great?

How does anyone—man or woman—achieve greatness? Is it not by mastery of the powers within ourselves?

Know the mysterious world within you! Attune yourself to the wisdom of the ages! Grasp the inner power of your mind! Learn the secrets of a full and peaceful life!

Benjamin Franklin, statesman and inventor . . . Isaac Newton, discoverer of the Law of Gravitation . . . Francis Bacon, philosopher and scientist . . . like many other learned and great men and women . . . were Rosicrucians. The Rosicrucians (NOT a religious organization) have been in existence for centuries. Today, headquarters of the Rosicrucians send over seven million pieces of mail annually to all parts of the world. Address: Scribe N.D.W.

THIS BOOK FREE



The ROSICRUCIANS

San Jose (AMORC) California, U.S.A.

SEND THIS COUPON

Scribe N.D.W.
The ROSICRUCIANS
(AMORC)
San Jose, California, U.S.A.
Please send me the free book, *The Mastery of Life*, which explains how I may learn to use my faculties and powers of mind.

Name _____

Address _____

City _____

State _____

FREE!
All New 1956
STARK BRO'S
Fruit and Landscape
CATALOG



You can
Make Money

Homer De Ville earned \$11,740 last year. Let Stark show you how to make big money in spare hours or full time. Ask for details, FREE.

Only from STARK can you get famous
Stark Leader Varieties

64-page catalog—all in gorgeous color! See famed Stark Roses, Flowering Shrubs and other home beautifying plantings! Also the vast variety of U.S. Patented and Trade Marked fruit offered exclusively by Stark Bro's . . . including the amazing Stark DWARF Fruit Trees. Contains valuable Planting Guide. Write for FREE catalog.

STARK BRO'S NURSERIES & ORCHARDS
Dept. 9586 - Louisiana, Mo.

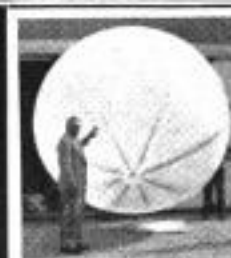

GIANT BALLOONS

They're really BIG—surplus U. S. Govt. (new average) Neoprene weather, target balloons. GREAT FUN in the backyard; at parties, picnics, dances, fairs. TERRIFIC for high school and college PROMS. They attract BIG crowds to BUSINESS openings, civic events, conventions, exhibitions, trade shows. ORDER TODAY! Approx. inflated sizes:

3 ft. dia., 49c — 5 ft. dia., 99c
10 ft. dia., \$1.59

Postage paid on prepaid orders. Calif. residents please add sales tax.

VOLUME SALES CO., War Assets Division

Dept. PM-855 3930 Sunset Blvd. Los Angeles 29, Calif.

SCIENTIFIC CRIME DETECTION



IT'S EASY TO LEARN
Let us teach you in your own home. Learn Finger Printing, Firearms Identification, Police Photography, Criminal Investigation Methods thoroughly, quickly, at small cost. Over 800 of all U. S. Bureaus of Identification employ I. A. S. students or graduates. Write today, stating age.

INSTITUTE OF APPLIED SCIENCE, 1920 Sannyside Ave., Dept. 135-C
Chicago 40, Ill.
(A Correspondence School Since 1910)

STUDY INDUSTRIAL DESIGN

You can train at Art Center School in California with practicing professionals for upper-level jobs in INDUSTRIAL DESIGN. Recent graduates have been added to the staff at General Motors, Chrysler, Raymond Loewy, Henry Dreyfuss, etc. Majors in transportation, general product design, structures, community development, furniture design, packaging, display. 4-year degree courses. Learn to combine imaginative design with technical proficiency, coordinate utility and beauty. Stimulating environment. Field trips. Advantages of mild Southern California climate and nearby holiday spots. Coed. Placement service. Established 24 years. New terms Feb., June, Sept. Write for catalog.

ART CENTER SCHOOL, Edward M. Adams, Director
5353 WEST THIRD STREET, LOS ANGELES 5, CALIFORNIA



OVER 700% PROFIT!

WITH THE
PDQ CHAMPION PHOTOMASTER

Makes finished pictures in 2 minutes.

Takes and finishes 30 to 40 everlasting, black and white or sepia photos in home. No dark room. Guaranteed not to fade. Photos taken on "SUPER-SPEED" direct positive paper. Picture size 2 1/2 x 3 1/2 in. Complete, easy-to-operate portable photo studio. Size 4 1/2 x 5 x 10. Wt. 6 lbs. **700% PROFIT.** Write quick, get details about the great PDQ CHAMPION PHOTOMASTER.

P D Q CAMERA CO.

1161 N. CLEVELAND AVE. Dept. PM-755 CHICAGO 10, ILL.

Work with and keep all of this practical, commercial type equipment

"YOU LEARN BY DOING! THAT'S WHY D.T.I. GETS REAL RESULTS!"



21 INCH
Build and keep D.T.I.'s NEW 2 Unit TV Set—ideal for custom installation. (D.T.I. also offers home training without the TV set.)



Television, Radio, Electronics, has created thousands of good jobs; jobs with money, respect, position; jobs you may choose among—if you only had training. DeVRY Training is modern, thorough, practical—followed by a real Employment Service. Thousands have stepped into good pay—why not you? No need to leave home; no need to quit your present job; no special preliminary training required. Fill out coupon below and get the full story. Men 17 to 45 preferred.

Amazingly effective NEW home training in
TELEVISION RADIO ELECTRONICS



NEW STYRENE ELECTRO-LAB® SPEEDS LEARNING
Simply place a pictorial diagram under transparent Styrene base. Follow the diagram. Wiring is tremendously simplified. Work a total of over 300 learn-by-doing projects—a wonderful way to get practical experience.
*Trade-mark

One of America's Foremost Television Training Centers



DeVRY TECHNICAL INSTITUTE
FORMERLY
DeFOREST'S TRAINING, INC.
CHICAGO 41, ILLINOIS



You build and keep a quality Oscilloscope—almost a necessity for Television servicing. Helps you earn while you learn. You also build and keep a Vacuum Tube Voltmeter—a highly versatile test unit you can use when you are ready to make real money! IF PREFERRED, you may get all your preparation in D.T.I.'s big Chicago training laboratories—among the finest. (See building pictured below.)
Valuable information for men subject to military service.



YOUR OWN HOME MOVIES
Movies are a remarkable feature of the D.T.I. System. You use a movie projector and many reels of films. Run off each film as often and as slowly as you want. A wonderful aid to help make important points crystal-clear. Get the full story! Send in that coupon.

Mail Coupon Today

89 WAYS TO EARN MONEY IN TELEVISION RADIO ELECTRONICS

DeVRY TECHNICAL INSTITUTE
4141 Belmont Ave., Chicago 41, Ill. Dept. PM-8-L

I would like complete facts including "89 Ways to EARN MONEY in Television-Radio-Electronics."

Name _____ Age _____
Street _____ Apt. _____
City _____ Zone _____ State _____
2 _____

D.T.I.'s training is available in Canada.

AFTER BATH OR SHOWER—

DRY OFF!

COOL OFF!

with new pure white!

He-man scent!



59¢

9 OZ. ECONOMY SIZE

SAVE 75% ON

WORK CLOTHES!

SURPLUS STOCK FROM MIDWEST SUPPLY FIRM!
Terrific values you've got to see to believe!

SHIRTS 79¢

Made to sell for 2.99! Now Only 4 for \$2.99

What a buy! 4 for the price of one! These shirts, though used, are washed, sterilized and ready for long, tough wear. In blue, tan or green. Send name, address, neck size.

PANTS to match Unbelievable 99¢

Bargains! Sold for 3.95. Now only 4 for \$3.75
Send waist measure and inside leg length.

COVERALLS . . . wear 'em used and save plenty! Originally 5.95. Now only \$1.95

3 for \$5.75
Send chest measurement.

SHOP COATS . . . fully reconditioned. \$1.79

Take advantage of this rock-bottom price. Send chest measurement. Now only 3 for \$5.00

SATISFACTION GUARANTEED! Your money back if you can beat these bargains anywhere! You can't lose so order TODAY for immediate delivery! Pay postman or send money with your order and save postage. \$1.00 deposit on C.O.D. orders.

GALCO SALES CO. Dept. 138

7120 Harvard Ave. • Cleveland 5, Ohio

SHORTHAND IN 6 WEEKS

**Write 120 words per minute
Age no obstacle—Lowest Cost**

Famous SPEEDWRITING shorthand. No symbols; no machines; uses ABC's. Easiest to learn and use. Fast preparation for a better position. Nationally used in leading offices and Civil Service. 120 words per minute—50% FASTER than Civil Service requirements. Over 300,000 taught by mail or through classroom instruction. The very low cost will surprise you. Typing available. 32nd Year. Schools in over 400 cities in U.S., Canada, Cuba, and Hawaii.

WRITE FOR FREE BOOKLET TO SCHOOL OF

Speedwriting

Dept. 1508-5, 55 W. 42 St., N.Y. 36

SHINE WITHOUT 'POLISH'



Cars Gleam Like Mirror

MEN! WOMEN! So easy a child can do it! Amazing "Ibry" Polisher puts mirror-like shine on car WITHOUT 'POLISH'. No messy pastes, liquids, sprays. Simply glide over car. FLESTO! Leaves hard, lustrous, long-lasting protective Wax Coating. Take orders! Earn money!

SAMPLES FOR TRIAL

Sample offer sent immediately to all who send name at once. Just a postcard will do. SEND NO MONEY—just your name.

KRISTEE CO., Dept. 684, Akron 8, Ohio

REAL ESTATE BE A BROKER

PAYS BIG! SEND FOR FREE, BIG, ILLUSTRATED CATALOG NOW! Graduates report making substantial incomes. Start and run your own business quickly. Men, women of all ages, learn easily. Course covers Sales, Property Management, Appraising, Loans, Mortgages, and related subjects. **STUDY AT HOME** or in classrooms in leading cities. Diploma awarded. Write TODAY for free book! No obligation.

Approved for World War II and Korean Veterans
WEAVER SCHOOL OF REAL ESTATE (Est. 1936)
2020R Grand Avenue Kansas City, Mo.



How to Make Money with Simple Cartoons



A book everyone who likes to draw should have. It is free; no obligation. Simply address **FREE BOOK**

CARTOONISTS' EXCHANGE
Dept. 98D Pleasant Hill, Ohio

BUILD LUGGAGE AT HOME WE SELL YOUR PRODUCTS!

ONLY NEW HOME MONEY-MAKING PLAN IN YEARS!

Make Luggage and cases for traveling, photographers, musicians, salesmen, electronics, tools, portables, 1001 other items. Also repair Luggage. No special equipment needed. **BIG PROFITS.** We supply complete instructions, materials—everything. Write for free details and Business Plan. **ABARSI CASE-CRAFT, Dept. G-8, 805 W. Sunset Blvd., Los Angeles 12, Calif.**

FREE — Amazing Book on RHEUMATISM, ARTHRITIS

If you suffer the aches, pains and discomforts of Rheumatism, as manifested in ARTHRITIS, NEURITIS, SCIATICA or LUMBAGO, send today for the FREE Book. It reveals important facts about why drugs and medicine give only temporary relief without removing cause. Explains fully a proven, specialized system of treatment that may save you years of distress. No obligation. Write for this FREE Book today!

BALL CLINIC, Dept. 756, Excelsior Springs, Mo.

Learn BAKING At Home

Baking is one of America's high industries in WAGES. Nearly DEPRESSION-PROOF. Thorough basic home course lays sound foundation. If you have aptitude, write for FREE Booklet, "Opportunities in Commercial Baking."
NATIONAL BAKING SCHOOL
835 Diversey Parkway Dept. 135C Chicago 14.



POPULAR MECHANICS

Copyrighted material



National Schools Graduates Prove
**AGE & PREVIOUS EDUCATION
NO BARRIERS TO SUCCESS!**

Get into **HIGH-PAYING
TELEVISION
ELECTRONICS-RADIO!**

Are you
between
17-55?

**LEARN AT HOME
IN SPARE TIME!**

Are you
alert, sincere,
ambitious?



**Master all Phases with our amazing
Shop-Method Home Training & Practical
Equipment! We have trained Thousands
for Big-Pay Jobs! WE WILL TRAIN YOU!**



SET REPAIR IS PROFITABLE!

Our easy Shop-Method Lessons & Manuals cover this Profitable Field! **LOW TUITION.** Opportunity to **EARN AS YOU LEARN!** Free Placement Assistance. Help with technical and personal problems. Send coupon for free **ILLUSTRATED BOOK, "Your Future in TV-Radio-Electronics."**



YOU RECEIVE THIS PROFESSIONAL MULTITESTER—a must for every Technician! Also standard parts to build Receivers, Oscillators, Signal Generator, Continuity Checker, Short Wave & Standard Broadcast Superhet Receiver, many other units. All part of your course, all yours to keep. Mail coupon today!

**OPPORTUNITIES WIDE OPEN IN THESE
AND OTHER SPECIALIZED FIELDS!**

Loudspeaker Systems TV-Radio Service,
Hi-Fi, F.M., Tape Recording Installation-Repair
Your own business Sales and Distribution

COLOR TV & ELECTRONICS

— America's Fields of the Future!
Thousands of **TRAINED TECHNICIANS** will make "small fortunes" in the next few years.



ATTENTION DRAFT-AGE MEN! National Schools training prepares you for **HIGHER RATINGS & PAY GRADES!**

NATIONAL SCHOOLS

TECHNICAL TRADE TRAINING SINCE 1905

Los Angeles 37, California Chicago: 323 W. Polk St.
In Canada: 811 W. Hastings St., Vancouver, B. C.

You can't buy
these Valuable
Books, but we
send them **FREE!**
MAIL COUPON!



50 YEARS' EXPERIENCE

training Men Like Yourself for Success

KNOW YOUR SCHOOL! These are the national headquarters of National Schools' famous Shops, Labs & Studios. Get your Home Training and "sheepskin" direct from Los Angeles, recognized as a major "World Center of Electronics"!

APPROVED FOR G. I. TRAINING
BOTH HOME STUDY AND RESIDENT COURSES OFFERED

ACT NOW! MAIL NOW TO NEAREST OFFICE!

(mail in envelope or paste on postal card)

NATIONAL SCHOOLS, Dept. RB-85

4000 S. FIGUEROA ST., LOS ANGELES 37, CALIF. OR 323 WEST POLK ST., CHICAGO 7, ILL.
Please rush **FREE TV-Radio Book & Sample Lesson.** I understand there is no obligation, no salesman will call.

NAME _____ BIRTHDAY _____ 19__

ADDRESS _____

CITY _____ ZONE _____ STATE _____

Check if interested **ONLY** in Resident Training at Los Angeles. **VETERANS:** Give date of Discharge _____



YOU
can
acquire

LAW NIGHTS AT HOME! L. L. B. DEGREE

LaSalle's famous Law Library—used as reference in many Law libraries and Law offices—has enabled thousands to master Law surprisingly fast, in spare hours at home, for business and professional advancement.

These 14 remarkable volumes, compiled by leading professors and lawyers, cover the whole basic field of Law in condensed, orderly, simplified manner.

You advance rapidly with this great library, plus special lectures furnished. We guide you step-by-step with personalized Problem Method of instruction . . . you learn by doing—handling legal problems—not by memorizing rules.

Send for two FREE 48-page booklets, "Law Training for Leadership," and "Evidence," answering questions about Law and its value to you, and telling how LaSalle Law graduates are winning rapid advancement in business and public life. Mail coupon below. No obligation.

LA SALLE EXTENSION UNIVERSITY A Correspondence Institution

417 S. Dearborn St. Dept. 864L Chicago 5, ILL.

Send me your two FREE booklets described above, without obligation.

Name.....Age.....

Street.....

City, Zone & State.....

MONEY in DONUTS

Make new greaseless donuts. Start in kitchen. No smoke. Sell stores, cash daily. No experience necessary. Free recipes. No obligation. Write! ARTIN RAY CO., 3605 SO. 15th AVENUE, MINNEAPOLIS 7, MINN.



HANDS TIED?

—because you lack a
HIGH SCHOOL DIPLOMA

• You can qualify for an American School Diploma in spare time at home! If you have left school, write or mail coupon for FREE booklet that tells how. No obligation of any kind.

OUR 58TH YEAR

AMERICAN SCHOOL, Dept. VC45
Drexel at 58th, Chicago 37, Illinois

Please send FREE High School booklet.

Name.....

Address.....

City & State.....

Canadian Residents: Complete Canadian Course Available. Write American School, 1610 Sherbrooke St. West, Montreal.



LEFAX

TECHNICAL DATA BOOKS

POCKET SIZE • LOOSE LEAF

Printed on loose leaf, 6 hole, 6 1/4" x 3 1/4" bond paper, each book contains about 140 pages of technical data, condensed, accurate, essential, for student, engineer, technical worker, business man **\$1.25** each

Architecture	Surveying	Mech'l Drawing	Metallurgy
Home Heating	Surveying Tables	Machine Design	Hydraulics
Illumination	Highway Eng'g.	Machinist's Data	Radio
Electrician's Data	General Math	Mech. of Materials	Television & FM
Builder's Data	Math Tables	Pwr. Trans. Mach.	Electricity, AC
Lumber Data	Physics	Thermo. Tbls. &	Electricity, DC
Air Conditioning	Trig-Log Tables	Charts	AC Motors &
Building Constr.	Gen'l Chemistry	Phys. & Thermo.	Gen'lrs.
Reinf. Concrete	Chemical Tables	Data	Transformers,
Piping Data	Analytic Chem.	Metals	Relays & Meters

Write for FREE catalogs (2000 listings). See how helpful LEFAX can be to you. Send \$1.25 book, or \$6 for any five books to

LEFAX PUBLISHERS, Dept. PM-8, PHILADELPHIA 7, PA.

LOOK! **A MILLION THRILLS!**
High Power
BINOCULARS
30 DAY FREE TRIAL
Finest Precision Optics
Money Back Guarantee
Easy Pay Plan
33 Models
\$9.95
UP
Free! Catalog & Book
"How to Select Binoculars"
Dept. MB 43 E. Green
Pasadena, Calif.

Secrets of VENTRILOQUISM
Now Revealed!
Easy to learn in 60 to 90 days with our Home Study Course. RESULTS GUARANTEED. Make Money! Be Popular! Have Fun! Big Opportunity! Radio, Television, Stage Appearances! For FREE information regarding price and terms, WRITE. You must state your age. Dummy Catalog 25c.
FRED MAHER SCHOOL OF VENTRILOQUISM
Box 36, Studio PM-8 Kensington Station
Detroit 24, Michigan

WATCHMAKING

Learn at home • FREE sample lesson • Approved for Vets.
CHICAGO SCHOOL OF WATCHMAKING
2330 N. MILWAUKEE AVE., DEPT. 185-A, CHICAGO 47, ILL.

AGENTS START BUYING SERVICE AT HOME

GET BIG NAME MERCHANDISE

for your clients up to 40% less than reg. price. Operate sparetime. Sales easy as you can give sizeable discounts, still make fat comm. Postcard brings free plan.

AMERICAN BUYERS SERVICE
HERTEL STATION, DEPT. R, BUFFALO 16, NEW YORK

GET
UP TO
40%
OFF

Print Your Own
Cards, Stationery, Advertising, labels, circulars, photo and movie titles, church work, tags, etc. Save money. Sold direct from factory only. Raised printing like engraving, too. **Print for Others, Good Profit.** Have a home print shop. Easy rules supplied. Pays for itself in a short time. Write for free catalog of outfits and all details.
KELSEY PRESSES
KELSEY PRESSES, N-37 MERIDEN, CONN.

RUPTURED

BE FREE FROM TRUSS SLAVERY

NOW there is a new modern Non-Surgical treatment that permanently corrects rupture. These Non-Surgical treatments are so certain, that a Lifetime Certificate of Assurance is given. Write today for our FREE Book that gives facts that may save you painful and expensive surgery, and tells how non-surgically you may again work, live, play and love and enjoy life in the manner you desire. There is no obligation.
Excelsior Hernia Clinic Dept. 8305 Excelsior Springs, Mo.

POPULAR MECHANICS

SEND FOR Free Record

START SPEAKING FRENCH OR SPANISH ALMOST OVERNIGHT!

HERE'S the easiest way to learn FRENCH, SPANISH, Russian, German, Italian, Japanese or Brazilian. Listen to FREE 2-sided non-breakable record. Let your eyes follow words in FREE sample lesson. Almost at once you'll be chatting in a new language with a perfect accent! That's all you hear! No memorizing needed. Just listen—imitate! It's that easy! Offer may end soon. Rush 25c to help cover cost of special packaging, shipping. State language you want. We'll also send free information on full Cortina course. **CORTINA ACADEMY, Dept. 648, 136 W. 52nd St., New York 19.**

LEARN TO MOUNT BIRDS

ANIMALS, FISH, PETS
Be a Taxidermist. Save your hunting TROPHIES. Have a fine home-museum. Hunters, save and MOUNT your beautiful DUCKS, QUAIL, DEER, TAN skins, FURS. Great Fun. Spare-time PROFITS. **FREE BOOK** Tells ALL about it. 100 fine wild-game pictures, 48 pages. SEND TODAY, don't delay. Get this WONDERFUL FREE BOOK, MEN AND BOYS. Learn Taxidermy. Double your hunting pleasure. Rush letter or POSTAL today. STATE YOUR AGE. **N. W. SCHOOL OF TAXIDERMY, Dept. 2508 Omaha, Neb.**

A "GOOD HAND" HELPS YOU SUCCEED!
LEARN TO WRITE WELL
Handwriting quickly improves with our easy-to-understand picture lessons! Put your spare time to good use; send today for **FREE BOOKLET**, "How to Become a Good Penman," or check volumes wanted below at \$1 each: Business Writing Artistic Writing Card Writing Bird & Design Flourishing Engraving Alphabets. **COMPLETE SET \$4.50.** Ask for price list of penman's supplies.
TAMBLYN SCHOOL of PENMANSHIP
S.A. Ziller, Pres., 442 Ridge Bldg., Kansas City, Mo., USA

SOCK-O
World's Most Powerful
SUPER SLINGSHOT
SILENT • RIFLE FAST • POWERFUL • ACCURATE
Great for small game, targets. 45 lb. pull. BIG steady Stock. Lively. Raw rubber. Sweet shooting! FREE! 100 steel balls, rubber and target. FREE!!! Thrilling SURPRISE PACKAGE with Two slings at \$2.95. *Harry, get 2! Guaranteed.* Approved by American Small Game Sling-shot Assoc.
SOCK-O, PM, 4860 W. 137 St., Hawthorne, Calif.

Send for **FREE** 112 page Illustrated Catalog of Farm, Home, and Workshop Bargains.
Write to **WELLWORTH TRADING COMPANY**
Dept. E-8
1832 S. WABASH AVE. CHICAGO 16, ILL.

RUN A CAFE OR DINER

I can show you how to get into this marvelous business. Opportunities plentiful when you know how to proceed. Be independent! Learn every phase of the business from how to get started quickly on small investment to menu planning, food preparations, money-making methods, the 7 ways to finance your first place. 20 fact-filled lessons in course. Study at home. Free trial. Money-back guarantee. Write today for FREE booklet.

SCHOOL OF RESTAURANT ARTS, Box 18-D, Fremont, Ohio
Please send me, without obligation, my copy of "Cafe, Diner Business."
Name _____
Address _____

FED UP?

with your present job? ...
your pay? ... your future?



"HERE'S MY SUCCESS SECRET ...

I studied ART at home— SO CAN YOU!"

says **ALBERT DORNE**,
one of America's highest-paid illustrators

"If You Have Talent, your future is secure. Prepare at home, in spare time, for a successful, money-making art career...as I did. This exciting field has no age limits, seniority or prejudices. Nothing to hold you back. So don't delay. Mail the coupon today."

Test Your ART Talent FREE!

Thousands gladly paid \$1 to take this revealing Talent Test ... to learn if they had hidden art talents. It's yours free of charge, without obligation.

America's 12 Most Famous Artists

Norman Rockwell	Harold Von Schmidt
Al Parker	Peter Helck
Jon Whitcomb	Ben Stahl
Austin Briggs	Doug Kingman
Stevan Dohanos	Fred Ludkens
Robert Fawcett	Albert Dorne

Famous Artists Schools

Stude 6-V Westport, Connecticut

Send me with no obligation the Famous Artists Talent Test

Mr. _____
Mrs. _____ Age _____
Miss _____ (PLEASE PRINT)
Address _____
City _____ Zone _____ State _____



IF YOU "EAT, SLEEP
AND LIVE" CARS...

**TURN YOUR HOBBY
INTO A CAREER!**

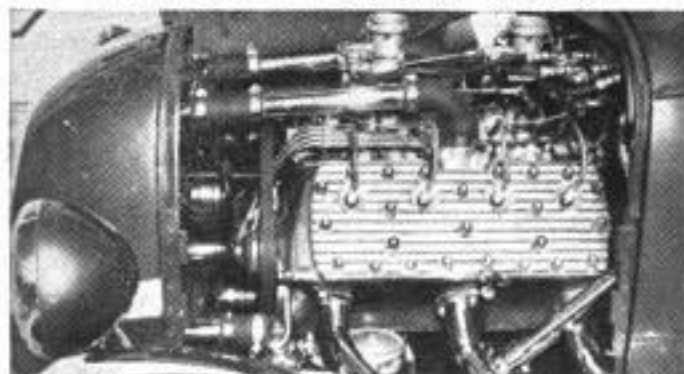

Get America's Big-time, Big-future

AUTO MECHANICS & DIESEL COURSE *at home in your spare time!*

Los Angeles' National Schools, America's automotive Technical Trade School since 1905, now brings its famous resident Shops and Faculty direct to you at home—to prepare you to earn more money, with job security, in today's fast-moving, opportunity-filled Auto Mechanics Industry! Get your home training from the "Car Capital of The World"—America's most auto-minded city, center of Hot Rod and Sports Car activity! Mail coupon right now!

"SHOP-METHOD" HOME TRAINING!

YOU MASTER ALL PHASES, INCLUDING DIESEL! All lessons fully illustrated. Latest equipment covered.



THIS SET OF LIFETIME TOOLS IS YOURS! Also all-metal tool box. Part of your course, yours to keep. **EARN WHILE YOU LEARN!** We show you how to start Spare Time Earnings soon after enrollment.

ATTENTION MEN OF DRAFT AGE. Learn how you can achieve higher rating and pay. Mail coupon *at once!* **APPROVED FOR G. I. TRAINING.** Both Home Study & Resident Courses. Free help with technical and personal problems—Job Placement Service.



Send for **FREE FACT-BOOK
AND SAMPLE LESSON!**

**NOW! 2 offices to serve you faster!
Mail coupon today to one nearest you!**

NATIONAL SCHOOLS

Technical Trade Training Since 1905

LOS ANGELES 37, CALIFORNIA

IN CANADA: 811 West Hastings Street, Vancouver, B. C.

MAIL NOW TO OFFICE NEAREST YOU!

(mail in envelope or paste on postal card)

NATIONAL SCHOOLS, Dept. DB-85

4000 S. FIGUEROA STREET
LOS ANGELES 37, CALIF.

OR

323 WEST POLK STREET
CHICAGO 7, ILLINOIS

Send **FREE** Auto-Mechanics Book and Sample Lesson. No obligation, no salesman will call.

NAME _____ BIRTHDAY _____ 19__

ADDRESS _____

CITY _____ ZONE _____ STATE _____

Check if interested **ONLY** in Resident School Training at Los Angeles.
VETERANS: Give Date of Discharge _____

WRITE: BREVITYPE INSTITUTE, SAN DIEGO, CALIF., DEPT 1828
**LEARN THE WORLD'S SIMPLEST,
SPEEDIEST SHORTHAND NOW**

FREE—please send me typical lessons, details on Brevitype—the world's simplest, speediest shorthand—first machine shorthand to eliminate coding. Tell me how I learn Brevitype in 30 days through your personally guided home-study course. Show me how switching to Brevitype, as hundreds have, prepares me for security as a stenographer, secretary, court or hearing reporter here, and abroad, in business or Civil Service—helps me increase my salary 50% to 100%. Include costs and budget plans.

BREVITYPE THE EASY-TO-LEARN MACHINE SHORTHAND



Guaranteed by
Good Housekeeping
NOT AS ADVERTISED THEN

MODERN:
TYPEWRITER KEYBOARD!
NO CODING! FAST ABC!

THE BREVITYPE
MACHINE, WHICH
CARRIES THIS SEAL,
COMES WITH
THIS COURSE

START YOUR OWN SHARPENING BUSINESS

WITH THE

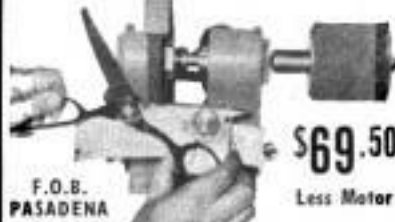

F.O.B.
PASADENA

\$69.50

Less Motor

New All-In-One Ball-Bearing Sharpener. Sharpens all makes pinking shears, scissors, knives, etc. Does a perfect job unmatched by other sharpeners. Easy to operate. The machine of many uses. Order today or write for new folder A-B.

TURPIN-JONES CO., Box 1109, Pasadena 1, California

TASOPE PHOTO-ENGRAVING PLANTS



Material Cost
Of This Cut 3/4c
Selling Price
\$1.00 And Up

Establish your own profitable **PHOTO-ENGRAVING** business. Make cuts for newspapers, printers, and advertisers. Make etched name plates, plaques etc. Instructions furnished, no experience necessary. Sold direct from factory since 1931. First five hundred cuts sold locally or by mail will pay for plant and pay you well for your time. Write for **FREE** catalog.

TASOPE, DEPT. PM-8, AURORA, MO.

RADIO

Engineering. All phases radio & electronics theory & practice; television; FM; broadcasting; servicing; aviation, marine & police radio. Prepare for good pay; 18-month course. Graduates in demand by major companies. Enter Jan., March, June, Sept. Regular campus life. Write for catalog. **VALPARAISO TECHNICAL INSTITUTE, Dept. D, Valparaiso, Ind.**

BECOME AN EXPERT IN

TRAFFIC

Traffic men earn \$4,000 to \$10,000 and up. Thousands of firms need experts on rates, tariffs, regulations. We train you *thoroughly* in spare time at home for executive traffic jobs. Personal training under traffic authorities. Placement counsel and help. Write for free, 68-page book "Traffic Management—the Fast Growing Profession."

LASALLE Extension University, 417 So. Dearborn St., A Correspondence Institution Dept. 864T Chicago 5, Ill.

POWER MOWER KITS **FREE PLANS**



Have one of the finest mowers money can buy. Write for **FREE PLANS** and **PARTS LIST** showing you how to **SAVE MONEY** by assembling Triangle's **POWER MOWERS**.

SPECIAL FACTORY PRICES

Kits, Parts, Engines, Wheel, etc. 18" and 20" sizes; 3 or 4-wheel models; belt or direct drive. Latest improvements, sturdy construction, money-back guarantee fully told in

FREE color folder, also complete **TRIANGLE MOWERS** ready to mow at low Factory Prices. Write today.

▲ TRIANGLE MFG. CO., Dept. MA-8, Ft. Scott, Kan.

BUILD HELICOPTER GLIDER



The famous new **GYRO-GLIDER**, world's simplest and safest aircraft, is now available to amateur builders in plans and kits. Send \$1.00 now for three-view drawings with specifications and ask about kits and detailed building and flying instructions.

**BENSEN AIRCRAFT CORP., Dept. PM-8
P.O. Box 2621 Raleigh, N. C.**

ONLY \$1

Greatest Thrill in Flying! Name _____ Address _____
City _____ State _____

Make SURE, SAFE INSULATED ELECTRICAL CONNECTIONS

The New

SUPER **CHAMP** Hand Tool

The ONE Tool for ALL Wire Sizes used in Home Wiring, Appliances, Automobiles.

DOES ALL THESE THINGS BESIDES

CRIMPS Solderless Terminals and Connectors without solder or tape for safe connections.

CUTS Wire, making clean, sharp cut through insulation and Conductor.

STRIPS Wire sizes #22-#10. Gauges assure proper length for sure, safe crimp.

SHEARS Bolts and screws without damaging threads — no filing or hack sawing.

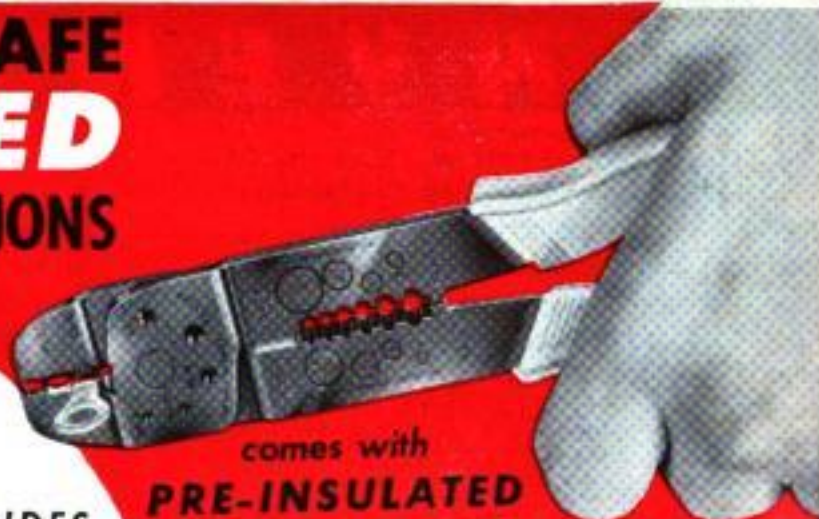

comes with
PRE-INSULATED



FREE with Each TOOL

ORDER DIRECT—USE COUPON

Satisfaction guaranteed or money back.
Send check or money order for \$3.95.
(Ohio residents add 12c sales tax.)

T. W. Berger, Inc.
National Distributor Consumers and Dealers
AIRCRAFT-MARINE PRODUCTS, Inc.
1315-AG American Bldg., Cincinnati 2, Ohio

Only
\$3.95

Post Paid

T. W. Berger, Inc.
National Distributor Champ Tool
1315-AG American Bldg., Cincinnati 2, Ohio
Send me post paid the new super Champ Hand Tool. I am enclosing \$3.95. (Ohio residents add 12c sales tax.)
 check money order

NAME

ADDRESS

CITY ZONE STATE

TELEPHONES



Desk Stand Style
Slightly used but in excellent condition
Many Valuable Uses
Inter-House Phones House to Barn, etc.
Loud Speakers Microphones
Educational Purposes, Toys, etc.

Come complete, ready to use with wiring diagrams included.
Two complete for only \$5.00 **\$2.75** Postpaid in U.S.A.
TELEPHONE LAMP KIT — with illustrated instructions for making Desk Telephone Lamp including all parts sharp, nipples, push switch, cord, plug, etc.)
... \$6.50 Ppd. (Shade is not included).

MICROPHONE, Dept. X2902, 1760 W. Lunt Ave., Chicago 26, Ill.

Shrinks Hemorrhoids New Way Without Surgery

Science Finds Healing Substance That Relieves Pain—Shrinks Hemorrhoids

For the first time science has found a new healing substance with the astonishing ability to shrink hemorrhoids and to relieve pain — without surgery.

In case after case, while gently relieving pain, actual reduction (shrinkage) took place.

Most amazing of all — results were so thorough that sufferers made astonishing statements like "Piles have ceased to be a problem!"

The secret is a new healing substance (Bio-Dyne*)—discovery of a world-famous research institute.

This substance is now available in suppository or ointment form under the name Preparation H.* Ask for it at all drug counters—money back guarantee. *Reg. U. S. Pat. Off.

AUGUST 1955

WORTH 2¢ or \$2,000?



DISCOVER HIDDEN TREASURE IN YOUR OWN COLLECTION!

Amazing FREE Stamp Identifier (profusely illustrated) clearly shows difference between the many rare and common U. S. stamps that look exactly alike. Extra! Other valuable aids: (1) Powerful magnifier; (2) Perforation gauge; (3) Handsome stamp wallet. PLUS Big illustrated U. S. Catalog; 64 pg. Collector's Guide. Other special offers for your free examination. Mailed with Roosevelt comm. stamps. Send 10c for handling.

USE THIS HANDY COUPON

H. E. HARRIS & CO., 1101 Transit, Boston 17, Mass.
Please rush all items listed above. I enclose 10c for handling.

Name

Address

City..... State.....

"Collect Stamps - Enjoy the World's Most Popular Hobby"

INVENTORS

WE recommend that you take the following preliminary steps toward patent protection. Make a disclosure of your invention; sign, date and have your disclosure witnessed by two people who understand your invention; authorize us to conduct a preliminary search among previously granted U. S. patents for similar types of invention. We give you a report on the probable patentability of your invention and our recommendation for further course of action.

Let us send you a copy of our instructive booklet, "Patent Protection for Inventors" and our convenient "Evidence of Invention" disclosure form. No obligation.

VICTOR J. EVANS & Co. *Merlin M. Evans*
REGISTERED PATENT ATTORNEY

130-J MERLIN BUILDING, WASHINGTON 6, D. C.

SPARE-TIME MONEY!

Make An Extra \$50.00 Every Week!

Bring wonderful air cushioned foot comfort to friends, neighbors, co-workers direct from factory at lowest cost! Over 150 men's, women's styles, sizes 1-18, AAA to EEEE. No investment, no deliveries, no collections. Just a few hours each week can add \$50 to \$100 to your regular income! Liberal advance profits, monthly cash bonus, automatic repeat business. NO EXPERIENCE NEEDED — we show you how. Get started now — write today for full details!

CHARLES CHESTER SHOE COMPANY
551 Foundry St., Brockton, Mass.



FREE
SALES
KIT!

12-Star
UTILITY PANTS
With Shirts to Match
**ARE
A BETTER
BUY**



Work comes easier
when you "tool up"
in comfort clothes

THERE'S more joy in any job when you slip into the relaxing ease of an Anvil matching suit. Stoop, reach, bend, twist — in any position there's comfortable freedom for action. Made of tough twills in choice of colors. Non-shrink waistband, foot-deep, double-lined safety pockets; every point of strain especially reinforced. Try out Anvil Brand for new satisfaction.

ANVIL BRAND FACTORIES HIGH POINT, N. C.



\$14,839 In 1 Year SERVICING RADIATORS

—REX RYAN, Bloomfield, Iowa

Hundreds earning \$8,000-\$20,000 a year servicing auto-truck-tractor radiators! New Inland equipment makes work easy, insures finest professional workmanship. "Pays-for-itself" financing available. \$100 training course included free by world's largest radiator servicing equipment manufacturer. WRITE for free folder "Want a business of your own?"

INLAND MFG. COMPANY Dept. PM-6
1108 Jackson St., Omaha 8, Nebr.



EARN WHILE YOU LEARN AT HOME

MAKE MONEY 90 WAYS IN PHOTOGRAPHY

If you are OVER 17—good pay, fascinating work await you in photography. Start earning at once as you learn to make money 90 ways with your camera. Our famous low-cost LEARN-BY-DOING method and INDIVIDUAL guidance train you quickly at home! Write TODAY for FREE catalog. Also Resident Training. 45th Year. GI Approved. NEW YORK INSTITUTE OF PHOTOGRAPHY
Dept. 49, 10 W. 33 Street New York 1, New York

Send for
FREE
BOOK

OWN a Business

If employed, start part time. Alert dealers can gross \$5 hourly profit on own service plus \$3 on EACH serviceman. Clean, revive, moth-proof rugs & upholstery on location. No shop needed. Services nationally advertised. Repeat customers. Easy to learn. We locally train and assist you. Quickly established. Easy terms. Send today for FREE booklet. No obligation.

DURACLEAN CO., 5-188 Duraclean Bldg., Deerfield, Ill.

LAW FREE BOOK THE LAW TRAINED MAN

Write today for a FREE copy of illustrated law book, "THE LAW-TRAINED MAN," which shows how to earn the professional Bachelor of Laws (LL.B.) degree through home study of the famous Blackstone Law Course. All necessary books and lessons provided. Moderate cost; convenient monthly terms. Write for FREE law training book today

Blackstone School of Law, 225 N. Michigan Ave.

Founded 1890

Dept. 50-C Chicago 1, Ill.

MAKE UP TO \$5 AN HOUR WITH

EASISHARP



MONEY
MAKING
SALES PLAN FREE

Big profits in your spare time sharpening scissors. We show you how to start making money immediately. This is your chance now to have your own business and a steady income. Sharpen a pair of scissors in less than two minutes. A child can operate it. Weighs only 10 lbs. Every home, barber, tailor, dressmaker—everybody uses scissors and all need sharpening two to four times a year. Don't let some one else beat you to this opportunity. Write immediately to

SERR-EDGE MACHINE CO., 9731 Lorain Ave., Cleveland, Ohio

NEVER AT THIS LOW PRICE! **GENUINE 120-POWER ACHROMATIC TELESCOPE**

with 3-POWER FINDER attached!

ONLY
\$18⁹⁵
PREPAID

EXTRA BONUS GIFTS:

- 108 page book, "Discover The Stars"
- Magic Star Finder Dial



Complete with 5 Ft. Hardwood Tripod!

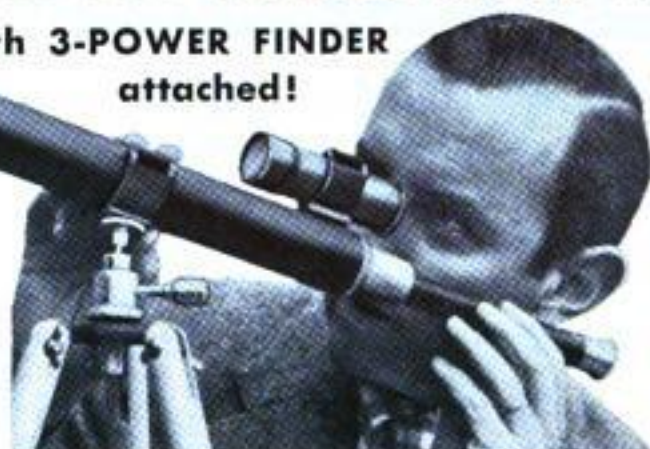

BRING THE MOON, PLANETS, SHIPS, PEOPLE 120 TIMES CLOSER, CLEARER, SHARPER!

Never in all the long years we've sold quality optical goods have we ever seen an ultra-powered Achromatic telescope—with a 3 power finderscope attached—offered at such an unbelievably low, low price!

Now you can explore the heavens—see stars, planets you never knew were there—perform amazing distance-defying feats—all with this superbly-crafted telescope. Its 120 power Achromatic main lens brings you distortion-free images so crystal-clear, you feel like reaching out and touching them! Little or no tinge of annoying color—no fuzz—nothing but breathtaking, needle-sharp images that are always erect. The kind of viewing that only a genuine Achromatic lens can bring you!

Ready for immediate use, its 5 precision lenses bring you viewing at 3 different powers—40x, 80x, and 120x! Tubes extend to 43", are made of solid jet bakelite, finished in camera-bellows black (for

sharper, clearer images) and are trimmed with gleaming brass. The 3 power finder-scope mounted on main tube is a feature usually found on more expensive telescopes, aids in bringing difficult objects "on target" before observing with higher-powered scope.

For extra stability, the 5 foot hardwood tripod is equipped with a heavy, cast iron head—fitted with Criterion's famous 360 degree all-aluminum mount that instantly locks in any position.

Obtainable only from Criterion and shipped to you PREPAID, with 2 Extra Bonus Gifts—108 page book "Discover The Stars" and Magic Star Finder Dial that locates any star, anywhere, at any time of the year! You must be thrilled with this remarkable telescope or your money will be promptly refunded in full.

Take advantage of this never-before bargain—send check or money order TODAY!

CRITERION CO. Dept. PMA2, 331 Church St. Hartford, Conn.

ATHLETE'S FOOT CUTICURA Relieves Faster

Clinical tests prove new, sensational CUTICURA MEDICATED LIQUID relieves 9 out of 10 cases—in just 4 to 14 days! It stops itching instantly—checks most cases of infection—usually kills pathogenic fungi—and soothes as it helps heal raw, open cracks, 60c at druggists. If your druggist hasn't it, don't waste money on substitutes but send us 10c for generous trial size.

CUTICURA, Dept. 16HY, Malden 48, Mass.

SAY YOU SAW IT IN POPULAR MECHANICS

YOU CAN GET THAT JOB..

If you have the ability.

The aids and examples completely detailed in Brochure can get THAT better job or career.

- PERSONAL INVENTORY
- RESUMES
- INTERVIEWS
- BUSINESS LETTERS
- JOB SOURCES
- EDUCATIONAL AIDS

Send \$1 cash — check — m.o. to:

T. P. HADLEY CO.

271 DOYLE AVE.

PROVIDENCE, R. I.

MAKE TREMENDOUS PROFITS

Have Fun! Earn Big Money! Cast plaster figurines, bookends, plaques, novelties at home in your spare time with X.L. rubber molds! NO EXPERIENCE NEEDED! Molds and rubber for 3 molds, only \$1.50 ppd. Send 25c (refunded with order) for 40 page catalog now!

PLASTIC ARTS STUDIO 3403 SO. MADISON, DEPT. PM2 MUNCIE, INDIANA

ENGINEERING DEGREE IN 27 MONTHS

Big Demand for Graduates

Aeronautical, Chemical, Civil, Electrical, Mechanical and Electronic Engineering (inc. Radio and TV)

Hundreds of young men are earning B. S. ENGINEERING DEGREES annually in this recognized institution — year around operation. New terms start quarterly. Many students earn a major part of their college expenses in this large industrial center.

Low tuition. Competent instruction. Thorough, intense practical program. Modern, well-equipped laboratories including new physics laboratory and modern wind tunnel. Individualized instruction emphasized.

Government approved for G.I.'s. Engineering preparatory courses. Students from 48 states and 21 foreign countries. Enter September, December, March and June. Send coupon for free catalog and full information. Enroll now.

SEND COUPON TODAY

INDIANA TECHNICAL COLLEGE

585 E. Washington Boulevard
Fort Wayne 2, Indiana

Please send me free information on B.S. Engineering Degree in 27 months as checked.

- Aeronautical Chemical Civil Electrical
- Mechanical Electronics

Name _____

Address _____

DRAFTSMEN



**CASH BIG
PAY CHECKS!**

**Train Now for
more success,
greater security**

**LEARN AT HOME IN SPARE TIME
(or at college in Chicago)**

Check the want ads in any newspaper—SEE the big-pay opportunities open to you as a draftsman. What's more, you can learn this well-paid, prestige profession at home—quickly, easily! No special talent needed. Get complete, step-by-step Chicago Tech lessons in the mail, spend a few pleasant hours studying each week. In a short time you'll be a well-trained draftsman, ready to take your pick of many good jobs. Act now!



Free Information—Mail Coupon Today!

Get **FREE TRIAL LESSON** plus information about C.T.C. practical training. Learn what successful Chicago Tech graduates say about high pay and opportunities in drafting. No charge, or obligation.

CHICAGO TECHNICAL COLLEGE

K-253 Tech Bldg., 2000 So. Michigan Ave.
Chicago 16, Illinois

Mail me **FREE** lesson with facts about big opportunities in **DRAFTING**.

Name _____ Age _____

Address _____

City _____ Zone _____ State _____

\$200 Weekly Cleaning Venetian Blinds



No Selling Required!

Operate your **OWN** profitable Venetian Blind Laundry business. Even if now employed, start spare time, and build a permanent, lifetime full-time business. Clean Venetian Blinds from Homes, Offices, Institutions, etc. **EASY** to learn and operate. **NEW**, uncrowded field. Experience unnecessary.

FREE BOOK! Our revealing book explains everything. How to earn \$40 up on your day off, spare time—\$200 or more full time. How to get business by phone and mail. Your large profits. Repeating customers. Building a permanent, steady increasing life income. Protected territory franchise, etc.

WRITE NOW! NO OBLIGATION!

A. H. LAUNDRY CO.

442 No. Seneca Street, Wichita 12, Kansas



Start Home-Spare Time

Here it is—a new **UNDERWATER CAMERA BOX** that's tops in quality, yet low in price.

All parts are corrosion resistant.
Brownie Holiday Camera included.



All for ONLY

\$17.95

C.O.D., or send check



DIVERS SUPPLY

Send 35c for a complete catalog of professional and amateur diving gear.

6906 COAST HIGHWAY, NEWPORT BEACH, CALIFORNIA

See the Greatest Show on Earth with this GIANT ASTRONOMICAL TELESCOPE

**\$1500
FULL PRICE**



Delivered ready for use. Has 45X, 75X and 100 power individually mounted eyepieces with brass focusing tube plus sun projector lens for observing sun spots and solar storms. Steel telescope tube 50 in. long. Rigid 6 ft. tripod adjustable to any height. Steel fork mounting with closely machined aluminum tripod head assembly assures extra fine adjustments. This professional type instrument provides full power with clear vision at all times. See the moons of Jupiter, our own moon, planets, milky way, double stars, star clusters, etc. All for only \$15.00 F.O.B. Mattituck. **SOOT** express. C.O.D. orders require \$5.00 deposit. Satisfaction guaranteed. 200X and 400X eyepieces available at \$2.00 ea.

SUFFOLK SCIENCE SERVICE
Dept. ATD-B MATTITUCK, N. Y.

Become a Doctor of **PSYCHOLOGY**

Win the degree of Ps.D. Learn the secret of contentment, happiness. Solve mental worries. Experience the revelation of truth. Correspondence only. Individual help. Write for **FREE** book. **COLLEGE OF UNIVERSAL TRUTH, 5038-B Broadway, Chicago.**

**PLEASE
SEND ME**



for the
time checked.
I am enclosing . . .

- 1 year \$3.50
 2 years \$6.00

name _____

address _____

city _____

zone _____

state _____

C-85

Hand this order to your newsdealer or send it to

POPULAR MECHANICS
200 East Ontario St. Chicago 11, Ill.

If Ruptured

For lasting relief your rupture must
BE HELD BACK DAY and NIGHT.

Consult Your Doctor.

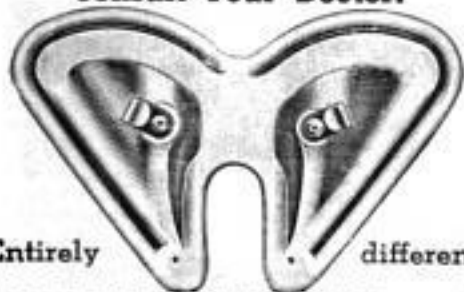

Entirely different

SOFT, FLEXIBLE, and fits neat as a glove. The famous Miller saves you **TIME, MONEY, DISAPPOINTMENT.**

Write for my **FREE** booklet today.

FRED B. MILLER Manufacturer
Dept. PM-A, Hagerstown, Maryland

MAKE MONEY WRITING

.. short paragraphs!

You don't have to be a trained author to make money writing. Hundreds now making money every day on short paragraphs. I tell you what to write, where and how to sell; and supply big list of editors who buy from beginners. Lots of small checks in a hurry bring cash that adds up quickly. No tedious study. Write to sell, right away. Send for free facts. **BENSON BARRETT**, 1751 Morse Ave., Dept. 27-N, Chicago 26, Ill.

Learn **ACCOUNTING**
Business Administration

Bookkeeping, secretarial and allied subjects at home in your spare time or attend nationally approved resident school. Write for **FREE** Success Book giving complete details on courses, plans, rates and employment opportunities. G.I. approved.

Hills **BUSINESS UNIVERSITY AND EXTENSION SCHOOL**
629 W. MAIN ST. OKLAHOMA CITY 2, OKLAHOMA

SHEET METAL BRAKES

Forms angles, locks, pans, etc. New eccentric clamps. All steel construction. Size 15"—16 gauge steel, \$21.50; 36"—22 ga., \$33.00; 48"—24 ga. \$48.00. Floor Stand, \$7.00.



FOOT POWER PRESS BRAKE. Open ends, any length, 12" from edge, \$42.00
SHEARS—7"—16 ga. Angle stop gauges, \$16.50. 36"—24 ga. floor shear, \$21.50.
FOLDERS—15"—1 1/4" to 1", 24 ga., \$16.50. 36"—28 ga., \$36.00
IRON BENDER. Forms braces, eyelets, angles up to 1 1/2" x 3" x 3/8". \$9.50
ORDER DIRECT OR SEND FOR CATALOG

VYKE MFG. CO., 2435 15th St., Denver 2, Colo.

WARN HUBS STOP FRONT END DRAG ON 4-WHEEL DRIVES



PATENTED Warn Hubs disengage front differential for use in 2 W.D. range, give 4 W.Ds. amazing pep, getaway, steering ease; save gas, tires; stop front end shimmy! Automatic models also stop front axle torque, permit high road speeds in 4 W.D. high range! Use either drive, anytime! Select drive needed—automatically with Warn Automatic Hubs, manually with Warn Locking Hubs. Willys models factory approved, sold only by Willys dealers worldwide. Dodge, other 4 W.Ds. at dealers or write—

OVER 60,000 IN USE! **WARN MFG. CO.** Riverton Box 4064-A9 Seattle 88, Wash.

BECOME A Mechanical Engineer

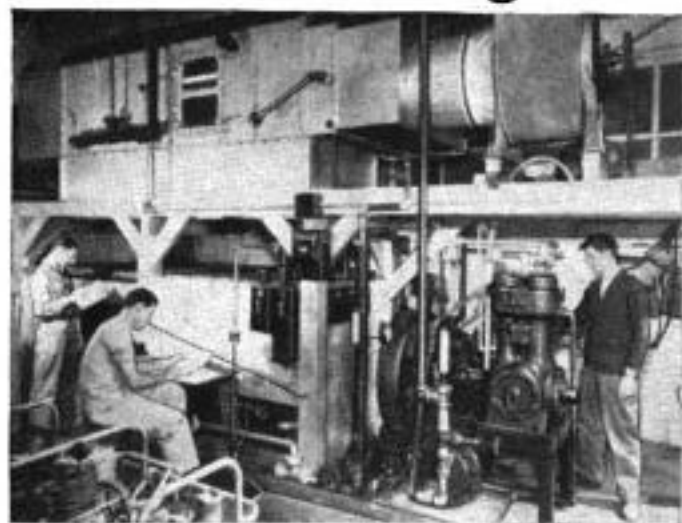

B. S. Degree in 36 months

 Mechanical Engineers hold respected, well-paying, and highly interesting jobs in many fields of industry. You can prepare now... for a secure future and a well-paid career as an engineer or engineering technician at the Milwaukee School of Engineering.

Choose from these courses at the Milwaukee School of Engineering

ENGINEERING 36 months, Bachelor of Science Degree

- Mechanical Engineering with a major in Design, Metal Fabrication or Plant Engineering.
- Electrical Engineering with a major in Electronics or Power.

SERVICE 6 to 12 months

- Electricity ● Heating
- Refrigeration ● Welding

TECHNICIAN 12 to 18 months

- Radio and Television
- Electronics
- Electrical Power
- Mechanical Technician
- Air Conditioning
- Welding

General preparatory course — 3 months.

TERMS OPEN SEPTEMBER, JANUARY, APRIL, JULY
Faculty of specialists. Over 50,000 former students. Annual enrollment from 48 states and 2 overseas countries. *Non-profit*. 52nd year. Military, Practical or Academic training evaluated for advanced credit. Approved for Veterans Training. Write for details today.

MILWAUKEE SCHOOL OF ENGINEERING

MS-8A

MILWAUKEE SCHOOL OF ENGINEERING
Dept. PM-855, 1025 N. Milwaukee
Milwaukee 1, Wisconsin

Send free illustrated career booklets Radio-TV
 Mechanical Technology Electrical Technology

I am interested in.....
(name of course)

Name.....Age.....

Address.....

City.....Zone.....State.....

If veteran, indicate date of discharge.....

Free! 75 ORIENTALS



Brought to you from the farthest ends of the earth—these exotic valuable genuine Stamps of the Orient! 75 all-different from Borneo, Siam, China, Japan, Hong Kong, Malaya, Sarawak, Singapore.—and other exciting mysterious lands of the Far East. **EXTRA!** Free booklet, bargain lists, fascinating offers for your free examination. Send 10c for mailing expenses. Supplies limited. **Act NOW!**

USE THIS HANDY COUPON

JAMESTOWN STAMP CO., D-199, Jamestown, N.Y.
RUSH my FREE Collection of 75 Orientals & other offers. I enclose 10c for cost of mailing.

Name _____
Street _____
City _____ State _____

DEUTSCHES REICH

205 GERMANY only 25¢

This fabulous collection contains **Scarce Stamps** nearly 100 years old; giant and midget stamps; Hitler & blood-red swastikas; battle scenes; inflation issues with pre-war face of millions of dollars; Peace, Music & Religious stamps; birds, animals, sports, airmails—205 all different, worth \$4.22 at Catalog prices! **PLUS** free booklet, bargain lists and other offers for your free consideration. All for only 25c. Send TODAY!

FALCON STAMP CO., D-275, Falconer, N. Y.

PROFITABLE HOBBIES

Do **WONDERFUL** things with your spare time! Make beautiful and **UNUSUAL** items for the home, as fascinating gifts, or for **RESALE!** Build a profitable home occupation or hobby! We show you how. Make astonishing jewelry, Ceramics without a kiln, dolls, toys, puppets, figurines, Planters, Ivory, embedded plastics, etc. Send 25c for big catalog and details. Refunded with first order. Write Dept. C-149.

PLASTICAST COMPANY
6612 N. Clark St., Chicago 26, Ill.



BE YOUR OWN MUSIC TEACHER

and for Free Book Telling How Easily You Can Learn Piano, Guitar, Accordion, ANY Instrument This EASY A-B-C Way

NOW IT'S EASY to learn music at home. No tiresome "exercises." No teacher. Just **START RIGHT OUT** playing simple pieces. Thousands now play who never thought they could. Our pictured lessons make it easy as A-B-C to learn to play popular music, hymns, classical and any other music. Only a few cents a lesson. Over 900,000 students! (Our 57th successful year.)

Mail Coupon for **FREE BOOK**

Find out why our method can teach you quickly, easily, inexpensively. Write for 36-page illustrated Book. No obligation. Mention your favorite instrument. Just mail coupon below.

U. S. SCHOOL OF MUSIC
Studio A308,
Port Washington, N. Y.



FREE BOOK

U. S. SCHOOL OF MUSIC, Studio A308, Port Washington, N. Y.

Please send me Free 36-page illustrated Book. I would like to play (Name Instrument):

Instrument _____ Have you _____ Instrument?

Name _____ Please Print

Address _____

You can have a career instead of a job

Industrial growth . . . automation . . . technical advances create tremendous opportunities for engineers, accountants, management experts. Share the rewards awaiting college trained men in engineering and commerce. Important concerns visit campus regularly to employ Tri-State College graduates. Start any quarter in this world-famed college. *Approved for veterans.*

Bach. of Science degree in 27 months

in Mechanical, Civil, Electrical, Chemical, Aeronautical, Radio (TV-Electronics), Administrative Engineering; Business Administration and Accounting. 36-weeks course in Drafting. *Intensive program; technical fundamentals stressed; comprehensive courses with more professional class hours.*

Small classes; personalized instruction. For earnest, mature students whose time and budget requires accelerated courses and modest costs. Preparatory courses. Beautiful campus in friendly college town. Well-equipped, new and modernized buildings and labs. Enter Sept., Jan., March, June. Write Jean McCarthy, Director of Admissions, for "Your Career in Engineering or Commerce".



TRI-STATE COLLEGE

485 College Avenue

Angola, Indiana



TALK - SING - PLAY OVER YOUR RADIO

with the real Radio Mike! Attaches in a jiffy — full instructions given! Swell for "parties"—"cut in" on or "kid" regular network programs or put on your own broadcasts! Amaze your friends—real fun. Beautiful Metallic Plastic 6 in. high!

12 RADIO BROADCAST LESSONS GIVEN with each Mike

SEND NO MONEY Just pay postman \$1.99 COD plus postage or send \$3.99 and we pay postage! Radio Mike is available only from us by mail—guaranteed. Midway Co., Dept. MPM-8, Kearney, Nebr.

WHEELS WHEELS WHEELS

- 7" Disc Wheel 3/4" Tire 3/4" sleeve 45c ea.
 - 8" Disc Wheel 1 1/4" Tire 1/2" sleeve 70c ea.
 - 7" Disc Wheel 1" Tire 1/2" ball bearing 80c ea.
 - 8" Disc Wheel 1 1/4" Tire 1/2" ball bearing \$1.00 ea.
 - 6" Disc Wheel 1.50 semi-pneum. Tire 1/2" B.B. \$1.35 ea.
 - 8" Disc Wheel 2" semi-pneum. T. 1/2" B.B. \$1.50 ea.
 - 10" Disc Wheel 1.75 semi-pneum. Tire 1/2" B.B. \$1.50 ea.
 - 10" Disc Wheel 2.75 semi-pneum. Tire 1/2" B.B. \$3.50 ea.
 - 12" Disc Wheel 1.75 semi-pneum. T. 1/2" B.B. \$1.85 ea.
- Above wheel prices include hub cap, Flange Postage, C.O.D.'s accepted. AXLES—Sizes 5/16 in., 3/8 in., 1/2 in.—Cut to size—End holes drilled.

UNITED WHEEL STAMPING CO.
12131 S. PEORIA STREET PM-8 CHICAGO 43, ILLINOIS

earn as TAX EXPERT

\$15 HOUR

Our students earn as much as \$3,000 in 3 short months preparing income tax returns in spare time. Also operate lucrative year-round Business Tax Service. Dignified home-office business. Experience unnecessary. We train you; help you start. State approved home training program. Write today for free prospectus. **UNION INSTITUTE, 68 Hudson, Hoboken 20A, N. J.**

FREE - BIG CATALOG

HOBBY - PROFESSIONAL

MICROSCOPES

100 to 2000 POWER—\$6.95 to \$319. 40 pages of fascinating information on microscopes, micro-hobby materials, telescopes and binoculars **SEND POSTCARD.**

PRECISION OPTICAL CO.

20 Precision Bldg., 4379 Sunset Blvd. Los Angeles 27, Calif.

Better Than Your Own

SHOE STORE AT HOME



No investment, no experience needed. Just show magic cushion comfort to friends, neighbors, co-workers. Advance commissions to \$4.00 a pair, plus Cash Bonus, Paid Vacation, \$25.00 Reward Offer. Outstanding values for men, women, children. Money back guarantee. Shoe samples supplied without cost. Write TODAY for FREE new 84 page catalog and full details. **TANNERS SHOE CO., 628 BROCKTON, MASS.**

Two-Eyelet Hit With Cushioned Comfort

NOW-POWER YOUR MODEL PLANES, BOATS, RACE CARS!

Real **DIESEL ENGINE**
Fully Assembled 1/7 HP!

Not a toy! A real Diesel Engine that runs at 7500 RPM and produces 1/7 HP! Precision-tooled as carefully as giant army engines! Cylinder honed to .0001 and hand-fitted to pistons. Durable! 100% metal except for neoprene tubing. Yet weighs only 5 oz.! Easy operating instructions. Over 100,000 sold at higher price. Now at a special low, low price!

NOW \$2.95
Plus 5¢ Postage

2/3
ACTUAL SIZE

SPECIAL!

196-PAGE BOOK ON MODEL ENGINES. Covers everything hobbyists should know. Only \$1 Postpaid. FREE with purchase of \$5 or more.

CHESS COMPUTER. Gives opening moves of the 16 leading chess variations. Only \$1 Postpaid. FREE with purchase of \$10 or more.

GOTHAM HOBBY CORP., Dept. P, 107 E. 126th St., New York 35,

I'm enclosing cash, check, or money order. Send me postpaid.

Quan.	Item	Amount	Quan.	Item	Amount
.....	DIESEL ENGINE.....	\$3.00 \$	Also send these genuine accessories:	
.....	Prop (Free Flight).....	35¢ \$	Flywheel (boat or car)	75¢ \$
.....	Shut-Off Valve.....	\$1.25 \$	Tank	50¢ \$
.....	Test Mount	\$1.25 \$	Spinner	75¢ \$
.....	Fuel Pump	75¢ \$	Control Wire	75¢ \$
.....	Fuelmix (Express Collect Only).....	\$1.00 \$	Control Handle	\$1.00 \$
.....	Model Engine Book	\$1.00 \$	Electric Motor	\$1.95 \$
.....			Chess Computer	\$1.00 \$

Name _____
Address _____
City _____ Zone _____ State _____

\$ TOTAL AMOUNT



HAVE A BIGGER — MORE EFFICIENT HOME WORKSHOP
Popular Mechanics **PLANNING YOUR HOME WORKSHOP** shows you how to make use of every inch of space in your workshop; detailed floor plans, wiring layouts and power tool hookups plus actual photographs of famous home workshops you can use as models. Save money by building your own shop furniture. Special Where-to-Buy-It Guide, 450 Illustrations. Cloth Bound. Working Diagrams. Order your copy today from **\$2.50**
POPULAR MECHANICS PRESS
200 E. Ontario Street Chicago 11

YOU BUILD EICO KITS
in one evening. SAVE 50% & LEARN
Easy Instructions | Vacuum Tube Voltmeter
38 Instruments | **KIT \$25.95** Wired \$39.95
Write now for FREE Catalog . . . **PM-8**
Electronic Instrument Co., Inc. • 84 Withers St. • Brooklyn 11, N.Y.

LEARN MEAT CUTTING AT NATIONAL
Pay After Graduation



The steady dependable trade of Meat Cutting taught easily in 8 short weeks. **YOU LEARN BY DOING** under actual meat market conditions in big modern school at Toledo.

For beginners or men with experience. Get a profitable store of your own. Remember, **PEOPLE MUST EAT!** Big pay jobs. Free employment help. Thousands of successful graduates.

Buying, cutting, percentage, pricing, advertising, selling, etc. A complete retail meat education. National School established over 30 years. Get National training **NOW**. Pay your tuition in easy weekly payments

after you graduate. Send coupon for **FREE** 52 page school catalog — **TODAY**. G.I. approved.

National School of Meat Cutting, Inc., Dept. 50-U, Toledo 4, Ohio
Send me your **FREE** school catalog on National Training at Toledo in Meat Cutting, Meat Merchandising and Self Service Meats. No obligation. No salesman will call.
Name _____ Age _____
Address _____
City _____ State _____
Approved for training Korean Veterans

AUGUST 1955



Blue Print for FINE PROFITS

Your Own Home Business Here's Your Success Plan



a few cents worth
of materials
BRINGS YOU DOLLARS!!

*Have Your Own Lasting,
Successful Business—Be Your
Own Boss—Help Fill Huge Demand
... No Experience Necessary*

HIGH LIVING COST GOT YOU DOWN? Want an extra \$100 or more added to your monthly pay check for a few SPARE TIME HOURS AT HOME? That's what I wanted to few years ago when I ran across an Old-World formula for applying short cotton fibers to practically any surface, so that it looked and felt like costly velvet or velour.

THIS PROCESS AMAZED ME. I spent several years experimenting and developed the NEW FLOK-KRAFT MICRO-FLUFF METHOD of applying short fibers of Rayon in many colors, as well as cotton.

NO OVERHEAD, NO EXPENSIVE EQUIPMENT. Start in your basement, garage, service porch, or on card table in bedroom. With an hour's practice you can apply a few pennies worth of MICRO-FLUFF to a yard or two of butcher paper, and make it look like \$15-a-yard velvet for window displays in fine jewelry. Jewelers love this gift, or department stores. Taken only minutes and practically no effort.

MICRO-FLUFF IS BEAUTIFUL—LONG WEARING. Comes in every rainbow color, long lasting, has the TOUCH APPEAL of luxurious velvet. Uses on nearly any surface—paper, metal, wood, glass, plastic, plaster, rubber, etc. Line silverware, hosiery drawers, and jewelry boxes, decorate lamps and shades, finish auto trunks or glove compartments, re-cover women's party shoes, photograph turntables. Apply to toys, figurines, plaques, signs, store displays, instrument cases—1001 other items, new or old. MICRO-FLUFF makes old objects beautiful, saleable—increases value of many new products by 500%.

BIG-PROFIT ORDERS come from neighbors, gift shops, stores of all kinds. Every household has several items you can save from discard. Decorate jewelry, department store display cases, windows. Also supply them with fast-selling FLOK-KRAFTED gifts and other merchandise. Every neighborhood needs a FLOK-KRAFTER. Help us fill HUGE DEMAND.

I'LL HELP YOU START RIGHT AWAY. Since succeeding beyond my wildest dreams in my own FLOK-KRAFT business, I have concentrated on helping ambitious men get started toward a successful future. My plan is designed to help you start at home in spare time, and build gradually toward a full-time business if you wish. **START RIGHT NOW.** Fill out and mail coupon today. I'll rush you **FREE SAMPLE OF FLOK-KRAFT MICRO-FLUFF** with full FREE details and I'll arrange to send you the complete FLOK-KRAFT MICRO-FLUFF outfit to try out right in your home, without risk. Outfit includes simple instructions, hundreds of show-how illustrations that make everything easy, specially designed, high-velocity Applicator and generous supply of FLOK-KRAFT MIC-FLUFF — EVERYTHING YOU NEED TO START RIGHT AWAY. You owe it to yourself to investigate. **SEND NO MONEY. RUSH COUPON TODAY** by Airmail. I'll show you how to **START MAKING MONEY AT ONCE!**

NELS IRWIN, Coast Industries, Dept. 28
Los Angeles 61, California

MAIL COUPON NOW!

NELS IRWIN Coast Industries Dept. 28
Los Angeles 61, California
Show me how I can start at once to make money at home with FLOK-KRAFT. Send me all the FREE material. Remember, I am under no obligation of any kind.

NAME _____

STREET _____

CITY _____ STATE _____



FULLY GUARANTEED TIRES COST LESS!

Nationally famous FIRESTONE, GOODRICH, U. S. ROYAL, GOODYEAR, and other makes. Every tire selected and inspected for your safety.

BUY WITH CONFIDENCE FROM PYRAMID TIRE **WHITE WALL TIRES \$1 EXTRA**

HIGH GRADE TIRES GUARANTEED 12 MONTHS					
600x16	4.14	700x16	5.14	32x6 (R)	8.84
650x16	4.84	670x15	4.74	32x6 (10)	10.84
680x15	4.34	650x20	7.84	750x20 (R)	8.84
700x15	4.64	700x20 (R)	8.94	750x20 (10)	9.94
825x20	14.34	900x20	13.34	1000x20	14.14
1100x20	16.14				

AAA PREMIUM GRADE GUARANTEED 18 MONTHS					
350x15	5.48	700x15	5.98	760x15	5.58
600x16	5.28	700x16	6.78	550x17	5.48
600x16 (6)	5.58	700x16 (6)	7.98	600x20	9.78
640x15	5.68	750x15 (6)	8.98	650x20	10.88
650x16	5.78	800x15	6.88	700x20	12.88
680x16 (6)	6.98	820x15	7.48	32x6 (R)	10.48
650x15	5.98	710x15	6.09	32x6 (10)	12.48
670x16	6.18	550x18	5.98	750x20 (R)	12.98

MILITARY SPECIAL AA Guaranteed 12 Months—
 900x16 10.69 | 1000x20 19.98 | **NEW TREAD GUAR. 24 MOS.**
 750x20 10.98 | 1100x20 21.98 | 600x16 8.98
AAA GUARANTEED 18 MONTHS | 700x15 (6) 9.98
 800x16 14.98 | 750x20 (R) 16.48 | 750x20 (10) 15.98

Largest stock of used tires in the East. Thousands of satisfied customers. Write for Free Catalogue. **MONY ORDER OR CHECK WITH ORDER.** **NO C.O.D.'s**

PYRAMID TIRE CO.
1333-35 North 5th St.
Dept. M., Phila. 22, Pa.



**Everything You Need For
UNDERWATER
Sports and Adventure
DIVEMASTER
SKIN AND LUNG DIVING EQUIPMENT**
 Leading nationally known and foreign made products. Inspection tested at money saving prices. Underwater Breathing Apparatus, Swimming Masks and Fins, Diving Masks, Spear Guns, Water Skis, Diving Suits, etc. **Send 25c for illustrated Catalog.**
 (Dealer Inquiries Invited)
U. A. S. CORPORATION, Dept. PM-8
 5637 W. 63rd Place, Chicago 38, Ill.

**NO TANKS USED
NEW SIMPLIFIED METHOD**



ELECTROPLATE
 ANY OBJECT IN HOME, SHOP, GARAGE OR START YOUR OWN WELL PAYING ELECTROPLATING BUSINESS
 NOW, using NEW plating kit. It's easy to electroplate any object. Complete kit and instructions on plating metal and non-metal objects, with nickel, copper, chrome, gold, etc., plus full data on obtaining all the business you desire and make **BIG MONEY** full or spare time. **ONLY \$5.95 SEND NO MONEY**—everything sent C.O.D. plus postage—OR send \$5.95 now and receive it postpaid. Money back in 7 days if not satisfied.
M. Z. SALES CO., Dept. PM-17, 113 W. 42 St., New York 36, N. Y.

MONEY in WORMS

Make thousands of dollars raising and selling fishworms and crickets—Start in backyard or basement—No odor—No experience necessary. Free Literature—No obligation. Write **CARTER WORM RANCH, PLAINS, GEORGIA**



WAR SURPLUS BARGAINS
\$500,000.00 INVENTORY for QUICK LIQUIDATION
 Surplus items—hundreds of them for home, shop, factory, farms and outdoor use. New items, used items, reconditioned items—all at tremendous savings—all priced for quick sale.
Page After Page of Values
 This big catalog shows page after page of amazing money saving values. Write for your copy today. Send 10c to cover postage, mailing, etc. Write today! **SEND TODAY FOR YOUR COPY**
STARK'S 212 W. Madison St.
 Dept. PM-8
 CHICAGO 6, ILL.

FREE!
Sample & Plan



when one burns out...



don't get rid of all three—

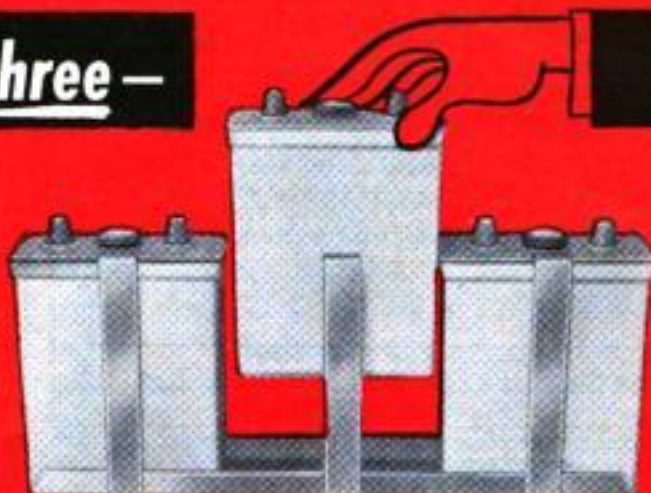

NOW, A PREMIUM BATTERY—WITH REPLACEABLE CELLS! THE STARTLING **NEW** CELLOMATIC

The most practical battery design of half a century is incorporated into the new Cellomatic—individually demountable and replaceable cells. This outstanding and highly functional feature means that the consumer's battery dollar is no longer reduced to the pennies of salvage when for ANY reason a cell in his battery goes dead. Now, instead of buying a complete new battery, the motorist need replace only one cell.

"POWER DRY PACK" Another equally revolutionary feature of the new Cellomatic is "Power Dry Pack." This amazing scientific advancement not only gives the Cellomatic the power and stamina of a truly premium battery but also eliminates the handling of acid. The Cellomatic can be shipped dry anywhere in the world and **NO ACID NEED BE HANDLED AT ANY TIME!** ONLY THE ADDITION OF DISTILLED WATER IS NECESSARY! And in the "Power Dry Pack" state the Cellomatic battery can be stored in your garage or warehouse **INDEFINITELY** without harm.

OTHER OUTSTANDING FEATURES: ✓ Individual, universally sized cell cases are made of rugged, colorful "high impact" polystyrene. ✓ Space channels between cells allow cooling, free air circulation between and around the cell cases at all times. ✓ Harmful vibration and shock are greatly reduced by a foam rubber mat that "nests" under each cell. ✓ A steel frame enclosing and supporting the individual cells is an integral part of the Cellomatic battery.

ONLY
\$24⁹⁵
SIX VOLT
CARS OR TRUCKS

The amazing **PLUS** features of the Cellomatic make it truly a premium battery selling at a popular price. The finest materials coupled with spectacular engineering and scientific advancements establish the Cellomatic as the only battery buy for you. The keynote of the Cellomatic battery is economy, for when and if needed, individual cells can be replaced for as low as 50¢.

The Cellomatic is the only battery in the world that carries a perpetual guarantee. Unlike batteries with limited guarantees, Cellomatic can be transferred from one vehicle to another and from one owner to another under the same perpetual guarantee. No complicated warranty or guarantee slips are needed. The Cellomatic battery is its own guarantee.

**PERPETUAL
GUARANTEE**

ORDER BY MAIL TODAY!

If no dealer near you, use coupon.
GUARANTEE IMMEDIATE SHIPMENT.

CELLOMATIC DIVISION, SPAN-O-LIFE CORPORATION

P.O. Box 99, New Braunfels, Texas

Please ship a new Cellomatic 6 volt automotive battery.

For _____
Make & Model, year of car or truck.

I enclose () \$24.95 in cash, check or money order. There will be no charge for shipping or handling.

I enclose () \$5.00 deposit, will pay balance C.O.D.

Name _____

Address _____

City _____ Zone _____ State _____

CELL O MATIC

DIVISION

SPAN-O-LIFE CORPORATION

NEW BRAUNFELS, TEXAS

For distributor or dealer information please give details of your organization and of area interested in.

Copyrighted material

Check the Kind of Body You Want



Charles Atlas

...and I'll Prove How EASILY You Can Have It!

Just tell me, in coupon below, the kind of body you want—and I'll give it to you SO FAST your friends will be amazed! "Dynamic Tension," my easy, 15-minutes-a-day method, will make your chest and shoulders bulge... arms and legs surge with power... your whole body feel "alive!"

FREE BOOK 32 pages on how "Dynamic Tension" changed me from a 97-pound weakling into "World's Most Perfectly Developed Man"—and how I'll prove it can change YOU too. Mail coupon NOW!

**CHARLES ATLAS, Dept. 8V,
115 East 23rd St., New York 10, N. Y.**

Dear Charles Atlas: Here's the Kind of Body I want:

(Check as many as you like)

- | | |
|--|--|
| <input type="checkbox"/> More Weight—Solid—in The Right Places | <input type="checkbox"/> Powerful Arms, Legs, Grip |
| <input type="checkbox"/> Broader Chest, Shoulders | <input type="checkbox"/> Slimmer Waist, Hips |
| | <input type="checkbox"/> Better Sleep. More Energy |

Send me absolutely FREE a copy of your famous book "Everlasting Health and Strength"—32 pages, crammed with photographs, answers to vital questions, and valuable advice. No obligation.

NAME _____ AGE _____
(please print or write plainly)

ADDRESS _____

CITY _____ STATE _____

GROW Living MIDGET TREES! EARN EXTRA MONEY



It's New! Amazing! At last, the little known method of growing miniature (MING) trees can be yours. FULL GROWN, dwarf trees—only a few inches high. Beautiful miniature fir, orange oak, Chinese elm, peach, vine, cypress—any kind! ALL BLOOM and even BEAR FRUIT. All perfect healthy specimens—but miniature in size! Make costly home decorations and expensive centerpieces. Costs only pennies—takes only minutes per week. IT'S FASCINATING—Fun! A new, sensational hobby—a new profitable \$\$\$\$ business. Send for free revealing plan details and real seed.

These trees are being purchased by STORES CLUBS • HOTELS • FLORISTS • HOUSEWIVES • INTERIOR DECORATORS • COLLECTORS • HOBBYISTS—A Big Money Opportunity FOR YOU.

FREE!

National Nursery Gardens, Dept. M-B
8463 So. Van Ness Avenue
Inglewood 4, Calif.

Rush me FREE plan and seed IMMEDIATELY!

Name _____

Address _____ Zone _____

City _____ State _____



INVENTORS

PROTECT YOUR INVENTION BY A U. S. PATENT. SEND FOR FREE "INVENTION RECORD" FORM AND "PATENT INFORMATION EVERY INVENTOR SHOULD HAVE".

CARL MILLER
REGISTERED PATENT ATTORNEY

WOOLWORTH BLDG., 35th FLOOR, 85A
NEW YORK CITY

INVENTORS

Whether an invention is patentable can be substantially determined by a search of the U. S. Patent records. Without obligation, write for information explaining the steps you should take to secure a patent.

JOHN N. RANDOLPH
Registered Patent Attorney

201 Columbian Building, Washington 1, D. C.

PATENTS

C. A. SNOW & CO.

REGISTERED PATENT ATTORNEYS

WRITE FOR INFORMATION TO
428 SNOW BUILDING, WASHINGTON 1, D. C.

HELPFUL BOOKS

Send post card asking for FREE catalog

Popular Mechanics Press, 200 E. Ontario, Dept. 601, Chicago 11

INVENTIONS For Sale

Our clients have excellent inventions in many fields to be manufactured and marketed on a cash, royalty or license basis. Full description of clients' inventions will be sent if you state your field of interest. INVENTORS: WE ALSO WANT INVENTIONS OF EVERY TYPE. Write for details.

GLOBAL MARKETING SERVICE

1404 Mitchell Street Dept. MS Oakland 1, Calif.

INVENTORS

Send for PATENT INFORMATION Book and INVENTOR'S RECORD without obligation

GUSTAVE MILLER
55-PM WARNER BUILDING WASHINGTON 4, D.C.

REGISTERED PATENT ATTORNEY
ASSOCIATE EXAMINER
U.S. PAT. OFF. 1922-1929
Patent Attorney & Advisor
U. S. NAVY DEPT. 1930-1947
PATENT LAWYER

INVENTORS

I shall be pleased to furnish you, upon request, with full information relative to patent procedure—without any obligation on your part.

PATRICK D. BEAVERS

Registered Patent Attorney
934 Columbian Building Washington 1, D. C.



EXTRA MONEY
Selling **EXCLUSIVE**
PARAGON Cushion Shoes

Even If Now Employed

Enjoy your own lifetime, independent shoe business without investment. Steady repeats. To \$4.00 pair advance commissions. Big bonus. Make \$50 and more a week in full or spare time. 115 latest smart styles. Magic cushion. Easy to start. Write for FREE **OUTFIT** today!

PARAGON SHOE COMPANY
79 Sudbury St., Dept. 20, Boston 14, Mass.

LOCKSMITHING & Key Making



PRACTICAL UP-TO-DATE COURSE—ONLY \$4.95

Easy-to-learn modern information for self-instruction. How to work on locks, de-code, make master-keys, repair, install, service, etc. For every handyman, home owner, carpenter, mechanic, service station operator, fix-it shop, hardware dealer, gunsmith. 53 plain illustrated lessons. **Full price only \$4.95. SEND NO MONEY.**

Just pay postman plus C.O.D. postage. Or send \$4.95 with order. We'll ship postpaid. Satisfaction guaranteed or refund.

NELSON-HALL CO., 210 S. Clinton St., Dept. HV-2, Chicago 6, Ill.

FREE GERMAN STEEL HUNTING KNIFE



4-INCH BLADE

We give you handiest hunting and fishing knife you've ever had! Has 4-INCH LONG highly tempered steel blade—VERY SHARP! Attractive handle. We send knife FREE to acquaint you with our below-wholesale bargains. Please send 25c for handling. **NO LIMIT—but send 25c handling for each knife. Order TODAY!**

HUNTING KNIFE, Dept. K-20, Box 881, St. Louis, Mo.

SAY YOU SAW IT IN
POPULAR MECHANICS

STAMMERING

may be overcome by re-education of vocal muscles and speech mechanism. Scientific Home Method for adults & children by **EX-STAMMERER** based on physiology of speech leads to **FLUENT SPEECH**. Write:

Dept. A, VOCAL METHODS

P.O. BOX 5123 SAN ANTONIO, TEXAS

Finish HIGH SCHOOL AT HOME

Complete 4 Yrs. in 12 Months

Learn More! Earn More! Enter professional or technical schools. Advance Socially. Live a Happier, Fuller Life. Individual Courses or complete schedule. **WRITE FOR SCHOOL BULLETIN.**

ACADEMY FOR ADULTS

30 W. Washington, Dept. PM-85, Chicago, Ill.



GIANT 6 Ft. Balls 59c

Great fun for Kids and Grownups. Inflates to a Giant 6 ft. across. 21 ft. around. Use at beach or playground. Made of genuine neoprene rubber for extra durability. Can be painted to carry your message! Terrific for attracting crowds at fairs, openings, school games, gas stations, etc. Government surplus, never used, sold at a fraction of original cost. 59c each, (2 for \$1.00, 5 for \$2.00, dozen only \$5.00). Sorry no C.O.D.'s

Dealer Inquiries Invited

NOVEL MFG. 33 2ND AVE., DEPT. G-1036 NEW YORK 3, N. Y.

EARN BIG PAY

Industry needs skilled mechanics. **GREER**, leader for more than 50 years in the Trade School field, can train you quickly—You "learn by doing," using the finest equipment, under the supervision of expert technicians.

APPROVED FOR CIVILIANS OR GI'S

— CHOOSE YOUR TRADE —

CHECK HERE	WEEKS
<input type="checkbox"/> DIESEL MECHANICS	20
<input type="checkbox"/> AUTO MECHANICS	20
<input type="checkbox"/> BODY & FENDER	16 1/2
<input type="checkbox"/> GAS-ARC WELDING	4 - 12
<input type="checkbox"/> REFRIGERATION	13 1/2
<input type="checkbox"/> AIR CONDITIONING	8 1/2
<input type="checkbox"/> MACHINIST TRADE	30
<input type="checkbox"/> ADVANCED MACHINIST (includes tool & die)	32 1/2
<input type="checkbox"/> PIANO TUNING & REPAIR	36

CHOOSE YOUR ENGINEERING COURSE

These courses are intended as terminal education for men who wish to enter the Diesel-Automotive and Refrigeration-Air Conditioning fields as technicians. These courses are designed to prepare men for supervisory positions. Students with a high school education, or equivalent, will be accepted.

<input type="checkbox"/> DIESEL AUTOMOTIVE ENGINEERING	2 years
<input type="checkbox"/> REFRIGERATION & AIR COND. ENGINEERING	18 months

HOME STUDY COURSES

Learn at Home — Approved for Civilians & G.I.s. Write for detailed information on Courses in

- PLASTICS
- REFRIGERATION & AIR-CONDITIONING
- DIESEL ENGINES

FREE EMPLOYMENT HELP

Start your career with Greer by checking your interest above and mail coupon for complete information at no obligation.

NAME _____ AGE _____
STREET _____
TOWN _____ ZONE _____ STATE _____

Established 1902 — Over 50,000 Graduates.
53 years of continuous trade school experience to guide your training.

GREER SHOP TRAINING

Box H, 2236 S. Michigan Ave.
Chicago 16, Illinois



**\$100.00 Profit
In My First 3 Days!**

—that's what Leon Landis, Michigan, reports. Many others are "cleaning up" showing the amazing new PRESTO. So can YOU!

A amazing new kind of fire extinguisher. Tiny "Presto" (about size of a flashlight!) does job of bulky extinguishers that cost 4 times as much, are 8 times as heavy. Ends fires as fast as 2 seconds. Fits in palm of hand. Never corrodes. Guaranteed for 20 years! Over 2 million already sold! Show it to civil defense workers, owners of homes, cars, boats, farms, etc.—and to stores for resale. Make good income. H. J. Kerr reported \$20 a day. Wm. Wydallis \$15.20 an hour. Write for FREE Sales Kit. No obligation.



Science's
New Midget
Miracle
"PRESTO"

MERLITE INDUSTRIES, Dept. 58
114 East 32nd Street New York 16, N. Y.
IN CANADA: Mopa Co., Ltd., 371 Dowd St., Montreal
1, P. Q. (If you want a regular "Presto" to use as a
demonstrator, send \$2.50. Money back if you wish.)

**"NOW I'M MY OWN BOSS
at Double My Former Salary"
As A CUSTOM
UPHOLSTERER**



Paul M. De Vita, Former Low Paid Auto Mechanic
Steps-Up Earnings to Over \$100 a Week

"I can hardly believe how quickly I've gotten ahead in this interesting and profitable trade. I was a mechanic making \$55 a week. Now I operate my own shop and make over \$100 a week. UTS Training has been invaluable."

WHAT DO YOU WANT? Your Own Profitable Business—A Steady Job—Substantial Sparetime Earnings—A More Secure Future? They're all waiting for YOU in the Big-Opportunity Field of Custom Furniture Upholstery.

The big nationwide housing boom has created a great demand for trained upholsterers. Prepare for this well-paid trade—easily, quickly. You can earn as you learn to make good money all year 'round at home, in your own shop, or in a well-paid job. The practical N. Y. State-approved UTS Course teaches you professional custom furniture upholstery, reupholstery, slip-covers, furniture finishing, window cornice, cushion, and drapery making. You get—FREE—ALL tools, complete frames and materials to make beautiful furniture. Yours to keep or sell.

FREE ILLUSTRATED BOOK WITH SAMPLE LESSON!
Our FREE book, "YOUR NEW WAY TO A SUCCESSFUL CAREER" with Sample Lesson shows you how. WRITE TODAY! Training in N. Y. School also available. UTS, Dept. DM-305, 721 B'way, N. Y. 3

MAIL COUPON TODAY

**APPROVED
FOR VETERANS**

UPHOLSTERY TRADES SCHOOL, Dept. DM-305
721 Broadway, New York 3, N. Y.

Send me FREE book and FREE Sample Lesson. No obligation—no salesman will call.
 Home Study In N.Y. School Training

Name _____
Address _____
City _____ Zone _____ State _____

Check if Korean Veteran

**MATERIALS FREE
WITH COURSE
YOU MAKE**

SLIPPER
CHAIR

CLUB
CHAIR

OTTOMAN
PLUS SLIP COVERS

Yours to keep
or sell

**BE A FROGMAN!
JOIN THE NATIONAL FROGMAN CLUB!**

**FREE FATHOMETER DEPTH
GAUGE \$2. VALUE.**



A free Fathometer depth gauge (\$2 value) with a membership in the famous National Frogman Club. Learn the fun and thrill of exciting underwater adventures! Join with thousands in this new underwater sport that is sweeping the country. Start your own local Frogman chapter with our guidance. For just \$2 you get all this:

1. An instruction booklet on "How to Swim Underwater" and "The Supreme Sport of Spearfishing."
2. Club NEWS BULLETINS issued periodically on the latest activities, developments, news, photographs, etc.
3. Club emblem (miniature Frog Feet).
4. An attractive membership card.
5. Frogman deal with Club insignia.
6. Many PREMIUM OFFERS to Members Only, for official, recommended equipment, with complete catalog.
7. A FREE coupon worth \$1.00, to apply on purchase of merchandise valued at \$5.00 or more.
8. Book of the Month bonus offers the latest books on Underwater adventure and instruction. Send name and \$2 for FREE Fathometer depth gauge and the other EIGHT offers mentioned above.

NATIONAL FROGMAN CLUB
Dept. PM-85 Glendale, Calif.

P.O. Box 4246

**DRAW The First Day!
NO LESSONS! NO TALENT!**



New Amazing Invention—"Magic Art Reproducer." You can draw Your Family, Friends, Anything From REAL LIFE—Like An Artist Even If You CAN'T DRAW A Straight Line! Anything you want to draw is automatically seen on any sheet of paper thru the "Magic Art Reproducer." Then easily follow the lines of the "picture image" with a pencil for an original "professional looking" drawing. Also reduces or enlarges. SEND NO MONEY! Free Trial! Pay Postman on delivery \$1.98, plus postage. Or send only \$1.98 with order and we pay postage. Money Back Guarantee.

NORTON PRODUCTS, Dept. 5808T, 296 Broadway, N. Y.

**BUILD YOUR OWN
AIR CONDITIONERS**

From Junked Refrigerators for a Few Dollars
INSTRUCTION BOOKS SHOW YOU HOW. 75c EACH Special Offer
2 or 3 books
50c each
or all 5 for \$2.00

- "HOW TO BUILD a Low Cost Air Conditioner"
- "HOW TO BUILD an Automobile Air Conditioner"
- "HOW TO BUILD a Low Cost Home Freezer"
- "HOW TO BUILD an Electrostatic Precipitator"
- "HOW TO BUILD a Low Cost Dehumidifier"

Complete "Install-It-Yourself" Air Conditioner
kits for home and automobile, 2 Ton capacity,
Brand New Parts—\$179.70 and up.

FREE!
Instructions
and Literature
on kits.

KOOL ENGINEERING CO., Dept. A-8, 3716 Belmont, Chicago 18, Ill.

**200
ONE-EVENING
PROJECTS**

**Start and Finish Any One of
These Projects in One Evening!**

The editors of Popular Mechanics have assembled 200 projects, any one of which you can start and complete in a single evening. In a few hours' time, using only simple hand tools, you can build a coffee table, magazine rack, end table or scores of other useful projects. There are projects for the entire family. Best of all, any one may be built in just a few hours. No special skills are needed. Even if you have never built anything before, you can build the 200 projects in this big new book!

**Step-by-Step Instructions,
Show-How Photos, Drawings**

First you read how to do it in famous Popular Mechanics step-by-step instructions and then actual photos, drawings and diagrams show you how it is done.

Each Project Costs Just 1c

Just imagine! Each project costs you only 1c. Where else today can you get so much for so little? Fill out and mail the coupon now. Full money-back guarantee, of course.



POPULAR MECHANICS PRESS, Dept. EP-1
200 E. Ontario St., Chicago 11, Ill.

Gentlemen:
Remittance for \$2.00 enclosed. Rush postpaid my copy of 200 ONE-EVENING PROJECTS. Unless it is entirely satisfactory I may return it in seven days for a full refund.

NAME _____
ADDRESS _____
CITY _____ ZONE _____ STATE _____
 Send C.O.D. (U.S.A. only). Postage extra.

NEW RUBBER STAMP BUSINESS PAYS BEGINNERS UP TO \$9.20 AN HR.

**START AT HOME
IN SPARE TIME**
with Table Top Machine!

The multi-million dollar Rubber Stamp business—once controlled by a few big companies—is now being taken over by small operators—one in each community throughout the United States. Men and Women who have this inexpensive machine can turn out huge quantities of Rubber Stamps with special wording that buyers once were forced to buy from big cities. Material costing only 27c makes a stamp that sells for \$1.80. The machine that does the work is simple and easy to operate and it turns out as many as six Rubber Stamps at a time, each with different wording such as names, addresses, notices, stock numbers, prices and other "copy" needed by offices, factories and individuals. Working full capacity, it can earn as much as \$9.20 an hour for the operator! Now you can get into the big-pay business yourself, with your own home as headquarters. You don't need experience. We supply everything, including complete instructions and eight ways to get business coming in fast. Start making up to \$9.20 an hour from the very beginning. Cash in on the profitable Rubber Stamp business in your community, right away. We'll mail full particulars FREE and no salesman will call. Be first in your locality. Rush coupon today or send your name on postcard to

RUBBER STAMP DIV., Dept. R-2-J
1512 JARVIS AVENUE • CHICAGO 26, ILLINOIS



RUBBER STAMP DIV.
1512 Jarvis Ave., Dept. R-2-J
Chicago 26, Illinois

FREE!

Please rush full particulars about the little machine that can get me started in the profitable Rubber Stamp business at home in spare time. Everything you send me is FREE and no salesman will call.

NAME _____
ADDRESS _____
CITY _____ ZONE _____ STATE _____

HOW TO DOUBLE YOUR SALARY! **FREE LESSON**

Turn your natural common sense to big money in a high paying, prestige job. Our graduates PROVE that you can make more than double or triple your salary. Industry desperately needs trained men. Men like you have saved business millions of \$888 every year. IEC can train you for this wide open field of Time Study. Your pay is excellent. Your future secure. Wonderful chances for promotion. Write today for your FREE Lesson. No salesman will call. Free job help for students. Indicate whether you want home-study or Chicago resident training information.

INDUSTRIAL ENGINEERING COLLEGE 3309A W. WASHINGTON
CHICAGO 24, ILL.



DEVELOP A HE-MAN VOICE!

Write for FREE book "How to Strengthen Your Voice for Greater Success" by Eugene Feuchtinger. No obligation. Book will be mailed at once in plain wrapper, postpaid. Just send your name and address. State age. **PREFECT VOICE INSTITUTE, 210 S. Clinton St., Studio MV-2, Chicago 6, Ill.**

CABINET MAKING

LOW COST HOME TRAINING COURSE FOR BEGINNERS & ADVANCED CRAFTSMEN

Make money. Learn skills and secrets of fine woodworking and tool use. Professionally prepared shop method training tells and shows how. Covers everything. Easy to master.

Write for **Free Booklet**
INTERSTATE TRAINING SERVICE
DEPT. F3, PORTLAND 13, OREGON

CIVIL DEFENSE POCKET RADIO!

NO TUBES — BATTERIES OR ELECTRIC PLUG-INS NEEDED!

Ordinary radios MAY BE USELESS DUE TO RUN DOWN BATTERIES OR POWER FAILURES during atomic attacks but this NEW CD Perma-Crystal Diode Pocket Radio operates during power blackouts. Receives regular radio stations and CIVIL DEFENSE BROADCASTS. Works anywhere when used as directed. COMPLETE, SELF-CONTAINED SPEAKER PHONE. GUARANTEED TO WORK and should last for years. BE PREPARED — GET YOUR CD POCKET RADIO NOW! **SEND ONLY \$1.00** (cash, ck. mo) and pay postman \$3.99 COD postage or send \$4.99 for postpaid delivery. COMPLETE READY TO PLAY WITH CIVIL DEFENSE INSTRUCTIONS. By mail from—**MIDWAY COMPANY, Dept. CPM-8, Kearney, Nebr.**



HOW TO GROW ORCHIDS AT HOME

Most enjoyable hobby I know. People drive 100 miles to see this plant... 10 flowers, 8 1/2 inches across!
Thomas Hurst-Utah

Learn how you may have real ORCHID FLOWERS blooming in YOUR OWN HOME within a few weeks. Successful home grower now reveals his secrets. Shows you how to grow gorgeous CATTLEYS, CYMBIDIUMS, EPIDENDRUMS, etc. in your living room. No previous experience needed. World's most fascinating hobby — PROFITABLE HOME BUSINESS. Big profit orders come from friends, neighbors, florists, etc. **FREE — real ORCHID SEEDS** and full details, including PLAN FOR STARTING YOUR OWN BUSINESS — SEND NO MONEY. Write today.



YEAR 'ROUND ANY CLIMATE NO Green House

FREE! REAL ORCHID SEEDS & \$\$\$ PLAN

TROPICAL FLOWERLAND, Dept. 318
4622 Wilshire Blvd., Los Angeles 9, Calif.

How to Learn ORCHID SECRETS! 48 PAGES 100 SEEDS

SAY YOU SAW IT IN POPULAR MECHANICS

Want a Government Job?

START AS HIGH AS \$4,205.00 A YEAR

MEN—WOMEN Prepare NOW for next exams
Thousands of appointments being made. 36-page Book FREE.
FRANKLIN INSTITUTE (Not Gov't Controlled)
Dept. F-93, Rochester 4, N. Y.
First: Rush FREE: (1) 36-page book with list of U. S. Gov't Jobs; (2) Tell me how to qualify.
Mail Coupon Today. SURE.
Name _____ Age _____
Address _____

MAKE \$15,732.00 IN ONE SUMMER \$9,504.00 WITHOUT LEAVING YOUR HOME

DON'T READ THIS!

Unless you are near a healthy fire extinguisher or a plentiful supply of WATER. We cannot assume responsibility if this ad breaks out in ROARING FLAMES. So please do stop reading this until you have taken the necessary safety precautions. Yes, we have an item that's H O T —so H O T that we are not going to say other than the usual words of a good product for fear of setting this

good magazine on FIRE. This product is NEW! SENSATIONAL! COLOSSAL! AMAZING! and REVOLUTIONARY.—NO! No long story—All we have to say, and this is modestly, we have an ELECTRICALLY controlled bulb that is the BEST insect killer CONSOLIDATED RESEARCH has been able to produce—bar none. Not to be compared with any other unit ever sold.

Testimonials like these are pouring in by the hundreds.

"It works like a charm. I am amazed at its results."—Mrs. A. F. Wills, Atlantic City, N. J.

"Your magic bulb has at last solved my roach and fly problem."—Mrs. C. I. Thompson, Miami, Fla.

"Has given my family endless hours of comfort living."—Mr. P. V. Zane, Los Angeles.

You have heard of the 7 Wonders of the World. Now, consolidated research introduces the 8th Wonder, acclaimed a MUST in every home and establishment. Being hailed by salesmen as the biggest MONEY MAKER since the opening of the U.S. MINT.

ABSOLUTELY EVERYONE

Now that you have taken the safety precautions, read every word in this ad, as we have said above, this item is **HOT**, so hot that to be extra safe we have ordered the publishers not to use any **RED** ink. Now, getting serious, fellows, here's the scoop. We are going to do **EVERYTHING** to make you the most welcomed salesman to ever approach a customer. We will give you **GLOSSIES, MATS, IMPRINTS**, all the material needed for an immediate mail order set up, also documented test reports of how prominent colleges and testing labs, **RATE** our product, also at your disposal is a powerful pulling pitchman sound T.V. movie on Bug Weapon. The production value of this film cost us more than \$2000.00, **PLUS BELIEVE IT OR NOT** an advertising allowance. We will **PRE-SELL** this Bug Weapon for you, by launching a tremendous advertising barrage, including almost all national magazines, radio, and T.V. The entire population of the U.S. will be put in a buying mood. Especially so since hundreds of insects will help you make every sale. They will dive bomb about him, molest his comfort, interrupt his sleep, destroy his property, and spread contagious diseases about his home, and food. Business establishments suffer enormously combating the ugly insect problem. They will greet you with arms wide open. It's a tested natural with **STAGGERING** public acceptance and mountainous profits. Yes, you will be **WELCOMED**, you will be **THANKED**, most important you will make **MONEY**.

NATIONAL VOLUME SALES CORP., Research Dept. PM-8
1024 Cottman Ave. Phila. 11, Pa.



DEATH
TO DISEASE-CARRYING, DESTRUCTIVE AND ANNOYING PESTS



AMAZING NEW INVENTION
KILLS ALL TYPES OF INSECTS
SCIENTIFICALLY-AUTOMATICALLY

10-YEAR GUARANTEE

Not a gadget — not a halfway measure. Not to be compared with flimsy, untried imitations. A finished quality appliance. Carries an ironclad 10-year guarantee and parts replacement policy. Sound by signature.



that flies and roaches are suspected carriers of 13 communicable diseases including **POLIO**. One fly can reproduce 8 million others. Flies seldom leave anything without first excreting on it. Don't take chances with your health. **YES**, you can now insect proof your home without lifting a finger. Throw out old fashioned fly swatters, and messy spray guns. A new, small, clean, decorative, little bulb enables you to destroy **HUNDREDS** of types of **INSECTS** like **MAGIC**. Only one 2 hour application keeps killing disease carrying, destructive and annoying insects around the clock for more than 2 weeks. More powerful than D.D.T. yet harmless to humans, pets and plants. Approved **SAFE**. Not a gadget, not a half way measure. Carries a **10 YEAR GUARANTEE**. It must **KILL** not **TICKLE** roaches, flies, moths, ants, and hundreds of others or your money **REFUNDED**. For your health's sake order **SEVERAL** units **NOW**. Everyone send us a check, M.O. or cash for \$2.98—C.O.D.'s accepted. Should you, after testing your unit, decide that you would like to join us in the sales of this new public servant, we will refund your \$2.98 making your unit **ABSOLUTELY FREE**.

ODORLESS • SILENT
• MYSTERIOUS

FREE DEMONSTRATOR COUPON

- Enclosed is \$2.98. Send me one unit for my personal use.
- Enclosed is \$2.98 in cash, check or M.O. Rush me one 20th CENTURY BUG WEAPON with sales aids, and LOWER wholesale prices. However, should I become an active salesman, you of the Volume Sales Outlet are to REFUND my \$2.98 making my demonstrator FREE. Furthermore, I must agree that everything you say be true or I will return everything for a refund within one week.
- Send one MONEY MAKING sales kit C.O.D.
- Lost time is lost money. Rush me _____ dozen BUG WEAPONS, at your wholesale price. Don't forget to include my FREE demonstrator and sales aids. C.O.D. (I enclose \$5.00 Deposit.)
- Together with the enclosed order don't forget to show me how to make \$4.37 on each \$2.98. \$15,732.00 in one summer. \$9,504.00 without leaving my home.

NAME _____
ADDRESS _____
CITY _____ STATE _____
(Members of the Mail Order Business Bureau)

NATIONAL VOLUME SALES CORP., Research Dept. PM-8
1024 Cottman Ave. Phila. 11, Pa.

ABSOLUTELY EVERYONE MAIL THIS COUPON NOW!

**WORLD'S
BEST
WANT-AD
MEDIUM**

CLASSIFIED ADVERTISEMENTS



Advertisements in this section \$1.00 per word, each insertion, minimum 10 words, payable in advance.
To be inserted under proper classification, copy must be in our office the
20th of the second month preceding date of issue
F. W. Johnson, Manager, Classified Advertising
Popular Mechanics Magazine, 200 East Ontario Street, Chicago 11, Illinois

YOU'LL PROFIT

By reading and answering the classified ads in this section. Hundreds of opportunities for you to make and save money

AUTOMOBILES, MIDGET CARS

BUILD 1902 Rambler, 1909 Hupmobile, antique cars. Authentic 1/2 inch scale plastic model kits. Collectors pair. Both for \$2.00 postpaid. Kaysun, Manitowoc, Wis.

HUNDREDS Of automobile catalogs—American, antique, foreign; dealer books, glossy photographs, shop manuals; free motor magazines—Offered by non-profit club. Write immediately; get on free mailing list. Auto Maniacs, Stockbridge, Mich.

AUTOMOBILES. Brand new 1955, 15% discount. Proposition, stamped envelope. Auto Dyer, Livonia Branch, Detroit, Mich.

ENGINES. Wheels and equipment for midget cars \$10.00 up. Cauffiel Motors, Temperance, Michigan.

ANTIQUE Automobile color slides, 2x2. Illustrated catalog free. Universal, Box 779A, Beverly Hills, Calif.

'55 INDIANAPOLIS Race pictorial. Complete behind the scenes word and photo coverage of this world famous race. Limited edition. Rush \$2 today. Don Francisco Publications, P.O. Box 241B, Alhambra, Calif.

1955 SUPERIGNITIONER. Starting, pep, mileage. \$4.50. Correspondence courses catalog \$1.00. Barbells wholesale. EG, Elmsford, N. Y.

BOYS' Power-driven auto. Build your own. Plans 25 cents. Sypher Co., Box 39, Sta. F, Toledo, Ohio.

AUTO SUPPLIES AND EQUIPMENT

FABULOUS "Free-trial" automotive bargains! Send no money! Try for seven days—then send low, low payment or return instruments! Sensational Perf-O-Meter, nationally advertised \$27.95, only \$9.95! Famous Gale Hall Mile-O-Meter, regularly \$9.95, only \$4.98! Jet-Matic compression gauge, dealer cost \$7.50, only \$2.98! All brand-new, original cartons! Add 40c each for postage or send payment with order and we pay postage! Order now! New England Surplus Sales, Dept. PM-85, Newburyport, Mass.

CLEAN. Shine autos the easy way with Dustex. Chemically treated long lasting dirt removing cloth. Saves wash jobs, waxing lasts longer, eliminates extra work. Order yours now. \$2.00 prepaid. Dustex, 2616 Harrison, Waukegan, Illinois.

ISO-Mite—Lubricant and engine conditioner. Totally new approach to increased engine economy, performance, efficiency. Sensational proven results. Guaranteed \$1.95. Iso-Mite Eastern, Annapolis, Md.

GM71-110 Discarded injector parts wanted. Bonus on HV. Bares, 7120 Carnegie, Cleveland 3, Ohio.

BUY Wholesale nationally advertised auto supply, thousands other products at big discount. Free "Wholesale Plan." American Buyers, Hertel Station, Buffalo 14-01, N. Y.

VISOR-Pak holds everything. Free circular, write Gibson Distributing Co., Box 344, Dayton 1, Ohio.

CUSTOMIZE Your car—Complete instruction booklet. \$1.00. Alanne, Box 135, Watertown, Conn.

IMPORTANT! Automobile owners, guard against fire, theft, flat tires! Write: Burns, 1967 Gerritsen Avenue, Brooklyn 29, N. Y.

AUTOMOBILE Burglar alarms. Free sample offer. Salesmen wanted. Novak, 3131-W13, Gary 18, Indiana.

GENUINE Motor treatment, Lachapelle's, (patented). Only \$3.00 delivered. Increases compression, power. Saves gas, oil, repairs. Money back guarantee. You can't lose. Free circular. Write Joe Dillon, Authorized Warehouse and Agents Distributor, Box 323-11 Bridgeport, Ohio. Exclusive distributorships, agencies open.

OVERLOAD Springs for pickups. Half price. Send \$11.95. Write Heco, Albert City, Iowa.

BUY Wholesale! Auto supplies, 10,000 other products. Save 66%!! Free catalogs. National Buyers Service, Box 426ED, Oakland, California.

ALIGN-A-Matic outperforms all drive over alignment devices. \$22.50. Align-A-Matic, 62 Gaston St., W. Orange, N. J.

SAVE Money on bronze permanent oil filter cartridge, standard \$3.95, super fits all cars \$7.95. Gasoline vaporizer increases mileage, power, performance, single \$3.00, dual \$4.00, 4 throat \$6.00, guaranteed. Postage paid. Dealers wanted. Zenick Prod. Corp., Box 2461, Los Angeles 54, Calif.

CAR Burning oil? Losing compression? Try Clifford's Compression Seal Tube, \$2 postpaid. Clifford's Engineering, 1329 Seventh, Aurora, Illinois.

SAVE \$50-\$175 Yearly in car, truck, or any gasoline, diesel engine operation. Install yourself. New patented process prevents, eliminates carbon by cracking gasoline before combustion. Thousands satisfied users! Only \$12.95, postpaid. Money-back guarantee. Send personal check or money order. Worthwhile writing for free information to: Hydrocarbon Systems, 2808 McKinney Ave., Dallas 4, Texas.

ELECTROPLATE Auto parts, novelties, mirrors. Easy, inexpensive home processes. Free booklet. Tyco Metals, Box 13291-BG, Houston 19, Texas.

AUTO Accessory and parts catalog, 1955 edition—All new! 148 pages. Save up to 50%. Over 50,000 items, including Hollywood accessories, hi-speed equipment, rebuilt engines, all parts and accessories for all cars and trucks! Hard-to-get parts! Send 25c Refundable. J. C. Whitney, 1919-PM Archer, Chicago 16, Illinois.

NEW And used parts at savings. Complete guaranteed parts service for all models cars and trucks, 1924 and later. Largest in the West. Army parts specialists. No catalog, write for quotations. Fast mail order service. Pioneer Auto and Truck Parts Co., 1560 Speer Blvd., Denver 4, Colorado.

HARDTOP And convertible owners. Save \$10.00 by cleaning your own leather seats. Kit includes cleaning compound and applicator for \$2.49. Oetter Products, 7894 Watson Rd., St. Louis County 19, Mo.

MECHANICS Attention. Plymouth and Dodge pistons, all sizes, \$15.84 a set. Merryman, Box 422, Ontario, Calif.

FORD-T parts. Most complete stock in U.S. for all old cars. Try to stamp us. Wisneski, Milwaukee 7, Wisconsin.

FREE Discount catalog—Speed, power, custom equipment. Almqvist Engineering, Milford 7P, Pennsylvania.

AUTO TRAILERS

TRAILER Parts catalog. Largest in mid-west. Send 25c. Refundable. Hanna Trailer Supply, 615 West Layton, Milwaukee, Wis., Dept. M.P.

EXCEPTIONAL Expanding eight foot trailer. Accommodates family of five. Build yourself. Literature 10c. Pramarc Company, Wilmington, Mass.

BUILD Your own trailer! Plans for all kinds. Illustrated catalog 10c. Jim Dandy, 125-M, Wausau, Wisconsin.

ASSEMBLE Yourself kits. Slip-on cabin coach for all pick-up trucks. Trailer blueprints. Literature 10c. Comstock Trailers, 646-P, Parsons, Kansas.

MOTORCYCLES, BICYCLES, MOTORSCOOTERS AND SUPPLIES

NSU And BWM motorcycles, 2 to 35 h.p., singles and twins, chaindrive and shaft-drive. Butler & Smith, P.O.B. 45, New York 24, N. Y.

PARTS. Pistons, new, used. Harley. Indian. Henderson, list 10c. Ballak, 811 N. 9th, St. Louis 1, Missouri.

SERVICYCLE \$20.00; Whizzer motorbike \$25.00; Cushman motorscooter \$25.00; midget auto \$25.00. Rush 25c (35c first class mail) for new catalog #957 listing many other amazing bargains in motors, midget cars, motorscooters, motorbikes, construction plans. Associated, Box 534, Toledo, Ohio.

AMERICAN Motorscoot \$20; midget motorcycle \$25; Cushman \$25; midget car \$50; Whizzer engine \$5. (Mailorder only). Send 25c (35c for first class mailing) for directory catalogue Number 66, just out, listing these and hundreds of other bargains in new and used midget cars, motorscooters, Home builders parts, plans, etc. Midget Motors Directory, Athens, Ohio.

"BUZZZZ" The motorcycle magazine. International coverage. Thoroughly illustrated. Yearly \$2.00. Sample 25c. 5424-A Sawyer, Chicago 25.

HARLEY-Davidsons—America's finest used bargains! We pay shipping on motorcycles. Genuine new, used parts, accessories for current and obsolete models. Send 25c for bulletin, catalog. Knuth's (factory dealer), 1753 Muskego, Milwaukee, Wis.

AVIATION

AIRLINE Steward-purser. Fly 85 hours monthly. Starting salary \$235 up. G.I. approved. Free catalog. Air-Purser School, Room P, 1030 Nicollet Ave., Minneapolis, Minnesota.

HOMEBUILT Handbook. Formulas; airfoils; engines. \$1.00. Urshan, Box 4332 N.P. Sta., San Diego 4, Calif.

PROPELLERS. Plans, supplies for air boats, snow sleighs. Catalog 10c. Gano Propellers, Box 3284-A, Ft. Worth, Texas.

HELICOPTER, One man. Experimental marvel. Construct own. Instructions \$3.50. Mayberry Company, Box 343, St. Clair Shores, Michigan.

PROPELLERS. Plans, kits for snow sleighs, air boats. Immediate delivery, satisfaction guaranteed. Catalog 25c. Banks-Maxwell, Box 3301E, Ft. Worth, Texas.

BATTERIES, GENERATORS

GENUINE Edison alkaline batteries. Fifteen year life. Unconditionally guaranteed. Illustrated literature. Kohler gasoline, diesel generating plants. Emergency Lite Company, 300 Twelfth Avenue, Paterson, New Jersey.

BATTERY Ignition, works from any type magneto. Parts available at small garages. Except battery parts cost about \$4 for any size engine. Instructions \$1.00. Money back guarantee. Aubrey Pearce, 328 Gulfport St., Hattiesburg, Miss.

EDISON Nickel storage batteries. Any voltage, any amperage. Unconditionally guaranteed. Power plants, generators, motors. Literature. Hawley Smith Co., Croton Falls 1, N. Y.

ELECTRICAL SUPPLIES

NEW 1955 Lamp parts catalog showing everything you need to make and repair most types of lamps. Everything at lowest wholesale prices. Send only 25c today for both catalog and wholesale price list. Gearon Co., Dept. 503-B8, 27 S. Desplaines, Chicago 6, Ill.

TELEPHONE Transmitter. Hand set type. Suitable for inter-house phones, speakers or any communication purpose. Delivered two for \$1.00. No c.o.d.'s. Telephones, Dept. C-125, 1760 Lunt, Chicago 28.

6 KVA G. E. saturable reactors, \$300 value, \$60.00. Also government surplus transformers. D. Smith, 106 Verbena Road, Oak Ridge, Tennessee.

LAMPS—25c Brings bargain catalog showing all parts for repairing, building. Contains instructions for electrifying vases, oil lamps, etc. Gyro Lamps, \$402P Clark, Chicago 40.

WELDING, SOLDERING, PLATING

NEW, Portable oxy-acetylene outfit welds sheet, light plate; cuts heavy steel; heats, brazes. Just change tips. Complete, with instructions, only \$76.50. Special money-saving plan for oxygen and acetylene supply. Write today for free literature. Dept. M, Linde Air Products Company, 30 East 42nd Street, New York 17, N. Y.

A.C. Welders, 130 amperes, \$39.50. Morris, 1070 Inner Drive, Schenectady 3, N. Y.

"BUILD-UP-OWN" a.c. welder and a.c. power plant with a good used engine and low cost Hobart generator. Welds anywhere and supplies 5kw stand-by power for any emergency. Write Hobartweld, Box M-853, Troy, Ohio.

WELDERS \$50 to \$75. Build your own welder. Free directions. Government surplus G. E. 150 amp. welding transformers. \$200 value, \$50. DuPont Smith, 106 Verbena Road, Oak Ridge, Tennessee.

AMAZING Necco torch guides. See ad August issue page 244. New Era Engineering Co.

ELECTROPLATING Equipment, anodes and solutions for all types of plating. Instructions. Assemble your own plater and save. Free catalog. Ramyr, Dept. E-4, 1624 East First Street, Los Angeles 33, California.

ACETYLENE Welding outfits, new \$49.00; used \$29.00; arcwelders \$56.50. Eagle Welding, Dept. PM, 5085 Broadway, Chicago 40, Ill.

MAGNA-Weld lenses for welders who need glasses. The Magna-Weld lens is an optically ground magnifying inside cover glass 4"x4 $\frac{1}{4}$ ". Fits all standard helmets. Number one weak power, number two stronger power. Price \$5.00 each. Satisfaction guaranteed. Industrial Optical Co., P.O. Box 444, Jacksonville, Florida.

A.C. Welders. 4 sizes. Lowest prices. Free literature. Holgerson's Serv., Canton, Kan.

MACHINERY, TOOLS, SUPPLIES

COMPOUND-Angle setups simplified with the amazing Setup-Master. A pocket slide chart that adjusts to machining operation and machine type, identifies setup angles and locates part on three standard shop fixtures. Shows formulas. With complete instructions. Only \$1.00. B. Black, Box 2112, Inglewood 4, California.

CRANKSHAFT Grinding equipment bargain. Will finance. Send references. Eaton Roller & Manufacturing Co., Box 304, Eaton, Indiana.

CRAFTERMAN'S Pride center punches, ground, hardened, polished. Five for \$1.00. David Myers, Victory Box 66, Gastonia, N. C.

SHEBEL Saw filer files hand and circular saws sharper than new. Circular. A. P. Shebel, 730 So. 2nd St., Milwaukee 4, Wis.

MAKE Interesting shop projects from our quality iron castings. Free folder. McKIn Industries, Box 3172, Lennox, California.

ENGLISH Made accurate small lathe, catalog. Science Now Company, Catskill, New York.

ELECTRIC Tools. Name brand. $\frac{1}{2}$ " drill \$10.87; $\frac{3}{4}$ " drill geared chuck \$17.47; grinder \$14.44; 5" saw \$26.88. Many bargains. Last 10c. Howdy Makit Power Shop, Box 6, Harper Station, Detroit 13, Michigan.

COMBINATION Square and gauge \$2.85. Nelson, 7822 S.W. Chestnut, Portland 19, Oregon.

REPAIR Damaged threads fast with hex dies! Coarse or fine set, \$1.00 each, $\frac{1}{4}$ " through $7/16$ ". Guaranteed. Jaw Mfg. Co., Reading, Penna.

WORLD'S Finest hand presses, 6 famous models to choose from, priced to fit all pocketbooks. Supplied with type and all needed equipment. In use by leading schools, Vet. hospitals, industrial co., churches, greeting card mfg., and artists. Do it yourself for fun and profit. Send 25c for instruction book and catalog. Craftsmen Machinery Company, 76 W. Dedham Street, Boston, Mass.

NEW Surplus air compressors; portable tank mounted; 6-8 hp. B&S engine; 15-20 cu. ft.; 175#; for paint spraying; sand blasting; etc. \$725 value; \$269.50. Croul's, Killbuck, Ohio.

ELECTRIC Hand saw 7" 1 h.p. \$79.95 value \$48.00 p.p. V. Swain, 9144 117th St., Richmond Hill 18, N. Y.

ALLEN Two ton power bench type punch press. \$97.50. Circular. Allen, Dept. FMB, Clinton, Missouri.

ENGINES, MOTORS, DYNAMOS

REBUILT $1\frac{1}{2}$ To 3 h.p. engines \$17.00 to \$37.00. Cauffiel Motors, Temperance, Michigan.

A.C. Generators, 750 watt \$38.50. Twin cylinder compressors with $\frac{1}{2}$ horse \$22.00. Motors 1 horse \$37.50. Butler, 1885 Milwaukee, Chicago 47.

WINDING Data. 225 motors, single and three phase, \$1.00. Data Company, Box 7631, Kansas City 28, Mo.

REWIND Motors yourself. Complete instructions \$1.00. Lewis Mfg., Howell, Michigan.

BOATS, OUTBOARD MOTORS

AUTOMATIC Sculler. Positively silent and weedless. Patented features make it the best. Literature free. Whidden's, 913 Benbow Street, Jacksonville 9, Florida.

JOHNSON Outboard specialists. Used parts for all models at substantial savings. Prompt quotations. Specify model serial. Crandall-Hicks, 910 Commonwealth, Boston, Mass.

BAROAINS Galore. Steer wheels \$9.95, windshield brackets \$7.95. Handles. Hundreds polished items. Free folder. Marine, 3604 Stevens So., Minneapolis 9, Minn.

BUY Wholesale nationally advertised outdoors, thousands other products at big discount. Free "Wholesale Plan." American Buyers', Hertel Station, Buffalo 16-H1, N. Y.

PLYWOOD Boat plans, 21 for \$1.00. Catalog boat building plans 25c. The Rudder, 15 Murray Street, New York 7.

SEA Legs boat kits, prices from \$39.00. Complete kits, including brass wood screws, precut parts, pre-assembled frames, fool-proof illustrated instructions. Write for free literature. Penney Woodcraft Industries, Dept. C-43, Defiance, Ohio.

CLEAN Outboard gas tanks. Harmless. Send 25c. Box 417, Delray Beach, Fla.

BOAT Patterns. Literature and illustrated boat construction book \$1.00. German Boat Company, West Saginaw, Mich.

NEW 12V. batteries for boats, motors, cars, etc. Include box and lid \$12.50 each. No c.o.d.'s. Leibe Supply, Selma, Calif.

CONVERT Fords and Jeeps to 100% marine engines with Osco's world famous Convo-Kits. Deluxe catalogue 25c (coin). Oscomotors, 3627B Lawrence, Philadelphia 40, Penna.

OUTBOARD Motor parts—New, used for all makes. Send stamp for price quotation, listing parts needed. Outboard Motor Mart, Inc., 229C State Street, Boston, Massachusetts.

FULL Size, cut-to-shape boat patterns, blueprints, 7 $\frac{1}{2}$ -38 feet. New 1955 illustrated "Build a Boat" catalog of 50 naval architect-designed cruisers, runabouts, sloops, skiffs, outboard boats, sailing, racing, houseboats, 50c. Marine hardware catalog, \$1.50. Bigger, better 1955 "How to Build Boats" book, \$2.50. PolyWog Houseboat Plans, \$12. Cleveland Boat Blueprint Co., Dept. A-66, 9400 Steinway, Cleveland 4, Ohio.

FIBERGLAS Permanent boat water-proofing. Lowest wholesale prices. Guaranteed materials. Easy application. Full instructions. Complete kits, \$12.60 up. Free literature. Ajax Plastics, Dept. PM, P.O. Box 1323, Fort Worth, Texas.

NEW, Used, rebuilt marine motors. Marine conversions, fittings. Free catalog. Stokes Marine Supply, Dept. 24, Coldwater, Michigan.

AIR Boat plans, supplies, catalog 25c. Banks-Maxwell, Box 3301F, Ft. Worth, Texas.

MARINE Conversion, Willys to Cadillac engines, kits and parts. Catalogue and conversion hints free. Barr Marine, 2706 Castor Avenue, Philadelphia 34, Penna.

PLANS, Patterns, frame kits for modern boats 12'-22'. Complete selection of modern boats especially for the amateur builder. State your requirements or send 40c for our complete catalog. Glen Designs, Box 568, Compton, Calif.

FREE Catalog! Boat kits, trailers, fiberglass, marine hardware. Lager Industries, Dept. M, 4452 Nicollet, Minneapolis, Minn.

MARINE Conversions for Ford and Jeep engines. Catalog 25c. Lehman Manufacturing Company, 972D Broad Street, Newark 2, New Jersey.

FABULOUS Bargains on marine hardware. 35c for small boat, \$1.00 for complete catalog. Free Glasticote literature. We pay freight. Marine Associates, Box 6188-M, Long Beach 11, Calif.

STOP Boat leaks forever with perfected Fiberglas. Instructions free. Ev-R-Shield, 4917-P Alhambra Avenue, Baltimore 12, Maryland.

FIBERGLAS Boat coating, Plexiglas boat windshields—clear, blue, green tints. Wholesale-retail. Complete information catalog 15c. Gem-O-Lite, Box 6861B, North Hollywood, California.

ATHLETIC EQUIPMENT, BODY BUILDING COURSES

MEN'S Athletic supporters, underwear. Free price list. Poly Shop, Box 3203, Ft. Worth 5, Texas.

DELUXE Athletic abdominal belts for men, \$7.49. Give waist size. Stillwell's, 1209 Minn. Ave., Kansas City, Kansas.

COMPLETE Arm, chest, back muscle building course and apparatus. \$1.00. Joseph Dryer, Box 5527, Chicago 80.

FREE Catalogue, 10c for postage appreciated. Dr. Thompson, 919 Fourth, Manhattan 30, Kansas.

BARBELLS. Exercise equipment. Courses. Free booklet. Good Barbell Co., Reading, Penna.

SPORTING GOODS, GUNS, FISHING TACKLE, ARCHERY, TRAPPING

DUCK Blind—Portable. Warm, dry, comfortable, two-man Porta-Blind. Wind and waterproof covering and flooring over sturdy metal frame. Carry in one hand. Set up in minutes. \$29.95 complete. Guaranteed. Free details. Porta-Blind, Box 1758-M, Wichita, Kansas.

FLIES—Buy at wholesale prices! Vicky's handmade imports. Send for beautiful colored pin-up cards. They're free! Reilart Products, Box 4430, San Francisco 1, Calif.

TEXAS Cowpuncher boots, illustrated circular free. Box 5651, Beacon Hill Station, San Antonio 2, Texas.

FREE Fishing catalog—132 pages. Over 3000 hard to find fishing specialties. Netcraft Company, Dept. PMS, Toledo 13, Ohio.

RUANA Hunting and Bowie knives. Send stamp for illustrated folders. Ruana Knife Works, Box 574, Bonner, Montana.

BUY Wholesale nationally advertised sporting goods, thousands other products at big discount. Free "Wholesale Plan." American Buyers', Hertel Station, Buffalo 16-II, N. Y.

REELS Wholesale, Pflueger supreme \$23.50; Ocean City # 251, \$18.40; South Bend #915, \$11.25; Coxe #25C, \$21.95. Prompt delivery, prepaid. Barry Sales, Box 234, Miami 50, Florida.

GUNS? Bargains? Always ask Agramonte! Big bargain catalog 50c. 100,000 Colts, Winchester's, swords, armour. New-used modern guns. Agramonte's, 201 Warburton, Yonkers 2G, N. Y.

TROUT Fishing, Stag at Eve, Mallards in Flight, Yacht Race, Collies, Thorobred, and Palomino coded oil painting kits in size 17"x15", Each kit \$2.95 postpaid, also North Woods Retreat size 18"x24", \$6.95 postpaid. You can paint in oils the first time you try. Send for free literature. Ralox, P.O. Box 1256, Decatur, Illinois.

SAVE 50% Finest archery equipment. Revealing "How to Bow-Fish, Bow-Hunt, Make Own Tackle, Improve Accuracy" booklet plus catalog. Both free! Malibu Archery, 1936-RAU La Brea, Los Angeles 19, California.

AMMUNITION 50% Discount—Catalog, list 200 calibers 10c. Pacific Firearms, 1517 Gardner, Los Angeles 46, California.

PORTABLE Duck blinds—4x5 foot woven tulle mats. \$3.00 each, two for \$5.00. Peacock PM, 915 Bryant, San Francisco, Calif.

DISCOUNTS On archery equipment. Savings on bows, arrows, tackle. Free magazine with illustrated catalog 25c (refunded). Pride Archery, RFD #1, Danbury, Conn.

20,000 GUNS—Huge 162-page photo catalog \$2. Big frontier sixshooter catalog 50c. Hy Hunter, Burbank 51H, California.

BUY Wholesale! Guns, fishing, sporting goods. Save 66%!! Free catalogs. National Buyers Service, Box 426EC, Oakland, California.

SWIMMERS! Send \$3.95 for imported French mask. Catalog of skin divers' equipment and books 25c. Aquafun PM, Davenport, Iowa.

180 PROFUSELY illustrated pages antique pistols, swords, daggers, armor, etc. 50c. Robert Abels, M860 Lexington Ave., New York 21.

TENTS, Camping equipment. Send 10c for new 1955 100 page tent, camping equipment catalogue—handbook. Morsan, 10-21R 50th Avenue, Long Island City 1, N. Y.

MOLDS—For making fishermen's sinkers. Free illustrated booklet. Hending Instrument Co., Box 78, Reading, Penna.

5000 BARGAINS, Firearms, binoculars, war relics. Catalog 50c. Smith Firearms, Runnemeade, N. J.

MOLDS For fisherman's sinkers, jigs, squids, casting and spinning lures. Free catalog. Sweet's Molds, Tonawanda 1, New York.

JAP Rifle altering to 30-06. \$6.00. Jap-shells, \$3.75. Catalog 5c. T. P. Shop, West Branch 11, Mich.

FISH Crazy about amazing new fish lure. Bite like hungry wolves. Works like magic on any lure. Bottle \$1.00. Results guaranteed or money back. Literature free. Smith-Parish, Rupert, Idaho.

TAXIDERMISTRY

MODERN Taxidermist magazine, Greenfield Center 2, N. Y. Devoted entirely to taxidermy, methods, photos. Trial year's subscription, \$1.00.

BINOCULARS, TELESCOPES, MICROSCOPES, MAGNIFIERS

DYNASCOPE—Sensational new reflector telescope. Send for details. Criterion Co., Dept. DP 10, Hartford, Conn.

REFLECTOR Telescope kits \$6.25 (3") to \$175. (12"). Mirrors, cells, focusing mounts, tripods, eye-systems. Anything, everything in telescopes. Free illustrated catalog. Also ready to use telescopes from \$26 to \$176. Inquiries to Esco Products, Dept. PM-8, 1428 Willow Ave., Hoboken, N. J. Sales showroom, 166 Church St., New York City.

BUILD Your own reflector telescope. Complete kits, mirrors, eyepieces, tripod, all other accessories. Request free illustrated literature. Criterion Manufacturing, Dept. KPM 7, Hartford, Conn.

6 THUMBS On each hand? Even you can assemble our telescope kits from our easy instructions. Enjoy the heavens with a high precision telescope assembled in less than an hour. You'll like our complete line of accessories. Send 10c for catalog of finest quality and newest design astronomical kits. Optical Engineering Co., 164-19 Northern Boulevard, Flushing, New York.

WAR Surplus bargains! Millions of lenses, instruments, telescopes, binoculars, components and complete line of astronomical telescope items. World's greatest optical market place! Send only \$1.00 for beginner's 10-lens kit and big instruction booklet stock 2-CH. Write for catalog CH, free! Edmund Scientific Corp., Barrington, New Jersey.

BINOCULARS—40MM, leftover stock, without carrying cases. In excellent condition! Ideal for any general purpose. Reduced for clearance \$3.40 ppa. Check or money order, no c.o.d., please, to Mail-Mart, Box 101, Kingsbridge Sta., New York 63, N. Y.

BINOCULARS, Telescopes, microscopes. Terrific values \$3.98 up. Request free money saving catalog. Criterion, Dept. P32, Hartford, Conn.

MAKE 6" Telescope reflector. Glass, abrasives, instructions—\$10.50. F. Cameron, Box 65, Inwood 96, N. Y.

IMPORTERS' Amazing prices, precision binoculars, 23 models. Free trial. Folder, "Binocular Selecting," catalog free. Dealers wanted. Prentiss Importers, Mercury Bldg., West Los Angeles 25, Calif.

SPECIALISTS! Used microscopes and accessories. Unusual slides. Supplies. Catalog free. Research Scientific Supplies, 60 Wall St., New York City 5.

MICROSCOPES, Binoculars, everything optical and photographic direct from importer. Lowest prices. Free catalog. Magnification Instrument Co., 2 East 45 Street, New York City.

LOWEST Prices, all sizes, binoculars, telescopes, microscopes. Also repaired. Free catalogue. Joe's Binocular Sales, 4827 Second Blvd., Detroit 1, Michigan.

TELESCOPES, Microscopes, binoculars, past quarter century. Comprehensive scientific instrument catalog \$1.00. None free. Dollar deductible from orders. Harry Ross, 70 West Broadway, New York 7, N. Y.

400X TELESCOPE Makers kit contains focusing tube, erector, five finished lenses and instructions. \$3.75. Giant astronomical telescope completely assembled with 6 ft. tripod, \$15.00. Free information. Suffolk Science, Mattituck 3, N. Y.

SAVE 25%! Get interesting facts. Free 56 page binocular, telescope catalog. \$3.95 to \$250.00! United, 9043 S. Western, A-8608, Chicago 20. Dealers wanted.

PETS—DOGS, BIRDS, RABBITS, HAMSTERS, ETC.

TALKING Mynah birds, other pets. Herb Miller, 1911-N. Lubbock, Texas.

HAMSTERS—Golden; young, \$4.00 pair, fully developed, \$5.00 pair. Adirondack Hamstery, Prospect 100, New York.

BEAUTIFUL Pure white pedigreed police puppies. Ansonia Kennels, Mose, N. Dak.

DESCENTED Skunks, monkeys, reptiles, etc. Illustrated catalogue 25c. Trails End, St. Stephen, S. C.

CHINCHILLAS. Registered. Guaranteed reproduction. Far-West Chinchilla, 1446-A Jones, San Francisco 9, Calif.

ANGORAS, Chinchillas. World's most profitable rabbits! Catalog free. Grinsteeds, Edwardsville, Illinois.

RABBIT Raising facts complete in 48 page illustrated book, by world's largest rabbit association. 10 cents. Address American, 36 Arba Building, Pittsburgh, Penna.

CHINCHILLAS—Big profits. Send 25c for literature to Tom McGowan, 170 Horton Ave., Valley Stream, L. I. N. Y.

CHINCHILLAS Top-quality registered sturdy young stock, \$75.00 per pair. Slater Chinchillas, 1535 Ruhand Ave., Manhattan Beach, California.

SOOPER Dooper Pooper Scooper. To clean dog pen or yard. \$3.98. Free literature. Scooper, Box 7505, Indianapolis 22, Ind.

MAKE Money raising chinchillas, mink, pigeons, rabbits, cavies for us. Free catalog. Keeney Brothers, New Freedom 2, Penna.

RAISE Money-making Angora, New Zealand rabbits. Particulars free. White's Rabbitry, Jackson, Mich.

STANDARD Rabbit Journal, Milton 3, Penna. Year \$1.00. Sample dime. Beginners manual 25c.

GROW Mushrooms, Cellar, shed, and outdoors. Spare, full time, year round. We pay \$3.50 lb. We paid Babbitt \$4,165.00 in few weeks. Free book. Washington Mushroom Ind., Dept. 171, 2954 Admiral Way, Seattle, Washington.

MINK Raising information free. Complete. Lake Superior Mink Farm, Superior, Eel, Wisconsin.

MAKE Big money! Raise Chinchilla rabbits. Cash markets supplied. Write today! Rockhill Ranch, Sellersville 15, Penna.

SPORTSMEN! World's largest kennel offers 500 Pointers, Setters, Straight Cooners, Combination Hounds, Rabbit and Squirrel Dogs, Beagles, Fox and Wolf Hounds. Trial. Prices reasonable. Catalogue free. Smokey Mountain Kennels, Cleveland, Tennessee.

MINK, Pastels, sapphires, platinum, Aleutians. \$25.00 up. Huebl Minkery, LeSueur, Minn.

PLANTS, SEEDS, NURSERY AND GARDEN SUPPLIES

WORLD'S Greatest cash crop. Free information. Write Ginseng Gardens, Asheville, N. C.

RAISE Your shrubs, trees from seed. Free planting guide, price list. Woodlot Seed Co., Norway, Michigan.

FARMS, FARM LANDS, REAL ESTATE

RETIREMENT Homes, gardens, nothing down. List free. Perrys, Brier Hill, Penna.

CALIFORNIA Farm and ranch lands, \$15 to \$35 per acre. 10 to 640 acre parcels. Easy terms. Free catalog. Pacific Tax Sales, 1621-A Cabuenga, Hollywood 28, California.

HOMESITES \$400—Convenient payments. California's finest garden section. On Morro Bay's scenic shores. Wonderful fishing, boating, bathing. Fertile soil, softest water, temperate climate, congenial community. Free literature. Richard Otto, Department M, San Luis Obispo, Calif.

\$5.00 MONTHLY Buys 40 acres productive land; near town; price \$240.00; free list. Box 425-P, Carthage, Mo.

STROUT Catalog—Mailed free! Farms, homes, businesses, 35 states, coast-to-coast, 3036 bargains described. World's largest; 55 years' service. Strout Realty, 7-MP So. Dearborn St., Chicago 3, Ill.

FARM \$600, \$15 Terms. Others. Write Mr. Armstrong, Shook, Missouri.

FLORIDA—Beautiful retirement homesites near gulf coast. Excellent hunting, fishing in 9 fresh and salt water rivers. 11 bays and gulf. \$250 at \$10 monthly. Free literature. V. M. Mathews, Box 1406, Asheville, N. C.

PROFITABLE OCCUPATIONS

WANT A diesel job? New opportunities to increase income. Higher pay. More money. We can help you qualify. Tools. Shop method home training. Write today! Diesel, Tractor, Heavy Equipment Division, Interstate Training Service, Dept. B-3-H, Portland 13, Oregon.

MAN Wanted. Are you dissatisfied with your work? Would you like a business of your own? If so, write Rawleigh's, Dept. H-GG-PPM, Freeport, Ill.

WELDING Pays big money. Learn easily at best equipped school in country. Non-profit school with low cost training. G.I. approved. Write Hobart Trade School, Box M-852, Troy, Ohio.

ANNOUNCING Home study course in commercial baking. Practical basic training. Good field for those with aptitude. Free booklet. "Opportunities in the Baking Industry." National Baking School, 835 Diversey Pkwy., Dept. 343C, Chicago 14.

BUY Wholesale thousands nationally advertised products at big discount. Free "Wholesale Plan." American Buyers, Hertel Station, Buffalo 16-B1, N. Y.

FREE! "301 Profitable Small Businesses!" Amazing shoestring plans! Work home! Start sparetime! Deumant Surveys, Kenmore 23-R, N. Y.

MEN Wanted—Build luggage and cases at home. We sell your products, supply complete instructions, materials, everything. No special equipment needed. Free details. Cascraft, 805-G20 Sunset, Los Angeles 12, Calif.

EVERYBODY Likes candy. Learn to make professionally. Our 44th year. Ragdale Candies, D6, East Orange, New Jersey.

MAKE Money writing short paragraphs! No tedious study. I tell you what to write, where and how to sell; and supply list of editors buying from beginners. Many small checks add up quickly. Write to sell, right away. Send for free facts. Benson Barrett, 1751 Morse, Dept. C-27-H, Chicago 28.

SELL Auto radios. Large profits. Details free. Regent, 920 Erie, Philadelphia 40.

INVESTIGATORS Wanted. Work furnished. Credit Correspondent Service, 517-M New York Bldg., St. Paul 1, Minn.

SAN Francisco and bay area offer marvelous mild climate year round, excellent jobs, opportunities. Any S.F. classified columns airmailed, only \$1.00. Stanley Hurbert, Box 3129, San Francisco.

WE Specialize in latest information on jobs with travel, adventure and top pay. Construction, aviation, shipping, unusual opportunities, all types of work. Foreign and U.S. Only \$2.00, including year advisory service. (\$2.25 airmail.) Guaranteed best service of this type available or double your money back. Act today. Research Services, Box 2904-PMA, St. Louis 17, Missouri.

WANT Overseas job? With high pay, bonus, transportation paid. Then get our Overseas Guide. With information on foreign countries, income tax, age limits, hours, overtime, etc. With actual advertisements of construction, oil and mining companies wanting men now. Rush \$1.00. Airmail \$1.25. Overseas Guide, Box 14, Dept. 104, Palmer, Texas.

MUSHROOMS Grown boxes, barrels. Manureless process 50c. Spawn \$1.00. Gordons, 553 William, Winnipeg, Manitoba.

EARN To \$1500 monthly. Many jobs available. Work in fabulous South America, the Islands, Africa, USA, etc. All trades. Labor, clerical, truck drivers, mechanics, engineers, etc. Tax free earnings. Chance to travel. Fare paid if hired. Make and save a fortune. Application forms. Free information. Write Dept. 76G, National Employment Information, 1020 Broad, Newark, N. J.

MUSHROOM Spawn plus complete instructions various processes. \$1.00. Luxur, 641 S. 19th, Newark 3, N. J.

HOME Mailorder starting instruction manual, sources, methods, opportunities. 25c. Carnahan Bros., 5580 Nelson, Cypress, Calif.

BUY Wholesale 450,000 products. Literature free. Carter, Box 6011-A, Chicago 80.

MAGAZINE Subscriptions. Highest commissions, bonus. Qualified Publications, 451GU Kingston, Brooklyn 25, N. Y.

JOBS On ships, including yachts and liners. No previous experience necessary. Age requirements 18 to 56. Wages as high as \$1000.00 monthly. Send \$2.00 for full information. E. J. McCaskill's Marine Directory, Box 541, Carthage, N. C.

\$1300.00 MONTHLY For truck drivers. \$1400.00 monthly for carpenters, electricians, plumbers, mechanics, \$1200.00 for clerks and laborers. Full information and complete foreign listings, with current information on Spain, Korea, Australia, Alaska and Canada. \$1.00. Current information on stateside projects, \$1.00. Dept. 3-H, Opportunities Unlimited, 1110 Commerce Bldg., St. Paul, Minn.

WE Operate a successful television rental business by telephone from our home. Details \$1.00. Alpha Television Rental, Box 5173, Austin, Texas.

CHINCHILLA Breeding for beginners. Read this expert booklet, just printed. Not a sales pamphlet. Gives true picture how to start this lucrative future with small capital. Send \$1.00 for copy. Emil Hollert, Dept. MP, 38-14, 218th Street, Bayside 61, New York City.

FLAMEPROOF Clothes, mattresses, rugs, curtains, Christmas trees, etc. Go into flameproofing business; hotels, motels, houses excellent prospects. Formula \$2.00. Sample package our "Flame-X" flameproofing compound \$1.00 postpaid. Satisfaction or refund. Flameproofers, Box 1071, Mobile, Alabama.

OFFICE. Factory, professional help wanted for 200 newly-built, big U.S.A., foreign industries, enterprises. Directory \$1. World Enterprises, Lake Guindon, Que., Can.

FOREIGN Employment construction work. If interested in foreign projects with high pay write Foreign Service Bureau, Dept. PM, Metuchen, N. J.

AUCTIONEERING—Home study course. Diploma granted. Auction School, Ft. Smith, Ark.

OVERSEAS, Latin American, Alaska, Canada employment. Originator 1955 "Foreign Service Directory" up-to-minute report on military and civilian construction; oil companies; aviation; transportation; steamship; mining; government job info. How-when-where to apply. Listing firms hiring. \$1.00. Global Reports, Box 883-P, Hollywood 28, Calif.

\$5 TO \$10 An hour. I've did it. I'm disabled now. Real genuine offer. Complete information only \$1. Lucas, 2260 Carson St., Pittsburgh 3, Penna.

RAISE Pheasants on \$100 week plan. Little capital and space can make you independent. Free details. Great Central System, Columbus 1, Kansas.

FREE Fello "Up to \$45,000; Unlimited Vacations." No merchandise, equipment. Unknown! Work home, sparetime! Haylings, Carlsbad, Calif.

GROW Mushrooms. Cellar, shed, and outdoors. Spare, full time, year round. We pay \$3.50 lb. We paid Babbitt \$4,165 in few weeks. Free book. Washington Mushroom Ind., Dept. 99, 2954 Admiral Way, Seattle, Wash.

HOME Workers needed! Spare time, full time. Assemble luggage and cases with our complete illustrated step-by-step instructions. We sell your product—Supply everything. Manufacturing representative needed in your area immediately. Unlimited profits possible. Investigate at our risk. Free details. Cascraft, 897-G10 Sunset, Los Angeles 12, Calif.

FREE Book "505 Odd, Successful Businesses." Work home. Expect something odd! Pacific, Occasionside, Calif.

MAKE New greaseless doughnuts in kitchen. Sell stores. Free recipes. Michael Ray, 3695 South 15th Ave., Minneapolis 7, Minnesota.

BE The Popular Mechanics representative in your neighborhood and earn big profits in your spare time. Write Popular Mechanics Magazine, Room 408M, 200 E. Ontario St., Chicago, Ill.

MONEY With your 8mm camera? Highly profitable. No overhead. Details free. Film Wizard, Hollywood 38, California.

WHOLESALE Catalog! 30-80% discounts! Typewriters, appliances, housewares, watches, jewelry, etc. Consolidated Distributors, 21-14 Lafayette, Paterson 15, New Jersey.

LEARN Real estate business for highly profitable lifetime career. Study at home. Low cost. Easy terms. Write for free literature. Seavy Realty Institute, 1750-B Colorado Blvd., Los Angeles 41, California.

EARN To \$1200 monthly. Foreign and domestic job openings. Full information of all contractors. Including name, address, wage rates. Both U.S.A. and foreign. Working hours, living conditions with complete information on how to apply. Truck drivers, laborers, mechanics, pipe fitters, plasterers, electricians, clerks, etc. Get application blank by return mail. All for only \$1.00; air mail \$1.25. Money back guarantee. Overseas Job Bulletin, Dept. PM5, P.O. Box 13667, Dallas, Texas.

BOOKS, PERIODICALS, PICTURES, POSTCARDS

SAN Francisco! 10 fascinating photographs, beautiful salon originals created by famed California photographer! \$1.00. Western Pictorial Guild, 3575 Sacramento Street, San Francisco 18, California.

PICTURE Post cards, made from your photograph. 1000. \$1.00. Raun's, 4154 Fifth Street, Philadelphia 40.

BOOKHUNTERS! All subjects. Send wants! College Book Service, 52 W. Kingsbridge Rd., New York 63, N. Y.

HAVANA Calling! Get those unusual books from us. Send wants. Macias, Apartado 3498, Havana, Cuba.

HOW And where to find uranium. Price \$3.95. Winston & Pierce, Box 144, Dayton, Ohio.

BOOK Catalog, 1000 interesting titles, send 10c. Books Publishing Co., Amityville 3, N. Y.

SPARETIME Profits taking subscriptions all magazines. Wholesale catalog free. Cassell Publishers, Westfield, New Jersey.

NATIONAL Geographic Magazines, 1888-1962. Periodical Service, Box 465-PM, Wilmington, Delaware.

BOOKS Found! Any author, old or new. Rush titles wanted; no obligation. International Bookfinders, Box 3003-PM, Beverly Hills, California.

BOOKS, Government surplus. Bargain prices. Free catalog listing 50 other free catalogs. Instructional, educational, vocational subjects. Millions of volumes, new and used. Books bought. Est. 1902. Long's College Book Co., Dept. PM, Columbus 1, Ohio.

"SCIENCE Milestones." Records march of science starting 400 years before Christ, right up to date. Amazing facts revealed. 312 pages packed with startling information that will thrill you. A real history of science. \$5.00. Literature free. Popular Mechanics Press, 200-SM East Ontario St., Chicago 11, Ill.

BOOKFINDERS! All subjects. Send wants! Jaher Book Service, 183 Hazelwood Drive, Westbury, N. Y.

GAMES, TOYS, NOVELTIES

AMAZE People. Know any date. Mental calendar \$1.00. Box 1741CS, Toledo 3, Ohio.

AMAZING Electronic game. Details 25c. Wilson, Box 86, Oakland Garden Station, Flushing 64, N. Y.

MAGIC TRICKS, PUZZLES, JOKER NOVELTIES

SENSATIONAL Pocket trick! Life-like rabbits. Multiply in your hand, easy to show, no palming. Hilarious finish. Send \$1.00. Rabbits, Box 73, Universal City, Calif.

WOODEN Nickels. Magic catalog, free trick, 10c. Fun'n Magic, Box 1375, San Antonio, Texas.

7 TRICK Dice, list price \$3.50, only \$1.00 postpaid. Dice odds chart included free. Gelazin, Bridgeport 7, Conn.

MAGIC Trial lessons free. Write today! Magic School, Sparta 9, Michigan.

EARN Money as a magician; fine hobby. Large professional catalog \$1.25. Holden's, 120 Boylston Street, Boston, Mass.

LEARN Ventriloquism. 3c stamp brings particulars. Smith, 801 Bigelow, Peoria 3, Ill.

PROFESSIONAL Catalog, 175 pages, 25c. Williams, 900 Plymouth, Ellwood City, Penna.

500 TRICKS, Douglas famous 120-page catalog, only 10c. Fastest service to magicians for 30 years. Send 10c today. Douglas Magicland, Dept. 1, Dallas, Texas.

BEST Magic, Joker's novelties. Lower prices. Catalog 10c. Top Hat, Evanston 12, Ill.

FREE Deck trick cards with catalog 50c. 1746-PM Market, Philadelphia 3.

3100 NOVELTIES. Tricks, jokes, gadgets, funmakers, hobbies. Catalog 10c. Johnson-Smith, D101, Detroit 7.

VENTRILLO. Professional voice-throwing instrument and catalog 25c. Box 971-PM, Philadelphia 5.

LEARN Ventriloquism. Details without obligations. Harry Harmon, Box 33, Mint Spring, Va.

DOLLAR Magic set free with catalog 25c. 4462-PM Germantown, Philadelphia.

SENSATIONAL Magician's wand 25c. Vanishes handkerchief! Catalog included. Box 1352-PM, Philadelphia 5.

COINS, TOKENS, CURRENCY

6-IN-1 Special: Magnifying glass; check list; 25 coin envelopes; giant 60 page bargain catalog; ten different Indian pennies; Mexican ten-peso: All six, \$1.00 postpaid. Ben's Coin Shop, 31 North Clark, Chicago 2, Illinois.

COMPLETELY New Fell's 1955 U.S. coin book. Lists, evaluates every coin ever minted. How many of your coins are worth money—do you know? Over 150 illustrations. Chapters on profits in buying and selling, speculation, investment, etc. Clothbound. Send no money. Pay postman \$2 (plus postage) or send \$2 (postpaid). Refundable. Fell Publishers, 386 M-10 4th Ave., New York City 16.

OLD Money wanted. Do you know that coin collectors pay up to \$100.00 for certain U.S. cents? And high premiums for all rare coins? We buy all kinds. Send 4c for large coin folder. May mean much profit to you. Numismatic Co., Dept. 20, Fort Worth, Texas.

WORLD'S Greatest magazine for coin collectors and wooden nickel 10c. Laurence Brothers, Anamosa, Iowa.

50 COINS And bills \$1.00. Oddehon, Box 482, St. Louis, Mo.

KANSAS Official centennial coins 1854-1954 bronze, proof surface, 1 1/4 inch diameter, small issue. \$1.00 each. Want lists appreciated. Dooley, 213 East 11th, Topeka, Kansas.

BARGAIN List, United States coins, Indianhead cent, 10c. Economy Sales Company, Mansfield, Mass.

U. S. Large cent, 2c piece and bargain list, only \$1. Delmaco, Box 1123, Wilmington, Del.

FOREIGN Coins. 10 Diff. 25c. Foreign bills, 20 Diff. 25c. Lists. Oliver Arnold, Macon, Mo.

FREE! Foreign coin, banknote and coin collectors illustrated catalog to approval service applicants. Send 3c postage. Tatham Coinco, Springfield 30, Mass.

15 COINS From 15 countries, \$1.00. Joel Tillberg, Proctor 4, Vermont.

MORGAN Dollars; 1878, 1887, 1890, 1891, 1897 S mint unc. \$2.00 ea. Illustrated catalogue, 25c. Shultz, Salt Lake 10, Utah.

GET Profit and pleasure in collecting old coins. Send 10c for 56-page illustrated coin catalog. You'll be delighted with it. Send for it now. B. Max Mehl, 370 Mehl Building, Fort Worth, Texas. Largest rare coin establishment in U. S. Established 35 years.

COIN Collector's Magazine. Over 1000 pages per year. Sample copy 30c; \$3.00 per year. Hewitt, T320-J Milwaukee, Chicago 31.

INDIAN Cent with bargain lists 10c. Hutchinson, 3463 "I" Street, Philadelphia 34, Penna.

STAMP COLLECTING

378 DIFFERENT Genuine pictorials, airmails, commemoratives, charities. Includes British, French Colonies, Monaco Prince, Netherlands Myths, Asia, Africa plus hundreds more high values, 25c. Approvals. Money-back guarantee. Kingsway Stamps, Dept. 88, Pulten, Maryland.

325 DIFFERENT Worldwide collection, includes everything. Airmail, complete sets, triangles, bi-colors, birds, flowers, animals. Everything (catalogs over \$6.00) 25c to approval applicants. Century Stamps, Box 1090-P, Palm Springs, Calif.

FREE Complete set of famous Americans, flags, parks and presidentials to approval buyers. Send 5c for 15 of the above stamps plus full particulars. Triboro Stamp Company, 145 Nassau Street, Dept. 108, New York 38, N. Y.

PLEASURE Is yours for pennies from our books of 1000 stamps. Neatly arranged for your selection. All catalogued for your convenience. Large discounts. Wolverine Stamp Service, Dept. A-26, Fruitport, Mich.

OLD United States—25 different before 1933, 10c. approvals. Ladue Stamp Co., 9815 Clayton, St. Louis 17, Mo.

FREE Stamp magazine, 327 different stamps 25c. Including Indonesia, Newfoundland, British Colonies, Vatican, Red Russia, Hitler heads, Indian states, animals, airmails. French Colonies, rarities, unusuals. Wonderful bargain. Approvals. Niagara Stamp Co., St. Catharines 21, Ontario.

THOUSANDS Of stamps for your collection at 1c and 2c. See our big books of attractive approvals. Everything catalogued. Large discounts. Modern Stamp Co., Dept. A-2, Ferrysburg, Mich.

FREE Sample stamp newspaper, information on collecting, special lists. Approvals. Littleton Stamp Co., Littleton A1, N. H.

WORLD Airmail covers. Extensive list for postage. William Peters, Interlachen, Florida.

GIGANTIC Collection free. Includes triangles, early United States, animals, commemoratives, British Colonies, high value pictorials, etc. Complete collection plus big illustrated magazine all free. Send 5c for postage. Gray Stamp Company, Dept. PM, Toronto, Canada.

HAITI. Hurricane Hazel helicopter set, 25c with approvals. Seminole Stamps, Box 1138-P, Coral Gables 34, Florida.

66 DIFFERENT U. S.—10c. Approvals. Utechs, 1143D North Keeler, Chicago 51.

12,000 U.S. Stamp grabbages, 25c each. Monjar, Fairmount, Cincinnati 14, Ohio.

FREE U.S. Illustrated bargain catalogue. Rothberg's, Box 60, Boston 1, Mass.

YORKTOWN Mint with 500 mixed 10c. Approvals. Hudson's, Box 4015, Fresno 44, Calif.

SPAIN. 100 Different 10c to approval applicants. 1c approvals. Morrel, 203 Fenimore Street, Brooklyn 25, N. Y.

HOW Many of your album pages would a few stamps complete? Want to fill them? Try our approval books of 1000 at 1c and 2c. Values will amaze you. Also U.S. Rose-land Stamp Co., Dept. A-36, Spring Lake, Mich.

25 DIFFERENT Israel 25c. Approvals. Pattison's, 349 Adams, Scranton, Penna.

NEBR. Overprint 5c with approvals. References please. Peirco, Red Cloud, Nebr.

FIRST U.N. set. Among world's prettiest. Only 10c. Approvals. Welles, Box 1246-R, New York City 8.

NUDE Pioneer, animals packet—10c with approvals! Atlas, Eisenhower, Racine, Wisconsin.

NICARAGUA Roosevelt mint set (6), catalog \$1.70, plus 500 worldwide only 50c with approvals. Montalto, New Church, Virginia.

FREE Greatest offer—Croatia Legion set honoring heroes of Russian-German war. Dead country. Also albums, supplies. All to our approval buyers. Bell Stamp Service, S-6, Bell, California.

30 DIFFERENT Commemoratives 1893 up 10c. U. S. approvals. K & B Stamp, Box 5, Brooklyn 14, N. Y.

TRIANGLES. 13 Different 6c with approvals. Nickerson, 310 Idaho, La Habra, California.

FREE! Azerbaijan, Pope triangle, Roosevelt "mourning," 26 more! Approvals. Accessories. Premiums. Castleline, 800-B Kildonan, Winnipeg 5, Canada.

QUEEN Elizabeth miniature collection! Six different colonial sets—21 handsome mint bicolors 25c. Approvals. Gannon Stamps, Box 931, Canton 1, Ohio.

NOW Try us! We've the lowest priced penny approvals available! Just try 'em, you can't lose, we pay all postage! Riviera, Box 971e, Santa Barbara, Calif.

\$12.00 FOR \$1.00! Only better stamps cataloging 4c to \$1.00 sent from 40,000 collection. Order 2 selections. Receive free Israel mint tab airmail. Rosen, 238 8th Avenue, Paterson, N. J.

U.S. 40 Different 10c. 40 different commemoratives 20c. Both 25c. Bargain lists. No approvals. Seidenberg, Appleton, Wis.

THOUSANDS Of exciting stamps, all different, yours for 1c, 2c each. Fill your album for pennies! Big collection sent for free examination. Cole, 43-A Rinewalt, Buffalo 21, N. Y.

99 LATIN American stamps, many pictorials, airmails, 10c. Approvals included. Fred Pittsley, South Montgomery, Napa, Calif.

100 DIFFERENT, British Colonies, Dutch Empire, French Colonies and Belgian Empire. 10c with approvals. Supreme Stamp Service, 2205 So. Grand Ave., Los Angeles 7, Calif.

100 JAPAN 10c. All different, with approvals. Gould's Stamps, Box 631, San Francisco 1, California.

\$12.00 VALUE \$1.00. 500 Stamps. Ray, 321 S. Cicero, Chicago 44.

EISENHOWER Stamp, plus worldwide packet, free to approval buyers. Conquistador, 2627J Troy Road, Schenectady 9, N. Y.

AIRMAILS. Triangles, others. Perforation gauge, magnifying glass, dime. Approvals. Russ, 4105—57th, Woodside 77, New York.

TEN Different foreign sets, 10c. Adults. Approvals. Farmer, 4913 Rosewood, Los Angeles 4, Calif.

FREE Surprise gift! Astounding fabulous offers! Adventure Studios, Buckland, Connecticut.

FREE: 20 Different Canadian commems. 10c for postage. Approvals. Baumann, 8380 De L'Épee Ave., Montreal 15, Canada.

START Your own stamp business. Send 10c for wholesale catalog and magazine. Shepard, Box 1147, Chicago.

ASTONISHING Gift! 40 U.S. with superior approvals. Send 5c for postage. Sparta, Box 1082, Rochester 3, N. Y.

50 DIFFERENT United States 5c with bargain approvals, lists. Bookman, Box 8245-M, Madeira Beach, Fla.

100 DIFFERENT France 10c. Approvals. Aronson, 91 Marion, Brookline 46, Mass.

CIPEX Souvenir sheet plus 25 different U.S., 10c. Approvals accompany. Village Stamps, 90-39P 214 St., Queens Village 28, N. Y.

FREE U.S. 72 page catalogue. Contains almost 1,000 illustrations; over 10,000 delightful bargains. Stone's, 192 Washington, Boston 8, Mass.

CORONATIONS, Triangles, animals, sports, free with approvals. Exotic, Box 482, Coral Gables 34, Florida.

U. S. Classics. Over 50 yrs. old. 15 selected old-timers. Missing in biggest collections. All 15 at less than 1c each. 10c with approvals. Jaro, Box 246-T, New York City 8.

WOW! 153 All different Germany 10c. Zeppelins, semi-postals, airmails, high values. Big bargain lists and approvals included. Jamestown Stamp, Dept. 512, Jamestown, N. Y.

50 DIFFERENT United States 5c with bargain approvals, lists. Bookman, Manatee 1, Florida.

FREE United States price list. Mark Hanna, 335 Fifth Ave., Pittsburgh 22, Penna.

\$1000.00 U.S. Collection divided into 750 \$1 packages. Terrific bargain. Send dollar to Albert, 6420 Del-Norte, Dallas, Tex.

FREE! Giant catalog. Offering thousands of bargains. Sent with beautiful approvals. Jamestown Stamp Co., Jamestown 612, N. Y.

FREE Animals, birds, triangles, flowers, ships, locomotives, kings, dictators, multi-colored, historical, geographical, musical, battles, giants, midjets and over 100 others. Fascinating story approvals. Send 10c handling, please. Lincoln Stamp Co., St. Catharines 318, Ontario.

FREE! Flower triangles, others. Approvals. Delton Page, Box 201X, East Paterson, New Jersey.

50 DIFF. U. S. commemoratives 25c. Mammoth packet list free. Econopackets, Box 168, Riverside 9, Calif.

STAMPS Wanted, Mint and used, collections, accumulations. Good grades only. Buy outright if bargain. What have you? Write, give details. Vanroy Shirh, Lebanon, Penna.

FREE 105 British Colonials, pictorials, Mauritius, Tanganyika, Pakistan, Nigeria, Rhodesia, Singapore. Fascinating story approvals. Send 10c handling, please. Lincoln Stamp Co., St. Catharines 218, Ontario.

50 DIFFERENT Argentine 10c. Approvals. Reuter, 611 W. 40th Pl., Los Angeles 37.

AMAZING Offer! 200 United States stamps—including commemoratives, airmails, high denominations to \$1.00. Only 10c to approval applicants! Illustrated bargain lists free. Mystic Stamp Co., Dept. 80, Camden, New York.

100 DIFFERENT Spain 25c. Penny approvals included. Reed, Box 980, Chicago 90, Ill.

OLD Scarce U.S. seconds on approvals. Slight imperfections, lowest prices. Hernefield, Clintonville Sta., Newark 8, N. J.

SPEND Pennies! Not dollars! Thousands of fascinating stamps to choose from our 1c and 2c approvals. No premiums. Just honest value. Pat F. Knowles, Box 2247, Van Nuys, Calif.

FREE Sample! Interesting, illustrated, informative! National Stamp News, Anderson, South Carolina.

PROFITABLE Surprise: Asia, 113 diff., 20c. China, Hejaz, Japan, Israel, Siam, Manchukuo. Approvals. Robert Boger, 3401 Oakmont Ave., Philadelphia 36, Penna.

SELL Stamps to our readers. Your ad in this space will be read by thousands of stamp buyers. I'll prove that to you. Write now for Folder "S," F. W. Johnson, Classified Advertising Manager, Popular Mechanics, 200 E. Ontario St., Chicago 11, Ill.

50,000 STAMP Grabbags 25c each. Anderson, Box 1, Reading, Penna.

300 DIFF. World wide 25c. plus surprise packet. Packet list free. Econopackets, Box 168, Riverside 9, Calif.

BAROAN Hunters attention! Free stamp magazine, 1000 interesting stamps for your approval inspection. Completely catalogued, substantially reduced. Free tongs and hinges with purchase. Niagara Stamp Co., St. Catharines 31, Ontario.

WORLD'S Largest stamp (7 1/2 x 14 inches). A real curiosity! Retail for 50c. Only 3c to approval applicants. Tatham Stamp Co., Springfield 30, Mass.

WEIRD Diamond shape coffee stamp! Lovely flower triangle! First American big commemorative. Greenland, idol dancer, etc. Free with approvals. Capital Stamp Co., Little Rock 2, Ark.

100 OLD United States between 1861 and 1935, \$1.00. Roush Stamps, 51 Chestnut, Mansfield, Ohio.

TWO \$5.00 U. S. stamps plus 20 different, 10c with U. S. approvals. Irwin Stamp Co., Box 1105, Brooklyn 30, N. Y.

ECONOMICAL 1/2c-1c-2c-Approvals, 22,000 varieties available. Dresel, Box 270-n, New York 25, N. Y.

225 STAMPS For only 10c! This mammoth value includes airmails, pictorials; stamps from strange countries cataloging up to 25c each! Also approvals. Mystic Stamp Company, Camden 80, New York.

EXCITING New book, "How to Collect Stamps, Coins, Paper Money." Packed with amazing facts; information worth dollars. Fully illustrated, 160 pages, 75c. Popular Mechanics Press, 200-87 E. Ontario St., Chicago 11, Ill.

TRIANGLES. Birds, butterflies, flowers—Big packet 10c with approvals. Southwest Stamps, Box 117, Long Beach 1, Calif.

\$12.50 VALUE—Scott, only \$1.00! All different, catalog 4c up. Satisfaction guaranteed. Quality approvals accompany. Essex, 5946 Arlington Avenue, Los Angeles 43, Calif.

ADD 30,000 Different Scott-listed stamps to your collection for only 1 1/4c each. Send \$12.50 for book of 1000 mounted by country in chronological order, as often as you wish until you have the entire collection. Stop anytime without penalty. J. Huppert, 1970 E. 18th St., Brooklyn 39, N. Y.

UNITED STATES—58 different including 8 airmails, 15 commemoratives, 10c. Approvals. Sunset, Box 47, South Gate, Calif.

FREE! Large new profusely illustrated catalog of United States postage issues complete; 64-page, four-color Stamp Collectors' Guide; other unusual offers. Write today! Harrisco, 1039 Transit Bldg., Boston 17, Mass.

FREE—Valuable U.S.A. (1) Scarce genuine stamp picturing first U.S.A., issued in 1847! (2) Big collection 30 all-different U.S.; ancient 19th century, valuable \$3 stamp, etc. (3) Packet gorgeous commemoratives. (4) Large illustrated U.S. catalog; 64-page, four-color Collectors' Guide; other unusual offers. Everything for only 10c covering mailing costs! Harrisco, 1047 Transit Bldg., Boston 17, Mass.

14,000 DIFFERENT—Yours on our streamlined systematic club plan for only 50c weekly. Big shipment every two weeks. Details free. Sjoquist, Box 217, Valley Stream 75, New York.

FABULOUS United States commemorative collection, 31 different 10c. Approvals. White, 516-A Avenue L, Brooklyn 30, New York.

FREE! Big illustrated catalog! Send today! "Stamps By Mail," 2133 Lunt, Chicago 45.

ANTIQUES, RELICS, INDIAN GOODS, CURIOS

4 FINE Arrowheads \$1.00. Flint thunderbird \$2.00. List free. Arrowhead, Box 5283, Indianapolis, Indiana.

SIX Arrowheads or three triangular war-pieces \$1.00. Fifteen piece beginners collection \$3.00. Charles Palmer, R.D. #1, McKeesport, Penna.

REAL Sea horse. Rare. Fascinating. Guaranteed. \$1.00. Sea Deep, Bay Head, New Jersey.

FOSSILIZED Rock specimen. Rare. Scientific. \$1.00. Box 1741CS, Toledo 3, Ohio.

4 FINE Arrowheads \$1.00. Flint thunderbird \$2.00. List free. Lear's, Glenwood, Arkansas.

4 SELECTED Arrowheads \$1.00. List 5c. H. Talburt, Calico Rock, Ark.

PRECIOUS STONES, MINERALS

GEMSTONES, Mineral specimens. Every variety. Lowest prices. Free booklet. Plummer's, 4720 Point Loma Ave., San Diego 7, Calif.

GEMCUTTING—Silvercraft illustrated magazine. Tells how to cut gems, make jewelry. 150 ads illustrating equipment, gems for collectors, cutters. Free literature. Lapidary Journal, Del Mar 2, Calif.

EARTH Science, the Rockhound's national magazine. Subscription \$2.00, sample 25c. Box 1357, Chicago 90.

SAPPHIRE, Topaz, tourmaline, garnet, peridot. Five uncut gem specimens, \$1.00. Ten polished gems, baroque shaped, \$1.00. Free big bargain list jewelry, gems, profitable, easy "do it yourself" projects. O'Brien's, 1116M Wilcox, Hollywood 38, Calif.

HOBBIES AND COLLECTIONS

50 ARMY Insignia \$1.00. Insignia Mart, 703A Broadway, New York 3, N. Y.

WANTED Old cigarette cards. Write Charles Bray, East Bangor, Penna.

MILITARY Miniatures, insignia catalog 25c. Griffin and Gray (B), 72-05 67 Street, Glendale 27, N. Y.

UNUSED Matchbook covers. 100 different \$1.00. 36 page catalog 25c. Match-cover album \$3.00. Charles Edelman, 1311C East 84, Cleveland 3, Ohio.

PAINT In oils the first time you try. Finest coded oil painting kits that money can buy. Size 12"x16" \$2.95; size 18"x24" \$6.95 postpaid. Many lovely subjects from which to choose. Send for free literature. Ralox, P.O. Box 1256, Decatur, Illinois.

NAZI WW-II medals, books. Illustrated listing free. Kingston, 3224-22 West, Seattle 99, Washington.

NAZI Medals, ribbons, armbands, flags, daggers. Big introductory packet \$1.00. Illustrated lists, Medcrafts, 1923 34th St. S.W., Calgary 2, Canada.

INVENTING Can be an interesting and profitable hobby. Write for complete particulars. Institute of American Inventors, Dept. 40-E 631-E St., N.W. Washington 4, D. C.

UNUSUAL Hobby: Authentic army patches, insignias, ribbons, enameled crests, navy rates, 50 assorted for \$1.00. Rex Military, Dept. C, 1186 Broadway, New York City.

HISTORICAL Documents (reproductions) \$1.00. Howard Sawyer, 5813 Benton Hgts., Baltimore 6, Md.

CAMERAS. PHOTO SUPPLIES

FREE! Free! Free! Central Camera Co. photographic headquarters since 1899. saves you money on all photographic equipment. Send for Central Camera Co.'s free photographic bargain list today! Central Camera Co., Dept. 8-B, 230 S. Wabash, Chicago 4, Ill.

PHOTOGRAPHY For pleasure or profit. Learn at home. Practical basic training. Long established school. Free booklet. American School of Photography, 835 Diversey Parkway, Dept. 3431, Chicago 14.

BUY Wholesale nationally advertised cameras, photo supplies, thousands other products at big discount. Free "Wholesale Plan." American Buyers, Hertel Station, Buffalo 16-E1, N. Y.

NEW Mansfield action editor 40% off. Thousand other tremendous savings. Photo equipment, typewriters, appliances. Free catalog. Camera Shoppe, Box 601-Y7, Mt. Vernon, New York.

BRAND New DeJur "500" projector \$50.00. Terrific bargains. Free catalog. Economart, Box 242, Tarrytown, New York.

BASS Says: Quality cameras since 1910. When in Chicago visit the camera cross roads of the world, or write us for your favorite equipment, new or used. Satisfaction guaranteed. Bass Camera Co., Dept. AG, 179 W. Madison St., Chicago 2, Ill.

CAMERA Repairmen greatly needed! You can learn manufacturers' service methods at home, in your spare time! Free, big illustrated book tells how: Write today. National Camera Repair School, Dept. PM4, Englewood, Colorado.

OUR Direct buying means greater savings on cameras, and photographic accessories. Write us for free quotations on your photographic needs. Camera Import Corporation, 521 Fifth Avenue, New York 17, New York.

PHOTO FINISHING

EKTACHROME—Ansochrome processing. Roll \$1.00. National Color Corporation, Box 55 Northside, Atlanta 5, Georgia.

FREE! 6x7 Studio enlargement coupon plus film developed and 8 prints 25c. Free mailers. Richtone Photo Service, Box 5, Glen Oaks, New York.

HANDY Album of jumbo prints, 8 exposures 35c, 12 exposures 50c. Pacific Photo Service, Dept. E, Box 2310, Hollywood 28, California.

FREE Roll film (#127, #120, #620, or #616) with every roll developed and printed. 8-exposure 60c; 12-exposure 75c; 16-exposure 95c. All prints oversize. Custom Photo Labs, Box 126-PM, Berwyn, Ill.

4x6 OR 3 1/4x4 1/4 Glossy prints, 8 exposures 40c, 12 exposures 60c, 16 exposures 80c. Hagner, 1318 West Columbia Avenue, Philadelphia 22, Pennsylvania.

SPECIAL Introductory offer. 8 jumbos 25c, 12-35c. Western Photo, PM85, Box 298, San Francisco 1, Calif.

CONFIDENTIAL Rolls developed and glossy 5x7 prints, 8 exposures 50c, 12 exposures 75c. Confidential Photo Service, Box 1515, Tacoma, Wash.

FOR Just \$1.00 we'll make 20 copies of your favorite picture in convenient wallet size. Send any photo or negative for prompt service. Money back if you're not delighted. Mail To-Day Co., Altoona 16, Penna.

12 JUMBOS From any size roll developed 25c, with this ad only. S. Skrudland, Lake Geneva, Wis.

FREE Film! Write for free mailers. Vets Film, Montalvo, California.

TRIAL Offer—Good with ad only. One roll film developed, 8 exposures 25c, 12 exposures 35c. King sized, dated prints from roll only. Don't send negatives. Sir Walter Photo, Raleigh, N. C.

ENLARGEMENTS! Eight 5x7's or five 8x10's, \$1.00. Wilart Enlargers, Box 967, Little Rock, Ark.

12 EXPOSURE Rolls 30c. jumbo prints. Guaranteed work, one day service. Lincoln Studios, Dept. K, Box 13, Lincoln, Nebraska.

PARTICULAR? Custom finishing guaranteed. 8 jumbos 35c, 12-50c. Special! 35mm. 36 exposures \$1.10. Free mailer. Flash-Foto, Box 36G, Brooklyn 4, N. Y.

GUARANTEED Quality. Fast service. Eight jumbos in beautiful super pak plastic ring binder albums only 35c. Send for free mailers and particulars of our complete photo finishing service. Grand Fotos, G.P.O. Box 1410, New York 1, N. Y.

TWO Beautiful enlargements from each picture on roll—8 exposures 55c, 12 exposures 75c. Cut Rate Photos, Dept. B-4, Janesville, Wisconsin.

TOP Quality. Fast service. 8 Jumbos 35c in beautiful super pak album. 16 contacts 40c. Reprints—Jumbos 4c; contacts 3c. Satisfaction guaranteed. Write for free mailers and circulars. Fast-X-Photo, Box A, Jersey City, N. J.

6 OR 8 Picture roll 35c. 12 or 16 picture roll 55c. Each roll developed and printed in handy album pack. Send coin with roll. No c.o.d.'s. Mailing containers sent free. Deluxe Film Service, Box 1268-A, Shreveport, Louisiana.

TWO Beautiful prints from each picture on roll. 8 exposure 40c; 12 exposures 50c. Thirty four years of satisfied customers. Quick Service. Lens Photos, Dept. J-4, Janesville, Wis.

QUALITY Kodak finishing. 8 exposure roll 35c; 12 exposure 50c; 16 exposure 60c. Reprints 4c. Fast service. Guaranteed quality. 40 years continuous operation. Be a satisfied customer. We do color. Send for mailers. Mail Order Photo Service, Box 297, Watertown, Wisconsin.

MOTION PICTURES AND SOUND EQUIPMENT

SMM. Outstanding Kodachrome library. Free listings and projection sample; \$1.00. Film Wizard, Hollywood 38, Calif.

ALL Kinds 16mm sound films. Rent, sale. Roshon, 335 Fifth, Pittsburgh 22, Penna.

FREE! Blackhawk's big sale catalog new and used 16mm., 8mm. films; 2"x2" color slides; used 16mm. sound projectors. Biggest stock in U.S.A. Blackhawk Films, 1200 Eastin, Davenport, Iowa.

8-16MM. Silent-sound films. Latest subjects. Free catalogue, sample film 10c. Garden Film, 690 Howard Ave., Brooklyn, N. Y.

TAPE Recorders, tapes, accessories. Unusual values. Dressner, Box 66M, Peter Stuyvesant Station, New York City 9.

5,000 8-16MM. Silent-sound films. International, 2129 Strauss, Brooklyn 12.

MOVIE Camera film: 8mm. roll \$1.50, 16mm. 100' \$3.00. Free processing. Better Films, 742 New Lots, Brooklyn, N. Y.

SAVE 50%! Guaranteed-fresh color. b.w. movie film! 8mm., 16mm. Free catalog! ESO-R, 47th Holly, Kansas City 12, Missouri.

TAPE Recorders, accessories. Best buys. Boynton Studio, 10M Pennsylvania, Tuckahoe, N. Y.

STOP Searching! Cine adventures as you like them. 50'—8mm. \$4.00. 2 for \$7.00; 100'—16mm. \$7.00. 2 for \$13.00. Danny Davis, Box 1202, Room 668, Chicago 90, Ill.

FREE Sample kit. Make movie titles in color. A-to-Z Movie Accessories. Flatiron Building, New York City 10.

8-16 SHORTS. Features, 50%. Sale, library. Sound, silent. Mogulis, 112 W. 48, New York City.

MUSIC AND MUSICAL INSTRUMENTS

ACCORIONS—Direct from importer. Save 50% and more! Free trial. Lifetime guarantee. Trade-ins accepted. Free color catalog. Write Accordion Outlet, Dept. 85-R, 2003 Chicago, Chicago 22, Ill.

PHONOGRAPH Records cheap. Catalogue. Paramount, MC-313 East Market, Wilkes-Barre, Penna.

SONGWRITERS: Large recording company wants new songs. Royalty basis. National sales, promotion if selected. No charge for melodies. Send songs, song poems. Music Makers, Dept. E-12, Box 297, Hollywood, California.

POEMS Wanted for musical setting. Send poems. Free examination. Crown Music Company, 1476 Broadway, New York City 36.

POEMS Wanted for musical setting by America's largest songwriters organization. Immediate consideration. Five Star Music Masters, 630 Beacon Bldg., Boston.

ELECTRIC Guitars, amplifiers, parts. Wholesale. Free catalog. Carvin, PM287, Covina, Calif.

PLAY Piano classics without lessons. talent. New game, "Music Like Magic." \$1. K. Irwin, 1029 E. 29 St., Brooklyn 10, N. Y.

RETIRED Church organist composes beautiful music to sacred words. Reginald Beiber, Cumington, Massachusetts.

SONGWRITERS: Melody composed, \$5.00. Guaranteed. Paramount, 1944 Linwood, Toledo, Ohio.

SONGWRITING Details. Newart Pubs, G.P.O. Box 1226, Syracuse, N. Y.

SONGS—Poems wanted. Good opportunity. Tunemsmiths, 1609 Vista Del Mar, Dept. U, Hollywood, Calif.

SONGWRITERS—Success, fame, fortune if talented. Songs revised, composed, published, promoted by largest firm. Free appraisal. Since 1943. Postcard to Nordyke Publishing Co., 6000 Sunset Blvd., Hollywood 28, PM, Calif.

WHOLESALE! Musical instruments, phonographs, recorders, watches, appliances, etc. Discounts to 75%! Large catalog 50c (refundable). Strauss Music Company, 25-10, Lafayette, Paterson 23, N. J.

SONGS, Poems wanted! Free examination. Bengal Music, 93 Jefferson Avenue, Chelsea 50, Massachusetts.

POEMS—Urgently needed to set to music! Write clever poems, catchy rhymes. Achieve fame, money in popular music field! Send sample poems. Free evaluation. TinPan Alley, 1650 Broadway, Dept. X, New York City.

SWISS Musical movements, \$1.90. Helax, 218 West 72nd Street, New York 23.

POEMS Needed for new songs. Send poems for free examination, details. Immediate consideration. Songcrafters, 2724 Arcade Station, Nashville, Tenn.

1955 ACCORIONS—Wholesale. Free catalog. American Accordion Center, PM-3, 5329 Belmont, Chicago.

SONGWRITERS! Send poems, songs. Music Service, 243 West 72nd St., PM, New York City 23.

FREE Records of your song. Your words, my melody. Free information. Johnny Mack's Melody Mart, 1094 West 39th Street, Dept. A, Los Angeles 37.

POPULAR Songs. How to write and sell them. Write for free booklet Successful Songwriting. Gateway Songs, Box 2470, Hollywood 28, Calif.

WANTED! Poems for musical settings. Write Songwriters' Service, Clifton, N. J.

ACCORIONS, Wholesale to everyone. Save up to 60%. All national known brands. Free catalogue. Del Principe, 29 South Cicero, Chicago 44.

SONGWRITERS! Protect your ideas! Hold all songs, poems! Write for safe correct procedure first! Song Service, Dept. P. 333 W. 56th St., New York 19, N. Y.

WRITE Songs. Big money and reputation. Write for information. J. Gordon Pub. Co., 4700 South California Avenue, Chicago.

POEMS Wanted to be set to music. Free examination. Send poems. McNeil, Master of Music, 516-PM 8, Alexandria, Los Angeles, California.

RADIO, TELEVISION AND ELECTRONICS

NEW TV catalog free. Loaded with bargains. Finest new TV antennas, converters, motors, boosters, parts, instruments, hundreds of quality accessories. Get your catalog now. National Electronics, Dept. P-8, 6508 Euclid, Cleveland 3, Ohio.

REPAIR Your own TV. Instructions compiled exclusively for your set. Simple as replacing light bulb. Send set name, chassis, model number, \$2.00. LE Engineering Company, Box 4113-PM-8, North Hollywood, Calif.

BUILD 15 Radio circuits at home—Progressive Radio "Edu-Kit" only \$19.95 complete. Free electric soldering iron and radio tester with "Edu-Kit." No radio background required. 30-day unconditional money back guarantee. Order direct or send for free descriptive literature, no obligation. Valuable radio and TV repair guide sent on request, no charge, no obligation. Progressive "Edu-Kits" Inc., Room 32-B, Progressive Building, 497 Union Avenue, Brooklyn 11, N. Y.

FREE Transistor code practice oscillator kit. Write for details. Trans-Alre Electronics Inc., 149 Broadway, Dept. M, New York 6, N. Y.

ELECTRIC Brain plays game! Build it! Challenge your friends to beat it! No tricky parts, easy to make. Complete instructions, fifty cents. Jay Acey, Dept. P-2, Box 132, Greenwich, Conn.

BUILD Super crystal radios. Electrotonic crystal detector, instructions 50c. Electrotonics, Box 98M, Dixon, Missouri.

NEW! Wrist radio! 400 mile reception. own antenna. Details-diagram 25c. Electronics, 4406 74th, Hyattsville, Maryland.

RADIO Beginners booklet, 62 pages, 28 illustrations, 25c. Franks Book Service, 3121 Racine, Chicago 8.

BEGINNER'S "Radiobuilder" 25c; 12, \$2.50. Laboratories, 328-C Fuller, Redwood City, California.

MAKE Simple, tubeless, batteryless, distance-getting radio. Genuine Melomite crystal, detector, illustrated instructions, 50c postpaid. Allen, 427-PM5, Clinton, Missouri.

TV Trade-in sets. Philco, Emerson, G.E., Admiral, Motorola, Tele-King, others. List available. 10"—\$17, 12"—17"—\$20 up. Washtek Service Co., 1501 Boston Rd., Bronx, N. Y. DA 3-9281.

T.V. Repair Secrets. Complete individual guide by experts. Send make, model and \$2.00. TV Lab, Box 185, Yuba City, California.

RADIO-TV service course. New method. No theory. Learn by experience. Guaranteed results. Complete course \$7.50. Radio Service School, 3502 Mills Avenue, Austin, Texas.

MAKE Simple powerful distance-getting crystal radio. Works anywhere. Illustrated booklet 25c. Money back guarantee. Jay Francis, Box 5963, Cleveland, Ohio.

BUSINESS OPPORTUNITIES

GROW Earthworms. Raise anywhere, sell breeding stock, soil culture, fishbait. Instructions free with orders. California Wonder Worm Farm, Box 4083 Catalina Station, Pasadena, California.

MAKE Money at home as renewal headquarters for all magazines. Big profits now. Liberal commissions. Supplies furnished. Experience unnecessary. Write for free catalog. McGregor Magazine Agency, Dept. 500-B, Mount Morris, Illinois.

BECOME A game warden, professional hunter! Join forestry, park, fishery services. Good pay! Opportunities open! Free revealing "Select-Job Chart," details, job-getting secrets. Write Home Study Institute AG, Los Angeles 19, California.

GROW Herbs and spices at home (many rare and unusual.) Make 101 useful and salable products. Big profit orders come from neighbors, gift shops, restaurants, etc. Also mail orders. Window box supplies household needs. Successful home grower shows you how. Free, full details. Herb Center, 601-CK So. Vermont Ave., Los Angeles 5, Calif.

WHOLESALE! 16-80% Discounts! Appliances, tools, etc. Catalog 25c. Levesque Supply, Atlanta, New York.

LEARN New product promotion. Start national business from home promoting your own new product ideas. Sell through retailers, wholesalers, chains, agents or by mail. Expert instruction. Details free. Banning A4, 46 South Los Robles Avenue, Pasadena 1, California.

VITAMINS! Terrific profits! Direct and mailorder sales to homes, offices, stores and get your own needs wholesale. Details free. VitaVite, 2908PM Beverly, Los Angeles 57.

ADVERTISING Book matches—Cash in on big demand; sell union label matches. Cuts for all businesses and political parties. Free powerhouse selling kit, low prices, protection guaranteed on repeat orders. Cash commissions. Superior Match Co., Dept. MX-855, 7530 Greenwood, Chicago.

NAMES Of ambitious men seeking own business. Recent, 1000, \$6.50. MacLachlan, 378 Baldwin, Jersey City 6, N. J.

SELL Popular Mechanics and all other magazine subscriptions. Free catalog, supplies. Subscription Service Company, Dept. A, P.O. Box 2070, Birmingham, Alabama.

START Your own business on credit. Your own boss, 1135 of our dealers sold \$5000 to \$30,000 in 1954. We supply stocks, equipment on credit, 200 home necessities. Sales experience unnecessary. Pleasant profitable business backed by worldwide industry. Write Rawleigh's, Dept. H-U-PPM, Freeport, Ill.

BECOME Exclusive franchised distributor, agency operator. Opportunities nationwide. Request interesting information today. National Franchise Reports, 333 North Michigan, Chicago 1.

BOOKKEEPERS, Increase earnings operating sensational bookkeeping service. Kern, 5632 Lankershim, North Hollywood, California.

\$1000 MONTHLY Possible in collection agency business. Free details. Write Cole Associates, Syracuse 2, N. Y.

FREE "At home money-making plan." Increase your income. Add to your savings. Start your own discount business. Send for free plan today. BTS Products, Box 217, Oakland 3, N. J.

NEW Plastic mending tape. Just press on! Repairs clothing instantly. Lightning seller. Samples sent on trial. Kristee 111, Akron, Ohio.

CALIFORNIA Bound? Good jobs available. Skilled, unskilled. Who to contact, \$1.00. Personal Job Service, Dept. PM, 2842 Aurora, Sacramento 21, California.

START A buying service, buy wholesale thousands nationally advertised products. Make big profits selling at sizable discounts. Postcard brings details. American Buyers, Hertel Station, Buffalo 16-Cl, N. Y.

FREE "301 Profitable Small Businesses!" Amazing shoeing plans! Work home! Start sparetime! Deumant Surveys, Kenmore 23-R, N. Y.

COLOR Concrete with chemicals. Marble-glaze cement benches, pottery. Home-shop. Hundreds beautiful designs, made without molds. Birdbaths to waterfalls. Your chance for fame, fortune. 10c brings sample, pictures. Hollywood Cementcraft, 8527-R Wonderland, Hollywood 46, Calif.

USED And new watches. \$2.00 up. Free list. Southern Watches, Gray, Georgia.

WHAT'S New in mailorder? Let "Mail-order World," published monthly, keep you informed. Sample, 25c. Wayte, 1233 Elden, Los Angeles 6, Calif.

C-4 Type filter, sample \$1.00 prepaid. Big discount on re-orders. Kilgore's, Box 281, Chickasha, Okla.

USE Our capital to start your own business. Normaloids, 655 N. Arden, Los Angeles 4, California.

NEW, Unique plan can earn hundreds of dollars for you. Free details. No obligation. Write: Best Distributors, 200 West 34th St., New York City 1. Suite 1003.

LEARN Sewing machine servicing differently. Trade secrets surprisingly odd! This vocation booming! 20c inclosed gets \$1.00 lesson, plus details. Purdy's, Box 207-M, Weatherford, Texas.

RUN Cafe, diner. How to get started, menus, foods, revealed in home training. Write for free book "Cafe, Diner Business." School of Restaurant Arts, BU18, Fremont, Ohio.

MAKE Perfumes, other products. Sell mailorder. Catalog free. International, 6347 Parnell PM-8, Chicago 21, Illinois.

BECOME Tax consultant. Our students earn to \$3,000 part-time in 3-month tax-season. We train you, help you start. Union Institute, 68 Hudson, Hoboken 2-A, New Jersey.

VALUABLE Business opportunity. New automatic 3 in 1 hot drink unit handling the world famous, nationally advertised Maxwell House coffee, Bakers chocolate, Tenderleaf tea. This is a permanent highly profitable year round business which can be operated from your home in spare or full time. Thorough training by our factory trained service men. Initial location contracts obtained for you. Immediate unbelievable income; 10 units doing the 1953 national average would give you an income of \$423.50 per week, \$1834.73 per month. You must have \$1190.00 or more to start. Liberal financing for large operations and expansion. For full details write giving phone to Superior Distributing Corp., 4555 East Warren Ave., Dept. A, Denver, Colo.

EXTRA Money sparetime sharpening farm discs. \$20 to \$25 daily profits. No dismantling—No moving. Simple portable machine sharpens whole disc right on farm. Free plan explains. B. L. Foley Company, Columbia Heights, Minnesota.

"FROG Raising!" Season just starting. Get this year's eggs. New book tells how. Folder 10c. Broel-A. Box 506, New Orleans 1, Louisiana.

EXPORT Business made easy! Expect something different. Complete setup, everything furnished. Hermes, 152 West 42, New York City 36.

DOLLARS: Baby record books. Kitty Kat shoes, My Baby albums, eleven thousand new prospects daily. Sold by mail, use our literature. No-Co-Ro, Oakland 6, Calif.

EARN \$35.00 Daily! Sell Liqui-Moly, new wonder lubricant for cars, trucks, buses, tractors. Used in jet engine, atomic energy plants. Nationally advertised magazines, newspapers, radio, television. Over 3,000,000 cans sold. Territories available. Write Moly Products, 314 Scholes Street, Brooklyn 6, N. Y.

NEW, Different home business. Earn \$8.00 per hour. No shop or equipment needed. Everything supplied. Free details. Lopez Press, Lopez, Penna.

TELEVISION Can sell your product faster for less money. Free information. Telesales, Box 34A, New York City 19.

NEW Compound fireproofs, waterproofs fabrics. Nylife lengthens hosiery life. 12 other processes. \$1.00. Dr. Teycer, Box 1287P, Chicago 90.

WANTED! Home producers, by manufacturers in our clearing house service. Become subcontractor, casting plastic products for these companies. Thousands of easy-to-make items required for consumer-industrial use. Cash in at home, without previous experience. Plastic Service Associates, Dept. 8-PM, East Boston 28, Mass.

LIQUID Marble—Brushed, sprayed! Mold novelties, tile. Particulars free. Marbleizing Service, Edwardsville, Illinois.

HOT Promotional items! Free catalog. Metropolitan Wholesalers, 4143-3 Ave., New York City.

WANT Up to \$100.00 weekly deposited in your mail box? Details free! Smith, 2708-P Ladera, San Bernardino, Calif.

FREE Literature! 301 successful home businesses. Eugene Davis, 750C Tilden, Flint 5, Mich.

YOUR Own wholesale hosiery-underwear business pays you up to 40% profit. No investment, no inventory. Sensational new stretch nylons direct from mill. Guaranteed runproof. Offer free-trial pair. Catalog, money-making plans free. American Mills, Dept. 469, Indianapolis 7.

MAKE Tough, attractive building plastic, easily 88½% waste—101 uses—800% profit. Exclusive district. Grab it. Bays Laboratory, Oklahoma City 9.

START Prosperous buying service. Buy wholesale thousands nationally advertised products. Make big profits selling at substantial discounts. Catalog-directory \$1.00. Johnson's, 3262X Medina, Fort Worth 15.

START Home business, sparetime, opportunities unlimited. Write, Heam, Box 8892, Richmond 25, Va.

HANDY Scribe. 100% profits; 8 tools in 1, 101 uses. Sample \$2.00. Scriber Gauge Mfg., P. O. Box 1946, Hartford 1, Conn.

SELL Printed stationery, business cards, by mail! Free catalog, samples. Sutton Printing, Box 853-M, Waycross, Georgia.

SAWDUST. Turn it into cash. Twenty methods. Instructions 50c. Charles Company, 12-DEF, Norwood, Ohio.

MAKE Money helping others get out of debt, stop garnishments, save jobs, re-establish credit. Details, Borum 86, 411 West Walnut Street, Kalamazoo, Michigan.

BUY it wholesale! Manufacturers, distributors offer 850,000 items. Literature free. Olsen, 1231-A East Third, Duluth 5, Minnesota.

EARN \$2.00 Hourly, making and selling sandals! Youngs, 1308-PM, South First, Arcadia, California.

ADVERTISING Business—City, country. Low overhead, substantial income. Experienced advertising company offers complete setup. Harold, 69-S Bennett, New York City 33.

WHOLESALE Catalog of tools, sporting goods, jewelry, toys, etc. available free. Open your own business. No investment. J. M. Arnoff Company, Dept. X, 24470 Lakeland Blvd., Cleveland 23, Ohio.

AMBITIOUS? We establish you in your own business, supply catalogues, circulars etc., ship orders under your name, paid or c.o.d., show you exactly what to do. Household items needed in every home. Sell direct, by mail or through agents. Complete details absolutely free. Write Topval Corp., Lindenhurst 518, New York.

FREE, Home business plan. Samples & tails. Fender, Box 448-ACF, Kalamazoo, Michigan.

COIN Radios and coin television for installation in hotels and motels. Operate 4 route in your area and earn amazing profits. Send for details. Dept. PM, Corada, Inc., 196 Albion Ave., Paterson 2, N. J.

LIST Of ten firms who manufacture cosmetics, perfumes, etc., wholesale. Label as your name, \$1.00. Fortunes have been made, selling direct, by agents, by mail. Centry, 79 Massachusetts, Detroit, Mich.

ELECTROPLATE Auto parts, novelty mirrors, baby shoes. Easy, inexpensive home processes. Free booklet. Tyco Metals, Box 13231-MM, Houston 19, Texas.

\$70 WEEKLY Guaranteed—Home, sparetime. Simplified mail bookkeeping. Immediate income; easy! Auditax 34751AQ, Los Angeles 34.

COPUBLISHERS Make 3400% profit! Sample, details, 25c. Gerald Watt, 2117 Tripp, Chicago.

I Average \$180.00 weekly with new fabulous mail-order idea! Receive \$10.00 orders every mail—pocket \$8.00! I supply everything! Start sparetime! Hurry, limited! Donn's, Box 128-P, Miami 1, Fla.

BARGAIN. 20 Ways each to make money from sawdust and tin-cans. Nine ways for glass-bottles. 50c each. 3 for \$1.00. Fender, Box 448-ACE, Kalamazoo, Mich.

WHOLESALE, Thousands items. Supply source list, 10c. Idealar, Park Ridge, Ill.

LEARN Sewing machine repair. How to make big money at home sparetime. New machines. Everything supplied. Write Taylor Service, Box 2126, San Bernardino, California.

\$5 TO \$10 An hour. I've did it. I'm disabled now. Real genuine offer. Complete information only \$1. Lucas, 2200 Carson St., Pittsburgh 3, Penna.

IMPORT-Export opportunity, profitable, world-wide, mail-order business from home, without capital; or travel abroad. Established world trader ships instructions for no-risk examination. Experience unnecessary. Free details. Mellinger E701, Los Angeles 24.

REBUILD Batteries; repair dolls; make rubber stamps; silk screen printing. Catalogue "60 Ideas" free. Universal, Box 1076-A, Peoria, Ill.

700% PROFIT Earned with a PDQ camera. No experience needed. Simple instructions teach you how to take photos of individuals, groups, etc. and finish them on the spot in two minutes. No darkroom. Get details. PDQ Camera Co., 1161 N. Cleveland Ave., Dept. PM, Chicago 10, Ill.

BREED Rare tropical fish at home. Earn big money! Learn secrets! Help fill huge demand. Amazing opportunity! Free plan. Tropical Fish Breeders, Los Angeles 61, Calif.

HOW And where to obtain capital. Particulars free. Star Service, Wapakoneta, Ohio.

TO \$50.00 Weekly. Sparetime, home-operated mailorder business. Successful beginner's plan. Everything supplied. Lynn, 10420-M National, Los Angeles 34, Calif.

BE Appointed state notary public now. Write, Stationers, Helotes, Texas.

I Want to send you proof of the wonderful pulling power of Popular Mechanics classified pages. What's your proposition? Write me today. Include literature if possible. F. W. Johnson, Manager Classified Advertising, Popular Mechanics Magazine, 200 E. Ontario St., Chicago 11, Ill.

FORTUNES Made raising crickets and fishworms. Write for free information. Carter Farms, Plains, Ga.

MAKE Money growing miniature trees on your window sill. Free seed and plan. National Nursery, Dept. FC, Inglewood 4, Calif.

FREE Folio "Up to \$45,000; Unlimited Vacations." No merchandise, equipment. Unknown! Work home, sparetime! Haylings, Carlsbad, Calif.

FREE Electroplating information. Money making plans. (Formula included). Send postcard for your copy. Highly paid, interesting, uncrowded field. Plater D. Hyde, 327 West 120th Street, Los Angeles 61, California.

MONEY In sparetime fixit shop at home. Repeat cash business. Experience unnecessary. No selling. Free booklet explains. Victor Foley Company, Columbia Heights, Minnesota.

RESILVERING Mirrors, formula 50c; two-way look-out mirrors, (No one sees you), 50c; coppered mirrors, 50c. All \$1.00. Neiko-Mir. Box 3462-J, Chicago 54.

WE Love our mailman—He leaves over \$1000.00 monthly in our rural mailbox. My college professor husband drafted a scientific home mailorder method. We bought a Texas ranch, live as we always wanted. Now we sell the Ranch Mailorder Method. Operates anywhere. Inquire: Eveningshade Ranch, Helotes, Texas.

POPCORN And potato chip equipment. Eakins, Box 933-A5, Springfield, Ohio.

MEN—Income from local information. No selling. Neherco, LaVerne, California.

RUBBER Molds for casting plaques, figurines, novelties. Catalog illustrating over 100 fast sellers, 10c. Castcraft Studios, 508-PM Marion Street, Brooklyn 33, N. Y.

NEWEST Spare, full-time home business, \$5 to \$10 hour possible. Paint with suede—The finish with touch and eye-appeal. Beautify auto dashboards, signs, radios, toys, figurines, lamps—1001 others. Complete, step-by-step instructions sent for no-risk examination. Free details. Coast, Los Angeles 61.

START Home manufacturing business. Make cleaners, soaps, polishes, cosmetics. Free literature. Kemix, Park Ridge, Ill.

IMPORT-Export mailorder opportunities! Details. Warner, Box 6, Fort Scott, Kansas.

NATURAL Molding rubber, extra thick. Free sample. Flock, W. Wooley, 115-A Donald, Peoria, Ill.

BOOKKEEPERS, Keep books, small firms spare time. Manual latest technique by C.P.A., \$3.00. Modern Business, Box 406, Youngstown 1, Ohio.

MAKE Money at home—Mail cards, circulars feature real merchandise. Everything furnished. Big earnings. Philip's, Box 3-P, Boston 22, Mass.

COPUBLISH Mail Sale Advertiser, leading mail order paper. Details, latest copy, dime. Vanroy Shirk, Lebanon, Penna.

GROW Mushrooms. Cellar, shed, and outdoors. Spare, full time, year round. We pay \$3.50 lb. We paid Babbitt \$4,168.00 in few weeks. Free book. Washington Mushroom Ind., Dept. 172, 2954 Admiral Way, Seattle, Washington.

\$25 WEEKLY Working two hours daily at home. Lycke, Box 2471-A, Cleveland 12, Ohio.

OPERATE Profitable mail order business. Write Walter Service, 4159-A East 112th, Cleveland 5, Ohio.

COLORGLAZED Concrete pottery made without molds. Patented method. Cemetery products, novelties, tiles. Basement leak-sealing. Money-making projects. Booklet, details free. Men only. National Potteries Company, Grand Rapids, Minnesota.

MINK Raising information free. Complete. Lake Superior Mink Farm, Superior, Eel, Wisconsin.

FREE Book "505 Odd, Successful Businesses." Work home. Expect something odd! Pacific, Oceanide, Calif.

MONEY In new greaseless doughnuts. Start in kitchen. No smoke. Sell stores. Free recipes. M. Ray Company, 3605 South 15th Ave., Minneapolis 7, Minn.

VENDING Machines—No selling. Operate a route of coin machines and earn amazing profits. 32-page catalog free. Parkway Machine Corporation, Dept. 72, 715 Ensor St., Baltimore 2, Md.

BRONZE Baby shoes. Instructions, equipment and mountings for genuine electroplated process. Free catalog. Hollywood Bronze Supply, Dept. B-3, 1624 East First Street, Los Angeles 33, Calif.

YOUR Own name brand business. No investment; no inventory. Part time or full time. Sell famous brands of appliances, housewares, silverware, radios, vacuum cleaners, lamps, tools, clocks, watches, jewelry, etc., etc., over 1000 items. Join thousands of successful independent dealers. Send for free catalog and dealer price list. H. B. Davis Corp., Dept. W, 145 W. 15 St., New York City.

UNUSUAL Opportunity. Spinning at home. Supplies, market, furnished. Angora House, PM, Springfield, Illinois.

LIQUID Rubber. Make flexible molds. Free sample. Chaney, 1130 E. 16th St., Jacksonville 6, Fla.

MAKE Best doughnuts, yeast raised. Start in kitchen. Sell retail and wholesale. Formula and full instructions \$1.00. Another valuable pastry receipt free. Write Lyon, 1605 W. 17th St., Davenport, Iowa.

STEADY Profits, home-operated business. Simply add water to concentrates. Make waterless hand cleaner, chrome renewer, etc. Free samples. Western B Aircraft, Los Angeles 19.

GOOD Paying business silvering mirrors, plating articles in the shop and home by late method. No tanks or shop required. Free booklet. Gunmetal Co., Ave. H, Decatur, Illinois.

WHOLESALE Catalog! 30-80% discounts! Typewriters, appliances, housewares, watches, jewelry, etc. Consolidated Distributors, 21-11 Lafayette, Paterson 15, New Jersey.

GROW Orchids at home—Profitable, fascinating. Year 'round, Maine to California. No greenhouse. Gorgeous cattleyas, cymbidiums, etc. Successful home grower shows you how. Full details free. Flowerland, 4623 Wilshire, Los Angeles 5.

FIX Typewriters. Inexpensive home course teaches factory secrets. Free booklet. Write, Typewriter, Tarentum 1, Penna.

\$200 WEEKLY Cleaning Venetian blinds. Free book. Burt, 2434A, Wichita 13, Kansas.

\$1,000 MONTHLY, Home, mailorder, free advertising method. Revealing information. Seidel, 6000-AG Sunset, Los Angeles 28.

WANT To make big money at home? \$5 profit in an hour possible with invisible reweaving. Make tears, holes disappear from clothing, fabrics. Steady year-round demand from cleaners, laundries, homes. Details free. Fabricon, 8334-S Prairie, Chicago 18, Ill.

IMPORT Precision 17 jewels watches from Switzerland. Profitable. Little capital. Copyrighted course \$2.00. Robert Celaya, Brownsville, Texas.

PRINT Without a printing press! Amazing new method! Print colorful signs, banners, cards, posters, glassware; anything at home. Big profits. Money-making opportunity! We supply everything. Beautiful sample, home-business plan free! Write Screen-Print Company, PM-8, Los Angeles 61, California.

MONEYMAKING OPPORTUNITIES

NEWLY Found money in Whitehall's fascinating photo line of Christmas and everyday cards, jewelry, gift items. Personalized stationery, napkins. Send for free samples. You, too, can make big money with Whitehall's photo line. Whitehall Studios, 15 Main Street, Elmira, New York.

\$30.00 DAY Profits easy. Sell and install iron railings for porches and steps. Every new home needs and buys. Ideal for full or part time business. We sell you at wholesale and ship direct to your customers. Write for details. K. Jerome Co., 740 W. Superior Ave., Cleveland 13, Ohio.

COST Of things going up faster than your income? You can make more full or part time as a Rawleigh dealer. Write for full particulars. Rawleigh's, Dept. H-RR-PPM, Freeport, Ill.

"**MONEY** Getter's Bulletin." Prints helpful money-making ideas, plans, tips. Sample 25c; details free. Distributors, Box 831-D, Monessen, Penna.

FREE Literature! 301 successful home businesses. Eugene Davis, 759C Tilden, Flint 5, Mich.

\$9.00 RETURNS \$100.00 repeats. Make us prove it. Ezee, Bayport 7, Mich.

SELL Titania gems; far more brilliant than diamonds. Catalog free. Diamonite, 1404-M Mitchell, Oakland 1, California.

START A buying service, buy wholesale thousands nationally advertised products. Make big profits selling at sizable discounts. Postcard brings details. American Buyers, Hertel Station, Buffalo 16-D1, N. Y.

FREE! "301 Profitable Small Businesses!" Amazing shoestring plans! Work home! Start sparetime. Deumant Surveys, Kenmore 23-R, N. Y.

NEW Comedy, religious, general "T"x11" signs. 7c, retail 50c, 15 samples, \$1.00. Lowy, 812 Broadway, Dept. 888, New York 3.

YOU Cast metal products. Free literature. Box 124, Lynwood, California.

STUCCO Paint, joint cement, etc., exclusive formula, easy money. Larstone, 3419-9-East, Salt Lake City 6, Utah.

LEARN Technical metaphysics and insure your future. Easy, inexpensive correspondence course. Simplest method known. Diploma. Write: Premier College of Technical Metaphysics, 2532 McKenzie St., Vancouver, B. C., Canada.

INTERESTED Contacting model-maker. Must be able to work out details, produce workable model in wood, plastic. Terms to be worked out. Write facilities available. Claudia Oipa, 505 East 82 Street, New York, N. Y.

LEARN Mailorder fundamentals. Plans, Opportunities. Will Kell Company, 5255 Wilshire, Beaumont, Texas.

EARN Money evenings, copying and duplicating comic cartoons for advertisers. Adservice, Argyle 1, Wisconsin.

\$1,000 MONTHLY Possible raising earthworms! Backyard, garage, basement. Complete illustrated booklet explains raising, feeding, packing, marketing. 25c postpaid! Ozark Worm Farm-J, Willow Springs, Missouri.

BIG Income at home! \$1.00 brings literature describing two amazing new plans. Melco, 2099 Cornell, Cleveland 6, Ohio.

START Your own toy business. Assemble, finish and sell wooden toys. Milled parts and kits available. Write Fulton Mfg. Co., Box 707, Blowing Rock, North Carolina.

BUY Wholesale! Save 66½%! Appliances, furniture, jewelry, toys, sporting goods, tools. Free catalogs. National Buyers Service, Box 426EB, Oakland, California.

WANT To go in business for yourself without capital? We show you how. Start part time your own home. Postcard brings details absolutely free. Topval Corp., Lindenhurst 518, New York.

21 USES For old newspapers. Turn them into cash, \$1.00. Money back guarantee. Crawford, Anthony, Kans.

BOOKKEEPERS Wanted your locality. \$100 weekly. Free details. Grady, Box 2191, Ft. Worth, Texas.

\$5-\$10 AN Hour teaching driver training in your own car. Complete detailed information \$1.00. Driving School Services, Box 42BP, Goleta, Calif.

SCHEMER Magazine, Canfield 1, Ohio, monthly mailorder ideas, plans. Year \$2.00. Sample 25c.

DO You want your own business? For money-making opportunities. Write: Central Sales Outlet, Robbins, N. C.

IF You need more income. Start a home business in spare time. Make extra money. Experience not necessary. Literature free. World Sales Co., P.O. Box 179 PM, Ripley, Miss.

WINNING Prize contests is fabulous, confidential, home opportunity! Send stamp! National Contest Bulletin, Box 2685-P, Miami 16, Florida.

EARN \$50.00 Daily making mats, shoes and mud guards from old tires. S and S Patents Inc., 1307 North Clark St., Chicago 10, Ill.

\$5 TO \$10 An hour. I've did it. I'm disabled now. Real genuine offer. Complete information only \$1. Lucas, 2200 Carson St., Pittsburgh 3, Penna.

MAKE To \$300 extra. New! Different! No selling! No mailorder! Details free. J-M Enterprises, 801½-A North Marsalis, Dallas 3, Texas.

DOLLARS In baby record books, baby shoe kits. Liebig Industries, Beaver Dam 2, Wisconsin.

FREE Literature describing money-making mailorder plans. Lewis Barlett, Richland, Georgia.

BUILD Sales by recruiting productive distributors selling direct or to retail outlets. Secure most concentrated circulation through classified columns of Salesman's Opportunity. Write for facts. Gilbert, Salesman's Opportunity, Room 1700, 850 N. Dearborn, Chicago 40.

FREE Folio "Up to \$45,000; Unlimited Vacations!" No merchandise, equipment. Unknown! Work home, sparetime! Haylings, Carlsbad, Calif.

SPARETIME Profits taking subscriptions all magazines. Wholesale catalog free. Cassell Publishers, Westfield, New Jersey.

GENERAL Contest Bulletin. Issued monthly. Sample, 25c. 1609½ East 5th, Duluth, Minn.

GROW Mushrooms. Cellar, shed, and outdoors. Spare, full time, year round. We pay \$3.50 lb. We paid Babbitt! \$4,165.00 in few weeks. Free book. Washington Mushroom Ind., Dept. 173, 2954 Admiral Way, Seattle, Washington.

50,000 ARTICLES Wholesale. Source directory, dime, Nelko, Box 3462-DR, Chicago 64.

READ Progressive Mailtrade. the magazine that tells how to make money by mail. Dime brings sample and special offer. Progressive Mailtrade, Box 357, Sheboygan, Wisconsin.

FREE Book "505 Odd, Successful Businesses." Work home. Expect something odd! Pacific, Oceanside, Calif.

MONEYMAKING Opportunities with inexpensive portable sawshop equipment. Zapart, 586-PM Manhattan, Brooklyn 22, N. Y.

ATTENTION: Typewriter owners. Make handsome profits. Write today. Groves Company, 682, Hastings 8, Nebraska.

WHOLESALE Catalog! 30-80% discounts! Typewriters, appliances, housewares, watches, jewelry, etc. Consolidated Distributors, 21-12 Lafayette, Paterson 15, New Jersey.

START A profitable subscription business in spare time! We need men and women (young or old) as representatives for all leading national magazines. Liberal commissions paid for new and renewal subscriptions. Start earning money in this pleasant work at once! Clip this ad and send with your name and address to: Agency Bureau, Dept. PM, Hearst Magazines, 250 West 55th St., New York 19, N. Y.

FORMULAS, PLANS, ETC.

FREE Formula catalog. Anything analyzed \$35.00. Western Chemical, Salem, Oregon.

ONE Commercial formula and catalog \$1.00. Milici-P.M.-Chemist, 1709 W. 7th St., Los Angeles 17, Calif.

MODERN Formulas for today's fastest selling big-profit products. Literature free! Miller, Chemist, 1517-N, Tampa, Florida.

FORMULAS: All kinds, latest, best. Literature free. Kemixal, Park Ridge, Ill.

REAL Manufacturing formulas. Lists free. Cummings, Chemist, Gordon Ave., Syracuse 4, N. Y.

PLASTICS

PLASTICS Home-craft course for men and women. Tells and shows how to make hundreds of fast selling plastics products. All plastics and materials for 23 projects included in course. No special tools needed. Course pays for itself. Write for free booklet. Interstate Training Service, Dept. D-3-H, Portland 13, Oregon.

PLEXIGLAS, Lucite. Square foot cost 1/16", \$1.15; 1/8", \$1.52; 3/16", \$1.86; 1/4", \$2.21; 3/8", \$3.25; 1/2", \$4.38. Colors add 10%. Send 15¢ for postage. Aristocrat Plastics, 55 Clarkson St., New York City.

LAMINATING Supplies. Free price list. Solomonson, 46 Cornhill, Boston 8, Mass.

PLEXIGLAS. Cut to size. Clear. Any thickness. Colors. Rods. Tubing. McClarin Plastics, P.O. Box 168H, Hanover, Penna.

PLEXIGLAS, Fiberglas, polyester, acetate, vinylite. Fast service. Wholesale-retail. Catalog 15c. Gem-O'-Lite, Box 6861P, North Hollywood, California.

CHEMISTRY

AMAZING New book of science. Experiments, formulas and catalogue of laboratory supplies. Only 25c. National Scientific Co., Dept. PM-8, 2204 W. North Ave., Chicago 47, Illinois.

CHEMICAL Consultant. M. S. graduate, highly experienced. Box 747, Evanston, Illinois.

NEW Idea chemical and apparatus outfits for home experimenting. photo-scales, microscopes, chemicals, biologicals and laboratory supplies in small quantities. Catalog 25c. Established 1931. John H. Winn, 124A West 23rd St., New York, N. Y.

ILLUSTRATED Catalog: Chemistry, mineralogy, biology 20c. Tracey Laboratories, Evanston, Illinois.

CHEMICALS And apparatus for industrial, analytical, and private laboratories. Catalog 25c. Dept. M-50, Biological Supply Co., 1176 Mt. Hope Ave., Rochester 20, N. Y.

AGENTS WANTED

CHRISTMAS Cards—Unique gallery of personalized greetings for those who want something different. No other line like it. Selection of 132 exclusive designs, including 36 especially for business firms, all with customer's name. Wide price range. Up to \$5 to \$75 commission on each sale. Full or part time. For elaborate sample outfit from famous old-established firm, write Process Corp., 1950 S. Troy, Dept. FD, Chicago 23, Ill.

AMAZING Tall-Glow, Kodachrome Christmas cards sell swiftly. Free samples. \$52.50 profit on 50 boxes easy! Many cards, stationery, novelties. Profits to 100%, gift bonuses. Samples on approval. Hurry—Get sensational mail minder free. Creative, 4401 Cermak, Dept. 516-B, Chicago 23.

WANTED: Men interested in making up to \$15,000 a year. Exclusive line of personalized articles. No investment. Free information and sales kit. Write Hook-Fast, Box 480 (PM), Roanoke, Virginia.

MAKE Extra money—Selling \$1.00 and \$1.25 Christmas and all occasion card assortments, "slim" cards, gift wrappings, gifts, gadgets. Experience unnecessary. Bonus! Free imprinted Christmas card and stationery samples, selling plan, catalog. Write for samples on approval. Free \$1.00 gift for promptness. Hedenkamp, 361 Broadway, Dept. PM-38, New York.

TREMENDOUS Profits! Every man, woman and child a customer. Suits \$1.50, pants 35c, dresses 20c, shoes 20c. Operate from store, home, car. Free catalog. Superior, 1250-A Jefferson, Chicago 7.

179 EASY Ways to make extra money! Sell new tall style Christmas, all occasion greeting card assortments. Unusual novelties. Make up to \$1.00 per box plus bonus. Write for feature boxes on approval. 77 free samples personal Christmas cards, stationery. New England Art Publishers, North Abington 833-M, Mass.

NEED More money to live on? Increase your weekly income \$20 to \$25 or more in spare time. Supply Rawleigh Products to consumers. Also openings for full time dealers. Write Rawleigh's, Dept. H-DD-PPM, Freeport, Ill.

SELL Sunshine cards, the name quality has made famous. No investment or experience necessary. 21 card deluxe tall slim assortment sells on sight! Imprints, Carrier-Ives, religious, gift wraps, many others. Samples on approval, write: Sunshine Art Studios, Inc., Dept. PM-8, Springfield 1, Mass., Pasadena 1, Calif. (Note: East of Rockies address Springfield office.)

AT Last! Something new and sensational in latest tall Christmas cards. Make extra money fast! Show satins, velours, metallics. Gets easy orders. Pays up to 100% profit. 30 free samples. With name 50 for \$1.50. Big line. Amazing convertible pen-pencil, napkins, gifts, stationery. Several \$1.00 boxes on approval. Puro Greetings, 2801 Locust, Dept. 540-K, St. Louis, Mo.

BIGGER Profits selling greeting cards. Get list of sensational factory surplus bargains. \$1.25 boxes for 50c, \$1 boxes for 35c—while they last! Big line new 1955 Christmas cards, stationery, gifts. Assortments on approval. Personalized samples free! Midwest Cards, 1113 Washington, Dept. 557-C, St. Louis 1, Mo.

LOWEST Wholesale prices. Thousands of name brand items. Free literature. Parker Distributors, Box 55 (Dept. C) Williamsbridge Sta., New York City 67.

EASY Handwork makes fast-selling articles. Sample free. Sunmade Company, Brockton 64, Massachusetts.

150¢ PROFIT Selling 50¢ name and address labels—\$1.00 retail. You keep 60¢ profit. Free selling kit. Bruce, Box 71-Y, Boston 1, Mass.

BEAUTIFUL Feather pictures. 200% profit! Free sample. Apartado 9036, Mexico 1, D. F.

MAKE Money introducing world's cutest children's dresses. Big selection, adorable styles. Low prices. Complete display free. Rush name. Harford, Dept. P-3341, Cincinnati 25, Ohio.

SHINE Shoes without polish. New invention. Lightning seller. Shoes gleam like mirror. Samples sent on trial. Kristee 74, Akron, Ohio.

FREE Color catalog of religious jewelry. 100% profit. Virgin Mary heart necklace, sample \$1.00 (value \$2.50). Money back guarantee. Stephen-New York Inc., 1947 Broadway, New York 23.

CHRISTMAS—All occasion cards, novelties and gift items. Largest selection. Highest profits. Satisfaction guaranteed. Send for sample offer coupon now! Klotz Distributing Co., Dept. 89A, 1012 Western Ave., Toledo, Ohio.

PRINTING! Sell quality letterpress—Offset printing. Free wholesale pricelist, supplies, details. Napco, 2337-A Bath Avenue, Brooklyn 14.

BUY Wholesale thousands nationally advertised products at big discount. Free "Wholesale Plan." American Buyers, Herchel Station, Buffalo 16-A1, N. Y.

MAKE More money showing Elmira greeting cards this Christmas! Why more? Because Elmira offers more variety; beautiful cards for every taste, every purse. You get heart-warming, old-fashioned favorites and smartly simple ones for today's tastes. No matter who you sell, Elmira has a style to please everybody from grandmother to young Mrs. Executive. Send today for free personalized samples, catalog and sparkling assortments on approval with personalized stationery, imprinted napkins and lovely gift wrappings! Elmira Greeting Card Co., Elmira 199, N. Y.

USED And new watches. \$2.00 up. Free list. Southern Watches, Gray, Georgia.

NEW Tall Christmas cards pay 75c profit on \$1.25 assortment. 40 exclusive name-imprints \$1.25; gift wraps by-the-yard; 30 for \$1 assortment; 250 new fast sellers. 5 assortments on approval. \$1.95 gift for promptness. Cardinal, 1400 State, Dept. 79-S, Cincinnati 14.

\$15.20 AN Hour is what W. F. Wydallis reports he earns with amazing Presto fire extinguisher. Sells itself. No experience needed. Free sales kit. Merlite Industries, 114 E. 32nd St., Dept. 58A, New York 16.

TURN Your spare time into profits! Friends, neighbors, relatives buy these unusual gifts, gadgets, toys, jewelry, gift wraps, and greeting cards on sight. Over 600 terrific new items—Up to 100% profit! Send for sensational money-making free catalog now. Start to make big money immediately on Christmas sales! Samples on approval. Write Greetings Unlimited, 3604 Park Square, St. Paul, Minnesota.

EXCITING Razor blade deal. Free sample, details. Nucleus Trading, 2440 Amsterdam Ave., New York City 33.

EARN \$35.00 Daily! Sell Liqui-Moly, new wonder lubricant for cars, trucks, buses, tractors. Used in jet engine, atomic energy plants. Nationally advertised magazines, newspapers, radio, television. Over 3,000,000 cans sold. Territories available. Write Moly, 314 Scholes Street, Brooklyn 6, N. Y.

EARN Extra dollars selling cameras, film, projectors, recorders, typewriters, etc. Write: Gladrose Gift Co., 150-M Broadway, New York 38, N. Y.

NAMEPLATES, Desk signs. Free samples. Biggest profits. Whitney Signs, West Springfield, Massachusetts.

HOME Agency. "Pa-Ma" deal. Power mowers 40% off. Delivered. Rotacut-PM, Excelsior Springs, Mo.

MEN, Students, girls, housewives, of Catholic faith, earn \$50 weekly, spare time. Foreign Treasures, Box 224, Kansas City 41, Missouri.

NEW Way to make money! Sell nothing yourself. Just offer free item to women for every two they sell for you. Household wares needed in every home. Postcard brings catalogue and details of amazing new kind of money-making plan. Absolutely no obligation. Topval Corp., Lindenhurst 11, New York.

WE Put you into big mail order business. drop shipping orders, no investment, no minimum. Catalogues supplied. Terrific new sellers, tremendous profits. Turner Company, 1170 Broadway, New York 1, New York.

"STARLIGHT" Name markers. Every home a prospect. Embossed name plates, nationally advertised. Affix to mailbox, lawn or post. Sales agents wanted, high profits, fast sellers. Write: Starmetal Co., R.D. 3, Box 380, Plainfield 9, N. J.

AGENTS: Sell Mexican feather cards. Good profit. Free sample. Apartado 7118, Mexico City.

EARN \$200 A week and up! Amazing profits are yours selling Seal-Tite, miracle puncture-proofing discovery! \$1.98 tube stops flats forever. Sure-fire appeal to America's 50,000,000 motorists! Complete sales kit free on request. M & M, Dept. M-2, 842 Third Ave., New York City 22.

NEWLY Found money in Whitehall's fascinating photo line of Christmas and everyday cards, jewelry, gift items—Personalized stationery and napkins. Send for free samples. You, too, can make big money with Whitehall's line. Whitehall Studios, 15 Main Street, Elmira, N. Y.

BUY Wholesale! 100,000 name brand products! Save 66%!
Big profits selling others spare time! Free catalogs. National Buyers Service, Box 426EE, Oakland, Calif.

WHOLESALE Catalogue! Appliances, cameras, watches! Anelag Industries, Rochester 1, Wisconsin.

60% PROFIT On cosmetics—Famous nationally advertised Hollywood Cosmetics pay 60%! Make \$25 day up! Hire others. For free samples, details, write Studio Girl, Glendale, Calif., Dept. PM-65.

EARN \$150.00 Per week, giving away stainless steel tableware. Nueblings-M, Sicklerville, N. J.

\$5 TO \$10 An hour. I've did it. I'm disabled now. Real genuine offer. Complete information only \$1. Lucas, 2200 Carson St., Pittsburgh 3, Penna.

30,000,000 WOMEN Want amazing new automatic refrigerator defroster. You sell 8 out of 10 on sure-fire free trial. \$250.00 weekly profit not uncommon. Rush postcard for guaranteed plan. D-Frost-O-Matic, Dept. H-102, 173 W. Madison St., Chicago 2, Ill.

YOUR Own business—Used suits \$1.50, overcoats 65c, mackinaws 35c, shoes 12½c, ladies coats 30c, dresses 15c. Enormous profits. Catalog free. Moro, 1218AA South Jefferson, Chicago 7.

HAVE Your own business, buy wholesale, make big profits. Free general mdse. catalog. Jay Norris, Dept. P, 445 Broome St., New York.

PRINTING, Advertising salesmen—Excellent moneymaking sideline selling decalcomania name plates, small quantities. Automobile initials, sign letters. Free samples. Ralco, XL, Boston 19, Mass.

GOLD Or silver letters, numbers. Windows, doors, trucks. 1" to 6". 500% profits. Free samples. Atlas-T, 544 West 79th, Chicago 20.

MAKE Extra money. Sell front door name plates to friends, neighbors. Retail \$1.98; you make \$1.00! Free selling kit. Modern Engraving Co., P.O. Box 194, Boston 14, Mass.

\$1.00 PROFIT Selling \$2.95 photo enlarger deal. Allen Studio, Riegler Bldg., Little Rock, Ark.

AGENTS — 300% Profit selling genuine gold window letters; stores and offices. Free samples. Metallic Sign Letter Co., 431-D North Clark, Chicago.

YOUR Ad in this space will get some good agents for you. Yes, I'll prove it. Write for Folder "A" right now. F. W. Johnson, Classified Advertising Manager, Popular Mechanics Magazine, 200 E. Ontario St., Chicago 11, Ill.

CALIFORNIA Sweet smelling beads. Sensational sellers. Particulars free. Mission, 2328 PR, W. Pico, Los Angeles 6, Calif.

RUN Spare-time greeting card and gift shop at home. Show friends samples of our new 1955 Christmas and all-occasion greeting cards and gifts. Take their orders and earn to 100% profit. No experience necessary. Costs nothing to try. Write today for samples on approval. Regal Greetings, Dept. 78, Ferndale, Mich.

NEW Bathroom deodorizer. Hangs on wall. Banishes odors bathroom, kitchen. Lightning seller. Samples sent on trial. Kristee 73, Akron, Ohio.

EARN \$46.80 A day! Sell Car-Glo, amazing silicone, wax treated cloth. Cleans cars with one wipe. Fantastic automotive market wide open for this sensational profit-maker! Start earning immediately! Send for free sales kit. M & M, Dept. M-3, 842 Third Ave., New York City 22.

WHOLESALE Catalogue! Appliances, cameras, watches! Cam Company, 6806PM 26th Ave., Brooklyn 4, N. Y.

EARN \$30 A day! Sell Dab-It, amazing pocket-size, stick-form, "no ring" spot remover. Works like magic! Guaranteed! M & M, Dept. M-1, 842 Third Ave., New York City 22.

EASY Money selling the new Pro Candid 35 mm. cameras. Your area is open for anyone to cash in on these fast-selling cameras. Selling kits furnished, cash commissions guaranteed. For complete information write Beaurline Industries Inc., 500 N. Robert Street, St. Paul 1, Minn.

BUY IT WHOLESALE

BUY Wholesale! National known brands. Large illustrated catalog \$1.00. Refundable. D'Auria, Box 355M, Jackson, Mich.

YOUR Cost as little as 25c on dollar! Household items needed in every home. Sell direct, by mail or to agents. Catalogue, confidential distributors' wholesale prices and money-making plans absolutely free. Rush postcard to Topval Corp., Linden-hurst 124, New York.

WHOLESALE! Musical instruments, phonographs, recorders, watches, appliances, etc. Discounts to 75%! Large catalog 50c (refundable). Strauss Music Company, 25-33 Lafayette, Paterson 23, N. J.

BARGAINS, Joblots, close-outs. 2000 items. Save to 50%. Clothing, hosiery, toys, toiletries, gifts, jewelry, television, etc. Get acquainted. 25c brings wholesale catalog plus free \$1.00 merchandise certificate. Reliable Jobbing, 311-B North Des-plaines, Chicago.

WHOLESALE Catalog! 30-80% discounts! Typewriters, appliances, housewares, watches, jewelry, etc. Consolidated Distributors, 21-20 Lafayette, Paterson 15, New Jersey.

INDIVIDUALS. Nationally advertised merchandise. Wholesale. Tremendous discounts. Kingsley, Chepachet, Rhode Island.

SALESMEN—DISTRIBUTORS

WILL You wear new suits and topcoats without one penny cost and agree to show them to friends? You can make up to \$30.00 in a day even in spare time, without canvassing. J. C. Field, Harrison and Throop Sts., Dept. F-1626, Chicago 7, Ill.

AD Matches! Sell amazing designs—10, 20, 30, 40 and 240-light book matches. Bigger spot cash commissions; every business a prospect. Low prices for high quality. Repeats. Start without experience; men, women; full, part time. Buy nothing! Sales kit furnished. Match Corp., Dept. PM-68, Chicago 32, Illinois.

\$8000 PROFIT A year—From just one sale a day! Keep safe, only full-size personal safe sold direct, lets you offer low-cost fire and theft protection that all homeowners, farmers and businessmen need—and less than 5% have! \$73.95 sale means \$26.45 profit, plus big bonus. No competition. Exclusive territory. Full details from Manufacturer, John D. Brush & Co., 578 West Ave., Rochester, N. Y.

START Your own business on credit. Your own boss. 1135 of our dealers sold \$5000 to \$30,000 in 1954. We supply stocks, equipment on credit. 200 home necessities. Sales experience unnecessary, pleasant profitable business backed by world-wide industry. Write Rawleigh's, Dept. H-U1-PPM, Freeport, Ill.

GOOD Man can make \$3,000.00 next 90 days. Every house in town wants amazing Nilite glowing curbside house numbers. Automatic selling plan pays profits everyday. Write today for details free. Nilite, 173 W. Madison, Dept. L-80, Chicago.

UP To 40% profit on famous direct-to-home line dresses, children's wear, other apparel. Write for free sample kit and details. C. E. Israel, Dept. P-3703, Cincinnati 25, Ohio.

ADVERTISING Book matches—Cash in on big demand; sell union label matches. Cuts for all businesses and political parties. Free powerhouse selling kit, low prices, protection guaranteed on repeat orders. Cash commissions. Superior Match Co., Dept. M-855, 7530 Greenwood, Chicago.

GET New shirt outfit free! Make \$90.00 weekly on 5 average orders a day. Famous quality made-to-measure dress and sport shirts at \$3.95 up sell fast to all men. No experience needed. Full or part time. Write: Packard Shirt Co., Dept. 132, Terre Haute, Ind.

BIG Money-making opportunity. Exclusive line work uniforms. Jackets, pants, shirts, coveralls. Advertising embroidered. Every business prospect. Outfit free. Master Div., 569 Water, Ligonia, Ind.

BUY Wholesale thousands nationally advertised products at big discount. Free "Wholesale Plan." American Buyers, Hertel Station, Buffalo 16-JI, N. Y.

\$1,000.00 A Month for making dramatic 3-second demonstration of amazing light-weight Presto Fire Extinguisher. New chemical used by airforce, army snuffs out fires instantly. Only \$3.98. Terrific commissions. Millions want it. Free kit, Merlite, 114 E. 32nd, Dept. 58B, New York 16.

EARN \$30 A day showing our famous boots. Part or full time. No experience necessary. Write for free sales outfit. No obligation. Jim Richards Shoe Co., Dept. M-8, Wellesley Hills, Mass.

SELL Calendars. You make big money daily. Giant line. Every business buys. Also business printing, book matches, advertising specialties. Big sales outfit free. Write, Arrow Press, 515-P Fourth Ave. So., Minneapolis, Minn.

ANYONE Can sell famous Hoover uniforms for beauty shops, waitresses, nurses, doctors, others. All popular miracle fabrics—Nylon, dacron, orlon. Exclusive styles, top quality. Big cash income now, real future. Equipment free. Hoover, Dept. T-100, New York 11, N. Y.

100% PROFIT. Fast money for you! Take orders for Sweet Georgia Brown cosmetics. Colored people buy it quick. Free sample. Write Valmor, 2451-RL Michigan, Chicago 16.

CHAMOIS, Retail \$5.00 to \$6.50, whole skin's, wholesale \$2.50. Kennedy Importers, Box 644, Solana Beach, Calif.

MAKE Big money on bad checks! 39,000,-000 businessmen waiting for amazing Todd Checkwriter, ½ cost nearest competitor, stops check fraud! \$21.95 profit on every sale. 30-second demonstration. Outfit free. Merlite, Dept. 9HA, 114 E. 32nd, New York 16.

ALUMINUM Masticote liquid roofing brings big orders and big money. Madison Paint Co., Mfgs., Dept. PM558, Cleveland 2, Ohio.

BIG Future for vitamin food supplement distributors, who can sell quality product at sensible price. Profit-sharing plan. Get good territory now, before boom hits. 3-P Products Co., 962 Mission St., South Pasadena, Calif.

MAKE Up to 75c profit on each dollar! Household items needed in every home. Have others sell for you on commission. Sell wholesale to agents. Postcard brings details absolutely free. Topval Corp., Linden-hurst 125, New York.

ADVERTISING Specialties, party goods, Free samples. Phil Brautigam, Eugene, Oregon.

GOLDMINE Of 600 money-makers. Copy free. Specialty Salesman Magazine, Desk 5, 307 N. Michigan, Chicago 1.

DISTRIBUTORS—Large profits, Terrific repeat orders. Unique Italian brooms, details free. Write P.M. Peacock, 915 Bryant, San Francisco, California.

NEW Jobs open in selling! Send name, address for five free issues of Opportunity Magazine's money-making guide, listing hundreds of companies who'll pay you well, full or part-time. No experience needed. Opportunity, 850 N. Dearborn, Dept. 17, Chicago 40, Ill.

\$5 TO \$10 An hour. I've did it. I'm disabled now. Real genuine offer. Complete information only \$1. Lucas, 2200 Carson St., Pittsburgh 3, Penna.

EDUCATIONAL AND INSTRUCTION

WANT A diesel job? New opportunities to increase income. Higher pay. More money. We can help you qualify. Tools. Shop method home training. Write today! Diesel, Tractor, Heavy Equipment Division, Interstate Training Service, Dept. B-3-H, Portland 13, Oregon.

HOW To write short stories, mysteries, articles. Learn at home for career or extra part-time income. Graham Doar sold one story to Post, CBS radio and NBC-TV. Professional writers show you how. Send today for free lesson. Palmer Institute of Authorship, Desk TM-85, 1680 N. Sycamore, Hollywood 28, Calif.

COLLEGE Degree — Independent study. Keep employed. Brentwood College, Box 19-721, Los Angeles 19, California.

FREE "Inspirational Letter." Box 1730, Grand Central, New York 17, N. Y.

YOU For president of your own collection business. \$1000.00 monthly possible! Hundreds who answered our ads now have their names on office doors. Franklin Credit, Roanoke 7, Virginia.

AT Last professional typing taught by mail. Harris System, Box 2303, Phoenix, Ariz.

WELDING Training pays at Hobart Welding School, Box M-851, Troy, Ohio. VA contract. Best equipment. Catalog free.

UNHAPPY? Restless? Dissatisfied? Uncover your hidden abilities, aptitudes, personality with psychological testing. Do tests at home. Receive complete analysis prepared from tests by professional psychologists. Low cost, confidential. Write Psychologic Testing Institute, Dept. 248, 291 N. Wells, Chicago, Illinois.

COMPLETE Your high school at home in spare time with 58-year-old school. Texts furnished. No classes. Diploma. Information booklet free. American School, Dept. XC45, Drexel at 58th, Chicago 37, Ill.

BLUEPRINT Reading for machine and building trades. Train at home. Learn to read blueprints with confidence in 10 easy lessons. Earn more pay. Literature free. Belton School, 1059-W North Lawn-dale, Chicago 51, Illinois.

A Pleasing dynamic singing and speaking voice can be yours! Use self-training Canfield Voco-Records. Thrilling details! 2018-A—5th Avenue South, Minneapolis 4, Minnesota.

HIGH School—No classes. Study at home. Spare time. Diploma awarded. Write for free catalog HF-56, Wayne School, 2527 N. Sheffield, Chicago 14, Ill.

CORRESPONDENCE Courses, educational books bought, sold, rented. Catalog free. Willard Bayles, 211 Essex, Hackensack, New Jersey.

DOCTOR Degrees, correspondence. Optometry, divinity, psychotherapy. Aures, 156 West 73rd Street, New York City.

ORTHODOX Bible courses. Earn degree. Free bulletin! Bible School, 517 Merchants Bank Bldg., Indianapolis.

FREE Voice book! Shows how you can train for strong, successful voice. Sound masculine! (State age.) Perfect Voice Institute, 210 South Clinton, Studio 2HV-2, Chicago 6.

567 HOMESTUDY Courses, textbooks. Sensational bargains! Free illustrated catalog. Nelson Company, 210 South Clinton, Dept. 9HV-2, Chicago 6.

INVESTIGATE Accidents! Many earn to \$10,000 yearly. Thousands of insurance companies, airlines, and steamship lines need claim investigators. We train you at home spare time. Placement counsel and help. Free book—Now! Universal Schools, Dept. 108, Box 8202, Dallas 5, Texas.

EDUCATE Yourself with progressive cross word puzzles. Dictionary furnished. Calco, Drawer 988, East Chicago, Indiana.

BE A real estate broker. Study at home. Write for free book today. GI approved. Weaver School of Real Estate, 2018P Grand, Kansas City, Missouri.

UNIVERSITY Degrees by residence, correspondence. Golden State University, Box 2883, Hollywood, Calif.

PIANO Tuning pays. Big money in spare time. Learn at home in 30 days. No musical knowledge necessary. Phonograph, records, tools and instructions furnished. Information free. Capitol City Tuning School, 16 Southwest 2nd, Dept. 102, Fort Lauderdale, Florida.

BECOME A doctor of psychology or metaphysics. Learn secret of contentment, happiness. Win degree of Ps.D. or MsD. Correspondence only. Free book. College of Universal Truth, 5038-C Broadway, Chicago.

INVESTIGATOR Training. Phillips Secret Service System, 1917-B North Kenneth, Chicago 39.

AUCTIONEERING. Be an auctioneer. Earn big money. Term soon. Write for catalog. Kansas City Auction School, Suite 307, Shankman Building, 3119 Troost, Kansas City, Missouri.

HIGH School diploma at home. Licensed teachers—Approved materials. Southern States Academy, Box 144-MX, Station E, Atlanta, Georgia.

SECRET Investigation. Experience unnecessary. Investigators particulars free. George Wagner, M125 West 86th, New York 24.

GROW Mushrooms. Cellar, shed, and outdoors. Spare, full time, year round. We pay \$3.50 lb. We paid Babbitt \$4,165.00 in few weeks. Free book. Washington Mushroom Ind., Dept. 174, 2954 Admiral Way, Seattle, Washington.

EARN While you learn. Auto and diesel mechanics master this top paying trade. Many graduates earn \$100 a week and up. Approved for Korean veterans. For free information write Dept. No. 256, Nashville Auto-Diesel College, Nashville 3, Tenn.

BOOKKEEPERS! Increase your earnings! Operate your own simplified "Dollar-A-Week" bookkeeping and tax service. Full or spare time. Details free. No obligation. Ellis, Box 200, Cedar Grove, North Carolina.

MEDICAL Laboratory technicians in great demand. We train you in your own home. Catalogue free. Imperial Technical Institute, Box 973-J, Austin, Texas.

USED Correspondence courses and books sold and rented. Money back guarantee. Catalog free. (Courses bought.) Lee Mountain, Pisgah, Alabama.

PIANO Tuning pays. Learn this profitable profession at home easily with patented Tomometer and mechanical aids. No knowledge music necessary. Diploma granted. Write for booklet. Miles Bryant School, 3731 Stockton Blvd., Dept. P, Sacramento 20, California.

STUDY For doctor's degree of psychology, metaphysics and divinity. Correspondence courses only. College of Divine Metaphysics, Dept. P-M, 2811 North Illinois, Indianapolis 8, Indiana.

PHYSICAL Therapy and massage. We train you at home. Earn big profits from your own private practice or work with hospitals and doctors. Free catalog. National Institute, Desk 4, 159 East Ontario, Chicago 11.

BECOME An expert real estate broker or salesman. Make money anywhere. Complete home study course. Free information. Kansas City Realty School, Suite 307, 3119 Troost, Kansas City, Missouri.

PLAYS, STORIES, MANUSCRIPTS

NO Luck finding a book publisher? Write for free Booklet PM. Vantage Press, 120 W. 31, New York.

SPECIAL SERVICES

FREE Consultation service on your mail order product. All inquiries promptly answered. Prestoflex Corporation, Mason City, Iowa.

CARTOONING, COMMERCIAL ART, SHOWCARD & SIGN PAINTING, TATTOOING

"**HOW** To Make Money With Simple Cartoons"—A book everyone who likes to draw should have. It is free; no obligation. Simply address Cartoonists' Exchange, Dept. 98C, Pleasant Hill, Ohio.

FREE, Limited time only. Oil painting with cartoon and commercial art instruction book \$3.00. John Snyder, 3350 Nevada Avenue, Fresno 2, California.

CARTOONISTS: Amateur, professional. Prepare for animation with Max Fleischer's plan. Write Vera Coleman, Lincoln Building, New York, N. Y.

CHALK Talks. Laugh producing program \$1.00. Catalog 10c. Balda The Cartoonist, Oshkosh, Wisconsin.

LEARN Sign painting at home. Test lesson free. Ben Kerns, Box 812-PM, Greenville, S. C.

ADVERTISING AGENCIES, LETTER WRITERS, FOR ADVERTISERS

ADVERTISE—24 Words, 20 big newspapers, \$30.00. Newspaper, magazine, rate-book free. Chicago Advertising Agency, Chicago 4.

FREE Publicity for your product. Inquire. Box 642, Tallahassee, Fla.

WANT More business? Here's an amazing opportunity to increase your sales. Talk to thousands of interested readers of "Mechanica Popular." Our Spanish Edition covers the Latin American countries like a blanket. They're real mailorder buyers. Classified rate 75c per word. Try an ad in our next issue. Classified Advertising Department, Popular Mechanics Magazine, 200 East Ontario Street, Chicago 11, Ill.

MAILING Lists, most any classification. 1000 names \$5.00. 1000 your circulars mailed with ours \$4.00. 5000 your circulars printed and mailed \$12.95. Write Dixie Mailers, King, North Carolina.

ADS Placed in out of town newspapers and magazines. Low rates. Catalogue free. Ideas that pay. Baker Advertising Agency, Successors Ankrum Agency, 189 W. Madison, Chicago 2.

RUBBER STAMPS AND OFFICE SUPPLIES

3 LINE Rubber stamp, self inking pad, plastic case \$1.00. Extra line, 35c. Anderson, Box 855, Mountain Home, Tennessee.

FREE Catalogs. Lowest priced, top quality rubber stamps. Printing for every purpose, any style, size, quantity. Delivered. Unconditional guarantee. Inquiries, charge accounts invited. Esco, 185 Print, 8 Holt, Dayton 7, Ohio.

MAKE Rubber stamps, cuts. Literature free. Walp, Box 4308-M, Mobile, Alabama.

RUBBER Stamps by professional craftsmen. 3 lines \$1.00. Price list. South Coast Press, P.O. Box 2074, San Bernardino, Calif.

TYPEWRITERS, DUPLICATORS, OFFICE DEVICES

RECONDITIONED Typewriters, duplicating, printing devices, \$25.00 up. Supplies. Appliances. DixieGraph, King, N. C.

PRINTING, MULTIGRAPHING, MIMEOGRAPHING, GUMMED LABELS

100 $8\frac{1}{2} \times 11$ WATERMARKED Letterheads \$1.00 postpaid, envelopes same. Other printing, samples free. R. Hussey Printing, Abbeville, Miss.

1000 EMBOSSED Business cards, one color \$3.95; two color \$4.50. Samples free. L. Watson, Box 162, St. Charles, Illinois.

OFFSET Printing, \$6.50, 1000, $8\frac{1}{2} \times 11$, 16 lb. National Letter, 1463 Broadway, New York City 36.

QUALITY Printing! Offset—Letterpress. Free pricelist. Napco, 2337-PM Bath Avenue, Brooklyn 14.

100 LETTERHEADS ($8\frac{1}{2} \times 11$) Printed carefully \$1.00 postpaid. Envelopes same. Race Printers, Hudson, New York.

\$1.00, 100 LETTERHEADS Or envelopes. Postpaid. Poor Boy PM, Box 1055, Little Rock, Ark.

ILLUSTRATED Printing catalog. Proofs. Klifford, 545 North Oakland, Pasadena 4, California.

FREE Catalog. Letterpress, offset printing. D & M Sales, Sebastopol, Calif.

$8\frac{1}{2} \times 11$ 30 LB. Bond letterheads, \$6.95, 1000, postpaid, $6\frac{3}{4}$ envelopes same price. 250 each \$4.95. Ayers, 2001 Columbia Rd., N.W., Washington, D. C.

CARDS \$2.95 Per 1000 postpaid. Economy Printing Co., Box 8251, Tampa 4, Florida.

QUALITY Printing, reasonable prices. Samples free. Postpaid. Gillingham, Milford P, Connecticut.

MIMEOGRAPHING—Letters, pricelists, formulas, instructions. Lowest prices. Lem's Letter Shop, 5710 Stanton, Detroit 8.

500 $2\frac{1}{2} \times 2\frac{1}{4}$ **FOUR** Line gummed stickers 50c. Red border \$1.00. Moritz Printery, Saginaw, Mich.

100 LETTERHEADS, \$1.00, $2\frac{3}{4}$ Envelopes same, two colors, \$1.50. Broadbrook, Botsford, Conn.

ADS Running under this heading sell printing. Ask me for proof. I'll gladly send you amazing facts. Ask for Folder "P" F. W. Johnson, 200 E. Ontario St., Chicago 11, Ill.

PRINTING OUTFITS AND SUPPLIES

PRESSES, Type cabinets, supplies. List for stamp. Lincoln Press Company, 220-H Hartwell, Fall River, Mass.

MAKE Your own self-molding rubber stamps and printing cuts. Plexirubber, Argyle 1, Wisconsin.

HAND Presses; cutters; cases; type. Open Saturdays. Damon & Peets, 56 Beekman St., New York City.

DO Your own printing. Save money. Simple rules. We supply everything. Print for others; good profit. Raised printing like engraving too. Have home shop. Details free. Kelsey Presses, V-11, Meriden, Connecticut.

PATENT ATTORNEYS

INVENTION Record form free and "Patent Information Every Inventor Should Have." Carl Miller, Registered Patent Attorney, Woolworth Building, New York.

REGISTERED Patent attorney offers services. Sanders, 6439 Evans, Chicago 37, Illinois.

INVENTORS: Learn how you can protect your invention. A specially prepared booklet "Patent Guide for the Inventor" containing detailed information concerning patent protection and procedure together with "Record of Invention" form will be promptly forwarded to you upon request, without obligation. We are registered to practice before the United States patent office and are prepared to serve you in the handling of your patent matters. Clarence A. O'Brien & Harvey Jacobson, Registered Patent Attorneys, 51B-G District National Building, Washington, D. C.

INVENTORS—Take these preliminary steps toward patent protection. Sketch and describe your invention. Sign, date and have this disclosure witnessed by two people who understand your invention. Have us make a preliminary search among U.S. patents already granted for similar types of invention. We report on the probable patentability of your invention and recommend your further course of action. Write for our instructive booklet, "Patent Protection for Inventors" and convenient "Evidence of Invention" disclosure form. Victor J. Evans & Co., 131-J Merlino Building, Washington 6, D. C.

INVENTORS—If you believe you have an invention, you should find out how to protect it. The firm of McMorrow, Berman & Davidson with offices in Washington, D. C., is qualified to take the necessary steps for you. Send for copy of our patent booklet "How to Protect Your Invention." We will also send you an "Invention Record" form. No obligation. They are yours for the asking. McMorrow, Berman & Davidson, Registered Patent Attorneys, 134-C Victor Building, Washington 1, D. C.

CANADA—Ramsay Company Registered, 273 Bank Street, Ottawa, Canada.

C. A. Snow & Co.—M427, Snow Building, Washington 1, D. C. Registered Patent Attorneys. Write for information.

INVENTORS: When you are satisfied that you have invented something of value write me, without obligation, for information as to what steps you should take to secure a patent. Write Patrick D. Beavers, Registered Patent Atty., 935 Columbian Bldg., Washington 1, D. C.

PATENTS. "Proof of Invention" free. E. E. Vrooman, Registered Patent Attorney, 507 McKim Building, Washington 5, D. C.

"INVENTOR'S Guide" and "Record of Invention" free on request. Frank P. Ledermann, Registered Patent Attorney, 154 Nassau Street, New York City.

INVENTORS: Without obligation, write for information explaining the steps you should take to secure a patent. John Randolph, Registered Patent Attorney, 203 Columbian Bldg., Washington 1, D. C.

FOR INVENTORS

EXCLUSIVE: We help inventors to help themselves. Save hundreds. Triple your chances of success before investing in searches, patents, or promotions. Send brief description or request free information. The Dynavolt Company, 3310 Huntington, Newport News, Virginia.

MECHANICAL Problem answered. \$3.00. Confidential. Retired machinist. Don Ross, 3230 S.E. 122, Portland, Oregon.

WILL Finance the manufacture of acceptable patented article. John Rick, 438 Penn St., Reading, Penna.

INVENTORS—This firm is registered to practice before the United States Patent Office and available to assist you in the preparation and prosecution of your patent application. "Patent Protection for Inventors" booklet containing detailed information and steps to take toward patent protection sent promptly upon request. No obligation. Victor J. Evans & Co., 132-J Merlino Building, Washington 6, D. C.

INVENTORS—Send for free patent information book and inventor's record. Registered Patent Attorney, Associate Examiner, Patent Office 1922-29, Patent Attorney & Advisor, Navy Department 1930-47, Gustave Miller, 85A Warner Building, Washington 4, D. C.

INVENTORS—If you believe you have an invention, you should find out how to protect it. The firm of McMorrow, Berman & Davidson with offices in Washington, D. C., is qualified to take the necessary steps for you. Send for copy of our patent booklet "How to Protect Your Invention." We will also send you an "Invention Record" form. No obligation. They are yours for the asking. McMorrow, Berman & Davidson, Registered Patent Attorneys, 148 Victor Building, Washington 1, D. C.

PATENT Searches, including copies of nearest patents, \$5.00. Reports airmailed within 48 hours. More than 100 registered patent attorneys use my service. For free invention protection forms, write Miss Ann Hastings, P.O. Box 176, Washington 4, D. C.

INVENTORS: If you have an invention for sale, patented or unpatented, write Institute of American Inventors, Dept. 40A, 631-E St. N.W., Washington 4, D. C.

"INVENTOR'S Guide" and "Record of Invention" free on request. Frank P. Ledermann, 154 Nassau Street, New York 38, N. Y.

INVENTION Record form free and "Patent Information Every Inventor Should Have." Carl Miller, Registered Patent Attorney, Woolworth Building, New York.

INVENTORS: Information on patent procedure furnished on request, without obligation. John Randolph, Registered Patent Attorney, 202 Columbian Building, Washington 1, D. C.

SEARCHES—Put your patent searches in the hands of a registered patent attorney or agent, as he qualifies to give a worthwhile patentability report. Record of invention form upon request and information on patent protection. Patrick D. Beavers, Registered Patent Attorney, 935 Columbian Bldg., Washington 1, D. C.

PATENT Searches \$5.00. 48-hour airmail service. Invention protection forms free. Write Patent Engineering Service, 711 14th Street, N.W., Washington 5, D. C.

INVENTORS: Learn how you can protect your invention. A specially prepared booklet "Patent Guide for the Inventor" containing detailed information concerning patent protection and procedure together with "Record of Invention" form will be promptly forwarded to you upon request, without obligation. We are registered to practice before the United States patent office and are prepared to serve you in the handling of your patent matters. Clarence A. O'Brien & Harvey Jacobson, Registered Patent Attorneys, 51A-G District National Building, Washington, D. C.

SPECIAL! Two for one value: Washington patent search plus free Chicago marketability analysis. Protection form, list of manufacturers' requests free. Patent Sales, 208 Clinton, Oak Park, Illinois.

PATENT Searches \$5.00. 48-hour service. Free invention protection forms. Write Raymond L. Smith, Patent Searcher, 622 Sheraton Building, Washington 5, D. C.

INVENTIONS WANTED

AMERICA'S Largest housewares, children and novelty manufacturers wishes to purchase for outright sale or royalty basis, patented or unpatented items in these fields. E-Z-For Manufacturing Co., 4514 N. Broadway, Chicago, Illinois.

YOUR Invention placed with the right company by our "Do it yourself" system may make money for you. Thirty years experience. Write Page, 1311 Riverside Drive, Los Angeles 31, Calif.

INVENTIONS Wanted. Patented and unpatented. For latest list and particulars of foremost promotion service write, Superior Inventions, 338-344 North Rodeo, Beverly Hills, Calif.

INVENTORS: Inventions needed immediately, all fields. Demand never greater. We franchised one for Lykins, West Virginia, in 4 months. Write for free booklet "Your Invention." Kessler Corporation, 58X, Fremont, Ohio.

CANADIAN Patent Enterprises, 31 Leighland Road East, Burlington, Ontario. Patent brokers, industrial consultants, design engineers.

ATTENTION Inventors! Sell your invention to manufacturers, investors, through the pages of: "Gadgets, Patents & Invention News." Write Inventors' Service Bureau, 847 W. Roscoe, Chicago 13, Illinois.

INVENTIONS Wanted. Patented; unpatented. Tremendous manufacturers lists. Global Marketing Service, 1404 Mitchell, Oakland 1, California.

INVENTORS: Hundreds of manufacturers have requested our assistance in locating marketable new products. Complete information free. Institute of American Inventors, Dept. 40-D, 631-E St. N.W., Washington 4, D. C.

INVENTIONS Promoted. Patented or unpatented. A-1 service for inventors since 1911. Write Adam Fisher Co., 3418 Idaho, St. Louis, Mo.

INVENTIONS Wanted. Patented or patent pending. 24 years experience promoting inventions. National Service Bureau, 3120 Meramec, St. Louis 18, Mo.

INVENTORS, Don't sell your invention patented or unpatented until you receive our offer. Write Cowgill, Box 298, Marion, Ohio.

PATENTS FOR SALE

INVENTORS: Test the commercial value of your patented or unpatented inventions, quickly and inexpensively. Write for free information. Institute of American Inventors, Dept. 40-B, 631-E St., N.W., Washington 4, D. C.

MANUFACTURING

DESIGNING, Manufacturing, special machinery, parts, fittings, inventions, models. Henry Engineer, 2136 E. Monmouth, Philadelphia 34, Penna.

MODELS—Small lot manufacturing. Metals, plastics, etc. Milburn, Burlington, Kentucky.

MODELS, MODEL SUPPLIES

POWER Models. Unusual steam, gasoline and traction engines, fittings, metals. Anniversary catalog 50c. Chas. Cole, Ventura, Calif.

WANTED: Model steam engines, locomotives, steam toys, boats, tractors. Kandier, 618 E. Michigan Ave., Kalamazoo, Mich.

MODEL Airplane engines new, used. Big discounts. Catalog 10c. Platteville Hobby Shop, Box 77, Platteville, Wisconsin.

STEAM Engines, boilers, castings. Catalog 35c. Anton Bohaboy, 2297 Price, Rahway, N. J.

BALSA Wood and model aircraft. 40-page catalog 10c. Sig Co., Montezuma, Iowa.

SHIP Models and yacht supplies. Complete, large 68 page catalogue 50c. Bill Wild's, 510 East 11 St., New York City 9.

SHIP And other scale models. Most complete line in New England. Kits, fittings, plans, books, tools, engines, motors. Illustrated catalog 25c. James Bliss & Co., Inc., Dept. 8M, 342 Atlantic Ave., Boston 10, Mass.

BUILD Miniature passenger hauling live steam locomotive with file and drillpress. We do machine work, you bolt it together. Catalog 50c. Little Engines, Lomita, Calif.

SHIP And yacht model fittings; blueprints. Send 35c for illustrated catalog listing hundreds of items. A. J. Fisher, 1002-1 Etowah Ave., Royal Oak, Mich.

HOME CRAFTSMEN

89 FULL Size jig saw patterns of beautiful shelves, ornaments, toys, novelties. Plus "How, Where to Sell." Only \$1.00. Mastercraft 84M, 7041 Olcott, Chicago 31, Illinois.

PLASTICS Home-craft course for men and women. Tells and shows how to make hundreds of fast selling plastics products. All plastics and materials for 23 projects included in course. No special tools needed. Course pays for itself. Write for free booklet. Interstate Training Service, Dept. D-3-H, Portland 13, Oregon.

LEATHERCRAFT For pleasure or profit. Make easy-to-assemble purses, belts, gloves, wooskin toys. 100 other items for gifts or to sell. Send 10c today for big catalog. Largest leathercraft stock in U.S. J. C. Larson Co., 820 S. Tripp, Dept. 5350, Chicago 24.

WROUGHT Iron legs, various sizes. One set or a car load, literature free. Hibbard's, 624 Celey, Hampton, Va.

LEATHERCRAFT. Send 10c for new 60-page catalog of tools, supplies, kits, including metalcrafts, enameling, ceramics, all other crafts. Complete stock. Reasonable. Since 1910. Sax Bros., Dept. PM8, 1111 N. 3rd, Milwaukee, Wis.

LEATHERCRAFT. Metal enameling, beadcraft, shellcraft, metal tooling, textile painting, many other crafts. Free big illustrated catalog. Kit Kraft, Dept. 228, Studio City 1, California.

16 NEW Lawn chairs, 22 picnic tables, benches, trellises, etc. All 38 plans with necessary full size patterns. \$1.00. Mastercraft 83M, 7041 Olcott, Chicago 31, Ill.

BUY Wholesale nationally advertised power, hand tools, thousands other products at big discounts. Free "Wholesale Plan." American Buyers', Hertel Station, Buffalo 16-Fl, N. Y.

WOODWORKING Course for home craftsmen. Twenty-two manuals. Over 1000 pages. 75 training projects. Only complete home training program available today. Carefully written, profusely illustrated. Covers everything from wood selection to final finishing. Complete instruction in care and use of all hand and power tools. Prepared by expert manual training instructors. Write for free booklet. Interstate Training Service, Dept. G-3-H, Portland 13, Oregon.

101 FULL Size patterns. Smart, new, gifts, novelties, lawn figures, shelves, action windmills, alphabets. Plus "Make Money Jig Sawing." Only \$1.00. Mastercraft 85M, 7041 Olcott, Chicago 31, Illinois.

WHY Push, convert your hand mower into electric power mower. Free information. Duracraft Products Company, Box 185, Royal Oak, Michigan.

LEATHERCRAFT Supplies at lowest prices. "Craftool" stamps. Catalog 10c. Crown Leather, 22 Spruce Street, New York 38.

STYLECRAFT Sure fire hits. "Pre-traced" leather kits. Handbags, billfolds, filigree belts, over fifty other projects. Patterns on leather. Why trace? Just carve, assemble and lace. Large assortment "pre-carved" kits also available. Send 25c for catalog, free folder. Refunded first order. Apache Leather Company, 2804 E. Washington St., Phoenix, Arizona.

KNOCKDOWN Cedar chests and lumber. Free price list. Bedford Lumber Company, Shelbyville, Tennessee.

129 NEW Full-size jigsaw patterns. Artist-drawn. \$1. Craftplans, 1321-A South Michigan, Chicago 5.

FREE "Do-It-Yourself" leathercraft catalog. Tandy Leather Company, Box 791-H-10, Fort Worth, Texas.

FREE Handicraft supply and project catalog. American Handicrafts, Box 1479-CQ, Fort Worth, Texas.

DO IT YOURSELF

DRILL Water well by hand. Rotary method. Use same pump and pipe for both drilling and producing. Very cheap and fast. Plans \$1.00. Bennett, 3461 Lucas Drive, Beaumont, Texas.

BUILD Inexpensive concrete blockmaker. Motor-hand. (for less than \$7.). Output to 500 daily. Write C. Lee, Mountain View, Oklahoma.

BUILD A real swimming pool, fully equipped. Ask about plans and instructions. Aquatite Swimming Pool Co., Inc., 48 Broad St., Pittston, Penna.

"CEMENT-Brick Work." 64 page booklet. 25 illustrations, 25c. Franks Book Service, 3121 Racine, Chicago 8.

LATEST Enameling on copper kit. No kiln or furnace required. Everything furnished for complete fabrication. \$3.95 post-paid. Now you can make your own lovely earrings, cuff-links, brooches, and many other original jewelry pieces. Ralox, P.O. Box 1256, Decatur, Illinois.

CLOCK Movements — Gorgeous dials, plans, kits. See ad page 219.

AIR Conditioners — Home, automobile. See Kool Engineering ad page 38.

TERMITES! U-do-it. Instructions \$2.00. Jordan's, 1112 Tell, Tell City, Ind.

18 FULL-Size patterns. Save money with easy-to-use, professionally designed full-size patterns. Make money selling beautiful, useful furniture. Make modern step and cocktail tables; metal lamps; cupola; 12-foot outboard. All patterns test-built; sold with money-back guarantee. Get your free list of these convenient, economical patterns today. Popular Mechanics Press, 200-HH E. Ontario Street, Chicago 11, Illinois.

MELT Cast iron, brass and aluminum. Make castings for yourself and for profit. Send for literature. Ursuts Burner Co., Box 2293, Globe, Arizona.

FURNITURE — Wrought iron legs and frames! You assemble. Free catalogue. Phillips Furniture, East Peoria 8, Illinois.

GEIGER Counter and metal detector kits. Inexpensive, educational. Free literature. Electronic Applications, 5024 Lee Highway, Arlington 7, Va.

DO It yourself. What? Repair TV, build furniture, make barbecue, plumbing repairs, build boats, do house wiring, remodel home, lay tile, modernize kitchen, repair home, and scores of other things you can do yourself. Books covering each subject, only 25c. Send for descriptive list. It's free. Popular Mechanics Press, 200-LB East Ontario St., Chicago 11, Ill.

WATCHES, OLD GOLD, JEWELRY

FREE Sample pair of earrings with catalog 25c. Exclusive line of make your own costume jewelry. Barry's, 196 Ardsley Ct., Newark 2, N. J.

WATCH And clock repairing books for hobbyists. Free information. North American, Dept. 15-H, 2320 N. Milwaukee, Chicago 47, Illinois.

WATCHMAKERS' — Jewelers' supplies, instructions. Catalog 20c. Bengale Company, Culver City, California.

RHINESTONES. Jewelry settings, copper enameling. Sample earring kit and catalog 25c. J & M Novelties, Dept. CJ-3, Griffith, Indiana.

USED And new watches, \$2.00 up. Free list. Southern Watches, Gray, Georgia.

COPPER Enamelling, complete supplies, information. Valuable catalog free. Bergen Arts, 128MR Main, Hackensack, N. J.

HIGHEST Cash for old gold, broken jewelry, gold teeth, watches, diamonds, silverware, spectacles, platinum. Free information. Satisfaction guaranteed. Rose Refiners, Heyworth Bldg., Chicago 2.

COSTUME Jewelry supplies. Catalog and samples. 35c. Largest line in America. Milady-Fair Co., G.P.O. Box 1328, New York City 1.

JEWELERS Diamond testing instrument. Tells instantly whether stone is diamond. Precision made. Guaranteed. \$4.50 post-paid. Southwest Jewelers Supply, Box 2828, Phoenix, Arizona.

GOLD, Silver, platinum, diamonds wanted. Cash immediately, highest prices, appraisals made. Wilmot's, 2547 102nd St., Toledo 11, Ohio.

MAKE Costume jewelry for fun and profit. Catalog 25c. Bergen Arts, 128MH Main, Hackensack, N. J.

TOBACCO, SMOKERS' SUPPLIES

MAKE Your own pipes. Complete instructions. 50c. Briar blocks, stems. Inexpensive tools. Walter Miller, Germantown, Ohio.

PIPE Smokers! Cigar smokers! Free illustrated catalog offers fabulous savings on choice imported and domestic pipes, cigars, tobaccos, supplies. Write Wally Frank, Dept. 25, 150 Nassau Street, New York 38, N. Y.

RAZORS, BLADES, SHARPENING

AMAZING Discovery has been made to give you more and better shaves for the rest of your life—With the "New Miracle Shave" your blades get and stay sharp with each shave. No contraptions. No sharpeners. Send only \$1.00 to the New Miracle Shave, Box 186, Station B, Canton 6, Ohio.

100 DOUBLE Edge blades \$1.00. Guaranteed! Park Sales, Box 73, Rochelle Park, New Jersey.

FOR THE HOME

FOAM Rubber furniture cushions. Factory seconds. 50% discount. Free catalog. Perma-Foam, 429C Central Ave., East Orange, New Jersey.

SHEETS, Pillow cases, towels, diapers, etc. at wholesale prices. Free price list. Michael Baker, Box 1023, Springfield, Ore.

YOUR Neighbors enjoy the convenience of a home inter-com phone system. Do you? Write Osgoods, 1320-D Prospect, New York City 59.

PORTRAITS—Always wanted. Now affordable! Free illustrations. Edorsey, Ojai, California.

OF INTEREST TO WOMEN

MAKE Enamelled jewelry for gifts or to sell—Beautiful ash trays, bracelets, earrings, pins, cuff links. It's easy with Larson Beginners' kits. 50 different copper shapes, 30 brilliant enamel colors. Complete stock for craftsmen. Tools, findings, late model professional kilns. Send 10c for big catalog. J. C. Larson Co., 820 S. Tripp, Dept. 5375, Chicago 24.

FREE Literature! 301 successful home businesses. Eugene Davis, 759C Tilden, Flint 5, Mich.

LADIES, Make money. Glamour brand apron way. Details. Barnitz Manufacturers, Manchester, Penna.

SEW Baby wear at home. High profits. Write: ADCO Mfg., New Airport Road, Bastrop, La.

DRESSMAKERS. Sewers, wholesale lists. Dress suitings, formal fabrics. Box 863, Norwalk, Conn.

GOOD Money in weaving. Weave rug at home for neighbors on \$69.50 Union Loom. Thousands doing it. Booklet free. Union Looms, 153 Post St., Boonville, N. Y.

PROFITABLE Home business. Make fast-seller chenille monkey trees, dolls, flowers. Terrific holiday demand. Information free. Velva, Bohemia 16, N. Y.

GROW Mushrooms. Cellar, shed, and outdoors. Spare, full time, year round. We pay \$3.50 lb. We paid Babbitt \$4,165.00 in few weeks. Free book. Washington Mushroom Ind., Dept. 176, 2954 Admiral Way, Seattle, Washington.

WANT To make big money at home? \$5 profit in an hour possible with invisible reweaving. Make tears, holes disappear from clothing, fabrics. Steady year-round demand from cleaners, laundries, homes. Details free. Fabricon, 8332-S Prairie, Chicago 19, Ill.

FOR SALE—MISCELLANEOUS

HEARING Aid batteries, wholesale. Free list. Habs, Box 51, York, Penna.

WANTED—MISCELLANEOUS

PRODUCTS Wanted to sell auto, variety, chain stores. Established 1919. Salesperson, Box 818, Cleveland 22, Ohio.

QUICKSILVER, Sterling, silver solders, precious metals. Wholesale Terminal, Norwood, Massachusetts.

SCRAP Mercury (quicksilver) containers supplied — Tantalum, bismuth, tungsten. Metallurgical Products Company. Established 1909, 35th and Moore Sts., Philadelphia 45, Penna.

PERSONAL

REMAILS 25c, 6 For \$1.00. Historic Hyde Park, Rhinebeck or Poughkeepsie. Sunday classified—\$1.00. Dee Co., Clinton Corners, New York.

REMAILS 25c. Sunday classified \$1.00. Orbit, Box 3906A, Detroit 27, Michigan.

WASHINGTON, D. C. want-ads. Airmailed. \$1.00. Letters remailed, Washington, Mt. Vernon, Washington home 25c. Modern Supply, P.O. Box 693, Alexandria, Virginia.

SQUARE Peg in round hole? Dissatisfied? Restless? Unhappy? Do psychological tests at home. Uncover true abilities, aptitudes. First time available. Low cost. Details free. Write Psychologic Testing Institute, Dept. 245, 301 N. Wells, Chicago 6, Ill.

BORROWING By mail. Loans \$50 to \$600 to employed men and women. Easy, quick. Completely confidential. No endorsers. Repay in convenient monthly payments. Details free in plain envelope. Give occupation. State Finance Co., 323 Securities Bldg., Dept. J-227, Omaha 2, Neb.

WRITE For Milwaukee, Wisconsin, re-mail rates. Classifieds \$1.00. Free map. Reid, 5001 West Oklahoma.

MEXICAN Legal matters. A. Espejo. Box 234, Hermosillo, Sonora, Mexico.

PERSONALIZED Cigars, your name, company name, trademark printed on three color cigar bands. Box of 25—\$4.10. Write plainly names wanted. Cigar-Ad Co., 38 Clay St., Dept. D, Pawtucket, R. I.

HOW Can I get out of debt? Stop garnishments? Save jobs? Write E. Borum, 411 West Walnut Street, Kalamazoo, Mich.

HAVE A Miami, Fla. address. \$3.00 month. Letters remailed. Shaffer, 7715 N. W. 2 Ct., Miami 50, Fla.

AUSTRALIA Calling! 1/2-oz. letters re-aired, two \$1.00. Sydney newspapers and viewcards, \$1.00. Australian magazine parcel, \$1.00. Worldwide Magazine Agency, Lakemba, Sydney, Australia.

GOMEZ Trevino—Mexican law practice. Bank references. Box 7112, El Paso, Texas.

LETTERS Remailed 25c. Write for personal mailing-receiving address rates. McLaughlin, 800 Stewart, Columbus 6, Ohio.

MEXICAN Law. General Practice Attorney. Apartado 79, Juárez, Chih., México.

WORK in Detroit, help wanted ads airmailed \$1.00. Remails 25c. Slay, 4113 Joy Road, Detroit 4.

REMAILING 25c. Replies forwarded. Ace Service, Box 186, Tampa 1, Fla.

"HOW Can I find out?" You can! Information confidentially developed. Any matter, person, problem. Worldwide. Officially licensed. Established 1922. William Herman, 170 Broadway, New York City.

LETTERS Remailed 25c. Personal forwarding address. Monthly rates. Hicks Service, Box 1547, Washington 13, D. C.

BEAUTIFUL Charcoal portrait (life size) done from your photo \$10.00. John Walencik, 15703 Kennicott, Harvey, Ill.

PERMANIZED in plastic - Pictures, newspaper clippings, valuable papers, to 5 $\frac{1}{2}$ "x7 $\frac{1}{2}$ ". Only 8c square inch. Social security cards 45c. U. S. Plastics, Box 523, Shawnee, Kansas.

SUNDAY Classified, any metropolis airmailed \$1.00; New York Times 75c; Manhattan remails 20c. Theuer, 4359 Furman, Bronx 66, New York.

PROFIT! Prestige! Publish a magazine under your own name! Only \$3.25 per month! Sample, details 5c! Pilmer, 910 Marion, Pharr 22, Texas.

REMAILING SERVICE

REMAILS 25c. Reairmails \$1.00. Receiving, forwarding, Parker, 1644 Naldo, Jacksonville, Florida.

CHICAGO Letters remails 25c. Henry A. Bell, Box 596, Chicago 90, Ill.

KANSAS City remails 25c. Continental, 804 Grand, Kansas City, Mo.

DENVER Remails 25c, classifieds \$1.00. Ajax, Box 293, Englewood, Colo.

LETTERS Reairmailed from any Alaskan post-office 50c each. KPE, Box 148, Homer, Alaska.

TREASURE FINDERS

GEIGER Counters, Scintillators, Nuclidometers, Airborne instruments, Geiger tubes \$5. Scintillation circuits \$1. Crystals at low cost. Western Radiation Laboratory, 1167 W. 24th Street, Los Angeles 7, Calif.

HOME Study course—Uranium prospecting. Free information and outline of course. Home Study Course, Box 1309, Odessa, Texas.

"SNOOPER" Geiger counter. Only \$29.95 complete. Super-sensitive. Pocket size. Find a fortune in uranium. Order now. Send \$5.00 balance c.o.d. Money-back guarantee. Free catalogue—Scintillator and larger uranium and metal detectors. Micromatic Associates PMA, 2322 W. Whittier Blvd., Montebello, California.

URANIUM Hunters! Buy from specialists. Largest instrument stock in Rocky Mountain area. Official factory repair station. Write for free catalog. Mail orders shipped anywhere. The Geiger Center, Dept. P.M., 1201 Broadway, Denver 3, Colorado. Tabor 5-8914.

LEARN Mineralogy and oil locating at home. Fortunes now being made in uranium, oil, and other minerals. Free catalog. American Geological Institute, Desk 2, 139 East Ontario, Chicago 11.

URANIUM! Informative booklet gives hot known and potential locations. Government map included free. \$1.00. Uranium Research, Box 1555, College Station, Texas.

URANIUM Finding made easy! Completely transistorized Geiger counters available for first time. Extra sensitive. Lightweight. Scientifically engineered. Unconditionally guaranteed. Also complete line prospecting instruments from \$19.95. Write for free information, maps, techniques. Universal Atomic Corp., Dept. PMS, 19 East 48th Street, New York City.

URANIUM, Gold, silver treasure. New, power-packed, highly sensitive metal detectors, Geiger counters and mineralights, kits and assembled models from \$12.50. Lightest weight, guaranteed, free literature. Electronic Applications, 5024 Lee Highway, Arlington 7, Va.

URANIUM Prospector's U. S. county map—\$1.00. Radioactive, uranium, mineral deposit locations. Department 106, Lakeshore Publishing Co., Route 8, White Bear Lake, Minnesota.

AMAZING Triple-action Geiger counter U-238C, combines audio, neon flasher, meter. Guaranteed best available. Also metal detectors and scintillation counters from \$49.50. For radioactive uranium sample send 25c to Goldak Company, 1541 W. Glenoaks Blvd., Glendale, California.

TREASURE, Metal, mineral locators M-scope type. Latest electronic design \$75.00 up. Geiger counters, scintillators, mineralights for uranium prospecting \$35.00 up. Fully guaranteed. Monthly payment plan available. Books "How to Be a Successful Uranium Prospector," "For Fun and Profit." Literature free upon request. Fisher Research Laboratory, Inc., Palo Alto, Calif.

GOLD, Silver, metal detectors. Geiger counters for uranium. Mineralights. Sensational new fully guaranteed models. None finer. Information free. Detector Corp., 5528 Vineland Ave., North Hollywood, California.

MISCELLANEOUS

FISH Bite better with Bonita Liquid Lure on worms, minnows. Guaranteed. \$1.00 postpaid. Haskins, PMA, Greenfield, Tenn.

FOREIGN Address lists, samples imported novelties \$1.00. Burke Associates, Manchester 1, Mass.

GEIGER Counter and mineral locators, assembled and kits. Free geological advice; write for details. Frontier Instruments, Box 276, Annandale 2, Virginia.

AIR Force Academy, Colorado Springs! Construction soon. Town booming. Sunday help wanted columns airmailed \$1.00. Box 249, Manitou Springs, Colo.

BUY Wholesale thousands nationally advertised products at big discount. Free "Wholesale Plan." American Buyers, Hertel Station, Buffalo 16-K1, N. Y.

GUATEMALAN Cowhide leather bags, belts, skirts. Free catalog. Mapilon, Box 268, Guatemala, C.A.

70 BIBLE Lessons, 25c. Bulletin, Box 87, Cathedral Station, New York 25.

SEPTIC Tanks reactivated. Outdoor toilets sanitized. ActivO bacterial-enzyme concentrate. Trial bag, 8 treatments, \$1.00 postpaid. ActivO, Bridgeton, 33, Indiana.

\$1.00 ATTACHMENT (Fits $\frac{1}{4}$ " drill), trims hedge, grass easy. Details free. Wilco, Box 294, Danville, Ill.

\$49.95 VALUE Room ventilator, only \$21.95. Consterdine, 12730 Promenade, Detroit 13, Michigan.

DISCOVERY Of fire in time saves lives and homes. "Chief" automatic fire alarm will discover fire day or night and give the alarm. Order one for every room in your home. Only \$2.98 each, postpaid if remittance is sent with order. For c.o.d. shipments, send \$1.00 deposit on each alarm ordered. Cronin-Staples Mfg. Corp., Dept. PM, 1514 Park Street, Houston 19, Texas.

BOYS, Put a gasoline engine on your coaster wagon. Send \$1.00 for instructions and drawings. Joseph Davidhizer, Holsopple, Penna.

BE Somebody! Do things! Get somewhere with our simplified self-training plan of positive thought motivation and constructive action mastery. Eye-opening information free. Write today. Applied Christian Psychology, Inc., Box 1924-T, Louisville 1, Kentucky.

REAL Four leaf clovers in cellophane. Unusual prize, gift, sale item. Ten cents, twelve one dollar, cheaper wholesale. S. Harper, 315 Avondale, Haddonfield, N. J.

NAME Brands wholesale! Lowest prices. Park Sales, Box 73, Rochelle Park, N. J.

LIKE Full mail boxes? Interesting offers galore, 25c. Traylor's Enterprises, La Feria, Texas.

PAINT A lovely religious painting in oils the first time you try. Christ in the Garden, size 18"x24" \$6.95 postpaid, also Sacred Heart, Angelus, and Old Mission in size 12"x16" each \$2.95 postpaid. Many other subjects from which to choose. Send for free literature. Ralox, P.O. Box 1256, Decatur, Illinois.

LIVE in Mexico—Filet mignon 2 $\frac{1}{2}$ c lb. Unusual business opportunities! Booklet with legal residence requirements, tourist information \$1. Blair Publications, Dept. PM, 1267 North Vermont, Los Angeles 29, Calif.

MEXICAN Jumping beans of the new crop 1955. Send your order to Joaquin Hernandez, Exporter, Alamos, Sonora, Mexico.

SENSATIONAL Gold ink. Amaze friends. Drawdy Home Service, Cleveland 2, Ohio.

STUPENDOUS Mental power. Adults. Details 10c. Delmar Wisdom, 833 Sunny-side, Chicago 40.

PARRAKEETS Like bark to chew. Bundle selected fresh green perches \$2.00 postpaid. No c.o.d. Nollingers, 826 N. Main, Jamestown, N. Y.

HAVE Fun—Build backyard roller coaster. Free plan for stamp. Funcraft, 1013 Garfield, Aurora, Ill.

CESSPOOLS, Outdoor toilets, septic tanks cleaned like magic. New amazing powder cleans and deodorizes in double-quick time. No digging, no pumping, no mess. Moneyback guarantee. Free literature. Chippewa Products Co., Burnt Bridge, Chippewa Falls, Wis.

CLOGGED Drains, cesspools and septic tanks cleaned by new powerful chemical. Sursolvent removes grease, soap, tree roots, etc., without expensive digging and electric rodding machines. No pumping necessary. Mix with water and pour down drain. Free details. Electric Drain Cleaning Co., Boston 34, Mass.

GROW Mushrooms. Cellar, shed, and outdoors. Spare, full time, year round. We pay \$3.50 lb. We paid Babbitt \$4,165.00 in few weeks. Free book. Washington Mushroom Ind., Dept. 175, 2954 Admiral Way, Seattle, Washington.

HOW To paint. Do it yourself. Illustrated instructive book, 25c. Catalog free. Popular Mechanics Press, 200-HP E. Ontario St., Chicago 11, Ill.

PANNING Gold—Free lesson; catalogue of mining, mineral books, supplies. Old Prospector, Box 729D1, Lodi, Calif.

BE Your own plumber. You can. Few inexpensive tools and our instructive book, "Home Plumbing Guide," shows and tells you how. Hundreds of photographs and diagrams. Easy to follow. 160 pages. \$3.50. Catalog free. Popular Mechanics Press, 200PG East Ontario St., Chicago 11, Ill.

OUTDOOR Toilets, cesspools, septic tanks cleaned, deodorized with amazing, safe, harmless powder. Easy, economical to use. Saves digging, pumping. 150,000 customers guarantee satisfaction. Details free. Burson Laboratories, Dept. O-36, Chicago 22, Ill.

LOCKS And Lockmaking by Francis Butter is acclaimed by experts throughout the world as the finest book ever written on the subject. Order your copy today, \$4.95. McLean's, 2703 E. Third, Denver 6, Colorado.

I want to send you proof of the wonderful pulling power of Popular Mechanics classified pages. What's your proposition? Write me today. Include literature if possible. F. W. Johnson, Manager Classified Advertising, Popular Mechanics Magazine, 200 E. Ontario St., Chicago 11, Ill.

RECEIVE Magazines, samples, catalogues. Mails from everywhere. Offers, hundreds. Get listed 25c. Rorick, Box 86, Cincinnati 26, Ohio.

SKETCH-O-Graph; amazing invention for sketching, designing and layout work. Craftsmen, engineers, artists, draftsmen, architects praise this 7 in 1 tool. \$2.00. Moneyback guarantee. Literature free. Sketch-O-Graph Instrument Co., Kenton, Ohio.

FREE; Exciting catalog packed with books covering most everything. Think of it—From cover to cover you will find described and illustrated hundreds of books telling how to fix and how to build almost anything. How to remodel your home; do your own decorating, plumbing, electrical work. Simplified books covering concrete work, carpentry, painting, furniture making and refinishing. How to build your own boat, home workshop tools. Best books on photography, welding, hobbies, homecraft. How to make a home freezer. Send for your free copy now. Popular Mechanics Press, 200-BC East Ontario St., Chicago 11, Ill.

BIG VALUES IN ALLIED'S

LATEST TV-RADIO SUPPLEMENT



FREE Send for it

Bargains for Experimenters, Builders, Amateurs, Servicemen, Hi-Fi Fans

Send for our latest Supplement packed with big values and new releases in builders' kits, High Fidelity systems and components, P.A. systems, recorders, test instruments, TV accessories, electronic parts, tubes and tools. Make your selections from the world's largest stocks at money-saving prices!

ALLIED RADIO

100 N. Western Ave., Dept. 5-H-5
Chicago 80, Illinois

Send for **FREE** supplement

ALLIED RADIO

LEARN WATCH REPAIRING

AT HOME Modern, original instruction. Prepare for a position or start in business after completing our course. Write Today!
WISCONSIN SCHOOL OF WATCH REPAIRING
2908 N. 44th St. Dept. 38 Milwaukee 10, Wis.

FOR SALE!

Over 2000 Businesses, Farms and Income Properties throughout the United States and Alaska. Many at sacrifice prices.

FREE, 280-PAGE BOOK. just off the press tells who the owners are, where they are, what they want to sell or trade, prices, terms, earnings, etc. Contains thousands of opportunities from \$3000 to \$3,000,000! No commission to pay us. No salesman will call. **ABSOLUTELY FREE.** Write what and where you want to buy and we'll advise owners of your requirements.

Write for Book No. 76 National Business & Property Exchange, 5400 Wilshire Blvd., Los Angeles 36, Calif.

RUPTURED?

WE GUARANTEE RELIEF OR YOUR MONEY BACK

Forget rupture pain and worry from trusses that gouge your thighs, hips, or spine — that may aggravate your condition! Cluthe **GUARANTEES TO HOLD** your reducible groin rupture (inguinal hernia) against strain, with comfort you never dreamed possible. You can work and play again without nagging fear or embarrassment. Amazing lightweight Cluthe has been tested and proved in 500,000 cases, is individually made by Master Fitters to YOUR measurements. No cutting springs, no straps, no harness to bind your skin. 100% waterproof and sanitary. Wear it bathing or swimming. Send for **FREE** book, "Help for the Ruptured". Gives scientific, authoritative facts on rupture care and details of **UNCONDITIONAL GUARANTEE** and 60-day trial offer.

CHAS. CLUTHE & SONS Dept. 31, Bloomfield, N. J.

HAND CARVING

YOU CAN NOW MAKE BEAUTIFUL THINGS OF WOOD, PROJECTS THAT LOOK LIKE REAL HAND-CARVING.

Fast easy method, no previous experience necessary. Use hand or power tools. Indian heads, dogs, horses, elephants, palm trees, flowers, are beautiful on plaques, book-ends, lamps, furniture. Full instructions and ten patterns, plus 5 border patterns, only \$2. Send your name and address and \$2 to

KENIMER, 557 St. Charles Ave., N.E., Atlanta, Ga.

NEW PORTABLE Kitchen-like STOVE

Cooks • Boils • Fries • Melts Solids fast —without fuss

- Fits your pocket — Only **\$1.98** postpaid
- Simple to operate — no valves — pumps
- Thousands of satisfied users
- Get one today!

checks, cash or money order. Dealer inquiries invited. Send to: 1929 Opdyke Rd., Clay Mfg. Co., Pontiac, Mich.

ENGINEERING DEGREE IN 27 MONTHS

INDIANA TECHNICAL COLLEGE

B. S. DEGREE. Aeronautical, Chemical, Civil, Electrical, Mechanical and Electronic Engineering (Inc. Radio and TV), Drafting, 1-yr. G.I. Gov't. approved. Low rate. Earn board. Large industrial center. Students from 48 states, 21 countries. Demand for graduates. Enter September, December, March, June. Write for catalog, 1685 E. Washington Boulevard, Fort Wayne 2, Indiana.

250 POWER



Complete Telescope Lens Kit only **\$3.49** postpaid

Conquer Space, Explore the Universe, Planets, Moon Craters, New Stars, etc. Complete Lens Kit consists of 80 inch focal length ground and polished objective lens, eyepiece lenses for 50 POWER, 100 POWER, 150 POWER, 200 POWER, 250 POWER, and all necessary lens fittings. Easy to make from simple step by step instructions. (Tripod and mount not included.) Money back guarantee.

BUSSE SALES CO., Hartford 1, Conn., Dept. PM 36

Earn over \$800⁰⁰ PER MONTH DRAFTING

SEND FOR **FREE** SUCCESS BOOK

CLEVELAND ENGINEERING INSTITUTE
DEPT. PM 8E
6300 Euclid Ave. • Cleveland 3, Ohio

Aeronautical Mechanical

NAME

ADDRESS

CITY..... STATE.....

No Obligation — No Salesmen

APPROVED FOR VETERANS

RECEIVE THIS SET OF INSTRUMENTS AT NO EXTRA COST



"MY INCOME JUMPED FROM \$350 UP TO \$820 PER MONTH", says G. T. WISEMAN. "My first position after I completed the C.E.I. homestudy course in Engineering Drafting more than doubled my pay. I highly recommend this valuable, easy course to anyone interested in getting ahead in life."

CLEVELAND ENGINEERING INSTITUTE

REVOLUTIONARY NEW SELF-CONTAINED, COMPLETE SPRAY KIT MAKES PAINTING EASY!

Now Spray Anything In Minutes With Amazing New Super Jet!

Nothing To Do But Pull The Trigger!
Astonishing New Principle Requires
No Air Compressor, No CO₂ Cartridges,
No Tank! Nothing Extra To Buy!

Simply plug Super Jet into any 110 Volt A.C. electrical outlet and start spraying! The *patented* precision pumping mechanism allows you to spray from *open* or *closed* containers; spray paints, enamels, varnishes, shellacs, lacquers, water, oil, insecticides, fungicides, even water soluble fertilizers! And amazing Super Jet operates as well on a thimbleful or a barrelful of spraying liquid!

All metal Super Jet contains **NO BREAKABLE PLASTIC OR GLASS** parts! Lightweight and rugged, it sprays as well as professional equipment costing up to 3 times as much! Unlike cumbersome professional equipment or impractical toy-like spray guns, you can use Super Jet every time you have *anything* to paint or spray. It's so simple to use, so easy to clean. Super Jet pays for itself!

No Special Air Compressors or Extra Motors Needed!

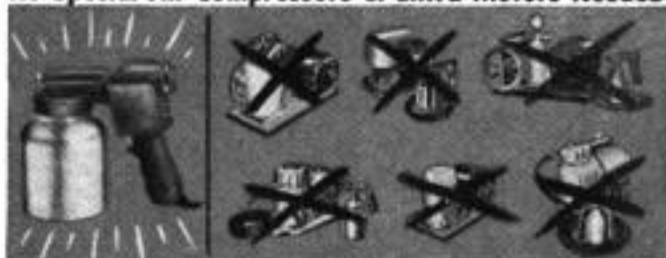

No Spraying Experience Needed To Operate Easy-to-Use SUPER JET!

Independent laboratory tests *plus* consumer testimonials show that Super Jet is the most versatile spray unit on the market! Super Jet is so rugged, so efficient and economical to use that Army, Navy and Air Corps used them. Thousands in use today in homes and industry. Simple to operate, non-clogging and easy to clean, amazing new Super Jet Spray Kit saves time, work, money!

3 DIFFERENT WAYS TO SPRAY WITH SUPER JET!



AVERAGE JOBS — Aluminum jar holds enough material for average paint jobs . . . chairs, tables, shelves, refrigerators, radiators, storm windows, screens, metal furniture, etc. Also perfect for spraying insecticides, liquid fertilizers, removing wall paper, lubricating tools and machinery, etc.

SMALL JOBS — Spray direct from container! Excellent for small spray jobs; painting garden tools, toys, metal grill work, flower pots, lamps, and hobby projects. Also permits spraying deodorizers or disinfectants right from bottle! This feature saves money too. Sprays last drop of paint or spray material!

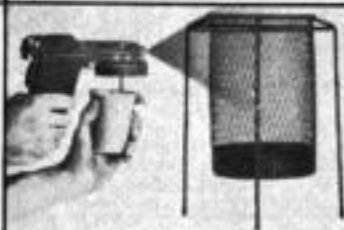

LARGE JOBS—Super Jet's revolutionary principle permits *continuous* spraying direct from large containers of spray material. Special "long-distance" tubing eliminates refilling. No expensive tanks or compressors to buy! Spray walls, floors, ceilings, gardens, lawns, etc.



A COMPLETE SPRAY KIT!
Only \$29.95-\$1. a week!

- NEW SUPER JET SPRAY GUN
 - POLISHED ALUMINUM JAR
 - AUTOMATIC PAINT STRAINER
 - 15 FT. DISTANCE TUBING
 - 23 FT. NEOPRENE CORD SET
 - GEM NOZZLE DISC
 - WALL CHART & INSTRUCTIONS
 - STEEL CARRYING CASE
- PLUS Your Name in 23 KARAT GOLD written on Super Jet Carrying Case



FULLY GUARANTEED! 10 Day Free Trial
plus 90 Day Guarantee Against Mechanical Defects.

POWER PRODUCTS, INC., 175 E. 87th St., N. Y. C.

AUTOMATIC FILTER!



NO MORE STRAINING!—Super Jet comes equipped with an ingenious, fine screen, metal filter that *automatically strains* paint and spray materials. Dirt, pigments, lumps, paint skin, etc. are automatically filtered out and prevented from clogging the gun!

SELF-CLEANING!



NOTHING TO TAKE APART TO CLEAN!—Super Jet cleans itself. Simply spray solvent through the gun for 20 seconds and Super Jet is clean and ready for another job . . . for a different spray material . . . or for storage! No work! No time wasted!

FREE! Mail Coupon TODAY and get Free 5-piece pocket Screw Driver Set.

EXTRA BONUS! Send \$29.95 in full payment of your SUPER JET SPRAY KIT and receive as extra bonus tool kit pictured! Tempered steel 6 inch wrench, 7 inch pliers, screw driver blades and chuck, complete with carrying case. Not a toy!



MAIL COUPON TODAY FOR 10 DAY FREE TRIAL

POWER PRODUCTS, INC.

Super Jet Division 8-A

175 E. 87 St., New York 28, N. Y.

Please send amazing new SUPER JET SPRAY KIT. I must be completely satisfied or I may return within 10 days for full refund. I am using payment plan checked below.

Enclosed is \$29.95 in FULL PAYMENT including postage. Be sure to send my FREE GIFT plus EXTRA BONUS for full payment.

SIMPLIFIED BUDGET PLAN. Enclosed is \$3.00. I will pay balance of \$26.95 at \$1.00 per week plus postage and small credit service charge. (No credit charge if paid within 60 days.) Be sure to send my FREE GIFT.

YOUR NAME will be written in 23 Karat Gold on your kit. Please Print Carefully.

NAME _____

ADDRESS _____

CITY _____ ZONE _____ STATE _____

... TURN CONCRETE INTO GOLD!

MAKE UP TO \$75 A DAY IN YOUR OWN BUSINESS

If you want to have your own business — to start a business on your own — here's your big opportunity! New high speed, low cost General block machine produces up to 1,000 concrete blocks a day. Sell all you make to builders, supply houses, and others for homes, factories, buildings, garages. Cash in on the building boom! You can make profits of 100% to 150% — up to \$75 a day! General block machine equipped with 1/2 h.p. electric motor — or can be supplied with gasoline engine — works anywhere, in little space, indoors or out. Operates from ordinary house light socket. Simple, foolproof 3 step operation — so easy a child can do it. Makes superior 3 core blocks any size from 4" to 12". Also makes chimney, sink, corner and other types. Blocks meet any building code anywhere in the country. Materials — sand, water, cement, available anywhere. Simple illustrated operating instructions and mixing formulae for cement and Cinder blocks supplied with each machine. Write for FREE folder with full information.

MOTOR DRIVEN

R. L. T. of New York City reports: "MY GENERAL BLOCK MACHINE PAID FOR ITSELF IN FIRST 2 WEEKS!"

Hundreds now in use the world over! Write for FREE details today!

EXTRA Amazing illustrated book gives floor plans for 6 sensational concrete block bungalows. Tells how to lay blocks, lay out building fees, mix concrete, build steps, porch and concrete floors all at great savings. Written by experts. Can save many times the cost of the machine! Get it now! No strings attached. Send \$1.

BOOK SENT FREE IF YOU BUY MACHINE.
\$1 REFUNDED IF YOU BUY LATER.

GENERAL ENGINES CO.
DEPT. M-85, ROUTE 130, THOROFARE, N. J.

HOW TO BUILD YOUR OWN CONCRETE BLOCK HOME
Only \$1 Prepaid

PREPARE FOR THE BEST JOBS IN INDUSTRY

TRAIN at HOME IN YOUR SPARE TIME or at **ALLIED INSTITUTE** in Chicago

- MECH. ENGINEER
- DRAFTSMAN
- TOOL DESIGNER
- TOOL ENGINEER
- TOOL & DIE MAKER
- MASTER MACHINIST

NO RECESSION FOR ALLIED TRAINED MEN

MORE JOBS THAN GRADUATES Shortages of Draftsmen, Designers, Tool Engineers, Machinists, Tool & Die Makers are so widespread that you can pick a highly paid key job and look forward to Achievement and Security.

You can begin your training in Short Courses and continue progressively to a Bachelor Degree in 26 months.

Allied is approved by Industry, Dept. of Education, Office of Public Instruction, State of Illinois, U. S. Veterans Admin., U. S. Dept. of Justice. Accredited: C. S. A.

SEND FOR FREE BOOKS

ALLIED SCHOOL of MECHANICAL TRADES
1338-42 South Michigan Ave. Dept. PM-8 Chicago 5, Illinois

SEND ME WITHOUT OBLIGATION INFO. ON YOUR COURSES:

HOME STUDY RESIDENT VETERAN NON VETERAN

NAME _____

ADDRESS _____ AGE _____

CITY _____ STATE _____

WHERE-TO-BUY-IT INDEX

Source of supply appears after items commercially available

AUTOMOTIVE AND MOTORCYCLING

Italian motorcyclist sets records lying down..... 82
Detroit Listening Post..... 88
Plastic "ceiling" replaces fabric in Plymouth station wagon... 124
Four-cylinder sportster goes 116 miles per hour..... 125
Hydraulics raise or lower truck bed for loading and unloading (C & R Transfer Co., 1502 Kettner Blvd., San Diego, Calif.)... 143

AVIATION

Turbojet engine is 50 percent more powerful than famed J47... 71
Long-winged 1957 Constellation will fly 6500 miles nonstop (Lockheed Aircraft Corp., Burbank, Calif.)..... 89
Helicopter carries prospector in search for uranium..... 95
"Wigwam" hanger for vertical-take-off fighter..... 104
Powered glider takes to highway..... 109
Convertiplane with pusher propeller may go 175 miles per hour..... 112
Aids to sea rescue (Pan Avion Co., P. O. Box 213, Miami International Airport, Miami 48, Fla.)..... 119
Experimental craft converts from helicopter to plane in mid-air..... 121
Pilot seated on ground flies drone helicopter..... 125
Compressed-air slots in wing enable jet to land at low speed... 131
Vertical-take-off turbojet has no propeller..... 139

CONSTRUCTION

Cone lays ribbon of mortar (Master Products Co., 1346 Beach Blvd., Bay St. Louis, Miss.)..... 89
Midget hoist lifts half ton (Western Control Corp., P. O. Box 1194, Wichita 1, Kans.)..... 101
Leveling jack for docks (Central Machine Works Co., 1234 Central Ave., Minneapolis 13, Minn.)..... 120

FARM AND FARMING

Gas engine pushes lawn roller and fertilizer (Hardsoc Pneumatic Tool Co., Ottumwa, Iowa)..... 135
Mixer blends farm feeds in desired proportions (Belle City Engineering Co., Racine, Wis.)..... 135
Planter distributes two bands of fertilizer..... 138

FISH AND FISHING

Net clamped to side of boat holds fish and two rods (Alliance Manufacturing, 3121 Milwaukee Ave., Chicago 18)..... 70
Lightweight plastic oar stores fly rod in handle (Plastic Age Sales, Inc., San Fernando, Calif.)..... 89
Battery-operated aerator keeps minnows alive (Silco, Inc., Nashville, Tenn.)..... 101

HOUSE AND HOME

Floor-tile adhesive applied with brush (Johns-Manville, 22 E. 40th St., New York City 16)..... 71
What's New For Your Home—
Water softener styled for the kitchen (Culligan, Inc., Northbrook, Ill.)..... 140
Food holder (Roblex Products Co., 1525 Griffith Park Blvd., Los Angeles, Calif.)..... 140
Hanger enables you to hang pictures and mirrors flush with wall (Design Craft, 504 Interurban Bldg., Dallas, Tex.)... 140
Legless high chair (Luger Products, 12 E. 25th St., Minneapolis 4, Minn.)..... 140
Carpet cleaner (American Floor Surfacing Machine Co., Toledo 3, Ohio)..... 141
Electric broiler with rotisserie (Electriglas Corp., Bergenfield, N. J.)..... 141
Meat thermometer in new range (Philco Corp., Philadelphia, Pa.)..... 141
"Peg-Board" clip grips tools and utensils (Newhart Products, P. O. Box 157, Devon, Conn.)..... 141
Plastic holder has hideaway feature (J. & S. Mfg. Co., 2645 S. State St., Chicago 16)..... 141

LAWN AND GARDEN

Attachment for rake helps seed (Lee Mfg. Co., 10 Pulaski St., Brooklyn, N. Y.)..... 74
Hose holder (Wood-Regan Instrument Co., Inc., Nutley, N. J.)... 120
Sickle bar on front of reel mower trims weeds and tall grass (Moto-Mower Co., Richmond, Ind.)..... 121
Riding sulky for rotary mower (George Garden Tools, 811 S. Hamilton St., Sullivan, Ill.)..... 134

MILITARY AND NAVAL

Army troop-cargo carrier rolls on rubber pillows (Four Wheel Drive Auto Co., Clintonville, Wis.)..... 70
Eight-foot timbers line Air Force all-angle firing range (Avco Mfg. Corp., Evendale, Ohio)..... 74

MISCELLANEOUS

Rubber tanks for shipping save labor, protect materials (Bakelite Co., 260 Madison Ave., New York City 16)..... 82
Adjuster for bicycle pedals..... 82
Portable television set weighs only 34 pounds (General Electric Co., Electronics Park, Syracuse, N. Y.)..... 83
Robot train announcers take over in England..... 83
Buffer protects garage walls (Tuthill Spring Co., 760 W. Polk St., Chicago 7)..... 95
Covers shield rifle scope (E. D. Vissing Co., Idaho Falls, Idaho)..... 109
Meter on telephone shows call charge..... 113
Power handrun runs many tools (Toro Mfg. Corp., 3042 Snelling Ave., Minneapolis, Minn.)..... 113
Junior-size umbrella (David L. Cohn Haberdasher, 1841 E. 6th St., Cleveland, Ohio)..... 120
Fleet of surplus ships stores USDA grain..... 120
Hand truck climbs stairs on power-driven wheels (Valley Craft Products, Inc., 750 Jefferson Ave., Lake City, Minn.)..... 125

(Continued to page 60)

Maybe You **WRITE** Too Can Stories, Articles, Plays

Would you spend a few hours a week learning to write so you may earn \$500-\$1500 a year part-time? Or many thousands full-time? FREE book, "Art of Writing Salable Stories" tells how to get started. Many students earn while learning (Graham Doar sold one story to Post, CBS Radio and NBC-TV). Endorsed by famous authors, scores of successful graduates; approved for veterans. Write today for free book (No salesman will call). Barton A. Stebbins (Pres.)

Palmer Institute of Authorship, Since 1917
1680 N. Sycamore, Hollywood 28, California, Desk M85

FREE! 60 APPROVED EXERCISES, 68 PHOTOS
with **FAMOUS DAN LURIE**

BARBELLS

50 lb. set \$ 8.48 • 100 lb. set \$13.98
150 lb. set \$20.48 • 200 lb. set \$25.98

SEND FOR FREE CATALOG

Order by mail—50% with order Balance COD. Extra WTS. 13c lb. FOB Plant.

DAN LURIE BARBELL CO.

52MB Bristol St., Dept. 559H, Brooklyn 12, N.Y.

SEE DAN ON T V "BIG TOP" SHOW



SAVE UP TO 50% ON FAMOUS ITALIAN ACCORDIONS

Buy direct from America's leading distributor. Offers Students, Teachers and Professionals SPECIAL DISCOUNTS. Send NOW for FREE Literature and lowest wholesale prices. Easy Terms. Trade-ins accepted. Write today.

ACCORDION MANUFACTURERS & WHOLESALE OUTLET
DEPT. R-85 2003 W. CHICAGO AVE., CHICAGO 22, ILL.

**5 DAY
FREE
TRIAL**

PRINTS POST CARDS

Learn how both large and small businesses are boosting sales with new advertising machine. Write today for **FREE** illustrated **BOOK** of unique advertising plans, money-making ideas for your business. **Cardmaster, 1920 Sunnyside, Dept. 12-J, Chicago 40, Ill.**



FREE DOG BONE WRENCH 1001 USES

We'll send you a \$1.00 value **GENUINE 10-in-one Dog-Bone Wrench** to get your name on our mailing list. (P's. include 25c for packing & handling). Like a complete set of 10 Box and socket Wrenches in one Wrench! Fits almost **EVERY SIZE** square or hexagon nut or bolt 1/4 to 9/16-inch. **NO LIMIT—but send 25c for each Wrench. Order TODAY!**

DOG-BONE CO. Dept. DW-81

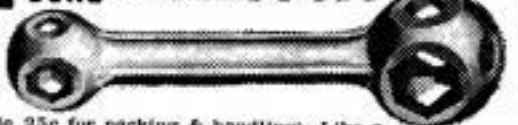

Box 881, St. Louis, Mo.

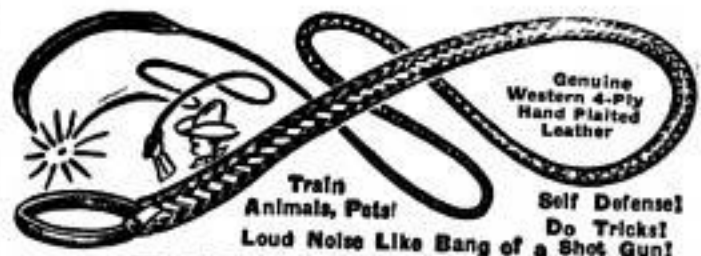

**Train
Animals, Pets!** **Self Defense!**
Loud Noise Like Bang of a Shot Gun!

PLAITED LEATHER BIG BULL WHIP

Experts knock ashes off cigaret, gun out of hand, yank people off feet, etc. Used by trainers, ranchmen, etc. Grip lightly (pressure is on loop), then crack or coil; snake out or back; overhand, underhand, side-arm. Neat's oil finished for plianity & long life. "Cracker" or tongue on end. Solid grip handle with loop.

6-ft. Whip \$1.98; 8-ft. Whip \$2.69.
JOHNSON SMITH & CO., Dept. 157, Detroit 7, Michigan

Catalog of 3000 Novelties 10c

Send 10c for amazing catalog of novelties, live animals, scientific supplies, hobbies, funmakers, planes & boats, lemons, magic tricks, joke articles, unusual seeds, gadget timesavers, cameras, optical goods, projectors, movies, lucky jewelry, religious novelties, disguises, musical instruments, stamps, coins, puzzles, fortune tellers, radios, auto & bike accessories, telescopes, magnifiers, compasses, banks, smokers' gadgets, artists' supplies, printing sets, engines, motors, shockers, knives, billfolds, guns, rifles, sports, books, games, plants, etc. Send 10c (3 for 25c—get for friends!). **JOHNSON SMITH & CO. Dept. 157** **Detroit 7, Michigan**

Precision Miniature Camera

Less than half size of regular cigaret package! Take everywhere! Take surprise, candid & regular pictures. Weights 2 1/2-ounces. Solid, all metal construction with leather fitted body, chrome trim. Enclosed eye-level view finder. Single action, 1/25th second or time shutter. Precision ground lens. Takes 10 1/4-inch pictures per roll. Standard 16 mm. film. Fine enlargements from negatives. Low film cost. Spools can be used to load with 16 mm. Kodachrome color movie film. Take indoor or night pictures by use of flash or flood unit (not supplied). Beauty in looks & performance. **Precision made. Camera Only... \$1.98. Camera with Pigskin Leather Ever-Ready Case & Strap \$2.50. Film 20c per roll, 6 rolls \$1.00. Case only 75c. JOHNSON SMITH CO., Dept. 157, Detroit 7, Michigan.**

POWERFUL ELECTRIC GENERATOR

Cost Over \$20.00 New; While They Last, \$3.95
Generates Up To 75 Volts. Use to generate electricity to ring bells, light up lights, as medical battery, deliver terrific electric shock as joke, many electrical experiments, classroom uses, etc. Cost over \$20 new. Used but excellent operating condition. Hand crank or gear wheel drive. Made by leading electrical companies. Each has 3, 4, or 5 five-inch 1-lb. bar magnets (alone worth more than total cost), generating armature, wire leads, gear crank, ready for use. Originally used to crank phones. Complete unit weighs over 5 lbs. Each Postpaid \$3.95 (Over 1000 miles from Detroit, send \$4.95, otherwise shipped express charges collect). Other Used Items in Good Operating Condition: Standard Upright Phones, \$3.00 each postpaid (\$3.95 over 1000 miles); Telephone Carbon Mike \$1.75 Postpaid; Ringer Box (Use with generator for battery-less bell system; complete with induction coil, condenser & bell) \$3.50 (\$4.50 over 1000 miles). Mail order to: **Johnson Smith Company, Dept. 157, Detroit 7, Mich.**



Say You Saw It in Popular Mechanics

Get into.. **PLASTIC LAMINATING AT HOME!**



THIS MAN
... is taking out of the machine a Plastic Sealing Job—ordered by mail—only 1c in material cost brings back \$2.58 in cash by mail. Capacity of machine: **\$25.00 profit per hour of operation.**

Get **ORDERS** and **CASH** from your mailman—do work in **SPARE TIME** at home—or expand into **FULL TIME** business. Send coupon for Free facts about the newest and most fascinating of all home operated businesses. For the first time a simplified machine brings the fabulous profits of **Plastic Sealing** and **Plastic Laminating** within the reach of the small operator. Anyone can learn to operate the machine with a few minutes practice—then with our **Magic Mail Plan** can get mail orders pouring in daily with cash in every envelope. **No canvassing—no selling.** We even

**Make \$20 to \$30 a Day by..
MAGIC MAIL PLAN!**

Make Thousands of Beautiful Art Creations
COSTUME JEWELRY • CIGARETTE BOXES
TRAYS • CANDLESTICKS • COASTERS
LAMP BASES • BOOK ENDS...ALL IN
SPARKLING COLORED PLASTIC



**WARNER ELECTRIC CO., 1512 Jarvis Av.
Dept. L-10-J, Chicago 26, Ill.**

At no cost to me, please rush complete details postage prepaid. I am under no obligation.

Name.....

Address.....

City..... Zone..... State.....

supply the circulars you mail to bring back cash and orders. Don't waste a minute. Rush your name. We'll send you **FREE** and postpaid, pictures, prices, details, and all the facts you need to start. Mail coupon or send name on postcard. No charge. **Warner Electric Co., 1512 Jarvis Av., Dept. L-10-J, Chicago 26, Ill.**

TERRIFIC!

USED 16 x 50
Regularly sold at \$69.50
NOW \$37⁶⁰

These are not "used" in the sense that someone else owned them, but their frames have been scratched or some of the paint rubbed off while being taken off of the shelves or when handled on our viewing range. Their cases, too, sometimes show scuff marks. **OPTICALLY AND MECHANICALLY THEY ARE A-1.** 7" high. Water-dust resistant. 2" wide objectives assure greater illumination and brighter sharper images. Weigh only 27 ounces!



SALE
20 POWER
Regularly \$39.95
NOW \$29.95

Brand new glasses. Never in the 100 years since Carl Zeiss invented binoculars has it been possible to get a 20 POWER PRISMATIC BINOCULAR that weighed only 18 ounces! Precision made. Individual focus with removable, screw-in protective caps. Lens are color corrected. Handsome crackle finish with satin chrome trim. Increased sales have lowered production costs and we are passing on this \$10.00 savings to you!

30 DAY NO RISK TRIAL

If not satisfied return for full refund. Made in Japan. Leather case, straps included. Add 10% Fed. tax. Cash orders prepaid. C.O.D.'s require \$2.00 deposit. **UNITED BINOCULAR CO.**, Dept. ARF-9408, 1043 S. Western Ave., Chicago 20. **DEALERS WANTED!**

Say You Saw It in Popular Mechanics

TRAINED MEN NEEDED

BIG PAY—GOOD FUTURE

TELEVISION ELECTRONICS
 DIESEL AUTO

WHY WORK FOR LOW PAY or risk being out of a job??? Usually the properly trained man has a steady job... through good times or bad. Even back during DEPRESSION there was a big demand for Bailey Trained men.

In only 5½ to 6 months we can train YOU to enter one of the big pay fields!

No previous experience or special education necessary. With our method of training you do not spend years pouring over books, figures, charts and graphs. You learn by rebuilding, repairing, testing and operating the most modern equipment, under the guidance of experienced, courteous and friendly instructors. This method of training gives you the experience and confidence required to step right into the big pay jobs without spending years as a mechanic's helper.

It's EASIER and COSTS LESS than you may think to get this residence shop training... we help you find part-time jobs while in school—full-time jobs after graduation. Check subject above in which you are interested and mail for complete information.

BAILEY Technical SCHOOLS

Veteran Approved

1634 S. Grand St. Louis 4, Mo.

NAME.....AGE.....
STREET.....
TOWN.....ZONE.....STATE.....

(Continued from page 58)

Folding hothouse made of plastic.....	131
Telephone trouble spotter.....	135
Six wheeled hand truck built for stair-climbing (Frost Engineering Co., 308 N. East Ave., Oak Park, Ill.).....	139
Collapsible sawhorse (Commercial Welding Co., 185 H East St., New Haven, Conn.).....	216
Air purifier (Sampson Chemical and Pigment Corp., 2830 W. Lake St., Chicago 12).....	222
Radar controls freight cars in "hump" yards (General Railway Signal Co., Rochester 2, N. Y.).....	222
Automatic sextant (Kollman Instrument Corp., 80-08 45th Ave., Elmhurst 73, N. Y.).....	240

PHOTOGRAPHY

Toll-collecting robot photographs chiselers (Raritan Toll Plaza, Raritan, N. Y.).....	112
Underwater camera case (Underwater Camera Case, 2219 Biscayne Blvd., Miami, Fla.).....	124
Camera uses aircraft lamps (Natural Lighting Corp., 612 W. Elk St., Glendale, Calif.).....	134

SCIENCE

"Perfect" iron crystals produced in laboratory (Westinghouse Electric Corp., Pittsburgh 30, Pa.).....	70
Rubber "concrete" (United States Rubber Co., Naugatuck Chemical Div., Naugatuck, Conn.).....	80
Mufflers cut roar in wind tunnels (U. S. Steel Corp., 402 Pacific Mutual Bldg., Los Angeles 14, Calif.).....	104
Scientific steer.....	109
First men on the moon need not fear radioactivity.....	112
"Bubble chamber" charts paths of atomic particles.....	124
Long-extinct elements made by scientists.....	134
America takes underwater atomic furnace to world conference.....	143
Projectiles fired into artificial rain reveal raindrop damage.....	144
Listening to lightning.....	220

THE OUTDOOR LIFE

Clip for golf cart holds extra tees and balls (Jad Products, 1209 Marmion Ave., Toledo, Ohio).....	74
Disposable barbecue grill comes equipped with fuel (Winro Corp., Detroit, Mich.).....	83
Campstove burns 2½ hours on ¼ pint of fuel (Palley Supply Co., Dept 28, 2263 E. Vernon Ave., Los Angeles 58, Calif.).....	120
Glass-fiber golf shafts are lighter than steel (Golcraft, Inc., Escondido, Calif.).....	121
Portable boat assembled in seven minutes from small package (Stow-Away-Boats, 10494 Dixon Drive, Seattle 88, Wash.).....	134
Pressure-can fuel for lamps and torches.....	135
Bracket holds boat lantern.....	139
Outdoor powers catamaran.....	144
Sun patches for eyeglasses (Champion Mfg. Co., 111 Highland Ave., Highland Park, Mich.).....	236

Radio-Television, Electronics

Geiger counter (Allied Radio Corp., 100 N. Western Ave., Chicago 80).....	145
Hard-of-hearing television adapter (Multitone Electric Co. Ltd., 223-227 St. John St., London, E.C. 1, England). Other kits: Cannon-Ball headphone adapter (C. F. Cannon Company, Springwater, N. Y.); Bu-Ko extension speaker (Bu-Ko Distributing Co., 4608 Norwaldo Ave., Indianapolis 5, Ind.); Headphone kit (Edward Fleming, Inc., Broad St., Westport, Conn.).....	146

Craftsman and Shop Notes Index

AUTOMOTIVE

Weight of automobile used to break bead from rim.....	151
Car-door upholstery replaced with prefinished wall paneling.....	160
Car-polishing time reduced.....	180
Multipurpose farm trailer transports heavy machinery.....	197

CONSTRUCTION

Sawhorse holds flags and sign to protect highway workers.....	161
Determining correct dimensions of stair treads and risers.....	168
Attic fan aids air conditioning (Lau Blower Co., Dayton, Ohio).....	175
Safeguards minimize damage to retaining wall.....	180
Hub ends need not be broken when replacing clay pipe.....	181

FARM AND FARMING

Windmill vanes on farm road indicate culvert location.....	172
Tractor scoop used as scaffold when assembling grain bins.....	176
Kittis at road entrance identifies farm owner.....	186
Portable farm sprayer powered by gas engine.....	189
Tractor equipment installed with aid of fence stretcher.....	189

HOUSE AND HOME

Change in gate-hinge angle adds self-closing action.....	156
Broken keys in ceiling plaster renewed with melted sulphur.....	161
Holder bent from metal rod supports flowerpots.....	161
Solving Home Problems—	
Storage for leaves of kitchen or dinette table.....	162
Sticking ice-cube trays placed on sheet of aluminum foil.....	162
Hiding place for door key.....	162
Brushing candles with a coat of clear shellac prevents drooping.....	162
Easy removal of fruit-jar lid.....	163
Discarded lipstick case used as handy needle holder.....	163
Shelves for small potted plants.....	163
Ventilation and privacy without noise.....	163
Eliminating problems caused by toddler lifting telephone.....	163
Flashlight located in dark.....	164

(Continued to page 62)

NEW! PERSONAL POCKET RADIO

YOU ALONE ACTUALLY LISTEN WHILE YOU WALK, RIDE, WORK!



Slips in any pocket—Wt. only 5 ozs. Size 2 3/4" x 4 1/4" x 1 1/2". Beautiful Black Gold plastic case. NO HOOKUPS—NO WIRES—NO PLUG IN'S! Self contained with 150-hour life flashlight batteries. (Available anywhere) and BUILT IN ANTENNA!

GUARANTEED RECEPTION OF RADIO STATIONS TO 50 miles—up to 1500 miles for powerful stations! Has new Patented Super-regenerative Duo-triode tube and transformer audio stages for sharp selectivity and sensitivity—NO SQUEALS OR TRICKY TUNING! Easy to use tip controls (while walking). Almost invisible plastic foam personal earplug lets you alone listen while you walk, visit, work, ride or sleep—anytime—anywhere in the world radios are used. **GUARANTEED TO SATISFY**—or your money back in 10 days!

SEND ONLY \$5.00 (Ck. Mo) and pay postman \$14.95 plus postage on delivery or send \$19.95

for postpaid delivery. Get YOUR Tinseltone REAL pocket radio now and be ready to listen, personally for weather, Civil Defense alarms, news, music, sports, etc., on a moment's notice. **COMPLETE IN EVERY DETAIL**—Not a Kit or plaything! Shipped complete with batteries and 1 Year Guarantee—Order now—today for early delivery. (We also supply all kinds of radios, TV & parts for anything electronic ever described in any magazine.) Write.

WESTERN RADIO Dept. APM-8 Kearney, Nebraska

PUMP WATER FAST!



Drains Wash Tubs, Cellars, Cisterns. Famous #7 pumps 2800 gph. 420 gph. at 75' high or 1600 gph. from 25' well. Sturdy rustproof alloy metal. Six blade impeller. 1/4" inlet, 1/2" outlet. Standard pipe threaded. Uses any 1/4 to 1/2 H.P. Motor. Will not leak or clog. Iron clad guarantee. Send check, M.O., or sent C.O.D. **\$8.95** M.S.R.

Irrigate, Fill Tanks, Draw Well Water. Heavy duty #8 pumps 7000 gph. 3000 gph. 75' high 3000 gph. from 25' well. Rustproof alloy metal. 8 blade impeller. 1" inlet, 1" outlet. Standard pipe threaded. Will not leak or clog. Iron clad guarantee. Send check, M.O., or sent C.O.D. **\$11.95** M.S.R.

Free Catalogue—Gear Pumps, Large Centrifugal Pumps, Deep and Shallow Well Pumps, Sump Pumps.
MOORE MANUFACTURING CO.
SWEDESBORO 1, NEW JERSEY

LEARN PLASTICS



COMPLETE LOW COST SHOP METHOD HOME TRAINING NOW AVAILABLE

Get in on Big Money opportunities in Plastic molding, casting, forming, carving, etc. Earn as you learn with Interstate's professionally prepared course. All plastic materials furnished.

WRITE FOR FREE BOOKLET

INTERSTATE TRAINING SERVICE
DEPT. C-3, PORTLAND 13, OREGON

WELD

BRAZE

SOLDER

CUT



Acclaimed by thousands of Homeowners, Mechanics and Hobbyists as the welder of 1001 uses. Easily operated from properly wired 110 volt AC or DC line. The ideal gift with a life-long use... Order today on 10 day money back guarantee.

FOUR-WAY WELDER CO., Dept. F2-H
1810 S. Federal St. • Chicago 16, Ill.

Want a Government Job

START AS HIGH AS \$3,795.00 A YEAR
Prepare NOW for next exams
FRANKLIN INSTITUTE (Not Gov't. Controlled)
Dept. F-94, Rochester 4, N. Y.
Start Rush without charge. (1) 30-page book with list of U.S. Gov't. Jobs; (2) Test me how to qualify for one.
COUPON
Name _____
Address _____
Age _____
Mail Coupon Today. **SURE.**

Hundreds of Companies Want Advertising Work Uniforms LIKE THESE!



We need men to take their orders

Perhaps you have wondered where gas station attendants get the uniforms they wear—the ones with company names embroidered above the pocket and on the back. Geo. Master originated the idea of advertising work uniforms 25 years ago. Giant companies use them, "little fellows" buy them too. We have so many customers, we need more men to take orders.

If you qualify, we will set you up in business FREE. We give you everything you need to operate right from your own home—plus year-round advertising to pre-sell prospects.

One of our men, on his first call, took an order from a small dairy. His profit—\$758. He is almost sure to get repeat business automatically.

Master uniforms and work garments are sold and serviced all over the world. We ship direct to the customer from our factory. You work with one of the most complete kits ever devised. It's an expensive kit to prepare, but it costs you nothing.

Try our method for 10 days. Then, if you don't like the business, simply return the kit and forget the entire matter. This could well be the BIG OPPORTUNITY you have been looking for. Certainly, you have nothing to lose by trying it out. So fill out and mail coupon below today.

The Geo. MASTER GARMENT DIV.
589 WATER STREET - LIGONIER, INDIANA

Del V. Bergstrom, President
The Geo. MASTER GARMENT DIV.
589 Water Street, Ligonier, Indiana
Dear Mr. Bergstrom: Please send me a Complete Order Kit, with instructions, so I can make a 10-Day Test. I understand everything you send is FREE. If, after 10 days, I'm not delighted with the money I've made, I'll send the kit back.
NAME _____
ADDRESS _____
CITY _____ ZONE _____ STATE _____

FREE TO NEW MEMBERS... IMPORTS



FROM FOREIGN LANDS
NOW! EASY TO START YOUR OWN BIG-PROFIT IMPORT-EXPORT BUSINESS AT HOME!

FREE to new members of the International Traders Guild—many unusual, useful products from France, India, Germany and other foreign lands, and trade bulletins listing hundreds of import bargains. World trade boom offers new, big-money opportunities for men and women! Now you can import at low foreign prices for buyers in your locality at high U. S. prices.

BUY - SELL, WORLD-WIDE, WITHOUT CAPITAL
Big profits possible, no investment in goods. Operate a world-wide mail-order business from home, spare or full-time. Also, for your own use, big savings on clothes, tools, gems, antiques, watches, cameras, china, silk, toys, etc. (see examples at left). No matter where you live World Trade can be carried on—in small towns or large cities, anywhere. World travel opportunities. Established World Trader shows you how. Teaches you quickly at home.

START AT ONCE-IMPORT PROFITABLE ITEMS
Complete training includes many exciting imports that come to you from 'round the world AT NO EXTRA COST. Go after big profits NOW—importing and exporting. No previous experience is required. 2000 members in 42 countries. 7th successful year. Free details, write Now. Airmail reaches us overnight.



"Business good... importing paintings... selling to gift shops." - C. Renick, Penn.
Mrs. M. G. Bowman - Her entire import of beaded purses from India bought by large department store.

The MELLINGER CO., Exporters-Importers,
Dept. E258, 1717 Westwood Blvd., Los Angeles 24, Calif.

FREE! MINT BRITISH AFRICAN STAMPS



Rush coupon today. Exciting offer! Newest issue Elizabeth II stamps — all mint, all different, all yours, — absolutely FREE! Scarce, beautiful, 2-color stamps from obscure African countries — Nigeria, Basutoland, Gambia, St. Helena — many others! And MORE — free copy helpful "Stamp Collector's Guide" — free color reproduction and story World's Rarest Stamp — free 1/2 penny Falkland Island stamp. Other valuable offers for your free inspection. Limited offer, so rush coupon today! If coupon has been clipped, rush 10c for postage and handling to GARCELON STAMP CO., Dept. PMSBA, Calais, Maine.

GARCELON STAMP CO., DEPT. PMSBA, Calais, Maine
Rush FREE mint British African Stamps and other offers. Enclosed 10c for postage and handling. (PLEASE PRINT)

NAME _____
ADDRESS _____
CITY _____ STATE _____

HELPFUL BOOKS

Send post card asking for FREE catalog
Popular Mechanics Press, 200 E. Ontario, Dept. 601, Chicago 11



BIG PROFIT making Concrete Drain Tile

Millions of dollars' worth of drain tile are used every year for farm drainage, building construction, reclamation projects, highways, and other purposes. And the big swing is to concrete tile because it's better and costs less. Sales potentials are BIG.

Concrete drain tile is locally manufactured of local materials, for direct selling to local users or contractors. Useless costs—freight, distribution, breakage—are eliminated. While worth more than clay tile, concrete tile can sell for less and still earn a handsome profit.

Tile made on the Champion Machine are strong and uniform. Truly round. All sizes up to 12" diameter. Easy to make because the Champion is simple to operate.

Get The Champion Facts

Write for the Champion book. Tells about concrete drain tile as an outstanding manufacturing opportunity. Describes the machine and outlines liberal payment terms.

W. E. DUNN MFG. CO.
522 W. 24th Street, Holland, Mich.

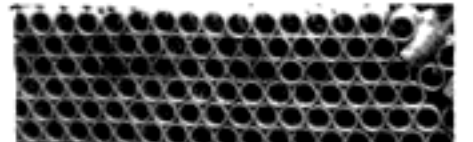

IN CANADA: DUNN MASONRY MACHINERY LIMITED
970 Dundas Highway, Cookville, Ont.

(Continued from page 60)

Paper bag catches plaster dust when drilling hole in wall...172
Water with copper sulphate destroys root growth in sewer...176
Framed shadowbox...177
How to install your own dehumidifier (Adams Equipment, Inc., 511 S. Jackson, Jackson, Mich.)...178
Length of soil pipe in floor determined by joist depth...180
Adjustable-height clothesline requires no props...181
Improve plain appearance of house front by adding scrollwork...181
Care of plastic-covered chairs...186
Sign has charred background and raised lettering...189

HOUSEHOLD HINTS

Sand-filled "fire buckets" are novel ash trays...151
Adjustment of rotating brush improves vacuum cleaner...174
Hardboard disk in trash can replaces rusted-out bottom...174
Empty milk cartons utilized as frozen-food containers...180

MISCELLANEOUS

Eatable decorative wreath made of hard candies...156
Greater contrast in blueprints assured by facing carbons...160
"Pinhole lens" permits reading when glasses are misplaced...169
Adhesive-tape strip on triangle used as handy penwiper...168
Passing canines refreshed at shop "puppy bar"...168
Lemon-juice invisible ink made visible by heat...172
Light-green enlarger filter...172
Drawing reversed by tracing...173
Rainy day marble game made of milk cartons...173
Copy held to typewriter stand by small permanent magnet...176
Holder for shipping labels...178
Model-plane parts assembled with toy-balloon "clamp"...177
"Bill Bug" outrigger raft for water fun...182
Simple cardboard frame helps to align jigsaw-puzzle pieces...183
Helper springs on windmill permit easier starting...204

PHOTOGRAPHY

Dark blocks used as tanks for developing color film...156
Dunkroom shelf with holes provides graduate storage...164
Fountain pen provides storage for cotton swabs...166
Quick immersion in developer prevents film fogging...166
House lamp wired through three-way plug used as flash holder...173
Line on photoflood reflector prevents equipment damage...176

TOOLS

Rubber washer on drill bit protects finished surface...166
Table-saw miter gauge used as oversized T-bevel...172
Power workshop has new features (Ideal Metal Products, Inc., Detroit 16, Mich.)...201
Shopping for Tools—
Nailing machine speeds up nailing of hardwood floors (Independent Nail and Packing Co., Bridgewater, Mass.)...202
Accessory saw for 1/4-in. electric drills (Little Beaver Industries, 38809 Mentor Ave., Willoughby, Ohio)...202
Magnetic lathe chuck comes in 10 and 12-in. diameters (Magnetic Holding Devices, 2034 E. 22nd St., Cleveland 15, Ohio)...202
Fence-alignment gauge corrects fence alignments on circular-saw tables (Adams Products Co., 119 Ann St., Hartford 3, Conn.)...202
Combination hammer and wrench (G. M. Co. Manufacturing, Inc., 13-08 43rd Ave., Long Island City, N. Y.)...202
Miter for compound angles (Bay City Foundry, 133 N. Avalon Blvd., Wilmington, Calif.)...203
Circular-saw vise takes all blades in the common sizes (Anton L. Ponsetti, 309 W. Dakota St., Spring Valley, Ill.)...203
Hammer-operated punch press (Chase Manufacturing Co., Los Angeles 6, Calif.)...203
Paint scraper (Leyton Enterprises, Box 17234, Foy Station, Los Angeles 17, Calif.)...203
Precision boring fixture for drill press (Donnell Co., P. O. Box 84, St. Joseph, Mich.)...203
Jig for cutting plastic and metal-backed tile...204

WORKSHOP HINTS

Nails pulled without bending...151
Pocket liner fastened on wall provides small-tool holder...151
"Sharpening" wax crayons...151
Magnet on paint-stirring paddle keeps it against can side...156
Felt oiling pad on sawhorse rustproofs handsaws...160
Marbles dropped into paint can assist thorough mixing...160
Interlocking crate corners provide maximum strength...161
Glass cut to close tolerance by using paper pattern...164
Modified garden rake used as seedbed leveler...166
Padded base under lantern reduces mantle breakage...166
Magnetic hammer picks up tacks singly from plastic screen...168
Wiper for hot soldering iron utilizes steel-wool pad...168
Coin protects wooden rule from razor-blade cuts...174
Flooring strip braces plywood held on edge for sawing...174
Level maintains constant slope by using small block...174
Suede-cleaning brush removes excess metal when sweat-soldering...177
Spray outfit made portable by using golf-bag cart...179
Washer soldered to can spout lifts covers of oil cups...179
Pointing ends on pipe stakes makes driving easier...181
Better electrical connections...183
Metal bench drawers improvised by utilizing cake pans...183
Rain gauge made from bottle and length of wooden rule...183
Glue pot from coffee can...186
Bench holder...187
Lifted wood chip hides nailhead in furniture construction...189
Expanding plug holds center-bored work...197
Rule held for glass cutting by bits of friction tape...197
Tap wrench used as valve handle on compressed-gas tank...197
Piece of bandsaw blade used as keyhole saw...204

IMPORTANT NOTICE—It is the intention of this magazine to provide its readers with information regarding the latest developments in the mechanical arts. We take no responsibility as to whether the disclosures contained in our articles are covered by patents and advise readers to investigate this subject before making, using, or selling any of the products, machines, or processes described in order to avoid possible liability for patent infringements.

Family Safe, Partially Used. CHECK MY GUARANTEE & PRICES! **FOOLISH TO PAY MORE - DANGEROUS TO PAY LESS!** If you buy 2 or more TIRES you get an extra tire FREE. Be wise! Why buy only one! **FREE TUBE!**

CHOOSE YOUR FAVORITE BRAND **GOOD YEAR** **Firestone** U. S. Goodrich, Lee & others.

Not Recaps—36 MONTH GUARANTEE & FREE TUBE	600-16	670-15	700-20	750-20	800-16	850-16	900-20	1000-20	1100-20	1200-20
\$4.81	\$4.71	\$4.71	\$9.11	\$9.01	\$9.01	\$9.01	\$9.01	\$9.01	\$9.01	\$9.01
650-16	700-16	750-15	800-15	850-15	900-15	950-15	1000-15	1100-15	1200-15	1300-15
4.71	5.21	4.71	5.11	5.11	5.11	5.11	5.11	5.11	5.11	5.11
640-15	700-15	750-15	800-15	850-15	900-15	950-15	1000-15	1100-15	1200-15	1300-15
4.81	4.51	4.51	4.51	4.51	4.51	4.51	4.51	4.51	4.51	4.51
600-20	700-20	750-20	800-20	850-20	900-20	950-20	1000-20	1100-20	1200-20	1300-20
7.91	7.91	7.91	7.91	7.91	7.91	7.91	7.91	7.91	7.91	7.91
WHITEWALLS \$1. EXTRA										

MARVIN BLATT 6th & Spring Garden Sts. Philadelphia, Pa.

MILITARY MUD-GRIP TIRES
 AA Guar. 20 Mos. AAA 36 Months
 900-16 \$10.21 900-16 \$13.91
 750-20 9.71 750-20 13.51

Send Ck. or M.O. & this ad for instant shipment. FOB Phila. I personally select your tires—as if my future depended on it. Thousands of tires shipped the world over! Read that top line again.

Try it for one full week! If not fully satisfied return it—and your money will be refunded!



AMAZING BARGAIN ELECTRIC SHAVER

Fully Guaranteed \$9.95
Second to none Now, only

TOP ELECTRIC SHAVER will give you the closest, smoothest shave you ever had—and durably constructed to last for years. Made in Switzerland like a fine watch. Features flexible micro-thin contour head with self-sharpening blades. Guaranteed for one year. Service and parts always available throughout the United States. An amazing low price for a wonderful shaver. Order today!

STEVENS INDUSTRIES
 Dept. PM-8, New Goshen, Indiana

Paint STRIPES with New "PAINT PEN"!

Straight, Curved or Parallel Lines

Use like a fountain pen with any color paint to stripe furniture, bikes, autos, model planes, toys, linoleum, wall board. Beautiful clean, crisp results every time. Can't clog or smear. Also use with glue, tempera, textile paint or ceramic under glaze. Paints on wood, glass, plastic, metals, fabrics and paper. Tool complete with tip for 1/16" stripe only \$1.00 post-paid. Other complete tools with following tips, 1/64", 1/32", 3/64", 5/64", 3/32", 5/16" — \$1.50 each. Extra tips 15c each. Entire kit with tool and 7 tips—\$5.00. A 1/4" tip only \$1 each. COD's postage collect.

New! "DOUBLE-STRIPE" 5 Way Combination Model only \$2.95

Double Stripes— one wide and one narrow or two wide or two narrow at the same time. **FREE**— Send postcard for complete information **\$2.95**

DEALERS: Master Paint Stripping Tool in display cartons of 1 doz. FAST, Profitable seller. Write for discounts.

HOME CRAFTSMEN! New Paint Stripping Tool gives "professional" results every time, simple, easy to use. Send \$1.00 now

MANUFACTURERS: Write today for information about industrial and production stripping tools.

WENDELL MFG. CO., Dept. 38
 4234 Lincoln Ave., Chicago 18, Ill.

WHOLESALE TOOL CATALOG

UP TO 50% OFF

MAKE EXTRA MONEY

Start Your Own Business

Sell tools part time, full time. Save money for your Industrial and Institutional use. A MILLION DOLLAR INVENTORY AT YOUR FINGERTIPS.

Buy NATIONALLY ADVERTISED hand tools, hardware, fans, motors, power tools, paints, etc., NO INVESTMENT REQUIRED. Buy as you need it. Up to 50% DEALERS DISCOUNT.

Send \$1 Deposit for Dealers Card and multi-month dealers catalog. \$1 refunded on first purchase or returned if you are not 100% satisfied.

SILVO HARDWARE CO., Dept. PM-8, 108 Market St., Phila. 6, Pa.

OWN YOUR OWN BUSINESS!

Repair electrical appliances of friends and neighbors.
 Service electrical equipment in factories, stores, etc.

New Shop Method home training system. Rush name today for FREE BOOK and special form for getting Electronic kit, illustrated instructions on new easy payment plan. Pay us later with your EARNINGS WHILE LEARNING.

CHRISTY TRADES SCHOOL 4804 N. Kedzie Ave., Dept. D-4803, Chicago 25

Say You Saw It in Popular Mechanics

HELPFUL BOOKS

Send post card asking for FREE catalog
 Popular Mechanics Press, 200 E. Ontario, Dept. 601, Chicago 11

MAKE \$5 PER HOUR WITHOUT A PRINTING PRESS

PRINTING

REVOLUTIONARY NEW SCREEN METHOD

PRINT colorful signs, posters, banners, fabrics, wall paper, show cards—ANYTHING! Print on any surface. NO printing press or special equipment is needed with this amazing "approved" new printing secret. 300% profit on nearly every job. Easy to learn. —NO EXPERIENCE or art ability necessary. Exceptional opportunity. Complete illustrated detailed plan and colorful sample FREE—Write:

SCREEN-PRINT COMPANY, Dept. 28
 15127 S. Broadway, Los Angeles 61, Calif.

EARN AT HOME
 SPARE or FULL Time

FREE complete "BIG MONEY" Plan and SAMPLE!

HIGH WAGES!

Are being paid to Operators of Bulldozers, Draglines, Back Hoes, Earthmovers and Motor Graders. Contractors want our graduates. Learn these skills NOW

National School of Heavy Equipment Operation
 P.O. Box 8243-D2, Charlotte, N. C.

Please send me your School Catalog FREE

Name _____
 Street Address _____
 City _____ State _____

BETTER JOB, BIGGER PAY

Learn How You Can Win A

Today, choose the career you want and prepare for success during spare time at home. Or if you are in work you like best, start training at once for quick promotion and higher pay. For

- Accounting
- Architecture & Building
- Automotive Technician
- Bookkeeping
- Business Management
- Civil Engineering
- Drafting
- Electrical Engineering
- Electronics—Industrial
- High School Courses
- Mechanical Engineering
- Plumbing—Practical
- Private Secretary
- Salesmanship—Outside
- Sheet Metal Work

58 years American School has helped many, many thousands of ambitious persons to make their dreams come true—important positions, high incomes, job security. List at right contains only a few of many big opportunities we offer.

For FREE career information, send us your name and address and tell us which opportunity subject you prefer. Do it TODAY.

AMERICAN SCHOOL, Dept. 6C45, Drexel & 58th, Chicago 37, Ill.
 Canadians: Write American School, 1610 Sherbrooke W., Montreal

If you put a thermometer in your engine . . .
 . . . you would get this "inside story" on the AC Hot Tip!



Install
 a new set of
HOT TIP



every
 10,000 miles!



AC Insulator Tips Get Hot to Stay Clean Longer!

When each cylinder fires . . .

AC Spark Plug tip temperatures rise rapidly. At these temperatures, carbon and oil deposits are burned away as soon as they form.

Exhaust stroke . . .

AC's thin-tip design allows combustion left-overs to be cleared away by a cyclone of hot, swirling gases.

AC Insulator Tips Cool Fast to Avoid Pre-ignition!

Intake stroke . . .

The rushing intake of cooling gas drops tip temperature of thin-tip ACs faster and farther than is possible with thick-tip plugs.

Compression stroke . . .

AC Spark Plugs, with low insulator-tip temperature at this point, vastly lessen chances of pre-ignition—a common problem with ordinary plugs.



AC SPARK PLUG DIVISION
 GENERAL MOTORS CORPORATION

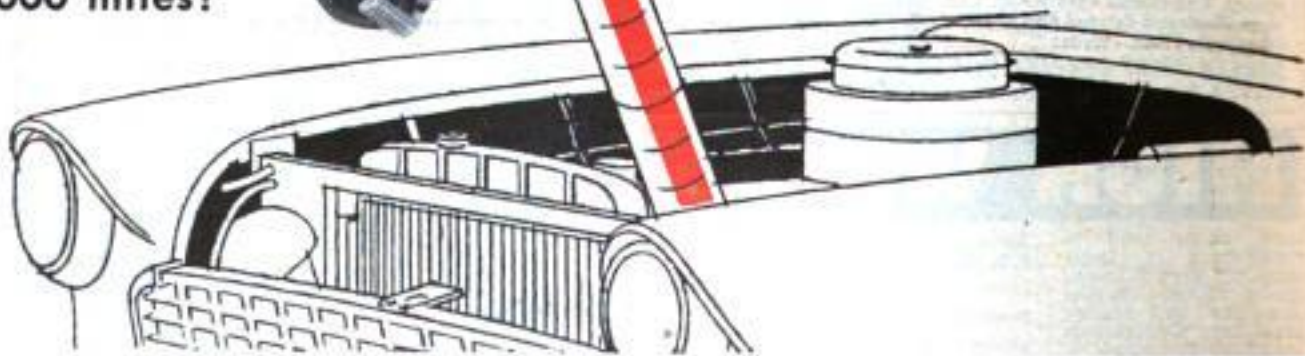

POPULAR AUGUST 1955 MECHANICS

WRITTEN SO YOU CAN UNDERSTAND IT
VOL. 104 NO. 2

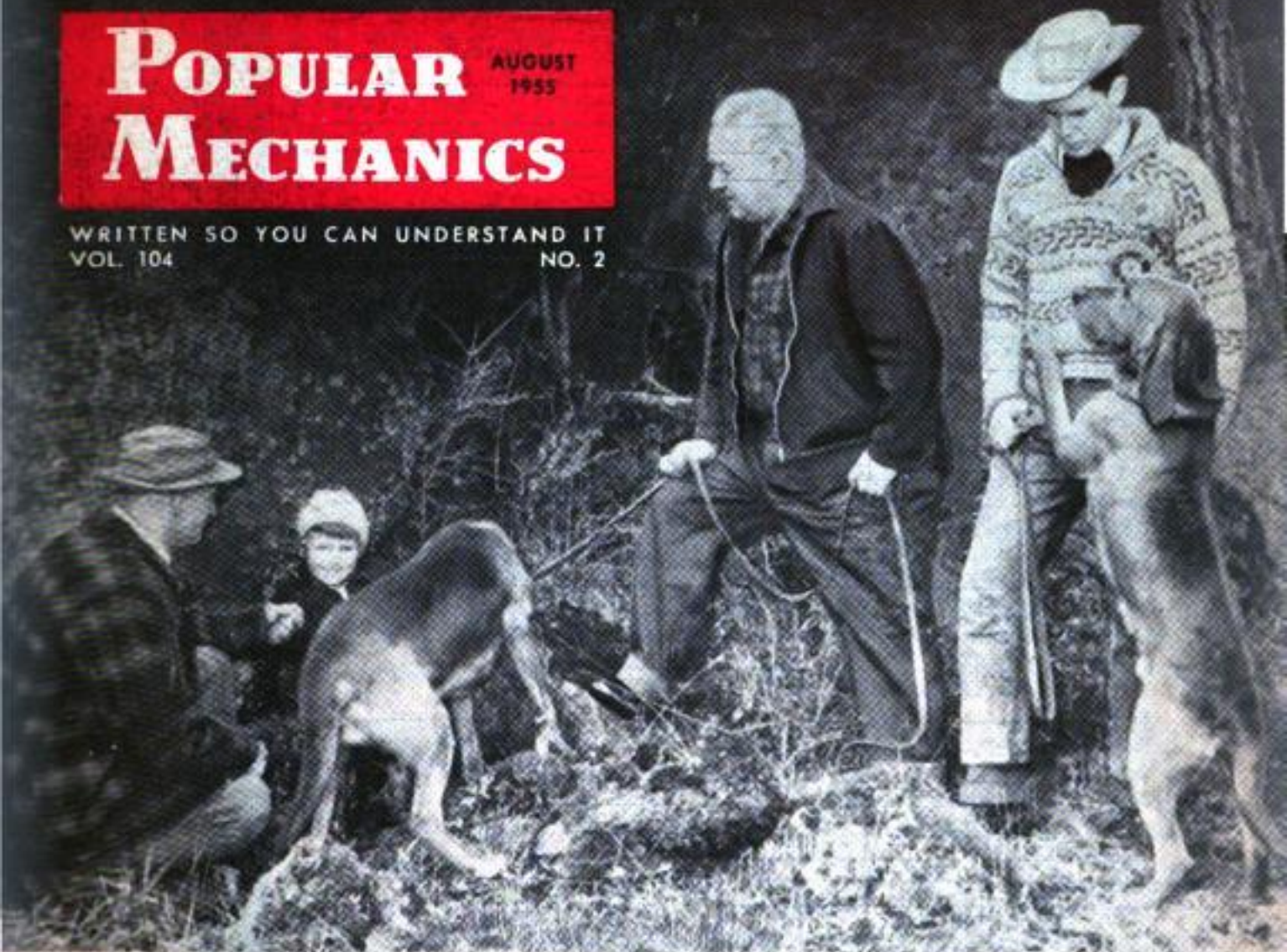

South Vancouver Island Rangers with the help of their bloodhounds find a little girl lost in the woods

Rangers on the Trail of the Lost

By Carson Kerr

FIVE O'CLOCK in the afternoon of Thursday, Nov. 11, 1949, was a momentous time for William Reader. As dusk rapidly descended and rain began to fall he realized that, for the first time in his life, he was hopelessly lost in the woods. An hour earlier, he had separated from his son, William, Jr., and headed for the spot where the younger man's motorcycle had been parked, intending to rest and wait for him there. However, after leaving a logging trail to take what he thought would be a short cut, he had twice traveled in a complete circle. Now, the only thing that seemed familiar to him was a large, lightning-blasted Douglas fir that he had just sighted for the second time.

The Readers had left their home in Victoria, British Columbia, that morning to go deer hunting in the rugged Vancouver Island mountains north of the city. By nightfall the pangs of hunger were gnawing at the 49-year-old father and he managed to make a meal of berries from spiny salal vines but was unable to find any dry wood for a fire. Cold and tired, he took refuge under a big cedar tree, where he spent a sleepless night.

Shouts and shots having brought no response from his father, young Reader had returned home and enlisted the aid of a friend. The two searched without success through the night and were joined by a dozen neighbors in the morning. That

INFORMATION

Submitted by WM. READER JR.
 State Relationship SON

Name WM. READER SR.
 Age If Minor, State age in Years and Months 49
 Sex M
 Address COLWOOD
 Height 5'10" Weight 160 Color Eyes BLUE Color Hair GRAY
 Physical Description GOOD
 Mentality SOUND
 Disposition CHEERFUL
 Habits and Hobbies FISHING - SPORT & COMMERCIAL
 Time of Last Meal THURSDAY NOON
 When Last Seen 4 P.M. THURSDAY (LOST 2 DAYS)
 Where Last Seen APP. 2 MI. WEST OF MILE 34 - C.N.E.

By Whom Last Seen SON, WHO HAD BEEN HUNTING WITH HIM.
 Direction of Travel GENERALLY S.E.

Customary Playground X
 Clothing Worn, Describe Color BRN. JACKET, RED SHIRT, DARK TROUSERS, CHECK CAP.

Shoes in Detail BOOTS, LEATHER SOLE & HEEL

Food and Equipment Carried (Ammo in rds.) NO FOOD
CIG. LIGHTER - 25 ROUNDS.

Woodsmanship Ability CONSIDERABLE EXPERIENCE

Knowledge of Area SLIGHT

Knowledge of Firearms GOOD

Swimming Ability "

Special Remarks LEFT SON AT R.R. TO GO TO MOTORCYCLE AT POINT SHOWN. NOT CARRYING COMPASS.

Recorded by

R.C.M.P. Signature

Capacity

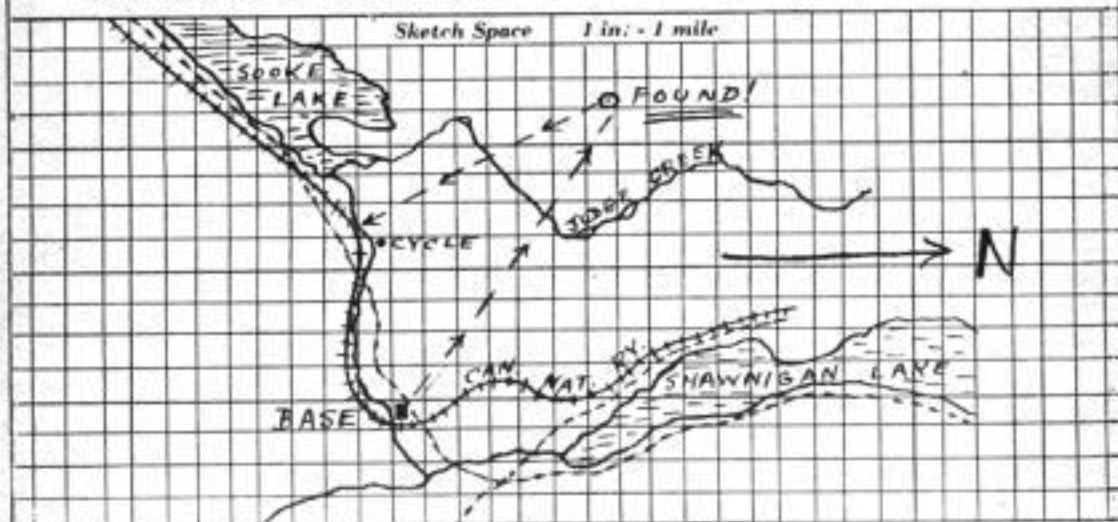

Rangers' file on rescue of William Reader (see text) includes detailed questionnaire

Panel truck that converts to field ambulance is used by rangers to rush emergency cases to hospital





This seagoing diesel-powered craft is owned by the ranger organization and saves lives of fishermen

afternoon, Reader repeatedly responded to their calls but the searchers were so confused by echoes that they came no closer to finding him than the night before. Twenty-four hours after his father's disappearance, Bill, Jr., notified the police and almost immediately a call went out for assistance from the South Vancouver Island Rangers. The members of this sportsman's service club had won local laurels for locating lost persons and been recognized for their vast knowledge of Vancouver Island. Their emergency squad set up a search base that evening and, at 7:30 Saturday morning, 27 experienced woodsmen wearing the luminous hat badges of the SVIR started combing the heavily wooded area where Reader's gunfire had been heard:

Friday afternoon, the harried hunter had finally started a fire, which he kept alive through the night despite continuing rain, but not before a thorough chill had reduced his voice to a whisper. Unable to answer the calls he heard on Saturday, he fired 27 shots to guide the searchers, keeping his remaining three cartridges in case he should see something he could kill for

food. Oddly enough, if he had fired them, he might have been located a lot sooner. The rangers had gradually separated the echoes from the real thing and were rapidly approaching him when his rifle fell silent. Weak and hungry, Reader saw his fire go out. He began to lose heart and soon lapsed into semiconsciousness.

At nearby Shawnigan Lake, rangers remaining at the search base debated the advisability of using the bloodhound they'd flown in to the area. They decided against it. The combination of the tramped-over

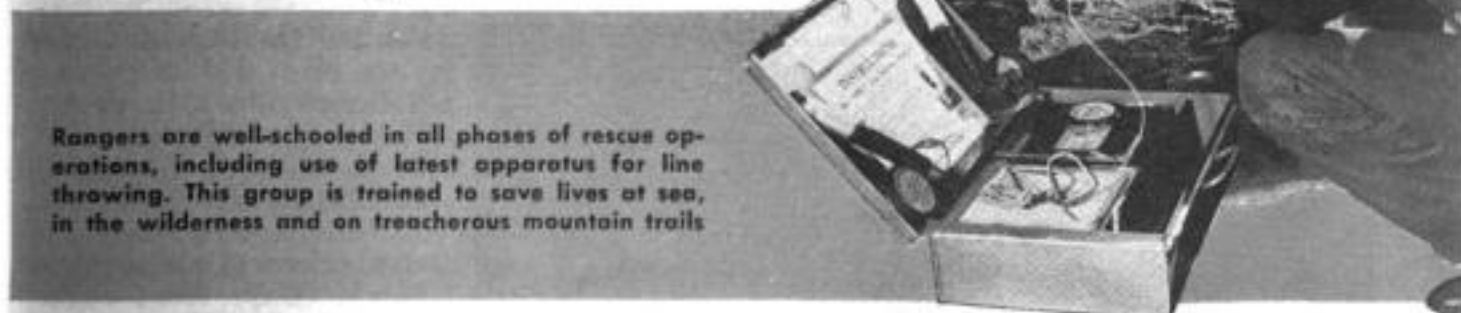

Rangers are well-schooled in all phases of rescue operations, including use of latest apparatus for line throwing. This group is trained to save lives at sea, in the wilderness and on treacherous mountain trails



One of the group's bloodhounds arrives by ranger plane for tracking duty near lake in remote wooded area

trails, rain and the wearing of some of Reader's clothing by members of his family engaged in the search would make the dog detective's work extremely difficult. They were on the point of contacting SVIR headquarters in Victoria to give the green light to the stand-by searchers when they received a call from a walkie-talkie in the field.

"We've found him!" an exultant ranger's voice crackled. "He's in bad shape. We'll do what we can for him here and then take him out to the logging road. It's going to

be a slow tug, though, so don't expect us for at least an hour."

Although they traveled only three miles to reach the ranger ambulance (a converted panel truck), it took the stretcher bearers more than two hours because of the ruggedness of the terrain. Given oxygen en route, Reader was rushed to his home, to which his family physician had been summoned. The doctor pronounced him out of danger, but expressed his belief that a few more hours in the woods would have meant death from exposure. Apart

Tired rangers carry a rescued hunter on stretcher over rough terrain. It took the rangers two hours to travel three miles to the ambulance



from the time element, the big storm that broke the following day would have hampered search efforts to such a degree that it is doubtful whether even the rangers could have succeeded. As it was, they found him less than four hours after taking up the search.

The Reader rescue marked the first time the SVIR were credited beyond all doubt with spelling the difference between life and death. However, they've cheated the Grim Reaper on several occasions since then.

More recently, they rescued Peter Davidson of Maple Bay, Vancouver Island, a man in his

seventies who was in no condition to survive even a single night outdoors. Wandering into the woods while out for a walk, he was lost for 36 hours and was close to death when discovered by rangers and rushed to a hospital. He had disappeared during late afternoon and a volunteer search party had failed to find him that night and the following day. Called in on the case the second night, SVIR searchers used their bloodhound, Sir Roderick of Ogden. Working on a cold scent, he caused some concern when he led them far from the area where it was expected that the elderly man would be found. Encouraged by finding where Davidson had obviously spent the night, they pushed on until midnight, when their elation changed to dejection and doubt. Sir Roderick had led them from a well-traveled trail into timber thick with undergrowth, which seemed an unlikely course for the missing man to follow. Nevertheless, the search was successfully concluded soon afterward.

"Our hound was nose to the ground," reads the official ranger report of the incident, "when we heard the old gentleman call feebly from the bushes, about 15 feet to one side. While some of the men cut through in the direction of the sound, the dog circled the bushes and came upon him a minute later. The spot where he was picked up was approximately six miles from the original area of intensive investigation. Several authorities have assured us, and we ourselves have every reason to believe, that a life would have been lost if at least a few of us hadn't persisted in believing that Sir Roderick knew his business."

The headquarters of the SVIR, in the basement of a centrally located service station, boasts a fat file of successful search case histories, totaling more than a hundred. The rangers have engaged in almost every type of emergency work, in cooperation with the Royal Canadian Mounted Police and military, game and forestry officials, and haven't yet chalked up a failure. Their peacetime service to British Columbia communities, combined with the wartime record of their charter

(Continued to page 238)

AUGUST 1955



Rangers are using walkie-talkie equipment to coordinate the efforts of search party. Below, rescued man receives oxygen



Army Troop-Cargo Carrier Rolls on Rubber Pillows



Eight giant air pillows take the place of tires on the experimental "Teracruz," a cargo and personnel carrier built for Army Ordnance. The tire bags, inflated to a pressure of three to five pounds, swallow up surface irregularities to give the springless 20-ton vehicle a safe and comfortable ride over all types of terrain. The four trucks on which the carrier rests can be tilted forward or backward 10 degrees so that half of the bags act as compactors in

snow and soft terrain. Air pressure in any or all of the bags can be changed by the driver while the carrier is in motion. The Teracruz is propelled at speeds up to 25 miles per hour by rubber-coated steel rollers resting on top of the bags. The machined rollers mesh with the tread of the bags to turn the pillow wheels. A driver and an observer-navigator man the vehicle, which is powered by an air-cooled, 8-cylinder, 340-horsepower engine.



Net Clamped to Side of Boat Holds Fish and Two Rods

Performing double duty, a new net not only holds the angler's catch but also supports two fishing rods. The net is clamped to the side of the boat with one of its two 12-inch supporting rings under water. The angler drops his catch into the net to keep the fish alive. He also can slip the two fishing rods through steel rings, which hold the rods in fishing position.

"Perfect" Iron Crystals Produced in Laboratory

Slivers of iron so pure they can be considered "perfect" have been produced in the laboratory. Scientists at Westinghouse Research Laboratories have made the pure iron in crystals up to two inches long and $\frac{1}{1000}$ inch thick. Tests show that the crystals have a breaking strength of almost 1,000,000 pounds per square inch—10 times the strength of ordinary iron which has been drawn into wire.

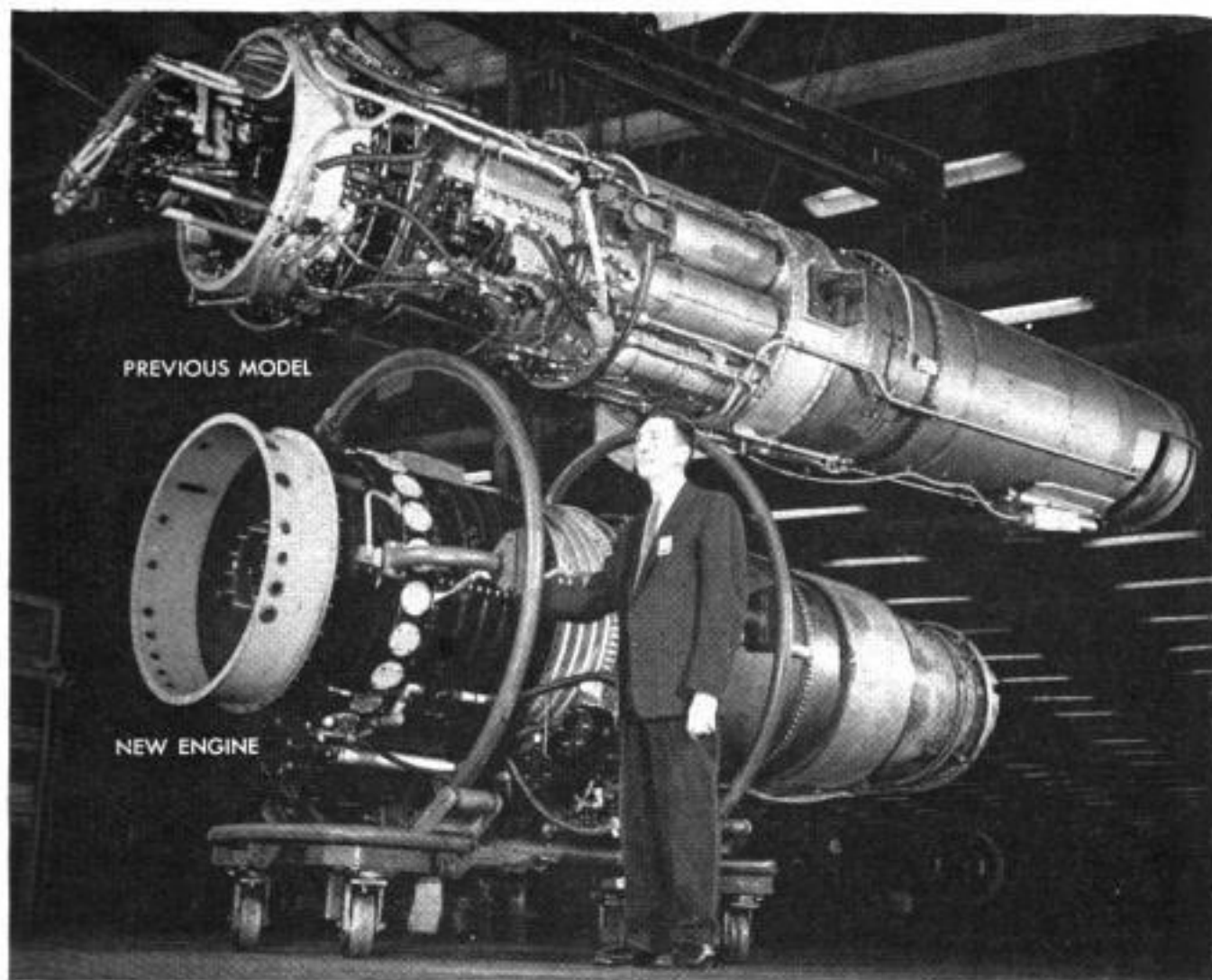

Turbojet Engine Is 50 Percent More Powerful Than Famed J47

Out of wraps is General Electric's J73 turbojet engine, which has the same diameter but is 50 percent more powerful than the company's battle-tested J47 jet. The J73, which powers the F-86H Sabre Jet, is in the 9000-pound-thrust class and has a lower specific fuel consumption than the

J47. The "cannular" combustion system of the J73 has a single combustion space containing 10 individual "cans." A two-stage turbine is connected to the 12-stage compressor, which forces air in great quantities to the combustion section. Warm air forced into the hollow nose combats icing.

Floor-Tile Adhesive Applied With Brush

You can apply a new adhesive for floor tile with an ordinary paint or whitewash brush. The adhesive, designed for use by the homeowner, requires no troweling. It is used to bond vinyl-asbestos tile to concrete latex underlayment and plywood. Resistant to water, heat and alkali, it can safely be used over concrete on or below grade. One gallon covers 250 square feet.



Sources of available products described in this issue are listed on pages 58, 60 and 62. Sources of further information on other articles are listed in our free WHERE-TO-FIND-IT LIST. For your copy just write to the Bureau of Information, Popular Mechanics, 200 East Ontario Street, Chicago 11



Prospectors depart for the wastelands at dawn. The equipment atop the lead Jeep detects radioactivity

OLD-TIME PROSPECTORS in the rugged wastelands of the Rio Grande Valley are somewhat startled when they see the latest uranium-hunting equipment whiz by. Francis K. Campbell of Houston, Tex., has fitted out a two-Jeep caravan with everything he needs for fast but thorough prospecting of the desolate terrain.

Campbell believes he has the answer to many problems unique to the task of seeking out precious uranium ore. He's testing his belief across 100,000 acres of barren land where his own airborne explorations have revealed promising radioactivity.

The big problem is to pinpoint the source of radioactivity and determine whether it indicates uranium. Atop the cab of his pilot Jeep, Campbell has installed a detecting device that not only reports radioactivity but whether the rays are of the type produced by uranium. The findings are recorded on a moving graph beside the driver's seat, so Campbell has a continuous check as he drives across the hills and through rocky gullies. A direction finder enables him to follow a charted course across desolate terrain without missing any sector of the area.

Through his radio Campbell maintains constant communication

Uranium Hunt by Jeep

Even the modern prospector must use some shoe leather to check hot spots with a geiger counter and to pick up rock samples



with Henri P. Kaseoru, his assistant in the second Jeep. This eliminates stops for instructions or course changes. The second Jeep is the work horse that goes into action when explorations on foot with a geiger counter have confirmed location of a hot spot first indicated by the detecting device on the lead Jeep. The second Jeep has a diamond-bit drill, operated by the power take-off, which brings up deep rock samples. It also has a plow attachment to turn up rock beneath the topsoil.

Campbell points out that the clicking of the geiger counter frequently means nothing more than false hopes and wasted time, as radioactivity doesn't necessarily mean uranium. In the pilot Jeep Campbell carries such equipment as a microscope, a fluoroscope and a chemical assay kit for on-the-spot analysis of the hot spot.

Prospector Campbell estimates that with his Jeep caravan he will be able to conduct a thorough search of 100,000 acres in a little more than three months. He figures the same job would take years with the prospecting methods of yesterday, and even then there would be no assurance the uranium hunters had not passed up valuable deposits tucked away in some nook or cranny of the vast terrain. ★ ★ ★



Jeep's interior is packed with instruments. Beside the driver is a moving graph that continuously records the radioactivity. ↓ Campbell subjects a rock sample to a check with a fluoroscope. Jeep also carries a microscope and chemical assay kit



Plow on second Jeep is used to turn up rock samples. Prospectors use diamond drill to bring up deeper samples



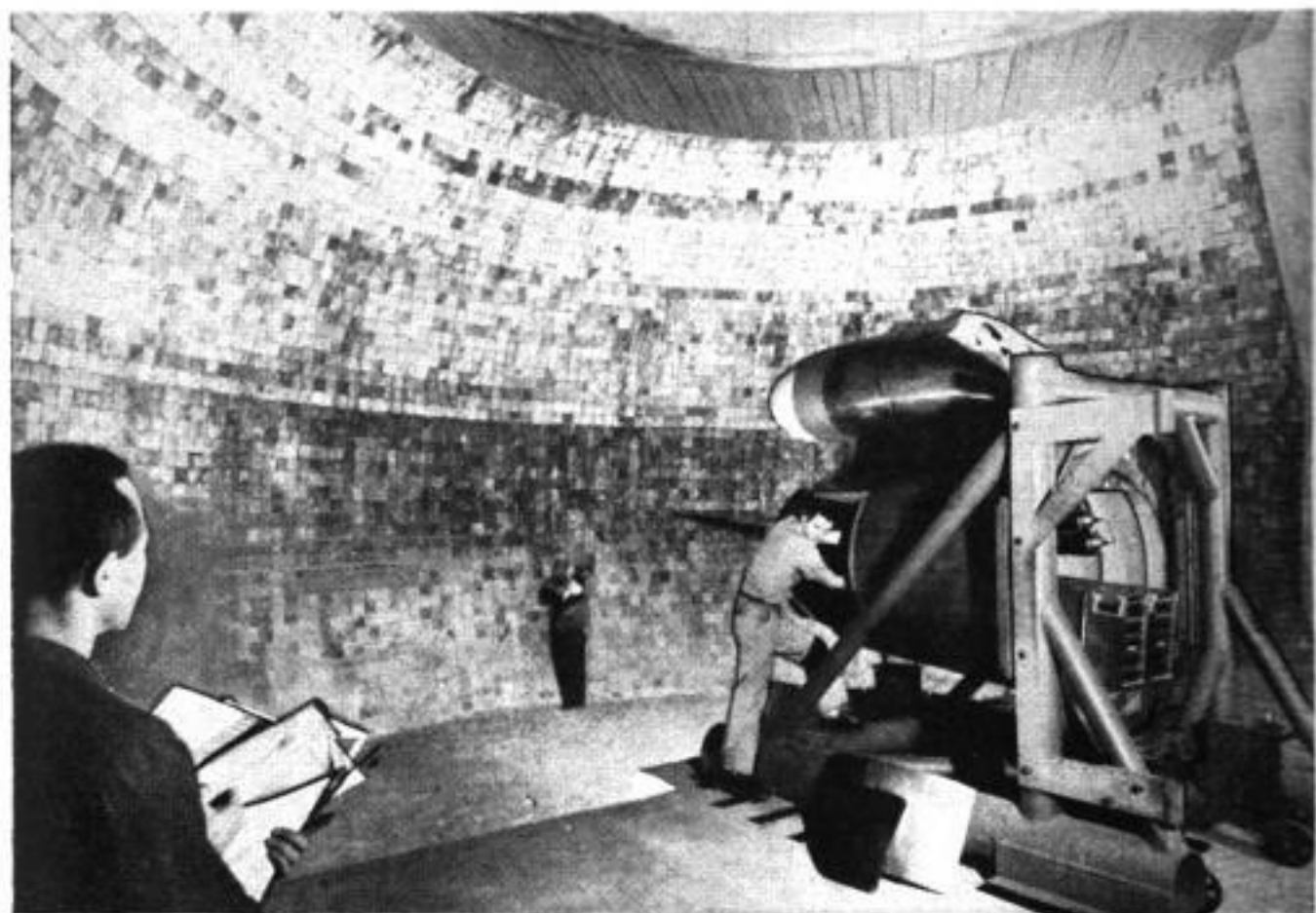

Eight-Foot Timbers Line Air Force All-Angle Firing Range

What look like tiles in a new close-quarter firing range are actually the ends of 8000 eight-foot timbers. The all-angle firing range, as it's called, will be used

to test fire-control mechanisms made for the tail "stingers" of long-range bombers. An operator in an observation room controls the firing system electronically.

Rake Attachment Helps Seed

Attached to an ordinary rake, a new tool harrows, rakes and rolls the earth to help in seeding new lawns. The attachment has a crossbar with 14 wooden teeth and a roller. After fertilizer and seed are spread on the lawn bed, the user pulls the rake toward him. The teeth furrow the ground, depositing the seed and fertilizer at the proper depth, the roller completes the job.



Clip for Golf Cart Holds Extra Tees and Balls

Bulging pockets are a thing of the past with golfers who employ a clip to carry extra balls, tees and a pencil. The clip clamps to the handle of any caddy cart and holds two balls and five tees. Made of durable plastic and available in three colors, it can be attached quickly to handles of various sizes. No provision has been made for a score card, since this is flat and easily carried in a pocket.

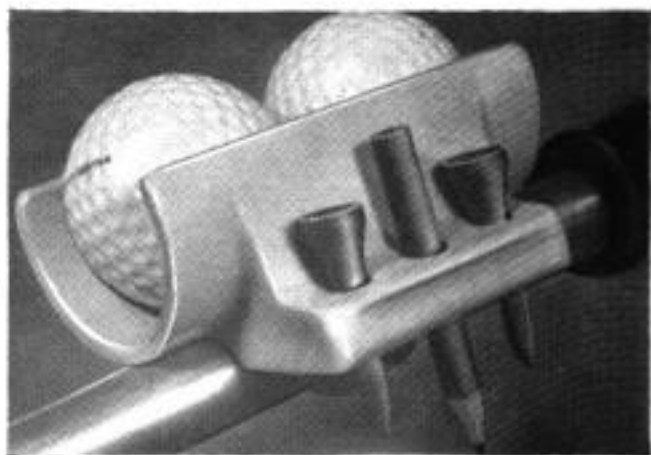



At start of high-altitude flight, little rocket plane is dropped from bomb bay of B-29 at 30,000 feet. Below, author gets help in shedding his "space" suit

Maj. Arthur Murray has flown a rocket plane higher than any other man. This is the story of his record flight in the X-1A

IT'S LONESOME UP IN SPACE

By Maj. Arthur Murray, USAF

I HAVE BEEN farther from the earth than any other human, out where the blazing sun is almost blinding and you see the ground through a haze that turns the mountains a dark, olive drab and makes brown fields appear a brilliant straw color.

I'm one of the rocket pilots at the Air Force's flight test center at Edwards Air Force Base in California.

Our job is to find the safest ways of flying the new supersonic aircraft that are powered with rocket motors. The planes are shaped like bullets with tiny wings. You get the feeling that you are actually riding an artillery shell during a flight. Because of their tremendous speeds, brand-new flight problems have been encountered.

One of these problems involves the loss of controllability at higher flight speeds.

One of the first men to encounter this problem was Maj. Chuck Yeager. He was

AUGUST 1955

75

Copyrighted material

90,000 FEET
STRATOSPHERE

POINT OF MAXIMUM ALTITUDE

45,000 FEET
TROPOSPHERE

BEGIN DESCENT, POWER OFF

COURSE OF HIGH-ESCORT CHASE PLANE

SLOW TO
SUBSONIC SPEED

SEA LEVEL

SANTA BARBARA

riding the X-1A at about 1650 miles per hour when the plane began a violent fish-tailing that slammed him around in the cockpit, finally knocking him out. Still traveling like a bullet, the plane plunged 50,000 feet while Yeager was regaining consciousness and getting control again.

I have flown faster than 1400 miles per hour myself, and I too have flown into the region of uncontrollability. But with the slight modifications to the plane that Yeager recommended and the changed flight technique I worked out, I was never

in what could be called real trouble.

Another problem I've encountered arises from the sensation of weightlessness that occurs when "going over the top" in a ballistics-type flight path. This is very confusing. You find it hard to tell up from down, you have a feeling you are in an uncontrolled fall, you tend to clutch at

Band of frost on plane shows that fueling with liquid oxygen is complete. Plane is hanging under B-29



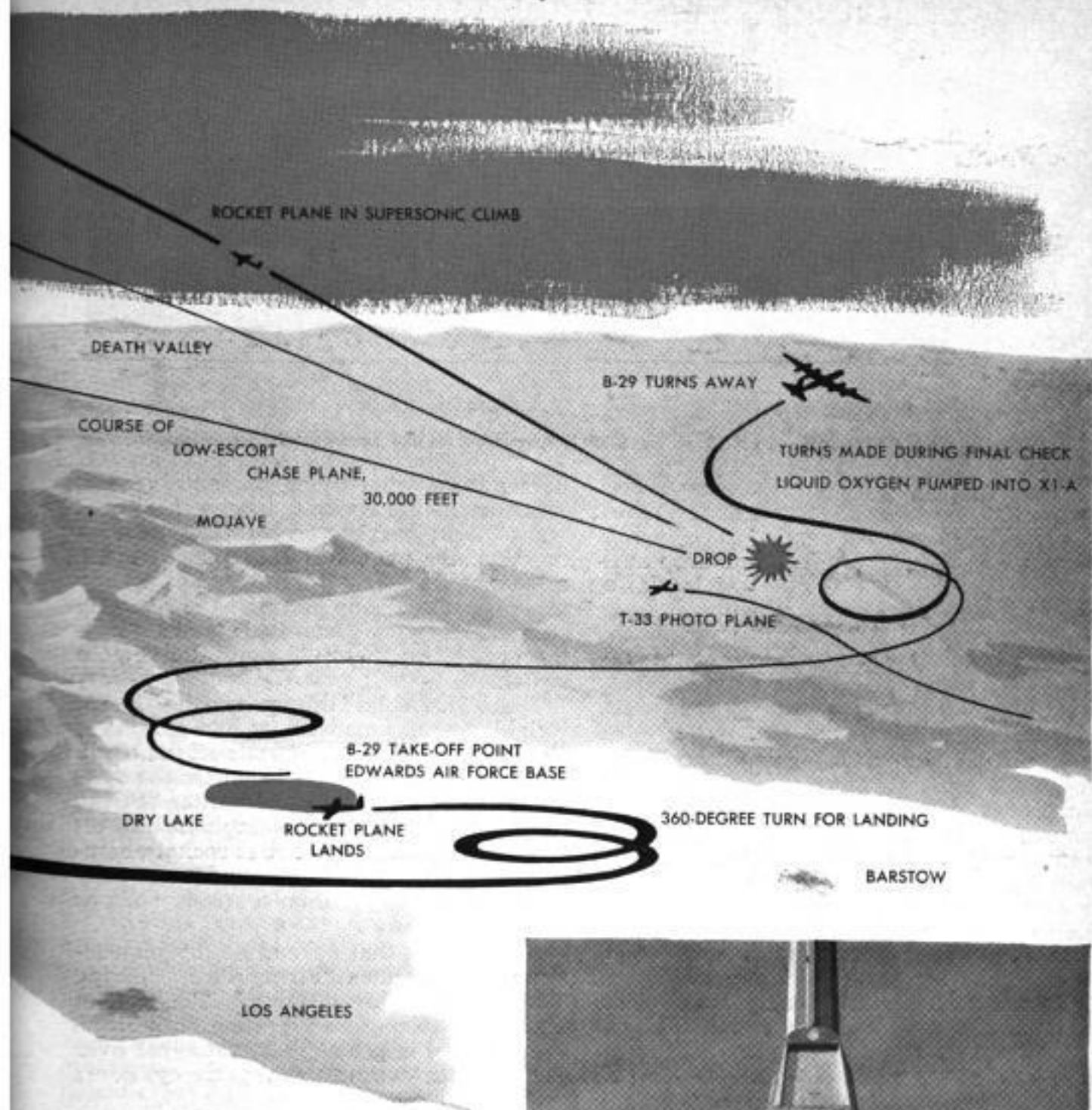

things and make jerky motions. That's the last thing you should do, actually, for the plane also is affected by weightlessness and you can lose stability if you give the controls a quick jerk. We try to stay away from completely weightless situations.

No official figure on the altitude I've reached has been announced though newspapers have estimated that I've been higher than 90,000 feet, some 17 miles above sea level. But without discussing classified information I can give you a good idea of what a high flight is like.

X-15 barely clears the ground when both planes are fueled and ready for take-off

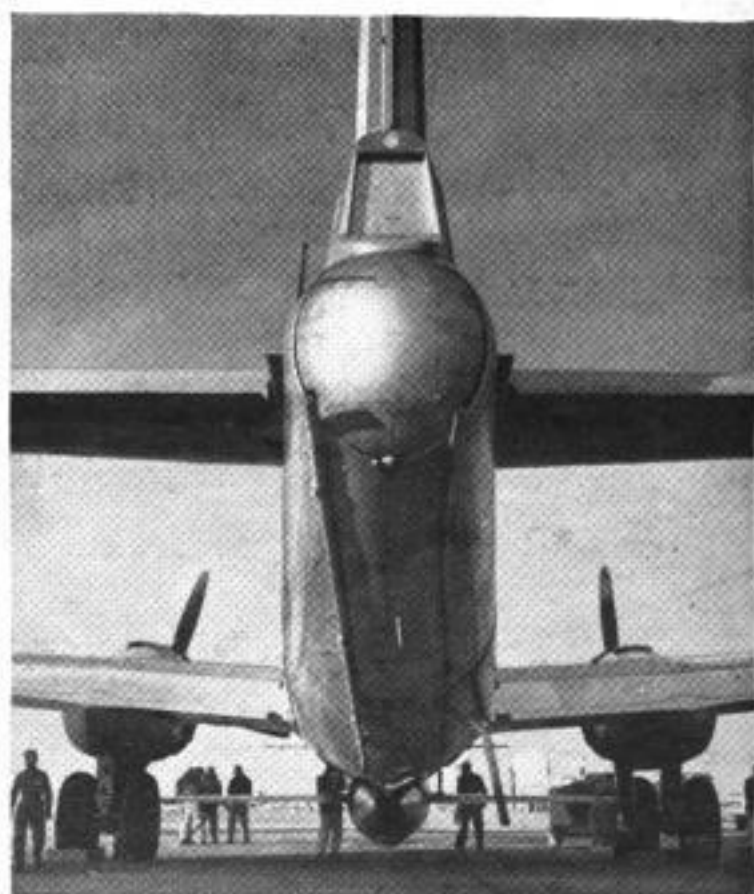



Cloud of frosty vapor rises from the X-1B as the B-29 is towed out to the runway just before the take-off

At the start, I'm sitting in the pressurized cockpit of the Bell X-1A research rocket plane while it is being carried in the bomb bay of a B-29 to 30,000 feet, our drop altitude. I'm wearing a G-suit that is also a space suit complete with pressure helmet and face plate. Strapped to my chute is an oxygen bottle that will inflate the suit and thus pressurize my body if I have to bail out. Without this pressure my blood would boil in the thin upper air.

The X-1A and its sister ship, the X-1B, are each some 35 feet long with a wing span of 28 feet. Each plane has a skin of polished duralumin and has the general contour of a .50-caliber bullet. Each is powered by a Reaction Motors rocket motor with four firing chambers. The chambers may be operated singly or simultaneously. The motor burns a mixture of water and alcohol, using liquid oxygen as an oxidizer. The motor develops some 6000 pounds of thrust, which is equal to 12,000

Author has climbed into the cockpit from inside the B-29, and an airman slides the cockpit canopy forward onto the rocket plane



horsepower when flying at sonic speeds.

Sitting in the cockpit, I keep the green "drop" light burning on my panel and on the repeater panels in the B-29 carrying me aloft. The light indicates that all my pressures are steady and that I'm ready to go. Suddenly my green light winks out as the copilot on the B-29 pulls the release switch.

There's a solid thump as the X-1A, weighing eight tons with its 2000 gallons of fuel and oxidizer aboard, rolls off the bomb shackles and falls away. I'm out in the open now, under the B-29, and I mutter "Firing Number One" into the microphone and hit the firing switch for the first rocket chamber. There's a grinding sound caused by the turbine pumps, then a steady roar as the fuel ignites.

At intervals that depend on my instructions I'll announce "Firing Two," "Firing Three" and "Firing Four." The rocket plane will keep on accelerating until all its fuel is gone. This takes just over four minutes when all cylinders are blasting.

There's a slight buffeting and jarring as the plane accelerates through the speed of sound and then, quite suddenly, the noise of the rocket motor dies out. I'm traveling too fast for the sound of the motor to reach me. I can still hear the fuel pumps at work. The radio seems quite loud in my ear-phones. It will be quieter still when I turn off the fuel pumps for then I'll hear only the whine of the instrument inverter, a small motor in the cockpit.

By now I am well up into the stratosphere. Visibility is unlimited but I'm nevertheless flying on instruments. The nose is at too high an angle for lining up with any features on the ground, and

there's too much to do inside the cockpit to spend much time sightseeing through the canopy. Most of the impressions of the sky and the earth that I have were gathered inadvertently during moments before the onset of the controllability problems.

I know that the sky seems black at, say, 15 miles up but I'm principally aware of the blinding sun. It lights up the cockpit so brightly that I can't read the climb schedule on my white knee pad. On my record altitude flight, instead of white paper I used a sheet of gray cardboard cut from a shoebox for the knee pad. It looked blue in the upper air.

Probably we will tint the upper portions of our face plates in the future to reduce this solar glare. Dark goggles would be better but it could be dangerous to wear them. They are apt to be thrown around if the plane gets into violent buffeting and you can't reach inside the face plate to adjust them.

Traveling out away from the earth, there's a feeling of lonesomeness that's easy to understand. You are very much aware that you are exploring a new region of space and that you are completely on your own. There isn't a chance of outside help in case of trouble. Yet everything that is possible is done to protect the research pilot.

I can still communicate by radio, for instance, and other aircraft are standing by at lower altitudes. A T-33 photo plane and an F-86 low escort were right beside me when I dropped from the B-29. The F-86 pilot chased me as well as he could. A second F-86 was already on station higher

up to provide high escort and was moving at top speed toward my point of maximum altitude.

Both F-86 pilots watch my vapor trail while the rockets are blasting; afterward they follow me by radar. Both meet me at the descent area. Watching me as closely as possible, either might be able to give advice if something seemed wrong.

On the test flight that I made to learn the plane's maximum altitude I stole a little time from the instruments for a look around outside. The horizon seemed to be bent, and, of course, it was, for I could see the gentle curvature of the earth.

There was a low band of haze over the ocean. I could see mountains in the San Francisco area almost 400 miles toward

(Continued to page 234)



Major Murray examines the exhaust nozzles of the four rocket motors after a flight. The four motors can be fired one at a time or simultaneously

Dead-stick landing is a ticklish job. Pilot of escort "talks down" author by judging distance of X-1A from its shadow

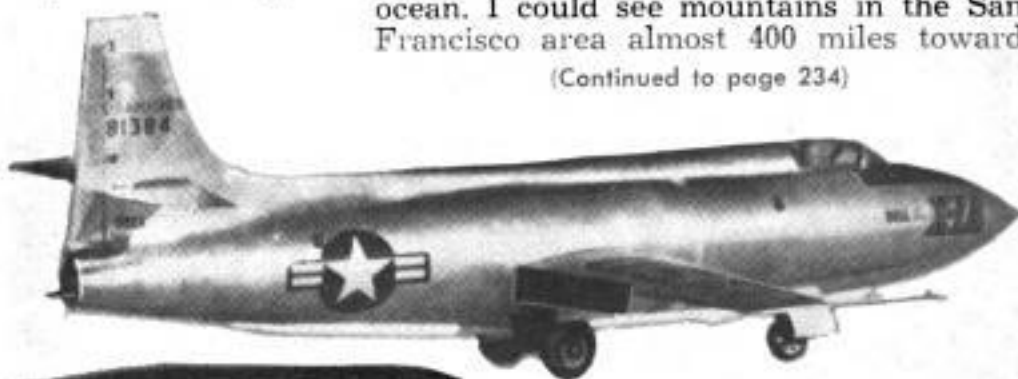

You can swap shoes for shells,
stamps for stones at Milwaukee's

TRADING POST FOR JUNIORS



On an average trading day the museum plays host to 300 youngsters who come to swap everything from rock specimens to football uniforms. Below, an assistant trader dickers with customer over a sale of stamps



By Benn Ollman

OLD-FASHIONED THRIFT, modern merchandising and 20th-century educational ideas mingle at a trading post that lures hundreds of boys and girls to the Milwaukee Museum.

Transactions are handled on a barter basis, in a modification of the method followed in the trading post set up many years ago by Solomon Juneau, Milwaukee's first white settler. Juneau, in his log-cabin store, made handsome profits by exchanging rifles, cloth and trinkets for the red man's furs.

The patrons of the new trading post, who range in age from 8 to 16 years, conduct their commerce along more modern lines.

Youngsters are paid for their wares in trading-post money (this is a dollar), use it to buy other items



Counter of the trading post is lined with customers on the first Saturday of every month. Boy in plaid shirt is exchanging unwanted rock for a fistful of trading cash

They bring in their possessions for appraisal and receive payment in trading-post dollars, or "tepee money." With this currency they can buy items on display in the trading post's showcases. The post is open only the first Saturday of each month, but then it is jammed with youngsters eager to trade their wares.

The post was started in 1951 by Donn Brazier, scientific assistant on the staff of the Milwaukee Museum. Brazier hated to see duplicate material and museum discards tossed out, for he knew that a foreign stamp or a fossil rock worthless to the museum could start a child on a valuable lifelong hobby.

He opened the post in October of 1951. Attendance the first day totaled eight, but now it averages 300, with about 900 trading-post dollars changing hands in a typical day. Six boys and girls, under Brazier's supervision, act as assistant traders in appraising, selling and making inventory.

Stamps and coins are the items most traded. Youngsters are also encouraged to bring in sea shells, insects, minerals, fossils, American Indian curios, foreign items and scientific objects. The highest price ever paid for an article was \$45 in tepee money for a stuffed partridge. The only toys accepted for trade are educational ones like Erector sets, word games, magic tricks, model airplanes and handcraft sets.

"We frequently take in trade a lot of stuff we can't use," says Donn Brazier, "because we hate to disappoint any of our customers." But comic books and weapons are banned.

An exception to the rule occurred not long ago when some moppets tried to cash in on a loaded hand grenade that had been lying around the house. It was quickly exchanged for a nonexplosive toy. ★ ★ ★

Sea shell, right center, is traded by a boy who will use trading money received to buy a new item. Crowd of customers, right, includes a boy with a set of football shoulder pads. Athletic gear is in demand



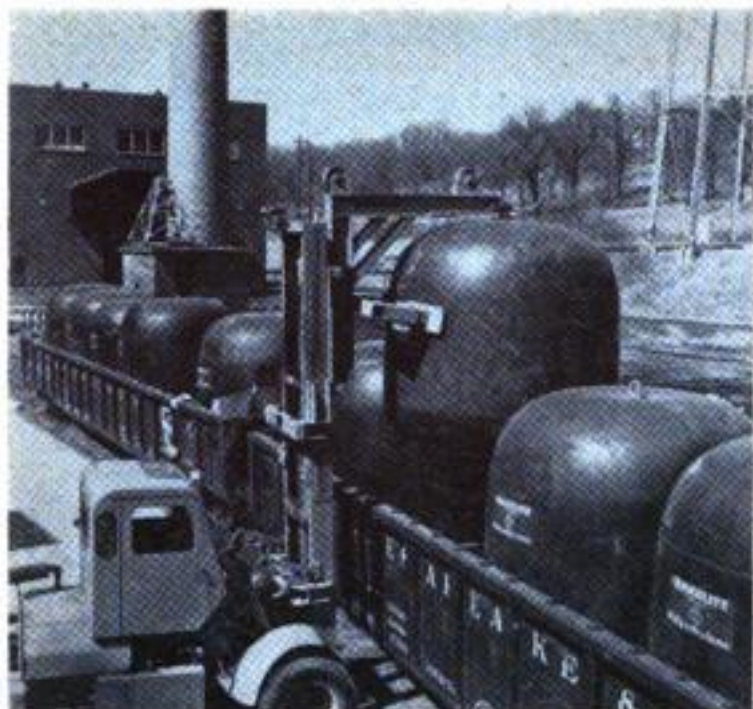

Rubber Tanks for Shipping Save Labor, Protect Materials

Huge rubber shipping tanks handled by lift trucks are speeding the transportation of materials. Loading a gondola freight car with the collapsible tanks takes only half a man-hour instead of the 16 man-hours required to load an equal volume of materials packed in paper bags. Each 300-cubic-foot

container holds the equivalent of 190 paper bags. The units withstand high pressures, resist puncture and protect the enclosed materials against air, water and contaminants. When the tanks are empty, they can be collapsed and stored outside, thus saving storage costs.

Italian Motorcyclist Sets Records Lying Down

Looking more like Superman than a cyclist, Orlando Ghiro rode his tiny 75-cubic-centimeter motorcycle at 84.151 miles per hour for a new record in Rome, Italy. Once the ride begins, Ghiro lies prone atop a shell that covers everything except the front wheel. He covered the one-mile standing start in 56.01 seconds for an average of 64.277 miles per hour. The 84-mile-per-hour figure is for the flying mile.

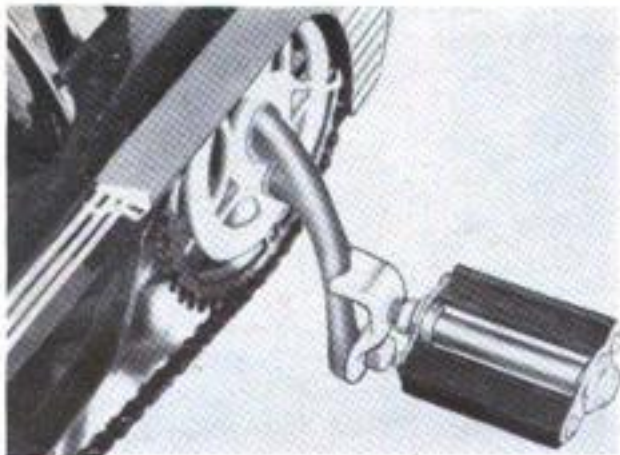

Adjuster for Bicycle Pedals

Bicycle-pedal level is easily adjusted with a device that raises the pedal socket. The adjuster fits into the threaded socket of any American or foreign bicycle, and can be installed quickly without special tools. Use of the adjuster eliminates bulky rubber blocks.

Consumption of butane and propane gases as motor fuels rose to 625,000,000 gallons in 1954, powering 200,000 tractors, 2500 buses and 9200 highway trucks, stationary engines and lift trucks.

Portable Television Set Weighs Only 34 Pounds

You can easily carry a 34-pound TV set designed for use in hotels, school dormitories, trailers and hospital rooms. The set has a 14-inch screen, is 17 inches deep and 10½ inches high. It has a vertical chassis and over half of the circuit is printed. A folding antenna attached to the back of the case pulls in nearby stations.

Rubber "Concrete"

"Concrete" made with rubber by a new process is so flexible that a long thin slab can be bent in a circle by hand. Yet it carries heavy loads without cracking or showing wear, is waterproof and slip-proof. Designed for industrial flooring, the mixture comes in two parts, the cement powder and a liquid rubber, and is prepared like ordinary concrete. It can also be used for patching damaged concrete and in waterproofing the interiors of storage tanks.

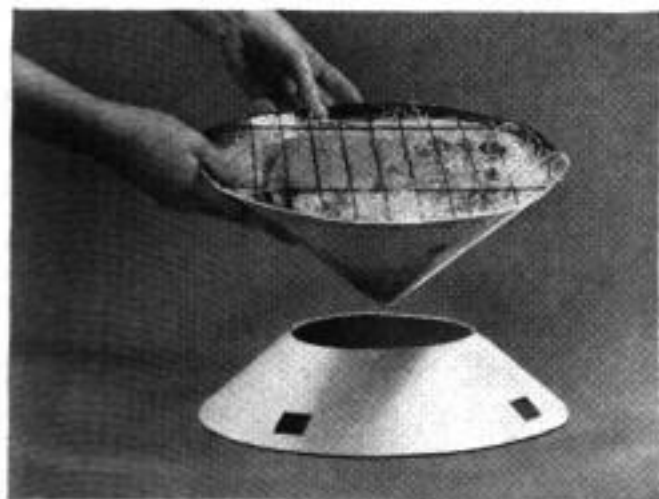

Disposable Barbecue Grill Comes Equipped With Fuel

Asbestos coated with aluminum foil forms a portable barbecue grill (left and below) that is thrown away after it's used. The unit comes complete with excelsior for easy starting and enough charcoal to burn for over an hour. It consists of a cone resting on a circular holder and a rack for several frankfurters or ribs.



Robot Train Announcers Take Over in England

Human train announcers at Stratford Station in London have been superseded by an automatic address system. Announcements for various trains are recorded on a continuous loop of magnetic tape. The right announcement for an incoming train is pre-selected by a member of the station staff, and when the train approaches the station it closes a track circuit connected with the signaling system, which switches on the tape recording heard over a public-address unit. This gives the platform number at which the train stops. When the train stops at a platform, it operates an adjustable delay relay to stop the tape for a specific lapse of time. Then the automatic address system reproduces another section of tape which tells the stations at which the train will stop.



TRAILER KIT includes all parts needed to build unit. Buyer supplies tires and makes built-in furniture



Land Cruiser Division, Chris-Craft Corp., Algonac, Mich.

The two-wheeled trailer is covered with aluminum sheeting, weighs 1070 pounds, is 12 by 6½ feet in size

Kit and Caboodle

FOUR-FOOT BOAT made from kit is model of Chris-Craft Corvette. All parts are die-cut or shaped; all are internotched for good fit. Boat easily holds motors or radio gear

Sterling Models, Belfield Ave. & Wister St., Philadelphia 4, Penn.

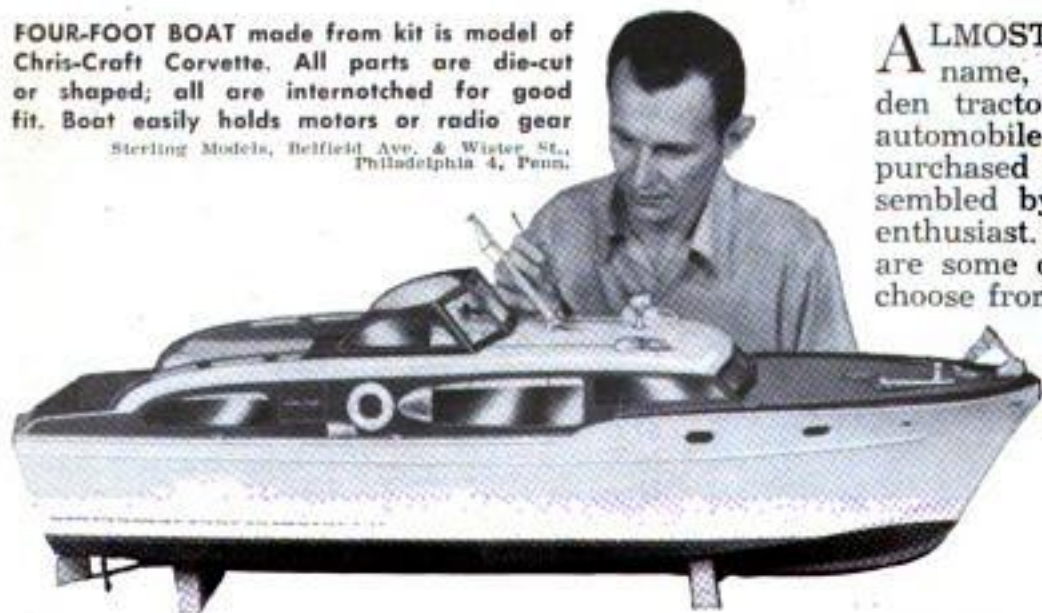

ALMOST any item you can name, whether it's a garden tractor, a garage or an automobile trailer, can now be purchased in kit form and assembled by the do-it-yourself enthusiast. On these four pages are some of the kits you can choose from.



GLASS-FIBER repair kit patches auto fenders, boats, downspouts or toys. It includes Fiberglas cloth plus a resin and a setting agent
 Fiberglas Evercoat Co., 7008 Reading Rd., Cincinnati 37, Ohio

TRACTOR assembled from kit powers lawn mower, pulls various yard and garden tools. Tractor and mower are assembled from package that includes all parts down to the last bolt

Belsaw Machinery Co., 315 Westport Rd., Kansas City 11, Mo.



LAWN SPRINKLER system is installed underground in a few hours. Fittings, pop-up spray heads and 80 feet of flexible plastic pipe are included in the package

Anesite Co., 3575 Touhy Ave., Chicago 45

LOCKS are installed with a kit loaned by hardware stores to home craftsmen. It includes all the tools used by professional locksmiths

The Yale & Towne Mfg. Co., Chrysler Bldg., New York City 17





STEPLADDER made of aluminum is put together with a screwdriver. The ladder is lightweight and sturdy, designed to outlast wooden counterpart. The top step of ladder is handy tray for nails and tools

sky Service Corp., Highway 57 at Municipal Airport, Evansville, Ind.

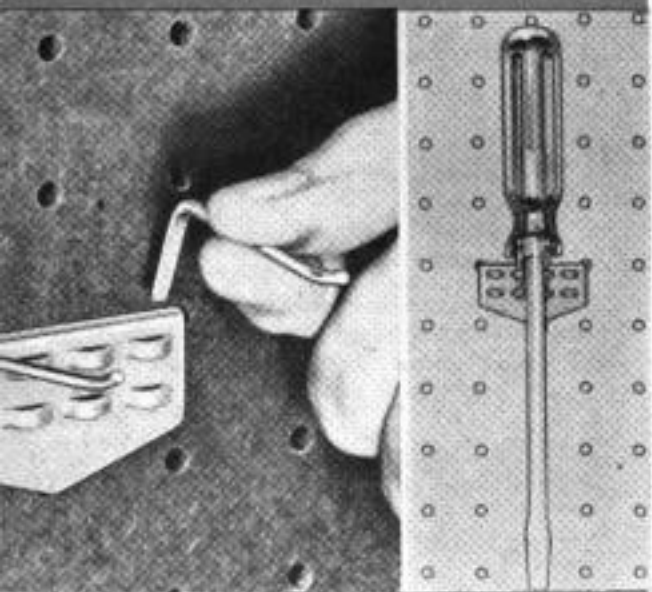
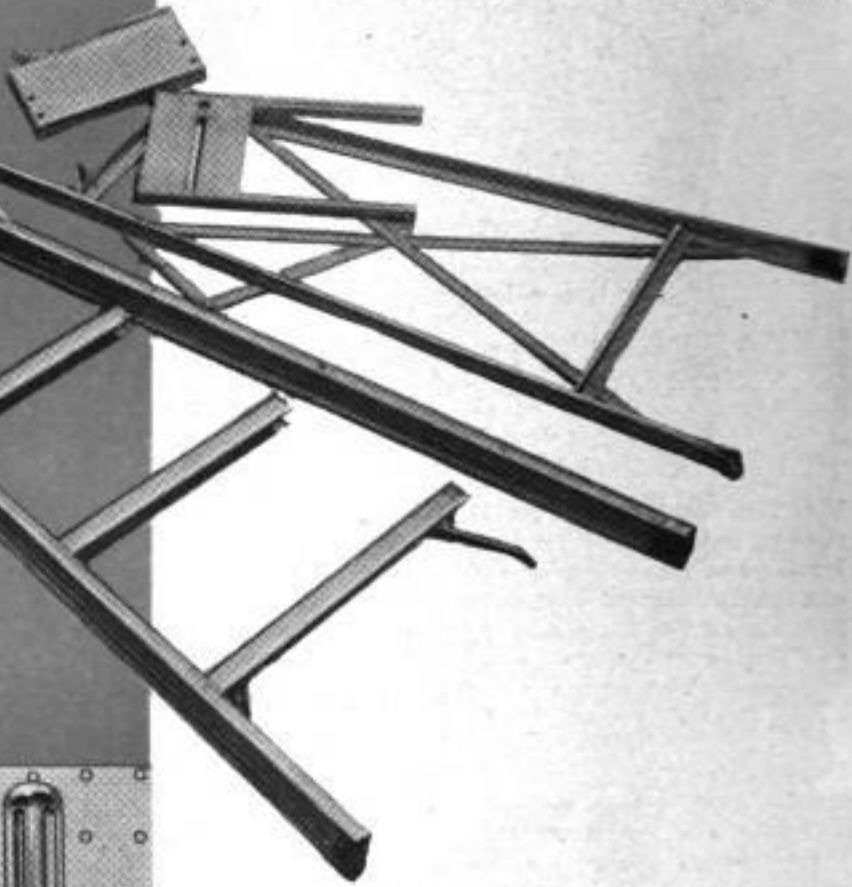

SCREWDRIVER set includes six screwdrivers of various kinds, a perforated tool board, and eight brackets from which tools can be hung. The tools rest on hanger hooks which slip into bracket slots

Vaco Products Co., 317 E. Ontario St., Chicago 11

PRECUT WORK BENCH is put together with just a hammer, a screwdriver and a simple blueprint. The six-foot bench is made of select wood and contains special racks and shelves to hold the various tools

Atlantic Engineered Products, Inc., 1041 Dixwell Ave., Hamden, Conn.

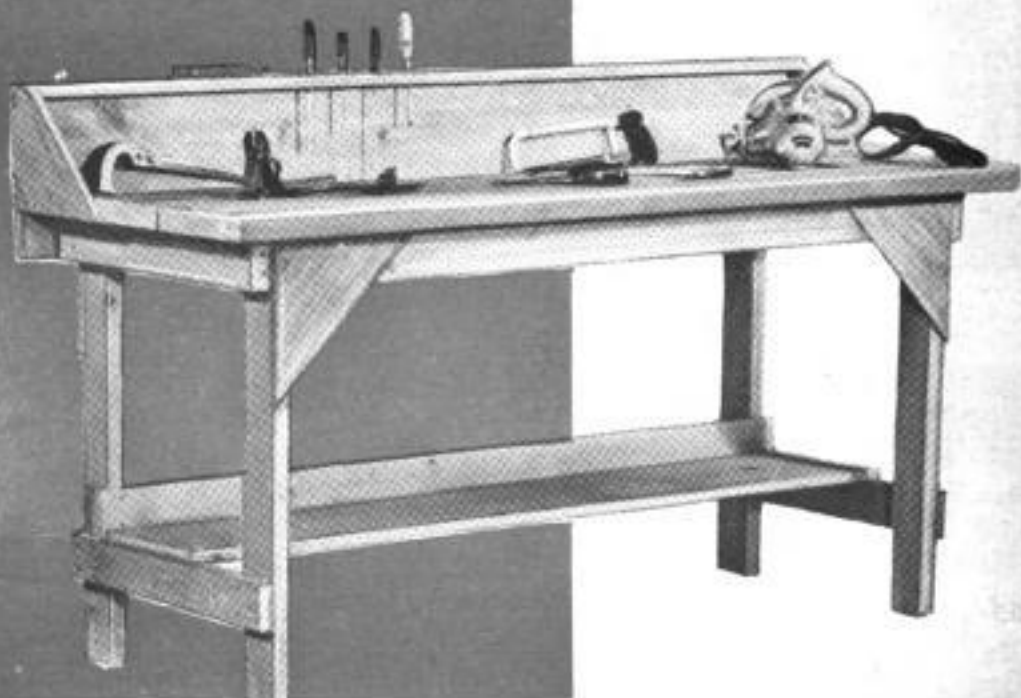

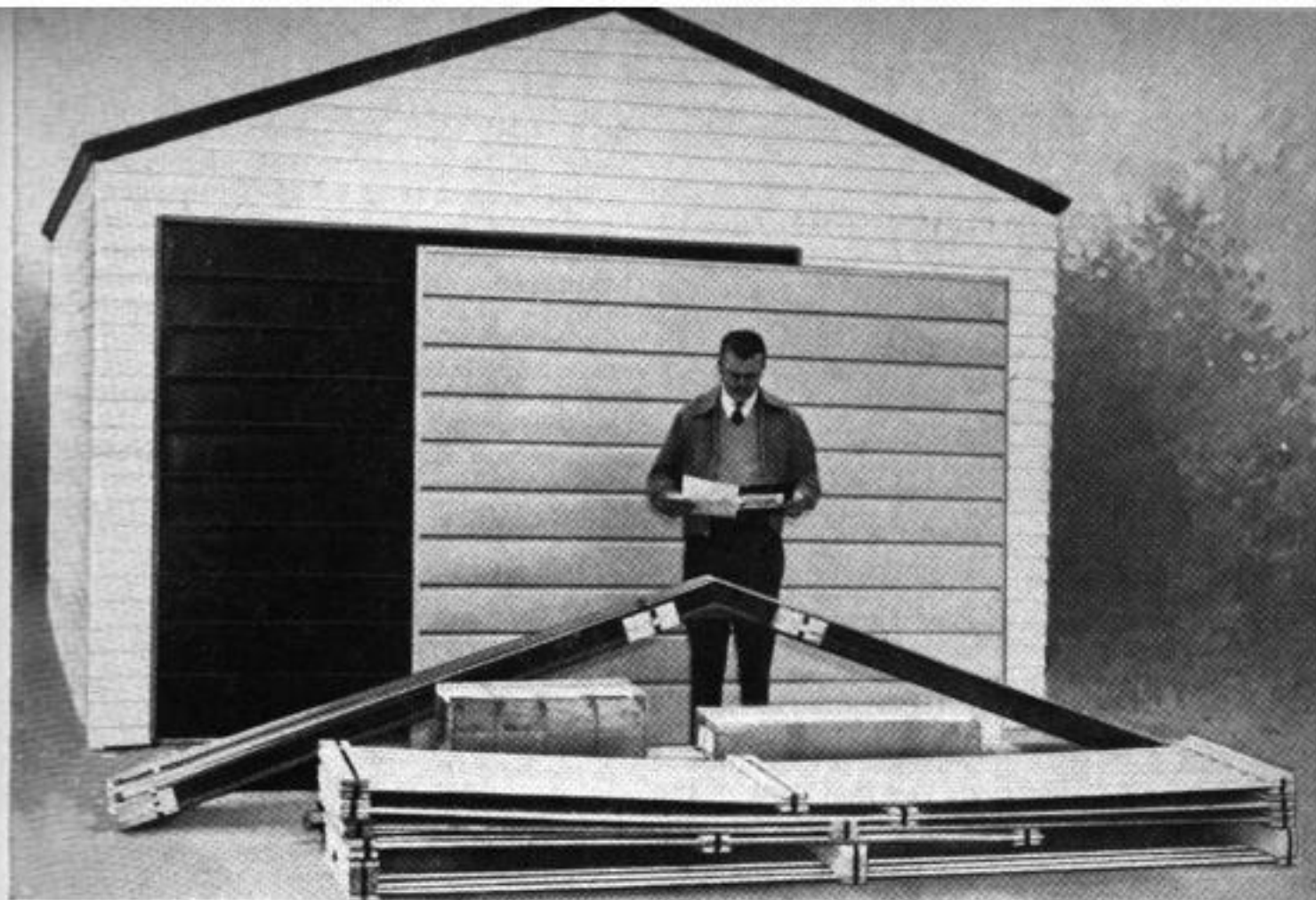

STEEL GARAGE can be erected in a few hours. Roof and the clapboard-style siding are simply nailed to the special steel framework. Package includes all parts

The Steelcraft Mfg. Co., Rossinoyne, Ohio

LAWN MOWERS are converted to electric power with a simple kit that includes a motor platform, pulleys and a belt system. Any $\frac{1}{4}$ -horsepower electric motor is used

Motron, 5212 Foothill Blvd., Oakland 1, Calif.

ATTIC FAN big enough to cool average house is built from furnished parts and powered by small electric motor. The 30-inch horizontal fan has hardboard blades

Fan Kit Co., Box 5842N, Memphis 4, Tenn.

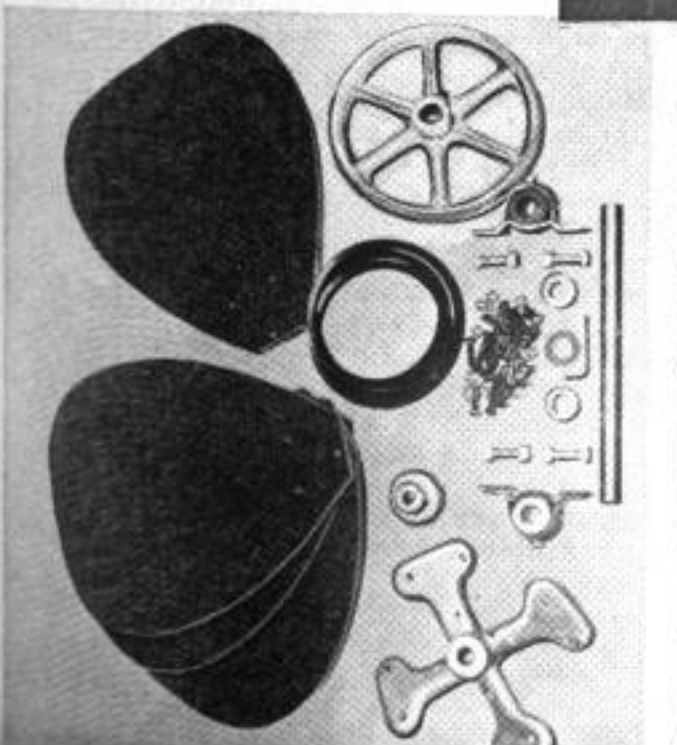
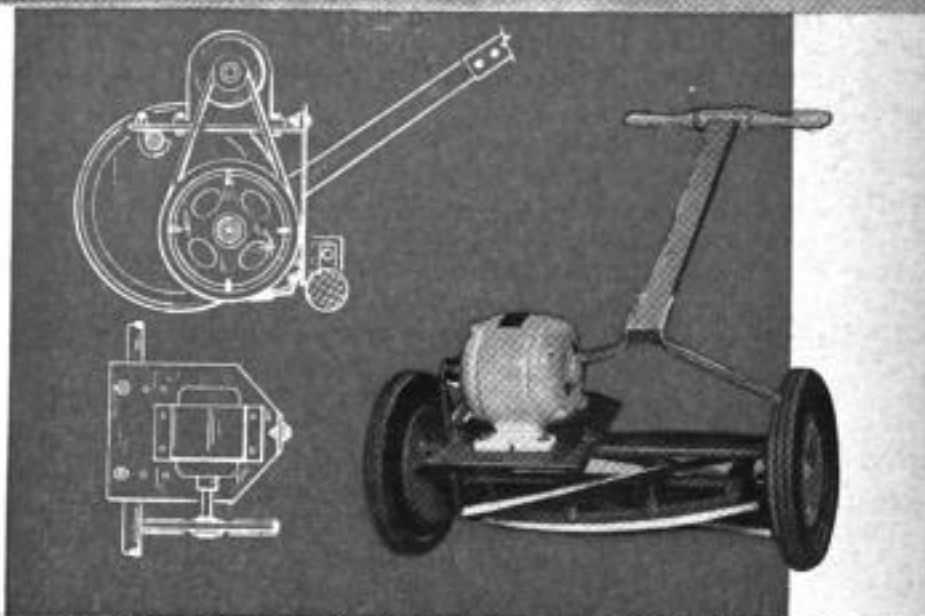

Copyrighted material

Detroit Listening Post

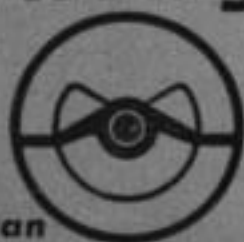

By Leo Donovan

ROLLING AT A HIGH but controlled pace, the automobile-engine race will continue. You can expect engine performance to improve with each year's new models. The industry's engineers can be expected to chart a step-by-step course in their planning for higher and higher compression ratios in engines of the future.

Your memory tells you that none of the passenger-car engines have declined in compression ratios, and few have remained static. The 1956 models will follow the same upward pattern. Engines will have faster acceleration throughout the entire speed range. But it's all carefully plotted and measured.

The Ford Motor Co., for instance, isn't likely to provide better performance in its Ford cars than in its Lincolns in 1956, any more than GM would offer a Chevrolet that would outperform a Cadillac.

Automotive engineers, working with petroleum-industry engineers, see no sudden jump to 10-to-1 compression ratios because the necessary higher octane fuel won't be available. Some refiners already have begun marketing 98-octane gasoline, a development that wasn't expected until 1960. But the 10-to-1 compression engine will require a fuel of about 100 octane.

Automotive engineers are learning a lot about "building higher octane numbers" into the engines themselves—designing combustion chambers so that higher compression ratios may be had without boosting octane requirements of the gasoline very much.

In experimental engines, combustion chambers have had their shapes altered to resemble pots of many different forms and contours in order to produce more efficient combustion. A combination of more efficient combustion chambers and higher-octane gasolines by 1960 may reach the goal of 12-to-1 compression ratios and a savings of billions of dollars in the nation's annual gasoline bill.

When is the transition to gas-turbine engines coming? Most automotive engineers

tell you the switch is unlikely for at least 10 years—and not then unless cheaper steel alloys able to withstand the terrific temperatures of gas-turbine engines are developed.

Although most 1956-model cars won't be displayed until October and November, the preview season in the industry already is under way. The new Lincoln has been privately displayed, and sneak pictures of prototype models of most cars are circulating in Detroit.

Tool-and-die-shop schedules indicate the following introduction times for the new models: Chrysler, Plymouth, Dodge and De Soto, plus Lincoln and Continental, Studebaker-Packard and American Motors cars in September and October; Buick, Cadillac, Chevrolet, Oldsmobile and Pontiac in October-November, with Ford and Mercury in the same period; the Rambler probably in November or December.

Many old-time dealers tell you that now is the best time of the year to get the most transportation for your money. Factories are slowing down output to give dealers time to clear out stocks of unsold new cars.

All manufacturers agree that the intense competition of 1955 will continue throughout 1956. And by 1957, they say, it will be the fiercest in history. All car makers are preparing for the most extensive changes in their products in the history of the industry, insiders report. There will be completely new body and engine changes in many models, with a wide variety of mechanical innovations, probably including an automatic lubrication system and a centralized hydraulic-power system for operating power options such as power brakes, seats, window lifts, etc.

The cumulative effect of the modified guaranteed annual wage in labor contracts, plus higher wages generally, is expected to be passed on to the customer in the prices of 1956 models. There will be more "face liftings" in the 1956 models, despite the all-time-high investment in tooling costs for current cars.

Having regained much of its lost ground in the sales contest so far this year, Chrysler will press for an even greater share of the market in 1956. Industry speculation has it that eventually Plymouth may become an independent car line instead of being dualed with Chrysler, Dodge and De Soto.

Although the trend toward multicolored cars is expected to be lessened in next year's models, you can expect General Motors to provide an even wider variety of body styles as one result of their expansion program. Cadillac and Chevrolet are likely to have their own versions of the four-door hardtop.

Cone Lays Ribbon of Mortar

Amateur masons can lay a smooth ribbon of mortar along the top of concrete blocks with a new mechanical dispenser. The mortar feeds from a cone-shaped reservoir that rolls along on a guide wheel. The device is said to cut waste by 50 percent and increase block-laying capacity up to three times. Any standard mortar mix is used. The instrument, which largely replaces a trowel, is said to require fewer mortar boards, less scaffolding and cleanup.



Lightweight Plastic Oar Stores Fly Rod in Handle

Oars made of glass fiber won't warp, check or split and never require painting. The handgrip of each oar can be removed for access to a built-in compartment that can be used to store a fly rod. The lightweight oars float and will never become waterlogged. They are available in three sizes and five colors.

Fly rod is inserted in the hollow handle after handgrip is removed. Plastic holder keeps equipment dry

Long-Winged 1957 Constellation Will Fly 6500 Miles Nonstop

Nonstop flights from New York to Rome or from Vancouver to Amsterdam will be possible with Lockheed's newest Super Constellation. Due for delivery in 1957, the 1649A will have a record range of 6500 miles. Serving TWA and Air France on long-distance flights, the craft will carry up to 9600 gallons of fuel. Its four turbo-compound engines, rated at 3400 horsepower, will give it a cruising speed of 350 miles per hour and a top speed of 400 miles per hour. The plane will have the basic fuselage and triple-finned tail of its predecessor. The wing, however, will be longer and more tapering. Sound and vibration will be reduced by larger propellers revolving at slower speeds, and placement of the engines five feet farther out on the wings.

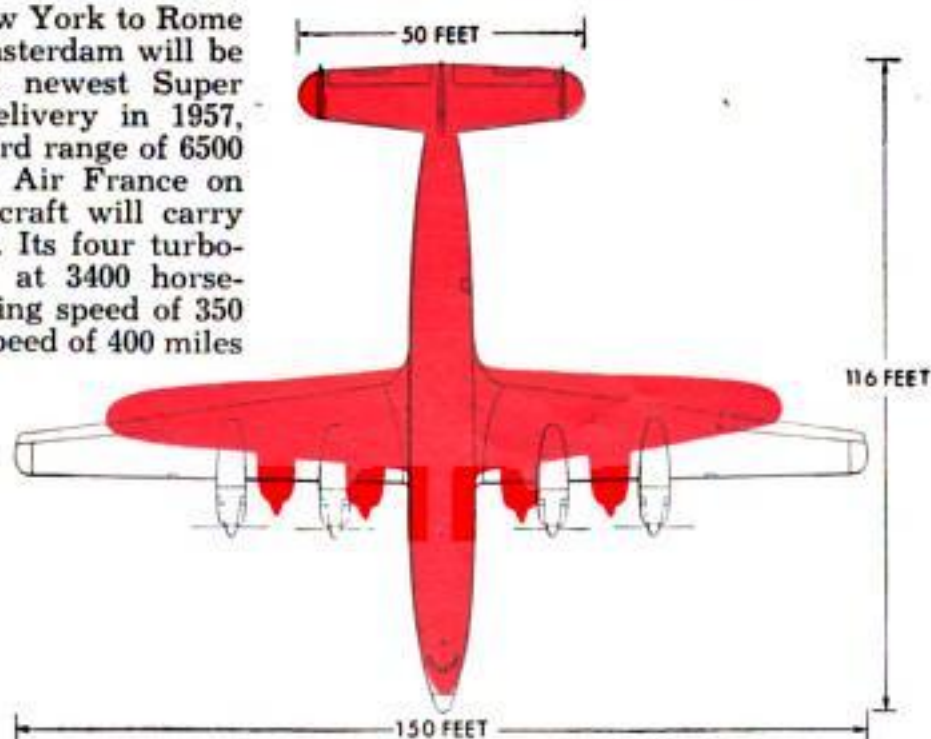



Shop foreman signals to crane operator in suspended cab as 122-ton locomotive in Santa Fe shop is lifted by two giant cranes. Below are signals used by floor men to tell crane operator what he should do

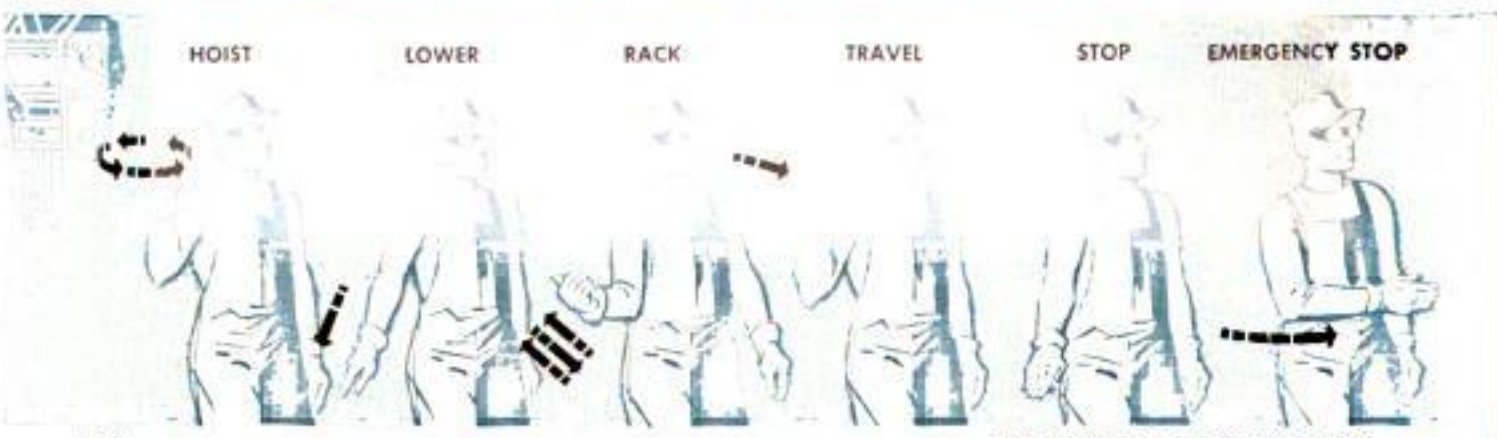



Standard radio-studio signals mean: 1. Program is on schedule; 2. One minute to go; 3. Performance was "OK"

The Sign Language of Industry

By Robert H. Forbes

I'VE BEEN WATCHING Bill's hands for my instructions for 25 years now," says Jasper Hogweide, setter on the No. 2 log carriage at the Northwest Timber Company sawmill, Coeur d'Alene, Idaho.

Nimble fingers of Bill Harris, sawyer sitting beside the mill's No. 2 bandsaw, direct Jasper's shifts of the log-carriage setworks. This machine advances a log a little at a time on the rapidly moving carriage; thus a board of precise thickness is cut on each "shotgun feed" carriage trip to the bandsaw.

Sawyers' hand signals have been a part of American lumbering almost from the first 17th century water-wheel sawmill in Maine. Ever since, the same number and combinations of fingers have meant just about the same things.

An index finger sticking up out of a sawyer's fist means a one-inch cut. Add a protruding thumb to the one-inch signal for "six quarter inches," the sawmiller's way of saying 1½ inches." All five fingers tell the log setter to flip the setworks to five inches.

"Jasper and I have stuck together so long," says Bill, "because it's hard to get into the rhythm for good sawing with a strange partner." Sawyer-setter teams see that each log is cut to its best advantage. They also control lumber flow in the rest of the sawmill, so the two jobs based on hand signals are the most important in a lumber-manufacturing plant.

The continual racket of a whining head saw and a noisy log carriage makes sign-language talk between sawyer and setter necessary. Instruction relay is needed because only the sawyer can see the face of a partly sawed log and know how to make the best cuts.

Various-sized timber in different parts of the country and the number of remanufacturing machines in an individual sawmill have varied the traditional pattern of signals, however. Large logs on the West Coast give a sawyer a real workout. He may have to use his arms as well as the fingers of both hands to tell his partner what to do.

Forefinger and little finger of a sawyer's hand mean a 6¼-inch bite of a log in the big-timber country beside the Pacific Ocean. In Idaho, it signifies a five-quarter-inch-thick chunk of a log.

Crane operator in the Armco steel mill at Middletown, Ohio, is Al West, who watches the hands and fingers of floor-crew men beneath him to know what to do. He then lifts and lowers loads and moves his rumbling giant back and forth 75 feet above its mill-bay floor according to the number and crook of fingers he sees.

Hand signals fly thick and fast at Al's mill, which has 117 different cranes scattered around 50 acres of floor space. There are big ladle cranes to tap furnaces, little ones like the five-tonners in a small bar mill, short ones, fat ones; steam, electric



1. "Cut the coolant!" signals a mill operator at Kaiser's Trentwood aluminum rolling plant. 2. Half a load is signaled by remelt trucker who slashes arm

across waist. 3. Scratching his cheek is operator's way of saying "Adjust scratch brushes." 4. Cupped hand means "Adjust to align rolled edge of sheet"

and diesel cranes that must be directed.

It takes a lot of lifting to make each ton of steel, but directions shouted to a crane man can get mixed up in the din of a busy steel mill. "A floor man sticks his index finger straight up and waves it in a circle, when he has fastened a load under the latticework 'spider' on my rig," says Al. "That means 'lift 'er up.'"

"Floor men have more than a dozen other sign-language motions. A wide circle made with fingers of both hands tells me to go to a rolling mill. Three fingers of one hand in the air indicate the No. 3 machine."

Some of these signal directions are standard throughout the steel industry and elsewhere where large hoists, great distances and interfering noises combine. Other signals are peculiar to the Middletown mill and its crew of helpers.

George Fisher, a Union Pacific railroad brakeman in eastern Washington state, signals with his hands by day and with a lantern by night. Main-line railroad signals are usually made from the rear of a train

toward the locomotive, between train conductor and engineer or between "brakie" and conductor. The motions of all United States railroad men have been codified for operating safety by the Association of American Railroads.

Main-line signals are relatively few, simple and easy to use with a lantern, but hand signals in switchyards are many and varied. "All over this division of the U.P.," says George, "a trainman's hands waved in front of him, thumbs raised, means 'Tie her up. Let's go eat.'" The same signal meaning the same thing might have been used by stagecoach drivers of the Old West.

Since the days when Indians had the continent to themselves, sign language has been an important means of communication in America. The red men had an elaborate system of talking with their hands, which permitted members of strange tribes to converse on their first meeting. A Chipewa buck made the sign for "big" by parting his outstretched hands from a

palm-together position. This was understood by his Dakota neighbors, who intently watched the next sign—which might be for a herd of deer—and then where the buck pointed.

Modern radio and television broadcasters use the Chippewa's sign for "big" to tell an announcer to "stretch it out"—make his part of a program longer than planned. The studio signal for "lower the volume" is actually "kill part of the sound." It is a gesture because spoken words might be heard on the air and is made by a program director dropping his hands before him. The Indian sign for "kill" was to drop a nearly closed hand from the shoulder.

Broadcasters borrowed heavily from the Indians for signals, but they also used other sources. Horse racing furnished the inspiration for "on the nose," which TV and radio people act out and interpret as "the program is on schedule." One, two or three fingers of a broadcast engineer's hand, to let actors know the remaining minutes of a program, just came naturally.

The well-known studio "OK" sign, made by circling the thumb and index finger and more or less separating other fingers, was first used in advertising by a brewing company. A radio director of long ago thought the finger circle was good for an "O" and remaining fingers weren't too bad for a "K". At least, this is the sign that every performer hopes to get from his director.

In a studio, the boss draws his index finger across his throat to cut a program off the air. The same motion in many railroad switchyards means to "bleed" the compressed air out of a car and so release its brakes.

Motor truckers once transferred information between approaching vehicles by finger signals. But as trucks and highways became faster, the point was reached where trucks traveling in opposite directions were in close range for only seconds. "Our underwriters do not like the distraction of that type of signal, either," says Roy Bloss, West Coast Fast Freight, Inc., Los Angeles.



Sawyer at West Coast sawmill makes signal for 1½-inch cut

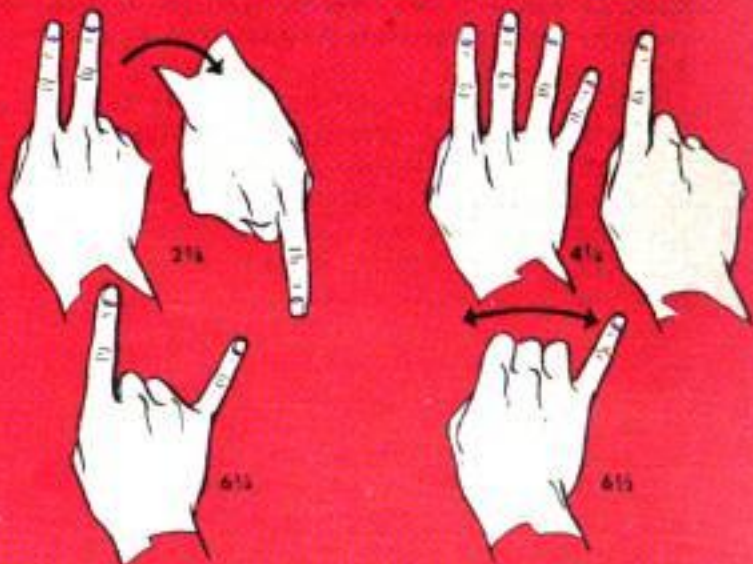

Hand signals used by sawyers in Pacific Northwest indicate inches of cut to be made. Below, George Crouch, head sawyer in Weyerhaeuser sawmill, tells setter he wants 6½-inch cut





Thumbs to his ears, Union Pacific brakeman George Fisher makes the sign for "stockyards track," to indicate that track is right one to take for livestock unloading. Right, he tells engineer, "Tie 'er up. Let's go eat."

Now truckers just give a friendly wave of the hand when passing each other, or at night "talk" by flashing the small identification lights above their cabs.

Auction bidders and stock-market traders often work their fingers instead of their jaws. They've reached the point where different bends in fingers have meanings in dollars and cents. Many wealthy Texans sit in cattle or oil-land exchanges all day long and make deals in the millions, yet never open their mouths.

Steel workers on skyscraper-construction jobs, cargo handlers on ships, motion-picture directors on sets and plane handlers at airports and on aircraft carriers wig-wag messages with their hands and arms.

Walkie-talkie and mobile radios and intercom systems have cut drastically into the use of hand signals where distance is the difficulty in getting orders across.

Strides were taken in this direction over 10 years ago, with the allocation of wave lengths to many industrial radio users by the Federal Communications Commission. Since then, industry has clamored for more and more radio frequencies—more than were available a couple of years ago. One of the latest moves is the development of microwave equipment which uses radio waves approaching the length of light waves.

The use of radio has replaced much of the sign-language vocabulary once used at open-pit mines.

Radios are being installed on freight trains for communication between caboose and engine.

"Walkie-talkies will not take the place of hand signals in switchyards," states H. W. Logan, Union Pacific engineer. "Switchers, who are always dashing around and hitching rides on moving cars can't bother with a bulky radio pack."

Now, walkie-talkies in switchyards are used only by car inspectors, who can thus call in freight-car numbers to the office quickly.

The importance of hand and arm signals by infantry troops has also suffered because of radio, but the method has not been dropped altogether. Army recruits now have to learn both communication systems, in case one is not usable at a given time. Air Force pilots flying in formation once had a number of hand signals to use between planes, but extensive outfitting with radio has boiled these down to one. A pilot's hand placed on the side of his flying helmet means, "My radio is not working."

Some modern sawmills are doubling their sawyers' output and eliminating the need for log setters and the use of signals. The mills are rigging up automatic, electric or compressed-air-operated setworks controlled by the sawyer. But, even at these mills, hand signals will continue in use between sawyer, foreman, edgerman, trimmerman and others. ★ ★ ★



Helicopter Carries Prospector in Search for Uranium



Graph paper rolls out of a recorder in the helicopter. Peaks in graph line indicate increased radioactivity

Far removed from the traditional bearded prospector and his burro is the modern geologist who hovers above the earth in a bubble of Plexiglas while he searches for uranium. Bell Aircraft Corporation has equipped a helicopter with the instruments needed for aerial uranium prospecting. A scintillation counter and recording instrument in the cabin measure the amount of radioactivity radiating from the earth's surface. The helicopter is superior to the airplane for this purpose because the instrument is most effective when operated at less than 100 feet altitude while traveling about 30 miles per hour. Broken down and packed on the helicopter's landing gear is a portable diamond-core drill which can be set up at any promising spot and used to drill holes as deep as 300 feet.

Buffer Protects Garage Wall

Bolted to the studs on the back wall of the garage, a spring buffer prevents the car bumper from pushing a hole through the wall if the driver misjudges stopping distance slightly. Three steel-spring leaves fasten to the studding and a steel crossbar attaches to them at a height that matches that of the bumper. The springs are painted black and the crossbar is painted bright aluminum.

☐ Aluminum yarn may soon be used in automobile tires to disperse heat caused by road friction.

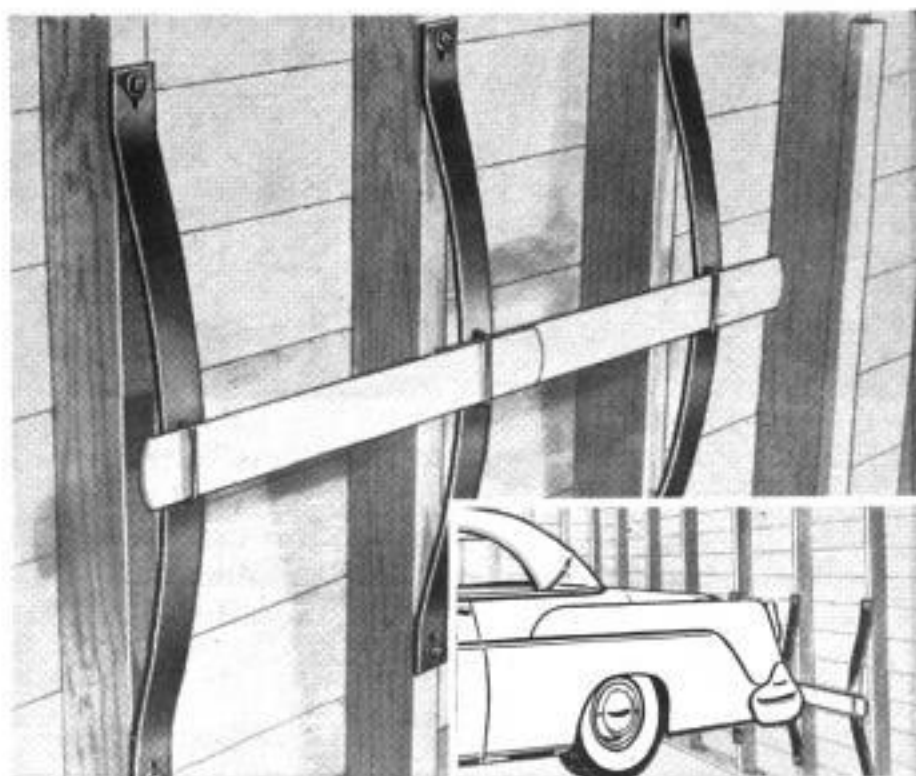



Frances Poe, the "big-game sculptress" of the story beginning on the opposite page, stumbled into her art while caring for sick and orphaned wildlife. Today animals and birds, like this wounded heron, share a studio with this self-taught artist



Antelope with three feet in air and bear teasing a pack rat are caught in porcelain by Frances Poe, who uses air brush (left) to color a half-finished animal

BIG-GAME SCULPTRESS

By Elliott H. McCleary

Photographs by Dan Honick

A FRIGHTENED little rabbit started it all. You might say the chloroformed rattlesnake helped too, along with the wounded possum. But not as much.

Frances Poe had found the orphan rabbit nestled in some brush along a railroad track and brought him back to the wild-animal "hospital" she'd established in her basement.

Now she was busy making a duplicate of the tiny foundling—in clay.

It was a casual beginning for a person whose specialized art today is not matched

by any other artist in the entire world.

Miss Poe makes porcelain figurines of North American game animals, and they're not the kind of work you'll pick up in a ten-cent store. There's a glint in the eye of each handmade statuette, a poise in the stance, a spark of life that makes you want to grasp it to prevent it from running off the table.

The reason the little ceramic animals are so different may be that their maker is a self-taught sculptress. If she'd gone to the proper authorities she would have learned,



Polar bear with authentically sharp teeth and caribou with finely shaped antlers share display with a bison

first of all, that you can't make porcelain deer and moose with antlers, because the prongs warp and shatter in the fiery heat of the kiln.

That's exactly what happened the first time she tried it. But today the finely shaped antlers of her elk, deer and moose are a trademark of her work, for she's the

Everything in this piece is made of porcelain, even shrub, stump and geese beneath meditating moose



only one in the field who hasn't yet learned that it can't be done.

"Impossible" tasks have always been a challenge for the pretty Wilmette, Ill., woman. Once, as a staff artist for an encyclopedia, she had to sketch the interior of a rattlesnake's mouth—while the snake was striking. The trick was accomplished by chloroforming a deadly timber rattler. As the snake awoke from his stupor, the mouth gradually opened and he began to strike—in slow motion. There was plenty of time for the artist to sketch an excellent picture of fangs, throat and tongue.

Actually, Miss Poe doesn't care much for snakes. Her best friends, next to some humans, are the birds and burrowing animals that make their temporary home in her basement sanctuary. Some, like an amiable possum who poses frequently for her sculptures, decide to stay on after their injuries have mended. There are usually several grounded pigeons, a sea gull and a squirrel or a raccoon around the cellar studio to lend encouragement. And always, roosting nearby with a critical air, is a rare and doleful-looking black-crowned night heron.

She has a good many acquaintances in Chicago's Lincoln Park Zoo, too. There's a buffalo named Moco, a grizzly bear and a mountain lion who help her out now and then by acting as models. The zoo is usu-



Slinking jaguar, mountain goat, two playful deer and a belligerent walrus were individually modeled. Molds are never used

ally her first stop when she's starting a new sculpture. Equipped with her drawing board and a folding campstool, she'll capture the tilt of an antelope's head or the gait of a hungry puma in fine, detailed sketches. Then she's off to the city's natural-history museum for sketches of skeletons and mounted animals. The last stop is likely to be the library, where she'll dig up such details as the girth of bears after hibernation or the capacity of a possum's pouch.

Back in her basement studio, she'll begin the preparation of the basic stuff which gives porcelain its amazing qualities. It's a mixture of almost one half English china clay, one fourth flint, one fourth feldspar and three percent ball clay. Good porcelain is actually harder than steel, for you can't scratch it with a knife blade. Neither can you harm it with most acids. It's highly translucent and sounds a clear, bell-like ring when struck.

Is it strong? Frances Poe answers the question by placing a delicate little deer only five inches high on the floor and standing on it with her full weight.

Rolling a lump of the clay mixture between her palms, she shapes a rough pedestal to support the weight of her sculpture. Another lump is placed on top of that, like the cross of a "T." It will become the body.



Next come the rough legs, the neck and the head.

Pressing little lumps of clay into the rough form, she builds up the body of the animal. Then, with knives and wire tools, she starts to carve and cut fine details in the soft mass. Now and then she pauses to transfer anatomical measurements from her data to the clay with an ordinary foot ruler.

Within hours, details start to emerge—legs bent as if in running, an arched neck, the stub of a tail. But you're not exactly certain whether it's going to be a caribou or a deer until she begins to shape the delicate antlers, building them up with bits of pressed clay. Often, she shapes the antlers separately and then sticks them to the head, for they are easily marred.

Two other tiny blobs of clay become wild ducks, wings spread in a take-off flight, for this is to be a group of figures affixed to a common base.

Suddenly it seems that she is deliberately destroying the half-finished animal. With a



Model of a deer begins as a single lump of clay on a rough pedestal. Rolled lumps for legs, neck and head are added. Smaller lumps add other details to body



Deer is decapitated and section of back removed so interior can be hollowed out. This assures even firing. Air passage goes from nostrils to interior



After the body is built up with bits of pressed clay, fine details are cut away with a knife. Antlers are often formed separately and then affixed to head



Color is applied and deer is placed in gas kiln for firing. Upside-down position helps prevent antlers from warping. This firing takes seven to nine hours



Finished piece is the result of several firings. The main firing changes the clay into porcelain and brightens and fuses the coloring. Later, the piece is glazed and fired again

slice of her knife she lops off the half-formed head and cuts a healthy segment from the back of the figurine. But it's only so that she may hollow out the body to insure even firing in the kiln. Using a slender stick, she gouges out air passages from the nostrils to the hollow interior, then reassembles the parts and smooths over the division lines.

The next morning, after the animal has had time to dry, she adds final details preparatory to "toasting."

Baking for four hours in a gas-fired kiln heated to a temperature of 1800 degrees Fahrenheit hardens the objects so they can be handled without breaking.

Except for its stark-white color, the animal now looks as it will when finished. Tiny ribs and lumps of muscle duplicate the features of a deer in motion.

Using metallic oxides—uranium for yellow, cobalt for blue, iron for black—mixed with glaze and some of the basic body material, she fills her air brush and sprays colors onto the white figurine.

(Continued to page 218)

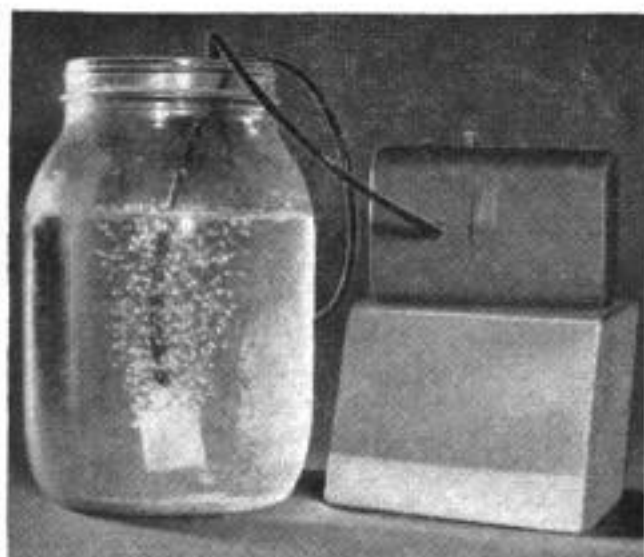

Battery-Operated Aerator Keeps Minnows Alive

Oxygen supplied by a new aerator will keep minnows alive in the same water indefinitely. The aerator is powered by four flashlight batteries, and uses only half as much current as a flashlight bulb. The batteries will run the pump continuously for about 30 hours. The aerator also is supplied with a lead which can be plugged into a

car's cigarette lighter. A large dry-cell battery of the type used for electric farm fences will operate the aerator through the entire season for most fishermen. An aluminum-oxide aerating stone breaks the air into thousands of tiny bubbles per minute. As many as four minnow buckets can be aerated at once.

Midget Hoist Lifts Half Ton

You can pull your car out of a ditch, hang a deer, or raise heavy machinery with a little hoist that fits in your glove compartment. The outfit weighs about a pound and will raise half a ton of weight a height of 12 feet. Blocks and sheaves are of heat-treated aluminum and the pulley wheels are mounted on roller bearings, pre-lubricated and sealed. The line consists of 100 feet of rotproof nylon cord. For lifting heavier loads, the nylon cord can be replaced with steel cable. Two canvas straps with welded steel eyes are used for attaching the hoist to the load and to the support.

☐ In 1939 about 30,000 tons of mail and 45,000 tons of express were shipped by air. In 1954 air cargo was estimated at 800,000,000 ton miles and mail at 190,000,000 ton miles.

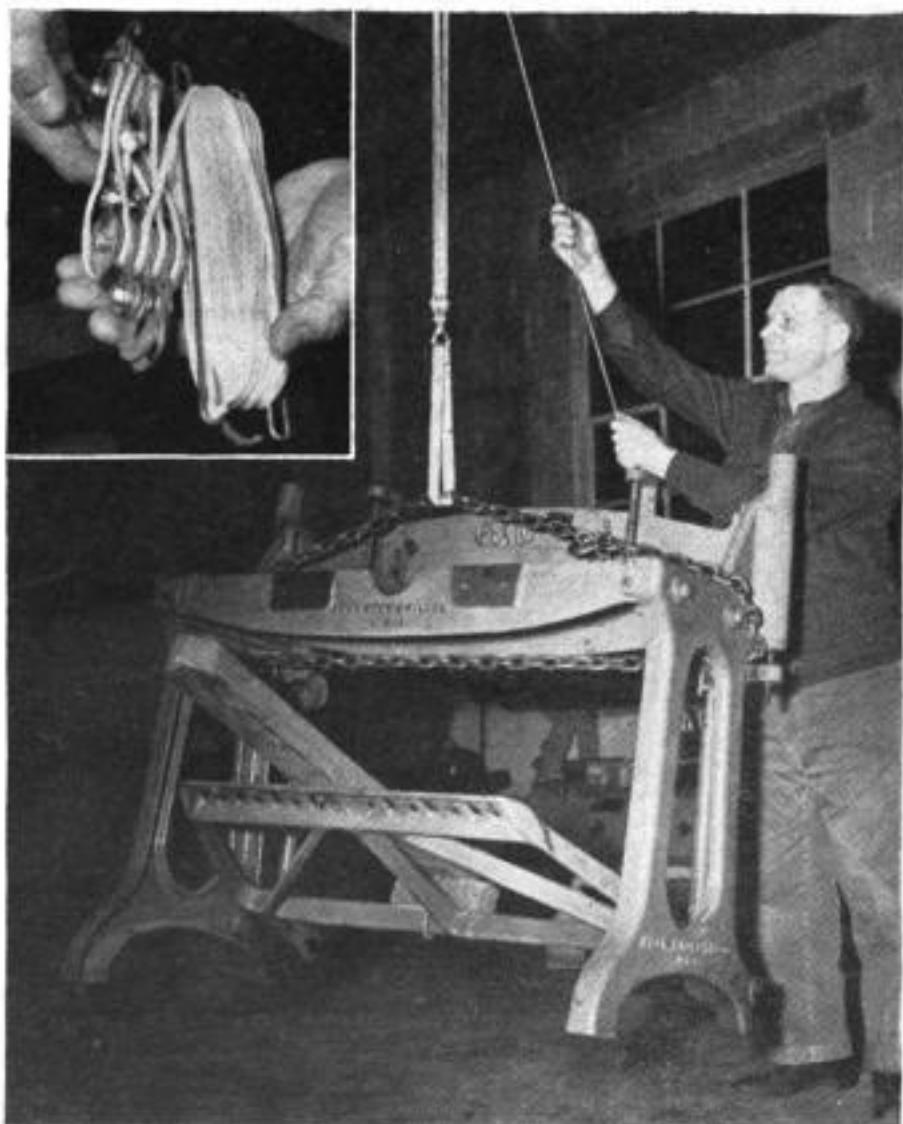

HONEYCOMB

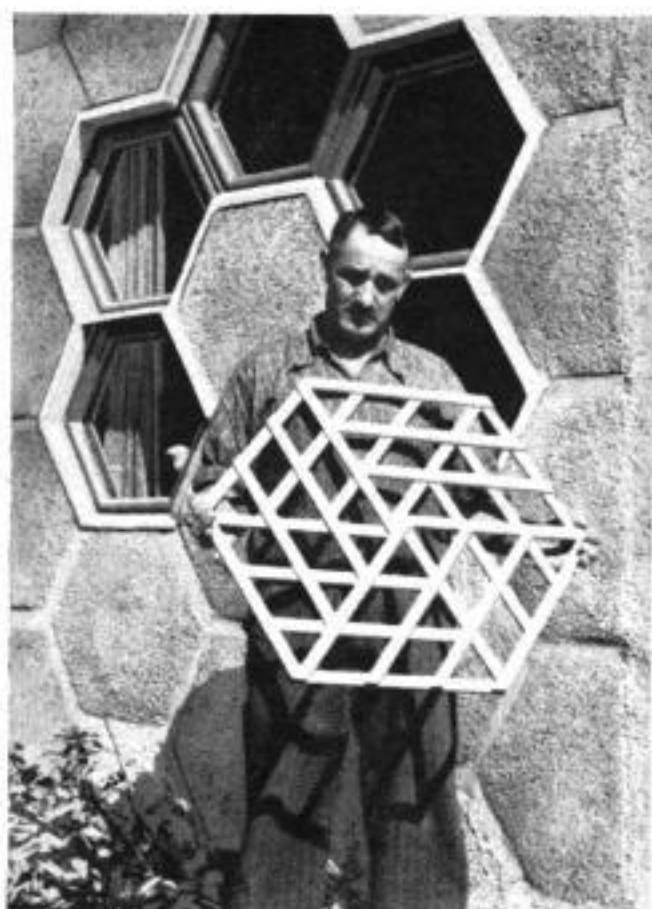

E. R. Brewster, New Zealand beekeeper, displays the basic hexagonal unit made of laths with which he constructed his house using honeycomb principles

By J. M. D. Hardwick

IF YOU WANT TO BUILD a house of your own, take a lesson from the bees," says beekeeper E. R. Brewster of New Plymouth, New Zealand. "They've been building for thousands of years."

Brewster claims to have solved the problem of how to build a durable house at low cost and without experience. To prove his point he built such a house for himself and is now living in it with his family.

Pondering on the hexagonal cells that make up every honeycomb, it occurred to Brewster that a similar method could be used for precut houses with a gain in strength and reduction of expenses. Long ago the bees worked out the greatest economy in regard to space and material for the cells of a honeycomb, he explains.

"These cells are set at an angle that never varies," says Brewster. "This accords perfectly with the angle determined by calculus which will give the cell the greatest strength for the amount of materials used. Nature often uses the hexagon in her work, but never the square."

Commercially developed for a precut house, Brewster believes his method would enable an amateur builder to construct a seven-unit house of 1176 square feet in less than 4000 hours of work. The cost would be considerably less than conventional construction, he reports. With a precut kit,

Even the front door of Brewster's house is made of hexagonal sections; hall walls are polished hexagons

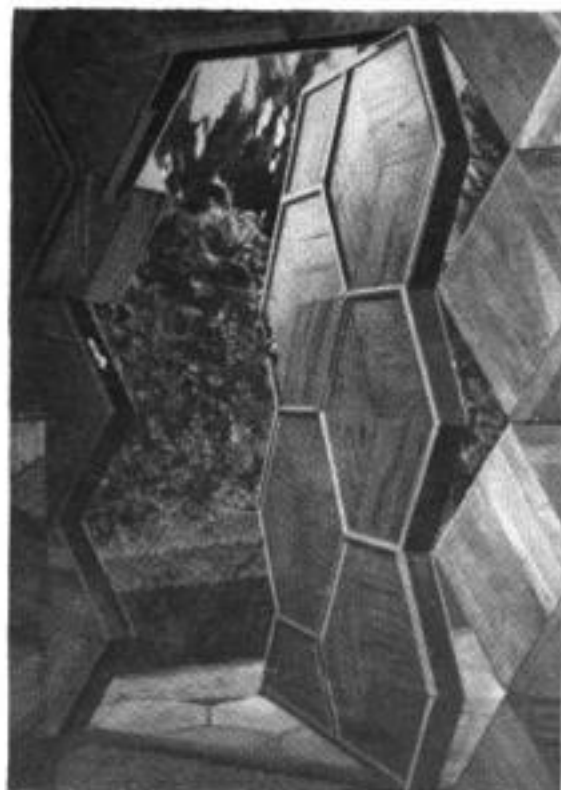

HOUSE

more than three fifths of the work would be in assembling the pieces into sections, and less than two fifths in actual construction. The precut kit would consist of as few as 16 items, out of which everything, including cupboards, doors and windows, could be made.

The hexagonal sections are made of short lengths of lumber and used for wall-lining panels and the lath frame for plaster. No jigs are required for the lath frame.

Much of the work on this house can be done indoors working at a small bench. Brewster advises a builder to construct the first three units, move into them and build the rest of the house around him.

The floors are built in three laminations of half-inch timber. Bottom layers are pine and the top layer of any selected wood. All walls are 10 feet high by 8 feet wide and have a laminated outer frame of pine. The ceilings are of triangular framework and each is composed of 42 sections. Brewster's house has a roof made of triangular sections, but a cheaper dome-shaped roof would serve as well. His home consists of seven units: Two for bedrooms, one kitchen and breakfast unit, three as a triple-hall and main-lounge unit with no dividing walls, and the remaining rear unit

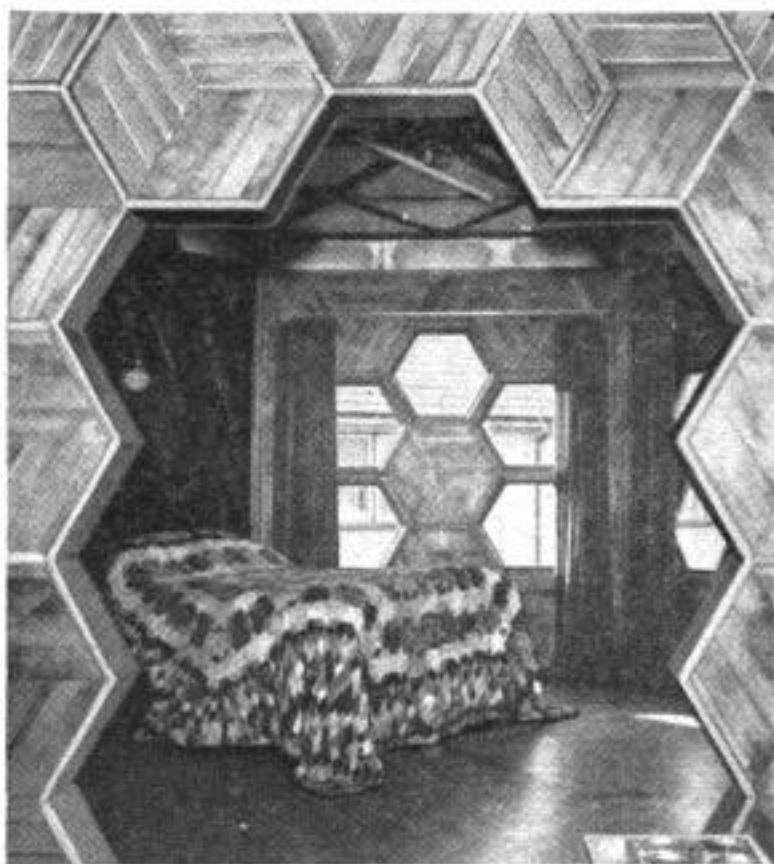

Wall sections around door show how pieces of wood are applied to make six-sided panels. All the windows, too, are hexagonal. Builder, like Nature, avoids all right angles in construction

subdivided into bathroom and laundry. Any number and combination of additional 168-square-foot units can be built on.

Among the points listed by the building beekeeper in favor of his system are: Economy of wall area for floor space, use of short lengths of lumber often wasted, standardization of parts and assembly and low cost for a do-it-yourself builder. ★★

The honeycomb house is built in seven 168-square-foot units to which any additional number could be added

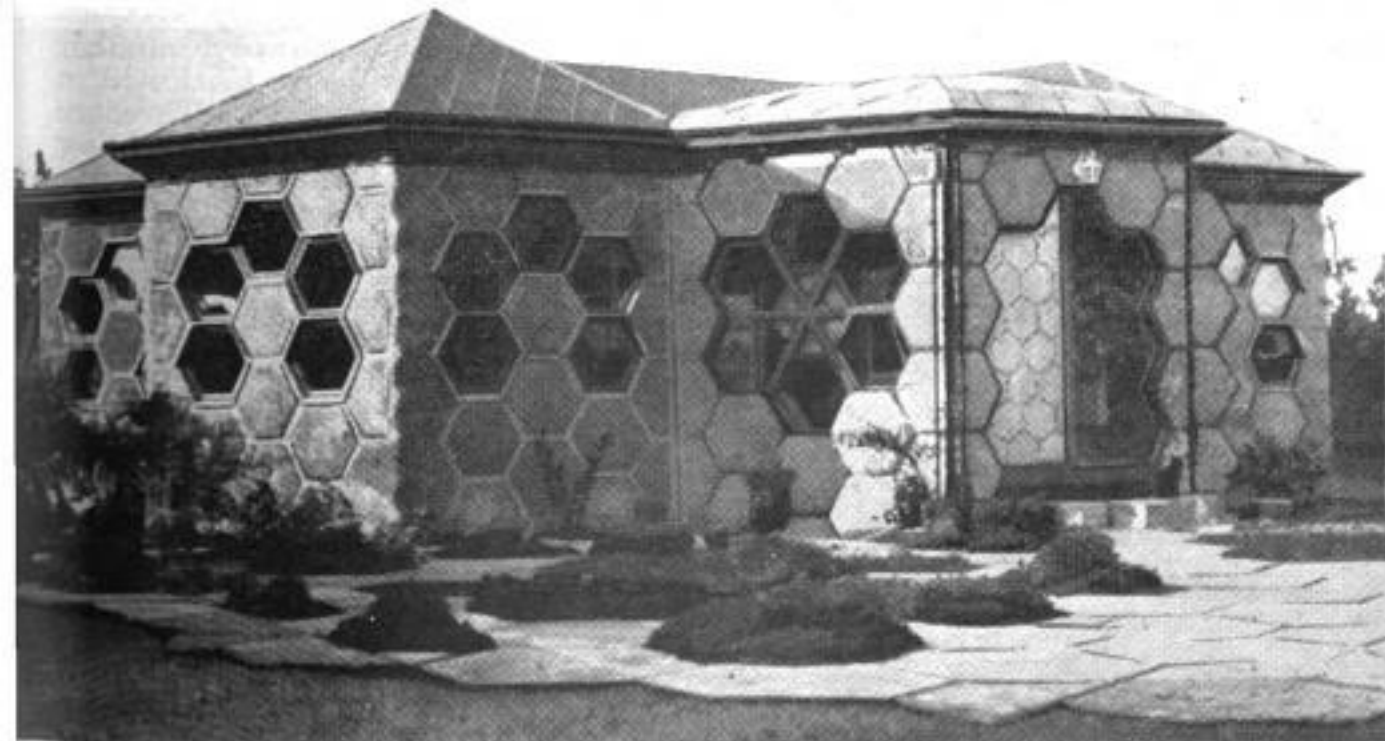

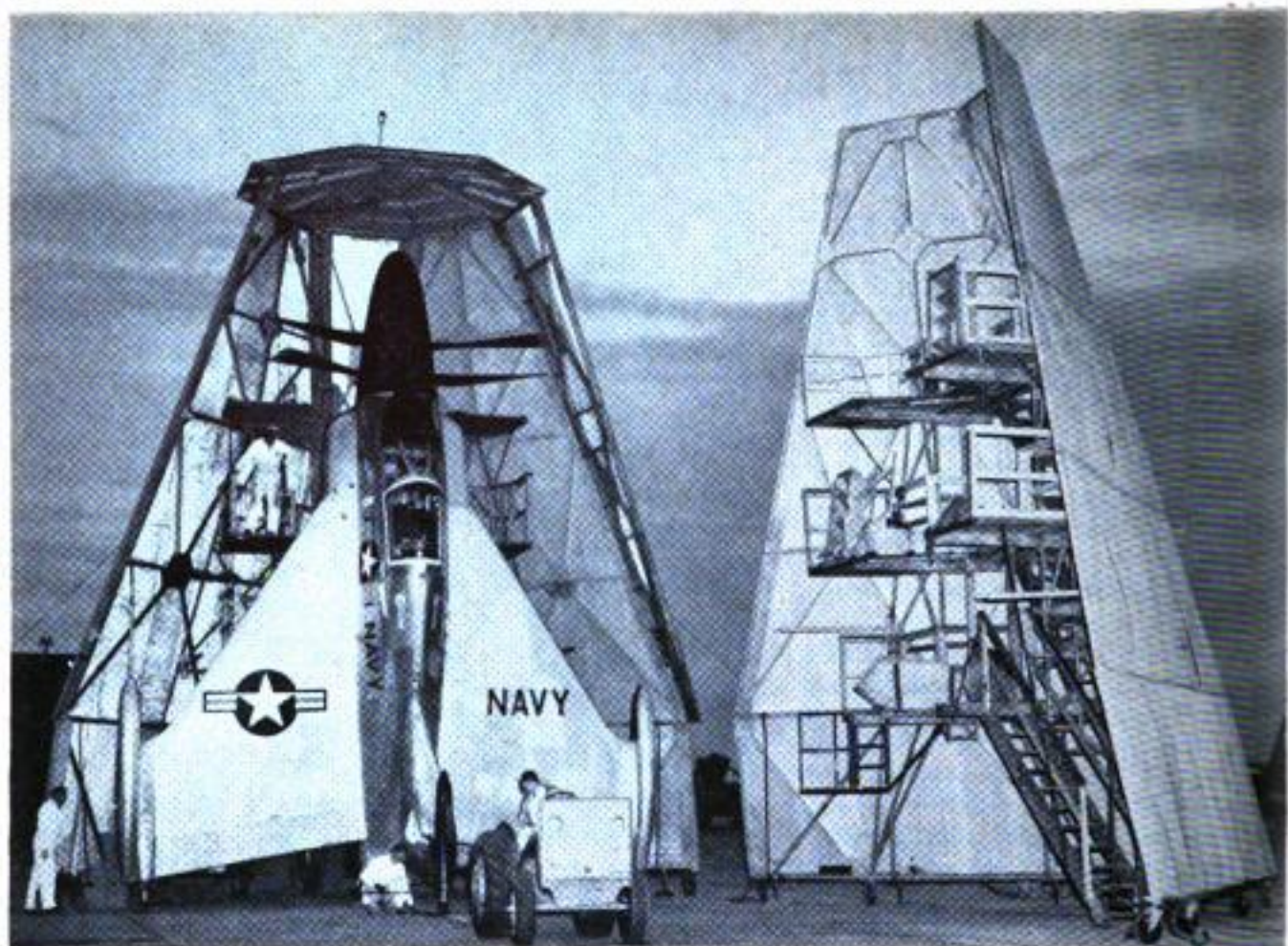

"Wigwam" Hangar for Vertical-Take-Off Fighter

Shaped like a flat-topped wigwam and opening like a clamshell, a form-fitting hangar has been built to house the Navy's vertical-take-off fighter, the Convair Pogo XFY-1. The hangar contains three levels

of mechanics' scaffolding, and is lighted and heated for round-the-clock maintenance. The hangar can be disassembled and transported by air to any new location where this type of plane is based.

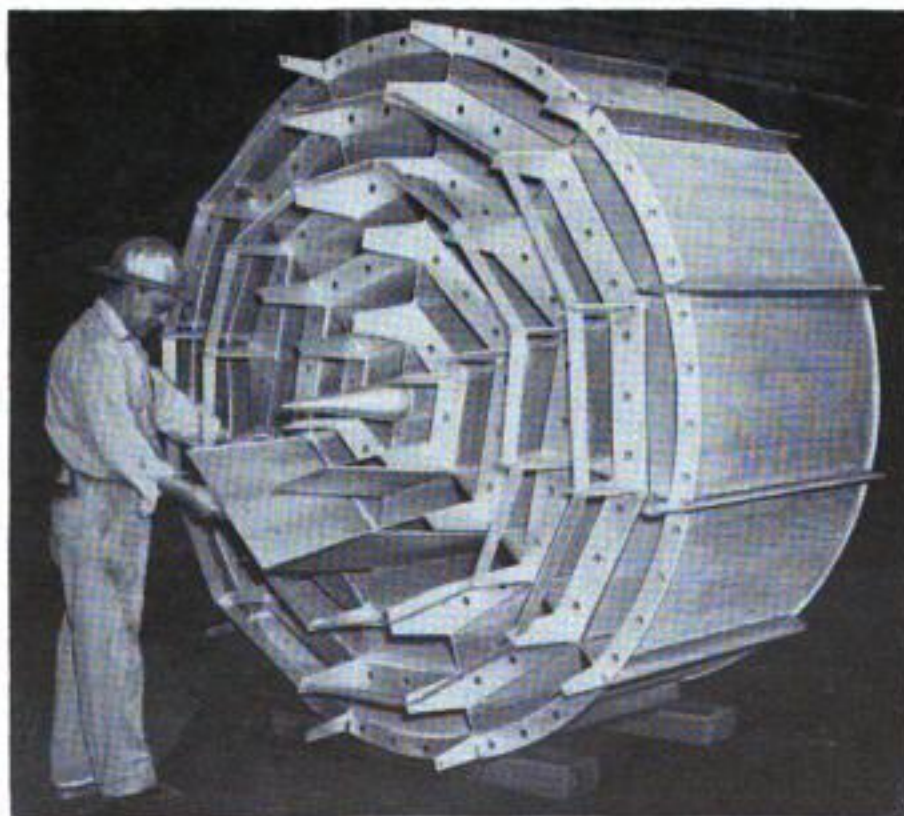

Mufflers Cut Roar In Wind Tunnels

Odd-shaped mufflers now being fabricated in Los Angeles will reduce the roar of three new wind tunnels. The tunnels, under construction by U. S. Steel, will be used to test aircraft, missiles and engines at air speeds well over five times the speed of sound. When completed, they will be installed at the Arnold Engineering Development Center, Tullahoma, Tenn. The mufflers consist of vanes arranged in compartments, with alternate compartments filled with acoustic pillows. When installed, they will absorb the wind's roar.

SWEDEN'S NAVY JOINS THE UNDERGROUND



American Swedish News Exchange photo

Top, tunnel is blasted through solid rock to join other tunnels in a network of underground shelters

By G. Alison Raymond

TUNNELS ARE not new; but structures excavated from solid rock that are cheaper than equivalent structures on the surface—that indeed is news. In this age of atomic and hydrogen weapons, developments along these lines are of substantial interest to industrial, military and government officials throughout the world.

Less than 10 years ago no engineer would willingly accept that tedious, tremendously expensive undertaking of tunneling except as a last resort. Since then, however, new equipment and new techniques have inspired a new concept of underground engineering design.

Sweden has been the leading pioneer in

developing methods which rip rock from the depths of the earth quickly and easily, prompting one Swedish engineer to say, "We have lost our respect for hard rock."

Sweden has already put several power stations and a considerable number of her factories underground; even her armed forces are based deep beneath hundreds of feet of solid granite. Sweden's navy, for example, is housed in huge, coastal, rock tunnels which disappear straight into the mountains directly from the sea. These tunnels can house destroyers of 2600 tons as well as submarines and other units, providing adequate docks for them all. Heavy gateways and pockets have been blasted at

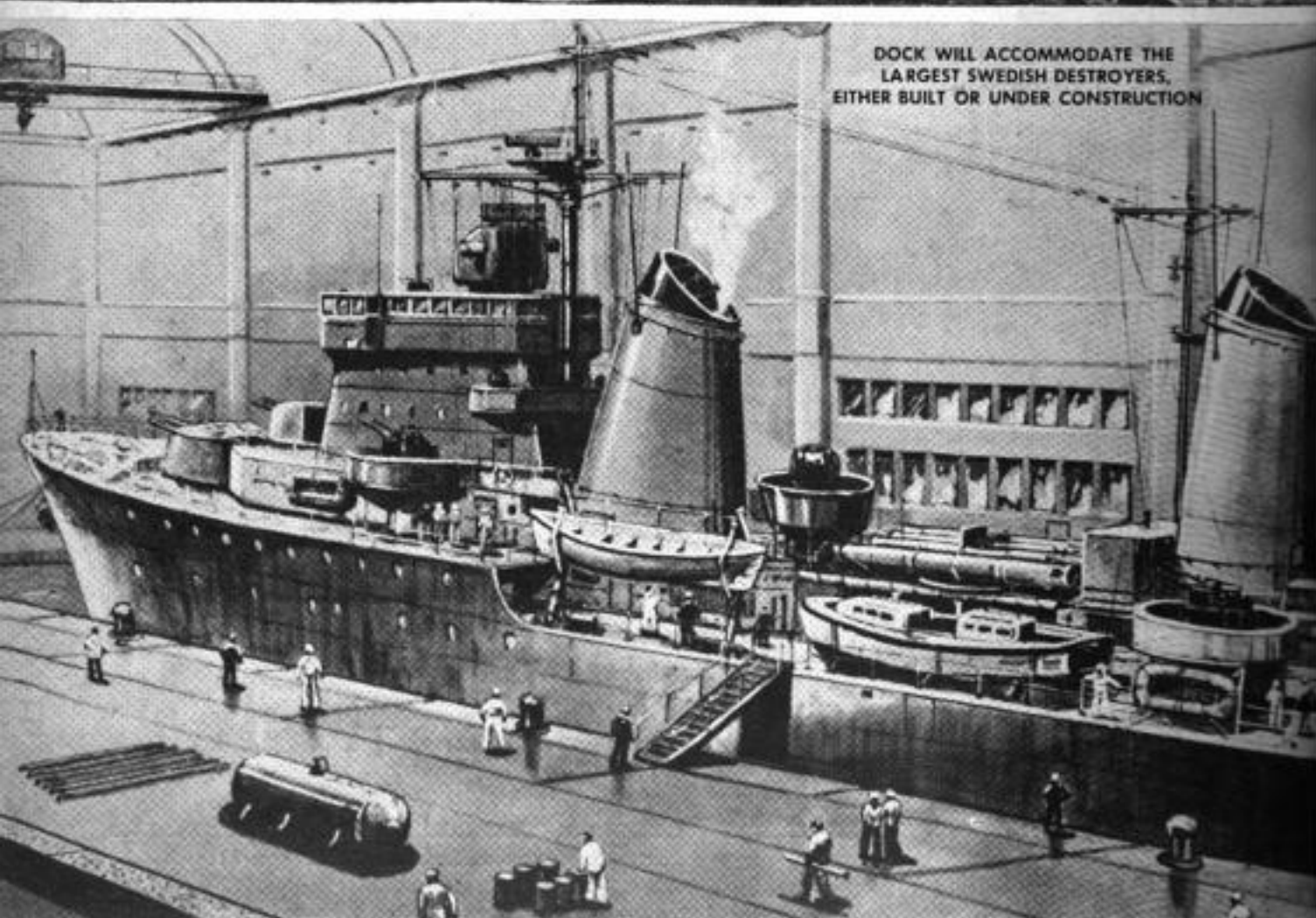
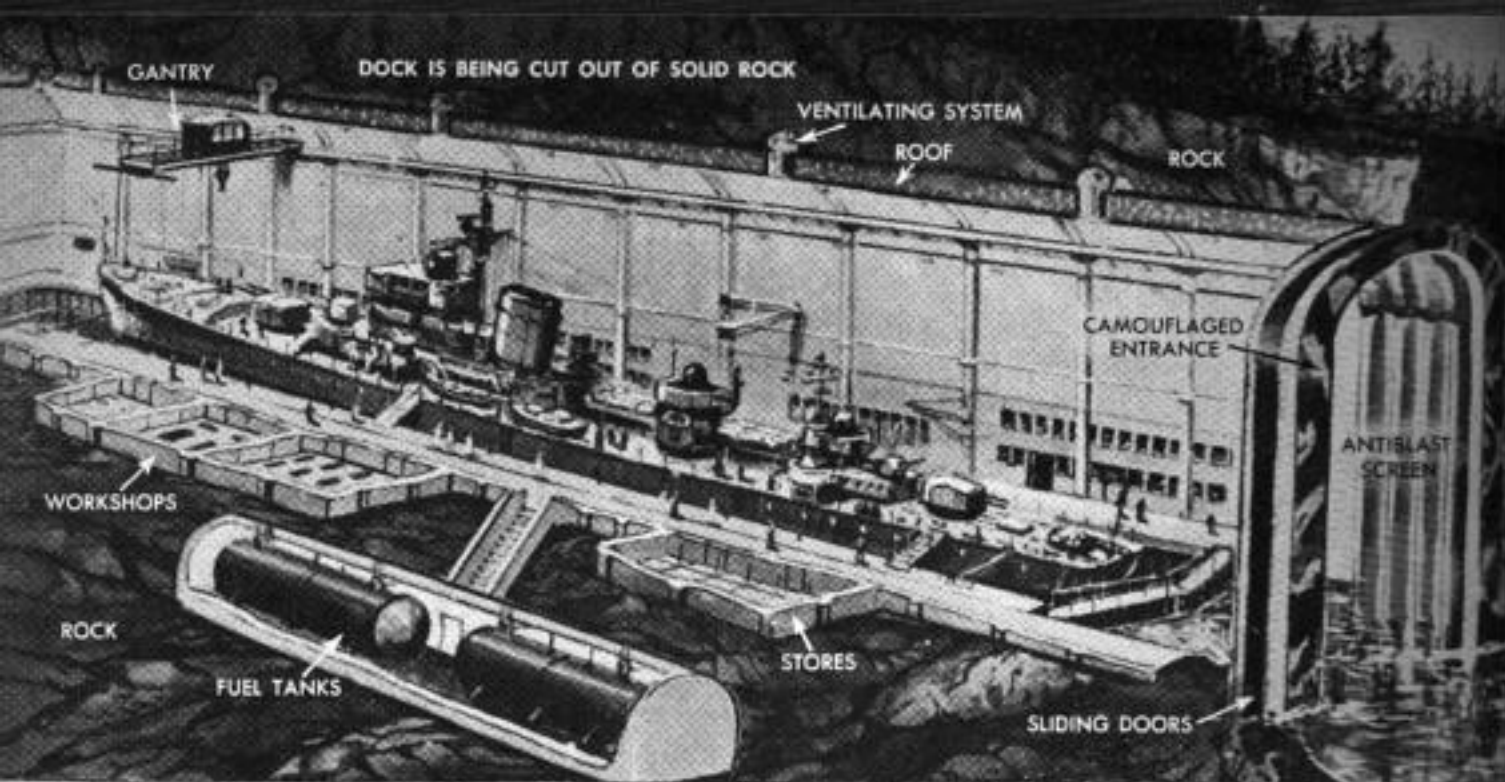

oblique angles into the rock to protect the tunnels against the impact of air and water pressure in case of enemy attack. So far, the largest tunnel is 96 feet high and 57 feet wide. Not only docks, but also repair depots, workshops, storage areas and living quarters for personnel have already been built deep in the granite. Gradually Sweden plans to house more and more of her combat strength in similar tunnels.

The air force also is well protected with

underground hangars for an estimated 1500 planes. There are permanent installations for the coast artillery. A control center for high military and civil authorities has been buried far below the earth's surface, as well as radar controls, workshops, supply depots, fortifications and military rock shelters. About 500 underground shelters are either completed or well underway. Millions of cubic feet of granite have been steadily blasted away since the end of

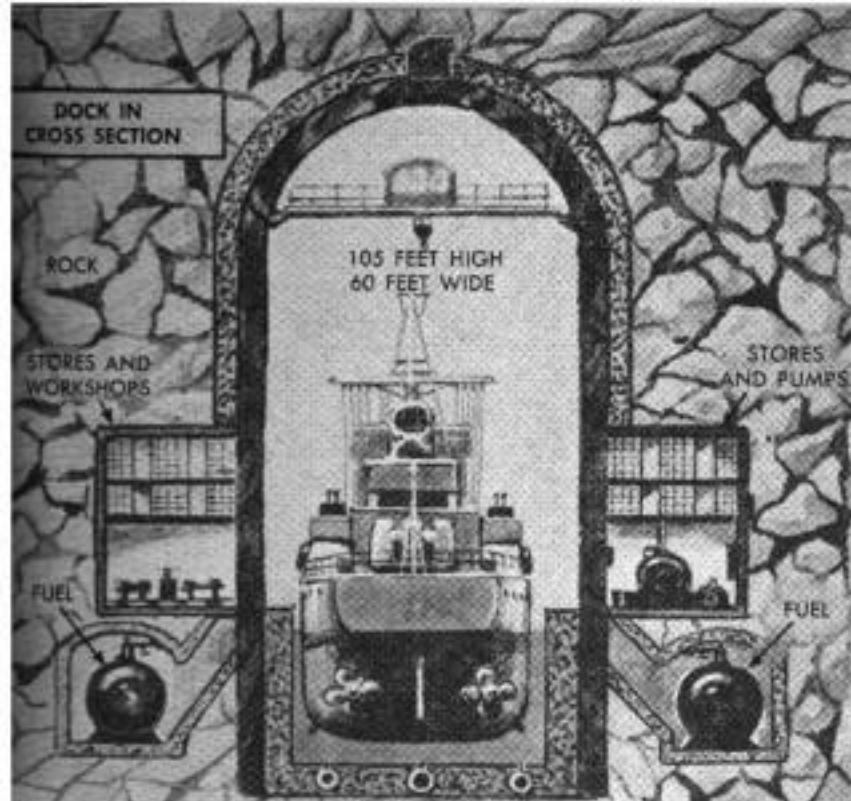

ROCKY, PINE-CLAD ISLANDS OF SOUTHEASTERN SWEDEN ARE WELL SUITED FOR THE CONSTRUCTION OF SUBTERRANEAN DOCKS

SWEDISH DESTROYER LEAVES THE UNDERGROUND DOCK. DARKENED DOCK AND CAMOUFLAGED ENTRANCE WILL MAKE THE DOOR ALMOST INVISIBLE AGAINST THE PINE-COVERED ISLAND

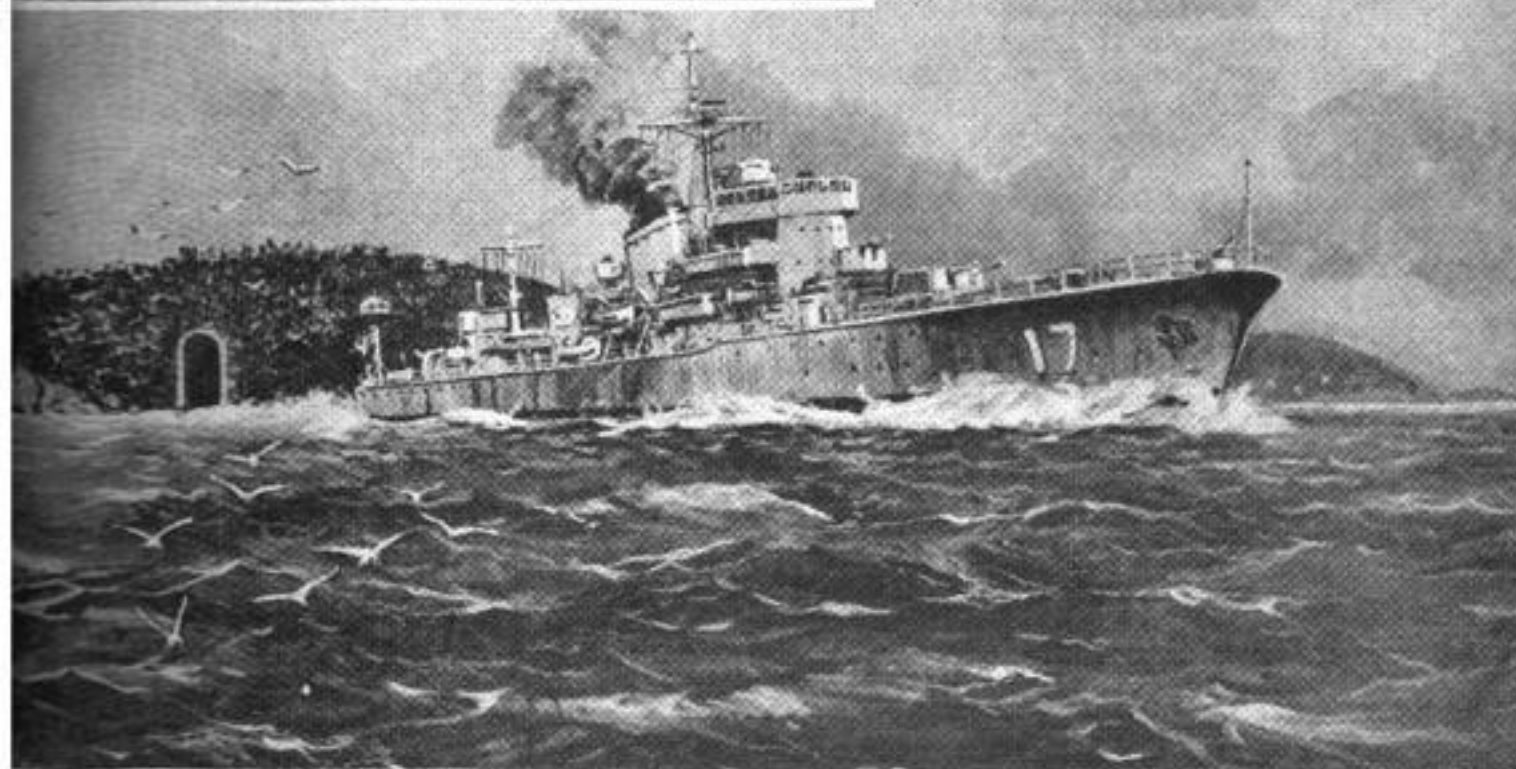

World War II, making a close network of hidden chambers along the entire Swedish coast and at certain strategic inland centers. Near the Arctic Circle one of the world's largest power plants has been buried far beneath the surface. With its generator as large as a cathedral, 380,000-volt Haespranget lies, as do power plants in Canada and the western part of the United States, so deep within the bowels of the earth that even a direct hit would not de-

stroy it. In this age of rapid oil consumption it is exceedingly difficult to store enough fuel to keep a nation going, but Sweden has gone a long way in this direction. Enormous underground cement tanks, lined with metal, have been built in scattered locations. In some areas it has been possible to take over abandoned mines, converting them into almost bottomless storage tanks where increasing supplies of fuel are being hidden away.



American Swedish News Exchange photo

Two mechanics of Sweden's air force work on a jet plane deep in an underground cavern carved from granite

Well aware that its military forces would not survive long if the nation's skilled workers were lost, Sweden also is protecting its civilians with installations in the mountain fastnesses. Schools, an 1100-bed hospital and several smaller hospitals, sanitation facilities, food supplies, key factories and mines, large stockpiles of rubber, oil, tungsten and chemicals—all these and more are already established far within the granite protection. In one place a city of over 1000 rooms has been laid out in several stories. Here large numbers of people could live for a considerable time, if necessary, fully equipped with the basic necessities. Deep shelters in Stockholm, already completed, can accommodate 80,000 persons; in five to seven years, authorities expect, there will be enough deep space to hold 400,000. This is half the capital's population. The situation is similar in other Swedish cities. Threading like a spiderweb under much of Sweden is a giant network of shelters to protect the cities' workers and keep Sweden's production in full swing. That part of the population which could not be productive, such as children, old people and the sick, would be evacuated to rural areas under detailed and extensive plans, including transportation by every means from planes to skis.

In all-out war, the utmost productive ability would have to be maintained and protected in every country of the free world. Skilled workers, once lost, cannot easily be replaced. As Gen. Walter Bedell

Smith remarked, "Wars are fought by men, but they are won by production." If a country loses its ability to produce, it cannot long maintain its fighting force; once that is gone, there is no choice but to surrender to the enemy.

Far-reaching efforts such as these are, of course, enormously costly. Ten years ago they would have appeared prohibitively expensive, but new discoveries based on cementing tungsten and titanium carbides, using cobalt as a binder, have revolutionized the processes. Now, as a result of new tunnel-cutting techniques, mining costs have been so substantially decreased that the change is being reflected throughout the world. The change is apparent on the west coast of this country and in the rich silver mines in Ontario. Helped by EDC financing from America, huge new power stations have been built by both French and Italian workers deep within the Alps.

What is the big new difference?

It lies in the development of so-called "hard metal," a tungsten carbide cemented with cobalt, which has a hardness unsurpassed by anything but diamonds and a melting point of about 2800 degrees C. At temperatures in which other cutting tools would melt and soften like jelly, carbide-tipped tools continue to cut at high speeds. To achieve this, all sorts of manufacturing problems have been studied and finally overcome in the laboratories and workshops of many engineering firms. Such

(Continued to page 214)

Covers Shield Rifle Scope

New lens covers for rifle telescopes snap open at the push of a button. The button is mounted on a rod which connects the front and rear lens covers and is pulled back to close the covers. Small neoprene bumpers eliminate any clicking sound. The neoprene seals have a 10-degree taper and shut out moisture and snow. Lens scratches caused by wiping are ended.



Powered Glider Takes to Highway

There's a motor used to power a glider built by Gerhard Blessing of Hamburg, Germany. The engine is strictly within the rules of gliding, however, for Blessing uses it to move the craft from place to place on the ground. With the glider's wings folded, Blessing sits in the cockpit and heads down the highway. The three wheels, one mounting the small motor, are removable. When Blessing takes to the air, he leaves wheels and engine on the ground.

Scientific Steer

Serving science in England is a steer that wears an electronic harness. The harness records every movement the animal makes as a series of wavy lines on a moving paper tape. The tape registers how many times a day the steer stretches its neck to chew grass, how many times it lies down and even the number of switches of its tail. The results show which grasses cattle like best, how many mouthfuls go into each pound the steer gains and which grasses increase the animal's weight most.

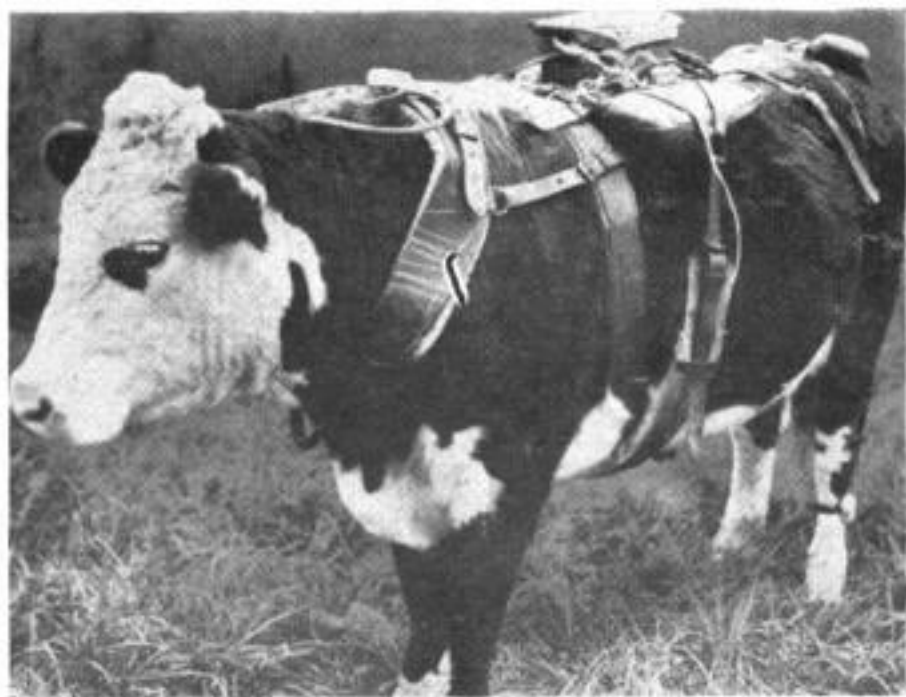

One Way to Earn a Living



BEING SHOT out of a cannon was an old stunt until it was modernized by Bill Horton of the Irish Horan Lucky Hell Drivers Troupe. In a burst of smoke, Horton hurtles out of a cannon's breech driving a Dodge convertible. The car arcs down to a two-point landing on a sturdy ramp, only slightly damaged. The cannon is open on both ends. Horton speeds into the lower end at 55 miles per hour. A jet-assisted-take-off unit on the car pushes its speed up to 75, and a small explosive smoke bomb heightens the realistic effect. ★ ★ ★

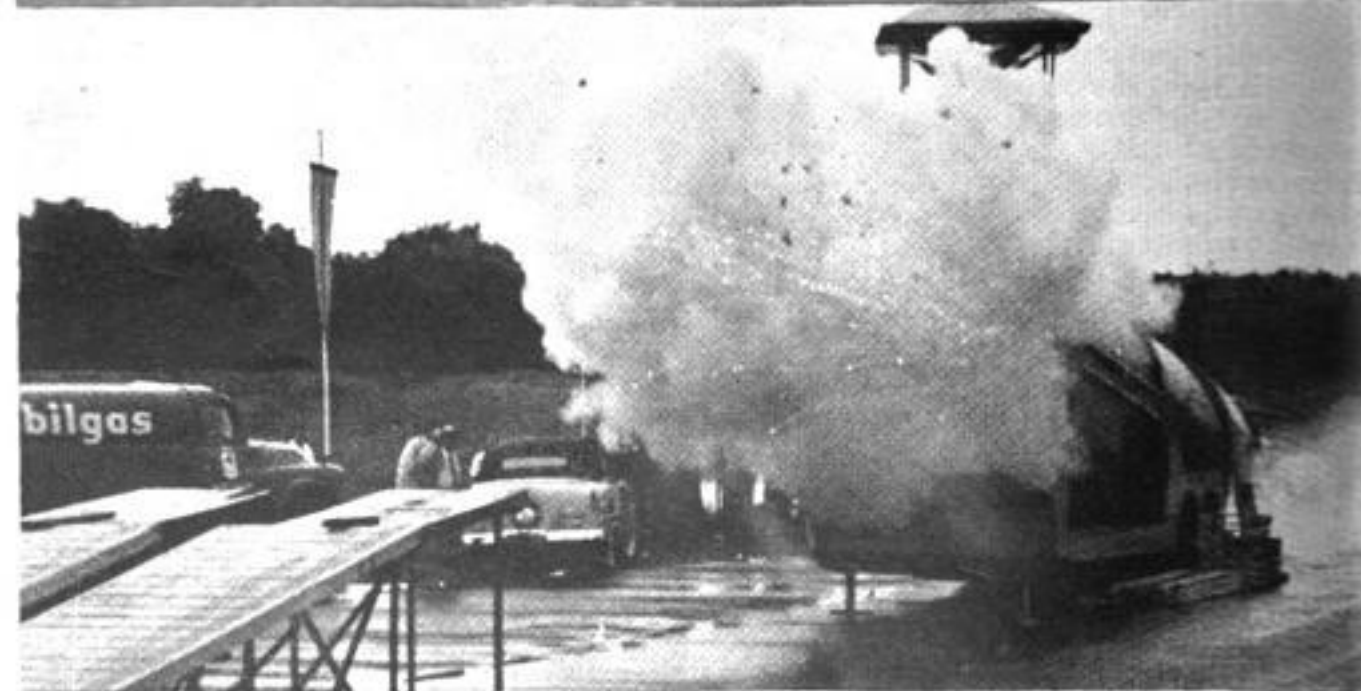

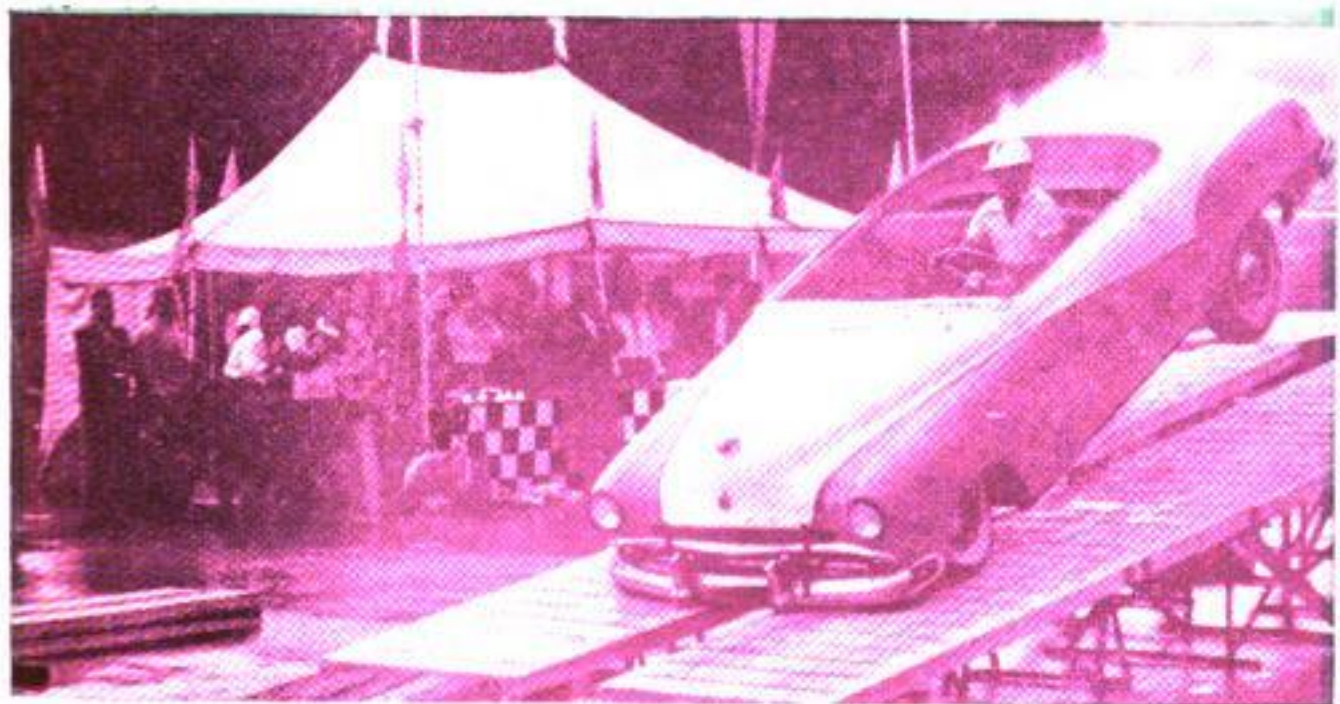
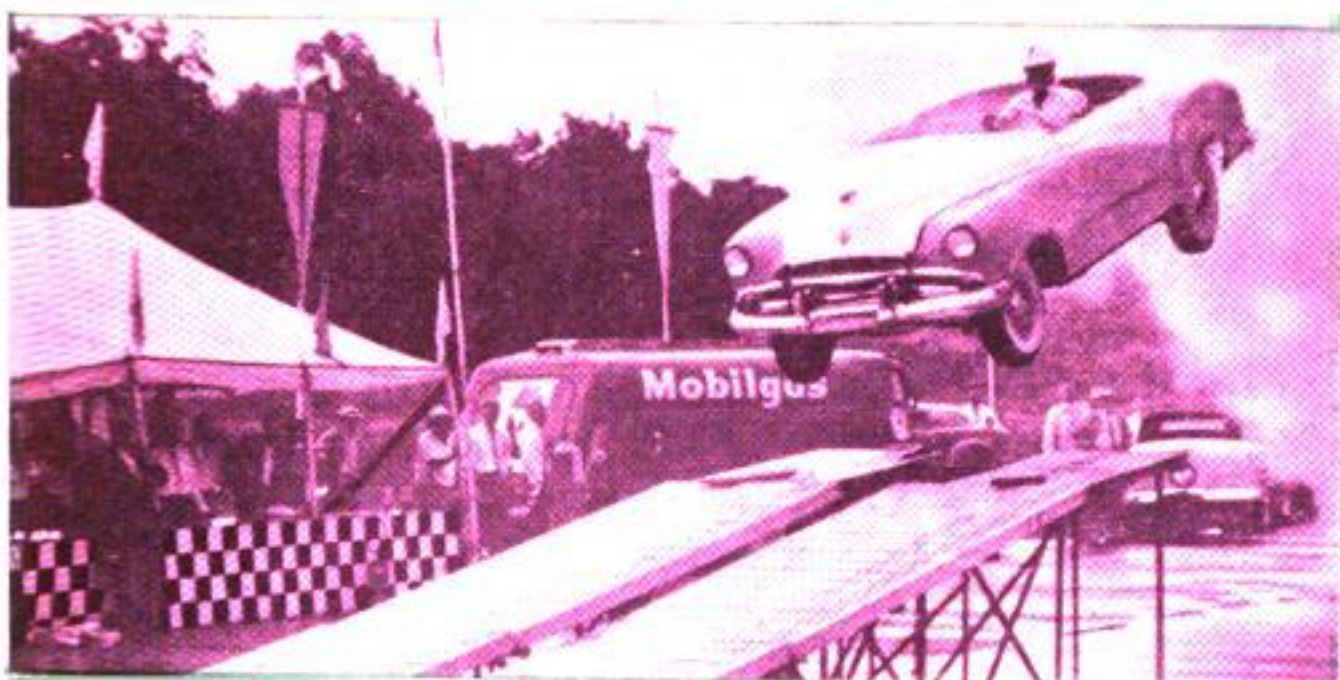



Convertiplane With Pusher Propeller May Go 175 Miles Per Hour

Recent entrant in the convertiplane race is the Jacobs Aircraft Engine Corporation, of Pottstown, Pa., producer of a helicopter with stub wings, a pusher propeller and a top speed expected to be 175 miles per

hour. Powered by a 350-horsepower Jacobs engine, the aircraft has flown as a helicopter, but without its pusher propeller or wings. In horizontal flight, 30 percent of the lift should come from the stub wings.

First Men on the Moon Need Not Fear Radioactivity

Explorers of the moon won't be harmed by radioactivity. The moon's surface, according to Dr. S. F. Singer, physics professor at the University of Maryland, is not dangerously radioactive. Cosmic rays bombard the moon to produce tritium, the triple-weight hydrogen that goes into the H-bomb, but the amount, says the earth-bound Doctor Singer, is too small to have any biological effects on humans.

Fleet of Surplus Ships Stores USDA Grain

Surplus ships and surplus grain account for the fact that the Department of Agriculture now has a "navy" of 422 ships borrowed from the Maritime Commission. The stand-by ships are used to store 69,000,000 bushels of CCC grain. The fleet is composed of 162 ships at Astoria, Ore.; 73 at Olympia, Wash.; 112 in the James River, Va.; and 75 in Hudson River, N. Y. Storage damage is under one percent.



Toll-Collecting Robot Photographs Chiselers

Motorists on the Garden State Parkway in New Jersey pay the 25-cent toll by tossing 25 cents into a hopper at the tollgate. There is no attendant to watch or check the amount paid. But the motorist had better pay the right amount because if he doesn't, a camera mounted above the collecting station photographs his license plate as he drives away. After the film is developed, the gate-crashing driver gets a letter from the police asking for an explanation and the 25 cents.

Mounted on an automobile steering wheel so that its face is always right side up, a clock recently patented by a Swiss watchmaker is wound by the turning of the steering wheel.

Power Handle Runs Many Tools

NOW, INSTEAD OF INVESTING in separate garden power tools, you can obtain a motorized handle that clips to any one of several units. The 39-pound power unit mounts a 2 $\frac{3}{4}$ -horsepower gasoline engine, and is attached or detached in 20 seconds. This is done by fastening a wing bolt and connecting a drive belt to the powerless garden tool. Five engineless garden tools designed for use with the motorized handle are now being produced. Eventually, some 30 types will be made.



Power handle mounts a 2 $\frac{3}{4}$ -horsepower gasoline engine, is quickly fitted to powerless tool. It weighs 39 pounds and is easily lifted

Edger-trimmer is turned sidewise for fast edging of bank around flower bed

Tools that attach to the power unit include an edger-trimmer, a 21-inch reel mower, a 20-inch rotary mower and a sidewalk snowplow

Tiller can chop up lawn for reseeding or pulverize garden soil for planting

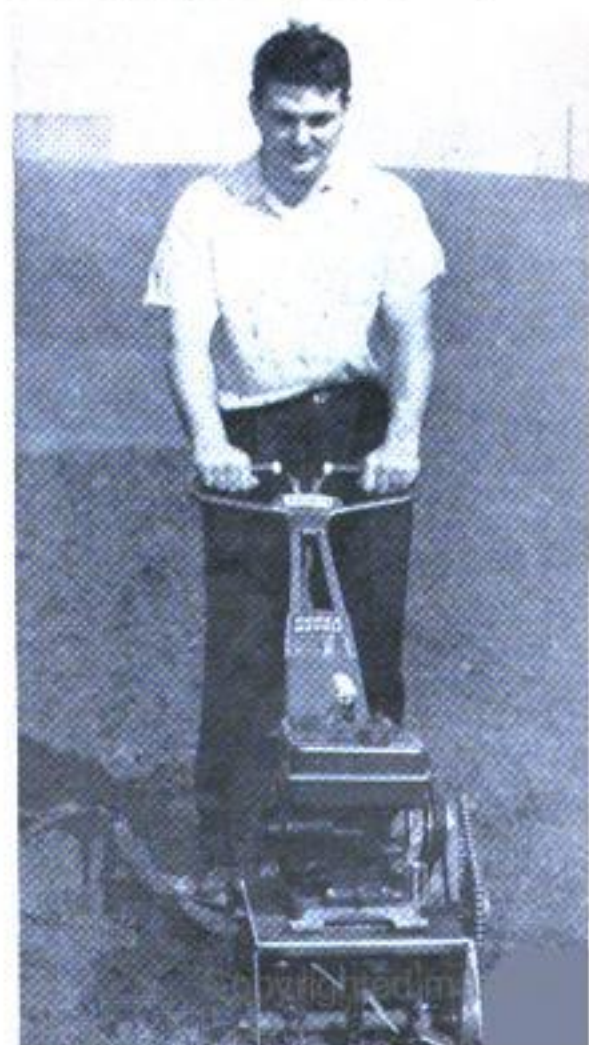



LOOK IN
A LUMBERMAN'S CRYSTAL BALL AT
Forestry in A.D. 2005

By L. J. Carr

The author, president of the Forest Products Research Society and a committee chairman of the Western Pine Association, is a widely known authority in the lumber industry

LIKE A GIANT EAGLE spotting supper from the air, the helicopter hovers over the densely timbered mountainside. As the pilot checks instruments, the logger member of the two-man crew refers to a memorandum dated that day—August 12, 2005.

"Move over to the trees near that big rock . . . see it—shaped like a frying pan," says the logger. "Now, what do you get on the counter?"

"Action," replies the pilot. Watching every flick of the helicopter's supersensitive geiger counter, the pilot begins to "zero in" on a big pine. The tree is one that had been radioactively marked by a ground crew.

With the helicopter over the

marked pine, the pilot nods, and says, "Hooks away!"

The logger quickly flicks switches, starting the mechanism which lowers two steel cables with hooks and chokers. Electronically controlled, one cable is connected to the pine near the top and the other near the base.

"Okay on the TV?" queries the pilot.

The logger studies one hookup on the television screen at his side, then shifts the scene to the other connection.

"Yep. Snugged up tight," replies the logger. "You'd better give this air buggy everything it's got. The roots of that pine will be deep."

"Betsy here has yanked out bigger trees than this one," says the pilot. "Easy does it."

First the pull on the tree is to the north, then the south, east and west. This is known in lumbering jargon of the period as "root rattling." Then comes the "dentist's big yank."

The ground crew, which had marked the tree, had also given it a shot of "root juice." This substance caused the roots to contract and shrivel, loosening them in the earth. But the pull is still heavy. The helicopter strains. Five seconds . . . ten . . . Crew members brace themselves. Eighteen seconds . . . The helicopter jerks, then steadies. The big tree is airborne.

The logger adjusts the cables to bring the tree into a horizontal position beneath the helicopter. Again he checks connections on the television screen and gives the hand signal for "Home, James."

Fantastic? Not at all. The above imaginary incident is a glimpse of logging operations a half century in the future that many experts will tell you is not only possible, but probable.

Some persons will say, "Yes, the tree-



Future forester will pack hypodermic needle to stain lumber as it grows. Outer wood can be stained today

pulling helicopters may be there, but they will have few trees to pull."

As a natural resource which is particularly significant because it is renewable, trees should be in plentiful supply in 2005—an estimated two trillion board feet. Tree farming by private industry and advances in forestry in other managed lands are expected to expand tree production greatly. In 1955, farmers in 35 states are cooperating in the formalized tree-farm movement under the sponsorship of the American Forest Products Industries, Inc. The goal of

WHAT'S HAPPENED TO OUR SAW TIMBER IN 350 YEARS?

(Figures in board feet)

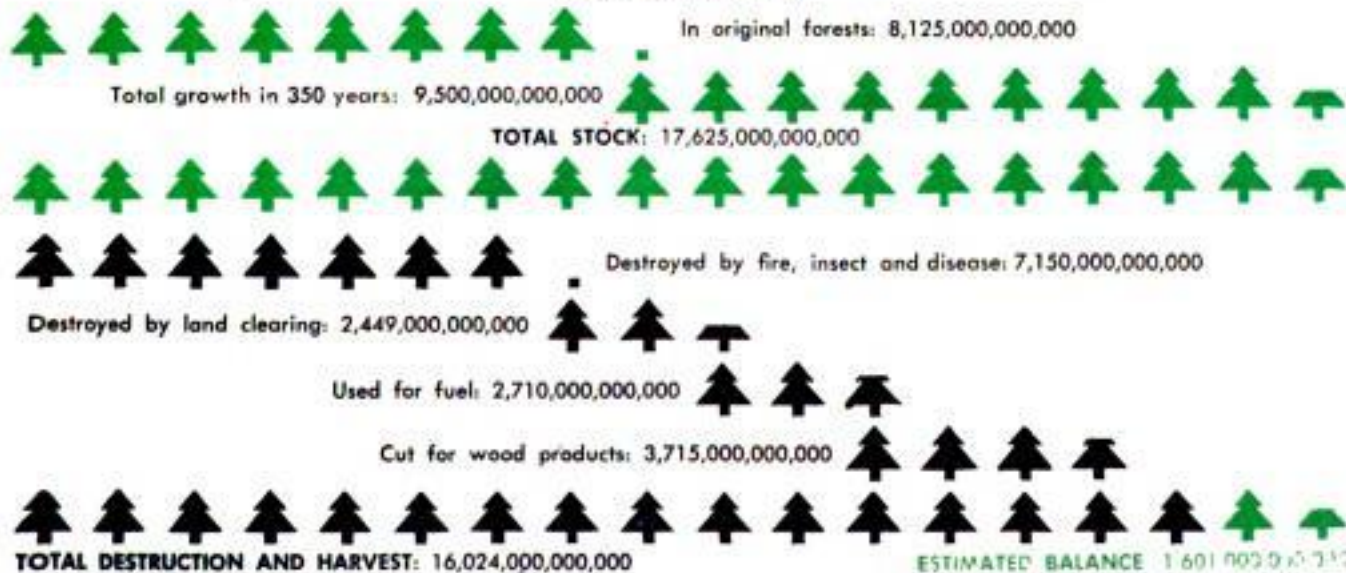



Artist's idea of future lumber mill: Helicopter delivers trees, combing machine strips needles from limbs

balancing forest growth with forest withdrawal should not only have been reached long before the 21st century, but surpassed.

A recent forestry report put it this way:

"The man who reads only the obituary column in his newspaper may come to the conclusion that the human race is dying out. But for the true picture, he should also look to the birth column. Each year, new growth of trees is now adding 35,000,000,000 board feet of lumber."

During the last 350 years, twice as much wood has been removed from America's forests as was growing here when the Pilgrims started clearing land for corn planting. Only one third of the wood was used for man's needs — from homes to railroad ties. The rest? Destroyed by fire, insects and disease. And here is where modern science will do much for the timber supply of 2005.

By that year, whole forests should be going through fire seasons without significant loss. "Smokey," the Forest Service's famed bear, may have gray whiskers by that time, but he will be grinning happily. Radar tracking of fires, utilization of television by

forest lookouts, use of helicopters in getting to the scene of a fire quickly and chemical fire suppression should have our forests' greatest enemy stopped cold.

Since cloud formations are already traceable by radar, improved apparatus of the future should be able to trace smoke by its density difference from fog and clouds, which might otherwise block a view. Experiments utilizing television for forest lookouts are already under way (see *PM*, July 1954).

Science has done much in the last decade to curb timber diseases and will do much more in the decades to come. By 2005, there should be complete control of tree diseases as well as of the insects which attack the trees.

Pulling out trees by helicopter instead of felling them will eliminate much damage to other trees and plants. Hazards of fire and insect and disease breeding grounds left by slash will be eliminated. After the tree is removed the ground will be fertilized and made ready for new growth to supply future generations.

But even more important, through genetics the trees of 2005 will be stronger and healthier. Howling winds will not mean tumbling trees.

Tree growth will be greatly speeded up. Scientific breeding will expedite growth of new trees from seed to maturity so that saw timber will be produced perhaps three times as fast as it is today.

But now let's take a look at the lumber mill of 2005. It holds even more intriguing possibilities than the forest.

Foresters of future will harvest trees from seedlings planted today by modern machinery. The goal is to balance forest growth and withdrawal

American Forest Products Industries photo





Rays may be used to knock branches and roots from trunk. Powerful debarker might scrape bark off log

The helicopter bearing the big pine from the frying-pan-rock site has just reached the mill, which is powered by atomic energy.

Gently the tree is lowered beside a row of others in the storage yard, which looks like Paul Bunyan's Christmas-tree lot. Again the logger in the helicopter flicks switches. The tree hooks are released and the cables drawn back into the helicopter.

"Just time to pick up another before lunch," says the logger, and the helicopter whirs back to the forest.

Meanwhile, a complete tree is being carried by remote control from the yard into the plant. First it travels through a machine where brushes and suction strip off all needles, leaving the tree looking somewhat like a plucked chicken. The needles move to laboratories for processing into chemical products.

Next, all limbs of the tree are bumped off, and these are sent for resin extraction and eventually to the pulping or hardboard departments. Roots are cut off and follow the trail of the limbs.

Now the debarking machine goes to work on the tree. The bark drops onto a moving belt, which carries it to the fertilizer-processing department.

The sawyer, perched high in his control room, has a lot of log to work with—one complete tree, in fact—but he gets an assist from the latest in scientific lumbering aids. Through television he studies the exterior of the log from end to end and, through X ray, the interior.

With the diagnosis completed, the sawyer is ready for the cutting—with powerful, superheated rays. Bandsaws of the 20th century have long since gone the way of the scrap heap.

No diamond was ever cut more precisely than the log as the rays move



Author suggests that X rays will spot flaws in logs

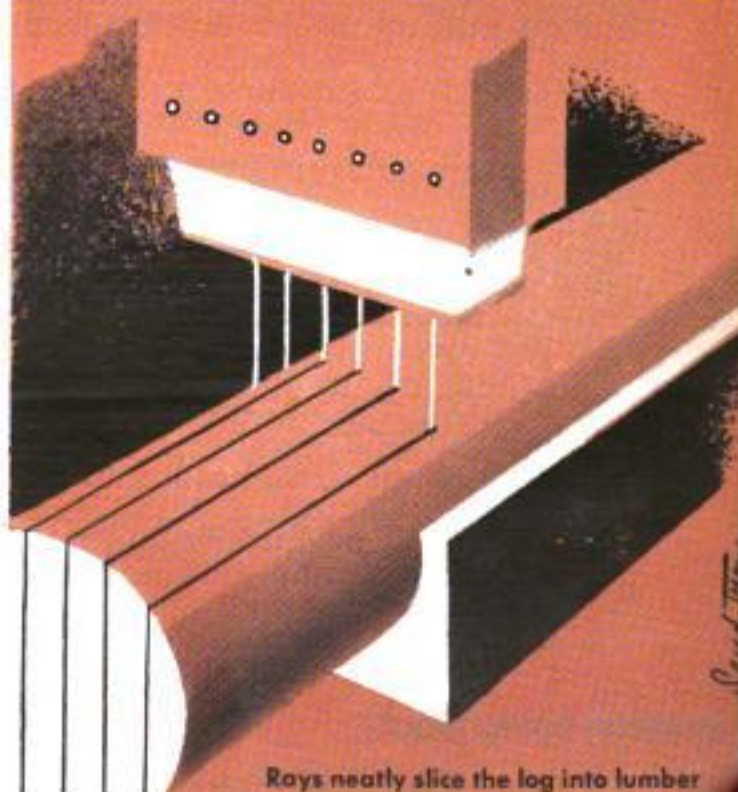

Rays neatly slice the log into lumber

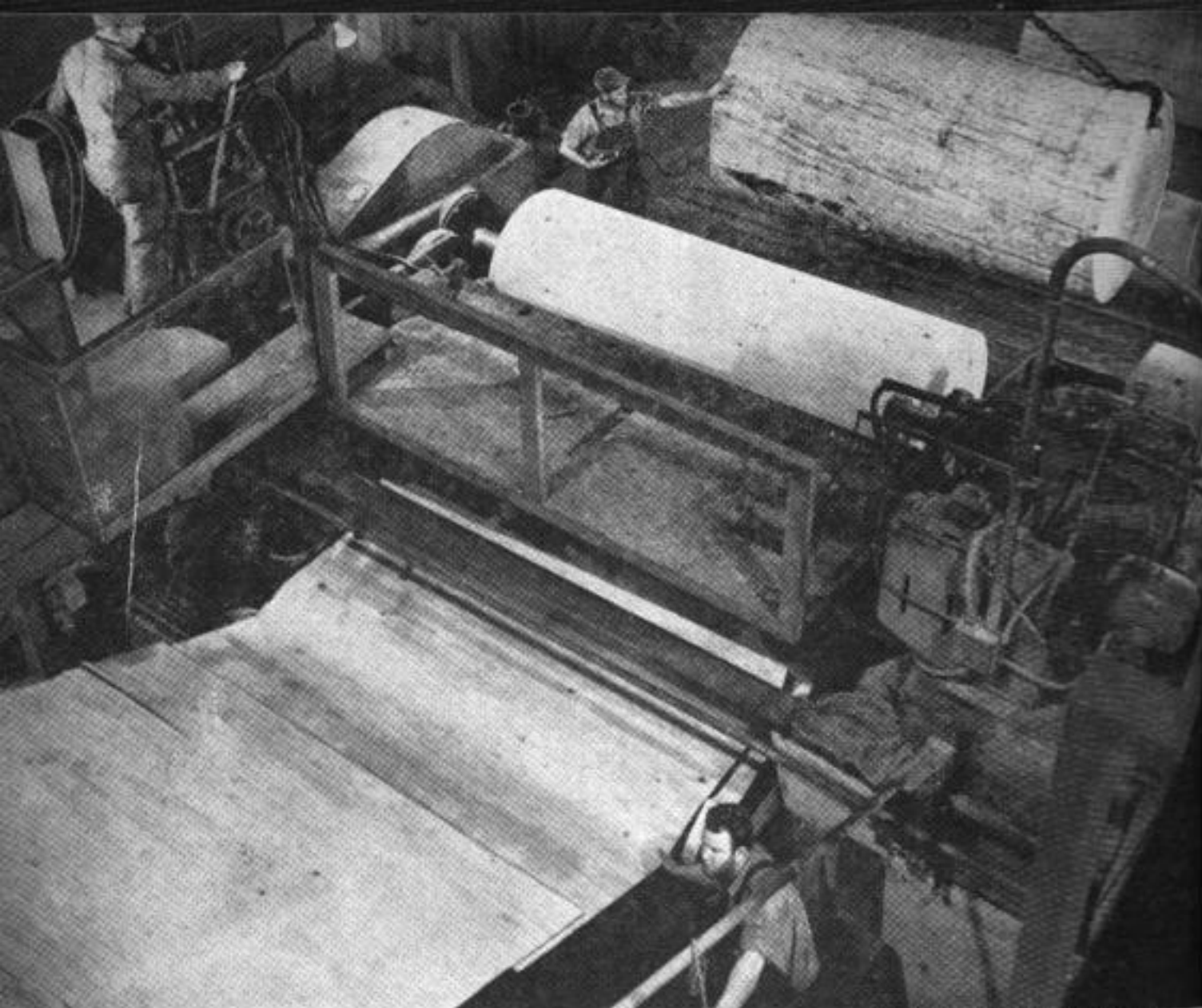

Douglas Fir Plywood—AFPI photo

Example of the mechanization of today's mills is this huge lathe that peels off ribbon of wood for plywood

down it. There is no loss to saw kerf—no sawdust.

In this single operation the boards are not only cut, but planed to mirror smoothness. The particular boards being cut are a maroon shade, which has gained wide popularity among East Coast homebuilders. A hypo-packing forester had previously stained the tree in the forest.

As far back as 1955, scientists were able to stain the outer wood of a tree, but now radiation has made possible the staining of the entire tree.

What happens in the dry kiln of 2005? There is none. Trees are seasoned in the woods before the helicopter cables ever reach down to pluck them out.

But the skeptic may say, "Okay, so in 2005 there will be helicopter loggers, ray cutting machines and plenty of trees, but with synthetic products all over the place, what has happened to the lumber market?"

Conservative estimates place the demand for lumber and lumber products in 2005 at three times that of today, or about 100,000,000,000 board feet per year.

Prefabrication is expected to be funda-

mental to virtually all building in the next century. Even storage and cabinet fixtures for homes will be part of prefab construction. Readjustment of wall panels will be all that is necessary to meet the desires of a new tenant.

Studies of fire-resistant treatments for wood are expected to give lumber a great advantage over steel and other metals, which even today are falling short in supply. Where metals become brittle, snapping and buckling under extreme heat, wood will stand firm.

Densified wood, which has gone through a compression process, will have hardness that will add both to its strength and wearability. The Western Pine Association Laboratory in Portland, Ore., for instance, has already developed a densified hardwood by compressing white fir and other woods. Wood can be expected to get harder with further advancement on such processes.

What effect will all this have on the carpenter of 2005? He will still be needed, but he may be seen driving a nail made from superhardwood with a hammer head of the same stuff! ★ ★ ★

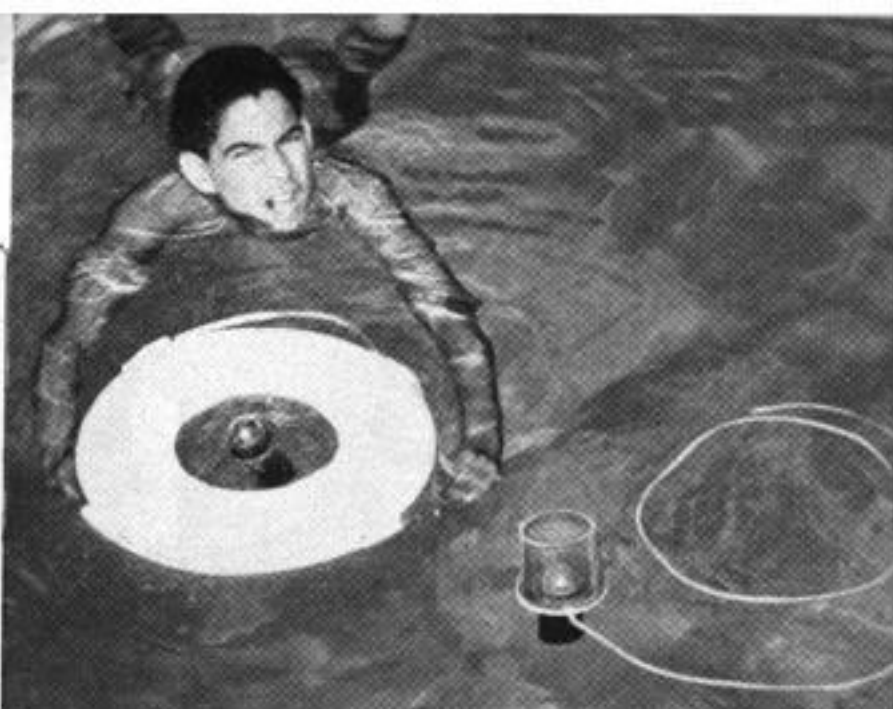
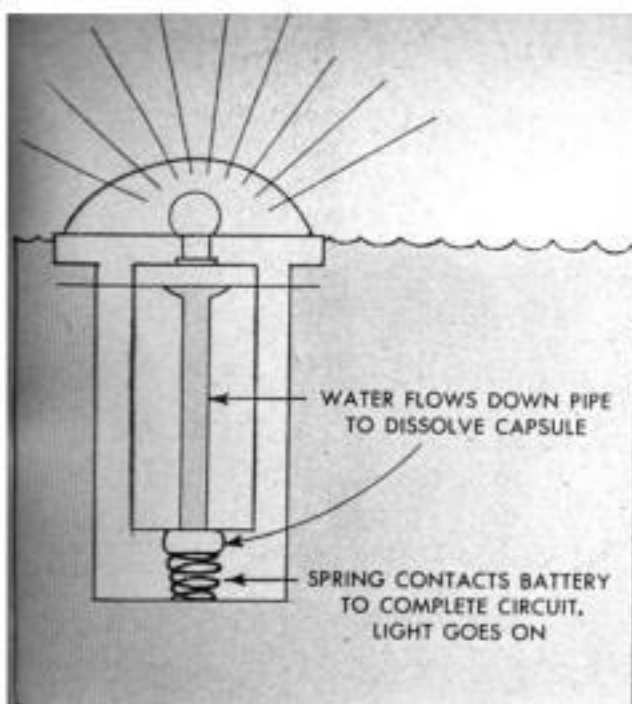

Aids to Sea Rescues

A FLOATING flashlight, a life preserver for small children, and a tent-covered life raft are among the latest safety equipment on transoceanic planes.

The flashlight turns itself on when it hits the water. Sea water enters a hole in the side of the unit and flows down to a soluble capsule that separates the spring and the battery. In a few seconds the water dissolves the capsule and the spring contacts the battery to complete the circuit and turn on the light.

The flashlight, attached to life buoys, life preservers and life rafts, aids the round-up of survivors after an air-sea crash. At night, the bobbing light can be seen for many miles by searching planes.

The midget life preserver, unlike standard preservers, will keep an eight-year-old child or an infant afloat. The life raft holds seven and has a tent to protect survivors.

Diagram shows how water turns on flashlight. It can be mounted on a life buoy or attached by a floating plastic rope to a life raft. Below, it aids night rescue of child wearing special small life preserver



Below, stewardesses of South America's Tan Airlines test life raft. Raft is equipped with hand pump and sturdy steel oars, one of which serves as a tent pole for canopy. Special "sea anchors" prevent capsizing



Copyrighted



Junior-Size Umbrella

Sun and rain can be kept from the new hat or from the hair with a new small-size umbrella that straps to a man's hat or around his head. Termed the Sunbrella, the colorful head protector has an adjustable band that can be fitted to hat or head. It is fine for fishing, golfing, beach wear or baseball bleachers, its makers claim.

Campstove Burns 2½ Hours On ¼ Pint of Fuel

Designed for hikers and campers, a tiny gasoline cookstove will burn for 2½ hours on a quarter of a pint of fuel. The stove has a collapsible grill for holding a pan or coffee pot, weighs one pound and fits into a 3½ by 5-inch container. It generates its own pressure without priming or pumping and is equipped with a chimney-type windshield for use in strong winds.



Leveling Jack for Docks

With a pair of crank-operated jacks, you can level a tilting dock without wading in icy water. The jack is designed for use with support clamps fastened to dock legs made of hollow pipe. The jack hooks into the top of the dock post and a chain sling supports one side of the dock. The operator stands on the dock, operates the crank to raise or lower it, then locks the support bracket to the pipe at the new level.

Hose Holder

Flexibility in sprinkling lawns and gardens is afforded by a stand that holds a garden hose in any of five positions. The hose can be placed to spray at angles from 15 to 90 degrees. The base is wide and tip-proof, providing stability even when the holder is placed on a slope.

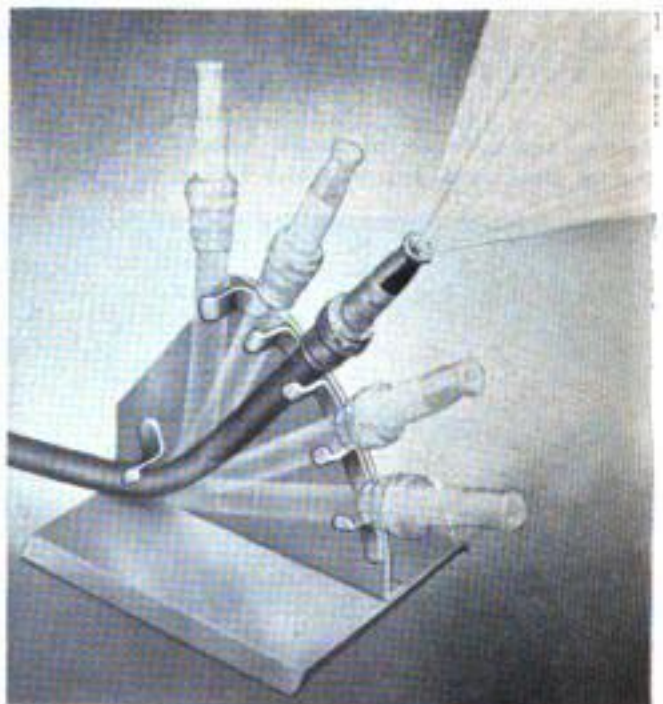



Experimental Craft Converts From Helicopter to Plane in Mid-Air

Recently an experimental craft changed from a helicopter to a conventional plane in mid-air. This is said to be the first successful flight of this type ever made. The craft is the McDonnell XV-1 Convertiplane, developed for the Army. It combines the vertical-flight characteristics of a helicopter with the speed and range of a conventional fixed-wing aircraft. The pilot uses an overhead rotor to take off and fly forward until he exceeds the stall speed of the plane

wings. He then shifts the power from the rotor to a pusher propeller and uses conventional aircraft flight controls. The overhead rotor is allowed to "windmill" during airplane flight. The plane is powered by a reciprocating engine. It drives the propeller and also drives the compressors which supply air to the pressure jets at the tips of the rotor blades. The plane was developed for possible liaison-reconnaissance missions by the Army.

Sickle Bar on Front of Reel Mower Trims Weeds and Tall Grass

Grass is "pre-mowed" by a little sickle bar mounted on the front of a new reel mower. The bar cuts off stem-type weeds and long, tough grasses so that the reel can do a clean job of mowing. The problem of uncut weeds and grasses that mat down under the mower only to pop up afterwards is eliminated. Because weeds are never given a chance to seed, weed control is made easier.

Glass-Fiber Golf Shafts Are Lighter Than Steel

Golf clubs with shafts made of glass fiber are lighter than their steel counterparts. The shafts are made by laminating glass-fiber cloth to a thin steel core. They are said to absorb shock, minimize vibration and impart a "softer" feel throughout the swing of the golf club.





It's not unusual for an angler to walk away with a big string of perch and catfish. Many lakes have an admission price of \$1, which entitles the angler to four fish. More fish, extra pay. Below, some lucky angler will catch this 41-pound catfish which was trucked in from Lake Erie



THEY PAY TO FISH

By George Laycock



MORE AND MORE followers of Izaak Walton are paying admission for the privilege of plunking a dry fly, a bait-casting lure or a plain earthworm into waters filled with fish.

The newest angle in fishing is the "pay lake" where the angler is virtually assured of a catch. Pay lakes are privately owned and are stocked by the owner. In the area around Cincinnati alone, pay lakes do an estimated business of \$2,000,000 annually. Fishermen try for a variety of game fish caught in the nets of Lake Erie's commercial fishermen. Just trucking fish into lakes and ponds has become a big business.

One of the largest pay lakes near Cincinnati is owned by Paul Muller. As many as 300 people fish his 18-acre lake in a single day, catching bass, walleyes, pike, perch, channel catfish and crappies. Muller has his own fish-hauling trucks which can haul up to two tons of fish in a load. Each truck has equipment to maintain the temperature of the water and supply the fish with oxygen.

Pay lakes have one big appeal to the angler: He's almost certain to catch some fish! ★ ★ ★



Holding pool near Muller's pay lake serves as a showcase for the whoppers which will be released later



Pay-lake operator weighs fish so he'll know how many pounds to replace, and whether he is making money



Some owners raise their own fish. Here owner fertilizes water to produce more plant life on which fish feed



Box holds up to a ton of fish for a few hours. Truck dumps fish into box, from which they are soon released



Plastic "Ceiling" Replaces Fabric in Plymouth Station Wagon

Plymouth station wagons are wearing one-piece plastic "ceilings." Available in various colors, the ribbed plastic headlining (as it is known to the trade) wipes clean with a wet sponge. Other advantages are: It fits closer to the roof to give more head-

room; it's durable and won't tear if caught by a crate or other bulky object; it has an insulating value against heat and cold. The single-piece plastic molding has another feature that body shops will like: It is easily removed for roof repairs.

"Bubble Chamber" Charts Paths Of Atomic Particles

Trails of tiny bubbles chart the paths of high-speed atomic particles in a new research instrument (see photo, right). The instrument is called a "bubble chamber" by its inventor, Prof. Donald A. Glaser of the University of Michigan. It consists of a glass container in which a clear, superheated liquid is held under pressure to delay its boiling. When particles from a nuclear accelerator pass through the chamber, their paths appear as trails of tiny bubbles. This occurs for a few thousandths of a second between the release of the pressure and the boiling of the superheated liquid.

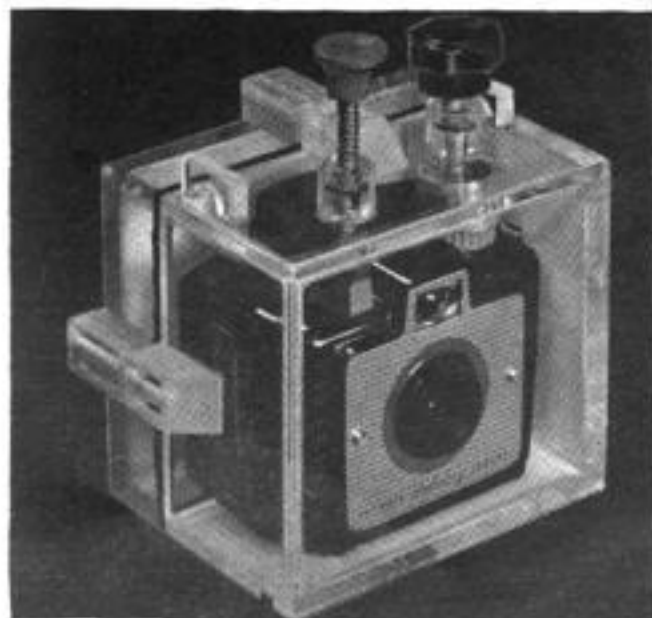
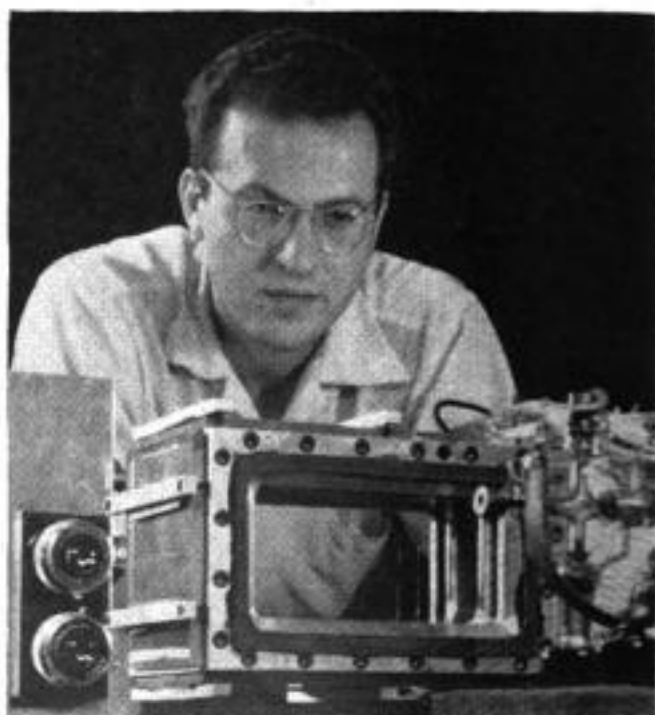

← Underwater Camera Case

Beginning skin divers now can take underwater pictures with a Brownie camera. An inexpensive, transparent plastic case for the little camera allows a full roll of film to be shot in one dive. A spring-back button that projects through the case is pushed to snap a picture. A projecting dial is revolved to turn the film. A carrying strap loops through two eyelets on top of the waterproof case.

☞ Paint said to make objects "invisible" to radar has been developed in Canada.

Pilot Seated on Ground Flies Drone Helicopter

More than a year's flight testing of a remote-control helicopter is being evaluated at the Kaman Aircraft Corporation plant at Bloomfield, Conn. The helicopter is a Kaman HTK-1, with an automatic pilot and radio controls, so that it can be flown by an operator on the ground. To date it has been flown forward, backward and sideways, has taken off, landed and hovered. A stand-by safety pilot has occupied the aircraft on flights.



Four-Cylinder Sportster Goes 116 Miles per Hour

With a four-cylinder engine that develops only 66 horsepower, an Italian sports car has a top speed of 116 miles per hour. Designed for competition, the completely streamlined car has a flush-fitting lid that covers the passenger seat and a fin behind the driver's headrest. The chassis was designed by Boano of Turin, Italy, and the manufacturer is the Arbath Company, also of Turin.

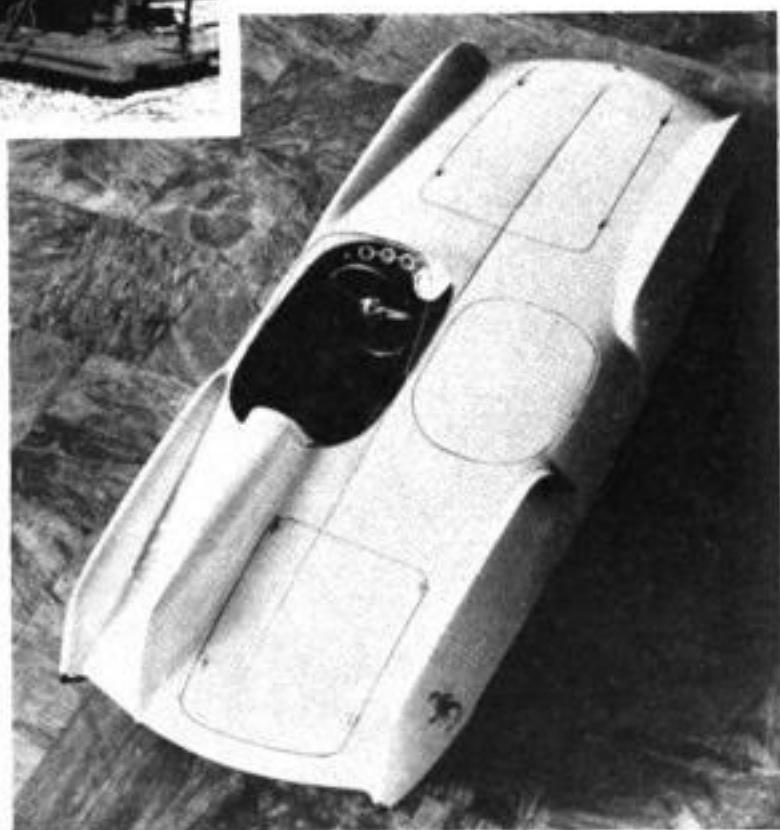

Hand Truck Climbs Stairs On Power-Driven Wheels

Heavy loads can be moved up and down steps on a new stair-climbing hand truck. The truck is equipped with a hand-operated power drive. The operator pulls on a drive cable, which transmits additional power to the two wheels through ratchet gears. According to the manufacturer, the power drive doubles the amount of load that can be rolled up steps. Two-wheel brakes permit heavy loads to be moved down stairways or steep ramps safely. The hand truck is made in a variety of models and sizes for handling barrels, castings, hardware, machinery and other heavy items.

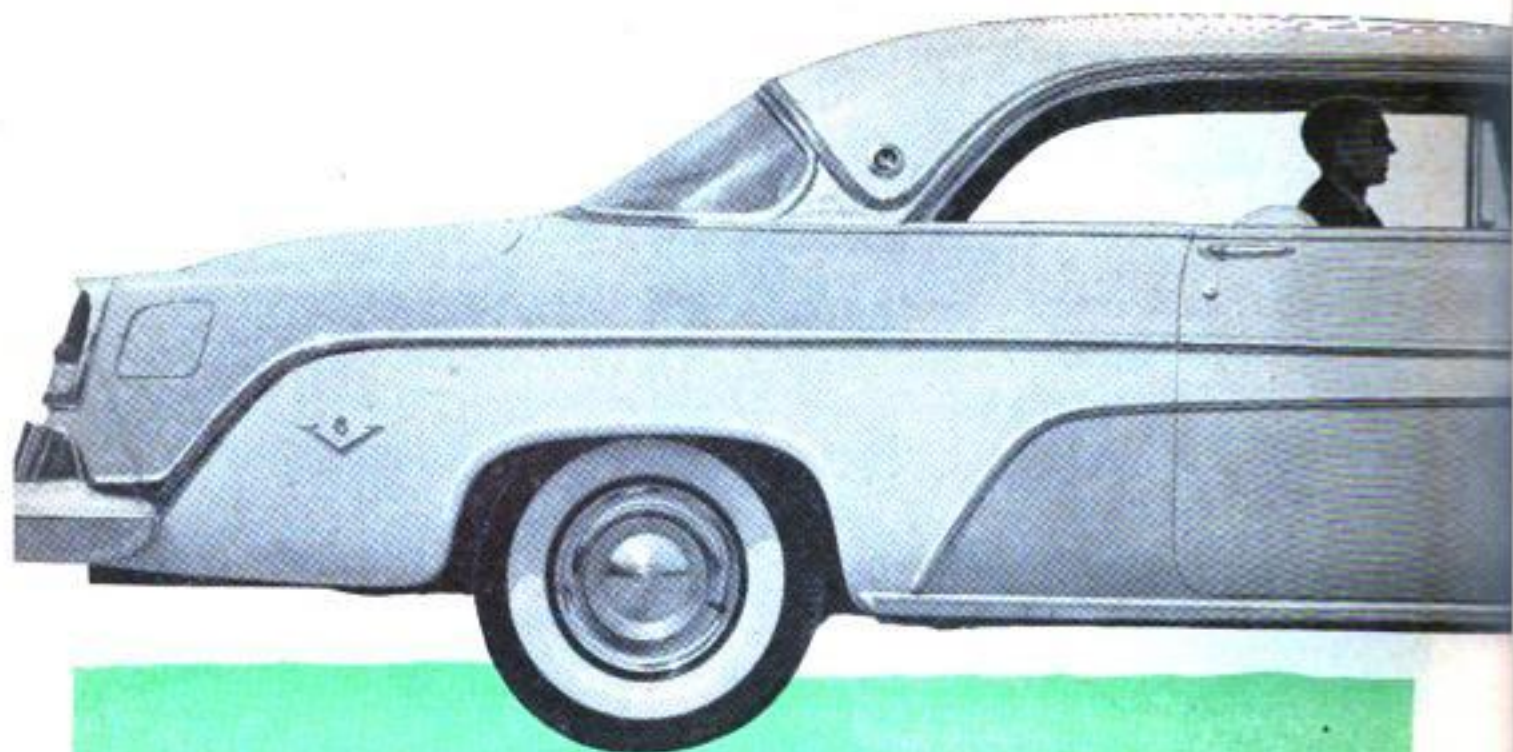

De Soto Owners Like . . .

Handling

"Best handling car I ever owned. Remarkable road hugging at all speeds."

Tennessee busdriver operator

Riding comfort

"I like the seats. I never get tired riding in this car."

North Dakota farmer

Styling

"My hardtop gets raves for its styling every day."

Michigan bacteriologist

But They Don't Like . . .

Body leaks

"Doors very poorly fitted. Water leaks during rain or wash jobs."

Rhode Island teacher

Poor assembly

"Very poor assembly. Improper fit of components."

Texas naval officer

Rattles

"It rattles and has quite a lot of squeaks."

Ohio glass worker



CLYMER TESTS DE SOTO V8

By Floyd Clymer

THE TEST CAR was the 1955 De Soto Fireflite four-door sedan, with 4-barrel carburetor, 200-horsepower V8 engine and PowerFlite transmission. The test was from Los Angeles to Yuma, Ariz., via Riverside, the Salton Sea (246 feet below sea level), and returning via Needles, over the desert to Barstow and back to Los Angeles for a total of 697 miles, which in-

cluded some unpaved back-road testing. De Soto's new model has more power, acceleration and higher top speed than last year's. Although the big car is 200 pounds heavier than the 1954 model, its wheelbase is only ½ inch longer.

I found better cornering, roadability, an improved ride over rough roads and a

(Continued to page 224)



OWNERS REPORT: 1955 DE SOTO V8

By De Soto Owners

THERE'S A WHOPPING amount of agreement among De Soto owners on the best-liked feature. More than half (57 percent, to be statistical) of the owners rate handling ease as the thing they like most about their new cars.

"Handling is excellent. I can drive it all day and it does not tire me at all."—North Carolina bookkeeper.

"Easy to steer. I drive relaxed. There is no wandering on the road at any speed and no driving fatigue on long trips."—Kansas cafe owner.

Second and third on the best-liked list are riding comfort and exterior styling. Only a single percentage point separates these two. Comfortable ride was mentioned by 38 percent and the new body styling by 37 percent of the De Soto owners.

"I like the riding comfort. It's built so you don't get the jolts. My friends keep telling me it's like riding on a cloud."—Arkansas saleslady.

"My hardtop model gets raves for its styling every day in the week."—Michigan bacteriologist.

"It looks neat without being flashy. The long, low body has a sleek appearance that others don't have. There are no bulging taillights. I especially like the headlight design with the chrome frame instead of the fender metal extending over the light."—Louisiana housewife.

And There are Complaints

What do De Soto owners complain about? Well, 20 percent of them made no complaints at all when asked to list them on the PM questionnaire. Among those who did complain, the most frequent complaint

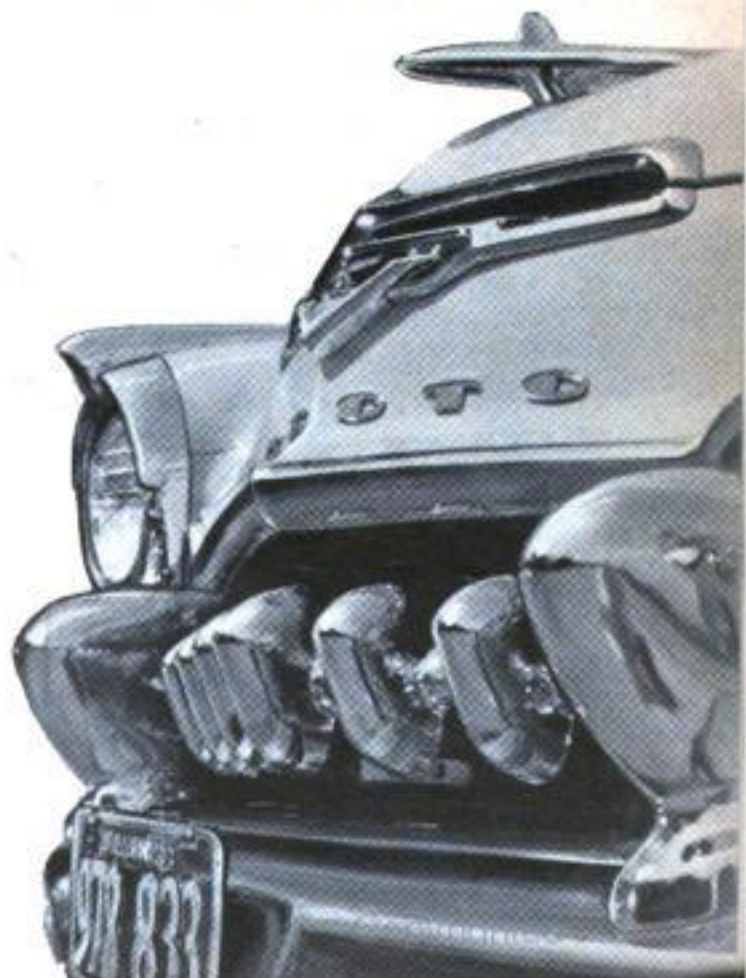



Although the De Soto is a big car (over 18 feet long), owners praise its maneuverability and handling ease

mentioned is dust and water leaks in the body. There are 24 percent who mention this. Another 22 percent list poor body assembly as their big complaint and 16 percent more list the related complaint of body rattles.

"Both front doors leak during heavy rains. So far the dealer has not been able to correct this."—Kansas Army officer.

"Sloppy, careless assembly of the body. The engineers did a fine job on this car and then the fabricators and assemblers loused it up. Driving over very rough roads there is a sensation of looseness as if there were a number of places where bolts and screws should be tightened in the frame and body."—Delaware engineer.

"Unable to get the rattles out of the body,

especially the doors."—Nebraska factory representative.

We asked the De Soto owners if they had any trouble with the V8 engine. The great majority of them had absolutely no trouble to report (68 percent). Another 29 percent had some trouble and only 3 percent state that they had considerable trouble with the power plant.

Of the owners who had trouble, 9 percent list the power-steering system (almost always the trouble involved leaks in the hose couplings or leaks due to hoses breaking). Another 5 percent had carburetor trouble, 3 percent had trouble with the water pump, another 3 percent had trouble with the automatic choke.

"Power-steering hose broke four times.

Clymer says De Soto's shock absorbers provide good rebound control even on severe bumps like this water hole





This month's survey just about blanketed the nation. De Soto owners from 43 states (in color) took part

Percentages from *PM* Poll of 1955 De Soto Owners

Miles per gallon

City driving 13.5 m.p.g.
On trips 16.1 m.p.g.

Oil consumption

None 58%
Some 36%
Considerable 6%

Had trouble with the engine?

None 68%
Some 29%
Considerable 3%

What was the engine trouble?

Power steering 9%
Carburetor 5%
Water pump 3%
Automatic choke 3%
Stalls frequently 2%
Noisy 2%

Do you want more horsepower?

No 87%
Want less 2%
Want more 11%

What did you trade in?

De Soto 58%
Other Chrysler make 17%
Other Big Three make 16%
Independent make 4%
No trade 5%

OVER-ALL RATING OF THE DE SOTO	
Excellent	67%
Average	28%
Poor	5%

How was your trade-in allowance?

De Soto traders
Above average 32%
Average 60%
Below average 8%

Other Chrysler traders
Above average 44%
Average 50%
Below average 6%

Other Big Three traders
Above average 43%
Average 57%
Below average 0%

Independent traders
Above average 37%
Average 63%
Below average 0%

Would buy another De Soto?

Yes 70%
Might 21%
No 9%

What convinced you to buy De Soto?

Previous ownership 23%
New styling 16%
Chrysler engineering 4%
Trade-in allowance 4%
Handling ease 4%

What Should Be Changed?

Needs no changes 43%
Improve dashboard 10%
Outside door handles 5%
Better body work 5%
Improve gas mileage 3%
More headroom 2%

Most-Frequent Complaints

Dust and water leaks 24%
Poor assembly 22%
Rattles 16%
Dash design, assembly 14%
Poor gas economy 11%
Power steering leaks 8%
Trunk hard to operate 6%

20% of the De Soto owners made no complaints at all

Best-Liked Features

Handling ease 57%
Riding comfort 38%
Exterior styling 37%
Power, performance 28%
Roadability 12%
Roominess 9%
Brakes 9%

Carburetor gave trouble but corrected now."—South Dakota salesman.

"Power-steering hose parted at coupling."—Michigan labor-relations director.

"Water pump and fan had bad vibration."—Mississippi sales engineer.

"Automatic choke keeps giving trouble."—Montana farmer.

"Thumping water pumps. Control of engine idle for PowerFlite gave trouble."—Massachusetts sales representative.

What Would They Change?

In each survey we ask owners what single thing they would like changed in their cars. The De Soto owners don't agree on any one thing to any great extent. However, there is one large area of agreement: 43 percent of the owners say the De Soto is all right as it is and needs no changes.

But another 10 percent want something done to the dashboard. De Soto has what it calls a "gull wing" design and some of the owners are not impressed with it.

"Dash panel is a little childish. I would

like a smarter-looking panel."—New York chemical engineer.

Second on the list of features to be changed are the unusual flush-fitted exterior door handles. These handles remain flush with the door until you want to use them. Then you push in one end of the handle with your thumb and the main portion of the handle swings out so you can grab it to pull open the door. There are 5 percent of the owners who would like these handles changed.

"I wish they would change the door handles. I don't think they will last too long."—Massachusetts baker.

Within a fraction of a percentage point of second place among the most-wanted changes is improved body workmanship (5 percent mentioned this).

"More care should be the goal for manufacturers in such work as window trim, dashboard trim, glove-compartment door, trunk-lid fits, and other small details."—North Dakota salesman.

De Soto owners, like most other owners,

TEST DATA

1955 DE SOTO FIREFLITE SEDAN
with PowerFlite Transmission

Driver's Blind Spot

Farthest point 21'-1" Nearest point 12'-8"

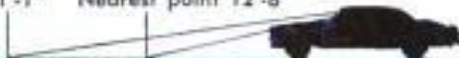

Acceleration Test

¼ mile from zero	21.2 seconds
½ mile from zero	31.8 seconds
0 to 30 m.p.h.	4.9 seconds
0 to 60 m.p.h.	15.1 seconds
Top speed by speedometer	112 miles per hour
Actual top speed	about 106 miles per hour

Economy Test

Constant-Speed Mileage

At constant 30 m.p.h.	20.3 miles per gallon
At constant 50 m.p.h.	17.4 miles per gallon
At constant 60 m.p.h.	15.8 miles per gallon
At constant 75 m.p.h.	13.1 miles per gallon

Cross-Country Mileage

Los Angeles, Calif., to Yuma, Ariz. (via Salton Sea)	16.5 miles per gallon
Yuma, Ariz., to Needles, Calif. (very little traffic)	17.1 miles per gallon
Needles to Los Angeles (considerable traffic)	15.2 miles per gallon
(Regular and premium gasoline used)	

Comparison with 1954 De Soto

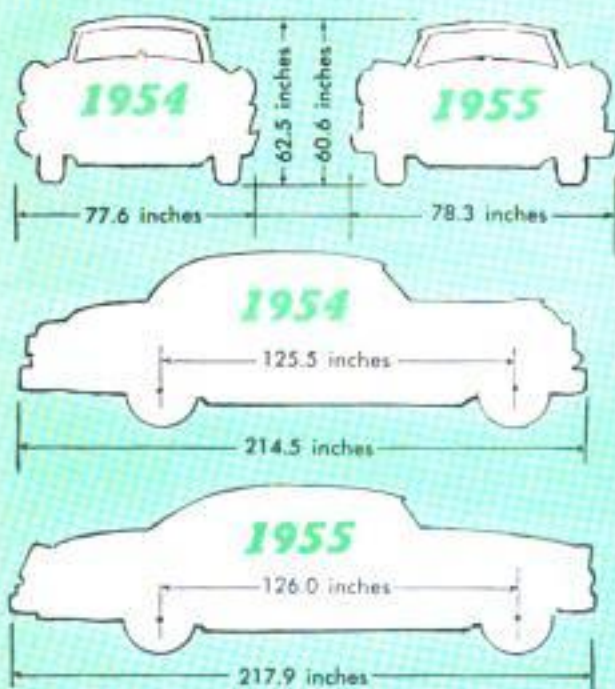

Popular Mechanics' Owners Reports are prepared this way: 1000 questionnaires are mailed to a random selection of new-car owners each month. Names of owners polled are provided by an independent organization and are taken from state registration lists. The owners' names are kept confidential. Their opinions are carefully tabulated. Sample quotations are then selected for publication in the monthly articles



Operation of front-seat adjustment is difficult, says Clymer. The piano-wire linkage (arrow) works poorly

would like to go more miles per gallon. "Manufacturer should stress better gas mileage."—Iowa locomotive engineer.

Other most-wanted changes are more headroom in front and rear, a better rear-view mirror, easier entry and exit to the back seat of hardtop models and more-durable belts for driving the power-steering pump.

The Horsepower Race

Everybody seems to be concerned about the so-called horsepower race. The 1955 models, more than any others in history, offer greatly increased power ratings. What does the buying public think of this? We asked the De Soto owners.

(Continued to page 228)

De Soto's flush door handles should be changed, say five percent of the owners, but Clymer likes them





In a test flight, T2V-1 in foreground is paced by its predecessor, a Shooting Star type of training plane

Compressed-Air Slots in Wing Enable Jet to Land at Low Speed

Fast in the air, Lockheed's new T2V-1 Navy jet trainer exceeds 600 miles per hour in flight but slows to 97 miles per hour for landing. The first two-place jet trainer designed for carrier as well as land use, it features a "boundary-layer control system." In this, compressed air from the jet engine is channeled into the wing and blown through tiny slots out over the

wing flap and aileron. This effect makes the normal flow of air over the wing hug the skin surface, increasing lift and delaying the approach to stall. The 38-foot plane has a height of 13 feet, a span of 42 feet, carries 760 gallons of fuel and has a range of 900 miles. The craft is powered by a 6100-pound-thrust Allison engine and contains a simplified cockpit-instrument panel.

Folding Hothouse Made of Plastic

Plastic covering over an easily assembled frame of light metal tubing makes a folding hothouse developed in Germany. The hothouse, which can be set up in a short time, weighs but 80 pounds and covers 190 square feet.

By strengthening the walls of the capillaries, preventing their being penetrated by virus, a compound made from the peel and pulp of oranges has produced dramatic results in treating head colds, influenza, tonsillitis and bursitis.

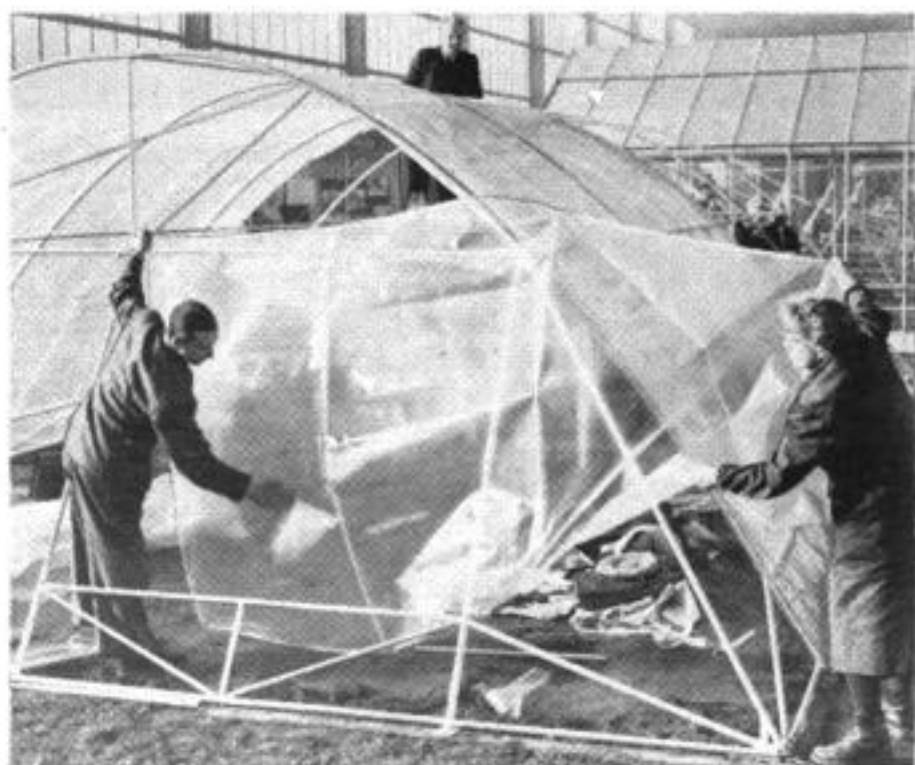

SMOKE-EATING CATALYST

By Fred Steffen

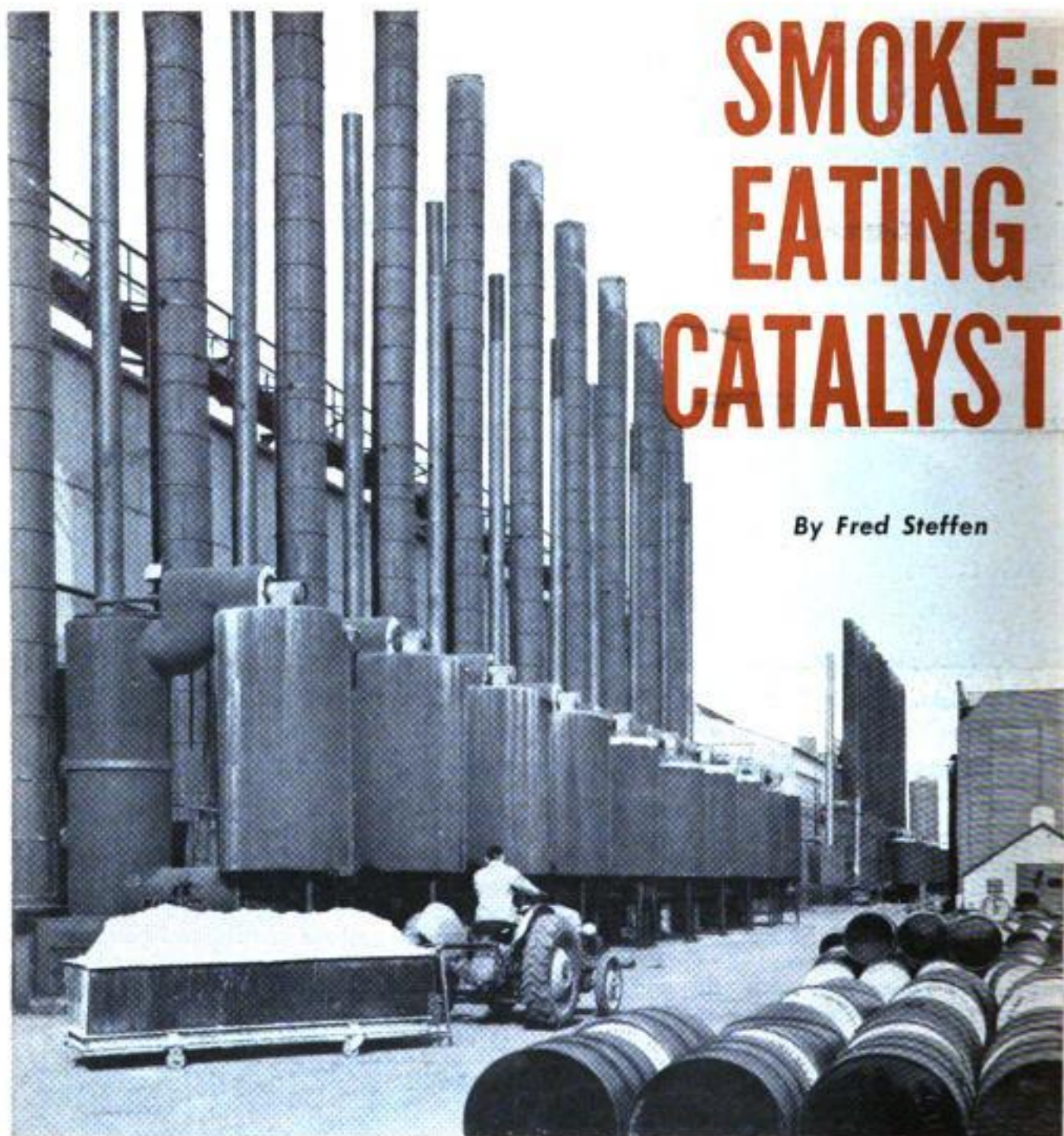

Reichold Chemical plant in Detroit, first to use the fume-killers, now has 28 catalytic units on stacks

THREE FARM BOYS turned engineer have fashioned a fume killer that's taking the bite from smog wherever it's used.

Catalytic Combustion Corporation devices, small enough to fit into the palm of your hand and big enough to fill two flat-cars, are wiping out dangerous and annoying gases and fumes from Pennsylvania to California.

A Brazilian paint manufacturer has ordered one. Italian, English and Australian firms are interested. Delighted owners of units are discovering important allied uses. Heat formed in "burning up" the objectionable fumes is returned to warm the building or to dry paints or perform a

dozen other uses including preheating the fumes themselves.

Graphing the temperatures of the burning wastes shows when the industrial process is at its best and worst and the process can be adjusted accordingly.

Thermometers hooked to the units can sound an alarm when mine shafts or plants with explosive potential reach the danger point.

An adaptation for the mufflers of lift trucks turns deadly carbon monoxide into harmless carbon dioxide.

All this began when three farm boys who later became engineers in Detroit decided to do something about destroying end-product fumes and gases that embarrass



Norbert Ruff holds a catalyst element. It is made of resistance wire coated with platinum and palladium derivatives in bottle

and harass many industrialists throughout the world.

They are Richard J. Ruff, president of the Catalytic Combustion Corp.; his brother Norbert, and Russell Suter. The Ruffs, natives of Bloomer, Wis., met Suter, a native of Ohio, at Detroit Tech. Richard Ruff and Suter invented the process and the younger Ruff built the first units. At a plant in Bloomer, he's still building the catalytic filter elements that are the heart of the system.

Ingenious application of a simple truth of chemistry is the foundation of the process which nullifies deadly fumes like those that killed people at Donora, Pa., and make Los Angeles eyes smart.

Smoke-abatement devices are in two general categories: Mechanical methods that use water sprays, turbulence, charcoal or other actual filters to remove solids; chemical or burner units which destroy objectionable fumes by burning them up and turning them into harmless wastes. Some actually use flames from tiny gas jets to do the work.

The Ruff-Suter unit, which is housed in a sheet-steel container that looks like a piece of heating equipment, is of the chemical type.

The catalyst element resembles

(Continued to page 212)

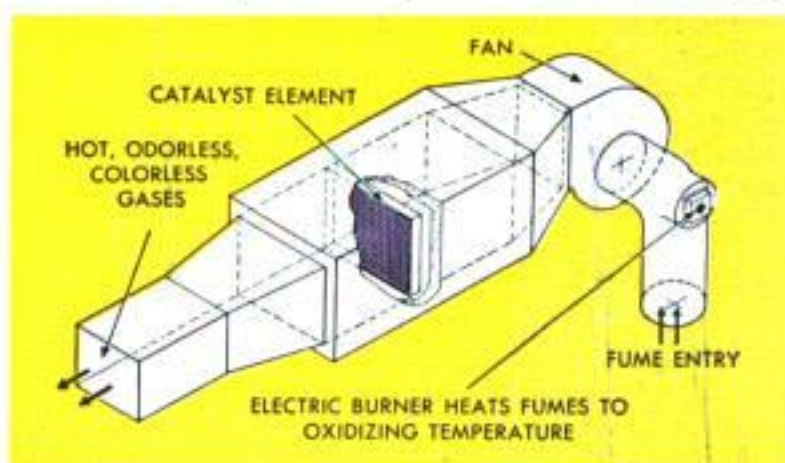

Preheated fumes are forced through catalyst element, which speeds oxidation of objectionable hydrocarbons. Waste gases are "burned up." Heat from the combustion is sometimes used to preheat fumes. Below, lab unit destroys gases used in rat tests

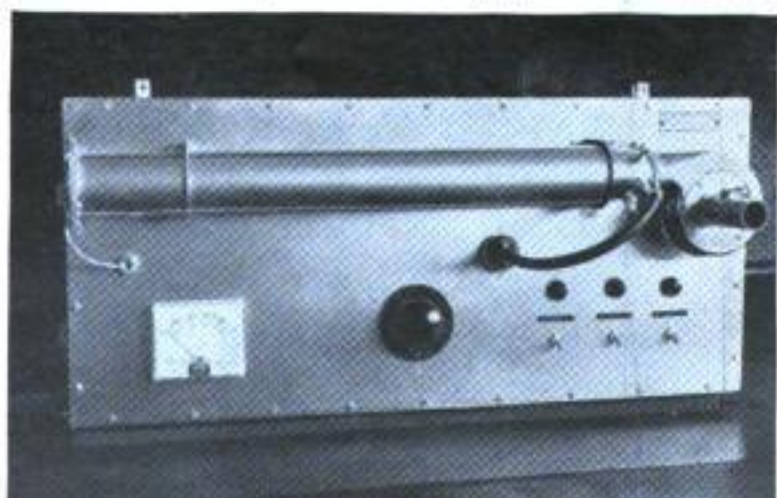



Portable Boat Assembled in Seven Minutes From Small Package

Completely portable is a 56-pound, 8½-foot boat that is assembled in seven minutes from a compact package. After its wooden parts are assembled, the flat-bottom boat is made waterproof by a nylon and vinyl

skin fitted around the hull. Aluminum oars or a 3½-horsepower outboard motor can be used to propel the craft, which can be carried in a car trunk or divided into two 28-pound back packs for easy portaging.

Camera Uses Aircraft Lamps

Two aircraft landing lamps and some small motorcycle batteries allow newsreel and TV cameramen to carry all the light they need for covering after-dark events. The batteries are carried in a knapsack strapped to the back of the operator. With the outfit a cameraman can walk anywhere without an external power source and can even parachute to a remote disaster scene. The landing lamps are mounted at the ends of a short aluminum rod to which the movie camera and gun-type trigger are also attached.



Riding Sulky for Rotary Mower

Behind a new rotary mower is a riding sulky. You sit on a swivel seat and ride as you mow. The mower can be steered with hand controls, foot controls or both, and has a turning radius of only 36 inches. It can be operated in forward and reverse, and has a power take-off. The sulky is available separately and can be adapted to fit most self-propelled lawn mowers.

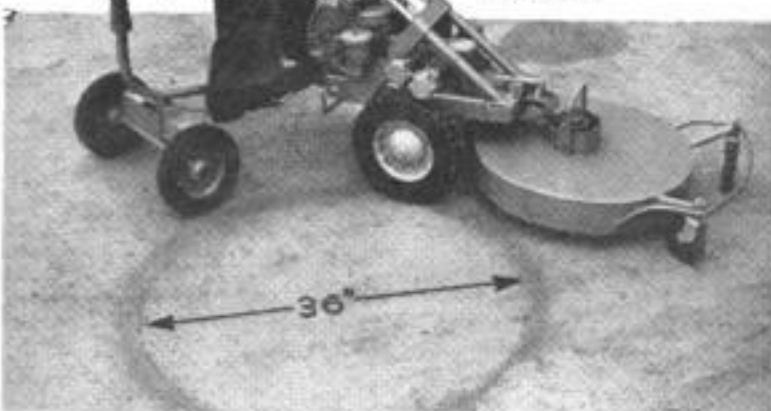

Long-Extinct Element Made by Scientists

Element 101, which existed at the birth of the earth but soon became extinct, has been regenerated by University of California scientists. The element was produced by bombarding element 99 with alpha particles. Intensely radioactive, it has a half-life of a half hour to three hours and chemical properties similar to thulium. The 101 isotope discovered by the scientists has a mass of 256 and is thus the heaviest matter ever found on earth. Named mendelevium, it was found by the same scientific team that discovered plutonium. Only 17 atoms of 101 were identified in the experiments.

☛ Songs of more than 80 insect species have been captured in the field by portable tape-recording equipment in an Ohio State research project.



Pressure-Can Fuel For Lamps or Torches

Fuel for mantle lamps, torches or portable stoves is instantly available without pumping through use of fuel contained in an aerosol-type container. The fuel feeds through a valve that vaporizes it while drawing in air to facilitate combustion. A mixture of two flammable hydrocarbons, the fuel provides its own pressure because its boiling point is so low that it builds up pressure at 35 degrees Fahrenheit. Each container delivers at least 8500 B.T.U.



Mixer Blends Farm Feeds In Desired Proportions

All the farmer has to do to produce a daily ration of feed for his livestock is turn a series of dials on a new electric mixer. The machine measures the correct amounts of up to four different feeds, mixes them and turns itself off. The feeds, which can include grains, dry molasses, cob-mix, concentrates and ground alfalfa, are piped into the mixing hopper. An automatic timer shuts off the machine when the right amount of feed is produced.

Gas Engine Pushes Lawn Roller and Fertilizer

All the heavy work is taken out of rolling a lawn by a new roller powered by a gasoline engine. With optional attachments the roller also can be used to aerate, fertilize and seed the lawn. The aerator can be adjusted to a depth of 1½ inches, and the fertilizing and seeding equipment can be set to the quantities desired. The operator can use the attachments separately or combine them to do all the jobs at once. A small trailer is available for transporting the machine.

Telephone Trouble Spotter

Telephone repairmen use a new instrument to find trouble spots in lines before an actual break occurs. The device sends electronic impulses along a line and measures the received signal to determine how far away the spot is and how big a break is present to cause power loss. The electronic impulses activate a machine which punches out information to indicate the line number and the trouble-spot location. It can check 900 lines per hour.



ARROWS SHOW AIR FLOW
AROUND CONVENTIONAL
TRACTOR-TRAILER

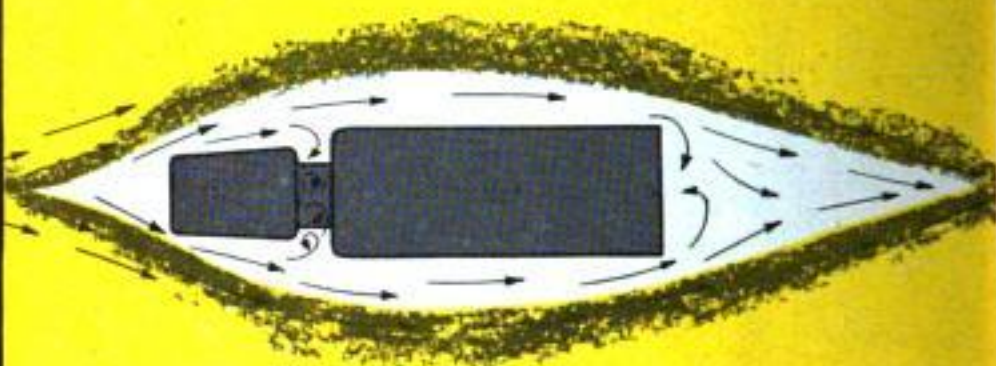

***Conventional Tractor-Trailer:
Fuel Costs \$3600 Per Year***

WIND RESISTANCE
CUT 56%
FUEL COSTS CUT 19.3%

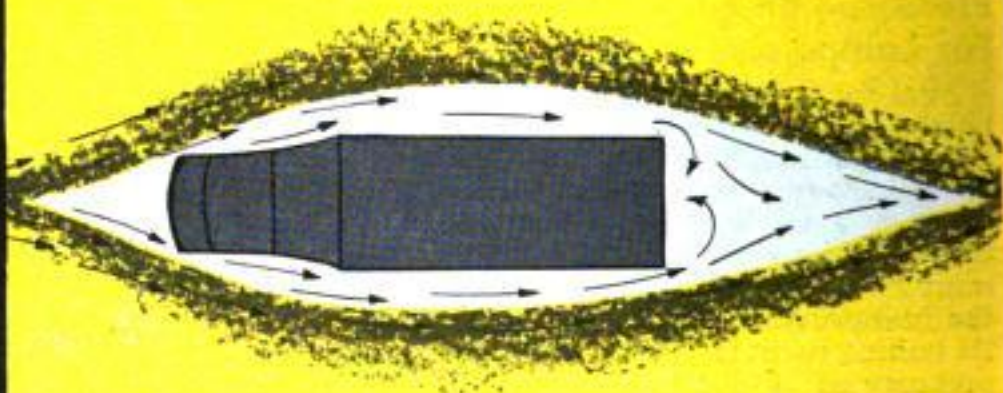

Partial Streamlining Saves \$700 Per Year

Radical Streamlining Saves \$1080 Per Year

WIND RESISTANCE
CUT 86%
FUEL COSTS CUT 30%

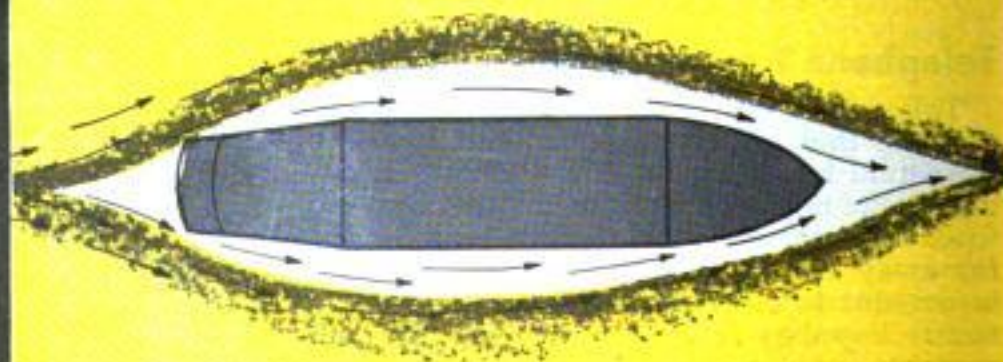

Streamlining the Highway Freighter Would Save Gas

THERE'S NOTHING new about streamlining. In recent years, it has even changed the shape of such unlike items as vacuum cleaners and safety-razor travel cases.

Yet the biggest, noisiest and, some motorists suspect, fastest machine on the highway, the tractor-trailer, gets bigger, noisier and faster without streamlining.

But changes may be coming. Wind-tunnel experiments by the University of Maryland and Trailmobile, Inc., show that truckers can cut as much as \$1000 a year from fuel bills by streamlining trucks.

Here are some facts the wind-tunnel tests disclose:

- At 50 miles per hour, it takes 58.3 horsepower to overcome the wind resistance of a boxy trailer. Radical (and impracticable) streamlining would cut this to 8.1 horsepower and save 30 percent on fuel costs or \$1080 a year.

- It takes 6.5 more horsepower to pull a trailer with exposed vertical posts 50 miles per hour than a smooth-sided trailer.

- Simply rounding the front end of the trailer saves about 9 horsepower or \$200 a year in fuel costs.

- Biggest drag is the gap between the tractor and trailer. Closing it would cut resistance 25 percent; adding skirts to the trailer wheels cuts another 20 percent.

- A long, streamlined tail on the trailer cuts drag 12 percent, but legal-length limitations and loading problems make this impracticable. ★ ★ ★

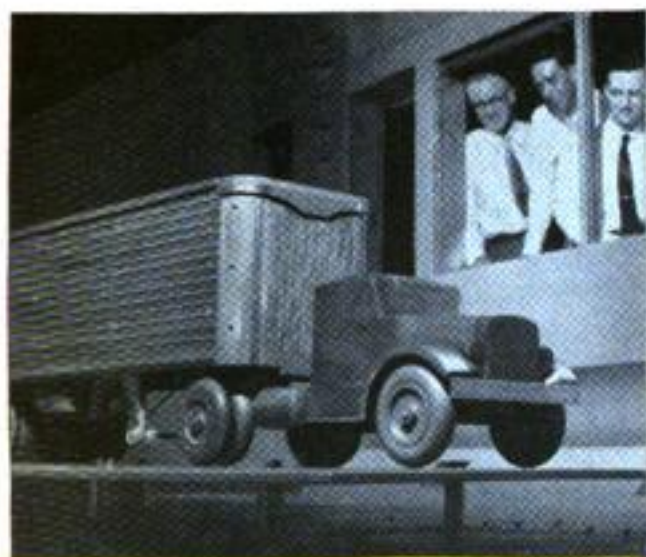

Above, truck-trailer in the wind tunnel. The rounded front end and horizontal corrugations cut fuel costs \$270 a year below gas bill of trailer with square front and vertical posts



Partial streamlining (mostly closing the gap between tractor and trailer) would save \$700

Radical streamlining, below and right, would save \$1080, but it is obviously impracticable

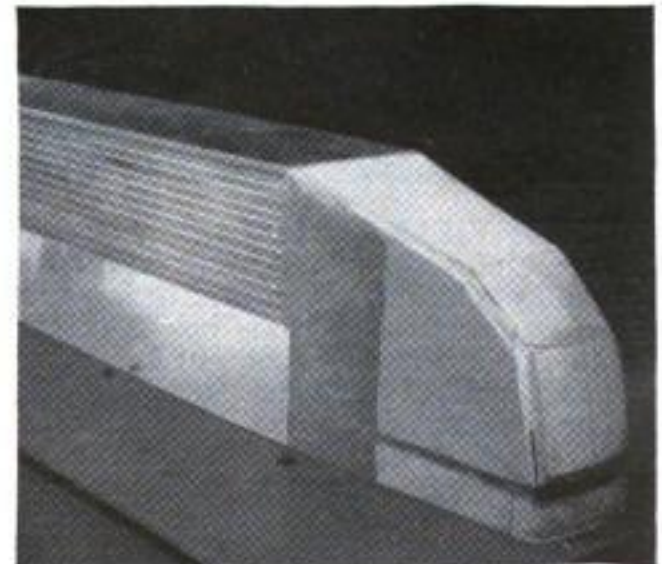
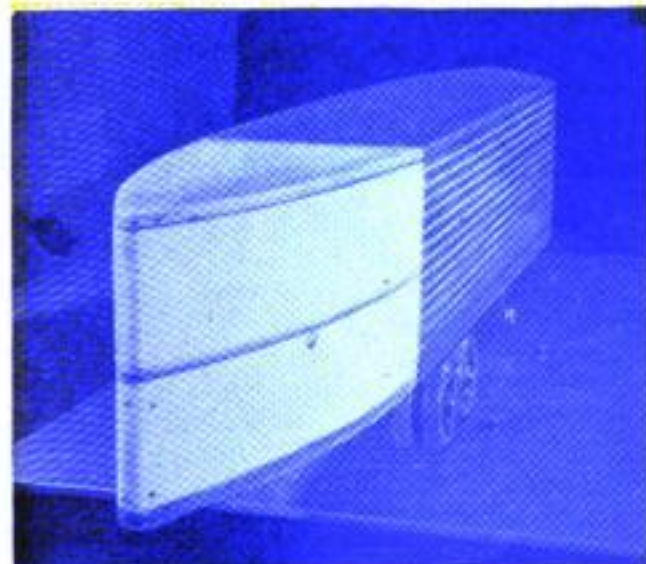

Planter Distributes Two Bands of Fertilizer

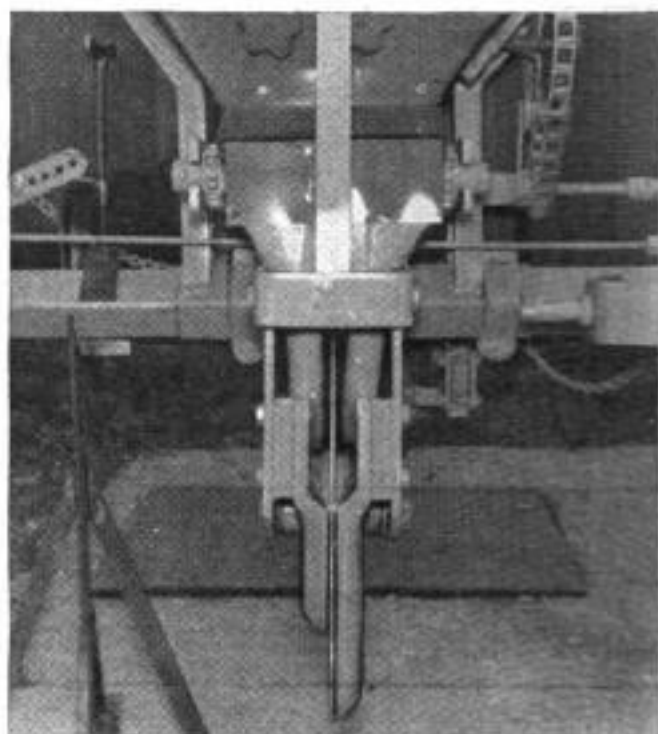
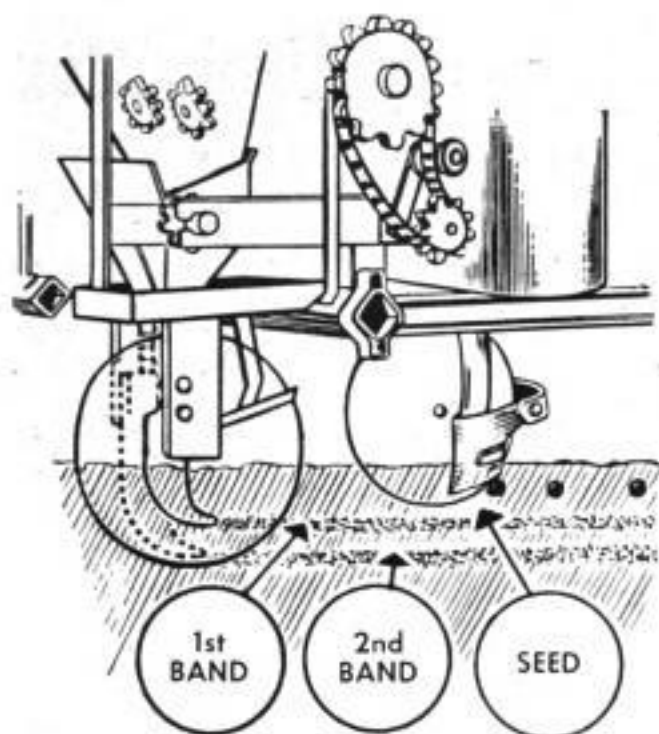

Four-inch saber and eight-inch saber on opposite sides of rolling colter lay fertilizers at different depths



BETTER YIELDS and less work result from use of a seed planter that distributes two different kinds of fertilizer as it plants. Seed is placed two inches below ground level, one fertilizer band at four inches and another band at eight inches.

The shallow band of fertilizer starts the crop, and the second band becomes effective as the plant matures and the roots reach down to the deep layer. A second "side dressing" is unnecessary. As much as

1000 pounds of fertilizer per acre can be distributed without danger of "burning" the seed. Deep root growth, valuable in droughts, is promoted.

In operation, a fertilizer saber descends on each side of a rolling colter to the proper level. The seed colter follows by some 18 inches. In each seed hopper are two seed metering plates, which drop seeds alternately and make a planting speed of five miles per hour possible.



Bracket Holds Boat Lantern

You can mount a gasoline lantern on your boat with a bracket that clamps to any surface up to $3\frac{3}{4}$ inches thick. The bracket, which needs no tools to install, holds lanterns upright or in a tilted position on boats, wagons, tractors, trailers, tent poles or fence posts.



Six-Wheeled Hand Truck Built for Stair-Climbing

You can pull a heavy load up stairs with a hand truck that mounts six wheels. The rubber-tired wheels—three on each side—always have a two-point contact with the treads and risers to prevent unbalancing of the load. The truck climbs steps with risers up to nine inches high. Several models for different-size loads are made.

Vertical-Take-Off Turbojet Has No Propeller

Twin turbojet engines provide all the thrust to lift and propel an experimental vertical-take-off aircraft made by Bell Aircraft Corporation. Unlike other VTO planes, the Bell VTOL (vertical take-off and landing) has no propeller to lift it from the ground. Its jet engines blast it

straight up into the air and then rotate 90 degrees to provide forward thrust. Low-speed control is by compressed-air jets at tail and wing tips, flying control by conventional tail and ailerons. The VTOL has the wing of a light plane, a glider fuselage and a helicopter landing gear.

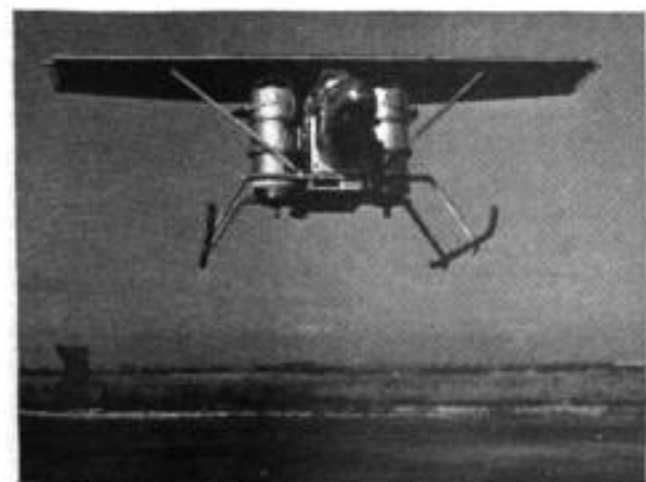

WHAT'S NEW FOR Your Home



1. WATER SOFTENER styled for the kitchen is regenerated by pushing two buttons. Salt is easily added to the 36-inch-high unit, and an electric timer returns the unit to service at end of cycle. Table top hides all controls, furnishes work space
Culligan, Inc., Northbrook, Ill.

2. HANGER enables you to hang pictures and mirrors flush with wall. Two interlocking metal plates, one of which fastens to the wall, the other to the object to be hung, comprise the unit. Heavy objects like flower boxes, cabinets and shutters can be hung
Design Craft, 504 Interurban Building, Dallas, Tex.

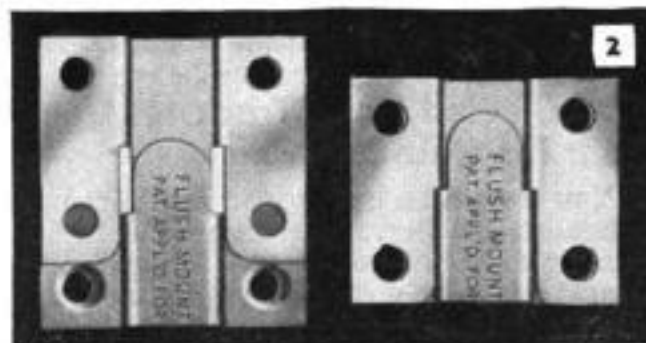

3. LEGLESS HIGH CHAIR adapts itself to any table. Arms rest on top of table while section below presses upward on underside of table top. The unit folds for carrying, eliminates the tipover danger and is said to prevent the youngster from standing
Luger Products, 12 E. 25th St., Minneapolis 4, Minn.

4. FOOD HOLDER speeds the slicing, dicing and shredding of fruits, vegetables and meats. Chrome-plated prongs hold the food in cutting position until the last bit is utilized. There's no danger to fingers. The wooden unit is also a knife holder
Roblex Products Co., 1525 Griffith Park Blvd., Los Angeles, Calif.

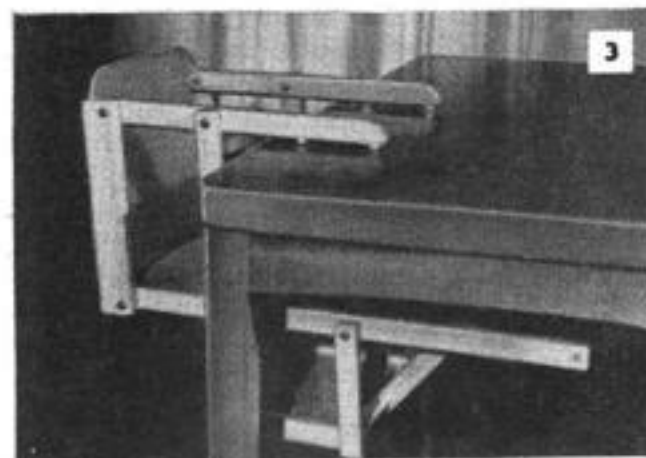

5. ELECTRIC BROILER with rotisserie employs radiant-heating panel made of glass. Embedded in the glass is a film of conductive material. The glass helps to produce long heat waves which sear the food to seal in the juices, odors and flavors
Electrigras Corp., Bergenfield, N. J.

6. "PEG-BOARD" CLIP grips tools and utensils firmly. A screw is adjusted to give correct spring tension for holding light or heavy objects. The clip is quickly inserted in kitchen or workshop "Peg-Board" and it is easily moved. Various sizes are made
Newhart Products, P. O. Box 157, Devon, Conn.

7. CARPET CLEANER scrubs rug-cleaning powder into rug by whirling action of a circular brush. The dirt-filled cleaner material is then picked up by any vacuum. The rented unit can also be used as a floor scrubber, polisher, sander, buffer or waxer
American Floor Surfacing Machine Co., Toledo 3, Ohio

8. MEAT THERMOMETER in new range tells when a roast or fowl is cooked enough. Probe is placed in center of meat and the jack plugged into outlet in oven. A window on the control panel indicates the progress of the cooking from rare to well-done
Phileo Corporation, Philadelphia, Pa.

9. PLASTIC HOLDER for glass, soap, toothbrushes and toothpaste has hideaway feature. Glass and soap tray swing out to reveal a lower shelf. Designed for use in kitchen or bathroom, the easily cleaned unit is glued to the wall with a special cement
J. & S. Mfg. Co., 2045 S. State St., Chicago 16

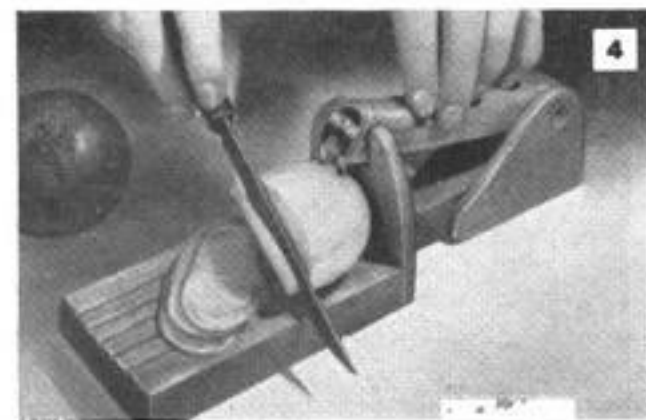

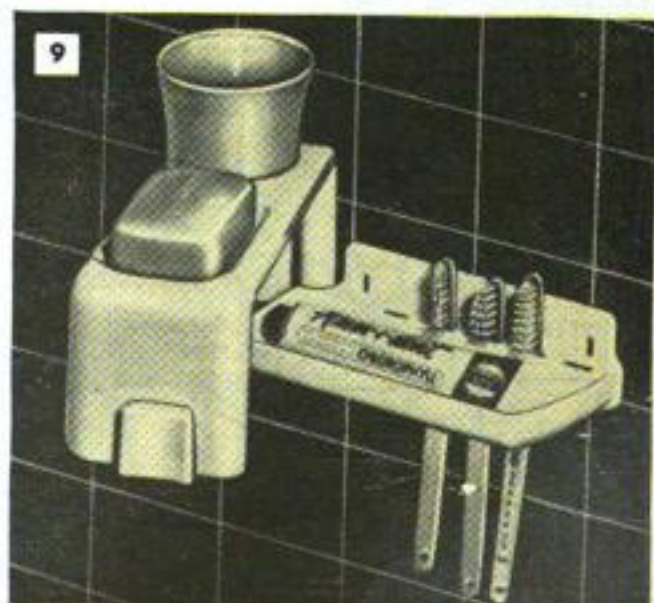
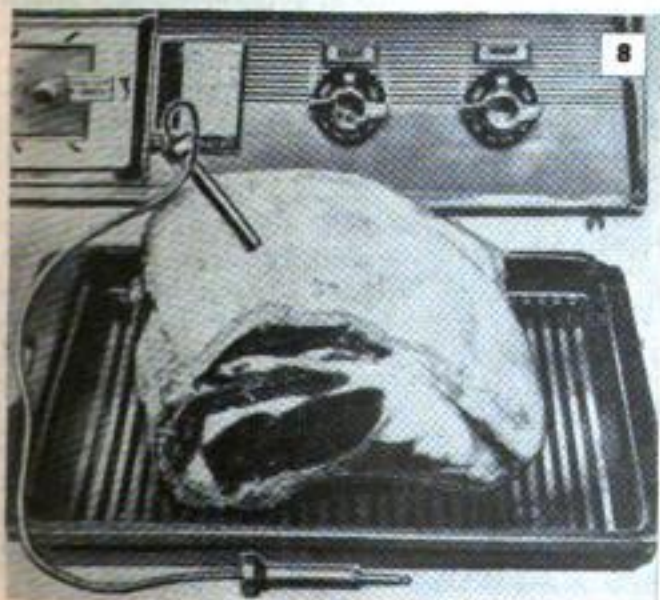
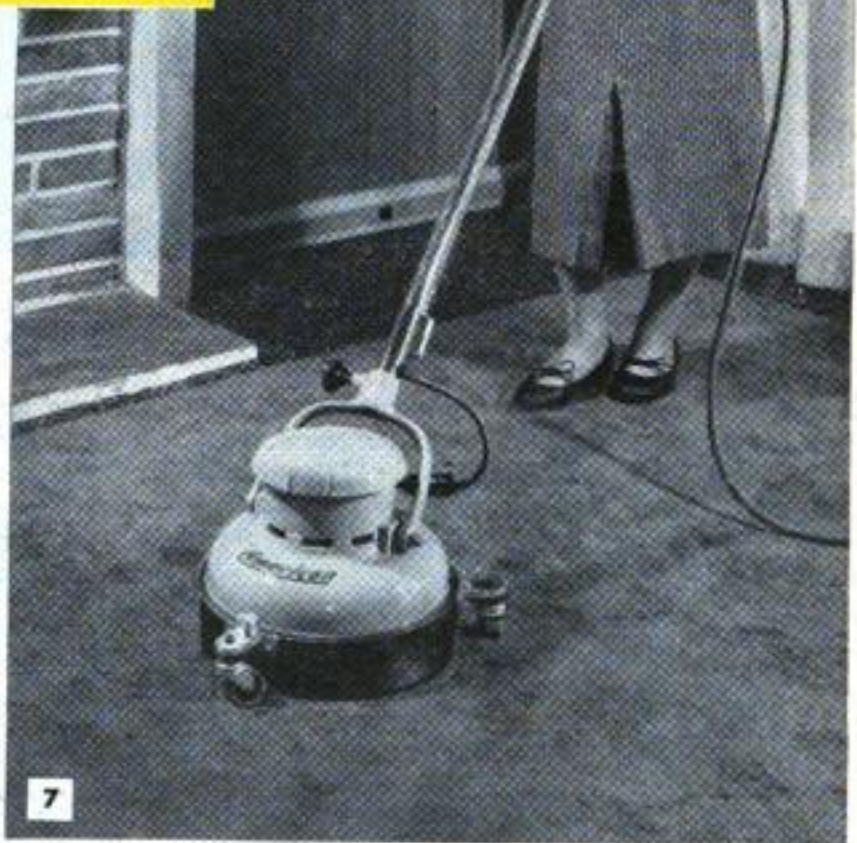

KEEPING UP WITH THE ATOM

RADIOACTIVE cobalt is put to work in a new inspection tool (in circle, right) that can "see through" steel up to a thickness of seven inches. The new "Isoscope," developed by the Babcock and Wilcox Company, requires only one third the exposure time of a 1,000,000-volt X-ray unit used in similar radiography.

☆☆☆

Atomic-powered airplanes will cross the Atlantic in 30 minutes, within the lifetime of some persons now living, it is predicted by industrialist John Jay Hopkins, president of the General Dynamics Corporation.

☆☆☆

The Atomic Energy Commission has some heat for sale in the Los Angeles area. The heat will be a disposable by-product of the sodium-graphite reactor now under

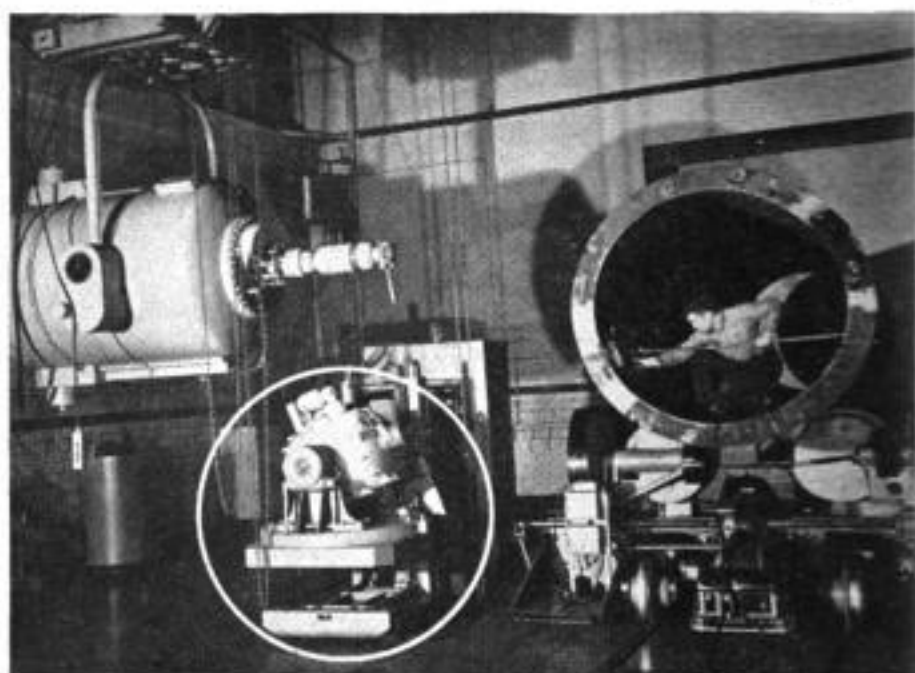

construction for the AEC some 30 miles northwest of Los Angeles, whose peak heat load will be about 20,000 kilowatts, permitting generation of about 7500 kilowatts of salable electricity.

☆☆☆

Chicagoans may be using atomic power before long. The city's electric utility company, Commonwealth Edison, has proposed a 180,000-kilowatt power plant (see drawing) of the "boiling water" reactor type originated at Argonne National Laboratory. In this plant fissioning uranium produces heat which boils the water in the reactor and develops steam, which is piped to the turbine to create electricity.

☆☆☆

The shock of an H-bomb explosion is sufficient to cause an earthquake detectable on distant seismographs. Dr. Edward Teller, physicist of the University of California, reported he watched the earthquake recorder at the university jump when the Nov. 1, 1952, H-bomb explosion occurred.

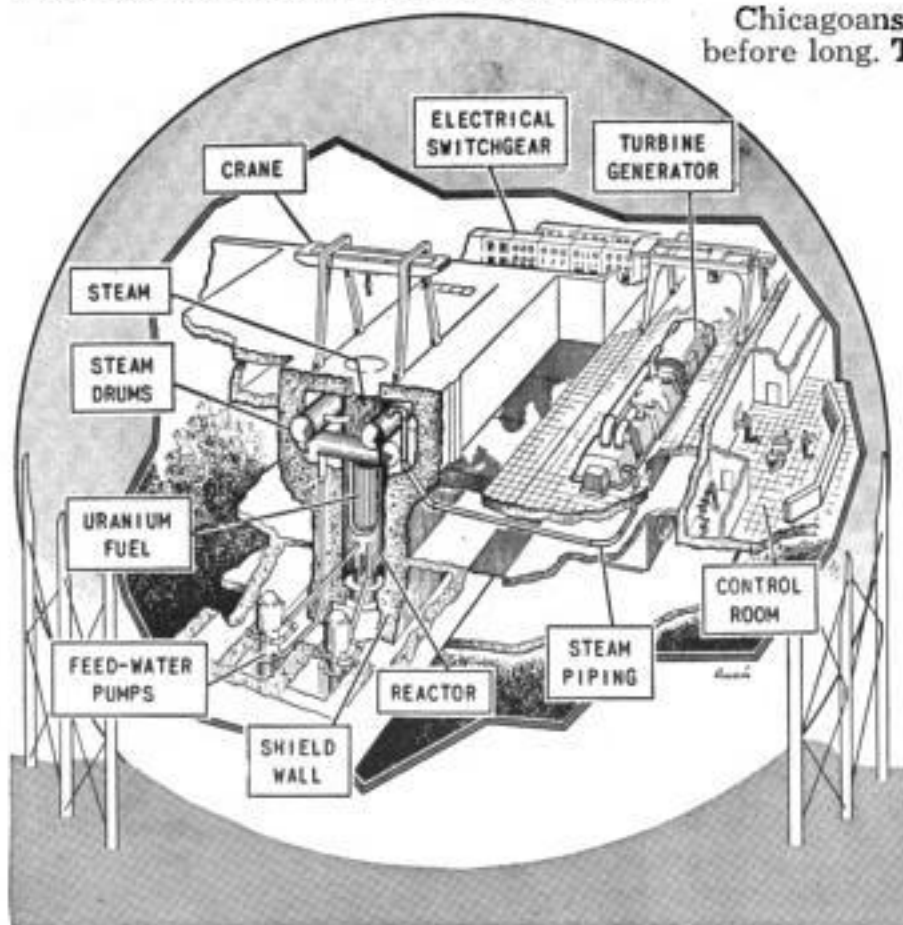



Hydraulics Raise or Lower Truck Bed for Loading and Unloading

Hydraulic action raises the bed of a unique truck to a height of 45 inches or drops it to ground level. Loading and unloading time is cut 50 percent, reports one company using the truck which was engineered, designed and manufactured by

a garage owner and a truck foreman. The truck bed is carried at a 25-inch height most of the time, but it can be used continually at any height. It can be raised to an angle in four different directions to accommodate loading or unloading.

America Takes Underwater Atomic Furnace to World Conference

Delegates to a United Nations conference at Geneva, Switzerland, this month will view a "swimming pool" atomic reactor like the one in operation at Oak Ridge. The reactor operates beneath 20 feet of water.

The water provides visibility while protecting onlookers from atomic rays, and at the same time acts as a moderator to control the nuclear reaction. Qualified foreign scientists will be allowed to operate it.

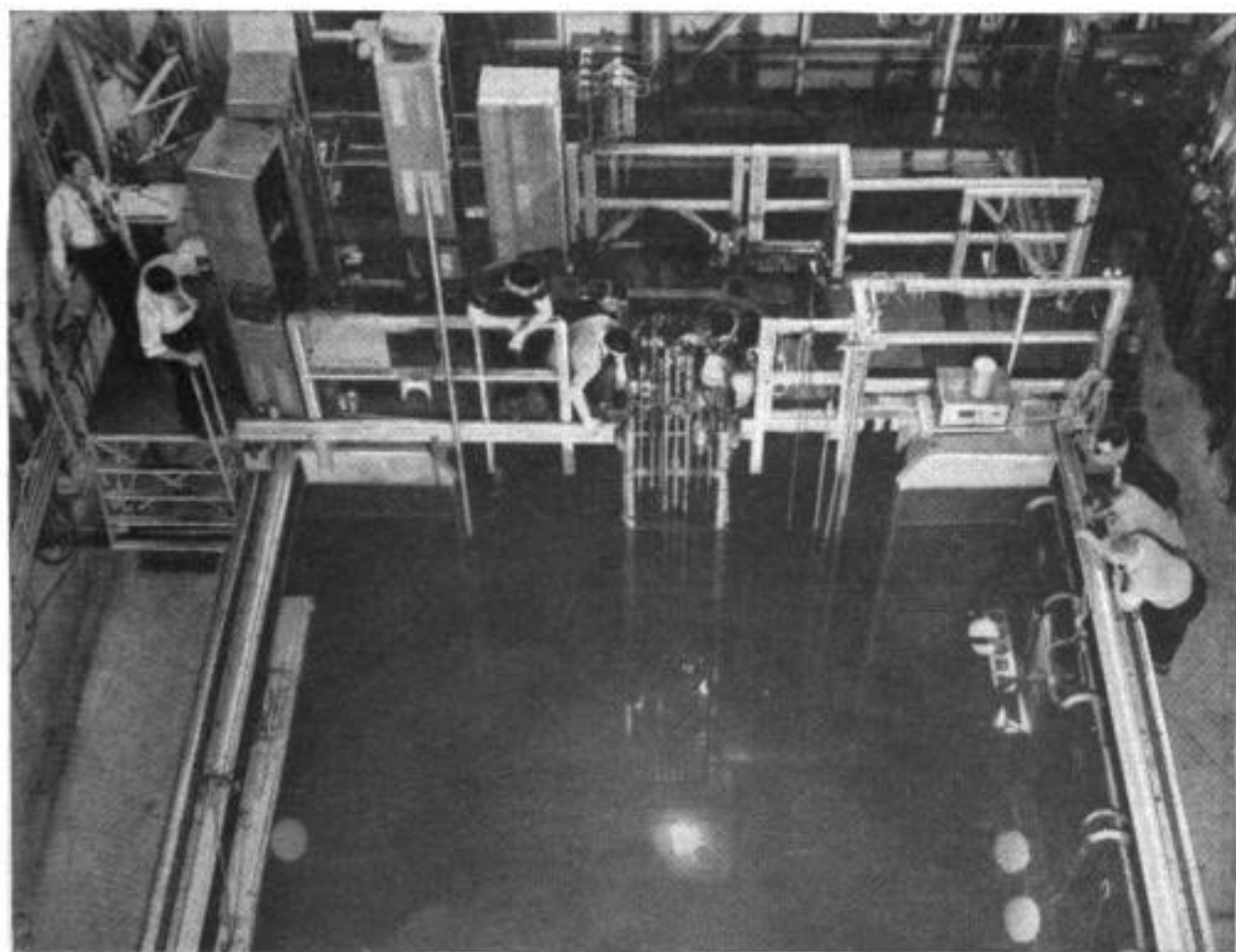

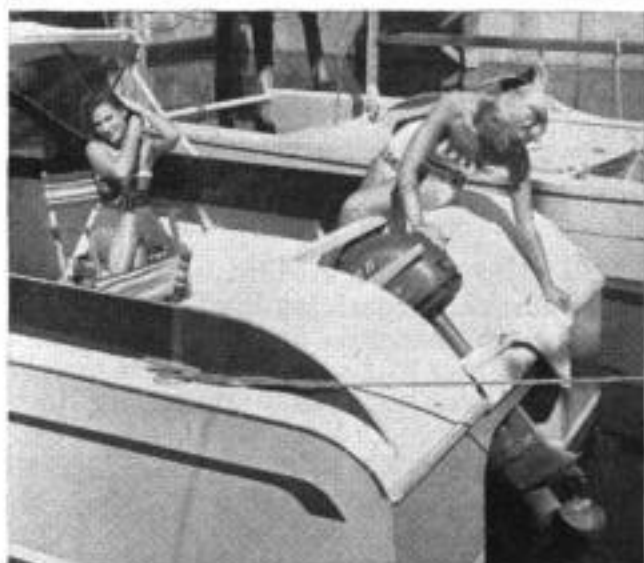

Outboard Powers Catamaran

Though it is big enough to accommodate four persons comfortably, a new catamaran cruiser draws only four inches of water. With a 25-horsepower motor installed between the twin hulls, the catamaran will make 20 miles per hour. Gear and duffel can be stored in the hulls, leaving the 8 by 11-foot cockpit free for lounging. During an extended cruise, two cots can be fitted into the cockpit. The family-type craft is 18 feet long. The hulls are made of plywood covered with glass fiber. Because of the stability and buoyancy of the twin hulls, the catamaran will take four-foot waves with very little pitching.

Projectiles Fired Into Artificial Rain Reveal Raindrop Damage

Drops of rain have the effect of bullets when encountered at supersonic speeds. In order to study the destructive effect of raindrops on aircraft or missiles traveling faster than sound, Convair developed a process which tests structural materials by firing them from a 20-mm. cannon into an arti-

ficial rainstorm. The tested projectiles, which are recovered by parachutes that open after they are fired, reach speeds as high as 1900 miles per hour, or approximately $2\frac{1}{2}$ times the speed of sound at sea level. Raindrop damage often is extensive.



In one evening you can assemble a **VACATION GEIGER COUNTER**

IF YOU'RE LOOKING for a vacation in the open with adventure thrown in, why not consider prospecting for uranium? It is this generation's "gold rush."

Uranium prospectors need more than the piepan used by gold rushers of yesterday. They need a precision electronic instrument called a geiger counter.

Scores of counters are on the market, ranging from \$25 to \$500 or more. Just announced is a build-it-yourself kit that sells for \$15.95.

Everything is included, even a radioactive sample for test purposes and the Atomic Energy Commission's booklet on uranium prospecting.

No toy, the counter is an accurate scientific device with a maximum sensitivity of 0.2 milliroentgens per hour. Current is provided by a 22½-volt hearing-aid battery and a 1½-volt dry cell.

The only tools required to assemble the counter are a soldering iron, screwdriver and wire-cutting long-nose pliers.

Several tricks have been used by the kit designers to keep costs down. One is a simple rectifier consisting of two metal screws and a chunk of plastic. Another is the absence of a separate high-voltage circuit. The necessary high voltage is built up by flipping a switch several times to charge a capacitor. Once the capacitor is charged the counter will operate about an hour.

Below, the kit as you get it. Below right, after an evening's work, here's how the assembled parts look

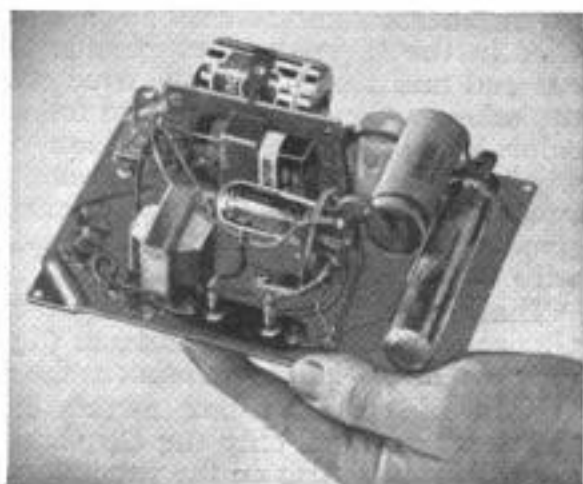
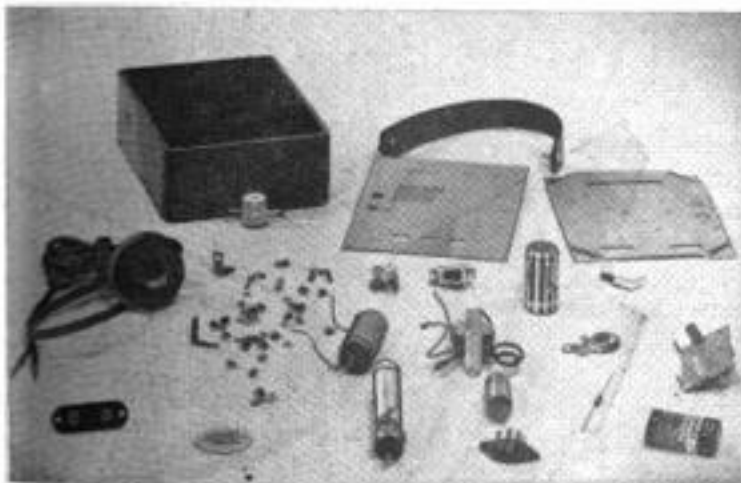



Specially designed for the deaf, a quiet-listening kit has a tiny plastic earphone that fits in the ear

PUT a SILENCER on YOUR

CHILDREN PLUS TV means noise. Space ships blast off; cowboys fire at "dry gulching" bad men; Howdy Doody outshouts Clarabelle's horn. It's fun, but noisy.

Yet there's no need to be a nervous victim of television audio. You can quiet the set so Mother and her friends can enjoy a cup of coffee and some gossip while Rocky Jones blasts off from a satellite only a half-room away. And you don't have to be an electronics engineer to do it.

Kits are available for adding earphones to TV. These consist of a three-conductor cable, junction box with switch and volume control, and earphones. Such a kit is shown at top of the opposite page. Or you can buy the parts and build one yourself.

First, open the back of your set, making sure the current is disconnected. Locate the two wires from the chassis to the loudspeaker. If your set is a console, you probably won't even have to open the back to get at these two wires.

Second, cut one of these two wires at a point convenient for soldering. Follow the kit instructions and solder one color-keyed wire in the three-conductor cable to one cut end and another color-keyed wire to the other cut end. Be sure you follow the color keying or the junction-box switch won't function properly. Next, remove insulation from one inch of the uncut loudspeaker wire. Solder the third color-keyed wire to it. Tape joints.

That's all there is to it. Plug the earphones into the junction box and the children can listen while you relax in the quiet.

With the junction-box switch in the "Phones" position, only the earphones get the TV sound. Also on the junction box is

a control so the youngsters can regulate the volume to suit their eardrums. With the switch in the "Speaker" position, both earphones and speaker get the sound. This position is fine for hard-of-hearing persons. They hear easily without raising the volume to a level annoying to other listeners. By the way, there are special kits for the hard-of-hearing installed the same way.

To make a big hit with the kids, go one



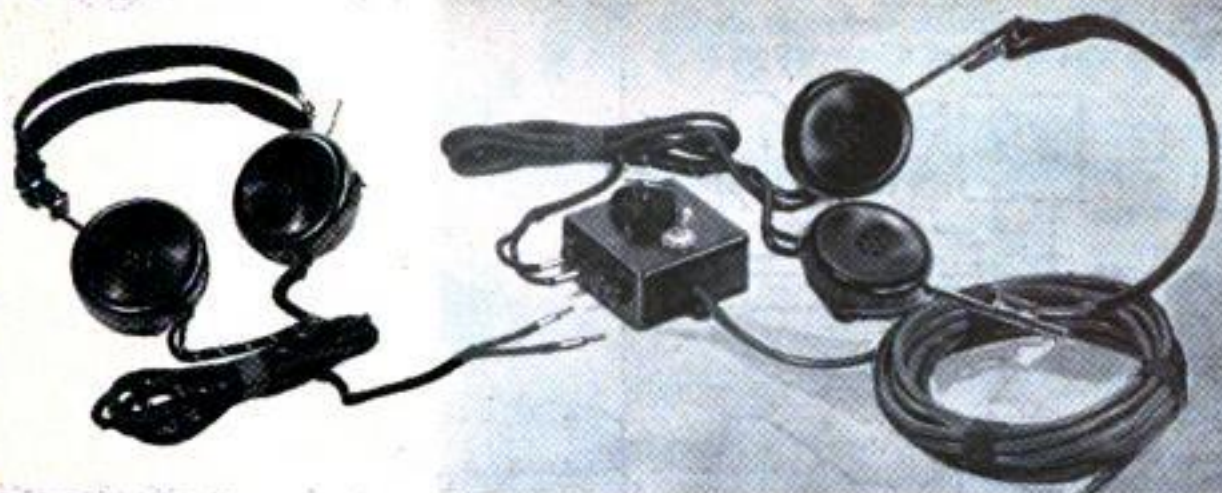

Typical quiet-listening kit for television set consists of cable, control box and two pairs of earphones

TV SET

Mother and her guest relax while the Space Cadets blast off noiselessly! Earphones are attached to the helmets



ALL THESE QUIET-LISTENING DEVICES ARE HOOKED UP THE SAME WAY. HERE IS HOW YOU DO IT:

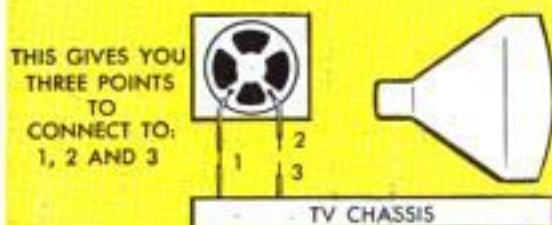
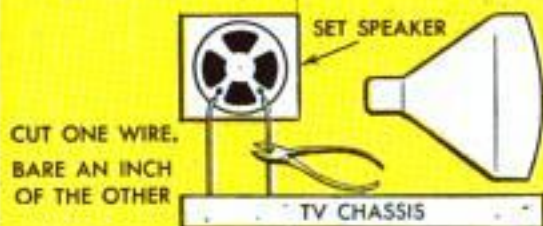

TO INSTALL QUIET-LISTENING HEADPHONES YOU SIMPLY SOLDER THE THREE WIRES OF THE THREE-CONDUCTOR CABLE TO POINTS 1, 2 AND 3, AS SHOWN BELOW

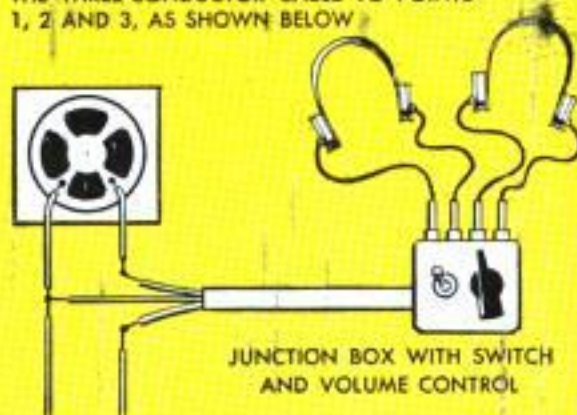

TO INSTALL A REMOTE SPEAKER YOU ADD A CLOSED-TYPE TWO-CIRCUIT JACK LIKE THIS.

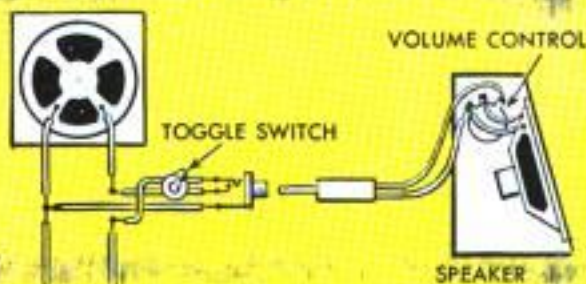

OR YOU CAN USE A MAKE-BREAK JACK TO HOOK IN A PAIR OF EARPHONES, BUT YOU HAVE TO ADD A 3-OHM, 5-WATT MATCHING RESISTOR AS SHOWN HERE:

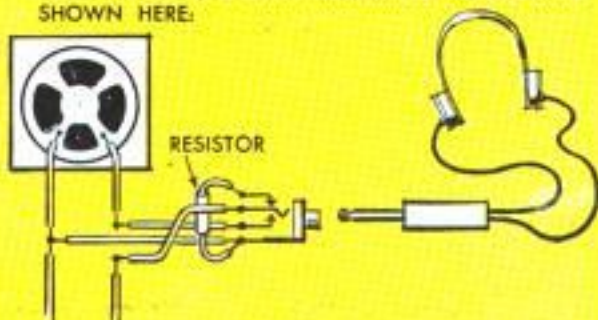

In an hour, you can make an extension speaker with these parts. Diagrams (left) and text explain how

step further and mount the phones inside space helmets, available at toy stores. Remove the phone units from the headbands. Drill holes in the helmets to match the earphone assembly-bolt positions. You will have to replace these bolts with longer ones.

You can add earphones to TV without a special kit by installing a closed-circuit, make-break jack and a matching resistor of 3 ohms, 5 watts on the back of your TV set. Details are shown in column at the left.

Another TV silencer is a small extension speaker that can be placed on the floor in front of the youngsters so the sound level can be kept low.

One way to assemble such a unit is shown in column at left. You will need a jack, plug, speaker volume control and a small speaker with wood case. The jack is mounted on the TV cabinet and wired as shown. The diagram also shows how to wire the volume control on the small speaker. By adding a toggle switch across the two wires shown, you can use both speakers at once or one at a time, as you prefer. The volume control on the extension speaker only lowers the sound level of the TV set. To increase the volume, you must use the control on the TV set. ★★★

(These kits are available at radio stores. If there is none near you, we will send a list of mail-order houses.)

the

POPULAR
MECHANICS

CRAFTSMAN



Tote Case for Your Guns

HERE IS AN IDEAL CASE for transporting shotguns and rifles on hunting trips where you are going to use more than one gun. It furnishes protection against marring and breakage, and at the same time is easy to carry. Because of its flat shape, it packs easily into a car or station wagon and at home, between trips, it pro-

vides a dry and dustproof storage cabinet.

The construction is simple, as no difficult-to-make joints are used. The over-all dimensions will be determined by the sizes of the guns to be carried in it. The top and bottom pieces are $\frac{1}{4}$ -in. plywood and the sides are of 1 x 4-in. stock. Drill holes for 1-in. screws $\frac{3}{8}$ in. from the edges of the



After box is assembled, top and bottom are separated by making a saw cut all around, shown above left



Above center, the 1 x 4 crosspieces are fitted in place. Next, at the right, gun positions are marked



Lower left, cutouts are made on a jigsaw. Center, attaching screws must not be driven through cutout

Lower right, the crosspieces are lined with strips of rubber held in place with broad-headed tacks

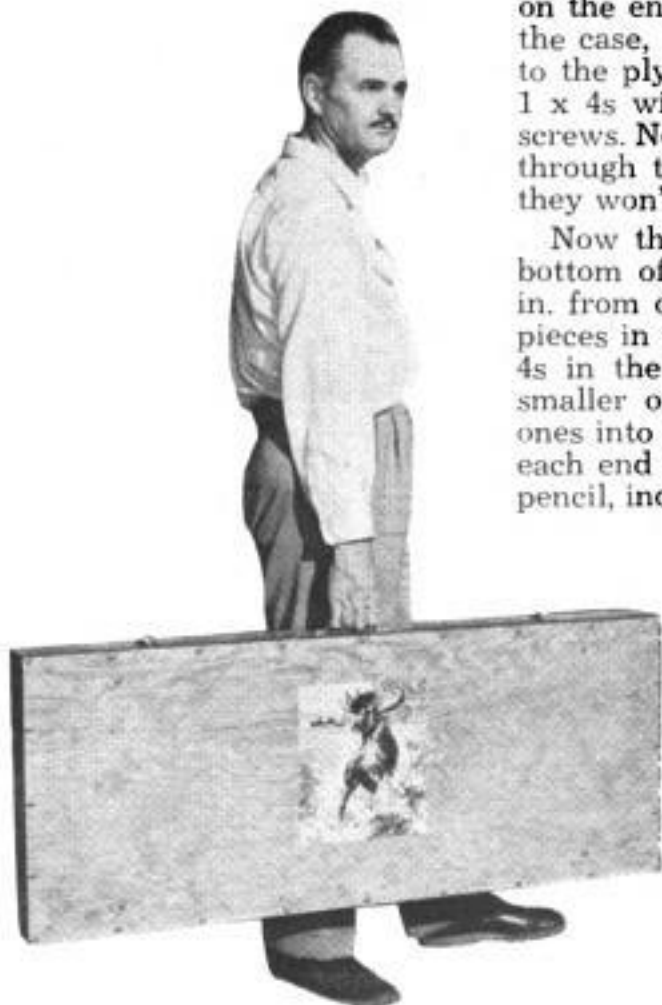
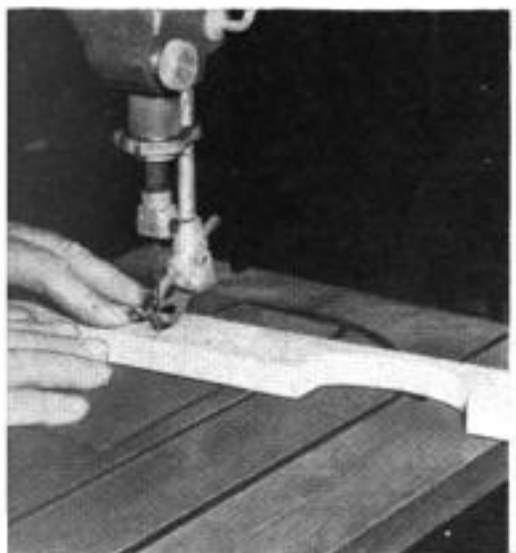

plywood pieces, 6 in. apart on the sides and 5 in. apart on the ends, with a screw at each corner. To assemble the case, a box is made first by joining the 1 x 4 sides to the plywood top and bottom. Coat the edges of the 1 x 4s with glue, put them in position and drive the screws. Next, join the corners with finishing nails driven through the long sides. Space these nails carefully so they won't interfere with the saw cut to be made later.

Now the box is cut all around to form the top and bottom of the case. The cut should be off-center, $2\frac{3}{4}$ in. from one side and 2 in. from the other. The crosspieces in the top and bottom are made by splitting 1 x 4s in the same proportion as the box was split, the smaller ones being fitted into the top and the larger ones into the bottom. These are laid in place 6 in. from each end and the guns are positioned on them. With a pencil, indicate the cutouts that will be necessary in the bottom crosspiece to take the stocks and barrels. Cut on a jigsaw, making each cut slightly larger than the marking to allow for padding to be added later. Fasten the crosspieces in place with glue and screws, then pad them with $\frac{3}{4}$ -in. strips of rubber cut from an inner tube. Join the top and bottom together with two or three butt hinges or a length of piano hinge. Finally, attach a handle and two suitcase latches to the front side. ★ ★ ★

Nails Pulled Without Bending



Nails can be pulled easier, faster and without bending, if a slotted wedge instead of a solid wooden block is slipped under the hammer head. As the nail is drawn, adjustments can be made in leverage by sliding the wedge to straddle the nail so the hammer is

located directly over the nail to maintain a straight upward pull. For longer wear, the wedge should be cut from hardwood.

"Sharpening" Wax Crayons



Wax crayons that must be kept pointed when used for lettering and other work requiring a fine line, can be "sharpened" in a cone shaped from window-screen wire. The edges of the wire are stapled together after it has been rolled into a

cone and the cone then is tacked to a wooden block or to the inside surface of a small box. The box serves the added purpose of being a receptacle for the wax shavings.

Sand-Filled "Fire Buckets" Are Novel Ash Trays

Miniature sand-filled "fire buckets" not only safely snuff out cigarettes but furnish conversation pieces as well. The fire-bucket ash trays are children's sand pails, purchased at a ten-cent store and painted bright red. The word "fire" is stenciled or painted on the side in black or yellow.



Aquarium sand can be purchased for use in the pails. To clean the buckets, pour the sand through a metal strainer. The strained sand can be used almost indefinitely.—Frank A. Javor, North Bergen, N. J.



Weight of Automobile Used To Break Bead From Rim

The job of breaking loose the bead from the rim of a tire is made easy by using your bumper jack and car bumper. Simply lay the tire partly under the car bumper and place the base of the jack on the casing in the manner shown. As the jack is worked, the weight of the car will force the bead from the rim. The tire and rim are then turned over and the same procedure is followed on the other side.

Ralph G. Preston, Buckley, Ill.

Pocket Liner Fastened on Wall Provides Small-Tool Holder

A plastic pen-and-pencil holder, usually fitted inside a suit or shirt breast pocket to protect the material against soiling, can be used as a handy receptacle for small tools and accessories in a home workshop or darkroom. Use a strip of adhesive or cellulose tape to attach the holder to a wall. As with any material, care should be taken not to force knives or pointed scissors through the bottom of the holder.—John J. Rea, Urbana, Ill.



☞ To prevent misplacing the instruction sheets and parts lists that come with power tools, drop them into a glass jar having a screw-type lid. The jar is stored with attachments that go with the machine.

SIDEWALK SPORTS CAR

By
Ralph T. Moore



These boys share all the thrills of driving a real car, and learn while they're doing it

A SMALL BOY and a motor-driven car are about as happy a combination as you can find. And what better way to train a future driver in both the handling and mechanical phases of owning and operating a car than to supply him with a sidewalk version of the real thing?

Powered with a lawn-mower motor, the car pictured above will attain a speed of 15 m.p.h., carry a 180-lb. load on level ground and turn in a 9-ft. circle. An 18-in. power mower rated at 1 hp. was used in the original car. In purchasing a used mower for this purpose, select it primarily for condition of motor, belts and tires.

After you have the mower, remove the

cutting blades, roller and the belt used to drive the blades. These items may be discarded, but save the various small parts.

The next step is to adapt the motor for accelerator-pedal control. This is done by removing the linkage that connects the butterfly valve to the air vane inside the flywheel cover, and making a special lever for the butterfly. Make the lever from a $\frac{1}{4} \times \frac{1}{2} \times 3$ -in. piece of aluminum or steel and drill one end for a small eyebolt. Bolt the lever to the butterfly quadrant with two small bolts so downward movement of the lever opens the valve. Then replace the spring with a length of screen-door spring to return the butterfly to the closed

Raising rear deck, as in photo at left, gives easy access to motor for mechanical adjustments and refueling. Bracket holds deck in raised position. Pattern for car sides is given below

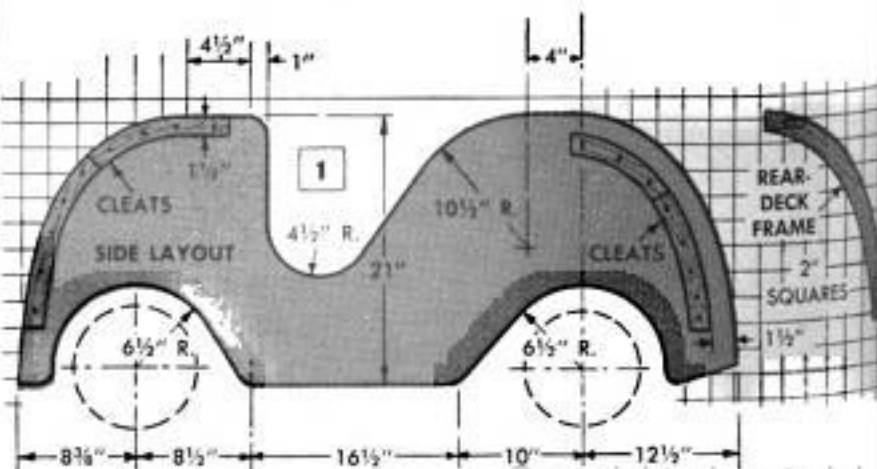

Copyrighted material

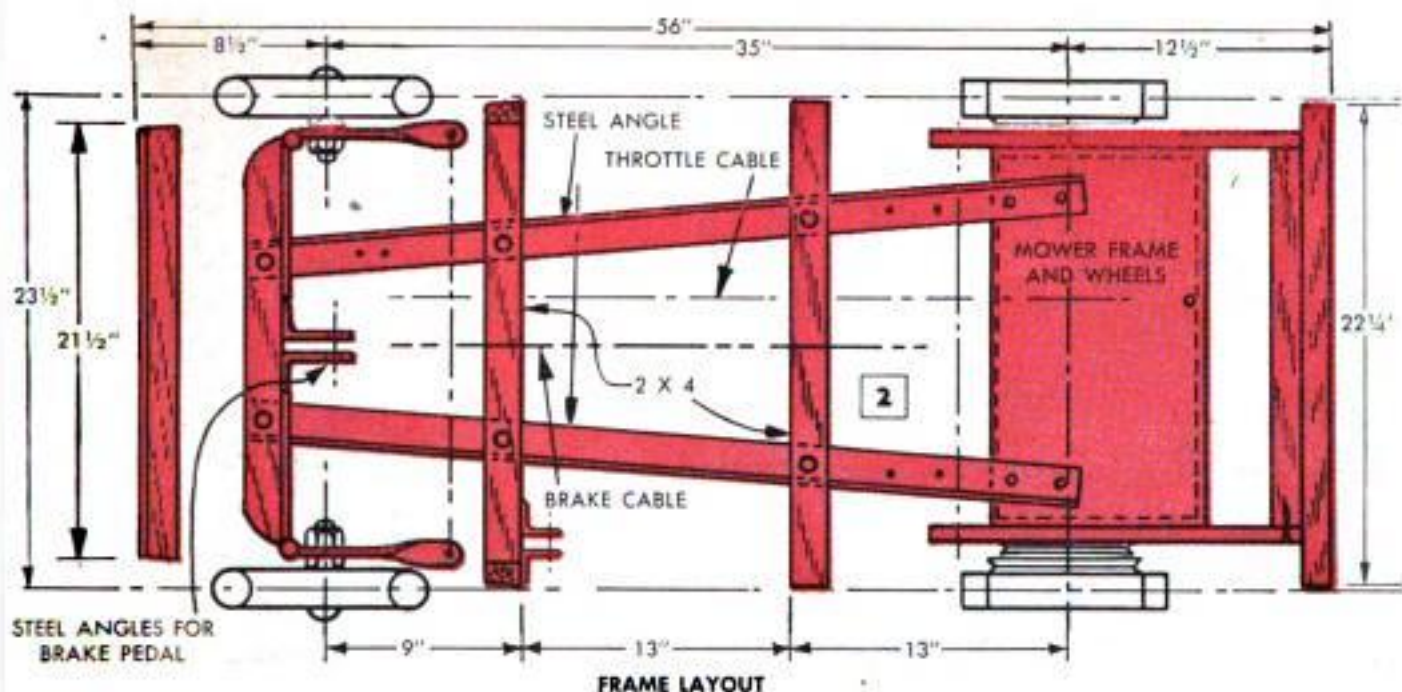

position. The accelerator pedal, Fig. 5, is connected to the lever with aircraft cable.

Remove the gas tank and thoroughly clean the inside. Before mounting the tank on the car, be sure to fit the cap with a leakproof breather tube. This is done by bending a short length of gas-line tubing to a full coil, or loop, and soldering one end of the coil to a hole drilled in the cap.

Although the rear wheels of the car are part of the mower-motor unit, front wheels and a steering arrangement will have to be provided. Use 10-in. semi-pneumatic wheels, and a pair of 8-in. strap hinges as steering knuckles. The portions of the hinge leaves that are bent around the pin should be welded to themselves to keep

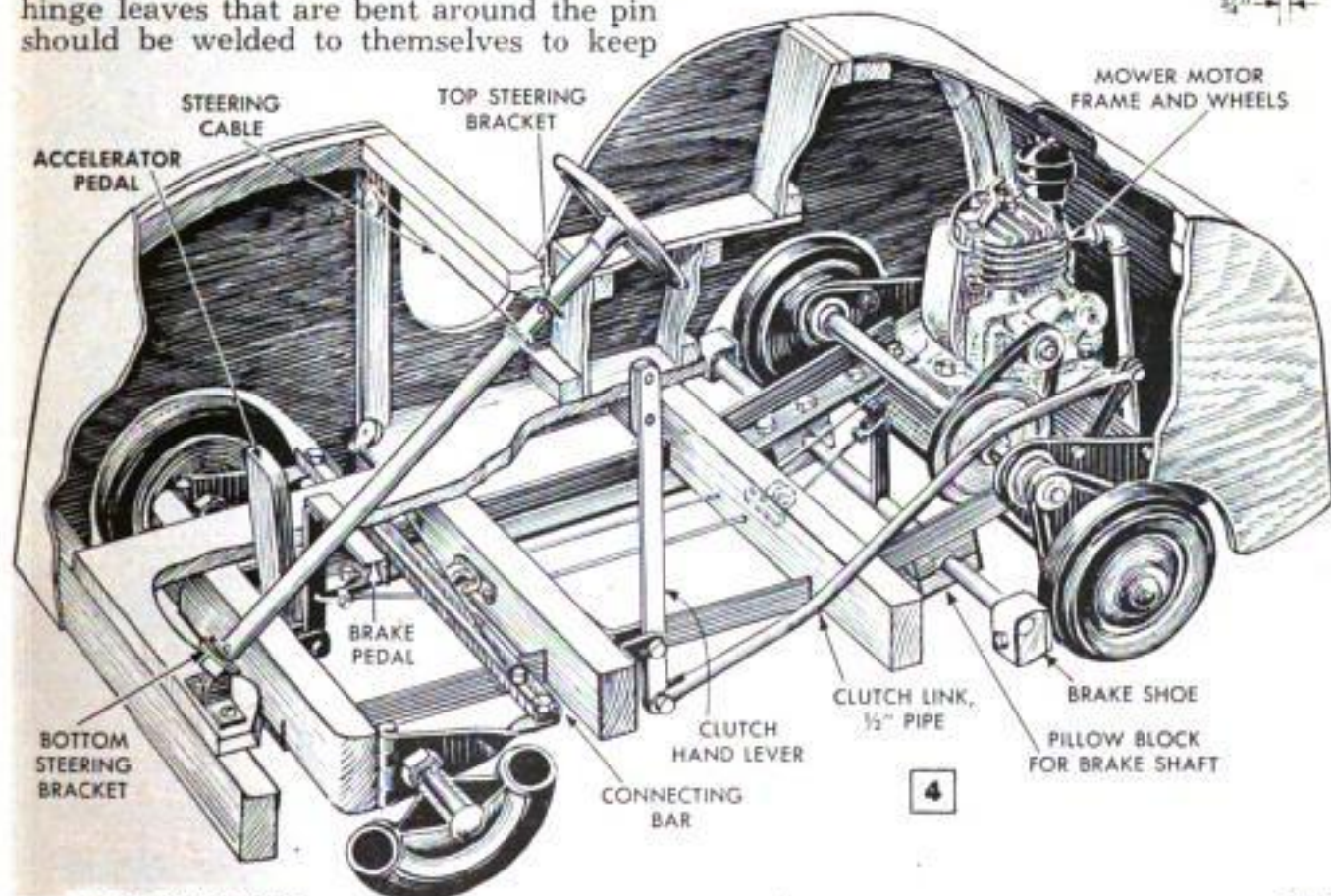
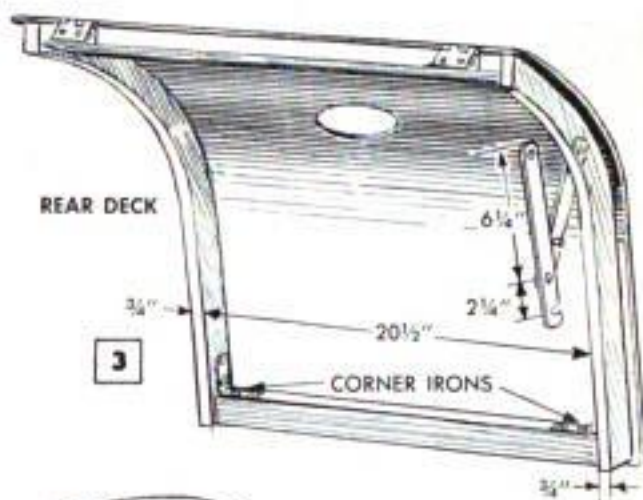

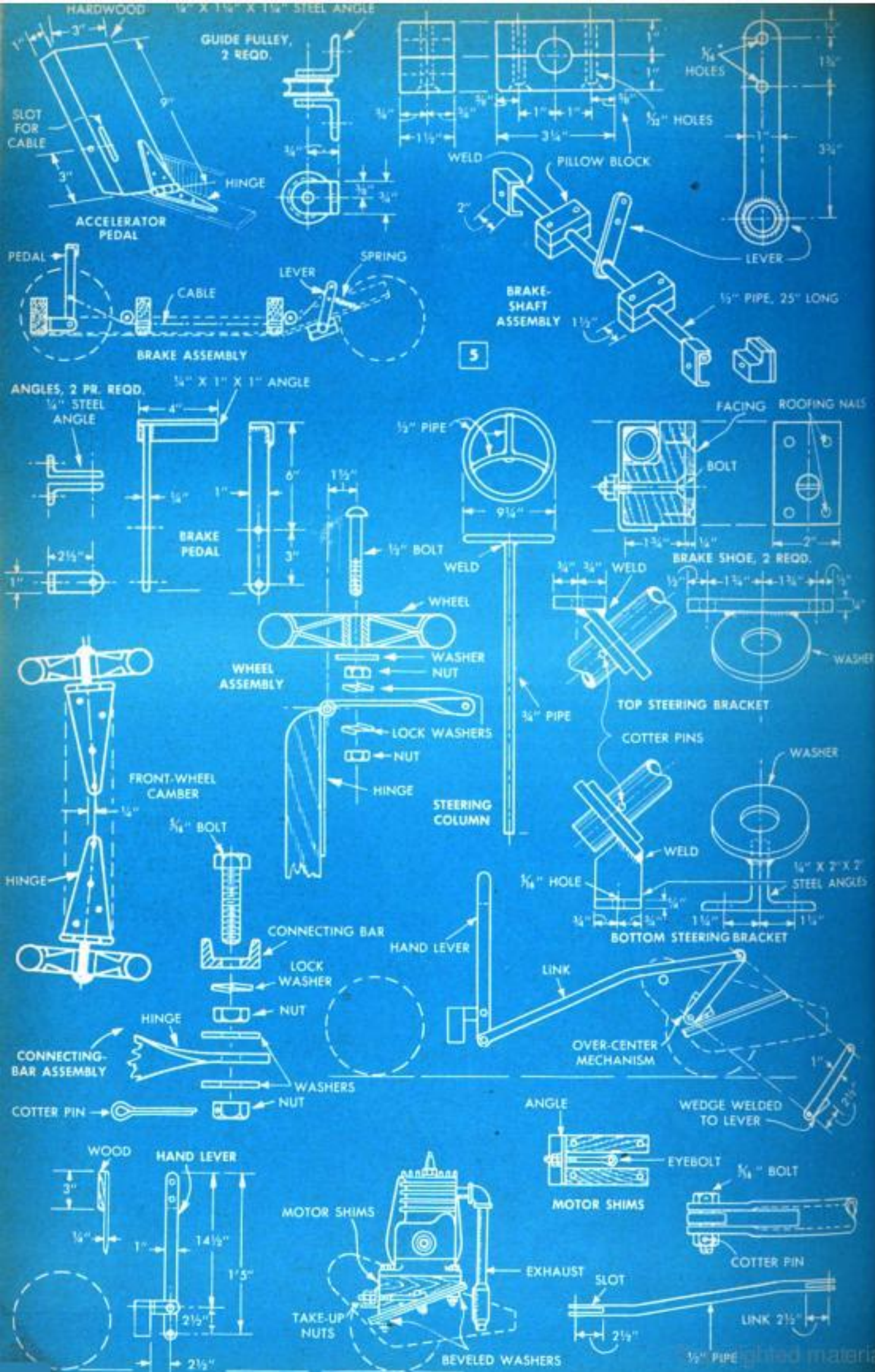

them from separating during operation. Clamp one leaf of each hinge in a vise and twist its end at right angles to the hinge pin, Figs. 2 and 5, to permit attaching the connecting bar.

Check the distance between the mower wheels and cut a length of 2 x 4 so that the front wheels will be spaced the same distance when the hinges are bolted to the 2 x 4, Fig. 2. Note that camber is obtained by mounting the hinges at a slight angle.

The frame, Fig. 2, is made from two lengths of steel angle (bed rail will do) and crosspieces of 2 x 4. Slot the 2 x 4s for the angle, Fig. 4, and fasten the parts together with $\frac{3}{8}$ -in. carriage bolts and lock washers. Then cut wedge-shaped shims from hardwood to hold the motor vertical, as in Fig. 5. Note that an eyebolt is installed between the shims to permit adjusting belt tension.

The parts of the brake assembly are shown in Fig. 4 and the upper details of Fig. 5. The brake pedal, made of steel angle welded to a flat-steel lever, pivots in a yoke also of steel angle. It is best to make the brake-shaft pillow blocks from hardwood, preferably maple. The lever welded to the shaft is of $\frac{3}{16}$ -in. steel and the brackets which hold the wooden brake shoes are of steel channel. Facing for the brake shoes is cut from an old tire casing.

Make the connecting bar from $\frac{3}{4}$ -in. bar or channel. Drill it 4 in. from each end for a $\frac{1}{4}$ -in. steering-cable bolt and assemble the bar and hinges, Fig. 5. The clutch hand lever is made of $\frac{1}{4}$ -in. flat steel and pivots in an angle-steel yoke. It is connected with $\frac{1}{2}$ -in. pipe to a lever mounted on the over-center mechanism of the mower. As the normal movement of this lever allows too much play, weld a wedge-shaped piece of steel to its lower end to restrict it.

Next the vertical side-frame members and the crosspiece for the top steering bracket are installed. Either 1 x 2 or 2 x 2 lumber may be used for these parts, the joints being reinforced with corner irons. After two lengths of aircraft cable, having turnbuckle ends, are bolted to the connecting bar, floor boards are added.

The steering wheel may be purchased or made from $\frac{1}{2}$ -in. pipe, Fig. 5. A steering column of $\frac{3}{4}$ -in. pipe is passed through two steering brackets and held in place with cotter pins. Drill the column and tie the cable in place. Then make the final motor installation and add the muffler. Use $\frac{1}{2}$ -in. pipe to bring the end of the muffler flush with the bottom of the car.

Cut and fit the seat and saw the side panels from $\frac{1}{4}$ -in. plywood as in Fig. 1. Screw bandsawed cleats to the sides and fit a $\frac{1}{8}$ -in. hardboard hood in place. Finally, make the rear-deck frame, cover it with sheet metal and hinge in place. ★ ★ ★

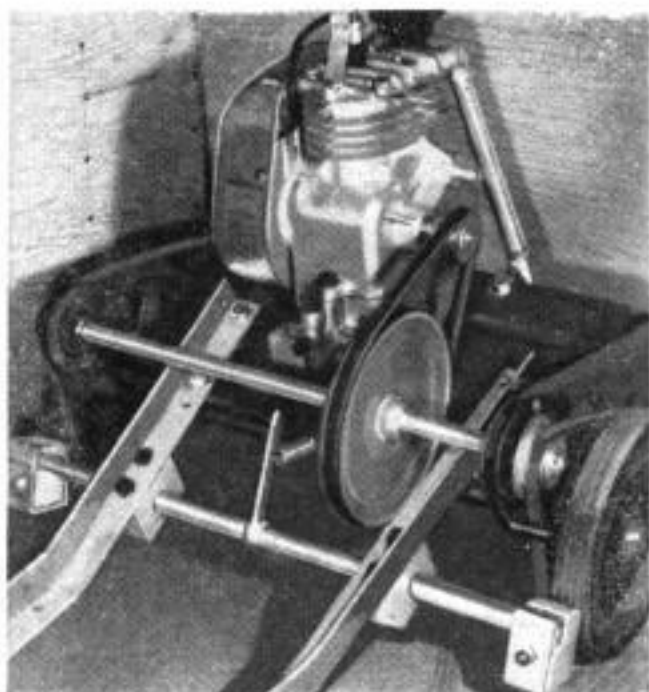

Note above how steel-angle frame members are bent to fit mower frame. Brake assembly is shown clearly

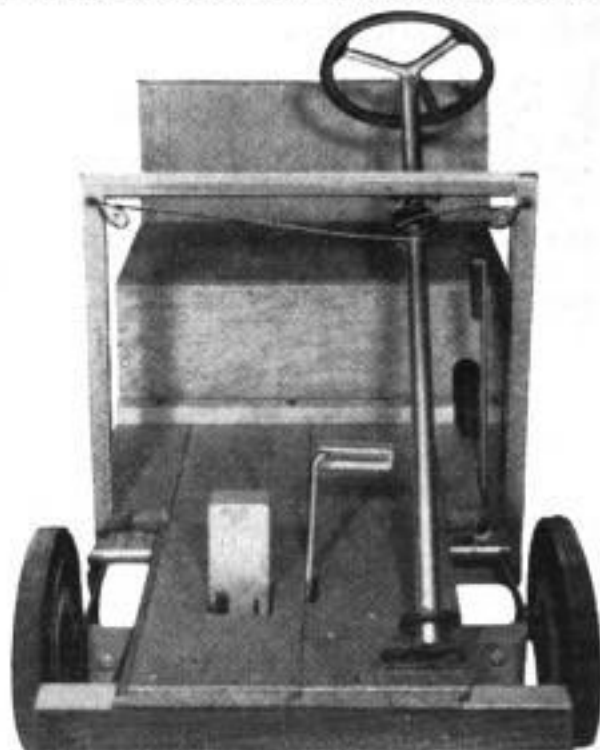

Cables are brought from column, above, to connecting bar where they are crossed and fastened, below

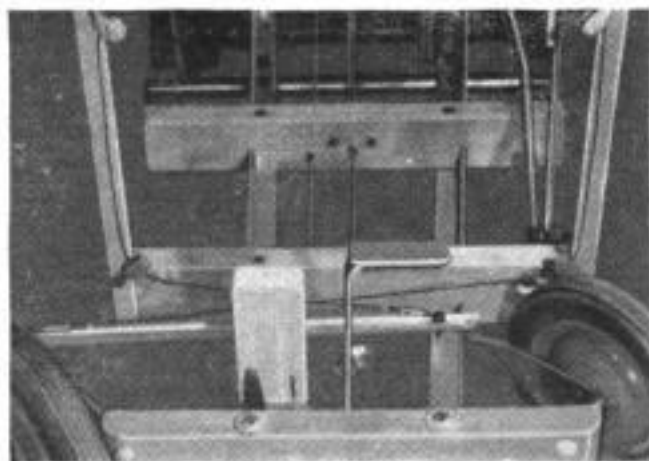



Eatable Decorative Wreath Made of Hard Candies

An eatable party wreath that will be a big hit with children, and many adults, too, is made by attaching individually wrapped pieces of hard candy to a wire frame to form a wreath. The wreath is shaped by bending a wire coat hanger to a circular shape. Wrap the wire with metal foil or colored ribbon, then tie on each piece of candy with a short length of string or light wire. A small pair of scissors, suspended from the wreath on a ribbon, is used to remove the candies. Three or four pounds of candy can be attached to the wreath by spacing the pieces closely together. The wreath is hung by a coat-hanger hook.

Change in Gate-Hinge Angle Adds Self-Closing Action

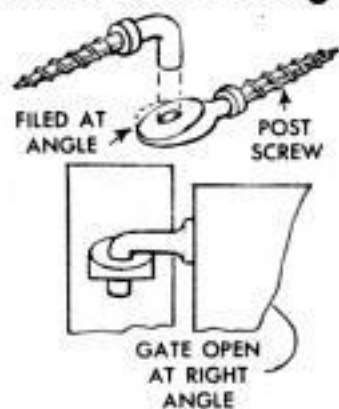

Most gates can be hung so they will close automatically by the force of gravity. On wooden gates, use L-hooks in the gate to fit over screw eyes driven into the gatepost. The bearing face of the screw eye should be smooth

and installed at an angle so the L-hooks ride upward on the eyes when the gate is opened. When the gate is released, its weight will cause the L-hooks to slide down the inclined plane of the screw eyes. The inclined plane may be attained in either of three ways: By driving the screw eyes in

at an angle, by bending them downward after they have been screwed in horizontally, or by filing the bearing surface at an angle, as shown in the detail. On steel gates which have hook-and-eye hinges, the eyes are inclined in a similar manner.

Magnet on Paint-Stirring Paddle Keeps It Against Can Side

Instead of removing the paddle each time paint is stirred, which wastes paint and is messy, simply fit the paddle with a small magnet to contact the side of the can. This will hold it out of the way when the brush is dipped into the can. Locate the magnet so the lower end of the paddle hangs above the paint can bottom. The magnet can be cemented to the paddle permanently, or held on temporarily with a rubber band.



Joseph Amorose, Richmond, Va.

Glass Blocks Used as Tanks For Developing Color Film

Glass building blocks can be used to provide developing tanks for color film at much less cost than the stainless-steel tanks recommended for color processing. The blocks should be the type which have one open end, such as are used as planters. Clean glass marbles can be used to raise the level of the developing solution.

Lynda Carpenter, Los Angeles, Calif.

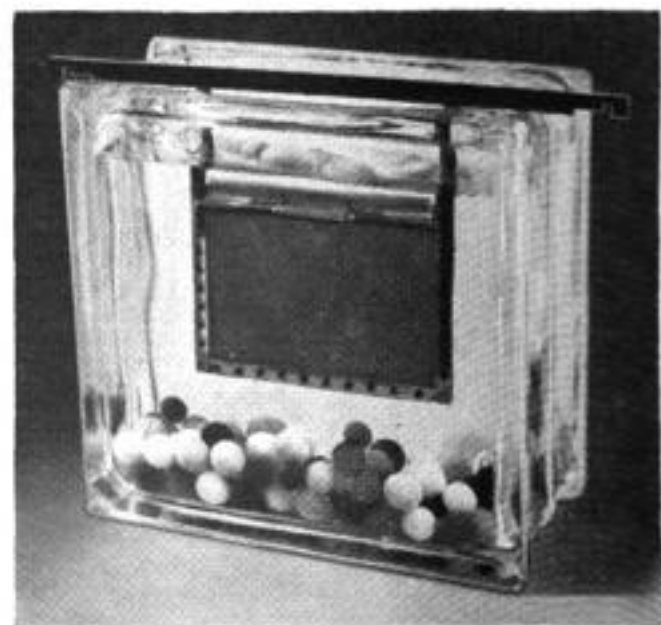



A.D. 200



A.D. 1800



A.D. 1955

HOW MODERN DETERGENTS WORK

By J. P. Mullen

IN ANCIENT DAYS on Sapo Hill, near Rome, there were many altars where bullocks and sheep were burned as offerings to the gods. Fat drippings from their carcasses mixed with the ashes from the wood fires and, as time went on, this mixture was washed down the hill by rain and absorbed into the soil. Roman housewives discovered that a little of the earth from Sapo Hill rubbed into the clothes was a great help on laundry day—and thus soap was discovered.

Later, some Roman deduced the real reason for the cleansing action of the Sapo earth and, by cooking animal fat with wood ashes (containing potash), was able to make soap uncontaminated with earth or clay. "Soap" perpetuated the name of Sapo Hill, and until the last century, soapmaking didn't progress much past this primitive stage. Up to a generation or two ago, every home had its iron soap kettle. And even modern soapmakers follow essentially the same process, although careful control of materials and processes produces a uniform product that is a far cry from the slippery clay of Sapo Hill.

The word "detergent" describes any cleaning agent, including soap. However, popular usage has taken detergent to mean the synthetic detergents, as distinguished from soap, that are put out for home use. Detergents became possible when we began

to understand just how soap worked and why it cleaned.

The main reason that water alone is an ineffective cleaner is its high "surface tension." Its surface acts like an elastic skin over the liquid, resisting penetration and tending to contract. This surface tension is so high that it will float a small heavier-than-water object, like a needle, set carefully on the surface. Detergents and soap lower the surface tension of the water so that the "skin" or liquid film is much weaker. This can be shown by sprinkling

The soap molecules separate oil and water in an emulsion by gathering around the oil drops as shown

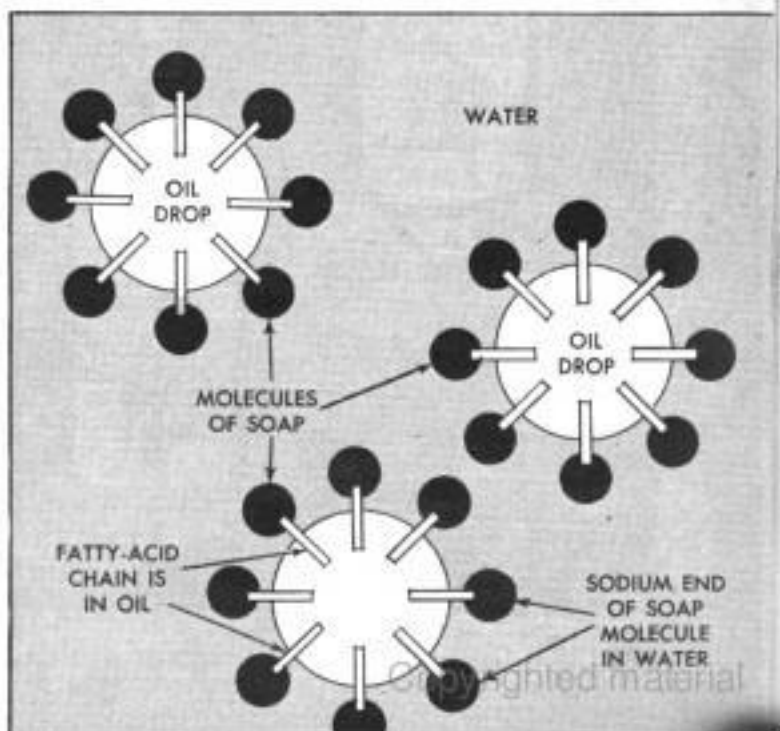

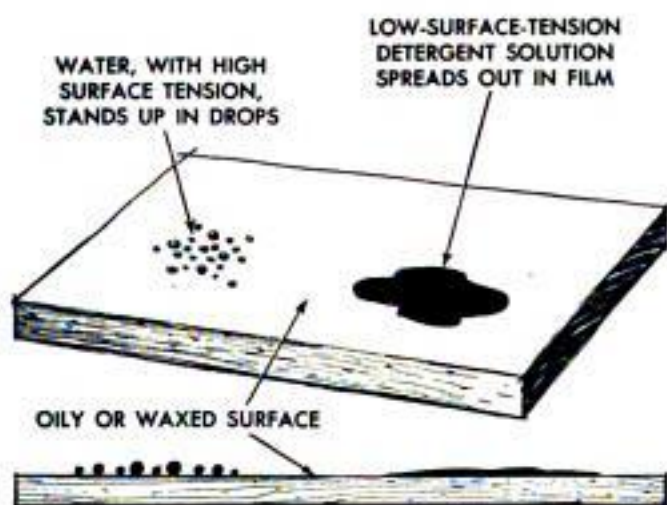
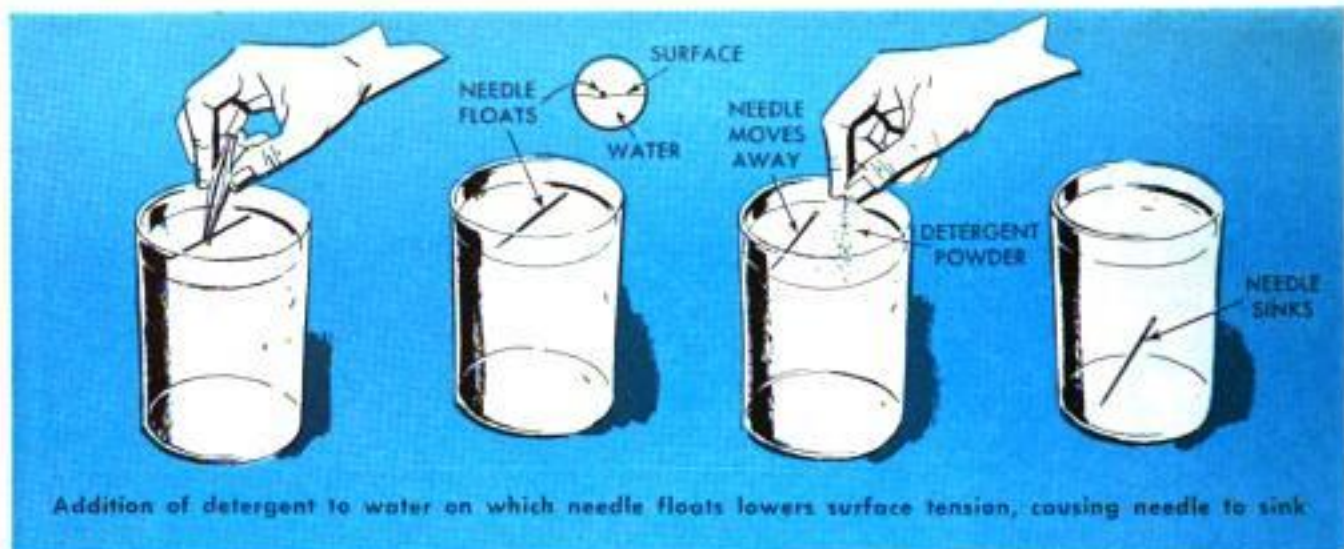

The cleaning of oily or greasy material depends in part on reduction of interfacial tension, which is the surface tension or film strength where the oily liquid meets the watery liquid. A cleaning liquid which wets the oil can float it away more readily

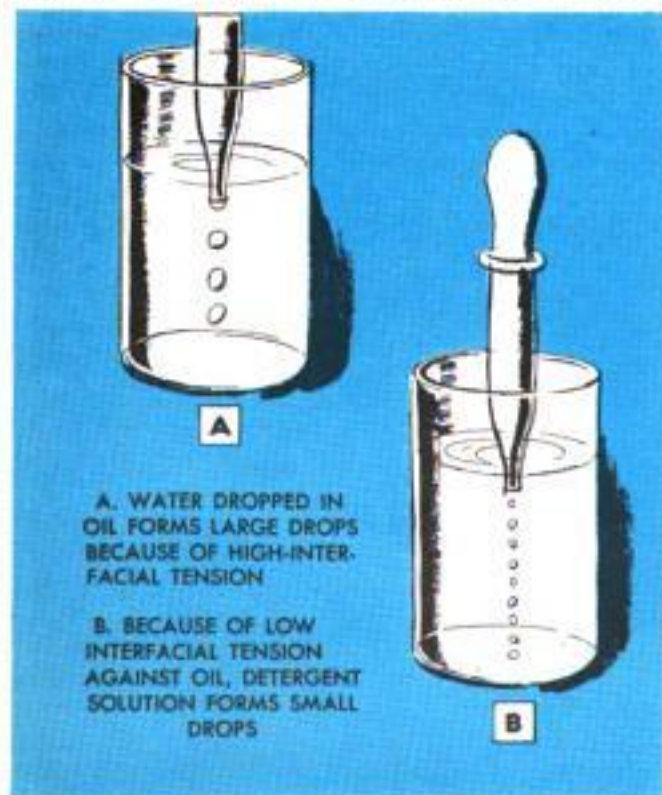

a few grains of detergent powder on one side of a floating needle. The high surface tension on the other side will immediately pull the needle over. Then, within a few seconds, as the detergent dissolves and the surface tension drops, the liquid will wet the needle and sink it. This increase in wetting action when the surface tension of water is lowered is one of the main factors in detergency, since unless the washing solution wets the dirt, it cannot float it away.

The cleaning of oily or greasy material also depends in part on the reduction of surface tension. (More strictly, on the reduction of "interfacial tension," or the film strength where the watery liquid meets the oily liquid.) Drop water on an oily surface and it will stand up in little balls, almost perfect spheres. The high surface tension is responsible, because it makes the "skin" contract. However, when detergent solution is dropped on an oily surface, the liquid spreads out in a thin film because one liquid wets the other. The surface tension isn't great enough to form the drops into spheres, so they spread out shapelessly. Naturally, a liquid that wets the oil can float it away more readily than one which doesn't. Also, the detergent solution wets the underlying surface (textile fibers, for instance) and lifts the oil off. Thus the oil is removed by rough emulsification.

To form stable emulsions (mixtures of liquids, like oil and water, that won't ordinarily mix), one of the liquids must be dispersed as extremely small drops. Detergents and soap help this process because the low interfacial tension between oils and cleaning solutions makes it easy to form the necessary small drops. A detergent solution dropped into oil will form tiny droplets naturally, proving how low the interfacial tension is. Water dropped into oil will form large drops.

Soaps and detergents have a "split personality" molecular structure, having one

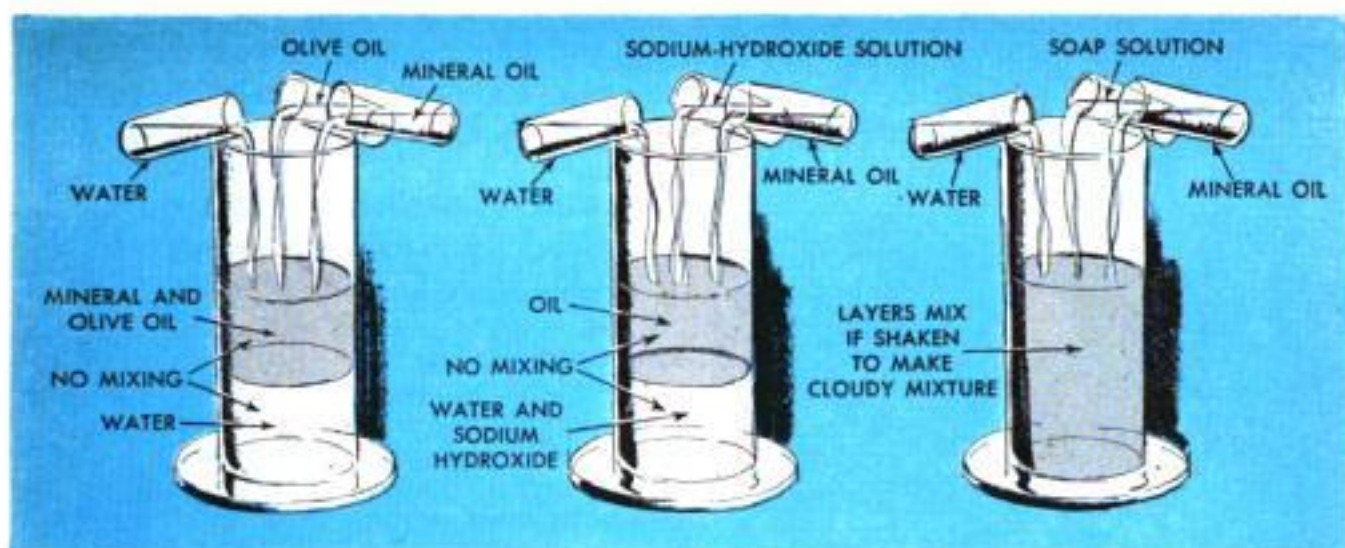

end that wants to dissolve in oil and the other end compatible with water. This can be seen by pouring mineral oil and water into a glass, and adding first some sodium-hydroxide (lye) solution, and then some salad oil, such as corn or olive oil. The sodium hydroxide will mix with water, and the salad oil will mix with mineral oil, but the oil and water layers still won't mix. However, if soap is added, the two layers can be mixed to form a milky emulsion. Soap combines in one molecule the fatty structure of the salad oil with the sodium from the sodium hydroxide, and shares the solubilities of the two materials.

This is what happens: The long fatlike end of the soap molecule dissolves in the oil drops, while the sodium end of the molecule dissolves in the water. As a result, the soap molecules arrange themselves around the oil drops, half in the oil and half in the water, thus separating the oil from the water and, at same time, keeping the drops from coming together.

Is a drop always the same size? You might think it depends on the size of the dropper, but it is actually the surface tension of the liquid that determines the size of the drop. The surface "skin" supports the drop as it grows on the end of the dropper until its weight becomes too great. This can be proved by counting the number of drops obtained from a dropperful of water and from one of soap solution, glycerin or alcohol. Each of these latter will yield more than twice as many as the water, showing that their surface tension is less than half that of water.

It is easy to make bubbles out of a liquid with a low surface tension, because the surface of such a liquid can be increased. However, it is viscosity rather than surface tension that makes bubbles long lasting. Good soap-bubble mixtures include glycerin to give greater strength. Suds that last, incidentally, have no particular relationship to cleansing ability, since their

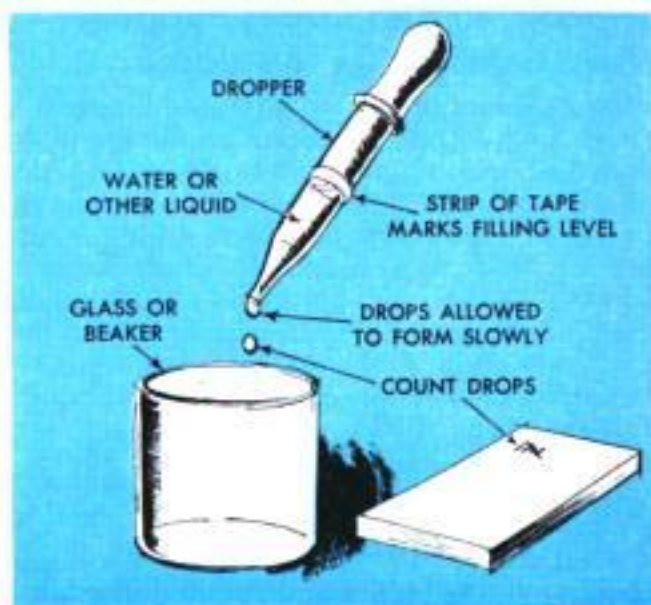

Upper detail shows that soap solution permits emulsion of oil and water. Lower detail indicates test to prove that drop size depends on surface tension

longevity doesn't depend on low surface tension. Many fine detergents form very few suds.

This question is often asked: "Which is better, a soap or a detergent?" The answer is that under normal conditions they both lower the surface and interfacial tension of the water, permitting it to float away the dirt. However, in hard water there is a difference in their actions, for in hard water soap precipitates calcium stearate, an insoluble substance that you recognize as soap scum or as the ring around a bathtub. In the laundry, the calcium stearate is formed right in the fibers of the fabric, where it is difficult to rinse out. It is the cause of "tattle-tale gray" in white goods. Since detergents do not precipitate the calcium stearate in hard water, they are easier to use. However, softened water, from which the calcium has already been precipitated, eliminates this problem. In it, the action of both soap and detergent is essentially the same. ★ ★ ★



"Pinhole Lens" Permits Reading When Glasses Are Misplaced

In an emergency, a farsighted person, whose corrective glasses have been misplaced or broken, can read fairly small type with the aid of a "pinhole lens." The lens is a strip of cardboard in which a pinhole is punched. To minimize light reflection, the side facing the eye should be a dull black color. *Caution:* The pinhole lens should be used only as a temporary expedient. Consult an optometrist or oculist as soon as possible for proper fitting of corrective glasses.

Felt Oiling Pad on Sawhorse Rustproofs Handsaws

FELT PAD SATURATED WITH OIL UNDERNEATH SAWHORSE



the slot and down through the slit in the pad, the pad being saturated with oil.

Marbles Dropped Into Paint Can Assist Thorough Mixing

To assure quick and easy mixing of left-over paint, drop a couple of marbles or ball bearings into the can before storing it. The objects eventually will become embedded in the thickening paint in the bottom of the can. When the sealed can is shaken vigorously, the marbles or bearings will not rattle until the thickened paint has begun to

mix with the oil. As soon as the objects rattle freely in the bottom of the can, you can be certain the paint is completely mixed.—Ed Packer, Oak Park, Ill.

Greater Contrast in Blueprints Assured by Facing Carbons

Traced drawings that are to be blueprinted or photo-printed can be given greater contrast and sharper detail by using carbon paper on both sides of the tracing paper. As shown in the drawing, the bottom carbon is face up, while the top carbon is face down. Carbon is deposited on both sides of the paper, providing a maximum density of line. Typed copy can be handled in the same way.

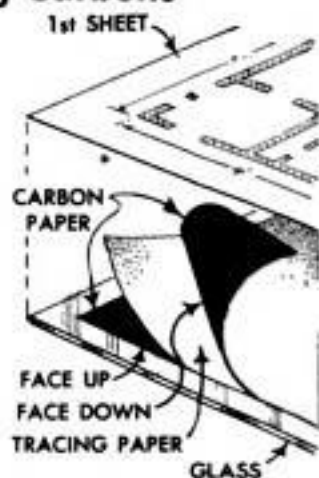

Car-Door Upholstery Replaced With Prefinished Wall Paneling

One motorist replaced the badly worn upholstery on the doors of his older-model car with pieces of Marlite prefinished wall paneling. A paper pattern first was made of the door, then transferred to the paneling. Color and design of the paneling were chosen to match the wood-grain finish of the car instrument panel. Solid colors also are available. Before it is remounted, the inside door handle can be covered with vinyl plastic to match the door.

Marah Wall Products photo



Sawhorse Holds Flags and Sign To Protect Highway Workers



One foreman on a highway construction job employs sawhorses to hold up the warning flags and sign which protect his men while they are working. The horses are drilled at an angle to receive the flag-staffs, and drilled in the center to

take the sign support. To prevent the sign from turning in the wind, a small wedge is inserted beside the support.

Broken Keys in Ceiling Plaster Renewed With Melted Sulphur

When a sagged spot in a ceiling indicates that plaster keys between the laths have broken, the ceiling can be repaired by using melted sulphur. The upper surface of the ceiling must be accessible. First, a piece of plywood large enough to cover the sagged spot is nailed to the end of a post and forced against the ceiling with a jack so the ceiling is leveled. Next, sweep away broken plaster above the laths. Finally, melt sulphur and pour it over the damaged area from above. The sulphur will fuse with the plaster and, when cooled, will key around the laths. Ten pounds of sulphur will repair an area about $2\frac{1}{2}$ ft. square.—O. A. Nelson, Seattle, Wash.

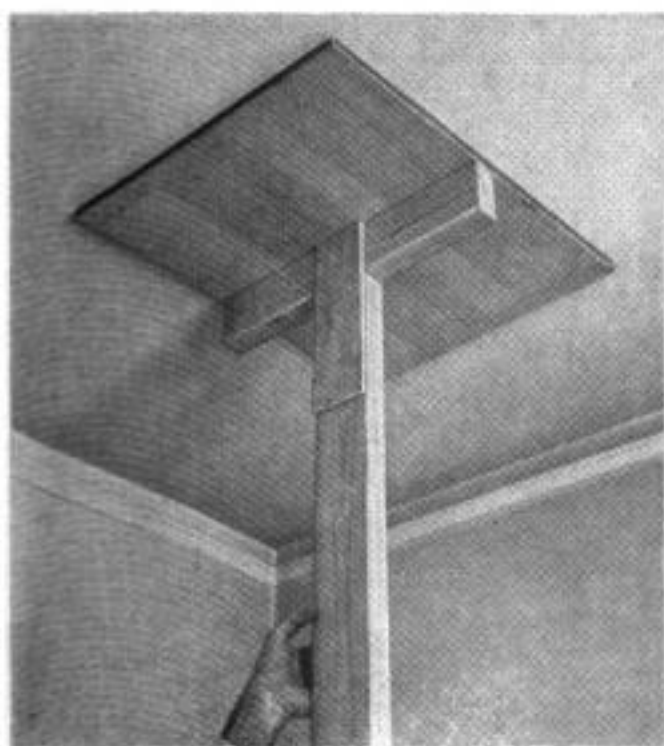

AUGUST 1955

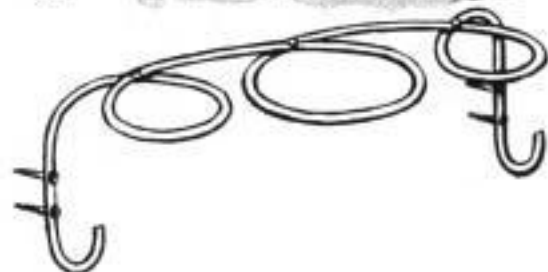

Holder Bent From Metal Rod Supports Flowerpots

A flowerpot holder bent from $\frac{1}{2}$ -in. metal rod can be used in place of a flower box when the box presents too bulky an appearance for window or house. The rod can be steel or brass, steel, of course, requiring paint to rustproof it. When bending the holder make the center circle larger than the two side circles to provide a balanced look. The vertical portions of the holder are drilled so wood screws can be passed through them and driven into the house siding. Further rigidity is assured if the points at which the rod crosses are riveted or welded together.

Interlocking Crate Corners Provide Maximum Strength

The next time it is necessary to crate a heavy object for shipping, use the interlocking method illustrated to provide maximum strength at the corners of the crate. Pieces

A, B and C all extend the thickness of the wood past the pieces nailed to their edges, and flush with the pieces nailed across their faces. Two nails should be used in each piece, and the nails should extend into the bottom piece a distance equal to thickness of the upper pieces.

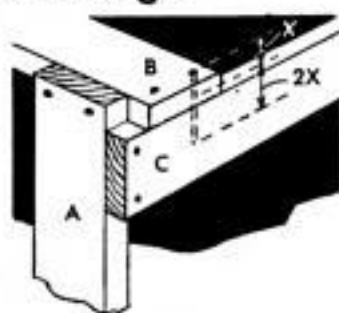

161

Copyrighted material

Solving Home Problems



1. STORAGE FOR LEAVES of kitchen or dinette table may be provided by installing flat-iron brackets on the underside of the table top. If table has deep apron, locate brackets so leaves can be inserted while table halves are apart as shown

2. STICKING ICE-CUBE TRAYS will not be a problem if trays are placed on sheets of aluminum foil in freezer compartment. The foil prevents tray bottoms from freezing to compartment, permits trays to be removed without having to be pried loose from ice



3. HIDING PLACE FOR DOOR KEY, not as commonly known as usual locations under door mats or in mailboxes, can be made by drilling overlapping holes to form a recess in top crossrail of a combination door. A similar recess in inside door provides a hiding place for small objects of value

4. BRUSHING CANDLES with a coat of clear shellac will prevent them from drooping during hot weather. The shellac coating provides the additional advantage of causing the candles to burn more uniformly and with much less dripping. Candles are cleaned by wiping with damp cloth

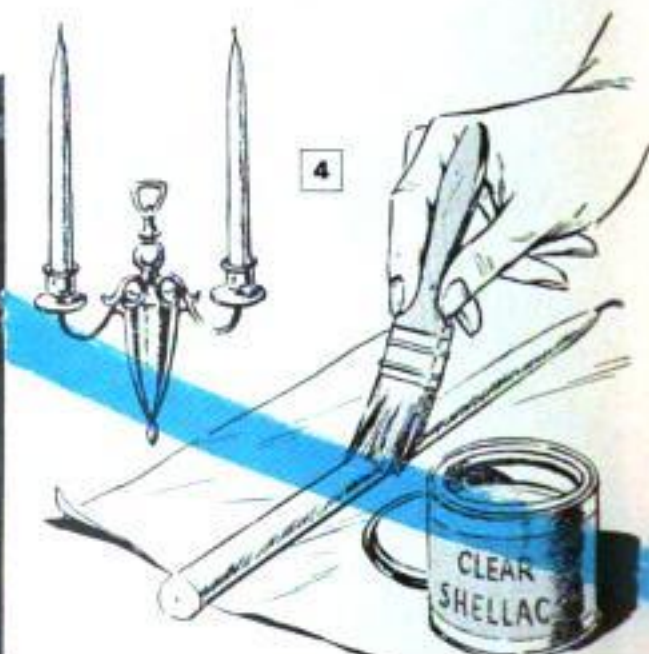
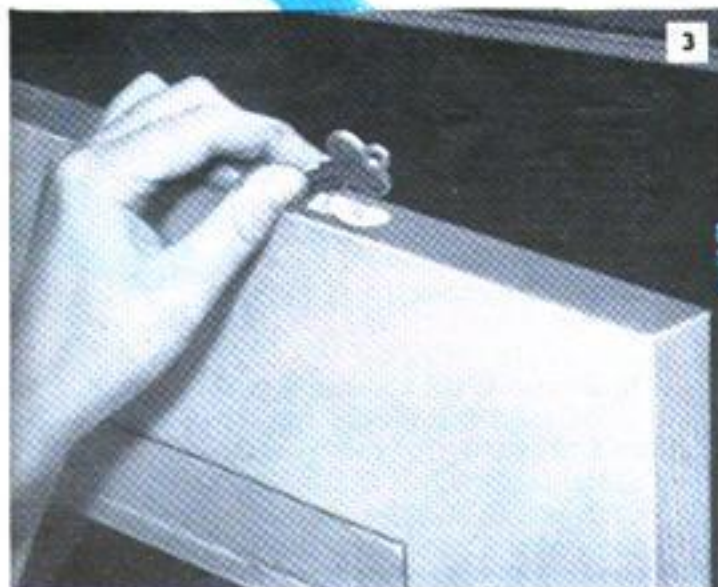

5. EASY REMOVAL OF FRUIT-JAR LID will be assured by lubricating the threads of lid with wax. A few drops of wax from a candle on the inside of lid will not interfere with screwing the lid on the jar and will prevent formation of corrosion between lid and jar

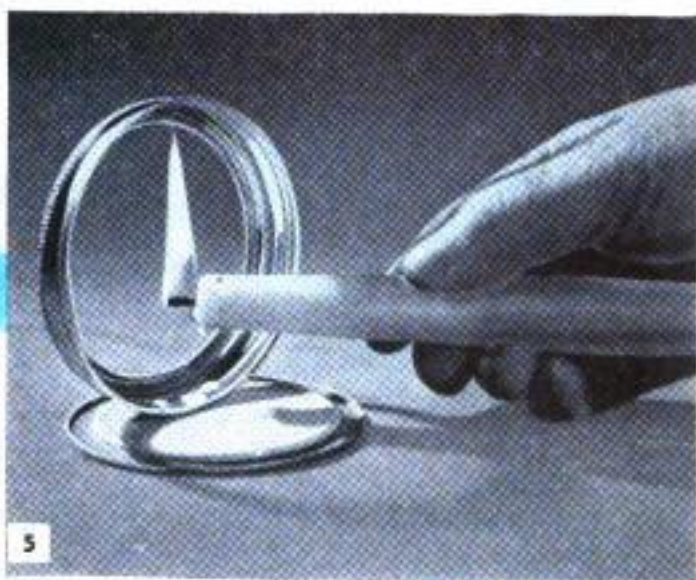

6. DISCARDED LIPSTICK CASE is converted to handy needle holder. Remove remnants of lipstick from retractable inner tube and substitute short length of cork. Needles to be stored are forced into cork, tube is retracted and top of lipstick case is fitted over needles



7. "SHELVES" FOR SMALL POTTED PLANTS may be improvised from bathroom or kitchen water-tumbler holders. In some rooms the holders may match other fixtures or be painted to agree with room decor. For contrast, holders may be painted black to simulate wrought iron



8. VENTILATION AND PRIVACY without noise of flapping shade are provided by attaching shade brackets to top rail of upper sash instead of window frame. When top sash is lowered for ventilation, shade remains below draft of air even when pulled down to window sill

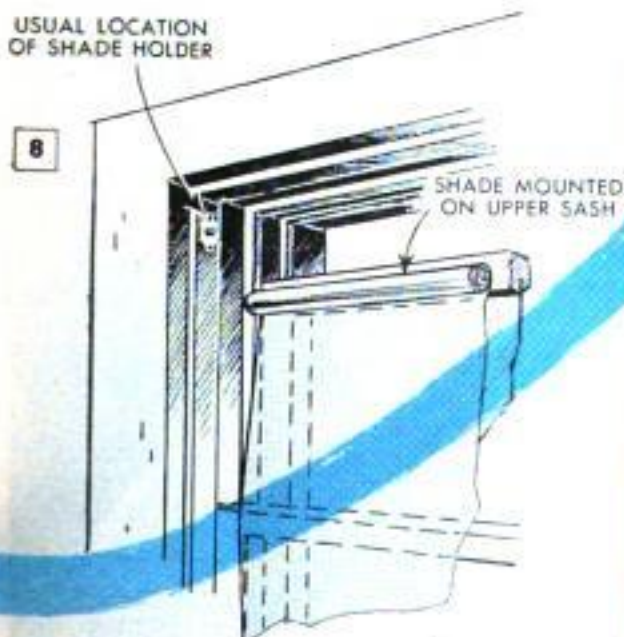

9. TO ELIMINATE THE PROBLEMS caused by toddlers lifting a telephone from its cradle, fit a wide rubber band around the cradle to hold down the contacts. The rubber band can readily be slipped off the contacts when the telephone is to be used for call by an adult



Glass Cut to Close Tolerance By Using Paper Pattern

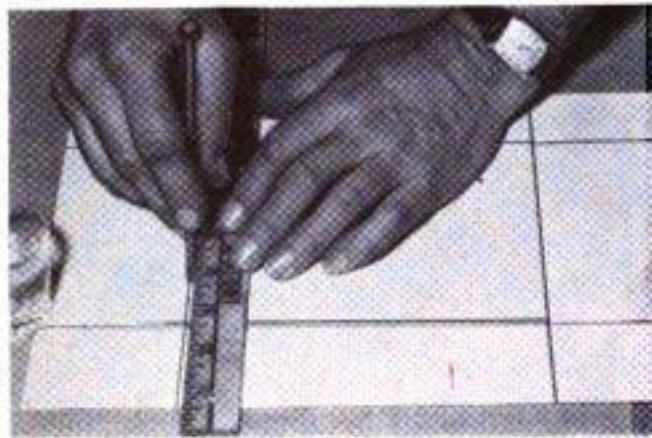

Amateur photographers, artists and home craftsmen, who only occasionally have need to cut glass, can be sure of doing an accurate job if a pattern is used. Lay out the pattern on a sheet of paper, making it the exact size and shape needed. To cut the glass, place the pattern under it and score the glass by following the lines. This method will keep errors to a minimum.

Ivan Grosvenor, Indian Rock, Fla.

Flashlight Located in Dark

A band or two of luminous paint applied around the case of a flashlight will make it possible to locate the light if it is dropped in a dark room. If luminous paint is not readily available, a strip or two of reflecting tape, obtainable at all automobile-supply stores, may be used.

Harry J. Miller, Sarasota, Fla.

Darkroom Shelf With Holes Provides Graduate Storage

Easily tipped graduates in one darkroom are stored safely by being dropped into holes cut in a shelf. The diameter of each hole matches the diameter of a particular graduate at the midway point of the graduate's height. After being used, a graduate is dropped into its own storage spot for safety, then washed later.

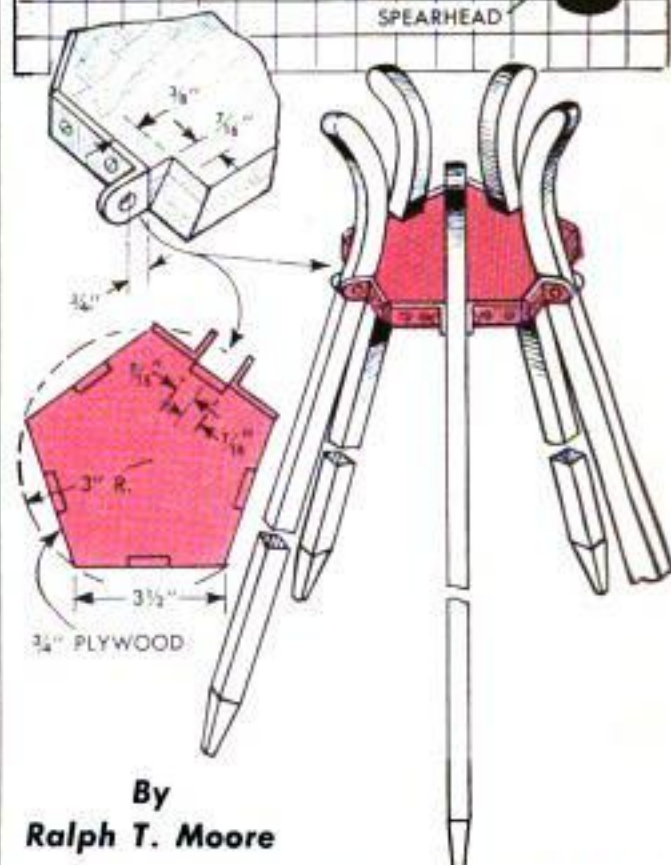
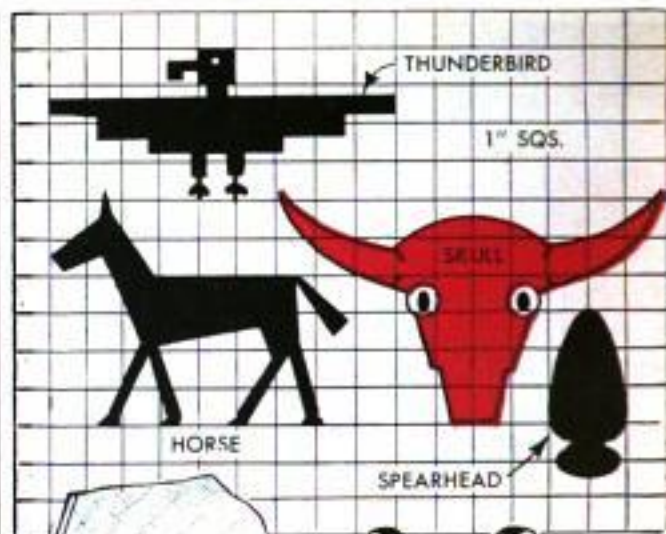
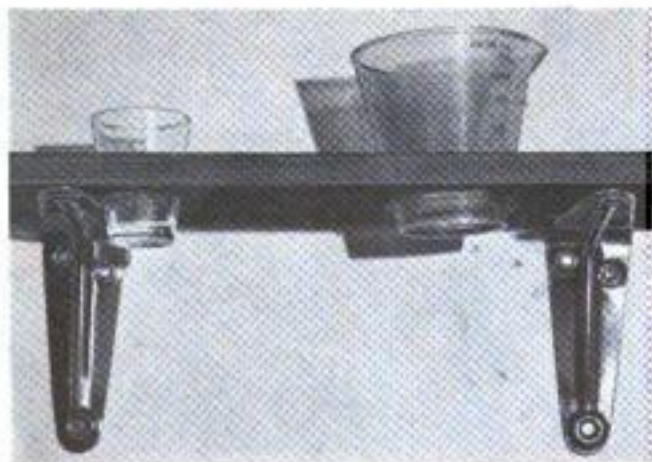

By
Ralph T. Moore



LITTLE-INJUN

TEPEE

CHILDHOOD'S favorite game of cowboys and Indians can be double fun when the back-yard "reservation" has a real Indian tepee in it. The one shown here will appeal to parents, too, because it can be erected and dismantled so easily. To set up the tepee, it is only necessary to squeeze the top curved portions together. To begin construction, cut the five poles from $\frac{3}{4}$ -in. spruce or fir. Then saw the curved ends and fasten them to the tops of the poles with glue and screws. Next, prepare the pivot block from the detail at the right, bending the angles from $\frac{3}{32}$ -in. aluminum or sheet metal. For the covering, you will need $3\frac{1}{2}$ yd. of heavy denim or light duck, 48 in. wide. ★ ★ ★

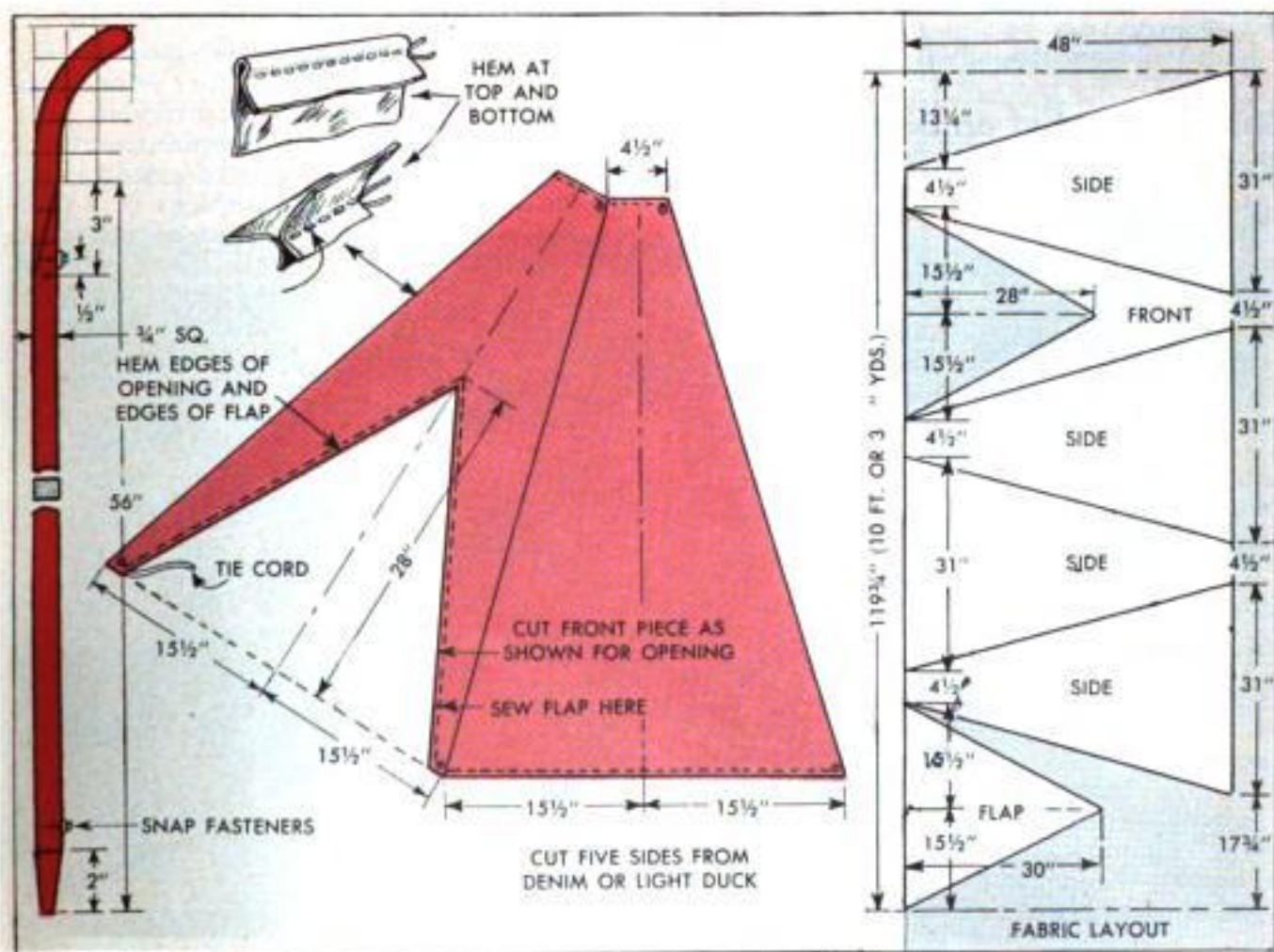

Modified Garden Rake Used As Seedbed Leveler



A simple attachment on a garden rake will save both time and labor when leveling a freshly spaded seedbed. The attachment is a 4-ft. length of $\frac{1}{2}$ x 4-in. lumber bolted to the rake teeth by means of $\frac{1}{4}$ -in. bolts and large washers. Cut a bevel on the bottom edge as shown in the detail, to increase the "bite" of the leveler. Only a few moments are required to return the rake to its original use.

Neal Houlahen, Van Nuys, Calif.

Rubber Washer on Drill Bit Protects Finished Surface



To protect a finished surface when drilling holes, slip a rubber washer over the drill bit. Should the bit unexpectedly break through, the washer

will prevent the chuck jaws from marring the finish. The washer may be the kind used in faucets or may be cut from an inner tube or stair tread.

Quick Immersion in Developer Prevents Film Fogging

Because photograph emulsions are much more sensitive to light when dry than wet, loaded film hangers should be immersed in the developer as quickly as possible. Light leaks and reflections in the darkroom which can quickly fog a film are no longer a hazard when the film is in the solution. And, although some developers incorporate

an antifog agent in their formula, care should be taken to prevent holding the film out of the developer too long when developing cut film in an open tank.

Padded Base Under Lantern Reduces Mantle Breakage

Breakage of mantles in gasoline-type lanterns can be reduced by fitting the base with a pad of sponge rubber. The pad protects the mantle by absorbing shocks, as when a lantern is set down quickly on a hard surface. When the lantern is placed on a boat deck, or other smooth surface that is subject to vibration, the pad also prevents it from sliding around. The pad need not be thick.



Fountain Pen Provides Storage For Cotton Swabs

Convenient and dust-free storage for small cotton swabs used for retouching work in a darkroom can be provided by a discarded fountain pen. Penpoint and ink sac are removed. A supply of cotton is inserted in the cap, and toothpicks or a pair of tweezers are fitted in the barrel. The pen then is screwed together and slipped in a pocket or stored with other retouching materials. A number of ready-prepared swabs could also be stored in the barrel.

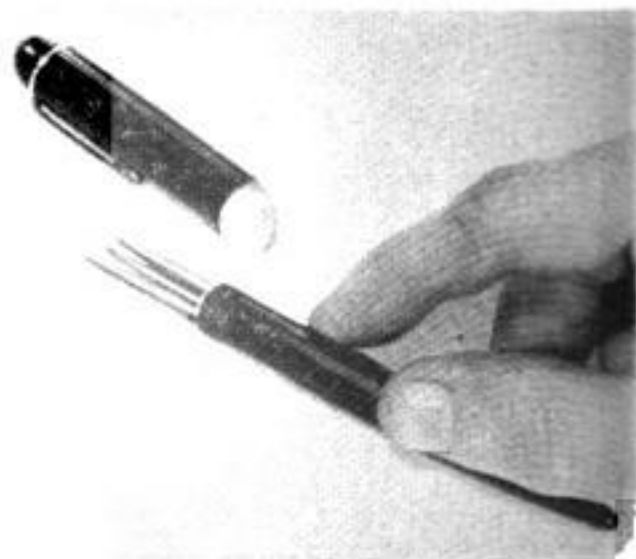

PATTERN CRAFT

Traditional Magazine Rack

Made of walnut or mahogany plywood, this attractive magazine rack is extremely easy to cut out and assemble. If you have a jigsaw or bandsaw, it is best to cut duplicate parts, such as the ends and side pieces, at the same time. This is done by fastening the pieces together temporarily with tape or by nailing through the waste stock. The rack is assembled with finishing nails. These are set and the depressions are filled with tinted wood putty

FULL-SIZE PATTERN

A full-size trace-and-cut pattern of the traditional magazine rack can be obtained by sending 50 cents to Patterncraft, *Popular Mechanics Magazine*, 200 E. Ontario St., Chicago 11. When ordering, ask for pattern No. 117

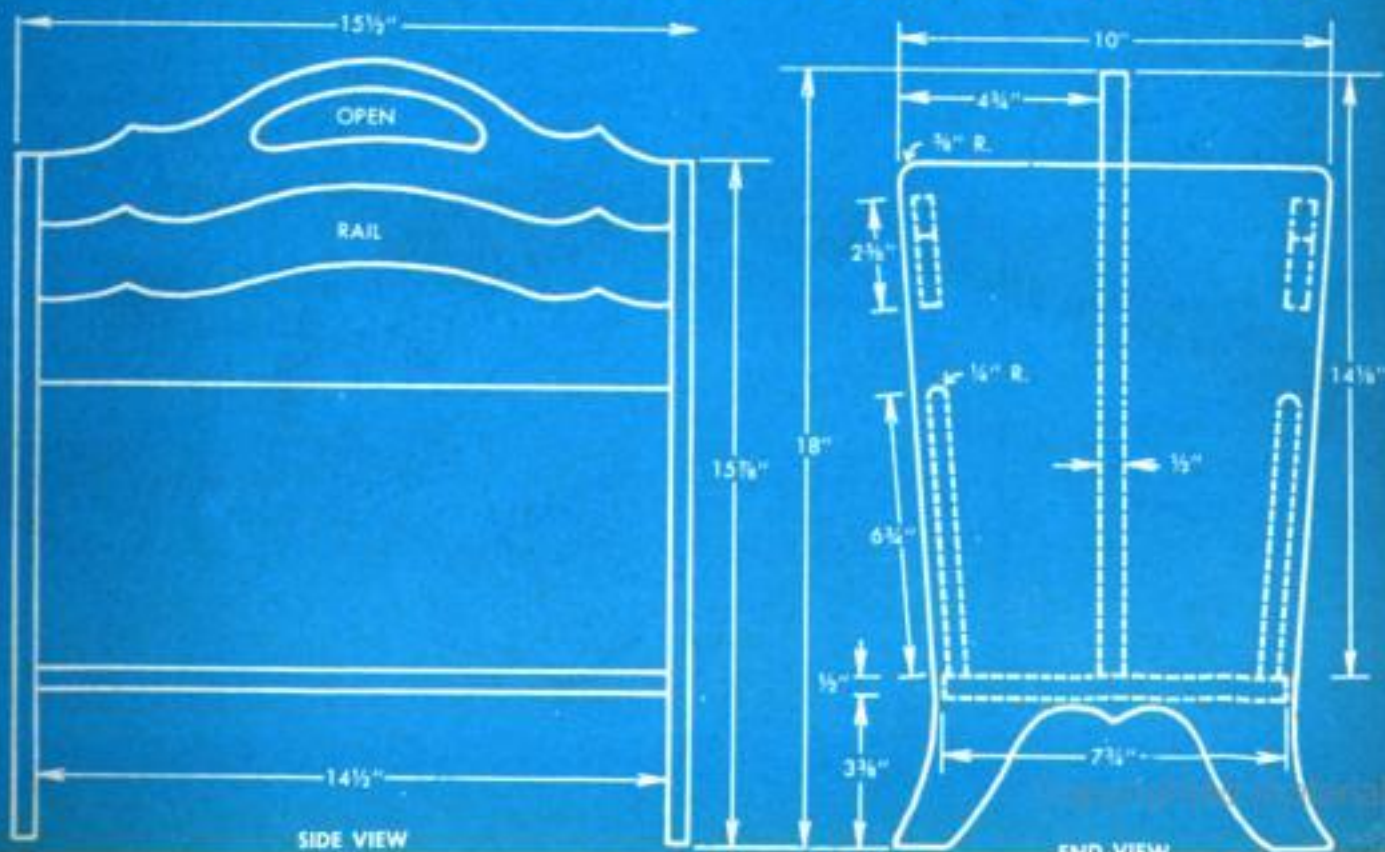
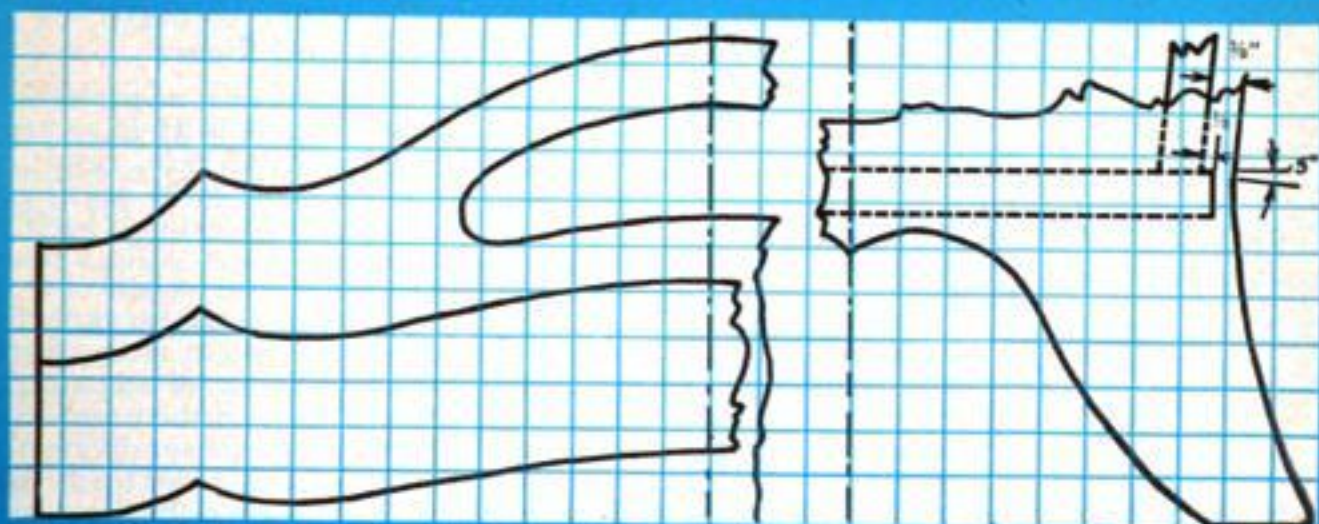



Passing Canines Refreshed At Shop "Puppy Bar"

Combining a flair for publicity with a love for dogs, one California shopkeeper built a "puppy bar" on the walk in front of his store. On sizzling-hot summer days many a passing canine stops for a refreshing drink of water. The bar was made by mortaring a few bricks together to fit around a water container.

Magnetic Hammer Picks up Tacks Singly From Plastic Screen

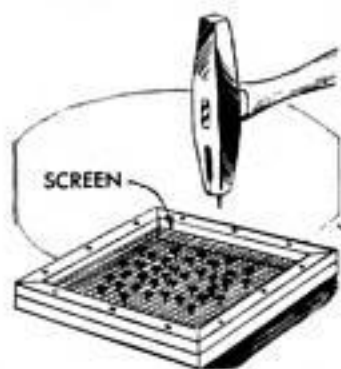

To easily pick up small tacks individually with a magnetic hammer, scatter them on a piece of plastic window screen tacked to a wooden frame. Shaking the screen will cause the tacks to drop into the mesh

openings point first, thus exposing their heads for easy contact with the hammer. It is convenient to use when upholstering.

Adhesive-Tape Strip on Triangle Used as Handy Penwiper



Artists and draftsmen whose work requires a penpoint free of lint and dust will find that a strip of adhesive tape attached to a triangle or T-square blade provides a handy wiper.

When it has become soiled, the tape is easily removed and replaced with a clean strip. Cloth, rather than plastic-type adhesive tape, furnishes the best wiping surface.

G. E. Hendrickson, Argyle, Wis.

Wiper for Hot Soldering Iron Utilizes Steel-Wool Pad

A steel-wool scouring pad, of the type mounted on a wooden handle, is handy for cleaning the tip of a hot soldering iron. To hold the pad in place while in use, drop the handle into a hole bored in the workbench top.



When not in use, the pad can be removed and stored with the other soldering supplies.

Determining Correct Dimensions Of Stair Treads and Risers

In stairway construction a preferable width for the treads is 10 to 11 in., with a riser height of from $6\frac{3}{4}$ to $7\frac{1}{2}$ in., resulting in a stairway angle of 30 to 36 deg. from horizontal. In restricted locations, such as in stair flights to basement or attic, a tread width of $9\frac{1}{2}$ in. and a riser height of 8 in. is acceptable. There should be no variation in tread width or riser height in any flight of steps or adjacent flights of steps separated by a landing. To find the number of risers to build into a stairway, divide the vertical distance in inches between two finished floors by 7. Generally the result will be a whole number plus a fraction. If the latter is less than one half of a riser, divide the whole number into the vertical distance to determine the individual riser heights. If the fraction is greater than one half a riser, divide the next higher whole number into the vertical distance between floors.

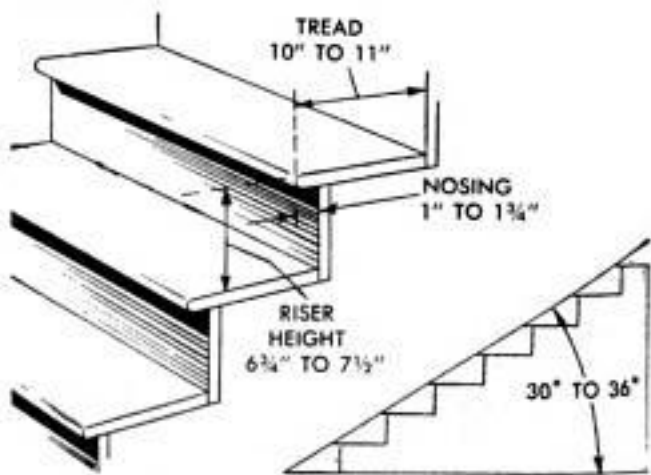

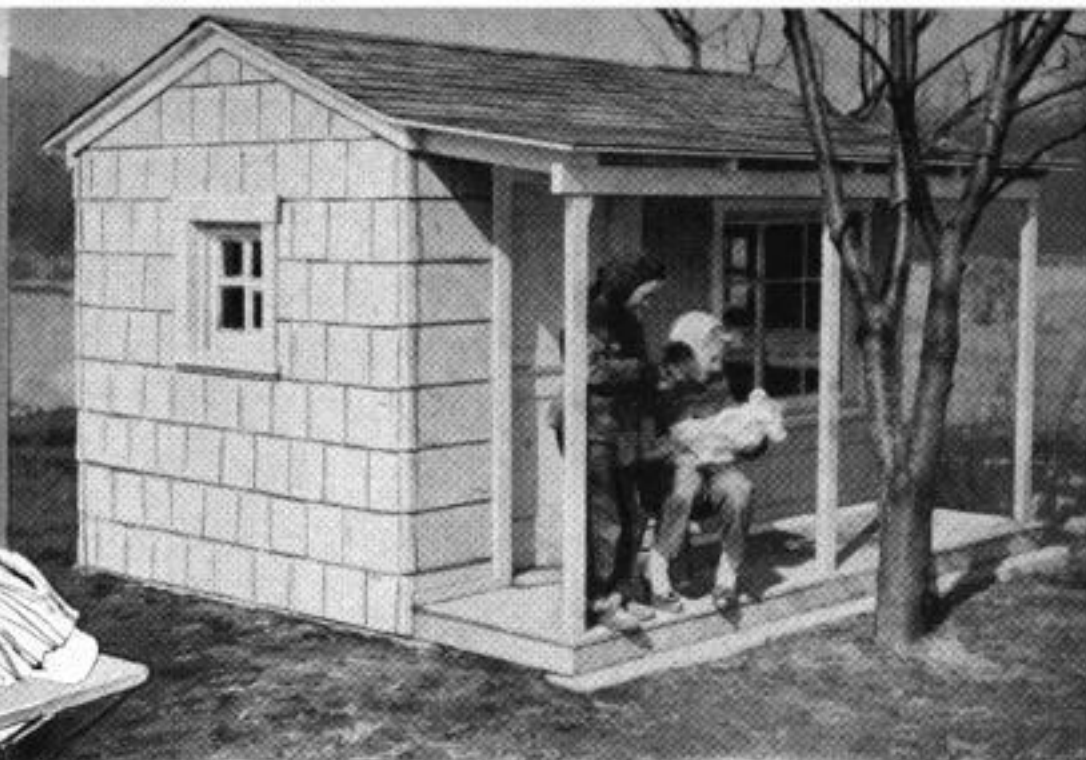

PLAYTIME COTTAGE

Part II

By Edward Mickley

You've been shown how the cottage is built, now to furnish it. Details show how to make a chair, table, bunk bed, even a stage for a marionette or puppet show

ALL THE FURNISHINGS for the playtime cottage are easy to make. Where two or more chairs are to be made, time can be saved by sawing several sets of duplicate parts, such as the legs, at one time. The drawing at the top of the next page gives the sizes of the seven parts that comprise each chair. Plywood, $\frac{3}{8}$ and $\frac{5}{8}$ in. thick, is recommended, the $\frac{5}{8}$ -in. thickness being used for the legs. The details show how the latter can be laid out economically by nesting the leg patterns on the plywood. The chair back is held in place with four screws.

Kiddie-size bunks will increase the "livability" of the cottage. These are detailed in the drawing at the bottom of page 171 and are designed to swing upward and flat against the wall where they are hooked out of the way. The frame of each bunk is made of 2 x 2s, half-lapped and bolted at the corners and then rounded. Common furniture webbing is used to cover the frames. The individual strips are interlaced and stretched tautly across the frame and brought around and tacked to the inside. Each bunk is hinged to the wall, one above the other, with two 5-in. T-hinges, and suspended with two lengths of porch-swing chain attached to screw eyes in both the bunk and wall. Blocks of 2 x 4, installed



4 X 48"

6 X 36"

LAYOUT OF LEGS

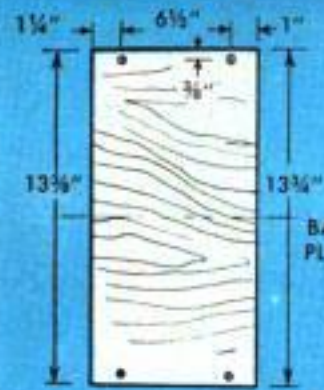

BACK, 3/8" PLYWOOD

1 1/4" SCREW

#10-1 1/2" SCREWS 2" SCREW

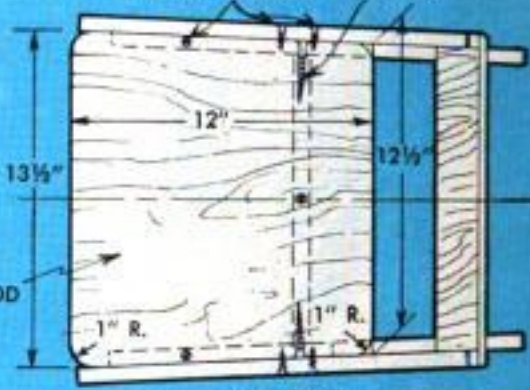

SEAT, 3/8" OR 1/2" PLYWOOD

TOP VIEW

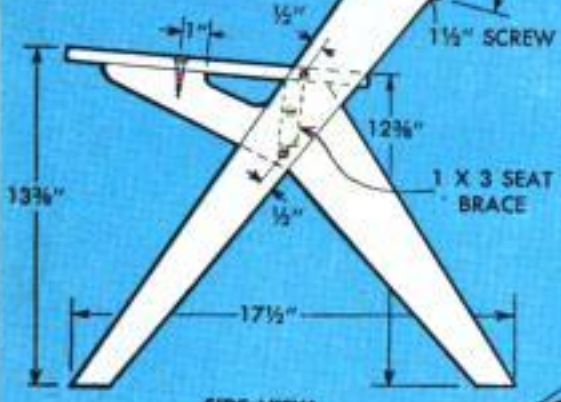

SIDE VIEW

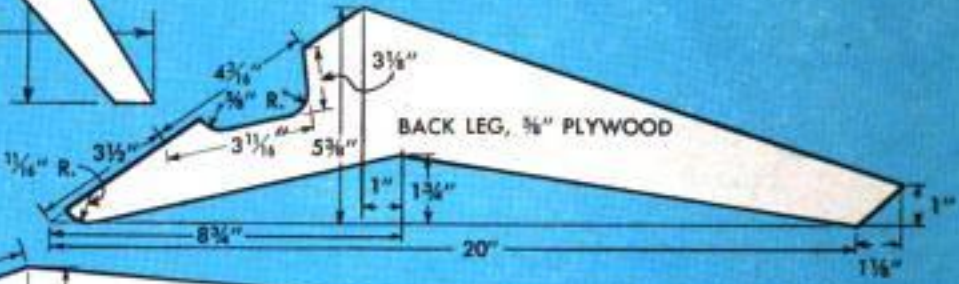

BACK LEG, 3/8" PLYWOOD

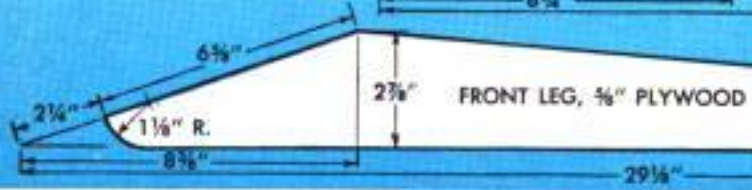

FRONT LEG, 3/8" PLYWOOD

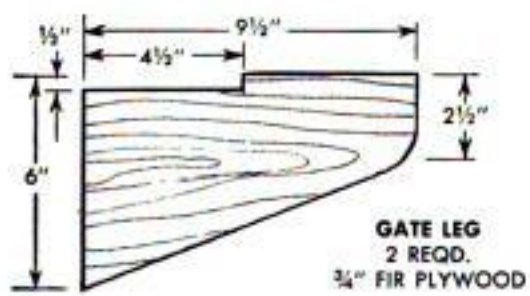
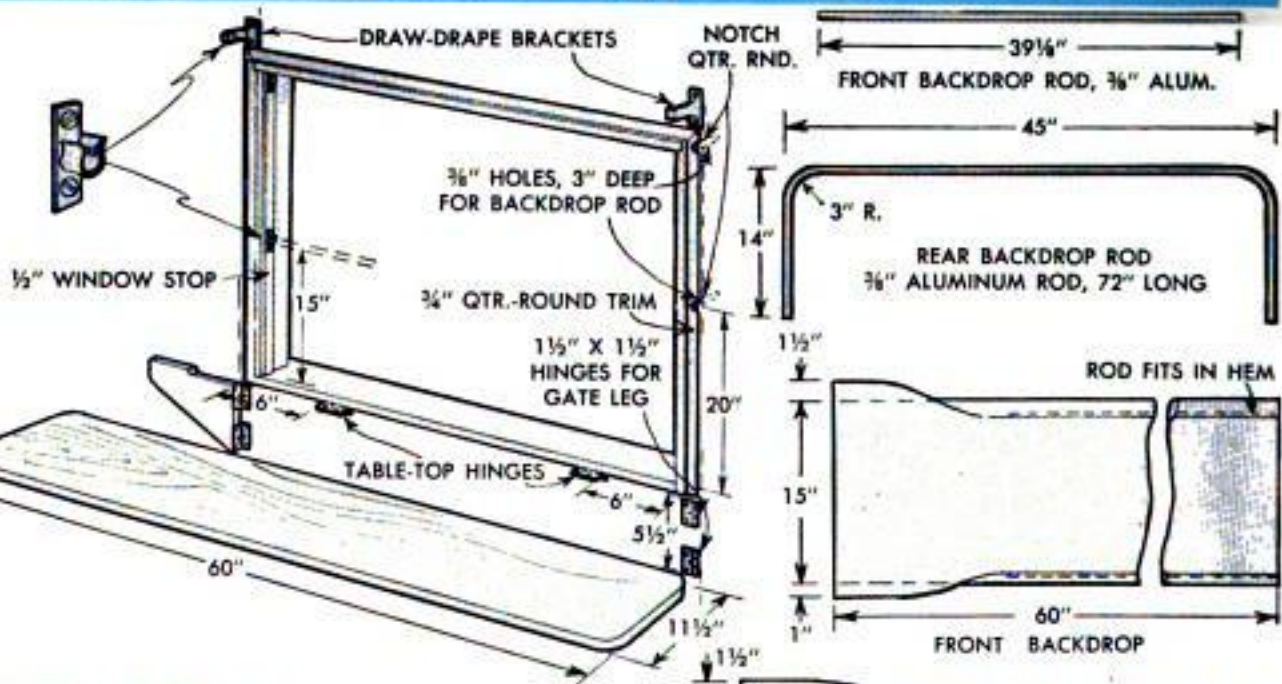

GATE LEG 2 REQ. 3/4" FIR PLYWOOD

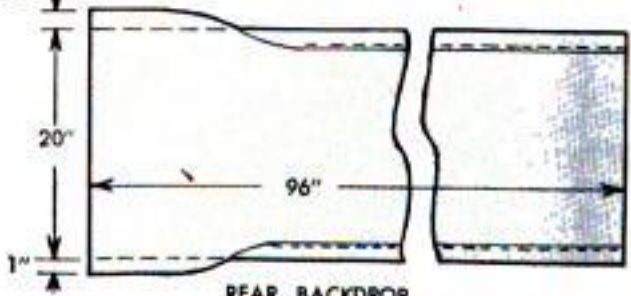

REAR BACKDROP POPULAR MECHANICS

between the rear-wall studs and behind the hardboard interior lining, provide solid support for the wall screw eyes.

The table, which is fitted across the front window, is a 5-ft. length of 1 x 12 hinged to fold down and is supported by two swinging brackets, or gate legs. Resembling a shelf, the table serves as a double-duty stage for producing Punch-and-Judy shows which are viewed through the window from the porch. With the table swung up, the rear backdrop in its low position and the front backdrop in its high position, you have a marionette stage which is used in the manner shown in the illustration at the right. By dropping the table and reversing the position of the front and rear backdrops, you have a stage for hand puppets as pictured on the opening page. Here, in actual use, the rear backdrop would be fully closed. A regular traverse rod is used for the stage curtains. A straight length of $\frac{3}{8}$ -in. aluminum rod supports the front backdrop and rests in two standard casing brackets, a pair of brackets being located at the two positions indicated. The rod for the rear backdrop is bent to the shape shown and is supported by inserting it in holes drilled in the wall studs alongside the window. Two sets of holes are provided for this rod. The backdrops can be made from most any cloth material. These are cut to the sizes given and hemmed to slip over the aluminum curtain rods. ★ ★ ★



Backdrops are interchangeable to convert "stage" from hand-puppet use to marionette presentations



Double-deck bunks, laced with strips of furniture webbing, are hinged to fold out of way against wall

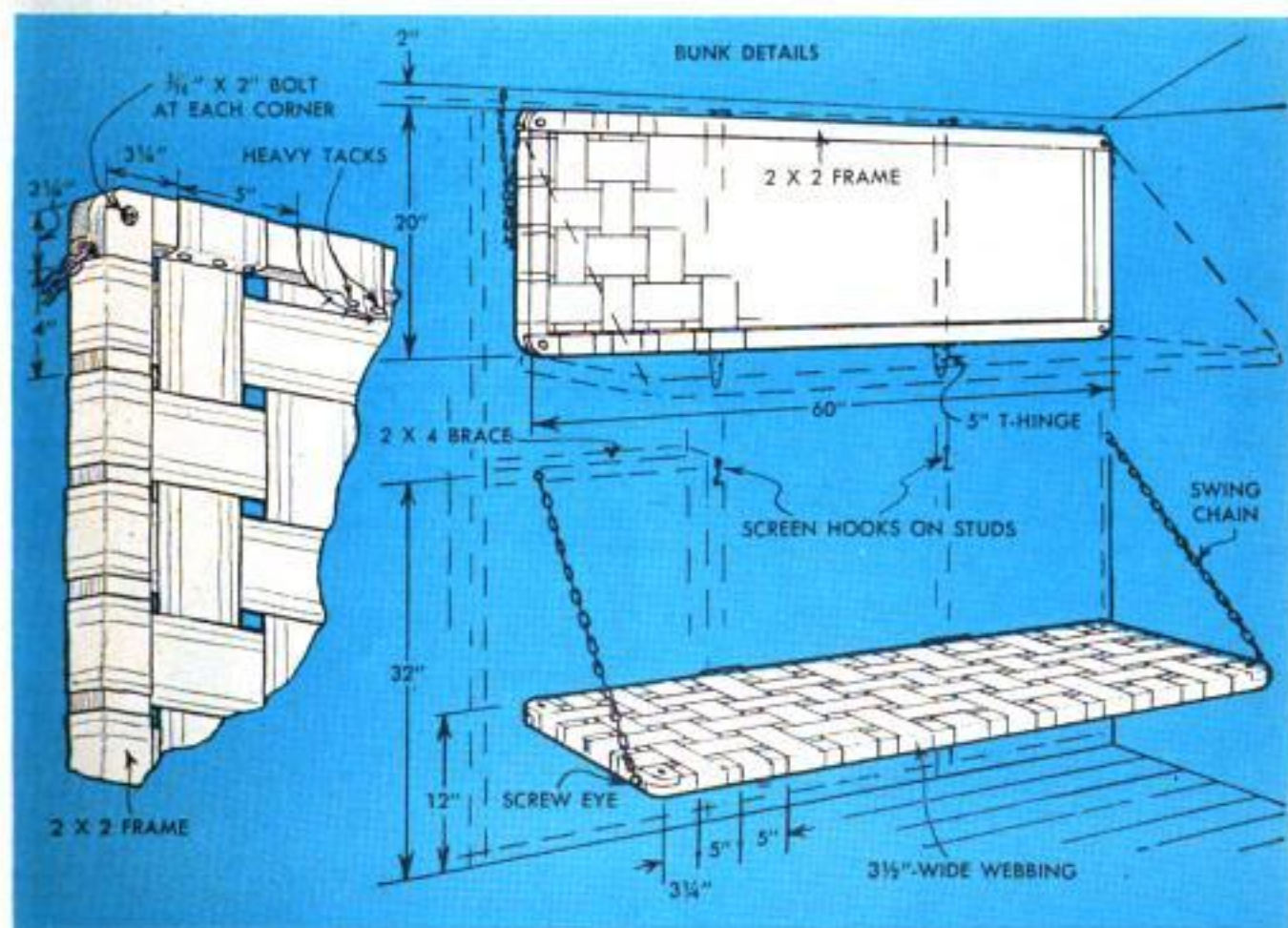



Windmill Vanes on Farm Road Indicate Culvert Location

Vanes from a dismantled windmill are used on a farm driveway to indicate the ends of a culvert. Three-vane sections at each side of the road are held in place with steel rods fitted through vane-brace rivet holes and driven into the ground. Aluminum paint assures greater visibility of the vanes at night.

Table-Saw Miter Gauge Used As Oversize T-Bevel

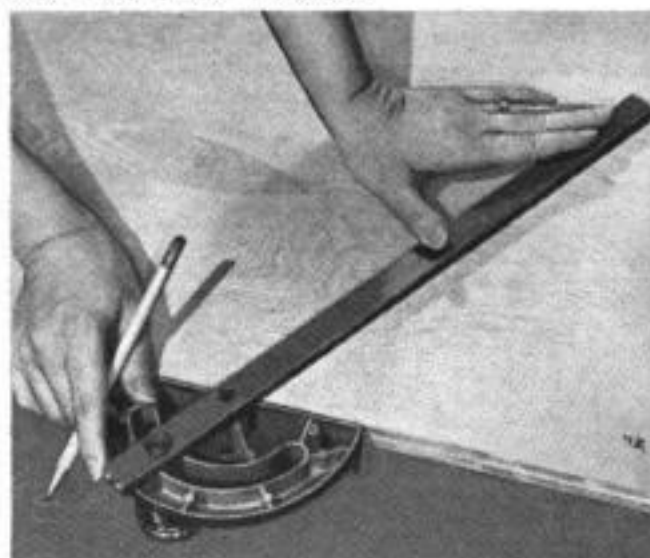

Next time there is need for an oversize T-bevel to mark off angles on plywood sheets, counter tops or other large surfaces, use the miter gauge from a table saw. Invert the gauge so the adjustable head will bear against the edge of the piece to be marked. Angles are set according to the protractor on the gauge.

Light-Green Enlarger Filter

A light-green filter on an enlarger will make focusing easier and more accurate. Green is the average focal length of all the colors of the spectrum and thus is the ideal color for judging sharpness. And also, as

it is a restful color, it will lessen the shock to the eye that results when you move from the yellow or red of the safelight to the blue of the enlarger light.

Robert C. Florian, Cicero, Ill.

Lemon-Juice Invisible Ink Made Visible by Heat



Lemon juice can be used as an invisible ink. Squeeze some into a bottle and use a clean pen for writing with it. When the liquid has dried, it cannot be seen. To make it visible once again, apply heat to the paper with an electric iron or a lamp bulb. The writing will appear brown and remain permanently visible. Use light strokes of the pen when writing so as not to cause visible scratches on the paper's surface.

Paper Bag Catches Plaster Dust When Drilling Hole in Wall

When drilling a hole or otherwise making a small opening in a plastered wall, tape a large paper bag to the wall, as shown. The bag will catch plaster and dust more efficiently than paper spread on the floor, because no dirt will settle on the baseboard or in the corner between the wall and floor. The paper bag full of debris also is easier to handle.—Ken Murray, Colon, Mich.

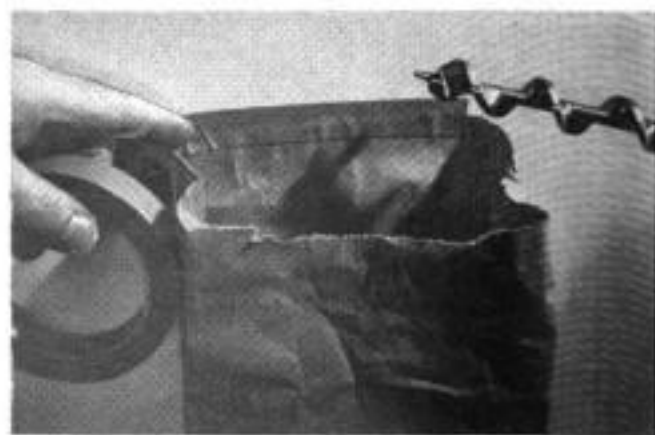

Rainy Day Marble Game Made of Milk Cartons

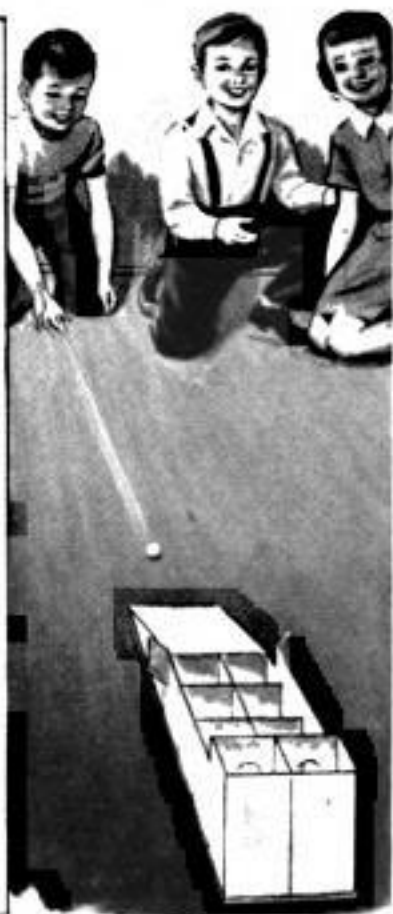
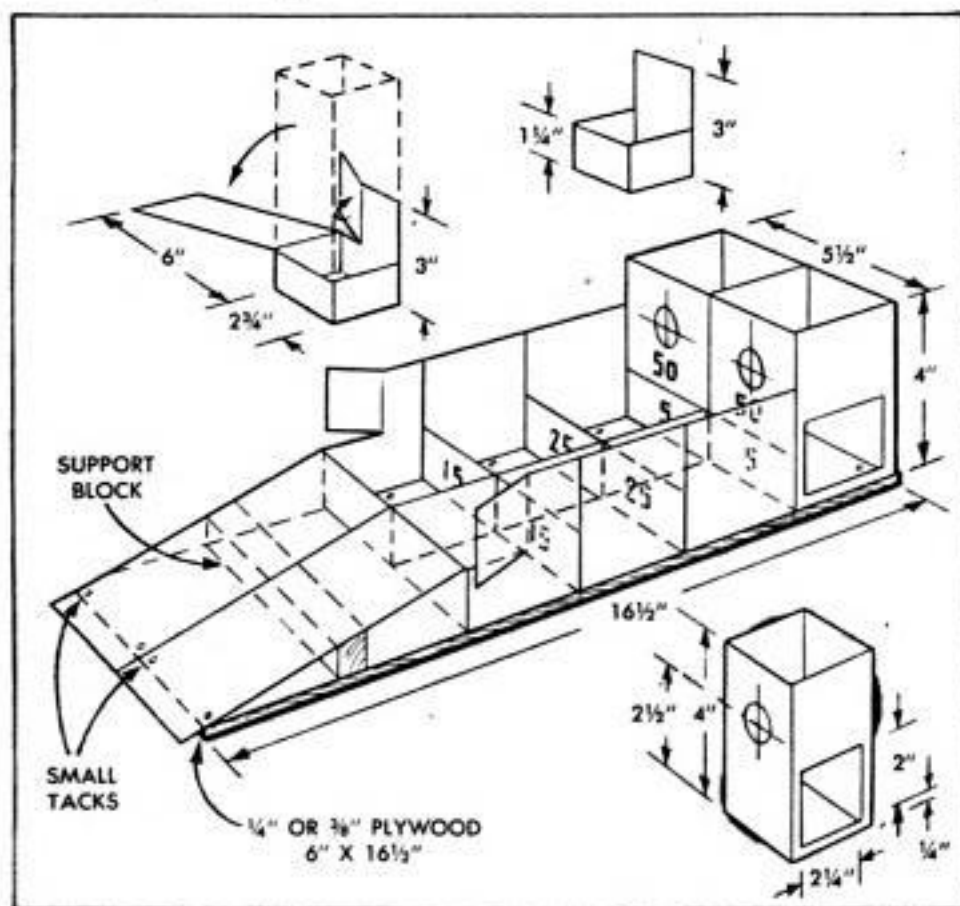

Small fry will enjoy expending some of their rainy day energy on this inexpensive marble game that requires only a sharp knife and a handful of tacks to assemble. The eight scoring boxes are cut from empty milk cartons and tacked to a 6 x 16 1/2-in. sheet of 1/4 or 3/8-in. plywood. A scrap of wood is cut to fit the ramp angle and provides a support block for the cartons. After being rinsed clean of milk, matching pairs of cartons are cut to the heights given in the details. Note that the front and rear cartons are marked and cut to make right

and left-hand scoring boxes. The angled wings on the front boxes guide any marbles that are rolled out of line. Holes are cut in the front sides of the two rear boxes, the holes being slightly larger than the marbles used. Openings also are cut in the sides near the bottoms of these same boxes to permit retrieving the marbles more easily. The ramp ends of the front cartons should overhang the end of the plywood base and touch the floor. It is best to use small carpet tacks to fasten the ramp.

Leonard W. Mitchell, Carrsville, Ky.

House Lamp Wired Through Three-Way Plug Used as Flash Holder



If a flash-attachment plug is wired to a regular three-way plug, almost any reflector or portable lamp can be used as a flash holder. Screw flash bulbs into the lamps, plug the cords into the three-way socket, plug the attachment cord into the camera and snap the picture in the regular way.

Walter Haase, Hartford, Conn.

Drawing Reversed by Tracing

A plan or drawing can be traced in reverse by placing a sheet of carbon paper face up on a hard surface, covering it with a sheet of drawing paper, then placing the drawing on top. Tracing the drawing results in a reversed copy on the drawing paper.

Flooring Strip Braces Plywood Held on Edge for Sawing



A short strip of tongue-and-groove flooring fitted over the top edge of a sheet of thin plywood or hardboard held on edge for sawing will prevent the saw blade from binding. As soon as the saw has cut to sufficient depth, fit the grooved edge of the flooring strip over the edge of the sheet across the saw cut.

Coin Protects Wooden Rule From Razor-Blade Cuts



When cutting material with a razor blade or sharp knife pulled along the edge of a wooden or plastic straightedge, use a coin to prevent cutting the straightedge. Hold blade and coin together between the fingers, with the coin bearing against the straightedge. The straightedge must be offset the thickness of the coin from the cutting edge. The coin trick also will work well when it is necessary to cut narrow parallel strips from leather, paper or other material.

Adjustment of Rotating Brush Improves Vacuum Cleaner

Very often the efficiency of a vacuum cleaner, which has a rotating brush in the suction nozzle, can be improved by adjust-

ing the brush to make better contact with the carpet. To check the adjustment, place a straightedge across the end of the nozzle. The brush should project $\frac{1}{32}$ in. above the edge of the straightedge. When too badly worn to permit adjustment, the brush should be replaced with a new one.

Hardboard Disk in Trash Can Replaces Rusted-Out Bottom

A wood or hardboard disk will extend the life of a trash can in which the bottom has rusted out. If the can has tapered sides, cut the disk oversize so it will fit tightly at a point just above the original bottom. Angle brackets must be used if the



can has straight sides. In cases where the lower edge of the can also is badly rusted, locate the disk just above the damaged portion, then cut off the can below the new bottom. Paint the disk and inside of the can with roofing cement.

Level Maintains Constant Slope By Using Small Block

By screwing a small block to the underside of a level, it is converted to a constant-grade tool for such jobs as laying drain-tile and grading lawns. Set a tile or other piece of work to the slope or to the angle desired and place the level on it. Then slide a small block of wood under the level until the bubble centers. Mark the spot and screw the block in place. The block can be removed after the job is done.

Clyde Allison, Cadillac, Mich.

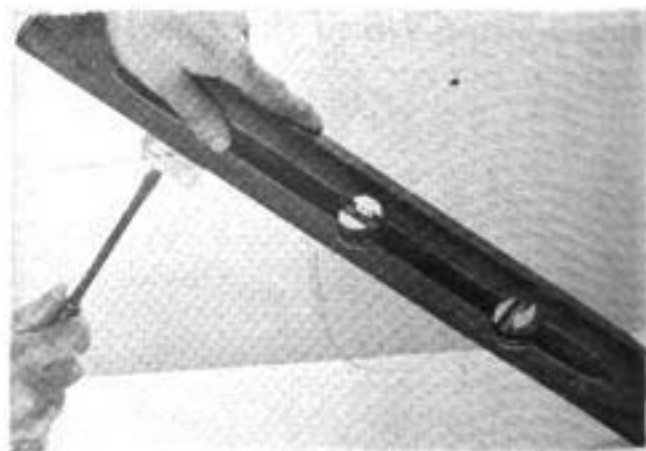

☞ To carry a shopping bag full of groceries comfortably, slip an ordinary clothespin through the handles.

ATTIC FAN AIDS AIR CONDITIONING

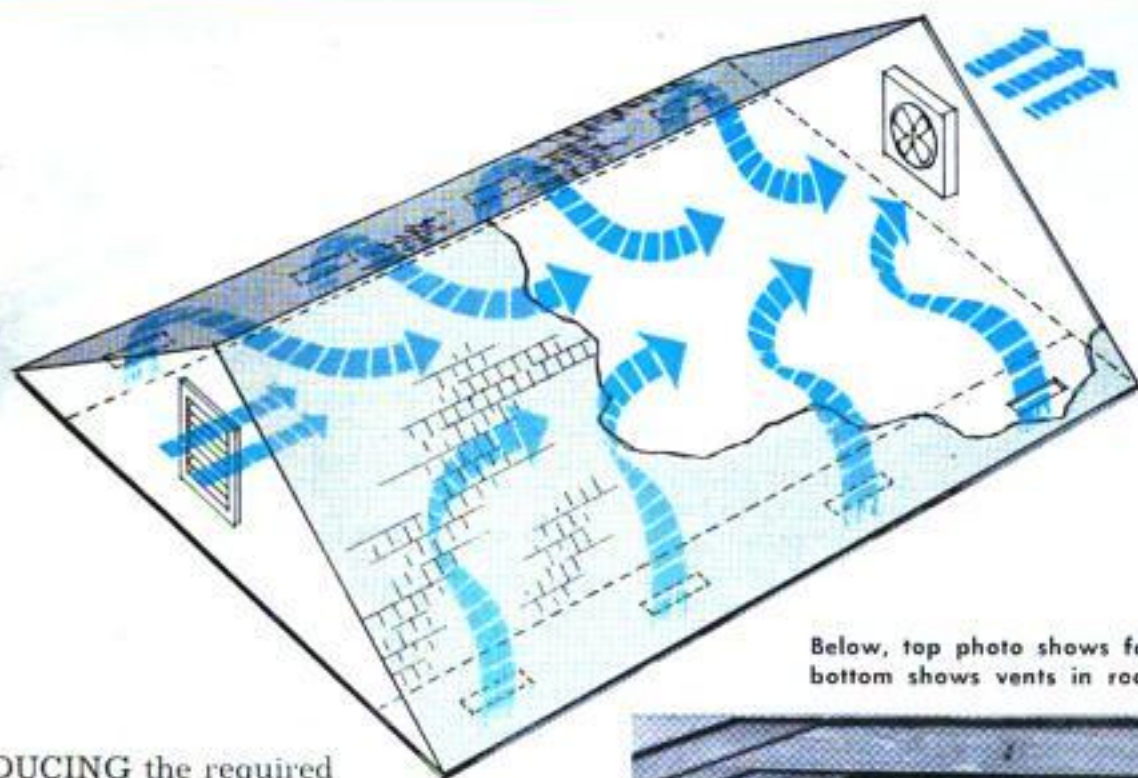

Below, top photo shows fan installed, bottom shows vents in roof overhang

REDUCING the required size of a home air-conditioning plant from a 5-ton to a 3-ton unit has been accomplished by installing an exhaust fan to "air wash" the attic.

Approximately 40 percent of the heat gain in a modern house is confined to the ceiling area. Heat from a hot-water tank, cooking range and other household equipment is added to the heat built up by the sun's rays on the roof. Exhausting heated air and drawing in fresh air prevents heat accumulation in the attic space.

Precedent for the air-washing system was set by the Lau Blower Company of Dayton, Ohio, who installed a 30-in. fan to air-wash the attic of their laboratory. Running the fan for two hours cooled the 150-ft.-long attic by 24 deg.

In the home installation, a 24-in. fan exhausts air from one end of the attic. A louvered opening at the opposite end of the attic, and several vents in the roof overhang, permit the entrance of outside air.

A savings of several hundred dollars is realized by the lower cost of the smaller air conditioner. Homeowners report lower operation and maintenance costs for the smaller units. Sizes of exhaust fans and air conditioners are determined by figuring the heat gain in a particular house. In the example described, a heat gain of 44,000 B.T.U. was handled by an air conditioner with a capacity of only 36,000 B.T.U.

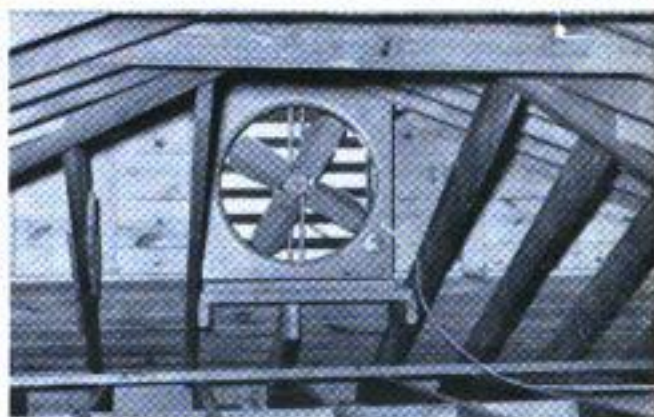



Tractor Scoop Used as Scaffold When Assembling Grain Bins

Instead of going up and down a ladder to assemble steel grain bins, one farmer used his tractor scoop as a portable scaffold. When working alone, it is necessary to raise the scoop to the desired height, then climb the framework to it. If a second person is at hand to operate the tractor, the workman can be raised and lowered in the scoop.

George R. Harrison, Valparaiso, Ind.

Holder for Shipping Labels



A handy dispenser for gummed shipping labels, that also aids in eliminating "damp-weather curl," can be improvised from a shallow glass jar. The depth and diameter of the jar are governed by the size of the labels used. Simply slip the labels into the jar with the gummed

side out, thus reversing the usual tendency of the labels to curl toward the gummed side. The jar must be clean and dry.

Water With Copper Sulphate Destroys Root Growth in Sewer

A clogged sewer, caused by tree roots penetrating the joints in the tiles, was cleared by one homeowner who treated the water in the toilet flush tank with copper sulphate. Once a week during the growing season, a lump of the chemical about the size of the end of a man's thumb is dropped into the tank in the corner opposite the outlet pipe. The lump slowly dissolves, chemically treating the water to destroy

any roots which find their way into the sewer system. *Caution:* Care must be exercised when handling and storing copper sulphate; it is poisonous if taken internally.

Arthur Richards, Belleville, Ill.

Copy Held to Typewriter Stand By Small Permanent Magnet

Sheets of copy can be held securely on the leaf of a steel typewriter stand by placing a small permanent magnet over the paper. When not in use, the magnet "stores" itself by clinging to any part of the table on which it is placed.

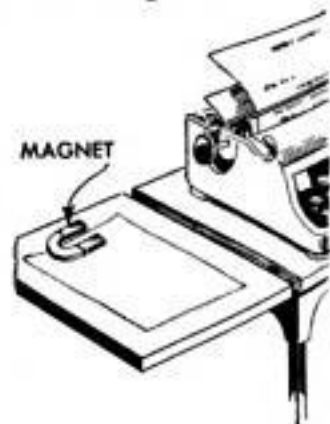

Line on Photoflood Reflector Prevents Equipment Damage

A "safety line" on a photoflood reflector will help to prevent broken bulbs and damaged equipment should the reflector accidentally be pulled or knocked off the stand. The line is a length of heavy cord or picture wire, one end of which is fastened to the reflector. The other end is tied to a clip-type notebook ring to permit disconnecting the line when the reflector is stored or used on a different stand. The safety line should be short enough to prevent the reflector from striking the floor.

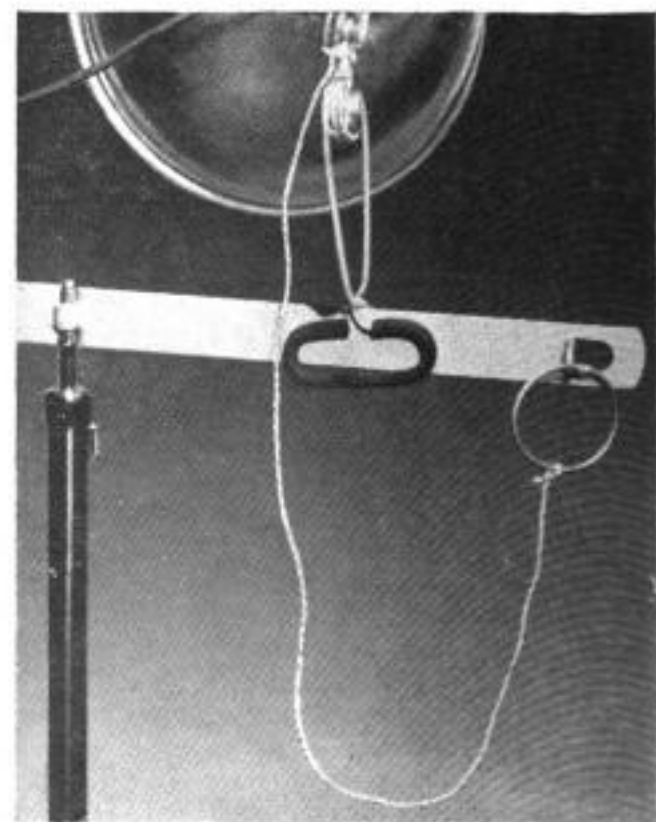

Framed Shadowbox

A scrolled frame gives this shadowbox an "antique" appearance that permits it to blend well with period furniture. Except for the top and bottom sections of the frame, all parts are made with straight cuts. Patterns for the jigsawed sections are drawn by enlarging the squared diagrams below. Sides and shelves can be made from $\frac{1}{4}$ or $\frac{3}{8}$ -in. plywood which would permit cutting grooves for the shelves. If thin plywood or hardboard is used, $\frac{3}{8}$ -in.-sq. strips can be nailed to the back to provide nailing surfaces. The sides then are cut $\frac{3}{8}$ in. wider. The frame on the front of the box is cut from $1\frac{1}{2}$ -in.-wide strips, mitered and nailed to the box so their inside edges align with the inside surfaces of the box. The scrolled top and bottom pieces are attached to the edges of the frame. Use a thin backing strip along each joint.

R. W. Madden, Palatine, Ill.

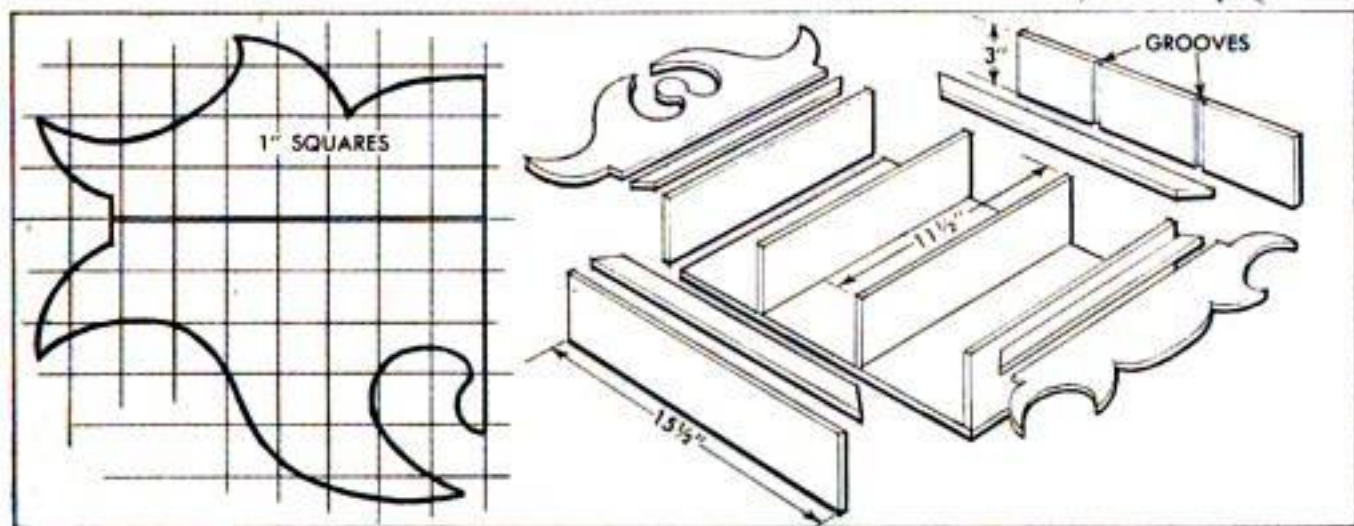

Suede-Cleaning Brush Removes Excess Metal When Sweat-Soldering

A small wire brush used for cleaning suede shoes provides a handy tool for removing excess solder when sweat-soldering two pieces of metal. The wire bristles are not affected by the solder and, being made of a brass alloy, will not scratch the surface of most metals. The brushes are available in several sizes at most shoe-repair shops and shoe stores.

Model-Plane Parts Assembled With Toy-Balloon "Clamp"

One model-airplane enthusiast has discovered that an inflated toy balloon can be used to hold the assembled parts of a model in position while the glue is drying. The deflated balloon is pushed inside the framework of the model, then inflated just enough to position the part being glued.



HOW TO INSTALL YOUR OWN DEHUMIDIFIER



Dehumidifier

Now available for the do-it-yourself craftsman, this practical unit can be installed in many unusual ways

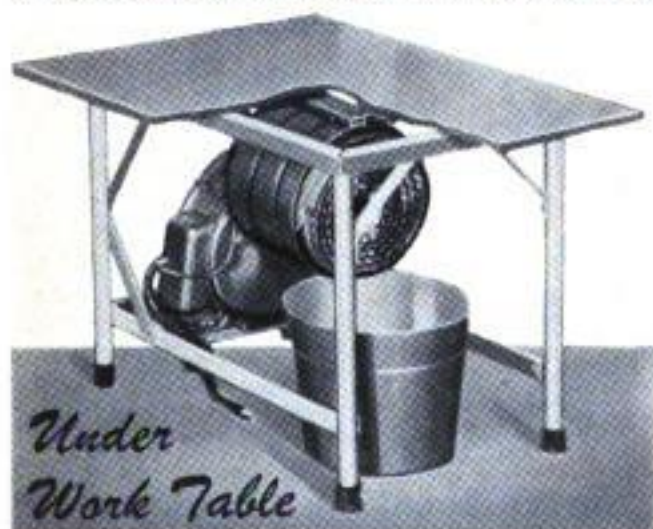

Under Work Table

Above, space under work table is utilized. Below, dehumidifier between joists drains into laundry tubs

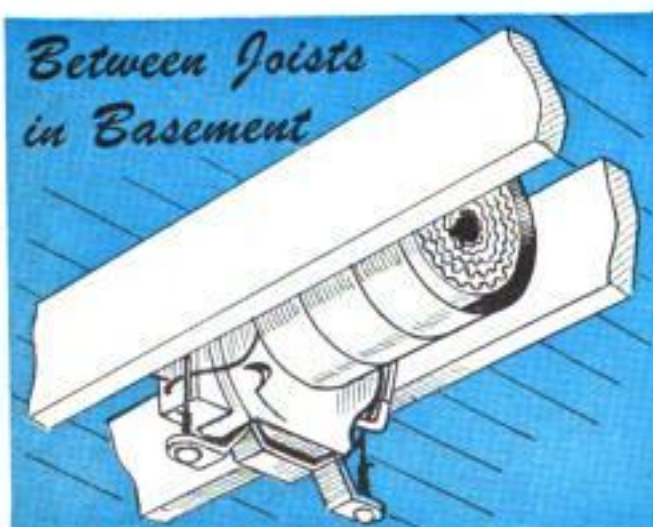

Between Joists in Basement

THE MAN who first said, "It isn't the heat, it's the humidity," knew what he was talking about. A good part of warm-weather discomfort comes from too much moisture in the air, which prevents rapid evaporation of perspiration from the skin—nature's way of keeping us cool. This excess moisture not only makes us uncomfortable, but also swells drawers so they won't open, pops joints on furniture and causes mildew in places, such as basements, where there is inadequate ventilation.

This excessive moisture can be removed by installing a dehumidifier. Now on the market, in addition to the types that come in a cabinet ready to be plugged in, is a do-it-yourself dehumidifier, pictured on these pages. It may be installed between the floor joists for basement operation, or concealed in a room divider, a cabinet or an end table for use in the living room. A kitchen cabinet or refreshment bar, louvered for air circulation, can house the unit, too. Mounted under a table or bench in the home workshop, it will help to keep tools from rusting.

Although supplied with mounting brackets, the unit can be hung from wires bent from coat hangers, as would be necessary when it is put between the floor joists. Keep in mind, when buying a dehumidifier for your home, that the maximum capacity of most models is about 3 gal. per 24-hr. running period in an excessively damp spot. They will give satisfactory air drying for about 1600 cu. ft. of room space under average conditions. ★ ★ ★

Unit can be mounted on brackets or hung from heavy wire attached to brackets in manner shown below

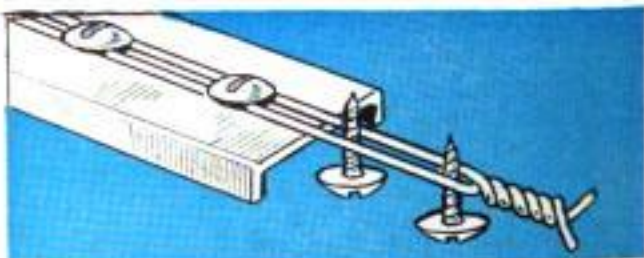

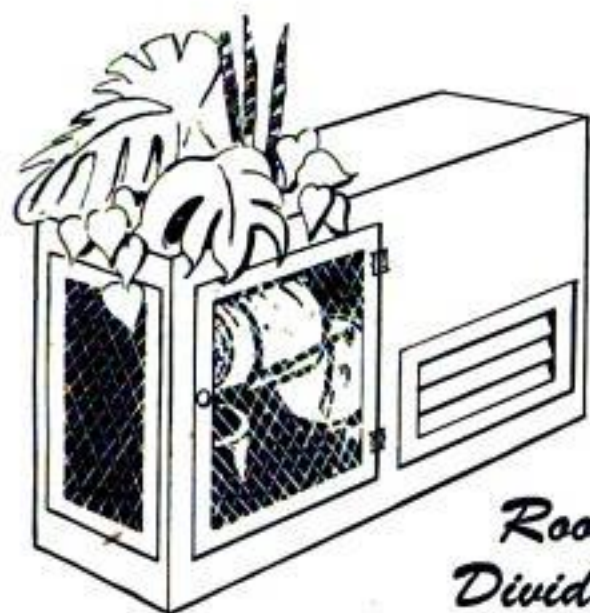

*Room
Divider*

Concealed in louvered end table or room divider, this unit can be used in living areas of the home

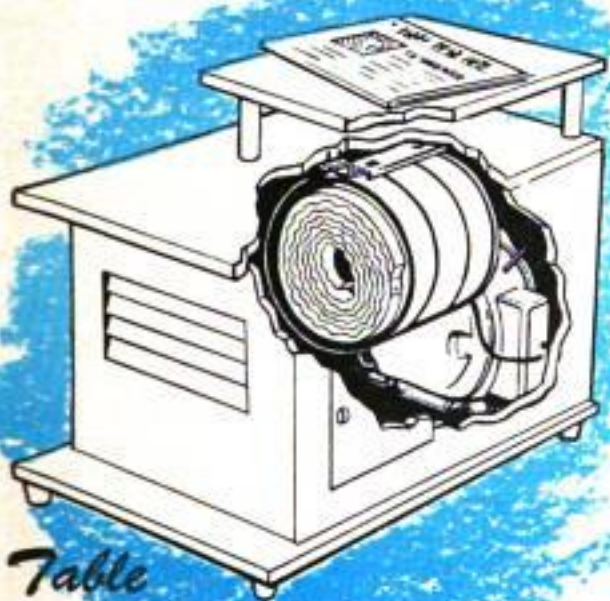

Table

Kitchen area is often source of excess moisture in a house. Dehumidifier concealed in a refreshment bar or cabinet base prevents spread of dampness

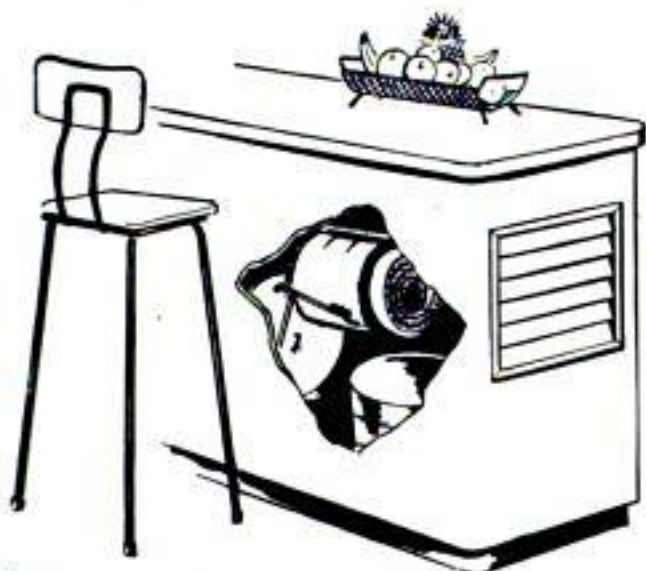

Refreshment Bar

Spray Outfit Made Portable By Using Golf-Bag Cart



Equipping a manually operated garden sprayer with wheels makes it possible to spray large areas with a minimum of work. A three-sided metal or plywood box is built to fit the particular sprayer used, and the box and tank are then strapped to a golf-bag cart. The tank pump can be operated without removing the tank from the cart.—George T. Lundeen, Ripon, Wis.

Washer Soldered to Can Spout Lifts Covers of Oil Cups

A small washer soldered near the end of an oil-can spout will eliminate the problem of lifting oil-cup covers with your fingers when the cups are in hard-to-reach locations or dangerously close to spinning pulleys or gears. In use, the edge of the washer is used to lift the oil-cup cover and push it to one side so the spout can be inserted in the cup.

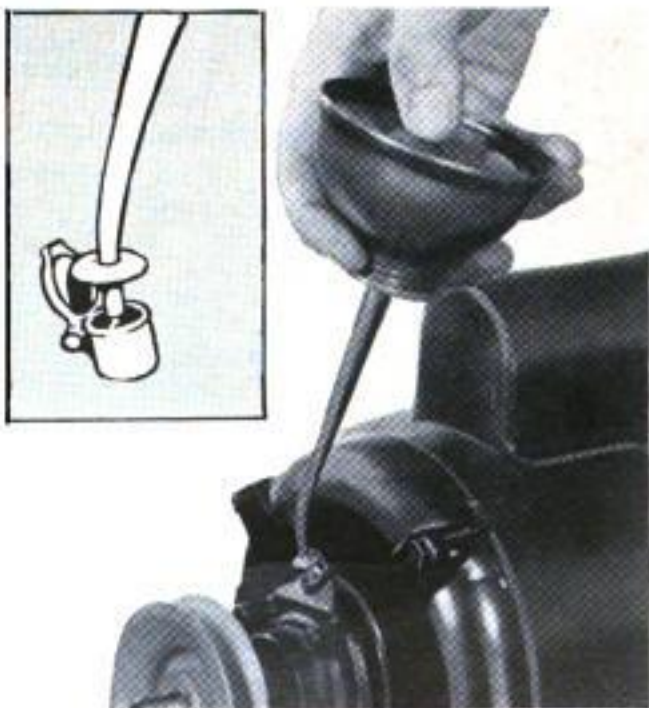



Empty Milk Cartons Utilized As Frozen-Food Containers

Empty milk cartons can be used as containers for packaging frozen foods. After the staples have been removed and the inside thoroughly washed, the sturdy, heavily waxed cartons can be used for any food from chopped stew meat to fruit juices. Freezer tape should be used to seal the cartons after the tops have been refolded on the original bends.

John Krill, North Lima, Ohio.

Safeguards Minimize Damage To Retaining Wall

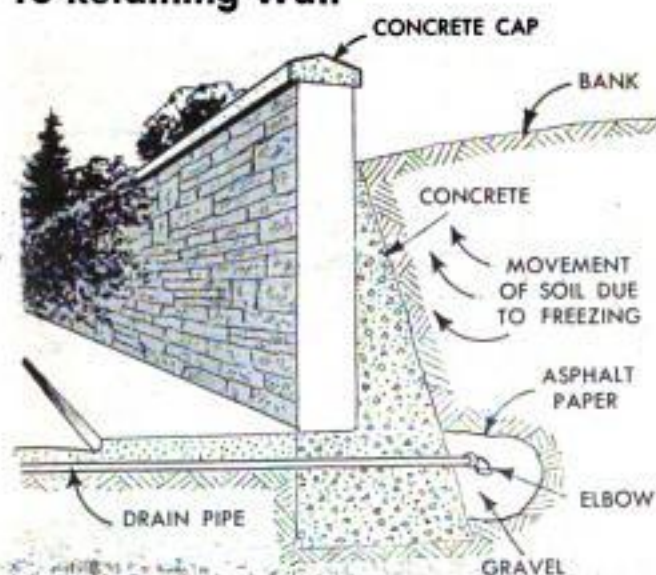

Damage to a retaining wall from frost and water can be minimized by including a few safeguards when constructing the wall. Proper drainage will be assured if drain-pipes are set under the wall with an elbow on the inside end pointing down. Surround the elbow with coarse gravel and cover the gravel with heavy building paper. The inside of the wall facing the bank of dirt should be smooth and slope upwards so lateral pressure from frozen earth is deflected upwards. A final precaution, if the wall is brick or masonry, is to fit the top of

the wall with a concrete cap which will prevent water from seeping down through the wall.

Length of Soil Pipe in Floor Determined by Joist Depth

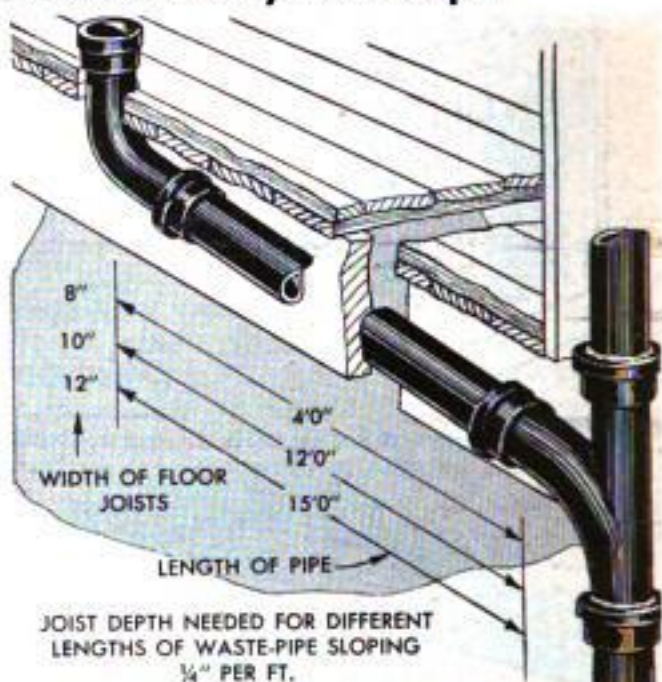

When a remodeling job includes installation of an extra water closet with plumbing and soil-pipe drains on a second floor, the depth of the floor joists should be considered when locating it, especially when the soil pipe must be concealed between an existing floor and ceiling. Minimum slope for adequate drainage in a soil pipe is $\frac{1}{4}$ in. per ft. The illustration gives the lengths of pipe which may be used between joists.

Car-Polishing Time Reduced

One owner cut down the time required for waxing the family car by wrapping the polishing cloth around a brush. The brush supports the cloth to permit polishing a wider area with each stroke. Use a brush with bristles just stiff enough to hold the cloth firmly against the curved surfaces of the car body and around chrome trim.

James E. Gray, Belton, Tex.



Pointing Ends on Pipe Stakes Makes Driving Easier

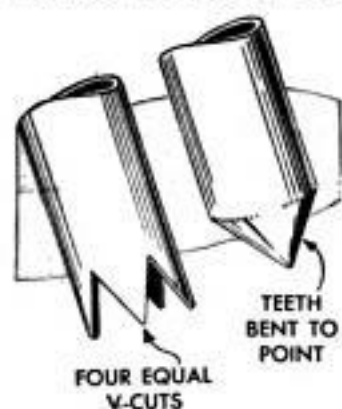

Pipe stakes will drive more easily if the ends are pointed. To form a point, cut four V-shaped notches in one end, as shown in the detail, and hammer the resulting teeth together. If the stakes are to be driven in very hard or stony ground, weld the teeth together after they are hammered to form a point. The teeth should be $1\frac{1}{2}$ to 2 times the length of the pipe diameter.

Hub Ends Need Not Be Broken When Replacing Clay Pipe

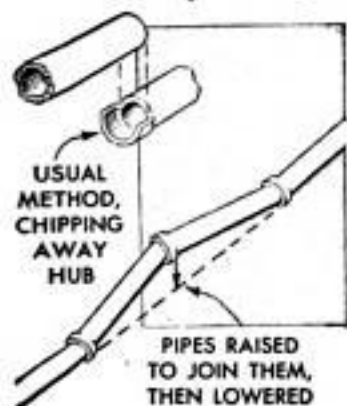

When it is necessary to replace one length of clay pipe in an otherwise undamaged sewer line, the hub of the adjoining pipe need not be broken if two lengths of pipe are removed instead of one. When two new lengths are set in position, they are raised first, so that the ends join properly, and then lowered in place in the sewer line. While there is more work involved in this method, it results in a tight joint. When the usual method of chipping away half of the hub is used, the joint is more likely to leak or admit tree roots.

Improve Plain Appearance of House Front By Adding Scrollwork



Dissatisfied with the plain appearance of his house, one homeowner improved the front by adding scrollwork in a contrasting color around the window and under the cornice at the roof peak. The scrolls were sawed from $\frac{1}{2}$ -in. exterior plywood, although $\frac{1}{2}$ or 1-in. solid stock could be used. Ready-cut cornice-board material, which can be purchased at most lumber yards, also might be used. —Hi Sibley, Nuevo, Calif.

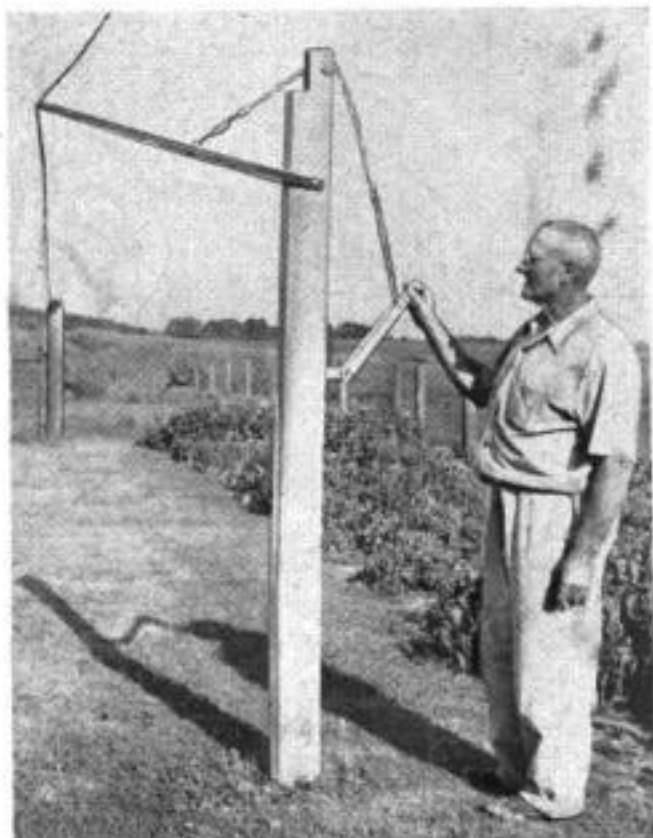

Adjustable-Height Clothesline Requires No Props

One housewife has no need for props under a clothesline which her husband installed and equipped with a built-in "line raiser." The mid-point of the line is supported on the end of an angle-steel arm pivoted to a post. A lever hinged to the back of the post is used to raise and lower the arm. Lever and arm are connected by a chain which passes over a pulley mortised into the top of the post. When the lever is pulled down, it raises the line. A means is provided for locking the lever in position. The line also is equipped with a ratchet device on one end which takes up the slack.



"Bill Bug" Outrigger Raft for Water Fun

SWIMMING is always more fun when there's a raft to play on, and the "Bill Bug" is a safe raft that won't sink and won't tip over. Built from scrap materials, it can be assembled in a couple of hours. Seven or eight inflated inner tubes provide the raft's buoyancy. They are lashed to the hull, and for better appearance can be covered with canvas. A partially inflated inner tube held in place with plastic screening was found best for the pontoon. The raft is light enough so that one man can launch it or lift it to the top of a car without difficulty.

Howard B. Hays, Chicago.

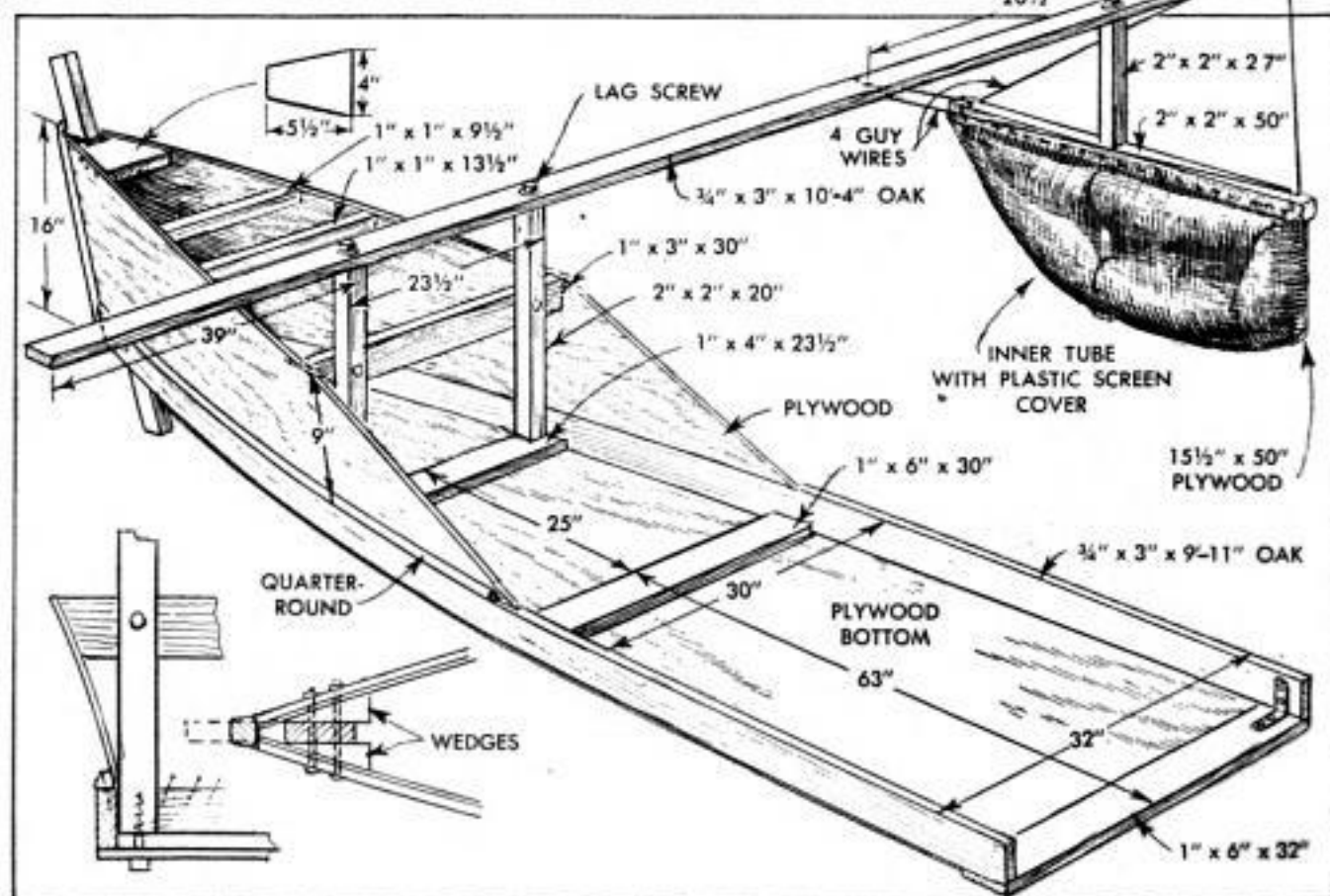
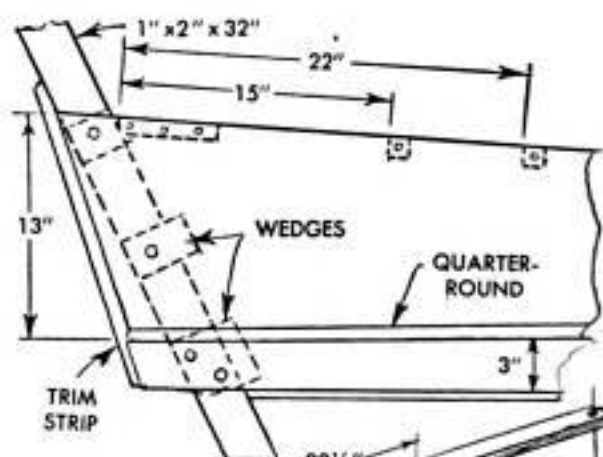

Rain Gauge Made From Bottle And Length of Wooden Rule



Amateur meteorologists, or anyone interested in keeping a record of the amount of rainfall in his area, can make a rain gauge which is accurate for all practical purposes. A glass bottle and a 5-in. length cut from a rule or yardstick are used to make the gauge. Bottle and rule are mounted

on a bracket which can be made of either sheet metal or wood. The bottle is 1½ in. in dia., the type in which Seltzer tablets are sold. Mount the rain gauge on top of a post, or in some location away from trees, buildings or other objects which might drain water into the gauge and cause a false reading.

Wm. P. Kupka, Chelsea, Iowa.

Better Electrical Connections

The "elastic locknut" used on aircraft is ideal for use on automobile and motorboat electrical connections. It is applied quickly, keeps the connection tight without lock washers and can be removed easily. Such nuts can be purchased in all sizes at any aviation-supply store.



Metal Bench Drawers Improvised By Utilizing Cake Pans

Strong metal drawers to fit under a workbench top can be provided inexpensively by using shallow cake pans or refrigerator-defrosting pans. Screw wooden strips, grooved to receive the rolled edges of the pans, to the underside of the bench top to act as drawer guides. Handles for the drawers can be made by bending up a section of the rolled edge at one end of the pans.

Simple Cardboard Frame Helps to Align Jigsaw-Puzzle Pieces



Jigsaw-puzzle fans will appreciate this frame to help in aligning the first pieces of the puzzles they put together. The frame consists of two long strips of cardboard, about ½-in. thick, laid out to form a right angle on a card table or other flat working surface. The cardboard is fastened to the table with cellulose tape, providing a firm base from which to work. For the larger, more-complicated puzzles, which may take several days to complete and must be left on the table for that time, this frame will help to prevent their being disarranged.—Thomas B. Lee, Bremerton, Wash.



Quiet Those Car-Body Squeaks

By Ed Packer

DID YOU KNOW that the body of your car has more separate places requiring periodic lubrication than the chassis? Many of those places that need a regular application of the right lubricant are direct metal-to-metal contacts over small areas and can produce annoyingly insistent squeaks if neglected. But a drop of oil or a touch of hard lubricant here and there can put the "new" back into a car body in a way that makes the time spent well worthwhile.

Oil and grease of the correct specifications take care of the needs of the chassis, but for wear parts of the body you should use four types of lubricant. You'll need a pump-type oil can filled with light oil (left-hand photo above), a stick of hard lubricant, a flake-graphite blower or a can of lock lubricant, and a special rubber lubricant.

The chart at the right is a typical body-lubrication chart, but it should be kept in mind that the instructions given may not always agree with those of the manufacturer of your car. Where there is any doubt, or variation, follow the manufacturer's instructions. Usually, it's handiest to begin with the hood latch and work back, taking one side of the body, or both sides, as desired. Wherever oil is specified, use only a drop or two and wipe away all excess. Note especially the detailed instructions on lubricating door locks, or latches, and strikers. Use a light oil on the rotary-type lock, but on bolt-type locks use a dry stick lubricant. In some cases mechanics use dry graphite on tumbler-type locks rather than oiling as in the lower right-hand de-

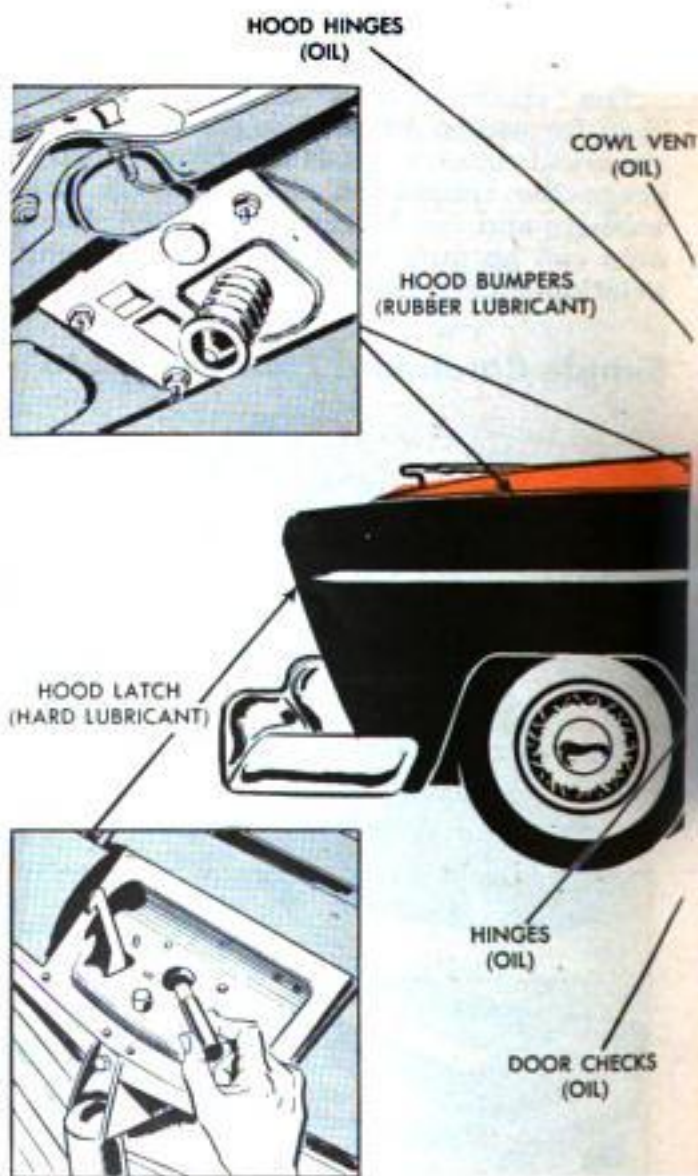

tail below, also the right-hand photo on the opposite page.

When you're working the doors it's a good idea to lubricate the glass channels with stick lubricant as in the center photo on the opposite page. This will relieve the load on the lifting mechanism caused by dry glass channels. As a rule the best way to lubricate the adjustable radio aerial is to go over the sections with a cloth on which a few drops of light oil have been placed. Then extend and retract the aerial several times to distribute the oil film uniformly. Another point often overlooked is lubrication of the rear wheel-cover latches. A drop of oil or a touch of hard lubricant on friction points of the latches not only will make the covers easier to remove, but will prevent rusting and the possible development of rattles and squeaks.

When you're lubricating the seat-adjusting mechanism, be sure to oil all surfaces that make contact when parts move. Usual-

ly a single drop of oil will do the trick. More will creep out of place and catch dust. Cable releases to the hood and emergency, or parking, brake can be lubricated adequately by placing a few drops of light oil on the housing. The oil will work inside and provide a film on the release wire. Wipe off all excess oil after application. In addition to the deck-cover, or lid, hinges and lock it usually is a good idea to oil the deck-cover brackets, especially if these are of the telescoping type. A drop or two of oil on the sliding contact surfaces eases the effort of opening and closing the cover and dampens out any squeaks that might develop as a result of direct contact of the metal parts. When you lubricate the gas-cap cover place a few drops of oil on the closure spring to ward off rust. Power units that actuate tops on convertibles and the windows on certain late-model cars should be lubricated according to each manufacturer's instructions. ★ ★ ★

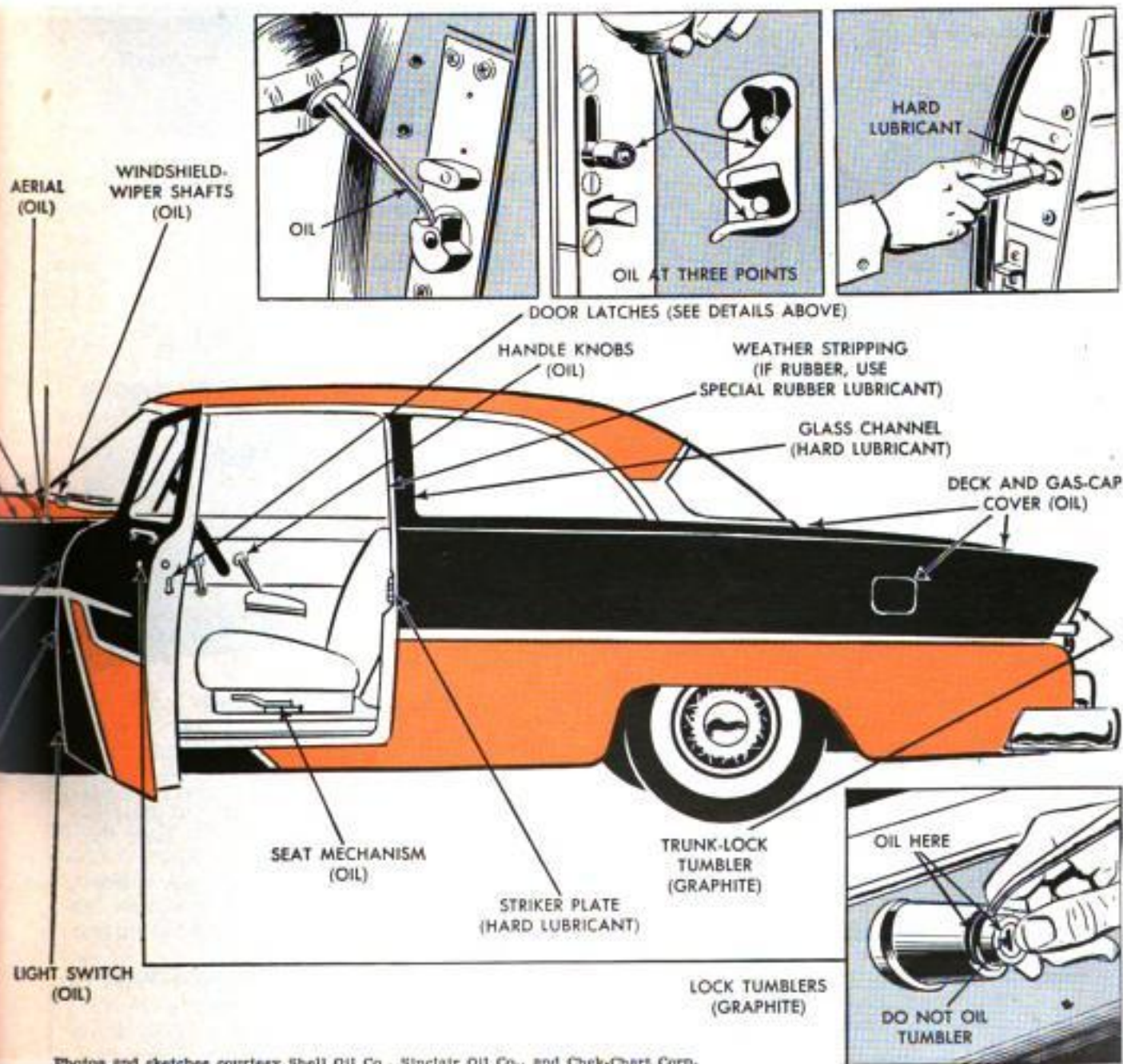

Photos and sketches courtesy Shell Oil Co., Sinclair Oil Co., and Chek-Chart Corp.

Trellis at Road Entrance Identifies Farm Owner

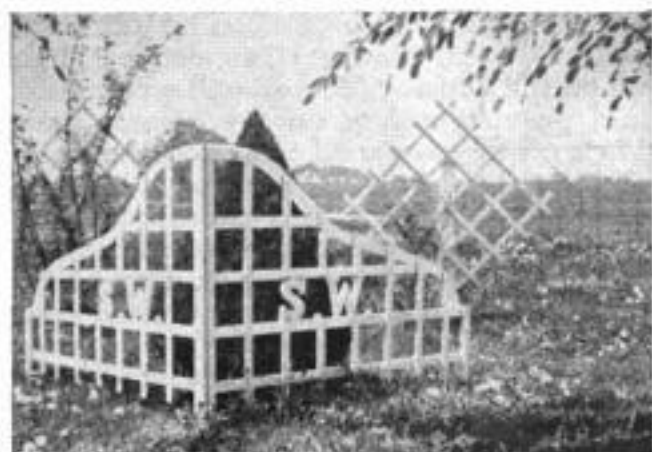

Both attractive and functional, this trellis indicates the entrance to a farm road that leads to the house. The owner's initials set in the trellis identify the farm. If a similar trellis were used on a city lot, a street name or a house number could be used instead of the initials.

Care of Plastic-Covered Chairs

Although the covering on plastic-covered chairs seems fairly impervious to abuse that would ruin other types of materials, washing the plastic occasionally with a mild soap-and-water solution will keep the

chairs looking new longer. And if food or liquid is dropped on the plastic, wipe it up immediately, because there are some kinds of food and beverages that will stain it.

Glue Pot From Coffee Cans

An improvised double boiler for heating glue can be made from two coffee cans. The glue is placed inside a 1/2-lb. can which is suspended in a 1-lb. can containing water. A spring-type paper clamp is used to hold the smaller can above the bottom of the larger. Pliers are used to lift out the heated glue can.



Sea shells can be made into ornaments and ash trays if they are first cleaned and then given two coats of white shellac.

A Finer, Fuller Life for Your Children . . .

Fore! . . . A solid drive off the tee, a day in the fresh air and sunshine and friendly talk later in the clubhouse. You'd like your youngsters to have these pleasures—whether you know them yourself or not.

Golf is fundamentally Drives, Approach Shots and Putts—all of which can be taught! Your children should be given good form, good playing habits and good mental attitudes right from the start. And now they can have just that!

Golf Does Not Have to Be Expensive

Public courses and inexpensive equipment make it easier for young people to play the game today. The one big expense left is professional instruction and the publication of *Golf for Boys and Girls* will reduce that cost too. Chick Evans, first man ever to win the National Amateur and National Open in one year, will take your youngsters from the tee, over the fairways and right up to the cup—getting them out of any rough spots along the way.

Popular Mechanics readers will like the Do-It-Yourself style of this book. It was written by one of the world's most famous amateurs for the enjoyment and instruction of other amateurs. Its main purpose is to make the game fun.

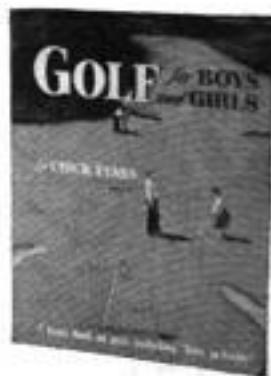

Easy-to-Understand Nontechnical Approach

All the essential know-how of golf is presented in a straight-forward, conversational way. Chick tells and shows (with 248 illustrations) your youngsters how to get the same fun from golf that he has had for 56 years!

An investment of \$3.50 will start your youngsters playing a game they will enjoy for a lifetime. Order *Golf for Boys and Girls* from:

Popular Mechanics Bookshop

208 East Ontario Street
Chicago 11, Illinois



SHOP NOTES

ALL-PURPOSE WORK HOLDER

By Walter E. Burton

FEW BENCH HOLDING DEVICES, except possibly a costly universal vise, can match the all-around usefulness of this bench plate with its simple shop-made accessories. It consists of a mild-steel bar, $\frac{1}{2}$ in. thick, which is mortised flush with the bench top as in Fig. 1, and the various clamps and accessories pictured in Figs. 2 to 9 inclusive. A pattern of holes of various diameters and spacings is drilled through the bar. Several of these holes are tapped and counterbored as indicated in Fig. 5. The counterbored holes take fillister-head screws which are used to attach the bar to the bench top. Tapped holes take the various clamping devices pictured in Figs. 2, 4 and 9. A row of through holes, A-B, Fig. 5, is drilled on $2\frac{1}{32}$ -in. centers and reamed to $\frac{3}{8}$ in. These take the board holder, Figs. 2 and 5, the bench stop, Fig. 3, and the bending jig, Fig. 6. Holes C-D, E-F, are reamed to $\frac{1}{2}$ in. to take the stationary jaw of the board holder, the bending-jig pegs, or pins, the hardie and the sheet-metal stake. Note in Fig. 5, the detail showing the side view of the board holder, that diameter of the pins is given as $\frac{3}{8}$ in. This dimension of the pins permits a slight lateral movement of the jaw, adding to the gripping power of the unit when holding stock on edge as in Fig. 2. Pins $\frac{1}{2}$ in. in dia. can be used.

Six holes, two of these spaced on 2-in. centers, are drilled and tapped $\frac{3}{8}$ -16 to take the clamp screws, Figs. 4 and 9. The detail of the overarm clamps, Fig. 5, gives the thickness of the clamping bars as $\frac{3}{16}$ in. For heavy work use $\frac{1}{4}$ -in. clamping bars. Note that one screw passes through a clearance hole drilled in the bar and is turned into a tapped hole in the plate. The second screw is run into a tapped hole in the bar and the end bears against the surface of the plate. When this screw is tightened, the screw nearest the work serves as a pivot. A typical setup is shown in Fig. 4.

The method of fastening the pins to the bench stop, Fig. 2, is shown in the upper right-hand detail in Fig. 5. The holes are

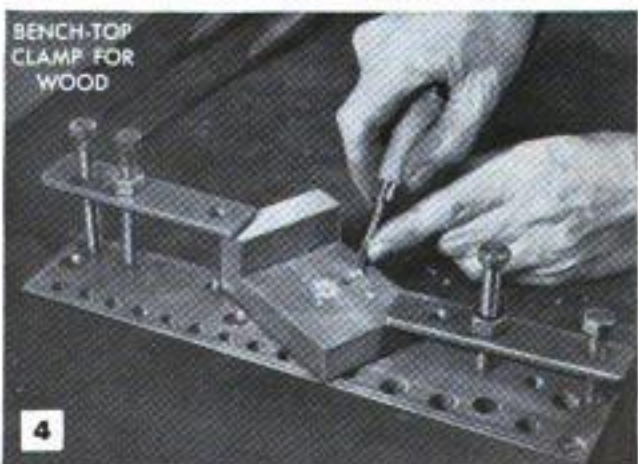
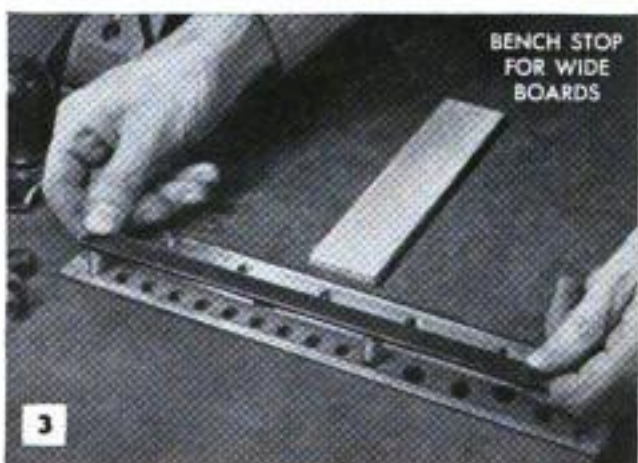
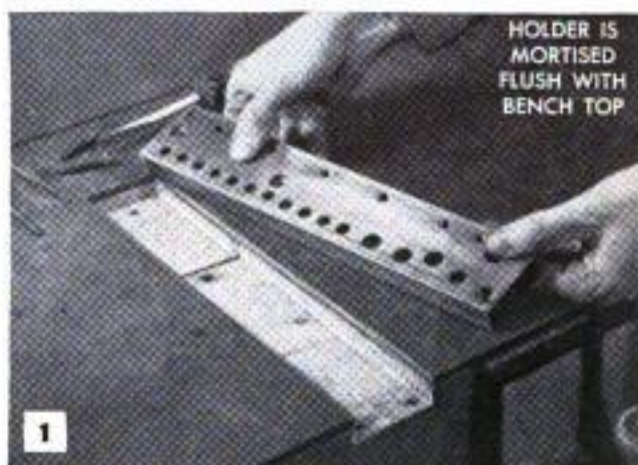

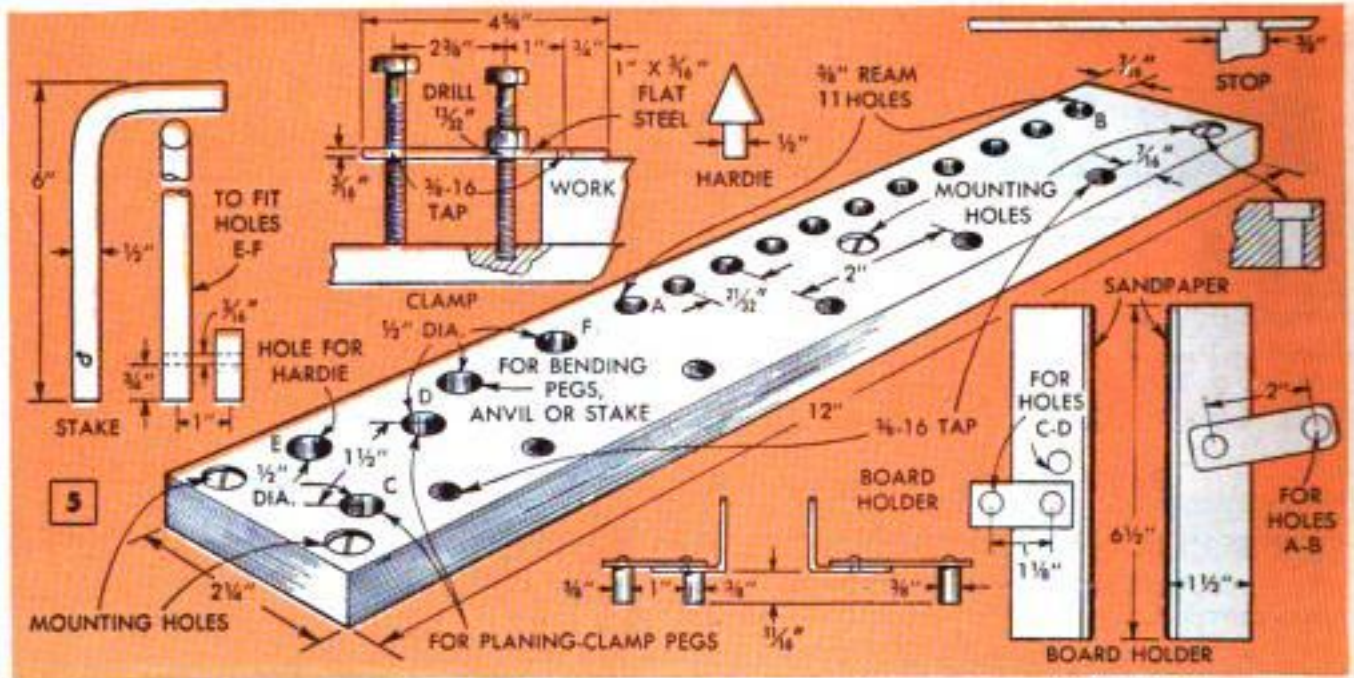

drilled in the bar to diameter of the shoulder on the pins. Then the holes are countersunk (with an angle-point countersink) and the projection of the pin peened over as shown. The same method of fastening can be used when attaching the pins to the links on the board holder.

The bending jig consists of two pins which are placed in adjacent 1/2-in. holes as in Fig. 6. If desired, a pair of 3/8-in. pins can be made to fit the holes A-B so

that any desired spacing may be obtained for various bending jobs. The stake, Fig. 8, is joined to a short pin which prevents it from turning while in use. The connecting transverse pin which joins the short pin to the stake should be a drive fit in 3/16-in. reamed holes. Where the plate is to be used as an anvil for light work it is desirable to have it hardened at a steel-treating shop to prevent denting and burring. Drill and tap before hardening. ★ ★ ★

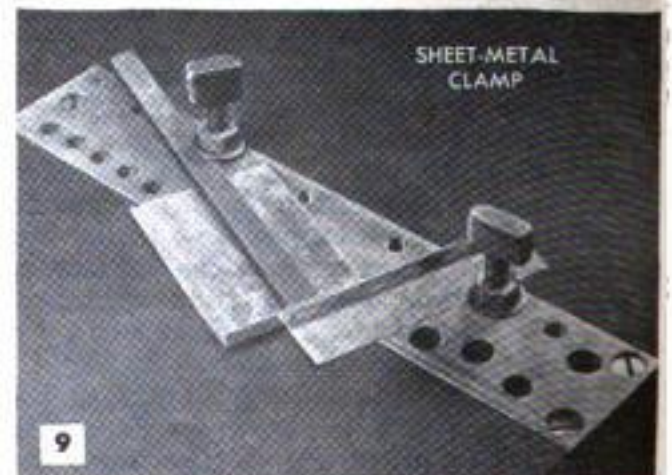
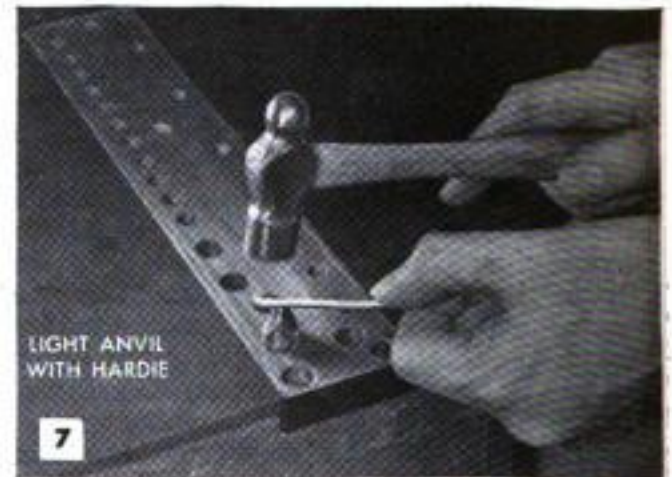
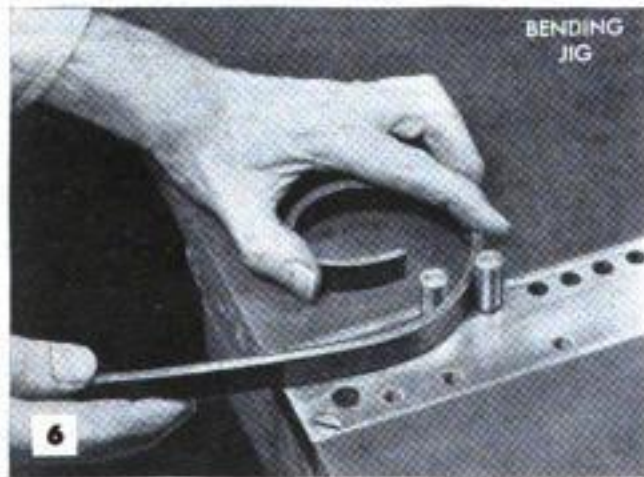

Lifted Wood Chip Hides Nailhead In Furniture Construction



An effective method of concealing nailheads in furniture construction is to cover each nail with a wood chip lifted from the surface with a wide-sweep gouge. Do not cut the chip loose. Drive the nail into the recess under the chip, using a nail set to drive it

so that the chip will not be broken. When the nail has been set, coat the chip with glue and press it into place. Hold it flat with a weight. After the glue has dried, sand the surface smooth. A fine line of glue will be the only indication of the nailhead location.

Tractor Equipment Installed With Aid of Fence Stretcher

A wire-fence stretcher of the block-and-tackle type having a locking brake, hooked to a hayfork carrier, provides one farmer with a crane for lifting and installing heavy equipment on his tractor. The hayfork carrier runs on a stub track which is mounted under the roof of the machine shed. The track permits greater flexibility of use for the stretcher and allows unused equipment to be lifted and moved over to the floor of the loft for storage.

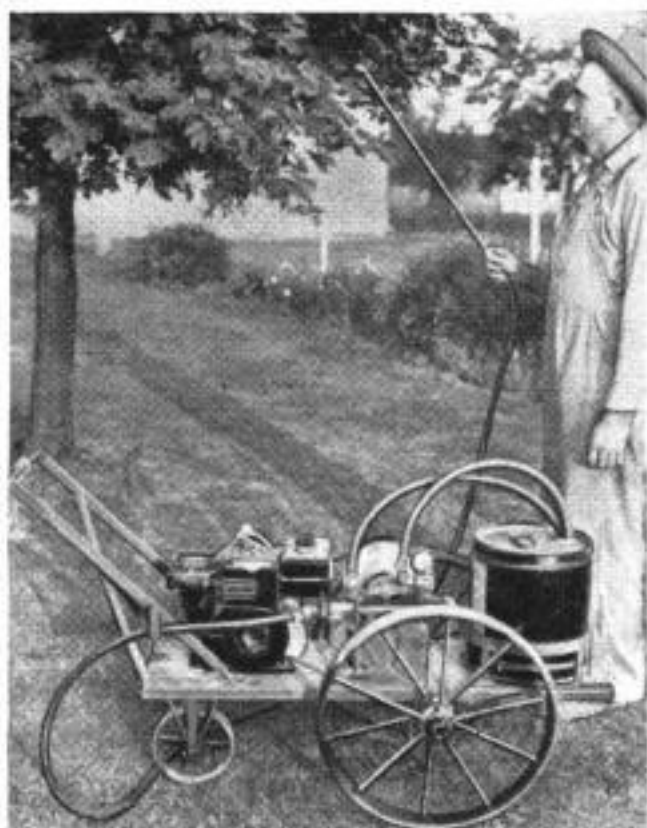
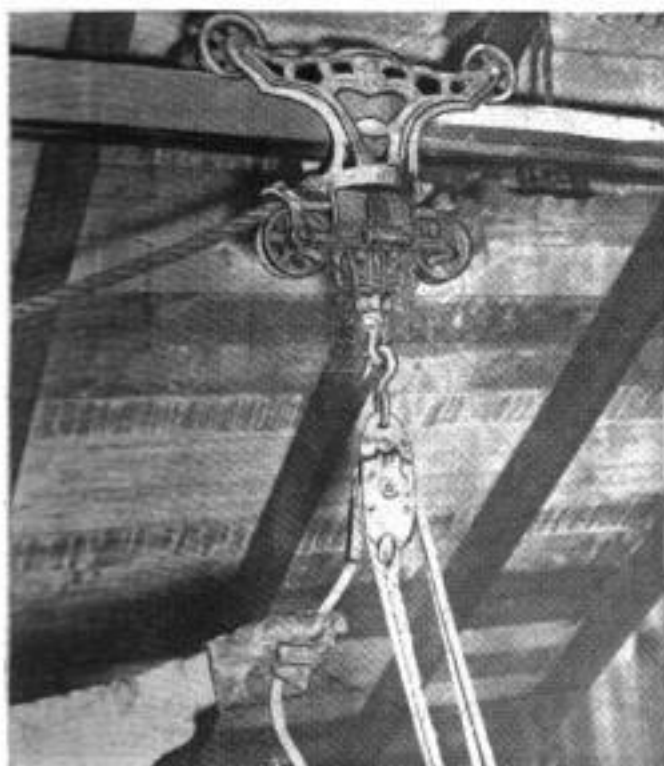

Portable Farm Sprayer Powered by Gas Engine

Powered by a small gasoline engine and mounted on a three-wheeled cart, this sprayer is completely portable. Insecticides, weed killers and other chemicals are carried in 5-gal. cans which fit in a welded rack on one end of the cart. When it is necessary to spray a distant outbuilding or pasture, the unit is light enough to be lifted onto a pickup truck for transport.

A. M. Wettach, Mt. Pleasant, Iowa.

Sign Has Charred Background And Raised Lettering

Novel wooden signs with charred backgrounds and raised letters, such as those used for cottage name and address numbers, can be made by using some asbestos paint or cement and a blow-

torch. First, the letters or numbers are painted with the asbestos mixture and allowed to dry thoroughly. Next, a torch is played over the wood until it is charred away enough for the characters to stand out. The characters then can be painted a bright color. If the asbestos compound is one with an asphalt base, it should be cleaned off before painting, because it will bleed through the paint.



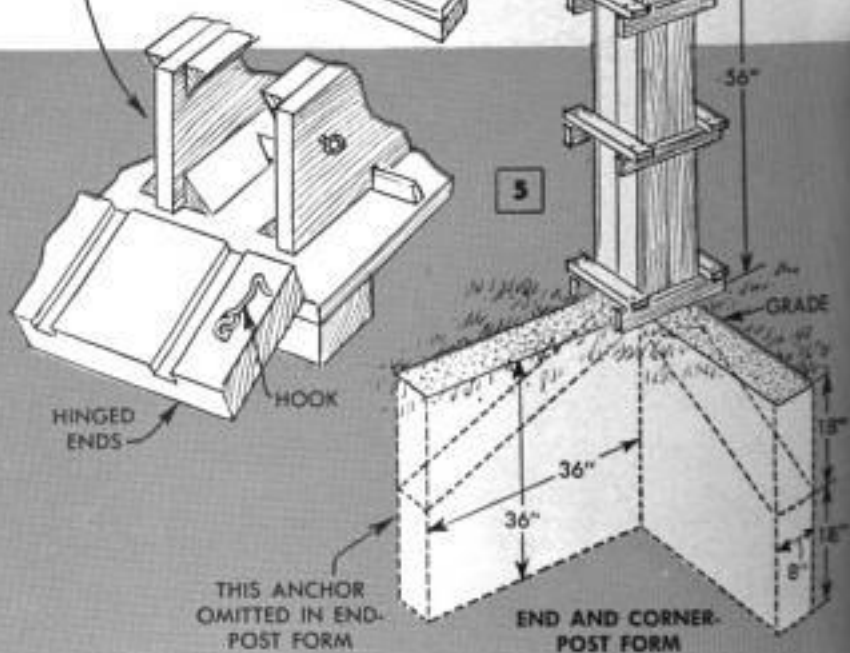
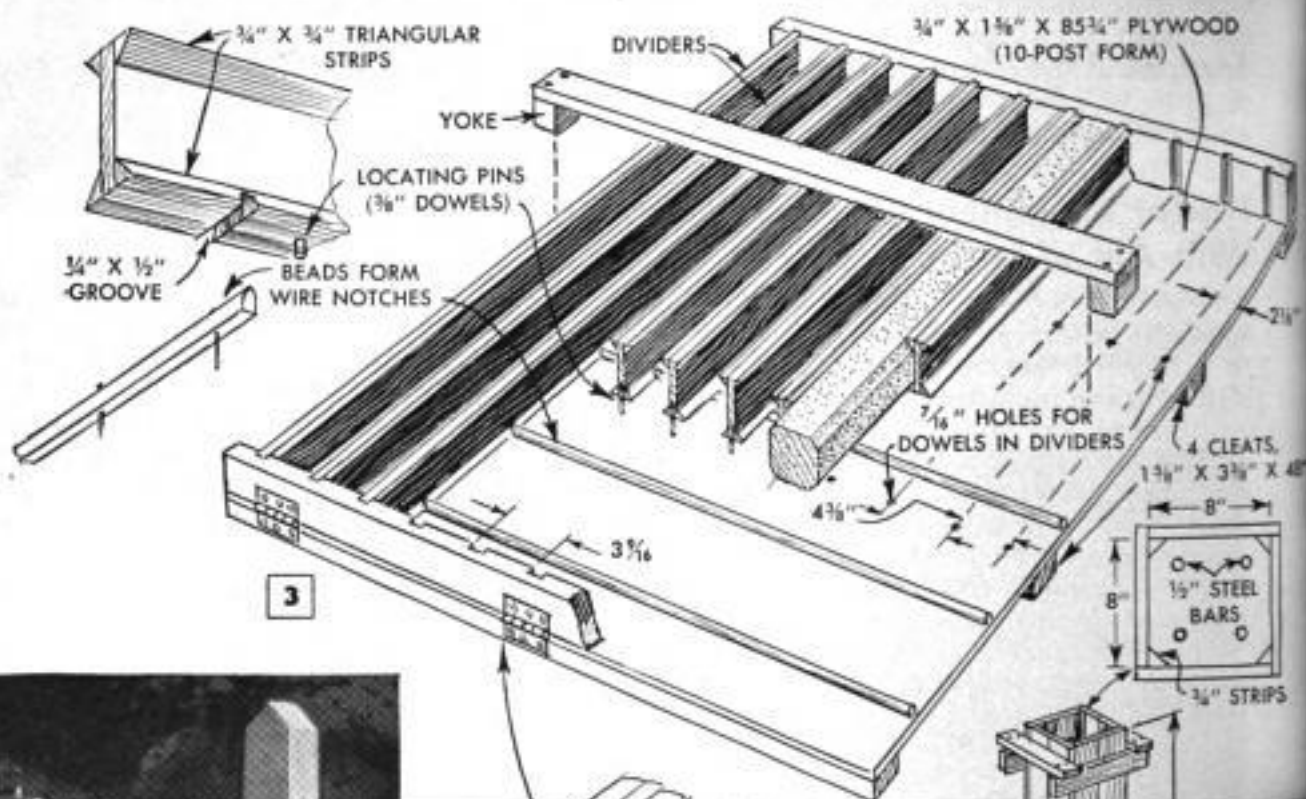
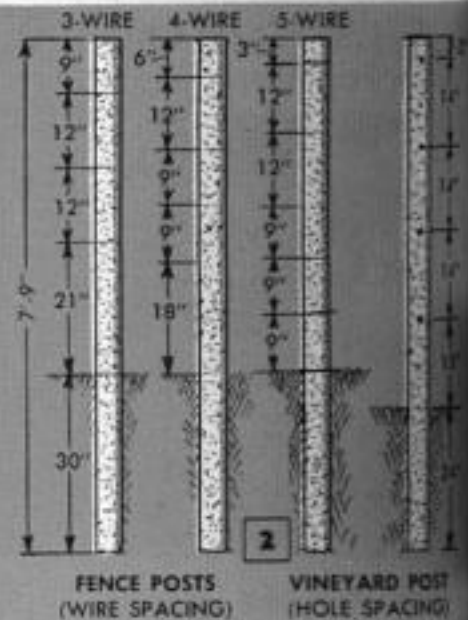
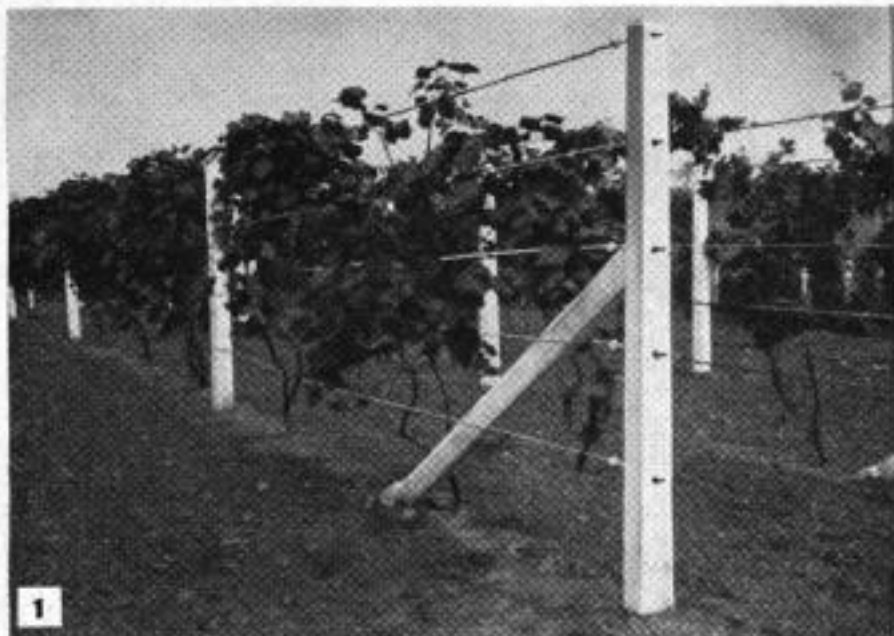

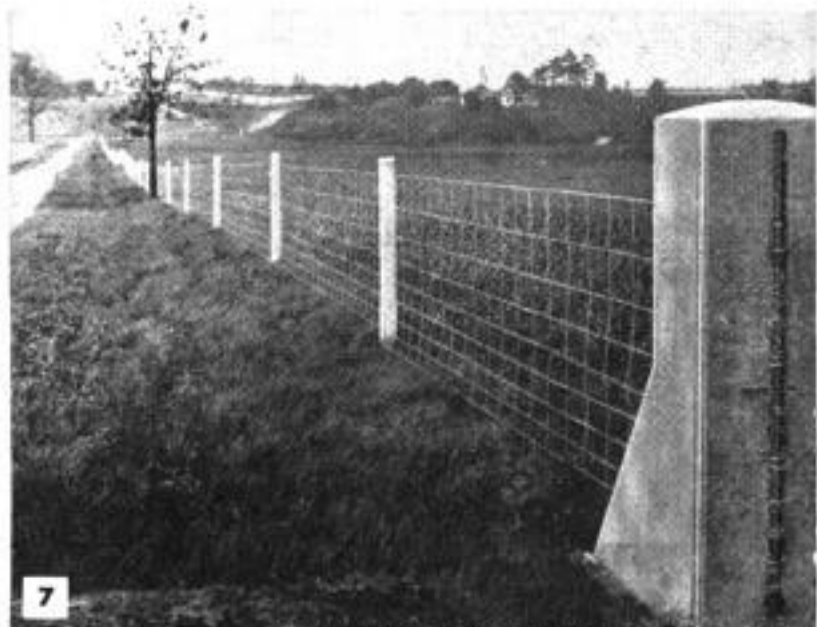
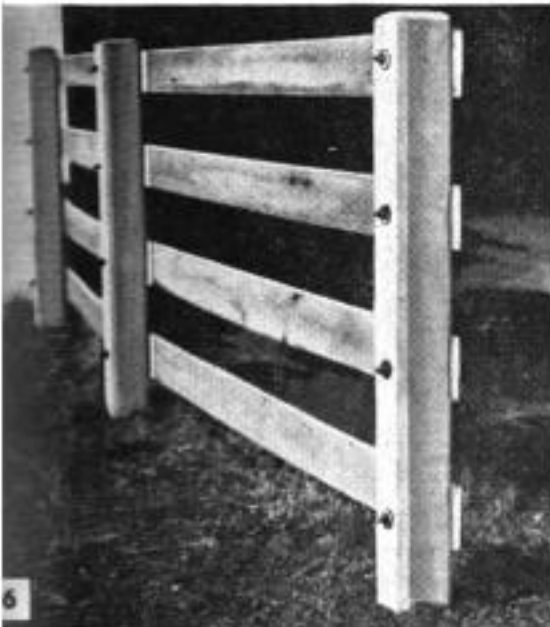

Photos and tables courtesy Portland Cement Association

FARM REPAIR AND IMPROVEMENT with concrete

THERE'S NO MATERIAL quite like concrete for making permanent repairs and improvements on the farm. It's easy to handle, easy to mix and requires no maintenance after curing. It's rodent, vermin, insect and fire proof and does not rust, rot or warp.

Concrete mix: A 1:2¼:2½ mix is recommended for casting into fence posts, vineyard posts and clothesline posts, but a 1:2¼:3 mix is best for tanks, floors and other projects pictured and detailed on these pages. The numerals, in the sequence given, refer to the proportions of the ingredients—portland cement, clean, sharp sand and gravel or crushed stone. A sack of portland cement equals 1 cu. ft. Before

mixing, measure the materials, then mix the dry sand and cement thoroughly. Add gravel in the correct proportion and mix again. Finally, add the correct amount of water and mix a third time. Use only clean water, from 3¾ to 6¼ gal. for each sack of cement used. If the sand is wet, add the minimum amount of water. If slightly damp, the maximum amount stated.

If less than the required amount of water is added the mix will be too stiff and air pockets will form. The larger gravel sizes will collect against the form boards. When pouring in deep forms, spade and tamp the mixture to obtain uniform distribution of the particles. A concrete mix should be used within 45 min. or less, as otherwise

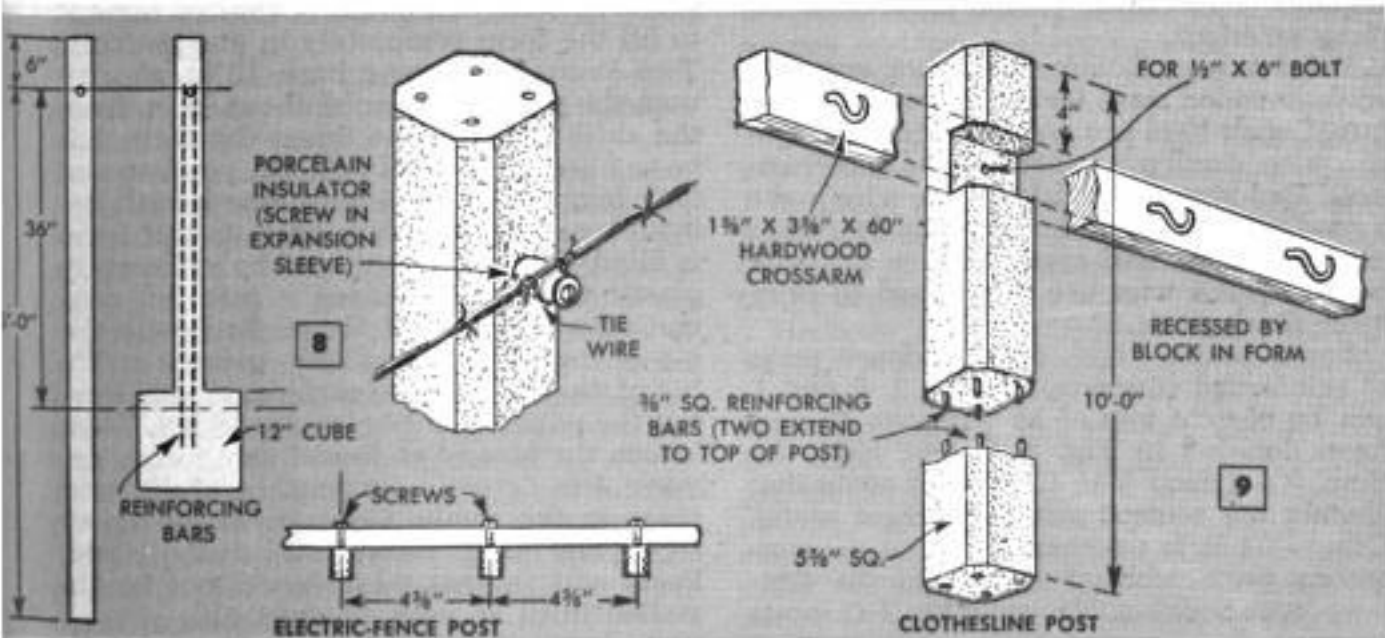

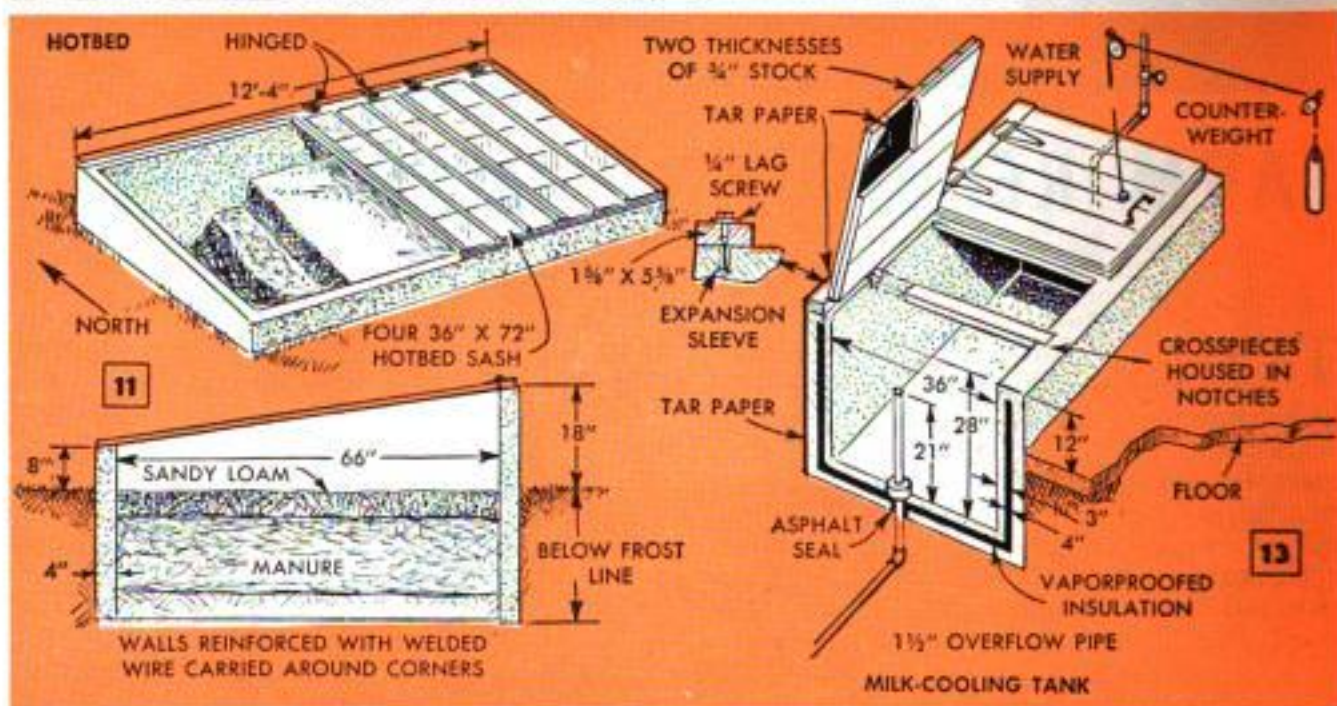
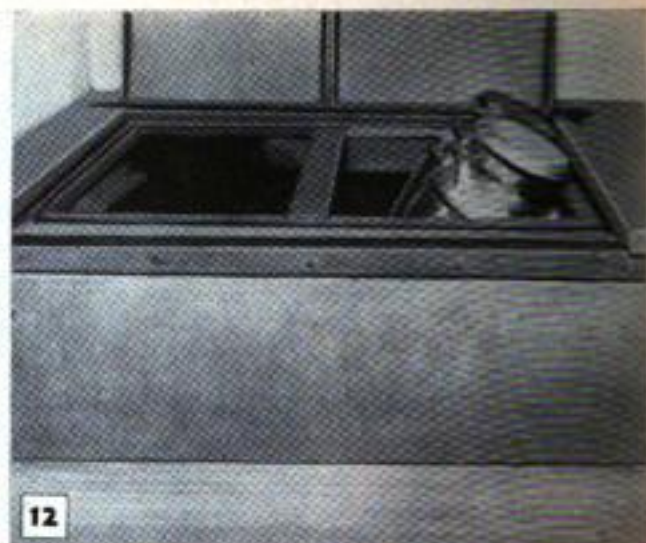

it begins to set and is no longer suitable for use. When the mixture has set sufficiently to resist finger pressure after pouring and finishing, cover with burlap, straw, or earth and keep the covering moist for 7 to 10 days. This curing period assures maximum strength.

Reinforcing: Reinforcing bars come in recommended sizes for every common job, but if such bars are not available you can use wire, small pipe, steel angles and channels. Two layers of welded fence wire make a good reinforcement for small tanks, ramps and floors of small area. Narrow strips of welded fence wire are often used to reinforce fence posts.

Fence posts: Rigid, durable fence posts of reinforced concrete, Figs. 1, 2, 6 and 7, can be cast in lots of 10 with the 10-post form detailed in Fig. 3. If you have the time, it's a good idea to face all parts that contact the cement mix with sheet metal. Otherwise it is necessary to coat all contacting parts with oil to prevent the mixture from sticking. To make ten 7-ft. posts

you will need 1½ sacks of portland cement. Gravel should be screened to ¾ in. or less. Note that the dividers and sides of the form each have two dowels that fit in holes in the bottom of the form to hold them in place. Be sure that you mix enough cement to fill the form completely in one pouring. Two ¼-in. reinforcing bars, 12 in. shorter than the posts, are placed about ¾ in. from the sides of each one when the form has been filled about half full. Or, you can use four lengths of No. 6 wire, one length being placed near each corner as the form is filled. The mixture should be sufficiently plastic to permit working it into full contact with the form. Strike off flush with the top of the form after filling, using a strike board, then trowel the surface smooth. Permit the pouring to harden for 48 hrs. Then loosen the hinged ends and side forms, remove the "green" castings carefully and place in the shade. Cover with burlap or earth and keep moist until fully cured. Posts cast in this way should not be installed until at least 30 days old.

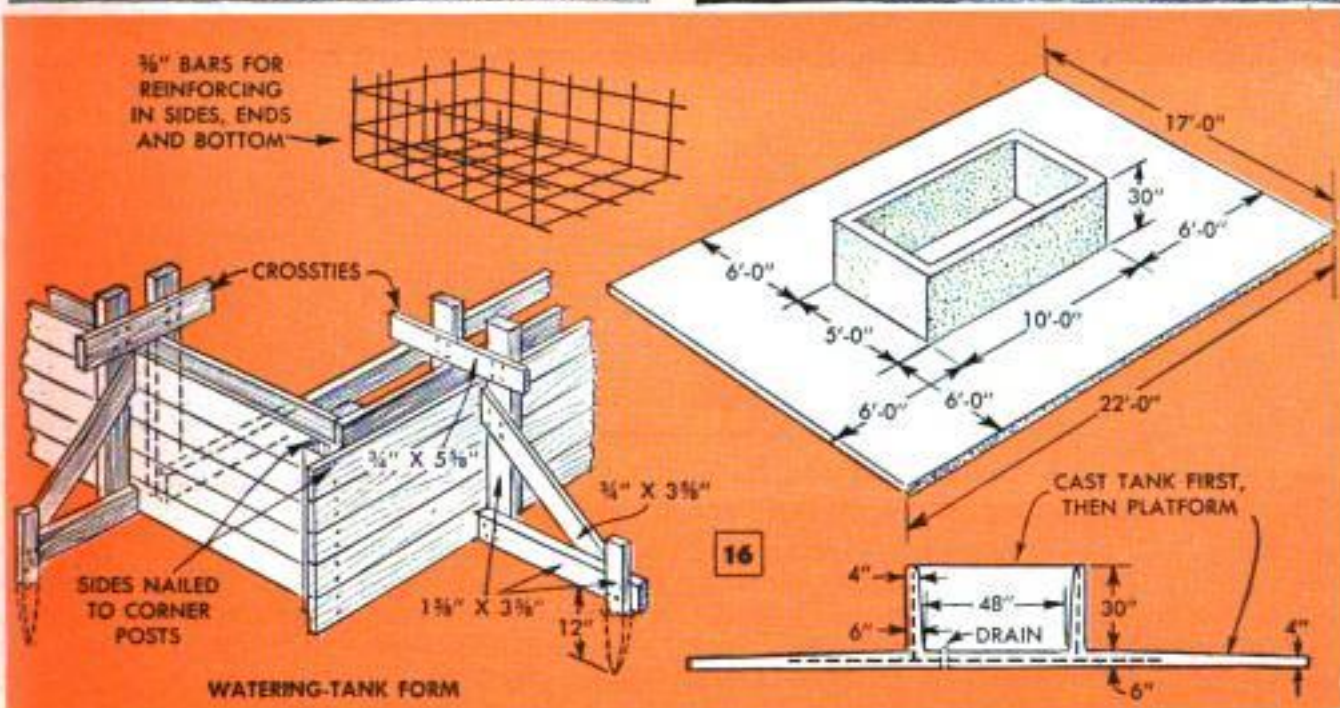
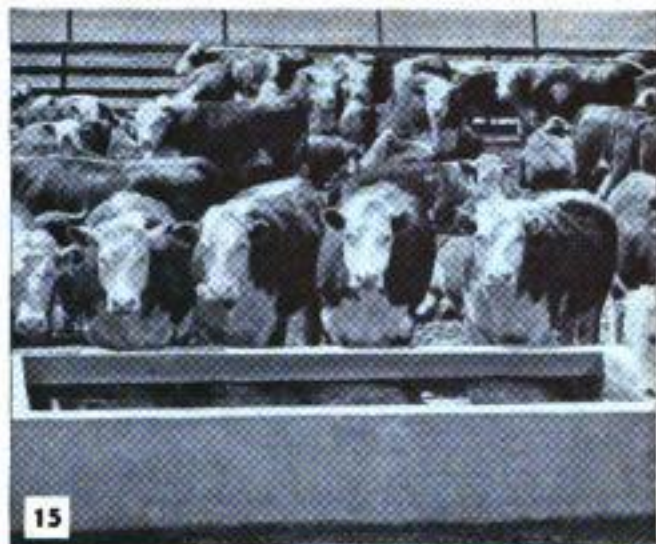
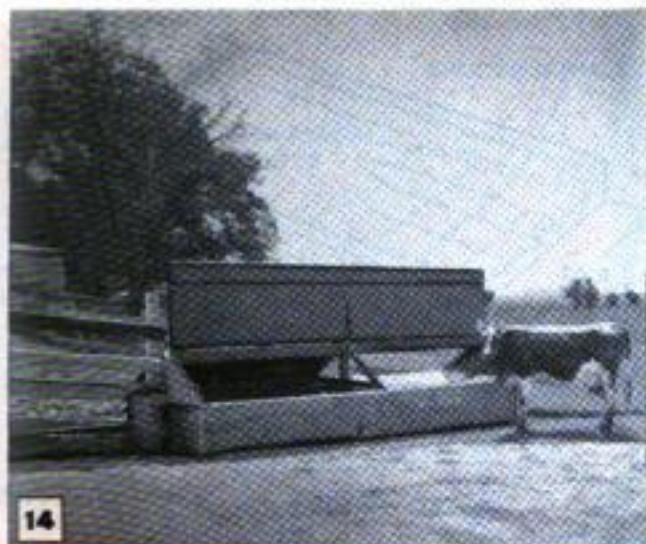

Beads on the bottom of the form shape round-bottom grooves on one side of the posts where the line wires are to be tied. Common spacings are given in Fig. 2 for 3, 4 and 5-wire fencing. Spacing of holes for vineyard posts is given in the right-hand detail, Fig. 2.

End and corner posts must resist much greater strains than line posts. Fig. 5 shows a method of casting a corner post with heavy anchors which extend in two directions to serve as braces. In most soils the excavation for the anchors can be dug with a tile spade, making the earth itself serve as a form below grade. The wooden form needed for that portion of the post which is above ground must be securely braced before pouring the concrete. Standard spacing of line posts is 16½ ft., but some requirements call for spacings of 10 ft. or less. Mailbox posts, Fig. 4, should be anchored in the same manner as corner posts. They can be cast with or without the brace pictured. For permanence, mailbox posts must be reinforced.

Electric-fence posts in permanent locations can be cast with below-grade bases as in Fig. 8. The base is a 12-in. cube of concrete. The wire is tied to porcelain insulators screwed to expansion sleeves cast in the post. Attach the sleeves to a strip with screws and press them into the soft concrete. The spacing indicated in Fig. 8 is quite commonly used.

Clothesline posts, Fig. 9, are cast somewhat heavier as they must extend about 7 ft. above grade. Reinforce the posts and place a block in the form to provide a recess near the top of the post for attachment of the crossarm.

Hotbeds and cold frames: Both should have a southern exposure and preferably should be located in a sheltered area where drainage is good. Use regular hotbed sash and hinge each one to a strip attached to the concrete with screws driven into expansion sleeves, the latter spaced in the same manner as those cast in electric-fence posts. In some cases hotbeds are placed close to a building wall and artificially

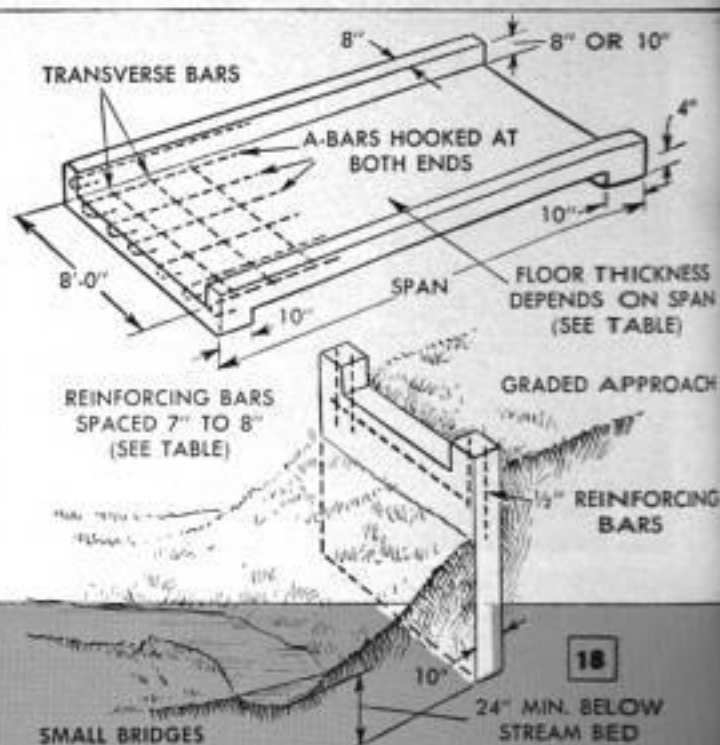
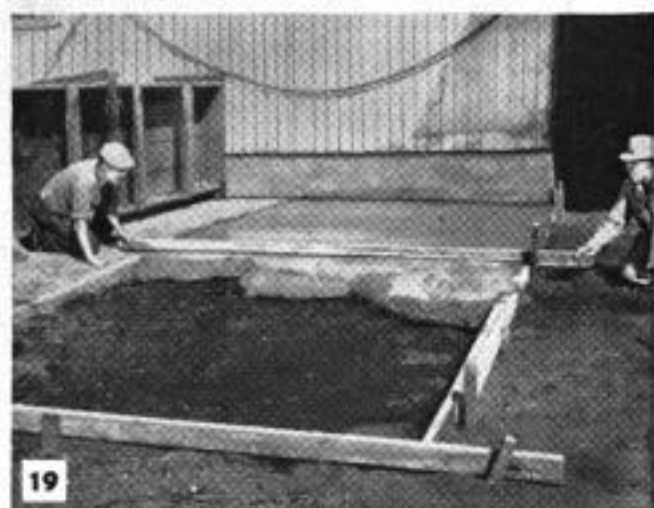

Clear span in feet	Thickness of slab in inches	"A" bars required in slab	
		Dia.	Spacing
6	5 1/2	3/8-in.	8 in. o.c.
9	6 1/2	3/8-in.	7 in. o.c.
12	7	3/4-in.	8 in. o.c.
15	8	3/4-in.	7 in. o.c.

All transverse reinforcing bars are 3/8-in. rounds placed 8 in. on centers.

heated by steam or hot water circulating in copper coils embedded in a layer of cinders in the bottom of the bed. A positive means of controlling the temperature must be provided. Electric heating cables, properly installed, also can be used.

Milk-cooling tank: Figs. 12 and 13 picture and detail an insulated milk-cooling tank which can be constructed with a capacity of 4, 6 or 8 milk cans of standard 10-gal. size. To cast the tank, build a form similar to that in Fig. 16 for the inside and that portion of the tank wall above the floor of the milkhouse. Nail small blocks to the inside face of the side forms to cast recesses for the removable crosspieces. When necessary to cut vaporproofed insulation, dip the cut edges in hot asphalt to form a seal against moisture. The rail to which the doors, or lids, are hinged is lag-screwed to the concrete, the lag screws being driven into expansion sleeves cast into one wall. For ease in handling, the doors should be counterweighted. An asphalt seal prevents leaks around the overflow pipe. The latter should be carried below frost level when run outside the milkhouse. Tanks of this type should be used only in locations where approved.

Stock-watering tanks: A clean watering tank is one of the first requirements on a

livestock farm. Figs. 14 and 15 picture typical rectangular stock tanks built of reinforced concrete. After building the form for the walls of the tank, it's a common practice to pour the bottom first, placing the reinforcing bars in position in the sides, ends and bottom. Be prepared to pour the sides before the bottom slab sets in order to obtain a solid bond between the two at the corners. After removing the forms (in two to four days) it's a good practice to plaster the inside with a cement mortar consisting of portland cement, 1 part, and sharp sand, 2 1/2 parts, adding just enough water to produce a plastic mix. Fill any air holes in the outside walls with the mortar. Pour a platform, or ramp, about 6 ft. wide around the tank, troweling to a 2-in. slope. Although not detailed in Fig. 16, some builders provide additional support for the ramp by spacing concrete "caissons" midway between the edge and the wall of the tank. The outer edges are supported on an apron which, in colder climates, extends below frost level. Hinged covers, Fig. 14, help keep the water cooler and also to prevent the entrance of chaff and dust.

Small bridges: On many farms, bridges over ditches and small streams are time-savers when it is necessary to move equipment from one part of the farm to another.

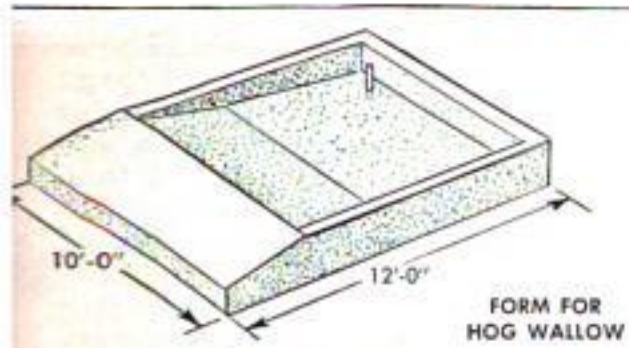

FORM FOR HOG WALLOW

RECOMMENDED SIZES

No. of head in herd	Width in feet	Length in feet
15	10	12
25	14	16
50	18	20
75	22	24
100	26	28

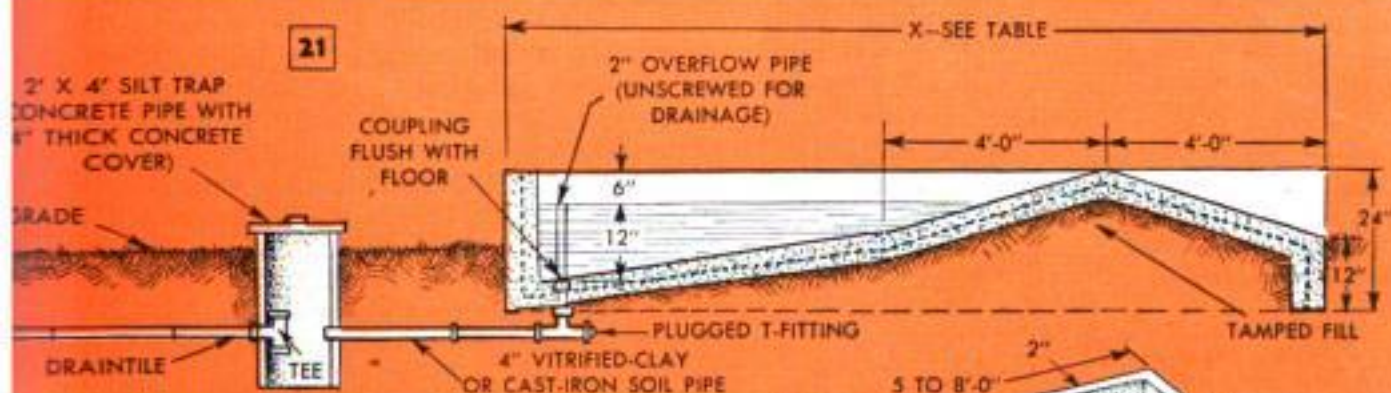

For short spans, a reinforced slab laid on buttresses, Fig. 18, will carry the average traffic safely across deep ditches and small streams. Short spans can be cast on level ground with only side and end forms to be built. Such slabs should be cast with end aprons. Longer spans, Fig. 17, must be cast directly on the buttresses and will require the building of a complete form. When the buttresses are poured, set steel rods in the concrete so that the ends project about 3 to 4 in. These will serve to anchor the slab. The size and spacing of reinforcing bars, also the thickness of the slab, will vary with the span. Recommended sizes of bars and thicknesses of the concrete are given in the table, Fig. 18. Buttresses should extend not less than 24 in. below the bed of the stream.

Floors: Few improvements save so much time and labor on the farm as concrete feeding floors, Fig. 19. Pouring a feeding floor is a simple job as you require only side and end forms. First step is to clear away all debris and level the grade. If the floor is to get hard service, or is in an exposed position, it's a good idea to excavate and put in a tamped gravel fill 5 to 6 in. deep. Then set the forms. Usually a form of 2 x 4s gives the right thickness, about 3 5/8 in. Pour the whole floor in one operation and level with a strike board as

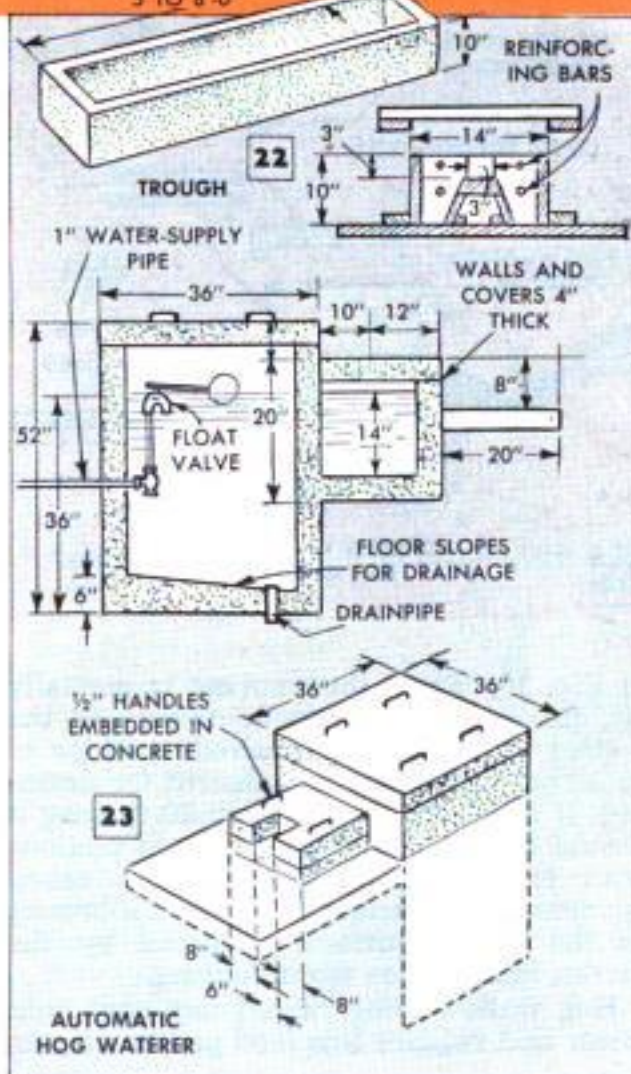

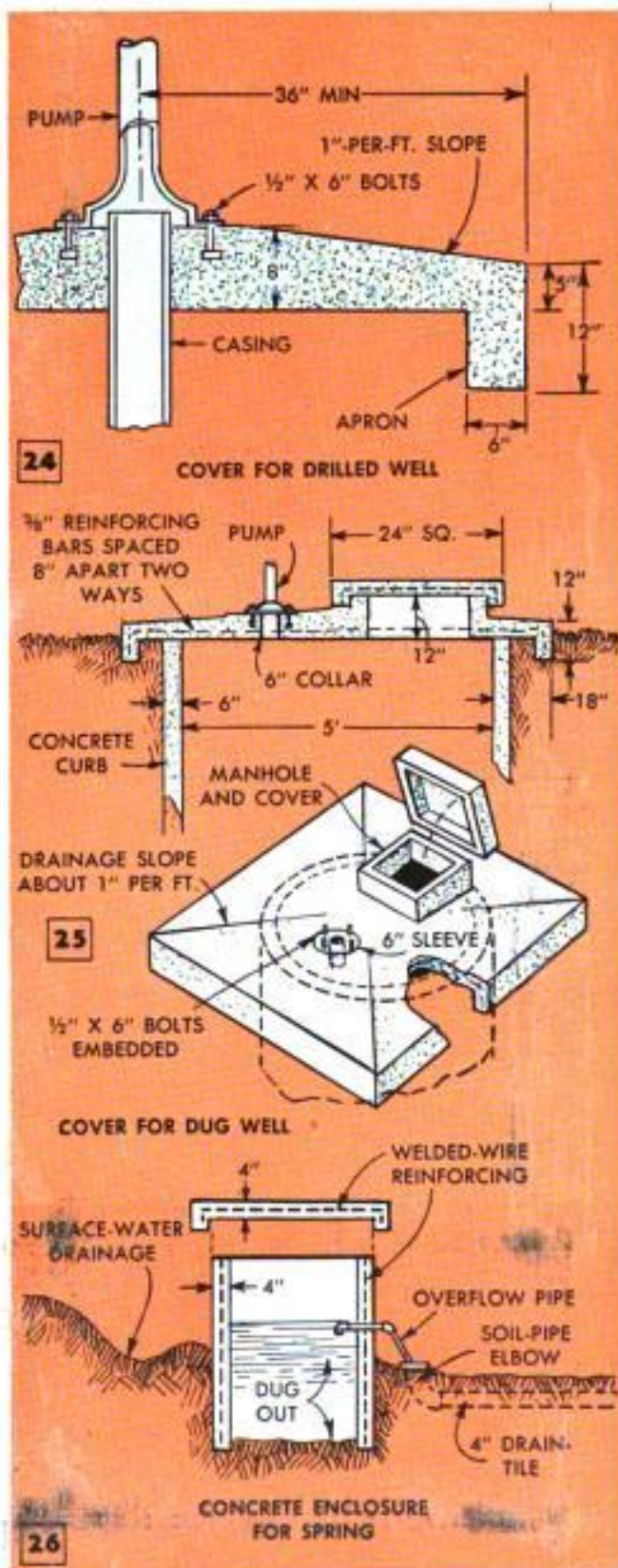

in Fig. 19. When the pouring is partially set, finish with a float or trowel to the degree of smoothness desired. A slope of $\frac{1}{4}$ in. per ft. usually is sufficient for drainage. If the floor is more than 20 ft. long it should be poured in two or more sections with expansion joints. In many cases, farmers finish feeding floors with a broom, as the rough surface produced by the broom finish gives surer footing.

Hog wallow: Hog raisers say hogs gain faster and require less feed per lb. of gain

when they have access to a wallow, especially in hot weather. Figs. 20 and 21 give the construction details for small and large sizes. Choose a location near the feed lot and, where possible, near shade. Some builders pour a platform, or ramp, 4 to 6 ft. wide around the wallow. This should include a curb to prevent undermining of the structure.

Hog waterers: Where hog waterers can be located permanently, farmers generally use concrete construction. Fig. 23 details an automatic waterer designed to be built with a storage tank below grade, keeping the water cooler in warm weather and helping to prevent freezing in cold weather. The dimensions given are average and can be varied to suit special requirements. When casting the covers, place a thin strip in the form to shape a recess, or rabbet, around the edges. This will prevent the covers from shifting when in place. Shut-off valves usually are located at the source to the supply line so the latter can be drained at the tank to prevent freezing in severely cold weather. In some cases, a trough, Fig. 22, serves the purpose better than a permanent watering tank. Cast the trough in the form, shown in the sectional view, and use at least four reinforcing bars. Use a $1:2\frac{1}{4}:2\frac{1}{2}$ mix for this type of casting.

Well covers: Well water may become contaminated if the well is not adequately protected against the entrance of surface water. Drilled wells, Fig. 24, should be covered with a concrete platform not less than 6 ft. square, the cover to be poured with an integral apron as shown in the sectional view. The purpose of the apron is to prevent seepage and undermining of the platform itself. The well casing should extend $1\frac{1}{2}$ to 3 in. above the surface of the platform and provision must be made for bolting the pump in place. Bolts embedded in the concrete can be protected against rust by coating with a corrosion inhibitor. In most locations a dug well can be given protection against contamination by a concrete curb and cover built as in Fig. 25. The construction is essentially the same as that in Fig. 24, except that the cover is provided with a manhole giving access to the pump cylinder. The platform has a 6-in. sleeve embedded to provide an opening of sufficient size for installing or pulling the pump. The manhole must be provided with a snug-fitting cover. It should be reinforced and cast with an overhanging lip.

Enclosure for spring: Spring pollution can be entirely prevented, or at least minimized, by enclosing the flow in a concrete curbing provided with a cover, Fig. 26. The curbing is set in an excavation. An overflow pipe runs the water into drain tile which carries it to the livestock tank. ★★

Expanding-Plug Holds Center-Bored Work

Center-bored work is held firmly for machining in a metal-working lathe using the expanding plug shown in the detail. The shaft of the plug is a No. 2 Morse taper shank cut from a discarded twist drill. The shank is faced off square and a center hole is drilled and countersunk in the end. The original hole in the tang end can be utilized if it is not badly damaged. The tool-steel body of the plug, which has been drilled and taper-reamed to fit the shank, is fitted over the shank and the assembled unit then is mounted in the lathe. The body first is machined to the desired outside diameter, after which three equally spaced holes are drilled close to

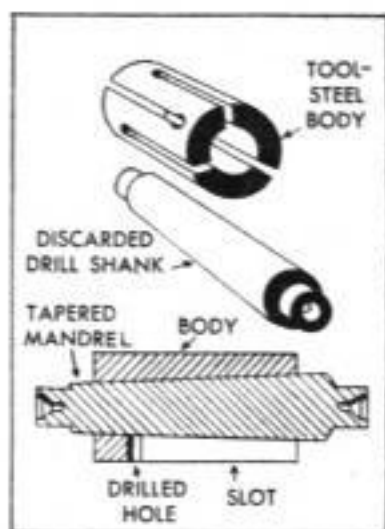

each end. A thin slitting saw next is used to make the six alternate slots that permit the body to expand when the taper shank is inserted.—C. W. Woodson, Chicago.

each end. A thin slitting saw next is used to make the six alternate slots that permit the body to expand when the taper shank is inserted.—C. W. Woodson, Chicago.

Multipurpose Farm Trailer Transports Heavy Machinery

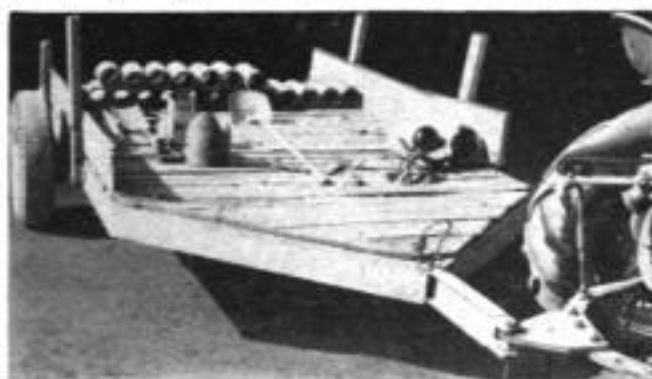

Originally built wide and low to transport heavy farm machinery, this two-wheeled trailer also is used as a portable workbench when a low work surface is convenient. A specially designed drawbar made from 4-in. steel channel permits the trailer to be tipped up so machinery can be rolled or driven up onto the bed. The frame of the trailer, which is clamped directly to the axle without springs, is a welded assembly of 5-in. steel channels and I-beams. The 7 x 10-ft. bed is floored with planks.

Tap Wrench Used as Valve Handle On Compressed-Gas Tank

A T-handle tap wrench can be used as an effective valve handle on tanks of compressed gas that are fitted only with a projecting valve stem. The wrench can be adjusted to fit snugly on the square shoulder of the valve stem to permit accurate control, and is easily removed and stored in a toolbox. Use of the tap wrench eliminates scored and burred valve stems which result when a pipe wrench is used.

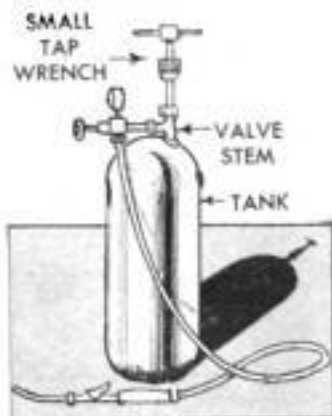

R. M. Woodbury, Natick, Mass.

Rule Held for Glass Cutting By Bits of Friction Tape

To hold a ruler or yardstick firmly and with less danger of slipping at a crucial moment during glass cutting, place a number of small tabs of friction tape on the underside of the ruler before putting it in position. Even with the cutter pressing against the ruler, there is little likelihood of its slipping.

What You Can Do With Gun-Type Soldering Irons

Lightweight, trigger-action guns reach working heat in seconds. Some have built-in lights to illuminate work

By E. R. Haan

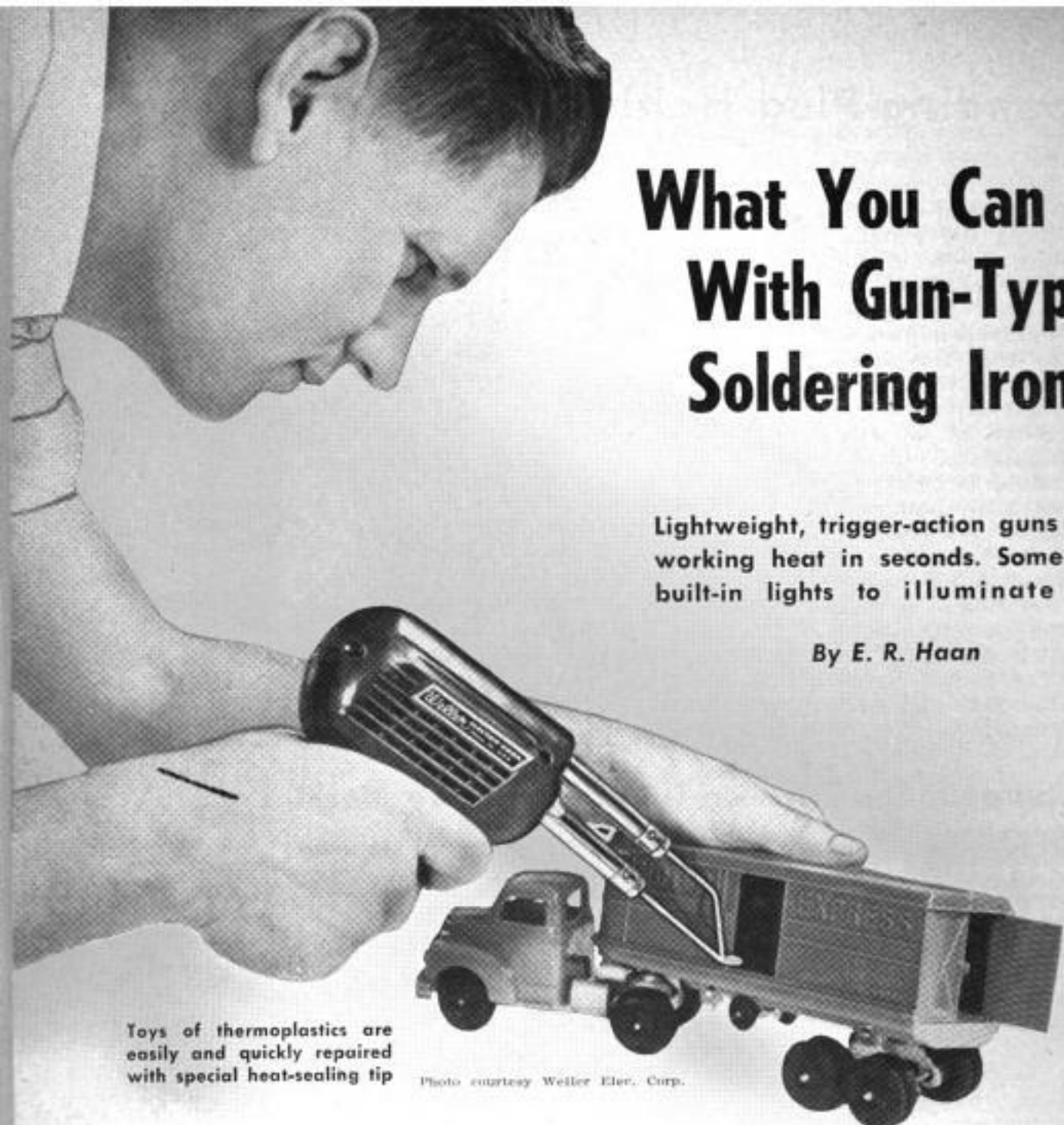

Toys of thermoplastics are easily and quickly repaired with special heat-sealing tip

Photo courtesy Weller Elec. Corp.

Small size of gun tips makes it easy to reach places inaccessible to conventional-type soldering irons

Gun fitted with cutting tip is the thing for cutting plastic tile. Just invert tile and follow mark

Photos courtesy Wen Products, Inc.

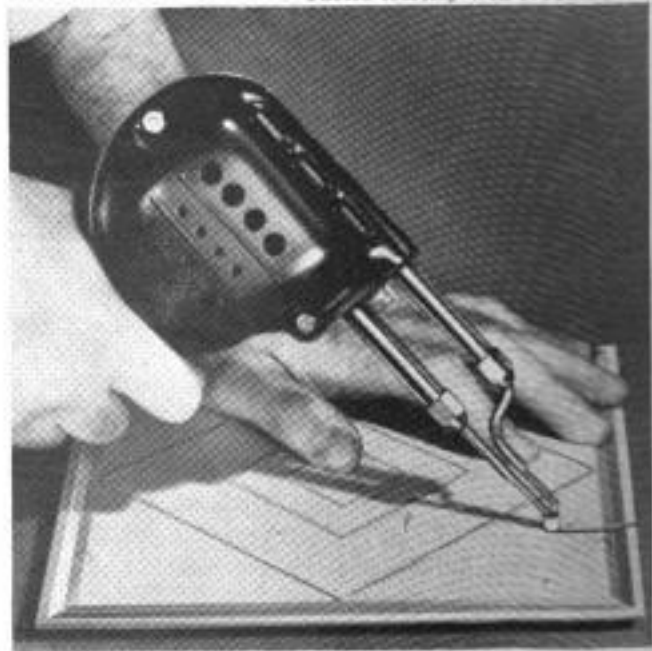
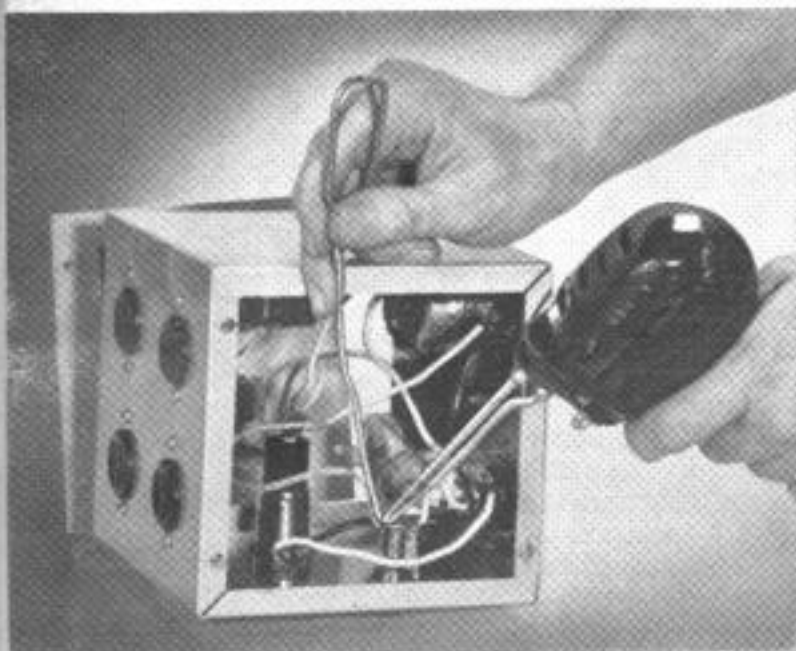

BALANCED on a positive pistol-grip handle, the new trigger-action soldering guns can be worked in almost any position safely and economically. The tips heat to working temperature in a few seconds, eliminating the necessity of holding the conventional iron in position until the heat transfers. The small tips of the guns can be worked effectively in restricted areas inaccessible to conventional irons. When not in use the gun is automatically turned off on release of the trigger, thus reducing current consumption to the minimum. The tips cool quickly, reducing the fire hazard when the gun is laid on a bench or stored in the toolkit. Trigger-type guns such as those pictured are available in different sizes (rated according to wattage) for light, medium and heavy-duty work.

Trigger guns are of two types, one having a built-in transformer, the other a resistance-wire winding controlled by a thermostatic element. The transformer-type gun works only on a.c. The resistance-type gun works on either a.c. or d.c. For good results it is necessary to use a gun of adequate size for the work, especially when it is necessary to heat metal rapidly, as in sweat-soldering long joints in flat work. Some guns have two-heat switches, the maximum being obtained by pulling the trigger all the way in. This is an advantage on heavy work, or where it is necessary to heat metals of the heavier gauges in seam soldering. The guns are especially fast and effective on electrical work, as the pistol grips give positive control when working in a confined area.

Due to the variety of tips available, the guns have many other practical uses around the home. For example, homeowners who install plastic tile themselves use the guns for cutting individual tiles when fitting around sinks and bathroom fixtures. There's a special knife-edged tip made for the purpose. Merely install the tip in the gun and invert the tile on a flat surface. Mark the cut on the back of the tile and then proceed as in the lower left-hand photo on the opposite page. The hot tip makes a clean, sharp-edged cut that fits snugly against square, mitered or curved edges. The trick is to keep the cutting tip moving uniformly across the work under a light, steady pressure. The knife-edged tip is also useful for softening hardened putty as in the center photo on the following page. Use of the gun with cutting tip eliminates the necessity of loosening old putty with a chisel, with the attendant possibility of the chisel slipping and damaging the sash frame. Running the knife-edged tip slowly along the joint where the putty joins the wood will cause the former to peel cleanly from the wood.

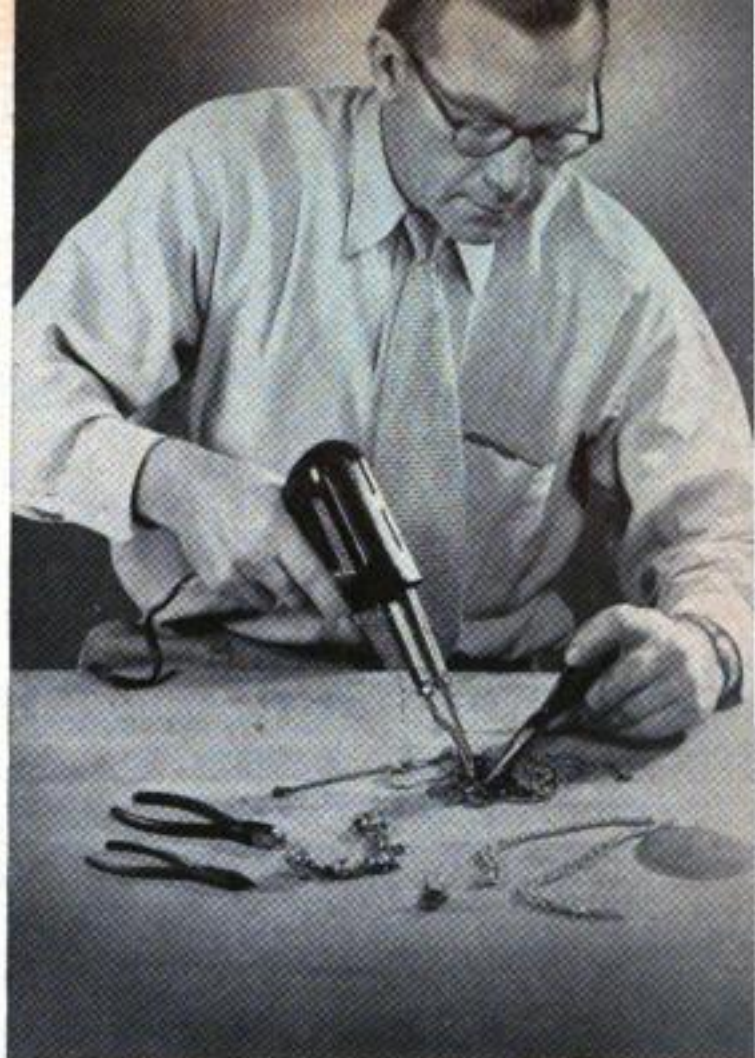

If you've ever tried to repair jewelry with a soldering iron you'll appreciate the speed of the gun

Note the comfortable, natural position of the hand on the pistol grip. Gives perfect control at the tip



Photo courtesy Garden City Industries, Inc.



Accessory tips are supplied for instant-heat guns. Pad-type is used for sealing plastic containers



Cutting tip also is useful for softening hardened putty. Removes putty quickly without damaging wood

Here's a gun in use with a pad tip. Works perfectly for sealing plastic containers of the type pictured



The smoothing tip quickly seals home-freezer packages of the thermoplastic type as shown in the lower left-hand photo. The tip used for this purpose terminates in a flat pad as in the upper photo at the left. The shape of the tip makes it simple to apply heat just where it is needed to effect a complete seal of freezer packages. The method works equally well for sealing breaks in the seams of thermoplastic galoshes, raincoats, shower curtains and other items made of the same material. The tip also can be used for melting sealing wax, or stick shellac when repairing furniture. Still another use is in the repair of plastic toys, an example of this application being pictured in the upper photo on page 198. A similar tip pictured in the right-hand photo below consists of a flat pad designed especially for raising dents when repairing furniture. Just apply a drop or two of water in the dent, spread a damp cloth over it and apply the iron tip directly over the dent. Steam is generated almost instantly, causing the wood fibers to swell, restoring the depressed surface to the original level. On very deep dents it may be necessary to repeat the operation. This type of tip also can be used to heat-seal plastic containers and wearing apparel and melt stick shellac. When heat-sealing containers and seams, it's a good idea to place a thickness of heavy paper over the area to be heat-sealed. The paper prevents any tendency of the tip to stick to the plastic.

When soldering with any gun-type iron it is essential to follow good soldering practice. Metal surfaces must be thoroughly cleaned and properly fluxed. Keep the soldering tip fully tinned by first cleaning and fluxing and then coating with solder while hot. Joints in flat work should be tinned and then joined by sweating. When possible, all other types of joints should be preheated, then soldered. In this way you get a thin film of solder between the joining thicknesses of metal. ★ ★ ★



Tip for repairing dents in finished surfaces is interchangeable with regular soldering tip. Also seals wax-paper packages and plastics



Above, drilling at an angle without blocking the work is an exclusive feature. Below, "chop sawing" short stock is fast and safe

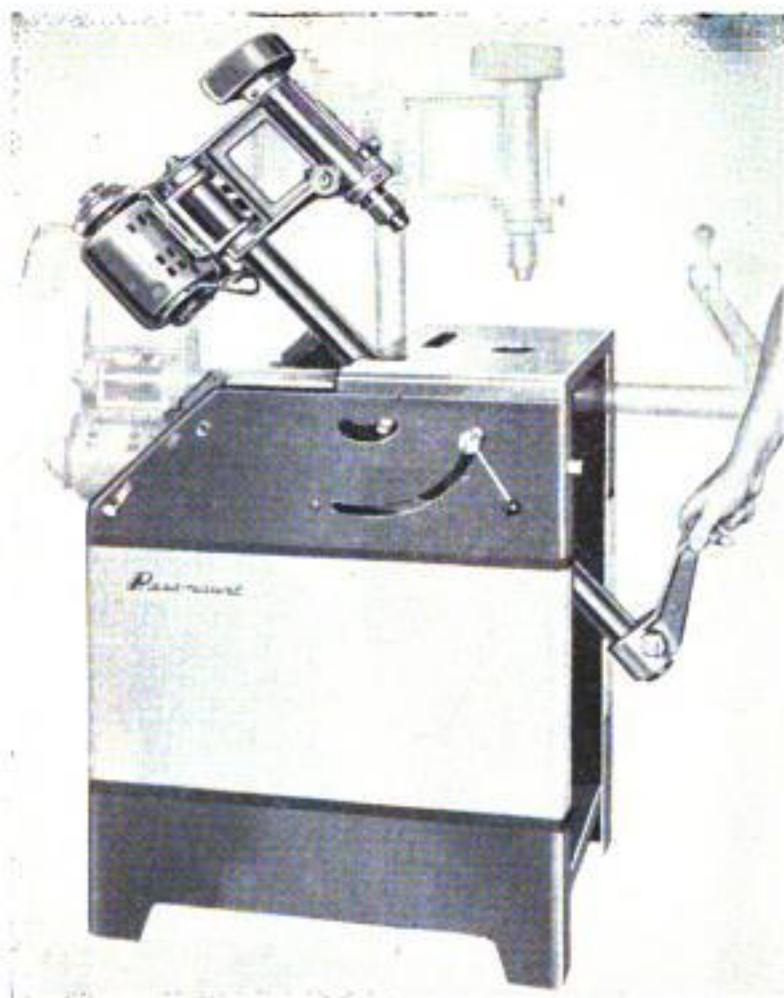

Above, right, multipurpose tool is five machines on steel floor stand. Change-overs are made in seconds

POWER WORKSHOP HAS NEW FEATURES

THIS PARAMOUNT multitool unit performs operations of five separate power machines. It changes from one tool to another in seconds due to an exclusive new design in which spindle and motor are mounted on a tilting boom. Unit has such features as a machined table without inserts, 360-deg. radial drill and novel hidden saw which retracts below table on completion of cut. Saw table tilts 45 deg. for sawing and disk-sanding. Spindle and motor swivel to any desired position, horizontally or vertically, for drilling and drum-sanding operations. Lathe tailstock serves as handle when tilting the boom for critical adjustment of blade or dado height when grooving and also for lifting the circular blade through the table slot when "chop sawing."

Right, another exclusive—sanding drum drops into hole in table, utilizing full length of sleeve. Below, lathe and sander are quickly set up

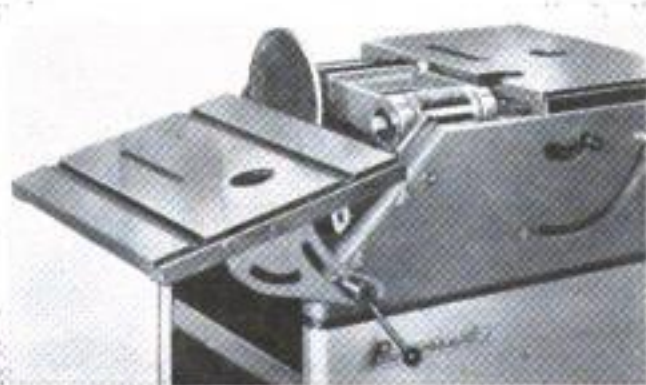

SHOPPING FOR



1. NAILING MACHINE speeds up correct nailing of hardwood flooring. Shortens distance the user must stoop in order to drive nails. Reduces the fatigue of the job many builders regard as the most tiring of any in the home-building industry. After driving one nail by striking the plunger of the tool with a special rawhide mallet, another nail drops automatically into place. Nail is driven and set in one operation
Independent Nail and Packing Co., Bridgewater, Mass.

2. ACCESSORY SAW for 1/4-in. electric drills doubles as a nibbler for cutting openings in sheet metal. Also cuts wood and plastics, using interchangeable blades. Moving parts are mounted on ball and needle bearings designed for hard service. There are no gears in housing. Drive to cutting tool is through crank and connecting rod. Wear parts are hardened steel
Little Beaver Industries, 38809 Mentor Ave., Willoughby, Ohio

3. MAGNETIC LATHE CHUCK comes in 10 and 12-in. dias. and has a magnet pattern consisting of 48 radial magnetic gripping edges. Magnet pattern assures a much stronger and more uniform gripping action on certain types of work which are difficult to hold. Operates on 6-volt d.c. and is controlled by a special panel-mounted switch in power-supply line
Magnetic Holding Devices, 2034 E. 22nd St., Cleveland 15, Ohio

4. FENCE-ALIGNMENT GAUGE quickly corrects fence alignment on circular-saw tables. Gauge is clamped to the blade in the position pictured and ripping fence brought up until it touches the contact button on end of gauge opposite the clamping screw. Then blade is rotated backward until it again rests on the machine table. If gauge binds, fence is out of true
Adams Products Co., 119 Ann St., Hartford 3, Conn.

5. COMBINATION HAMMER AND WRENCH has a wide application around the home, shop and on the farm. A hammer poll and short neck are forged on stationary jaw and there's a nail puller and case opener on outer end of handle. Movable jaw is spring-loaded and slides into position for instant grip on nuts of various sizes. Jaw has fine-screw setting
G. M. Co., Manufacturing, Inc., 13-08 43rd Ave., Long Island City, N. Y.

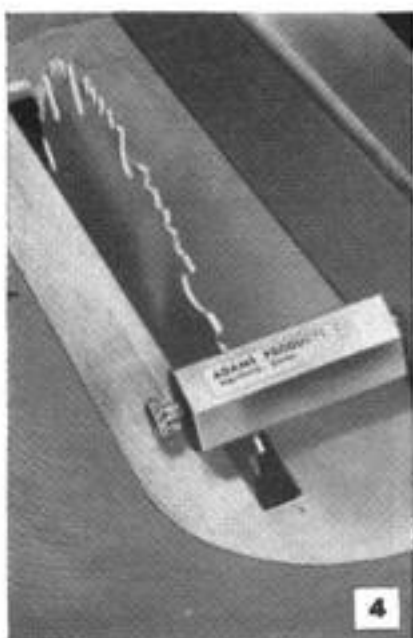
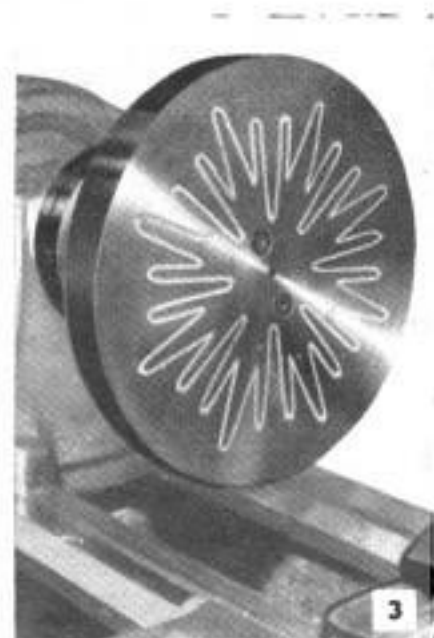
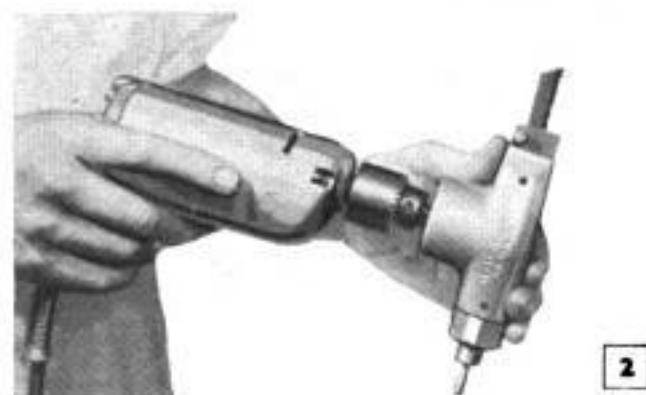

TOOLS

6. MITER FOR COMPOUND ANGLES is fitted with two powerful magnets that hold the saw blade tightly against the single guide face. Guide tilts 45 deg. in two directions, making it possible to cut compound miters up to 45 deg., or any angle between. Magnets are placed at each end of guide to prevent whipping of blade and thereby assure a straight precision cut

Bay City Foundry, 133 N. Avalon Blvd., Wilmington, Calif.

7. CIRCULAR-SAW VISE takes all blades in the common sizes. Holds blade rigidly in filing position, thus eliminating one of the principal objections to filing circular blades by hand, that of vibration of the blade under the file strokes. This special feature is due to the wide, curved sweep of the clamping jaw which grips blade tightly over a wide area

Anton L. Ponsetti, 309 W. Dakota St., Spring Valley, Ill.

8. HAMMER-OPERATED PUNCH PRESS cuts clean, accurate shapes in sheet metals up to 14-ga. Openings up to 1¼-in. dia. are easily punched by placing material over die, lowering the ram and then striking lightly with a hammer. Details at the left of the photo show the variety of work that can be done. Press can be bolted to bench top in handy position

Chase Manufacturing Co., Los Angeles 6, Calif.

9. PAINT SCRAPER is especially designed for removing paint smears from glass panes. Tool is fitted with a scraper blade held in a vertical position at the forward end of the holder, which also serves as a handle. Flat, sliding base supports the blade at the same height and prevents tilting. Removes paint from the glass without damaging the edges of the putty

Leyton Enterprises, Box 17234, Foy Station, Los Angeles 17, Calif.

10. PRECISION BORING FIXTURE for drill press is designed for industrial and home-shop use. Consists of boring bar and fly cutter and an auxiliary worktable with a working surface of 3½ x 8¼ in. Extended edges of the table permit rapid clamping of work. Holes in worktable base register with slots in any drill-press table. Bores holes from ½ to 2½-in. dia.

Donnell Co., P. O. Box 84, St. Joseph, Mich.

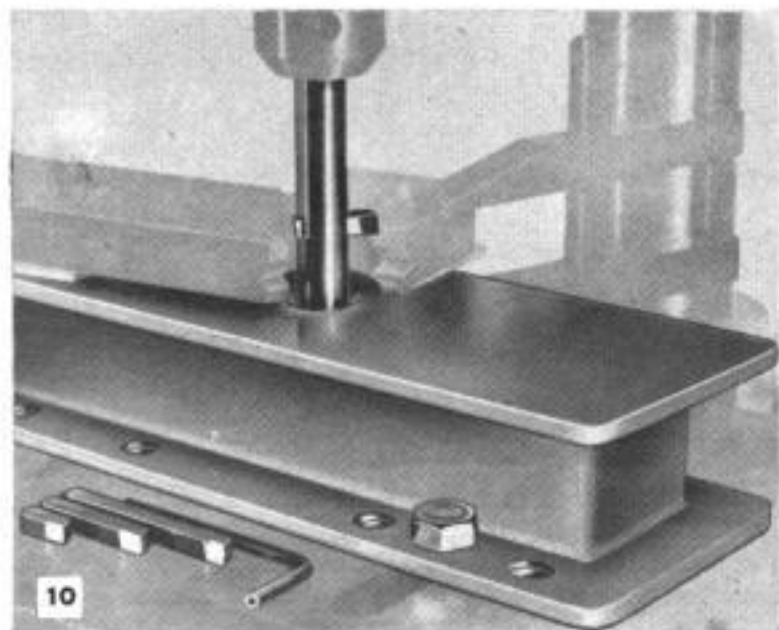
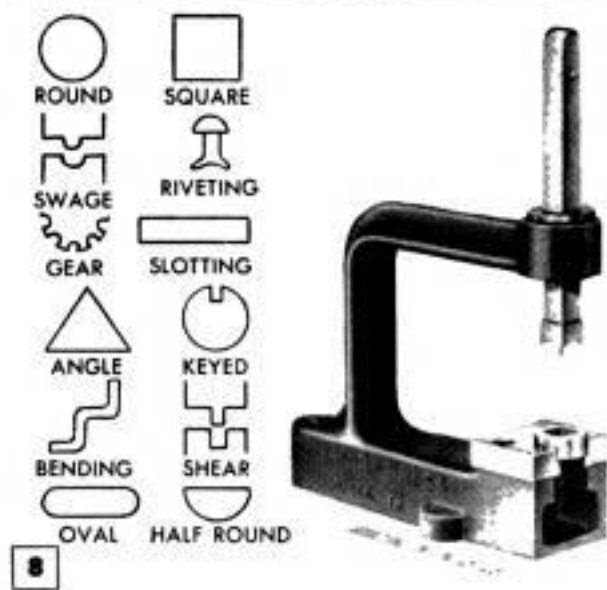
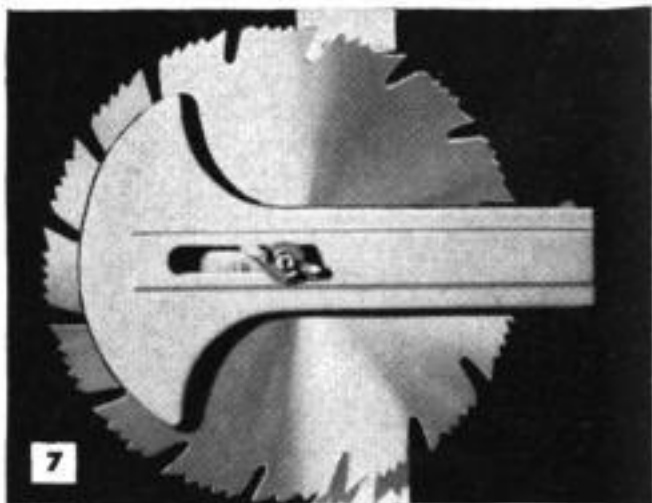
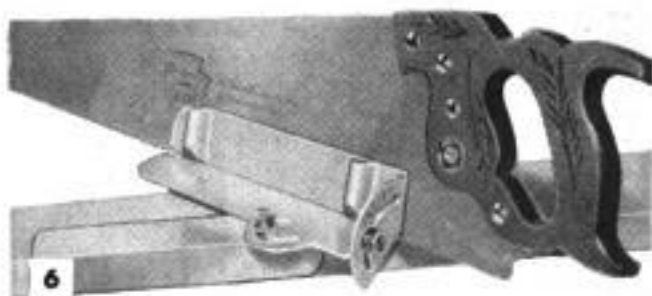

Jig for Marking Plastic and Metal-Backed Tile

By minimizing the chance of improperly cutting plastic or metal tile to fit in corners, the simple jig illustrated lessens the time and labor involved and saves the cost of spoiled tiles. The jig consists of a piece of plywood to which a tile is fastened with its back side out. On the opposite side of the plywood two strips are fastened. The strips are grooved and rabbeted, as shown in the detail, to hold two tiles in alignment with the tile on the back of the jig. In use, the tile on the back is placed

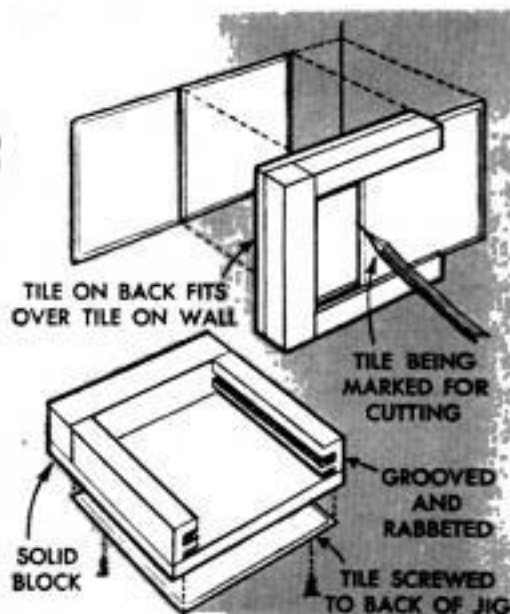

over the last tile on one wall. The outside tile in the jig then is moved until it touches the adjacent wall and the underneath tile is marked for cutting. Plastic tile can be scored and broken, while metal-backed tile

requires sawing or cutting with metal snips. Most hardware stores rent tile cutters, either the lever type or the small electric circular-saw type now on the market.

W. G. Waggoner, Sacramento, Calif.

Helper Springs on Windmill Permit Easier Starting

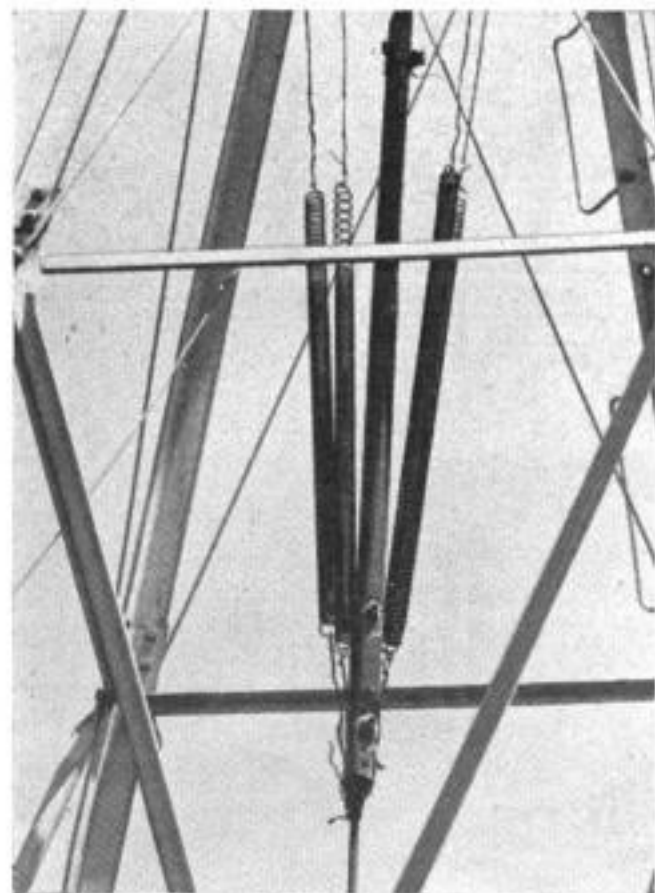

A windmill will start with much less wind when the pump shaft is fitted with helper springs to offset the weight of the shaft, pump rod and column of water in the pump. Because it usually stops at the bottom of a stroke, an ordinary windmill requires a maximum of power to start again. However, since the gate springs shown on the windmill in the photo are under tension at the bottom of the stroke, the mill will start with about one third of the wind usually needed.

Piece of Bandsaw Blade Used as Keyhole Saw

A short piece of a broken bandsaw blade, when fitted with a handle as shown, makes a very handy keyhole and hobby saw. A detachable file handle that features a setscrew to hold the file in place is most convenient, although any wooden handle could be used if a small hole were drilled through the blade and handle, and a pin driven through it.

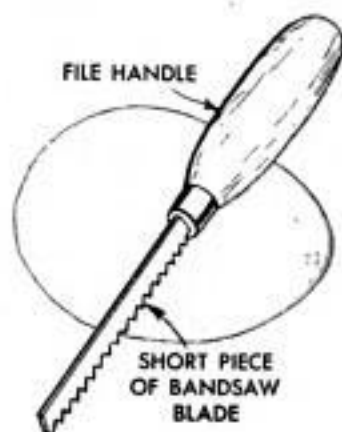

When a can of antifreeze or other similar liquid is opened for pouring by punching two holes in the top, the unused portion can be sealed airtight by using two lumps of modeling clay.

Only \$69⁵⁰!

New 3" belt sander MAKES TOUGH JOBS EASY!

You'll breeze through hundreds of sanding tasks with Porter-Cable's new Model 136 Homemaster Belt Sander!

Build and finish your own furniture and cabinetwork, or refinish antiques . . . remove paint and varnish, fit windows and doors . . . finish new or old wood, metals, plastics, ceramics . . . *get professional results every time!*

Full 3" belt width and powerful universal motor make short work of anything from rough sanding to velvet-smooth final finishing. Model 136 is Porter-Cable built for exceptional value and years of faithful service. See and try it soon.

MODEL 136 . . . ONLY \$69.50 COMPLETE

With locking trigger switch, quick-change belt tensioner, instant belt tracking control. Ballbearing construction, precision spur gear drive. Stand available for accurate bench sanding.

Porter-Cable

Homemaster Tools



VISIT YOUR PORTER-CABLE DEALER OR MAIL COUPON TODAY

PORTER-CABLE MACHINE CO.
5148 N. Salina St., Syracuse 8, N. Y.

Please send complete information on the Model 136 Homemaster Belt Sander.

Name.....

Address.....

City.....Zone.....State.....

How filters can improve your pictures



Filters are to photography something like the finish you add to a piece of furniture. The bench or table you make will serve perfectly well without the finish. But with it, its beauty is greatly enhanced. And so it is with your pictures. Film does a fine job—filters help it do an even better one.

What is a filter and what does it do?

Basically, it's a piece of scientifically tinted gelatin or glass placed over the camera lens. When photographing a scene on black-and-white film, objects in the scene, though

colored to your eye, will come out in the finished print in many shades between black and white. These shades will come out more accurately, properly light or dark, with the assistance of the proper filter.

Notice how the use of a filter has improved the picture above, bringing out clouds and other detail in dramatic contrast. Made without a filter it would have appeared as in the smaller illustration.

In other words, filters make good photographs *better*. They put *you* in command, so to speak, of every picture you make,

and enable you to emphasize important details which otherwise might not appear.

What filters to select? While there are hundreds to choose from, a few will cover nearly all normal black-and-white picture-taking needs. In the table below are listed the Kodak filters that make a practical kit—together with the primary uses of each. You can buy inexpensive all-glass filters, such as the new Kodak Pictorial Filters, or for finest picture results, the professional-quality, gelatin-in-optical-glass Kodak Wratten Filters.

There are some very useful Wratten filters for color photography, too. One is the

Kodak Skylight Filter (from \$1.75) which is used for outdoor Kodachrome shots on hazy or overcast days, and in open shade to reduce excess bluish light for a warmer, more pleasing result. Others are the Daylight Filter (No. 85) which adapts indoor Kodachrome Type A Film for outdoor use (from \$1.75), and the Flash Filter (No. 81C) which adds warmth to indoor Kodachrome Type A shots taken with Class M bulbs (from \$1.75).

For more detailed information on color filters and their uses, ask your Kodak dealer for the Kodak Data Book, "Filters and Pola-Screens." (\$.35)

KODAK FILTER GUIDE FOR BLACK-AND-WHITE FILMS

FILTER	SUBJECT	EFFECT DESIRED
Kodak K2 Wratten or Kodak Yellow Pictorial (with Verichrome or any panchromatic film like Plus-X)	Clouds against blue sky Object or figure against blue sky Distant landscapes	Clouds emphasized, sky darkened Normal contrast between object or figure and sky Slight haze reduction
Kodak X1 Wratten or Kodak Green Pictorial (with panchromatic films only)	Foliage Portrait of person Clouds against sky	Lighter Natural skin tones Clouds emphasized, sky darkened slightly
Kodak Wratten A or Kodak Red Pictorial (with panchromatic films only)	Object or figures against sky Distant landscapes	Sky greatly darkened for dramatic contrast Reduces atmospheric haze



Kodak Adapter Ring—Slips over camera lens, holds any filter of same Series size. Comes in Series IV to IX sizes. From \$1.35.



Kodak Wratten Filters in "B" Glass—In a wide range of colors for a variety of subjects. Series IV to IX sizes. From \$1.75.



Kodak Pictorial Filters—Available in Yellow, Green, and Red in Series IV, V, VI sizes. From \$1.50.

Prices are subject to change without notice

Eastman Kodak Company
Rochester 4, N. Y.

Kodak
TRADE MARK

Care and Feeding of Engines



BY
S. P. CORP

GET RID OF THAT RING RIDGE!

When you are about to install new rings, remember: Before you take piston and rings from a cylinder, *remove the ring ridge* to avoid trouble! This is the ridge, or rounded shoulder, which has formed at the top of ring travel in the cylinder. It's almost impossible to force a piston assembly out of the cylinder while the ridge is there—and even if you succeed, you are inviting damage to the lands of the piston. If the ridge is not removed the edge of the new top ring will strike the ring ridge, damaging both the new ring and the piston.

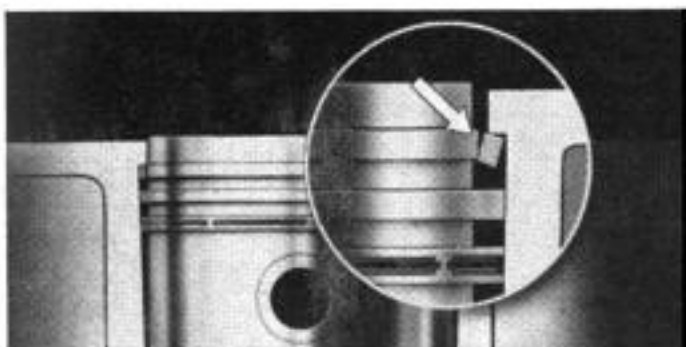

RING BROKEN DUE TO RIDGE

Use a good ring ridge cutting tool to remove the ridge. First, put the piston at the bottom of its stroke and cover it with a clean rag coated with oil. Then set the cutting tool so it will cut into the top of the ring travel not more than $1/32$ ". This will insure a smooth wall surface for the new compression ring.

Whenever new rings are installed, idling speed of engine should be increased so that there is ample oil pressure to lubricate the new rings until they have seated. If possible, driving speed of engine should be increased to, but not over, 50 mph for the first 200 miles. This assists in seating rings and insures good lubrication.

WRITE FOR NEW FREE MANUAL

Sealed Power has prepared a new 24-page illustrated booklet, "Care and Feeding of Engines," with carefully indexed articles on everything from automatic chokes to windshield wipers. It's yours for the asking, and a postal card will bring your copy by return mail. When you re-ring, use Sealed Power KromeX Ring Sets—with "chrome where it counts," to fight friction, corrosion, abrasion, and heat in modern engines. For power, economy, and long, long, ring life, be sure you get KromeX! Sealed Power Corporation, Dept. G-8, Muskegon, Mich.



Sealed Power

PISTON RINGS

Clinic for Homemakers



As a service to our readers in solving the hundreds of problems pertaining to a home—inside or out—the editors of *Popular Mechanics* invite you to present your problems to The Clinic Editor for help and advice. Address your questions to The Clinic Editor, *Popular Mechanics Magazine*, 200 East Ontario Street, Chicago 11, Ill.



Heating Basement

Q—I replaced my hand-fired furnace last year with a new gas-fired unit. During the winter my basement was cold. With the old furnace going it was always comfortably warm. What can I do about it?

—C. E., Ind.

A—Modern heating plants are designed to put the heat upstairs. Only a very small percentage of the total output escapes to the basement by radiation. About the only source is the vent pipe from the burner to the chimney. If this is short then the heat loss to the basement area is insufficient to raise the temperature of the room appreciably. However, we would hesitate to recommend that you install extra ducts to direct heat into the basement, as this would add considerably to the heating load. The additional load would not only raise fuel costs, but might result in unsatisfactory operation of the heating unit during severely cold weather, as the total heat requirement might be increased to a point above the maximum output of the furnace. Perhaps you would find that a single duct taken off the warm-air plenum would divert sufficient heat to "temper" the basement without greatly affecting the satisfactory operation of the furnace. This duct should be fitted with a means of regulating the amount of heat which is diverted to the basement.



Siding Shrinkage

Q—Although the siding on my new home was primed before application, shrinkage of the boards has opened the joints. The shrinkage is uneven, leaving cracks, or openings, which vary in width. What remedy is there, other than replacing the siding?—O. N., Ga.

A—We would not consider replacing the siding, at least at the present time. It can be suspected that the shrinkage which is causing the defect you describe is due not only to shrinkage of the siding boards, but to the framing members as well. This will stabilize at some point, after which a more or less permanent repair can be made. Little if any harm will result from waiting until stabilization of the framing and siding takes place. Then you have at least two choices as to the method of repair. One is to fill the openings at the ends of the boards with a calking compound, using a gun with a $1/8$ or $1/4$ -in. tip. Care must be taken to fill

(Continued to page 210)

DURATITE



with these 2 fine surfacers
you can fill any imperfection
from a hammermark to a knothole

With waterproof-weatherproof DURATITE Surfacing Putty and Wood Dough you can do a better job every time. These are the finest products on the market for filling dents, scratches or holes... in wood, plastic and other commonly used materials.

FOR SMALL CAVITIES

Use Surfacing Putty for all small cavities. It is extremely fine textured and can be sanded to mirror smoothness. Edges can be sanded to absolute perfection.

FOR LARGE CAVITIES

Use Wood Dough for all large cavities. Fine textured, rapid drying, it is quickly ready for sanding, sawing, milling or carving.

WEBB PRODUCTS CO. • ESTABLISHED 1923
SAN BERNARDINO, CALIF. AND NORCROSS, GEORGIA

8 TRUE COLORS AND 6 SIZES

Both Surfacing Putty and Wood Dough are now available in 8 true colors for easier wood matching and in 6 sizes to fit any need. Both take all commonly used stains.

AT LEADING STORES

You will find these DURATITE products at all leading hardware, paint, lumber and marine supply stores. Ask for them by the name DURATITE. You'll be glad you insisted.

"Handy" SANDY recommends



these fast
**GOOD
SHORT-CUTS**
... save and use 'em!

Want a nice "Satin" finish on your suede shoes? After you've cleaned them thoroughly, try buffing with a strip of Extra Fine Emery Cloth by CARBORUNDUM... makes worn and crushed spots in the nap look like new again.

Drippy paint cans are annoying, especially when you want to move them. Next time you're painting indoors, try this: tape a large paper plate to the bottom of your can of paint. This not only keeps drippings off the floor, but provides a wide non-tipping base... lets you slide the can across the floor with one hand. Best tape for the job, of course, is FLEXBAC® Masking Tape by CARBORUNDUM. Be sure to keep a couple of rolls around the house for all sorts of handy jobs. Always sticks to any surface... peels off easily, too!

Make a hit with your wife by showing her the easy way to cut small patterns out of thin cloth. Just give her a few sheets of CARBORUNDUM's Medium Flint Paper and tell her to trace the designs or shapes on the paper back. By placing the grit side of the sheet against the material, to keep it from slipping, she can cut accurately along the pencil lines, right through paper and cloth. A real time-saver for housewives who make patchwork quilts... won't hurt the shears, either!

Neat way to store drills so you can select the one you want in a hurry: roll a strip of corrugated cardboard into a tight circle and fit it into an empty tin can (a coffee can is perfect). Then place your drills between each layer of cardboard — using the corrugations as slots to hold them upright.

Tighten loose handles on picks or axes in a jiffy. Just fold a strip of Coarse Emery Cloth by CARBORUNDUM — so there's emery on both sides — and wrap it around end of handle. Then drive the handle back into place, for a tight, permanent fit.

Do you have any short-cut ideas that save time or work around the house and workshop? Send 'em to me — each on a separate postcard. I'll pay you \$5.00 right away for each one I can use in later columns. If I can't use 'em (because of duplicates, etc.), I'll send you a worthwhile little gift anyway.

For a free folder called "How to sand" which The Carborundum folks have printed, address a postcard to me...



"Handy" SANDY
CARBORUNDUM

REGISTERED TRADE MARK

Niagara Falls, New York

(Continued from page 208)

the openings flush with the surface, as otherwise an unsightly seam will result. The other method, one sometimes used by builders, is to square the ends of the siding boards with a portable electric saw. They do this by snapping a chalk line across the ends of the boards, then setting the saw to a depth that permits the blade to cut through the siding only. In some cases it is an advantage to tack a straightedge to the wall to serve as a guide for the saw. After the ends have been squared by removing only a fraction of an inch from each one in this manner, the original trim boards are replaced by new ones ripped to a snug fit against the ends of the siding boards. Although it takes somewhat longer to accomplish, this is the recommended repair.

Woodenware Finish

Q—I have just finished turning a salad set from hardwood and now I'm wondering how to finish the pieces. I've been told that linseed oil is the proper finishing material. Also, I understand that there is a special lacquer made for this purpose which is designed to bring out the graining of the wood and to withstand repeated washing. Which finish should I use for best results?—R. W., Tex.



A—We would not use ordinary linseed oil, as its purity cannot always be relied on. There are, as you say, lacquers made for the purpose. However, we would suggest that you consider using pure olive oil as a finishing material. You did not say what kind of hardwood you used for the turnings, but olive oil can be used as a finish on most common hardwoods. It absorbs readily, even in close-grained woods such as maple and, with repeated applications, builds a deep finish of exceptional durability. Simply apply with a soft cloth, allow the coating to absorb, and then wipe off the excess oil on the surface. Allow to dry overnight, then apply a second coat.

Blond Finish with Paint

Q—I have an old-style chest of drawers which I think is made of oak, at least the graining of the wood appears to be that of oak. The finish is dark colored and is in rather poor condition, although the chest itself is still good. I'd like to remove the old finish and re-do the piece in the new blond finish, but I don't know how to apply blond finishes of the type I see on modern furniture built of oak and other woods. How is it done?—M.L., N.H.

A—The degree of success you have in applying a blond finish to an old chest such as the one you describe depends more or less on the quality of the surface you are able to produce by scraping and sanding after the old finish has been removed. If you are sure that the wood is genuine oak (some old pieces were made of chestnut and ash, and some were combinations of several woods) the first step is to apply a varnish remover. Scrape off the softened varnish and as much of the stain underneath as possible. Cut off the remaining stain with a cabinet scraper. This will remove most of the filler and any discolorations and give you bare wood to start with. Then do a thorough job of sanding. A simple method of attaining a fairly attractive job is to apply a coat of oil-base paint or semigloss enamel in an ivory color, or if you like the coloring a little richer, use a cream color. Before the paint sets, rub off the excess with a soft cloth until the grain and character of the wood show through the coating. It may be necessary to continue the application-and-rubbing sequence until you get precisely the shade you want. The base pigment in the paint will act as a filler and the coloring pigment as a stain. When you have the right color, allow the coating to dry for several days. Then sand very lightly with fine paper and finish with a coat or two of pale varnish. There are other methods, of course but the procedure outlined is one of the simplest.

Put your electronic skills to work

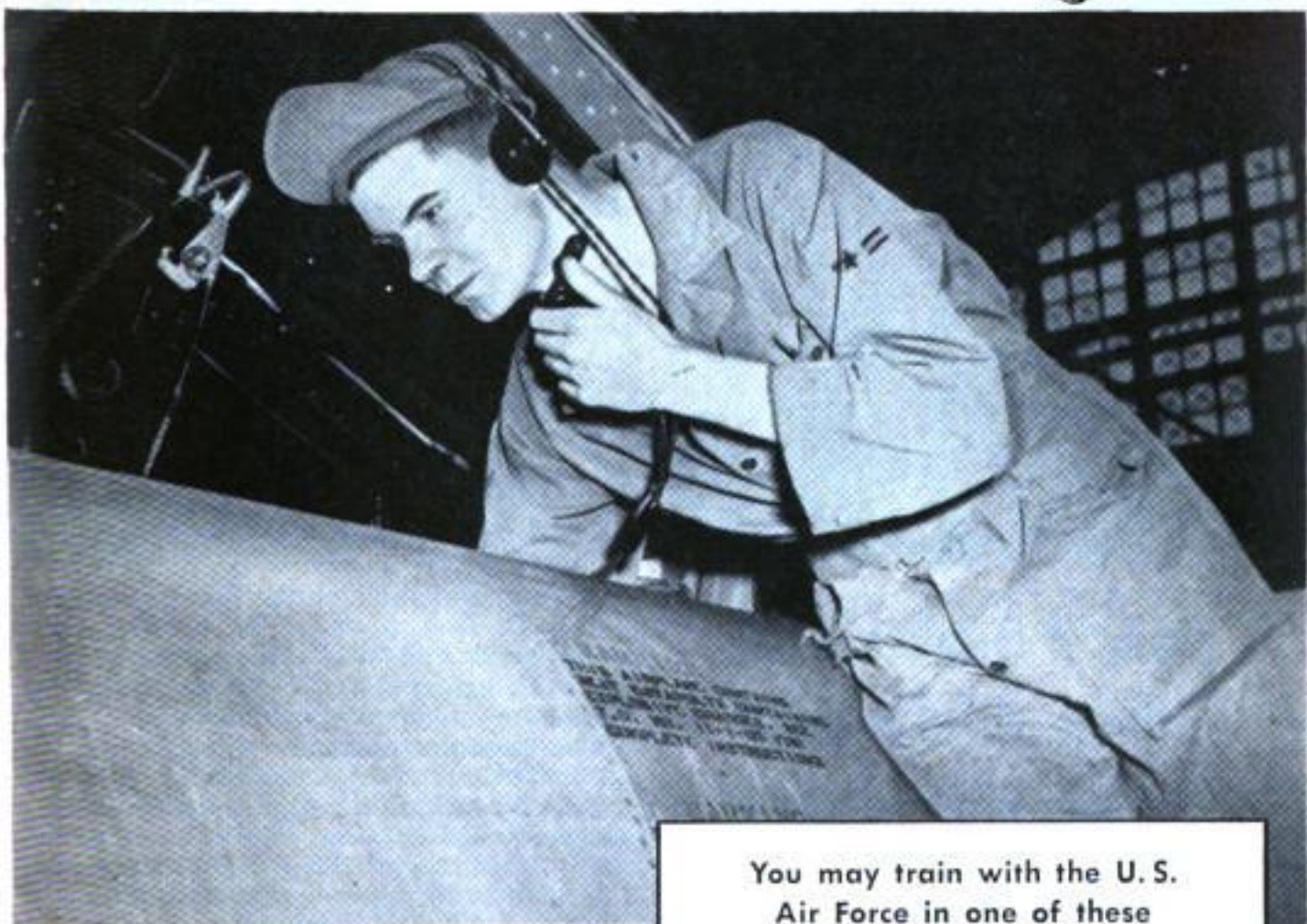

Young men who are interested in electronics, mechanics, or other technical specialties have an interest in the U. S. Air Force. As an Airman, you may have an opportunity to develop your technical ability and learn an interesting, exciting, and good paying skill. Act today and put your skills to work tomorrow. Put them to work where they'll do the most good...put your skills to work in the U. S. Air Force.

You go places – faster in the U. S. Air Force

You may train with the U. S.
Air Force in one of these
interesting specialties

Radio and Radar Maintenance • Mis-
sile Guidance Systems • Armament
Systems • Weapons • Training Devices
Maintenance • Wire Maintenance

M-10-PM

AIRMAN INFORMATION BRANCH
Personnel Procurement Division
Box 2202, Wright-Patterson AFB
Dayton, Ohio

Please send me more information on my oppor-
tunity as an Airman in the U. S. Air Force.

Name _____ Age _____

Address _____

City _____ Zone _____ State _____



"Make it Quaker State
...that's what is best
for my car!"



Super-refined from 100% Pure Pennsylvania Grade Crude Oil, world's finest. Famous for performance, protection, economy! Try it!

QUAKER STATE OIL REFINING CORP., OIL CITY, PA.
Member Pennsylvania Grade Crude Oil Association

Smoke-Eating Catalyst

(Continued from page 133)

a metallic air-filter mat and is made of high-resistance wire covered with platinum and palladium derivatives. It is designed to facilitate contact with as much of the fumes as possible without retarding the flow too much.

Hydrocarbons from the fumes unite with oxygen and "burn" without flame on the surface of the catalyst. The combustion heats the outflowing air. The higher the potential energy content of the fume-air mixture, the greater is the temperature rise.

An energy equivalent of 1 B.T.U. per cubic foot at 500 degrees Fahrenheit results in a catalyst-discharge temperature of about 600 degrees Fahrenheit. Energy concentrations of 5 B.T.U. per cubic foot or more, however, are encountered in fumes. The temperature rises as high as 1200 degrees and brings the catalyst element to a red glow.

The fumes are passed through the catalyst at around 500 degrees Fahrenheit to achieve the desired result. Grease on an axle doesn't do any pulling. Just so with the catalyst. The filter element doesn't enter the reaction—it just speeds it along at lower temperatures.

Norbert Ruff became the firm's sole employee in Detroit while his brother and Suter worked at other jobs. In 1948 he began building a test model with the research engineer of a chemical company.

The chemical company was faced with extinction if it couldn't control fumes from a phthalic-anhydride plastic base-making process. Fumes turned to acid on contact with moisture and the company was besieged by irate officials and householders from surrounding communities.

"They needed an answer—quick. We thought we had it," Norbert Ruff says.

The trio of engineers joined with the firm to build a tiny test model which worked. A full-scale test model uncovered a few bugs before 15 more units went into operation protecting the whole plant. The firm is socially acceptable now.

There are some shortcomings. Incombustible solids such as fly ash from wood fires will clog the elements. Fumes from zinc, lead and mercury "poison" them.

But the system does have wide application. It is used with paint, varnish, enamel and foundry core-baking ovens; with solvent-evaporation processes, coffee roasters, burn-off furnaces, fish-oil and animal-fat rendering processes; in paper printing and varnishing, asphalt processing, chemical plants and plastics manufacturing. ★ ★ ★

Just Married?

HERE'S A NEW HOME
COMPLETELY
FURNISHED FOR
\$2000 TO \$7500

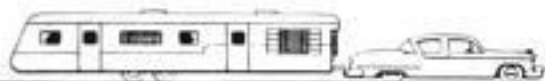

Kitchen comes fully equipped with latest gas range, electric refrigerator, trim sink and plenty of working and storage space.

Decorator styled living room is furnished with handsome modern pieces. Floor-length drapes cover big windows for evening privacy.

When you buy a new mobile home, you start right out with everything you need. Kitchen with the latest appliances! Living room, dinette, separate bedrooms beautifully furnished with sofa-bed, chairs, tables, beds, dressers, drapes. All the expensive needs you'd have to go out and buy for an ordinary house!

Automatic heat and proved insulation provide comfort in any climate. Tiled bathroom is complete with tub and shower! No other home offers so much for the money — plus mobility! You're free to move on a moment's notice to any of the beautiful mobile home parks now in every section of the country. It's the ideal home for young marrieds, industrial workers and folks who travel for work or pleasure.

Look for the MHMA emblem when you buy, for the members of the Mobile Homes Manufacturers Association are the leaders of the industry, pioneering improved designs, building to high standards.



Free book on latest models!

Pictures and full specifications. Write Dept. PM-85, Mobile Homes Manufacturers Assn., 20 N. Wacker Drive, Chicago 6, Illinois.

Name

Street

City..... Zone..... State.....



**MOBILE HOMES
MANUFACTURERS ASSN.**

From the start of the
job to the finish...



CHAN NEL LOCK

TRADE MARK REG. U. S. PATENT OFFICE

pliers are busy



here's why

Look for the Channellock line when you're shopping for hand tools. Channellock pliers offer features that you can't get with other makes. And when you buy a Channellock plier, ask to see the full line—you'll find a better way to do any job better.

SSSSSS

CHAN NEL LOCK

TRADE MARK REG. U. S. PATENT OFFICE

The Channellock line OBSOLETE ALL OTHERS
CHAMPION DEPARTMENT TOOL CO. • MEADVILLE, PA.

Sweden's Navy Joins the Underground

(Continued from page 108)

problems as brittleness, difference of expansion between the bit and the steel, variations in angles and radii of the bits, variations for different types of ore—all these and other difficulties had to be studied and solved. Millions of feet of rock were drilled from 1942 to 1952 while careful figures were maintained, comparing the efficiencies of conventional tools with those carbide-tipped. The startling results were clearly shown by the figures from a particular power project in the Alps where, halfway through the operation, a change was made from conventional to new methods: With conventional tunneling methods the men advanced 4500 feet in five months. The following five months, with new equipment, they advanced 12,400 feet. Speed increased from six to twelve inches per minute in hard granite.

Eight drill steels or jack bits were needed in the old equipment to accomplish the same work done by the new tools with only two or three sharpenings at the face.

Because the equipment is so light and flexible, it is now possible to place a hole exactly where it is wanted. It can be driven to any depth quickly, accurately and at a fraction of the old cost. Furthermore, a large Canadian mine, making a comparative study of the dust created by the conventional and the new steels, reported that conventional drilling produced two to seven times as much dust as the new drills. In other words, the new equipment lessens the hazard of silicosis.

Many companies in Sweden now share the rapidly expanding market for rock-drilling equipment. The output of that small country, estimated at 150 tons a year, is exceeded only by the rapidly growing output of the United States.

Though traditionally neutral and still aloof from NATO's defense pacts, Sweden is well aware that being rich in minerals and forests, and productive in her industries, she would be a rich prize for conquest. Four minutes by jet from Soviet air bases in the Baltic, she is in dead earnest in preparing her vulnerable nation, spending 17 times as much per capita as we do in the United States for home defense. For these shelters, for stockpiles of supplies, for training and promotional work, Sweden spends four dollars for every Swede. We, on the other hand, spend 23.5 cents per capita. Sweden allots seven percent of her military budget to the protection of her own country; only $\frac{1}{10}$ of one percent of

(Continued to page 216)

NEW POWERFUL ELECTRIC MOTOR for HOBBY • RESEARCH • INDUSTRY



Meet Wilson's NEW Hi-Drive motors—tiny yet powerful enough to motorize hobby items, toys, recording equipment, research devices, industrial models. Long motor and battery life. Other high-quality, low-cost items listed may help solve your motorizing problems.

- *No. 7-100—Hi-Drive Motor
1 1/2-3V **\$2.00**
- *No. 8-100—Same for 3-6V **\$2.50**
- *No. 9-100—Same for 6-12V **\$3.00**
- No. 3-100—Tiny Atom Motor,
1 1/2-3V **\$2.00**
- For higher voltages
- No. 5002—2-speed metal motor **\$2.50**
- No. 96—Steel frame motor with
gear, pinions, pulley, worm **\$4.00**
- *No. 3113—Tiny Atom motor
assembly kit with many acc. **\$3.00**
- No. 1300—Small accessories kit **\$1.00**
- No. 3700—Large accessories kit **\$3.00**
- No. 4000—Deluxe acc. kit with
motor **\$5.00**
- No. 700—Super-Power kit with
motor, speed reducer, all ac-
cessories **\$10.00**
- *No. 88—Kit of 8 pulleys—2 belts **\$2.00**
- No. 3000—Vari-speed gear unit **\$4.00**

* Item illustrated. Ask for FREE Cat.

All Wilson's motors have
Permanent Alnico V Magnets.

Remit with order and we pay
postage in U.S.A. No C.O.D. Add
2% Sales Tax for delivery in
Ohio. Write Dept. PM.

For quick delivery
see your local dealer
— or order direct



WILSON'S OF CLEVELAND

425 Lakeside Ave., N.W. • Cleveland 13, Ohio

POWER TOOL PROJECTS YOU CAN MAKE

This book shows you how to turn out professional-quality built-ins, furniture and toys. 30 easy-to-build projects. Drawings and step-by-step photos by the hundreds. Shop hints and short cuts. At most newsstands (Fawcett How-To Book 251) or at your SHOPSMITH dealer's! Get your copy today!



Guaranteed Auto Parts at Western Auto



URANIUM AND METALS

Easily located with the new M-Scope Detector. Superior Performance. Prices \$35.00 up. Monthly payment plan. Booklets "How to be a Successful Uranium Prospector"—"For Fun and Profit" free upon request.

FISHER RESEARCH LABORATORY, INC.
PALO ALTO CALIF.

Cut WEEDS, UNDERGROWTH & TREES FASTER—EASIER with



HOFFCO POWER TOOLS

Cut "from a blade of grass to 18" trees" with no pain or strain—use Hoffco's Portable clearing-cultivating tools. For complete details, write for FREE folder today! Hoffco Tools are fully guaranteed—sold everywhere.

HOFFCO, INC.

DEPT. 1 M • RICHMOND, INDIANA

Now! Do jobs you never tried before!

NEW! WELDWOOD® CONTACT CEMENT

MAKES "IMPOSSIBLE"
JOBS EASY!

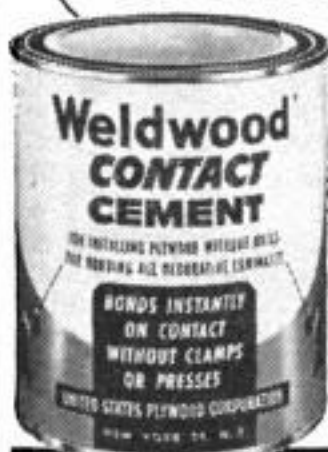

Another
Weldwood
Wizard

**BONDS INSTANTLY ON CONTACT
WITHOUT CLAMPS, PRESSES, NAILS!**

1001 USES FOR HOME, HOBBY, GARAGE!

THINGS YOU CAN DO!

APPLY MICARTA or other plastic surfacing materials, without clamps or presses!

PUT UP PLYWOOD paneling without nails!

STAIR TREADS—put down stair treads made of any material.
WEATHER STRIPPING—apply it to doors or windows of home or car.

PROTECT WITH FELT—apply felt bases to lamps, vases, etc.; make felt-backed protective covers for dining tables etc.

LEATHER—apply leather to any surface; desk tops, tables.

HOBBY WORK—model building; leather crafts; metal working; wood working.

ALUMINUM—make place or counter mats; cover anything with aluminum.

CLOTH & PAPER—apply cloth of any kind (canvas, upholstery material etc.) to wood, composition board or metal. Fasten paper to paper or anything else.

THINGS YOU CAN MEND!

Restore loose wood veneers, even in places where clamps can't hold — because no clamps are needed

Repair rainwear, beach bags, rubberized cases, furniture covers, etc.

Repair or replace weather stripping of home or car.

Repair or replace articles made of Novoply, Masonite, Weldwood Hardboard, Tekwood.

Reline or recover luggage; mend belts, bags, book bindings, etc.

Repair anything made of paper, cardboard, fabric and Fiberglas®

Repair convertible auto tops, torn seat covers or upholstery.

In tubes, bottles, cans, 25¢, 35¢, 60¢ and larger sizes at hardware, paint and lumber dealers and variety stores. Mail coupon for leaflet.

United States Plywood Corporation

Dept. 113, 55 W. 44th St., N. Y. 36

Please send me information on Weldwood Contact Cement.

Name _____

Address _____

City _____ Zone _____ State _____

America's military budget is spent to protect our industrial might or our irreplaceable skilled workers.

In this country, protective measures are left to the option of individuals. In defense-conscious Sweden, however, it is required by law that builders of all dwellings for three or more families must provide adequate underground shelter, and this must be done at their own expense, not that of the government.

Swedes are not only energetic, they are also tremendous realists. They know that enemy attack could strike at any moment, that neutrality in a hydrogen age is no longer a defense. With vigor, new tools and new speed, their blasting and burrowing continues.

In this country, only a small beginning has been made. To date, a limited number of insurance companies, banks and government agencies have started to convert caves to storage places for vital records—though not yet for the people. Large limestone caverns in western Pennsylvania, formerly used as mushroom cellars, are now being surveyed as possible public shelters. E. I. du Pont de Nemours & Co. recently built a huge underground concrete and steel vault beneath one of its buildings in Newark, Del., large enough to hold seven medium-sized houses. Perhaps this country

can look to Sweden for lessons in burrowing underground. ★★★

Collapsible Sawhorse

Wrought-iron brackets that clamp on to two-by-four lumber without tools permit assembly of a sawhorse in a matter of seconds. The brackets, made for over-all heights up to 36 inches, are strong enough to support 1000 pounds and can be used for interior scaffoldings. Their wrought-iron construction makes them particularly suitable for construction of horses that support picnic or banquet tables.

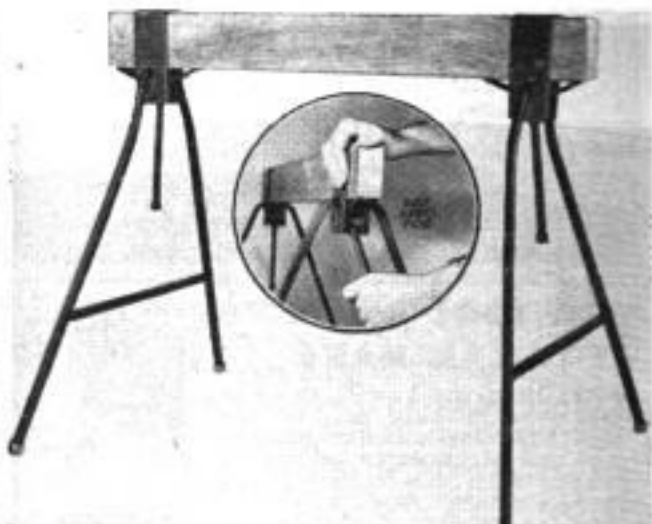

HOW AUTO ENGINEERS KEEP THEIR CARS TUNED UP WITH MIRACLE POWER

When engineers take a technical product to their hearts, you can bet it's really good. And auto engineers themselves tune up their engines with Miracle Power.

They know that most motor wear takes place in the first five minutes after you start your car, before oil has been pumped to all moving parts. They know, too, that the temperature in combustion chambers goes as high as 1400° F, while oil burns off at 550° F. And oil that's burned off can't lubricate. That's why even new cars can develop sticky valves, noisy hydraulic valve lifters, and sluggishness.

But Miracle Power provides lubrication under all circumstances. It contains colloidal synthetic graphite in suspension. The graphite forms a lubricating film that sinks into metal like hot butter into bread.

This coating won't burn off and it doesn't build up. It keeps your engine always tuned, prevents dry starting damage, lubricates in the combustion chamber, frees sticky valves and hydraulic lifters, cuts oil consumption.

Here's how you can use



Ford dealers' package

Miracle Power

Miracle Power is not a chemical. It's all lubricant. Follow the lead of auto engineers and try Miracle Power yourself. Add an 85c can to your oil and gas every 1000 miles; use the 39c size in gas between treatments.

Get Miracle Power at car dealers, garages, service stations. Miracle Power is available at Ford, Studebaker,

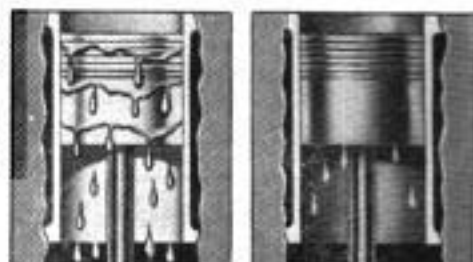

It takes up to 5 minutes for oil to be pumped to all moving parts of your engine. Meanwhile, your motor is running "dry" . . . and wearing out fast. Miracle Power prevents dry starting damage.

International Harvester, Kaiser, Willys dealers in their own Miracle Power containers. It treats the engine, not the oil.



Miracle Power Division
THE AP PARTS CORPORATION
AP Building E-8 Toledo 1, Ohio
Mufflers • Pipes • Miracle Power • dgf 123

FAMOUS LITTLE LIBRARY OF USEFUL INFORMATION

Complete Set
of 126 BOOKS
only \$17.95

25 BOOKS	\$3.75
12 BOOKS	\$2.00
5 BOOKS	\$1.00

SINGLE BOOK 25c

Here at amazingly low cost is the practical help and information you have always wanted. Articles in previous issues of Popular Mechanics have been classified according to subject and are now available in these handy reprint booklets.

Check titles wanted, clip ad, mail today.

HOME WORKSHOP

Power-Driven Saws—74: How to build.
Drill Presses, Plane, Grinders—79.
Sanders—80: Details on 8 machines.
Wood & Metal-Turning Lathes—81.
Filing Machine, Hacksaw, Cutoff Wheel, Shaper—82: Full details on these.
Metal Lathe Tools—101: How to build.
Workbenches and Tool Cabinets—47.
Spray Painting—94: Proper methods.
From Pattern to Casting—91: How castings are made in sand molds.
How to Use a Circular Saw—135.
Jigsaw Technique—136: How to use.
Bandsaw Know-How—137: Techniques.

HOME IMPROVEMENTS

Painting Your House Inside and Out—117.
Simple Home Improvements—104: Save money.
Building Extra Rooms in Your Attic—23: Add to the value of your home.
Basement Playrooms—24: Build an attractive playroom in your basement.
House Wiring—89: How-to-do-it.
Curing Leaky Basements—45.
Fitting Home Game Room—55.
Built-In Fixtures—78: Several.
Lower Your Fuel Cost—31: Practical kinks that will save you hundreds of dollars.
Hanging Wallpaper—38: Hints and tricks.
Ridding the Home of Insect Pests—107.
Constructing Indoor & Outdoor Fireplaces—88: Details on stone fireplaces.

CRAFTWORK • HOBBIES

Games and Puzzles—131: Have fun at home.
Model Planes You Can Build—129: Several.
Fun With Your Model Railroad—127.
How to Make Novelty Jewelry—126.
Working with Plastics—61: Novelties, etc.
25 Shelves You Can Make—64: Wall shelves, etc.
Novelties Turned on Lathe—62: Dishes, etc.
Projects in Plastics—112: How to use.
Inlay Pictures—Veneering—63.
Whittling and Wood Carving—65: Methods.
Action Toys—66: 21 easy-to-make toys.
Marionettes—113: How to make and use.
High Flying Kites—67: How to build.
Windmills & Weathervanes—68.
Lamps in Wood, Metal, Plastic—69: Several.
Bows and Crossbows—115: How to make.
Playground Equipment—73: 8 projects.
Metal Craft—28: Simple instructions.
Weaving and Recaning—37: Full details.
Gem Cutting—42: How to cut and polish.

USING TOOLS

How to Use Your Drill Press—125.
Correct Measurements—106: How to obtain.

Tool and Saw Sharpening—92: Tricks and hints.
Technique of Using Drills and Wood Bits—90.
Successful Wood Turning—32.
How to Read Blueprints—71: Tells you how.
Metal Turning Lathe Kinks—99.
Operating a Metal Turning Lathe—100.
Heat Treating and Case Hardening—102.
Working with Glass—103: Cutting, etc.
Using Basic Tools—120: Tips and hints.

WELDING • SOLDERING

Rewinding & Servicing Electrical Motors—75: Repairing and rewinding motors.
Electrical Appliances, How to Fix—111.
Electromagnets & Solenoids—44.
Transformer Construction—41: Directions.
The Boy Electrician—43: Five projects.
Soldering & Brazing—17: Tells how to.
Arc & Spot Welders—5: How to use & build.
Build Your Own Relays—123: Instructions.
Home Burglar Alarms, Secret Locks and Time-Setting Systems—128.
Welding with Arc and Gas—134: Tips.

AUTOMOBILE BOOKS

House Trailers—121: Build it yourself.
Automobile Kinks and Shortcuts—10.
Building Trailers—Small Teardrop and Utility—27: Can be built in your spare time.
Motor-Driven Midget Car & Scooter—34.
Curing Auto Electrical Troubles—95.

BUILD A BOAT

14 Ft. Outboard Runabout—2: How to build.
Rowboats, Bicycle Boat, Small Dinghy—83.
Small Sail Boats—84: For young sailors.
Two Outboard Runabouts—85: 14 ft. & 12 ft.
Build Your Own Canoe, Kayak, Surfboard—30: Complete building details.
Fast Glass-E Ice Yacht—22: Build your own.

GARDENING HELPS

Lawn and Garden Equipment—124.
Handy Farm Implements—114: How to build.
Tractor Attachments—116.
Backyard Gardening—39: Helpful hints.
Lawn & Garden Novelties—72: Easy to build.
Trellises, Pergolas, Fences—76.
Lawn & Garden Furniture—77.
Colored Concrete Garden Furniture—6.
Farm & Garden Tractors—8: How to build.

PHOTOGRAPHY

Home Movie Equipment—118: How to use.
Photo Lighting—119: Helpful information.
Photo Enlargers—1: Complete plans.
Photo Printers & Dryer—25: Describes three.
Photo Darkroom Equipment—96.
Picture Projector, Trick & Table Top Photography—97: Tips on how to make.
Photo Kinks—98: Money-saving ideas.

FURNITURE MAKING

Furniture Upholstery and Repair—122.
Rustic Furniture—18: How to build.
Children's Room Furniture—51.
Book Ends—52: Good selection from 10 designs.
Small Tables—54: Interesting styles.
Desks—53: Many varied designs.
Smoking Stands—56: Seven designs given.
Plain & Novelty Wood Finishing—40.
Book Cases—59: Eight designs.
Magazine Racks—49: Ten attractive racks.
Clock Cases—50: Several types.
Serving Trays for Every Occasion—53.

MISCELLANEOUS

Cleaning Formulas—11: Make your own.
Re-Silvering Mirrors—70: How to do it.
How to Build a Concrete Block Machine—110: Make your own block machine.
It's Easy to Tie Knots—105.
Chemical Experiments—93: Several.
Taxidermy—9: How to mount small animals.
Log Cabins and Tourist Cottages—14.
Magic for Everybody—29: Simple tricks.
Trapping Small Animals—33: How to trap.
Training Your Dog—35: Tricks and obedience.
Small Furnaces—36: For melting copper, etc.
Electroplating with Copper, Nickel, Chromium, Lead, Zinc, Cadmium—86.
Plating Non-Metallic Objects—Plating with Gold, Silver, Alloys—87.
Telescopes—20: Design and construction.
Poultry Houses—108: How to build.
Guns & Decoys—109: Clean guns, make decoys.
For Better Business—130: Timely tips.
For Better Business—132: Saves time.
For Better Business—133: For smooth operation.

USE THIS HANDY ORDER COUPON NOW!

POPULAR MECHANICS PRESS
200 E. Ontario St., Chicago 11, Ill.
I enclose \$_____ (U.S. currency may be mailed if carefully wrapped) for "Little Library" booklets numbers:

25 Books	12 Books	5 Books	1 Book
\$3.75	\$2.00	\$1.00	25c

NAME _____

ADDRESS _____

CITY _____ ZONE _____ STATE _____

Looking for Something?

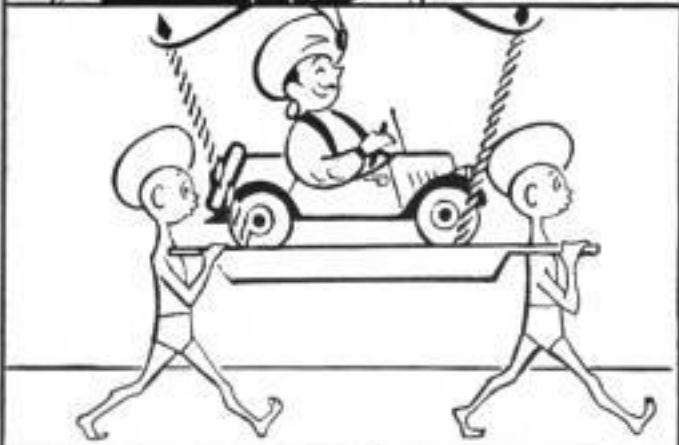
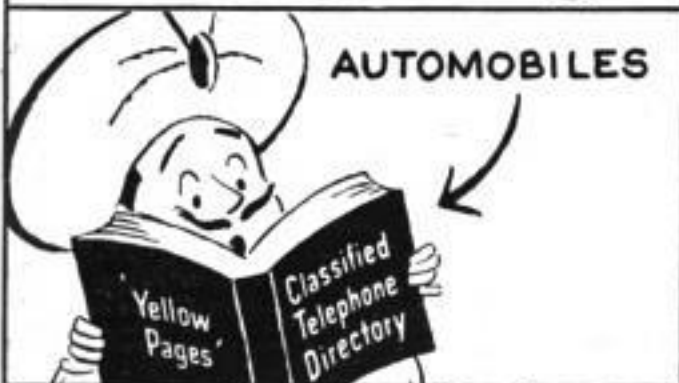

**FROM AUTOMOBILES TO TIRES
WHATEVER YOU NEED**

Find It Fast
In The
'Yellow Pages'



Big-Game Sculptress

(Continued from page 100)

Eyes, hoofs and noses she paints with the tip of an artist's brush.

It takes several hours for the coloring to dry, and in the meantime Frances Poe checks the weather forecast; you have to consider many things in this business. If a west wind is blowing the next morning, a downdraft will be created in the kiln and the oven won't reach the desired temperature. Gas pressure is at its height in the very early morning, so she places the pieces in the kiln soon after midnight. Baking, at a temperature of 2300 degrees, takes seven to nine hours.

The intense heat of the firing causes the decoration colors to fuse into the body of the figurine. At the same time, the clay and feldspar are gradually transformed into needlelike crystals suspended in glass. The network of crystals gives porcelain its strength. The purpose of the flint, which does not melt, is to act as a skeleton during the firing process. Silica remaining after the crystals have formed becomes the fine glass which gives porcelain its great scratch hardness and translucence.

Antlered figures like deer rest upside down in the kiln on little prefired clay racks. During the firing process, antlers twist and legs go out of shape. Miss Poe, checking on her work through a peephole in the door of the kiln, adjusts such peculiarities with clay weights hung on the twisted extremities.

Often she fires the figurines five or six times before all the pieces in a group are ready to be fired together on a common base. When all the pieces are perfect, she fills her air brush with a milky glaze and covers the entire group with the white substance. The glaze is composed of body material plus lead, zinc and whiting.

Again the pieces go into the kiln, this time for the glaze firing, which gives the figurines a permanent, durable and glossy sheen. This firing, at about 2200 degrees, lasts about five or six hours. If all goes well, and none of the pieces is broken, the group is ready for its trip to a customer or a showroom.

At this writing, you could only buy the miniature game animals from Miss Poe, from a small gallery on Chicago's Near North Side, or from her agent, Irving Tarrant. Tarrant, an art appraiser and special lecturer at the Art Institute of Chicago, will tell you that they're examples of a unique art form.

"To my knowledge," he says, "Frances Poe is the first and only artist to do the

(Continued to page 220)

1/4" ELECTRIC DRILL

One of the first and best home power tool investments. Full powered, permanently lubricated, drill in metal, wood, concrete. Complete Drill Tool set includes horizontal stand and accessories for polishing, sanding, sharpening, cleaning, buffing.



You'll Always Be Glad
You Bought a



FLAT SANDER

Fast, powerful, light, dependable—orbital action. At 4,000 cycles per second produces fine finish on all woods, metals, fibres, etc., wherever hand sanding is usually employed.

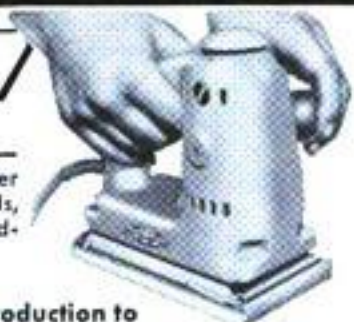

The SIOUX name needs no introduction to the skilled mechanic who makes his living working with power tools. In the aircraft and automotive fields and in industry they're the tools the professionals have used for over 40 years!

WRITE FOR
FREE
CATALOG!



ALBERTSON & CO., INC. • SIOUX CITY, IOWA

POWER SAW

This modern SIOUX hand saw is really rugged with a world of surplus power. Available in 8 1/4", 7 1/2" and a 6 1/2" Model that will saw through 2 x 4's at a 45° angle with plenty of blade to spare.

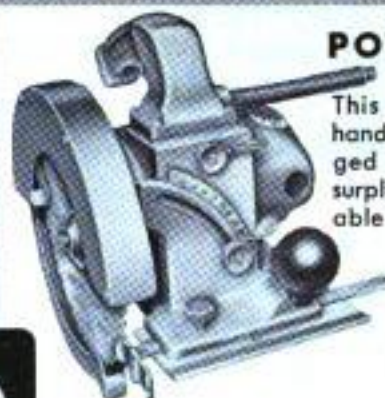

Mitre Cuts—Adjustable base for bevel cuts from 0 to 45°, to 1 1/4" depth. Spring lift with nut adjustment is quick, accurate.



Cross Cutting—Edge of base follows line. High speed makes it many times faster than hand sawing.



Rip Sawing—Adjustable rip scale guide is plainly graduated in fractions of an inch. Blower keeps line of cut free of saw dust.



1955 CATALOG—Send 35c

70 Models for '55! See the world's finest line before you buy. Rated tops in design, styling, performance by the experts. '55 catalog plus booklet "Boat Selection, Operation, Maintenance" \$1.00

Custom-Craft THE ORIGINAL "PACKAGED" BOAT KITS

BOAT PLANS AND FULL-SIZE: PATTERNS

Over 100 Modern plans and full size patterns. Racing classes, cruisers, inboards, outboards, sail boats. By famous designers. 6' to 30' DESIGN CATALOG only 35c. For Design Catalog plus boat building handbook send \$1.00.

CUSTOM-CRAFT (DEPT. A) BUFFALO 7, N. Y.

BUILD FINE GRANDFATHER CLOCK NOW

The simple sensible Red-i-Kut way as thousands have—SAVE HALF. SHOP TESTED PLANS "SPIRIT OF THE CENTURY"—Narrow waist, 8 1/2" tall or stately straight side "SPIRIT OF AMERICA." EASY-to-FOLLOW photographs! PLANS tell all—plus BROCHURE of heavy brass weight Westminster, tube chime, movements, gorgeous dials, 3/4" solid mahogany case kits. Send \$1.00 today—Both plans \$1.50 NOW.

KUEMPEL CHIME CLOCK CO., 7 Kuempel Bldg., Minneapolis 16, Minn.

Need an extra \$1,000, \$2,000, or more? Make it with an IDEAL LAWNMOWER SHARPENER



There are thousands of lawnmowers in your locality! Average \$1,000 profit per 250 mowers with customer satisfaction and repeat business assured. Provide this essential service with an Ideal Lawnmower Sharpener, the only machine that grinds the reel to "fit" the bed knife. Compare by any standard. The Ideal, backed by 53 years of experience, costs no more. Write today for complete, free catalog.

THE FATE-ROOT-HEATH COMPANY
Dept. PM-8 Plymouth, Ohio



LOWEST COST PER MILE

Here is the electric fuel pump that will give you greater power and faster acceleration. The Bendix* Electric Fuel Pump has better performance with less operating cost per mile. Sold by independent garages and service stations.

*REG. U. S. PAT. OFF.



FREE: A complete descriptive folder is yours for the asking. Write us today.

Bendix

ELECTRIC FUEL PUMP

Grand Prix Winner

ECLIPSE MACHINE DIVISION, BENDIX AVIATION CORP.
ELMIRA, N. Y.

Holt's WORLD FAMOUS
"Do-It-Yourself"
PRODUCTS

HOLT'S ORIGINAL
PistonSeal

does help in
6
important ways

- 1 - reduces oil consumption
- 2 - restores compression
- 3 - stops piston slap
- 4 - increases miles per gallon
- 5 - improves performance
- 6 - makes engine quieter

Good for 10,000 miles of carefree driving. Next best thing to a complete motor overhaul . . . at 1/20 the cost. Today's biggest seller. Millions of tubes have been sold throughout the World during the past 18 years. Undeniably safe for even the finest engines. Endorsed by leading technical automotive experts. Easy to use. \$4.95 a tube POSTPAID for most cars

\$1.69
CAN

Holt's
GUN-GUM
MUFFLER SEAL

Mends leaky mufflers -
seals pipes and joints

Sets like a weld in
a few minutes.
Apply by hand

At Every Auto and Accessory Store
TREGLOWN CO., Inc.
Fanwood 43, N. J.
CANADA: 1366 Greene Ave., Montreal 6
Prices slightly higher in Canada

Write
for full
details

Red Devil

**PUTTY KNIVES
WALL SCRAPERS
SPACHTLING
KNIVES**

Top-quality professionally-styled at prices to suit your pocket-book. High carbon, tempered steel blades — imported hardwood or tenite handles.

FREE How to Fix Broken Windows. Illustrated instructions on cutting and replacing window panes.

Red Devil Tools. Dept. 147
130 Coit Street, Irvington, N. J.
Please send FREE copy of "HOW TO FIX BROKEN WINDOWS."

NAME _____
ADDRESS _____
CITY _____ ZONE _____ STATE _____

diversified American animals in the difficult medium of porcelain."

On display in the gallery you'll find deer, elk, moose, caribou, sheep, goats, antelope, musk oxen, bison, bears, pumas, jaguars and even tiny skunks of porcelain. Once a week or so, Frances Poe will turn out a new figure. Just about as often, one of her admirers will purchase an animal at a price ranging from \$3.50 to \$150.

It's not a mass-production operation. Each figurine is an individual sculpture, and takes her at least three days. No molds are ever made. Twenty percent of the work still shatters in the kiln, and 40 animals are a good year's production.

The people who buy the figurines are almost as diversified as the animals themselves. And each has a different reason for his purchase. There's a doctor who likes the anatomical correctness of the animals, a ceramics engineer who's been to all the famous potteries of Europe without finding their match and an artist who's furnished an entire room around his collection of her work.

Her next big project? Chances are it will result from a bit of detective work she's conducting on the black jaguars of western Brazil. (Now that she's finished sculpturing all of the large North American game, she has turned to South America.) According to the natives, the jaguar lures fish with his tail. He slaps the water with it in imitation of falling fruit and grabs the deluded fish as they surface. But you won't be able to buy a fishing jaguar until the rumor is thoroughly checked, for Frances Poe is a careful "workman."

In the meantime, also, you'd have to play second fiddle to a kingfisher with a fractured wing or a stray dog with a broken foot. Animals always have priority over business at Poe's. ★ ★ ★

Listening to Lightning

Lightning flashes in all parts of the world are heard and recorded by special radio equipment built by Leonard N. Liebermann, associate professor of geophysics of the University of California's Scripps Institution of Oceanography. Lightning, it has been found, produces "static" which is able to travel around the world because of a layer of ozone 40 to 60 miles above the earth. The antenna of Liebermann's radio receiver gives him the direction from which the lightning strokes originate, and the tone of the signals tell him how far they have traveled. The received signals are within the frequency range picked up by the human ear.

DO IT YOURSELF

It's Easy With ...



Soldering's really a "cinch" ... when you use time-tested, reliable KESTER ... available everywhere.

FREE! "Soldering Simplified" ... 16-page how-to-solder booklet. At your dealer or write direct.

KESTER SOLDER COMPANY
4251 Wrightwood Avenue Chicago 39, Illinois

MONEY MEN ALL DATA FREE

THE PLASTEX Industry needs manufacturers on small scale and for big production of Lamp and Clock Stands, Art Goods and Novelties in Plastex and Marble imitation. Experience unnecessary. 1/2c material makes regular 10c store sellers. Rubber moulds furnished for speed production. Small investment brings good returns. We are now placing big Chain Store Orders with manufacturers. Ambitious men have chance for real prosperity. Our Free booklet will interest and benefit you.

PLASTEX INDUSTRIES, Dept. A
3400 Third Ave. New York 56, N. Y.

12 ft. SPORTBOAT KIT

Includes ready-cut parts and hardware. Models low as \$39.00 freight incl.



TAFT MARINE WOODCRAFT
Dept. PM-8, 636 39th Ave. N.E., Minneapolis 21, Minn.

only \$95 freight incl. Write For FREE FOLDER

Exclusive Double-Bearing HEAVY-DUTY PUMPS

IRRIGATE • DRAIN • CIRCULATE • SPRAY
Up to 7,500 GPH. 3,000 GPH from 20" well. Use 1/2 HP motor. 1 1/2" inlet; 1" outlet. Stainless shaft. **TYPE X**—2 oilless bronze bearings. **\$10.95**
TYPE XB—Ball bearing model. **\$12.95**
Postpaid if cash with order. (West of Miss. add 50¢)

MONEY BACK GUARANTEE
Centrifugal and Gear Pumps in All Sizes
LABAWCO PUMPS, Belle Mead 2A, N. J.

VIPEE - A SAWHORSE IN A Jiffy

Jiffy Brackets and 2x4s are all you need. Set up and knocked down in a jiffy—no nails, screws, or bolts required. Easy to move or store. Sold by hardware and building supply stores everywhere, or order direct.

GRAND HAVEN STAMPED PRODUCTS CO., Grand Haven, Mich.

2 GREAT AUTO BARGAINS



KING MIDGET for 1955. Lower priced, improved performance. Drive it for 75c per week. Rider agents wanted—earn your own car. Also just out, **KING MIDGET JUNIOR**, finely engineered, less than one-third cost of any comparable car, one twelfth cost of large cars. Agents wanted. **IT WILL PAY YOU TO GET THE FACTS**—send 25c for literature and agents propositions on both cars, or \$1 (refunded first order) for this plus actual assembly book and service manual.

MIDGET MOTORS MFG. CO.
ATHENS 1, OHIO



ADD-A-ROOM
the easy way...



use Gold Bond Building Products

Let Gold Bond show you how to turn a porch, an unfinished attic or unused basement into more living space for your family. Get the facts on how silvery Gold Bond Rock Wool Twinsulation can actually save you up to 25% on winter heat bills and keep you up to 15° cooler in summer. See the step-by-step construction details that show how fireproof Gold Bond Gypsum Wallboard makes smooth, strong walls. And finally—learn how to decorate with the easiest-going paint in the world—beautiful Gold Bond Velvet. Send in the coupon below, plus 10¢ to cover mailing, for your own Gold Bond Add-A-Room Packet. It's full of ideas for your home.

NATIONAL GYPSUM COMPANY • BUFFALO 2, N. Y.

MAIL THIS COUPON TODAY!

NATIONAL GYPSUM COMPANY
Dept. PM-85, Buffalo 2, N. Y.

Please rush me your new Gold Bond Add-A-Room Packet. I enclose 10¢.

Name.....

Address.....

City.....Zone.....County.....State.....



Air Purifier

Ultraviolet rays freshen and sterilize the air of a home equipped with a new electrical air purifier. The low-cost unit, which fits into an air-conditioning or heating duct, is said to produce a 90-percent kill of airborne organisms. The cold-cathode ultraviolet lamp used operates continuously for about two cents a day, and is replaced at

the end of a year. It produces one band of ultraviolet light which destroys airborne bacteria, and another band which attacks odors and eliminates staleness. Similar applications have been used for some time to purify recirculated air in hospitals, food plants and public buildings.

Radar Controls Freight Cars In "Hump" Yards

Several railroads are installing radar and electronic computers in "hump" yards to control freight cars. A hump yard has an artificial hill. Freight cars are pushed to the top of the hill, uncoupled and allowed to roll into the yard, where they are guided by switches to the proper track, thus assembling them into trains. Electric "car retarders" and push-button switches have taken most of the labor out of the hump yard. Now the General Railway Signal Company has developed radar instruments which track the car as it moves through the yard. An electronic computer integrates the car weight, curve resistance of the route, weather conditions, rolling distance and other variables. Electrical impulses then operate the retarders to ease the car into its proper track at just the right speed for gentle, damage-free coupling.

It's
Revolutionary!

INDESTRO
TOOLS Built for Service

Help Yourself to Better Tools at
the Store that Displays the . . .

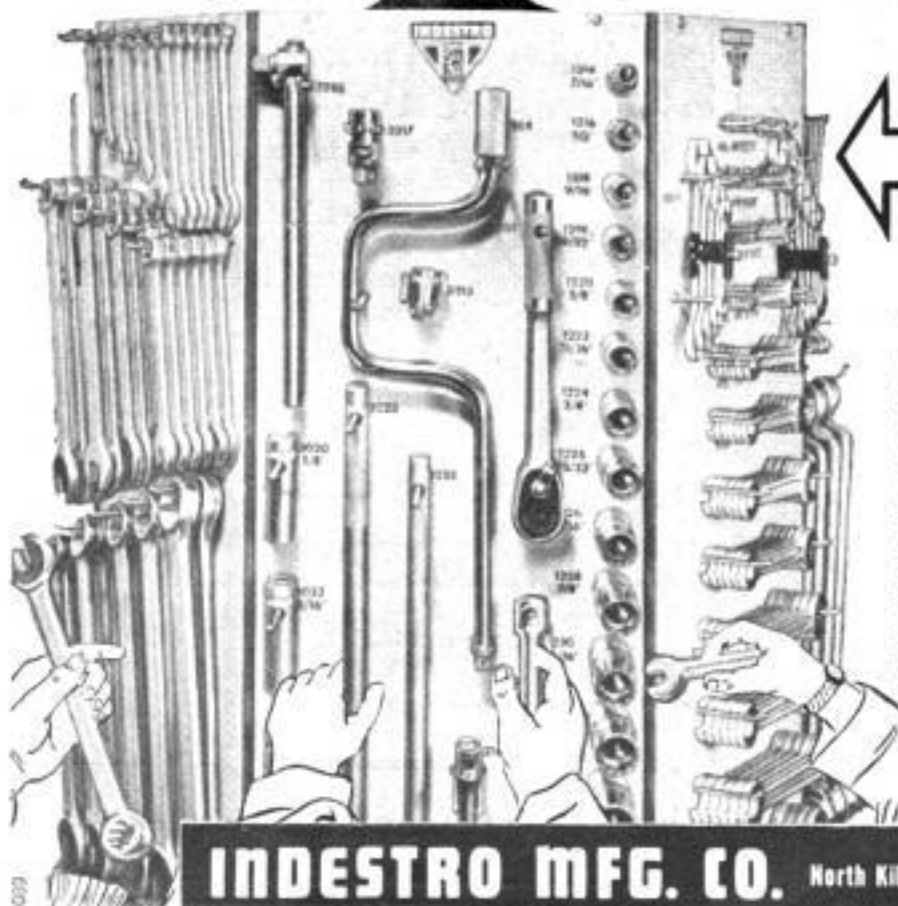

Wait-on-yourself for your "Do-it-yourself" tools, at the nearest hardware, auto supply or variety store that has the revolving Indestro Servatool Selector on the counter. Pick out your screw drivers, sockets, wrenches, pliers, chisels, punches and other hand tools this easy, quick, modern way. Get the "feel" of these professionally-preferred tools before you buy them; handle them; test their grip, fit and balance for yourself; feel the smooth chrome-plate finish of the chrome alloy steel. Select the tool that's right for you. You don't need to wait for a salesman; the sizes are all plainly marked. They're all Indestro Tools, which means a big value for your money.

If you can't find an Indestro Dealer near you, write us for the name and address of the one nearest your home.



INDESTRO MFG. CO. North Kildare at Schubert, Chicago 39, Illinois

HOME REPAIR TIP No. 16



MEND INFLATABLE TOYS quickly, easily, with "SCOTCH" 33 Plastic Tape. Stretchy, waterproof tape holds fast, makes airtight seal. Use it, too, to repair plastic wading pools, wrap electric wire splices, tool handles. Get "SCOTCH" 33 Plastic Tape—39¢ and 79¢—at your favorite store. Made by Minnesota Mining and Mfg. Co., St. Paul 6, Minn.



MAGNETS **225^{lb.}**
PULL
GENUINE ALNICO—NEVER WEAKENS

AMAZING, PERMANENT MAGNETS—WILL NOT WEAKEN! NON-ELECTRIC Retrieve guns, tackle, tools and other steel items from lake, river, plating tanks, drains or other hard-to-reach spots. Recover drills, taps, etc. from sweepings. Clear alley of harmful tacks, nails. Many other uses. Pays for itself quickly. **GUARANTEED.** Try any magnet one week. Money refunded if you are not well pleased.

No. M-725 (Weights 54 oz.) Has pull of 225 lbs. on steel block. \$15.00
No. M-925 (Weights 70 oz.) Has pull of 125 lbs. on steel block. \$ 8.50
No. M-575 (Weights 18 oz.) Has pull of 75 lbs. on steel block. \$ 6.00
No. M-500 (Weights 13 oz.) Has pull of 50 lbs. on steel block. \$ 4.00
No. M-101 U-shaped Magnet (Wt. 2 1/4 oz.) Pull of 6 1/2 lbs. 2 for \$ 1.50
No. M-291 Pocket Magnet (Wt. 1 1/2 oz.) Pull of 4 lbs. 2 for \$ 1.15
No. M-35 Hobbyist assortment of eight small magnets. . . . \$ 1.50
No. M-48 Powerful Hot Pad Magnets. 8 for \$1.00. 30 for \$ 3.00

Send Money Order or Check. We pay postage. No C.O.D.'s.
MIAMI MAGNET COMPANY, 3240 N. W. 27th Ave., Miami 42, Fla.

FIND URANIUM!!!

Prospecting made easy with Goldak's new U-238C triple-action geiger counter! Also famous line of metal locators, from \$49.50
Send 25c for radioactive uranium sample!
FREE DETAILS. Dealer Inquiries Welcome.



GOLDAK COMPANY 1542 W. Glendale Blvd., Glendale, Calif.

Earn Big Money! DRY CLEAN RUGS



New Easy Way! Dry clean rugs on location in homes, stores—fast and easy—machine does hard work for you! Amazing ALM-13 machine with Float-Action Brush whirled cleaning material into rug fibers—gets out grime, dirt like magic! Use rug at once. Also, use same machine with no-tool attachments to clean, wax, polish any floor—*make extra profits!* Write for details.

AMERICAN Floor Surfacing Machine Co.
535 So. St. Clair St., Toledo 3, Ohio

BUILD
your own **SMITH**
AIR COMPRESSOR

Operates spray guns, rock drills, tampers, paving breakers, sandblasting . . . Uses only 1 gallon of gas an hour! Famous the world over! Capacity 60 cu. ft.; pressure up to 100 lbs. per sq. inch. Just order the Smith Compressor Head and Accessories with complete instructions for assembling. All you need is a Ford Motor and shop facilities. Head equipped with high speed compressor valves; automatic unloading and idling.

Write for complete information!

GORDON SMITH & COMPANY, Inc.
410 College Street • Bowling Green, Ky.

CUT FUEL BILLS

UP TO
40%
with

TORIDHEET'S

Direct
Heating
Action



Unlike conventional heating units TORIDHEET'S flames actually *contact* the walls of the combustion chamber, communicating their tremendous heat directly to the surfaces which heat the water or air.

This *direct heating action* insures the maximum efficiency from your fuel. Think what this means to *you*—in dollars and cents.

COMPARATIVE EFFICIENCY TABLES

Conventional Coal Furnace	Oil in Ordinary Burner	Oil in Toridheet Burner
Heat	Heat	Heat
Wasted Gases	Wasted Gases	
Soot and Carbon	Carbon	
Ashes and Cinders		Wasted Gases

Complete furnaces or conversion burners—oil or gas

Get the **FACTS** on fuel savings up to **40%**
MAIL THIS COUPON TODAY

TORIDHEET DIVISION
Cleveland Steel Products Corporation
16027 Brookpark Road • Cleveland 11, Ohio
Please send me "Fundamental Combustion Facts"
—a report on TORIDHEET direct heating action.

Name _____
Address _____
City _____ Zone _____ State _____

Affiliated Canadian Manufacturer: Aero Tool Works Limited, Toronto, Ontario

How to **PROTECT** hobby equipment from **MOISTURE DAMAGE**



Just plug in the amazing
FRIGIDAIRE electric **DEHUMIDIFIER**

Positively controls moisture in workshops, basements, or any closed area up to 10,000 cu. ft. where moisture is a problem.

See your Frigidaire Dealer for details. Or for free folder write to Frigidaire, Dept. 2393, Dayton 1, Ohio. In Canada, Toronto 13, Ont.

18 1/4" high, 20 1/2" long,
11 3/4" wide



 **Built and backed by General Motors**

You get **MORE LEVERAGE,**
FIRMER GRIP with

**ADJUSTABLE
WRENCHES**

No Slipping
or "Knuckle Busting"

You get three full bearing surfaces! No inside corner lips to interfere. Special analysis P&C heat treated steel adds extra strength. There's a difference in wrenches. Be sure you buy P&C... guaranteed, the best tools money can buy. Shop from P&C displays; in over 10,000 stores. Send 10c for big tool catalog.



P&C
Hand Forged Tool Co.

Dept. H5, Box 5926
Portland 22, Oregon



Clymer Tests the De Soto V8

(Continued from page 126)

lively engine that on long stretches would push the car along at 110 miles per hour on the speedometer (which was about 6 percent on the high side). The engine is as free from vibration as any I've tested. All Chrysler-built products have rather soft front ends when cornering and De Soto has the usual amount of soft spring roll but, in spite of this, there is a great amount of stability at all speeds. I had the feeling that the car was always well under control, regardless of road condition or speed.

Chrysler's power steering is better than when first introduced. The steering wheel returns to normal position without help from the driver after cornering. If the hands are removed from the steering wheel when coming out of a corner, the front wheels automatically straighten out. The 3.5 turns of the wheel (without power there are 5.5 turns) from lock to lock are satisfactory, but there still is a tendency to oversteer with power steering.

I abuse the brakes a great deal in my tests and I found De Soto brakes to be tops. The parking brake is one of the best I have ever used, but I still don't care for a transmission hand brake as compared with the conventional parking brake on the rear wheels.

In passing other cars on steep grades and even on long hills the kickdown (below 60 miles per hour) feature is quick and positive. There is a real surge of power as the lower gear reduction smoothly takes place and, unlike with the old slow-shifting De Soto Fluid-Torque, there is a thrill in operating the PowerFlite-equipped car. There is some creep or forward movement when Low or Drive is engaged with the engine idling.

Over sand-rutted roads, up and down steep grades and on sharp turns I could uncover no defects, except a couple of body squeaks. Each was noticeable for a few miles and then disappeared.

I tested the car with both premium and regular gas. While premium is preferable, the car had less ping on regular gas than most cars with high-compression engines. Owners will get decent service on the cheaper grade of gas. De Soto's hemispherical combustion chambers are responsible for this.

The two-speed, electric windshield wipers are excellent. I am happy to see De Soto still using practical bumpers without the bulletlike projections, so that another car can be pushed in an emergency.

I especially like the instrument panel,

(Continued to page 226)



*To get the best in
do-it-yourself materials
and tools...*

**BUY
NAME BRANDS
FROM YOUR LOCAL
HARDWARE DEALER!**

Doing it yourself is real fun when you have the right materials and tools, and you get better results! The editorial pages of Popular Mechanics provide you with a wealth of do-it-yourself information and projects, and the advertising pages serve as your buyer's guide to quality tools and materials.

You'll find these tools and materials at your local hardware dealer. He's waiting to serve you . . . ready to help you

buy wisely. During August, many of the things you're looking for will be on display in his store window. For August is when leading hardware dealers throughout the nation will feature a special Popular Mechanics window display of quality do-it-yourself merchandise.

Visit your dealer to examine the products he has on display. You can buy any of these items with an assurance of quality and satisfaction, for they're advertised in Popular Mechanics!

*When you buy
brand names...you
can be sure it's good!*

To get the most for your money, always buy brand name tools or products. It's your assurance of quality, and will prove the most economical in the long run. As extra assurance, be sure the things you buy are advertised in Popular Mechanics!

**POPULAR
MECHANICS
MAGAZINE**

IN INDUSTRY...



The Jacobs Ball Bearing Super Chuck . . . unmatched for gripping power, accuracy and durability. The chuck for heavy duty drilling.

AND IN THE

HOME SHOP



The Jacobs Multicraft Geared Key Chuck . . . the tight-fisted grip of fine light weight power tools. Multicraft is a simplified version of Jacobs' rugged Super Chuck.

This is another practical example of how Jacobs engineering skill converts industrial experience into practical benefits for the home shop tool user.

When you buy power tools for your shop, look for Jacobs on the chuck. Whether you prefer the Multicraft Geared Key Chuck shown here, or the Rubber-Flex Hex-Key model, there is none better than Jacobs. The Jacobs Manufacturing Company, West Hartford 10, Conn.



Jacobs

CHUCKS

If it's a Jacobs it holds

except that I think the small gauges should be more readable. The needle indicators are preferable to the red warning lights now used by many makers.

The heating and ventilating system is efficient, although somewhat noisier than necessary with the blower operating.

You can't beat the window cranks on De Soto. Less than two turns of the crank open or close the window.

De Soto, like all other Chrysler products, has the new automatic-transmission lever on the instrument panel. The more I use this the more I like it. One reason is that it eliminates any obstruction under the right side of the steering wheel.

The wrap-around windshield affords good front vision, although some owners feel there is some distortion at the edges and that the corner posts are too thick. I can't see much difference in front and side vision with the wrap-around windshields.

I like the new door handles. When you push with the thumb, the handle pops out so it is easily grasped by the fingers. The doors open easily. From an opening of only 12 inches, the door will automatically close without assistance, merely by its weight. Very little pressure is needed to close the doors.

I like the driving position, the springing and the proximity of the wide brake pedal to the foot throttle, also the large trunk, the roomy interior and the appointments and color combinations.

I found some water leakage at the lower left corner of the windshield.

The turn-indicator lever is too far away from the steering wheel. It should be raised at least two inches.

The most annoying feature I found is the operation of the release lever for moving the front seat forward and backward. The lever not only requires a lot of pressure, but a flimsy wire arrangement runs across under the seat to lock it. There is too much effort required to adjust the seat. One wouldn't expect to find such sloppiness when almost every other feature is well designed. (I understand De Soto is changing this feature and perhaps by the time this article is in print an improvement will have been made.)

During a drizzling rain, when the front door was opened, water dripped onto the running board and carpet from a point below the ends of the windshield. When the door is closed, it squeezes the rubber water gutter, creating an obstruction where the water normally would drain out. ★ ★ ★

☞ Cosmic rays cause ions that give raindrops their electric charge, according to a recently advanced theory.

It's the **BOUNCE THAT COUNTS!**

Lumiclad
ROOF COATING

The amazing insulation quality of Lumiclad provides low-cost temperature control. Keeps buildings cooler in summer! Warmer in winter. Apply Lumiclad yourself...goes on quickly, easily.

WRITE FOR **FREE TEST KIT!**

Dept. 85J

Abesto MANUFACTURING CORP.
MICHIGAN CITY, INDIANA



24-Page Illustrated DO-IT-YOURSELF PROJECTS BOOK

Describes attic finishing, built-in cabinets, add-a-room, recreation room, kitchen remodeling, summer cottage and farm projects. Contains helpful information on how to get started, planning, cost estimating, materials purchasing, and proper procedures, also nail charts, moulding designs, etc. Send only 25c and also receive **FREE 52-PAGE POWER TOOL CATALOG.**

BOICE-CRANE COMPANY, 943 Central Avenue, Toledo 6, Ohio

EARN GOOD MONEY IN SPARE OR FULL TIME.

With a **Universal Lawn Mower Grinder**

Have a business of your own in your garage or basement, sharpening lawn mowers. Be your own boss. Small investment. We furnish everything you need to start. Write **FREE** Dept. M-85 today for complete details



ROGERS MANUFACTURING CO.
LINDSEY, OHIO

MACHINE TOOL RECONDITIONING & THE ART OF HAND SCRAPING

—USEFUL FOR DESIGN, SHOP & INSPECTION WORK—

SEND FOR FOLDER DESCRIBING ILLUSTRATED BOOK

MACHINE TOOL PUBLICATIONS, 382 Holly Ave., St. Paul 2, Minn.



Get New 148 Page Catalog of **WOOD AND WOODWORKING MATERIALS**

WORLD'S LARGEST SELECTION—Lowest Prices
Your buying guide for finest kiln dried domestic and rare imported woods, inlays, bendings, matched plywood, mouldings, ornaments, etc. Biggest selection of tools and hard-to-find hardware. Packed with a full saw pattern, projects, wood facts and money making ideas. Enclose 25c (refunded on first order) to help pay mailing and handling costs. Write today to **CRAFTSMAN WOOD SERVICE CO.**
2729 S. Mary St., Dept. A-8, Chicago 8, Ill.

INTERNATIONAL

Insist on the genuine original

DRILL SAW, REAM . . . metal, pipe, wood, plastic, Transite, etc. Use with electric drill, slow drill press, lathe, milling machine. Drills own starting hole, upper part of bit is used to cut, saw, ream circles, oval, square, scrolls. Easy to use. Ideal for carpenters, mechanics, electricians, plumbers, hobbyists, etc. Abrasive resistant, high speed steel. Flutes ground from solid. Withstands severe continuous use without breaking. Reshaped free. Takes place of up to 150 in tools. 1" diameter, 2" cutting sections, total length 3 1/2". Three types—All Purpose, Wood, Heavy Metal. Specify type wanted. Set of three \$11.50. Details on request. Shipped same day. Money-back guarantee. Dealer inquiries invited.

Order Now Send Cash, Check or Money Order to **INTERNATIONAL TWIST DRILL CORP.**
618 Wyandotte, Rm. 635, KANSAS CITY, MO.

Only \$3.95
POST PAID

Hastings Oil Filter Cartridges keep oil clean from filter change to filter change* when replaced as normally recommended... The reason is



DENSITE



Densite—an amazing new type of filtering material—is made of millions of selected raw cotton fibres, pressure packed so oil must flow through countless tiny openings, pass many surfaces of fibres. The most microscopic abrasives cling to these fibres—and stay there!

Next time you change oil—change your filter cartridge. Ask for Hastings and have clean motor oil *all the time!*

* As proven by tests conducted in accordance with U. S. Bureau of Standards procedure.

HASTINGS MANUFACTURING COMPANY
HASTINGS, MICHIGAN

HASTINGS
OIL FILTER CARTRIDGES
with **DENSITE**

NEW Easy-to-Use SOLDER*



Solders metals instantly
...just apply **Swift**
and heat

Swift is real 50/50 Tin-Lead solder with flux in paste form that makes all kinds of soldered connections permanently—and fast. No separate flux needed. Just apply Swift by squeezing the unbreakable plastic tube and heat with torch or iron—on small jobs even a match will do the job perfectly. Each tube holds enough solder for hundreds of jobs. Swift has been used by professional plumbers for years. At hardware stores, hobby shops, plumbing dealers, auto stores. 59¢.

HERCULES CHEMICAL CO., INC.
332 Canal St., New York 13, N. Y.



The easy way to paint!

Speedy Sprayer



Favorite of home owners and craftsmen for 20 years! SPEEDY SPRAYER gives your work that professional paint finish everyone admires. Sprays paint, enamel, varnish, lacquer, etc. . . . 4 to 7 times faster than hand brushing! Lightweight, portable, uses any 1/4 H.P. motor. Improved diaphragm principle assures clean, oil-free air. You'll find dozens of time and money saving uses for SPEEDY SPRAYER, including spraying insecticides 2-4-D and DDT. Complete outfit, without motor, only \$36.50.

At leading hardware, lumber, and auto supply dealers.
FREE—write for handy booklet "How to Spray."

W. R. BROWN CORPORATION
2635 N. Normandy • Chicago 35, Ill.

ONLY
\$36.50
LESS
MOTOR

"Easy to Handle and Beautiful," Report Owners of the De Soto

(Continued from page 130)

A big 87 percent of the owners say they don't want any more horsepower (De Soto now has 200 and 185-horsepower engines). However, 11 percent of the owners do want more power while a tiny 2 percent want less. This seems to bear out the claim of the industry that the public won't buy less power and that's why manufacturers are giving them more.

"I think present horsepower is satisfactory. You can't use all the power you have as it is."—Minnesota store owner.

"I would like more horsepower. There

1955 DE SOTO V8 SPECIFICATIONS

ENGINE

Bore and stroke.....	3.720 x 3.344 in.
Piston displacement.....	291 cu. in.
Brake horsepower.....	Fireflite: 200 at 4400 r.p.m. Firedome: 185 at 4400 r.p.m.
Compression ratio.....	7.5 to 1
Transmissions.....	3-speed conventional; overdrive; PowerFlite transmission (torque converter with gears)

GENERAL

Wheelbase.....	126 in.
Tread, front.....	60.2 in.
Tread, rear.....	59.6 in.
Weight, unladen.....	Fireflite: 3940 lb. Firedome: 3870 lb.
Turning-circle diameter....	43 ft. 9 in.
Steering wheel turns, lock to lock.....	5.5 turns
Length over-all.....	217.9 in.
Width over-all.....	78.3 in.
Height over-all.....	60.6 in.
Road clearance.....	Fireflite: 6.2 in. Firedome: 6.3 in.

CAPACITIES

Gasoline.....	20 gal.
Oil.....	5 qt.
Water.....	23 qt.

INTERIOR DIMENSIONS

Front hiproom.....	63.3 in.
Rear hiproom.....	64.0 in.
Front headroom.....	35.0 in.
Rear headroom.....	34.5 in.
Front legroom.....	44.6 in.
Rear legroom.....	44.8 in.

are some 1955 cars that will outdo the De Soto."—Arkansas contractor.

"I would rather have less horsepower and more economy although present power is satisfactory."—North Dakota telephone man.

Why did these owners buy a De Soto? Last year De Soto ranked 11th in total sales and this year it is still 11th despite a tremendous increase in the number sold.

(Continued to page 230)

SHOP BY MAIL and **SAVE** at **GROBAN'S**

SURPLUS & NEW MANUFACTURE EQUIPMENT FOR HOME, FARM & FACTORY
ALL ITEMS UNCONDITIONALLY GUARANTEED

SELF-PRIMING ALL BRONZE & MONEL GEAR PUMP

ITEM #383—USE FOR:
 • Sprinkling • Irrigation • Insecticide Spraying • Sump Pump
 • Fuel Transfer • Home Water Systems • Dewatering • Salt Water, Chemical, Acid Pumping.



FEATURES • Needle Bearing Construction • 1 1/2" Pipe Thread Inlet, 1 1/4" Hose Outlet • Standard 3/4" Keyed Shaft • All Bronze Body & gears, Monel Shaft • Equipped with Drain Cocks, Grease Cup, Steel Internal Drive Gears for long, trouble free service.

CAPACITY: From 10 to 80 Gal. Per Min. At Speeds from 550 to 2400 Rev. Per Min. Using from 1/2 to 16 Horse Power. For Pressures to 160 lbs. Ship. wt. 58 lbs. U. S. Navy Cost \$168.00. **F.O.B. Chicago 39.50** Ea. Two for 75.00

BERRY — HEAVY DUTY HYDRAULIC PUMP or MOTOR

ITEM #166—Use on road machinery, vibrators, paper mills, wire reels, hydraulic presses, speed control units. Ball bearing construction, balanced cam design assures high efficiency performance. When used as a pump: delivers 8 G. P. M., 1000 P.S.I., 8 H.P. At 1200 R.P.M. as a **HYDRAULIC MOTOR:** Rated up to 12 H. P., up to 2400 R. P. M. Standard 3/4" pipe thread ports, 3/4" shaft with keyway. Dimensions: 14 1/2" x 8" x 7". Weight 63 lbs. Regularly \$212.00. **OUR SPECIAL PRICE... ea. 59.50** F.O.B. Chicago 2 for 110.00



ORDER DIRECT FROM AD SATISFACTION GUARANTEED
 Send Payment Or Purchase Order Today

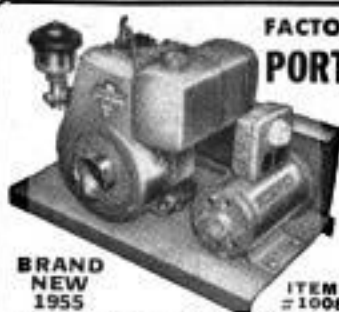

FACTORY-TO-YOU-VALUE PORTABLE ELECTRIC LIGHT PLANTS

POWER TO OPERATE:
 • Electric Saw, Electric Drills, Pipe Bender.
 • Refrigerator, Deep Freezer, Incubator.
 • Water Pump, Radio, Lights, Air-conditioner.

BRAND NEW 1955

ITEM #1008

COMPACT — FITS IN THE TRUNK OF YOUR CAR

1000 WATTS OUTPUT, continuous duty. 115 Volts A.C. 60 cycles, 9 amps. Powered by husky, easy starting Clinton engine. Engine and generator operate at 3600 R.P.M. for maximum efficiency at minimum weight. Both units are mounted on steel base, with heavy sheet metal belt guard. Generator is self regulating, and is equipped with outlet box containing fuse and 2 A.C. convenience receptacles. Cost only 5c an hour to operate. Dimensions: Length 20 1/2", Width 12", Height 16". Shipping wt. 100 lbs. F.O.B. Chicago.....

149.50

700 WATT-GENERATOR SET—same as above, slightly smaller—with Briggs-Stratton Engine—Model 708—F.O.B. Chicago..... **129.50**

1500 WATTS-GENERATOR SET—50% more capacity—with husky Clinton 3.8 H.P. Engine. \$100 below usual price—Model 1508—F.O.B. Chicago..... **199.50**

New... ALL PURPOSE 5-TON HAND WINCHES

IDEAL FOR:
 • Tow Trucks • Bricklayers
 • Loggers • Roofers
 • Construction uses

Manufactured by: Seattle Chain and Mfg. Co. — Div. of Republic Steel. 5-ton capacity, single drum, 2 speed, compound gear, locable cam and lever type, with hand grip steel shoe brake and spring actuated steel safety dog. The drum has a 5" core, is 9" long, and has a capacity of 365 feet of of 1/2" rope. Adjustable hand crank allows greater cranking speed. **DIMENSIONS:** 22"x24"x16". Packed in wooden box—Ship. Wt. 200 Lbs. Regular Value \$161.50. Now only..... **79.00** FOB Chicago



ITEM #737

To place phone orders call Webster 9-3793

GROBAN SUPPLY CO. Dept. **PM-8**
 1139 S. WABASH AVE., CHICAGO 5, ILL.

300 AMP. D. C. GENERATOR IDEAL FOR WELDING GENERATOR

Type R-1, ITEM #91
 rated 300 Amps. — 30 Volts. Mfg. by Jack Helms, Government Acquisition Cost \$380.00. Shpg. wt. 55 lbs. Dimensions: 16"x10"x7". Complete with instructions to connect as Welder. F.O.B. Chicago..... **35.0**



ITEM #90 — When connected as a welder, this unit will deliver 200 amps for a sustained period and 350 amps for intermittent service. This generator is widely used for shop-bu portable welders. Rated 200 amps., volts, 2500 R.P.M., using 10 H. Dimensions: 15" L. x 6" W. x 8 1/2" H. Spliced drive shaft. Gov't. Ac cost \$300.00. Shpg. Wt.: 51 lbs. F.O.B. Chicago..... **22.5**



GROBAN FOUR-WAY OPEN CENTER HYDRAULIC CONTROL VALVE

ITEM #126 — Four-way open center control valve with built-in adjustable relief valve factory set 1000 P.S.I. Spring loaded neutral position. For use with one double acting cylinder in neutral position. Locked pump unloads. Can be used as single unit or mounted in series. Has 3/4" pipe thread inlet and outlet 1/2" pipe thread cylinder port. Finger grip handle. Ship. w 10 1/2 lbs.



AN OUTSTANDING BUY!
F.O.B. Chicago 21.50

FREE CATALOG

52 PAGES, chockfull of unsurpassed War Surplus Equipment Bargains for farm, home, factory, workshop. Write letter today.



CUT RADIO CHASSIS HOLES IN 1-1/2 MINUTES OR LESS

Quickly make accurate round, square, key, or "D" openings... in metal, bakelite or hard rubber... with **GREENLEE** Radio Chassis Punches. Simply turn with a wrench. Many sizes. Write for details. Greenlee Tool Co., 2108 Columbia Avenue, Rockford, Illinois.



Now HULL AUTO COMPASSES IN NEW CAR TONES

You can now select a Hull Auto Compass that matches or blends with the sparkling, bright pastel color of almost any new car! Most beautiful and useful accessory on the market. Guaranteed. At better dealers everywhere. Write for literature.

THE FAMOUS NAME IN AUTO COMPASSES

HULL MFG. CO. P. O. Box 246, D-8 WARREN, OHIO

Beacombs, Inc. ILLUMINATED STREAMLINE \$4.95

SAY YOU SAW IT IN POPULAR MECHANICS

MAKE WATER HEATERS LAST YEARS LONGER

WITH THE AMAZING NEW

MCRAY ZINC ANODE

Made of zinc and copper on stainless steel core. Anode actually "zinc plates" inner surface of tank and adds years to life.

NOW ADOPTED BY MANY WATER HEATER MFGRS.

ASK YOUR PLUMBER OR ORDER DIRECT

For Gas, 20-30 gal. tank No. PD30. \$4.85 ea.
 Oil, To 40 gal. tank No. PD40. 5.80 ea.
 Electric To 60 gal. tank No. PD60. 7.15 ea.
 LP Gas. POSTAGE PAID

Also McRay Protecto Rods for Auto Radiators \$2 ea.

MCRAY PRODUCTS OF CALIFORNIA
 6806 MELROSE AV., LOS ANGELES 38, CAL.



Easily Installed. Insert in hot water outlet nipple. DO IT YOURSELF or ask your plumber. Send for literature. **SATISFACTION GUARANTEED OR MONEY BACK**



BEFORE—just an ordinary unfinished basement.



AFTER—see what a difference Weldwood makes! Weldwood Navaply® walls add a textured look that turns basement into beautiful, practical children's playroom. Large panels make it easy to plan, easy to do.

New do-it-yourself book by Weldwood shows you

how to wood panel a wall • how to make a plastic laminate sink top • how to saw and work plywood • how to finish plywood • what to do about a "problem" basement • how to glue plywood and has all kinds of tips for the home craftsman. Plus dozens of pictures of finished projects!

SEND FOR THIS BIG 40-PAGE BOOK TODAY! And see your lumber dealer for beautiful Weldwood Hardwood Plywoods and superior Weldwood Douglas Fir Plywood or, to see the complete line, visit any of the 87 United States Plywood showrooms in principal cities.

Weldwood® HARDWOOD PLYWOOD



Made by the World's Largest Plywood Organization

United States Plywood Corporation PM 8-5
Box 61, New York 46, New York

Enclosed is 25¢ for your new "Weldwood Do-It-Yourself" book. Please rush my copy!

Name

Address

City State

Most of them give previous ownership as the reason for buying a De Soto.

"The thing that convinced me was the performance of my 1953 De Soto."—Oklahoma machinist.

Next most frequently given reason is the new De Soto styling; after this comes the Chrysler reputation for good engineering. Fourth most frequently given reason is that the De Soto dealer offered them the best deal.

"Its beauty sold me. I like the body styling with sloping hood and rear deck. I don't like the boxed look other new cars have."—Texas chemical-plant operator.

"The engineering of Chrysler Corporation."—Ohio driving instructor.

"De Soto gave me the best offer on my old car."—Iowa insurance man.

More Best-Liked Features

The following quotations describe additional best-liked features in order of the frequency of mention by De Soto owners:

"Terrific response to the accelerator."—Nebraska welder.

"Remarkable road hugging at high speeds."—Tennessee Linotype operator.

"Roadability on mountain roads is exceptional."—New Mexico telephone man.

"Wide, roomy seats. Comfortable seat height."—Colorado farmer.

"I like it fine, especially its wonderful brakes."—Montana mechanic.

"Good visibility."—Virginia merchant.

"PowerFlite is excellent. Very smooth starts. Selector lever on dash is handy to use."—Illinois farmer.

"I like the low hood. Gear shift on dash."—Ohio glassworker.

"We have a pink and ivory De Soto. It is the most beautiful car we have ever had."—Alabama garage owner.

"I like the two-tone color divisions."—Washington truck driver.

"Roomy trunk."—Washington fisherman.

"Comfortable driving position."—Texas Naval officer.

"I drive a car hard in medical practice. I never warm it up before starting out and I drive fast. Yet I feel I am getting everything I want from this car. I have never been so satisfied with a car as with my De Soto."—Oregon physician.

More Complaints

The following quotations are typical of those giving owners' complaints. These are listed in order of frequency of mention.

"The dash panel is trimmed poorly. The trimming does not fit any place, which is a shame for such a pretty car."—New Mexico real-estate man.

(Continued to page 232)

MODERN

LAWN MOWER SHARPENER

COMPARE BEFORE YOU BUY



Write for free booklet 10E

Oil remains in engine while sharpening. Bed knife sharpened in same centers — no attachments needed.

Start your own business—**increase your income**

Sharpens any mower in ten to twenty minutes. Handles complete assembly of all reel types including 36 in. power mowers. Handle, wheels, roller, and engine are not removed.

\$26300

F.O.B. PASADENA

MODERN MFG. CO.

160 N. FAIR OAKS, PASADENA, CALIF.

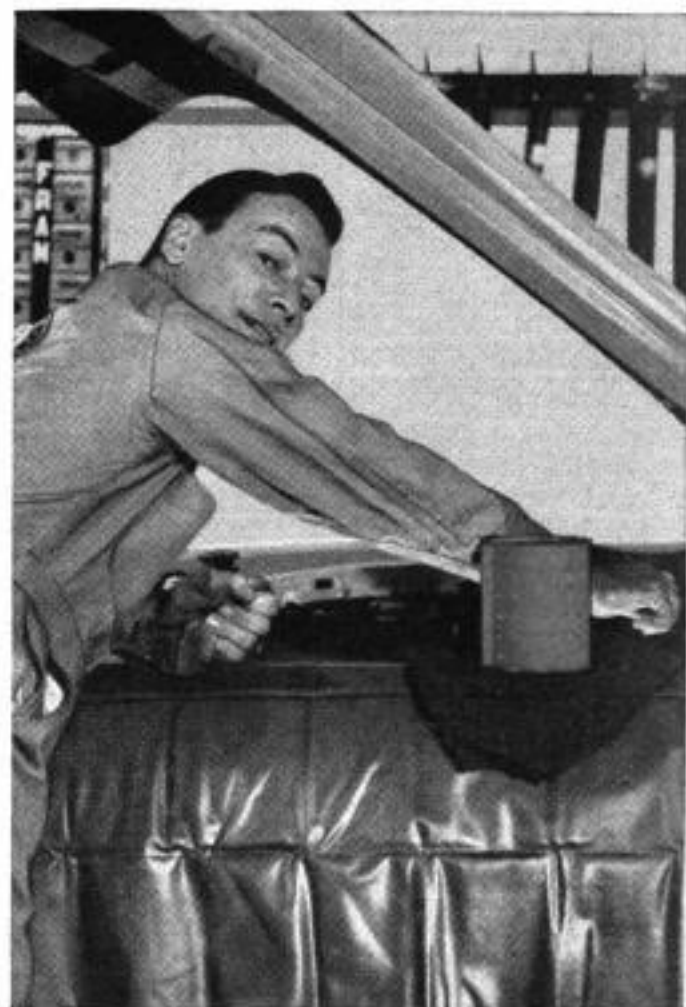

Want to find URANIUM?

Former government geologist, with nearly 30 years experience, tells you everything—what to look for, where to look, use of counter, staking your claim and all the other things you need to know—in his new pocket-size book for amateur prospectors. Order your copy of "MILLIONS IN URANIUM" now, \$1.95. Money refunded if not satisfied. Sorry, no C.O.D.'s.

GEOLOGISTS RESEARCH

166-8 CRESCENT PLACE

ITHACA, N. Y.

10 New DELTA Hard Cover Books

"How To Get The Most Out Of" your Power Tools. Clearly written, illustrated. New projects, ideas. Write for FREE descriptive folder: Delta Power Tool Div., Rockwell Mfg. Co., 502-H N. Lexington Ave., Pgh. 8, Pa.

MAGNETS

ASSORTED MAGNETS with big list of handy uses.....\$ for \$1
POWERFUL POCKET MAGNET ideal for testing metals.....\$1
RETRIEVING MAGNET pulls tools, etc., from tank or lake.....\$4
HOT PAD MAGNETS to insert in your own hot pads.....\$ for \$1
BULLETIN BOARD MAGNETS to "pin-up" memos, etc.....\$ for \$1
ZERO-ZONE sensational new ice box, freezer thermometer.....\$1
Write for free booklet including heavy retrieving magnets, also rods, bars, discs, sizes. 100% satisfaction guaranteed.....**POSTPAID**
PARK MAGNETS, 258, 1557 GREENBAY RD., HIGHLAND PARK, ILL.

SEND FOR FREE CATALOG

Money-Making Tools!

It's easy to own the same "pay-off" tools used and endorsed by America's top-earning mechanics! You can start building your own kit with basic Snap-on sets—add others any time. Never sold in stores—direct to users only. Send today for free catalog!

Snap-on Tools Corporation
8062-H 28th Ave., Kenosha, Wis.



Motorists prefer FRAM more than 2 to 1

Surveys prove it . . . and in many cases the preference for FRAM Oil Filters more than equals the preference for the next two most popular brands combined!

Here's why: FRAM is engineered for extra-high filter efficiency . . . keeps oil clean, cuts wear, saves power and reduces repair bills.

There's a FRAM Cartridge engineered for your car. See your FRAM Dealer today!

Send FRAM boxtop or 25c for big, colorful, 68 page Vacationland America Book describing motor trips throughout America!



FRAM CORPORATION, Providence 16, R. I.
Fram Canada Ltd., Stratford, Ont.

Get Your Own Copy of Money Saving NEW 148 PAGE Auto Parts and Accessory FREE! CATALOG

ORDER NOW!
This giant 148 page catalog, packed with over 30,000 items for the automotive, truck, taxi, hot rod and custom car owner is yours FREE with any order for items selected from this advertisement. If you just want the catalog, send only 25c to cover part of handling and mailing cost (included on your first order).

NEW EXHAUST CUT-OUT
Exhaust line is controlled from the dash. Can be used as a cut-out in the country and closed in restricted areas. Or may be used to operate two different toned mufflers. Well constructed of heavy plate steel. Strengthens the exhaust pipe.
UNIVERSAL—Fits All Cars
No. 64-POSTPAID/each **\$3.42**

AH-OOG-GAH Chrome HORN
Here it is for the sport car enthusiast. Not a vibrator or other substitute but a genuine motor driven horn.
No. 66-POSTPAID
State—3 VOLTS, 12 VOLTS **\$12.60**

BERMUDA CLANGING BELL
It's the New "Bee"! Gives a most amazing and commanding two-tone bell sound. Easily installed under car floor by driver's seat. Strap on plunger lightly polished. Fits any car.
No. 49-POSTPAID **\$3.95**

REAR-VIEW MIRRORS
Special Curved Convex Glass Gives Curb to Curb Vision—Eliminates Blind Spots—Wider Range of Vision thru the Larger Windows of New Cars. CURVED MIRROR—2 1/2"x10" in Metal Case Painted a Neutral Gray Hammered Finish with a Plastic Lens to Match. No. 93—Fits all cars. One each year, make & model. POSTPAID, Ea. **\$2.94**

Porous Bronze OIL FILTER ELEMENT
WITH LIFETIME GUARANTEE and Built-in Magnesium Acid Neutralizer
Porous bronze Element never wears out or needs replacement. Lasts for a lifetime of the car. Element removes all harmful particles yet retains your expensive additives. Lets you drive up to 10,000 miles without changing oil. Fits all cars except those with Full Flow Oil System listed below. State your make, model & car.
No. 114—Regular **\$4.95**
Element only, POSTPAID **\$4.95**

Porous Bronze FILTER ELEMENT FOR FULL FLOW OIL SYSTEM—Fits V8 Buick, Olds, DeSoto 52-55; Ford, Merc. 54-55; Chev. 51-55; Dodge 53-55; Plymouth 1953; Ford '6, '52-55; Lincoln 52-54; Chev. exc. V8 46-54. Buick car, year and model. No. 117—Regularly **\$13.95. POSTPAID, only **\$8.95****

HI-SPEED ELECTRIC SIREN
Developed especially for the U. S. Navy & Coast Guard. Now used by hundreds of fire & police departments, buses, ambulances, etc. Complete with bracket, screws, 10 ft. of cable & push button. Green Enamel.
No. 71—POSTPAID **\$13.24**
No. 91—POSTPAID **\$13.70**
12 VOLT ea.

HOW TO ORDER: Send payment in full or 25% deposit with order. Balance C.O.D. When payment in full accompanies order, we pay shipping charges on items marked Postpaid. Others F.O.B. Chicago. Be sure to give make, year, model of car. **SATISFACTION GUARANTEED or Money Refunded.**

J. C. WHITNEY & CO., 1917-P 28 Archer Ave., Chicago 16, Ill.

PUMP FASTER with a HYDRO-JET!

Made of aircraft grade aluminum alloy, this rugged #10 centrifugal pumps up to 4500 G.P.H. Ideal for irrigating, draining, filling, spraying. Uses 1.6 to 1/4 H.P. motor. Rustproof 1/2" shaft, oil less bearing. 1/2" suction, 1/2" discharge, std. pipe threads, adaptable to garden hose. **\$8.95**

Heavy-Duty HYDRO-JET #20 fits and empties pools, ponds, etc. Extra powerful up to 8000 G.P.H. Use 1/4 to 3 H.P. motor. Rugged, rustproof 1/2" shaft, oil less bearing. 1/2" suction, 1" discharge, std. threads. **\$11.95**

Prepaid if cash with order. Send Check or M.O. \$2 deposit if C.O.D. Money-back guarantee.

DEL-VAL PRODUCTS, Dept. M, Albany Ave., Westmont, N.J.

THE ROUTER... what it is and does

This 40-page book with 100 illustrations tells you. Write Stanley Electric Tools, 628 Myrtle St., New Britain, Conn., enclosing 50¢. Ask for ROUTER BOOK.

STANLEY Electric Tools
A DIVISION OF THE STANLEY WORKS

For Racing at its Thrilling Exciting Best...

JUNIOR MIDGET

Get in on Micro-Midget racing, America's newest, most exciting, and fastest growing sport. Speeds up to 30 M.P.H. on a 1/10 mile track. Can be purchased in kit form or complete ready-to-run. Send 25 cents for completely illustrated literature describing all details.

Now available the HANDBOOK for SAFELY RACING CARS. This handbook is the most complete and up-to-date information and has data on rules and regulations for 1/16, 1/32, 1/64, 1/8, 1/4, 1/2, 3/4, 1, and 200 C.C. Cars. Only \$1.00.

COMET MANUFACTURING CO., Dept. 16, P.O. Box 1882, Sacramento 9, Calif.

"I don't like the dash panel or the knobs. At night all the knobs are alike and it is hard to find the one you want. The shift lever should light up for night driving."—Missouri farmer.

"Uses too much gas. PowerLite is too expensive driving in city."—Arkansas minister.

"Only trouble I have had is the hose on the power steering came apart at the connection to the oil reservoir. I understand the old-type hose caused a lot of trouble. Dealer replaced it with a new type of hose without charge."—Texas telephone worker.

"Trunk lid weak. Sometimes have trouble latching it."—New York technician.

"Jerks when transmission shifts (Power-Flite). We need defrosters nine months of the year here and they are no good with the curved windshield. They clean only the lower half."—Nevada carpenter.

"Don't like the door handles. Doors too hard to close."—Utah contractor.

"Rear-view mirror too small and placed so sun visors hit it when pulled down."—Idaho retired Army officer.

"Hard to get in and out of back seat of special coupe because not enough foot clearance between front seat and door-frame. Paint holidays around trim."—Washington jeweler.

"Uses too much oil."—North Dakota businessman.

"Passing gear does not take hold quickly enough."—Texas grocer.

"Gas fumes from gasoline tank get into driving compartment. Up to now dealer has failed to fix this."—California barber.

"I bump my knee on the front door post because of wrap-around windshield."—Oregon textile worker.

"I don't like the ash tray. You have to take your eyes off the road too much when using it."—North Dakota farmer.

"Fan belt that drives power steering doesn't stand up. I have had two already."—Maine cement finisher.

"Clock can't be seen in daylight."—Massachusetts piano tuner.

"Clock located dangerously in case of an accident."—North Dakota salesman.

There you have it—the good and the bad, as described by the owners of the 1955 De Soto. For an exact tabulation of these likes and dislikes see the percentage table on page 129. ★ ★ ★

Turn back to page 126 to begin Floyd Clymer's road test of the De Soto.

☛ Meteoritic dust particles which act as nuclei on which raindrops condense are one of the principal factors in formation of rain, says Dr. E. G. Bowen, Australian radiophysicist.

For lawn mowers

New 3-in-one Oil-Spra lubricates all over — forms a barrier against rust! Press button for penetrating oil spray!



"3-IN-ONE" OIL

SHAW PLOW, CULTIVATE, MOW, RAKE
BULLDOZE, SNOWPLOW
SAW WOOD

TRACTORS

Just steer it with power turn. Several walking & riding models up to 14 H.P. Low price! Write for FREE literature.

SHAW Manufacturing Co.
4508 Front St., Galesburg, Kansas
668-G N. 4th St., Columbus, Ohio

VARIABLE SPEED

HYDRAULIC POWER TRANSMISSION

It has Infinite Speeds 0 to 550, Reverse, Automatic Overload Protection; Adjustable Torque up to 180 inch pounds. 5/8" Input and Output Shafts. It will handle 1/2 to 1 1/2 H.P. Motor. Case measures 7 1/2" long, 7" high, 6 1/2" wide. VALUE OVER \$300. Shipping Wt. 25 lb. On C.O.D. Orders we require a 10% only deposit.

\$54.50
Fab. Chicago

DIRZIUS MACHINE SHOP "E" 1423-25 So. 52nd Ave., Cicero 50, Ill.

CRESCENT TOOLS

Give Wings to Work

ASK YOUR HARDWARE DEALER

OVERLOAD SPRINGS

\$9.95 Per Pair
Postpaid
2,000 lb. Size \$11.95

For cars and trucks. Front and rear. Gives 2,000 lbs. extra capacity for all 1/2, 3/4, and 1 ton trucks, 500 or 1,000 lbs. extra for all cars. Easily installed. Guaranteed. State make, model. Dealers wanted.

BRINKMAN MFG. CO.
2315 CLAY, DEPT. 15-G, TOPEKA, KAN.

make your own Gems

29.50 F.O.B.

The Gem Maker comes complete with all necessary equipment, including a super-charged diamond blade for sawing, and all wheels for grinding, shaping and polishing; also complete instructions. The complete equipment as shown, less motor and belt, for only \$29.50, f.o.b., Burlington, Wisconsin. Write today for information and literature.

B & I MANUFACTURING CO.
Dept. S Burlington, Wis.

FREE CATALOG

NEW CHRYSLER BOAT KITS

BUY DIRECT—SAVE UP TO 2/3 FACTORY TO YOU!

No Dealers! You SAVE the BIG PROFIT!

12 MODELS—8 to 14 ft. —\$39 up
Finest quality Boat Kits at the lowest prices in history! Mahogany decks. Easy to build.
Also: FIBERGLAS—ACCESSORIES—TRAILERS

CHRYSLER-CRAFT (DEPT. 20) TONAWANDA, N.Y.

For easier work, better results— use these high quality



D-P COMPOUNDS!

D-P Glazing Compound

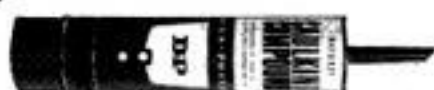

D-P Caulking Cartridge

- For glazing all sash—wood or metal.
- Perfect for dozens of additional home repair jobs—filling nail holes, cracks, etc.
- It's white—easy to handle—seals permanently!
- Finest caulking compound made—packed in handy 1/10 gallon cartridge with applicator tip.
- Designed for use in standard or half-barrel caulking guns.

At hardware, paint and building supplies stores, D-P means Dicks-Pontius—and that means high quality!



THE DICKS-PONTIUS COMPANY • Dayton, Ohio
Alexandria, Va. • Decatur, Ga. • Dallas, Tex.

The New Model 70 UTILITY TESTER FOR REPAIRING ALL ELECTRICAL APPLIANCES MOTORS • AUTOMOBILES • TV TUBES

As an electrical trouble shooter the Model 70:

- Measures A.C. and D.C. Voltages, A.C. and D.C. Current, Resistances, Leakage, etc.
- Will measure current consumption while the appliance under test is in operation.
- Incorporates a sensitive direct-reading resistance range which will measure all resistance commonly used in electrical appliances, motor, etc.
- Leakage detecting circuit will indicate continuity from zero ohms to 5 megohms (5,000,000 ohms).
- Will test toasters, irons, Broilers, Heating Pads, Clocks, Fans, Vacuum Cleaners, Refrigerators, Lamps, Fluorescents, Fans, Switches, Thermostats, etc.
- Will test all TV tubes for open filaments, inter-element shorts, burned out tubes, etc.

As an Automotive Tester the Model 70 will test:

- Both 6 Volt and 12 Volt Storage Batteries • Generators • Starters • Distributors • Ignition Coils • Regulators • Relays • Circuit Breakers • Cigarette Lighters • Stop Lights • Condensers • Directional Signal Systems • All Lamps and Bulbs • Fuses • Heating Systems • Horns • Also will locate poor grounds, breaks in wiring, poor connections, etc.

Handsome round-cased welded bakelite case, 3 1/4" x 5 7/8" x 3 1/4". Complete with all test leads. Also included is a \$2 paper book giving detailed instructions. For testing all electrical appliances, automotive equipment, TV tubes, etc. Only **15.85**

SHIPPED ON APPROVAL

NO MONEY WITH ORDER—NO C. O. D.

Try it for 30 days before you pay. If completely satisfied then send \$3.85 and pay balance at rate of \$4.00 per month for 3 months — No Interest or Finance Charge! Add! If not completely satisfied, return to us, no explanation necessary.

MOSS ELECTRONIC DIST. CO., Inc.
Dept. D-149, 3849 Tenth Ave., N.Y. 34, N.Y.

Please rush 1 Model 70. I agree to pay \$3.85 within 10 days after receipt and \$4.00 per month thereafter

Name _____
Address _____
City _____ State _____

Ride to work for
as little as **35¢** a week!

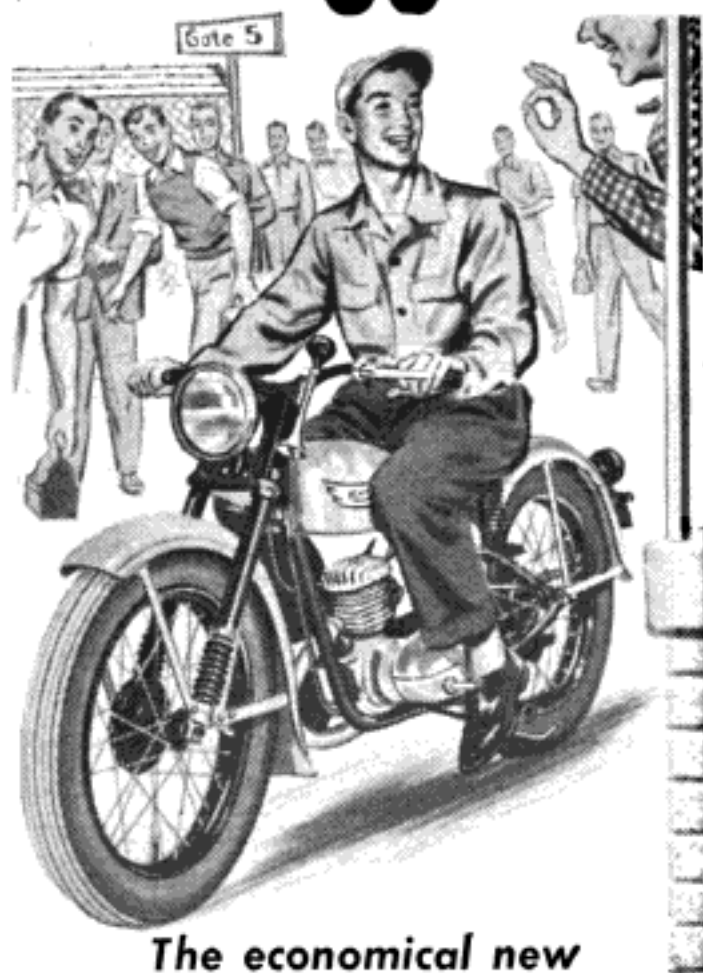

The economical new
HARLEY-DAVIDSON
HUMMER

That's right . . . 35¢ a week! The Hummer averages up to 100 miles per gallon. Owners living 10 miles from their jobs tell us that's all it costs them for gas and oil with the new Harley-Davidson Hummer. And the Hummer is easy to handle—cuts through traffic in half the time. Ends parking problems, too. See your Harley-Davidson dealer today or write for free literature.

*Average after minimum down payment includes Federal tax; fire, theft and collision insurance; freight and carrying charges.

Own the Hummer
for as little as
\$1700*
a month.
Averages up to
100 miles
per gallon!

The HARLEY-DAVIDSON Motor Co.
Dept. P, Milwaukee 1, Wisconsin

It's Lonesome Up in Space

(Continued from page 79)

the northwest, and there were clouds over Mexico in the south. There were broken clouds over the Sierra Nevada Mountains away below me. Everything seemed fuzzy and not even the mountain details were sharp and clear. I was looking down through virtually all of the earth's atmosphere and it created a hazy effect, partly obscuring the surface markings.

At the top of the flight I was out of power and I began preparing for a dead-stick landing that was more than 100 miles away. This wasn't as tough as it sounds. The first things to do were to level off gradually to avoid weightlessness, get back down through the speed of sound, and then begin a wide sweeping turn that was possibly more than 30 miles across. This would head me back over the desert east of Los Angeles and bring me down to 30,000 feet, not too far from Rogers Dry Lake at Edwards.

Slowing down through the speed of sound was alarming the first time it ever happened to me, and it's still a rather startling experience. You'll remember that supersonic flight is silent except for the sounds of the equipment in the cockpit. But as the plane loses speed there's a sudden loud commotion, a rush and roar of noise like the sound of a cascade or waterfall. It's the sound of the air hurtling past the canopy. This gradually subsides as the plane slows to subsonic speed.

Landing on the surface of the big, flat, dry lake at Edwards is a tricky job. I may touch down at 180 miles per hour, without power and with no points of reference on the lake bed to help gauge my height above the ground. So the pilot of the low-escort plane talks me in.

He's off to one side, pacing me in the air, and he judges my height by the distance to my shadow on the surface. "You are 100 feet high," he tells me. "Come on down. Come on down. Easy. Okay. You are landing."

Incidentally the F-86 escort pilot puts his own landing gear down before he comes in alongside to instruct me. Concentrating on my shadow, it's possible that he may fly too low and unintentionally land his own plane.

The Bell rocket aircraft have soft landing gear and yet when they roll to a stop after an altitude flight they hammer and jar like a farm wagon without springs. This is because the hydraulic fluid in the landing gear is still stiff from the minus 65 degrees in the upper air. It hasn't had time to warm up.

(Continued to page 236)

Build this space-saving sofa-storage unit



the Western Pines

get complete detail drawings and easy-to-follow directions in

FREE PATTERN KIT 321

along with the picture-packed booklet "Friendly Home Ideas in Western Pine." Write for it to Western Pine Association, Dept. 321-N, Yeon Bldg., Portland 4, Oregon.

You'll find this attractive modern sofa ideal for guest room or country cottage. The mellow woods of the Western Pines* lend a handsome look to the sofa, cabinets, drawers and end bookcases. The framework is built for a box spring—which slides back to comfortable sitting width during the day.

You will find it costs little to build with the carefully selected, well-seasoned woods of the Western Pines. Soft-textured, easy to work, they take all finishes without grain-raising. See the Western Pine woods at your local lumber dealer—he'll be glad to give you an estimate!

- * IDAHO WHITE PINE
- * PONDEROSA PINE
- * SUGAR PINE

Auxiliary Accelerator... LEFT FOOT PEDAL

Step on the gas with either foot with equal ease. Drive relaxed. Guaranteed for the life of the car—which originally installed on. **FITS ALL CARS.**

PRICE \$6.95 Per ORDER FROM
Delivered to You R. V. LEHNER, Ness City, Kansas

695 HEAVY OILIPH-BALL BEARINGS PUMPS MILLIONS OF GALS.

IRRIGATE, SPRAY, DRAIN OR FILL ANYTHING—ANYWHERE! Will not Rust—Clog—or Leak. Patented Seal. Pumps 2800 gph, 420 gph. at 75' high or 1600 gph from 25' well. Six blade impeller. Threaded for pipe. 3/4" inlet, 1/2" outlet. Use 1/4 to 3/4 hp motor... 7500 gph 9.95
Heavier 2800 gph. 8.95 Heavier 11.95

Check, MO or COD—Money Back Guarantee
FREE Literature—Comparison Charts
U. A. T. ENG. & MFG. CO. HICKSVILLE 273, NEW YORK

KEEP ALL SAWS SHARP SUPER SAW FILER NO. 6

IT'S NEW! With Automatic DEPTH CONTROL ROLLERS

Automatically controls **DEPTH—ANGLE—PITCH**

Perfect bevel and angle maintained, and fool-proof depth control for all Rip, Cross-cut, and Handsaws. Precision made and calibrated for instant setting at desired angle. Can be used in any vise or clamp. Complete with file, only... **\$6.50 ppd.**

SAVE TIME AND \$\$\$

JOINT & SHARPEN CIRCULAR SAWS

Sensational new Super Filer No. 11 joints and sharpens both hand and circular saws 6" to 10" with all teeth the correct height, depth, pitch and bevel. Easy to use—when file hits hardened steel roller, teeth are finished. Saw runs true and smooth with no side pull. Complete with special 8" file \$9.95 ppd. "TRU-CIRCLE" saw set automatically sets teeth at 10° or more \$2.95.

SEND FOR FREE CATALOG

Guaranteed.
A. D. McBURNEY, 5908 Hollywood Blvd., Hollywood 28, Cal., Dept. A-85

Also Adult Eshelman 2 Passenger Sport Cars

1/5 The Price of any other Auto

70 Miles Per Gal. Free Catalog.

ESHELMAN

FOR Better LAWNS And GARDENS

Women can operate it. 1 to 8 H.P.

Shipping Points: **BALTIMORE, CHICAGO, RENO**

Free Catalog Write: **ESHELMAN CO., Dept. R-58**
109 Light St., Balto. 2, Md.

RAKES
PLOW
CULTIVATORS
HARROWS
MULLS
SPRAYS
SAWS
DOZER
MOWS
CUTS
ROLLS
TILLS
SNOW
PLOW

Rotary Tillers
Riding Mowers,
Tractors
Low As **\$69**

BUILD YOUR OWN POWER TOOLS—GIL-BILT PARTS KITS

TILT/ARBOR SAW

• 27x28 in. table, 23 1/2 in. capacity in front of blade
• 10 in. blade cuts 3 1/4 in. deep, tilts full 45 degrees
• Floor model 34" high, table always stays level
• New Departure ball bearing arbor, 3/4" precision shaft turned down for 5/8" bore blades, alum. housing, shipped ready to run
• Jackscrew and 4 1/2 in. dia. handwheel lowers and raises blade
• Cast aluminum miter gauge and self-aligning rip fence guide

GIL-BILT Metal Parts Kit includes Plans, ball bearing arbor, miter gauge and bar, rip fence guide, dado insert, lock knobs, jackscrew mechanism and handwheel, and all other metal parts (less blade).....\$22.95
Same Kit with 10" Combination Blade...\$25.90
Same Kit with 8" Combination Blade...\$24.90

GIL-BILT 12-INCH BAND SAW

Ball bearing drive, rigid cast aluminum wheels, rubber tires. Handles stock up to 6 inches thick. Cuts to center of 24" circle. 18 x 18 inch tilt table. Capacity and performance of band saws setting for \$80 and up. Plans and all metal parts in kit with 3/4" blade **\$23.95**

Return Kits in 10 days for refund if not satisfied. For shipments up to 600 miles, add 5% over 600 add 15%. Amount in excess of actual postage will be refunded. Order Kit now, or order Plans at \$1.00 each and Kit later—less cost of plans.

Write for **FREE Catalog.**

Also Available: Plans & Parts Kits for 18" Band Saw, Belt Sander, Spindle Shaper, 8" Tilt-Table Saw

GILLIOM POWER TOOLS Dept. 80-H, Lambert Field St. Louis 21, Missouri

PLANS only \$1.00 EACH POSTPAID

AUGUST 1955

3 KLEINS

EVERYONE NEEDS

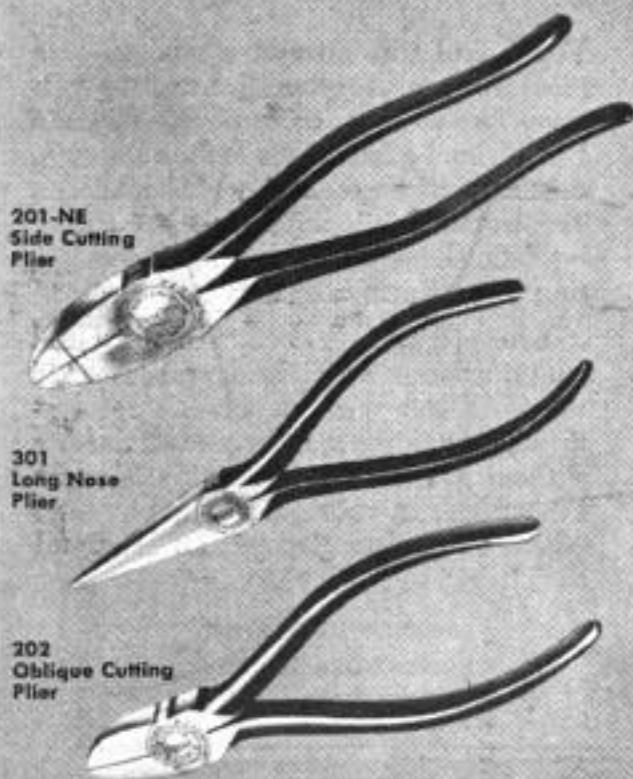

Here are three pliers everyone needs. With these Kleins on your workbench or in your tool kit you are equipped for any job where pliers can assist you.

And, of course, you have pride of ownership too, for as everyone knows, Kleins are the standard of quality in pliers—have been "since 1857."

201-NE—The famous side cutter originated by Klein. In 6", 7", 8" or 9" sizes.

301—You will be amazed at how many times a day you will use this handy long nose plier. Ideal for reaching into confined places, holding small parts, etc. In 5", 6" or 7" sizes.

202—This Klein oblique cutter is a tool that good workmen can't do without. Cuts close and clean and the knives stay sharp for years. In 5" and 6" sizes.

Good hardware dealers everywhere carry Kleins.



FREE KLEIN BULLETIN
Send for FREE Bulletin 455.
It shows all the most popular Klein Pliers.

Mathias KLEIN & Sons
Established 1857 Chicago, Ill., U.S.A.
7200 McCORMICK ROAD • CHICAGO 45, ILLINOIS

Aerodynamic heating has been no special problem to the rocket planes so far because most of the flights have been at altitudes where aerodynamic heating is not acute during speed runs of short duration. Too, the frigid liquid oxygen used as the fuel oxidizer helps keep the whole plane cool. Aerodynamic heating could distort a plastic cockpit windshield, however, so the Bell aircraft use glass windshields that resist the heat better.

Exhaustive studies of aerodynamic heating are being made with the X-1B which has been especially instrumented for recording the heat rise at supersonic speeds in medium altitudes.

There are about half a dozen qualified rocket test pilots in the Air Force today, each of whom has logged about 5000 hours in other kinds of aircraft. The full schooling before they qualify for rockets includes 500 hours in jets, six months at the Air Force test pilot school at Edwards, then one to three years testing the newest military jet aircraft and flying escort for rocket planes. After that come several weeks of intensive training in rocket-plane systems and their operation. Finally a pilot is ready to be coached for his first flight in a rocket.

The rocket planes we are flying today are really "Model T" aircraft compared to those we will have in the future. The new X-2 that looks superficially like another member of the X-1 series is the first step ahead. Eventually we will have rocket planes that can be flown with less effort and fly faster without encountering controllability problems. ★ ★ ★

Sun Patches for Eyeglasses

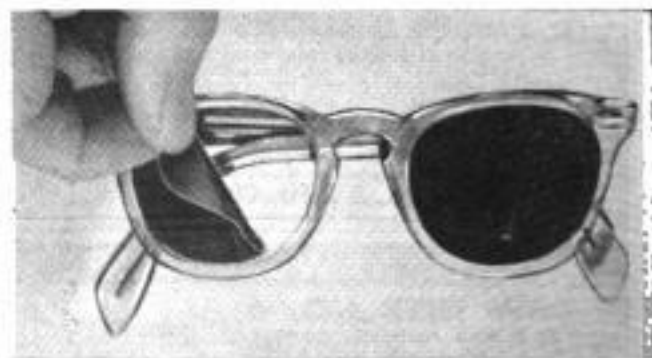

You can convert your regular spectacles to sunglasses with a pair of stick-on patches that cut down glare. The plastic patches, trimmed to size, are simply pressed onto the surface of the regular glass lens. They peel off easily and can be used again and again. Because the patches are unbreakable and so compact they will fit into a billfold when not in use.

New draw-string carton tells you it's Genuine!

**New Ford packages make it
easy to spot Genuine Ford Parts!**

A draw-string carton for oil filter elements . . . picture-window packages for distributor points, condensers, rotors, brushes, spark plugs . . . are designed so there can be no mistake! You get the part that's made right to fit right to last longer!

Through the "picture window" you can see that these Ford Spark Plugs are Genuine.

You can be *sure* you're getting the spark plugs that are track-tested by Ford engineers to be sure they're right before being okayed for manufacture.

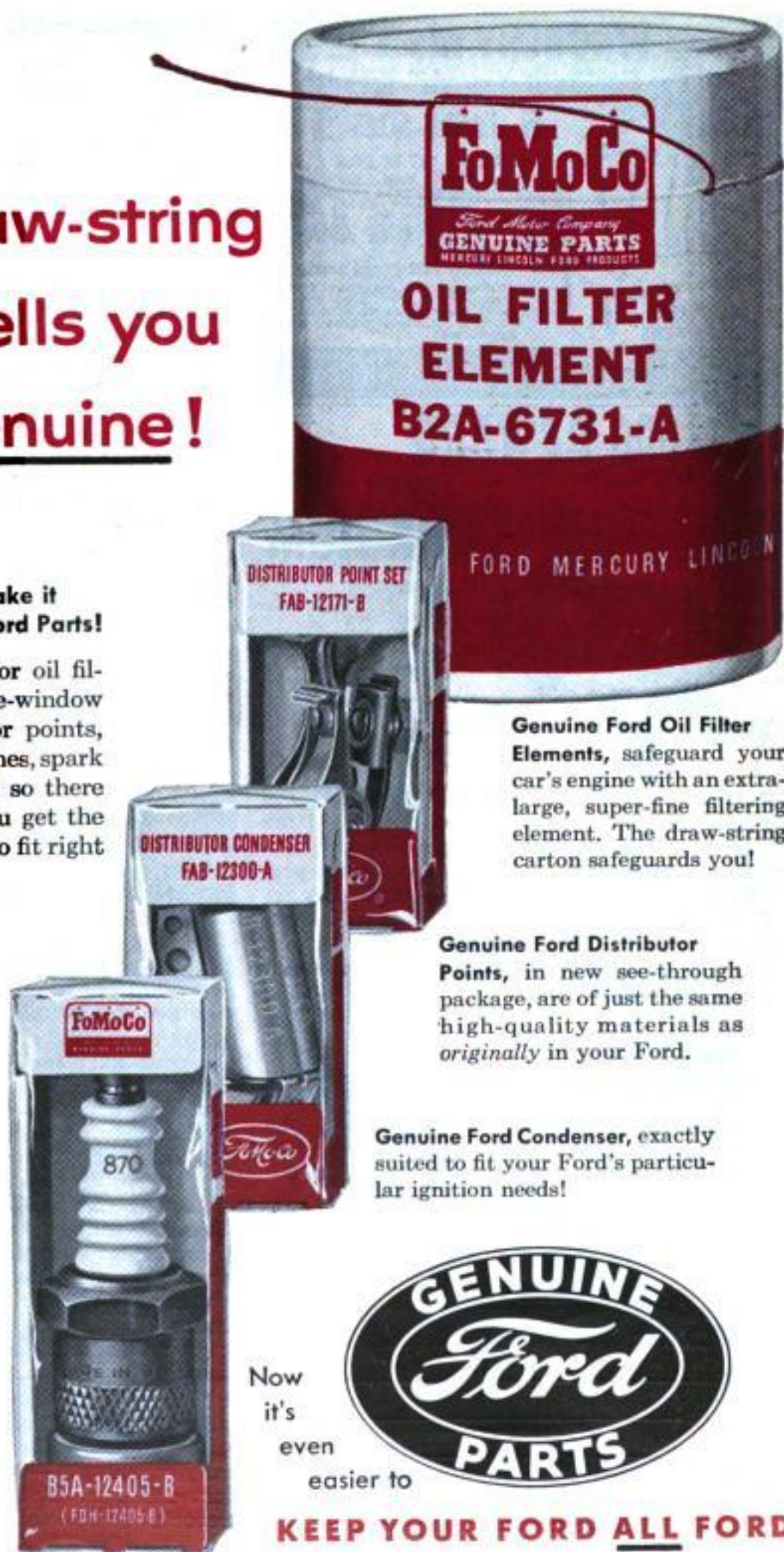

Genuine Ford Oil Filter Elements, safeguard your car's engine with an extra-large, super-fine filtering element. The draw-string carton safeguards you!

Genuine Ford Distributor Points, in new see-through package, are of just the same high-quality materials as *originally* in your Ford.

Genuine Ford Condenser, exactly suited to fit your Ford's particular ignition needs!

Now
it's
even
easier to



KEEP YOUR FORD ALL FORD

WROUGHT IRON LEGS
for "Do It Yourself" Hobbyists
5 HANDY SIZES 5



PRICE PER SET OF FOUR

6 Inch\$3.75	FOR coffee tables,
12 Inch 3.95	record players,
16 Inch 4.50	TV-Sets, book
22 Inch 4.95	cases, chests,
28 Inch 5.75	chairs, couches—
		WITH SCREWS.

ADD 50c Postage and Handling
V-Shape, rust-resistant legs,
made of 7/16" cold rolled
dull matte finish wrought iron,
Ebony painted! Chip and
rustproof!

COMPLETE WITH SCREWS

ENGMAN MFG. CO., 1317-19 LOCUST, DES MOINES, IA.

\$35,000 REWARD

FOR

URANIUM



Here's your chance to "cash in!" Over \$3,750,000 in Government Bonuses have been paid for URANIUM discoveries in the past 2 years. Currently \$175,000 a month is paid to people like you.

Precision Geiger Counters and Scintillators are the finest instruments made for URANIUM prospecting. These highly sensitive instruments are compact, lightweight and ruggedly built for field use. Prices start at \$29.95.

CONTACT YOUR NEAREST DEALER

or write direct to factory for FREE 12-PAGE CATALOG and our 24-PAGE BOOKLET with "64 QUESTIONS AND ANSWERS ON GEIGER COUNTERS AND SCINTILLATORS."

PROSPECTORS RELY ON...

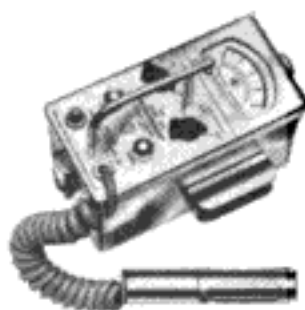

MAIL TODAY FOR FREE INFORMATION

Name _____ Title _____

Company _____

Address _____ City _____ State _____

PRECISION RADIATION INSTRUMENTS, INC.
4223 PMW. Jefferson Blvd., Los Angeles 16, Calif.
World's Largest Manufacturer of Radiation Instruments

Rangers on the Trail of the Lost

(Continued from page 69)

members, makes the ranger organization quite unique.

Incorporated as a nonprofit group in 1947, SVIR Inc. is an outgrowth of the Pacific Coast Militia Rangers—15,000 commandos who stood guard on Canada's west coast from 1942 to 1946. The nucleus of the present outfit was 86 veterans of No. 1 Company, PCMR, whose military duties included mapping and patrolling 16,000-square-mile Vancouver Island at a time when Japanese submarines were shadowing west-coast shipping and during which a Nip undersea raider surfaced and shelled a lighthouse at Estevan Point, on the west side of the island. They blazed trails, built cabins and established caches in previously unexplored territory and have made good use of this experience in carrying out peaceful pursuits.

Apart from the knowledge they've passed on and the training they've given, the rangers have made a number of notable contributions to safety in the woods. Techniques and equipment they have developed are now being adopted by other organizations throughout Canada and the United States. Their emergency questionnaire form, for example, is now being used by police officers. Incorporating a sketch map, it provides participants in a search with all pertinent information at a glance.

The ranger stretcher kit consists of two packboards—one bearing a robe-type sleeping bag, the other the canvas, aluminum spacer bars and small ax. The latter packboard weighs only seven pounds and, once two poles have been cut, can be assembled in a couple of minutes.

Another ranger brainchild is the use of a rescue flare for aircraft searches, overcoming the difficulty of a lost person revealing his position to the pilot of a plane, particularly at night. Because of the importance of ground-to-air signal, the key to the new idea is possession of a set of signal flares by each firearm license holder. Numbered and registered in Game Department records for their shelf life of seven years, the cost of these rockets runs about seven cents a year. Tied to a gun barrel or pole, the flares can be fired at a moment's notice, immediately pinpointing the user's position.

Rocket SOS flares may soon become standard equipment for hunters, hikers, trappers and skiers and the rangers have only one regret—they aren't applicable to lost children. Because missing-youngster reports evoke the most immediate and

(Continued to page 240)

Be Your Own Boss in the Profitable Excavating Business!

**CUSTOM OPERATORS OF
SHERMAN POWER DIGGERS EARN
UP TO \$1,000 AND MORE PER MONTH!**

Wherever you live, you'll find plenty of profitable work the whole year 'round for this versatile outfit . . . not just a "trencher" but an all-purpose excavating machine! Custom operators everywhere are making big money with Sherman Power Diggers. One bought a farm with just 3 years' profits! Work for builders, contractors, utilities, and municipalities on such jobs as • SEPTIC TANKS and DRAINFIELDS • SEWER LINES • FUEL TANK INSTALLATIONS • FOUNDATIONS and FOOTINGS • GAS and WATER LINES • FIELD TILING and many others. The Sherman Power Digger travels quickly from job to job, digs at a fraction of the cost of manual labor. It's simple to operate, easy to maintain, built to last . . . and, complete with tractor, actually costs less than many new cars! Send now for complete information about the easy-to-get jobs for your Sherman Power Digger. No obligation.

SHERMAN PRODUCTS, Inc.
Dept. PM Royal Oak, Michigan

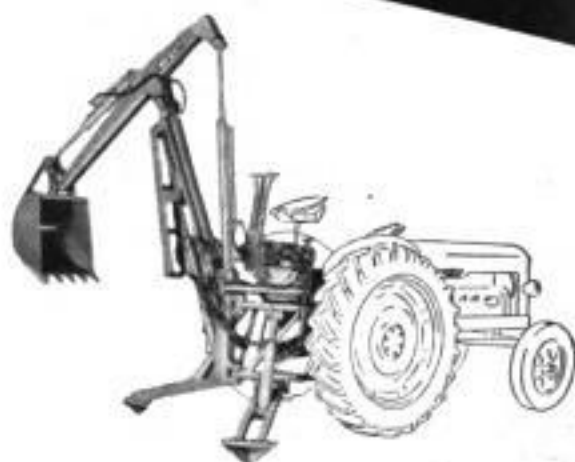

Send Now for FREE LITERATURE!

SHERMAN PRODUCTS, Inc.
Dept. PM Royal Oak, Michigan

Please send me complete information on the Sherman Power Digger

NAME _____

ADDRESS _____

CITY _____ STATE _____

PORTABLE JIG SAW

**CUTS AS FAST AS SAWS
COSTING \$50 AND UP!**

Does work of Jig, Keyhole, Coping, Band, Rip, Hacksaw. Has built-in air blower, fits any 1/4" drill, cuts wood, plastics, metals. At your dealer or try it on our 10-day trial. Send check, M.O. (Postpaid). C.O.D.'s—postage extra.

ARROW METAL PRODUCTS CO.

Dept. PM-8, 140 W. 87th St., N.Y. 13, N.Y.



HIGH TORQUE TROUBLE?

Try the
**Bonney
X-4**

Amazing, new Geared-Head Wrench. Makes tough jobs easy. Generates high torque (4-to-1 ratio) within limited space. Torque produced through planetary gearing. Small . . . rugged . . . compact . . . lightweight . . . portable.

Write for descriptive folder.

BONNEY FORGE & TOOL WORKS, ALLENTOWN 16, PA.

Automatic Saw Set...

MAKE EXTRA PROFITS!

Set 400 teeth per minute on hand or band saws, 4 to 16 point, with the BeMaCo Automatic Saw Set. Fast, accurate, true hammer-anvil action sets teeth uniformly, eliminates tooth breakage. Used profitably by saw shops and manufacturers everywhere. Every machine positively guaranteed! Write for details—today!



Saw
Machine
Division
17-C

BEAVER MFG. CO.
800 ISIS AVENUE • INGLEWOOD, CALIF.

You're out in front on a

**Cushman
EAGLE**



**AMERICA'S TOP
TRANSPORTATION
BUY**

Up to 75 miles per gallon . . . 34¢ per mile total operating cost . . . endurance proved.

Own a Cushman Eagle for as little as \$5.00 a week. See your nearest dealer for a FREE demonstration or write for illustrated literature.

CUSHMAN MOTOR WORKS, inc.
961 No. 21 Lincoln, Nebraska

AUGUST 1955

239

Copyrighted material

NEW, DUAL-PURPOSE APPLIANCE

IT'S A
BAR-B-Q



IT'S A PORTABLE

BLITZ-BURNER

(TRADE-MARK)

FOR HOME, LAWN, GARDEN WASTE

The new aluminized steel Blitz-Burner is the cleanest, safest, most efficient outdoor appliance ever designed for the collection, storage and disposal of waste basket contents, leaves, etc. (Not an incinerator.) Can be quickly converted into an attractive barbecue . . . simply invert the dome to seal off inside of container and insert low-cost charcoal burner and grill accessory!

STAYS GOOD LOOKING FOR YEARS!

Made of rust and corrosion resistant Armco Aluminized Steel. Special combustion dome induces fast, complete burning . . . eliminates flying ash . . . reduces smoke. Rolls easily wherever you want to use it on rubber-tired wheels. Burns safely anywhere! You need not scorch your lawn or driveway! For FREE Barbecue Cap, complete details and special introductory offer

MAIL COUPON TODAY!

MONTAMOWER DISTRIBUTING CO. (MFR.)
346 KEELER BLDG., GRAND RAPIDS, MICH.

Gentlemen: Please rush FREE Barbecue Cap, full-color illustrated literature and special introductory offer on your new Blitz-Burner.

NAME _____

ADDRESS _____

CITY _____

ZONE _____

STATE _____

**HONEST
CONSTRUCTION**



Honest value has been built into every Gerstner Chest for 50 years. Send for Free Catalog.

GERSTNER TOOL CHESTS

455 Columbia St., Dayton 7, Ohio

Say You Saw It in *Popular Mechanics*

**BUILD 15 RADIO
CIRCUITS AT HOME WITH THE DELUXE
PROGRESSIVE RADIO "EDU-KIT"**

ONLY **\$19.95** COMPLETE

All parts, Instructions, Soldering Iron, Tester Included. 30-Day Money Back Guarantee.

PROGRESSIVE "EDU-KITS" INC.
ROOM 534-B, PROGRESSIVE BUILDING
497 UNION AVE., BROOKLYN 11, N. Y.

Gentlemen: Please Rush me Free Descriptive Literature concerning "Edu-Kit." Also send me Free Radio-TV Servicing Literature. No obligation.

Name _____

Address _____

City _____

Zone _____

State _____

sympathetic response from SVIR members, they have made a detailed study of accidents involving children and adolescents. They have located close to 30 youngsters who were lost.

"In the beginning, rangers engaged in a search often had their pay docked by their employers," recalls head ranger Francis Morse. "Nowadays, pay continues. We regard the time and effort contributed to emergency service as comparable to the work of the average service club. We never criticize being called unnecessarily, but are dismayed when it is too late."

Representing men and boys in all walks of life, the rangers have grown to a strength of 150 seniors and 25 juniors. They engage in weekly outdoor activities, hold monthly meetings and "family days" and conduct hikes, hunting and fishing expeditions and tournaments. Those in the under-21 category conduct their own affairs, with senior supervision. An outstanding achievement of the juniors was the recent opening of a safe trail up Mount Finlayson, a 1342-foot peak with treacherous escarpments and shale slide areas.

Originally financed by a \$60 membership bond issue, the rangers raise funds by holding an annual Sportsman's Rummage Sale on the eve of the hunting season and by renting their club grounds for picnic purposes. Their emergency equipment includes a Cessna 195 seaplane, a 36-foot diesel craft, a gasoline-engine-equipped communications car with a Hallicrafters transceiver, modified Army surplus walkie-talkies, an ambulance, a dog trailer for their two bloodhounds and a field kitchen. While this makes an impressive list, they probably won't rest until they've added a helicopter to it. In any case, besides training youth, encouraging outdoor activity and having a lot of fun, they'll perpetuate the essence of the wartime ranger spirit by always being ready to serve their fellow men. ★ ★ ★

Automatic Sextant

Aerial navigation is advanced by an automatic sextant that sights and tracks the sun during the day and the stars and planets at night. A sextant tracking device is located at any point on the plane where a clear view of the sky is afforded. The navigator presets on his remote-control panel the estimated position of the celestial body. Then a photosensitive telescope on the tracking device searches the designated patch of sky. It finally locks on the proper star and the navigator reads the bearing on his control panel. He then use this information to determine his position.

AT HOME . . . Wherever You Go



in a 1955
PEERLESS
MOBILE HOME

MORE REAL COMFORT

DESIGNED for living! All modern conveniences. You'll enjoy the delightful comfort of the 1955 New Yorker's living room. Fully equipped kitchen. Here is America's Quality Mobile Home.

SEND FOR FREE FOLDER

Peerless Manufacturing Corp.
4320 Bluffton Rd., Ft. Wayne, Ind.



AGENTS — SELL

TOOLS! GUNS! CAMERAS!

Get up to
40% off

Buy tools, photo equipment, sporting goods, jewelry and thousand other nationally advertised products at big discounts. Big profits selling to others. Postcard brings free plan.

AMERICAN BUYERS SERVICE

HERTEL STATION, DEPT. 15
BUFFALO 16, NEW YORK

WORLD'S BEST SMALL TRENCHERS



Portable DITCH-WITCH digs 2" to 6" deep, even ditches to 36" depth in all types of soil. Complete unit—self propelled—outriggers 8 men. Four rugged models.

Write for illustrated literature.
THE CHARLES MACHINE WORKS
620 B Street Perry, Oklahoma

BRONZE FOUNDRY Schools and Home Workshops

Take your own castings of aluminum, copper, bronze, silver. Foundry sets are available in three sizes including 2400 Deg. F. blast furnaces. See advertisements in March or Apr. issues, free Circular.

KANSAS CITY SPECIALTIES CO.

P.O. Box 6022 Dept. P-8 Marysville, Kan.

Interested in Money?

Our distributors are making it hand over fist, handling our nationally advertised automotive products in their own protected territories. Some areas still open. No charge for exclusive franchises. For details, write Room 1010, 3460 Wilshire Blvd., Los Angeles 5, California.

BUILD YOUR OWN MIDGET ROADSTER \$25 BUILDS BODY & FRAME



BUILD A PONY ROADSTER or Pick-Up in few spare hours. Uses 2 hp engine, 450 lb. loads, 70 m.p.g., plenty of speed. Designed for VERY LOW-COST assembly from PARTS BOUGHT IN YOUR NEIGHBORHOOD. Use home tools. Great for kids, sturdy utility car. COMPLETE step-by-step plans, 17 large-size pages, 30 "show-how" photos. Body templates, complete material and parts list. Only \$1.95 post-paid. Satisfied or money back.

PONY PLANS, 7641-D TEXHOMA AVE., NORTHRIDGE, CALIF.

BUY FROM MANUFACTURER

ATTIC EXHAUST FANS \$6.66
F.O.B. N. Y.



20" Kit includes: Steel blade 2 self-aligning bearings 2 pulleys, shaft, collars, instructions. Easy to install and assemble.

VISIT US OR SEND FOR FAN PARTS & MOTOR BOOK
Albin Machine Co., Inc.

New York, 423 Broome St. | Detroit, Mich., 425 W. Jefferson Ave.
Cinn. Ohio, 1529 Vine St. | Louisville, Ky., 225 E. Market St.

WAR SURPLUS AND OTHER BARGAINS **SAVE UP TO 90%**

SENSITIVE ALTIMETER in 10 Ft. Increments.

Famous Pioneer! 0 to 35,000 ft. Inches of Mercury! Tested and inspected in our own instrument lab. Guaranteed perfect. Approx. Govt. Cost \$150. NOW ONLY \$13.95 Ppd. U.S.A.



SENSITIVE-TYPE TACHOMETER KIT



For cars, boats, tractors, trucks. Made by Pioneer Instrument Co. Can be hooked up to any engine. No bulky cable necessary. Just 2 wires required from tach generator to indicator to give true engine speed. Range: 0 to 3500 RPM. Brand new, tested in our own lab. Govt. Cost \$367.50. Indicator and Generator only \$23.50 ppd. USA.

PORTABLE POWER PLANT



Ideal for light welding. For boats, camps, emergency lights, battery charger. 2000 W. 30 V. 5 HP. Complete with carbon pile voltage regulator and ammeter. Like new, tested. Shock mounted. Deluxe type. Approx. Govt. Cost \$700.

Shpgt. Wt. 200 lbs. \$72.50.

NEW IMPROVED MODEL MAUSER-TYPE



PRECISION 1/1000" VERNIER CALIPERS

Quick, handy, accurate. 6" Vernier Calipers. Glass hardened, lapped measuring surfaces. Fine engraved scales—1/1000" & 1/10 mm for inside, outside & depth measurements. Friction thumb release. Larger capacity. 2 gib adjustments. Reg. \$25. Now only \$7.95. Leather case \$1 extra.



MICROMETER DEPTH GAUGE

With 3 rods to measure all depths from 0 to 3 inches by thousandths. Hardened tool steel lead screw has full 1 inch run. Base is 2 1/2" long, hardened ground and hand lapped. Accuracy guaranteed. Mfd. by Millers Falls Co. GOV'T COST approx. \$30. NEW—\$10.95 ppd. USA. In velvet case.

MICROMETERS Chrome plated, precision engineered, carefully tooling to give long life. All new 0-1" cap. \$2.25 ea. 1-2" cap. \$3.50.



P1 GENERATORS

Electric Auto-Lite, 200 Amps, 24 Volt, 4400 RPM. Dandy arc welder. Wt. 53 lbs. Approx. GOV'T cost \$450. Like NEW. \$12.50 incl. easy diagram.

ARC WELDER ELECTRODE HOLDER

For arc welding. Takes all popular size rods, 300 to 500 Amps. 60-deg. angle. 8 3/4" long. Mfd. by Allison. Purchased from Navy surplus. New. Boxed. Gov't cost approx. \$10.50. Weighs 19 oz. Now just \$2.50



NEW 1955 CATALOG

Biggest ever . . . new low prices . . . Send 25c for your copy today. Prices F.O.B. Culver City unless otherwise stated. Check, money order or cash. 25% deposit for C.O.D.

AIRBORNE SALES CO., INC DEPT. PM855
8501 Stellar Drive, Culver City, Calif.

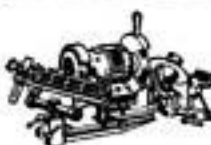

\$5 CASH AN HOUR!



Write today for
FREE BOOK

sharpening circular saws, planer and jointer knives in your home or garage . . . spare time. No experience needed. Hundreds of jobs in your neighborhood . . . no canvassing . . . no selling. Only \$15 down brings you this money-maker. Write today to:

BELSAW MACHINERY CO., 1646 Field Bldg., Kansas City 11, Mo.

get into the **URANIUM**

BOOM!

They're discovering URANIUM everywhere—and thousands of people just like YOU are making fortunes finding it! Get your share of big Govt. payoffs—find URANIUM all you need is a good uranium detector. Radia Co., the largest supplier of Strategic Metal & Mineral Detectors in the U. S. features a complete line of URANIUM prospecting equipment from \$35 to \$3500! Radia instruments are GUARANTEED to indicate presence of any uranium within detection range!



NOW A LOW-PRICED GENUINE GEIGER COUNTER!

Write today for free descriptive brochures. We supply the U.S. Atomic Energy Commission, and now you can keep your prospecting equipment from the same source, THE RADIA CO., Inc., Dept. PH-8, 489 Fifth Ave., New York 17, N. Y.

only \$35
f.o.b. N. Y.

(Continued from page 10)

A hole was drilled in the block of wood to put in the light socket. From that hole the battery hole was drilled crosswise of the block just back of the light socket. The hole for the wire that runs to the bulb was drilled from the light socket to the bottom of the battery hole. A hole was drilled from the switch to the light-bulb hole.

Wires were bared on the end and fed through the holes drilled for them.

The battery sits against the bared wire in the bottom of the battery hole for a ground.

A brass strip was used for the switch (first I used a doorbell switch but it made the microscope look clumsy) and was fastened against the other wire which runs from the bulb. This completed my circuit.

A plastic pie container was cut up to make a slide for the microscope.

Wayne Groth,
Seventh Grade,
Streator, Ill.

Correction

An item in the May issue, page 134, stated erroneously that a new life preserver is inflated with oxygen. Cartridges of carbon dioxide are used for inflation.

To the Editor:

On page 125 in the June issue of *Popular Mechanics*, the article "Skin Divers: Play It Safe" was written very well; but it left out one very important thing. This one thing is more apt to kill you than any one thing that you mentioned in your article. This is a fatal illness called air embolism and is one of the most feared things in diving work. Surprisingly enough, few amateur skin divers know about it. It is caused by expanding air in the lungs. If an amateur diver should suddenly lose his mouthpiece or come to the surface, and if he panicked, he would hold his breath. This is one mistake he won't make again. As he ascends, the air increases in volume and the air is forced through his lungs into his blood stream. By the time he has reached the surface he is unconscious and rarely can anyone be revived from this. The only chance there is is to put him under immediate compression in a decompression chamber and you don't find one of those on a public beach.

William J. Miller,
Shafter, Calif.

(Pictures of the atomization of fuels in jet engines are taken with a whirling mirror and a one-shot camera that stops action at $\frac{1}{4,000,000,000}$ second.)



Why electronic STROBOFLASH on the Pacemaker GRAPHIC?

Commercial, press and amateur photographers choose Stroboflash for better flash pictures. Why? Because Stroboflash is easier to use and less expensive than regular flash. By eliminating the need for flash bulbs, the cost of illumination is reduced to about one cent a picture. Choose from three models: Stroboflash I . . . light weight, fits into coat pocket; Stroboflash II . . . economical, long battery life; Stroboflash III . . . maximum light plus portability, excellent for color. Write for free folder: Dept. PM-85, Graflex, Inc., Rochester 8, N. Y.

GRAFLEX® *Price-Winning Cameras*

Make \$20 to \$30 a Week EXTRA MONEY!

With the high prices of food, clothing and everything else, just think what you could do with extra money every week! Turn your spare time into CASH—sharpening saws with a Foley Automatic Saw Filer pays up to \$3 or \$5 an hour. Start in your basement or garage—no experience necessary. "The first saw I sharpened with my Foley Filer came out 100%"—writes Clarence E. Parsons. No canvassing—"I advertised in our local paper and got in 93 saws"—says M. L. Thompson. With a Foley you can file all hand saws, also band and cross-cut circular saws.

FREE BOOK Shows How to Start

It explains how you can get business from home owners, farmers, carpenters, schools, factories, etc. "I get work from 20 to 30 miles away"—says Charles H. Smith. Free Book, "Money Making Facts,"

tells how to start. Send coupon today—no salesman will call.



Send Coupon for **FREE BOOK**

FOLEY MFG. CO. 816-5 FOLEY BLDG.
MINNEAPOLIS 18, MINN.

Send me free book
"MONEY MAKING FACTS"



Name _____

Address _____

GIGANTIC SURPLUS SALE!

SUMMER SUPER-CLOSEOUT BARGAINS

All prepaid to you

- Tractor Boom Spray Outfit.....\$97.65
- Window-Attic Fan Kit (30").....\$15.95
- 1-2 Man Air Corp Rubber Boots...\$27.15
- Surveyors Tripod Level.....\$42.00
- Step-by-Step Telephone Switches \$13.76
- Army Wool Sleeping Bags.....\$4.15
- AC-60v Power Plant, 1000-watt \$149.50
- Air Compressors, tanks, fittings
- Hydraulic Pumps, hose, valves, etc.
- Gov't. Power Plants—all types

FREE CATALOG

SPECIAL FOR AUGUST

NAVY IR-RIGATION
 P. U. M. P.
 Brand new Marine Products all bronze ball bearing hi-capacity centrifugal. Pressure to 65'. 2100-2700 speed. Complete with 8" pulley. Wt. 40 lbs. 10"x11"x9". 2 1/2" inlet, 2" outlet. 16,500 gpm. Natl. Adv. List #08. SALE, Prepaid \$44.37



BURDEN SALES COMPANY
 810 "O" St. LINCOLN, NEBR.

Save 50%! Assemble Your Own DIVING LUNG

FREE BOOK SHOWS HOW

We furnish the parts and instructions. Complete outfits \$49.95 and \$59.95. Write for our descriptive literature today!

UNDERWATER SPORTS, INC.
 Dept. G, 302 W. Adams
 O'Fallon, Ill., P.O. Box 65

MOTORIZED YOUR BARBECUE!

Easily rigged up by anyone. Handles whole ham or 4 small chickens. Commercial-quality thrust—2 r.p.m. gear-head motor (110V-AC)—spring-tension bronze bearing permits spit removal—

\$12.95

adjustable meat forks—heavy-duty, chrome-plated spit. Limited time, introductory offer. Postpaid. (\$13.95 Denver and West).

R SALES CO. — Dept. PM855 — Muncie, Indiana

FREE AMAZING NEW BOOK "HOW TO ANSWER ADS"

Never before have you seen anything like this. Tells you in simple language the correct way to answer ads. Gets you quicker replies—better results, and greater satisfaction. Will save you time and money and it's **ABSOLUTELY FREE**. No obligation whatever. Every reader of advertising should have this booklet. Send a postcard for your copy **NOW**. F. W. Johnson, Popular Mechanics Magazine, Room 600-A, 204 East Ontario Street, Chicago 11, Illinois.

Build Your Own Walks, Driveway, Outdoor Fireplace, Steps, Etc. What to Make With CONCRETE

The terrific high costs of even little concrete jobs are mostly for labor. Get Popular Mechanics **WHAT TO MAKE WITH CONCRETE** and save all the labor costs while making your home or farm ship-shape. You can lay foundations, sidewalks and driveways; build steps, outdoor fireplaces, sandboxes, tennis courts, garden and swimming pools and other installations at very little cost. Book shows all — tells all — how to make the right mixture, plan, apply and gives 50 professional short cuts. Hundreds of pictures. Only \$2.00 postpaid. Order today. Money back if not pleased.

POPULAR MECHANICS PRESS
 Dept. PM17, 200 E. Ontario
 Chicago 11, Ill.

AMAZING BARGAINS—SAVE TO 100%

75 MOUNTED WHEELS AND MINIATURE CUTTERS

Regular \$11.00 Value, Only **\$4.50** Post Paid

For cutting and grinding on wood, metal or plastic. Includes 26 mtd. wheels and points on 3/32" shanks; 24 miniature cutters on 3/32" shanks; 28 short shank min. cutters. Will fit all electric drills and hand grinders.

FLEXIBLE SHAFT \$9.50 Value \$4.95

Post Paid

Fits all electric drills & hand power tools. 35 3/4" long. Oilite bearings. Core of specially wound, high carbon steel wire in flexible steel casing. Will accommodate tool shafts up to 1/4" dia. For lathes, electric drills, etc.

10 Hi-Speed Steel & Carbon Drills \$1.00
 5 Woodworkers Drills \$2.95
 From 1/4" to 5/8" on 1/4" shank.
 Popular Sizes up to 1/4" Post-Paid \$2.75
 5 Hi-speed steel Drills \$1.95
 30 for \$2.75 1/4" to 1/2" Diameter.

SCHUPACK SUPPLY CO. 7331 Cottage Grove, Dept. PM-5
 Chicago 19, Ill.
NEW ILLUSTRATED CATALOG, 10c

RADIO CONTROL YOUR MODEL PLANES BOATS CARS

"CUSTOM MIDGET" RADIO \$9.98
 LICENSE FREE BAND
 OPERATES SAME AS \$50.00 SETS. INCLUDES LONG RANGE TRANSMITTER RADIO, RECEIVER RADIO AND CONTROL ACTUATOR ALL 3 EASY ASSEMBLY WITH OUR PARTS AND PLANS \$9.95. PLANS ALONE \$1.

DETAILED INFORMATION RE: RADIO CATALOGUE 23c
 SPECIAL "SUPPLY SOURCE DIRECTORY" & \$7.00 SUPPLY COUPON... \$1.00
 BOOK "RADIO CONTROL OF MODEL AIRCRAFT" CONTAINS 14 PLANS \$3.98
 RADIO CONTROL GARAGE DOOR DETAILS..... \$1.00

RADIOMODELS BOX 36 DEPT. PM BALTIMORE 6, MARYLAND

NEW SANDER L-I-G-H-T-S WORK AS IT SANDS!

Only Syner "900" gives you all this: built-in work light—most powerful reciprocating sander motor (patented) and guaranteed against burn-out during ownership—removes more material with less upkeep—no twisty torque to fight—heavy duty—low cost. Write for **FREE SANDING HANDBOOK, Catalog!**

SYNER CORP., Dept. I-CS, Oxford, Michigan, U. S. A.

SOUTH BEND

LATHES DRILL PRESS SHAPER

9" to 16-24" Lathes 14" Drill Presses 7" Bench Shaper

Write for literature—indicate machine.

SOUTH BEND LATHE, SOUTH BEND, IND.

URANIUM PROSPECTOR'S COUNTY MAP of U. S.—\$1

—Shows counties containing radioactivity, known deposits of uranium & other minerals important to prospectors. All county & state boundaries in U. S. shown with mineral symbols. Information invaluable for current prospecting. Cash, check, money order to **LAKESHORE PUBLISHING COMPANY**

Wte. 8, Overlake St. Dept. 102 White Bear Lake 10, Minn.

ESHELMAN ADULT SPORT CAR

Model 6 HP

1 THE 5 COST OF ANY OTHER AUTO

70 Miles Per Gal. Gas. 35 Miles Per Hour Also ideal GOLF CAR.

Shipping Points: BALTIMORE, CHICAGO, RENO Free Catalog Writer **ESHELMAN CO.** Pat. Pend. DEPT. MC-58, 109 Light St., Baltg 2, Md.

EARN \$\$\$ WELDING ANYWHERE plus LIGHT-POWER

EARN BIG PAY! Let HOBART help you set up your own shop. You'll soon be turning out top quality work—earning hundreds of extra dollars monthly. The 200 amp. "Husky Boy" at the left enables you to do profitable general shop and outside repair work.

FREE Welder's Vest Pocket Guide

With a 200 or 300 amp. AC Power AC Welder combination at the right, you can build your own unit—simply connect it to a good gas engine or power source to weld or operate tools, lights, etc. Tear out this adv. and mail with your name and address for complete details.

SAVE \$300 to \$500 build your own write-power combination

HOBART BROS. CO., BOX M-85, Troy, Ohio, Phone 21223 200 or 300 amp. AC-AC

BOATING IS FUN

GET STARTED NOW



NEW BOATING BOOKLET

Tells how to select or build a boat, how to locate boating waters and how to start having real boating fun. 16 pages full of action pictures. For your copy just send your name and address plus 10 cents to cover postage and handling to: Mr. Abbott, National Ass'n of Engine and Boat Mfrs., P. O. Box 1770, New York 17, N. Y.

BIG PROFIT IN METAL FLAME CUTTING "EXPAND YOUR BUSINESS" WITH AMAZING "NEECO" TORCH GUIDES



PRICE 1125 PPD IN USA

CUSTOM MADE TO FIT YOUR TORCH

In ordering give Name, Type, Model and degree of torch head. No experience needed to cut difficult metal parts, shapes in plate or structural steel, quickly, accurately. EASY TO USE. Your cutting torch will pay big dividends with AMAZING NEECO TORCH GUIDES. Complete instructions with each RUGGED and LONG LIFE GUIDE. ACT NOW, write Dept. PM6—NEW ERA ENG. CO. 458 W. 29th ST. CHICAGO 16, ILL.

ZONA SAW SET

THE SAW WITH A THOUSAND USES.

FOR MODEL BUILDERS — HOME CRAFTSMEN
CABINET MAKERS — JEWELERS

Blades of finest quality steel, thinner than a coping saw. Makes fine razor-like cuts without danger of spitting, chipping or leaving ragged edges. Ideal for notching, interlocking joints, inlaying blocks, mitre joints, etc.—REPLACEMENT BLADES AVAILABLE—HELD FIRMLY IN PLACE AND EASILY CHANGED.

Easily Cuts — PLASTICS • WIRE
• METAL FITTINGS • SCREWS
• THIN WALL TUBING

\$1.95

At your dealers or send direct
UNIVERSAL DISTRIBUTING CO.
802 W. HATCHER PHOENIX, ARIZ.

Metal Turning Lathe for Model Makers



With Ball Bearing Headstock Spindle

For Home Work Shops, Model Builders, Hobbyists. Use it to earn money; develop inventions; make repair parts; do machine work on models.

only \$25⁷⁵ f. o. b. Lansing

All steel, practical lathe. Length of Bed—12"; 4½" Swing; Distance between centers—7"; Tailstock travel—1½"; 0 Center in Tailstock; 0 Center in spindle; spindle has ½" x 20 thread—¼" hole; Complete with face plate, driving dog and mounting bolts. Weight, 25 lbs. Guaranteed. Price, except motor—

Rosemoor Mfg. Co., 2603 Bernice Rd., Lansing, Illinois

244

"NEED BACK ISSUES to round out your Shop Notes Files?"

This special offer is being made exclusively to Popular Mechanics readers... We have a few hundred surplus copies of SHOP NOTES for 1947, '49 and '52... On the newsstands, the 1947 annual sold for 50c, 1949 and 1952 for \$1.00 each...

Now, while the supply lasts, you can have all three collections of shop projects and do-it-yourself know-how at a saving of 40%!

All orders must be accompanied by your remittance (if your order reaches us too late, we'll refund your money by return mail). Remember—the supply is limited, so send your order today and save over \$1!

Popular Mechanics Press

200 E. Ontario St.,
Chicago 11, Ill.



\$250

VALUE

for only

\$149

POSTPAID

SEND ME

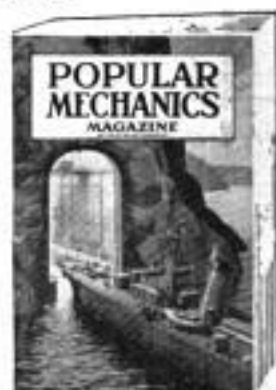

every month so I am sure to see each new issue. Here's

- \$3.50 for 1 year
 \$8.00 for 3 years

name

address

city

zone

state

Hand this order to your newsdealer or send it to

POPULAR MECHANICS
200 East Ontario St. Chicago 11, Ill.

POPULAR MECHANICS
Copyrighted material

DO IT YOURSELF!

Save Time and Money with the "NEW HOME SERVICE TESTER"

No more waiting for TV and Radio service . . . eliminate electrical and other repair bills . . . Now you can test all radio and TV tubes . . . Now you can check home appliance shorts and broken wires . . . Now you can test light bulbs and fuses.

You do all this yourself with the "NEW HOME SERVICE TESTER." Complete with easy instructions — SAVE MONEY—AND have fun, too.

ORDER TODAY! **\$4.95** EA. POSTPAID



Lindaily Products 2626 W. 103rd Pl., Dept. MP-8
Chicago 43, Ill.

Do It Yourself with DREMEL Straight-Line-Action SANDERS!



Send for free catalog of Dremel power tools.

DREMEL MFG. CO., Dept. 115-H, Racine, Wis.

AIR-VACUUM

Model 22 air compressor — Chapin Multi-Purpose Model 22 air compressor, air engine, vacuum pump, vacuum motor, etc. 2 cu. ft. displ. at 1725 rpm. With coupling to direct connect to any 1/2 or 3/4 h.p. motor with 1/2" shaft. 2 cyl. reversible. 35 psi. working pressure \$34.50.

Model 44—4 cyl.—4 cu. ft. displ. at 1725 rpm. Use also as torque motor, speed control, remote control, automatic devices, etc. With pulley and mount \$59.75.

Oilite bearings. Rotary ports. Bore 1 1/8"—Stroke 1". Prepaid with cash or send \$5.00 bal. C.O.D. and postage. Order today. Patent applied for. Mfg. & dist. by Bryan W. Chapin, Tully, N. Y.



Use also as torque motor, speed control, remote control, automatic devices, etc. With pulley and mount \$59.75. Oilite bearings. Rotary ports. Bore 1 1/8"—Stroke 1". Prepaid with cash or send \$5.00 bal. C.O.D. and postage. Order today. Patent applied for. Mfg. & dist. by Bryan W. Chapin, Tully, N. Y.

STARRETT "Tools and Rules" BOOK

Describes and illustrates the precision methods skilled mechanics use. Only one dime. Write Dept. AP.

The L. S. STARRETT CO., Athol, Mass., U. S. A.



#5 X-ACTO KNIFE \$1.20

x-acto

KNIVES • TOOLS
HANDICRAFT KITS



X-ACTO, INC.

48-45 Van Dam St.

Long Island City, N. Y.

Send 25c for 28-page Catalog

PUMP-FAST!

Bronze U.S.N. heavy duty Centrifugal Pumps. Run continuously—wet or dry! Mosaic shafts, sealed oversize ball bearings, one point lubrication. Slotted base adjusts belt tension. Perfect for swimming pools, irrigation, fire fighting, bilge, etc. Absorb 1 to 5 Hp. NEW SUPPLIES: L-120 has 1 1/2" & 1 3/4" hose connection. R-110 has 1 1/2" & 1 3/4" pipe thread ports. R-200 has 2" & 2 1/2" threaded ports. #110 pumps 9,000 GPH; #120 12,160 GPH; #200 16,500 GPH. Mod. L-120 \$29.99 F.O.B. Wt. 18 lbs. Reg. \$75 Val. Mod. R-110 \$32.95 F.O.B. Wt. 19 lbs. Reg. \$60 Val. Mod. R-200 \$44.95 F.O.B. Wt. 38 lbs. Reg. \$100 Val.

KARL ORT, Dept. 8 P.M., York, Pa.



\$29.99 FOB

Carpenters' NAILPULLER Pocket size!

Powerful, Easy to Use, Handy as a Hammer!

Satisfaction guaranteed up to tenpenny nails.

POSTPAID U.S. ONLY

\$1.74

No C.O.D. No Stamps.



Only 12" long.

Carpenters' favorite. Convenient in tight places, carries in pocket. Tool steel counteracting jaws driven into wood under nailhead. Double leverage with hammer. All steel, rustproofed.

K-D Mfg. Co., 526 N. Plum St., Lancaster, Pa.

NEW REVOLUTIONARY MORTARMASTER!



NOW ANYONE CAN LAY CONCRETE BLOCK WITH PROFESSIONALISM! No Experience Needed!

Simple to build your own concrete block home, garage, patio, barbecue pit, breezeway, week-end hideaway, etc. THE MORTARMASTER is the perfected tool of a Practical Builder and Master Chemist, after years of intensive research and actual use . . . A strong, durable, rust-resistant steel precision tool, designed to perform with less effort and up to three times faster the labor of applying mortar in masonry work, especially with concrete block. Largely replaces the trowel, the old and conventional tool of the trade . . .

- Light weight—4 1/2 lbs.
- Fast—increases block laid in a day up to 3 times
- Smooth, even supply of mortar cuts waste up to 50%
- Better job
- Requires less scaffolding, less mortar boards, less clean up
- Uses any standard mortar mix
- Gives years of dependable service
- Affords profitable recreation and lasting achievement

Capable of paying for ONLY \$17.50 POSTPAID itself in one day!

Special Introductory Offer: If order received within 30 days, with mention of this ad, the Mortarmaster will be sent to you for only \$14.95. \$5.00 deposit for C.O.D. Satisfaction Guaranteed or money back in 10 days. Full instructions with each. Illustrated literature on THE MORTARMASTER and our other Labor saving tools upon request. Plans for many popular projects available to purchasers. Early orders filled promptly.

MASTER PRODUCTS CO. 1346 N. BEACH BLVD. BAY ST. LOUIS, MISS.

Install your own!



CABINET TOP CHOPPING BOARD

Real kitchen convenience! Laminated edge-grain hardwood, fits cabinets or counters to 25" deep. Durable, attractive, lends "custom" look. Saw to size, install yourself. Splashback included. Guaranteed. Ask your building supply dealer or send check or M. O. for collect shipment 24" width \$12.95; 18" ONLY \$9.95.

SUNDOWN COMPANY
278 So. Front, Memphis, Tenn.

G. E. Stationary SWITCHES

FITS ALL SIZE G.E. MOTORS from 1/20 to 3/4 H.P.

EVERY Dealer, Repair Shop, Refrigeration Man, etc., should stock up with these SWITCHES for emergency replacements for type KH and KC General Electric Motors from 1/20 to 3/4 H.P. Single & Double Contact for New Style Automatic Washers and 2 Speed Fan Motors. When ordering specify Single or Double Contact. #SW-1 Per Dozen P. Paid **\$5.00**



16 TO 1 SPEED REDUCERS

For Display Table — Barbecue Spits — Toy Auto Gear Box — Experimental Uses, Etc. Gears Enclosed in Aluminum Housing. Bronze Gear, Hardened Worm, Input Shaft 1/4 in. Output Shaft 3/8 in. Speed Reducer #R 161 **\$5.95** Paid



Write for CIRCULAR Listing Motors; ALL SIZES: Fans and Air Compressors—ALL SIZES.

C. MARSHALL SALES, 3546 W. Fullerton Ave., Dept. P-8, CHICAGO 47

Amazing CAR POLISH Discovery!

FAST as a car wash!



Now! MAC'S new Resin Coat. A long-lasting polish that's quick and easy to apply. Fast-acting Solvent Action does it...loosens surface film harmlessly while special resins produce a hard, high gloss that lasts up to 6 months. Just rub on, wipe off. Do a perfect job in minutes—not hours. Nothing like it.

"DON'T WAX IT—MAC'S-IT"
...with MAC'S RESIN COAT!

AT
YOUR
SERVICE
STATION

MAC'S SUPER GLOSS CO., INC.
Los Angeles 42, California

Enjoy Modern Living • Make Your Home Worth More With This Popular Mechanics Book . . .



759 PICTURES

Above: How to lay a new roof over the old.

Right: New walls over the tired old walls. A few of the 83 modern kitchen ideas.

Below: Modern ceilings for old basements.

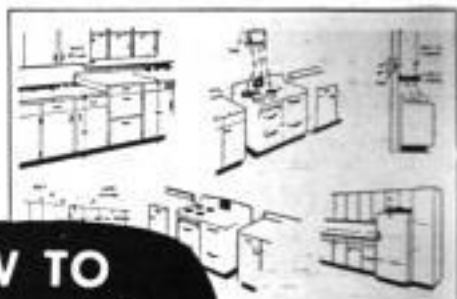

HOW TO Remodel Your Home

With Data on New Materials and Products Available to Home Owners

Here are hundreds of ways you can make a modern home out of an old house, make the house worth more and save money while doing it. If you own an old house or intend to buy one, get "How to Remodel Your Home" by E. R. Haan, formerly technical editor for Popular Mechanics. You can do the modernizing yourself or have it done for this vital book contains 547 methods and 759 illustrations covering complete modernization, adding rooms and living space, installing new kitchens and baths, adding closets, wardrobes, rumpus rooms. Complete face-lifting jobs for the outside and morale building jobs for the inside. Learn the joys and conveniences of modern living with this vital book prepared especially for the home owner. Mail coupon for your copy today

Money Back if You Want It.

Get the book now. Check it for information that will help you improve your home for appearance, convenience and value. If not fully pleased return the book in 7 days and Popular Mechanics will refund every penny you have paid.

Big Book.
Same Size as
This Magazine.

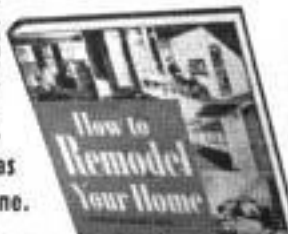

What to Do!
How to Do It!
How to Cut Costs
and Save

In this book — 17 big helpful sections. They are:

From old to new—Your modern kitchen—Better bathrooms—Basement rumpus rooms—Curing wet basements—Attic space and dormers—Adding rooms to the outside—Porches and breezeways—Utilizing idle space—New look for outside walls—Modern interior walls—Heat-loss and humidity controls—Roof framing and covering—Windows that modernize—Entrances and doors—Variety in floors—Wiring, plumbing heating. In all—547 money-saving articles you can use.

Use Coupon to Get Remodeling Book

POPULAR MECHANICS PRESS, 200 E. Ontario St., Chicago 11

Send at once "How to Remodel Your Home," postpaid for \$2.95.

I understand I may return the book in 7 days for full refund

Remittance for \$2.95 enclosed. Send book postpaid.

Send COD. I will pay postman.

Name _____

Address _____

City _____ State _____

AMERICA'S
LARGEST STOCKS
of JEEP PARTS



LOWEST PRICES!
SATISFACTION
GUARANTEED!

The King of Jeeps

BRAND NEW CAPSTAN WINCHES

NEW LOW PRICES



6000 lb. capacity. Accurately machined gears provide for smooth efficient operation. Suitable for both front or rear mounting. May be used on jeeps or trucks. All units are brand new and fully guaranteed.

EACH
\$25.00

NEW CANVAS TOPS



Specify Military or Civil. **\$22.50**

Slightly soiled NEW Military Tops, special.. **\$17.50**

The "K" Free Wheeling FLANGE Saves Gas Stops Growl Simple—Easy Conversion

\$19.95 Per Set

Complete With Ball Bearings

COMPLETE TRANSMISSION AND PARTS Willys \$65.00 exchange CJ2A and CJ3A-3B also available

PINTLE HOOK — NEW. A593 Military **\$6.95** or Civil.

BRAND NEW ARMY SURPLUS AMPHIBIOUS JEEP KITS, consisting of all rubbers for steering assembly, drive shafts, axles, and includes brake hoses, fan belts, spark plug, grease retainers and all other seals.

SPECIAL \$17.50 while they last

Brand New HENRY "J" front shocks.....\$2.25 each

New JEEP shocks A 6902 front.....\$4.06

A 6903 rear.....\$4.06

Brand New Universal Cross Joint Repair Kit A 1433....\$4.13

FREE JEEP CATALOG — WRITE FOR IT TODAY!

Thousands of other Jeep parts and accessories available. SHOP BY MAIL—Order Direct From This Today. TERMS: Net cash with order. Open account to rated firms only. C.O.D. shipments should have 25% deposit with order. Minimum order \$1.50. Inquiries invited from dealers, exporters and quantity buyers.

BERG TRUCK & PARTS CO., INC.

1608 S. WABASH AVE., DEPT. 13, CHICAGO 16, ILLINOIS



Cuts Cement Finishing Time in Half!

PONY TROWEL

Finishes complete to wall. One-man operation. Ring designed for self-adjusting blades. Sturdily built. Successfully used nationwide with 1/2" or 5/8" drills.

Handle and trowel complete less drill **\$49.50**

f. o. b. Muncie, Ind. Extra blades only \$3.50

See Your Dealer or Order Direct

ELMO MFG. CO.

Dept. C, 324 W. Howard St. Parker, Indiana (Pat. Pend.)



NEW! Lightweight, compact ELECTRIC PLANTS

2,500-watt model—only 154 pounds!

New AJ and AK models from 500 to 2,500 watts. High output, small size, low-cost. Powered by new Onan short-stroke engines.

WRITE FOR FOLDER.

D. W. ONAN & SONS INC. 3309 Univ. Ave. S.E. Minneapolis 14, Minnesota



REPLACEMENT TOOL HANDLES

5 SIZES Your tools work easier, more comfortably—with new AB Long-Life Replacement Handles. Only \$1 FIVE sizes, 3/4" to 6", fit most tools—rasps, files, chisels, awls, screw drivers. Metal Postpaid ferrule holds tool secure. Just press it on! A B MFG. CO., Dept. P, 1168 N. 50th Place Milwaukee 8, Wisconsin

HELPFUL BOOKS

Send post card asking for FREE catalog Popular Mechanics Press, 200 E. Ontario, Dept. 601, Chicago 11



P-1 GENERATORS

Aircraft type 200-250 Amps, 24 Volt D.C., 4500 RPM. Makes a dandy arc welder. Cost GOV'T. \$400. SPECIAL \$118. Like NEW! Diagram incl. P.O.B. York, or Texas NEW '55 catalogue with 1000's of other big bargains—10c.

KARL ORT, Dept. P-18, York, Pa.



ELECTRIC WELDER

AC or DC 110 Volts The "Little Marvel" all-metal welder, 5-year written guarantee. Welds 1/4" metal or money back. Repairs tanks, tools, fenders, machine parts, etc. Complete with everything—rods, unit, eye shield, directions. \$6.45

plus 50c postage. Flame torch accessory for soldering, cutting, brazing \$3.95 complete with carbons, brass rods, flux. \$2.00 Deposit on C.O.D. 1/4 inch Transformer Welder \$19.95 F.O.B.

SSAY MFG. CO., Dept. 51, Quincy 69, Mass.

\$6.45 Complete



AIR CONDITION ONE TO THREE ROOMS FOR ONLY \$34.50

NOW DELIVERED COMPLETELY ASSEMBLED, evaporative air conditioner easily installed in minutes in window opening; sliding side panels assure snug fit. Beautiful hammertone finish. Balanced fan and powerful 1/25-hp, 115-v AC shaded pole motor deliver 1500 cu. ft. cool, filtered air per minute through adjustable directional louvers. Pure aspen filters; clog-free drip trough; brass metering valve; toggle switch; pipe connection; 25' tubing. Send \$5.00 m.o. or check; balance C.O.D. plus shipping. Full price only \$34.50 f.o.b. Dallas. Supply limited—ACT NOW!

MOTOR GUARANTEED FOR ONE YEAR

LOOK! All New - All Precision - All Deluxe SUPERSHOP MODEL X

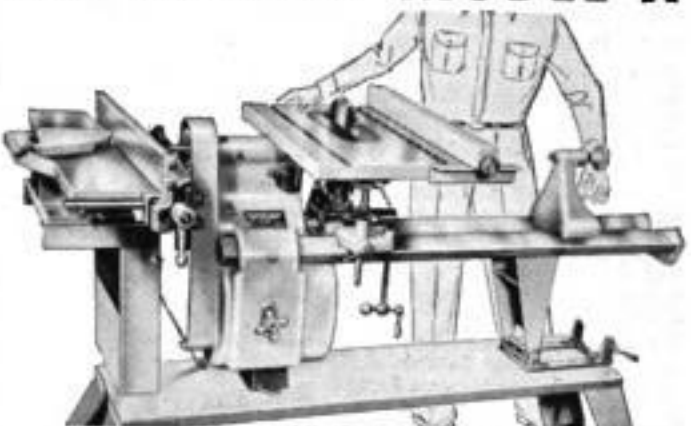

8" SAW

THE COMPLETE HOME WORKSHOP YOU'VE ALWAYS WANTED

Never before has so much workshop been offered for so little money! Massive cast headstock, self-centering bedways, non-friction speed changer, extra large cast and precision-machined table. Added savings because you buy direct from factory. Mail coupon for beautiful color brochures, photos, details, specifications, accessories — and our amazing FREE HOME TRIAL PLAN. All FREE.



Vert. Drill Press



Hor. Drill Press



8" Sander



30" Lathe



5" Grinder

MAIL COUPON FOR FREE BROCHURES...

POWER TOOLS, INC. 174 Yates Ave. Beloit, Wisconsin

NAME _____

ADDRESS _____

CITY _____ STATE _____

ELECTRIC WATER PUMP

With Powerful 1/4-HP MOTOR

Reg. \$54.00 Unit **\$24.00**
Tremendous BUY! PRE-PAID

Drains Cellars, Wash Tubs
IRRIGATES, Boat Pumping, etc.

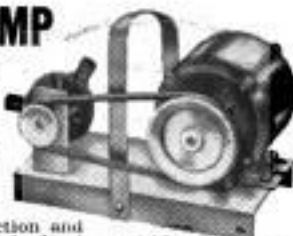

This whirlwind pump does all your suction and lifting jobs. Propelled by 1/4-HP Motor (single-phase, 110-volts, 60 cycle). Lifts waste water to overhead sewers up to 30 FEET! Pump has 2,000 gallon per hour capacity. Build a running water system to upper floors. Waters livestock. Circulates and transfers oils, liquids, etc. Non-clogging! Non-rusting! Sealed against leaking. Attach any 3/4" garden hose. Guaranteed 100% or money back. Limited supply at this price. Order Now!

WE PAY SHIPPING CHARGES! Free Catalog

ROBERTS ELECTRIC CO., Dept. P-310, 849 W. Grand, Chicago 22, Ill.

LARGEST SANDING AREA 25 sq. inches **\$14.95**

The Weller Power Sander and Polisher has no equal in its price class. Reciprocating type motor almost impossible to stall. Straight-line action gets into corners and sands smooth. Write for catalog.



WELLER ELECTRIC CORP.

816 Packer St., Easton, Pa.

BENJAMIN SUPER CO₂ GAS CARBINE-\$16.50

NEWEST TARGET

RIFLE-22
IDEAL
FOR
SMALL
GAME



**ECONOMICAL
SAFE-NON-TOXIC
ACCURATE-CONVENIENT**

PRACTICAL. Easy to operate—No spring recoil—No pumping. Uses low cost Soda Cartridges Cal. 22 Benjamin H-C Pellets and Darts.

New Benjamin
CO2 HOCKET Gas
Pistol \$15.00

WRITE FOR FREE ILLUSTRATED FOLDER OF ALL MODELS
BENJAMIN AIR RIFLES AND BENJAMIN AIR PISTOLS
BENJAMIN AIR RIFLE CO.

296 MARION ST., ST. LOUIS 4, MO. U.S.A.

BUILD D.C. WELDER!

Do it yourself in spare time at home. Amazingly easy to build D.C. welder with used auto or aircraft generator parts. Easy plan to follow only 35c. Will include Free catalog of war surplus electrical items. Write today.



LEJAY MFG. CO., 1247 Le Jay Bldg., Minneapolis 8, Minn.

INCREASE FARM INCOME

Level land, layout structures, roads, irrigation, water lines—No guesswork! **Professional Transit** at farm budget price! \$205.00. Earn money from your neighbors too. Bulldog rugged, brilliant optics, lifetime service.

PROVE AT OUR RISK! If you're not 100% happy, return undamaged in 5 days—full refund. If your dealer's out-of-stock, we pay freight. Start earning now! **FREE Literature.**

MIKRON INSTRUMENTS, INC.
ept. PM-85, 1966 E. Walnut St., Pasadena 8, Calif.

SAVE GAS! I'LL SEND YOU THIS FREE!

10 DAY FREE TRIAL! SEND NO MONEY! PAY POSTMAN NOTHING!

Users Report 4, 5, 6 Extra Miles per Gallon with New Miracle Gas Air-flow Needle. (\$1.50 Value)

Up to 25% MORE MILEAGE, FASTER PICK-UP, QUICKER STARTING reported. Phenomenal money-saving results coming from 1/2 MILLION USERS. Carburetor Engineering Co. reports **SAVING OF 72c PER DAY, YELLOW CAR CO., FLEET OWNERS, POLICE, EMERGENCY** vehicle users. Outstanding performance "approved". **FITS ALL CARS AND TRUCKS. INSTALL YOURSELF IN 2 MINUTES** with simple twist-of-the-wrist. (Replaces present idle adjustment screw in your carburetor.) **AMAZINGLY EASY TO DO!**

● TRY IT FREE! JUST SEND NAME AND ADDRESS! ●
PAY NOTHING! Test this revolutionary new automotive discovery in your car **AT OUR EXPENSE!** Check mileage. (Some users report no improvement—so **TRY BEFORE YOU BUY!**) If amazed at increased mileage **PAY WITHOUT MONEY.** Otherwise, just return the "little sinkers" and you owe us nothing. Fair enough? Specify make of car, cc. cyl. and year (8 cyl. cars use 2.) Rush, Free Trial **SUPPLY LIMITED.**

ECONOMY AUTOMOTIVE INDUSTRIES
Dept. A-8, 1036 S. LaBrea, Los Angeles 19, Calif.

also FREE!
Receive valuable revealing booklet if you **WRITE TODAY** without delay.

**HOW TO BUY
WITHOUT
MONEY**

BE YOUR OWN BOSS

Make Hundreds of \$ Spare or Full Time Work

You can make simply and cheaply

NO EXPERIENCE NEEDED

Here is the ideal business with no previous experience or large investment required and no high-priced equipment to buy. A business that will return dollars for the pennies you invest.

YOU CAN CAST ANYTHING

With *Flexible Mold Making and Ornamental Casting*, an amazing fact-packed book, you learn how you can cast practically any article in concrete, plaster, imitation marble or any other casting material using a marvelous new process. You can make ash trays, novelties, garden and lawn ornaments and hundreds of other highly profitable items that cost you but a few cents and sell for as much as \$5.00 and more. Why you can even make true-to-life full-sized busts of your neighbors and friends.

NO EXPENSIVE MOLDS TO BUY

Why buy high-priced molds from others? Learn how you can make your own molds quickly, easily and inexpensively with materials that can be used over and over. You get copyrighted formulas, complete instructions and detailed how-to-do-it photographs as well as complete sources of supply for the few inexpensive materials you need. This is the only book printed in America today that contains instructions for making profitable papier-mache casts.

MONEY BACK GUARANTEE

Start on your road to extra income and independence today. Send only \$1.98 for your copy of *Flexible Mold Making and Ornamental Casting*. Complete satisfaction guaranteed or your money refunded within seven days.

POPULAR MECHANICS PRESS, Dept. 46

200 E. ONTARIO ST., CHICAGO 11, ILL.



YES! SEND



directly
to my door
every month

I am enclosing

- \$3.50 for 1 year
 \$8.00 for 3 years

name _____

address _____

city _____

zone _____

state _____
A-85

Hand this order to your newsdealer or send it to

POPULAR MECHANICS
200 East Ontario St. Chicago 11, Ill.

SAVE 50% DO-IT-YOURSELF

Genuine Select PHILLIPINE MAHOGANY LUAN PLYWOOD

BUY DIRECT FROM IMPORTER

Ideal For Fine CABINET WORK, FURNITURE, Paneling DENS, OFFICES, HOTELS, etc.

Our prices are LESS THAN DOMESTIC PLYWOOD at WHOLESALE. This selected LUAN MAHOGANY means the most rigid specifications. It is WEATHER and WATER RESISTANT. You'll be amazed at the beauty of this fine wood. Its rich golden elegance will thrill you. Rotary cut for beauty of grain. Both sides sanded and ready to use. Bonded with finest resin adhesive. Face side unjointed.

See for YOURSELF FREE SAMPLE on request!

Available in three thicknesses - 3mm (approx. 1/8"), 4mm and 1/4". ALL orders shipped by special Truck for lowest rates. No order accepted for less than 100 lbs. - equal to (4) 1/4" sheets, (6) 4mm sheets or (8) 3mm.

3mm (1/8") x 3ft. x 8ft. - \$5.00 value. 179 PER SHEET Minimum order 8 sheets	4mm x 4ft. x 8ft. - \$7.50 value. 389 PER SHEET Min. order 6 sheets	1/4" x 4ft. x 8ft. - \$9.50 value. 499 PER SHEET Min. order 4 sheets
--	--	---

3400 RPM 1/2 HP POWER SAW

compares to saws selling up to 49.50

19.98 Complete with 5-1/2" Blade

CUTS THROUGH A FINISHED 2 x 4 LIKE A KNIFE THROUGH BUTTER RIPS-CROSSCUTS

A rugged, professional type, adjustable saw. Cut any angle, 0 to 45°. Max adjustable (0 to 6") rip fence. Safety-trigger switch on handle. Full 1/2 HP Universal AC-DC, 110-120 Volt, 60 cycle motor weighs only 6 1/2 lbs. A sensational Value - We sold over 700 Saws in Los Angeles in one EXTRA SAW BLADES - Available in Rip, Crosscut or Combination. Please specify. . . . price each **2.95**

12 PC. IMPORTED SPORTSMAN'S KNIFE

A COMPLETE CAMP KIT ONLY 4.95

12.95 VALUE

complete with genuine leather holster!

Includes: CAN & BOTTLE OPENER, BONESAW & FISH-SCALER, SCISSORS, DRAW KNIFE, 4 5/8" LONG BONE HANDLE, KNIFE, FORK, AWL, SPOON, SCREWDRIVER, FILE, CORKSCREW, and more!

GOING URANIUM PROSPECTING? SEE BARGAINS BELOW!

ARMY WATERPROOF BEDROLLS

Large 80"x96" heavy duty duck canvas bedroll. Has many pockets in each end to hold extra gear. An ideal enclosed ground cloth for a sleeping bag or air mattress. **4.95**

With (3) 8ft. straps & buckles.

ARMY CANTEEN, CUP AND BELT

Genuine U.S. Army equipment. Consists of a first quality 1 quart Canteen and aluminum Cup with holding handle, both of which fit snugly into an insulated canvas cover. Cover attaches to web type pistol belt. **ONLY 2.99**

URANIUM PICK AND HAMMER

Handy to pick or crack rocks. 7-1/2" head. Handle 14 1/2". Weight 22 lbs. **1.39**

MARINE BOLD KNIFE AND CASE

Made of top quality Vanadium steel. 15" long. Ideal for clearing brush. With sturdy belt sheath. **1.98**

U.S. ARMY MACHETTE

Has 22" Vanadium steel blade. A hardwood handle. Sturdy belt sheath. 27" overall. . . . **1.98**

NEW IMPORTED, SELF GENERATING CAMP STOVE

Smallest, most compact, yet entirely practical cooking stove you've ever seen. NO PUMPING - NO PRIMING necessary - entirely self-generating. Has collapsible grill for frying pan or coffee pot. Burns 2-1/2 hours on one filling of regular gas. ALL BRASS construction. Weighs 12ozs. Ideal for Prospector, Camper, Hiker, Picnic, etc. Guaranteed 1 year. **3.98**

SAVE UP TO 50% ON SPORT DIVING EQUIPMENT

BUILD YOUR OWN DIVING LUNG - SAVE up to \$100. Our special folder contains complete instructions showing how it's done. Kit includes Air Bottles, Pressure Regulator, Hoses, Safety Belt, Shoulder Harness, Clamps, Mouth-Piece, Valves, etc.

Price for above kit . . . **45.95**

With 2 Bottles (1 hour time) **130.00 value**

FREE CATALOG Has latest info on Diving Equipment. Plus an illustrated and described article on "How to build your own Diving Lung"

PALLEY BARGAINS IN DIVING EQUIPMENT

GENUINE AN-6004-1 Type DILUTOR DEMAND PRESSURE REGULATOR

Recommended type. Gives proper regulation at air on demand. . . . **10.95**

AIR HOSE ASSEMBLY For use with pressure regulator. Has vulcanized mouthpiece. **5.95**

CARTRIDGE BELT Pockets allow distribution of ballast weights around waist. **89c**

COMPRESSED AIR TANKS I.C.C. approved and dated. Will stand pressure of 1800 PSI

22 cu. ft. cap. (30 min. time limit) . No valve. . . . 9.75
28 cu. ft. cap. (45 min. time limit) . No valve. . . . 12.75
48 cu. ft. cap. (1 hour time limit. Without valve. ONLY 15.95

CONTROL VALVE for above bottles. \$3.00

TWO-TANK CONNECTOR - Doubles diving time. **4.95**

SINGLE TANK CONNECTORS - \$3.95

PAL SWIM FINs

New, first grade. Of top quality flexible rubber with treaded bottom on adjustable heel strap. Will float and are fully wood for speed and protection. Vented for air and drainage. Sizes: Small, Med., large. **2.99**

DIVING MASKS Made of gun rubber with a sturdy glass lens and adjustable head strap. A Bargain!

NEW FROGMAN SUITS Of finest quality seamless Latex rubber. Two piece type. Factory seconds with minor imperfections, but guaranteed. With either long or short arms and legs. Please specify. \$54.95 val. **24.95**

SMALL **99c** MED. **1.49** LARGE **1.89**

AIR CORPS RUBBER BOATS

Ideal for Fishing and Hunting. Made to top Gov't Specs. Reconditioned & ready to use. Order Today!

MAN **22.50** 7 MAN **69.50** 10 MAN **115.00**

COLLAPSIBLE OARS 1.25 EA.

NYLON ROPE Finest Quality. Lustrous White. Has tremendous tensile strength.

SIZE	Strength	PRICE
1/4" Nylon	1100 lbs.	8c run. ft.
3/8" Nylon	2700 lbs.	13c run. ft.
1/2" Nylon	5000 lbs.	27c run. ft.
1" Nylon	18,000 lbs.	50c run. ft.

ARMY LENSATIC COMPASS For hunter, camper, hiker, surveyor, Boy Scout, etc. Use for map orientation, azimuth reading or as a guide on unfamiliar terrain. Has 360° rotating bezel ring marked in 3° notches. "Peep" sight for sighting objects. **5.95 VAL.**

U.S. NAVY CHEST WADERS

Made to top Gov't specifications. Of finest quality rubber with worn felt inner lining. Comes up to your chest. Have built-in boots, shoulder straps & vulcanized seams. \$25.00 value. Size: Med., Large. **7.95 NEW**

NEW NAVY WADING BOOTS

A Surplus Bargain. Made of top quality, rubberized NYLON - vulcanized to Latex rubber shoe. Shoe is insulated against cold and has grip-reef sole. Boot is 4" high. Order one size larger than shoes. Sizes: 6, 8, 10, 11. **3.49**

NAVY WADING SUIT

Makes Surf or Deep Stream Fishing a pleasure. Also ideal for use when it is necessary to protect the body or clothes from mud, moisture, etc. Made to top Gov't specifications. Originally made for use in landing operations. Of heavy duty rubberized canvas with vulcanized seams. Built-in rubber boots & gloves. Sizes: Med. & Lg. **9.95 NEW** A \$35.00 VALUE

ARMY STEELFRAME RUCKSACK

Army Ski-Trooper Rucksack made of heavy duty duck. Has one large and 3 small compartments. Adjustable straps and bindings. Mounted on lightweight, comfortable, all-steel tubular frame. Ideal for hunter, hiker, boy scout, prospector, etc. . . . **8.95**

ORDER FROM THIS AD. Pay by Money Order or Check. 1/2 deposit with C.O.D.s. P.D.s accepted from D&B firms. All prices F.O.B. Los Angeles.

PALLEY SUPPLY CO 2263 E. VERNON AVE. DEPT. PM-B LOS ANGELES 38, CALIF.

Now—Do-it-Yourself and SAVE!

Cement Jobs are Quick, Easy with SAKRETE

Ready-to-use cement!

JUST ADD WATER AND USE!

Send 25c for 48-page Book
Photos, diagrams, etc. for hundreds of cement jobs with Ready-mixed SAKRETE. SAKRETE, INC., Dept. 14, Cincinnati 17, Ohio.

AUTO REPAIR MANUAL

Save money by making auto repairs yourself! Keep your car in the best possible running condition! Learn how to protect your trade-in value! Auto Repair Manual, by the Editors of POPULAR MECHANICS PRESS, can be used with any make, model or year of car. It's filled with money-saving shortcuts and maintenance procedures—will pay for itself the first time you work on your car. It's 160 pages long and has photos and diagrams to illustrate every point. Every car-owner should have a copy of this book. So get yours.



NOW ON SALE AT ALL NEWSSTANDS



Homeowner's DO-IT-YOURSELF IDEA BOOK

only 75¢ at YOUR FAVORITE NEWSSTAND

Popular Mechanics Press has come out with a new type of book. Now you can have, in one volume, information on every kind of job and project around the home. Learn how to upholster with foam rubber . . . use prefinished paneling . . . lay flagstone walks. Fix wobbly chairs and faded carpets. Sharpen scissors, remove paint, modernize old doors. 160 pages long—over 900 subject listings in the handy index. Ask your dealer for a copy today.

SAVE MONEY on SURPLUS PARTS for MILITARY TYPE TRUCKS & JEEPS

4 & 6 wheel drive. FREE catalog to owners only. State make truck or Jeep. (New Jeep Tops, steel or canvas all models). AMERICAN AUTO PARTS CO., Inc., 1830 Locust, Kansas City, Mo.

18 OUTDOOR FURNITURE PROJECTS

Clearly illustrated plans by outstanding designers. Step-by-step plans make it easy to build practical, attractive porch and lawn furniture at low cost. See your dealer or order direct. ONLY 50¢ (65¢ outside U.S.A.)

ATLAS PRESS COMPANY
824 N. Picher St., Kalamazoo, Mich.

MAKE A "Stradivarius" VIOLIN

—For Pleasure
—For Profit
—For Your Own Use

You Can Do It at Little Cost! It's Easy! It's Fun!

Here is the "top" of all home crafts projects. Make a violin—a replica of a famous "Strad"—the original of which sold for \$80,000.00. Joe Reid who has made hundreds of fine violins makes the job so easy—so inexpensive—in his new book "You Can Make a 'Stradivarius' Violin." You don't need any tools. Reid shows you how to make all the tools you need from old table knives, worn out files, sheet metal, etc. Eight full-size plans, 16x23 inches, folded into the book give you every detail in actual size.

Violins Bring High Prices
Make a violin and you probably will never want to sell it. But good tone modern violins bring terrific prices, yet the materials cost comparatively little. With Reid's plans and step-by-step instructions you can make such a violin for yourself. 15 chapters guide you in selection of wood, fashioning the belly, back, sides, mold, lining, neck, scroll, purfling. Other chapters cover varnishing, finishing, stringing. Others show how to make tools and clamps at little or no cost.

Order Book Today. Money Back if Not Satisfied.
Make your own violin for pleasure or profit. Get book and plans now. Clip this ad and mail with check, money order or cash for only \$3.50 or we will ship C.O.D. Money back in 7 days if not satisfied.

FULL SCALE PLANS INCLUDED
Working plans, drawn to full scale, are included in a special pocket inside the book where they may be withdrawn for quick and easy reference.



Complete Instructions
8 Actual Size Plans
How to Make the Tools You Need
Where to Get the Materials

You trace or work direct from actual size plans. No measurements to translate or confuse you. You see the entire violin in the plans. You read the how-to-do-it instructions in the book.

POPULAR MECHANICS PRESS Dept. 30 200 E. Ontario St., Chicago

Say You Saw It in Popular Mechanics

NOW! RCA GEIGER COUNTERS

for professional and amateur prospectors!

6 new models . . . \$119.50 to \$750*

Prospect With A Geiger Counter Backed By The Greatest Name In Electronics—RCA.

Full-vision easy-to-read meter • Rugged, durable construction • Complete with RCA long-life batteries • Factory-authorized service available • 6 models including super-sensitive units for aerial and car-borne surveys • All-weather metal case—easy to decontaminate.

Write Section H63MM for illustrated folder.

RADIO CORPORATION OF AMERICA
Radiation Detection Equipment
Harrison, N. J.

*Suggested List Prices

PORTABLE LIGHT PLANTS

DIESEL LIGHT PLANT
(Item 1660) Diesel Master-
11-12 kw. 110/220 v. AC
single or 3 phase, 1800
rpm direct connected.
Electric Self-starting.
Engineered for permanent
power where continuous
low-cost, heavy duty service
is important. Wt. 1350 lb. Reg.
Fact \$3650.00.



\$1895.00

(Item 1660)

NEW! PERMA-BRONZE "20 year" OIL FILTER



CLEAR OIL

Never replace this filter, just give it a periodic
clean in gasoline. Here, at last, is a permanent
non-clogging oil filter that protects oils longer,
adds years to engine life, reduces friction and
increases power! Revolutionary new filter element
made of microscopic bronze balls formed under
infinite heat and pressure into a finer screen than
can be woven from any metal or cloth. Amazing
pore size of micronized bronze passes valuable oil
additives and detergents, but filters out the tiniest
particles of hard carbon, metal or water. Assures
years of perfect, clear film of oil at all times. **CON-**
VERSION KIT—fits your present filter. **\$6.95**
(Specify filter make and model no.)
CONVERSION KIT for cars with Full **\$13.95**
Flow Models
COMPLETE FILTER for engine not **\$12.95**
required with any filter.

AUTOMATIC 6 VOLT COMPRESSOR



The ideal
compressor
for operating
loud blast air
horns on cars
or boats, and
for use as a
low inflating
equipment on
service trucks
or heavy equip-
ment. In-
flates tires in
seconds. Compact! Can be installed in small
space under hood, in trunk, etc. High air out-
put (4 CFM). Operates on standard 6 or 12 volt
storage battery current. Built-in 1/2 hp. electric
motor. Solenoid switch, 6"x24" air tank,
pressure gauge, safety valve, shut-off valve,
automatic on and off switch. (Runs only when
tip is needed.) Wt. 39 lbs. Item 353.
Regularly \$129.50
Our special **\$54.50**

HI-FLO Centrifugal PUMP



Completely self-priming! No
foot valve required. Tremendous
capacity—100 gal. per
min. . . . Special impeller
enables pump to handle muddy
or sandy water. Simple to
operate—simply start engine
and watch the water go. Power-
ed by a rugged, easy-starting
2 HP Briggs engine. Pre-
lubricated sealed bearings for
years of heavy low-cost service.
Big 1 1/2" Model. Item 502.
Wt. 79 lbs. **\$134.50**
Factory price. . . .
2 1/2" Model (150 gal. per min.) with 2 1/2 HP engine.
Item 502a. 90 lbs. Fact. Spec. **\$154.50**

BIG JOE Portable Pump

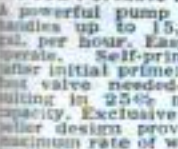

A powerful pump that
handles up to 15,000
gal. per hour. Easy to
operate. Self-priming
(after initial prime), no
foot valve needed—re-
sulting in 25% more
capacity. Exclusive im-
peller design provides
maximum rate of water
flow—horsepower. Jet
handles water contain-
ing a large percentage of
stone, gravel and
sand. 2 in. suction and
discharge. Powered by
easy starting 6 hp. Wisconsin
engine and mounted on
steel skids. Wt. 250
lbs. (Item 503). Factory price. **\$275.00**
Our special **\$200.00**

EXTENSION CORD



Heavy duty and very flexible.
Neoprene 14-2 cable.
20 year quality. Wt. 12
lbs. (Item 185) 100 ft.
Complete with rubber plug
and outlet. A terrific
buy at only **\$8.95**

NO. 12-2 POWER CABLE. Very flexible rubber
covered, special outside shield for grounding
power leads, etc. 50 ft. (Item 190) Wt. 8 lbs.
\$6.95. 100 ft. (Item 200) . . . **\$12.95**

SAVE middleman profits BUY DIRECT from MASTER MECHANIC factory

(Item 24)



600-700 WATTS PUSH BUTTON START

115 v. 60 cyc. AC
Powered by a rugged
2 HP easy starting
Briggs engine. No
wiring necessary!
Just plug in and op-
erate. Plenty of cur-
rent for any oil burn-
er, freezer, brooder,
emergency lights,
etc. which require
up to 700 watts. Ideal for television and
radio. Complete with Voltmeter and built-
in winding to charge 6 v. auto batteries. (Item
24.) Wt. 75 lbs. Easily fits in car trunk.
Re prepared if storm knocks out
power lines. Reg. \$275 value. . . . **\$143.50**
1000-1200 Watt Plant (Item 45) same as Item
24 but larger generator and engine
with 50% greater output. . . . **\$199.50**

1300-1500 WATT PLANT

115v. 60 cyc. AC Push But-
ton Start. Powered by a
3 1/2 HP. Clinton engine.
Combines big output with
easy portability. Provides
emergency power for oper-
ating any oil burner,
sump pump, freezer,
television, lights,
communications sys-
tems, etc, which re-
quire up to 1500 watts.
(Item 22.) Wt. 110 lbs.
Reg. \$475 value. Factory price. . . . **\$239.50**
1750 Watt Plant Powered by 4.5
Briggs engine. Electric starting & battery
charging built-in. Factory price. . . . **\$279.50**
2500 WATT PLANT—Push Button Start (Item
21) 110/120 60 cyc. A.C. A rugged,
powerful plant. Reg. \$645. Spec. . . . **\$329.50**

3500 Watt Plant Push Button Start (Item 23)
115 v. 60 cyc. AC. Similar to above, but larger
and 33% more capacity. Wt. 270 lbs. Reg.
\$760. Factory Price. . . . **\$379.50**
Dual Voltage 110/220 available for above
plants for \$30.00 additional.

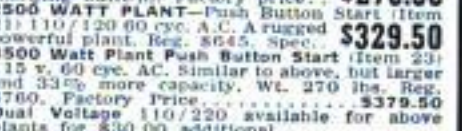

HEATING & VENTILATING FAN

(Item 10) Easily installed in
furnace pipes. Forces even heat
to all rooms. Over range re-
moves kitchen smoke and odors.
Powerful, continuous duty motor.
110-120v. AC. Mount in
wall or ceiling to ventilate any
area. Quiet, step-adjuster fan moves huge
volume of air: 400 to 600 CFM.
8" Pipe, wt. 5 lb. . . . **\$6.85**
9" Pipe, wt. 6 lb. . . . **\$7.85**
10" Pipe, wt. 7 lb. . . . **\$8.85**
12" Pipe, wt. 8 lb. . . . **\$9.85**
HEAVY DUTY FAN. Semi-enclosed motor,
suitable for spray booths, restaurant ex-
hausts, poultry houses, etc. 10" Fan, wt. 8
lbs. (Item 10E) . . . **\$11.95**
12" Fan, wt. 10 lbs. (Item 10D) . . . **\$12.95**



JET FLOW BLOWER

Tremendous air movement (1800
CFM) and quiet operation make
this double inlet 10" turbine
blower unbeatable for heating,
cooling, drying and air condition-
ing. Ideal for attic or barn ven-
tilation, converting gravity heat-
ing to forced air; spray booth ex-
hausts, etc. Operates with any
bearings. Includes variable speed motor pulley
and belt. Dimensions 19" hi x 18" x 16 1/2".
Outlet opening 13" x 11 3/4". Wt. 45 lbs. Item
245. Reg. \$54.50. . . . **\$27.50**

HEAVY DUTY 1 1/2 HP motor for above **\$16.95**
12" TURBINE BLOWER Similar to above, but
larger with 2400 CFM capacity. Wt. 65 lbs.
(Item 245a) Reg. \$70.00. Factory Spec. **\$34.50**

JET STEAM MASTER



Now a super efficient portable steam
generator that pro-
duces live steam at
160 lbs. pressure in
60 seconds from a
cold start! Produces
large volume of high
pressure steam on 2
pints of fuel oil. In-
stantly cleans sticky
grease, dirt, rust,
oil paint, etc. off
implements and road
machinery. Pays for
itself in a few weeks.
Sterilizes soil. Steri-
lizes milk equipment, etc.
Fully automatic—oil fired with new, built-in
lifetime bronze water circulating pump. Draws
water from bucket or pail. Simple and safe
operation. Can use 1/2" built-in safety valve.
Complete with 12 lb. of hi-pressure steam
hose and new triple efficiency steam gun that
automatically mixes in steam solution if de-
aired. Wt. 250 lbs. Item 463.
Special factory price. . . . **\$329.50**

LESS THAN WHOLESALE GIANT 2000-2800 WATT PLANT

110-120 v. 60 cyc.
AC, absolutely
best made—ex-
clusive dynamo
armature; heavy
windings develop
up to 5000 watt
overload for mo-
tor starting. Skid
mounted—portable.
Powered by
an easy starting Briggs or Wisconsin 8 HP
engine—complete with all accessories; engine
easily disconnected for other uses. Big outlet
box, voltmeter, no wiring necessary. Ample
current for all purposes. Factory warranty.
Item 233. Wt. 210 lb.
Reg. price \$815. Special at. . . . **\$299.50**
Same plant with electric
self starter (Item 31a) . . . **\$359.50**
Generator only and control box. . . **\$169.50**
DUAL VOLTAGE 110-220 available on any
of above models for \$28.00 additional.



52 pc. SOCKET SET

Highest quality,
guaranteed non-
breakable sockets
made by Husky.
Beautifully matched
chrome thin wall
alloy absolutely the
best. Contains a
complete set of 28
sockets in 1/2",
3/4", 1", 1 1/4",
1 1/2", 2", 2 1/2",
and 3" drive, plus
all necessary exten-
sions, handles,
speeders, reversi-
ble ratchets, etc.
all uncond. guaran-
teed against breakage. A beautiful set of tools
that will handle any job in a big doghouse
steel box. Wt. 17 lbs. (Item 203)
List price \$62.90. Factory special. **\$27.95**

CONDITIONAIRE VENTILATING FANS

Save big money installing
your own exhaust fan. Ef-
ficient propeller type blade
moves huge volume of air
quietly and effortlessly.
Heavy welded frame—pre-
drilled for easy installation.
Just cut opening and bolt
in place. Continuous duty
motors. Ideal for attics,
restaurants, garages, barns,
chicken houses, etc. Control
manually or with thermostat.



Blade Opening CFM	Wt.	Item	
18"	18 1/4"	2925	19 lb. 365a \$27.95
18"	18 1/4"	2950	27 lb. 365b \$31.95
24"	21 1/4"	4100	30 lb. 365c \$39.95

9 TON HYDRAULIC PRESS

A tremendously powerful hydraulic
press, capable of exerting 18,000
lbs. pressure. Pays for itself many
times over—straightening bent con-
necting rods, king pins, crank-
shafts, axles, link pins and
bars— or pushing out frozen
bearings and bushings. Devel-
oped pressure under pre-
cise control and visible
at all times on accurate
gauge. Complete with both
large and small anvils and
jigs to straighten any kind
of curve or bend. (Item 404)
Wt. 110 lb. Actual list price
\$365. Our special
close-out price. . . . **\$69.50**



MASTER DC ARC WELDERS



Now! a portable, rugged, industrial type welder with terrific performance, yet at a price hundreds of dollars less than you'd expect. Senior model made for years of trouble-free, continuous service. High capacity DC welding unit enables you to tackle any job with confidence—easily welds anything up to 2" plate using from 1/16" to 1/4" rods. Built-in stabilizer and cooling system makes arc easy to strike and hold. Dual control rheostat provides low heat soldering, brazing and welding from 30 to 300 amps. Complete with instructions, guarantee and triple V-belt or flat pulley. You can pay more, but you can't buy a better welder.
WELDER ONLY—DUAL CONTROL MODEL. Same as above but drive with your tractor, jeep or gas engine of 14 HP or more. (Item 282a.) Wt. 110 lbs. \$420 value. . . . **\$119.50**
WELDER ONLY—STANDARD MODEL. Same as above but with single rheostat for heavy metal welding only. (Item 282.) Wt. 110 lbs. \$400 value. Special. . . . **\$99.75**
COMPLETE POWER MASTER (Illustrated above) powered by a 14.6 hp., air cooled Wisconsin engine. Wt. 480 lbs. (Item 280) Compares with welder coating \$1200. . . . **\$449.50**
Factory Special.

WELDING KIT 20 ft. leads,
welding helmet, electrode holder,
ground clamp. Sold
only with welder at. . . **\$10.50**

Send check or M.O. Prices f.o.b. Factory. 10 day Money back guarantee. SEND 10c for . . . **BIG 1955 Catalog**

MASTER MECHANIC MFG. CO., DEPT. NRM

Burlington, Wis.

How to pass a genius



All of us can't be geniuses. But any ordinarily talented mortal can be a success—and that's more than some geniuses are.

Now, as in Æsop's time, the race doesn't always go to the one who potentially is the swiftest. The *trained* man has no trouble in passing the genius who hasn't improved his talents.

In good times and bad times, in every technical and business field, the *trained* man is worth a dozen untrained ones, no matter how gifted.

The International Correspondence Schools can't make you into a genius. For more than 60 years, however, I. C. S. has been helping its students to become *trained, successful leaders*—and it can do the same for you.

Mark your special interest on the coupon. Don't be like the unsuccessful genius who wastes his life in dreaming of what he intends to do. Act now!

For Real Job Security—Get an I. C. S. Diploma! ... Easy-pay Plan ... I. C. S., Scranton 9, Penna.

INTERNATIONAL CORRESPONDENCE SCHOOLS

ICS

BOX 59299H, SCRANTON 9, PENNA.

(Partial list of 277 courses)

Without cost or obligation, send me "HOW TO SUCCEED" and the opportunity booklet about the field BEFORE which I have marked X (plus sample lesson):

- | | | | | |
|--|---|--|---|--|
| <p>ARCHITECTURE and BUILDING CONSTRUCTION</p> <ul style="list-style-type: none"> <input type="checkbox"/> Air Conditioning—Refrig. <input type="checkbox"/> Architecture <input type="checkbox"/> Architectural Interior <input type="checkbox"/> Building Contractor <input type="checkbox"/> Building Maintenance <input type="checkbox"/> Carpenter and Mill Work <input type="checkbox"/> Estimating <input type="checkbox"/> Heating <input type="checkbox"/> Painting Contractor <input type="checkbox"/> Plumbing <input type="checkbox"/> Reading Arch. Blueprints <p>ART</p> <ul style="list-style-type: none"> <input type="checkbox"/> Cartooning <input type="checkbox"/> Commercial Art <input type="checkbox"/> Fashion Illustrating <input type="checkbox"/> Magazine Illustrating <input type="checkbox"/> Show Card and Sign Lettering <input type="checkbox"/> Sketching and Painting <p>AUTOMOTIVE</p> <ul style="list-style-type: none"> <input type="checkbox"/> Auto Body Rebuilding <input type="checkbox"/> Auto Elec. Technician <input type="checkbox"/> Auto-Engine Tune Up <input type="checkbox"/> Automobile | <p>AVIATION</p> <ul style="list-style-type: none"> <input type="checkbox"/> Aeronautical Engineering Jr. <input type="checkbox"/> Aircraft & Engine Mechanic <p>BUSINESS</p> <ul style="list-style-type: none"> <input type="checkbox"/> Advertising <input type="checkbox"/> Bookkeeping and Accounting <input type="checkbox"/> Business Administration <input type="checkbox"/> Business Correspondence <input type="checkbox"/> Public Accounting <input type="checkbox"/> Creative Salesmanship <input type="checkbox"/> Federal Tax <input type="checkbox"/> Letter-writing Improvement <input type="checkbox"/> Office Management <input type="checkbox"/> Professional Secretary <input type="checkbox"/> Retail Business Management <input type="checkbox"/> Sales Management <input type="checkbox"/> Stenographic-Secretarial <input type="checkbox"/> Traffic Management <p>CHEMISTRY</p> <ul style="list-style-type: none"> <input type="checkbox"/> Analytical Chemistry <input type="checkbox"/> Chemical Engineering <input type="checkbox"/> Chem. Lab. Technician <input type="checkbox"/> General Chemistry <input type="checkbox"/> Natural Gas Prod. & Trans. <input type="checkbox"/> Petroleum Engineering <input type="checkbox"/> Plastics <input type="checkbox"/> Pulp and Paper Making | <p>CIVIL, STRUCTURAL ENGINEERING</p> <ul style="list-style-type: none"> <input type="checkbox"/> Civil Engineering <input type="checkbox"/> Construction Engineering <input type="checkbox"/> Highway Engineering <input type="checkbox"/> Reading Struct. Blueprints <input type="checkbox"/> Sanitary Engineering <input type="checkbox"/> Structural Engineering <input type="checkbox"/> Surveying and Mapping <p>DRAFTING</p> <ul style="list-style-type: none"> <input type="checkbox"/> Aircraft Drafting <input type="checkbox"/> Architectural Drafting <input type="checkbox"/> Electrical Drafting <input type="checkbox"/> Mechanical Drafting <input type="checkbox"/> Mine Surveying and Mapping <input type="checkbox"/> Plumbing Drawing and Estimating <input type="checkbox"/> Structural Drafting <p>ELECTRICAL</p> <ul style="list-style-type: none"> <input type="checkbox"/> Electrical Engineering <input type="checkbox"/> Electrical Maintenance <input type="checkbox"/> Electrician <input type="checkbox"/> Contracting <input type="checkbox"/> Lineman <p>HIGH SCHOOL</p> <ul style="list-style-type: none"> <input type="checkbox"/> Commercial <input type="checkbox"/> Good English <input type="checkbox"/> High School Subjects <input type="checkbox"/> Mathematics | <p>LEADERSHIP</p> <ul style="list-style-type: none"> <input type="checkbox"/> Foremanship <input type="checkbox"/> Industrial Supervision <input type="checkbox"/> Leadership and Organization <input type="checkbox"/> Personnel-Labor Relations <p>MECHANICAL AND SHOP</p> <ul style="list-style-type: none"> <input type="checkbox"/> Gas—Electric Welding <input type="checkbox"/> Heat Treatment <input type="checkbox"/> Metallurgy <input type="checkbox"/> Industrial Engineering <input type="checkbox"/> Industrial Instrumentation <input type="checkbox"/> Industrial Supervision <input type="checkbox"/> Internal Combustion Engines <input type="checkbox"/> Machine Design-Drafting <input type="checkbox"/> Machine Shop Inspection <input type="checkbox"/> Machine Shop Practice <input type="checkbox"/> Mechanical Engineering <input type="checkbox"/> Quality Control <input type="checkbox"/> Reading Shop Blueprints <input type="checkbox"/> Refrigeration <input type="checkbox"/> Sheet Metal Worker <input type="checkbox"/> Tool Design <input type="checkbox"/> Toolmaking <p>RADIO, TELEVISION</p> <ul style="list-style-type: none"> <input type="checkbox"/> Industrial Electronics <input type="checkbox"/> Practical Radio TV Eng'ng <input type="checkbox"/> Radio and TV Servicing <input type="checkbox"/> Radio Operating | <ul style="list-style-type: none"> <input type="checkbox"/> Television Technician <p>RAILROAD</p> <ul style="list-style-type: none"> <input type="checkbox"/> Air Brakes <input type="checkbox"/> Car Inspector <input type="checkbox"/> Diesel Locomotive <input type="checkbox"/> Locomotive Engineer <input type="checkbox"/> Section Foreman <p>STEAM AND DIESEL POWER</p> <ul style="list-style-type: none"> <input type="checkbox"/> Combustion Engineering <input type="checkbox"/> Diesel—Elec. <input type="checkbox"/> Diesel Eng'g <input type="checkbox"/> Electric Light and Power <input type="checkbox"/> Stationary Fireman <input type="checkbox"/> Stationary Steam Engineering <p>TEXTILE</p> <ul style="list-style-type: none"> <input type="checkbox"/> Carding and Spinning <input type="checkbox"/> Cotton, Rayon, Woolen Mfg. <input type="checkbox"/> Finishing and Dyeing <input type="checkbox"/> Loom Fix'g <input type="checkbox"/> Textile Des'ing <input type="checkbox"/> Textile Eng'g <input type="checkbox"/> Throwing <input type="checkbox"/> Warping and Weaving <p>MISCELLANEOUS</p> <ul style="list-style-type: none"> <input type="checkbox"/> Domestic Refrigeration <input type="checkbox"/> Marine Engineering <input type="checkbox"/> Ocean Navigation <input type="checkbox"/> Professional Engineering <input type="checkbox"/> Short Story Writing <input type="checkbox"/> Telephony |
|--|---|--|---|--|

Name _____ Age _____ Home Address _____

City _____ Zone _____ State _____ Working Hours _____ A.M. to P.M. _____

Occupation _____

Canadian residents send coupon to International Correspondence Schools, Canadian, Ltd., Montreal, Canada. . . . Special tuition rates to members of the U. S. Armed Forces.

7 pt. Self-Cleaning Plug Alone Shows 8 hp Gain and 7 mph Greater Speed!

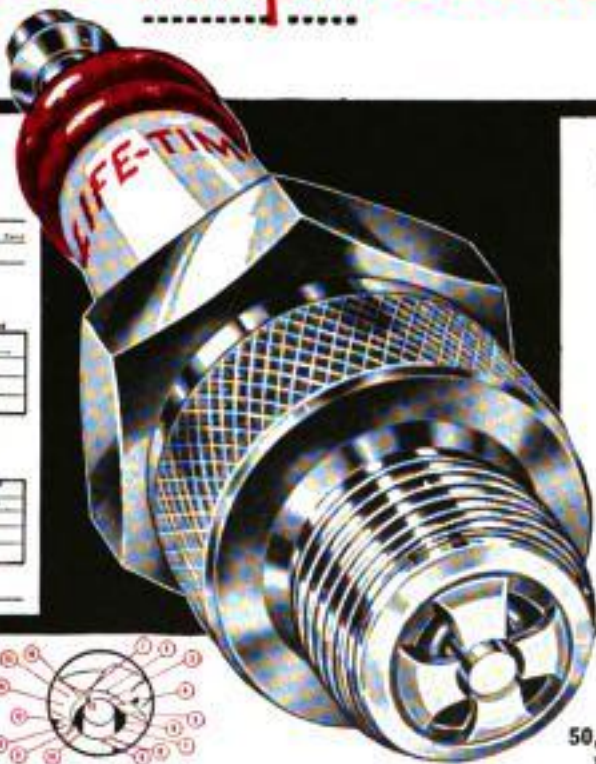

Eddie Edmunds
CHASSIS DYNAMOMETER CHART

Make: Continental Year: 1951
Model: Continental Super 80 Engine: 800 cc

Power Test

Power Test	Continental	LIFE-TIME	Continental	LIFE-TIME
Top Speed (mph)	84	91	87	94
0-30 (sec)	11.2	10.5	11.8	11.0

Recommendations

Tustin Auto Parts
118 West Main Street Tustin, California Phone ELectric 6933

Department No. 11
Customer Name: Edmunds

Dear Sirs:

In December 1951, 1951 at Orange County, California, Orange County, California, we tested 4000 sets of the LIFE-TIME Spark Plug in comparison with 4000 sets of the Continental Spark Plug in comparison with 4000 sets of the Continental Spark Plug with the following results:

Run in	Continental	LIFE-TIME
1 - 4000 sets	3000 sets	4000 sets
2 - 4000 sets	3500 sets	4000 sets
3 - 4000 sets	3000 sets	4000 sets
4 - 4000 sets	3500 sets	4000 sets

These sets included in other changes made during 50,000 car miles.

The above 4000 sets included in 50,000 car miles and 1000 sets of the LIFE-TIME Spark Plug in comparison with 1000 sets of the Continental Spark Plug.

F. Robinson *R. C. Calkins*



NOW 17 PT. FIRING WORKS
Note electrodes closely. A circular firing area (four concave segments) is being the same from all points. Electricity has property of arcing from closest point. Current also arcs more widely from apex of two planes than from the face of a flat, metallic surface. Note that there are 16 apexes (where two planes meet) - all the same distance from the center electrode. Normal heat and spark erosion are spread around the entire 360 degrees and around the whole circumference of the center electrode.

- **INDIVIDUAL INSPECTION**—Each LIFE-TIME Spark Plug is tested for firing in oil and for resistance to 20,000 volts C.M.
- **PERMANENT GAP**—After months of use LIFE-TIME Spark Plugs make at exact factory pre-gap.
- **SELF CLEANING FOR LIFE**—Confined gases exploding in chamber formed by multiple electrodes reclean arcing surfaces with each firing stroke.

50,000 CAR MILES!

Before LIFE-TIME development, the spark plug was the most often replaced part of your car. Engineers agreed that "creeping paralysis," gradual electrode disintegration, carbon buildup, widening gap, could waste one gallon in ten. The LIFE-TIME Plug has now gone far beyond the life of the average set of tires, the average battery. This plug still fired clean, hot and steady at 50,000 car miles!

Most spectacular spark plug research breakthrough in 50 years allows us to include this unique and unprecedented warranty with every set of LIFE-TIME Spark Plugs. We GUARANTEE GREATER GAS MILEAGE - GREATER ACCELERATION - A MAJOR POWER INCREASE - OR YOUR MONEY BACK.

FULL ROTATING SPARK
allows overall cooler electrode temperature for greatly increased life. Hotter spark prevents fouling, yet the rotating cooling effects minimize the common faults of burning, erosion, blistering and insulator failure. Compare this principle with the conventional 2-point spark plug design.



PLATINUM-NICKEL ALLOY ELECTRODES—Metallurgists' first major step beyond platinum-iridium alloy electrodes. Arcing points of this material have continued to function after the equivalent of 120,000 car-miles.

SPECIAL SINTERED CORUNDUM INSULATOR—Made of gem-like mineral which conducts heat 20 times better than ordinary porcelain. Special shape is designed to vaporize and disperse wet carbon and oil.

NOW... ORDER REGISTERED SET FOR YOUR CAR AT POPULAR PRICE!
Dealers and Distributors: *The LIFE-TIME Spark Plug* is now in full production. Write for full details. Distributors: Please inquire as to status of your territory.

YOU RECEIVE BY MAIL

this registered set of LIFE-TIME Spark Plugs in proper series (heat range and gap) for the car you indicate in coupon. NOW AVAILABLE FOR AMERICAN & EUROPEAN PASSENGER CARS, TRUCKS, BOATS, FARM EQUIPMENT, INDUSTRIAL ENGINES.

LIFE-TIME Spark Plug Division, CONTINENTAL MANUFACTURING CORP. Washington Blvd. at Motor Ave. Culver City 69, California

Continental Please mail postpaid. \$8.95 (includes) 1 set of LIFE-TIME Spark Plugs in proper heat range and gap for 800 cc 800 cc Continental price of 95c per plug (Set of 6) \$1.50, set of eight, \$7.50. 10r set of \$1 per set, balance C.O.D.)

Size of my car is: _____ Year: _____

Model: _____ No. Cyl. _____

I enclose \$ _____ (check, cash or money order)

Name: _____

Address: _____

City: _____ Zone: _____ State: _____

8 HORSEPOWER GAIN!

Dear Car Owner:

The real test of a spark plug is "What will it do in my own car?" Take the above dynamometer test on a 1951 Buick Super. It shows an 8 horsepower gain with Life-Time 11-point plugs. This was a 125% hp gain at 2000 RPM. You don't need a dynamometer with Life-Time plugs. You can feel the difference both in your ride and your pocketbook. Try a set and let the hose from you about them. Many thanks!



Frank Robinson
Inventor of the LIFE-TIME Spark Plug

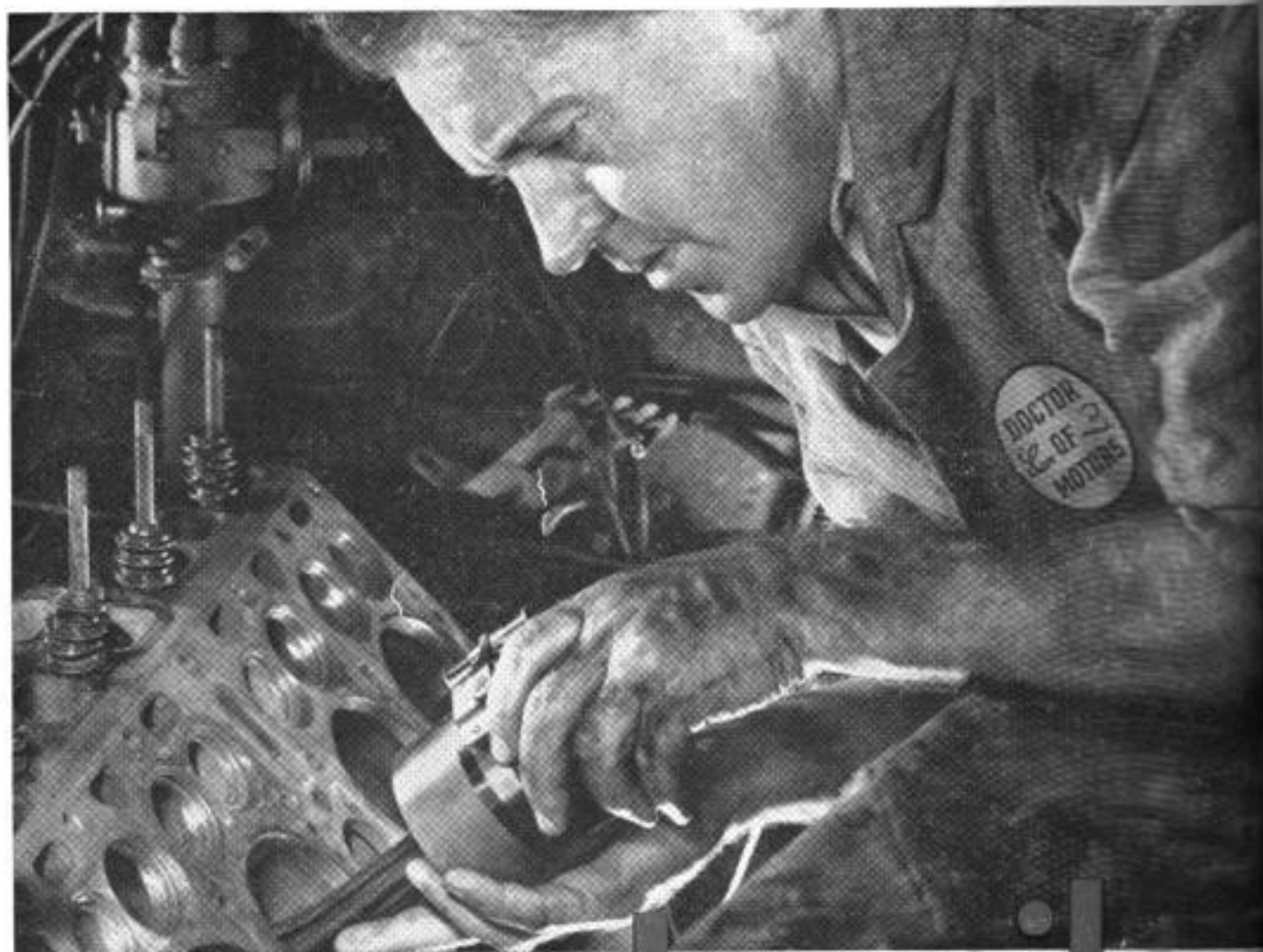

For thousands of **extra miles**
of peak-performance, re-ring with Perfect Circle...

THE BRAND MOST PEOPLE PREFER!

Doctors of Motors *everywhere* know from experience that Perfect Circle's 2-in-1 Chrome piston rings assure sustained power and positive oil control.

In Perfect Circle's 2-in-1 Chrome piston ring set, *both* the TOP ring *and* the OIL ring are plated with thick, solid chrome giving complete wear protection throughout the

entire area of ring travel. Life of cylinders, pistons and rings is *more than doubled!*

Enjoy thousands of *extra miles* of carefree, economical driving by installing Perfect Circle's 2-in-1 Chrome piston rings. Perfect Circle Corporation, Hagerstown, Indiana; the Perfect Circle Co., Ltd., Toronto, Ontario.



Perfect Circle

2 in 1 chrome piston rings

The Standard of Comparison

Copyrighted material